

Apple Multivendor Network Solutions Guide



MS-DOS



VAX

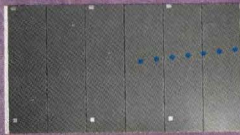

IBM



UNIX

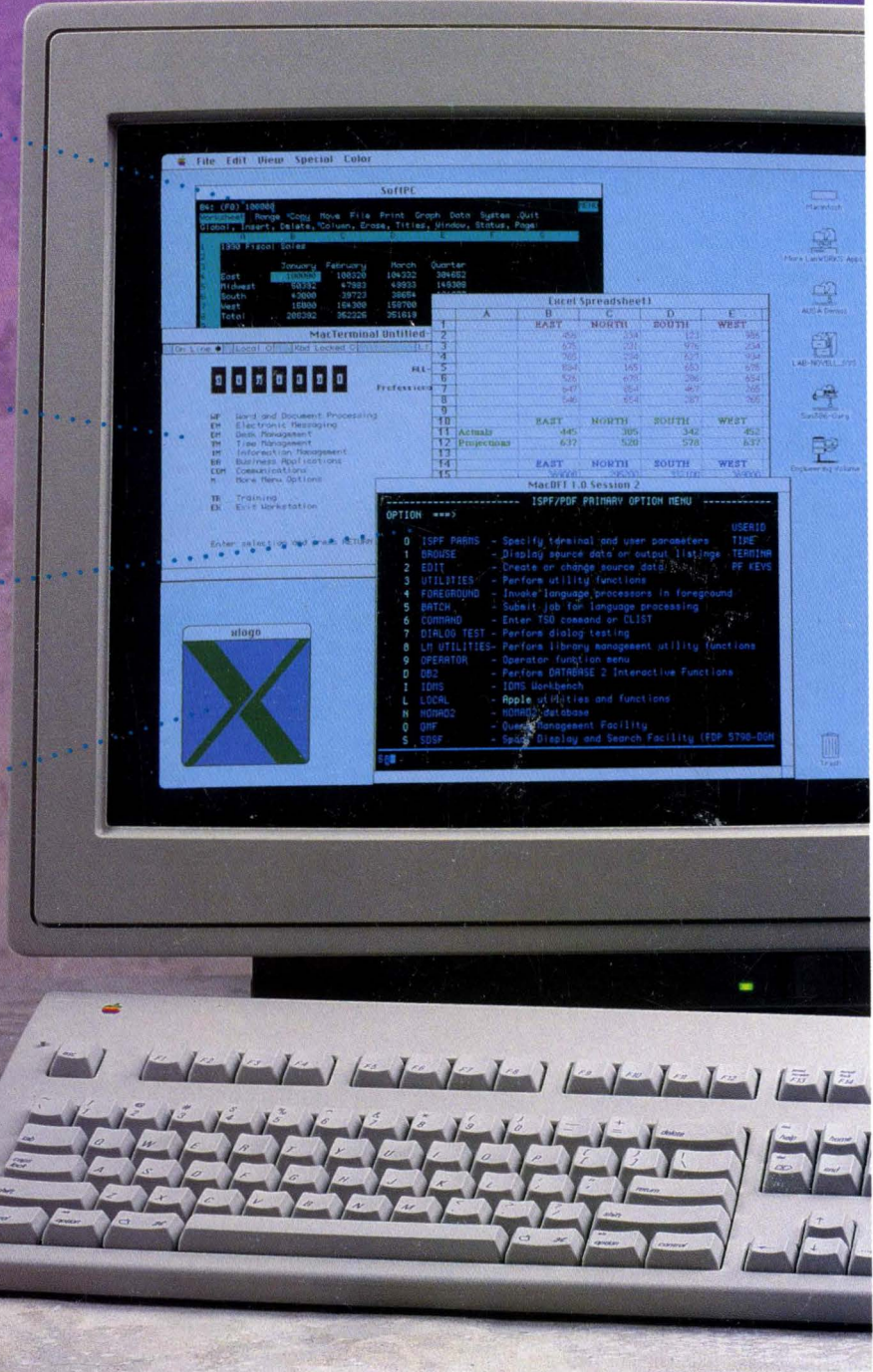

Apple Multivendor Network Solutions Guide

©1990 Apple Computer, Inc. All rights reserved.

©1990 Apple Computer, Inc. A/UX, Apple, the Apple logo, AppleCD SC, AppleShare, AppleTalk, EtherTalk, HyperCard, HyperTalk, ImageWriter, Inter•Poll, LaserWriter, LocalTalk, Mac, MacAPP, MacDFT, Macintosh, MacTCP, MacTerminal, MPW, MultiFinder, ProDOS, SADE, and TokenTalk are registered trademarks of Apple Computer, Inc.

APDA, Apple Desktop Bus, AppleFAX, FDHD, Finder, MacAPPC, MacPAD, MacWorkStation, MacX, MacX25, QuickDraw, ResEdit, and SuperDrive are trademarks of Apple Computer, Inc.

MacDraw, MacPaint, and MacWrite are registered trademarks of Claris Corporation. MS-DOS is a registered trademark of Microsoft Corporation. PostScript is a registered trademark of Adobe Systems Incorporated. UNIX is a registered trademark of AT&T.

NuBus is a trademark of Texas Instruments. Omnis is a trademark of Blyth Software, Ltd.

Mention of third-party products is for informational purposes only and constitutes neither an endorsement nor a recommendation. All product specifications and descriptions were supplied by the respective vendor or supplier. Apple assumes no responsibility with regard to the selection, performance, or use of these products. All understandings, agreements, or warranties, if any, take place directly between the vendors or suppliers and the prospective users.

Third-party product names and suppliers were accurate at the time of publication and are subject to change without notice.

The *Apple Multivendor Network Solutions Guide* is the property of Apple Computer, Inc.

All prices included in this Guide are based on manufacturers' suggested retail prices at the time of publication and are subject to change without notice.

Acknowledgments

Many people at Apple Computer, Inc. and our third-party community spent countless hours researching, writing, and producing the third edition of this publication. This project was undertaken at the request of Apple's customers, sales force, and resellers who asked for an update to this comprehensive directory of Macintosh communications capabilities. This Guide is an overview of the many environments where Macintosh® personal computers can be integrated.

The project was managed by the Large Business Marketing Group at Apple Computer, Inc. It would not have been possible without the help of Apple's product managers, systems engineers, and marketing organizations. We wish to express our sincere thanks to all our friends who helped create the *Apple Multivendor Network Solutions Guide*.

Project Executives: Peter Watkins, Mike Zivkovic

Project Manager: Victor C. Lee

Executive Editor: Jacque W. Swartz

Editor: Robin Gold

Project Coordinator: Cathy Breslin

Section Editors:

| | | | |
|-----------------|----------------|-------------------|-------------|
| Bill Berner | Bill Brown | Carol Clettenberg | Ed Forman |
| Jim Floyd | George Frazier | Tim Golden | Steven Lund |
| Frank Mara | Doug McLean | Cesar Melgoza | Dave Nagy |
| Fabio Pettinati | Michelle Ryder | Rob Stephan | Dan Torres |

Cover Design: Aplin, Uno & Chibana

Graphics: TBD Consulting Group

Print Production Management: Forbes Mill Press

Additional Contributors:

| | | | |
|---------------|-----------------|---------------------|-----------------|
| Debra Chong | Suzanne Dills | Diana Flynn | Kevin Flynn |
| Susan Grabau | Tracey Grown | Larry Hill | Peter Hirshberg |
| Lance Hoffman | Katrina Holman | Ford Johnson | Ray Kaupp |
| Denise Kelley | Pierre Leclercq | Teri Lord Navarrete | Greg Memo |
| Debbie Miani | Kirk Mosher | Larry Moss | Colleen Muller |
| Jim Pelkey | Karen Quek | Rhonda Rekieta | Katy Rodgers |
| Mike Shannon | Bruce Stancombe | Dale Streeter | Harald Striepe |
| Lou Tomafsky | Troy Trenchard | Jessa Vartanian | P. L. Wan |
| Blake White | Ron Wong | | |

How this book was produced:

This book was produced entirely on Apple Macintosh computers using Aldus PageMaker, Aldus FreeHand, Claris MacWrite II, Microsoft Word, Claris FileMaker and AppleLink. Network services over the AppleTalk network were provided by AppleShare, AppleShare Print Server, AlisaShare and Microsoft Mail. The computers and peripherals were connected using either Synoptic's LattisNet, Apple's LocalTalk or Farallon's PhoneNet cabling with the AppleTalk Internet Router used to route AppleTalk packets between the different cabling types.

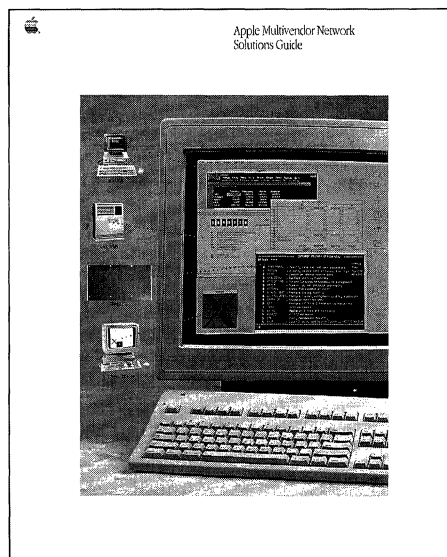

Some of the major environments where Macintosh computers can be integrated are shown. The Macintosh computer here displays actual integration with MS-DOS VAX, IBM, and UNIX environments.

| | |
|-------------------------------------------------------------------------|-----|
| Apple Multivendor Network Solutions Guide: An Introduction | x |
| A Note on Diagrams—Key to Illustrations | vii |
| Chapter I: AppleTalk Communications | |
| The Environment | 1 |
| Solutions | |
| Physical Connections and Devices | 7 |
| AppleTalk over Ethernet | 9 |
| Back-up Systems | 12 |
| AppleTalk Routing | 13 |
| Resource Sharing | 17 |
| File Service: AppleShare | 20 |
| Print Servers | 21 |
| Network Management Software | 22 |
| File Transfer | 24 |
| Electronic Messaging | 25 |
| Distributed File Service | 26 |
| Case History: Codex Corporation | 27 |
| Chapter II: Network Application Tools | |
| The Environment | 29 |
| Solutions | |
| Communication Development Environment | 31 |
| Host Interface Development Environment | 32 |
| Programming Development Environments | 34 |
| Computer Aided Software Engineering (CASE) | 35 |
| Database Environments | 36 |
| Host Database Access | 38 |
| Applications Using Data Access Language | 41 |
| Case History: Polaroid | 43 |
| Chapter III: Network Environments | |
| The Environment | 47 |
| Solutions | |
| Novell Environment | 51 |
| 3Com Corporation | 53 |
| TOPS Network Environment | 55 |
| Northern Telecom Environment | 58 |
| Networking Macintosh to Unisys | 66 |
| Network Bridges and Gateways | 68 |
| LattisNet: Ethernet over Twisted-Pair and Fiber-Optic Cabling | 70 |
| Fiber Optic Compatible Technology | 72 |
| Modem Related Products | 77 |
| Print Service | 81 |
| X.400 Electronic Messaging | 82 |
| Network Software Tools | 82 |
| PBX Services | 85 |
| Chapter IV: MS-DOS Related Systems | |
| The Environment | 87 |
| Solutions | |
| Hardware Components | 95 |
| File Translation Tools | 99 |
| Access Software Tools | 103 |
| MS-DOS Emulation | 106 |
| Case History: Hambrecht & Quist | 107 |

| | |
|--------------------------------------------------------------------------------|-----|
| Chapter V: Digital Equipment Corporation | |
| The Environment | 109 |
| Solutions | |
| Network Solutions in the VAX and VMS Environment | 115 |
| Integrated Macintosh & Digital Environment—DEC LanWORKS for Macintosh | 116 |
| AppleTalk Network Services | 121 |
| Terminal Emulation Products | 127 |
| VAX Database Access | 132 |
| Applications in the Macintosh/VAX Environment | 135 |
| Electronic Massaging Solutions | 137 |
| Network Solutions in the VAX/ULTRIX Environments | 139 |
| Case History: Union Carbide | 141 |
| Chapter VI: UNIX and TCP/IP | |
| The Environment | 143 |
| Solutions | |
| A/UX Functionality | 147 |
| Network Software: AppleTalk Solutions | 150 |
| TCP Solutions | 156 |
| X Window Servers | 159 |
| Electronic Mail | 161 |
| File Transfer and Translation | 162 |
| Asynchronous Connections to UNIX | 162 |
| Case History: Stanford University | 163 |
| Chapter VII: IBM Hosts | |
| The Environment | 165 |
| Solutions | |
| 327X Terminal Emulation/File Transfer: Coaxial Connection | 173 |
| 327X Terminal Emulation/File Transfer: Synchronous/Asynchronous Connections .. | 181 |
| System 3X Terminal Emulation/File Transfer: Overview | 182 |
| Token Ring Network Connections | 184 |
| AppleTalk-to-SNA Gateway Network Connection | 188 |
| IBM Host Electronic Mail Access | 192 |
| Database Access Tools | 193 |
| Host Interface Tools | 195 |
| Cooperative Processing Development Environment | 196 |
| Case History: Seafirst Bank | 195 |
| Chapter VIII: Tandem Computers | |
| The Environment | 199 |
| Solutions | 201 |
| Chapter IX: Wang Computers | |
| The Environment | 205 |
| Solutions | 207 |
| Case History: Chiat Day | 209 |
| Chapter X: Prime Computer | |
| The Environment | 211 |
| Solutions | 213 |
| Chapter XI: Hewlett-Packard | |
| The Environment | 215 |
| Solutions | 219 |
| Case History: Cray Computer Corporation | 221 |
| Product Directory/Index | 223 |

Apple Multivendor Network Solutions Guide:

An Introduction

As organizations move towards the turn of the century, they will continue to be inundated with data—from ever-increasing sources. The challenge all organizations face is turning this incredible quantity of data into the quality information needed to make informed, timely, and accurate decisions.

In the world of information management, the multivendor environment has become less the exception and more the rule. Since one supplier cannot be all things to all people, organizations typically purchase systems—whether computer network or telephone systems—from companies who specialize in the products that best suit the organization's needs.

The client/server architecture is emerging as the ideal way to deliver quality information in a multivendor world. But implementing these new, distributed systems can often tax the resources and capabilities of even the most ambitious information systems departments.

To help organizations in these multivendor environments, Apple provides unique solutions for people to readily access the information they need, use it in the way that they want, and share it with other people in their work groups.

What makes these Apple solutions unique is what they have in common—Macintosh, the ideal desktop client for information systems in the 90's. Macintosh is the personal computer that works the way people work.

Macintosh has been designed to insulate people from the technical complexities of computing, making it possible for them to concentrate on the task they need to get done—not on the tool they're using to do it. The Macintosh computer's intuitive user interface and consistent commands at both the system and application levels make it possible for people to quickly learn virtually any application needed to solve business problems.

With Macintosh multivendor solutions, information from throughout the enterprise can be provided at the desktop of the people who need it. The organization gains a significant competitive edge—not simply because they have more information, but because the information they have will be the information they need.



The Macintosh computer can display graphics and text from diverse computer systems, allowing users to access data stored on a host computer and incorporate that data into a local Macintosh application. Via the familiar “cut-and-paste” operations, information from dissimilar systems can be integrated, even though it originated in an incompatible format.

The Apple Approach

Apple Computer approaches computer communications with the same design philosophy that characterizes its approach to the Macintosh system. The goal is to allow users to work directly and intuitively with the information they need, whether it resides locally, on a network, on a departmental computer, or on a remote host. The Apple vision is to inspire creative decision making and timely problem solving by providing superior, consistent tools for accessing, enhancing, and sharing information, regardless of its location.

Toward this end, Apple strives to ensure that the resolution of differences in protocols, architectures, or interfaces is invisible to the user, regardless of the environment with which the Macintosh computer communicates. This includes such complex network environments as IBM’s Systems Network Architecture (SNA), Digital’s Network Architecture (DNA), the evolving Open System Interconnect (OSI) reference model as defined by the International Standards Organization (ISO), and the networking environments that use Transmission Control Protocol/Internet Protocol (TCP/IP) for connecting workstations. It also encompasses diverse local area network (LAN) wiring schemes such as Ethernet®, token ring, and LocalTalk®.

Integrating Multivendor Environments

Most computing environments today include systems from many different vendors. Apple’s strategy is designed to make Macintosh computers excel in a multivendor environment. To achieve this, Apple has given Macintosh computer users the ability to navigate through a variety of data sources on different systems with the same ease as searching a local hard disk.

Apple has targeted four key environments to implement its multivendor strategy:

- Digital Network Architecture (DNA)
- IBM’s System Network Architecture (SNA)
- Open System Interconnect Architecture (OSI)
- Transmission Control Protocol/Internet Protocol (TCP/IP)

Digital Network Architecture

The Digital Network Architecture (DNA) is the closest of these four environments to being “Macintosh computer-like” in conception and implementation. It is based on a rich set of services on top of flexible connectivity options and peer-to-peer network protocols. Due in part to these similarities, Apple and Digital began a

collaboration effort in January 1988, to leverage the strengths of the AppleTalk® and DECnet™ systems, respectively the companies' proprietary network systems. The objectives of this collaboration are to enhance the services currently available between the two environments and to provide developers with an architectural foundation upon which they can develop world-class collaborative applications. As a result of the alliance, Apple and Digital have announced DEC LanWORKS for Macintosh, a suite of products which provide network connectivity, network services, and application access.

IBM's SNA

IBM's System Network Architecture (SNA) now supports personal computers fully as true software peers in integrated personal computer and mainframe networks. Apple, with MacAPPC™, participates in the use of IBM's Advanced Program-to-Program Communications (APPC), including LU 6.2 and PU 2.1 protocols, which allow personal computers to perform task-to-task communications with other processors and with 3270 Enhanced Communication Facilities (ECF).

Apple's objectives in integrating with IBM SNA networks are to provide file transfer, terminal access, and application integration while simultaneously insulating users from the underlying protocols or required knowledge of SNA. Apple's 3270 terminal emulation product, token ring, and coaxial cards extend Macintosh and AppleTalk system metaphors to the SNA world and preserve the intuitive access methods to which Macintosh computer users are accustomed. And with MacAPPC software, Apple's implementation of the IBM LU 6.2 communications protocol, the Macintosh computer can function as a true software peer in an SNA network, with full multiple-session PU 2.1 capabilities.

OSI Standards

Apple believes that Open System Interconnect (OSI) standards from the International Standards Organization (ISO) greatly extend the reach of Macintosh users. However, Apple believes the potential of OSI will be realized only if the services available on an OSI network are presented in a noncomplex manner. Apple intends to develop OSI products that insulate users and administrators as much as possible from the inherent complexities of a standards-based architecture. The method of sending electronic mail to a person on another continent will be completely consistent with sending a note to the Macintosh computer user next door.

TCP/IP

Transport Control Protocol/Internet Protocol (TCP/IP) is a suite of protocols first developed by the Department of Defense to link together its dissimilar computers. At the University of California at Berkeley, TCP/IP was integrated with the Berkeley

Software Distribution (BSD) 4.2 version of UNIX® and soon moved into the commercial world. Today, it offers one of the few methods of true multivendor integration.

Apple has already successfully integrated the Macintosh computer into the TCP/IP world. Regardless of whether a user's Macintosh computer runs the Macintosh Operating System (OS) or the A/UX® operating system, Apple's UNIX implementation, complete TCP/IP services for file transfer, virtual terminal emulation, and electronic mail are available. In addition, they have been implemented in a manner consistent with Apple's objective of providing intuitive interfaces to often complex and confusing protocols.

How to Use This Guide

The purpose of this guide is to provide information to those people interested in integrating Macintosh computers into their existing computing environment.

The most effective way to use this guide is to determine which system the Macintosh computer needs to be integrated with and then turn to the chapter for that system. In networked environments with multiple vendors, the most widely installed environment should be referenced.

The *AppleTalk® Communications* chapter, the first chapter in this Guide, describes the AppleTalk environment and provides product solutions for work group applications, LANs, and internetworking. It also has information on the AppleShare® environment and the different ways of configuring an AppleShare file server.

The *Network Application Tools* chapter provides a framework for the remaining chapters. The products in this chapter transcend specific hardware environments and are the basis for many of the products in the remainder of this Guide.

The *Networking Environments* chapter pulls together products and information from the leading third-party networking vendors that have developed products and protocols for integrating the Macintosh computer.

The remaining chapters contain products most applicable to their respective environments. Many of these products will work in other environments; please contact the supplier for more specific information on each product.

The Multivendor Networks Solutions Guide

Each chapter of the Guide is divided into two sections with some chapters containing an optional third section.

The **Environment** section is designed to offer an overview of the networking architecture used by the particular systems, as well as some background data on the companies behind them. The intent is to give an understanding of each environment and the basic concepts and terms encountered when connecting the Macintosh computer to these environments.

The **Solutions** section is designed to offer concise descriptions of how to integrate the Macintosh computer into a given environment. Schematics are offered in some cases to better explain how the configurations and connections are made.

The optional third **Case Histories** section illustrates real-life integration of the Macintosh computer and third-party solutions into each environment.

In addition, a **Product Directory** is included at the end of the Guide, alphabetized by product name. The Directory also indexes the products by page number.

Information in the *Apple Multivendor Network Solutions Guide* is useful as a reference, as background information on the many environments where Apple products can be integrated, and as a primer on some of the major solutions available today.

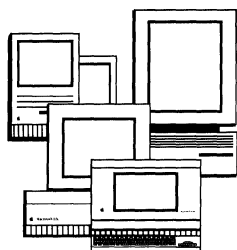

Apple's Macintosh Product Line

Introduced in 1984, the Macintosh personal computer represents a radically different vision of personal computing: tools for individuals. The Macintosh family of computers is characterized by the following:

- Powerful technology that is easy to use.
- Thousands of applications that all work together.
- Built-in networking.
- Growth without disruption.

The original Macintosh computer created a new standard for ease-of-use and personal computer interfaces. The Macintosh family has evolved to include a complete line including compact, modular, and portable Macintosh computers.

The Macintosh family of computers has spawned a robust development community which has created new markets for personal computing. Desktop publishing and desktop presentation products grew from the system's impressive graphics capabilities. And business productivity, communications, information management, and engineering/scientific applications for the Macintosh computer are creating new ways for individuals and groups to work.

All Macintosh systems are based on the Motorola 68000 Series of microprocessors allowing for a smooth upgrade path to future systems and ensures that software

purchased for today's Macintosh computers will continue to run on future models. Continued evolution of both hardware and the operating system will remain focused on the changing needs of the user while protecting the investment in software and training.

Macintosh Computer Family



Compact

In 1984, Apple Computer, Inc. introduced the first Macintosh computer. With improvements in performance and functionality, the compact line of Macintosh computers continues to share the same integrated, transportable design of the original Macintosh. A single system incorporates CPU, monitor, internal floppy disk drive, SCSI and networking capability. System software is provided at no additional cost. Additional features, depending on model selection, can include the Apple FDHD™ floppy disk drive, internal hard disk, Apple Desktop Bus™ (ADB) ports, and expansion slot for interface cards. All compact Macintosh computers provide the ability to increase the amount of memory on the CPU board.

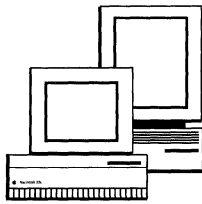

Modular

The modular line of Macintosh computers offers a wide range of choices in performance level, configurability and expansion. Modular Macintosh computers come with Motorola 68030 or 68020 processor, the capacity to hold up to 16 megabytes of RAM on the motherboard, the Apple FDHD floppy disk drive (allows users to read, write and format Macintosh, MS-DOS, and OS/2 floppy disks), and system software. The modular line provides users with the flexibility to configure a system to meet their specific needs. A choice of monitors, keyboards, hard disks, and memory are available. Up to eight expansion slots are available to support cards from Apple and third-party vendors. A/UX is available as an option to users who require the capabilities of the UNIX operating system without sacrificing the Macintosh user interface.

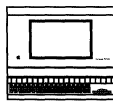

Portable

The Macintosh Portable combines all the features of a Macintosh including: point-and-click operation; graphics capabilities; the ability to run thousands of Macintosh applications; expansion options, and built-in networking capabilities; and standard Macintosh input and output ports-in an all-in-one design. In addition, the Macintosh Portable uses an Active Matrix LCD screen, which can display text, graphics, and animation in crisp, clear detail. The display is very responsive and can be read in a wide range of lighting conditions. For users who require the use of an external monitor or projection device, an optional video adapter is available. The rechargeable battery is capable of powering the Macintosh Portable for 6-12 hours on a

single charge. Also, intelligent power-management features ensures that the battery is used efficiently by turning off components in the computer that are not being used. Options for the Macintosh Portable include an internal modem, additional RAM, and a numeric keypad. A power adapter carrying case, and a second set of batteries are included.

Methodology

This publication was completed in July 1990, and all information was correct at that date to the best of our ability. Mention of products in this directory is for informational purposes only, and constitutes neither an endorsement nor a recommendation by Apple Computer, Inc. All product specifications and descriptions were supplied by the respective vendors or suppliers.

A Note on Diagrams:

Where possible, diagrams and sidebar notes have been used to clarify and embellish points made in the text. Schematics are offered throughout the publication to depict product and system configurations. At right is a template of figures and product representations used in this Guide.

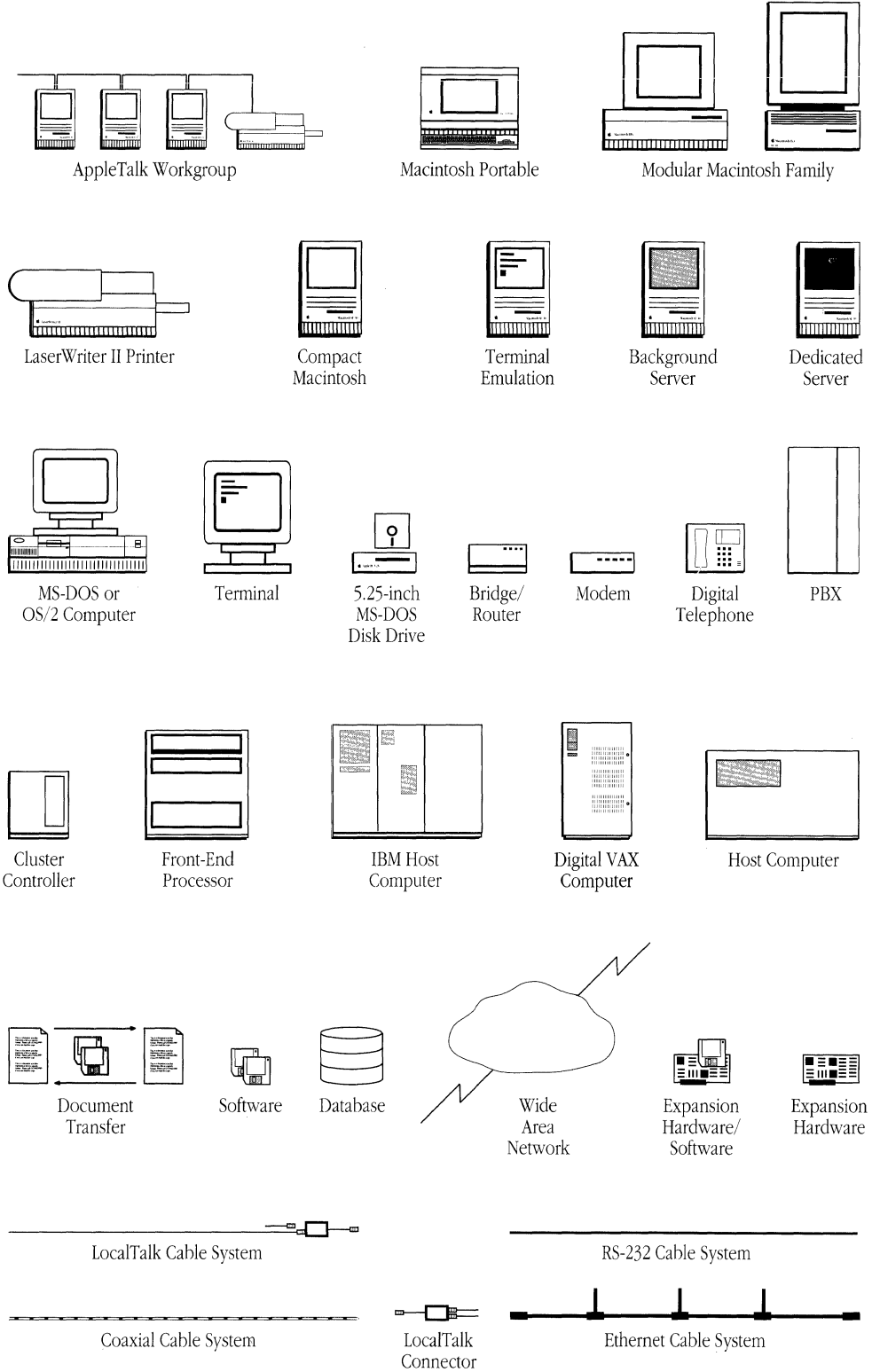

AppleTalk Communications

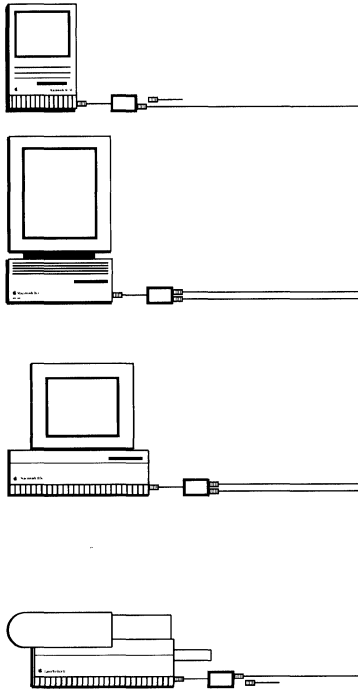

AppleTalk networking capabilities have been built into every Macintosh computer, ensuring the seamless extension of the Macintosh user interface across the network.

Background

When introduced in 1984, the Macintosh personal computer represented a radically different vision of personal computing: tools for individuals. The engineers who developed the Macintosh began with a vision of a computer that would be accessible, engaging, and exciting to use—a computer that would insulate users from the technical complexities traditionally associated with computing.

To accomplish this, two elements were added to the hardware and operating system that make up the Macintosh computer architecture:

- An environment, based on the metaphor of the desktop, that uses real-world graphic images and a see-and-point user interface.
- A toolbox of common routines, functions, and features from which all software applications can draw.

These elements created a foundation for applications that all work in the same way, sharing graphics and other information through the simple “cut-and-paste” metaphor. This has enabled the development of powerful, easy-to-learn software with a consistent look and feel, and has helped Apple establish a style of computing that has since become the industry standard. In fact, Apple is the only company to implement a consistent user interface successfully.

More than 3,000 applications have been created for the Macintosh computer, including programs from most of the world’s major software publishers. These include the basics such as spreadsheets, word processors, and database managers, but they also include such innovative software as Aldus PageMaker, which helped the Macintosh computer go beyond the basics to create entirely new application categories.

Macintosh computer desktop publishing and presentation applications, for example, have revolutionized printed materials. Presentation-quality graphics are now the norm, not only in creative and graphic arts departments but also throughout corporations.

In 1987, Apple introduced the Macintosh II computer which offered color and increased power over early Macintosh computers. The Macintosh II family of computers has since expanded to form the modular line. With this Motorola 68000 family of 32-bit computers, the Macintosh computer has become an ideal platform for applications in the design, visualization, and modeling categories. Applications

The Environment

previously available only on costly engineering workstations, such as two- and three-dimensional design and drafting applications, are now available on the Macintosh computer.

The consistent environment of the Macintosh computer allows these applications to be fully integrated and therefore exchange text and graphics with productivity, publishing, and presentation applications. As Macintosh computer graphics become even more powerful, new design applications using techniques such as solid modeling, parametric design, photo-realistic rendering, and animation will become commonplace on the Macintosh computer.

The Macintosh computer also has sophisticated sound capabilities incorporated into every system. This ability to play high quality sound permits the Macintosh computer to perform as a multimedia presentation system as well as a composition environment for advanced music applications.

The AppleTalk network system allows for a variety of network services including:

- *Sharing of files via file servers, which give multiple users simultaneous access to files and applications*
- *Sharing of high-quality printers and other network resources (modems, fax, etc.)*
- *Communication between users via electronic mail, electronic conferencing, or screen sharing*
- *Access to remote databases and applications*

The AppleTalk Network System

Apple's local area network system, AppleTalk, was the first significant step giving the Macintosh computer user the ability to reach beyond the desktop. The AppleTalk network system extends the user's experience across a network, providing access to electronic mail applications, print and file servers, and other network services in the same manner that Macintosh users access desk accessories, hard disks, or other Macintosh computer features. The user sees familiar aspects of the desktop interface, yet the software modules that control those services are hidden or transparent to the user.

The LocalTalk[®] network connection is built into every Macintosh providing access to AppleTalk network system services. Access to other network types, such as Ethernet or token ring, is available through additional interface cards.

The AppleTalk network system's design makes it simple to install by merely connecting the appropriate cable system into the computer network. Devices on an AppleTalk system, including printers and file servers, participate with all the other devices, without having to go through a host-provided service. This means that users never have to sacrifice the power and individuality of their own desktop in order to communicate with any other computer, even the most powerful mainframe.

The AppleTalk network system has an open, layered protocol system, on which a wide range of network services is built. It is consistent with the Open Systems Interconnection (OSI) reference model as defined by the International Standards Organization (ISO).

The Environment

| OSI Model | Functionality | AppleTalk Examples |
|--------------------|-------------------------------------------------------------------------------------------------------|------------------------------------------------------------------------------|
| Application Layer | Network-based applications and utilities | AppleShare print server AppleShare PC |
| Presentation Layer | File service; conversion of file formats; control of representation of information | AFP (Filing Protocol) PAP (Printer Protocol) |
| Session Layer | Delivery of sequenced packets of streams of characters; coordination of activity across network zones | ASP (Session Protocol) ADSP (Data Stream Protocol) ZIP (Zone Protocol) |
| Transport Layer | Reliable transportation; name-to-address mapping | ATP (Transport Protocol) Echo, NBP, ZIP |
| Network Layer | “Best effort” packet delivery between network entities | DDP (Datagram Delivery Protocol) |
| Data Link Layer | Access to physical transmission medium; speed of transmission; send/receive functions | ALAP (Link Access Protocol), Ethernet |
| Physical Layer | Transmission medium (cabling); electrical interface | Twisted-pair, coaxial, fiber-optic |

The OSI reference model organizes hierarchically the types of services that must be provided in a communications network environment, defining seven categories, or layers, of network services. It starts at the lowest layer with a characterization of the physical media that carry the communications signals, and moves up to the highest layer where services specific to end-user applications are provided. By using this model, AppleTalk offers a flexible and open environment.

AppleTalk is supported on a variety of computing platforms:

- VMS
- UNIX
- MS-DOS
- NetWare
- And Others

AppleTalk protocols are open to other vendors through a licensing program allowing networking companies to obtain AppleTalk software directly from Apple, instead of writing it from scratch. This program will extend the availability of AppleTalk network services on other computer platforms.

The AppleTalk network system offers a wide variety of choices in cabling and network data links including Apple's LocalTalk, which is built into every Macintosh, and industry-standard Ethernet (802.3) and token ring (802.5) networks. AppleTalk works with most major cable technologies—unshielded twisted-pair cable (phone wires), low-cost shielded twisted-pair wire, coaxial cable, infrared, and fiber-optics. And since AppleTalk is designed to be media-independent at the lowest levels of the OSI model, new cable technologies can be adopted as they evolve.

The Environment

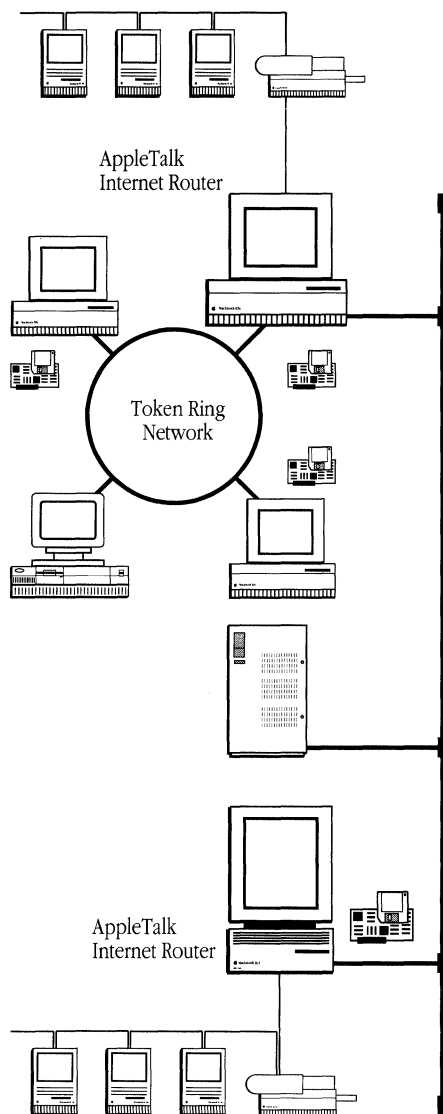

In the modern computing environment networking solutions are available to connect diverse environments. A wide variety of bridges, gateways, and routers exist to solve the most demanding requirements.

AppleTalk Phase 2

AppleTalk Phase 2, introduced in June 1989, provides compatible extensions to the AppleTalk network system that enable it to function effectively in large network environments. AppleTalk Phase 2 extends AppleTalk to large enterprise networking systems over many cabling schemes and with many different network topologies and performance characteristics. Such environments often include thousands of concurrently active devices and multiple concurrent network protocols and data links. AppleTalk Phase 2 removed the restriction of a maximum of 254 concurrently active AppleTalk devices on one network. In addition, AppleTalk Phase 2 was designed to integrate the AppleTalk protocols with other non-AppleTalk devices in the same environment.

Extended addressing allows more nodes to be addressed on a single network. Previously, AppleTalk networks were limited to 254 nodes; with AppleTalk Phase 2, an AppleTalk network may now have up to 16 million nodes.

The improved routing capabilities optimize the performance of an AppleTalk internet by transmitting information across the most efficient route.

Dynamic zone naming allows flexibility in the design of an internet so that, when machines or people move from place to place, the network administrator can easily track them without having to actually change the physical configuration of the network.

A key component of AppleTalk Phase 2 is the AppleTalk Internet Router product. In addition to serving as the first router to implement the Phase 2 protocols, the AppleTalk Internet Router allows up to eight AppleTalk networks (of any data-link type) to be interconnected. The router software runs on a Macintosh and thus provides the familiar Macintosh user interface for router setup and for monitoring of the internet. The router supports LocalTalk, EtherTalk®, and TokenTalk® network systems and can be extended to support other data links as they are added to the AppleTalk network system.

Information Sharing with AppleShare

Through the AppleTalk network system and the AppleShare File Server, Apple also offers transparent, intuitive information sharing for work groups.

AppleShare File Server software converts any Macintosh computer into a high-performance file server. And since the AppleShare File Server was designed together with the Macintosh Finder™ and system software, the interface between user and server is seamless and transparent.

The Environment

The user works with information on the server as if it were stored on his or her own hard disk. Individuals have the ability to control who has access to documents they create and store on the server. In addition, single-user and multi-user applications can be run directly from the server.

Network services such as print spooling and electronic mail can run concurrently with AppleShare. And AppleShare provides a predictable growth path. Users can enhance the overall performance of their servers by upgrading to a Macintosh II computer and a higher-performance protocol. Or users can upgrade to an AppleShare-compatible server running on a Digital VAX™ minicomputer. Refer to the *Digital Equipment Corporation* chapter in this Guide for more detailed information.

AppleShare protocols have been adopted by major systems vendors such as Digital, 3Com, and Novell. Thus when users work with any AppleShare-compatible server, the user interface remains the same.

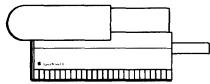

Printing

Historically, professional-looking printed output required extremely expensive peripherals. Networks, however, allow users to share those peripherals, making quality printing cost-effective.

Apple's LaserWriter® printer initiated a new era in printed office output, because it made high-quality printing available to work groups. The revolution in desktop publishing springs from the following enabling printing technologies:

- Adobe's PostScript® page-description language can describe and produce everything from simple fonts to complex graphic objects, all in many sizes and forms.
- The Printer Access Protocol (PAP) allows devices on a network to find and share different printers. It supports not only the LaserWriter family of printers, which are most commonly used as shared hardware devices, but also the less frequently shared ImageWriter II and ImageWriter LQ printers.



Network Administration

The larger a network grows, the more difficult it becomes to manage. Diagnostic and management tools are necessary to fine-tune network functioning to provide maximum efficiency and reliability. Apple's Inter•Poll® Network Administrator's Utility can identify network devices and system software versions from a single network station, allowing a network administrator to diagnose and correct problems quickly.

The AppleTalk network system offers transparent internetworking capabilities for organizations and work groups that need to connect more devices than a standard

The Environment

AppleTalk Phase 2 enhancement improves and extends AppleTalk network administration in three areas:

- *Extended addressing*
- *Improved routing capabilities*
- *Dynamic naming services across the internet*

AppleTalk network can handle. Apple's AppleTalk Internet Router dramatically increases the size and flexibility of an AppleTalk network system. It allows systems such as LocalTalk, EtherTalk, and TokenTalk to be interconnected to form an internet. Internets of up to 1024 networks and 16 million nodes can be created with AppleTalk Internet Routers.

Also, because Apple designed bridging capabilities into the AppleTalk network architecture, third-party vendors can create additional internetworking solutions. For example, a number of AppleTalk networks can be linked via the Hayes InterBridge, and products such as FastPath, from Shiva, allow communications between LocalTalk and Ethernet networks supporting AppleTalk, DECnet, or TCP/IP protocols.

AppleTalk Solutions

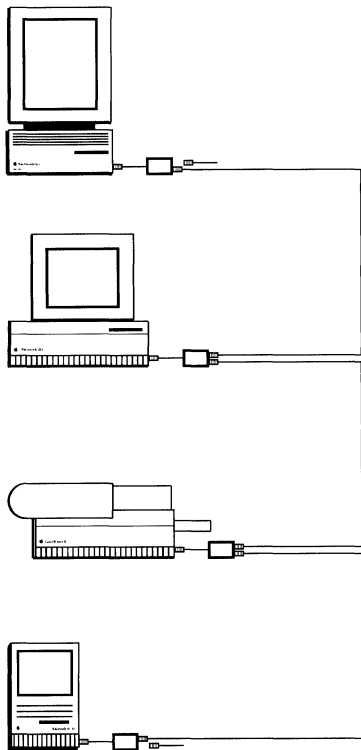

Every Macintosh computer is delivered with built-in networking, allowing untrained users to install local area networks easily.

Physical Connections and Devices

LocalTalk Cable System

The LocalTalk cable system is a standard work-group cable system that uses shielded twisted-pair wire. It is a flexible, low-cost method of connection and sets the standard for other cable systems that use the LocalTalk network connection. Computers, printers, and servers can communicate using built-in network connections over shielded twisted-pair wiring. LocalTalk allows up to 32 devices to be connected per network segment and operates at a bandwidth of 230.4 Kbps. Each segment can span a distance of 1000 feet (with a maximum distance between nodes of 1000 feet), and network segments can be interconnected using bridges. The LocalTalk Locking Cable Kit comes in 10 or 25 meter lengths. The LocalTalk Locking Connector Kit can be purchased with DIN-8 or DB-9 connectors.

Approximate Cost from \$75

Supplier: Apple Computer, Inc., 20525 Mariani Ave., Cupertino, CA 95014, 408-996-1010

StarBurst

The StarBurst is a star-hub controller that distributes LocalTalk cabling in a star topology. Each StarBurst module supports up to 16 connections. As many as four StarBurst modules can be mounted on the back of a rack or wall mounted, 64 port, RJ-11 patch panel measuring 7" by 19". Since each StarBurst module operates independently, each module on a panel can be in a different Internet Zone. Each StarBurst module includes a "Watch Dog Timer" to disable a chattering node. The StarBurst is re-enabled automatically when it is corrected. The StarBurst module is available as a stand-alone unit connected via a 50-pin connector to a standard punch-down block for telco wiring. The module can be replaced without disconnecting any wiring to the StarBurst case.

Approximate Cost \$449 to \$2046

Supplier: Cactus Computer, Inc., 1120 Metrocrest Dr., #103, Carrollton, TX 75006, 214-416-0525

PhoneNET Series

PhoneNET Connector allows different devices such as computers, printers and file servers on an AppleTalk network to communicate with each other over ordinary telephone cables. PhoneNET Connectors come in three models, a Mini DIN-8 plug, a DB-9 plug and a DB-25 plug. PhoneNET Connectors are compatible with LocalTalk cabling, FlashTalk, and DaynaTalk.

Solutions

Like standard PhoneNET Connectors, StarConnectors run AppleTalk over a single pair of telephone wires. StarConnectors are suited to both passive and active star topologies, the wiring plan used by telephone systems, and are designed for use with StarController Series 300. With an improved micro-transformer technology, single-jack StarConnectors are less than half the size of standard PhoneNET Connectors. StarConnectors are pre-terminated with 120-ohm resistors.

The PhoneNET StarController Series 300 hub is a multi-port LocalTalk repeater users mount in the telephone wiring closet. The hub connects all network devices together in a star configuration, repeating and amplifying signals over existing telephone wire or ordinary twisted-pair cable. The StarController is managed with StarCommand 2.0 software, and runs as a background application under Multi-Finder, automatically notifying network managers of problems.

The PhoneNET Repeater regenerates and reclocks AppleTalk and FlashTalk signals allowing networks to extend longer distances and link a variety of network topologies, including backbones, daisychains and stars; and StarControllers and networks in different buildings. Users can link multiple PhoneNET Repeaters together with over a mile of ordinary telephone cabling between each Repeater. Built-in PhoneNET connectors allow users to attach one or two wire pairs directly to the Repeater.

The StarConnector EN and StarController EN Series 500 allow Macintosh users to receive the throughput of Ethernet over ordinary twisted-pair telephone wiring. The 12-port repeating hub mounts in a telephone closet, and complies with the IEEE 10BASE-T standard. Network devices can be connected using twisted-pair with the StarConnector EN. It features a RJ-45 to AUI connection and status indicator LEDs. LocalTalk StarController hubs can be linked with StarController EN hubs to create hybrid networks, running LocalTalk for the majority of the users. The hubs can be managed with StarCommand management software. StarCommand tests line quality, switches ports on or off, and has password security.

PhoneNET Card is a twisted-pair Ethernet card for the PhoneNET System of networking products for Macintosh computers. The half-height card features a built-in twisted-pair transceiver and a built-in RJ-45 connector and universal AUI (Attachment User Interface) connector. PhoneNET Card, available for the Macintosh II and SE/30, also comes bundled with TIMBUKTU software.

Approximate Cost \$30 to \$2495

Supplier: Farallon Computing, Inc., 2000 Powell St., Suite 600, Emeryville, CA 94608, 415-596-9100

PHOTOLINK for LocalTalk: AppleTalk Over Infrared

PHOTOLINK is a cable-replacement product which uses infrared light as the data transmission medium to connect Macintosh computers or peripherals. PHOTOLINK

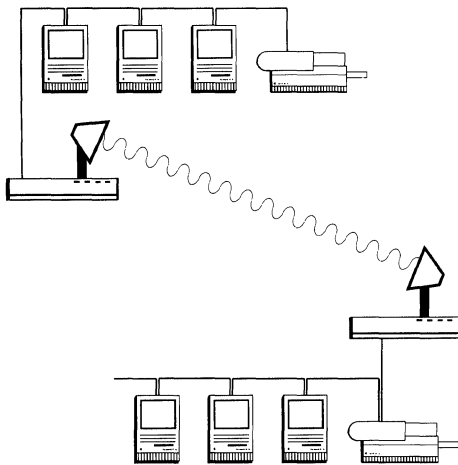

PHOTOLINK connects AppleTalk networks with infrared light when cabling is not available or cost-effective.

can connect AppleTalk/LocalTalk workgroups in open or partitioned offices or light manufacturing environments. Installation is “plug and play.” Each cluster of four or more computers or peripherals (e.g., printers, modems, bridges, star controllers) is connected to a PHOTOLINK transceiver that communicates with other PHOTOLINKs in the zone via infrared light aimed at the same area of ceiling or wall. Although invisible to the naked eye, the infrared light signals “look” just like the cable signals to the network. With AppleTalk Phase 1 or 2, up to 32 PHOTOLINKs and 128 computers or peripherals may be installed on every subnet. PHOTOLINKs may be connected to existing cable-based systems, wide-area networks, or directly to cable for through-the-wall connections. PHOTOLINK has a built-in microprocessor and proprietary error correction system.

Approximate Cost\$1195

Supplier: Photonics Corporation, 200 East Hacienda Ave., Campbell, CA 95008, 408-370-3033

CommCard

CommCard is a 4-port serial communications card for Macintosh II computers. It can be used as either four extra serial ports or one extra LocalTalk port. Connectors are identical to those on the Macintosh so customers can use the same cables. Up to five CommCards can be added to a system, adding a total of 20 additional serial ports or five LocalTalk ports. Hardware configuration is done totally in software; there are no dip switches or jumpers to configure. Software support is provided for Apple’s Communications Toolbox, the older style serial programmer’s interface and Apple’s Internet Router. Serial support is also provided for A/UX, Apple’s version of the UNIX operating system.

Approximate Cost\$450

Supplier: Taniwha Systems Design, 2206 Roosevelt Ave., Berkeley, CA 94703, 415-540-5557

AppleTalk over Ethernet

Apple EtherTalk NB Card

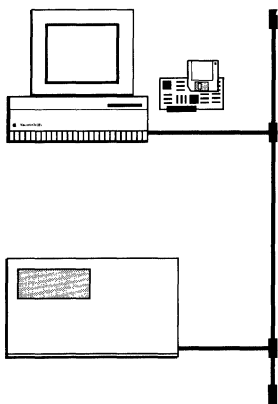

With the addition of a NuBus card and software, Macintosh computers become Ethernet compatible.

The Apple EtherTalk NB Card provides direct connectivity to 802.3 Ethernet networks for the Macintosh II family. It consists of a NuBus card plus software that implements the AppleTalk Phase 2 protocols over Ethernet. The card comes with a built-in transceiver and connectors to both standard and thin Ethernet. It can be connected to either kind of Ethernet; a switch located on the card selects the type of cable in use. In addition to AppleTalk support, the Apple EtherTalk NB Card supports a variety of networking protocols, including TCP/IP.

Approximate Cost\$699

Supplier: Apple Computer, Inc., 20525 Mariani Ave., Cupertino, CA 95014, 408-996-1010

Solutions

EtherPort Product Line

The EtherPort product line consists of a series of adapters for the Macintosh SE, SE/30, and II computers, all with an 'L' option for connection to SynOptic's LattisNet, an Ethernet network based on unshielded twisted-pair media. The EtherPort SE family of products have a 16-bit bus interface and the EtherPort II products have a 32-bit bus interface. These adapter products provide a high-performance link to Ethernet networks for Macintosh personal computers. When used with Novell's Macintosh connectivity products, the EtherPort products allow Macintosh workstations to access NetWare file servers at a data transfer rate of 10 Mbps. The EtherPort products are compliant with the ANSI/IEEE 802.3 standard for CSMA/CD baseband networks and the Apple EtherTalk standard. The adapter can be used to integrate Macintosh computers and IBM PCs and compatibles in networks based on the thin Ethernet and thick Ethernet cabling schemes. The adapter is switch-selectable between thin and thick Ethernet.

The EtherPort products are actually sets of two adapters. The EtherPort Control Adapter is installed in the Macintosh computer expansion slot and connects via cable to the EtherPort Access Adapter, which is mounted on the back panel of the Macintosh. The network cable is attached to the Access Adapter. The EtherPort product line requires the EtherTalk driver software, which comes with the adapters, to communicate across the network. The EtherTalk software requires Macintosh System version 6.0 or above. In NetWare 286 servers, NetWare version 2.15 or above is required, and NetWare for Macintosh must be installed in the server or an external bridge on the network. In NetWare 386 servers, NetWare version 3.0 or above is required for use in conjunction with NetWare for Macintosh running in an external NetWare 286-based bridge.

Approximate Cost\$595 to \$645

Supplier: Novell, Inc., 122 East 1700 South, Provo, UT 84606, 800-LAN-KIND

Ether2

Ether2 is an Ethernet NuBus Board for Apple's Macintosh II family of personal computers. All NuBus-equipped Macintosh computers, including the Macintosh II, IIx, IIcx, IIci, and IIfx, are supported by Ether2. The Ether2 board provides connections for both standard and thin-wire Ethernet and can be attached to a twisted-pair Ethernet network via third-party adapters. Ether2 is compatible with Apple's EtherTalk network software driver specifications. Software packages supported by Ether2 include TOPS, AppleShare, Novell Macintosh, Telnet, and other Macintosh network packages. Standard Ethernet connections are available for a variety of other computing devices.

Approximate Cost\$395

Supplier: Compatible Systems Corporation, P.O. Box 17220, Boulder, CO 80301, 303-444-9532

NRC Mac2000

The NRC Mac2000 is a NuBus expansion card that allows the Macintosh II family of computers to connect to Ethernet, broadband or fiber optic networks. The Mac2000 is based on Apple's Macintosh Coprocessor Platform (MCP). The Mac2000 is an interface card with its own 68000 microprocessor, 512K memory and multitasking operating system. The Macintosh Coprocessor Platform allows the off-loading of communications processing to the Mac2000's microprocessor. Concurrent execution of multiple networking protocols, such as EtherTalk, TCP/IP and NFS can be supported on the card. The Mac2000 is compatible with the IEEE 802.3 standards and both Apple and third-party network services. Network environments including those with Digital VAX computers, UNIX systems, AppleTalk server systems, PCs and terminals are supported by the Mac2000.

Approximate Cost\$995

Supplier: Network Resources Corp., 2450 Autumnvale Dr., San Jose, CA 95131, 408-263-8100

Access/One MaxTalk Interface Module

The Access/One MaxTalk Interface Module delivers high-performance networking among Apple Macintosh personal computers and other LocalTalk devices such as printers, and integrates those devices into an Ethernet, FDDI, token ring, or broadband network. The MaxTalk Module support 16 individual LocalTalk devices or 16 daisy-chained LocalTalk networks using unshielded twisted-pair wiring. LocalTalk connectors may be connected directly into twisted-pair cabling star-wired from Access/One Enclosures. Up to four MaxTalk Interface modules may be installed in a single ASE-3000 System Enclosure, and up to ten MaxTalk Interface Modules may be installed in a single ASE-7000 System Enclosure. The MaxTalk Module filters traffic on each of its 16 ports, forwarding data packets only to their addressed destinations. Each device has its own dedicated 230.4 Kbps transmission line. All 16 devices attached to the MaxTalk module can simultaneously use the network.

Approximate CostContact Supplier

Supplier: Ungermann-Bass, Inc., P.O. Box 58030, Santa Clara, CA 95052-8030, 408-496-0111

EtherMac II and EtherMac II/10T

The EtherMac II is a NuBus card that provides direct attachment to Ethernet for any Macintosh II computer. It is port compatible with Apple's EtherTalk driver and uses the same driver. EtherMac II has a 15-pin D connector and a BNC connector on the same card. The 15-pin D allows connection to an external transceiver that can be used for connecting to standard thick Ethernet (10Base5). The BNC connector allows direct connection to thin Ethernet RG-58 coax cable (10Base2). EtherMac II/10T comes with an RJ-45 modular phone connector for twisted pair Ethernet and

Solutions

a 15-pin D connector for thick Ethernet. It has a built-in twisted-pair Ethernet transceiver and supports 10BaseT Ethernet. It is compatible with any 10BaseT compliant concentrator.

Approximate Cost \$495 to \$595

Supplier: Adaptec, Inc., 691 S. Milpitas Blvd., Milpitas, CA 95035

Asanté MacCon+ Ethernet Cards

Asanté offers a line of network interface cards for Macintosh II, SE, and SE/30 computers on any Ethernet media: Thick, Thin, or the new 10BaseT unshielded twisted-pair. MacCon+ cards support both AppleTalk Phase 1 and Phase 2. Register-level compatibility with Apple's EtherTalk, and support for AppleShare, NetWare, and 3+Open is already built-in to the Asanté MacCon+ Ethernet cards. They feature diagnostic LEDs, and 32-bit data transfer at up to 10 Mbts/second throughput. Asanté's MacCon+ boards are available with an optional 64 Kb buffer for use in A/UX systems. All MacCon+ boards comply with the IEEE 802.3 Ethernet standard, with both enhanced thin Ethernet cable and thick Ethernet cable supported on the MacCon+E series cards. The MacCon+ ET series cards support the 10BaseT standard for unshielded twisted-pair cabling.

Approximate Cost \$495 to \$545

Supplier: Asanté Technologies, Inc., 405 Tasman Dr., Sunnyvale, CA 94089, 800-662-9686

Back-up Systems

NetStream 2.0

NetStream 2.0 is a network backup software program designed to provide automatic, unattended backups of an entire AppleTalk network, as well as AppleShare servers. Features include the ability to backup at any time; the ability to pre-program backup days or weeks in advance; DES or proprietary encryption, with backup across multiple zones; and the ability to support PCPC JetStream, PCPC DatStream, PCPC MacBottom hard drives, optical erasable drives, VAX, and other Macintosh peripherals.

Approximate Cost \$89

Supplier: Personal Computer Peripheral Corporation, 4170 Eisenhower Blvd., Bldg. A-4, Tampa, FL 33634, 813-884-3092

DatStream

DatStream is a tape backup system utilizing 4mm DAT technology. DatStream has 1.3 gigabytes of on-line storage, backs up across zones, and can find any file with an average seek time of 20 seconds. It also features unattended workstation

backups with bundled PCPC NetStream software and is compatible with DDS and DATA/DAT technology.

Approximate Cost\$3479

Supplier: Personal Computer Peripheral Corporation, 4170 Eisenhower Blvd., Bldg. A-4, Tampa, FL 33634, 813-884-3092

JetStream

JetStream tape backup system archives 2.5 gigabytes on one 8mm helical scan format video tape cartridge, with a speed of up to 14.4 megabytes per minute. It backs up multiple drives, crosses zones, and is bundled with NetStream 2.0 Network Backup Software Starter Pack which provides unattended network backups.

Approximate Cost\$4279

Supplier: Personal Computer Peripheral Corporation, 4170 Eisenhower Blvd., Bldg. A-4, Tampa, FL 33634, 813-884-3092

Nightshift at a glance:

- *Multizone Backup*
- *Timed, Unattended Backup*
- *Security 'Sleep' Mode*

Nightshift

Nightshift is an integrated tape-drive/software solution which facilitates centralized, unattended backup of an entire Macintosh network. Nightshift provides multi-zone backup of all nodes including servers without requiring AppleShare, TOPS, or any other network software. It is designed for network administrators who do regular backups. Features include a timer for scheduling backup at the desired time, a log window which shows progress and error information, and a security "sleep" mode which protects nodes from tampering and provides automatic shutdown when backup is complete. Once on tape, files can be viewed according to owner and can be restored individually, by volume, or by folder. Nightshift comes bundled with either a TTI 4mm or 8mm helical-scan, SCSI tape drive providing 1.3 and 2.3 gigabytes of storage, respectively. The 8mm drive features TTI's front-panel display while the 4mm DAT drive provides directory access and file retrieval.

Approximate Cost\$4795 to \$6295

Supplier: Transitional Technology, Inc., 5401 E. La Palms Ave., Anaheim, CA 92807, 714-693-1133

AppleTalk Routing

AppleTalk Internet Router

The AppleTalk Internet Router lets users increase the size and improve the performance and manageability of an AppleTalk system. It allows AppleTalk networks such as LocalTalk, EtherTalk, and TokenTalk to be interconnected to form an internet. The router moves data from one network to another transparently so that

Solutions

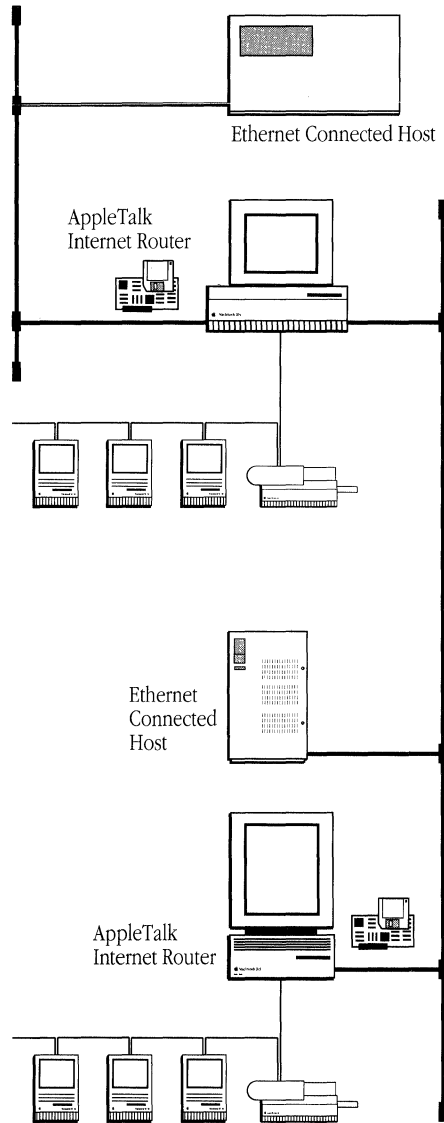

The AppleTalk Internet Router can connect up to eight networks including any combination of LocalTalk, EtherTalk, and TokenTalk interconnections.

the internet functions like a single network. This means that users can access file, print, and mail resources across the internet in the same way they access these resources on a single network. Each Internet Router can interconnect up to 8 networks, allowing flexible network topologies and optimum use of Macintosh resources. A total internet of up to 1024 networks can be created, providing extended network addressing for up to 16 million Macintosh computers or other nodes. The AppleTalk Internet Router provides greater monitoring and control of an internet. Through the router desk accessory, users or administrators can access several displays that allow them to monitor activity and network statistics on the router, view an active routing table of the entire internet, change the router setup information, and print the contents of the setup and administrative displays.

Approximate Cost\$399
Supplier: Apple Computer Inc., 20525 Mariani Ave., Cupertino, CA 95014, 408-996-1010

Liaison

Liaison is software that connects AppleTalk networks running on LocalTalk cable to ARCnet-compatible hosts; to an Ethernet backbone, or to remote AppleTalk networks. When used with any of the Macintosh-to-Ethernet connections, a Macintosh computer running Liaison in the background allows AppleTalk-based workstations to utilize VMS host services. When used with an ARCTalk adapter from ACTINET, a Macintosh computer running Liaison allows LocalTalk-based, AppleTalk network workstations to utilize the services of ARCnet-based Novell Netware hosts. With the addition of a Hayes-compatible modem, remote Macintosh computers and/or AppleTalk work groups can access the same services using dial-up or leased lines.

Approximate Cost\$295
Supplier: Infosphere, Inc., 4730 S.W. Macadam Ave., Portland, OR 97201, 503-226-3620

FastPath 4 Gateway

The FastPath 4 gateway connects AppleTalk workgroups to Ethernet networks, allowing Macintosh computers on LocalTalk access to systems and services on Ethernet. Macintosh users can participate in internetworks of heterogeneous machines, including other Macintosh computers, PCs, NetWare servers, VAX systems, UNIX systems, and remote networks. The FastPath provides Ethernet-based machines access to AppleTalk services—such as LaserWriter printers—on a LocalTalk network. Using the Ethernet network as a backbone, FastPath gateways can also function as high-speed AppleTalk bridges among LocalTalk networks. K-Star, the FastPath's gateway software, provides multiple protocol support—including AppleTalk Phase 1 and 2, TCP/IP, DECnet, and the network management protocol SNMP. With NCSA Telnet software, the FastPath helps provide TELNET and FTP services to Macintosh computers on a LocalTalk network. Other TCP/IP

The FastPath supports all standard AppleTalk-based applications:

- *NetWare for Macintosh*
- *File and disk servers*
- *Print spoolers*
- *Multiuser database systems*
- *Electronic mail*

and DECnet software compatible with the FastPath is available from third parties. The FastPath supports TCP/IP, DECnet, and SNMP on Macintosh computers running the appropriate software. Each FastPath gateway connects one LocalTalk network to an Ethernet network. One Ethernet network can support a number of FastPaths attached to LocalTalk networks. The FastPath requires a DB-9 connector for connection to LocalTalk cabling. The FastPath gateway ships with the download module, K-Star, the network diagnostic software package, and LAN Ranger.

Approximate Cost \$2795

Supplier: Shiva Corporation, 155 Second St., Cambridge, MA 02141, 617-864-8500

MaxWay 500 Family

Based upon the 10 MIPS SPARC CPU, the MaxWay 500 family utilizes the VME expansion bus for high-speed LAN options. The base MaxWay 500 is capable of concurrently supporting four LocalTalk LANs and two high-speed LANs (any combination of Ethernet/EEE 802.3 and Token Ring) and is intended to be used as a multi-LAN AppleTalk Router, instead of a Macintosh IIfx or Macintosh IIfx equipped with Apple's Internet Router software. In many configurations, the MaxWay 500 can replace up to four Novell FastPaths or comparable routers. The MaxWay family consists of two members, each equipped with four LocalTalk ports, one high-speed LAN, and one high-speed LAN expansion slot. The MaxWay 500E supports Ethernet and LocalTalk routing among four LocalTalk LANs and can be expanded to include another Ethernet or Token Ring LAN. The MaxWay 500TR supports Token Ring connectivity and routing among four LocalTalk LANs and a Token Ring (IEEE 802.5) LAN. Options exist for 4 Mbps and 16/4 Mbps Token Ring operation. The MaxWay 500TR can also be expanded to support an additional Ethernet or Token Ring LAN.

Approximate Cost \$7495

Supplier: Tri-Data Systems, Inc., 3270 Scott Blvd., Santa Clara, CA 95054, 408-727-3270

SyncRouter

The SyncRouter allows connection of remote AppleTalk networks over high speed synchronous communication links via one of three standard synchronous interfaces: V.35; RS-449; and RS-232. This enables the utilization of wide area network services and equipment, such as: 56 Kilobit Digital Data Service, DSU/CSU; switched 56K services; Fractional T1; T1 via multiplexors; digital radio; satellites; and fiber-optic modems, for remote AppleTalk connectivity. The SyncRouter is able to provide high performance full duplex remote interconnectivity at speeds from 9.6 Kilobits to 224 Kilobits (4 DS0 56 Kilobit Channels) per second. The SyncRouter supports AppleTalk Phase 2, and comes standard with: three standard synchronous interfaces; DB-9 LocalTalk port to connect to LocalTalk, PhoneNet or other LocalTalk compatible cabling. Included is SyncView, a network management application

Solutions

that can be used to monitor, maintain and configure the SyncRouters from a Macintosh anywhere on the AppleTalk network.

Approximate Cost\$1895 to \$2095

Supplier: Engage Communication, Inc., 9053 Soquel Dr., Suite 201, Aptos, CA 95003-4034, 408-688-1021

NRC MultiGate 2000

The NRC MultiGate 2000 is a series of high speed AppleTalk routers that allow users to connect LocalTalk/PhoneNET systems and connect LaserWriter printers to high speed EtherTalk, broadband or fiber optic networks. The MultiGate 2000 routers comply with IEEE 802.3 and AppleTalk Phase 1 and 2 standards. MultiGate 2000 routers interoperate with other third-party AppleTalk products including other AppleTalk routers and server environments such as AlisaTalk, PacerShare, AppleTalk for VMS, Novell with AFP support, 3Com 3+ for Macintosh and TOPS. Downline loading NRC's IPGate software to the MultiGate 2000 turns MultiGate 2000 into an AppleTalk to TCP/IP gateway. When used in conjunction with MultiGate Access or third-party software, the user can access a wide range of environments including Digital VAX computers, UNIX systems, PCs, terminals and TCP/IP-based computers. MultiGate 2000 ships with MultiGate Manager Jr. software. MultiGate Manager allows users to track routers, download software updates, troubleshoot the network and control each router from a central location.

Approximate Cost\$80 to \$2795

Supplier: Network Resources Corp., 2450 Autumnvale Dr., San Jose, CA 95131, 408-263-8100

NetBridge

The NetBridge is a local router for AppleTalk networks. It can be used to expand a network beyond AppleTalk Phase 1's 32 node limit or to connect two independent networks in the same location. The NetBridge includes the Internet Manager, a software application for managing the internetwork. The Internet Manager lets network administrators create and configure zones and specify access privileges between zones. The Internet Manager can be run from any Macintosh on the internetwork. The NetBridge has 32K of memory, supports the AppleTalk protocols and has two LocalTalk ports.

Approximate Cost\$499

Supplier: Shiva Corporation, 155 Second St., Cambridge, MA 02141, 617-864-8500

TeleBridge

The TeleBridge is a half-router for AppleTalk networks. Two AppleTalk networks, each equipped with a TeleBridge and a modem, can link over phone lines to form a single internet of shared resources. The connection process is password-

protected but can be initiated or broken from any Macintosh on the network. The TeleBridge also supports Dial-In Network Access which permits the use of AppleTalk resources from a remote single Macintosh or PC. Also included with the TeleBridge is the Internet Manager, a software application used for setting up zones on the internetwork. The Internet Manager's security features include zone access privileges and multiple levels of passwording. The TeleBridge has 8K of memory and supports the AppleTalk protocols. It can be connected to the network with a standard LocalTalk or PhoneNet connector. The TeleBridge has one LocalTalk port and one 8-pin mini-DIN serial port for the modem. A modem cable is included.

Approximate Cost\$499

Supplier: Shiva Corporation, 155 Second St., Cambridge, MA 02141, 617-864-8500

ComTalk

ComTalk is a modular AppleTalk internetwork router and Gateway. ComTalk's local router function connects Ethernet, Token Ring, and up to six PhoneNET (or LocalTalk) networks. Multiple 68000 processors and up to 1 Mbyte of buffer memory are used to deliver high throughput in multiple port configurations. A remote WAN option connects up to two remote LocalTalk, EtherTalk, or TokenTalk networks via high speed synchronous links (56 Kbps to 1.544 Mbps) with high throughputs (95% at 56 Kbps; 90% at T1 rates). ComTalk's gateway options include four network accessible asynchronous ports for shared access to high speed modems and X.25 PADs, and a TCP/IP gateway function (NCSA Telnet & CAP compatible) for access to TCP/IP network resources. ComTalk supports both Phase 1 and Phase 2 networks, and can be configured with multiple functions. An Internet Manager desktop accessory is included with every unit.

Approximate Cost\$5000 to \$12,500

Supplier: APT Communications, Inc., 9607 Dr. Perry Rd., Ijamsville, MD 21754, 800-842-0626.

Resource Sharing

FAXGATE

FAXGATE is a facsimile gateway for Microsoft Mail and QuickMail. FAXGATE networks any BackFAX compatible fax modem, and gives users on the local area mail system the ability to send faxes from a Macintosh. FAXGATE requires only that the fax server have a phone line and a fax modem. FAXGATE is integrated into the mail system, so users can send and receive faxes with little instruction. FAXGATE creates customized cover sheets, and lets users send messages at specified times. Users can create distribution lists of mixed E-mail and fax addresses. Users can send any Macintosh document to another fax modem or to any Group 3 fax device. FAXGATE includes a five-pack of MailMaker. MailMaker is made up of two parts, MailSender and MailViewer. MailSender is a printer-driver that lets users create

Solutions

“electronic printouts” of most Macintosh applications. Users can then send the printout via FAXGATE to any Group 3 fax device, or send the printout around the network. MailMaker images are viewed and printed with MailViewer.

Approximate Cost\$395

Supplier: Solutions, Inc., 30 Commerce St., Williston, VT 05495, 802-865-9220

Timbuktu

Timbuktu is a network application that allows users to observe or control one or more Macintosh computers over any AppleTalk network. With Timbuktu, multiple users can share screens across the network. Timbuktu also includes file transfer. The user can send files to other users or let them copy files to and from his/her Macintosh. Timbuktu includes password protection and options for complete host control. Possible applications for Timbuktu include: workgroup collaboration, user support, network management, shared resources, teaching, and training.

Approximate Cost\$149 to \$1995

Supplier: Farallon Computing, Inc., 2000 Powell St., Suite 600, Emeryville, CA 94608, 415-596-9100

Timbuktu/Remote

Timbuktu/Remote lets the user observe or control the operation of another Macintosh from the user's own Macintosh over a dial-up telephone line, serial links, or ISDN services. Timbuktu/Remote also can transfer or exchange files and allow a user to “chat” with another user. Timbuktu/Remote includes password protection and options for complete host control. Controlled by a desk accessory, Timbuktu/Remote's possible applications include support, remote access, training, network management, and workgroup collaboration.

Approximate Cost\$195

Supplier: Farallon Computing, Inc., 2000 Powell St., Suite 600, Emeryville, CA 94608, 415-596-9100

Farallon Portable Pack

A network for the Macintosh Portable, Farallon Portable Pack contains two of the following: StarConnectors, Timbuktu and Timbuktu/Remote file transfer and screen sharing software. With Timbuktu/Remote, users can use a Macintosh Portable to exchange files and share screens over telephone lines, read mail on their office-based Macintosh computers and send replies over the office local area network. Users can collaborate on documents with co-workers. With StarConnectors, users can connect a Macintosh Portable to an AppleTalk LAN at a branch office or customer site, and with Timbuktu, exchange files and share screens across the network.

Approximate Cost\$495

Supplier: Farallon Computing, Inc., 2000 Powell St., Suite 600, Emeryville, CA 94608, 415-596-9100

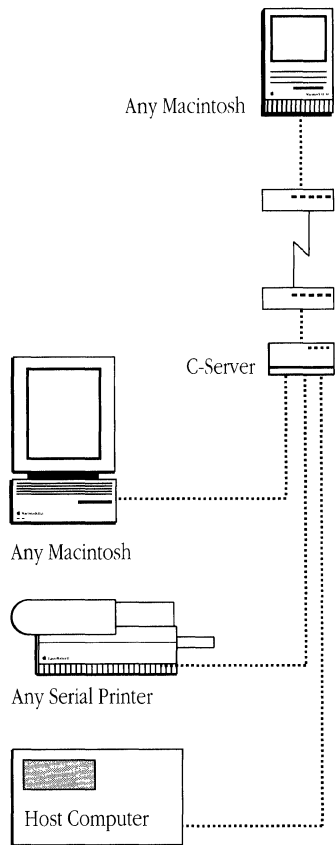

The Solana C-Server integrates many serial devices typically unavailable to Macintosh computer users.

C-Server

The C-Server allows AppleTalk network users to share serial devices that cannot normally be shared on a network. Each C-Server can support three connections and additional C-Servers can be connected to the network as needed. It is not necessary that all three devices on the C-Server be the same. Users may, for example, have a modem, a printer, and a DEC VAX on the same C-Server. Custom icons for the Chooser may be created using the Chooser Doc Creator (included) to select a particular device type(s) on the C-Server(s). A menu is available for connecting to an already chosen port, disconnecting from the port, choosing a different port, choosing a port of the device type previously selected, or closing the C-Server driver completely. The C-Server driver is transparent to applications and can be set up to connect automatically. Network users can select a particular C-Server port or set the Macintosh to connect to the next available port. Users also have the option of being notified when a busy port connection is free.

Approximate Cost\$695
Suppliers: Solana Electronics, 4907 Morena Blvd., Suite 1404, San Diego, CA 92117, 619-490-5050

NetModem V2400

The NetModem V2400 is a 2400 bps modem that can be shared by Macintosh computers and PCs on an AppleTalk network. It can be connected anywhere along the network with a single LocalTalk or PhoneNet connector and a single phone line. Accessed via the Chooser, the NetModem provides on-line help, on-screen LED's and modem tones through the Macintosh speaker. The NetModem also includes Dial-In Network Access, a password-protected feature that allows a user with a single Macintosh or PC and an ordinary modem to access an AppleTalk network from a remote location. The NetModem V2400 uses the Hayes command set and can transfer data at 300, 1200 or 2400 bps, and supports the AppleTalk protocols. It comes with 8K of memory and can be connected to the network using a standard LocalTalk or PhoneNet connector. NetModem V2400 is compatible with most communications software and includes an installation disk with Dial-In Network Access and FreeTerm, a public domain communications package.

Approximate Cost\$599
Supplier: Shiva Corporation, 155 Second St., Cambridge, MA 02141, 617-864-8500

NetSerial

The NetSerial is a high-speed hardware interface between a serial peripheral and an AppleTalk network. It allows users on the network to share any serial device, such as a printer, plotter, scanner or a high-speed synchronous or asynchronous modem. Accessed in the Chooser, the NetSerial can also be used as a gateway to a minicomputer or mainframe. The NetSerial has 8K of memory and uses a standard

Solutions

LocalTalk or PhoneNet connector. It has a maximum transfer speed of 57,600 bps. The NetSerial supports the AppleTalk protocols. It has a LocalTalk port and a mini-DIN-8 serial port.

Approximate Cost\$399

Supplier: Shiva Corporation, 155 Second St., Cambridge, MA 02141, 617-864-8500

NetModem V.32

The NetModem V.32 is a 9600 bps, V.32 compatible AppleTalk modem. As a stand-alone device, the NetModem V.32 plugs directly into LocalTalk and can be shared by all Macintosh computers and PCs on the network. The NetModem V.32 also includes Dial-In Network Access, a password-protected feature that allows a single Macintosh or PC to access an AppleTalk network from a remote location. In addition, the NetModem V.32 provides telebridging, the ability to link two remote AppleTalk networks over phone lines. The NetModem V.32 supports the AppleTalk protocols and has 256K of memory. It can be connected anywhere on the network with a standard LocalTalk or PhoneNet connector. The NetModem V.32 is completely Hayes-compatible, supports the V.32 high-speed standard, and can transfer data at 300, 1200, 2400, 4800 or 9600 bps.

Approximate Cost\$1999

Supplier: Shiva Corporation, 155 Second St., Cambridge, MA 02141, 617-864-8500

File Service: AppleShare

A folder's owner may choose to do any of the following:

- *Keep a folder completely private*
- *Share its contents with a group*
- *Make it available to all users of the file server*

The owner of the folder can give others a variety of privileges, allowing them to do any or all of the following:

- *See files in the folder (and therefore read and copy them)*
- *See folders inside the folder (and access their contents)*
- *Make changes inside the folder (create and modify files and folders)*

AppleShare system is the standard information-sharing environment for the AppleTalk network system: the basis for multi-user (shared information) and multilaunch (shared program) applications. AppleShare is built upon the AppleTalk Filing Protocol (AFP), a powerful extension of the Macintosh computer software environment that allows network users to share information easily yet maintain privacy controls.

An AppleShare file server consists of a Macintosh computer running AppleShare software, which controls and coordinates many users' access to the information stored on the server's hard disks. Users can begin with a Macintosh Plus computer as the server and easily move up to a more powerful Macintosh computer with more disk storage as their needs for performance and capacity increase. AppleShare software dedicates the file server to network tasks, providing the highest possible performance and security for stored data. The integrity of a dedicated file server is not subject to flaws in applications programs or mistakes made by users.

AppleShare provides true file service, extending the Macintosh personal computer's capabilities to access and control information. Using the familiar Macintosh Finder interface and Chooser desk accessory, work group members can extend their reach

across the network to shared documents, data, and applications with full personal control of shared information. AppleShare allows multiple users to simultaneously access and share information. When a Macintosh II family computer is used as the server, as many as 50 people can simultaneously use AppleShare. With a Macintosh Plus or Macintosh SE computer as the server, the limit is 25 users. The AppleShare server helps prevent two users from unintentionally using the same document or application at the same time unless the application is designed to coordinate simultaneous access. Even during shared access, the Macintosh “look and feel” is retained. AppleShare PC also allows MS-DOS users on the AppleTalk network to transparently access the file server. To MS-DOS machines, AppleShare file-server volumes function like local MS-DOS drives.

AppleShare provides data privacy facilities that are fully integrated with the Macintosh Finder. Each user must log on to gain access to the file server. Security within AppleShare file server is based on a powerful yet simple concept: each folder (or subdirectory) on the server has an owner, and the owner determines who will be able to access the contents of that folder and what kind of access they will have. These three privileges can be allocated in any combination, to give users maximum flexibility in sharing their information. Additionally, owners of folders can grant different sets of access privileges to a group and to the other users of the file server.

Approximate Cost \$799

Supplier: Apple Computer, Inc., 20525 Mariani Ave., Cupertino, CA 95014, 408-996-1010

Print Servers

AppleShare Print Server

The AppleShare Print Server lets all the users of an AppleTalk network share a spooling facility for a LaserWriter or ImageWriter® II printer. The AppleShare Print Server is designed to run in conjunction with the AppleShare file server, but it can be installed in a dedicated Macintosh computer if file service is not required.

AppleShare Print Server allows multiple users to simultaneously send documents to be printed. Its server-based architecture provides administration and print-job control from a single location via a centralized “spool queue,” or list of documents to be printed. Documents can be canceled (deleted from the queue) or elevated to “print-next” priority using the server’s administrative functions.

Additionally, the AppleShare Print Server print log can be used for print-job accounting. And since the AppleShare Print Server transparently emulates a LaserWriter, MS-DOS computers will be able to use it from any program that allows printing to the LaserWriter, including the laser-printing program that comes with the LocalTalk PC Card.

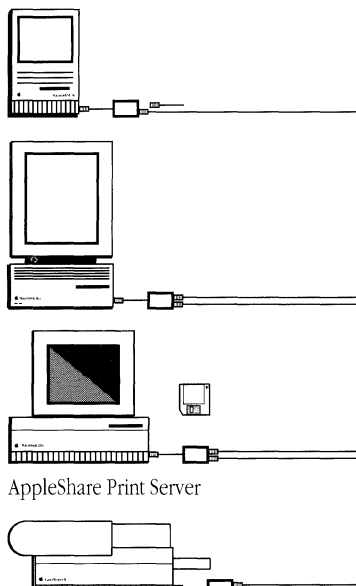

The AppleShare Print Server lets users queue print jobs, freeing them to continue working while the spooler manages the printing task.

Solutions

Users save both the time it takes a printer to process a document and the time they would otherwise spend in the print queue. This double saving can add up to more than 70 percent of the normal printing time. Because the spooler server handles the job of sending a spooled document to a LaserWriter printer, the user's workstation performance is not affected by a background "despooling" task. AppleShare Print Server will work with any LaserWriter-compatible printer on the AppleTalk system, including the Apple® LaserWriter, LaserWriter Plus, LaserWriter II family, the Varityper, and the Linotronic L300.

Approximate Cost \$299

Supplier: Apple Computer, Inc., 20525 Mariani Ave., Cupertino, CA 95014, 408-996-1010

Network Management Software

Inter•Poll Network Administrator's Utility

Inter•Poll helps isolate network problem areas and can be used to:

- Display listings of zones, connected networks, and active network devices
- Verify the connection status of any part of a network or internet
- Test the integrity and response of the network path to a specific device
- Localize possible trouble sources
- Query nodes in an AppleTalk internet for a report of current system software versions

The Inter•Poll Network Administrator's Utility contains tools to implement a network support program. These tools cover network mapping, troubleshooting methods, selective searches for active devices, network-link integrity tests, and version reporting for workstation system software. Inter•Poll supports a multivendor AppleTalk network, including Macintosh, MS-DOS & PS/2 and DEC VAX computers.

Approximate Cost \$129

Supplier: Apple Computer, Inc., 20525 Mariani Ave., Cupertino, CA 95014, 408-996-1010

STATUS*MAC

STATUS*Mac is a Macintosh software product that gathers profiles of critical software and hardware components on individual Macintosh computers. These profiles are then imported into a Master Database and made available for in-depth reporting and analysis purposes. STATUS*Mac v. 1.0 operates in conjunction with Microsoft Mail or, if MS Mail is not used, with an application called the Portable Profiler. Each STATUS*Mac profile contains information about the following categories of software and hardware components: CPU information, system files, Applications, INITs, DAs, fonts, drivers, SCSI devices, NuBus® Cards, monitors, ADB devices and volumes. STATUS*Mac does not profile individual files or folders. Profiles can be imported into the STATUS*Mac Master Database. Users can create layouts, sorts and filters to generate custom reports of profile data. Profile data can also be exported in SYLK or TEXT formats. The STATUS*Mac Base Package includes STATUS*Mac v. 1.0, Portable Profiler, Master Database with a 10 profile capacity, and documentation. Managers of larger networks can purchase Master Database upgrades in capacity increments of 10 profiles.

Approximate Cost \$600 to \$799

Supplier: Pharos Technologies, Inc., 4243 Hunt Rd., Cincinnati, OH 45242, 800-548-8871

Network Manager's Pack

The PhoneNET Manager's Pack is a complete software toolkit for monitoring, managing, and documenting an AppleTalk network. It includes a one-year subscription to Farallon's complete line of network management software including TrafficWatch II, NetAtlas, NetStats, CheckNet, and StarCommand 2.0. Also included are two copies of Timbuktu software. StarCommand manages both Ethernet and LocalTalk StarController repeating hubs from one Macintosh. NetAtlas creates a graphic map of the AppleTalk internet. CheckNet is a desk accessory that locates devices on a LocalTalk network. NetStats is a desk accessory that gives the user a continuous graphic display of network traffic without disrupting other network activities. TrafficWatch II analyzes traffic and error rates on Ethernet or LocalTalk networks, to determine the network's "rush hours" and locate traffic bottlenecks.

Approximate Cost\$995

Supplier: Farallon Computing, Inc., 2000 Powell St., Suite 600, Emeryville, CA 94608, 415-596-9100

MacInUse v3.0

MacInUse 3.0 is a background utility that records Macintosh system utilization. It automatically records certain information each time an application is run, saving the information into a file for later retrieval and use. The stored information includes the name of each application that was run, the date and time, duration of use, and other optional data and comments. MacInUse operates in the background; once activated, it is invisible to the system user and requires no special operations from the user or system manager, unless such options are activated. The administrator can set up a list of specific applications to be either included or excluded. MacInUse can also track individual documents rather than just applications, and can be set to ignore the time when the system is inactive.

Approximate Cost\$99

Supplier: Softview, Inc., 1721 Pacific Ave., Suite 100, Oxnard, CA 93033, 805-385-5000

NetMap

NetMap is a diagnostic means for visually troubleshooting AppleTalk networks. It is a desk accessory that lets users track down problems such as broken connectors in AppleTalk networks; retrieve and display in a columnar format information on device names, device types, network names and numbers, device nodes, and sockets found on any given AppleTalk network; sort the information and create a spreadsheet-ready data file; select a target network from a network list; save default settings, and customize look-up requirements to fit network traffic and size.

Approximate Cost\$90

Supplier: AESP, 1810 N.E. 144th St., N. Miami, FL 33181, 800-446-2377

Solutions

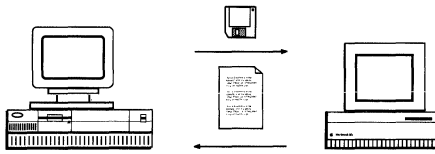

File Transfer

SmartTalk: Document Conversion Packages

SmartTalk converts fully formatted documents between the Macintosh computer and the Digital VAX, Wang VS, dedicated word processors, and IBM PCs. Users can activate conversions from their stand-alone Macintosh computers or from any terminal on an AppleTalk networking system. SmartTalk also provides terminal emulation for communication with minicomputer hosts. All formatting remains intact, including headers and footers, page numbering, decimal alignments, indents, bold face, centering, and more. SmartTalk is a complete conversion package: cables, manuals, and an innovative communications bridge. Users can exchange documents between Microsoft Word, WordPerfect, and MacWrite II on the Macintosh computer and more than 26 different word-processing formats.

Approximate Cost\$100 to \$4500
Supplier: INTERPRETER, INC., 11455 West 48th Ave., Wheat Ridge, CO 80033, 800-232-4687

Send Express, Version 1.0

Send Express is a Macintosh desk accessory that sends files and Clipboard selections directly between Macintosh computers connected to an AppleTalk network. Send Express sends and receives in the background and does not require a network server. Send Express can send multiple files to several people at once. The files can be of any size or type. The sender can attach a comment to send along with the files or Clipboard selection. Recipients are notified of new arrivals without having their work interrupted. Sending Clipboard selections has been designed to give users the feeling that they are copying and pasting across the network. Send Express works with any AppleTalk compatible network and supports communication between AppleTalk zones.

Approximate Cost\$179
Supplier: Gizmo Technologies, P.O. Box 14177, Fremont, CA 94539, 415-623-7899

MacBLAST

MacBLAST (BLocked ASynchronous Transmission) provides asynchronous file transfer for communications among Macintosh computers, PCs, minis, and mainframes under 30 different operating systems, including: VAX/VMS, PDP-11, Prime, Wang, Data General, IBM Mainframes, UNIX/XENIX, MS-DOS, and Macintosh-to-Macintosh. MacBLAST comes with multiple terminal emulators, including VT52, VT100 & VT220 for DEC, D200, D411, D461 (Data General), D80, ADM3A, TV 920, and TTY. MacBLAST supports background file transfers under MultiFinder. Wide area networks (WANs) can be set up among any number of remote Macintosh

computers and PCs, as well as between remote Macintosh computers and central computers. MacBLAST uses standard RS 232 connections, regular dial-up phone lines and X.25 networks. Features include: scripting capabilities for creating unattended operations, custom menus for integration with Macintosh applications; on-line help; automatic dialing, access, and modem control sequences.

Approximate Cost \$195

Supplier: Communications Research Group, 5615 Corporate Blvd., Baton Rouge, LA 70808, 800-24-BLAST

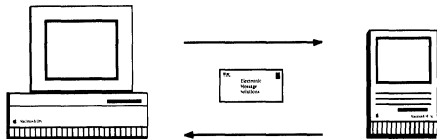

Electronic Messaging

cc:Mail

cc:Mail is an electronic mail system that operates in a multivendor (Macintosh, MS-DOS, and OS/2) local area network environment. It provides transparent connectivity with Digital and IBM-based E-mail systems; UNIX mail, public E-mail services, and the facsimile world. cc:Mail users can exchange compound messages consisting of text, files, graphic images, and fax messages among Macintosh, MS-DOS, and OS/2 users. The cc:Mail system consists of a central Post Office (the database) that resides on the network server's hard disk. No software actually runs on the server. Users can address, send, and receive mail to users, to other servers, mainframes, public E-mail services, and fax machines through a single gateway.

Approximate Cost \$495 to \$1295

Supplier: cc:Mail, Inc., 385 Sherman Ave., Palo Alto, CA 94306, 800-448-2500

Microsoft Mail 2.0

Microsoft Mail 2.0 is an electronic mail program that can be customized to the user's specific needs. Microsoft Mail allows integration with Microsoft Excel, Microsoft Word and Aldus PageMaker. It lets users share the job of creating documents and handles the distribution of information across the network. Microsoft Mail runs on the user's existing AppleTalk network. Microsoft Mail 2.0 gateways connect to outside E-mail systems such as X.400, UNIX SMTP, or IBM PROFS, as well as providing the ability to send and receive fax messages from the user's Macintosh.

Approximate Cost \$395

Supplier: Microsoft Corporation, P.O. Box 97017, Redmond, WA 98073-9717, 206-882-8080

QuickMail, Version 2.2.

QuickMail is an electronic mail system for use on AppleTalk networks that supports multiple zones and servers, with gateways to UNIX, VAX computers, fax, Novell MHS, CompuServe, AppleLink and many other systems and services. QuickMail is

Solutions

compatible with AppleShare, TOPS, MacServe, MultiFinder®, large-screen displays, and accelerator cards. QuickMail PC is also available for PC compatible computers.

Approximate Cost \$499.95 per 10 users

Supplier: CE Software, P.O. Box 65580, West Des Moines, IA 50265, 515-224-1995

DaynaMAIL

DaynaMAIL is an electronic mail system for users of Macintosh and IBM-compatible computers. On a network with a dedicated file server, DaynaMAIL runs on the server and does not require a workstation to be dedicated as a mail server. Based on the MHS (Message Handling Service) protocol from Action Technologies, DaynaMAIL can offer wide area communications with other MHS-compatible applications, such as The Coordinator. Connections can also be made to DEC and IBM mail systems, through MHS compatibility with Soft-Switch. DaynaMAIL is compatible with DaynaNET, NetWare, TOPS and AppleShare (Macintosh version only).

Approximate Cost \$295 for 5-pack

Supplier: Dayna Communications, 50 South Main St., Suite 530, Salt Lake City, UT 84144, 801-531-0600

Personal Phone 1.1

Personal Phone is an interactive AppleTalk desktop communications program. Personal Phone is based on the metaphor of a telephone. With Personal Phone, it is possible to establish an interactive link between two computers to carry on a conversation. Once a link is established, all typing immediately appears in a split window on each Macintosh and background file transfers are possible. No dedicated computer is required with Personal Phone. Personal Phone is a desk accessory.

Approximate Cost \$99 to \$169

Supplier: The Personal Software Development Corp., 22 Natalie Dr., Hampton, VA 23666, 804-898-3541

Distributed File Service

Personal Server Network, Version 2.0

Personal Server Network (PSN) is a distributed network server for Macintosh computers. PSN adopts the AppleShare user interface, but requires no dedicated file server. It is fully compliant with the AppleTalk Filing Protocol and supports multiuser applications like 4th DIMENSION and FoxBASE+/Mac.

Approximate Cost \$100 to \$149

Supplier: TOPS, 950 Marina Village Pkwy., Alameda, CA 94501, 800-445-TOPS

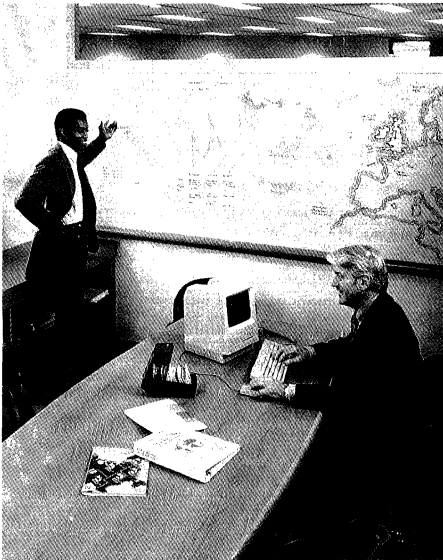

Access to the global Codex network is transparent to users with Macintosh computers.

Codex Brings Its Global Network to Every Macintosh User's Desk

Company Background

A subsidiary of Motorola, Codex Corporation manufactures data communications equipment and wide area network management systems. As a supplier of network solutions worldwide, Codex appreciates the importance of providing users with cost effective and efficient networking capabilities. Because its 3900 employees work at 69 direct sales and support offices on different continents, the company needed a cohesive network that would allow everyone to access E-mail services and corporate computing resources at its headquarters in Mansfield, Massachusetts.

Macintosh Solution

Codex has 2200 Apple Macintosh personal computers, each of which can access the company's Digital VAX minicomputers and IBM 3084 mainframe. According to principal communications specialist Robert Picchione, "We have one big network—that's the way we put it across to our users. We're gradually migrating to a more distributed processing environment, with Macintosh systems being the first step.

"Our decision to standardize on the Macintosh means users can access all key information systems in our organization: IBM mainframes, VAX minicomputers, and other Macintosh computers. In addition, the ease of use of the Macintosh has enabled individual departments to develop their own applications for mainframe access."

Worldwide Sites Connected

Internationally, satellite offices in each country are connected to that country's main office using Codex-manufactured X.25 or 19.2 Kbps dial-up connections. The main offices, in turn, are connected to Codex headquarters using a subchannel of Motorola's worldwide T-1 and satellite network. The company's nine buildings in two Massachusetts cities are connected by voice and data T-1 lines, with plans to upgrade the main trunks of its network to digital service, providing speeds of 56 Kbps.

Electronic Mail and File Sharing

According to Picchione, "The Macintosh has improved the ability of people separated by wide distances to communicate."

Case History

To enable the company's 2000 E-mail users to be more productive, Codex has installed 50 Macintosh II computers throughout the world—one at each major site—as dedicated Microsoft Mail servers. The local server sends the mail to the remote server automatically, freeing users from having to wait for low-speed telecommunications between countries.

To transfer large files, Codex uses AppleShare file servers. "We're discovering the advantages of AppleShare as an information distribution medium," says Picchione. "Because the Codex network is so large, it is often more practical to post service bulletins on the server instead of using E-mail." The corporate library uses AppleShare as a bulletin board, posting company news briefs.

Other Macintosh-to-Host Applications

Macintosh users at Codex can use network gateways to access databases and use the customer service application on VAX minicomputers, or they can connect to the mainframe to use the company's order entry system.

In addition, departments have developed special Macintosh-to-mainframe applications. For example, the sales department has written an application using ACIUS 4th DIMENSION and a terminal emulation program to download product information and to allow salespeople in remote offices to access shipping schedules. The benefits are more accurate information for customers, fewer backlogged orders, and better customer service.

Macintosh: Changing the Way People Work

Picchione notes, "Our users are becoming more aware of the benefits of the Macintosh: the ease of sending electronic mail, exchanging files, figuring out applications for their own departments. The Macintosh has changed the culture of the company—it's changed the way people work. When you're in IS, it's gratifying when people tell you that they can now do things they wouldn't have considered without the Macintosh."

Network Application Tools: Creating The Solution

Overview

As personal computers have become an integral part of more and more people's daily lives, user expectations of the applications they use have changed. It is no longer sufficient to provide great stand-alone applications. Today users demand from both commercial and MIS developers new types of applications that allow users to share the work they do on their computers with their managers, colleagues and subordinates. Users want to be able to use **all** of the power of their personal computers and leverage any network to which they are connected, seamlessly and transparently.

At Apple, applications that do this successfully are called collaborative applications. In its broadest sense a collaborative application is one that allows people to communicate and work with one another faster, more easily, or with richer content. What distinguishes a collaborative from a non-collaborative application is that the former always involves multiple people working on common data to achieve a shared objective. Thus, an application as simple as a terminal emulator **can** be used to accomplish collaborative work, but isn't used that way in all cases. Innovative collaborative applications are those that allow users to send and receive messages through the network as though the network did not exist. Applications such as electronic mail and screen sharing point the way to a new era of collaborative computing.

To assist developers in creating this new type of innovative application, Apple has created a suite of collaborative application development tools referred to as Network Application Tools. Simply stated, a Network Application Tool is software that empowers developers to design, build, test, and deliver distributed, collaborative applications. Apple's Network Application Tools model (shown on the next page) classifies all tools based upon the type of network functionality they provide, the "level" of interface to the network they provide, and what they allow the Macintosh user to access.

The model encompasses four different types of network functionality: front end or distributed user interface; file and database access; store and forward; and the most complex type of network functionality, cooperative processing. The different levels of access each tool provides to the network are: application level, system level, or

The Environment

network level. Application level tools are those applications such as HyperCard that also have a network development component built into them such as HyperCard's XCMD interface. System level tools ship with every Macintosh and include such tools as Data Access Language, the Macintosh Communications ToolBox and the components of Apple's Interapplication Communication Architecture. Network level tools are for those developers requiring low level access to the network for performance or flexibility reasons.

Macintosh & DOS/OS/2

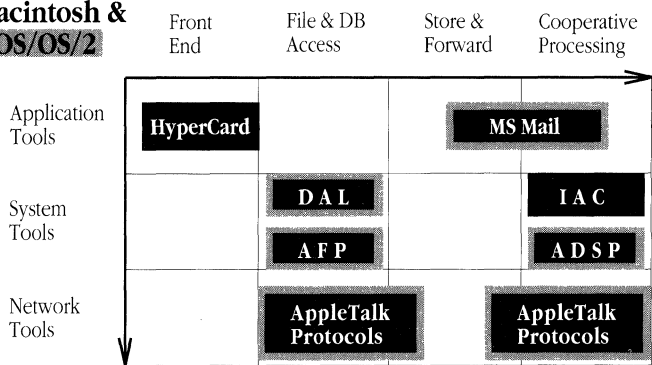

IBM

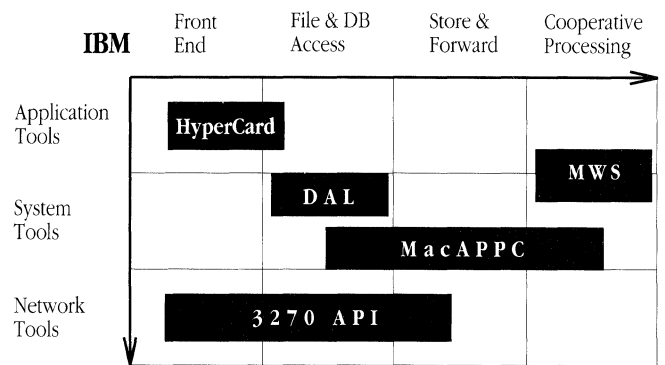

VAX

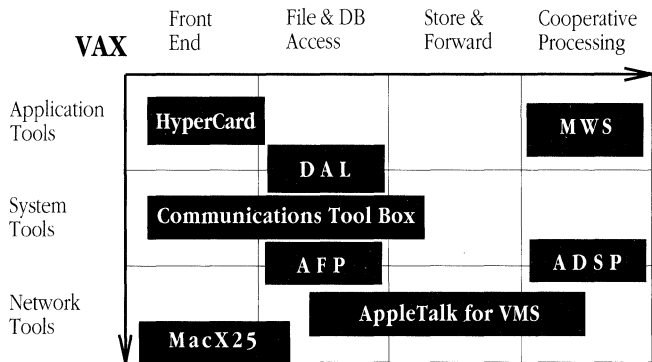

UNIX

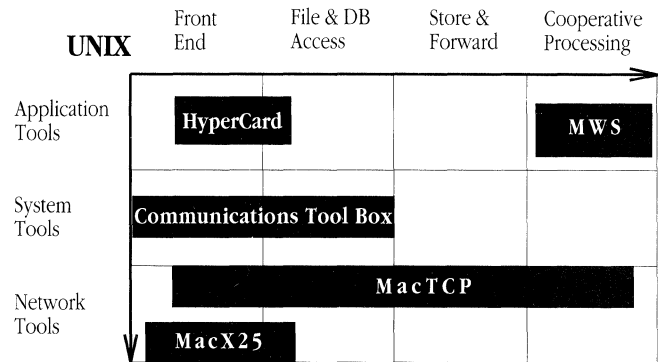

Apple's Network Application Tools

Model as it applies to :

- Another Macintosh or PC
- DigitalVAX systems
- IBM host
- UNIX host or workstation

Apple is not the only provider of Network Application Tools. A number of Apple developers provide highly functional tools that enable the implementation of collaborative applications. Products like MitemView and Masquerade allow MIS developers to renovate older host applications so they may be used effectively with intelligent desktop devices. Microsoft Mail and its executable forms capability allows developers to build customized data entry applications. Even products such as VersaTerm allow developers to build custom scripts to automate access and file transfer to host systems.

This section provides an in-depth look at the Network Application Tools for Macintosh available from Apple and third-parties. You will find a tool for almost every use and network environment.

Network Application Tools

Communication Development Environment

Toolbox managers include:

- *Connection Manager*
- *Terminal Manager*
- *File Transfer Manager*
- *Communications Resource Manager*

Macintosh Communications Toolbox

The Macintosh Communications Toolbox is system software that provides Apple Macintosh applications with standard access to communications services, including data connection, terminal emulation, and file transfer protocols. The Macintosh Communications Toolbox is designed to support multivendor connectivity for Macintosh computers in environments such as VAX, IBM, OSI, TCP/IP, and the AppleTalk network system.

Using the ToolBox, developers can add communications capabilities to general purpose applications, develop new applications, or enhance existing communications applications. The ToolBox also provides a way for developers or large organizations to create custom tools for their specialized needs or vertical markets.

The Communications Toolbox is an extension of the Macintosh Toolbox system software and provides a set of managers for the various tools that implement routines for a given connection or service.

The Connection Manager provides a consistent interface between applications and the connection tools installed in the system. The Terminal Manager provides a consistent interface between applications and various terminal tools installed in the Macintosh operating system (OS). Similarly, the File Transfer Manager provides a consistent interface between an application and the file-transfer tools installed in the Macintosh OS. The Communication Resource Manager registers and identifies installed communications devices such as serial cards or modems. These managers have been designed to work in concert with tools (such as a modem connect tool or a VT320 terminal emulation tool) created by Apple and third-party developers to provide applications with standard communications functions.

Users can install the Macintosh Communications Toolbox using the Installer and Communications Toolbox installation script. Tools can be easily added or removed by dragging them in or out of the Communications Folder in the same manner as standard Macintosh files.

Approximate Cost Contact Supplier

Supplier: APDA (Apple Programmers and Developers Association), Apple Computer Inc., 20525 Mariani Ave., MS 33G, Cupertino, CA 95014, 800-282-2732, 800-637-0029 in Canada, 408-562-3910 Internationally

Solutions

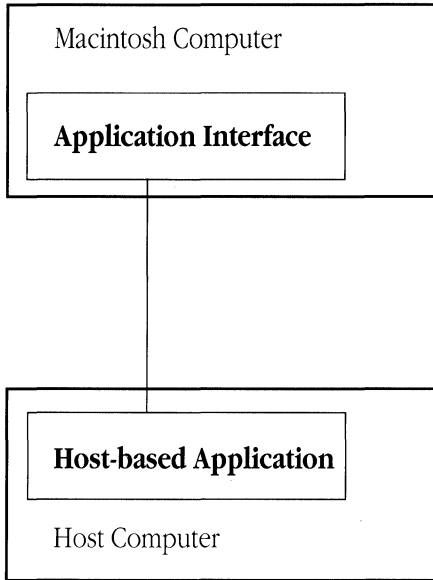

MacWorkstation provides the environment required to develop custom Macintosh interfaces to installed host applications.

Host Interface Development Environment

MacWorkStation, Version 3.1

MacWorkStation is a server application that runs on Macintosh computers and provides the Macintosh user interface, printing, and filing services to client applications running on a remote computer, such as Digital VAX or IBM 370s, or on the same computer as MacWorkStation. The client applications can be written in any language, on any host or personal computer connected over a wide variety of network and communication protocols.

MacWorkStation software provides programmers with full access and control over windows, pull-down menus, dialog boxes, and other features of the Macintosh user interface—without requiring them to learn the details of a traditional Macintosh programming environment. MacWorkStation handles all local processing between the user, desk accessories, the Clipboard, and user interface objects created by the client application. This reduces the level of client (host) processing necessary to maintain a graphic user interface and also reduces network messaging traffic.

Developers may create communications modules to allow the MacWorkStation messages to run over a wide variety of communications networks. Apple Computer, Inc. provides several standard communications modules to allow MacWorkStation to be used over asynchronous and AppleTalk system networks.

MWS™ Dialog Builder is a MacWorkStation utility that lets developers build dialog boxes for use in MacWorkStation applications. MacWorkStation developers can add the dialog boxes to local documents or transfer the command descriptions to the client application, which will send these commands to the Macintosh computer to draw the dialog box at the appropriate time.

MWS Event Handler is a MacWorkStation exec module that allows quick prototyping of MacWorkStation applications. For example, MacWorkStation developers can use Event Handler to model the Macintosh computer's user interface of an application without programming. Using Event Handler, scripts can be built to respond to MacWorkStation events, such as selecting a menu item or clicking a button in a dialog box. A script contains a series of MacWorkStation commands, so that when the event occurs, the script plays to execute the commands. Event Handler provides for the easy creation and editing of these scripts. MWS Event Handler works with MacWorkStation 3.0 and is fully compatible with MWS Dialog Builder.

Approximate Cost\$100

Supplier: APDA (Apple Programmers and Developers Association), Apple Computer Inc., 20525 Mariani Ave., MS 33G, Cupertino, CA 95014, 800-282-2732, 800-637-0029 in Canada, 408-562-3910 Internationally

HyperCard 2.0

HyperCard 2.0, a major revision of the Macintosh computer program, is a personal software toolkit and information manager for the Macintosh computer. HyperCard can be used in two different modes: browsing or scripting. The browsing mode lets users navigate through large quantities of information by means of the intuitive and easy-to-use hypertext metaphor. The scripting mode offers the capability to build customized front ends by using a sophisticated scripting language, similar to English, called HyperTalk®. This scripting language can be extended by adding sets of extensions to HyperCard; these extensions are called external commands and external functions. Apple provides separate sets of extensions (tool kits) for different environments, for example APDA offers tool kits to interface with Apple-Talk, MacTCP®, and Data Access Language™.

HyperCard 2.0 is included with every Macintosh computer. Upgrades or replacement copies can be purchased for \$49.

Supplier: Apple Computer, Inc., 20525 Mariani Ave., Cupertino, CA 95014, 408-996-1010

MitemView, Version 1.0

MitemView lets users build point-and-click, graphic interfaces to mainframe applications, without modifying the host applications. To the mainframe, MitemView looks like a terminal and does not affect performance or security. MitemView provides a number of tools and proprietary technologies that extend development platforms, such as HyperCard, that assist with both graphic interface development and the run-time tasks of emulating host terminals and transferring data between the user and the host application. MitemView's proprietary pattern recognition engine, the WHOOP, assists in developing applications that enter, modify, extract, and navigate through information found in remote information systems. The entry level MitemView toolkit includes support for asynchronous communications, TTY, VT52, and VT100 terminal emulation, XMODEM (regular and 1K block) error-free file transfer protocol, and MacBinary file format. Additional personality modules, such as 3270, TN6530, etc., are available. MitemView utilizes the capabilities of HyperCard to create Application Interface Modules (AIMs), which are HyperCard stacks linking the user to one or more host applications. Each AIM can be programmed to control the host applications. MitemView provides virtual terminal emulations and communications protocols for each host, a set of data transfer tools for moving data between HyperCard containers and the host computer, and a pattern matching 'event trigger' called a WHOOP Manager that initiates processes in HyperCard.

Approximate Cost\$995

Supplier: MITEM Corporation, 2105 Hamilton Ave., Suite 190, San Jose, CA 95125, 408-559-8801

Solutions

AcKNOWLEDGE

AcKNOWLEDGE is a communications development toolkit for the Macintosh that creates custom front ends for communicating with a variety of host computer systems. TAL programming language provides control over the Macintosh interface with custom dialog boxes, pull-down menus and icons. Double-clickable applications may be created with the Run Time version. TAL programming language supports string, constant and string variables, functions, subroutines, serial port IO, system variables, terminal emulation, file transfer control and other features. Debugging aids include syntax checking, single step trace and real-time trace. A free copy of MACKNOWLEDGE communications software is included.

Approximate Cost\$499

Supplier: Prometheus Products, Inc., 7225 SW Bonita Rd., Tigard, OR 97223, 800-477-3473

Programming Development Environments

NATURAL CONNECTION, Version 1.1.1

NATURAL CONNECTION for the Macintosh enables users to interact with the IBM Mainframe and DEC/VAX NATURAL environment from their Macintosh workstations. NATURAL CONNECTION provides host terminal emulation and transfer of data between host-based application written in NATURAL and the Macintosh workstation. Both directions of data transfer are supported without intermediate files. A procedure language allows automation of repetitive tasks, such as host access. NATURAL CONNECTION features include: terminal emulation including support for color monitors; support for a variety of host connections, including coax, LAN gateway, and serial (protocol converter or direct); integrated data upload/download facilities supporting several different file formats on the Macintosh; procedure file language for developing procedure files; integrated editor for procedure files and basic editing tasks; LEARN mode for capturing keystrokes into a procedure file; keyboard redefinition capabilities; documented Application Program Interface (API) accessible from a HyperCard 'XFCN'; profiling capabilities for both the user and administrator levels; system administration facilities; optional password protection of NATURAL CONNECTION documents; ability to communicate with different host systems from within a single NATURAL CONNECTION application; unattended operation facility; and context-sensitive help.

Approximate Cost\$300 to \$25,000

Supplier: Software AG of North America, 11190 Sunrise Valley Dr., Reston, VA 22091, 703-860-5050

NATURAL ARCHITECT Workstation

NATURAL ARCHITECT Workstation is a Computer Aided Software Engineering (CASE) facility that provides analysis and design support for the development of

NATURAL ARCHITECT Workstation components:

- *The Architect Data Dictionary for all information captured during analysis and design activities*
- *The Data Flow Diagram (DFD) Editor for visualizing the relationships between system components and information flow*
- *The Entity Relationship Diagram Editor for modelling business entity attributes and their relationships*
- *The Program Structure Diagram Editor for specifying a hierarchical program structure*
- *The Forms Editor for designing application screens and reports*

business application systems. NATURAL ARCHITECT Workstation provides graphic editors for entity-relationship, data flow, and program structure diagrams to support requirements analysis. It also includes editors for input/output forms, database schemata definitions, and program specifications to support application design. Once specification is completed on the Macintosh computer, the design information is uploaded to Software AG's data dictionary residing on a Digital VAX or IBM mainframe for application generation. The generated applications are production-ready and portable across Digital VAX, IBM mainframe, and Wang VS operating systems and telecommunications environments.

Approximate Cost\$2000 to \$8000
Supplier: Software AG of North America, Inc., 11190 Sunrise Valley Dr., Reston, VA 22091, 800-843-9534

Netwise RPC TOOL

The Netwise RPC TOOL allows developers to create client/server applications for a wide variety of platforms. The RPC TOOL generates the C-language communications software needed to distribute applications. The RPC TOOL also provides the programmer with a vendor-independent, open-system, ISO-standards-based network software development tool. In a single development process, the RPC TOOL enables an application to migrate from one operating system/network environment to another. Each Netwise RPC TOOL package includes a Remote Procedure Call (RPC) Compiler, Server Control Procedures, RPC Extensions, and a Network Library.

Approximate Cost Contact supplier
Supplier: Netwise, Inc., 2477 55th St., Boulder, CO 80301, 303-442-8280

Computer Aided Software Engineering (CASE)

Personal Deft

Personal Deft is a CASE (Computer-Aided Software Engineering) system for single developers who design and build relational database management systems. Deft supports a structured methods approach to designing quality systems. Deft is comprised of editors that draw Data Flow Diagrams, Entity Relationship Diagrams, and Program Structure Charts. Additionally, Deft provides a Forms and Report layout tool which uses PageMaker-style tags, allowing users to format reports to their own requirements. These editors are supported by a centralized, integrated data dictionary and a dictionary utility. Additionally, a compiler checks for syntactical consistency. Personal Deft utilizes the user interface of any Macintosh housing a minimum of 2 megabytes of RAM.

Approximate Cost\$5900
Supplier: DEFT Inc., 557 Dixon Rd., #110, Rexdale, Ontario M9W1H7, 416-249-2246

Tools

Solutions

The Deft Editor Set

The Deft Editor Set is used by the multi-user development team designing Relational Database Management Systems in Ingres, Oracle, Sybase, Rdb, Informix or DB2. It also supports a structured methods approach to designing quality systems. The tool set includes editors for Data Flow Diagrams, Entity Relationship modeling, Program Structure Charts and for customizing forms and reports. The integrated central dictionary may reside on a file server utilizing AppleShare, AlisaShare or PacerShare, which allows multi-user access to data being cross-referenced between the editors. The Dictionary Utility provides merging capabilities, and various reporting options. The Design Compiler checks for logical and syntactical consistency before generating an object file which can be used by Deft Gateway Products. An import/export facility allows data retrieval from other applications allowing documentation and modification of existing systems.

Approximate Cost\$7900
Supplier: DEFT Inc., 557 Dixon Rd., #110, Rexdale, Ontario M9W1H7, 416-249-2246

Deft Gateways

The Gateways allow relational portability among products such as Sybase, Ingres, Oracle, ADABAS and Rdb running on VAX/VMS. Deft is also available for the Tandem NonStop SQL environment. The Gateways allow the capability to reverse engineer data schema from an application into Deft for documenting, modification and updating of existing systems. Additionally, the Gateway allows forward engineering taking a system designed by Deft and translating it into Structured Query Language (SQL), which is then fed directly into the hosting database to create the schemata. The Deft forms are also created within the database catalogs.

Approximate Cost\$10,000 to \$20,000
Supplier: DEFT Inc., 557 Dixon Rd., #110, Rexdale, Ontario M9W1H7, 416-249-2246

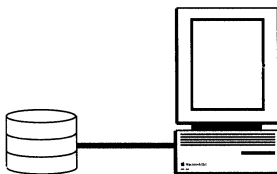

Database Environments

ORACLE for Macintosh, Version 1.2

ORACLE for Macintosh provides a SQL-based relational database management product for the Macintosh. By combining Oracle's relational DBMS with Macintosh technology developers can create Macintosh applications that access Oracle, DB2, SQL/DS, or RMS data on over 85 platforms, choosing from several development environments for creating applications. HyperCard developers may use Hyper*SQL, Oracle's interface to HyperCard and HyperCard-compatible products, to create applications that access Oracle databases. Hyper*SQL extends the HyperTalk environment to support the SQL language so that developers can create database applications by embedding SQL commands within HyperTalk scripts. With

4th*SQL, users can include SQL commands in 4th DIMENSION procedures to access Oracle and IBM databases. Oracle's Pro*C precompiler helps users create custom Macintosh applications, allowing users to embed SQL commands within C programs, and interlocking the core Macintosh Toolbox with ORACLE. Pro*C supports industry-standard C compilers such as MPW, ThinkC, and Aztec C. ORACLE for Macintosh also includes a suite of HyperCard-based tools for end-users. The Query Tool allows users to build queries graphically and output the results to their Macintosh spreadsheets or word processors. SQL*Net for Macintosh provides Oracle's networking software and drivers to enable communications between Oracle applications residing on the Macintosh system and Oracle and IBM databases on remote systems. Communication protocols supported include asynchronous, DECnet, TCP/IP, 3270 and AppleTalk.

Approximate Cost\$299 to \$699

Supplier: Oracle Corporation, 500 Oracle Pkwy., Redwood Shores, CA 94065, 800-ORACLE-1

Omnis 5

Omnis 5 is an application development environment for the MS-DOS platform operating under Microsoft Windows on PC as well as Macintosh computers. Omnis 5 can run in a mixed environment, supporting NetBIOS and AFP compatible networks such as Novell, 3Com, AppleShare, and TOPS. Developers can create data management applications which feature graphic user interfaces (GUI). SQL connectivity to Oracle and other Sequel databases allows Omnis 5 to retrieve and enter data on both the VAX and the mainframe. Data files can be up to 2560 megabytes. Application (design) files can be up to 32 megabytes in size, and there is no limit on the number of records (up to maximum data file size). Omnis 5 (Macintosh) applications and data can be shared with IBM PS/2's on a mixed network using DOS and OS/2 versions of Omnis 5.

Other features include: full color graphics included in windows design or stored in the data file; text data displayed in any font and color; HyperCard-like buttons; data displayed from different files in any window; user defined menus; push-button, radio-button, check-box field types; WYSIWYG reports; more than 200 programming commands; and variable length records. Applications and data files developed using Omnis 5 Macintosh run identically under Microsoft Windows™ and OS/2 Presentation Manager™. Applications can include external code written in Pascal, C, or Assembler languages. Omnis HyperCard/SuperCard access allows HyperCard/SuperCard Stacks to read and write to Omnis 5 data files in both single and multiuser installations.

Approximate CostContact supplier

Supplier: Blyth & Associates, 1065 E. Hillsdale Blvd., #300, Foster City, CA 94404, 415-571-0222

Solutions

4th DIMENSION

4th DIMENSION (4D) is a client-server database system with an open architecture and an integrated application generator. 4D facilitates cooperative data management across multiple hardware host platforms. The 4D Connectivity Kit is a general purpose tool built on Apple's Data Access Language that allows simultaneous connections to multiple hosts; connections to multiple DBMS systems on each host; connections to multiple databases for each DBMS system. Multiple asynchronous sessions can be opened simultaneously to any of the following DBMS systems: DB2, Sybase, Ingres, RDB, Oracle, and Informix. The 4D SQL Server, based on Sybase DB Library, extends the client server metaphor beyond data interchange to include database development. Applications can transparently access and update the Sybase SQL Server via TCP/IP or DECnet running on VAX, H-P, SUN, and other hardware. 4D SQL Server provides control over the Sybase development environment from within 4th DIMENSION, reducing the steps required to define and modify Sybase tables, triggers, stored procedures, and other functions.

Approximate Cost Contact supplier

Supplier: ACIUS, Inc., 10351 Bubb Rd., Cupertino, CA 95014, 408-252-4444

Host Database Access

Data Access Language: A Connectivity Language

Data Access Language (formerly CL/1) is a standard connectivity language that links personal computer applications to host data. Based on the client/server architecture, Data Access Language includes software components that run on both personal computer and host computer platforms, providing support for a wide range of operating systems, host database-management systems, and network connections.

Data Access Language gives Macintosh users access to data stored in relational databases on VAX or IBM systems. Macintosh applications can directly access data in Ingres, Oracle, Informix/SQL, SYBASE, and Digital's Rdb/VMS databases, as well as in DB2 and SQL/DS databases on IBM systems.

Data Access Language Architecture

Different types of personal computer applications, including spreadsheets, databases, and word processors, are becoming available with Data Access Language compatibility built into them. Users can transparently access host data without having to switch to a new interface, know where the data resides, or learn the intricacies of the underlying technologies involved in bringing remote data to the desktop.

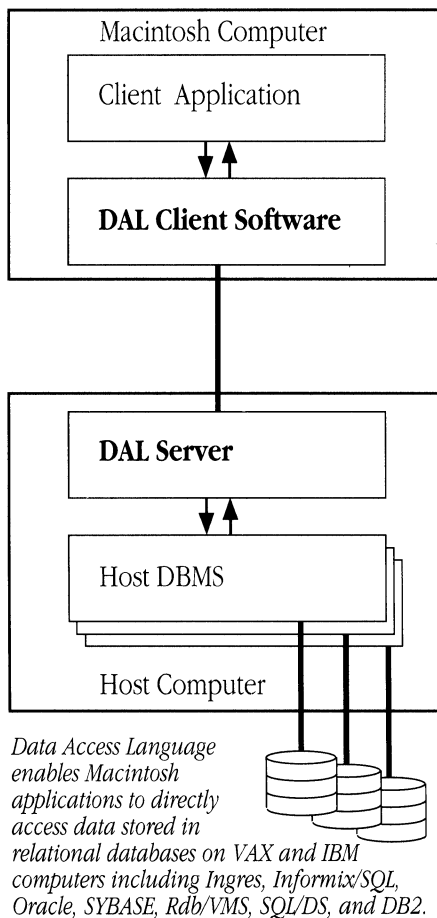

Major Data Access Language features include:

- *Data manipulation: Based on industry-standard ANSI SQL used by most relational database management systems on Digital VAX computers, IBM mainframes, and UNIX workstations; uniform support for main dialects of SQL as well as nonrelational data files such as Digital's RMS files and others.*
- *Host connection: Multivendor connectivity with ways to control and optimize the flow of information between client and host systems independently from the specific network connection used.*
- *Program control: Based on the C programming language; includes support for conditions, iterations, and procedure calls.*
- *Result processing: Support for one set of data types and error messages, with automatic mapping to heterogeneous environments.*

Data Access Language components include:

- Data Access Language Developer's Toolkit for the Macintosh computer: A set of Pascal and C Application Programming Interfaces (APIs); a driver that allows Macintosh software programmers to incorporate Data Access Language statements in their applications; a set of HyperCard external commands and functions (XCMDs, XFCNs) and driver to allow Macintosh StackWare® developers to incorporate Data Access Language statements in the HyperTalk® scripts of their stacks. Network support for the Data Access Language Developers Toolkit includes asynchronous communications, AppleTalk Data Stream Protocol (ADSP) and the Apple 3270 API.
- Data Access Language Server for VAX/VMS—See the *Digital Equipment Corporation* chapter
- Data Access Language Server for VM/CMS—See the *IBM Hosts* chapter
- Data Access Language Server for MVS/TSO—See the *IBM Hosts* chapter

Approximate Cost Contact supplier

Supplier: APDA (Apple Programmers and Developers Association), Apple Computer Inc., 20525 Mariani Ave., MS 33G, Cupertino, CA 95014, 800-282-2732, 800-637-0029 in Canada, 408-562-3910 Internationally

ClearAccess

ClearAccess is a desk accessory which gives Macintosh applications a window into corporate databases that reside on minicomputers or mainframes, across local networks or worldwide. Communication and translation tasks are handled in the background by ClearAccess. The user does not require the help of a database administrator, and doesn't need to learn a new operating system or database command language. ClearAccess' query builder lists the information that is available in the database, then builds an SQL-type query as the user clicks on the items wanted. Query results are then placed into any Macintosh application, or saved on disk in a variety of standard formats, including WKS, SYLK, and tab or comma-delimited text. Using DAL, ClearAccess can access these database management systems (DBMS) on Digital Equipment Corporation VAX and IBM Mainframes: Informix/SQL, SYBASE, Oracle, Ingres, VAX Rdb, and IBM DB2. With DAL, ClearAccess can communicate over direct serial and dial-up modem connections, across any network that supports AppleTalk, and via 3270 connections. Using ORACLE for Macintosh, ClearAccess can directly access data on ORACLE running locally, and through it, on Oracle databases worldwide. With ClearAccess, the user can record each step of data access as a macro-like script, then run it as an automatic procedure. Scripts can include all the features of DAL.

Solutions

ClearAccess using DAL can run on Macintosh 512KE or above, System 6.0 or later, and requires a copy of DAL Server Software from Network Innovations Corp. installed on the host computer running the database. ClearAccess connecting directly to ORACLE requires ORACLE for Macintosh.

Approximate Cost \$349 to \$2799

Supplier: Fairfield Software, 200 West Lowe, Fairfield, IA 52556, 800-522-4254

GQL Solution Set

GQL/Admin, Version 2.0, allows database administrators, MIS personnel, or database applications staff to develop customized graphic data models for GQL/User. The administrator loads the database schema directly from the host system to create the data objects in the data model. Using GQL/Admin, the administrator can rename data objects and attributes, choose the information the user may access, specify the relationship conditions between data objects, and develop a layout of the data model for use with GQL/User. Graphics and textual reports can be generated, with various levels of detail for use in printed documentation or training materials.

GQL/Design, Version 2.0, is a prototyping tool that provides a graphic interface for creating new databases. GQL/Design supports the entity relationship design method and includes built-in design checks. Database tables can be created directly on the host computer or a text file can be generated containing the SQL script to create the tables. Printed reports can be produced for documentation containing both text and graphic representations of the database. The data model can be used directly with GQL/User.

GQL/User, Version 2.0, allows corporate decision makers to formulate and execute database queries to retrieve information from host computers. The user views the database as a graphic data model representing the data objects and the relationships between objects. Query results are presented in a spreadsheet format. The results can be manipulated within GQL/User or exported to other Macintosh applications such as spreadsheets, word processors, or presentation packages.

GQL supports a range of connectivity solutions including: Apple Computer's DAL connectivity language, Oracle SQL*Net, Sybase DB-Library, SequeLink, TCP/IP, AlisaTalk, PacerLink, Tandem 6530, and asynchronous connections. GQL works with SQL databases, including: Ingres, Oracle, Informix/SQL, Sybase, DB2, SQL/DS, Tandem NonStop SQL, VAX Rdb, and VAX RMS.

Approximate Cost \$295 to \$1995

Supplier: Andyne Computing Limited, 544 Princess St., Suite 202, Kingston, Ontario K7L 1C7, 613-548-4355

DB-Library (for MPW C)

DB-Library is a MPW C library module that can be incorporated into MPW C-compatible applications, providing Macintosh applications with the ability to communicate with the Sybase SQL Server database server running on larger host systems (DEC VAX, Sun, HP 9000, etc.). DB-Library offers transaction processing capabilities, and use of both Macintosh and host resources. The Sybase SQL Server is a SQL-based relational database that can be used for both transaction processing and decision support types of activities. SQL Server features include data integrity, system availability, and distributed capabilities such as two-phase commit and server-to-server communications.

Approximate Cost\$195

Supplier: Sybase, 6475 Christie Ave., Emeryville, CA 94608, 800-8SYBASE

Hyper/DB-Library

Hyper/DB-Library is a set of HyperCard XFCN's (external functions) that can be incorporated into HyperCard stack scripts, providing those stacks with the ability to communicate with the Sybase SQL Server database server running on larger host systems (DEC VAX, Sun, HP 9000, etc.). Hyper/DB-Library offers transaction processing capabilities, and use of both Macintosh and host resources. The Sybase SQL Server is a SQL-based relational database that can be used for both transaction processing and decision support types of activities. SQL Server features include data integrity, system availability and distributed capabilities such as two-phase commit and server-to-server communications.

Approximate Cost\$195

Supplier: Sybase, 6475 Christie Ave., Emeryville, CA 94608, 800-8SYBASE

Applications Using Data Access Language

Tactician: DSS, EIS, and GIS combined

Tactician uses three types of technologies to manipulate data into an understandable format: Geographical Information System (GIS) technology provides ways to visualize data; Executive Information System (EIS) technology delivers timely information; and Decision Support System (DSS) technology furnishes solutions to complex management problems. The mapping system covers the entire United States with no restrictions on size. Tactician uses Apple's Data Access Language (DAL) to access host-based data.

Approximate CostContact supplier

Supplier: Tactics International Limited, 16 Haverhill St., Third Floor, Andover, MA 01810, 508-475-4475

Solutions

With Data Access Language Macintosh applications can:

- Determine what databases are available on all hosts connected to the network
- Determine the structure of a specific database
- Query databases to retrieve data
- Insert, delete, and update data in a database
- Use database facilities for transaction commit and rollback functions

Wingz-DataLink

Wingz-DataLink enables users to access and modify up-to-date information from remote SQL databases, without ever leaving the Wingz spreadsheet. This gives users access to Informix-OnLine UNIX databases, DB2 mainframe databases, as well as data stored in Rdb/VMS and other databases. Written in HyperScript (Wingz end-user programming language), DataLink lets spreadsheet users create their own custom database front ends.

Approximate Cost\$418

Supplier: Informix Software, Inc., 16011 College Blvd., Lenexa, KS 66219, 913-599-7100

Additional Products With Data Access Language Incorporated:

- 4th Dimension database from ACIUS, Inc.
- Authorware Professional multimedia tool from Authorware
- ClearAccess query tool from Fairfield Software
- Full Impact spreadsheet from Ashton-Tate
- GeoQuery GIS from Odesta Corporation
- GQL query tool from Andyne Computing Limited
- HyperCard multimedia tool from Apple Computer, Inc.
- HyperX expert system from Milleneum Software
- Microsoft Excel spreadsheet from Microsoft Corporation
- Nexpert Object expert system from Neuron Data, Inc.
- Omnis database from Blyth Software, Inc.
- RagTime integrated business tool from RagTime USA
- SuperCard multimedia tool from Silicon Beach Software

Polaroid Moves from Paper to Macintosh Computers

Macintosh computer technology helped to reduce paper documents at Polaroid with access to on-line information.



Company Background

In a mature, highly competitive market, one of the best ways to distinguish yourself from your competitors is through customer service. Polaroid Corporation was one of the first companies to offer a toll-free number for customers to call with questions on everything from camera prices to the closest film store. Now the company handles a million customer contacts each year through its Consumer Services division.

To support the consumer services reps who handle Polaroid's toll-free line, the company installed 30 Apple Macintosh computers. The systems are linked to a customer database, which is on a Digital VAX 6220 mainframe, via an EtherTalk network with a T1 bridge. The group accesses the Ingres database, which stores Polaroid's customer information, using the Data Access Language (DAL) from Apple.

Macintosh Gives a Competitive Edge

"In consumer services we're committed to providing excellent service to customers by answering questions and repairing products. The Macintosh also makes it easier for us to share information with other divisions. There was no system that allowed

Case History

us to do that before. Now we provide feedback to the corporation on what prompts customers to call us in the first place. This helps us to design better products, put together more effective sales and marketing programs, and remain competitive in the marketplace,” says Roberta Hurtig, director of the consumer services division.

According to Florence Farnsworth, a senior systems analyst at Polaroid, the ability to capture information, analyze it, and share it with other departments has not only given Polaroid an edge against its competition, but it has also raised the group’s profile among other divisions: “Having a powerful computing system like the Macintosh behind consumer services is an advantage. It’s one thing to talk to other departments about trends and quite another to show them published results. It gives us more clout.”

Macintosh Alternative Saved 75%

“A year ago we were a paper culture,” says Tim Crawford, information systems manager at Polaroid. “Our consumer reps had a telephone and 20 to 30 technical information manuals containing product information, pricing data, and information on Polaroid dealers. We knew there had to be a better way to handle the process.” Macintosh computers were not widely used in the corporation at the time, so there was some concern about bringing in a new computing platform without support personnel in place. “This was our first Macintosh-based system. It was not met with overwhelming support in Polaroid’s IS community,” says Crawford. “But its ease of use, the graphical interfaces, and the cost savings allowed the program to proceed.

“There were two things that really tipped the scales in selling this project to management,” he continues. “One was the cost savings.” Crawford demonstrated that he would be able to off-load a significant amount of work to the Macintosh, which meant he did not need to buy a dedicated VAX for the consumer services group as originally planned. “Because we could use existing VAX capacity together with the Macintosh, we were able to reduce the project cost to 25% of the budgeted cost,” he says.

“The second deciding factor was the ability to incorporate graphics and text to do the classical data acquisition and display on screen. That really caught management’s eye and got the system funded.

“The HyperCard front end we created allows us to use a graphical interface,” explains Crawford. “No other system has the ability to incorporate graphics and textual data capture. We’ve included an exploded parts diagram that allows consumer services reps to click parts of a camera to find out part numbers and other information. There’s a map of Polaroid dealers presented graphically, as

Case History

opposed to a straight listing. These are things that a purely VAX-based solution could not deliver at the same price point as the Macintosh.”

A Flexible Programming Environment

Crawford had about a month of programming experience with HyperCard before he launched the program, but he found that together with DAL, it was an extremely flexible development environment. “HyperCard is a very powerful development tool. I could incorporate the graphic elements and place buttons on the screen anywhere I wanted. And with DAL there’s no real limit to what you can do in a data acquisition sense. It has all of the functionality of SQL, plus the communications functionality that allows the user to communicate effortlessly with the corporate databases.”

DAL was critical to the consumer services group’s success, agrees Florence Farnsworth. “We were already committed to using Ingres because it had been purchased and licensed for use by the rest of the corporation,” she says. “We had to have a way to link the Macintosh computers to the Ingres database. DAL was the piece that made it all fall into place.”

Consistent, Accurate Information

The Macintosh system enables reps to provide customers with quality information. Explains Carl Kelley, manager of consumer services, “It’s very important to have consistent, accurate information going out to the customer. Before the computers were in place, we had to count on our consumer reps to have the most updated information and interpret it properly. Now all information on the Macintosh is updated from a central source. As a result, we can offer consistent, quality information on a timely basis.”

Macintosh: The Right Tool for the Job

“The Macintosh is a very strong IS solution for a couple of reasons,” explains Crawford. “It has the ability to put up the text data, capture type of screens, and it can be used as a productivity tool. The Macintosh is a window into corporate mainframes or mini computers. It combines transparent access to corporate databases along with an easy -to-use interface and multitasking capability. Other computers don’t have the combined host access, networking, graphics, and personal computer all in one package. It’s the right tool for the job here.”

Polaroid plans to have up to 50 users on the system, mostly in consumer services’ primary offices in Cambridge and a few additional users at each of Polaroid’s four distribution centers around the country. All users will be linked to a corporate minicomputer in Waltham, Massachusetts.

Case History

Macintosh Fits into Corporate Goals

Hurtig finds that “By having on-line information about products, programs, promotions, and dealer stock, customer services representatives are better equipped to give faster, more accurate information, and offer an overall higher level of service to customers.”

“It’s a lot easier to retain a customer than it is to find a new one,” adds Crawford. “Therefore, providing the consumer services rep with the best possible tool to provide good service is critical. With its graphical user interface, ease of access to corporate data, and cost-effectiveness, Macintosh fits right into our corporate goals.”

Network Environments

Background

Vendors, such as Apple Computer, Novell, 3Com, TOPS, and Northern Telecom, provide the networking software and hardware that link personal computers with other computers and peripherals on a network. Most of these vendors originated in the PC industry in the early 1980s and provided solutions for linking MS-DOS computers on a local area network (LAN) to share resources such as hard disks and laser printers.

As the market changed, however, and computing environments grew more demanding, these vendors responded with more sophisticated offerings. Businesses no longer only had MS-DOS computers; they were also using Macintosh® computers and UNIX®-based workstations, and vendors needed to connect these different kinds of computers across the corporate environment. In addition, customers were no longer content with communications solely among personal computers; they also wanted access to Digital minicomputers, IBM host computers, workstations, supercomputers, and other computers.

The Apple®-proprietary network system, AppleTalk®, was the first significant step in giving the Macintosh computer user the ability to reach beyond the desktop across a network. This system is a combination of hardware (LocalTalk™) and software providing access to electronic mail applications, print and file servers, and other network services in the same manner that Macintosh users access desk accessories, hard disks, or other Macintosh computer features. The user sees familiar aspects of the Desktop Interface, yet the software modules that control those services are transparent to the user. LocalTalk is built into every Macintosh computer, underscoring Apple's commitment to communications.

The third-party networking vendors achieved remarkable growth by providing many solutions to connectivity problems. Originally, the word “networking” primarily meant sharing resources on one LAN; today, however, the names of Novell and 3Com, among others, suggest that “networking” now has a more sophisticated meaning. Novell, for example, acquired CXI, providing the company with IBM gateway technology that extended the reach of Novell's network operating system, NetWare, to IBM host computers. Recently, Novell acquired Excelan, adding strong connections into the UNIX environment. In other developments, 3Com merged with Bridge Communications to increase the reach of 3+ users to

The Environment

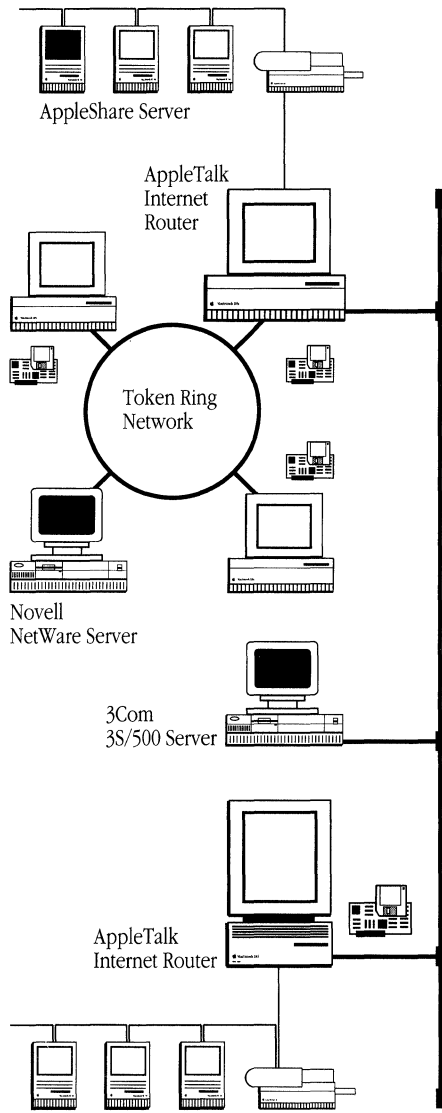

Macintosh computers can access a wide variety of file servers available on the network.

other environments. In 1988, 3Com formed a strategic alliance with Microsoft to develop a network operating system based on OS/2 which takes advantage of the increased power of OS/2 over MS-DOS.

Integration of Multiple Environments

These independent networking vendors have also responded to the market demand for the integration of multiple environments. Some have taken the approach that the integration of multiple environments will occur when standards such as those being developed by the International Standards Organization (ISO) are finalized. Others, such as Novell, have taken the approach that the market will continue to consist of multiple networking standards, and that the goal of trying to bring all networks under a single architecture, such as the ISO Open Systems Interconnection (OSI) reference model, may not be realized for many years to come. In the meantime, users want connectivity without compromising their basic networking capabilities and native user interface. Therefore, Novell's strategy has been to adapt NetWare to support AppleTalk rather than force-fit the Macintosh computer into the NetWare environment. NetWare, with Novell's Open Protocol Technology (OPT), fully incorporates the AppleTalk protocols, allowing PCs running NetWare to become AppleShare servers for Macintosh systems.

Information Sharing with AppleShare

Through the AppleTalk network system and the AppleShare® file server, Apple offers transparent, intuitive information sharing for work groups.

AppleShare File Server software converts any Macintosh computer into a high-performance file server. And since the AppleShare File Server was designed together with the Macintosh Finder™ and system software, the interface between user and server is seamless and transparent.

The user works with information on the server as if it were stored on his or her own hard disk. Individuals have the ability to control who has access to documents that they create and store on the server. In addition, single-user and multi-user applications can be run directly from the server.

Networking Through the Telephone System

Northern Telecom takes a different approach to networking: It provides data communications through its digital PBX systems located on the customer's premises or through its family of central-office switching systems, located on the premises of the local phone company. Both of these systems have outstanding benefits. Public telephone networks link a wide array of equipment and computers, remote as well as local. Data can be passed over the same wiring that is used for voice communications, eliminating the expense of separate cabling.

The Environment

Integrating the Macintosh computer into the PBX is as easy as plugging in a telephone, and data transmission is fast. The Macintosh computer can communicate at speeds of 19.2 kilobits per second (Kbps) with other Macintosh and IBM personal computers, host computers, and other centralized computing resources; and speeds as high as 64 Kbps can be reached using the central-office switching systems.

Novell

Novell Inc., based in Provo, Utah, is the LAN market leader. Its NetWare operating system is an established industry standard, with an estimated 40 to 50 percent market share. Today, there are more than 500,000 copies of NetWare installed worldwide, connecting more than 2 million workstations.

Novell's NetWare for Macintosh is a server-based software solution that provides NetWare connectivity to Macintosh computers. Because the Macintosh version of NetWare fully supports the Macintosh Hierarchical File System (HFS), the Macintosh user sees files stored on the server in standard Macintosh folders. The user has full access to IBM or Macintosh files stored on a NetWare server. Macintosh files are also accessible by MS-DOS and OS/2 workstations on the same NetWare network. And when users work with IBM PC, IBM PC-compatibles, and Macintosh computer applications that share the same application file format (such as Microsoft Excel for the Macintosh and for the IBM PC), no conversion needs to be made by the Macintosh computer to access MS-DOS files.

3Com

3Com Corp., based in Santa Clara, California, manufactures and markets network hardware such as network adapter boards and file servers, as well as network software such as its 3+ network operating system. Founded in 1979 by Bob Metcalfe, one of Ethernet's inventors, 3Com grew rapidly by basing its products around the evolving Ethernet standard.

3Com offers a system that integrates PC compatibles and Macintosh computers. The system consists of one or more 3Com multifunction servers, the 3+ network operating system, a group of MS-DOS or OS/2-compatible computers on an Ethernet or token ring network, and a group of Macintosh computers on either LocalTalk or Ethernet cabling.

Northern Telecom

Northern Telecom is the leading manufacturer of fully digital PBX-based communications systems. The U.S. company, which employs more than 20,000 people, has over 6 million lines installed in more than 20,000 customer sites.

The Environment

Northern Telecom offers Macintosh users a number of options for networking their computers. The Meridian SL-1 and Meridian SL-100 digital PBXs are used for customer-premises networking. The Northern Telecom DMS-100 central-office switch allows networking through the phone company's central office, providing access to wide area networks. In addition, Northern Telecom offers a LAN (LANSTAR/AppleTalk) that was developed cooperatively with Apple. This network implements the AppleTalk protocols on Northern Telecom's high-speed, twisted-pair network. Macintosh users have access to standard AppleTalk services, such as AppleShare and LaserShare™, and to third-party servers such as Novell NetWare, TOPS or MacServe.

Additional Solutions To Be Found

This chapter by no means represents all of the network solutions available today. There are additional solutions that were better placed in other chapters of this Guide and contacting the suppliers mentioned in this and other chapters will certainly lead the reader to other solutions. The following pages are intended to be a network sampler showing the major alternatives from which to choose in today's market.

Network Environments Solutions

Novell Environment

Novell NetWare 286

NetWare's Macintosh support, NetWare for the Macintosh, consists of extensions called Value Added Processes (VAPS) which run on NetWare file servers or bridges. The latest version of NetWare, version 2.15c is packaged with NetWare for Macintosh version 1.1. Also included are DOS and OS/2 client software.

A NetWare network operating system environment gives the Macintosh user the ability to access AppleTalk services in the NetWare worlds. Macintosh NetWare clients access NetWare servers through the Macintosh Chooser, and use the same AppleShare client software that they use for AppleShare.

NetWare for Macintosh was written to conform with Apple's AppleTalk Filing Protocol (AFP) and Printer Access Protocol (PAP), and was designed in strict compliance to Apple standards. To the Macintosh user, information stored on the network server is seen as Macintosh icons. Other workstations on the network (PCs running DOS, OS/2, or Windows/386), see the folders and file icons from the Macintosh listed as directories, subdirectories and files in the familiar format of the workstation operating system. Files from both PC users and Macintosh users are stored in the same folders of the same network server.

NetWare for Macintosh also provides print services, allowing DOS, OS/2 and Macintosh users to share Apple LaserWriter and other Apple printers. NetWare print queues emulate the Apple LaserWriter so that all users place print jobs in the appropriate print queue and NetWare for Macintosh spools the jobs to the printer.

Macintosh workstations can be directly connected to NetWare for Macintosh in two ways: LocalTalk or EtherTalk. NetWare for Macintosh support for LocalTalk is available for a Novell LocalTalk card called the NL1000, and is also available for Dayna LocalTalk card for both ISA and MCA busses. EtherTalk support is available through the Novell NE2000 for EISA and ISA servers, and the NE2 for Microchannel servers.

NetWare for Macintosh can also be used with any AppleTalk compliant routers that bridge LocalTalk to Ethernet, such as the Kinetics FastPath. Apple LaserWriter and ImageWriter printers can be connected to the network only through their built-in LocalTalk connectors. In large multiserver networks, NetWare for Macintosh can be

Solutions

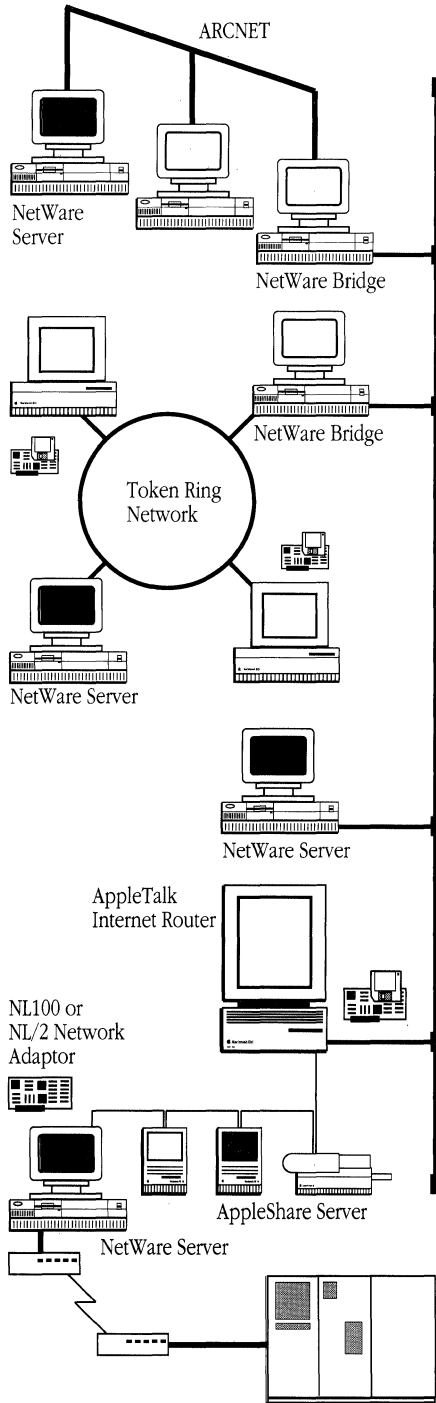

With NetWare, sharing printers, files, and messages across like or unlike network topologies is transparent. Users can access network resources from both a PC and a Macintosh computer.

installed in an external router. In small single-server networks, NetWare for Macintosh can run in the file server with the NetWare operating system. NetWare for Macintosh requires an Intel 80286 or 80386 machine used as a NetWare file server or external router. A server configured with NetWare for Macintosh requires a minimum of 2 MB of RAM.

Macintosh SE and SE/30 workstations on Ethernet LANs can use the Kinetics EtherPort SE, SEL, SE/30, or SE/30L or they can use Ethernet boards from Apple and other manufacturers. The Macintosh II line of workstations needing Ethernet connections can use the Kinetics EtherPort II or ILL, or Ethernet boards from Apple and other vendors.

NetWare for Macintosh version 1.1 must be used in conjunction with version 2.15c of NetWare operating systems. Currently, ELS NetWare Level II, Advanced NetWare and SFT NetWare are available in version 2.15c and come with NetWare for Macintosh included. Each Macintosh user will need the Apple AppleShare workstation software installed at his or her workstation. The AppleShare workstation software comes bundled with the Macintosh System software, version 6.0 and above. Driver software for the following adapters is included with NetWare for Macintosh: ISA Bus Servers or Routers, NL1000, NE2000, Micro Channel Servers or Routers, and NE2.

Approximate Cost \$200 to \$4995
Supplier: Novell, Inc., 122 East 1700 South, Provo, UT 84606, 800-LAN-KIND

LAN WorkPlace for Macintosh

LAN WorkPlace for Macintosh provides Apple Macintosh users with transparent access to a broad range of hosts, servers, and workgroups on a local area network. Using the Macintosh interface, users have access to all resources on an industry-standard TCP/IP network, including PCs, VAX minicomputers, IBM mainframes, UNIX workstations, and host-connected peripherals. Remote sessions look and feel as if they reside on the Macintosh desktop. LAN WorkPlace for Macintosh consists of TCPort transport system software and HostAccess network application software, including terminal emulation and file transfer capabilities.

LAN WorkPlace for Macintosh is designed for access to enterprise-wide computing resources, from minicomputers and mainframes to PCs and engineering workstations, via standard TCP/IP protocols. When used with NetWare for Macintosh, LAN WorkPlace allows Macintosh users to access TCP/IP hosts and NetWare servers simultaneously, transfer files, access applications, and communicate with host terminal users. In addition, it provides a platform for running distributed TCP/IP applications, such as SQL client and X Window server applications. Macintosh workstations running LAN WorkPlace can be directly connected to TCP/IP and NetWare networks through LocalTalk or EtherTalk.

Solutions

LAN WorkPlace for Macintosh requires a Macintosh II, IIcx, IIci, SE, SE/30, or Plus system with at least 1 MB of RAM and at least one 800 Kb drive. The Macintosh must be connected to an Ethernet network or a LocalTalk network that is connected to the Ethernet network via a gateway such as the Kinetics FastPath 4 gateway, or it must be connected directly to an Ethernet network via an Ethernet adapter interface such as a Kinetics EtherPort controller.

LAN WorkPlace for Macintosh is designed to run under the Macintosh Operating System 6.0 or higher. For access to NetWare servers, the AppleShare workstation software that comes with the Macintosh operating system is required, as is NetWare version 2.15 or above, and NetWare for Macintosh.

Approximate Cost\$250

Supplier: Novell, Inc., 122 East 1700 South, Provo, UT 84606, 800-LAN-KIND

ACTINET ARCTalk Interface Cards

ACTINET produces ARCTalk Interface Cards for the Macintosh SE (16-bit), the Macintosh SE/30 (32-bit) and the Macintosh II (32-bit). These provide a direct connection to ARCNET networks using the Processor Direct Slot of the Macintosh SE and SE/30, and the NuBus interface of any Macintosh II. Software from ACTINET Systems allows the ACTINET-equipped Macintosh to communicate with a diverse range of ARCNET-based computer systems, including other Macintosh computers, Novell NetWare servers (v2.15) and PCs. The ACTINET cards unite AppleTalk protocols with ARCNET cabling to create ARCTalk. They support AppleShare, the AppleTalk Internet Router and Infosphere's Liaison software bridge to LocalTalk networks. The included ACTINET software included allows simultaneous ARCTalk and LocalTalk connections using a built-in personal bridge. ACTINET ARCTalk is Novell certified.

Approximate Cost\$495 to \$695

Supplier: ACTINET Systems, Inc., 360 Cowper St., Suite 11, Palo Alto, CA 94301, 415-326-1321

3Com Corporation

3Com Corporation manufactures and markets network hardware such as network adapter boards and file servers, as well as network software such as its 3+ and 3+Open network operating system. Founded in 1979 by Bob Metcalfe, one of Ethernet's inventors, 3Com grew by basing its products around the then evolving Ethernet standard. The system consists of one or more 3Com multifunction servers, the 3+ or 3+Open network operating system, a group of Macintosh computers on either LocalTalk or Ethernet cabling and a group of MS-DOS or OS/2-compatible computers on an Ethernet or token ring network.

Solutions

3+Open Product Features:

- *AFP File Service.*
- *Server-based PostScript Print Spooling.*
- *AppleTalk Routing Service.*
- *Integrated Backup Service.*
- *Support for "Switch Launching" from the server.*
- *Transparent Integration with DOS, OS/2, LAN Manager Users.*
- *Value Added Services: electronic mail, remote-backup service, and gateway.*

3Com File Service: 3Com 3S/500 with 3+ or 3+Open Software

3Com Corporation makes a network system for the Macintosh computer and PC compatibles. The system consists of one or more 3Com 3S/500 multifunction servers, 3+ or 3+Open network operating system software (3+ or 3+Open and 3+ for Macintosh or 3+Open for Macintosh), a group of MS-DOS or OS/2-compatible computers on an Ethernet or token ring network, and a group of Macintosh computers on either LocalTalk or Ethernet cable. These network operating systems allow networks using the same or different physical media to be logically connected and appear to the user as a single network. For example, LocalTalk cable systems can be connected to Ethernet or token ring cable systems.

The 3+Open for Macintosh contains the Macintosh software and documentation. The 3+Open for Macintosh User Guide 5-pack contains five copies of the Apple AppleShare User Guide plus five copies of 3Com's addendum to Apple's guide. LocalTalk and Ethernet will be supported on a 3Com system. A LocalTalk Connector Kit is required for each Macintosh computer on a LocalTalk network cable system. An Ethernet card is required for each Macintosh on an Ethernet.

Approximate Cost\$595 to \$27,995

Suppliers: 3Com Corporation, 3165 Kifer Rd., Santa Clara, CA 95052, 408-562-6400
 Apple Computer, Inc., 20525 Mariani Ave., Cupertino, CA 95014, 408-996-1010

3S/500

This Intel 386-based network server includes: LocalTalk port and Ethernet connection (optional token ring connection) for support of both Macintosh computers and PCs; pre-installed 3+ network operating system software for file, application and printer sharing; automatic tape backup; global name service for accessing remote users, files and resources; 150, 320, or 630 MB hard disk; 250 MB to 2.3 GB of tape backup capability; and up to 16 MB RAM.

Approximate CostContact supplier

Supplier: 3Com Corporation, 3165 Kifer Rd., Santa Clara, CA 95052, 408-562-6400

EtherLink/NB

EtherLink/NB provides users with a data transfer rate of 10 Mbps, and uses Apple's standard EtherTalk driver. The board is compatible with software products written to this standard: 3Com's 3+ for Macintosh, Apple's AppleShare product, TOPS, Touch Communications, AlisaTalk, PacerLink, and CommUnity-Mac. EtherLink/NB is compatible with 3Com MultiConnect products, allowing users to run Ethernet on twisted-pair wire.

Approximate Cost\$595

Supplier: 3Com Corporation, 3165 Kifer Rd., Santa Clara, CA 95052, 408-562-6400

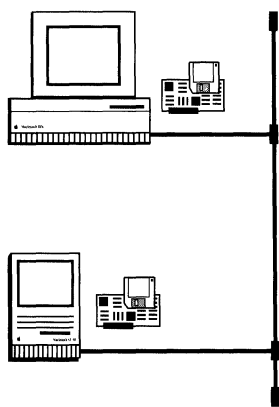

With the addition of an EtherLink card and software, Macintosh computers become Ethernet compatible.

EtherLink/SE

EtherLink/SE provides users with a data transfer rate of 10 Mbps. The EtherLink/SE driver is compatible with Apple's EtherTalk driver. The board is compatible with software products written to this standard: Apple's AppleShare, TOPS, Touch Communications, AlisaTalk, PacerLink, and CommUnity-Mac. The EtherLink/SE is compatible with 3Com MultiConnect products which allow users to run Ethernet on twisted-pair wire.

Approximate Cost \$595
Supplier: 3Com Corporation, 3165 Kifer Rd., Santa Clara, CA 95052, 408-562-6400

TOPS Network Environment

TOPS Network Bundle for Macintosh v3.0

The TOPS Network Bundle for Macintosh 3.0 allows users to access three network functions: File sharing, printing, and electronic mail. The Network Bundle for Macintosh contains TOPS File Sharing, TOPS Spool, MacLinkPlus/TOPS, and the 20-user version of TOPS InBox. With TOPS peer-to-peer file sharing, Macintosh, PC, and Sun Workstation users can establish networks with or without dedicated servers. TOPS/Macintosh 3.0 works with all leading AFP compatible multi-user applications. TOPS Spool v3.0 allows users to continue working while they print their documents to any AppleTalk laser printer. The MacLinkPlus/TOPS Translators from DataViz translate between Macintosh and PC file formats. TOPS InBox is an electronic mail system for up to 20 users.

Approximate Cost \$299
Supplier: TOPS, 950 Marina Village Pkwy., Alameda, CA 94501, 800-445-TOPS

TOPS Network Bundle for DOS v3.0

The TOPS Network Bundle for DOS 3.0 allows IBM PCs or compatibles to share files and applications, DOS and Apple printers, and electronic mail with other PCs, Macintosh computers, and Sun Workstations. The bundle contains TOPS File and Printer Sharing. With TOPS' peer-to-peer file sharing, Macintosh, PC, and Sun users can establish networks with or without dedicated servers. TOPS/DOS supports Apple HFS and AFP standards, allowing users' PCs to act as a Macintosh Server for TOPS/Macintosh users. TOPS/DOS allows PC users to connect to remote printers, including networked Apple LaserWriter printers for PostScript output from PC applications. The Network Bundle includes TOPS InBox, a store-and-forward electronic mail system for up to 20 users. TOPS/DOS is DOS and NetBIOS compatible and includes AppleTalk, FlashTalk, and Ethernet drivers.

Approximate Cost \$249
Supplier: TOPS, 950 Marina Village Pkwy., Alameda, CA 94501, 800-445-TOPS

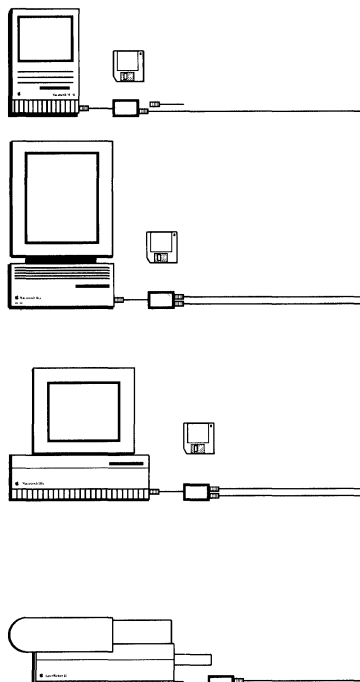

File sharing, print spooling, and electronic mail are provided with the TOPS Network Bundle for Macintosh.

Networks

Solutions

InBox 3.0

InBox 3.0 is a work-group electronic mail system for up to 20 users. It provides mail services to users on both Macintosh and DOS personal computers and operates on most networks including LocalTalk, AppleShare, NetWare, 3+, and LAN Manager. No central administration is needed, and the non-dedicated Message Center can be installed on a Macintosh, PC, or other network-addressable volumes. Client software for up to 20 Macintosh and DOS PC users is included. The user interface is consistent across both platforms and includes mail features such as Address Books for personal recipient-list management, mail with multiple file enclosures, and local Storage Boxes to organize and file mail. Features such as one-step reply, mail forwarding with comments, and message “undeletion” are provided. InBox is configurable; each user can specify choices of audio and visual new-mail alerts, display options for messages, and sorting preferences for both messages and address lists.

Approximate Cost \$329

Supplier: TOPS, 950 Marina Village Pkwy., Alameda, CA 94501, 800-445-TOPS

InBox Plus

InBox Plus is a mail solution for any size network. InBox Plus provides mail services for both Macintosh and DOS personal computer users, and operates on most networks including LocalTalk, AppleShare, NetWare, 3+, and LAN Manager. It supports multiple Message Centers (up to 100 users on each), which can be installed on Macintosh, PC, or other network-addressable volumes. A router is included for store-and-forward mail delivery between servers. The product supports Gateways for connectivity to other systems such as PROFS, VMS Mail, X.400, and SMTP. Client software for up to 100 Macintosh and DOS PC users is included. The user interface is consistent across platforms, with features such as public Distribution Lists and personal Address Books, multiple file enclosures, and local Storage Boxes to organize and file mail. Features such as one-step reply, mail forwarding with comments, and message “undeletion” are provided. InBox is configurable; each user can specify choices for new-mail alerts, display options for messages, and sorting preferences for both messages and address lists.

Approximate Cost \$995

Supplier: TOPS, 950 Marina Village Pkwy., Alameda, CA 94501, 800-445-TOPS

TOPS FlashCard

TOPS FlashCard is a network interface card that allows PCs to communicate on an AppleTalk network with other PCs and Macintosh computers using simple twisted-pair cabling. Tops FlashCard is available in AT bus and Micro Channel bus configurations allowing it to be used with any IBM PC, XT, AT, PS/2, or compatible

Solutions

machine. FlashCard installs in any PC by inserting it into an unused slot, attaching a TOPS TeleConnector or compatible network connector and snapping in telephone wire. TOPS FlashCard interconnects PCs and Macintosh computers by allowing a PC to communicate with any AppleTalk or FlashTalk device on the network. FlashCard supports both FlashTalk (770 Kbps) and LocalTalk (230 Kbps) by selecting the speed to communicate with any Macintosh, PC, LaserWriter, or AppleTalk peripheral. When used with TOPS Network Bundle for DOS, FlashCard allows PCs and PS/2s to connect to AppleTalk compatible printers including Apple LaserWriter printers, and even professional typesetters.

Approximate Cost\$239

Supplier: TOPS, 950 Marina Village Pkwy., Alameda, CA 94501, 800-445-TOPS

TOPS NetPrint

TOPS NetPrint allows a PC or compatible to print to an Apple LaserWriter or other AppleTalk compatible printer over an AppleTalk network. TOPS NetPrint is compatible with DOS software applications, including applications that do not offer PostScript drivers. TOPS NetPrint can be installed by beginning users as well as experienced computer professionals. NetPrint supports PostScript files generated by DOS application software. It also allows users to print accurate “screen dumps.” NetPrint can translate files to PostScript from applications that do not include PostScript drivers. NetPrint also translates IBM ProPrinter and Epson FX output into PostScript. Many font options, including sizes and styles, are available. NetPrint works transparently, with all network communications taking place in the background.

Approximate CostContact supplier

Supplier: TOPS, 950 Marina Village Pkwy., Alameda, CA 94501, 800-445-TOPS

TOPS FlashBox

A plug-in device for Macintosh computers, TOPS FlashBox moves data from one computer to another by increasing the data transfer rate from the standard AppleTalk 230 Kbps to FlashTalk 770 Kbps. FlashBox is compatible with all AppleTalk network applications, providing the same flexibility as AppleTalk. It is also compatible with all AppleTalk standard protocols. Twisted-pair phone wire or Apple LocalTalk cabling can be used. Restrictions: FlashBox is designed for networks in which all computers communicate at FlashTalk rate using FlashBoxes or FlashCards. Interoperability with bridges, gateways, or other AppleTalk-only devices may require network reconfigurations or the addition of repeating devices.

Approximate Cost\$189

Supplier: TOPS, 950 Marina Village Pkwy., Alameda, CA 94501, 800-445-TOPS

Solutions

TOPS TeleConnector

The TOPS TeleConnector is a network connector which provides a physical link between microcomputers and peripherals on an AppleTalk network. TOPS TeleConnectors allow simple telephone wire (unshielded twisted-pair cabling) to be used as the network cabling for a LAN. TeleConnectors allow users to connect Macintosh computers, IBM PCs and compatibles, laser printers, modems, and other peripherals. The TOPS TeleConnectors support both LocalTalk and FlashTalk network communications protocols. TOPS FlashTalk (770 Kbps) operates faster than LocalTalk (230 Kbps) on a PC-to-PC network, while maintaining compatibility with all AppleTalk-specific devices and applications. TOPS TeleConnectors provide convenient RJ-11 connections for telephone wire cabling and come in either DB-9 or DIN-8 versions for attachment to computers and peripherals.

Approximate Cost\$59

Supplier: TOPS, 950 Marina Village Pkwy., Alameda, CA 94501, 800-445-TOPS

TOPS Repeater

TOPS Repeater is an AppleTalk signal amplifier that allows users to expand the size of an AppleTalk network and alter its configuration. When an AppleTalk signal reaches the TOPS Repeater, the signal is amplified and sent to the rest of the network. This allows users to extend their network length. Two TOPS Repeaters can triple the network cabling's maximum length. In addition, TOPS Repeater allows users to add branches to the basic "bus" layout of the TOPS network, allowing increased network flexibility and potential for growth. TOPS Repeater supports both AppleTalk and FlashTalk network protocols. TOPS Repeater requires only two DB-9 network connectors and a standard electrical outlet. Users do not need any programming knowledge or computer experience.

Approximate Cost\$189

Supplier: TOPS, 950 Marina Village Pkwy., Alameda, CA 94501, 800-445-TOPS

Northern Telecom Environment

Northern Telecom, a leading global supplier of fully digital telecommunications systems, offers many networking options to Macintosh users, as part of a broad portfolio of products and services which are available to the telecommunications industry, businesses, universities, governments, and other institutions worldwide. The company has installed more than 12 million PBX telephone lines in more than 35,000 customer sites.

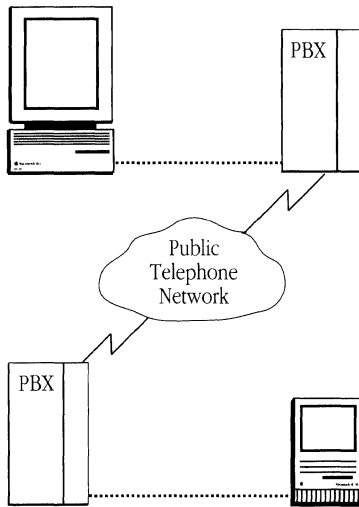

Meridian Data Services provide communications solutions through the Meridian 1 family of digital PBX systems.

Networking Through the Telephone System

Northern Telecom's approach to networking embodies several technologies, either individually, or in combination with one another. Because the telecommunications industry serves individual businesses, telephone companies, and long distance carriers, its definition of networking spans all aspects of wide area networks, including LANs.

Communications solutions from Northern Telecom include Meridian Data Services through the Meridian 1 family of digital PBX (Private Branch eXchange telephone) systems located on a customer's single or multiple sites. Many telephone companies offer digital communications available through Northern Telecom's DMS family of central-office switching systems to interconnect individual resources, or entire sites, across wide area public or private networks. Northern Telecom's Meridian LANSTAR family of local area network products, developed cooperatively with Apple, implements the AppleTalk protocols, including AppleTalk Phase 2, on Northern Telecom's high-speed, twisted-pair network.

Utilization of telephone switching systems allows telephone networks, both public and private, to link a wide array of equipment and computers, remote as well as local. Data can be passed over the same wiring that is used for voice communications, eliminating separate cabling. The Macintosh computer can be integrated into a telephone network by plugging it into the back of a Northern Telecom digital telephone. The Macintosh computer can communicate at speeds up to 64 kilobits per second (Kbps); higher speeds can be accomplished between sites through use of telephone company-based services such as T-1 and ISDN Primary Rate Access.

Macintosh to Meridian Data Services Connectivity Guide (DMS-100)

Meridian Data Services HyperCard stack (DMS-100)

Suppliers: Northern Telecom, 2305 Mission College Blvd., Santa Clara, CA 95054, 408-988-5550
Northern Telecom, Inc., 4001 E. Chapel Hill-Nelson Hwy., Research Triangle Park, NC 27709, 919-549-5000

Northern Telecom, Ltd., 8200 Dixie Rd., Brampton, Ontario, Canada L6V 2M6, 416-451-9150

Meridian 1 Communication Systems

The Meridian 1 is a family of fully digital telephone systems, comprised of the SL-1 and SL-100 systems. These systems handle the full range of voice communications, as well as Meridian Data Services. The Meridian 1 is available in several models, able to accommodate from 30 to over 60,000 users of telephones, computers, LAN gateways, and other data communications devices.

Solutions

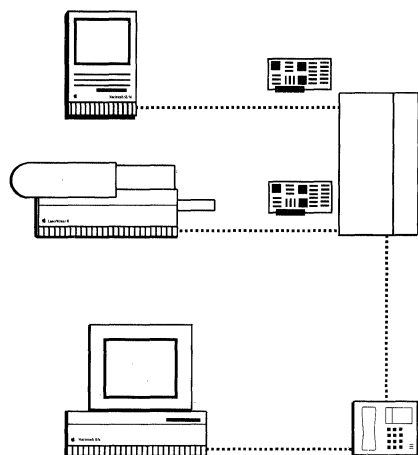

Meridian digital PBX systems allow Macintosh computers to connect directly or via an SL-1 digital telephone. LaserWriter printers can also be directly attached to the Meridian SL-1.

Northern Telecom Meridian 1 as a Network

Any Macintosh computer can be integrated into the Meridian Data Services environment by connecting to a data-equipped telephone set. Data can be passed over the same wiring that is used for voice communications. Devices such as protocol converters, modems, X.25 PADs, and multiplexers may be shared among Macintosh computer, MS-DOS computer, and terminal users. Meridian 1 also supports Integrated Services Digital Network (ISDN), a set of standard interfaces and protocols designed to provide a universal access medium to a global digital services network. ISDN also provides transparent connectivity, high bandwidth, and circuit/packet data and voice services to the end user. Meridian 1 currently employs ISDN Primary-Rate Access (PRA), allowing Meridian switches to deliver the caller's phone number, and even name, to the recipient of the call, for possible processing by a computer system.

Supplier: Meridian Business Systems, Northern Telecom, 2100 Lakeside Blvd., Richardson, TX 75080, 214-437-8000

Meridian Data Services Digital Line Cards

To connect to the Macintosh, a Line Card (AIRC or ISDLC) must be installed in the Meridian system cabinet. Desktop connectivity to the Meridian system cabinet is accomplished via the "Asynchronous Data Option" inside a digital telephone set, the "Meridian Programmable Data Adapter" (MPDA) inside a Meridian Modular Telephone set, or for a Macintosh-only connection, the appropriate cable directly connected to the line card. Connecting to a LaserWriter printer requires the "Asynchronous Interface Line Card," vintage E or above. Macintosh computers, printers, and LAN gateways, as well as host computers, can be attached to the Meridian system through use of the stand-alone HSDM (High Speed Data Module) enabling data throughput of up to 64 Kbps.

Approximate Cost \$271 to \$694 per port

Suppliers: Northern Telecom, 2305 Mission College Blvd., Santa Clara, CA 95054, 408-988-5550

Meridian TeleCenter

Meridian TeleCenter adds the telephone to the Macintosh desktop metaphor. Clients can use the telephone's features (such as to originate a Voice Call, Call Forward, Conference Call, Call Hold, Speed Dialing, and support of up to 20 multiple extensions per telephone station). Meridian TeleCenter also gives users on-line telephone directory dialing, multiple telephone directories, automatic phone call logging, incoming call notification, Meridian Mail voice messaging system screen menus, and network features such as Called/Calling Party Name Identification. Meridian TeleCenter has been designed to work in the background, allowing a user to use any other software concurrently.

Solutions

Meridian TeleCenter requires the user to have a Meridian 1, SL-1 or SL-100 Telephone System on their premises (with System Software X11-Release 14 or BCS 32 respectively), with Meridian Modular Telephone sets and Meridian Programmable Data Adapters (MPDA) in the telephone set. No additional hardware is required other than the serial cable used to connect the communication port of the Macintosh computer to the data adapter. In geographies where ISDN Primary Rate Access is available, private network users will see callers' names and telephone number displayed on the Macintosh screen via Meridian TeleCenter. This is also the case for incoming public network calls originated from ISDN Basic Rate-terminated stations.

Approximate Cost \$200

Supplier: Northern Telecom, 2305 Mission College Blvd., Santa Clara, CA 95054, 408-988-5550

Meridian SL-1 Support for the Apple LaserWriter Printer

To enable the Macintosh to print to an Apple LaserWriter through the Meridian SL-1 at distances of up to 8,000 feet, an asynchronous LaserWriter driver is needed. This driver is installed in the System folder of each Macintosh in addition to the standard LaserWriter driver, by using the Apple Installer program supplied with the Macintosh. The printer is then selected from within the Chooser like any other peripheral device. Print commands are executed in the same manner as one would print to a LaserWriter from within a LAN. The Apple LaserWriter printer is connected asynchronously to the Meridian SL-1 through a wall jack by using a DB9-to-RJ11 cable to a port on a QPC430 line card. The Macintosh that prints to this LaserWriter can be located anywhere there is a Meridian SL-1 (local site or from remote sites), where Meridian SL-1s are interconnected via Northern Telecom's ESN—Electronic Switched Network.

Approximate Cost \$301 to \$380

Supplier: Northern Telecom, 2305 Mission College Blvd., Santa Clara, CA 95054, 408-988-5550

Meridian LANSTAR Local Area Network for AppleTalk

Meridian LANSTAR is a network topology and transport system that is compatible with all the leading operating system standards, such as NetWare from Novell, Inc., Banyan VINES, and Apple Computer's AppleTalk. Different network interface cards are available for a range of servers or desktop computers, including Macintosh, IBM PC, PC/AT and compatibles, and PS/2 computers. Additional components, such as transceivers, are not needed; everything is self-contained on the card.

LANSTAR AppleTalk implements the AppleTalk Phase 1 and/or Phase 2 protocols on Northern Telecom's high-speed, twisted-pair network. Based on Northern Telecom's Meridian LANSTAR Hub, 40 Mbps bandwidth is available for as many as 1344 personal computers attached to the network, with a dedicated bandwidth to each desktop of 2.56 Mbps. The network layout is similar to that of a PBX:

Solutions

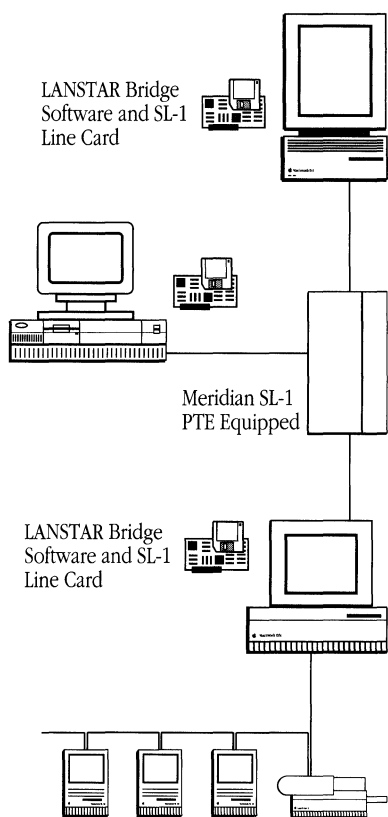

LANSTAR AppleTalk supports up to 2000 feet of twisted pair cabling to each node on the LANSTAR network at speeds up to 2.56 Mbps.

telephone-grade twisted-pair wiring in a star configuration. Connections can be made up to 2000 feet away from the hub, for a network span of 4000 feet. A LANSTAR NuBus Interface Card is inserted into a Macintosh II or a MacSCSI unit connects non-NuBus Macintosh computers to the LANSTAR Hub. LANSTAR AppleTalk Bridge software allows devices using AppleTalk Personal Network-type cabling to be attached to the network, "behind" Macintosh II nodes in the LANSTAR network. The LANSTAR FDDI Bridge from Northern Telecom allows multiple LANSTAR 40 Mbps transport hubs to be interconnected with a 100 Mbps fiber optic ring. High-speed data transmission is provided for resource sharing and communications among users on separate LANSTAR networks. Configured as a dual, counter-rotating fiber ring, the product is based on the Token Ring Medium Access protocol of the X3T9.5 ANSI standard, allowing multiple FDDI products to utilize the same fiber ring.

Price per node and per system varies, depending upon overall size, software used, and equipment used in the network.

Supplier: Northern Telecom, 2305 Mission College Blvd., Santa Clara, CA 95054, 408-988-5550

**Telephone Company Central Office Equipment:
Northern Telecom DMS Family**

The Meridian Data Services name is also used for circuit-switched data transmission on Northern Telecom's DMS-100 central office switches. Meridian Data Services via the Central Office provides full-duplex synchronous data transmission at speeds of 1.2 to 64 Kbps and asynchronous data transmission at speeds of 300 bps to 19.2 Kbps. Meridian Data Services can be used to network the Apple Macintosh personal computer to other Macintosh computers; IBM PCs and compatibles; main-frame computers; and shared resources like modem pools and protocol converters. Meridian Data Services is a package of business data communications features, available from the telephone company.

Meridian Data Unit Access

Meridian Data Units provide switched access facilities on the DMS-100 Family central office switches. Meridian Data Units are suitable for desktop use. They provide high-speed digital circuit switched data transmission up to 19.2 Kbps asynchronous and 64 Kbps synchronous, while providing forward error correction for speeds up to 9.6 Kbps. The data units can accommodate a full range of speeds from 300 bps to 64 Kbps. Users can dial through the data unit keypad or Hayes compatible keyboard dialing. The Meridian Data Unit is connected to the Macintosh through an RS-232 interface and to the public network through a standard two wire twisted pair. Rack mounted Data Units are available for locations where multiple connections are needed.

DIALAN Access

DMS Integrated Access Local Area Network (DIALAN) service provides simultaneous voice and data access through the public telephone network, with data speeds up to 19.2 Kbps. DIALAN service combines Northern Telecom's digital technology, Meridian Digital Centrex calling features, and commercially available third-party Integrated Voice-Data Modules (IVDMs) to provide WAN-type service through the public telephone network.

Similar to a modem, an IVDM connects to a Macintosh computer via a standard RS-422/RS-232 cable. Voice service is provided through a telephone jack on the IVDM. Voice and data are combined and simultaneously transmitted by a single twisted pair to the public telephone network. DIALAN service works with many available software communications packages such as SMARTCOM or CROSSTALK.

ISDN Basic Rate Access (BRA) provides the normal interface rate for an end user, having two 64 Kbps (B) channels and one 16 Kbps (D) channel on a single subscriber loop. B channels provide clear data paths for user voice and data. All associated signaling and messaging for the user channels are handled by the corresponding D channels. The D channel provides packet switched data access for the Basic Rate Access multiplexed with existing signaling and messaging data.

Meridian Data Services Internetworking

Digital switches, Public Switched Data Service (PSDS) and Integrated Services Digital Network (ISDN) use digital channels operating at 56 or 64 Kbps. Most data terminal equipment available today operates at rates up to 19.2 Kbps. To ensure data connectivity through the digital network, the T-link Rate Adaption Protocol translates the data terminal transmission into 56/64 Kbps data streams used by digital central office switches and networks. The T-link rate Adaption scheme allows Meridian Data Services equipment to communicate in an integrated fashion, without modem pooling. The T-link rate Adaption technique is supported in a number of vendor products, including the Harris Dracon ISDN Terminal Adapter, DIALAN compatible IVDMs, and Northern Telecom Meridian Data Units.

Approximate Cost: For pricing information and availability of particular services, please contact your local telephone company.

Northern Telecom Support of Macintosh to Other Environments

Macintosh to Mainframe Via DMS-100

A Macintosh is able to interface with an IBM mainframe through a protocol converter using high-speed Meridian Data Services. The protocol converter and

Solutions

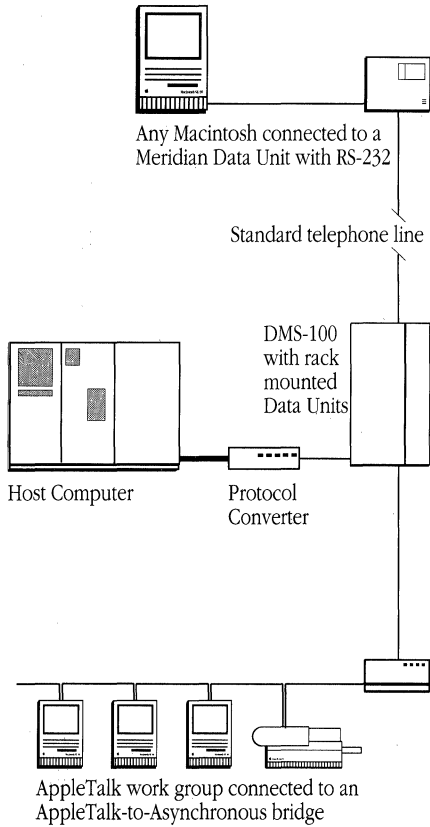

Meridian Data Services provide Macintosh connectivity to other Macintosh computers, mainframe host computers, and modem pools.

associated software on the Macintosh allow for IBM 3278 type 2 emulation on the Macintosh. The protocol converter looks like a 3274 cluster controller to the IBM host. Macintosh-to-mainframe communication can also be done via Mac3270 (Macintosh-based) and Sim3278 (host-based) software from SimWare. In this scenario, no protocol converters are needed.

Northern Telecom to MS-DOS

The Meridian 1 (SL-1 and SL-100) provides a way for an organization to transfer information from the MS-DOS environment to the Macintosh, at distances of up to 8,000 feet. A connect file for MacLinkPlus that enables the user to transfer and convert files between personal computers attached to the Meridian SL-1 is now available from DataViz. An IBM PC or compatible can be connected to the Meridian 1 by using a Personal Computer Interface card.

Approximate Cost\$580

Suppliers: Northern Telecom, 2305 Mission College Blvd., Santa Clara, CA 95054, 408-988-5550
DataViz, Inc., 35 Corporate Dr., Trumbull, CT 06611, 203-268-0030

The Meridian SL-100 provides a way for an organization to transfer information from the MS-DOS environment to the Macintosh, at distances of up to 36,000 feet. An IBM PC or compatible can be connected to the Meridian SL-100 by using a Personal Computer Interface card, Meridian Asynchronous Data Option, or Data Unit.

Approximate Cost\$550

Suppliers: Northern Telecom, 2100 Lakeside Blvd., Richardson, TX 75081, 214-437-8000
DataViz, Inc., 35 Corporate Dr., Trumbull, CT 06611, 203-268-0030

Northern Telecom to IBM Mainframe

Connecting a protocol converter to the Meridian SL-1 or Meridian SL-100 provides access on a dial-up basis, dividing the cost of each port across many users. Each port on the protocol converter is connected to the Meridian SL-1 by an RS-232 Line Card connection, and to the Meridian SL-100 via the Asynchronous Interface Line Unit. Using Macintosh communications software, the network administrator can set up the access sequence so that the user only has to click one button.

Approximate Cost\$847 to \$1783 per port

Suppliers: Northern Telecom, 2305 Mission College Blvd., Santa Clara, CA 95054, 408-988-5550
Perle Systems, Inc., 1980 Springer Dr., Lombard, IL 60148, 312-932-4171
(and other Protocol Converter suppliers)
Northern Telecom, 8200 Lakeside Blvd., Richardson, TX 75080, 214-437-8000

Solutions**Northern Telecom to Digital Equipment Corporation (DEC)**

Digital's computers can be directly linked to the Meridian 1 (SL-1 and SL-100 series systems) through asynchronous ports attached to line cards on the telephone system providing dial-up access to the host from any attached Macintosh computer. The access sequence can be automated using Macintosh communications software. This allows ports on the Digital computer to be shared—at speeds up to 64 Kbps—by many users attached to the Meridian 1. By connecting to a terminal server, the Macintosh computer user has connectivity to any of the resources on DECnet.

Approximate Cost \$350 to \$1200 per port

Suppliers: Meridian SL-1 - Northern Telecom, 2305 Mission College Blvd., Santa Clara, CA 95054, 408-988-5550

Meridian SL-100 - Northern Telecom, 8200 Lakeside Blvd., Richardson, TX 75080, 214-437-8000

Northern Telecom—AppleTalk LAN Applications**Hayes Interbridge**

The Meridian 1 can be used to build large AppleTalk networks. Using the Hayes Interbridge along with the Meridian SL-1, every network that can be reached by the Meridian 1 can be linked. Macintosh applications such as InBox can provide mail service to all users, while file servers and LaserWriter printers can be shared by everyone on the network. Each Interbridge can support the connection of two adjacent AppleTalk networks to the Meridian through an Asynchronous/ Synchronous Interface Module and associated line card port.

Approximate Cost \$1686

Suppliers: Hayes Microcomputer Products, Inc., P.O. Box 105203, Atlanta, GA 30348, 404-449-8791
Northern Telecom, 2305 Mission College Blvd., Santa Clara, CA 95054, 408-988-5550

Net Access

Frequently, users need access to a file that resides on a file server in another end of the building, or even in another part of the country. Apple and Northern Telecom provide a solution through the Meridian SL-1 and Meridian SL-100 PBXs. Using a Solana communications server, Macintosh users can select, and work as a part of, a remote AppleTalk network. Transparent to the user, this connection is made through the Meridian SL-1 or Meridian SL-100 at speeds of up to 64 Kbps, and at distances of up to 8000 feet (Meridian SL-1) or up to 36,000 feet (Meridian SL-100). When the link is made, the remote Macintosh has all the rights of a local one—access to LaserWriter printers, file servers, electronic mail. For off-site communications, performance will decrease noticeably if modems with a capacity of less than 9600 baud are used. Security is provided by a password check at the Solana communications server.

Solutions

Macintosh to AppleTalk Resources Via DMS-100

With high-speed Meridian Data Services, users can dial into a remote AppleTalk network and act as a node on the LAN. A Macintosh computer in a remote location can access resources such as file servers or printers as though they were physically connected to the LAN, at up to 64 Kbps. Two LocalTalk networks can be bridged together with high-speed Meridian Data Services. Users can access each other's resources such as file servers or printers, as though they were physically connected to the LAN, at up to 64 Kbps.

Approximate Cost\$937

Suppliers: Solana Electronics, 7887 Dunbrook Rd., Suite A, San Diego, CA 92126, 619-566-1701
Northern Telecom (Meridian SL-1), 2305 Mission College Blvd., Santa Clara, CA 95054, 408-988-5550
Northern Telecom (Meridian SL-100), 8200 Lakeside Blvd., Richardson, TX 75080, 214-437-8000

MacBLAST for Northern Telecom Environment

MacBLAST communications software handles the communications between Macintosh computers and the Northern Telecom Meridian SL-1. MacBLAST comes with a set of preconfigured terminal types and file transfer modes which permit it to connect to, interoperate with, and transfer files between every major type of computer through the Meridian PBX. MacBLAST uses a compressed, flow controlled, error-controlled protocol in all communications which is compatible with the flow control and packetizing techniques used in the SL-1 and the Meridian DMV PBX controlling computer. This protocol was implemented and tested on the DMV 5 through a joint agreement with Northern Telecom.

Approximate Cost\$195 to \$1295

Supplier: Communications Research Group, 5615 Corporate Blvd., Baton Rouge, LA 70808, 800-24-BLAST

Networking Macintosh to Unisys

AMIE II

AMIE II is a hardware/software package that makes the Macintosh II family plug compatible to a Unisys network by emulating a UTS-20, UTS-30, UTS-40 or SVT-1120 terminal while providing a Macintosh-style interface. A single NuBus card, based on a Motorola 68000 Series microcomputer, supports various methods of connectivity (Sperry T-Mux, synchronous modem, twisted-pair) and handles the communication line protocol to Unisys 1100 and 2200 mainframes. Unisys terminal functions are supported via pull-down and tear-off menus. Up to 31 simultaneous sessions may be viewed. Features include communications line monitoring, on-line

Solutions

help, resizable session windows, programmable macro keys, and multilevel password security. Standard Macintosh functions such as: cut/copy/paste and color capability are supported. AMIE II contains a text file transfer utility and is compatible with Performance Software's MasterLink transfer package.

Approximate Cost\$995

Supplier: Air Land Systems Corp., 2710 Prosperity Ave., Fairfax, VA 22031-4387, 703-573-1100

NetShare 1.0

NetShare is a hardware and software package that integrates Unisys/Convergent workstations into an AppleTalk network of Macintosh computers. The NetShare hardware is an X-Bus compatible module providing connectivity to an AppleTalk network via LocalTalk cabling. The software servers allow the Unisys/Convergent workstation to function as an AFP compliant file server on a Macintosh network. NetShare also provides a Macintosh resident mail gateway to the BTOS electronic mail system and file translation utilities for word processing and spreadsheet documents.

Approximate Cost\$1795 to \$2995

Supplier: Distributed Technologies, Inc., 19823 - 58th Place South, Kent, WA 98032, 206-395-7800

CTCBridge-Mac 3.50

CTCBridge-Mac offers connectivity to both Sperry and Burroughs host systems and supports the Uniscope, the Chi, and Poll/Select protocols. Terminal Emulation is available in both Sperry and Burroughs environments, and features macro editor; data capture; line monitor mode; print spooling; 16 addresses per Macintosh, each with up to 99 pages; addressable background printer support; baud rates up to 38400 BPS; and HyperCard-to-host support. Sperry features include UTS 20, UTS 30, UTS 40, and SVT 1120 emulation; expanded and UTS 400 style field control character support; synchronous and asynchronous connections to Sperry host systems; and MasterLink file transfer support. Burroughs features include Poll/Select and poll contention mode protocol support; TD830, MT983, ET1100 and T27 emulation; asynchronous, synchronous, and TDI host connection support; graphic tab set/save; and Daragal micro filter support. Host file transfer (Burroughs) systems supported include CMS - Small System (B1000 series); V-Series & Medium System (B-2000, B-3000, B-4000); A-Series and large Systems (B-5000, B-6000, B-7000); and CASTS.view file transfer support.

Approximate Cost\$395

Supplier: Core Technology Corporation, 7335 Westshire Dr., Lansing, MI 48917, 517-627-1521

Solutions

CTCBridge-Mac Gateway 1.01

CTCBridge-Mac Gateway offers connectivity to both Sperry and Burroughs host systems, and supports the Uniscope, the Chi and Poll/Select protocols. Gateway features include the same terminal features as CTC1003 CTCBridge-Mac 3.50; support for the AppleTalk protocol including both LocalTalk and EtherTalk hardware platforms; non-dedicated gateway running in the background under MultiFinder or as the concurrent application on an AppleShare file server; Gateway activity viewed on a per gateway or per session basis; up to 100 sessions per gateway; baud rates up to 38400 BPS; line monitor mode; auto dial; and TTY emulation.

Approximate Cost\$895

Supplier: Core Technology Corporation, 7335 Westshire Dr., Lansing, MI 48917, 517-627-1521

Network Bridges And Gateways

R-Server™

R-Server extends a network to remote locations. Network data is transformed so that it can be sent via modem, over ordinary dial-up telephone lines. Any modem of any speed up to 57.6K baud can be used; operation over telephone lines is limited by the speed of the modems. Direct connections can be made through the PBX such as SL-1. Modem pools can be used. R-Server can be operated in two modes: Remote User, which allows single-user access to the network; or Bridge, which links two networks via modems and two R-Servers. Security is provided by an encrypted password check at the Solana communications server; only those who know the password may gain access to the network.

Approximate Cost\$595

Suppliers: Solana Electronics, 4907 Morena Blvd., Suite 1404, San Diego, CA 92117, 619-490-5050

Nodem LIU

The Nodem LIU is a SCSI-to-Ethernet device that allows the Macintosh family of computers to connect to Ethernet networks. It is designed to provide Ethernet connectivity for the slot-limited Macintosh, such as the Macintosh Portable, Macintosh Plus, Macintosh SE or Macintosh SE/30. With the Nodem, users can use the internal slot for accelerator cards, or video cards for larger screens without giving up network connectivity. The Nodem LIU software (called NodemTalk) is compatible with AppleTalk Phase 2. It is also compatible with third-party software such as AlisaTalk/AlisaShare for communicating with DEC VAX/VMS systems, and NCSA Telnet 2.3, MacPathway Access, and TCP Connect for TCP/IP-based hosts. The Nodem LIU comes in four configurations: Nodem-C for thin Ethernet; Nodem-E for thick Ethernet; Nodem-T for Synoptics' Lattisnet and Farallon's Star Controller

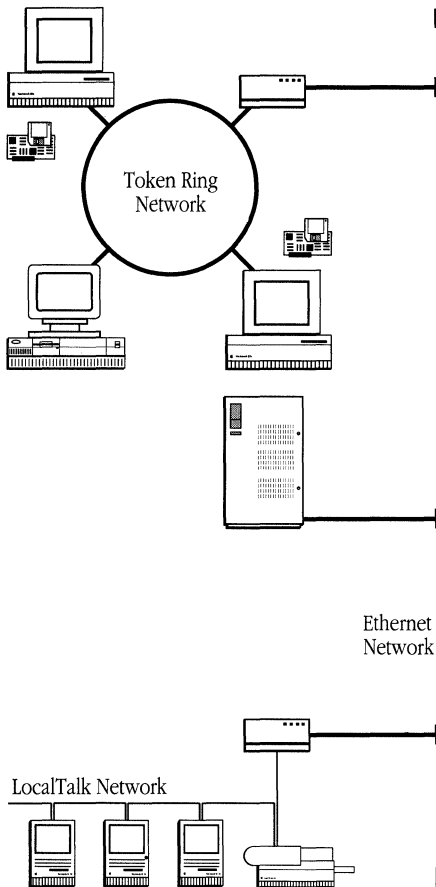

A wide variety of bridges and routers are available to create enterprise-wide internetworks.

EN twisted-pair Ethernet; and Nodem-10T for 10BaseT Ethernet. It is compatible with any 10BaseT compliant concentrator.

Approximate Cost\$495 to \$595

Supplier: Adaptec, Inc., 691 S. Milpitas Blvd., Milpitas, CA 95035, 408-945-2518

BroadTalk Local Area Network

The BroadTalk LAN is a Macintosh connectivity solution over broadband (CATV) cable. The BroadTalk consists of add-in boards to the Macintosh II family and the Macintosh SE for direct connections to the broadband cable. It also consists of gateways from broadband cable to LocalTalk cable and from broadband cable to Ethernet cable. The BroadTalk LAN operates as an alternative EtherTalk selection in the Control Panel and is transparent to the applications software. The BroadTalk LAN supports AppleTalk, TCP/IP, DECnet, and OSI protocols. The BroadTalk LAN includes an add-in board to the IBM-PC/XT/AT bus for connecting Macintosh computers to Novell's NetWare for the Macintosh.

Approximate Cost\$895 to \$3550

Supplier: Cactus Computer, Inc., 1120 Metrocrest Dr. #103, Carrollton, TX, 214-416-0525

Ether+

Ether+ is an external SCSI to Ethernet adapter box for the Macintosh. All SCSI-equipped Macintosh computers, including the Macintosh Plus, Macintosh SE, and Macintosh II, are supported by Ether+. No expansion slot is required for installation. The Ether+ box provides connections for both standard and thin-wire Ethernet and can be attached to a twisted-pair Ethernet network via third-party adapters. Ether+ is compatible with Apple's EtherTalk network software driver specifications. Software packages supported by Ether+ include TOPS, AppleShare, Novell Macintosh, Telnet, and other Macintosh network packages. Standard Ethernet connections are available for a variety of other computing devices.

Approximate Cost\$495

Supplier: Compatible Systems Corporation, PO Box 17220, Boulder, CO 80301, 303-444-9532

EtherGate

The EtherGate is an Ethernet gateway to LocalTalk networks, shared serial devices, and wide area connections. The hardware consists of a thick Ethernet port and a thin Ethernet port (only one is used at a time) and two LocalTalk/serial ports. These serial ports function independently and can be used to connect serial devices such as printers, plotters, and modems, or to connect LocalTalk networks. If a modem is connected to one of the serial ports it can be shared by Macintosh computers on the network, or it can be used to allow a remote single Macintosh or PC to dial-in and access network resources. In addition, the modem can be used for a wide area

Solutions

connection to any other network that contains another EtherGate or a Shiva NetModem V.32 or Shiva TeleBridge. The EtherGate has 128K of memory and supports the AppleTalk protocols. It has 4 ports: one BNC Ethernet port, one 15-pin AUI Ethernet port, and two 8-pin mini-DIN LocalTalk/serial ports.

Approximate Cost\$2399

Supplier: Shiva Corporation, 155 Second St., Cambridge, MA 02141, 617-864-8500

LattisNet: Ethernet connection over Twisted-Pair and Fiber-Optic Cabling

LattisNet LAN Utility Solutions

LattisNet products incrementally implement connectivity, internetworking and network management solutions for increasingly complex environments. The products are based on SynOptics' Network Utility Architecture, which defines local area networks (LANs) as communications utilities similar to the telephone. LattisNet concentrators reside in a building's wiring closet to provide basic connectivity for Apple Macintosh computers and other host devices. LattisNet Workgroup concentrators implement IEEE 802.3 Ethernet connectivity at 10 megabits per second (MB/s) over unshielded twisted-pair wire configured in an active hierarchical star for small, entry-level networks. LattisNet 1000-series concentrators, which support 10 MB/s Ethernet connectivity over unshielded twisted-pair, shielded twisted-pair and fiber optic cable, offer port densities for larger networks. The 1000-series concentrators also support LattisNet Network Management. System 3000 concentrators simultaneously support IEEE 802.3 Ethernet and 802.5 Token Ring. System 3000 concentrators offers greater port density than 1000-series concentrators and support integrated internetworking and network management capabilities.

Approximate Cost\$160 to \$350

Supplier: SynOptics Communications, Inc., 501 E. Middlefield Rd., Mountain View, CA 94043-4015, 800-PRO-8023

LattisNet System 3000 Ethernet Local Bridge Modules

LattisNet System 3000 networks support integrated internetworking functions via the LattisNet Ethernet local bridge module. The LattisNet local bridge enhances network performance by segmenting over-burdened LANs into more manageable subnetworks or by joining separate LANs to create a single premises-wide system. The LattisNet Ethernet local bridge directs data traffic based on Ethernet addresses assigned to each network device. The bridge, working with the bridge manager software program, has the ability to "learn" the location of each address—information which allows the bridge to know whether to retain a message on that network

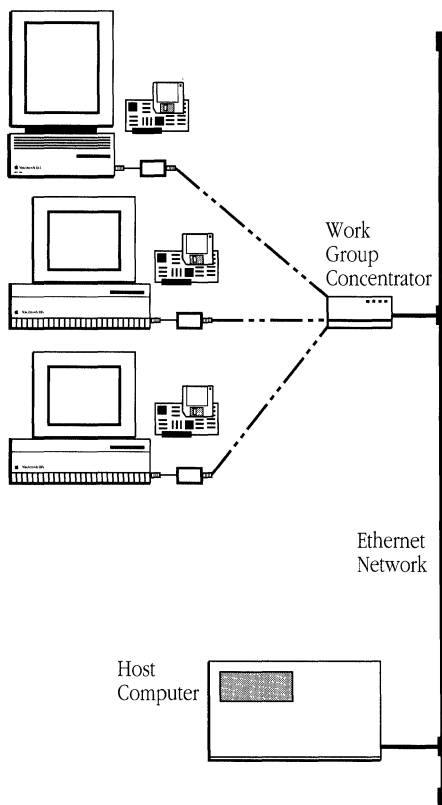

LattisNet supports Ethernet over twisted-pair and fiber-optic cable systems.

Solutions

segment or forward it to the rest of the system. The LattisNet Ethernet local bridge filters data traffic at 10,000 frames per second and forward 7,000 frames per second on a bidirectional basis. LattisNet local bridges also provide redundancy with the IEEE 802.1D-compatible Spanning Tree Algorithm and Protocol, which activates a standby bridge following a primary bridge failure to open an alternate data path.

Approximate Cost \$1995 to \$4595

Supplier: SynOptics Communications, Inc., 501 E. Middlefield Rd., Mountain View, CA 94043-4015, 800-PRO-8023

LattisNet Network Management Modules

LattisNet 1000-series and System 3000 equipment support LattisNet Network Management, a hardware and software system that provides centralized monitoring and control capabilities for a widespread LattisNet network. LattisNet Network Management modules reside in LattisNet concentrators, where they gather specific performance and diagnostic information. This information is forwarded to a central control console, where LattisNet Network Management software displays it as a graphics-oriented map of the network. Boxes, representing concentrators, appear within the hierarchy, and colored bars provide network status information. Data traffic information, diagnostic data and utilization levels are provided in real-time. Data activity and error thresholds, determined by the user, can be set to allow proactive network management. If a threshold is crossed, a user-specified response provides a warning and the graphic user interface guides the user to the offending device. With System 3000 equipment, LattisNet Network Management provides monitoring and control capabilities down to the individual port level. The Expanded View feature reveals a graphic representation of the selected concentrator.

Approximate Cost \$50

Supplier: SynOptics Communications, Inc., 501 E. Middlefield Rd., Mountain View, CA 94043-4015, 800-PRO-8023

SynOptics Coaxial-to-Unshielded Twisted-Pair Products

Some LattisNet unshielded twisted-pair products offer direct connections to existing coaxial cable LANs. SynOptics' thin net adapter provides an interface between unshielded twisted-pair wire and thick or thin coaxial cable segments. The thin net adapter features one unshielded twisted-pair port and one BNC connector to link existing thin Ethernet networks of Digital VAX workstations and other networking devices to unshielded twisted-pair LattisNet networks. The LattisNet thin net adapter can be used in locations where unshielded twisted-pair wire runs are limited or unavailable. The LattisNet attachment unit interface/unshielded twisted-pair (AUI/UTP) workgroup concentrator provides a direct connection between

Solutions

standard or thin coaxial Ethernet networks and unshielded twisted-pair LattisNet networks. The concentrator supports 8 host devices over unshielded twisted-pair wire and offers an AUI port to connect to standard or thin coaxial cable backbones.

Approximate Cost\$725 to \$1495

Supplier: SynOptics Communications, Inc., 501 E. Middlefield Rd., Mountain View, CA 94043-4015, 800-PRO-8023

SynOptics Network Interface Cards

Several network interface cards are available to provide a direct connection from Macintosh computers to unshielded twisted-pair LattisNet networks. The cards reside on the host computer, where an unshielded twisted-pair RJ-45 modular receptacle offers direct access to the building's installed unshielded twisted-pair wiring system. These cards eliminate the need for external transceivers and attachment unit interface (AUI) drop cables because they carry a chip-level version of the SynOptics' unshielded twisted-pair transceiver. SynOptics has completed interoperability testing with several leading adapter card vendors to confirm compatibility between new 10BASE-T adapter cards and LattisNet 10BASE-T products. The 10BASE-T standard, which governs the transmission of 10 MB/s Ethernet over unshielded twisted-pair wire, is currently under consideration for formal adoption by the Institute of Electrical and Electronic Engineers (IEEE). The 10BASE-T adapter cards and the LattisNet 10BASE-T products are all based on Draft 10 of the standard.

Approximate Cost\$645

Supplier: SynOptics Communications, Inc., 501 E. Middlefield Rd., Mountain View, CA 94043-4015, 800-PRO-8023

Fiber Optic Compatible Technology

Du Pont Fiber Optic LAN for AppleTalk

Du Pont's *LAN ONE Plus AppleTalk* products for the AppleTalk networking system allow Macintosh work groups to expand in area, number of users, and distance between stations by extending the reach of the AppleTalk network system cable interconnection through the use of fiber-optic cable. Fiber-optic cabling has a low error rate, insensitivity to EMI/RFI, and dielectric (nonconductive) immunity from lightning and ground-plane faults that can extend the AppleTalk network system beyond its previous limits. Fiber-optic cable does not radiate the signals it is carrying. Du Pont *LAN ONE Plus AppleTalk* networks can be configured in several ways: as a linear bus (like the AppleTalk network system), as a star topology, or as a combination of both.

Key components of the system are the fiber-optic AppleTalk converter (AFC) and fiber-optic AppleTalk Extender (AFE) units, a modular concentrator and fiber-optic

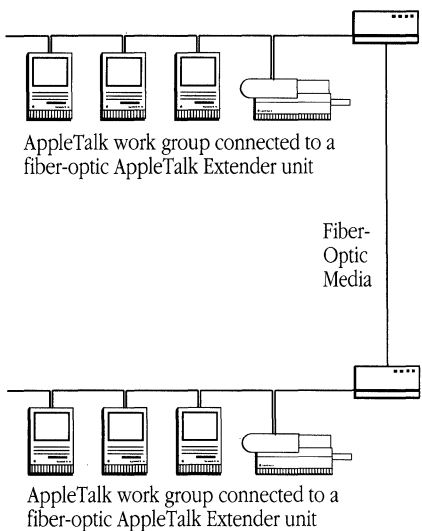

DuPont's LAN ONE Plus AppleTalk products allow expansion in distances and numbers of users.

Solutions

AppleTalk Dual-port Modules, and the optical fiber media. One converter unit is required for each AppleTalk station connected to a fiber optic LAN system. To extend copper twisted-pair networks, one fiber-optic extender is required at the end of each copper network. In a star-based system, AppleTalk Dual-Port Modules (ADM) may be plugged into a *LAN ONE* Universal Concentrator to establish a physical star/logical bus topology. Each ADM accommodates two optical ports allowing a maximum of 34 attachments at a single concentrator. Each optical port may be attached to either an AppleTalk Fiber Extender (AFE) connecting to a copper LocalTalk network, or an AppleTalk Fiber Converter (AFC) attached directly to a Macintosh. Additional concentrators can be cascaded using fiber-optic cables. AFE and AFC units can be used in pairs for point-to-point links. Du Pont offers its *LAN ONE Plus AppleTalk* products with 62.5/125 micron (μm) fiber, allowing a 400 MHz bandwidth over which voice, data, and video can be transmitted.

Approximate Cost\$230 to \$285

Supplier: Du Pont Connector Systems, 3300 Gateway Center Blvd., Morrisville, NC 27560, 800-888-LAN-1

LAN ONE Plus Ethernet

DuPont's *LAN ONE Plus Ethernet* products are comprised of concentrators, media connectivity modules and media access units (MAUs); *LAN ONE Plus Ethernet* multimedia Ethernet systems support multiple types of media and multiple types of networks within the same LAN hardware base. *LAN ONE Plus Ethernet* Multimedia Ethernet System Components are Universal Concentrator or Multiport Repeater Chassis, Concentrator Power Supply, Dual-Redundant Power Supply Assembly (optional), Collision Detection Module, Multiport Repeater Modules, Ethernet 10BaseT Module, Ethernet Fiber Optic Dual-Port Module, Ethernet Coax Module, Ethernet Attachment Unit Interface (AUI) Module, Ethernet Local Bridge Module with Management.

Approximate Cost\$188

Supplier: Du Pont Connector Systems, 3300 Gateway Center Blvd., Morrisville, NC 27560, 800-888-LAN-1

Du Pont 10BaseT Networking System

The Du Pont *LAN ONE Plus Ethernet* 10BaseT Networking System provides direct interconnecting between Ethernet stations via unshielded twisted-pair, IBM 150 ohm shielded twisted pair (Types 1 and 2), fiber-optic, and coaxial cable. The 10BaseT Networking System consists of an Ethernet or Universal concentrator, the hub for the system, and modules that allow users to tailor the system. A selection of multiport repeater modules, media connectivity modules that may be added to the system incrementally, and the media access units (MAUs) needed to connect the hub to devices or other network segments. When configured as a 100% twisted-

Solutions

pair system, the 10BaseT Networking system can interconnect as many as 60 Ethernet nodes or segments. Additional connections may be made directly to computing devices, fiber-optic backbones, inter-repeater links, or to coax segments. 10BaseT Networking System components include Universal Concentrator or Multiport Repeater Chassis, Concentrator Power Supply, and Dual-Redundant Power Supply Assembly (optional), Multiport Repeater Modules, Ethernet 10BaseT Module, and Transceivers.

Approximate Cost\$188

Supplier: Du Pont Connector Systems, 3300 Gateway Center Blvd., Morrisville, NC 27560, 800-888-LAN-1

Du Pont 10BaseT Transceiver

The Du Pont *LAN ONE* 10BaseT Transceiver (Model ETT-001) provides users with the ability to interconnect data terminal equipment (DTE) using standard Ethernet adapter card to unshielded twisted-pair cabling. Conforms with 10BaseT specifications. Du Pont's ETT-001 is small enough (2.5"W x 3.8"L x .9"H) that it may be attached via the AUI connection on an Ethernet adapter card; it may also be connected with a standard AUI cable. The ETT-001 provides LEDs with information on the status of the network, including power, polarity pass (indicating that all connections on the ETT's link are good), transmit, receive, and collision detection.

Approximate Cost\$159

Supplier: Du Pont Connector Systems, 3300 Gateway Center Blvd., Morrisville, NC 27560, 800-888-LAN-1

Du Pont Fiber Optic Inter-Repeater Link (FOIRL) Transceivers

The Du Pont *LAN ONE* Fiber Optic Inter-Repeater Link (FOIRL) Transceivers are used for implementing a fiber-optic Ethernet system. Using fiber-optic cable, users can construct point-to-point links between remote stations, multiport transceivers, repeaters, or bridges. The FOIRL transceivers were designed for environments subject to lightning, EMI and radio interference, and security considerations. Two versions of Ethernet optical transceivers are available for applications depending on loss budget requirements. Generally loss budget is related to link length. Model EOT-322 is conformant with IEEE 802.3 FOIRL specifications and is used on links which are typically less than 2.5 km with any of the common multimode fibers. The high power transceiver, Model IRL-222H, is compatible with the IEEE 802.3 standard at the AUI interface, and is for use with either 50/125 or 62.5/125 fiber on links greater than 1.5 km. This optical transceiver has sufficient gain to extend Ethernets to 4.5 km, when bridges or buffered repeaters are used.

Approximate Cost\$550 to \$860

Supplier: Du Pont Connector Systems, 3300 Gateway Center Blvd., Morrisville, NC 27560, 800-888-LAN-1

Du Pont Local and Remote Repeaters

The Du Pont *LAN ONE* RL6000Li Ethernet Local Repeater and RL6000Fi Ethernet Remote Repeater provide interconnection of IEEE 802.3/Ethernet Version 2.0 local area network segments. The RL6000Li uses two Ethernet Attachment Unit Interface (AUI) cables up to 50 meters in length to interconnect coax, twisted pair, or fiber-optic network segments. The RL6000Fi can be used to replace separate local repeaters and optical transceivers in Fiber Optic Inter-Repeater Link (FOIRL) applications by connecting to the fiber-optic media through an on-board optical transceiver. An Ethernet network may be expanded up to an overall 2.8 km by connecting up to three coaxial cable segments and two fiber-optic segments with a series of four RL6000Li or RL6000Fi Repeaters. *LAN ONE* repeaters feature front-panel diagnostic lights to indicate the presence of Ethernet packets or collisions. Additional diagnostic LEDs indicate if the repeaters have sensed an excessive number of collisions and have automatically segmented that portion of the Ethernet network causing the problem. Both the RL6000Li and the RL6000Fi also provide a manual segmentation function which stops data transmission between network segments. The RL6000Li Local Repeater and RL6000Fi Remote Repeater may be installed either as stand-alone units, or rack-mounted.

Approximate Cost \$795 to \$1495

Supplier: Du Pont Connector Systems, 3300 Gateway Center Blvd., Morrisville, NC 27560, 800-888-LAN-1

Du Pont Ethernet Local Bridge Module with Management

Du Pont's manageable Ethernet Local Bridge Module (Model ELB-001) adds bridge functions to a LAN ONE Universal Concentrator or Multiport Repeater Chassis. Du Pont's manageable bridge is a complete hardware and software solution for controlling Ethernet subnetworks and is configurable by plugging the ELB-001 Bridge Module into a *LAN ONE* Concentrator and installing bridge management software on the PC/386 hardware platform of the user's choice. The *LAN ONE* Ethernet Local Bridge uses the Spanning Tree Protocol to interconnect Ethernet segments and partition them into separate subnetworks, which confines failures to a single subsegment and subnetworks. The bridge automatically learns the location of different devices on the network, and provides custom filtering, blocking and passing capabilities for access security and node grouping. Statistics such as key networks may be monitored and controlled from any point on the network with a graphics interface through which subnetworks and nodes are displayed as colored icons that may be manipulated using a mouse.

Approximate Cost \$4995

Supplier: Du Pont Connector Systems, 3300 Gateway Center Blvd., Morrisville, NC 27560, 800-888-LAN-1

Solutions

Du Pont RL3000 Coax Transceiver

The Du Pont *LAN ONE* RL3000 Ethernet Coax Transceiver provides users with access from data terminal equipment (DTE) to Ethernet local area networks for transmitting and receiving data packets. It is compatible with IEEE 802.3 and Ethernet Version 2.0 specifications, allowing Carrier Sense Multiple Access with Collision Detection (CSMA/CD) network operation at a full 10 MB/s. The RL3000 may be used in all standard coax Ethernet environments. It is available with stinger or N-type connectors for attachment to 10Base5 "thick" Ethernet coaxial cable, or with two types of BNC connectors for 10Base2, "thin" Ethernet applications. The RL3000 will also assist users in network diagnosis and monitoring through LED indicators which provide information on whether the transceiver is powered, transmitting data, receiving data, or detecting collisions on the network. The RL3000 also has a Signal Quality Error (SQE) Test or "heartbeat" function which is user-selectable to meet the requirements of specific user devices.

Approximate Cost \$199

Supplier: Du Pont Connector Systems, 3300 Gateway Center Blvd., Morrisville, NC 27560, 800-888-LAN-1

Du Pont Portable Ethernet Transceiver Tester (PETT)

Du Pont's Portable Ethernet Transceiver Tester (PETT) is an Ethernet LAN installation tester and troubleshooting tool. It has the flexibility to be used with coaxial cable, twisted-pair, and fiber-optic media and transmission equipment. The PETT will assist users in verifying conformance to Ethernet/IEEE 802.3 specifications, as well as measure transmission performance parameters. The PETT can be attached to a terminal or even a portable PC for additional diagnostic information concerning each test. Test equipment may also be attached to Du Pont's PETT for monitoring Ethernet AUI signals.

Approximate Cost \$3500

Supplier: Du Pont Connector Systems, 3300 Gateway Center Blvd., Morrisville, NC 27560, 800-888-LAN-1

Du Pont Token Ring Media System

The Token Ring Media System provides interconnection of Token Ring (IEEE 802.5) and IBM-compatible stations (DTE) or Multi-Station Access Units (MSAUs) using fiber-optic cable. The system consists of a Universal Concentrator which interconnects as many as 34 DTE or MSAUs through Token Ring Transceivers (TRT's) in a single star/branching tree topology. These concentrators may be easily interconnected, permitting higher node count systems. Space requirements will be reduced by utilizing the multinetwork capabilities that allow both Ethernet and token ring systems to coexist in the same unit. Token ring networks can be ex-

panded by using the Token Ring Media System over a large area. The distance between TRT's and the Universal Concentrator can extend as much as 2.5 km, which is in effect 5 km between token ring lobes. Du Pont's *LAN ONE* Token Ring Media System is designed to support data rates up to 16 MB/s.

Approximate Cost \$420

Supplier: Du Pont Connector Systems, 3300 Gateway Center Blvd., Morrisville, NC 27560, 800-888-LAN-1

Du Pont Token Ring Transceiver

The Du Pont *LAN ONE* Token Ring Transceiver (TRT) allows users to connect IBM and IEEE 802.5 compatible token ring networks with fiber-optic technology. TRTs can be directly attached to token ring stations. The Du Pont TRT can accommodate distances of up to 2.5 km. Because the transceivers do not retime incoming signals, the data rate is not fixed. Operation at either 4 MB/s or 16 MB/s is possible. TRTs may be configured for attachment directly to token ring stations (DTE) including bridges, to the lobe ports of an MSAU, or to the MSAU Ring In (RI) or Ring Out (RO) ports.

Approximate Cost \$850

Supplier: Du Pont Connector Systems, 3300 Gateway Center Blvd., Morrisville, NC 27560, 800-888-LAN-1

Modem Related Products

Apple Data Modem 2400

The Apple Data Modem 2400 is a cost-effective solution for desktop communications that enables communication with other personal computers, minicomputers, and mainframes over the public telephone network. An error-correcting protocol, Microm Networking Protocol (MNP) Classes 1-4, is incorporated into the modem to ensure reliable communications over noisy or low-quality telephone lines. The Apple Data Modem 2400 can be connected to the entire Apple II and Macintosh families of computers. In addition, the Apple Data Modem 2400 provides an expansion port for the connection of an additional serial device (such as a printer).

Approximate Cost \$499

Supplier: Apple Computer Inc., 20525 Mariani Ave., Cupertino, CA 95014, 408-996-1010

Apple Personal Modem

The Apple Personal Modem is a compact, 300/1200-baud modem that provides a cost-effective data communications solution for any Apple personal computer system. Features include: automatic answer, dial and redial; the ability to work with either tone-generating or pulsed telephone systems; the ability to send visual status

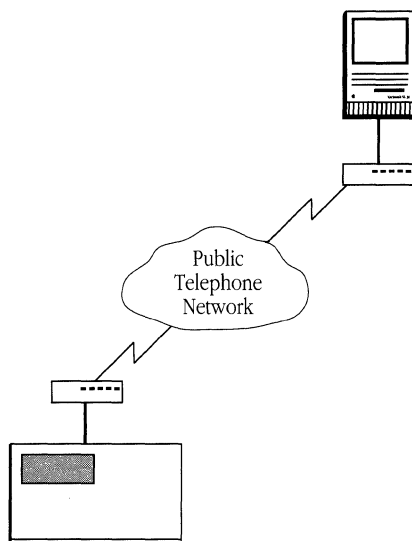

Point-to-point communications over the public telephone network are cost-effective using modem technology.

Solutions

messages, such as “Busy” and “No Dial Tone” to the computer’s screen; working with communications software, like MacTerminal® and other Hayes-compatible programs; and plugs into a wall socket or power strip.

Approximate Cost\$399

Supplier: Apple Computer Inc., 20525 Mariani Ave., Cupertino, CA 95014, 408-996-1010

SupraModem 2400 Line

The SupraModem 2400 line of modems work with MultiFinder, and supports these U.S. and international protocols: Bell 103/212A and CCITT V.21, V.22, V.22bis. They all feature Hayes compatibility; 300-1200-2400 bps operation; AutoAnswer/AutoDial (tone or pulse); a programmable, nonvolatile memory; status LEDs; and an adjustable volume speaker. The SupraModem 2400 and the MacPac work with all 512K and greater Macintosh models and all other RS-232 computers. The SupraModem Plus works with Macintosh Plus and greater Macintosh models and all other RS-232 computers.

The SupraModem 2400 Plus features MNP levels 2-5 and CCITT V.42bis error correction; and data compression protocols, which allow up to 9600 bps throughput when used with modems that have the same protocols. One cable connects the modem to a standard phone jack (RJ-11 type).

The SupraModem 2400 MacPac includes MicroPhone 1.5 telecommunication software, SupraModem 2400, Macintosh cable, and software and on-line time for the Macintosh specific American Online service. MicroPhone 1.5 features a scripting language; a capture buffer and text editor; DEC VT52, BT100/102, and TTY terminal emulation; and XMODEM and YMODEM file transfer protocols with support for MacBinary. One cable connects the modem’s RS-232 port to the Macintosh modem port, and a phone cable connects the modem to a standard phone jack. The SupraModem 2400 uses one phone cable to connect the modem to a standard phone jack (RJ-11) type.

Approximate Cost\$150 to \$230

Supplier: Supra Corporation, 1133 Commercial Wy., Albany, OR 97321, 800-727-8772

Hayes Modems

Hayes InterBridge expands an AppleTalk work group in a local environment by reorganizing network traffic flow among work groups, or connecting a remote work group with a local network. InterBridge can support one local bridge and two remote bridges simultaneously. Remote bridge operation allows two networks, each equipped with an InterBridge and a modem, to connect across either dial-up or leased lines at speeds of up to 19,200 bps.

The HayesConnect Server allows any Macintosh system to operate as a non-dedicated serial server allowing other users to access shared devices including modems, printers, and plotters. The software package uses the AppleTalk Data Stream Protocol (ADSP) to link served devices and workstations over LocalTalk or EtherTalk networks.

SMARTCOM II (Version 3.1) communications software is designed to take advantage of all the features of Hayes modem products. SMARTCOM II for the Macintosh incorporates features such as storing phone numbers and frequently used commands as well as capturing files to disk or printer.

Personal Modem 2400 Plus is an asynchronous dial-up computer communications system. It supports 300, 1200 or 2400 bps communications. The modem plugs directly into a standard U.S. electrical outlet and includes permanently attached cables for connection to Macintosh computers and phone lines.

Smartmodem 2400 is an external modem that supports CCITT V.22bis and V.22, as well as industry standards 103 and 212A for 300, 1200, and 2400 communications. Smartmodem 2400M provides high-speed data transfer with the convenience of an internal modem. The modem includes HayesConnect and HayesConnect Server, with ADSP (Apple Data Streaming Protocol) to support modem sharing on AppleTalk networks.

The V-series System Products support error control and data compression. CCITT V.42 compliance provides modem error-control through LAPM and the alternative protocol in Annex A for backward compatibility with MNP 2-4 modems. The support of CCITT V.42 bis data compression provides 4 to 1 compression — giving V-series Smartmodem 2400 an effective throughput of 9600 bps; and V-series Smartmodem 9600 up to 19.2 Kbps. It also supports CCITT X.32 (Dial X.25) through the PAD. V-series ULTRA Smartmodem 9600 (ULTRA 96) is an external modem that is compliant with CCITT V.32 and provides high-speed full-duplex 9600 bps dial-up communications. With the support of CCITT V.42 bis, ULTRA 96 gives data throughput up to 38.4 Kbps, and provides compatibility with the installed base of V-series

Smartmodem 9600 is a CCITT V.32 compatible modem for data communications network applications. The modem is designed for mainframe and local area network environments requiring high-speed, full duplex communications for transferring large volumes of data from host to host, between data processing centers and remote controllers, and from local area networks to hosts.

Approximate Price \$79 to \$799

Supplier: Hayes Microcomputer Products, P.O. Box 105203, Atlanta, GA 30348, 404-449-8791

Solutions

ProModem Product Line

The ProModem product line includes modems with throughput speeds from 300 bps to 19,200 bps, with both internal and external versions available. Versions specifically for the Macintosh SE, II, and Portable are available. All 2400 models are compatible with CCITT V.22bis/V.22 and Bell 212A/103 protocols for communications at 2400, 1200 or 300 bps. Several models use MNP-5 for automatic error correction and data compression to increase throughput.

MACKNOWLEDGE communications software is included with all versions. Individual models include additional software and "hardware-handshaking" Macintosh cables where required. Several models include Mirror II software for use on any computer system with a RS-232 compatible serial port.

Several models include send-and-receive fax capabilities compatible with any Group III fax machine or fax board.

Approximate Cost \$239 to \$995

Supplier: Prometheus Products, Inc., 7225 SW Bonita Rd., Tigard, OR 97223, 800-477-3473

FlexFAX

FlexFAX is a 9600 bps facsimile modem and 2400 bps data modem designed for the office environment. FlexFAX can be used as a personal Fax/Comm modem or shared amongst office teammates over a local network. FlexFAX is AppleFAX compatible, operates in any Macintosh environment, comes with BackFAX and cable, and is compatible with Faxgate. FlexFAX has a pass-through port, rack mounting capability, proprietary high-speed data mode (8200 bps), and was designed to reduce transmission time.

Approximate Cost \$895

Supplier: Circuit Research Corporation, 4 Townsend West, Suite 3, Nashua, NH 03063, 603-880-4000

Zap Fax

Zap Fax consists of a 99 year license to use four software modules. The first is a server which requires a 512K with old ROMS or better and Apple's AppleFAX modem or Abaton/Es. The server requires a dedicated Macintosh. The second is a patch to Apple's ImageWriter driver that captures the spooled print file, prompts the user for a phone number and sends the PICT file to the Zap Fax server via AppleTalk. The license for the printer-driver module extends to unlimited users within an organization. The third is called Failed Faxes and it shows the user all the faxes that have failed with the phone number. This runs on the client side and allows users to identify faxes that must be re-sent. The fourth is called Shutdown and it allows users to shut down the fax server. The Zap Fax & Back is a back-

Solutions

ground version of the Zap Fax fax server. It contains the same modules as the original Zap Fax except that the fax server module is two background tasks, leaving the server free to run other applications.

Approximate Cost \$795

Supplier: Sunrise Systems, 705 West Valley Dr., Suite 1, Campbell, CA 95008, 408-377-3753

**MicroPhone II includes
free subscriptions to:**

- CompuServe
- Delphi
- Dow Jones
- GEnie
- OAG

MicroPhone II Version 3.0

MicroPhone II version 3.0 is a general purpose telecommunications program and is used to connect Macintosh computers to mainframes, retrieve information from on-line research services, process electronic mail, send international telexes, and transfer files over telephone lines. MicroPhone II's Watch Me mode can monitor a communications session and write a script. The package includes Dialoger for MicroPhone, an application for designing dialog boxes with pop-up menus, color pictures, icons, and scrolling lists. Users can build customized front ends. Other features include extensibility through XCMDs and XFCNs; a mini BBS script to turn a Macintosh into a host computer for unattended file transfers; European character sets; support for all major file transfer protocols — XMODEM, YMODEM, YMODEM-G, ZMODEM and Kermit; emulation for TTY, VT52, and VT100/102; background file transfers compatible with MultiFinder; and modem drivers.

Approximate Cost \$295

Supplier: Software Ventures Corporation, 2907 Claremont Ave., Berkeley, CA 94705, 415-644-3232

Print Service

PServe 3.0 PostScript Server

PServe is a printer server designed for service bureaus, printers or any user with high-end PostScript devices. The Macintosh user can select via the Chooser up to eight printers, each with multiple queues. Jobs can be queued for later printing or be reprinted on demand. PServe also provides detailed banner pages and slugs (for typesetters), job accounting and other features. LaserPrep and AldusPrep management are provided. LaserWriter printers, typesetters, slide recorders and the ImageWriter are supported. Any version of the LaserWriter driver will work with PServe. PServe is software hosted on a 286 computer with a LocalTalk card from Apple, DayStar or Novell and will also support EtherTalk with a 3Com board. PServe can bridge (not a router) EtherTalk with LocalTalk, allowing EtherTalk-connected Macintosh computers to spool jobs. PServe will send documents via LocalTalk to the PostScript printer. PServe is available as software, and interface boards, or as a complete system.

Approximate Cost \$895 to \$1495

Supplier: CoOperative Printing Solutions, Inc., 5950 Live Oak Pkwy., Suite 175, Norcross GA 30093, 404-840-0810

Solutions

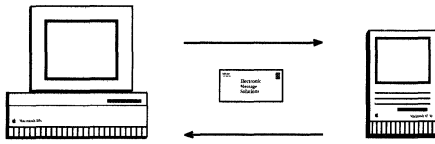

X.400 Electronic Messaging

Worldtalk 400

Worldtalk 400 is an architecture for enterprise-wide messaging based on X.400. Along with the core Worldtalk product, Touch provides seven gateways and the gateway engine based on this architecture. Worldtalk allows preservation of the end-user interface already installed as well as expansion of the communities of mail users that can be reached. LAN mail systems that were once separate can now be connected across the X.400 backbone through the use of Worldtalk 400.

Approximate Cost\$2000 to \$8000

Supplier: Touch Communications, 250 E. Hacienda Ave., Campbell, CA 95008, 408-374-2500

Network Software Tools

MAcKNOWLEDGE

MAcKNOWLEDGE is an icon-based communications software program for the Macintosh. It includes scripts for most major on-line services, and can be activated to log on with the click of an icon. The product includes ProMail script for sending and receiving electronic mail. A phonebook database supplies local access numbers for Tymnet, Telnet, GENie and Compuserve nodes. Features include script timer, learn mode, compatibility with MNP modems, background operation under MultiFinder, automatic testing and configuration of modems; and support for the TAL programming language.

Approximate Cost\$199

Supplier: Prometheus Products, Inc., 7225 SW Bonita Rd., Tigard, OR 97223, 800-477-3473

Backmatic v1.1

Backmatic will back up new or changed files at specified times, including Shut Down. Users can determine where their backups go: floppies, another hard drive, or removable cartridges. The Control Panel can be used to customize Backmatic. Files can be selected by choosing folders to backup or by filtering specific files from the backup. Backmatic makes its backups in Finder readable format. Features provide a distributed backup solution for network servers. Any Macintosh with Backmatic installed can make backups to a folder on a shared volume. Backmatic is compatible with Apple and third-party server software, including VAX, Novell, and UNIX servers. Network administrators can use a password to keep the settings from being tampered with. Backmatic can make unattended backups of AppleShare file servers without shutting down the server software.

Approximate Cost\$100 to \$495

Supplier: Magic Software, Inc., 2206 Franklin St., Bellevue, NE 68005, 402-291-0670

NetMinder Ethernet

NetMinder Ethernet is a software product that allows the user to capture, examine and analyze all types of Ethernet network data. It stores the data captured either in computer memory or in a file on the computer's disk. The user is then able to examine the data captured, either decoded by protocol or in hexadecimal format. The product collects statistics, in both numeric and graphic format, about Ethernet network utilization and data errors. NetMinder Ethernet also allows the user to customize the program to collect types of data based on a dialog-based configuration process. The product is designed to use hardware that exists in the marketplace presently, including the Apple EtherTalk NB card, the Asante Technologies MacCon II/E card, the 3Com EtherLink NB card, and the Kinetics EtherPort IIN card. Context-sensitive help buttons guide the user through the program. Analysis features include Ethernet bandwidth calculations, and protocol and node distributions. NetMinder Ethernet writes files to store Ethernet data and to store user configuration data in a proprietary format.

Approximate Cost\$495

Supplier: Neon Software, Inc., 1009 Oak Hill Rd., Suite 203, Lafayette, CA 94549, 415-283-9771

MacBLAST for Macintosh to BTOS/CTOS Connectivity

MacBLAST communications software interfaces with BLAST for BTOS/CTOS which operates under BTOS/CTOS and UNISYS Ngen/CTIX, running as a systems service in the background, using any asynchronous port. BTOS/CTOS BLAST runs under the context manager and can be operated as a submit facility. It provides file transfer, terminal emulation, and text file format conversion for interfacing the Macintosh with BTOS/CTOS computer systems. MacBLAST transfers binary data, text, or graphics. MacBLAST and BTOS/CTOS BLAST use RS 232 connections, dial-up phone lines, and X.25 networks for asynchronous communications unaffected by phone line noise or propagation delay on satellite links and X.25 networks.

MacBLAST for the Data General Environment

MacBLAST software interfaces with BLAST communications software running under AOS/VS on any DG MV, using any asynch port to transfer files to a Macintosh with BLAST (see MacBLAST). It provides file transfer, and text file format conversion for interfacing the Macintosh with DG AOS/VS systems. MacBLAST transfers binary data, text, or graphics. (Other BLAST products are compatible for DG RDOS and MPOS operating systems.) MacBLAST provides multiple terminal emulators for the Data General environment: TTY, D200, D411, D461, D80, and ADM 3A, plus VT100/220. MacBLAST provides scripts to interface with BLAST on Data General systems to create Wide Area Networks. Other features include: scripting capabilities for unattended operations, on-line help, automatic dialing and access to remote

Solutions

systems. MacBLAST uses standard phone lines and/or X.25 networks to provide reliable high-speed data communications unaffected by phone line noise or propagation delay on satellite-routed calls and X.25 networks.

MacBLAST for the NCR Tower Environment

MacBLAST interfaces with BLAST software for NCR Tower to provide file transfer between a Macintosh and Tower/UNIX. The Tower can dial out to poll multiple Macintosh computers for data collection, electronic mail, etc. It provides high-speed file transfer, and text file format conversion for interfacing the Macintosh with NCR Towers. MacBLAST transfers binary data, text, or graphics. MacBLAST and BLAST products for other computer systems can be used to create intelligent wide area networks between central computers and any number of remote sites. Features include: on-line help, automatic dialing and access to remote systems. BLAST runs over standard telephone lines, X.25 networks, and satellite links with no propagation delays.

Approximate Cost \$195 to \$1595

Supplier: Communications Research Group, 5615 Corporate Blvd., Baton Rouge, LA 70808, 800-24-BLAST

EtherPeek

EtherPeek is a network management tool designed to assist in monitoring and debugging the Ethernet from a Macintosh computer. EtherPeek will capture packet traffic on the network and display or print the packets in a variety of formats. Display and print options include format templates for the AppleTalk and IP protocols. EtherPeek also features the ability to limit the capture to a specific classification of packets as determined by type, physical or logical, source or destination address. EtherPeek will "save" captured packets to a file from which they can later be "restored" for review or comparison. It also allows arbitrary Ethernet packets to be constructed and sent out onto the network. EtherPeek is a software-only product which requires no special hardware other than one of the standard Macintosh Ethernet cards from Apple, Kinetics/Excelan/Novell, 3Com, or Asante.

Approximate Cost \$475

Supplier: The AG Group, Station B, P. O. Box 26728, San Francisco, CA, 94125, 415-937-2447

MacX25: X.25 Connectivity

Packet-switched networks that support CCITT X.25 protocols can be accessed using a combination of Apple software and hardware. MacX25 software links

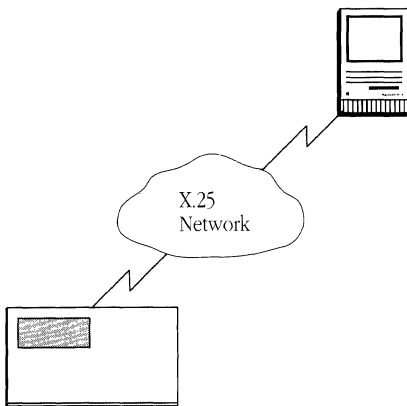

Access to packet-switched X.25 networks is provided using the MacX25 product from Apple Computer.

Macintosh computers to packet-switched data networks (PSDN) supporting CCITT Recommendation X.25. MacX25™ Server allows a Macintosh to be set up as a single entry point to the PSDN. The server distributes access to host computers and end-user services on the PSDN to other Macintosh computers over the AppleTalk network. MacPAD software, included with the MacX25 server, provides Packet Assembler Disassemblers (PADs) connectivity to the PSDN. MacPAD is implemented as a connection tool for the Macintosh Communications Toolbox tool (See the *Network Applications Tools* chapter for the Communications Toolbox description), which allows terminal applications using the toolbox to connect to host systems on the PSDN.

There are two major products that support the X.25 packet-switched network environment:

- **MacX25 Server:** This software connects Macintosh computers to packet-switched networks under MultiFinder, eliminating the need for a dedicated system. The server distributes X.25 access over the AppleTalk network to any Macintosh with MacPAD software installed. MacPAD allows access to the MacX25 server and creates a functionally complete PAD on a Macintosh computer. Using a terminal emulation program that accesses the Communication Toolbox, users can access the MacX25 Server using the MacPAD menu.
- **MacX25 Programming Library:** This is a collection of software routines that offer a high-level program interface; no detailed knowledge of AppleTalk and AppleTalk Data Stream Protocol (ADSP) is required to use the library. Some of the routines included are a packet-level interface using control blocks that provides maximum control, a higher-level logical packet interface to create translated, and formatted X.25 packets.

Approximate Cost Contact Supplier

Supplier: APDA (Apple Programmers and Developers Association), Apple Computer, Inc., 20525 Mariani Ave. MS 33G, Cupertino, CA 95014, 800-282-2732, 800-637-0029 in Canada, 408-562-3910 Internationally

PBX Services

RP244PC Utility

Using the Macintosh “point and click” features, the RP244PC Utility allows the user to program station features into the Rolmphone 244PC, including Autodial (including the number to be dialed), Camp, Conference, Speaker, Pick, and Phonemail. It allows the user to save the configuration and includes a data base dialing program that incorporates a find feature as well as a point-and-click dial feature. The RP244PC Utility allows the user to either import names and numbers from an

Solutions

existing data base or create a data base within the Utility. If provided by the PBX the Utility also provides internal call name display, trunk display, and timing of call. A null modem cable (not included) is used to connect the serial port of a Macintosh computer to a Rolmphone 244PC. This cable also provides a data connection for use with a Macintosh communications program such as MacTerminal®.

Approximate Cost\$495

Supplier: MACROL, INC., 496 Coelho St., Milpitas, CA 95035, 408-945-0346

Datakit II VCS

Datakit II Virtual Circuit Switch provides the foundation for building corporate-wide backbone utility networks. Typical Datakit networks support several types of protocols and are distributed over large geographical distances, usually with redundant data paths. Datakit II VCS nodes use either fiber trunks (in house) or leased facilities (DDS, T1) to connect to one another. Datakit's newest feature provides support for AppleTalk, appearing to Macintosh computers and printers as a router/gateway. A large Datakit II network can support hundreds of LocalTalk and EtherTalk networks, each of which can either communicate to (or NOT to, based on configuration files controlled by the network administrator) all other networks. Other features include TCP/IP connectivity from LocalTalk to Ethernet-based networks, a UNIX-based AFP compatible file server, async dial-in (using Dartmouth's Async AppleTalk DA), and a QuickMail to UNIX System E-mail gateway.

Approximate CostVaries depending upon configuration.

Supplier: AT&T Network Systems, 184 Liberty Corners Rd., Warren, NJ 07938, 201-580-5516

MS-DOS Related Products

Background

MS-DOS (the Microsoft Disk Operating System) has been the de facto standard operating system for the IBM Personal Computer and compatibles. In 1985, Microsoft introduced Windows which added a graphic user interface to DOS in order to make it more “user friendly.” In 1987, Microsoft and IBM introduced OS/2 which was planned to offer a more powerful set of operating system features and a graphical user interface called Presentation Manager.

Microsoft’s introduction of Windows was an attempt to bring uniformity to MS-DOS programs. The processing-intensive, graphics layer added to MS-DOS caused performance to suffer and Windows was widely criticized for being too slow on a standard IBM PC or compatible. More recent versions of Windows have improved performance, especially on 80286- or 80386-based personal computers. Still, it may be sometime before Windows gains widespread acceptance from software developers.

OS/2 represents a break from the MS-DOS world. It provides a number of improvements to DOS, such as expanding the 640K memory limit for applications to 16 megabytes (MB) and providing multitasking. However, OS/2 will operate only on certain 80286- and 80386-based personal computers, while MS-DOS runs on all IBM PC-compatible computers.

Today, developers of applications for IBM compatible computers have many operating systems to support. DOS is still the most widely used operating system, but developers are being encouraged (by Microsoft) to build applications that run under Windows. Furthermore, Microsoft is positioning OS/2 as a development platform for high-end applications that require its more sophisticated feature set and more expensive hardware configurations. IBM, on the other hand, sees OS/2 as the operating system of choice for “programmable workstations” under its OfficeVision and System Application Architecture (SAA).

MS-DOS Networking

Early Developments

As a single-user operating system, MS-DOS was never intended for multi-user applications on a single computer. Nevertheless, many users want to be able to share files and access work-group applications such as databases and accounting

The Environment

programs. To accommodate these needs, Microsoft introduced local area networking (LAN) extensions to MS-DOS, beginning with version 3.1. This version included support for file and record locking and sharing, paving the way for the creation of networked applications.

In the MS-DOS world, networks were slow to catch on prior to the 1985 introduction of IBM's PC Network. This broadband-based system was originally developed by Sytek and licensed to IBM. To control its new network, IBM also announced the PC Network program.

The PC Network included IBM's "network basic input/output system" (NetBIOS) functions on adapter cards. It was able to run on any IBM PC or compatible computer with enough memory to run the PC Network program, except the IBM PC Jr.

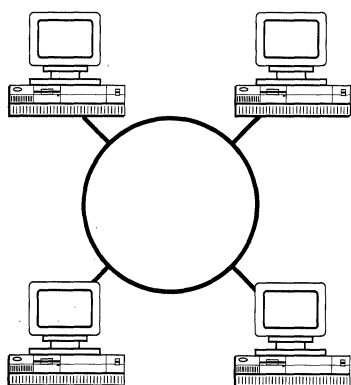

IBM's Token Ring network hardware system is considered by many analysts to be a better networking choice than IBM's broadband PC network offering.

A second hardware system, the IBM Token Ring, was announced in 1985 (though many deliveries were delayed until late 1986 and 1987). The Token Ring is a more powerful and flexible networking scheme than IBM's original broadband network. Its speed (16 MB) doubles the broadband network's bandwidth. The Token Ring is a network system that uses cables and connectors that are part of IBM's Cabling System, first described as a baseband network in 1984. And, at prices comparable to those of the broadband PC network, most analysts consider it a better buy.

Recently, IBM announced a new version of the IBM PC Network that also uses a baseband foundation. With three network offerings now in place, IBM's strategy is to target the new baseband PC Network for the education market. The original broadband system has been relegated to departmental systems. And the Token Ring is considered the backbone, with ties to IBM mainframes and minicomputers such as the IBM System 36.

PC Network applications generally run on all three hardware schemes from IBM. However, incompatibilities do appear from time to time. The Token Ring's NetBIOS, for example, is software (not hardware) based. Software developers who may have bypassed NetBIOS routines under the PC Network to enhance performance may find that their applications are not compatible with the Token Ring.

With the availability of MS-DOS 3.1, NetBIOS, and the PC Network program, network applications began to be developed. Tools such as Microsoft Networks (MS-Net) and Microsoft Redirector also contributed to new software development. Microsoft Redirector uses a presentation protocol called the Server Message Block Protocol (SMB).

The Environment

Some third-party network suppliers, including Novell, have chosen to write their own functional equivalents to these tools.

Recent Developments

With several alternative approaches now available, many vendors are responding with products that are in some ways better than IBM's own hardware and software solutions. Unfortunately, slight differences in how these networks are implemented occasionally result in software incompatibility between networks. A few developers have overcome this by writing slightly different versions of their applications to run on specific networks. Yet this approach causes confusion among dealers and distributors, who may have to stock more than one version of a network application.

Over time, IBM's LU 6.2-based Advanced Program-to-Program Communications protocol (APPC) may overshadow NetBIOS as the dominant interface for peer-to-peer communications. Already, APPC interfaces have been designed for the IBM Token Ring and other networks. When fully implemented in applications, APPC will allow personal computers, minicomputers, and mainframes to share processing resources. Apple Computer offers a developers' tool called MacAPPC that will enable application developers to create Macintosh applications for distributed processing that run in the peer-to-peer communications environment of APPC networks. (For more information on MacAPPC, see the *IBM Hosts* chapter in this Guide).

Few personal-computer-based applications that implement APPC exist today. Most vendors are still using MS-DOS 3.1 functions, NetBIOS, and Microsoft Redirector (or their functional equivalents) for software development.

Microsoft has announced LAN Manager, an enhanced version of MS-Net, to help developers write OS/2 network applications. Several companies (such as 3Com, Ungermann-Bass, and IBM) have licensed LAN Manager and made their own enhancements to this network operating system. Novell has developed software and hardware additions to its NetWare network operating system that will allow developers to build OS/2 network applications that use NetWare on a LAN. OS/2 is of special concern to third-party network suppliers. Questions remain regarding the extent to which their products will be able to communicate with IBM networks.

Today's MS-DOS network leaders include IBM, Novell, 3Com, Sytek, AT&T Information Systems, and Ungermann-Bass. Several of these vendors can provide Token Ring hardware solutions comparable to IBM's offerings, and all of them offer their own brand of networking software. For more information, please see the *Network Environments* chapter in this Guide.

The Environment

Novell's NetWare has become extremely popular, principally because it outperforms IBM's networking software for the IBM Token Ring. Much of NetWare's success can be attributed to its ability to run in the protected mode of the 80286 microprocessor. It does this by bypassing MS-DOS and directly accessing up to 16 MB of main memory. A file server running the more advanced versions of NetWare, therefore, has a performance edge over other operating systems that are tied to MS-DOS and its 640K RAM ceiling.

The Big Picture

IBM clearly has set its course on the Token Ring as the mainstream network of choice and OS/2 as the core for programmable workstations operating systems.

In the 1990s, IBM hopes to achieve compatibility across its product line under a recently unveiled umbrella called Systems Application Architecture (SAA). IBM hopes SAA will provide a common user interface and application portability across many dissimilar systems.

Under SAA, certain applications may someday be able to run on whatever computing power is available—mainframes, minicomputers, and even personal computers. If and when this happens, IBM's original vision of personal computers will have undergone a complete reversal—from stand-alone productivity enhancers to bona fide members of the IBM systems family within a networking environment.

The following section details the wide array of Macintosh solutions available for the MS-DOS environment. The chart introducing the solutions is designed to offer an overview of the wide spectrum of applications and products that support this environment.

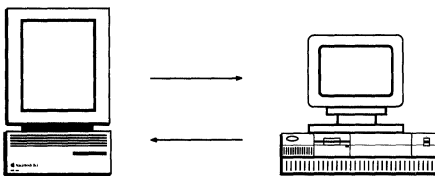

Macintosh/MS-DOS Interoperability: A Range of Options

The chart on the following two pages is designed to offer a snapshot of the range of options available to Macintosh users for connecting to and enhancing the MS-DOS environment.

Although the Macintosh and MS-DOS environments have been widely perceived as two distinct worlds, there is a wide spectrum of products that support compatibility between the two. There are three main approaches to integrating the Macintosh and MS-DOS environments—by means of media compatibility, data compatibility, and application compatibility. The chart illustrates the spectrum of MS-DOS compatibility solutions for each of these approaches. More detailed descriptions of the products listed are given in the Solutions section that follows and in the *Network Environments* chapter of this Guide.

The Environment

Note: *Media Compatibility* refers to the ability to read and write the same floppy disk from two different machines. *Data Compatibility* refers to the ability to move data files between two environments and make the information as usable in the new environment as it was in the source environment. The connection between the two environments could be a serial link between two computers, a pair of modems linked by telephone wires, or a sophisticated network. *Application Compatibility* refers to the ability to run MS-DOS software applications directly on a Macintosh computer. This can be performed by installing a NuBus board or using MS-DOS emulation software.

The Environment

Macintosh/MS-DOS Connectivity:

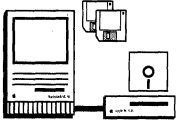
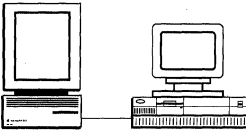
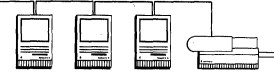
| | Media Compatibility | | Data |
|------------------------------|--------------------------------------------------------------------------------------------------------------------------------------------------------------------------------------------------------------------------------------------------------------------------------------------------------------------------|------------------------------------------------------------------------------------------------------------------------------------------------------------------------------------------------------|------------------------------------------------------------------------------------------------------------------------------------------------------------------------------------------------------------------------|
| |  |  |  |
| Sub Classification | Macintosh with MS-DOS compatible disk drive | RS-232 connection | AppleTalk network |
| Hardware Requirements | <ul style="list-style-type: none"> • External 5.25-inch drive • Internal FDHD 3.5-inch drive | <ul style="list-style-type: none"> • RS-232 cable | <ul style="list-style-type: none"> • LocalTalk PC Card for each MS-DOS computer • LocalTalk connectors and cables for each computer • Dedicated Macintosh computer for some solutions |
| Software Requirements | <ul style="list-style-type: none"> • The products include MS-DOS-to-Macintosh software | <ul style="list-style-type: none"> • File transfer software | <ul style="list-style-type: none"> • File server or mail software |
| Applicable Products | <ul style="list-style-type: none"> • Apple FDHD Internal Drive • Apple FDHD External Drive • Apple PC 5.25 External drive • DaynaFile external drive • DOS Mounter | <ul style="list-style-type: none"> • Apple File Exchange • MacLink<i>Plus</i> • MacBLAST • xFer • XCOM 6.2 • MacBinary | <ul style="list-style-type: none"> • AppleShare and AppleShare PC • SMB File Transfer Utility • TOPS • Microsoft Mail • cc:Mail |
| Application Notes | <ul style="list-style-type: none"> • Minimal setup required • Read/write MS-DOS-formatted diskettes without MS-DOS CPU • Simple solution when stand-alone Macintosh requires MS-DOS data • Macintosh computers and PCs need not be in same location • No LAN required | <ul style="list-style-type: none"> • For low-volume transfer • Most economical solution • No LAN is required • Appropriate for centralized file conversion | <ul style="list-style-type: none"> • Provides for maximum sharing and integration of MS-DOS and Macintosh data • Facilitates real-time information sharing |

A Range of Options

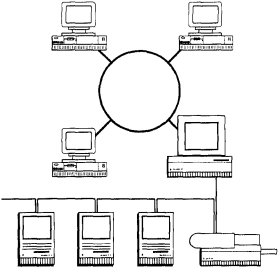
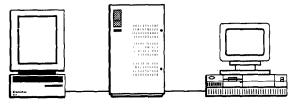
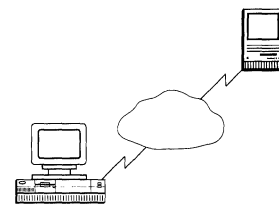
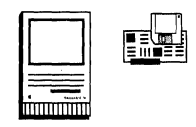
| Compatibility | | | Application Compatibility |
|--------------------------------------------------------------------------------------------------------------------------------------------------------------------------------------------------|--------------------------------------------------------------------------------------------------------------------------------------------------------------------------------------------------------------------------------------------------------------|--------------------------------------------------------------------------------------------------------------------------------------------------------------------------------------|---------------------------------------------------------------------------------------------------------------------------------------------------------------------------------------------------------------------|
|  |  |  |  |
| Internetworking | Via mainframe | Via public electronic-mail network | MS-DOS coprocessor board or MS-DOS emulation software |
| <ul style="list-style-type: none"> • Hardware server • Router • Bridge • Gateway | <ul style="list-style-type: none"> • 3270 interface hardware for IBM • RS-232 or Ethernet for Digital | <ul style="list-style-type: none"> • Modem • Network connection | <ul style="list-style-type: none"> • Coprocessor expansion board |
| <ul style="list-style-type: none"> • Router • Supplied by server manufacturer | <ul style="list-style-type: none"> • Macintosh-PC host file-transfer software | <ul style="list-style-type: none"> • Macintosh-PC electronic mail application • Network software | <ul style="list-style-type: none"> • MS-DOS emulation software |
| <ul style="list-style-type: none"> • DEC LanWORKS for Macintosh • Novell NetWare • Northern Telecom LANSTAR • 3Com 3S/500 and 3+ Open | <ul style="list-style-type: none"> • DEC LanWORKS for Macintosh • TokenTalk NB Card • Apple Coax Twinax Card • Apple 3270 API • MacDFT • IRMA software • MacMainFrame • pcLINK | <ul style="list-style-type: none"> • CompuServe • Dow Jones Desktop <i>Express</i> (for Macintosh) • Lotus <i>Express</i> for MCI Mail (for MS-DOS) | <ul style="list-style-type: none"> • Mac86 • Mac286 • SoftPC |
| <ul style="list-style-type: none"> • Appropriate for integrating Macintosh computers into existing LAN environments • Provides access to NetBIOS and Token Ring networks | <ul style="list-style-type: none"> • Appropriate when Macintosh and MS-DOS users are connected to the same mainframe network • Allows Macintosh and MS-DOS access to files stored on host | <ul style="list-style-type: none"> • Macintosh and MS-DOS users can exchange file anywhere in U.S. with a simple hardware/software configuration | <ul style="list-style-type: none"> • Allows Macintosh to run MS-DOS applications • Appropriate when an MS-DOS application is required • Eliminates need for two separate computers |

MS-DOS Related Products

Hardware Components

The Apple FDHD Drives

The Apple FDHD (floppy disk high density) Internal and External disk drives can exchange information between Macintosh files and MS-DOS, OS/2 and Apple II ProDOS® files. File exchange between non-Macintosh computers can be accomplished by using the Apple File Exchange, included in the Macintosh System Software, or from products provided by third parties such as Dayna Communication's DOS Mounter. The FDHD Drive provides up to 1.4 MB of storage space and can format, read from, and write to Apple 400K, 800K, and 1.4 MB disks. In addition, the FDHD is capable of formatting, reading from, and writing to MS-DOS 720K, 1.44 MB, and compatible 3.5-inch disks.

The FDHD Drive comes standard with every Macintosh computer, except the Macintosh Plus. Owners of Macintosh II and Macintosh SE (prior to 1990) computers who wish to take advantage of the FDHD's capabilities can do so by purchasing the Apple FDHD Internal Drive Upgrade kit.

Approximate Cost \$499 to \$629

Supplier: Apple Computer, Inc., 20525 Mariani Ave., Cupertino, CA 95014, 408-996-1010

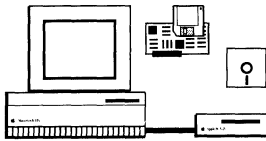

The Apple PC 5.25 Drive lets Macintosh users work with MS-DOS formatted data.

The Apple PC 5.25 Drive with AFE Software

The Apple PC 5.25 Drive is an MS-DOS-compatible disk drive that connects to a Macintosh SE or Macintosh II computer equipped with an appropriate controller card. The PC 5.25 Drive and AFE software give Macintosh II and Macintosh SE computers the ability to read files from and write them to 360K MS-DOS disks.

Apple's AFE software supports batch transfers and translations. A user selects which files to move onto a Macintosh computer disk and starts the process. AFE converts the selected files from MS-DOS-to-Macintosh format and transfers the files to a Macintosh computer disk. Entire disks of MS-DOS data can be transferred between the two operating environments. (For more information on AFE, refer to the *File Translation Tools* section later in this chapter.)

Approximate Cost \$530

Supplier: Apple Computer, Inc., 20525 Mariani Ave., Cupertino, CA 95014, 408-996-1010

Solutions
LocalTalk PC Card

The LocalTalk PC Card connects a PC-compatible computer to an AppleTalk network, allowing the user to print documents on the Apple LaserWriter and LaserWriter II family of laser printers. With additional software, PC-compatible computers equipped with the LocalTalk PC Card can access other network services on the AppleTalk network, including file sharing and electronic messaging.

Approximate Cost, LocalTalk PC/AppleShare PC Bundle \$299

Supplier: Apple Computer, Inc., 20525 Mariani Ave., Cupertino, CA 95014, 408-996-1010

DOS Connect

DOS Connect is a software application that works with the Shiva NetModem V2400, NetModem V.32, NetSerial and EtherGate. DOS Connect allows IBM PCs and compatibles on AppleTalk to share serial peripherals. When used with Shiva's NetModem V2400 or NetModem V.32, DOS Connect allows PCs to share a modem over AppleTalk. When used with Shiva's NetSerial or EtherGate, DOS Connect allows PCs to share a printer, plotter, or other serial peripheral over the network. DOS Connect runs under the DOS operating system and supports the AppleTalk protocols. It requires 512K of memory.

Approximate Cost \$99

Supplier: Shiva Corporation, 155 Second St., Cambridge, MA 02141, 617-864-8500

DaynaFILE

DaynaFILE is an external SCSI floppy disk drive that allows Macintosh computers to read from and write to MS-DOS data disks as easily as if they were Macintosh disks. Available as a single-drive or dual-drive unit, DaynaFILE can accept 5.25-inch or 3.5-inch MS-DOS disks in any format. MS-DOS disks appear as icons on the desktop and their subdirectories and files are shown as Macintosh folders and documents. Extension Mapping lets users set up a "map" or table that links MS-DOS file extensions to Macintosh applications. Opening an MS-DOS file with a Macintosh application then becomes a matter of double-clicking on the file. The 3.5-inch high density (1.44 M) DaynaFILE disk drive can also read and write to high density Macintosh disks formatted in the Apple SuperDrive.

Approximate Cost \$650

Supplier: Dayna Communications, 50 South Main St., Suite 530, Salt Lake City, UT 84144, 801-531-0600

DaynaTALK

DaynaTALK is a family of products for Macintosh and IBM personal computers that increase the 230 Kbps LocalTalk data transmission rate, to a maximum of 850 Kbps

Solutions

on the Macintosh and 1.7 Mbps on IBM PCs, PS/2s and compatibles. The increased transmission rate improves the data carrying capacity of networks that use LocalTalk, PhoneNET and compatible cable systems. This allows more work to be completed on an existing heavily-used network, or more computers to be added without degrading performance.

For Macintosh computers, DaynaTALK consists of driver software and a small box that plugs into the LocalTalk or PhoneNET connector. For IBM-compatibles, DaynaTALK consists of driver software and a full-sized PC or Micro Channel network interface card. As well as communicating at the higher speeds, the DaynaTALK PC and MC cards can be used as standard 230 Kbps LocalTalk cards. DaynaTALK products can be used on the entire network, or selected workstations only. The SpeedGuard Collision Filter ensures transmissions of data on networks that are not entirely equipped with DaynaTALK.

Approximate Cost \$139 to \$399

Supplier: Dayna Communications, 50 South Main St., Suite 530, Salt Lake City, UT 84144, 801-531-0600

DL2000

The DL2000 is a LocalTalk adapter for standard bus IBM-compatible computers. It supports DaynaNET, NetWare and TOPS network operating systems over LocalTalk, PhoneNET or compatible cable systems. The DL200 supports AFP as well as supporting NetWare NCP and IPX protocols. This allows access to all NetWare features, including print spooling and administration, over LocalTalk cables.

Approximate Cost \$299

Supplier: Dayna Communications, 50 South Main St., Suite 530, Salt Lake City, UT 84144, 801-531-0600

DL/2

The DL/2 is a LocalTalk adapter for Micro Channel bus IBM-compatible computers. The DL/2 supports DaynaNET, NetWare and TOPS network operating systems over LocalTalk, PhoneNET or compatible cable systems. As well as supporting AFP, the DL2000 also supports NetWare NCP and IPX protocols. This allows access to all NetWare features, including print spooling and administration, over LocalTalk cables.

Approximate Cost \$399

Supplier: Dayna Communications, 50 South Main St., Suite 530, Salt Lake City, UT 84144, 801-531-0600

Solutions

LT200 LocalTalk Interface Board

The LT200 LocalTalk Interface Board enables IBM PC or PS/2 owners to use LocalTalk printers or access TOPS or AppleShare. The LT200 is a card that fits into the expansion slot of a PC or PS/2. Users can plug directly into the LocalTalk network and have access to LaserWriter printers, Macintosh computers and other devices on the network. The LT200 supports Novell's NetWare, allowing LT200 equipped machines to function as NetWare file servers or workstations. The LT200 is compatible with 3Com 3+Open, AppleShare 2.0 and includes printer utilities that allow PCs to print to PostScript printers.

Approximate Cost\$249 to \$395

Supplier: DayStar Digital, Inc., 5556 Atlanta Hwy., Flowery Branch, GA 30542, 404-967-2077

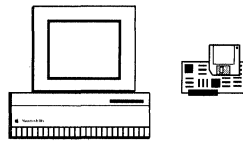

The Mac286 board allows Macintosh users to run most MS-DOS applications on their Macintosh computers.

Mac286

Mac286 is an 8 MHz 80286 coprocessor board for the Macintosh II series that allows the use of most DOS applications in a standard Macintosh window. Mac286 has its own processor and RAM, and provides support for Apple's SuperDrive (FDHD). Any 3.5-inch DOS disk can be used directly from the SuperDrive. Version 3.0 also supports extended memory, allowing up to 4 MB of on-board RAM for MS-DOS applications. This extended memory can be used by EMS (Expanded Memory) utilities. Mac286 supports CGA, MDA, and Hercules display modes, using the Macintosh monitor in all cases. For users without the Macintosh Extended Keyboard, a special menu is available to select and define function keys. There is a driver for emulating the MS-Mouse, and for printing on either the LaserWriter or ImageWriter from the DOS environment. Cutting and pasting of text is supported from either DOS or Macintosh windows, and graphics can be moved from DOS to the Macintosh. Mac286's "drive D" feature allows files to be stored and retrieved from any volume mountable from the Macintosh desktop, including file servers and external hard drives.

Approximate Cost\$1599

Supplier: Orange Micro, Inc., 1400 N. Lakeview Ave., Anaheim, CA 92807, 800-223-8029

Mac86

Mac86 is a 4.77 MHz 8086 coprocessor board for the Macintosh SE (SE/30 not supported). This solution uses the Macintosh RAM for processing, and it is capable of many "multitasking" operations due to its on-board processor. Mac86 requires no accelerator to operate. Mac86 uses peripherals of the Macintosh. The new 3.0 version accesses the new SuperDrive directly, allowing 3.5-inch DOS disks to be used to launch programs. The Macintosh keyboard, mouse and hard drive are used by the Mac86, with features for defining function keys. Cutting and pasting of text is

Solutions

supported from either DOS or Macintosh windows, and graphics can be moved from DOS to Macintosh. A special "drive D" feature allows any available volume, including TOPS and other file servers, to be used for file storage and retrieval.

Approximate Cost\$699

Supplier: Orange Micro, Inc., 1400 N. Lakeview Ave., Anaheim, CA 92807, 800-223-8029

Grappler LX

The Grappler LX is a parallel printer interface capable of connecting most 24-pin and laser printers to any Macintosh with at least 1 MB of RAM. By converting ImageWriter LQ codes into output other printers will understand, the Grappler supports models from Epson, Hewlett-Packard, Panasonic, Star Micronics and other manufacturers. The Grappler is compatible with most applications. The Grappler LX also comes equipped with a spooler, accessible through the control panel. The Grappler comes with seven complete fonts, and is compatible with Adobe ATM.

Approximate Cost\$199

Supplier: Orange Micro, Inc., 1400 N. Lakeview Ave., Anaheim, CA 92807, 800-223-8029

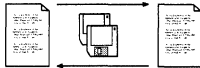

Apple File Exchange software is a modular file-translation utility enhanced by Apple and third-party translators.

File Translation Tools**Apple File Exchange**

Apple File Exchange (AFE) software is an advanced general-purpose file-translation utility that is part of the Macintosh system software package. AFE supports batch processing of conversions and, using individual translators, converts data from Macintosh applications into a format understandable by MS-DOS-compatible applications and vice versa.

Users are not limited by a fixed set of available translators because of the modular nature of AFE. Instead, a rich set of Apple and third-party translators will work with AFE to provide a wide range of file-translation solutions. Users can purchase these translators and install them in AFE in much the same way they install fonts and desk accessories. AFE software is shipped with Apple's DCA Translator, which transforms documents created under IBM's Document Content Architecture into MacWrite files or vice versa.

Approximate CostNo charge

Supplier: Apple Computer, Inc., 20525 Mariani Ave., Cupertino, CA 95014, 408-996-1010

AppleShare and AppleShare PC Version 2.0

The AppleShare file server is currently a dedicated server. This enables it to allow another service to run concurrently on the server processor and to deliver superior

Solutions

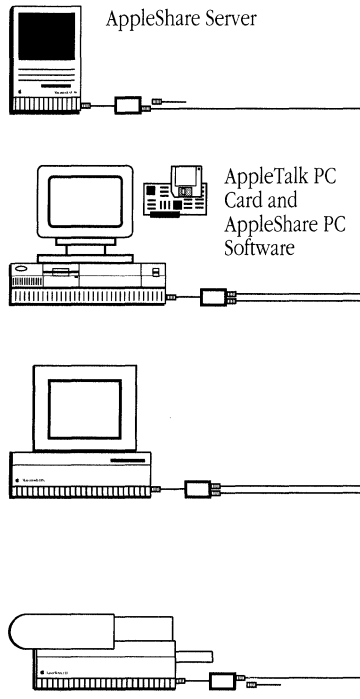

With AppleShare PC, MS-DOS computers can share information with Macintosh computers through the AppleShare Server.

performance (because file service is a processor-intensive activity, any nondedicated implementation would have to sacrifice performance and functionality). A dedicated file server also provides superior security by isolating resources from physical access. In addition, the chances of system failure caused by foreign software imperfections and operator error are reduced, because workstation problems do not affect the dedicated AppleShare server processor. For more information on the AppleShare File Server, please see the *AppleTalk Communications* chapter in this Guide.

With AppleShare and AppleShare PC Software Version 2.0, Macintosh systems and MS-DOS personal computers can access common documents on the server. Documents that share a common file format or that have built-in translation can be read directly by the appropriate Macintosh or MS-DOS applications software. Some examples of this are Lotus 1-2-3 to Microsoft Excel, Microsoft Word PC to Microsoft Word 3.0 for Macintosh, and ThinkTank PC to MORE for Macintosh. Applications that do not have built-in translation capabilities can be converted with Apple File Exchange (AFE) software (and other optional file-conversion products, such as MacLinkPlus/Translators), so that documents can be shared by either machine while retaining such formatting features as boldface, italics, and columns.

AppleShare PC Version 2.0 provides the connection necessary for MS-DOS personal computers to access information on an AppleShare file server. AppleShare PC software gives an MS-DOS computer user the same ability to access folders, documents, applications, and storage space on an AppleShare server as a Macintosh computer user. As with the Macintosh computer, using the AppleShare server from an MS-DOS personal computer is as easy as using a local disk drive. This and other features make AppleShare well suited to the requirements of the growing community of users who work in a mixed Macintosh/MS-DOS environment.

The LocalTalk PC Card, or any other MLI driver-compliant interface card, is required with AppleShare PC. The card gives the MS-DOS computer access to the AppleTalk network, and allows the computer to print documents that were created with MS-DOS applications on an Apple LaserWriter or LaserWriter II printer family.

AppleShare PC Version 2.0 is compatible with AppleTalk Phase 2 and is data-link independent. It offers advanced capabilities such as extended AppleTalk addressing, which provides support for networks of up to 16 million nodes. Each AppleShare PC software package includes two AppleShare PC Installer disks (both 5.25-inch and 3.5-inch formats), along with the AppleShare PC User's Guide.

Approximate Cost \$75 to \$100

Supplier: Apple Computer, Inc., 20525 Mariani Ave., Cupertino, CA 95014, 408-996-1010

The SMB File Transfer Utility

The SMB File Transfer Utility software, provided with the Apple TokenTalk NB Card, allows users of Macintosh and IBM-compatible personal computers to exchange files and share information in their workgroups. Apple Macintosh II systems on a token ring network can access information on IBM PC LAN Program SMB (Server Message Block) file servers. A desk accessory provides easy mounting and dismounting of SMB server volumes. Files can be transferred and translated using the Apple File Exchange (included). For additional information on the TokenTalk NB Card, please see the *IBM Hosts* chapter in this Guide.

Approximate Cost Included with Apple TokenTalk NB Card

Supplier: Apple Computer, Inc., 20525 Mariani Ave., Cupertino, CA 95014, 408-996-1010

DOS Mounter

DOS Mounter is a utility that lets the Apple SuperDrive hardware access MS-DOS disks from the desktop, instead of through Apple File Exchange. With DOS Mounter in the System Folder, MS-DOS disks appear on the desktop and behave like Macintosh disks. Subdirectories are shown as folders and files as document icons. Users can select and drag items with the mouse, copy MS-DOS files, documents and applications and put them in the trash. DOS Mounter contains Extension Mapping™, which links MS-DOS file extensions with Macintosh applications. Opening an MS-DOS file with the application is a matter of clicking on its icon.

Approximate Cost \$89

Supplier: Dayna Communications, 50 South Main St., Suite 530, Salt Lake City, UT 84144, 801-531-0600

MacBLAST for MS-DOS Communications

MacBLAST communications software provides file transfer and text file format conversion between Macintosh and MS-DOS, plus terminal emulation (VT220, D200, D411, etc.) and file transfer to many other computers. MacBLAST supports MultiFinder for background file transfers and allows users to switch back and forth between Macintosh and PC operations. Wide area networks can be created between central computers running BLAST and any number of remote Macintosh computers or PCs. MacBLAST uses standard RS 232 connections, regular dial-up phone lines and X.25 networks. Features include: scripting capabilities for creating unattended operations, on-line help, automatic dialing and access to remote systems, and operation via standard phone lines or X.25 packet networks, satellite links and noisy environments such as international phone lines.

Approximate Cost \$195 to \$250

Supplier: Communications Research Group, 5615 Corporate Blvd., Baton Rouge, LA 70808, 800-24-BLAST

Solutions

xFer 1.1

xFer is a file transfer system which allows DOS computers to exchange files, folders, and directories with the Macintosh family of computers. xFer includes software for both computers and an optional 12-foot serial cable used for communications. xFer allows modem or direct connections, supporting baud rates from 300 to 57.6 Kbps. User-configurable translators consist of Macintosh and PC file filters, user defined search and replace strings, Macintosh type and creator specs, high bit processing, and import/export capabilities. Other features include DOS file/directory moves and copies from the Macintosh, support for non standard modems, upper-to-lower case conversion of new Macintosh file/directory names, stand-alone MacBinary translations on the Macintosh, Macintosh user interface updated to Apple's latest standards, transfers under/supports MultiFinder, and COM3 and 4 support on the PC.

Approximate Cost \$100 to \$130

Supplier: Messenger Software, Inc., 180 W. Streetsboro Rd., Unit #5, Suite #302, Hudson, Ohio 44236, 216-688-0696

XCOM 6.2

XCOM 6.2 is a facility for transferring data (including reports, jobs, and files) between Macintosh and IBM mainframes, Systems 3X's, AS/400's, DEC VAX's, PC's (both DOS and OS/2), Stratus, S/88, Data General's, token ring LAN's, LAN gateways and UNIX-based systems including Sun and Apollo workstations. XCOM 6.2 provides a consistent user interface regardless of the computer it's installed on. By utilizing APPC/LU 6.2, XCOM 6.2 permits high-speed peer-to-peer transfers to be initiated at either end, unattended, with error checking and automatic error recovery. Communications are at the operating system level, without terminal emulation. XCOM 6.2 typically allows record lengths of up to 32K. It supports dial-up or dedicated lines, CPU channels, coax, and token ring LAN. It handles both binary and character data, in either ASCII or EBCDIC. XCOM 6.2 runs on Macintosh Plus systems (and higher) running System 6.0 (and higher) with 512K RAM (minimum). It uses MacAPPC in conjunction with the Serial NB or TokenTalk NB card.

Approximate Cost \$495

Supplier: Spectrum Concepts, Inc., 150 Broadway, Suite 814, New York, New York 10038, 212-766-4400

MacLinkPlus/PC, Version 4.5

MacLinkPlus/PC is a complete kit for transferring and translating documents between a Macintosh computer and an IBM PC, compatible, or laptop. It has a library of over 150 translators for word processors, spreadsheets, databases, and

Solutions

graphics. Converted files remain fully formatted and usable in the new environment. The product comes with software for both machines, allowing the user to transfer and translate files from one computer to the other.

Approximate Cost\$199

Supplier: Data Viz Inc., 35 Corporate Dr., Trumbull, CT 06611, 203-268-0030

MacLinkPlus/Translators, Version 4.5

MacLinkPlus/Translators is a set of over 150 translators for most word processing, spreadsheet, database, and graphic formats. The conversion process resides on the Macintosh computer and is used to translate files between PC and Macintosh formats. Translated files retain their original formatting and are fully usable in their new form. The translators included in the program are usable as a desktop utility or within different applications. They can be used to extend the translation capabilities of the Apple File Exchange utility, used within MacWrite II, in conjunction with an external DOS disk drive or file server, or with the new FDHD SuperDrive. Once the files reach the Macintosh desktop, the translation process can be completed with a few clicks.

Approximate Cost\$169

Supplier: Data Viz Inc., 35 Corporate Dr., Trumbull, CT 06611, 203-268-0030

MacBinary To Mac v1.0

MacBinary To Mac is an Apple File Exchange translator document that translates files stored in the industry standard MacBinary format back into its original Macintosh format. It reads files stored on Macintosh, ProDOS, and MS-DOS disks.

Approximate Cost\$10

Supplier: PEEK[65], P.O. Box 586, Pacifica, CA 94044, 415-359-5708

Access Software Tools**MacChuck PC Remote Control**

MacChuck controls a PC from a Macintosh via AppleTalk or a direct connect cable. MacChuck allows users to operate DOS programs through a window on a Macintosh. With MacChuck, users can use the Macintosh Clipboard Copy and Paste commands with PC programs. MacChuck also copies text, binary, and MacBinary files between the Macintosh and the PC. When a PC with a PC AppleTalk card running MacChuck is used in an AppleTalk network, any Macintosh on the network can operate the PC. When direct serial communication is used, MacChuck operates at 57,600 baud. The MacChuck PC Remote Control Program package includes software for both Macintosh (800K disk) and PC (both 5.25-inch and 3.5-inch disks). A 10-foot direct connect cable that connects a Macintosh Plus, SE,

Solutions

or II to a 9-pin or 25-pin PC serial port is also included. A mini-8 to 9-pin “classic” Macintosh adapter is available separately.

Approximate Cost \$100
Supplier: Vano Associates, Inc., P.O. Box 12730, New Brighton, MN 55112, 612-788-9547

HandOff II

HandOff II allows all files to be opened directly from the Finder, even if the application is missing or if the files were transferred to the Macintosh from another computer. Users can assign files to applications by creator (e.g. MacWrite, MacPaint), by type (e.g., TEXT, PICT) or by file name extension (e.g., .ASC, .TXT, .WK1). HandOff II includes a file launcher. Users can build pop-up menus of applications and documents, and access the menu with a click of the mouse. Users can create “working sets” of documents to be opened with a single selection. HandOff II can also be configured to change the color depth and sound level when launching or switching applications. HandOff II will find the application even if it’s been renamed or moved.

Approximate Cost \$80
Supplier: Software Innovations, Inc., P.O. Box 811, Allen, TX 75002, 214-727-2329

PIXymbols™

PIXymbols are PostScript-based fonts for use in instructional materials and computer documentation relating to the PC. Users can duplicate and create PC screen images for printing. The fonts emulate the extended ASCII character set used on the IBM PC as well as a complete mono-spaced alphabet, including accented characters. PIXymbols 2107 is for use with SoftPC v.1.3., to dump an ASCII screen created in MS-DOS on the Macintosh II, or SE/30, via the Scrapbook. PIXymbols 2108 matches the IBM key assignments, and can be used like 2107 with older versions of SoftPC, and other DOS-emulating utilities. PIXymbols 2109 re-assigns the PC extended characters on the Macintosh keyboard, to make it possible for Macintosh-only users to create the same type of screens. A character in each font allows users to highlight text in grey. PCcharSet generates PC characters 01 to 31. After the fonts are installed once, they will download automatically to the printer. Screen fonts are provided in sizes appropriate to each specific font. Included is a Desk Accessory utility, FindPIXymbols, which allows users to locate a specific character in any font.

Approximate Cost \$145
Supplier: Page Studio Graphics, 3175 N. Price Rd. #1050, Chandler, AZ 85224, 602-839-2763

AccessPC

AccessPC enables Macintosh users to use disks and files from MS-DOS and OS/2 PCs as icons in the Finder just like Macintosh icons. AccessPC mounts locked or full

Solutions

disks, formats MS-DOS disks using the Finder's Erase Disk command, and maintains the normal MS-DOS disk format even when moving files to the disk. MS-DOS data files can be recognized and assigned to Macintosh applications through the Control Panel, so they may be opened or printed directly from the Finder. AccessPC works with virtually any disk drive that can support PC disks: Apple's SuperDrive (FDHD), PLI's TurboFloppy, Kennect's Drive 360, Drive 1200 or Drive 2.4 connected to the Rapport interface, DaynaFile drives and the Outbound Portable disk drive. Formats supported are 1.44 MB and 720K 3.5-inch disks, and 1.2 MB and 360K 5.25-inch disks. AccessPC also mounts "hard disk" container files used by the SoftPC PC-compatible, so files can be moved to and from this MS-DOS environment that runs in a Macintosh.

Approximate Cost\$90

Supplier: Insignia Solutions Inc., 254 San Geronimo Wy., Sunnyvale, CA 94086, 408-522-7600

DBF-Access Tools for HyperCard 1.0

DBF-Access Tools for HyperCard 1.0 is a software add-on that gives HyperCard users the ability to access information stored in dBASE III PLUS compatible database (DBF) and memo files. DBF-Access Tools for HyperCard 1.0 provides a set of eleven external commands and functions which give the HyperCard user the ability to analyze DBF files and import records from them into any stack. Additional commands allow the user to update the DBF files in place, or to create new DBF files for use by Dbase-language applications. Support is provided for dBASE III field types, including memo fields. The DBF-Access package comes in its own stack that contains documentation, a script-writer's tutorial, and many example handlers and buttons. An "installer" button allows users to install the desired commands and scripts into their stacks. The DBF-Access package also includes eleven additional external commands and functions which provide general-purpose file management capabilities.

Approximate Cost\$25 to \$95

Supplier: Nittany Development Group, Inc., 606 North Armistead St., Alexandria, VA 22312, 703-256-0791

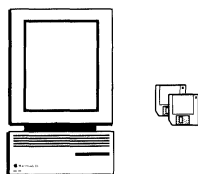

SoftPC emulates the IBM PC hardware environment in software.

MS-DOS Emulation

SoftPC

SoftPC provides PC-compatibility for Macintosh by emulating the hardware environment of an IBM PC XT with EGA graphics, or optionally an IBM AT, computer. SoftPC uses the SuperDrive and the Macintosh hard disk to read/write PC files. The Macintosh runs the MS-DOS programs that create and modify PC files and data directly. MS-DOS version 3.3 is bundled with SoftPC, pre-installed. Any PC file types can be used. Serial communications are also supported. SoftPC can move

Solutions

data into the Macintosh realm by offering copying and pasting of text and graphics into Macintosh applications, printing on Macintosh printers, and shared Macintosh/PC file storage. Macintosh file types can be set as needed. The Macintosh runs the MS-DOS and Windows program. SoftPC is entirely software-based. Upgrading from PC to AT compatibility requires Option Module.

Approximate Cost \$399 to \$598

Supplier: Insignia Solutions Inc., 254 San Geronimo Wy., Sunnyvale, CA 94086, 408-522-7600

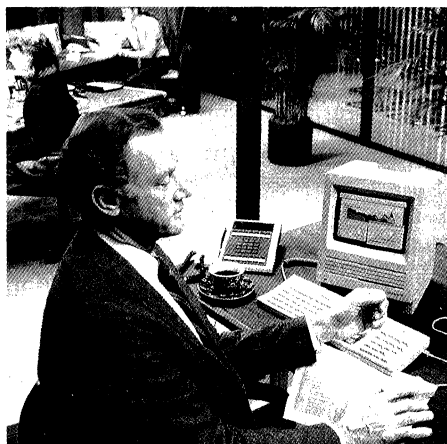

At Hambrecht & Quist the power and flexibility of the Macintosh makes it the standard throughout the organization.

The Standard at Hambrecht & Quist Is Low-Cost, High-Quality Macintosh Technology

Hambrecht & Quist (H&Q) is an investment banking and brokerage house with 300 employees. The firm has its headquarters in San Francisco, California, and offices in New York, Chicago, Boston, London, and Taipei.

In late 1987, Hambrecht & Quist decided to streamline the process of producing financial reports. "We had four different systems: Macintosh personal computers, IBM PCs, NBI computers, and Sun workstations," says Information Center manager John Anderson. "That meant our information base was fragmented, so it was difficult to get our reports out on a timely basis."

Hambrecht & Quist decided to standardize on the Apple Macintosh personal computer because of its low-cost networking capabilities, high quality printer output, low training costs, and MS-DOS connectivity. "Though we do almost everything on the Macintosh, we realize that the rest of the world may not," says Anderson. "It is important that we have the ability to run applications that are not available for the Macintosh, and that we can share MS-DOS files from sources outside the firm."

Hambrecht & Quist uses two products to ensure Macintosh-to-PC connectivity: SoftPC and AppleShare PC. "We use SoftPC for applications that don't run on the Macintosh, such as on-line databases that provide financial information, and a database of publicly traded companies that runs on an IBM-compatible CD-ROM. Using SoftPC, the Macintosh performs at least as fast as an IBM PC XT."

To share MS-DOS files received from outside the company, Hambrecht & Quist has installed one MS-DOS machine with an AppleShare PC card on every AppleTalk zone. Anderson explains, "With AppleShare PC, we can put MS-DOS files on the fileserver so they are available to everyone."

Macintosh personal computers are used throughout the firm by analysts, secretaries, and brokers. Analysts and secretaries use Microsoft Word or Microsoft Works for producing financial reports, and Microsoft Excel for financial analysis, graphs, and financial statements. Brokers use Macintosh II personal computers as workstations for accessing stock information, news, and customer account information.

Case History

Anderson reports, “With Macintosh-to-IBM PC connectivity products, we have the best of two worlds: The Macintosh makes it easy to introduce new applications to our employees, and products such as SoftPC and AppleShare PC let us do anything an MS-DOS user can do.”

“The Macintosh makes my life easier,” concludes Anderson. “It’s so easy to use that support issues are drastically reduced.”

Digital Equipment Corporation

Background

Founded in 1957, Digital Equipment Corporation (DEC) carved an early sales niche as a supplier of computer add-in modules, primarily for specialized technical applications. Digital's early sales experience soon alerted it to the industry's need for affordable, stand-alone, complete computer systems. Digital responded in 1960 by introducing its first in a line of Programmable Data Processor (PDP) computers: the PDP-1. Digital's PDP family of computer products established appeal in technical and scientific systems markets and quickly attracted the enthusiastic support of OEMs who had been looking for cost-effective embedded computers for their system products.

Digital's small, stand-alone computers also gained favor in commercial environments, as they offered a distributed-processing alternative to the large, centralized, and very expensive machines that were used in a typical large company's data-processing department. The natural tendency among Digital's large customers to network their Digital systems prompted the company's introduction of its Digital network architecture and DECnet (Phase I) in the early 1970s. Continued customer acceptance and demand fueled its evolution to the powerful and comprehensive DECnet Phase IV, released in 1983 and recognized as one of the computer industry's leading network architectures. DECnet continues to evolve toward DECnet Phase V, based on OSI standards.

In the mid-1970s, Digital began work on a new computer system that would serve as the future development focus of the PDP-11. The VAX system, which offers virtual address extension, was introduced in 1977. This new 32-bit addressing architecture offered programmers practically unlimited amounts of virtual memory (the PDP-11 16-bit architecture confined programmers to 64K areas) and provided a compatibility mode of operation that supported the direct execution of most existing PDP-11 applications software.

Digital sought to standardize on a single VAX operating system. Digital's VMS™ operating-system software, a virtual memory system, offers real-time, time-sharing, and batch-processing capabilities suitable for general use in both scientific and commercial environments.

Digital also offers an alternative operating system, ULTRIX™, for organizations requiring UNIX compatibility. The ULTRIX-32 operating system for VAX computers

The Environment

is a compatible System V UNIX implementation with the commonly sought Berkeley 4.2 functional extensions.

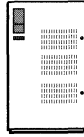

The VAX Family Today

The VAX family quickly established itself as the foundation of Digital's future computing strategy. With the rapid growth of market acceptance for VAX systems, Digital refocused its corporate approach on high-end computing in 1983, with official plans for future high-end VAX systems eventually to replace its older DECsystem 20. Thus, the first product based on the new VAX computer technology (the VAX-11/780), released in 1977, quickly evolved into the full range of larger and smaller VAX systems available today. The VAX 6000 Series and more powerful VAX 9000 Series, both complemented by VAXcluster™ and MicroVAX™, are the current systems.

VAXclusters: Connecting VAX Systems

Digital offers the VAXcluster™, which connects up to 16 VAX systems and Hierarchical Storage Controller (HSC) mass-storage control devices into a single system offering a pool of up to 100 MIPS of processing power. Minicomputers with VAXclusters clearly rival IBM mainframes, and compete with minicomputers made by Prime, Data General, and Hewlett-Packard. VAXclusters have been very popular; Digital estimates that 75 percent of 8600s and 8650s are clustered.

MicroVAX: A VMS Microcomputer

MicroVAX 3300/3400 systems provide two-and-one-half times the CPU performance and three times the data throughput and bandwidth of the MicroVAX II. These systems offer high-end storage functionality with the new Digital Storage Systems Interconnect (DSSI) bus. The same CMOS microprocessor technology is featured in the MicroVAX 3500/3600.

With three times the processing power of MicroVAX II in compact, quiet packages, MicroVAX 3500/3600 systems are powerful enough to provide complete time-sharing computer support for a large work group or department. The systems support 80 directly connected users, and even more users through the network.

The VAXserver™ 3300/3400 systems are designed as Local Area VAXcluster boot nodes and PC LAN managers, and for control of local dedicated services. Designed to perform as cluster boot nodes, VAXserver 3500/3600/3602 systems are ideal for customers who want the high performance of the MicroVAX 3500 and 3600 without time-sharing capabilities.

The Environment

All MicroVAX systems can run either ULTRIX-32 or MicroVMS. (MicroVMS operating system is a repackaged version of VMS requiring less space on smaller MicroVAX system disks.) MicroVAX systems fully support all levels of DECnet, interconnected either via Ethernet cable (for the MicroVAX II or 2000) or using point-to-point lines (for the MicroVAX II only). Where Ethernet is available, up to 30 MicroVAX systems can be linked together using VAXclusters, allowing them to share (and, if necessary, even bootstrap from) each other's disks.

VAXstations: Engineering and Graphics

Digital's family of VAXstation™ systems offers engineering workstations based on MicroVAX technology and fitted with various high-resolution graphics displays. The systems range from the low-end VAXstation 3100 to the high-end VAXstation 3520 and 3540 models, and run either VMS- or UNIX-based engineering and graphics applications.

| <i>OSI</i> | <i>DECnet</i> |
|--------------|----------------------|
| Application | User Layer |
| Presentation | Network Applications |
| Session | Session Control |
| Transport | End-Communication |
| Network | Routing |
| Link | Data Link |
| Physical | Physical Link |

Although the DECnet architecture pre-dates the OSI reference model, it is very similar in structure.

DECnet—An Architectural Overview

Digital is committed to building products that comply with the Open Systems Interconnection (OSI) model recommended by the International Standards Organization (ISO). In addition, Digital supports multivendor networks by providing gateways to networks developed by other vendors, such as IBM's Systems Network Architecture (SNA) network and X.25-compliant systems. These gateways allow access to the functions of other vendors' networks. In cases where Digital does not offer an off-the-shelf method for communications with different vendors' products, Digital's Computer Special Systems group can build customized hardware and software to create such a link.

Digital uses its own network architecture, called Digital Network Architecture (DNA), to tie its many systems together. Digital's implementation of DNA is DECnet—a family of software and hardware products that link systems into a single network. DECnet software is layered on each of Digital's operating systems as well as MS-DOS/PC-DOS, OS/2 and the Macintosh operating system, allowing all Digital systems and select non-Digital systems to communicate across the network with compatible functions. DECnet supports a wide variety of physical media and data-link protocols. For example, it can use simple twisted-pair cabling, Ethernet, or X.25 packet-switched data networking, making everything from local area networks (LANs) to wide area networks (WANs) seamless and transparent to the end user. The DNA provides peer-to-peer communications over a variety of LAN and WAN technologies.

DNA's data-link layer handles the communications hardware and performs message packeting. For point-to-point links using Digital's own family of synchronous

The Environment

or asynchronous communications devices, DECnet builds, transmits, and decodes these packets using its own Digital Data Communications Message Protocol (DDCMP). Ethernet or X.25 communications, if used, replace DNA's link layer with their own message-handling software and hardware.

DNA's end-communication and routing layers assume responsibility for finding and routing messages between sending and receiving DECnet systems (nodes). Its routing capability connects the sender and receiver by calculating the lowest-cost alternative from among the variety of physical links that the network might offer. At the same time, its adaptive routing capability will automatically establish alternative connections in response to the failure of selected communications lines or intermediate (routing) network nodes.

DNA's application layer allows programs running on different network nodes to easily exchange logical messages and cooperate with each other, in a manner similar to that of IBM's LU 6.2 software. These task-to-task DECnet transactions, in turn, are used by DECnet to provide end users with networked applications, such as electronic mail and access to data on remote computer systems.

Developed before the ISO established the OSI seven-layer network model, DECnet nonetheless generally corresponds to and can work together with OSI-standard networking software, and can communicate via gateways to other network systems, such as the Manufacturing Automation Protocol (MAP) and Apple's AppleTalk® network. DECnet Phase V is fully OSI-compliant. Digital offers several OSI-based refinements to DECnet:

- **X.25 Router 2000 and VAX P.S.I.** The company's packet-switching interface hardware and software products underscore Digital's long-standing commitment to support X.25 and other widely accepted communications standards. Either VAX P.S.I. or Ethernet (standardized by IEEE's 802.3 specifications) can provide the necessary low-level OSI network protocols required for OSI integration.
- **VAX DEC/MAP.** This product consists of the hardware and software necessary to integrate VAX systems into MAP networks. This is an evolving product, and its underlying MAP specifications (version 2.1) are still incomplete.
- **VAX OSI Applications Kernel (OSAK).** This software provides OSI program-to-program communications for LAN and WAN environments. It provides programs running on a networked VAX system with a callable interface through which they can cooperate with programs running on other nodes (even non-Digital systems) using OSI's Network, Transport, and Session layers.
- **VAX File-Transfer Access and Management (FTAM).** This software provides for file transfer among open systems. VAX FTAM complies with the require-

Digital's DECnet/SNA Gateway**Products:***Flexible Transports:*

- VMS/SNA
- DECnet/SNA Gateway-ST
- DECnet/SNA Gateway-CT

Interactive Access:

- DECnet/SNA VMS 3270TE
- DECnet/SNA 3270TE for MS-DOS
- DECnet/SNA 3270TE for ULTRIX
- Distributed Host Command Facility

Application Interfaces:

- DECnet/SNA 3270
- Data Stream Programming Interface
- DECnet/SNA APPC/LU 6.2
- DECnet/SNA API

Information Access:

- DECnet/SNA Data Transfer Facility
- DECnet/SNA RJE
- DECnet/SNA PrE (Printer Emulation)
- DISOSS Document Exchange Facility (DDXF)
- Ede with IBM DISOSS
- VIDA
- VAXLink

ments for National Bureau of Standards (NBS) Phase II FTAM. VAX FTAM uses the services of OSAK and VAX PSI.

- **Message Router X.400 Gateway.** This software product provides an electronic-mail gateway service between Digital's traditional VAX-to-VAX mail products (such as ALL-IN-1 integrated office system's mail) and external mail services (normally using X.25 communications) that conform to the NBS Specification for the Message Format for Computer-Based Message Systems.
- **MAILbus.** MAILbus is a set of applications software based on X.400 that links multivendor electronic-mail systems and messaging applications into an enterprise-wide electronic messaging system. MAILbus is Digital's Message Transfer Service and also includes VAX Message Router, VAX Message Router VMsMail Gateway, VAX Message Router/S Gateway (for IBM SNADS), VAX Message Router/P Gateway (for IBM PROFS), VAX MAILGATE for MCI Mail, and VAX Message Router Programmer's Kit.

Digital's DECnet-to-SNA Gateway Capabilities

Digital offers a number of solutions for communications with IBM's SNA. It already offers support of IBM's LU 6.2 Advanced Program-to-Program Communications (APPC) protocol, which provides peer-to-peer communications in IBM's SNA world. Digital's implementation of SNA lets individual workstations in a Digital network participate in a peer-to-peer manner with nodes on an SNA network. Digital's SNA and gateway products for communicating with the IBM world include the products listed on this page.

Digital's Internet family of products supports the connection of Digital computers and networks to other systems, including IBM, UNIVAC, CDC, Wang, UNIX, Packetnet, and DSI.

Digital-Based Solutions

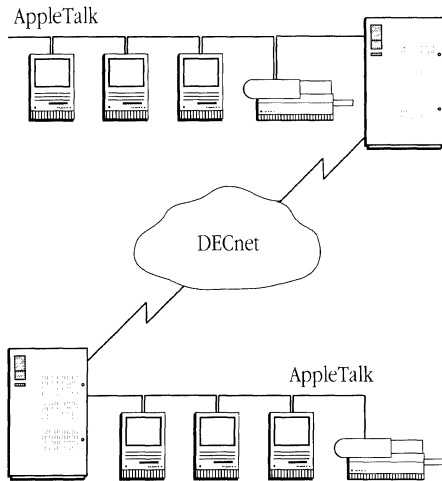

AppleTalk and DECnet can cooperate to form large, geographically dispersed networks, allowing workgroups to exchange data and share resources without concern for physical proximity.

Network Solutions in the VAX and VMS Environment

Apple has developed AppleTalk for VMS to enable the integration of AppleTalk-based Macintosh systems and Digital's VMS computing environment. With AppleTalk for VMS, a VAX computer system can participate on an AppleTalk internet. Likewise, any computer on the AppleTalk internet can access the VMS environment.

With AppleTalk for VMS, VMS system-based applications and services can appear just like other AppleTalk services. These VMS system-based services register their names on the AppleTalk internet in the same way that AppleShare servers and LaserWriter printers register their names. Macintosh users can find VMS system-based services through the Chooser or through application-specific interfaces.

As networked Macintosh/VAX system work groups proliferate, they can be internetworked by means of DECnet wide area networking products. AppleTalk and DECnet can cooperate to form large networks, allowing work groups to exchange data and share resources. For example, a Macintosh on an AppleTalk network with a VAX system in California can transparently use an X.25, synchronous or asynchronous, DECnet link to print a document on a LaserWriter on an AppleTalk network with a VAX system in New York. The user can select the LaserWriter in New York using the standard Macintosh Chooser desktop accessory on his or her Macintosh computer in California.

It's easy to imagine how a work group of Macintosh users interlinked via AppleTalk can share the large-scale computing power of VAX, using products incorporating AppleTalk for VMS. End users requiring this unique fusion of Macintosh flexibility and VAX power will find that file- and print-server products, terminal service, and networked Macintosh and VAX databases built on AppleTalk for VMS are already available. Software developers wishing to integrate their Macintosh applications into the VMS marketplace, or value-added resellers (VARs) recognizing the competitive advantage that a custom Macintosh-based VAX front end can give their systems, will find a documented and proven programming tool in AppleTalk for VMS.

Making the Ethernet Connection

Ethernet is an industry-standard, high-speed networking media system that transmits data at 10 Mbps. Apple's Ethernet boards are available to connect Macintosh

Solutions

computers to Ethernet. All of these products make use of Apple's EtherTalk software, which allows use of AppleTalk network system protocols on high-speed Ethernet media. This type of performance is particularly useful in environments where there is heavy use of the file-server for such applications as multi-user database or application development with shared libraries on the file server.

The Apple EtherTalk NB card and other third-party products allow Macintosh computers to communicate with a diverse range of Ethernet-based computer systems. Shiva and Cayman Systems offer intelligent, or application-level, routers and bridges between LocalTalk and Ethernet systems that transparently integrates Macintosh computers into Ethernet. For more information on these products, see the *Networking Environment* chapter of this Guide.

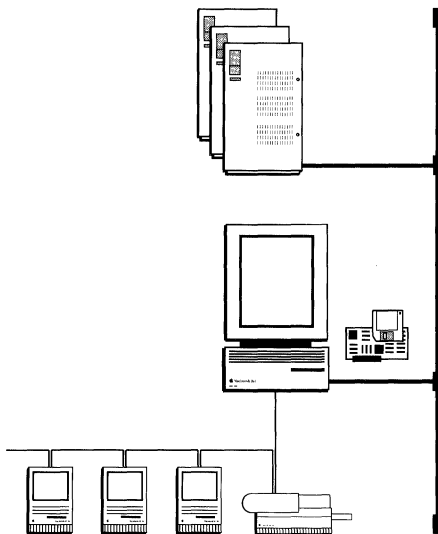

DEC LanWORKS for Macintosh software provides powerful, transparent integration of Macintosh computers into the VAX environment.

Integrated Macintosh and Digital Environment— DEC LanWORKS for Macintosh

DEC LanWORKS software for Macintosh computers integrates Apple Computer, Inc.'s Macintosh computers and the AppleTalk network with Digital Equipment Corporation's VAX computers and DECnet/OSI network. Jointly developed by Digital and Apple, DEC LanWORKS for Macintosh offers VMS server software, Macintosh client applications, connectivity software, and developer tools.

DEC LanWORKS software for Macintosh computers is an implementation of Digital's Network Application Support (NAS) services. The client/server implementation provides transparent interoperability between the Apple and Digital environments; users can access VAX systems power and scalability, DECnet/OSI networking functionality, Macintosh tools, and AppleTalk resources while using the interfaces with which they are most familiar.

File Sharing

VAXshare VAX-resident file services are indistinguishable from familiar AppleShare devices, and provide the additional benefits of shared resources, enhanced data security, increased file storage, and improved data integrity through automated backups. VAXshare file service is compliant with Apple Filing Protocols (AFP V2.0). By using a VAX as a file server, VMS and Macintosh users and applications can share the same files and folders or directories. VAXshare file service supports VMS Access Control Lists, which provides VMS system managers with the ability to determine, on a user-by-user basis, who has access to a particular file or directory.

Print Services

Macintosh and VAX users can share PostScript printers from Digital and Apple LaserWriter printers. VAXshare print service implements Apple's Printer Access Protocol and uses VMS print queues on the VAX for high capacity print spooling.

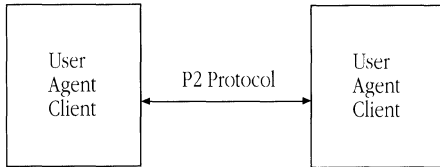

ALL-IN-1 MAIL for Macintosh implements all of the mandatory services defined by X.400 "P2" User Agent recommendations. It also features:

- Access to Digital's Distributed Directory Service (DDS)
- CDA architecture support for compound documents
- Access to MAILbus multivendor interconnect services

Electronic Mail

Macintosh users can communicate with other users on a MAILbus enterprise messaging system, either locally or worldwide, via ALL-IN-1 MAIL (X.400 compliant) or PCMAIL (a client for VMS Mail utility). ALL-IN-1 MAIL for the Macintosh provides electronic mail capabilities such as store-and-forward services, binary attachments, and message delivery notifications as well as information about the message and the user. ALL-IN-1 MAIL for the Macintosh implements all the mandatory services defined by the 1984 CCITT X.400 "P2" user agent recommendations.

The client application allows users to create, edit, file and manipulate messages. Users can access Digital's Distributed Directory Service for assistance in addressing other users anywhere on the MAILbus electronic mail network. The ALL-IN-1 MAIL Server provides local message delivery services within a local area network and submits messages to MAILbus for remote message delivery. Messages can be exchanged with other ALL-IN-1 MAIL servers, Digital's ALL-IN-1 Integrated Office System, VMSmail, as well as users of IBM PROFS, IBM DISOSS, and public and private systems conforming with X.400 recommendations.

PCMAIL provides all the functionality accessible in the VMSmail utility. PCMAIL for Macintosh enables users to read newly received mail, review previously received mail, send a Macintosh text file, and create messages with its built-in text editor. PCMAIL users can send messages to other PCMAIL users on Macintosh, VMS, and IBM, and compatible computers running PCMAIL for DOS or OS/2.

Application Access

LanWORKS offers easy access to enterprise applications anywhere on a wide area network through either MacTerminal, a VT320 compatible terminal emulator, or MacX™, an X Window System server. MacX enables users to display (on their Macintosh) DECwindows applications running remotely on VAX systems. For more detailed information, please see the MacTerminal description located in this chapter and the MacX description in the *UNIX and TCP/IP* chapter of this Guide.

Database Access

The Apple-Digital development effort offers access to departmental and enterprise data stored in VAX Rdb/VMS relational databases with Apple's Data Access Language (included with this product) or Digital's SQL/Services (included with VAX

Solutions

DEC LanWORKS for Macintosh

Includes:

VMS Server Software

- VAXshare file services, based on AFP
- VAXshare print services for Apple LaserWriter, LaserWriter-PLUS, LaserWriter-IINT, LaserWriter-IINTX and Digital LNO3R ScriptPrinter, PrintServer 20 and 40+ printers
- Network-based file and print server management
- Data Access Language VMS server software with adapter for Rdb/VMS relational database

Macintosh Client Application Software

- Electronic Mail
 - ALL-IN-1 MAIL for Macintosh, an X.400 client (license only)
 - PCMAIL for Macintosh, a VMS Mail client
- MacX, an X Window System server for DECwindows applications access
- MacTerminal V3.0 terminal emulator

Connectivity Software

- Data Access Language client
- AppleTalk for VMS V3.0
- AppleTalk-to-DECnet Transport Gateway
- DECnet for Macintosh: NCP, Netcopy, FAL

Developer Tools

- Application Programming Interface (API) for AppleTalk for VMS V3.0
- API for AppleTalk-to-DECnet Transport Gateway
- DECnet programming documentation

Rdb/VMS V4.0 product). For more information on Data Access Language, please see the *Network Application Tools* chapter in this Guide. Information on available Data Access Language servers can be found in this chapter and the *IBM Hosts* chapter.

Network Connectivity Software

LanWORKS includes AppleTalk for VMS, DECnet for Macintosh, and Macintosh Communications Toolbox with TCP/IP, LAT and CTERM tools for network and communications flexibility. AppleTalk for VMS 3.0 is an implementation of AppleTalk Phase 2 networking protocol and interface libraries for VMS systems. AppleTalk for VMS enables routing or “tunneling” through DECnet, whereby AppleTalk is encapsulated in DECnet so Macintosh users can “see” across DECnet wide area networks and AFP file servers as if they were local.

DECnet for Macintosh allows Macintosh computers to participate as full DECnet Phase IV nonrouting end nodes. This means that direct connections can be made from the Macintosh to DECnet applications and services on any DECnet node without having to be routed to a VAX server.

The Apple Macintosh Communications Toolbox provides tools used by Macintosh applications for network connections, terminal emulation and file transfers. Additional information for the Macintosh Communications Toolbox can be found in the *Network Application Tools* chapter in this Guide.

Interoperability in Mixed Environments

DEC LanWORKS for Macintosh and Digital’s Personal Computing Systems Architecture (PCSA) deliver Digital’s Network Application Support (NAS) services, allowing users to share information and resources between Macintosh, DOS, OS/2, VMS, UNIX, and terminal-based users on the same network. Open interfaces and tools provide capability for the development of distributed applications.

Service and Support

Digital offers worldwide service and support for the DEC LanWORKS for Macintosh product. Digital Desktop Services offers support for third-party Macintosh applications. Digital is an authorized service provider for the Apple family of products at U.S. Digital sites.

AppleTalk for VMS

AppleTalk for VMS is Apple’s implementation of the AppleTalk network protocols on Digital’s VMS operating system. With AppleTalk for VMS, a VAX computer system can participate in an AppleTalk internet. Likewise, any computer on the

Solutions

AppleTalk internet can access the VMS environment of a VAX computer. Apple and Digital have chosen AppleTalk for VMS and its integration with DECnet as the primary way to interconnect the products they develop under the Apple-Digital agreement. Thus, using AppleTalk for VMS as a base, a developer can build distributed applications across Macintosh, Apple II, MS-DOS, and VMS systems.

With AppleTalk for VMS, VMS system-based applications and services can appear just like other AppleTalk services. These VMS system-based services register their names on the AppleTalk internet in the same way that AppleShare servers and LaserWriter printers register their names. Macintosh users can find VMS system-based services through the Chooser or through application-specific interfaces.

AppleTalk for VMS has the following features:

- AppleTalk Phase 2 routing
- enhanced performance by running in the VMS kernel
- enhanced tunneling capabilities
- support for the AppleTalk ADSP to DECnet NSP transport gateway
- a more complete and easier configuration and management utility
- a simple, well documented API

AppleTalk for VMS Router

In the AppleTalk network architecture, routers forward datagrams between separate AppleTalk networks. With AppleTalk for VMS, a VAX computer can become a full-function AppleTalk router, providing internet routing, zone information management, routing table maintenance, and management of name-binding requests. An AppleTalk for VMS router has multiple ports, so that it can simultaneously route datagrams over different physical communication channels. For example, a router can route datagrams over multiple Ethernet local area networks or over DECnet/OSI wide area networks. By encapsulating AppleTalk datagrams into a DECnet packet and routing this packet through DECnet/OSI networks—a technique called *tunneling*—the AppleTalk for VMS router can interconnect AppleTalk internets separated by great distances.

How AppleTalk for VMS Works

AppleTalk for VMS version 3.0 has four main parts:

- AppleTalk Protocol Stack Driver
- Ancillary Control Process
- Protocol Interface Library
- Configuration Program (ATK\$MANAGER)

Solutions

The AppleTalk Protocol Stack Driver is a standard VMS I/O driver that implements the main capabilities of the AppleTalk protocol suite. The Ancillary Control Process works with the Protocol Stack Driver to implement the more complex protocol functions, such as creating processes, authenticating users, and managing AppleTalk for VMS.

The Protocol Interface Library is the applications programming interface with the AppleTalk Protocol Stack Driver. The library is a set of simple subroutine calls, each implementing a different protocol function. Using these subroutines, applications can perform protocol functions such as looking up names, executing transactions, and transferring data. The Protocol Interface Library conforms to the VAX procedure-calling standard and can be called from any VMS system-supported programming language.

The Configuration Program is the user interface through which VMS system managers set up and observe AppleTalk for VMS. With this program, a system manager can perform such tasks as starting the AppleTalk for VMS router, opening and closing router ports, and reading performance counters.

Approximate Cost \$295 client license per Macintosh; \$440 for media and documentation (1 copy for network)—no VAX server license required.

Supplier: Digital Equipment Corporation and Authorized Digital Distributors. Contact your local DEC sales office.

Macintosh-to-VAX Integration Toolkit

The Macintosh-to-VAX Integration Toolkit is a set of software components, APIs and documentation made available to developers interested in building distributed applications between the Macintosh and the VAX. This package includes AppleTalk for VMS, an AppleTalk-to-DECnet transport gateway, a VAX-based configuration utility, as well as an ADSP and a Gateway access connection tools for the Macintosh Communications Toolbox. These are described in more detail in the DEC LanWORKS for Macintosh section earlier in this chapter.

These components are the connectivity foundation for products developed under the Apple/Digital joint development agreement. This package includes programmer documentation for all of the exposed APIs. Developers interested in redistributing some of the software components with their application can obtain a license from Apple Software Licensing.

Approximate Cost Contact supplier

Supplier: Apple Computer, 25025 Mariani Ave., Cupertino, CA 95014, 408-996-1010

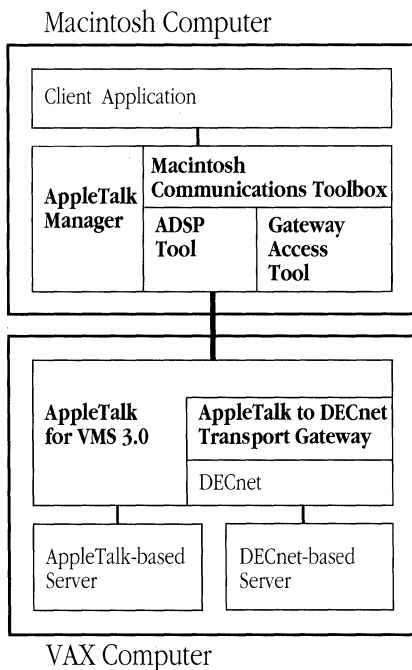

The Macintosh-to-VAX Integration Toolkit.

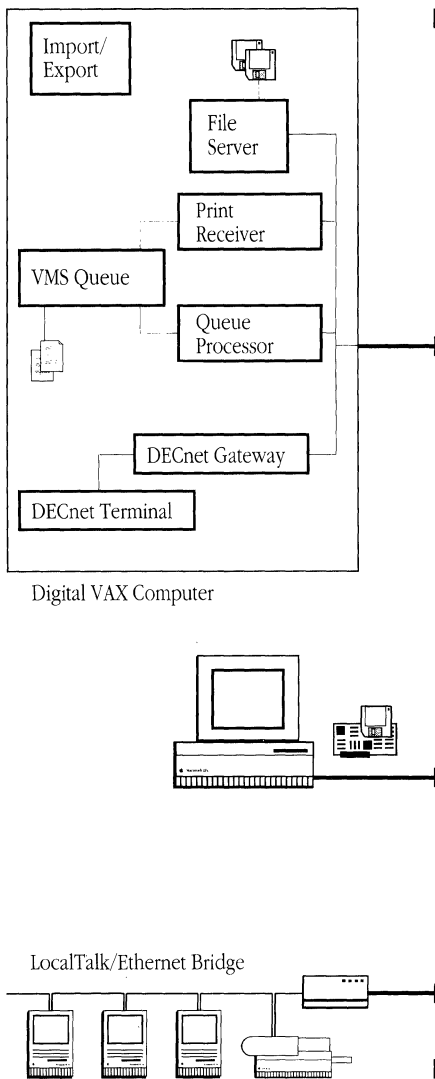

AppleTalk Network Services

AlisaTalk Network Services for VAX and VMS and Macintosh Systems

AlisaTalk, which includes AlisaShare, AlisaPrint System, AlisaTerminal and the optional Alisa Digital Print package, provides a package of network services for Macintosh, VMS and PC users. New features of AlisaTalk V3.3 include support for ACLs for file access, command file procedures for AlisaShare and APS or ADP managers and a print job notifier for Macintosh users.

AlisaTalk retains the Macintosh graphic interface. AlisaTalk can be set up on existing AppleTalk networks, so additional cabling may not be needed. AlisaTalk uses standards endorsed by both Apple and Digital, including AppleTalk Network Architecture, AppleTalk for VMS, AFP, DECnet CTERM, PostScript, and standard Macintosh AppleShare and LaserWriter software.

AlisaShare AFP File Server

AlisaShare is a VAX-based file server for Macintosh and IBM PC-compatible systems using the AppleTalk network. AlisaShare uses Macintosh and VMS standards, including user interface, file-security, and file-structure systems. AlisaShare uses the Macintosh graphic interface so that Macintosh users see VMS files as icons on their desktops. AlisaShare's use of ACL and UIC-based security makes it possible to maintain standards of security across networks. AlisaShare maps the Macintosh Hierarchical File Structure (HFS) to the VMS hierarchical file structure. Macintosh, VMS, and IBM PC files share the same directories on the VAX.

AlisaPrint System

AlisaPrint is a print system that makes use of the VMS printing and queuing utilities to deliver PostScript printing to both Macintosh and VMS users. AlisaPrint consists of a receiver process and a symbiont, both resident on the VAX. The receiver mimics a LaserWriter printer and captures Macintosh print jobs, which are then queued for printing by the symbiont. This means that only one VMS process is needed to handle the Macintosh users. AlisaPrint also provides electronic forms and paper type control, optional job and file flag/trailer pages, generic queues, automatic download of special fonts and dictionaries, Diablo 630 emulation, and records for VMS accounting.

AlisaTerminal Remote Terminal

AlisaTerminal provides Macintosh users with access to remote Digital systems via the AppleTalk network. A driver resident on the Macintosh implements the DECnet CTERM protocol to communicate with the standard DECnet remote terminal

Solutions

services via Alisa's proprietary DECnet gateway. Terminal emulators and front-ends on the Macintosh, such as VersaTerm and Mac240, use the driver as though it were an async driver. AlisaTerminal supports DCL line editing and line recall, and provides access to any Digital host on DECnet internet.

Alisa Digital Printer Support System

Alisa Digital Printer (ADP) support system is an add-on option to the AlisaTalk package that provides printing services to Digital's PostScript printers. ADP consists of a receiver process on the VAX that mimics a LaserWriter. The receiver captures Macintosh print jobs and queues them for printing to a Digital PostScript printer. ADP uses standard Macintosh, LaserWriter software, and standard Digital-supplied print symbionts and queueing systems.

Approximate Cost, AlisaTalk\$2950 to \$14,400
Supplier: Alisa Systems, Inc., 221 East Walnut St., Suite 175, Pasadena, CA 91101, 818-792-9474

Pacer Network Services

Pacer Software offers a family of products for Macintosh-to-VAX (VMS operating system), Data General, Prime, Stratus and UNIX systems including Sun, Harris, NCR, VAX (ULTRIX operating system), DECsystem/station, Interactive and Motorola networked environments. These include PacerLink, which provides terminal-emulation, file-transfer, and print-spooling capabilities; PacerPrint, which provides PostScript print spooling for VMS and ULTRIX system users; PacerShare, which enables VAX (VMS and ULTRIX) and DEC RISC systems to implement AppleShare file services that can be accessed from a Macintosh or MS-DOS-compatible computer; PacerPost, which provides a VAX and VMS-based Microsoft Mail 2.0 compatible server and gateways to various other VMS-based mail systems; and PacerTOPS, which enables a VAX and VMS system to participate in the distributed file serving environment with any Macintosh or IBM PC on a TOPS network.

Pacer's Macintosh to host communications products have been developed using the AppleTalk protocol suite. PacerLink also operates over asynchronous serial connections to host systems and can use the TCP/IP protocol in an Ethernet environment. With Pacer Software's AppleTalk implementation on the VMS and ULTRIX systems, the lower levels of the protocol run as a driver. Any application based on Apple's AppleTalk for VMS standard can coexist on the same VAX system that is running communications software from Pacer.

PacerShare AppleShare File Server on the VAX/VMS, VAX/ULTRIX and RISC/ULTRIX

PacerShare extends PacerLink to let a VAX running ULTRIX or VMS or a RISC-based DECstation/system running ULTRIX to act as a large, AppleShare-compatible file server for a Macintosh computer network, eliminating the need for dedicated Macintosh file servers. To access the file server, a Macintosh computer (or other suitably equipped microcomputer) runs only the standard AppleShare client software from Apple.

Maintaining Macintosh and VAX files in a common area means that VAX files can be accessed by Macintosh applications. For example, VMS text files can be created and edited using Microsoft Word, MacWrite, or any other Macintosh word-processing application. The Macintosh computer views part or all of the ULTRIX or VMS file system as HFS volumes whose folders represent host directories and whose files represent host files. PacerShare integrates the Macintosh computer and host file systems, allowing the same file to be accessed from either the host or the Macintosh computer. It enforces full AppleShare concurrency handling, including byte-level locking, and is compatible with multi-user applications.

Host access security and file access protection are preserved in all cases. With the mouse, a Macintosh computer system user can peruse the ULTRIX or VMS file system, drag-copy files between ULTRIX and VMS, create directories, move subdirectory trees, and access any type of file with a Macintosh application. Users can view and modify only those directories that they would be authorized to access through a normal terminal session.

Approximate Cost \$400 to \$7500
Supplier: Pacer Software, Inc., 7911 Herschel Ave., Suite 402, La Jolla, CA 92037, 619-454-0565

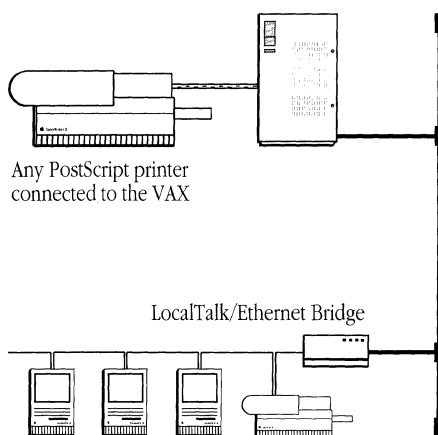

PacerLink Print Services
The Macintosh computer can access any printer on the VAX network through the Chooser.

PacerPrint PostScript Printing and AppleTalk Printer Access for VMS and ULTRIX Users

Initially available in the VMS and ULTRIX environments, PacerPrint is a print server software product that enables both Apple Macintosh and host users to print in their normal fashion to PostScript compatible printers. VMS users can submit jobs to the PacerPrint queues via the standard PRINT command under VMS, while ULTRIX users access printers attached to Apple LocalTalk networks with the Berkeley Standard Distribution (BSD) lpr(1) mechanism, following the same procedure as for a locally attached printer. PacerPrint connects to the printer, transfers PostScript files across the network, and interacts with the printer to coordinate and download Apple LaserPrep files (Macintosh-specific PostScript macros). PacerPrint provides a set of translators that convert ASCII text, Tektronix 4014 (VMS version only) and Diablo 630 (VMS version only) file formats to PostScript. Options to the print

Solutions

command are provided to request a particular translation as well as to specify page layout (e.g., portrait vs. landscape). From a Macintosh, using the standard Chooser to select a target printer provides the option of transparently spooling all print jobs through the host server. PacerPrint thus enables Macintosh and host users to share networked PostScript-compatible printers.

Approximate Cost \$1000 to \$4000
Supplier: Pacer Software, Inc., 7911 Herschel Ave., Suite 402, La Jolla, CA 92037, 619-454-0565

PacerTOPS

PacerTOPS enables VAX and VMS systems to participate in the distributed file serving environment with any Macintosh or IBM PC on a TOPS network. The merging of the VMS and TOPS file systems results in information sharing with performance comparable to a local hard disk. PacerTOPS enables Macintosh and PC users to share their files stored on the VAX and to also transparently access VMS files. In addition, VMS users can access Macintosh and PC files which are stored on the VAX. PacerTOPS allows TOPS workstation users to take advantage of the VAX system's disk storage capacity, high volume backup functions and data security features. PacerTOPS is an extension of PacerLink, Pacer's core communication package and requires an Ethernet connection between the Macintosh computers or PCs and the VAX and VMS systems via either a direct connection or AppleTalk bridged to Ethernet.

Approximate Cost \$400 to \$7500
Supplier: Pacer Software, Inc., 7911 Herschel Ave., Suite 402, La Jolla, CA 92037, 619-454-0565

AsyncServerR

AsyncServerR is VAX and VMS software that communicates with a client Macintosh system over an ordinary asynchronous terminal port, providing the Macintosh with access to all AppleTalk facilities available through the Digital VAX. Supported AppleTalk services include not only advanced Macintosh-to-VAX networking products, such as AlisaTalk, Helix VMX, and PacerShare, but also access to other AppleTalk-based services, such as Apple's LaserWriter and AppleShare servers.

Locally connected Macintosh computers can use AsyncServerR to network with their host Digital VAX systems over dedicated asynchronous lines at high baud rates, in many cases eliminating specialized network "bridge" hardware. Similarly, remote Macintosh users can dial into their host VAX systems and join the VAX host's AppleTalk internetwork, using existing modem hardware and communications lines.

AsyncServerR is licensed for use on the host VAX system. The product may be used interactively at dial-up, or it may be started in batch mode on one or more pre-defined asynchronous ports. AsyncServerR supports several simultaneously

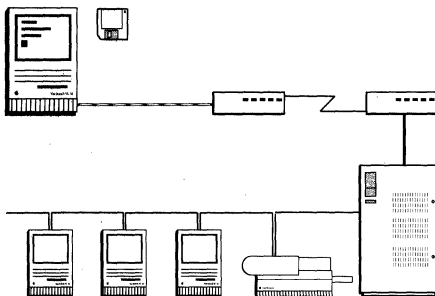

AsyncServerR provides Macintosh access to AppleTalk services through existing VAX asynchronous ports.

Solutions

connected Macintosh systems (up to the host's load limits), even on VAX and VMS hosts with server (one interactive user only) VMS licenses.

Approximate Cost \$595 to \$1895

Supplier: Computer Methods, Inc., 525 Route 73 South, Marlton, NJ 08053, 609-596-4360

TSSnet-DECnet Services on the Macintosh

TSSnet is a software package that enables Macintosh communications with a DECnet network as a DECnet Phase IV end node. The Macintosh can communicate with any DECnet host including Digital systems, IBM-PC systems and IBM mainframes, as well as other Macintosh systems. TSSnet allows DECnet and AppleTalk to operate on the same Macintosh simultaneously providing access to services on both networks.

TSSnet enables Macintosh communication with a DECnet network as a Phase IV end node. It provides a complete set of DECnet services, including background objects for VMSmail and file access (FAL). TSSnet consists of a DECnet driver, a Control Panel (CDEV) resource, and three applications (NetMail, NetCopy and NCP). TSSnet V2.0 also includes a version of White Pine's Mac220 terminal emulator that can be used with either CTERM or LAT sessions. The DECnet driver contains DECnet Phase IV protocols for Ethernet, LocalTalk and serial (DDCMP) connections. It also contains the file access listener (FAL), the background mail receiver, a CTERM module and a loopback mirror object for network testing.

Approximate Cost \$195

Supplier: Alisa Systems, Inc., 221 East Walnut St., Suite 175, Pasadena, CA 91101, 818-792-9474

CommUnity-Mac

CommUnity-Mac is a software product that utilizes an intelligent Ethernet controller to provide DECnet connectivity for Macintosh Plus, SE, and II computers. The controller reduces the networking load on the Macintosh for high-speed performance on a DECnet Phase IV Ethernet network. This networking solution provides terminal emulation (VT100, VT220, and, as an option, VT240), file transfer, compatibility with VAX and VMS services from Digital, and task-to-task communications for Macintosh-to-VAX system programming, VMS mail, and File Access Listener for Macintosh-to-Macintosh networking.

Approximate System Cost \$350 to \$495

Supplier: EMAC, 48431 Milmont Dr., Fremont, CA 94538, 415-683-2222

MacRAF

MacRAF is a Macintosh-to-VAX Ethernet integration package that provides the Macintosh user with remote file and print service. Users can access files stored on the VAX as if those files were on their Macintosh hard disks. MacRAF uses a LAT

Solutions

compatible protocol to connect the Macintosh to remote VAX hosts providing the user with file transfer speeds of up to 100,000 bytes per second. The software also provides users with VT100 and VT200 terminal emulation and supports up to 10 terminal sessions. MacRAF is supported on the Macintosh II series, Macintosh SE and SE/30. Approximately 115 kilobytes of disk space and a minimum of one megabyte of memory is required on the Macintosh. MacRAF uses Apple EtherTalk specifications so MacRAF can be run using any Ethernet card that has an Apple EtherTalk interface. On the host side, MacRAF is supported on VMS versions 4.7 through 5.2.

Approximate Cost\$794
Supplier: Datability Software Systems, Inc., 322 Eighth Ave., New York, NY 10001, 800-DIAL DSS

MacBLAST for Asynchronous Connectivity

MacBLAST communications software provides an asynchronous communications link between Macintosh and Digital VAX and PDP/RSX or RT-11. VAX BLAST runs under VAX and VMS (Rev. 4.4+) providing transfer and text file conversion between VAX and Macintosh computers with BLAST (see MacBLAST). It uses any RS-232 port and provides TTY/VT 52/100/VT220 emulation on the Macintosh end. MacBLAST transfers binary data, text, or graphics. MacBLAST and VAX BLAST products can be used to create wide area networks between central computers and any number of remote sites via dial-up or X.25 nets. BLAST runs over standard telephone lines, X.25 networks, and satellite links, and is unaffected by line noise or propagation delays. Features include: scripting capabilities for creating unattended operations, polling and data collection routines; custom menus, for transparent integration with Macintosh and VAX applications; on-line help; and automatic dialing and access to remote systems.

Approximate Cost\$495 to \$1295
Supplier: Communications Research Group, 5615 Corporate Blvd., Baton Rouge, LA 70808, 800-24-BLAST

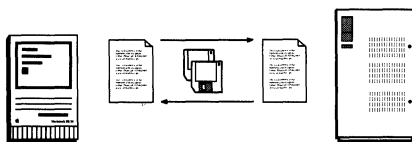

Keyword KEYpak, Version 2.8

Keyword document interchange solutions are designed to allow the exchange of documents between PC, Macintosh and host terminal users through a computer system or local area network (LAN) server using many different document processing systems. Keyword KEYpak software, running on either a computer system or LAN server, allows users to exchange documents between otherwise incompatible document processors or word processing systems such as Microsoft Word on the Macintosh, WordPerfect, MultiMate and many more. KEYpak software is designed to provide flexibility for revisable document exchange between end-users on different computer systems (e.g. IBM mainframes, Digital VAX, Bull, WANG and others) by supporting system interchange architectures. KEYpak software runs on

Solutions

many systems platforms including DOS, VAX and VMS, UNIX, IBM/VM, IBM/MVS and many other vendor specific operating systems.

Approximate Cost \$1000 to \$100,000

Supplier: Keyword Office Technologies, 2816 - 11 ST. N.E., Calgary, Alta T2E 7S7, 403-250-1770

VMacS

VMacS is a VAX application that allows Macintosh users to store Macintosh files on the Digital VAX computer. All Macintosh files can be transferred to the VAX, stored in MacBinary format, and they will retain all original characteristics when returned to the Macintosh computer. Once files are stored on the VAX, all Macintosh work groups can exchange and distribute them. Macintosh word processing and text files can be converted to VMS formats and output to VAX printers or displayed on VAX terminals using VMacS. VMS text and data files can also be converted to Macintosh formats using VMacS.

Approximate Cost \$399 to \$999

Supplier: White Pine Software Inc., 94 Route 101A, P.O. Box 1108, Amherst, NH 03031, 603-886-9050

Makeasy Version 2.1

Makeasy is a distributed software allowing Macintosh users access to the host VMS facilities via the Macintosh user interface. VMS files are displayed as Macintosh-like icons and are given a specific set of operations. Operations can be called by selecting menu options with the mouse. MultiFinder compatibility lets users access VMS services and Macintosh applications at the same time. The file transfer utility permits files, folders, or directories to be copied to or from any part of the file system; the user can specify the file format for the target file. The available file formats are: ASCII, Binary, Image, Apple double and MacBinary standard. Menu options are automatically set by Makeasy according to the type of selected object. Makeasy includes a full text editor, which allows uploading and downloading VMS as well as local files. Makeasy is a distributed software based on a Client/Server architecture. Connections can be made either via serial lines or via Ethernet network using AppleTalk or DECnet protocols.

Approximate Cost \$3000 to \$9800

Supplier: Unipress Inc., 2025 Lincoln Hwy., Edison, NJ 08817, 201-985-8000

Terminal Emulation Products

The simplest form of connection between Macintosh personal computers and Digital minicomputers is via terminal emulation, using asynchronous communications. In this solution, the Macintosh computer is connected to the host exactly as a terminal would be. Terminal connections can be made either by directly linking the

Solutions

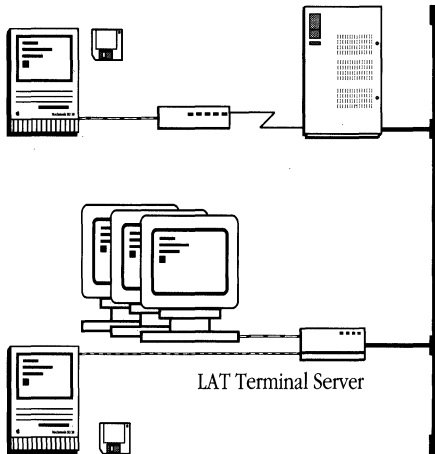

RS-232 connections enable terminal emulation, file-transfer, and virtual-disk solutions. Emulation software makes the Macintosh computer appear as another RS-232 terminal to the VAX. Terminals can be connected directly to the VAX via RS-232 cable, remotely via a modem, or through a LAT terminal server connected to the VAX via Ethernet.

Macintosh computer to the VAX system via RS-232 cabling or via a modem. In many DECnet installations, a DECserver 200 terminal server connected to Ethernet provides up to eight RS-232 serial terminal ports. Each of these connection methods provides the same functionality. Since Macintosh terminal emulators require no special communications software on the host, they can be used with any host system that supports asynchronous terminals, as well as with on-line services.

MacTerminal 3.0

MacTerminal is a terminal emulation and communications application that enables Apple Macintosh personal computer users to communicate with many host computers such as VAX and UNIX systems. With MacTerminal, users can also access electronic bulletin boards and on-line databases such as CompuServe, DIALOG and Dow Jones News/Retrieval. MacTerminal has been completely rewritten based on the Macintosh Communications Toolbox, system software that provides Macintosh applications with standard access to communication capabilities, including data connections, terminal emulation, and file transfer protocols. For more information on the Macintosh Communications Toolbox, refer to the *Network Application Tools* chapter in this Guide.

Through the use of the Macintosh Communications Toolbox, MacTerminal 3.0 provides Digital VT102 or VT320 and TTY terminal emulation, ASCII text and XMODEM file transfer protocols and serial and Apple Modem (Hayes compatible) connections. Additional communications tools such as Digital's Local Area Transport (LAT) protocol and AppleTalk Data Stream Protocol (ADSP) are also available.

Approximate Cost\$125
Supplier: Apple Computer, Inc., 20525 Mariani Ave., Cupertino, CA 95014, 408-996-1010

PacerLink Terminal Emulation and Network Connectivity

PacerLink is an advanced terminal emulation and desktop connectivity program that allows Apple Macintosh users to connect to and use many host computers such as DEC VAX, Data General, Stratus, Prime and several UNIX hosts including DECsystem/station, Sun, NCR, Interactive, Motorola and Harris systems. PacerLink provides a variety of capabilities such as terminal emulation, file transfer, virtual disk and print services that enables Macintosh users to solve their communication and resource-sharing problems. A server program running on the host carries out PacerLink requests to copy files, access local or remote printers and perform other host functions. The Macintosh computer connects to the hosts via any combination of RS-232 (direct serial line or dial-up through a modem), Ethernet, or Apple LocalTalk cable bridged to Ethernet. PacerLink can make several connections to one host or multiple simultaneous connections to several hosts, each in its own terminal emulation window.

Solutions

Multiwindow terminal emulation lets the Macintosh computer replace any of nine terminals, including the VT100 and VT220. It augments the standard terminal capabilities with features that simplify running host programs, integrating the various hosts and microcomputers throughout a network to create a homogeneous environment that users can treat as a network system. A Macintosh computer user, for example, might have a spreadsheet window and an electronic publishing window already open, and decide to interact with a VAX host. This user opens a third window by choosing a host and the communication protocol (AppleTalk, TCP/IP, or RS-232C) to use.

Terminal-emulation sessions can be opened in multiple windows to communicate with several hosts. The user enters data through the keyboard into one selected window at a time, while the host updates the display in every window continually. PacerLink windows can be moved, stacked, sized, scrolled, panned, and zoomed, and data can be moved between windows, using the customary Macintosh techniques. A MiniWindows mode reduces all windows to miniature size. They can then be stacked or tiled on the screen and expanded to full size by clicking the zoom box.

Mouse-activated SoftKeys can be defined to activate host commands. Host parameters can be accepted through Macintosh dialog boxes, allowing casual users to execute mainframe programs. A "mark table" option selects a rectangle of information, which can be cut from a word-processing document, for instance, and pasted into a spreadsheet. Special features integrate the Macintosh computer into the ALL-IN-1 and CEO office-automation environments for handling of menus, files, and mail messages. Keys can be mapped to execute repetitive command or keystroke sequences, and any combination of the Shift, Command, Control, and Option augmentations can be used.

File-transfer features move text, binary or MacBinary files to or from hosts by copying single files, or multiple files identified with wildcards. The Macintosh computer can relay files between two different hosts, with optional conversion to compensate for differing storage conventions, and can transfer files even while operating unattended.

Virtual Disk uses host disk space to store Macintosh programs and data, reducing local disk requirements. Besides sharing virtual disk data, microcomputers can be integrated into the host backup procedure. Host users can access virtual disks to read or write the files stored there.

Approximate Cost\$2000 to \$37,500

Supplier: Pacer Software, Inc., 7911 Herschel Ave., Suite 402, La Jolla, CA 92037, 619-454-0565

Solutions

PacerGraph Color Graphics Terminal Emulation

PacerGraph software adds VT240 monochrome graphics and VT241 color graphics to the PacerLink terminal emulation choices. With PacerGraph, a VT240 window can display ReGIS or Tektronix 4010/4014 graphics. The graphics window has the capabilities of any standard PacerLink window, including Macintosh drag, scroll, pan, and zoom features and its own set of SoftKeys. PacerGraph windows respond to the standard VT220 escape sequences as well as to the special ReGIS or Tektronix graphics escape sequences. On the Macintosh, PacerGraph provides status icons and editing capabilities that are used to mark a graphics region, print it and copy it to the clipboard. The graphic can then be pasted into a paint, draw or electronic publishing program.

Approximate Cost \$75 to \$150

Supplier: Pacer Software, Inc., 7911 Herschel Ave., Suite 402, La Jolla, CA 92037, 619-454-0565

VersaTerm/VersaTerm-PRO

VersaTerm allows Macintosh computers to emulate the Digital VT100 and VT220, Data General D200 text terminals, and Tektronix 4010, 4012, and 4014 graphics terminals. VersaTerm-PRO adds emulation of the Tektronix 4105 terminal and enhanced Tektronix 4014 features. Both VersaTerm and VersaTerm-PRO support screen-driven text-editing capabilities offered by software such as ALL-IN-1 and CEO. Additionally, VersaTerm-PRO allows users to pan across or zoom in on a displayed graphics object, copy all or part of it to the Clipboard, and paste it into other Macintosh applications (such as MacDraw or PageMaker) for subsequent editing or inclusion in desktop-published documents. VersaTerm and VersaTerm-PRO support Apple's Communications Toolbox. VersaTerm-PRO's Tektronix graphics emulation is used in science and engineering applications, with host-based graphics software such as RS/1, 20/20, SAS/GRAPH, DI-3000, Enter/Act, and CAS ONLINE. VersaTerm-PRO can integrate images created by the host (using tools like Intergraph CAD/CAM software, and MACCS or REACCS for chemical design) into Macintosh documents and presentations. VersaTerm and VersaTerm-PRO support background printing, terminal session and file transfers using MultiFinder. VersaTerm-PRO also offers color hard-copy output to Apple's ImageWriter II printer.

Approximate Cost \$149 to \$295

Supplier: Synergy Software, 2457 Perkiomen Ave., Reading, PA 19606, 215-779-0522

White Pine Terminal Emulation Software

Mac220 is a DEC VT220 terminal emulator with support of large-screen monitors, 132-column mode, function and user-defined keys, DRCS, double-wide and

Solutions

double-high characters and blinking. Mac220 includes Kermit, XMODEM and YMODEM file transfer capability. Users can connect to the VAX directly, through a modem, or over a network.

Mac240 is a DEC VT240 terminal emulator, featuring file-transfer capabilities using Kermit, XMODEM and YMODEM protocols. Mac240 supports ReGIS and Sixel graphics, and also emulates Tektronix terminals. Other features include color background, command key equivalents, resizable and multiple windows, scrolling capabilities and review buffers to allow reading or printing of scrolled text.

Mac241 is a color DEC VT241 terminal emulator, featuring file-transfer capabilities using Kermit, XMODEM and YMODEM protocols. Mac241 supports ReGIS and Sixel graphics, and also emulates Tektronix terminals. Other features include command key equivalents, resizable and multiple windows, scrolling capabilities and review buffers to allow reading or printing of scrolled text.

All these products support DECnet and TCP/IP protocols and work with the Macintosh Communications ToolBox.

Approximate Cost\$129 to \$300

Supplier: White Pine Software, Amherst Technology Park, 94 Route 101A, Amherst, NH 03031, 603-886-9050

TGRAF-07/MAC

TGRAF-07/MAC is Tektronix 4107 graphics-terminal emulation software that allows the Macintosh II to connect to a host computer and access mainframe applications. TGRAF is a tool for CAD/CAM, data analysis and representation, mapping, molecular design, and application development. TGRAF-07/MAC is a complete terminal-emulation product that provides graphics and text support by emulating Tektronix 4010, 4014, 4105, 4106, 4107, and 4109 graphics terminals, and Digital VT102, VT100, and VT52 text terminals. It runs under MultiFinder software applications, supports "cut- and-paste" operations, and works with TSSnet by Alisa Systems.

Approximate Cost\$995

Supplier: Grafpoint, 1485 Saratoga Ave., San Jose, CA 95129, 408-446-1919

Reflection 2 PLUS

Reflection 2 PLUS provides emulation of Digital's VT320, VT220, VT102, and VT52 terminals while preserving the Macintosh user interface and MultiFinder. Dynamically Redefinable Character Sets, User Defined Keys (UDKs) and double-high double-wide characters are supported. Reflection 2 connects the user's Macintosh to VAX computers and other hosts, letting users send files between their Macintosh computers and VAX and/or UNIX/ULTRIX host computers using Reflection's proprietary file transfer protocol, XMODEM, or KERMIT. ASCII, Binary, MacBinary

Solutions

and VMS Image file transfer formats are supported. Users can backup an entire hard disk to a single file on the host. Reflection's command language has more than 40 commands, 30 functions, 65 settings, and 800 variables. Dialogs and pull-down menus may be created in script commands. Commands may be executed from pull-down menus, or in script files. Context-sensitive help, complete with "See Also" branching, is provided. Printing support includes font and size selection, as well as the ability to resize wide reports to fit on a page. AlisaTalk, AlisaShare, TSSnet, PacerLink, and PacerTalk are supported as well as direct connections through modem and printer ports.

Approximate Cost\$249

Supplier: Walker Richer & Quinn Inc., 2815 Eastlake Ave. East, Seattle, WA 98102, 206-324-0407

CommSolutions

CommSolutions is a network driver package that functions as a companion product to the White Pine VT Series Emulators and eXodus. White Pine Software has licensed Network/Communications software from third-party vendors. Networking software included consists of Runtime TSSnet (Peer-to-peer DECnet communications for eXodus), and MacTCP (TCP/IP for eXodus & VT Series emulators).

Approximate Cost\$4795 to \$6295

Supplier: White Pine Software, Amherst Technology Park, 94 Route 101A, Amherst, NH 03031, 603-886-9050

VAX Database Access

Data Access Language Server for VAX and VMS

The Data Access Language Server for VAX and VMS is a networking software product that provides Data Access Language access to files and databases on a VAX and VMS host system. Running on the VAX and VMS host, the Data Access Language Server works cooperatively with Macintosh applications that support Data Access Language. The server receives a request from a Macintosh application, carries it out on the VAX, and sends the desired data back to the Macintosh application.

Data Access Language operates under existing host and database-management security and integrity schemes, assuring complete data security with no additional maintenance requirements. Network connections can be established with the Data Access Language Server using either serial lines (directly or via modem) or AppleTalk Data Stream Protocol (requires Apple's AppleTalk for VMS running on the VAX system). Databases supported by the Data Access Language Server for VAX and VMS include Informix, Ingres, Oracle, Rdb/SQL, Sybase and RMS files (requires CDD and Datatrieve). The Data Access Language Server provides standard database

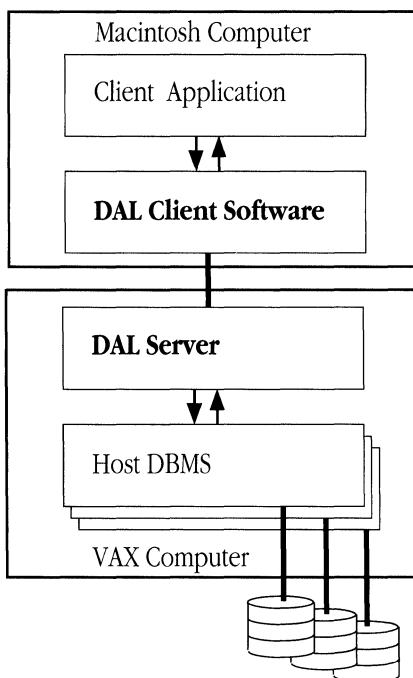

naming, data types, system catalog structure, error codes and buffer management, resulting in a uniform interface for the host databases.

Approximate Cost\$5000

Supplier: APDA (Apple Programmers & Developers Association), Apple Computer, Inc., 20525 Mariani Ave. MS 33G, Cupertino, CA 95014, 800-282-2732, 800-637-0029 in Canada, 408-562-3910 Internationally

Helix VMX: Applications for VAX/Macintosh Networks

Helix VMX is a multi-user database application development environment for VAX/Macintosh networks. It allows users to create applications on the Macintosh using a simple visual toolkit, and run them without modification on a Digital VAX system under the VMS operating system. Macintosh computers access these VAX-hosted applications by functioning as intelligent workstations connected to the VAX system.

Helix VMX makes use of its own distributed network architecture. On the Macintosh, a user has access to the Macintosh user interface, including pictorial database records. When the user searches for information, a request is sent to the database server (in this case, the VAX system), which performs the sorting and processing. Network traffic is kept to a minimum, and processing is conducted on the appropriate resource. Helix VMX uses the AppleTalk for VMS protocols, and requires an AppleTalk-to-VAX network connection.

Users of the VT family of terminals can access Helix VMX applications using the Helix VMX VT Terminal Support option. This software provides VT terminal users with a multiple-window, pull-down-menu interface for directly accessing Helix VMX applications.

Approximate Cost\$4500 to \$70,000

Supplier: Odesta Corporation, 4084 Commercial Ave., Northbrook, IL 60062, 800-323-5423

MultiUser Helix

MultiUser Helix allows any Double Helix application to run on an AppleTalk local area network, giving users access to current inventory, pricing, or the status of a job. As soon as an order is entered, a new client is recorded, or a price changes, that information is available to everyone who should have access to it. MultiUser Helix contains its own network software so users don't need to use a file server. In addition, MultiUser Helix incorporates database server technology rather than file server technology. The power and flexibility of Double Helix are incorporated in MultiUser Helix. This includes Double Helix's visual interface, modifiable structure, and ad hoc queries. In addition, MultiUser Helix has multithreaded searching for performance, personalized menus and password protection for customization, and

Solutions

data logging for data security. Double Helix/MultiUser Helix applications run on Digital Equipment Corporation's line of VAX computers.

Approximate Cost\$495

Supplier: Odesta Corporation, 4084 Commercial Ave., Northbrook, IL 60062, 800-323-5423

SequeLink, Version 2.1

SequeLink 2.1 allows co-operative processing between Macintosh and VAX computers. It enables users to write a Macintosh front-end to a relational database residing on a VAX, using environments such as HyperCard, MS Excel or 4D, and compiled languages such as C, Pascal or MacAPP. In this way the Macintosh application transparently accesses the relational database on the VAX, off-loading the VAX. This software can be used to write on-line transaction processing applications as well as decision support applications. SequeLink supports Oracle, Ingres, Rdb and Sybase. It requires at least 1 MB of memory on the Macintosh, but 2 MB is recommended if HyperCard is being used. It runs over AppleTalk as well as over DECnet. The SequeLink product family includes other client and server platforms, such as MS-DOS, OS/2, UNIX, AS/400, and MVS.

Approximate Cost\$195 to \$4995

Supplier: TechGnosis, Inc., 621 NW 53rd St., Boca Raton, FL 33487, 407-997-6687

RMS Access: Database Server

Odesta's RMS Access is a database server for information stored in native VAX RMS files. It allows users of Odesta's Double Helix database on the Macintosh to access and build applications directly using data stored in VAX RMS files. Using Double Helix with RMS Access, users can build applications that provide a Macintosh front-end to existing VAX-based data. Double Helix combines a powerful relational database with a nonprocedural, icon-based, development environment, allowing rapid applications development by both Macintosh end-users and MIS professionals, either from scratch or as incremental additions to existing MIS systems.

The distributed-database architecture of the Double Helix/RMS Access combination allows a user to combine data from any number of RMS files, even files located on different VAX computers in a network. In addition, local (Macintosh-resident) tables can be used to incorporate either personal information or special data types (such as graphics) into the applications. Double Helix treats each RMS file as a table of data, adding relational capabilities to RMS files. In addition, RMS Access supports the VAX and VMS Common Data Dictionary, all RMS data types and indices, and VMS access controls. Double Helix/RMS Access utilizes the AppleTalk for VMS product. It is compatible with bridged LocalTalk/Ethernet, PhoneNET/Ethernet,

EtherTalk, and combinations of these network configurations. The RMS Access package includes the VAX-based server and a single copy of Double Helix for application development and use.

Approximate Costfrom \$4900

Supplier: Odesta Corporation, 4084 Commercial Ave., Northbrook, IL 60062, 800-323-5423

SQL/Services for Macintosh

Digital's SQL/Services software extends the power and capacity of Digital's database server environment to the desktop by incorporating existing and emerging industry-standard interfaces into Digital's relational database platform. SQL/Services software lets remote desktop applications access VAX Rdb/VMS relational databases. The SQL/Services API for Macintosh access is consistent with the SQL/Services callable API offered by Digital on other platforms. Applications developed using SQL/Services can also retrieve information from certain IBM-based databases, such as DB2, accessible through Digital's VIDA (VAX-IBM Data Access) interoperability software products. Applications can use the data accessed from an IBM mainframe as they would use data accessed from an Rdb/VMS database.

Approximate CostContact supplier

Supplier: Digital Equipment Corporation and authorized Digital dealers. Contact your local DEC sales office.

SyBase API for Macintosh

Sybase is a relational database management system for on-line applications and decision support. With Sybase's client/server architecture, client-user interface functions are separated from server data management and transaction functions. The client server interfaces facilitates the management of multivendor computing environments.

Approximate CostFrom \$3000

Supplier: Sybase, 6475 Christie Ave., Emeryville, CA 94608, 800-8SYBASE

Applications in the Macintosh/VAX Environment

Odesta Document Management Systems

Odesta Document Management Systems (ODMS) is a family of workflow and document-management applications for Macintosh/VAX multi-user networks. ODMS lets team leaders see and manage what people are doing, while at the same time providing advanced document management capabilities. ODMS gives a bird's eye view of the status of all work being done on the network—who's doing what, when it's due, whether it's finished, and so on. At the same time, ODMS applications let anyone on the network find and use any type of document.

Solutions

Work done with word processors, spreadsheets, graphics, and page layout programs—any type or size document—can be copied from an individual workstation, along with user-defined keywords and comments, to a VAX server. Other identifying information about the document is automatically entered. Document management functions include access control and security, version control and revision tracking, and a project/task organizational structure. Automatic exception reporting, work assignments, and work audit trails are also provided.

ODMS includes built-in networking software; no file server is required. This networking technology maintains the associative links between documents, offering more flexibility and organizational power than simple file servers provide. However, at sites that already have file servers, ODMS applications may be run on the same Macintosh computer as Apple's AppleShare file server. ODMS is compatible with most VAX-based file servers, and can incorporate DOS PC documents using Digital's VMS Services for MS-DOS. ODMS is available as a suite of customized industry solutions for applications such as newspaper production, engineering/technical documentation, and large-scale proposal and legal document management systems.

Approximate Cost from \$20,000

Supplier: Odesta Corporation, 4084 Commercial Ave., Northbrook, IL 60062, 800-323-5423

Central System Manager (CSM), Version 2.1

Central System Manager allows the management of networked VAX computers from a Macintosh using a standard point-and-click interface. All features and command functions are user-definable. CSM allows the system administrators to treat groups of VAX computers as a single management domain without knowledge of DCL. Grouping can be by node, cluster or user-determined configuration. Sixteen windows or dialogs of VAX information can be opened and updated simultaneously. Items can be shrunk to an icon for future reference of system and network status. Alarms can be set to notify operations of system conditions. Color and custom icons can be created. CSM users may customize menus, windows, dialogs and command sets. Command and window definitions can be shared with other users or combined with private or group definitions. CSM allows users to select processes, batch jobs, network lines and other user defined items with a click of the mouse. If one or more items have been highlighted, commands can be performed on this set of items with a single click.

Approximate Cost \$750

Supplier: Integrated Solutions, Inc., 1020 Eighth Ave., King of Prussia, PA 19406, 215-337-2282

ALL-IN-1 DESKtop for Macintosh

ALL-IN-1 DESKtop for Macintosh integrates the Macintosh users into the ALL-IN-1 Integrated Office System server through a graphic user interface. It supports remote capabilities including file transfer and electronic mail for locally creating, reading, and processing mail on the PC, and then connecting with the ALL-IN-1 Integrated Office System server to exchange mail with other members of the workgroup. ALL-IN-1 DESKtop for Macintosh provides terminal emulation services, for accessing VMS-based applications and supports local filing of documents and data with the DESKtop for Macintosh file cabinet.

Approximate Cost Contact supplier

Supplier: Digital Equipment Corporation and Authorized Digital Distributors. Contact your local DEC sales office.

MacNOW

MacNOW from Telos Information Systems provides a Macintosh interface to Digital's ALL-IN-1 office-automation software. MacNOW supports electronic mail, file management, file transfer, terminal emulation, and other features of ALL-IN-1. Users work with ALL-IN-1 in a Macintosh environment—complete with pull-down menus, dialog boxes, and the mouse to select, drag, and click.

Approximate Cost \$200 to \$3000

Supplier: Telos Information Systems, 3420 Ocean Park Blvd., Santa Monica, CA 90405, 213-450-2424

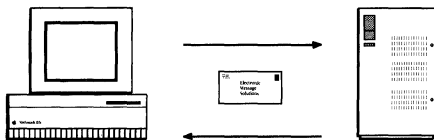

Electronic Messaging Solutions

AlisaMail

AlisaMail is a VAX-based electronic mail system for VAX and VMS, Macintosh and PC users. AlisaMail consists of a VAX-based server for Microsoft Mail V2.0, a VMSmail server and an SQL-based engine called the Information Switch. The Information Switch provides message and directory services for the AlisaMail servers and administration facilities, including accounting and reporting for tracking delivery delays and message traffic loads. Messages and attachments are stored in the relational database; only one copy is needed for multiple recipients. AlisaMail's Microsoft Mail server is compatible with Microsoft Mail V2.0 and provides services needed for store-and-forward message delivery and automatic directory updates in cooperation with other mail servers on the AppleTalk network. AlisaMail's VMSmail server provides message exchange with Digital mail services, permitting message exchange between users of VMSmail, ALL-IN-1, IBM PROFS, X.400 and others.

Approximate Cost \$10,000 to \$17,500

Supplier: Alisa Systems, Inc., 221 E. Walnut St., Suite 175, Pasadena, CA 91101, 818-792-9474

Solutions

MailMate

The MailMate family of products provide gateways to DECnet mail users for existing Macintosh-based E-mail packages. MailMate gateways are available for CE Software's QuickMail and Microsoft Corp.'s Microsoft Mail V2.0. The MailMate gateways provide two-way exchange of text messages with Digital Equipment Corporation's DECnet mail (also known as VMSmail), making mail exchange possible between QuickMail or Microsoft Mail and Digital's ALL-IN-1 system, IBM PROFS, X.400 and other services supported by MAILbus, when used with Digital's Message Router/MAILbus services and the MRGATE gateway. MailMate products support use of automatic address prefix and suffix for groups of users, restricting access to gateway services, logging of all gateway activity for the mail manager, use of pre-defined forms and templates for users, and on-off addressing. MailMate products work with existing mail packages. MailMate site-licenses are available. MailMate uses Alisa's DECnet package for the Macintosh, making the Macintosh a true DECnet node capable of receiving and sending DECnet mail. DECnet access may be via Ethernet, LocalTalk (and the Kinetics FastPath IV), or asynchronous (DDCMP) connection.

Approximate Cost\$450 to \$4950

Supplier: Alisa Systems, Inc., 221 E. Walnut St., Suite 175, Pasadena, CA 91101, 818-792-9474

MaxNotes

MaxNotes provides a Macintosh-based graphic point-and-click interface interface to Digital Equipment Corporation's VAX Notes electronic conferencing system. It uses Alisa's Macintosh DECnet package or a special AppleTalk for VMS package to connect to remote VAX Notes conferencing servers. Most features of the VMS terminal-based front-end for VAX Notes are supported by MaxNotes. MaxNotes supports a multiwindow interface that allows browsing of several topics at once, each with its own "threading" context; and cutting/pasting between windows. A "paste quotation" feature permits inclusion of quotations from other notes complete with ">>" marks and a template citation header. MaxNotes provides tools for conference moderators, including a single dialog that handles the membership roster, member privileges and node assignments, a dialog to add, delete or rename keywords and read-only topic and conference controls.

Approximate Cost\$295

Supplier: Alisa Systems, Inc., 221 E. Walnut St., Suite 175, Pasadena, CA 91101, 818-792-9474

PacerPost: Microsoft Mail 2.0 compatible server and gateways for VAX and VMS

PacerPost is a 100% compatible Microsoft Mail server running under VMS, functioning like Microsoft's Macintosh-based mail server for Microsoft Mail 2.0 clients. A VAX TTY client is provided for direct interaction with Microsoft Mail from a

Solutions

terminal. In addition, PacerPost provides VAX and VMS resident gateways to VAX-based mail systems. These gateways are also compatible with the Microsoft Mail server and gateway architecture. PacerPost mail servers and gateways are designed to function in conjunction with other Microsoft Mail 2.0 servers and gateways to provide enterprise-wide electronic mail capability.

The PacerPost mail server gives sites access to the entire range of VAX models and processing power, allowing for a larger number of mail clients and flexibility in designing a mail network. A site can select the appropriate processor size based on mail user population, message volume and application load.

Approximate Cost\$1000 to \$8000

Supplier: Pacer Software, Inc., 7911 Herschel Ave., Suite 402, La Jolla, CA 92037, 619-454-0565

Network Solutions in the VAX/ULTRIX Environments

The ULTRIX-32 Operating System is a UNIX operating system for Digital's VAX family of hardware. The current version is compatible with both System V and the University of California at Berkeley Software Distribution (BSD). The ULTRIX-32 Operating System is also compatible with the IEEE 1003.1 trial use standard for a Portable Operating System Environment (POSIX).

These ULTRIX systems are interactive, demand-paged, virtual-memory, time-sharing operating systems. They incorporate a high-performance file system, compatible device and interprocess I/O, asynchronous processes, disk quotas, job quotas, and a user-selectable system command language. Specific capabilities provided by these systems include tools and commands for UNIX time-sharing user interfaces, program development, documentation preparation, and communications and networking. DECnet-ULTRIX offers the flexibility to design networks that take advantage of multiple operating systems: VMS, RSX, DOS, TOPS-20, and ULTRIX. With the addition of the DECnet-Internet gateway, the resources of DECnet networks are also extended to users of non-Digital operating systems using the TCP/IP networking protocols.

The DECnet-ULTRIX software includes a semi-transparent, bidirectional gateway that bridges DECnet networks and internet (TCP/IP) networks. DECnet-ULTRIX offers task-to-task communications, network virtual terminal capabilities, remote file transfer, mail facilities, coexistence with the Internet protocols (TCP/IP-based), network-wide resource sharing, and management as defined by the DNA architecture.

See the *UNIX and TCP/IP* chapter in this Guide for product descriptions.

Researchers in remote facilities can access important information quickly.



At Union Carbide, the Ethernet Backbone Brings Sites Closer Together

Union Carbide Corporation has more than 30,000 employees located in its Connecticut headquarters, its two major research centers in New Jersey and West Virginia, its two satellite facilities in New Jersey and two major plants in Texas. Engineers and managers in all five locations need to access information on Digital VAX minicomputers at the research sites and an IBM host in West Virginia.

Macintosh Solution

The company has linked the computing resources of all five facilities, using a network of 3,000 Apple Macintosh systems on AppleTalk and Ethernet networks. Many Macintosh personal computers can access the VAX minicomputers at either research facility for chemical research data, scientific research programs, or Digital's ALL-IN-1 office automation program; or files stored on AppleShare file servers in any location.

Every AppleTalk network is connected to the Ethernet backbone in each building through Ethernet bridges. The two VAX clusters and the AppleShare file servers in remote sites communicate with one another over dedicated T-1 phone lines.

With File Sharing, Five Sites Seem Like One

Because team members on a single project might work at different sites, it was critical that employees could access financial and engineering information regardless of location. Union Carbide found a solution in AppleShare file servers, which

Case History

workgroups now use extensively to exchange information with other workgroups at their site or at other sites. The file server capability has enabled engineers to save time waiting for document transport and to avoid costly duplication of efforts.

The New Jersey research facility has a VAX running AlisaShare as its AppleShare file server. According to Keith Sproul, an engineer in the Applied Math and Computer Services group, “We make great use of the Macintosh and the AlisaShare server. In addition to exchanging files, we use Alisa Print Services to access printing resources, such as a fast, high-resolution Digital laser printer.”

“Another major advantage of linking the AlisaShare servers in different facilities is the convenience of printing at different locations. I’ve saved full-day trips by making revisions and printing them at destination instead of hand-delivering documents. People also like using the servers instead of faxing — you get better quality in almost the same time, and since the T-1 line is already in place, you don’t have to pay extra for this service.”

The VAX systems communicate with one another using DECnet. Because AppleTalk runs on top of DECnet, the VAX systems appear to Macintosh users as ordinary AppleShare file servers. “Users don’t want to know — or need to know — what type of file server they’re using,” says Sproul. “That’s what’s so great about the Macintosh — you can just choose a file server from a menu without knowing its location.”

VAX And IBM VM/CMS Terminal Emulation

Union Carbide’s engineers use their Macintosh systems with Mac240 or Mac241 from White Pine Software for Digital terminal emulation. They’ve recently begun using eXodus from White Pine Software for X Window and DECwindows™ terminal emulation.

The Accounting and Purchasing employees at Union Carbide use their Macintosh computers to access finance or accounting data on the IBM VM/CMS host in South Carolina. The VAX systems and the host are connected via another dedicated T-1 link, so users simply connect to the VAX through Ethernet, then log on to CMS.

Macintosh Network Open To All

Sproul is convinced of the advantages of the Macintosh for Union Carbide. “The Macintosh makes my job significantly easier. It’s easy to learn, so I don’t have the training concerns I’d have with other systems. And if people do have a valid reason for using a different machine, Macintosh connectivity tools mean they can still be part of the overall network.”

“When people ask if they can put their computer on our network, I can say ‘yes.’ That’s what I like about the Macintosh.”

UNIX and TCP/IP

Background

Major hardware suppliers offering UNIX:

- *Apple*
- *AT&T*
- *Cray*
- *Data General*
- *Digital*
- *Hewlett-Packard*
- *IBM*
- *NeXT*
- *Sun*

Developed at Bell Labs and first popular on university campuses in the 1970s, the AT&T UNIX operating system and its derivatives have become the most popular multi-user, multitasking operating systems available on minicomputers and workstations. At last count, over 100 manufacturers offered implementations of UNIX on their hardware, including Apple, Data General, Digital, Hewlett-Packard (HP), IBM, Sun, Cray, and NeXT.

Several versions of UNIX are available. Some of the more popular are System V, Release 2 and Release 3, from AT&T, and Berkeley Software Distribution (BSD) 4.2 and 4.3 from the University of California at Berkeley. Digital's ULTRIX implementation of UNIX is based on BSD 4.2. Apple's A/UX 2.0 is based on AT&T V.2.2 with Berkeley 4.3 extensions and it complies to all major UNIX standards including POSIX.

The major features of UNIX accounting for its popularity and growth include the following:

- UNIX is a multitasking, multi-user operating system: Many people can use it simultaneously to do one task, or one user can run many tasks concurrently.
- UNIX supports simple point-to-point asynchronous communications as well as sophisticated high-speed Ethernet networking. UNIX was developed to connect a variety of machines, whether this connection is room-to-room or across the country on packet-switched networks. Networks include TCP/IP and X.25 packet-switched public networks.
- The UNIX community has developed standards to promote implementation in a consistent fashion on many different machines—from micros to supercomputers. Thus, a program written on one machine can be moved to another one.
- UNIX offers a rich environment for software development and a large number of ad hoc utilities that can be quickly combined to build and integrate software subsystems.

UNIX was originally designed for scientific computation and data processing for technical development at Bell Labs. Codeveloped with UNIX was the C programming language (and its now-lost predecessors, A and B), in which most of UNIX is implemented. UNIX emerged from Bell Labs into the world because of AT&T's

The Environment

generous licensing policy toward universities. (The schools used UNIX for educational computing on Digital's PDP and VAX computers.)

Like most large organizations, schools have different kinds of computing machinery and a strong desire to tie the machines together to run the same software on them. Because of this, UNIX was "ported" to a variety of new machines, and new vendors in the university, and the scientific/technical marketplace offered machines that ran UNIX. Communications tools, from simple point-to-point telephone modems to sophisticated high-speed Ethernet protocols, were developed to connect the various UNIX machines together.

What did the schools do with UNIX? And what was it about UNIX that helped them? Mostly, it permitted them to share expensive computers. Computer science classes could teach any course from *Introduction to Programming to Compiler Design* on a 30- to 40-user minicomputer, distributing lessons and sample programs on line. Professors could communicate with their students or with their government grant administrators via network mail. Graduate students could create computer-aided design tools on a minicomputer, with many students participating in the coding, and then move the tools to a graphics workstation for use. The many features of UNIX, which include simultaneous management of multiple users, multitasking, and text preparation and printing, quickly made UNIX a popular choice.

The Independent Approach

UNIX was designed to be machine-independent; that is, it is an operating system that allows easy porting of applications, and UNIX, itself, can be ported from one computer design to another. In most cases, UNIX programs need some minor modifications when they are ported, but they are regarded as eminently transportable. Computer manufacturers appreciate this capability because it spares them the enormous expense of writing a new operating system from scratch. What's more, software applications already written to run under UNIX often run on any UNIX-based machine with a minimal porting effort.

UNIX has grown into an industry standard—a robust operating system that has the power many elaborate computer systems need.

Designed for Programmers

Originally designed by programmers for programmers, UNIX provides a rich set of utilities to get applications running quickly. UNIX remains a complex system to administer (adding new users, configuring networks, and so on) on conventional systems. It offers many options for every command. Personal computers or work-

The Environment**UNIX features:**

- *Complies with major standards*
- *Manages multiple users simultaneously*
- *Provides multitasking*
- *Delivers powerful communications capability*
- *Provides developer tools*
- *Includes an integral electronic mail facility*
- *Provides text preparation and printing services*

stations require a relatively large amount of hard-disk storage and random-access memory (RAM) to support UNIX.

The current popularity of the C programming language also continues to keep interest in UNIX high. A Bell Laboratories researcher, Dennis Ritchie, based the C language on B, which was invented by Kenneth Thompson. Ritchie went on to rewrite UNIX in the C language, adding many utilities and programming aids along the way. Today the ties between UNIX and C remain strong, and many C programmers continue to develop applications under UNIX.

The concept of the UNIX Kernel and the UNIX Shell are fundamental to the success of the operating system. The Kernel contains the programs that directly control hardware, such as Input/Output (I/O) devices and the processor. The Shell is the command line interface to the Kernel.

The UNIX Shell interprets programmer or user commands well as choosing between foreground or background execution of tasks and I/O redirection or command chaining. The UNIX Shell acts as the user's interpreter for the Kernel.

Among the more powerful UNIX utilities are a versatile hierarchical filing system and a feature called "pipes." Using pipes, programmers can hook together several simple programs to do something more complex, thereby avoiding the need for new software development. Pipes are typically used with filters, which are commands that take their input from the standard input, perform some transformation—such as restricting the type of input (for example, only those names beginning with the character "H")—and return the result to the pipe. The pipe then redirects the output to the input of another program, thus saving the programmer time spent on design and coding functions.

Three uses of UNIX:

- *Operating system for large, shared computers*
- *A single user desktop computer*
- *A base for multiuser turnkey applications*

Major Uses of UNIX

Timing and fate seem to be as much responsible for current UNIX popularity as anything else. Having matured during the height of the minicomputer marketing phenomenon of the mid- to late 1970s, UNIX was recognized as the only capable operating system that could run on a number of vendors' machines. This portability was also a factor in its popularity in the early 1980s, with the appearance of a new generation of microcomputers that had the processing power of earlier minicomputers. UNIX and Microsoft's XENIX derivative were the only multi-user operating systems that could readily tap these more powerful computer systems.

Each of the following implementations takes advantage of the strengths of UNIX: Digital's VAX uses its multi-user, multitasking power; engineering workstations tap its rich complement of tools; and turnkey systems rely on its software portability and machine independence.

The Environment

A/UX: Apple Computer's Implementation of UNIX Combines Both Worlds

Apple's Macintosh computers are capable of running two operating systems, the Macintosh Operating System and A/UX, Apple's implementation of UNIX. The Macintosh OS, which comes standard with the Macintosh, can talk to UNIX computers. A/UX makes the Macintosh a UNIX system, while still being able to run Macintosh applications.

A/UX 2.0 combines Macintosh and UNIX in one desktop computer. It retains the features of previous versions of A/UX—full UNIX standards-compliance and the ability to run Macintosh applications. A/UX 2.0 adds the Macintosh Finder graphics-based desktop; the ability to run multiple UNIX, X Window System, and Macintosh applications simultaneously; and integrates Macintosh and UNIX functionality.

A/UX 2.0 is based on AT&T V.2.2 with Berkeley 4.3 extensions. It complies with all major UNIX standards, including: IEEE POSIX 1003.1-1988 FUS, AT&T System V Interface Definition (SVID), ISO 9945-1, and FIPS #151-1. A/UX also includes customer-demanded standards such as NFS 3.2, TCP/IP, and the X Window System (sold separately).

On the Horizon

As personal computers continue to meet or surpass minicomputers in power, and as rapidly dropping prices make shared computers less attractive than large networks of personal computers, UNIX will continue to cultivate a large role in business computing. It has been an ideal system for file, communications, and database servers on networks, and its multitasking ability allows it to perform multiple services simultaneously. Suppliers of UNIX are now rushing to cover its complexities and broaden its appeal by embracing the standards of new visual user interfaces.

UNIX committees are also proposing standards for UNIX for federal and commercial use. Today's emphasis on user-friendly systems will allow many users to utilize the power of UNIX, while shielding them from the complexity of the operating system. Having taken the first two steps, from the lab to the colleges to the engineering market, UNIX is now poised to step into its place in the networked businesses of the 1990s. And A/UX 2.0 has exactly what these customers need: Standards, the Macintosh human interface, and applications.

UNIX and TCP/IP-Related Solutions

The Macintosh computer is capable of running two operating systems, the Macintosh Operating System (OS) and A/UX, Apple's implementation of AT&T UNIX System V, Release 2.2. The Macintosh OS, which comes standard with the Macintosh and runs the Finder and the Chooser, can talk to UNIX computers. A/UX makes the Macintosh a UNIX system.

| |
|-------------------|
| Applications |
| MultiFinder |
| Macintosh Toolbox |
| UNIX |
| Hardware |

A/UX from Apple is a complete implementation of AT&T System V UNIX for the Macintosh II. A/UX features key elements of BSD 4.3 extensions, as well as support for the Macintosh Toolbox.

A/UX Functionality

Users who require UNIX have access to the benefits of the Macintosh, including:

The Macintosh Desktop

The Macintosh desktop on A/UX 2.0 effectively shelters users from the sometimes arcane command-line interface of traditional UNIX. As a result, A/UX 2.0 will make UNIX much more accessible to mainstream users, while providing the rich UNIX environment expected by technical users.

All the elements of the distinctive Macintosh desktop—point and click simplicity, menu bars, and familiar icons have been incorporated into A/UX 2.0. And A/UX 2.0 provides this desktop on an industry-standard UNIX platform. A/UX 2.0 also supports MultiFinder, 32-bit QuickDraw™, Chooser selection of network resources, the Macintosh start-up and shutdown process, and much more.

Macintosh Applications

A/UX is the only UNIX platform which can run the high-quality productivity applications that are used on the Macintosh. These applications are also easier to obtain than UNIX applications and are usually much lower in price.

Any Macintosh application which is “32-bit clean” and conforms to *Inside Macintosh* rules should run on A/UX. (Future releases of the Macintosh System Software will also require “clean” applications.) As a transitional step, A/UX also includes a 24-bit mode to allow customers to run older applications.

Mix and Match Applications

With A/UX, users can have a single system on their desktops to do all their daily work and run UNIX, and X Window System applications alongside Macintosh applications. With third party products, customers can run Motif, OPEN LOOK, and MS-DOS applications. Additionally, A/UX supports text cut-and-paste between all these applications plus graphics cut-and-paste between Macintosh applications.

Solutions

Most of the major Macintosh applications are now A/UX compatible including:

- *Hypercard*
- *Word 4.0 from Microsoft*
- *MacWrite II from Claris*
- *MacDraw II from Claris*
- *Powerpoint 2.0 from Microsoft*
- *WingZ from Informix*

This capability to effectively mix and match applications from these environments provides users with a powerful, unified computing platform. The integration of Macintosh applications into a standard UNIX base is unmatched in the computer industry.

Macintosh and UNIX Integration

A/UX 2.0 integrates the benefits of both Macintosh and UNIX environments in to one system. A/UX 2.0 also brings the methods of Macintosh personal computing to many traditional UNIX functions. For example, an application called “Commando” allows users to run UNIX commands by selecting options from a menu—without memorizing the string of complicated parameters associated with these UNIX utilities. A/UX software includes a new Macintosh text editor for UNIX text files, which provides seamless point and click access to both UNIX and Macintosh file systems. A/UX 2.0 gives customers the choice of using UNIX in the traditional UNIX manner—all within windows on the desktop.

X Window System for A/UX, Version 2.0, permits people to use the X Window System in the traditional manner and to run X Window System applications within windows on a Macintosh desktop.

By combining the power of Macintosh and UNIX on a single system, A/UX 2.0 provides users with an extremely flexible computing environment. Users can employ Macintosh techniques for traditional UNIX activities, or they can work in the UNIX environment. All the while, users have access to the power and functionality of Macintosh applications.

Standard UNIX Base

A full implementation of industry standard UNIX, A/UX 2.0 is based on AT&T's UNIX System V.2.2 with BSD 4.3 extensions. It is compliant with all the major UNIX standards including AT&T's System V Interface Definition (SVID), IEEE's POSIX 1003.1-1988 FUS, ISO 9945-1, and the FIPS 151 requirement from the US Federal Government. A/UX also meets customer-demanded standards such as NFS 3.2, Berkeley Networking Services, and the X Window System (X sold separately). Customers can therefore easily port both AT&T and BSD based applications to their A/UX system.

Multitasking and Virtual Memory Support

A/UX 2.0 supports the execution of multiple processes simultaneously. Under MultiFinder, multiple Macintosh applications can run simultaneously, just as though using MultiFinder with the Macintosh operating system. At the same time, multiple

UNIX and X Window System applications can run in Macintosh windows. A/UX also provides virtual memory, which allows users to run more applications than the physical memory in the system can hold.

Communications

A/UX provides standard UNIX communications such as `cu` and `uucp`, as well as more advanced communication standards from UNIX (TCP/IP) and Macintosh (AppleTalk). Users can connect TCP/IP networks using Ethernet or serial lines (SL/IP). With TCP/IP, users can take advantage of the X Window System, Berkeley Networking Services, NFS, and Network Information Services. Users can also connect to AppleTalk networks using EtherTalk (sharing the Ethernet connection with TCP/IP protocols) or LocalTalk. With the AppleTalk system, users can take advantage of AppleTalk printing and AppleShare file services (client only).

Programming

A/UX 2.0 offers an assembler, a C compiler, debuggers, the Source Code Control System (SCCS), an ANSI Standard Fortran compiler, and related tools to assist in developing new applications or porting existing software to A/UX. Version 2.0 also includes a set of UNIX libraries that allow C programs to access the functionality of the Macintosh Toolbox, so A/UX applications can present the graphics-based user interface that is familiar to Macintosh users, as well as the traditional UNIX appearance. Numerous other languages and tools are available from third-party developers.

AppleCD SC Support

The AppleCD SC drive can be used as a read-only UNIX file system or Macintosh file system of up to 500 megabytes, giving information systems providers an inexpensive distribution medium.

Hardware Support

A/UX 2.0 runs on Macintosh personal computers with 68030 processors or with 68020 computers which have the 68851 Paged Memory Management Unit (PMMU). The Macintosh IIfx is an especially powerful A/UX platform, as A/UX 2.0 takes full advantage of the system's SCSI/DMA, and input/output processor capabilities. Four megabytes of memory are recommended as a minimum for all platforms.

Approximate Cost\$795 (A/UX on CD);
\$995 (A/UX on Appletape); \$995 (A/UX on Diskettes).

Refer to your local dealer for additional A/UX product offerings.

Supplier: Apple Computer, Inc., 20525 Mariani Ave., Cupertino, CA 95014, 408-996-1010

Solutions

| OSI | TCP/IP |
|--------------|---------------------------|
| Application | NFS, FTP, Telnet, SMTP |
| Presentation | |
| Session | |
| Transport | TCP, UDP |
| Network | IP |
| Link | Ethernet |
| Physical | Coaxial Cable |

TCP/IP provides a rich set of network protocols. Although TCP/IP was created before the OSI Reference Model was developed, this schematic shows how TCP/IP protocols relate to the seven-layer OSI Model.

Networking Macintosh OS Computers to a UNIX Host System

When Macintosh OS computers are connected to a UNIX system, software products provide specific network services to Macintosh computer users. Some software, such as file servers and print spoolers, run under the UNIX system itself to provide services. Other software, such as network terminal emulators, enables the Macintosh to be used as a “window” into the UNIX system’s environment.

The UNIX networking environment has the capability to support multiple protocols. A commonly encountered protocol in the UNIX world is TCP/IP (Transmission Control Protocol/Internet Protocol). Originally developed for the ARPAnet, a forerunner of modern networks, TCP/IP protocols have long been used on Ethernet LANs. Support for TCP/IP is standard in BSD 4.2 UNIX and has been added to many UNIX System V implementations, including A/UX.

One means for bridging the Macintosh OS personal computer with UNIX systems is to use TCP/IP, and provide software that enables the Macintosh to “speak” TCP/IP. Two Macintosh-to-UNIX solution packages based on the TCP/IP protocols are Ultra-Office from Information Presentation Technologies, and pCLINK from Pacer Software. For further information see the *TCP Solutions* section later in this chapter.

Network Software: AppleTalk Solutions

GatorCard E/II

The GatorCard E/II connects any of the Macintosh II family of computers directly to standard or thin Ethernet. Macintosh users can share files, use electronic mail and print over the 10 Mbit per second Ethernet network. The GatorCard E/II lets Macintosh users communicate with other Macintosh users on Ethernet or LocalTalk using AppleTalk applications. Software included with GatorCard E/II also supports TCP/IP and DECnet. The GatorCard E/II software also includes NCSA Telnet, a terminal emulation program that lets Macintosh users log on to TCP/IP workstations eliminating the need for a second desktop terminal to log on to UNIX-based computers on Ethernet. GatorCard E/II is A/UX compatible. Refer to the *Networking Environments* chapter in this Guide for more information.

Approximate Cost\$595

Supplier: Cayman Systems, Inc., 26 Landsdowne St., Cambridge, MA 02139, 617-494-1999

GatorBox

The GatorBox connects an entire Macintosh network to Ethernet, offering physical connections for LocalTalk and standard and thin Ethernet. The hardware supports

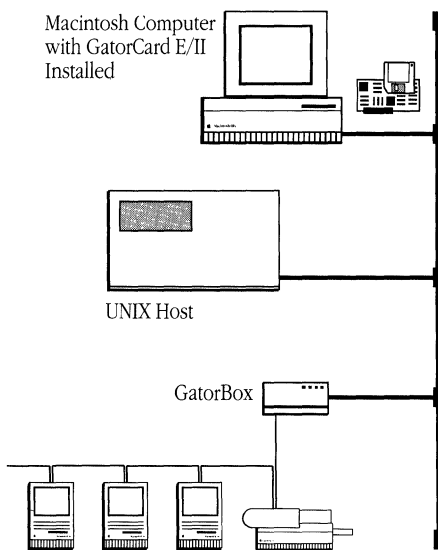

The GatorCard E/II and the GatorBox products provide connections to the Ethernet environment.

Solutions

AppleTalk routing so Macintosh users on both LocalTalk and Ethernet can share laser printers, E-mail, and storage. GatorBox also supports TCP/IP for terminal sessions from Macintosh computers to UNIX hosts. In addition, GatorBox supports proprietary network architectures from TOPS, Wollongong, Pacer, Alisa and others.

Approximate Cost\$2795

Supplier: Cayman Systems, Inc., University Park at MIT, 26 Landsdowne St., Cambridge, MA 02139, 617-494-1999

MultiGate

Webster's MultiGate allows integration of Apple Macintosh and Ethernet networks. MultiGate performs AppleTalk routing on four independent LocalTalk networks while acting as a TCP/IP gateway. Single, large LocalTalk networks can be separated into smaller, compact LocalTalk networks connected by MultiGate to form an internet. This results in reduced traffic on each smaller network. Several MultiGates may be interconnected by an Ethernet backbone to form large, segmented Macintosh LocalTalk networks. An Ethernet host need not be present when using Ethernet as a backbone. With appropriate third party software, Macintosh users can access the Ethernet network's printing, file serving, electronic mail and file transferring capabilities, while Ethernet hosts can access AppleTalk services, such as a LaserWriter, or any of the LocalTalk networks.

Approximate Cost\$4995

Supplier: Webster Computer Corp., 2109 O'Toole Ave., Suite J, San Jose, CA 95131-1303, 408-954-8054

DTSX-14

The DTSX-14 is an intelligent co-processor card for the Macintosh II that provides X.25 access to packet-switched wide area networks (WANs). Equipped with a 16 MHz Intel 80188 processor and 1 Mbyte of onboard RAM, the efficient design of the DTSX-14 meets the CCITT 1988 standards and is certified for operation on packet-switched networks throughout the world. STS supports up to 255 virtual circuits, and provides the functions of the first four layers of the OSI model (Physical, Data Link, Network and Transport layers). Input/output to the card and to the WAN is accomplished via Symicron's SYMNIX. This driver, which runs under A/UX, includes full X.3, X.28, and X.29 support, and can allow an application program to access STS at any of the four OSI layers. Transport level access is simplified by an Application Program Interface (API), implemented via 'C' language subroutine calls. STS also includes an SNA 'engine', making it possible for Macintosh applications to communicate with remote IBM hosts using IBM 3270 or 3770 emulation.

Approximate Cost\$745 to \$1395

Supplier: Symicron, Inc., 23545 Crenshaw Blvd., Suite 104, Torrance, CA 90505, 213-530-2610

Solutions

K-AShare

K-AShare is AFP-compatible file server software for UNIX hosts. K-AShare provides the benefits of UNIX hosts while allowing implementation of AppleShare for Macintosh users. Users access K-AShare by using the Chooser to select a network zone and then selecting AppleShare. K-AShare appears as an AppleShare icon on the desktop. The icon can be opened and read, copied, moved, trashed or launched like a local file. Access to files on the host conforms to standard UNIX system security with login validation and file access permissions enforced. In addition, AppleShare security (drop folders, see folders, see files, and make changes) is mapped to UNIX security. The AppleShare administrator can create groups of users with common access privileges to files and folders and can register individual users. Users need only have a valid UNIX host account and use the appropriate password. K-AShare supports the following host systems: Hewlett-Packard 9000/300 with HP-UX 6.5 or 7.0; HP 9000/800 with HP-UX 3.1 or 7.0; DEC VAX with ULTRIX 3.1, 4.0; other UNIX workstations.

Approximate Cost\$995 to \$5395
Supplier: Mt. Xinu, 2560 Ninth St., Berkeley, CA 94710, 415-644-0146

K-Spool supports the following host systems:

- *Hewlett-Packard 9000/300 with HP-UX 6.5 or 7.0*
- *HP 9000/800 with HP-UX 3.1 or 7.0*
- *DEC VAX with Ultrix 3.1, 4.0*
- *Other UNIX workstations*

K-Spool supports the following protocols:

- *AFP*
- *PAP*
- *ASP*

K-Spool

K-Spool software allows users of Macintosh computers and UNIX systems to share PostScript printers. K-Spool is a UNIX application which functions as a print server for the Macintosh. K-Spool advertises its address to Macintosh computers as a LaserWriter, allowing Macintosh users to see it through the Chooser. For users, K-Spool is a spooler; print jobs may be sent to the spooler, which dispatches jobs as the printer becomes available. For UNIX system users, K-Spool allows printing of both ASCII text files and PostScript format files to PostScript printers. K-Spool also includes tpscript, a public domain ditroff-to-PostScript translator, to accommodate files from AT&T's device-independent troff package. K-Spool also provides management and diagnostic tools for the UNIX system administrator. Tools that monitor printer and spooler status are included with the K-Spool package.

Approximate Cost\$695
Supplier: Mt. Xinu, 2560 Ninth St., Berkeley, CA 94710, 415-644-0146

IPGate

The NRC IPGate is AppleTalk to TCP/IP internetworking software which is downloaded to NRC's MultiGate 2000 router platform. IPGate lets users route between LocalTalk or PhoneNET networks and Ethernet, broadband or fiber-optic TCP/IP networks. IPGate adheres to the TCP/IP "Interior Gateway" RFC-950 and proxy-ARP specifications allowing users to integrate LocalTalk networks as TCP/IP

Solutions

subnets on their TCP/IP network. IPGate supports KIP and CAP-style encapsulation and AppleTalk routing, allowing access to AppleTalk server environments, DEC computers networked with TCP/IP or AppleTalk, and any UNIX or TCP/IP-based computer system. IPGate translates the MSP protocol. MSP is used by NRC's MultiGate Access applications to transfer TCP/IP information across AppleTalk networks. IPGate allows users to configure the LocalTalk network as an insecure network. This configuration permits connections only to designated TCP/IP hosts or networks and prevents the propagation of faulty network information onto the TCP/IP network. A password-protected Operational Interface provides network information for AppleTalk and TCP/IP networks. SNMP is also supported.

Approximate Cost \$395 to \$2795

Supplier: Network Resources Corp., 2450 Autumnvale Dr., San Jose, CA 95131, 408-263-8100

MultiGate Mac

The NRC MultiGate Mac is AppleTalk to TCP/IP internetworking software which runs on any computer in the Macintosh II family. MultiGate Mac lets users route between as many as six AppleTalk and TCP/IP networks. MultiGate Mac adheres to the TCP/IP "Interior Gateway" specifications RFC-950 and proxy-ARP. MultiGate Mac supports KIP and CAP-style encapsulation, AppleTalk to IP routing, AppleTalk routing, IP to IP routing and MSP to TCP protocol translation. MSP is used by NRC's MultiGate Access applications to transfer TCP/IP information across AppleTalk networks. Placing one MultiGate Mac on or between EtherTalk and/or TCP/IP networks allows any Macintosh user to access TCP/IP and/or UNIX hosts using MultiGate Access or any application based on MacTCP such as NCSA Telnet. MultiGate Mac allows users to configure attached networks as secure networks preventing inbound connections or the propagation of faulty network information. An Operational Interface provides detailed network information and troubleshooting capabilities for both AppleTalk and TCP/IP networks. SNMP support is provided.

Approximate Cost \$795

Supplier: Network Resources Corp., 2450 Autumnvale Dr., San Jose, CA 95131, 408-263-8100

MultiGate Access

MultiGate Access provides Macintosh users with UNIX and TCP/IP host access. MultiGate Access is a set of software applications which make use of the Macintosh interface for connectivity between Macintosh computers and TCP/IP host computers. The MacEdit application allows users to edit UNIX or VMS host-based documents on their Macintosh computers. The MacFTP application allows Macintosh users to transfer files to and from TCP/IP-based computers. MacFTP converts host text files to the Macintosh word processor format of choice. Users can choose the

Solutions

proper file type for graphics files during file transfer. The MacTerm 2000 is a VT100 terminal emulator. Features include on-line help, keyboard mapping and the ability to save session settings for later use. LocalTerm is a serial driver replacement which allows users to access IBM mainframes, DEC computers, HP mainframes, and Tandem mainframes over existing AppleTalk and corporate networks using third-party serial-based terminal emulation packages. MultiGate Access uses NRC's MSP protocol and is designed to work in tandem with NRC's TCP/IP gateways, MultiGate Mac or IPGate, to provide access to TCP/IP host computers.

Approximate Cost \$80 to \$2795

Supplier: Network Resources Corp., 2450 Autumnvale Dr., San Jose, CA 95131, 408-263-8100

MultiGate Manager

The NRC MultiGate Manager is a network management application that allows users to manage the entire line of MultiGate products from a central location. The Oracle relational database is employed for control of network information. MultiGate Manager allows users to specify the routers they want to update and specify the time at which the new software is to be downline loaded or other changes made. Features include router management, statistical analysis of performance, failure diagnosis and report generation. Support for standard AppleTalk configuration criteria such as zone naming, network numbering and router naming is also provided. MultiGate Manager also provides access to NRC's IPGate or MultiGate Mac Operational Interface. This interface allows users to control, monitor and troubleshoot their TCP/IP networks from the same central location.

Approximate Cost \$795 to \$2395

Supplier: Network Resources Corp., 2450 Autumnvale Dr., San Jose, CA 95131, 408-263-8100

GatorShare

GatorShare software provides transparent file service between Macintosh and UNIX computers. Using the AppleShare interface, Macintosh users can store and retrieve files on Ethernet hosts that support Network File System (NFS). Most UNIX implementations include NFS. GatorShare runs on the GatorBox and translates between AppleShare and NFS, eliminating the need to add AppleTalk protocols to the UNIX kernel. Features include file service between Apple and UNIX computers; printing from UNIX machines to LocalTalk devices; and UNIX machines acting as AppleShare file servers for Macintosh computers. GatorShare also includes a printing component, GatorPrint, which allows UNIX computer users to print through the GatorBox to LocalTalk devices.

Approximate Cost \$1995

Supplier: Cayman Systems, Inc., University Park at MIT, 26 Landsdowne St., Cambridge, MA 02139, 617-494-1999

The uShare family of products includes:

- *AppleTalk network support for UNIX System V and BSD 4.2*
- *AppleShare/AFP-compatible file server*
- *Print system utilizing lp, lpr, and queuing capabilities*
- *VT100 Terminal Emulation*
- *Virtual disk*
- *Support for ADSP, K-STAR, DDP/IP (Translation), EtherTalk, and NFS transfers over unaltered IP routers*

uShare

uShare connects Macintosh computers and IBM-compatible PCs to the UNIX environment while maintaining the AppleShare interface. uShare complies with Apple's data communications protocols as well as with TCP/IP protocols. uShare allows the UNIX host to act as an AppleShare file server, providing AppleTalk Filing Protocol bidirectional file sharing. uShare provides Macintosh and PC environments with UNIX features and utilities. Print Server/Spooler options include mixed Macintosh, PC, and UNIX PostScript print jobs queued on the UNIX host; and Apple LaserWriter and other PostScript-compatible printers supported on LocalTalk or attached to a port on the UNIX host. Electronic mail options include Macintosh user interface; priority mail, delayed mail, and attachment features; and world-wide ARPAnet mail systems compatibility. Virtual disk options include UNIX storage providing the functions of a Macintosh hard disk uShare runs on UNIX computers from a dozen manufacturers. For some UNIX hosts, IPT offers a board for direct connection to LocalTalk. All hosts can connect to Macintosh computers on Ethernet, LocalTalk, or other cabling. uShare is compatible with gateway devices from Kinetics, Liaison, and others.

Approximate Cost\$955 to \$3625

Supplier: Information Presentation Technologies, Inc. (IPT), P.O. Box 8609, Calabasas, CA 91372, 818-347-7791

ICP (Intelligent Communications Processor)

The Orange Micro-ICP is an intelligent communications processor for the Macintosh II family of computers. Features include: the Motorola 68000 microprocessor; 512K RAM with no wait states; up to four RS-232 DTE ports, two of which are configurable to AppleTalk; and compatibility with A/UX, Mr. DOS, and Macintosh operating systems. The ICP performs all AppleTalk and RS-232 communications tasks, and has up to four serial ports that can be used for RS-232C asynchronous communications. Two of the ports may be configured for RS-422 communications, to work with the AppleTalk network, enabling A/UX to send printed output to any printer device on AppleTalk. AppleTalk/ICP software that provides A/UX with access to the AppleTalk network is available from Apple Computer. When configured with MacAPPC software, the ICP serves as a communications platform to connect an AppleTalk network to an SNA network. The ICP is attached to one of the NuBus slots in a Macintosh II and acts as a bridge between Apple and IBM networks. A MacAPPC tool kit is available from Apple Computer. Macintosh developers can write communication applications to the ICP for use with Mr. DOS (Multitasking, Real-Time Disk Operating System).

Approximate Cost\$949 to \$999

Supplier: Orange Micro, Inc., 1400 N. Lakeview Ave., Anaheim, CA 92807, 714-779-2772

Solutions

A/UX-DRV

A/UX-DRV - Installer driver allows a Macintosh running A/UX to communicate over 10 Mbps Ethernet. A/UX-DRV is used in conjunction with Racal InterLan's NIA310 MacConnect, MacConnect 10BT, or MacConnect SE/30 Ethernet networking boards. Features include a driver that works with A/UX versions 1.1 and 1.1.1; compatibility with Racal InterLan MacConnect Ethernet board family; installation via the A/UX built-in utility "finstall;" and a free upgrade disk to A/UX 2.0

Approximate Cost \$75;
 NIA310 MacConnect, \$549; MacConnect 10BT, \$625; MacConnect SE/30, \$595

Supplier: Racal InterLan, Inc., 155 Swanson Rd., Boxborough, MA 01719, 800-LAN TALK

TCP Solutions

MacTCP

The MacTCP® application provides a standard platform for developing applications and services using C and Assembly language interfaces over TCP/IP protocols. Licensed to third-party developers, MacTCP includes TCP, UDP, and IP protocols and conforms to Internet RFCs and MIL-STDs, ensuring interoperability with systems on the TCP/IP Internet. Using MacTCP, an application developer can create a Telnet application—a standard terminal-emulation utility on TCP/IP—that allows a user to access a host computer from a Macintosh computer over a TCP/IP network. MacTCP also allows concurrent TCP/IP and AppleTalk operation. For example, MacTCP can run while a print job travels to an Apple LaserWriter printer over LocalTalk cable. MacTCP runs over both Ethernet and LocalTalk cable systems. MacTCP is built into A/UX 2.0.

Approximate Cost Contact supplier

Supplier: APDA, (Apple Programmers and Developers Association), Apple Computer, Inc., 20525 Mariani Ave., MS 33G, Cupertino, CA 95014, 800-282-2732, 800-637-0029 in Canada, 408-562-3910 Internationally

TCP/Connect II terminal emulators include:

- DEC VT100/102, VT220, VT240/241
- IBM 3278-2,3,4,5
- Tektronix 4010/4014

TCP/Connect II

TCP/Connect II is an application that allows an Apple Macintosh to access TCP/IP services. Included in the extended edition are support for Telnet (the network terminal protocol), FTP (file transfer protocol), POP/SMTP (electronic mail), and NNTP (the network news protocol). TCP/Connect II can be used to access IBM mainframes, DEC VAX systems, PC Compatibles, most UNIX machines, and other Apple Macintosh computers. TCP/Connect II supports a variety of network interfaces, including MacTCP, A/UX MacTCP, direct Ethernet devices, and SLIP (serial line IP). Features include: Telnet virtual terminal access including IBM 3278 and DEC VT240/241 emulation; "Font/DA Mover"-type interface to FTP for file transfer;

Solutions

electronic mail access, including the ability to send and receive files, refile messages, and maintain address books; and electronic news, providing access to the world of USENET news.

Approximate Cost \$495

Supplier: InterCon Systems Corp., 950 Herndon Pkwy., Suite 390, Herndon, VA 22070, 703-709-9890

TelnetDriver

The InterCon TelnetDriver installs into VersaTerm-Pro or MicroPhone II 3.0, and allows these programs to communicate with a host computer over a TCP/IP virtual terminal connection (TELNET).

Approximate Cost \$149

Supplier: InterCon Systems Corp., 950 Herndon Pkwy., Suite 390, Herndon, VA 22070, 703-709-9890

TCPort Version 2.0

TCPort Developers Toolkit is a software platform for the development of distributed Macintosh applications running on top of TCP/IP. TCPort consists of two parts: (1) a choice of two basic TCP/IP transport systems: Novell's TCPort and Apple Computer's MacTCP, and (2) an application programming interface (API). The TCP/IP transport system, which includes drivers for TCP, IP and UDP, provides TCP/IP connectivity, allowing Macintosh computers to communicate with other TCP/IP hosts, servers and workstations on a network. The 4.3 BSD socket library API assists programmers and developers in developing distributed TCP/IP applications for the Macintosh. This socket model gives developers who are accustomed to the standard UNIX programming environment a consistent means of accessing the transport protocol layer. The socket model is compatible with and recognizes both the TCPort transport system from Novell and the MacTCP transport software from Apple, both of which are included in the Developer Kit.

Approximate Cost \$2500

Supplier: Novell, Inc., Sales Dept., Developer Products, 5918 W. Courtyard Dr., Suite 220, Austin, TX 78730, 800-733-9673

telnet•PM

telnet•PM is a protocol module for MacWorkStation which uses TCP/IP to send commands and events between the host application and MacWorkStation. Developers using MacWorkStation to give their host applications a Macintosh interface can take advantage of Ethernet communications speeds and reliability. Many host computers use the TCP/IP Telnet virtual terminal protocol to allow terminal connections to host computers over Ethernet communications links. MacWorkStation, when enhanced with telnet•PM, can also use this communications method.

Solutions

telnet•PM can be added to any existing MacWorkStation application by copying the resources provided in telnet•PM to a MacWorkStation document with existing developer tools such as ResEdit™. The TCP/IP communications resources are invoked by a simple change to the MacWorkStation Communication Command Language (CCL) script.

Approximate Cost\$75

Supplier: Ramsay Consulting, 507 Second St., Ann Arbor, MI 48103, 313-665-2819

Net/One MacUWS

MacUWS provides a Macintosh front-end to host applications, turning routine activities into an interactive process with pull-down menus, scroll bars, and selection buttons for point-and-click mouse support. End users can share resources and information throughout the network with MacUWS. Included is a VT100 terminal emulator that supports up to five Telnet sessions. Each session runs in a user-configurable window. Using a standard File Transfer Protocol (FTP) facility, network users can download data from host computers for local use. MacUWS includes a standards-based TCP/IP driver, FTP/Telnet capabilities, and the Advanced Scripting and Application Platform (ASAP) language. MacUWS provides support for Apple's EtherTalk (IEEE 802.3) and LocalTalk, and users can run MacUWS under Finder and MultiFinder.

Approximate Cost Contact Supplier

Supplier: Ungermann-Bass, 3900 Freedom Cir., Santa Clara, CA 95052-8030, 408-496-0111

MacNIX 3.1, Serial

MacNIX is a distributed software allowing Macintosh users access to host UNIX facilities via the Macintosh user interface. The system provides integration between the Macintosh and the UNIX environments. UNIX files are displayed as Macintosh-like icons and are given a specific set of operations. MacNIX supports multitasking management of the UNIX processes, which lets users have multiple process windows and multiple icon windows on the screen at the same time. MacNIX includes a full text editor, which allows uploading and downloading of UNIX as well as local files. The file transfer utility permits files, folders, or directories to be copied to or from any part of the file system; the user can specify the file format for the target file. The available file formats are: ASCII, Binary, Image, Apple double and MacBinary standard. MacNIX is a distributed software based on a client/server architecture. Connections can be made either via serial lines or via Ethernet network using TCP/IP protocols. From the Macintosh side, the communication with UNIX systems is possible with MacTCP.

Approximate Cost\$800 to \$9800

Supplier: Unipress Inc., 2025 Lincoln Hwy., Edison, NJ 08817, 201-985-8000

X Window Servers

X Window System for A/UX

Apple's X Window System for the A/UX operating system lets A/UX users run X client applications that have the Macintosh interface. The A/UX Finder software, a special version of the Macintosh MultiFinder adapted for A/UX, allows users to run X client applications, Macintosh productivity applications, and UNIX programs concurrently. Users can cut and paste text between the different application environments. Apple's X Window System for A/UX complies with the standards and conventions stipulated by the MIT X Consortium. The X Window System for A/UX includes two separate X components. The first, MacX, allows X Window System client applications to share the A/UX Finder desktop with Macintosh and UNIX applications (For more information on MacX, please see the separate MacX description in this chapter). The second, X11, is for more experienced or technical X Window System users, and offers the native X Window System Version 11 Release 4 (X11R4) server environment with no access to Macintosh functionality. X11 supports both monochrome and 8-bit color video cards and displays. Developers who wish to develop X client applications under X11 can do so using the Xlib and Xtk library and toolkit.

Approximate Cost \$295

Supplier: Apple Computer, Inc. 20525 Mariani Ave., Cupertino, CA 95014, 408-996-1010

OSF/Motif™ 1.0.3 for A/UX 2.0

OSF/Motif is a vendor-independent toolkit for developing graphic user interfaces for the X Window System. Interfaces developed are portable to all X platforms and compatible with Presentation Manager behavior. Motif features UIL (User Interface Language) which allows prototyping of the interface. With UIL, the user interface can be changed without rebuilding the application. The Motif Window Manager (MWM) provides keyboard access to the interface and "real world" correspondence to desktop metaphors while also observing Inter-Client Communications Conventions (ICCC). MWM allows users flexibility in customizing their environments. A style guide and documentation are also included.

Approximate Cost \$500

Supplier: Integrated Computer Solutions, Inc., 163 Harvard St., Cambridge, MA 02139, 617-547-0510

XView 2.0 with OPEN LOOK™ for A/UX 2.0

XView, the X-based Visual/Integrated Environment for Workstations, features an object-oriented interface that follows the specifications for the OPEN LOOK Graphic User Interface (GUI). The XView Toolkit offers a complete set of OPEN LOOK-conformant interface objects, graphic metaphors and help for novice users.

Solutions

The OPEN LOOK Window Manager (OLWM) is independent of any toolkit code. It is ICCCM-compliant and based on the OPEN LOOK GUI. The package includes sample XView applications, including: Clock, Text editor, Terminal emulator, and Script that helps convert SunView programs to XView. Also included are bitmap fonts, glyph fonts and the XView Programming Manual.

Approximate Cost\$500 per CPU

Supplier: Integrated Computer Solutions, Inc., 163 Harvard St., Cambridge, MA 02139, 617-547-0510

Apple's MacX implementation of the X11 server includes support for:

- *Monochrome and 8-bit color X client applications*
- *Multiple physical screens (up to six) attached to one Macintosh computer*
- *Cut and paste between X Window and Macintosh applications*
- *Multiple concurrent connections to multiple X clients*
- *Multiple network protocols, including AppleTalk, DECnet, and TCP/IP*
- *DECwindows conventions*

MacX

MacX software is an X11 compliant X Window display server that runs under the Apple Macintosh operating system and A/UX, providing users with the inherent portability of the X Window system in conjunction with the intuitive user interface of the Macintosh computer. The X Window System, developed by the MIT X Consortium, was created to provide a network-transparent and vendor-independent operating environment. It is often used for UNIX-based scientific applications. Applications that have been written or adapted to support the X Window protocol, which is based on a client/server model, can be displayed in windows on the user's desktop while executing on remote host computers. By providing an X Window display server for the Macintosh, Apple allows its customers to access such host-based applications from their Macintosh computers. The MacX application utilizes multiple networking protocols for the Macintosh, including the AppleTalk networking system, TCP/IP and third-party DECnet implementations. MacX also supports multiple monitors, enabling users who are doing complex work, such as CAD/CAM/CAE or color publishing, to split the display of an image over multiple video monitors. Remote start-up capabilities allows host applications to be launched via a command from the Macintosh menu bar. MacX has been optimized for use with DECwindows, offering support for DECwindows conventions for remote start-up of applications and for cutting and pasting between local and host resident applications. For additional information on DECwindows and using MacX in a Digital environment, please refer to the *Digital Equipment Corporation* chapter in this Guide.

Approximate Cost\$295

Supplier: Apple Computer, Inc., 20525 Mariani Ave., Cupertino, CA 95014, 408-996-1010

eXodus

eXodus is a Macintosh-to-miscellaneous mainframes Color X Window System Display server that turns a Macintosh into a X Window Workstation. eXodus interacts with applications, including DECwindows, running on a variety of host computer systems such as DEC VMS and ULTRIX, and other UNIX based systems. It

conforms to the Macintosh user interface standards and is Finder/MultiFinder compatible. eXodus supports most network communication protocols including DECnet and TCP/IP. Features include: multiple window support, auto client launch, modeless dialogs including color and client editors, cut and paste of both graphics and text to the Macintosh Clipboard.

Approximate Cost Contact supplier
Supplier: White Pine Software, Amherst Technology Park, 94 Route 101A, Amherst, NH 03031, 603-886-9050

CommSolutions

CommSolutions is a network driver package that functions as a companion product to the White Pine VT Series Emulators and eXodus. White Pine Software has licensed Network/Communications software from third-party vendors. Networking software included consists of Runtime TSSnet (Peer-to-peer DECnet communications for eXodus), and MacTCP (TCP/IP for eXodus & VT Series emulators).

Approximate Cost \$4795 to \$6295
Supplier: White Pine Software, Amherst Technology Park, 94 Route 101A, Amherst, NH 03031, 603-886-9050

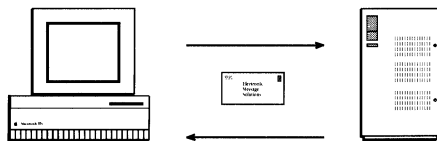

Electronic Mail

GatorMail-Q

GatorMail-Q is a bridge between CE Software's QuickMail and UNIX mail systems on SMTP networks. It integrates electronic mail on multiple platforms including Macintosh, AT&T, Digital, Sun, Silicon Graphics, and Apollo. Features include mail exchange, aliasing and data enclosures. Using GatorMail-Q, QuickMail users can send mail to remote sites over worldwide TCP/IP networks like the Internet. Cayman Systems also offers GatorMail-M, a software bridge between Microsoft Mail and SMTP mail. GatorMail-Q is A/UX compatible.

Approximate Cost \$995
Supplier: Cayman Systems, Inc., University Park at MIT, 26 Landsdowne St., Cambridge, MA 02139, 617-494-1999

Mail*Link SMTP

Mail*Link SMTP is an E-mail gateway between Macintosh mail systems and UNIX mail. Mail*Link provides peer-to-peer mail delivery between Macintosh mail (QuickMail, Microsoft Mail, TOPS InBox Plus) and Apple's A/UX as well as other systems that support Simple Mail Transfer Protocol (SMTP). Mail*Link runs on a

Solutions

Macintosh using MacTCP for TCP/IP support, allowing mail to be transferred over both Ethernet and LocalTalk. Users can send text or binary files as mail enclosures to and from SMTP mail networks.

Approximate Cost\$249

Supplier: StarNine Technologies, Inc., 2126 Sixth St., Berkeley, CA 94710, 415-548-0391

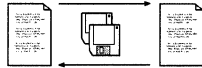

File Transfer and Translation

MacBLAST in the UNIX Environment

MacBLAST communications software provides file transfer, terminal emulation, and text file format conversion for interfacing Macintosh with UNIX /XENIX computers. MacBLAST translates Macintosh and UNIX text file formats, transferring any binary data, text or graphics. Any dev/TTY port can be used. MacBLAST comes with multiple terminal emulators, including VT 52, VT100 & VT220 for DEC, D200, D411, D461 (Data General), D80, ADM3A, TV 920 and TTY. It also supports MultiFinder for background file transfers and allows users to switch back and forth between Macintosh and UNIX /XENIX operations. Wide area networks (WANs) can be set up among any number of remote Macintosh, PC, and UNIX systems. The UNIX system can be scripted to control multiple remote Macintosh computers or PCs. MacBLAST uses standard RS 232 connections, regular dial-up phone lines and X.25 networks. Features include: scripting capabilities for creating unattended operations, on-line help, automatic dialing and access to remote systems; use of standard phone lines, leased lines, or X.25; and asynch performance over satellite links and noisy phone lines.

Approximate Cost\$195 to 695

Supplier: Communications Research Group, 5615 Corporate Blvd., Baton Rouge, LA 70808, 800-24-BLAST

Asynchronous Connections to UNIX

UNIX systems have always supported user access through asynchronous terminal connections. When a Macintosh is connected to UNIX through asynchronous links, it can act as a terminal. With the unique user interface and processing power of the Macintosh computer, the concept of "terminal" is extended to include Macintosh-based access to UNIX, including the use of its visual interface.

Terminal emulators are discussed in depth in the *Digital Equipment Corporation* chapter of this Guide. Some of the asynchronous terminal emulators discussed include MacTerminal, VersaTerm, and Mac240.

Stanford University Uses MacTCP to Connect the Campus

With MacTCP implemented, students can access multiple hosts concurrently during research projects.

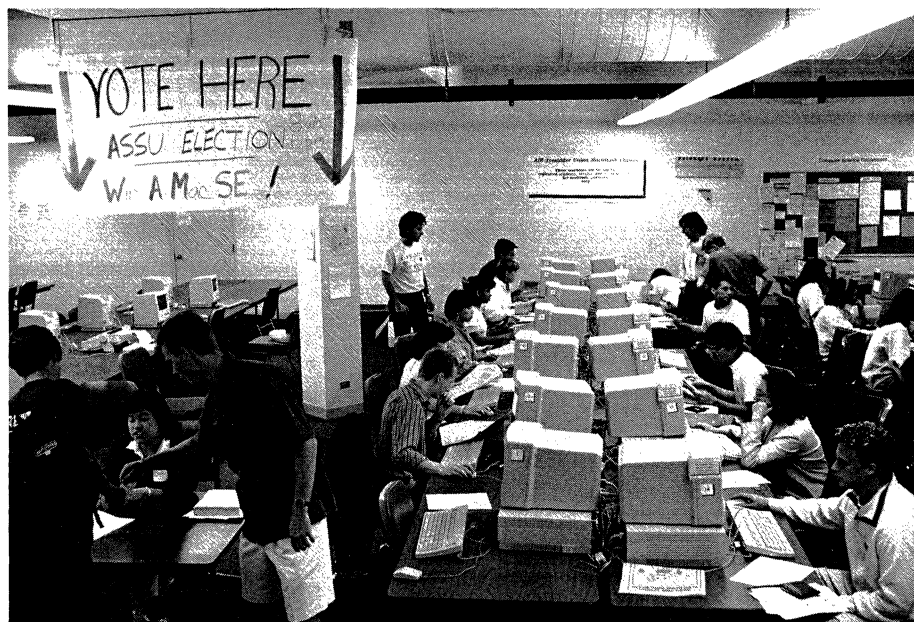

Located in Palo Alto, California, Stanford University has 1000-4000 Macintosh personal computers on AppleTalk and TCP/IP networks and another 6000 Macintosh personal computers owned by students. The faculty use Macintosh personal computers for research; the staff uses them for administrative functions; and university students use clusters of Macintosh personal computers in dormitories and libraries for research and writing.

Many Macintosh users at Stanford need to use TCP for high-speed access to remote machines on the Stanford campus or at other locations. For example, the administrative staff uses an IBM 3090 supercomputer for centralized administrative information such as financial data, purchasing, student services, and personnel. Stanford developed MacSamson, a Telenet-based MacTCP application, to provide closely integrated terminal interaction with the 3090 timesharing system. In addition, the university has Digital VAX systems, SUN file servers, and a variety of minicomputers from other manufacturers.

To develop mainframe communications programs, the university has implemented MacTCP over Ethernet cabling. According to Director of Networking and Communication Systems, Bill Yundt, "Before MacTCP was available, we had written our own TCP/IP protocol stacks and used them in several applications. When Apple

Case History

introduced MacTCP we removed our protocol stacks and replaced them with MacTCP. It fits better into the friendly, Apple communications environment, is integrated with the Apple Communications Toolkit, and frees us from making updates as Apple introduces new versions of the System software.”

The most widely used application based on MacTCP enables users to conduct up to five Telnet sessions with remote computers, concurrently. According to Yundt, “This is a real time-saver. The overhead for keeping a session open is very low, so it’s much easier to leave multiple sessions open than to close them and restart them as needed.”

For example, the reference librarian might run one session with the university’s on-line catalog, one to a minicomputer running a data library, another session to the Lockheed Dialog service, and yet another session to another information service. The librarian can consult several sources to answer a question, without spending time logging on and off different systems.

Another application, FTP (file transfer protocol), allows high-speed file transfer. “Using FTP, I frequently transfer Macintosh and mainframe programs under development at other universities or the National Center for Supercomputing Applications (NCSA) to the Macintosh at my desk at speeds of 50-100,000 bits/second,” says Yundt. “By allowing this kind of exchange, MacTCP has vastly improved the ability of institutions to collaborate with each other in software development.”

The university has used MacTCP to develop two applications to aid users in locating other users. Using the Finger program, a user can indicate a specific UNIX machine to find the identification of the person using that machine and contact information. Using the Whois program, a user can enter an individual’s name and find out directory information about the individual, including their E-mail address. “Both applications are integrated with MacTCP, which permits their use while Telenet and FTP sessions are active. A user can be running five sessions, while interspersing use of Finger or Whois from a pull-down menu,” says Yundt.

The next phase of MacTCP software development at Stanford will focus on interprocessing and co-processing applications. One planned program is a software license server that will allow a Macintosh user to access software that is licensed for a limited number of concurrent users. Another database application under consideration is an access program using SQL-type queries that will enable administrators to establish dynamic links between their own spreadsheets and mainframe data.

IBM Hosts

Background

IBM was one of the pioneers of the information-processing industry, and so its computers are installed in most large management information system/data processing (MIS/DP) locations today. IBM cemented its leadership position during the 1960s with the introduction of the 360 Series. For the first time, users were offered a family of products that ran a variety of commercial and scientific applications on a single extensive architecture. During the early 1970s the 360 evolved into the 370 architecture in use today. With over 20 years of investments in these systems and in related application software and training, the commitment to IBM architecture is strong even in many sites that don't have a single IBM mainframe. Even though the mainframes may not be from IBM, the architecture usually is built around the IBM environment.

The traditional mainframe environment can be envisioned as a centralized core of computing power accessed by a large number of non-programmable terminals (NPT). These terminals are typically "dumb" devices or personal computers emulating dumb devices. The design of traditional Systems Network Architecture (SNA) protocols, pacing and routing algorithms has been based on a system in which dumb devices are in continuous connection with a central host.

As a class of workstations, these 327X devices are slowly being replaced by PC-based intelligent workstations capable of 3270 emulation. The inclusion of 3270 emulation in the extended version of OS/2 for the IBM PS/2 Series presages the eventual replacement of the 327X family by intelligent devices. Many industry experts believe, however, that this phasing out will occur over an extended period of time.

In a mainframe environment, access to host services is typically handled through a cluster controller that allows the 327X displays and printers attached to it to share a communications line or 370 channel, thereby reducing communications costs. In traditional 370-based products, the cluster controller is a separate product such as the 3274 or 3174. In newer processor lines, such as the 9370, the cluster-controller function is handled by a built-in board-level adapter. In either case, communications from the 327X device to the controller/adapter are transmitted via coaxial cable or token ring, and those from the cluster controller via channel connections, dial-up-telephone, token ring, leased telephone lines, or X.25 packet-switched networks.

The Environment

| OSI | SNA |
|--------------|-----------------------|
| Application | Transaction Services |
| Presentation | Presentation Services |
| Session | Data Flow Control |
| Transport | Transmission Control |
| Network | Path Control |
| Link | Data Link Control |
| Physical | Physical |

SNA was developed before the OSI reference model was created. While SNA does not conform precisely with the OSI model, it still provides similar functionality to the seven layers defined by OSI.

Establishing Communications Standards

Since IBM has defined and established the communications standards associated with IBM products, most computer companies have created protocol support and communications software that allow their products to appear to the network and its components as IBM 327X devices.

The problems associated with IBM's traditional network architecture are based on the state of computing at the time of its initial development. During the early 1970s, computing power was very expensive. Minicomputers were just emerging, and personal computers were not yet conceived. As a result, the hierarchical communications architecture developed by IBM in this environment reflected the need for large numbers of dumb devices to access and share the costly central computing resource.

Communications architectures developed in the late 1970s (such as TCP/IP) reflected the economics of computing at that time: The cost of computing had gone down sufficiently to allow distribution of intelligence at the node level throughout a network. Now, with the proliferation of personal computers, the ability to distribute computing power to every individual is a fact of life. The challenge today is to connect these intelligent end points in a fashion that optimizes and balances the benefits of distributed processing power for individuals, departments, divisions, and corporations.

IBM's SNA is a very robust networking architecture. It has been able to accommodate advances in computer technology over the 16 years of its life, but maintaining compatibility with previous software has made progress much slower than most users would like. IBM has had to accommodate new technologies to meet the demands of users in a constantly changing market.

To date, most PC-to-host interaction within the IBM environment has been limited to 3270 terminal emulation. While this technology allows the personal-computer user to access host resources, it essentially eliminates the main strengths of the personal computer.

As the personal computer steadily replaces the 327X device as the universal workstation, the communications procedures and protocols between the micro and mainframe must be streamlined to allow more transparent interaction for cooperative processing. Host-based services and enhanced access to these services, via improved device-interconnection capabilities, will continue to evolve. File servers, database servers, virtual disk emulation, distribution services, library services, and transformations are some of the functions that will receive increased attention from IBM and other vendors.

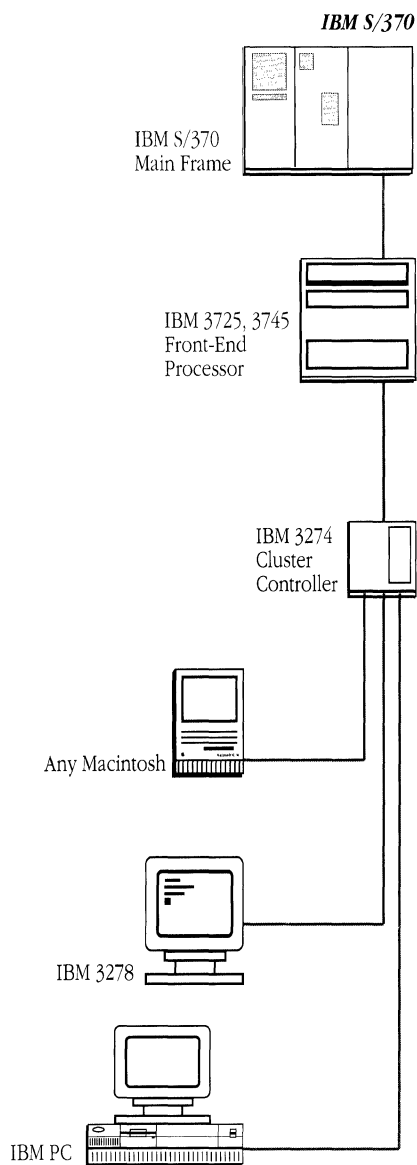

Personal computers commonly appear as 327X devices to the S/370 environment.

Product Groups

The term “micro-mainframe links” has degenerated over the last few years, through inappropriate usage, to the point that the meaning any one individual might attach to it is very likely to be misinterpreted by any other person hearing the phrase. It is, therefore, preferable to describe the basic types of interactions possible between personal computers and mainframes, illustrated by representative products.

Terminal Emulation

Terminal emulation is a form of link that presents the personal computer to the network as a dumb terminal supported within SNA. Terminal emulation typically is provided by a board and accompanying software.

Virtual Disks

These products, which allow the personal computer user to treat the massive storage capacity of the mainframe as a local disk, usually involve coordinated software at both the host and PC nodes. The user can store data on the host in PC format for sharing with other users who have access authority, and take advantage of the backup and archiving capabilities in place within the MIS/DP world. Tempus Link from Micro Tempus, and PC-Organizer from IBM, are examples of virtual disks.

User Interface for Host-Based Applications

These products extend the advantages of easy-to-use PC interfaces to host-resident applications software. There are two main product types, differing in whether or not changes are required in the host software.

User interface products that do not require alterations to host applications are essentially operating in terminal-emulation mode and present the user with a graphics, icon-based application interface. Products of this type include Masquerade for Macintosh computers and Easel for IBM PCs and compatibles.

The second type of product involves either adding new software or altering existing software on the host, as well as adding software at the PC. Apple's MacWorkStation, Simware's terminal emulator for the Macintosh computer, and SIMPC for the IBM PC are examples of products that allow data processing managers to customize a user interface to facilitate working with screens.

The essence of both approaches is to enhance end-user interaction with mainframe software by introducing an easy-to-use icon-based interface.

The Environment

Extraction Tools

These products are typically based on the ANSI Structured Query Language (SQL) developed initially by IBM and now used by virtually all host-based database vendors. They can extract data to the field or record level for use within PC applications.

Vendor-specific extraction tools, such as FOCUS/PC FOCUS, interact with and extract data from a single database for use within a particular PC application. The interaction is made much more transparent to the end user with this method, but flexibility is lost.

Cross-vendor extraction tools allow interaction with and data extraction from a variety of host database-management systems. Thus, applications are provided with more flexibility, although the transparency of interaction may be lost to the extent that less knowledgeable end users are excluded from using these tools.

Apple's Data Access Language (DAL) is a standard connectivity language that links personal computer applications to host data and provides a transparent extraction tool. Based on the client/server architecture, Data Access Language includes software components that run on both personal computer and host computer platforms, providing support for a wide range of operating systems, host database-management systems, and network connections.

Major Host Environments

It is important to understand that much of the complexity associated with IBM host-based environments is largely a function of the many different operating-system environments used within a single product line. The following is a quick overview of those environments deemed strategic enough by IBM to be included in its Systems Application Architecture (SAA).

Operating Systems Within the 370 Environment

Multiple Virtual Storage/Enterprise System Architecture (MVS/ESA) is the flagship operating system for large mainframes (308X, 309X). It is a multi-user, multitasking operating system used as the production system for most large mainframe sites. Its main strengths are in the batch and transaction-processing environments. It is the only operating system presently being shipped that supports the four- and six-processor models of the 3090 line. Interactive processing is accommodated via the Time Sharing Option/Extended (TSO/E) product. The Customer Information Control System (CICS) is the teleprocessing monitor within the MVS world. It provides a common interface between the communications facilities of the network and applications that employ its utilities.

The Environment

Virtual Machine/Extended Architecture (VM/XA) is the primary operating environment for PROFS office automation systems of the newly announced 9370 Series. Jointly developed by IBM and MIT, VM/XA divides the processor into several virtual machines, each under the control of a separate guest operating system. Originally developed as a migration tool, it has now become the only mainframe operating system supported over the entire product range from the 3090 down to the VM/PC. The Conversational Monitoring System (CMS) component of VM handles interactive processing. Limitations within the VM environment preclude it from driving the larger models of the 3090 mainframe line. It also cannot run CICS-based applications in a production environment (code and test only).

Disk Operating System/Virtual Storage Extended (DOS/VSE) is not deemed a strategic operating system by IBM. It remains popular, however, due to its relatively low cost compared to MVS, its large installed base within the 4300 line of 370 processors, and its ability to run CICS applications. DOS/VSE is not an SAA system.

Existing within the System 370 environment, but likely to be encountered far less frequently, are UNIX, in the guise of VM/IX, and TPF2 (Transaction Processing Facility-2), which exists at only 250 sites in the airline and financial-services sectors. Neither system is included in IBM's SAA, though TPF2 is IBM's strategic mainframe-based high volume transaction processing system.

Operating Systems Within the System 3X Environment

SSP is the operating system of the small-business-oriented processors of the System/34 and its successor, the System/36. There are well over 150,000 System/34/36 installations throughout the world. This environment stresses ease of use and does not focus on System/370 affinity. There is an extensive base of small- and medium-sized business software available for the S/3X.

CPF is the operating system of the System/38. Strengths associated with the System/38 center on its integral database-management system and the fact that it extends programmer productivity in a less support-intensive environment than that of the host.

Operating Systems Within the AS/400 Environment

The AS/400 replaces the S/34, S/36, and S/38 models. OS/400 is the operating system of the AS/400 system and will run applications from these systems. The OS/400 operating is a preloaded, integrated operating system for all AS/400 models. Most system functions are menu driven, with a fast path capability for the more experienced user. Graphics and image support is built into the OS/400 operating system, but not yet fully implemented by applications.

The Environment

| APPC | SNA |
|---------------------------------|-----------------------|
| Application | Transaction Services |
| LU 6.2 | Presentation Services |
| | Data Flow Control |
| PU 2.1 | Transmission Control |
| | Path Control |
| SDLC, Token Ring, or X.25 | Data Link Control |
| | Physical |

With the advent of personal computers, IBM began evolving toward peer-to-peer networks. The Advanced Program-to-Program Communications architecture, or APPC (including LU 6.2 and PU 2.1), defines an environment where all devices communicate as intelligent peers, without the master/slave overhead.

Network Architecture—The Future

IBM is steadily moving SNA away from a rigidly hierarchical network toward a more peer-oriented method of interconnection. This migration has been underway for several years and will continue. Enhanced interconnectivity within SNA is possible through Advanced Program-to-Program Communications (APPC), a combination of Logical and Physical Unit Types—LU 6.2 and PU Type 2.1—within SNA. Applications designed in accordance with APPC rules and procedures can meaningfully communicate with other APPC applications located elsewhere on the network. Physical Unit Type 2.1 defines the necessary physical characteristics that allow a device to interconnect directly with other Type 2.1 nodes rather than having to pass through the host (as was the case with traditional SNA). Support of LU 6.2 without concurrent support of PU Type 2.1 allows for peer-to-peer communications, but doesn't allow a direct connection with the desired destination.

Eventually, end users running applications supported under SAA will be able to make requests for information without having to be aware of the location of the information or the underlying architecture of the device at that location. Today, that capability is available only within the System/3X environment, via the Advanced Peer-to-Peer Networking (APPN) feature.

In the long run, any device that contains the necessary communications capabilities (LU 6.2/PU 2.1) will be able to interconnect in an ever-increasing variety of connectivity modes, including:

- Packet-switched networks
- Computerized Branch Exchanges (CBXs)
- Low-Entry Network Nodes, which are special types of PU Type 2.1 nodes defined for APPN

Macintosh in the IBM Environment

Apple's 3270 API, a high-level application programming interface, and MacDFT™, which is end-user software, provide a variety of new functions. These include a platform for developing 3270 applications that emulate IBM display terminals yet use the Macintosh computer graphic user interface, the ability to transfer entire documents between Macintosh computers and IBM hosts, and the ability to copy text from an IBM host word-processor program and paste it into a MacWrite II document. MacDFT software also provides capabilities for copying data between host and Macintosh-based spreadsheets.

The Macintosh computer, with its graphics and intuitive interface, is an effective workstation with outstanding communications capabilities. As the Macintosh

The Environment

computer has become an open-architecture machine, and one for which impressive communications tools have been developed, it has become increasingly effective in the IBM environment. While communications products today allow the Macintosh computer to emulate an IBM 3278 terminal and transfer files, newer products from Apple such as MacAPPC software are offering exciting possibilities for the Macintosh computer as a participant in IBM's still evolving SNA strategy for peer-to-peer communications. MacAPPC makes it possible to develop commercial applications on the Macintosh computer that can dynamically exchange information with IBM host-based applications. These applications will use the full capabilities of the Macintosh as a powerful computer with its own intelligence, not simply as a dumb terminal.

Apple and SAA

A key element of Apple's networking strategy has been Macintosh integration with IBM systems. The goal is to provide developers and customers with an Apple-standard set of protocols, interfaces, and tools that enable the development of consistent, integrated Macintosh applications for the IBM environments.

The Apple approach is to implement the IBM Systems Application Architecture technologies that complement the Macintosh, thereby enabling user-transparent access to IBM data and services. Apple's product development will continue to focus on the core networking protocols, interfaces, and services enabling commercial developers and customers to create applications for end users. This helps developers to produce fully functional software in the shortest possible time by allowing them to concentrate on the application and user interface rather than networking. Both the customer and developer benefit from interoperability among applications based on consistent, integrated networking functions in the Macintosh.

Apple will continue to enhance the IBM-connectivity product line through improvements in functionality, performance, and usability. The commitment is to provide customers with a common Macintosh view of IBM data, services, and applications through support of key SAA technologies. With the key connection and communication standards available, SAA application services such as SNA/DS and DIA are planned as well as enhancements to the existing products. Apple will also investigate implementations of SNA/MS, DDM, and SNA/FS as those technologies and IBM implementations evolve. As the customer requirement for LU 6.2 products expands, CPI-C (the SAA interface to LU 6.2) will be implemented as an enhancement to existing Apple APPC products.

The Common User Access (CUA) element of SAA covers a wide range of guidelines, technologies, and products aimed at improving user interface consistency

The Environment

across IBM platforms. Apple does not plan to support the diverse elements of CUA since the Macintosh provides the most consistent and mature user interface across IBM systems as well as in multivendor environments. The fundamental goal of Common Applications (CA) is to enable applications that span the several IBM platforms with a base level of user interface, functionality, and portability.

In addition to the advantages in a multivendor environment discussed above, Macintosh participates in SAA environments through support of key IBM SAA communications protocols and programming interfaces. Combined with the rich and diverse networking and toolbox facilities in the Macintosh environment, these SAA functions provide Macintosh users with a “common view” of the IBM host environments.

IBM Host-Related Solutions

This section describes how to use the Macintosh computer for terminal emulation and file transfer in both the IBM mainframe (3270) environment and the IBM System/3X minicomputer environment (525X terminal communications).

Three main connection methods are available in the 3270 environment:

1. Coaxial connection (The Macintosh computer directly replaces a 3270-type terminal.)
2. Network connection (The Macintosh computer connects through a network.)
3. Asynchronous connection (The Macintosh computer connects to host via RS-232.)

Later in this chapter, details are presented for solutions in the System/3X environment, where the main connection methods include local twinax connection and remote connection.

327X Terminal Emulation/File Transfer: Coaxial Connection

The most common way for Macintosh personal computers to communicate with IBM host processors is by emulating an IBM 3278 terminal, the most widely used terminal type in the IBM environment. The functionality of a Macintosh computer enhances simple terminal emulation by adding capabilities such as:

- File transfer
- Automated file connections and sessions with the host
- Copying and pasting from a host session to a local Macintosh application such as MacWrite II or Microsoft Excel

In the solutions described here, the Macintosh computer replaces the IBM 3278-type terminal attached to the coaxial cable. This is particularly important in offices that have been wired for 3278s and other coaxial-connected devices. In these environments, personal computers must be able to function without requiring that the office be recabled or that other networking hardware be added.

Solutions

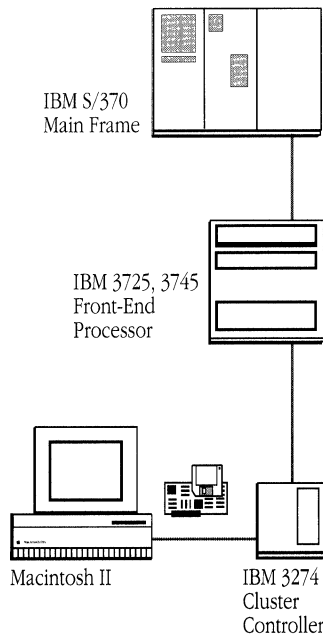

The Apple Coax/Twinax Card connects Macintosh computers to the IBM SNA environment.

Apple Coax/Twinax Card

The Apple Coax/Twinax Card is an intelligent NuBus interface card that allows the Macintosh II family of computers to connect to an IBM SNA (Systems Network Architecture) network as a 3270 Information Display System. The card has its own 68000 microprocessor, memory, and multitasking operating system and supports the execution of communications protocols with minimal access to the main Macintosh II computer processor and operating system. The card allows users to access mainframe-based 3270 applications in the same manner as they would from a terminal, while enjoying all of the benefits of Macintosh computer technology for their local applications. The MacDFT application works with the Apple Coax/Twinax Card to allow single-session Control Unit Terminal (CUT) emulation or up to five-session Distributed Function Terminal (DFT) 3270 emulation. The Apple Coax/Twinax Card also has a twinax (15-pin D-style) connector in addition to the Coax (BNC) connector for third-party 5250 terminal-emulation support.

Approximate Cost \$1250 to \$1495
Supplier: Apple Computer, Inc., 20525 Mariani Ave., Cupertino, CA 95014, 408-996-1010

MacDFT

MacDFT software works with the Coax/Twinax Card and allows a Macintosh II computer to emulate the characteristics of an IBM 3270 Information Display System attached to an IBM host, while retaining the Macintosh user interface—including pull-down menus and windows. This application provides both single-session Control Unit Terminal (CUT) emulation and up to five-session Distributed Function Terminal (DFT) 3270 emulation. MacDFT enables users to transfer entire documents between the Macintosh II computer and IBM host computers running VM/CMS or MVS/TSO using the IBM IND\$FILE package. MacDFT supports text, binary, and MacBinary file transfers. MacDFT stays active in the background in MultiFinder. Users can also copy and paste data between applications running on the Macintosh computer and on the mainframe. MacDFT provides the ability to customize the user's work space by allowing keyboard remapping and keystroke record and playback.

Since the Apple Coax/Twinax Card, the TokenTalk NB Card, and the Apple Serial NB cards all support MacDFT application software, customers can have access to both mainframe and local area network (LAN) services (such as token ring) at the same time. If the Serial NB card is used, the Macintosh computer running MacDFT can establish a synchronous connection to a host using an RS-232C cable.

Approximate Cost \$245
Supplier: Apple Computer, Inc., 20525 Mariani Ave., Cupertino, CA 95014, 408-996-1010

MacMainFrame DX, Version 3.2

MacMainFrame DX is an external box IBM 3270 communications product that provides a coax Macintosh-to-mainframe communications capability for Macintosh computers, including the Macintosh Portable. MacMainFrame DX provides IBM 3278/3279 terminal emulation and file transfer capabilities while allowing Macintosh users to have the ability to maintain portability of their Macintosh computers and have access to their mainframe from any location, either local or remote. Available in single-session Control Unit Terminal (CUT) mode, MacMainFrame DX provides IBM 3278 Models 2-5 and 3279 Models 2A, 2B, 3A and 3B terminal emulation. File transfer capabilities include support for IBM's IND\$FILE host file transfer software as well as for Avatar's own Host File Transfer software. In a local communications environment, RS-232 wiring connects MacMainFrame DX to the serial port of the Macintosh allowing information to be sent from MacMainFrame DX to the IBM control unit and mainframe via coax cable. In a remote environment, asynchronous modems are used to connect the Macintosh Portable to the MacMainFrame DX unit.

Approximate Cost\$1195

Supplier: Avatar Technologies, Inc., 65 South St., Hopkinton, MA 01748, 508-435-3000

MacMainFrame Graphics, Version 3.2

MacMainFrame Graphics is a software application that allows Macintosh users to access and manipulate host graphics locally on their Macintosh computers. MacMainFrame Graphics emulates IBM graphics terminals and allows users to upload and download color graphics files into Macintosh compatible files. MacMainFrame Graphics is based on the existing MacMainFrame Series, and emulates IBM 3179G and 3192G color graphics terminals in addition to IBM's 3278/3279 data terminals, providing the functionality required to communicate with host graphics packages like SAS/Graph and Tell-a-Graf. MacMainFrame Graphics supports IBM's Graphics Data Display Manager (GDDM). Based on Distributed Function Terminal (DFT) technology that allows processing to occur locally on the Macintosh, the product utilizes a DFT graphics method called All Points Addressable (APA). MacMainFrame Graphics allows host Graphics Data Format (GDF) and PC Interchange Format (PIF) files to be accessed, manipulated, transferred and converted to Macintosh formats including EPS, PICT, MacDraw and MacPaint files. Sharing of graphic information between PC and Macintosh users is also possible. In addition, MacMainFrame Graphics allows users to export graphics to various output devices connected to their Macintosh computers, including plotters, slide makers, printers, etc.

Approximate Cost\$195

Supplier: Avatar Technologies, Inc., 65 South St., Hopkinton, MA 01748, 508-435-3000

Solutions
MacMainFrame Coax Workstation, Version 3.2

The MacMainFrame Coax Workstation Series combines MacMainFrame Internal cards (for the SE, SE/30 or II) and application software to provide IBM 3278/3279 terminal emulation, file transfer capabilities and 3287 printer emulation for Macintosh computers. Via a direct coax connection to an IBM 3174/3274/3276 control unit, all MacMainFrame products provide Macintosh connectivity to IBM CICS, TSO or VM/CMS operating environments. Internal cards and software packages are offered in either CUT (Control Unit Terminal) mode providing access to one host session, or DFT (Distributed Function Terminal) providing access to up to five simultaneous host sessions. Features include keyboard remapping, tear-off menus, customizable color palettes, MultiFinder support, mouse, keyboard or jump key facilities, on-screen font size selection, and standard copy and paste functionality. In addition, the EasyKeys feature allows users to record and play back log-on, log-off and other repetitive tasks. Included with MacMainFrame DFT software is MacMainFrame 3287. MacMainFrame Graphics is an optional software applications package.

Approximate Cost\$995 to \$1295

Supplier: Avatar Technologies, Inc., 65 South St., Hopkinton, MA 01748, 508-435-3000

MacMainFrame Coax Gateway, Version 3.2

MacMainFrame Coax Gateway is a hardware and software product that provides workgroups of Macintosh users with access to as many as five IBM host sessions. The MacMainFrame Coax Gateway server card and server software is installed on a Macintosh server and can be co-resident on an AppleShare server allowing the sharing of computing resources. Users need only the MacMainFrame Coax Gateway client software which includes the MacMainFrame DFT and 3287 printer applications. Users do not need hardware but must be able to access the server Macintosh via an AppleTalk network. MacMainFrame Coax Gateway client software is based on MacMainFrame Series software and is available for any Macintosh computer on the AppleTalk network. MacMainFrame Coax Gateway also operates in the Ethernet and token ring environments if the appropriate hardware is installed in the Macintosh. Since MacMainFrame Coax Gateway uses the AppleTalk Data Stream Protocol (ADSP), it is also compatible with Apple's Internet Router allowing MacMainFrame clients to access 3270 sessions provided by a MacMainFrame Server in a different zone. MacMainFrame Coax Gateway is compatible with version 3.2 of the MacMainFrame Programmer's Toolkit.

Approximate Cost\$2495

Supplier: Avatar Technologies, Inc., 65 South St., Hopkinton, MA 01748, 508-435-3000

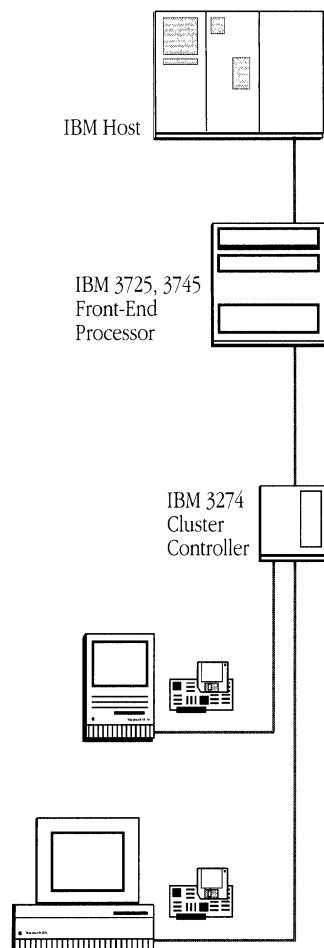

Terminal Emulation and File Transfer with MacIRMA.

MacIRMA

DCA MacIRMA coax adapters and MacIRMA Entry Emulator Software (MacIRMA EE) allows the user's Macintosh to function as an IBM 3278 or 3279 terminal, communicating with an IBM mainframe computer. MacIRMA adapters are available for Macintosh SE, SE/30 and NuBus models, and include the MacIRMA Entry Emulator software. Background file transfer facilities are built-in to MacIRMA EE. Support includes DCA's two mainframe file transfer packages, IRMAlink FT/TSO and FT/CMS and ForteNet TSO and CMS. In addition, MacIRMA EE includes support for IBM's IND\$FILE file transfer products for VM/CMS, MVS/TSO, and CICS. All functions of 3270 terminals are supported, including base terminal attributes (protect, unprotected, bold), extended attributes (blink, reverse video, underline, 7 colors), and status line symbols. MacIRMA EE also supports IBM's Multiple Logical Terminal (MLT) for up to five CUT sessions on 3174 controllers with MLT support. MacIRMA EE supports light pen applications. Macintosh users with color monitors can customize their mainframe colors using MacIRMA EE's color wheel feature. MacIRMA EE supports the Apple, Apple Extended, and Apple ISO keyboards for International use.

Approximate Cost Contact supplier

Supplier: DCA, 1000 Alderman Dr., Alpharetta, GA 30201-4199, 404-442-4000

MacIRMA Graphics

Available as a software upgrade for any MacIRMA user as well as a stand-alone hardware/software product, MacIRMA Graphics works with the MacIRMA hardware to turn the user's Macintosh SE, SE/30, II, IIX, IICX, IICI or IIFX into a mainframe APA (All Points Addressable) graphics workstation. A Macintosh equipped with MacIRMA Graphics allows users to display a graphic generated by a GDDM program running on a host computer. Mainframe graphics applications, such as SAS/GRAPH, TELLAGRAF, and IBM Interactive Chart Utility can be used to create charts, bar graphs, CAD drawings and architectural sketches. DCA MacIRMA Graphics lets users copy and paste mainframe graphics into Macintosh applications, like MacDraw II and MacPaint. Graphics can be modified after downloading to the Macintosh. To store a file for use on a Macintosh computer, PICT format is used. To store a file for use on a PC, mainframe, or Macintosh, PIF format is used. Output devices that are supported by the Macintosh AppleTalk and PostScript standards, such as an Apple LaserWriter, are compatible with DCA MacIRMA Graphics. Users can print the file to a local printer or other output device, such as Apple LaserWriter, Mirus Film Printer, or the Tektronix 4693D color laser printer. MacIRMA Graphics uses the MacIRMA EE interface for standard 3270 terminal emulation.

Approximate Cost Contact supplier

Supplier: DCA, 1000 Alderman Dr., Alpharetta, GA 30201-4199, 404-442-4000

Solutions
MacIRMA WorkStation

MacIRMA WorkStation (MacIRMA WS) is software that works with the MacIRMA card to allow the Macintosh SE, SE/30 or NuBus computer to function as a multiple-session Distributed Function Terminal (DFT) device within a 3270 SNA mainframe network. With MacIRMA WS, the Macintosh computer emulates IBM 3270 display sessions with 3287 printer support. Users get support for up to five host sessions, one of which can be designated as a printer session. All the functions of 3270 display stations are supported, including base terminal attributes (protected, unprotected, bold), extended attributes (blink, reverse video, underline, 7 colors), and status line symbols. MacIRMA WS offers 3287 printer emulation with LU1 and LU3 support. MacIRMA WS lets users set up a printer session with its own window that provides information about the print job and gives users control over the print session. Print jobs can also be run in the background using MultiFinder. MacIRMA WS includes support for DCA's two mainframe file transfer packages, IRMAlink FT/TSO and FT/CMS and ForteNet TSO and CMS. In addition, MacIRMA WS includes support for IBM's IND\$FILE file transfer products for VM/CMS, MVS/TSO, and CICS. MacIRMA WS lets users copy text or columns of numeric information from a host application and paste it in the Clipboard or Scrapbook, for use in other Macintosh applications.

Approximate Cost Contact supplier

Supplier: DCA, 1000 Alderman Dr., Alpharetta, GA 30201-4199, 404-442-4000

3270 Doradus Solution (3270DS) Version 1.09

For IBM 3270 users, Doradus offers 3270 emulation software bundled with a Doradus internal 2400/1200bps, CCITT V.22bis card modem for the Macintosh Portable. 3270DS Communications Software, SDLC version, allows up to 20 precoded telephone numbers, and supports up to four concurrent 3270 sessions. IND\$FILE File Transfer protocol supported in Version 1.10. The 3270DS Synchronous Modem is internal to the Macintosh Portable and communicates both synchronous and asynchronous at 2400bps. It conforms to CCITT V.22bis, CCITT V.22/V.21, Bell 212A/103. The product uses AT command set, has a built-in speaker for call monitoring. It is software configurable, with dial-back support, and auto-dial or auto-answer.

Approximate Cost \$1260

Supplier: Doradus Corp., 6095 E. River Rd., Minneapolis, MN 55104, 612-572-1000

327X Terminal Emulation/File Transfer: Synchronous/Asynchronous Connection

Simware Mac3270 2.0

Simware offers a software-only 3270 communications solution that allows Macintosh users full implementation of the Macintosh computer interface to access host data and applications across most emulation methods, including hardware protocol converters, coaxial boards, and Simware's asynchronous protocol conversion software. Simware will also support the Apple 3270 API. Users can move data across multiple communications paths and protocols. MIS managers can customize host access and file transfer to their users' particular requirements and automate network navigation, application access, and data exchange. User functions such as access and file transfer can be fully customized. Mac3270 standardizes the user interface and file transfer across many different 3270 emulation methods and network protocols and is functionally equivalent to its sister product SIMPC for IBM PCs and compatibles.

Approximate Cost Contact Supplier

Supplier: Simware, Inc., 20 Colonnade Rd., Ottawa, Ontario K2E 7M6 Canada, 613-727-1779

RELAY Baton

By connecting to IBM mainframes running RELAY Communications' RELAY/VM or RELAY/TSO software, RELAY Baton offers Macintosh-to-mainframe file transfer. The product works asynchronously, over normal phone lines; no boards or cables are needed. RELAY Baton graphically represents the IBM mainframe files in the same way as Macintosh computer files. Users can transfer files to and from the mainframe by simply pointing and clicking on file names. RELAY Baton also incorporates Apple's MacWorkStation, providing file-transfer vehicle for mainframe users and MacWorkStation developers. By supporting Apple's MultiFinder, RELAY Baton can also transfer files in the background while other Macintosh applications are being run in the foreground.

Approximate Cost \$150

Supplier: RELAY Communications, Inc., 41 Kenosia Ave., Danbury, CT 06810, 203-798-3893

PACKET/3270 MAC

PACKET/3270 MAC is the Macintosh computer component of Packet/PC's micro-to-mainframe communications software. It is an SNA/ASYNCR 3270 emulator for Macintosh computers which provides common, worldwide access to IBM 3270 SNA mainframe application systems via dial-up and public packet networks. The software uses a proprietary link-level protocol to extend SNA communications to

Solutions

the Macintosh computer. The protocol provides the functionality of SNA/SDLC including full duplex, error-free, bit compressed transmissions; simultaneous mainframe display and printer sessions; and DFT file transfer to CICS, TSO, and CMS. When used in conjunction with public packet networks, PACKET/3270 MAC's eight-bit, compressed, data stream reduces response time. For applications that do not require packet network access, PACKET/3270 MAC also supports alternative solutions including IBM's 3708.

Approximate Cost\$295

Supplier: PACKET/PC, 270 Farmington Ave., Farmington, CT 06032, 203-678-1961

MacBLAST for IBM Mainframes Systems under MVS/TSO or VM/CMS

BLAST software for IBM mainframes transfers text or binary files via asynchronous ports or protocol converters, or any virtual asynchronous pathway, including NTO and X.25 interfaces such as NPSI. Macintosh computers with BLAST (see MacBLAST) can connect error-free or act as terminals. BLAST provides file transfer, and text file format conversion for interfacing the Macintosh with IBM computer systems. MacBLAST transfers binary data, text, or graphics. MacBLAST and BLAST products for IBM Mainframes can be used to create low-cost dial-up asynchronous networks between central computers and any number of remote Macintosh sites. For applications requiring more security than offered by passwords, the Private Network BLAST products offer "Lock and Key" codes for securing access between Macintosh and Mainframe. MacBLAST uses standard dial-up phone lines and X.25 networks for reliable data communications unaffected by phone line noise or propagation delay on satellite-routed phone calls or X.25 packet networks.

Approximate Cost\$3995 to \$9995

Supplier: Communications Research Group, 5615 Corporate Blvd., Baton Rouge, LA 70808, 800-24-BLAST

System 3X Terminal Emulation/File Transfer: Overview

In small- and medium-size businesses, IBM's minicomputers represent a significant portion of the market. IBM's primary offering in this market is the AS/400 system, which ranges from 4 to 300 concurrent users and has sold over 50,000 units since its debut in 1988.

IBM is no longer shipping most models of System/36 and System/38. The older Model 34 is no longer sold, but is still found at many customer sites. The AS/400 and all System 3X computers utilize the 5250 terminal type, which employs a different data stream from 3270 terminals, and runs over Twinax cable.

KMW Systems Corporation actively targets the Macintosh computer market with products for System/3X protocol conversion. Any terminal emulator that is VT100

Solutions

compatible (for example, MacTerminal or inTalk software) can be used with their products. KMW offers file transfer through their terminal emulators, working in conjunction with additional software on the System/3X. In each case, a single application on the Macintosh computer provides both file transfer and terminal emulation.

NetAccess

NetAccess connects any IBM System/36, System/38 or AS/400 to any Macintosh on an AppleTalk network. NetAccess is an expansion card (SE, SE/30, Macintosh II) and server software that runs in the background on any Macintosh to distribute the midrange connectivity across the AppleTalk network to all other Macintosh computers on the network. NetAccess features include: file transfer of data files to/from the host computer; HyperCard API; HyperCard File Transfer Stack for file transfers; terminal and printer emulations; and AppleTalk Phase 2, and usage with LocalTalk, EtherTalk and TokenTalk.

Approximate Cost\$3995

Supplier: Andrew KMW Systems Inc., 6034 West Courtyard Dr., Austin, TX 78730, 512-338-3000

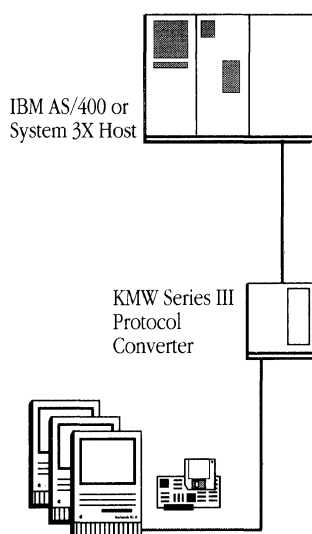

KMW's Series II and Series III Twinax protocol converters connect directly to IBM AS/400 and System/3X minicomputers. The Series II connects one asynchronous device, while the Series III connects up to eight devices.

Andrew KMW Series II and III Protocol Converters—Hardware

Andrew KMW offers the Series II and III Twinax protocol converters. The Series III is a single-port converter, while the Series II provides up to seven asynchronous ports (it has one port and provides slots for up to six option cards that fit into the converter itself). The Andrew KMW Twinax protocol converters can direct-connect to the Twinax ports on a System/34/36/38, or AS/400 minicomputer with cabling over distances of up to 5000 feet, or communicate remotely via an IBM 5294 or 5251-12 cluster controller. The user must specify the first port address on either converter; on the Series II Twinax the converter assigns successive addresses. The Andrew KMW Twinax converter can intermix serial and parallel devices. They support any parallel printer with a Dataproducts- or Centronics-compatible interface. Printers can also be attached to some CRTs and PCs and thus communicate with the host as separate devices. Other features include: data rates up to 19.2 Kbps supported for serial communications; ASCII printers appearing to the host as IBM 5225/5256 printers; standard displayable characters and format controls translated into ASCII equivalents; and format control obtained by using LF, CR, and FF control characters.

Andrew KMW Series II and III Protocol Converters—Software

Andrew KMW's emulation software includes a device driver for the Series II or Series III Twinax protocol converter, as well as the TwinAccessLink program running on the Macintosh computer. TwinAccessLink allows for advanced features

Solutions

such as automatic error detection and correction, file transfer, and printer pass-through. For file-transfer capabilities, TwinAccessLink works with host-resident software called Emulation Transfer Utility (ETU). There are separate versions of ETU for the System/34, System/36, System/38 and AS/400.

Approximate Cost\$1595 to \$4095

Supplier: Andrew KMW Systems Corporation, 6034 West Courtyard Dr., Austin, TX 78730, 512-338-3000

IDEAcomm Mac 2.0

IDEAcomm Mac is a 5250 terminal emulation board which allows the Macintosh SE and II families to have multiple-host sessions on and transfer data from the IBM Midrange family, the IBM S/36, S/38 and AS/400. It attaches via twinax cable to the host. IDEAcomm provides four-session emulation, with either 80- or 132-column displays, and the ability to choose from three types of host screen copy: full screen copy, table copy and word-wrap mode. The product is compatible with MultiFinder. Bidirectional file transfer application is included with host-side server software. Version 2.0 allows the user to select specific fields from data files. Files on the Macintosh can be used in any Macintosh application. The file transfer runs in the background. 5224, 5225, and 5256 IBM system printers are emulated allowing users to print directly from the host to a LaserWriter, ImageWriter, or other AppleTalk compatible printers. A keyboard remapping utility is included, which allows users to swap the location of "host" keys. Users have the ability to edit the scan codes sent and received. HyperCard API allows developers to create custom front-ends to host applications under HyperCard. There is a complete set of external commands which accommodates host access, etc.

Approximate Cost\$995 to \$1195

Supplier: IDEAssociates, Inc., 29 Dunham Rd., Billerica, MA 01821, 508-663-6878

Token Ring Network Connections

In 1985, IBM introduced a series of token ring products for their IBM personal computer family as a new standard for physically interconnecting its personal, mini and mainframe computers in a local area network (LAN).

The solutions listed below describe how Macintosh computers can be connected to industry-standard IEEE 802.2/802.5 token ring local area networks. In addition to offering a physical connection to token ring, Apple Computer's TokenTalk software (described in this section) provides AppleTalk Phase 2 protocol support over 802.5 token ring networks—bringing AppleTalk services to Macintosh users over token ring.

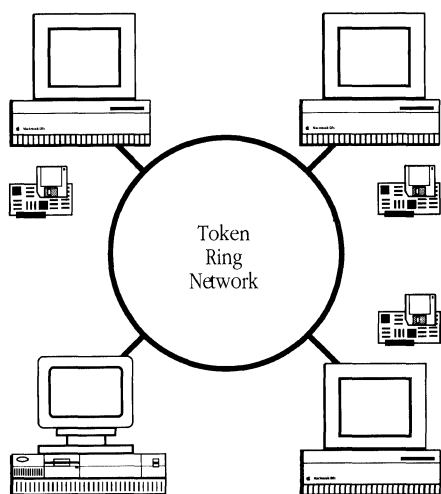

The Apple TokenTalk NB Card connects Macintosh computers to token ring networks.

Apple TokenTalk NB Card

Apple's TokenTalk NB Card is an expansion card that connects Macintosh II computers to token ring networks. When used with other Apple software products, the card supports a variety of network environments, including AppleTalk, IBM 3270, APPC, and SMB. This support allows users to access local area network and mainframe-based services connected to the token ring.

The Apple TokenTalk NB Card is an intelligent NuBus interface card that has its own 68000 microprocessor, memory, and multitasking operating system. Independent of the Macintosh II computer processor, the card supports the concurrent execution of multiple networking protocols with minimal access to the main Macintosh II processor and operating system. The Apple TokenTalk NB Card offers a flexible hardware platform than can be used with four different software packages, depending on the network environment.

Users can run the following communications software: TokenTalk software and SMB File Transfer Utility (described below) or MacAPPC and MacDFT (described in this chapter). The card incorporates the industry-standard Texas Instruments' TMS 380 chip set for all token ring access functions and is compatible with the IEEE 802.5 Media Access Control (MAC) standard for token ring networks, as well as the IEEE 802.2 Logical Link Control (LLC) standard for higher-level software access to 802.5 facilities. It transmits and receives data at 4 Mbps, and interoperates with other IEEE 802-compatible token ring interface cards at the physical and data link layers.

Apple's TokenTalk Software, included with the TokenTalk NB Card, provides support for AppleTalk Phase 2 protocols running over 802.5 token ring networks, bringing AppleTalk services to Macintosh users in token ring environments. (For a more detailed explanation of the AppleTalk network, please see the *AppleTalk Communications* chapter in this Guide). Once installed via a simple Macintosh program, AppleTalk services appear in the Chooser as they would on any other AppleTalk network. The TokenTalk software delivers AppleTalk services concurrently with other token ring services, such as MacDFT or MacAPPC software.

The SMB File Transfer Utility software allows users of Macintosh and IBM-compatible personal computers to exchange files and share information in their workgroups. Apple Macintosh II systems on a token ring network can access information on IBM PC LAN Program SMB (Server Message Block) file servers. A desk accessory provides easy mounting and dismounting of SMB server volumes. Files can be transferred and translated using the Apple File Exchange (included).

Approximate Cost\$1250

Supplier: Apple Computer, Inc., 20525 Mariani Ave., Cupertino, CA 95014, 408-996-1010

Solutions
MacCon+ Token Ring Cards for the Macintosh II Family

MacCon+ IITR boards are designed to comply with the IEEE 802.5 Token-Passing Protocol Standard as well as built-in support of AppleShare, NetWare, 3+Mac, and 3270 emulation software. Optional Link Level Control (LLC) support provides compatibility with IBM's APPC, and MAP/TOP OSI protocols. Diagnostic LEDs for troubleshooting are incorporated and there are no jumpers or switches to set. Type 1 and Type 2 shielded twisted-pair as well as Type 3 unshielded twisted-pair media are supported with 32-bit data transfer at up to 4 Mb/second throughput.

Approximate Cost\$745 to \$845

Supplier: Asanté Technologies, Inc., 405 Tasman Dr., Sunnyvale, CA 94089, 800-662-9686

MacRing NB

MacRing NB is a NuBus expansion card (with firmware and software) that connects a Macintosh II series computer to a token ring network. MacRing NB provides IBM and AppleTalk compatibility. MacRing NB users can interconnect Macintosh computers and IBM-compatible PCs on the same token ring networks. MacRing NB is compatible with third-party software that provides 3270 connectivity to IBM mainframes over token ring networks. When used with the AppleTalk Internet Router, MacRing NB can connect token ring networks to LocalTalk and EtherTalk networks. MacRing NB supports AppleTalk, IEEE 802.2 Logical Link Control (LLC, Type 1 and Type 2), and IEEE 802.5 token ring protocols. MacRing NB supports the Apple LLC IPC interface and IBM source routing. The MacRing NB package consists of the MacRing NB expansion card, software and downloadable firmware on a 3.5-inch disk, and a user's guide.

Approximate Cost\$895

Supplier: h-three Systems, P.O. Box 12557, Research Triangle Park, NC 27709, 800-MAC-RING

MacRing SE and SE/30

MacRing SE and SE/30 are expansion cards (with firmware and software) that connect Macintosh SE and SE/30 computers to a token ring network. They provide IBM connectivity and AppleTalk compatibility and permit users to interconnect Macintosh computers and IBM-compatible PCs on the same token ring networks. Both products are compatible with third-party software that provides 3270 connectivity to IBM mainframes over token ring networks. When used with the AppleTalk Internet Router, MacRing products can connect token ring networks to LocalTalk and EtherTalk networks. They support AppleTalk, IEEE 802.2 Logical Link Control (LLC, Type 1 and Type 2), and IEEE 802.5 Token Ring protocols as well as the Apple LLC IPC interface and IBM source routing. The MacRing packages consist of

the MacRing expansion card, software and downloadable firmware on a 3.5-inch disk, a hardware installation guide, and a user's guide.

Approximate Cost\$795 to \$895

Supplier: h-three Systems, P.O. Box 12557, Research Triangle Park, NC 27709, 800-MAC-RING

MacMainFrame Token Ring Workstation, Version 3.3

MacMainFrame Token Ring Workstation is a hardware and software product that allows Macintosh users to access and manipulate host information over a token ring network. MacMainFrame Token Ring Workstation provides direct connection of a Macintosh to a token ring network, giving users access to as many as eight simultaneous IBM 3270 sessions. The product combines Token Ring Workstation card and MacMainFrame Token Ring Workstation software to provide a Macintosh SE, Macintosh SE/30 or Macintosh II family computer with IBM 3278/3279 terminal emulation and file transfer capabilities over a token ring network. The card is installed in an option slot of a Macintosh computer; transmits and receives data at 4 Mbps; and supports a variety of networking environments including AppleTalk and IBM 3270 SNA. It also provides Macintosh-to-Macintosh and Macintosh-to-PC communication capabilities. MacMainFrame Token Ring Workstation is compatible with version 3.2 of the MacMainFrame Programmer's Toolkit which allows applications written with the Toolkit to also run on this product.

Approximate Cost\$1295

Supplier: Avatar Technologies, Inc., 65 South St., Hopkinton, MA 01748, 508-435-3000

MacMainFrame Token Ring Gateway, Version 3.3

MacMainFrame Token Ring Gateway allows Macintosh users in an AppleTalk environment to run host applications on an IBM host that is resident on a Token Ring network. It combines the MacMainFrame Token Ring Gateway card and MacMainFrame Token Ring client and server software to provide any Macintosh on an AppleTalk network with IBM 3278/3279 terminal emulation and file transfer capabilities. Up to eight simultaneous IBM 3270 sessions per Macintosh user and up to 64 sessions per server are provided. The server card and software are installed on a Macintosh server and can be co-resident on an AppleShare server. The server distributes up to 64 IBM 3270 SNA sessions over any AppleTalk network configuration including TokenTalk, EtherTalk and LocalTalk. MacMainFrame Token Ring Gateway is compatible with Apple's Internet Router allowing MacMainFrame clients to access 3270 sessions provided by a MacMainFrame Server in a different zone. Client software is available for any Macintosh connected to the AppleTalk network. MacMainFrame Token Ring Gateway is compatible with version 3.2 of the

Solutions

MacMainFrame Programmer's Toolkit which allows applications written with the Toolkit to also run on this product.

Approximate Cost \$2495 to \$6495

Supplier: Avatar Technologies, Inc., 65 South St., Hopkinton, MA 01748, 508-435-3000

LanWay TR 16/4 Family

The LanWay TR 16/4 family is a 16/4 token ring (IEEE 802.5) LAN option for the Macintosh computer. The LanWay TR 16/4 for the Macintosh NuBus is a token ring (IEEE 802.5) NuBus LAN interface adapter capable of being used in the Macintosh NuBus family-the Macintosh II, IIx, IIcx, IIci and IIfx systems. The LanWay TR 16/4 SE/030 adapter is a token ring (IEEE 802.5) interface card for use in the SE/030. Equipped with the Texas Instruments TMS380C16 Token Ring processor, the LanWay Token Ring card is capable of both 16 Mbps and 4 Mbps operation in a single adapter. It is software switchable between the two speeds. 128K of on-board RAM is provided for multiple transmit and receive operations. The board is Token-Talk compatible. When coupled with Tri-Data's Netway 2000 SNA Gateway equipped with a token ring option, the LanWay TR 16/4 provides Macintosh users 3270 mainframe access in token ring LAN environments.

Approximate Cost \$1095

Supplier: Tri-Data Systems, Inc. 3270 Scott Blvd., Santa Clara, CA 95054, 408-727-3270

MacToken

MacToken is a diagnostic problem-determination tool for the Apple TokenTalk NB Card. The software allows the user to visually troubleshoot AppleTalk, IBM, Novell, and IEEE 802.5 token ring networks. MacToken can display and print a graphic representation of network statistical information including average MAC/LLC message size, largest/smallest message size, and percent of ring utilization. Problem situations can be highlighted and real-time network performance can be displayed.

Approximate Cost \$2000

Supplier: EDI Communications Corporation, 20440 Town Center Ln., Suite 4E, Cupertino, CA 95014, 408-996-1343

AppleTalk-to-SNA Gateway Network Connection

When a number of Macintosh computers and LaserWriter printers are connected via the AppleTalk network system in a work group environment, an AppleTalk-to-IBM host gateway device can emulate an IBM cluster controller to provide a flexible, cost-efficient solution. With this approach, any Macintosh computer on the AppleTalk network system can establish host sessions via a shared AppleTalk network system resource.

The gateways described below are compatible substitutes for an IBM 3274-61C control unit, operating with Systems Network Architecture (SNA) using Synchronous Data Link Control (SDLC) protocols. Rather than using coaxial cable, these implementations makes use of the AppleTalk-network capability included in every Macintosh computer.

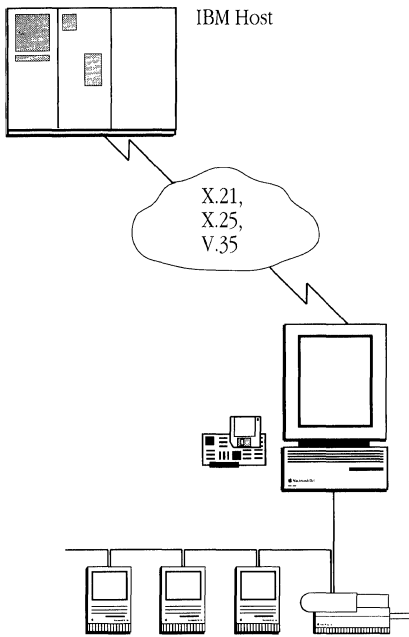

The Apple Serial NB Card provides an SDLC solution at the physical layers in the IBM SNA environment.

Apple Serial NB Card

The Apple Serial NB Card is an expansion card that allows the Macintosh II family of computers to connect to remote systems via a variety of industry-standard serial communications protocols. The card includes four serial ports that support RS-232, RS-422, X.21 or V.35 communications.

The Apple Serial NB Card is an intelligent NuBus card that has its own 68000 microprocessor, memory, and multitasking operating system. It operates independently of the main Macintosh II computer processor, and supports the execution of communications protocols with minimal access to the Macintosh II computer processor and operating system. The card has four serial ports, two of which can send and receive at 64K per second.

When used with Apple's MacAPPC or MacDFT software, the Serial NB Card provides a complete SDLC solution, at the physical and data-link layers, for LU 6.2 or LU 2 connectivity into the IBM SNA environment.

MacX25 software, running on the Serial NB Card, provides packet assembler/disassembler (PAD) services, and X.25 packet-level services to application programs outside the SNA environment.

Approximate Cost\$1324

Supplier: Apple Computer, Inc., 20525 Mariani Ave., Cupertino, CA 95014, 408-996-1010

MacMainFrame SDLC Workstation, Version 3.3

MacMainFrame SDLC Workstation is a hardware and software product that allows Macintosh users to directly access and manipulate host information over a Synchronous Data Link Control (SDLC) connection. MacMainFrame SDLC Workstation provides access to eight simultaneous IBM 3270 host sessions from remote locations. Macintosh users can access information on a host regardless of where the host is located. Users only need MacMainFrame SDLC Workstation and a synchronous modem to access the host. The MacMainFrame SDLC Workstation card is installed in the option slot of a Macintosh SE, SE/30 or II family computer. An RS-232 cable is connected from the DB25 connector on the card to a synchronous modem. IBM 3270 data can be transmitted over a wide area network to a host or front-end processor. MacMainFrame SDLC Workstation can operate over leased

Solutions

lines or switched lines in point-to-point or multi-drop configurations and supports data rates of 1200 bps to 56 Kbps with support for NRZ and NRZI signalling techniques.

Approximate Cost\$1295

Supplier: Avatar Technologies, Inc., 65 South St., Hopkinton, MA 01748, 508-435-3000

MacMainFrame SDLC Gateway, Version 3.3

MacMainFrame SDLC Gateway allows Macintosh users in an AppleTalk environment to run host applications on a local or remote IBM host without the need for an IBM controller. Using Synchronous Data Link Control (SDLC) communications, MacMainFrame SDLC Gateway provides up to eight simultaneous IBM 3270 host sessions per Macintosh user and up to 64 sessions per server. Macintosh users can access information on a host regardless of where the host is located. The product combines a MacMainFrame SDLC Gateway card and MacMainFrame SDLC Gateway server and client software to provide any Macintosh on an AppleTalk network with IBM 3278/3279 terminal emulation, file transfer capabilities and other mainframe services. Users access to AppleTalk, MacMainFrame SDLC Gateway and a synchronous modem to access the host. IBM 3270 data can be sent directly to an IBM front end processor or host. MacMainFrame SDLC Gateway can operate over leased or switched lines in point-to-point or multidrop configurations and supports data rates of 1200 bps to 56 Kbps with support for NRZ and NRZI signalling techniques.

Approximate Cost\$2495 to \$6495

Supplier: Avatar Technologies, Inc., 65 South St., Hopkinton, MA 01748, 508-435-3000

Netway 1000: IBM 3174 Controller Functionality

The Netway Family of 3270 SNA gateway products provides LocalTalk, Ethernet or token ring networks with direct access to an IBM mainframe, without the need for emulator boards and cabling. Acting as an IBM 3174 controller, the Netway Family provides full 3278/9 terminal emulation for models 2,3,4 &5, industry-standard IND\$FILE and proprietary file transfer, remote 3287 printing and Extended Color and Attribute Byte (EAB) support. Apple-compatible 3270 API & HyperCard™ API support host front-end applications. The Netway 1000 series, via LocalTalk and EtherTalk, supports up to 16 sessions, allowing up to six on the PC and eight on the Macintosh using MultiFinder, accessing the main-frame at speeds of up to 19.2 Kbps. Using the 10 MIPS SPARC™ CPU, the Netway 2000 series supports up to 64 sessions, four serial ports, LocalTalk, Ethernet and token ring interface adapters. The ports allow the user to choose any of three interfaces, including LocalTalk, RS-232 and an optional 56 Kbps V.35.

Approximate Cost\$995 to \$9995

Supplier: Tri-Data Systems, Inc. 3270 Scott Blvd., Santa Clara, CA 95054, 408-727-3270

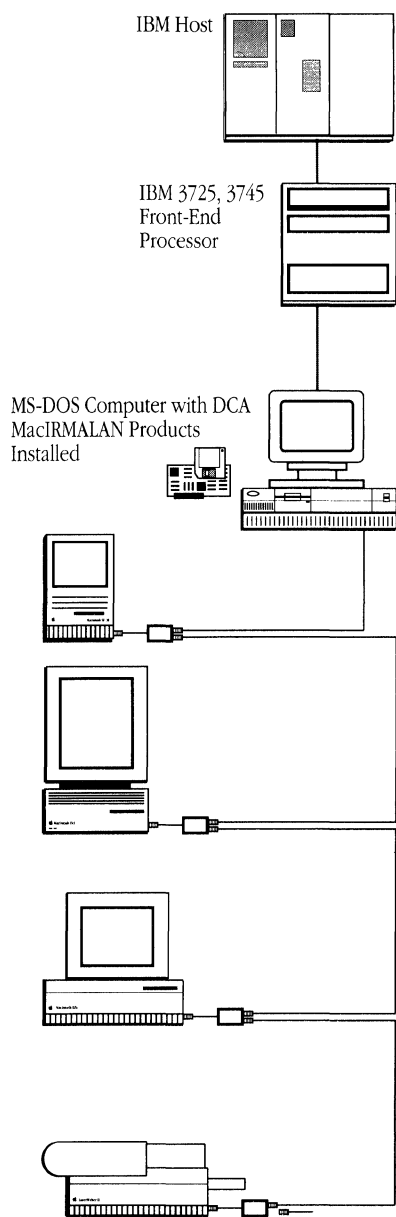

The MacIRMALAN products from DCA convert an MS-DOS computer into an IBM 3274/3276 control unit.

DCA MacIRMALAN Servers SDLC Gateway and 802.2 Gateway

The MacIRMA family of products introduces two new local area network (LAN) solutions — DCA MacIRMALAN SDLC Gateway Server and DCA MacIRMALAN 802.2 Gateway Server™. With the MacIRMALAN setup, Macintosh computers connected to an AppleTalk LAN can access an IBM SNA host. The server package includes gateway software (and hardware for SDLC) and MacIRMA WorkStation software. The gateway software and hardware run on an IBM PC, PC XT, PC AT, or PS/2, with the appropriate LAN adapter. MacIRMA WorkStation is installed at Macintosh workstations. Clients can use LocalTalk, EtherTalk, or TokenTalk media or mix them with the appropriate bridges or routers for their AppleTalk LAN. Once the software is installed (and hardware for SDLC), users can connect 16 or 64 concurrent users (depending on the version) to the MacIRMALAN server gateway.

Each user can run up to five host sessions. Users needing to increase their concurrency rate can purchase an upgrade from DCA to convert from 16 to 64 concurrent users. With either gateway, users can distribute up to 128 host sessions to workstations without adding emulation hardware to each workstation. The MacIRMALAN Servers also provide gateway administration support tools that give detailed information on the gateway's status. A gateway monitoring program called Net Util, comes in two versions — one for the gateway PC and one for Macintosh workstations. There's also an Info option with MacIRMA WorkStation that gives workstation status. MacIRMALAN SDLC Gateway 2 makes it possible for a LAN-attached PC or PS/2 to emulate an IBM 3274 or 3276 control unit. Macintosh computers on the LAN can access an IBM SNA host through this gateway.

There are two SDLC gateway hardware versions. The Personal Computer Architecture (PCA) version fits any full-size PC or PC AT slot. The Micro Channel Architecture (MCA) version fits any available IBM PS/2 Model 50, 60, 70, or 80 slot. Either card communicates with an IBM 3705, 3720, 3725, 3745, or compatible front-end processor with a synchronous modem. A point-to-point or multipoint connection can be used. The RS/232 connection supports speeds up to 19.2 Kbps (full- or half-duplex). The V.35 interface supports line speeds up to 72 Kbps (full- or half-duplex). Cables for RS-232 or V.35 are included. The 802.2 gateway fits into existing LAN environments, without requiring more PC hardware. The gateway communicates directly with the host by the IEEE standard LLC 802.2 protocol, and communicates with Macintosh LAN workstations using AppleTalk.

The 802.2 gateway provides a migration path to the 3270 token ring environment for existing non-token ring LANs, such as EtherTalk or LocalTalk. It supports up to two LAN adapters in the gateway PC. The token ring adapter provides 3270 host connectivity. Token ring or non-token ring hardware, such as Apple LocalTalk or 3Com EtherLink adapters can be used for the second adapter connecting to

Solutions

workstations. MacIRMA WorkStation Software, which provides 3270 DFT emulation, is included in the server-based MacIRMALAN products. This software product is the same workstation software offered for use with the DCA MacIRMA coax adapters.

Approximate CostContact supplier

Supplier: DCA, 1000 Alderman Dr., Alpharetta, GA 30201-4199, 404-442-4000

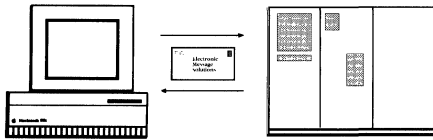

IBM Host Electronic Mail Access

Connections 1.0P

Connections serves as a basis for creating enterprise-wide EIS and custom information systems. Connections is a family of software modules that integrate information on an individual's Macintosh with IBM's PROFS software. Connections requires a Macintosh SE or II series (II-series recommended), minimum 2 MB RAM, 20 MB hard disk, and one of: Avatar MacMainFrame, DCA MacIrma, or Tri-Data Netway 1000/2000 for mainframe connection. As a front-end to PROFS, Connections provides PROFS Notes E-mail support including create, send, retrieve, reply, and forward.

Additional features include batch deletion or retrieval of Notes, the ability to create Notes off-line and collect them in an OutBasket for later sending, and support for distribution lists. Individual and group calendars and scheduling are also supported via PROFS. The user can view others' calendars, schedule meetings and conference rooms, and set access privileges. Connections includes a Daily Calendar, Monthly Calendar, To-Do lists, customizable Telephone Directory, Outgoing Phone Log, Daily Journal, extensive export/import capabilities, and user-definable Personal Libraries that support full-text search.

Approximate Cost\$495

Supplier: Concentrix Technology, Inc., 7 Ashdown Pl., Half Moon Bay, CA 94019

Hardware Required for MacPROFF:

1. Macintosh computer (SE/30, Macintosh II family) with a hard disk and at least 1 MB of memory (2 MB with MultiFinder).
2. Avatar MacMainFrame Coax card or DX box or MacIRMA Coax Card or a connection to a Tri-Data Netway.
3. Appropriate SNA network connection configured for an IBM 3270 Model 2, 3, or 4 terminal.

MacPROFF Version 1.2

MacPROFF is a HyperCard-based front-end for the IBM PROFS electronic mail system. The High Level Language Application Program Interface (HLLAPI) technology is capable of displaying IBM mainframe computer screens (like PROFS screens) in HyperCard on the user's Macintosh. Features include more than 100 pre-defined cards that match the most commonly used PROFS screens; a set of tools for changing the look and feel of the interface to PROFS; ability to send multiple page PROFS notes from a scrolling field; and full screen note editing in a Macintosh environment. MacPROFF supports schedule and calendar functions; sends multiple-page Macintosh text files as PROFS notes; stores nicknames, user ids, and distribution list names on the Macintosh; saves and searches PROFS notes in a

Solutions

HyperCard stack; displays multiple-page notes in scrolling fields; deletes multiple notes in batches; prints PROFS notes on a Macintosh printer; supports PROFS document features; and facilitates customization of MacPROFF to match the user's PROFS installation with built in tools.

Approximate Cost Contact supplier

Supplier: Mariette Systems International, 29 El Cerrito Ave., San Mateo, CA 94402, 415-344-1519

SNADS Gateways to 3+Mail, cc:Mail, and MS Mail

The Soft•Switch SNADS Gateways, in conjunction with other Soft•Switch products or with IBM's DISOSS, extend the distribution capabilities of 3Com's 3+Mail for PCs and 3+Mail for Macintosh, Microsoft Mail, and cc:Mail. Users can exchange mail in the form of final-form messages, editable documents, and binary files with users of other systems that are connected to a Soft•Switch Enterprise Mail Network or to DISOSS. The Soft•Switch SNADS Gateways execute on a non-resident Macintosh II computers that has been configured with MacAPPC (described later in this chapter). The gateway interacts with the respective mail server to provide transfer of mail.

Other electronic mail systems supported by Soft•Switch products include Banyan Mail; Consumers Software's The Network Courier; Digital's ALL-IN-1 and MVSmal; Enable Software's Higgins; Hewlett-Packard's HP Desk; IBM's OfficeVision, DISOSS, PROFFS, PS/36, PS/38, AS/40, and 5520; Novell LANs with MHS; Wang MAILWAY and OFFICE; Soft•Switch WP Mail, PC/TSO Mail; and other systems certified for interoperability, including Data General's CEO/DXA. Microsoft Mail users can exchange mail with users of systems connected to the Soft•Switch network via SMTP or X.400.

Approximate Cost \$1665

Supplier: Soft•Switch, Inc., 640 Lee Rd., Wayne, PA 19087

Database Access Tools

One of the main reasons to interface the Macintosh computer to an IBM host is to gain access to the large databases that reside on these hosts. Once the Macintosh computer is connected to an IBM host the user can use the following tools to access the data stored on the hosts storage systems.

Data Access Language Server for VM/CMS

The Data Access Language Server for VM/CMS is a networking software product that provides Data Access Language access to the Structured Query Language/Data System (SQL/DS) on a VM/CMS host system. Running on the VM/CMS host, the Data Access Language Server works cooperatively with Macintosh applications that

Solutions

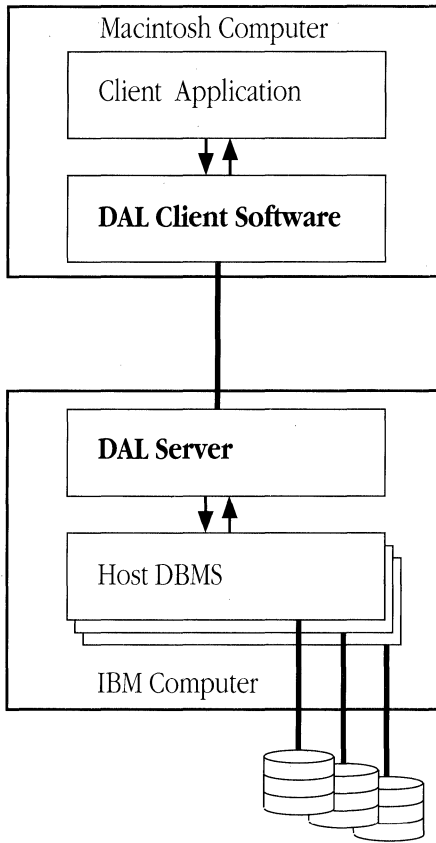

support Data Access Language (Applications with Data Access Language support are discussed in the *Networking Application Tools* chapter). The server receives a request from a Macintosh application, carries it out on the host, and sends the desired data back to the Macintosh application.

Data Access Language operates under existing host and database-management security and integrity schemes, assuring complete data security with no additional maintenance requirements. The Data Access Language Server provides 3270 datastream support, allowing SNA or non-SNA connection. To access the Data Access Language Server on the host, the client must have the supported 3270 hardware and software to emulate a 3278-type device operating in Control Unit Terminal (CUT) mode, MacDFT and either the Apple Coax/Twinax Card or the Apple TokenTalk NB Card for the Macintosh II family of computers.

The Data Access Language Server also supports the Apple 3270 API (Application Program Interface), which provides applications developers a consistent platform to developing customized 3270 applications.

Approximate Cost Contact supplier
Supplier: APDA (Apple Programmers & Developers Association), Apple Computer, Inc., 20525 Mariani Ave. MS 33G, Cupertino, CA 95014, 800-282-2732, 800-637-0029 in Canada, 408-562-3910 Internationally

Data Access Language Server for MVS/TSO

The Data Access Language Server for MVS/TSO is a networking software product that provides Data Access Language access to IBM Database 2 (DB2) databases on an MVS/TSO host system. Running on the MVS/TSO host, the Data Access Language Server works cooperatively with Macintosh applications that support Data Access Language (Applications with Data Access Language support are discussed in the *Network Applications Tools* chapter of this Guide). The server receives a request from a Macintosh application, carries it out on the host, and sends the desired data back to the Macintosh application.

Data Access Language operates under existing host- and database-management security and integrity schemes, assuring complete data security with no additional maintenance requirements. The Data Access Language Server provides 3270 datastream support, allowing SNA or non SNA connection. To access the Data Access Language Server on the host, the client must have the supported 3270 hardware and software to emulate a 3278-type device operating in Control Unit Terminal (CUT) mode, MacDFT and either the Apple Coax/Twinax Card or the Apple TokenTalk NB Card for the Macintosh II family of computers. The Data Access Language Server also supports the Apple 3270 API (Application Program

Interface), which provides applications developers a consistent platform to developing customized 3270 applications.

Approximate Cost Contact supplier

Supplier: APDA (Apple Programmers & Developers Association), Apple Computer, Inc., 20525 Mariani Ave. MS 33G, Cupertino, CA 95014, 800-282-2732, 800-637-0029 in Canada, 408-562-3910 Internationally

Host Interface Tools

In large and mature companies there are many installed systems developed by the MIS staff. These systems have communications interfaces optimized for a specific business requirement and therefore are not addressed directly by any software developers. The tools that follow provide development environments that enable custom interface design.

Masquerade3270

Masquerade3270 is a software product that enables users to create IBM host front-ends without modifying the mainframe application and without programming on the Macintosh. Masquerade3270 enables a user to create (via point-and-click) a custom Macintosh application (a "front-end") that acts as an intelligent layer between a 3270 mainframe application and its end-users. The front-end redesigns the human interface as well as the behavior of an existing 3270 application: it will look, feel and act like a Macintosh application, but the 3270 application program is untouched.

Approximate Cost \$200 to \$1200

Supplier: Connectivité Corporation, 101 Executive Blvd., Elmsford, NY 10523, 914-592-2853

Apple 3270 API

Apple 3270 API (Application Programming Interface) is a high-level application programming interface that gives application developers a consistent platform for developing customized 3270 applications. Because the Apple 3270 is based on the IBM 3270 PC High-Level Language Application Programming Interface (HLLAPI), application programmers can apply their knowledge of the IBM high-level interface to develop Macintosh-to-mainframe applications. The API is designed to allow terminal emulators, file-transfer programs, and other Macintosh computer applications and tools such as Data Access Language and MacWorkStation to use the 3270 services without being aware of the physical network connection details of coaxial, token ring, or SDLC.

Approximate Cost Contact supplier

Supplier: APDA (Apple Programmers & Developers Association), Apple Computer, Inc., 20525 Mariani Ave. MS 33G, Cupertino, CA 95014, 800-282-2732, 800-637-0029 in Canada, 408-562-3910 Internationally

Solutions

MacIRMA API™

MacIRMA API (Application Programming Interface) is a Macintosh-based programming tool used to develop custom applications that use DCA MacIRMA coax and LAN gateway solutions to communicate with an IBM mainframe. These applications may be written in C or HyperTalk. The API allows the development of “programmed operator” applications that simulate routine operator functions, such as log-on procedures and file transfer (through IBM IND\$FILE), as well as complicated data transfer operations. Host applications can be made to look like Macintosh applications or HyperCard Stacks. A customer-oriented training course is also available for MacIRMA API.

Approximate Cost\$195 to \$6495
Supplier: DCA, 1000 Alderman Dr., Alpharetta, GA 30201-4199, 404-442-4000

Cooperative Processing Development Environment

MacAPPC

MacAPPC software provides the tools to create powerful distributed applications that provide transparent access to information—regardless of its location or the type of system on which it resides. And because it is a Macintosh computer tool, MacAPPC software makes this remote information accessible through the familiar Macintosh computer user interface.

MacAPPC provides a complete implementation of IBM's Systems Network Architecture (SNA) Logical Unit 6.2 peer-to-peer protocol. It is a modular extension to the Macintosh system software, ensuring its availability on all members of the Macintosh computer family, as well as its compatibility with other networks (such as AppleTalk) and software that may already be installed. MacAPPC makes it possible to develop commercial applications that provide access to other Macintosh computer and non-Macintosh computer environments using the services of LU 6.2 protocols.

Approximate Cost Contact supplier
Supplier: APDA (Apple Programmers & Developers Association), Apple Computer, Inc., 20525 Mariani Ave. MS 33G, Cupertino, CA 95014, 800-282-2732, 800-637-0029 in Canada, 408-562-3910 Internationally

Seafirst Relies on Macintosh Computers for Easy Acquisitions

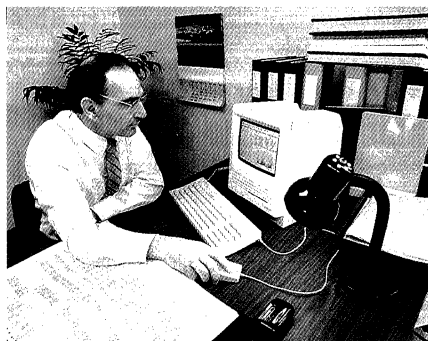

Making the acquisition of a new bank transparent to its customers led Seafirst to the Macintosh choice.

Seafirst Bank, the largest bank in Washington State, is an \$11 billion financial institution headquartered in Seattle. Its 6500 employees — from the chairman on down — use 3500 Apple Macintosh computers to create reports, send electronic mail, set up new customer accounts, and check the latest rates.

In 1985, Seafirst recognized that to be the leader in a competitive banking environment, it would have to involve all of its banking professionals in using computers to access critical customer and business information quickly. One of the company's primary objectives in the conversion to computers was to collect data at its source and make the information available throughout the system. "We viewed data as a corporate resource, and our goal was to make it available across the entire bank rapidly and easily," says Bob Bowman, vice president and manager of PC Support. At the time, Seafirst had one major on-line application that supported the teller stations in the bank's branches. However, most of its operations were built around batch processing on the mainframe.

Seafirst analyzed a number of different platforms and ultimately selected Macintosh personal computers. "We felt that because of the Macintosh computer's ease of use, we would be more successful at making the change to computers," says Bowman. "The intuitive Macintosh interface allowed us to introduce terminal emulation to people who had no affinity for a keyboard or a CRT, and get them productively involved in the computing process."

Faster Response To Business Needs

In 1989, when Seafirst acquired a competing bank in Washington, it wanted to make sure that the new customers wouldn't perceive any change in ownership. That meant ensuring that the acquired bank's products and services were incorporated into Seafirst's operating structure seamlessly.

One such product was a Certificate of Deposit (CD). The most important feature of the CD was that interest checks would be generated a few days before interest was due, so that the check would be in the customer's mailbox the day the interest was accrued.

Although Seafirst was in the process of developing a mainframe application to handle a similar product, it couldn't be implemented quickly enough. In order to issue the 5000 CD interest checks early, Seafirst would have needed at least two

Case History

months for mainframe reprogramming. Seafirst's Customer Services group had to find an alternative.

After analyzing numerous options, the group decided to use Macintosh computers. Using a Macintosh SE/30 with an Avatar board to access the mainframe, they designed a HyperCard program that would allow them to pull down the appropriate data, manipulate it, and transfer it to a FileMaker database, and print the checks on an Apple LaserWriter printer—complete with address, tax withholdings, digitized signature, and interest payment amount. Though the group had never tried it before, they were up and running in three days.

“What would have taken 30 temporary employees two weeks to complete took only three days with the Macintosh,” says Cathy Murray, vice president and manager of the Operations Group's Customer Services division. “On interest payment day, the checks were in the mailbox.”

As Tim Turnpaugh, Vice Chairman of Operations, puts it, “The Macintosh is a flexible tool that gives the ability to go from ground zero to up and running in no time. This is where, with the Macintosh, you realize a competitive edge.”

Access To IBM Mainframe Is Vital

There are approximately 1000 Macintosh personal computers in Seafirst's 185 branches. With few exceptions, all of the Macintosh computers emulate IBM 3270 terminals on the bank's SNA network allowing them to access IBM host information. In the bank's 185 branches statewide, customer service representatives use Macintosh computers to access the mainframe's Customer Information System for checking, savings, and credit information; loan applications; and other customer account information.

In Seafirst's corporate offices, senior managers in the Finance group use Macintosh computers equipped with Avatar boards to access host data, used in sophisticated Microsoft Excel spreadsheets for reports and presentations to the board of directors, shareholders, and financial analysts.

“We have a large number of people whose jobs involve manipulating data produced by numerous applications that run on the host,” says Bill Anderson, senior vice president and manager of the Technology Services Division. “We need to be able to provide data to those people so that they can incorporate it into reports, complete pro forma analyses, or use it to create boardroom presentations. If we can transfer data electronically and download it directly to the Macintosh, we reduce our costs and increase productivity.

“We have a lot of IBM equipment here,” he continues. “We have a large IBM mainframe. We have a lot of IBM terminals, and we have a lot of Macintosh

Case History

computers that act as IBM terminals. The IBM terminal is a closed environment. Macintosh adds an entire wealth of possibilities to the computing experience of the end user."

The company is currently looking at IBM's Systems Application Architecture (SAA) platform, for application development and network expansion. "Since so many of the applications we use run on IBM systems, we have to embrace it," explains Anderson. "What's great is that the Macintosh fits right into IBM's SAA future. Even if Seafirst chose to be strictly an SAA shop, we would still keep all of our Macintosh computers. We would use the Macintosh computers for what they excel at. For us, those functions are not going to be supplanted by another personal computer overnight. In fact, the more we use Macintosh, the more we like it."

DAL Will Permit Seamless Mainframe Access

Seafirst is also using Apple's Data Access Language (DAL) to create prototype HyperCard applications that will allow end users to access information in multiple DB2 databases residing on the bank's IBM host mainframe. Says Mike Harburg, vice president of Advanced Research, "The beauty of DAL is that the user just opens up an application and logs on to the host, and DAL brings the data down to the Macintosh." In the future Seafirst expects to see a number of popular software products incorporate DAL capabilities into the application structure. "We're looking for ways to seamlessly integrate workstation productivity tools with data on the mainframe, in order to maximize the use of Macintosh systems as decision support tools."

Macintosh Network Supports Corporate Goals

Seafirst estimates that since the Macintosh network became fully functional, productivity has increased, because multiple rekeying of documents has been largely eliminated. With the availability of better data and graphical presentation, the decision-making process has been improved. Internal communications convey more information faster.

Seafirst also estimates an 87 percent reduction in training costs with the Macintosh compared to MS-DOS machines. "Our people get paid to make loans and provide customer service," says Turnpaugh. "They don't get paid to learn how to use computers."

An indication of the Macintosh computer's broad acceptance and wide usage throughout the bank is the fact that Seafirst has the highest per capita computer usage in the banking industry. For every two people in the corporation, there is one Macintosh computer. But as Turnpaugh explains, "This is not technology for

Case History

technology's sake, but rather technology that make the bank a better place to work and more helpful to our customers."

Seafirst's avowed corporate mission is to provide high-quality customer service while achieving superior profitability, maintaining its dominant market share, and being the lowest-cost producer of banking products in the state. According to Harburg, the Macintosh computer is a vital component of the bank's ability to achieve those goals. "I can say without a doubt that the Macintosh has provided us with the ability to help more customers in more ways, more efficiently than any other computer system would have," says Harburg. "I think this is a reason that Seafirst has become a more profitable and successful corporation."

Tandem Computers Overview

Background

Tandem Computers, Incorporated, offers a full range of computing systems, expanding from small multiprocessor departmental machines to very large transaction processing systems. The company is a leader in the worldwide on-line transaction processing (OLTP) market, one of the fastest growing markets in commercial data processing. Tandem pioneered on-line, fault-tolerant computing, and is the primary supplier of such systems.

Tandem concentrates on transaction processing systems that consist of many processors, distributed databases, and large networks. Because the Tandem architecture is specifically engineered for distributed OLTP, Tandem applications support many thousands of terminals, intelligent workstations, and other devices. Tandem's fundamental advantages are in OLTP price/performance, linear expandability of processing power, fully distributed SQL databases, data integrity, security, and fault tolerance.

Tandem now offers Macintosh personal computers as part of its product line, bringing Macintosh into major corporate OLTP systems.

Tandem specializes in on-line transaction processing (OLTP). Its fault-tolerant computers feature expandable systems and networks that support the Macintosh, as well as other personal computers.

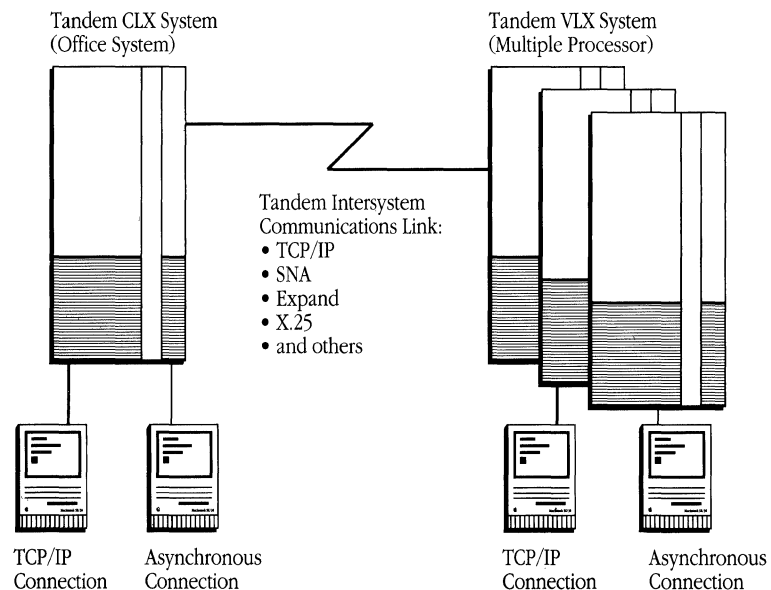

The Environment

Tandem computers are installed by banks, manufacturers, major retailers, and other transaction-oriented businesses. Many automatic teller machine (ATM) systems, stock exchanges, bank funds-transfer operations, manufacturing applications, and library services run on Tandem computers. In addition, more than 200 third-party software vendors provide application solutions for Tandem customers.

Tandem Computers: The Hardware Environment

Tandem networks can have as many as 255 separate nodes (locations), each of which can be configured to support up to 16 processors. Using the GUARDIAN 90 operating system, all Tandem systems are able to share applications, distributed databases, and communications.

Hardware and software are designed specifically for OLTP, and Tandem's modular design allows users to develop systems over time and to distribute processing without changing their applications. Full data integrity guarantees that distributed customer databases will be consistent and accurate after every transaction.

Tandem provides a communications support environment that includes integrated support for TCP/IP, NetBIOS, SNA, X.25, and other industry standard protocols. Tandem systems are compatible with a range of languages, including Pascal, C, FORTRAN, COBOL, and the Tandem Application Language (TAL).

Tandem Connectivity Solutions

FOUNDATION Vista

FOUNDATION Vista is a Computer Aided Software Engineering (CASE) product offering integrated tools for on-line application analysis and design. FOUNDATION Vista, which is Macintosh-based, compliments the FOUNDATION application development system and is SQL oriented. The system automates the documentation and diagramming process. Data Flow Diagrammer lets users visually reflect the flow of information through your proposed system. Two data-flow diagramming methodologies, Yourdon and Gane-Sarson, are supported by FOUNDATION Vista. Modifications are reflected on other levels of the design. Entity-Relationship Diagrammer models static relationships between data entities, including key fields definitions. It supports relational-database design, allowing users to specify SQL attributes. Program Structure Diagrammer enables users to express program logic with the Jackson program-structure methodology. Screen/Form Designer allows users to design application screens, forms, and reports using a point-and-click interface. Design Compiler analyzes design diagrams for syntactical and logical correctness. Following analysis, the compiler reports on errors and warns of potential problems. The system stores compiled output in an object file, available for translation and transfer to the host computer.

Approximate Cost \$8900

Supplier: Menlo Business Systems, Inc., The Menlo Building, 201 Main St., Los Altos, CA 94022, 415-948-7920

FOUNDATION Vista Translator

The Translator automatically interfaces compiled Vista designs with the Tandem environment by generating PATHWAY screen definitions and DDL components. The Vista Translator also reverse engineers DDL source from the Tandem environment to the entity Relationship Module of the Vista Design Workbench.

Approximate Cost \$16,000

Supplier: Menlo Business Systems, Inc., The Menlo Building, 201 Main St., Los Altos, CA 94022, 415-948-7920

FOUNDATION Graphics ToolBox:

- *Graphics Database*
- *Data Security*
- *Data Retrieval*
- *Simultaneous Display*

FOUNDATION Graphics Toolbox

FOUNDATION Graphics Toolbox, in combination with MacMenlo—a software bridge that connects a Macintosh to a Tandem computer—provides a graphic capability for Tandem computer mainframe applications. In addition to the Tandem mainframe access window, a second window can be opened that supports all

Solutions

native Macintosh graphics, both bit-mapped and object-oriented. The graphics window can be positioned according to user commands. When the Tandem FOUNDATION Graphics Toolbox package is installed on a Tandem mainframe, the graphics images can be treated as part of the Tandem mainframe application and are actually incorporated into the Tandem application database.

Approximate Cost \$19,500

Supplier: Menlo Business Systems, Inc., The Menlo Building, 201 Main St., Los Altos, CA 94022, 415-948-7920

FOUNDATION CBT

Menlo's computer-based training system, FOUNDATION CBT leverages the power of both the Macintosh workstation and mainframe computing through cooperative processing. Instructional designers can use a graphic point-and-click Macintosh authoring platform to deliver training to a wide variety of devices, terminals as well as workstations. A Tandem-based management platform provides an integrated data base for consolidating and managing courseware, user registration, and training validation. Using Tandem's networking power, training can be delivered to Tandem, IBM and other mainframe users, worldwide.

Approximate Cost Contact supplier

Supplier: Menlo Business Systems, Inc., The Menlo Building, 201 Main St., Los Altos, CA 94022, 415-948-7920

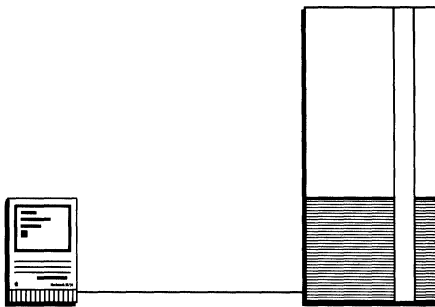

MAC MENLO emulates the Tandem 6510 and 653X terminals in both character and block/page modes.

MAC MENLO

MAC MENLO is a terminal-emulation program that lets Macintosh users access any Tandem application. It supports Tandem 6510 and 653X terminal emulation in both conversational and block (page) modes. This provides access to block-mode applications, including TEdit, Pathway, FOUNDATION, and the VS-Editor. A file-transfer facility allows transfer of text and/or graphics files and documents between a Macintosh and the host computer as well as from person to person and site to site. The program works with MultiFinder, allowing *MAC MENLO* to run in conjunction with other Macintosh applications. Users can cut and paste information directly between *MAC MENLO* Tandem screens and Macintosh applications. Graphics, formatted data, programs, and other data can be transferred from a Macintosh computer to a Tandem host and then to other Macintosh computers connected to the host. *MAC MENLO* also supports selection techniques that allow users to copy-protect data, select words or whole lines by double- or triple-clicking the mouse, and select columns or other rectangular portions of the screen.

Approximate Cost \$395

Supplier: Menlo Business Systems, Inc., The Menlo Building, 201 Main St., Los Altos, CA 94022, 415-948-7920

MENLOCOM

MENLOCOM applies the Macintosh interface to standard Tandem database information. As a result, data can be viewed in user defined formats on the Macintosh screen. In addition, MENLOCOM allows integration of data from Tandem and Macintosh databases. This gives Tandem users the ability to access and display information. MENLOCOM defines a full-service gateway and interface between applications operating on the Tandem and applications operating on the Macintosh. Examples of Macintosh applications include Apple's HyperCard and 4th DIMENSION from Acius, both of which can be programmed to meet internal data and communications interfaces. Using 4th DIMENSION, for example, the user may design applications that combine corporate data from the mainframe (Tandem) with local Macintosh data to create new data and present the data using presentation techniques under the control of the 4th DIMENSION relational database management application.

Approximate Cost Contact supplier

Supplier: Menlo Business Systems, Inc., The Menlo Building, 201 Main St., Los Altos, CA 94022, 415-948-7920

MAX at a glance:

- *Uses XModem and MacBinary protocols*
- *Offers standard Macintosh file-transfer interface*
- *Provides reformatting of Tandem files*
- *Offers interactive or predefined execution modes*
- *Provides file transfer with error detection and correction*
- *Allows transfer of Tandem Edit files to workstations as workstation Edit files that can be used with Macintosh word-processing and text-editing applications*

MAX

Menlo Business Systems' MAX is a Tandem-based program that facilitates error-free file transfer between Tandem Computer mainframes and Macintosh computers. Most users can transfer files using Macintosh point-and-click file selection and predefined command macros stored in a Tandem database. Tandem data-file reformatting commands are also available. With them, data can be selected and reformatted into records that can be transferred and used directly in Macintosh applications. This reformatting capability allows the insertion of tabs, control characters, and data strings. It also provides conversion from binary to decimal format and the restructuring of record definitions, so users can sequence data fields to their needs. Several files, even whole Tandem libraries or Macintosh folders, can be transmitted in a single transaction. MAX provides a real-time summary of the progress and status of each transfer operation and maintains statistics about each Macintosh data file stored on a Tandem database.

Approximate Cost \$3500

Supplier: Menlo Business Systems, Inc., The Menlo Building, 201 Main St., Los Altos, CA 94022, 415-948-7920

Solutions

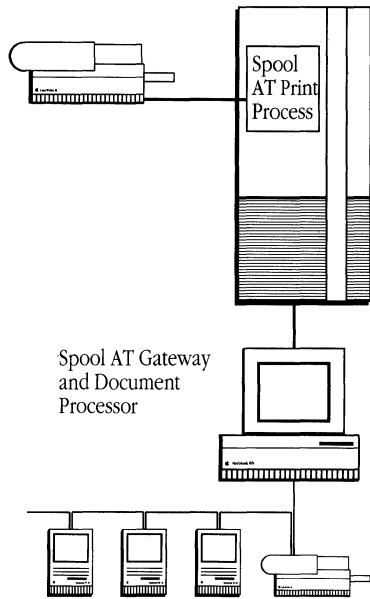

Spool AT allows the connection of Apple LaserWriter printers and other printers on AppleTalk networks to Tandem hosts.

Spool AT

Spool AT software connects the Apple LaserWriter printer and other AppleTalk-connected printers to a Tandem host. This allows a Tandem-resident print process to be used in conjunction with Macintosh applications. Up to 16 separate Macintosh print locations can be supported by a single Spool AT Tandem print process. Connection to a Tandem computer can be direct, over a network, or via a dial-up communications link. The Macintosh user can control both the spooling (data transfer) and printing operations. Spool AT provides a library of standard document formats and font selections. Spool AT provides real-time process status information, and it uses the standard Macintosh interface.

Approximate Cost\$295 to \$995

Supplier: Menlo Business Systems, Inc., The Menlo Building, 201 Main St., Los Altos, CA 94022, 415-948-7920

Current Loop Converter (CLC)

Menlo's Current Loop Converter (CLC) connects RS-232 (EIA) devices (Macintosh and IBM workstations) to 20 mA current loop connections (Tandem, Unisys, Prime, and so on). It weighs two ounces, and measures 0.5- by 2- by 2.5-inches, requires no external power, and is fitted with two DB25 connectors for standard connections. The CLC is compatible with DTE devices and can be changed for use with DCE devices. It can also be used as a connector changer (DTE to DTE), or as a crossover (null modem) connector for DTE to DCE connections.

Approximate Cost\$100 to \$125

Supplier: Menlo Business Systems, Inc., The Menlo Building, 201 Main St., Los Altos, CA 94022, 415-948-7920

MacBLAST for Asynchronous Connectivity

Tandem BLAST operates on Tandem LXN systems under UNIX, using any /dev/TTY port, and connects to Macintosh computers running BLAST for file transfer, and text file format conversion. MacBLAST transfers binary data, text, or graphics. MacBLAST and BLAST products for other computer systems can be used to create wide area networks between central computers and any number of remote sites. Other features include: on-line help, automatic dialing, access to remote systems, and unattended operations. BLAST runs over standard telephone lines, X.25 networks, and satellite links with no propagation delays. In addition, BLAST is resistant to line noise.

Approximate Cost\$195 to \$695

Supplier: Communications Research Group, 5615 Corporate Blvd., Baton Rouge, LA 70808, 800-24-BLAST

Wang Laboratories Overview

Background

Wang Laboratories (Wang) was founded in 1951 by Dr. An Wang. From the 1950s to the early 1970s, Wang specialized in laboratory instrumentation and calculators for small businesses. In 1972, Wang introduced its first business computer line—the Wang 2200 System. In 1976, Wang introduced the first full-screen word-processing system, called the Wang WPS. The Wang WPS used the same hardware and software architecture as the Wang 2200.

Each terminal (called a “workstation” in the Wang environment) contains a Z80-based microprocessor. The Z80 reduces the work load on the central processor during I/O-intensive activities. This feature allows the overall system performance to remain relatively unaffected by the number of workstations in use. The Wang WPS line was very successful, propelling Wang to the \$500 million sales mark by the year 1975.

In 1977, the company introduced its Office Information Systems (OIS) product family, also based on the Z80 microprocessor. The OIS is a shared word-processing system, and the basic system configuration consists of a central unit with hard disk storage and from 4 to 48 workstations connected via dual coaxial cable.

The Wang Virtual Storage (VS) system, introduced in 1979, is now the workhorse of the Wang product line. The Wang VS is a sophisticated minicomputer system that is most often used in office-automation settings. In essence, the Wang strategy revolves around configuring a minicomputer to act as a file server, traffic cop, and main storage device for workstations and personal computers connected to the host. These workstations and personal computers are intelligent, and system software is loaded into them via the host.

The typical VS system configuration consists of a central computer with hard disk storage and from 10 to 292 workstations typically connected via Wang’s proprietary 928 dual coaxial cable.

Other products in the Wang line include the Wang Alliance, a sophisticated database computer product line; Wang MS-DOS-based personal computers, which work as independent devices or within Wang VS-based networks; Wang Integrated Imaging System (WIIS), a new series of image-based systems for storing and retrieving large volumes of documents; and Freestyle, an MS-DOS-based system that permits users to annotate documents electronically using handwriting or voice.

The Environment

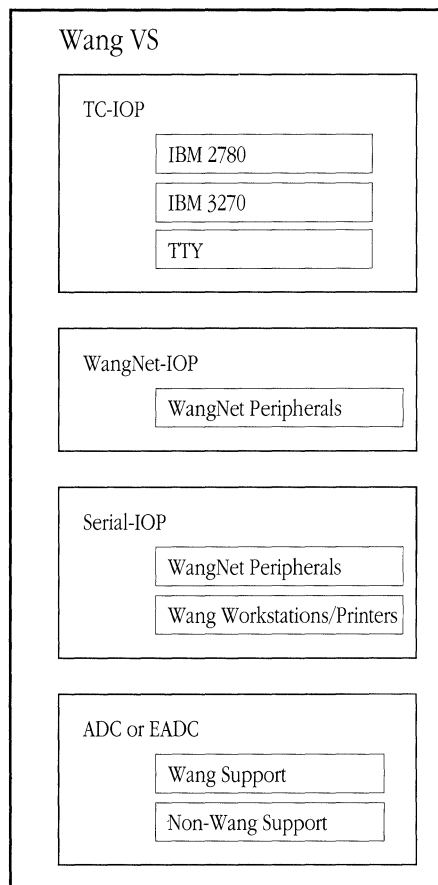

The Wang VS forms the hub of many departmental networks and is a communications processor within the IBM environment.

Networking and Communications

Wang VS and OIS central processors can exchange files and documents, and can act as terminal processors to remote VS systems using Wang Systems Networking (WSN), Wang's overall networking strategy.

WSN can be implemented using a variety of protocols or transports, including a point-to-point switched telephone line (dial-up or dedicated), multipoint (multi-dropped) dedicated telephone line, and X.25 packet-switched public data networks such as Telnet and Tymnet.

Wang's workstations are generally connected to the VS central processor by Wang's proprietary 928 dual coaxial cable or via WangNet, a broadband local area network (LAN). WangNet is based on dual half-inch coaxial cable, broadband amplifiers, and terminal multiplexers known as Netmuxes. The LAN supports five different services:

- **WangBand** allows VS central processors and OIS dedicated word processors to exchange files and documents, and allows OIS dedicated word processors to act as terminals to any VS system in the network. This service is part of the overall WSN architecture. Processors are connected to the WangNet network via Cable Interface Units (CIUs).
- **Peripheral Band** acts as a coaxial cable replacement service, allowing Wang workstations to connect with the VS or OIS central processors. It can also be used to connect IBM 3278 workstations to IBM's 3271 or 3274 cluster controllers.
- **Interconnect Band** emulates switched and dedicated telephone lines to allow communications between Wang or non-Wang systems via radio frequency modems.
- **Wang PC Band** allows Wang PCs to participate in Wang's proprietary Token Ring network.
- **Utility Band** provides cable television channels for CATV or remote-control applications.

Non-Wang Communications Capabilities

The Wang VS supports a variety of terminal emulation packages. These allow the Wang VS to emulate: IBM 3271 cluster controller and IBM 3278 terminals; IBM 3274 SNA cluster controller; IBM batch terminal for remote job entry; TTY terminals; and the X.25 packet-switching network, which permits Wang workstations to emulate TTY or VT100 terminals, using a public data network such as Telnet or Tymnet.

Wang Laboratories Solutions

Basic Wang Terminal Emulation

Any Macintosh application that supports VT100 emulation, such as MacTerminal software, can emulate a standard VT100 terminal on a network using the Wang VS. This allows the Macintosh computer to function as a Wang workstation by direct or modem connection to the Wang-provided asynchronous device controller (ADC) or enhanced asynchronous device controller (EADC). Additional terminal emulators can be found in the *Digital Equipment Corporation* chapter of this Guide.

MacLinkPlus/Wang VS

The DataViz MacLinkPlus/WangVS terminal-emulation feature enables Macintosh users to emulate a Wang workstation, while eliminating the burden of memorizing complex keystroke commands. It uses on-screen buttons and pull-down menus that allow workstation functions to be accomplished with customary Macintosh computer simplicity and ease, including mouse control of the Wang screen plus Clipboard copy and paste.

Approximate Cost\$125 to \$395

Supplier: DataViz Inc., 35 Corporate Dr., Trumbull, CT 06611, 203-268-0030

MacLinkPlus/Wang VS for Wang Hosts

The DataViz MacLinkPlus/WangVS software provides a bridge between Wang word-processing and Macintosh applications with two-way file transfer and document translation. Macintosh documents can be converted to standard Wang word-processing documents and stored on the Wang VS in a one-step process. Wang VS documents can be sent to the Macintosh computer and automatically translated to MacWrite, MacWrite II, Microsoft Word, or WordPerfect format. In all, more than 150 translators are provided. Macintosh users can read mail received via Wang Office electronic mail and can create and send Wang Office memos and packages (including MacBinary and binary files) to Wang users, as well as other Macintosh computer and IBM PC users. A version of MacLinkPlus/WangVS is available for Macintosh connectivity via the Wang VS TC TCP or MLTC ports.

Approximate Cost\$395 to \$895

Supplier: DataViz Inc., 35 Corporate Dr., Trumbull, CT 06611, 203-268-0030

MacLinkPlus/Wang OIS

MacLinkPlus/Wang OIS is a package for transferring and translating word processing documents between a Macintosh personal computer and a Wang OIS. The

Solutions

included library of file translators allows conversion in either direction between Wang OIS word processing documents and MacWrite, MacWrite II, Microsoft Word, Microsoft Works WP, and WordPerfect applications. Users can connect the Macintosh to the Wang or TC workstation using the included cable or modems (modems not included in the product). The Macintosh and Wang software included in the product allow the user to choose the types of files to be translated. Files maintain their original formatting, and are usable in their new environment. MacLinkPlus/Wang OIS also allows connections to Wang PC's, as well as IBM PC's, compatibles, and laptops. The necessary PC software is included with the product.

Approximate Cost\$495
Supplier: DataViz Inc., 35 Corporate Dr., Trumbull, CT 06611, 203-268-0030

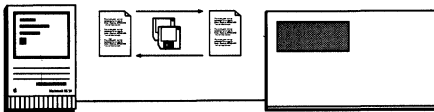

VSterm provides Wang 2110 terminal emulation for document transfer and conversion.

VSterm and VsCom/Macintosh

VSterm from MacSoft and VsCom/Macintosh from M/H Group provide Wang 2110 terminal emulation for document transfer and conversion. With VSterm, any PC with a serial port can emulate the Wang 2100 or VT100 terminals, exchange documents and data with the Wang VS, and convert Wang VS data to PC formats. MacSoft also offers a program called Converse that provides file transfer and conversion through the Wang VS TC-IOP ports.

VsCom/Macintosh provides Wang VS 2110 terminal emulation, including quick screen response, support of Wang WP graphics and characters, and access to Wang function keys. The program also provides file transfer and conversion between Macintosh and Wang word-processing formats.

Approximate Cost\$195 to \$2495
Suppliers: MacSoft, 2920 F St., Bakersfield, CA 93301, 805-324-4291
 M/H Group, 222 West Adams St., Chicago, IL. 60606, 312-443-1222

MacBLAST for Asynchronous Communications

MacBLAST software interfaces with BLAST for the WANG VS/OS Revision 6.4 or later, equipped with TCIOIP boards and asynchronous ports with ADC/EADC options. MacBLAST provides file transfer and text file format conversion for interfacing the Macintosh with Wang computer systems. MacBLAST transfers binary data, text, or graphics. MacBLAST and Wang VS BLAST can be utilized to create simple file transfer links or dial-up networks between Wang VS computers and any number of remote Macintosh or PC sites. MacBLAST features include: on-line help, automatic dialing and access to remote systems, and scripting for unattended Macintosh operations. BLAST runs over standard telephone lines, X.25 networks, and satellite links. In addition, BLAST is resistant to line noise.

Approximate Cost\$195 to \$2195
Supplier: Communications Research Group, 5615 Corporate Blvd., Baton Rouge, LA 70808, 800-24-BLAST

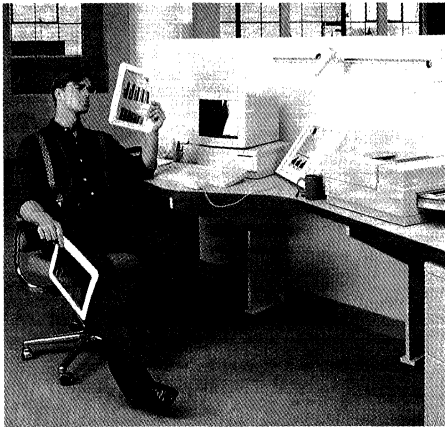

One of the country's most acclaimed advertising agencies uses Macintosh computers and Wang VS minicomputers to create great ads for its clients . . . and great management systems for its business.

Chiat/Day Advertising, Inc. Connects Macintosh and Wang Systems with VSterm and NetSerial

Chiat/Day Advertising, Inc. is integrating Macintosh computers, Dell PCs, and its Wang VS minicomputers into a network that will connect every office, in every department, touching virtually every element of the agency's business.

Chiat/Day's 700 employees, in offices worldwide, use more than 450 Macintosh computers and each office has a Wang VS minicomputer. VSterm, from MacSoft, integrates the Macintosh and Wang VS minicomputer. VSterm combined with NetSerial from Shiva, allows the Macintosh to emulate Wang terminals, exchange documents, and convert VS data into Macintosh formats.

Wang VS systems were used for business management, daily transactions and database functions, while Macintosh computers were used for word processing and graphics. Chiat/Day decided to integrate the Wang and Apple systems (by using the Macintosh as a terminal) to the Wang VS, to eliminate the need for two terminals on each desk.

The next challenge was to encourage Chiat/Day employees to take advantage of the integrated system. So, in true advertising agency style, Steve Alburty, MIS Director, and his staff created custom documentation. A Chiat/Day user manual became required reading.

Not long after distribution of Chiat/Day's user manual, "Introducing the world's first ad agency run by a mouse," the computer equipment was redistributed (some returned Wang terminals since they could log-on with the Macintosh). Alburty believes the Macintosh supplies more functionality to the user than Wang terminals do—for a lower price.

Alburty foresees the day when the Wang systems will be completely replaced at Chiat/Day offices. And beyond that? "I challenge Apple to show us what the future will be," Alburty concludes. "I know Chiat/Day will be right there to take advantage of the breakthrough."

The Macintosh—all in a day's work for Chiat/Day.

Prime Computer Overview

Background

Based in Natick, Massachusetts, Prime Computer, Inc. is an international Fortune 500 company with more than 19 years of experience in systems integration. Prime markets general-purpose computer and CAE/CAD/CAM systems in 53 countries throughout North America, Latin America, Europe, the Middle East, Africa and the Asia Pacific Basin. Prime's major products include the 50 Series TM, a multitasking, fully compatible line of superminicomputers, the industry-standard Prime EXL TM family of multi-user, multitasking super microcomputers, and a full line of integrated CAE/CAD/CAM solutions based on PCs, workstations, minicomputers, and mainframes.

Prime Computer also offers standard communications products for distributed processing networks. Since 1979, when Prime introduced PRIMENET, its wide area network (WAN) and local area network (LAN) software for PRIMOS-based 50 Series systems, the company has developed other WAN and LAN products. These include PRIME/SNA, which allows Prime computers to connect to IBM environments, and PRIMELINK software, which is used to connect Prime systems to the Apple Macintosh computer and PC-DOS-compatible personal computers.

Prime implements industry-standard protocols, such as X.25, IEEE 802.3 Ethernet, and TCP/IP. All of Prime's communications products are compatible, and any Prime communications product can be used on any 50 Series system without modification.

Connectivity Between Prime Systems

PRIMENET Configurations

PRIMENET software is used to interconnect Prime systems in a proprietary, token-passing LAN called RINGNET, or in an industry-standard IEEE 802.3 CSMA/CD LAN, called LAN300. PRIMENET software offers a range of ways to connect systems that are located far from each other. If heavy access is required, Prime systems can be connected via leased telephone lines or even via satellite in a synchronous, point-to-point network. If only occasional access is required, a synchronous dial-up network may be used.

The Environment

PRIMENET Services

Remote Terminal Access allows any terminal in a LAN or WAN to access any Prime host on the network. Remote File Access allows users to access files on other networked Prime systems without regard to their physical location. For specialized network applications, an interprocess communications facility provides a high-level language subroutine interface. Another facility, the File Transfer Service, is a queued mechanism for transferring files between systems.

X.25 Interface

PRIMENET software also provides access to X.25-based Packet Switched Data Networks (PSDNs). All the PRIMENET software services previously mentioned are available when X.25 is used, just as if the link were based on the RINGNET LAN.

TCP/IP for PRIMOS

TCP/IP is supported across Prime's broad range of products: terminal servers, 386-based supermicrocomputers, CAE/CAD/CAM workstations, and supermini-computers. TCP/IP for PRIMOS supports: mail transfer among 50 Series system users and other users on the network with Simple Mail Transfer Protocol (SMTP); file transfer applications using File Transfer Protocol (FTP); remote access to and from a 50 Series system via Server and User Telnet; and (4) program-to-program communication with another system on the LAN supporting sockets.

Prime Computer directly supports the integration of Macintosh systems into its networking solutions, through PRIMELINK software, which is described in the following section.

Prime Computer Solutions

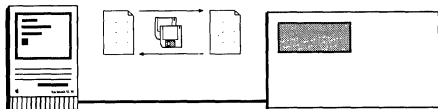

PRIMELINK Software for the Macintosh emulates many major terminals as well as facilitating file transfer between Macintosh computers and Prime hosts.

PRIMELINK Software for the Macintosh

Using PRIMELINK, Prime products can connect via asynchronous or high-speed LAN communications to Macintosh computers and PC-DOS-compatible personal computers to form integrated computer networking systems. PRIMELINK communications software for the Macintosh includes the following features: file transfer, virtual disk, remote printing, and terminal emulation.

PRIMELINK's features use the Macintosh interface. Programmable softkeys can generate simple commands, complex sequences of terminal functions, clear text, or script files. PRIMELINK's File Transfer facility allows Macintosh users to transfer ASCII, MacBinary files and binary files between a Macintosh computer and MS-DOS-compatible personal computers and the Prime host system, allowing the personal computers to act as Prime workstations.

PRIMELINK software has a Virtual Disk facility that transparently expands the Macintosh environment to include the Prime host, allowing multiple personal computer users to access the same files. PRIMELINK's Remote Print facility lets Macintosh users print files to a designated shared printer, either on the LAN or directly connected to the Prime host system. PRIMELINK also allows the Macintosh to emulate the Prime PT200 terminal. PRIMELINK software also supports emulation of Televideo 950, ADDS Viewpoint 60+, Stratus V102, Digital VT100, VT220, VT241, and Tektronix 4010/4014 and 4105.

Approximate Cost \$2250 to \$10,250

Supplier: Prime Computer, Prime Park, Natick, MA 01760, 617-655-8000

MacToPic, Version 2.2

MacToPic, for the Macintosh computer is a terminal emulation and file transfer program to link Macintosh computers to the Pick operating system world. It emulates Adds Viewpoint, DEC VT101 and McDonnell Douglas Prism terminals. All three emulators support cursor positioning, erase commands, inverse video, underlining and dim characters.

The Viewpoint and VT101 emulators support host-generated graphics characters. The Viewpoint emulator supports Viewpoint function keys and Wyse cursor positioning. MacToPic transfers data from Pick hosts and converts from a relational database format to the Macintosh file format. Data transferred from the Pick host can be used in Macintosh spreadsheets, databases, word processors and page

Solutions

layout programs. Macintosh text files can be transferred to the Pick host. Text can be cut from a Macintosh word processor and pasted into a Pick word processor.

Color and 13-inch monitor format supported on the Macintosh II family of computers. Users can direct connect to a Pick host or use a modem. A phone list and dialer for Hayes-compatible modems is included.

Approximate Cost\$195 to \$2000

Supplier: Carnation Software, P.O. Box 608, Carnation, WA 98014, 206-333-4288

MacBLAST for Asynchronous Communications

MacBLAST communications software interfaces with Prime computers running BLAST software under the PRIMOS operating system, Rev. 19+. MacBLAST provides file transfer, and text file format conversion for integrating the Macintosh with Prime computer systems. MacBLAST transfers binary data, text, or graphics. MacBLAST and BLAST products for Prime computer systems can be used to create wide area dial-up networks between Prime computers and any number of remote Macintosh computers or PCs. MacBLAST uses standard phone lines or X.25 networks to provide communications unaffected by phone line noise or propagation delay on satellite-routed calls and X.25 packet networks. MacBLAST features include: on-line help, automatic dialing, and scripting for creating unattended operations, custom menus, and seamless integration within Macintosh applications.

Approximate Cost\$195 to \$595

Supplier: Communications Research Group, 5615 Corporate Blvd., Baton Rouge, LA 70808, 800-24-BLAST

Hewlett-Packard Overview

Background

Hewlett-Packard's three lines of minicomputers are:

- *The HP 3000 Series of general purpose business computers includes products ranging from the four-user Model 37 to the 400-user Model 70.*
- *The HP 9000, used primarily in scientific and engineering computation, includes products ranging from UNIX system and BASIC workstations to the 100-user Model 850.*
- *The HP 1000 Series is used primarily for real-time monitoring and instrument control.*

Hewlett-Packard (HP) is a \$10 billion international company with 50 years of experience in scientific instrumentation and 20 years of experience in computer products. The company is headquartered in Palo Alto, California, and has manufacturing, sales, and service offices throughout the world. HP manufactures three major lines of minicomputers, as well as a large number of hand-held and desktop calculator products. Approximately 60 percent of HP's revenues are derived from its three lines of minicomputers.

In 1986, Hewlett-Packard introduced its first HP Precision Architecture (HP-PA) computer—HP's implementation of RISC architecture, the HP 9000 Model 840. It was followed in 1987 by two new members of the HP 9000 family (Models 825 and 850) and the first two HP-PA members of the HP 3000 family (Models 930 and 950).

HP offers a wide range of data communications products that permit the construction of networks connecting systems within the same HP computer family, systems from different HP families, and computers from other vendors. The earliest of these products, Distributed Systems (DS), consists of networking software for the interconnection of HP 3000s or HP 1000s. HP's networking products have since expanded to include proprietary Network Services (NS), software for the interconnection of HP 3000s or HP 9000s, and ARPA and Berkeley network services under HP-UX, HP's implementation of the UNIX operating system for the interconnection of HP 9000s and other UNIX-based machines. HP data communications products also include an X.25 network, a Systems Network Architecture (SNA) gateway, IEEE 802.3 and Ethernet services. HP's hardware, software, and service products for data communications and networking are all incorporated under the name HP AdvanceNet.

HP intends to adhere to the developing OSI model and evolving industry standards in its network software and hardware products.

HP Terminal Types

The HP 700 family of terminals is HP's fourth generation of terminals. These terminals offer value-packed functionality, more standard memory, and a choice of green, amber, or soft-white screen color. Superior ergonomics on these terminals include sharp character definition, excellent keyboard feel, and 72 Hz, flicker-free operation.

The Environment

The HP 700/92, /93, /94, /97 are the HP block-mode terminals. These terminals have local-storage capability to receive transfers of blank forms in advance of data to be transmitted as update information, which improves the throughput speed of the devices. The 700/93 and /97 are also graphic terminals.

The HP 700 family of terminals also offers terminals for the ASCII, ANSI, and IBM markets. The 700/41 and /43 are ASCII terminals. Terminals in this market segment connect to a variety of computer systems including microcomputers, minicomputers, and mainframes.

The 700/22, /32, and /44 are ANSI terminals. Digital has chosen the ANSI standard as the basic communication protocol for DEC terminals. Also, UNIX-based computer systems are popular hosts for ANSI terminals. The 700/71 terminal is an IBM-3270-type terminal. These terminals are designed to work with IBM mainframes such as the 3090, 4300, and 9370.

Connectivity Between HP Systems

Terminal Connections

Terminals, and microcomputers that emulate terminals, are connected to HP computers through RS-232 or RS-422 ports. Both hard-wired and dial-up connections are supported. Recently, both HP and third-party suppliers have provided direct terminal connections from microcomputers via an Ethernet LAN.

Network Services

The NS/3000 software product is an implementation of OSI layers six and seven. This software family permits communications between HP 3000s with a wide variety of services.

A subset of these services is supported over point-to-point, X.25, or satellite network links, as well as in communications between HP 3000s and other HP computers.

Similar products (NS/1000 and NS/9000) exist for the HP 1000 and HP 9000 computer lines. A subset of network services is provided between the different HP computer product lines.

Distributed Systems Network Services

The Distributed Systems (DS) products provide extensive networking capabilities among HP 3000s and between HP 3000s and HP 1000s. Connection may be made

The NS/3000 software family provides thin-wire Ethernet between HP 3000s for the following functions:

- *Remote database access*
- *Remote file access*
- *Remote device access*
- *Network file transfer*
- *Virtual terminal access*
- *Program-to-program communications*
- *Remote process management*
- *Network interprocess communications*

The Environment

| OSI Layer | Functionality |
|------------------|-------------------------------------------------------------------------------------------------------|
| Application | Network-based applications and utilities |
| Presentation | File service; control of representation of information; conversion of file formats |
| Session | Delivery of sequenced packets or streams of characters; coordination of activity across network zones |
| Transport | Reliable transportation; name-to-address mapping |
| Network | "Best effort" packet delivery between network entities Data Link |
| Link | Access to physical transmission medium; speed of transmission; send/receive functions |
| Physical | Transmission medium (cabling); electrical interface |

The OSI Reference Model identifies the major layerings of functionality that network designers strive to meet to create compatible networks.

using bisync and X.25 protocols, hard-wired local connections, dialed and leased telephone lines, and X.21 and X.25 public data networks. Network database access, file access, device access, file transfer, and interprogram communications are supported among HP 3000s, and a subset of these services is supported between HP 3000s and HP 1000s. The DS products are older products that have been superseded by the NS products.

X.25 Packet-Switched Networks

HP NS and DS products can be used over both public and private X.25 packet-switched networks. The principal communications capabilities provided include system-to-system communications, system-to-dial-up-terminal communications, and system-to-leased line, remote terminal cluster communications.

SNA Gateway

The IBM System Network Architecture (SNA) link permits an HP 3000 or an HP 9000 to connect to an IBM System 370-compatible host processor in a SNA environment. This facility emulates the functions of the lower three SNA layers and supports SNA/IMF and SNA/NRJE concurrently.

ARPA Services

HP 9000 Series 800 computers running HP-UX can communicate in a multivendor environment using the networking services defined by the Department of Defense Advance Research Project Agency (ARPA) and the Berkeley Software Distribution (BSD) UNIX 4.2 system. ARPA services are the de facto standard throughout the scientific and engineering communities, and they provide protocols for electronic mail, file transfers, and terminal access over local and wide area networks. Similar services are available on the HP 9000 Series 300 and Series 500 computers, and interconnectivity with Digital's VAX (running BSD 4.2 or 4.3, or VMS), UNIX, and IBM PC AT compatibles running MS-DOS or PC-DOS is also possible.

Ethernet Alternatives

Ethernet is an industry-standard, high-speed networking media system that transmits data at 10 Mbps. Several products are available for connecting Macintosh computers to Ethernet. All of these products make use of Apple's EtherTalk software, which allows use of AppleTalk Phase 2 network system protocols on high-speed Ethernet media. For more information on these products, see the *Network Environments* and *AppleTalk Communications* chapters of this Guide.

The Environment

Microcomputer Connections

HP provides AdvanceLink, a software product for its own Touchscreen and Vectra (IBM PC AT compatible) personal computers that enables these microcomputers to connect to and communicate with HP systems and other computers.

The following section details the products that enable the Macintosh personal computer to function within the HP communications environment.

Hewlett-Packard Solutions

Reflection 1 PLUS

Reflection 1 PLUS provides emulation of Hewlett Packard's 2392A alpha-numeric terminal while preserving the Macintosh user interface and MultiFinder. Reflection 1 PLUS lets users send files between their Macintosh and HP and/or UNIX/ULTRIX host computers using Reflection's proprietary file transfer protocol, XMODEM, or KERMIT. ASCII, Binary, MacBinary and Preserve file transfer formats are supported. Users can backup an entire hard disk to a single file on the host. Printing support includes font and size selection, as well as the ability to resize wide reports to fit on a page. Reflection's command language has more than 40 commands, 30 functions, and 65 settings. Context-sensitive help, complete with "See Also" branching, is provided in most areas of Reflection operation.

Approximate Cost \$299

Supplier: Walker Richer & Quinn Inc., 2815 Eastlake Ave. East, Seattle, WA 98102, 206-324-0407

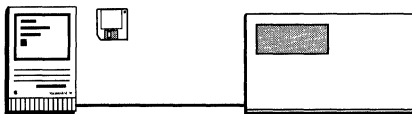

Reflection 3 PLUS emulates Hewlett-Packard's 2393A graphics terminal.

Reflection 3 PLUS

Reflection 3 PLUS provides emulation of Hewlett-Packard's 2393A graphics terminal while preserving the Macintosh user interface and MultiFinder. Reflection 3 PLUS lets users send files between their Macintosh computers and HP and/or UNIX/ULTRIX host computers using Reflection's proprietary file transfer protocol, XMODEM, or KERMIT. ASCII, Binary, MacBinary and Preserve file transfer formats are supported. Users can backup an entire hard disk to a single file on the host. Printing support includes font and size selection, as well as the ability to resize wide reports to fit on a page. Reflection's command language has more than 40 commands, 30 functions, and 65 settings. Context-sensitive help, complete with "See Also" branching, is provided in most areas of Reflection operation.

Approximate Cost \$399

Supplier: Walker Richer & Quinn Inc., 2815 Eastlake Ave. East, Seattle, WA 98102, 206-324-0407

Session

Session is a family of terminal emulators for the Macintosh computer that allows the Macintosh to communicate with the HP 3000, 9000, and 1000 lines of computers. Building on four years of experience with Mac2624, a block-mode emulator for the Macintosh computer, three connectivity solutions have been developed that take advantage of the Macintosh computer hardware and software.

- Business Session emulates a 2392 block-mode terminal, and provides on-line access to the data, applications, and storage of any HP host.

Solutions

- Graphic Session adds full HP graphics capability to Business Session, running any software that supports a 2393 terminal. The emulator offers a variety of windowing, sizing, scaling, and resolution options, and lets users “plot” output on the LaserWriter or ImageWriter printers.
 - Color Session adds the color text and graphics capabilities of the 2397 terminal.
- All Session products include a file-transfer facility that lets users move data between the HP system and the Macintosh computer and supports intelligent file-conversion options for both systems.

Approximate Cost\$199 to \$399

Supplier: Tynlabs Corporation, 811 Barton Springs Rd., Suite 511, Austin, TX 78704, 512-478-0611

XINET for HP 9000

Shiva hardware can be used with XINET software for HP 9000 with HP-UX from Mt. Xinu, Inc. XINET for HP 9000 resides on the HP host and functions in the following ways:

- Macintosh and MS-DOS computers share files
- Macintosh computer acts as a terminal emulator to HP hosts
- XINET serves as a PostScript print spooler for both Macintosh and HP users

Approximate Cost\$895 to \$6895

Supplier: Mt. Xinu, Inc., 2560 Ninth St., Suite 312, Berkeley, CA 94710, 415-644-0146

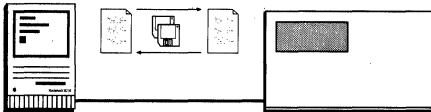

MacBLAST for Asynchronous Connectivity within the HP environment

MacBLAST software provides a Macintosh interface to HP BLAST for Hewlett-Packard HP 1000 computers under the RTE Operating System, and Hewlett-Packard HP 3000 computers under the MPE Operating System, transferring any binary or text files to and from any Macintosh with BLAST. It uses any available RS-232 port on an HP machine. HP 9000 series computers can run the UNIX version of BLAST for intelligent applications such as polling, data collection, and other automated operations between field computers and Macintosh computers. BLAST features include: on-line help, automatic dialing and access to remote systems. MacBLAST and HP/UX BLAST products can be used to create wide area networks between central computers and any number of remote sites via dial-up or X.25 nets. BLAST runs over standard telephone lines, X.25 networks, and satellite links, and is unaffected by line noise or propagation delays. Features include: scripting capabilities for creating unattended operations, polling, custom menus, on-line help, and automatic dialing and access to remote systems.

Approximate Cost\$195 to \$1595

Supplier: Communications Research Group, 5615 Corporate Blvd., Baton Rouge, LA 70808, 800-24-BLAST



The engineers at Cray use Macintosh computers to design supercomputers.

Macintosh Computers Improve Productivity at Cray Computer Corporation

Cray Computer Corporation is designing and building a supercomputer based on gallium-arsenide chip technology. This new machine—the Cray 3 will run at a clock speed of 2 nanoseconds—is two times faster than the silicon-based Cray 2 supercomputer. To speed up that design process, the Information Systems and Hardware Engineering departments at the company's Colorado Springs development facility, decided to exchange their MS-DOS systems for a platform with faster microprocessors and an easy-to-use interface for developing applications.

Cray Computer Corporation has 250 Apple Macintosh computers. Every Macintosh can access the building's Ethernet backbone, either through an Ethernet bridge or directly, using an Apple EtherTalk interface card, or a Kinetics Etherport card.

Almost everyone in the company has a Macintosh on his or her desk, and the Macintosh is used for everything from general office productivity to a HyperCard-based executive information system accessing the Hewlett-Packard HP 3000 for accounting and human resources data, HP 3000 terminal emulation, and engineering functions such as logic design, testing and simulation. According to Jerry Stevens, Information Systems specialist, "Macintosh computers have improved productivity, reduced training requirements throughout the organization, and facilitated development of end-user applications."

In addition to the Macintosh computers, the Ethernet network includes Sun file servers and workstations, MS-DOS machines, HP 3000 and HP 9000 minicomputers, and Cray 2 supercomputers. Users can access Hewlett-Packard plotters or do HP terminal emulation through Shiva NetSerial devices. In addition, dedicated NetSerial, connected directly into the company's telephone system, is used for electronic messaging.

Using Apple's HyperCard software, Stevens recently developed an executive information system (EIS) that charts information on head count, inventory, and expenses versus budgets that is updated daily on an HP 3000. The program calls the HP minicomputer every morning at 1:30 and requests the latest figures. It takes only about one minute for the information to be downloaded from the HP to the Macintosh and into HyperCard. HyperCard then creates bar charts and graphs from the information and places a copy on the AppleShare file server in the folders of

Case History

everyone who is cleared for it. This enables managers to view up-to-date information first thing in the morning.

“I don’t know how I would have written our EIS using something other than the Macintosh,” says Stevens. He wrote the EIS in three months, fitting it between other tasks, and credits the Macintosh personal computer and HyperCard with the short development time. “At first, I thought I would have to use a variety of software products to get the job done, but I was able to write the whole system using only HyperCard. The system we developed is user friendly, it’s packed with information, and it gets really specific. The system is a lot better, and its development was a lot easier than anyone expected it could be.”

- 3+Open for Macintosh**
 3Com Corporation
 3165 Kifer Rd.
 Santa Clara, CA 95052-8145
 408-562-6400
page 54
- 3+Open for Macintosh integrates Macintosh computers into the 3+Open LAN Manager environment, providing Macintosh clients with the multi-vendor connectivity to communicate with DOS and OS/2 workstations on the network, and other connectivity products through its support for OSI. Integration includes AFP compatible file service, server-based print spooling service, AppleTalk routing service, support for Macintosh files under 3+Open backup service.
- The following products include 3+ Share:
 3S/500 with 2MB RAM and 150MB hard disk 3C1300; Price: \$10,995
 3S/501 with 2MB RAM, 150 MB hard disk, and 250MB tape option 3C1301; Price: \$12,750
 3S/510 with 2MB RAM and 320MB hard disk 3C1310; Price: \$12,750
 3S/511 with 2MB RAM, 320MB hard disk, and 250MB tape option 3C1311; Price: \$14,495
 LocalTalk Locking Cable Kit (10 meter) M2066; Price: \$75
- The following servers include 3+Open LAN Manager:
 3S/520 with 8MB RAM and 320MB hard disk 3C1320; Price: \$17,250
 3S/521 with 8MB RAM, 320MB hard disk, and 250MB tape option 3C1321; Price: \$18,995
 3S/530 with 8MB RAM and 630MB hard disk 3C1330; Price: \$20,495
 3S/531 with 8MB RAM, 630MB hard drive, and 2.3GB tape option 3C1331; Price: \$27,995
 3S/500 2MB Memory Expansion Board 3C1380; Price: \$1795
 3S/500 8MB Memory Expansion Board 3C1381 (\$5995)
 EtherLink/NB (for Macintosh II)3C543; Price: \$595
 EtherLink/SE (for Macintosh SE)3C563; Price: \$595
- 3270 Doradus Solution v1.09**
 Doradus Corporation
 6095 E. River Rd.
 Minneapolis, MN 55432
 612-572-1000
page 178
- The 3270 Doradus Solution provides dial-in synchronous SNA 3270 communications for the Macintosh Portable. Communications take place via an internal V.22bis synchronous modem card bundled with SNA 3270 software. Allows dial-in communications directly to a front-end processor without protocol converters or hardware add-ons to the Macintosh Portable.
 Part No.: 3270DS; Price: \$1260
- 3Com Corporation**
 Products: 3+Open for Macintosh, EtherLink/NB, EtherLink/SE
 3165 Kifer Rd., Santa Clara, CA 95052-8145, 408-562-6400
- 4th DIMENSION**
 Acius
 10351 Bubb Rd.
 Cupertino, CA 95014
 408-252-4444
page 38
- 4th DIMENSION is a client-server database system with an open architecture and an integrated application generator. It is a multiuser relational database for the Macintosh that has built in report writer, mailing labels, and graphics capabilities. 4th DIMENSION supports Apple's Data Access Language through its connectivity kit.
 Part No.: N/A; Price: \$795
- A/UX v2.0**
 Apple Computer, Inc.
 20525 Mariani Ave.
 Cupertino, CA 95014
 408-996-1010
page 147
- A/UX v2.0 is the Macintosh operating system for customers who require UNIX. With A/UX v2.0, users access the Macintosh desktop on an industry standard version of UNIX. All the connectivity of a standard UNIX system is provided, including TCP/IP, NFS, Yellow Pages, Berkeley Networking Services, and X Window System (sold separately). Users can run multiple Macintosh, UNIX, and X applications at the same time.
 Part No.: N/A; Price: \$795-\$2395 depending on media purchased
- A/UX-DRV**
 Racial InterLan, Inc.
 155 Swanson Rd.
 Boxborough, MA 01719
 800-LAN-TALK
page 156
- A/UX-DRV Installer driver allows a Macintosh running A/UX to communicate over 10 Mbps Ethernet. A/UX-DRV is used in conjunction with Racial InterLan's NIA310 MacConnect, MacConnect 10BT, or MacConnect SE/30 Ethernet networking boards.
 Part No.: N/A; Price: \$75

Access/One MaxTalk Interface Module

Ungermann-Bass, Inc.
P.O. Box 58030
Santa Clara, CA 95052-8030
408-496-0111
page 11

The Access/One MaxTalk Interface Module delivers high-performance networking among Apple Macintosh personal computers and other LocalTalk devices such as printers, and integrates those devices into an Ethernet, FDDI, token ring, or broadband network. The MaxTalk Module supports 16 individual LocalTalk devices or 16 daisy-chained LocalTalk networks using unshielded twisted-pair wiring.
Part No.: N/A; Price: Contact Supplier

Access PC

Insignia Solutions Inc.
254 San Geronimo Wy.
Sunnyvale, CA 94086
408-522-7600
page 104

AccessPC enables Macintosh users to use disks and files from MS-DOS and OS/2 PCs as icons in the Finder just like Macintosh icons. AccessPC mounts locked or full disks, formats MS-DOS disks using the Finder Erase Disk command, and maintains the normal MS-DOS disk format even when moving files to the disk. MS-DOS data files can be recognized and assigned to Macintosh applications through the Control Panel, so they may be opened or printed directly from the Finder.
Part No.: N/A; Price: \$90

Acius

Product: 4th DIMENSION
10351 Bubb Rd., Cupertino CA 95014, 408-252-4444

AcKNOWLEDGE

Prometheus Products
7225 SW Bonita Rd.
Tigard, OR 97223
800-477-3473
page 34

AcKNOWLEDGE is a communications development toolkit for the Macintosh that creates custom front ends for communicating with a variety of host computer systems. TAL programming language provides control over the Macintosh interface with custom dialog boxes, pull-down menus and icons.
Part No.: SFT-16; Price: \$499

ACTINET SE, SE/30, II ARCTalk Interface Cards

ACTINET Systems, Inc.
360 Cowper St., Suite 11
Palo Alto, CA 94301
415-326-1321
page 53

ACTINET produces ARCTalk Interface Cards for the Macintosh SE (16-bit), the Macintosh SE/30 (32-bit) and the Macintosh II (32-bit). These provide a direct connection to ARCNET networks, using the Processor Direct Slot of the Macintosh SE and SE/30 and the NuBus interface of Any Macintosh II.
Part No. 900-1000 (SE); Price: \$495
Part No. 900-1011 (SE/30); Price: \$695
Part No. 900-1001 (II); Price: \$695

ACTINET Systems, Inc.

Products: ACTINET II ARCTalk Interface Card, ACTINET SE ARCTalk Interface Card, ACTINET SE/30 ARCTalk Interface Card
360 Cowper St., Suite 11, Palo Alto, CA 94301, 415-326-1321

Adaptec

Products: Nodem, EtherMac II, EtherMac II/10T
691 S. Milpitas Blvd., Milpitas, CA 95035, 408-945-2518

AESP

Product: NetMap
1810 N.E. 144th St., N. Miami, FL 33181, 800-446-2377

The AG Group

Product: EtherPeek
Station B, P.O. Box 26728, San Francisco, CA 94126, 415-945-7194

Alisa Systems, Inc.

Products: Alisa Digital Printer Support System, Alisa Print System, AlisaMail, AlisaShare ATP File Server, AlisaTalk, AlisaTerminal Remote Terminal, MailMate, MaxNotes, TSSnet
221 East Walnut St., Suite 175, Pasadena, CA 91101, 818-792-9474

- AlisaMail** AlisaMail is a VAX-based electronic mail system for VAX/VMS, Macintosh and PC users. AlisaMail's core SQL-based engine provides message switching and directory services, and its mail server provide access to external electronic mail systems. The AlisaMail Microsoft Mail and VMSmail servers make mail exchange possible between Microsoft Mail and Digital's ALL-IN-1 system, IBM PROFS, X.400 and other services supported by MailBus.
Alisa Systems Inc.
221 East Walnut St., Suite 175
Pasadena, CA 91101
818-792-9474
page 137 Part No.: N/A; Price: \$10,000-\$17,500
- AlisaTalk** AlisaTalk is the family name for a set of software components that provide file-sharing, file-transferring, file-printing, and terminal-emulation services for Macintosh and VAX/VMS networked systems. AlisaTalk consists of the AlisaShare AppleTalk Filing Protocol (AFP) File Server, the AlisaPrint System, and the AlisaTerminal Remote Terminal emulator. The Alisa Digital Printer Support package is an add-on option for Digital/PostScript printer support.
Alisa Systems Inc.
221 East Walnut St., Suite 175
Pasadena, CA 91101
818-792-9474
page 121 Part No.: N/A; Price: \$4700-\$14,400
- ALL-IN-1 DESKtop for Macintosh** ALL-IN-1 DESKtop for Macintosh integrates Macintosh users into the ALL-IN-1 Integrated Office System server through a graphic user interface. It supports remote capabilities including file transfer and electronic mail. ALL-IN-1 DESKtop for Macintosh provides terminal emulation services for accessing VMS-based applications and supports local filing of documents and data with the DESKtop for Macintosh file cabinet.
Digital Equipment Corp.
30 Porter Rd. (LJO2/C10)
Littleton, MA 01460
and Authorized Digital Distributors
page 137 Part No.: N/A; Price: Contact supplier
- AMIE II** AMIE II is a hardware/software package that makes the Macintosh II family plug compatible to a Unisys network by emulating a UTS-20, UTS-30, UTS-40 or SVT-1120 terminal while providing a familiar Macintosh-style interface. A single NuBus card, based on a Motorola 68000 Series microcomputer, supports various methods of connectivity (Sperry T-Mux, synchronous modem, and twisted-pair) and handles the communication line protocol to Unisys 1100 and 2200 mainframes.
Air Land Systems Corp.
2710 Prosperity Ave.
Fairfax, VA 22031-4387
703-573-1100
page 66 Part No.: N/A; Price: \$995
- Andrew KMW Series II and III Twinax Protocol Converters-Hardware** Andrew KMW offers the Series II and III Twinax protocol converters. The Series III is a single-port converter, while the Series II provides up to seven asynchronous ports. The Andrew KMW Twinax protocol converters can direct-connect to the Twinax ports on a System/34,/36,/38 or AS/400 minicomputer.
Andrew KMW Systems Corp.
6034 W. Courtyard Dr.
Austin, TX 78730
512-338-3000
page 181 Part No.: 03260; Price: \$1495, Base unit with single port
Part No.: N/A; Price: \$300, Each additional port (up to 7)
Part No.: N/A; Price: \$300, Expansion Board (3 or more ports)
Part No.: 06200; Price: \$1195, Series III Twinax Protocol Converter (single port only)
- Andrew KMW Series II and III Twinax Protocol Converters-Software** Andrew KMW's emulation software includes a device driver for the Series II or Series III Twinax protocol converter, as well as the TwinAccessLink program running on the Macintosh computer. There are separate versions of ETU for the System/34, System/36, System/38 and AS/400.
Andrew KMW Systems Corp.
6034 W. Courtyard Dr.
Austin, TX 78730
512-338-3000
page 181 Part No.: 5308-01-34-1; Price: \$400, ETU System 34 Macintosh
Part No.: 5308-01-36-4; Price: \$500, ETU System 36 Macintosh
Part No.: 5308-01-38-7; Price: \$800, ETU System 38 Macintosh
Part No.: N/A; Price: \$900, ETU AS/400
- Andrew KMW Systems Corp.** Products: Andrew KMW Series II and III Twinax Protocol Converters-Hardware, Andrew KMW Series II and III Twinax Protocol Converters-Software
6034 W. Courtyard Dr., Austin, TX 78730, 512-338-3000
- Andyne** Products: GQL/Admin V2.0, GQL/Design V2.0, GQL/User V2.0
544 Princess St., Suite 202, Kingston Ontario K7L 1C7, 613-548-4355

Apple 3270 API

APDA (Apple Programmers & Developers Association)
Apple Computer, Inc.
20525 Mariani Ave., MS 33G
Cupertino, CA 95014
800-282-2732 (U.S.)
800-637-0029 (Canada)
408-562-3910 (International)
page 193

The Apple 3270 API is designed to allow terminal emulators, file-transfer programs, and other Macintosh computer applications and tools such as Data Access Language and MacWorkStation to use the 3270 services without being aware of the physical network connection details of coaxial, Token Ring, or SDLC.
Part No.: M0663LL/A, Price: \$500, Internal license; \$1000, External license

Apple Computer, Inc.

Products: A/UX 2.0, Apple Coax/Twinax Card, Apple Data Modem 2400, Apple EtherTalk NB Card, Apple FDHD Drive, Apple File Exchange (AFE), Apple PC 5.25 Drive, Apple Personal Modem, Apple Serial NB Card, AppleShare File Server 2.0, AppleShare PC, AppleShare Print Server 2.0, Apple TokenTalk NB Card, LocalTalk Cable System, LocalTalk PC Card, Macintosh-To-VAX Integration Toolkit, MacDFT, MacX, MacTerminal, SMB File Transfer Utility, X Window System for A/UX
20525 Mariani Ave., Cupertino, CA 95014, 408-996-1010

Apple Programmers & Developers Association (APDA), Apple Computer, Inc.

Products: Apple 3270 API, Data Access Language Developer's Toolkit, Data Access Language MVS/TSO Server, Data Access Language VAX/VMS Server, Data Access Language VM/CMS Server, MacAPPC, MacTCP, MacX25 Programming Library, MacWorkstation
20525 Mariani Ave. MS 33G, Cupertino, CA 95014, 800-282-2732 (U.S.), 800-637-0029 (Canada), 408-562-3910 (International)

Apple Coax/Twinax Card

Apple Computer, Inc.
20525 Mariani Ave.
Cupertino, CA 95014
408-996-1010
page 174

The Apple Coax/Twinax Card is an expansion card and software that allows the Macintosh II family systems to connect to an IBM SNA network as 3270 Information Display Systems via industry standard coaxial cable. The card allows users to access mainframe-based 3270 applications. 5250 terminal emulation software is available from other suppliers.
Part No.: M0261/A; Price: \$1495

Apple Data Modem 2400

Apple Computer, Inc.
20525 Mariani Ave.
Cupertino, CA 95014
408-996-1010
page 77

The Apple Data Modem 2400 enables communication with other personal computers, minis, and mainframes over the public telephone network. An error-correcting protocol, Microm Networking Protocol (MNP) from Microm, Inc., is built in to the modem to ensure reliable communications over noisy or low-quality telephone lines. The Apple Data Modem 2400 can be connected to the entire Apple and Macintosh families of computers.
Part No.: C0002LL/A; Price: \$499

Apple EtherTalk NB Card

Apple Computer, Inc.
20525 Mariani Ave.
Cupertino, CA 95014
408-996-1010
page 9

The EtherTalk NB card provides direct connectivity to IEEE 802.3 Ethernet networks for the Macintosh II family of computers. Any of a number of networking protocols may be used with the card, including the AppleTalk network system and TCP/IP. The EtherTalk NB card includes a built-in Ethernet transceiver, with connectors for both thick and thin Ethernet cabling.
Part No.: M0410LL/A; Price: \$699

- Apple FDHD Drive**
Apple Computer Inc.
20525 Mariani Ave.
Cupertino, CA 95014
408-996-1010
page 95
- The Apple FDHD Internal and External disk drives can exchange information between Macintosh files and MS-DOS, OS/2, and ProDOS files. File exchange between non-Macintosh computers can be accomplished by using the Apple File Exchange, included in the Macintosh System Software, or with products provided by third parties such as Dayna Communication's DOS Mounter.
Part No.: M0112, Apple FDHD External Drive (Macintosh FDHD SE or SE/30 only); Price: \$629
Part No.: M0247, Apple FDHD Internal Drive Upgrade (Macintosh IIX & SE/30 users); Price: \$499
Part No.: M6051 Apple FDHD Macintosh II Upgrade Kit; Price: \$599
Part No.: M6052 Macintosh SE FDHD Upgrade Kit (Upgrade Macintosh SE to Macintosh SE FDHD); Price: \$599
- Apple File Exchange (AFE)**
Apple Computer, Inc.
20525 Mariani Ave.
Cupertino, CA 95014
408-996-1010
page 99
- Apple File Exchange (AFE) software is a general purpose file-translation utility that is part of the Macintosh system software package. AFE supports batch processing of conversions and, using individual translators, converts data from Macintosh applications into a format understood by MS-DOS-compatible applications and vice versa. AFE is shipped with Apple's DCA Translator. Other translators are available from 3rd party vendors.
Part No.: N/A; Price: No Charge
- Apple PC 5.25 Drive**
Apple Computer, Inc.
20525 Mariani Ave.
Cupertino, CA 95014
408-996-1010
page 95
- The Apple PC 5.25 Drive is an MS-DOS-compatible disk drive that connects to a Macintosh SE or Macintosh II computer equipped with an appropriate controller card. The PC 5.25 Drive and AFE software give Macintosh II and Macintosh SE computers the ability to read files from and write them to 360K MS-DOS disks.
Part No.: A9M0110; Price: \$399 (Drive only)
- Apple Personal Modem**
Apple Computer, Inc.
20525 Mariani Ave.
Cupertino, CA 95014
408-996-1010
page 77
- The Apple Personal Modem is a compact 300/1200 baud modem that provides a data communications solution for any Apple personal computer. Features include auto answer, dial, and redial. It works with either tone or pulsed phone systems and is Hayes compatible.
Part No.: A9M0334; Price: \$279
- Apple Serial NB Card**
Apple Computer, Inc.
20525 Mariani Ave.
Cupertino, CA 95014
408-996-1010
page 187
- The Apple Serial NB Card is an expansion card for the Macintosh II family of computers. When used with Apple's MacAPPC or MacDFT software, the Serial NB Card provides a complete SDLC solution for connectivity into the IBM SNA environment. MacX25 software, running on the Serial NB Card, provides PAD services and X.25 packet-level services to application programs. Requires RS-232 or v.35 cable.
Part No.: M0264; Price: \$1195
Part No.: M0128LL/A, Apple RS-232 cable; Price: \$129
Part No.: M0127LL/A, Apple V.35 cable; Price: \$189
- AppleShare File Server 2.0**
Apple Computer, Inc.
20525 Mariani Ave.
Cupertino, CA 95014
408-996-1010
page 20, 99
- The AppleShare File Server is software that turns a Macintosh Computer into a dedicated file server that allows file sharing among Macintosh, Apple IIe and IIgs, and MS-DOS based computers. The File Server has a security system that allows users to control how and with whom information is shared. The File Server supports up to seven hard disks and allows simultaneous access for up to 50 users.
Part No.: M0548/B, \$799
Part No.: M0559/A, AppleShare User's Guide (5 per pack); Price: \$129

- AppleShare Print Server 2.0** The AppleShare Print Server is software that turns a Macintosh Computer into a dedicated print spooler to print documents onto any AppleTalk compatible LaserWriter or ImageWriter printer. The Print Server will handle printing documents from Macintosh, Apple IIe and IIGS, and MS-DOS based computers. The Print Server allows users to monitor and change the status of the documents being printed.
Apple Computer, Inc.
20525 Mariani Ave.
Cupertino, CA 95014
408-996-1010
page 21 Part No.: M0576; Price: \$299
- AppleShare PC, version 2.0** AppleShare PC software allows users of MS-DOS personal computers access to the services of the AppleTalk Network System. AppleShare PC offers a menu system modelled after the Macintosh Chooser. Application compatibility and Data file mapping make using AppleShare PC simple, efficient, and virtually transparent.
Apple Computer Inc.
20525 Mariani Ave.
Cupertino, CA 95014
408-996-1010
page 99 Part No.: M0098LL/A; Price: \$149
- AppleTalk Internet Router** The AppleTalk Internet Router lets users increase the size and improve the performance and manageability of an AppleTalk system. It allows AppleTalk networks such as LocalTalk, EtherTalk, and TokenTalk be interconnected to form an internet. The router moves data from one network to another transparently so that the internet functions like a single network.
Apple Computer, Inc.
20525 Mariani Ave.
Cupertino, CA 95014
408-996-1010
page 13 Part No.: M0705, AppleTalk Internet Router; Price: \$399
- Apple TokenTalk NB Card** Apple's TokenTalk NB Card is an expansion card that connects Macintosh II computers to token ring networks. When used with other Apple software products, the card supports a variety of network environments, including AppleTalk, IBM 3270, APPC, and SMB. This allows users to access local area network and mainframe-based services connected to the token ring.
Apple Computer Inc.
20525 Mariani Ave.
Cupertino, CA 95014
408-996-1010
page 183 Part No.: M0237; Price: \$1250
- APT Communications, Inc.** Product: ComTalk
9607 Dr. Perry Rd., Ijamsville, MD 21754
- Asanté MacCon+Ethernet Cards** Asanté offers a line of network interface cards for Macintosh II, SE, and SE/30 computers on any Ethernet media: Thick, Thin, or the new 10Base T unshielded twisted-pair. MacCon+ cards support both AppleTalk Phase 1 and Phase 2. Register-level compatibility with Apple's EtherTalk, and support for AppleShare, NetWare, and 3+Open is already built-in to the Asanté MacCon+ Ethernet cards.
Asanté Technologies, Inc.
405 Tasman Dr.
Sunnyvale, CA 94089
800-662-9686
page 12 Part No.: N/A; Price: \$495 to \$545
- Asanté Technologies, Inc.** Products: Asanté MacCon+Ethernet Cards, MacCon+Token Ring Cards for the Macintosh II Family
405 Tasman Dr., Sunnyvale, CA 94089, 800-662-9686
- AsyncServerR** AsyncServerR is VAX and VMS software that communicates with a client Macintosh system over an ordinary asynchronous terminal port, providing the Macintosh with access to all AppleTalk facilities available through the Digital VAX.
Computer Methods Inc.
525 Route 73 South
Marlton, NJ 08053
609-596-4360
page 124 Part No.: N/A; Price: \$595 to \$1895
- AT&T Network Systems** Product: Datakit II VCS
184 Liberty Corners Rd., Warren NJ 07060, 201-580-5516

- Avatar Technologies, Inc.** Products: MacMainFrame DX, MacMainFrame Graphics, MacMainFrame Coax Gateway, MacMainFrame Coax Workstation, MacMainFrame Token Ring Workstation, MacPROFF
65 South St., Hopkinton, MA 01748, 508-435-3000
- Backmatic v1.1** Backmatic will back up new or changed files automatically at specified times, including shut down. Files can be backed up to floppies, another hard drive, removable cartridges, or file servers. Any Macintosh with Backmatic installed can make backups to a folder on a shared volume. Backmatic is compatible with Apple and third-party server software, including VAX, Novell, and UNIX servers.
Magic Software, Inc. 2206 Franklin St. Bellevue, NE 68005
800-342-6243
Part No.: N/A; Price: \$295/5-pack; \$495/10-pack.
page 82
- Blyth & Associates** Product: Omnis 5
1065 East Hillsdale Blvd., Suite 300, Foster City, CA 94404, 415-571-0222
- BroadTalk** The BroadTalk LAN is a Macintosh connectivity solution over broadband (CATV) cable that consists of add-in boards to the Macintosh II family and the Macintosh SE for direct connections to the broadband cable. It also consists of gateways from broadband cable to LocalTalk cable and from broadband cable to Ethernet cable. The BroadTalk LAN supports AppleTalk, TCP/IP, DECnet, and OSI protocols.
Cactus Computer, Inc. 1120 Metrocrest Dr., #103 Carrollton, TX 75006
214-416-0525
page 69
Part No.: CC 200/RF, BroadTalk for the Macintosh II; Price: \$895
Part No.: CC 220/RF, BroadTalk for the Macintosh SE; Price: \$895
Part No.: CC RF/EN, BroadTalk Gateway to Ethernet; Price: \$3550
Part No.: CC RF/LT, BroadTalk Gateway to LocalTalk; Price: \$2985
Part No.: CC 240/RF, BroadTalk/PC for Novell NetWare; Price: \$1595
- C-Server** Serial-communicating equipment such as modems, printers, mini-computers, protocol converters, x.25 PADs, etc. can be shared by AppleTalk users. The three password-protected serial ports can be set-up to contend so that a user doesn't have to select a specific port when sharing a mini-computer or modems. C-Server units can be stacked. Software is included for custom chooser icon creation.
Solana Electronics 7887 Dunbrook Rd., Suite A San Diego, CA 92126
619-573-0800
Part No.: SE814; Price: \$695
page 19
- Cactus Computer** Products: BroadTalk, StarBurst
1120 Metrocrest Dr., #103, Carrollton, TX 75006, 214-416-0525
- Carnation Software** Product: MacToPic
P.O. Box 608, Carnation, WA 98014, 206-333-4288
- Cayman Systems** Products: GatorBox, GatorMail-Q, GatorShare, GatorCard E/II.
26 Landsdowne St., Cambridge, MA 02139, 617-494-1999
- cc:Mail** cc:Mail is an electronic mail system that operates in a multivendor (Macintosh, MS-DOS, and OS/2) local area network environment. It provides transparent connectivity with Digital and IBM-based E-Mail systems; UNIX mail, public E-Mail services, and the facsimile world. The cc:Mail system consists of a central Post Office (the database) that resides on the network server's hard disk. No software actually runs on the server.
cc:Mail, Inc. 385 Sherman Ave. Palo Alto, CA 94306
800-448-2500
page 25
Part No.: N/A; Price: \$495 to \$1295
- cc:Mail, Inc.** Product: cc:Mail
385 Sherman Ave., Palo Alto, CA 94306, 800-448-2500

Central System Manager (CSM) v2.01
Integrated Solutions
1020 Eighth Ave.
King of Prussia, PA 19406
215-337-2282
page 136

Central System Manager allows the management of networked VAX computers from a Macintosh computer using a standard point-and-click interface. All features and command functions are user definable. CSM allows the system administrators to treat groups of VAX computers as a single management domain without knowledge of DCL.
Part No.: CSM-VMS-M; Price: from \$750

CE Software

Product: QuickMail
P.O. Box 65580, West Des Moines, IA 50265, 515-224-1995

Circuit Research

Product: FlexFAX
4 Townsend West, Suite #3, Nashua, NH 03063, 603-880-4000

ClearAccess

Fairfield Software
200 West Lowe
Fairfield, IA 52556
800-522-4254
page 39

ClearAccess is a desk accessory which gives every Macintosh application a transparent window into corporate databases: on minicomputers, on mainframes, across local networks or worldwide. Communication and translation tasks are handled invisibly in the background by ClearAccess. ClearAccess supports Apple's Data Access Language. Volume discounts and site licenses available.
Part No.: N/A; Price: \$349

CommCard

Taniwha Systems Design
2206 Roosevelt Ave.
Berkeley, CA 94703
415-540-5557
page 9

CommCard provides either four asynchronous serial ports or one LocalTalk port per card to the Macintosh. Its software supports the Macintosh Communications Toolbox, the older style serial programming interface, AppleTalk Internet Router, and A/UX.
Part No.: N/A; Price: \$450

CommSolutions

White Pine Software
94 Route 101A
Amherst, NH 03031
603-886-9050
pages 132, 161

CommSolutions is a network driver package that functions as a companion product to the White Pine VT Series Emulators and eXodus. White Pine Software has licensed Network/Communications software from third-party vendors. Networking software to be included consists of Runtime, TSSnet (Peer-to-peer DECnet communications for eXodus), and MacTCP (TCP/IP for eXodus & VT Series emulators).
Part No.: N/A; Price: \$4795 to \$6295

Communications Research Group (CRG)

Products: MacBLAST and host products (UNIX/XENIX BLAST, MS-DOS BLAST, BTOS/CTOS BLAST, DG BLAST, VAX BLAST II, HP BLAST, IBM BLAST, NCR TOWER BLAST, Tandem BLAST, Wang BLAST, Prime BLAST)
5615 Corporate Blvd., Baton Rouge, LA 70808, 800-242-5278

CommUnity-Mac

EMAC
48431 Milmont Dr.
Fremont, CA 94538
415-683-2222
page 125

CommUnity-Mac is a software product that utilizes an intelligent Ethernet controller to provide DECnet connectivity for Macintosh Plus, SE, and II computers. The controller reduces the networking load on the Macintosh for high-speed performance on a DECnet Phase IV Ethernet network.
Part No. N/A; Price: \$350 to \$495

Compatible Systems Corp.

Products: Ether+, Ether2
P.O. Box 17220, Boulder, CO 80301, 303-444-9532

Computer Methods Inc.

Product: AsyncServeR
525 Route 73 South, Marlton, NJ 08053, 609-596-4360

- ComTalk** ComTalk is a modular, high-throughput AppleTalk Phase 1 or Phase 2 internetwork router. It connects Ethernet, Token Ring, and up to six LocalTalk networks; supports remote connections via high speed synchronous links (up to 1.544 Mbps); and provides gateway access to four asynchronous ports and TCP/IP network resources. Internet Manager desktop accessory is included.
APT Communications, Inc.
9607 Dr. Perry Rd.
Ijamsville, MD 21754
800-842-0626
Part No.: N/A; Price: \$5000 to \$12,500
page 17
- Concentrix Technology, Inc. (Bantam)** Product: Connections 1.0P
7 Ashdown Place, Half Moon Bay, CA 94019
- Connections v1.0P** Connections supports PROFS Notes and PROFS calendaring/group scheduling with additional E-Mail features such as batch deletion and retrieval and an OutBasket. Other features include Daily and Monthly Calendars, To-Do lists, Telephone Directory, Outgoing Phone Log, Daily Journal, Export/Import capabilities, and Personal Libraries that support full-text search.
Concentrix Technology Inc. (Bantam)
7 Ashdown Place
Half Moon Bay, CA 94019
Part No.: N/A; Price: \$495.00
page 190
- Connectivité Corp.** Product: Masquerade3270
101 Executive Blvd., Elmsford, NY 10523, 914-592-2853
- CoOperative Printing Solutions, Inc.** Product: PServe 3.0
5950 Live Oak Pkwy., Suite 175, Norcross, GA 30093, 404-840-0810
- Core Technology** Products: CTCBridge-Mac 3.50, CTCBridge-Mac Gateway 1.01
7335 Westshire Dr., Lansing, MI 48917, 517-627-1521
- CTCBridge-Mac v3.50** CTCBridge-Mac offers connectivity to both Sperry and Burroughs host systems and support of the Uniscope, Chi, and Poll/Select protocols. Sperry features include UTS 20, UTS 30, UTS 40 and SVT 1120 emulation. Burroughs features include Poll/Select and poll contention mode protocol support, and TD830, MT983, ET1100, and T27 emulation. Volume and site licenses available.
Core Technology
7335 Westshire Dr.
Lansing, MI 48917
517-627-1521
Part No.: CTC1003; Price: \$395
page 67
- CTCBridge-Mac Gateway 1.01** CTCBridge-Mac Gateway offers connectivity to both Sperry and Burroughs host systems and support of the Uniscope, Chi, and Poll/Select protocols. Features include: the same terminal features as CTCBridge-Mac 3.50; support of AppleTalk protocol; non-dedicated gateway; up to 100 sessions per gateway; baud rates up to 38400 BPS; line monitor mode; auto dial; and TTY emulation.
Core Technology
7335 Westshire Drive
Lansing, MI 48917
517-627-1521
Part No.: CTC1008; Price: \$895 (4 stations), additional stations \$95
page 68
- Current Loop Converter & Cable** Menlo's Current Loop Converter (CLC) connects RS-232 (EIA) devices (Macintosh and IBM workstations) to 20 mA current loop connections (Tandem, Unisys, Prime, and so on). It requires no additional desk space or external power and is fitted with two DB-25 receptacle connectors for standard connections.
Menlo Business Systems, Inc.
201 Main St.
Los Altos, CA 94022
415-948-7920
Part No.: N/A; Price: \$125 w/cable
page 204

Data Access Language Developer's Toolkit

APDA (Apple Programmers & Developers Association)
Apple Computer, Inc.
20525 Mariani Ave., MS 33G
Cupertino, CA 95014
800-282-2732 (U.S.)
800-637-0029 (Canada)
408-562-3910 (International)
page 38

Data Access Language (formerly CL/1) is a standard connectivity language that links personal computer applications to host data. Data Access Language gives Macintosh users access to data stored in relational databases on VAX or IBM systems. Macintosh applications can directly access data in Ingres, Oracle, Informix/SQL, SYBASE, and Digital's Rdb/VMS databases, as well as in DB2 and SQL/DS databases on IBM systems.
Part No.: N/A; Price: Contact supplier

Data Access Language Server for MVS/TSO

APDA (Apple Programmers & Developers Association)
Apple Computer, Inc.
20525 Mariani Ave., MS 33G
Cupertino, CA 95014
800-282-2732 (U.S.)
800-637-0029 (Canada)
408-562-3910 (International)
page 192

The Data Access Language Server for MVS/TSO is a networking software product that provides Data Access Language access to IBM Database 2 (DB2) databases on an MVS/TSO host system. Running on the MVS/TSO host, the Data Access Language Server works cooperatively with Macintosh applications that support Data Access Language. The server receives a request from a Macintosh application, carries it out on the host, and sends the desired data back to the Macintosh application.
Part No.: C0164LL/A; Price: \$20,000

Data Access Language Server for VAX and VMS

APDA (Apple Programmers & Developers Association)
Apple Computer, Inc.
20525 Mariani Ave., MS 33G
Cupertino, CA 95014
800-282-2732 (U.S.)
800-637-0029 (Canada)
408-562-3910 (International)
page 132

The Data Access Language Server for VAX and VMS is a networking software product that provides Data Access Language access to files and databases on a VAX and VMS host system. Running on the VAX and VMS host, the Data Access Language Server works cooperatively with Macintosh applications that support Data Access Language. Data Access Language operates under existing host and database-management security and integrity schemes, assuring complete data security with no additional maintenance requirements.
Part No.: N/A; Price: \$5000

Data Access Language Server for VM/CMS

APDA (Apple Programmers & Developers Association)
Apple Computer, Inc.
20525 Mariani Ave., MS 33G
Cupertino, CA 95014
800-282-2732 (U.S.)
800-637-0029 (Canada)
408-562-3910 (International)
page 191

The Data Access Language Server for VM/CMS is a networking software product that provides Data Access Language access to the Structured Query Language/Data System (SQL/DS) on a VM/CMS host system. Running on the VM/CMS host, the Data Access Language Server works cooperatively with Macintosh applications that support Data Access Language. The server receives a request from a Macintosh application, carries it out on the host, and sends the desired data back to the Macintosh application.
Part No.: C0163LL/A; Price: \$15,000

Datability Software Systems, Inc.

Product: MacRAF
322 Eighth Ave., 11th floor, New York, NY 10001, 800-DIAL DSS

Datakit II VCS
 AT&T Network Systems
 184 Liberty Corners Rd.,
 Warren, NJ 07060
 201-580-5516
page 86

Datakit II Virtual Circuit Switch provides the foundation for building corporate-wide backbone utility networks. Typical Datakit networks support several types of protocols and are distributed over large geographical distances, usually with redundant data paths. Datakit II VCS nodes use either fiber trunks (in house) or leased facilities (DDS, T1) to connect to one another.
 Part No.: N/A; Price: Varies depending on configuration

DataViz, Inc.

Products: MacLink Plus/PC v4.5, MacLink Plus/Translators
 35 Corporate Dr., Trumbull, CT 06611, 203-268-0030

DatStream
 Personal Computer Peripheral Corp.
 4170 Eisenhower Blvd.
 Tampa, FL 33634
 813-884-3092
page 12

DatStream is a tape backup system utilizing 4mm DAT technology. DatStream has 1.3 gigabytes for on-line storage, backs up across time zones, and can find any file with an average seek time of 20 seconds. It also features unattended workstation backups with bundled PCPC NetStream software and is compatible with DDS and DATA/DAT technology.
 Part No.: N/A; Price: \$3479

Dayna Communications

Products: DaynaFile, DaynaMail, DaynaTalk, DL2000, DL/2, DOS Mounter
 50 S. Main St., Suite 530, Salt Lake City, UT 84144, 801-531-0600

DaynaFile
 Dayna Communications
 50 S. Main St., Suite 530
 Salt Lake City, UT 84144
 801-531-0600
page 96

DaynaFile is an external SCSI floppy disk drive which allows Macintosh computers to read from and write to MS-DOS data disks as if they were Macintosh disks. Available as a single-drive or dual-drive unit, DaynaFILE can accept 5.25-inch or 3.5-inch MS-DOS disks in any format. MS-DOS disks appear as an icon on the desktop and their subdirectories and files are shown as Macintosh folders and documents.
 Part No.: DF0100 (5.25-inch 360K drive); Price: \$650 and up

DaynaMAIL
 Dayna Communications
 50 S. Main St., Suite 530
 Salt Lake City, UT 84144
 801-531-0600
page 26

DaynaMAIL is an electronic mail system for users of Macintosh and IBM-compatible computers. On a network with a dedicated file server, DaynaMAIL runs on the server and does not require a workstation be dedicated as a mail server. Based on the MHS (Message Handling Service) protocol from Action Technologies, DaynaMAIL can offer wide-area communications with other MHS-compatible applications.
 Part No.: DM0100; Price: \$295 for 5-pack

DaynaTALK
 Dayna Communications
 50 S. Main St., Suite 530
 Salt Lake City, UT 84144
 801-531-0600
page 96

DaynaTALK is a family of products for Macintosh and IBM personal computers that increase the 230 Kbps LocalTalk data transmission rate to a maximum of 850 Kbps on the Macintosh and 1.7 Mbps on IBM PCs, PS/2s, and compatibles. This allows more work to be completed on an existing heavily-used network, or more computers to be added without degrading performance.
 Part No.: DT0100; Price: \$139

DayStar Digital

Product: LT200 LocalTalk Interface Board
 5556 Atlanta Hwy., Flowery Branch, GA 30542, 404-967-2077

**DB-Library,
 Hyper/DB-Library**
 Sybase
 6475 Christie Ave.
 Emeryville, CA 94608
 800-8SYBASE
page 41

Relational database management system for on-line applications and decision support. With Sybase's Client/Server Architecture, client user interface functions are separated from server data management and transaction functions. The Client/Server Interfaces facilitate the management of multi-vendor computing environments.
 Part No.: N/A; Price: \$3000 and up

- DBF-Access Tools for HyperCard** DBF-Access Tools for HyperCard 1.0 is a software add-on that gives HyperCard users the ability to access information stored in dBASE III PLUS compatible database (DBF) and memo files. Users can import DBF files into any stack, update the DBF files in place, or create new DBF files for use by Dbase-language applications. Commercial distribution licenses are also available at a fee of \$25 per end-user copy.
Nittany Development Group
606 No. Armistead St.
Alexandria, VA 22312
703-256-0791
page 105 Part No.: N/A; Price: \$95
- DCA** Products: MacIRMA, MacIRMA API, MacIRMA Graphics, MacIRMA Lan Servers SDLC Gateway and 802.2 Gateway, MacIRMA Workstation
1000 Alderman Dr., Alpharetta, GA 30201, 404-442-4000
- DEC LanWORKS for Macintosh** DEC LanWORKS software for Macintosh computers enables VAX and MicroVAX computers from Digital to act as file, data, electronic mail, and resource servers to large groups of Macintosh computers. In this client/server implementation, the integrated set of components is designed to work together as a network solution. This jointly developed product is the result of the technology exchange and development agreement between Digital and Apple.
Digital Equipment Corporation
30 Porter Rd. (LJO2/C10)
Littleton, MA 01460
page 116 Part No.: N/A; Price: \$295 client license per Macintosh
- Deft, Inc.** Products: Personal Deft, The Deft Editor Set, Deft Gateways
557 Dixon Rd., #110, Rexdale, Ontario M9W1H7, 416-249-2246
- Deft Editor Set** The Deft Editor Set can be used by multi-user development teams to design relational database systems in Ingres, Oracle, SYBASE, Rdb, Informix or DB2. The tool set includes editors for DFDs, ERDs, Structure Charts, and Forms and Reports. It includes a Design Compiler, for checking logical and syntactical consistency, an im/export facility, mapping amongst RDBMSs, multi-user dictionary access, and selection of multiple host types.
Deft, Inc.
557 Dixon Rd., #110
Rexdale, Ontario M9W1H7
416-249-2246
page 36 Part No.: N/A; Price: \$7900/license
- Deft Gateways** Deft Gateways is software to forward/reverse engineer RDBMS schema. The Gateways offer portability amongst Ingres, Oracle, Sybase and Rdb running on VAX/VMS. Reverse Engineering allows the developer to download data schema to Deft's repository offering the ability to modify and/or document existing applications. Forward engineering using Deft's object file will generate SQL schema and forms. This utility provides versioning and automatic compilation and linking.
Deft, Inc.
557 Dixon Rd., #110
Rexdale, Ontario M9W1H7
416-249-2246
page 36 Part No.: N/A; Price: \$10,000-\$20,000
- Digital Equipment Corporation** Products: ALL-IN-1 for the Macintosh, DEC LanWORKS for Macintosh, SQL Services for Macintosh
30 Porter Rd. (LJO2/C10), Littleton, MA 01460
- Distributed Technologies, Inc.** Product: NetShare 1.0
19823 58th Place South, Kent, WA 98032, 206-395-7800
- DL2000** The DL2000 is a LocalTalk adapter for standard IBM-compatible bus computers. It supports Dayna Communications DaynaNET, NetWare and TOPS network operating systems over LocalTalk, PhoneNET, or compatible cable systems. As well as supporting AFP, the DL2000 also supports NetWare NCP and IPX protocols. This allows complete access to all NetWare features, including print spooling and administration, over LocalTalk cables.
Dayna Communications
50 S. Main St., Suite 530
Salt Lake City, UT 84144
801-531-0600
page 97 Part No.: DT0500; Price: \$299

- DL/2** The DL/2 is a LocalTalk adapter for Micro Channel bus IBM-compatible computers. The DL/2 supports DaynaNET, NetWare and TOPS network operating systems over LocalTalk, PhoneNET, or compatible cable systems. As well as supporting AFP, the DL2000 also supports NetWare NCP and IPX protocols. This allows complete access to all NetWare features, including print spooling and administration, over LocalTalk cables.
Dayna Communications
50 S. Main St., Suite 530
Salt Lake City, UT 84144
801-531-0600
page 97
Part No.: DT0600; Price: \$399
- Doradus Corporation** Product: 3270 Doradus Solution 1.09
6095 E. River Rd., Minneapolis, MN 55432, 612-572-1000
- DOS-Connect** DOS Connect is a software application that allows IBM PCs and compatibles on AppleTalk to share serial peripherals. DOS Connect is used with the Shiva NetModem V2400 or NetModem V.32 to allow modem sharing, or with the Shiva NetSerial or EtherGate to allow the sharing of any serial device.
Shiva Corporation
155 Second St.
Cambridge, MA 02141
617-864-8500
page 96
Part No.: N/A; Price: \$99
- DOS Mounter** DOS Mounter is a utility that lets the Apple FDHD SuperDrive access MS-DOS disks from the desktop, instead of through Apple File Exchange. With DOS Mounter in the System Folder, MS-DOS disks appear on the desktop and behave like Macintosh disks. Subdirectories are shown as folders, and files as document icons. DOS Mounter contains Extension Mapping, a feature that links MS-DOS file extensions with Macintosh applications.
Dayna Communications
50 S. Main St., Suite 530
Salt Lake City, UT 84144
801-531-0600
page 101
Part No.: DS0200; Price: \$89
- DTSX-14** The DTSX-14 is an intelligent co-processor card for the Macintosh II that provides X.25 access to packet-switched wide area networks (WAN). Input/output to the card and to the WAN is accomplished via Symcicon's SYMNIX. This driver, which runs under A/UX, can allow an application program to access STS at any of the four OSI layers.
Symcicon, Inc.
23545 Crenshaw Blvd., Suite 104
Torrance, CA 90505
213-530-2610
page 151
Part No.: N/A; Price: \$1395
- Du Pont 10BaseT Networking System** Du Pont's LAN ONE Plus Ethernet 10BaseT Networking System provides a flexible means of directly interconnecting Ethernet stations via unshielded twisted-pair, shielded twisted-pair, fiber-optic, and cable. The system consists of an Ethernet or Universal concentrator that acts as the hub for the system and a variety of modules that allow users to tailor the system to fit their needs.
Du Pont Connector Systems
3300 Gateway Center Blvd.
Morrisville, NC 27560
800-888-LAN1
page 73
Part No.: N/A; Price: \$188/node and up
- Du Pont 10BaseT Transceiver** Du Pont's LAN ONE 10BaseT Transceiver provides users with the ability to interconnect data terminal equipment using any standard Ethernet adapter card to unshielded twisted-pair cabling. The transceiver (ETT-001) can be attached via the AUI connection on an Ethernet adapter card or with standard AUI cable.
Du Pont Connector Systems
3300 Gateway Center Blvd.
Morrisville, NC 27560
800-888-LAN1
page 74
Part No.: N/A; Price: \$159
- Du Pont Connector Systems** Products: Fiber-Optic LAN for AppleTalk, 10BaseT Networking System, 10BaseT Transceiver, Portable Ethernet Transceiver Tester (PETT), RL3000 Coax Transceiver, Ethernet Local Bridge Module with Management, Local and Remote Repeater, Fiber-Optic Inter-Repeater Link, Token Ring Media System
3300 Gateway Center Blvd., Morrisville, NC 27560, 800-237-2374

Du Pont Ethernet Local Bridge Module with Management

Du Pont Connector Systems
3300 Gateway Center Blvd.
Morrisville, NC 27560
800-888-LAN1

page 75

Fiber-optic local area network (Model ELB-001) brings bridge functions to a *LAN ONE* Universal Concentrator or Multiport Repeater Chassis. The ELB-001 is a complete hardware and software solution for controlling Ethernet subnetworks in complex data communications environments. Du Pont's ELB-001 can confine failures to a single segment and provides users with the capability of building redundant links between subnetworks.

Part No.: ELB-001; Price: \$4995

Du Pont Fiber Optic LAN for AppleTalk

Du Pont Connector Systems
3300 Gateway Center Blvd.
Morrisville, NC 27560
800-237-2374

page 72

Du Pont's *LAN ONE* Plus AppleTalk products for the AppleTalk networking system allow Macintosh work groups to expand in area, number of users, and distance between stations by extending the reach of the AppleTalk network system cable interconnection through the use of fiber-optic cable.

Du Pont *LAN ONE* Plus AppleTalk networks can be configured in several ways: as a linear bus (like the AppleTalk network system), as a star topology, or as a combination of both.

Part No.: N/A; Price: \$230 to \$285

Du Pont Fiber-Optic Inter-Repeater Link

Du Pont Connector Systems
3300 Gateway Center Blvd.
Morrisville, NC 27560
800-888-LAN1

page 74

Fiber-Optic Inter-Repeater Link (FOIRL) Transceivers provide a straightforward approach to implementing a fiber-optic Ethernet system. Using fiber-optic cable the user can construct point-to-point links between remote stations, multiport transceivers, repeaters, or bridges. The FOIRL transceivers assist in network diagnosis and monitoring.

Part No.: EOT-322; Price: \$550

Du Pont Local and Remote Repeaters

Du Pont Connector Systems
3300 Gateway Center Blvd.
Morrisville, NC 27560
800-888-LAN1

page 75

Du Pont's *LAN ONE* RL6000Li Ethernet Local Repeater and RL6000Fi Ethernet Remote Repeater provides interconnection of IEEE 802.3/Ethernet Version 2.0 local area network segments. RL6000Li uses two Ethernet Attachment Unit Interface (AUI) cables up to 50 meters in length to interconnect coax, twisted-pair, or fiber-optic network segments. RL6000Fi can replace separate local repeaters and optical transceivers.

Part No.: RL6000Li Ethernet Local Repeater; Price: \$795

Part No.: RL6000Fi Ethernet Remote Repeater; Price: \$1495

Du Pont Portable Ethernet Transceiver Tester (PETT)

Du Pont Connector Systems
3300 Gateway Center Blvd.
Morrisville, NC 27560
800-237-2374

page 76

Du Pont's Portable Ethernet Transceiver Tester (PETT) is an Ethernet LAN installation tester and troubleshooting tool. It has the flexibility to be used with coaxial cable, twisted pair, and fiber-optic media and transmission equipment. The PETT can assist users in verifying conformance to Ethernet/IEEE 802.3 specifications, as well as measure important transmission performance parameters.

Part No.: N/A; Price: \$3500

Du Pont RL 3000 Coax Transceiver

Du Pont Connector Systems
3300 Gateway Center Blvd.
Morrisville, NC 27560
800-888-LAN1

page 76

Du Pont's *LAN ONE* RL3000 Ethernet Coax Transceiver provides access from data terminal equipment to Ethernet local area networks for transmitting and receiving data packets. It is compatible with IEEE 802.3 and Ethernet Version 2.0 specifications, and allows Carrier Sense Multiple Access with Collision Detection network operation at a full 10 Mb/s. It provides user selectable SQE test and extensive diagnostic LED indicators.

Part No.: N/A; Price: \$199

Du Pont Token Ring Media System

Du Pont Connector Systems
3300 Gateway Center Blvd.
Morrisville, NC 27560
800-888-LAN1

page 76

Du Pont's fiber-optic Token Ring Media System can provide interconnection of up to 34 token ring (IEEE 802.5) and IBM-compatible stations (DTE) or Multi-Station Access Units (MSAUs) using fiber optic cable. This system supports data rates up to 16 Mb/s, and is adaptable to changing token ring environments.

Part No.: N/A; Price: \$420 per node and up

Du Pont Token Ring Transceivers (TRT)

Du Pont Connector Systems
3300 Gateway Center Blvd.
Morrisville, NC 27560
800-888-LAN1

page 77

Du Pont's Token Ring Transceivers connect IBM and IEEE 802.5 compatible token ring networks with fiber-optic technology. The TRT builds a fault network by providing noise immunity, security, and has the ability to extend distances between stations. TRTs interconnect with either ring in, ring out, lobe ports of multi-station access units, or directly to DTE.

Part No.: N/A; Price: \$850 and up

EDI Communications Corp.

Product: MacToken

20440 Town Center Ln., #4E1, Cupertino, CA 95014, 408-996-1343

Engage Communications, Inc.

Product: SyncRouter

756 Marlin Ave., Suite 4, Foster City, CA 94404

Ether+

Compatible Systems Corp.
P.O. Box 17220
Boulder, CO 80301
303-444-9532

page 69

Ether+ provides a direct connection to Ethernet networks for all Macintosh computers equipped with a SCSI port. The Ether+ equipped Macintosh computer can utilize third-party software to communicate over high-speed Ethernet networks with other Macintosh computers and a variety of Ethernet-based computer systems, including UNIX systems, Digital VAX computers, and PCs.

Part No.: Ether+; Price: \$495

Ether2

Compatible Systems Corp.
P.O. Box 17220
Boulder, CO 80301
303-444-9532

page 10

Ether2 is an Ethernet NuBus card for all Macintosh II family computers. The Ether2-equipped Macintosh can utilize third-party software to communicate over high-speed Ethernet networks with other Macintosh computers and a variety of Ethernet-based computer systems, including UNIX systems, Digital VAX computers and PCs.

Part No.: Ether2; Price: \$395

EtherGate

Shiva Corporation
155 Second St.
Cambridge, MA 02141
617-864-8500

page 69

EtherGate is an Ethernet gateway which permits connections to local and remote LocalTalk networks, shared serial peripherals, and single remote Macintosh computers.

Part No.: N/A; Price: \$2399

EtherLink/NB

3Com Corporation
3165 Kifer Rd.
Santa Clara, CA 95052-8145
408-562-6400

page 54

EtherLink/NB is an Ethernet adapter designed to plug into an expansion slot of the Macintosh II computer. It provides users with a high speed data transfer rate of 10 Mbps and uses Apple's standard EtherTalk driver. The board is compatible with software products written to this standard. It is compatible with 3Com MultiConnect products which allow users to run Ethernet on twisted-pair wire.

Part No.: 3C543; Price: \$595

- EtherLink/SE**
3Com Corporation
3165 Kifer Rd.
Santa Clara, CA 95052-8145
408-562-6400
page 55
- EtherLink/SE is an Ethernet adapter designed to plug into an expansion slot of the Macintosh SE computer. It provides users with a high speed data transfer rate of 10Mbps. The EtherLink/SE driver is compatible with Apple's EtherTalk driver and is compatible with software products written to this standard. The EtherLink/SE is compatible with 3Com MultiConnect products which allow users to run Ethernet on twisted-pair wire.
Part No.: 3C563; Price: \$595
- EtherMac II and EtherMac II/10T**
Adaptec
691 S. Milpitas Blvd.
Milpitas, CA 95035
408-945-2518
page 11
- The EtherMac II is a NuBus card that provides a direct attachment to Ethernet for any Macintosh II computer. It is port compatible with Apple's EtherTalk driver and actually uses the same driver. EtherMac II/10T comes with an RJ-45 modular phone connector for twisted-pair Ethernet and a 15-pin D connector for thick Ethernet. It has a built-in twisted-pair Ethernet transceiver and supports 10BaseT Ethernet. It is compatible with any 10BaseT compliant concentrator.
Part No.: EtherMac II; Price: \$495
Part No.: EtherMac II/10T; Price: \$595
- EtherPeek**
The AG Group
Station B, P.O. Box 26728
San Francisco, CA 94125
415-937-2447
page 84
- EtherPeek is a software-only network management tool for monitoring and debugging the Ethernet from a Macintosh. EtherPeek captures ALL packet traffic or limits itself to a specified subset. It displays or prints the captured packets in several formats including protocol templates. EtherPeek also "saves" and "restores" captured packets or sends user-constructed packets onto Ethernet.
Part No.: N/A; Price: \$475
- EtherPort SE/30L**
Novell, Inc.
1340 Treat Blvd., #500
Walnut Creek, CA 94596
page 10
- The EtherPort SE/30L Ethernet controller card for the Apple Macintosh SE/30 features one unshielded twisted-pair RJ-45 modular receptacle and one AUI connector on the same card. The EtherPort SE/30L carries SynOptics' on-board LattisNet transceiver, which allows Macintosh SE/30 computers to connect directly to unshielded twisted-pair LattisNet networks.
Part No.: 9900118-00; Price: \$645
- EtherPort SEL**
Novell, Inc.
1340 Treat Blvd., #500
Walnut Creek, CA 94596
page 10
- The EtherPort SEL Ethernet controller card for the Apple Macintosh SE features one unshielded twisted-pair RJ-45 modular receptacle and one AUI connector on the same card. The EtherPort SEL carries SynOptics' on-board LattisNet transceiver, which allows Macintosh SE computers to connect directly to unshielded twisted-pair LattisNet networks.
Part No.: 9900134-00; Price: \$645
- eXodus**
White Pine Software
P.O. Box 1108
Amherst, NH 03031
603-886-9050
page 160
- eXodus is a Color X Window System Display server that turns the Macintosh into an X Window Workstation. eXodus interacts with applications (including DECwindows), running on a variety of host computer systems such as Digital VMS and ULTRIX, and other UNIX based systems. eXodus features multiple window support; auto client launch; modeless dialogs, including color and client editors; and cutting and pasting of both graphics and text to the Macintosh Clipboard.
Part No.: N/A; Price: Contact Supplier
- Fairfield Software**
Product: ClearAccess
200 West Lowe, Fairfield, IA 52556, 800-522-4254
- Farallon Computing, Inc.**
Products: PhoneNET Card, PhoneNET CheckNet, PhoneNET Connector, PhoneNET Repeater, PhoneNET Star Controller Series 300, Farallon Portable Pack, Network Manager's Pack, Network Administrator's Utility, Timbuktu, Timbuktu/Remote.
2000 Powell St., #600, Emeryville, CA 94608, 415-596-9100

Farallon Portable Pack

Farallon Computing, Inc.
2000 Powell St., #600
Emeryville, CA 94608
415-596-9100

page 18

Farallon Portable Pack is a network for the Macintosh Portable and contains two of the following: StarConnectors, Timbuktu, and Timbuktu/Remote file transfer and screen sharing software. With Timbuktu/Remote, users can use the Macintosh Portable to exchange files and share screens over telephone lines. With StarConnectors, users can connect a Macintosh Portable to an AppleTalk LAN at another site, and with Timbuktu, exchange files and share screens across the network.

Part No.: SW495; Price: \$495

FastPath 4 Gateway

Shiva Corporation
155 Second St.
Cambridge, MA 02141
617-864-8500

page 14

The FastPath 4 Gateway connects AppleTalk workgroups to Ethernet networks, allowing Macintosh computers on LocalTalk access to systems/services on Ethernet. Macintosh users can participate in internetworks of heterogeneous machines, including other Macintosh computers, PCs, NetWare servers, VAX computers, UNIX systems, and remote networks.

Part No.: 9900072-01; Price: \$2795

FAXGATE

Solutions, Inc.
30 Commerce St.
Williston, VT 05495
802-865-9220

page 17

FAXGATE sends and receives faxes using Microsoft Mail 2.0 or QuickMail, a single phone line and one BackFAX-compatible fax modem. FAXGATE includes a 5-Pack of MailMaker which lets users create electronic printouts of most Macintosh applications, which may be sent out to any Group 3 fax device via FAXGATE or around the local area network.

Part No.: N/A; Price: \$395

FlexFAX

Circuit Research
4 Townsend West, Suite #3
Nashua, NH 03063
603-880-4000

page 80

FlexFAX/Faxgate provides a link from the Macintosh workstation to any facsimile machine worldwide. Residing on any Microsoft Mail, QuickMail, or InBox server, FlexFAX/Faxgate allows 9600 bps facsimile capability. When fax facilities are not in use, FlexFAX can be used as a Hayes compatible 2400 bps modem by other installed gateways.

Part No.: 9624M; Price: \$895

FOUNDATION CBT

Menlo Business Systems, Inc.
201 Main St.
Los Altos, CA 94022
415-948-7920

page 202

Menlo's computer-based training system, FOUNDATION CBT, is an authoring process for computer based training. Instructional designers use a graphic point-and-click Macintosh authoring platform to deliver training to a wide variety of devices, terminals and workstations.

Part No.: N/A; Price: Contact Supplier

FOUNDATION Graphics Toolbox

Menlo Business Systems, Inc.
201 Main St.
Los Altos, CA 94022
415-948-7920

page 201

FOUNDATION Graphics Toolbox, in combination with *MAC MENLO*, is a software bridge that connects a Macintosh to a Tandem computer, and provides a graphic capability for Tandem computer mainframe applications. In addition to the Tandem mainframe access window, a second window can be opened that supports all native Macintosh graphics, both bitmapped and object oriented.

Part No.: N/A; Price: \$19,500

FOUNDATION Vista

Menlo Business Systems, Inc.
201 Main St.
Los Altos, CA 94022
415-948-7920

page 201

FOUNDATION Vista is a Computer Aided Software Engineering (CASE) product offering an set of integrated tools for on-line application analysis and design. FOUNDATION Vista, which is Macintosh computer-based, compliments the FOUNDATION application development system and is SQL oriented. The system automates the documentation and diagramming process.

Part No.: N/A; Price: \$8900

FOUNDATION Vista Translator The Translator automatically interfaces compiled Vista designs with the Tandem environment by generating PATHWAY screen definitions and DDL components. The Vista Translator also reverse engineers DDL source from the Tandem environment to the entity Relationship Module of the Vista Design Workbench.
Menlo Business Systems, Inc.
201 Main St.
Los Altos, CA 94022
415-948-7920
Part No.: N/A; Price: \$16,000
page 201

GatorBox The GatorBox connects an entire Macintosh network to Ethernet, offering physical connections for LocalTalk and standard and thin Ethernet. The hardware supports AppleTalk routing so Macintosh users on both LocalTalk and Ethernet can share laser printers, E-mail, and storage. GatorBox also supports TCP/IP for terminal sessions from Macintosh computers to UNIX hosts.
Cayman Systems
26 Landsdowne St.
Cambridge, MA 02139
617-494-1999
Part No.: 10100-1; Price: \$2795
page 150

GatorCard E/II The GatorCard E/II connects any Macintosh II, IIx or IIcx directly to standard or thin Ethernet. It lets Macintosh users share files, use electronic mail software and print over the 10 Mbit per second Ethernet network. Software included with GatorCard E/II also supports TCP/IP and DECnet. The GatorCard E/II software also includes NCSA Telnet, a terminal emulation program that lets the Macintosh user log on to TCP/IP workstations.
Cayman Systems
26 Landsdowne St.
Cambridge, MA 02139
617-494-1999
Part No.: N/A; Price: \$595
page 150

GatorMail-Q GatorMail-Q is a bridge between CE Software's QuickMail and UNIX mail systems on SMTP networks. It integrates electronic mail on multiple platforms including Macintosh, AT&T, Digital, Sun, Silicon Graphics, and Apollo. Features include mail exchange, aliasing, and data enclosures. Using GatorMail-Q, QuickMail users can send mail to remote sites over worldwide TCP/IP networks like the Internet.
Cayman Systems
26 Landsdowne St.
Cambridge, MA 02139
617-494-1999
Part No.: 10200-2; Price: \$995
page 161

GatorShare GatorShare software provides transparent file service between Macintosh and UNIX computers. Using the AppleShare interface, Macintosh users can store and retrieve files on Ethernet hosts that support Network File System (NFS). GatorShare runs on the GatorBox and translates between AppleShare and NFS, eliminating the need to add AppleTalk protocols to the UNIX kernel.
Cayman Systems
26 Landsdowne St.
Cambridge, MA 02139
617-494-1999
Part No.: 10200-1; Price: \$1995
page 154

Gizmo Technologies Product: Send Express 1.0
P.O. Box 14177, Fremont, CA 94539, 415-623-7899

GQL/Admin v2.0 GQL/Admin allows database administrators to develop customized graphic data models for GQL/User. The database schema is loaded from the host system, and join conditions are specified. The graphic data model can have alias names to increase readability. Executive buttons with stored queries and annotations can be added.
Andyne
544 Princess St., Suite 202
Kingston, Ontario K7L 1C7
613-548-4355
Part No.: N/A; Price: \$1995
page 40

GQL/Design v2.0 GQL/Design is a prototyping tool that provides a graphic interface for creating new databases. It supports entity relationship design method and includes built-in design checks and design reports. It can create tables directly on host or generate SQL script files. Data models can be used directly by GQL/User.
Andyne
544 Princess St., Suite 202
Kingston, Ontario K7L 1C7
613-548-4355
Part No.: N/A; Price: \$995
page 40

GQL/User v2.0 GQL/User allows users to retrieve information from host computers using a graphic point-and-click interface. Users view the database as a graphic data model representing the data objects and relationships. Results are presented in spreadsheet format, and can be manipulated within GQL/User or exported to other applications.
 Andyne
 544 Princess St., Suite 202
 Kingston, Ontario K7L 1C7
 613-548-4355
page 40 Part No.: N/A; Price: \$295

Grapoint Product: TGRAF-07/Mac
 1485 Saratoga Ave., San Jose, CA 95129-4934, 408-446-1919

Grappler LX The Grappler LX is a parallel printer interface capable of connecting most 24-pin and laser printers to any Macintosh with at least 1 MB of RAM. By converting ImageWriter LQ codes into output other printers will understand, the Grappler supports models from Epson, Hewlett Packard, Panasonic, Star Micronics, and other manufacturers. The Grappler comes with seven complete fonts, and is compatible with Adobe ATM.
 Orange Micro, Inc.
 1400 N. Lakeview Ave.
 Anaheim, CA 92807
 800-223-8029
page 99 Part No.: N/A; Price: \$199

h-Three systems Products: MacRing SE, MacRing NB, MacRing SE/30
 P.O. Box 12557, Research Triangle Park, NC 27709, 800-MAC-RING

HandOff II HandOff II allows all files to be opened directly from the Finder, even if the application is missing or if the files were transferred to the Macintosh from another computer. HandOff II includes a file launcher. Users can build a pop-up menu of applications and documents and access the menu anytime with a click of the mouse. HandOff II can also be configured to change the color depth and sound level when launching or switching applications.
 Software Innovations, Inc.
 P.O. Box 811
 Allen, TX 75002
 214-727-2329
page 104 Part No.: N/A; Price: \$80

Hayes InterBridge Hayes InterBridge provides a means of expanding an AppleTalk work group in a local environment, reorganizing network traffic flow among work groups, or connecting a remote work group with a local network. InterBridge can support one local bridge and two remote bridges simultaneously.
 Hayes Microcomputer Products
 P.O. Box 105203
 Atlanta, GA 30348
 404-449-8791
page 78 Part No.: N/A; Price: \$799.

Hayes Microcomputer Products Products: InterBridge, SMARTCOM II for the Macintosh, Smartmodem 1200, Smartmodem 2400, Smartmodem 2400M, V-Series System Products, Smartmodem 9600
 P.O. Box 105203, Atlanta, GA 30348, 404-449-8791

Helix VMX Helix VMX is a multi-user database application development environment for VAX/Macintosh networks. It allows users to create applications on the Macintosh using a visual toolkit, and run them without modification on a Digital VAX system under the VMS operating system. Macintosh computers access these VAX applications by functioning as intelligent workstations connected to the VAX system.
 Odesta Corp
 4084 Commercial Ave.
 Northbrook, IL 60062
 800-323-5423
page 133 Part No.: N/A; Price: \$4500 to \$70,000

HyperCard v2.0 HyperCard v2.0, a major revision of the Macintosh computer program, is a personal software package which lets users manage information using virtually any type of media. Based on the index card metaphor, HyperCard v2.0 takes advantage of the Macintosh interface to let users explore and build applications ranging from personal information managers to multimedia software and mainframe interfaces.

Apple Computer, Inc.
20525 Mariani Ave.
Cupertino, CA 95014
408-996-1010
page 33

Part No.: M0556/B; Price: HyperCard 2.0 is included with every Macintosh computer. Upgrades or replacement copies can be purchased for \$49

ICP (Intelligent Communications Processor)

Orange Micro, Inc.
1400 N. Lakeview Ave.
Anaheim, CA 92807
714-779-2772
page 155

ICP is an intelligent communications processor for the Macintosh II family of computers. Features include the Motorola 68000 microprocessor; 512K RAM with no-wait states; up to four RS-232 DTE ports, two of which are configurable to AppleTalk; and compatibility with A/UX, Mr. DOS, and the Macintosh operating system.

Part No.: N/A; Price: \$949 to \$999

IDEAcomm Mac 2.0

IDEAssociates
29 Dunham Rd.
Billerica, MA 01821
508-663-6878
page 182

IDEAcomm Mac is a 5250 terminal emulation board which allows the Macintosh SE and Macintosh II family to have multiple host sessions on and transfer data from the IBM Midrange family, the IBM S/36, S/38 and AS/400. It attaches via twinax cable to the host.

Part No.: Mac 2/5251 for the Macintosh II; Price: \$1195

Part No.: Mac SE/5251 for the Macintosh SE; Price: \$995

IDEAssociates

Product: IDEAcomm Mac
29 Dunham Rd., Billerica, MA 01821, 508-663-6878

InBox 3.0

Sun Microsystems, TOPS Division
950 Marina Village Pkwy.
Alameda, CA 94501
800-445-TOPS
page 56

InBox 3.0 is an electronic mail system for Macintosh and DOS computers. No central administration is needed and the software comes ready for up to 20 users; Macintosh and PC software is included. Features include Address Books for personal recipient-list management, and local Storage Boxes to organize mail.

Part No.: 600-2496; Price: \$329

InBox Plus

Sun Microsystems, TOPS Division
950 Marina Village Pkwy.
Alameda, CA 94501
415-769-9669
page 56

InBox Plus is an electronic mail system for Macintosh and DOS computers. It routes mail between Message Centers (up to 100 users each) for use on networks of any size. InBox Plus supports Gateways for connectivity to other mail systems such as VMS Mail, X.400, SMTP, and PROFS.

Part No.: 600-2493; Price: \$995

Information Presentation Technologies

Products: Personal Server Network 2.0, uShare
23801 Calabasas Rd., Suite 2008, Calabasas, CA 91302, 818-347-7791

Informix Software, Inc.

Product: Wingz-DataLink
16011 College Blvd., Lenexa, KS 66219, 913-599-7100

Infosphere

Product: Liaison
4730 SW Macadam Ave., Portland, OR 97201, 503-226-3620

Insignia Solutions

Product: SoftPC
254 San Geronimo Wy., Sunnyvale, CA 94086, 408-522-7600

Integrated Computer Solutions Products: OSF/Motif 1.03 for A/UX 2.0, XView 2.0 with OPENLOOK for A/UX 2.0
163 Harvard St., Cambridge, MA 02139, 617-547-0510

Integrated Solutions Product: Central System Manager (CTM) v2.01
1020 Eighth Ave., King of Prussia, PA 19406, 215-337-2282

InterCon Systems, Corp. Products: TCP/Connect II, Telnet Driver
950 Herndon Pkwy. Suite 390, Herndon, VA 22070, 703-709-9890

Interpreter, Inc. Product: SmartTalk
11455 West 48th Ave., Wheat Ridge, CO 80033, 800-232-4687

Inter•Poll Network Administrator's Utility The Inter•Poll Network Administrator's Utility contains tools to implement a network support system. These tools cover network mapping, trouble-shooting methods, selective searches for active devices, network-link integrity tests, and version reporting for workstation. Inter•Poll supports a multivendor AppleTalk network, including Macintosh, MS-DOS & PS/2 and Digital VAX computers.
Apple Computer, Inc.
20525 Mariani Ave.
Cupertino, CA 95014
408-996-1010
Part No.: M0687; Price: 129
page 22

IPGate IPGate provides the LocalTalk to Ethernet router with AppleTalk, AppleTalk to TCP/IP (KIP and CAP-style encapsulation) and MSP to TCP routing and gateway functionality. IPGate adheres to TCP/IP "Interior Gateway" specifications RFC-950 and proxy-ARP. Features include network management interface, security controls and SNMP support.
Network Resources Corp.
2450 Autumnvale Dr.
San Jose, CA 95131
408-263-8100
Part No.: N/A; Price: \$395
page 152

JetStream JetStream tape backup system archives 2.5 gigabytes on one 8mm helical scan format video tape cartridge, with a speed of up to 14.4 Mbs per minute. It backs up multiple drives, crosses time zones, and is bundled with NetStream v2.0 which provides unattended network backups.
Personal Computer Peripheral Corp.
4170 Eisenhower Blvd.
Tampa, FL 33634
813-884-3092
Part No.: N/A; Price: \$4279
page 13

K-AShare K-AShare is an AFP-compatible file server software for UNIX hosts. K-AShare provides all the benefits of UNIX hosts while allowing transparent implementation of AppleShare for Macintosh users. To access K-AShare, Macintosh users go into the Chooser, select a network zone and then select AppleShare. K-AShare appears as an AppleShare icon on the desktop.
Mt. Xinu, Inc.
2560 Ninth St., #312
Berkeley, CA 94710
415-644-0146
Part No.: N/A; Price: \$995 to 5395
page 152

K-Spool K-Spool software allows users of Apple Macintosh computers and UNIX systems to share PostScript printers. It is a UNIX application which functions as a print server for the Macintosh. K-Spool advertises its address to Macintosh computers as a LaserWriter, allowing Macintosh users to see it through the familiar Chooser.
Mt. Xinu, Inc.
2560 Ninth St., #312
Berkeley, CA 94710
415-644-0146
Part No.: N/A; Price: \$695
page 152

- KEYpak** KEYpak software, running on either a computer system or local area network (LAN) server, allows users to exchange documents between otherwise incompatible document processors or word processing systems and is designed to provide flexibility for revisable document exchange between end-users on different computer systems by supporting system interchange architectures.
Keyword Office Technologies 2816 Eleventh St., NE
Calgary, Alberta, Canada T2E 7S7
403-250-1770
Part No.: N/A; Price: \$1000 to \$100,000
page 126
- Keyword Office Technologies** Product: KEYpak
2816 Eleventh St. NE, Calgary, Alberta, Canada T2E 7S7, 403-250-1770
- LAN ONE Plus Ethernet** Du Pont's LAN ONE Plus Ethernet Multimedia Ethernet System supports requirements for multiple types of media and networks within the same LAN hardware base. Comprised of concentrators, media connectivity modules, and media access units (MAUs).
Du Pont Connector Systems 3300 Gateway Center Blvd
Morrisville NC 27560
800-888-LAN1
Part No.: N/A; Price: \$188 per node and up
page 73
- LanWay TR 16/4** LanWay TR 16/4 is a token ring (IEEE 802.5) NuBus LAN Interface adapter used in the Macintosh NuBus family (II, IIX, IICx, IICI and IIFx systems). LanWay TR 16/4 SE/030 adapter is a token ring (IEEE 802.5) interface card for use in the SE/030. The LANWay token ring card is equipped with Texas Instruments TMS380C16 token ring processor, and is capable of both 16 Mbps and 4 Mbps operation in a single adapter.
Tri-Data Systems, Inc. 3270 Scott Blvd.
Santa Clara, CA 95054
408-727-3270
Part No.: N/A; \$1095
page 186
- LanWorkPlace for Macintosh** LanWorkPlace for Macintosh provides Apple Macintosh users with transparent access to a broad range of hosts, servers, and workgroups on a local area network. Remote sessions look and feel as if they reside on the Macintosh desktop. LAN WorkPlace for Macintosh consists of TCPort transport system software and HostAccess network application software.
Novell, Inc. 122 East 1700 South
Provo, UT 84606
800-LAN-KIND
Part No.: 9870074-00; Price: \$250
page 52
- LattisNet LAN Utility Solutions** LattisNet products implement connectivity, internetworking and network management solutions for complex environments. LattisNet concentrators reside in a building's wiring closet to provide basic connectivity for Apple Macintosh computers and other host devices. LattisNet Workgroup concentrators implement IEEE 802.3 Ethernet connectivity at 10 megabits per second (Mb/s) over unshielded twisted pair wire configured in an active hierarchical star for small, entry-level networks.
SynOptics Communications 501 E. Middlefield Rd.
Mountain View, CA 94043-4015
800-PRO-8023
Model 3000 Premises Concentrator
Model 3030 Department Concentrator
Model 1000 Premises Concentrator
Model 1010 Department Concentrator
Model 2510 Retiming Workgroup Concentrator
Price: \$160 to \$350 per node
Model 2530 AUI/UTP Workgroup Concentrator
Price: \$1495
page 70

LattisNet Network Management Modules

SynOptics Communications
501 E. Middlefield Rd.
Mountain View, CA 94043-4015
800-PRO-8023

page 71

LattisNet Network Management modules reside in LattisNet concentrators, where they gather specific performance and diagnostic information. This information is forwarded to a central control console, where LattisNet Network Management software displays it as part of graphics-oriented map of the network. Boxes, representing concentrators, appear in their proper place within the hierarchy, and colored bars provide network status information at a glance.

Model 213 AUI Network Management Module with Built-in Modem
Model 218-ST ST Fiber Network Management Module with Built-in Modem
Model 3324-ST Fiber Network Management Module with Built-in Modem
Model 3313MAUI Network Management Module with Built-in Modem
Model 3314M-ST Fiber Network Management Module with Built-in Modem
Model 633M Network Management Control Console Package with Built-in Modem
Price: \$50 per node

LattisNet System 3000 Ethernet Local Bridge Modules

SynOptics Communications
501 E. Middlefield Rd.
Mountain View, CA 94043-4015
800-PRO-8023

page 70

LattisNet System 3000 Ethernet networks support integrated internetworking functions via the LattisNet Ethernet local bridge module. The LattisNet local bridge directs data traffic based on Ethernet addresses assigned to each network device. The LattisNet Ethernet local bridge filters data traffic at 10,000 frames per second and forward 7000 frames per second on a bidirectional basis.

Model 3323 AUI Ethernet Local Bridge Module
Model 3324-ST Fiber Ethernet Local Bridge Module
Model 3320S Ethernet Local Bridge Manager Software
Price: Ethernet Local Bridge Modules, \$4195 to \$4595

Liaison

Infosphere
4730 SW Macadam Ave.
Portland, OR 97201
800-445-7085

page 14

Liaison is a software product that can connect AppleTalk networks running on LocalTalk cable, or remote AppleTalk networks, to ARCNET compatible hosts using Novell NetWare for Macintosh. Liaison can also connect LocalTalk cable to a high-speed Ethernet backbone, or connect AppleTalk networks running on LocalTalk cable to EtherTalk compatible hosts such as Digital's VAX systems.
Part No.: 38212-040; Price: \$295

LocalTalk Cable System

Apple Computer Inc.
20525 Mariani Ave.
Cupertino, CA 95014
408-996-1010

page 7

The LocalTalk cable system is a standard work-group cable system that uses shielded twisted-pair wire. It sets the standard for other cable systems that use the AppleTalk protocols. It allows up to 32 devices to be connected per network segment and operates at a bandwidth of 230.4 Kbps. Each segment can span a distance of 1000 feet (with a maximum distance between nodes of 1000 feet), and network segments can be interconnected using bridges.

M2066 LocalTalk Locking Cable Kit (10 meter); Price: \$75
M2068 LocalTalk Locking Connector Kit-din 8; Price: \$75
M2065 LocalTalk Locking Connector Kit- DB9; Price: \$75
M2069 LocalTalk Locking Cable Kit (25 meter); Price: \$125
M2070 LocalTalk Custom Wiring Kit; Price: \$849
Approximate System Cost: \$200 to \$900

LocalTalk PC Card

Apple Computer Inc.
20525 Mariani Ave.
Cupertino, CA 95014
408-996-1010

page 96

The LocalTalk PC Card connects a PC-compatible computer to an AppleTalk network, allowing the user to print documents on the Apple LaserWriter and LaserWriter II family of laser printers. With additional software, PC-compatible computers equipped with the LocalTalk PC Card can access other network services on the AppleTalk network, including file sharing and electronic messaging.
Part No.: M0040LL/B; Price: \$299

LT200 LocalTalk Interface Board

DayStar Digital
5556 Atlanta Hwy.
Flowery Branch, GA 30542
404-967-2077
page 98

The LT200 enables IBM PC or PS/2s to use LocalTalk printers or access TOPS or AppleShare. The LT200 is compatible with Novell's NetWare, 3Com 3+Open, AppleShare 2.0, and includes printer utilities that allow PCs to print to PostScript printers.
Part No.: N/A; Price: \$249 retail for PC standard bus
Part No.: N/A; Price: \$395 retail for Micro Channel

Mac86

Orange Micro, Inc.
1400 N. Lakeview Ave.
Anaheim, CA 92807
800-223-8029
page 98

Mac86 is a 4.77 Mhz 8086 coprocessor board for the Macintosh SE (SE/30 not supported). Although this solution uses the Macintosh computer's RAM for processing, it is still capable of many multitasking operations due to its on-board processor. Benchmark-rated at better than IBM-XT speeds, Mac86 requires no accelerator to operate.
Part No.: N/A; Price: \$699

Mac220

White Pine Software
P.O. Box 1108
Amherst, NH 03031
603-886-9050
page 130

A DEC VT220 terminal emulator with support of large-screen monitors, 132-column mode, function and user-defined keys, DRCS, double-wide and double-high characters and blinking. Includes Kermit, XMODEM and YMODEM file transfer capability. Connect to the VAX directly through a modem, or over a network. Mac220 supports DECnet and TCP/IP protocols and works with the Macintosh Communications Toolbox.
Part No.: N/A; Price: \$129 to \$300

Mac240

White Pine Software
P.O. Box 1108
Amherst, NH 03031
603-886-9050
page 130

Mac240 features file-transfer capabilities using Kermit, XMODEM, and YMODEM protocols. Mac240 supports ReGIS and Sixel graphics, and also emulates Tektronix terminals. Other features include color background, command key equivalents, resizable and multiple windows, scrolling capabilities, and review buffers to allow reading or printing of scrolled text. Mac240 supports DECnet and TCP/IP protocols and works with the Macintosh Communications Toolbox.
Part No.: N/A; Price: \$129 to \$300

Mac241

White Pine Software
P.O. Box 1108
Amherst, NH 03031
603-886-9050
page 130

Mac241 features complete file-transfer capabilities using Kermit, XMODEM, and YMODEM protocols. Mac241 supports ReGIS and Sixel graphics, and also emulates Tektronix terminals. Other features include command key equivalents, resizable and multiple windows, scrolling capabilities, and review buffers to allow reading or printing of scrolled text. Mac241 supports DECnet and TCP/IP protocols and works with the Macintosh Communications Toolbox.
Part No.: N/A; Price: \$129 to \$300

Mac286

Orange Micro, Inc.
1400 No. Lakeview Ave.
Anaheim, CA 92807
800-223-8029
page 98

Mac286 is an 8 Mhz 80286 coprocessor board for the Macintosh II series. It allows the use of most DOS applications in a standard Macintosh window, even under MultiFinder. Mac286 has its own processor and RAM on board. Mac286 supports CGA, MDA, and Hercules display modes, using the Macintosh monitor in all cases.
Part No.: N/A; Price: \$1599

MacAPPC

APDA (Apple Programmers & Developers Association)
20525 Mariani Ave., MS 33G
Cupertino, CA 95014
800-282-2732 (U.S.)
800-637-0029 (Canada)
408-562-3910 (International)
page 194

MacAPPC provides a complete implementation of IBM's Systems Network Architecture (SNA) Logical Unit 6.2 peer-to-peer protocol. It is a modular extension of Macintosh system software, ensuring its availability on all members of the Macintosh computer family, as well as its compatibility with other networks (such as AppleTalk) and software that may already be installed. MacAPPC makes it possible to develop commercial applications that provide access to other Macintosh computer and non-Macintosh computer environments using the services of LU 6.2 protocols.
Part No.: M0698/A MacAPPC; Price: Contact Supplier
Part No.: M0701/A MacAPPC Documentation Kit; Price: Contact Supplier
Part No.: M0218LL/B MacAPPC Evaluation Kit; Price: Contact Supplier

MacBinary to Mac

Peek[65]
 P.O. Box 586
 Pacifica, CA 94044
 415-359-5708
page 103

MacBinary to Mac is an Apple File Exchange translator document that converts Macintosh files into MacBinary format, the telecommunications industry standard for transferring Macintosh files via modem. The resulting files can be written to Macintosh, ProDOS, or MS-DOS disks.
 Part No.: N/A; Price: \$10

MacBLAST

Communications Research Group (CRG)
 5615 Corporate Blvd.
 Baton Rouge, LA 70808
 800-242-5278
pages 24, 66, 83, 84, 101, 126, 162, 180, 204, 208, 214, 220

MacBLAST provides high-speed asynchronous file transfer for error-free communications between Macintosh computers, PCs, UNIX/XENIX, VAX, and other minis and mainframes, and converts the text file formats between systems. MacBLAST consists of a Macintosh computer-based module and a host-based module for the following environments: UNIX/XENIX, MS-DOS, Unisys, Data General, VAX, Hewlett-Packard, IBM mainframe, NCR Tower, Tandem, Wang, and Prime.
 MacBLAST, Part No.: N/A; Price: \$195
 Host modules, Part No.: N/A; Price: \$250 to \$995

MacChuck v1.5

Vano Associates
 P.O. Box 12730
 New Brighton, MN 55112
 612-788-9547
page 103

MacChuck controls a PC from a Macintosh over AppleTalk or using a direct connect cable. MacChuck allows users to operate MS-DOS programs through a window on a Macintosh. With MacChuck, users can use the Macintosh Clipboard Copy and Paste commands with PC programs. MacChuck also copies text, binary, and MacBinary files between the Macintosh and the PC.
 Part No.: N/A; Price: \$100

MacCon+Token Ring Cards for the Macintosh II Family

Asanté Technologies, Inc.
 405 Tasman Dr.
 Sunnyvale, CA 94089
 800-662-9686
page 184

MacCon+ITR boards are designed to comply with the IEEE 802.5 Token-Passing Protocol Standard as well as built-in support of AppleShare, NetWare, 3+Mac, and 3270 emulation software. Optional Link Level Control (LLC) support provides compatibility with IBM's APPC, and MAP/TOP OSI protocols.
 Part No.: N/A; Price: \$745 to \$845

MacDFT v1.1

Apple Computer
 20525 Mariani Ave.
 Cupertino, CA 95014
 408-996-1010
page 174

MacDFT v1.1 is a full-function 3270 terminal-emulation program that enables any Macintosh II family computer to communicate with IBM mainframes. It can display up to five separate 3270 sessions simultaneously. It also supports file transfer based on IBM's IND\$FILE. Copy and paste functions between the Macintosh and mainframe applications are supported. MacDFT Can be used with either the Apple Coax/Twinax or TokenTalk NB Cards.
 Part No.: M0695; Price: \$245

Macintosh Communications Toolbox

APDA (Apple Programmers & Developers Association)
 Apple Computer, Inc.
 20525 Mariani Ave., MS 33G
 Cupertino, CA 95014
 800-282-2732 (U.S.)
 800-637-0029 (Canada)
 408-562-3910 (International)
page 31

The Macintosh Communications Toolbox is system software that provides Apple Macintosh applications with standard access to communications services, including data connection, terminal emulation, and file transfer protocols. The Macintosh Communications Toolbox is designed to support multivendor connectivity for Macintosh computers in environments such as Digital, IBM, OSI, TCP/IP, and the AppleTalk network system. Users can install the Macintosh Communications Toolbox using the Installer and Communications Toolbox installation script. Tools can be added or removed by dragging them in or out of the Communications Folder.
 Part No.: M0232LL/B Macintosh Communications Toolbox
 Part No.: M0379LL/A Basic Connectivity Set
 Part No.: M0380LL/A Source Code Examples
 Price: Contact Supplier

Macintosh-to-VAX Integration Toolkit

Apple Computer, Inc.
20525 Mariani Ave.
Cupertino, CA 95014
408-996-1010
page 120

The Macintosh-to-VAX Integration Toolkit is a set of software components, APIs, and documentation made available to developers interested in building distributed applications between the Macintosh and the VAX. This package includes AppleTalk for VMS, an AppleTalk-to-DECnet transport gateway, a VAX-based configuration utility, as well as ADSP and Gateway access connection tools for the Macintosh Communications Toolbox.
Part No.: N/A; Price: Contact Supplier

MacInUse v3.0

Softview, Inc.
1721 Pacific Ave., Suite 100,
Oxnard, CA 93033
805-385-5000
Page 23

MacInUse v3.0 tracks system usage. The program records application name, date, start time, and duration into a file. The commenting feature allows designation of business vs. personal usage. MacInUse creates records needed for client billing. Compatible with AppleShare and other networking products.
Part No.: N/A; Price: \$99

MacIRMA API

DCA
1000 Alderman Dr.
Alpharetta, GA 30201
404-442-4000
page 194

MacIRMA API is a Macintosh-based programming tool used to develop custom applications in C or HyperTalk that use DCA MacIRMA products to communicate with an IBM mainframe. Routine operator functions, such as log-on procedures and file transfer, as well as complicated data transfer operations, can be automated.
Part No.: N/A; Price: \$195 to \$6495

MacIRMA

DCA
1000 Alderman Dr.
Alpharetta, GA 30201
404-442-4000
page 177

MacIRMA coax adapters for Macintosh SE, SE/30 and NuBus models with MacIRMA Entry Emulator (EE) software let the Macintosh function as an IBM 3278/3279 terminal, communicating with an IBM mainframe computer. MacIRMA EE supports file transfer, copy and paste, color customization, QuickPad, light pen, and all 3270 terminal functions.
Part No.: N/A; Price: Contact Supplier

MacIRMA Graphics

DCA
1000 Alderman Dr.
Alpharetta, GA 30201
404-442-4000
page 177

MacIRMA Graphics works with MacIRMA hardware to make the Macintosh a high-resolution, mainframe APA graphics workstation. MacIRMA Graphics allows users to display, manipulate, and print graphics generated by GDDM programs, such as SAS/GRAPH, TELLAGRAF, and IBM Interactive Chart Utility. Graphics can be saved in both PICT and PIF formats.
Part No.: N/A; Price: Contact Supplier

MacIRMALAN Servers SDLC Gateway and 802.2 Gateway

DCA
1000 Alderman Dr.
Alpharetta, GA 30201
404-442-4000
page 189

With the MacIRMALAN SDLC and 802.2 Gateway Servers, Macintosh computers connected to an AppleTalk LAN can access an IBM SNA host. The gateway software and hardware run on a PC and provide up to 128 host sessions to the LocalTalk, EtherTalk, or TokenTalk LAN. MacIRMA WorkStation software allows each Macintosh client to access up to five sessions.
Part No.: N/A; Price: Contact Supplier

MacIRMA Workstation

DCA
1000 Alderman Drive
Alpharetta, GA 30201
404-442-4000
page 178

MacIRMA WorkStation (WS) is software that allows the Macintosh to function as a multiple-session Distributed Function Terminal (DFT) device in a 3270 SNA network either via coax or as an AppleTalk (MacIRMALAN) client. It supports five host sessions, including 3287 printer emulation, and file transfer in TSO, CMS, and CICS environments.
Part No.: N/A; Price: Contact Supplier

- MacKNOWLEDGE** MacKNOWLEDGE is an icon-based communications software program for the Macintosh. It includes scripts for most major on-line services which are activated to log on automatically with the click of an icon.
Prometheus Products
7225 SW Bonita Rd.
Tigard, OR 97223
800-477-3473
Part No.: SFT-17; Price: \$199
page 82
- MacLinkPlus/PC v4.5** MacLinkPlus/PC is a kit for transferring and translating documents between a Macintosh computer and an IBM PC, compatible, or laptop. It has a library of over 150 translators for word processors, spreadsheets, databases, and graphics. The product comes with software for both machines, allowing the user to transfer and translate files from one computer to the other.
DataViz, Inc.
35 Corporate Dr.
Trumbull, CT 06611
203-268-0030
Part No.: N/A; Price: \$199
page 102
- MacLinkPlus/Translators** MacLinkPlus/Translators is a set of over 150 translators for most word processing, spreadsheet, database, and graphic formats. The conversion process resides on the Macintosh computer and is used to translate files between PC and Macintosh formats. Translated files retain their original formatting.
DataViz, Inc.
35 Corporate Dr.
Trumbull, CT 06611
203-268-0030
Part No.: N/A; Price: \$169
page 103
- MacLinkPlus/VS for Wang Hosts** The DataViz MacLinkPlus/Wang VS software provides a bridge between Wang word-processing and Macintosh applications with two-way file transfer and document translation. Macintosh documents can be converted to standard Wang word-processing documents and stored on the Wang VS in a one-step process. A version of MacLinkPlus/Wang VS is available for Macintosh connectivity via the Wang VS, TC, TCP, or MLTC ports.
DataViz, Inc.
35 Corporate Dr.
Trumbull, CT 06611
203-268-0030
Part No.: N/A; Price: \$395 to 895
page 207
- MacLinkPlus/Wang VS** The DataViz MacLinkPlus/Wang VS terminal-emulation feature enables Macintosh users to emulate a Wang workstation. It uses on-screen buttons and pull-down menus, mouse control of the Wang screen, and Clipboard copy and paste.
DataViz, Inc.
35 Corporate Dr.
Trumbull, CT 06611
203-268-0030
Part No.: N/A; Price: \$125 to \$395
page 207
- MacLinkPlus/Wang OIS** MacLinkPlus/Wang OIS is a package for transferring and translating word processing documents between a Macintosh personal computer and a Wang OIS. The included library of file translators allows conversion in either direction between Wang OIS word processing documents and MacWrite II, Microsoft Word, Microsoft Works WP, and WordPerfect applications. Users can connect the Macintosh to the Wang or TC workstation.
DataViz, Inc.
35 Corporate Dr.
Trumbull, CT 06611
203-268-0030
Part No.: N/A; Price: \$495
page 207
- MacMainFrame Coax Gateway v3.2** MacMainFrame Coax Gateway is a hardware and software product that provides access to up to five IBM host sessions for any client Macintosh users connected to a Macintosh server via AppleTalk. The MacMainFrame Coax Gateway card can be co-resident on an AppleShare server and is available for the Macintosh SE, SE/30, and II families.
Avatar Technologies, Inc.
65 South St.
Hopkinton, MA 01748
508-435-3000
Part No.: N/A; Price: \$2495
page 176

MacMainFrame Coax WorkStation

Avatar Technologies, Inc.
65 South St.
Hopkinton, MA 01748
508-435-3000
page 176

The MacMainFrame Coax Workstation Series combines MacMainFrame Internal cards (for the SE, SE/30, or II) and application software to provide IBM3278/3279 terminal emulation, file transfer capabilities, and 3287 printer emulation for Macintosh computers. Products provide Macintosh connectivity to IBM CICS, TSO, or VM/CMS operating environments; available in CUT or DFT modes. Part No.: N/A; Price: \$995 to \$1295

MacMainFrame DX

Avatar Technologies, Inc.
65 South St.
Hopkinton, MA 01748
508-435-3000
page 175

MacMainFrame DX is an external IBM 3270 communications product that provides coax Macintosh-to-mainframe communications capability for all Macintosh computers, including the Macintosh Portable. It provides IBM 3278/3279 terminal-emulation and file transfer capabilities. Part No.: 89-2530-501; Price: \$1195

MacMainFrame Graphics v3.2

Avatar Technologies, Inc.
65 South St.
Hopkinton, MA 01748
508-435-3000
page 175

MacMainFrame Graphics is a software application that allows Macintosh users to access and manipulate host graphics locally on their Macintosh. Using the All Points Addressable (APA) graphics method, Macintosh users can access, transfer, and manipulate PICT, MacDraw, MacPaint, PIF, and GDF files from and between host applications. Part No.: 89-2570-501; Price: \$195

MacMainFrame SDLC Gateway v3.3

Avatar Technologies
65 South St.
Hopkinton, MA 01748
508-435-3000
page 188

MacMainFrame SDLC Gateway allows Macintosh users in an AppleTalk environment (LocalTalk, TokenTalk or EtherTalk) to run host applications on a local or remote IBM host without the need for an IBM controller. Using Synchronous Data Link Control (SDLC) communications, MacMainFrame SDLC provides up to 8 simultaneous IBM 3270 sessions per user and up to 64 sessions per server. Part No.: For II family, 8 sessions, 89-3208-000; 32 sessions, 89-3232-000; 64 sessions, 89-3264-000 Part No.: For SE/30, 8 sessions, 89-3308-000; 32 sessions, 89-3332-000; 64 sessions, 89-3364-000 Part No.: For SE, 8 sessions, 89-3408-000 Price: 8 host sessions, \$2495; 32 sessions, \$4495; 64 sessions, \$6495

MacMainFrame SDLC Workstation v3.3

Avatar Technologies
65 South St.
Hopkinton, MA 01748
508-435-3000
page 187

MacMainFrame SDLC Workstation combines hardware and software to allow a Macintosh user to directly access and manipulate IBM host information over a Synchronous Data Link Control (SDLC) connection. It provides an individual Macintosh user with access to up to eight simultaneous host 3278/3279 terminal, 3179G graphics, and 3287 printer sessions from remote locations. Part No.: For II family, 89-3201-000 Part No.: For SE/30, 89-3301-000 Part No.: For SE, 89-3401-000 Price: \$1295

MacMainFrame Token Ring Gateway v3.3

Avatar Technologies, Inc.
65 South St.
Hopkinton, MA 01748
508-435-3000
page 185

MacMainFrame Token Ring Gateway allows Macintosh users in an AppleTalk environment (LocalTalk, TokenTalk, EtherTalk) to run host applications from an IBM host that is resident on a token ring network. It combines hardware and software to provide IBM 3278/3279 terminal-emulation and file transfer capabilities and the ability to access up to 8 host sessions per user and up to 64 per server. Part No.: For II family, 8 sessions, 89-2808-000; 32 sessions, 89-2832-000; 64 sessions, 89-2864-000 Part No.: For SE/30, 8 sessions, 89-3008-000; 32 sessions, 89-3032-000; 64 sessions, 89-3064-000 Part No.: For SE, 8 sessions, 89-2908-000 Price: 8 host sessions, \$2495; 32 sessions, \$4495; 64 sessions, \$6495

MacMainFrame Token Ring Workstation v3.3

Avatar Technologies, Inc.
65 South St.
Hopkinton, MA 01748
508-435-3000
page 185

MacMainFrame Token Ring Workstation combines hardware and software to provide Macintosh users with access to host information on a token ring network. It provides access to up to 8 simultaneous host sessions and because it is TokenTalk compatible, also provides Macintosh-to-Macintosh and Macintosh-to-PC communication capabilities. It transmits and receives data at 4 Mbps.
Part No.: For II family, 89-2801-000
Part No.: For SE/30, 89-3001-000
Part No.: For SE, 89-2901-000
Price: \$1295

MACMENLO

Menlo Business Systems, Inc.
201 Main St.
Los Altos, CA 94022
415-948-7920
page 202

MACMENLO is a terminal emulation program that lets Macintosh users access any Tandem application. It supports Tandem 6510 and 653X terminal emulation in both conversational and block (page) modes, providing access to block-mode applications, including TEdit, Pathway, FOUNDATION, and the VS-Editor.
Part No.: N/A; Price: \$395

MacNIX 3.1 Serial

Unipress, Inc.
2025 Lincoln Hwy.
Edison, NJ 08817
201-985-8000
page 158

MacNIX is a distributed software allowing Macintosh users access to the host UNIX facilities via the Macintosh user interface. UNIX files are displayed as Macintosh computer-like icons and are given a specific set of operations. Operations can be called by selecting menu options with the mouse. MacNIX is a distributed software based on a Client/Server architecture. Connections can be made either via serial lines or via Ethernet network using TCP/IP protocols.
Part No.: N/A; Price: \$800 to 9800

MacNOW

Telos Advanced Systems
1315 Directors Row
Fort Wayne, IN 46808
219-484-0348
page 137

MacNOW from Telos Advanced Systems provides a Macintosh interface to Digital's ALL-IN-1 office-automation software. MacNOW supports electronic mail, file management, file transfer, terminal emulation, and other features of ALL-IN-1 in a Macintosh environment—complete with pull-down menus, dialog boxes, and the mouse to select, drag, and click.
Part No.: MacNow/VAX license; Price: \$3000
Part No.: MacNow/Macintosh; Price: \$200

MacPROFF v1.2

Mariette Systems International
29 El Cerrito Ave.
San Mateo, CA 94402
415-344-1519
page 190

MacPROFF is a HyperCard based front-end for the IBM PROFS electronic mail system. It uses High Level Language Application Program Interface (HLLAPI) technology capable of displaying IBM mainframe computer screens (like PROFS screens) in HyperCard.
Part No.: 90-0000-003; Price: Contact Supplier

MacRAF

Datability Software Systems Inc.
322 Eighth Ave., 11th floor
New York, NY 10001
800-DIAL DSS
page 125

MacRAF provides users with high speed remote file and print service between a Macintosh and a VAX host computer on the Ethernet network. The software includes VT100 and VT200 terminal emulation and supports up to 10 simultaneous terminal sessions.
Part No.: N/A; Price: \$495 for Macintosh Software
Part No.: N/A; Price: \$295 for VAX/VMS Software

MacRing NB

h-Three Systems
P.O. Box 12557
Research Triangle Park, NC 27709
800-MAC-RING
page 184

MacRing NB is an expansion card that connects a Macintosh II series computer to a token ring Network and provides complete AppleTalk compatibility and IBM connectivity. MacRing NB users can interconnect Macintosh computers and IBM-compatible PCs on token ring Networks, and use third-party Macintosh software to connect to IBM mainframes and midrange systems.
Part No.: 00051101; Price: \$895

- MacRing SE, SE/30** MacRing SE and MacRing SE/30 are expansion cards that connect Macintosh SE and SE/30 computers to token ring networks and provide AppleTalk compatibility and IBM connectivity. MacRing SE and SE/30 users can interconnect Macintosh computers and IBM-compatible PCs on token ring networks, and use third-party Macintosh software to connect to IBM mainframes and midrange systems.
h-Three systems
P.O. Box 12557
Research Triangle Park, NC 27709
800-MAC-RING
page 184
Part No.: N/A; Price: \$795 for Macintosh SE
Part No.: N/A; Price: \$895 for Macintosh SE/30
- MACROL, Inc.** Product: RP244PC Utility
496 Coelho St., Milpitas, CA 95035, 408-945-0346
- MacSoft** Products: VSterm, VsComm
2920 F St., Bakersfield, CA 93301, 312-443-1222
- MacTCP** The MacTCP application provides a standard platform for developing applications and services using C and Assembly language interfaces over TCP/IP protocols. Licensed to third-party developers, MacTCP includes TCP, UDP, and IP protocols and conforms to Internet RFCs and MIL-STDs, ensuring interoperability with systems on the TCP/IP Internet. MacTCP runs over both Ethernet and LocalTalk cable systems.
APDA (Apple Programmers & Developers Association)
Apple Computer, Inc.
20525 Mariani Ave., MS 33G
Cupertino, CA 95014
800-282-2732 (U.S.)
800-637-0029 (Canada)
408-562-3910 (International)
page 156
Part No.: M0230LL/A; Price: \$100, single user license; site and commercial license also available.
Part No.: M0216LL/A, Documentation Kit; Price: \$60
- MacTerminal v3.0** MacTerminal v3.0 is a terminal emulation and communications application that enables Macintosh users to communicate with many host computers such as VMS and UNIX systems. With MacTerminal, users can also access electronic bulletin boards and on-line databases such as CompuServe, DIALOG, and Dow Jones News/Retrieval. MacTerminal supports the Macintosh Communications Toolbox.
Apple Computer, Inc.
20525 Mariani Ave.
Cupertino, CA 95014
408-996-1010
page 128
Part No. MO521/C; Price: \$125
- MacToken** MacToken allows users to identify all devices connected to a token ring network and also to capture link-layer data passing along the network. MacToken allows users to set up, maintain, and troubleshoot token ring networks.
EDI Communications Corp.
20440 Town Center LN., #4E
Cupertino, CA 95014
408-996-1343
page 186
Part No.: LEV011048; Price: \$1500
- MacToPic** MacToPic emulates Adds Viewpoint, DEC VT101 and McDonnell Douglas Prism terminals and transfers data from Pick hosts to the Macintosh computer. Data transferred from the Pick host can be used in all Macintosh spreadsheets, databases, word processors and page layout programs. Macintosh text files can be transferred to the Pick Host.
Carnation Software
P.O. Box 608
Carnation, WA 98014
206-333-4288
page 213
Part No.: 101; Price: \$195 per program or \$2000 site license

MacWorkStation v3.1

APDA (Apple Programmers & Developers Association)
 Apple Computer, Inc.
 20525 Mariani Ave., MS 33G
 Cupertino, CA 95014
 800-282-2732 (U.S.)
 800-637-0029 (Canada)
 408-562-3910 (International)
page 32

MacWorkStation is a high-level programming tool for Macintosh computers which provides the standard Macintosh user interface, printing, and filing services to client applications running on a remote computer, such as Digital VAX or IBM 370s, or on the same computer as MacWorkStation. The client applications can be written in any language, on any host or personal computer connected over a wide variety of network and communication protocols.

Part No.: M0684; Price: \$100, single user license; site & commercial license also available.

Part No.: M7059/A, MacWorkStation v3.1 documentation kit; Price: \$65

Part No.: M0124LL/A, MacWorkStation Dialog Builder v1.0B1; Price: \$25

Part No.: M0123LL/A, MacWorkStation Event Handler v1.0B1; Price: \$25

MacX

Apple Computer, Inc.
 20525 Mariani Ave.
 Cupertino, CA 95014
 408-996-1010
page 160

MacX is an X Window system display server that implements X Windows, a network-based, industry-standard windowing and graphics environment. MacX supports multiple networking protocols, including AppleTalk, TCP/IP, and DECnet, using the Macintosh Communications Toolbox. MacX supports monochrome and color applications, allows for cut and paste between Macintosh applications and X applications. MacX has been optimized for DECwindows support.

Part No.: N/A; Price: \$299

MacX25

APDA (Apple Programmers & Developers Association)
 Apple Computer, Inc.
 20525 Mariani Ave., MS 33G
 Cupertino, CA 95014
 800-282-2732 (U.S.)
 800-637-0029 (Canada)
 408-562-3910 (International)
page 84

This is a collection of software routines that offer a high-level program interface that links Macintosh computers to packet-switched data networks. No detailed knowledge of AppleTalk and AppleTalk Data Stream Protocol (ADSP) is required to use the library. Some of the routines included are a packet-level interface using control blocks that provide maximum control, and a higher-level logical packet interface to create translated and formatted X.25 packets.

Part No.: B0314LL/A, MacX25 Developer's Kit; Price: \$2324

Part No.: MO711, MacX25 Server Software Kit; Price: \$800

Part No.: B0315LL/A, MacX25 Server Software Kit w/serial NB card; Price: \$2124

Magic Software, Inc.

Product: Backmatic v1.1.
 2206 Franklin St., Bellevue, NE 68005, 402-291-0670

Mail*Link SMTP

StarNine Technologies, Inc.
 2126 Sixth St.
 Berkeley, CA 94710
 415-548-0391
page 161

Mail*Link SMTP is an E-mail gateway between Macintosh mail systems and UNIX mail. Mail*Link provides peer-to-peer mail delivery between Macintosh mail (QuickMail, Microsoft Mail, and TOPS InBoxPlus) products and Apple's A/UX and other systems that support Simple Mail Transfer Protocol (SMTP). Mail*Link runs on a Macintosh using MacTCP for TCP/IP support, allowing mail to be transferred over both Ethernet and LocalTalk.

Part No.: N/A; Price: \$249

MailMate

Alisa Systems Inc.
 221 East Walnut St., Suite 175
 Pasadena, CA 91101
 818-792-9474
page 137

The MailMate family of products provide gateways to DECnet mail users for existing Macintosh computer-based electronic mail packages. MailMate gateways are available for CE Software's QuickMail and Microsoft Corp.'s Microsoft Mail v2.0. The MailMate gateways provide two-way exchange of text messages with Digital Equipment Corporation's DECnet mail (also known as VMSmail).

Part No.: N/A; Price: \$950 to \$9450

Makeasy 2.1 Makeasy is a distributed software allowing Macintosh users access to the host VMS facilities via the Macintosh user interface. VMS files are displayed as Macintosh computer-like icons and are given a specific set of operations. Operations can be called by selecting menu options with the mouse.
Unipress, Inc. Makeasy is a distributed software based on a client/server architecture. Connections can be made either via serial lines or via Ethernet network using AppleTalk or DECnet protocols.
2025 Lincoln Hwy. Part No.: N/A; Price: \$3000 to \$9800
Edison, NJ 08817
201-985-8000
page 127

Mariette Systems International

Product: MacPROFF
29 El Cerrito Ave., San Mateo, CA 94402, 415-344-1519

Masquerade3270 Masquerade3270 is a software product that enables users to create IBM host front-ends without modifying the mainframe application and without programming on the Macintosh. Masquerade3270 enables a user to create a custom Macintosh application the acts as an intelligent layer between a 3270 mainframe application and its end users.
Connectivité Corp. Part No.: N/A; Price: \$200 to \$1200
101 Executive Blvd.
Elmsford, NY 10523
914-592-2853
page 193

MAX Menlo Business Systems' MAX is a Tandem-based program that facilitates error-free file transfer between Tandem Computer mainframes and Macintosh computers. Most users can transfer files using Macintosh point-and-click file selection and predefined command macros stored in a Tandem database.
Menlo Business Systems, Inc. Part No.: N/A; Price: \$3500
201 Main St.
Los Altos, CA 94022
415-948-7920
page 203

MaxNotes MaxNotes provides a Macintosh-based interface to Digital Equipment Corporation's VAX Notes electronic conferencing system. It uses Alisa's Macintosh DECnet package or a special AppleTalk for VMS package to connect to remote VAX Notes conferencing servers. DECnet access may be via Ethernet, LocalTalk (and the Shiva FastPath), or asynchronous (DDCMP) connection.
Alisa Systems Inc. Part No.: N/A; Price: \$295
221 East Walnut St., Suite 175
Pasadena, CA 91101
818-792-9474
page 138

MaxWay 500 Family MaxWay 500 is based on the 10 MIPS SPARC CPU and utilizes the VME expansion bus. MaxWay 500 concurrently supports four LocalTalk and two high-speed LANs (any combination of Ethernet/IEEE 802.3 and token ring); used as multi-LAN AppleTalk Router. MaxWay 500E supports Ethernet and LocalTalk routing among four LocalTalk LANs and expands to include another Ethernet or token ring LAN. MaxWay 500TR supports token ring connectivity/routing among four LocalTalk and Token Ring (IEEE 802.5) LANs.
Tri-Data Systems, Inc. Part No.: N/A; Price: \$7495
3270 Scott Blvd.
Santa Clara, CA 95054
408-727-3270
page 15

Menlo Business Systems, Inc.

Products: FOUNDATION Vista, FOUNDATION Graphics, FOUNDATION CBT, MACMenlo, MENLOCOM, MAX, Spool AT, Current Loop Converter, FOUNDATION Vista Translator
201 Main St., Los Altos, CA 94022, 415-948-7920

MENLOCOM MENLOCOM applies the Macintosh interface to standard Tandem database information. As a result, data can be viewed in user defined formats on the Macintosh screen. In addition, MENLOCOM allows integration of data from Tandem and Macintosh databases.
Menlo Business Systems, Inc. Part No.: N/A; Price: Contact Supplier
201 Main St.
Los Altos, CA 94022
415-948-7920
page 203

Meridian Data Services Digital Line Cards

Northern Telecom
2100 Lakeside Blvd.
Richardson, TX 75080
214-437-8000
page 60

The Meridian 1/SL-100 Async Interface Line Card and Data Line card enables Digital's computers to be directly linked to the Meridian 1 (SL-1 and SL-100 series systems).
Part No.: N/A; Price: \$350 per port

Meridian LANSTAR Local Area Network for AppleTalk

Northern Telecom
2305 Mission College Blvd.
Santa Clara, CA 95054
408-988-5550
page 61

LANSTAR AppleTalk is a network topology and transport system compatible with all the leading operating system standards. Different interface cards are available for a wide range of servers or desktop computers, including IBM PCs, PC/ATs and compatibles, PS/2 computers, and Macintosh computers. LANSTAR AppleTalk implements AppleTalk protocols on Northern Telecom's twisted-pair establishment-wide network.
Part No.: N/A; Price: Contact Supplier

Meridian SL-1 Data Services

Northern Telecom
2305 Mission College Blvd.
Santa Clara, CA 95054
408-988-5550
page 66

The Meridian 1 provides a way for an organization to transfer information from the MS-DOS environment to the Macintosh, at distances of up to 8000 feet. A connect file for MacLinkPlus that enables the user to transfer and convert files between personal computers attached to the Meridian SL-1 is available from DataViz. An IBM PC or compatible can be connected to the Meridian SL-1 by using a Personal Computer Interface Card.
Part No.: N/A; Price: \$580

Meridian SL-1 Support for the Apple LaserWriter Printer

Northern Telecom
2305 Mission College Blvd.
Santa Clara, CA 95054
408-988-5550
page 61

The Apple LaserWriter printer is connected asynchronously to the Meridian SL-1 through a wall jack by using a DB9-to-RJ11 cable to a port on a QPC430 line card. The Macintosh computer that prints to this LaserWriter printer can be located anywhere there is a Meridian SL-1, where Meridian SL-1s are interconnected via Northern Telecom's ESN.
Part No.: N/A; Price: \$301 to \$380

Meridian SL-100

Northern Telecom
2100 Lakeside Blvd.
Richardson, TX 75080
214-437-8000
page 61

The Meridian SL-100 provides a way for an organization to transfer information from the MS-Dos environment to the Macintosh, at distances of up to 36,000 feet. An IBM PC or compatible can be connected to the Meridian SL-100 by using a Personal Computer Interface card, Meridian Asynchronous Data Option, or Data Unit.
Part No.: N/A; Price: \$550

Meridian TeleCenter

Northern Telecom
2305 Mission College Blvd.
Santa Clara, CA 95054
408-988-5550
page 60

Meridian TeleCenter adds the telephone to the Macintosh desktop metaphor. It gives users on-line telephone directory dialing, multiple telephone directories, automatic phone call access, incoming call notification, Meridian Mail voice messaging system screen menus, and network features such as Called/Calling Party Name Identification.
Part No.: N/A; Price: \$200

Messenger Software, Inc.

Product: xFer 1.1
180 W. Streetsboro Rd., Unit #5, Suite #302, Hudson, OH 44236

MicroPhone II v3.0

Software Ventures
2907 Claremont Ave.
Berkeley, CA 94705
415-644-3232
page 81

A general purpose telecommunications program for both novice and expert users. Its Pascal-like scripting language can be extended through standard XCMDs and XFCNs. The program supports many terminal emulations and a wide range of file transfer protocols, including ZMODEM.
Part No.: N/A; Price: \$295

Microsoft Corporation

Product: Microsoft Mail 2.0
Box 97017, Redmond, WA 98073-9717

Microsoft Mail 2.0

Microsoft Corporation
P.O. Box 97017
Redmond, WA 98073-9717
page 25

Microsoft Mail 2.0 is an electronic mail system. Notes, files, graphics, and voice messages can be sent and received. Mail gateways and applications allow connectivity with other E-mail systems and customization of the user's system. Mail is also integrated with Microsoft Excel and Word.
Part No.: N/A; Price: \$395

Mitem Corporation

Product: MitemView
2105 Hamilton Ave., San Jose, CA 95125, 408-559-8801

MitemView

Mitem Corporation
2105 Hamilton Ave., Suite 190
San Jose, CA 95125
408-559-8801
page 33

MitemView allows users to create graphic user interfaces to mainframe applications by combining HyperCard/HyperTalk with pattern-recognition. MitemView supports TTY, VT52, VT100, 3270, 6530 terminal emulation, and async, SNA communications protocol.
Part No.: MV-K-DEV; Price: \$995

Mt. Xinu, Inc.

Products: K-Share, K-Spool, K-Talk, XINET
2560 Ninth St., #312, Berkeley, CA 94710, 415-644-0146

MultiGate

Webster Computer Corp.
2109 O'Toole Ave., Suite J
San Jose, CA 95131-1303
408-954-8054
page 151

MultiGate allows integration of Apple Macintosh and Ethernet networks. MultiGate performs AppleTalk routing on four independent LocalTalk networks while acting as a TCP/IP gateway. Single, large LocalTalk networks can be separated into smaller, compact LocalTalk networks connected by MultiGate to form an internet.
Part No.: N/A; Price: \$4995

MultiGate Access

Network Resources Corp.
2450 Autumnvale Dr.
San Jose, CA 95131
408-263-8100
page 153

MultiGate Access is a collection of software applications that allow users to access host systems using the Macintosh interface, including: MacEdit, which allows users to edit host-based documents; MacFTP, which allows users to transfer files to and from hosts; MacTerm 2000, a VT100 terminal emulator; and LocalTerm, a serial driver replacement. MultiGate Access must be used in conjunction with either MultiGate Mac or IPGate/MultiGate 2000.
Part No.: N/A; Price: \$80

MultiGate Mac

Network Resources Corp.
2450 Autumnvale Dr.
San Jose, CA 95131
408-263-8100
page 153

MultiGate Mac routes between as many as six networks. AppleTalk, AppleTalk to TCP/IP (KIP and CAP-style encapsulation), full TCP/IP to TCP/IP and MSP to TCP routing and gateway functions are handled by MultiGate Mac. MultiGate Mac adheres to TCP/IP "Interior Gateway" specifications RFC-950 and proxy-ARP. Features include a powerful network management interface, security controls and SNMP support.
Part No.: N/A; Price: \$795

- MultiGate Manager** MultiGate Manager is a centralized network management package which uses standard network management protocols and the Oracle database to manage AppleTalk networks. Features include the ability to make router changes at specified times, statistical analysis of performance, failure diagnosis, report generation, backbone tuning, zone naming, network numbering and router naming.
Network Resources Corp.
2450 Autumnvale Dr.
San Jose, CA 95131
408-263-8100
page 154 Part No.: N/A Price: \$795
- MultiUser Helix** MultiUser Helix is the database server for Double Helix applications. Built-in referential integrity provides immediate on-screen information and updating across the network, multi-threaded searching, personalized menus and password protection, and data logging for data security. MultiUser Helix does not require any special fileserving hardware or software.
Odesta Corp.
4084 Commercial Ave.
Northbrook, IL 60062
800-323-5423
page 133 Part No.: N/A; Price: \$495, additional nodes \$150 each
- NATURAL ARCHITECT Workstation** NATURAL ARCHITECT Workstation is a Computer Aided Software Engineering (CASE) facility that provides analysis and design support for the development of business applications systems. NATURAL ARCHITECT Workstation provides graphics editors for entity-relationship, data flow, and program structure diagrams to support requirements analysis.
Software AG
11190 Sunrise Valley Dr.
Reston, VA 22091
703-860-5050
page 34 Part No.: N/A; Price: \$2000 to \$8000
- NATURAL CONNECTION** NATURAL CONNECTION for the Macintosh enables users to interact with the IBM Mainframe and DEC/VAX NATURAL environment from Macintosh workstations. NATURAL CONNECTION provides host terminal emulation, and transfer of data between host-based application written in NATURAL and the Macintosh workstation. Both directions of data transfer are supported. Automation of repetitive tasks, such as host access, is allowed.
Software AG
11190 Sunrise Valley Dr.
Reston, VA 22091
703-860-5050
page 34 Part No.: N/A; Price: \$300
- Neon Software** Product: NetMinder Ethernet
1009 Oak Hill Rd., Suite 203, Lafayette, CA 94549, 415-283-9771
- Net Access** Using a Solana communications server, Macintosh users can select, and work as a part of, a remote AppleTalk network. Transparent to the user, this connection is made though the Meridian SL-1 or Meridian SL-100 at speeds of up to 64 Kbps, and at distances of up to 8000 feet (Meridian SL-1) or up to 36,000 feet (Meridian SL-100). When the link is made, the remote Macintosh has all the rights of a local one—access to LaserWriter printers, file servers, and electronic mail.
Solana Electronics
4907 Morena Blvd., Suite 1404
San Diego, CA 92117
619-490-5050
page 65 Part No.: N/A; Price: \$937
- NetAxxess** NetAxxess connects any IBM System/36, System/38 or AS/400 to any Macintosh on an AppleTalk network. NetAxxess is an expansion card (Macintosh SE, SE/30, and II) and server software that runs in the background on any Macintosh to distribute IBM midrange connectivity across the AppleTalk network to all other Macintosh computers on the network.
Andrew KMW Systems
6034 West Courtyard Dr.,
Austin, TX 78730, 512-338-3000
page 181 Part No.: N/A; Price: \$3995
- NetBridge** NetBridge is a local AppleTalk router. It can either extend a network beyond its normal wiring and node limits, or connect two local, separate networks into one internetwork.
Shiva Corporation
155 Second St.
Cambridge, MA 02141
617-864-8500
page 16 Part No.: N/A; Price: \$499

- NetMap**
AESP
1810 N.E. 144th St.
N. Miami, FL 33181
800-446-2377
page 23
- NetMap is a desk accessory that lets users trace the activity of every AppleTalk device on the network. Remote capability allows users to maintain local network as well as any network that connects to the user's network through a series of AppleTalk bridges.
Part No.: N/A; Price: \$90
- NetMinder Ethernet**
Neon Software
1009 Oak Hill Rd., Suite 203
Lafayette, CA 94549
415-283-9771
page 83
- NetMinder Ethernet is a software product that allows the user to capture, examine and analyze all types of Ethernet network data. The user captures all Ethernet data or filter data using dialog-based protocol configuration templates. Captured data is examined decoded by protocol. Analysis features include bandwidth, by protocol, and node.
Part No.: NME1; Price: \$495
- NetModem v32**
Shiva Corporation
155 Second St.
Cambridge, MA 02141
617-864-8500
page 20
- NetModem v32 is a 9600 bps, v32-compatible modem that is shared over an AppleTalk network. NetModem v32 provides dial-in network access, which allows a user to access file servers, printers, electronic mail, and other AppleTalk resources from a remote location. Remote network-to-network routing between two networks which have NetModem V.32's is also included.
Part No.: N/A; Price: \$1999
- NetModem v2400**
Shiva Corporation
155 Second St.
Cambridge, MA 02141
617-864-8500
page 19
- NetModem v2400 is a 2400 bps modem that is shared over an AppleTalk network. It includes dial-in network access software which lets a user access file servers, printers, electronic mail and other network resources from a remote location.
Part No.: N/A; Price: \$599
- Net/One MacUWS**
Ungermann-Bass
3900 Freedom Cir.
Santa Clara, CA 95052-8030
408-496-0111
page 158
- MacUWS provides a Macintosh front-end to host applications, allowing users to turn routine activities into an interactive process with pull-down menus, scroll bars, and selection buttons for point-and-click mouse support. End users can share resources and information though the network with MacUWS. Included is a VT100 terminal emulator that supports up to five Telnet sessions.
Part No.: N/A; Price: Contact Supplier
- NetShare 1.0**
Distributed Technologies, Inc.
19823 58th Place South
Kent, WA 98032
206-395-7800
page 67
- NetShare allows a Unisys/Convergent workstation to function as an AFP file server on a Macintosh network. A Macintosh resident mail gateway to the BTOS electronic mail system and translation utilities for word processing and spreadsheet documents are included.
Part No.: A/U-001; Price: \$2995, 1 to 8 users; \$1795, 9- to 32-user upgrade
- NetSerial X232**
Shiva Corporation
155 Second St.
Cambridge, MA 02141
617-864-8500
page 19
- NetSerial is a high-speed hardware interface which connects a serial peripheral to an AppleTalk network. NetSerial is compatible with any serial device which can connect directly to a Macintosh, including printers, plotters, and modems.
Part No.: N/A; Price: \$399

- NetStream** NetStream 2.0 is a network backup software program designed to provide automatic, unattended backups of an entire AppleTalk network, as well as AppleShare servers.
Personal Computer Peripheral Corp.
4170 Eisenhower Blvd., Bldg A-4, Tampa, FL
33634, 813-3092
Part No.: N/A; Price: \$89
page 12
- NetWare for Macintosh** NetWare's Macintosh support consists of NetWare extensions called Value Added Processes (VAPS) which run on NetWare file servers or bridges. Features include multitasking; performance-optimized disk seeking, and disk caching; file and printer sharing between Macintosh, MS-DOS and OS/2 workstations; transaction tracking; disk write verification; uninterruptible power source monitoring; support for LocalTalk, Ethernet, and ARCNET cabling media.
Novell, Inc.
1122 East 1700 South
Provo, UT 84606
800-LAN-KIND
Part No.: 883-000585-001; Price: \$200
page 51
- Netway 1000** The Netway 1000AE Communication Server allows Macintosh users on an AppleTalk network to access an IBM host computer. By emulating an IBM 3274 controller, this hardware and software system establishes a link between Macintosh computers and an IBM host system, allowing the Macintosh computers to operate as 3278-2, 3, 4 and 5 terminals and communicate with the host system.
Tri-Data Systems, Inc.
3270 Scott Blvd.
Santa Clara, CA 95054
408-727-3270
Part No.: 1000AE; Price: \$3995 retail
page 188
- Netwise, Inc.** Product: Netwise RPC TOOL
2477 55th St., Boulder, CO 80301, 303-442-8280
- Netwise RPC TOOL** Based on Remote Procedure Call (RPC) technology, the Netwise RPC TOOL enables C programmers to write applications across multivendor networks. The tool generates network communications source code to support distributed processing between all components of a network, regardless of underlying operating systems and hardware.
Netwise, Inc.
2477 55th St.
Boulder, CO 80301
303-442-8280
Part No.: N/A; Price: Contact Supplier
page 35
- Network Administrator's Utility** The Network Administrator's Utility contains tools to implement a network support program. It supports a multi-vendor AppleTalk network, including Macintosh, MS-DOS and PS/2 and DEC VAX computers.
Farallon Computing
2000 Powell St., #600
Emeryville, CA 94608
415-596-9100
Part No.: M0697; Price: \$129
page 23
- Network Manager's Pack** The PhoneNET Manager's Pack is a software toolkit for monitoring, managing, and documenting an AppleTalk network. It includes a one-year subscription to Farallon's line of network management software: TrafficWatch II, NetAtlas, NetStats, CheckNET, and StarCommand 2.0. Also included are two copies of Timbuktu software.
Farallon Computing, Inc.
2000 Powell St., #600
Emeryville, CA 94608
415-596-9100
Part No.: NM200; Price: \$995
page 23
- Network Resources Corp.** Products: MultiGate 2000, IPGate, MultiGate Manager, MultiGate Mac, MultiGate Access, Mac2000
2450 Autumnvale Dr., San Jose, CA 95131, 408-263-8100

- Nightshift v3.1** Transitional Technology, Inc.
5401 E. La Palms Ave.
Anaheim, CA 92807
714-693-1133
page 13
- Nightshift is a tape-drive/software solution which facilitates centralized, unattended backup of an entire Macintosh network including servers. Features include a backup log window, timer scheduler, node security, and auto-shutdown. Hardware consists of a TTI 4mm or 8mm helical-scan tape drive providing 1.3 and 2.3 gigabytes of storage respectively.
Part No.: 4mm bundle, CTS4M; Price: \$4795
Part No.: 8mm bundle, CTS8000M; Price: \$6295
- Nittany Development Group**
- Product: DBF-Access Tools for HyperCard 1.0
606 No. Armistead St., Alexandria, VA 22312, 703-256-0791
- Nodem LIU** Adaptec Inc.
691 So. Milpitas Blvd.
Milpitas, CA 95035
408-945-2518
page 68
- The Nodem LIU provides Macintosh computers direct connection to Ethernet using the SCSI port. It is an Ethernet device that does not require the user to remove the case of the Macintosh. The Nodem is available in four different models to support the different Ethernet cabling schemes.
Part No.: N/A; Price: \$495to \$595
- Northern Telecom**
- Products: Meridian SL-1, Meridian SL-100, Meridian LANSTAR Local Area Network for AppleTalk, LANSTAR NetWare for Macintosh, Meridian Data Services Digital Line Cards, Meridian TeleCenter
2305 Mission College Blvd., Santa Clara, CA 95054, 408-988-5550
2100 Lakeside Blvd., Richardson, TX 75080, 214-437-8000
- Novell, Inc.**
- Products: NetWare for the Macintosh, TCPort, LanWorkPlace for Macintosh, Etherport SEL, Etherport SE/30L
1122 East 1700 South, Provo, UT 84606, 800-LAN-KIND
- NRC Mac2000** Network Resources Corp.
2450 Autumnvale Dr.
San Jose, CA 95131
408-263-8100
page 11
- NRC Mac2000 is an MCP-based network interface board with 512K of RAM, a microprocessor and operating system for Macintosh II computers. Currently, a Mac2000-equipped Macintosh can communicate with a diverse range of computer systems based on Ethernet, broadband and fiber-optic including Digital VAX and MicroVAX computers, UNIX-based computers and PCs.
Part No.: N/A; Price: \$995
- NRC MultiGate 2000** Network Resources Corp.
2450 Autumnvale Dr.
San Jose, CA 95131
408-263-8100
page 16
- The MultiGate 2000 connects LocalTalk/PhoneNET systems and LaserWriter printers with Ethernet, broadband and fiber-optic networks. Fully self-configuring, NV RAM protects configuration parameters during power outages. MultiGate Manager Jr. software is provided. Functionality can be expanded by downloading IPGate TCP/IP software.
Part No.: LT2000E for Ethernet, LT2000FO for Fiber Optic; Price: \$2395
Part No.: LT2000 for Broadband versions; Price: \$2795
- Odesta Corp.**
- Product: Odesta Document Management System, Multiuser Helix, Helix VMX
4084 Commercial Ave., Northbrook, IL 60062, 800-323-5423
- Odesta Document Management Systems** Odesta Corp.
4084 Commercial Ave.
Northbrook, IL 60062
800-323-5423
page 135
- Odesta Document Management Systems (ODMS) is a family of workflow and document-management applications for Macintosh/VAX multi-user networks. ODMS gives a bird's eye view of the status of all work being done on the network. ODMS includes built-in networking software. ODMS is compatible with most VAX-based file servers and can incorporate MS-DOS PC documents using Digital's VMS Services for MS-DOS.
Part No.: N/A, Price: from \$20,000

- Omnis5** Omnis5 is a development platform that enables users to create multiuser, multiplatform applications. SQL connectivity to Oracle and other Sequel databases allows Omnis 5 to retrieve and enter data on both the VAX and the Mainframe. The graphic user interface supports full color graphics. Omnis HyperCard/SuperCard access allows HyperCard/SuperCard Stacks to read and write to Omnis 5 datafiles in both single and multiuser installations.
Blyth & Associates
1065 East Hillsdale Blvd., Suite 300
Foster City, CA 94404
415-571-0222
page 37 Part No.: N/A; Price: \$795
- Oracle Corp.** Product: ORACLE for the Macintosh.
500 Oracle Pkwy., Redwood Shores, CA 94065, 800-ORACLE-1
- ORACLE for the Macintosh** ORACLE for the Macintosh is a development tool product which makes possible the creation of Macintosh front-end applications that access Oracle databases on mainframes and minis. With Oracle, data can reside in the local Macintosh database, as well as in remote databases.
Oracle Corp.
500 Oracle Pkwy.
Redwood Shores, CA 94065
800-ORACLE-1
page 36 Part No.: N/A; Price: \$299 to 999
- Orange Micro, Inc.** Products: Mac286, ICP, Grappler LX, Mac86
1400 No. Lakeview Ave., Anaheim, CA 92807, 800-223-8029
- OSF/Motif 1.0.3 for A/UX 2.0** OSF/Motif is a vendor-independent toolkit for developing graphic user interfaces for the X Window System. Interfaces developed are portable to all X platforms and compatible with Presentation Manager behavior. Motif features UIL (User Interface Language) which allows prototyping of the interface.
Integrated Computer Solutions, Inc.
163 Harvard St.
Cambridge, MA 02139
617-547-0510
page 159 Part No.: N/A; Price: \$500
- PacerGraph** PacerGraph adds VT240 monochrome graphics and VT241 color graphics to the PacerLink terminal emulation product, allowing a Macintosh computer to display ReGIS and Tektronix 4010/4014 graphics. Macintosh editing features are used to mark a graphics region, cut it and paste it into another window where a paint or drawing program can modify it. Volume discounts available.
Pacer Software, Inc.
7911 Herschel Ave., Suite 402
La Jolla, CA 92037
619-454-0565
page 130 Part No.: N/A; Price: \$150
- PacerLink** PacerLink is a terminal emulation and desktop connectivity program that allows Apple Macintosh users to connect to and use many host computers. PacerLink provides a variety of capabilities such as file transfer, virtual disk, terminal emulation, and print services that enable Macintosh and PC users to solve their communication and resource-sharing problems. Volume discounts available.
Pacer Software, Inc.
7911 Herschel Ave., Suite 402
La Jolla, CA 92037
619-454-0565
page 128 Part No.: N/A; Price: \$2000
- PacerPost** PacerPost is a Microsoft Mail-compatible server that runs on a VAX using VMS. It functions like Microsoft's Macintosh based mail server. In addition, PacerPost provides VAX/VMS resident gateways to VAX based mail systems. PacerPost mail servers and gateways are designed to function in conjunction with other Microsoft Mail 2.0 servers and gateways to provide enterprise-wide electronic mail capability.
Pacer Software, Inc.
7911 Herschel Ave., Suite 402
La Jolla, CA 92037
619-454-0565
page 138 Part No.: N/A; Price: \$1000 to 8000

- PacerPrint** PacerPrint enables VMS or ULTRIX users to take advantage of PostScript printers. PacerPrint includes several filters that translate common file formats (text, Tektronix, Diablo) into PostScript. PostScript files created by users, host applications, or other computers (e.g., IBM PC or Apple Macintosh) can be printed in VMS or ULTRIX fashion.
Pacer Software, Inc.
7911 Herschel Ave., Suite 402
La Jolla, CA 92037
619-454-0565
page 123
Part No.: N/A; Price: \$1000 to 4000
- PacerShare** PacerShare is a software product that enables a VAX VMS, VAX ULTRIX or DEC system/station to act as a large file server for a Macintosh network, providing the same core functionality as a dedicated Macintosh running an AppleShare server. No software beyond the Apple-provided AppleShare client software is required on a Macintosh to access the PacerShare file server.
Pacer Software, Inc.
7911 Herschel Ave., Suite 402
La Jolla, CA 92037
619-454-0565
page 123
Part No.: N/A; Price: \$400, volume discounts available
- Pacer Software, Inc.** Products: PacerLink, PacerPrint, PacerShare, PacerGraph, PacerPost, PacerTOPS
7911 Herschel Ave., Suite 402, La Jolla, CA 92037, 619-454-0565
- PacerTOPS** PacerTOPS enables VAX VMS systems to participate in the distributed file serving environment with any Macintosh or IBM PC on a TOPS network. The merging of the VMS and TOPS file systems results in complete information sharing with performance comparable to a local hard disk. PacerTOPS allows TOPS workstation users to take advantage of the VAX system's disk storage capacity, backup functions and data security features.
Pacer Software, Inc.
7911 Herschel Ave., Suite 402
La Jolla, CA 92037
619-454-0565
page 124
Part No.: N/A; Price: \$40, volume discounts available
- Packet/3270 MAC** Packet/3270 MAC is the Macintosh computer component of Packet/PC's micro-to-mainframe communications software. It is an SNA/ASYNCR 3270 emulator for Macintosh computers which proves common, worldwide access to IBM 3270 SNA mainframe application systems via dial-up and public packet networks.
Software By Design, Inc.
98 C Pitkin St.
East Hartford, CT 06108
203-289-5561
page 179
Part No.: N/A; Price: \$295
- Page Studio Graphics** Product: PIXymbols
3175 N. Price Rd., #1050, Chandler, AZ 85224, 602-839-2763
- Personal Computer Peripheral Corp.** Products: DatStream, JetStream, NetStream
4170 Eisenhower Blvd., Tamp., FL 33634, 813-884-3092
- Personal Deft** Personal Deft is a CASE system supporting structured methods approaches of designing relational databases. Used by a single developer working on a Macintosh, the system is comprised of editors for drawing DFDs, ERDs, structure charts, forms and reports, and includes a syntax checker.
DEFT Inc.
557 Dixon Rd., #110
Rexdale, Ontario M9W1H7
416-249-2246
page 35
Part No.: N/A; Price: \$5900.
- Personal Phone** Personal Phone is an interactive AppleTalk desktop communications program based on the metaphor of a telephone. Personal Phone establishes an interactive link between two computers in order to carry on a conversation. All typing appears in a split window on each Macintosh. Background file transfers are possible. No dedicated computer is required.
Personal Software Development Corp.
22 Natalie Dr.
Hampton, VA 23666
804-898-3541
page 26
Part No.: N/A; Price: \$99 to \$169

Personal Server Network 2.0 PSN (Personal Server Network) is a distributed network server for Macintosh computers. PSN adopts the AppleShare user interface but requires no dedicated file server. It is compliant with the AppleTalk Filing Protocol and supports multi-user applications like 4th DIMENSION and FoxBASE+/Mac.
Information Presentation Technologies
23801 Calabasas Rd., Suite 2008
Calabasas, CA 91302
818-347-7791
Part No.: N/A; Price: \$100 to \$149

page 26

Personal Software Development Corp. Product: Personal Phone
22 Natalie Dr., Hampton, VA 23666, 804-898-3541

Pharos Technologies, Inc. Product: STATUS*Mac
4243 Hunt Rd., Cincinnati, OH 45242, 800-548-8871

PhoneNET Card PhoneNET Card, a twisted-pair Ethernet card for Macintosh computers, features a built-in twisted-pair transceiver, a built-in RJ-45 connector, and universal AUI (Attachment User Interface) connector. It is available for the Macintosh II and SE/30, and comes bundled with Timbuktu software.
Farallon Computing, Inc.
2000 Powell St., #600
Emeryville, CA 94608
Part No.: PN480; Price: \$649

415-596-9100

page 8

PhoneNET Connector PhoneNET Connector allows different devices such as computers, printers, and file servers on an AppleTalk network to communicate with each other over ordinary telephone cables. PhoneNET Connectors come in three models: Mini DIN-8 plug, DB-9 plug, DB-25 plug. They are compatible with LocalTalk cabling, FlashTalk, and DaynaTalk.
Farallon Computing, Inc.
2000 Powell St., #600
Emeryville, CA 94608

415-596-9100

page 7

Part No.: PN208, Mini DIN-8; Price: \$60, Single Pack

Part No.: PN210; Price: \$395, 10 Pack

Part No.: PN209, DB-9; Price: \$60

Part No.: PN225, DB-25; Price: \$75

PhoneNET Repeater PhoneNET Repeater regenerates and reclocks AppleTalk and FlashTalk signals allowing networks to extend longer distances and link a variety of network topologies including backbones, daisychains and stars, and StarControllers and networks in different buildings. PhoneNET Repeater includes built-in PhoneNET connectors allowing users to attach wire pairs directly to the Repeater.
Farallon Computing, Inc.
2000 Powell St., #600
Emeryville, CA 94608

415-596-9100

page 8

Part No.: PN200; Price: \$495

PhoneNet StarConnector Like standard PhoneNET Connectors, StarConnectors run AppleTalk over a single pair of telephone wires. StarConnectors are suited to both passive and active star topologies, the wiring plan used by telephone systems, and are designed for use with StarController Series 300. Pre-terminated with 120-ohm resistors, they automatically provide correct termination of each network branch.
Farallon Computing, Inc.
2000 Powell St., #600
Emeryville, CA 94608

415-596-9100

page 8

Part No.: PN301/PN311; Price: \$29, Single Pack; \$249, 10 Pack

PhoneNET Star Controller Series 300 PhoneNET StarController Series 300 is a repeating hub used to build AppleTalk networks. It includes a LED display for a summary of traffic on the 12 ports and alerts users to signal errors, and StarCommand 2.0 software for network management.
Farallon Computing, Inc.
2000 Powell St., #600
Emeryville, CA 94608

415-596-9100

page 8

Part No.: PN307; Price: \$1295

PHOTOLINK PHOTOLINK is a cable-replacement product which uses infrared light as the data transmission medium for connecting Macintosh computers or peripherals in open or partitioned offices or light manufacturing environments. Installation is "plug and play."
Photonics Corp. 200 E. Hacienda Ave. Campbell, CA 95008
408-370-3033
Part No.: 000193; Price: \$1195

page 8

Photonics Corp. Product: PHOTOLINK
200 E. Hacienda Ave., Campbell, CA 95008, 408-370-3033

PIXymbols PIXymbols are PostScript-based fonts for use in instructional materials and computer documentation relating to the PC. Users can duplicate and create PC screen images for printing from Macintosh system. In addition to a complete monospaced alphabet, including accented characters, the fonts emulate the extended ASCII character set used on the IBM PC. Four system-specific fonts come in one package.
Page Studio Graphics 3175 N. Price Rd., #1050 Chandler, AZ 85224
602-839-2763

Part No.: 2107/09; Price: \$145

page 104

Prime Computer Products: PRIMELINK, PRIMENET
Prime Park, Natick, MA 01760, 508-655-8000

PRIMELINK PRIMELINK's File Transfer facility allows Macintosh users to transfer ASCII, MacBinary, and binary files between a Macintosh computer and MS-DOS-compatible personal computers and the Prime host system, allowing the personal computers to interact with Prime workstations.
Prime Computer Prime Park Natick, MA 01760
508-655-8000

Part No.: N/A; Price: \$2250 to \$10,250
page 213

PRIMENET Remote Terminal Access allows any terminal in a LAN or WAN to access any Prime host on the network. Remote File Access allows users to access files on other networked Prime systems without regard to their physical location. For specialized network applications, an interprocess communications facility provides a high-level language subroutine interface. Another facility, the File Transfer Service, is a queued mechanism for transferring files between systems.
Prime Computer Prime Park Natick, MA 01760
508-655-8000

Part No.: N/A; Price: Contact Supplier
page 212

Prometheus Products Products: AcKNOWLEDGE, MAcKNOWLEDGE, Promodem, Promodem Minifax
7225 SW Bonita Rd., Tigard, OR 97223, 800-477-3473

ProModem Product Line The ProModem product line includes modem with throughput speeds from 300 bps to 19,200 bps, with both internal and external versions available.
Prometheus Products 7225 SW Bonita Rd. Tigard, OR 97223
800-477-3473
Part No.: PMD-4MF; Price: \$449 (Macintosh compatible). Part No.: PMD-8MF; Price: \$399 (MS-DOS compatible). Part No.: PMD-4; Price: \$279 (ProModem 2400M). Part No.: PMD-8GMNP; Price: \$299 (ProModem 2400M Plus). Part No.: PMD-24MII (Standard configuration); Price: \$299
Part No.: PMD-24MIIB (with MNP-5); Price: \$349. Part No.: PMD-24MIIC (with extra serial port); Price: \$349. Part No.: PMD-24MIID (with extra serial port and MNP-5); Price: \$399
Part No.: PMD-7M; Price: \$239. Part No.: PMD-7MFAX; Price: \$299. Part No.: PMD-24SE; Price: \$299
Part No.: PMD-24SEP; Price: \$349. Part No.: PMD-96M; Price: \$995
page 80

- PServe 3.0** PServe provides spooling, queueing, job management and accounting, and supports all Macintosh and DOS computers on LocalTalk and/or Ethernet. PServe is software hosted on a 286 computer with any AppleTalk interface card.
CoOperative Printing Solutions, Inc.
5950 Live Oak Pkwy., Suite 175
Norcross, GA 30093
404-840-0810
page 81
Part No.: 10102; Price: \$1125 (PServe with LocalTalk Card)
Part No.: 10121; Price: \$1495 (PServe with EtherTalk and LocalTalk Card)
- QuickMail v.2.2** QuickMail is an electronic mail system for use on AppleTalk networks, with connections to local and wide area networks, supporting multiple zones and servers, with gateways to UNIX, VAX mainframes, Fax, Novell MHS, CompuServe, AppleLink, and many other systems and services. QuickMail is compatible with AppleShare, TOPS, MacServe, MultiFinder, large-screen displays, and accelerator cards.
CE Software
P.O. Box 65580
West Des Moines, IA 50265
515-224-1995
page 25
Part No.: N/A; Price: \$500 per 10 users.
- R-Server** R-Server is a remote AppleTalk NetAccess and gateway/bridge-router. Users can dial-connect two remote AppleTalk networks or dial-in from a stand-alone Macintosh. A remote network appears as a local network and provides all network services such as printing, E-mail, TOPS, AppleShare, etc. Asynchronous speeds up to 57,600 bits/second are available.
Solana Electronics
7887 Dunbrook Rd., Suite A
San Diego, CA 92126
619-573-0800
page 68
Part No.: SE810; Price: \$595
- Racal InterLan, Inc.** Product: A/UX-DRV
155 Swanson Rd., Boxborough, MA 01719, 800-LAN-TALK
- Reflection 1 PLUS** Reflection 1 PLUS provides emulation of Hewlett-Packard's 2392A terminal. Features include basic-like script language, KERMIT, XMODEM, proprietary file transfer, MacBinary, context sensitive help, and the ability to backup entire hard disks to a single file on the host.
Walker Richer & Quinn, Inc.
2815 Eastlake Ave., East
Seattle, WA 98102
206-324-0407
pages 219
Part No.: R1mac; Price: \$299
- Reflection 2 PLUS** Reflection 2 PLUS provides emulation of Digital's VT320, VT220, VT102, and VT52 terminals. Features include basic-like script language, KERMIT, XMODEM, Proprietary file transfer, MacBinary and VAX image support, context sensitive help, and the ability to backup entire hard disks to a single file on the host.
Walker Richer & Quinn, Inc.
2815 Eastlake Ave., East
Seattle, WA 98102
206-324-0407
pages 131
Part No.: R2mac; Price: \$249
- Reflection 3 PLUS** Reflection 3 PLUS provides complete and accurate emulation of Hewlett Packard's 2393A graphics terminal. Features include basic-like script language, KERMIT, XMODEM, Proprietary file transfer, MacBinary, context sensitive help, and the ability to backup entire hard disks to a single file on the host.
Walker Richer & Quinn, Inc.
2815 Eastlake Ave., East
Seattle, WA 98102
206-324-0407
pages 219
Part No.: R3mac; Price: \$399
- RELAY Baton** RELAY Baton offers Macintosh-to-mainframe file transfer by connecting to IBM mainframes running RELAY Communications' RELAY/VM or RELAY/TSO software. The product works asynchronously, over normal phone lines; no boards or cables are needed. RELAY Baton graphically represents the IBM mainframe files in the same way as Macintosh computer files.
RELAY Communications, Inc.
41 Kenosia Ave.
Danbury, CT 06810
203-798-3893
page 179
Part No.: N/A; Price: \$150

- RELAY Communications, Inc.** Product: RELAY Baton
41 Kenosia Ave., Danbury, CT 06810, 203-798-3893
- RMS Access** RMS Access is a database server for information stored in native VAX RMS files. It allows users of Odesta's Double Helix database on the Macintosh to access and build applications directly using data stored in VAX RMS files. Using Double Helix with RMS Access, users can build applications that provide a Macintosh front-end to existing VAX-based data.
Odesta Corp.
4084 Commercial Ave.
Northbrook, IL 60062
800-323-5423
Part No.: N/A; Price: \$4900 and up
page 134
- RP244PC Utility** Using the Macintosh point-and-click features, the RP244PC Utility allows the user to program station features into the Rolmphone 244PC, including Autodial, Camp, Conference, Speaker, Pick, and Phonemail.
MACROL, Inc.
496 Coelho St.
Milpitas, CA 95035
408-945-0346
Part No.: N/A; Price: \$495
page 85
- Send Express v1.0** Send Express is a desk accessory that sends files and Clipboard selections directly between Macintosh computers on an AppleTalk network. It sends and receives in the background and does not require a network server. Sending Clipboard selections simulates copying and pasting across the network.
Gizmo Technologies
P.O. Box 14177
Fremont, CA 94539
415-623-7899
Part No.: N/A; Price: \$179
page 24
- SequeLink v2.1** SequeLink 2.1 allows co-operative processing between Macintosh and VAX computers. Users can write a Macintosh front-end to a relational database residing on a VAX, using environments such as HyperCard, SuperCard, MS Excel, or 4D, and compiled languages such as C or Pascal.
TechGnosis, Inc.
621 NW 53rd St.
Boca Raton, FL 33487
407-997-6687
Part No.: N/A; Price per server: \$4995. Price per simultaneously connected Macintosh varies between \$195 and \$695 depending on the number of connections desired.
page 134
- Session** Session is a family of terminal emulators for the Macintosh computer that allows the Macintosh computer to communicate with the HP 1000, 3000, and 9000 lines of computers. All Session products include a file-transfer facility that lets users move data between the HP system and the Macintosh computer and supports intelligent file-conversion options.
Tym labs Corp.
811 Barton Springs Rd., Suite 511
Austin, TX 78704
512-478-0611
Part No.: N/A; Price: \$199 to \$399
page 219
- Shiva Corporation** Products: NetModem V2400, NetSerial X232, NetBridge, TeleBridge, EtherGate, DOS-Connect, NetModem V.32, FastPath 4 Gateway
155 Second St., Cambridge, MA 02141, 617-864-8500
- Simware, Inc.** Product: Mac3270
20 Colonnade Rd., Ottawa, Ontario Canada K2E 7M6, 613-727-1779
- Simware Mac3270** Mac3270 standardizes the user interface and file transfer across many different 3270 emulation methods and network protocols and allows Macintosh users full implementation of the Macintosh computer interface to access host data and applications across most emulation methods.
Simware, Inc.
20 Colonnade Rd.
Ottawa, Ontario Canada K2E 7M6
613-727-1779
Part No.: N/A; Price: Contact Supplier
page 179

SMARTCOM II for the Macintosh

Hayes Microcomputer Products
P.O. Box 105203
Atlanta, GA 30348
404-449-8791

page 79

SMARTCOM II (Version 3.1) communications software is designed to take advantage of all the features of Hayes modem products. SMARTCOM II for the Macintosh incorporates features such as storing phone numbers and frequently used commands as well as capturing files to disk or printer.
Part No.: N/A; Price: \$149

Smartmodem Series

Hayes Microcomputer Products
P.O. Box 105203
Atlanta, GA 30348
404-449-8791

page 78

Smartmodem 1200 is an external 103, 212A/CCITT V.22 compatible 1200 bps modem. Smartmodem 2400 is an external 103, 212A/CCITT V.22, CCITT V.22bis compatible 2400 bps modem. Smartmodem 2400M is an internal 103, 212A/CCITT V.22 and V.22bis 2400 bps modem. Smartmodem 9600 is a CCITT V.32 compatible 4800 and 9600 bps modem for data communications network applications.
Part No.: N/A; Price: \$499 to \$1999

SmartTalk

INTERPRETER, Inc.
11455 West 48th Ave.
Wheat Ridge, CO 80033
800-232-4687

page 24

SmartTalk converts fully formatted documents between the Macintosh computer and the Digital VAX, Wang VS, dedicated word processors, and IBM PCs. Users can activate conversions from their stand-alone Macintosh computers or from any Macintosh on an AppleTalk network. SmartTalk also provides terminal emulation for communication with minicomputer hosts.
Part No.: N/A; Price: \$100 to \$4500

SMB File Transfer Utility

Apple Computer, Inc.
20525 Mariani Ave.
Cupertino, CA 95014
408-996-1010

page 101

The SMB File Transfer Utility software, provided with the Apple TokenTalk NB Card, allows users of Macintosh and IBM-compatible personal computers to exchange files and share information in their workgroups. Macintosh II systems on a token ring network can access information on IBM PC LAN Program SMB (Server Message Block) file servers. Files can be transferred and translated using the Apple File Exchange (included).
Part No.: N/A; Price: \$1250 for TokenTalk NB Card (Includes TokenTalk software and SMB File Transfer)

SNADS Gateways to 3+Mail, cc:Mail, and MS Mail

Soft•Switch, Inc.
640 Lee Rd.
Wayne, PA 19087

page 191

The Soft•Switch SNADS Gateways, in conjunction with other Soft•Switch products or with IBM's DISOSS, extend the distribution capabilities of 3Com's 3+Mail for the PCs and 3+Mail for Macintosh, Microsoft Mail, and cc:Mail. Users can exchange mail in the form of final-form messages, editable documents, and binary files with users of other systems that are connected to a Soft•Switch Enterprise Mail Network or to DISOSS.
Part No.: N/A; Price: \$1665

SoftPC

Insignia Solutions
254 San Geronimo Wy.
Sunnyvale, CA 94086
408-522-7600

page 105

SoftPC provides PC-compatibility for Macintosh computers by emulating the hardware environment of an IBM PC XT with EGA graphics, or optionally an IBM AT computer. SoftPC uses the SuperDrive and the Macintosh hard disk to read/write PC files. The Macintosh runs the MS-DOS programs that create and modify PC files and data directly.
Part No.: N/A; Price: \$399 to \$598

Software AG

Products: NATURAL ARCHITECT, NATURAL CONNECTION
11190 Sunrise Valley Dr., Reston, VA 22091, 703-860-5050

Software By Design, Inc.

Product: Packet/3270
98 C Pitkin St., East Hartford, CT 06108, 203-289-5561

Software Innovations, Inc.

Product: HandOff II
P.O. Box 811, Allen, TX 75002, 214-727-2329

- Software Ventures** Product: MicroPhone II v3.0
2907 Claremont Ave., Berkeley, CA 94705, 415-644-3232
- Solana Electronics** Products: R-Server, C-Server, Net Access
7887 Dunbrook Rd., Suite A, San Diego, CA 92126, 619-573-0800
- Solutions, Inc.** Product: FAXGATE
30 Commerce St., Williston, VT 05495, 802-865-9220
- Spectrum Concepts, Inc.** Product: Xcom
150 Broadway, Suite 814, New York, NY 10038, 212-766-4400
- Spool AT** Spool AT software connects the Apple LaserWriter printer and other AppleTalk-compatible printers to a Tandem host. This allows a Tandem-resident print process to be used in conjunction with Macintosh applications. Up to 16 separate Macintosh print locations can be supported by a single Spool AT Tandem print process.
Menlo Business Systems, Inc. Part No.: N/A; Price: Per Macintosh \$295, Per Tandem site \$995
201 Main St.
Los Altos, CA 94022
415-948-7920
page 204
- SQL/Services for Macintosh** SQL/Services software extends the power and capacity of Digital's database server environment to the desktop by incorporating existing and emerging industry-standard interfaces into Digital's relational database platform. SQL/Services software lets remote desktop applications access VAX Rdb/VMS relational databases.
Digital Equipment Corp. Part No.: N/A; Price: Contact Supplier
30 Porter Rd. (LJO2/C10)
Littleton, MA 01460
page 135
- StarBurst** The StarBurst is an active star-hub controller that distributes LocalTalk cabling in a star topology. Each StarBurst module supports up to 16 connections. Up to four StarBurst modules can be mounted on the back of a rack or wall mounted, 64 port, RJ-11 patch panel measuring 7" by 19". Since each StarBurst module operates independently, each module on a panel can be in a different Internet Zone.
Cactus Computer, Inc. Part No.: CC SB16PP (One StarBurst Module & Patch Panel, 16 ports); Price: \$699
1120 Metrocrest Dr., #103
Carrollton, TX 75006
214-416-0525
page 7
- StarNine Technologies, Inc.** Product: Mail*Link SMTP
2126 Sixth St., Berkeley, CA 94710, 415-548-0391
- STATUS*MAC** STATUS*Mac allows Macintosh network managers to gather comprehensive information about software and hardware components on their network. This is accomplished remotely, without the need to visit workstations. Information is then imported into the STATUS*Mac Master Database. The Master Database generates customized reports using searches, sorts, and filters.
Pharos Technologies, Inc. Part No.: N/A; Price: \$799
4243 Hunt Rd.
Cincinnati, OH 45242
800-548-8871
page 22
- Sun Microsystems, TOPS Division** Products: TOPS FlashCard, TOPS FlashBox, InBox Plus, InBox Plus/PC, TOPS Network for Macintosh, TOPS Network Bundle for DOS, InBox, TOPS netPrint, TOPS Repeater, TOPS TeleConnector
950 Marina Village Pkwy., Alameda, CA 94501, 800-445-TOPS
- Sunrise Systems** Product: ZapFax
705 West Valley Dr., #1, Campbell, CA 95008, 408-377-3753
- Supra Corporation** Products: SupraModem 2400, SupraModem 2400 Plus, SupraModem MacPac
1133 Commercial Wy., Albany, OR 97321, 503-967-9075

SupraModem Series The SupraModem 2400 line of modems work with MultiFinder and supports U.S. and international protocols: Bell 103/212A and CCITT V.21, V.22, V.22bis. They all feature Hayes compatibility; 300-1200-2400 bps operation; AutoAnswer/AutoDial (tone or pulse); a programmable, non-volatile memory; status LEDs; and an adjustable volume speaker. The SupraModem Plus features MNP levels 2-5 and CCITT V.42bis error correction and data compression protocols. The SupraModem 2400 MacPac includes MicroPhone 1.5 telecommunication software, SupraModem 2400, Macintosh cable, and software and on-line time for the Macintosh specific American Online service.
 Supra Corp.
 1133 Commercial Wy.
 Albany, OR 97321
 503-967-9075
page 78
 Part No.: N/A; Prices: \$150 to \$230

Sybase Products: DB-Library, Hyper/DB-Library
 6475 Christie Ave., Emeryville, CA 94608, 800-8SYBASE

Sybase API for Macintosh Sybase is a relational database management system for on-line applications and decision support. With Sybase's client/server architecture, client-user interface functions are separated from server data management and transaction functions.
 Sybase
 6475 Christie Ave.
 Emeryville, CA 94608
 800-8SYBASE
page 135
 Part No.: N/A; Price: from \$3000

Symicron, Inc. Product: DTSX-14
 23545 Crenshaw Blvd., Suite 104, Torrance, CA 90505, 213-530-2610

SyncRouter SyncRouter allows connection of remote AppleTalk networks over high speed synchronous communication links. Remote AppleTalk networks are connected so that transparent access to services such as printers, file servers, mail servers, and databases are accessible via the Macintosh Chooser. Standard synchronous interfaces: V.35, RS-449, RS-232 with built-in link diagnostics.
 Engage Communications, Inc.
 9053 Soquel Drive, Suite 201
 Aptos, CA 95003-4034
 408-688-1021
page 15
 Part No.: SyncRouter-LT; Price: \$1895 to \$2095

Synergy Software Products: VersaTerm, VersaTerm PRO
 2457 Perkiomen Ave., Reading, PA 19606, 215-779-0522

SynOptics Coaxial-to-Unshielded Twisted-Pair Products SynOptics' thin net adapter provides an interface between unshielded twisted-pair wire and thick or thin coaxial cable segments. The LattisNet attachment unit interface/unshielded twisted-pair (AUI/UTP) workgroup concentrator provides a direct connection between standard or thin coaxial Ethernet networks and unshielded twisted-pair LattisNet networks.
 SynOptics Communications
 501 E. Middlefield Rd.
 Mountain View, CA 94043
 800-PRO-8023
page 71
 Part No.: N/A; Price: \$725 to \$1495

SynOptics Communications Products: LattisNet Utility Solutions, LattisNet Network Management Modules, LattisNet System 3000 Ethernet Local Bridge Modules, Network Interface Cards, Coaxial-to-Unshielded Twisted-Pair Products
 501 E. Middlefield Rd., Mountain View, CA 94043, 800-PRO-8023

SynOptic's Network Interface Cards SynOptics' Network Interface Cards provide a direct connection from Macintosh computers to unshielded twisted-pair LattisNet networks. The cards reside on the host computers, where an unshielded twisted-pair RJ-45 modular receptacle offers direct access to the building's installed unshielded twisted-pair wiring system.
 SynOptics Communications
 501 E. Middlefield Rd.
 Mountain View, CA 94043
 800-PRO-8023
page 72
 Part No.: N/A; Price: \$645

Tactician Tactician uses three types of technologies to manipulate data into an understandable format: Geographical Information System (GIS) technology, Executive Information System (EIS) technology, and Decision Support System (DSS) technology. Tactician uses Apple's Data Access Language (DAL) to access host-based data.
Tactics Int'l Ltd.
16 Haverhill St., 3rd Floor
Andover, MA 01810
508-475-4475
Part No.: N/A; Price: Contact Supplier
page 41

Tactics Int'l Ltd. Product: Tactician
16 Haverhill St., 3rd floor, Andover, MA 01810, 508-475-4475

Taniwha Systems Design Product: CommCard
2206 Roosevelt Ave., Berkeley, CA 94703, 415-540-5557

TCP/Connect II TCP/Connect II is an application that allows a Macintosh computer to access TCP/IP services. Included in the extended edition are support for Telnet (the network terminal protocol), FTP (file transfer protocol), POP/SMTP (electronic mail), and NNTP (the network news protocol). TCP/Connect II can be used to access IBM mainframes, Digital VAX systems, PC compatibles, most UNIX machines, and other Macintosh computers.
InterCon Systems Corp.
950 Herndon Pkwy., Suite 390
Herndon, VA 22070
703-709-9890
Part No.: N/A; Price: \$495
page 156

TCPort v2.0 TCPort Developers Toolkit is a software platform for the development of distributed Macintosh applications running on top of TCP/IP. TCPort consists of two parts: (1) a choice of two basic TCP/IP transport systems: Novell's TCPort and Apple's MacTCP, and (2) an application programming interface (API). The TCP/IP transport systems, including drivers for TCP, IP and UDP, provides TCP/IP connectivity, allowing Macintosh computers to communicate with other TCP/IP hosts, servers, and workstations on a network.
Novell, Inc.
Sales Dept., Developer Products
5918 W. Courtyard Dr., Suite 220
Austin, TX 78730
800-733-9673
Part No.: N/A; Price: \$2500
page 157

TechGnosis Product: SequeLink 2.1
621 NW 53rd St., Boca Raton, FL 33487, 407-997-6687

TeleBridge TeleBridge is a remote router for AppleTalk networks. Two networks, each equipped with a TeleBridge and modem can connect over phone lines to form a single internetwork. TeleBridge also includes dial-in network access, which allows a user to access file servers, printers, electronic mail, and other AppleTalk resources from a remote location.
Shiva Corporation
155 Second St.
Cambridge, MA 02141
617-864-8500
Part No.: N/A; Price: \$499
page 16

Telnet Driver The InterCon Telnet Driver installs into VersaTerm-Pro or Microphone II v3.0, and allows these programs to communicate with a host computer over a TCP/IP virtual terminal connection (TELNET).
InterCon Systems Corp.
950 Herndon Pkwy., Suite 390
Herndon, VA 22070
703-709-9890
Part No.: N/A; Price: \$149
page 157

telnet•PM telnet•PM is a protocol module for MacWorkStation which uses TCP/IP to send commands and events between the host application and MacWorkStation. Many host computers use the TCP/IP Telnet virtual terminal protocol to allow terminal connections to host computers over Ethernet communications links.
Ramsay Consulting
507 Second St.
Ann Arbor, MI 48103
313-665-2819
Part No.: N/A; Price: \$75
page 157

Telos Systems Development

Product: MacNOW
3420 Ocean Park Blvd., Santa Monica, CA 90405, 219-484-0348

TGRAF-07/Mac

Grafpoint
1485 Saratoga Ave.
San Jose, CA 95129-4934
408-446-1919
page 131

TGRAF-07/MAC is Tektronix 4107 graphics-terminal emulation software that allows the Macintosh II to connect to a host computer and access mainframe applications. TGRAF is a tool for CAD/CAM, data analysis and representation, mapping, molecular design, and application development. It emulates Tektronix 4010, 4014, 4105, 4106, and 4109 graphics terminals, and Digital VT102, VT100, and VT52 test terminals.
Part No.: N/A; Price: \$995

Timbuktu

Farallon Computing, Inc.
2000 Powell St., Suite 600
Emeryville, CA 94608
415-596-9100
page 18

Timbuktu allows users to observe or control another Macintosh over an AppleTalk network. Multiple users can share screens across the network for workgroup collaboration, user support, network management, shared resources, teaching, and training purposes. Timbuktu includes file transfer to exchange files and password protection options.
Part No.: SW400; Price: \$149, Single Pack
Part No.: SW430; Price: \$1995, 30 Pack

Timbuktu/Remote

Farallon Computing, Inc.
2000 Powell St., Suite 600
Emeryville, CA 94608
415-596-9100
page 18

Timbuktu/Remote allows users to observe or control another Macintosh computer from their own over a dial-up telephone line, serial links, or ISDN services. It includes file transfer to exchange files, "chat" with another user, and password protection and options. The product is used for remote access and support, training, network management, and workgroup collaboration.
Part No.: SW401; Price: \$195

Tops FlashBox

Sun Microsystems, TOPS Division
950 Marina Village Pkwy.
Alameda, CA 94501
800-445-TOPS
page 57

A plug-in device for Macintosh computers, TOPS FlashBox increases the data transfer rate from the standard AppleTalk 230 Kbps to FlashTalk 770 Kbps.
Part No.: A8300088 (DIN-8); Price: \$189
Part No.: A8300107 (DB-9); Price: \$189

TOPS FlashCard

Sun Microsystems, TOPS Division
950 Marina Village Pkwy.
Alameda, CA 94501
800-445-TOPS
page 56

TOPS FlashCard is a network interface card that allows PCs to communicate on an AppleTalk network with other PCs and Macintosh computers using simple twisted-pair cabling. Tops FlashCard is available in AT bus and Micro Channel bus configurations allowing it to be used with any IBM PC, XT, AT, PS/2, or compatible machine.
Part No.: A1400118; Price: \$239

TOPS NetPrint

Sun Microsystems, TOPS Division
950 Marina Village Pkwy.
Alameda, CA 94501
800-445-TOPS
page 57

TOPS NetPrint allows a PC or compatible to print to an Apple LaserWriter or other AppleTalk compatible printer over an AppleTalk network. TOPS NetPrint is compatible with DOS software applications, including applications that do not offer PostScript drivers. NetPrint supports PostScript files generated by DOS application software. It also allows users to print accurate "screen dumps."
Part No.: N/A; Price: Contact Supplier

TOPS Network for Macintosh v3.0

Sun Microsystems, TOPS Division
950 Marina Village Pkwy.
Alameda, CA 94501
800-445-TOPS
page 55

TOPS peer-to-peer file sharing lets users connect Macintosh, PC, and Sun workstations. TOPS Spool allows users to spool documents to any AppleTalk laser printer. The MacLinkPlus/TOPS Translators translate between Macintosh and PC file formats. TOPS InBox is an electronic mail system for up to 20 users.
Part No.: 600-2360; Price: \$299

- TOPS Network Bundle for DOS v3.0** The TOPS Network Bundle for DOS allows PCs to share files, printers, and electronic mail on an AppleTalk LAN. TOPS connects PCs, Macintosh computers, and Sun Workstations. TOPS allows PC users to share printers, including networked LaserWriter printers. The bundle includes TOPS InBox, an electronic mail system for up to 20 users.
Sun Microsystems, TOPS Division
950 Marina Village Pkwy.
Alameda, CA 94501
800-445-TOPS
page 55
Part No.: 600-2470 (5.25-inch); Price: \$249
Part No.: 600-2471 (3.5-inch); Price: \$249
- TOPS Repeater** TOPS Repeater is a hardware unit that amplifies electrical signals along LocalTalk or twisted-pair cabling. TOPS Repeater also allows users to add branches to the basic "bus" layout of the TOPS network.
Sun Microsystems, TOPS Division
950 Marina Village Pkwy.
Alameda, CA 94501
800-445-TOPS
page 58
Part No.: A8100127; Price: \$189
- TOPS TeleConnector** The TOPS TeleConnector is a network connector which provides the physical link between microcomputers and peripherals on a LAN by allowing telephone wire to be used as the network cabling. The TOPS TeleConnectors support both TOPS FlashTalk (770 Kbps) and AppleTalk (230 Kbps) network communications protocols on a PC-to-PC network.
Sun Microsystems, TOPS Division
950 Marina Village Pkwy.
Alameda, CA 94501
800-445-TOPS
page 58
Part No.: 605-1177 (Din-8); Price: \$59
Part No.: 605-1176 (DB-9); Price: \$59
- Tri-Data Systems, Inc.** Products: Netway 1000, LanWay TR 16/4, MaxWay 500 Family
3270 Scott Blvd., Santa Clara, CA 95054, 408-727-3270
- TSSnet** TSSnet provides DECnet services for the Macintosh allowing the user to communicate with any DECnet host including VAX systems, IBM-PC systems, and IBM mainframes, as well as other Macintosh systems. TSSnet allows DECnet and AppleTalk to operate on the same Macintosh simultaneously providing access to services on both networks.
Alisa Systems Inc.
221 East Walnut St., Suite 175
Pasadena, CA 91101
818-792-9474
page 125
Part No.: TSSnet TSS1D; Price: \$495
- Tymlabs Corp.** Product: Session
811 Barton Springs Rd., Suite 511, Austin, TX 78704, 512-478-0611
- Ungermann-Bass, Inc.** Products: Access/One MaxTalk Interface Module, Net/One MacUWS
P.O. Box 58030, Santa Clara, CA 95052-8030, 408-496-0111
- Unipress, Inc.** Products: Makeasy 2.1, MacNix 3.1
2025 Lincoln Hwy., Edison, NJ 08817, 201-985-8000
- uShare** uShare networks Macintosh computers and PCs to UNIX. Besides allowing the UNIX host to act as an AppleShare file server, uShare offers print spooling, electronic mail, and remote Macintosh system disks. Macintosh clients can be on Ethernet or LocalTalk, connected to the host directly or through a gateway.
Information Presentation Technologies
23801 Calabasas Rd., Suite 2008
Calabasas, CA 91302
818-347-7791
page 155
Part No.: N/A; Price: \$955 to \$3625
- Vano Associates** Product: MacChuck v1.5
P.O. Box 12730, New Brighton, MN 55112, 612-788-9547

- VersaTerm/VersaTerm-PRO** Synergy Software
2457 Perkiomen Ave.
Reading, PA 19606
215-779-0522
page 130
- VersaTerm and VersaTerm-PRO provide text and color graphics terminal emulation to DEC VT 100, VT220, and Data General D200 text terminals and Tektronix 4010,4012 and 4014 graphics terminals. VersaTerm-PRO also provides a Tektronix 4105 color graphics emulation. File transfer capability is compatible with XMODEM, YMODEM and Kermit protocols in text , binary, and MacBinary formats. Part No.: MAC555; Price: \$149
- VMacS** White Pine Software
P.O. Box 1108
Amherst, NH 03031
603-886-9050
page 127
- VMacS is a VAX application that allows Macintosh users to store Macintosh files on the Digital VAX computer. All Macintosh files can be transferred to the VAX, stored in MacBinary format, and they will retain their original characteristics when returned to the Macintosh computer. Part No.: N/A; Price: \$399 to \$999
- V-series System Products** Hayes Microcomputer Products
P.O. Box 105203
Atlanta, GA 30348
404-449-8791
page 79
- In addition to the functionality of a standard Smartmodem product, the V-series products support error control and data compression. CCITT V.42 compliance provides modem error-control through LAPM and the alternative protocol in Annex A for backward compatibility with MNP 2-4 modems. The support of CCITT V.42bis data compression provides 4 to 1 compression. Part No.: N/A; Price: V-series Smartmodem 2400, \$649
Part No.: N/A; Price: V-series Smartmodem 9600, \$999
- VSterm and VsCom/Macintosh** MacSoft
2920 F St.
Bakersfield, CA 93301
312-443-1222
M/H Group
222 West Adams St.
Chicago, IL 60606
312-443-1222
page 208
- VSterm from MacSoft and VsCom/Macintosh from M/H Group provide Wang 2110 terminal emulation for document transfer and conversion. With VSterm, any PC with a serial port can emulate the Wang 2100 or VT100 terminals, exchange documents and data with the Wang VS, and convert Wang VS data to PC platforms. VsCom/Macintosh provides Wang VS 2110 terminal emulation. The program also provides file transfer and conversion between Macintosh and Wang word-processing formats. Part No.: N/A; Price: \$195 to \$2495
- Walker Richer & Quinn, Inc.** Products: Reflection 1 Plus, Reflection 2 Plus, Reflection 3 Plus
2815 Eastlake Ave., East, Seattle, WA 98102, 206-324-0407
- Webster Computer Corp.** Product: MultiGate
2109 O'Toole Ave., Suite J, San Jose, CA 95131-1303, 408-954-8054
- White Pine Software** Products: Mac240, Mac 241, Mac220, eXodus, VMacS, CommSolutions
P.O. Box 1108, Amherst, NH 03031, 603-886-9050
- Wingz-DataLink** Informix Software, Inc.
16011 College Blvd.
Lenexa, KS 66219
913-599-7100
page 42
- Wingz-DataLink, gives users the ability to access and update corporate data directly from the desktop computer. Without knowing SQL, the user can access data and then apply Wingz' analytical and presentation functions to manipulate the information. Part No. N/A; Price: Wingz 1.1 \$399, DataLink \$19

Worldtalk 400 Worldtalk 400 is an architecture for enterprise-wide messaging based on X.400. Along with the core Touch Communications Worldtalk product, Touch provides seven gateways and the gateway engine based on this architecture. Worldtalk allows preservation of the end-user interface already installed as well as expansion of the communities of mail users that can be reached.
250 E. Hacienda Ave.
Campbell, CA 95008
408-374-2500
Part No.: N/A; Price: \$2000 to \$8000
page 82

XCOM XCOM 6.2 on the Macintosh provides a set of file transfer functions, remote report printing, and job submission between Macintosh and all major IBM and non-IBM systems. It utilizes APPC/LU 6.2 to create a peer-to-peer environment.
Spectrum Concepts, Inc.
150 Broadway, Suite 814
New York, NY 10038
212-766-4400
Part No.: N/A; Price: \$495
page 102

xFer 1.1 xFer is a file transfer system which allows MS-DOS computers to exchange files, folders, and directories with the Macintosh family of computers. xFer includes software for both computers and an optional 12 foot serial cable used for communications. xFer allows modem or direct connections, supporting baud rates from 300 to 57.6 kbps.
Messenger Software, Inc.
180 W. Streetsboro Rd., Unit #5, Suite #302
Hudson, OH 44236
216-688-0696
Part No.: N/A; \$100
page 102

XINET for HP 9000 Shiva hardware can be used with XINET software for HP 9000. XINET for HP 9000 resides on the HP host and functions in the following ways: Macintosh and MS-DOS computers share files; the Macintosh computer acts as a terminal emulator to HP hosts; and XINET serves as a PostScript print spooler for both Macintosh and HP users.
Mt. Xinu, Inc.
2560 Ninth St., #312
Berkeley, CA 94710
415-644-0146
Part No.: N/A; Price: \$895 to \$6895
page 220

XView 2.0 with OPEN LOOK for A/UX 2.0 XView, the X-based Visual/Integrated Environment for Workstations, features an object-oriented interface that follows the specifications for the OPEN LOOK Graphic User Interface (GUI). The XView Toolkit offers a set of OPEN LOOK-conformant interface objects, graphic metaphors, and help for novice users.
Integrated Computer Solutions
163 Harvard St.
Cambridge, MA 02139
617-547-0510
Part No.: N/A; Price: \$500 per CPU
page 159

X Window System for A/UX X Window System for the A/UX operating system lets A/UX users run X client applications. The A/UX Finder software, a special version of the Macintosh MultiFinder adapted for A/UX, allows users to run X client application, Macintosh productivity applications, and UNIX programs concurrently. X Window System for A/UX complies with the standards and conventions stipulated by the MIT X Consortium.
Apple Computer, Inc.
20525 Mariani Ave.
Cupertino, CA 95014
408-996-1010
Part No.: N/A; Price: \$295
page 159

Zap Fax Zap Fax consists of a 99-year license to use four software modules: a server; a patch to Apple's ImageWriter driver that captures the spooled print file; Failed Faxes, which shows the user all the faxes that have failed; and Shutdown, which allows users to shut down the fax server.
Sunrise Systems
705 West Valley Dr., #1
Campbell, CA 95008
408-377-3753
Part No.: N/A; Price: \$795
page 80

If you have any comments, suggestions, or updated product information for future editions of the *Apple Multivendor Network Solutions Guide*, please send them to: Apple Computer, Inc., *Apple Multivendor Network Solutions Guide*, 20330 Stevens Creek Blvd., MS 36G, Cupertino, CA 95014
AppleLink Address: COOK.BOOK

