

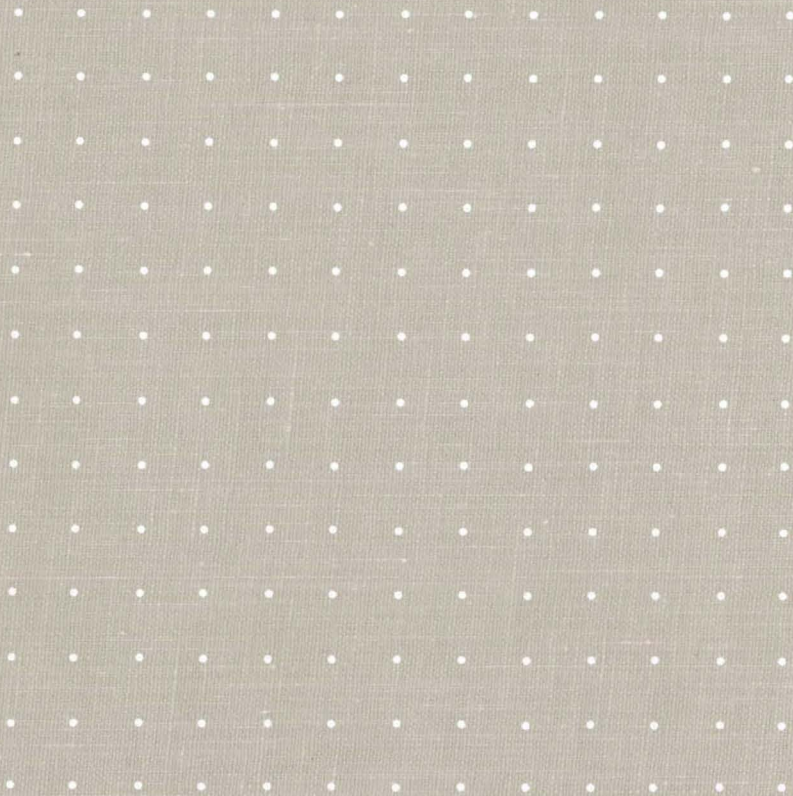

LisaDraw

Lisa

LisaDraw



LisaDraw

Guide to Lisa Manuals

Set up your Lisa following the setup procedures in the Lisa accessories box or in Appendix 1, Setup Procedures, in the *Lisa Owner's Guide*.

Go through Section A, LisaGuide, in the *Lisa Owner's Guide*, for an introduction to the Lisa.

If your dealer or service representative did not set your system Preferences so that the Lisa knows what external devices are attached, follow the instructions in Section D, Desktop Manager Reference Guide, under Set, in the *Lisa Owner's Guide*.

- ▶ Go to Section A, Getting Started, in the manual for each office tool that you want to learn, for the essentials of using that tool.
-

Go to Section B, Lisa Fundamentals, in the *Lisa Owner's Guide*, for the background information you need before beginning long-term work on the Lisa.

You are now ready to start doing your own work on the Lisa:

- If you want self-paced instructions for using a tool, go to Section B, Tutorial, in that tool manual.
 - If you want instructions for performing specific tasks with a tool, go to Section C, Reference Guide, in that tool manual.
-

For specific instructions on filing and desktop management, go to Section D, Desktop Manager Reference Guide, in the *Lisa Owner's Guide*.

For more information on the Lisa hardware, tips on caring for the Lisa, and suggestions for troubleshooting when the system isn't working properly, go to the other sections of the *Lisa Owner's Guide*.

LisaDraw

Customer Satisfaction

If you discover physical defects in the manuals distributed with a Lisa product or in the media on which a software product is distributed, Apple will replace the documentation or media at no charge to you during the 90-day period after you purchased the product.

In addition, if Apple releases a corrective update to a software product during the 90-day period after you purchased the software, Apple will replace the applicable diskettes and documentation with the revised version at no charge to you during the six months after the date of purchase.

In some countries the replacement period may be different; check with your authorized Lisa dealer. Return any item to be replaced with proof of purchase to Apple or to an authorized Lisa dealer.

Limitation on Warranties and Liability

All implied warranties concerning this manual and media, including implied warranties of merchantability and fitness for a particular purpose, are limited in duration to ninety (90) days from the date of original retail purchase of this product.

Even though Apple has tested the software described in this manual and reviewed its contents, **neither Apple nor its software suppliers make any warranty or representation, either express or implied, with respect to the software described in this manual,**

its quality, performance, merchantability, or fitness for any particular purpose. As a result, this software is sold "as is," and you the purchaser are assuming the entire risk as to its quality and performance.

In no event will Apple or its software suppliers be liable for direct, indirect, special, incidental, or consequential damages resulting from any defect in the software or manual, even if they have been advised of the possibility of such damages. In particular, they shall have no liability for any programs or data stored in or used with Apple products, including the costs of recovering or reproducing these programs or data.

The warranty and remedies set forth above are exclusive and in lieu of all others, oral or written, express or implied. No Apple dealer, agent, or employee is authorized to make any modification, extension, or addition to this warranty.

Some states do not allow the exclusion or limitation of implied warranties or liability for incidental or consequential damages, so the above limitation or exclusion may not apply to you. This warranty gives you specific legal rights, and you may also have other rights that vary from state to state.

License and Copyright

This manual and the software (computer programs) described in it are copyrighted by Apple or by Apple's software suppliers, with all rights reserved, and they are covered by the

Lisa Software License Agreement signed by each Lisa owner. Under the copyright laws and the License Agreement, this manual or the programs may not be copied, in whole or in part, without the written consent of Apple, except in the normal use of the software or to make a backup copy. This exception does not allow copies to be made for others, whether or not sold, but all of the material purchased (with all backup copies) may be sold, given, or loaned to other persons if they agree to be bound by the provisions of the License Agreement. Copying includes translating into another language or format.

You may use the software on any computer owned by you, but extra copies cannot be made for this purpose. For some products, a multi-use license may be purchased to allow the software to be used on more than one computer owned by the purchaser, including a shared-disk system. (Contact your authorized Lisa dealer for information on multiuse licenses.)

Product Revisions

Unless you have purchased the product update service available through your authorized Lisa dealer, Apple cannot guarantee that you will receive notice of a revision to the software described in this manual, even if you have returned a registration card received with the product. You should check periodically with your authorized Lisa dealer.

Contents

Preface

A. Getting Started with LisaDraw

A quick introduction to the basic skills needed to use LisaDraw.

B. LisaDraw Tutorial

Self-paced instructions on LisaDraw using examples on the Lisa.

C. LisaDraw Reference Guide

Complete information on LisaDraw consisting of an overview and step-by-step procedures.

D. Appendixes

E. Index

Preface

LisaDraw is a graphics tool that makes it easy to create flowcharts, pictures, technical diagrams, and maps for reports and presentations. You use the mouse to produce lines, circles, and other geometric shapes, as well as freehand drawings. Text can be added in your choice of size and style to complete the drawing.

This manual contains three kinds of documentation of LisaDraw:

- Section A, *Getting Started with LisaDraw*, is a quick introduction to the tool. It is designed to give you the basic skills for using LisaDraw.
- Section B, *LisaDraw Tutorial*, is a step-by-step guide to the major features of LisaDraw. It includes suggestions on how to use LisaDraw efficiently and effectively.
- Section C, *LisaDraw Reference Guide*, is a complete reference section. It contains instructions for performing specific tasks, including the details of how each feature works.

The material in this manual assumes that you have used *LisaGuide*, which teaches you the fundamentals of using the Lisa. The *LisaGuide* diskette came in the front pocket of the *Lisa Owner's Guide*, and instructions for using it appear in Section A of that manual.

Section B, *Lisa Fundamentals*, of the *Lisa Owner's Guide*, contains important background information about setting up and using the Lisa for long-term work. Make sure you understand the concepts in that section before going on to either the Tutorial or the Reference Guide. Refer to Section D, *Desktop Manager Reference Guide*, of the *Lisa Owner's Guide*, when you need to know how to do filing or how to perform any of the other tasks outlined in Section B, *Lisa Fundamentals*.

The material in this manual can be used in either short or long blocks of time. You can complete Getting Started in about 30 minutes. Then you can either go through the Tutorial one chapter at a time or start creating your own documents, looking up procedures in the Reference Guide as you need them.



***Section A
Getting Started
with LisaDraw***

Getting Started with LisaDraw

With LisaDraw you can produce all kinds of drawings, such as organization charts, diagrams, flowcharts, and graphics for slide presentations.

LisaDraw can assist you to effectively conceptualize and communicate information, with professional looking graphics.

Getting Started with LisaDraw is a hands-on exercise. By going step by step through an easy example, you will quickly become familiar with the basic skills for using LisaDraw, and afterward be able to create, edit, file, and print your own LisaDraw documents.

What You Need to Get Started

Here's what you need

- A Lisa set up and plugged in, with the keyboard and mouse attached.
- A ProFile set up and plugged in, with the Office System and LisaDraw tool on it.
- A Printer set up and plugged in if you want to print. Make sure your printer is hooked up to your Lisa and turned on. Printing is optional.
- About 30 minutes.

Note: If your system is not already set up and configured, refer to the *Lisa Owner's Guide*, Appendix 1, Setup Procedures.

ProFile

Lisa

Keyboard

Mouse



If you haven't yet gone through LisaGuide, in which Lisa introduces Lisa, now is a good time to do so — it will make Getting Started even easier. For instructions on starting LisaGuide, refer to the *Lisa Owner's Guide*, Section A, LisaGuide.

If you've already gone through a Getting Started for another Lisa tool, you'll see many similarities in using LisaDraw — the basic concepts for using each Lisa tool are the same.

Starting Up

What You're About To Do

Follow the numbered steps below and on the next page to:

- Turn on and start up your ProFile and Lisa.
- Learn how to brighten the screen if it has dimmed automatically.

Note: If your ProFile and Lisa are already on, skip to step 3. The red ProFile light is lit when the ProFile is on, and the Lisa on-off button is lit when the Lisa is on.

Do This

- 1** Turn on your ProFile by pressing the on-off switch on the back, left-hand side of the ProFile, as shown.
- 2** Turn on your Lisa by pressing the on-off button, at the lower, right-hand side of the Lisa, as shown.

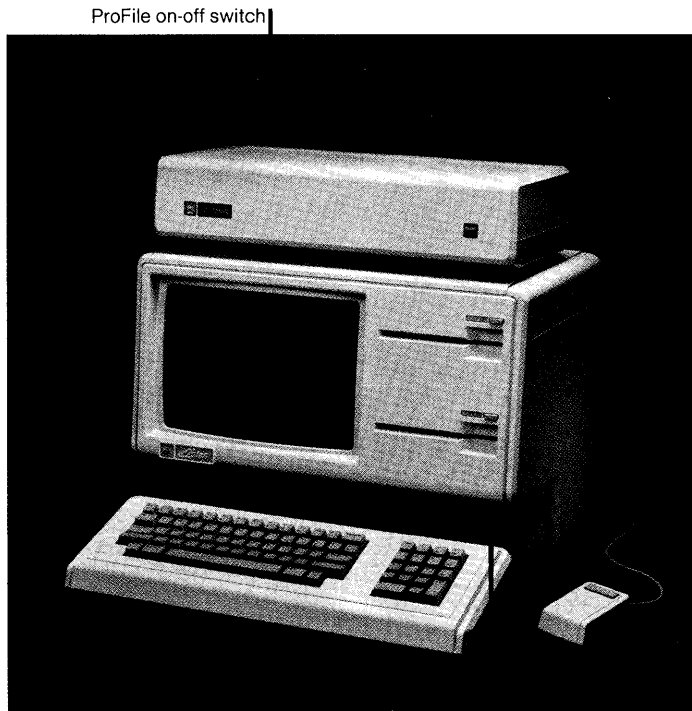

Do This

- 3 After several minutes, when the red ProFile light stops flashing, your screen should look something like the one to the right. (See something different? Refer to the *Lisa Owner's Guide*, Section G, Troubleshooting.)

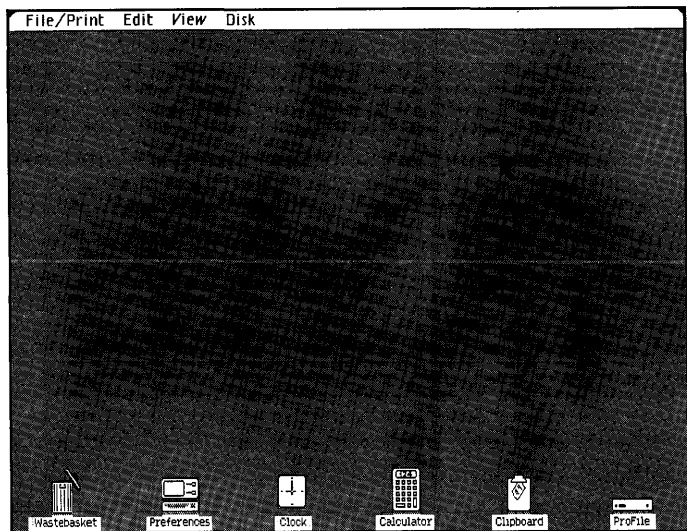

- 4 If your Lisa has been on for a period of time with no activity, the screen may have automatically dimmed. If your screen is dim, just move the mouse to brighten it.

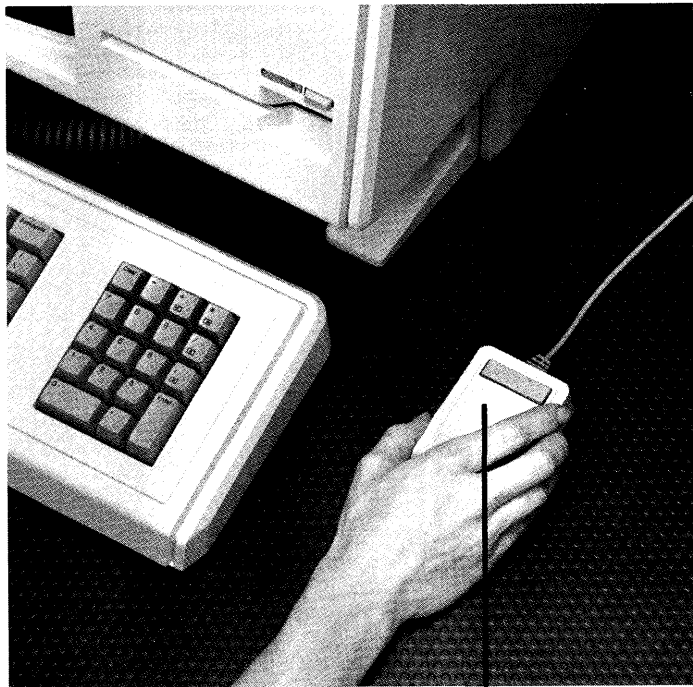

Screen dim? Move the mouse

The Desktop and the Mouse

What You're About To Do

The gray area of your screen is called the **desktop**. Like the desktop of an office desk, it's where you do your work.

The **mouse** is what you use to communicate with your Lisa — you use it to point out what it is you want done.

To get familiar with your Lisa's desktop and how to use the mouse, follow the steps below.

Do This

- 1 Hold the mouse as shown. (Don't press the mouse button yet.)

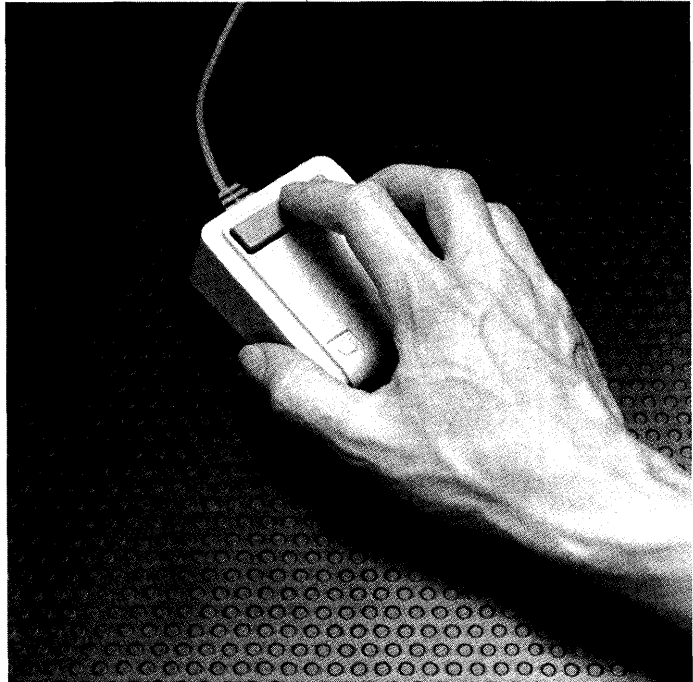

Do This

- Slide the mouse on your desk to move the pointer around the Lisa desktop — the gray part of your screen.

Notice the **menu bar** across the top of your screen — it contains **menus** of different actions you can take. Along the bottom of your screen are various **icons** — graphic symbols that stand for different things.

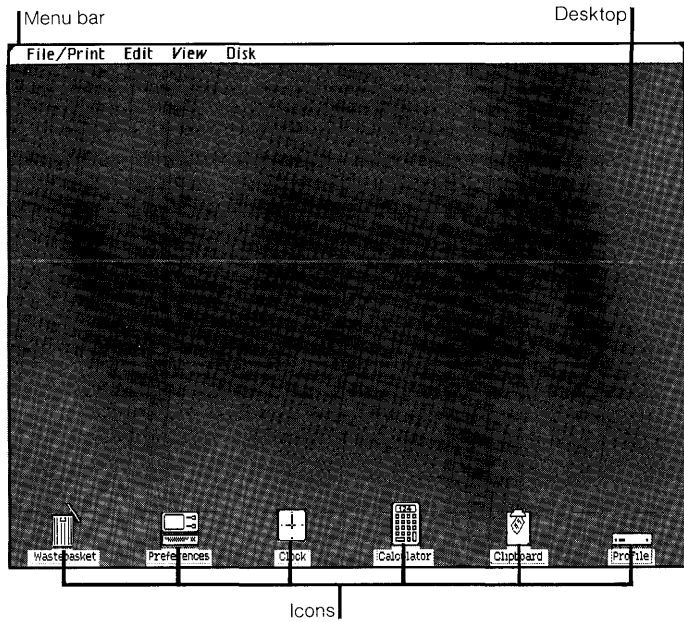

- To get oriented, move the pointer to the different spots shown to the right. (Trouble making the pointer go where you want it to go? Lift up and reposition the mouse.)

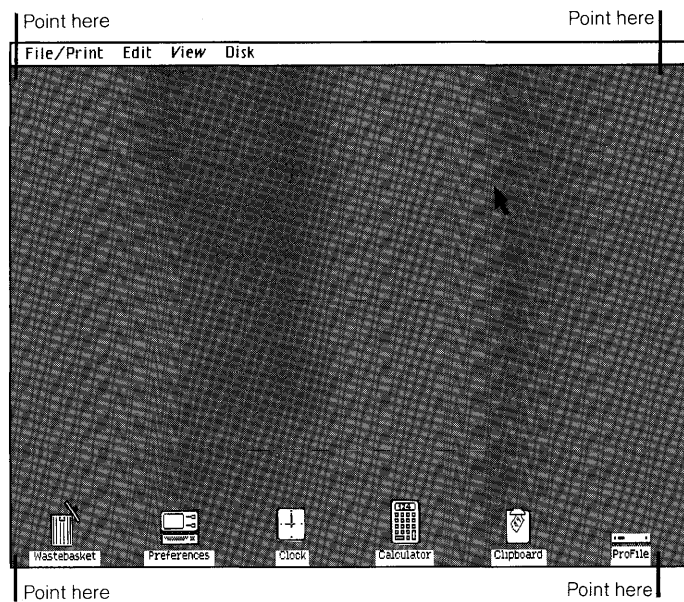

Seeing What's on a Disk

What You're About To Do

To get at the document you'll work with, you first need to open the ProFile disk icon as described in the steps below.

The way you'll open the disk will illustrate your Lisa's most general principle:

- First you select something.
- Then you do something to what you've selected.

Do This

- 1 Select (highlight) the ProFile disk icon by placing the tip of the pointer on it and clicking the mouse button, as shown. (Icon not highlighted? Try again.)

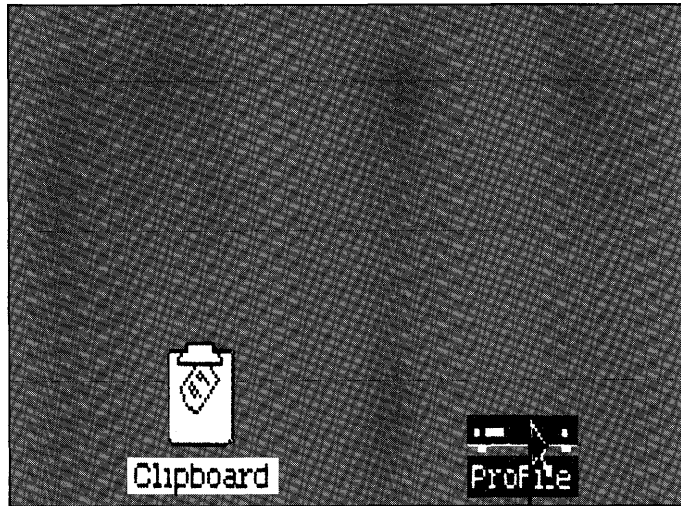

Click on ProFile to select

Do This

- 2 Open the selected disk icon by choosing Open "ProFile" from the File/Print menu.

Here's how

- Press and hold with the pointer's tip on File/Print in the menu bar.
- Move the pointer down and release when Open "ProFile" is highlighted. (Is the Open menu item dim? You probably clicked somewhere else on the gray part of the screen and deselected the ProFile icon. Go back to step 1 and make sure the ProFile icon is selected.)

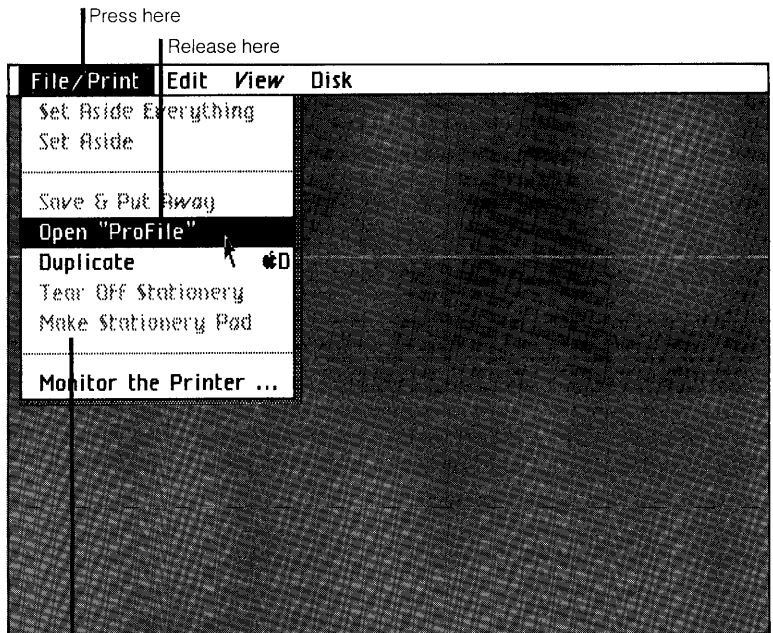

Note: When a menu item is dim, you can't choose it

- 3 Notice the window to the ProFile that zooms open on your Lisa's desktop. Your ProFile is like a very large file drawer — it's where you'll keep most of your work.

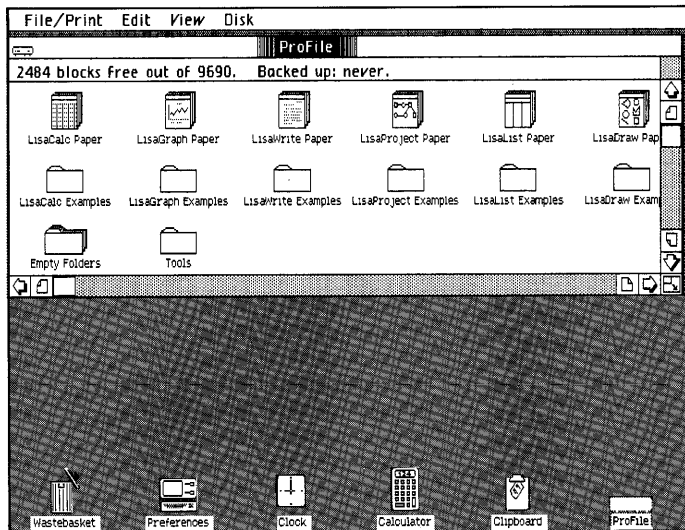

Pulling a Document

What You're About To Do

Inside the ProFile window you should see several stationery pads and folders. The LisaDraw Examples folder contains the example you'll be working on here. In the steps below, you will:

- Open the LisaDraw Examples folder.
- Tear off a sheet from the Getting Started stationery pad that's inside the folder.
- Move the new sheet, or document, to a clear spot in the folder.
- Give the new document the name Top Sales.
- Open the document.

Do This

- To open the LisaDraw Examples folder:
 - 1 Select the LisaDraw Examples folder by clicking on it.
 - 2 Choose Open "LisaDraw Examples" from the File/Print menu.

Notice the window to the LisaDraw Examples folder that zooms open, and its contents, as shown. The "drawing" patterns on the icons in the folder show they are LisaDraw icons.

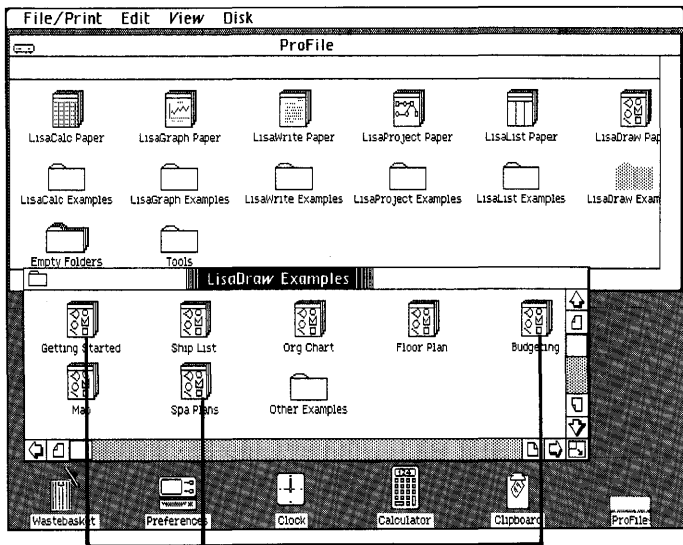

LisaDraw icons

Do This

- Copies of the Getting Started example are on the Getting Started stationery pad. To tear off a sheet from the pad:

- 1 Select the Getting Started pad icon.
- 2 Choose Tear Off Stationery from the File/Print menu and wait a moment until the new document appears, as shown.

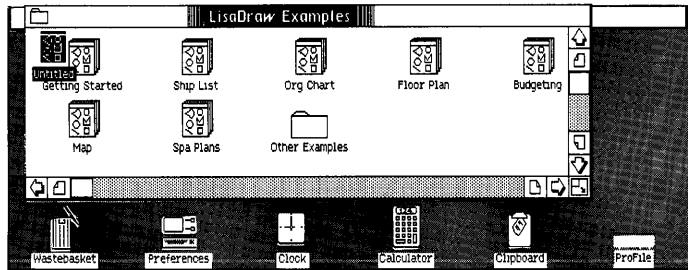

- To move the new icon out of the way, to a clear spot in the folder:

- 1 Place the pointer on the icon.
- 2 Press and hold down the mouse button and move the icon as shown; then release the mouse button.

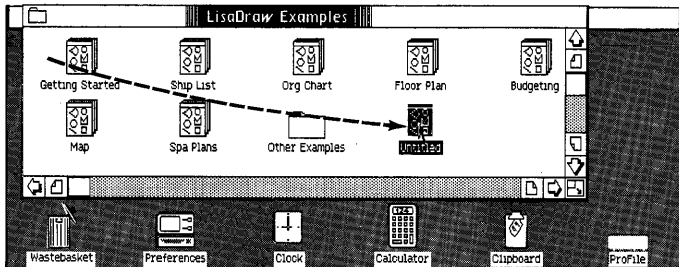

- To rename the new document:

- 1 Make sure the untitled document icon is still selected (highlighted). If you've deselected the icon by clicking elsewhere on the screen, select it again by clicking on it.
- 2 Type the name **Top Sales**. (Typing mistake? Use the **Backspace** key to correct it.)

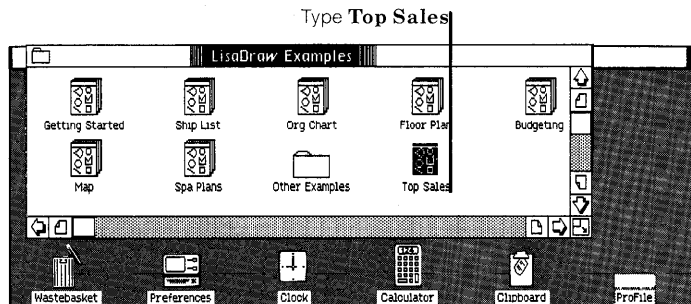

Do This

- To open the Top Sales document:

- 1 Make sure the document icon is selected (highlighted).
- 2 Choose Open "Top Sales" from the File/Print menu.

Notice how the icon zooms open into a window. Wait a minute — the hourglass, ⌵, means wait — until the LisaDraw tool displays the Top Sales document, as shown.

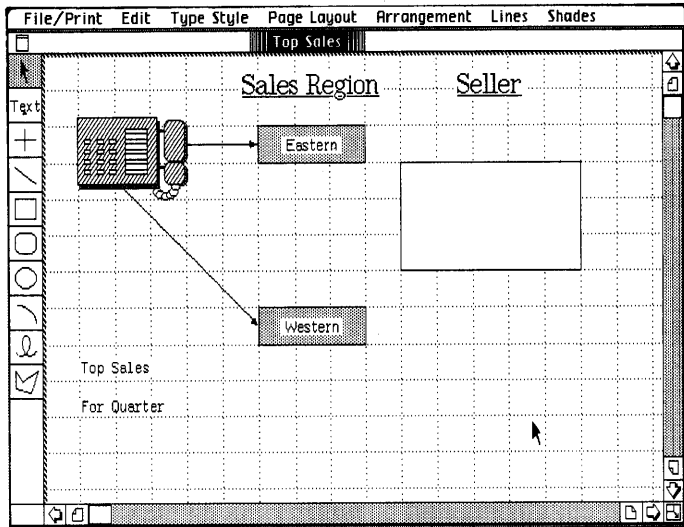

The LisaDraw Document

The Top Sales document is now open on your Lisa's desktop.

Across the menu bar at the top of the screen are the **LisaDraw menu names**. Each menu contains a list of actions you can take with a LisaDraw document.

Along the left side of the LisaDraw document is a column of symbols called the **palette**, like an artist's palette. You use the palette to draw, add text, and edit different objects in the drawing area. Notice the shading around the top symbol in the palette, the **change symbol**. The shading indicates that the change symbol is activated.

Without pressing the mouse button, move the pointer around the screen and notice that it is shaped like an arrow pointer, \uparrow . In LisaDraw it is called the **change pointer** because it appears when the palette's change symbol is activated, and allows you to edit, or change, drawings and text in your chart.

You will see two other kinds of pointers as you go through Getting Started with LisaDraw. When the palette's text symbol is activated, the shape of the pointer changes to a **text pointer**, I , and when a drawing symbol is activated, the shape of the pointer changes to a **drawing pointer**, $+$.

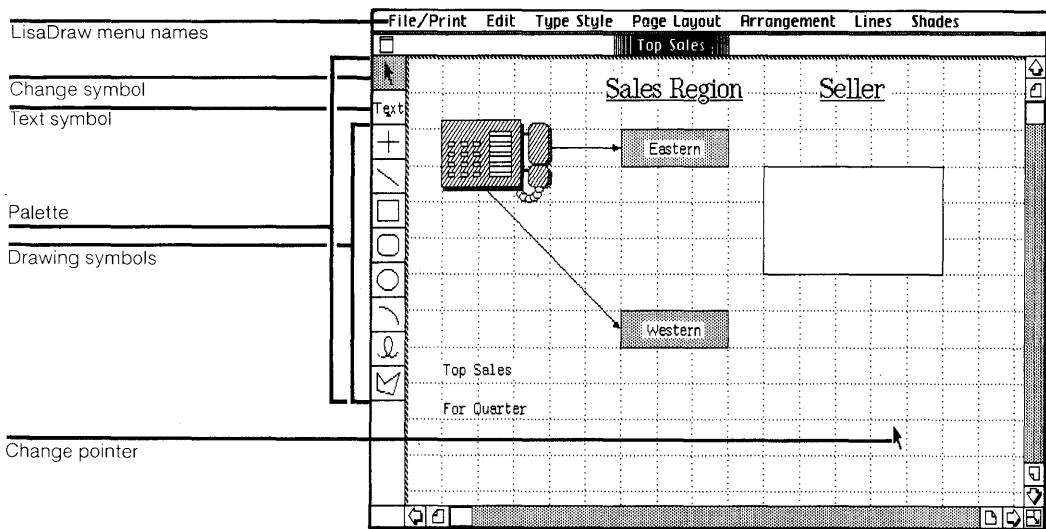

What You Are Going To Do

Imagine you work for a fictional company called Switch-On Communications, Inc. You want to finish drawing a chart showing last quarter's top sellers from the Eastern and Western regions in time for a meeting later in the day.

In the next several pages you will learn to:

- 1.** Clear an unwanted drawing from the chart.
- 2.** Draw a box, duplicate it, and then move the duplicate boxes into place on the chart.
- 3.** Add text to the chart.
- 4.** Add arrows to the chart.
- 5.** Add shading to boxes on the chart.
- 6.** Change the type style of the chart's title.

When you are finished, your chart will look like the one below. Compare it with the chart now on your screen.

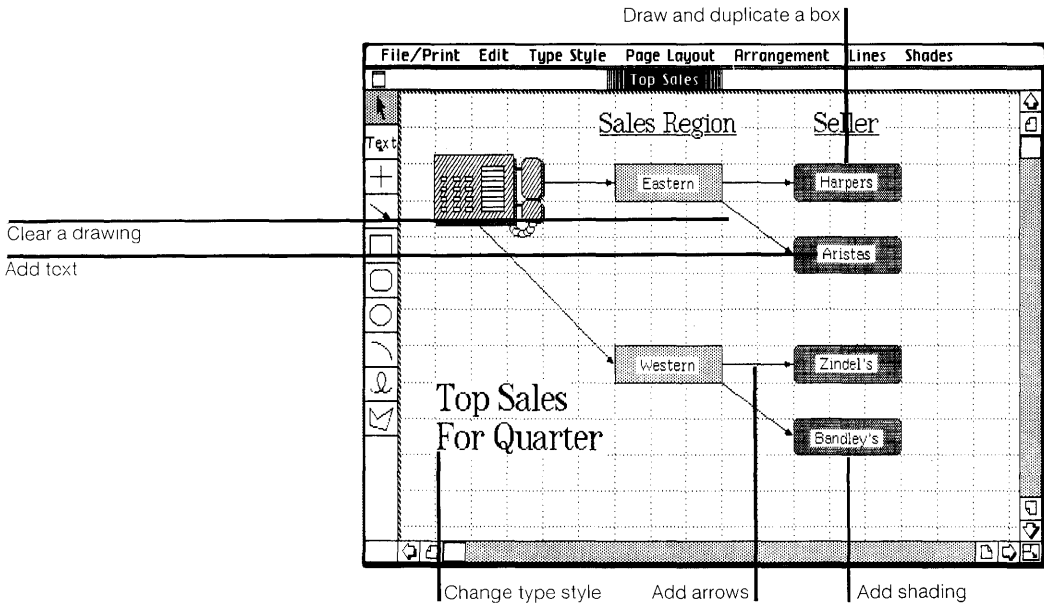

Clearing A Drawing from the Chart

What You're About To Do

The chart now contains a large, empty box. Follow the steps below to clear it from the chart.

Do This

- 1 Use the change pointer, , to select the large box to the right of the chart, as shown.

Here's how

- Place the tip of the pointer on the box.
- Hold the pointer still, and lightly click the mouse button.

*Notice the small black squares, called **handles**, around the box; they show that it's selected.*

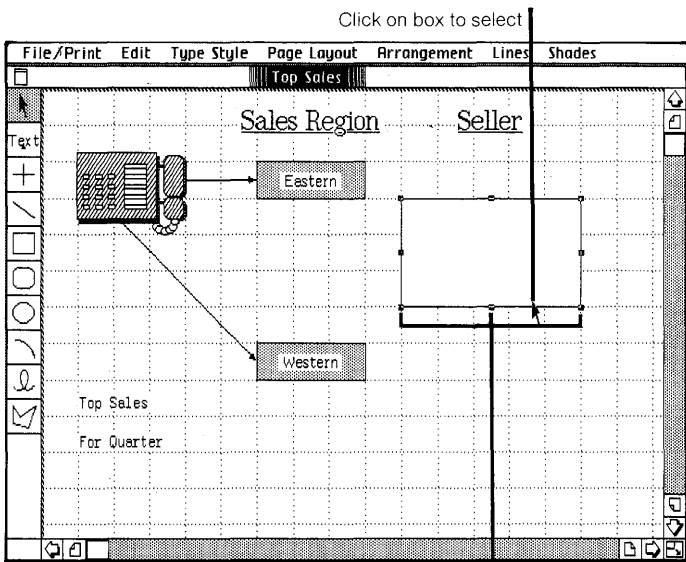

"Handles" show box is selected

Do This

- 2 Choose Clear from the Edit menu.

Notice that the box disappears. If at any time you draw something you don't like, you can follow this procedure to clear it from the drawing area.

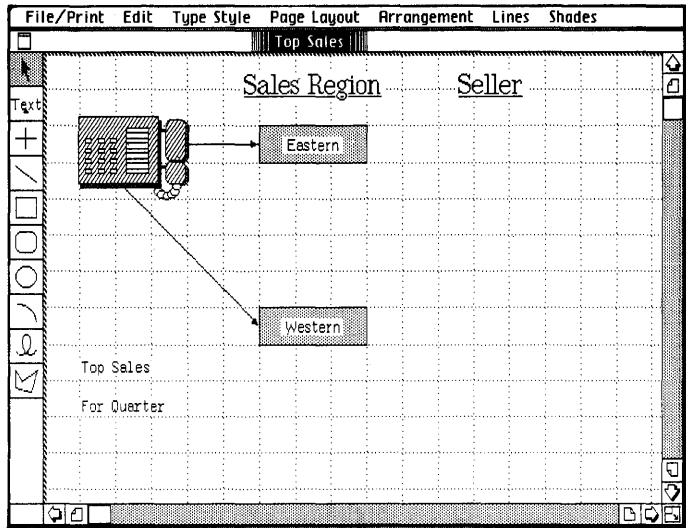

Drawing

What You're About To Do

Follow the steps below to draw a rounded-corner box under the Seller column of the chart.

Do This

- 1 Activate the rounded-corner box symbol in the palette, as shown. (Place the pointer on the palette symbol and click.)

Notice the shading around the palette symbol, showing that it's activated, and how the pointer changes to a drawing pointer, +, when you move it back into the drawing area.

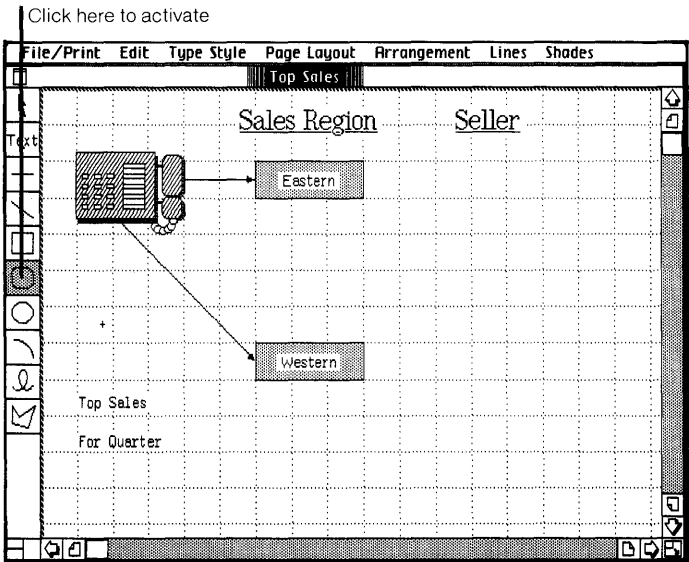

Do This

- 2 Draw a rounded-corner rectangle, 1 square high and 3 squares wide, 2 squares to the right of the "Eastern" box, as shown.

Here's how

- Place the drawing pointer where you want the upper-left corner of the new box.
- Hold down the mouse button; as you move the drawing pointer down and to the right, a box appears.
- Release the button when the box is the size shown to the right. (Box not the right size, or not in the right spot? Clear it and go back to step 1 to try again.)

Notice that two things happen anytime you draw something. Handles appear around the drawing, showing that it's selected, and the palette's change symbol is automatically activated, as can be seen by the appearance of the change pointer in the drawing area.

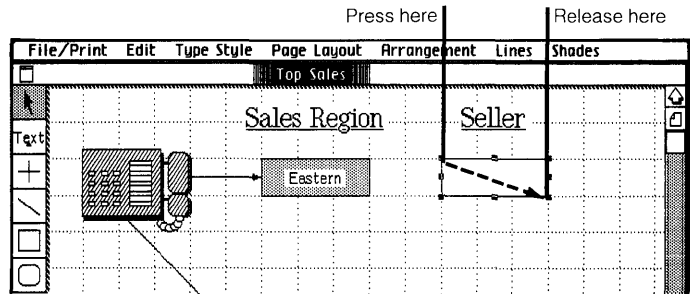

Duplicating A Drawing

What You're About To Do

You need three more boxes like the one you've just drawn. Instead of drawing new boxes, duplicate the one you have, as described in the steps below.

Do This

- 1 Make sure the box you just drew is still selected — that there are handles around it. If you've clicked somewhere else on the chart and deselected the box, click on the box to select it again.

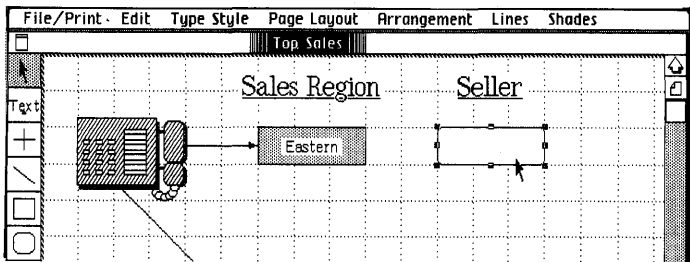

- 2 Choose Duplicate from the Edit menu three times, so you have three more boxes, as shown.

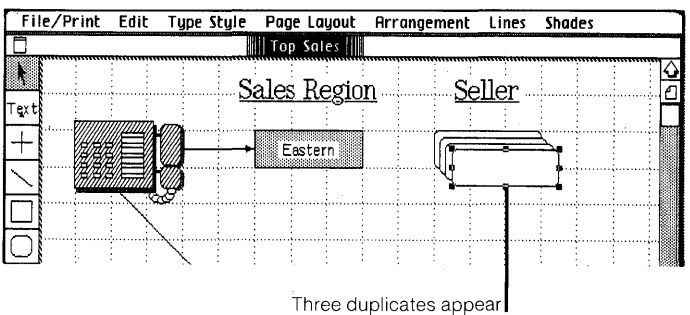

Moving A Drawing

What You're About To Do

Now that you have all the boxes you need, you're ready to move them into place.

Do This

- 1 Place the tip of the pointer on a line of the front box, but not on a handle, as shown.

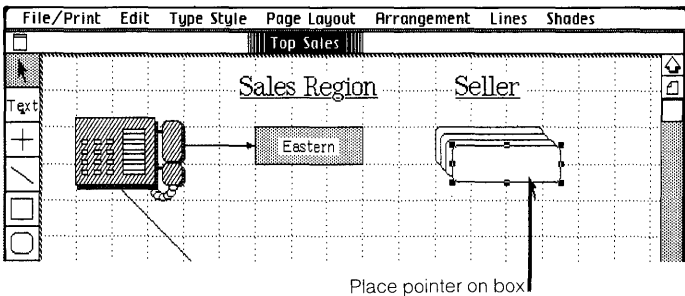

- 2 Hold down the mouse button and move the box down so it's 2 squares to the right of the "Western" box, as shown. Release the mouse button when the box is where you want it.

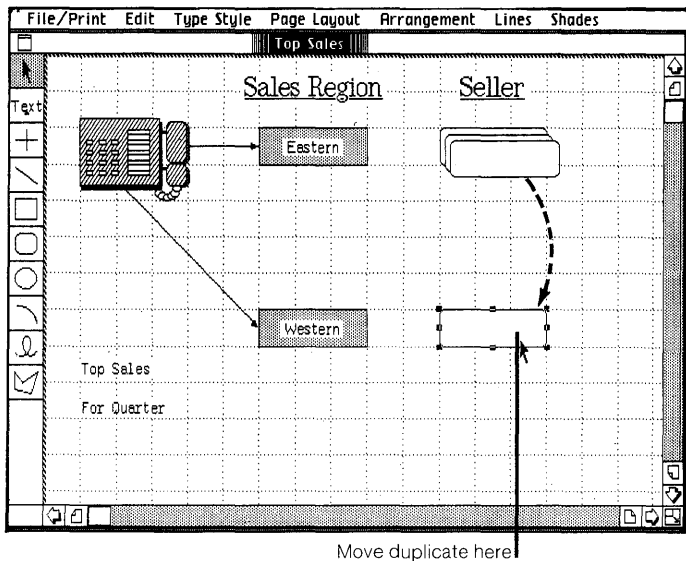

Do This

- 3 Move the other two drawings so one is 1 square below the original box, and the other is 1 square below the box you just moved in step 2, as shown. Don't worry about moving one box over other boxes. (Change the shape of a box by mistake? You pressed with the pointer on a handle. Try using the handles to reshape the box back to size, then move it into place.)

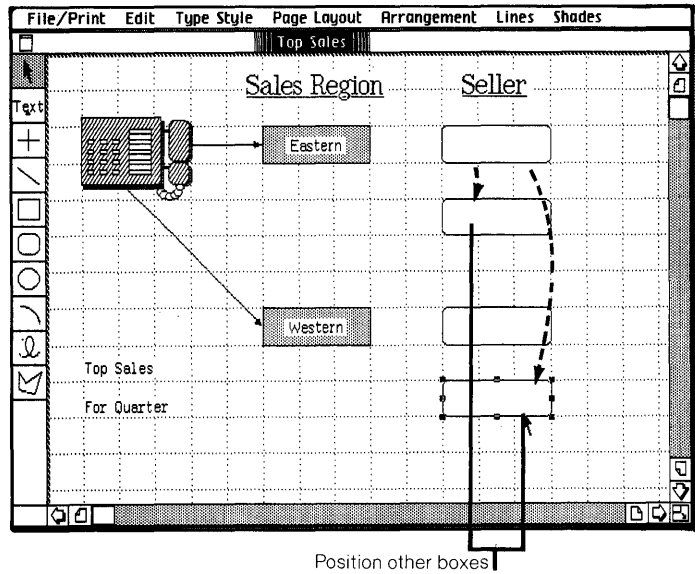

Adding Text

What You're About To Do

Now you need to add the names of the top sellers to the four new empty boxes.

Do This

- 1 Activate the palette's text symbol by clicking on it, and notice how the pointer changes to a text pointer, **I**.
- 2 Move the text pointer into the middle of the top empty box and click the mouse button to select an insertion point — a blinking vertical line. (Insertion point not where you want it? Click again where you want it to appear.)

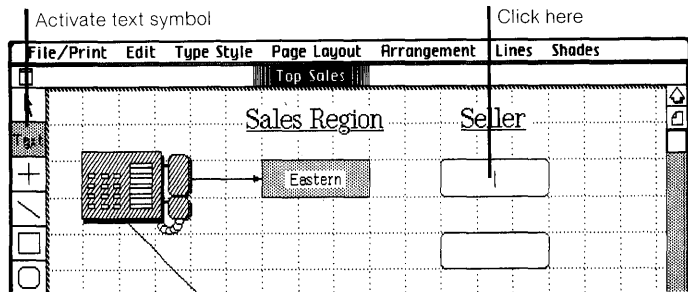

Do This

3 Type the name **Harper's**. (Typing mistake? Use the **Backspace** key to correct it.)

4 Follow the procedure in steps 2 and 3 to type in the other three names, **Aristas**, **Zindel's**, and **Bandley's** — into the other three boxes, as shown. (Click to select an insertion point, then type.)

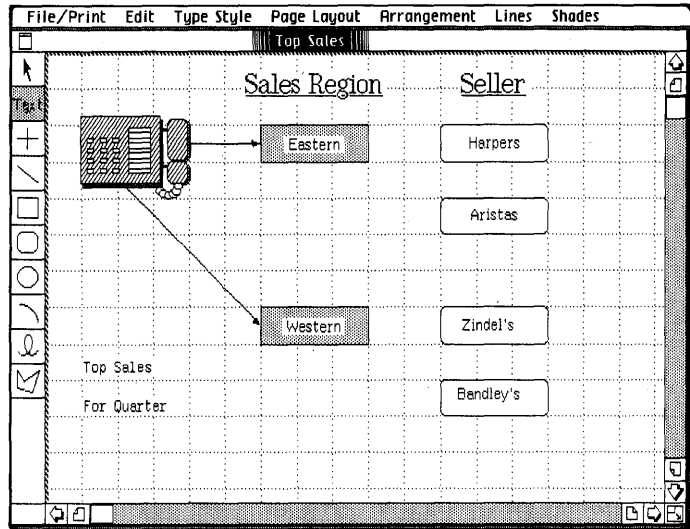

5 Now activate the palette's change symbol by clicking on it.

Notice that once you activate the change symbol, the last thing you typed is automatically highlighted, showing that it's selected.

6 With LisaDraw you can move text just as you move drawings. Use the change pointer to center any name that needs centering. (Place the tip of the pointer on the name you want to center, then hold down the mouse button and move the name into place.)

Note: If you want to deselect selected text, click once on a blank part of the drawing area.

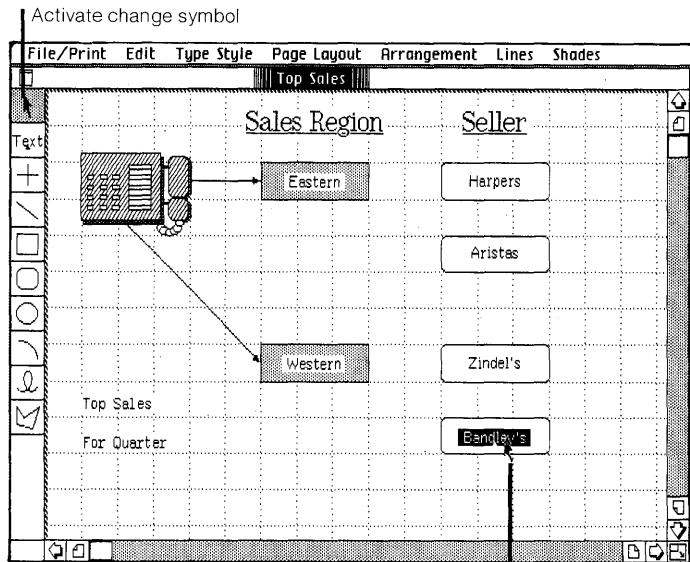

Use change pointer to center text

Adding Arrows To The Chart

What You're About To Do

Follow the steps below to draw arrows from the "Eastern" and "Western" boxes to the four new boxes.

Do This

- 1 Activate the diagonal line symbol on the palette by clicking on it, as shown.

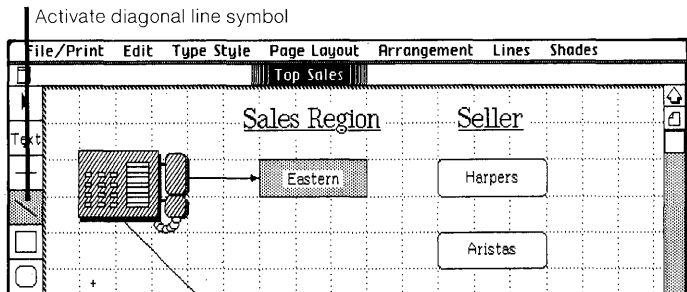

- 2 Choose the Single-arrowhead line from the Lines menu.

Notice that the activated palette symbol now shows a single arrowhead.

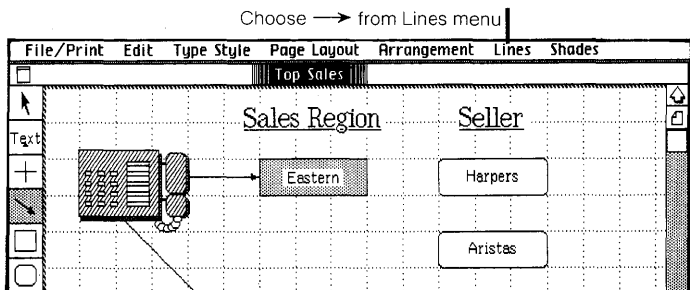

Do This

- 3 Draw an arrow from the “Eastern” box straight across to the “Harper’s” box, as shown.

Here’s how

- Place the drawing pointer where you want to begin the arrow.
- Hold down the mouse button; as you move the drawing pointer, an arrow appears.
- Release the button when the arrowhead is where you want it. (Don’t like what you drew? Choose Clear from the Edit menu, activate the diagonal line symbol on the palette, and try again.)

Notice the handles on the arrow and the now activated change symbol on the palette.

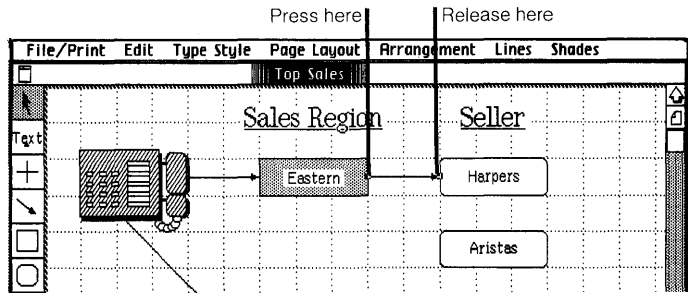

- 4 Each time you draw an object, you need to first activate the appropriate drawing symbol on the palette. Activate the diagonal line symbol again and draw a second arrow from the corner of the “Eastern” box to the middle of the “Aristas” box, as shown. (You don’t need to choose from the Lines menu again.)

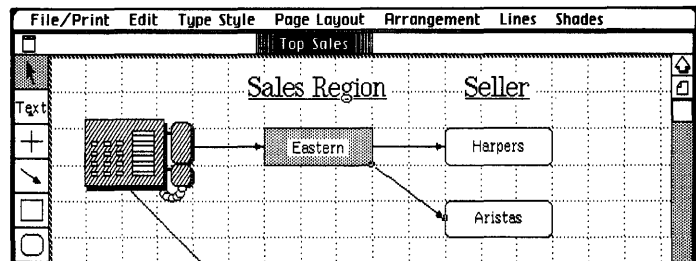

Do This

- 5 Follow the procedure in step 4 to draw two more arrows between the bottom set of boxes, as shown.

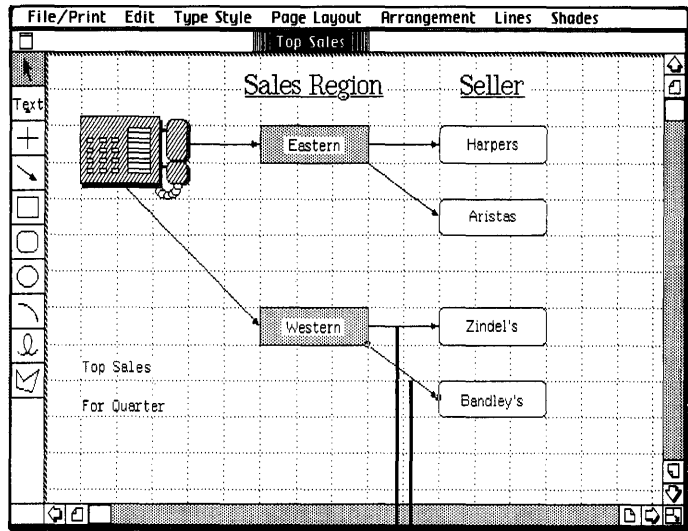

Shading Boxes on the Chart

What You're About To Do

Follow the steps below to add shading to your rounded-corner boxes.

Do This

- 1 Make sure the palette's change symbol is activated, and then use the change pointer to select the top box containing the word "Harpers". (Place the tip of the pointer on the edge of the box, but not on the text, hold it still, and click.)

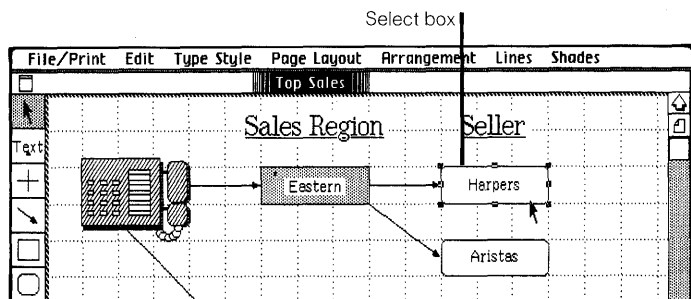

- 2 Choose the second gray shade above black from the Shades menu, as shown. (Choose the wrong shade? Make sure the box is still selected and choose the shade you want.)

Notice how the selected box is now shaded.

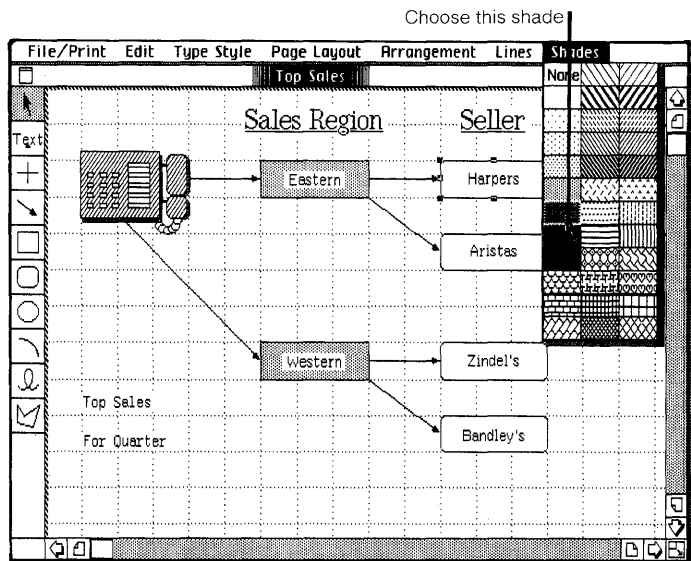

Do This

- 3 Select and shade the other three boxes in the same way.

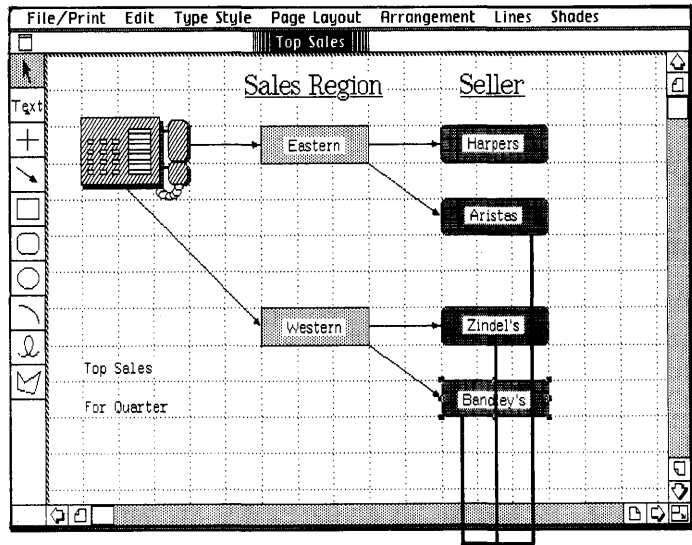

Shade other boxes

Changing Type Style

What You're About To Do

The title in the lower-left corner, "Top Sales For Quarter", will look better if it stands out more. Follow the steps below to change the type style into something larger.

Do This

- 1 Activate the palette's text symbol by clicking on it.
- 2 Select the first two words of the title, "Top Sales", as shown.

Here's how

- Place the text pointer just to the left of the "T" in "Top".
- Hold down the mouse button and move the pointer through the words; then release. ("Top Sales" not completely highlighted? Try again. Make sure you start with the text pointer right before the "T".)

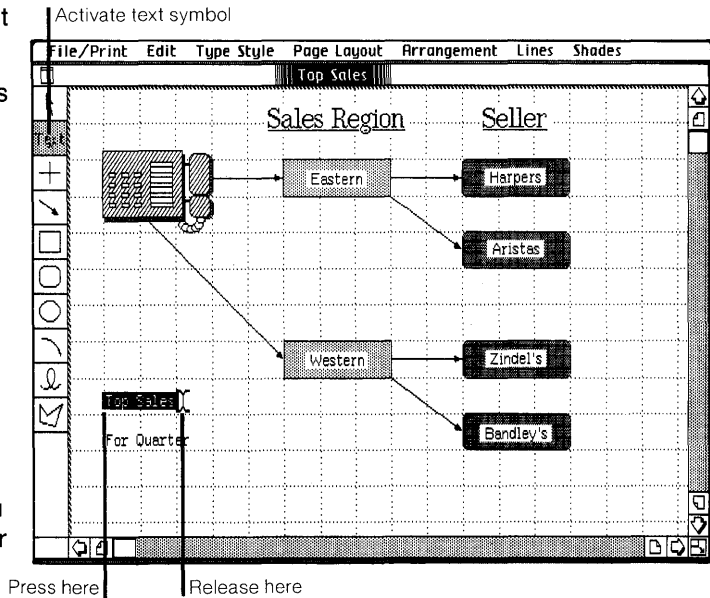

Do This

- 3 Choose PS 1/3 inch Classic from the Type Style menu. (Choose the wrong type style? Make sure the words are still selected and choose the type style you want.)

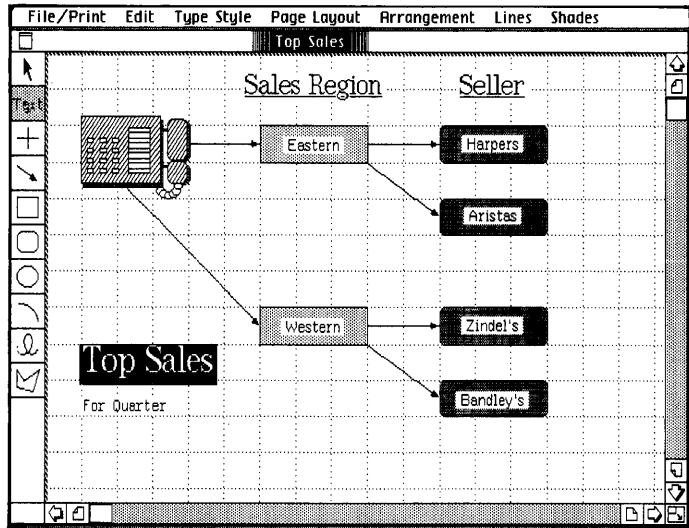

- 4 Follow the procedure in steps 2 and 3 to change the type style of the rest of the title, "For Quarter".

Your chart is now complete. To see it with nothing selected (no highlighting), activate the change symbol and click on a blank part of the drawing area.

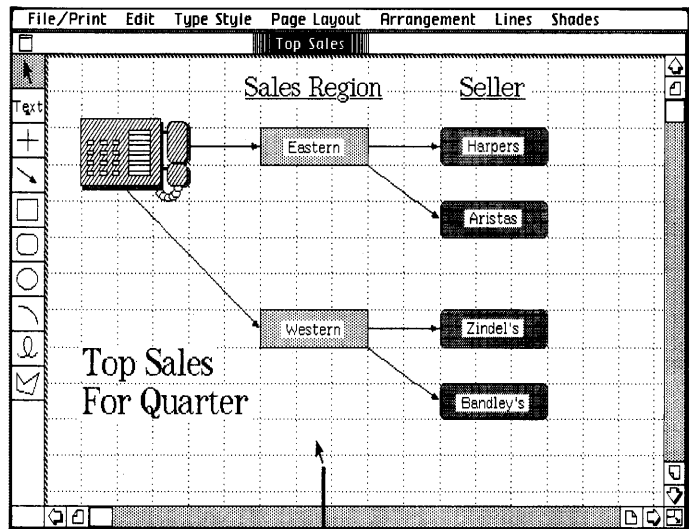

Click with change pointer to deselect

Printing Your Document (Optional)

What You're About To Do

If you don't want to print your chart now, or don't have a printer available, you can skip this section and go on to **Putting Your Document Away**.

To print a copy of your finished chart, follow the steps below.

Do This

- 1 To ensure that your work is saved on the ProFile before you print, choose Save & Continue from the File/Print menu.
- 2 Make sure your printer is hooked up and turned on. (Refer to the manual that came with your printer for information on connecting the printer and loading paper and print ribbons.)

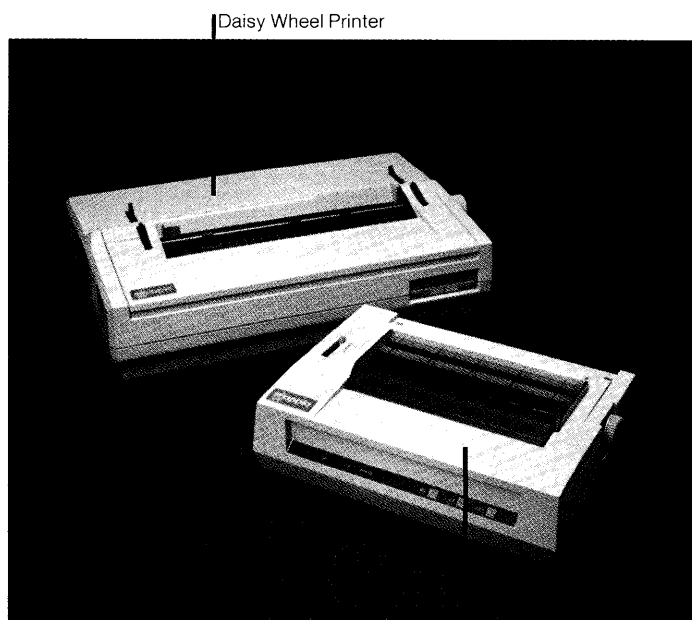

Daisy Wheel Printer

Dot Matrix Printer

Do This

- 3 Choose Print from the File/Print menu to bring up the Print dialog box shown to the right. (See a different message on the screen? Go to the next page and read the “Trouble with printing?” section.)

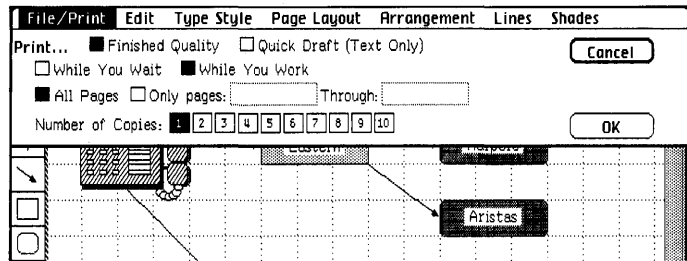

- 4 The current settings in the Print dialog box are fine, so use the mouse to check “OK”, as shown. (Trouble? See “Trouble with printing?” on the next page.)

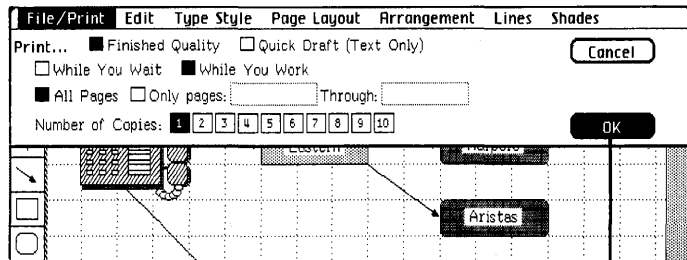

Notice that the hourglass appears for a few moments — the hourglass means wait — as your Lisa records the information necessary to print the document.

- 5 When your document begins printing and you see the Monitor the Printer dialog box, check “Proceed”, as shown. (Trouble? See “Trouble with printing?” on the next page.)

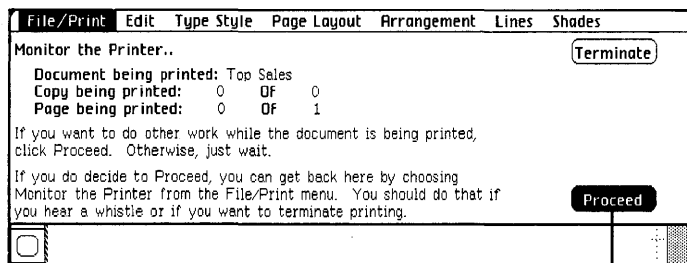

Notice that once the hourglass disappears and printing begins, you can use your Lisa to do other work.

Trouble with printing?

- If you see the alert message to the right, refer to the *Lisa Owner's Guide*, Section D, Desktop Manager Reference Guide, under Set Printer Configuration.
- If you see any other alert message, follow its instructions. If needed, refer to the *Lisa Owner's Guide*, Section G, Troubleshooting, under Printers, or see the manual that came with your printer.
- To learn more about printing, refer to Section C, *LisaDraw Reference Guide*, Chapter 2, under Print.

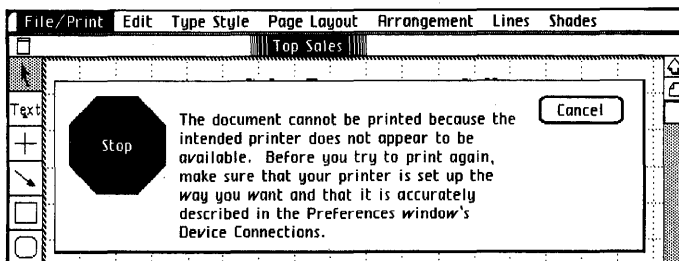

Putting Your Document Away

What You're About To Do

Now that you've finished working on your document, follow the steps below to put it away. Even if you chose to print your document and it's still printing, you can continue to use your Lisa to do other work.

Do This

- 1 Choose Save & Put Away from the File/Print menu. (Is the Save & Put Away menu item dim? Then you need to click in the document to make the window active.)

Notice how the window zooms down to a document icon back in its filing home in the LisaDraw Examples folder.

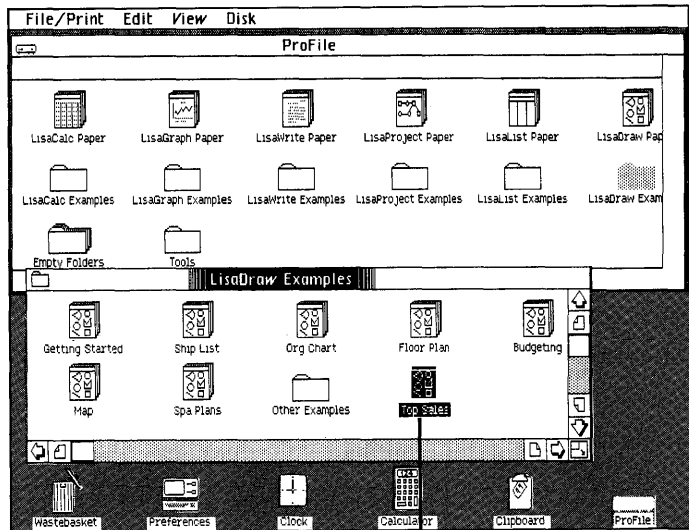

Document is Saved & Put Away

Starting from Scratch

What You're About To Do

In order to start a new drawing, you need to get a piece of LisaDraw stationery, as described below. Blank LisaDraw stationery is in a pad called LisaDraw Paper, in the ProFile window.

Do This

- 1 Tear off a sheet from the LisaDraw Paper pad at the top of the ProFile window. (Select the pad icon; choose Tear Off Stationery from the File/Print menu.)

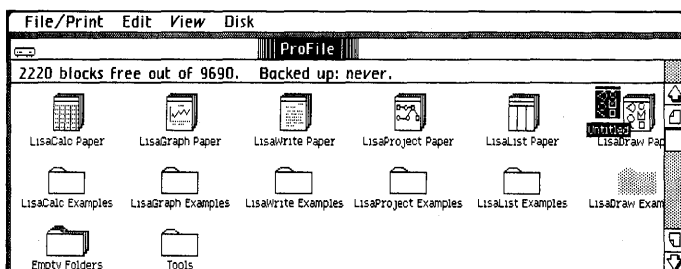

- 2 Don't worry right now about moving the untitled document out of the way. Change the name of the untitled document to **Organization Chart**. (Make sure the icon is selected; then type.)

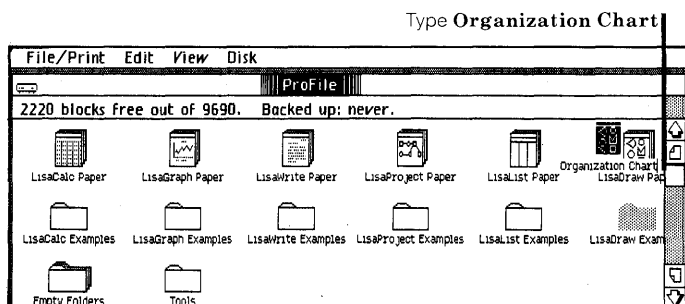

Do This

- 3 Open the piece of LisaDraw paper you named Organization Chart as you would any document. (Choose Open "Organization Chart" from the File/Print menu.)
- 4 Now if you want to draw, activate a palette symbol and draw. Experiment — try different things. Press and move across the menu bar and look at what's in all your menus. If you want specific information on something, look in the LisaDraw Reference Guide, Section C, or check the index.

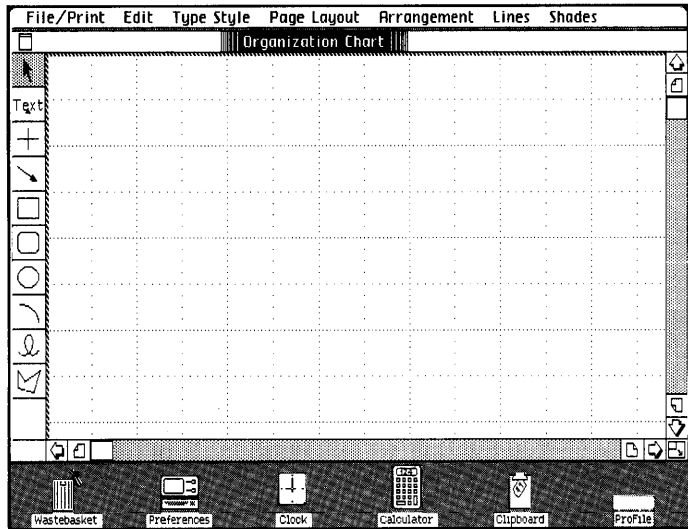

Finishing Up

What You're About To Do

It is a good idea to save all your documents and clear off your Lisa's desktop at least once a day. The steps below illustrate one of the many ways you can manage things on the Lisa desktop.

Note: When you are connecting, disconnecting, moving, or servicing equipment, you must turn off the power. But normally, you should turn off your Lisa only at the end of each week, and always leave your ProFile turned on.

Do This

1 Choose Set Aside
"Organization Chart"
from the File/Print menu
and notice how
Organization Chart is set
aside as an icon on the
desktop.

Note: When you're working with
several documents at the same
time, it's often convenient to
keep some of them set aside on
the desktop, where it's easy to
get at them.

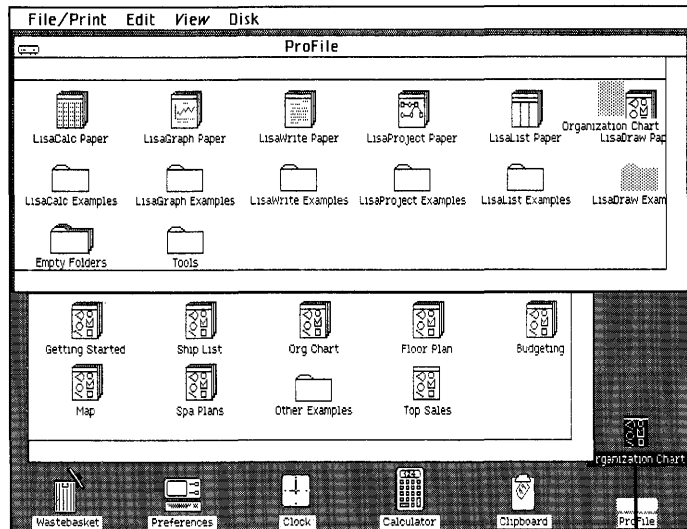

Organization Chart is
Set Aside

Do This

- 2 If you want to file the Organization Chart document in a new place, move it to a clear area in the LisaDraw Examples folder, as shown. (Press with the pointer on the icon, move it, and release when the icon is where you want it.)

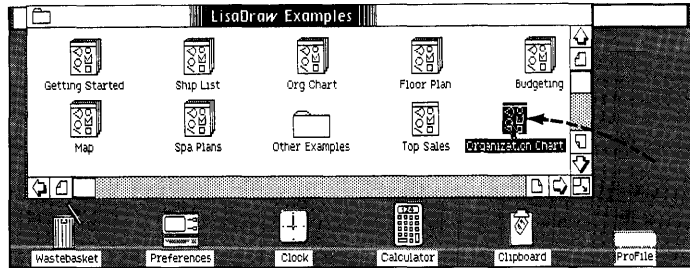

- 3 If you want to throw away the Organization Chart document, move it to the Wastebasket icon. When the document icon is on the Wastebasket and the Wastebasket icon highlights, release the mouse button and wait for the document to be deposited.

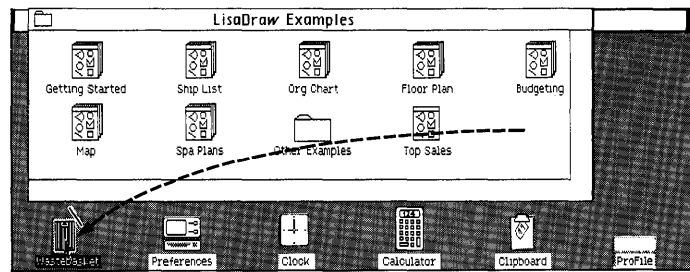

Note: You can always get back the last thing you've thrown away by opening the Wastebasket icon and moving the deposited document back out.

Do This

- 4 Now set aside both the LisaDraw Examples folder and ProFile by choosing Set Aside Everything from the File/Print menu.

Notice that both the Folder and ProFile icons are now set aside on the desktop.

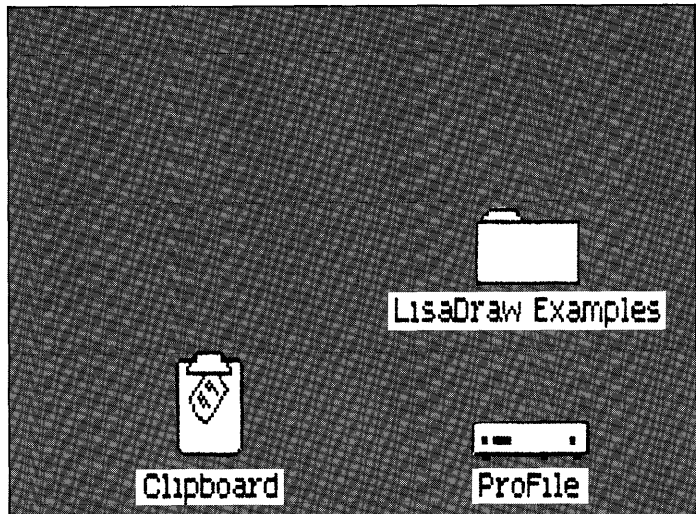

- 5 You can put away the LisaDraw Examples folder back in its filing home in the ProFile even when the ProFile window is closed. To do so, select the LisaDraw Examples folder and choose Save & Put Away "LisaDraw Examples" from the File/Print menu.

Note: If you want to deselect a selected icon, click once when the pointer is not over the icon.

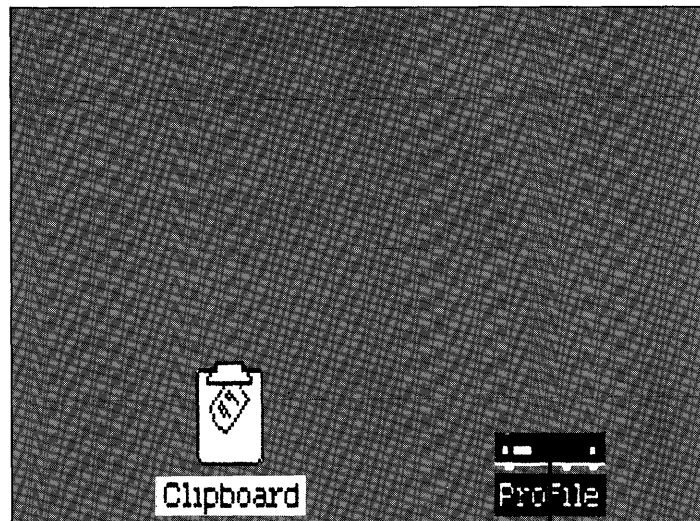

Folder is Saved & Put Away

Do This

- 6** When you are ready to work on something else, just open the ProFile again. When you want to turn off Lisa's power — for example, over the weekend — press the lit on-off button, as shown. When you turn on the Lisa again, everything will reappear as you left it when you turned the Lisa off, including documents you may have left open on the desktop. Normally, you should leave the ProFile turned on.

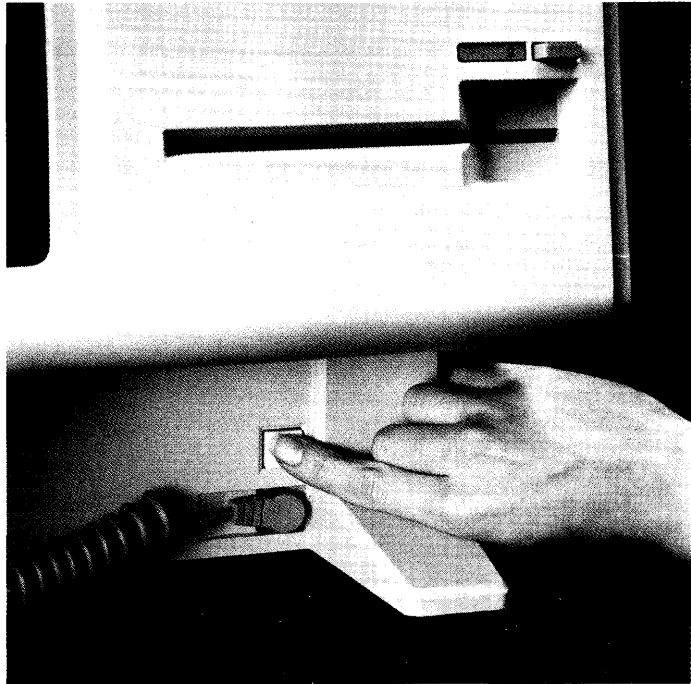

Using LisaDraw

You now have the basic skills necessary for using LisaDraw to produce your own LisaDraw documents. Because the concepts for using each Lisa tool are the same, you also have some of the basic skills for using other Lisa tools: LisaCalc, LisaGraph, LisaList, LisaProject, and LisaWrite.

There is much more you can do with LisaDraw. You can learn about other LisaDraw features by:

- Going through other exercises in the LisaDraw Tutorial, Section B.
- Using the LisaDraw Reference Guide, Section C, as you do your work.
- Just experimenting as you use LisaDraw. Remember — when experimenting, you usually have to select something before taking action with it. It's safe to experiment because most of the things you do can be undone by choosing Undo Last Change from the Edit menu. And if you're experimenting with a document you've torn off of a stationery pad, you can try almost anything and always start fresh by either choosing Revert to Previous Version from the File/Print menu, or by throwing the document away into the Wastebasket, and tearing off a fresh copy from the same stationery pad.

Other LisaDraw Features

-
- Automatic alignment of selected drawings and text.
 - Grouping several drawn objects to be treated as one.
 - Changing the shape and size of a drawing.
 - Shading text.
 - Displaying rulers for precision drawing.
 - Choice of drawing paper — from the Page Layout menu, choose Plain Paper, Grid Paper, or Auto-Grid Paper.
 - Designing custom rulers to increase the precision of drawing with Auto-Grid Paper.
 - Locking drawings so they can't be altered accidentally.
 - Cutting and pasting between LisaDraw documents, and from LisaGraph and LisaProject to customize your graphs and charts.

Guide to Lisa Manuals

Set up your Lisa following the setup procedures in the Lisa accessories box or in Appendix 1, Setup Procedures, in the *Lisa Owner's Guide*.

Go through Section A, LisaGuide, in the *Lisa Owner's Guide*, for an introduction to the Lisa.

If your dealer or service representative did not set your system Preferences so that the Lisa knows what external devices are attached, follow the instructions in Section D, Desktop Manager Reference Guide, under Set, in the *Lisa Owner's Guide*.

Go to Section A, Getting Started, in the manual for each office tool that you want to learn, for the essentials of using that tool.

- ▶ Go to Section B, Lisa Fundamentals, in the *Lisa Owner's Guide*, for the background information you need before beginning long-term work on the Lisa.
-

You are now ready to start doing your own work on the Lisa:

- If you want self-paced instructions for using a tool, go to Section B, Tutorial, in that tool manual.
 - If you want instructions for performing specific tasks with a tool, go to Section C, Reference Guide, in that tool manual.
-

For specific instructions on filing and desktop management, go to Section D, Desktop Manager Reference Guide, in the *Lisa Owner's Guide*.

For more information on the Lisa hardware, tips on caring for the Lisa, and suggestions for troubleshooting when the system isn't working properly, go to the other sections of the *Lisa Owner's Guide*.

Section B
LisaDraw Tutorial

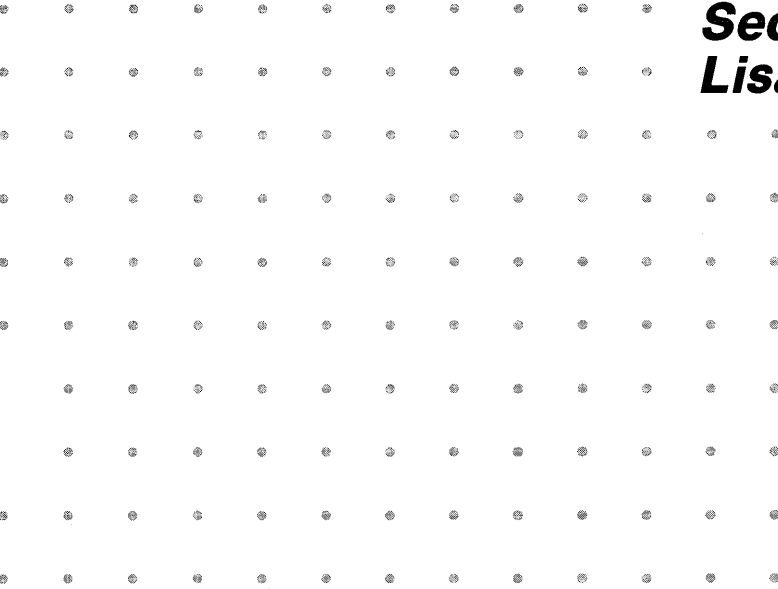

Contents

Bvii What's in the LisaDraw Tutorial?

Chapter 1 **Learning the Basics** **B1**

B4 Getting a New LisaDraw Document

B4 A Look at LisaDraw

B5 Drawing Lines

B6 Using the Apple Key

B7 Three Kinds of Drawing Paper

B9 Drawing Boxes and Circles

B11 Saving Your Drawings

B11 Making Selections

B13 Multiple Selections

B14 Using the Selection Box

B15 Correcting Mistakes

B17 Drawing Freehand

B18 Moving Things Around

B19 Stretching and Shrinking Objects

B21 Shade and Pattern

B23 Changing the Style of Lines

B26 Printing Your Drawing

B28 Saving and Filing a Drawing

B29 Chapter Summary

Chapter 2
Creating a Flowchart
B35

B38 Why Draw a Flowchart?

B39 Changing the Size of the Window

B39 Drawing Boxes with Rounded Corners

B40 Making Duplicates

B41 Taking Advantage of Rulers

B43 Scrolling in LisaDraw

B46 The View Buttons

B46 The Elevators

B47 Drawing a Polygon

B49 Reshaping a Polygon

B50 Drawing Arrows

B52 Adding Text to Graphics

B53 Selecting and Editing Text

B55 Using Cut and Paste

B56 Changing Type Styles

B59 Chapter Summary

Chapter 3
An Org Chart
and a Map
B63

B66 A Word about Organization Charts

B67 Looking for Similarities

B69 Grouping Objects

B76 Locking and Unlocking

B79 Making a Shaded Org Chart

B80 Printing and Putting Back

B81 Drawing a Freehand Map

B83 Stretching and Shrinking Freehand Lines

B84 Changing Segments of a Freehand Line

B85 Smoothing a Freehand Line

B87 Adding Text to the Map

B88 The Shrink-to-Size Technique

B89 Printing and Putting Back

B90 Chapter Summary

Chapter 4
More about LisaDraw
B93

B96 Deselecting Selectively

B98 Easy Alignment

B99 Setting Text Alignment

B100 All about Arcs

B102 Moving, Stretching, and Shrinking Arcs

B104 Filling Arcs

B106 Changing Polygons

B107 Measuring Size

B108 Aligning to Auto-Grid “After the Fact”

B109 Metric and Custom Rulers

B110 Going Metric

B110 Designing a Custom Ruler

B112 Drawing a Frame

B113 Centering Drawings on the Page

B114 Copy and Paste between Drawings

B116 Changing the Drawing Size

B117 Previewing Page Boundaries

B118 Chapter Summary

Chapter 5
LisaDraw and
Other Tools
B121

B124 Adding Graphics to a LisaGraph Graph

B125 Adding Graphics to a LisaProject Chart

B126 Making Overhead Slides

B127 Overhead Examples

B129 Chapter Summary

Chapter 6
LisaDraw Examples
B131

B134 The LisaDraw Examples Folder

What's in the LisaDraw Tutorial?

This tutorial teaches you about LisaDraw as it guides you step by step through several real-life examples. To get the maximum value from it, you should try out the examples on your Lisa as you go through it.

All major LisaDraw features are covered in the tutorial. A complete description of each LisaDraw feature also can be found in Chapter 2 of Section C, the LisaDraw Reference Guide, in this manual.

Before you start this tutorial, be sure you have completed LisaGuide, in which Lisa introduces Lisa. You can find the LisaGuide diskette in the front pocket of the *Lisa Owner's Guide*. Also, be sure you have completed Section A, Getting Started with LisaDraw, in this manual. If you haven't completed one or both already, now is a good time to do so.

To complete the activities in this tutorial, you need

- The blank LisaDraw stationery pad that is on the ProFile.
- The example drawings that are in the LisaDraw Examples folder on the ProFile, when you get to Chapter 6.

The arrow symbol (►) appears before each activity in the tutorial, and it means "Do something." For example,

- Turn the page to begin the tutorial.

Chapter 1

Learning the Basics

Learning the Basics

This chapter leads you step by step through the basics of LisaDraw. Gaining experience as you go, you

- Draw lines, boxes, and circles.
- Use different kinds of drawing paper.
- Select and move objects.
- Correct mistakes.
- Draw freehand.
- Stretch and shrink objects.
- Fill objects with patterns.
- Change line shades and widths.
- Print your drawings.
- Save and file your drawings.

You'll find LisaDraw easy to use, and soon you'll be an expert.

Getting a New LisaDraw Document

To create a new LisaDraw drawing,

- ▶ Open the ProFile window by clicking twice on the ProFile icon.



- ▶ Tear off a sheet of paper for the new document by clicking twice on the LisaDraw stationery pad icon.



LisaDraw Paper

- ▶ Name the new document by typing your initials. This allows other people to use the same ProFile and not get their drawings confused.

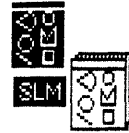

LisaDraw Paper

- ▶ Open the new drawing's window by clicking twice on the drawing icon.

You now have a new piece of LisaDraw paper on your screen.

A Look at LisaDraw

The main elements of the LisaDraw screen are shown in Figure 1. The palette is the column along the left side containing a number of symbols and the word "Text."

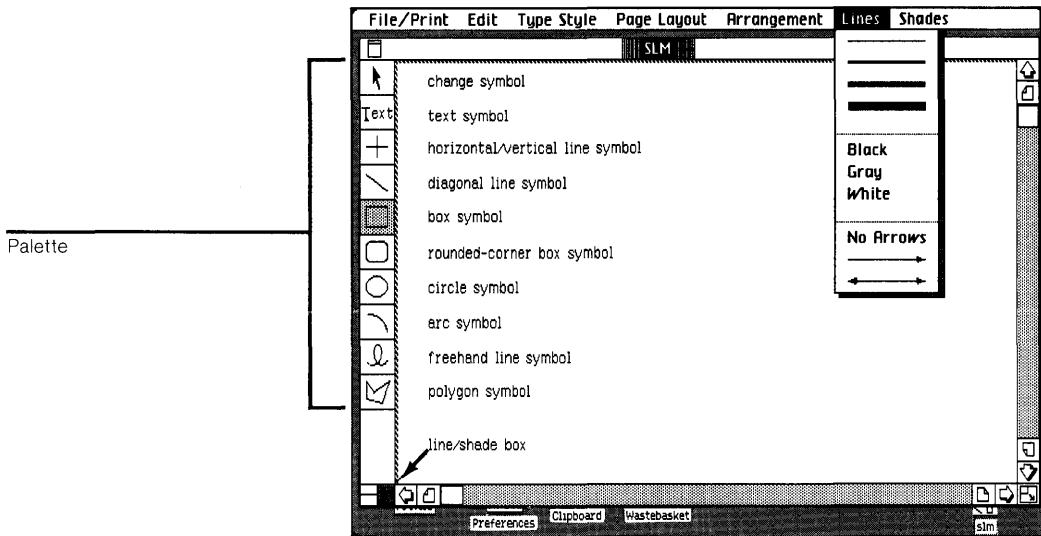

Figure 1. LisaDraw Screen

You tell LisaDraw what you want to draw by selecting the appropriate symbol from the palette.

Drawing Lines

One of the most basic things you can draw is a line. To draw a horizontal or vertical line,

- ▶ Move the pointer to the horizontal/vertical line symbol.
- ▶ Press and release the mouse button once and move the pointer back into the drawing area.



The symbol in the palette is now surrounded by a shaded outline indicating that it is active and that you can draw a horizontal or vertical line.

- ▶ Move the pointer, which now has the shape of a cross, to a place in the drawing area where you want to begin drawing.

- ▶ Press the mouse button and move the pointer to the right or the left to draw a horizontal line. The point where you release the button determines the end of the line.

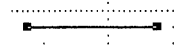





Even though you may not draw a perfectly horizontal line, LisaDraw automatically makes it horizontal for you.

The black squares at the ends of the line are called handles. They appear on whatever you've most recently drawn, and on objects that you select. You'll learn more about handles in a few minutes.

Using the Apple Key

When you have chosen a drawing symbol and have drawn an object, there are two ways to continue to draw more of the same kind of object.

- ▶ Reactivate the appropriate drawing symbol before drawing each object,
or
- ▶ Press and hold down the  key as you continue to draw.

Using the  key is a shorthand way of telling LisaDraw that you want to continue using the same drawing symbol that you've just used. Notice that all the lines that you draw are selected when you release the  key. If you release the  key and then press it again, it will still work. It always remembers the last drawing symbol that you used.

- ▶ Draw several vertical lines using the same technique, but moving the pointer up and down from the starting point.

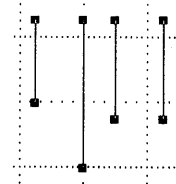

To clear the screen,

- ▶ First, choose Select All of Document from the Edit menu.

- Then, choose Clear from the Edit menu.

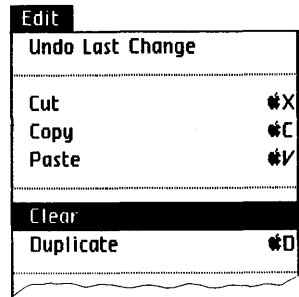



To draw diagonal lines,

- Activate the diagonal line symbol in the palette by moving the pointer to it and clicking the mouse button.

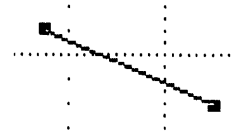

- Move the pointer into the drawing area, press the mouse button, and draw a diagonal line at any angle, releasing the button when the line is the desired length and angle.



- Practice drawing the letters W, X, Y, and Z, using the  key to reactivate the diagonal line symbol. And don't worry about making the letters perfect, this is just practice.

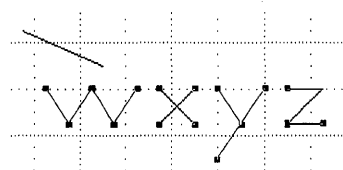

Remember, you determine the starting and ending point of each line by pressing and releasing the mouse button.

Three Kinds of Drawing Paper

Did you notice how easily the letters lined up as you were drawing them? That's because whenever you start a new drawing, auto-grid paper is turned on. Auto-grid paper displays a visible grid on the screen and also puts into effect an invisible grid that works like a magnet, attracting objects or text to it.

In LisaDraw, you have a choice of three different kinds of drawing paper, and you can change from one kind to another whenever you like. There are times when you will want to turn the auto-grid off so that you can position things between the invisible grid lines. The second kind of paper, grid paper, gives you the visual aid of the grid, but not the magnetic effect of the auto-grid. To get a feeling for the difference,

- ▶ Choose Grid Paper from the Page Layout menu.

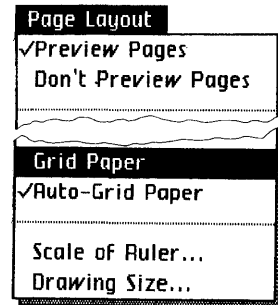

- ▶ Draw a W again, using the diagonal line symbol from the palette.

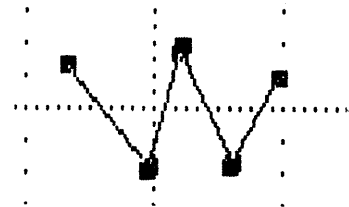

With grid paper selected, the lines go exactly where you put them instead of snapping to the invisible auto-grid. You will find grid paper especially useful when you are positioning text. By the way, the grid lines are never printed, whether you are using grid or auto-grid paper.

The third kind of drawing paper is plain paper. Choose this paper when you don't want guide lines or an automatic gridding effect. Plain paper is often appropriate when drawing freehand. In Chapter 4, More about LisaDraw, you will learn how to adjust the fineness of the grid.

Now, to continue with the examples,

- ▶ Choose Auto-Grid Paper from the Page Layout menu.

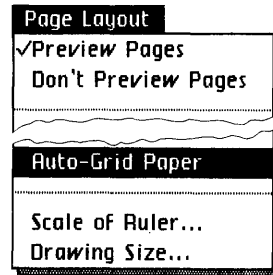

To clear the screen,

- ▶ Choose Select All of Document and then Clear from the Edit menu.

Drawing Boxes and Circles

Drawing boxes and circles is just as easy as drawing lines. With the box symbol activated, you can draw squares and rectangles of any proportion. With the circle symbol activated, you can create circles of any diameter.

To draw a box,

- ▶ Move the pointer into the palette and activate the box symbol.



- ▶ Now, move the pointer back to the drawing area to the place where you want a corner to be.

- ▶ Press and hold the mouse button as you move the pointer diagonally in any direction.

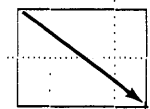

LisaDraw creates a box around the diagonal you draw.

- ▶ When the box is the size and shape you want, release the button.

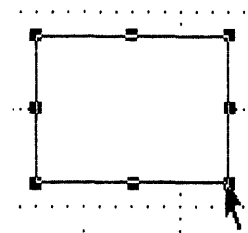

- ▶ Practice making a number of different shaped boxes. Remember that you can use the  key to keep the box symbol active.

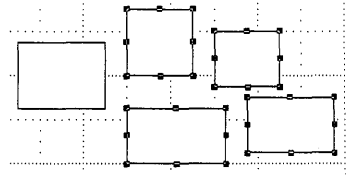

- ▶ Choose Select All of Document, and then Clear from the Edit menu to clear your screen.

Now, to practice making some circles,

- ▶ Activate the circle symbol in the palette.



- ▶ Move the pointer into the drawing area and press the mouse button.

- ▶ Move the pointer diagonally from the starting point to create a circle. Release the button.

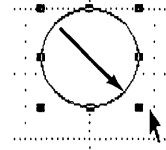

- ▶ Practice making circles and ovals of different shapes.

To use what you've learned, try a quick game of tic-tac-toe.

- ▶ Draw the following grid using the lines on the screen as a guide, and play a game solitaire or with someone nearby.

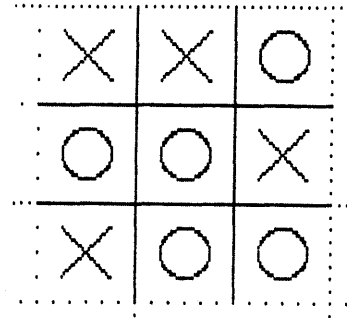

- ▶ Leave the game on the screen for another exercise in a moment.

Saving Your Drawings

It is a good idea to save the current version of your drawing at regular intervals. You will develop a sense of how often is right for you — perhaps every 5 or 10 minutes when you are working steadily. That way, you'll have an up-to-date version of the drawing to fall back on if an unforeseen power failure wipes out the changes you're making. In that case, you will only have to redo what you've done since the last time you saved your work.

To save your drawing,

- ▶ Choose **Save & Continue** from the **File/Print** menu.

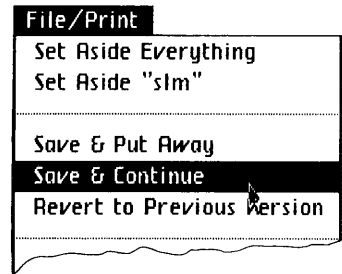

Then if, after working on a drawing for a while, you decide to return to the last version that you saved,

- ▶ Choose **Revert to Previous Version** from the **File/Print** menu.

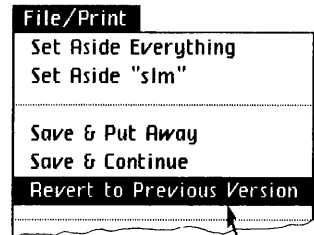

Making Selections

The black squares on the objects you drew are called handles. You've probably noticed that these handles appear whenever you draw a new object. Handles mark the current or "active" selection. They also appear when you select an object that already exists.

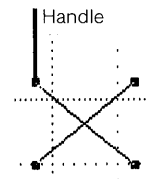

LisaDraw automatically activates the arrow-shaped change symbol for you after you draw an object, unless you hold down the  key to reactivate the last drawing symbol that you used. If you select a drawing symbol and then decide you want the change symbol instead, just click on the change symbol.



If you want to change or delete an object, you must first select it by clicking on that object when the change symbol in the palette is active. By selecting, you tell LisaDraw which object or objects you want to work with.

To see how selecting an object works,

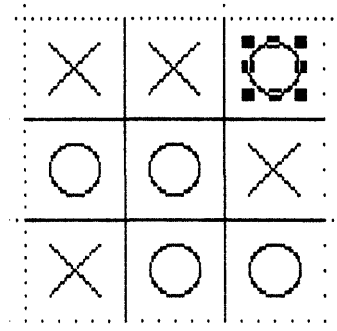

► First, click in an open area of the window to deselect everything. Deselect is the opposite of select. In this case, you don't want anything to be selected.

► Move the pointer to the edge of the upper right circle of the tic-tac-toe game and click the mouse button. The circle is now selected.

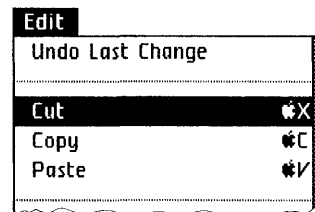

► Open the Edit menu and choose Cut; the selected circle is deleted.



The “X” to the right of the Cut menu item means that you can also cut by holding down the  key and pressing “X” on the keyboard. Sometimes this is more convenient than using the menu. Anytime you see a letter to the right of a menu item, you have the choice of this alternative keyboard method. Refer to Appendix 2, Apple Keys, for more information about the .

If handles do not appear when you select an object, it means that you did not click exactly on it, so just try again. To deselect whatever is selected, either select another object or press the mouse button when the pointer is not over any object.

- ▶ Try selecting and then deselecting another circle.

Multiple Selections

When you select more than one object at a time, you are making a multiple selection. Multiple selections are useful if you want to edit or delete several objects simultaneously. For example, if you want to change the linestyle of all the diagonal lines in the tic-tac-toe game to a thicker black,

- ▶ Make sure the change symbol is active.



- ▶ While holding down the **(Shift)** key, move the pointer to each diagonal line and click the mouse button. Notice that handles appear as you select each line.

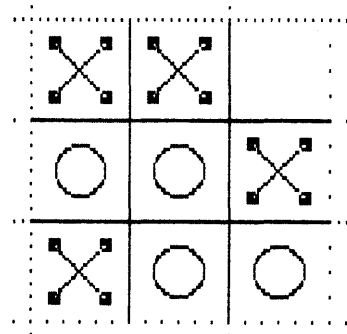

As long as you hold down the **(Shift)** key, you can add other objects to your multiple selection. If you release the **(Shift)** key and then decide to add more objects to your selection, you can press the **(Shift)** key again and continue with your selection.

- ▶ Open the Lines menu and select a thicker line.

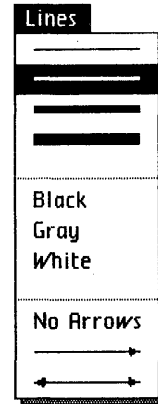

All the selected lines now have a thicker linestyle.

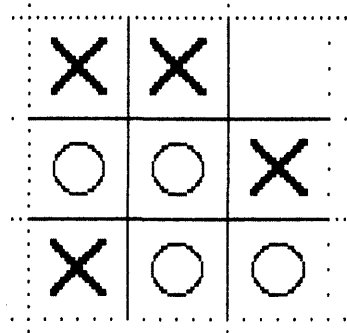

Remember, any time you want to get rid of the selection handles, move the pointer so that it is not over any object and click. This always deselects everything.

Using the Selection Box

There is a second method for making single or multiple selections. To see how it works,

- ▶ Activate the horizontal/vertical drawing symbol.



- ▶ Draw three lines.

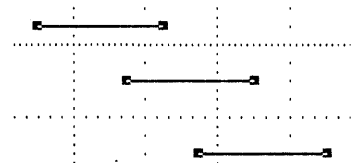

For the sake of this example,

- ▶ Click in open space to deselect everything.

The next step is to draw a temporary selection box that completely encloses everything you want to include in your selection—in this case, the three lines. To do this,

- ▶ Make sure the change symbol is active — if it isn't, click on it.



- ▶ Move the pointer to a place above and to one side of the top line. Press the mouse button and the pointer changes to the shape of a hand, indicating that you are going to draw a selection box. Move the pointer diagonally and draw a box; release the mouse button.

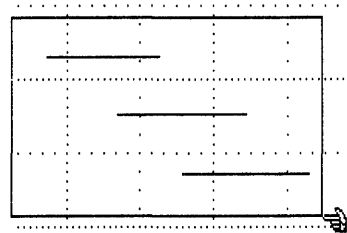

The temporary selection box and hand disappear, and the three lines are selected. Remember, only objects that are *entirely* enclosed in the selection box are selected.

- ▶ Choose Clear from the Edit menu. The lines disappear.

You can use whichever multiple selection method you like—the most efficient method is usually determined by the positions of the objects that you want to select.

Correcting Mistakes

In LisaDraw, there are several ways to correct errors. You have already learned how to use Cut in the Edit menu to delete an object. You can also undo the last thing you've done by choosing Undo Last Change from the Edit menu.

There are very few things that you can't undo. If you try to undo some action that is not "undoable," you will see a message that looks like Figure 2.

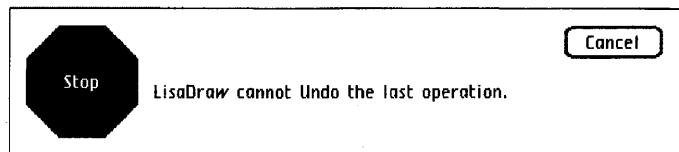
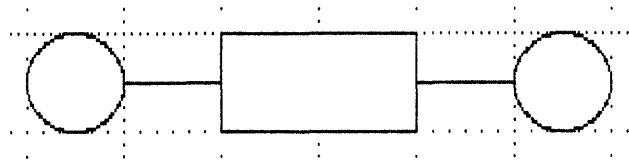
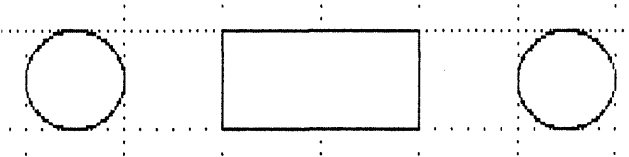

Figure 2. When Something Can't Be Undone

► Draw the following diagram with grid paper turned on:



► Now, using the **(Shift)** key to make a multiple selection, select both horizontal lines and delete them by choosing Clear from the Edit menu.



To bring the lines back,

► Choose Undo Last Change from the Edit menu.

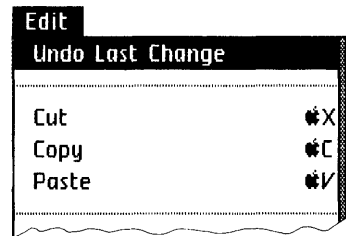

When you create more complex drawings, this feature is a great time-saver. If you do something to your drawing that doesn't work out, you always have Undo Last Change to fall back on. If you cut something that shouldn't have been deleted, just Undo Last Change.

And remember, if you want to get rid of all edits that you've made since the last time you saved your work,

► Choose Revert to Previous Version from the File/Print menu.

You should remember that Revert to Previous Version is not undoable.

Drawing Freehand

The freehand symbol is quite useful in producing many types of drawings. Try your hand at some freehand now:

- ▶ Clear the screen, if you haven't already.

- ▶ Activate the freehand symbol in the palette.



- ▶ Move the pointer into the drawing area and press and hold the mouse button; as you move the pointer around, you create a freehand line. Draw your own first initial. Then release the button. Note that there is a limit to the length of a freehand line.

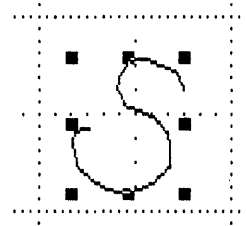

- ▶ Add your last initial. Use the  key.

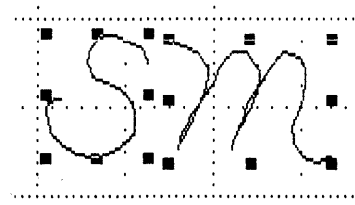

- ▶ Draw several different shapes, clearing the drawing area whenever you wish.

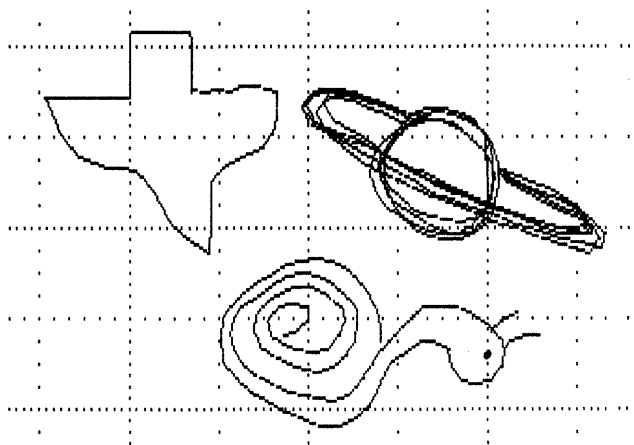

In Chapter 3, An Org Chart and a Map, you will learn how to change the shape of a freehand line after it has been created.

Moving Things Around

After you have drawn objects with LisaDraw, you can move them around on the screen.

- ▶ Clear your screen, activate the box symbol, and draw three boxes. Hold down the  key to draw the second two boxes.

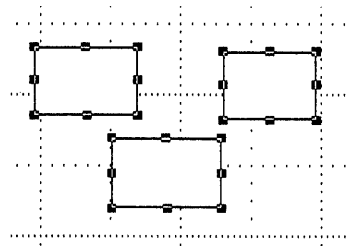

- ▶ Select just the right box and move the pointer inside it.

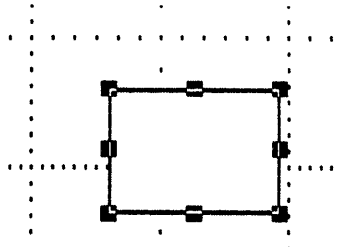

- ▶ Press and hold the mouse button as you move the pointer around the screen. The box moves with the pointer.

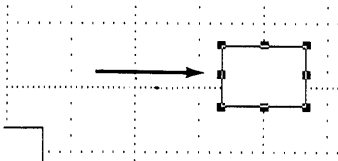

- ▶ Release the button when the box is where you want it.
- ▶ Move one box so that it covers part of another box on the screen.

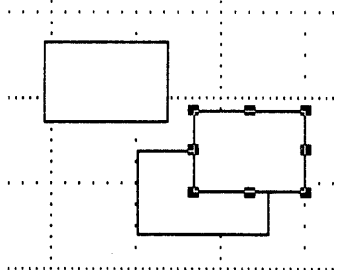

You can rearrange overlapping objects. To move the selected box beneath the one it partially covers,

- ▶ Open the Arrangement menu and choose Send to Back.

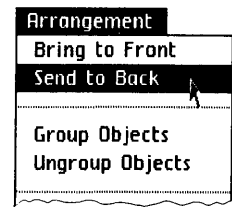

The box moves behind, but you can still see all the handles.

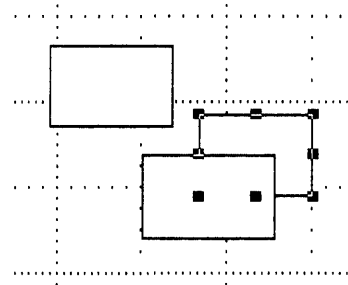

- ▶ Open the Arrangement menu again and choose Bring to Front. The selected box returns to the top again.

Experiment with these features. There are many times when they will be very useful.

- ▶ Clear the screen.

Stretching and Shrinking Objects

You can stretch or shrink any kind of object after it has been drawn. A line can be made longer or shorter. A circle can be made into an oval of any size or shape. A box can change shape or be made larger or smaller. Figure 3 shows some objects before and after stretching.

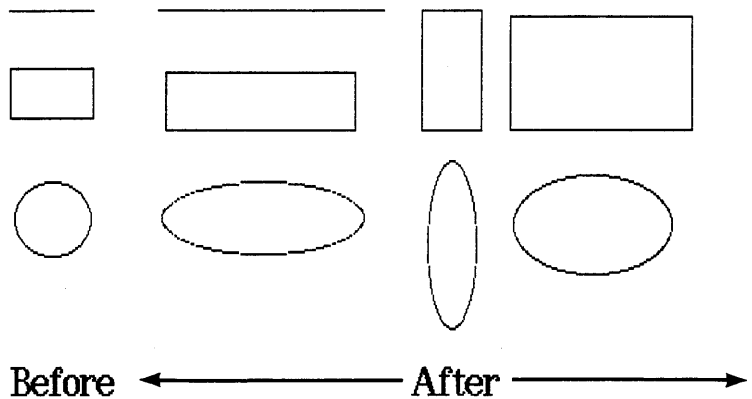
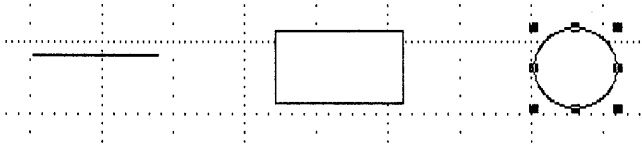

Figure 3. Stretching Common Objects

- ▶ Draw a line, a box, and a circle. Leave the circle selected.



To stretch the circle,

- ▶ Move the pointer so that the point touches the right center handle on the circumference of the circle.

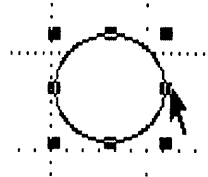

- ▶ Press and hold the mouse button as you move away from the circle. The circle stretches and becomes an oval.

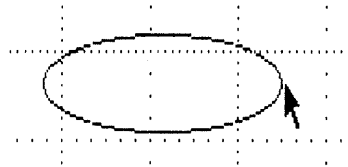

- ▶ Now, move toward the center of the circle and release the mouse button.

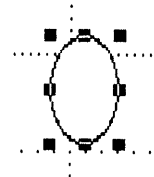

- ▶ Delete the oval by choosing Cut from the Edit menu.

You can use any handle to stretch or shrink a selected object. In the case of every kind of object except a straight line, different handles give you control over different dimensions. Stretching or shrinking using corner handles changes both the height and the width of an object.

- ▶ Select the box. Shrink it and then stretch it back out, using the lower right corner handle. Both the height and the width change.

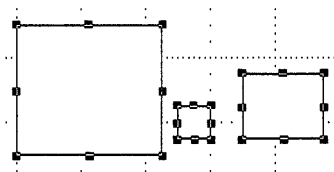

- ▶ Use the center right handle to shrink and stretch the box. Only the width changes.

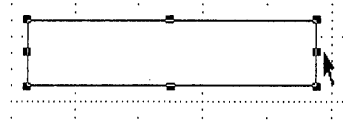

- ▶ Now, use the center top handle. Only the height changes.



To see how this process works with lines,

- ▶ Select the line. Stretch and then shrink it. Only the length changes.

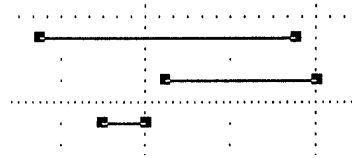

Shade and Pattern The Shades menu allows you to change the shades or patterns that fill enclosed shapes.

- ▶ Draw a box. The initial shade is white, which means that you can't see the grid behind it.

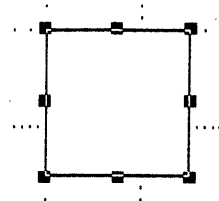

- ▶ Draw a second box and move it so that it covers about half of the first box. Since white is opaque, you can't see through the top box.

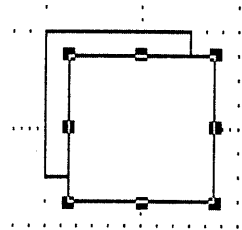

- Open the Shades menu and choose None.

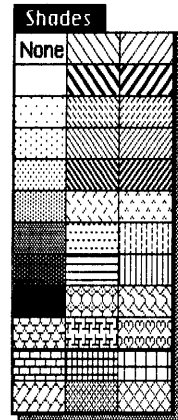

Now there is no fill shade and your rectangle is transparent. Also, selection is different when the fill pattern is "None." This is important: you have to click on the edge of an object to select it when it has no fill pattern. An object really has no "inside" unless it is filled. On an object that does have a fill pattern, you can click on the edge or anywhere inside to select it.

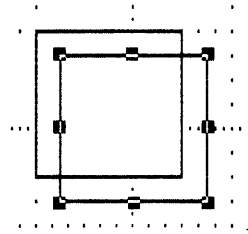

- Choose a gray shade from the Shades menu and the selected rectangle becomes gray.

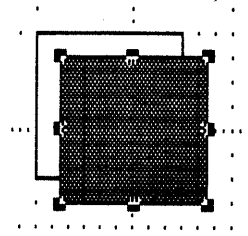

Experiment with the other fill patterns. Figure 4 shows an assortment of filled objects.

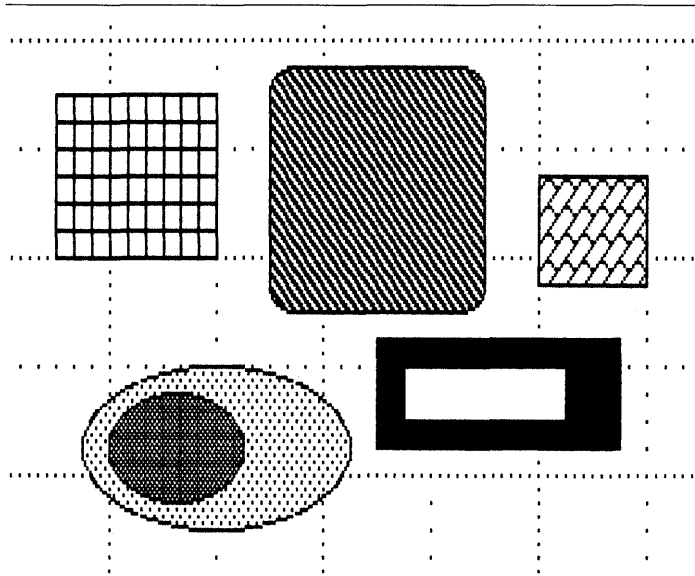

Figure 4. Using Shades to Fill Objects

Changing the Style of Lines

The Lines menu lets you choose the thickness of the lines with which you draw. It also lets you choose whether a line is black, white, or gray, as well as whether or not the line is an arrow. There are two ways to determine linestyle. In one method, you change the linestyle of the linestyle symbol in the line/shade box before you begin to draw. The location of the line/shade box is shown in Figure 5.

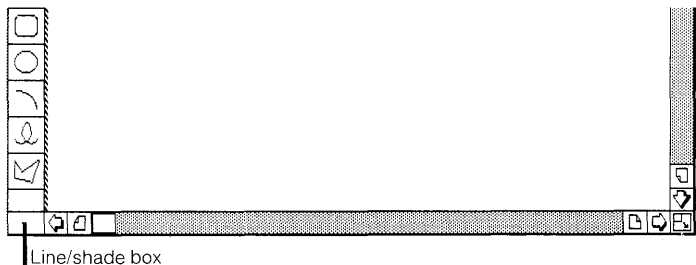

Figure 5. Line/Shade Box

To try this,

- ▶ Activate the box symbol.



- ▶ Open the Lines menu and choose the thickest black line.

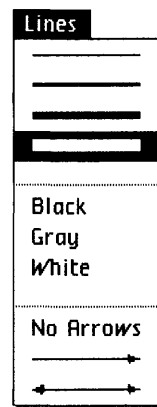

Notice that the line in the line/shade box has changed.

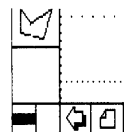

This indicates that from this point on, any line you draw will have the new linestyle, until you go through the same steps to change the line/shade box again.

- ▶ Now, draw a box.

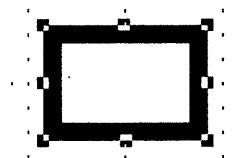

The second method of changing the linestyle is used when you want to change the linestyle of an object that already exists.

- ▶ Select the object whose linestyle you want to change. In this case, the box is already selected.
- ▶ Open the Lines menu and choose the word Gray.

You now have a box that looks like this:

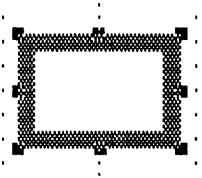

But remember, any future object that you draw will have the thick black linestyle shown in the line/shade box, until you change the line/shade box again.

The lines of an existing object can be changed as many times as you like. Experiment with the other items in the Lines menu.

White lines can be used to draw over black or gray lines or backgrounds.

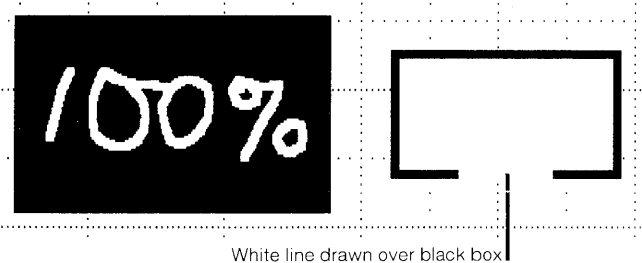

To practice drawing arrows,

- ▶ Activate the diagonal line symbol in the palette.
- ▶ Open the Lines menu and choose the double-headed arrow item.

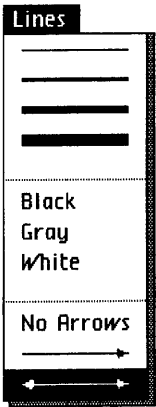

Notice that the diagonal line drawing symbol now has arrows.

- ▶ Open the menu again and choose the thickest line, if it is not already chosen.
- ▶ Now draw a series of diagonal lines in a snowflake pattern.

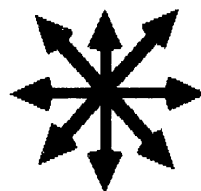

To change the snowflake to gray,

- ▶ Draw a selection box around the snowflake, selecting all its parts.

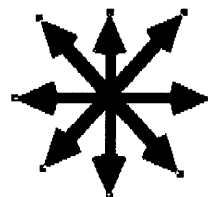

- ▶ Choose Gray from the Lines menu.

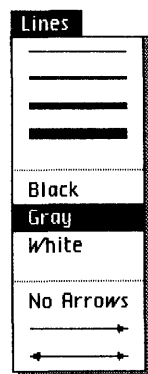

To stop drawing arrows,

- ▶ Activate the diagonal line symbol.
- ▶ Choose No Arrows from the Lines menu.

You can also add arrows to the horizontal/vertical line symbol. And again, choose No Arrows when you want to go back to drawing plain lines.

Printing Your Drawing

To print a drawing, you naturally have to have a printer connected to your Lisa. If you don't have a printer, or it is not set up, you may skip this section for now, and proceed to Saving and Filing a Drawing, later in this chapter.

To find out how to set up your printer and hook it up to your Lisa, refer to the manual that came with your printer.

You also need to set up Preferences correctly for your printer. If you have not already done this, do it now. Refer to Section D, Desktop Manager Reference Guide, in the *Lisa Owner's Guide*, under Set Printer Configuration.

Once the printer and Preferences have been set up, printing your first drawing is very easy.

- ▶ Just choose Print from the File/Print menu.

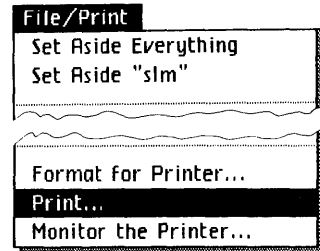

A Print dialog box appears on your screen, like Figure 6.

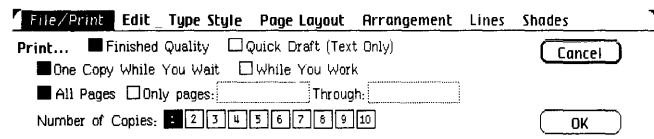

Figure 6. Print Dialog Box

All print settings are as you need them right now. You can learn to use the different settings available in the Print dialog box and the Format for Printer dialog box in Section C, *LisaDraw Reference Guide*, Chapter 2, under Print.

- ▶ Click OK in the dialog box.

Your Lisa then displays a message saying that it is preparing to print your document and allow you to continue working, since the Print dialog box specified that you wanted to print your drawing while you work. After that message, the Lisa displays an alert box asking you if you want to cancel the printing or proceed with it. To respond to the message,

- ▶ Click Proceed to continue working while your document is being printed.

If your Lisa cannot print the drawing while you work, it will display a message to let you know that, and you will have to wait until the document is finished printing and the message disappears.

Saving and Filing a Drawing

Suppose you want to put the drawing away, just as it is now, and look at it or work on it again later.

- ▶ Choose Save & Put Away from the File/Print menu.

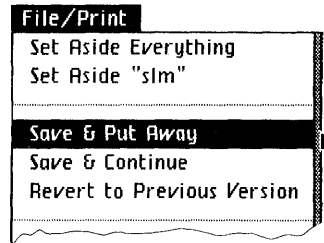

The drawing window closes automatically, and its drawing icon goes back beside the stationery pad in the disk window.

Now move the document icon to an empty place in the disk window.

Chapter Summary

Choose drawing
paper type

- Choose Plain Paper, Grid Paper, or Auto-Grid Paper from the Page Layout menu.

Draw a line

- Depending on the type of line you want, activate the horizontal/vertical or diagonal line symbol from the palette.
- Move the pointer into the drawing area, press the mouse button, and move the mouse.
- Release the button when the line is the desired length.

Draw a box

- Activate the box symbol in the palette.
- Move the pointer into the drawing area.
- Press the mouse button and move the pointer in any direction until you have the shape you want.
- Release the mouse button.

Draw a circle or an oval

- Activate the circle symbol in the palette.
- Move the pointer into the drawing area; press the mouse button and move the pointer in a diagonal direction until you have the size circle or oval you want.
- Release the mouse button.

Make a selection

- Make sure the change symbol is active.
- Move the pointer to the edge of the object to be selected.
- Press and release the mouse button.
- or
- Make sure the change symbol is active.
- Move the pointer above and to the left of the object to be selected.
- Press and draw a selection box around the object and release the mouse button.

Make multiple selection

- With the change symbol active, hold down the **(Shift)** key and click on each object to be selected.
- Release the **(Shift)** key.
- or
- Move the pointer above and to the left of the objects to be selected.
- Press the mouse button, draw a selection box around the objects, and release the mouse button.

Select everything on the screen

- Choose Select All of Document from the Edit menu.

Delete a selection

- Choose Clear or Cut from the Edit menu. Cut puts a copy of the deletion on the Clipboard; Clear does not.

Undo the last thing
you've done

- Choose Undo Last Change from the Edit menu.

Draw a freehand line

- Activate the freehand symbol from the palette.
- Press the mouse button and move the pointer in the drawing area.
- Release the mouse button when the line is complete.

Move an object

- Select the object.
- Move the pointer to an edge (not on a handle), press the mouse button, and move the pointer.
- Release the mouse button when the object is in the desired location.

Move an object
behind another

- Select the object to be moved.
- Choose Send to Back from the Arrangement menu.

Move an object
in front of another

- Select the object to be moved.
- Choose Bring to Front from the Arrangement menu.

Stretch or shrink an object

- Select the object.
- Move the pointer to one of the handles.
- Press and move the pointer away from the center of the object to stretch, toward the center to shrink.
- Release the mouse button.
- Note that using a corner handle of a box can change it in both height and width. Using a center handle changes only its height or its width.

Choose a pattern or shade to fill an enclosed object

- Select the object to be filled.
- Choose a pattern or shade from the Shades menu.

Change line thickness, style, or shade

- Select the line to be changed.
- Choose the desired linestyle or shade from the Lines menu.
- or
- Select any drawing symbol.
- Choose a new linestyle or shade from the Lines menu. All new objects will have the new linestyle.

Print a drawing

- If you haven't set up your printer yet, see the manual that came with your printer.
- If you haven't set printer Preferences yet, see Section D, Desktop Manager Reference Guide, in the *Lisa Owner's Guide*, under Set Printer Configuration.
- If you need to change any of the options in the Format for Printer dialog box for your drawing, choose Format for Printer from the File/Print menu and change the options.
- Choose Print from the File/Print menu.
- Respond to any dialog boxes that appear.

Save and File a Drawing

- Choose Save & Put Away from the File/Print menu.

Chapter 2

Creating a Flowchart

Creating a Flowchart

In this chapter you get more practice with LisaDraw as you put together a flowchart. In a short lesson you

- Draw boxes with rounded corners.
- Duplicate objects.
- Use the standard rulers.
- Learn how to scroll in LisaDraw.
- Draw and reshape polygons.
- Enter, edit, and move text in your chart.
- Use different type styles.

Why Draw a Flowchart?

A flowchart is an effective way to show a sequence of operations, services, or ideas. Sequence is a key word here, and a flowchart generally has arrows to convey the order of events. Figure 7 shows the flowchart that you will be creating in this chapter.

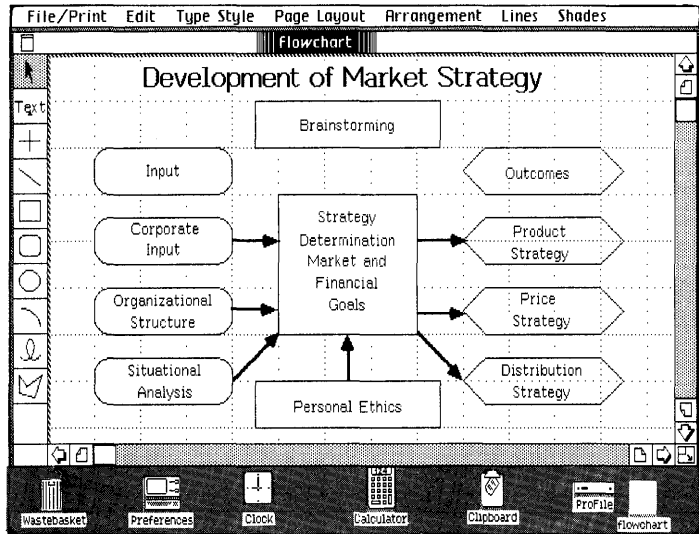

Figure 7. Flowchart Created with LisaDraw

To begin,

- ▶ Open the ProFile window.
- ▶ Tear off a new piece of drawing paper and name it "Flowchart."



- ▶ Click twice to open "Flowchart."

Changing the Size of the Window

You can make any LisaDraw window larger or smaller. For this chart, it will be convenient to make the window larger so that more of the drawing area is visible at one time. The drawing size is currently set to 8 by 10 inches, and depending on the size you make the window, you see more or less of the drawing area.

To enlarge the window,

- ▶ Move the pointer into the size control box at the bottom right corner of the window.

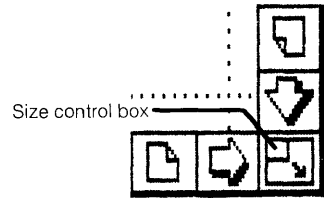

- ▶ Press and hold the mouse button as you move the pointer down and to the right. A flickering outline shows the changing window boundary.

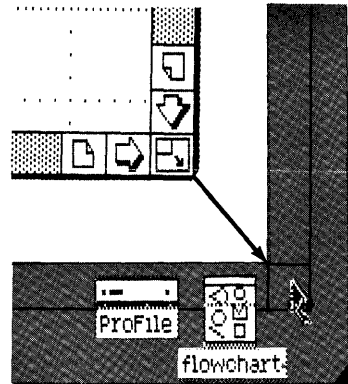

- ▶ Release the mouse button when the window fills the entire screen.

Drawing Boxes with Rounded Corners

Look at the rounded boxes in the left column of Figure 7. To draw one,

- ▶ Choose the rounded-corner box symbol from the palette.
- ▶ Move the pointer into the drawing area and, using the grid as a drawing aid, make a rounded box three grid squares long and one square high.

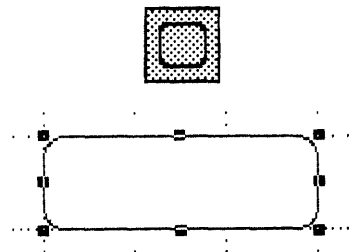

Now, to make the corners slightly more rounded,

- ▶ Choose Round Corners from the Edit menu.

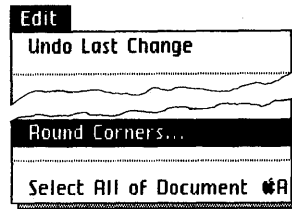

- ▶ In the dialog box that appears, check 3/16" and then click OK.

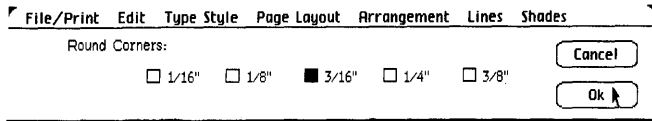

You can select a rounded box and change its corner radius in this way at any time. Another way is to click on the rounded-corner box symbol in the palette, and then choose a new radius. All new rounded boxes will have the new corner radius until you change it again.

Making Duplicates

You need three more matching boxes for your chart. The easiest way to create them is to make three duplicates of the first one. To do this,

- ▶ Make sure the box to be copied is selected.

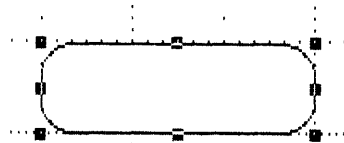

- ▶ Open the Edit menu and choose Duplicate.

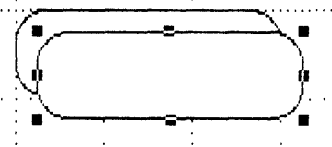

You now have a second copy. In the menu, the letter D next to the word Duplicate means that you can also type D on the keyboard while holding down the ⌘ key to duplicate the selected item. Many times this is more convenient than using the menu.

To try this alternative method for duplicating,

- ▶ Hold down the  key and press D twice; you now have a total of four identical boxes with rounded corners.

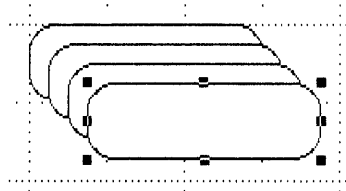

Now, referring to Figure 8, move the objects into place using the grid lines as a visual aid.

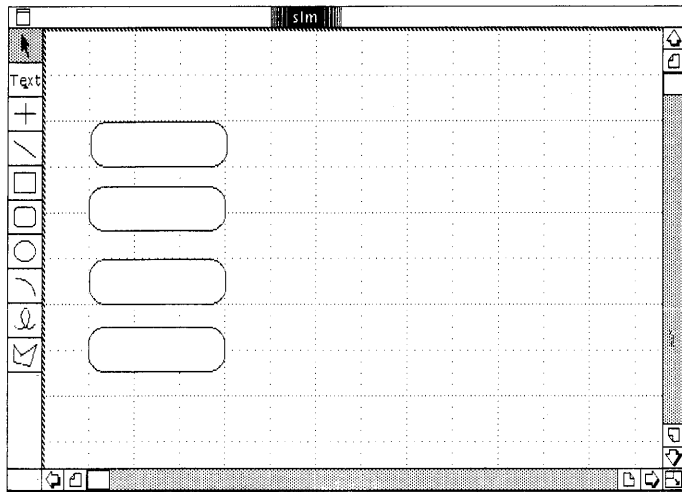

Figure 8. Moving Objects into Place

Taking Advantage of Rulers

LisaDraw offers standard and custom rulers which you can turn on and off whenever you like. They let you measure exactly how large an object will be when it is printed. The rulers themselves are never printed, even when you leave them turned on.

The standard rulers are divided into inches (or centimeters) and appear across the top and down the left side of the drawing area. To turn them on,

- ▶ Choose Show Standard Rulers from the Page Layout menu.

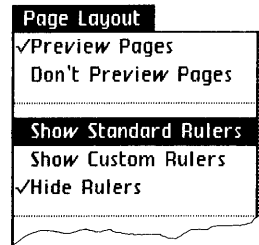

- ▶ Using the rulers to guide you, draw a box 1-1/2 by 1-1/2 inches in the center of the drawing area.

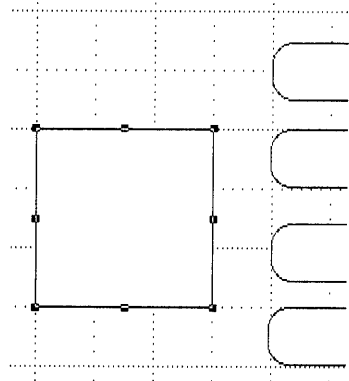

- ▶ Draw another box 1/2 by 2 inches and duplicate it.

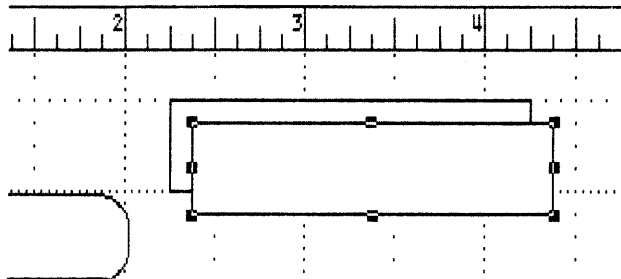

- Move these three boxes into position, as shown here.

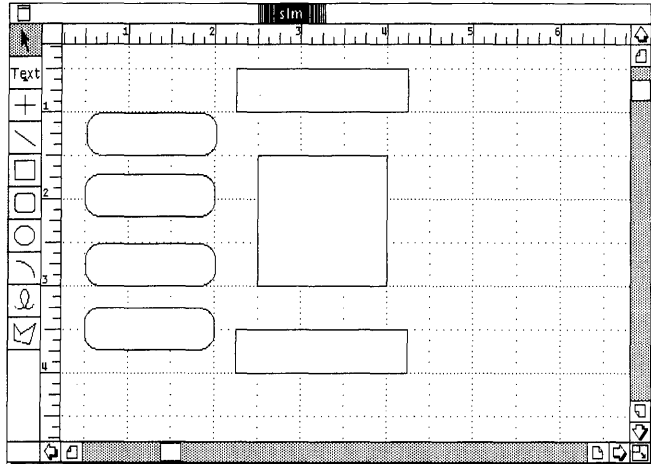

To turn the rulers off,

- Choose Hide Rulers from the Page Layout menu.

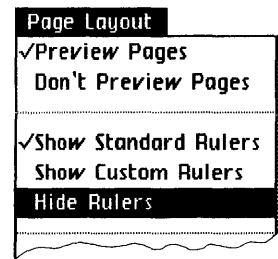

In Chapter 4, More about LisaDraw, you will learn how to create your own custom rulers.

Scrolling in LisaDraw

Scrolling lets you see other parts of the drawing area when the entire drawing is not all visible at one time. In LisaDraw there are two ways to scroll. The first is automatic: if you press the mouse button and move an object or the pointer in any direction to the edge of the drawing area, LisaDraw scrolls in the direction you are moving.

To see how auto-scroll works,

- ▶ Press the mouse button and move the pointer as far as you can to the right of the screen.

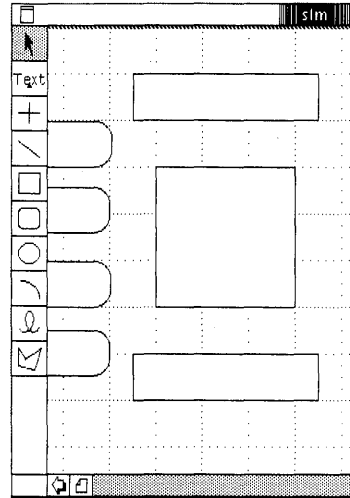

Notice that your view changes. The same thing happens when you move toward any other edge of the drawing.

- ▶ Press the mouse button and move the pointer as far to the left of the screen as possible, to return to your original view.

You can also use the scroll bars, shown in Figure 9, to move unseen parts of the drawing into view.

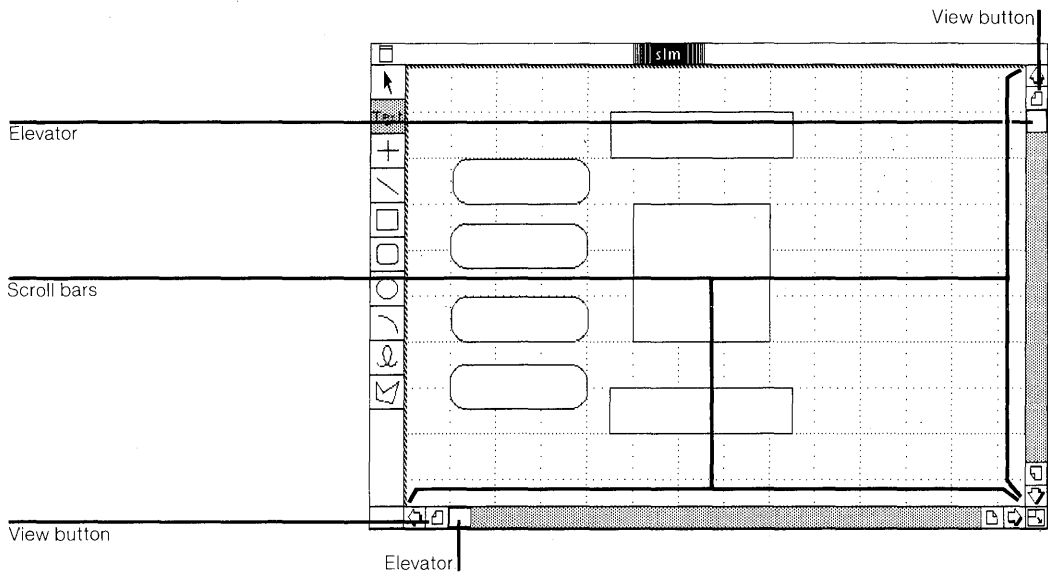
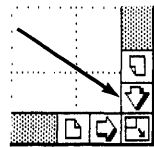

Figure 9. View Controls

To scroll the lower part of the drawing up,

- ▶ Move the pointer to the box containing the down arrow.



- ▶ Press and hold the mouse button and watch the lower part of the graph move up.
- ▶ When scrolling stops, release the mouse button.

To scroll the drawing back down,

- ▶ Move the pointer to the box containing the up arrow; press the mouse button until motion stops.

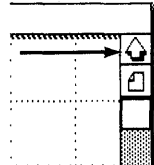

To scroll the drawing to the right,

- ▶ Move the pointer to the right arrow; press the mouse button.

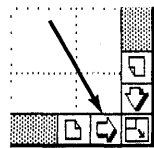

To scroll the drawing back to the left,

- ▶ Move the pointer to the left arrow; press the mouse button until motion stops.

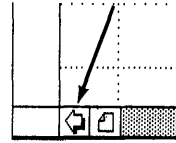

The View Buttons

The small boxes in each scroll bar, shown in Figure 9, are called view buttons. Clicking once on a view button takes you one full window ahead, back, right, or left, depending on which view button you click on.

- ▶ Move the pointer to the bottom right view button and press the button.

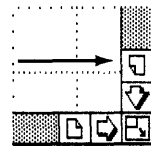

- ▶ Now click once on the upper right view button to get back to where you started.

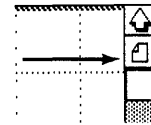

The Elevators

Each elevator will slide if you move the pointer to it and hold the mouse button down while moving the pointer. Figure 9 shows the elevator locations.

You can use the elevators to move quickly from one part of a drawing to another — quite useful when you are working with a large drawing.

- ▶ Move the pointer to the vertical elevator, press the mouse button, and slide it up and down. When you release the mouse button, you see the new view.
- ▶ Now, do the same with the horizontal elevator, sliding it right and left.
- ▶ Finally, readjust the view so that you can see as much of the drawing as possible.

Drawing a Polygon

Now you can go on to draw the polygons that appear on the right in Figure 7.

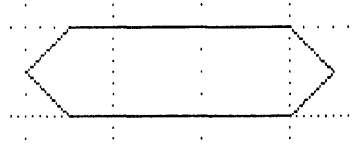

A polygon is any open or closed figure with two or more straight sides. Here, your chart will look balanced if you draw the six-sided polygon with about the same area as the rounded boxes. One easy way to do this is to draw the first polygon just above one of the rounded boxes so you can visually compare them as you draw. Since its ends are pointed, the polygon should be slightly longer than the rounded box in order to seem about the same size.

- ▶ Activate the polygon symbol in the palette.



- ▶ Move the pointer to a starting point above the upper rounded box. Press the mouse button and move the pointer to the edge of the drawing area to auto-scroll, if you need more drawing space. Release the mouse button.

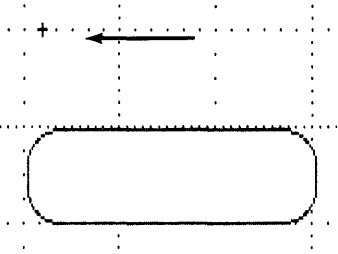

- ▶ Click the mouse button to start the first line of the polygon.

- ▶ Move the pointer to the place where you want the end point of the line to be; click the mouse button. Notice that you can continue to adjust the line until you click the mouse button.

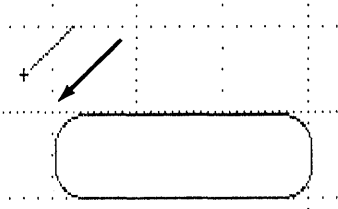

If you don't get the line exactly right, don't worry. You will learn how to fix it in a moment.

- ▶ Continue drawing the rest of the lines that make up the polygon. If you draw the lower line of the polygon directly over the top line of the rounded box, you won't be able to see that line until you complete the polygon.

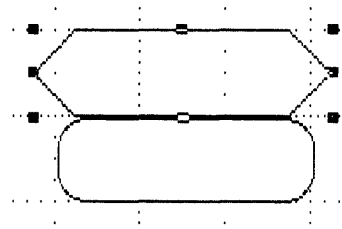

If you get to a point where you would rather begin the polygon again, use Clear from the Edit menu to delete the one you started.

You can always continue to adjust any line in a polygon until you click to set its endpoint. When you join the last line to the first, or double click, the polygon is complete and selection handles appear.

Because of the way it is constructed, a polygon is not automatically filled with the white shade like a box or a circle. Its style in the Shades menu is "None." Therefore, you must choose a shade or pattern from the Shades menu if you want to fill a polygon. In the case of the flowchart you are constructing now, it doesn't matter that you can see the grid through the polygon since the grid is never printed.

- ▶ When the polygon is complete, move the pointer to one of its edges and move it over to the right side of the chart; using the grid lines, line up the polygon with the upper-left rounded box.

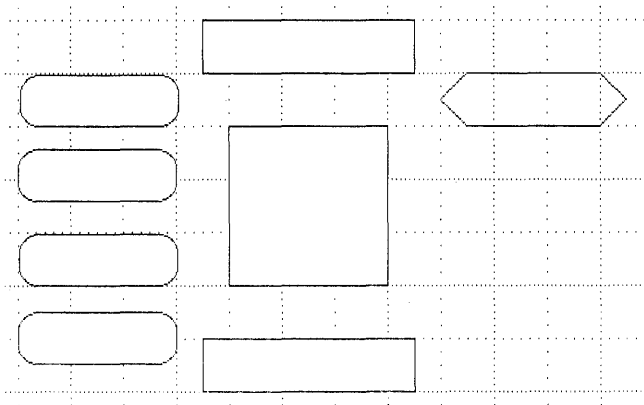

Reshaping a Polygon

You can reshape a polygon any time after it has been created. To try this out,

- ▶ Make sure the polygon is selected.
- ▶ Choose Reshape Polygon from the Edit menu.

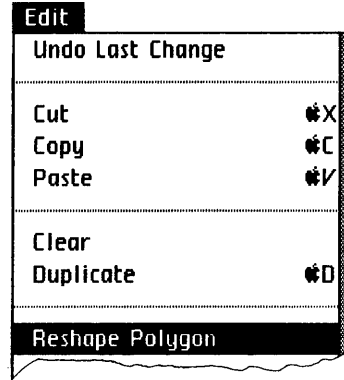

Notice that the handles have changed position. They are now on the ends of each line that make up the polygon. You can now move the pointer to any of these handles and move, stretch, or shrink the associated lines. You change two lines with each handle.

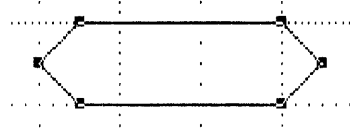

- ▶ If necessary, edit the polygon by using the handles to adjust the line lengths.
- ▶ With the polygon still selected, use Duplicate to make three more polygons.

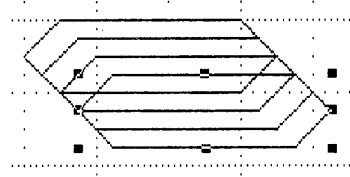

- ▶ Move these three duplicated polygons into position, again using the grid lines to help you.

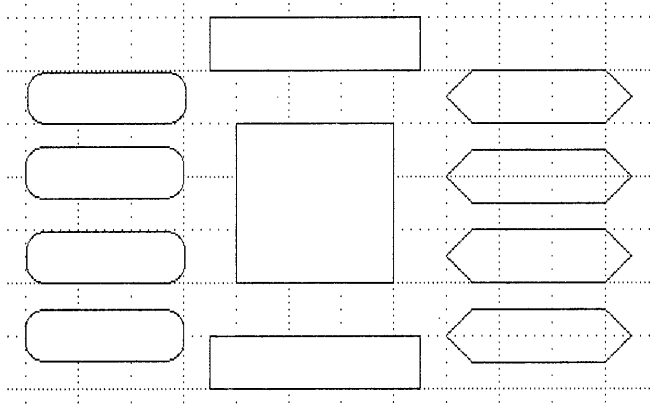

Drawing Arrows

Once you have the polygons arranged in the drawing area, you can add the arrows. When you go on to create original graphics, the order in which you add objects is determined by what is most convenient and logical for you.

- ▶ Select the diagonal line symbol from the palette.



- ▶ Choose the next-to-thinnest line, the second one down, from the Lines menu.

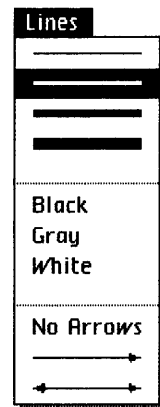

- ▶ Select the single arrow line from the Lines menu.

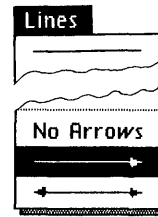

So that you can put the arrows exactly where you want them,

- ▶ Choose Grid Paper from the Page Layout menu.
- ▶ Now hold the **Ⓢ** key down and draw the arrows in, from left to right, as shown in Figure 10. Don't worry if they aren't placed exactly right, you can move them later. The arrow head on single-headed arrows appears where you release the mouse button.

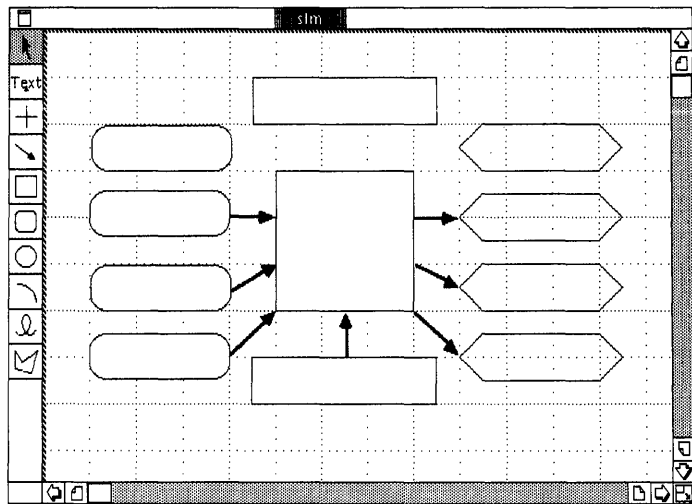

Figure 10. Adding Arrows to the Chart

You can stretch, shrink, or move arrows after you've drawn them. Just select the one you want to change, and then use the handles to stretch or shrink it. Remember to grab anywhere but on the handles to move.

Adding Text to Graphics

Adding text to your chart is just as easy as drawing objects. To see,

- ▶ Select the upper left box. Now type

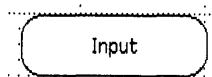

Input

The word is automatically centered in the selected object. If you make any errors while typing, you can use the **(Backspace)** key to correct them.

To move the word around to another spot within the box,

- ▶ Move the pointer to the word, press the button, and move the word around; the change symbol is already selected. Release the button.

As you can see, it is helpful to be using grid paper rather than auto-grid paper when you are changing the position of text.

You can also enter text by using the text symbol, which does not cause text to be automatically centered. To try it,

- ▶ Activate the text symbol.



- ▶ Move the pointer to the top center of the next box, and press the button.

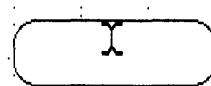

- ▶ Type

Corporate

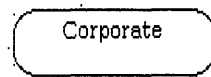

- ▶ Press **(Return)**; the insertion point is repositioned so that the second line is centered under the first line.

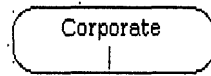

- ▶ Type the second line

Input

Misspell "Input" on purpose.

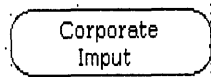

Depending on how close to the edge of the box you placed the text, part of the box may be covered, as it is in the following example. If this should happen,

- ▶ Activate the change symbol, press the mouse button, and move the text up slightly, away from the edge of the box.

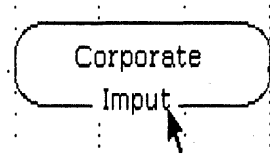

Remember that if you want text to be automatically centered in a selected object, just start typing; if you want to position text manually, activate the text symbol, click where you want to begin typing, and type.

Selecting and Editing Text

You need to select text before you can edit it, and there are two ways to select text. When you use the change pointer, you automatically select the entire line, no matter how many characters are in it. When you use the text pointer, you can select specific characters one by one. To see how this works,

- ▶ Move the text pointer just to the left of the “m” in the word “Input.”

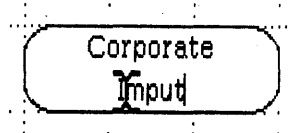

- ▶ Press and hold the button as you draw the pointer through the “m”; release the button.



The highlighted character is now selected.

- ▶ Type the replacement letter

n

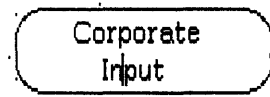

You can select one character, one word, or an entire sentence with this technique. If you want to delete part of a line, select the text which is to be deleted and choose Cut from the Edit menu.

- ▶ Complete the chart so that it looks like Figure 11, using the text symbol method.

- ▶ With the text symbol active, click in the upper center of the box if you are entering two words, or click in the center of the box if you are only adding one word.

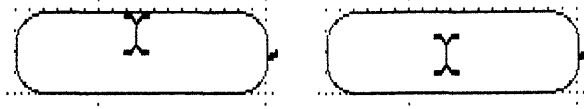

- ▶ Type in the text, pressing **Return** when necessary.
- ▶ Adjust the position of the words as necessary.

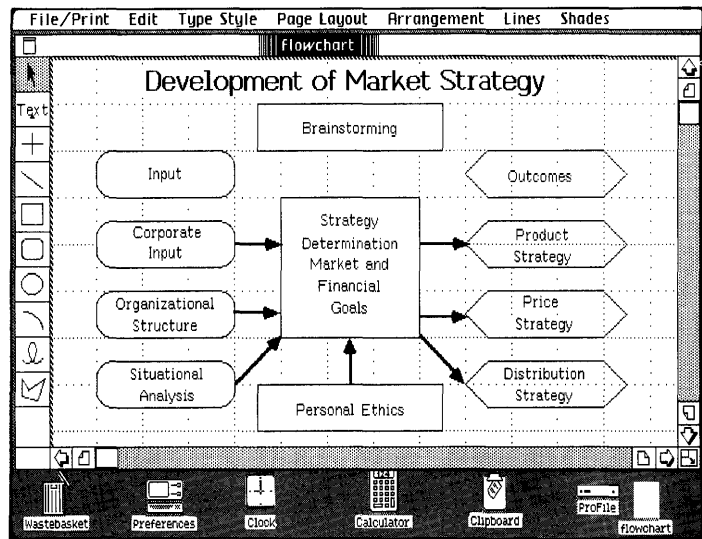
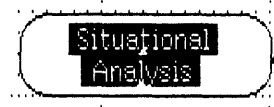

Figure 11. Adding Text

Using Cut and Paste

You've used the change symbol to move text. You can also use cut and paste. To try this,

- ▶ Select the words "Situational Analysis" in the bottom left box: if you draw a selection box, hold the **(Shift)** key down as you make your selection so that you don't get the rounded-corner box too; if you click on the first word, hold the **(Shift)** key down as you click on the second.



- ▶ Choose Cut from the Edit menu.

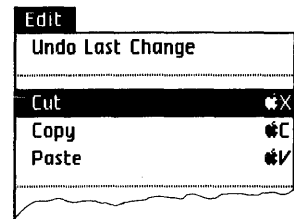

A copy of the selection is now on the Clipboard, and the original text is gone. Now, to paste the text somewhere else for practice,

- ▶ Click the mouse button anywhere in the drawing area to set the insertion point.

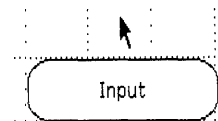

- ▶ Choose Paste from the Edit menu. Paste places a copy of what is on the Clipboard centered around where you placed the insertion point. What is on the Clipboard remains there until you cut or copy something else. Then the latest thing that was cut or copied becomes the contents of the Clipboard.

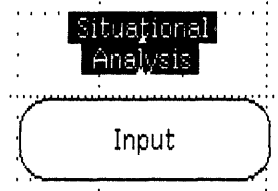

- ▶ With the text still selected, choose Cut again.

The text is deleted from the page and put on the Clipboard again. To return the text to its original spot,

- ▶ Click in the center of the box where the text was originally and then choose Paste.

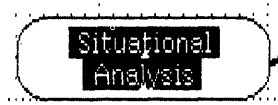

Each new cut or copy will replace the previous contents of the Clipboard. If you cut something by mistake, you can paste the contents of the Clipboard back into your drawing. You can use the combination of Copy and Paste in the same way, except in that case, you copy something, the original remains where it is, a copy goes onto the Clipboard, and you paste the copy into the new location. In Chapter 4, More about LisaDraw, you learn to cut, copy, and paste text and objects between drawings.

Changing Type Styles

The Type Style menu allows you to change the way your text looks. When any particular text is selected, you can open the Type Style menu and see which style is currently in effect. "Plain Text" is the kind of text you have been working with so far. You can also choose text that, instead of being plain, is in italics, bold face, underlined, shadow, or in any combination.

- ▶ Select the title "Development of a Market Strategy" at the top of your chart.

A diagram showing a portion of a drawing. The text "Development of Market Strategy" is highlighted with a solid black background, indicating it is selected.

- Choose PS 1/4 Inch Modern from the Type Style menu.

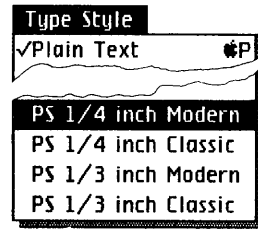

- Now choose Bold from the Type Style menu.

What if you are typing a line and come to a word that you want to appear in a different type style such as bold? When you get to the word, just choose Bold from the Type Style menu, type the word, and then go back to the Type Style menu and choose Plain Text or whatever you were using before and continue typing.

Notice that you can only see which menu items are active (checked) when the text in question is actually selected. Figure 12 shows an example of each type style.

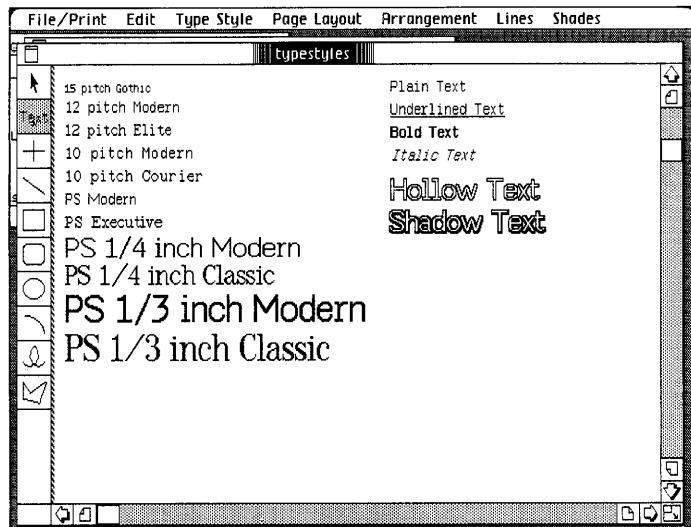

Figure 12. Available Type Styles

Plain text refers to text of any size or type that is not underlined, boldfaced, italicized, hollow, or shadowed. PS stands for proportionally spaced text, where large letters like “m” take up proportionately more space than small letters like “i.”

Now, to file the flowchart,

- ▶ Choose Save & Put Away from the File/Print menu.

You could leave the drawing where it is in the disk window, but your disk window would soon become cluttered with a lot of drawing icons. To solve this problem, you can create a folder to contain all your related drawings.

- ▶ Move the pointer into the empty folder pad icon and click the mouse button twice.



- ▶ Type "Tutorial-" followed by your initials.



To file the drawing in the new folder,

- ▶ Move the pointer into the drawing icon. Press and hold the mouse button while moving the drawing icon over the folder icon.

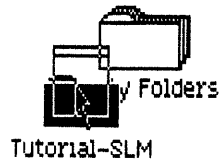

- ▶ Release the mouse button when the folder icon flashes.
- ▶ Move the folder icon to an empty place in the disk window.

This completes Chapter 2. Go on to the next chapter if you like, or come back to it later.

Chapter Summary

Draw a box with rounded corners

- Activate the rounded box symbol in the palette.
- Press the mouse button and move the pointer in any direction.
- Release the button when the box is the desired size.

Change the corner radius of a rounded-corner box

- Select the rounded box whose radius you want to change.
- Choose Round Corners from the Edit menu.
- Check the desired corner radius and then click OK.

Duplicate an object

- Select the object or objects to be duplicated.
- Choose Duplicate from the Edit menu.
- or
- Select the object or objects to be duplicated.
- Press the  key and the D key at the same time.

Move the window on the screen

- Move the pointer to the title bar at the top of the window and press the mouse button.
- Move the pointer and the window moves with it.
- Release the mouse button when the window is in the desired location.

Change the window size

- Move the pointer to the size control box in the lower right corner of the window.
- Press and move toward or away from the center of the window to decrease or increase its size.
- Release the mouse button when the window is the desired size.

Draw a polygon

- Activate the polygon symbol in the palette.
- Click the mouse button where the beginning of the first line is to be.
- Move the pointer until the line is the desired length and at the necessary angle.
- Click the mouse button to determine the endpoint of the first line, and to begin the second line.
- Join the last line to the first, or click twice to complete the polygon.

Add text to an object

- Select an object into which text is to go.
- Type in the desired text; text is automatically centered.
- Reposition the text if desired.
- or
- Activate the text symbol in the palette.
- Click the mouse button where text is to begin.
- Type; if placed inside the object, text is not automatically centered.
- Reposition text if desired.

Select text

- Activate the change symbol.
- Click the mouse button on the line of text to be selected.
- or
- Activate the text symbol.
- Move the pointer to the left or right of the character or characters to be selected.
- Press and draw the pointer through the appropriate characters.
- Release the mouse button.

Move text

- With the change symbol active, move the pointer to the text, press the mouse button, and move it to the new location.
- Release the mouse button.
- or
- Select the text to be moved.
- Choose Cut from the Edit menu.
- Move the pointer to the new location.
- Click the mouse button.
- Choose Paste from the Edit menu. Text is centered around the insertion point.

Change type style

- Select the text to be changed.
- Choose a new type style from the Type Style menu. Only the selected text changes.
- or
- Activate the text symbol in the palette.
- Choose a new type style from the Type Style menu. All new text will have the new style.

Chapter 3

An Org Chart and a Map

An Org Chart and a Map

In this chapter, you learn more LisaDraw techniques as you create an organization chart and a map. In a short session you

- Draw a basic organization chart.
- Use the lock feature.
- Learn how to make the chart more detailed.
- Learn another duplication technique.
- Group and ungroup objects.
- Draw a freehand map.
- Smooth and reshape freehand lines.
- Practice the shrink-to-size technique.

A Word about Organization Charts

Almost every business uses organization or “org” charts to illustrate company structure and personnel relationships. With a series of simple steps, you will be creating the org chart shown in Figure 13.

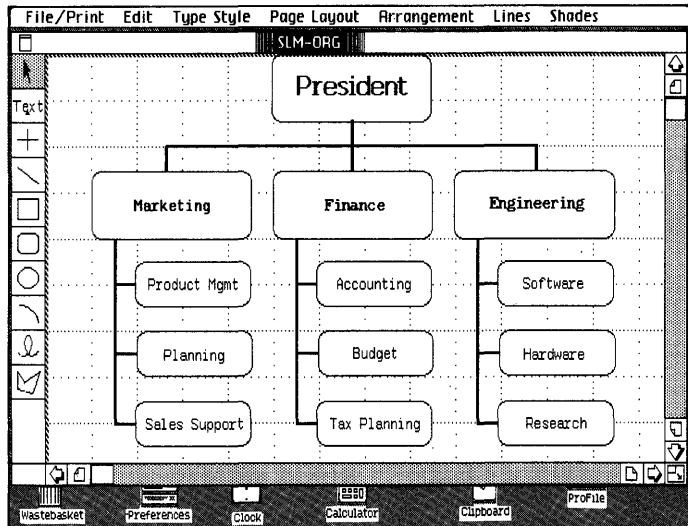

Figure 13. Basic Organization Chart

To get ready to draw,

- ▶ Tear off a new piece of LisaDraw paper.



- ▶ Name the drawing with your initials and the word Org, for example, “SLM-Org.” Of course, you can call it whatever you like, but this will tell you it is yours, and what it is.

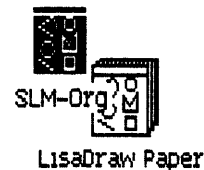

- ▶ Open the new LisaDraw document; click twice on its icon or use Open from the File/Print menu.

Looking for Similarities

A technique that saves time and gives your drawings a professional uniformity is this: look for identical parts of the drawing. Draw the recurrent section once, and use duplicates of it in those places where it reappears. To see how this works,

- ▶ Open the window to its largest size.
- ▶ Choose Show Standard Rulers from the Page Layout menu.
- ▶ Draw a rounded-corner box approximately 1-3/4 inches long and 3/4 inch high.

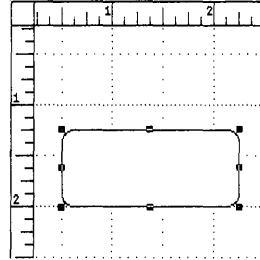

Look at the org chart in Figure 13 again. Notice that the “branch” structure at the left appears three different times.

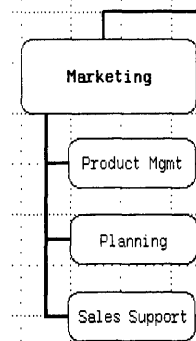

To continue constructing the branch,

- ▶ Activate the horizontal/vertical line symbol.



- ▶ Open the Lines menu and choose the second line thickness.

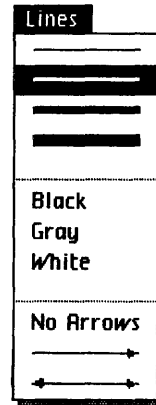

Notice the new linestyle is shown in the lower left corner of the drawing area, in the line/shade box.

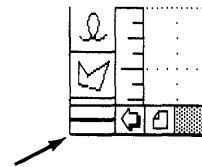

- ▶ Draw the 2 inch vertical line that extends from the box, and a 1/4 inch horizontal line that will connect with a smaller rounded box. Use the grid marks to help position the lines. Remember you can use the  key to draw the second line.

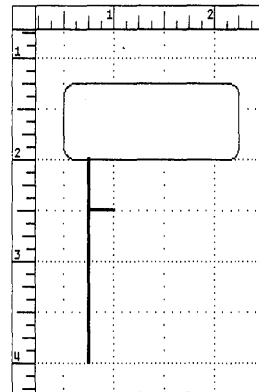

- ▶ Choose the rounded-corner box symbol.
- ▶ Choose the thinnest line from the Lines menu.
- ▶ Draw a rounded box about 1-1/4 inches long and 1/2 inch high next to the horizontal line. You can draw the box near the rulers and then move it into place, if you prefer.

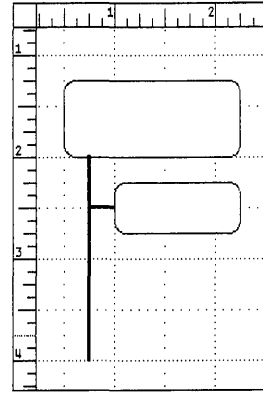

Grouping Objects

Now, to make two more duplicate boxes with connecting lines, you can use a technique called grouping.

- ▶ With the change symbol active, draw a selection box around the rounded box and the small line that connects it to the chart. Or, click on the box, hold down the **(Shift)** key, and then click on the short line. This selects the two parts.

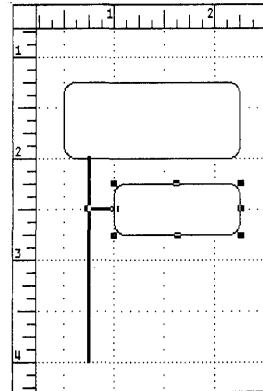

- ▶ Choose Group Objects from the Arrangement menu.

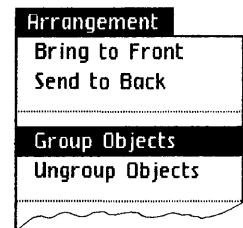

The two objects are now grouped as one single object with one set of handles. The group remains a group until you select it again and choose Ungroup.

- ▶ Now, with the group selected, choose Duplicate and move the copy into place on the chart.

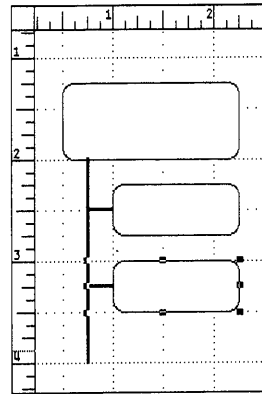

- ▶ Choose Duplicate again to create the third rounded box, then move it into place.

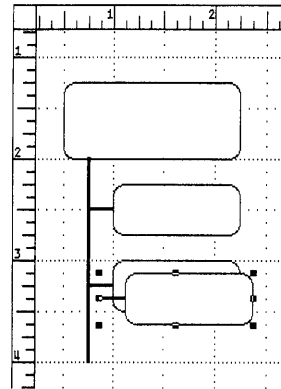

If you lined the second box up perfectly with the first one when you moved it into place, the second duplicate will be automatically placed the same distance from the second box as you placed the second from the first. This feature is called auto-duplication. If you made successive copies, they would also be placed at the interval you determined between the original and the first copy.

If you didn't line the first copy up exactly beneath the original, the next copy will appear right next to the copy before it and you can move it into position yourself.

- ▶ If the vertical line needs length adjustment, do it now.

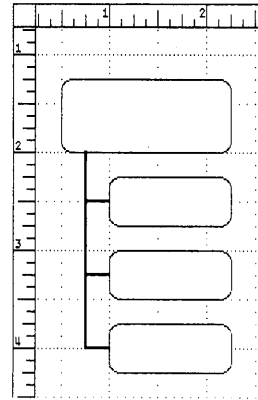

The first branch is now complete. Now, to make two more branches like the first,

- ▶ With the change symbol active, draw a selection box around the branch to select all its parts or choose Select All of Document from the Edit menu.

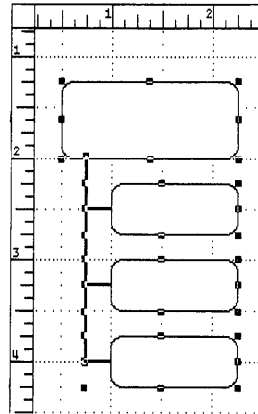

- ▶ Choose Group Objects from the Arrangement menu.

You now have a single set of handles to show that the branch is one object instead of a number of different ones.

► Choose Duplicate.

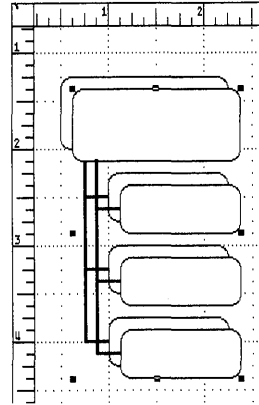

► Line up the new branch to the right of the first one.

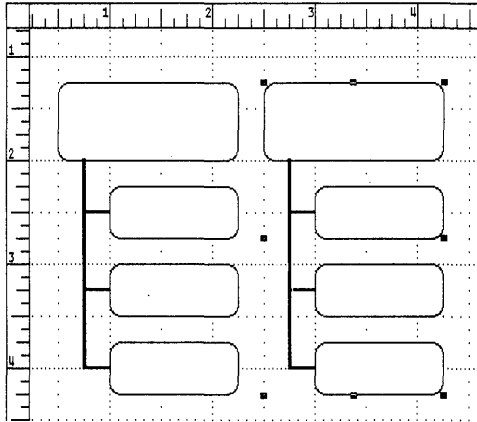

► With the second branch selected, choose Duplicate again.

- ▶ Move the third branch into position if it wasn't automatically positioned.

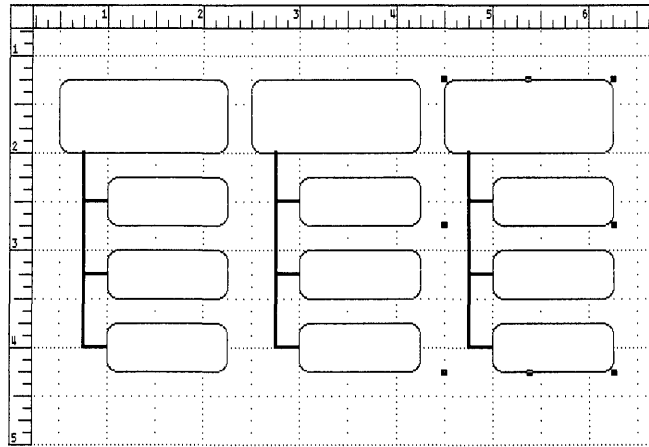

To make an additional large box to put at the top of the chart,

- ▶ With the last branch still selected, choose Ungroup Objects from the Arrangement menu.

The branch is now a number of separate parts again.

- ▶ Click the pointer in open space to deselect the branch.
- ▶ Now, select just the large box.

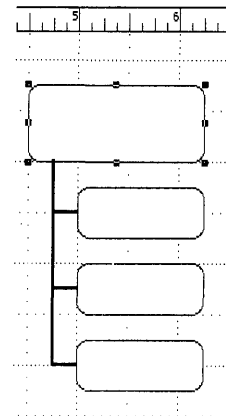

- ▶ Duplicate it.

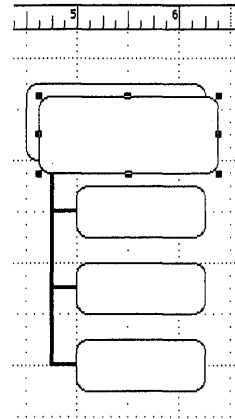

- ▶ Choose Hide Rulers from the Page Layout menu, so you'll have more space to work with.
- ▶ Move the new box into location at the top of the chart. LisaDraw will scroll automatically for you if necessary.

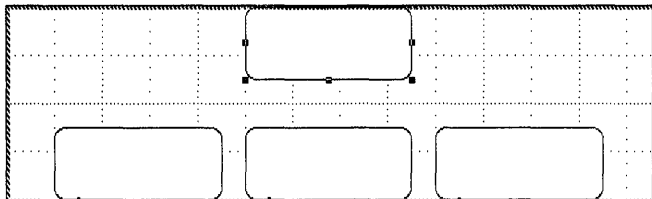

If you don't have enough room to move the box to the top of the drawing area,

- ▶ Choose Select All of Document from the Edit menu.
- ▶ Place the pointer anywhere on the diagram except on a handle, press, and move the entire drawing down. Release the button.

Now, to draw the remainder of the lines,

- ▶ Activate the horizontal/vertical line symbol, and choose the next-to-thinnest line from the Lines menu.
- ▶ Draw the lines connecting the new box to the other boxes.

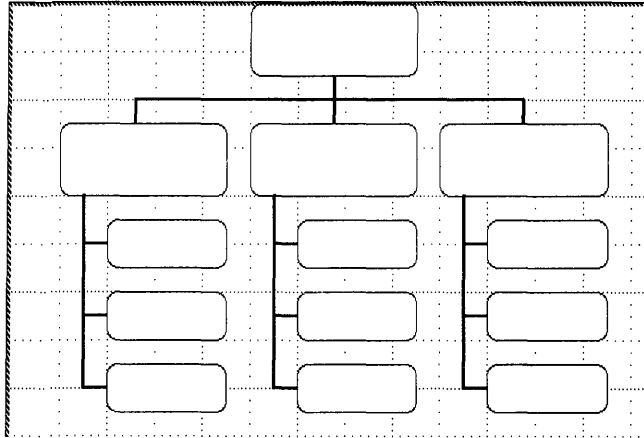

- ▶ Choose Select All of Document from the Edit menu.
- ▶ Choose Ungroup Objects from the Arrangement menu.

Your chart is now complete, except for the text. This is a good time to make a stationery pad from what you have done so far. Then if you want to use a copy of the chart for other org charts later, you can use a piece of paper from the pad. To make the pad,

- ▶ Choose Save & Put Away from the File/Print menu.
- ▶ Open the ProFile icon, if necessary, to see the org chart icon.

- ▶ With the org chart icon selected, choose Make Stationery Pad from the File/Print menu. You now have a stationery pad.



SLM-Org

- ▶ Click twice on the pad to tear off a sheet.



SLM-Org

- ▶ Name the new piece of paper and click twice to open it.

Locking and Unlocking

Before you begin entering text,

- ▶ Choose Select All of Document from the Edit menu.

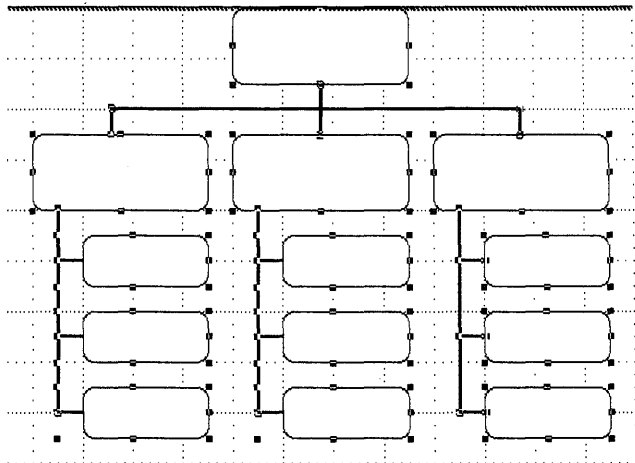

- ▶ Choose Lock Objects from the Arrangement menu.

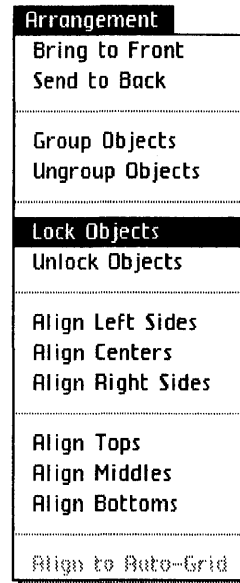

This will prevent you from moving the boxes or lines around accidentally as you enter the text. And everything you lock stays that way until you select the objects again and choose Unlock Objects.

- ▶ Activate the text symbol.
- ▶ Choose PS Modern from the Type Style menu.

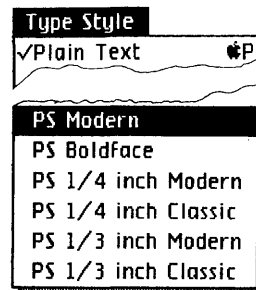

- ▶ Choose Grid Paper from the Page Layout menu so you can position the text between the grid lines if you need to.
- ▶ Click in the center of each box, and add the appropriate text as shown in Figure 14.

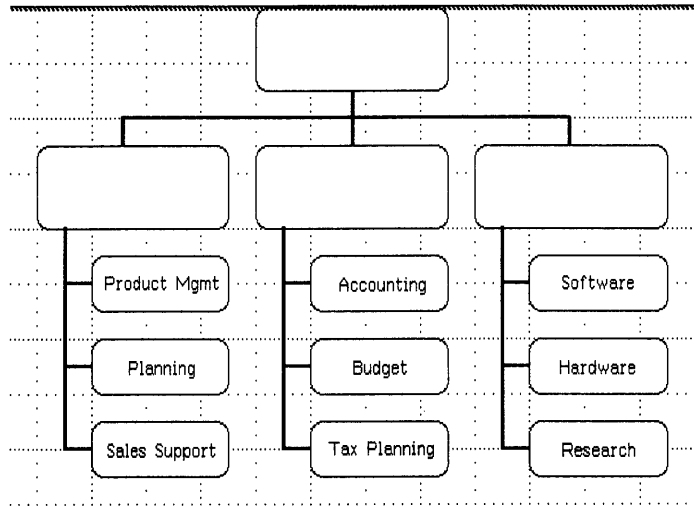

Figure 14. Adding Text to the Org Chart

Now, to enter larger text into the top box,

- ▶ Click in the center of the top box.
- ▶ Choose PS 1/4 Inch Modern from the Type Style menu.
- ▶ Type

President



To add text to the three middle boxes,

- ▶ Click on the text symbol.
- ▶ Choose PS Modern and then Bold from the Type Style menu.
- ▶ Click in the centers of the remaining empty boxes, entering the necessary text.

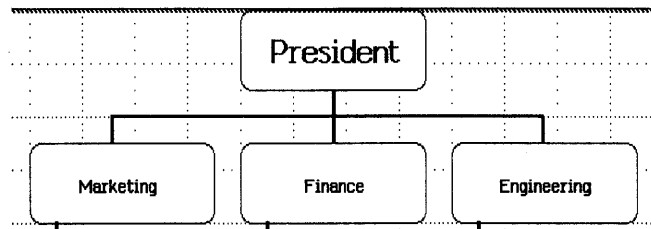

To unlock the locked portions of the chart,

- ▶ Choose Select All of Document from the Edit menu.
- ▶ Choose Unlock from the Arrangement menu.

Now, to go back to a nonbold text for the next section,

- ▶ Activate the text symbol.
- ▶ Choose Plain Text from the Type Style menu.

Making a Shaded Org Chart

It is easy to make your chart more detailed. For example, suppose you want each box to appear 3-dimensional. You can do this by making the boxes “shaded,” as shown in Figure 15.

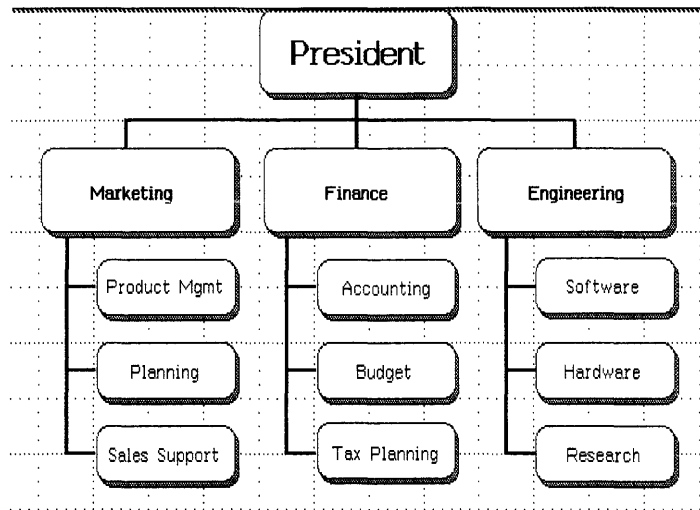
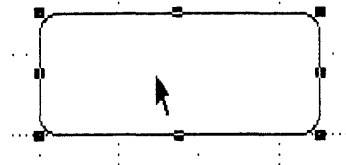

Figure 15. Shaded Org Chart

Again, all you need to do is construct the repeated branch, this time shaded, and then duplicate the branch. Here are some steps for making a shaded branch, but not all the steps for an entire chart.

- ▶ Draw a rounded-corner box.



- ▶ Make a duplicate of the box.

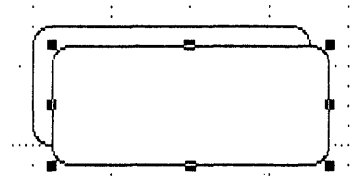

- ▶ Choose a gray fillstyle from the Shades menu.

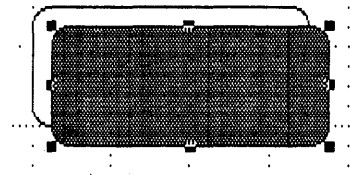

- ▶ With the gray box selected, choose Send to Back from the Arrangement menu.

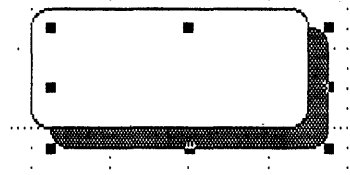

- ▶ Choose Grid Paper from the Page Layout menu. The auto-grid needs to be off.
- ▶ Move the gray box so that it is just below and to the right of the white box so that it shadows it.

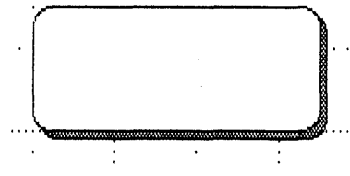

- ▶ Continue constructing the branch, creating a smaller box that is shaded.

Then you can make duplicates of the smaller box, and finally duplicates of the complete branch. You needn't construct the complete shaded chart right now, unless you want the practice.

Printing and Putting Back

Now you can print your org chart. To do this,

- ▶ Choose Print from the File/Print menu.
- ▶ Click OK first in the dialog box that appears, and then click Proceed in the second.

- Then, to save the chart and return it to the disk,
- ▶ Choose Save & Put Away from the File/Print menu.
 - ▶ Move the drawing icon to your folder.

Drawing a Freehand Map

The drawings you can create with the freehand symbol are limitless. One very useful drawing is a map. For practice, go through the following steps to draw a map of the area around the Stanford University campus, as shown in Figure 16.

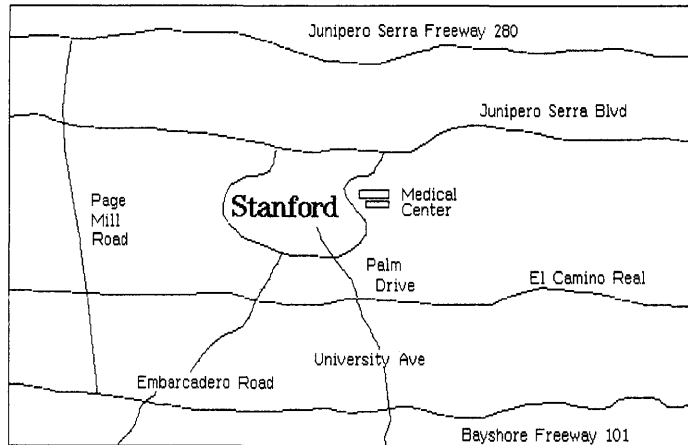
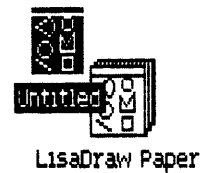

Figure 16. Freehand Map of the Stanford University Campus

To get ready to draw,

- ▶ Tear off a new piece of drawing paper.



- ▶ Name it “your initials-map,” for example, “SLM-map.”

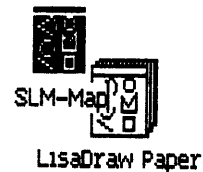

- ▶ Open the document.
- ▶ Choose Plain Paper from the Page Layout menu.

► For ease in drawing, enlarge the window to its maximum viewing size.

► Activate the freehand symbol.



► Draw in the four horizontal freehand lines. Remember that you can activate the freehand symbol each time or just hold down the  key. And don't worry if your lines don't quite match those in the illustration — this is just practice.

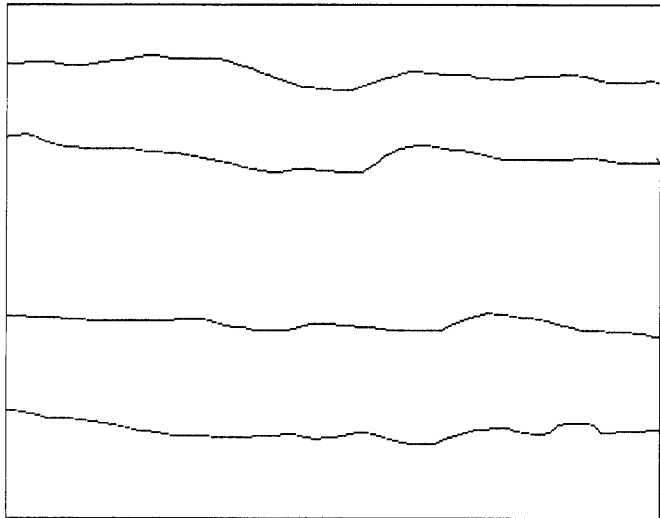

► Draw the circular road in the center.

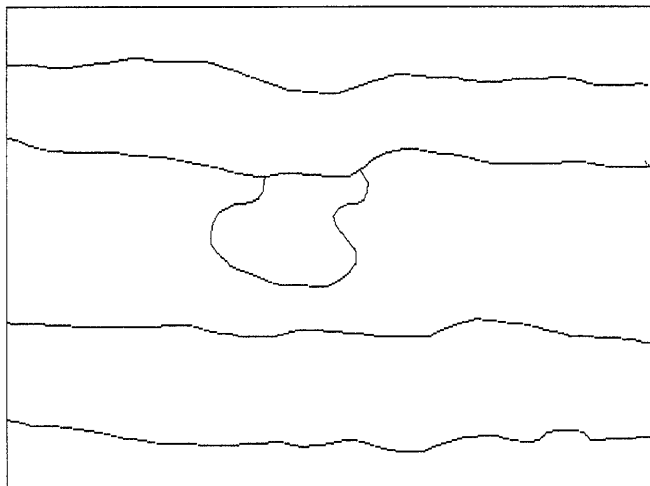

- ▶ Draw the three vertical freehand lines.

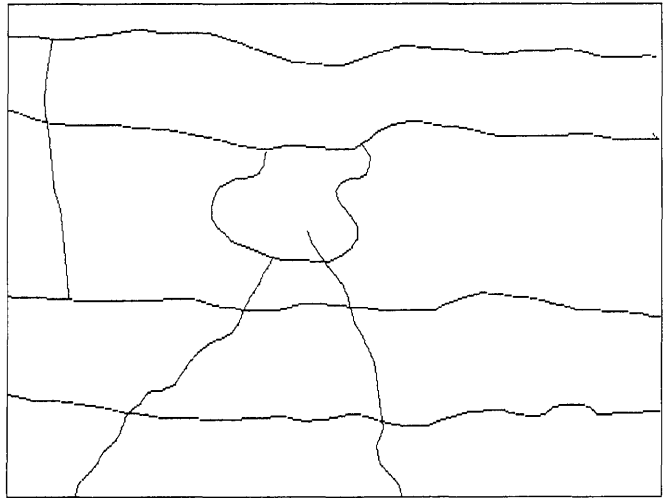

Stretching and Shrinking Freehand Lines

You can adjust the length of a freehand line. To see how,

- ▶ Select the left vertical line on the map.

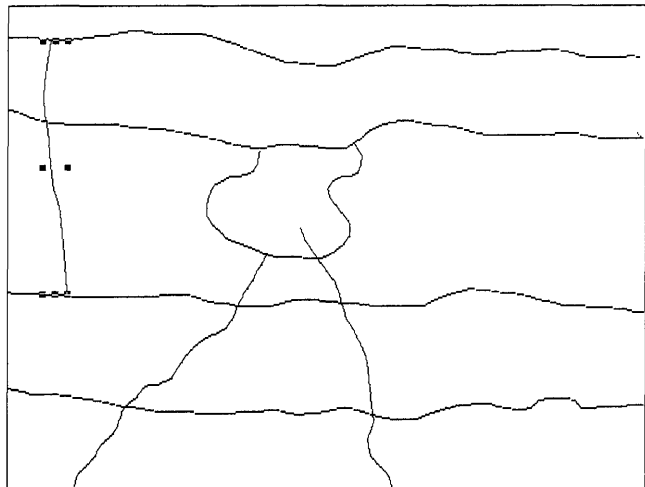

- ▶ Stretch the line as shown, using the lower right handle, just as you have done with horizontal and other lines.

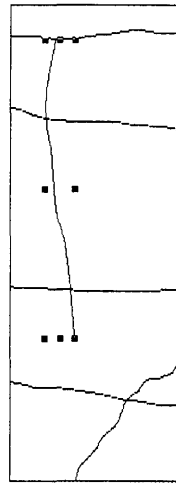

Changing Segments of a Freehand Line

You can also edit specific segments of a freehand line. To try this,

- ▶ Select the line you were just working with, if it is not still selected.
- ▶ Choose Reshape Curve from the Edit menu.

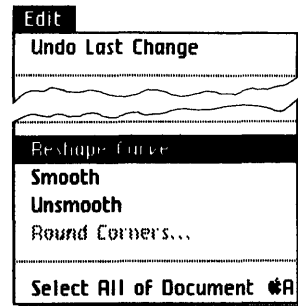

This moves many more handles directly onto the selected line.

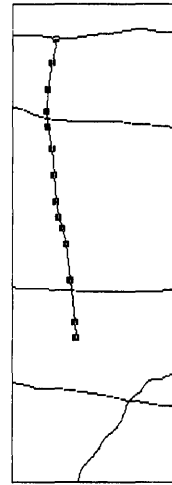

- ▶ Edit the bottom segment of the line by grabbing the lowest handle and moving it down to the horizontal line. Release the button.

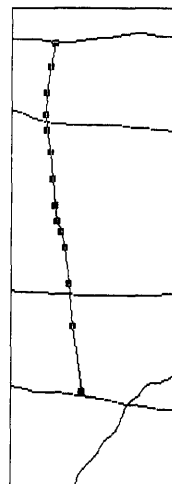

Smoothing a Freehand Line

To make a freehand line smoother,

- ▶ Make sure the line to be smoothed is selected. Use the same line you've just been working with.

- Choose Smooth from the Edit menu.

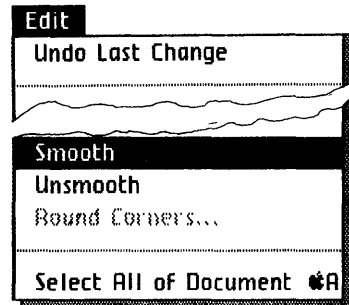

The line is now smoothed.

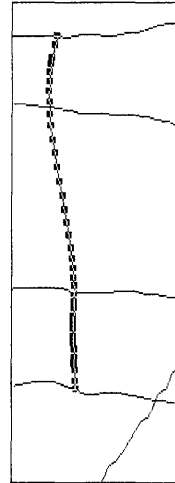

Now, if you want to continue editing the line, and you want to space out the handles,

- Choose Unsmooth from the Edit menu.

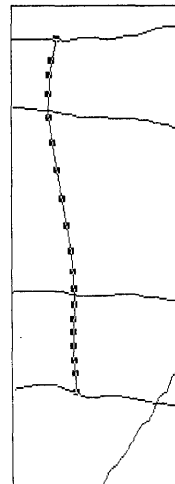

You can continue to edit the line until you are satisfied with it. Notice that unsmooth does not reverse the smooth process. It just spaces out the handles. If you want to reverse the smooth process, choose Undo Last Change from the Edit menu before you do anything else.

Adding Text to the Map

Now, go on and add text to your map.

- ▶ Activate the text symbol.



- ▶ Click at the appropriate spots and enter the text as shown in Figure 17, including the word "Stanford" which you will change to a larger type size in a moment.

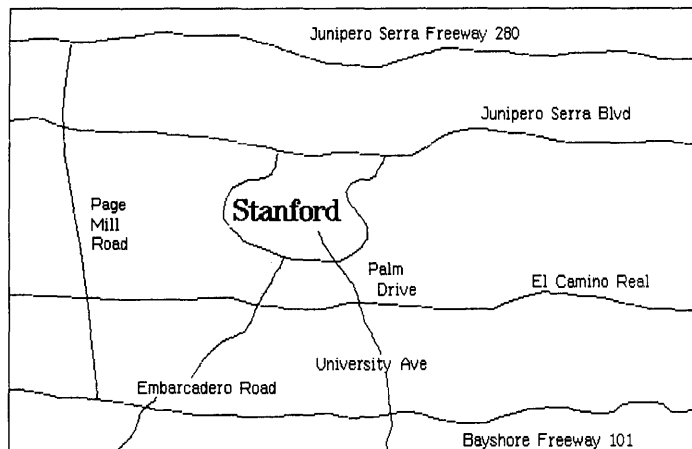

Figure 17. Adding Text to the Map

To change "Stanford" to a larger type,

- ▶ Select the word "Stanford."



- ▶ Choose PS 1/4 Inch Classic from the Type Style menu, and then choose Bold.



Remember, you can determine type style before you type by activating the text symbol and then choosing the desired type style from the Type Style menu — or you can select a word that has already been typed and then make the appropriate selection from the Type Style menu. Also, you can start typing, choose a new type style, and then continue typing to change type style mid-line.

The Shrink-to-Size Technique

Suppose you want to add some detail to your map, such as the Medical Center building shown here. In this case, you can use a technique called shrink-to-size. You draw the object in a large size that is easy to work with, shrink it to the final size you want, and then move it into place.

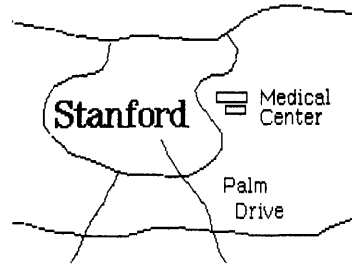

To see how this works,

▶ Activate the box symbol.



▶ Draw a large version of the two buildings in an open space in the drawing area.

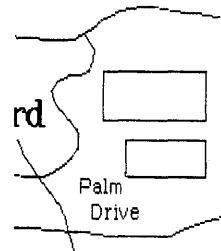

▶ Select both buildings.

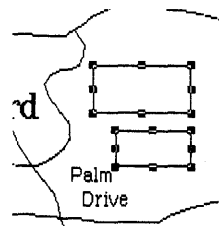

- ▶ Using a corner handle, shrink the buildings to a smaller size.

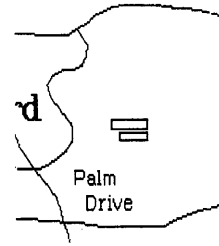

- ▶ Move them into place on the map; add the text "Medical Center."

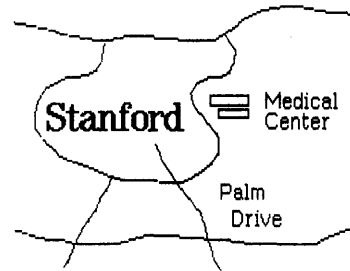

You can add to a freehand drawing using any of the drawing symbols. Go ahead and experiment with this map by adding more to it if you like.

Printing and Putting Back

To print your map,

- ▶ Choose Print from the File/Print menu.
- ▶ Click OK in the first dialog box that appears, and then click Proceed in the second.

Now, to put the map back,

- ▶ Choose Save & Put Away from the File/Print menu.
- ▶ Move the document icon to your folder.

Chapter Summary

Duplicate using grouping

- Select the part to be duplicated.
- Choose Group from the Arrangement menu.
- Choose Duplicate from the Edit menu.
- Move the pointer to the duplicated section (not on a handle) and press the mouse button.
- Move the new section into place in the drawing.
- Release the mouse button.
- Repeat process if necessary.
- Ungroup the sections if you need to edit them.

Make a shaded box

- Draw a box.
- Make a duplicate of the box.
- Choose a gray shade from the Shades menu.
- With the gray box selected, choose Send to Back from the Page Layout menu.
- Choose Grid Paper from the Page Layout menu.
- Move the gray box just below and to the right of the first box.

Lock an object

- Select the object or objects that you want to lock.
- Choose Lock from the Arrangement menu.

Unlock an object

- Select the object or objects that you want to unlock.
- Choose Unlock from the Arrangement menu.

Edit a freehand line

- Select the freehand line to be edited.
- Choose Reshape Curve from the Edit menu.
- Move the pointer to any handle and press the mouse button.
- Move the pointer and the line moves with it.
- Release the mouse button when finished.

Smooth a freehand line

- Select the line to be smoothed.
- Choose Smooth from Edit menu.

Unsmooth a freehand line

- Select the line to be unsmoothed.
- Choose Unsmooth from the Edit menu. This spaces out the handles on the line, but does not reverse the smoothing process.

Use the shrink-to-size technique

- Draw an object larger than you want it to appear in the finished drawing so it is easy to work with.
- Select the object or objects, if it has more than one part.
- Using a corner handle, shrink the object to the actual size that you want it to be.
- Move the pointer to the edge of the object, not to a handle, press the mouse button, and move it to its appropriate position in the drawing.

Make a stationery pad

- Select the icon of the appropriate drawing.
- Choose Make Stationery Pad from the File/Print menu.

Chapter 4

More about LisaDraw

More about LisaDraw

In Chapters 1, 2, and 3, you have learned the basics of LisaDraw. As you create more drawings and begin to develop your own drawing style, you'll find that the same task can often be accomplished in several ways. One method may be quick and simple, while another is slower. In this chapter, you'll add to your growing repertoire of time-saving techniques as you

- Use deselect creatively.
- Learn how alignment works.
- Draw and edit arcs.
- Work more with polygons.
- Measure size in the drawing area.
- Align existing objects with the auto-grid.
- Set text alignment.
- Design custom rulers and control the fineness of the auto-grid.
- Copy and paste between drawings.
- Change the drawing and printing size and preview pages.

Deselecting Selectively

What if you want to delete most of a drawing, but save some specific items? To learn an easy way to do this, get a new piece of drawing paper and fill your screen with a number of objects and some text, something like Figure 18.

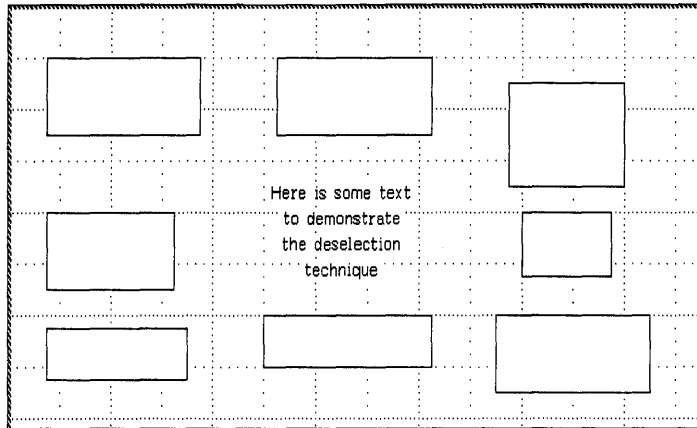
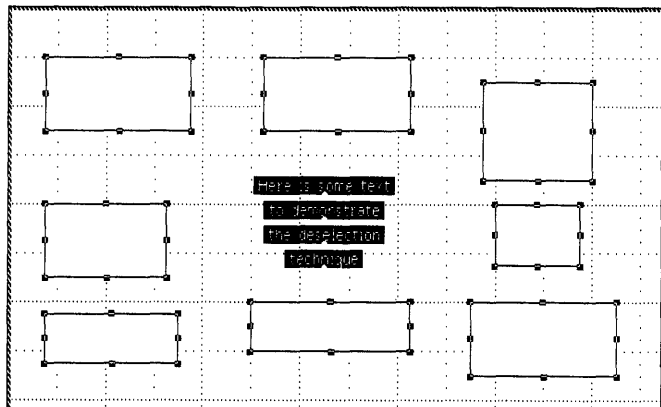

Figure 18. Assorted Objects and Text

- Choose Select All of Document from the Edit menu.



- Hold the **(Shift)** key down and click on one object in each corner of the screen, as shown in Figure 19.

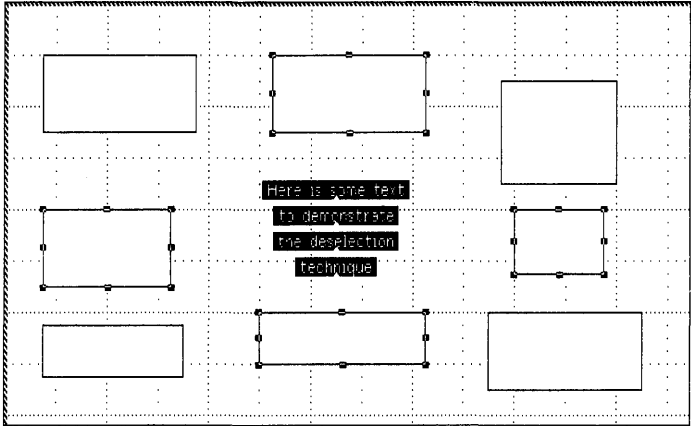

Figure 19. Deselecting an Object in Each Corner

Each object you clicked on is now deselected.

► Choose Clear from the Edit menu.

Only the objects that you deselected remain, as shown in Figure 20. Leave them in the drawing area for the next exercise.

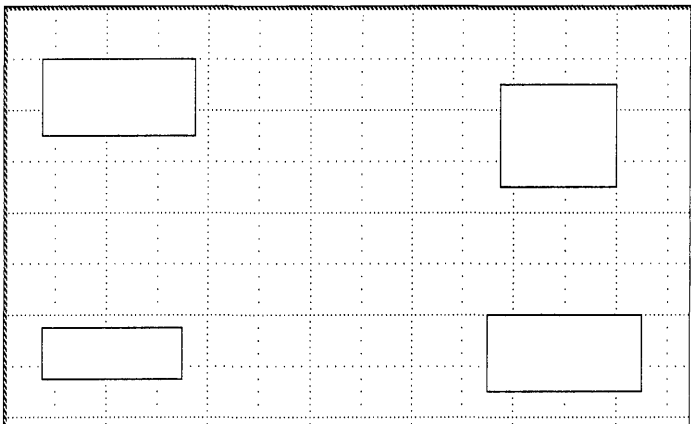
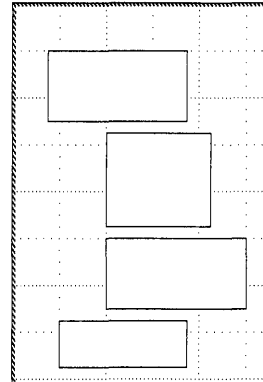

Figure 20. Remaining Objects

Easy Alignment

Suppose you want to align the four remaining boxes at the left side of the drawing area.

- ▶ Move the two boxes on the right to the left side so they are positioned approximately as shown here.



Now, to line them up perfectly,

- ▶ Select all the objects.
- ▶ Choose Align Left Sides from the Arrangements menu.

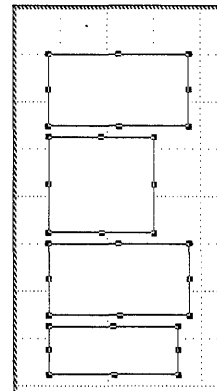

The other align options work similarly. Figure 21 shows what they do.

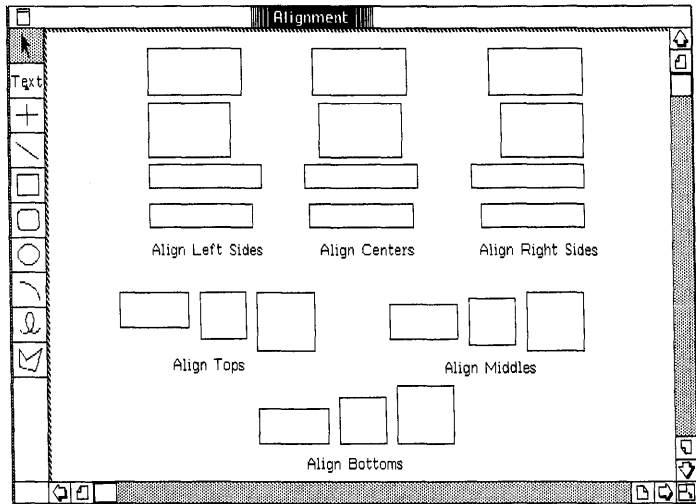

Figure 21. Using the Align Options

The align options are especially useful if, for example, you forget to turn on auto-grid when drawing, or if you want to line up several lines of text.

Setting Text Alignment

You've probably noticed the little caret that appears in the text symbol in the palette. This caret shows how the text alignment is currently set, either left, center, or right. If the caret appears in the center under the word "Text," the alignment is currently set to center, and so forth.



Left alignment means that when you set the insertion point to enter text, all words that you type will appear to the right of the insertion point. Right alignment means that all characters go to the left of the insertion point. With center alignment, all characters are centered around the insertion point. Figure 22 gives examples of alignment. The vertical line in the figure shows the location of the insertion point.

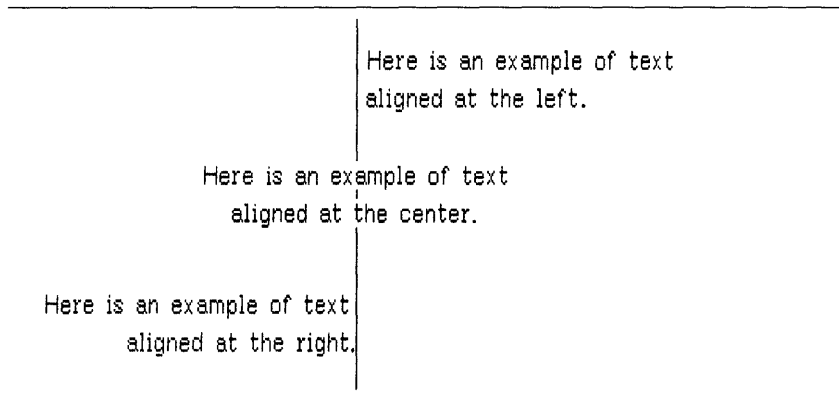

Figure 22. Text Alignment

To reset the text alignment,

- ▶ Activate the text symbol in the palette.
- ▶ Choose Align Centers, Align Left Sides, or Align Right Sides from the Arrangement menu. You have to click on the text symbol first, each time you choose a new text alignment style.

Notice that the caret position in the text symbol changes to reflect your current choice.

- ▶ Experiment with the three text alignments, entering some text as you try each one.

As you can see, each text alignment remains set until you specifically change it.

All about Arcs

You can draw perfect arcs with LisaDraw. An arc is a part of the circumference of a circle or oval. If you fill an arc, the result is a shape that looks like a pie slice. Some examples of arcs and filled arcs are shown in Figure 23.

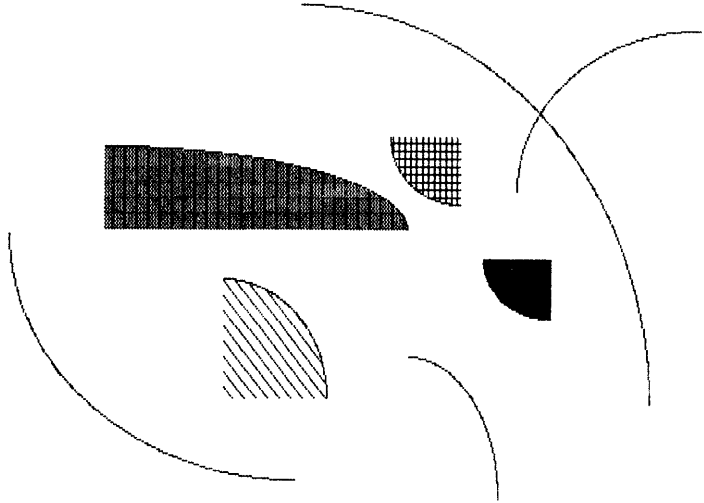
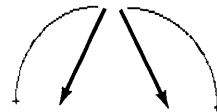

Figure 23. Examples of Arcs and Filled Arcs

- ▶ Clear the drawing area.
- ▶ Activate the arc symbol in the palette.



- ▶ Press the mouse button with the pointer in the drawing area and, holding the button down, move down and to the right and then left; then up and to the right and left. Release the mouse button to complete the arc.



You will learn how to edit arcs in a moment. Right now,

- ▶ To develop control, practice drawing arcs until you can fit four of them together as shown here.

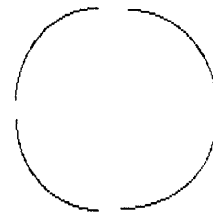

- ▶ Leave these four arcs on the screen for the next exercise.

Moving, Stretching, and Shrinking Arcs

You can move, stretch, and shrink arcs just like you can another object. To see how this works,

- ▶ Move the pointer so that it touches the upper right arc.

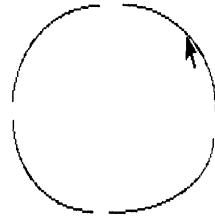

- ▶ Press the mouse button and move the arc away from the other three arcs. Release the mouse button.

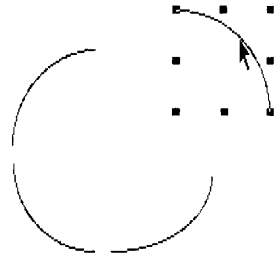

- ▶ Use the right center handle to stretch the arc horizontally; then return it to approximately its original shape.

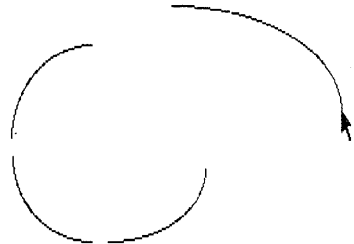

- ▶ Now, shrink it by using a corner handle; it shrinks in both height and width.

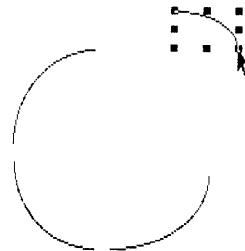

There is another way you can change the shape of an arc.

- ▶ Select the lower right arc.

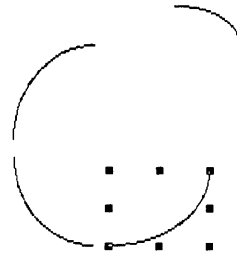

- ▶ Choose Reshape Arc from the Edit menu.

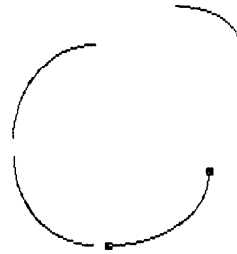

The handles are now at the ends of the arc, and you can grab either one and extend the curve of the arc or make it smaller.

- ▶ Grab the upper handle and stretch the arc around.

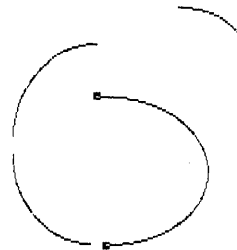

When an arc is filled, you can move the pointer anywhere inside the arc to move it.

- ▶ Try filling and then moving the arc you just stretched.
- ▶ Clear your screen.

Filling Arcs

To practice filling arcs, go through the following steps to create a pie chart.

▶ Choose Auto-Grid Paper from the Page Layout menu.

▶ Draw a quarter-circle arc, using the grid lines to help judge the angle.

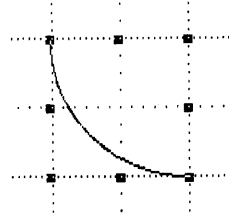

▶ Choose a shade or a pattern from the Shades menu.

Your arc now looks like this:

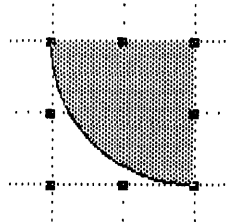

▶ Draw a second quarter-circle arc and fill it with black.

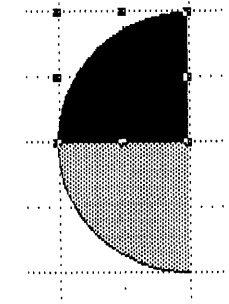
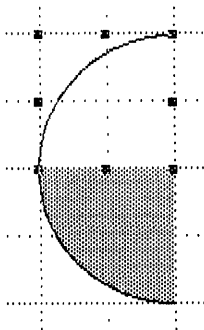

- ▶ Now, draw a third quarter-circle arc and fill it with stripes.

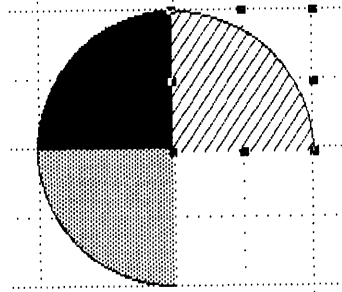

- ▶ Choose Reshape Arc from the Edit menu.

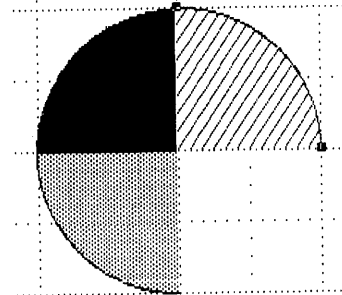

- ▶ Grab the lower handle and stretch the arc so that it closes the circle.

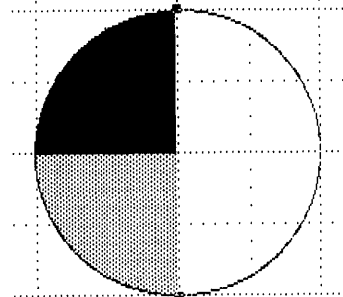

Notice that when you're done, the arc is not filled, although the entire outline is visible. As soon as you click somewhere else and deselect it, the arc regains its fillstyle.

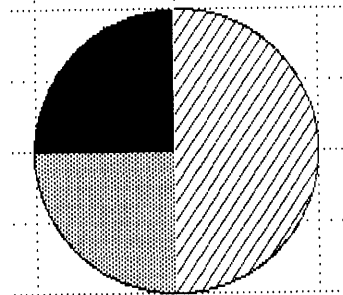

Changing Polygons

You drew a polygon for the flow chart in Chapter 2. You can move, stretch, and shrink polygons just as you do any other shape in LisaDraw. In Figure 24, the triangle in the upper left has been changed into all the other shapes by duplicating, moving, stretching, and shrinking.

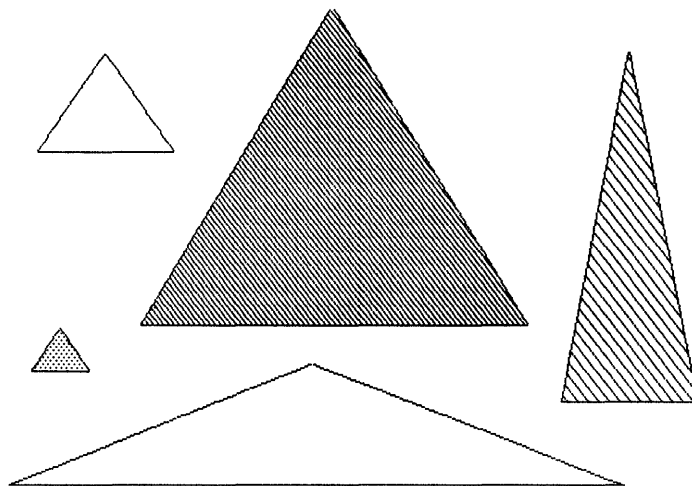

Figure 24. Stretching and Shrinking Polygons

- ▶ Practice drawing, stretching, shrinking, and reshaping a few polygons.

Measuring Size

Suppose you want to make a box with dimensions of 1.45 by 2.10 inches. Sounds like a lot of trouble? Not at all. To see,

- ▶ Clear the drawing area.
- ▶ Choose Show Size from the Page Layout menu.

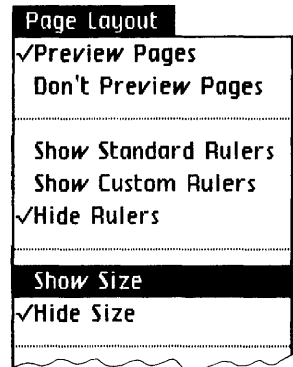

- ▶ Activate the box symbol.
- ▶ Begin stretching out a box.
- ▶ When the measurements read 1.45 and 2.10 inches, release the button.

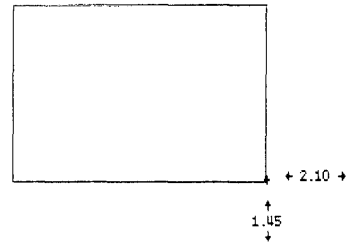

To measure an object that has already been drawn,

- ▶ Move the pointer inside the object and press the button. If the object is a line, move the pointer to the line and press.

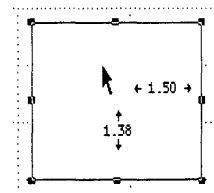

You will be able to read the measurement until you release the button. The measurements will be in inches, unless you put metric rulers or custom rulers into effect.

To turn the size feature off,

- ▶ Choose Hide Size from the Page Layout menu.
- ▶ Now, clear the screen to go on to the next exercise.

Aligning to Auto-Grid “After the Fact”

What if you draw some objects on plain or grid paper, and realize that you want to have these objects line up to the auto-grid? For example,

- ▶ Choose Show Standard Rulers from the Page Layout menu.
- ▶ Choose Grid Paper from the Page Layout menu.
- ▶ Draw several boxes. The idea is to create them off-grid.

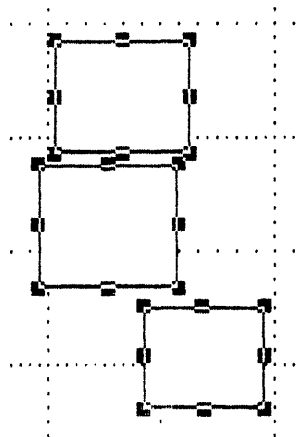

- ▶ Choose Auto-Grid Paper from the Page Layout menu.
- ▶ Click the mouse button while the pointer is in open space to deselect everything.
- ▶ Select one box and move it around.

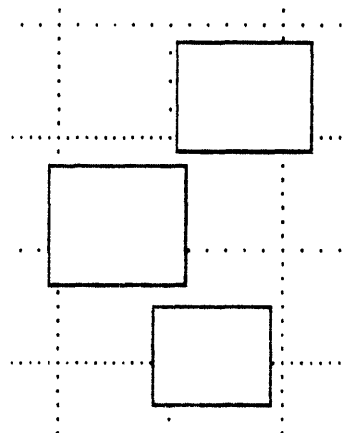

Notice that you can't put the box exactly on the grid. To make all of the boxes line up with the auto-grid,

- ▶ Select all the boxes.
- ▶ Choose Align to Auto-Grid from the Arrangement menu.

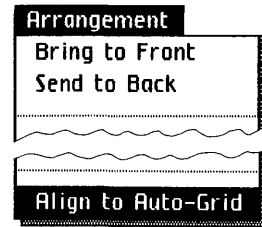

The objects are now lined up exactly to the auto-grid and, therefore, to the increments of the ruler.

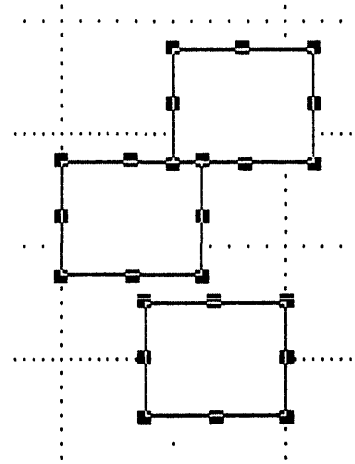

Metric and Custom Rulers

So far you have been using the standard inch rulers, but you can also use the metric rulers or design your own custom rulers — varying the fineness of the auto-grid at the same time.

Going Metric

To change the ruler to metric, you need to change the scale.

- ▶ Choose Scale of Ruler from the Page Layout menu.

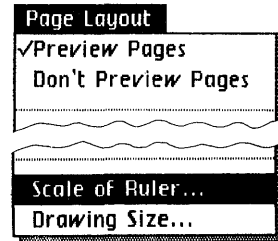

- ▶ A dialog box, shown in Figure 25, appears. Check Centimeter and click OK.

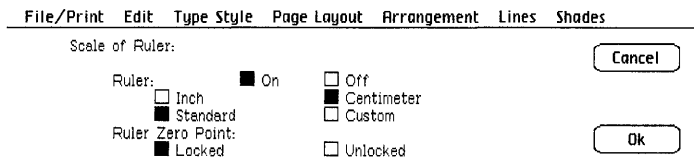

Figure 25. Scale of Ruler Dialog Box

Designing a Custom Ruler

Suppose you want to draw a floor plan of your office, and instead of a ruler with 1 inch divisions, you want a ruler with 2 foot divisions. To make a custom ruler for this floor plan,

- ▶ Choose Scale of Rulers from the Page Layout menu; check Inch and then check Custom. More information appears in the dialog box, as shown in Figure 26.

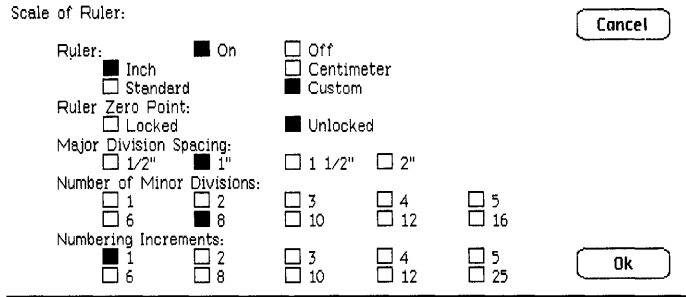
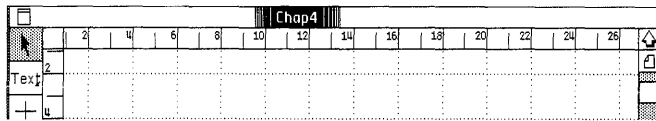

Figure 26. More Information in the Dialog Box

- Check Major Division Spacing = 1/2, Number of Minor Divisions = 2, and Numbering Increments = 2. Then click OK.

Your ruler looks like this:



This is only one of many rulers that you might design for a floor plan. There are numerous other combinations that you could use. And LisaDraw remembers what you've done—any time you choose Show Custom Rulers, you get the latest one that you've designed. You can also design a centimeter custom ruler. The difference between an inch custom ruler and a centimeter custom ruler is the basic increment size upon which the ruler is based. LisaDraw remembers both the latest centimeter and inch custom ruler, and these are saved with the drawing.

- Choose Show Standard Rulers from the Page Layout menu for the next example, and clear the drawing area.

Drawing a Frame

What if you want to make a drawing, and you want it to fit within a 3 by 3 inch area, as shown in Figure 27. An easy way to do this is to turn on the rulers and draw a 3 by 3 inch frame. Then construct your drawing within it.

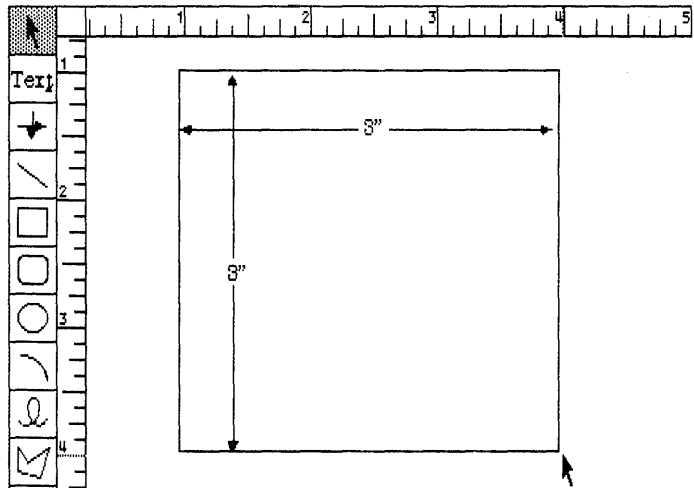

Figure 27. Using a Frame to Control the Size of a Drawing

When rulers are turned on, a dotted line appears on the rulers corresponding to the vertical and horizontal location of the pointer.

- ▶ Draw a 3 by 3 inch box and draw something inside it.
- ▶ Clear the drawing area when you're through.

You can lock the frame, if you like, so it doesn't move while you are drawing. Then unlock it and delete it when you are finished drawing.

Centering Drawings on the Page

Your drawing size is now set to 8 by 10 inches. If you want to position an object precisely in the middle of the page, one way is to use the rulers to draw some temporary guide lines through the vertical and horizontal center of the drawing area. Since half of 8 by 10 inches is 4 by 5 inches,

- ▶ Draw a vertical line at 4 inches and a horizontal line at 5 inches.

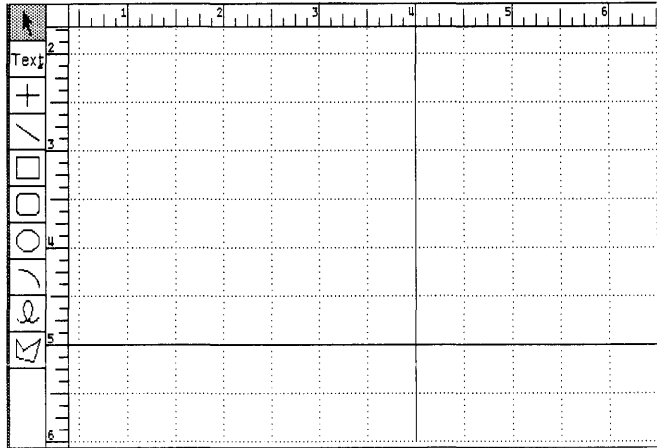

These lines show where the actual center of the drawing area is.

- ▶ Now, draw using the lines as a guide, or move an existing drawing into place.
- ▶ Then, select the guidelines and delete them.

Your drawing will be perfectly centered on the page when you print it.

Copy and Paste between Drawings

It is easy to copy anything you want from one drawing to another. You can copy into a new piece of drawing paper, or into a drawing that already contains material.

- ▶ Draw a simple picture of your Lisa.

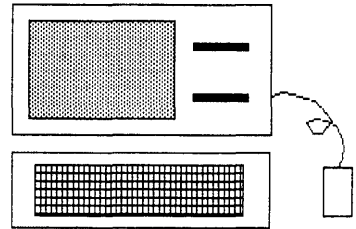

Suppose you want to use this drawing in a report, and you need to put together another report that requires only a drawing of the keyboard. You can copy just the keyboard onto another piece of drawing paper, and use it later. To do this,

- ▶ Using the size control box, make the window smaller, so that it fills the top half of the drawing area.

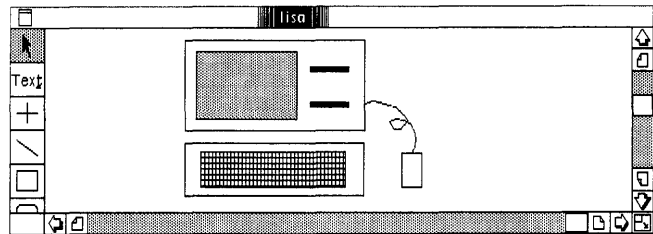

- ▶ Tear off a new piece of drawing paper, name it "Keyboard," and open it.
- ▶ Position the Keyboard drawing so that it fills the bottom half of the screen, as shown in Figure 28.

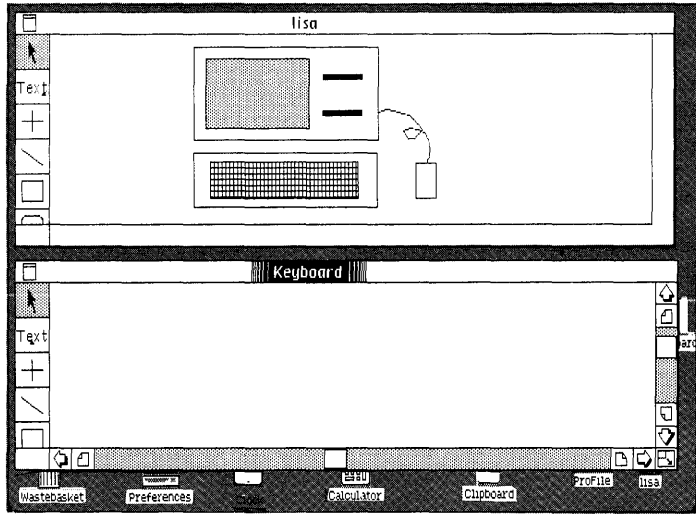
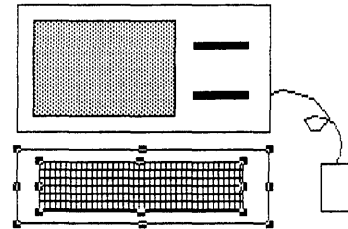

Figure 28. Two Drawings Positioned

► Activate the window that contains the Lisa drawing.

► Select the keyboard; then choose Copy from the Edit menu. This puts a copy on the Clipboard.



► Now, activate the empty Keyboard window and choose Paste from the Edit menu.

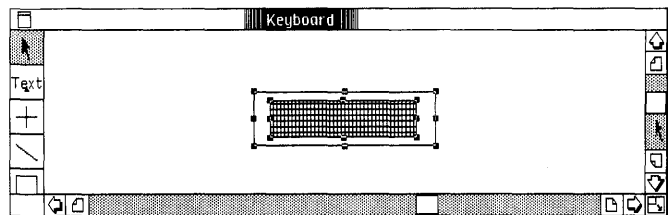

This puts the contents of the Clipboard into Keyboard.

► Save and put away the Keyboard drawing.

► Reactivate the window you've been working with, and resize it to full screen size.

Changing the Drawing Size

Up until now your drawing size has been set to 8 by 10 inches. To change this,

- Choose Drawing Size from the Page Layout menu.

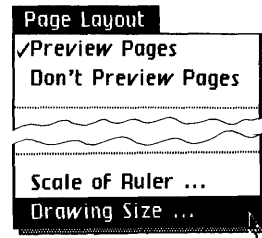

A dialog box appears that looks like Figure 29.

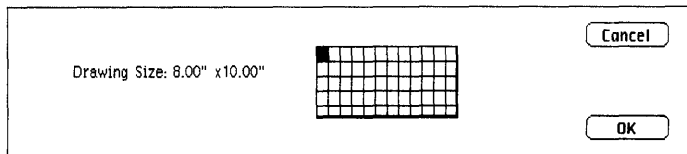
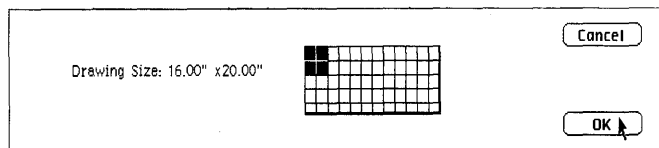

Figure 29. Drawing Size Dialog Box

Let's say you want to change the drawing size to 16 by 20 inches,

- Click on the squares to increase the drawing size until the drawing size reads 16 by 20 inches; then click OK.



You now have a 16 by 20 inch drawing size. You will need to scroll to see the entire drawing area. To change size again, just go through the same process. By the way, this 16 by 20 inch setting is appropriate for any size between 8 by 10 inches and 16 by 20 inches, such as 11 by 14 inches. Note that you can have a drawing up to 96 by 48 inches: that's 8 feet by 4 feet!

Previewing Page Boundaries

How will you know where one page ends and the next one begins when you set your drawing size to larger than one page? To see the page divisions on the screen,

- ▶ Choose Preview Pages from the Page Layout menu, if it is not already chosen.



When Preview Pages is chosen, lines appear to divide the pages, as shown in Figure 30.

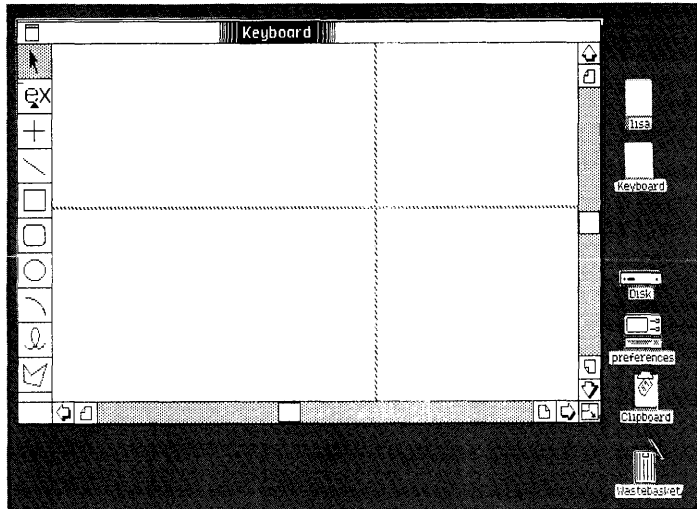

Figure 30. Example of Preview Page Lines

The preview lines are not printed, even when you have them turned on. And if you don't want to see them on the screen,

- ▶ Choose Don't Preview Pages from the Page Layout menu.

Chapter Summary

Use the deselect
technique

- Choose Select All of Document from the Edit menu.
- Hold the **(Shift)** key down and click on each object that you want to keep.
- Choose Clear from the Edit menu.

Align objects

- Select the objects to be aligned.
- Choose the appropriate align item from the Arrangement menu.

Draw an arc

- Activate the arc symbol.
- Press and hold the mouse button and move the pointer until the arc is the desired shape and size.
- Release the mouse button.

Stretch and shrink an arc

- Move the pointer to one of the arc handles.
- Press and move the pointer in the desired direction to make the arc larger or smaller.
- Release the mouse button.

Reshape an arc

- Select the arc to be changed.
- Choose Reshape Arc from the Edit menu.
- Use either handle to reshape the arc.
- Release the mouse button when the arc is the desired shape.

Change polygon line lengths	<ul style="list-style-type: none"> ■ Select the polygon. ■ Choose Reshape Polygon from the Edit menu. ■ Use the handles on the ends of individual lines to shorten or lengthen lines.
Show size	<ul style="list-style-type: none"> ■ Choose Show Size from the Page Layout menu. ■ The size appears as you draw, or stretch out a selection line.
Don't show size	<ul style="list-style-type: none"> ■ Choose Hide Size from the Page Layout menu.
Align an object to auto-grid after the object is drawn	<ul style="list-style-type: none"> ■ Make sure Auto-Grid Paper is chosen. ■ Select the object to be aligned. ■ Choose Align to Auto-Grid from the Arrangement menu.
Design a custom ruler	<ul style="list-style-type: none"> ■ Choose Scale of Ruler from Page Layout menu. ■ Click on the appropriate choices to determine the ruler scale. ■ Click OK.
Use custom rulers	<ul style="list-style-type: none"> ■ Choose Show Custom Rulers from the Page Layout menu.
Put rulers away	<ul style="list-style-type: none"> ■ Choose Hide Rulers from the Page Layout menu.

Copy objects or text from one drawing to another

- Select the objects and/or text to be copied.
- Choose Copy from the Edit menu.
- Activate the document that is receiving the copy.
- Place the insertion point where you want the copy to be placed.
- Choose Paste from the Edit menu.

Change the drawing size

- Choose Drawing Size from the Page Layout menu.
- Click on the appropriate squares in the dialog box; then click OK.

Preview page boundaries

- Choose Preview Pages from the Page Layout menu.

Don't preview page boundaries

- Choose Don't Preview Pages from the Page Layout menu.

Chapter 5
LisaDraw and Other Tools

LisaDraw and Other Tools

This chapter has two parts. In the first part, you learn how to bring graphs from LisaGraph and charts from LisaProject into LisaDraw for customizing. In the second part, you learn how to make overhead slides from documents created with LisaDraw. In a few simple steps you

- Add information to a LisaGraph graph.
- Add a company logo to a LisaProject chart.
- Make an overhead slide from a LisaDraw organization chart.

Adding Graphics to a LisaGraph Graph

In addition to cutting and pasting between LisaDraw documents, you can also bring a graph created in LisaGraph into a LisaDraw document and add graphics and text. To see how this works,

- ▶ Open the ProFile window and then the examples folder you created for yourself in LisaGraph.
- ▶ Open the graph "Report." Your screen should now look like Figure 31.

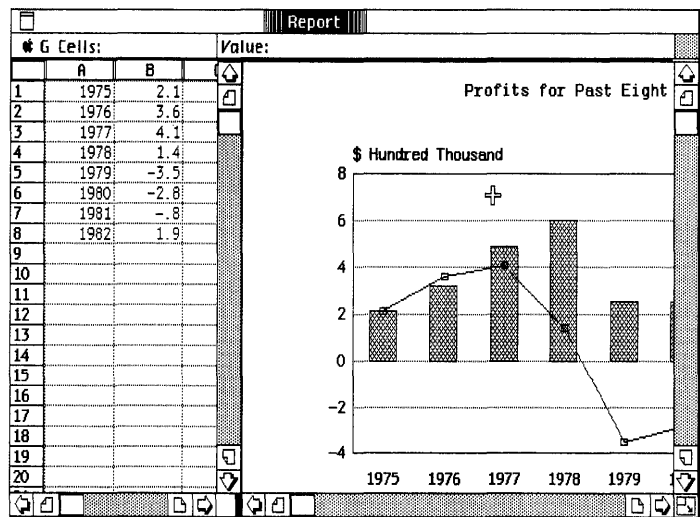
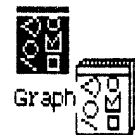

Figure 31. LisaGraph Report Brought into LisaDraw

- ▶ If you haven't completed Chapter 2 of the LisaGraph tutorial, open the LisaGraph Examples folder, tear off a piece of stationery from "Report," and open it.
- ▶ Copy the entire graph onto the Clipboard by choosing Select All of Graph from the Edit menu, and then Copy from the Edit menu.
- ▶ Put away the graph.
- ▶ Get a new piece of LisaDraw paper. Name it and open it.



LisaDraw Paper

- ▶ Choose Plain Paper from the Page Layout menu. If you leave the auto-grid on, some shapes may change when you paste in the graph.
- ▶ Choose Paste from the Edit menu.
- ▶ Move the pointer to an empty area of the drawing area and click the mouse button to deselect everything.

You should now have the graph on a piece of LisaDraw drawing paper. Add the words “Overall Economic Slump” and the arrows as shown in Figure 32.

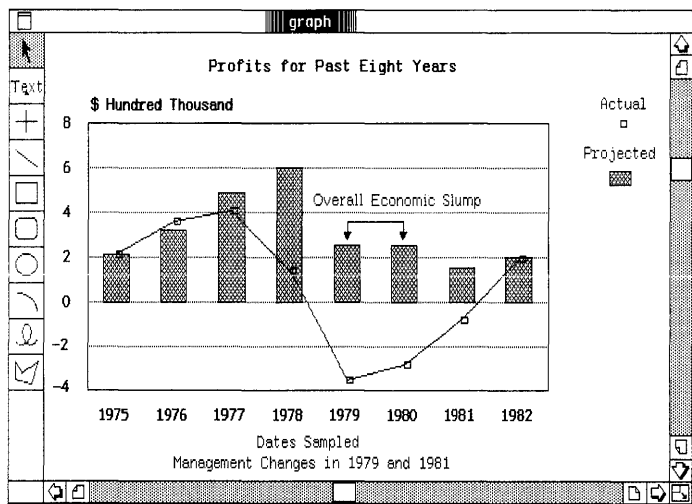

Figure 32. Adding Graphics to a LisaGraph Document

- ▶ Choose Save & Put Away from the File/Print menu.

Adding Graphics to a LisaProject Chart

You can also add graphics to a LisaProject chart. To add a company logo to a Schedule chart,

- ▶ Follow the instructions in the previous section for bringing the document into LisaDraw. In this case, get the document called “Product Design” from the LisaProject Examples folder. Your screen should look like Figure 33.

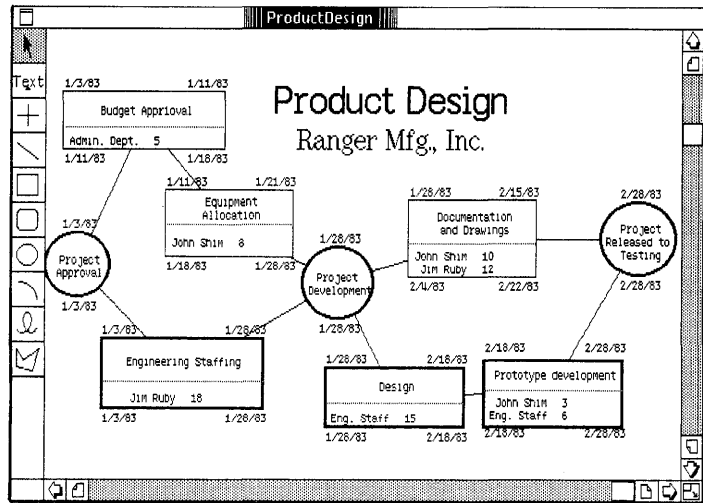
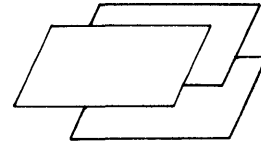

Figure 33. LisaProject Document Brought into LisaDraw

- ▶ Draw a logo something like this in the lower left corner of the chart, or design your own logo.



- ▶ Choose Save & Put Away from the File/Print menu.

Making Overhead Slides

Many people use overhead transparencies in meetings to help get their ideas across quickly and effectively. There are a few simple tricks that will help you make beautiful overhead slides from LisaDraw documents.

- Limit the amount of material in your drawing. Simplicity is effective. Study the examples that follow.
- A border around your material will make it stand out, and the slide will often look better.
- Use a premium quality heavyweight transparency film. In general, the heavier the film weight, the better the slide.
- When making the transparency, use a clear reproduction of your drawing made with the copy machine set to "dark."
- Be sure your printed copy of the drawing is spotless — you can't wipe off spots later.
- Try to use at least 1/4 inch size letters whenever possible. They are much easier to read.

- Leave a border of about 1/2 inch on all edges of the slide, if you want to use a mounting frame. If you use heavyweight transparency film, you probably won't need a frame.
- To add the emphasis of color, use color transparency film or color background film. Color adhesive film can be used to color in bar charts, pie charts, and so forth. There are also two-color transparency films which have come out recently and are very easy to use.

Overhead Examples

Here are some examples of drawings that will produce good overhead transparencies. Notice that, in general, the simpler they are, the better they look.

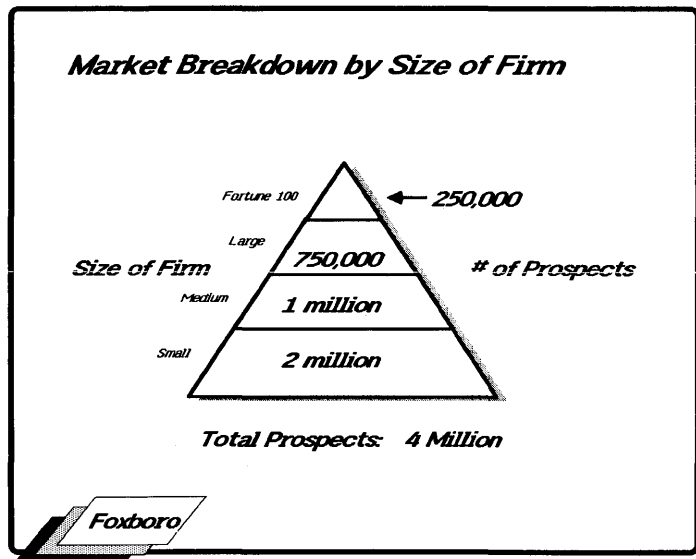

Production Cost Breakdown Dallas Facility

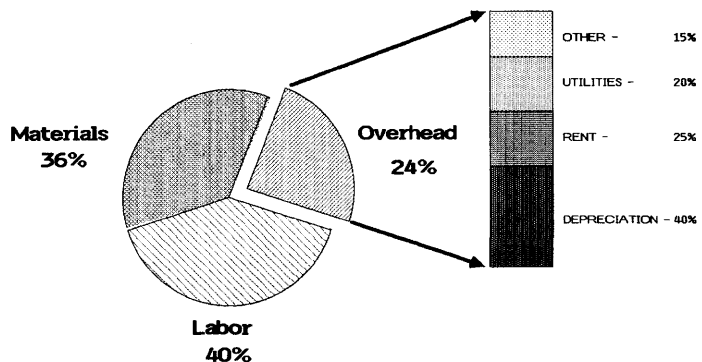

Report on South American Operations

5 years 1976-1980

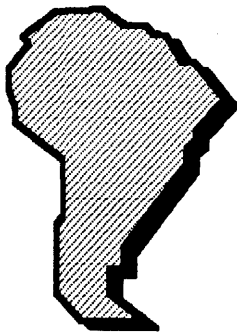

1976: \$ 32 mil

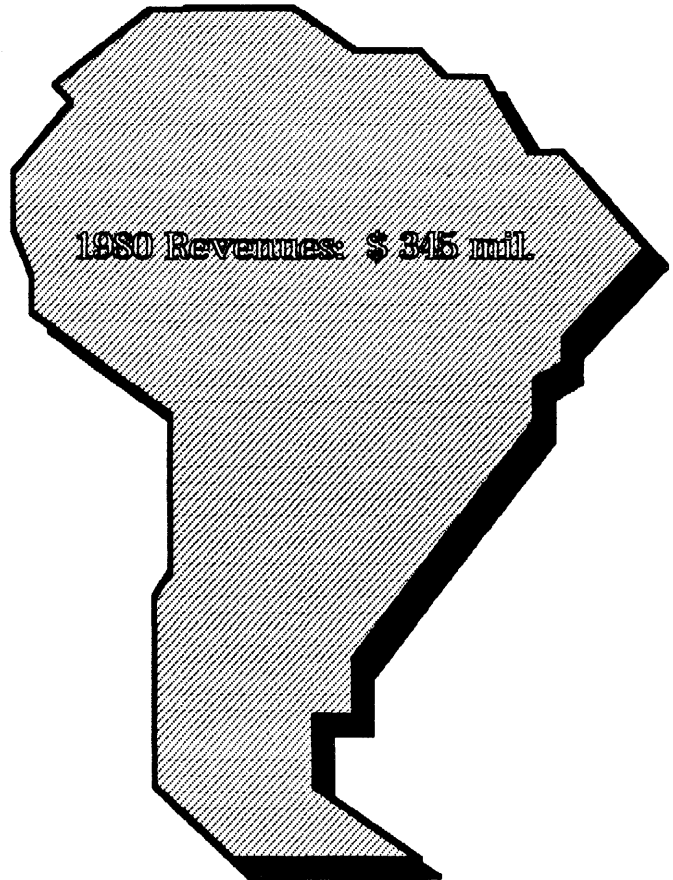

1980 Revenues: \$ 345 mil.

Prepared by the Financial Planning Dept., South American Operations
November 1, 1982

Chapter Summary

Add graphics to a LisaProject or LisaGraph document

- Open the ProFile, folder, and document containing what is to be brought into LisaDraw.
- Select the appropriate material. Choose copy from the Edit menu.
- Open the LisaDraw document into which the material is to be placed.
- Choose Paste from the Edit menu.

Make an overhead transparency from a printed LisaDraw document

- Use high quality, heavyweight paper in the transparency machine.
- Keep the information simple and uncluttered.
- If possible, use a dark copy of the drawing when making the transparency.
- Draw a border if it makes the drawing stand out better.
- Make sure the copy that you use to produce the transparency is spotless.

Chapter 6

LisaDraw Examples

LisaDraw Examples

In this chapter, you have a chance to look at more drawings created with LisaDraw. Some of these drawings are on stationery pads in the LisaDraw Examples folder and include

- Ship List.
- Org Chart.
- Floor Plan.
- Budgeting.

The LisaDraw Examples Folder

To get a piece of paper from a LisaDraw Examples folder stationery pad,

- ▶ Open the ProFile.
- ▶ Open the LisaDraw Examples folder.
- ▶ Tear off an example drawing from one of the stationery pads.

One of the stationery pads in the LisaDraw Examples folder is called "Template." It contains a number of flowchart shapes that you may find useful.

MEMORANDUM

John --

January 27, 1983

Here's a copy of the alternative floor plan for our section. Please look it over. This arrangement would give us more offices with windows, though of course they are smaller than the current layout. It also allows room for 3 more offices. What do you think?

David

Northeast Wing Building 4

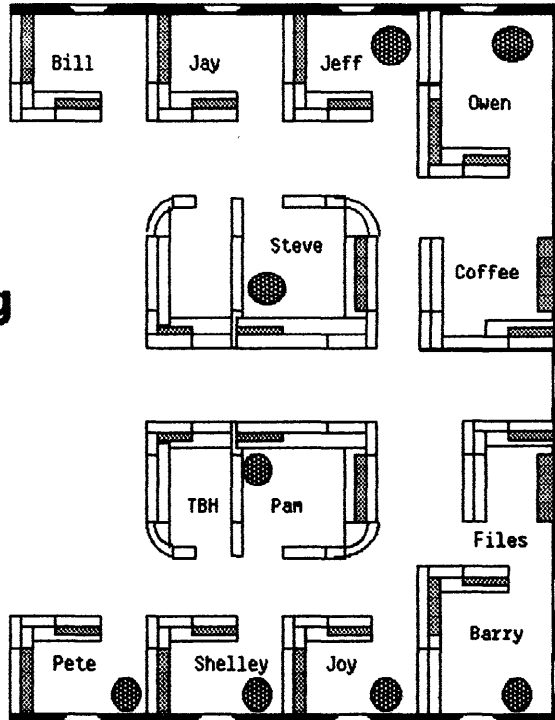

The Budgeting System

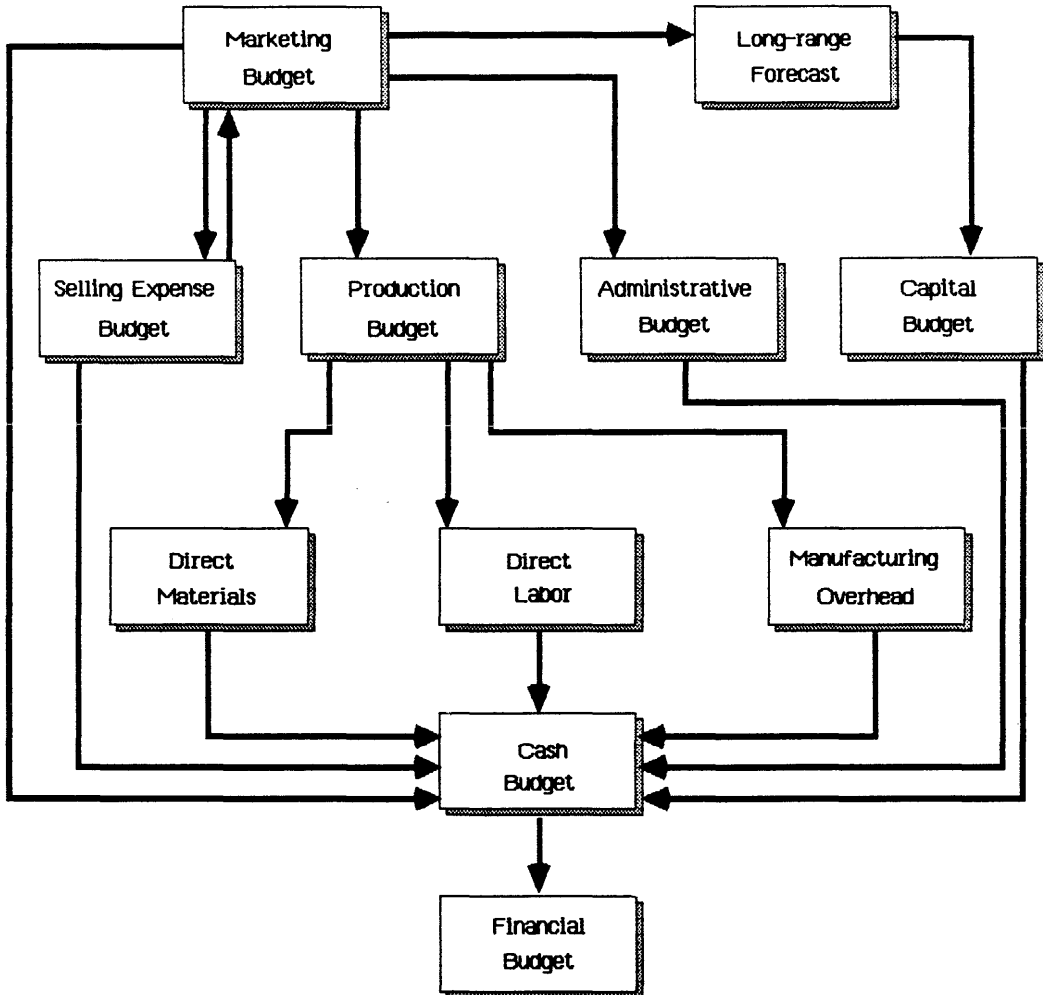

Before

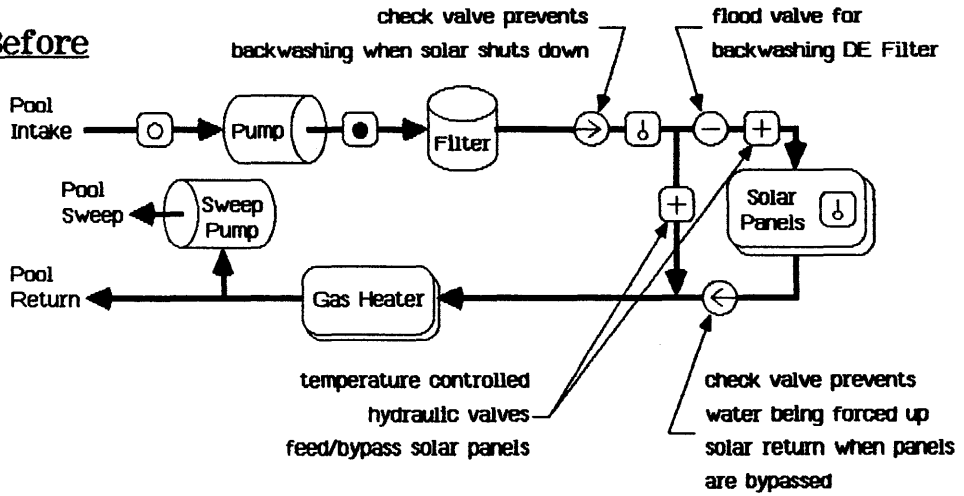

After

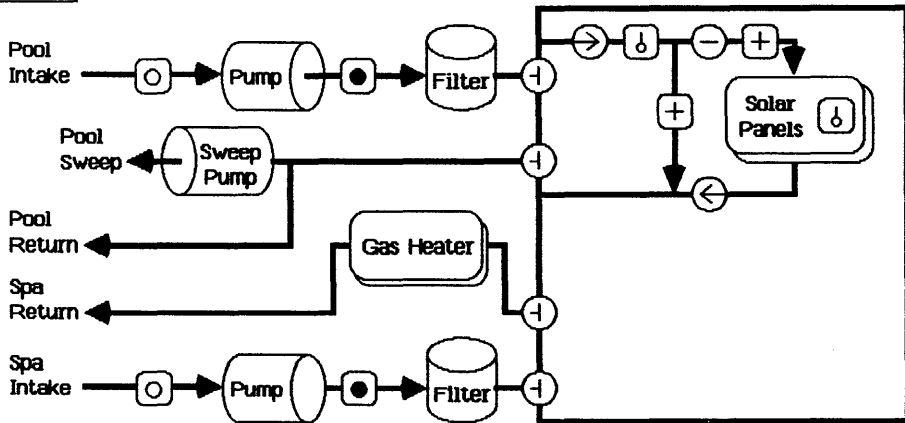

Legend					
	Check Valve		Temp Sensor		Hydraulic Feed
	Flood Valve		Hydraulic Valve		Hydraulic Return
	Ortega Valve				

Detail of Solar/Gas Heater Connections for Spa Installation
12/2/82

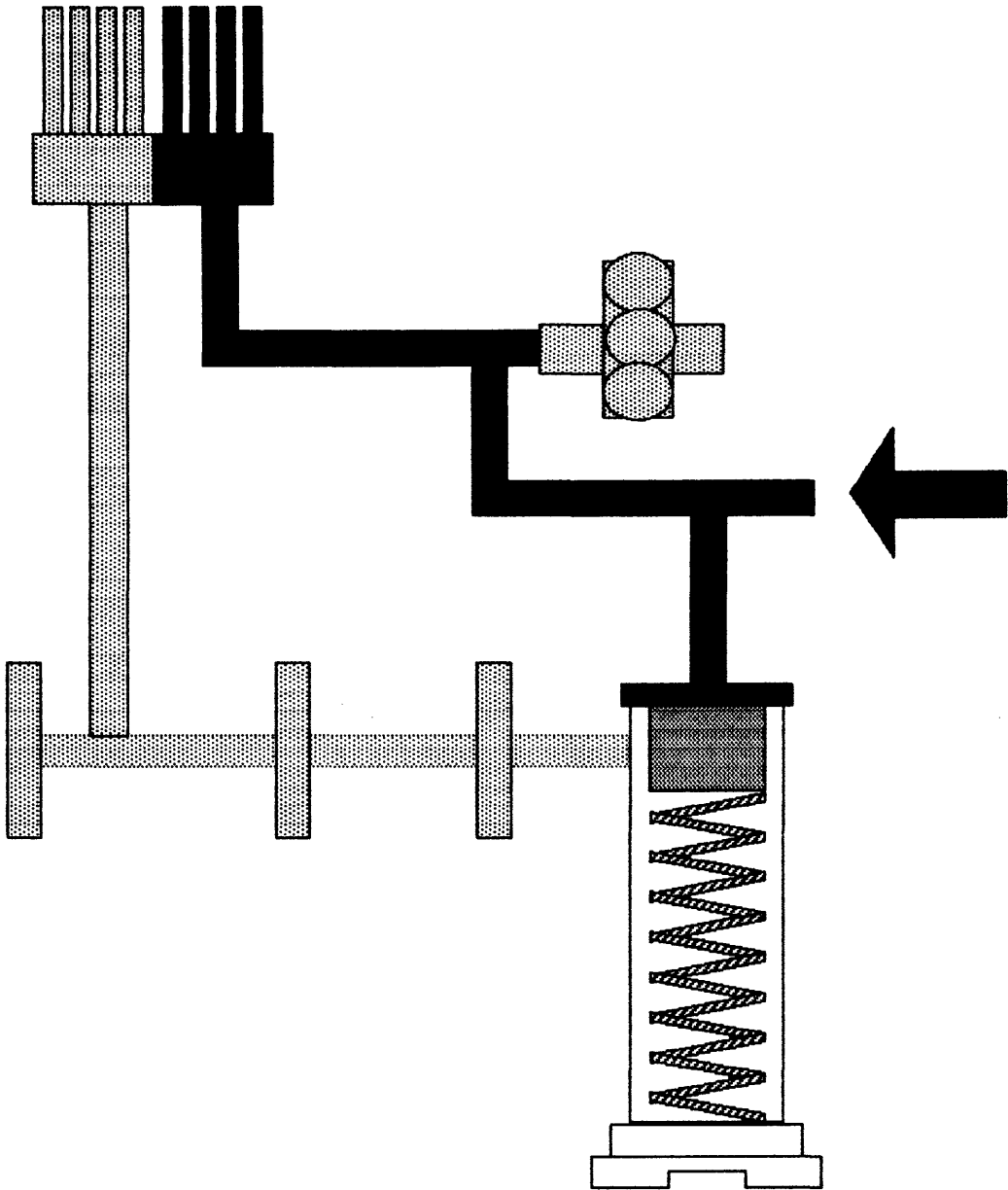

In hot engine the pressure is low. Plunger of pressure relief valve now can rise to the highest position, blocking gallery to left and by-pass port at right.

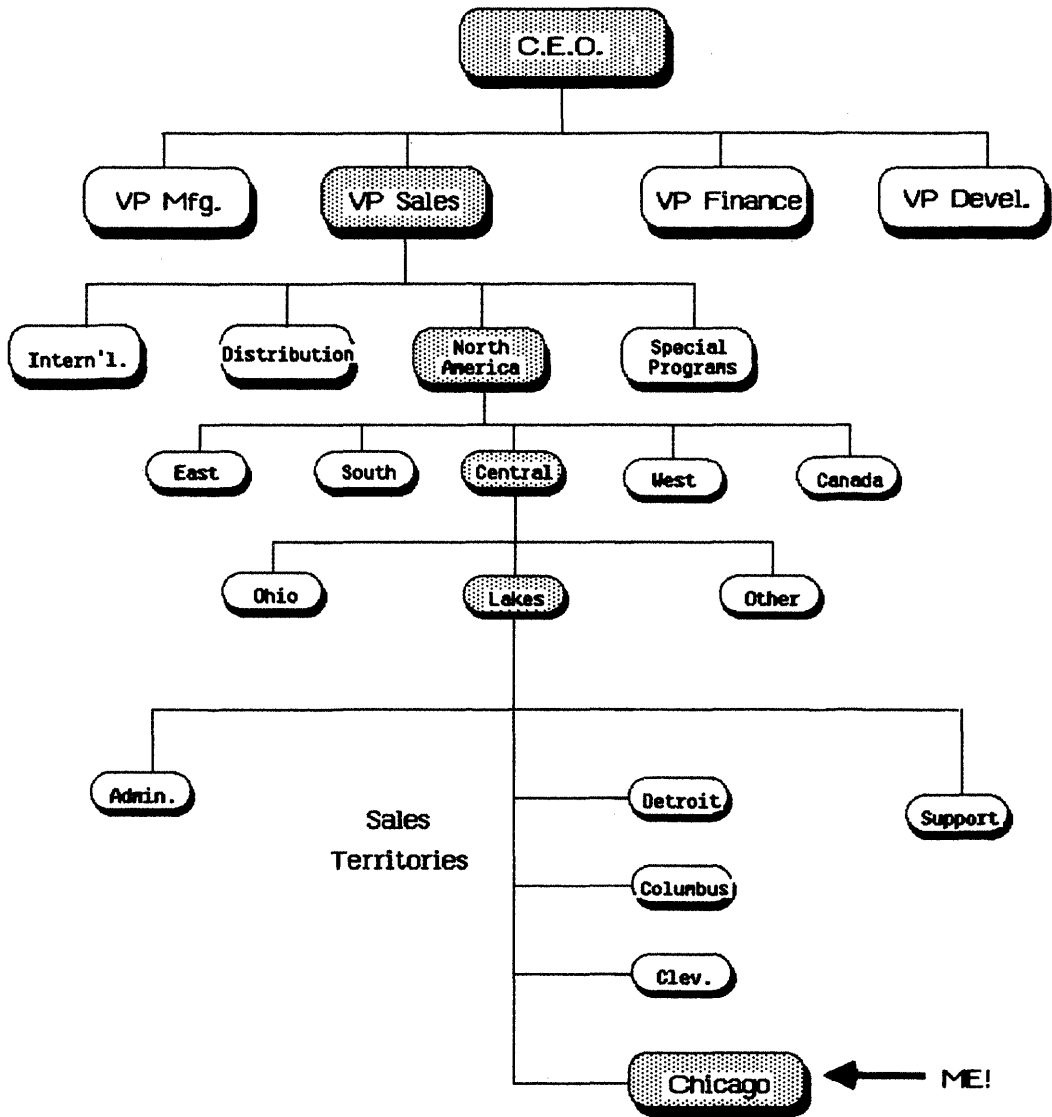

Materials Operating Guide Change Flow

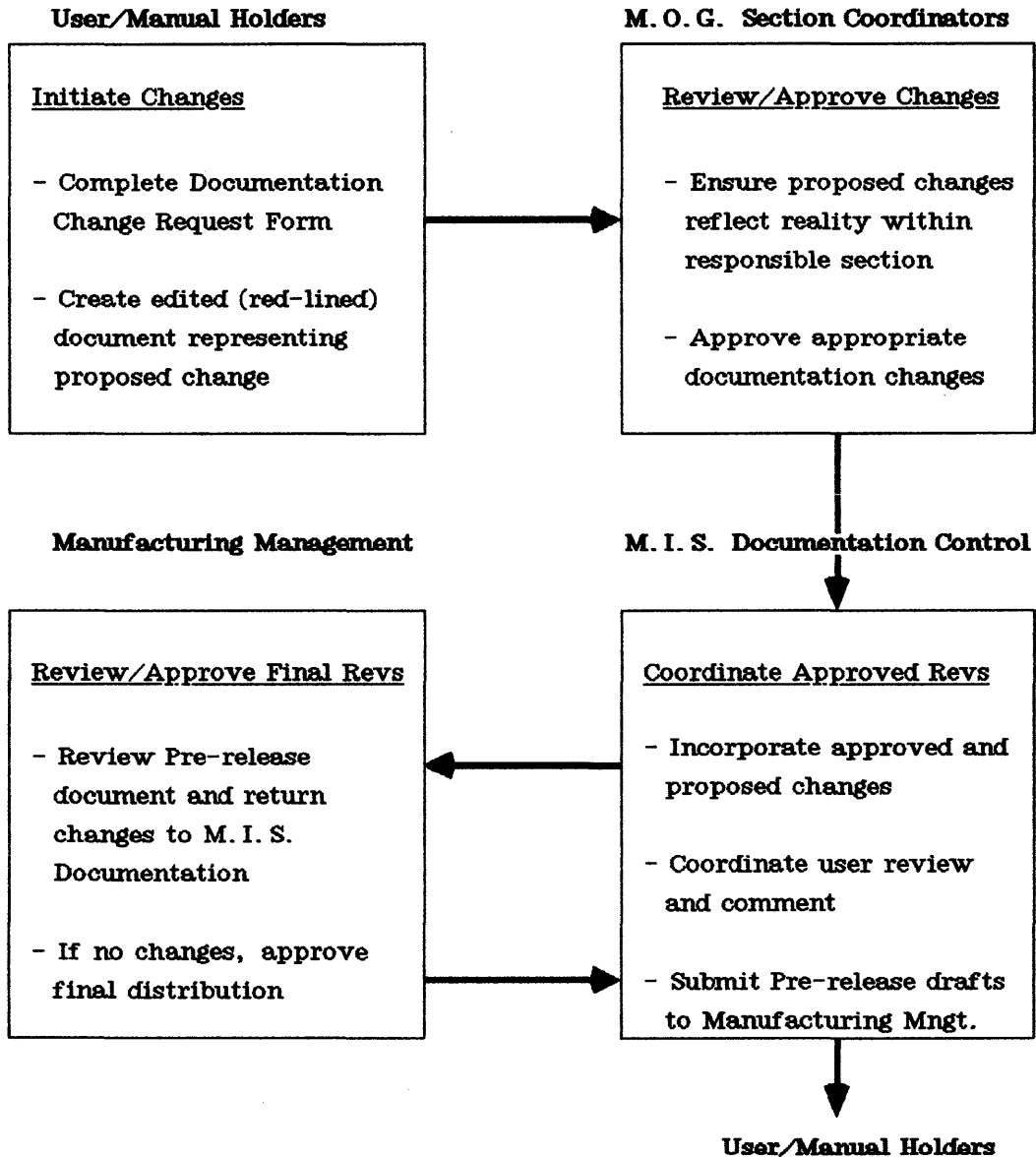

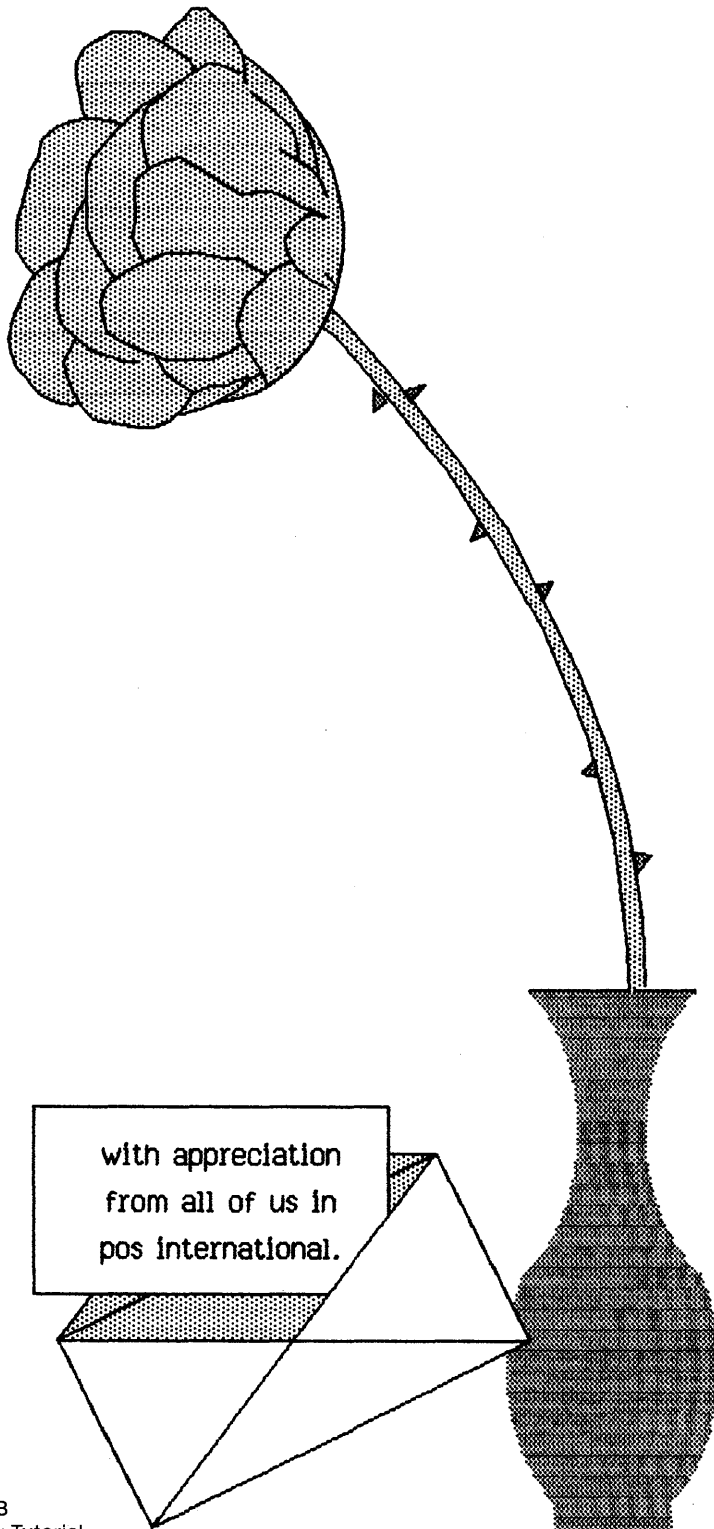

French Keyboard Layout

TN / 8 Nov, 82

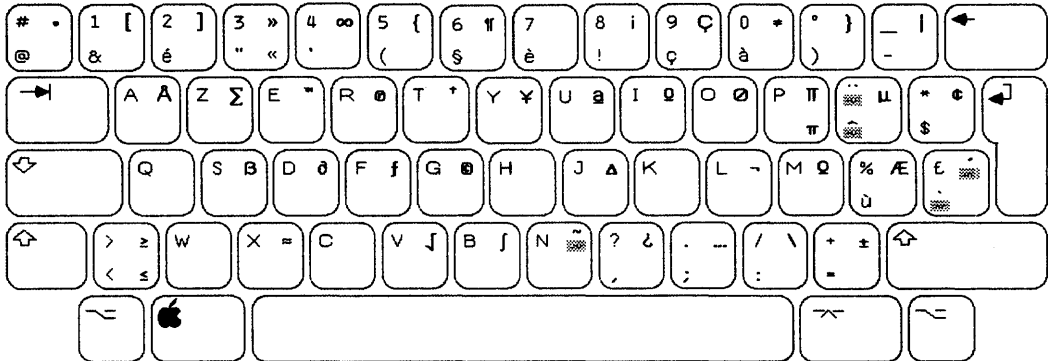

LEGEND

	Left		Right
	Up		Down
	Horizontal Tab		
	Caps Lock		
	Shift		
	Alternate Keyboard		
	Command		
	Back Space		
	Return (New Line)		
	Enter		
	Clear		

☞ Dead key, no character is generated until next key is pressed.

Left:	Right:
Primary keyboard	Alternate keyboard
	Upper: Shifted
	Lower: Unshifted

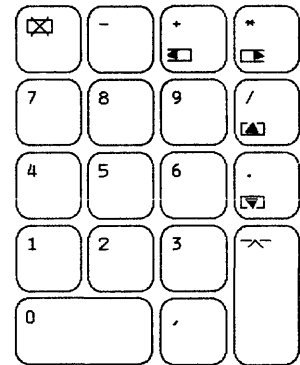

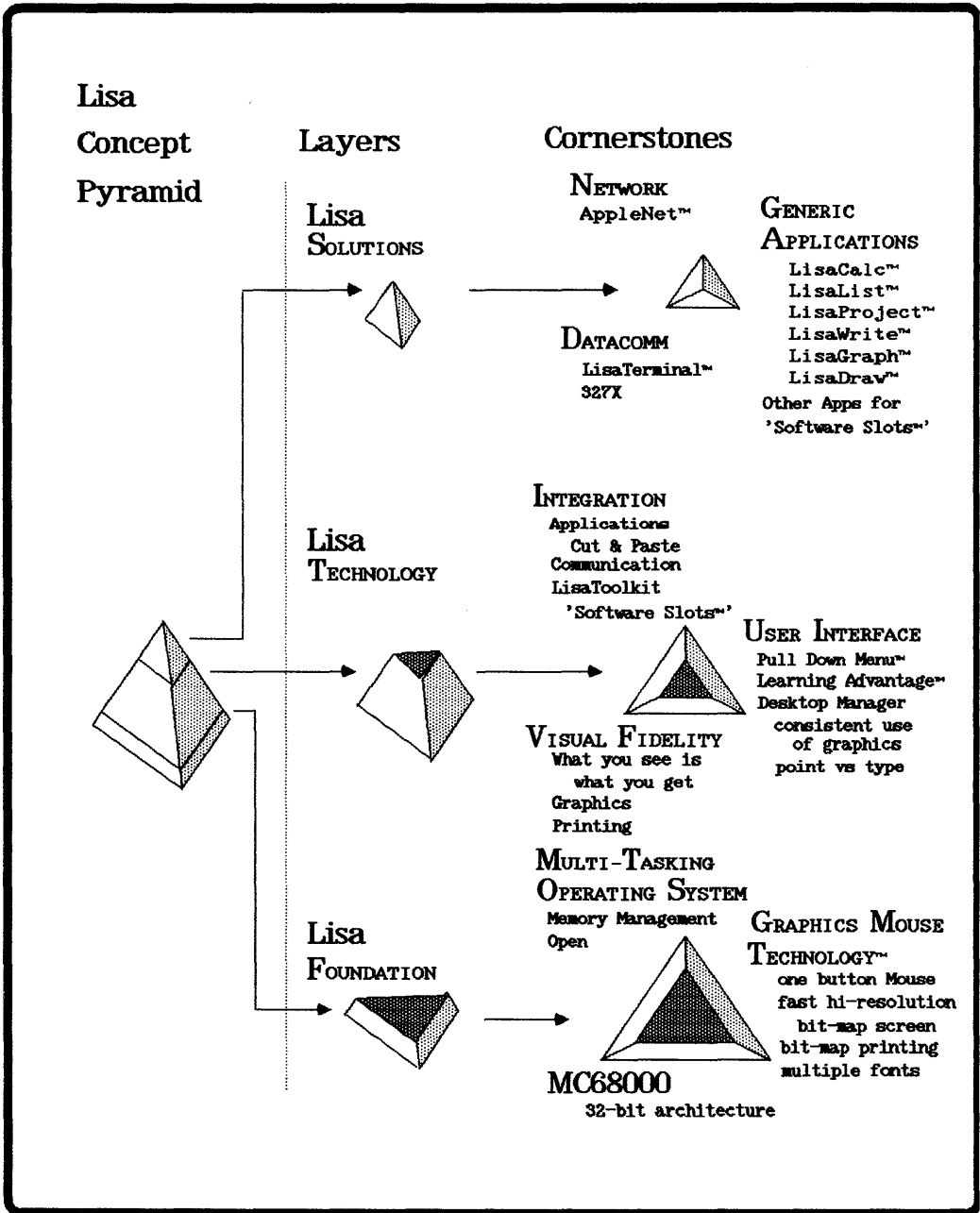

1982

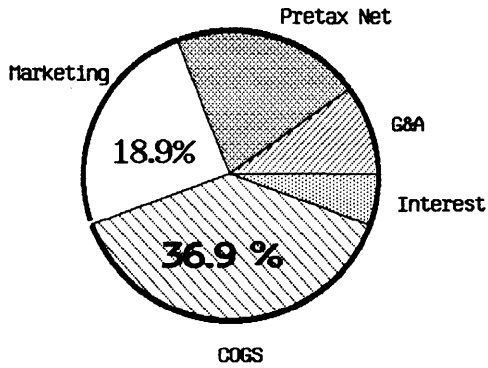

1981

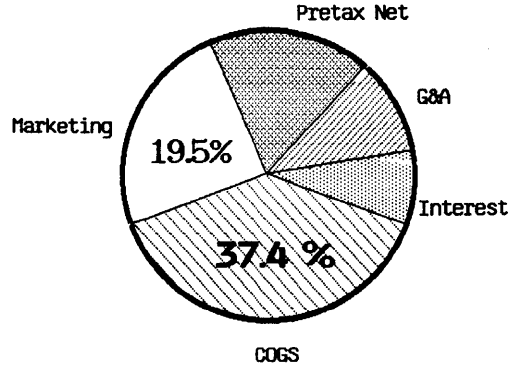

1980

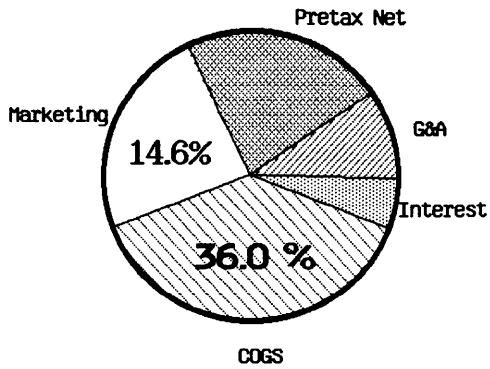

1979

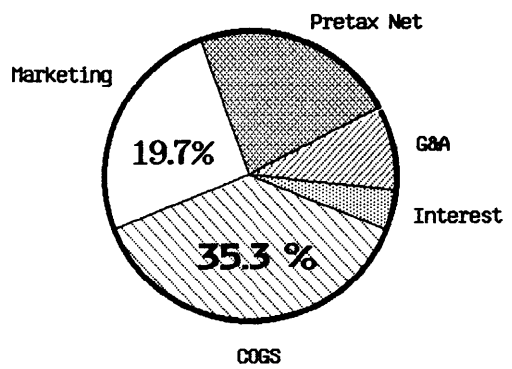

The Effect of Dirt on a Magnetic Disk

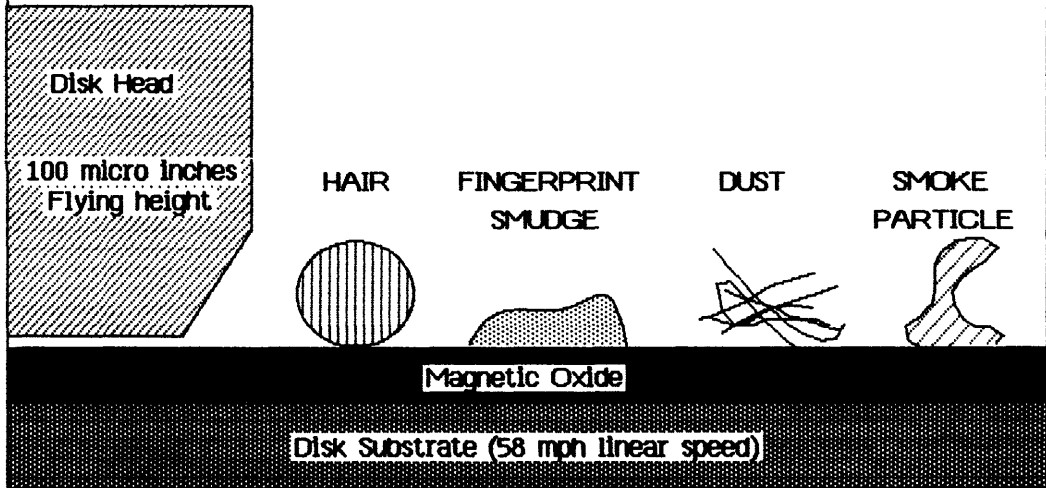

North American Distribution System

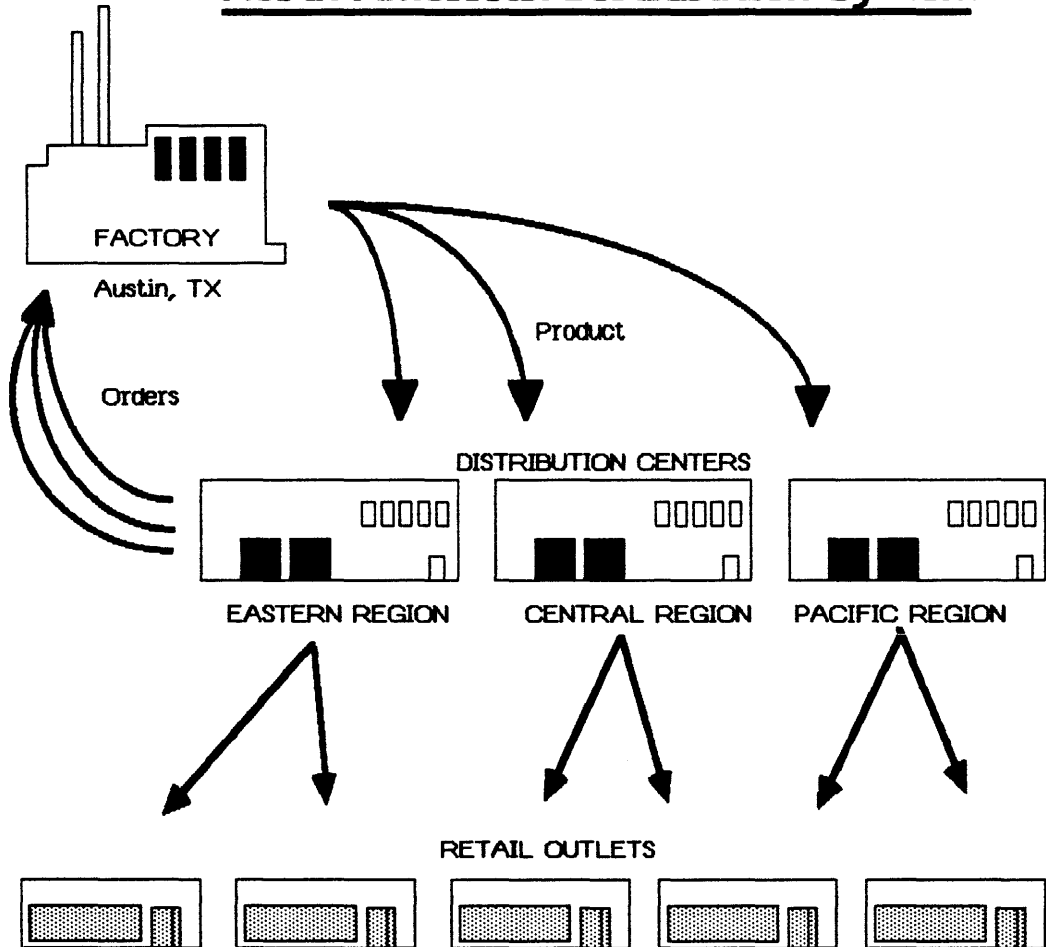

Number of retail outlets

EASTERN REGION: 120 independents
35 chains

CENTRAL REGION: 85 independents
32 chains

PACIFIC REGION: 89 independents
16 chains

Do You Owe Something To An Eliza McCardle?

She met a
tailor
when he was twenty.
He had never been
to school.
She married him.
Taught him
to
read,
write,
spell.
He learned fast.
Became President.
Inherited
post-Civil War
reconstruction problems.
Beat an
impeachment rap
by just one vote
after trying to
fire his Secretary of War
for justifiable reasons.
Bought Alaska
from the Russians
for \$7 million.
Lost his try at a
second term.
Ran for
U.S. Senate instead,
and won.
His name?
Andrew Johnson.
America will reach
its full maturity
when Andrew
does the
same
for an Eliza.

© United Technologies Corporation 1981

A message as published in the
Wall Street Journal by United Technologies
Corporation, Hartford, Connecticut 06101

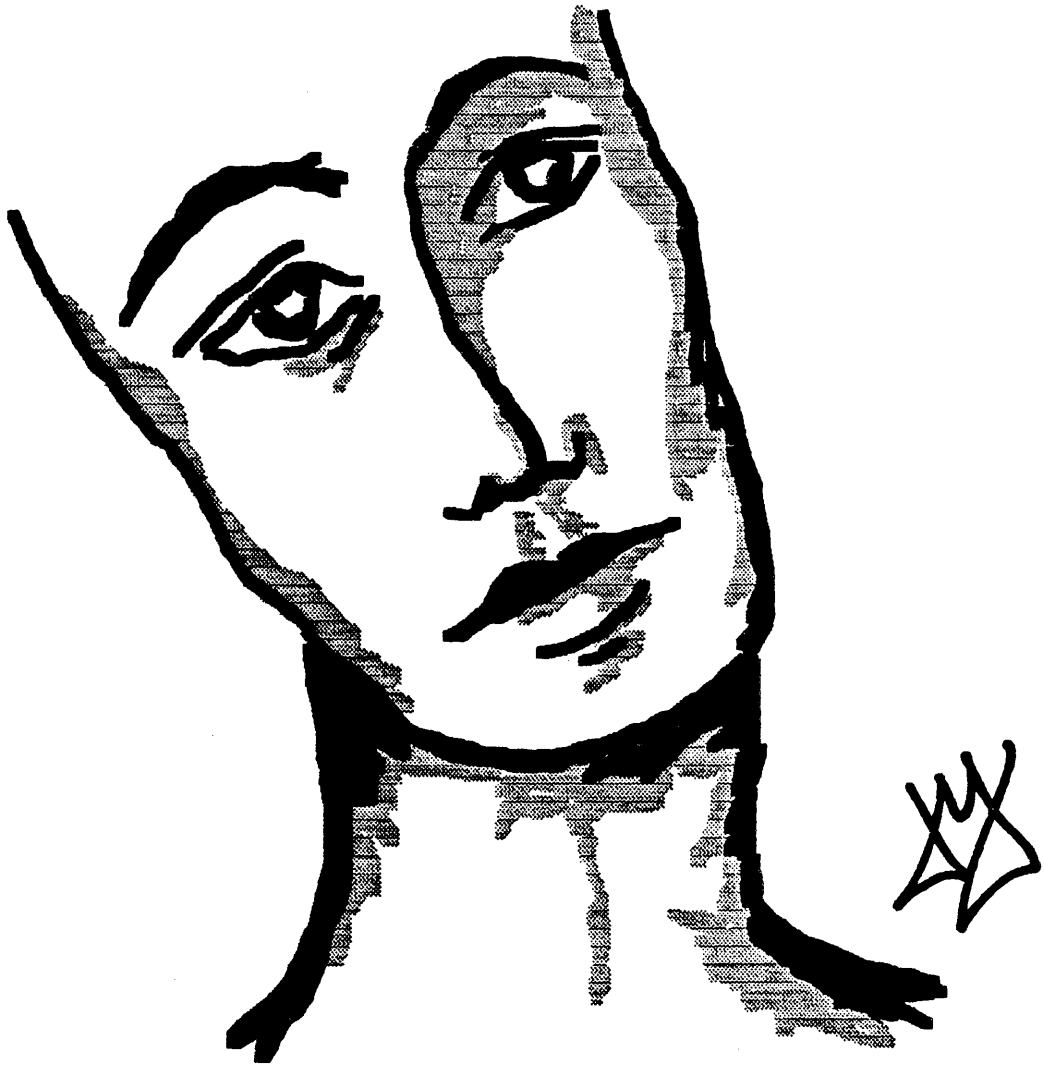

As the growth in oil and gas revenues decline . . .

. . . producers cut back on exploration

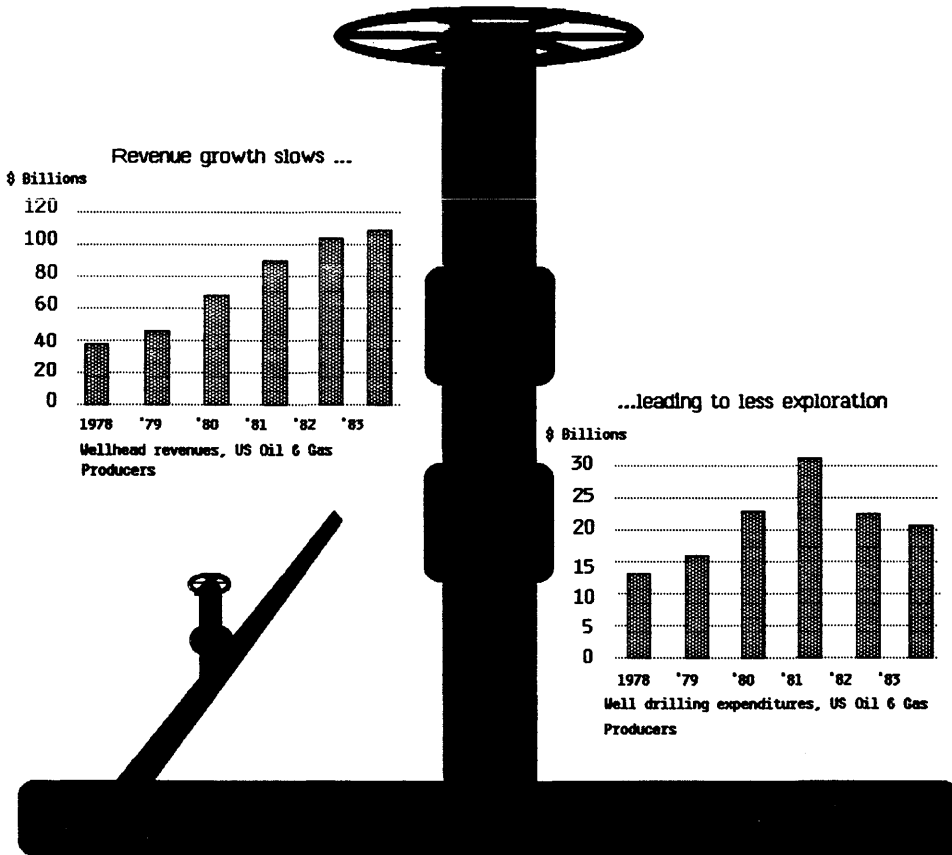

Source: Business Week, 9/27/82.



Section C
LisaDraw
Reference Guide

Contents

Cv What's in the LisaDraw Reference Guide?

***Chapter 1
Overview
C1***

C3 What's in Chapter 1?

C3 The LisaDraw Screen

C5 LisaDraw Concepts

C5 Pointers

C6 Selecting

C10 Group and Lock Techniques

C11 Changing Shapes

C11 Drawing Paper

C12 Scrolling

C14 About Menus

C15 Dialog Boxes

C16 Alert Boxes

C18 LisaDraw Work Flow

C18 Starting a New Document

C19 Working with an Existing Drawing

Chapter 2
Procedures
C21

C23 What's in Chapter 2?

C25 Draw

- C26 Arcs
 - C27 Boxes
 - C29 Circles
 - C30 Freehand
 - C31 Lines
 - C33 Polygons
-

C35 Edit

- C36 Clear
 - C37 Copy
 - C41 Cut
 - C42 Group
 - C44 Insert Text
 - C45 Lock
 - C46 Move
 - C48 Revert to Previous Version
 - C49 Undo Last Change
-

C51 Format

- C52 Align to Auto-Grid
 - C53 Alignment
 - C59 Linestyle
 - C61 Paper
 - C65 Rulers
 - C69 Send to Back/Bring to Front
 - C71 Shading
 - C73 Show Size
 - C75 Stretch and Shrink
 - C77 Type Styles
-

C79 Print

- C80 Change Drawing Size
 - C81 Format for Specific Printers
 - C85 Preview a Drawing
 - C86 Print a Drawing
-

C91 Other Tools

- C92 LisaGraph and LisaProject
- C93 Overhead Slides

What's in the LisaDraw Reference Guide?

This LisaDraw Reference Guide contains complete information about LisaDraw and is divided into two parts. Chapter 1 briefly explains basic LisaDraw concepts. Read Chapter 1 for an overview of LisaDraw and how to use it. Chapter 2 is divided into categories. Within each category there are procedures for accomplishing specific tasks and some examples. Use Chapter 2 for step-by-step instructions on how to complete a particular task within LisaDraw.

You can look for specific topics in the Index, in the table of contents of this Reference Guide, or at the beginning of each category of Chapter 2 of this Reference Guide.

The information in the LisaDraw Reference Guide is based on the assumption that you have completed LisaGuide, for an introduction to your Lisa, and Section A, Getting Started with LisaDraw, for a brief introduction to the basic skills needed to use LisaDraw. For more self-paced instructions on LisaDraw, you can use the LisaDraw Tutorial, Section B.

Chapter 1

Overview



Overview

What's in Chapter 1?

Chapter 1 covers the basic concepts and terminology in LisaDraw. It introduces you to the LisaDraw screen, pointers, selecting, scrolling, and other basics.

The LisaDraw Screen

Figure 1 shows a typical LisaDraw screen. Definitions and explanations follow the illustration.

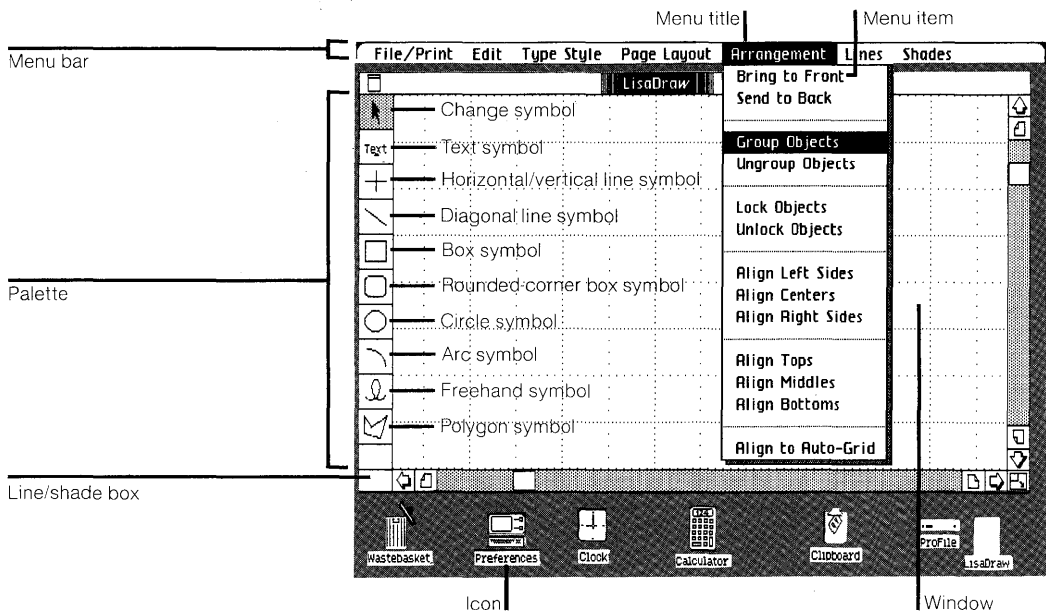

Figure 1. The LisaDraw Screen

The following brief descriptions explain the functions of the items you see in Figure 1.

Menu bar	Shows the menus available in LisaDraw.
Icon	Graphic symbol representing something on the Lisa desktop.
Menu title	Shows the name of a list of menu items.
Menu item	An option, command, or instruction that affects the current selection when you choose it.
Window	Displays the contents of a drawing that is open.
Palette	The vertical row of boxes containing symbols at the left of the LisaDraw screen.
Change symbol	Used to select, move, stretch, shrink, or reshape objects that already exist.
Text symbol	Used to enter and select text.
Horizontal/vertical line symbol	Used to draw horizontal and vertical lines.
Diagonal line symbol	Used to draw diagonal lines at any angle.
Box symbol	Used to draw boxes of any size.
Rounded-corner box symbol	Used to draw boxes of any size with rounded corners.
Circle symbol	Used to draw circles or ovals of any size or shape.
Arc symbol	Used to draw arcs of any size or shape.
Freehand symbol	Used to draw freehand lines and curves.
Polygon symbol	Used to draw multisided objects.
Line/shade box	Shows the line thickness and shade of the selected palette symbol.

LisaDraw Concepts

LisaDraw lets you draw anything from a company logo to a flowchart. It also lets you create illustrations containing many different sizes of text. LisaDraw documents are composed of objects or text or both.

- “Objects” include anything you draw — lines, circles, boxes, and so forth.
- “Text” is one or more characters, including letters, numbers, symbols, and punctuation.

Pointers

As you move the mouse, the pointer moves around the screen. Depending on what you are doing, the pointer can have any of the following shapes.



The check pointer is used to make choices within a dialog box or the Preferences window.



The hourglass appears when you need to wait while the Lisa finishes what it is doing.



The change pointer appears when the change symbol is active. It is also called the arrow pointer and is used for view controls, menu items, and selecting icons.



The drawing pointer appears when a drawing symbol is active.



The selection box hand appears when the change symbol is active and you are drawing a selection box.



The text pointer appears when the text symbol is active and you are entering or selecting text.

Selecting

When you want to work with a particular object, you tell LisaDraw by selecting that object. And you make a new selection whenever you like. This is an important concept: you must *always* select an object before you can work with it.

Small square markers called handles show that an object is selected. Handles may appear on the edge of or surrounding an object, depending on the object type. A darkened background shows that text is selected. Figure 2 shows a number of selected objects.

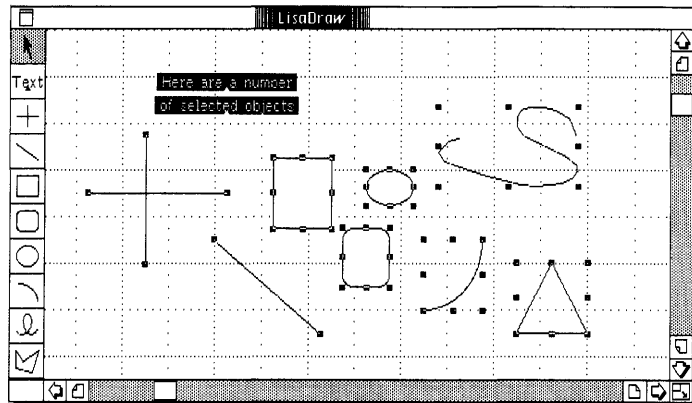

Figure 2. Examples of Selected Objects

For convenience, there are several ways to select objects and text. Table 1 provides a summary of the various methods.

Table 1. Selecting in LisaDraw

To Select	Do the Following
A single object	■ Make sure the change symbol is active.



Table 1. Selecting in LisaDraw, continued

To Select

Do the Following

A single object,
continued

- Move the pointer so that it touches the object. If the object is filled, you can move the pointer anywhere inside the object.

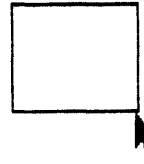

- Click the mouse button. Be sure you don't move the mouse while clicking. Handles appear to show that the object is selected.

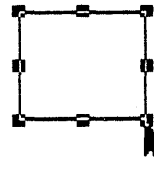

Multiple objects
or lines of text

- With the change symbol active, press the **(Shift)** key and keep it down.
- Move the pointer to, and click the mouse button on, each object you want to select. Handles appear as the objects are selected.

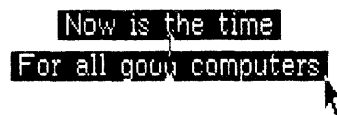
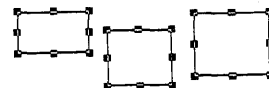

Table 1. Selecting in LisaDraw, continued

To Select	Do the Following
Multiple objects or lines of text, continued	<ul style="list-style-type: none"><li data-bbox="840 256 1134 326">■ Release the (Shift) key. or<li data-bbox="840 348 1174 661">■ Draw a selection box that completely surrounds the objects to be selected by first moving the pointer to a point above and to the left of the upper leftmost object. The pointer should not be touching any of the objects you want to select.  <ul style="list-style-type: none"><li data-bbox="840 840 1147 1008">■ Then, press the mouse button and move the pointer diagonally until the box completely encloses the objects to be selected.  <ul style="list-style-type: none"><li data-bbox="840 1239 1163 1529">■ Release the mouse button. If an object moves or stretches instead of becoming selected, you must have started with the pointer on top of it. In that case, choose Undo Last Change from the Edit menu and try again.

Table 1. Selecting in LisaDraw, continued

To Select	Do the Following
A word or any group of characters in a line of text	<ul style="list-style-type: none">■ Activate the text symbol.■ Move the pointer to the left of the first character to be selected.■ Press and hold down the mouse button, and move the pointer through the characters you want to select. The background darkens to show selection; this is also called "highlighting."  <ul style="list-style-type: none">■ Release the mouse button.
A line of text	<ul style="list-style-type: none">■ With the change symbol active, move the pointer to the line and click the mouse button. 
Select everything	<ul style="list-style-type: none">■ Choose Select All of Document from the Edit menu.

Table 1. Selecting in LisaDraw, continued

To Select	Do the Following
Deselect; select nothing in the drawing	<ul style="list-style-type: none">■ Click when the pointer is not over any object. or <ul style="list-style-type: none">■ Hold down (Shift) while you click on each selected object. or <ul style="list-style-type: none">■ Activate a drawing symbol.
Select most things	<ul style="list-style-type: none">■ Choose Select All of Document from the Edit menu.■ Hold the (Shift) key down while you click on the objects you don't want selected.
Select objects but not the objects behind them	<ul style="list-style-type: none">■ Hold the (Shift) key down while you make your selection.

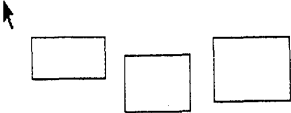
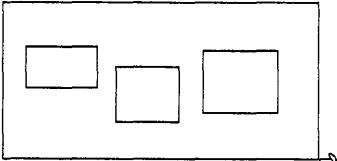
Group and Lock Techniques

You can select several objects and make them into one single object by grouping them. This technique is useful if you want to move or change all the objects at once as a single unit. Then later, if you want to edit parts of the group you have created, you can ungroup the objects and they will be separate again as they were originally. See the Group procedure, under Edit, in Chapter 2 of this section.

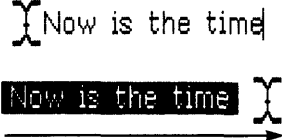
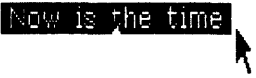
You can also lock selected parts of a drawing into place. Once you have done this, these sections cannot be changed, deleted, or moved until you unlock them. See the Lock procedure, under Edit, in Chapter 2 of this section.

Changing Shapes

In LisaDraw, you can stretch or shrink any object after you have drawn it. You can make a line longer or shorter. You can make any other kind of object wider or thinner, taller or shorter, or change both dimensions at the same time. The way an object changes when you stretch or shrink it depends on which of its handles you use. For step-by-step directions, see the Stretch and Shrink procedure, under Format, in Chapter 2 of this section.

Drawing Paper

In LisaDraw, you can choose three kinds of drawing paper from the Page Layout menu.

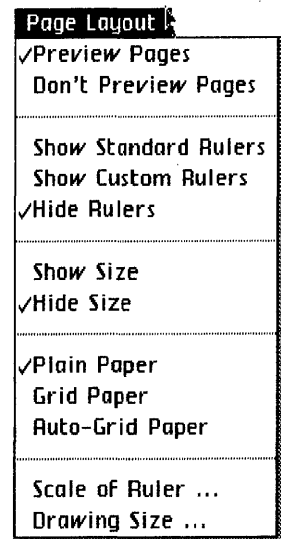

- Plain paper is completely blank with no grid lines.
- Grid paper has grid lines that are useful as a visual drawing aid. Use grid paper when you want to position objects and text manually.
- Auto-grid paper also has grid lines, and in addition, anything you draw will snap to these grid lines automatically, as if the lines were magnetic. The auto-grid is very useful when you are drawing charts or anything that has to be lined up perfectly in order to look good.

Scrolling

The window of an active drawing has controls that you may use to bring hidden portions of the drawing into view. These controls are shown in Figure 3.

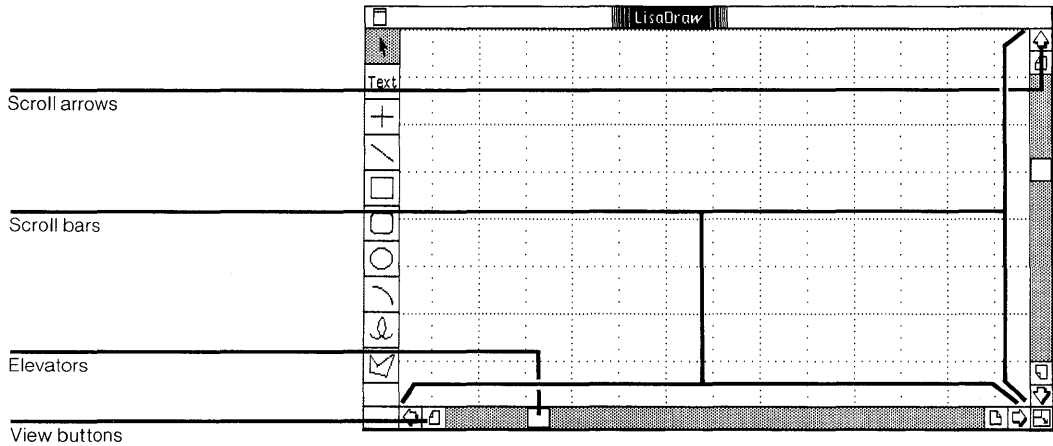

Figure 3. Window with View Controls

The following brief descriptions explain the functions of the items you see in Figure 3.

Scroll arrows	Enable you to bring hidden portions of a drawing into view line-by-line.
Elevators	Indicate where the current view is in relation to the rest of the drawing. Enable you to move quickly to the top, bottom, right, or left of the drawing.
Scroll bars	Change the view of the drawing.
View buttons	Scroll the drawing one full view at a time.

Table 2 shows the different ways to scroll in LisaDraw.

Table 2. Scrolling in LisaDraw

To Scroll	Do the Following
Line by line	■ Click on the scroll arrow.
Continuous lines	■ With the pointer on a scroll arrow, press the mouse button and release it when the drawing is positioned where you want it.
View-sized increments	■ Click on the view button.
Continuous view-sized increments	■ With the pointer on the view button, press the mouse button and release it when the drawing is positioned where you want it.
Large jumps	■ Move the pointer into an elevator and hold down the mouse button while moving the elevator. Release the mouse button when the elevator is positioned where you want it, relative to its scroll bar, and therefore also relative to the beginning and end of the drawing.
Auto-scrolling	■ With the mouse button down, move the pointer or any object to an edge of the drawing area. The contents of the window scroll automatically away from that edge of the window.

About Menus



Many of the things that you do in LisaDraw you do by choosing an item from a menu. The menus available are listed on the menu bar as shown in Figure 4. A description of all LisaDraw menu items can be found in this manual in Appendix 1, Menu Items.



Figure 4. Menu Bar

To choose a menu item,

- ▶ Move the pointer to the menu bar and position it over the name of the menu you want. 
- ▶ Press the mouse button and hold it down. Notice that the menu is now showing.
- ▶ Move the pointer to the menu item you want.
- ▶ Release the mouse button.

Some menu items have an Apple symbol and a letter beside them. This means that you can hold down the  key and the letter to choose a menu item rather than choosing the item with the mouse. Refer to Appendix 2, Apple Keys, in this manual, for a list of menu items that you can choose using the  key.

Some menu items are followed by an ellipsis (. . .). When you choose one of these menu items, you must respond to a dialog box before the item takes effect. (Dialog boxes are explained below.)

When a menu item is shown in gray instead of black, it cannot be chosen at that time. This is because the menu item does not apply to the current selection.

Some menu items are grouped together and represent the available choices for a particular menu setting. The current setting has a check mark next to it, while the others don't. If you choose another setting, the current one automatically turns off. For example, in the Page Layout menu, if Plain Paper is checked, Grid Paper and Auto-Grid are automatically turned off.

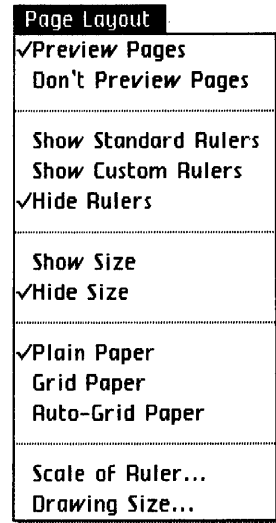

Dialog Boxes

A dialog box is a box that appears on the screen in response to certain menu items. It allows you to accept or change various options that apply to the command. A dialog box for LisaDraw is shown in Figure 5.

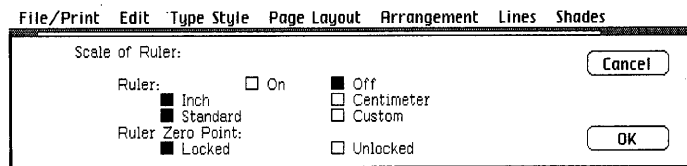

Figure 5. LisaDraw Scale of Ruler Dialog Box

To fill in a dialog box,

- ▶ For each option that you wish to change, check the box next to the option you want by moving the pointer to the box and clicking the mouse button.
- ▶ When the dialog box reflects the options you want, click OK.
- ▶ If you change your mind and decide not to perform the operation called for by the menu item, click Cancel.

Alert Boxes

An alert box is a box in which a message from the Lisa is displayed. The message can be Wait, Note, Caution, Stop, or ?, as described below. You can usually respond to these messages by clicking the OK or Cancel button. To do this, move the pointer to the OK or Cancel button and click the mouse button.

Wait Message

The Wait message tells you that the Lisa is carrying out an operation that may take some time. You don't need to respond to a message of this type. However, some Wait messages give you the option of being able to terminate the operation by holding down the  key while typing a period. Figure 6 is an example of a Wait message.

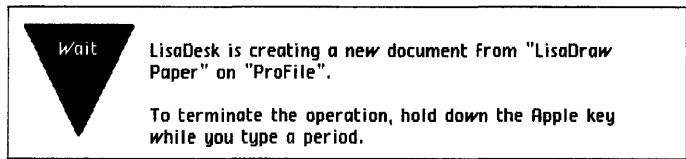

Figure 6. A Wait Message

Note Message

The Note message tells you that something might need your attention. Most likely, everything is all right, but the Lisa wants to tell you about something just in case. To dismiss the alert box with a Note message, you just click OK. Figure 7 is an example of a Note message.

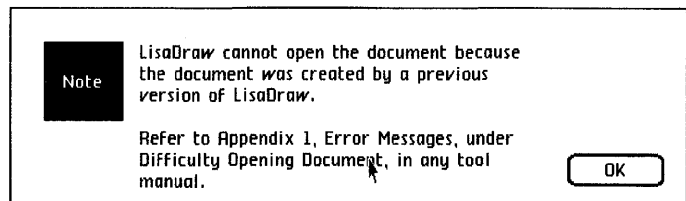

Figure 7. A Note Message

Caution Message

The Caution message tells you that you are about to do something risky that cannot be undone or something that may take a long time. To dismiss the alert box with a Caution message, you click OK or Cancel. Figure 8 is an example of a Caution message.

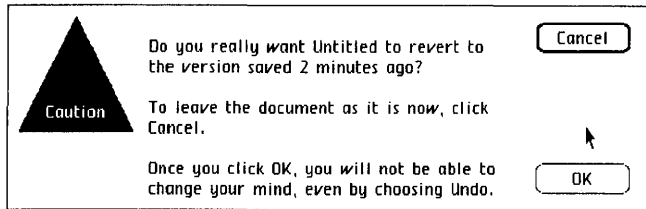

Figure 8. A Caution Message

Stop Message

The Stop message tells you that something you requested cannot be done, and why. To dismiss the alert box with a Stop message, click Cancel. Figure 9 is an example of a Stop message.

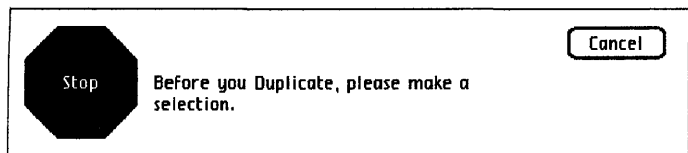

Figure 9. A Stop Message

? Message

The ? message tells you that you can choose one of a number of alternative actions. Most ? messages have two or three choices. You dismiss the alert box with a ? message by clicking on one of the choices. Figure 10 is an example of a ? message.

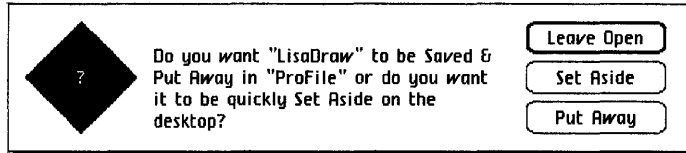

Figure 10. A ? Message

LisaDraw Work Flow

The following material outlines how to start the Lisa and LisaDraw, how to start a new LisaDraw document, and how to work with an existing LisaDraw document. For specific information and step-by-step instructions, refer to Chapter 2 of this Reference Guide and to Section D, Desktop Manager Reference Guide, in the *Lisa Owner's Guide*.

Starting a New Document

To start a new LisaDraw document,

- ▶ Open the ProFile window.



- ▶ Tear off a sheet of paper from the LisaDraw stationery pad.

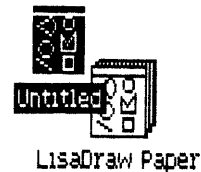

- ▶ Type the new document's name.

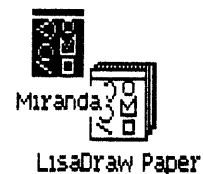

- ▶ Open the new document's window.
- ▶ Create the desired drawing.
- ▶ Save all changes about every 15 minutes and continue working.
- ▶ Print the drawing, if you like.
- ▶ Put away the completed drawing.

To organize your drawing into a folder and to keep the disk window uncluttered, you might want to

- ▶ Move the saved drawing into a folder of related documents, or tear a new folder from the pad, name the folder, and move the drawing into it.

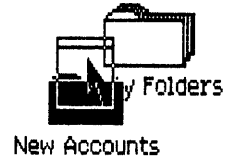

Working with an Existing Drawing

To work with a filed LisaDraw drawing,

- ▶ Open the ProFile window.
- ▶ If the drawing is in a folder, open the folder that contains the drawing that you want to work with.
- ▶ Open the drawing.
- ▶ Edit the drawing, saving it every 15 minutes.
- ▶ Print the drawing, if you like.
- ▶ Put away the drawing in its original location.

Chapter 2

Procedures

Procedures

What's in Chapter 2?

Chapter 2 contains the procedures for doing everything that can be done in LisaDraw. To make the procedures easier to find, they have been divided into categories according to functions. The categories are:

Draw

Look here for operations that involve the creation of objects.

- C26 Arcs
- C27 Boxes
- C29 Circles
- C30 Freehand
- C31 Lines
- C33 Polygons

Edit

Look here for operations that change the contents of a drawing.

- C36 Clear
- C37 Copy
- C41 Cut
- C42 Group
- C44 Insert Text
- C45 Lock
- C46 Move
- C48 Revert to Previous Version
- C49 Undo Last Change

Format

Look here for operations that change the appearance of a drawing.

- C52 Align to Auto-Grid
- C53 Alignment
- C59 Linestyle
- C61 Paper
- C65 Rulers
- C69 Send to Back/Bring to Front
- C71 Shading
- C73 Show Size
- C75 Stretch and Shrink
- C77 Type Styles

Print

Look here for instructions on how to print your drawing.

- C80 Change Drawing Size
- C81 Format for Specific Printers
- C85 Preview a Drawing
- C86 Print a Drawing

Other Tools

Look here for instructions on how to use LisaDraw with other tools.

- C92 LisaGraph and LisaProject
- C93 Overhead Slides

Draw

-
- C26 Arcs
 - C27 Boxes
 - C29 Circles
 - C30 Freehand
 - C31 Lines
 - C33 Polygons

Draw

Arcs

To draw an arc

- ▶ Activate the arc symbol in the palette.
- ▶ Press the mouse button and move the pointer in any direction.
- ▶ Release the mouse button when the arc is the required size and shape.



The arc you draw is a quarter oval. It follows your initial direction. To change an arc after you've started drawing it, return to the beginning point with the mouse button still down and start off in a new direction. Use the guidelines of grid paper or auto-grid to help you if you like.

After you've drawn it, you can shrink an arc by using its handles when it is selected. In addition, you can change an arc's angle by choosing Reshape Arc from the Edit menu and then by using the handles.

To draw a box

- ▶ Activate the box symbol in the palette.
- ▶ Press the mouse button and move the pointer in any direction.
- ▶ Release the mouse button when the box is the size and shape you want.

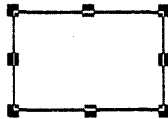
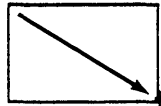

You can continue to change the shape of the box until you release the mouse button. After that, you can move, stretch, or shrink the box. You can also fill any box by choosing from the Shades menu when the box is selected.

To draw a box with rounded corners

- ▶ Activate the rounded-corner box symbol.
- ▶ Press the mouse button and move the pointer in any direction.
- ▶ Release the mouse button when the box is the size and shape you want.

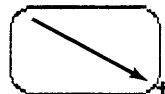

Draw

Boxes (continued)

To change the corner radius

- ▶ Make sure the box to be changed is selected. Choose Round Corners from the Edit menu.

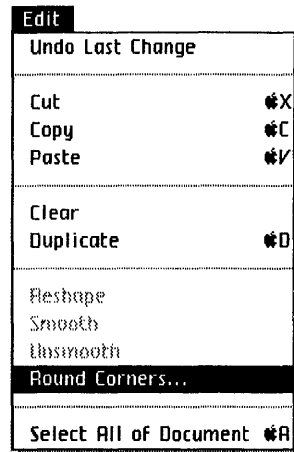

- ▶ Click on the desired corner radius; then click OK and the radius changes.

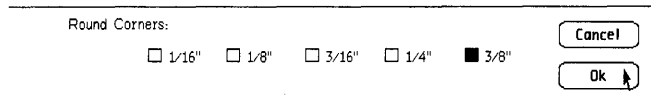

To draw a circle or an oval

Circles

- ▶ Activate the circle symbol in the palette.



- ▶ Press the mouse button and move the pointer in any direction.

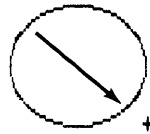

- ▶ Release the mouse button when the circle or oval is the desired size.

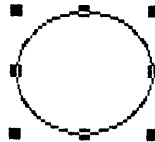

You can continue to change the diameter of the circle or oval until you release the mouse button. If you want help drawing a perfect circle, use the guidelines of grid paper or auto-grid paper.

Draw

Freehand

To draw freehand

- ▶ Activate the freehand symbol in the palette.
- ▶ Press the mouse button and move the pointer, just as if you were writing with a pen.
- ▶ Release the mouse button when the line is finished. There is a limit to the length of a freehand line, but you can always start a new one.

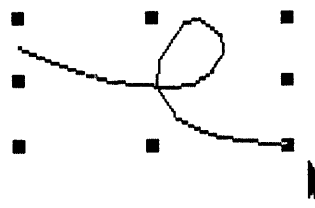

You can edit a freehand line after you've drawn it by stretching and shrinking or by choosing Reshape Curve from the Edit menu when the line is selected. You can also smooth the line by choosing Smooth from the Edit menu, and fill it by making a choice from the Shades menu. If you choose Unsmooth after you have smoothed a line, you do not reverse the smoothing process. Instead, many additional handles are added to the line to aid in editing it.

Lines

To draw a horizontal line

- ▶ Activate the horizontal/vertical line symbol in the palette.
- ▶ Press the mouse button and move the pointer to the right or left.
- ▶ Release the mouse button when the line is the desired length.

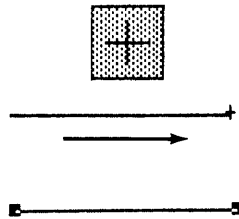

To draw a vertical line

- ▶ Activate the horizontal/vertical line symbol in the palette.
- ▶ Press the mouse button and move the pointer up or down.
- ▶ Release the mouse button when the line is the desired length.



Draw

Lines

(continued)

LisaDraw makes the line perfectly horizontal or vertical for you. If you begin to draw a line and decide you want to change the direction of the line, just keep the mouse button down and back up to the starting point. If you draw a line, release the mouse button, and then want to get rid of the line, choose Clear from the Edit menu while the line is selected.

To draw a diagonal line

- ▶ Activate the diagonal line symbol in the palette.
- ▶ Press the mouse button and move the pointer in any direction.
- ▶ Release the mouse button when the line is the desired length.

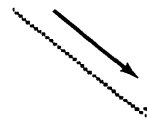

You can continue to change the angle of a diagonal line until you release the mouse button. After that, you can move, stretch, or shrink it. You cannot use the Shades menu to fill lines, even if you make a triangle out of them. If you want to fill such a shape, use the polygon symbol to construct it.

Polygons

To draw a polygon

- ▶ Activate the polygon symbol in the palette.
- ▶ Press and release the mouse button in the drawing area.
- ▶ Without pressing the mouse button, move the pointer until the first line is the desired length, then click the mouse button.
- ▶ Move the pointer to draw the second line, and then click the mouse button.
- ▶ Continue to draw until your polygon is complete.



+

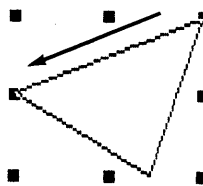
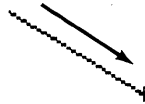

Draw

Polygons

(continued)

Handles appear when you connect the last line of the polygon to the first one, or when you click on the last point twice if you are not drawing a closed figure. You can edit a polygon after you've drawn it by using Reshape Polygon from the Edit menu, or by stretching and shrinking it. You can also fill any polygon by selecting it and making a choice from the Shades menu.

Here are some examples of polygons.

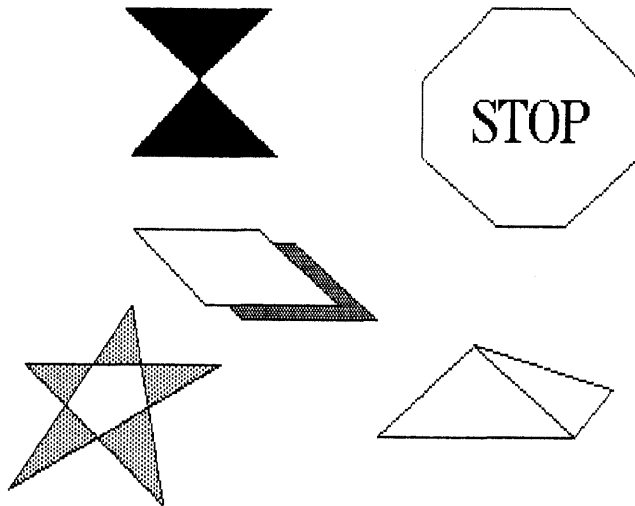

-
- C36 Clear
 - C37 Copy
 - C41 Cut
 - C42 Group
 - C44 Insert Text
 - C45 Lock
 - C46 Move
 - C48 Revert to Previous Version
 - C49 Undo Last Change

Edit

Clear

To clear the entire drawing area

- ▶ Choose Select All of Document from the Edit menu.

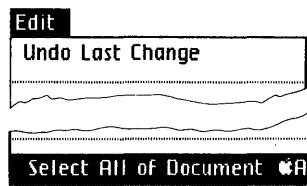

- ▶ Choose Clear from the Edit menu.

Clear is different from Cut. When you use Clear, LisaDraw does not keep a copy of what you cleared on the Clipboard. However, if you change your mind and want to get back what you just cleared, you can choose Undo Last Change from the Edit menu.

To clear specific objects from the drawing area

- ▶ Select the objects to be cleared.

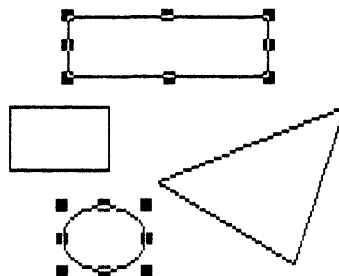

- ▶ Choose Clear from the Edit menu.

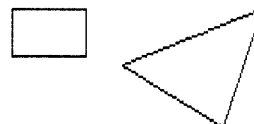

To copy objects or text within a drawing using Duplicate

- ▶ Select everything you want to copy.



- ▶ Choose Duplicate from the Edit menu. This places a copy just below and to the right of the original, and you can move the copy wherever you like.

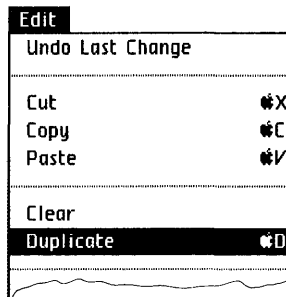

To make a row of identical objects within a drawing

- ▶ Choose Auto-grid from the Edit menu.
- ▶ Draw the first object in the row and make sure it is selected.

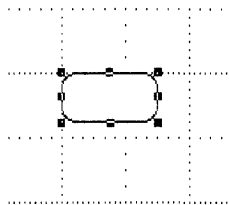

Edit

Copy (continued)

- ▶ Choose Duplicate from the Edit menu.

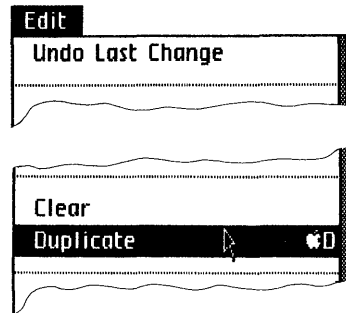

- ▶ Move the copy into position directly in line, horizontally or vertically, with the first object.

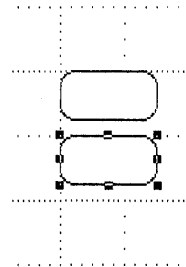

- ▶ Choose Duplicate repeatedly for each additional copy. Each new duplicate will then be evenly spaced automatically.

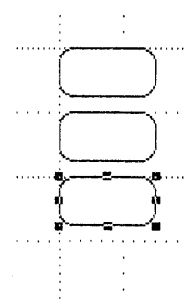

Duplicate does not affect the Clipboard.

Copy (continued)

To copy objects or text, or both, within a drawing using Copy and Paste

- ▶ Select everything you want to copy.

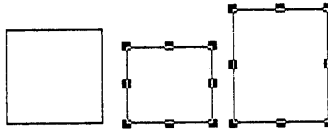

- ▶ Choose Copy from the Edit menu. This puts a copy of the selection on the Clipboard.

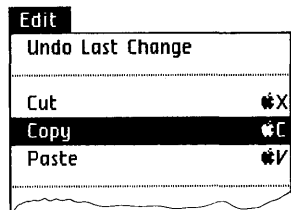

- ▶ Move the pointer to the location where the center of the copy is to be placed and click the mouse button.



- ▶ Choose Paste from the Edit menu. The copy appears, centered at the spot where you clicked. If it is not exactly at the right place, you can move it.

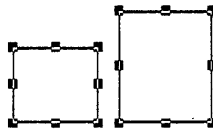
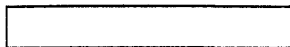

Edit

Copy

(continued)

To copy from another drawing

- ▶ Get or activate the drawing that you are copying from.
- ▶ Select the part of the drawing you want to copy, and then choose Copy from the Edit menu.

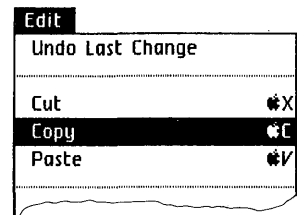

- ▶ Get or activate the drawing you are putting the copy into.
- ▶ Choose Paste from the Edit menu and the copy is centered in the window.

To put the copy in a place other than the center

- ▶ Move the pointer to the place where you want the center of the copy to be placed and click the mouse button.
- ▶ Choose Paste from the Edit menu.

You can also copy a graph from LisaGraph or a chart from LisaProject into a drawing. See the LisaGraph and LisaProject procedure, under Other Tools, in this chapter.

To delete objects or text

Cut

- ▶ Select what you want to delete.

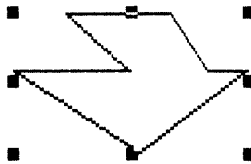

- ▶ Choose Cut from the Edit menu. This puts what has been deleted onto the Clipboard, so you can paste it somewhere else if you like.

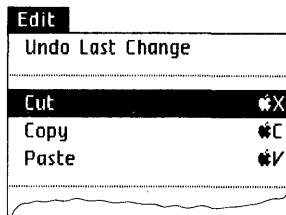

When you want to cut specific characters from a line of text, activate the text symbol and use the text pointer to make your selection. The change pointer only selects an entire line of text at a time.

When you use cut, what you've deleted goes onto the Clipboard — removing whatever was previously on the Clipboard. You can bring back the contents of the Clipboard by choosing Paste from the Edit menu. When you use Clear, what you've deleted is gone and does not go onto the Clipboard.

Edit

Group

To group objects

- ▶ Select all of the objects to be grouped.



- ▶ Choose Group Objects from the Arrangement menu. The handle pattern changes to surround the group.

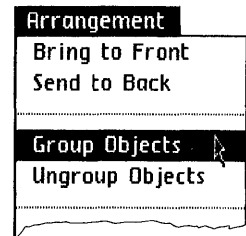

Grouping is very useful when you want to change several objects at one time. For example, to make three boxes proportionately smaller, just group them together and shrink them as one object. Also, if you usually treat a particular group of objects as a unit, it will be more convenient to group them so that they can be selected with one click.

Grouping always brings the new group on top of any other objects.

To ungroup objects

- ▶ Select the group.

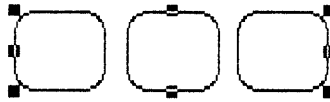

- ▶ Choose Ungroup Objects from the Arrangement menu. The handles return to surround the individual objects.



Group
(continued)

As an example, if you group two existing groups, and then later ungroup them, the original two groups are still grouped. You can go on to ungroup them if you like.

Edit

Insert Text

To insert text

- ▶ Begin typing when any object is selected, and text is automatically entered in that object, according to the text alignment style shown by the text symbol caret (left justified, centered, or right justified).

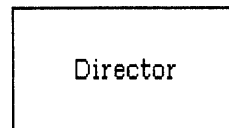

To insert text using the text symbol

- ▶ Activate the text symbol in the palette.
- ▶ Move the pointer to the place where you want to begin entering text and click the mouse button.
- ▶ Type the text.



Now is the time!

Text is always positioned on top of objects, except if the text is part of a group. See the **Alignment** procedure, under **Format**, in this chapter, for how to change text alignment.

To lock an object or objects

Lock

- ▶ Select the object or objects to be locked.



- ▶ Choose Lock Objects from the Arrangement menu.

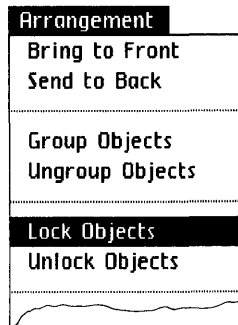

Locked objects cannot be moved, stretched, or edited. If locked objects are selected along with any other objects, only the unlocked objects will change. This is very useful if you want to be sure a certain part of a drawing does not get changed or moved.

To unlock an object or objects

- ▶ Select the object or objects to be unlocked.



- ▶ Choose Unlock Objects from the Arrangement menu.
-

Edit

Move

To move any object or group of objects, or any complete line of text within a drawing,

- ▶ Move the pointer so that its tip touches the object or text you want to move. If an object is already selected, be sure not to touch a handle, or you'll change the shape of the object instead of moving it.
- ▶ Press the mouse button and move the pointer; the object moves with it. Release the mouse button when the object is where you want it to be. You can't move anything "off the paper."



If you are moving several objects, you must select them all before you move them, or move them one by one.

Move (continued)

To delete something and then insert it in a new location in the same or in another drawing

- ▶ Select the object or objects to be moved.



- ▶ Choose Cut from the Edit menu.

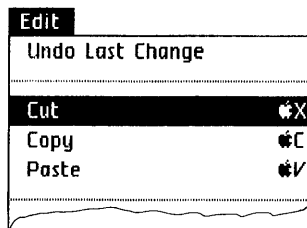

- ▶ Activate the other drawing, if appropriate.
 - ▶ Move the pointer to the new location and click the mouse button.
 - ▶ Choose Paste from the Edit menu.
-

Edit

Revert to Previous Version

To undo all changes made to a drawing since it was last saved

- ▶ Choose Revert to Previous Version from the File/Print menu.

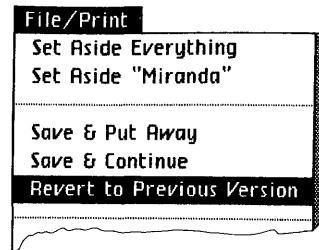

- ▶ Click OK in the alert box that appears.

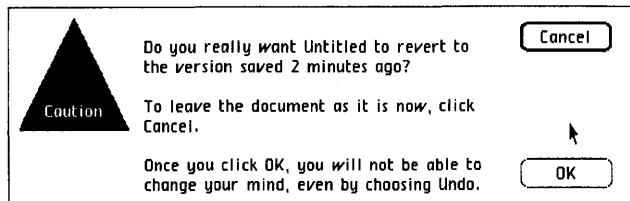

To undo the last thing you've done

- ▶ Choose Undo Last Change from the Edit menu.

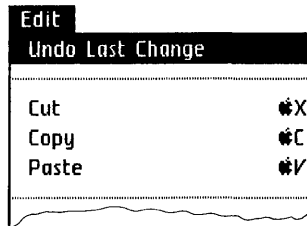

Undo Last Change

Undo itself is undoable, but there are a few things that are not. If you try to undo something that cannot be undone, you will see this message:

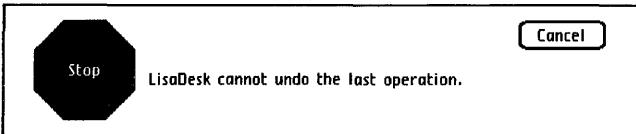

-
- C52 Align to Auto-Grid
 - C53 Alignment
 - C59 Linestyle
 - C61 Paper
 - C65 Rulers
 - C69 Send to Back/Bring to Front
 - C71 Shading
 - C73 Show Size
 - C75 Stretch and Shrink
 - C77 Type Styles

Format

Align to Auto-Grid

To line up objects or text, or both, with the auto-grid

- ▶ Select the objects or text that you want to line up to the auto-grid.

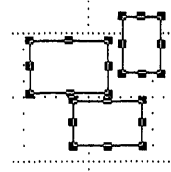

- ▶ Choose Auto-Grid Paper from the Page Layout menu, if you haven't already.

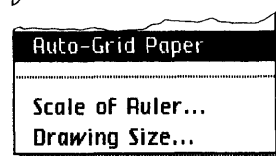
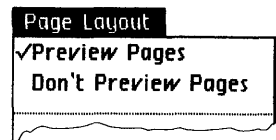

- ▶ Choose Align to Auto-Grid from the Arrangement menu.

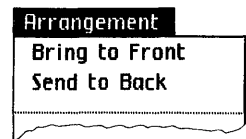

- ▶ The objects are aligned to the auto-grid. Notice that the shapes of the objects change slightly, as they match up with the grid.

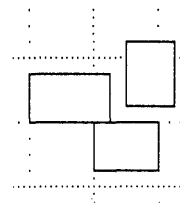

Alignment

To line up any number of objects or lines of text with the left side of the leftmost object

- ▶ Select all of the objects that you want to align.

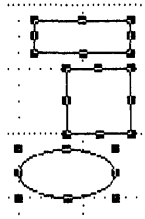

- ▶ Choose Align Left Sides from the Arrangement menu. The objects line up at the left.

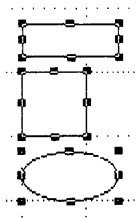
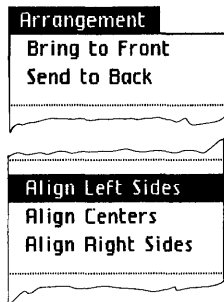

Format

Alignment

(continued)

If you activate the text symbol and then choose Align Left Sides, the text alignment style changes to left justified, as shown by the caret in the text symbol. Note that the various alignment choices do not realign items within a group, although they do align the group itself with other objects. There's more on text alignment later in this Alignment procedure.

To align objects or lines of text so they are centered in a single column

- ▶ Select all the objects that you want to align.

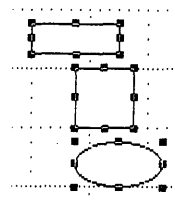

- ▶ Choose Align Centers from the Arrangement menu. The objects line up according to their horizontal centers.

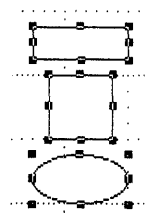

Alignment (continued)

To line up any number of objects or lines of text with the right side of the rightmost object

- ▶ Select all of the objects that you want to align.

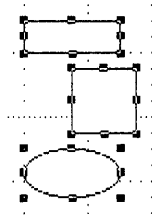

- ▶ Choose Align Right Sides from the Arrangement menu. The objects line up at the right.

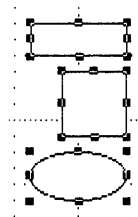
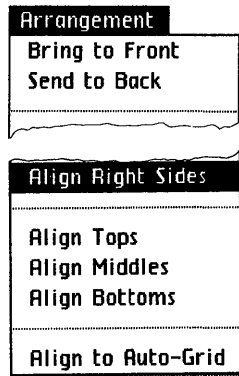

Format

Alignment

(continued)

To line up the tops of any number of objects or lines of text with the top of the uppermost object

- ▶ Select all of the objects that you want to align.

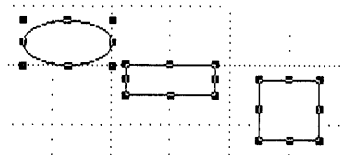

- ▶ Choose Align Tops from the Arrangement menu. The objects line up at the top.

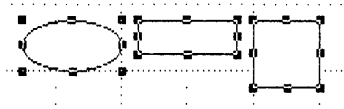

To align objects or lines of text so they are centered in a single row

- ▶ Select all of the objects to be aligned.

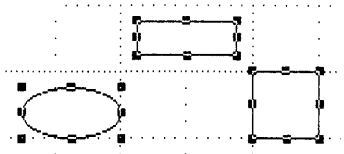

- ▶ Choose Align Middles from the Arrangement menu. The objects line up by their vertical centers.

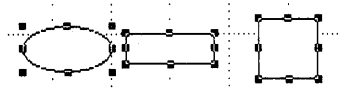
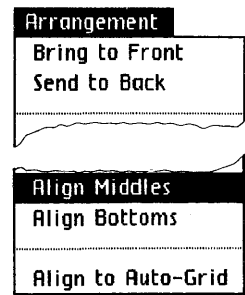

Alignment (continued)

To line up the bottoms of any number of objects or lines of text with the bottom of the lowermost object

- ▶ Select all of the objects that you want to line up.

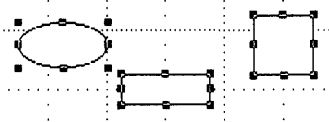

- ▶ Choose Align Bottoms from the Arrangement menu. The objects line up by their bottom edges.

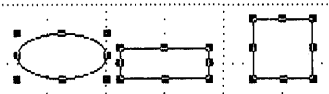

To change the alignment of the text symbol so that any new text has the new alignment

- ▶ Activate the text symbol.



- ▶ Choose Align Left Sides, Align Centers, or Align Right Sides from the Arrangement menu. The caret in the text symbol changes position to show which alignment choice you have made.

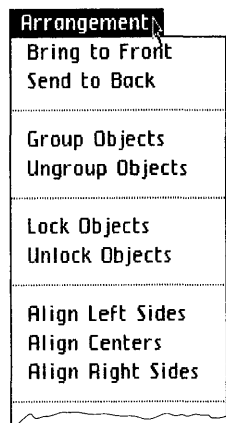

Format

Alignment *(continued)*

This does not change the alignment style of text that you have already typed.

To change the alignment of text that already exists

- ▶ Select the text.

A screenshot showing the text "Now is the time!" selected in a document. The text is highlighted with a dark background, and a vertical dashed line is visible to the right of the text, indicating the selection boundary.

- ▶ Choose Align Left Sides, Align Centers, or Align Right Sides from the Arrangement menu.

This does not change the alignment style of the text symbol.

Linestyle

To change the linestyle of all the drawing symbols so that any new object has the new linestyle

- ▶ Activate any drawing symbol in the palette, or click on the line/shade box.
- ▶ Choose a new linestyle from the Lines menu.

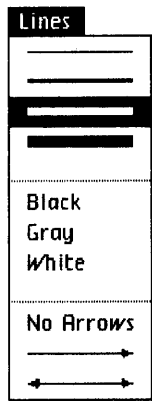

Notice that after you change the linestyle, the line/shade box in the palette changes to reflect the new linestyle.

All new objects that you draw will have the new linestyle until you change the linestyle again. Objects that already exist will not change.

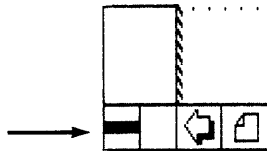

Format

Linestyle (continued)

To change the linestyle of an object that already exists

- ▶ Select the object or objects whose linestyle you want to change.



- ▶ Choose the new linestyle from the Lines menu. The object now has the new linestyle.

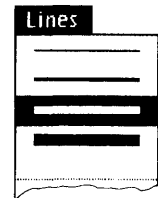

For example, if you want a thick gray line that has an arrow at one end, first choose the thick line, then the word Gray, then the one-sided arrow from the Lines menu. The line/shade box in the palette does not change.

To turn on plain paper that has no grid lines

- ▶ Choose Plain Paper from the Page Layout menu.

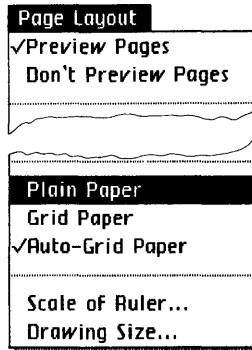

To turn on grid paper

- ▶ Choose Grid Paper from the Page Layout menu.
-

Format

Paper

(continued)

When grid paper is on, vertical and horizontal lines are displayed in the drawing area but no automatic gridding is in effect. Turn grid paper on when you want to position text or objects in between the grid lines.

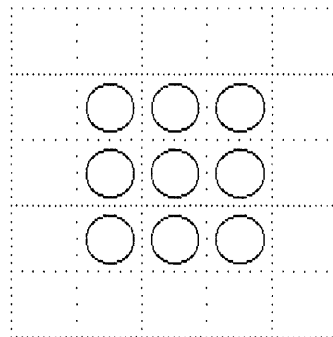

To turn on auto-grid paper

- ▶ Choose Auto-Grid Paper from the Page Layout menu.

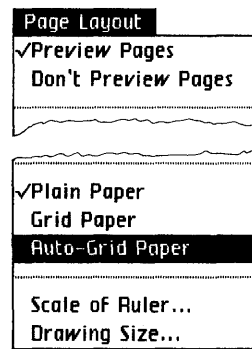

Paper (continued)

Auto-grid paper causes anything you draw to snap to the grid lines, or the invisible divisions between them, as if the grid lines were magnetic. This is very useful when you want to draw a number of objects and line them up easily. The divisions of the grid lines correspond directly to those of the rulers, whether or not you have the rulers turned on.

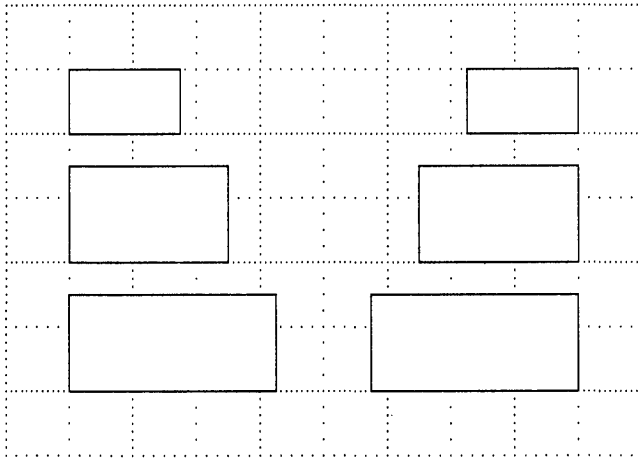

The grid size corresponds to the scale of the ruler currently in effect.

Format

Paper (continued)

To change the size of the auto-grid

- ▶ Choose Scale of Ruler from the Page Layout menu.

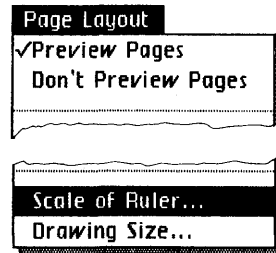

- ▶ Click on the desired scales in the dialog box that appears, and then click OK.

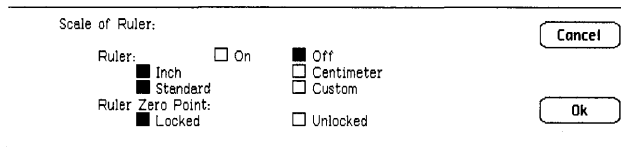

Rulers

To turn on the standard rulers

- Choose Show Standard Rulers from the Page Layout menu.

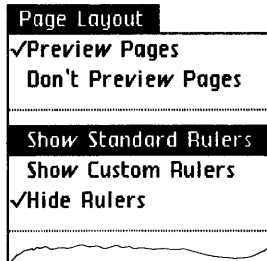

Rulers appear at the top and left side of the drawing area, and cross hairs appear on the rulers when you move the pointer.

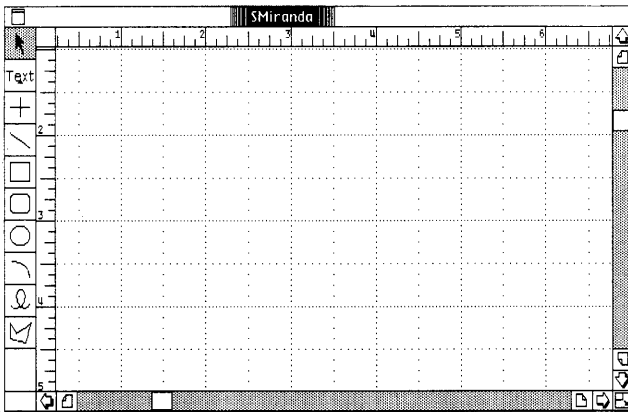

To turn the rulers off

- Choose Hide Rulers from the Page Layout menu.

Format

Rulers (continued)

To define your own ruler

- ▶ Choose Scale of Ruler from the Page Layout menu.

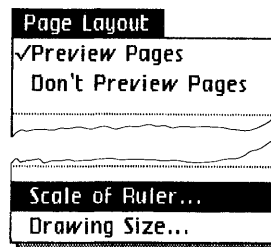

- ▶ Click on Custom in the dialog box; more options appear.

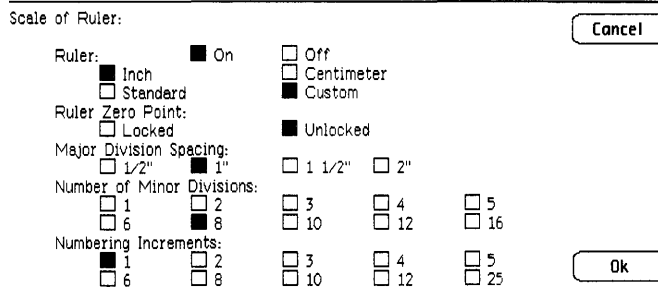

- ▶ Click on either Inch or Centimeter, depending on which scale you want to base your custom ruler on.
- ▶ Click on the desired scale options, and then click Ruler On. Now click OK.

Rulers (continued)

If you forget to turn the rulers on in the dialog box, you can choose Show Custom Ruler from the Page Layout menu. The latest custom ruler you create, Inch or Centimeter, is saved with the drawing.

To move the zero point of a ruler

- ▶ Choose Scale of Ruler from the Page Layout menu.

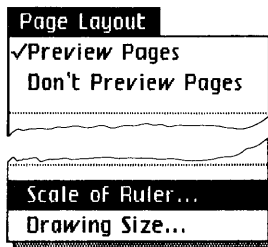

- ▶ Choose Unlocked under Ruler Zero Point, and then click OK.

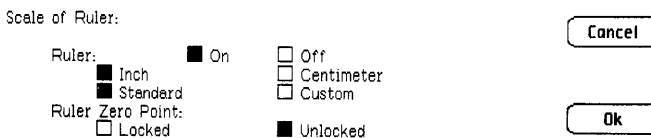

- ▶ Choose Show Standard Rulers or Show Custom Rulers.
- ▶ Click on the ruler where you want the new zero point to appear.

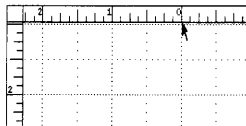

Format

Rulers

(continued)

To reset both the horizontal and vertical zero points at the same time

- ▶ Move the pointer into either ruler.
- ▶ Press the mouse button, and move the pointer to the appropriate spot in the drawing.
- ▶ Release the mouse button.

Resetting both the horizontal and vertical zero points at the same time is useful, for example, if you are making a floor plan and want to start measuring from zero somewhere away from the edge of the page. That way you leave a border around the floor plan.

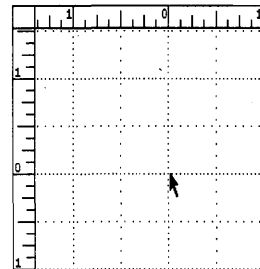

To lock the zero point of a ruler so you won't move it accidentally

- ▶ Choose Scale of Ruler from the Page Layout menu.
- ▶ Choose Locked under Ruler Zero Point, and then click OK.

The zero point stays in place until you unlock it and move it again.

To move an object behind another object that it covers or partially covers

Send to Back/ Bring to Front

- ▶ Select the object.

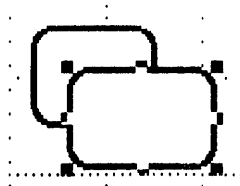

- ▶ Choose Send to Back from the Arrangement menu. The selected object moves to the back.

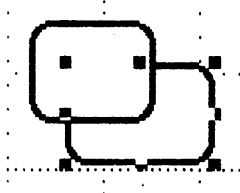
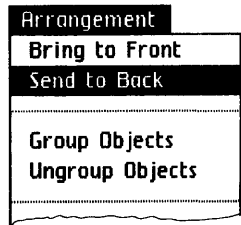

Format

Send to Back/ Bring to Front *(continued)*

Notice that while the box is selected, any “covered” handles show even when the box is moved to the back. This is helpful if you need to use a covered handle for editing. Remember that text is always in front and can’t be sent to the back.

To move an object in front of another object

- ▶ Select the object.

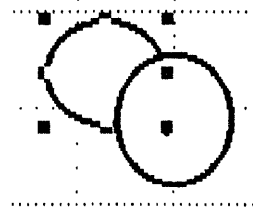

- ▶ Choose Bring to Front from the Arrangement menu. The selected object moves to the front.

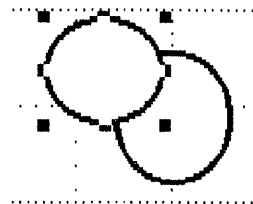

Text is always in front of any other objects. When text is part of a group, it can be sent to the back.

Shading

To change the pattern within an existing object or the pattern behind existing text

- ▶ Select the object or text.



- ▶ Choose the desired pattern from the Shades menu. The object or text has a new pattern.

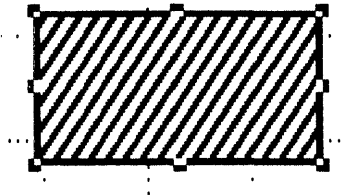
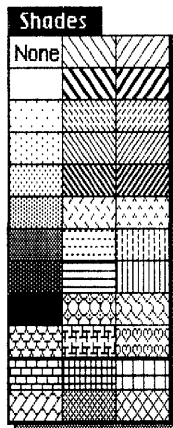

Shaded Text

Format

Shading (continued)

To change the shade of a symbol (except for line symbols) so that everything you draw with it from then on has the new shade

- ▶ Activate the symbol to be changed.



- ▶ Choose a pattern from the Shades menu.

You can shade the text symbol just like the other symbols, and all new text you type will have the background chosen. Notice that after you choose a shade, it is shown in the line/shade box in the palette. This shade is visible in the line/shade box whenever the symbol is active. The linestyle currently in effect for all drawing symbols is also shown in the line/shade box.

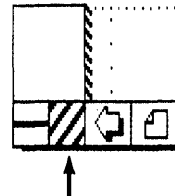

To measure distances in the drawing area

Show Size

- Choose Show Size from the Page Layout menu.

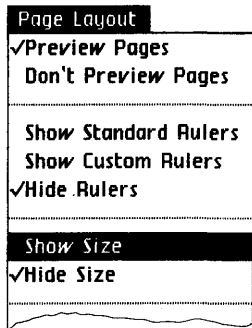

With Show Size on, you can measure the size of any object as you draw it. This distance is displayed at the lower right of the pointer.

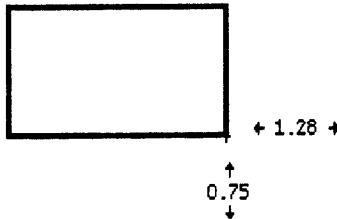

Format

Show Size (continued)

To measure an object that has already been drawn

- ▶ Move the pointer inside the object.
- ▶ Press the mouse button; the measurements appear.

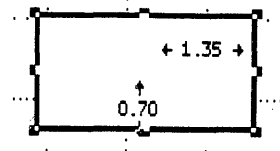

- ▶ If the object to be measured is a straight line, move the pointer on top of the line and press the mouse button.
-

To stretch or shrink an object

Stretch and Shrink

- ▶ Select the object or objects to be made larger or smaller.

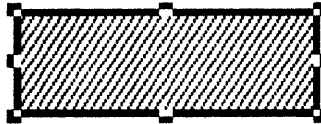

- ▶ Move the pointer so that it touches any handle. Press the mouse button and pull either handle away from the center of the object to stretch it, or toward the center to shrink it. The fill pattern doesn't show until you release the mouse button.



To change only the height of an object

- ▶ Use the center handle at the top or the bottom.



Format

Stretch and Shrink (continued)

One thing to remember is that an object can't be stretched to a size larger than the size you've specified for the drawing.

To change only the width

- ▶ Use the center handle on either the right or left side.

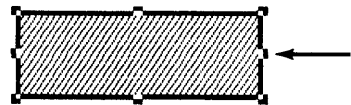

To change both dimensions at the same time

- ▶ Use a corner handle.

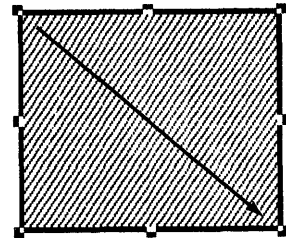

These techniques work for any object except a straight line, which you can only make longer or shorter using the handles. Note that if you shrink a polygon, freehand line, multiple selection, or group too small, the parts may not keep their relative proportions. If this happens, choose Undo Last Change from the Edit menu to start over.

To change the type style

- ▶ Activate the text symbol.



- ▶ Choose the new type style from the Type Style menu.

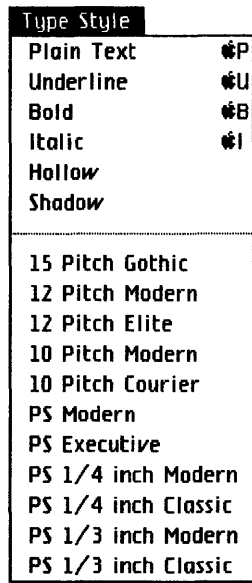



You can make several choices from the Type Style menu at the same time, like Bold, Italic, and PS Modern. All new text that you add to your drawing will be in the new type style until you change the text symbol again.

Format

Type Styles

(continued)

To change the type style of text that already exists

- ▶ Select the text that you want to change. 
- ▶ Choose the new type style from the Type Style menu. The type style of the selected text is changed. 

To change the type style of only part of a line of text, use the text symbol to select the appropriate text, then make your choice from the Type Style menu.

-
- C80 Change Drawing Size
 - C81 Format for Specific Printers
 - C85 Preview a Drawing
 - C86 Print a Drawing

Print

Change Drawing Size

To change the number of pages that a drawing contains

- ▶ Choose Drawing Size from the Page Layout menu.

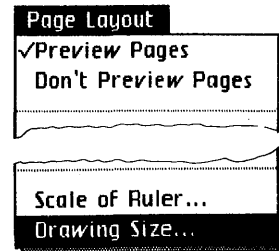

- ▶ Check the appropriate box in the dialog box to increase or decrease the number of pages in the drawing; then click OK. Note that you can't make the drawing size smaller than any existing objects that have been drawn.

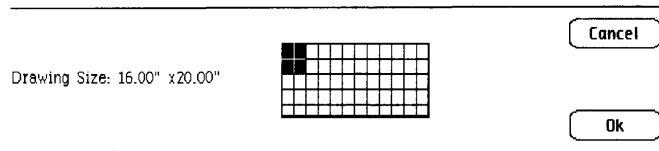

Note that the drawing size depends on the paper size and the orientation specified in the Format for Printer dialog box.

Format for Specific Printers

To format your drawing for a specific printer

- ▶ Choose Format for Printer from the File/Print menu.

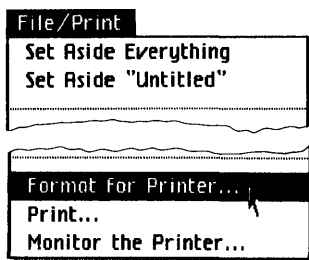

- ▶ Check the type of printer that this drawing will print on, either dot matrix or daisy wheel.
- ▶ If you are using a dot matrix printer, check the orientation and resolution that you want to use for this drawing.
- ▶ If you are using a daisy wheel printer, check the paper size and print wheel style that you want to use for this drawing.
- ▶ Check the response you want the Lisa to make if no printer matches the settings you've picked.
- ▶ Click OK.

The settings you check in the Format for Printer dialog box are saved with each drawing and become part of the settings that determine how your drawing is displayed on the screen, as well as how it prints out.

Printer format settings take effect in your drawing after you click OK in the dialog box.

Print

Format for Specific Printers (continued)

Settings in the Format for Printer Dialog Box

The Format for Printer dialog box lets you check the kind of printer you want this drawing to print on, and then lets you specify some details on size of paper and type style.

You can tell the Lisa to print your drawing on a dot matrix or daisy wheel printer. The items that follow Print Method in the dialog box change when you change your printer preference from dot matrix to daisy wheel, or back.

Dot Matrix Printer Settings

When you choose Dot Matrix printer in the Format for Printer dialog box, you see these additional choices:

Format For Printer... Cancel

On which printer do you intend to print this document?

Print Method: Dot Matrix Daisy Wheel

Paper Length: 11" 14"

Orientation: Portrait (tall) Landscape (wide)

Resolution: Normal High

What do you want done if the printer you've specified does not appear to be connected to this machine?

Tell Me Pick an Available Printer for Me Disregard it OK

Paper Length: With a dot matrix printer, you can print on 11 or 14 inch paper.

Orientation: This setting tells the Lisa whether to print your drawing horizontally or vertically on the paper in your printer. When the orientation is Portrait, the Lisa prints the text of your drawing across the 8-1/2 inch width of your paper, from left to right. When the orientation is Landscape, the Lisa treats the length of the paper (11 or 14 inches) as the width. In other words, it treats the paper as though it could turn it on its side before printing. When using landscape orientation and normal resolution, the font size and picture size will be smaller when it is printed than it is shown on the screen.

Format for Specific Printers (continued)

Resolution: This tells the Lisa what quality you want the drawing to print with. Normal resolution gives you a standard character image. High resolution produces a much finer quality character image, but takes longer to print.

Daisy Wheel Printer Settings

When you choose Daisy Wheel printer in the Format for Printer dialog box, you see these additional choices:

Format For Printer... Cancel

On which printer do you intend to print this document?

Print Method: Dot Matrix Daisy Wheel

Paper Size: 8.5x11" 11x8.5"
 8.5x14" 14x8.5" 14x11"

Print Wheel: 15 Pitch 12 Pitch 10 Pitch Executive
 Multi-Font Multi-Pitch Lisa Complete

What do you want done if the printer you've specified does not appear to be connected to this machine? OK

Tell Me Pick an Available Printer for Me Disregard it

Paper Size: When you print with a daisy wheel printer, you have five choices for paper size: 8-1/2x11 inches; 11x8-1/2 inches; 8-1/2x14 inches; 14x8-1/2 inches; and 14x11 inches. The size you choose is reflected in your drawing.

Print Wheel: You have a range of choices in print wheels. The wheel you decide to use does limit the range of type styles and fonts that you may use in your drawing. For instance, if the print wheel you choose does not contain italic characters, italics will not display in the text of your drawing. Similarly, if you check 15 Pitch as your print wheel, text will not display in 10 pitch on your screen, even if you've chosen it on the Type Style menu. When you try to use a type style or font that is incompatible with the current printer settings, you'll see this alert box:

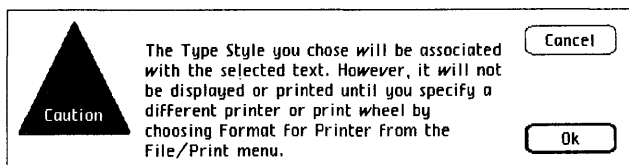

Print

Format for Specific Printers (continued)

When Settings Don't Match a Printer

In order for the Lisa to follow your instructions in this Format for Printer dialog box, two other factors must be true: Preferences must show that the type of printer with the settings you choose here is attached to the Lisa, and such a printer must be attached.

Whenever you click OK in the Format for Printer dialog box, the Lisa checks the new settings against the printer settings listed in Preferences. If they don't match, the Lisa then looks at the bottom line of the dialog box to see what you want done.

Tell Me: When Tell Me is checked, the Lisa notifies you that no printer specified in Preferences meets the settings you have checked. An alert box appears, so that you can decide what you want to do next.

Pick an Available Printer: When Pick an Available Printer is checked, the Lisa will choose an alternative printer if one doesn't match the settings you requested exactly. For instance, if you've specified a daisy wheel printer but only a dot matrix is attached and checked in Preferences, the Lisa formats your drawing for the dot matrix printer, rather than for a daisy wheel printer.

Disregard It: When Disregard It is checked, the Lisa notes the difference in printer settings and available printers but doesn't do anything. This allows you to continue working with your drawing without being interrupted to make a decision about print formats now. An alert message will appear when you attempt to print.

Preview a Drawing

To preview a drawing

- ▶ Choose Preview Pages from the Page Layout menu.



To turn previewing off

- ▶ Choose Don't Preview Pages from the Page Layout menu.

Turning on Preview Pages tells LisaDraw to mark the page boundaries in a drawing larger than one page. Preview lines are inserted into the drawing. You can draw while preview is on, just like at any other time, but the preview lines do not print.

Print

Print a Drawing

To print a drawing

- ▶ Make sure your printer is set up and connected to your Lisa. For assistance, see the manual that came with your printer.
- ▶ If you have not previously specified the printer(s) you use in Preferences, do so now. For assistance, refer to Section D, Desktop Manager Reference Guide, in the *Lisa Owner's Guide*, under Set Printer Configuration.

▶ Get or activate the drawing.

- ▶ If you need to change any of the options in the Format for Printer dialog box for this document, choose Format for Printer from the File/Print menu.

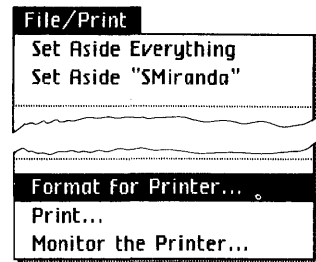

- ▶ Make any necessary changes in the Format for Printer dialog box that appears.
 - ▶ Click OK.
 - ▶ Choose Print from the File/Print menu.
 - ▶ Make any necessary changes in the Print dialog box that appears.
 - ▶ Click OK.
-

Print a Drawing *(continued)*

Note that if you are printing gray lines, you should avoid the thinnest line thickness, since it may not print properly. Also, when you use normal resolution landscape print settings, your drawing may print smaller than reported in the drawing size dialog box.

Using the current printer settings and the formats you specified in the text, your drawing begins printing.

For how to make changes in the Format for Printer dialog box, see the Format for Specific Printers procedure, under Print, in this chapter.

If the printer settings and printer don't match, an alert box appears. Alert boxes resulting from a mismatch are discussed in the Format for Specific Printers procedure, under Print, in this chapter.

Sometimes a dialog box titled Monitor the Printer will appear. See While You Work, later in this chapter, for information on this alert.

Print Dialog Box Settings

Print... Finished Quality Quick Draft (Text Only) Cancel
 While You Wait While You Work
 All Pages Only pages: [] Through: []
Number of Copies: OK

The Print dialog box lets you specify some final details about how your drawing will print. The choices in the Print dialog box are discussed below.

Print

Print a Drawing (continued)

Quality

Finished Quality: Finished Quality prints your drawing as you have formatted it on the screen, including special type styles and fonts. Remember that grid lines are never printed.

Quick Draft: Quick Draft lets you get a printed copy of the text faster, but without any graphics or special type styles and fonts used in your drawing. On a dot matrix printer, the built-in font is used for Quick Draft. On a daisy wheel printer, whatever print wheel is on the printer will be used, even if you've specified a different one in your drawing. Remember, Quick Draft gives you text, but no graphics.

Speed

While You Wait: You can have the Lisa use most of its attention to print your drawing while you wait. A drawing will print more quickly if you choose While You Wait, but you won't be able to use the Lisa for any other tasks.

While You Work: You can have the drawing print while you continue to use the Lisa for other tasks at the same time. Some printing conditions make printing while you work inconvenient, however. For example, if you are single sheet feeding paper into your printer, and printing a quick draft, you won't have time to do other activities on the Lisa.

When you choose While You Work, a dialog box appears. This dialog box tells you the name of the document, the copy, and the page now being printed. Click Proceed to return to LisaDraw to continue working. Click Terminate if you want to stop the printing. If you decide to proceed, you can return to this dialog box at any time to stop the printing by choosing Monitor the Printer from the File/Print menu.

Note that if you hear a whistle, there is a problem with printing while you work. Choose Monitor the Printer from the File/Print menu to see what the problem is.

Print a Drawing (continued)

Number of Pages

All Pages: You can print all pages of a drawing. Just make sure All Pages is checked in the Print dialog box.

Selective Pages: To print selective pages of a drawing, check Only Pages and then fill in the boxes with the starting and ending pages to print.

When you want to print from the beginning of a drawing through some page number, say 8, you enter “8” in the second box after Through. Similarly, if you want to start at a given page number and print to the end, you need to enter the starting page number in the box after Only Pages.

Number of Copies

You can print from 1 to 10 copies of any drawing. Just check the box with the number of copies you want printed.

Other Tools

C92 LisaGraph and LisaProject

C93 Overhead Slides

Other Tools

LisaGraph and LisaProject

To copy a graph from LisaGraph or a chart from LisaProject into LisaDraw

- ▶ Get or activate the graph or chart that you want to copy.
- ▶ Choose Select All of Document or Select All of Graph from the Edit menu.
- ▶ Choose Copy from the Edit menu.

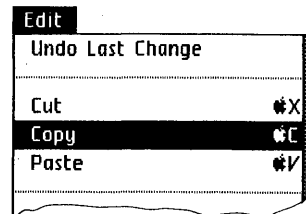

- ▶ Get or activate an existing drawing or tear off a new piece of drawing paper and open it. Click where you want the copy to be centered, otherwise the copy will be automatically centered in the middle of the drawing.
- ▶ Choose Paste from the Edit menu.

You now have a LisaGraph or LisaProject document on a piece of LisaDraw paper, and you can add whatever graphics or text you like. The LisaGraph or LisaProject document has now become a LisaDraw document.

To make an overhead slide from a drawing

Overhead Slides

- ▶ Print your drawing using high resolution.
 - ▶ Make a good dark copy of the drawing on a copy machine, if possible.
 - ▶ Run the copy through a transparency machine with a high quality (heavy weight) transparency sheet.
-

Section D
Appendixes

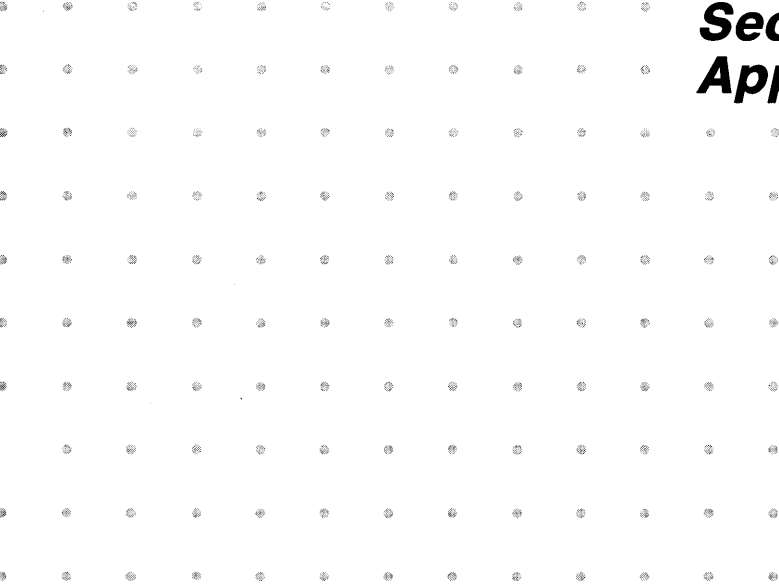

Contents

D1 Appendix 1. Menu Items

D7 Appendix 2. Apple Keys

D9 Appendix 3. Type Fonts

Appendix 1

Menu Items

File/Print Menu

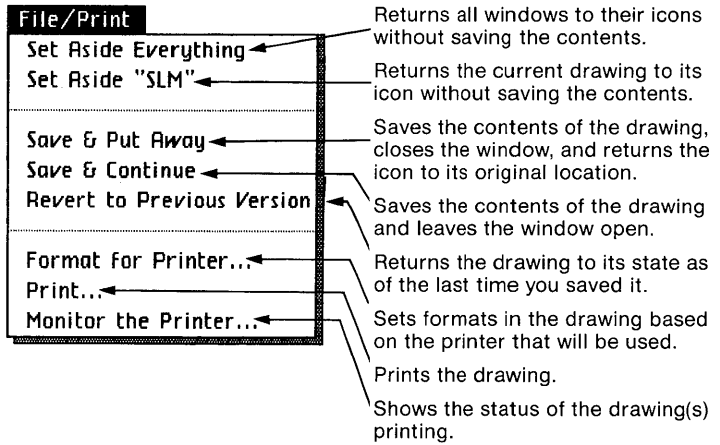

Edit Menu

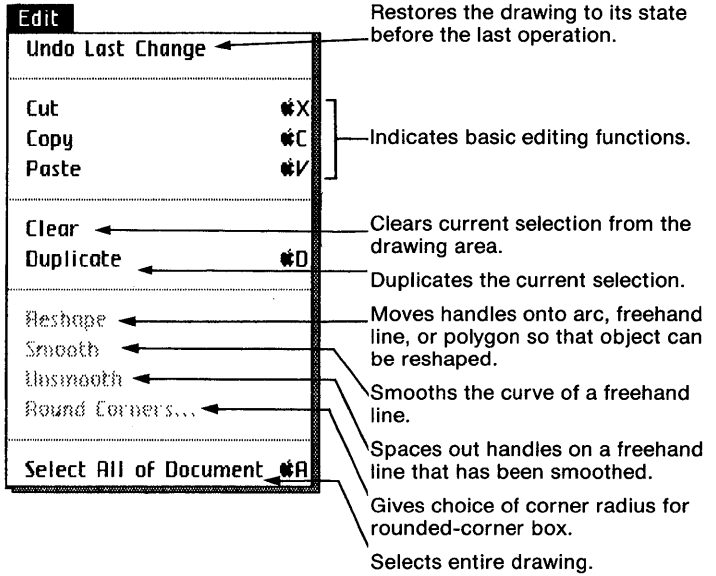

Type Style Menu

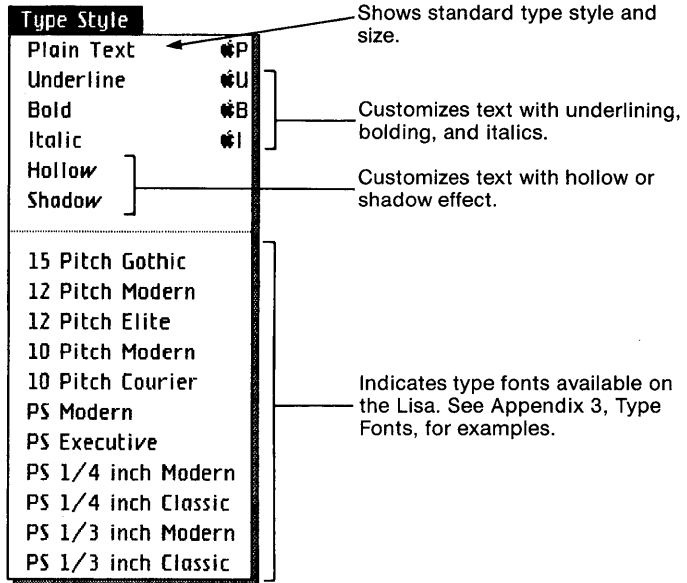

Page Layout Menu

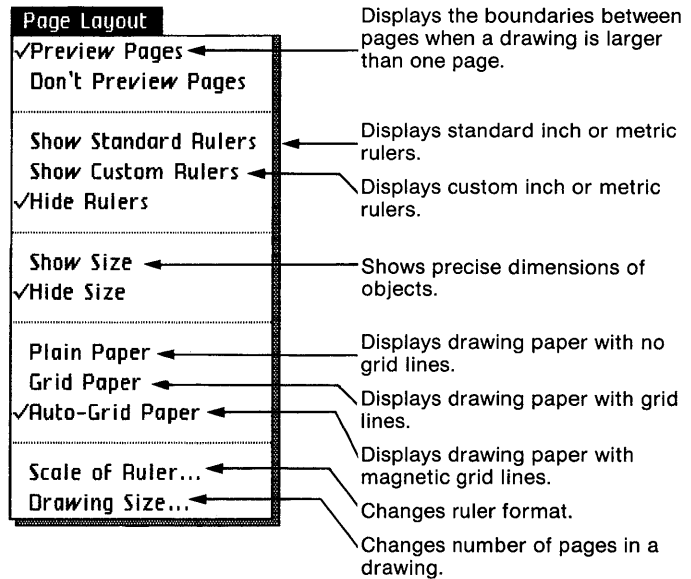

Arrange Menu

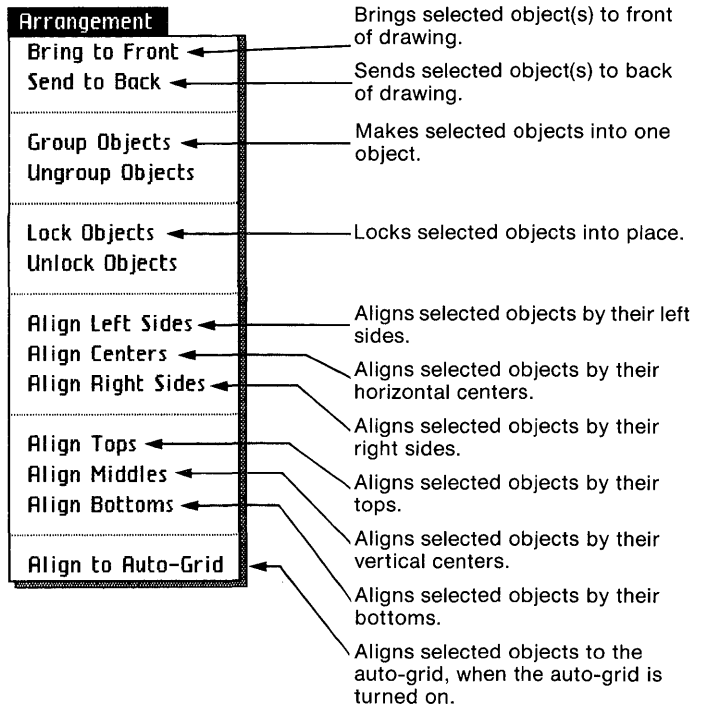

Lines Menu

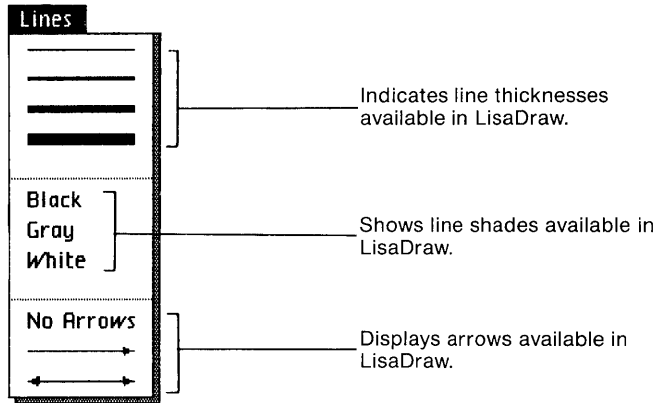

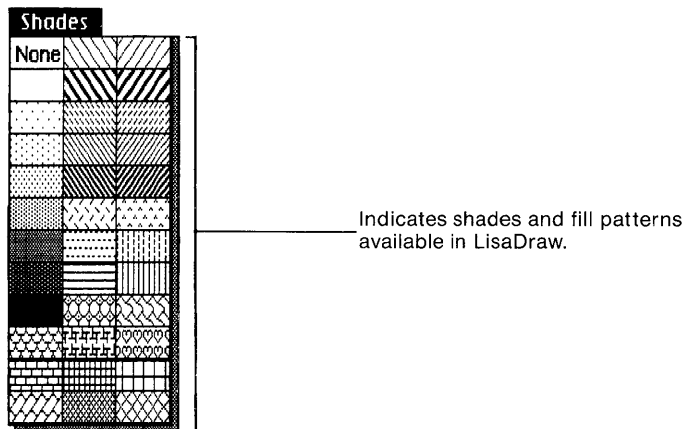

Shades Menu



Appendix 2

Apple Keys

Some LisaDraw menu items contain the Apple key symbol  followed by a character.

Menu items that appear with the Apple key symbol can be chosen by using the mouse or by pressing the  key and the character associated with that menu item. For example, to use the Cut menu item, you first select what you want to delete, press the  key, and while holding it down, press the X key.

The following list shows the characters that can be used in combination with the  key in LisaDraw:

A	Select All of Document
B	Bold
C	Copy
D	Duplicate
I	Italics
P	Plain Text
U	Underline
V	Paste
X	Cut
.	Terminate

Appendix 3

Type Fonts

Type of one size and face is called a font. The “face” is the portion of the character that displays and prints. On the Type Style menu, some font names are preceded by a number that indicates character size. This number indicates how many characters will print per inch when you use that type font. “PS” in front of a font name stands for proportionally spaced.

The list below shows the fonts as they print. The type style of each font is “plain.” Each of these fonts also may be bold, underlined, and italic. They also may be hollow or shadowed.

You can print any combination of type fonts and styles on a dot matrix printer. In order to use them with a daisy wheel printer, however, you must have the appropriate print wheel for each type font. If you choose a font that your printer is not set up to use, an alert message is displayed on the screen.

15 pitch Gothic

12 pitch Modern

12 pitch Elite

10 pitch Modern

10 pitch Courier

PS Modern

PS Executive

PS 1/4 inch Modern

PS 1/4 inch Classic

PS 1/3 inch Modern

PS 1/3 inch Classic

Plain Text

Underlined Text

Bold Text

Italic Text

Hollow Text

Shadow Text



Section E
Index

Index

A

Alert boxes, C16
Align Bottoms, B99, C57
Align Centers, B99, C54
Align Left Sides, B98, C53
Align Middles, B99, C56
Align Right Sides, B99, C55
Align text, B99
Align to Auto-Grid, B108, C52
Align Tops, B99, C56
Apple key, B6, B10, B12, B13, B17, B40, B68, C14, D7
Arc, B100, C26
 Move, B102
 Stretch and shrink, B102
Arc symbol, B101, C4, C26
Arrangement menu, D4
Arrows, B25, B50
Auto-duplication, B70
Auto-grid paper, B7, C11
Auto-scroll, B44, C13

B

Backspace key, B52
Box, B9, B19, C27
Box symbol, B9, C4, C27
Bring to Front, B19, C70

C

Caret, B100
Caution message, C17
Change, Object, B12
Change pointer, C5
Change symbol, B12, B13, B14, B71, C4
Check pointer, C5
Circle, B10, C29

Circle symbol, B10, C4
Clear, B7, B48, C36
Clipboard, B53, B115, C36, C41
Copy, B114, C37
 LisaGraph into LisaDraw, B124, C92
 LisaProject into LisaDraw, B124, C92
Create drawing, B4
Custom rulers, B43
Cut, B12, B55, C36, C41, C47

D

Daisy wheel printer, C81
Delete, see Cut
Deselect, B12, B14
 Selective deselection, B96
Diagonal line, C32
Diagonal line symbol, B7, C4, C32
Dialog boxes, C15
Don't Preview Pages, C85
Dot matrix printer, C81, C82
Drawing paper, see Paper
Drawing pointer, C5
Drawing Size, B116, C80
Duplicate, B40, B49, C37

E

Edit menu, D2
Elevators, B46, C12

F

File/Print menu, D1
Fill patterns, B23
Flowchart, B38
Format for Printer dialog box, B27, C80, C82
Freehand line, B17, C30
 Reshape Curve, B84, C30
 Smooth, B85, C30
 Stretch and shrink, B83
 Unsmooth, B85, C30
Freehand symbol, B17, C4, C30

G

Grid paper, B8, B51, B52, C11
Group Objects, B69, C10, C42

H

Handles, B6, B11, B13, B20
Hide Rulers, B43, B74, C65
Hide Size, B107
Horizontal/vertical line symbol, B5, B14, C4, C31
Hourglass, C5

I

Icon, C4

K

Keys
 Apple, B5, B17, B40, B68, D7
 Backspace, B52
 Shift, B13, B16, B55

L

Line/shade box, B23, C4, C72
Lines, B5, B7
Lines menu, B14, B24, B25, C59, D5
Linestyle, B14, B23, C59, C72
LisaGraph, B124, C40, C92
LisaProject, B124, C40, C92
Lock Objects, B77, C10, C45

M

Make Stationery Pad, B76
Map, B81
Menu bar, C4, C14
Menu items, C4, D1
Menu title, C4
Move, B18, B49, B51, C46
Multiple selection, B13, B14, C7

N

Note message, C16

O

Organization chart, B66
Oval, see Circle
Overhead Slides, B126

P

Page Layout menu, B9, D3
Palette, B5, C4
Paper, C61

- Auto-grid paper, B9
- Grid paper, B8, B51, B52
- New, B4
- Plain paper, B8

Paste, B55, C47
Plain paper, B8, C11
Pointer shapes, C5

- Change symbol, B71
- Cross, B5
- Hand, B15
- Hourglass, C5
- Text pointer, B53

Polygon, B47, B106, C33

- Reshape, B49
- Stretch and shrink, B106

Polygon symbol, B47, C4, C33
Preview Pages, B117, C85
Print, B26, B80, C86

- Daisy wheel printer, C81
- Don't Preview Pages, C85
- Dot matrix printer, C81, C82
- Finished Quality, C88
- Format for Printer dialog box, B27, C80, C82
- Paper sizes, C83
- Preview Pages, C85
- Print dialog box, B27
- Print wheels, C83
- Quick Draft, C88
- Resolution, C83
- While You Wait, C88
- While You Work, C88

R

Reshape Curve, B84, C30
Reshape polygon, B49, C34
Revert to Previous Version, B11, B16, C48
Round Corners, B40, C28
Rounded-corner box, B39
Rounded-corner box symbol, B39, B67, C4, C27

Ruler Zero Point, C68

Rulers

Custom rulers, B43

Hide Rulers, C65

Move zero point, C67

Show Custom Rulers, C67

Show Standard Rulers, C65

Standard rulers, B42, B67

S

Save & Continue, B11

Save & Put Away, B28, B58, B75, B81

Save drawing, B11

Scale of Ruler, B109, C64

Screen, B5, C3

Scroll, B43, B74, C12

Auto-scroll, B44

Elevators, B44, B46, C12

View buttons, B46, C12

Scroll arrows, B45, C12

Scroll bars, B44, C12

Select, B12, B22, C6

Multiple selection, C7

Selection box, B71, C8

Selecting text, B53, C9

Select All of Document, B6, B9, C9, C36

Selection box, B15, C5, C8

Send to Back, B19, B80, C69

Shades menu, B22, B48, B80, C34, C71, D5

Shift key, B13, B16, B55

Show Custom Ruler, B110

Show Size, B107, C73

Show Standard Rulers, B42, B67, C65

Shrink, B19, B49, B51, C11, C75

Shrink-to-size technique, B88

Slides, B126

Smooth, B85, C30

Standard rulers, B42

Start new document, C18

Stationery pad, B75

Stop message, C17

Stretch, B19, B49, B51, C11, C75

T

Text, B52, C44
 Auto-center, B53
 Selection, B53
Text pointer, B53, C5
Text symbol, B52, B87, C4, C44, C77
Transparencies, B126
Type fonts, D9
Type Style menu, C77, D3, B56, B80
Typestyles, B56

U

Undo Last Change, B16, C36, C49
Ungroup Objects, B73, C43
Unlock Objects, B77, C45
Unsmooth, B86, C30

V

View buttons, B46, C12

W

Wait message, C16
Window, C4
 Size, B39

Z

Zero point, C68

? message, C18