

NOTE: UNLESS OTHERWISE SPECIFIED

REV.	ZONE	ECO #	REVISION	APPD
0			ENGINEERING CONTROL	
1			CA12, E, MA20, BE, BG, SJ10	4/14/81
2			J13, J14, J12, J11	6/9/81
3			J2, J5, J6, J7, J8, J9, J15, J16, ICS-7, J12, J3, L1-4, C1-2, C5-2	10/20/81

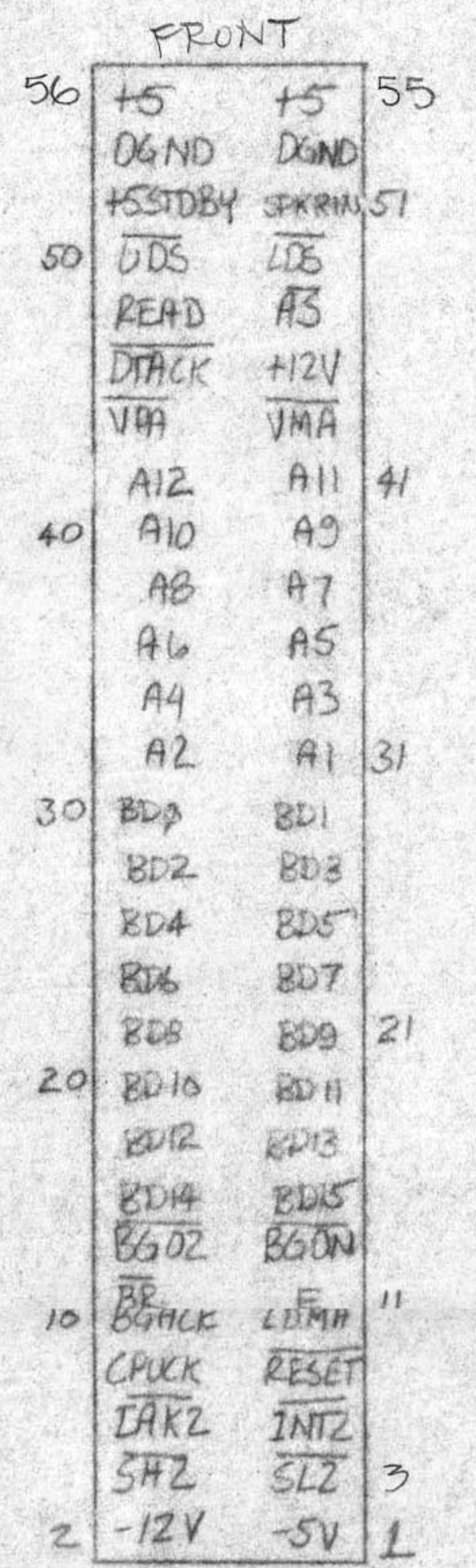

FLOPY DISK / KBD Conn

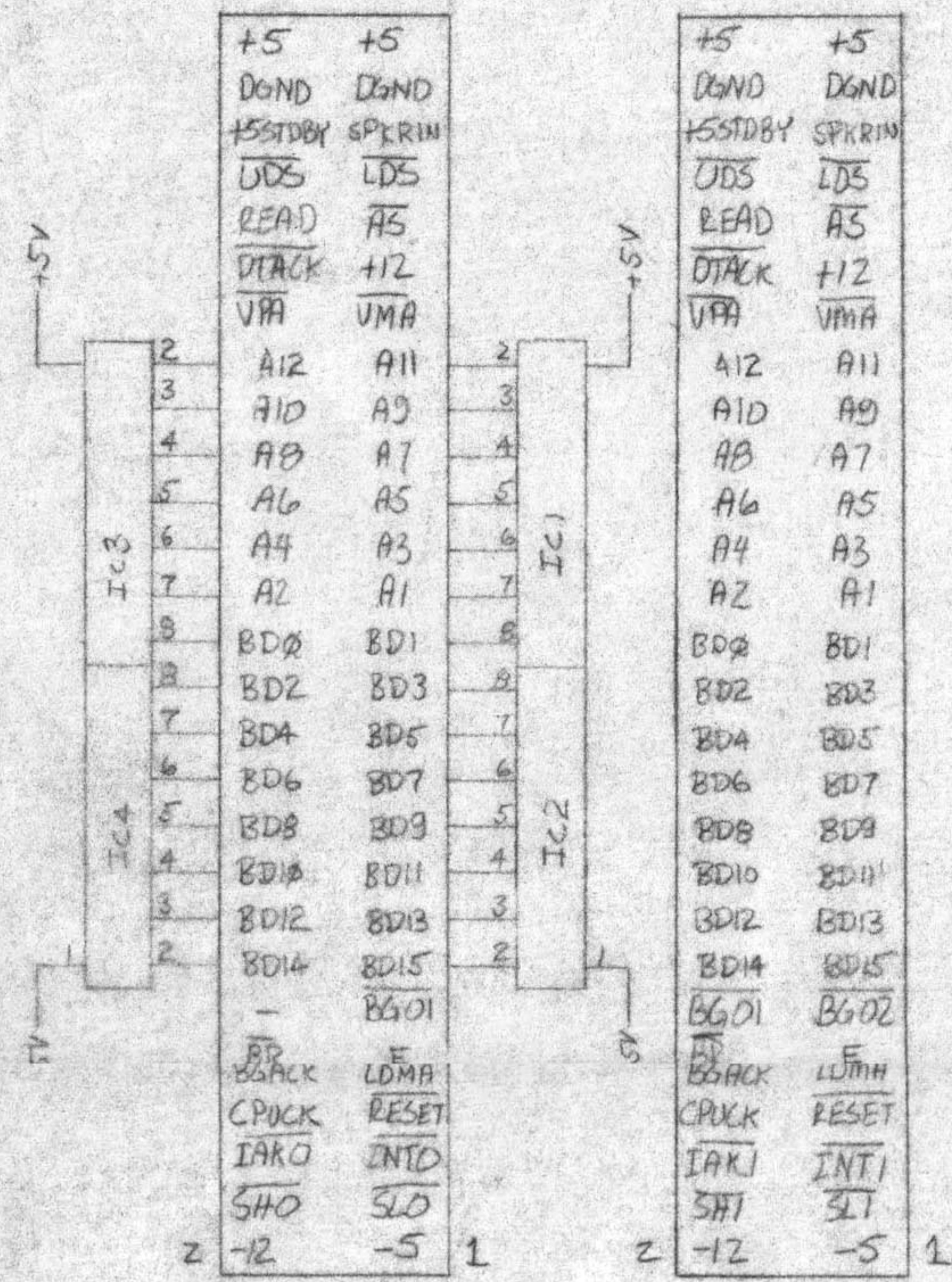
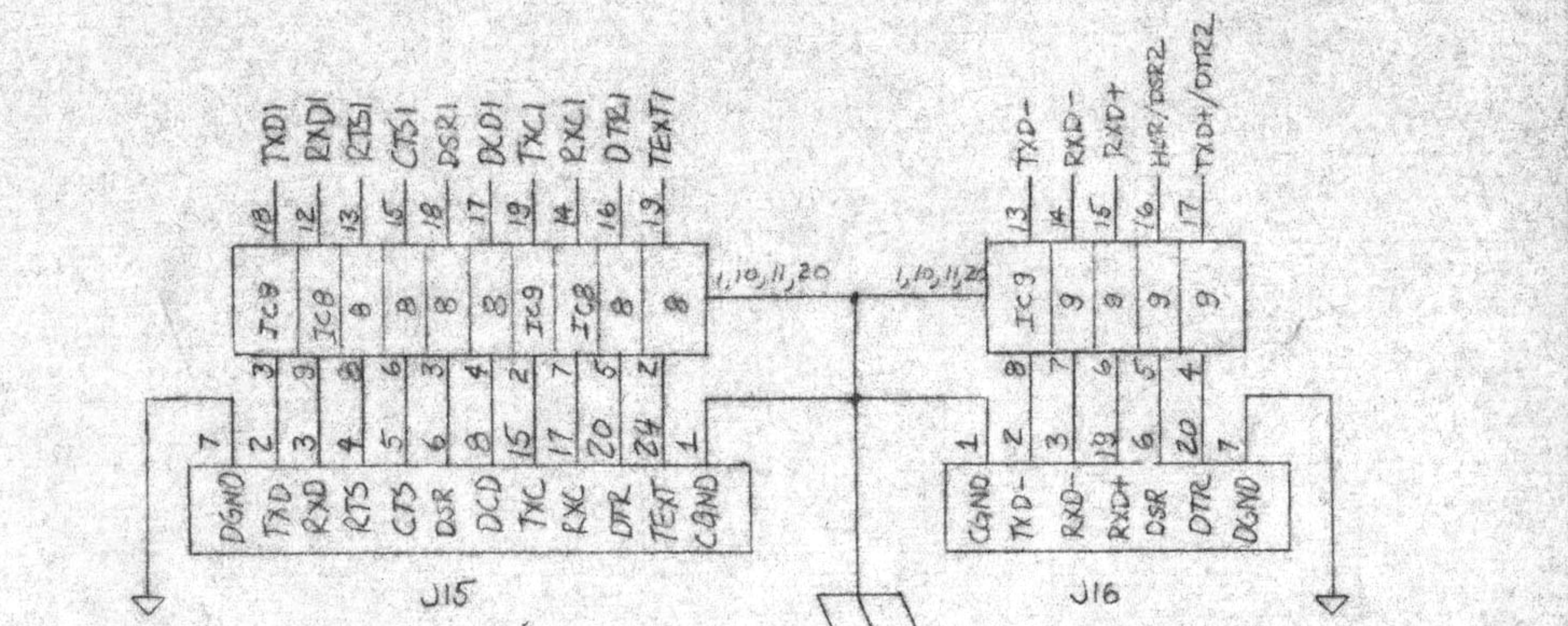
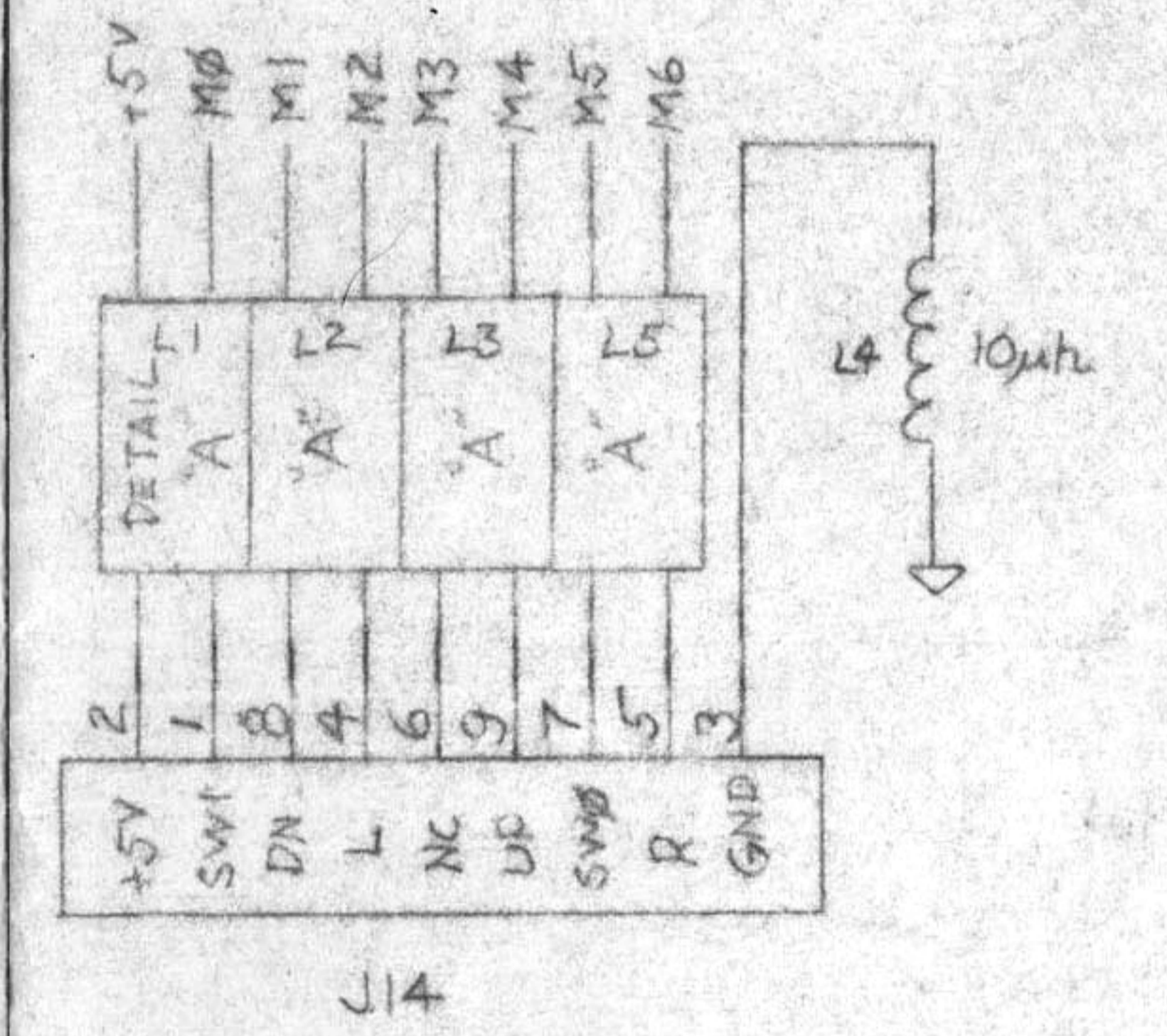
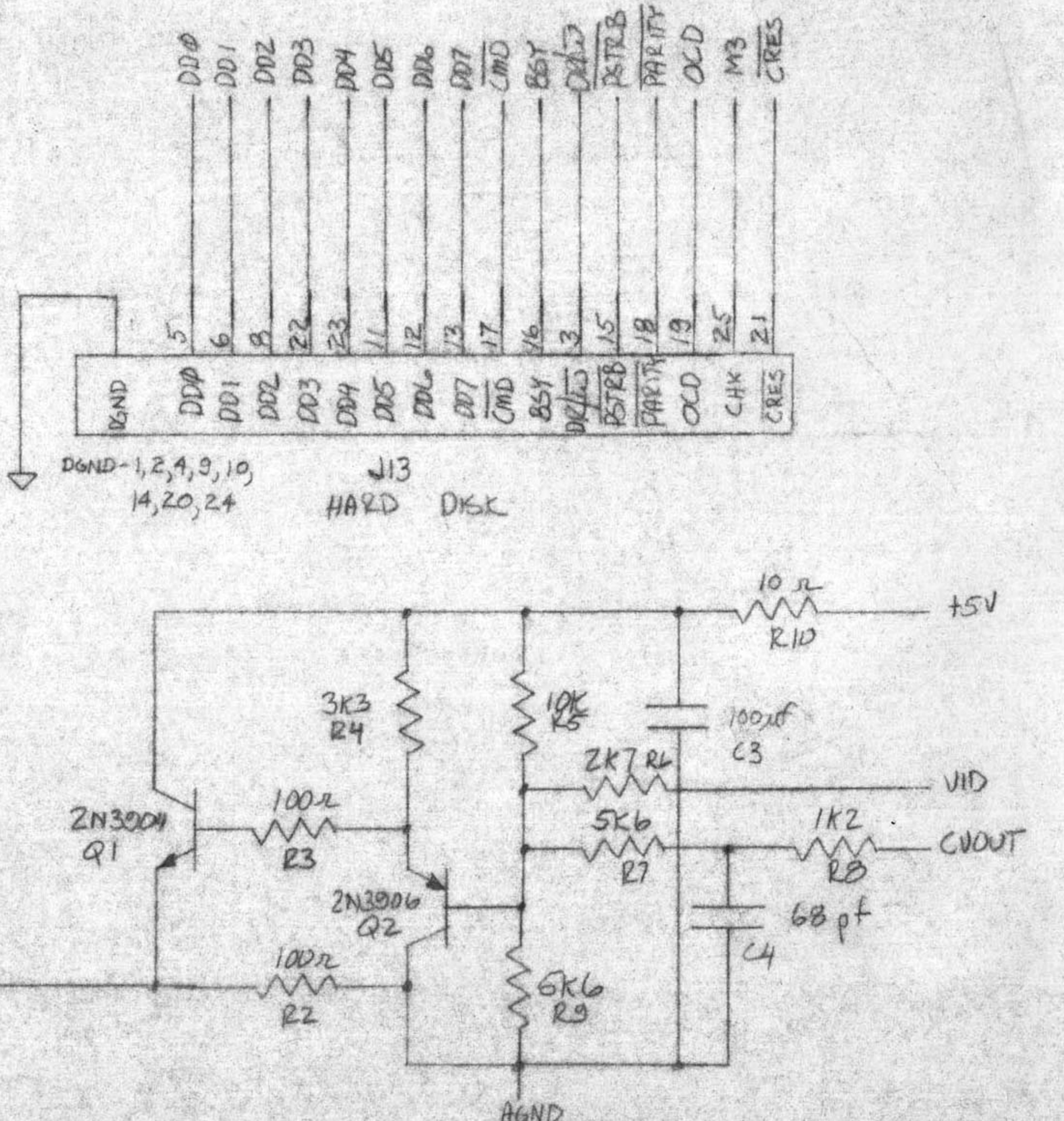
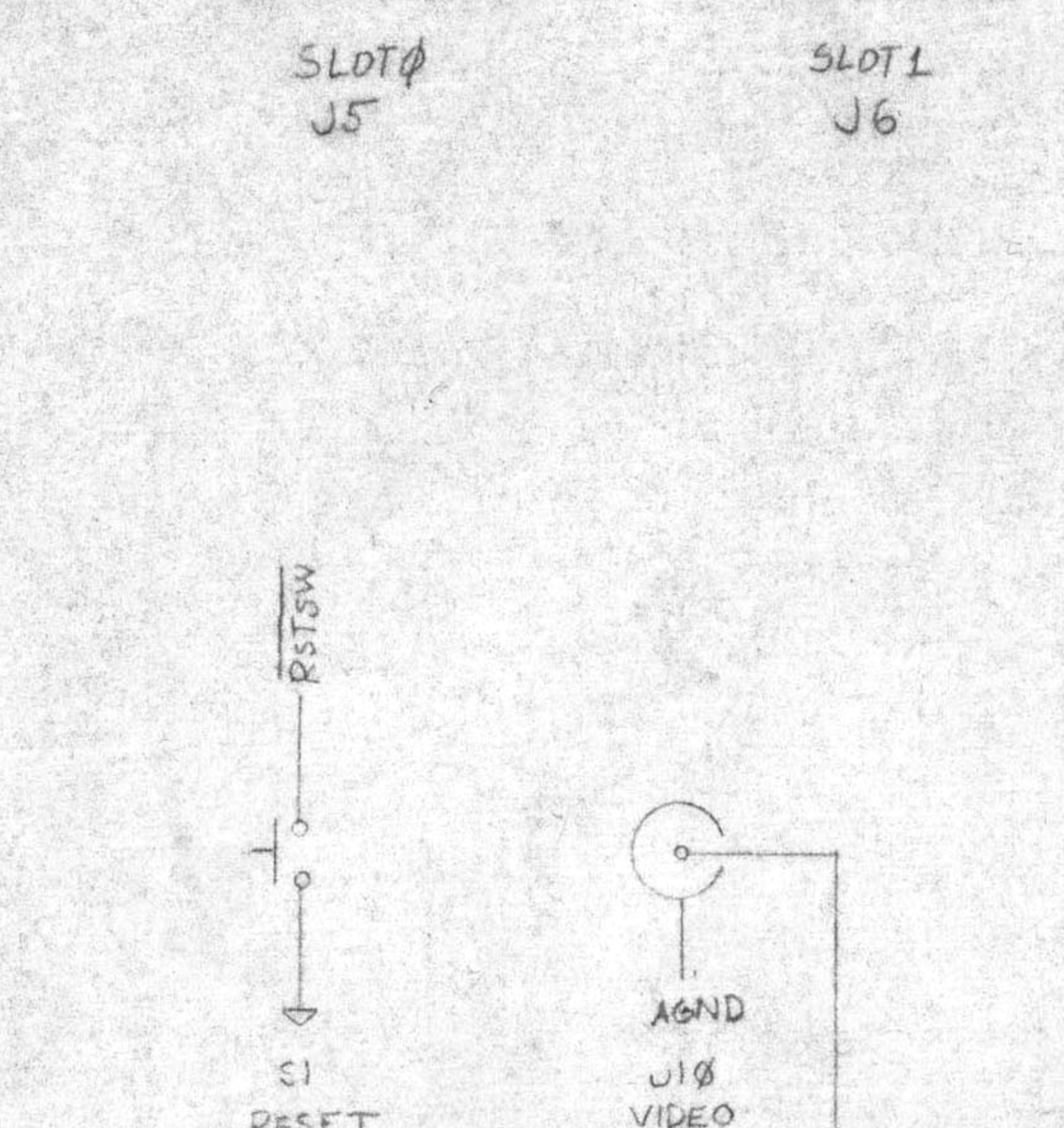
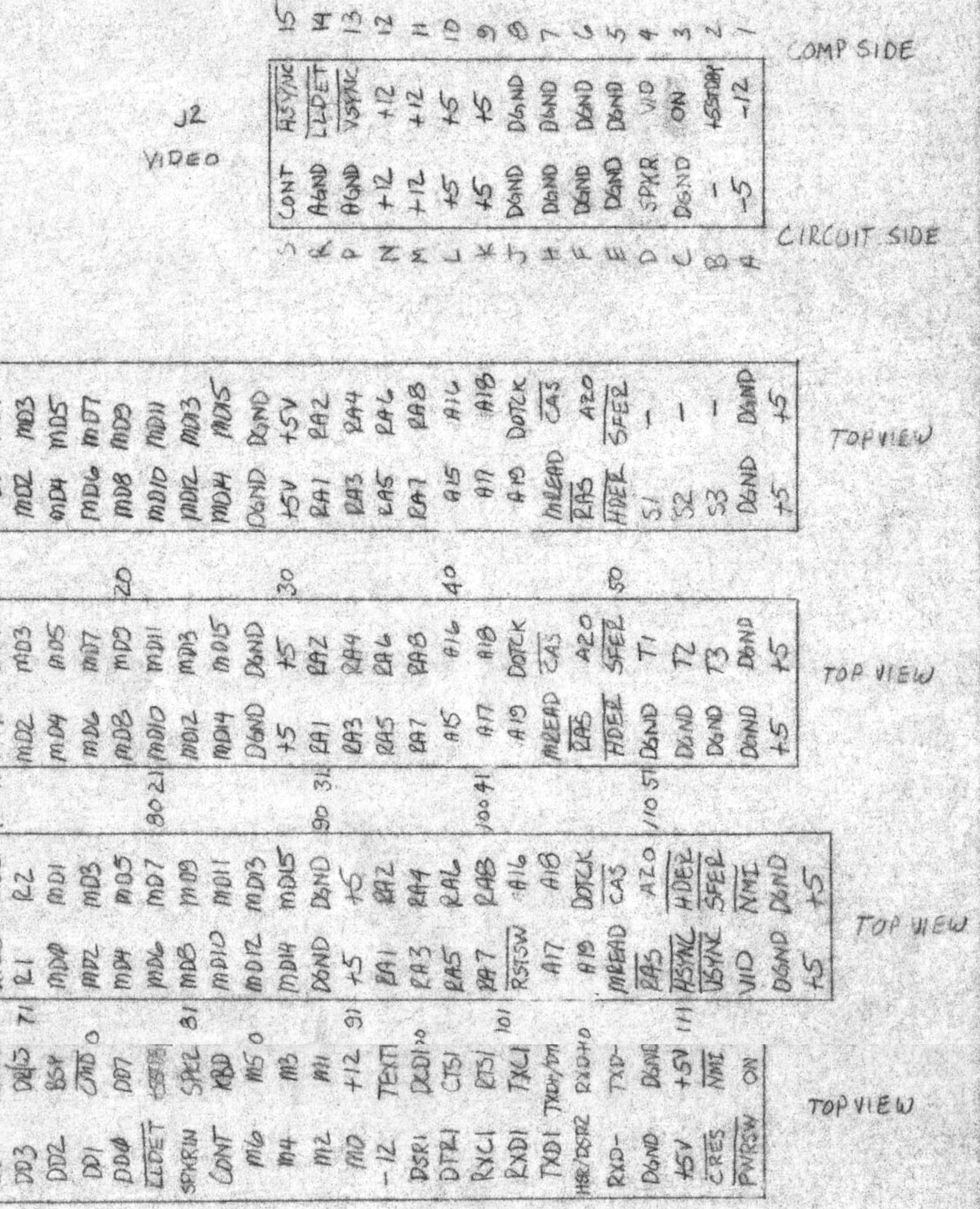
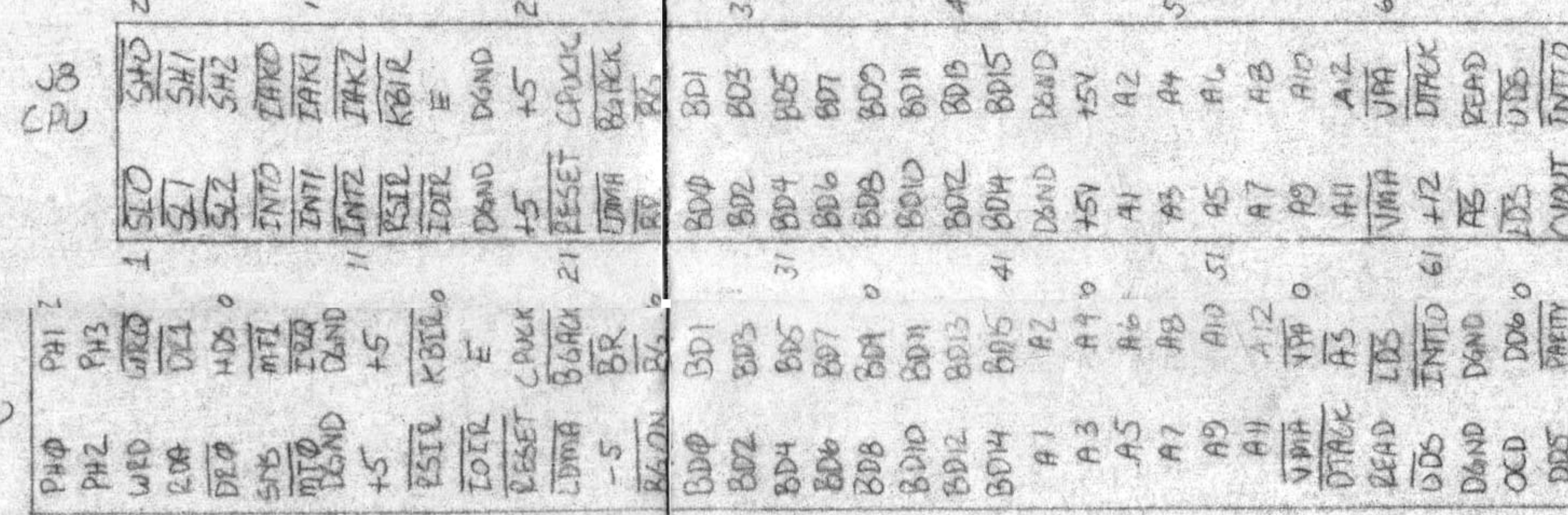
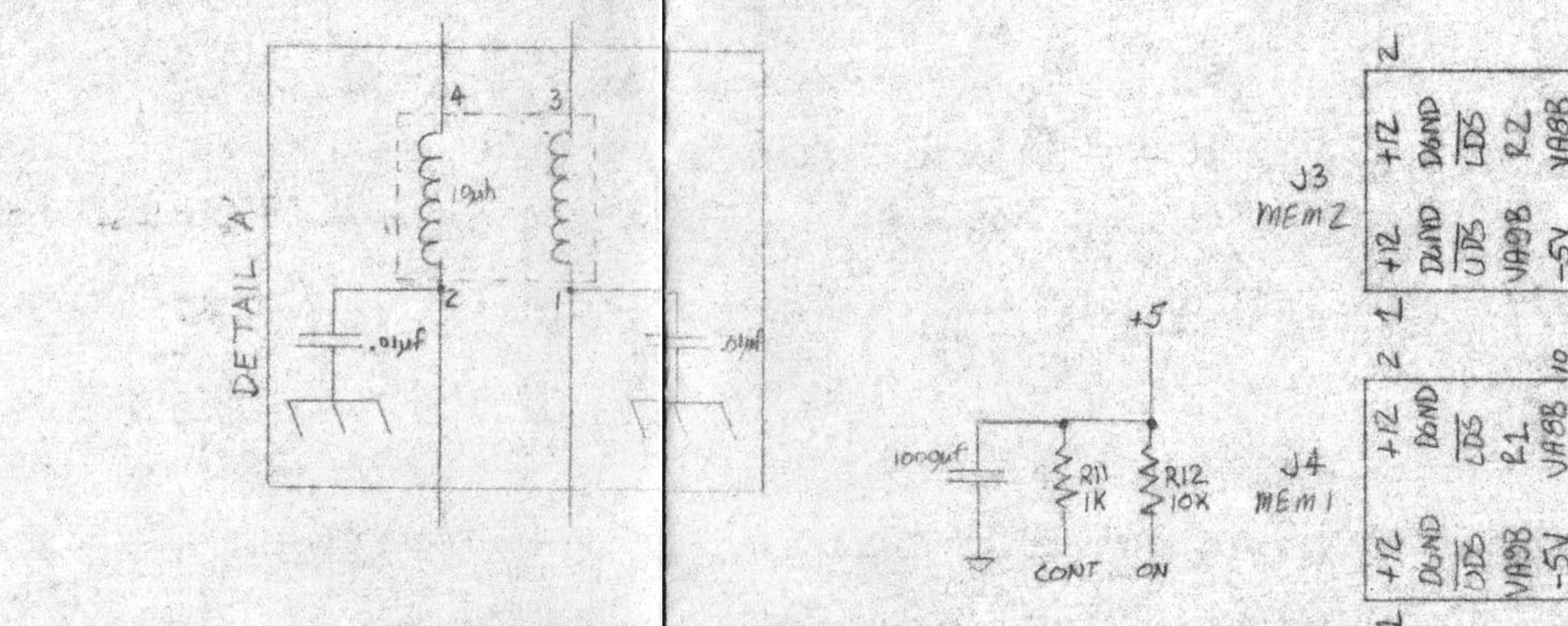
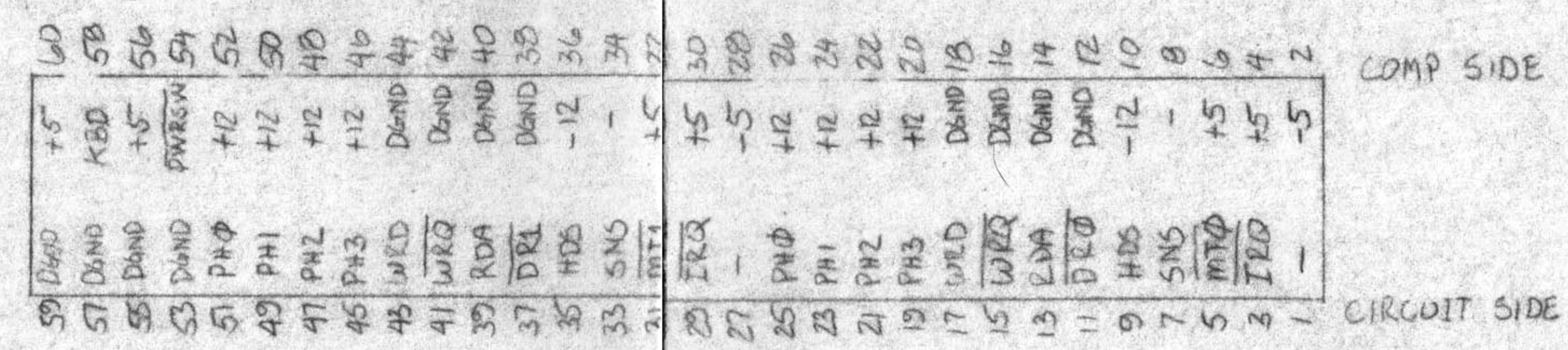

ITEM	QTY	PART NUMBER	DESCRIPTION
TOLERANCES UNLESS OTHERWISE SPECIFIED DIMENSIONS ARE IN INCHES. DECIMALS .X ± .XX ± .XXX ± ANGLES XX.X ± FRACTIONS ± DIMENSIONS IN PARENTHESES ARE IN MILLIMETERS.			
DRAWN BY		DATE	
CHECKED BY		DATE	
APPROVED BY		DATE	
RELEASED BY		DATE	
MATERIAL:			 apple computer inc. TITLE LISA MOTHERBOARD
NEXT ASSY. FINISH:			SIZE C DRAWING NUMBER SK-1130-3
SCALE:			SHEET 1 OF 1