

NOTE: UNLESS OTHERWISE SPECIFIED

1. ALL CAPACITORS ARE IN μ F.
2. FOR 512K MEMORY, ALL RAM ARE USED. USE BILL OF MATERIAL 620-0112.
3. FOR 256K MEMORY, ONLY RAM IN ROWS B AND C ARE USED. USE BILL OF MATERIAL 620-0156.

IC PART REFERENCE DESIGNATION USED:
C97 L2 R2 RP6

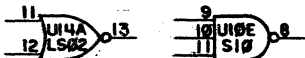
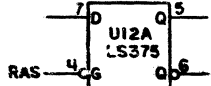

SPARES

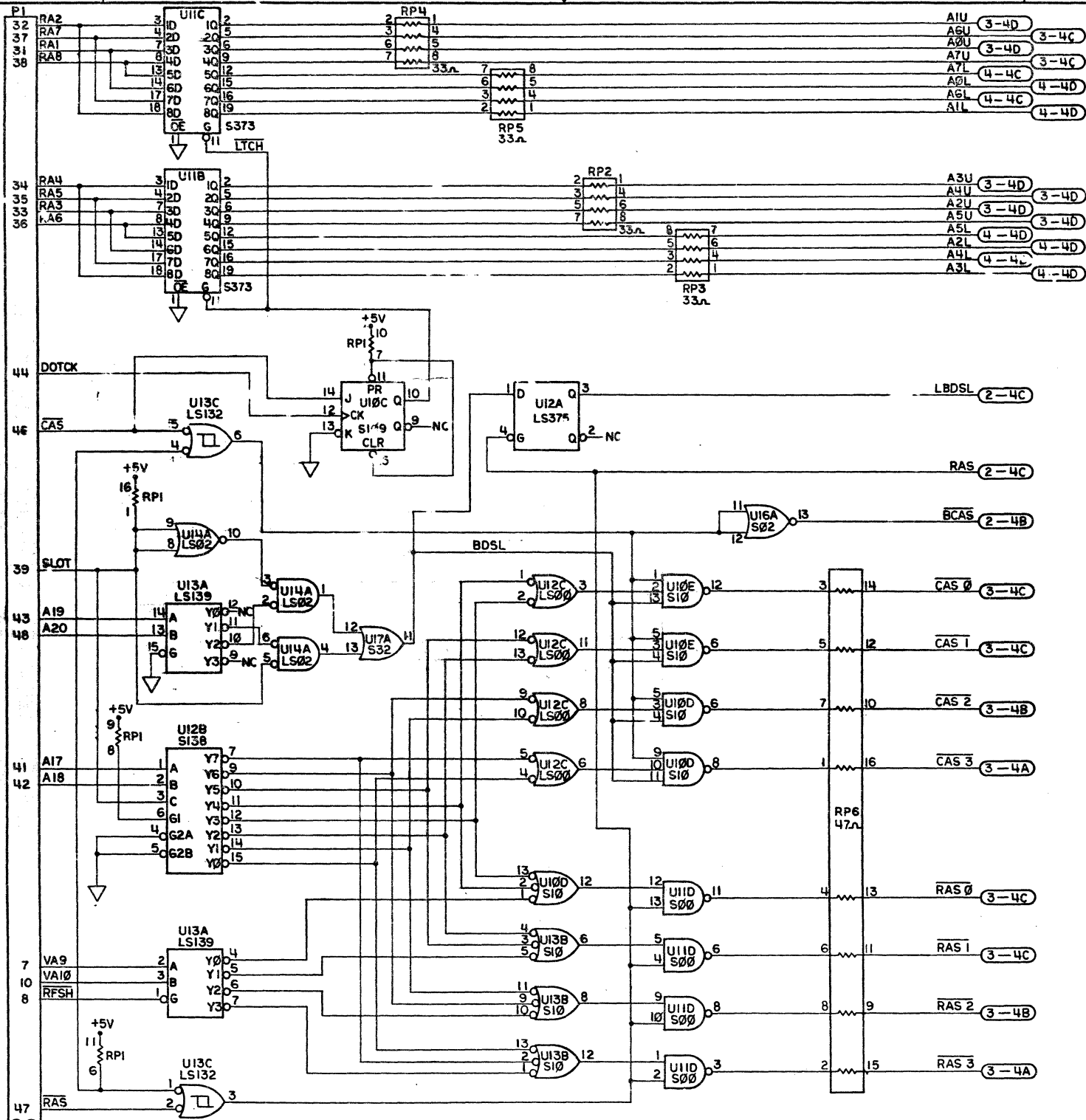
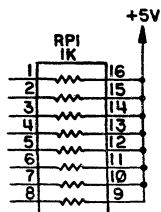

REV	ZONE	ECO #	REVISION	APPD
A		BO80	INITIAL RELEASE	2/23/78
B	3CA	BI12	SHT1-U13C WAS NAND GATE. ADDED HI TO PIN 11 U11C, U11B, PIN 15 U13A, PIN 445 U12B AND PIN 1 U13A.	J. Fall 7/21/82
	3D		SHT2-DO8-DO15 WAS DB-D15 ADDED C18, C29, C61 & C73	
	3B		0.1 X32 UPPER AND LOWER BYTE WAS 0.1 X36. ADDED HI TO PIN 11 U13E, U12E.	
	2A		SHT3-DO8-DO15 WAS DB-D15	
	4A		64K RAM DETAIL A0 WAS A5. A2 WAS A4, A1 WAS A3, A3 WAS A2, A4 WAS A1 & A5 WAS A0.	PB 1/22/82
	2CA		SHT4-64K RAM DETAIL WAS SAME AS SHEET 3.	
	2D			
	2C			

METRIC		apple computer inc.	
NOTICE OF PROPRIETARY PROPERTY			
THE INFORMATION CONTAINED HEREIN IS THE PROPRIETARY PROPERTY OF APPLE COMPUTER, INC. THE POSSESSOR AGREES TO THE FOLLOWING:			
(1) TO MAINTAIN THIS DOCUMENT IN CONFIDENCE			
(2) NOT TO REPRODUCE OR COPY IT			
(3) NOT TO REVEAL OR PUBLISH IT IN WHOLE OR PART			
DESIGNER		TITLE	
P. Fall		SCHEMATIC, MEMORY BOARD LISA	
DATE		DRAWING NUMBER	
3/82		050-4010-B	
SCALE		SIZE	
NONE		D	
FITCH		SHEET	
		1/4	

050-4010-B 1/4

NOTE: UNLESS OTHERWISE SPECIFIED

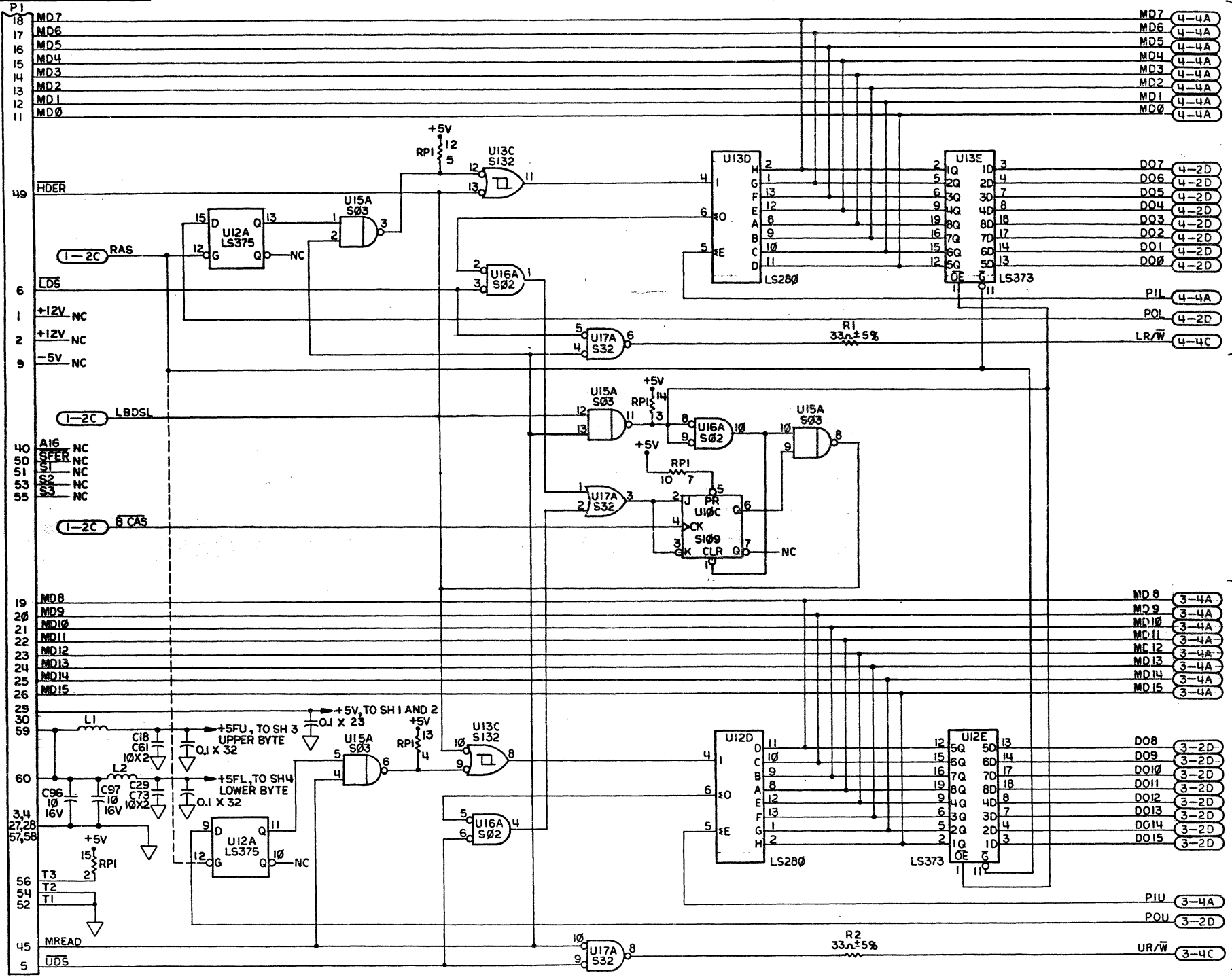

LOWER BYTE

UPPER BYTE

METRIC <small>DIMENSIONS ARE IN MILLIMETERS</small> TOLERANCE: X: .000 Y: .000 Z: .000 ANGLES: ° ' "		apple computer inc. <small>NOTICE OF PROPRIETARY PROPERTY</small> THE INFORMATION CONTAINED HEREIN IS THE PROPRIETARY PROPERTY OF APPLE COMPUTER, INC. THE POSSESSOR AGREES TO THE FOLLOWING: 1. TO MAINTAIN THIS DOCUMENT IN CONFIDENCE 2. NOT TO REPRODUCE OR COPY IT 3. NOT TO DISSEMINATE OR FURNISH IT IN WHOLE OR PART	
<small>DESIGNER</small> FITCH	<small>SCALE</small> NONE	<small>DATE</small> 3/82	<small>REV.</small> 2/4
<small>TITLE</small> SCHEMATIC, MEMORY BOARD LISA		<small>DRAWING NUMBER</small> 050-4010-B	

050-4010-B 1/2

NOTE: UNLESS OTHERWISE SPECIFIED

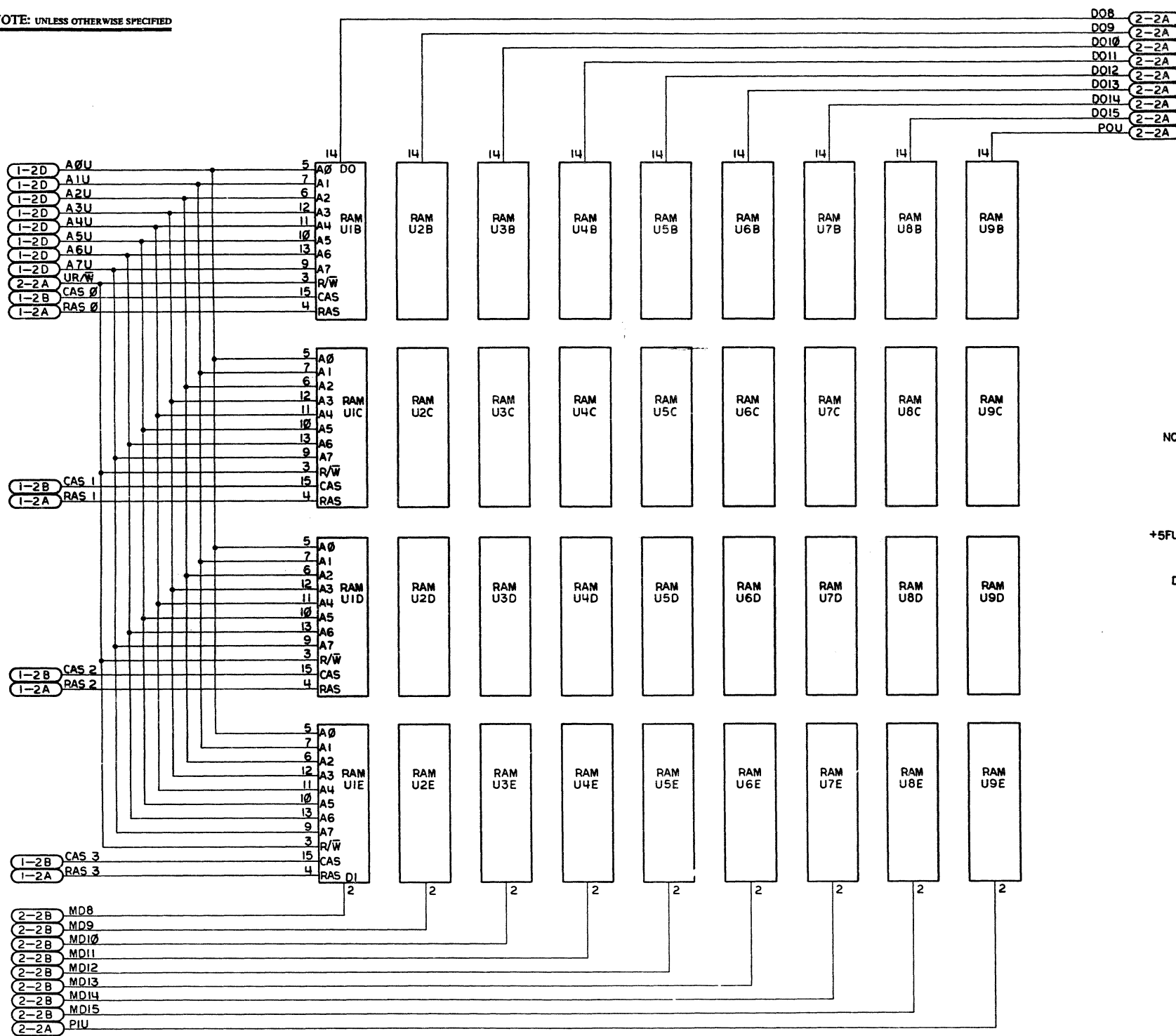

- D08 2-2A
- D09 2-2A
- D010 2-2A
- D011 2-2A
- D012 2-2A
- D013 2-2A
- D014 2-2A
- D015 2-2A
- PQU 2-2A

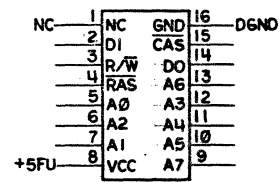

DETAIL FOR ALL 64K RAM

UPPER BYTE

METRIC <small>DIMENSIONS ARE IN MILLIMETERS</small> <small>TOLERANCES</small> <small>XX ANGLES</small> <small>(EXCEPT AS NOTED)</small>		apple computer inc. <small>NOTICE OF PROPRIETARY PROPERTY</small> <small>THE INFORMATION CONTAINED HEREIN IS THE PROPRIETARY PROPERTY OF APPLE COMPUTER, INC. THE POSSESSOR AGREES TO THE FOLLOWING:</small> <small>(1) TO MAINTAIN THIS DOCUMENT IN CONFIDENCE</small> <small>(2) NOT TO REPRODUCE OR COPY IT</small> <small>(3) NOT TO RESELL OR FURNISH IT IN WHOLE OR PART</small>	
<small>DRFT</small> <small>ENGR APPL</small> <small>RELEASE</small>	<small>3</small> <small>3</small> <small>3</small>	<small>3</small> <small>3</small> <small>3</small>	<small>3</small> <small>3</small> <small>3</small>
<small>DESIGNER</small> FITCH		<small>SCALE</small> NONE	
<small>SIZE</small> D		<small>DRAWING NUMBER</small> 050-4010-B	
		<small>SHT</small> 3/4	

050-4010-B 3/4

NOTE: UNLESS OTHERWISE SPECIFIED

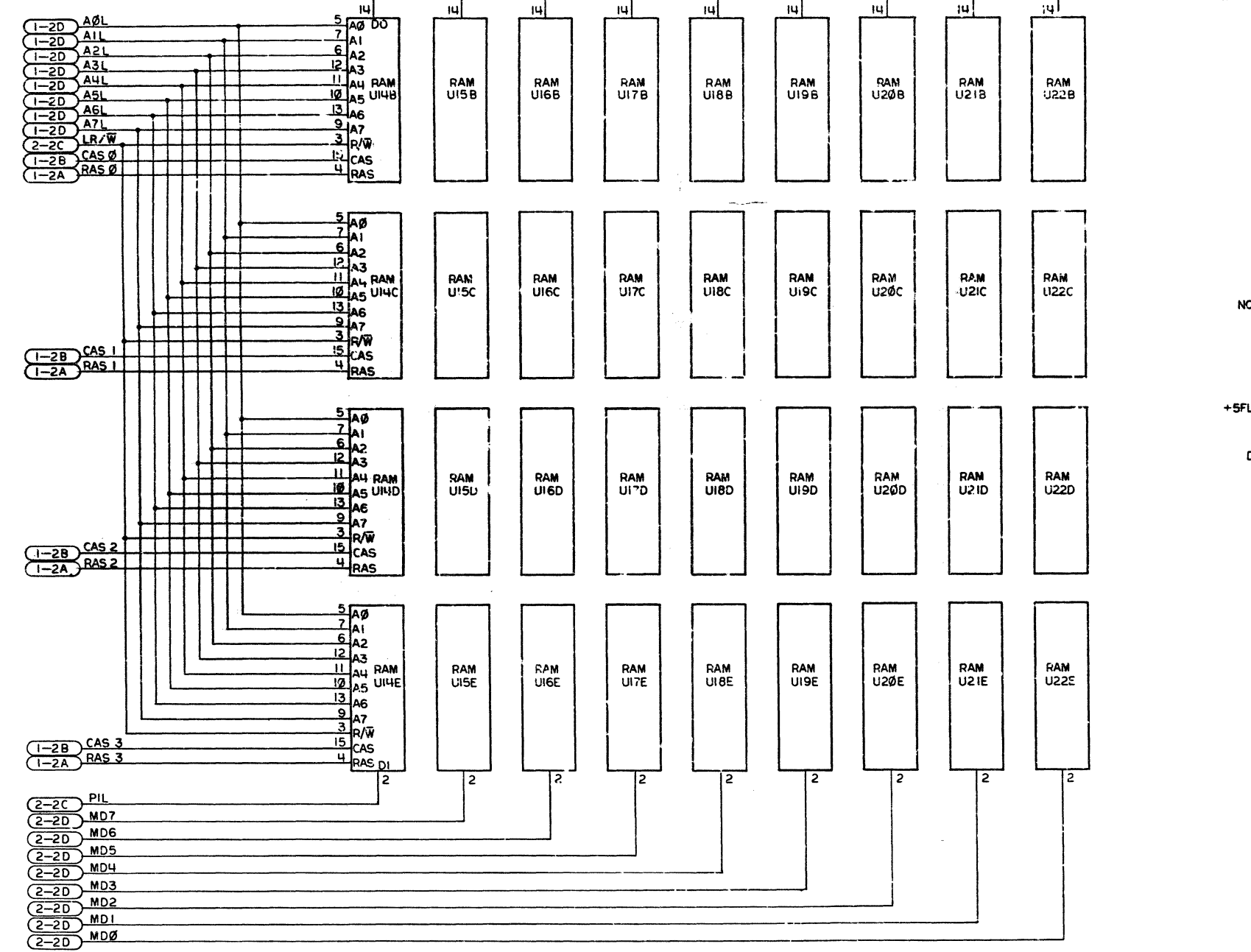

- POL 2-2C
- DQ7 2-2D
- DQ6 2-2D
- DQ5 2-2D
- DQ4 2-2C
- DQ3 2-2C
- DQ2 2-2C
- DQ1 2-2C
- DQ0 2-2C

REV. ZONE	ECO #	REVISION	APPD
		SEE SHEET 1	

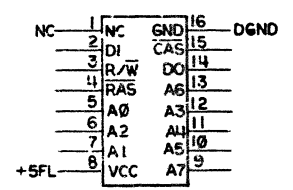

DETAIL FOR ALL 64K RAM

LOWER BYTE

<p>NOTICE OF PROPRIETARY PROPERTY</p> <p>THE INFORMATION CONTAINED HEREIN IS THE PROPRIETARY PROPERTY OF APPLE COMPUTER, INC. THE REPRODUCER AGREES TO THE FOLLOWING:</p> <p>TO MAINTAIN THIS DOCUMENT IN CONFIDENCE</p> <p>NOT TO REPRODUCE OR COPY IT</p> <p>NOT TO REVEAL OR PUBLISH IT IN WHOLE OR PART</p>			
<p>DATE: 8/22/82</p> <p>ENG/APPL: 3/22</p> <p>RELEASE: /</p>	<p>DRFT CA: 1/22</p> <p>DRFT APPL: 3/22</p> <p>DRFT DIV: /</p>	<p>SCALE: NONE</p> <p>SIZE: D</p>	<p>TITLE: SCHEMATIC, MEMORY BOARD LISA</p> <p>DRAWING NUMBER: 050-4010-B</p> <p>SHT: 4/4</p>

1/4 B-0104-050