

# THE ELECTRONIC ENGINEER

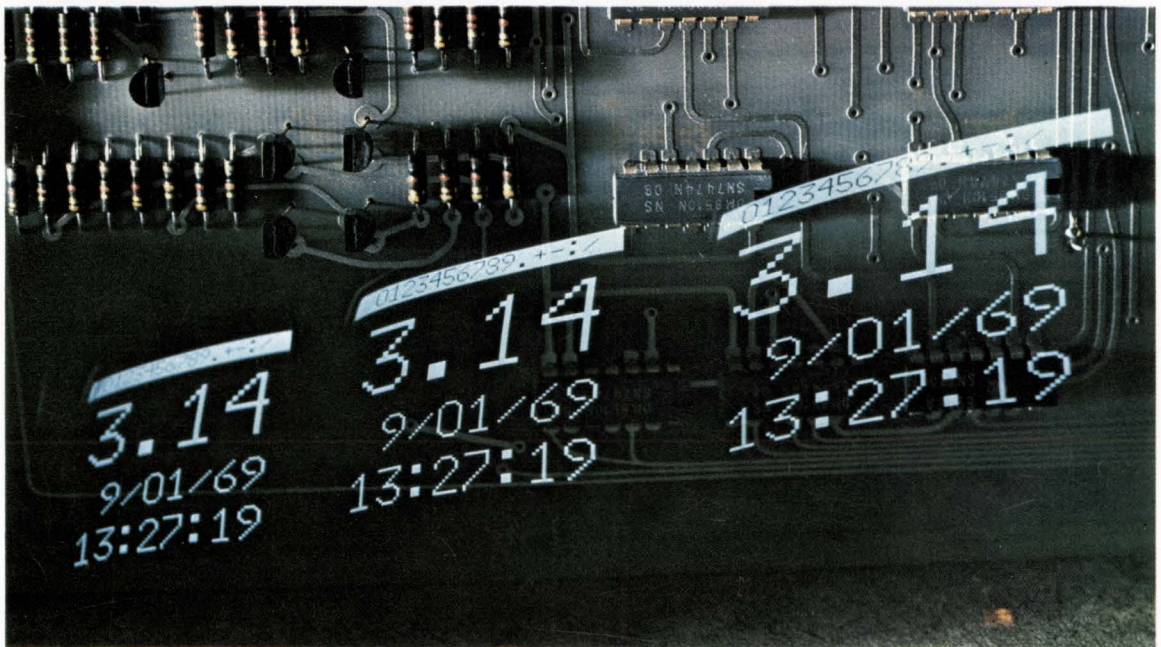

**Alphanumeric readouts on TV p. 93**

**New dot matrix readout p. 10**

**Design guide to hybrid package size p. 45**

**A code for environmental specs. p. 49**

**Get regulated current with FETs p. 64**

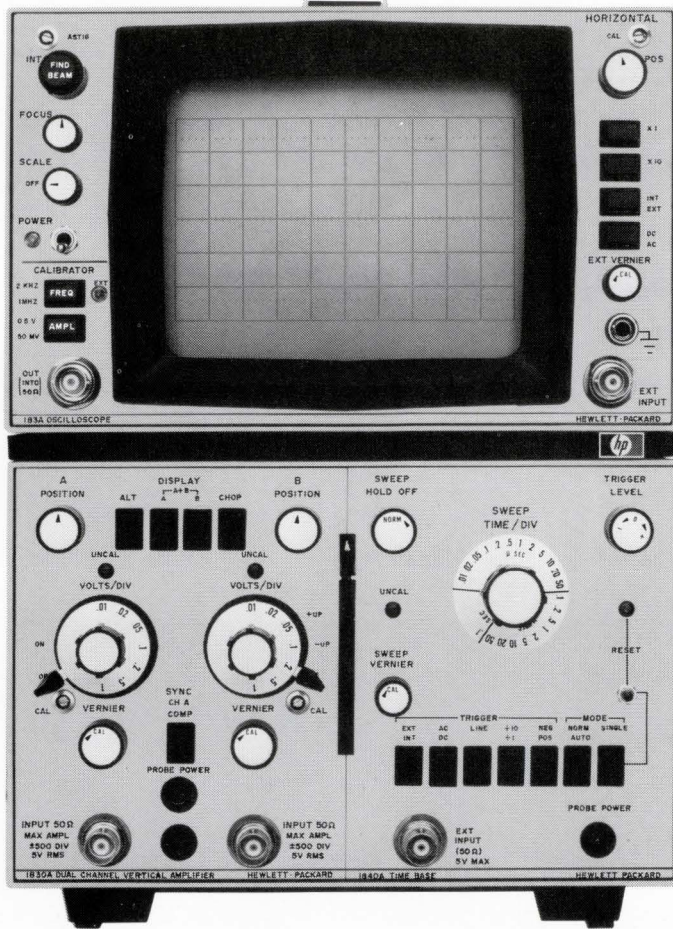

# 250 MHz Real Time With 10 mV Input

**New to the 180 System**—for the first time you can get a 6 centimeter vertical display of repetitive wave-forms or single-shot transients in frequencies from dc to 250 MHz. And, you can see these displays with only 10 mV/division input.

A major breakthrough in CRT technology provides the 183A with a high sensitivity CRT compatible with solid-state circuitry and bandwidths above 500 MHz. This capability will prevent the mainframe from limiting future advances in vertical plug-ins. The new CRT design also gives you a fast writing rate of 4 cm/ns, so you can have bright displays of low rep-rate, narrow pulses.

With the HP resistive dividers or active probes and the 50  $\Omega$  inputs you can make accurate measurements, regardless of your source impedances. Capacitive effects on rise time and CW amplitude have been minimized—VSWR is < 1.35:1 at 250 MHz, 10 mV/cm.

Since the 180 scopes first appeared in 1966, the all-solid-state concept has proved that service and maintenance are minimized. All-solid-state design also lends itself well to the versatile plug-in concept. Packed in small plug-in modules are such capabilities as dual-channel,

four-channel, 7 ns 50 MHz, 3.5 ns 100 MHz, 12.4 GHz sampling, 35 ps calibrated TDR, mixed sweep, delayed sweep, variable holdoff, differential/dc offset—to cover only part of the growing list of field-proven plug-ins, all of which are compatible with the new 183A. This versatility is possible because all 180 scope mainframes contain only the CRT and its power supply—you will not be mainframe-limited in the future selection of advanced plug-ins.

When your job depends on your measurements, when your reputation rests on your purchases, when you want maximum performance per dollar invested, **step forward with the growing HP 180 Scope System.**

For price and availability of the HP 183A 250 MHz Oscilloscope (cabinet or rack model), and other mainframes and plug-ins in the HP 180 Scope System, call your nearest HP field engineer. Or, write Hewlett-Packard, Palo Alto, California 94304. Europe: 1217 Meyrin-Geneva, Switzerland.

HEWLETT  PACKARD

OSCILLOSCOPE SYSTEMS

**All the advantages of tantalum...at low cost!**

# Type 196D Dipped Solid-Electrolyte Tantalex<sup>®</sup> Capacitors

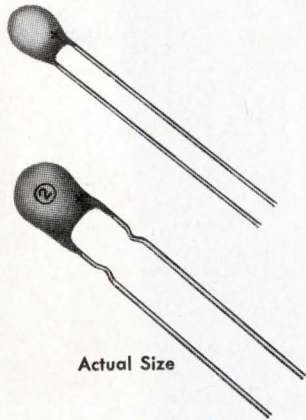

Actual Size

Circle 5 on Inquiry Card

Here's a capacitor design that admirably fills the need for low-cost yet dependable solid tantalum capacitors suitable for printed wiring boards. Straight leads as well as crimped leads are readily available to meet your manufacturing needs.

Covering a broad range of capacitance values from .1  $\mu$ F to 330  $\mu$ F, with voltage ratings from 4 to 50 VDC, Type 196D Capacitors are protected by a tough insulating coating which is highly resistant to moisture and mechanical damage.

45C-9124

**Tiny in size...Giants in volume efficiency!**

# Type 160D, 161D Solid-Electrolyte Tantalex<sup>®</sup> Capacitors for hearing aids and ultra-miniature circuits

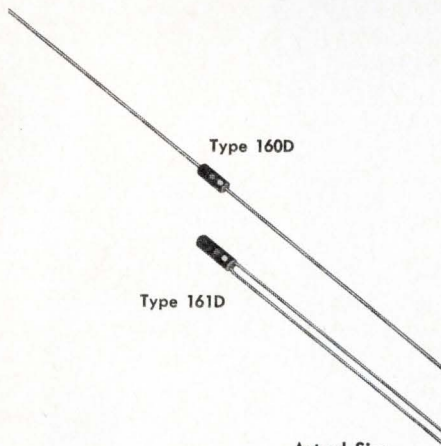

Type 160D

Type 161D

Actual Size

Circle 6 on Inquiry Card

Tiny Type 160D/161D Tantalex Capacitors are sealed within a polyester film tube with tightly-bonded epoxy fill, so the assembly is both electrically insulated and highly resistant to moisture. They are available with axial leads as well as in single-ended construction.

Offering extremely high capacitance per unit volume (for example: 0.25  $\mu$ F @ 20 VDC in a case only .065" D. x .125" L.), Tantalex Hearing-aid Capacitors let you select from a broad range of ratings in five different case sizes.

For complete technical data on Type 196D Capacitors, request Engineering Bulletin 3545A. For the full story on Type 160D/161D Capacitors, write for Engineering Bulletin 3515D. Address Technical Literature Service, Sprague Electric Co., 233 Marshall St., North Adams, Mass. 01247.

45C-9125

**SPRAGUE<sup>®</sup>**  
THE MARK OF RELIABILITY

Sprague<sup>®</sup> and <sup>®</sup> are registered trademarks of the Sprague Electric Co.

**THE BROAD-LINE PRODUCER OF ELECTRONIC PARTS**

1969  
*Viking  
Packaging  
Technology  
Symposium  
Report.*

Questions, answers, and enthusiastic discussion followed the Viking Packaging Technology Group's presentation of a new concept in computer circuit packaging at Wescon. The newly-designed system uses complete wire wrap back panels and related accessories. Interconnection of common circuit functions and operating power is accomplished by multi-layer bus strips that are simply pushed on to rows of Viking P/C wire wrap connectors.

Benefits: Quick, low-cost assembly. Low impedance, high capacitance, and low inductance.

And many, many more.

Write for our printed synopsis and schedule of up-coming symposiums in every major city.

VIKING  
INDUSTRIES  
INC.



21001 Nordhoff St. • Chatsworth, Calif. 91311 • Phone: (213) 341-4330 TWX: 910-494-2094

# THE ELECTRONIC ENGINEER

September 1969 Vol. 28 No. 9

Editorial . . . . .	9
Up to date . . . . .	10
Forefront . . . . .	17
Calendar . . . . .	22
Courses . . . . .	27
EEs Get Ahead . . . . .	32
Seminars . . . . .	34
Speak up . . . . .	36
Careers . . . . .	39
Books . . . . .	43
Microworld . . . . .	45
Lab . . . . .	49
Drawer . . . . .	61
Design Features . . . . .	64
IC Ideas . . . . .	73
Abstracts . . . . .	81
Product Applications . . . . .	85
New Products . . . . .	93
Microworld New Products . . . . .	100
Lab Products . . . . .	104
Literature . . . . .	122
Ad Index . . . . .	131
Product Index . . . . .	132

## Dot matrix lights with gas 10

Here is an inexpensive flat-panel display using gas discharge light emitters arranged in a dot matrix.

## One giant leap for mankind . . . One step backward for engineers 39

As the first men stepped out on the moon, hundreds of engineers stepped out of MOL. The electronic firms went immediately to work to help find their men jobs, with much success. Yet the specter of layoffs remains. By Joan Segal

## Design guide to hybrid package size 45

Package size is set by the area of the components and interconnects, and the power to be dissipated. Here is an easy way to figure out the package size.

## Environmental code: A shortcut to specifications 49

With this 10-digit code you can easily keep track of environmental specifications for both military and non-military parts and equipments. By Rudolf Wernick

## Guide to electrical tape 53

Here is another useful multi-color wall chart for you. It contains information that will guide you in the selection and use of electrical tape for your applications. Remove your copy before you forget.

## Divided-gap choke is a real swinger 61

Here's a better way to build swinging chokes. A divided air gap gives you larger swings, higher efficiency, and smaller size than in conventional chokes. By Herbert I. Keroes

## Get regulated current with FETs 64

With the rapid advancement of semiconductor technology, a two-terminal current regulator was inevitable. Today's state of the art in diodes is merely the beginning of a wide range of capabilities. Spark your imagination with these suggestions. By Bob Botos

## IC Ideas 73

- Zero-symmetry sweep circuit . . . . . C. J. Huber
- Clock waveform maintains its symmetry . . . . . C. A. Herbst
- Simple-to-make toggling flip-flop . . . . . T. P. Benzie
- Linear agc amplifier has 30-dB range . . . . . R. C. Gerdes

## New approach to alphanumeric readouts 93

Inexpensive TV monitors provide the key to low-cost display of messages. By Jay Freeman

### COVER

What's the most economical way to display a message? In this system by Applied Digital Data Systems, character generators build alphanumeric characters, line by line, on an inexpensive TV monitor. When the number of characters to be displayed is small, the most economical choice may be to build the message, character by character, out of individual readouts, or line by line with matrices of dots. For more information on this timely subject read the articles on the TV display (page 93) and on the dot-matrix (page 10).

# There is only ONE authentic method to measure Phase Angle...

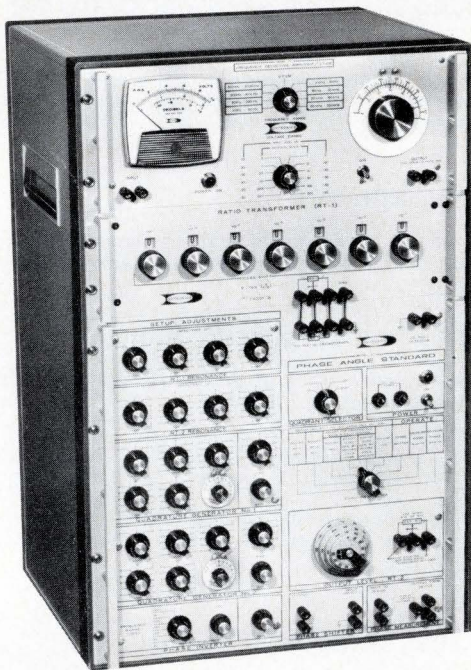

## And this is it!

An original technique for the measurement of phase angle has been developed by Dytronics. It's recognized as an authentic "PRIMARY" technique. Measurements are dependent upon fundamental concepts, and not upon secondary considerations. The results . . . absolute unmatched performance. Hundreds of these instruments are in use throughout the world.

Dytronics also has Tunable Electronic Filters (d-c to lower radio frequencies) for separating frequencies.

For full details about these and other products, contact Dytronics Company, Inc., 4800 Evanswood Drive, Columbus, Ohio 43229.



**EE**

## The Electronic Engineer Vol. 28 No. 9 September 1969

Alberto Socolovsky, *Editor*  
John E. Hickey, Jr., *Managing Editor*  
Smedley B. Ruth, *Associate Editor*  
Sheldon Edelman, *Associate Editor*  
Stephen A. Thompson, *Western Editor*  
Robert Patton, *Eastern Editor*  
Joan Segal, *Assistant Editor*  
Joseph T. Griffin, *Assistant Editor*  
Dr. O. M. Salati, *Consultant*  
Anne Axe, *Editorial Assistant*  
Dorothy Vondran, *Editorial Assistant*  
Lynda Rothstein, *Editorial Assistant*  
Mae Moyer, *Editorial Reader Service*  
Andrew Mittelbrunn, *Chilton Art Director*  
Phaue Featherson, *Artist*  
George Baker, *Washington News Bureau*  
Neil Regeimbal,  
K. Robert Brink, *Publisher*

Chilton 

### Executive and Editorial Offices:

One Decker Square, Bala Cynwyd, Pa. 19004

Tel. (215) SH 8 2000

Address Mail to: 56th & Chestnut Sts.  
Philadelphia, Pa. 19139

### Western Office: Stephen A. Thompson

1543 W. Olympic Blvd., Los Angeles, Calif. 90015

Tel. (213) DU 7-1271

### New York Office: Robert Patton

100 E. 42nd St., New York, N.Y. 10017  
Tel. (212) OX 7-3400

Chilton Officers & Directors: Chairman of the Board: G. C. Buzby; President: R. E. McKenna; Financial Vice-President: S. Appleby; Senior Vice-Presidents: J. Kofron, L. King; Vice-President: H. Barclay; Publishing Vice-Presidents: C. W. Hevner, W. A. Barbour, R. H. Groves, K. Robert Brink; Treasurer: James Miades; Secretary: J. A. Montgomery, Jr.; Other Directors: T. J. Casper, S. H. Collmann, R. Rimbach, Jr.; Asst. Secretary: I. C. Holloway.

Monthly publication of Chilton Company, Chestnut & 56th Sts., Phila., Pa. 19139. (Area Code 215) SHERWOOD 8-2000. Controlled circulation postage paid at Philadelphia, Pa. \$1 a copy. Subscription rates U. S. and U. S. Possessions: 1 yr. \$12.00; 2 yrs. \$20.00. Canada 1 year \$14.00; 2 yrs. \$25.00. All other countries 1 yr. \$20.00; 2 yrs. \$35.00. © Chilton Company 1969. Title Reg. U.S. Patent Office. Reproduction or reprinting prohibited except by written authorization.

The Chilton Electronics and Instrumentation Group •  
The Electronic Engineer ■ Instruments and Control  
Systems ■ Instrument & Apparatus News ■ Medical  
Electronics News ■ Electronic Component News

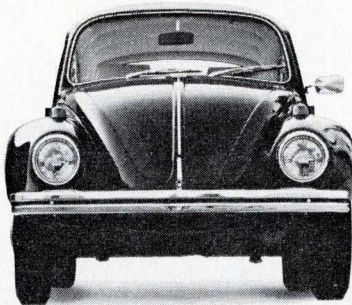

# Win a bug for Christmas.

No big thing. Just whip out the stub of a pencil and jot down one little idea. An application for the Minilever<sup>®</sup>. Either a brand-new application, or as a replacement in an existing system.

The Minilever<sup>®</sup> is a lot like the bug: Beautifully built, efficient, compact, and economical over the long haul. It's designed to increase operator efficiency where frequent, rapid switch-settings are required. Its lever clicks over a

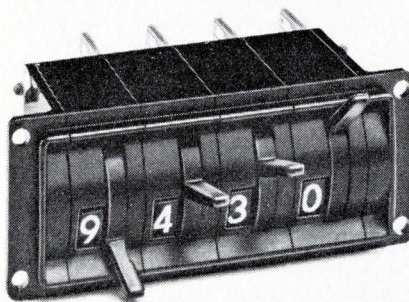

90-degree arc as the wheel rotates displaying 0.200 inch high characters. And a sweep of the hand re-sets everything—up to 12 positions—back to zero.

Now, if you circle the reader card number below, we'll send you the two things you'll need to win: Our Official Entry Blank, and a Spec Sheet that details why and how the Minilever<sup>®</sup> works.

Okay?

## THE DIGITRAN COMPANY

A Division of Becton, Dickinson and Co. **B-D**

855 So. Arroyo Pkwy., Pasadena, Calif. 91105  
Phone (213) 449-3110 TWX 910-588-3794

# PNP/NPN COMPLEMENTARY POWER SWITCHES

This month's power products include eight high-powered NPN/PNP complementary power switches capable of handling loads of 10 and 20 amps. They're new to the industry, so you've never seen the 2N numbers before. But you'll see a lot of them from now on.

We've built these complementary pairs with our double diffused epitaxial Planar\* technology so they don't just switch power—they switch it safely. Besides excellent reverse-biased safe area operation for handling highly inductive loads, this technology gives you faster switching times. Better overall switching characteristics. Very low  $V_{CE(sat)}$  and  $V_{BE}$ . And transistors that operate over the full  $-65^{\circ}\text{C}$  to  $+200^{\circ}\text{C}$  temperature range. At competitive prices.

#### NEW:

CURRENT	PACKAGE	NPN	PNP COMP.
10A	TO-5	2N5729†	2N5769†
	TO-59	2N5730†	2N5770†
20A	TO-3	2N5732†	2N5772†
		2N5731†	2N5771†
	TO-61	2N5313	2N5312
		2N5315	2N5314
		2N5317	2N5316
		2N5319	2N5318

†New to the industry

In case you've forgotten, we've also got some other complementary power switches you might find useful:

#### NOT-SO-NEW, BUT AVAILABLE:

CURRENT	PACKAGE	NPN	PNP COMP.
2A	TO-39	2N5148	2N5147
		2N5150	2N5149
	TO-59	2N4998	2N4999
5A	TO-39	2N5152	2N5151
		2N5154	2N5153
	TO-59	2N5002	2N5003
10A	TO-61	2N5004	2N5005
		2N5006	2N5007
		2N5008	2N5009

Both the new and the not-so-new devices are on your Fairchild distributor's shelves. Grab a handful now.

\*Planar is a patented Fairchild process.



**THE  
GREAT  
FAIRCHILD  
POWER  
GRAB**



# FAIRCHILD'S POWER GRAB GOES ON!

So far in the Great Fairchild Power Grab, we've introduced our NPN Power Switches and Amplifiers. Our PNP Complementary Power Switches and Amplifiers. And our NPN/PNP Complementary Power Switches. A lot of second-source devices. And a lot of devices no one else can make.

They're all listed below. Just take your pick. You'll never have a better choice. (Until next month, when we bring out our Plastic Power Transistors.)

PACKAGE	NPN DEVICE	DATA PLEASE	PACKAGE	NPN DEVICE	DATA PLEASE	PACKAGE	PNP DEVICE	DATA PLEASE	
TO-3	2N3055	_____	TO-61	2N5002	_____	TO-3	2N3789	_____	
	2N3232	_____		2N5004	_____		2N3790	_____	
	2N3233	_____		2N5346	_____		2N3791	_____	
	2N3234	_____		2N5347	_____		2N3792	_____	
	2N3442	_____		2N5348	_____	2N4398	_____		
	2N3713	_____		2N5349	_____	2N4399	_____		
	2N3714	_____		2N5477	_____	**2N5772	_____		
	2N3715	_____		2N5478	_____	TO-5	2N4234	_____	
	2N3716	_____		2N5479	_____		2N4235	_____	
	2N3771	_____		2N5480	_____		2N4236	_____	
	2N3772	_____		2N5730	_____	**2N5769	_____		
	2N3773	_____		TO-63	2N2811	_____	TO-39	2N5147	_____
	2N4913	_____			2N2812	_____		2N5149	_____
	2N4914	_____			2N2813	_____		2N5151	_____
	2N4915	_____			2N2814	_____	2N5153	_____	
	2N5038	_____			2N4301	_____	TO-59	2N4999	_____
	2N5039	_____			2N5006	_____		2N5001	_____
	2N5067	_____	2N5008		_____	2N5003		_____	
	2N5068	_____	2N5313		_____	2N5005		_____	
	2N5069	_____	2N5315		_____	**2N5770		_____	
2N5301	_____	2N5317	_____		TO-61	2N5007	_____		
2N5302	_____	2N5319	_____	2N5009		_____			
2N5303	_____	2N5731	_____	**2N5312		_____			
2N5732	_____	TO-66	2N3597	_____		**2N5314	_____		
2N5734	_____		2N3598	_____	**2N5316	_____			
TO-5	2N3439		_____	2N3599	_____	**2N5318	_____		
	2N3440		_____	2N4002	_____	**2N5771	_____		
	2N4300		_____	2N4003	_____	TO-66	2N3740	_____	
	2N4877		_____	2N5733	_____		2N3741	_____	
	2N5336	_____	2N3054	_____	2N4898		_____		
	2N5337	_____	2N3441	_____	2N4899		_____		
	2N5338	_____	2N3738	_____	2N4900	_____			
2N5339	_____	2N3739	_____	**NEW THIS MONTH					
2N5729	_____	2N4910	_____						
TO-39	2N5148	_____	2N4911	_____					
	2N5150	_____	2N4912	_____					
	2N5152	_____	2N4912	_____					
	2N5154	_____	2N5427	_____					
TO-59	2N4998	_____	2N5428	_____					
	2N5000	_____	2N5429	_____					
			2N5430	_____					

NAME \_\_\_\_\_ ADDRESS \_\_\_\_\_

COMPANY \_\_\_\_\_ CITY \_\_\_\_\_

DEPARTMENT \_\_\_\_\_ STATE \_\_\_\_\_ ZIP \_\_\_\_\_



A Division of Fairchild Camera and Instrument Corporation / Mountain View, Calif. 94040 / (415) 962-5011 TWX: 910-379-6435

Circle 10 on Inquiry Card



One  
diode.

One cavity.  
One watt.

Now Varian delivers the highest power single-diode oscillators on the market. These Impatt-mode devices put out 1 watt CW in C or X band, operate at 6% typical efficiencies and require only 160 mA at 95 Vdc for X band or 110 mA at 150 Vdc nominal for C band.

Operating frequency range is from 6 to 10 GHz. Two versions are offered: a  $\pm 250$  MHz tunable model and a fixed-frequency model. Delivery is 60 days or less.

These Varian oscillators are available with optional current regulators and power supplies, operating from 115 Vac, 60-400 Hz, or 28 Vdc. Or you can order the high power Impatt diode alone.

Only from Varian. What you need in Microwave Solid State. Contact our more than 30 Electron Tube and Device Group Sales Offices around the world, or call our Solid State Microwave Operation, Salem Road, Beverly, Massachusetts.



Circle Reader Service No. 40.

## Who should write op amp specs?

Remember the charts on commercial op amps (both monolithic and hybrid) that we recently published? [The Electronic Engineer, June 1969, pp. 61-71.] These charts included a set of proposed definitions for the parameters we charted. Well, these definitions are causing quite a furor in the op amp field.

The definitions we published were based on a draft by the MED-20 committee of the Electronic Industries Association. This committee, which is responsible for microelectronic terms, definitions, and symbols, acts on recommendations made by the MED-33 committee on analog devices. It turns out that MED-33 consists mainly of manufacturers of monolithic operational amplifiers such as Fairchild Semiconductors, Motorola, RCA and Texas Instruments—who have been selling op amps for the past four years—plus a few users such as Boeing, General Dynamics, and the Applied Physics Lab.

So where's the furor? It's at the camp of the classical manufacturers of operational amplifiers such as Analog Devices, Burr-Brown, Philbrick-Nexus, and Fairchild Controls (sister of the Semiconductor Div.), whose interest in operational amplifiers in some cases predates even the advent of transistors, let alone integrated circuits. These manufacturers, who now make both hybrid *and* monolithic op amps, complain that the definitions recommended by MED-33 and endorsed by MED-20 are not realistic.\*

Who is right? As with all things in our industry, it's what you, the user, thinks that counts. And our experience is that you usually don't care whether an operational amplifier is monolithic or hybrid, as long as it satisfies your application. But the situation changes when an institution of the prestige of the EIA endorses a set of definitions.

Actually, the problem exists because the big manufacturers of integrated circuits—who make monolithic IC op amps—are members of the EIA, while the smaller manufacturers of op amps are not. Ironically, these manufacturers find themselves in the same situation where some of their rivals were just over ten years ago, when they first fought and then joined the EIA over the JEDEC standards for transistors. If the manufacturers of operational amplifiers feel that EIA standards carry any weight with their customers, they would be better advised to join it rather than fight it. And they will find that they'll be ahead in the bargain, since EIA membership renders benefits that go beyond the writing of definitions.

In the meantime, we are seeing some positive steps. As we close this edition, the MED-20 and 33 committees are meeting at a hotel in San Francisco, a few doors away from a meeting of the manufacturers of op amps. We hope these manufacturers will take positive steps to make their reputable opinions heard—either as members or as a group—at the MED committees. If they don't, the loss will be not only theirs—but yours, too.

*Alberto Socolovsky*  
Editor

\*To give you some idea about the complaints, here is what Alan Risley of Philbrick-Nexus says about the definitions for bias current and bandwidth:

"The definition proposed that the bias current be one-half the sum of the separate bias currents entering into the two input terminals of a balanced amplifier . . . is very misleading, since this represents the average of the two bias currents. . . . The averaging tends to hide the fact [that the two separate currents may not be equal] and makes the bias current specification look better than it is. . . ."

"To specify the  $-3$  dB point for op amps is rather meaningless since when the loop is closed, the open-loop  $-3$  dB point does not provide any useful information for closed loop consideration. . . . The unity gain bandwidth provides more information than the  $-3$  dB point for closed loop considerations especially if the amplifier does not have a 6 dB/octave rolloff, but a combination of rolloffs."

## Dot matrix lights with gas

A new dot-matrix panel display by Burroughs

.0123456789+- E.

Burroughs Corp., Electronic Component Division showed a flat-panel-display at WESCON. It uses gas discharge light emitters arranged as a dot-matrix and displays an entire message rather than a few numbers. Ionized-gas readout tubes (such as the Nixie®) or other digital readouts are still the most economical for a few digits. However, for large messages, an expensive CRT such as the Hughes "Charactron" is the best choice. The Burroughs dot-matrix display fits neatly between these two categories and promises to be the most economical display for messages with about 10 to 300 characters.

The array is being introduced as a 7 x 112 dot matrix (about 8½ inches long). It is either 16 digits

(continued on page 13)

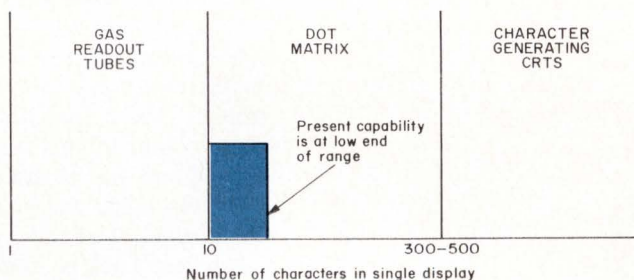

**Practical ranges of characters for single displays.** Below 10 digits, the dot matrix becomes more expensive per digit than gas tubes, while above 300-500 characters, CRTs are more economical. Contrast this with the CRT-vs-gas tube graphs shown in the article "New approach to alphanumeric readouts" on page 93 of this issue. Although the present capability for dot matrices is at the low end of their applicable range, their true value will be in larger arrays to come.

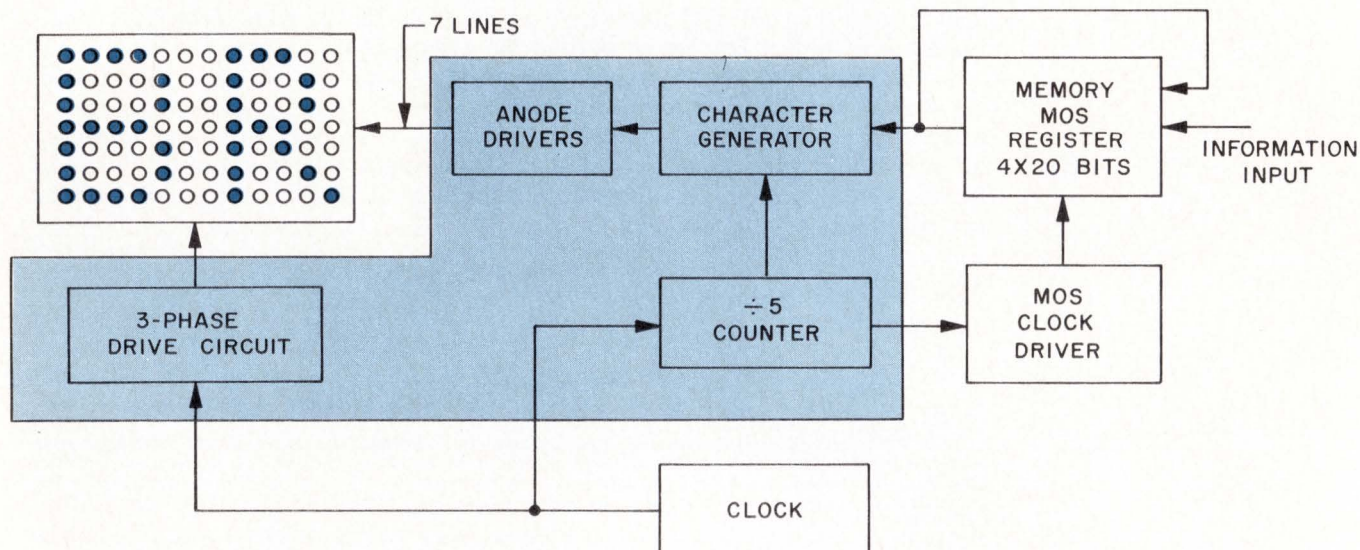

The block diagram of a 16-digit dot-matrix display shows the necessary components required to operate the actual array. The circuitry enclosed in the colored block is supplied by the

manufacturer with the dot matrix. The user must supply the rest. Notice that all the components are designed to interface directly with low-level MOS, DTL, or TTL circuitry.

There was a time when network analysis was a long, drawn-out process — consisting of *measuring* amplitude and *interpreting* phase response.

Now, with the HP 675A/676A network analysis system, you get a complete characterization of your network. You have **both** phase and amplitude information on a swept basis to 32 MHz — and you save hours of time because you can see changes in phase and amplitude responses as you make adjustments. Add the HP 11138A impedance measuring accessory for making complex driving point impedance measurements on a swept basis — and you have a complete network analysis system.

You can use this analysis system for your circuit design checking, operational amplifier characterization, crystal characterization, classroom demonstrations and many other applications. The system is completely programmable for automatic or computerized production and quality analysis testing.

The 675A Sweeping Signal Generator has a 10 kHz to 32 MHz range with settings anywhere in this range for single or continuous sweep. The 676A Phase/Amplitude Tracking Detector adds a full 360° phase measurement capability and an 80 dB dynamic amplitude range.

Channel A and B outputs on the 676A provides simultaneous amplitude measurements of two devices for comparison. Amplitude A-B and

PHASE A-B make difference measurements easy. Outputs can be easily calibrated in linear dB and linear phase on a low frequency oscilloscope or X-Y recorder.

Get complete characterization of your network with the HP 675A/676A network analysis system. Call your HP field engineer for complete specifications. Or, write to Hewlett-Packard, Palo Alto, California 94304. Europe: 1217 Meyrin-Geneva, Switzerland. Price: 675A, \$2250; 676A \$1275; 11138A, \$175.

**HEWLETT  PACKARD**  
SIGNAL ANALYZERS

099/14

# Now You Can Completely Characterize Your Networks to 32 MHz

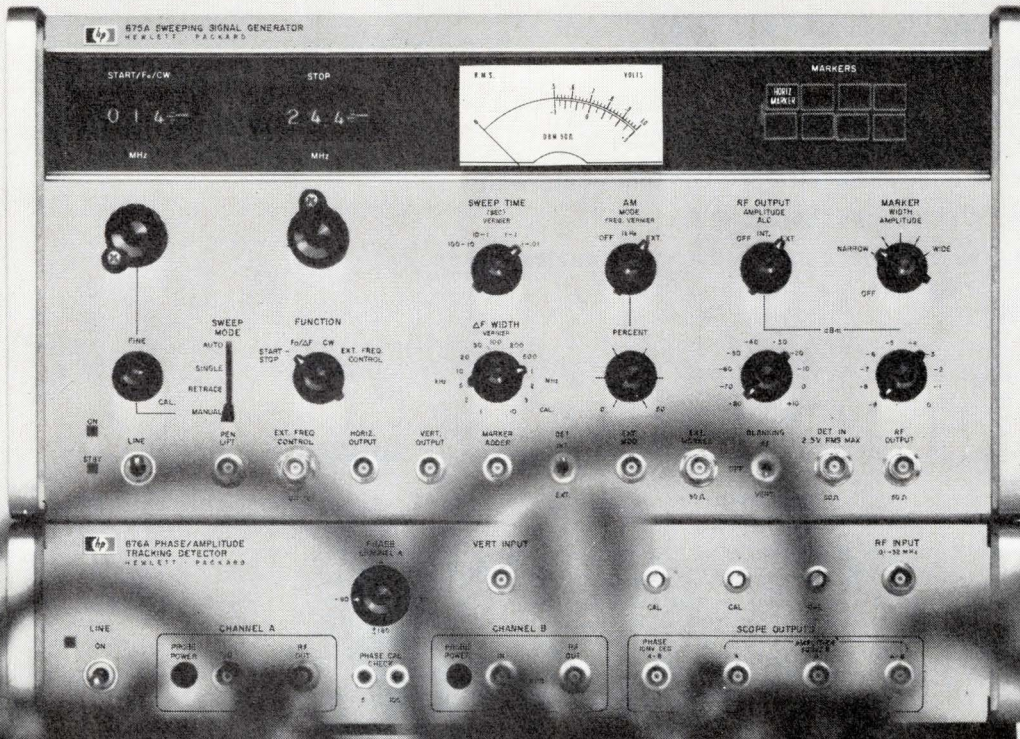

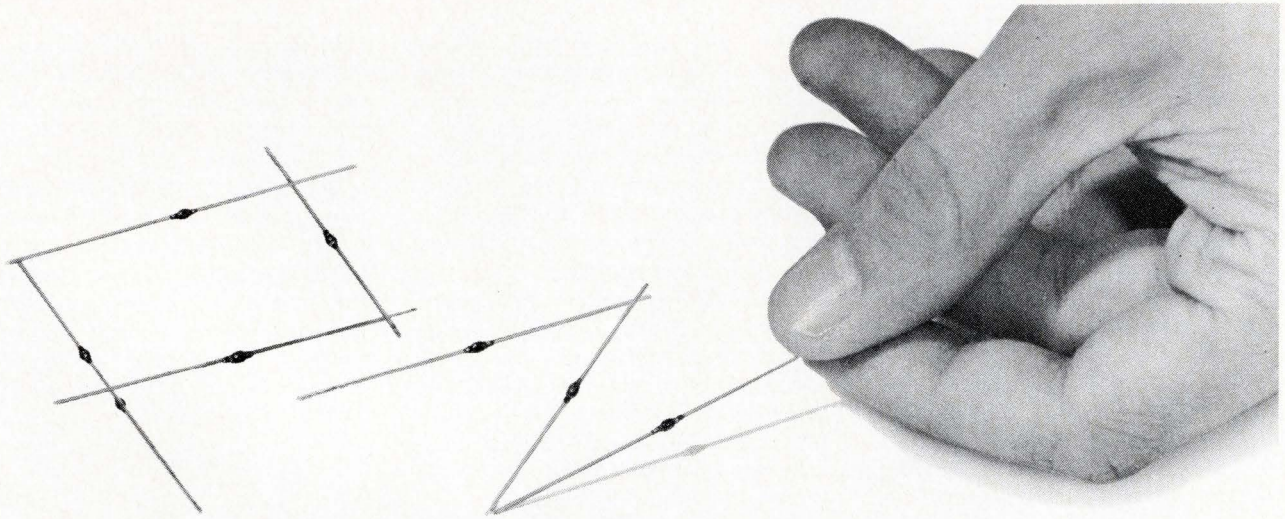

## Introducing the PZ Zener

The new fused-in-glass  
1 watt zener . . .

Typical Unitrode fused-in-glass  
stability and high-performance at  
the price of an ordinary device

Order your free samples today

- Fills the bill from 400 mw thru 1 watt
- Voltages from 6.8 to 200 V
- 8 millisecond surges to 30 watts
- Low reverse current — to 500 nA
- A quarter the size of a conventional 1 watt
- Weighs less than 1/4 gram
- No plastics, epoxies, silicones, oxides, gases, or solders are used

580 Pleasant St., Watertown, Mass. 02172 • (617) 926-0404

# UNITRODE

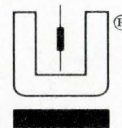

TOUGH AS ALL GET-OUT FROM THE INSIDE OUT

With the silicon die metallurgically bonded between terminal pins of the same thermal coefficient, the hard glass sleeve is fused to the entire outer silicon surface. Result — a voidless, monolithic structure.



### 4 EASY WAYS TO GET FREE SAMPLES AND SPECS

1. Call Bud Anderson COLLECT, at (617) 926-0404.
2. Call your nearest Compar office.
3. Call your nearest Daniel & Co. office.
4. Check off the magazine Reply Card number.

**Dot matrix lights with gas (continued)**

(5-column characters with 2-column spaces between characters) or 18 digits (5-column characters with 1-column spaces). The light output is 200 foot-lamberts—among the brightest arrays available. The array is supplied with the logic drivers (3 for the columns and 7 for the rows), a counter, and a character generator. The first displays will be numeric only (1-2-4-8 BCD input to the character generator) with alphanumeric displays available late this fall.

The present 7 x 112 dot matrix—designed for calculators, instruments, data terminals, and cash registers—costs about \$250 (as low as \$70 in large quantities) for the 16 digits. This low price makes the Burroughs dot array more economical than any other dot matrix. Last December, Hewlett-Packard introduced its 5082-7000 light-emitting gallium arsenide-phosphide matrix of mesa diodes. However, it has a total price per digit of about \$75 in single units (compared with Burroughs' cost of about \$16 per digit-16 digits minimum). Monsanto, on the other hand, has a device with a 7-bar pattern of bar-shaped light-emitting diodes and a price tag of \$48 in single units. But, Monsanto is also planning to introduce a dot-matrix read-out. Even the quantity prices for these diode arrays don't compare with the Burroughs gas-discharge matrix. Of course, the low voltage required (4 V) for the diode arrays make them very appealing when compared with the 250 V supply needed for the gas-discharge array. Also, as with other semiconductors, it is a good bet that the price of the diodes will go way down as manufacturing techniques improve.

For further information on the manufacturers and their products, circle the numbers to the right on the Inquiry Card.

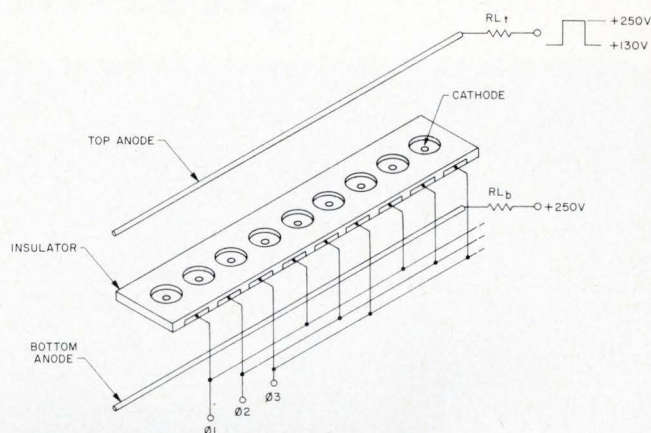

Here is what a single row in the Burrough's dot array looks like. It shows the cathode structure, driven by a 3-phase scanning voltage. Since the bottom anode is always at 250 V, then when any cathode turns on, a glow appears at the back of the panel (underneath, in the figure) invisible from the front. If the glow starts at  $\phi 1$ , then when  $\phi 2$  turns on as  $\phi 1$  turns off, the glow will be transferred to the second column, and then to the third column, and so on down all the columns. The entire array is scanned in this manner 50-60 times a second. Burroughs calls this feature SELF-SCAN®. Now, if the upper anode is pulsed at the same speed as the cathode scan and in synchronism with a certain column, then the glow behind that particular dot spreads through the small circular aperture in the center of a dot and mushrooms to the front of the array (top, in the diagram). That particular dot then becomes visible to the observer. By adding additional cathodes a row can be expanded to any length in the horizontal direction but still requires only a single three-phase driver for all the cathodes. By lengthening all the cathodes and adding additional anodes, the array can be expanded in the vertical direction (each row requires its own driver).

**Burroughs Corp.**  
**Hewlett-Packard**  
**Monsanto**

**Circle Number 268**  
**Circle Number 269**  
**Circle Number 270**

**Listening to stress and strain**

Battelle-Northwest scientists are working on a device which can detect fatigue in aircraft structures during flight. This system will also have use in many other areas of testing. During the early tests, the scientists placed transducers on each wing near the connection of the strut and wing spar of a single engine, single wing aircraft. Instruments inside the aircraft monitored the acoustical emissions from the wing spar.

The aircraft, equipped with the stress-detecting transducers, was flown through several abrupt climbs and dives which were measured in "g's." Many burst-type

acoustical emission signals resulted from the high flight maneuvers, indicating a very slight plastic strain on the parts. The strain was not enough to alter the structural integrity of the spar, nor was there any visual change in appearance of the part.

This acoustical emission technique is so sensitive, however, that even these slight strains were easily detected. Before the "listening" device becomes completely practical, more work and study must be done by Battelle-Northwest, P.O. Box 999 Richland, Washington 99352.

# Meet the talented toggles with the multiple-circuit personalities

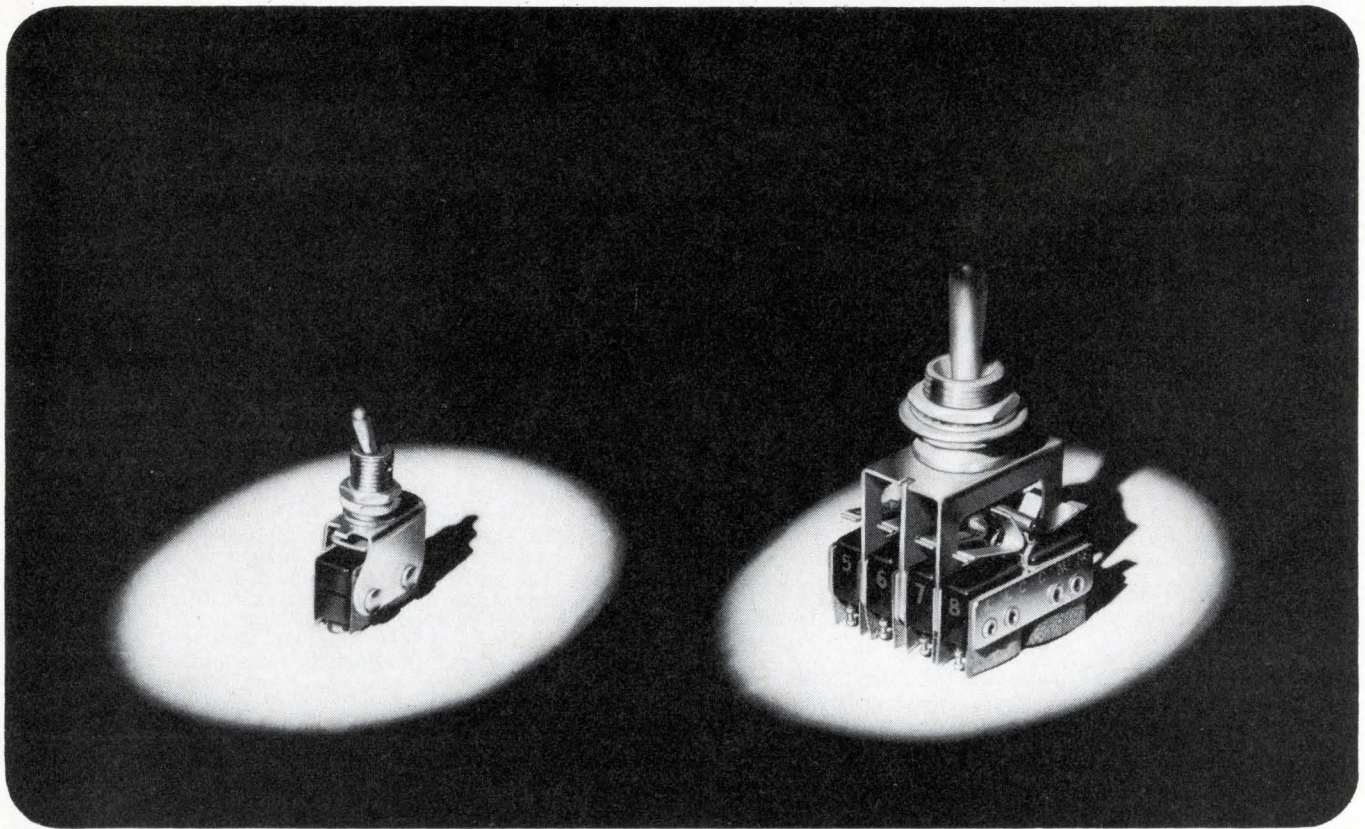

You may be surprised when you discover all the action and control combinations you can have in one compact AT toggle switch.

These assemblies offer scores of control options. For example, in just one assembly, you can actuate up to a dozen precision, snap-action SPDT

switches. You can get subminiature switches with gold contacts for dry circuit reliability, V3 switches with 15-amp capacity, and even hermetically sealed switches for the utmost in sealed protection.

You can also choose from a wide selection of toggle actions: main-

tained or momentary, 2- or 3-position, and pull-to-unlock levers.

And, no matter which switch you select, you'll get that old reliable MICRO SWITCH quality!

Call a Branch Office or Distributor (Yellow Pages, "Switches, Electric"). Or, write for Catalog 51.

AT toggle switch assemblies offer 145 versions of 7 basic types.

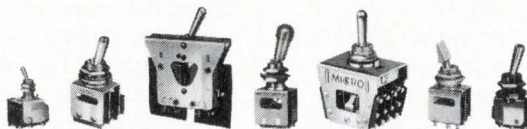

## MICRO SWITCH

FREEPORT, ILLINOIS 61032  
A DIVISION OF HONEYWELL

HONEYWELL INTERNATIONAL • Sales and service offices in all principal cities of the world. Manufacturing in United States, United Kingdom, Canada, Netherlands, Germany, France, Japan



## Prism transfers laser light to thin-films

Passing laser light through thin-films may lead to laser amplifiers, light modulators, harmonic generators, and parametric oscillators.

Bell Lab scientists are working hard toward the integration of laser and thin-film solid state circuits and have made an interesting step forward. They are using prisms to guide laser beams into thin crystal films. The laser beams are flattened by the prism, which then couples the laser light into a thin-film for transmission.

Before using the prism, Bell Lab's people attempted to concentrate the beam directly through the film's edge. However, the ragged edge of semiconducting film scattered the light. In addition, such a film is generally much thinner than the laser beam, sometimes many thousands of times thinner. Even if the beam could have been focused to the size of the film, the precise alignment of the beam and the film was impractical.

In the new prism setup, the base of the prism is placed parallel to the film, but at a precisely controlled distance away. The laser beam, entering the prism through its longest side, reflects from the base, as predicted by laws of optics. However, laser energy is not reflected totally. A portion of the light waves "tunnels" through the gap between the prism base and the film and generates evanescent electric and magnetic fields in the film.

Early experiments show more than 50% of the incident laser energy can be transferred into the film. Theoretical calculations predict a transfer efficiency of 80%.

The light waves travel in semiconductor films—very much like electromagnetic waves in waveguides—in predictable and distinct patterns or modes. Acting as a dielectric waveguide, the film can support a number of different modes. They move at different speeds and do not interfere with each other.

The major parameters are the angles at which the laser beams enter the prism and the size of the gap between the film and the base of the prism. The separation between the film and the base of the prism is very critical. It must be small enough to insure significant coupling strength, yet large enough to prevent the light from coupling back into the prism. A typical gap width is one-half the wavelength of the light. The necessary angle of incidence is influenced by the characteristics of the film, of laser beam, and of the prism material.

To couple energy into the film, the speed of the evanescent fields must match exactly the speed of the desired mode in the film. Modes in the film have distinctly oriented electric and magnetic field components. They are polarized. To couple the beam, the incident beam must have the same polarization as the mode to be generated.

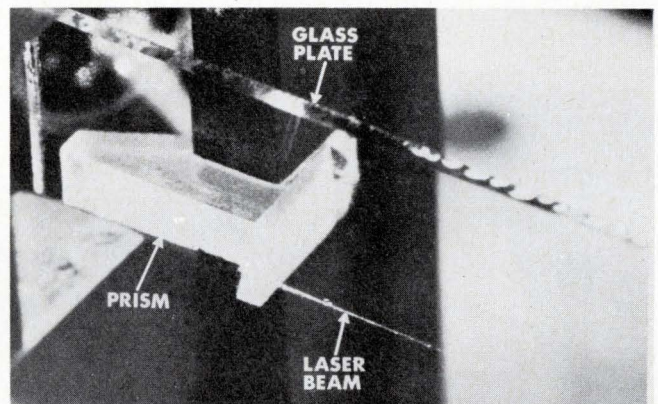

The streak of light in the photo is a laser beam traveling in a very thin crystal film deposited on the back side of the glass plate. The prism feeds a laser beam to the thin-film.

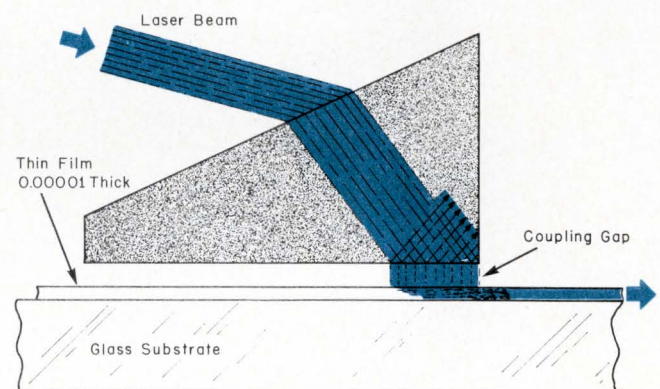

A rutile prism feeds light into a thin, semiconducting film. The light waves "tunnel" out of the prism base and create fields in the coupling gap. The laser energy from these fields is transferred into the film. The angle of prism, polarization, and gap size are critical points.

Rutile (titanium dioxide) prism and films of zinc oxide and zinc sulfide were used by BTL. The films were deposited on glass plates and held at the proper distance by a mechanically adjustable arm.

By using this coupling system, the scientists are taking a promising step towards integration of laser and thin-film solid state circuits. They foresee the development of new laser amplifiers, light modulators, harmonic generators and parametric oscillators. All may be useful in thin-film form for future laser communication systems.

**LITPAK  
POWTRAN**  
SOLID STATE  
SSPI PRODUCTS  
DIVISION OF UNITRACOR CORPORATION



**OFFICE OF THE EMBASSY**  
18 Newbury Street, Boston, Massachusetts 02116

Cmsr. Ivan Nyork  
INTERSAB  
1919 Blorvich Blvd.  
Moscow, U. S. S. R.

15 August 1969

Dear Comrade Ivan:

Regarding the Capitalist Imperialist capabilities in the area of power transistors:

Our sources reveal that their foremost manufacturer, SSPI, has introduced such a wide number of power transistors that we can only suspect the Americans of not knowing what they really want. SSPI offers devices rated from 300 m.a. up to 30 amps, for five different current ranges, capable of handling up to 150 watts, in 10 different packages. This wasteful display of versatility suggests that SSPI is merely showing off for the favors of the Design Engineer. The devices all display an extravagantly high and flat Beta.

As for dependability: we have tested 53,789 of them, without a single failure. However, we remain optimistic.

Actual specs and prices are documented in the attached power-transistor literature package called LITPAK-POWTRAN. (We have not yet been able to translate this word.) Comrade Petrasha obtained the document under his cover name (Comrade Hilton) by writing direct to Mr. Alex Polner at SSPI, 1 Pingree Street, Salem, Massachusetts 01970, (617) 745-2900, as the American engineers do.

My kindest regards to your wife Anna, and to your brother Alexei after his unfortunate disagreement with Department policy. I am sure that the mines, and the salt air, will be beneficial to his bronchial condition.

Faithfully,

*Nikita*  
Nikita

МИНИСТЕРСТВО ПИЩ  
ПРОМЫШЛЕННОСТИ  
РОСГЛАВТАБ

ПАПИРО  
ВЫСШЕГО СОР  
"БОГАТ

10

ТАБАЧНАЯ ФАБРИКА  
"ЯВА"  
г.МОСКВА  
Cigarettes CLASS A  
IN USSR

# EE FOREFRONT

The EE Forefront is a graphical representation of the practical state of the art. You will find here the most advanced components and instruments in their class, classified by the parameter in which they excel.

**A word of caution**

Keep in mind the tradeoffs, since any parameter can

be improved at the expense of others. If there is no figure-of-merit available, we either include other significant parameters of the same products, or we provide additional bar graphs for the same products.

Do not use these charts to specify. Get complete specifications first, directly from the manufacturers.

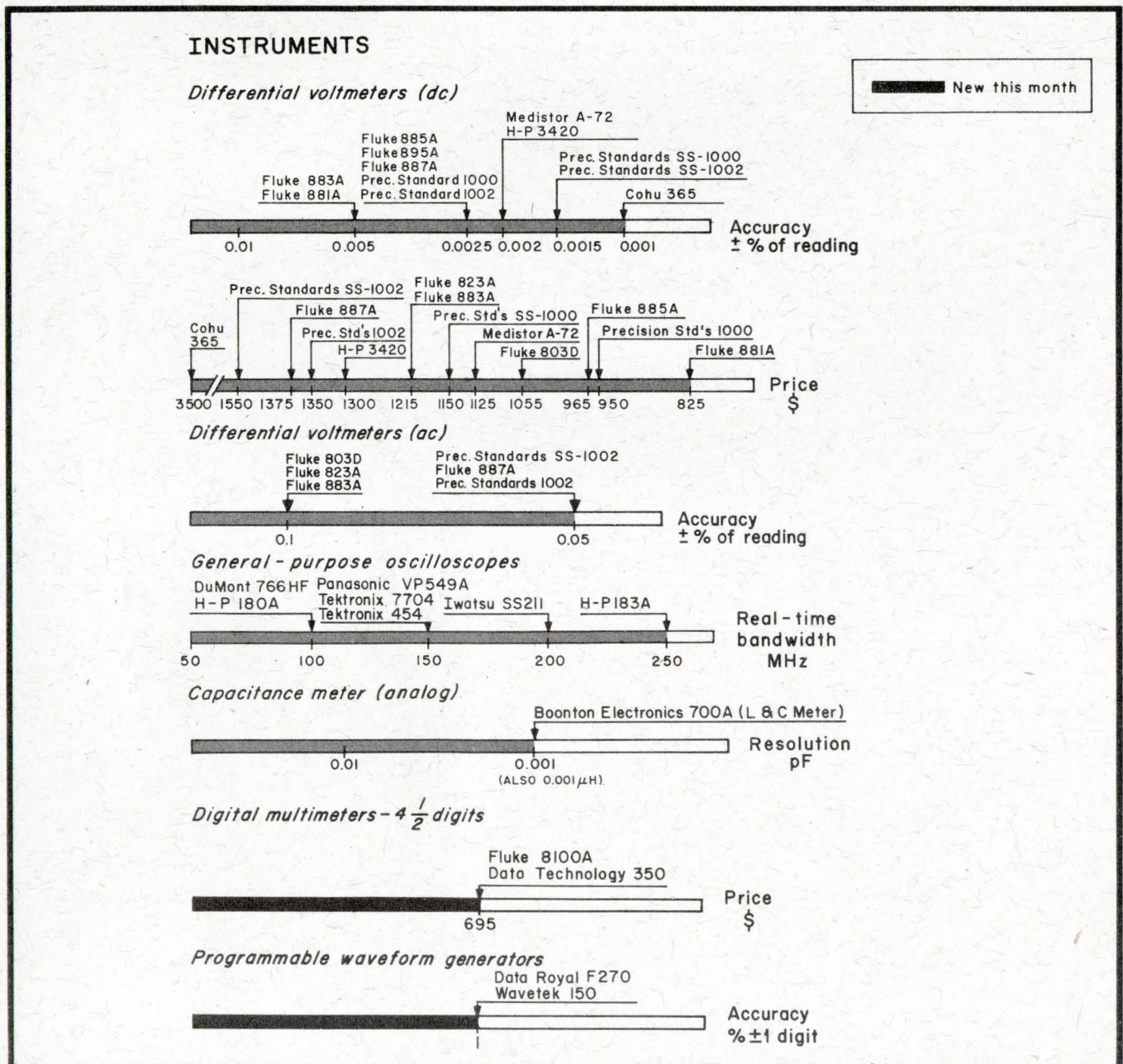

**INTEGRATED CIRCUITS**

*Digital ICs (DTL)*

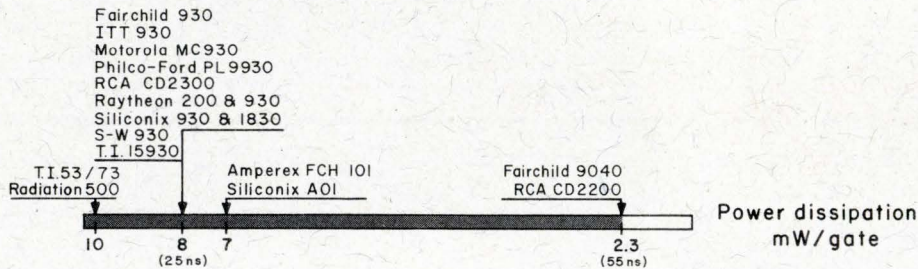
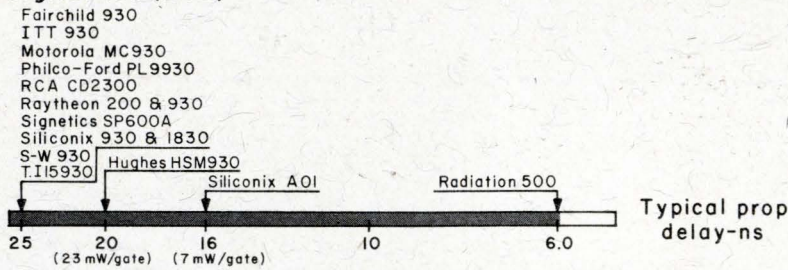

*Digital ICs (TTL)*

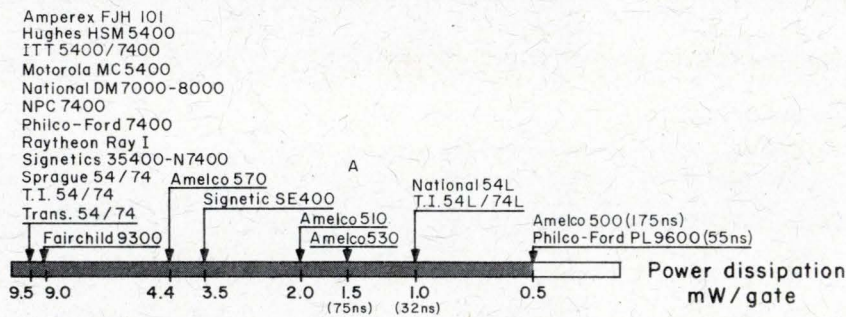
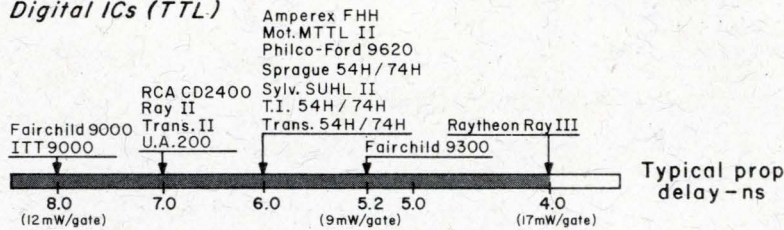

*Digital ICs (ECL and special types)*

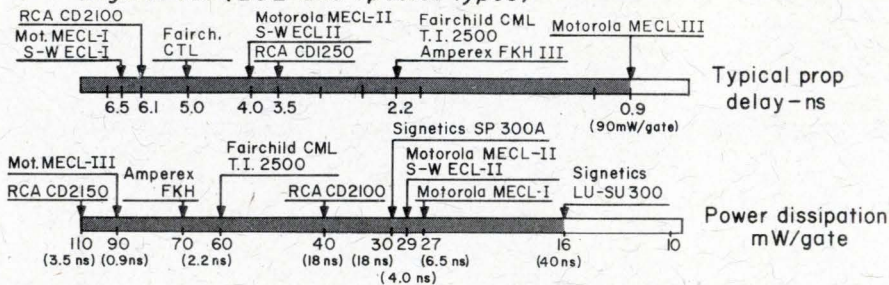

*Operational amplifiers*

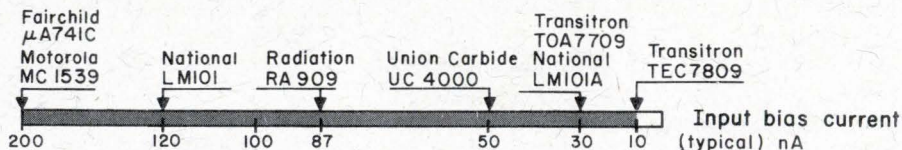

# THE GOOD OLD DAYS



## are here again - with the new Beckman 6155 Counter and Timer.

In the good old days there were vacuum tubes, and the instruments made with them were big, slow, hot and not too reliable... but they were easy and inexpensive to repair. Then there were printed circuits that were smaller, faster, more reliable (still hot, though), easy to repair... but expensive. And then there were integrated circuits that were still smaller, much faster, much more reliable (cool)... but very difficult and expensive to repair.

Now, we have the Beckman Model 6155 that really takes us back to the good old days with small, fast, reliable, (cool) and easy-to-repair integrated circuits. How? It's easy. We have field-replaceable integrated circuits that can be handled just like the old vacuum tubes... a new dimension in instrumentation which provides the lowest total cost of ownership: costs less to buy, less to own.

Before you buy your next counter/timer, consider all the costs: basic instrument,

plug-ins, test equipment, spare parts, and servicing. Then compare to the new Beckman Model 6155, which adds up to the lowest total cost-of-ownership expandable IC counter and timer on the market today. Note such features as: field-replaceable IC chips; a complete set of spare parts for less than \$100; MTBF of over 35,000 hours (about 4 years of continuous 24-hour service); plug-in expandability to 12.4 GHz and 1 nanosecond time interval; TIM-1 PULSE MEASUREMENTS: front-panel slope select switches provide pulse width measurement capability; a general purpose, low cost IC tester is the only test equipment needed for rapid servicing. (Ask about our Model 999 IC Tester.) Total the dollar value benefit of all these and you'll know why we say, THE GOOD OLD DAYS ARE HERE AGAIN!

For complete information, contact your local Beckman office, sales representative or the factory direct.

### Model 6155 Specifications

*Measurement Modes:* Frequency: 100 MHz (to 12.4 GHz with optional plug-in). Period: To 100 ns (to 1 ns or 10 ns with optional plug-in). Multiple Period Averages: 1 to 10<sup>9</sup> in decade steps. Ratio: X/Y with X = 0 to 100 MHz and Y = 0 to greater than 1 MHz. Pulse Width & Separation: (To 1 ns or 10 ns with optional plug-in). Voltage & Current: (Optional plug-in). Scaling: By decades up to 10<sup>9</sup>. *Crystal Frequency:* 1 MHz. *Stability:* Better than 3 parts in 10<sup>9</sup> per 24 hours. (5 parts in 10<sup>10</sup> per 24 hours optional). *Output Frequencies:* 0.1 Hz to 10 MHz in decade steps selected by front-panel TIME BASE selector. *External Frequency:* 1 MHz, 1V rms into 1000 ohms required at rear-panel BNC connector. *Display:* 8 inline digits of glow-tube display, 9th digit optional. *Signal (X input) Sensitivity:* 100 mV rms. *Digital Output:* Four-line, 1-2-4-8 BCD output at rear panel. Output compatible with Beckman 1453 Digital Printer. *Power:* 115/230 Vac, 50 to 400 Hz, 80 W. *Size:* 5¼ in. high, 16¾ in. wide, 19 in. deep. *Weight:* 30 lbs. *Price:* \$2,450.

**Beckman**®

INSTRUMENTS, INC.

ELECTRONIC INSTRUMENTS DIVISION

RICHMOND, CALIFORNIA • 94804

INTERNATIONAL SUBSIDIARIES: AMSTERDAM; CAPETOWN; GENEVA; GLENROTHES, SCOTLAND; LONDON; MEXICO CITY; MUNICH; PARIS; STOCKHOLM; TOKYO; VIENNA

Circle 14 on Inquiry Card

 **The  
Trend  
is TTL.**

 6917A  
SN74150M

 6917A  
SN74151N

 6917A  
SN74151J

 6917A  
SN74152 F

*To help you cut the cost of multiplexing...*

## TI announces a new 16-bit and two new 8-bit MSI data selectors.

Here are three new ways to cut the cost of multiplexing and related operations. Each of these data selectors/multiplexers selects one of sixteen (or eight) data sources determined by the binary address inputs.

Each contains both inverter-drivers and AND-OR-INVERT gates in a single package.

This reduces your design time, inventory requirements and circuit costs. In addition, manufacturing costs are reduced and reliability is improved.

Applications include:

- Boolean function generation
- Random or sequential parallel-to-serial conversion
- Multiplexing from N-lines to one line (or N lines to M lines)
- Read-only memory or pulse-pattern generation.

SN54150/SN74150 are 16-bit data selectors in 24-pin plastic packages (left). SN54151/SN74151 are 8-bit circuits in either the 16-pin plastic or ceramic dual-in-line packages

shown at the left. SN54152/SN74152 are 8-bit selectors available in the 14 pin  $\frac{1}{4}$ " x  $\frac{1}{8}$ " flatpacks.

An SN7493 4-bit binary counter may be used as the select register to perform sequential selection. Or a register with parallel load capability—such as the SN7495—will provide flexibility to perform random selection and/or pulse pattern generation.

Any Boolean function of up to five variables can be implemented with the SN74150 without any external gating.

Any number of bits—and any word length—may be multiplexed by paralleling and cascading circuits. Decoding may be accomplished with SN7442 BCD-to-decimal decoders.

Propagation delay is only 10 ns from data input to output, and 20 ns total through three select levels.

Power dissipation is low...only 200 mW typical for the SN74150.

The SN54151/SN74151 features complementary outputs, while

SN54150/SN74150 and SN54152/SN74152 have inverted outputs.

SN54150/SN74150 and SN54151/SN74151 have strobe inputs to enable the data selectors. This provides maximum flexibility when cascading the circuits.

### New TTL Design Aid

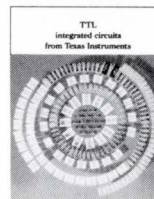

These new data selectors/multiplexers take their places in industry's broadest line of TTL/MSI circuits. To tell you the full story, we have just completed a new 80-page brochure that gives valuable design information on all Series 54/74 circuits including the data selectors. Circle 195 on the Reader Service card for your copy...or write Texas Instruments Incorporated, P. O. Box 5012, MS 308, Dallas, Texas 75222.



**TEXAS INSTRUMENTS**  
INCORPORATED

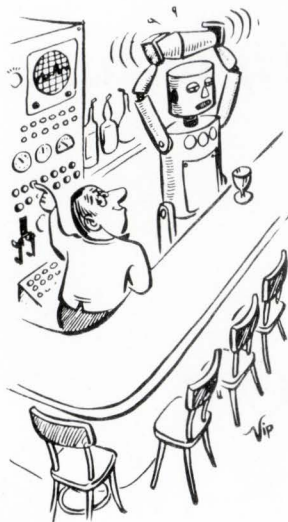

Electronically tuned solid-state oscillators for any purpose.

Circle 15 on Inquiry Card

**If Quality is Important  
If Service is Important  
If Pricing is Important**

**SCHRACK DELIVERS**  
Immediately from New York Stock

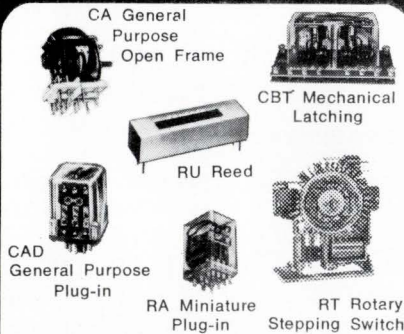

Schrack relays meet specifications far in excess of those required by the most exacting standards — and are priced much less.

Schrack has available a complete line of sockets, plugs and dust covers for custom modular construction to suit all your requirements — including accessories.

Send for complete catalogs today



Circle 16 on Inquiry Card

## EE CALENDAR

### SEPTEMBER

14	15	16	17	18	19	20
21	22	23	24	25	26	27
28	29	30				

**Sept. 15-17: Int'l Telemetry Conf.,** Sheraton Park Hotel, Washington, D. C. Addtl. Info.—R. J. Blanchard, Defense Electronics, Rockville, Md. 20854.

**Sept. 16-18: Electronic Mfg. Engineers Conf. & Exhibit,** New York Hilton Hotel, New York, N.Y. Addtl. Info.—Circuits Mfg., 167 Corey Rd., Brookline, Mass. 02146.

**Sept. 17-19: Symp. on the Biological Effects and Health Implications of Microwave Radiation,** Hotel John Marshall, Richmond, Va. Addtl. Info.—Stephen F. Cleary, Symp. Chrmn., Va. Commonwealth Univ., Medical College of Va., Health Sciences Div., MCV Sta. Box 877, Richmond, Va. 23219.

**Sept. 23-25: Ninth Annual Symp. on Physics & Nondestructive Testing,** Holiday Inn-Lake Shore Drive, Chicago, Ill. Addtl. Info.—W. J. McGonagle, Coordinator, Symp., Box 554, Elmhurst, Ill. 60126.

**Sept. 24-26: Ultrasonics Symp.,** Chase Park Plaza Hotel, St. Louis, Mo. Addtl. Info.—C. K. Jones, Westinghouse R&D, Churchill Boro, Pittsburgh, Pa. 15235.

### OCTOBER

			1	2	3	4
5	6	7	8	9	10	11
12	13	14	15	16	17	18
19	20	21	22	23	24	25
26	27	28	29	30	31	

**Oct. 1-7: Japan Electronics Show,** Osaka, Japan. Addtl. Info.—Electronics Div. of the Japan Light Machinery Info. Ctr., 437 Fifth Ave., New York, N.Y. 10016.

**Oct. 6-8: Int'l Electronics Conf. & Exposition,** Automotive Bldg., Exhibition Park, Toronto, Canada. Addtl. Info.—Int'l Electronics Conf. & Exposition, 1819 Yonge St., Toronto 7, Canada.

**Oct. 9-12: PATEXPO '69,** New York Coliseum, New York, N.Y. Addtl. Info.—Larry Penzell, Public Relations, 501 Madison Ave., New York, N.Y. 10022.

**Oct. 22-23: 2nd Annual Connector Symp.,** Cherry Hill Inn, Cherry Hill, N.J. Addtl. Info.—Jim Pletcher, AMP Incorporated, Harrisburg, Pa. 17105.

**Oct. 26-30: Joint Conf. on Mathematical & Computer Aids to Design,** Disneyland Hotel, Anaheim Conv. Ctr., Anaheim, Calif. Addtl. Info.—J. M. Kinn, IEEE, 345 E. 47th St., New York, N.Y. 10017.

**Oct. 27-30: ISA Conf. & Exhibit,** Astrohall, Houston, Tex. Addtl. Info.—Ray Cooley & Assoc., Inc., 4848 Guiton St., Houston, Tex. 77027.

**Oct. 29-31: Int'l Electron Devices Meeting,** Sheraton Park Hotel, Washington, D.C. Addtl. Info.—IEEE, Technical Activities Board, 345 E. 47th St., New York, N.Y. 10017.

### NOVEMBER

						1
2	3	4	5	6	7	8
9	10	11	12	13	14	15
16	17	18	19	20	21	22
23	24	25	26	27	28	29
30						

**Nov. 5-7: IEEE Northeast Electronics Research & Eng'g Meeting,** War Mem. Aud. & Sheraton Boston Hotel, Boston, Mass. Addtl. Info.—NEREM, 31 Channing St., Newton, Mass. 02158.

**Nov. 18-20: Fall Joint Computer Conf.,** Las Vegas Conv. Ctr., Las Vegas, Nevada. Addtl. Info.—AFIPS Hqds., 210 Summit Ave., Montvale, N.J. 07645.

**Nov. 18-21: Conf. on Magnetism & Magnetic Materials,** Benjamin Franklin Hotel, Phila., Pa. Addtl. Info.—J. D. Blades, Franklin Inst. Res. Labs., Phila., Pa. 19103.

**Nov. 20-21: Assembly of the Radio Tech. Comm. for Aeronautics,** Marriott (Twin Bridges) Motel, Washington, D.C. Addtl. Info.—Radio Tech. Comm. for Aeronautics, 2000 K St., N.W., Washington, D.C. 20006.

### '69-'70 Conference Highlights

**NEREM — Northeast Electronics Research and Eng'g Meeting, Nov. 5-7; Boston, Mass.**

**IEEE—Institute of Electrical and Electronics Engineers Int'l Convention & Exhibition, March 23-26; New York, New York.**

### Call for Papers

**Feb. 18-20, 1970: Int'l Solid-State Circuits Conf.,** Phila., Pa. Submit both a 35-word abstract and a 300-500 word summary by **October 10, 1969** to L. D. Wechsler, General Electric Co., Electronics Park, Bldg. #3, Syracuse, N.Y. 13201.





NEW AMI/MOS — 256 x 10 Bit Read Only Memory. This unique ROM is one of a family of LSI ROM's mass produced by AMI for your immediate needs. Even if you don't need to miniaturize your system, you can stand a substantial reduction in complexity

and a startling increase in reliability, can't you? Send for the MOS facts of life. Better yet, hop a jet and visit the new, expanded AMI/MOS production facility — America's largest.

**NOW IN PRODUCTION**  
**2560**  
**BIT/READ ONLY MEMORY**



**AMERICAN MICRO-SYSTEMS, INC.**

3800 Homestead Road, Santa Clara, California 95051  
Telephone 408-246-0330, TWX 910-338-0018  
CUSTOM & STANDARD MOS ARRAYS/MEMORIES/REGISTERS/LOGIC

# THE PLASTICS

Back in the forties, one of the few uses of plastics in TV was for tube sockets. Today

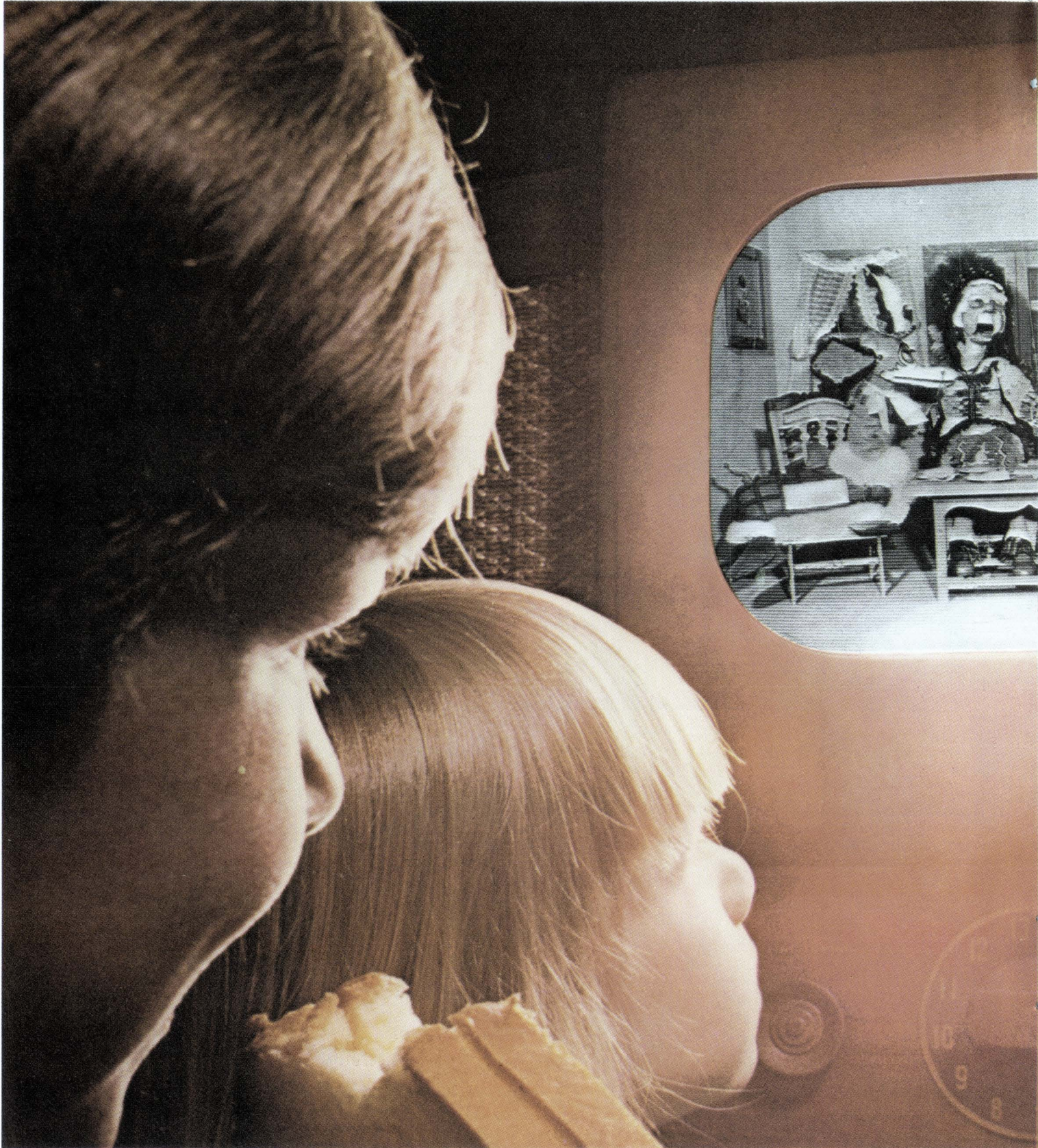

Howdy Doody is a trademark of the National Broadcasting Company, Inc.

# AGE + 20

there are hundreds.

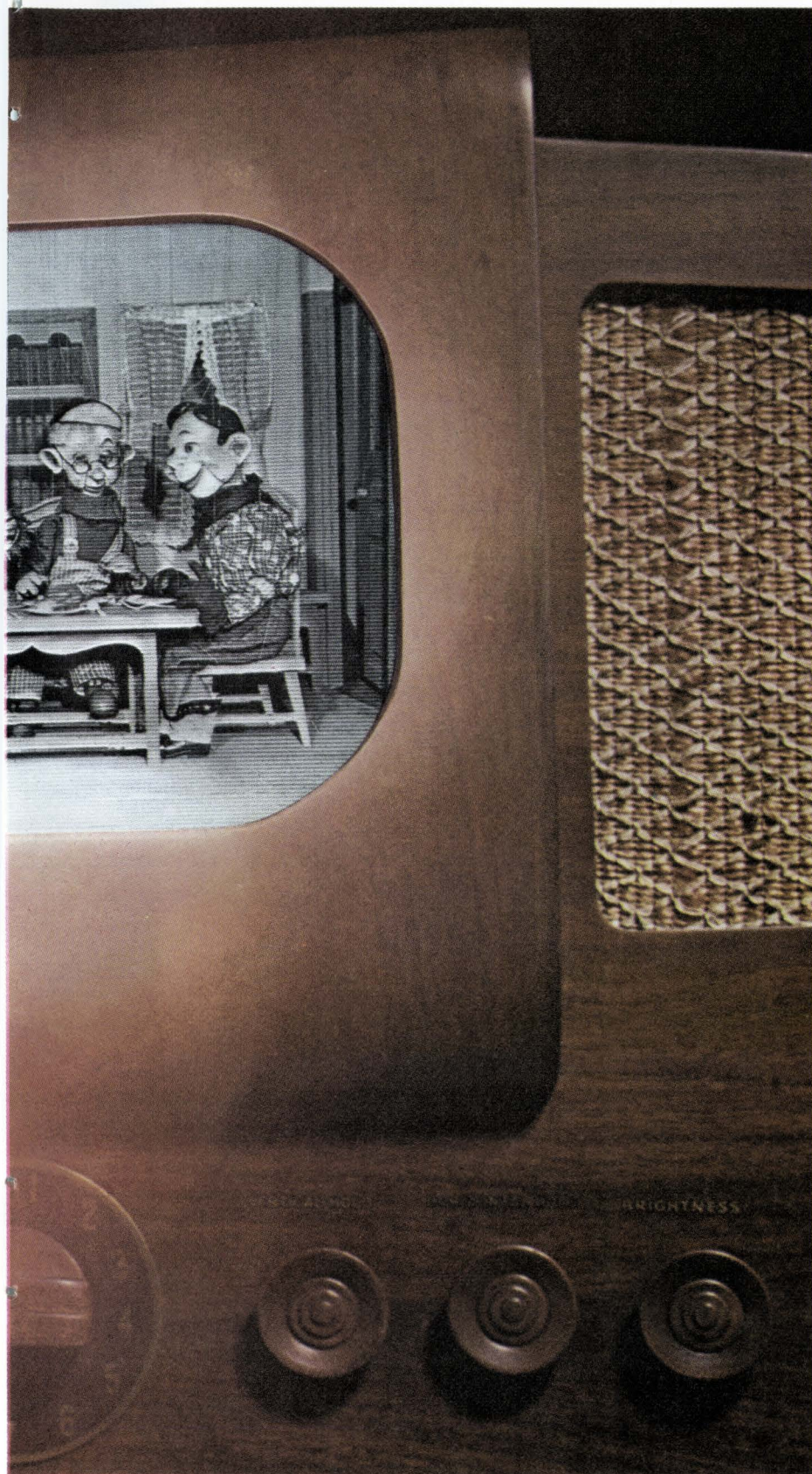

Ask us about our PLASKON® materials for TV and other electronic and electrical applications.

We have PLASKON Urea for electrical wire connectors, sockets, and toggle switches... Urea and Alkyds for circuit breakers... Flame-retardant polyolefins for TV sockets... Epoxies to encapsulate coils, motors, resistors, and semi-conductors... Diall® (DAP) for high-reliability electronic connectors... Phenolics for computer memory frames and encapsulated transistors... Nylon for connectors, terminal strips, and wire jacketing... Alkyds for tuner components and grid caps... Halon® TFE for insulation on coaxial cables.

Our Plastics Division, a major factor in plastics since 1956, offers 30 different types to work with—one of the widest lines in the field. Conventional plastics. Proprietary plastics. And we back up our PLASKON line with highly trained engineering and design specialists, and with one of the largest technical service laboratories in the business, for the benefit of designers, fabricators, and equipment manufacturers.

Let us help you take advantage of the Age of Plastics.



Plastics Division  
A Plus Factor in the Plastics Age  
P.O. Box 365, Morristown, N.J. 07960

Circle 18 on Inquiry Card



*Extending man's senses:*

## **Command joint forces from 20,000 feet.**

Bounce a newscast around the world.

Navigate precisely from Cape Horn to the Cape of Good Hope.

Turn night into day with an airborne floodlight.

Set up a TACAN transceiver, anywhere, in minutes.

Airborne command and control stations. Communications satellite networks. The global Omega navigation system. Nighttime military and civilian operations. Portable TACAN.

All demand fail-safe technology — the finest electronics

and systems available.

That's our business.

LTV ElectroSystems has the scientific and engineering talent, fast-reaction capacity and the production facilities (15 nationwide) to build the sophisticated, new-generation systems our customers need to extend their senses and capabilities into every environment.

Why don't you join us?

*See the opposite page for a listing of current professional opportunities at LTV ElectroSystems.*

**LTV ELECTROSYSTEMS, INC.**

PO BOX 6030, DALLAS, TEXAS 75222

A quality company of Ling-Temco-Vought, Inc. **LTV**

## EE COURSES

**Integrated Circuit Engineering:** Sept. 15-18, Oct. 27-30, Nov. 17-20, Dec. 1-4; Phoenix; \$500. Latest state-of-the-art techniques; design, application, basic fabrication, and assembly practices. Seminar Registrar, ICE Corp., 4900 E. Indian School Rd., Phoenix, Ariz. 85018.

**PL/I-Techniques and Perspectives:** Sept. 18, San Francisco and Sept. 19, Los Angeles, \$55 (ACM members) and \$90 (nonmembers). History and objectives of PL/I, language structure, features, implementations and dialects, extension to PL/I, evaluations of PL/I, special applications. Association for Computing Machinery, 1133 Ave. of the Americas, New York, N.Y. 10036.

**Integrated Circuit Management:** Sept. 19, Phoenix, \$175. School Registrar, ICE Corp., 4900 E. Indian School Rd., Phoenix, Ariz. 85018.

**High Voltage dc Cable Testing & Fault Finding:** Sept. 23-24, Oct. 21-22, and Nov. 18-19, Chicago, Ill., \$75. Covers the value of testing, the insulation resistance test, ac vs. dc testing, Plotting the dc test curve, safety, preparation, and fault locating. Associated Research, Inc., 3777 1830 S. 54th Ave., Chicago, Ill. 60618.

**Economic Evaluation of Engineering Alternatives:** Sept. 24-26, Washington Univ., St. Louis. Theory and practice of economic analysis as an important factor in the problem of selecting alternative technological solutions. Joseph Movshin, Washington Univ., Box 1048, St. Louis, Mo. 63130.

**Phase Equilibria in Metallic Systems:** Sept. 24-26, Denver. Chemical and physical aspects of bonding, alloy formation, phase stability, compound formation, and properties of crystal-line phases. Dr. William M. Mueller, Dir. of Education, ASM, Metals Park, Ohio 44073.

**Performance of Refractory Materials Systems at Temperatures between 3000°F and 7000°F:** Sept. 29-30, Cambridge, Mass. Dr. William M. Mueller, Dir. of Education, ASM, Metals Park, Ohio 44073.

**Seventh Annual Research and Development Management Program:** Oct. 5-17, Ohio Univ., Athens and Columbus Labs. of Battelle Memorial Institute, \$650. Problems, objectives, and theory of R&D management, operations research, computer use, technological forecasting, human behavior, motivation, creativity, and computer-assisted decision techniques. Continuing Education, 309 Tupper Hall, Ohio Univ., Athens, Ohio 45701.

**Control of Industrial Processes Subject to Disturbances:** Oct. 6-10, Purdue Univ., \$150. Surveys significant results obtained recently on the estimation and control of systems whose parameters are known only partially and presents them with a unified terminology and viewpoint. Prof. R. L. Kashyap, Electrical Engineering, Purdue Univ., Lafayette, Ind. 47907.

**Product Liability in Metallurgical Components:** Oct. 8-9, Chicago. Engineering and legal aspects of product liability. Dr. William M. Mueller, Dir. of Education, ASM, Metals Park, Ohio 44073.

**Introduction to Polymer Science and Engineering:** Oct. 13-17, New York. Program Design, Inc., 3645 Warrensville Center Rd., Cleveland, Ohio 44122.

**Principles of Heat Treatment:** Oct. 13-18, Philadelphia. Dr. William M. Mueller, Dir. of Education, ASM, Metals Park, Ohio 44073.

**Automatic Impedance Measurement:** Oct. 21-23, West Concord, Mass., no charge. Techniques, instrumentation, and systems for the automated measurement of Z, R, L, and C. General Radio Co., West Concord, Mass. 01781.

**Elements of Metallurgy:** Oct. 29-Nov. 6, Chicago. Dr. William M. Mueller, Dir. of Education, ASM, Metals Park, Ohio 44073.

**LSI Technology:** Oct. 31, Phoenix, \$175. Seminar Registrar, ICE Corp., 4900 E. Indian School Rd., Phoenix, Ariz. 85018.

*(Continued on following page)*

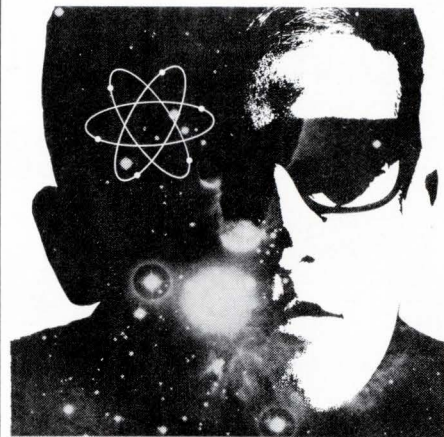

## A new bulletin of professional opportunities at LTV ElectroSystems.

### Greenville Division

(Systems for strategic and tactical surveillance, reconnaissance, detection; tracking; command and control; airborne lighting systems; artificial intelligence; tactical warfare.)

Digital Systems Analysts  
Digital Circuits Designers  
Electro-Optics Systems Analysts  
RF Systems Analysts  
RF Circuits Designers  
Scientific Programmers  
Business Programmers

Facilities — Greenville, Texas; Greenville, South Carolina; Roswell, New Mexico

### Garland Division

(Long-range digital communications; fluid mechanical systems for aircraft, missiles, spacecraft; high-precision antennas; guidance and navigation systems; space systems.)

RF Circuits Designers  
RF Systems Analysts  
Digital Circuits Designers  
Digital Systems Analysts  
Antenna Design Engineers  
Scientific Programmers

Facilities — Garland and Arlington, Texas

### Continental Electronics

(This subsidiary company builds super-power RF transmitters for radio communications, broadcasting, re-entry physics radars, radio astronomy, nuclear accelerators.)

Transmitter Design Engineers  
RF Circuit Designers  
RF Systems Engineers

Facilities — Dallas, Texas; Waltham, Massachusetts

### Memcor Division

(Portable and stationary TACAN systems, tactical radio systems, nuclear controls, resistance products.)

Project Engineers (TACAN Systems)  
Electronic Design Engineers  
Instrumentation Engineers  
Mechanical Engineers  
Digital Systems Engineers

Facilities — Huntington, Indiana; Salt Lake City, Utah

Please call or write: Bill Hickey, Supervisor of Professional Placement, LTV ElectroSystems, Inc., P. O. Box 6118, Dallas, Texas 75222, Telephone (214) 276-7111. An equal opportunity employer.

**LTV ElectroSystems:  
extending man's senses.**

Circle 20 on Inquiry Card

(Please Use Home Address on the Card)

# Diversified Glass-to-Metal Hermetic Seals like these...

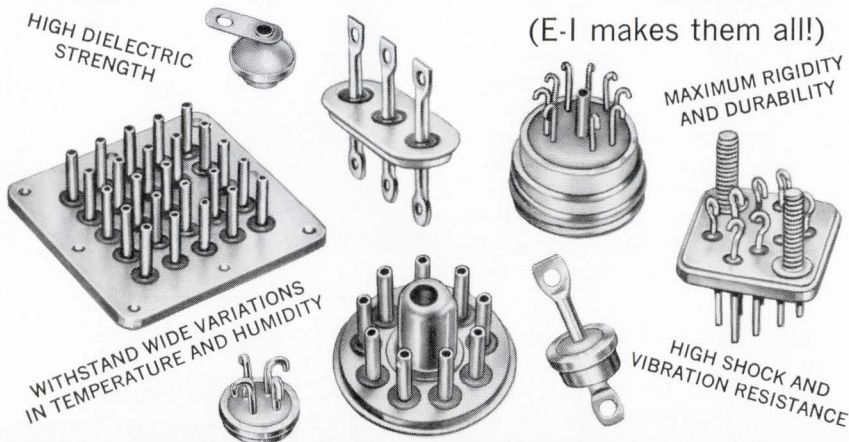

## Require Highly Specialized Engineering Capabilities...

(E-I has the know-how!)



### Specify E-I Sealed Terminations for Unusual Service Applications!

How does E. I. produce a quality line of hermetic seals? The answer is simple. A stringent program of testing and control! Above is shown an optical comparator being utilized to measure wire terminals for use in a hermetic seal. Testing in this manner assures that the finished hermetic seal will comply with all your requirements.

Available in thousands of standard types, E-I seals can be produced in 'specials' to meet particular component or equipment requirements.

Technical literature edited for the engineer/designer/specifier, and containing complete data and information, is available on request.

- Sealed Terminations Multiple Headers
- Transistor and Diode Bases
- Semiconductor Bases
- Compression-type Threaded End Seals
- Plug-in Connectors
- Vibrator Plug-in Connectors
- High Voltage Glass-bonded Ceramic Seals
- Hermetically-sealed Relay Headers
- Special Application Custom Seals
- Custom Sealing to Specifications



## Electrical Industries

A Division of Philips Electronics and Pharmaceutical Industries Corp.  
Murray Hill, N. J. 07971 — Tel. (201) 464-3200

Patented in U.S.A., No. 3,035,372; in Canada, No. 523,390; in United Kingdom, 734,583; other patents pending.

## EE COURSES

(Continued from page 27)

**Integrated Circuit Processing:** Nov. 3-14, Phoenix, \$3000. Detailed processing techniques for silicon monolithic circuits. Seminar Registrar, ICE Corp., 4900 E. Indian School Rd., Phoenix, Ariz. 85018.

**Hybrid Computing Techniques, Programming, and Applications:** Nov. 10-21, Purdue Univ., \$300. The programming of the computer and its application to various types of problems. Prof. T. J. Williams, Purdue Lab. for Applied Industrial Control, Purdue Univ., Lafayette, Ind. 47907.

**Hybrid Microelectronic Bonding & Packaging:** Nov. 12, Monrovia, Calif., \$5. Bonding fundamentals, metallurgical considerations, theory & fabrication of semiconductor chips, bonding techniques, and hybrid packaging. E. F. Koshinz, Unitek/Weldmatic Div., 1820 S. Myrte Ave., Monrovia, Calif. 91016.

**Mathematical Models for Solid State Devices:** Nov. 13-14, Univ. of Wisconsin, Madison, \$70. Problems encountered in solid state device and array modelling, and their solutions. David P. Hartmann, Institute Director, 725 Extension Bldg., 432 N. Lake St., Madison, Wis. 53706.

**SimOptimization Techniques:** Nov. 19-21, Santa Monica, \$200. Automatic optimum-seeking procedures for simulation models. Consolidated Analysis Centers Inc., 225 Santa Monica Blvd., Santa Monica, Calif. 90401.

**On-line Data Acquisition and Control System Technology:** Nov. 20-21, IEEE Computer Group's Data Acquisition and Control Committee, Las Vegas. Problems, progress, and promises of the technology. Dr. Albert Hopkins, M.I.T. Instrument Lab, Station #35, 75 Cambridge, Mass. 02142.

**Integrated Circuit Reliability:** Nov. 21, Phoenix, \$175. Seminar Registrar, ICE Corp., 4900 E. Indian School Rd., Phoenix, Ariz. 85018.

**Integrated Circuit Product Selection:** Nov. 21, Phoenix, \$175. Seminar Registrar, ICE Corp., 4900 E. Indian School Rd., Phoenix, Ariz. 85018.



*think*  
**Bourns**  
*Cermet*  
*Model*  
**3329!**

.....*why?*

**BECAUSE**

it has a standard TC of  $\pm 100$  ppm/ $^{\circ}$ C over the entire temperature and resistance range. ( $-55$  to  $+150^{\circ}$ C & 10 ohms to 1 megohm).

**BECAUSE**

it is sealed to withstand wave soldering and immersion cleaning techniques;

**BECAUSE**

it is the first low-cost, commercial cermet single-turn to meet or exceed MIL-R-22097;

**BECAUSE**

it is now available in two new configurations . . . and if those aren't enough reasons . . .

**BECAUSE**

No Other  $\frac{1}{4}$ " Diameter Potentiometer In The Industry Can Match It . . . *Not One!*

These units are as close as your telephone. Simply call your local Bourns sales office or authorized Bourns stocking distributor.



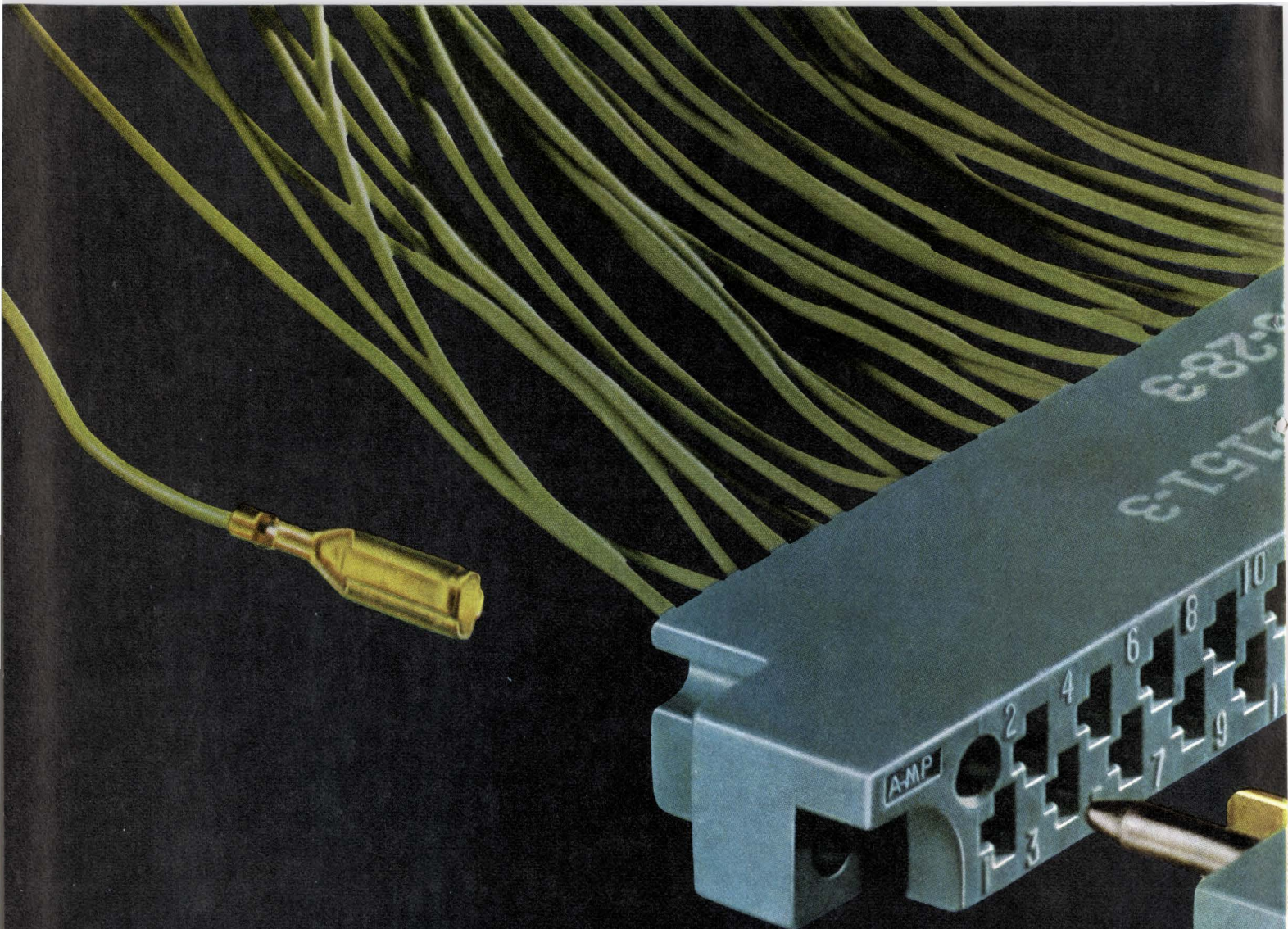

**MIL-C-21097**  
**MIL-E-5400 (Rev. K)**  
**Crimp. Snap in.**  
**Two piece.**



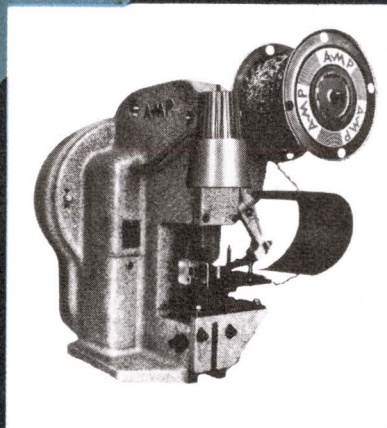
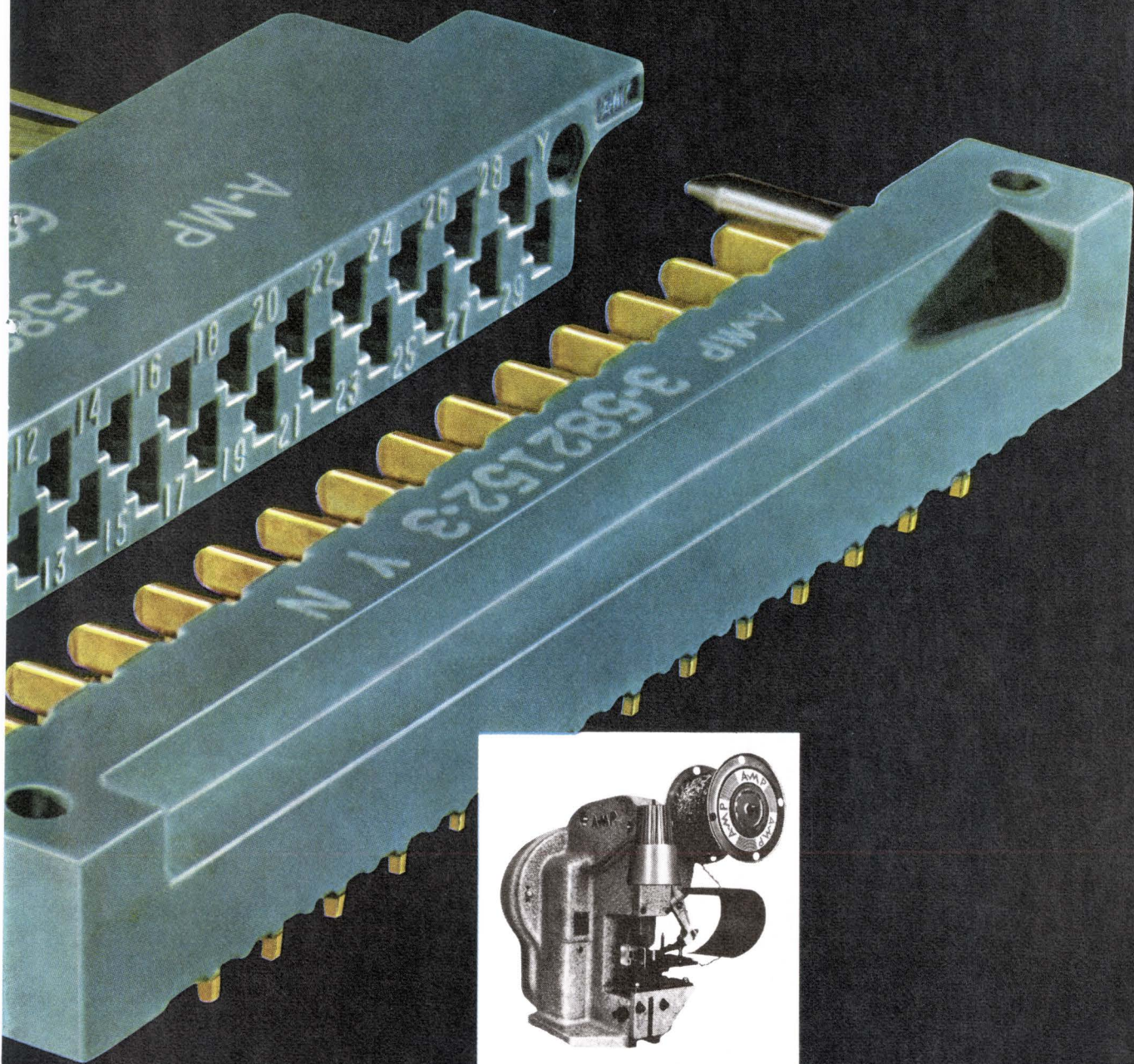

**The AMP-BLADE<sup>★</sup> Printed Circuit Connector. Male housing: staked to board, prevents warping; encapsulated tabs, polarizing guide pins. Female housing: snap-in receptacles, easy keying. Large contact areas, gold over nickel plating, wiping action. Famous AMP reliability. Automatically crimp 3,000 receptacles an hour with the AMP-O-LECTRIC<sup>★</sup> machine. Lowest installed cost. Available in 17, 23, 29, 35, 41 and 47 contact positions. Send for full information today. Industrial Division, AMP Incorporated, Harrisburg, Pa. 17105.**

★Trademark of AMP Incorporated

**Circle 23 on Inquiry Card**

# **AMP**

**INCORPORATED**

*This is only one of a full line of printed circuit connectors available from AMP... Worldwide.*

# a complete digital system

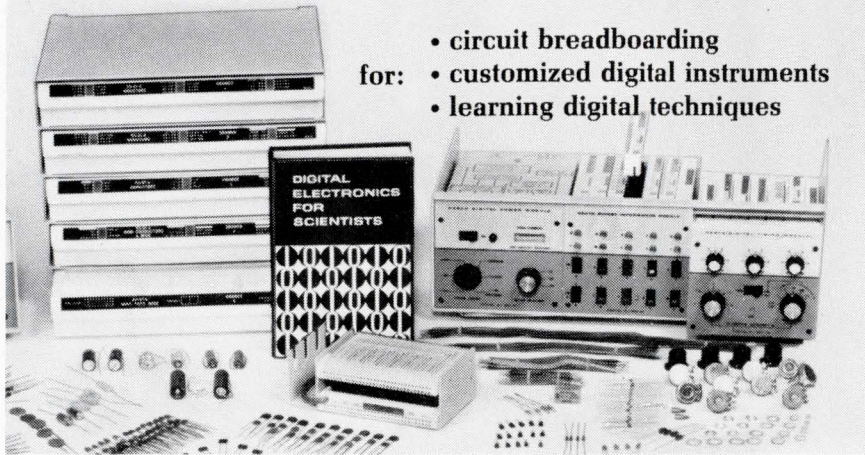

- for:
- circuit breadboarding
  - customized digital instruments
  - learning digital techniques

## HEATH 801 Digital System...

buy the complete system or discrete components

Now . . . A Complete System to Enable You to Get the Most Out of Digital Electronics. Here is a system that is revolutionizing instrumentation in labs and classrooms throughout the world. The basic design concepts of Professors H. V. Malmstadt and C. G. Enke combined with the engineering of Heath's scientific instrument group have resulted in the unique 801 Analog Digital Designer (ADD) and the EU-51A breadboard and parts group. This versatile system can perform equally well in constructing high performance research-quality instruments, in performing hundreds of experiments in the teaching laboratory, in rapid testing of new digital ideas, or in interfacing to computers.

Start . . . By Learning the New Digital Electronics. Drs. Malmstadt and Enke have written a pioneering new text "Digital Electronics for Scientists" (published by W. A. Benjamin, Inc.) that provides a systematic introduction to the digital circuits, concepts and systems that are basic to the new instrumentation — computation revolution. The book is written for engineering and science students and for practicing engineers, scientists, and technicians so that all may effectively utilize the startling recent advances in digital electronics.

Never before have the latest "state-of-the-art" methods been made so rapidly and conveniently accessible through an integrated combination of new text and versa-

tile equipment. The experimental section of the text is written specifically for utilizing the Heath 801A and 51A to provide experience and working knowledge with hundreds of digital and analog-digital circuits, instruments and systems.

Write . . . for Complete Information on Cards, Modules and Parts in the Heath Digital System. The basic Analog-Digital Designer (EU-801A) contains 3 modules (power supply, binary information, and digital timing) and 13 circuit cards including TTL gates, flip-flops, monostable MVs, relays, op amps, and V-F converter. The EU-51A Experimental Parts Group is a highly flexible breadboard system for circuit design and teaching. The group includes a desk chassis, 493 components, a patch card accepting these components, and a power patch card.

The system is open-ended. New cards and modules are continuously being introduced so you can construct your own special frequency meters, counters, timers, DVMs, rate meters, and many dozens of other instruments.

Take . . . advantage of the digital revolution — order your Heath Digital System now.

**EU-801A**, Analog-Digital Designer. . . . \$435.00\*  
**EU-51A**, Experimental Parts Group. . . . \$135.00\*  
**EUP-19**, text "Digital Electronics For Scientists" by H. V. Malmstadt and C. G. Enke (published by W. A. Benjamin, Inc.) . . . . . \$9.50\*

## EES GET AHEAD

"MOS has arrived, is even undersupplied . . ."

Dr. Raymond M. Warner, Jr.  
Semiconductor specialist

Dr. Raymond M. Warner, Jr. is the new Director of Technology for semiconductors at Union Carbide in San Diego. In this position, he will be responsible for such tasks as product engineering, materials research, and product development.

Dr. Warner describes the main thrust of his efforts as "finding the most useful and profitable combinations from the technology available. For example," he says, "glass isolation technology exists for our line of dual transistors."

"Materials considerations are very important to us here. Dielectric isolation and complex epitaxy are examples of severe materials demands that get more emphasis here than many other places." Once the materials processes have been determined, he agrees that the process control of making them gets very important.

Union Carbide makes junction FETs, dual bipolars, linear ICs, MOSFETs, and MOS-integrated circuits. According to Dr. Warner, MOS has really arrived and is under-supplied now because many customers are eager to have it. He thinks that visible MOS successes, such as desktop calculators, are responsible for the demand.

The new director has had more than 17 years of experience in high-level R&D related to semiconductors at Bell Labs, Motorola, Texas Instruments, and ITT. At ITT, part of his work was in Computer Aided Design. Dr. Warner feels that a company can go a long way without CAD if it has a top-notch mask-making operation. But, he states, "Union Carbide will definitely go into CAD to help get the cost out of complex, custom ICs. CAD has to come and we will be well into it next year."

He is not sure of the place of graphic console CRT displays for CAD, because they have not yet proven themselves costwise. One problem is that the screen is too small to accommodate the entire circuit. This is worse in MOS than in bipolar, because the density is higher and the chips tend to be even larger.

Ray Warner holds a BS in physics from Carnegie Institute of Technology and an MS and PhD from Case Institute of Technology. He is co-holder of a basic patent on the epitaxial junction FET; and, in 1958, he was first to propose a planar FET with the inversion layer channel.



a Schlumberger company

### FREE Heath Scientific Instrumentation Catalog

Describes these and other precision instruments for laboratory, engineering, education and R & D applications. Send for your FREE copy now . . . just write on your school or company letterhead.

HEATH COMPANY, Dept. 586-25  
Benton Harbor, Michigan 49022

Please send FREE Heath Scientific Instrumentation Catalog

Name \_\_\_\_\_

Address \_\_\_\_\_

City \_\_\_\_\_ State \_\_\_\_\_ Zip \_\_\_\_\_

Prices and specifications subject to change without notice.

\*Mail Order Prices; F.O.B. Factory

EK-278



**We just stole  
the automatic  
stick shift**

**and put it on our new Counters.**

The automatic stick shift. That's the whole idea behind our new family of Counters. Snap to "pre-set" for automatic, knob-free sine wave measurements to 50 MHz or go stick shift with full trigger control if your signal is unsymmetrical.

But there's a lot more to our new Counters than just convenience:

- 500 Microvolt Sensitivity from 10 MHz to 500 MHz with automatic gain control for perfect triggering.
- 8 digits in 1 second with auto-ranging, even at 1 Hz.
- Complete solid state input/output interface in systems models.

And, incidentally, automatic operation improves accuracy, too.

Prices for the DANA Model 8100 start at \$1495.

Dana Laboratories, Inc./2401 Campus Drive/Irvine, California 92664



# 8 reasons why BELL precalibrated Hall Effect GAUSSMETERS\* give unmatched performance

MODEL  
620

All solid-state automatic battery take-over in case of line power failure. Available from stock.



MODEL  
640

All solid-state — 1000X scale expansion — 5V AUX output standard.



\* with temperature compensated probes — with  $\pm 0.005\%/^{\circ}\text{C}$  temperature dependence make possible a stability not formerly available in medium priced gaussmeters.

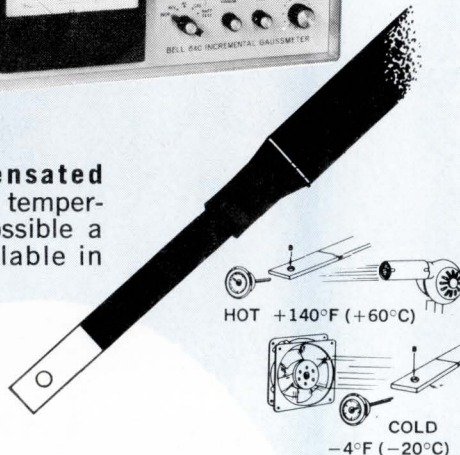

HOT +140°F (+60°C)

COLD -4°F (-20°C)

**GOLD SEAL GUARANTEE**  
All ceramic encapsulated transverse probes guaranteed one year against breakage

Other features are ■ **precalibrated probes** — new imaginative design permits changing probes without recalibration (probe and instrument are programmed) ■ **high accuracy** — 0.5% FS to 10 kG and 1.0% FS to 30 kG (possible without reference to cal magnet) ■ **true zero and field polarity** — measure direction as well as magnitude ■ **probe versatility** — 15 standard transverse, axial and multi-axis probes ■ **direct and independent** meter readout of ac and dc fields ■ **1 V calibrated output** at front panel output jacks ■ **1000X scale expansion** with automatic zero center meter reading in incremental mode (640 only).

Write Today  
for latest CATALOG

"BELL PRODUCTS for PLANNED PROGRESS"

**BELL INC.**  
1356 Norton Avenue  
Columbus, O. 43212  
Ph. 614-294-4906  
TWX: 810-482-1716

## EE PRODUCT SEMINARS

This column lists product seminars that electronic companies offer to users of their products.

**Instrumentation for Industrial Measurement and control:** Oct. 6-17, North Wales, Pa., no charge. Emphasis on process industries. Leeds & Northrup Co., Sumneytown Pike, North Wales, Pa. 19454.

Circle 415 on Inquiry Card

**Repair and Maintenance Training Session:** Oct. 6-10 and Nov. 3-7, Amsterdam, N. Y., no charge. Covers EMC-25 and EMC-10 receivers, EFC-125 programmer, SPD-125 spectrum display, various antenna models, and FSS-250 spectrum surveillance system. Dale Lamuelson, V.P., Fairchild Electro-Metrics Corp., 100 Church St., Amsterdam, N. Y. 12010.

Circle 416 on Inquiry Card

**Optical Character Recognition:** Oct. 13-15 and Nov. 12-14, New York City, Tuition free. Current OCR applications with emphasis on software and general planning for an OCR installation. Control Data Corp., Institute for Advanced Technology, 5272 River Rd., Wash., D.C. 20016.

Circle 417 on Inquiry Card

**Real-Time Sound & Vibration Measurements:** Oct. 28-29 and Nov. 18-19, West Concord, Mass., no charge. The real-time analyzer, its theory, operation and applications; ancillary support equipment, analysis systems, and the use of the instrumentation computer. General Radio Co., West Concord, Mass. 01781.

Circle 418 on Inquiry Card

**Precision dc Measurements & Standards:** Nov. 3-7, North Wales, Pa., no charge. Leeds & Northrup Co., Sumneytown Pike, North Wales, Pa. 19454.

Circle 419 on Inquiry Card

**Veritrak™ Process Control Instrumentation:** Nov. 10-21, Phoenix, Tuition-free. Product organization, structural design and calibration, computer interface, primary sensors, computing networks, circuit theory and maintenance. Motorola Instrumentation and Control Inc., Box 5409, Phoenix, Ariz. 85010.

Circle 420 on Inquiry Card

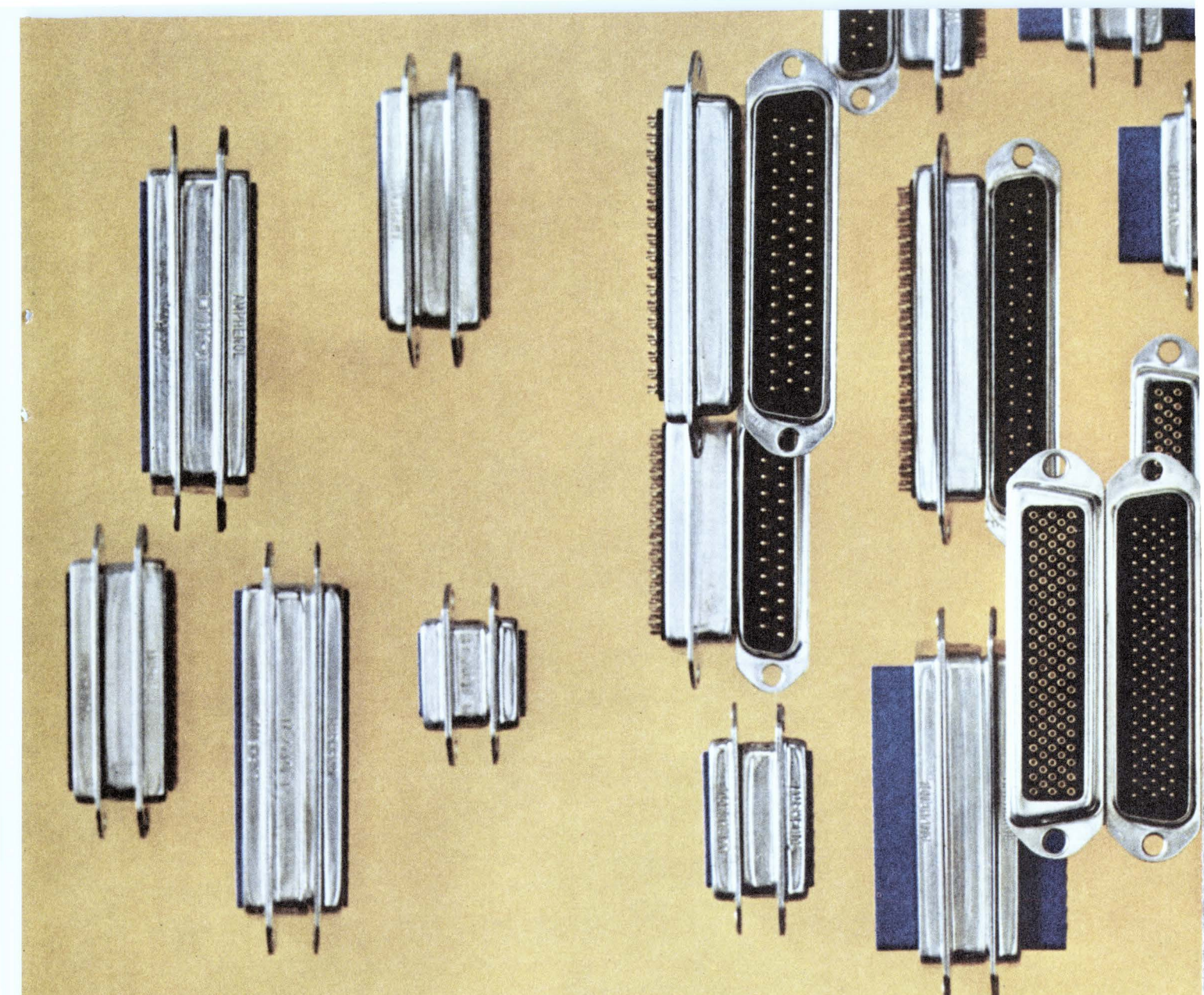

## Amphenol has added **fixed contact, high density, encapsulated contact and power**

NOW AMPHENOL GIVES YOU A COMPLETE LINE of pin and socket connectors. We've added four new families to our original Poke-Home® and hard dielectric standards — fixed contact, high density, encapsulated contact and power/coax. And they'll intermate with the ones you're buying now.

EXPECT TWO BIG DIFFERENCES FROM AMPHENOL—availability and down-to-earth prices. We'll meet *your* delivery schedule and *match* prices with anyone.

SEND FOR A FREE WALL CHART showing all six families with a wide variety of pin configurations, contact types and dielectrics. Return the card in this ad or write Amphenol Industrial Division, 1830 S. 54th Ave., Chicago, Illinois 60650.

\***Fixed Contact**—Fixed solder contacts with 2-piece glass-filled nylon insulator. **High Density**—Removable crimp Poke-Home® contacts with glass-filled nylon insulator. **Encapsulated Contact**—Removable crimp or solder Poke-Home® contacts with encapsulating nylon insulator. **Power/Coax**—Removable crimp or solder Poke-Home® contacts for either power or coax with glass-filled nylon insulator. **Original Poke-Home®**—Removable crimp or solder Poke-Home® contacts with nylon insulator. **Hard Dielectric**—Removable crimp or solder Poke-Home® contacts with diallyl phthalate insulator.

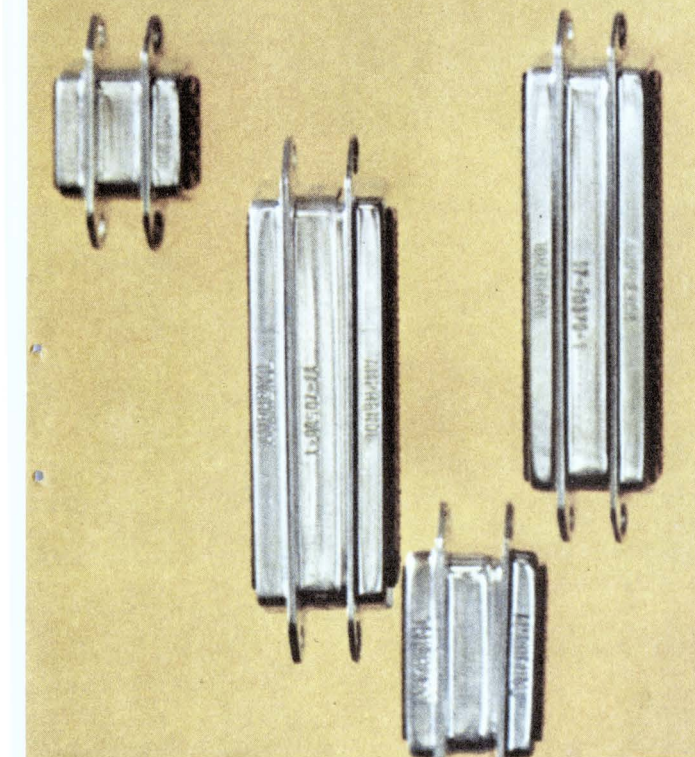

**To help or not to help**

Sir:

I see that you published my letter in the May 1969 issue of *The Electronic Engineer* (p. 20). I can scarcely believe my 250 word letter was so potent as to occasion Mr. Field's fierce 1000 word reply. Rather I think Mr. Field used it as a point of departure, to answer all the engineers who are reluctant to donate assistance to the medical profession. I wasn't the only reluctant electronic engineer.

Assume for a moment that the situation was reversed: that MDs had been requested to help EEs for the good of mankind. Imagine further that a doctor had written to an MD magazine to say the request is illogical. Can you imagine an MD magazine publishing a lengthy rebuttal? Such a thing is inconceivable. It is a sad commentary on the status of the EE, when his own journals take him to task for wishing remuneration for his professional efforts. Even if doctors in research hospitals are not earning 30K they're not working gratis. Why then should we?

I feel that because Mr. Field went to such length to refute my letter, I should have been given a simultaneous right of reply. Since this is now impossible, the least you can do is to allow me a subsequent reply to this letter.

Robert Bruce  
Senior Engineer  
Sperry Systems  
Syosset, New York

Sir:

I have been drafting up a reply to "Is there an EE in the house", but I am compelled to comment immediately to your "Speak Up" article in the May 1969 issue (p. 20). With 8 years experience, I must warn all the EEs who are rushing to help the MD, be prepared to do so on your knees and in abject awe at the presence of their (MD's) holiness. Only the slightest minority of your "research" MDs will accept you as a knowledgeable partner on the team. The rest regard you as a lower form of animal life, who say build me a "black-box" to do this "thing", but never explain why they do their "thing" or what their goal is. If you present a mathematical model of their system, and propose your own "black-box" that does more than their "thing", you are told that medicine is the only "true science"

and that systems analysis and math models are just paper. In short, don't think or try to be part of the team—just be a technician who builds those funny little boxes with those pretty blinking lights. When I go to my personal physician, I heed his medical advice. When a physician comes to me, will he heed my electronic advice?

K. Coombs, Res. Engr.  
Medical Electronics  
USAF School Aero Med.  
SMSBR  
Brooks AFB, Tex. 78235

Sir:

I read the EE Speak Up column in the May 1969 issue of *The Electronic Engineer* (p. 20), and felt compelled to comment on Mr. Bruce's reply to your magazine's article "Help your Doctor" (Nov. 1968 issue, p. 51). I feel Mr. Bruce was much too harsh in his comments. I, too, am not satisfied with the level of compensation that I receive. It is not commensurate with the responsibility that we are required to assume as Senior Lead engineers. However, condemnation of another profession will not solve engineers' problems. We owe a great deal to our dedicated medical profession and if there are a few that abuse the privileges of the profession, we should not condemn the whole profession. I would like you to add my name to your list of engineers who are willing to assist the medical profession. I would gladly donate some of my time to non-profit programs in medical electronics. Naturally, if the program were a profit making one, I would expect to share in that profit. I am a Senior electronics engineer with 11 years experience. I have had four years experience as a development engineer, developing instrumentation and control systems with particular emphasis on instrumentation and control of nuclear reactors. I have had four years of experience as a research engineer at a radiation effects laboratory where I worked with two high energy particle accelerators and the related instrumentation. The past three years I have been employed in the instrumentation and data collection areas working with all types of data processing equipment up to and including digital computers.

I do not feel that Mr. Bruce's views are representative of EEs in general and would not want anyone to think that he speaks for the profession in his comments.

The effort your magazine is making is commendable and I believe that it will be of great service.

L. D. Worster  
2148 Hoxie  
Richland, Wash. 99352

Sir:

I have followed with interest the various article in *The Electronic Engineer* concerning "Help the Doctor", *The Electronic Engineer*, (November, 1968 issue, p. 51). In reference to your questions, you might be interested in one of our programs sponsored by NASA. The work involves NASA's Technology Utilization program. Basically, we seek out medical researchers with problems that can be solved using technology developed by NASA. We work with medical centers in this area (Duke University, University of North Carolina, Bowman Gray) although other teams cover other geographical areas.

You may be able to help us by supplying the list of volunteers for work in medical electronics. In our program we supply free volunteers for work in medical electronics. We are often either completely swamped with requests or feel that we have no expertise in the physicians' area of interest. The list of volunteers may provide help for the physicians when we are unable to do so.

F. Thomas Wooten, Ph.D.  
Research Triangle Institute  
Research Triangle Park, N.C. 27709

EDITOR'S NOTE: We are sending the list to Dr. Wooten, and hope that it can help to improve the communication between EEs and MDs. Even if some of the results are as traumatic as those experienced by Mr. Coombs, and feared by Mr. Bruce, we feel that the experience that our readers will gain is worth the effort.

**Name the guilty party**

Sir:

I disagree violently with Mr. Benzvi's statement that he could not name the manufacturer's of the faulty equipment. (*The Electronic Engineer*, July 1969, p. 35). If it can kill, he is guilty of murder by not preventing it. He knowingly allows lethal equipment to be used and will not disclose the name. Tell the State University that to condone is the same as committing a crime.

T. F. Van Natta, Jr.  
Pan Am Aerospace  
Cape Kennedy, Fla.

P. C. board courtesy of  
Monitor Systems  
an Aydin Company

## Pick your own happy ending.

All good things, including circuit boards, must come to an end.

That's where we come in. We've got the happy ending patented.

Four times. (Pat. nos. 2,248,686; 2,294,056; 3,182,276; 3,208,026.)

In all the configurations you need. Four plug styles. Ten receptacle styles. For direct staking, or with their own insulator. With or without card guides. With or without guide pins. With any number of contacts (up to 135, on one triple-decker receptacle).

Every one meets Mil-E-5400 including the new revision "K", which makes metal-to-metal contacts mandatory.

Our Varicon™ metal-to-metal contacts are patented — and famous, in their quiet way. Because, in millions of operating hours, not one has failed.

The Varicon contacts have a unique fork-like design, with four large, coined, mating surfaces that form a firm gas-tight seal. Even after being mated for years, they remain clean and unoxidized. They have, and

keep, a low contact resistance and high current capacity. And they're exceptionally resistant to shock and vibration.

Several members of our p.c. connector family come with our Varilok™ contact. These have all the advantages of the Varicon contacts — except that you can insert and remove them from the receptacle yourself.

They're available by the handful for small scale production and on 1800-contact reels for use with automatic crimping equipment.

They're all described in our printed circuit connector guide. To get your copy, write, wire, call or TWX us. Elco Corporation, Willow Grove, Pa. 19090. (215) 659-7000. TWX 510-665-5573.

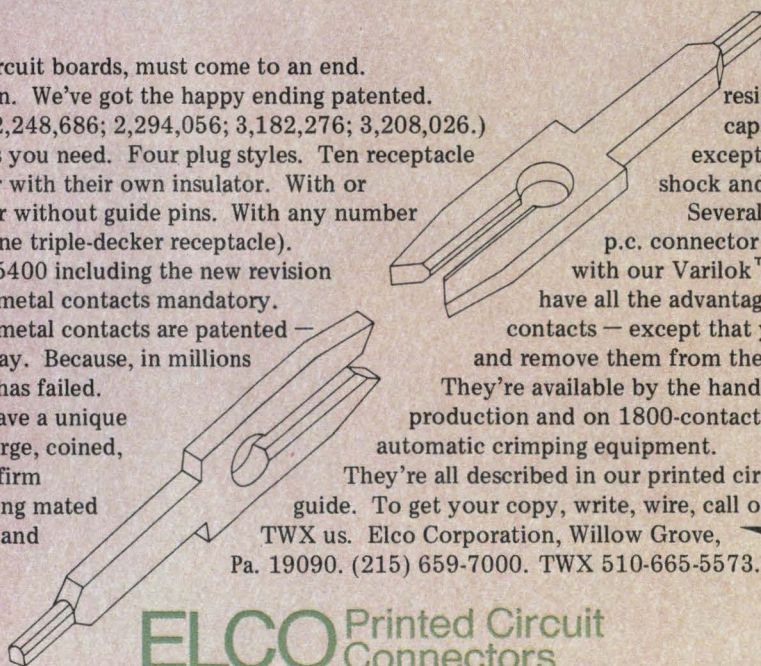

**ELCO** Printed Circuit  
Connectors

YOU MEAN I SHOULD BUY **GENERAL ELECTRIC  
PANEL METERS AND METER RELAYS**  
NOT JUST BECAUSE THEY'RE **GENERAL ELECTRIC-**  
NOT JUST BECAUSE THEY'RE THE FULLEST LINE IN  
THE INDUSTRY, BUT BECAUSE THEY'RE BACKED BY A  
**SALES AND SERVICE ARMY** READY TO HELP ME  
AT A MOMENT'S NOTICE?

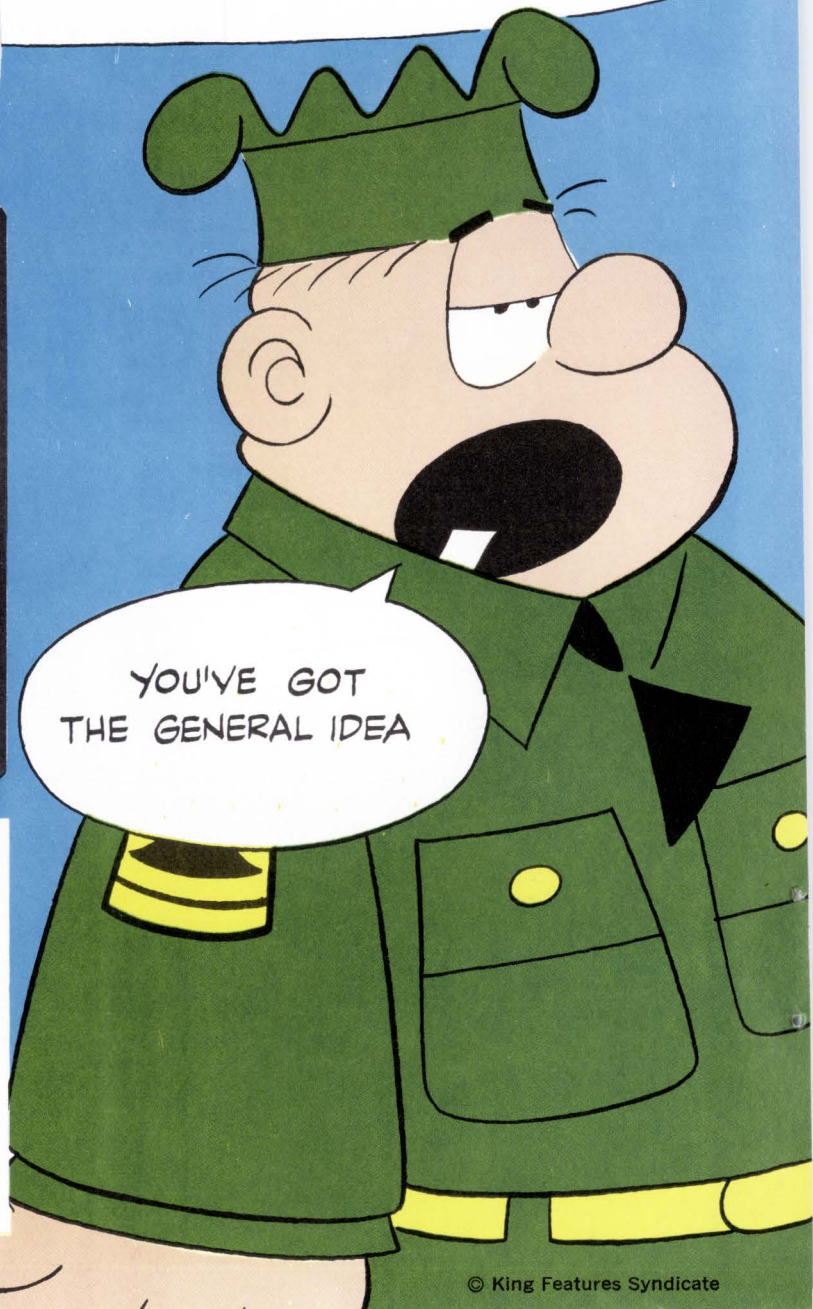
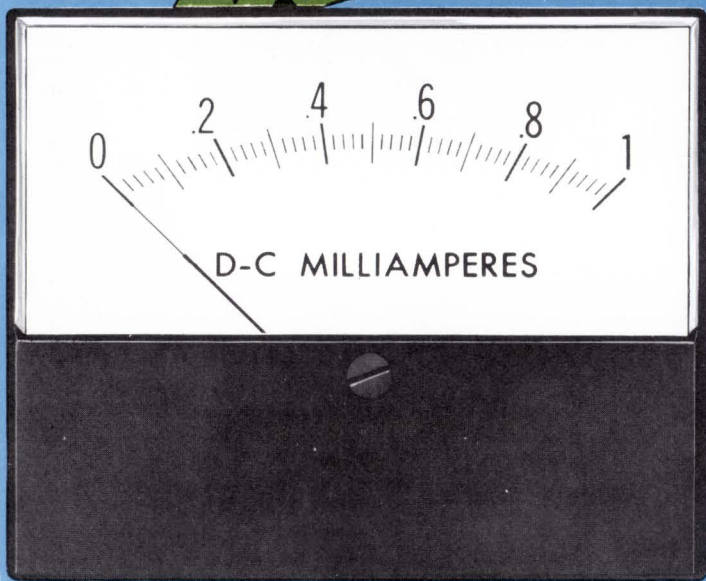
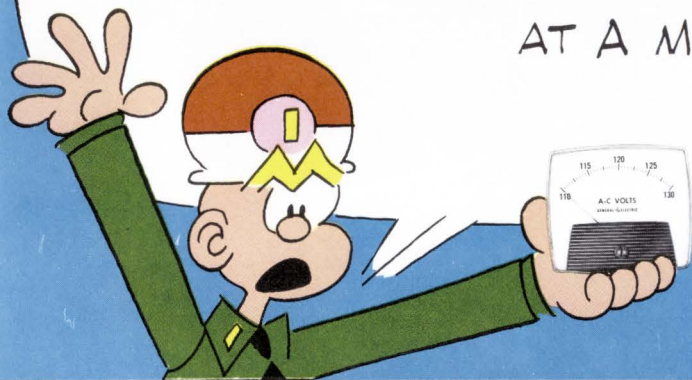

YOU'VE GOT  
THE GENERAL IDEA

General Electric's Sales and Service Army—the largest in the industry—offers you the fullest line of quality panel meters. And that same Sales and Service Army is at your command, ready to bring you the finest, most comprehensive back-up available—whenever you need it. Remember, quality instruments and the in-depth ability to back them up are yours every time you specify and buy panel meters from General Electric. Contact your GE Electronic Components Sales Office or your dependable General Electric panel meter distributor.

592-33

**GENERAL**  **ELECTRIC**



# One giant leap for mankind ... One step backward for engineers

**As the first men stepped out on the moon, hundreds of engineers stepped out of MOL. The electronic firms went immediately to work to help find their men jobs, with much success. Yet the specter of layoffs remains.**

**By Joan Segal, Assistant Editor**

Joe Q. Engineer is 48 years old. He's been in the aerospace business since graduating school, and holds an MSEE which he earned by attending classes at night for several years. He's a project leader, and has been with his present company almost eight years. He tries to keep up to date, reads heavily and takes a course almost every semester.

Joe has a wife and three kids. His eldest child is a sophomore in college, the other two are in high school. He holds a mortgage on a new home, has two cars, a color television, and enjoys the "nice things in life."

Joe's been through two layoffs, the last in 1964, and came out of them unscathed. But now a series of circumstances has left him without a job, and he feels threatened.

Sound like fiction? Perhaps so, but there's more reality than you may wish to admit. It started a month or two ago, when Congress tightened its pursestrings and told Secretary of Defense Laird to cut his budget. Laird complied, and the MOL (Manned Orbital Laboratory) contract became the inadvertent victim.

Now layoffs are certainly not a novelty in the defense business—they're almost expected, and to a great extent accepted, as just a risk of the trade. What is noteworthy is the reaction of the companies involved to the layoffs. Footing much of the bill themselves, the companies immediately geared up to find work for their displaced engineers.

Especially hard hit by the MOL cancellation were General Electric's Space Systems Div. in Philadelphia and McDonnell Douglas in Los Angeles. About 1600 people (roughly half of them engineers or related pro-



**Outplacement Center in action.** General Electric personnel worked almost round the clock to ensure that displaced engineers got "as much exposure as possible."

professionals) were affected at GE; at McDonnell Douglas the figures were even higher—about 2000.

### **Outplacement is no outing**

At General Electric, as at McDonnell, attempts were made to give each person caught in the layoffs "as much exposure as possible." General Electric in particular tried to keep everyone on the payroll for a month, during which time the employees affected were urged to look around for a job both within and outside the company.

But GE did far more than this. For a week it ran an "Outplacement Center," similar to the increasingly popular career centers held throughout the country for college seniors (see **The Electronic Engineer**, Feb. 1968, p. 24). The way it worked, all those affected were asked to prepare brief resumes (with the help of a personnel representative, if needed). These resumes were collected and put into booklets according to specific categories, e.g., Electrical Engineering, Mechanical Engineering, Test, Systems Engineering, Quality, and so forth. Then representatives from the various GE departments or components, from all over the country, were invited to Philadelphia to attend the center, held at a local motel.

Once at the Center, these recruiters could look through the books of resumes, pick out the names of those that most interested them, and request more detailed resumes. From this additional information they could then select those they actually wanted to interview, and the interviews were arranged. During this phase of the Outplacement Center, GE's staff worked almost round the clock to schedule and hold as many interviews as possible.

The statistics show that 99 representatives from 52 different GE components attended the week-long Center, and that they conducted 850 interviews with 332 of the 825 professional employees who were seeking new positions.

### **Success story**

In a period of two weeks, 327 professional employees were placed within GE. One problem, of course, is that many of them had to relocate to other parts of the country. But one group of engineers really "lucked out," as the expression goes. Sixty-five members of the MOL software group were hired by the company's Information Systems Equipment Div. in Phoenix—and are being retained as a group right in Philadelphia. This may not mean much to a fellow right out of college, who is often not adverse to moving, but to an older man with a mortgage and kids in school it's certainly a boon.

### **A cheap way to get good help**

The Outplacement Center was not just for GE recruiters. After an interval of one week, the Center opened for Phase II of its operation. Approximately 90 companies representing as many as 3000 openings

were invited in to interview those not already placed within GE. Although three out of four firms were from the general Philadelphia area, there were some, such as General Dynamics, from as far away as California. Burroughs, AMP, Control Data, LTV Electro-systems, Motorola, Norden, RCA, Sanders, Sperry Rand, Stewart Warner, Univac, Westinghouse, Xerox, Boeing, Globe Union, Hughes Aircraft, Leeds & Northrup, and Raytheon Equipment Div. were some of the familiar names recruiting at the Center.

GE used still other techniques to help its displaced personnel. It made a list of all the job openings—within and outside the company—and put together a catalog. An employee could then consult this catalog to see if he fit any of the openings and contact the company himself. In addition, basic information on each person on the layoff list was fed into the company's computer system. This data was then available to all GE components in the country, many of which were unable to send representatives to the actual Outplacement Center. In the first three days of this system's operation, there were requests for 139 resumes from various GE components.

Richard T. Kimball, manager of manpower planning and resources at the Space Systems Div., sums up GE's attitude toward the layoffs: "Ours is a people product. What we market is our technical capability and our systems engineering, so we're highly dependent on maintaining an extremely competent work force . . . . So if people are your most important resource, then you try to do everything you can to attract good people—and to retain them."

### **What the engineers say**

Nobody likes being laid off. And engineers are no exception. But among GE engineers, the consensus is that "the company is being more than fair" and "is doing an excellent job in trying to get people relocated." Most say the MOL layoffs are just part of "the risk you have to take in this kind of business." Says one EE, a program manager who's been with GE for 8½ years, "Their practices are more than one can expect in a situation like this. They're certainly extending themselves."

No one, on the other hand, was pleased by the cancellation. A circuit designer who had once worked on the Apollo project noted that he'd be able to sit home and watch the moon landing—in which he had played some small part—and at the same time have to worry about finding a new job.

### **Meanwhile, back on the Coast . . .**

McDonnell Douglas followed some of the same procedures that GE used. Salaried employees got two weeks notice (salaries during this period were paid by the government due to a union contract with the company)—many got more than this.

The first thing the company then did was try to



**Interview statistics.** During the Center's first phase, recruiters from 52 different GE components conducted 850 interviews with 332 professional employees.

match the engineers laid off against existing openings within the company. This included replacing job shoppers with *bona fide* McDonnell employees. Secondly, all people on the layoff list were asked to fill out resume forms, and interviews were arranged with over 100 local and national firms.

As of now, there is no data on how successful McDonnell has been in placing its people. But if you estimate that 1500 interviews might lead to, say, 100 to 500 jobs, then that still leaves a great number of engineers laid off and without new jobs. (It's estimated that over 2500 professional people were actually affected by MOL layoffs at McDonnell Douglas.)

### Who gets hurt the most?

Giving credit where credit is due, we should recognize the fine job these companies have done in attempting to help their engineers. But some facts emerge from the MOL situation that are not so encouraging. First of all, of those that do get laid off, the ones that get relocated fastest are the most marketable people—one or two years out of college, relatively low-priced, working in the state of the art. Software people have fared particularly well in the MOL layoffs. But the older fellows, who have the greatest financial needs, not only tend to be among the first to go but also find it much more difficult to get another job.

Bob Leventhal, business manager of the Southern California Professional Engineering Association (the engineering union at McDonnell Douglas), comments, "If you were to analyze who got laid off, you'd probably find that the average age of those laid off is higher than the average age of the work force. Those laid off are generally older . . . and it hits them at a time when their earnings should be at a peak and their needs are the greatest. Many have to relocate outside engineering or take inferior jobs with less pay."

Another type that gets hurt is the fellow who's been with a company only a short while. He may have spent a considerable amount moving to a new area, and

often has put large sums into a new home. Yet this is the fellow that is usually kept on the payroll the least amount of time when a layoff comes. John Cunha, president of Lockheed's Engineers and Scientists Guild, notes, "On a cancellation a fellow—no matter how short a time he's been with the company—should be given a month's notice; it takes that much time to relocate to a suitable job."

### The layoff phantom strikes again

The specter of the 1963-64 layoffs seems to be looming on the horizon. At the end of May, Lockheed laid off 50 professional engineers on the Cheyenne contract. Now McDonnell Douglas and General Electric are facing mass layoffs. Martin in Denver has had similar problems. Yet the government, the defense firms, and the engineers themselves are no better prepared for this than they were back in 1963. They may indeed be worse off, with the skyrocketing cost of living.

Leventhal feels that the layoffs themselves are not the relevant issue—what is at issue is the failure to pre-plan. "Why are we so poor at planning?" he asks. "What are we doing with a resource that is so important to the nation's progress? We just must do a better job or we're going to discourage even more people from going into engineering." Leventhal cites the reluctance of engineers to have their children go into engineering, plus the general alienation of students against destruction, as reasons for the lower percentage of students entering our engineering schools today.

What about the companies and their commendable efforts to help their engineers? "We're very appreciative of the effort that's being made," says Leventhal, "but it's after the fact."

**INFORMATION RETRIEVAL**

**Careers**

# Try to do this with semiconductors

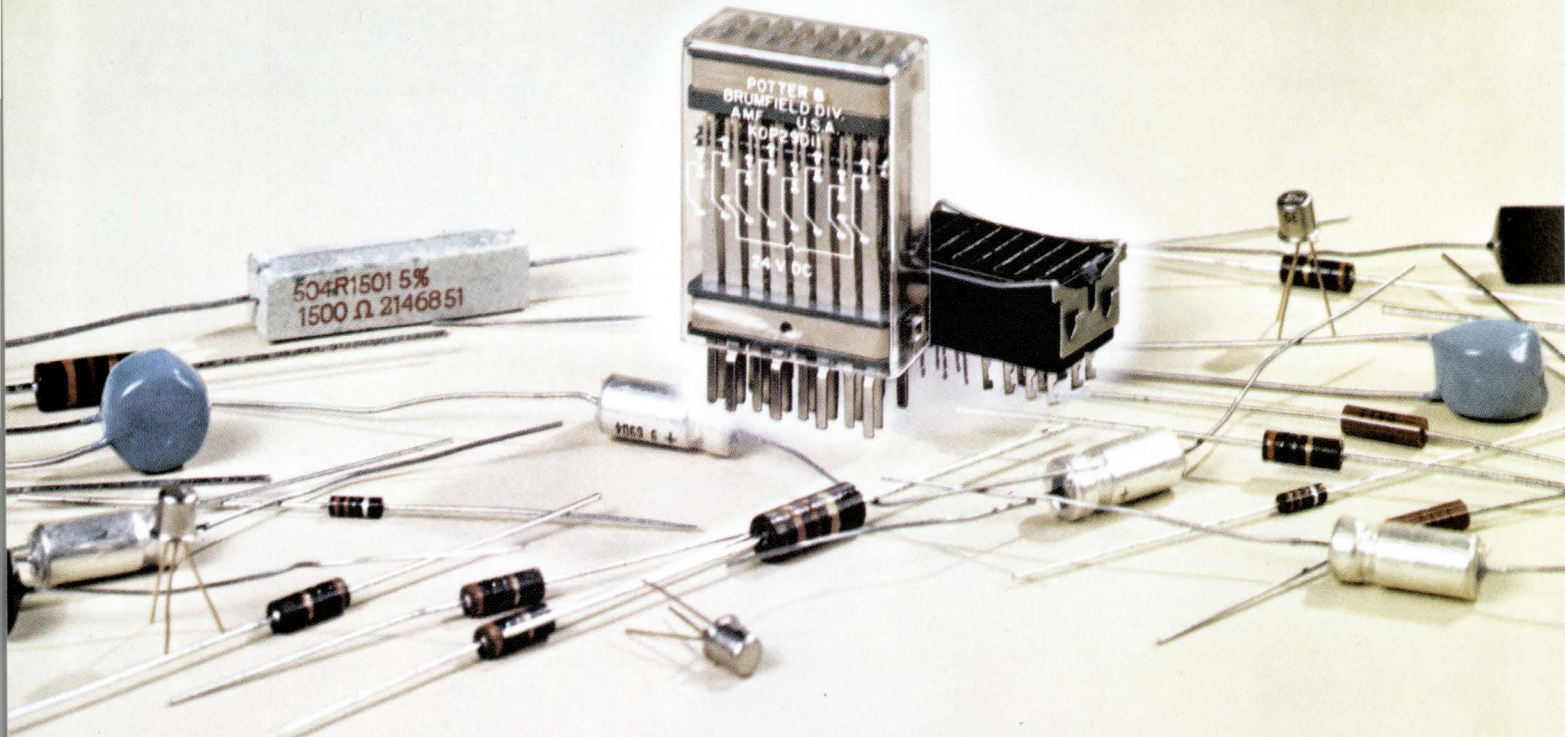

Where else can you get 8 Form C switching in a package that measures just over a cubic inch and costs less than 50¢ per pole?\* You can't with semiconductors. You'd wind up with a much larger, more expensive array.

Speaking of cost, the KDP has a single lot price of \$9.35. The list price, by the way, is less than two of our most popular 4-pole relays.

The compact KDP is ideal for logic circuits where a single input will give you a fan-out of eight. Open-minded engineers will find that a strong case for this relay over solid state switching. Remember, too, you get electrical isolation on both the input and switching sides.

Bifurcated contacts are rated at 1 ampere at 30V DC or 120V AC, resistive. Standard relays have an 8 Form C contact arrangement. Combinations of Form C and Form D (make-before-break) are available on special order. Coil voltages range from 6 to 48V DC.

Order prototype models today from your local P&B representatives or call us direct. Potter & Brumfield Division of American Machine & Foundry Company, Princeton, Indiana 47570. 812-385-5251.

\*Maximum discount

## KDP SPECIFICATIONS

### General

Temperature range  $-45^{\circ}$  to  $+70^{\circ}$ C.

### Contacts

Arrangements: 8 Form C (8PDT).  
Rating: 1 amp at 30V DC or  
120V AC, resistive.

### Coils

Voltages: To 48V DC  
Duty: Continuous  
Pick-up @  $25^{\circ}$ C: DC, 75% of nominal voltage.  
Operate Time: 15 ms maximum at nominal voltage @  $25^{\circ}$ C.

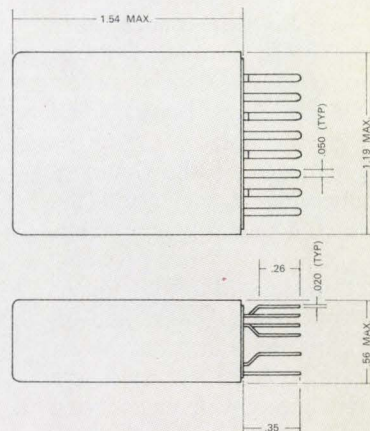

NOTES:  
1. DIMENSIONS APPLY TO TERMINAL CENTERS

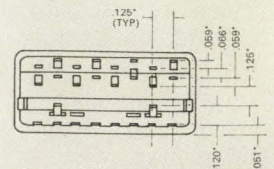

POTTER & BRUMFIELD

## EE READ THESE BOOKS

For more information about these books (sorry, no free copies), circle the corresponding number on the reader inquiry card.

### Electronics: BJTs, FETs, and Microcircuits

By E. James Angelo, Jr. Published 1969 by McGraw-Hill Book Co., 330 West 42nd St., New York, N. Y. 10036. Price \$13.50. 630 pages.

Because electronics is such a fast changing field, textbooks must constantly be revised and updated. The relatively recent rise of MOSFETs, bipolar junction transistors, and integrated analog circuits have created a new need for a basic text explaining their operation and application. This book fills that need.

This book is meant primarily as an introductory text for a college course in electronics. However, it could very well serve as an up-to-date source of self-instruction for the practicing engineer who wants to acquire a basic analytical knowledge of modern electronics.

Circle 321 on Inquiry Card

### Condensed Computer Encyclopedia

By Philip B. Jordain. Published 1969 by McGraw-Hill Book Co., 330 West 42nd St., New York, N. Y. 10036. Price \$14.50. 605 pages.

Forget how an Accumulator works? Want to know a little about PL/1? This book answers those questions and a thousand more.

Here is a perfect up-to-date guide for those who come in contact with a computer. It fills the gap between elementary computer dictionaries and complicated computer manuals. A fine reference for the business man, junior programmer, or student as well as for the experienced computer specialist. A complete index supplements the alphabetical arrangement of entries.

Circle 322 on Inquiry Card

### Understand and Using Unijunction Transistors

By Stu Hoberman. Published by Howard W. Sams & Co., Inc., Indianapolis, Indiana 46268. Price \$2.50. 95 pages.

Circle 323 on Inquiry Card

### The Oscilloscope—New Third Addition

By George Zwick. Published 1969 by Tab Books, Blue Ridge Summit, Pa. 17214. Price \$4.95 for paperback.

Circle 324 on Inquiry Card

### Introduction to the Theory of Linear Systems

By E. A. Faulkner. Published by Barnes and Noble Inc. 105 Fifth Ave., New York, NY 10003. Price \$3.25. 89 pages.

Circle 325 on Inquiry Card

### Audio Systems Hand Book

By Norman H. Crowhurst. Published 1969 by Tab Books, Blue Ridge Summit, Pa. 17214. Price \$4.95 paperback. 192 pages.

Circle 326 on Inquiry Card

← Circle 30 on Inquiry Card

### 17th Annual National Relay Conference Proceedings

By the National Association of Relay Manufacturers, P.O. Box 1649, Scottsdale, Arizona 85252. Price \$5.

Circle 327 on Inquiry Card

### Computerized Approximation and Synthesis of Linear Networks

By Jeri Vlach. Published 1969 by John Wiley & Sons, Inc., 605 Third Ave., New York, N. Y. 10016. Price \$14.95. 477 pages.

Circle 328 on Inquiry Card

### The Technology of Computer Music

By M. V. Mathew. Published 1969 by the MIT Press, 50 Ames Street, Cambridge, Mass. 02142. Price \$12. 188 pages.

Circle 329 on Inquiry Card

### Computer-Aided Design of Magnetic Circuits

By Alexander Kusko and Theodore Wroblewski. Published 1969 by the MIT Press, 50 Ames Street, Cambridge, Mass. 02142. Price \$6.95. 113 pages.

Circle 330 on Inquiry Card

### Electron Optics

By B. Paszkoski. Published 1969 by American Elsevier Publishing Co., Inc., 52 Vanderbilt Ave., New York, N. Y. 10017. Price \$13. 305 pages.

Circle 331 on Inquiry Card

### Logical Design of Switching Circuits

By Douglas Lewin. Published 1969 by American Elsevier Publishing Co., Inc., 52 Vanderbilt Ave., New York, N. Y. 10017. Price \$10.50. 368 pages.

Circle 332 on Inquiry Card

### Thin Film Dielectrics

Edited by Frederick Vratny. Published by the Electrochemical Society, Inc., 30 East 42 Street, New York, N. Y. 10017. Price \$12. 669 pages paperback.

Circle 333 on Inquiry Card

### Ohmic Contacts to Semiconductors

Edited by Bertram Schwartz. Published 1969 by Electrochemical Society, Inc., 30 East 42 Street, New York, N. Y. 10017. Price \$10. 356 pages paperback.

Circle 334 on Inquiry Card

### Electronic Spectra of Transition of Metal Complexes

By B. Sutton. Published 1968 in England by McGraw-Hill, Ltd., McGraw-Hill Book Co., 330 West 42 Street, New York, N. Y. 10036. Price \$8.50. 208 pages.

Circle 335 on Inquiry Card

### Mathematics for Science and Engineering

By Phillip A. Alger. Published 1969 by McGraw-Hill Book Co., 330 West 42 Street, New York, N. Y. 10036. Price \$9.75. 374 pages.

Circle 336 on Inquiry Card

### Control Systems for Technicians

By G. T. Bryan. Published 1969 by Hart Publishing Co., Inc., 510 Sixth Ave., New York, N. Y. 10011. Price \$12.50. 328 pages.

Circle 337 on Inquiry Card

### The Art of Computer Programming Volume 2 Seminumerical Algorithms

By Donald E. Knuth. Published 1969 by Addison-Wesley Publishing Co., Inc., Reading, Mass. 01867. Price \$18.50. 624 pages.

Circle 338 on Inquiry Card

### Color TV Reception and Decoding Technique

By B. W. Osborne. Published 1969 by Hart Publishing Co., Inc., 510 Sixth Ave., New York, N. Y. 10011. Price \$12.50. 168 pages.

Circle 339 on Inquiry Card

# Looking beyond the 'specs' with P&B

## Quiet, rugged long life Medium Power Relay

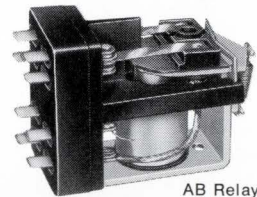

AB Relay

Here's a 10 amp relay you can depend on. It's ideal for industrial controls and similar applications requiring rugged construction, long life and quiet operation. Available for AC or DC operation, these relays have a mechanical life in excess of three million operations.

This series is available in two styles. The AB, an open relay and the ABC Series with a heavy metal dust cover for protection against dust, dirt and accidental jars.

Both relays are available with DPDT contacts or DPST, normally open or normally closed. Equipped with .250" quick connect terminals. Screw terminal adapters are available.

Standard AB and ABC relays carry component recognition by Underwriters' Laboratories and are listed by the Canadian Standards Association. U/L and CSA listed relays are available in the following operating voltages: 6, 12, 24, 120 and 240 volts AC, 50/60 Hz.

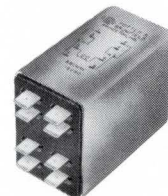

ABC Relays Heavy Metal Dust Cover

**PLUS P&B Capabilities and Facilities that insure**  
■ Controlled Quality ■ Reliability  
■ Long Life ■ On Time Deliveries

**AMF**  
**POTTER & BRUMFIELD**  
Division of American Machine & Foundry Co.  
Princeton, Indiana 47570

Circle 31 on Inquiry Card

“”

“Funny,  
you don't  
look  
resistive”



## Dale reacts faster to your non-standard needs.

The resistive function you design doesn't have to have a standard shape and size...not when you deal with Dale. Look at these examples. The big one is a point for a vending machine can opener. Inside a Dale resistor provides heat for sterilization after each use. The small one is deceptively powerful – capable of 21 watts when heat sink mounted inside a computer to terminate line drive impulses. Of course, your problems will be different. But Dale has a head start toward solving them. Production blueprints on hundreds of special design situations including special packaging, termination, performance extremes, matching let us slash the lead time you'd expect for a non-standard part. Wirewound or film, single component or network, if you can't find it in your catalogs, call Dale first...402-564-3131.

Write for Dale's  
**FUNCTIONAL GUIDE  
TO NON-STANDARD  
RESISTORS**

...listing by function  
hundreds of readily  
available design combina-  
tions involving special  
size, shape, performance  
and other variables.



**DALE ELECTRONICS, INC.**

1352 28th Avenue,  
Columbus, Nebr. 68601

In Canada, Dale Electronics, Ltd.



# Design guide to hybrid package size

Package size is set by the area of the components and interconnects, and the power to be dissipated. Here is an easy way to figure out the package size.

By **Robert G. Bristol**, CTS Microelectronics Inc., Lafayette, Indiana 47906

There are many package shapes and sizes available, so you have to know whether the circuits will fit into the package you desire. One of the "secrets" in good hybrid design is being able to select the right package size. This is important because of heat problems and room for components and interconnections.

### Design guideline

This step-by-step design guideline will help you determine whether a circuit is compatible with a given hybrid package using chip and wire assembly techniques. For ease of testing, it is recommended that circuitry be divided into functional modules wherever possible. Here are the steps to follow:

List all devices to be included in the hybrid package and list the average power dissipation. Calculate the total average power\* of the circuit and be certain that the package required will meet the power needs over your ambient temperature range. (See Fig. 1 as an example.)

Count the number of external leads required for your circuit and check to see that the desired package has sufficient leads available.

Calculate the total area required for circuit elements using Table 1 and multiply this figure by five to determine the total area for all components and interconnections. Compare this area to the available area in the desired package as listed in Table 2. Here is an example, using Fig. 1:

### Itemizing the space required in package

8 Small signal transistors	0.0120 in. <sup>2</sup>
4 Signal diodes	0.0040 in. <sup>2</sup>

\*Normally average power is used, but our example is calculated with maximum power.

3 Capacitors	0.0210 in. <sup>2</sup>
16 Resistors	0.301 in. <sup>2</sup>
	<hr/>
	0.0671 in. <sup>2</sup>
Multiplier for interconnections, etc.	x 5
	<hr/>
Total area required in package	0.3355 in. <sup>2</sup>

**INFORMATION RETRIEVAL**  
Integrated circuits, Hybrid packages

**Table 1**  
Area required for components

**Resistors:**

$$\text{Area} = \frac{0.04 \text{ in.}^2}{\text{watt}} \times \text{Power dissipation (W)}$$

- All resistors of less than 25 mW should be listed as 25 mW.
- Area should be doubled for resistors less than 10Ω or greater than 50 KΩ.

**Active Devices:**

Small signal silicon transistors	0.0015 in. <sup>2</sup>
Signal diodes	0.0010 in. <sup>2</sup>
Integrated circuits	0.0040 in. <sup>2</sup>
Rectifier diodes	0.0040 in. <sup>2</sup>
Power transistors	0.0040 in. <sup>2</sup>

**Capacitors: (50V)**

	NPO	K1200	K7000
0.005 in. <sup>2</sup>	2pF-500pF	120pF-.02μF	560pF-.056μF
0.008 in. <sup>2</sup>	5pF-1000pF	180pF-.04μF	560pF-1μF

Parts list				
	Value (ohms)	Max. Diss. (mW)	Type	Max. Diss. (mW)
R1	2000	10	Q1 2N2894	19
R2	120	4	Q2 2N2894	23
R3	390	50	Q3 2N709	26
R4	120	4	Q4 2N709	26
R5	220	73	Q5 2N2894	67
R6	330	85	Q6 2N2894	67
R7	330	20	Q7 2N2894	65
R8	330	85	Q8 2N709	22
R9	330	20	CR1	10
R10	2000	10	CR2	10
R11	2000	10	CR3	10
R12	150	129	CR4	10
R13	220	81	FDM6000	10
R14	510	25	C1 1000 pF	>2V
R15	150	8	C2 .1 μF	
R16	50	0.1	C3 .1 μF	

Fig. 1: Here is a hybrid circuit that we can use as an example to select the right package size. Along with having the parts list, the power dissipation of the components was determined. Because of the number of parts and power dissipation this circuit was placed in a 0.8 x 0.8 in. package.

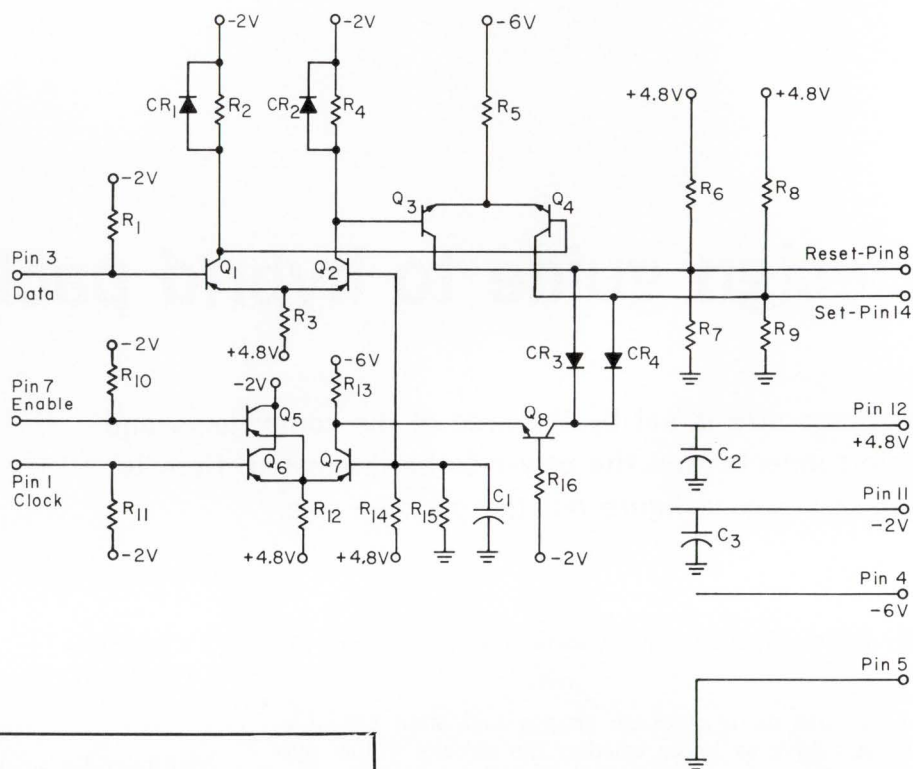

Table 2  
Packages for hybrid ICs

Package	$P_d$ (25°C amb.)	Linear derating	Area available
TO-5 0.180" max. ht.	500 mW	3.3 mW/°C	0.04 in. <sup>2</sup>
0.250" max. ht.	500 mW	3.3 mW/°C	0.08 in. <sup>2</sup>
TO-8 0.150" max. ht.	1.25 W	0.008 W/°C	0.09 in. <sup>2</sup>
0.185" max. ht.	1.25 W	0.008 W/°C	0.18 in. <sup>2</sup>
0.275" max. ht.	1.25 W	0.008 W/°C	0.27 in. <sup>2</sup>
TO-3	4 W	0.02 W/°C	0.25 in. <sup>2</sup>
¼ x ¼ in.	500 mW	3.3 mW/°C	0.020 in. <sup>2</sup>
¼ x ¾ in.	500 mW	3.3 mW/°C	0.045 in. <sup>2</sup>
¾ x ¾ in.	500 mW	3.3 mW/°C	0.055 in. <sup>2</sup>
½ x ½ in.	750 mW	5 mW/°C	0.15 in. <sup>2</sup>
⅝ x ⅝ in.	1 W	0.007 W/°C	0.23 in. <sup>2</sup>
¾ x ¾ in.	1.25 W	0.008 W/°C	0.29 in. <sup>2</sup>
1 x 1 in.	1.5 W	0.01 W/°C	0.64 in. <sup>2</sup>

Note: The TO packages permit stacking of substrates to increase complexity of circuits, but watch power dissipation and leave several leads to allow for interconnections. As hybrid circuits have an added substrate interface over semiconductors in same package, their power dissipation will not be as great.

We had to use a special 0.8 x 0.8 in. package because it had to be designed to fit dual-in-line lead centers.

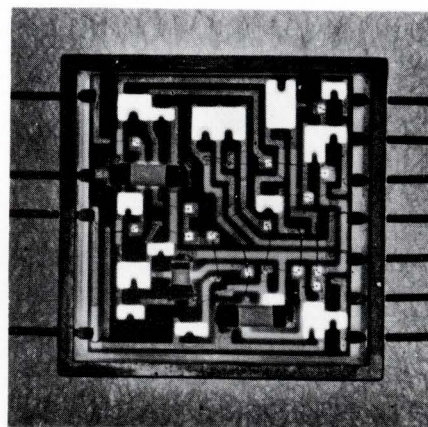

Fig. 2: The circuit in Fig. 1 was laid out and placed in the 0.8 x 0.8 in. flat package. This package is now completed except for the top or lid.



# What's the best Monolithic Chip Capacitor?

Centralab Mono-Kap\*!



CENTRALAB MONO-KAP

## See for yourself.

ACTUAL MICROGRAPHS OF RANDOMLY SELECTED MONOLITHIC CHIP CAPACITORS.



COMPETITOR A

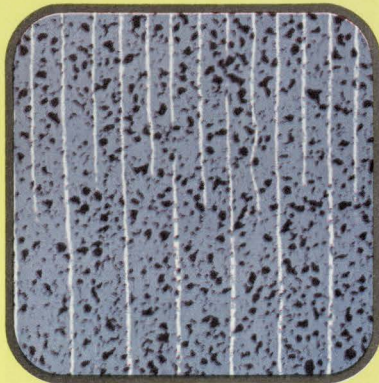

COMPETITOR B



COMPETITOR C

The superiority of Centralab Mono-Kap chips is clearly visible . . . pin holes that destroy reliability and long life are virtually eliminated. The beauty and superiority of these new monolithic chip capacitors is much more than skin deep, too. Centralab is alone in testing 100% for flash, insulation resistance, dissipation factor and capacitance. We also manufacture our own ceramics, thick film microcircuits and a broad line of capacitors. As a designer of microcircuits, Centralab developed the Mono-Kap to increase the scope of

circuits we could manufacture. Centralab's Mono-Kaps have been tried and proven in a wide variety of industrial and military microcircuits. We have a wide variety of materials, physical sizes and capacitance values, all priced competitively and delivered in as little as four weeks. If seeing is believing, and you'd like a closer look, call on your local Centralab Representative for samples and product data. Have requirements for encapsulated Mono-Kaps with terminations? Send your specifications to Centralab, Application Engineering Dept.



CENTRALAB

Electronics Division  
GLOBE-UNION INC.

5757 NORTH GREEN BAY AVENUE  
MILWAUKEE, WISCONSIN 53201

\*TM

M-6919

# Ferroxcube is $\pm 1\%$ intolerant about pot cores

Ferroxcube is extremely intolerant of wide tolerances in pot core inductance.

As one example out of dozens, our 3B9 material 1408 size pot cores with 100  $A_L$  maintain  $\pm 1\%$  tolerances. No one else in the industry holds to better than  $\pm 3\%$ . Maybe they could. But then maybe they couldn't match our competitive prices.

Ferroxcube's ability to beat down pot core tolerances means that you get better stability (be-

cause you have a smaller tuning range). And it isn't just  $A_L$  values. We keep our specs strict in every parameter.

We also deliver faster. No one else has eight Stocking Centers nationwide . . . loaded for immediate local shelf-to-you deliveries.

And no one else gives you such a wide choice of bobbins and hardware accessories. Not to mention

an unbeatable variety of pot cores in sizes from 9 mm to 42 mm and in five materials.

If you were harder on your pot core supplier, maybe you could be easier on yourself . . . in design, in costs. Write to Ferroxcube for Bulletin 220-C. When you study the pot cores there, you won't tolerate any other kind.

**Ferroxcube**   
Saugerties, New York  
A NORTH AMERICAN PHILIPS COMPANY.

**BEAT  
POT CORE  
TOLERANCES**

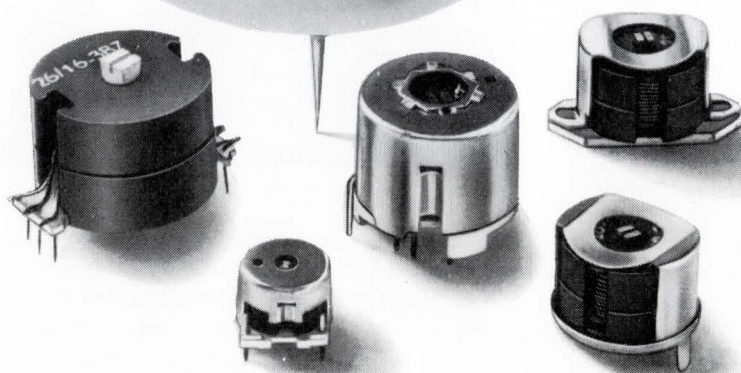

Atlanta—Cartwright & Bean, (404) 237-2273; Baltimore—Eastern Components, (301) 322-1412; \*Burbank, Calif.—(213) 849-6631; Cedar Rapids—Thomas & Modricin, (319) 377-6261; Columbus, Ohio—Mulligan & Mathias, (614) 486-2976; \*Dallas—Gillett Industries, (214) 363-0107; Fayetteville, N.Y.—R. P. Kennedy Co., (315) 637-9531; Hazelwood, Mo.—Thomas & Modricin, (314) 838-6446; Huntsville, Ala.—Cartwright & Bean, (205) 852-7670; Hyde Park, N.Y.—R. P. Kennedy Co., (914) 229-2269; Indianapolis—Thomas & Sukup, (317) 251-4574; Kansas City—Thomas & Modricin, (913) 432-2131; Littleton, Col.—Wm. J. Purdy Agents, (303) 794-4283; Marion, Ia.—Thomas & Modricin, (319) 377-6261; Minneapolis—(612) 920-1830; \*New York—Kahgan Sales, (516) 538-2300; \*Northlake, Ill.—(312) 261-7800; No. Miami Beach—Cartwright & Bean, (305) 945-2962; Orlando—Cartwright & Bean, (305) 425-8284; Ormond Beach, Fla.—Cartwright & Bean, (904) 677-3480; \*Philadelphia—Eastern Components, (215) 927-6262; Phoenix—(602) 264-3129; Rochester, N.Y.—R. P. Kennedy Co., (716) 271-6322; \*San Francisco—Wm. J. Purdy Agents, (415) 347-7701; Saugerties, N.Y.—(914) 246-2811; Shawnee Mission, Kans.—Thomas & Modricin, (913) 432-2131; St. Louis—Thomas & Modricin, (314) 338-6446; Union, N.J.—(201) 964-1844; \*Waltham, Mass.—(617) 899-3110; \*Woodstock, N.Y.—Elna Ferrite Labs, (914) 679-2497; \*Toronto, Ont.—Philips Electron Devices, Ltd., (416) 425-5161. \*Denotes stocking distributor.

# Environmental code: A shortcut to specifications

With this 10-digit code you can easily keep track of environmental specifications for both military and non-military parts.

By **Rudolf Wernick**, Project Officer  
Dept. of National Defense, Ottawa, Ontario, Canada

Military specifications describe, often at great length, the environmental parameters of military electronic parts and equipments. (See "A quick guide to environmental specifications," **The Electronic Engineer**, March, 1969, pp. 79-85.) These detailed requirements are needed to ensure accuracy, but they are difficult to record and to compare. Here, at last, is a short, simple method of specifying the exact parameters.

## What is E.C.?

The Environmental Code (E.C.) consists of a 10-digit number. The position of each digit defines a specific parameter, while the value of the digit represents a particular level of that parameter.

For example, the first digit always represents altitude, the second represents high operating ambient temperature, and so forth. If the first digit is a 1, then this specifies 15,000-ft. altitude, whereas a 6 represents 100,000 ft. In this way 10 different environmental parameters are represented in the code (see Fig. 1).

## How to use E.C.

The Environmental Code table on p. 50 lists the various levels for each parameter along with the corresponding code number. In addition, the test methods for parts are listed as per MIL-STD-202. These methods are not the only ones to be used since different parts and equipments use different military specifications, some of which are shown in Table I. In general, an item

to be coded should be tested according to its relevant specification. Since it is the document most commonly used in evaluating electronic parts, MIL-STD-202 is the basis for E.C.

Occasionally the levels in mil specs are slightly different from the levels in E.C. In that case, the deviation is indicated by an asterisk (\*) next to the appropriate code number. For example, MIL-E-16400F specifies the temperature +50°C, while MIL-E-4158C specifies +52°C. Both of these temperatures would be represented by a 1\* in the second position of the E.C., indicating that the temperature is close to, but not exactly, +55°C.

## Using the code

By coding the mil specs themselves, you can compare coded parts and equipments to the specifications. Note that the mil specs need only be coded once since they apply as long as the specification remains unchanged. Some sample codings for parts and equipment specifications are shown below.

Parts Specs	Environmental Code
MIL-R-11F, Resistor	3 2 4 - 7 5 - 4 0 0 - D 0
MIL-R-93D, Resistor	6 5 5 - 7 5 - 4 6 0 - D*0
MIL-STD-446A, Group I	1*1 4 - 1 4 - 4 5 3 - J 0
Group II	4 3 5 - 5 5 - 4 5 3 - J 0
Group III	1*5 5 - 5 5 - 4 5 3 - J 0
Group IV	6 5 5 - 5 5 - 4 5 3 - F 0
Group V	6 7 5 - 6 5 - 4 5 3 - J*0
Group VI	7 7 5 - 6 5 - 4 5 3 - F 0
Group VII	7 8 5 - 7 5 - 4 5 3 - F 0
Group VIII	7 9 5 - 8*5 - 4 5 3 - I 0

## ENVIRONMENTAL CODE

for Military Electronic Parts and Equipments

ALTITUDE					HI TEMPERATURE				LO TEMPERATURE						
				Method											
				105	°C		102	107	°C		102	107			
kFt	km	in. of Hg													
0					0				0						
1	15	4.3	17.3	F	1	+55			1	-10					
2	30	9.1	8.9	A	2	+71			2	-25					
3	50	15.2	3.4	B	3	+85	A,D	A	3	-40					
4	70	21.3	1.3	C	4	+105			4	-55	A,D	A			
5	80	24.4	.82		5	+125	C	B	5	-65	C	B-F			
6	100	30.5	.32	D	6	+150		F	6	-75					
7	150	45.7	.043	E	7	+200		C	7						
8	656	200	9x10 <sup>-8</sup>	G	8	+350		D	8						
9					9	+500		E	9						

VIBRATION				SHOCK					
			Method						
g	Hertz								
0				0					
1	-	10-55	201	1	Drop		203		
2	10	10-500	204A	2					
3	20	10-500		3	15g, 11ms		205A		213G
4				4	30g, 11ms		205B		213H
5	10	10-2k	204C	5	50g, 11ms		205C		213 I
6	15	10-2k	204B	6					
7	20	10-2k	204D	7	Hi Impact		207		
8	30	10-2k		8					
9				9					

3
5
5

2
4

4
5
0

0
M

MOISTURE RESISTANCE				CORROSION				FLAMM. & EXPL.		
			Method							
Hrs				Salt		Sand	Fungus	Flamm.		Expl.
0				0				0		
1	96	103B	Humidity	1	101B, 48h			1	111	
2	240	103A	(40°C)	2	101A, 96h			2		109
3				3		110A		3	111 +	109
4	240	106	Moist. R	4		101B + 110A		4		
5			(25° to 60°)	5		101A + 110A		5		
6				6			Fungus	6		
7				7		101B + 110A + Fungus		7		
8				8		101A + 110A + Fungus		8		
9				9				9		

LIFE (Hours)				LIFE (Cycles)						
			Method 108				Method 206			
							(at high ambient temperature and full load)			
0				0						
A	96	J	30k	A	500	K	300k			
B	250	K	50k	B	2k	L	500k			
C	500			C	5k	M	1M			
D	1k			D	10k	N	2M			
E				E	15k					
F	2k			F	25k					
G	3k			G	50k					
H	5k			H	100k					
I	10k			I	200k					

### Levels

Designate the required level by the appropriate digit.

### Test Methods

Test Methods specified are for parts as in MIL-STD-202. For Equipments, use the applicable methods of MIL-STD-810.

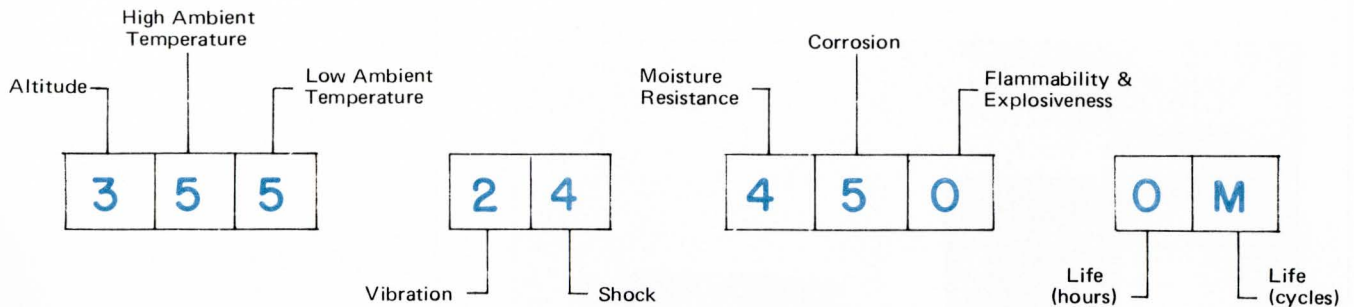

**Fig. 1: The Environmental Code (E.C.)** consists of a 10-digit number representing 13 environmental parameters in a fixed order. The value of the digit in a position represents the

level of that parameter as determined in the Environmental Code table on the opposite page.

Military Specifications		
NAME	CONTENTS	USED FOR
MIL-STD-202	Test methods for electronic and electrical component parts	Parts in general
MIL-STD-750	Test methods for semiconductor devices	Semiconductors
MIL-STD-883	Test methods and procedures for microelectronics	Microelectronics
MIL-STD-810	Environmental test methods	Equipments

Equipment Specs	Environmental Code
MIL-E-5400J, Class 1	3 1 4 - 2*4* - 1 7 2 - 0 0
Class 1A	2 1 4 - 2*4* - 1 7 2 - 0 0
Class 2	4 2 4 - 2*4* - 1 7 2 - 0 0
Class 3	6 4*4 - 2*4* - 1 7 2 - 0 0
Class 4	6 5 4 - 2*4* - 1 7 2 - 0 0
MIL-E-16400F, Class 1	0 2*4 - 1 7 - 4*1*0 - 0 0
Class 2	0 2*2 - 1 7 - 4*1*0 - 0 0
Class 3	0 1*3 - 1 7 - 4*1*0 - 0 0
Class 4	0 1*1* - 1 7 - 4*1*0 - 0 0

### Evaluating those parts

You now see how easy it is to code mil spec parts. But what about those non-military (Non-MS) parts? They can be coded just as easily if acceptable test evidence exists. By comparing the E.C.'s for these parts with the code of an equipment, you can greatly simplify the task of parts evaluation.

For example, if the equipment E.C. is

314 - 24 - 400 - D0

and the E.C.'s of two parts are

Resistor (MIL-R-11F) 324 - 75 - 400 - D0

Resistor (Non-MS) 334 - 53 - 400 - F0

then a comparison will show that the digits of the resistors are equal to or higher than those of the equipment. Hence, both resistors meet the environmental requirements of the equipment.

If, however, some of the digits of a part are lower than the corresponding digits in the equipment code, it is immediately known that the part is not suitable for the equipment.

### A little background

This environmental code was developed by the author in 1963 and is currently used by the Canadian Military Electronics Standards Agency (CAMESA) for its evaluation procedures of non-standard parts. CAMESA is the Canadian military agency for electronic parts and is equivalent to the American DESC in Dayton, Ohio.

The original code contained other parameters such as reliability, sunshine, rain, and radiation; but these have been deleted for the sake of simplicity.

In general, E.C. provides an accurate, easy way to define the environmental characteristics of electronic parts and equipment. It greatly simplifies parts evaluation, especially when large numbers are involved. It is a simple and effective information retrieval system, and can be used either manually or with computers.

**INFORMATION RETRIEVAL**  
Instruments and measurements,  
Reliability, Charts and nomographs

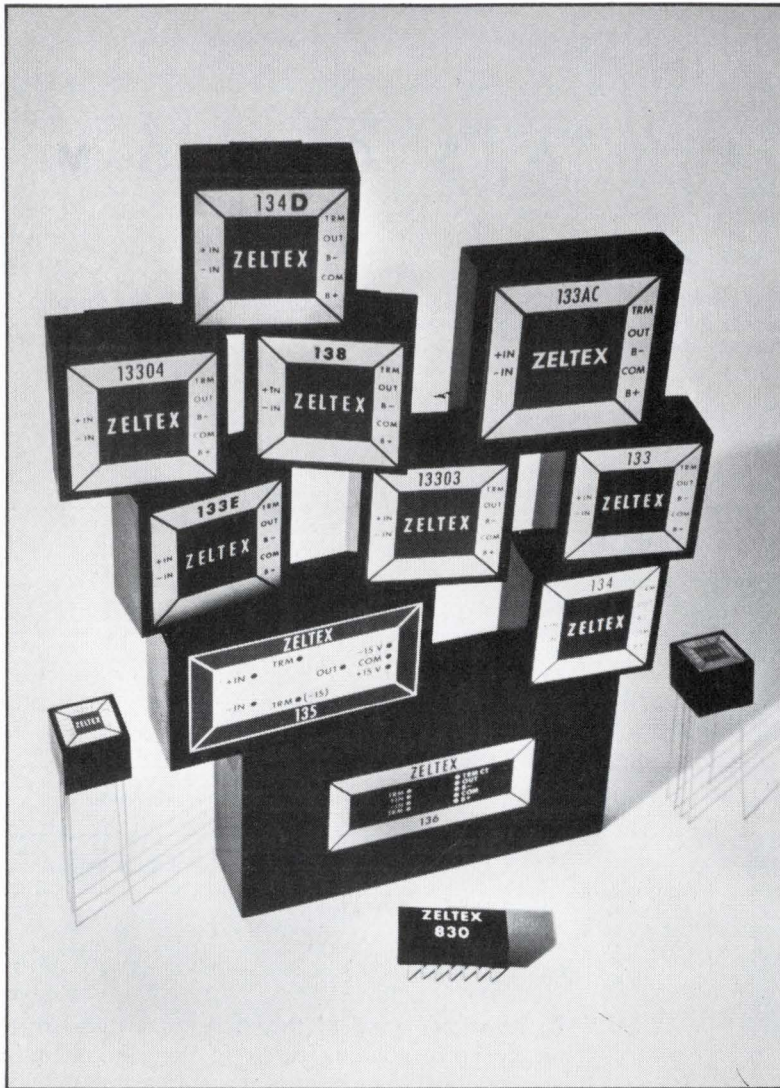

## Here are 13 solutions to your FET OP AMP problems

Thirteen FET-input op amps to solve just about any problem you have—whether it's drift, slew rate, package size, CMRR, settling time, input bias current, common-mode input voltage or cost.

But we didn't stop there. We've developed another five-dozen specials tailored to our customers' individual needs.

Get the point? If you're looking for a FET-input op amp, you should be looking at our data sheet. The one with all the answers.

### **ZELTEX, INC.**

A subsidiary of REDCOR CORP.

1000 Chalamar Road, Concord, Calif. 94520  
(415) 686-6660

Here is your  
copy of a brand new  
reference chart



## Guide to ELECTRICAL TAPE

Tear it out, ►

**NOW**

. . . and  
mount it on  
your wall

If the chart has been  
removed, Circle Num-  
ber 41 on the Inquiry  
Card for a copy.

# Divided-gap choke is a real swinger

Here's a better way to build swinging chokes. A divided air-gap gives you larger swings, higher efficiency, and smaller size than in conventional chokes.

By **Herbert I. Keroes**, President  
Quaker City Transformer Co., Philadelphia, Pa.

Iron-core chokes have weight and bulk. They are a problem to the power-supply designer trying for a minimum-size design. But in high-current supplies, they are indispensable. And in such supplies, a *choke-input filter* is especially attractive because:

- It reduces initial and repetitive peak currents through the rectifiers.
- It reduces the ripple voltage.
- It reduces the volt-ampere requirements of the power transformer.
- It gives you better regulation than does a capacitor-input filter.

(But keep in mind that a choke-input filter needs a higher input voltage than does a capacitor-input type, for the same output voltage.)

Figure 1 shows a common rectifier/filter circuit. The inductance of the choke,  $L_c$ , must let the diodes conduct over a full cycle of the input frequency, or else the filter will act like a capacitor-input type. If the inductance is too small for the current that's flowing, the diodes will switch off before the end of a complete cycle, and current flow will not be continuous. The inductance at which switch-off occurs is called the *critical inductance*,  $L_{crit}$ , and is the smallest inductance you may use.

## Why non-linear?

If the load current ( $I_L$ ) varies, you will have trouble maintaining a suitable  $L_{crit}$  for all values of current. For instance, at zero current, you would need an infinite inductance! To get around this problem, and ensure continuous current flow, you can connect a bleeder resistor ( $R_b$ ) across the shunt capacitor. This ensures that some current flows through the choke at all times.

Now, the amount of bleed current you need varies inversely with the inductance of the choke. So it is to

your advantage to give the input choke a non-linear characteristic, one that provides high inductance at low currents, and low inductance at high currents. Such an inductor is called a *swinging choke*: its inductance is an inverse function of the dc current through it. By using it, you maintain good regulation over a range of load currents, and do so more efficiently than with a linear choke and bleeder resistor.

## The usual way

The choke you select should give you the widest swing possible, but most show less than a 2:1 ratio. The design of such chokes derives from that of linear chokes, for which there is much information available.<sup>1</sup> You start by selecting a linear design with an inductance, at maximum current, that is the mean of the two values you need at your maximum and minimum currents. You then undergap this choke, so that it goes further into saturation than it should, at high currents, further decreasing its inductance. In this way, you guarantee at least the minimum value. But there is no assurance at all that you will be able to hit the maximum that you need. In fact, if you have chosen a wide swing, you will find it impossible to closely approach the maximum value.

## To really swing . . .

Undergapping the choke means that you're not efficiently using the iron at higher currents; the choke is larger and heavier than it would be with an optimum gap. But a simple expedient lets you design a choke that gives you predictable inductance swings up to six times the minimum value, one that uses most of the iron to maximum advantage.

First, remember that you can replace any single inductance with two or more inductances in series. There-

<sup>1</sup>Irving Richardson, "New Procedure for Designing Linear and Swinging Chokes," *Electrical Manufacturing*, Dec. 1957.

fore, you can also simulate a swinging choke with a series combination of two chokes. One of these is butt-stacked (i.e., it has a very small air gap) to give high inductance at low currents. The other is a linear choke with an air gap that's optimum at maximum current, to meet your minimum-inductance requirement.

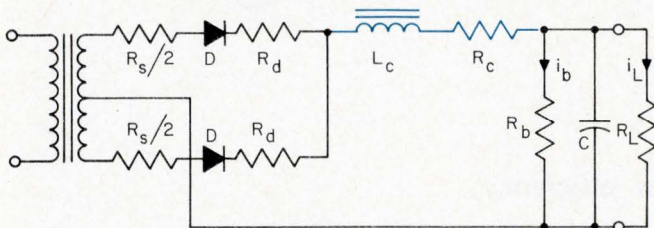

**Fig. 1. A common rectifier/filter circuit.** The minimum inductance of  $L_c$  must allow the diodes to conduct over a full cycle of the input, or you lose the advantages of a choke-input filter. Almost any textbook will show the derivation of this minimum value, called  $L_{critical}$ . For a 60-Hz input,  $L_{crit.} = R_{eff}/1131$ , in henries, where  $R_{eff}$  is the sum of the resistances around the circuit. In this illustration,  $R_{eff} = R_a + R_c + R_s/2 + R_b R_L / (R_b + R_L)$ .

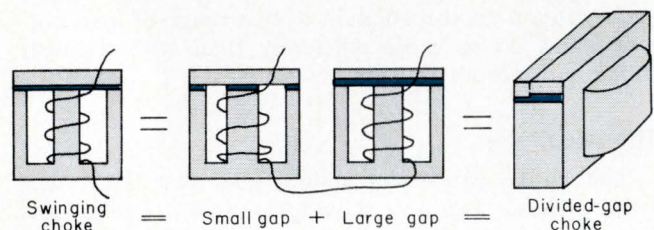

**Fig. 2. The divided-gap choke as the equivalent of a swinging choke.** Consider it as derived from two linear chokes in series, one with a small gap, the other with a large gap, to give you the high- and low-limits of the inductance swing. In practice, you need only one winding.

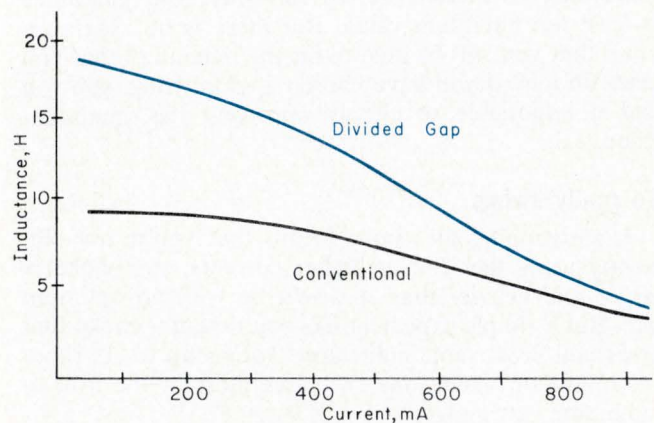

**Fig. 3. This is a performance comparison between conventional and divided-gap choke designs.** Both use the same number of turns on the same stack, but the conventional choke has a 0.04-in. air gap. Note that it swings about 2.4:1, while the divided-gap choke has a 4:1 swing.

Figure 2 shows such a *divided-gap* choke. At minimum current, the total inductance is the sum of the component inductances. But at high currents, the butt-stacked choke saturates, and its inductance falls almost to zero. The total inductance is thus that of the optimally-gapped choke alone.

To build a divided-gap choke, you must, in effect, design two separate chokes that, working together, give you the swing you need. Both chokes can use iron of the same size. You can, in addition, vary the amount of stack, so that both chokes will have the same number of turns. Finally, since the property of inductance is tied to a magnetic field, and the magnetic field is constrained within a core, you need use only one winding that links both cores.

In practice, you will rarely have to go through a full design of both chokes. For instance, you can pick, from tables, a linear choke that will give you something in excess of the minimum, high-current inductance. Then, a portion of the stack (usually estimated at 10 to 25%) is butt-stacked to meet the high-inductance, low-current requirement. You then vary the two sections, either in proportion or in depth, until you have the end values that you need.

### Comparing results

Suppose you need a swinging choke with an inductance of 4.5 H at 900 mA, 18 H at 50 mA, and a resistance of 25  $\Omega$ . From tables, you can pick a 5.25-H linear choke. It will have a 1500-turn coil of #22 wire on a core with a 1.75-in. tongue, and a 3.5-in. stack depth. The optimum gap would be 0.06 in., so the gap spacer is half this value. If you make the spacer cover somewhat less than the full stack depth, you'll get a butt-stacked section. A 0.5-in. butt-stacked section gives the 18-H inductance you need at 50 mA, and makes the high-current inductance only slightly higher than the 4.5 H value that you need.

Figure 3 compares this inductance-swing range to that of a choke of conventional design. Note that the conventional choke never meets the 18-H design figure. It uses the same number of turns on the same stack, but with a 0.04-in. air gap. This makes the high-current inductance 3.8 H, and the low-current inductance 9.2 H.

A divided-gap choke uses iron more efficiently than does a conventionally-designed choke, which is advantageous to you. For instance, suppose the minimal performance of a conventional choke is acceptable for your application. Then, for the same performance, a divided-gap design saves you about 20% of the iron. On the other hand, you can use the higher low-current inductance of the divided-gap choke to halve the bleed current. Or, you can also retain this feature but reduce the high-current inductance, and still save some iron.

**INFORMATION RETRIEVAL**  
Magnetic devices, Passive components,  
Power supplies



# NEW TI ELECTRONIC CHEMICALS.

They've already made  
our first customer  
very happy.

For years, Texas Instruments has been manufacturing electronic chemicals for just one customer: ourselves.

They've worked so well for us, we'd like you to try them. The same chemicals we use in silicon production, high-temperature gas reactions and epitaxial technology. All of which require, as you know, purity to parts-per-billion standards plus extremely high integrity in lot-to-lot uniformity.

Perhaps the wealth of experience behind TI chemicals can offer you some improvements... even if it's just the security of a new source. In either case, your files should contain the following data sheets:

- Epitaxy Grade Trichlorosilane (5 and 55 gallon stainless drums)
- Epitaxy Grade Silicon Tetrachloride (5 and 55 gallon stainless drums)
- Boron Tribromide Dopant (50 and 100 gram ampules)

Please write. You'll find us very eager to double our satisfied customer list.

TEXAS INSTRUMENTS INCORPORATED  
Chemical Materials Division  
P. O. Box 5621 • M/S 924  
Dallas, Texas 75222



## TEXAS INSTRUMENTS INCORPORATED

A small part of our new, high-capacity electronic chemicals facility.

# Get regulated current with FETs

With the rapid advancement of semiconductor technology, a two-terminal current regulator was inevitable. Today's state of the art in diodes is merely the beginning of a wide range of capabilities. Spark your imagination with these suggestions.

By **Bob Botos**, Applications Engineering  
Motorola Semiconductor Products, Phoenix, Ariz.

Field effect transistor (FET) circuits are very appealing as constant-current sources for several reasons:

- The FET constant-current source is usually a very simple, easy-to-design circuit. Either a fixed or an adjustable current source can be constructed with nothing more than a FET, a resistor (fixed or variable), and a battery.
- Depending on the device and configuration, output impedances range from kilohms to tens of megohms.
- FETs have  $g_{os}$  values from one-half to several hundred micromhos.
- Saturation or minimum operating voltages are about 1 V.
- Working voltages approach the 100-V level.
- With proper biasing, a nearly zero temperature coefficient is practical.

## Some FET circuits

The simplest constant-current (see Fig. 1) is a FET with the gate and source shorted. The FET operates at  $I_{DSS}$ , the zero-bias drain current. The circuit output conductance equals the FET  $g_{os}$  which at low frequencies equals  $y_{os}$ . For higher frequencies, depending on the device's output capacitance, series inductance can be added. If  $V_{DS}$  changes,  $I_o$  will change according to the relationship

$$\Delta I_o = \Delta V_{DS} g_{os} \quad (1)$$

This simple circuit delivers a relatively constant current from about  $2 V_p$  (the pinch-off or threshold vol-

## Development of current regulator circuits

The original constant current device was simply a high resistance in series with a power supply. A variation was the pentode with its high plate resistance. The transistor reduced the size and improved the power efficiency . . . and permitted encapsulation.

The first constant-current-diode<sup>1</sup> apparently was only a working hypothesis; a laboratory substitute used the reverse leakage of a large germanium junction to build circuits.

FETs, being analogous to electron tubes, gave rise to a variety of circuits (current sources, regulators, limiters). Significant is their drain current, with the gate-source shorted, that remains constant over a wide range of drain-source voltages. Coupled with the low output conductance, these devices make good current sources. Although FETs exhibit degrees of current limiting, these devices have been designed for maximum impedance over the operating range, broad voltage range, and packaged for convenience.

tage) to  $BV_{DS}$  the breakdown voltage drain to source), as shown in Fig. 2.

When a source resistor<sup>3</sup> is added (see Fig. 3), the previous circuit becomes capable of supplying any current below  $I_{DSS}$ . The approximate gate-source voltage  $V_{GS}$ , for a given operating current,  $I_o$ , is:

$$V_{GS} = V_P \left[ 1 - \sqrt{\frac{I_o}{I_{DSS}}} \right] \quad (2)$$

The source resistor,  $R_S$ , required is then:

$$R_S = \frac{V_{GS}}{I_o} \quad (3)$$

Resistor  $R_S$  may be variable to provide an adjustable current source. As  $R_S$  increases, the FET  $g_{os}$  decreases. The circuit output conductance decreases more rapidly than the FET  $g_{os}$  because of the feedback action produced across  $R_S$ . The circuit output conductance is:

$$g_o = \frac{g_{os}}{1 + R_S (g_{os} + g_{fs})} \approx \frac{g_{os}}{1 + R_S g_{fs}} \quad (4)$$

where  $g_{fs}$  is the real part of  $y_{fs}$ , the forward transfer admittance.

If two FETs are cascaded as in Fig. 4, a much lower  $g_o$  for a particular  $I_o$  results. Here  $I_o$  is regulated by Q1 and  $V_{DS1} = -V_{GS2}$ .  $R_S$  and Q1 control the dc value of  $I_o$ . However, Q1 and Q2 both affect current stability.

When  $R_S = 0$

$$I_o = \frac{V_{DS2} g_{os1} g_{os2}}{g_{os1} + g_{fs2}} \quad (5)$$

and

$$g_o = \frac{g_{os1} g_{os2}}{g_{os1} + g_{os2} + g_{fs2}} \quad (6)$$

if  $R_S = 0$  and  $g_{os1} \approx g_{os2}$

$$g_o = \frac{g_{os}}{2g_{os} + g_{fs} + R_S (g_{fs2} + g_{os} g_{fs} + g_{os2})} \approx \frac{(g_{os})^2}{g_{fs} (1 + R_S g_{fs})} \quad (7)$$

When you design cascaded FET current sources, be sure that both FETs operate with adequate drain-source voltage preferably  $V_{DS} > 2 V_P$ , and that Q2 has a significantly higher  $I_{DSS}$  than has Q1.

The above FET circuits are two-terminal devices and can be used easily as circuit elements. The devices are N-channel JFETs; for P-channel devices, reverse all polarities.

For a zero temperature coefficient OTC, each transistor must operate at a specific current,  $I_{DZ}$ —the drain current for OTC:<sup>4</sup>

$$I_{DZ} \approx I_{DSS} \left[ \frac{0.63}{V_P} \right]^2 \quad (8)$$

the gate-source bias voltage is

$$V_{GSZ} \approx V_P - 0.63 \quad (9)$$

Because  $I_{DZ}$  increases with  $I_{DSS}$ ,  $I_{DZ}$  is as high as 1 mA for  $I_{DSS}$  units of 20 mA.

Operation at  $I_D < I_{DZ}$ , but near  $I_{DZ}$  yields a positive TC if desired, negative TCs result if  $I_D > I_{DZ}$ . At 4 mA, the 2N5361 for example offers negative TCs of 1.2  $\mu\text{A}/^\circ\text{C}$ .

### The FET diode

The natural evolution of the circuit in Fig. 1 is the current-regulating diode (CRD) which is in essence an

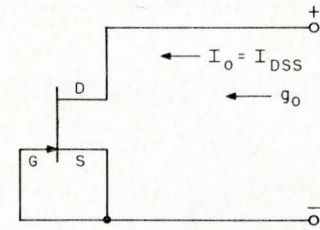

Fig. 1. The simplest constant current source is a FET with the gate and source shorted.

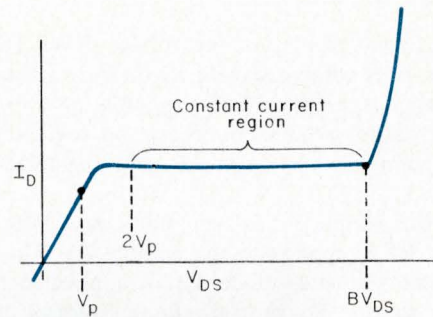

Fig. 2. The current output is relatively constant from the pinch-off or threshold voltage ( $2 V_P$ ) to the breakdown voltage drain to source ( $BV_{DS}$ ).

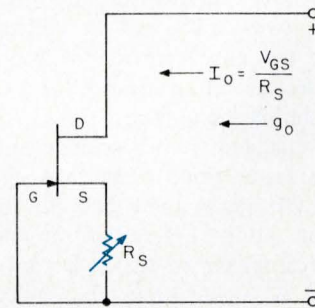

Fig. 3. When a source resistor is added, any current below the zero-bias drain current is possible.

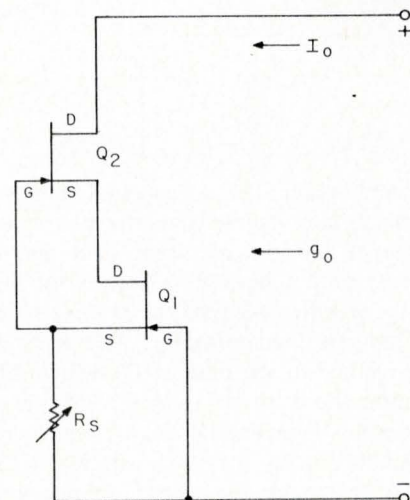
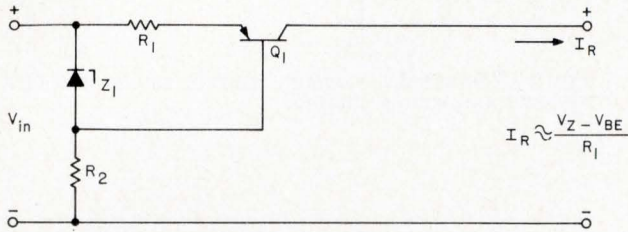

Fig. 4. If you cascade two FETs you'll get a much lower output conductance for a given load current.

## Bipolar transistor current-regulating circuits



In current regulators, the voltage developed across a resistor is compared with a voltage reference. Any difference is amplified and applied to a series regulating transistor which completes the regulating feedback connection by controlling the regulated current flow.

In this simple series regulator circuit, the voltage across  $R_1$  is applied to the emitter  $Q_1$ . The voltage from the reference diode,  $Z_1$ , is applied to the base of  $Q_1$  so that  $Q_1$  is itself the comparison element.  $Q_1$  attempts to pass a current that will keep the voltage across  $R_1$  closely equal to that across  $Z_1$ .

Performance is limited because the current through  $R_1$  is not the output current (it contains the base current of  $Q_1$  and does not contain  $I_{cb0}$ ). The only regulating gain is that provided by  $Q_1$  itself. Performance improves as  $R_1$  and the voltage across  $Z_1$  increase, but the output resistance can never surpass the collector-base resistance of  $Q_1$  which is effectively shunting the output.

$I_R$  will be regulated from a positive limit of about  $V_{IN} - V_{Z1}$  to a lower limit which can even become negative. (If  $Q_1$  has suitable collector-base voltage and dissipation ratings). Here the transistor acts as a common-base amplifier so the collector-base voltage rating, which is higher than the collector-emitter rating, may be used as long as the total base circuit resistance is held low enough to prevent instability.

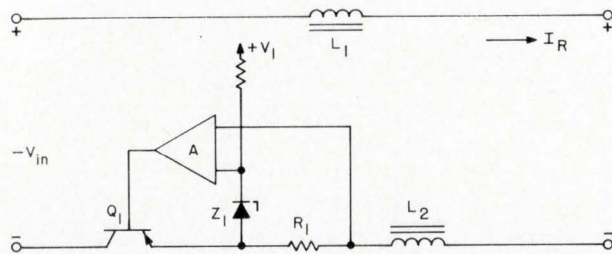

This common-emitter series regulation is capable of practically any degree of performance, providing the amplifier has the necessary gain and stability. The actual output current is sensed by  $R_1$  whose voltage is compared with that of  $Z_1$  which is operated from a separate voltage source. Any error is amplified and applied to the base of  $Q_1$  which adjusts  $I_R$  to minimize the error.  $L_1$  and  $L_2$  help to maintain a high output impedance at high frequencies where the regulating gain inevitably decreases and the transistors are unable to maintain a high impedance themselves.

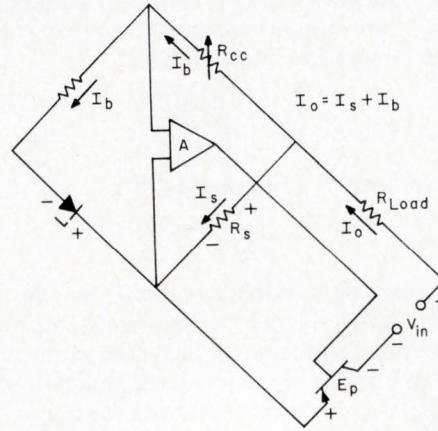

The bridge-balancing regulator<sup>2</sup> is the refinement of the series-sensing type. The voltage to be regulated is the drop across  $R_s$ . The feedback resistor is  $R_{CC}$ , a current control. The only current flowing through the current control is the bridge current. When the voltage drop in  $R_{CC}$  equals the drop in  $R_s$ , the bridge balances.

$I_o$  can be programmed by varying  $R_{CC}$  or changing  $I_b$ , either event causing the voltage drop across  $R_{CC}$  to change. To restore balance, the voltage drop across  $R_s$  must change. This happens when the feedback to the "pass" element alters its conduction to permit a change in  $I_o$  in the proper direction and amount. The refinement then, is the capability of varying the output current, without changing the sensing resistance.

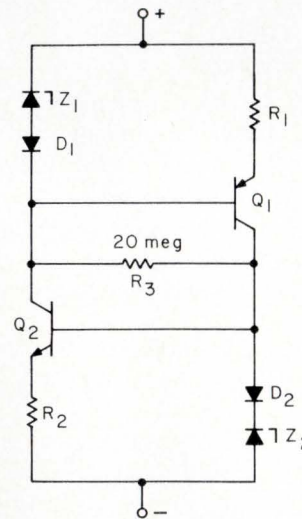

A variation of the simple series regulator circuit can readily be used as a two terminal constant current device. It has a PNP and an NPN current source connected to regulate the other's reference. The current through the compensating diodes  $D_1$  and  $D_2$  is the same as the current through the transistor base-emitter junctions, which improves the tracking with temperature. The circuit requires a minimum voltage of  $2(V_Z + V_D)$  for operation, the maximum is determined by transistor ratings.  $R_3$  is high because it is merely a voltage neutralizer.

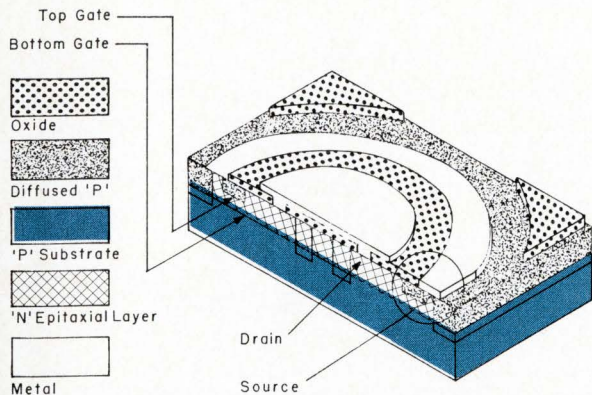

Fig. 5. Typical cross-section of a field effect diode.

N-channel JFET with an internal gate-source short. The design of these diodes has been especially optimized for high impedance and current regulating capability.

Since you define a semiconductor diode as a two-electrode semiconductor device, and since the FET is such a device, you can refer to the FET as a diode. In Fig. 5, the circled area shows that the metal distinctively spans the gate-source areas.

The equivalent circuit of the diode is either a current generator in series with a parallel combination of  $Z_T$  and a capacitance or the same generator shunted by a conductance  $g_T$  and the same capacitance (see Fig. 7). The shunt capacitance,  $C_T$ , associated with Motorola's current regulating diodes is about 6 to 8 pF within the useful voltage range of the devices and is relatively constant. Capacitance does tend to increase and peak as the applied voltage nears  $V_L$ , but falls to zero as the voltage goes below  $V_L$ .

### Variations in configurations

If you wish to extend maximum operating voltage and current ranges of these diodes, you can implement various configurations.

Placing the devices in series, as in Fig. 8a extends the dynamic voltage range. To do this you must introduce voltage-balancing resistances. The resistive values should be high because they shunt the output resistance. This method is synonymous to the current-balancing required when you parallel zener diodes.

Paralleling the diodes (as in Fig. 8b) extends the current range, without requiring any special precautions. The resultant current is merely the sum of the individual currents.

When a bipolar device, one which regulates or limits in both directions, is useful, connect the diodes in series-opposing fashion, as in Fig. 8c. During the cycle when one is limiting, the other is a forward-biased junction, producing a diode voltage drop.

### General applications

**Low voltage references:** To attain references with below normal zener voltages (2.5 V), or with good characteristics (below 6 V), connect the current-regulator diode in series with a resistor. These diodes by driving a known resistor serve well as precision millivolt references (Fig. 9).

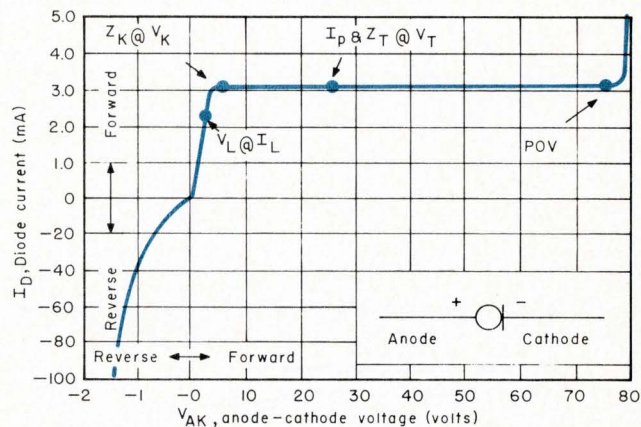

### Symbols and definitions

- $I_D$ —Diode Current.
- $I_L$ —Limiting Current: 80% of  $I_P$  minimum used to determine Limiting voltage,  $V_L$ .
- $I_P$ —Pinch-off Current: Regulator current at specified Test Voltage,  $V_T$ .
- $P_{OV}$ —Peak Operating Voltage: Maximum voltage to be applied to device.
- $V_{AK}$ —Anode-to-cathode Voltage.
- $V_K$ —Knee Impedance Test Voltage: Specified voltage used to establish Knee Impedance,  $Z_K$ .
- $V_L$ —Limiting Voltage: Measured at  $I_L$ .  $V_L$ , together with Knee ac Impedance,  $Z_K$ , indicates the Knee characteristics of the device.
- $V_T$ —Test Voltage: Voltage at which  $I_P$  and  $Z_T$  are specified.
- $Z_K$ —Knee ac Impedance at Test Voltage: To test for  $Z_K$ , a 90 Hz signal  $v_K$  with rms value equal to 10% of test voltage,  $V_K$ , is superimposed on  $V_K$ .  

$$Z_K = v_K / i_K$$
 where  $i_K$  is the resultant ac current due to  $v_K$ .  
 To provide the most constant current from the diode,  $Z_K$  should be as high as possible; therefore, a minimum value of  $Z_K$  is specified.
- $Z_T$ —ac Impedance at Test Voltage: Specified as a minimum value. To test for  $Z_T$ , a 90 Hz signal with rms value equal to 10% of Test Voltage,  $V_T$ , is superimposed on  $V_T$ .

Fig. 6. Typical current regulator characteristics, symbols, and definitions.

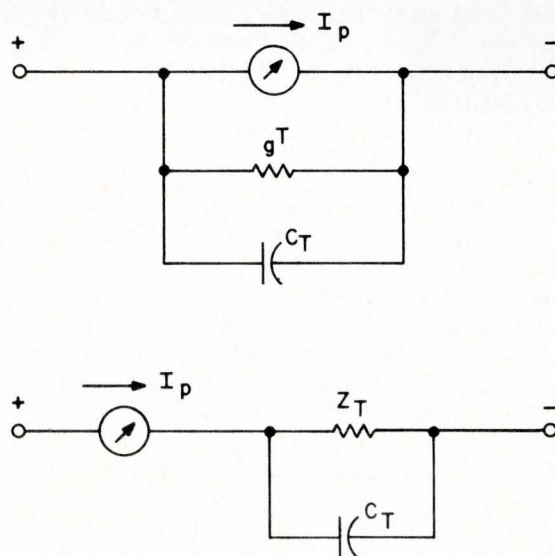

Fig. 7. The diode's equivalent circuit may be either a current generator in series with a parallel combination of  $Z_T$  and a capacitance,  $C_T$ , or the generator shunted by a conductance,  $g_T$ , and the same capacitance.

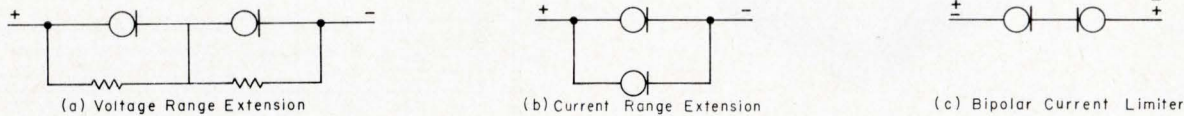

Fig. 8. Constant current diode variations: (a) voltage range extension, (b) current range extension, and (c) bipolar current limiter circuits are shown.

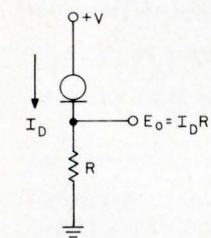

Fig. 9. As a precision low voltage reference, the diode drives a known resistor, producing an output reference voltage that is determined by Ohm's Law.

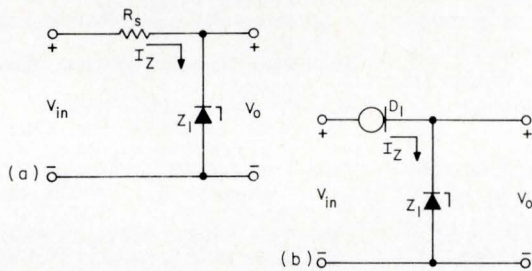

Fig. 10. The standard (a) and modified (b) zener voltage regulator circuits.

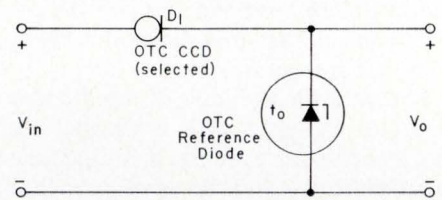

Fig. 11. A zener-CRD combination offers a most absolute voltage reference.

**Zener diode source element:** The current regulating diode has several prime advantages. Figure 10 illustrates the unmodified and modified zener regulator circuits.

Distinct advantages of the zener-CRD combination are: 1) The maximum current-regulating diode voltage (100 V), rather than maximum zener dissipation determines the maximum  $V_{in}$  or operating voltage, and 2) Variations in  $V_{in}$  have virtually no effect on  $V_{out}$ . In either circuit of Fig. 10

$$\Delta V_{out} = \Delta V_{in} \frac{Z_{ZT}}{R_s + Z_{ZT}} \quad (10)$$

where  $R_s$  is the series resistance, either discrete or the dynamic impedance ( $Z_T$ ) of the CRD, and  $Z_{ZT}$  is the zener dynamic impedance.

Because  $Z_{ZT}$  is relatively low, as  $R_s$  increases in value, the regulation  $V_{out}/V_{in}$ , improves. In practical circuits  $R_s$  is normally in the hundreds or thousands of ohms, while the CRD presents megohms. This yields regulation improvements of three to four orders of magnitude.

As  $V_{in}$  varies  $I_Z$  also varies according to

$$\Delta I_Z = \frac{\Delta V_{in}}{R_s + Z_{ZT}} \quad (11)$$

From the relationship given, as  $V_{in}$  increases, the current through, and consequently, the power dissipated in the zener, increases. Thus, zener power rating limits  $V_{in}$ . Using a CRD alleviates this problem entirely.

A zener-CRD combination, as in Fig. 11 offers a most absolute voltage reference. The CRD exhibits a zero temperature coefficient characteristic at currents around 0.5 mA. A Motorola family of OTC reference diodes also operate on zener currents of 0.5 mA. A combination of the two with OTC characteristics, yields a constant reference voltage between the input voltage limits of  $2V_L + V_Z$  to  $POV + V_Z$  (practically, about 8.4 to 106.4 V with a 6.4 V zener), and the temperature range of  $0^\circ$  to  $100^\circ\text{C}$ . The  $V_{out}$  varies about 10 mV over the  $V_{in}$  range; TC is  $0.001\%/^\circ\text{C}$  over the temperature range. Suggested devices are the 1N4569A reference diode and a selected 1N5290 current-regulator diode.

When a zener provides voltages lower than system power supplies, another CRD advantage is tremendous decoupling of either ripple or noise on the supply lines. Because the CRD as compared to the zener, has a high ratio of dynamic impedance, the attenuation is about 100dB at frequencies up to several hundred kilohertz.

**Direct current coupling:** Substituting a zener diode for resistor R1, greatly improves a standard dc coupling (see Fig. 12) by substantially reducing the loss of gain introduced by the coupling circuit. Substituting a CRD for R2, gives a similar increase in gain (see Fig. 12c). Furthermore, as you might expect, a coupling circuit with very desirable characteristics results when these methods are combined. Figure 12d shows an amplifier stage that incorporates this approach.

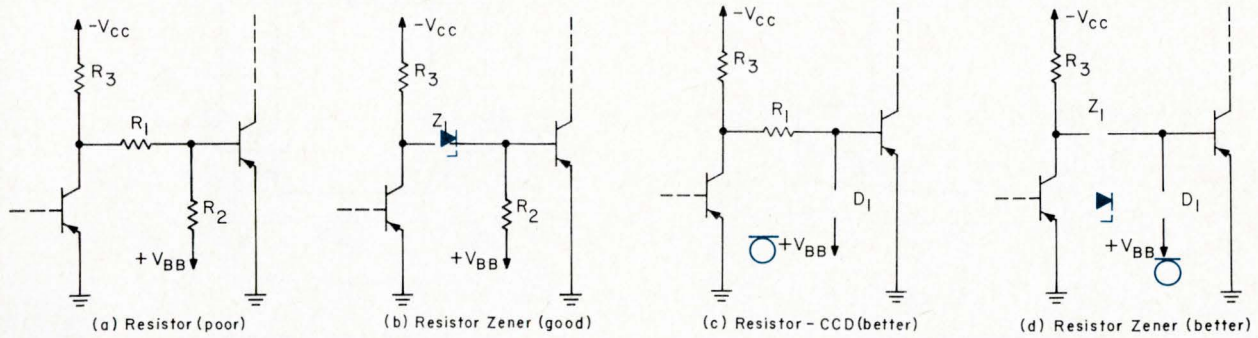

**Fig. 12. DC coupling methods:** (a) A resistor offers the poorest performance; (b) substituting a zener improves the

coupling; but (c) a resistor-CRD combination is even better; as expected, a combination (d) of zener and CRD is best.

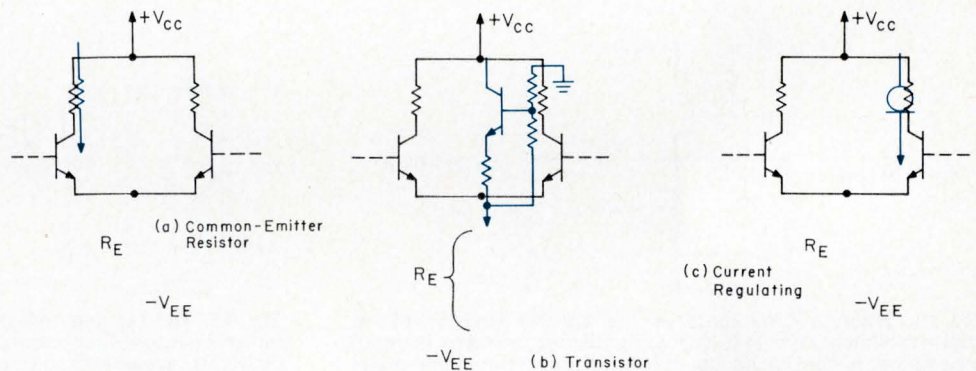

**Fig. 13. Common sources in differential amplifiers:** (a) Common-emitter resistor, (b) transistor, and (c) current regulating diode.

**Emitter-coupled differential amplifiers:** The common mode rejection ratio of these amplifiers is directly proportional to the common-emitter impedance. For this reason current sourcing in the emitter is commonly used<sup>5</sup>. Figure 13a shows a resistor voltage combination; Fig. 13b, the biased-transistor version. The CRD in Fig. 13c is an improvement over both methods.

For high input impedance, the differential amplifier incorporates the Darlington input configuration (Fig. 14a). The modified amplifier, (Fig. 14b) has three current sources D2 provides the high common mode rejection, while D1 and D3 provide fixed currents in Q1 and Q4. Using this method, the characteristics of transistors Q1 and Q4 are not a function of the betas of the input transistors Q2 and Q3, as they would be with a standard Darlington circuit<sup>6</sup>.

**Emitter resistor:** A CRD can often replace the emitter resistor of emitter-followers, resulting in a significant increase in input impedance, a gain closer to unity, and, less obvious, a lower transistor dissipation when a heavy external load is supplied. Figure 15 shows an example where an output of 5 V peak is required in a 600Ω load, with ±10 V supplies. When the input peak is +5 V the load current is 8.33 mA. The drop across R1 is now 5 V and to prevent cut-off of Q1, R1 must pass more than 8.33 mA. Thus, R1 should be less than 600Ω. Under quiescent conditions, the emitter of Q1 is near zero, quiescent current is 16.7 mA, and Q1 is dis-

sipating 167 mW. When an 8.33-mA CRD replaces R1, the quiescent dissipation is 83 mW. Thus, power consumption is halved, and since the transistor load is 600Ω instead of 300Ω, the voltage gain is nearer unity.

Note the parallel operation of two CRDs to obtain the 8.33 mA.

**Amplifier circuits:** Where an external feedback loop defines the collector voltage, a CRD can replace the collector load resistor to give a greatly increased voltage gain. Using T equivalent parameters, the voltage gain,  $A_v$ , of a grounded-emitter amplifier approaches the value given by

$$A_v = \frac{r_c}{r_e} \quad (12)$$

To realize this gain a large collector load is required. Replacing the collector resistor with a CRD, provides this load. The result is actual voltage gains from 700 to 1000 with currently available small-signal transistors. Substantially loading the amplifier reduces the voltage gain.

Using the CRD as drain elements in FET circuits yields similar results.

### Particular applications

**Simple sawtooth generators<sup>7</sup>:** The two circuits of Fig. 16 use four-layer and field effect diodes to provide exceedingly simple, fixed-frequency sawtooth generators

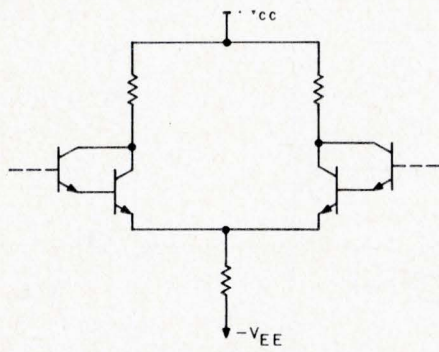

(a) Common-Emitter Resistor

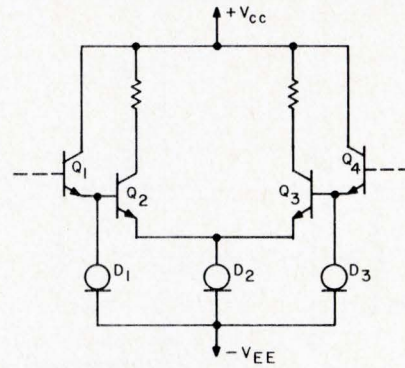

(b) Improved Emitter Current Source

**Fig. 14. Common-emitter current sourcing for Darlington-input differential amplifier: (a) common-emitter resistor, (b) improved emitter current source.**

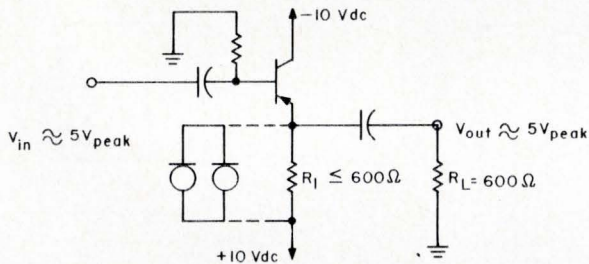

**Fig. 15. When a CRD replaces the emitter resistor of an emitter-follower, the result is a significant increase in input impedance, a gain closer to unit, and lower transistor dissipation when a heavy load is supplied.**

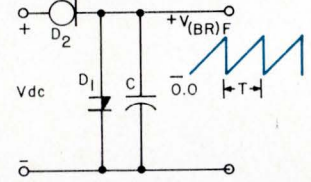
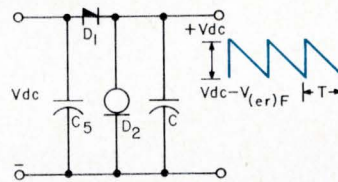

**Fig. 16. The (a) negative-going ramp and (b) positive-going ramp sawtooth generators use four-layer and field-effect diodes to provide fixed-frequency, linear output waveforms.**

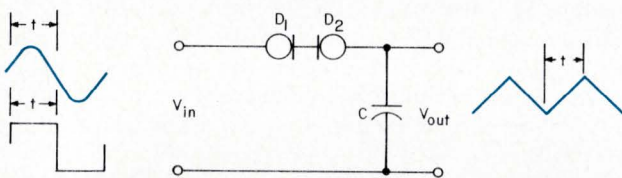

**Fig. 17. When CRDs are used in series-opposing fashion, a high-quality triangular wave can be produced from a sine or square wave.**

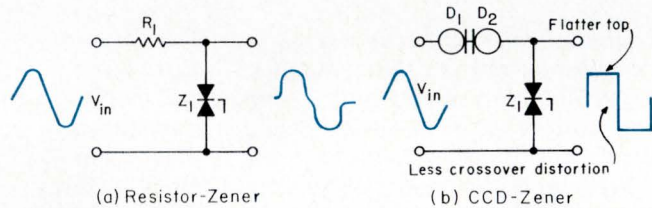

**Fig. 18. A popular square-wave generator uses a resistor-zener combination (a); but a much improved version (b) uses a CRD-zener.**

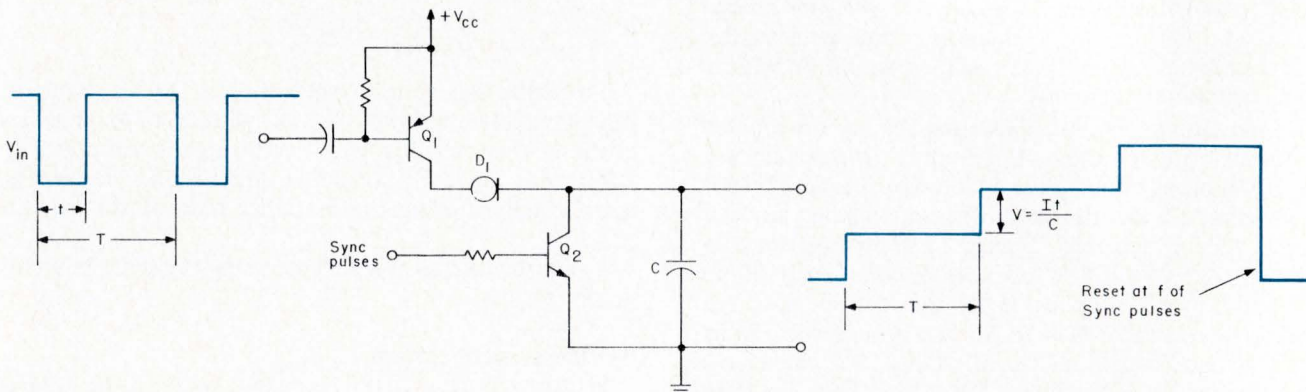

**Fig. 19. This stairstep generator operates on the same principle as the triangular wave generator of Fig. 17.**



with linear output waveforms. The principal design equation for these circuits is:

$$T = \frac{CV_{BR}}{I_P}, \quad (13)$$

where

- $T$  = period of one cycle
- $I_P$  = pinch-off current of the current limiting diode
- $C$  = timing capacitor in  $\mu F$
- $V_{BR}$  = breakover voltage of the four-layer diode

**Triangular-wave generator:** The CRD when used in series—opposing fashion, makes it possible to generate a high-quality triangular wave from a sine or square wave source (see Fig. 17). Square wave drive results in a better waveform at the zero crossings. Here the output frequency is identical to the input frequency. The peak to peak amplitude is given by:

$$V_{o\ p-p} = \frac{I_t}{C} \quad (14)$$

where  $V_{o\ p-p}$  is in volts,  $C$  is in microfarads,  $I$  is in milliamperes,  $t$  is in milliseconds, and  $V_{o\ p-p} < V_{in\ p-p}$ .

**Square wave generator or an improved clipper:** A popular circuit and the improved version are shown in Figs. 18a and 18b, respectively. Note the vast improvement in the output waveforms. The output frequency is naturally the same as the input frequency. The peak value of the output waveform is:

$$V_{o\ pk} \approx (0.7 + V_Z) \text{ volts} \quad (15)$$

where the  $V_Z$  is the zener voltage.

The improved circuit also has the added advantages of increased efficiency and reduced power dissipation in the zener.

**Stairstep generator:** This circuit (see Fig. 19) operates on the same principle as the triangular wave generator. A single CRD is used and the ratio of  $I$  to  $C$  is much greater. Equation 14 defines the height of each step. The period of the input pulse governs the time between steps. In this application  $V_{CC} - V_{CE(sat)}$  of Q1 must exceed the level of the highest step by at least  $2V_L$  of the CRD.

### Rule of thumb

If the advantages gained by using the CRD outweigh the disadvantage of added cost, the CRD is highly recommended. An inexpensive plastic FET can also serve the purpose, but with poorer overall characteristics.

### References

1. Hemingway, F., "Applications of the current-regulating diode," Electronics, Oct. 20, 1961.
2. Berman, P., Power Supply Handbook, Kepco Inc., Flushing, N. Y.
3. Eimbinder, J., FET Applications Handbook, TAB Books.
4. Gosling, W., "Field Effect Transistor Applications," J. Wiley & Sons.
5. Middlebrook, R., Differential Amplifiers, J. Wiley & Sons.
6. Wiseman, S., "A high voltage monolithic operational amplifier," Motorola Inc., Semiconductor Products Div., AN-248.
7. Bliss, J. and Zinder, D., "4-Layer and Current-Limiter Diodes Reduce Circuit Cost and Complexity," AN-221 Motorola, Inc.
8. Hemingway, Op Cit.

**INFORMATION RETRIEVAL:  
Transistors, Circuit design,  
Power supplies**

**Total reliability . . .  
Incredible versatility . . .  
And, 1200 switching contacts . . .  
all within less than one cubic foot of space!**

## Now, that's a Switch!

The versatility of North's crossbar switch has been proven in a variety of applications, such as those shown here. And, you're invited to meet with a North Sales Engineer to discuss how this great switch and North's engineering team can help you achieve total systems capability! Write to North Electric Co., Dept. 542, Electronics Division, Galion, Ohio 44833.

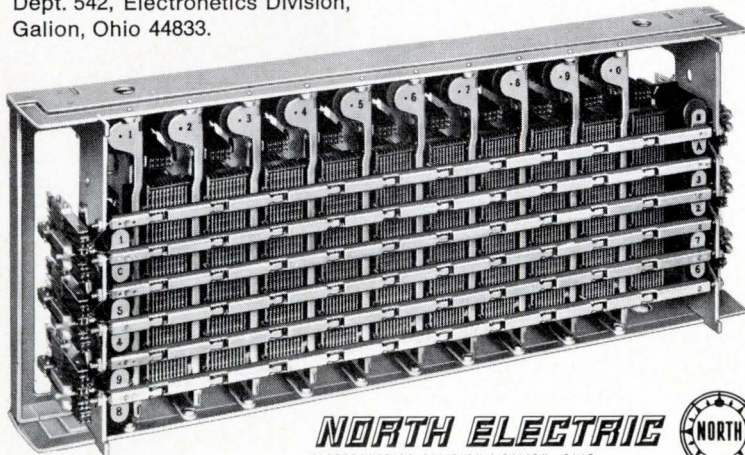

**NORTH ELECTRIC**  
ELECTRONICS DIVISION / GALION, OHIO  
A SUBSIDIARY OF UNITED UTILITIES, INCORPORATED

Precision Test Programming



Data Switching Applications

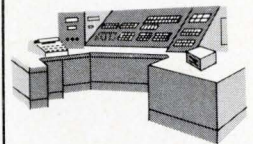

Cable Harness Testers

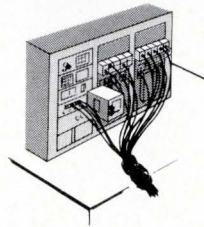

Information Retrieval Systems



Military Applications

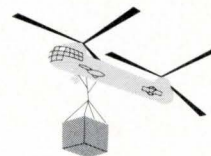

Special Switching Systems

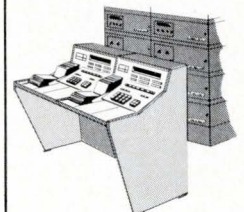

NEC - 2

# $\pm 50 \text{ ppm}/^\circ\text{C}$ in all Helipot Cermet Trimmers

This significant advance in Helipot's cermet technology is now available at only a dime/unit more . . . 100 ohms thru 2 megohms. In addition, you get essentially infinite resolution, environmental stability, reliability, no catastrophic failures — all superior to wirewound trimmers. We'll also deliver off-the-shelf, locally stocked trimmers with a standard tempco of  $\pm 100 \text{ ppm}/^\circ\text{C}$  in the 100 ohm thru 2 megohm range.

**Beckman**

INSTRUMENTS, INC.

HELIPOT DIVISION

FULLERTON, CALIFORNIA • 92634

INTERNATIONAL SUBSIDIARIES: AMSTERDAM; CAPE TOWN; GENEVA; GLENROTHES, SCOTLAND; LONDON; MEXICO CITY; MUNICH; PARIS; STOCKHOLM; TOKYO; VIENNA

Zero-symmetry sweep circuit . . . . .	930
Clock waveform maintains its symmetry . . . . .	931
Simple-to-make toggling flip-flop . . . . .	932
Linear agc amplifier has 30-dB range . . . . .	933

**Vote** for the one you like best.

Write the number of the Idea you like best in the box on the Inquiry Card, and send to us.

**Send us** practical, reproducible ideas that are original with you and have been implemented with linear or digital ICs.

- If we publish your idea you win a check for \$25.00.
- If our readers vote yours the best of the issue in which it appears, you have your choice of a Simpson 270 or a Triplet 600 multimeter.
- After 12 issues our readers will vote on the best

idea for all 12 issues. The winner gets his choice of either a Hewlett-Packard 1206A or a Tektronix 310A oscilloscope.

Submit your IC Ideas to:  
 Alberto Socolovsky  
 Editor  
 THE ELECTRONIC ENGINEER  
 Chestnut & 56th Sts.  
 Philadelphia, Pa. 19139

## Here's how you voted

The winning Idea for the April 1969 issue is, "Sweep circuit has triggered, free-run modes."

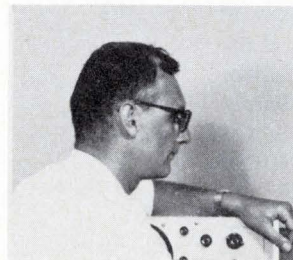

Chuck Ulrick is a Circuit Design Engineer in the Memory Development Group of Collins Radio Company, in Cedar Rapids, Iowa. Mr. Ulrick has selected the Triplet Model 600 TVO multimeter.

### 930 Zero-symmetry sweep circuit

**Charles J. Huber**

Westinghouse Electric Corp., Baltimore, Md.

This circuit gives you a sweep output symmetrical about zero. And it holds the zero symmetry regardless of changes in the height of the sweep caused by variations in the input level,  $V_i$ .

The output of the first  $\mu A709$  op amp is shown in (a) for  $V_i < 0$ . The second amp's output is

$$e_{02}(t) = - \left[ \frac{R_4}{R_2} e_{01}(t) + \frac{R_4}{R_3} V_i \right],$$

and has a waveform as in (b), where  $\beta$  is an arbitrary gain constant defined as the ratio of  $e_{02}$  pk-pk to  $V_p$ . Evaluating  $e_{02}(t)$  at  $t = 0$ , you can find that  $R_4/R_3 = -\beta V_p/2V_i$ .

Variations in the input pulse width will cause changes in  $V_p$ . But a third signal, proportional to  $t_1$  and summed into the second op amp, holds the symmetry of  $e_{02}(t)$ .

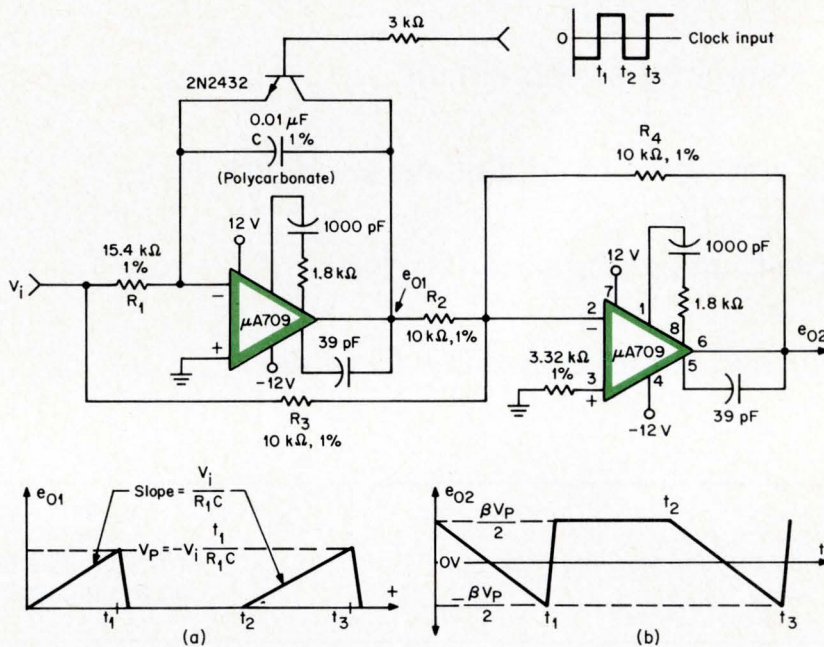

### 931 Clock waveform maintains its symmetry

**Charles A. Herbst**

Consultant, Dumont, N. J.

It is often necessary that a clock's waveform symmetry be insensitive to supply voltage changes. One way of accomplishing this is as shown here, where diodes  $CR_1$  and  $CR_2$ , in the feedback circuit, hold the oscillator out of saturation.

A series-resonant, high series-resistance (25 kΩ), very low frequency crystal supplies positive feedback for oscillation. Resistors  $R_1$  and  $R_2$  control the op amp's negative feedback, and set the gain at 11. Because  $CR_1$  and  $CR_2$  limit the positive feedback signal to about 1 V pk-pk, the regulated output signal at point B is about 11 V pk-pk. This keeps the op amp out of saturation, because its actual output capability is about 20 V pk-pk. The output waveform's symmetry and amplitude are thus independent of supply voltage—in this case, over a range of 8 to 18 V.

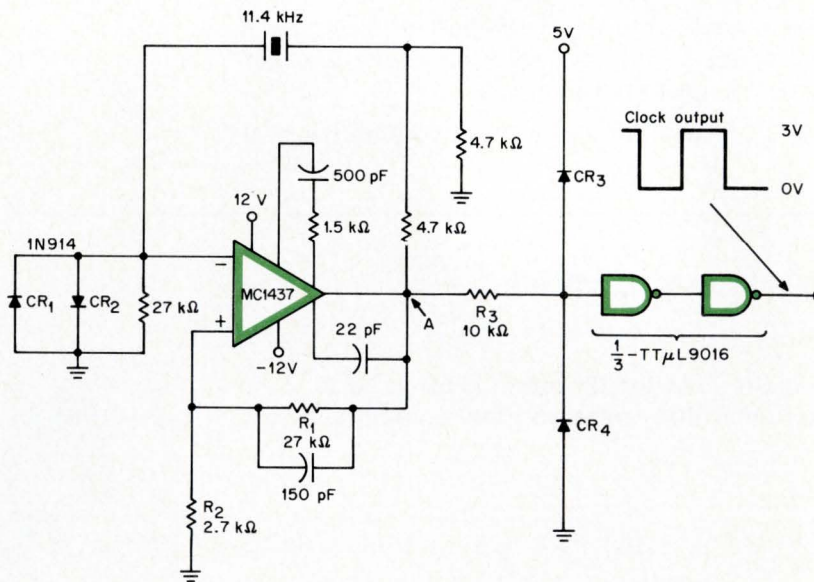

A clipper circuit ( $CR_3$ ,  $CR_4$ , and  $R_3$ ) changes the oscillator's level to one suitable for the TTL output

circuits. These inverters square the signal, and improve its rise and fall times to about 20 ns.

# **FIRST** again... with the largest lineup of new linear ICs

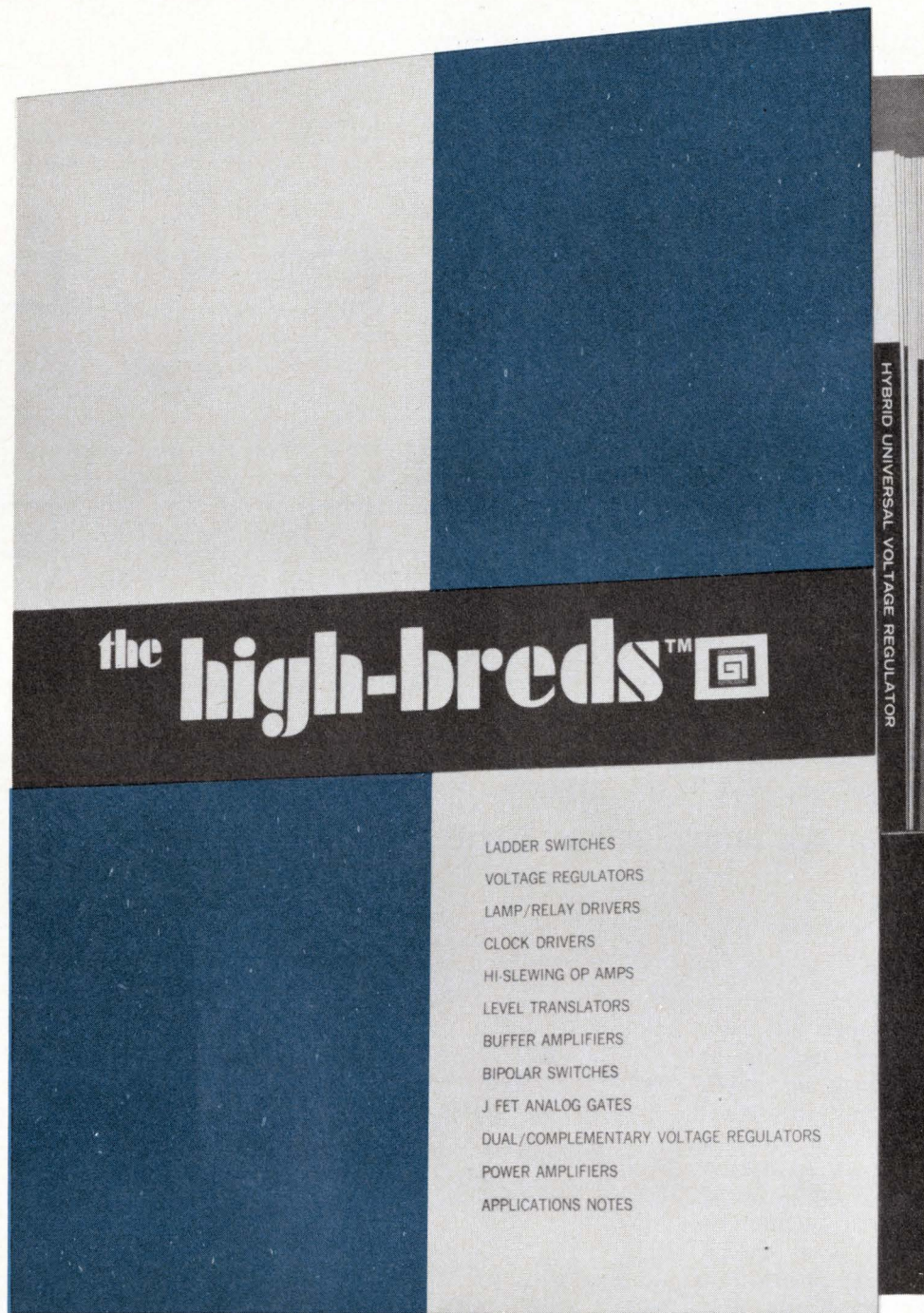

## **order your free copy today!**

Call 516-733-3243 or write General Instrument Corporation, Dept. H, 600 West John St., Hicksville, L.I., N. Y. 11802.



### 932 Simple-to-make toggling flip-flop

**Thomas P. Benzie**  
U. S. Steel Corp., Monroeville, Pa.

Here is a toggle-mode flip-flop that you can make simply and economically from a single, quad 2-input NAND gate. In this case, the circuit shown uses a Fairchild DT $\mu$ L9946.

The circuit triggers from a positive clock pulse with an amplitude between 2 and 3.5 V, and a duration that can be as narrow as 25 ns.

Resistor  $R_1$  determines the clock pulse level that you need to trigger the flip-flop. If you should use a gate other than the DT $\mu$ L9946, you may have to adjust  $R_1$  to a value other than the 680  $\Omega$  shown here.

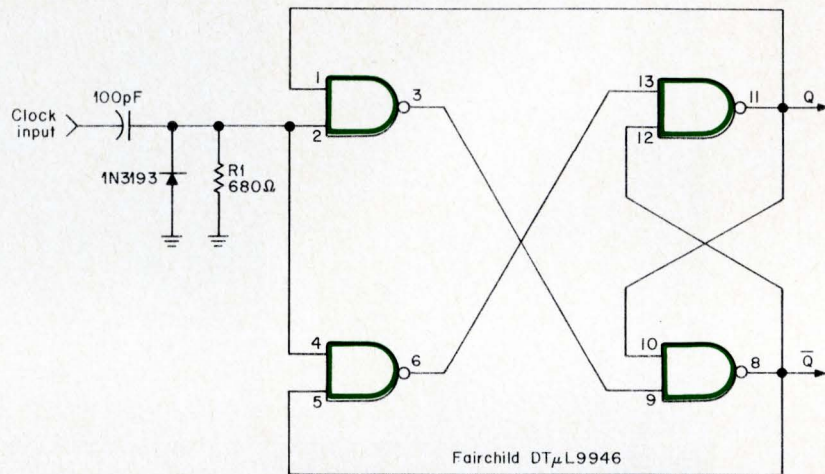

### 933 Linear agc amplifier has 30-dB range

**Richard C. Gerdes**  
Optical Electronics, Inc., Tucson, Ariz.

Many measurements require you to generate a leveled, distortion-free output from inputs that vary. This circuit performs such a task: it is a constant-output agc amplifier with good output-input linearity. The agc range is 30 dB for a bandwidth of 100 Hz to 30 kHz.

The circuit is basically an analog multiplier made up of an OEI 5500 multiplier and half of an Amelco 810 dual op amp. The other half of the 810 senses, integrates, and amplifies the multiplier output to provide a correction voltage for the other multiplier input. (You can think of a multiplier as a voltage-controlled linear amplifier, which is the way it is used here.)

Although only positive output peaks are sensed, non-sinusoidal

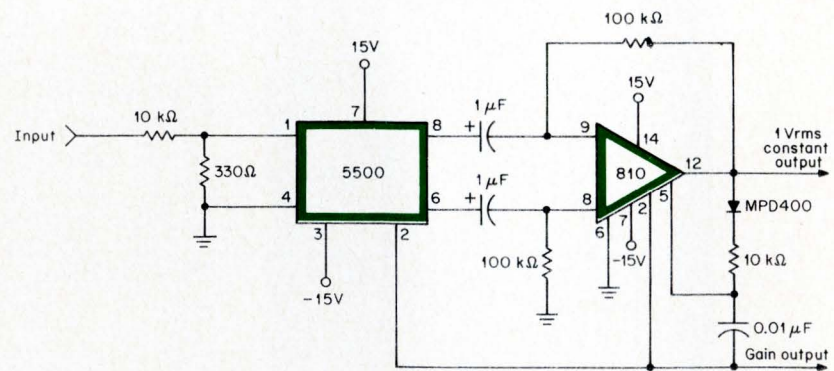

waveforms are not a problem, because of the long integration time. The output is essentially constant for input levels of 30 mV to 1 V peak. At levels greater than a volt, the 5500 input circuitry begins to limit, and distortion occurs. But the peak output amplitude—set by

the MPD400 diode—stays constant despite the clipping. You can cascade several of these circuits to get a large input dynamic range.

The circuit has a dc voltage output that is linearly proportional to the gain. This *gain output* indicates the unknown input level.

# Save Time, Save Money with BUSS QUICK-CONNECT Fuseholders and Fuseblocks

An important thing to remember when ordering fuseholders and fuseblocks is that BUSS has the most complete line available with quick-connect terminals.

BUSS fuseholders and fuseblocks with quick-connect terminals can save you money by greatly

reducing assembly time for wire attachment. Harnesses can be pre-assembled, then simply "plugged in" to the BUSS fuseholders or blocks. You can forget about soldering guns and screwdrivers.

To learn more about the many applications in which you might cut costs with BUSS Quick-Connect Fuseholders and Fuseblocks, get in touch with your local BUSS Representative or write for BUSS Bulletin SFB.

BUSSMANN MFG. DIVISION, McGraw-Edison Co.  
University at Jefferson, St. Louis, Mo. 63107

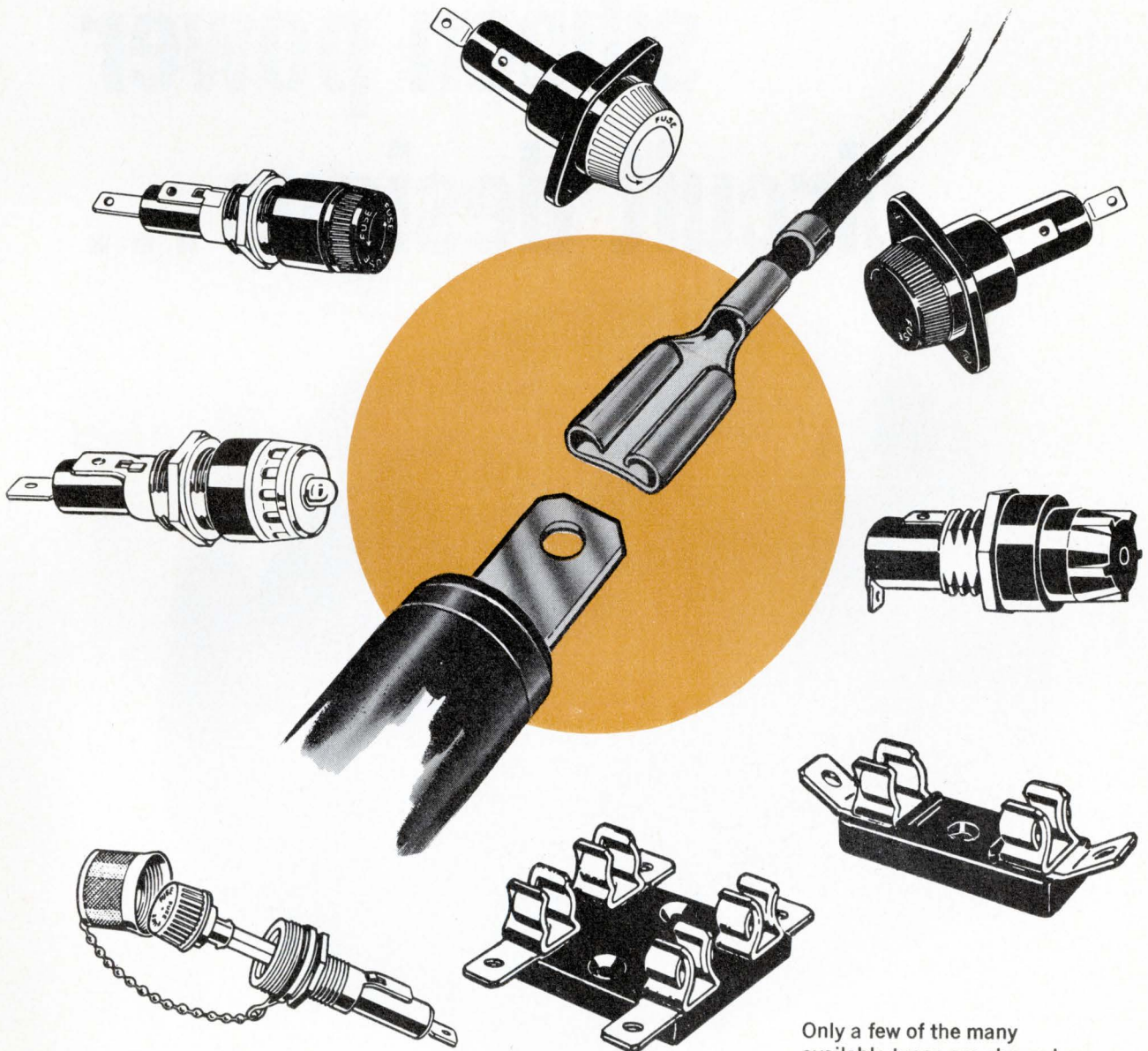
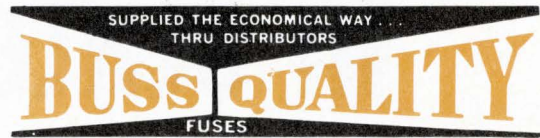

Only a few of the many available types are shown here.

# You can imagine what the future holds in state-of-the-art, silicon power circuit designs...

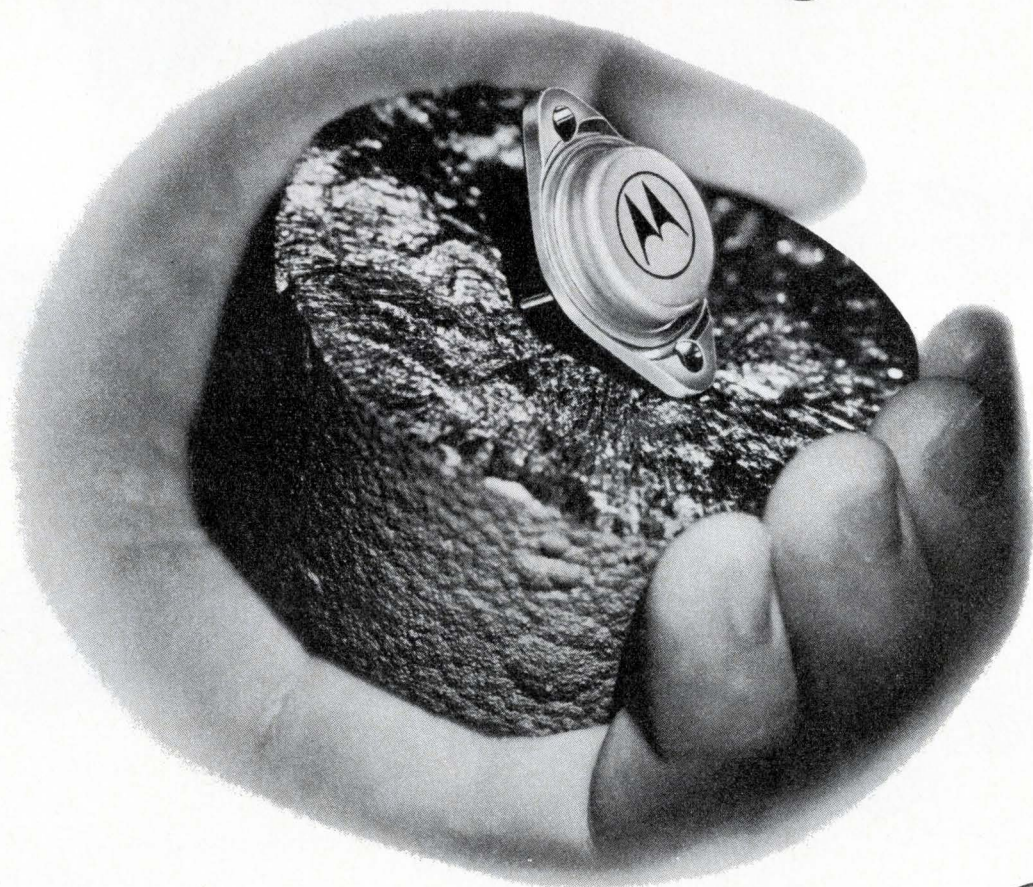

*- where the priceless ingredient is care!*





Maximum Current Rating	Consumer		Industrial		Military	
	Switching Voltage (max) V	Amplifying Voltage (max) V	Switching Voltage (max) V	Amplifying Voltage (max) V	Switching Voltage (max) V	Amplifying Voltage (max) V
100mA	250 - 325			300 - 350		
250mA	325	325				
500mA	200 - 325		200 - 325	225 - 350		
1A				40	250 - 300	
2A			40 - 80	120 - 325		120 - 200
2.5A			400	400		
3A	30 - 80	30 - 80	40 - 80	30 - 80 225 - 300	60 - 80	225 - 300
3.5A	200 - 325			200 - 325		
4A	1,400*	40 - 80		40 - 80		60
5A	500*	40 - 80	60 - 80	40 - 80	80 - 100	80 - 100
7A			80 - 100		80 - 100	80 - 100
7.5A				60 - 100		80 - 120
10A	700*	60 - 100	100 - 140	40 - 100 100 - 325	80†	
16A			100 - 140	100 - 140		
20A				60		
30A		40 - 90		40 - 80	100	100
50A			60 - 80	60 - 80		
60A					80 - 100	

\*V<sub>CEs</sub>

■ Shaded Area = Complementary Capability

† Darlington Amplifier

**...when you see our  
state-of-the-art past and  
present**

Write Box 20912, Phoenix, Arizona 85036 for our new Silicon Power Transistor Selector Guide — biography of today's most complete silicon power device capability. You'll find the broadest complementary offering... the highest voltage current capability... Annular, EpiBase,\* hybrid and triple-diffused devices... and 10 different plastic and metal package styles. Then contact your franchised Motorola distributor about any of them.

\*Trademark Motorola Inc.

**MOTOROLA** Silicon Power Transistors

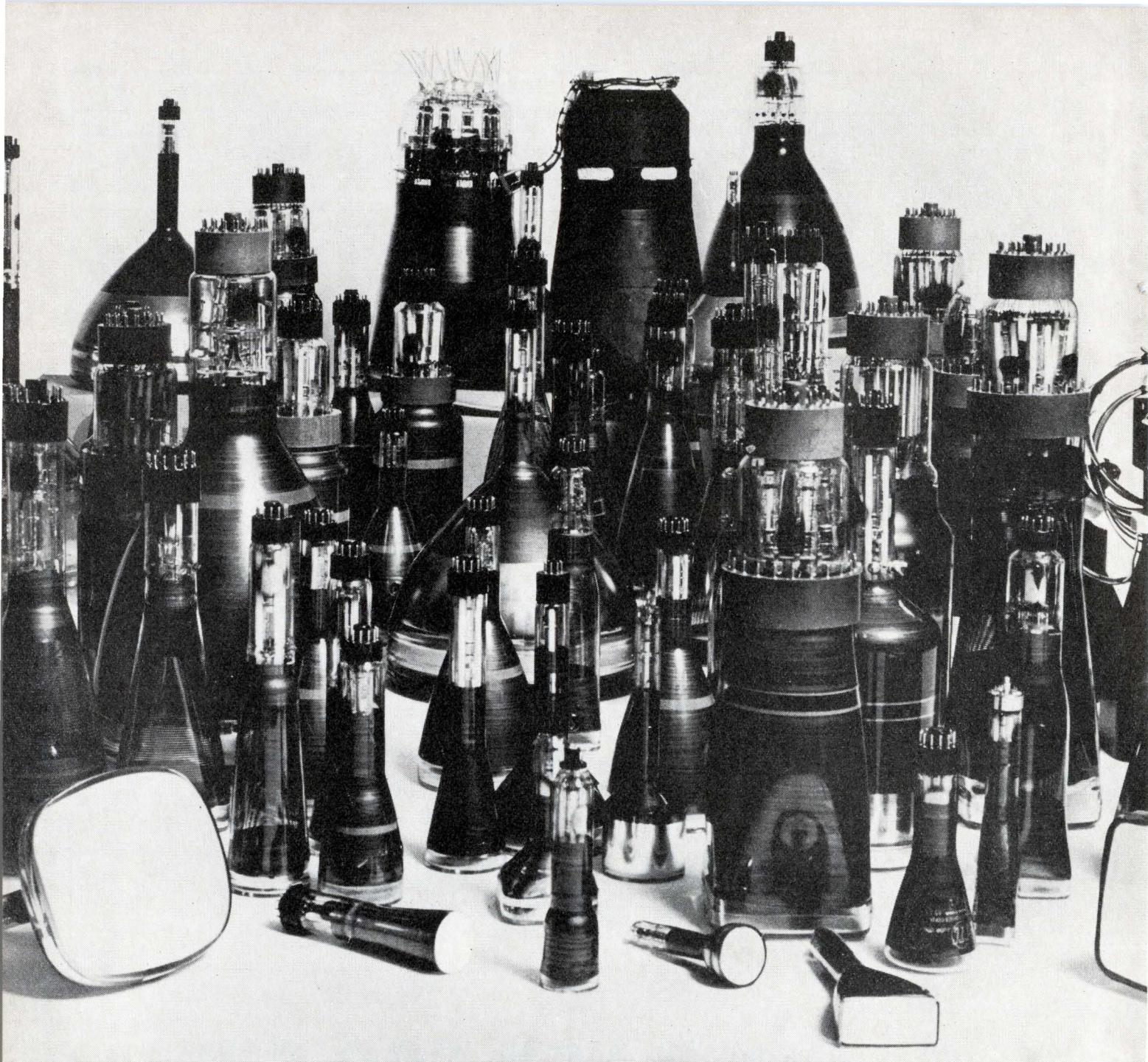

## 98 million to 1 we have what you need in a CRT

Try us. Just pick up the phone and call. Do it now, before your design is locked in. Or write if there's time.

Your problem is no problem at all to us. We've got 98,112,000 different ways to go. That's our capability in producing cathode ray tubes. We've made over two hundred different versions, and they're available . . . practically off-the-shelf.

Our ETC tubes come in any one of 511 shapes and sizes. Use any one of 40 different phosphors. One to twelve electron guns. A choice of four filaments. They can be ruggedized or not. And

include fiber optics faceplates (something we pioneered in the industry), rear windows and optically ground faceplates.

So . . . feel free to call for exactly what you want. Not a modification. Or add-to. But something that specifically fits your design and answers your total read-out requirement.

There's only one way to find out. Call us. Anytime. (215) 248-3700. Or write: Electronic Tube Division ETC®, General Atronics, Philadelphia, Pennsylvania 19118. A subsidiary of Magnavox Corp.



**GENERAL ATRONICS**

Circle 44 on Inquiry Card

# Feature article abstracts

Published information is vital to your job.

To save time in finding this information, we have abstracted the important technical features

from eight electronic engineering publications.

Should any of these articles interest you, contact the magazine—names and addresses are listed below.

Reprints of articles with an asterisk are available free.

Save this section for future reference.

## Circuits

**Active filters: part II-Varying the approach,** Jack W. Mullaney, Avco Corp., "Electronics," Vol. 42, No. 15, July 21, 1969, pp. 86-93. Now active filters have reached the point where they perform as well, if not better, than RLC filters. The active filters offer the advantages of being tuned easily, less power, and freedom from non-linear inductors. How the filters work, and how to use them are described. The article also contains a four-page chart that can be removed for reference.

## Circuit Design

**Don't shun the shunt regulator,** Walter G. Jung, KMS Industries, Inc., "Electronic Design," Vol. 17, No. 14, July 5, 1969, pp. 70-72. Shunt regulators require only four active components to implement, and have inherent short circuit protection, are insensitive to input transients, and are automatically protected against over-voltage transients at the output. These advantages must be traded off against the series regulator's higher efficiency.

**Get rid of ground loop noise,** H. C. Brown, Westinghouse Defense & Space Center, "Electronic Design," Vol. 17, No. 15, July 19, 1969, pp. 84-87. The ground loop problem and the usual solutions are explained. Techniques are introduced for using by-pass capacitors and op amps to reduce ground loop noise. They replace transformers and baluns in many cases.

**Design T feedback networks with ease,** William B. Crittenden, Westinghouse Electric Corp., "Electronic Design," Vol. 17, No. 14, July 5, 1969, pp. 64-68. A six-step method for direct synthesis of T-type networks is given. The designer specifies the desired transfer function, closed loop gain, and gain and corner frequencies in making the determination of his components.

**The case for the discrete comparator,** Daniel H. Sheingold, Analog Devices, "EEE," Vol. 17, No. 7, July 1969, pp. 72-75. While recognizing that monolithic IC comparators are the best choice for most applications, the author suggests that, when you need a comparator in large quantities (particularly when you need a sophisticated comparator), you may be better off designing and building your own. He lists the main characteristics to consider in the design input bias current, differential input overvoltage, noise immunity, stability (freedom from oscillations), and output power. For low speed applications, he suggests building the circuits around

commercially-available op amps, and gives eight circuit examples, some of which put out not just pulses but also rectangular and triangular waveforms.

## Communications

**How to deal with earth RFI in space,** Eugene Dusina, Radiation Inc., "EDN," Vol. 14, No. 13, July 1, 1969, pp. 45-48. The bulk of this article is devoted to the effects of earth-originated signals on spacecraft communications at lunar distances. The author presents three figures, the first of which shows maximum received levels at the moon of such services as standard broadcast, TV, fm, radars, and so forth. The other two figures give you the interference level for a receiving system at lunar distance, as a function of the receiver i-f bandwidth, for each of the services shown in the first figure.

## Components

**\*Divided-gap choke is a real swinger,** Herbert I. Keroes, Quaker City Transformer Co., "The Electronic Engineer," Vol. 28, No. 9, Sept. 1969, pp. 61-62. In today's world of small electronic components and miniaturized equipments, the power supply stands out like a sore thumb. Why? Because in equipment that runs from ac power-lines, you need a transformer to set voltage levels, and a choke inductance to smooth the raw dc before passing it to regulator circuits. Iron is a major part of these two components, and makes them bulky and heavy—two facts of life for designers who use them. In this article, however, the author shows a new way to design a choke, one that not only reduces its size, but also improves its performance.

**Upgrade your diode applications,** J. A. Williamson & R. E. Jones, Autonetics, "Electronic Design," Vol. 17, No. 15, July 19, 1969, pp. 90-94. A curve tracer is recommended for obtaining diode characteristics such as dynamic resistance, voltage constant, and leakage current, so that proper evaluation can be made. A simple form of the diode equation also results from knowledge of these measurements.

## Computers and Peripherals

**Revolt within the rack,** R. T. Ollivier, and A. L. Linton, Jet Propulsion Labs, "EDN," Vol. 14, No. 14, July 15, 1969, pp. 51-57. This is a survey of small, general-purpose computers. It categorizes a typical computer as one with a cost of less than \$35,000, easily programmable, easily interfaced, and needing only a modest facility. A brief discussion of mini-computers includes a number of definitions, and is followed by several pages of specifications of small, commercially-available computers.

## Magazine publishers and their addresses

### EDN

Cahners Publishing Company  
3375 S. Bannock Street  
Englewood, Colo. 80110

### EEE

Mactier Publishing Co.  
820 Second Avenue  
New York, N. Y. 10017

### Electronic Design

Hayden Publishing Co.  
850 Third Avenue  
New York, N. Y. 10022

### Electronic Products

United Technical Publications  
645 Stewart Avenue  
Garden City, N. Y. 11530

### Electronics

McGraw-Hill, Inc.  
330 W. 42nd Street  
New York, N. Y. 10036

### Electro-Technology

Industrial Research Inc.  
Industrial Research Bldg.  
Beverly Shores, Ind. 46301

### IEEE Spectrum

Institute of Electrical & Electronics Engineers  
345 East 47th Street  
New York, N. Y. 10017

### The Electronic Engineer

Chilton Company  
56th & Chestnut Streets  
Philadelphia, Pa. 19139

\*Reprints available free. Request them on your company letterhead.

**Cellular redundancy brings new life to an old algorithm.** Joseph O. Campeau, Litton Systems, Inc., "Electronics," Vol. 42, No. 15, July 21, 1969, pp. 98-104. A new computer, referred to as Block-Oriented Computer (BOC), is lower priced because it uses large scale MOS arrays that are redundant in construction. Unlike the natural right-to-left processing of today's computers, this one operates left-to-right with a technique of binary power-increment algorithm. With this method the computer can start working on the most significant bit, right away, because it is the first one available from the machine's computations.

**Digital Design**

**Micropower—an answer to the power-speed trade-off in digital systems.** Robert H. Cushman, N. Y. Regional Ed., "EDN," Vol. 14, No. 15, Aug. 1, 1969, pp. 51-60. This is a discussion of the power-speed relationships among the various logic families of the bipolar and MOS technologies. It makes the point that we must re-examine the power-speed spectrum in order to decide the best logic for any given application. This is true because MOS circuits are capable of much lower power consumption and superior noise immunity. The author presents several power vs speed curves, and there is a lengthy discussion of the factors affecting power needs.

**EMI**

**Interference coupling—attack it early.** Richard J. Mohr, Cutler-Hammer, "EDN," Vol. 14, No. 13, July 1, 1969, pp. 33-41. Cross-talk between interconnecting cables in a piece of equipment is a problem more easily cured in initial design stages, rather than in a finished piece of equipment. This article gives you key parameters and equations that determine coupled interference in both shielded and unshielded cables.

**Integrated Circuits**

**Linear ICs—the "now" generation.** George Flynn, Sr. Assoc. Ed., "Electronic Products," Vol. 12, No. 2, July 1969, pp. 33-41. The premise of this article is that all manufacturers now making linear ICs agree that this is the year of the LIC. The op amp will remain the foremost universal LIC for a long time to come, but the second most popular universal LIC appears to be the voltage regulator. The article goes on to describe the processing differences between digital and linear ICs, and briefly discusses MOS and bipolar technologies. Custom ICs and power dissipation problems are also touched upon. Included in the article is a brief discourse by Robert A. Hirschfeld, of National Semiconductor, on the future of communication microcircuits from 1969 to 1974.

**How to prototype hybrid-circuit patterns and screens at budget prices.** Leon Jacobson, General Electric Co., "IEEE Spectrum," Vol. 6, No. 7, July 1969, pp. 82-88. Often, when building prototypes, the normal techniques of developing screen patterns are too costly, and production time too long. The author discusses a simple method by which master artwork and screen patterns can be made with a minimum of equipment in only a few minutes.

**Specifying a comparator.** Alfredo Gomez, Computer Components, "EEE," Vol. 17, No. 7, July 1969, pp. 68-71. This article provides a good analysis of the main comparator characteristics—input threshold, propagation time, and common mode recovery. Since a comparator is basically a threshold detector, the author dwells on the discussion of input threshold, and discusses how it varies with supply voltage and with temperature. The whole discussion refers to the simplest and most popular sense amplifier, the 711.

**Second-generation IC comparators.** Robert M. Murphy, Transitor Electronic Ltd., "EEE," Vol. 17, No. 7, July 1969, pp. 66-67. By "second generation" the author means dual comparators, i.e., two comparators integrated in a single chip. Without illustrating any circuits, the article suggests four factors to consider in applying comparators: input series resistance, connection of strobe terminals, supply voltages, and stray capacitances and couplings.

**Custom metal shapes up big chips.** Robert Joepfer, Mang. Ed., "EDN," Vol. 14, No. 15, Aug. 1, 1969, pp. 33-41. Some IC manufacturers stock-pile silicon wafers that have been processed through all diffusion stages, but no further. Such wafers need first- and second-layer metalization to transform the basic cells into functional subsystems. The customer's logic requirements dictate these mask patterns. Custom MSI design done in this way saves development time and cost. The article discusses the approaches of Motorola, Fairchild, Sylvania, and TI to this custom MSI field.

**Schottky diodes make IC scene.** R. N. Noyce, R. E. Bohn, and H. T. Chua, Intel Corp., "Electronics," Vol. 42, No. 15, July 21, 1969, pp. 74-80. Because Schottky diodes do not store a charge, they, in integrated circuits, can be used in diode-transistor logic to make these ICs as fast as TTL and ECL. These diodes will reduce power and real estate required on a chip. Processing these diodes on IC chips is now possible because reproducibility problems have been licked. This article describes how the diodes are made and discusses other IC components that are compatible with the diodes.

**\*How big a package for your hybrid circuit?** Robert G. Bristol, CTS Corporation, "The Electronic Engineer," Vol. 28, No. 9, Sept. 1969, pp. 45-46. In this article, Mr. Bristol addresses himself to two problems, and gives a detailed list of popular components used in screened-and-fired hybrid circuits (such as chip transistors, thick-film resistors, and chip capacitors) with the area and power expended by each one. He illustrates the method with an example of a hybrid operational amplifier.

**Semiconductors**

**\*FET current regulators.** Bob Botos, Motorola, "The Electronic Engineer," Vol. 28, No. 9, Sept. 1969, pp. 64-70. Field effect transistors (FETs) have proved to be a boon for the electronic engineer who likes semiconductors but is still longing for some of the good characteristics of vacuum tubes, such as high input impedance. FETs are so versatile that they are rapidly becoming the workhorse of solid state devices. New applications are constantly being found. Mr. Botos has done a lot of applications work with these devices and has prepared this article describing how to use FETs as constant current regulators for power supplies. (A current regulator keeps the output current constant, in spite of variations that may occur at the load or supply.) Through the simple design mathematics and basic circuits in this article, any design engineer can build a successful regulator, and do it economically.

**Test and Measurement**

**\*Environmental code: A shortcut to specifications.** Rudolf Wernick, Department of Defense, Canada, "The Electronic Engineer," Vol. 9, Sept. 1969, pp. 49-51. In this new article, Mr. Wernick proposes a 10-digit coding system. A manufacturer would use this code to grade his product, clearly indicating the environmental specifications it meets. Such a code applies to any component or equipment, both military or non-military. By coding the Mil Specs themselves, it then is a simple matter to determine whether a component meets military specifications or not. In particular, the digitized code lends itself to computerized information retrieval—very useful when a large number of components or equipment are involved. If industry adopts this proposal, it will be taking a major step to iron out a problem that is causing much confusion today.

**The 80 most significant new test instruments.** Staff Report, "Electronic Products," Vol. 12, No. 2, July 1969, pp. 65-114. Of all the instruments introduced in the past 18 months, the editors have selected 80 that they feel "make the most significant contribution to the state-of-the-art." Their listing is broken down into six categories: generators, IC testers, counter/timers, scopes/spectrum analyzers, electrical measurements, and L-C-Z measurements. Each selection leads off with an introductory discussion that points out trends in that particular area of instrumentation, compares many of the products listed, and helps put the instruments within the group into focus.

**Laboratory signal sources.** "Electro-Technology," Vol. 84, No. 2, August 1969, pp. 75-82. This staff report describes most of the signal sources used in a laboratory—from pulse generators and frequency synthesizers to noise generators and function generators. Some applications for these devices are discussed, and a listing of device manufacturers is included.

**Pulse testing is on the move.** Earle Dilatash, Tech. Ed., "EDN," Vol. 14, No. 14, July 15, 1969, pp. 33-48. Pulse testing determines a device's characteristics by the response of the device to an applied pulse or string of pulses. This has long been accepted in the testing of digital devices, but is only slowly being adapted to linear device testing. The article describes various forms of pulse testing and their ramifications, such as the use of microwave techniques in fast-pulse systems. Some available equipment for this type of testing is also described.

**Adapter lets digital IC tester check on operational amplifiers.** Robert McIntyre, Amelco Semiconductor, "Electronics," Vol. 42, No. 15, July 21, 1969, pp. 94-96. With an interface circuit described here, a digital IC tester can be used to test linear circuits, such as op amps. The tester can be programmed to make the right connections and apply the proper power supply voltages to device under test.

**Count backward for high resolution.** Howard J. Gannes, General Electric Co., "Electronic Design," Vol. 17, No. 15, July 19, 1969, pp. 78-81. In laser or radar ranging measurements, only the last return, that of the target, is of interest. A two counter method of working only with the last return is presented. The effects of reset time are also considered.

**Automated testing: Trends in control and equipment.** Dr. William T. Cave and Ron G. Myers, Monsanto Electronic Instruments, "Electro-Technology," Vol. 84, No. 2, August 1969, pp. 99-105. Every manufacturer faces the task of product testing. Automated testing is being turned to as an economical, and more efficient method than manual testing. This article explains the several levels of automatic testing—from pre-programmed cards to full computer control—and analyzes the advantages of each. From a profit viewpoint, testing is shown to be a help, not a hindrance.

**Miscellaneous**

**\*One giant leap for mankind . . . One step backward for engineers.** Joan Segal, "The Electronic Engineer," Vol. 28, No. 9, Sept. 1969, pp. 39-41. As the first men stepped out on the moon, hundreds of engineers stepped out of MCL. The electronic firm went immediately to work to help find their men jobs, with much success. Yet the specter of layoffs remains.

**Avionics for the private flier ready for take-off.** Jim McDermott, East Coast Editor, "Electronic Design," Vol. 17, No. 15, July 19, 1969, pp. 38-45. The expanding general aviation market is examined. Increased aircraft sales, and the desires for greater instrument capability and reduced pilot workloads are creating a demand for smaller, lighter, lower priced instruments. There is plenty of room for innovators. Some new instruments are discussed.

**So you want to start a company.** Richard Turmail, Management & Careers Editor, "Electronic Design," Vol. 17, No. 14, July 1969, pp. 74-78. Some very illuminating remarks are made by Nicholas DeVolf, co-founder and president of Teradyne, in this very quick-moving and hard-hitting interview. Good insight into the problems of starting a company are provided, and some tough criteria are spelled out.

**Anti-sub warfare and the hostile sea.** John G. Mason, Military/Aerospace Editor, "Electronic Design," Vol. 17, No. 14, July 5, 1969, pp. 34-45. This is a survey of the problems encountered in locating submarines. Sound is by far the longest range detection tool, but the signal/noise problem is severe. Better understanding of myriad underwater sounds, methods for processing the raw data, and pattern recognition seem to be the answers.

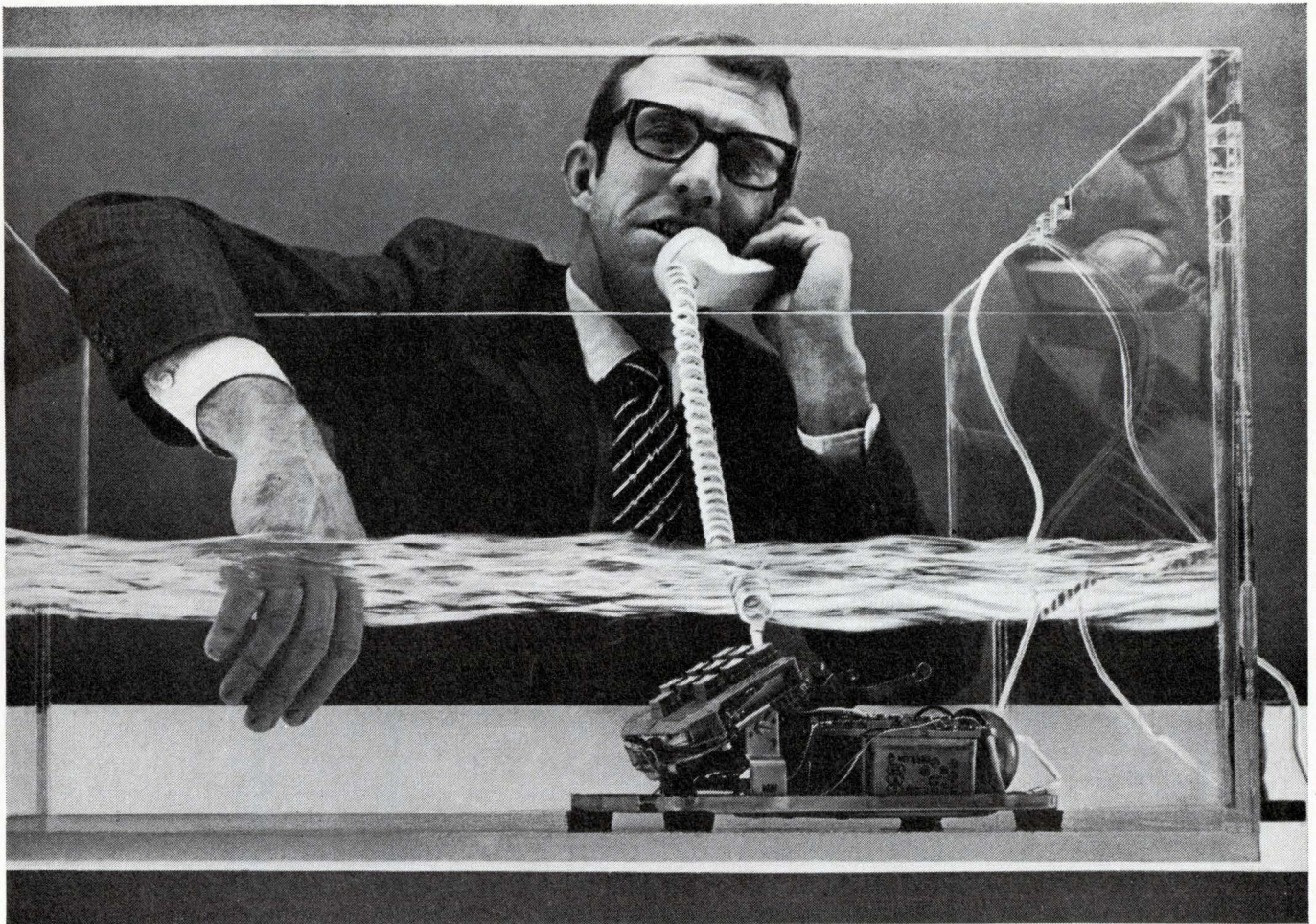

## Call us for more information on the dry test bath

Yes, that telephone is working perfectly in its bath of Fluorinert® Brand Electronic Liquid.

In your testing procedures, Fluorinert Liquids will show up flaws and leaks with great accuracy. In fact, the MIL-Standard 883 and the MIL-Standard 750A tests for gross leak-

age in microcircuits approve the use of Fluorinert Liquids...which says a lot about dependability.

They are efficient over a wide temperature range and compatible with the most sensitive materials. Fluorinert Liquids are non-flammable and won't conduct electricity.

And because tested units drain clean and dry fast upon removal from the bath, you can use or package your product right out of the bath.

We have lots of interesting information about these unusual liquids. Send the coupon...or call your local 3M representative.

### Fluorinert® Electronic Liquids 3M BRAND COMPANY

3M Company, Chemical Division, 3M Center  
St. Paul, Minn. 55101

Dept. KYZ-9-69

Send me all the details about Fluorinert Brand Electronic Liquids.

Name \_\_\_\_\_

Company \_\_\_\_\_ Title \_\_\_\_\_

Address \_\_\_\_\_

City \_\_\_\_\_ State \_\_\_\_\_ Zip \_\_\_\_\_

Hot clamp termination photomicrograph shows positive termination and inherent stability.



Alloy resistance wire continuously wound on fiberglass core—provides greater uniformity and extremely low inductance.

Wide band indicates wirewound construction—EIA/MIL color code.

Exclusive IRC molded jacket provides superior strength and moisture protection.

Tin/lead-alloy coated leads for excellent solderability over extended periods of time.

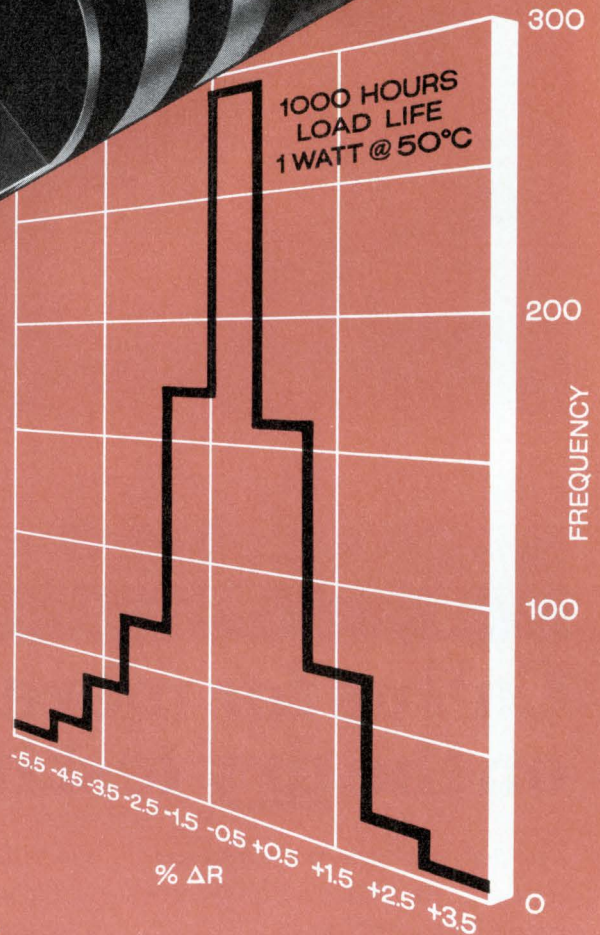

# Saver

BW-20 saves space,  
saves cost.  
Has excellent stability.

The BW-20 bridges the cost-performance gap between composition resistors and premium wirewounds. Its one-watt rating in 1/2-watt size means you can replace one-watt units and save space; or use it in 1/2-watt space with the advantages of two-time safety factor and wirewound stability. As shown in the histogram, average load-life change is less than 1%.

The money-saving BW-20 has lower ranges than metal films or deposited carbons. It is ideal for semi-precision resistor needs in instrumentation, computer peripherals, networks, and other low-power needs.

BW-20's come in six forms of packaging to cut assembly costs, fit 1/2-watt inserting machines, and can be ordered with many cut-and-formed lead configurations. Write for data, prices, and samples to: IRC, Philadelphia Division of TRW, Inc., 401 N. Broad St., Philadelphia, Pa. 19108.

## CAPSULE SPECIFICATIONS

Size:	.390" x .140" diameter.
RESISTANCE:	0.24 ohm to 750 ohms
POWER:	1-watt @ 50°C. Derated to zero @ 160°C.
TOLERANCE—STANDARD:	±5%, ±10%
—SPECIAL:	±2%
TEMPERATURE:	300ppm/°C. to 0.62 Ω
COEFFICIENT:	150ppm/°C. over 0.62 Ω
INDUCTANCE:	0.22 μh (0.24 ohm) to 2.4 μh (750 ohms)
EIA STANDARD:	RS-344



**DIVISION OF TRW INC.**

Boon to designers:

# A new network analyzer

If you have video or rf design and test problems, help is on its way. This new instrument reduces design time and simplifies your toughest measurements.

By Douglas C. Spreng, Product Mgr.  
Hewlett-Packard, Palo Alto, Calif.

Did you ever wish that you could sweep-test a filter down to  $-80$  dB or more, without interference from noise or from the spurious responses of your source? What about your feedback amplifier design—do you have a stable phase-gain margin? Have you minimized distortion? And that antenna—is its complex input impedance smooth throughout its usable range, or did you miss a hole in point-by-point testing?

You can solve such problems, plus many others, with a new measurement system from Hewlett-Packard. Measurements that, before, were difficult or time-consuming to obtain, or of questionable accuracy, can now be made with great accuracy and in just seconds.

The 8407 network analyzer is a two-channel tracking detector that gives you swept displays of amplitude and phase, from 100 kHz to 110 MHz. Its dynamic range is more than 80 dB, so you can look closely at steep filter skirts or measure high gain amplifiers. And yet you can resolve down to 0.05 dB—or more with a sensitive voltmeter, scope, or x-y recorder on the rear outputs—to determine insertion loss, passband flatness, attenuator accuracy, and so forth. To make your life even easier, all calibrations are in dB.

The swept-phase capability of the 8407A lets you work with phase responses as easily as with the more familiar frequency displays, and resolves down to  $0.2^\circ$ . You can design stable amplifiers, locate filter poles, adjust for constant group-delay, measure complex impedance and reflection coefficients, and so forth, quickly and accurately.

## In three parts

Figure 1 shows the components of the 8407S network analyzer system: **transducers** interface the device under test to the **mainframe**, which processes the test data for presentation by the **display**.

Three transducer kits are available now, with others to follow. The *transmission* kit is a power splitter with three matched, double-shielded cables for wide dynamic range measurements. The splitter splits the source signal into the TEST and REFERENCE signals needed by the analyzer. A *reflection-transmission* kit adds return loss, VSWR, and complex impedance/reflection coefficient measurements to the basic transmission testing capability. This kit has a directional bridge, a precision 50- $\Omega$  load and short, a splitter, and matched cables.

Finally, for probing circuits directly, there is a *passive probe* kit. It has two sets of probe cables with six different voltage heads (1:1 to 100:1), a current

## Some applications in transmission ...

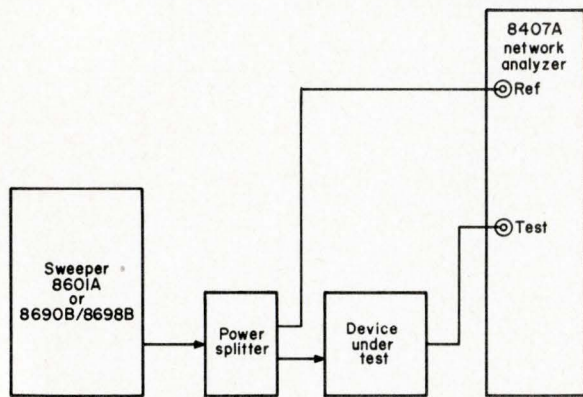

**Transmission.** The most common use of the 8407S is to look at the transfer frequency response of some device. Since the instrument is a ratiometer, it needs two inputs; these are called TEST and REFERENCE. An agc amplifier inside the 8407A mainframe holds the REFERENCE signal constant, while other circuits compare the TEST signal to it. This comparison gives amplitude ratio and phase difference information for the display. You use an external power splitter to derive equal TEST and REFERENCE signals from the source output signal.

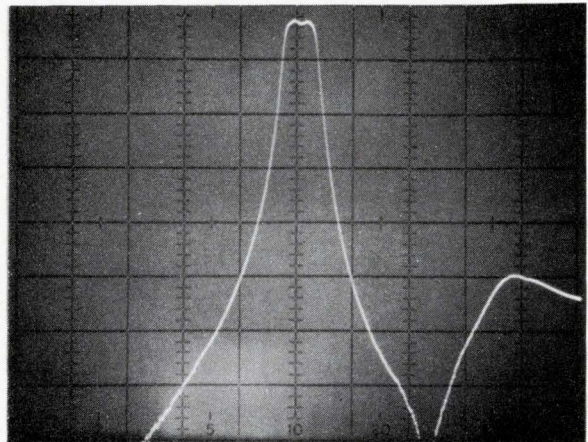

**Bandpass filter response.** This 4-pole circuit has skirts that disappear below the display's  $-80$  dB point. (The amplitude calibration in the photo directly above is  $10$  dB/div., with the  $0$ -dB reference at the top of the graticule. The horizontal scale is  $10$  MHz/div., with the full sweep width set at  $1$  to  $100$  MHz.) You can read the  $-60$  dB points as  $36$  and  $63$  MHz. Note the spurious hump at the far right; it is only  $50$ -dB below the passband level. Point by point techniques might miss it. You can raise the display still another  $20$  dB to show the full  $-100$  dB skirt response.

## ... and reflection

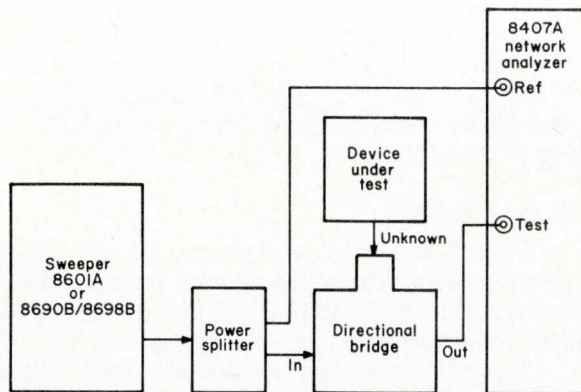

**Reflection.** The ability to measure return loss (VSWR), complex impedance/reflection coefficients, and S parameters greatly enhances the usefulness of the 8407S. Its two-channel capability simplifies such measurements by using the incident wave as the REFERENCE input, and the reflected wave from the directional bridge as the TEST input. The TEST to REFERENCE ratio is then the reflected-wave to incident-wave ratio, which is the reflection coefficient. Use the 8412A to display return loss, and the 8414A (with a Smith chart overlay) for complex impedance/reflection coefficient measurements.

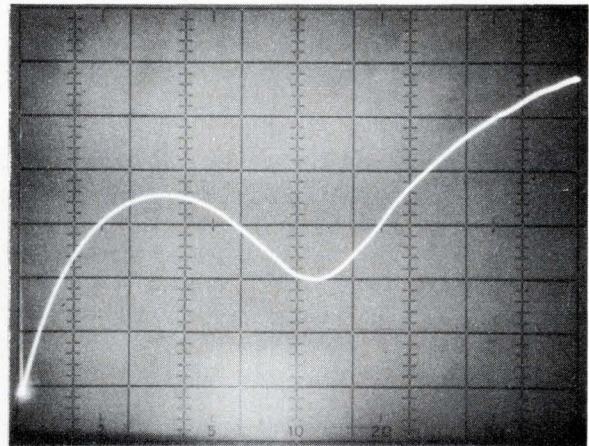

**Cable return loss.** A length of cable is seldom a perfect  $50\text{-}\Omega$  transmission line. First calibrate the system for  $0$ -dB return loss by placing a short on the LOAD port of the directional bridge, and adjusting the display reference for a convenient  $0$ -dB setting. Then, remove the short and attach the length of cable in its place. The amplitude calibration lets you read return loss directly in dB, from which you can easily compute VSWR, if required. You could also show the phase of the return loss. In this photo, the sweep width is  $1$  to  $110$  MHz. The mid-screen graticule line represents  $32$ -dB return loss, and the display is expanded, for better resolution, to  $2.5$  dB/div. See how the return loss varies from  $40$  dB at  $1$  MHz ( $1.02$  VSWR) to  $25.5$  dB at  $110$  MHz ( $1.11$  VSWR).



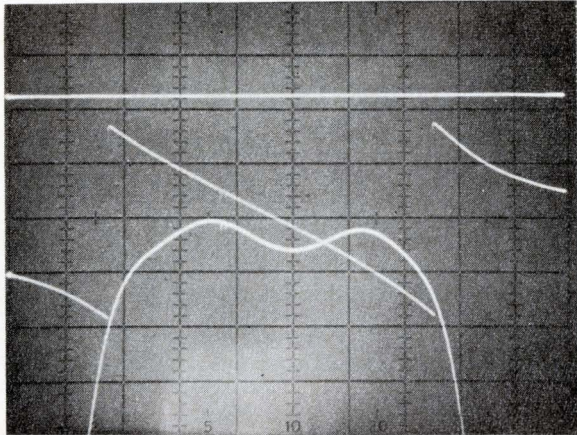

To examine the filter's passband more fully, set the sweep to cover  $50 \pm 5$  MHz at 1 MHz/div., and 1 dB/div. in amplitude. You can identify the  $-3$  dB points, 46.6 and 52.9 MHz, without any frequency markers. Because the 8412A is now in its DUAL mode, you can also show the filter's phase response (the scale is here set to  $100^\circ/\text{div.}$ ). Note the four poles—nearly  $720^\circ$  of phase shift—and  $230^\circ$  phase shift from 48 to 52 MHz. You can compute the group delay in this region as 160 ns, from  $\Delta\phi/(360)(\Delta f)$ . Insertion loss is 2.2 dB, with 0.6-dB passband ripple.

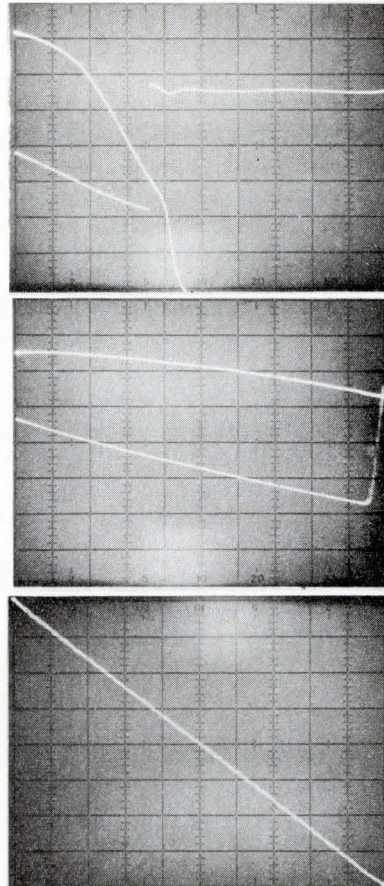

**Feedback amplifier.** This picture sequence shows how the 8407S helps you to design stability into a feedback amplifier in its bread-board stage. The condition for stability is that the phase shift of the open-loop gain (the amplitude response of the feedback loop at the summing point) be less than  $-180^\circ$  at unity gain. The difference between the actual phase shift at unity gain and  $-180^\circ$  is the phase margin, and the difference between unity gain and the loss at  $-180^\circ$  is the gain margin. The top photo shows the open-loop gain of a feedback amplifier. The sweep is 1 to 51 MHz at 5 MHz/div., with amplitude and phase set to 2.5 dB/div. and  $100^\circ/\text{div.}$ , respectively. Unity gain response is at 16 MHz at which point the phase is  $-160^\circ$ , implying a phase margin of  $20^\circ$ . At  $-180^\circ$  (note the jump from  $-180^\circ$  to  $180^\circ$ ), the loss, and the gain margin, is 2.5 dB. The amplifier will be stable. The center photo shows the closed-loop gain of the stable amplifier. All calibrations are the same as before except amplitude resolution, now set to 10 dB/div. The gain is 26 dB at 1 MHz, and falls off to 13 dB at 51 MHz. Phase shift is quite linear, and there are no oscillations apparent. The bottom photo is a close look at the 20-MHz phase response. The full sweep is  $20 \pm 1.1$  MHz, with phase resolution  $1^\circ/\text{div.}$  Because  $\Delta\phi$  is  $8^\circ$  and  $\Delta f$  is 2.2 MHz, the group delay is 10 ns. (This photo also shows the linearity of the sweeper and display.)

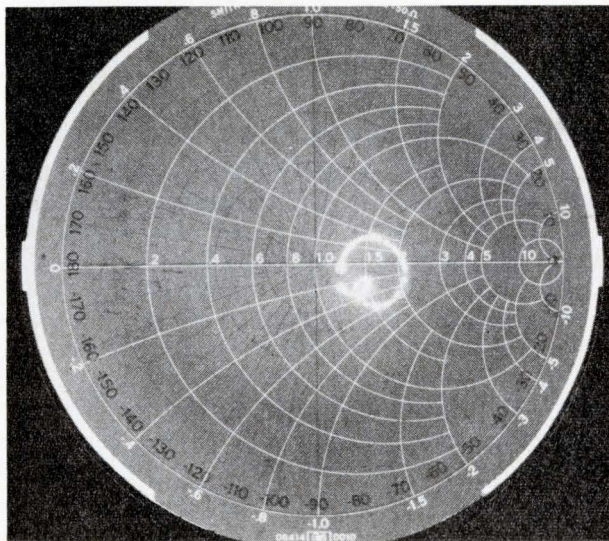

**Antenna input impedance.** An fm antenna is shown here, swept over its usable frequency range of 88 to 108 MHz, and with a Smith chart overlay on the polar display. The center of the display represents the desired  $300\text{-}\Omega$  input impedance. Note that the antenna is capacitive over most of the sweep range. Its impedance varies from  $(375 - j0.1)$  ohms, at 88 MHz, passing through real impedances of  $375\Omega$  and  $610\Omega$  on the way to  $(375 - j0.2)$  ohms at 108 MHz.

head, and many accessories to help you get at difficult-to-measure circuit points.

The two-channel 8407A mainframe is the heart of the system. Its TEST and REFERENCE channels each have two inputs: DIRECT, which operate with signal inputs of  $-90$  to  $-10$  dBm; and ATTENUATED, which operate at  $-50$  to  $+20$  dBm input levels. Use of the two in combination lets you accommodate ratios of greater than 100 dB, without additional accessories.

There are three plug-in displays for the 8407A mainframe. The 8412A phase-magnitude display is a linear crt readout which shows amplitude and phase vs frequency, with 80-dB and  $\pm 180^\circ$  display ranges. Selectable resolutions to 0.25 dB and  $1^\circ$  per division let you read to at least 0.05 dB and  $0.2^\circ$ . This display is for transmission measurements of gain or attenuation and/or phase shift, or for return loss (VSWR) measurements.

The 8414A polar display has 60-dB and  $\pm 180^\circ$  ranges, and is most useful for Smith-chart displays of complex impedance or reflection coefficients.

### What goes on inside

The 8407 system spans more than three frequency decades without harmonic skipping, because of its tracking design. You can use either one of two HP sources: the 8601A generator/sweeper, or the 8690B/8698B sweeper. The HP 8601A mixes a 200.1- to 310-MHz voltage-tuned oscillator (VTO) with a 200-MHz oscillator signal to give 0.1- to 110-MHz rf output. (The 8698B does the same, except that its low end is 0.4 MHz.) Both instruments have 0.5% linearities, calibrated sweep widths, 1% frequency accuracies, and 100-dB attenuator ranges.

Figure 2 shows the innards of the 8407A/8412A. The 8407A mainframe accepts the 200- to 310-MHz VTO source signal and mixes it with a phase-locked 199.722-MHz oscillator (200 MHz less the 278-kHz i-f frequency), to give frequencies of 0.378 to 110.278 MHz. This signal, split and mixed with the input rf, gives a 278-kHz i-f with all the amplitude and phase information that was present on the original input signal.

In short, the 8407A is a narrowband, tracking detector that rejects all out-of-band signals (harmonics, spurious signals, and noise). As such, it makes log detection meaningful over a broad frequency range.

### And outside . . .

The REFERENCE CHANNEL LEVEL control lets you operate this channel's agc amplifier in its usable 40-dB range. You do this by adjusting the reference-level switch so that the meter reads in its white region. Best accuracy and signal-to-noise ratio comes with a meter reading in the upper white area. If you should set an improper TEST/REF input signal ratio, the UNCAL warning light comes on to show an agc or TEST channel overload. Lowering the source's output or changing the reference channel level restores proper operation.

The DISPLAY REFERENCE CAL—a precision, minimum-phase shift, i-f attenuator—changes the display

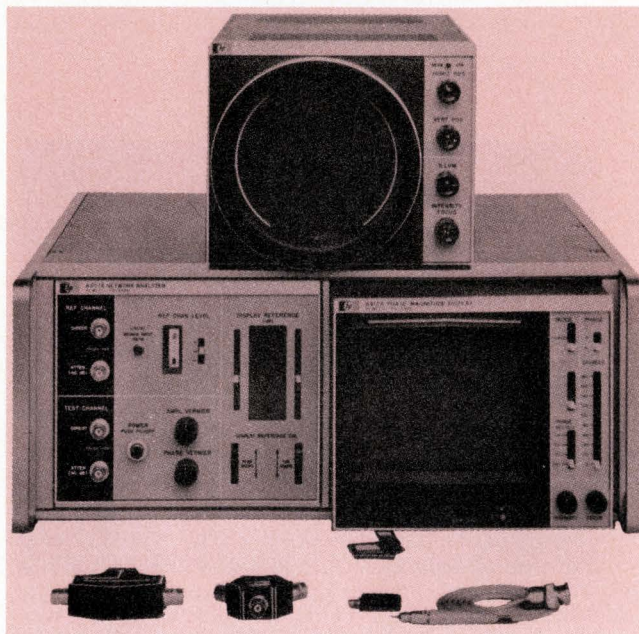

Fig. 1. Hewlett-Packard's 8407S network analyzer system. It consists of a mainframe, plug-in displays (the 8414A polar display is shown sitting on top of the mainframe, which holds a phase-magnitude display plug-in), and transducer kits. In the foreground, from left to right, is a directional bridge, a power splitter, and a passive probe set.

amplitude in 10- and 1-dB steps. You use it to set a calibration point on the display. Once set, the i-f attenuator lets you return the device's response to the original calibration point on the display, over a  $\pm 80$ -dB range. In essence, you are using i-f substitution to measure device response levels, so the basic accuracy of your measurement is tied directly to the i-f attenuator.

### Calibration and measurement

You must set a calibrated reference point on the display prior to an actual measurement. Your display reference should be at mid-screen, because you expand about the mid-screen point for greater resolution.

First, adjust the i-f attenuator and phase offset (the latter is on the 8412A display) to the closest mid-screen reading. Then increase amplitude and phase resolution (both controls are on the 8412A) to maximum. The traces will not be exactly mid-screen, but the phase and amplitude verniers let you bring them back. You have now calibrated the instrument, and can reset its controls to your desired resolution.

With the DISPLAY REFERENCE CAL thumbwheels, you can set a 0-dB reading on the scale; then, any changes in the DISPLAY REFERENCE switches (the i-f attenuator) give you the number of dB you have added or subtracted, without any mental gymnastics.

### Display

The 8412A display carries the amplitude and phase resolution controls. Steps of 10, 2.5, 1, and 0.25 dB per division let you vary the display range from 80-dB

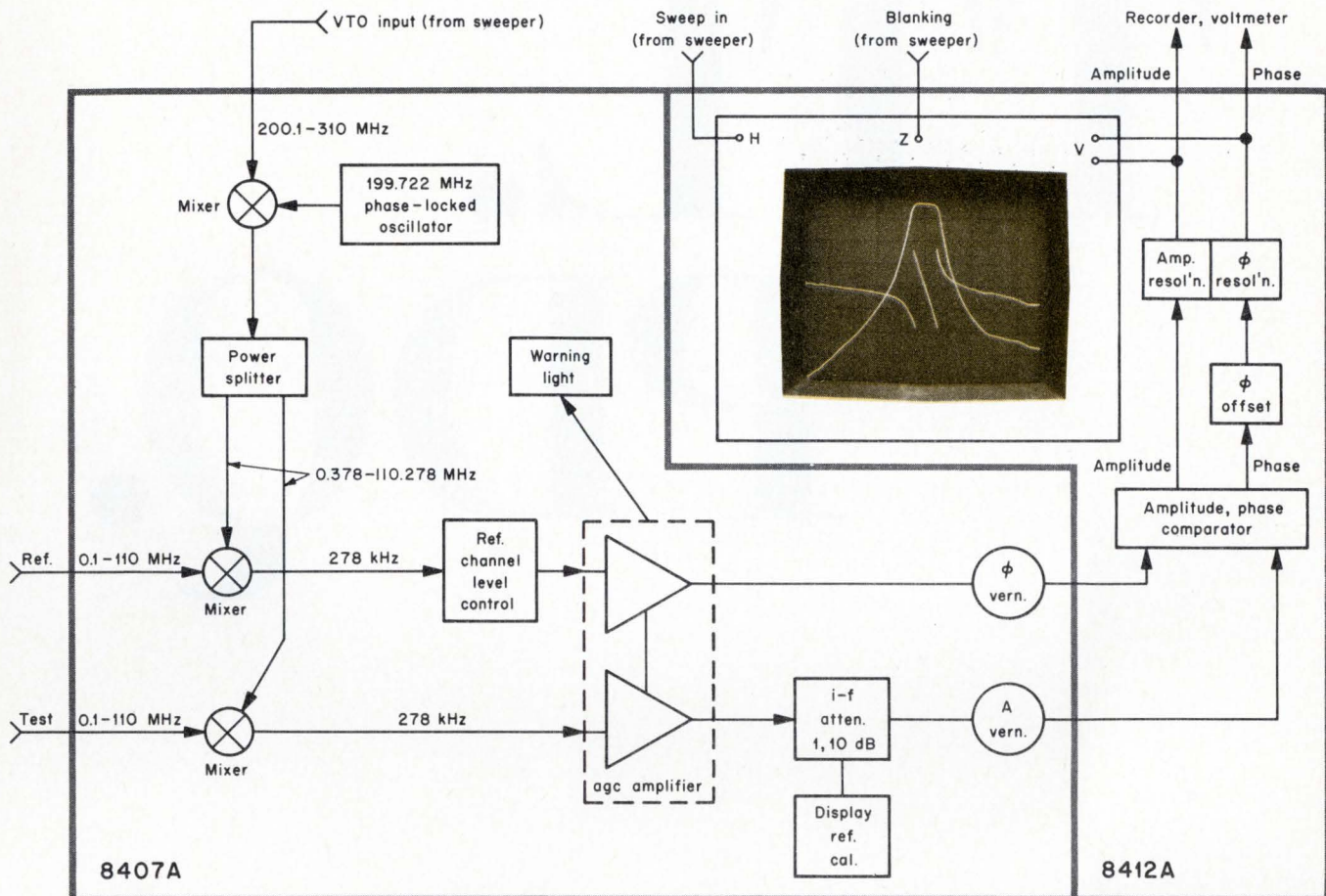

Fig. 2. This simplified block diagram of the network analyzer shows it to be a two-channel, tracking detector. Comparators yield amplitude ratio and phase difference information for

display. The photo-insert shows an actual display of a filter's phase and amplitude responses vs frequency, as shown by the 8412A phase-magnitude display in its DUAL mode.

full screen, down to a resolution of 0.05 dB. The phase resolution has steps of 90, 45, 10, and 1° per division, and shows everything from  $\pm 180^\circ$  of phase, to 0.2° resolution. This means that you can make accurate measurements of gain or loss, and phase shift, with extremely high resolution over wide dynamic ranges. Furthermore, for even greater resolution, you can connect a digital voltmeter or an x-y recorder to outputs at the rear. These outputs are scaled at 50mV/dB for amplitude, and 10 mV/deg. for phase.

The 8412A display also has a video filter with selectable bandwidths of 100 Hz and 10 kHz. The filter gives you a noise-free, narrow, display bandwidth for high-resolution or low-level presentations.

#### How accurate is it?

Accuracy depends so much upon the type of measurement and how you choose to make it, that a single number does not suffice. But the accuracy equals or exceeds present techniques that use a cw source with rf voltmeters and phasometers, or a sweeper with broadband detectors. Two reasons for the improved accuracy are: the two-channel approach incorporates an agc amplifier to remove source and transducer variations; the i-f substitution method uses precision attenuation with minimum phase shift to perform the actual measurement.

A data sheet is available that combines accuracy specifications with a simplified error analysis. This lets you calculate the accuracy of any particular measurement. You can replace those rf voltmeters, crystal detectors, log amplifiers, impedance meters, phase meters, vswr bridges, and so on, without sacrificing swept capability, dynamic range, or accurate phase plots. You can forget about measurement by comparison, and read the response of your device directly with speed and accuracy.

#### Price and availability

First shipments of the 8407A mainframe (\$2950), the 8412A rectangular display (\$1575), and the transducer kits (from \$80 to \$300) are scheduled for November. The 8414A polar display (\$1250) is already available.

For more information, contact Inquiries Manager, Hewlett-Packard Co., 1501 Page Mill Rd., Palo Alto, Calif. 94304. (415) 326-7000.

Circle 276 on Inquiry Card

INFORMATION RETRIEVAL  
Instruments and measurements,  
Circuit design, Communications

# TTL. PDQ.

# RSVP: Your National distributor

## Gates

DM8000N (SN7400N)	Quad 2-Input, NAND gate
DM8001N (SN7401N)	Quad 2-Input, NAND gate (Open Collector)
DM8003N (SN7403N)	Quad 2-Input, NAND gate (Open Collector)
DM8010N (SN7410N)	Triple 3-Input, NAND gate
DM8020N (SN7420N)	Dual 4-Input, NAND gate
DM8030N (SN7430N)	Eight-Input, NAND gate
DM8040N (SN7440N)	Dual 4-Input, Buffer
DM8050N (SN7450N)	Expandable Dual 2-Wide, 2-Input AND-OR-INVERT gate
DM8051N (SN7451N)	Dual 2-Wide, 2-Input AND-OR-INVERT gate
DM8053N (SN7453N)	Expandable 4-Wide, 2-Input AND-OR-INVERT gate
DM8054N (SN7454N)	Four-Wide, 2-Input AND-OR-INVERT gate
DM8060N (SN7460N)	Dual 4-Input expander
DM8086N (SN7486N)	Quad Exclusive-OR-gate

## Flip Flops

DM8501N (SN7473N)	Dual J-K MASTER-SLAVE flip flop
DM8500N (SN7476N)	Dual J-K MASTER-SLAVE flip flop
DM8510N (SN7474N)	Dual D flip flop

## Counters

DM8530N (SN7490N)	Decade Counter
DM8532N (SN7492N)	Divide-by-twelve counter
DM8533N (SN7493N)	Four-bit binary counter
DM8560N (SN74192N)	Up-down decade counter
DM8563N (SN74193N)	Up-down binary counter
DM8520N	Modulo-n divider

## Decoders

DM8840N (SN7441N)	BCD to decimal nixie driver
DM8842N (SN7442N)	BCD to decimal decoder

## Shift Registers

DM8570N	Eight-bit serial-in parallel-out shift register
DM8590N	Eight-bit parallel-in serial-out shift register

## Miscellaneous

DM8200N	Four-bit comparator
DM8210N	Eight channel digital switch
DM8220N	Parity generator/checker
DM8820N	Dual line receiver
DM8830N	Dual line driver
DM8800H	Dual TTL to MOS translator
DM8550N (SN7475N)	Quad latch

## Drivers

NH0006C	High voltage, high source current driver
NH0008C	High voltage, high source current driver
NH0011C (SH2002)	High voltage, high sink current driver
NH0011CN (SH2002P)	High voltage, high sink current driver

TTL devices for industrial applications. Stocked in depth—available immediately, through National distributors. For our TTL Specification Guide and pricing, write or call National Semiconductor, 2975 San Ysidro Way, Santa Clara, California 95051. (408) 245-4320. TWX: 910-339-9240. Cables: NATSEMICON.

# National/TTL

P.S. We've got low power TTL too. Meets 883 mil standards; off-the-shelf availability.

The  
Choice  
is **TTL.**

$$Y = A \oplus B$$

**TI's new MSI SN5486/SN7486  
does it fast.**

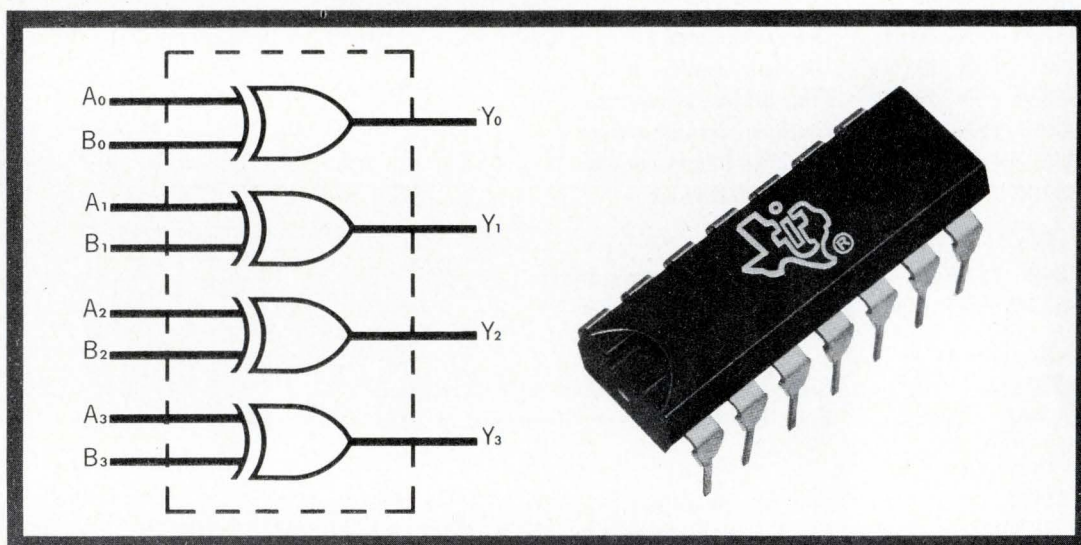

**(And easy on the pocketbook.)**

Typical propagation delay of this new TI monolithic quadruple 2-input exclusive-OR gate is 12 ns. Power dissipation per exclusive-OR function is only 39 mW. In 100-999 quantities, the plastic dual-in-line carries a \$3.00 price tag.

TI's low-power version, SN54L86/SN74L86, will help ease your critical power dissipation situations. Power dissipation: 3.75 mW per exclusive-OR function. Propagation delay: 58 ns. Cost: \$3.41 for the plastic dual-in-line.

You can get both versions promptly

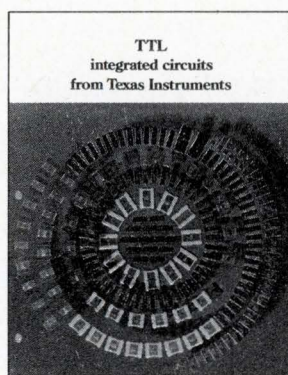

and both are fully compatible with TI's growing family of Series 54/74 integrated circuits.

For all the facts, fast and easy, get our data sheet on the SN5486/SN7486. We'll also send along our new 80-page brochure on our Series 54/74 ICs. Circle 190 on the Reader Service Card or write Texas Instruments Incorporated, P.O. Box 5012, M. S. 308, Dallas, Texas 75222. Or call your nearest authorized TI Distributor.



**TEXAS INSTRUMENTS**  
INCORPORATED

## New approach to alphanumeric readouts

Inexpensive TV monitors provide  
the key to low-cost display of messages

By **Jay Freeman**, Senior Engineer,  
Applied Digital Data Systems, Hauppauge, N. Y.

The inexpensive, ubiquitous TV monitor is the basic display element in a new readout system that offers strongly competitive advantages in applications involving the display of messages with more than 30 characters of alphanumeric and symbolic data. Basically, the new system takes the digital representation of a character and converts it into a digital signal to drive a standard television monitor.

Developed by Applied Digital Data Systems, Hauppauge, N. Y., the new system really comes into its own when relatively large amounts of data must be displayed simultaneously at several widely separated locations. To add remote terminals in a system using, say, glow readout tubes, would cost about \$20 to \$60 per character and would require four input lines for each digit. Each additional terminal would be as costly as the first. Contrast this with low-cost tv monitors, fed by a single coaxial line, all displaying the same volume of data.

The new system will be available in two basic configurations. The first one, called a Static Raster Display (SRD), is available now and displays up to 160 characters of numerics and special symbols. Input to the SRD is controlled by a digital multiplexer and each character location on the screen is driven by a four-wire binary output. Display distribution is 10 lines of 16 characters per line. This version was developed to display outputs of static sensors such as DVMS or brush encoders.

The SRD offers various options on a line-by-line basis. The user can control blinking, select one of the three character sizes, or reverse the background of any combination of data lines. Blinking is achieved by overriding the video signal with a blinking signal eight

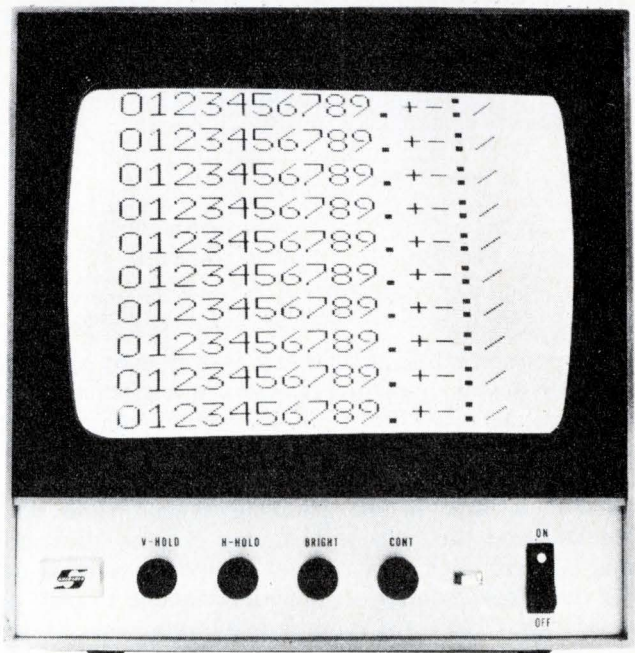

**Standard TV monitor** displays 160 characters. Background, size, and blinking of characters can be controlled line by line.

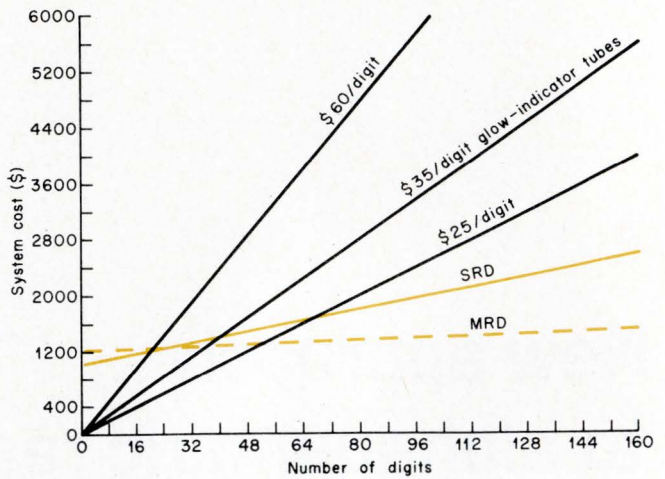

**Cost of the two new systems (SRD and MRD) compared with that of systems that use conventional glow readout tubes.** The new system becomes economical in applications displaying 40 or more characters. What this graph does not show is the savings in systems where data must be duplicated at several different locations. In such cases, the inherent economy of the television monitor for remote display makes it economically attractive to use the new system even to display as few as 10 characters. Note that the prices shown for glow readout tube systems include the cost of circuitry required to drive the tube.

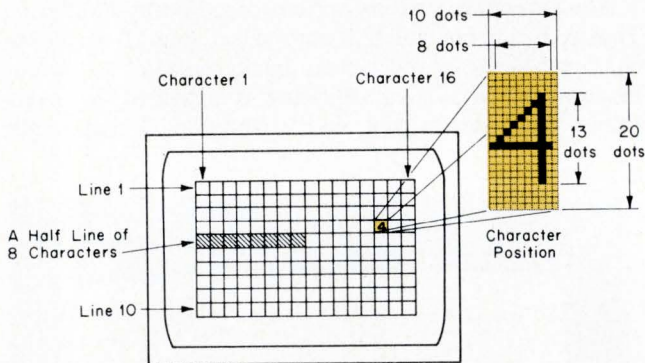

**The system forms characters** by modulating the video and sync input to a TV monitor. The new display system uses 13 horizontal scan lines to form a data line of characters. As the beam scans horizontally through each position, it is turned on and off to form the character on an 8 x 13 dot matrix. Spacing between characters is such that each position on the display area is a 10 x 20 matrix.

times per second. Character size is varied by allowing 1, 2, or 4 scan lines to perform a given sequence of video modulation. Inverting the video data changes the background.

The second version, called a Memory Raster Display (MRD), is now in the planning stage. While both the SRD and the MRD will employ a video generator that converts digital data into a composite video signal for the same quantity of numeric/symbolic display on a TV screen, the MRD's primary application is as a computer output device. Therefore, the MRD input unit will be an LSI, dynamic read-only-memory (ROM), eliminating the impractical requirement of having the computer refresh the monitor's screen.

There are significant differences between the two systems. The SRD is basically a parallel input system while the MRD is a sequential input system. The MRD accepts sequentially four lines of binary coded data (a character at a time) and stores this data in local LSI memory registers where it is used to refresh the TV monitor display.

Unlike the SRD, the MRD has no size control. Background for the entire screen is factory set according to the user's preferences and is not variable on a line-by-line basis as in the SRD.

The nature of the TV monitors provides much additional flexibility for the display engineer. He can display the data at one or more remote locations by sim-



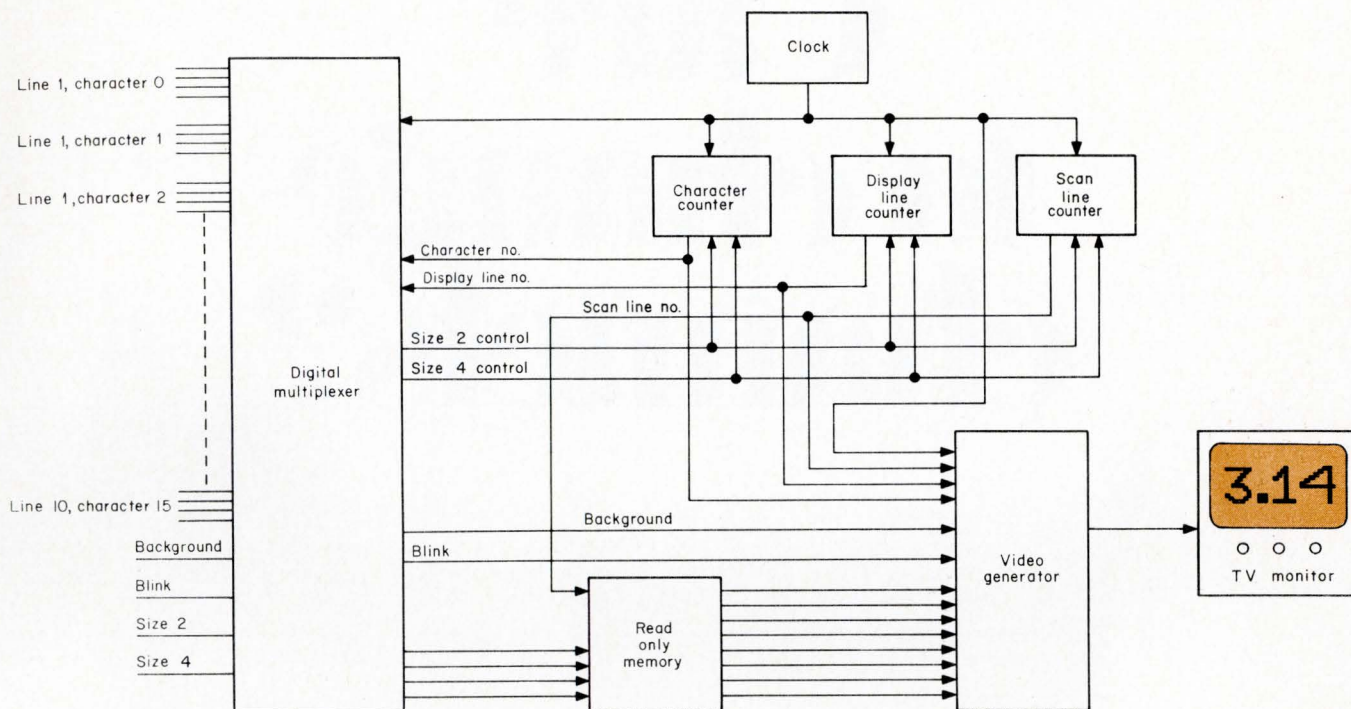

**How it works** both SRD and MRD systems use the same basic technique: a video generator converts digital data into a standard composite video signal suitable for display on any 525-line TV monitor. They differ only in the preparation of data for entry into the video generator. In the SRD, the input unit is a digital multiplexer; in the MRD, the input unit is a solid state memory drum using LSI dynamic shift registers.

The video generator in both systems also establishes timing signals that keep track of the location of the electron beam at any moment. A scan line counter keeps track of the beam's vertical position on the screen and a character counter monitors the horizontal position.

In the SRD, a digital multiplexer sequentially samples each BCD character input on a command from the character counter in the video generator. The input data and the

vertical beam position are presented to an LSI read-only-memory (ROM), which is functionally a large diode matrix. Its purpose is to convert the character code and beam position information into video signals for writing an 8-bit segment on the TV screen. As the beam scans horizontally across the screen the character counter advances, calling up a new character position. Whatever code is present at the new position goes to the ROM, which forms a new 8-bit segment. For each data line the beam must scan 13 times, sampling the same set of characters on each scan. As the scan line counter advances, however, different 8-bit segments are encoded in the ROM. After 13 scans a full line of characters forms on the screen. This process repeats every 20 scan lines for each of the data lines (up to 10 lines). The full screen of characters is refreshed 60 times per second.

ply running a single coaxial cable. He can also display the data on a 5-in. or a 23-in. monitor, or both—depending on whether he needs to concentrate the data for a single operator or display it to a roomful of viewers. Also he can repeat the display inexpensively and easily by adding additional TV monitors to the system.

Price of the SRD with the three options is \$1095 plus \$160 per line of 16 characters (that is, \$2695 for a screenful of 160 characters). The price of the MRD, not yet announced, will be somewhat higher. For additional information, contact Applied Digital Data Systems, 89 Marcus Boulevard, Hauppauge, N.Y. 11787. (516) 273-7799

#### Thanks

The author wishes to acknowledge the assistance of David Ophir, vice-president of Applied Digital Data Systems, who invented both the SRD and MRD, and Richard Kaufman, Sales Manager.

Circle 201 on Inquiry Card

**INFORMATION RETRIEVAL**  
Computers and peripherals, Data acquisition and processing, Integrated circuits

# Care to change channels?

## Be our guest.

Hughes now offers multi-channel selection. All from one and the same crystal-controlled source.

Twelve models are available in the frequency range of 800 to 9600 MHz. Pick one and then tell what three, four—or even more—discrete frequencies you'll be needing within that range.

Hughes makes changing channels about as compli-

cated as switching programs on a TV set.

Modular crystal oscillator construction makes it all possible. No expensive re-tooling or re-engineering required to achieve a new center frequency. Or a different set of channel frequencies.

The modular and EMI shielded construction permits .005% frequency stability. The built-in shielding

also achieves exceptionally low harmonics. You get both high and low power outputs, plus an operating temperature spread from  $-40^{\circ}\text{C}$  to  $71^{\circ}$ . Extended temperature and higher frequency stability also available.

These new series 40000H multi-channel sources are another demonstration of Hughes technology. For the first time, one source gives

the same channel selection as four or more separate units.

Tell us your needs in high power solid state sources. We're convinced our Hughes research resources, experience and wide capabilities make us uncommonly qualified to help you. Write: Hughes Aircraft Company, Electron Dynamics Division, 3100 West Lomita Blvd., Torrance, California 90509.

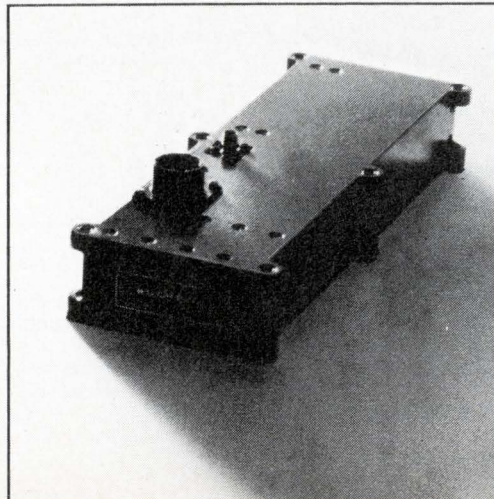

**HUGHES**

HUGHES AIRCRAFT COMPANY  
ELECTRON DYNAMICS DIVISION

## A high-impedance, bipolar DPM

Here's the latest addition to a popular line of digital panel meters. This one combines automatic bipolar operation with high input impedance. Model 1292 is a 3½-digit unit with input impedances greater than 100 MΩ on the 100-mV range, 1000 MΩ on the 1-V range, and 10 MΩ on all the other ranges, which go to 1000 V.

The instrument's measurement circuitry uses dual-slope integration, of course. But an interesting feature of the 1292 is that it has separate references for both end points of a range. This not only makes the zero-point independent of end scale adjustments,

but also simplifies those adjustments and gives zero-input stability.



For current measurements, you can choose scale ranges from 1 μA to 100 mA. The DPM reads to 0.1% f.s. ±1 digit accuracy, has 100% overrange,

80-dB common mode rejection at 60 Hz, 35-dB normal mode rejection at 60 Hz, 1-2-4-8 BCD output, and full-storage display. Phaselocked sampling rates give excellent noise rejection characteristics. Other features are a remote HOLD, and a wired-out decimal point. Power needs are less than 7 W at 117 V ±10%, 60-400 Hz.

Packaged in its maker's standard Model 1290 case, Model 1292 costs less than \$200 ea. in 100-pc. lots. Weston Instruments Div., 614 Frelinghuysen Ave., Newark, N.J. 07114. (201) 243-4700.

**Circle 273 on Inquiry Card**

## Radio on a chip

Although it's not exactly Dick Tracy's wrist radio, you can now buy something that comes close: a single, monolithic IC chip that holds all the active components for a complete a-m radio receiver. Inside the package of the TAD100 are oscillator, mixer, i-f amplifier, detector, agc, and audio preamp and driver stages.

According to the manufacturer, the TAD100's performance is comparable to that of a quality a-m receiver made from discrete components. For instance, with the TAD100, you would have a radio with an a-m sensitivity of

50 mV/m for 100 mW audio out; an agc range of 65 dB for a 10-dB audio output change; and a total harmonic distortion of 2% (typ.).

You can also use the device as an

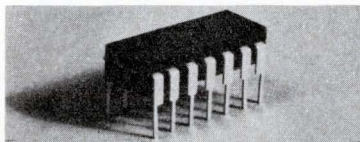

fm receiver, because its frequency response lets you use the chip as a 10.7 MHz i-f amplifier. Of course, in such an application, you must add an external rf stage as a front end.

With this IC, you can build complete a-m and fm radios that run from batteries of 6 to 9 V, and with current drains as low as 15 mA. The chip is housed in a dual inline package about 0.68 x 0.255 x 0.197 in. high. You can solder this package directly into wired circuits, or you can dip- or flow-solder it into PC boards.

For complete specs and application data on the TAD100, write or call Amperex Electronic Corp., Semiconductor and Microcircuits Div., Slatersville, R.I. 02876. (401) 762-9000.

**Circle 274 on Inquiry Card**

## An interface instrument for magnetic field measurements

This instrument—the first of a series of modular units—consists of a high stability, constant-current supply for a Hall probe, and a high linearity, high stability Hall voltage amplifier. The model 810 field monitor interfaces its manufacturer's high-performance Hall probes with data acquisition, recording, and readout systems. Along with the high performance probes, the instrument also interfaces with soon-to-be-introduced digital, limit, and control modules. Such modules are for data conversion to digital formats, for driving analog control systems, and so forth.

The field monitor has four decade ranges, from 100 G to 100 kG, 1-V f.s. output, and 100% overrange



capability. Its internal calibration to 0.1% is NBS-traceable, and the instrument's stability is 100 ppm/°C.

There is a wide range of uses for

this instrument. In the scientific field, for example, you can use the 810 to measure magnetic fields in particle accelerators, beam-focusing magnets, laboratory electro-magnets, and so forth. And in the industrial field, there's quality assurance testing, magnet sorting and classifying, motor magnet testing, traveling wave tube assembly testing, solenoid testing, and so forth.

The model 810 field monitor is priced in the neighborhood of \$1000, and is available from F. W. Bell, Inc., 1356 Norton Ave., Columbus, Ohio 43212. (614) 294-4906.

**Circle 275 on Inquiry Card**

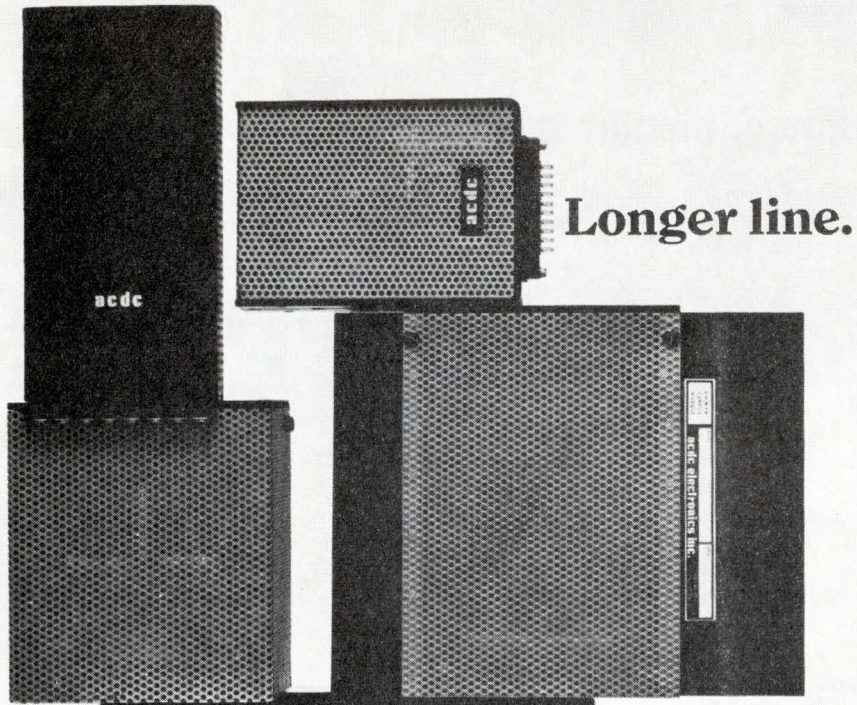

Longer line.

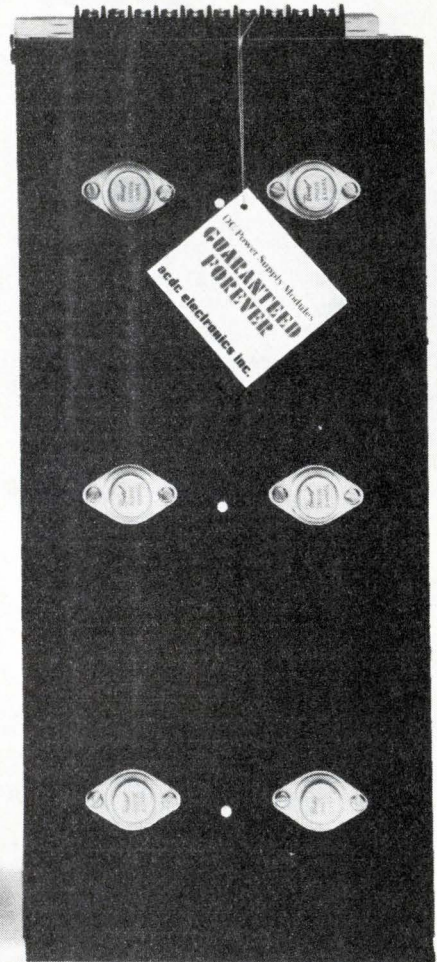
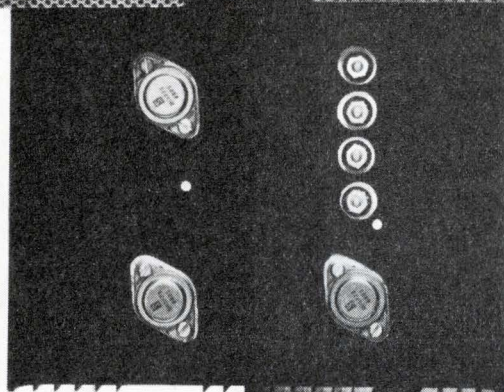

Shorter delivery.

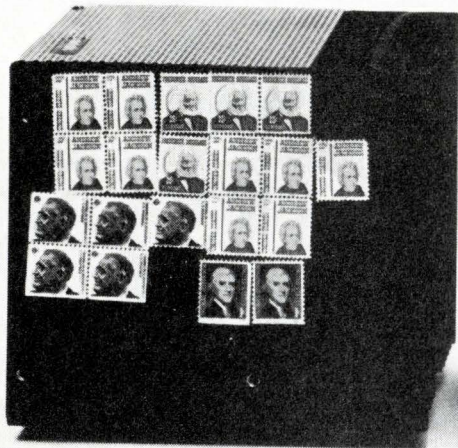

We've added more power supplies. And put more of them on the shelf. So now you get a wider selection and faster delivery. Write for our complete catalog. (It includes the new miniaturized JR.) **acdc electronics, inc.** 2979 N. Ontario St., Burbank, Calif. 91504.

## A programmable, go/no-go op amp tester

Here's an instrument that should prove useful for engineering evaluation, incoming inspection, and quality control and incoming inspection. It's an automatic instrument in which you program test conditions either by front-panel switches or by switch-type program cards. You program GO/NO-GO limits with plug-in, resistor cards.

Model 5104 performs both dynamic and static tests on discrete, hybrid, and monolithic op amps with both bipolar and FET input stages. Besides the GO/NO-GO indication, a large front-panel meter shows the test results in dB, volts, or amps.

There are a number of external outputs, as well. These include the analog metering output, the GO/NO-GO signals, test-selected lines, scale-selected lines, and the output itself of the amplifier under test.

You can set the test sequence manually—with front-panel pushbuttons—or, if you wish, an internal scanning circuit will do the sequencing for you,

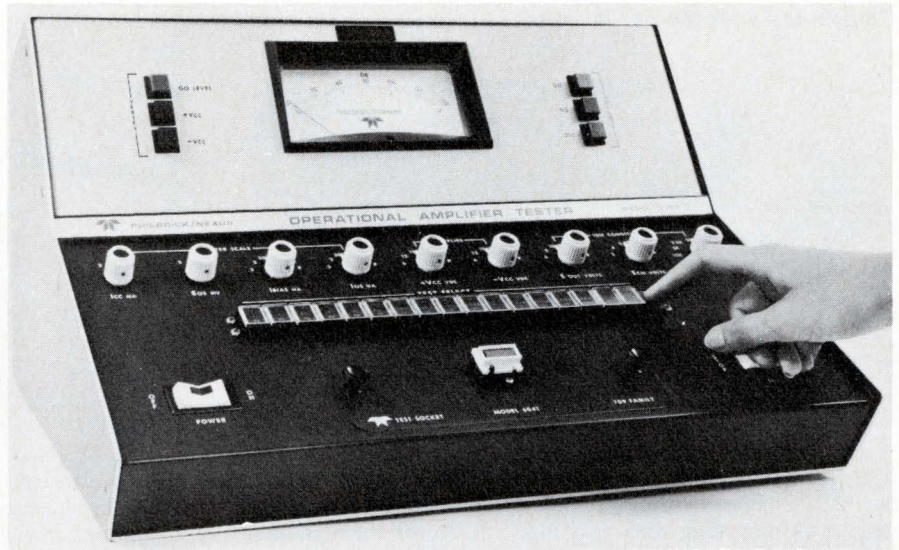

automatically. In this mode, the instrument cycles rapidly through a series of GO/NO-GO tests at 200 ms per test.

The 5104 sells for \$4500. For more

information, call or write Philbrick-Nexus Research, Allied Drive at Rte. 128, Dedham, Mass. 02026. (617) 329-1600.

Circle 272 on Inquiry Card

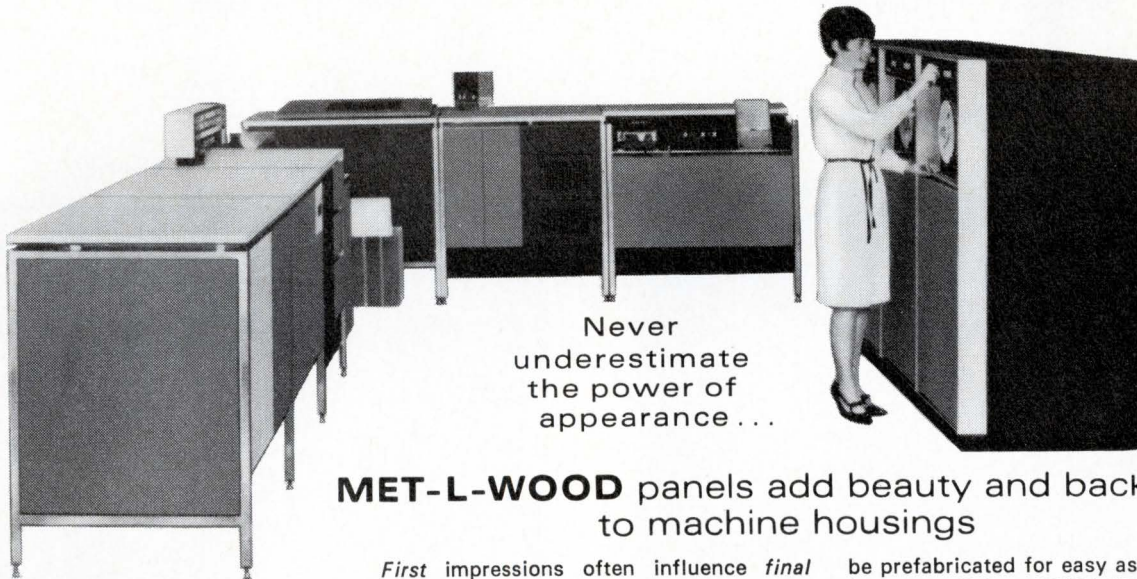

Never underestimate the power of appearance...

## MET-L-WOOD panels add beauty and backbone to machine housings

First impressions often influence final decisions. To compete in today's marketplace, even sophisticated machinery cries out for housing design that says . . . beauty . . . purpose . . . versatility. And nothing says it better than unique MET-L-WOOD. MET-L-WOOD is a laminate, consisting of a core of plywood or other lightweight material with metal or other durable facings structurally bonded to both surfaces. The result is a panel of great durability and versatility that lends itself to dramatic design, withstands abuse and continues to look like new for years. MET-L-WOOD panels are easy to work with, requiring no special tools, or may

be prefabricated for easy assembly. Learn for yourself how MET-L-WOOD fits into your housing plans. Write for brochure to: MET-L-WOOD CORPORATION, 6744 West 65th Street, Chicago 60638.



**MET-L-WOOD**  
Corporation

STRUCTURAL LAMINATES SINCE 1925

**TTL ONE-SHOT MULTIVIBRATOR**

Compatible with the 54/74-series TTL line.

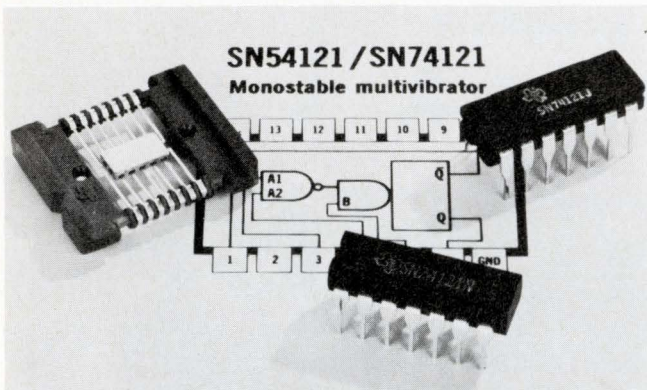

The SN74121 monolithic, monostable multivibrator triggers at a specific voltage level of the input pulse. It normally triggers through the gated A-inputs on the negative-going edge of a fast input pulse, or through the Schmitt B-input on the positive-going edge of a slow pulse. Firing inhibits the inputs; the output pulse duration, which is variable from 40 ns to 40 sec, depends only on the value of the timing resistor and capacitor. A short (30 ns) pulse is available by using the internal timing components. The SN74121 costs \$4.40 ea. in lots of 100-999. Texas Instruments Inc., Components Gp., P. O. Box 5012, Dallas, Tex. 75222. (214) 238-3741.

Circle 243 on Inquiry Card

**PARITY TREES**

For error detection in computers.

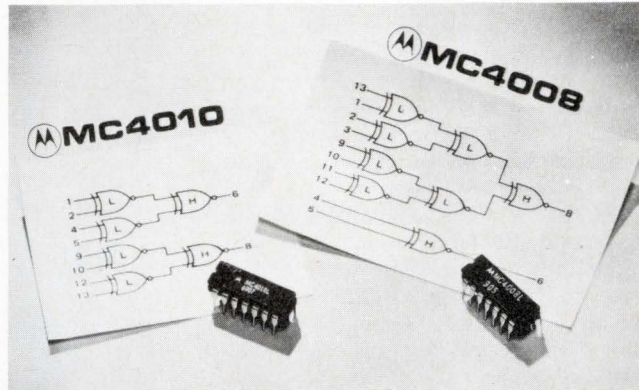

The MC4008 8-bit parity tree and the MC4010 dual 4-bit parity tree are parity checkers and generators. The MC4008 consists of seven, internally connected 2-input EXCLUSIVE NOR gates, plus one extra that you can connect externally to increase the number of bits, or to generate the function's complement. The parity tree has a 30-ns propagation delay, a 150-mW dissipation, and an output loading factor of 11. The same parameters for the MC4010 (six 2-input EXCLUSIVE NORs) are 22 ns, 125 mW, and 11. In TO-116 DIPs, they cost \$7.75 ea. in lots of 100. Motorola Semiconductor Prods. Inc., Box 20924, Phoenix, Ariz. 85036. (602) 273-6900.

Circle 245 on Inquiry Card

**MOS READ/WRITE, RANDOM-ACCESS MEMORY**

128 bit storage.

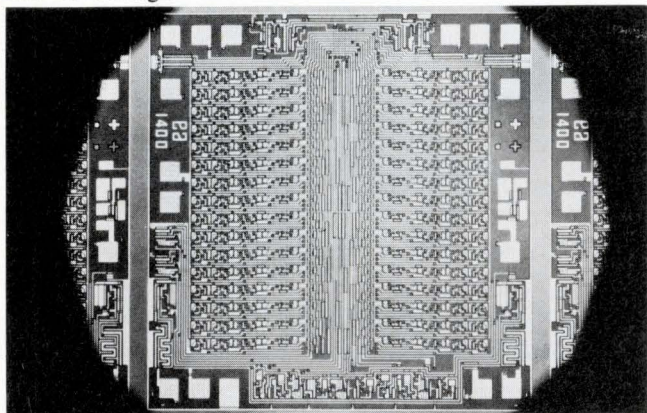

The EA 1400 is organized as 64 words of 2 bits each. It is primarily targeted for digital computer and computer-related applications. All decoding circuitry is on the monolithic chip. This keeps the number of package leads to a minimum. The device has nondestructive readout, bipolar output drive capability, and low power (135 mW typ. at 1-MHz read rate). Access time is 1  $\mu$ s or better, from  $-55^{\circ}$  to  $85^{\circ}$ C. A chip-disable on the output lets you couple several devices together to form expanded memories. In a 16-lead DIP, the EA 1400 is \$35.60 ea. in lots of 100. Electronic Arrays, Inc., 501 Ellis St., Mountain View, Calif. 94040. (415) 964-4321.

Circle 244 on Inquiry Card

**BIPOLAR LSI MEMORY**

Fully decoded 64-bit random access memory.

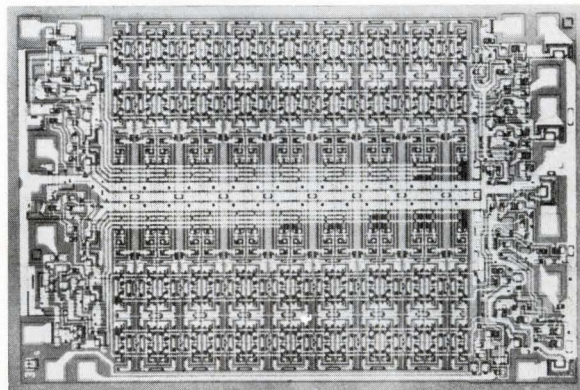

Designed for use as a high speed, scratch pad memory or as a general purpose storage element, the Model 3101 is a 16-word by 4-bit array. You address each word in binary code, through four address-input leads; access time is 50-ns. For simple interfacing, the unit is fully decoded with on-chip address, decoding, and buffering. A separate chip-select input simplifies memory expansion. Power dissipation is 6 mW/bit. Inputs are 1-TTL load; outputs sink 20 mA. In a 16-lead DIP for  $0^{\circ}$  to  $85^{\circ}$ C, the 3101 costs \$99.50 to \$38.50 ea. depending on quantity. Intel Corp., 365 Middlefield Rd., Mountain View, Calif. 94040. (415) 969-1670.

Circle 246 on Inquiry Card



# MOS. Now.

## 20 standard Philco types are ready to ship from stock.

Our line of standard production MOS integrated circuits keeps growing broader every day. From our Lansdale plant, one of the largest MOS facilities in the country, you can now get instant delivery of many of the devices that you'll need for your next generation designs. For example:

- Shift registers; including the longest (256 bits) and the fastest (5MHz clock) commercially available in production quantities.
- Compatible gates, up to 2MHz clock, in a variety of configurations.
- Binary counters . . . 16-channel sequential/random access multiplexer . . . 1024-bit dynamic read-only memory, programmed to your bit pattern; off-the-shelf model is a sine look-up table.

Many more are being readied for production. When you want MOS *now*, we're the people to see. Write or call MOS Marketing, Philco-Ford Microelectronics Division, Blue Bell, Pa. 19422. (215) 646-9100.

*the better idea people in MOS*

**PHILCO** 

Device	Description
pL4C07C pL4C07AC(1)	7-stage binary counter 7-stage binary counter
pL4G10C pL4G10AC(2)	Hex 2 input NOR + 2 inverters Hex 2 input NOR + 2 inverters
pL4G11C pL4G11AC(2)	Dual 4 input NOR + dual 5 input NOR Dual 4 input NOR + dual 5 input NOR
pL4G12C pL4G12AC(2)	Dual 9 input NOR Dual 9 input NOR
pL4S16C	16 channel multiplexer
pL5R32C	Dual 8/16-bit shift register
pL5R40C	Dual 20-bit shift register
pL5R100C	Dual 50-bit shift register
pL5R96C	Dual 48-bit shift register
pL5R128C pL5R128AC(3)	Dual 64-bit shift register Dual 64-bit shift register
pL5R250C pL5R250AC(3)	250-bit shift register 250-bit shift register
pL5R256C pL5R256AC(3)	256-bit shift register 256-bit shift register
pM1024C	1024-bit read-only memory

(1) Clock rate 500KHz (2) Clock rate 2MHz  
(3) Clock rate 5MHz

# KEEP INFORMED

## A NEW SERIES OF REFERENCE BOOKS

is available from INSTRUMENTS AND CONTROL SYSTEMS. These up to the minute texts are designed to help you stay aware of new techniques, systems, and products in electronics and computer control.



### ACCELEROMETER SURVEY

14-page tabulation giving specifications of over thirty manufacturers' instruments, including range, linearity, frequency, impedance, etc.

### DDC TUNING REFERENCE BOOK

36-page text presents five approaches to parameter tuning for direct digital control.



### ANALOG SYSTEMS REFERENCE BOOK

36-pages of analog systems and techniques, including comprehensive survey of commercially available operational amplifiers.

### ELECTRICAL MEASUREMENTS REFERENCE BOOK

36-page reference source; thirteen useful articles dealing with signal conditioning, precision measurements, ratio-metric systems, potentiometry, etc.

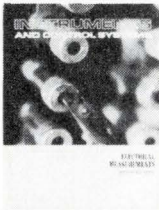

### DIGITAL INSTRUMENTS REFERENCE BOOK

36-page text presents design considerations and operating principles of digital voltmeters, and a survey of DVMs representative of 42 manufacturers.

Rimbach Publications Div. of Chilton Co.  
56th and Chestnut Sts., Phila., Pa. 19139

Please send the following at \$2.00 each (quantity rates on request):

- |  |       |        |
|--|-------|--------|
| <input type="checkbox"/> Accelerometer Survey    | _____ | copies |
| <input type="checkbox"/> DDC Tuning              | _____ | copies |
| <input type="checkbox"/> Analog Systems          | _____ | copies |
| <input type="checkbox"/> Electrical Measurements | _____ | copies |
| <input type="checkbox"/> Digital Instruments     | _____ | copies |

Name \_\_\_\_\_

Address \_\_\_\_\_

City \_\_\_\_\_ State \_\_\_\_\_ Zip \_\_\_\_\_

Payment enclosed.

Send invoice.

## EE NEW MICROWORLD PRODUCTS

### LOW NOISE, HIGH GAIN OP AMP

Gain accuracy is 0.03% at closed loop gain of 1000.

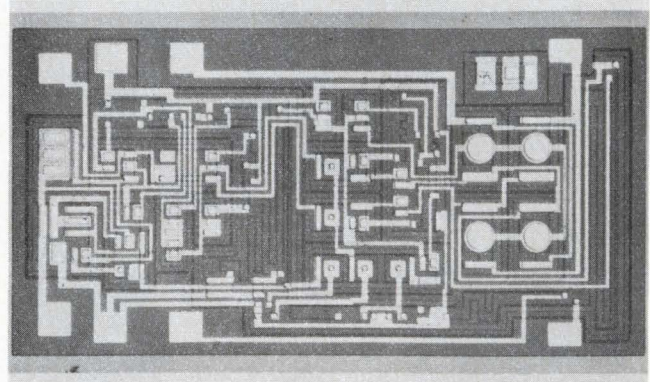

The  $\mu A725$  is a monolithic op amp made with high gain, low noise transistors. It has an open-loop gain of 3,000,000 (130dB), a noise current of only 0.6 pA per square-root cycle, and a common mode rejection of 120 dB. The device has an input offset voltage drift of  $0.6 \mu V/^\circ C$ , with an input offset voltage of 1 mV max. Input offset current is 3 nA. The input voltage range is  $\pm 14$  V. The price in a TO-5 can is \$48 ea. in quantities of 100 for a full temperature range version, \$37.50 ea. for a commercial range version. It will be available later this year in DIPs and flatpacks. Fairchild Semiconductor, 313 Fairchild Dr., Mountain View, Calif. 94040.

Circle 247 on Inquiry Card

### CORE MEMORY SENSE AMPLIFIERS

Interchangeable with Motorola's MC1440 and MC1540.

Both the QC 1440 and QC 1540 amplifiers are for the conversion of bipolar signals (from a core memory) to logic level signals, at cycle times as low as 0.5  $\mu s$ . The QC 1540 has a recovery time of 50 ns max. at input levels of 1.8 V common mode or 400 mV differential mode. Each of these two sense amplifiers consists of a wideband differential amplifier, a dc restoration circuit, and a DTL output gate. The amplifier core signal is strobed through this gate. The threshold level is externally adjustable. The devices are available in either a 10-lead TO-5 can or a flatpack. Qualidyne Corp., 3699 Tahoe Way, Santa Clara, Calif. 95051. (408) 738-0120.

Circle 248 on Inquiry Card

### HYBRID FET OP AMP

Input bias current is 5 pA max.

The Model 20-248 has a voltage offset of less than 1 mV. It is internally phase compensated, and the open-loop gain is 25,000 min. with a 2 k $\Omega$  load. The open-loop, unity-gain bandwidth is 4 MHz; slew rate, 3 V/ $\mu s$ . The common mode rejection ratio is 10,000, and the noise current is 3 pA. The op amp requires a  $\pm 15$  V supply and operates over the MIL temperature range. Input offset voltage  $\tau_c$  is 5  $\mu V/^\circ C$ . The differential input voltage range is 30 V max. The 20-248 is available in a TO-8 can at \$30 ea. in unit quantities. Bell & Howell, Control Products Div., 706 Bostwick Ave., Bridgeport, Conn. 06605. (203) 368-6751.

Circle 271 on Inquiry Card



# New GAF "B" film gets the details in half the time!

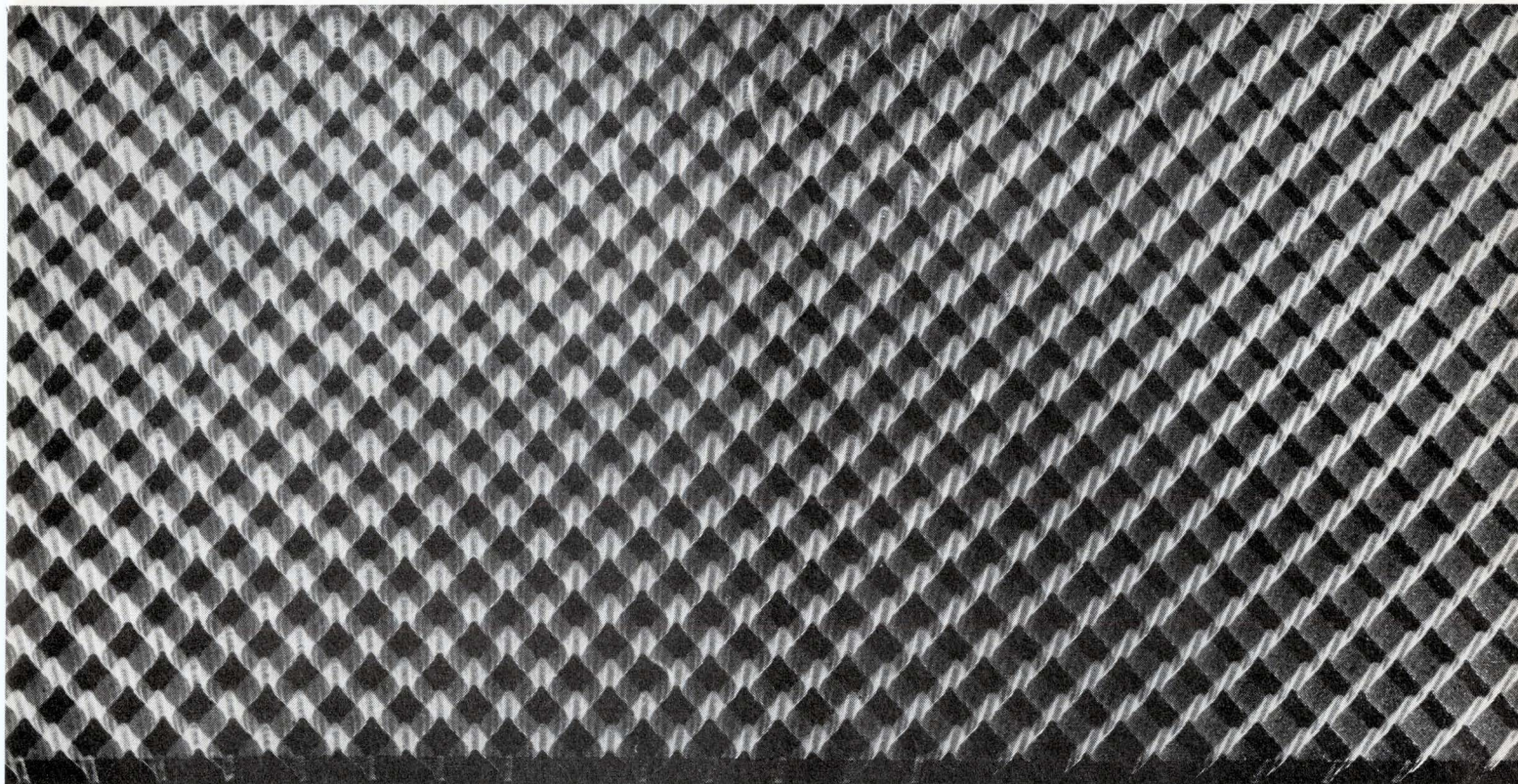

Get a clean, clear Class I-type x-ray (like the honeycomb structure shown above) on short processing cycles, and short exposure times with new GAF Industrial "B" Polyrapid™ film.

New GAF Industrial "B" x-ray film is the fastest speed Class I film available. It gives you a high degree of penetrator sensitivity within economical exposure times, resulting in excellent image quality with all gamma or x-rays. It's fastest in another way, too: Processing. GAF Industrial "B" film produces clear, clean radiographic images even on 5 to 6½ minute dry-to-dry processing cycles. But no matter how you process... short cycle or regular cycle automatic machine systems, or in manual, tank-type systems... you'll get excellent results. Along with speed, GAF Industrial "B" film gives you all the extra fine detail and extremely high contrast that you need for Class I film applications such as weldments and light alloy radiography.

GAF Industrial "B" film comes on a tough Gafstar®

polyester base which virtually eliminates the possibility of cracking or tearing in processing, handling or storage.

Ask your GAF representative for a demonstration of the excellent qualities of this film or fill out the coupon for further information.

Circle 52 on Inquiry Card



231-0450

GAF Corporation  
Dept. 204-969  
140 West 51 Street, New York, New York 10020

Gentlemen:

- Please have a GAF representative call for an appointment to demonstrate the advantages of GAF Industrial "B" X-Ray film.
- Please send me additional information on this film.

Name \_\_\_\_\_ Title \_\_\_\_\_

Company \_\_\_\_\_

Address \_\_\_\_\_

City \_\_\_\_\_ State \_\_\_\_\_ Zip \_\_\_\_\_



# Now Available... A Course in TELEMETRY

A special course on Telemetry is now being offered to all electronic engineers. It appeared originally in *The Electronic Engineer*. The course analyzes the fundamentals of telemetry and describes the function of telemetry equipment. The course consists of several parts, each one patterned after one specific portion of a telemetry system.

Today, more than ever before, there is a critical need for more reliable, smaller, lighter *data gathering hardware*. This course provides a sound insight into the modern methods of data acquisition, processing and display and how they are organized. Some of the areas covered are:

- Sensors, Transducers and Signal Conditioning
- Multiplexers and Encoders
- Analog to Digital conversion
- Demultiplexing and Decoding
- Processing and Display

This course is especially useful to digital designers, design engineers, engineering managers, telemetry engineers, instrument designers and computer designers.

The complete 5 part course is available for just \$3.00 and this includes a test. All those successful in passing the examination will receive a formal Certificate of Completion that is suitable for framing.

To get this course, fill out and mail the coupon below. Send your order to *The Electronic Engineer*, Chestnut and 56th Streets, Philadelphia, Pennsylvania 19139.

Yes, I do want to participate in your course in Telemetry. Send me  complete course(s) at a cost of only \$3.00 each. My check, (cash or money order) is enclosed. Send the course to me at:

Name \_\_\_\_\_

Address \_\_\_\_\_ Company \_\_\_\_\_

City \_\_\_\_\_ State \_\_\_\_\_ Zip \_\_\_\_\_

Send me special quantity prices

## EE NEW LAB INSTRUMENTS

### SOLID-STATE EMI METER

Covers 1 to 10 GHz frequency range.

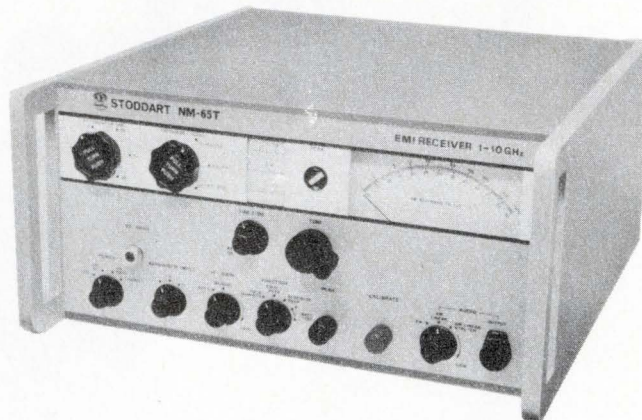

The Model NM-65T gives average field intensity, direct peak, and slide-back peak measurements. Maximum voltage measurement capability is 120 dB, and accuracy is within 2.5 dB. Dial accuracy is within 2%. The meter has selectable 6-dB bandwidths—100 kHz, 500 kHz and 5 MHz. The instrument's cw sensitivity ranges from 1.0  $\mu$ V at 1 GHz to 18  $\mu$ V at 10 GHz depending on the bandwidth. Other features are afc, mercury-switch impulse calibrator, 21.4 MHz i-f output, X and Y outputs for external recording, and four simultaneous video outputs. \$13,000. Stoddart Electro Systems, 2045 W. Rosecrans Ave., Gardena, Calif. 90249. (213) 770-0270.

Circle 249 on Inquiry Card

### PULSE GENERATOR

First model in a new series.

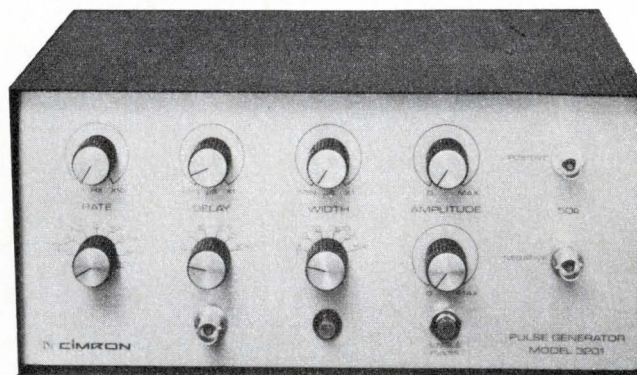

The Model 3201 is a versatile, portable, solid-state unit with features that include both remote and manual control of pulse width, frequency and pulse delay, dual polarity amplitude and pulse separation in double-pulse mode. The 3201, which is 5½-in. h x 11¼-in. w x 7½-in. deep, weighs 10 lbs., and is designed for use in automated systems, laboratories, or field service applications. The basic instrument is priced at \$745. Delivery is from stock. Cimron Division, Lear Siegler, Inc., 1152 Morena Boulevard, San Diego, Calif. 92110. (714) 276-3200.

Circle 250 on Inquiry Card

# MB Environmental Dynamics

Analysis Instruments · Signal Conditioning · Electrohydraulics · Pressure Measurement · Vibration Systems

## FREQUENCY COUNTER

Push-button controls; low cost.

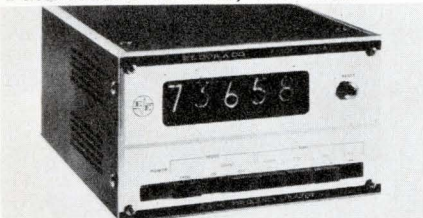

Model 325A is a 15-MHz counter with multiple gate selection, count ON/OFF, and automatic triggering. Gate times are 1 ms, 100 ms, 1 s, and 10 s. Sensitivity, 100 mV rms. Five-digit display with storage, BCD output. \$400. Eldorado Electrodata Corp., 601 Chalomar Rd., Concord, Calif. 94520. (415) 686-4200.

Circle 251 on Inquiry Card

## BROADBAND POWER AMPLIFIER

Power output. 3 W; metered.

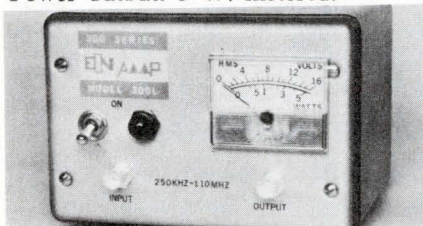

Model 300 L covers 0.25 to 110 MHz, and works into any load mismatch (including opens and shorts). Class A gain is 40 dB; input/output impedance, 50Ω; VSWR 1.5:1. \$485; \$390 without power supply. Electronic Navigation Industries, Inc., 1337 Main St. East, Rochester, N. Y. 14609. (716) 288-2420.

Circle 252 on Inquiry Card

## CONSTANT-CURRENT SUPPLY

For YIG tuning applications.

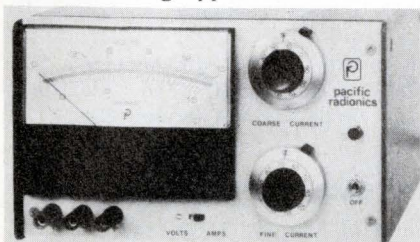

The PP-21-6 gives you up to 1 A output current, with a compliance voltage to 12 V. A 10-turn dial adjusts the output current with 10-μA resolution. Ripple and noise, less than 0.05 mA rms. \$225, with 2-3 weeks delivery. Pacific Radionics, Inc., 581 Division St., Campbell, Calif. 95008. (408) 379-3280.

Circle 253 on Inquiry Card

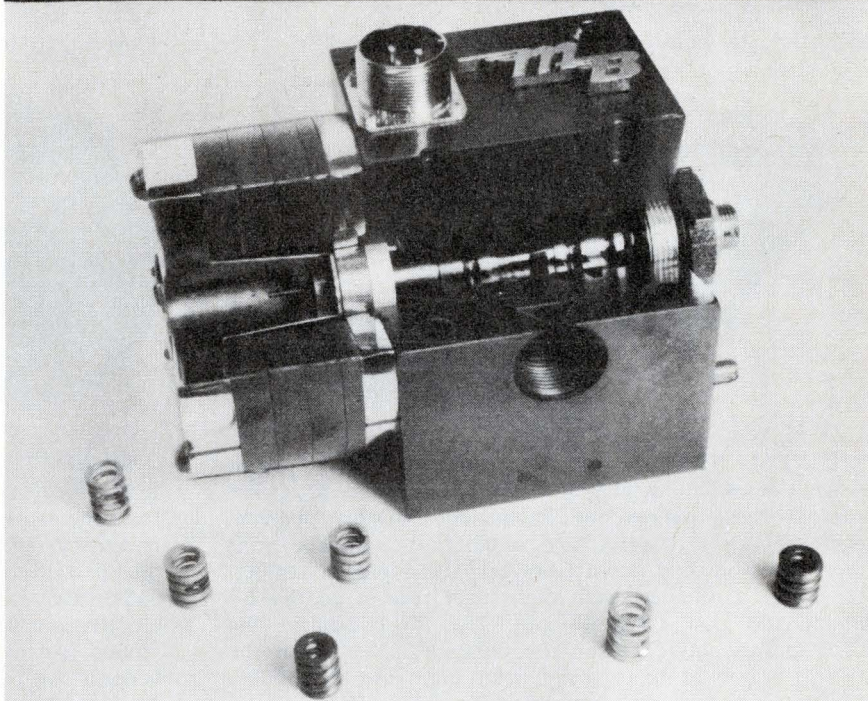

The HV-40 high precision, industrial servo valve can be converted to any of six flow ratings with a simple spring change in less than three minutes.

## Single high flow / high frequency servo valve offers six dynamic ranges

The HV-40 electrohydraulic servo valve offers a unique combination of features not available in any other valve design. Each valve can be provided with six springs which

### Stock items offered for OEM pressure measuring needs

In addition to packaged systems, a complete line of off-the-shelf components is now offered by MB to meet needs for high accuracy pressure measurement in all types of equipment. The essential elements of the all-electronic system are the N925 28v DC power supply, a Series 500 pressure transducer and the N926 indicating meter. Transducers can be selected from numerous ranges for obtaining measurements to 10,000 psi. Because of their high 5 volt output, these transducers can be also used in remote locations hundreds of feet from the indicating meter without special cabling. Ten standard panel meter faces are available and custom faces can be made to order. Meter movements with "high" and "low" level settings for use with external alarm circuits are also stocked.

### Reader Service No. 102

System components now available for OEM use.

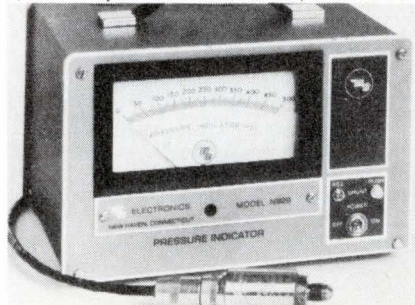

make it possible to adapt to a variety of production or test needs simply and quickly. The HV-40 offers high flow ratings, up to 50 gpm (at 0-170Hz), as well as high frequency performance to 500Hz (at 8 gpm).

As a result of its unique design, the HV-40 combines versatility as operating requirements change, a wide safety-margin in matching valve specifications to actual demands, and the selection of the best dynamic range to provide optimum signal-to-noise ratio.

In terms of reliability, the HV-40 is essentially impervious to dirt and contamination because of high force electrodynamic piloting and the absence of small orifices. Consequently, it is drift-free and may be interchanged with a variety of actuators without time-consuming cleaning procedures.

Another resultant benefit is the valve's ability to cope with contaminants caused by the reaction of mild steel and non-flammable hydraulic fluids, thus eliminating the necessity for costly stainless steel piping, tubing, fittings and reservoirs required by flapper-nozzle designs.

Full details on the HV-40 are contained in Bulletin No. I-500.

Reader Service No. 101

## MB ELECTRONICS

A **Textron** COMPANY

P.O. BOX 1825, NEW HAVEN, CONNECTICUT 06508  
Tel. (203) 389-1511 Twx 710 465-3283 Telex 0963-437

**DECADE PULSE COUNTER**

Electronically controlled, rear projection readout.

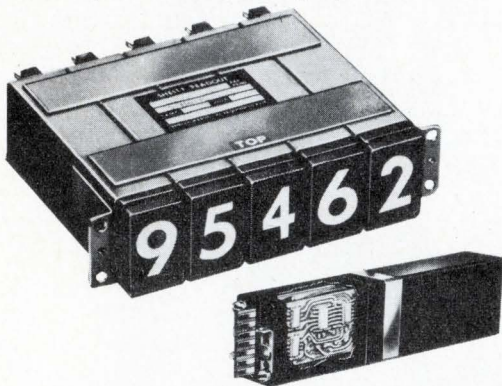

The P611 Series are ultra-miniature, decade pulse counters that count and display at a 15-MHz rate. The series has internal carry gating, one independent display position, asynchronous zero reset, and a binary preset. The units count both up and down from zero or a preset number. To preset a number, each digit must receive an 8-4-2-1 binary and LOW ENABLE input. The P611 displays the clock pulses entered when the pulses stop, or when the INHIBIT is LOW at the least significant digit. Twelve parallel, miniature, optical projectors provide the readout. Shelly Associates, Inc., 1111 Eucalyptus Dr., El Segundo, Calif. 90246. (213) 322-2374.

Circle 254 on Inquiry Card

**TUNABLE RF FILTER**

Covers 210 to 420 MHz telemetry frequencies.



Model TTF-315-3-3EE can tune any center frequency in the telemetry band. It is a 3-section device with a 30-dB form factor of 3. Typical insertion loss is 1.3 dB at center frequency, and the average power rating is 30 W. The filter is also available in a 5-section version, Model TTF-315-3-5EE, for maximum stopband rejection. Both filters are iris-coupled with 0.05-dB Chebyshev cavities. Each section is capacity loaded to tune over a full octave. Inherently high-Q construction assures low insertion loss. A precision vernier dial on the front panel sets the center frequency. Telonic Engineering Co., Box 277, Laguna Beach, Calif. 92652. (714) 494-4901.

Circle 255 on Inquiry Card

**CRITIC'S CHOICE!**

**CHOOSE INTERCONNECTION OPTIONS WITH NEW BARNES BREADBOARDS FOR DIP, FLAT-PACK AND "TO" PACKAGES**

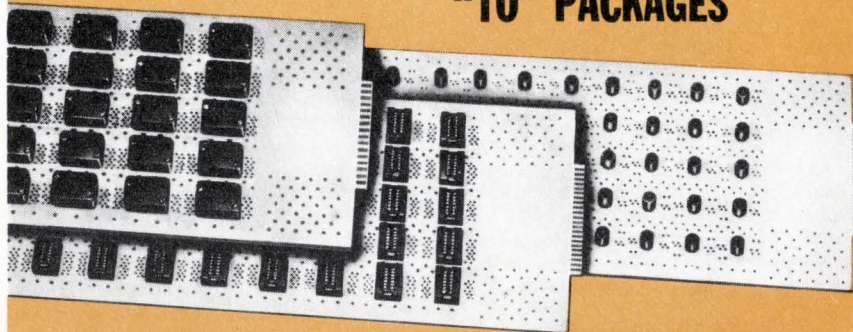

Take the "task" out of breadboarding. New Barnes 030 Series Breadboards offer you a choice of interconnection options for maximum design flexibility. Available with wiping action spring jacks for simple lead insertion without special interconnection jumpers, or turret lugs for soldering. Two jacks or lugs for each device lead. Boards available with 5 to 75 socket positions depending upon device type. Write or call us today for complete information.



Lansdowne, Pa. 19050 • 215/MA2-1525

**barnes** / THE FIRST WORD IN CARRIERS, CONTACTORS AND SOCKETS FOR I.C.'S

**DIGITAL MULTIMETER**

Has 1-MHz frequency counter.

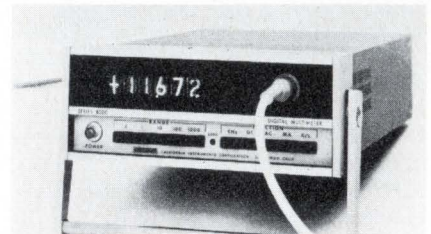

The Calico 8300 makes seven types of measurements: ac/dc volts and current, resistance, frequency, and ratio. All functions have a 0.01% resolution and a 20% overrange. Ohmmeter gives 0.02% accuracy, measures 10 mΩ to 1 MΩ. \$1595. California Instr. Corp., 3511 Midway Dr., San Diego, Calif. 92110. (714) 224-3241.

Circle 256 on Inquiry Card

**AUTOMATIC RLC BRIDGE**

Tests at 120 and 1000 Hz.

The 1683 is a series-impedance bridge accurate to 0.1% for R, L, and C, and to 1% for D or esr. Its digital readout gives you 5-digit resolution in nine impedance ranges of 10 Ω to 1 MΩ. Bias, to 600 V external, 0.3 V internal. General Radio Co., 300 Baker Ave., West Concord, Mass. 01781. (617) 369-4400.

Circle 257 on Inquiry Card

## FREQUENCY/INTERVAL METER

Four digits with overflow indicator.



Model 4034 measures frequency to 1 MHz, time intervals from 10  $\mu$ s to 10<sup>6</sup> s. Control is via remote-program contact closures or IC voltage level changes. Cascadable. \$450. Tech. Info. Sect., Electronic Instr. Div., Beckman Instruments, Inc., 2400 Harbor Blvd., Fullerton, Calif. 92634. (714) 871-4848.

Circle 258 on Inquiry Card

## TIME INTERVAL GENERATOR

Also performs frequency division.

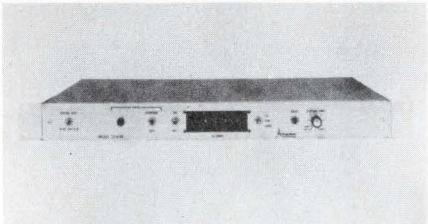

Model CF-611R generates time periods of 10  $\mu$ s to 100 s, and divides from 1 to 9,999,900. A PERIOD mode gives a burst of pulses equal in number to the interval thumbswitch setting, and at a 100-kHz rate. \$645. Anadex Instruments, Inc., 7833 Haskell Ave., Van Nuys, Calif. 91406. (213) 782-9527.

Circle 259 on Inquiry Card

## DIGITAL TIMER/PROGRAMMERS

From 0 to 9.9 s, each channel.

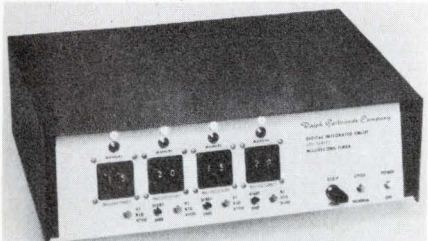

Series 300 generates timed pulses with  $\pm 0.005\%$  accuracy. Front-panel programming with thumbwheel and multiplier switches. Manual/remote start and stop; repeat cycle switch. Relay and complementary 5-V TTL outputs. Ralph Gerbrands Co., Inc., 8 Beck Rd., Arlington, Mass. 02174. (617) 648-6415.

Circle 260 on Inquiry Card

# Sweeping superiority

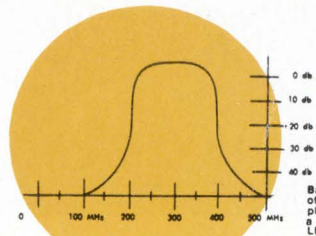

Bandpass presentation of a 200-400 MHz amplifier as tested with a VS-50, HM-50, and LN-40 log amp.



## THE UNIQUE VS-50

## SOLID-STATE SWEEP GENERATOR 2-500 MHz

Master of hundreds of applications in the FM radio, VHF TV and TV IF, and most communication bands, the Texscan VS-50 can cover the 200-400 MHz range in a single sweep—and add 300 MHz of extra coverage. As the above frequency plot of a 200-400 MHz amplifier bandpass presentation shows, the oversweep permits out-of-band tune-ups and slope characteristics to be measured easily in a single test. Descriptive literature covering all technical details of this unique instrument—available only from Texscan—is yours for the asking, free on request.

### STATE-OF-THE-ART LEADERSHIP

**RF Output:** RF output is at least 1 vrms into a 50 ohm load.

**Sweep Width:** The sweep width is continuously variable from 500 KHz to 500 MHz at any center frequency, but the unit will not sweep above 500 MHz at rated output. The unit is also provided with a CW output mode for signal generator applications.

**Frequency Range:** The unit can be centered at any frequency between 2 MHz and 500 MHz and sweep anywhere within that range.



*Texscan*

CORPORATION

2446 NORTH SHADELAND AVENUE  
INDIANAPOLIS, INDIANA 46219



# this is Simpson's 2700 digital system...

*New-Fast warm-up\**

- 4 1/2 digits
- 0.05% accuracy
- 5 plug-in function modules

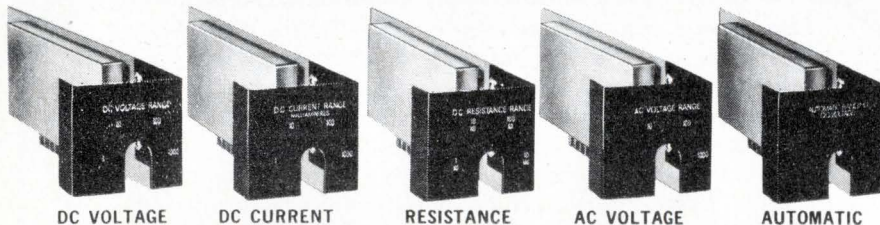

DC VOLTAGE    DC CURRENT    RESISTANCE    AC VOLTAGE    AUTOMATIC RANGING DC VOLTAGE

- Automatic Polarity Selection
- Built-in Self Calibration
- 100 Microvolt Resolution
- Optional BCD output
- IC Modular Design for reliability

\*Just 1 minute for 0.1% accuracy. 5 minutes for 0.05%.

**2700 DIGITAL SYSTEM \$615<sup>00</sup>**  
complete with DC voltage range module, test leads, and operator's manual

AVAILABLE "OFF-THE-SHELF" AT ELECTRONIC DISTRIBUTORS STOCKING SIMPSON INSTRUMENTATION PRODUCTS.

**Simpson** ELECTRIC COMPANY



5200 W. Kinzie Street, Chicago, Illinois 60644 • Phone (312) 379-1121  
Export Dept: 400 W. Madison Street, Chicago, Illinois 60606. Cable Simelco  
IN CANADA: Bach-Simpson Ltd., London, Ontario • IN INDIA: Ruttonsha-Simpson Private Ltd., International House, Bombay-Agra Road, Vikhroli, Bombay

Circle 55 on Inquiry Card

## NEW LAB INSTRUMENTS

### HIGH OUTPUT PULSER

Total control of output parameters.

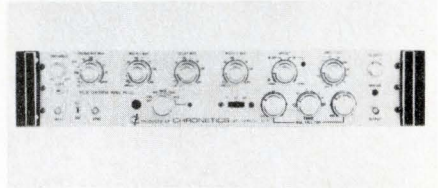

Model PG-13A gives  $\pm 2$  A or  $\pm 100$  V, single or double pulses, at 50 $\Omega$  or 1 k $\Omega$  impedances. Rep rates to 25 MHz. Rise/fall times, 10 ns to 50 ms. Widths: 10 ns to 500 ms to 25 V; 10 ns to 5 ms, 50 V; 10 ns to 0.5 ms, 100 V. \$1750. Chronetics, Inc., 500 Nuber Ave., Mt. Vernon, N. Y. 10550. (914) 699-4400.

Circle 261 on Inquiry Card

### PULSE MODULATOR

Three plug-in output modules.



Series 10299B has outputs of 0-1.5 kV at 6 A pk, 0-3 kV at 3 A pk, or 0-6 kV at 1.5 A pk. Risetimes, 170-400 ns; falltimes, 200-400 ns. Pulse droop, 8% max. Rep rates, 100 Hz to 10 kHz; pulse widths, 0.5 to 10  $\mu$ s. Microwave Cavity Labs., Inc., 10 North Beach Ave., LaGrange, Ill. 60525. (312) 354-4350.

Circle 262 on Inquiry Card

### POWER SUPPLY

General-purpose lab unit.

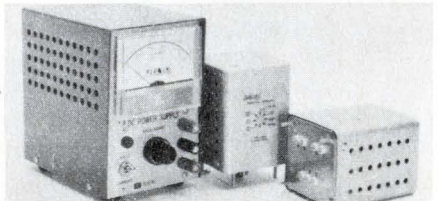

This all-silicon supply has a dc output adjustable from 1 to 28 V for loads to 500 mA. A panel-meter shows voltage or current output. The floating output has less than 0.1- $\Omega$  output impedance. Overload and short-circuit protected. \$98. Rosemount Engrg. Co., Box 35129, Minneapolis, Minn. 55435. (612) 927-7711.

Circle 263 on Inquiry Card

## MICROWAVE POWER METER

Reads 3  $\mu$ W to 100 mW, from 10 MHz to 18 GHz.



Model 437A uses a single, broadband, coaxial, thermocouple mount. The mount's VSWR is less than 1.35 from 20 MHz up to 18 GHz, and does not exceed 1.6 at 10 MHz. To calibrate the system, simply remove rf from the mount, and set a front-panel switch to CALIBRATE position. An internal oscillator delivers a 10-kHz calibrating signal, at 3 mW, to the thermocouple. The signal at the meter is then compared to a reference, and the error signal causes the meter to read correctly. \$625. Model 8485A thermocouple mount is about \$300. Inquiries Mgr., Hewlett-Packard Co., 1501 Page Mill Rd., Palo Alto, Calif. 94304. (415) 326-7000.

Circle 264 on Inquiry Card

## LINEAR IC TESTER

Handles up to 16-pin packages.



Model 1420 linear IC tester is an advanced model of the 1410, and tests op amps, differential amps, and comparators. Its options include classification, data logging, automatic handling, computer calculated program values, 1% or 5% program boards, and environmental testing. The insertion of a pre-programmed test board and a touch of the test button operates the tester. Each of 14 dynamic tests is registered as a percentage of a pre-programmed limit. The tests include noise and oscillation measurements, and slew rate (positive and negative slopes). \$7,540. Signetics Measurement/Data, 341 Moffet Blvd., Mountain View, Calif. 94040. (414) 961-9384.

Circle 266 on Inquiry Card

## WAVEFORM GENERATOR

Programmable unit covers 0.01 Hz to 1.1 MHz.

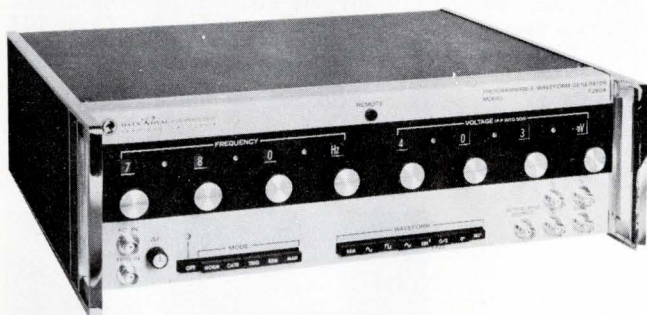

Model F280A delivers up to 11 V pk-pk into 50 $\Omega$  in its manual mode, or you can program it to generate up to 16 V pk-pk into a similar load. All manual controls are remotely programmable by contact closures or by DTL-, TTL-compatible logic, with a minimum number of lines or bits. Isolated signal and programming commons reduce system ground loop problems. Sine, square, and triangle waveforms can be generated continuously. You can also trigger a single cycle, or gate a burst of cycles. Other features include offset, 0°/180° phase selection, and sine-squared pulse. \$1545. Data Royal Corp., 8014 Armour St., San Diego, Calif. 92111. (714) 279-4020.

Circle 265 on Inquiry Card

## DIGITAL MULTIMETER

Portable model has 0.02% dc accuracy.

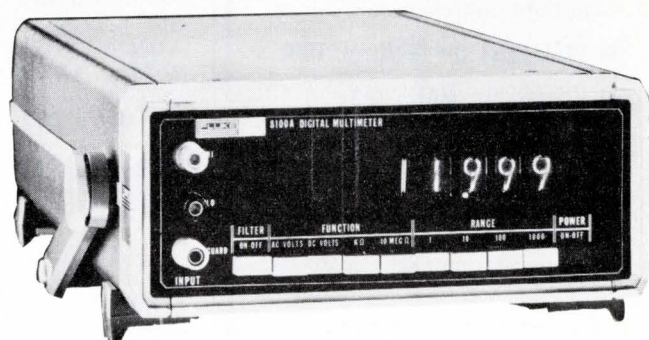

Model 8100A has four full digits plus 20% overranging. You can measure both ac and dc voltages in four ranges to 1200 V, and resistance in five ranges to 12 M $\Omega$ . All functions are push-button selectable. Polarity is automatically indicated. An active, 2-pole, switchable filter is included. The meter's ac accuracy is 0.2%, and its resistance accuracy is 0.1%. Optional batteries (\$100 additional) will operate the multimeter up to eight hours without recharging. Accessories include high-frequency and voltage probes, switched ac-dc shunts, and a ruggedized case. \$695. Fluke Mfg. Co., P. O. Box 7428, Seattle, Wash. 98133. (206) 774-2211.

Circle 267 on Inquiry Card

HELLO, DIP. LET'S GET TOGETHER AND CHECK THINGS OUT.

HI, CLIP.

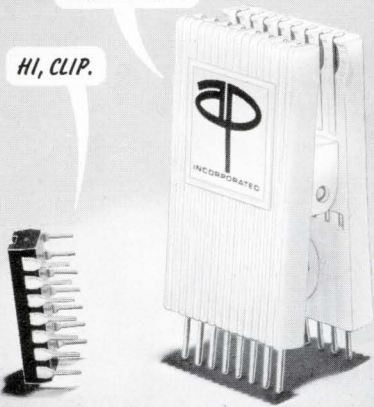

**TEST CLIP**

for DIP integrated circuits

**CLIPS ONTO IC PACKAGES FOR QUICK ATTACHMENT OF CIRCUIT TEST PROBES**

■ **ELIMINATES SHORTING BETWEEN DIP LEADS**

Unique "contact comb" separates and safely guides clip contactors onto DIP leads.

■ **FITS 14 & 16-PIN DIP IC'S**

■ **IDEAL FOR ALL TESTING**

Use it on prototype breadboards —in production circuit inspection —in field unit checkout.

■ **EXCELLENT DIP-REMOVAL TOOL**

■ **HIGH-GRADE MATERIALS**

Test clip contactor pins are gold-plated, spring-temper phosphor bronze. Clip body is high density dielectric acetal copolymer. Quality-controlled helical spring assures strong wiping-action contact between clip pins and DIP leads.

Created and produced by:

**A P Incorporated**, 72 Corwin Drive  
Painesville (Cleveland) Ohio 44077

**ORDER OFF-THE-SHELF FROM NEAREST COMPAR DISTRIBUTOR**

(203)288-9276	(312)692-4125	(602)947-4336
(205)539-8476	(312)775-7883	(607)723-8743
(206)822-4191	(313)357-5369	(609)429-1526
(213)245-1172	(314)542-3399	(612)922-7011
(206)822-9731	(315)471-3356	(617)969-7140
(214)363-1526	(317)545-6081	(713)667-3420
(216)333-4120	(415)347-8244	(716)271-2230
(301)484-5400	(505)265-1020	(813)446-2991
(303)781-0912	(513)878-2631	(913)432-6333
(305)855-3964	(516)921-9393	(919)723-1002
(305)943-5529	(518)489-7408	

Circle 56 on Inquiry Card

**EE NEW PRODUCTS**

**IR SOLID STATE LAMPS**

Only 1/10 in. in diameter.

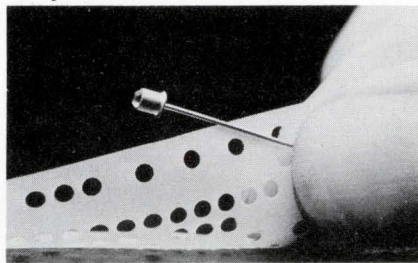

SSL-15 and 25 lamps produce non-coherent IR radiation which peaks at 9400 Å. SSL-15 is hermetically sealed with a std top-mounted glass lens, while SSL-25 is plastic encapsulated. Power output when driven at 20 mA forward current is 0.5 mW for the SSL-15 and 1.5 mW for the SSL-25. G.E. Co., Nela Park, Cleveland, Ohio 44112. (216) 266-2258.

Circle 202 on Inquiry Card

**INFRARED DETECTORS**

InSb photosensitive element.



Series J-10 InSb photovoltaic IR detectors operate at liquid nitrogen temp and cover the wavelength range from the visible through 5½ microns. Sensitivities are available to 20 x 10<sup>10</sup> cm/W at 5 microns with time constants of typ. <2 µs. Judson Research & Mfg. Co., Conshohocken, Pa. 19428.

Circle 203 on Inquiry Card

**VARIABLE RF COILS**

For PC application.

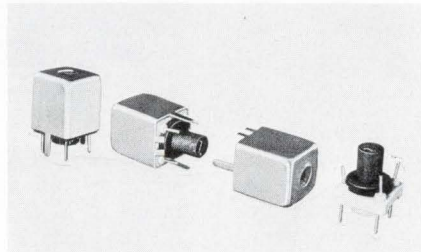

MB series of miniature coils come in ind. ranges from 0.10 µH to 1000 µH. Designed for use in resonant circuits, they are especially suited for portable field equipment and specialized military equipment. Automatic Coil Co., Div. of Designatronics, Inc., Mineola, N.Y. 11501.

Circle 204 on Inquiry Card

**SOLID STATE SOURCE**

Tuning volt. is ±0.8 Vdc at 5 mA max.

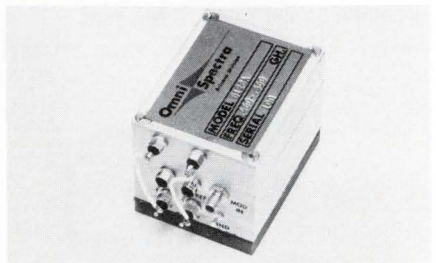

This voltage tuned oscillator maintains linearity of ±1 MHz from the best straight line over a freq range of 460 to 560 MHz with power output of 10 mW min. Frequency stab. is held to ±1 MHz over the full temp range of -30°C to +85°C. Omni Spectra, Inc., 253 S. Hinton Ave., Scottsdale, Ariz. 85251. (602) 947-4346.

Circle 205 on Inquiry Card

**FET**

Low 2.5Ω max. on-resistance.

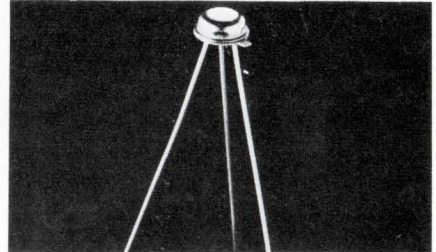

CMX740 FET provides accurate analog switching in D/A and A/D converters. It is also a core-driving transistor, handling short-duration high current pulses. On and off times are typically 50 and 75 ns respectively. Crystalonics, a Teledyne Co., 147 Sherman St., Cambridge, Mass. 02139. (617) 491-1670.

Circle 206 on Inquiry Card

**MINIATURE RFI FILTERS**

Weigh only 5.6 grams.



Series 2220 L section RFI/EMI filters block interference in 200 Vdc lines. The low pass filters offer better atten. from 10 kHz to 10 GHz. Minimum atten. of 70 dB is attained at the higher freqs. USCC, 2151 No. Lincoln St., Burbank, Calif. 91504. (213) 843-4222.

Circle 207 on Inquiry Card



# OLD PRODUCT OF THE MONTH

(with new reliability  
for your old circuits)

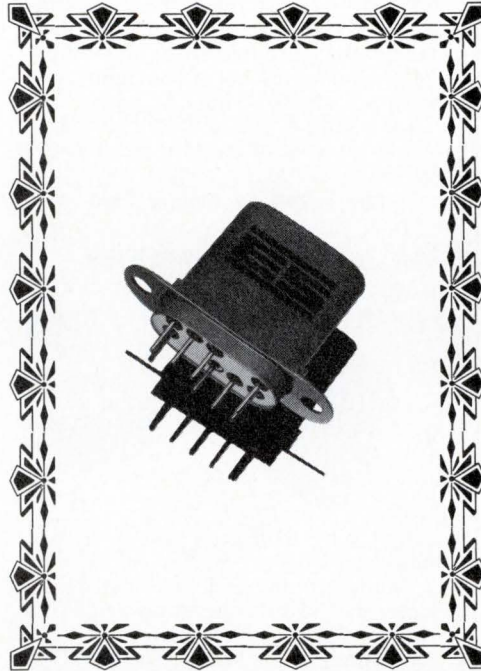

## We're a little reluctant to call the 68N relay a "new product" . . .

If you look closely, you can see Electronic Specialty's "new" 68N relay is an oval-shaped, S-header crystal can . . . a type that hasn't been designed into a new system for several years.

But if you're manufacturing an older system that requires this type of 2PDT, 2-amp, 300 mW pull-in relay, the 68N offers several new advantages:

- New resilient bifurcated contacts permit switching of minimum current (100mA to .5A) with same reliability as

dry circuit, low level and high level . . . 100,000 cycle test, without failure over entire current range.

- New contact design does not change the relay's basic specifications or outline drawing requirements. Available in pin, hook and 3" wire terminals.
- The 68N relay meets the requirements of MIL-R-5757.
- No increase in price over 68 Series.
- Permits upgrading of existing systems to state-of-the-art standards.

*For detailed information on the 68N relay or on our complete line of state-of-the-art relays, call or write:*

## ELECTRONIC SPECIALTY CO.

PORTLAND ELECTRONICS DIVISION  
18900 N. E. Sandy Boulevard  
Portland, Oregon 97220 • Phone (503) 665-0121

A COMPLETE LINE OF MINIATURE MILITARY RELAYS WITH PROVEN PERFORMANCE

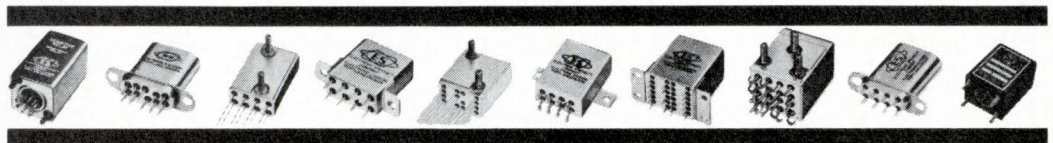

invaluable

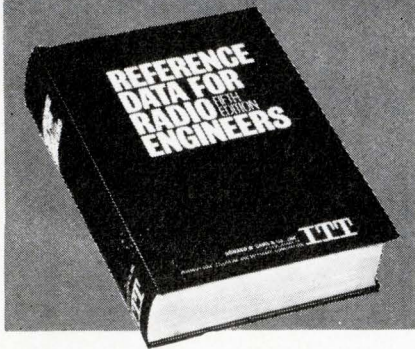

## NEW 5TH EDITION OF THE WORLD-FAMOUS Reference Data for Radio Engineers

Now contains 50% MORE DATA to include major information developed over the past 12 years. Prepared by an outstanding group of practicing engineers, professors, and industry and government experts, under the direction of the International Telephone and Telegraph Corporation staff.

OVER 160,000 COPIES SOLD  
IN THE FOURTH EDITION

The new FIFTH EDITION of this widely used reference work has been completely revised and updated. It provides in a single volume comprehensive data on all basic phases of electronics, including tables, formulas, standards, and circuit information—PLUS—all-new data on microminiature electronics, space communications, navigation aids, reliability and life testing, international telecommunication recommendations, switching networks and traffic concepts, and quantum electronics. 45 data-packed chapters provide invaluable information for practicing radio and electronics engineers. Includes over 1300 charts, nomographs, diagrams, tables, and illustrations. 1155 pages, plus 41-page index.

### 10-Day Free Examination

Howard W. Sams & Co., Inc. Dept. EG-9  
A Subsidiary of International Telephone and Telegraph Corp.  
4300 W. 62nd St., Indianapolis, Ind. 46268

Send me REFERENCE DATA FOR RADIO ENGINEERS for 10-day examination, without cost or obligation.

If I decide to keep the volume, I will send:  
 \$20.00 (plus postage), or  \$7.00 (plus postage) in 10 days, and \$6.50 per month for 2 months. Otherwise, I will return the book postpaid within 10 days.

\$20 payment enclosed. Send my copy postpaid with full 10-day return privilege. (Include sales tax where applicable.)

Name \_\_\_\_\_

Company \_\_\_\_\_

Address \_\_\_\_\_

City \_\_\_\_\_ State \_\_\_\_\_ Zip \_\_\_\_\_

Circle 58 on Inquiry Card

## EE NEW PRODUCTS

### FET OP AMP

Max. drift is  $\pm 75 \mu\text{V}/^\circ\text{C}$ .

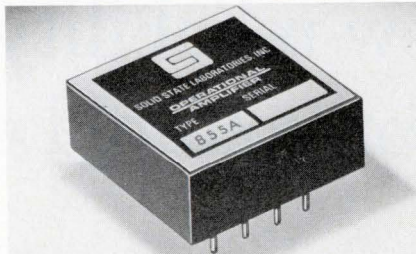

Using a supply rated at  $\pm 15 \text{ V}$ , the Model 855A has an open loop gain of  $10^5$  min. dc rated load, plus differential and common mode input impedances of  $10^{11}$ . Its CM input volt. range is  $\pm 11 \text{ V}$ . Solid State Labs, Inc., 495 E. 22nd St., Paterson, N.J. 07514. (201) 652-7200.

Circle 208 on Inquiry Card

### VHF IC HYBRID AMPLIFIER

Power output is +12 dBm.

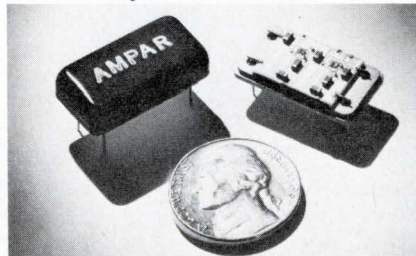

Miniature amplifier provides 21 dB gain and stable operation from 0.5 to 200 MHz. Noise figure is 4.6 dB (measured at 30 MHz). The MWDH-20G-12 comes in a ruggedized package with feed-through (pin) leads for use with PCs and strip transmission lines. Ampar Div. of Adams-Russell Co., Inc., 39 Green St., Waltham, Mass. 02154. (617) 899-1900.

Circle 209 on Inquiry Card

### EMI FILTERS

Hermetically sealed.



Miniature low pass filters are for operation at 50 Vdc at  $85^\circ\text{C}$  and 28 Vdc at  $125^\circ\text{C}$ . Typical unit offers guaranteed atten. of 70 dB from 1 MHz to 10 GHz. Series 1211 filters cost  $< \$15.00$  in production quantities. Erie Technological Products, Inc., 644 W. 12th St., Erie, Pa. 16512. (814) 456-8592.

Circle 210 on Inquiry Card

### CHIP RESISTORS

Values range from  $10\Omega$  to  $5 \text{ M}\Omega$ .

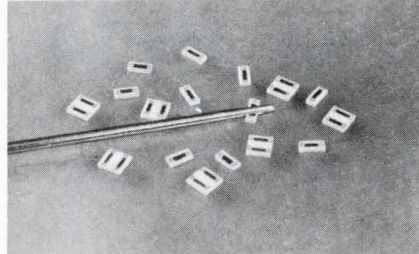

New line includes thick film dual resistors on  $50 \times 50$  mil chips, and thick film single chip resistors, measuring  $20 \times 50$  mils. TCs range from below 50 ppm to about 200 ppm, depending on the resistance range. Mini-Systems, Inc., Box 429 North Attleboro, Mass. 02761.

Circle 211 on Inquiry Card

### CERMET POTENTIOMETER

Range of  $10\Omega$  to  $1 \text{ M}\Omega$ .

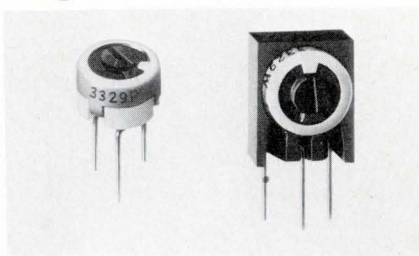

Model 3329, an infinite resolution cermet element pot, is now available in two new PC pin configurations. Operating temp range is  $-55$  to  $+150^\circ\text{C}$ ; pwr rating, 0.5 W at  $70^\circ\text{C}$ ; and TC  $\pm 150 \text{ ppm}/^\circ\text{C}$  over entire res. range. Bourns, Inc., Trimpot Products Div., 1200 Columbia Ave., Riverside, Calif. 92507. (714) 684-1700.

Circle 212 on Inquiry Card

### LOW PROFILE SOCKETS

For module-type op amp.

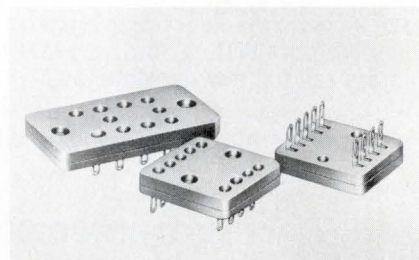

The 041-015 series sockets are for testing or production uses. Available with four different pin arrangements, they have a life expectancy of 50,000 insertions. They accept leads from 0.038 to 0.042 in. in dia. with min. length of 0.140 in. Barnes Corp., 24 N. Lansdowne Ave., Lansdowne, Pa. 19050. (215) MA 2-1525.

Circle 213 on Inquiry Card

Circle 59 on Inquiry Card →



# Four big reasons why you need

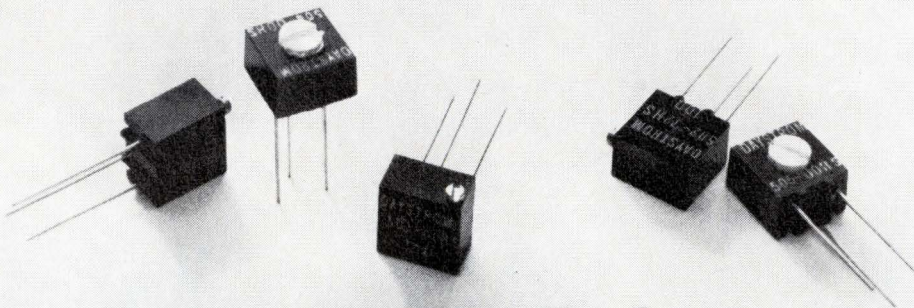

# The Immersibles.

There are many reasons why our Daystrom 501 thru 505 series industrial potentiometers have become a favorite of design engineers. Their space-saving  $\frac{5}{16}$ " size, for one. Weston's patented wire-in-the-groove construction, 5% standard tolerance, superior resolution, low noise and low cost, to name a few others. Now, with the option of total immersibility, we're offering you four more

—complete protection against water, cleaning solvents, flux, and encapsulating compounds. All five configurations are available O-ring sealed to meet MIL-STD-202, Method 106, moisture resistance requirements. And at a price you'd expect to pay for unprotected pots. Play it safe and specify The Immersibles. Your choice of 15-turn or single turn types, top or side adjustable,

in our standard 10 ohm to 20K range are in stock now at selected distributors. Higher values on request. Write today for data sheets and evaluation samples. WESTON COMPONENTS DIVISION, Archbald, Pennsylvania 18403, Weston Instruments, Inc.  
a Schlumberger company

**WESTON®**



Color TV Exposure  
 • Photo Copying •  
 Image Projection •  
 Photo-Resist Systems •  
 Photoflood Systems •  
 Spectrofluorometers •  
 Missile Flares •  
 Optical Ranging •  
 Stroboscopes •  
 Photoflood Lamps

**XENON FLASH AND STROBE LAMP** — 8 TO 18,000 JOULES •  
**LAMPHOUSING** — 35 TO 350 WATTS •  
**MERCURY SHORT ARC LAMPS** — 100 TO 500 WATTS, 2,000 TO 30,000 LUMENS •  
**POWER SUPPLIES** — 35 TO 500 WATTS, 50 OR 60 CYCLE, 117 TO 220 VOLTS •  
**XENON SHORT ARC LAMP** — 35 TO 300 WATTS, 600 TO 7,500 LUMENS

Metallographs •  
 Optical Reader •  
 Color Matching •  
 Optical Bench Accessory •  
 Slit Illuminators •  
 Schlieren Systems •  
 Hologram Illuminators •  
 Step & Repeat Printing Systems

Where the resource is  
**LIGHT**  
 and the product is  
**IMAGINATION!**

For information write to:  
**ILLUMINATION INDUSTRIES INCORPORATED**  
 610 VAQUEROS  
 SUNNYVALE, CALIFORNIA 94086

(408) 738-2744

Circle 60 on Inquiry Card

## EE NEW PRODUCTS

### IC BREADBOARD

No clips, clamps or special tools.

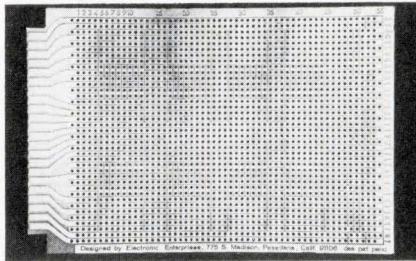

Instead of patchcords or wire, this board uses built-in printed leads. These permit circuits to be constructed with only a soldering iron and a few thru-board connections. Capacity is 10 assorted ICs, plus unlimited diodes, resistors, capacitors, and transistors. Electronic Enterprises, 775 S. Madison, Pasadena, Calif. 91106 (213) CA 9-1106.

Circle 214 on Inquiry Card

### SIGNAL I/O CONNECTOR

For back-panel interconnections.

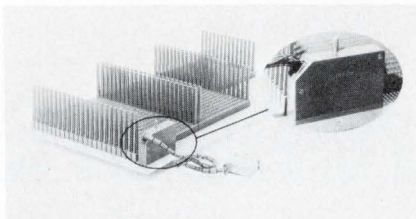

Series 8032 transmits signals between back-panel connectors and the outside world. Available with 42 contact positions, receptacle has 0.031 x 0.062 in. terminals, compatible with most automatic wiring methods. Plug features insertable/removable wire crimp contacts rated at 8.5A. Elco Corp., Willow Grove, Pa. 19090. (215) 659-7000.

Circle 215 on Inquiry Card

### TRANSISTOR TRANSFORMER

For PC applications.

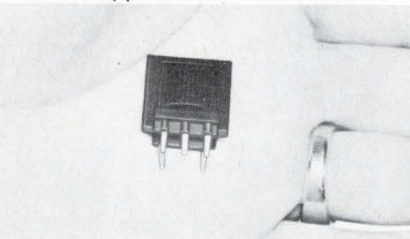

Input interstage, and output TAPC Series transformers have a good freq. response. Those in the 150 mW group weigh about 0.5 oz, and are 13/16 x 13/16 x 3/4 in. Those in the 300 mW group weigh about 1 oz, and are 7/8 x 1 1/16 x 15/16 in. Essex International, Inc., 3501 W. Addison St., Chicago, Ill. 60618. (219) 743-0311.

Circle 216 on Inquiry Card

### LOGARITHMIC TO DC AMP

Convert If-if signals to dc voltage.

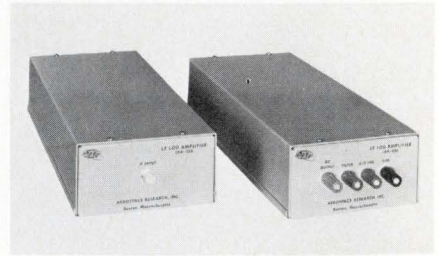

Series 200 amplifiers convert If-if signals to a dc voltage that is directly proportional to the log of the input signal level. They operate over a center freq range of 100 to 250 kHz with a BW of 8 to 24 kHz (fc and BW must be specified). Aerospace Research, Inc., 130 Lincoln St., Boston, Mass. 02135. (617) 254-7200.

Circle 217 on Inquiry Card

### FREQUENCY CONVERTER

Image rejection is 60 dB min.

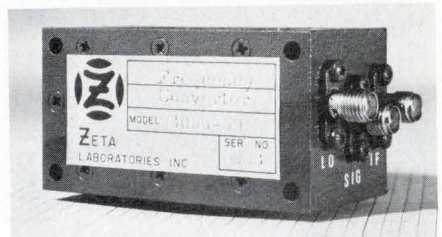

Model 3000 down-converts the 3.9 to 4.0 GHz freq band to 2.2 to 2.3 GHz. With nominal local-osc. drive of +7 dBm at 1700 MHz, the max conversion loss is 4 dB with a GaAs Schottky barrier diode and 5 dB with a Si Schottky barrier diode. Zeta Laboratories, Inc., 616 National Ave., Mountain View, Calif. 94040. (415) 961-9050.

Circle 218 on Inquiry Card

### THUMBWHEEL SWITCHES

Need no mounting hardware.

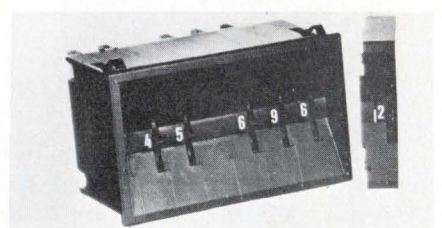

Switches (Model B) and associated circuitry insert into a 2 1/8 in. high panel cutout. Cam-action mounting springs allow fast, secure assembly. The 1/2 in. wide binary and decimal-coded switches are rated from 0.5 to 50 Vac or dc. Current carrying capacity is 1 A. Interswitch, 770 Airport Blvd., Burlingame, Calif. 94010.

Circle 219 on Inquiry Card

# Nomex<sup>®</sup> for Class B insulation.

## Works like H.

Motors, generators, transformers and wrapped wire have a new reliability when you use insulation of NOMEX\* nylon. NOMEX gives Class H performance and better for just about any application — no matter what the class.

NOMEX has high overload capacity. It will not melt or support combustion. UL-rated at 220° C., it also conforms to MIL-I-24204.

What's more, NOMEX is tough enough to withstand the stresses of automated production. It will not crack when creased. It's easily formed or punched. And it's exceptionally re-

\*Du Pont registered trademark.

sistant to chemicals and moisture.

NOMEX is available in a variety of forms. And it's compatible with all major resins, varnishes and enamels.

So don't waste time and money on different insulations. All you need is NOMEX. It's the one insulation that can be used efficiently for any class of application.

To get more information, write: Du Pont Company, NOMEX Marketing, Wilmington, Delaware 19898. In Canada, write Du Pont of Canada Ltd. In Europe, Du Pont de Nemours Int. S.A., 81, Route de l'Aire, Geneva, Switzerland.

NOMEX<sup>®</sup>



Better things for better living...through chemistry



when you think  
**HIGH VOLTAGE**  
think  
**KEPCO Hybrid**

The Kepco hybrid technique for taming high voltage uses high voltage tubes in high voltage control circuits and low voltage transistors in small signal gain circuits. A natural division of labor that places no undue strain on any component — the secret of high reliability.

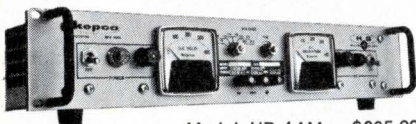

Model HB 4AM — \$365.00

We also get reliability by using hermetically sealed metal can TO-5 transistors plugged into nylon sockets, on coated glass epoxy plug-in circuit boards. Filter capacitors are all high temperature aluminum types; rectifiers are of silicon and all wiring is harnessed. HB models are available from 0–250 volts at 1 ampere to 0–525 volts at a half amp. All have built-in coarse/fine voltage controls and are, additionally, programmable.

For complete specifications, write Dept. BY-29

with **KEPCO**  
**IT'S CONTROL!**



131-38 SANFORD AVE. • FLUSHING, N.Y. 11352  
(212) 461-7000 • TWX # 710-582-2631

Circle 62 on Inquiry Card

**EE NEW PRODUCTS**

**POWER TAB TRANSISTORS**

Plastic encapsulated.

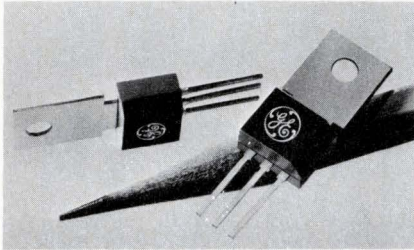

New npn and pnp 1 A complementary Si transistors (D40D and D41D) offer low collector saturation voltages, 0.5 V typ. at 1 A. The complementary pair also have good linearity and fast switching. The D40D is an npn and the D41D a pnp device. A&SP Distribution Services, General Electric Co., 1 River Rd., Schenectady, N.Y. 13021.

Circle 220 on Inquiry Card

**LIGHT PEN**

All electronics are in barrel.

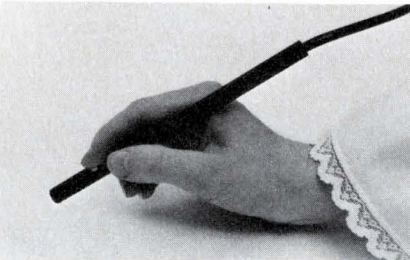

"The Hawk" light sensing pen is 6½ in. long by ⅜ in. in dia. By using ICs, all electronics are packaged in the pen barrel, providing a compact and rugged device. Response time is under 200 ns from light input to logic output. Peripheral Products Co., 892 Worcester St., Wellesley, Mass. 02181. (617) 235-1623.

Circle 221 on Inquiry Card

**PHOTO SCRs**

High light sensitivity.

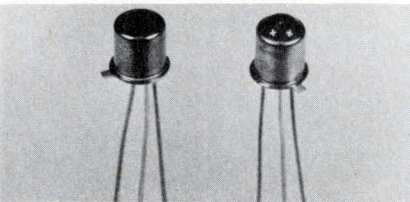

PR30 and PF30 Series have a max light trigger intensity of 10 and 50 ft candles respectively. The PR30 has a round lens for max light sens., while the PF30 has a flat lens for wide angle response. They have a 300 mA dc cont. current and 5 A surge current rating. Solid State Products, One Pingree St., Salem, Mass. 01970. (617) 745-2900.

Circle 222 on Inquiry Card

**CERMET RESISTOR NET**

Space-saving DIP.

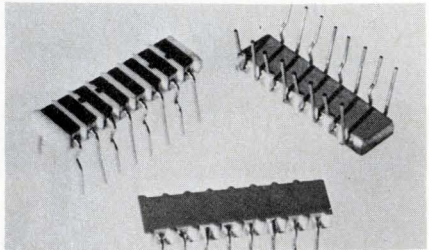

Series 760 16-lead DIL resistor network package increases packaging flexibility, simplifies automatic insertions, and reduces assembly costs. It provides up to 15 resistors/module with an infinite number of passive circuit combinations. It can also be supplied as a complete hybrid circuit. CTS of Berne, Inc., Berne, Ind. 46711. (219) 589-3111.

Circle 223 on Inquiry Card

**HIGH POWER OP AMP**

Gives 18.5 V common mode voltage.

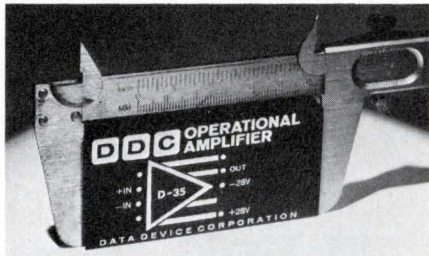

Model D-35 amplifiers provide a min. output of ±250 mA at ±18.5 V, and have 1.5 A surge capability. They are well suited to servo and synchro uses. These self-balanced devices have a voltage drift of 15 µV/°C. Input bias current 0.7 nA/°C. Data Device Corp., 100 Tec St., Hicksville, N.Y. 11801. (516) 433-5330.

Circle 224 on Inquiry Card

**DC TO DC CONVERTER**

Inputs to 28 V—outputs to 200 V.

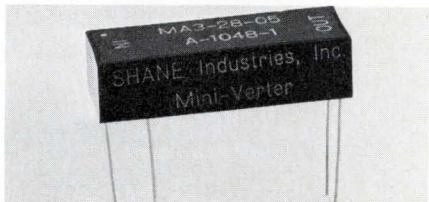

Mini-verter can be used as a converter, inverter, voltage amplifier or isolator. It is a dc to dc converter packaged as an extended DIL component only 1.4 l x 0.5 w x 0.4 in. h. Basic design can handle 3 W of power with a wide range of I/O voltages. Shane Industries, Inc., 1098 Independence Ave., Mountain View, Calif. 94040. (415) 964-4624.

Circle 225 on Inquiry Card

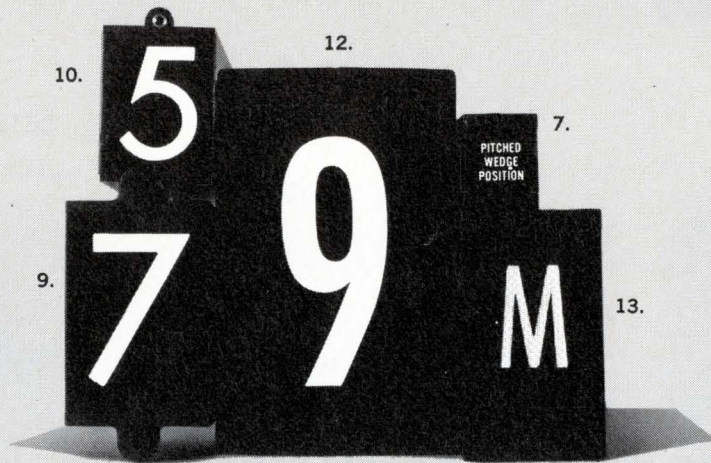

## It's what's up front that counts!

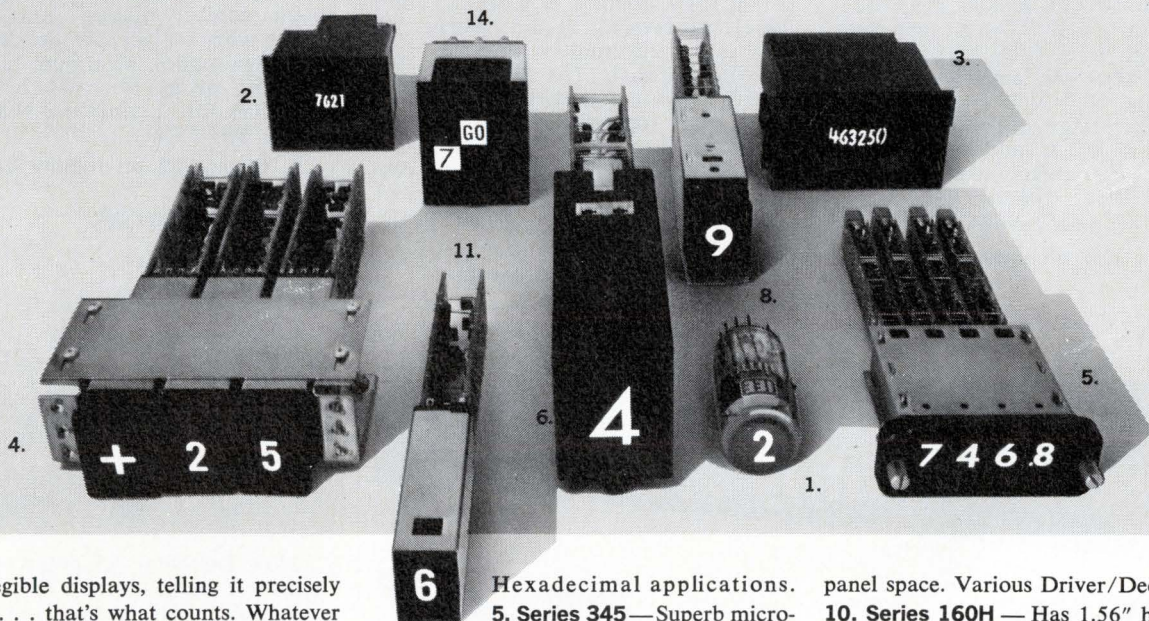

Bright, legible displays, telling it precisely like it is . . . that's what counts. Whatever the application, IEE has a readout and mating driver/decoder geared to deliver unsurpassed displays, up front . . . where the action is.

1. **nimo™, single-decade** — Single plane, 10 gun CRT. Displays numbers, letters and words with unsurpassed brightness and clarity. Driver/Decoder with BCD input.
2. **nimo™, 4-decade display** — 1.13" dia; 3/8" high characters. \$3.50/decade. Various Driver/Decoders, MSI/LSI compatible.
3. **nimo™, 6-decade display** — Ideal for instrument use, read bright and clear at 75 F.L. — low, \$2.90/decade. Highly compatible electronic interface cards.
4. **Series 860 Cue Switch** — Unique readout and data input unit; displays up to 24 messages. Depressing viewing screen/switch initiates or changes inputs.

5. **Series 345** — Superb micro-miniature readout with 1/2" w x 3/4" h screen. 20' viewing distance, 175° viewing angle. Matching miniature Driver/Decoder assures optimum performance.
6. **Series 10H** — World's most popular rear-projection readout. Projects any numeral, character, message, color, etc. High performance Driver/Decoder.
7. **Series 120H** — Miniature readout, only 1" wide, presents 5/8" h characters. Readability unmatched at 30'. High reliability potted Driver/Decoder for military application.
8. **Series 220H** — Optimum clarity even under high ambient light conditions. Front plug-in capability: press viewing screen, remove insert. New IC Driver/Decoder.
9. **Series 360H** — Jumbo size (2") characters, clearly visible from 50'. Unit is 3" h x 2" w; mounts on 2" centers for minimum

- panel space. Various Driver/Decoders.
10. **Series 160H** — Has 1.56" h x 1.12" w message area, readable at 30'. Lamps are decoded and driven by one of three styles of IEE Driver/Decoders, 14 models in all.
11. **Series 880** — Compact, sub-panel readout offers 0.50" message area, choice of 12 Driver/Decoders, with or without data storage, plus many options.
12. **Series 80** — The "Big Boy" (3 3/8" h characters). Suited to many annunciator applications, control boards, etc. Easily read from 100'. New Driver/Decoders.
13. **Bina-View** — Unique readout utilizing up to 64 character plates. Accepts any binary code up to 6 bits. Self decodes and displays in any color.
14. **Status Indicator** — Back lighted multi-message indicator. Displays one or all (12) messages simultaneously. Ideal for sequential instructions or operational procedures.

The World's broadest line of rear-projection readouts.



Industrial Electronic Engineers, Inc.  
7720 Lemona Ave., Van Nuys, California 91405  
Telephone: (213) 787-0311 • TWX 910-495-1707

**PNP TRANSISTORS**

For fast switching to 500 mA.

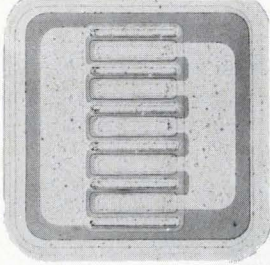

The 2N5455 and the 2N5456 have a turn-on time of 20 ns max. and a turn-off time of 30 ns at a 300 mA collector current. Switching times are good from 10 mA to 500 mA. Marketed in a metal TO-52, they also feature high freq. (450 MHz min. at 30 mA) and low capacitance (6.0 pF max. at 10.0 V). They differ in breakdown voltage levels, the 2N5455 operating to 15 V and the 2N5456 to 25 V. Fairchild Semiconductor, 313 Fairchild Drive, Mountain View, Calif. 94040. (415) 962-3563.

Circle 226 on Inquiry Card

**INSULATING MATERIALS**

Ready-to-use.

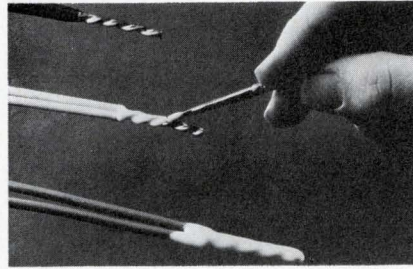

These two silicone rubber materials, both cure at room temp. on exposure to moisture in the air. They do not give off corrosive by-products. The 3141 RTV coating is a white, pourable, self-leveling liquid rubber for use as a conformal coating and as a potting material. The 3144 RTV adhesive/sealant (shown) is a translucent, high strength paste-consistency, nonflowing material. It is used for sealing, mounting, insulating, and protecting and as a flexible adhesive. Dow Corning, Midland, Mich. 48640. (517) 636-8510.

Circle 227 on Inquiry Card

**DETECTORS**

Have high sensitivity.

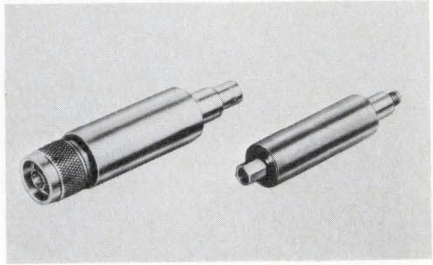

Detectors for use from 1.0 to 12.4 GHz over full octave ranges have low vswr at tangential levels. The XG series is supplied with replaceable point contact diodes, and the XH series with replaceable Schottky type cartridge diodes. Minimum tang. sens. is -50 dBm. Microlab/FXR, Ten Microlab Rd., Livingston, N.J. 07039. (201) 992-7700.

Circle 228 on Inquiry Card

**FILM CAPACITORS**

Operate from -55°C to +85°C.

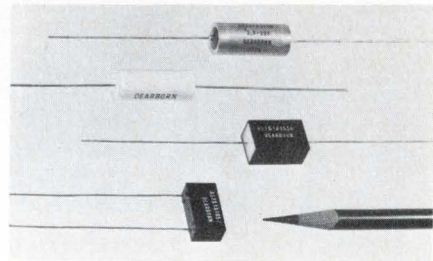

Now Deltafilm AS polystyrene film dielectric capacitors are for such uses as 1-f tuned ckts., analog computer ref. capacitors, and precision timing and ICs. They come in ratings of 24, 35, 50, 100, and 200 WVdc and are dual rated for both ac and dc uses. Dearborn Electronics, Inc., Box 530, Orlando, Fla. 32802.

Circle 229 on Inquiry Card

**POSITIVE PHOTO RESISTS**

For semiconductor manufacture.

These resists can resolve submicron line pairs with good edge sharpness and dimensional fidelity. Called Micro-line photo resists PR-102, PR-106 and PR-115, they are used in making semiconductor devices and in the preparation of high resolution metallized photomasks. Designed to coat relatively thin layers, they produce coatings with an unusually hydrophobic surface and provide improved etch resistance at a given layer thickness. This also makes them useful where thicker coatings would normally be required. GAF Corp., 140 W. 51st St., New York, N.Y. 10020.

Circle 230 on Inquiry Card

**Standard for Dependability ...**

**Ammeter Insertion Jack**

Designed for flush mounting behind panels up to 1/8" thick. 50 ampere rating ... matching plug available.

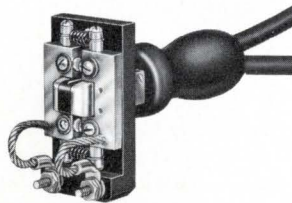

**Plug and Receptacle**

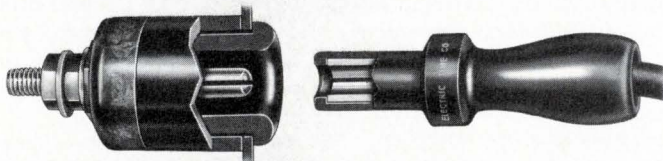

Permit full use of all power supplies at all points. Choice of Socket Receptacle and Pin Plug or Pin Receptacle and Socket Plug. Sizes up to 250 amp. Write today for full particulars to:



**STANDARD ELECTRIC TIME CORP.**

89 LOGAN STREET • SPRINGFIELD, MASS. 01101



## FLAT CABLE

For connectors on 0.050 in. centers.

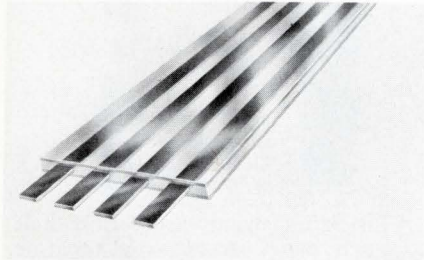

Cable can be used as a multiple transmission line for several pulse circuits. Tape cable Type 50M 2 x 25 Series has fully annealed flat copper wire conductors 0.002 x 0.025 in. (equiv. to 32 AWG). Insulation is biaxially-oriented Type M polyester, Burndy Corp., Tape Cable Div., 15 Linden Pk., Rochester, N.Y. 14625. (716) 586-0330.

Circle 231 on Inquiry Card

## PLASTIC SILICON DIODE

Replacement for damper tube.

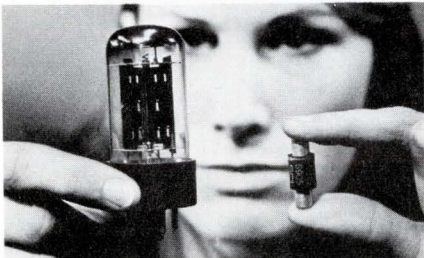

This diode is 1/15th the size of normal TV damper tubes. It can rectify 5000 Vac at freqs to 15 kHz and deliver an avg forward rectified current of 300 mA. "Vidiode" makes possible increased picture size and improves brightness. Scientific Component, Inc., 350 Hurst St., Linden, N.J. 07036. (201) 925-4022.

Circle 232 on Inquiry Card

## ADHESIVE

For plastic bonding.

New clear adhesive bonds a variety of plastics, including hard-to-bond polypropylene, polyethylene and polystyrene. Designated Scotch-Grip brand industrial adhesive 4693, it provides flexible, high strength transparent bonds between many materials. It can be applied by brushing or by low volume or production type spraying equipment. Adhesives, Coatings and Sealers Div., 3M Co., 3M Center, St. Paul, Minn. 55101.

Circle 233 on Inquiry Card

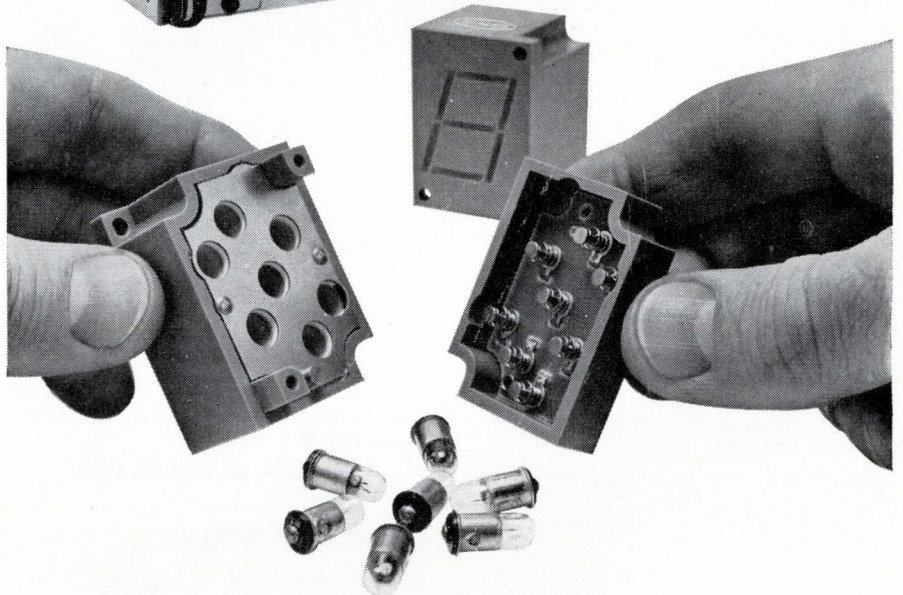

# What makes low-cost Dialight readouts so reliable and easy-to-read?

Reliable because of simple module construction and long life lamps. Designed for use with neon or incandescent lamps to meet circuit voltage requirements. Easy-to-read from any viewing angle. 1" high characters are formed by unique patented light-gathering cells, and may be read from distances of 30 feet. Sharp contrast makes for easy viewing under high ambient lighting conditions.

## Dialight Readout Features

1. Operate at low power.
2. 6V AC-DC, 10V AC-DC, 14-16V AC-DC, 24-28V AC-DC, 150-160V DC or 110-125V AC.
3. Non-glare viewing windows in a choice of colors.
4. Available with RFI-EMI suppression screen.
5. Available with universal BCD to 7 line translator driver.
  6. Can be used with integrated circuit decoder devices now universally available.
7. Caption modules available; each can display 6 messages.

## Send for catalog

Catalog-folder contains complete specifying and ordering data on numeric and caption modules, translator drivers, mounting accessories. Dialight Corporation, 60 Stewart Avenue, Brooklyn, New York 11237. Phone: (212) 497-7600.



# DIALIGHT

DT-126

## HOW ELSE WOULD YOU DO IT . . . ?

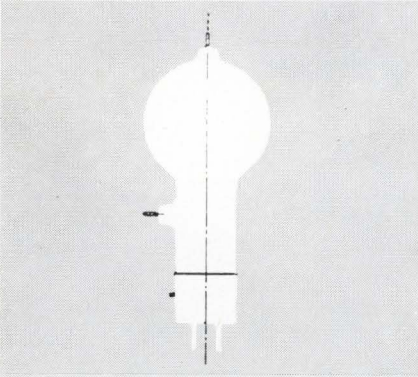

Many of the leading manufacturers of power tubes (and other electronic components) rely on Tempilaq<sup>®</sup> to determine operating-temperature characteristics of their products . . . recommend it to their customers as a practical and accurate means of monitoring.

**Here is what some original equipment manufacturers say about Tempilaq<sup>®</sup> in their technical literature:**

"Considering the importance of tube temperatures, every design engineer should familiarize himself with the use of Tempilaq<sup>®</sup> or some other similar substance. Measurements of this kind yield basic information sometimes obtainable in no other way."

"It is considered that Tempilaq<sup>®</sup> gives the most suitable method for checking the compliance of valve operating temperatures with their ratings."

"Cooling of power tubes, inductors and other components under operating conditions needed to be carefully evaluated. Tempilaq<sup>®</sup> temperature indicators proved to be a practical method of checking the operating temperature of these critical items."

"Your products are officially recommended in our Service Bulletin to insure proper operation of our tubes . . . as well as being extensively employed in our production and research facilities."

"Temperature measurements of the x-ray radiator by direct reading instruments was impossible because of the high voltage (125KV to ground) present on the radiator . . . Tempilaq<sup>®</sup> was the answer."

"The maximum seal temperature of 250°C is a tube rating and is to be observed in the same manner as other ratings. The temperature may be measured with temperature-sensitive paint, such as Tempilaq<sup>®</sup>."



### Tempilaq<sup>®</sup>

. . . a simple quick-drying coating, can be applied to glass and other smooth surfaces — frequently provides the only practical means of determining temperatures of electronic tubes and other components.

- 103 certified temperature ratings, available in closely spaced intervals.
- Accuracy within one percent of the stated rating.
- Response delay of a thin coating: a few milliseconds.
- Change of appearance on melting irreversible.

Write to: SPECIAL APPLICATIONS DIVISION

**"MEET US AT ISA BOOTH 644"**

**Tempilaq<sup>®</sup>**

DIVISION OF  
BIG THREE INDUSTRIAL  
GAS & EQUIPMENT CO.

132 WEST 22nd St., NEW YORK, N.Y. 10011  
Phone: 212 • 675-6610 TWX: 212 • 640-5478

Circle 66 on Inquiry Card

## EE NEW PRODUCTS

### LADDER SWITCH

Eliminates redundant packaging.

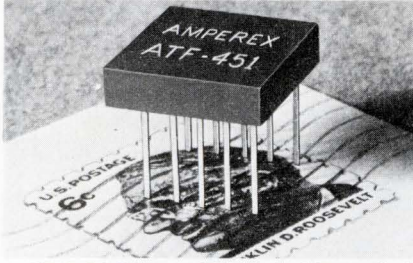

Hybrid IC quad D/A ladder switch (ATF-451) is for binary and BCD coded voltage summing ladders up to 14 bits with 1/4 LSB accuracy. The ATF-451 has an on-resistance of only  $4 \pm 1\Omega$  from  $-25^\circ$  to  $+85^\circ\text{C}$  and offset voltage of 1 mV max. Amprex Electronic Corp., Microcircuits Div., Cranston, R.I. 02920.

Circle 234 on Inquiry Card

### QUARTZ CRYSTALS

Long term stab, of  $< 5$  parts  $10^{-9}$ /wk.

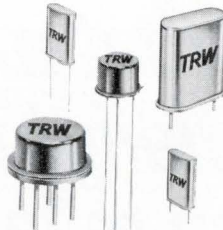

Coldweld units' freq range is 3 to 30 MHz in fundamental operation and up to 200 MHz in overtone mode. Lower freq units are specifically designed for SSB, data handling, and TCXO operation. TRW Semiconductors, 14520 Aviation Blvd., Lawndale, Calif. 90260. (213) 679-4561.

Circle 235 on Inquiry Card

### POWER TRANSISTORS

Fast switching.

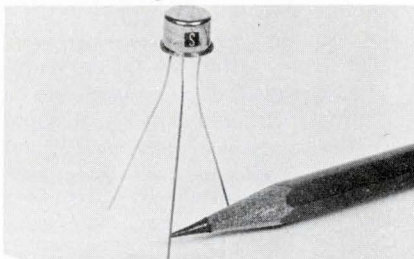

Turn on time of the SDT6100 Series is  $< 10$  ns. Typical characteristics of these devices are:  $V_{CE0} = 40$  V,  $h_{FE} @ 2.0$  A = 20 to 60;  $V_{CE} (SAT) = 1.5$  V max;  $t_R @ 2.0$  A = 10 ns max; and  $I_C$  max = 5.0 A. Solitron Devices, Inc., Transistor Div., Riviera Beach, 1177 Blue Heron Blvd., Fla. 33404 (305) 848-4311.

Circle 236 on Inquiry Card

### LIGHTED SWITCHES

Push-on, push-off type.

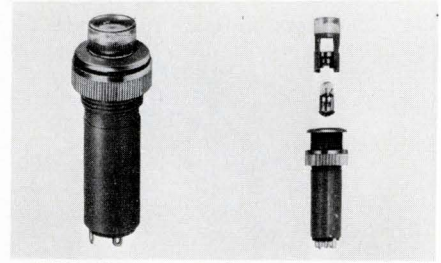

LPB Series switch needs only half as much panel space as a separate switch and indicator light and is easier to install. It mounts in a 9/16 in. dia. hole and extends  $< 2$  in. behind the panel. Switches have fixed lamps — only the pushbutton moves. Switch Div., Maxson Electronics Corp., Ives Rd., Wallingford, Conn. 06492.

Circle 237 on Inquiry Card

### NEON INDICATOR

Mounts on 3/8 in. centers.

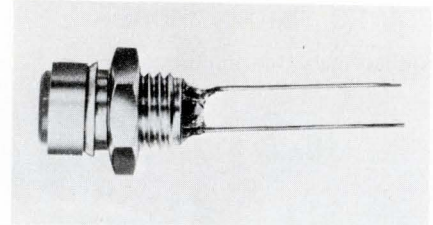

The 104S assembly uses a T1-1/8 neon lamp. With a 220 k $\Omega$  resistor the 104S can be used on a 115 V line and with a 560 k $\Omega$  resistor it can be used on a 230 V line. Starting voltage is 60 Vac or 90 Vdc. The Sloan Co., 7704 San Fernando Rd., Sun Valley, Calif. (913) CH7-8552.

Circle 238 on Inquiry Card

### VHF LINEAR AMP/BOOSTER

Increases op amp output drive.



Model 9510 provides true 100 MHz bandwidth. It can be used with almost any op amp to increase output driving capability without upsetting stability. It has  $\pm 2000$  V/ $\mu$ s min. slewing rate and  $\pm 10$  V to 100 $\Omega$  load output capability. Input imp is 10 k $\Omega$ . Optical Electronics Inc., Box 11140, Tucson, Ariz. 85706.

Circle 239 on Inquiry Card

## MOTOR-BLOWER

High air pressure at low volume.

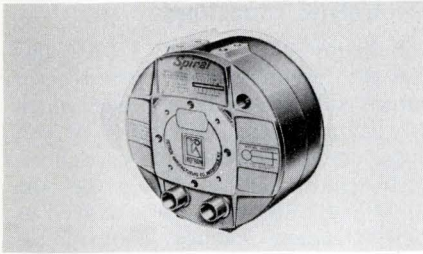

Compact unit provides high positive or negative air pressure at low air volume. Called the Spiral, it is only 10 in. in dia. and 5 $\frac{7}{8}$  in. in axial depth. Life expectancy is enhanced by low motor speed and the absence of brushes and commutators. Rotron Inc., Hasbrouck Lane, Woodstock, N.Y. 12498.

Circle 240 on Inquiry Card

## HYBRID CKT FLATPACK

With 15, 30, 45 or 60 leads.

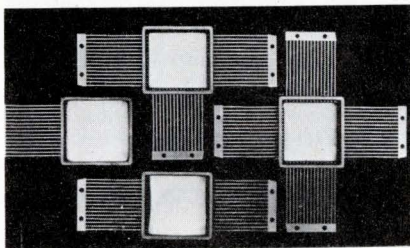

The HA-1752, 1 in.<sup>2</sup> high reliability flatpack has an internal depth of 0.125 in. min. The package can be supplied with either bare ceramic, metallized ceramic or kovar base and is available with sealing preform and lid. Mitronics, Inc., 132 Floral Ave., Murray Hill, N.J. 07974. (201) 464-3300.

Circle 241 on Inquiry Card

## HV PIN DIODES

Switch microwave power.



Low forward resistance and a 1000 V breakdown volt. give these type 5082-3051 diodes the ability to switch up to several hundred watts CW and, if the power is pulsed, up to tens of kW peak. Thermal resistance is 16° C/W for steady-state conditions but is even lower for short rf bursts, e.g. less than 1° C/W for a 10  $\mu$ s rf burst. Hewlett-Packard, 1501 Page Mill Rd., Palo Alto, Calif. 94304. (415) 326-7000.

Circle 242 on Inquiry Card

# READ OUT THESE FOUR RECEIVERS

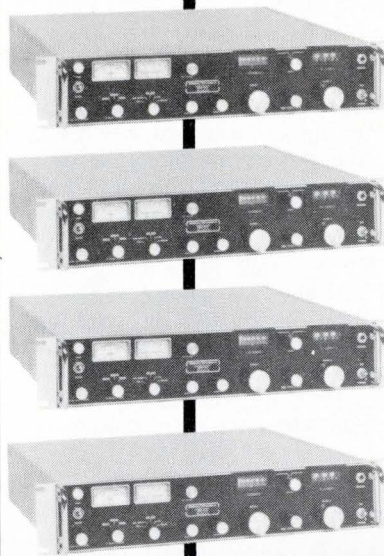

## WITH THIS ONE COUNTER



### TYPE DRO-307 TIME-SHARED READOUT WITH DIGITAL AUTOMATIC FREQUENCY CONTROL

Four receivers with a 30-300 MHz frequency range and a 21.4 MHz IF can be read out with W-J's new Type DRO-307 Time-Shared Digital Readout.

The counter alternately samples and counts the LO signal from each of the receivers, automatically subtracts 21.4 MHz IF and stores the result in integrated circuit storage elements. The unit reads out a six-digit visual display of the tuned frequency of any one of the receivers as selected by a front panel switch. Information is updated 12.5 times each second.

Other features include simultaneous BCD output from the storage elements for all receivers and full-time digital automatic frequency control (DAFC), which locks the receivers to a desired frequency. Separate DAFC circuitry is provided for each receiver.

For details circle the Reader Service Card number, write CEI Division or contact a W-J representative.

*World's largest selection of receiving equipment for surveillance, direction finding and countermeasures*

CEI DIVISION



WATKINS-JOHNSON

6006 Executive Boulevard, Rockville, Maryland 20852 (301) 881-3300

Circle 67 on Inquiry Card

## Opportunities for

# CIRCUIT DESIGNERS

Expanding activity on long-range programs and advanced projects has created many stimulating growth-assignments for Circuit Designers at Hughes.

Some of our most urgent requirements exist in the following areas:

- Development of high-power airborne radar transmitters, the design of which involves the use of the most advanced components
- Design of low-noise radar receivers using parametric amplifiers and other advanced microwave components
- Design of digital radar signal processing subsystem circuits, including range and speed trackers, doppler filter banks and a variety of display circuits
- Design of high-efficiency power supplies for airborne and space electronic systems
- Development of telemetering and command circuits for space vehicles and communications satellites

Requirements: an accredited Engineering degree, a minimum of two years of directly relatable experience and U.S. citizenship.

For immediate consideration, please airmail your resume to:

**MR. ROBERT A. MARTIN**  
 Head of Employment  
 Hughes Aerospace Divisions  
 Dept. 78  
 11940 W. Jefferson Blvd.  
 Culver City, Calif. 90230

## HUGHES

HUGHES AIRCRAFT COMPANY  
 AEROSPACE DIVISIONS

An equal opportunity employer—M & F

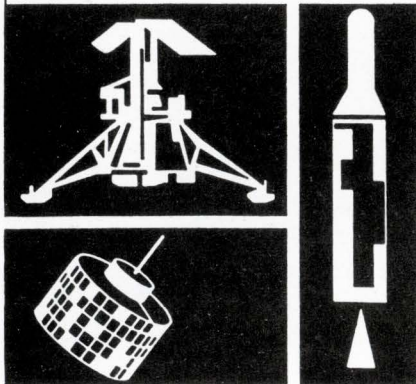

### EMI filters

Catalog 9000R2, a 48-pager, describes a line of standard low pass, signal, and power line filters, as well as custom multisection and black box devices. Included is a reference guide designed to help you quickly locate those filters which fit your application. The guide lists voltage and size, two critical parameters in selecting filters. Filter Products Div., Erie Technological Products Inc., 2206 W. 15th St., Erie, Pa. 16512.

Circle 340 on Inquiry Card

### ICs for major logics

A 54-page catalog aimed at design engineers is the second edition of a publication issued by Fairchild. Descriptions include compatible current

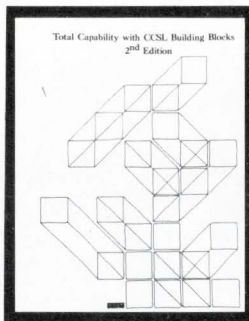

sinking logic building blocks, their special features, and applications. Much of the brochure is devoted to the manufacturer's digital MSI family, including decoders and demultiplexers, counters, multiplexers and encoders, adders, parity devices, comparators, function generators, and latches. Fairchild Semiconductor, 313 Fairchild Dr., Mountain View, Calif. 94040.

Circle 341 on Inquiry Card

### Potentiometers and dials

A 48-page catalog covers the company's lines of precision potentiometers and turns-counting dials. Described are 37 series of standard, linear pots—including single- and multi-turn types—and six series of dials. A section on custom, non-linear pots contains detailed design and application notes. Send a letterhead request, including job title or primary job function, to Technical Information Sect., Helipot Div., Beckman Instruments, Inc., 2500 Harbor Blvd., Fullerton, Calif. 92634.

Circle 342 on Inquiry Card

### Electrolytic capacitors

Bulletins 3700.2 and 3701.2 discuss the development of a new type of porous sintered tantalum anode, which has increased the capacitance of wet slug tantalum electrolytic capacitors. Performance characteristics of the 109D and 130D capacitors, as well as their standard ratings and typical curves, are given. The bulletins also contain guides to application and operation. Technical Literature Service, Sprague Electric Co., Marshall St., North Adams, Mass. 01247.

Circle 343 on Inquiry Card

### Log circuits

Of particular interest to design engineers, a 12-page article discusses logarithmic feedback principles and circuits for use with operational amplifiers. The note combines theoretical analysis and practical design information. It is divided into four sections: theoretical underpinnings, circuit design, hardware, and six useful circuits. Analog Devices, Inc., 221 Fifth St., Cambridge, Mass. 02142.

Circle 344 on Inquiry Card

### Switch selector

This selector guide for design engineers covers a line of precision switches. The 12-pager contains photos, cutaway illustrations, descriptions, and specs for 75 different switches, including a wide variety of coil spring snap action types. Other products include gold "crosspoint" contact switches for low energy circuits and leverwheel and thumbwheel rotary switches. Cherry Electrical Products Corp., 1650 Old Deerfield Rd., Highland Park, Ill. 60035.

Circle 345 on Inquiry Card

### Logic systems library

A 27-page MHTL systems design library provides technical data for engineers engaged in designing logic systems where noise immunity is a primary factor. Applications information for a high threshold logic line of ICs is included as is a discussion on the operation and application of MHTL flip-flops. Available on company letterhead from Motorola Semiconductor Products, Inc., Box 20924, Phoenix, Ariz. 85036.

### TTL IC guide

This concise specifying guide covers 40 different types of 54/74 series TTL-ICs. Products include gates, flip-flops, decoders, counters, adders, shift registers, and miscellaneous types. The guide lists power dissipation, propagation delay, and other comments for each circuit. National Semiconductor Corp., 2950 San Ysidro Way, Santa Clara, Calif. 95051.

Circle 346 on Inquiry Card

### Measurement instruments

Short form catalog SF-69 covers a line of instruments for rf power measurement. Coaxial load resistors and absorption and directional wattmeters are the featured products. The 4-pager lists prices, specs, and accessories. Bird Electronic Corp., 30303 Aurora Rd., Cleveland, Ohio 44139.

Circle 347 on Inquiry Card

### Linear IC reliability

A 12-page reliability report describes the company's testing program on linear ICs. The discussion covers production processing, quality control, and seal, environmental, and life testing. National Semiconductor Corp., 2950 San Ysidro Way, Santa Clara, Calif. 95051.

Circle 348 on Inquiry Card

### TTL integrated circuits

Catalog CB-102 contains 80 pages of data on three transistor-transistor logic IC series—standard, low-power, and high-power 54/74. Listed are more than 90 distinct functions, including

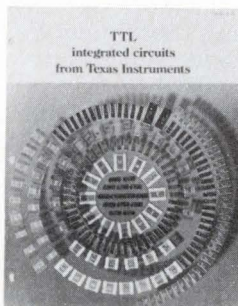

35 MSI circuits. Typical applications, truth tables, design loading rules, and pin configurations are presented. Texas Instruments Incorporated, Inquiry Answering Service, Box 5012, M/S 308, Dallas, Tex. 75222.

Circle 349 on Inquiry Card

### Electrical resins

The characteristics of electrical insulating resins and consideration



factors in selecting a resin are described in a foldout guide. The brochure discusses the advantages of different resin systems for various electrical applications. Descriptions of the physical and electrical properties along with application data are listed for the insulating systems. 3M Co., 3M Center, St. Paul, Minn. 55101.

Circle 350 on Inquiry Card

### FET test instrument

An automatic, high-speed, go/no-go instrument for testing field-effect devices—including MOS and junction, single and dual-gate FETs, and current-limiting diodes—is the subject of a 12-page brochure. The unit is designed for production line testing and classification and for incoming inspection. Teradyne, Inc., 183 Essex St., Boston, Mass. 02111.

Circle 351 on Inquiry Card

### Plated-thru process

A punched-plated-through-hole process for volume production of PC boards is the subject of a new brochure. The automated process is described and its advantages are outlined. Methode Electronics, Inc., 7447 W. Wilson Ave., Chicago, Ill. 60656.

Circle 352 on Inquiry Card

### Kilowatt amplifiers

This 11-page article will help you specify and evaluate large amplifiers. It describes high-powered amplifiers for driving sonar transducers, and explains why these amps must be characterized more completely than typical high fidelity audio power amps. Several important specifications are discussed in detail. Instruments, Inc., 3434 Midway Dr., San Diego, Calif. 92110.

Circle 353 on Inquiry Card

# RF POWER

Introducing the

## ENI AMP



... broadband, untuned, power amplifier, Model 300L which will extend the power output of your signal or sweep generator to 3 watts.

In other words,

- Power output: 3 watts max.
- Frequency coverage: .250–110 MHz
- Gain: 40 dB  $\pm$  1 dB
- Input/output Impedance: 50 ohms
- Noise figure: 8 dB
- Unconditionally stable
- Fail-safe for any load mismatch
- Output rf voltage and power meter

This compact solid state model has low harmonic and intermodulation distortion making it an ideal laboratory tool for:

- antenna testing
- transmitter design
- S-parameter measurements
- receiving multicouplers
- signal distribution
- sweep frequency measurements
- component testing
- RFI/EMI measurements

Priced at \$485.00

Where identical specifications but higher output is required, the Model 310L will provide 10 watts of power.

Let ENI solve your Broadband Amplifier problems. For additional information, write, wire or call:

Marketing Department  
**ENI ELECTRONIC NAVIGATION INDUSTRIES, Inc.**

1337 Main Street East  
Rochester, New York 14609  
(716) 288-2420

Circle 68 on Inquiry Card

If you don't  
find it here,  
give us a call.

# SILICON RECTIFIERS

Ask about our many  
types of custom  
rectifiers and rectifier  
assemblies.

FULL WAVE BRIDGE RECTIFIERS*		
50V	$I_0$	1-99
W 111	1A	.95
100V		
VE 18	1A	1.00
VS 148	2A	1.00
VH 148	6A	1.93
200V		
VE 27	1A	1.20
VE 28	1A	1.10
VS 247	2A	1.20
VS 248	2A	1.10
VH 247	6A	2.25
VH 248	6A	2.15
IN 4436	10A	4.15
VT 200	25A	5.35
400V		
VE 47	1A	1.30
VE 48	1A	1.20
VS 447	2A	1.30
VS 448	2A	1.20
VH 447	6A	2.59
VH 448	6A	2.49
IN 4437	10A	5.45
VT 400	25A	7.00
600V		
VE 67	1A	1.59
VE 68	1A	1.49
VS 647	2A	1.60
VS 648	2A	1.50
VH 647	6A	2.98
VH 648	6A	2.88
IN 4438	10A	7.45
VT 600	25A	9.85

\*Available with fast recovery characteristic



SEMICONDUCTOR DIVISION, 1000 N. SHILOH  
ROAD, GARLAND, TEXAS 75040 (214) 272-4551

Circle 69 on Inquiry Card

## EE LITERATURE

### Antennas

This catalog contains 95 pages of data on antennas, transmission lines, cables, waveguides, and related equipment. Product information and performance data directed at antenna

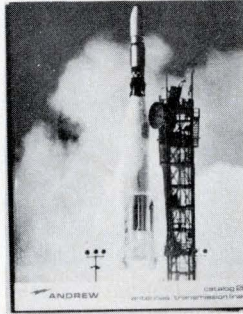

system engineers are given—as are suggested applications and specs. Included, too, is an antenna directivity graph and a VSWR conversion chart. Andrew Corp., 10500 W. 153rd St., Orland Park, Ill. 60462.

Circle 354 on Inquiry Card

### Semiconductor handbook

This second volume of a technical data handbook covers a line of semiconductors. Products include thyristors, bridges, firing circuits, solid-state regulators, rectifier diodes, reference diodes, integrated circuits, signal diodes, Hall devices, and microwave diodes. Application notes are provided. Publicity Dept., AEI Semiconductors Ltd., Carholme Rd., Lincoln, England.

Circle 355 on Inquiry Card

### Decibel tables

Systems engineers and others using decibels (dB) as tools for precision measurement will be interested in this voltage and power ratio to dB table. The table also shows percent deviation of voltage and power to dB. Pacific Measurements, Inc., 940 Industrial Ave., Palo Alto, Calif. 94303.

Circle 356 on Inquiry Card

### Photocells

"Using Photocells for Electro-optical Potentiometers" is the subject of an 8-page booklet. Described is a frictionless, stepless, heatless, and noiseless pot which uses two photocells and an optical mask to perform the potentiometer function without physical contact. The note includes short descriptions of other photocell applications. Clairrex Electronics, Inc., 1239 Broadway, New York, N.Y. 10001.

Circle 357 on Inquiry Card

### Potentiometers

Technical Data Bulletin No. TD-114 is a guide to specifying output smoothness of precision potentiometers. Some of the practical questions it answers are: How do output smoothness figures relate to system requirements? What characteristics of the system determine the output smoothness that must be specified? Markite Corp., 155 Waverly Pl., New York, N.Y. 10014.

Circle 358 on Inquiry Card

### Magnetic pickups

This easy-to-use chart is helpful for choosing the correct magnetic pickup for speed-measuring applications. Listed are the key parameters for the pickups: size and length, type of electrical connection, voltage output range, and temperature. Airpax Electronics, Inc., Seminole Div., Box 8488, Ft. Lauderdale, Fla. 33310.

Circle 359 on Inquiry Card

### Switches

A line of switches for various applications is outlined in an 11-page catalog. Operating characteristics and specs are provided for each type, as are schematics. Included too is a cross-reference table of standard rotary switches which should serve as a valuable aid. Oak Manufacturing Co., Crystal Lake, Ill. 60014.

Circle 360 on Inquiry Card

### Selecting lock washers

Titled "How to Select the Right Lock Washers," this pocket-size guide covers a wide range of general and special applications and shows which lock washer to use and why. A special feature of the 10-pager is an application index. Shakeproof Div., Illinois Tool Works Inc., St. Charles Rd., Elgin, Ill. 60120.

Circle 361 on Inquiry Card

### Headers and receptacles

This 16-page catalog will provide circuit designers with specs of many of the basic headers and connecting receptacles used in the NAFI Standard Hardware Program. Also shown are accessories available from stock for use with these components. Methode Electronics, Inc., Connector Div., 7447 W. Wilson Ave., Chicago, Ill. 60656.

Circle 362 on Inquiry Card

### Semiconductor chips

Semiconductor and IC chips and wafers are the subject of a foldout brochure. Given are outline diagrams, type numbers, and operating characteristics for a line of chips that includes single and dual FETs, monolithic dual bipolar transistors, linear ICs, and MOS devices. Union Carbide, Semiconductor Dept., Box 23017, San Diego, Calif. 92123.

Circle 363 on Inquiry Card

### Fluidic sensor

A 4-page brochure suggests 13 applications for a fluidic proximity sensor. This sensor is intended as a tool for materials handling controls, automatic sequencing operations, and other industrial applications where no moving part detection of proximity or distance gauging is desired. General Electric Co., Specialty Fluidics Operation, Schenectady, N.Y. 12305.

Circle 364 on Inquiry Card

### Automation dictionary

A 47-page glossary defines more than 200 automation terms ranging from "algorithm" to "zener diode." Along with the definitions, the booklet contains historical data on events in the automation field, including computer development. Honeywell, Inc., Inquiry Supervisor G2118, 2701 Fourth Ave., S. Minneapolis, Minn. 55408.

Circle 365 on Inquiry Card

### Hermetic connectors

There is a summary of over 100 types of hermetically sealed connectors in this 12-page catalog. Covered are a high density multi-pin connector line; coaxial, miniature, and subminiature push-pull series; a slim line series designed to MIL-C-38999, and other MIL Spec types. Microdot Inc., 220 Pasadena Ave., South Pasadena, Calif. 91030.

Circle 366 on Inquiry Card

### CLASSIFIED ADVERTISING

#### GROWTH POSITIONS \$12,000-\$25,000

MANAGEMENT — ENGINEERING — SALES  
RESEARCH — MANUFACTURING

Nationwide Coverage

Fees company paid. Include present salary, minimum salary requirement and location flexibility with resume. Longhery Employment Service, Inc., 910 Niles Bank Bldg., Niles, Ohio 44446. (216) 632-5871.

### Thin film hybrids

"The Structure of Thin Film Hybrids" is the title of a 12-page brochure for advanced circuit designers. This source contains a technical review of thin film hybrids, the seven

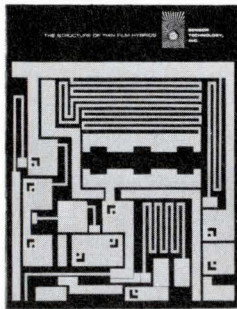

steps of manufacture, and the specs required for ordering. Included are three useful reference tables: (1) conversion of thin-film units, (2) comparison of thin and thick films, and (3) a specification guide. Sensor Technology, Inc., 7118 Gerald Ave., Van Nuys, Calif. 91406.

Circle 367 on Inquiry Card

### Selector switches

Catalog 4001, a 16-page source, discusses the availability of a complete switch package from a single source. Highlighted are the CTS 216 wafer assembly and the 215 index assembly. Electrical and mechanical specs for all the company's switch types, and special construction features, are given. CTS Corp., 1142 W. Beardsley Ave., Elkhart, Ind. 46514.

Circle 368 on Inquiry Card

### Short-term stability

Short-term stability—its specification and measurement—is discussed in a 25-page technical note (Memo No. 5). The paper covers areas where short-term stability is needed, reviews fm theory, and describes how to measure short-term stability. Microwave/Systems, 1 Adler Dr., East Syracuse, N.Y. 13057.

Circle 369 on Inquiry Card

### Quartz crystals

A bulletin on quartz crystals covers products in the range from 50 kHz to 200 MHz. Included is a chart which lists specs on military-type crystals, and a handy ruler which contains a dB to ratio conversion scale and an Ohm's law scale. K-W Industries, Inc., Box 508, Prague, Okla. 74864.

Circle 370 on Inquiry Card

# Find it fast! in the **FREE NEW 1970 Newark industrial electronic catalog**

A \$9,000,000 INDUSTRIAL ELECTRONIC INVENTORY  
720 PAGES • OVER 70,000 ITEMS; 500 MAJOR LINES  
INCLUDING THE COMPLETE LINE OF

## CORNING

### RESISTORS/CAPACITORS

*For guys who can't stand failures*

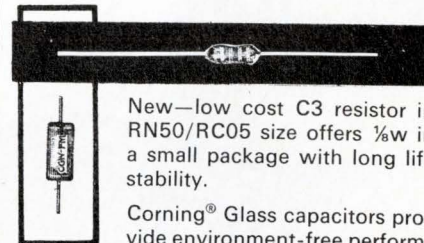

New—low cost C3 resistor in RN50/RC05 size offers  $\frac{1}{2}w$  in a small package with long life stability.

Corning® Glass capacitors provide environment-free performance with proven stability and reliability.

Corning precision and semi-precision resistors for both military and commercial application offer design versatility and guaranteed performance along with economy.

*Immediate delivery from stock—factory OEM prices  
—fast efficient service from 11 Newark warehouses.*

*One source for the products  
you need, in the quantities  
you need.*



For your free catalog write to:

**Main Office & Warehouse**

**NEWARK ELECTRONICS CORPORATION**

500 North Pulaski Chicago, Illinois 60624  
(312) 638-4411

#### WAREHOUSES IN

- |                                     |                                       |   |
|-------------------------------------|---------------------------------------|---|
| * Minneapolis, Minn. (612) 331-6350 | Los Angeles Area (213) 678-0441       | * |
| * Cincinnati, Ohio (513) 421-5282   | Grand Rapids, Michigan (616) 452-1411 | * |
| * Denver, Colorado (303) 757-3351   | New Orleans, Louisiana (504) 834-9470 | * |
| * Detroit, Michigan (313) 548-0250  | Dallas, Texas (214) 271-2511          | * |
| * New York City (212) 255-4600      | Houston, Texas (713) 782-4800         | * |

Circle 70 on Inquiry Card

**Solid-state ballasts**

Application Note AN-2616 discusses the advantages of ss switching-regulator ballasts over conventional ballasting devices for high-pressure mercury-arc lighting systems. Of special interest in the 14-pager is the description of three basic circuits for electronic ballasts and their operation. RCA Electronic Components, Harrison, N.J. 07029.

Circle 371 on Inquiry Card

**Digital integrated circuits**

This 6-page guide, suitable for wall-mounting, is designed to speed your selection of digital integrated circuits. Featured is a 3-page graph which compares the operating characteristics of the company's 29 series of digital ICs. These devices are conveniently color-divided by family (MDTL, MTTL, MHTL, and MECL). Write on company letterhead to Motorola Semiconductor Products, Inc., Box 20924, Phoenix, Ariz. 85036.

**Semiconductor standards**

"Methods of Measurement for Semiconductor Materials, Process Control, and Devices" is a quarterly progress report from the National Bureau of Standards. The 35-pager discusses NBS efforts to improve methods of measurement for use in specifying semiconductor materials and devices and in control of device fabrication processes. Priced at 45¢, it is available from the U.S. Dept. of Commerce, National Bureau of Standards, Washington, D.C. 20234.

**Delay lines, filters**

Precision delay lines, L-C filters, and passive lab instruments are featured in a 12-page brochure, P12. Included are descriptions, application information, specs, and charts for a variety of custom-built and stocked delay lines and filters. Allen Avionics, Inc., 255 E. 2nd St., Mineola, N.Y. 11501.

Circle 373 on Inquiry Card

**Computer peripherals**

Publication G315 describes applications of magnetic tape drives and core memories in a range of data processing programs. The use of digital tape transports in nuclear medicine and in testing the F-111 fighter aircraft are just two of the examples given in the 16-pager. Ampex Corp., Mail Stop 7-13, 401 Broadway, Redwood City, Calif. 94063.

Circle 374 on Inquiry Card

**Rectifiers and diodes**

A 40-page catalog, C159, covers a line of controlled avalanche fused-in-glass rectifiers, zener diodes, and MIL-type devices. Included is application information on temperature and lead length derating, recovery time measurement, lead material, mounting method, and surge rating capabilities. Tables, graphs, and outline drawings are given. Unitrode Corp., 580 Pleasant St., Watertown, Mass. 02172.

Circle 375 on Inquiry Card

**Free DC motor bulletins**



**72 performance curves on motors and gearheads**

Indiana General has released specifications on custom-designed DC motors, available at off-the-shelf prices. Tolerances on these motors are often held to .0001".

They come in 8, 9, 12, 13 and 15 frame sizes, with delivery in 6 to 8 weeks instead of the normal 12.

For technical details, including performance curve data for each, plus information on gearheads, write: Mr. R. D. Wright, Manager of Sales, Indiana General Corporation, Electro-Mechanical Division, Oglesby, Illinois 61348.

**INDIANA GENERAL**

*We make it easy for the design engineer.*

Circle 71 on Inquiry Card

\* FROM STOCK \*  
IMMEDIATE DELIVERY

knobs

mil & commercial

TACTILE SHAPE CONTROL KNOBS  
CRANK KNOBS  
POINTER KNOBS  
SAFETY KNOBS

Circle No. 72 on Reader Service Card.

rubber bumpers • grommets

mil & commercial

BUTTON  
MACHINE  
STEM  
TACK  
RECESSED

Circle No. 73 on Reader Service Card.

shielding materials

tape & foil, flexible tubing

FULL SPECTRUM  
ELECTROMAGNETIC  
RADIO FREQUENCY

Circle No. 74 on Reader Service Card.

russell industries inc.

96 STATION PLAZA, LYNBROOK, L. I., N. Y. 11563 • (516) 887-9000



### Multichannel analyzer

Application Note 93, a 60-pager, surveys the measurements that can be made with multichannel analyzers.

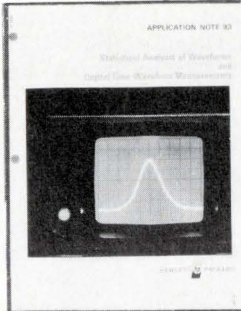

The booklet describes how to measure probability density functions and distributions, distortion, modulation, and other statistical properties of signals and noise. An appendix gives details of probability theory. Inquiries Mgr., Hewlett-Packard Co., 1501 Page Mill Rd., Palo Alto, Calif. 94304.

Circle 376 on Inquiry Card

### Pin and socket connectors

This handy wallchart should help component specification and design engineers evaluate the available electrical and rf connector types. The full-color chart shows specs, photographs, and line drawings for the entire Min-Rac® connector line, and is cross-referenced by general application area. Included on the chart are contact configurations, assembly tools, and accessories. Amphenol Industrial Div., 1830 S. 54th Ave., Chicago, Ill. 60650.

Circle 377 on Inquiry Card

### Electromechanical relays

A 20-page Distributor Stock Catalog provides technical data on over 500 electromechanical relays and optoelectronic components. A handy selection guide cross-references desired performance features to specific relays. Factors in relay selection are discussed. Sigma Instruments Inc., 170 Pearl St., Braintree, Mass. 02185.

Circle 378 on Inquiry Card

### Active filter

An 8-page data sheet covers the WM3 active filter, designed for applications that require a lowpass, bandpass, or highpass output. Typical performance and applications are shown graphically, and tuning techniques are illustrated. Western Microwave, Hybrid Microcircuits Group, 16845 Hicks Rd., Los Gatos, Calif. 95030.

Circle 379 on Inquiry Card

## For low-pressure differential measurements with 50,000 hour MTBO, Gulton makes sense with the 3135.



Here's a low-cost linear variable differential transformer that monitors pressure as low as  $\pm 0.1$  psid—such as airspeed, oil pressure, hydraulic pressure, etc.—a continuous resolution DC-DC transducer in ranges from  $\pm 0.1$  to  $\pm 400$  psid. Linearity of  $\pm 0.1\%$ . Up to 28 Vdc output

without amplification. Humidity proof, excellent long term zero stability. Ready to monitor any fluids or gases compatible with the 3135's Ni-Span C, Inconel 718, or stainless steel sensing element.

The name is Gulton.



**Gulton**  
INDUSTRIES, INC.  
SERVONIC DIVISION

1644 Whittier Avenue, Costa Mesa, California 92627 / (714) 642-2400

Circle 75 on Inquiry Card



## Every Engineer or Draftsman should have the NEW BY-BUK CROSS REFERENCE GUIDE P-45

(supersedes By-Buk Catalog No. P-42)

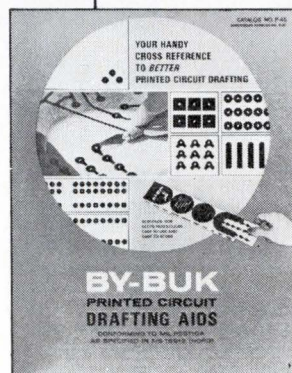

to better printed circuit drafting.

This FREE 24 page booklet contains color-coded standard MIL-SPEC SIZES and design standards . . . plus a newly added numerical index for easy reference to over 2000 pre-cut tapes, pads, shapes, transistor tri-pads, spaced IC

terminal pad sets and other drafting aids for faster, more accurate, distortion-free printed circuit master drawings.

Send for your FREE guide today!

**BY-BUK COMPANY**

4326 West Pico Blvd. • Los Angeles, Calif. 90019 • (213) 937-3511



Circle 76 on Inquiry Card

**NEW**  
**High-Voltage**  
**Corona-Free**  
**J-Series**  
**Connectors**

New J-Series Rowe Connectors for economical use in lasers, power supplies, display systems, etc.

- Unmated flash-over value 12KV DC
- Mated 20 KV DC, unmated 10 KV DC
- Corona inception in excess of 5 KV at 75,000 feet
- Operating temperature range -55°C to 125°C
- Current 2 amps DC
- Quick-disconnect

Also available in complete cable assembly form.

J-Series Connectors are adaptable to standard coaxial cables RG-58, -59, -54, etc. with reduced ratings.

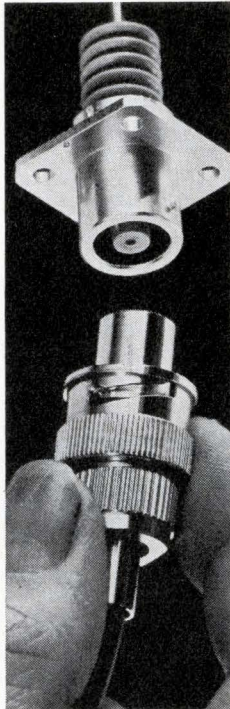

Phone or write today.

**ROWE INDUSTRIES, INC.**  
1702 Airport Highway,  
Toledo, Ohio 43609  
Phone: 419-382-5666,  
TWX: 810-442-1734

Circle 77 on Inquiry Card

**EE LITERATURE**

**Voltage stabilizers**, ac line type, used to provide stable voltages for electrical and electronic equipment, catalog GEA-8236A (8 pages). General Electric Co., Building 705, Corporation Park, Scotia, N. Y. 12302.

Circle 380 on Inquiry Card

**Compact, oiltight pushbuttons**—lighted, unlighted, and indicating light types—16 pages. Micro Switch, a div. of Honeywell, Inc., 11 W. Spring St., Freeport, Ill. 61032.

Circle 381 on Inquiry Card

**Metallized polycarbonate capacitors**, radial-lead, in rectangular epoxy cases, for printed wiring board applications—Bulletin 102 (6 pages). Dearborn Electronics, Inc., Box 530, Orlando, Fla. 32802.

Circle 382 on Inquiry Card

**Optoelectronic devices**—photon detectors, light sources, time delay generators, vacuum photo diodes, image converter tubes, and so forth (18-page catalog). Abtronics, Inc., Box 712, Livermore, Calif. 94550.

Circle 383 on Inquiry Card

**Miniature ceramic capacitors**, including "chip," axial lead, radial lead, Mil Spec, microminiature, coaxial feed-thru, and "dipped" types, plus EMC/RFI filters (22 pages). Electro Materials Corp., 11620 Sorrento Valley Rd., San Diego, Calif. 92121.

Circle 384 on Inquiry Card

**Miniature electronic switches** and keyboard assemblies, including five lines of toggle switch types (20 pages). Alco Electronic Products, Inc., Box 1348, Lawrence, Mass. 01842.

Circle 385 on Inquiry Card

**Sockets**, including miniature chassis, tube and low-cost SCR versions—bulletins PB-001 - PB-004. Amphenol Industrial Div., Bunker Ramo Corp., 1830 S. 54th Ave., Chicago, Ill. 60650.

Circle 386 on Inquiry Card

**IC core memory**, 2- $\mu$ s cycle time, 800-ns access time, modular capacity to 131,072 words, word length to 76 bits—Brochure C104 (5 pages). Ampex, Mail Stop 7-13, 401 Broadway, Redwood City, Calif. 94063.

Circle 387 on Inquiry Card



Actual Size

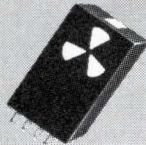

**New Microminiature**  
**"BITE"\* Indicators**

\* Built-In-Test-Equipment

Now you can design a continuous monitor into electric or electronic circuits to give a visual warning of faulty performance. These indicators provide a sharply-contrasting change in color to signal a malfunction. Even if the failure is transient, the indicator continues to register the fault by means of magnetic latching until a reset signal is applied.

You can use these indicators on a system, sub-system, module, or individual circuit card level to pinpoint malfunctions quickly. They eliminate the need for special test instruments, troubleshooting time, and highly-qualified personnel. Unnecessary downtime can be virtually eliminated.

These indicators respond to a pulse width as low as 15 milliseconds, and use power only during transition from "normal" to "malfunction" state. Several variations are available; all meet the applicable requirements of MIL-E-5400H (ASG) Class 1-A Equipment. Send for information now!



232 North Elm Street  
Waterbury, Conn. 06720

See EEM for local  
Representatives in U. S.

In Europe s.a. Polymotor • 29 Av. Paul Henri Spaak • Brussels 7 • Tel. 23.40.83  
Timing & Stepper Motors • Electromechanical & Electronic Timing Devices & Systems

**Power**  
**Supply**  
**Problem?**

If it's surge loading . . .

get the new 24VDC/2.5 AMP

**WANLASS C-214!**

Rated at 60 Watts—Distributor priced at \$46<sup>00</sup> (1 to 9)

For relay, solenoid, motor and other surge loading, you won't find a better answer! Wanlass "Economy by Design" plus fast delivery from local stock makes it your best buy, too. Interesting? Check the specs, then call us TOLL-FREE for more data and your local distributor's name.

**DIAL (800) 854-3528**

\*In Calif. or Canada, call (714) 545-4467 collect.

BRIEF SPECIFICATIONS

AC Input . . . . .115/230 Volts  
1 Phase, 60/50 Hz  
DC Output . . . . .24 Volts @ 2.5 Amps  
Regulation . . . . . $\pm 2\%$  Line and Load  
Ripple . . . . .0.1% +10MV RMS Max.  
Temperature . . . . .0-40°C  
Dimensions . . . . .6"L x 5"W x 5.5"H

INDUSTRIAL/DISTRIBUTOR PRODUCTS DIVISION

**WANLASS ELECTRIC COMPANY**

A SUBSIDIARY OF AMBAC INDUSTRIES, INC.



THE ONE SOURCE FOR ALL POWER CONVERSION EQUIPMENT

**Transformers and delay lines** for computer applications (17-page 1969 catalog). Available on company letterhead from Pulse Engineering Inc., 560 Robert Ave., Santa Clara, Calif. 95050.

**Quick-setting adhesive** for production-line assembly, models and prototypes, design studies (10 pages). Loctite Corp., 705 N. Mountain Rd., Newington, Conn. 06111.  
**Circle 389 on Inquiry Card**

**Receiving system**, including tuners, demodulators, signal monitors, AGC units, digital readouts, and so forth (8 pager). Watkins-Johnson Co., CEI Div., 6006 Executive Blvd., Rockville, Md. 20852.  
**Circle 390 on Inquiry Card**

**Data acquisition instrument** for use as a multiplexer, A/D or D/A converter, sample-and-hold amplifier, or differential amplifier (12 pages). Astrodata, Inc., Box 3003, Anaheim, Calif. 92803.  
**Circle 391 on Inquiry Card**

**Pressure measuring systems** and components including transducers, power supplies, and panel meters—Bulletin 500S. MB Electronics, Box 1825, New Haven, Conn. 06508.  
**Circle 392 on Inquiry Card**

**Fluidic variable restrictors** in either low or high flow design (Data Sheet FAD-900). Corning Glass Works, Corning, N.Y. 14830.  
**Circle 393 on Inquiry Card**

**TTL IC logic assemblies**, series 74/54, (4 pager). Cambridge Thermionic Corp., 445 Concord Ave., Cambridge, Mass. 02138.  
**Circle 394 on Inquiry Card**

**Square-wave generator**, miniature, hand-held, transistorized (data sheet). Mini-Tron Co., Box 348, Feasterville, Pa. 19047.  
**Circle 395 on Inquiry Card**

**Thermal cycling and shock test chambers** for both in-house and Mil-Spec testing—12-pager. Blue M Engineering Co., 138th & Chatham St., Blue Island, Ill. 60406.  
**Circle 396 on Inquiry Card**



## RF and POWER SWITCHES

A complete line of rotary, high voltage and high current ceramic-type switches for RF and low frequency applications.

Write for catalog, containing information on the mechanical and electrical properties of our standard line of switches.

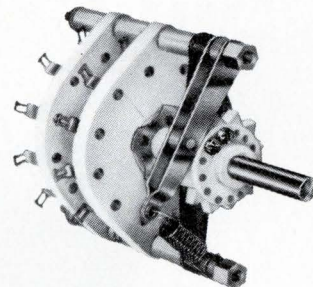

**RADIO SWITCH CORPORATION**

MARLBORO, NEW JERSEY

Telephone: HOpkins 2-6100 (Area Code 201)

**Circle 81 on Inquiry Card**

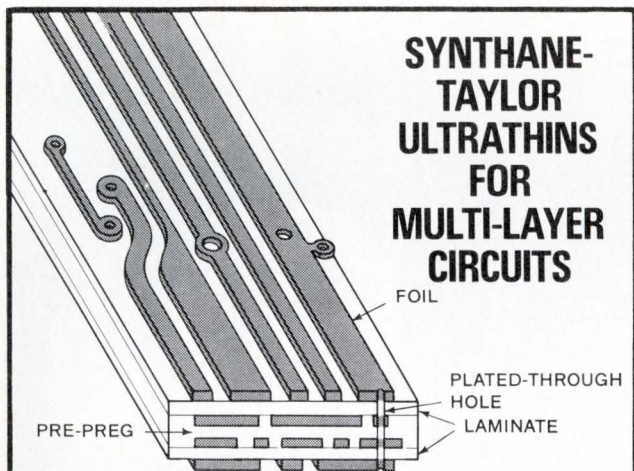

### Good Dimensional Stability

You won't find a void or resin-starved area in our 0.003" to 0.031" thin circuit board laminates. They're made from continuous woven glass epoxy under white room conditions, and bonded to purest quality copper foil. Synthane-Taylor regular and flame-retardant grades both provide outstanding electrical and mechanical properties, long-term stability and uniformity. Complete specifications are included in our metal-clad folder. Write for it today. Synthane-Taylor Corp., 18 Valley Forge Road, Valley Forge, Pa. 19481.

**synthane-taylor**

Valley Forge, Pa. 19481 (215) 666-0300  
 An Alco Standard Co.

**Circle 80 on Inquiry Card**



**VARGLAS  
 SILICONE RESIN  
 "500"  
 SLEEVING**

**So flexible you can get it on spools or in coils!**

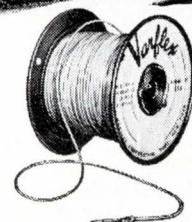

**FLEXIBLE**—at -70° to +500° F. without cracking or checking. Dielectric strength remains.  
**DIELECTRIC STRENGTH** up to 7000 V., even when knotted. Meets MIL-I-3190, revised.  
**RADIATION RESISTANT**—remains nonconductive under higher random intensities.  
**SIZE AND COLOR CODES**—.010" to 3" I. D., in 12 brilliant, non-fade colors.  
**CHOICE OF LENGTHS**—continuous lengths to 5000'; 36" lengths where preferred.  
**IMMEDIATE DELIVERY** on standard items from stock . . . 48 hr. for new production.

Ideal where miniaturization increases heat and dielectric load on small wires.

● Send for free test samples

**Vargflex** SALES CO., INC.  
 "Never Satisfied Until You Are"

Manufacturers of Electrical Insulating Tubing and Sleeveing  
 308 N. Jay St., Rome, N. Y.

**Circle 82 on Inquiry Card**



**NORTON<sup>®</sup>  
MAGNETIC  
HEADS**

**MULTITRACK  
ERASE  
RECORD  
PLAY**

Send now for complete technical literature.

**NORTON**  
ASSOCIATES, INC.

10 Di Tomas Court, Copiague, N.Y. 11726  
Phone: 516 598-1600

Circle 83 on Inquiry Card

**EE LITERATURE**

**Contact resistance**

Contact or constriction resistance is a key criterion of contact reliability. Described in an 8-page booklet is a system designed to measure this resistance rapidly. The system has four key functions: pre-adjusted voltage sensor, two stable timing devices, an inhibitor, and a coded binary counter. Cherry Electrical Products Corp., 1650 Old Deerfield Rd., Highland Park, Ill. 60035.

Circle 397 on Inquiry Card

**Counter selection**

This new edition of an electronic counter selection guide is in the form of an easy-to-read table. The guide compares all H-P counters, giving model numbers, descriptions, frequency ranges, numbers of digits, prices, and so forth. Also covered are plug-ins and complementary equipment, Inquiries Mgr., Hewlett-Packard Co., 1501 Page Mill Rd., Palo Alto, Calif. 94304.

Circle 398 on Inquiry Card

**Panel meters**

An 8-page condensed catalog describes a line of electrical instruments, including ammeters, voltmeters, milliammeters, and microammeters. Dimensional drawings or tables are given for each model along with mounting specs and prices. Hoyt Electrical Instrument Works, Inc., Burton-Rogers Co., Sales Div., Cambridge, Mass. 02142.

Circle 399 on Inquiry Card

**Monolithic memory driver**

A 6-page application note (CA-107) briefly describes the SN75 324 monolithic integrated-circuit memory driver and shows how to use it to address and drive a magnetic memory. Though specifically designed to replace discrete transistor-transformer circuits in magnetic memory systems, the unit can also be used as a lamp driver, relay driver, or high-fanout logic gate. Texas Instruments Incorporated, Inquiry Answering Service, Box 5012, MS/308, Dallas, Tex. 75222.

Circle 400 on Inquiry Card

**NEW!**

**\$20.00** each

**PROBE HEAD ASSEMBLY**

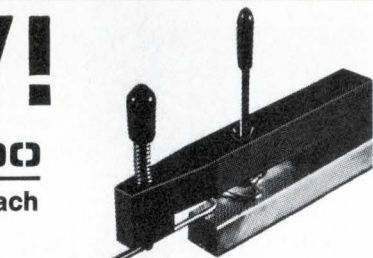

**DESIGNED FOR THICK AND THIN FILM APPLICATIONS**

**FEATURES:**

- "Snap-in" probe point
- Magnetic base
- 6-1 ratio joystick for fine positioning
- Height and pressure adjustment

Request Probe Head Assembly Bulletin 1068

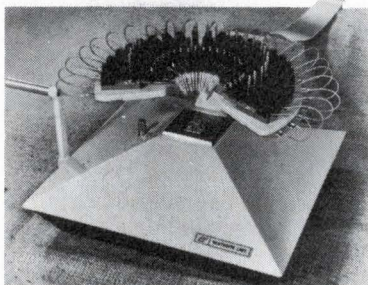

Also available... the New **MP-0200 Microcircuit Prober** accommodates up to 34 Probe Head Assemblies on pre-wired ring.

Features include an automatic vacuum system for substrate hold-down; an interchangeable chuck and a shielded double flat cable interface with connectors. Rate: 700-900 substrates/hour.

**WENTWORTH LABORATORIES INC.**  
ROUTE 7, BROOKFIELD, CONN. 06804 — (203) 775-1750

130

Circle 84 on Inquiry Card

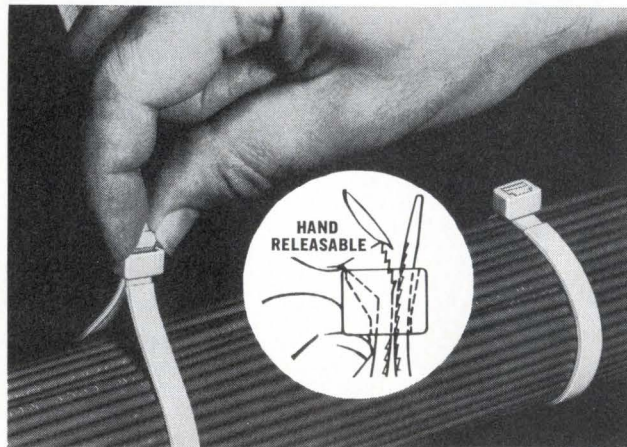

**PANDUIT STA-STRAP<sup>®</sup> TIES**  
releasable prior to final tightening

PANDUIT Cable Ties offer you the exclusive advantages of releasability by hand prior to tool installation or final tightening by hand. Simply move the head down (see above) and pull the wedge end away from the lead end of the cable tie. This permits easy adjustments in the harness, allows you to move the cable tie. Full line of all nylon, self-locking cable ties for harnesses up to 8" diameter. No metal barbs or twisting. Meet applicable MIL Specs.

At your PANDUIT Distributor. **FREE SAMPLES**

**PANDUIT<sup>®</sup> CORP.**

Tinley Park, Ill. 60477 • Phone: 312-532-1800 • Telex 25-4560

FROM THE MANUFACTURERS OF  
PANDUIT<sup>®</sup> PLASTIC WIRING DUCT



Circle 85 on Inquiry Card

# Advertisers—September 1969

This index is published as a convenience.  
No liability is assumed for errors or omissions.

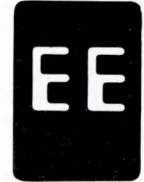

ACDC ELECTRONICS ..... 98 Chiat/Day Inc.	KEPCO, INC. .... 116 Weiss Adv.
ALLIED CHEMICAL CORP., PLASTICS DIV. .... 24, 25 Benton & Bowles Inc.	LTV ELECTROSYSTEMS, INC. .... 26, 27 Lennen & Newell, Inc., The Wyatt And Williams Div.
AMERICAN MACHINE & FOUNDRY CO., POTTER & BRUMFIELD DIV. .... 42, 43 Grant, Wright & Baker, Inc.	MB ELECTRONICS, A TEXTRON CO. .... 105 Codella Savage Peck Inc.
AMERICAN MICRO-SYSTEMS INC. .... 23 Jordan Adv. Marketing Services, Inc.	MET-L-WOOD CORP. .... 99 Drew & Carr, Inc.
AMP INC. .... 30, 31 Garceau, Hallahan & McCullough, Inc.	MICRO SWITCH ..... 14 N. W. Ayer & Son
AMPHENOL INDUSTRIAL DIV. OF BUNKER-RAMO CORP. .... Insert Fol. P. 34 Marsteller Inc	3M CO. .... Insert Fol. P. 52 Batten, Barton, Durstine & Osborn, Inc.
A P, INC. .... 110 McNichol & Assoc., Adv.	3M CO., INDUSTRIAL CHEMICAL DIV. .... 83 Young & Rubicam, Inc.
BARNES CORP. .... 106 Industrial Public Relations, Inc.	MOTOROLA SEMICONDUCTOR PRODUCTS, INC. .... 78, 79 Lane and Bird Adv.
BECKMAN INSTRUMENTS, INC. EID DIV. .... 19 HELIPOT DIV. .... 72 N. W. Ayer/Jorgensen/MacDonald, Inc.	NATIONAL SEMICONDUCTOR ..... 90, 91 Hall Butler Blatherwick Inc.
F. W. BELL, INC. .... 34 Wheeler, Kight & Gainey, Inc.	NEWARK ELECTRONICS CORP. .... 125 Stroll Adv. Co., Inc.
BOURNS, INC. .... 29 The Lester Co.	NORTH ELECTRIC CO. .... 71 Marc Assoc.
BUSSMANN MFG. DIV. .... 77 Henderson Adv. Co.	NORTON ASSOC., INC. .... 130 J. J. Coppo Co., Inc.
BY-BUK ..... 127 Albert Frank & Guenther Law Inc.	PANDUIT CORP. .... 130 Donald L. Arends, Inc.
CEI DIV., WATKINS-JOHNSON CO. .... 121 William C. Estler	PHILCO FORD CORP. .... 101 Aitkin-Kynett Co., Inc.
CENTRALAB DIV. OF GLOBE UNION ..... 47 The Brady Co.	POTTER & BRUMFIELD DIV. AMERICAN MACHINE & FOUNDRY CO. .... 42, 43 Grant, Wright & Baker, Inc.
DALE ELEC., INC. .... 44 Swanson, Sinkey, Ellis, Inc.	RCA, INTEGRATED CIRCUITS DIV. .. Back Cover Al Paul Lefton Co., Inc.
DANA LABS., HIGH FREQUENCY DIV. .... 33 Smith-Kliffen Inc.	RADIO SWITCH CORP. .... 129 Carpenter, Matthews & Stewart, Inc.
DIALIGHT CORP. .... 119 Michel, Cather, Inc.	RAYTHEON SEMICONDUCTOR ..... Inside Back Cover Botsford, Constantine & McCarty, Inc.
THE DIGITRAN CO. .... 5 Jansson Adv., Inc.	ROWE INDUSTRIES ..... 128 Carr Eyster Assoc., Inc.
DUPONT, NOMEM DIV. .... 115 Batten, Barton, Durstine & Osborn, Inc.	RUSSELL INDUSTRIES ..... 126 A. D. Adams Inc.
DYTRONICS ..... 4 Paul G. Fahrenholz	HOWARD W. SAMS & CO., INC. .... 112 George Brodsky Adv., Inc.
ELCO CORP. .... 37 Schaefer Adv., Inc.	SCHRACK ELECTRICAL SALES CORP. .... 22 Franklin Adv. Agency, Inc.
ELECTRICAL INDUSTRIES ..... 28 Douglas Turner, Inc.	SIMPSON ELECTRIC CO. .... 108 Amerad Adv. Service, Inc.
ELECTRONIC NAVIGATION INDUSTRIES, INC. .... 123	SOLID STATE PRODUCTS, DIV. UNITRODE CORP. .... 16 Van Christo Assoc., Inc.
ELECTRONIC SPECIALTY CO. .... 111 Hugh Dwight Ody., Inc.	SPRAGUE ELECTRIC CO., CAPACITOR DIV. 1 The Harry P. Bridge Co.
FAIRCHILD SEMICONDUCTOR ..... 6, 7 Chiat/Day Inc.	STANDARD ELECTRIC TIME CORP. .... 118 William Schaller Co., Inc.
FERROXCUBE CORP. .... 48 W. H. Schneider, Inc.	SYNTHANE-TAYLOR CORP. .... 129 Arndt, Preston, Chapin, Lamb & Keen, Inc.
GAF CORP. .... 103 Michel, Cather, Inc.	TEMPIL DIV. .... 120 Black Russell, Morris
GENERAL ATRONICS CORP. .... 80 Garceau, Hallahan & McCullough, Inc.	TEXAS INSTRUMENTS, INC., CHEMICAL MATERIALS DIV. .... 63 Winfield Adv. Agency, Inc.
GENERAL ELECTRIC, INDUSTRIAL SALES DIV. .... 38 Robert S. Cragin, Inc.	TEXAS INSTRUMENTS, INC., COMPONENTS GROUP ..... 20-21, 92 Albert Frank-Guenther Law, Inc.
GENERAL INSTRUMENT CORP. .... 75 Norman Allen Assoc., Inc.	TEXSCAN CORP. .... 107 Burton Browne Adv.
GULTON INDUSTRIES, SERVONIC ..... 127 Smith Kliffen Inc.	UNITRODE CORP. .... 12 The Siltan Co., Inc.
THE A. W. HAYDON CO. .... 128 J. B. Rundle, Inc.	VARFLEX SALES CO., INC. .... 129 Barlow/Johnson Inc.
HEATH CO. .... 32 Advance Adv. Service	VARIAN ASSOCIATES ELECTRON TUBE AND DEVICE GROUP ... 22 SOLID STATE MICROWAVE ..... 8 Botsford, Constantine & McCarty, Inc.
HEWLETT-PACKARD CO. COLORADO SPRINGS DIV. .... Inside Front Cover LOVELAND DIV. .... 11 Tallant/Yates Adv., Inc.	VARO, INC., SEMICONDUCTOR DIV. .... 124 Tracy-Locke Co., Inc.
HUGHES AIRCRAFT CO. AEROSPACE DIV. .... 122 ELECTRON DYNAMICS DIV. .... 96 Foote, Cone & Belding	VIKING INDUSTRIES, INC. .... 2 Jansson Adv.
ILLUMINATION INDUSTRIES, INC. .... 114 Gallott Adv.	WANLASS ELECTRIC, INDUSTRIAL/ DISTRIBUTOR PRODUCTS DIV. .... 128 William E. Wilson Co. Adv.
INDIANA GENERAL CORP. .... 126 The Griswold Eshleman Co.	WENTWORTH LABS., INC. .... 130 William Bridgaham Assoc.
INDUSTRIAL ELECTRONIC ENGINEERS, INC. 117 Van Der Boom, McCarron, Inc.	WESTON INSTRUMENTS, INC., ARCHBALD DIV. .... 113 Arndt, Preston, Chapin, Lamb & Keen, Inc.
IRC, INC., DIV. OF TRW INC. .... 84 Gray & Rogers, Inc.	ZELTEX, INC. .... 52 Helme Assoc., Inc.

## DISTRICT SALES MANAGERS

**EDWARD G. SHAUD**  
PHILADELPHIA 19139—56th &  
Chestnut Sts.  
(Area Code 215) SHERWOOD 8-2000

**JOSEPH DRUCKER**  
NEW YORK 10017—100 East 42nd St.  
(Area Code 212) OXFORD 7-3400

**JOHN UPHUES**  
**JOHN W. BERNHARDT**  
CHICAGO 60606—120 S. Riverside  
Plaza  
(Area Code 312) 782-1400

**G. T. ALFANO**  
NEEDHAM HEIGHTS, MASS. 02194—  
570 Hillside Ave.  
(Area Code 617) 444-0010

**TERRENCE D. BUCKLEY**  
**THOMAS R. BORIS**  
LOS ANGELES 90015—1543 W.  
Olympic Blvd.  
(Area Code 213) DUNKIRK 7-1271

**RALPH PETERSEN**  
SAN FRANCISCO—839 Mitten Rd.  
BURLINGAME 94010  
(Area Code 415) 697-8703

**LEONARD PREYSS**  
CLEVELAND 44114—601 Rockwell Ave.  
(Area Code 216) SUPERIOR 1-2860

**FRANK A. SMITH**  
HOLLYWOOD, FLA. 33020—  
2419 Hollywood Blvd.  
(Area Code 305) 927-7829

**NEWTON B. COLLINSON**  
ATLANTA 30309—1776 Peachtree St.  
N.W.  
(Area Code 404) 872-4723

**HAROLD E. MOTT**  
**WAYNE L. LOVING**  
DALLAS 75206—Meadows Bldg.  
Expressway at Milton  
(Area Code 214) EMERSON 3-6426

**JOHN F. WALLACE**  
HOUSTON 77027—West Loop Bldg.  
Rm. #209, 4848 Guiton  
(Area Code 713) 621-3428

**European Sales Offices**

**MAX F. HOLSINGER**  
LONDON, S.W. (1)—67/68 Jermyn St.  
St. James  
Tel: TRafalgar 6318/9

4 DUSSELDORF—RATH, Germany  
United International Industrial Press  
Eitelstrasse 32  
Tel: Dusseldorf 632031

**STEPHEN BROWN-JOUSSARD**  
PARIS 8e, France  
70 Rue de Ponthieu  
Tel: ELYsees 65-77

**Far East Sales Office**

**CLARENCE T. SAKAGUCHI**  
TOKYO, MARUNOUCHI, Japan  
C.P.O. Box #1572, Room 814  
Tel: 211-3506-3509  
Togin Bldg.

**BUSINESS STAFF**

**K. ROBERT BRINK**  
Publisher

**STEPHEN A. FARKAS**  
Marketing Services Manager

**BERNARD GITTELMAN**  
Directories Manager

**DENNIS J. PERKINS**  
Promotion Manager

**THOMAS A. MORIE**  
Eastern Advertising Manager

**PAT PIEHL**  
Advertising Production

**WILLIAM M. COFFEY**  
Circulation Director

**JAMES F. NAGY**  
Circulation Manager

**JOSEPH P. BABCOCK**  
Reader Service Manager

**JOHN H. KOFRON**  
Chilton Research Services

**C. R. WILHIDE**  
Washington Vice-President



# We make 95% of the most popular types of logic transistors, RF transistors, diodes and diode arrays.

## Nobody's perfect.

We've made a heap of hullabaloo lately about what we're doing in ICs. Don't infer from this we've forgotten discrete components. We're lavishing the same technological attention on them as on ICs.

**Take core drivers.** We're off-the-shelving 10 high voltage, high current or high speed NPN drivers, including the ever popular 2N3725. Soon we'll log a 1 amp version of our 2N3735 with 20 nanosecond storage time and six new PNP models. And you get them all in a panorama of packages: TO-5 or TO-46 cans, DIPs or flatpacks, all in dual or quad versions.

**And monolithic diode arrays.** We deliver 16-diode arrays in DIPs. Flatpacks are imminent. And expect a 64-diode package for your Christmas stocking.

Or RF transistors. Today our distributors stock a 1 Watt, 1 GHz 2N5108 transistor in a TO-39 package, and sell it for \$10.70 in 100 quantities. But right around the corner we have a tighter-leakage A version looming. And then a 10 Watt model. And by year's end a 1 GHz 20 Watt device.

To prove our discrete dedication we've just moved into a shiny new facility. With quick-response special products section and fully equipped applications lab. But it's that same old knowhow that keeps our more than 400 standard and high-rel transistors and 1800 diodes hustling out the back door. Because in discrete components, too, we're the company that gets the ideas and delivers the goods. Raytheon Semiconductor, Mountain View, California. (415) 968-9211.

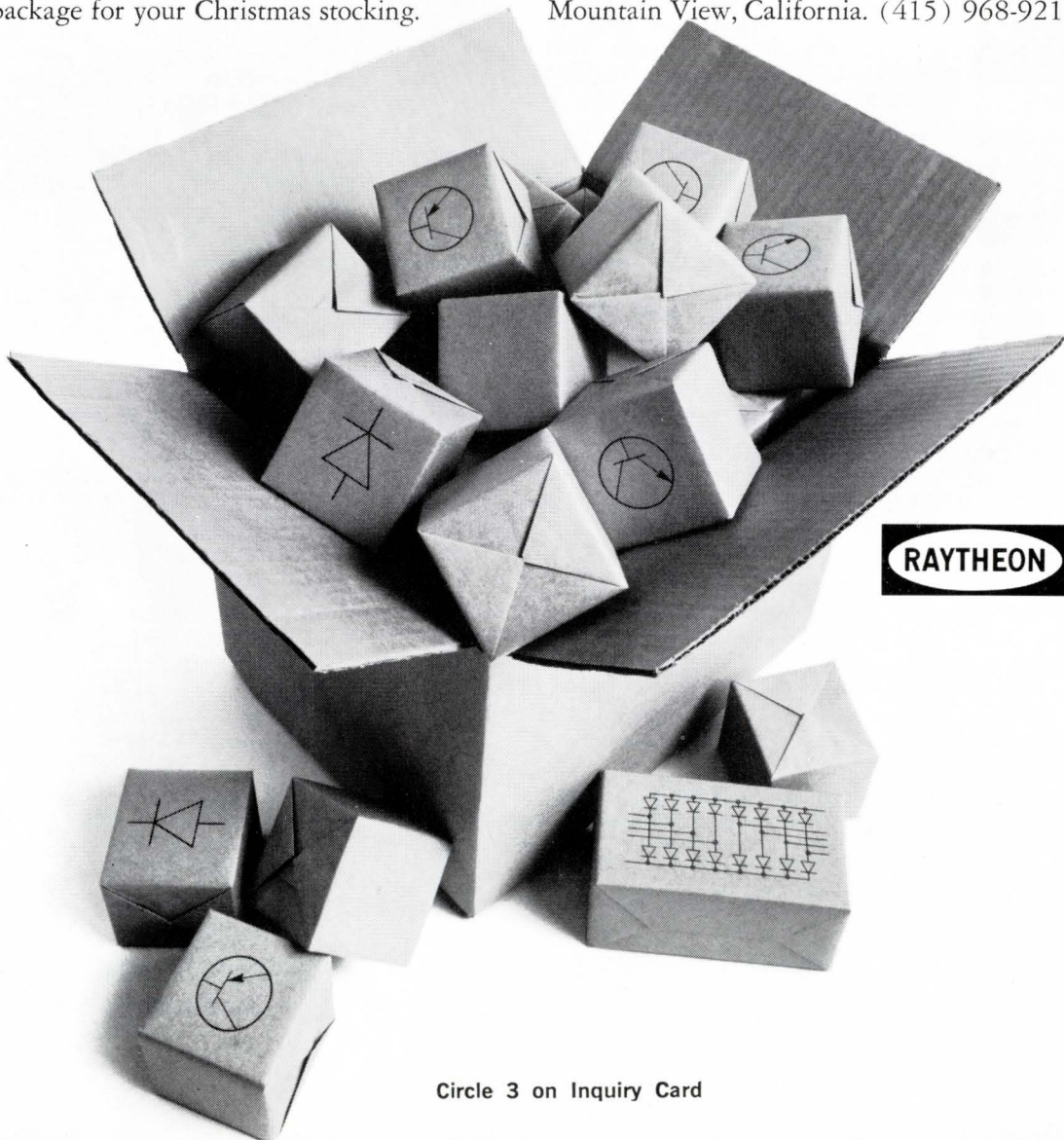

Circle 3 on Inquiry Card

# COS/MOS

**RCA's unique approach to digital design  
—at new low prices**

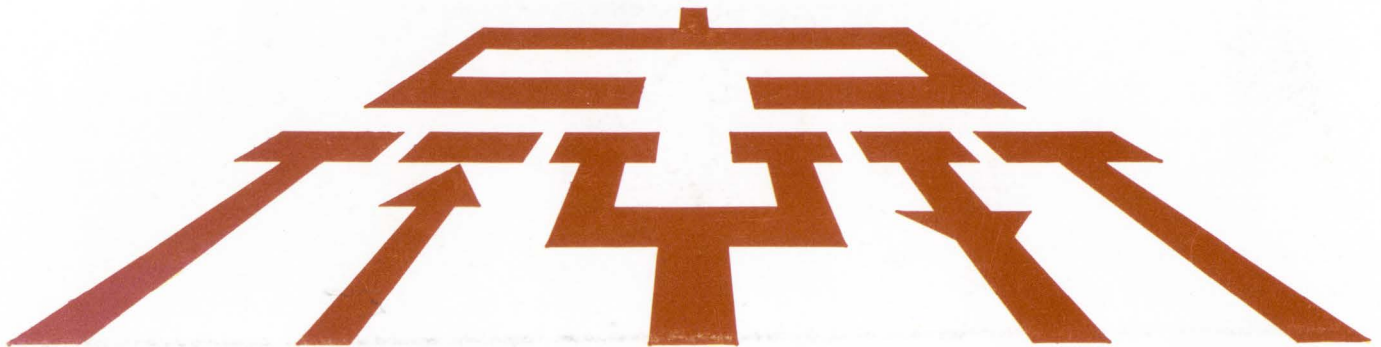

## For practical circuit designs...

High performance and new low prices combine to make COS/MOS—RCA's unique Complementary Symmetry MOS integrated circuits—an even greater value for a broader range of digital equipment designs. Now you can re-evaluate—and find even more advantages in—these COS/MOS features that no other logic circuitry has matched to date:

- Quiescent power dissipation in nanowatts
- Noise margin—4.5 volts
- Fanouts up to 50
- Single power supply required—6 to 15 V, positive or negative
- Logic level swing—"0" to power supply voltage
- Compatible gate level and MSI functions
- Frequency capabilities from DC to 5 MHz
- Single-phase clocking
- Full military operating temperature range—from  $-55^{\circ}\text{C}$  to  $+125^{\circ}\text{C}$
- Hermetic packages—DIC or ceramic flat pack

To get acquainted with COS/MOS, see your RCA Distributor for the COS/MOS Sampler QK2201, yours for only \$50.00 (optional distributor resale price).

## For new economy...

Effective now, new low prices—combined with unrivalled application advantages—put COS/MOS squarely in the picture for all your digital designs. Check the list of device numbers, descriptions and prices. Then ask your local RCA Representative or your RCA Distributor for details. For specific circuit data, write RCA Electronic Components, Commercial Engineering, Section ICJ-9 Harrison, N. J. 07029.

CD4000D	Dual 3-Input Gate and Inverter (DIC)	NOW \$ 4.00
CD4001D	Quad 2-Input Gate (DIC)	NOW \$ 4.75
CD4002D	Dual 4-Input Gate (DIC)	NOW \$ 4.50
CD4003D	Dual "D" Type Flip-Flop (DIC)	NOW \$ 8.00
CD4004T	7-Stage Counter-Divider (12-lead TO-5)	NOW \$10.00
CD4005D	16-Bit NDRO Memory (DIC)	NOW \$10.00
CD4006D	18-Stage Static Shift Register (DIC)	NOW \$17.25
CD4007D	Dual Complementary Transistor Pair and Inverter (DIC)	NOW \$ 3.00

(All prices at 1,000 unit level. These COS/MOS IC's also available in ceramic flat-pack at slightly-higher prices.)

Consider the systems advantages to be provided by these developmental types, soon to be added to the growing COS/MOS series. See your local RCA Representative.

	Dev. Type No.	Description
Buffers	TA5660	Hex Inverting Buffer
	TA5668	Hex Non-Inverting Buffer
MSI	TA5519	4-Bit Full Adder
	TA5578	8-Stage Synchronous Parallel-Input/Serial-Output Register
	TA5579	Dual 4-Stage Serial-Input/Parallel-Output Register
	TA5684	Decade Counter
	TA5971	5-Stage Binary/Decade Counter
	TA5580	Pre-settable Divide by "N" Counter

**RCA**  
Integrated  
Circuits