

A picture is worth a thousand points in a time interval measurement.

SR620 Output

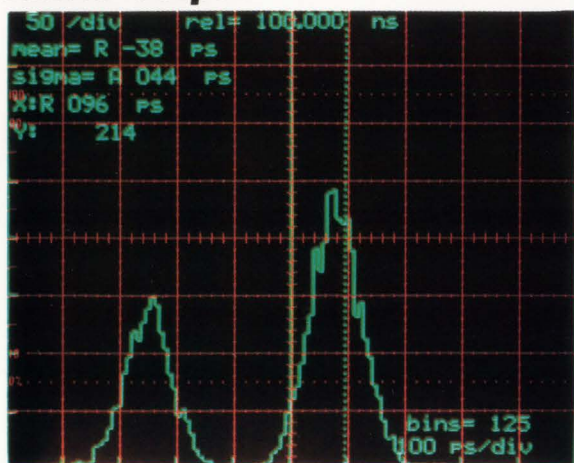

The SR620 brings graphic statistical analysis to time interval and frequency measurements. The SR620 shows you more than just the mean and standard deviation - multimode frequency distributions or systematic drift for example. Histograms or time variation plots are displayed on any X-Y oscilloscope, complete with Autoscale, Zoom, and Cursor functions. Hardcopy to plotters or printers is as easy as pushing a button.

HP5370B Output



Of course, the SR620 does everything else you'd expect from a high resolution universal counter, such as frequency, period, time interval, pulse width, rise / falltime, and phase measurements. The SR620 offers 25 ps single-shot time and 11 digit frequency resolution and complete statistical analysis, all for a fraction of the cost of comparable instruments.

For the whole picture, call SRS and ask about the SR620.



SR620

\$4500

- 4 ps single shot least significant digit
- 25 ps rms single shot resolution
- 1.3 GHz maximum frequency
- 10^{-9} Hz frequency resolution
- Sample size from 1 to 1 million
- Frequency, period, time interval, phase, pulse width, rise and fall time
- Statistics - mean, standard deviation, min max, and Allan variance
- Analyzer display on any X-Y oscilloscope
- Hardcopy to printer or plotter
- GPIB and RS232 interfaces
- Optional oven timebase



STANFORD RESEARCH SYSTEMS

Control Tower

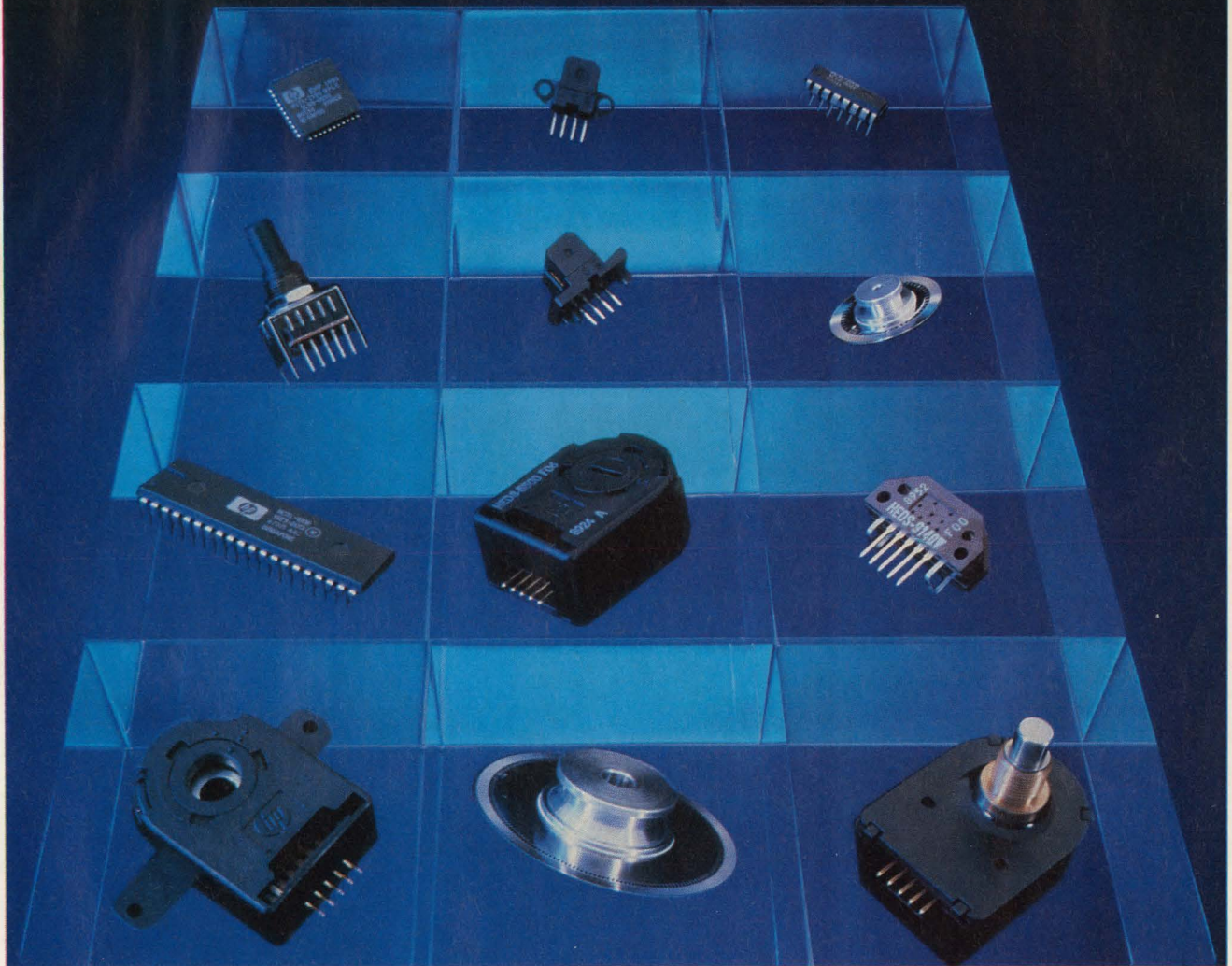

When it comes to motion control products, Hewlett-Packard towers over the rest with a more diversified and innovative line of solutions. Giving you one source to meet all your design needs.

Just look at our award-winning HEDS 9000 series of encoder modules. Using HP's unique optical technology, these modules are the ideal building blocks for creating precision high-speed linear or rotary applications.

Your choices include everything from a 3-channel module for industrial applications to the small footprint of our 9700 collection for business equipment.

Control panel: the HRPG series.

For front panel applications, turn to our RPG series of potentiometers. Offering you full configuration flexibility, improved rotational feel, and small footprint, HP delivers the perfect line of data entry devices for your test, medical, analytical, and computer equipment.

Controlled performance: the HCTL series.

Our new line of high-speed HCTL ICs give you high performance servo control in low-power CMOS. The result: superior performance and more microprocessing

power left over for your laboratory, medical, and industrial automation designs.

And because these motion control solutions come from HP, you're assured of our on-going commitment to excellence in service, support, and reliability.

So why take a chance, when you can take control. With motion control products from HP. Call for our free brochure: 1-800-752-0900, ext. 1497.

There is a better way.

 **HEWLETT
PACKARD**



CAN'T SEE THE FOREST FOR THE TREES? MOTOROLA CLEARS THE PATH TO 16-BIT PERFORMANCE.

With Motorola, your path to power is virtually a straight shot, thanks to the families of microcontrollers we've mapped out to take you from here to high performance. Without unnecessary changes in software and architectures along the way.

IF YOU'RE HEADED FOR HIGH PERFORMANCE, HERE'S WHERE TO START.

Motorola's new 68HC711K4 microcontroller is the latest development on our pathway to performance. It's twice as fast as any member of the original HC11 Family. With powerful new features like an enhanced 16-bit timer. And expanded memory, including 24K bytes of EPROM as well as on-chip EEPROM.

WHAT'S NEXT?

A NON-STOP TRIP TO 16-BIT.

Want even more power? Step right up to our soon-to-be-announced 16-bit portfolio. Fully



upward source compatible with our popular HC11 Family, our 16-bit pathway makes migration easier than ever before.

Today, the 68HC711K4. Tomorrow, an entire family of 16-bit.

And, in the months to come, a host of new Motorola microcontrollers that makes one thing very clear.

For well-planned migration to high performance, travel with the leader. Motorola.

To receive a Technical Product Preview for the 68HC711K4, plus all the news to come on our high performance migration path, please complete and return this coupon to:

Motorola, Inc.
Dept. OE39
P. O. Box 1466
Austin Texas 78767

ED9/13/90

Name _____
Company _____
Title _____
Address _____
City _____
State _____ Zip _____ Phone _____

THE PATHWAY TO PERFORMANCE.



MOTOROLA

ELECTRONIC DESIGN

Comlinear Corporation

CLC936

12-BIT 20MSPS

USA

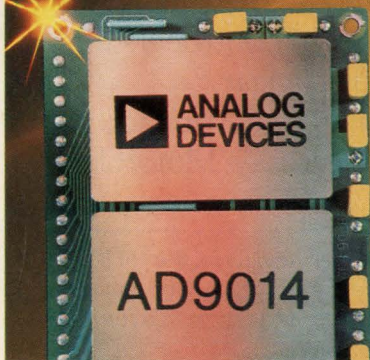
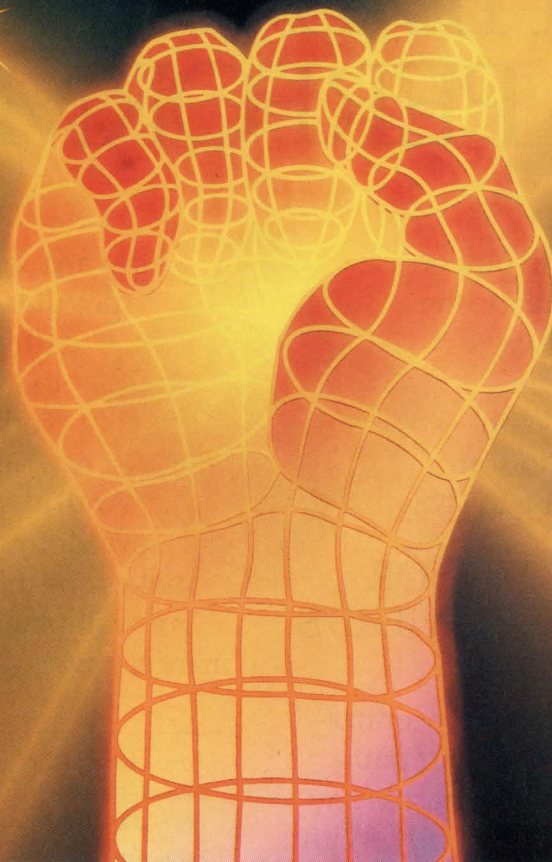
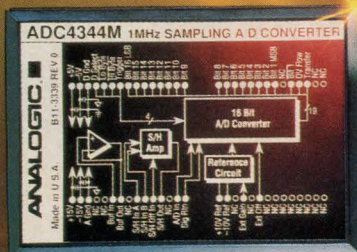

COVER FEATURE 37 FOUR HYBRID ADCS HIT NEW PERFORMANCE HIGHS

12-to-16-bit ADCs sample and quantize 16 bits at 0.5 or 1 MHz, 14 bits at 10 MHz, and 12 bits at 20 MHz.

ELECTRONIC DESIGN REPORT 47 12-BIT SAMPLING ADCS COME OF AGE

IC sampling 12-bit ADCs reach 1-MHz Nyquist and hybrids reach 20 MHz—all sport dynamic specifications.

DESIGN APPLICATIONS 61 PLD-BASED COPROCESSOR STABILIZES SERVO SYSTEM

Designers can offload a servo system's microprocessor by adding a coprocessor based on programmable logic devices.

71 ACCELERATE FPGA MACROS WITH ONE-HOT APPROACH

When designing state machines, a technique called one-hot encoding creates efficient circuits for top-performing FPGA macros.

PRODUCT INNOVATION 101 ENHANCED SCSI PROCESSOR PUSHES SYSTEM PERFORMANCE

Scripts chip adds multithreaded I/O, 80-Mbyte/s DMA transfers, and more for maximum system data throughput.

14 EDITORIAL

16 TECHNOLOGY BRIEFING

The promise of electronic imaging

23 TECHNOLOGY NEWSLETTER

- Optical system bridges 153 km without repeaters
- AMP, Siemens agree on DIN standards
- Vendors join to fight software bottleneck
- GaAs diodes cutoff at 2.5 THz
- Mosaic and Cypress share mil packaging
- High-performance CPUs appear at Hot Chips

29 TECHNOLOGY ADVANCES

- Rotating plastic disk produces real 3D images
- RISC technologies produce single-chip telephone IC
- Improved routing and process scaling boost FPGA gate count

81 QUICK LOOK

89 IDEAS FOR DESIGN

- Get pulse train from one pulse
- Quality preamp cuts cost and size
- Ground load with V/I converter



Certificate of Merit
Winner, 1988
Jesse H. Neal Editorial
Achievement Awards

Cover photo: Jook Leung

94 PEASE PORRIDGE

What's all this analog stuff, anyhow?

97 PRODUCTS NEWSLETTER

- Speedy FIFO memories come in by-9 widths
- Synthesized generator includes trigger source
- Energy IC cold-starts computer from keyboard
- Software measures antenna patterns
- Toolset simplifies motif interface design

NEW PRODUCTS

- 107 Computer-Aided Engineering**
An HDL raises the level of abstraction for programmable-logic design
- 113 Software**
- 117 Analog**
- 118 Power**
- 121 Computer Boards**
- 124 Instruments**
- 132 Digital ICs**
Embedded control version of 6800 packs DMA, serial I/O, and more

144 INDEX OF ADVERTISERS

147 READER SERVICE CARD

WHAT'S YOUR OPINION?

- How important are analog design skills for engineers in the future?
- How do the design skills of today's EE graduates stack up against those of young engineers of the past?

Send us your opinions on these questions on our Reader Opinions fax: (201) 393-0637. Or, mail your responses to ELECTRONIC DESIGN, Reader Opinions, 611 Route 46 West, Hasbrouck Heights, NJ 07604.

COMING NEXT ISSUE

- Special Report: Graphics ICs take on more functions
- Memory-system-design feature: Designing a secondary cache for the 80486 microprocessor
- Evaluate microprocessor system architectures with a hardware modeller
- First details on a new, minimum-count PC chip set
- Pease Porridge: What's All this Noise Stuff, Anyhow? (Part 1)
- A new image-processing chip set offers expanded options
- PLUS:
Special Section: PIPS
Power, interconnections, passive components, switches and relays—latest products and complete manufacturers listings
Design feature: Use power bypassing and bussing for high-performance circuits

ELECTRONIC DESIGN (USPS 172-080; ISSN 0013-4872) is published semi monthly by Penton Publishing Inc., 1100 Superior Ave., Cleveland, OH 44114. Paid rates for a one year subscription are as follows: \$75 U.S., \$140 Canada, \$230 International. Second-class postage paid at Cleveland, OH, and additional mailing offices. Editorial and advertising addresses: ELECTRONIC DESIGN, 611 Route #46 West, Hasbrouck Heights, NJ 07604. Telephone (201) 393-6060. Facsimile (201) 393-0204.

Printed in U.S.A. Title registered in U.S. Patent Office. Copyright © 1990 by Penton Publishing Inc. All rights reserved. The contents of this publication may not be reproduced in whole or in part without the consent of the copyright owner.

Permission is granted to users registered with the Copyright Clearance Center Inc. (CCC) to photocopy any article, with the exception of those for which separate copyright ownership is indicated on the first page of the article, provided that a base fee of \$1 per copy of the article plus \$.50 per page is paid directly to the CCC, 27 Congress St., Salem, MA 01970 (Code No. 0013-4872/90 \$1.00 + .50). Copying done for other than personal or internal reference use without the express permission of Penton Publishing, Inc. is prohibited. Requests for special permission or bulk orders should be addressed to the editor.

For subscriber change of address and subscription inquiries, call (216) 696-7000.

POSTMASTER: Please send change of address to ELECTRONIC DESIGN, Penton Publishing Inc., 1100 Superior Ave., Cleveland, OH 44114.

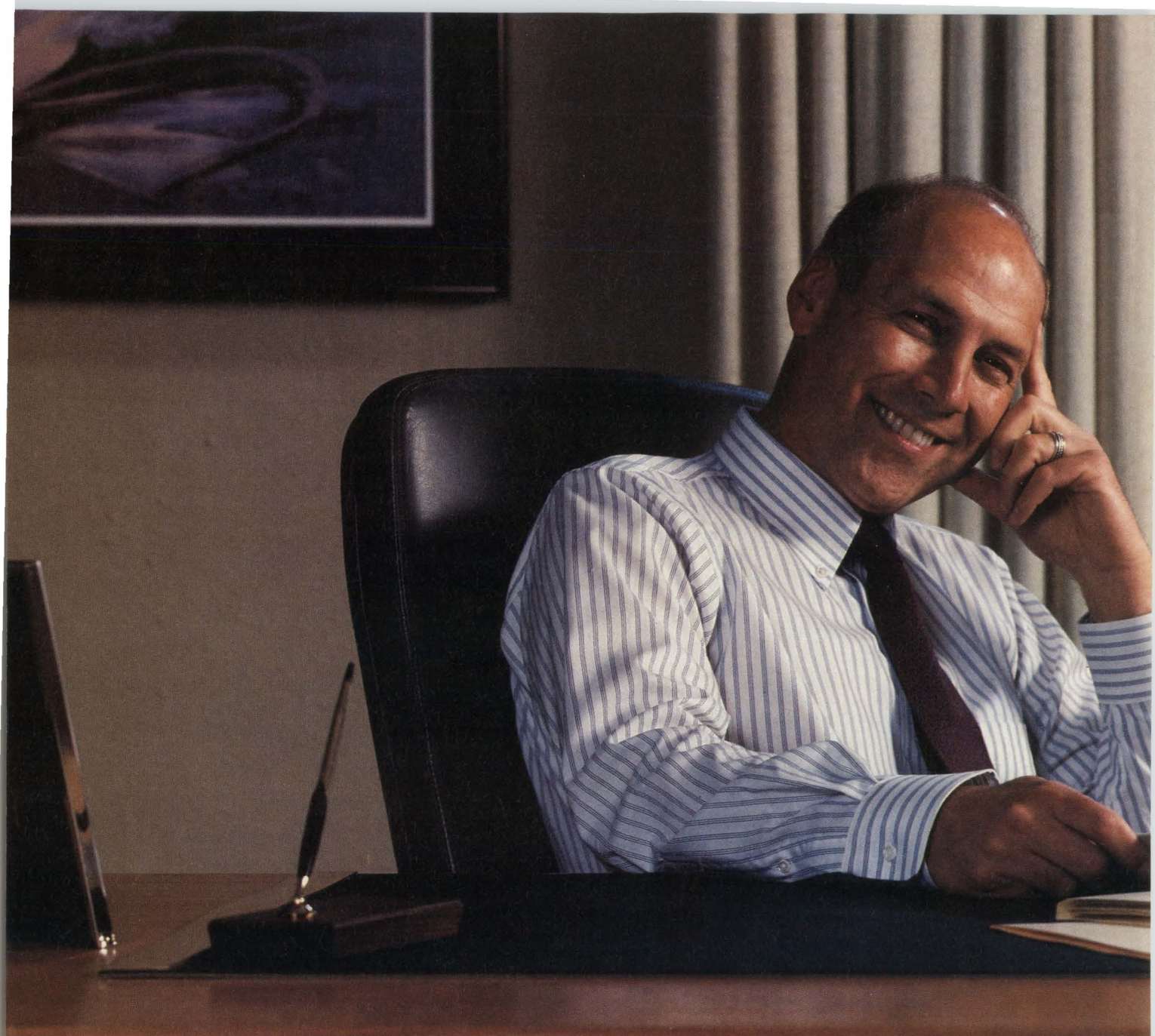

THIS MAN MANAGES MULTIPLE DESIGN DISCIPLINE DEADLINES THAT COULD KILL

The dilemma rears its ugly head time and time again. Do the impossible. By tomorrow. Worse yet, do it with an intimidating hodge-podge of design automation tools and data formats. And while you're at it, make sure all these tools and data play together freely and efficiently. No problem. Right?

To avoid this kind of chaos, you need to consider a fundamental change in your engineering strategy. Which is why we now offer you our Concurrent Design Environment.™

Simply put, the Concurrent Design Environment allows tools from virtually any source to work together.

Within it, our new Falcon Framework™ lets you assemble precisely the design automation environment your situation requires — without sacrificing the considerable benefits of integration. And our OpenDoor™ program ensures that your choice of tools includes the best the entire industry has to offer.



ES 125 ENGINEERS, ES, DISPARATE TOOLS AND L. SO WHY IS HE SMILING?

The Concurrent Design Environment also includes engineering management tools of unprecedented scope and power. Like our Decision Support System, which automatically monitors any aspect of the design process you care to specify. So you spot and correct little problems long before they grow into big ones.

No matter how tight your deadlines, no matter how large your engineering teams, our Concurrent Design Environment will keep you ahead of the game. Which, after all, is a very nice place to be. For a free videotape, call **1-800-547-7390**.

 **Mentor
Graphics**[®]
Changing The Way The World Designs. Together.

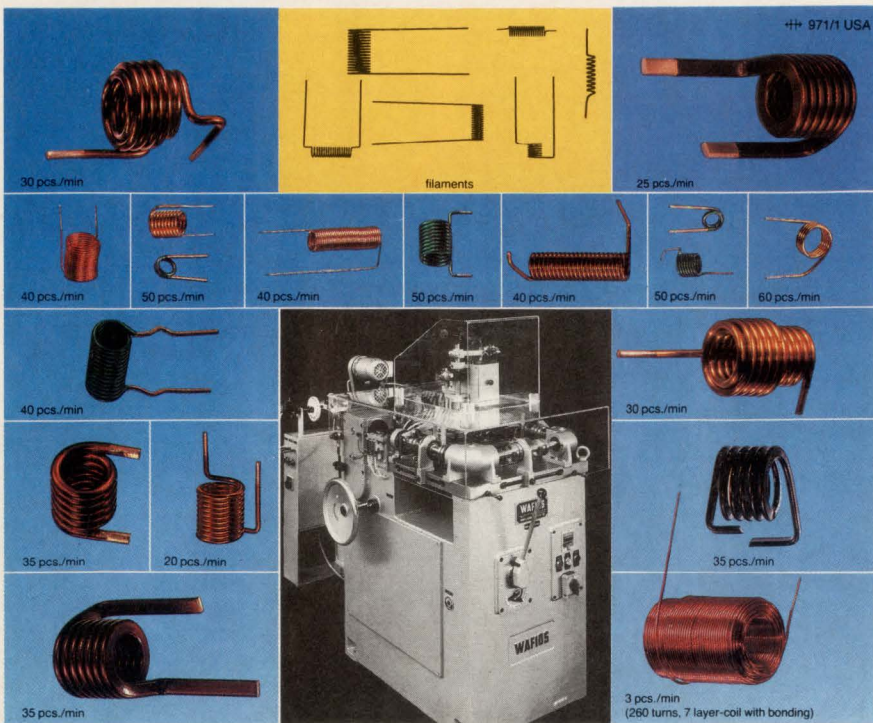

**For manufacture of single- and multi-layer coils and chokes:
WAFIOS Series FTU-97: Ø 0.3–3.5 mm (.012"–.138")**

Insulation stripping at the ends of the legs. Automatic bonding or soldering.



WAFIOS

Also with CNC-Control!
Any number of coils!
Precise positioning
through Adaptive Control.

MACHINERY CORPORATION · P.O.B. 148, BRANFORD, CT 06405 · TEL. 203/481-5555 · FAX 203/481-9854

CIRCLE 82

Analog Designers...

COMTRAN® Is Now On The 386™

Automatic optimization adjusts selected component values of your topology to make its response fit your arbitrary target curves in magnitude, phase, Z_{in} , Z_{out} , or any combination. Multiple passes allow standard value capacitors in precision filters or other networks.

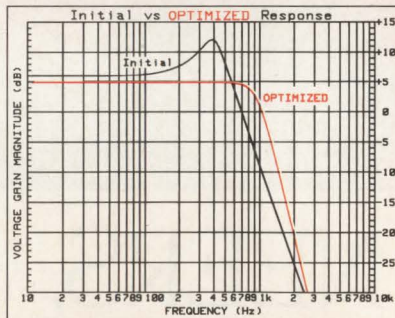
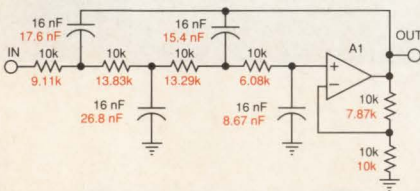

Actual Plotted Output of COMTRAN (Reduced Size)

- COMTRAN® is fast. Each plot here was generated on screen in 6 seconds. Optimization took less than 3 minutes using a 25 MHz 386/387 (or an HP 310).
- COMTRAN® is an interactive, intuitive AC circuit analysis program that handles component entry, editing, analysis, optimization, and user scaled Linear/Log graphics in one program.
- COMTRAN®'s tolerance mode graphically shows the effect of real world components. Impedance mode plots impedance at ANY node in your circuit.

- COMTRAN® can create, capture and analyze time domain data, then use it to stimulate your circuit and plot the result in either time or frequency domain.
- COMTRAN® has over 10 years of field experience on HP computers. Now it runs on 386™ machines, too. And it still drives HPGL plotters.
- COMTRAN® is modular—buy only what you need today. Ready-to-use packages start at under \$1000.

COMTRAN® Integrated Software

A Division of Jensen Transformers, Inc.
10735 BURBANK BOULEVARD, N. HOLLYWOOD, CA 91601
FAX (818) 763-4574 PHONE (213) 876-0059

COMTRAN is a registered trademark of Jensen Transformers, Inc. 386 is a trademark of Intel Corporation.

CIRCLE 95

ELECTRONIC DESIGN

Editor-in-Chief: Stephen E. Scrupski

Executive Editor: Roger Allan

Managing Editor: Bob Milne

Senior Editors: Frank Goodenough,
Milt Leonard, John Novellino

Technology Editors:

Analog & Power: Frank Goodenough

Communications & Industrial:

Milt Leonard (San Jose)

Components & Packaging: David Maliniak

Computer-Aided Engineering: Lisa Gunn

Computer Systems: Richard Nass

Semiconductors: Dave Bursky (San Jose)

Test & Measurement: John Novellino

News Editor: Sherrie Van Tyle

New Products Editor: Susan Nordyk

Field Bureaus:

West Coast Executive Editor:

Dave Bursky (San Jose)

Boston: Lawrence Curran

Dallas: Jon Campbell

Frankfurt: John Gosch

London: Peter Fletcher

Chief Copy Editor: Roger Engelke, Jr.

Editorial Production Manager:

Lisa Iarkowski

Associate Art Director: Alice Topf

Administrative Assistant: Janis Kunkel

Editorial Support Supervisor: Mary James

Editorial Assistant: Ann Kunzweiler

Editorial Secretary: Bradie Guerrero

Editorial Offices: (201) 393-6272

Advertising Production:

(201) 393-6093 or FAX (201) 393-0410

Production Manager: Michael McCabe

Production Assistants:

Donna Marie Bright, Doris Carter,

Eileen Slavinsky

Circulation Manager: Elaine Brown

Subscription Inquiries:

Mary Lou Allerton (216) 696-7000

Promotion Manager: Clifford Meth

Reprints: Helen Ryan (201) 423-3600

Group Art Director: Peter K. Jeziorski

Computer Systems Administrator:

Anne Gilio Turtoro

Published by Penton Publishing

Vice President-Editorial: Perry Pascarella

Group Editorial Director: Leland Teschler

Publisher: Paul C. Mazzacano

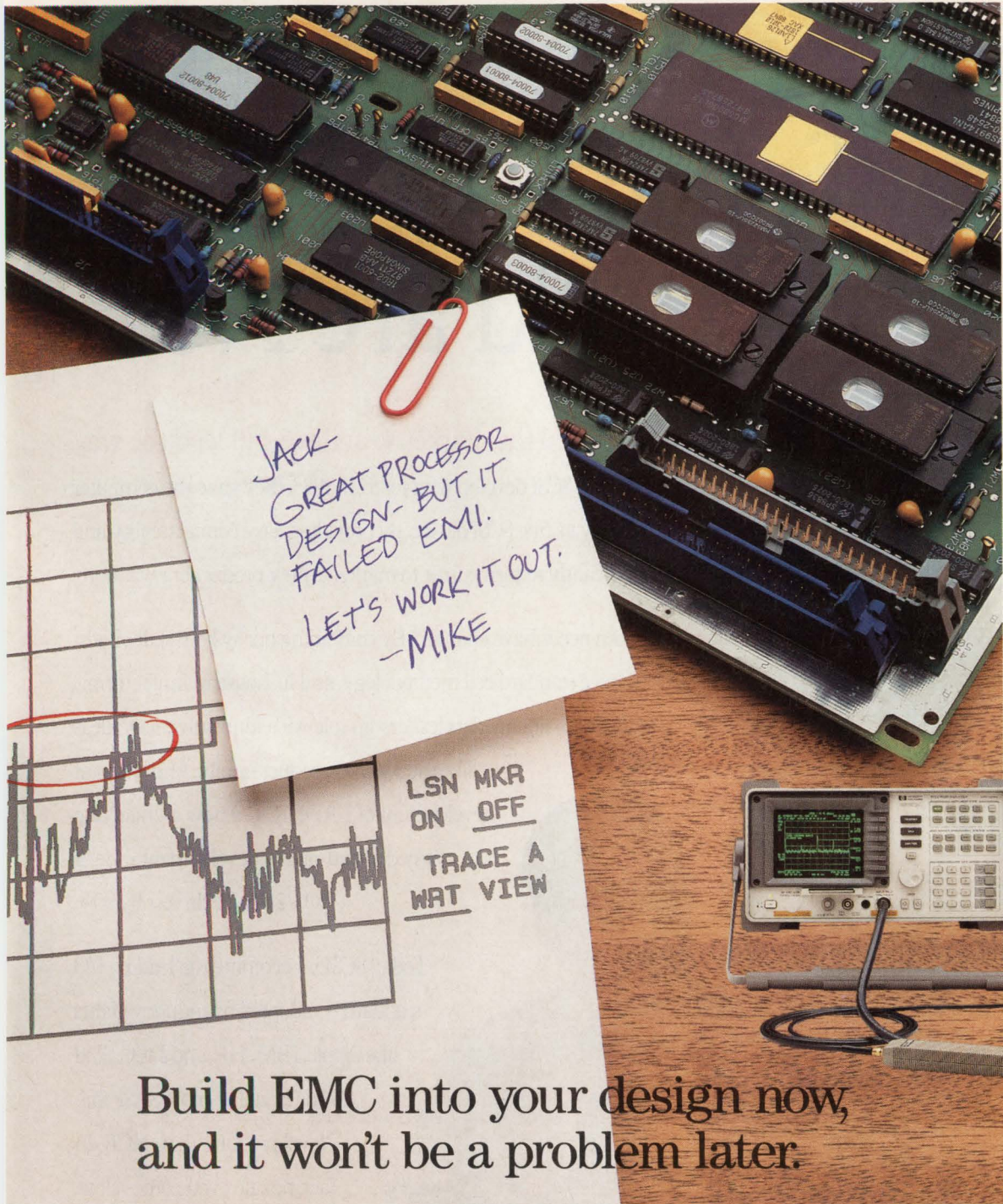

JACK-
GREAT PROCESSOR
DESIGN- BUT IT
FAILED EMI.
LET'S WORK IT OUT.
-MIKE

LSN MKR
ON OFF
TRACE A
WRT VIEW

Build EMC into your design now, and it won't be a problem later.

With all the new regulations surrounding electromagnetic compatibility (EMC), the best way to avoid costly delays is to locate problems as early as possible. Two new HP EMC solutions make that easy.

The HP 84100A Design Development Solution helps you correct problem areas at the design stage. It pinpoints hot spots on breadboards and prototypes

using a spectrum analyzer with software memory cards that simplify troubleshooting.

The HP 84110A Pre-Production Solution gives you added confidence that your designs will pass compliance. It has all the analysis capability, software and accessories you need to uncover conducted and radiated emission problems before final EMI testing. So, find out how to build EMC

into your designs. For information about HP's full line of EMC solutions and design training programs, call 1-800-752-0900. Ask for Ext. 1351, and we'll send you our EMC Measurement Solutions fact kit.

There is a better way.



Here's one reason that over half of all SCSI devices sold are NCR.

We created the market... and we still lead the way.

Meet NCR's SCSI development team. In 1983, they gave the computer industry its first SCSI device. By providing easy connectability and significantly reducing time to market, a new product era was born.

Since then needs have changed. By combining our system skills, high-performance standard cell methodology, and in-house manufacturing,

NCR has maintained its leadership role with innovative new ideas

like the 53C700 product family. And the joint development of LADDR — a new architecture aimed at cutting the development time of OS/2 device drivers by 90%.

Today SCSI is becoming the leading I/O standard — adopted by industry giants like Apple, IBM, HP, and DEC. And no one is selling more SCSI chip level products than NCR. In fact, no one even comes close.

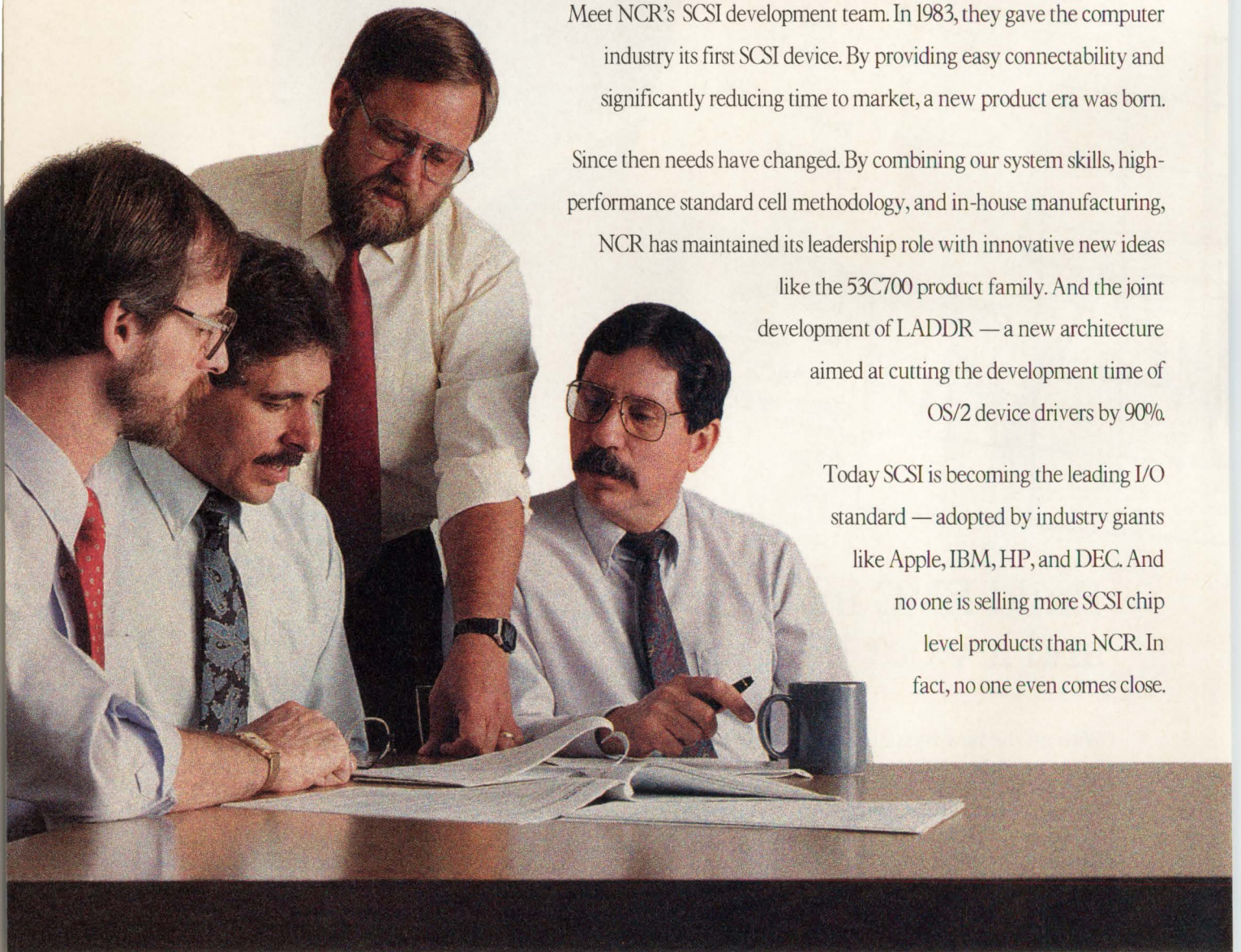

Part of the NCR SCSI Development Team: (left to right)
Jerry Armstrong, Sr. Software Engineer; **Harry Mason**, Strategic Marketing Manager; **John Lohmeyer**, NCR Sr. Consulting Engineer and Chairman of the ANSI X3T9.2 Committee and **Dave Skinner**, SCSI Product Manager.



Worldwide Sales Headquarters
3130 De La Cruz Boulevard, Suite 209
Santa Clara, California 95054
1-800-334-5454

New Product
Announcement!

Here's another.

The NCR 53C700 SCSI I/O Processor...
So good, *Electronic Design* named it the
product of the year.

"You can't tell a good SCSI chip just by looking at it..." and according to *Electronic Design*, NCR's 53C700 is the best there is.

The only third generation SCSI device on the market today, it concentrates all the functions of an intelligent SCSI adapter board on a single, smart and extremely fast, chip... for about 15% of the cost.

As the first SCSI I/O processor on a chip, the 53C700 allows your CPU to work at maximum speed while initiating I/O operations up to thousands of times faster than any non-intelligent host adapter. DMA controllers can burst data at speeds of up to 50 Mbytes/s. This new chip cuts down system time hookup to a fraction of what it has been.

Those are just a few of the reasons *Electronic Design's* "Best of the Digital IC's" award went to NCR's 53C700 last year.

And now the NCR 53C710!

For the complete story on the NCR SCSI product line featuring the new 53C710, as well as the upcoming SCSI seminars with the NCR SCSI Development Team, please call:

1-800-334-5454



NCR

Creating value

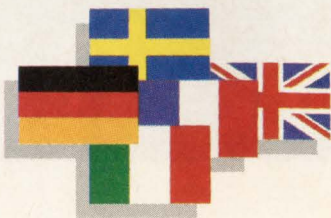

European Sales Headquarters
Gustav-Heinemann-Ring 133
8000 Munchen 83
West Germany
49 89 632202

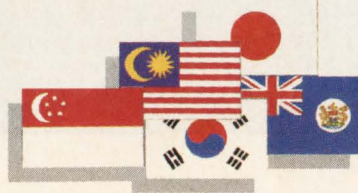

CIRCLE 143

Asia/Pacific Sales Headquarters
2501 Viewood Plaza
199 Des Voeux Road
Central Hong Kong
852 859 6044

2 8 6 DESIGNER'S TOOLKIT

AT MOTHERBOARD
CORE LOGIC CHIP SET
40MB IDE DRIVE
ORCAD SCHEMATIC DISKETTES
AND DESIGNER'S MANUAL
WD USER'S MANUALS
AND MORE

 WESTERN DIGITAL

Would you rather have what's in Box Number One or Box Number Two?

The Western Digital Designer Kit gives you everything you need to start and complete your next design. All in one handy box.

A box that lets you avoid a lot of headaches and hassles. Such as all the begging, pleading, and conniving necessary to get the parts that are necessary.

The designer kit gives you a Western Digital 286 Motherboard, the WD286-LPM16. You also get a 4-chip FE3600 AT Core Logic Set. The WD16C452 Serial/Parallel Controller.

The WD37C65 Floppy Disk Controller. The WDPVGA1A VGA Controller. The WD93044-A 40Mb IDE Drive. 512K RAM. All the cables you'll need for the drive and the keyboard. An expansion slot riser card. LPM Utilities Diskettes. ORCAD Schematic Diskettes and Designer's Manual. Complete data sheets for all the Western Digital chips. And a Western Digital User's Manual.

The entire Western Digital Designer Kit costs just \$999. Obviously, rounding up all the parts by yourself would take far more money. And far more time.

All you need to supply is a little brain power. And before you know it, your next great idea will be off the drawing board and into production.

The Western Digital Designer Kit is available for a limited time. And in limited quantities. So call your favorite Western Digital distributor now.

And let's make a deal.

Almac Electronics at 206-643-9992.
Anthem Electronics at 408-453-1200.
Hall-Mark Electronics at 214-553-2171.

Pioneer-Standard Electronics at 800-874-6633.
Pioneer Technologies Group at 800-227-1693.
Wyle EMG at 408-727-2500.

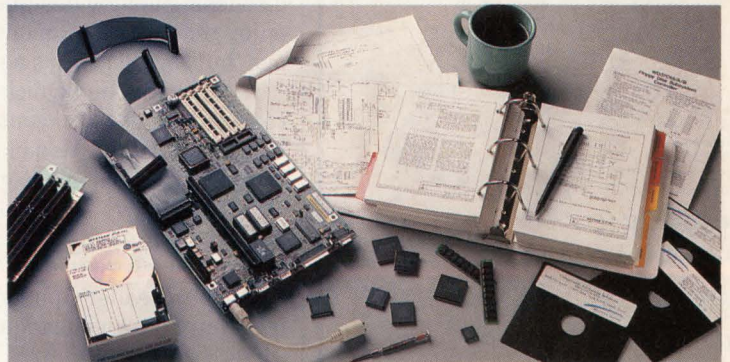

Matched sets, unmatched performance.

 WESTERN DIGITAL

CIRCLE 152

LCD Proto Kit

Everything you need to start your LCD application create complex screens in just a few hours!



Kit also includes:



\$495 - Kit
Popular LCD Starter Kit.

(MC) (VISA) (AMEX)
(\$595 pre-assembled & tested)

*The CY325 40-pin CMOS LCD Controller IC is available from stock @ \$75/singles, \$20/1000s (Surface mount also avail in qty.)
CyberneticMicroSystems
Box 3000 • San Gregorio CA 94074
Tel: 415-726-3000 • Fax: 415-726-3003

EDITORIAL

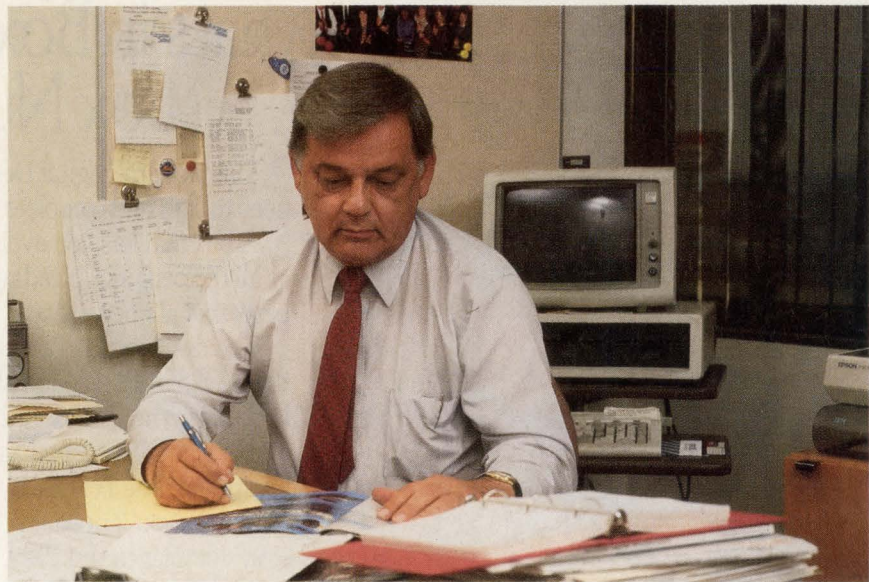

ANALOG TAKES THE SPOTLIGHT

Designing in the analog technology world comes with its share of problems, but it also has many opportunities for innovation. In this issue, these topics are brought to the forefront. To start, there's the Special Report (page 47) by Analog Technology Editor Frank Goodenough, which covers the latest developments in fast, 12-bit sampling analog-to-digital converters. This field has blossomed in the past few years, with many new devices brought on by market demand, new semiconductor processes, and by the creativity of analog designers. Frank also penned the cover article (page 37), which introduces four new high-precision a-d converters from four different companies, all of which exploit the performance advantages of hybrid technology.

Next, we have the kickoff of a new column on analog: "Pease Porridge." This column, on page 94, is written by Bob Pease, Staff Scientist at National Semiconductor and an acknowledged expert in analog circuitry. By reading this first installment, you'll see that Bob addresses the challenges of designing analog systems in his own distinctive way. We're giving Bob a lot of freedom in this column because we believe he knows whereof he speaks when discussing analog designers' problems, and because, frankly, we think you'll enjoy reading his opinions. Sometimes they'll be outlandish and even humorous, but they'll always be insightful and thought-provoking.

In our expanded QuickLook section (page 81), we continue to publish our readers' opinions on contemporary topics affecting engineers and the electronics industry. We'd like to hear your thoughts on analog: How important do you think analog design skills will be in the future? (Our question doesn't suggest that we feel analog will be less important in the future—we simply want to hear what you think.) Send us your opinions on this question, and if possible, back them up with some examples.

Use our Reader Opinion fax number, 201-393-0637, or send your opinions to us at our editorial headquarters, 611 Route 46 West, Hasbrouck Heights, NJ 07604.

Stephen E. Scrupski
Editor-in-Chief

CIRCLE 80

rugged plug-in amplifiers

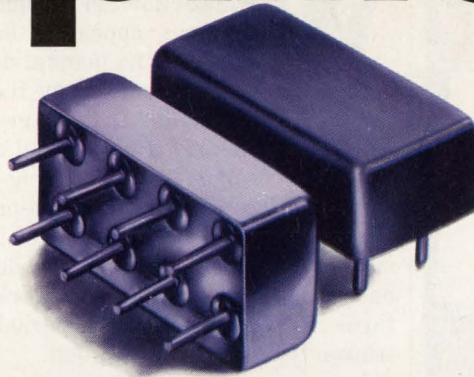

0.5 to 1000 MHz from \$13⁹⁵ (10 to 24 qty)

Tough enough to meet full MIL-specs, capable of operating over a wide -55° to $+100^{\circ}\text{C}$ temperature range, in a rugged package... that's Mini-Circuits' new MAN-amplifier series. The MAN-amplifier's tiny package (only 0.4 by 0.8 by 0.25 in.) requires about the same pc board area as a TO-8 and can take tougher punishment with leads that won't break off. Models are unconditionally stable and available covering frequency ranges 0.5 to 1000MHz, NF as low as 2.8dB, and power output as high as +15dBm. Prices start at only \$13.95, including screening, thermal shock -55°C to $+100^{\circ}\text{C}$, fine and gross leak, and burn-in for 96 hours at 100°C under normal operating voltage and current.

Internally the MAN amplifiers consist of two stages, including coupling capacitors. A designer's delight, with all components self-contained. Just connect to a dc supply voltage and you are ready to go.

The new MAN-amplifiers series...
another Mini-Circuits' price/performance breakthrough.

MODEL	FREQ. RANGE (MHz)	GAIN dB		MAX. OUT/PWR†	NF	DC PWR	PRICE
	f_L to f_U	min	flatness††	dBm	dB (typ)	12V, mA	\$ ea. (10-24)
MAN-1	0.5-500	28	1.0	8	4.5	60	13.95
MAN-2	0.5-1000	19	1.5	7	6.0	85	15.95
MAN-1LN	0.5-500	28	1.0	8	2.8	60	15.95
◇MAN-1HLN	10-500	10	0.8	15	3.7	70	15.95
*MAN-1AD	5.500	16	0.5	6	7.2	85	24.95

††Midband $10f_L$ to $f_U/2$, $\pm 0.5\text{dB}$ †dB Gain Compression ◇Case Height 0.3 In.
Max input power (no damage) +15dBm; VSWR in/out 1.8:1 max.

*Active Directivity (difference between reverse and forward gain) 30 dB typ.

finding new ways ...
setting higher standards

Mini-Circuits

A Division of Scientific Components Corporation
P.O. Box 350166, Brooklyn, New York 11235-0003 (718) 934-4500
Fax (718) 332-4661 Domestic and International Telexes: 6852844 or 620156

hey!
if you know
SUSIE

Digital Logic Simulator
for 286/386/486

FPGAs
PLDs
MPUs
Memories

like we know
SUSIE

- Real time interactive
- Displays:
Timing violations
Bus conflicts
Race conditions
- On-the-fly changes to:
Test vectors
Propagation delays
Interconnections
HEX files
- Compatible with all
CAD software
- The best package for
price/performance

you'll wonder how
you ever got
along without her!

Call for a free demo disk
(805) 499-6867

ALDEC
Newbury Park, CA Fax: (805) 498-7945

CIRCLE 101

THE PROMISE OF ELECTRONIC IMAGING

When streamlining paper-intensive business transactions, electronic-imaging technology becomes appealing because it eliminates much of the manual document-handling. A recent study commissioned by the American Bankers Association concluded that image processing is highly beneficial for both transactional applications, such as check processing, and for storing business records, including correspondence and loan-processing documents. The study, conducted by Chicago-based Andersen Consulting Co., also found that reducing manual paper-based tasks and a simplified workflow translates to a three- to five-year payback period for an image-based transaction-processing system.

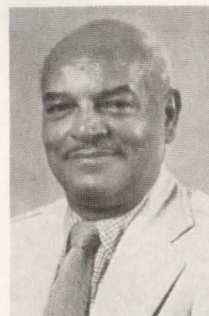

MILT LEONARD
SENIOR EDITOR

Image processing replaces paper by electronically scanning a document's text and graphics onto a magnetic or optical storage medium for subsequent access and display. According to the Association for Information and Image Management (AIIM), the biggest users are the health-care industry, government, manufacturing companies, and financial services. In each of these industries, documents must often be shared by multiple users across the organization. Ongoing advances in image-compression technology promise to benefit the engineering community as well.

Emerging image-compression chips can apply data-reduction algorithms that strip out redundant information in digitized text, engineering drawings, photos, and even moving video pictures—in black-and-white or color. This operation reduces the digital equivalent of a document by several orders of magnitude, slashing the amount of memory needed for data storage. Equally important, image compression minimizes the bandwidth required to transmit the data over ordinary telephone lines to remote sites where the document or drawing is reconstructed to its original form.

Employing this technology, new communication tools being developed will link widely dispersed design offices and manufacturing facilities for paperless sharing of information in real time. At a fraction of the cost, new silicon solutions for image processing offer the same functionality that once required multiple printed-circuit boards populated with expensive custom ICs and DSP chips. These developments will lower the cost of sophisticated communication tools, such as color facsimile machines, video telephones, and teleconferencing systems, to the point where they'll become commonplace.

Image-processing technology, however, isn't for everyone. "At this time, electronic imaging is usually not the best candidate for replacing microfilm- or microfiche-based systems with low retrieval rates when you're only trying to store information," says Sam Altiero, a partner in Andersen Consulting's office in metropolitan New York. Even when the technology appears viable for solving an organization's workflow problems, potential users may be frightened off by a number of barriers that stand in the way of a successful application.

First and foremost is high start-up cost for hardware and software. Andersen Consulting uses a three-step approach that evaluates a client's existing data-processing and document-handling infrastructure, and then examines image-processing options for meeting the client's business requirements within economic and technical constraints. Finally, the firm demonstrates the technology's viability by integrating a prototype image-processing system into the client's infrastructure. The prototype consists of imaging and data-processing software running on workstations that emulate the various hardware elements of the system. "Depending upon the business requirement, the cost of converting a document into an electronic image typically ranges between \$0.05 and \$0.35 per page," notes Altiero.

SMC. Above the rest.



Climbing takes skill, experience and teamwork. Reaching the top also takes leadership, forward thinking and focus. Since 1971, Standard Microsystems has applied this philosophy to the design and manufacture of standard and semi-custom integrated circuits.

Today, SMC's engineering expertise and extensive SuperCell™ library, allows us to offer innovative and timely solutions to your unique application needs. Our portfolio focuses on networking and mass storage controller devices for the computer industry.

The next time you face a networking or mass storage challenge, call SMC. Discover how our cost-effective and technically superior products can help you climb ahead of your competition.

**STANDARD MICROSYSTEMS
CORPORATION**
COMPONENT
PRODUCTS DIVISION

The Standard for LAN and Mass Storage ICs.

35 Marcus Blvd., Hauppauge, NY 11788 (516) 273-3100 Fax (516) 231-6004

SuperCell is a trademark of Standard Microsystems Corporation.

CIRCLE 171

We've got all the answers for your answer

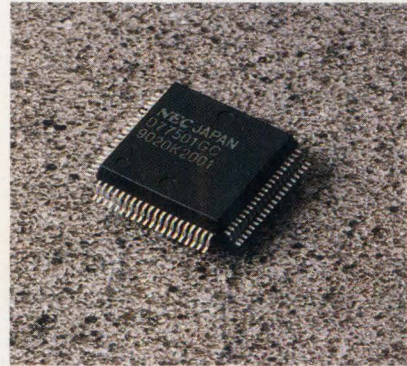

For fast answers, call us at:

USA Tel:1-800-632-3531. TWX:910-379-6985. W. Germany Tel:0211-650302. Telex:8589960. The Netherlands Tel:040-445-845.
Telex:51923. Sweden Tel:08-753-6020. Telex:13839. France Tel:1-3946-9617. Telex:699499. Italy Tel:02-6709108. Telex:315355.
UK Tel:0908-691133. Telex:826791. Hong Kong Tel:755-9008. Telex:54561. Taiwan Tel:02-719-2377. Telex:22372.
Korea Tel:02-551-0450. Fax:02-551-0451. Singapore Tel:4819881. Telex:39726. Australia Tel:03-267-6355. Telex:38343.

Sophisticated speech LSI boosts performance of current and future models.

phone.

Whether you're designing a cassette-based answer phone for today's market, or planning a solid-state model for the future, our new multi-function speech LSI is the answer to your needs.

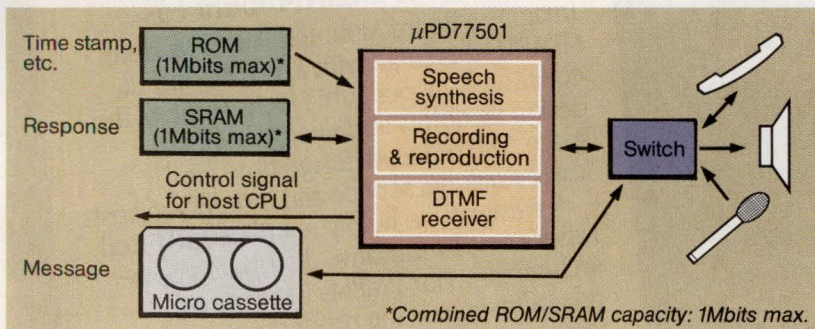

Streamline IC/tape circuits.

The μ PD77501 lets you drastically simplify IC/tape circuitry. It offers a speech synthesizer for ROM-stored words, an ADPCM encoder/decoder for voice recording and reproduction, and a DTMF receiver for remote control—all on a single chip. The μ PD77501 also gives you superior voice quality with ADPCM

coding and on-chip over-sampling AD/DA converters for recording and reproduction.

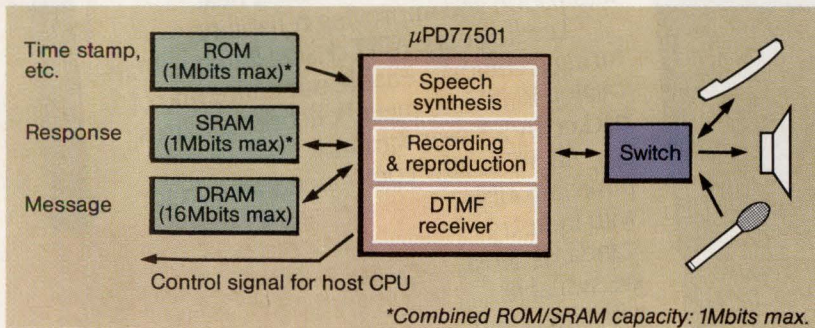

Nine times more message capacity for solid-state models.

The 77501 is the high-performance answer for solid-state systems. A competing chip lets you record 7 variable-length messages. The 77501 lets you record 64 messages of any length. That's a ninefold improvement in message capacity.

For systems featuring random access to messages and instant reproduction, only the 77501 can control three memory blocks—ROM for time stamps and other fixed words, SRAM for responses, and 16Mbits of DRAM for up to 23 minutes of recording at 12kbps. Higher bit rates are also selectable: 18 and 24kbps.

For designers of answer phones, the message is clear. Call NEC, ask about our new speech LSI, and you'll hear all the right answers.

AT&T is

packing it in.

Packing 5 full watts of reliable power into a space-saving 1.1 x 2 x .46" board-mount case.

Imagine a Board Mounted Power Module (BMPM) this small with a full 5W output, equaling 4.9W per cubic inch. Think of the design flexibility and savings in board space. The reduced design time. The lower stocking, service and installation costs.

Designed to help you utilize AT&T Bell Laboratories' innovative distributed power architecture, our BMPMs incorporate reliability-enhancing product and system features. They operate at an efficiency rate surpassing 80% with ambient temperature tolerances up to 85°C, reducing heat dissipation and improving reliability.

Leading edge AT&T design and manufacturing techniques enable our entire line of catalog BMPMs to meet Bellcore standards, backed by a 3-year warranty.

All 5W to 20W components are pin-for-pin compatible with industry standards. Most are available with single and multi-output voltages and international input ranges.

Cut power down to size with AT&T BMPMs. Call for our catalog of 5W to 150W modules: **1 800 372-2447, ext. 591.**

The
components
of success.



AT&T

The right choice.

OPTICAL SYSTEM BRIDGES 153 KM SANS REPEATERS

Engineers at W. Germany's Philips Kommunikations Industrie AG (PKI) successfully sent 2.5 Gbits/s on a monomode optical fiber over a distance of 153 km, or about 95 miles, without repeaters along the line. The transmission system was tested under real operating conditions. The Nuremberg-based company, an affiliate of Philips N.V. of the Netherlands, thus established a new record. Until now, the greatest repeater-less distance for an optical transmission system was around 100 km, or roughly 62 miles. Most responsible for the feat is a new laser developed at the Philips Research Laboratories in Eindhoven, the Netherlands. Putting out 2 mW of power, the laser operates in the third optical window at 1550 nm. The 2.5-Gbit/s rate corresponds to 30,720 digital speech channels of 64 kbits/s each. The optical components that PKI is testing, including transmitters and receivers, are part of a synchronous multiplexing and line-transmission system slated for trials by Australia's communications authorities. JG

AMP, SIEMENS AGREE ON DIN STANDARDS

In accordance with the International Electrotechnical Commission's (IEC) decision, metric designs will soon supplant the traditional inch-based technology for connectors. Modular Order 917 and the applicable DIN standards are the groundwork for this changeover. As a result, Siemens AG, Munich, Germany, is working with AMP Inc., Harrisburg, Pa., to develop a new generation of connectors that mix both 2- and 2.5-mm standard sizes. The first prototypes will be shown at November's Electronica show in Munich. In the future, connector users will be able to choose between the two system-compatible sizes, or mix the grid sizes in uniformly standardized metric equipment. DM

VENDORS JOIN TO FIGHT SOFTWARE BOTTLENECK

A CAE company and silicon manufacturer are collaborating to battle software development, which is often a critical bottleneck in embedded-processor designs. Mentor Graphics Corp., Beaverton, Ore., and Intel Corp., Chandler, Ariz., will work together toward a full-system-simulation environment that includes simulating software running on the target hardware. The relationship will link Mentor's hardware-design and CASE tools with Intel's 80C186 embedded-processor core to develop standard or custom parts. Intel will contribute its library of fully functional VHDL models for the 80C186 core and its peripherals. To create code for their chip, engineers use Mentor's Code-Link Station software debug and test tool suite. Mentor's Express I/O tool will then model the target hardware and build test fixtures for quick software verification. With this environment, the actual software acts as the stimulus for the hardware simulation. Call Mentor at (503) 645-1551. LG

GAAS DIODES CUTOFF AT 2.5 THZ

A family of GaAs Schottky diodes with a cutoff frequency of 2.5 terahertz (THz), or 2.5 million MHz, was developed by Telefunken Electronic GmbH, Germany. This high frequency suits the diodes for use in mixers operating at up to 100 GHz. Low input capacitances (typically between 6 and 34 fF) and small series resistances (from 3 to 13 Ω) create the high cutoff frequency. To produce the submicron structures needed on the GaAs wafer, Heilbronn-based Telefunken uses direct-write electron-beam lithography. So far, the firm has developed six different single and five double diodes in an antiparallel circuit configuration. The diodes will come as chips that can be soldered into the circuit, or contacted with a conductive paste for low series inductance. The development follows the company's work on GaAs mixers in superhigh-frequency (SHF) and extremely-high-frequency (EHF) receiver circuits operating at 35 GHz. JG

MOSAIC AND CYPRESS SHARE MIL PACKAGING

Designers of rugged industrial and military digital systems now have more options for squeezing very dense memories into tight spots. A licensing agreement between Mosaic Semiconductor, San Diego, Calif., and Cypress Semiconductor, San Jose, Calif., enables both companies to use Mosaic's proprietary vertical-in-line (VIL) packages. Under the agreement, Cypress' Multichip Technology subsidiary will produce high-density memory products using Mosaic's rugged, space-saving package. Multichip currently offers static-RAM (SRAM) modules in capacities up to 4 Mbits in various DIP, SIP, and ZIP packages. Mosaic now offers VIL-packaged 256-kbit and 1-Mbit SRAMs, 1- and 4-Mbit dynamic RAMs, and 256-kbit-by-4 video RAMs. DM

HIGH-PERFORMANCE CPUs APPEAR AT HOT CHIPS

At the second "Hot Chips" Symposium recently held at Santa Clara University, designers saw the future architectural direction of some popular CPUs, as well as math and image processor chips. Intel Corp., Santa Clara, Calif., for instance, divulged details of three processors—its next high-performance member of the 960 family, a long-instruction-word processor that's part of its iWarp project, and a two-chip set for digital-video interactive systems.

The forthcoming 960xx family member will include dual 2-kbyte caches (one for data, one for instructions) as well as a 64-entry translation-lookaside buffer and an on-chip MMU. High-speed math operations are possible thanks to 3-clock floating-point multiplication, addition, or subtraction, and 14-clock division. The CPU will have two buses—a 64-bit-wide memory bus that runs at 50 MHz, and a 32-bit I/O bus that runs at 25 MHz, giving the chip an aggregate I/O capability of 264 Mbytes/s. Intel's iWarp processor employs a 96-bit instruction word. It can simultaneously perform single-precision floating-point calculations at 20 MFLOPS, while running 20 MIPS in its integer processor and performing as many as three 20-Mword/s transfers. The processor was designed for a systolic environment and has four bidirectional communication ports for nearest-neighbor interconnections.

For digital-video subsystems, Intel reviewed its i750 chip set for digital video interface (DVI), the 82750DA display processor, and the 82750PA pixel processor. The chip set can create full-screen 30-frame/s motion video, perform real-time image capture and compression, display high-resolution still images, and perform graphics and animation. Furthermore, the company released details of its "B" level upgrade, which runs at twice the clock speed of the DA and PA and offers double the on-chip memory and I/O bandwidth. Moreover, the DB upgrade packs the triple color-palette memory and video digital-to-analog converters.

Working in GaAs technology to implement a Sun Sparc-compatible multichip module, designers at Systems and Processes Engineering Corp., Austin, Texas, described their attempt to build a Sparc CPU module with cache that runs at 200 MHz and delivers a peak throughput of 200 MIPS. The chip set will consist of an integer unit, a floating-point coprocessor, twin cache-and-memory-management units, and dual 16-kbyte caches. Expecting CMOS to deliver about the same throughput as GaAs, Metaflow Technologies Inc., San Diego, Calif., is working with LSI Logic Inc., Milpitas, Calif., and Hyundai Electronics, Seoul, Korea, to create a superscalar version of the Sparc. The performance target is 100 MIPS (average) for a chip set running at 50 MHz, with a peak speed of 200 MIPS. The superscalar approach issues four instructions per clock (up to three integer or floating-point instructions and one branch). Therefore, four of the six functional units can be kept busy. The chips will also permit data-flow-based out-of-order instruction execution with in-order completion, as well as speculative execution beyond unresolved branch instructions.

The forthcoming C4 chip set from Intergraph Inc.'s Advanced Products Div., Palo Alto, Calif., combines superscalar and superpipelined architectural approaches. Although code-compatible with its previous Clipper family chip sets, the C4 chip set splits the floating-point unit off as one of the two chips; previous families included that functionality on the CPU. Most instructions execute in one clock cycle. Because multiple instructions (floating-point and integer, for example) can be issued simultaneously, the processor will have an efficient clocks-per-instruction ratio of less than 1. When running at 50 MHz, the C4 can achieve a throughput of 21 to 33 MFLOPS (scalar or vector, respectively) with an integer throughput of about 50 MIPS.

For high-speed floating-point computations, Weitek Corp., Sunnyvale, Calif., unveiled a 120-MFLOPS (double-precision) CMOS floating-point processor. It's expected to be released in 1991. To achieve that performance level in CMOS, the company's designers will incorporate a large (32-word-by-64 bit, or 64-by-32) 8-port register file on the chip and a unique dual adder section in the ALU that reduces computation time by close to 50%. The multiplier section has a 2-cycle latency, but can deliver a 32- or 64-bit floating-point or integer result every cycle.

LSI Logic Corp. has focused on image processors for such applications as video compression, image compression, video telephones, and others. As a result of this effort, the company described a multichip set that puts the toughest parts of the algorithms onto four chips. The chips perform motion estimation, discrete cosine transform processing, quantization, and BCH encoding and decoding. To interconnect processors in an array, researchers from The California Institute of Technology, Pasadena, described a mesh-routing chip that has five input and five output channels, with each channel providing 11 signal lines. The chip was originally designed as part of the Defense Advanced Research Projects Agency (Darpa)-sponsored Touchstone project, for which Intel applied its iWarp processor. DB

High-Speed Amplifiers

WB05

CURRENT
BUFFER

- ▶ 10,000 V/ μ s Slew Rate
- ▶ 1 Amp Output (1.5 A Pulse)
- ▶ ± 5 to ± 15 Supply
- ▶ 70 MHz Full Power Bandwidth
- ▶ Up To 15 Watts Dissipation

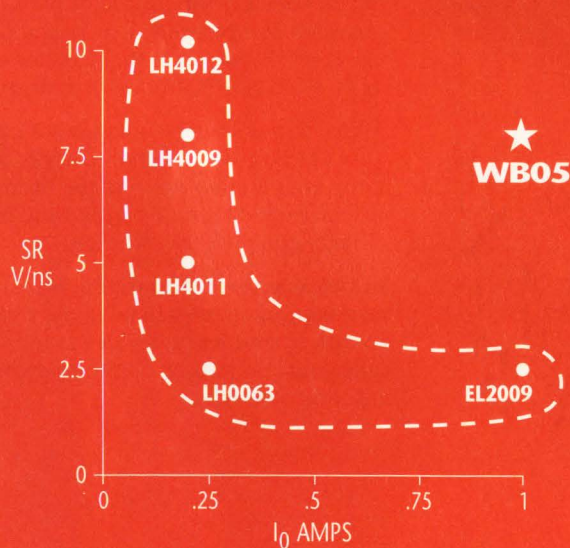

WA01

TRANSIMPEDANCE
AMPLIFIER

- ▶ 4,000 V/ μ s Slew Rate
- ▶ 400 mA Output
- ▶ ± 12 to ± 15 Supply
- ▶ 40 MHz Full Power Bandwidth
- ▶ Up To 10 Watts Dissipation

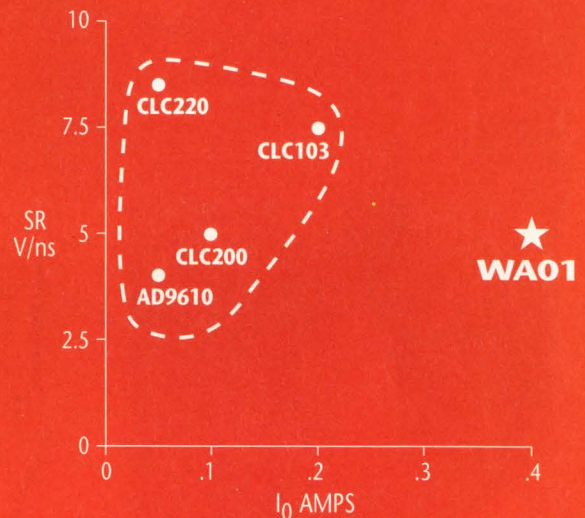

APPLICATIONS

LASER DIODE DRIVERS
SONAR TRANSDUCER DRIVERS
PIN DRIVER

LASER DIODE DRIVERS
VIDEO AMPLIFIERS
WAVEFORM GENERATORS

To Place An Order Call
602-742-8601

For Applications
Assistance Call
1-800-421-1865

APEX
μtech

DEDICATED TO EXCELLENCE

APEX
MICROTECHNOLOGY
CORPORATION



To receive
your copy of our
High Performance
Amplifier Handbook
please call toll free
1-800-448-1025



Signetics. Because into making

WITH OUR FULL FAMILY

To design successful new systems, you need an IC vendor who understands your ever-changing needs. A partner who can match the right device to your application.

That's exactly what you get from Philips Components-Signetics.

As the design world changes, Signetics changes. We're listening to your needs. And designing and enhancing our devices to meet those needs.

Like the growing need for personal communication devices and for ICs in desktop and portable computing. As well as devices for computer networking with compatibility across platforms. And for ICs that meet the need for robotics and automation in manufacturing.

We're also drawing from nearly a century of Philips innovation to apply our consumer technologies to the business world. Including digital video and high-density compact disc storage.

In fact, wherever your design needs take you, Signetics will be there with complete families of devices to meet emerging computing, communications and control needs.

© 1990 NAPC

Philips Components

you've put so much it perfect.

OF ICs, YOU GET OUT OF IT WHAT YOU PUT INTO IT.

COMPUTING		COMMUNICATIONS		CONTROL	
APPLICATION	PRODUCT	APPLICATION	PRODUCT	APPLICATION	PRODUCT
Workstations	<ul style="list-style-type: none"> ● Advanced BiCMOS Logic ● High Speed ASICs ● Futurebus Chip Set ● High Speed PAL[®]-type Devices ● High Performance MCUs ● SRAMs 	Cellular Communications	<ul style="list-style-type: none"> ● Cellular Chip Set ● Frequency Synthesizers 	Automotive Control Systems	<ul style="list-style-type: none"> ● 8-bit 80C51-based MCUs ● OTP EPROMs ● Linear/Digital/Mixed Mode ASICs
Personal Computers	<ul style="list-style-type: none"> ● High Density ASICs/PLDs ● DRAM Controllers ● OTP EPROMs ● FLASH Memory 	Mobile Telephony	<ul style="list-style-type: none"> ● Paging ICs ● Frequency Synthesizers 	Consumer Appliances and Entertainment	<ul style="list-style-type: none"> ● A/D MCUs ● LCD Displays ● Audio Circuitry ● Dolby Noise Reduction ● Frequency Synthesizers
Desk Top Video	<ul style="list-style-type: none"> ● A/D Converters ● Digital Color Decoders 	FAX/Modems/Features Phones	<ul style="list-style-type: none"> ● 8-bit 80C51-based MCUs ● E²PROM ● LCD Drivers ● Dialers ● Speech Circuits ● RF Chip Set 	Industrial Control & Robotics	<ul style="list-style-type: none"> ● Advanced BiCMOS Logic ● UV/OTP EPROM MCUs ● Real-Time Bus Communications Controller
Peripheral Products	<ul style="list-style-type: none"> ● 8-bit 80C51-based MCUs ● Zero Power PLDs ● Programmable Sequencers ● 3-State ECL Transceivers 	DataComm LANs	<ul style="list-style-type: none"> ● Ethernet Chip Set ● 100-Mbit Fiber ● High Speed PLDs ● Advanced BiCMOS Logic 	Portable Instrumentation	<ul style="list-style-type: none"> ● Low Voltage/Power MCUs ● Advanced CMOS Logic ● LCD Drivers
		Multi-Protocol	<ul style="list-style-type: none"> ● Dual Universal Serial Controller ● UARTs and DUARTs 		

As illustrated above, we're listening to customer needs and developing products in three focused areas: computing, communications and control.

This includes products based on our advanced BiCMOS technology, QUBiC. Developed from our strength in bipolar technology and fully integrated with our sub-micron CMOS technology, QUBiC gives you nearly twice the speed of previous-generation bipolar ICs. With CMOS power savings. We're incorporating QUBiC into all our product families, creating a new class of high-performance devices.

Philips Components-Signetics is committed to the military market, with over 80% of our ICs meeting MIL-SPEC certification. This commitment is evident in our Class S domestic assembly plant and DESC-certified wafer fabs.

To learn how Philips Components-Signetics helps you make the perfect design, call today for more information: 800-227-1817, ext. 711C.

PAL is a trademark of AMD/MMI

Signetics

EXTENDING THE DIMENSIONS OF PERFORMANCE



PHILIPS

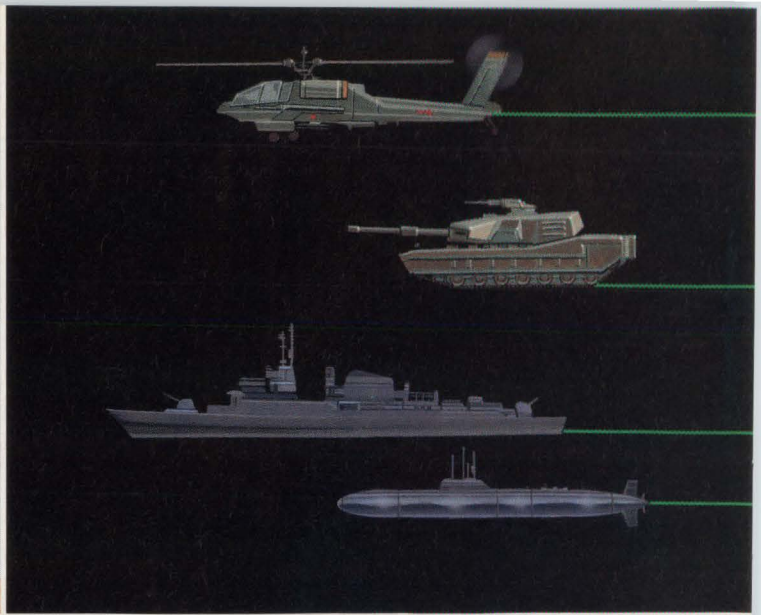

The programmable display system:

Design applications for land, sea or air.

Vivisun Series 2000, now the leading programmable display pushbutton system, interfaces the operator with the host computer. The user-friendly LED dot-matrix displays can display any graphics or alpha-numerics and are available in green, red or amber. They can efficiently guide the operator through any complex sequence with no errors and no wasted time.

They also simplify operator training as well as control panel design. One Vivisun Series 2000

programmable display system can do the work of 50 or more dedicated switches. In short, Vivisun Series 2000 gives the design engineer more control over the design.

Contact us today.



AEROSPACE OPTICS INC.

3201 Sandy Lane, Fort Worth, Texas 76112
(817) 451-1141 • Telex 75-8461 • Fax (817) 654-3405

*Vivisun Series 2000
programmable displays. The intelligent
communications system.*

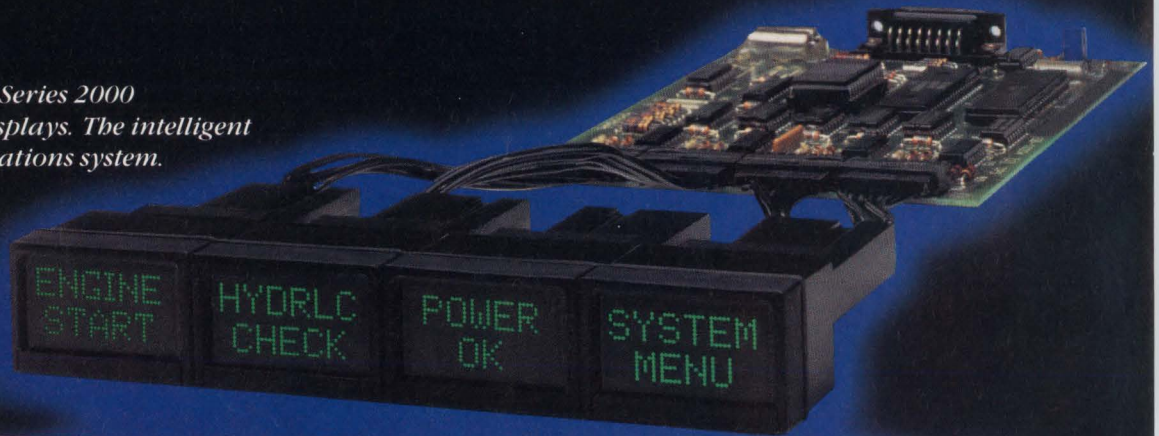

SERIES

VIVISUN 2000™

ROTATING DISK PRODUCES REAL 3D IMAGES

A unique prototype laser-display system can create true spatial 3D images viewable from any angle. According to Texas Instruments, Dallas, the new display technology overcomes many limitations inherent in other 3D display approaches, such as holographic, stereo-pair, and mirror-based multiplanar displays.

Unlike other techniques, the TI OmniView system presents a real, rather than a virtual, image within a dome-shaped display volume. As a result, the visual perspective of the displayed image changes with the viewing angle, just as it would with an actual object. Any number of individuals can watch the display simultaneously without special glasses, masks, or other viewing aids. The display can be viewed from any angle—even if walking around it in a 360-degree circle. The projected object remains stationary during movement of the viewer.

The 3D images are produced with a clear rotating plastic disk. The disk is set at an angle atop a motor shaft and rotated to create a display volume inside the dome-shaped bubble. In operation, the image appears as a double helix, occupying height, width, and depth. The size and shape of the disk can be varied to provide the best display volume for a specific application, ranging from tall and narrow to short and wide.

In TI's prototype system, which displays images created and stored on a Sun workstation, an extremely low-power laser

modulated 10,000 times per second shines points of light on the display disk rotating at 600 rpm. The beam scans the disk in two dimensions; synchronization of the laser and the spinning disk create the image in the third dimension. The viewer's eyes fuse the discrete points of light

painted on the disk into a 3D volume.

The current laser-scanning system design has a resolution of approximately 750-by-750 picture elements or pixels; multiple scanning systems can be used to increase resolution or support extremely large displays. Red, green, and

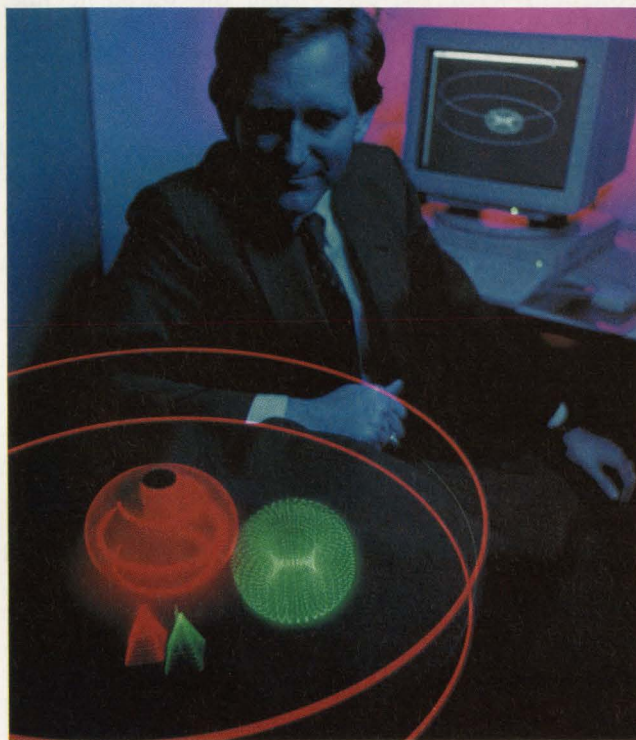

blue lasers can be mixed to produce a full-color display

According to the company, the OmniView display technology particularly suits applications in which real 3D objects must be viewed in a volume. One application in this category is air traffic control. Such a system could show several controllers the positions of aircraft relative to one another, and ground-based reference points, such as airports, mountains, and tall buildings. Color coding could identify protected airspace and provide an index relating to different altitude levels.

Other potential applications cited by the company involve the modeling of real-world objects. Such examples include medical imaging, molecular modeling, weather-pattern analysis, and remote positioning and control of objects.

Texas Instruments is seeking partners to develop applications for the system. It will also grant licenses to those companies interested in producing the display for selected markets.

JON CAMPBELL

RISC TECHNIQUES PRODUCE SINGLE-CHIP TELEPHONE IC

Incorporating a bit-oriented reduced instruction set (Boris) and an on-chip read-only memory, a microcontroller chip contains all of the active circuitry needed to make a mid-range, single-chip telephone configurable to most countries' standards. Developed at Mietec Alcatel, Brussels, Belgium, the controller uses what communications product manager Ron Spooner calls a

"data-movement engine," under the control of a ROM-based sequencer, to control all keypad operations, produce dialing tones or pulses, and perform hookflash and reperitory dialing. "Its architecture has a specially developed counter structure for addressing ROM," says Spooner. "This allows program jumps and loops to be implemented without using wide-ROM or multiple

word instructions as normally used in controllers of this type."

It has just 22 instructions in its vocabulary—all of which can be conditionally executed—as defined by internal and external flag bits. Similar to most telecommunications applications, timing is critical, even to operate a "simple" telephone. "The application requires the generation of accurately timed events, such as hookflash, pulse dialing, and so on," Spooner notes. "The exact

timing can vary depending on specifications set by the local telephone authority."

In Europe, for example, there are nearly 20 national PTTs (government-operated postal, telephone, and telegraph networks) each with its own slight variations on the specifications that a telephone must meet in order to be approved for connection to the public switched telephone network. These variations are handled with a selectable clock as well as a hardware loop-counter structure, while the mask-programmable ROM gives flexibility in setting and controlling options and operation sequences.

The chip—the MTC-20294 micro-MIP (maximum-integration phone)—was originally designed to meet the requirements of the French Centre National des Etudes pour Telecommunications (CNET), but Spooner says that it can be adapted easily to meet the specifications required by most PTTs and telephone administrations. It will sell for \$2.50 in high quantities. Initially, standard parts will be made for use in France, but Spooner says that versions for the United Kingdom, Italian, and Spanish markets will be launched before the year's end. Meanwhile, Mietec is preparing to customize the device for potential North American and other international telephone makers.

The device has three 24-digit repertory memories, each of which can be activated by one keystroke. Dialing from memory and manual dialing can be connected in any order, provided that the maximum capacity of 24 digits isn't ex-

ceeded. Operating a last-number redial function follows a "sliding cursor" algorithm, which is intended to speed automatic dialing when intermediate pauses for PBX access or international dialing are required. Other features include on-hook dialing, and speech and tone processing.

The chip can be set up to conform with various hookflash, dialing, and pulse-period parameters through a matrix of diodes

associated with a 20-key dial pad. Available options include dual-tone multifrequency (DTMF) or pulse dialing, regulated or unregulated speech gain, regulated or unregulated DTMF gain, 0 ms or 270 ms hookflash time, and a pulse mark-space ratio of either 3:2 or 2:1.

The chip requires between 3 V and 7 V, derived from the telephone line, and consumes about 60 mA in the active mode. However, when the phone is on-

hook, all circuits except the repertory and last number redial memories are disconnected. In that condition, the chip draws about 2 μ A from the line. A crystal or ceramic resonator oscillator provides a frequency reference for generating DTMF tones and loop-disconnect dialing pulses. More information is available from Mietec Alcatel, Raketstraat 62, B-1130 Brussels, Belgium. Telephone +32 (0)2 242 75 52.

PETER FLETCHER

IMPROVED ROUTING BOOSTS FPGA GATE COUNT

With increases in on-chip routing resources and antifuse programming elements, along with an improved logic cell, a field-programmable gate array can achieve the equivalent logic capability of an 8000-gate mask-programmable array. The array is part of Actel Corp.'s, Sunnyvale, Calif., second-generation of FPGAs that employ a 1.2- μ m CMOS process, which leaves plenty of room for future scaling.

To get better routability with the higher gate counts, the Act-2 family employs many more programmable antifuses than in the Act-1 family—750,000 are on the 8000-gate chip. As many as 36 horizontal routing tracks are positioned between the rows of logic cells, and up to 15 vertical tracks are provided for every column on the chip. As part of the routing resources, unbroken long-line segments can be used for global (cross-chip) routing. Short segments are available for localized routing.

The logic cell module was also redesigned: Rath-

er than one module type, Actel incorporated two module types on the chip. One module type was optimized for sequential operations, while the other was optimized for combinatorial functions. The combinatorial modules permit 13% more 4-input macros, or 12% more 5-input macros, than the cells in the Act-1 family. A combinatorial block has four data inputs, two control inputs, and one output. A sequential block includes a configurable flip-flop optimized to form high-speed flip-flops and latches.

Software makes it possible for users to specify critical speed paths in the circuitry. Those paths are then routed with a maximum of only two low-resistance antifuses (less than 200 Ω each vs. about 500 Ω apiece in the previous family) in the signal path. The result is predictable performance even with fully automatic placement and routing. Moreover, gate utilization can reach close to 80% with a logic-cell utilization of about 95%. Furthermore, although the largest of the Act-2 family

chips will offer about four times the gate count and twice the number of I/O lines (140) of the largest Act-1 family chip, it will operate at twice the speed.

Operating at system clock speeds of between 50 and 60 MHz, the Act-2 arrays can tackle many newer system applications that run with clock speeds of over 50 MHz. The A1280 is currently the largest Act-2 family member, packing about 8000 gates (equivalent to about 20,000 gates if PLD gate-counting rules are used). Two smaller family members, the A1240 and A1225, with 4000 and 2500 gates, and 104 and 82 I/O lines, respectively, are to be released the first half of 1991.

Improved software tools also play a significant role in achieving the high utilization, higher performance, and ease of circuit development. The enhanced software developed by Actel added about 50% to the circuit library, increasing the number of macrocells to about 250. For details, call Andy Haines, (408) 739-1010.

DAVE BURSKY

Embedded RISC

	Intel 80960	<u>IDT R3001</u>	AMD29000
REAL-TIME PERFORMANCE			
Clock Rate	12.5-33MHz	12.5-33MHz	12.5-33MHz
Interrupt Response	Fair	<u>Fast</u> 10 μ s	Fair
Context Switch	?		29 μ s
DEVELOPMENT TOOLS			
Native Platform	No	Yes <i>MIPS, DEC, Mac II, Sanyo</i>	No
IBM PC Tools	Yes	Yes	Yes
In-circuit Emulation	Intel	EPI <i>under \$50</i>	Intel
Simulation Tools	Intel	MIPS, IDT, EPI	Intel
Evaluation Board	*960	*845	*2995
CPU Modules	No	Yes <i>several</i>	No
SOFTWARE SUPPORT			
Robust Compilers	No	Yes <u>MIPS</u>	Yes
RTOS	VxWorks	C EXECUTIVE	VRTX, C EXECUTIVE

Get the Facts

When evaluating RISC processors for embedded applications, you need real benchmark data from independent sources. The R3001 Performance Comparison Report is a collection of the original third-party data used in the graph below.

Benchmark Your Code

Of course, we know that published data can't give you all the information. You'd prefer to perform benchmarks for your specific application, and our six technology centers are equipped to do just that — bring us your code and we'll run your benchmarks!

You Can Count On Us

IDT offers a full array of complementary high-performance system building blocks for all your applications. Contact us today and get the facts: an R3001 Data Pak and R3001 Performance Comparison Report.

IDT Corporate Marketing
P.O. Box 58015
3236 Scott Blvd.
Santa Clara, CA 95052-8015

(800) 345-7015
FAX: 408-492-8454

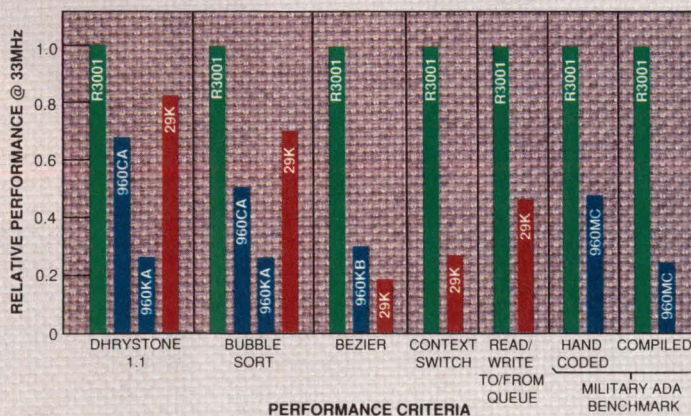

Sources: Electronic Engineering Magazine, High-Performance Systems Magazine, Microprocessor Forum Conference Fall 1989, Independent Assessment Benchmark Report Atlantic Research Corporation

RISController is a trademark of Integrated Device Technology.



When cost-effective performance counts

Integrated Device Technology

IN THE ERA OF MegaChip™ TECHNOLOGIES

ASIC SOLUTIONS:

“I want a PAL so fast it pins me to the back of my chair, and it's got to have a standard pinout. I need samples yesterday to get my design rolling today. Any questions?”

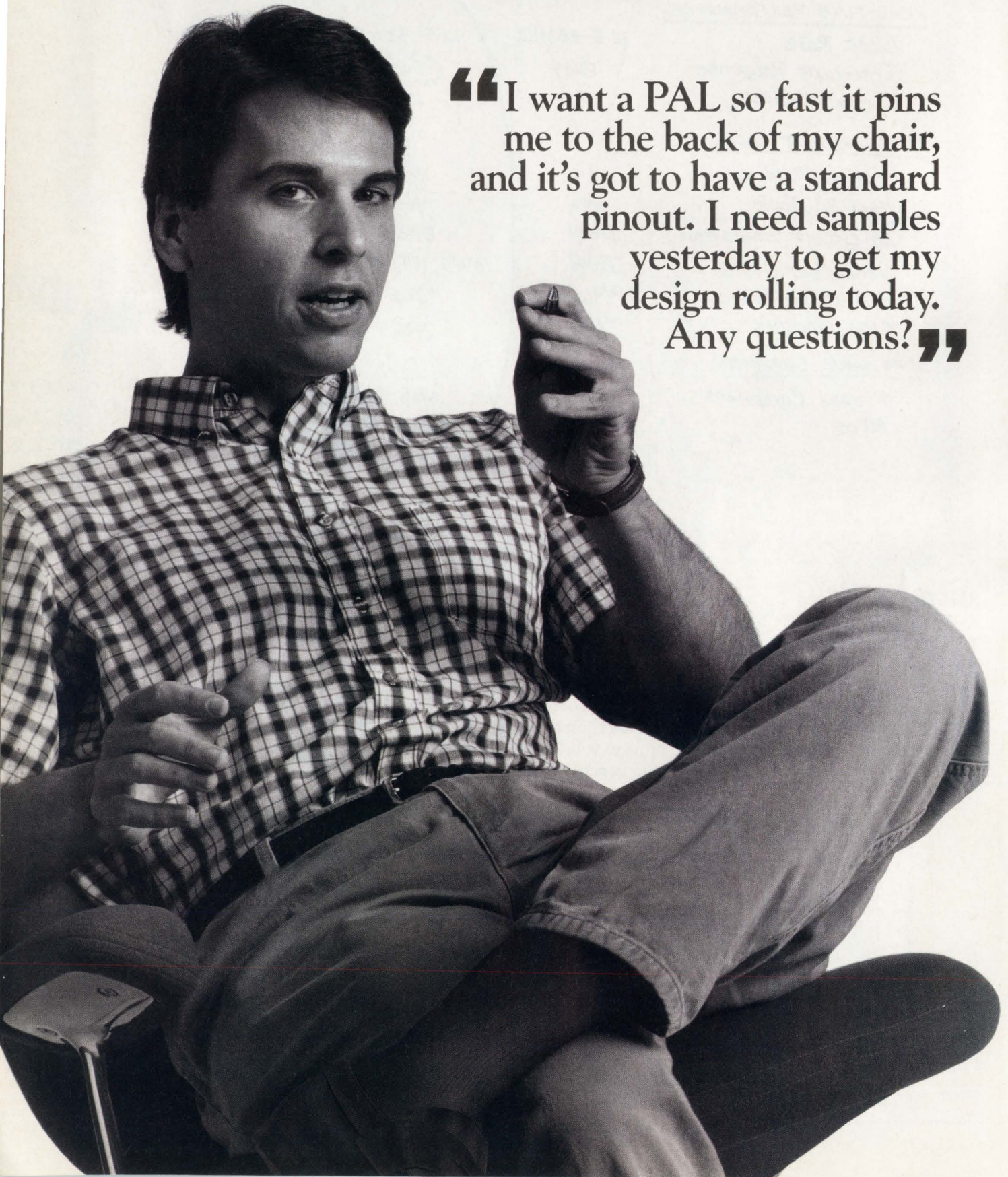

5-ns PALs

Texas Instruments introduces the world's first 5-ns TTL PAL[®] device in a standard pinout. At 5 ns these new PALs break the speed barrier while remaining within the familiar JEDEC-standard PAL pinout. To get your design off to a fast start, just call us or return the card, and we'll send you a free sample.

Matching fast CPU speeds

Operating at 125 MHz, our 5-ns PALs enable you to take greater advantage of advanced microprocessor speeds. Our new PAL incorporates an innovative chip design, but it is fabricated in the reliable IMPACT-X[™] bipolar process to which you are accustomed. Just design them in.

Simple upgrades

You can easily boost the performance of your present systems with these new superfast PALs. They come in 20- and 24-pin industry-standard footprints that fit right into your present system, allowing pin-for-pin replacements.

Superfast and superquiet

In addition to 5-ns speed, you get less noise than in standard 7-ns PAL devices. In fact, groundbounce has been reduced by 21%.

Adding to our comprehensive PLD family

TI's broad family of programmable logic devices (PLDs) includes PALs that offer a choice of speeds from 5 ns to 25 ns in both latched and registered configurations:

20-pin Devices	24-pin Devices
TIBPAL16L8-XX	TIBPAL20L8-XX
TIBPAL16R8-XX	TIBPAL20R8-XX
TIBPAL16R6-XX	TIBPAL20R6-XX
TIBPAL16R4-XX	TIBPAL20R4-XX

XX is the speed designator; from 5 ns to 25 ns.

All are available in plastic DIPs and PLCCs. We offer military versions, too.

Two easy ways to program TI PALs

Programming our 5-ns PALs is simple and quick. You can program them yourself, using your choice of third-party equipment. Or, if you prefer, your local TI distributor can handle the programming for you.

For a FREE sample of the PAL that breaks the speed barrier, call 1-800-336-5236, ext. 3709

Or use the attached business reply card. Either way, we'll send you your 5-ns PAL sample along with our PLD DataFile. The file contains information on our new 5-ns PALs as well as our entire PAL family.



TI Authorized North American Distributors: Alliance Electronics, Inc., Almac Electronics, Arrow/Kierulff Electronics Group, Arrow (Canada), Future Electronics (Canada), GRS Electronics Co., Inc., Hall-Mark Electronics, Marshall Industries, Newark Electronics, Schweber Electronics, Wyle Laboratories, Zeus Components, Rochester Electronics, Inc. (obsolete product only)

[™] MegaChip, IMPACT (Implanted Advanced Composed Technology), and IMPACT-X are trademarks of Texas Instruments Incorporated.

[®] PAL is a registered trademark of Monolithic Memories, Inc.

©1990 TI

08-0105

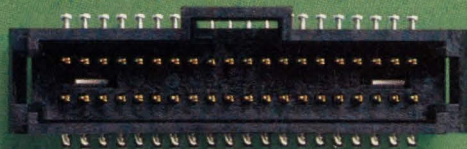

**TEXAS
INSTRUMENTS**



Think small. Think surface.

Our latest high-density surface-mount connectors offer a special design advantage — they bring you all the flexibility of the AMPMODU System 50 connector family.

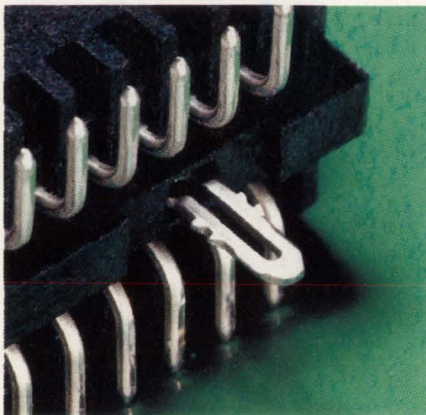
System 50 SMT receptacles and headers intermate with our complete .050" x .100" system, including cable-to-board types that expand your design thinking to include flat flex cable, .050" center flex etched circuitry, and .025" center ribbon cable.



Unique hold-down design requires only simple board support during placement. Design, materials are process-compatible.

Surface-mount versions are available in vertical, double-row versions, fully shrouded, in select sizes from 8 through 100 positions. Our compact design uses the same reliable System 50 interface, with dual-beam phosphor bronze receptacles plated gold-over-nickel on the mating end, tin-lead on the tail.

Dimensioning, tolerances, and positioning datums are engineered for robotic placement. A simple, low insertion

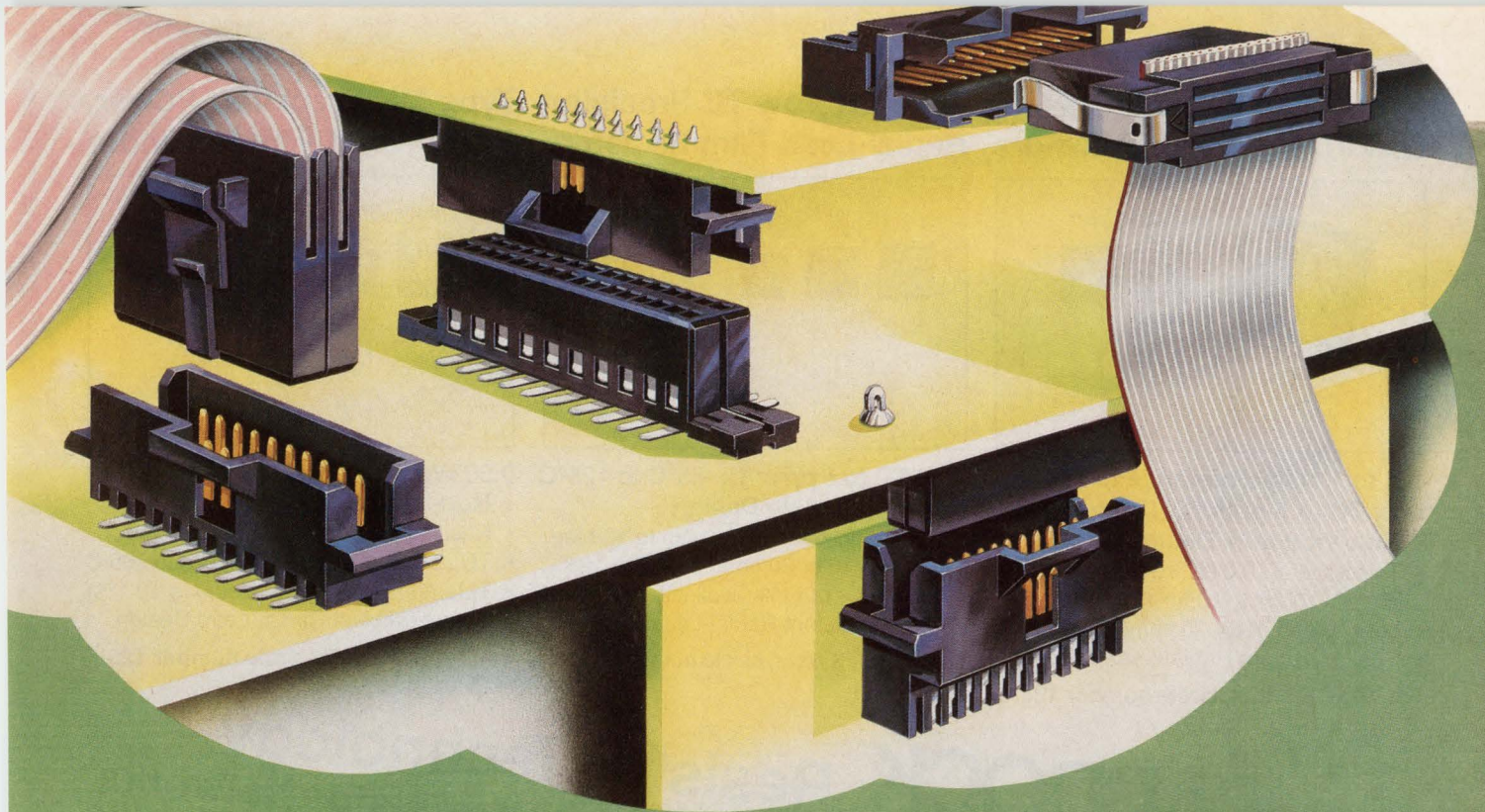

Think system.

force hold-down secures the connector during processing and provides long-term strain relief. 94V-0 housings are compatible with reflow soldering.

Intermate with the AMPMODU System 50 family for board-to-board stacking and mother/daughter configurations, and mass-termination cable-to-board interface.

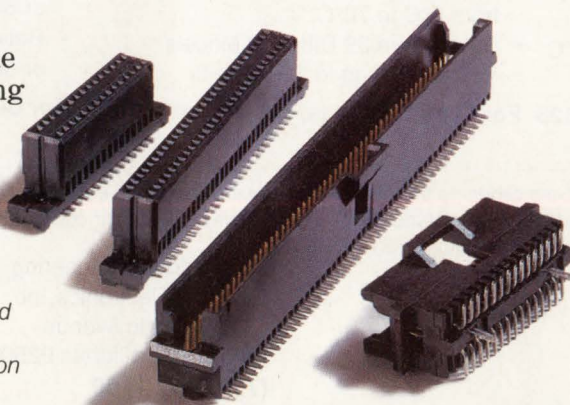

Call the AMP Product Information Center at 1-800-522-6752 for more information on AMPMODU System 50 surface-mount connectors, and the System 50 family. AMP Incorporated, Harrisburg, PA 17105-3608.

AMP and AMPMODU are trademarks of AMP Incorporated.

THIS IS AMP TODAY.

AMP

Type TN Lab Grade New
Low TC Precision Resistors

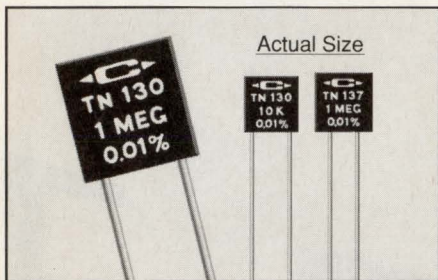

- 1 K to 1 Meg, Tolerance to $\pm 0.01\%$
 Low TC to 5 ppm/ $^{\circ}$ C, 0 $^{\circ}$ C to 70 $^{\circ}$ C
- Non-Inductive Design
 - Tolerance of $\pm 0.01\%$, $\pm 0.025\%$, $\pm 0.05\%$, $\pm 0.1\%$, $\pm 0.25\%$, $\pm 0.50\%$ or $\pm 1\%$
 - Low TC of 5, 10 or 20 ppm/ $^{\circ}$ C, 0 to 70 $^{\circ}$ C
 - Space Efficient Radial-Lead Design
- For Type TN data, circle number 123

Type TK Low TC Precision
Radial-Lead Film Resistors

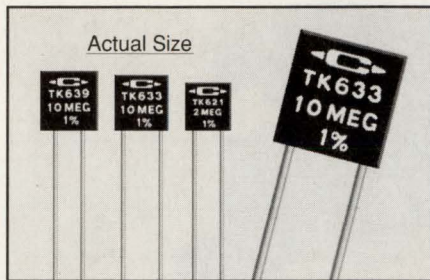

- Low TC to 5 ppm/ $^{\circ}$ C, -55 $^{\circ}$ C to 125 $^{\circ}$ C
- Non-Inductive Design
 - Resistance Range 1 Kohm to 10 Meg
 - TC of 5, 10 or 20 ppm/ $^{\circ}$ C, -55 to 125 $^{\circ}$ C
 - Tolerance of $\pm 1\%$ (available to $\pm 0.05\%$)
 - Space Efficient Radial-Lead Design
- For Type TK data, circle number 124

Type MK Precision Power
Radial-Lead Film Resistors

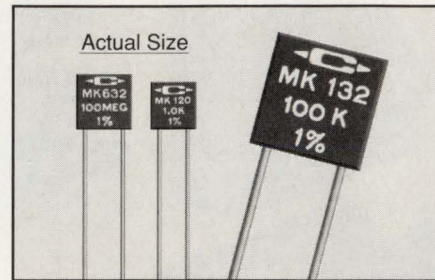

- 0.50 Watt (CK05), 0.75 Watt (CK06)
- Non-Inductive Design
 - Resistance Range 1 Ω to 100 Meg
 - TC as low as 50 ppm/ $^{\circ}$ C, -15 $^{\circ}$ C to 105 $^{\circ}$ C
 - Tolerance of $\pm 1\%$ (available to $\pm 0.1\%$)
 - Space Efficient Radial-Lead Design
- For Type MK data, circle number 125

CADDOCK[®] Resistor Technology

Precision and Ultra Precision Resistors and Resistor Networks
 with a 25 year record for solving problems across the board!

Type T912 and Type T914
Precision Resistor Networks

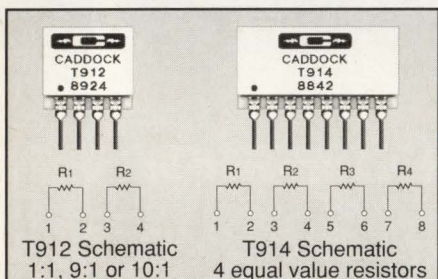

- Ultra Precise Ratios to 0.01%**
- 14 Standard Resistance Values from 1 Kohm to 1 Meg (Custom to 2 Meg)
 - Ratio Tolerance from 0.01% to 0.1%
 - Ratio TC of 2, 5 or 10 ppm/ $^{\circ}$ C, 0 to 70 $^{\circ}$ C
 - Custom ratios available, 1:1 to 250:1

Type 1776 Precision
Decade Voltage Dividers

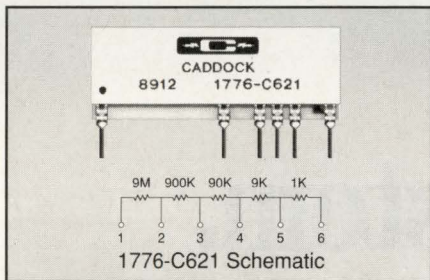

- Voltage Division 10:1 to 10,000:1**
- Ratio Tolerance 0.02%, 0.05%, 0.1%, 0.25% or 0.5%
 - Ratio TC of 5, 10, 25 or 50 ppm/ $^{\circ}$ C, from 0 $^{\circ}$ C to 70 $^{\circ}$ C
 - Select from 39 Different Models
 - Voltage Rating to 1,200 Volts

Custom Precision and
Ultra-Precision SIP Networks

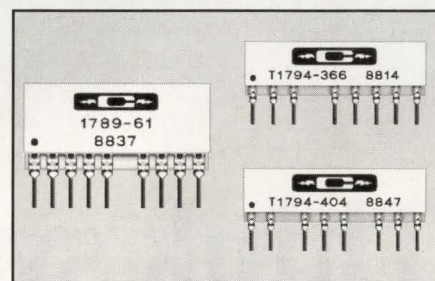

- Ratio Tolerance to 0.01%**
- Resistance Range 0.5 ohm to 50 Meg
 - Abs. Tolerance from $\pm 0.025\%$ to $\pm 1\%$
 - Ratio Tolerance from 0.01% to 1%
 - Abs. TC of 15 ppm, 25 ppm, 50 ppm or 80 ppm/ $^{\circ}$ C, from 0 $^{\circ}$ C to 70 $^{\circ}$ C
 - Ratio TC of 5 ppm, 10 ppm, 25 ppm or 50 ppm/ $^{\circ}$ C, from 0 $^{\circ}$ C to 70 $^{\circ}$ C

For Type T912/T914 data, circle number 126

For Type 1776 data, circle number 127

For Custom data, circle number 128

More high performance resistor products from

CADDOCK

ELECTRONICS, INCORPORATED

These products are manufactured with Caddock's exclusive Micronox[®] or Tetrinox[®] Resistance Film Technologies. For your copy of the Caddock General Catalog call or write:

Applications Engineering
 Caddock Electronics, Inc.
 1717 Chicago Avenue
 Riverside, California 92507
(714) 788-1700

The Caddock General Catalog includes specifications on over 200 models of high performance resistor products.

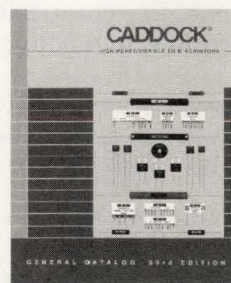

12-TO-16-BIT ADCs SAMPLE AND QUANTIZE
16 BITS AT 0.5 OR 1 MHz, 14 BITS AT 10 MHz,
AND 12 BITS AT 20 MHz.

FOUR HYBRID ADCs HIT NEW PERFORMANCE HIGHS

FRANK GOODENOUGH

It wasn't that long ago that 12-bit, 10-MHz ADCs, as well as true 16-bit sampling ADCs, would fully occupy 5-by-7-in. pc boards. However, four new analog-to-digital converters demonstrate the rapid advances made in today's hybrid and semiconductor technologies. Two of the converters, the ADS-930 from Datel and the ADC4344 from Analogic, bring 500-kHz and 1-MHz sampling rates, respectively, to the 16-bit arena. A third, the AD9014 from Analog Devices, provides 14-bit samples at 10 MHz, while a fourth, the CLC936 from Comlinear, delivers 12-bit samples at 20 MHz.

All of these ADCs have several important characteristics in common: They are sampling-type converters incorporating proprietary circuit techniques and/or custom ICs; they employ some form of hybrid packaging technology; and their performance is based on two-step subranging architectures that use digital error correction. Perhaps most important, the mix of multistep design with hybrid packaging is the only practical way to meet the combined demands of size, speed, and resolution.

Each of the new converters presently holds sampling-rate speed records for its respective resolution (for more information on the industry's latest high-resolution, high-speed, sampling ADCs, see the special report on page 47 of this issue).

The largest of the group is Analog Devices' AD9014, which can be considered a complete subsystem. Consisting of two custom chip-and-wire hybrids mounted on a multilayer pc

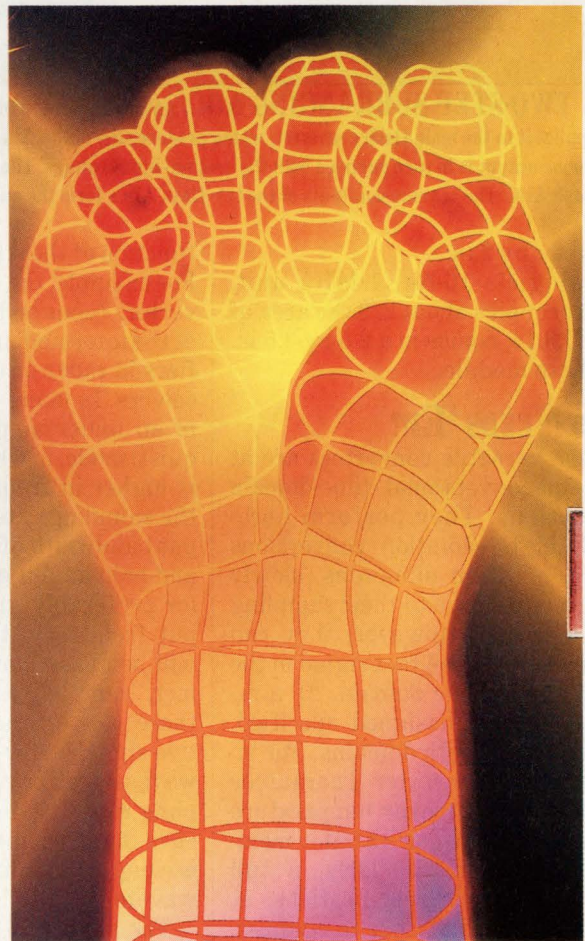

board of 3.25 by 4.225 in., it contains power-supply bypass capacitors and a right-angle SMC connector carrying the analog input signal. The total "thickness" of the board plus components is still just 0.5 in.

Although positioned at opposite ends of the speed-resolution spectrum, the 16-bit Datel converter and the 12-bit Comlinear unit each can squeeze into a 40-pin triple-width DIP. These chip-and-wire hybrids

HIGH-SPEED, HIGH-RESOLUTION ADCS

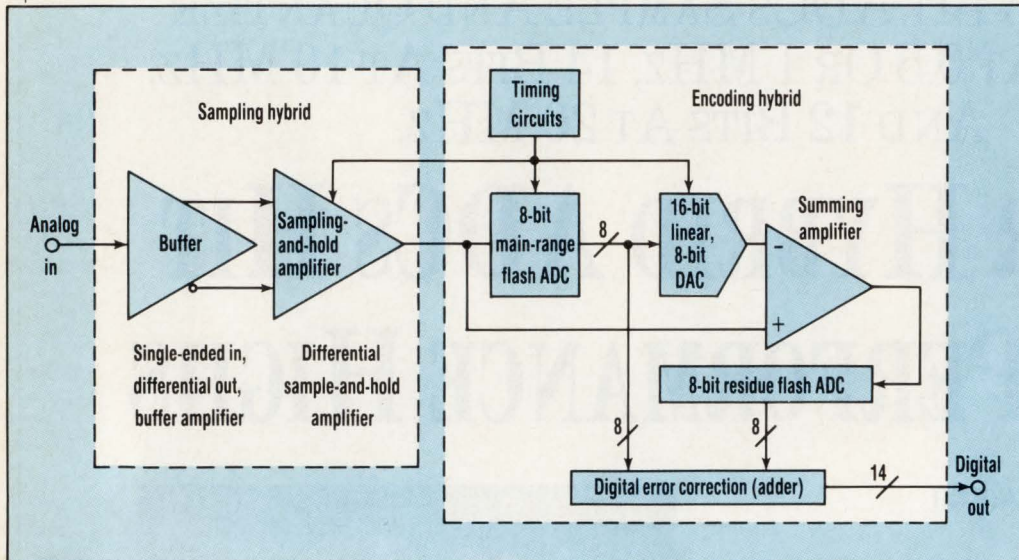

A TWO-STEP SUBRANGING ADC, Analog Devices' AD9014, samples the input signal and applies it to the main flash converter, which produces the MSBs. The flash output is applied to a DAC, whose output is in turn summed with the original input voltage. The difference is then applied to a second flash ADC. The combined outputs of the two flash ADCs form the output of the two-step ADC.

are just 1 by 2 in.

Analogic's 16-bit, 1-MHz unit, which occupies about 2/3 the area of the AD9014, comes in a 2.5-by-3.5-in. metal-can module.

WHO NEEDS 'EM?

These versatile converters are at home in conventional time-domain applications. They perform high-speed, high-resolution conversions of one, or often numerous, slowly changing (relative to their sampling rate) signal(s). However, they can also operate on one fast signal in the frequency or time domain. As a result, all are well-designed, specified, and tested for both domains. For instance, each converter guarantees no missing codes over temperature for time-domain use—at the maximum resolution. Similarly, a full suite of dynamic specifications, at low frequency and close to Nyquist, were provided for frequency-domain applications. These include one or more signal-to-noise and one or more harmonic distortion characteristics (see the table).

In a basic frequency-domain application, ADCs simultaneously down-convert and digitize a band-limited "high-frequency" signal. Here, the definition of "high frequency" is a

function of the ADC's sampling rate. For example, the 10- and 20-MHz converters focus on handling the output of the intermediate-frequency amplifiers in radar or communications receivers. In many cases, they operate in an undersampling (or super-Nyquist) mode, in which the input signal is higher in frequency than half of the sampling rate. As long as the input bandwidth of the ADC's sample-and-hold amplifier (SHA) is equal to (or preferably greater than) the input frequency, the digitized signal will be aliased into base band. Similarly, sampling oscilloscopes can use these converters to digitize repetitive signals—for example, pure sine waves—well beyond the ADC's sampling rate. It's only necessary to ensure that each incoming signal cycle is sampled at a different point on the waveform.

The slower 16-bit devices employ lower carrier frequencies. However, they too can undersample: For example, the full-power bandwidth of the ADS-930 is a minimum of 1.5 MHz, and is typically at 2 MHz. Alternatively, they can be used at base band after the classic heterodyne techniques downconvert high-frequency carriers.

With the exception of pure oscillo-

scope-type applications, the output of virtually all of these converters feeds a digital-signal-processor chip or system. The processor in turn pulls signals out of noise, filters them, and often determines their source and intimate characteristics, such as "Is this radar signal friend or foe?" Usually the processor performs one or repeated fast Fourier transforms (FFTs) on the signal to produce its spectrum. In fact, a major application area for these types of ADCs is spectrum analysis.

Time-domain applications break down into the two major areas typically served by ADCs: digitizing a single fast-changing

waveform, such as from CCD optical/infrared detectors and imagers; and digitizing many slowly varying signals at the output of a multiplexer at high speed. These include various medical and analytical instruments ranging from CAT scanners and nuclear-magnetic-resonance (NMR) systems to blood analyzers and gas and liquid chromatography systems. Input signals for most of these instrument applications carry information with a dynamic range from 100 to 120 dB and thus use a programmable gain amplifier (PGA) ahead of the ADC. However, the greater the ADC's dynamic range, the simpler the software for the digital signal processor and the faster it can run.

HOW THEY WORK

Those are the similarities shared by these four machines; the next step is to look at how they work and the features that set them apart. While lower sampling-rate 16-bit converters have existed a while, the concept of a converter spitting out 14-bit parallel words at 10 MHz may still seem like something out of a designer's dream.

The AD9014 is a good example of what can be achieved with a two-step

The Aries Chip Set

Why disk drive designers call it the eliminator.



The ARIES Chip Set does away with many significant design headaches, that's why. It collapses virtually all disk drive electronic functions onto just 4 chips, so you can accomplish your hard disk drive design in less space. And get your finished product to the market a lot sooner.

Packed inside ARIES are the 32R4610 Read/Write Amplifier, the 32P4620 Pulse Detector/Data Separator, the 32H4631 Servo and Motor Speed

Controller, and the 32C4650 Combo AT Controller.

ARIES appreciates your ongoing need for shrinking footprints and high 24-Mbit/s performance. Plus it equips you with low-power +5 volt only operation.

In other words, the ARIES Chip Set is a revolutionary idea that just might help you eliminate your competition. For more on ARIES, contact your nearest Silicon Systems

representative. Or call us for literature package SPD-2.

Silicon Systems, Inc.
14351 Myford Road, Tustin, CA 92680
Ph 1-800-624-8999, ext. 151 Fax (714) 669-8814
European Hdq. U.K. Ph (44) 79-881-2331
Fax (44) 79-881-2117

CIRCLE 141 FOR PRODUCT INFO
CIRCLE 142 FOR CAREER INFO

silicon systems[®]

HIGH-SPEED, HIGH-RESOLUTION ADCS

digital error-correcting architecture when the technology is pushed (not all multistep ADCs incorporate error correction, but at resolutions beyond 10-bits, it's virtually mandatory to ensure accuracy). Sampling a 10-MHz sine wave at 10 MHz (twice Nyquist), the device achieves a typical spurious-free dynamic range (SFDR) of 72 dB (11.7 bits). At close to Nyquist (a 4.3-MHz signal) SFDR is a minimum of 86 dB (14 bits). The AD9014's design typifies one of the two basic architectures used to build two-step ADCs (see the figure). It consists of eight basic blocks. An input amplifier and a SHA form one of the hybrids. The other hybrid holds the 8-bit main-range flash ADC, an 8-bit digital-to-analog converter that's 16-bit accurate, a summing amplifier, a second 8-bit (residue) flash ADC, digital error-correction circuits, and timing circuits.

The input amplifier, a single-ended-in, differential-out buffer, drives the unique differential-in, differential-out SHA. The SHA samples the signal on a pair of capacitors, one between each input and output. Its output is then applied to the 8-bit main-flash converter and is quantized.

The resulting digital word (the MSBs) is fed to the 8-bit DAC and to

the digital correction circuit—an adder. The output of the DAC and the voltage held in the SHA drive opposite-polarity inputs of the summing amplifier. At this point, they're subtracted from each other by the high-speed precision summing amplifier, and the difference is gained up and applied to the second flash converter. Its 8-bit output combines the 8 MSBs that provide the typical two bits of overlap required by the correction circuits to create the converter's 14-bit-accurate output.

The differential SHA reduces even-order spurious harmonics in the digital output. The harmonics are caused both by the amplifier's finite gain-bandwidth and by noise that affects the switching points between the sample-and-hold states. The circuit is switched between states by two diode bridges, one for each input-output.

The AD9014's 16-bit DAC is a custom chip that also uses differential circuits, including the diode switches that replace transistor current switches, to minimize settling time. The ECL encode input is also differential. The device's input impedance at the SMC connector can act as the termination of a 75- Ω coax line. A 1-k Ω resistor isolates each ECL output

from the analog circuits. This isolation requires placing ECL latches, or receivers, as close as possible to the output pins.

At 20 MHz, the Comlinear CLC936 sets a sampling-speed record for hybrid 12-bit ADCs, which was 10 MHz. Sampling a near-Nyquist 9.992-MHz sine wave at 20 MHz, it achieves a spurious-free signal range of 69 dB (11.2 bits). Like the other ADCs, it comes complete with a reference and clock. The input buffer amplifier has a bandwidth of 70 MHz and an input impedance of 50 k Ω in parallel with 5.5 pF. As a result, it hangs easily on a 50- to 100- Ω terminated input line and will not degrade signals well above Nyquist. In fact, the converter's large signal bandwidth is a minimum of 45 MHz. Furthermore, internal ECL latches and buffers on the output eliminate the need to add them to the pc board.

CIRCUIT MAGIC

If it takes two bits of overlap for error correction, how is a 16-bit two-step ADC built with 8-bit flash ADCs? Though several 10-bit flash ADCs are available with 1024 comparators each, they're uneconomical in today's 16-bit ADCs.

Therefore, to achieve 16 bits, Da-

HIGH-SPEED SAMPLING ADC SPECIFICATIONS

Specifications	CLC936AC		AD9014K		ADC4344		ADS-930	
	Value	Conditions (f _{in} , MHz)	Value	Conditions (f _{in} , MHz)	Value	Conditions (f _{in} , kHz)	Value	Conditions (f _{in} , kHz)
Resolution (bits)	12		14		16		16	
Maximum sampling rate (MHz)	20		10		1		0.5	
Signal-to-(noise + distortion) (dB)	-72 -68	1.98 9.992	-75 (t)	0.54			-87 (t) -80 (t)	100 250
Total harmonic distortion (dB)	-71 -68	1.98 9.992	-90 -86	0.54 4.3	-90 -75	20 500	-95 (t) -89 (t)	100 250
Spurious-free dynamic range (dB)	72 72	1.98 9.992	90 86	0.54 4.3	92 82	100 500	not specified not specified	
Intermodulation distortion (dB)	-73	6.3 and 6.4	-90	2.3 and 2.4	Not available			
Full-power bandwidth (MHz)	45		60 (t)		1		1.5	
No-missing-code operation (bits)	12	Over temperature	14	Over temperature	16	Over temperature	16	Over temperature
Input-signal ranges (V)	±1		±1		±2.5, ±5 0 to +5, 0 to +10 0 to -5, 0 to -10		±5, ±10 0 to +10 0 to -10	
Power supplies (V)	±5, ±15		±5, ±15		±5, ±15		±5, ±15	
Power dissipation (W)	4.5		11.5		4		2.2	
Price (100s) (\$)	750		2800		750		337	

Note: All specifications are minimums or maximums unless specified as typical (t).

At last, radiation survivability is standard procedure.

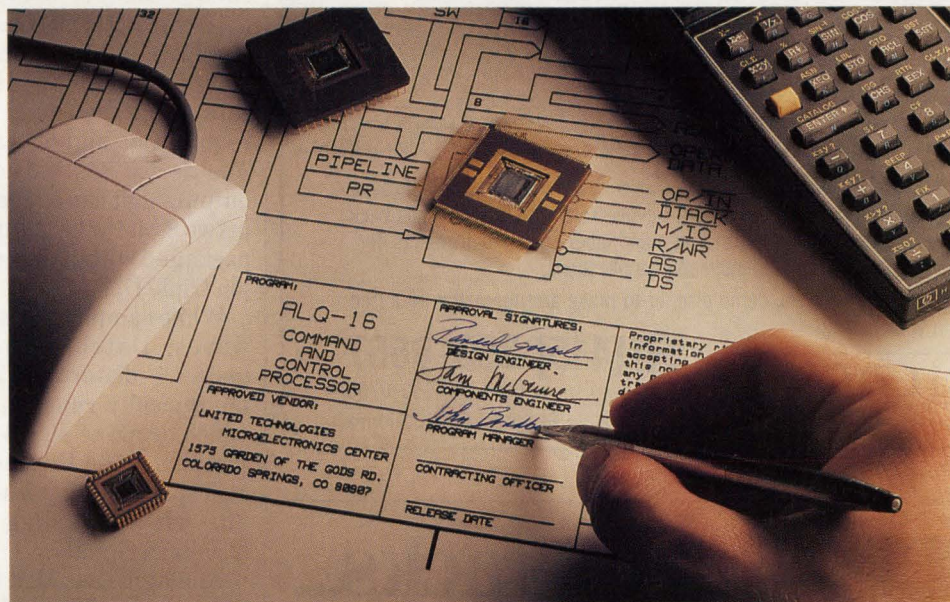

You can sign-off on it.

Forget about special screening, SCDs, and lot-by-lot testing of non-hardened parts. Now you can sign-off on radiation survivability with off-the-shelf RAD-SPECSM products from UTMIC. Our RAD-SPEC circuits are guaranteed to meet MIL-M-38510 radiation levels M, D, R, and H after irradiation. And you get guaranteed M- and D-level RAD-SPEC products at a small premium over standard non-hardened parts. RAD-SPEC is possible because UTMIC has developed the hardest production-proven CMOS process in the industry. And we've ramped-up production of military-standard and semicustom products. You can select from 1553 bus interface components, 1750 RISC processors, 75 MFLOP IQMAC vector floating-point DSP, SRAMs, and gate arrays with up to 50,000 gates. You can order RAD-SPEC products to Level S, 883 Level B, and SMD to simplify procurement procedure. Whether you need kilorad levels for a tactical program or megarad-plus for a space-

borne system, RAD-SPEC guarantees better pricing, delivery, and performance. So end the confusion. Remove the risk and high cost from your radiation-survivable program. Call UTMIC for more information on our complete line of off-the-shelf RAD-SPEC products.

RAD-SPEC is a service mark of
United Technologies Microelectronics Center, Inc.

1-800-MIL-UTMC
1575 Garden of the Gods Rd.
Colorado Springs, CO 80907

UTMIC
★ ★ ★
**RAD
SPEC**SM



DEDICATED TO MILITARY AND AEROSPACE

SCSI INSTRUMENTS



ANCOT's SCSI instruments are powerful, easier to use, and cost less. Proven in use worldwide, Ancot's portable equipment travels from bench to field and back again without ever slowing down. They are time and labor saving instruments, for design, manufacturing, repairing, and inspection applications.

Call today for product data sheets, demo disc, or to make arrangements for a free evaluation unit in your facility.

ANCOT
CORPORATION

[415] 363-0667

fax: (415) 363-0735

Redwood City, California

CIRCLE 110

HIGH-SPEED, HIGH-RESOLUTION

tel's ADS-930 employs several clever circuit tricks with 8-bit flash chips. It uses the second basic two-step architecture, in which the signal is passed through the same flash ADC twice, first to get the MSBs and then to develop the remaining LSBs.

In addition to the proprietary circuits needed for 16 bits, Datel added a 16-word FIFO (first-in, first-out) memory, whose contents can be stored at the 500-kHz throughput rate and passed on to the host when required at higher, or lower, rates. The device has latched, three-state outputs that can be read in parallel or in two 8-bit bytes. All of this has been packaged within the confines of a 40-pin triple DIP.

While sampling dc-to-100-kHz sine waves, Datel's device signal-to-(noise + distortion) ratio— $S/(N + D)$, typically runs 87 dB (14.2 bits), which drops to 80 dB (13-bits) when sampling 250-kHz sine waves. Datel also specifies no missing codes to 15 bits when sampling Nyquist-rate (250-kHz) signals.

Analogic cascaded two 8-bit flash ADCs to build a 9-bit ADC. Two passes through it supply two bits of overlap. The overrange bit from one flash ADC becomes the MSB. A 16-bit-accurate, 9-bit DAC assures 16-bit accuracy. Total harmonic distortion plus noise is a minimum of 88, 84, and 77 dB as it samples, at 1 MHz, signals of 20, 100, and 500 kHz, respectively (14.3, 13.7, and 12.5 effective bits, respectively). □

PRICE AND AVAILABILITY

Sample quantities of all devices are available. See the table for prices.

Analogic Corp., 360 Audubon Rd., Wakefield, MA 01880; Don Travers, (508) 977-3000. CIRCLE 511

Analog Devices Inc., P.O. Box 9106, Norwood, MA 02062-9106; Allen Hill, (919) 668-9511. CIRCLE 512

Comlinear Corp., 4800 Wheaton Dr., Fort Collins, CO 80525; Allan Hansford, (303) 226-0500. CIRCLE 513

Datel Inc., 11 Cabot Blvd., Mansfield, MA 02048-6356; Bob Leonard, (508) 339-3000. CIRCLE 514

Make Tracks...

... to your nearest mailbox and send for the latest copy of the free Consumer Information Catalog.

It lists about 200 free or low-cost government publications on topics like health, nutrition, careers, money management, and federal benefits.

Take a step in the right direction and write today for the free Consumer Information Catalog. Just send your name and address to:

**Consumer Information Center
Department MT
Pueblo, Colorado 81009**



A public service of this publication and the Consumer Information Center of the U.S. General Services Administration.

HOW VALUABLE?	CIRCLE
HIGHLY	547
MODERATELY	548
SLIGHTLY	549

Designing in National's one-chip motor driver could be the smartest move you'll make.

UNSURPASSED INTEGRATION.

Power. Protection. Control. These critical elements—essential to all motor-driving applications—are also inherent in the most highly integrated Smartpower™ device available today, the LMD18200.

Our one-chip solution with on-chip intelligence eliminates multiple discrete parts, saving you valuable board space.

The control logic of the LMD18200 connects both sides of the H-Bridge. Which eliminates crossover problems and makes it easy to use. Plus, its rugged design and process makes it extremely reliable. The device operates at supply voltages from +12V to +55V with continuous output of 3A. Or peak to 6A.

BORNE OUT OF A STRATEGIC PARTNERSHIP.

The LMD18200 is the brainchild of National Semiconductor and International Rectifier (IR). A jointly developed product made

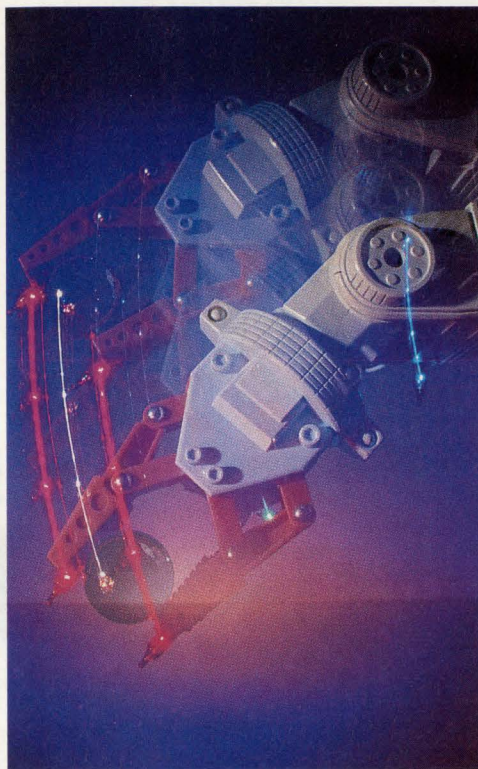

possible through distinct, leading-edge process technologies.

CMOS and bipolar from National. And DMOS with HEXSense™—for virtually lossless current sensing—from IR.

An optimized process mix that results in a high-performance, smartpower solution.

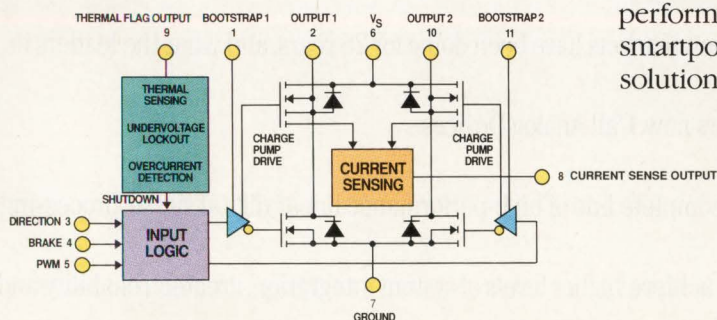

FAIL-SAFE PROTECTION.

Not only does the LMD18200 know when to start, it knows when to quit. Specially equipped with a two-stage thermal warning system, it transmits a distress flag to the host system at 145°C, allowing you enough time to take any corrective action.

And if the temperature reaches 170°C, the device automatically shuts down. A fail-safe feature that eliminates damage to your equipment.

What's more, the LMD18200's on-chip defense system provides overcurrent protection, which prevents damage both to the device and the motor in case a shorted load causes the motor to draw excessive current.

PLAY IT SMART.

For your LMD18200 design information kit, call or write us today. But make the move now. Before your competition wises up.

1-800-NAT-SEMI, Ext. 18

National Semiconductor Corp.
P.O. Box 7643
Mt. Prospect, IL 60056-7643

Analog Devices can meet your needs, no matter what your volume

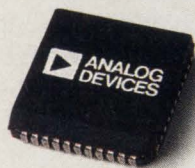
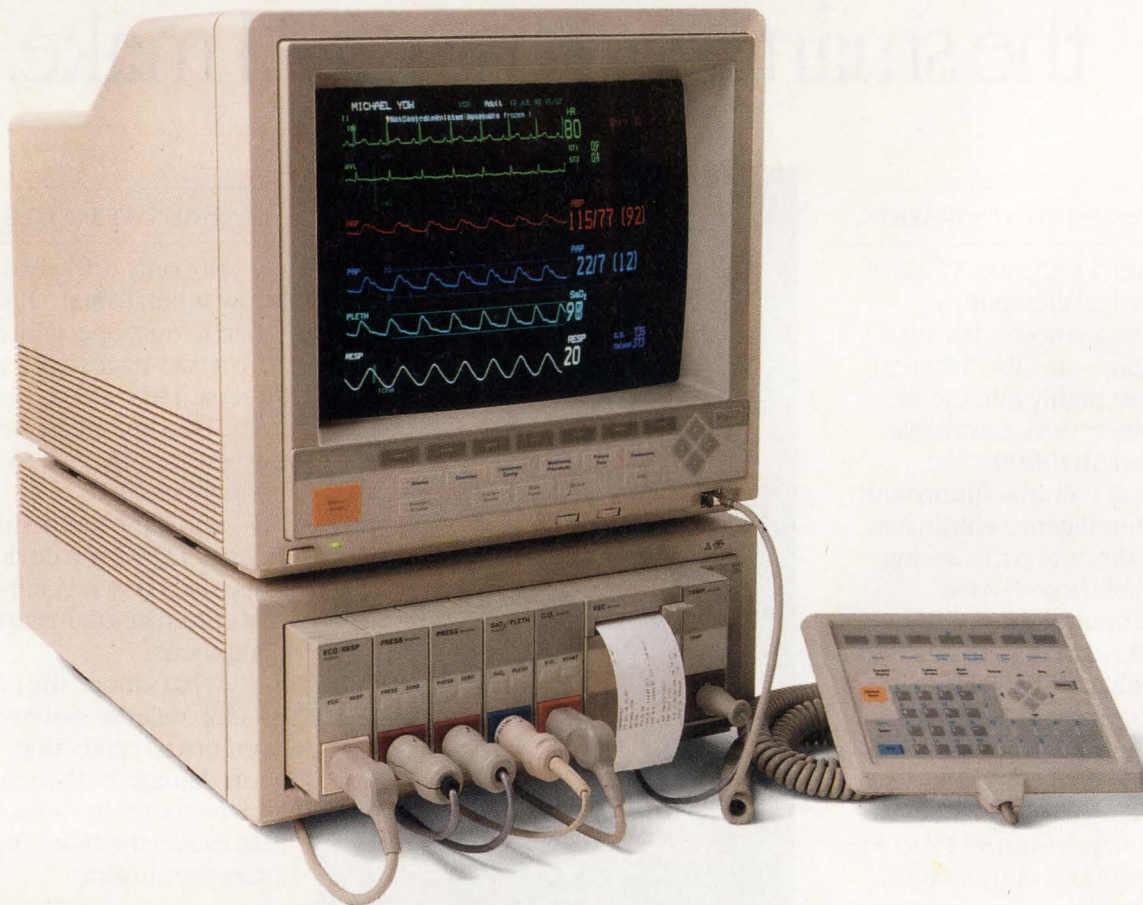

Custom Medical Instrumentation ASIC—
Provides complete data acquisition on a chip. Replacing 30 separate ICs, it integrates a low-noise instrumentation amp with gains of 15 to 2,000, a 50/60 Hz switched-capacitor notch filter, 11-bit a/d converter, 7-bit d/a converter, and a serial UART communications interface.

Whether your market is a few thousand or a few million, there's one customer demand for your product that'll always remain high—the demand for high performance.

The best way to meet this demand is to follow what

the leaders in the medical, military and instrumentation markets have been doing for 25 years, and what the leaders in consumer electronics have been doing for several years now. Call Analog Devices.

These companies call us because we offer a complete line of high-performance linear, digital signal processing and mixed-signal components. ICs that allow them to achieve higher levels of system integration, greater reliability, and

Meet your mixed-signal volume you're dealing in.

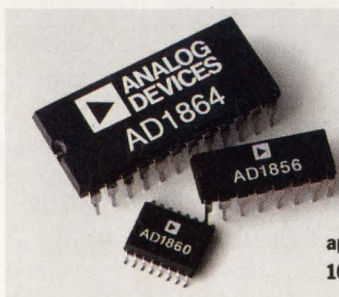

Digital Audio Converters – The SOUNDPORT™ family of data converters comes complete with output amplifier, reference and digital logic interface. These mixed-signal ICs for high fidelity digital audio and multimedia applications achieve SNRs as high as 108 dB and THDs as low as 0.0025%.

better performance in their products.

And as a global operation, we're able to respond to calls from any corner of the earth. In fact, international sales account for half of our \$450 million in revenues. And

three of the top five Japanese electronics companies rely on us for their mixed-signal needs.

So call 1-800-262-5643 and request a free copy of our recent white paper on Mixed-Signal Technology. Or speak to an applications engineer by asking for Extension 101. You'll see that no matter how big or small your mixed-signal needs are, we're in the best position to help.



CIRCLE 161

Analog Devices, Inc., One Technology Way, P.O. Box 9106, Norwood, MA 02062-9106. Headquarters: (617) 329-4700. Offices and applications support available worldwide.

Now! Up to 120,000 usable gates in a three-layer metal array.

Toshiba's 1-micron CMOS gate arrays provide the capability for a whole system-on-a-chip with gate delays of 0.4 ns.

Toshiba's TC150G series of 1.0 micron CMOS gate arrays pack up to 120,000* usable gates on a 172K master. The series uses our proven architecture combined with triple-layer wiring technology that makes highly efficient use of silicon.

The TC150G series is supported by a compatible library of more than 800 macrocells and over 150 macrofunctions. Our design environment covers the full CAD tool spectrum which includes high-level description language; design capture; design simulation; synthesis/design optimization ... and more! The Toshiba design environment is compatible with all major EWS including AIDA, Cadence, Dazix, HILO, HP, IKOS, Mentor, Synopsys, VALID, Verilog and Viewlogic.

Where design economy is a priority, Toshiba offers high pin-count plastic flat packs as a surface mount alternative to PGAs for many applications.

The series is available in 14 master array sizes ranging from 1,400 usable gates to 120,000, or up to 40,000 in plastic. And, you can depend on Toshiba to meet virtually any production quantity your business demands.

THE POWER IN GATE ARRAYS.		
SERIES	2-LAYER METAL TC140G	3-LAYER METAL TC150G
GATES	2,300 TO 172,000	2,300 TO 172,000
USABLE GATES	1,000 TO 68,000	1,400 TO 120,000
GATE LENGTH	1.0 μ (drawn)	1.0 μ (drawn)
GATE SPEED	0.4 ns	0.4 ns
OUTPUT DRIVE	up to 24 ma.	up to 24 ma.
PART NUMBERS	14	14
SECOND SOURCE	YES	YES
AVAILABILITY	NOW	NOW

There are five Toshiba design centers around the U.S. and one in Ottawa, Canada to help you. For technical literature, call 1-800-888-0848, extension 517 today. *Service is our key component.*

In Touch with Tomorrow
TOSHIBA

TOSHIBA AMERICA ELECTRONIC COMPONENTS, INC.

*Gate utilization is dependent upon architecture.
AIDA, Cadence, Dazix, HILO, HP, IKOS, Mentor, Synopsys VALID, Verilog and Viewlogic are registered trademarks by others.

© 1990 Toshiba America Electronic Components, Inc.

MAS-90-030

Toshiba semiconductor products are available from the following Toshiba offices: Deerfield, IL, (708) 945-1500; Burlington, MA, (617) 272-4352; Sunnyvale, CA, (408) 737-9844; Tustin, CA, (714) 259-0368; Richardson, TX, (214) 480-0470; Norcross, GA, (404) 368-0203.

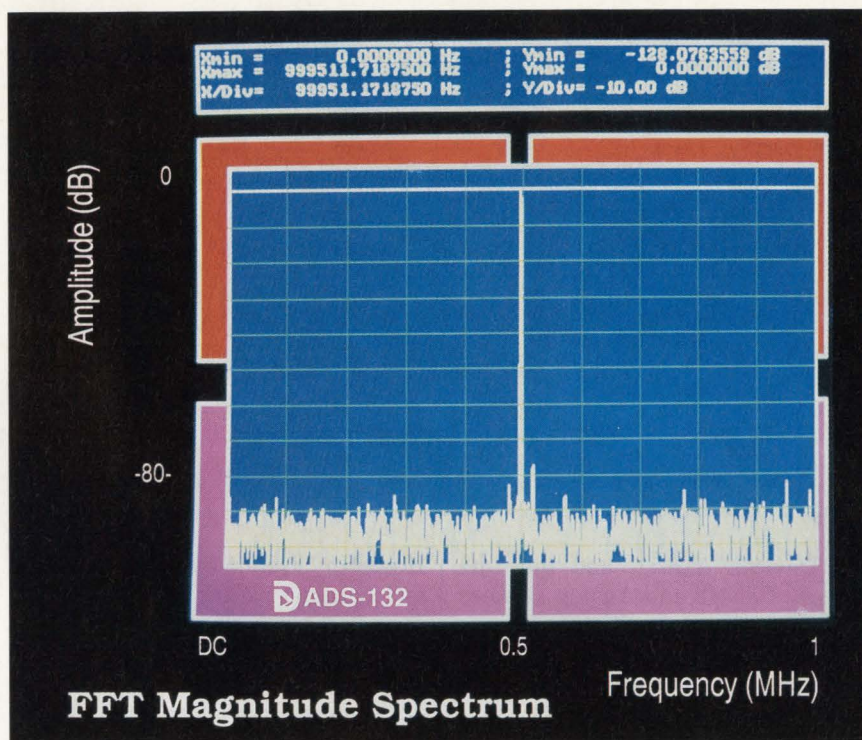

12-BIT SAMPLING ADCs COME OF AGE

Fast 12-bit and greater analog-to-digital converters (ADCs) have grown exponentially over the past four years, flooding the field with continually improving devices. The tables in this report defining just the 12-bit converters show that more than 90% of those converters didn't exist in the fall of 1986, when *ELECTRONIC DESIGN* published a similar roundup of ADCs (*ELECTRONIC DESIGN*, Sept. 4, 1986, p. 90). And the performance reported in this report was just a goal back then.

Even if you're "up" on ADCs, you may find a few surprises while perusing these tables:

- Hybrid, and even discrete-device, converters are still going strong. In fact, in the gray area of throughput rates between 200 kHz and 2 MHz (conversion times between 5 and 0.5 μ s), they still vie for sockets.

- If you haven't used sampling converters—converters with built-in sample-and-hold amplifiers (SHAs)—you may be surprised by the dominance of that architecture in both new ICs and hybrid 12-bit ADCs. In the 200-kHz to 2-MHz gray area and at higher speeds, virtually all new designs employ a multistep (multipass or subranging) architecture, regardless of other design aspects.

- Autocalibrated converters, new just four years ago, are now coming

FRANK GOODENOUGH

IC SAMPLING 12-BIT ADCs REACH 1-MHz NYQUIST AND HYBRIDS REACH 20 MHz—ALL SPORT DYNAMIC SPECIFICATIONS.

to center stage. Today they challenge classic laser-trimmed devices and newer, open-loop switched-capacitor designs in performance, power, and price.

- Though monolithic 12-bit ADCs seem to have hit a wall at 1 to 2 MHz, hybrids apparently don't have any speed limits. But you still may see a one-chip 12-bit converter running at 10 MHz within 18 months.

- With price erosion, you can now buy a 12-bit, 15- μ s, ADC for "a buck a bit." (Note: Throughout this report, and in the tables, all values are minimums/maximums and over the device's operating-temperature range, unless noted.)

- The biggest surprise may be that the granddaddy of all 12-bit IC ADCs, the 12-year-old Analog Devices' 574, is still spawning clones (how many 12-year old digital ICs can make that boast?). Moreover, it didn't become a one-chip IC until about four years ago.

WHO'S DRIVING?

Many questions arise when trying to analyze the high-resolution ADC boom. Was it driven by the market, the technology, or the people? And what made it possible—new process, new architectures, or both? As with most major advances, it took a mix of all of these factors. Both the military and industrial markets have demanded faster, more-complete, smaller, lower-power, and lower-

12-BIT SAMPLING ADCS

TABLE 1. A FEW 12-BIT, NON-SAMPLING MONOLITHIC ADCS

Model	Company	Conversion time (ms)	Integral linearity error (\pm LSB)	Offset error (LSB)	Gain error (\pm LSB)	Input voltage range(s) (V)	Nominal supply voltage(s) /power (V/mW)	Package, features and output format (see footnotes)	Cost (100s)
ADC601	Burr-Brown	0.9, 0.7 (t)	1/2	2	± 4	$\pm 5, \pm 10, 0$ to -10	$\pm 15, +5/1.7$	1, 2, 4, 6, 21	\$86
AD671K-750	Analog Devices	0.75	1	10	± 4	$\pm 5, 0$ to $5, 0$ to 10	$\pm 5/620$	2, 4, 26, 27	\$75
AD7586K	Analog Devices	1	1.5	2	± 2	0 to -4	$\pm 5/300$	2, 3, 4, 28	\$80
AD7572L	Analog Devices	3	1/2	4	± 8 (25°C)	0 to 5	$+5, -15/215$	1, 2, 3, 4, 5, 27, 29, 30	\$27
MAX7572	Maxim	3	1/2	4	± 10 (25°C)	0 to 5	$+5, -15/215$	1, 2, 3, 4, 5, 27, 30	\$25
MAX170	Maxim	5.6	1/2	3	± 10 (25°C)	0 to 5	$+5, -15/205$	1, 6, 31, 32	\$15
ADC-912	PMI	12	1/2	NA	NA	0 to 10	$+5, -15/95$	2, 3, 4, 5, 27, 32	\$12

Notes: All specifications are maximums or minimums and overtemperature unless noted.

Footnotes:

- | | | |
|---------------------------------|----------------------------|---|
| ¹ Reference | ⁶ Serial | ²⁹ 28-pin PLCC |
| ² Clock or timing | ²¹ 32-pin DIP | ³⁰ 5- 10-, 12-ms devices available |
| ³ Three-state output | ²⁶ Overage flag | ³¹ 8-pin DIP |
| ⁴ Parallel output | ²⁷ 24-pin DIP | ³² SOIC |
| ⁵ Two bytes | ²⁸ 28-pin DIP | |

cost converters. However, technology was also a driving force: hybrid for the fastest and most-complete devices, and monolithic for minimum size, power, price, and complexity without loss of versatility or accuracy. Moreover, it took new architectures and new semiconductor processes in both hybrids and ICs.

Hybrids (and other forms of multi-device technology) are still here today because they and the IC converter represent a symbiosis, which at times is planned. Multidevice converters act as the leaders in applying the latest semiconductor devices and in developing new architectures. Although first used to build 10-to-40-MHz pc-board converters, the two-step, or half-flash, architecture employing digital error correction was refined to build the first 12-bit, 1- μ s (conversion time) IC ADCs in hybrid form (for a working description of a subranging ADC and a taste of greater-than-12-bit devices, see the cover feature in this issue, p. 37).

Today, the two-step converter (or a subranging design using a greater number of passes) replaces the successive-approximation architecture for virtually all high-speed IC and hybrid ADCs, even challenging the monolithic flash itself. Yet, indicative of the hybrid-monolithic symbiosis, one or more monolithic flash converters lie at the heart of every hybrid and monolithic subranging ADC. For example, the four fastest monolithic 12-bit ADCs—the 0.5- μ s Catalyst CAT5412, the 0.75- μ s Ana-

log Devices AD671, and the 1- μ s Crystal CS5412 and Analog Devices AD7586—all use multistep designs (see Tables 1 and 2).

DESIGN DECISIONS

Complementing these ICs are non-sampling, two-step hybrids. Hybrids with conversion times ranging from 0.3 to 1 μ s are available from Analog Devices, Burr Brown, Datel, ILC Data Devices Corp. (DDC), Micro Networks, Sipex (formerly Hybrid Systems) and Teledyne Components (formerly Teledyne Philbrick). Moreover, some of these hybrids are challenging the monolithics. For example, Datel's ADC-530 converts in 300 ns and offers no-missing codes to 12 bits over temperature along with $\pm 3/4$ -LSB integral linearity. It comes in a 32-pin triple-width ceramic DIP and costs just \$237 each in 100s. Another Datel device, the ADC-511, converts in 1 μ s, is also 12-bit accurate over temperature, goes for \$154 each in 100s, and comes in a tiny 24-pin double-width ceramic DIP (for the performance). Both chips run off 5- and ± 15 -V rails. The ADC-530 and -531 dissipate 2.1 W and 1.25 W, respectively. Full-scale input voltage ranges of the ADC-530 are 0 to 10, 0 to 20 and ± 10 V. The ADC-511 handles 0 to 2.5, 0 to 5, and 0 to 10 V, as well as ± 2.5 , ± 5 and ± 10 V.

Looking at the monolithic ADCs, the AD671K-750 converts in 750 ns and guarantees 12-bit no-missing-codes over temperature, coupled with ± 1 -LSB integral linearity.

However, it comes in 24-pin plastic and ceramic skinny DIPs with the former costing \$75 each in 100s. The brand new Analog Devices AD7586 converts in 1 μ s and also guarantees 12-bit no-missing-codes over temperature, delivering an integral linearity of ± 1.5 LSB. Moreover, it also boasts a bus-access time of 57 ns while that of the AD671 is typically 200 ns. Few hybrids specify the access time. In fact, this specification, which is vital if you're interfacing with a microprocessor bus, is either missing from most data sheets or buried somewhere in a data sheet's interior (the same is often true of conversion times). The AD7586K also goes for \$80 each in 100s.

Input signal ranges and power-supply requirements may be the key factors in choosing between these converters. The 530 and 511 need 2.5 and 1.2 W of power, respectively, from their 5-V and classic ± 15 -V rails, while the 671 and 7586 run off ± 5 V. The 530 and 511 need just 621 mW, and the 671 and 7586 need a mere 300 mW. On the other hand, the hybrids handle a wide range of "standard" input voltages without signal conditioning; the 530 takes 0 to 10, 0 to 20, and ± 10 V; the 511 takes those ranges plus 0 to 2.5, ± 2.5 , and ± 5 V. The 671 handles 0 to 5, 0 to 10 and ± 5 V. However, the 7576, like many of the newer IC converters, is limited to a rather unconventional signal-voltage range—in this case 0 to -4 V.

None of the converters were de-

Frustrated with microprocessor system debugging?

How the right
preprocessor interface
can simplify logic
analysis.

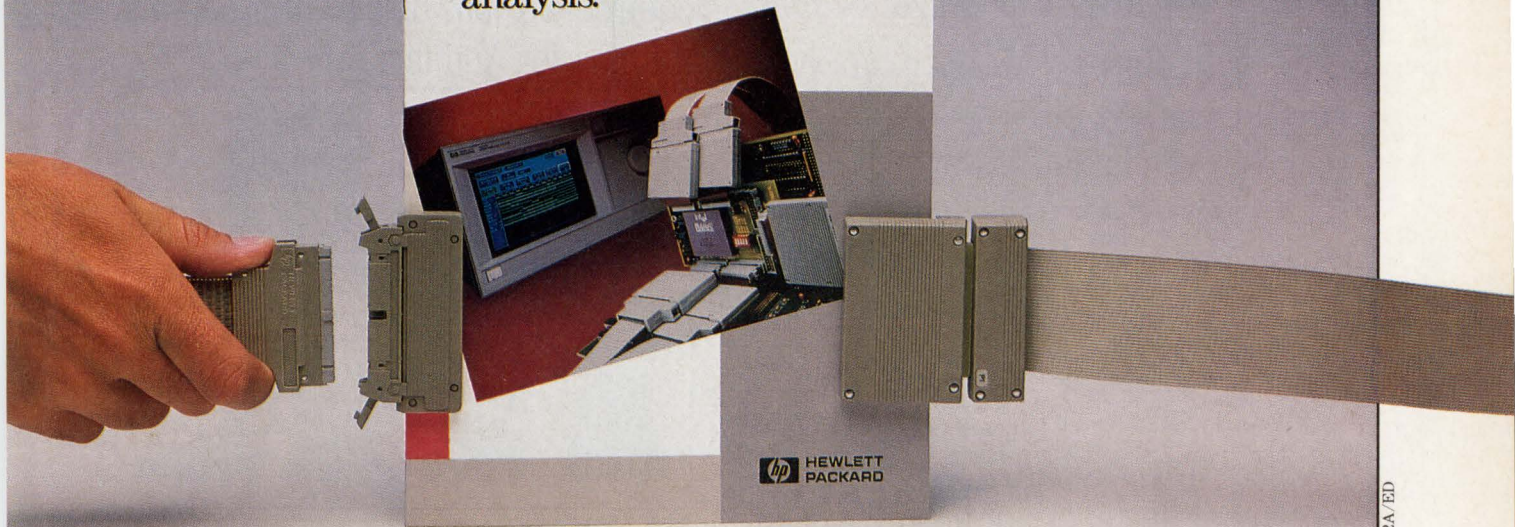

Here's free help in making the connections.

Plug into our new series of application notes today. And learn how to save time and aggravation when you're debugging microprocessor systems and busses.

Find out how an HP preprocessor literally makes it a snap to connect your microprocessor to an HP logic analyzer. And see how completing your HP logic analysis system with a preprocessor will speed and simplify measurements and data

analysis. You'll also discover the industry's broadest selection of preprocessors—over 60 models support more than 70 microprocessors and busses.

So call **1-800-752-0900** today. Ask for **Ext. 1404** or mail the reply card and we'll send the application information you need from our **FREE** series of six industry-specific application notes.



There is a better way.

 **HEWLETT
PACKARD**

The newest tw

Finally, a plug and play 10BASE-T network.

With our new ML4650 family of Single Chip 10BASE-T transceivers, you're covered all across the LAN. Because we have single chip twisted pair solutions for both ends, hub to node. Available now. In quantity. Giving you a fast, no hassle 10BASE-T solution.

On the PC side, the ML4651 and ML4652 transceivers incorporate AUI interfaces designed for both Ethernet adapter cards and external MAUs.

On the hub side, the ML4654 is tailor-made for a hub design with TTL or ECL outputs. All are highly integrated

single chip solutions, minimizing

the number of external components required. So your design-in process is much easier. And faster.

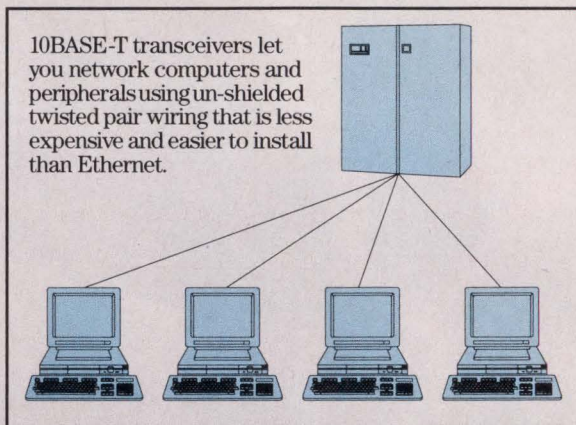

On-chip current driven transmitters are less sensitive to noise and power supply variations. So you get superior jitter performance and low noise outputs that help you easily pass FCC requirements. And the receiver includes an intelligent squelch that rejects cross-talk noise commonly found coupling from the phone wires into the LAN. There's no external crystal oscillator required either, and devices use 5 volts only power supplies.

Parts are available in 20- and

Micro Linear
10BASE-T products
are available in both
adapter card and
external MAU configurations.

ist in 10BASE-T.

24-pin skinny DIPs and 28-pin PLCCs. There's even an ML4621 Fiber Optic Inter-Repeater Link (FOIRL) receiver available to satisfy 10 Mbps fiber optic Ethernet requirements.

And, unlike much of the technology you've been hearing about, these are products of experience. We've been shipping twisted pair transceivers since 1987, as part of Synoptics' LattisNet network.

Semi-standard options.

We're one of the first to market for one simple reason. Our 10BASE-T family is based on our standard FB3651 bipolar tile array. So we were able to quickly modify our "standard" product to satisfy the rapidly-emerging IEEE 802 standards.

And, for the same reason, they can be easily modified with semi-standard capability to give you proprietary product advantages. Like

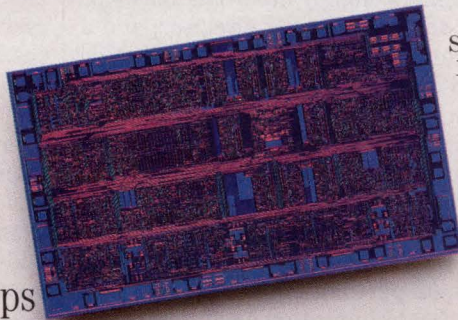

Semi-standard options of the standard 10BASE-T circuits are possible simply by modifying the metal mask on the FB3651 tile array.

functional or performance modifications. Or special screening packaging or reliability

levels to meet your specific network requirements. Whether it's an on-board AUI device. Or a multi-port repeater (MPR) designed to achieve that critical time-to-market advantage you've been looking for.

Call us on it.

If you'd like to turn your 10BASE-T idea into a deliverable product, just call Charles Yager today at (408) 433-5200 and ask him for the complete story on our ML4650 family of single chip 10BASE-T transceivers. Or ask for a free sample. It could add a whole new twist to your networking scheme.

Micro Linear, 2092 Concourse Drive,
San Jose, CA 95131

 **Micro Linear**

©1990 Micro Linear Corporation. LattisNet is a registered trademark of SynOptics Corp.

12-BIT SAMPLING ADCS

veloped without potential customers. Driven by the microprocessor's ubiquitous computing power, military, industrial, scientific, and medical-instrumentation markets need high-speed, multichannel, data-acquisition systems. By adding a fast sampling amplifier externally, you can grab 500-kHz waveforms.

In truth, five years ago, who would have expected to be able to buy a 10-MHz, 12-bit ADC smaller than a business card? On top of that, who would have presumed that the price for a commercial device would drop to under \$500 and the size to 1 by 2 in.—with multiple suppliers? Nonetheless, today seven suppliers of these converters exist with prices running from less than \$500 to over \$1000 (see Table 3). To cap it off, these sampling converters can continuously grab pieces of Nyquist-rate (5-MHz) sine waves.

Only hybrid technology could do the job of meeting all the specifications, requiring the two-step architecture. The first four hybrids came from a military-funded development involving Analog Devices, Burr-

Brown, DDC, and TRW. The four companies agreed on the package size and pinout (2.4 by 1.6 in. and 46 pins). A fifth player, Comlinear, helped reduce the package to a 40-pin, 1-by-2-in. DIP. Since then, Datel and Sipex have entered the fray.

Although one or more off-the-shelf 6- to 8-bit flash converters can do the basic quantizing job, most suppliers employ many custom chips for the pure-analog circuitry, and a gate array for the high-speed logic and digital output circuits. The custom analog chips perform precision switching, sampling, gain, and buffering. Most are built on ultra-fast complementary-bipolar processes. In addition, custom, 12-bit-accurate IC DACs with 6-, 7-, or 8-bit resolution (depending on the resolution of the flash converters used) determine basic ADC accuracy. These high-speed DACs employ bipolar current switches and laser-trimmed thin-film resistors in segmented and/or binary-weighted architectures. All of these hybrids are complete converters incorporating a reference, SHA, clock, and timing circuits.

The military uses these converters in radar and electronic-countermeasure receivers to simultaneously down-convert the output of the intermediate-frequency amplifiers to base band and digitize the base band. The converters' outputs are fed to a digital signal processor, which pulls signals out of noise and performs a spectrum analysis to identify the signal source—is it friend or foe? As a result of their price-performance, these tools are now finding their way into various non-military applications. These span from broadband rf communication systems, where they duplicate their radar function, to general- and special-purpose spectrum-analysis equipment for test and measurement, to medical equipment, such as CAT scanners, where they digitize many channels of data at high speed.

What's next in this land of blinding speed and accuracy? To start, as the cover story on page 37 indicates, speed and resolution have already moved up, with Comlinear offering 15- and 20-MHz 12-bit converters and Analog Devices a 10-MHz, 14-bit unit. Datel is ex-

TABLE 2. A SAMPLING OF 12-BIT, SAMPLING IC ADCS

	Model	Company	Conditions		AC specifications			Total conversion time (μ s)
			Sampling rate (kHz)	Input frequency (kHz)	Signal-to-noise + distortion ratio (db)	Total harmonic distortion (dB)	Spurious-free dynamic range (dB)	
Non-autocalibrated	ADS7800K	Burr-Brown	330	47, 150	69, 67 (t)	-77	77, 75 (t)	3
	AD678K	Analog Devices	200	10, 100	71, 70 (t)	-80	80	5
	AD7870L	Analog Devices	100	10, 100	72, 71, 5 (t)	-80, -86	80, 86	7.6
	AD7875L	Analog Devices						9
	MAX164	Maxim	100	10, 50	70, 70 (t)	-76	76	8.7
	MAX177	Maxim	100	10	64	-72	72	7
	AD7880C	Analog Devices	66	1, 30	70, 66 (t)	-80 (t)	80 (t)	15
	LTC1292	Linear Technology	50	25 (Nyquist)	73 (t)	na	na	20
Autocalibrated 12-bit + sign	CAT5412	Catalyst	2,000	100/490	70 (t)/NA	0.02% (t)/NA	75 (t)/72 (t)	0.7
	CS5412	Crystal/Gould	1,000	100/490	68/70 (t)	0.013% (t)/NA	75/70 (t)	1.4
	C55012A	Crystal/Gould	100	12	72 (1 kHz in)	0.008% (t)	84	7.2
	SDA11812D	Siemens	100	1/50	69/66	na/-75 (t)	na	6
	SDA0812A	Siemens	100	na	na	na	na	6
	TLC1225B	Texas Instruments	100	na	na	na	na	10
	ADC7802	Burr-Brown	83	na	na	na	na	8
	ADC12451	National/TRW	83	20	73.5	-78	80 (t)	8
	ADC12441	National/TRW	55	20	76.5	-75	na	14
	ML2230	Micro Linear	32	10	73 (t)	-75 (t)	na	31
ML2221	Micro Linear	32	10	73 (t)	-75 (t)	na	31	

Notes: NA = not available, na = not applicable, (t) = typical

Footnotes:

- | | | |
|----------------------|--|----------------|
| 1 Reference | 9 Two-, six- eight-channel versions available | 28 28-pin DIP |
| 2 Clock or timing | 12 Four-channel | 29 29-pin PLCC |
| 3 Three-state output | 13 12-bit + sign | 31 8-pin DIP |
| 4 Parallel output | 14 Eight-channel versions with reference available | 32 SOIC |
| 5 Two bytes | 27 24-pin DIP | 34 40-pin DIP |
| 6 Serial | | 35 40-pin CLCC |
| 8 Power-down | | |

12-BIT SAMPLING ADCS

pected to have similar devices sometime next year, while other players to plug away. However, the dream of a 12-bit monolithic ADC running at 10 MHz may come true before the end of 1991; it, too, will be a sampling converter.

To answer questions that may have arisen concerning sampling, it's probably best to discuss a few IC and hybrid devices available from the feast of sampling ADCs (see *Tables 2 and 3, again*). In the classic SHA-ADC application, the SHA is located between an analog multiplexer and a successive-approximation-register (SAR) ADC in a data-acquisition system. It ensures that even the slowly changing data from a thermocouple, or noise on the ac line, won't degrade the conversion's accuracy. It also enables the multiplexer to move on to another channel (Remember, the aperture time of a SAR-type converter is its conversion time. For example, the maximum sine wave that can be converted by a 12-bit, 100- μ s SAR ADC is about 10 Hz. Higher frequencies—signals slewing faster than 0.2 V/ μ s—will be aliased).

Data-acquisition systems incorporate a multiplexer, SHA, and ADC in one package, thus simplifying the job of system designers. However, with the advent of digital signal processors operating on just one, or several, ac signals, the SHA's job has changed. Now, it must accurately and repeatedly supply samples of a fast-changing waveform to a high-speed ADC. With the ideal SHA, the ADC can quantize, or digitize, Nyquist-rate signals that are just a few hertz below one-half the sampling frequency. New rules apply when handling these dynamic signals. Now the important specifications are signal-to-noise ratio (SNR), signal-to-(noise + distortion) S/(N + D) ratio, effective number of bits (ENOB), total harmonic distortion, peak harmonic or spurious noise (also called spurious-free dynamic range), and intermodulation distortion (*to define and measure these specifications, see ELECTRONIC DESIGN, May 10, p. 95*).

All of these specifications are measured at the converter's output by running a fast Fourier transform

(FFT) on a PC or other computer. The result is a spectrum analysis (see *opening figure, which shows the spectrum of Datel's ADS-132 ADC sampling a 1-MHz sine wave at Nyquist frequency*). For example, S/(N + D) is the ratio, expressed in dB, of the rms value of the measured input signal (which must be a "pure" sine wave) to the rms sum of all other spectral components below the Nyquist frequency—including harmonics but excluding dc. For the "ideal" ADC, S/(N + D) = (6.02n + 1.76) where n is the number of bits. Thus, for an "ideal" 12-bit ADC, the effective number of bits equals 74 dB. Solving the equation for n we get

$$n = \frac{S/(N + D) - 1.76}{6.02}$$

which is the ENOB, the dynamic performance of the converter, in bits, for a given sampling rate. Note that in the tables, the best specified converters give the dynamic specifications at some low frequency and at a frequency that's close to Nyquist. Ideally, data sheets should supply a

Integral linearity error (LSB)	Errors (\pm LSB)			Input voltage range(s) (V)	Nominal supply voltage(s) and power (V/mW)	Package features and output format (see footnotes)	Cost (100s)
	Offset		Gain				
	Unipolar	Bipolar					
$\pm 1/2$	NA	2	4 (25°C)	$\pm 10, \pm 5$	5, -15/215	1, 2, 3, 4, 5, 27, 32	\$34
± 1 (t)	2	10	4	0 to 10, ± 5	$\pm 12, +5/745$	1, 2, 3, 4, 5, 27	\$35
± 1	NA	5	5	± 3	$\pm 5/95$	1, 2, 3, 4, 5, 6, 28, 29	\$30
± 1	5	NA	8 (25°C)	0 to 5	$\pm 5/95$	1, 2, 3, 4, 5, 27, 29	\$30
± 1	NA	6	10 (25°C)	± 5	$\pm 5, -12/150$	1, 2, 3, 4, 5, 27, 32	\$21.25
± 1	NA	± 8 mV	4 (25°C)	± 2.5	$\pm 5, -15/150$	1, 2, 3, 4, 5, 29, 32	\$10
± 1	5	5	5	0 to 5, 0 to 10, ± 5	+5/25	3, 4, 8, 27, 32	\$16
$\pm 1/2$	1.5	1.5	1/2	0 to 5, ± 5	5 or $\pm 5/500$	3, 6, 8, 9, 31	\$16
± 1.5	1/2	1/2	1/2	0 to 3, ± 1.5	$\pm 5/1000$	3, 4, 34	\$98
± 1	NA	8	8	3 (pk-pk)	$\pm 5/1000$	3, 4, 34, 35	\$162
$\pm 1/2$	Total unadjusted error = $\pm 1/2$ LSB			0 to 5, ± 5	$\pm 5/250$	3, 4, 5, 6, 34, 35	\$24.60
$\pm 1/4$	Total unadjusted error = $\pm 3/4$ LSB			0 to 5	5/25	2, 3, 5, 8, 12, 28, 29	\$22.95
	Total unadjusted error = $\pm 1/2$ LSB			0 to 5	5/25	2, 3, 5, 8, 12, 28, 29	\$20.15
$\pm 1/2$ (unipolar input)	1/2	1/2	1	0 to 5, ± 5	$\pm 5/25$	3, 5, 13, 28	\$17.25
	Total unadjusted error = $\pm 1/2$ LSB			0 to 5	5/25	2, 3, 5, 8, 12, 28, 29	\$19.95
± 1 (t)	3	3	3	0 to 5, ± 5	$\pm 5/113$	3, 5, 13, 29	\$14.90
± 1 (t)	1	1	2	0 to 5, ± 5	$\pm 5/113$	3, 5, 13, 29	\$13.90
$\pm 1/2$	NA	1	1	± 2.5	$\pm 5/400$	3, 5, 13, 14, 28	\$15.95
$\pm 1/2$	NA	1	1	± 2.5	$\pm 5/400$	3, 6, 13, 28, 29	\$14.95

12-BIT SAMPLING ADCS

TABLE 3. 12-BIT, HYBRID SAMPLING ADCS

Model number	Company	Sampling rate (MHz)	Input frequency (MHz)	Signal-to-(noise + distortion) ratio (dB)	Total harmonic distortion (dB)	Peak harmonic or spurious noise (dB)	Full-power bandwidth (MHz)	Integral linearity error (LSB)	Input-voltage range (s)/power (V/W)	Package, features and output format (see footnotes)	Cost (100s)
AD9005	Analog Devices	10	0.54/4.3	65/60	NA	-70/-65	38 (t)	±2.5	±1/4.2	1, 2, 4, 15, 18	495
ADC603	Burr-Brown	10	0.1/4.99	64/61	-67/-62	NA/-65	30	±1.25	±1.25/6.1	1, 2, 4, 15, 18	590
CLC926	Comlinear	10	0.4/4.99	62/59	-64/-60	-65/-63	45	±3	2pk-pk ±2/5 (t)	1, 2, 4, 16, 18, 34	835
ADC-00110	DDC*	10	0.1/4.99	66/64	-66/-64	NA	30	±0.05%	±2.5/9	1, 2, 4, 15, 18	1150
ADS-130	Datel	10	0.5/4.99	65/63	-68/-65	-69/-66	30	±1	±1.25/4	1, 2, 4, 16, 34	549
SP9560	Sipex	10	0.1/4.99	68/64 (t)	-72/-68 (t)	NA	NA	±1/2 (t)	±1/3.6 (t)	1, 2, 4, 15, 18	700
THC1202	TRW	10	0.4/4.99	62/59	-64/-60	-65/-63	45	±3	2pk-pk ±2/6	1, 2, 4, 16, 34	595
ADC604	Burr-Brown	5	0.08/2	65/62	-77/-73	-77/-73	30	±1.25	±1.25/7	1, 2, 4, 15, 18	1121
ADS-131	Datel	5	0.5/2.5	65/63	-68/-65	-68/-65	30	±1	±1.25/4	1, 2, 4, 16, 34	439
ADS-132	Datel	2	0.1/1	NA	-72/-67	NA	(19)	±1/2	(20)/3.2	1, 2, 3, 4, 16, 21	277
ADC-00305	DDC*	2	0.1/NA	65	NA	-68	10	±0.025%	(22)/3.7	1, 2, 3, 4, 18, 23	340
MN6249K	MicroNetworks	2	0.1/0.94	66/66	NA	-70/-70	12	±1	-2.5, -5/3.5 (t)	1, 2, 3, 4, 18, 23	305
ADS602	Burr-Brown	1	0.01/0.48	70/64	-75/-70	-76/-70	4	±1.25	0-to-10, ±5/3	1, 2, 4, 16, 21	165
ADS-112	Datel	1	0.1/0.5	66/66	-75/-68	-75/-70	2.5	±3/4	0-to-10, ±5/1.7	1, 2, 3, 4, 16, 27	207

Notes: * ILC Data Devices, NA = Not available, (t) = typical

Footnotes:

¹ Reference

² Clock or timing

³ Three-state output

⁴ Parallel output

¹⁵ Case: 2.3" × 1.6", 46 pins

¹⁶ 5-V and ±15-V supplies

¹⁸ ±5-V and ±15-V supplies

¹⁹ sample-and-hold slew rate =

300V/μs, aperture jitter 40 ps max.

²⁰ 0 to -5, -10, -20, ±10, and ±5, ±10

²² 0 to -5, -10, +5, +10, and ±2.5, ±5

²³ Case: 1.3" × 2.2", 40-pin TDIP

²⁷ 24-pin DIP

³⁴ 40-pin DIP

family of curves made at various sampling rates, plotting input frequency on the horizontal axis, and ENOB and S/(N + D) on the vertical axis. In the sampling tables, dynamic specifications are given for two signal frequencies when available. A simple X-Y plot of ENOB vs. S/(N + D) makes a handy tool for relating the two specifications.

All of those dynamic specifications are for the SHA and ADC operating together, with the SHA first acquiring the signal and then switching into the hold state in minimum time. Then the converter can do its job. When sampling even Nyquist signals at rates below 10 kHz, circuit timing (and layout) with such ICs as the Harris HA-5320 and a 574 ADC isn't difficult. However, as frequencies climb, the need for a high-speed SHA and a converter in one package becomes obvious.

When 12-bit sampling ADCs started hitting the street, the auto- or self-calibrated devices for that venue began arriving—all being samplers as well as ICs. These can be found on the lower portion of the sampling IC table. These sophisticated devices either continuously, on command, or in the background, correct themselves for differential/integral linearity, zero, and gain errors. This eliminates

the effects of time, temperature, and supply voltage. In fact, some offer a total unadjusted error of specification—at 12 bits—which includes linearity, zero, and gain. Autocalibrated ADCs should be considered when the ultimate in accuracy is required, even if sampling isn't an issue.

You can divide sampling ADCs into three basic classes offering overlapping cost-performance trade-offs: hybrids, non-autocalibrated or basic ICs, and autocalibrated ICs.

In contrast with most hybrids, which employ two-step architectures with thin-film resistors setting their basic accuracy, the slower, basic sampling IC ADCs stick with the faithful SAR. Moreover, with the exception of the LTC1292 and the Burr-Brown ADS7800, which use a switched-capacitor (charge-redistribution) DAC, laser-trimmed thin-film resistors set the limits of both differential and integral linearity. Both the LTC1292 and ADS7800 are pure CMOS, but the remaining chips employ some form of bipolar-CMOS (biMOS, biCMOS) process. While some of the latter employ bipolar transistors for the current switches, most use CMOS switches. The ADS7800 samples at 330 kHz. However, unlike other monolithic sampling ADCs, it runs off standard sup-

ply rails (+5 and ±15 V) and handles standard ±5- and ±10-V input signals. Yet it dissipates only 215 mW. All of the non-sampling ICs also employ a SAR architecture implemented in biMOS.

On the other hand, the autocalibrated converters (except for the Catalyst CAT5412, which is the fastest member of the species) employ some form of switched-capacitor technology, which in most cases offers inherent sampling. Both the Crystal CS5412 and the Catalyst chip employ two-step architectures. Catalyst's, however, is more conventional and uses a resistor-ladder DAC, while the former employs a capacitor DAC and a variable-reference generator for the chip's 6-bit flash converter. In addition, the Micro Linear ML2230 family, and the National/TRW ADC12451, ADC12441, ADC1251, and ADC1241 offer 12-bit + sign outputs. Though the last four are all sampling devices, the 1241 and 1251 offer superior dc performance (ac specifications aren't provided). Test procedures, and the number of good die per wafer, differ for the ac and dc specifications, resulting in different prices.

In addition to Analog Devices, there are at present count at least seven additional sources for the 574

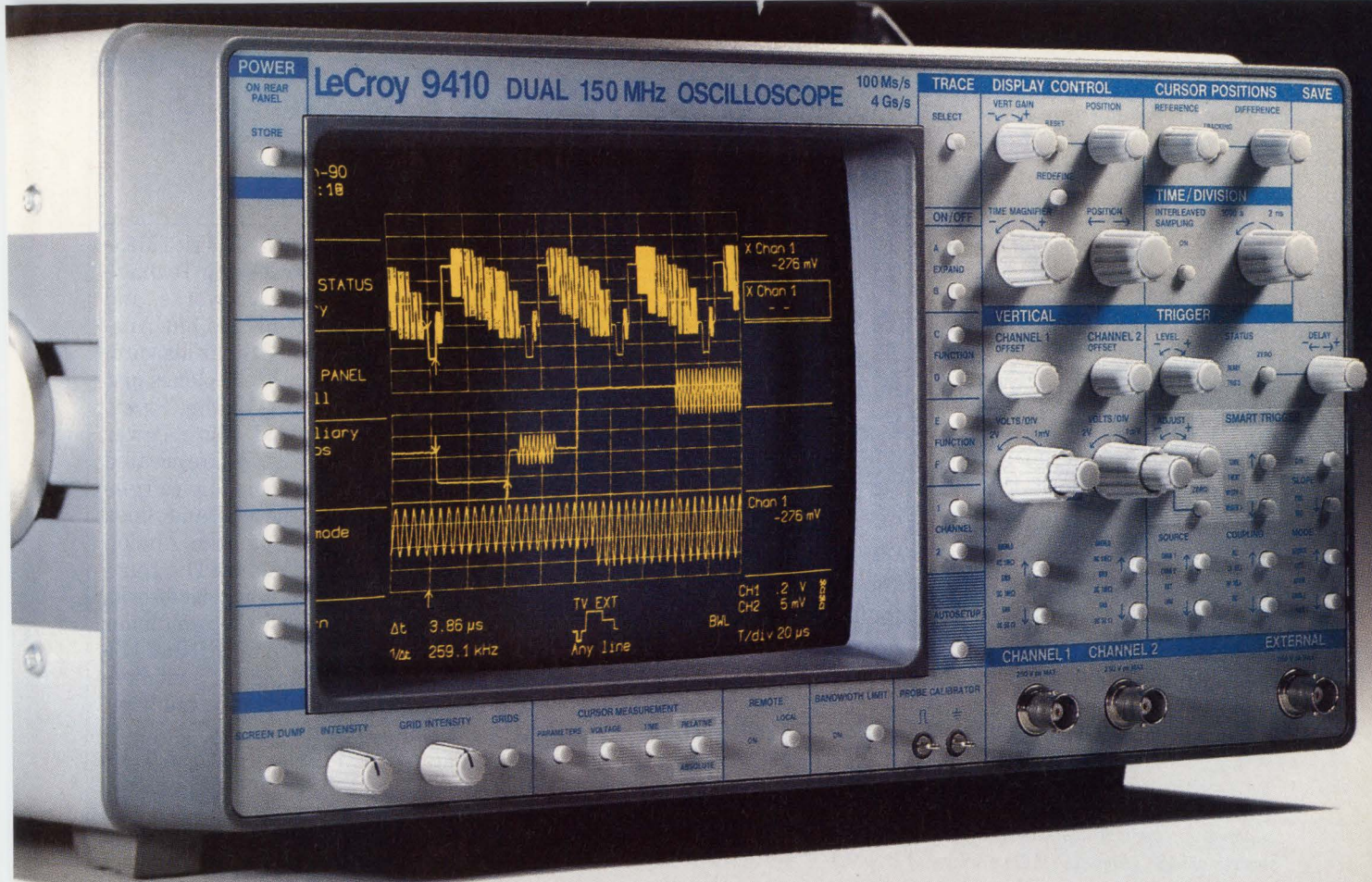

At last, a LeCroy you won't have to beg for.

Now you can get LeCroy Digital Oscilloscope performance for the price of an ordinary oscilloscope. At just **\$6,990**, the new Model 9410 offers you unrivaled measurement capabilities. Waveforms are digitized with high signal fidelity into 10K acquisition memories and presented on the sharpest display of any oscilloscope (the above picture speaks for itself). One can zoom in on fine details, expand signals, and use the 9410's digital cursors to get the ultimate in precision.

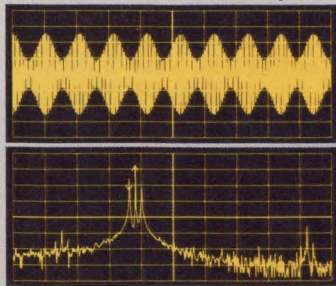

*Spectrum
Analysis
Option*

The Model 9410 doesn't stop there. It also includes LeCroy's SMART trigger that detects buried glitches, timing violations, and logic states (you'll be prepared for the most elusive signals). Internal signal processing calculates time, voltage and frequency parameters in fractions of a second.

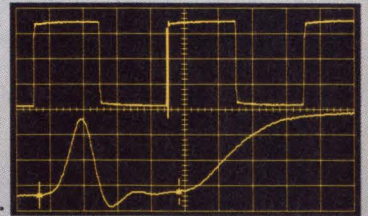

*Glitch
Trigger*

And all the data can be transferred directly to printers, plotters or PC's using the 9410's high-speed GPIB or RS-232.

Price being equal, wouldn't you rather have a LeCroy?

LeCroy Corporate Headquarters

700 Chestnut Ridge Road - Chestnut Ridge, NY 10977-6499
Tel.: 1-800-5 LeCroy - (914) 425 2000 / TWX: (710) 577-2832
Fax: (914) 425-8967

LeCroy

Innovators in Instrumentation



LOG/iC

THE SHORTEST CONNECTION BETWEEN IDEA AND SILICON!

Design Advantage #3

OPTIMIZATION

By using our own proprietary algorithm which allows for table optimization and 'Don't Cares' on outputs, LOG/iC achieves unparalleled reduction. This allows use of the smallest devices from a wider selection, often preventing the need for partitioning.

Design Advantage #7

PARTITIONING

'Interactive' device partitioning keeps you in control of complex designs for the most intelligent design implementation. Works with our PLD Database for architectural reference and aids in automatic device selection.

Contact ISDATA 1-800-777-1202 for complete details on these and other design advantages of LOG/iC.

Design tools that take your functional descriptions for optimal implementation into semicustom ASICs from PLDs to Gate Arrays.

ISDATA™ 800 AIRPORT RD.
MONTEREY, CA
93940
INCORPORATED 408 373-7359

CIRCLE 132

Just Published! A practical handbook to help you design today's sophisticated machines —

STANDARD HANDBOOK OF MACHINE DESIGN

By Joseph E. Shigley and Charles R. Mischke

1,632 pages, 929 illustrations, \$108.00

The entire subject of machine design is presented with emphasis on solving problems that arise daily in engineering design. The wide range of new materials, new components, new processes, and new analytical tools that have brought great changes in the way machines are designed have been covered to permit the design of machines in the future to meet more rigorous standards of reliability, safety, lighter weight, greater speed, and compactness. Use of computer-aided design methods as well as other machine-computation facilities are integrated throughout the handbook and presented in such a manner that future developments in computer hardware and software will not render the contents of the handbook obsolete.



47 GIANT SECTIONS fully cover every aspect of machine design.

To order your copy, complete the coupon below and mail to: Penton Education Division, 1100 Superior Avenue, Cleveland, Ohio 44114 or, for faster service, call 800-321-7003 (In Ohio, call 216-696-7000).

ORDER FORM

Please send me _____ copy(s) of STANDARD HANDBOOK OF MACHINE DESIGN. I understand that I can review it for 15 days and, if not satisfied, return it for full refund or credit.

- My payment is enclosed for postage-free shipment in the U.S. and Canada.
- Bill my company and include shipping and handling charges. Company purchase order required.
- Charge my: MasterCard Visa American Express Card

Account No. _____ Exp. Date _____

Name _____

Company _____

Address (not P.O. Box) _____

City _____ State _____ Zip _____

Signature _____

Penton Education Division • 1100 Superior Avenue • Cleveland, Ohio 44114

12-BIT SAMPLING ADCS

and 674: Burr-Brown, Harris, Maxim, SPT (Signal Processing Technologies), Sipex, Micro Networks, and Micro Power Systems. All but Analog Devices, SPT, and Sipex also provide a 774. And four of the clones just appeared this year—Maxim, Sipex, Micro Networks, and Micro Power Systems. But not all 574s are created equal. Power dissipation ranges from 150 mW for the SPT and Sipex devices to 720 mW for the Analog Devices and Harris units. The Burr-Brown, Harris and Micro Networks ADCs use two chips, the remainder one. In addition, both the SPT and Sipex converters employ a switched-capacitor DAC, while the remainder, like the original 574, use laser-trimmed thin-film resistors. Thus the SPT and Sipex units are in the sampling camp. As a result, although not yet given ac specifications, they can digitize 10-kHz sine waves to 12-bit accuracy. And, these chips do not need a -15-V supply.

While the basic conversion specifications for all of these converters are similar, the ADCs can't necessarily drop into each other's sockets, due to subtle differences in timing characteristics. For example, bus-access times can vary. However, Micro Power Systems guarantees its new chips will work in any socket that has held a working Analog Devices 574 or 674. Less subtle is that fact that if you've designed in an SPT or Sipex device, you can't easily switch to the higher wattage units that need -15 V.

Finally, before the year is over, we'll see a one-chip 574 and 774 from Burr-Brown, using just 100 and 150 mW, respectively. These chips are based on the core of the AD57800. They'll not only be sampling ADCs with switched-capacitor DACs, but will also be able to run off just a single 5-V rail. In addition, they'll be in skinnyDIP and SOIC packages. Why use a 574 if you're going to a new design and a new package? You can keep the same software.

How VALUABLE?

HIGHLY
MODERATELY
SLIGHTLY

CIRCLE

550
551
552

Food For
Thought
About Field
Programmable
Gate Arrays.

Be Brilliant At In Productio

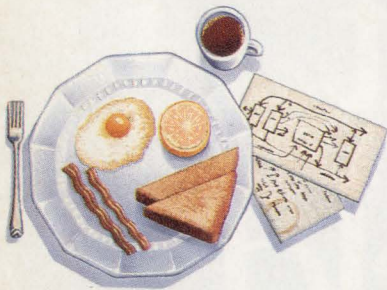

7:05 am: Breakfast

Suddenly, between bites, the answer to that new system design jumps right into your brain. But how to make it work in silicon? Use an Actel field programmable gate array!

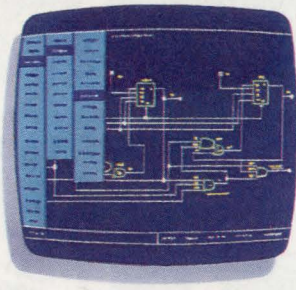

8:50 am: Design

You warm up the design program on your 386 and put in the final touches. Then a quick rule check and 25 MHz system simulation with the Action Logic System software.



11:00 am: Place & Route

You watch the system place and route all 1700 gates (out of 2000 available) in under 40 minutes. 100% automatically! A final timing check. Then think of something to do until lunch.

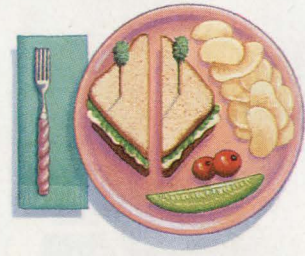

12:00 pm: Lunch

Remember lunch? Normal people actually *stop working* and have a nice meal — right in the middle of the day! With Actel's logic solution, this could become a habit.

Actel Field Programmable Gate Array Systems.

They're a feast for your imagination.

Actel's ACT™ 1 arrays bring you a completely new approach to logic integration. Not just another brand of EPLD, PAL® or LCA™ chips. But true, high density, desktop configurable, channeled gate arrays.

They're the core of the Action Logic System, Actel's comprehensive design and production solution for creating

your own ASICs. Right at your desk. On a 386 PC or workstation. With familiar design tools like Viewlogic™, OrCAD™, and Mentor™.

And do it in hours instead of weeks. Even between meals.

How? With features like 85% gate utilization. Guaranteed. Plus

100% automatic placement and routing. Guaranteed. So you finish fast, and never get stuck doing the most

Actel FPGA Product Family		1010A	1020A
Equivalent Gates	Gate Array	1200	2000
	PLD/LCA	3000	6000
User I/O		57	69
System Clock (MHz)		20-40	20-40
Availability		NOW	NOW
Technology (micron)		1.2	1.2

Breakfast And n By Dinner.

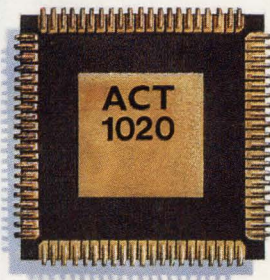

1:15 pm : Program

You load the Activator™ programming module with a 2000-gate ACT 1020 chip and hit "configure." Take a very quick coffee break while your design becomes a reality.

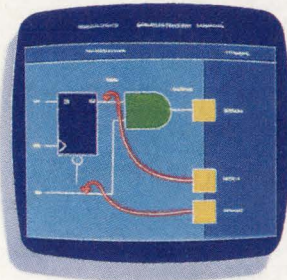

1:25 pm : Test

You do a complete, real-time performance check, with built-in test circuits that provide 100% observability of all on-chip functions. *Without* generating any test vectors.

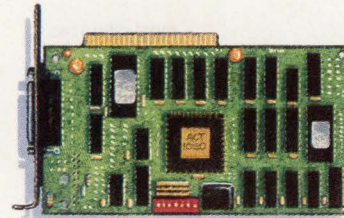

4:00 pm : Production

Your pride and joy is designed, created, tested, and off to the boys in Production. And you're finished way ahead of schedule! Better think of something to do until 5:00.

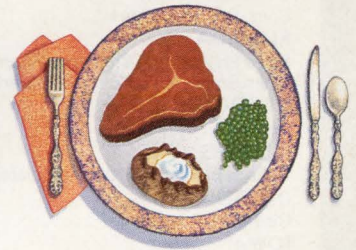

6:00 pm : Dinner

Remember dinner? Normal people actually go home and eat with their families. On your way, start thinking about how Actel's logic solution can help you be brilliant tomorrow.

tedious part of the job by hand.

Design verification is quick and easy with our Actionprobe™ diagnostic tools, for 100% observability of internal logic signals. Guaranteed. So you don't have to give up testability for convenience.

In fact, the only thing you'll give up is the NRE you pay with full masked arrays. You can get started with an entry level Action Logic System for under \$5000. Guaranteed.

And Actel FPGAs are even 883 mil-spec compliant.

You can be brilliant right now

with 1200- and 2000-gate devices, and a whole new family of 8000-, 4000- and 2500-gate parts are on the way. Call 1-800-227-1817, ext 60 today for a free demo disk and full details about the Action Logic System.

It could make your whole day.

Risk-Free Logic Integration

© 1990 Actel Corporation, 955 E. Argus Ave., Sunnyvale, CA 94086. ACT, Action Logic, Activator, and Actionprobe are trademarks of Actel Corporation. All other products or brand names mentioned are trademarks or registered trademarks of their respective holders.

ACTEL CORPORATION DIRECT SALES OFFICES

955 E. Arques Ave.
Sunnyvale, CA 94086
Tel: (408) 739-1010

8130 McFadden Ave., Suite 109
Westminster, CA 92683
Tel: (714) 373-4488

425 N. Martingale Rd., Suite 800
Schaumburg, IL 60173
Tel: (708) 706-3866

1740 Mass Avenue
Boxborough, MA 01719
Tel: (508) 635-0010

9101 Guilford Road, Suite 107
Columbia, MD 21046
Tel: (301) 604-0111

2350 Lakeside Blvd., Suite 850
Richardson, TX 75082
Tel: (214) 235-8944

DOMESTIC REPRESENTATIVES

ALABAMA

Rep Inc. (205) 881-9270

ARIZONA

Luscombe Engineering (602) 949-9333

CALIFORNIA

Centaur Corporation (Calabasas) (818) 704-1655

Centaur Corporation (Irvine) (714) 261-2123

Centaur Corporation (San Diego) (619) 278-4950

I² Inc. (Santa Clara) (408) 988-3400

I² Inc. (Orangevale) (916) 989-0843

COLORADO

Luscombe Engineering (303) 772-3342

CONNECTICUT

CompRep Associates (203) 269-1145

FLORIDA

Sales Engineering Concepts (Altamonte Springs) (407) 682-4800

Sales Engineering Concepts (Deerfield Beach) (305) 426-4601

GEORGIA

Rep Inc. (404) 938-4358

ILLINOIS

Carlson Electronic Sales Associates (708) 956-8240

INDIANA

Giesting & Associates (317) 844-5222

IOWA

Carlson Electronic Sales Associates (319) 378-1450

KANSAS

DLE Electronics (316) 683-6400

MARYLAND

New Era Sales (301) 544-4100

MASSACHUSETTS

CompRep Associates (617) 329-3454

MICHIGAN

Giesting & Associates (Livonia) (313) 478-8106

Giesting & Associates (Comstock Park) (616) 784-9437

MINNESOTA

Gibb Technology Sales (612) 835-3370

MISSOURI

John G. Macke Co. (314) 432-2830

NEW JERSEY

Nexus (201) 947-0151

NEW MEXICO

Luscombe Engineering (505) 888-0333

NEW YORK

L-MAR Associates (Apalachin) (607) 687-1828

L-MAR Associates (E. Rochester) (716) 381-9100

L-MAR Associates (Poughkeepsie) (914) 462-8025

NORTH CAROLINA

Rep Inc. (Charlotte) (704) 563-5554

Rep Inc. (Morrisville) (919) 469-9997

OHIO

Giesting & Associates (Cincinnati) (513) 385-1105

Giesting & Associates (Cleveland) (216) 261-9705

Giesting & Associates (Columbus) (614) 486-5616

OREGON

L² Ltd. (503) 629-8555

PENNSYLVANIA

Omega Sales (215) 244-4000

TENNESSEE

Rep Inc. (615) 475-4105

TEXAS

OM Associates (Austin) (512) 794-9971

OM Associates (Houston) (713) 789-4426

OM Associates (Richardson) (214) 690-6746

UTAH

Luscombe Engineering (801) 565-9885

WASHINGTON

L² Ltd. (206) 827-8555

WISCONSIN

Carlson Electronic Sales Associates (414) 476-2790

CANADA

Clark-Hurman Associates (Quebec) (514) 426-0453

Clark-Hurman Associates (Ontario-Brampton) (416) 840-6066

Clark-Hurman Associates (Ontario-Nepean) (613) 727-5626

INTERNATIONAL DISTRIBUTORS

AUSTRALIA

Reptechnic (Neutral Bay, NSW) (2) 953.9844

BELGIUM

Acal Auriema N.V.S.A. (Zavenlem) (2) 720.5983

DENMARK

Nordisk Elektronik AS (Herlev) (42) 84.20.00

EGYPT

SEE (Cairo) (2) 665.948

ENGLAND

Gothic-Crellon Ltd. (Wokingham) (0734) 78.88.78

Manhattan Skyline Ltd. (Maidenhead) (0628) 75.85.1

FINLAND

OY Fintronic AB (Helsinki) (0) 69.26.022

FRANCE

ASAP (Montigny Le Bretonneux) (1) 30.43.8233

SCAIB S.A. (Meylan-Zirst) (76) 90.22.60

SCAIB S.A. (Rungis Cedex) (1) 46.87.2313

HONG KONG

Twin-Star Trading Co. (Yau Tong Industrial City) (852) 346.9085

INDIA

Benchmark Systems (Madras) (44) 413.866

ISRAEL

A.S.T.Ltd. (Herzlia) (52) 58.33.55

ITALY

LASI Elettronica S.p.A. (Milan) (3) 499.8351

JAPAN

Innotech Corporation (Tokyo) (3) 499.8351

Matsushita Electronics Corporation (Kyoto) (75) 951.8151

KOREA

Eastern Electronics, Inc. (Seoul) (2) 566.0514

NETHERLANDS

Transfer B.V. (Enschede) (53) 33.43.81

NORWAY

Nordisk Elektronik AS (Hvalstad) (2) 84.50.70

SPAIN

Semiconductores S.A. (Barcelona) (93) 217.23.40

Semiconductores S.A. (Madrid) (1) 742.2313

SWEDEN

Traco AB (Farsta) (8) 93.00.00

SWITZERLAND

Omni Ray AG (Dietlikon) (1) 835.21.11

TAIWAN

SEED TECH Corporation (Taipei) (2) 521.1100

WEST GERMANY

bit-electronic AG (Munich) (089) 41.80.070

ECN Component Network (Ismaning) (089) 96.09.080

DOMESTIC DISTRIBUTORS

Actel products can be purchased from the major distributors listed below:

Wyle Laboratories: call (714) 851-9953 for the number of the office nearest you.

Pioneer Standard Electronics and Pioneer Technologies: call (516) 921-8700 for the number of the office nearest you.

PLD-BASED COPROCESSOR STABILIZES SERVO SYSTEM

DESIGNERS CAN OFFLOAD A SERVO SYSTEM'S MICROPROCESSOR BY ADDING A COPROCESSOR BASED ON PROGRAMMABLE LOGIC DEVICES.

Keeping up with a servo control system can overload even a powerful processor. The problem is that a sampling rate of 8 to 10 times the highest frequency sampled may be needed to avoid aliasing or to increase stability, and at that rate the processor's bandwidth can be quickly exceeded.

But designers can free up the processor and ensure a stable design by creating a servo "coprocessor" using programmable logic devices (PLDs).

The PLDs form a servo loop that functions as a coprocessor for the main CPU. Consequently, the CPU need not perform the control algorithm at a pace equal to the target sampling rate. Instead, all it has to do is merely input the desired reference point. Essentially, the processor can "set and forget" the servo coprocessor.

A good example is a laser-positioning system, in which an embedded 32-bit microprocessor orients a mirror to form images with a laser beam. As the microprocessor's tasks increase, its ability to maintain a stable servo system becomes marginal. Other servo applications that might have similar problems include: robotic assemblies, such as arms, camera mounts, etc.; aircraft control systems; printers, copiers, optical scanners, and plotters; and disk drives, VCRs, CD players, and turntables. The application described here was generalized from the real-world case of the laser-positioning system.

Designers can implement the coprocessor with several PLDs configured in a hybrid control loop. Using such third-generation devices as the CY7C330 simplifies design execution. Although engineers who have designed with 22V10s will be familiar with the general functionality of the CY7C330, the device has many other features that make it an ideal solution for this applica-

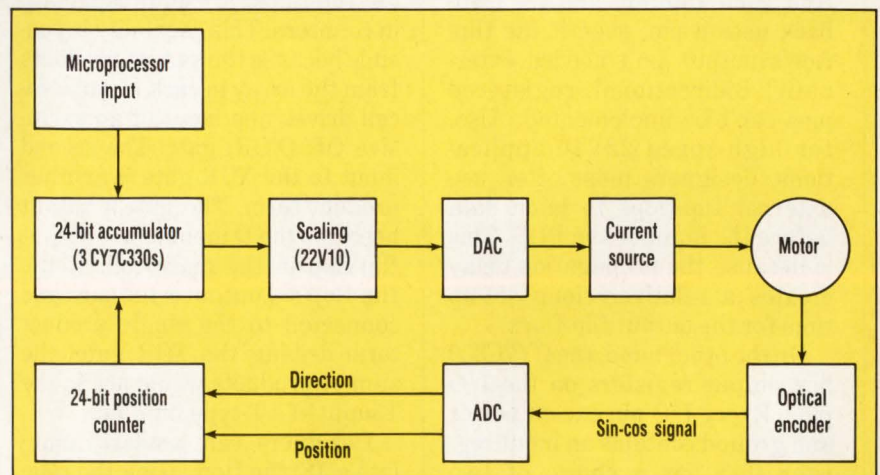

1. ADDING A HIGH-PRECISION accumulator to handle the feedback portion of a servo control system enables designers to take the host microprocessor out of the loop. Therefore, it doesn't have to run the control algorithm as fast as the target sampling rate.

MARK AALDERING
Cypress Semiconductor,
3901 N. First St.,
San Jose, CA 95134-1599;
(408) 943-2600.

PLD-BASED COPROCESSOR

tion (see "A flexible PLD," below).

In the example circuit, three PLDs are used to perform the loop's summing and proportional-feedback functions (see "Closed-loop servo systems," p. 64). The PLDs form an accumulator, with each device generating an 8-bit accumulate for 24 bits of precision (Fig. 1). The microprocessor simply provides the PLDs with a 24-bit position reference target, which is latched into the devices' on-board registers.

The desired position is compared to the present position, which is maintained in an external 24-bit present-position counter. The result of the comparison is the error signal, which is multiplied by a fixed unity gain. This proportional control signal is first converted to an analog signal and then to a current level so that it can control the positioning motor. The motor's shaft has an optical encoder that creates a sin-cos analog signal. When it's digitized, the signal

indicates the direction of rotation and supplies a pulse that increments or decrements the present-position counter.

With this arrangement, the loop can operate as fast as the slowest of the following elements: the PLDs configured as a multistage accumulator/subtractor, the digital-to-analog converter (DAC), or the analog-to-digital converter. The host microprocessor is completely decoupled from the servo loop. Should the microprocessor halt, the servo circuitry will maintain the desired reference position without intervention.

TWO OPERATING MODES

Essentially, the 7C330 macrocell output registers are programmed to act as an accumulator. Depending on the operation, the value generated by this accumulator represents one of two things: either a new servo-motor target position or the proportional-error feedback value to the servo.

When the system starts, the macrocell input registers, which are dedicated to holding the motor's current target position, wake up with an initial value of zero.

At the same time, the external position counter is also set to zero. Then the microprocessor steps the target position until the laser targets an alignment sensor.

The first mode is the target-position update mode, which includes the following steps. First, the outputs of the external 24-bit position counter are placed into a three-state condition.

These outputs are shared with the microprocessor's outputs as inputs to the dedicated input registers. The processor then drives a step value onto the inputs, which is clocked into the 7C330's dedicated input registers with the CLK₁ pin (Fig. 2). On the rising edge of the CLK pin, the step value is added (from a set of PLD equations) to the current value in the ma-

A FLEXIBLE PLD

Although it's more flexible than simpler PLDs, the 22V10 does have limitations. The architecture of the CY7C330 addresses these shortcomings, increasing flexibility even further.

The 22V10 offers only D flip-flops, which are cumbersome for such applications as counters. And each flip-flop and its feedback uses a pin, even if the flip-flop's output isn't needed externally. Bidirectional, registered pins can't be implemented. Also, for high-speed 22V10 applications, designers must often use external flip-flops to latch data before the input of the PLD. This is because the propagation delay creates a relatively long set-up time for the output flip-flops.

On the other hand, the CY7C330 has output registers on the I/O pins. Every I/O pin except power and ground contains an input register that has a choice of two clocks. In some applications, including up and down counters,

three-stating the macrocell output drivers and loading data into the macrocell input register allows designers to use these macrocell input registers to hold reference values, such as the counter's upper or lower limit.

The CY7C330 also expands on the 22V10's functions by permitting designers to emulate T and JK flip-flops, a useful capability in counters. This capability is possible because the sum-of-products from the array in each I/O macrocell drives one input of an exclusive OR (XOR) gate. The second input to the XOR gate is another product term. The gate's output becomes the D input of the output flip-flop in the macrocell. If the flip-flop's Q output is fed back and connected to the single product term driving the XOR gate, the sum-of-products would act as the T input of a T-type flip-flop.

Designers can similarly emulate a JK flip-flop, using the relation $T = J!Q + KQ$. The "!" symbol is an invert or NOT operator

used in most PLD software packages. Of course, if a D flip-flop is all that's required, the XOR gate can be used to control polarity.

There are two paths into the CY7C330 array. The first is through a multiplexer that selects feedback from the register or the Q output of the input register. This is called the feedback multiplexer. The second path is through the shared-input multiplexer, whose inputs are the Q outputs of input registers belonging to adjacent I/O macrocells. This enables users to feed back the Q output of a macrocell's output register and still use the pin associated with that macrocell as an input. Of course, this can only be done with 6 of the device's 12 I/O macrocells.

If more registers are needed for an application, the CY7C330 has four additional buried (or hidden) registers. These are identical to the output register portion of the I/O macrocell, except they're not connected to any pin.

NEW
with **ABEL-4**
intelligent device selection



Knock-your-socks-off PLD software on a shoestring budget.

Who says you can't afford the world's best PLD development tools? Data I/O's industry-standard design software and programming solutions are more powerful—and more affordable—than ever before. So now the best tools on the market are also the best value.

NEW ABEL™-4 marks a major milestone in PLD software. The leader in device support, ABEL-4 automatically identifies which PLDs match your design needs with new SmartPart™ intelligent device selection. New optional device fitters automatically assign pins and

configure macrocells for complex device architectures. And an all-new user interface speeds the entire PLD design process.

A major new version of the leading schematic capture software, **NEW FutureNet®-5**, redefines "ease-of-use" with pop-up menus, extensive dialog boxes and a fast symbol browsing feature.

To make designing for testability practical, choose **NEW PLDgrade™**. This inexpensive fault grading software helps you optimize your design for testability before production.

And the affordable **NEW 2900 Programming System** brings the cost of high-performance programming down to earth. Its innovative technology makes programming any PLD—even surface-mount devices—fast and easy.

CALL TODAY for your **FREE** tutorial on designing with PLDs—a \$12.95 value.

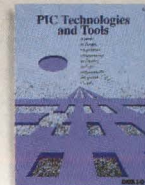

1-800-247-5700

The Personal Silicon Experts

DATA I/O
Corporation

Data I/O Corporation 10525 Willows Road N.E., P.O. Box 97046, Redmond, WA 98073-9746, U.S.A. (206) 881-6444/1-800-247-5700
Data I/O Canada 6725 Airport Road, Suite 302, Mississauga, Ontario L4V 1V2 (416) 678-0761
Data I/O Europe World Trade Center, Strawinskylaan 633, 1077 XX Amsterdam, The Netherlands +31 (0)20-6622866/Telex 16616 DATIO NL
Data I/O Instrument Electronic Systems Vertriebs GmbH Lochamer Schlag 5A, 8032 Graefelfing, W. Germany, +49 (0)89-858580
Data I/O Japan Sumitomoseimei Higashishinbashi Bldg., 8F, 2-1-7, Higashi-Shinbashi, Minato-Ku, Tokyo 105, Japan
 (03) 432-6991/Telex 2522685 DATAIO J

©1990 Data I/O Corporation

CIRCLE 119



You could call
for two sales engineers...
or ask for this free video.

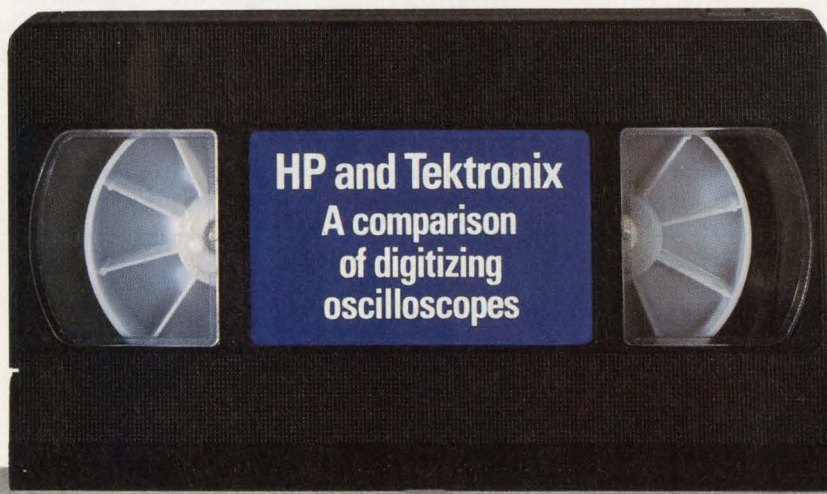

©1990 Hewlett-Packard Co. TMCOL016/ED

The world is crossing over to digitizing oscilloscopes. Which means new issues in making scope decisions. How do you know the right questions? Where do you find the answers?

The first step is to call for this FREE videotape. It shows you an objective comparison of HP & Tektronix

digitizing oscilloscopes. Not just the features and specs, but the practical differences in real measurement situations. Information which is vital for a good decision.

So call **1-800-752-0900*** today. Ask for **Ext. 1228** and we'll send your FREE videotape.

*In Canada call 1-800-387-3867, Dept. 411.

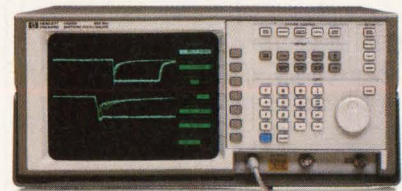

There is a better way.

 **HEWLETT
PACKARD**

DESIGN APPLICATIONS

PLD-BASED COPROCESSOR

rail high and low conditions, and two off-scale bits are generated for each of these conditions. These four off-scale bits and the seven low-order bits are passed to another PLD (a 22V10) that drives the DAC (Fig. 1, again).

If the four off-scale bits indicate that the upper bits are all close to zero, the seven low-order bits sent to the DAC are masked to zero. Likewise, if the upper bits are mostly ones, the DAC bits are set to one. This determination of how to use the off-scale bits for compensation in the scaling PLD is specific to a given application.

LOGIC EQUATIONS

The backbone of this design is the accumulator implemented in the PLDs. The logic required for a synchronous full adder is described by the equations for the sum and the carry of a given bit. In the general case,

$$S_n = (A_n \text{ XOR } B_n \text{ XOR } C_{n-1})$$

where S_n is the sum at bit position n with inputs A_n and B_n , and C_{n-1} is the carry in from the previous stage.

The equation for the carry out is:

$$C_{outn} = (A_n * B_n) + (A_n * C_{n-1}) + (B_n * C_{n-1}).$$

Several equations are involved when a 4-bit synchronous adder requires four clocks to complete (see the table).

THE SPEED OBJECTIVE

The overall objective is to calculate a complete 24-bit sum as fast as possible. Therefore, the equation for the carry out from the first bit of the adder (C_0) can be substituted into the equation for the second bit of the adder.

This substitution allows the first two bits to be added in one clock cycle. Likewise, the equation for the carry out from the second bit can be substituted into the equation for the third sum, and so on. The result is equations for three bits of substitution (see the table, again).

ADDER EQUATIONS

General 4-bit adder

$$S_0 = A_0 \text{ XOR } B_0 \text{ XOR } C_{in} \\ C_0 = (A_0 * B_0) + (A_0 * C_{in}) + (B_0 * C_{in})$$

$$S_1 = A_1 \text{ XOR } B_1 \text{ XOR } C_0 \\ C_1 = (A_1 * B_1) + (A_1 * C_0) + (B_1 * C_0)$$

$$S_2 = A_2 \text{ XOR } B_2 \text{ XOR } C_1 \\ C_2 = (A_2 * B_2) + (A_2 * C_1) + (B_2 * C_1)$$

$$S_3 = A_3 \text{ XOR } B_3 \text{ XOR } C_2 \\ C_3 = (A_3 * B_3) + (A_3 * C_2) + (B_3 * C_2)$$

C_3 is the carry-out of the 4-bit adder.

Synchronous 3-bit adder

$$S_0 = A_0 \text{ XOR } B_0 \text{ XOR } C_{in} \\ C_0 = (A_0 * B_0) + (A_0 * C_{in}) + (B_0 * C_{in})$$

$$S_1 = A_1 \text{ XOR } B_1 \text{ XOR } [(A_0 * B_0) + (A_0 * C_{in}) + (B_0 * C_{in})] \\ C_1 = (A_1 * B_1) + (A_1 * [(A_0 * B_0) + (A_0 * C_{in}) + (B_0 * C_{in})]) + (B_1 * [(A_0 * B_0) + (A_0 * C_{in}) + (B_0 * C_{in})])$$

$$S_2 = A_2 \text{ XOR } B_2 \text{ XOR } \{ (A_1 * B_1) + (A_1 * [(A_0 * B_0) + (A_0 * C_{in}) + (B_0 * C_{in})]) + (B_1 * [(A_0 * B_0) + (A_0 * C_{in}) + (B_0 * C_{in})]) \} \\ C_2 = (A_2 * B_2) + (A_2 * \{ (A_1 * B_1) + (A_1 * [(A_0 * B_0) + (A_0 * C_{in}) + (B_0 * C_{in})]) + (B_1 * [(A_0 * B_0) + (A_0 * C_{in}) + (B_0 * C_{in})]) \}) + (B_2 * \{ (A_1 * B_1) + (A_1 * [(A_0 * B_0) + (A_0 * C_{in}) + (B_0 * C_{in})]) + (B_1 * [(A_0 * B_0) + (A_0 * C_{in}) + (B_0 * C_{in})]) \})$$

Note: The equations use substitution of the carry-out in the first 3 bits to generate a 3-bit result in one clock cycle.

A_n and B_n are inputs to be added at bit n ; C_{in} is the carry-in to the adder. S_n is the sum out for bit n and C_n is the carry-out from adder stage n .

Although the 7C330's XOR product term helps reduce the number of product terms required for a given sum bit, the equations for the fourth bit are complex. Even after Boolean reduction, the adder's fourth bit re-

quires 30 product terms for the sum bit and 31 product terms for the carry-out bit to generate a 4-bit result in one clock cycle.

Because the maximum number of product terms for a given macrocell in the 7C330 is 19, the accumulate process must be accomplished over multiple 3-bit stages. Adding the first three bits will be complete after one clock cycle, the second three bits after two cycles, and so on. Therefore, the complete 24-bit accumulate requires nine clock cycles implemented on three 7C330s. With 66-MHz devices, this translates to a complete 24-bit calculation cycle in 120 ns.

The minimized equations for the three 8-bit adder stages are available on the Cypress Applications Bulletin Board System, (408) 943-2954 (1200/2400 bps, 8-N-1). The syntax used for the equations is from the Cypress PLD Toolkit.

The terms in the equations are derived from the target-update and

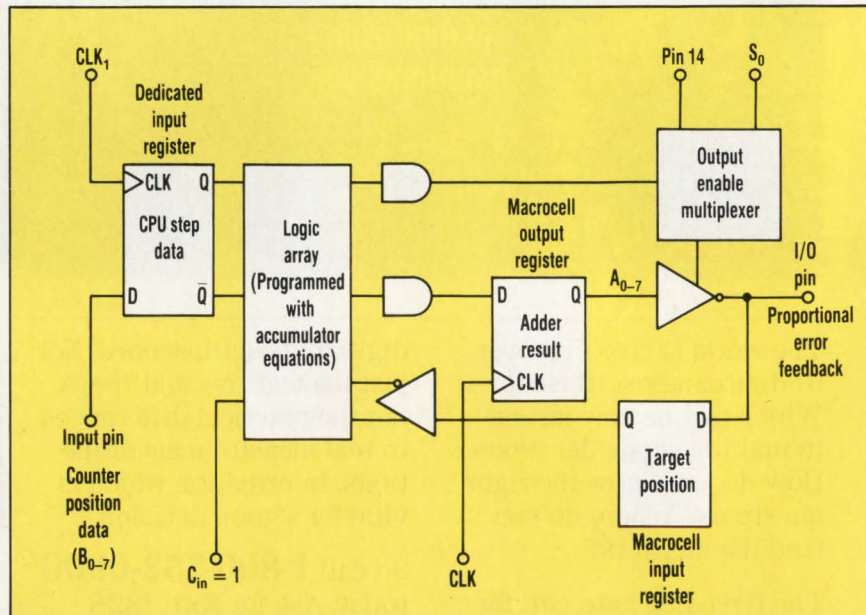

3. WHEN THE CIRCUIT IS IN THE control mode, the dedicated input register receives position data from the external position counter. With the carry-in (C_1) now set to one, the logic equations subtract the current position from the target position, creating an error value.

SIEMENS

From top to bottom: RISC, ISDN, Microprocessors, Smart Power and 4 MB DRAMs.

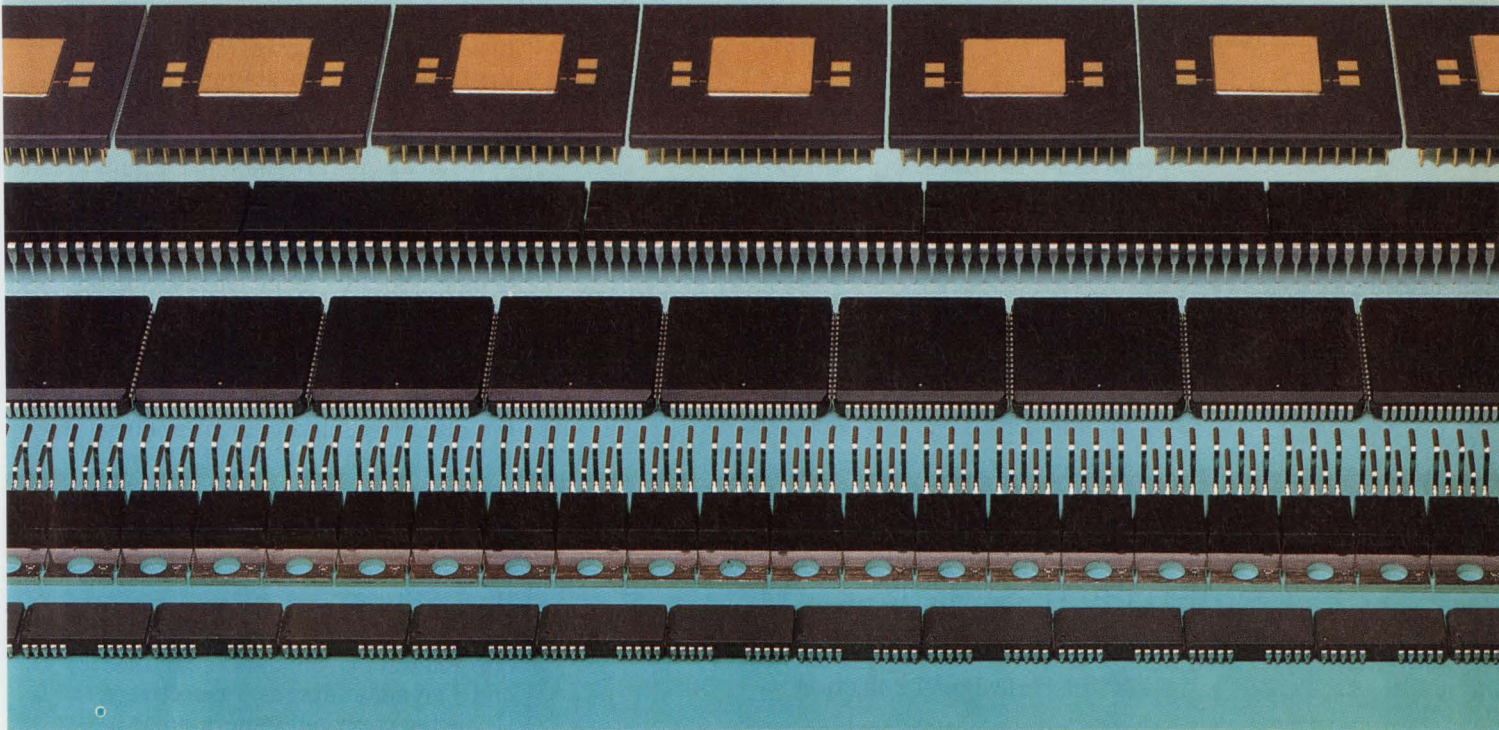

A Fine Line Separates Us From Other ASIC Suppliers.

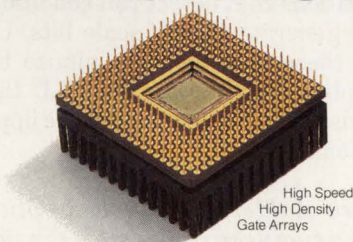

High Speed
High Density
Gate Arrays

We back our world-class ASIC technology with a full line of standard semiconductor devices, offering you a complete solution for any of your IC needs, with technological advancements across the board. From our 32-bit RISC Processors, to our 4 MB DRAMs, to our comprehensive line of ISDN ICs. In fact, it's our extensive experience in standard semiconductor technology that sets Siemens apart from other ASIC suppliers.

And our significant R&D investments have made us a world-class leader in ASIC technology. We feature 1.5 μ m and 1.0 μ m CMOS Sea of Gates ASICs, offering up to 172K raw gates, and a full line of ECL gate arrays.

Through ADVANCELL[®], our cell-based custom capability, we offer compiled megacells in 1.5 μ m and 1.0 μ m CMOS technology for maximum flexibility and functionality. And both our CMOS product families are alternatively sourced by, and identical to, industry-leading families at the mask level, giving you the added flexibility of multiple sourcing.

From R&D to design to production, Siemens offers the quick turnaround and high-precision capabilities, to get

you to market fast, and supply you with quality ASIC parts and support. As well as a world-class line of standard semiconductor products. Ensuring you a line you can believe in.

For details on our ASIC products, call (800) 456-9229, or write: Siemens Components, Inc. 2191 Laurelwood Road Santa Clara, CA 95054-1514. Ask for literature package M31A003.

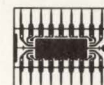

Siemens
Practical Solutions by Design.

CIRCLE 109

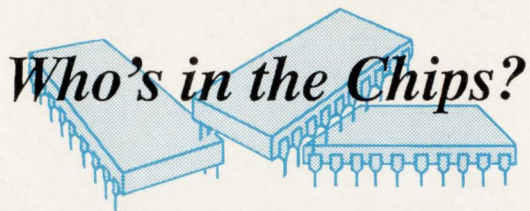

Who's in the Chips?

PLD designers using SCHEMA's winning design tools

SCHEMA III schematic capture \$495

- ✓ EDIF 2.0
- ✓ ADF format
- ✓ Intel iPLSII* interface option
- ✓ XILINX XACT* interface option

SCHEMA /PGA XILINX Simulator

- ✓ only \$1995
- ✓ Series 2000
- ✓ Series 3000

SCHEMA PLD \$495

- ✓ PLD design & selection
- ✓ 5 minimization options

VARI X PROGRAMMERS

- ✓ only \$595
- ✓ 4 socket SET/GANG



FREE DEMO DISKS

FREE 1-800 Support * 30 Day Money Back Guarantee

1-800-553-9119

*Intel iPLSII is a registered trademark for Intel
*XILINX XACT is a registered trademark for XILINX



CIRCLE 163

DESIGN APPLICATIONS PLD-BASED COPROCESSOR

control-mode schematics. For example, variables B_{0-7} are the inputs to the CY7C330 from either the microprocessor or the current position counter (Figs. 2 and 3, again). The variable INCLK in the equations is CLK_1 , which clocks in B_{0-7} . C_{in} is a carry-in signal derived from external logic or from the previous stage of the adder (in the control mode, when the first 8-bit adder stage is set for subtraction, the external logic must assert C_{in}).

Variables A_{0-7} are the sum outputs for either the target update or control mode. If the processor is updating the target position by a step increment, A_{0-7} are loaded into the macrocell input registers with CLK_2 (ACLK in the equations). During the update process, the macrocells' output drivers aren't three-stated with the output-enable pin or a product-term equation. As a result, the macrocell output registers, which have the newly calculated target position, can be loaded into the macrocell input registers that are used to hold the target position.

C_2 and C_5 are internal carry-out bits generated from the first and second 3-bit adder stages, respectively. C_{out} is the carry-out generated as either the final carry-out or as the input to the carry-in of the next 8-bit adder stage.

The equations for the two upper stages are the same as those for the first stage, except for the addition of equations that detect rail conditions and generate the off-scale bits. Using these bits, which minimize the number of inputs for the PLD that feeds the DAC, depends on the application. □

Mark Aldering, a field applications engineer responsible for supporting Cypress Semiconductor customers in the Northwest US and Canada, received a BS in engineering from California State University at Northridge.

HOW VALUABLE?	CIRCLE
HIGHLY	541
MODERATELY	542
SLIGHTLY	543

THE NO COMPROMISE 22V10

Programmable logic always has been a give-and-take affair. If you wanted speed, the price was power—lots of it. And, if you tried to cut power, you lost the speed. It seems you could have either one or the other—but not both. **NOW YOU CAN HAVE THE BEST OF BOTH WORLDS.**

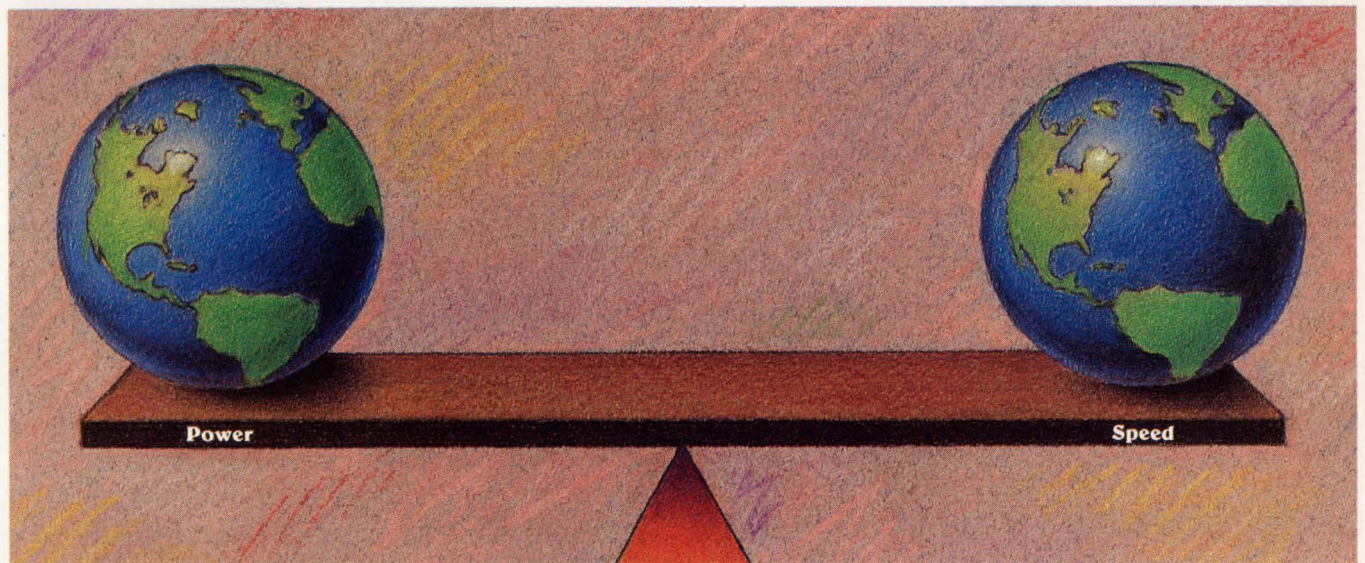

Announcing the AT22V10-15—the no compromise 22V10.

Talk about fast. A blazing 15 nanoseconds. That's fast enough for those advanced 32-bit systems you're designing today for tomorrow's machines.

And it's cool. When you plug in the AT22V10 you won't even think it's on. It typically draws a stingy 55 milliamps

in standby and never asks for more than 90 milliamps.

So, if you're tired of having to compromise. Don't. Call Atmel, the home of the no compromise 22V10. If you're not sure yet that we make the best CMOS 22V10 in the whole world drop us a note on your company's letterhead, and we'll send you one. Or in the U.S. call us at **1-800-292-8635**.

ATMEL CORPORATION
2125 O'Neil Drive
San Jose, CA 95131



The people who make the difference.

Tel. (408) 441-0311
FAX (408) 436-4200

The way
we build
workstations,
you'd think
we had
to use them
ourselves.

We do.



There's nothing like some real world proof to establish the viability of a product.

Which is why you might find it comforting to know that the Sony NEWS® line of workstations are being used by real designers. On real chip, board, and product development projects. For one of the world's most successful electronics manufacturers: Sony.

In fact, Sony engineers are using NEWS workstations to design everything from SRAMs and other chips to advanced video and audio controllers for the professional broadcast markets.

All of which uniquely positions us to understand your engineering and product development needs. Because here is a case where the supplier is acutely aware of the consumer's needs. And has to meet those needs. On a daily basis.

The result is our very affordable NEWS 3710 desktop workstations—the latest additions to our current workstation line. Fast, powerful, and expandable, these R3000®-based systems offer extensive memory plus high capacity, cost-effective storage options—including Sony's unique magneto optical drives and DAT tapes. Of course, you can choose the black-and-white, grayscale, or high-resolution Trinitron® color monitor that best fits your application.

We even have most of the popular EDA software packages—including applications from vendors such as Cadence, Valid Logic, Data I/O, Synopsys, Racal-Redac, Silvaco and an ever-expanding roster of others.*

To find out more about why Sony's solutions should be your solutions, give us a call at 1-800-624-8999, ext. #96.

Then just sit back and watch the NEWS.

CIRCLE 122

SONY®

Sony Microsystems Company

Sony Microsystems Company, 651 River Oaks Parkway, San Jose, CA 95134 (408) 434-6644 FAX: (408) 954-0849 • Sony of Canada, Ltd., Ontario, Phone: (416) 499-1414 FAX: (416) 497-1774 • Sony Microsystems Europe, Köln, Phone: (0221) 59 30 42 FAX: (0221) 59 35 42 • Sony (Australia) Pty, Ltd., N.S.W. Phone: (02) 887-6666 FAX: (02) 887-4351 • International Sales Division, Tokyo, Phone: (03) 448-4041 FAX: (03) 448-4043 • Sony NEWS, and Trinitron are registered trademarks of Sony Corporation. R3000 is a registered trademark of MIPS Computers, Inc. © 1990 Sony Corporation of America. Design and specifications subject to change without notice. *Some of the software mentioned herein may not be available for all NEWS models or for worldwide distribution. Call your Sony representative to check for availability.

WHEN DESIGNING STATE MACHINES, A TECHNIQUE CALLED ONE-HOT ENCODING CREATES EFFICIENT CIRCUITS FOR TOP-PERFORMING FPGA MACROS.

ACCELERATE FPGA MACROS WITH ONE-HOT APPROACH

State machines—one of the most commonly implemented functions with programmable logic—are employed in various digital applications, particularly controllers. However, the limited number of flip-flops and the wide combinatorial logic of a PAL device favors state machines that are based on a highly encoded state sequence. For example, each state within a 16-state machine would be encoded using four flip-flops as the binary values between 0000 and 1111.

A more flexible scheme—called one-hot encoding (OHE)—employs one flip-flop per state for building state machines. Although it can be used with PAL-type programmable-logic devices (PLDs), OHE is better suited for use with the fan-in limited and flip-flop-rich architectures of the higher-gate-count field-programmable gate arrays (FPGAs), such as offered by Xilinx, Actel, and others. This is because OHE requires a larger number of flip-flops. It offers a simple and easy-to-use method of generating performance-optimized state-machine designs because there are few levels of logic between flip-flops.

A state machine implemented with a highly encoded state sequence will

STEVEN K. KNAPP
Xilinx Inc., 2100 Logic Dr.,
San Jose, CA 95124;
(408) 879-5172.

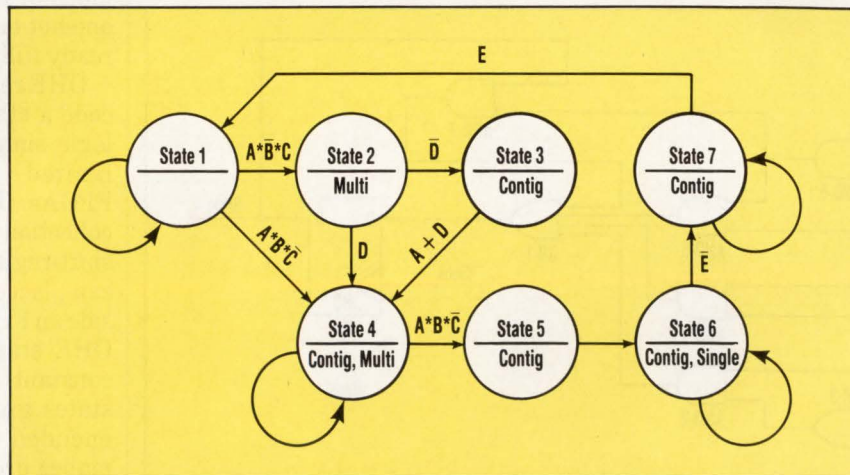

1. HERE, A TYPICAL STATE MACHINE BUBBLE diagram shows the operation of a seven-state state machine that reacts to inputs A through E as well as previous-state conditions.

STATE MACHINE DESIGN

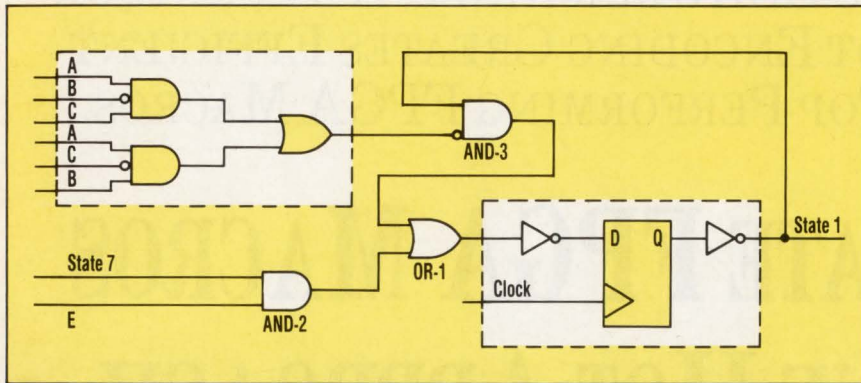

2. INVERTERS ARE REQUIRED at the D input and the Q output of the state flip-flop to ensure that it powers on in the proper state. Combinatorial logic decodes the operations based on the input conditions and the state feedback signals. The flip-flop will remain in State 1 as long as the conditional paths out of the state are not valid.

generally have many, wide-input logic functions to interpret the inputs and decode the states. Furthermore, incorporating a highly encoded state machine in an FPGA requires several levels of logic between clock edges because multiple logic blocks will be needed for decoding the states. A better way to implement state machines in FPGAs is to match the state-machine architecture to the device architecture.

LIMITING FAN-IN

A good state-machine approach for FPGAs limits the amount of fan-in into one logic block. While the one-hot method is best for most FPGA applications, binary encoding is still more efficient in certain cases, such

as for small state machines. It's up to the designer to evaluate all approaches before settling on one for a particular application.

FPGAs are high-density programmable chips that contain a large array of user-configurable logic blocks surrounded by user-programmable interconnects. Generally, the logic blocks in an FPGA have a limited number of inputs. The logic block in the Xilinx XC-3000 series, for instance, can implement any function of five or less inputs. In contrast, a PAL macrocell is fed by each input to the chip and all of the flip-flops. This difference in logic structure between PALs and FPGAs is important for functions with many inputs: Where a PAL could implement a

many-input logic function in one level of logic, an FPGA might require multiple logic layers due to the limited number of inputs.

The OHE scheme is named so because only one state flip-flop is asserted, or "hot," at a time. Using the one-hot-encoding method for FPGAs was originally conceived by High-Gate Design—a Saratoga, Calif.-based consulting firm specializing in FPGA designs.

The OHE state machine's basic structure is simple—first assign an individual flip-flop to each state, and then permit only one state to be active at any time. A state machine with 16 states would require 16 flip-flops using the OHE approach; a highly encoded state machine would need just 4 flip-flops. At first glance, OHE may seem counter-intuitive. For designers accustomed to using PLDs, more flip-flops typically indicates either using a larger PLD or even multiple devices.

In an FPGA, however, OHE yields a state machine that generally requires fewer resources and has higher performance than a binary-encoded implementation. OHE has definite advantages for FPGA designs because it exploits the strengths of the FPGA architecture. It usually requires two or less levels of logic between clock edges than binary encoding. That translates into faster operation. Logic circuits are also simplified because OHE removes much of the state-decoding logic—a one-hot-encoded state machine is already fully decoded.

OHE requires only one input to decode a state, making the next-state logic simple and well-suited to the limited fan-in architecture of FPGAs. In addition, the resulting collection of flip-flops is similar to a shift-register-like structure, which can be placed and routed efficiently inside an FPGA device. The speed of an OHE state machine remains fairly constant even as the number of states grows. In contrast, a highly encoded state machine's performance drops as the states grow because of the wider and deeper decoding logic that's required.

To build the next-state logic for

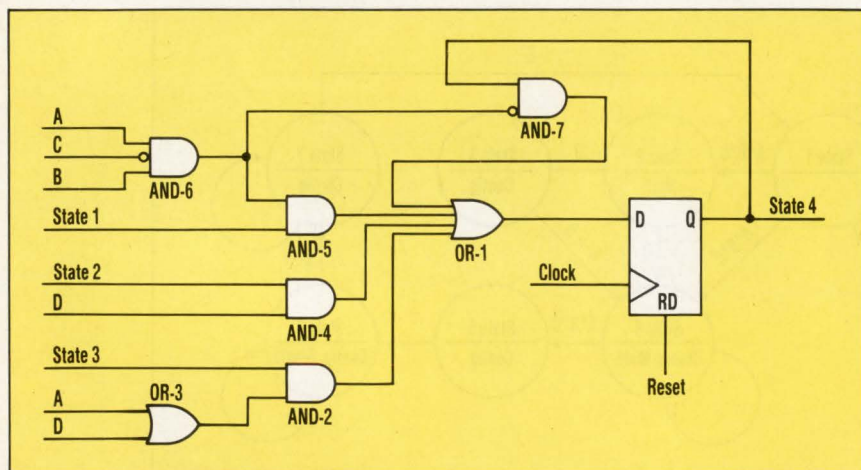

3. OF THE SEVEN STATES, the state-transition logic required for State 4 is the most complex, requiring inputs from three other state outputs as well as four of the five condition signals (A-D).

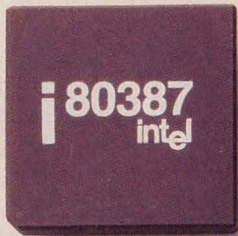

Is Your PC Really Up to Speed?



You may think your PC is already up to speed, but what if it could run even faster? The fact is, with the Intel Math CoProcessor, your software can run up to 500% faster.

And speaking of fast, installation is fast — and easy — because compatible PCs already have a socket for an Intel Math CoProcessor. And with Intel Math CoProcessors for PCs, ATs and 386™ microprocessor-based systems in stock, Hamilton/Avnet can deliver in virtually no time.

In fact, the only thing that isn't fast about the Intel Math CoProcessor is its five-year warranty and the continuous service and support that you can count on from Intel.

So don't waste another nanosecond. Get your system up to speed by calling Hamilton/Avnet, toll free, **1 (800) 442-6458**.



*386 is a trademark of Intel Corp.



CIRCLE 100



Hamilton Avnet
ELECTRONICS AN AVNET COMPANY

People Dedicated to Service. Committed to Quality

STATE MACHINE DESIGN

OHE state machines is simple, lending itself to a "cookbook" approach. At first glance, designers familiar with PAL-type devices may be concerned by the number of potential illegal states due to the sparse state encoding. This issue, to be discussed later, can be solved easily.

A typical, simple state machine might contain seven distinct states that can be described with the commonly used circle-and-arc bubble diagrams (Fig. 1). The label above the line in each "bubble" is the state's name, the labels below the line are the outputs asserted while the state is active. In the example, there are seven states labeled State 1-7. The "arcs" that feed back into the same state are the default paths. These will be true only if no other conditional paths are true.

Each conditional path is labeled with the appropriate logical condition that must exist before moving to the next state. All of the logic inputs are labeled as variables A through E. The outputs from the state machine are called Single, Multi, and Contig. For this example, State 1, which must be asserted at power-on, has a doubly-inverted flip-flop structure (shaded region of Fig. 2).

The state machine in the example was built twice, once using OHE and again with the highly encoded approach employed in most PAL designs. A Xilinx XC3020-100 2000-gate FPGA was the target for both implementations. Though the OHE circuit required slightly more logic than the highly-encoded state machine, the one-hot state machine operated 17%

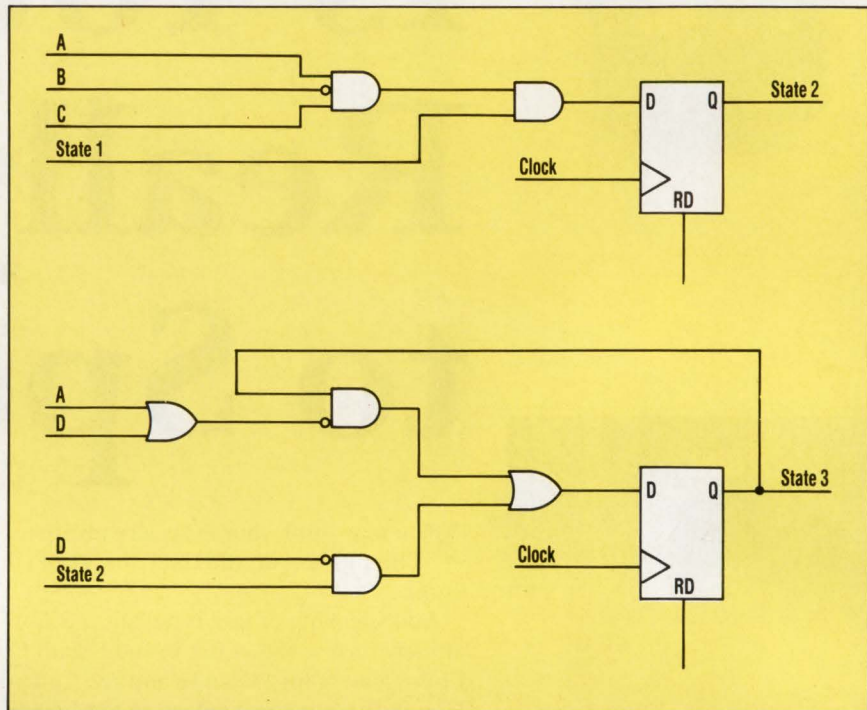

4. ONLY A FEW GATES are required by States 2 and 3 to form simple state-transition logic decoding. Just two gates are needed by State 2 (top), while four simple gates are used by State 3 (bottom).

faster (see the table). Intuitively, the one-hot method might seem to employ many more logic blocks than the highly encoded approach. But the highly encoded state machine needs more combinatorial logic to decode the encoded state values.

The OHE approach produces a state machine with a shift-register structure that almost always outperforms a highly encoded state machine in FPGAs. The one-state design had only two layers of logic between flip-flops, while the highly en-

coded design had three. For other applications, the results can be far more dramatic. In many cases, the one-hot method yields a state machine with one layer of logic between clock edges. With one layer of logic, a one-hot state machine can operate at 50 to 60 MHz.

The initial or power-on condition in a state machine must be examined carefully. At power-on, a state machine should always enter an initial, known state. For the Xilinx FPGA family, all flip-flops are reset at power-on automatically. To assert an initial state at power-on, the output from the initial-state flip-flop is inverted. To maintain logical consistency, the input to flip-flop also is inverted.

All other states use a standard, D-type flip-flop with an asynchronous reset input. The purpose of the asynchronous reset input will be discussed later when illegal states are covered.

Once the start-up conditions are set up, the next-state transition logic can be configured. To do that, first examine an individual state. Then

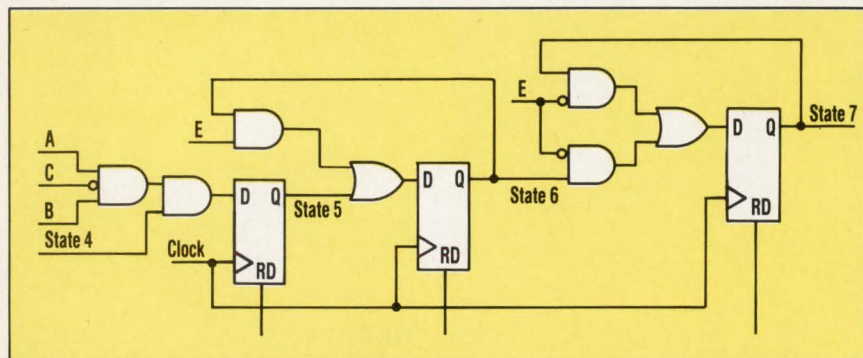

5. LOOKING NEARLY THE SAME as a simple shift register, the logic for States 5, 6, and 7 is very simple. This is because the OHE scheme eliminates almost all decoding logic that precedes each flip-flop.

AT&T's new ECL ASICs let you

opt for speed and keep your cool.

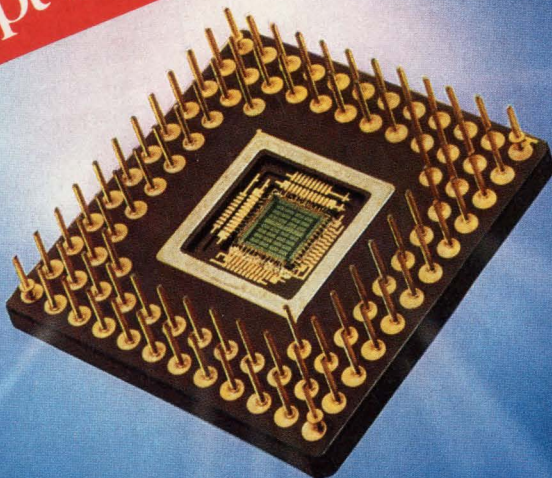

Ready for gate arrays and standard cell ICs that offer superior design solutions? Our 80 ps BEST-1 process is ready to deliver them.

High speed with low power is one part of AT&T's BEST-1 (Bipolar Enhanced Self-Aligned Technology) story; cost-effective ASIC development is another.

Our 1K, 4K and 9K arrays and our 20K gate complexity standard cell ICs share a common function library, so you can prototype with quick-turn gate arrays—then easily convert to standard cells from the world's number one standard cell supplier, for high-volume, low-cost production.

Flexibility? Our ECL ASICs offer more than 200 ECL or TTL input, output or bi-directional pins. Our library provides over 50 function blocks, each available in three speed/power ratings (e.g. 3, 4 and 6mW D-FFs at .5, 1 and 2 GHz unloaded) and 40 ECL/TTL I/O buffer choices.

Design? It's a no-problem proposition with single -5.2V or -4.5V power supply and Mentor

Graphics* and Viewlogic† CAD support.

BEST-1 is just the starting point in our ECL/BiCMOS process road map—moving ahead in performance well into the 1990s.

For more reasons to opt for AT&T in ECL ASICs, get our BEST-1 Gate Array and Standard Cell ASIC datasheets. Just give us a call at 1 800 372-2447.

*Mentor Graphics is a registered trademark of Mentor Graphics, Inc.
†Viewlogic is a registered trademark of Viewlogic, Inc.

The
components
of success.



AT&T

The right choice

CIRCLE 117

STATE MACHINE DESIGN

count the number of conditional paths leading into the state and add an extra path if the default condition is to remain in the same state. Second, build an OR-gate with the number of inputs equal to the number of conditional paths that were determined in the first step.

Third, for each input of the OR-gate, build an AND-gate of the previous state and its conditional logic. Finally, if the default should remain in the same state, build an AND-gate of the present state and the inverse of all possible conditional paths leaving the present state.

To determine the number of conditional paths feeding State 1, examine the state diagram—State 1 has one path from State 7 whenever the variable E is true. Another path is the default condition, which stays in State 1. As a result, there are two conditional paths feeding State 1. Next, build a 2-input OR-gate—one input for the conditional path from State 7, the other for the default path to stay in State 1 (shown as OR-1 in Fig. 2).

The next step is to build the conditional logic feeding the OR-gate. Each input into the OR-gate is the logical AND of the previous state and its conditional logic feeding into State 1. State 7, for example, feeds State 1 whenever E is true and is implemented using the gate called AND-2 (Fig. 2, again). The second input into the OR-gate is the default transition that's to remain in State 1. In other words, if the current state is State 1, and no conditional paths leaving State 1 are valid, then the state machine should remain in State 1. Note in the state diagram that two conditional paths are leaving State 1 (Fig. 1, again).

The first path is valid whenever $(A * \bar{B} * C)$ is true, which leads into State 2. The second path is valid whenever $(A * B * \bar{C})$ is true, leading into State 4. To build the default logic, State 1 is ANDed with the inverse of all of the conditional paths leaving State 1. The

first path is valid whenever $(A * \bar{B} * C)$ is true, which leads into State 2. The second path is valid whenever $(A * B * \bar{C})$ is true, leading into State 4. To build the default logic, State 1 is ANDed with the inverse of all of the conditional paths leaving State 1. The

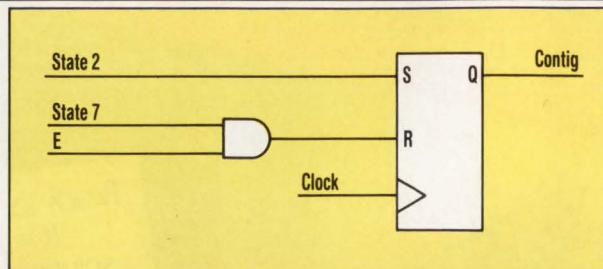

6. S-R FLIP-FLOPS OFFER ANOTHER

approach to decoding the Contig output. They can also save logic blocks, especially when an output is asserted for a long sequence of contiguous states.

logic to perform this function is implemented in the gate labeled AND-3 and the logic elements that feed into the inverting input of AND-3 (Fig. 2, again).

State 4 is the most complex state in the state-machine example. However, creating the logic for its next-state control follows the same basic method as described earlier. To begin with, State 4 isn't the initial state, so it uses a normal D-type flip-flop without the inverters. It does, however, have an asynchronous reset input, three paths into the state, and a default condition that stays in State 4. Therefore, a four-input OR-gate feeds the flip-flop (OR-1 in Fig. 3).

The first conditional path comes from State 3. Following the methods established earlier, an AND of State 3 and the conditional logic, which is A ORed with D, must be implemented (AND-2 and OR-3 in Fig. 3). The next conditional path is from State 2, which requires an AND of State 2 and variable D (AND-4 in Fig. 3). Lastly, the final conditional path leading into State 4 is from State 1. Again, the State-1 output must be ANDed with its conditional path logic—the logical product, $A * B * \bar{C}$ (AND-5 and AND-6 in Fig. 3).

Now, all that must be done is to build the logic that remains in State 4 when none of the conditional paths away from State 4 are true. The path

leading away from State 4 is valid whenever the product, $A * B * \bar{C}$, is true. Consequently, State 4 must be ANDed with the inverse of the product, $A * B * \bar{C}$. In other words, "keep loading the flip-flop with a high until a valid transfer to the next state occurs." The default path logic uses AND-7 and shares the output of AND-6.

Configuring the logic to handle the remaining states

is very simple. State 2, for example, has only one conditional path, which comes from State 1 whenever the product $A * \bar{B} * C$ is true. However, the state machine will immediately branch in one of two ways from State 2, depending on the value of D. There's no default logic to remain in State 2 (Fig. 4, top). State 3, like States 1 and 4, has a default state, and combines the A, D, State 2, and State-3 feedback to control the flip-flop's D input (Fig. 4, bottom).

State 5 feeds State 6 unconditionally. Note that the state machine waits until variable E is low in State 6 before proceeding to State 7. Again, while in State 7, the state machine waits for variable E to return to true before moving to State 1 (Fig. 5).

OUTPUT DEFINITIONS

After defining all of the state transition logic, the next step is to define the output logic. The three output signals—Single, Multi, and Contig—each fall into one of three primary output types:

1. Outputs asserted during one state, which is the simplest case. The output signal Single, asserted only during State 6, is an example.

2. Outputs asserted during multiple, contiguous states. This appears simple at first glance, but a few techniques exist that reduce logic complexity. One example is Contig. It's asserted from State 3 to State 7, even though there's a branch at State 2.

3. Outputs asserted during multiple, non-contiguous states. The best solution is usually brute-force decoding of the active states. One

ONE-STATE VS. BINARY ENCODING METHODS

Method	Number of logic blocks	Worst-case performance
One-hot	7.5	40 MHz
Binary encoding	7.0	34 MHz

"I was looking for a graphic example of what could be done with a laptop PC... Zenith Data Systems showed me two."

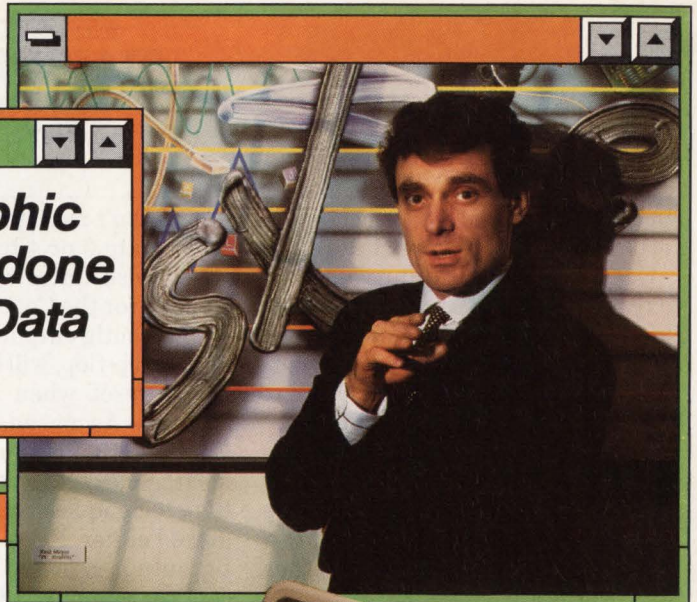

ZENITH DATA SYSTEMS INNOVATES AGAIN™



SupersPort 286e



SupersPort SX



ZENITH
data systems 

Groupe Bull

The number one laptop brand in America* offers you the clear choice in portable VGA graphics.

Zenith Data Systems brings you *two* advanced laptop PCs that can run today's sophisticated color VGA applications, using 16 corresponding shades of gray for superior graphics presentations.

First, there's the number-crunching SupersPort® 286e with its dazzling backlit LCD display. Then there's the SupersPort SX with a *Page White* screen that virtually duplicates the printed page... plus Intel386SX™ power to handle tomorrow's graphical user interfaces.

And each features our *Intelligent Power Management™* System, which puts power usage in *your* control for hours of battery life.

So, if you want to carry away the clear choice in portable VGA graphics, see our leading VGA-enhanced SupersPort laptops in action. For more information and the name of your nearest Zenith Data Systems Medallion Reseller, call: 1-800-523-9393.

*Source: 1990 Dataquest estimate for U.S. battery-powered laptops. Graphics simulate Microsoft® Windows™ version 3.0, a product of Microsoft Corporation. Intel386SX is a trademark of Intel Corporation. SupersPort is a registered trademark and Intelligent Power Management is a trademark of Zenith Data Systems Corporation.

STATE MACHINE DESIGN

such example is Multi, which is asserted during State 2 and State 4.

OHE makes defining outputs easy. In many cases, the state flip-flop is the output. For example, the Single output also is the flip-flop output for State 6; no additional logic is required. The Contig output is asserted throughout States 3 through 7. Though the paths between these states may vary, the state machine will always traverse from State 2 to a point where Contig is active in either State 3 or State 4.

There are many ways to implement the output logic for the Contig output. The easiest method is to decode States 3, 4, 5, 6, and 7 with a 5-input OR gate. Any time the state machine is in one of these states, Contig will be active. Simple decoding works best for this state machine example. Decoding five states won't exceed the input capability of the FPGA logic block.

ADDITIONAL LOGIC

However, when an output must be asserted over a longer sequence of states (six or more), additional layers of decoding logic would be required. Those additional logic layers reduce the state machine's performance.

Employing S-R flip-flops gives designers another option when decoding outputs over multiple, contiguous states. Though the basic FPGA architecture may not have physical S-R flip-flops, most macrocell libraries contain one built from logic and D-type flip-flops. Using S-R flip-flops is especially valuable when an output is active for six or more contiguous states.

The S-R flip-flop is set when entering the contiguous states, and reset when leaving. It usually requires extra logic to look at the state just prior to the beginning and ending state. This approach is handy when an output covers multiple, non-contiguous states, assuming there are enough logic savings to justify its use.

In the example, States 3 through 7 can be considered contiguous. Contig is set after leaving State 2 for either States 3 or 4, and is reset after leaving State 7 for State 1. There are no conditional jumps to states where

Contig isn't asserted as it traverses from State 3 or 4 to State 7. Otherwise, these states would not be contiguous for the Contig output.

The Contig output logic, built from an S-R flip-flop, will be set with State 2 and reset when leaving State 7 (Fig. 6). As an added benefit, the Contig output is synchronized to the master clock. Obvious logic reduction techniques shouldn't be overlooked either. For example, the Contig output is active in all states except for States 1 and 2. Decoding the states where Contig isn't true, and then asserting the inverse, is another way to specify Contig.

The Multi output is asserted during multiple, non-contiguous states—exclusively during States 2 and 4. Though States 2 and 4 are contiguous in some cases, the state machine may traverse from State 2 to State 4 via State 3, where the Multi output is unasserted. Simple decoding of the active states is generally best for non-contiguous states. If the output is active during multiple, non-contiguous states over long sequences, the S-R flip-flop approach described earlier may be useful.

One common issue in state-machine construction deals with preventing illegal states from corrupting system operation. Illegal states exist in areas where the state machine's functionality is undefined or invalid. For state machines implemented in PAL devices, the state-machine compiler software usually generates logic to prevent or to recover from illegal conditions.

In the OHE approach, an illegal condition will occur whenever two or more states are active simultaneously. By definition, the one-hot method makes it possible for the state machine to be in only one state at a time. The logic must either prevent multiple, simultaneous states or avoid the situation entirely.

Synchronizing all of the state-machine inputs to the master clock signal is one way to prevent illegal states. "Strange" transitions won't occur when an asynchronous input changes too closely to a clock edge. Though extra synchronization would be costly in PAL devices, the

flip-flop-rich architecture of an FPGA is ideal.

Even off-chip inputs can be synchronized in the available input flip-flops. And internal signals can be synchronized using the logic block's flip-flops (in the case of the Xilinx LCAs). The extra synchronization logic is free, especially in the Xilinx FPGA family where every block has an optional flip-flop in the logic path.

RESETTING STATE BITS

Resetting the state machine to a legal state, either periodically or when an illegal state is detected, gives designers yet another choice. The Reset Direct (RD) inputs to the flip-flops are useful in this case. Because only one state bit should be set at any time, the output of a state can reset other state bits. For example, State 4 can reset State 3.

If the state machine did fall into an illegal condition, eventually State 4 would be asserted, clearing State 3. However, State 4 can't be used to reset State 5, otherwise the state machine won't operate correctly. To be specific, it will never transfer to State 5; it will always be held reset by State 4. Likewise, State 3 can reset State 2, State 5 can reset State 4, etc.—as long as one state doesn't reset a state that it feeds.

This technique guarantees a periodic, valid condition for the state machine with little additional overhead. Notice, however, that State 1 is never reset. If State 1 were "reset," it would force the output of State 1 high, causing two states to be active simultaneously (which, by definition, is illegal). □

Steve Knapp, new product development manager at Xilinx, spent the last four years as a field applications engineer aiding customers in FPGA designs. He received a BS in materials science and engineering from Massachusetts Institute of Technology, Cambridge, Mass.

HOW VALUABLE?	CIRCLE
HIGHLY	544
MODERATELY	545
SLIGHTLY	546

NEWS

ABOUT
1553 DATA BUS
SYNCHRO CONVERSION
A/D & D/A CONVERSION
POWER & MEMORY HYBRIDS

DDC
ILC DATA DEVICE CORPORATION

DC - DC CONVERTERS OPERATE OVER MIL TEMP RANGE

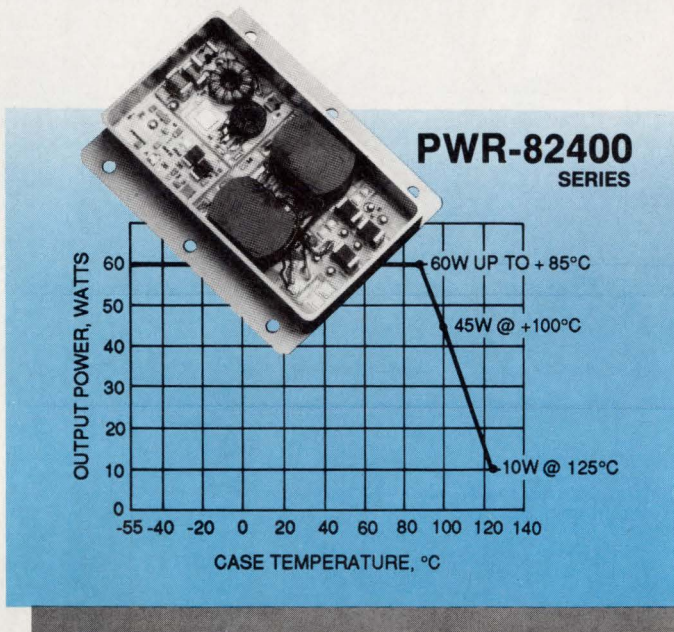

- 60 WATT POWER OUTPUT
- MIL PROCESSING
- 2,650,000 HRS MTBF

DDC introduces the PWR-82400 Series 60 watt, triple output, DC-DC Converters. These converters operate from -55°C to $+125^{\circ}\text{C}$ with a minimum of 10 watts output power at $+125^{\circ}\text{C}$.

The PWR-82400/402 are 60W triple output, 225 kHz DC-DC Converters. The PWR-82400 supplies $\pm 15\text{V}$ at 1.33A each and $+5\text{V}$ at 4A while the PWR-82402 supplies $\pm 12\text{V}$ at 1.7A each and $+5\text{V}$ at 4A. The PWR-82400 Series uses an internal Pi filter to limit the input reflected current ripple noise and operates over a wide input voltage range of 16V to 40VDC, even during MIL-STD-704D emergency power conditions.

High input-to-output isolation along with separate output returns enables the user to power both sensi-

tive analog circuitry while maintaining isolation from digital signals. The PWR-82400 Series allows the user both inhibit or synchronization features for system design. The inhibit feature disables the internal PWM thus, halting operation of the converter. This allows for remote turn-on and turn-off of the converter with very low quiescent current during the off cycle. Synchronization is achieved by applying an external signal with a frequency range of 250 kHz to 400 kHz. This allows the user to synchronize the converter with a system clock thus eliminating false triggering from digital and system generated noise.

Using internal pulse-by-pulse current limit circuitry which monitors the output load, the PWR-82400 Ser-

ies are short circuit protected. Excellent line and load regulation are achieved by monitoring the $+5\text{V}$ output through opto-coupling. Additionally, by using internal filters, the output ripple is typically 50mVp-p.

Available in a small 3.195"L x 2.45"W x 0.550"H hermetically sealed case, the PWR-82400 requires only 7.8 square inches of board space including the mounting flange.

With their small size, high power density, and FULL-MIL operating temperature range, the PWR-82400 Series DC-DC converters are excellent for distributed power applications.

For additional information contact Bob Fryer at 516/563-5390, or call toll-free 1-800-DDC-1772 (outside New York). □

DDC
ILC DATA DEVICE CORPORATION

HEADQUARTERS AND MAIN PLANT: ILC Data Device Corporation, 105 Wilbur Place, Bohemia, N.Y. 11716, (516) 567-5600, TLX: 310-685-2203, FAX: (516) 567-7358
WEST COAST (CA.): GARDEN GROVE, (714) 895-9777, FAX: (714) 895-4988; WOODLAND HILLS, (818) 992-1772, FAX: (818) 887-1372; SAN JOSE, (408) 236-3260, FAX: (408) 244-9767
WASHINGTON, D.C. AREA: (703) 450-7900, FAX: (703) 450-6610
NORTHERN NEW JERSEY: (201) 785-1734, FAX: (201) 785-4132
UNITED KINGDOM: 44 (635) 40158, FAX: 44 (635) 32264; JAPAN: (3) 814-7688, FAX: (3) 814-7689
FRANCE: 33 (1) 4333-5888, FAX: 33 (1) 4334-9762
WEST GERMANY: 49 (8191) 3105, FAX: 49 (8191) 47433; SWEDEN: 46 (8) 920635, FAX: 46 (8) 353181

If the new Little Board™/386 fits in your pocket, think how it would fit in your product.

Big power. Small package. Little Board/386 is a complete, 32-bit, 20MHz, 80386 computer which occupies just 5.75" X 8". It's perfect for embedded applications such as instrumentation, telecomm, network servers, data acquisition, CAM and others. Anywhere that you need big power in small space.

A complete 386.™ 1 or 4 Mbytes DRAM. Dual serial ports and parallel port. Floppy and SCSI controllers. Plus solid state disk (EPROM or NovRAM), and an expanding list of MiniModule™ expansion modules. You can even add standard PC and AT form factor boards.

Priced right. Little Board/386 can jump-start you in 386-based, embedded-processor product development. Little Board/386 is shipping now. In quantity. And, we can deliver at prices that are more than competitive.

Answers. Now. Little Board/386 is the newest in our complete family of IBM PC and AT-compatible, single board systems. If you embed microcomputers in your products, call today for complete information on Little Boards, MiniModules and the name of your nearest Ampro representative. Worldwide.

Call Toll Free:

1-800-966-5200

AMPRO
SINGLE BOARD SYSTEMS

Ampro Computers, Inc., 1130 Mountain View/Alviso Rd., Sunnyvale, CA 94089

TEL: (408) 734-2800. FAX: (408) 734-2939. TLX: 4940302

All trade marks are the property of their respective owners.

CIRCLE 155

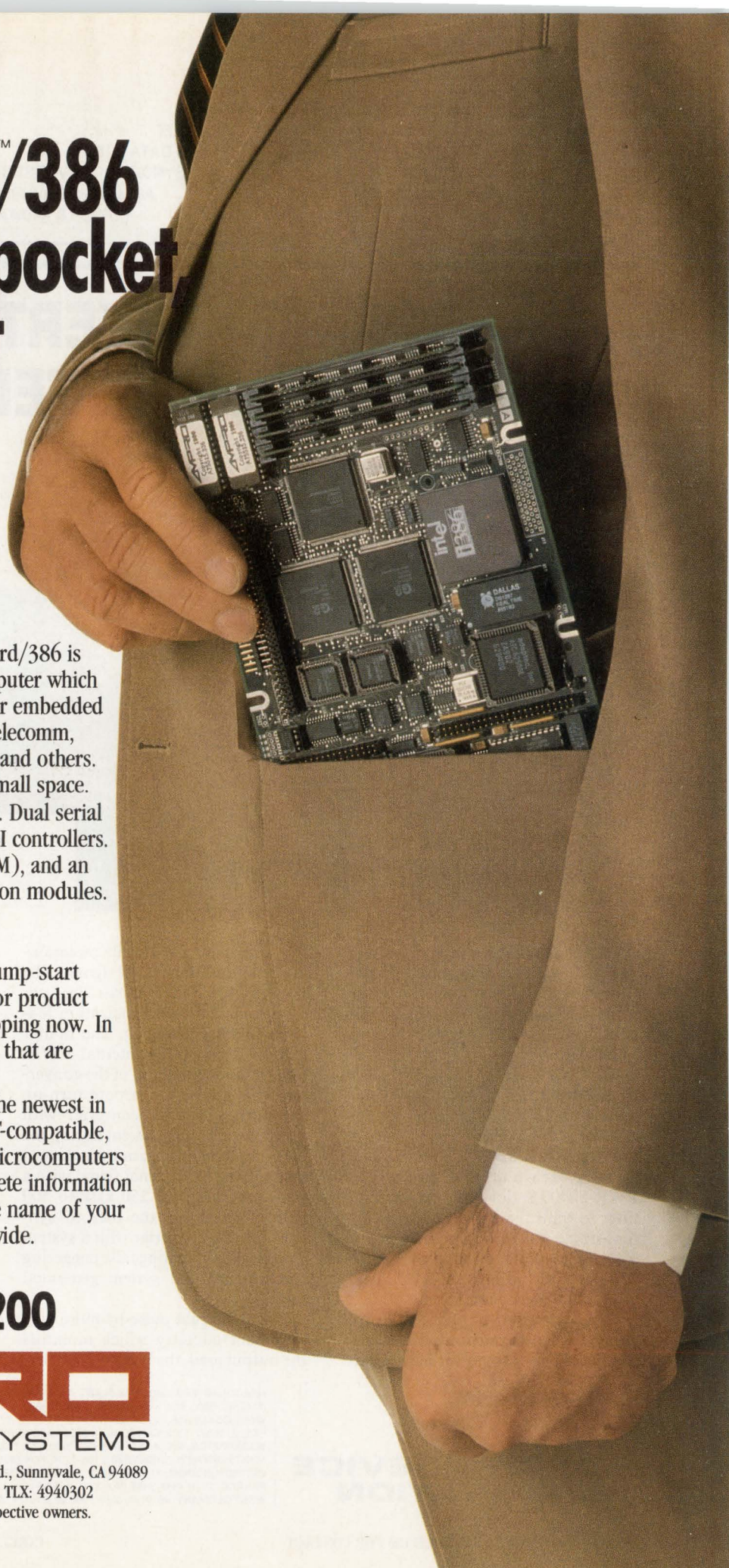

BEST SELLERS

Which technical books are the most popular in Silicon Valley?

ELECTRONICS:

- 1. SPICE: A Guide to Circuit Simulation and Analysis Using PSPICE.** Paul Tuinenga. Prentice-Hall, 1988. **\$21.**
- 2. Noise Reduction Techniques in Electronic Systems,** 2nd ed. Henry W. Oh. Wiley, 1988. **\$42.95.**
- 3. Microelectronics Packaging Handbook.** Rao R. Tummala and Eugene Rymaszewski. Van Nostrand-Reinhold, 1989. **\$94.95**
- 4. Logic Design Principles.** Edward McClusky. Prentice-Hall, 1986. **\$58.60.**
- 5. Art of Electronics.** Paul Horowitz and Winifred Hill. Cambridge University Press, 1989. **\$49.50.**

COMPUTER SCIENCE:

- 1. Object-oriented Analysis.** Peter Coad and Edward Yourdan. Prentice-Hall, 1990. **\$29.80.**
- 2. Object-oriented Design with Applications.** Grady Booch. Addison-Wesley, 1990. **\$37.25.**
- 3. Envisioning Information.** Edward R. Tuft. Graphics Press, 1990. **\$48.**
- 4. Computer Architecture: A Quantitative Approach.** John L. Hennessy and David A. Paterson. Morgan Kaufman, 1990. **\$54.95.**
- 5. A Practical Guide to Structured Systems Design,** 2nd ed. Meilir Page-Jones, Prentice-Hall, 1988. **\$39.**

This list is compiled for *Electronic Design* by Stacey's Bookstore, 219 University Ave., Palo Alto, CA 94301; (415) 326-0681; fax (415) 326-0693.

HOW WOULD A COMPANY TAKEOVER OR BUYOUT AFFECT YOUR JOB STABILITY, PENSION, AND BENEFITS?

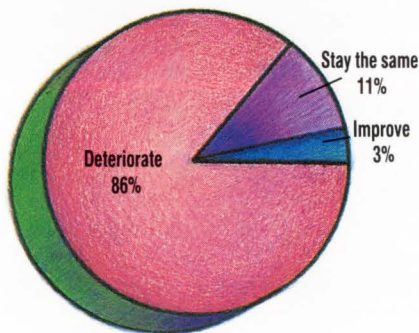

Source: 1990 IEEE Member Opinion Survey

QUICKLOOK

K M E T S K O R N E R

...Perspectives on Time-to-Market

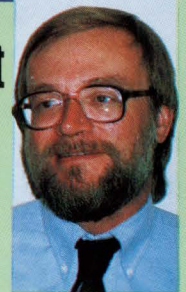

BY RON KMETOVICZ

President, Time to Market Associates Inc.
Cupertino, Calif.; (408) 446-4458

Defining a project or program can be confusing and difficult. For one thing, many questions need to be answered before the definition can be produced. Generating acceptable responses is time-consuming and requires collecting input from many sources. For another, information from one source often conflicts with that produced by another. Privately held assumptions made by one group regularly cloud and stall the overall effort.

The product definition team must answer the same questions associated with making a decision to do just about anything. Why are we doing this? How will we do it? Who will do it? Just what, exactly, are we going to do? When do we need to complete the job? How much money do we have to spend? The list goes on . . .

Two extreme approaches can be followed to produce answers to the long, but finite, list. The first approach is to dive straight in with little or no information and figure things out as you go. Excessive analysis and analytic justification lie at the opposite end of the spectrum. With the first approach, the project starts quickly, but, because the definition changes with each new discovery, it is likely to finish outside the market window. The second approach is equally undesirable and produces nearly the same results; that is, the project never finishes because it never starts. For most projects, the right answer lies somewhere between the two poles. How do you go about determining the right balance for a given project or program? Clearly, a means is needed to guide the generation of a product's definition while being able to evaluate its quality and applicability to the work environment.

Before looking at generation methods, I'll give some insights on how you can go about evaluating the quality of a product's definition. When a product definition is weak, one of the responses emanating from R&D may be: "We're building this thing to be a top performer using only the latest in new technology. Its appearance is unlike anything you've ever seen before. Performance is a much higher priority than cost. Of course, we'll have it done within the next six months. But we can't get a sales forecast out of marketing, and manufacturing seems too busy dealing with today's shipments to even care about this effort." Marketing folks say, "Those wizards in the lab are brilliant, but we can't seem to get out of them what they are really doing. Try to talk to a customer about something you don't understand and see how far you get!" From manufacturing you might hear, "The last time we got involved good things happened, but then the war effort terminated and no one has been around since." Comments of this type lead to asking some probing questions of the cross-functional team and their managers:

- Does the product's definition fit your company's long-term vision of itself?
- Do you have some information to suggest that a market exists for the product?
- Does what you are about to do fit within your company's business plan?
- What is the product's classification (first-of-a-kind, me-too-with-a-twist, and so on)?
- What is the product's internal purpose?
- What is the product's external purpose?
- Do you have sample promotion material available to help others better understand the product?
- What are the necessary performance, feature, cost, prices, and time-to-market parameters?
- What does the user interface look like and how does it work?
- How do the financial numbers look?
- What do the people in other management positions and other functions think?

A quality business definition must be in place before a quality product definition can be produced. Understanding the meaning of the questions is the first test of definition quality from both perspectives. When definitions change, expenditures rise, time to market extends, frustrations ignite, and apathy spreads. In the next column, I'll begin exploring how to generate a definition from business and product perspectives.

OFFERS YOU CAN'T REFUSE

Like many areas in electronics, networking is rife with buzzwords and acronyms. To translate such abbreviations as QLLC (qualified logical link control), Racal-Milgo offers a free, 82-page *Networking Dictionary*. The dictionary defines 1200 networking terms, from ABAM (a Western Electric twisted-pair cable) to zero code suppression. For a copy of the dictionary, contact Racal-Milgo, 1601 N. Harrison Pkwy., Sunrise, FL 33323-2899; (305) 846-1601.

Calculating optical loss in fiber-optic testing can be confusing—measuring optical loss requires subtracting power transmitted from power launched. To simplify matters, Fotec has an optical loss calculator, a circular slide rule calibrated in dBm. An engineer sets the launched power in a window on the front of the calculator and reads the optical loss on the outer scale opposite the receiver power. The P600 converts from dBm to milliwatts, microwatts, and nanowatts, for those working in linear units. The calculator, which sells for \$5, is available from Fotec Inc., 529 Main St., Box 246, Boston, MA 02129; (800) 537-8254.

Engineers working with power distribution may find a pocket handbook useful. Rochester Instrument Systems' *Power Distribution Handbook* is a quick reference tool that contains tables, conversion factors, device function numbers, and definitions. The free handbook also has information on the company's new fault monitor, which warns of deteriorating electrical insulation to ground without equipment shutdown. For a copy, contact Kathy Nancy at Rochester Instrument Systems, 255 North Union St., Rochester, NY 14605; (716) 238-4950.

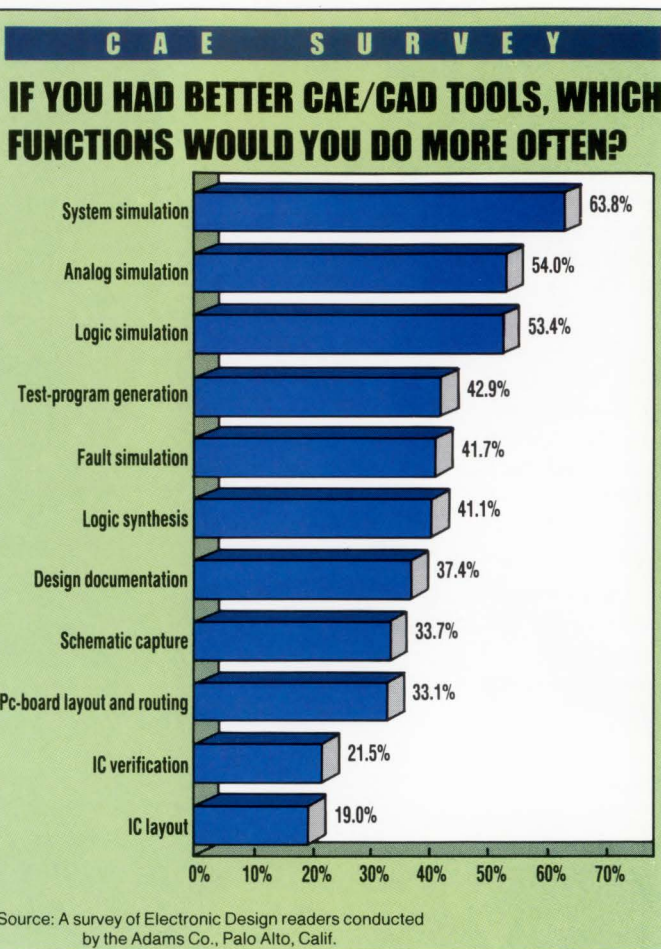

WHAT'S HAPPENING IN ... ORLANDO

While tourism employs the most workers in Orlando, high-tech runs a close second. And Orlando's roster of electronics companies is growing. In the past 10 years, employment in Central Florida's high-tech sector soared 114%. In comparison, the national growth rate hovers at 40%.

Electronics and related companies head the list of 850 area manufacturers that employ 43,000 people. These industries got their start in the '50s, when aviation pioneer Glenn Martin built a missile manufacturing plant. Martin Co. became Martin Marietta; now the company puts 13,000 to work at two sites making defense and aerospace products. Stromberg-Carlson assembles electronic switching equipment for telephones. NCR manufactures electronic components for cash registers. Other electronics employers include Westinghouse Electric, AT&T Microelectronics, Asea Brown Boveri, Emerson Electric, Litton Laser Systems, Piezo Technology, and Control Laser.

One lure for manufacturers is a total labor force of 656,470 out of a population in the greater metropolitan area that tops 1.2 million. The city of Orlando's population, which numbers 166,283, has more than doubled since 1970. And 400,000 more people are expected to live in the area by the year 2000. However, wages in Florida lag national averages. The average worker nationwide made \$20,540 last year while Floridians earned an average of \$20,117 annually. Engineers stand to do much better—salaries are competitive and range up to \$2000 per week, according to the U. S. Department of Labor.

Belying a popular misconception about Florida, the average area

resident is 32.1 years old. One attraction for people of all ages is Orlando's climate. This central Florida city, flourishing between the Atlantic and Gulf coasts, has an average year-round temperature of 72°. Another bonus is that Florida has the second lowest tax bite of the 10 most populous states. Transportation, food, and health care also cost less in Florida than the national average.

Florida's climate fosters many outdoor sports. With more than 40 public golf courses and 17 private ones, the Orlando area plays host to two PGA and two LPGA tournaments a year. Greater Orlando also has 800 tennis courts and 2,000 lakes, which offer various water sports: boating, sailing, water-skiing, canoeing, and fishing. The Orlando area also has 2,500 acres of park area. A large one is the 1,280-acre Orlando Wilderness park. The Ocala National Forest is nearby. Beaches on the Gulf and Atlantic coasts are about an hour's drive.

There are indoor attractions for the culturally inclined. Among Orlando's 11 museums is the Morse Museum of American Art, which houses a collection of Louis C. Tiffany's work. The Orlando Museum of Art offers a collection of pre-Columbian art. The Florida Symphony Orchestra gives concerts from November through May. There is also the Orlando Opera Company, Southern Ballet Theatre, and the Ballet Royal of Orlando and Winter Park. Plays are staged at the Bob Carr auditorium.

Because of tourist traffic, Orlando is geared to handling visitors. Orlando International Airport is the 20th busiest airport in the world and 17th busiest in the nation. About 24 carriers supply about 800 scheduled flights a day. Amtrak offers four daily trains that originate in New York, Miami, and Tampa.

NEED A REASON TO USE OUR PROGRAMMABLE GATE ARRAYS? WE'LL GIVE YOU OVER 10,000.

Tens of thousands of designs have proven Xilinx Field Programmable Gate Arrays to be the ideal logic device. In fact, there are over four million of our FPGAs in use around the world today.

Some are commanding satellite earth station receivers. Others are controlling optical disk drives.

Still others are controlling graphics for workstations, PCs and Local Area Networks.

With toggle rates of up to 100 MHz and densities up to 9,000 gates (with faster speeds

and higher gate densities to come), Xilinx Field Programmable Gate Arrays can meet the specs for your most ambitious designs.

In a fraction of the time.

And at a fraction of the cost of anything else available in the industry today.

Turnaround time on design revs is measured in hours, not months.

Non-recurring engineering charges are non-existent.

Our new Automated Design Implementation and Design Manager software give

you the easiest-to-use user interface in the industry. And they run on PCs and the most popular engineering workstations.

Just call, 1-800-255-7778 or if you're working in California, call 408-559-7778. And we'll send you a free copy of the FPGA fact book. It's an objective look at the key reasons why FPGAs should be in your next design.



XILINX

The Programmable Gate Array Company.SM

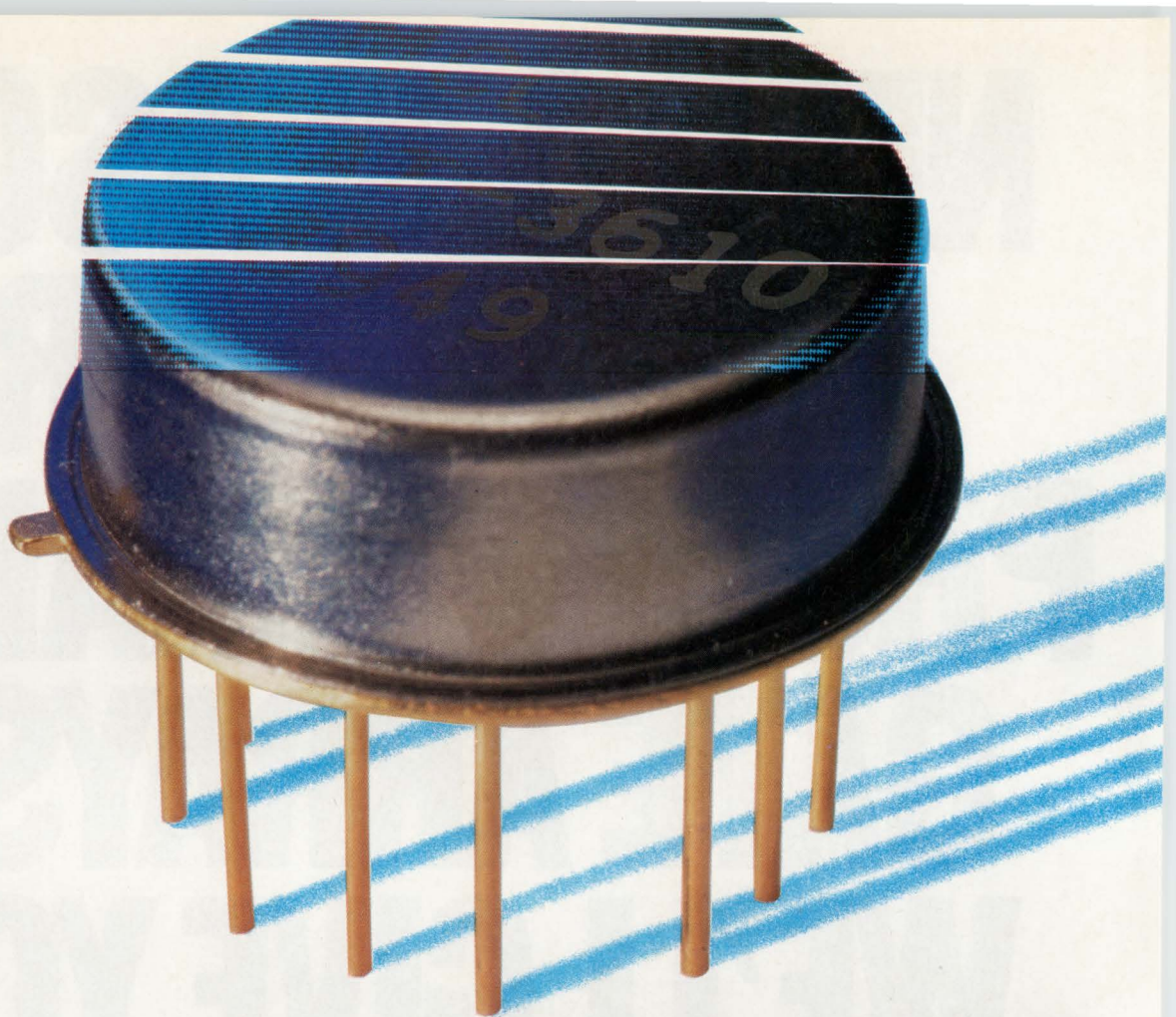

PRECISION TTL-CONTROLLED ATTENUATORS

up to 35dB
10 to 1000MHz
only **\$5995**

TOAT-R512		TOAT-124		TOAT-3610		TOAT-51020	
Accuracy (dB)	(+/-dB)	Accuracy (dB)	(+/-dB)	Accuracy (dB)	(+/-dB)	Accuracy (dB)	(+/-dB)
0.5	0.12	1.0	0.2	3.0	0.3	5.0	0.3
1.0	0.2	2.0	0.2	6.0	0.3	10.0	0.3
1.5	0.32	3.0	0.4	9.0	0.6	15.0	0.6
2.0	0.2	4.0	0.3	10.0	0.3	20.0	0.4
2.5	0.32	5.0	0.5	13.0	0.6	25.0	0.7
3.0	0.4	6.0	0.5	16.0	0.6	30.0	0.7
3.5	0.52	7.0	0.7	19.0	0.9	35.0	1.0

bold faced values are individual elements in the units

Now...precision TTL-controlled attenuators accurate over 10 to 1000MHz and -55 to +100°C. Four models are available in the new TOAT-series, each with 3 discrete attenuators switchable to provide 7 discrete and accurate attenuation levels (see chart). Cascade all four models for up to 64.5dB control in 0.5dB steps. Custom values available on request. The 50-ohm TOAT-series performs with 6µsec switching speed and can handle power levels up to 0dBm. Units are housed in a rugged hermetically-sealed TO-8 package to withstand the shock, vibration, and temperature stresses of MIL-STD-883. Connector versions are available. Take advantage of the \$59.95 (1-9 qty) price breakthrough to stimulate new applications as you implement present designs and plan future systems.



finding new ways...
setting higher standards

Mini-Circuits

WE ACCEPT AMERICAN EXPRESS

CIRCLE 114

P.O. Box 350166, Brooklyn, New York 11235-0003 (718) 934-4500 Fax (718) 332-4661 Domestic and International Telexes: 6852844 or 620156

CIRCLE
521 GET PULSE TRAIN FROM ONE PULSE

ELIAS ELIOPOULOS

117 Konstantinoupoleos, GR-132 31 Petroupoli, Greece.

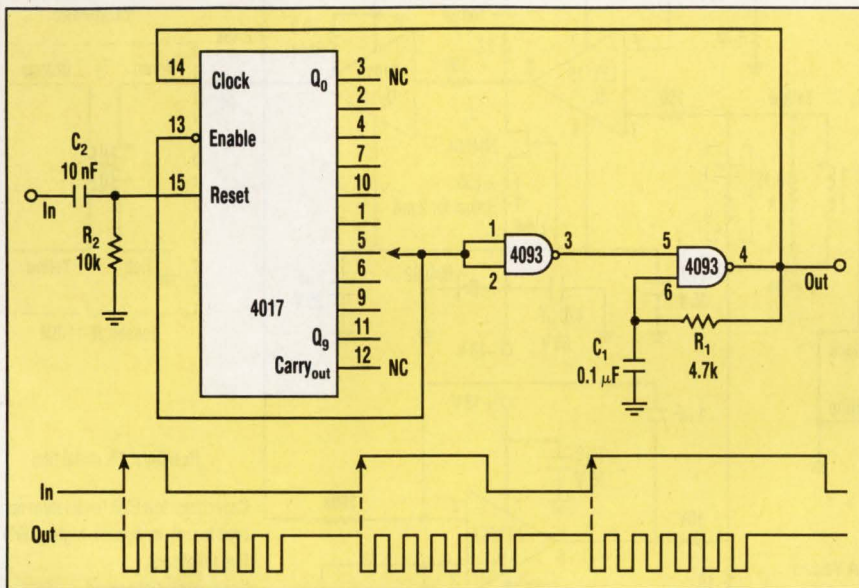

THIS RATE-MULTIPLIER CIRCUIT contains a 4093 Schmitt trigger that acts as an oscillator, toggling the circuit's output (pin 4). The oscillator's pulses are then counted by the 4017 decade counter.

A rate-multiplier circuit can be used where one pulse must produce a pulse train, as in frequency multiplication, data sampling, etc. The circuit

was originally designed to convert the digital readout of an optical tachometer from revolutions/s to revolutions/min. It produces six pulses, but can be configured to generate a

predetermined number of pulses for every input pulse. The circuit's advantage over frequency multipliers using a phase-locked loop and dividers is that phase loss doesn't occur at the stabilization of the pulse train. This trait is especially useful when sampling asynchronous data signals.

One NAND Schmitt trigger (1/4 4093) acts as an oscillator (see the figure). When pin 5 goes low, the output stays high. When pin 5 goes high, the gate starts to oscillate with a free-running frequency:

$$f_{OSC} = R_1 \times C_1 \times \ln \left\{ \frac{V_{T+} \times (V_{DD} - V_{T-})}{(V_{DD} - V_{T+}) \times V_{T-}} \right\}$$

where V_{T+} and V_{T-} are the positive and negative-going threshold voltages for the 4093. Their values can be found in the manufacturer's databook for the corresponding V_{DD} value.

When a positive-going pulse arrives at the In input, the 4017 decade counter is reset, output 0 goes high, and the decoded outputs 1 through 9 go low. The oscillator starts running and its pulses are counted by the 4017. The 4017's outputs go high sequentially until the sixth pulse. Then, the oscillator is inhibited and its output remains high, waiting for the next triggering pulse. To configure the circuit to produce between 1 and 9 pulses, tie pins 1 and 2 of the 4093 to the appropriate 4017 output. □

IFD WINNERS

IFD Winner for
May 24, 1990

Noor Singh Khalsa, EG&G Inc., EM Div., P.O. Box 809, MS E-1, Los Alamos, NM 87544. His idea: "Circuit Detects Switch Closure."

VOTE!

Read the Ideas for Design in this issue, select your favorite, and circle the appropriate number on the Reader Service Card. The winner receives a \$150 Best-of-Issue award and becomes eligible for a \$1,500 Idea-of-the-Year award.

CIRCLE
522 QUALITY PREAMP CUTS COST, SIZE

WALT JUNG and RICHARD MARKELL

Linear Technology Corp., 1630 McCarthy Blvd., Milpitas, CA 95035; (408) 432-1900.

To achieve low noise and 600-Ω (or less) load capability, traditional recording-studio mixing panels use high-cost modular or hybrid amplifiers with matched input-stage transistors and push-pull A-B outputs. Though the expected high performance is achieved, the solution is large and expensive. An alternative approach uses a low-input-noise audio op amp added to a high-quality class-A buff-

er amp. The resulting circuit forms a variable-gain, transformer-coupled microphone preamp. The preamp is equal to the discrete design in performance, and superior in cost, size, and overall complexity.

IC U_1 is a low-noise LT1115 audio op amp that's operated in a class-A mode by J_1 , a 2-mA current source (Fig. 1). U_1 's output is buffered by U_2 , an LT1010 buffer amp. U_2 is added to supply a class-A stand-

IDEAS FOR DESIGN

ing current by the 49.9- Ω resistor at the Boost pin, and is capable of very low open-loop distortion.¹ U₃, an LT1097 precision op amp, is configured as a dc servo to null output offsets that can cause distortion in the output transformer, T₂. T₁ is carefully selected to match R_n, the LT1115's characteristic noise resistance.² Both transformers should be properly shielded and grounded for optimum performance in this low-level application.

Using the gain control, the circuit's overall gain can be adjusted from 12 to 50 dB. The distortion and frequency-response, plotted at an operating gain of 20 dB, illustrate the circuit's performance (Fig. 2). The risetime of the preamp approximates the Bessel response characteristic, now favored by specialists in the audio field. For top performance, the circuit should be operated with well-bypassed, low source-impedance power supplies. □

¹Jung, W.G., R.N. Markell, "Low

Distortion Video Buffer," *ELECTRONIC DESIGN*, March 9, 1989.

²Jung, W.G., *Audio IC Op-Amp*

Applications, Third Edition, Howard W. Sams and Co., Indianapolis, Ind., 1987.

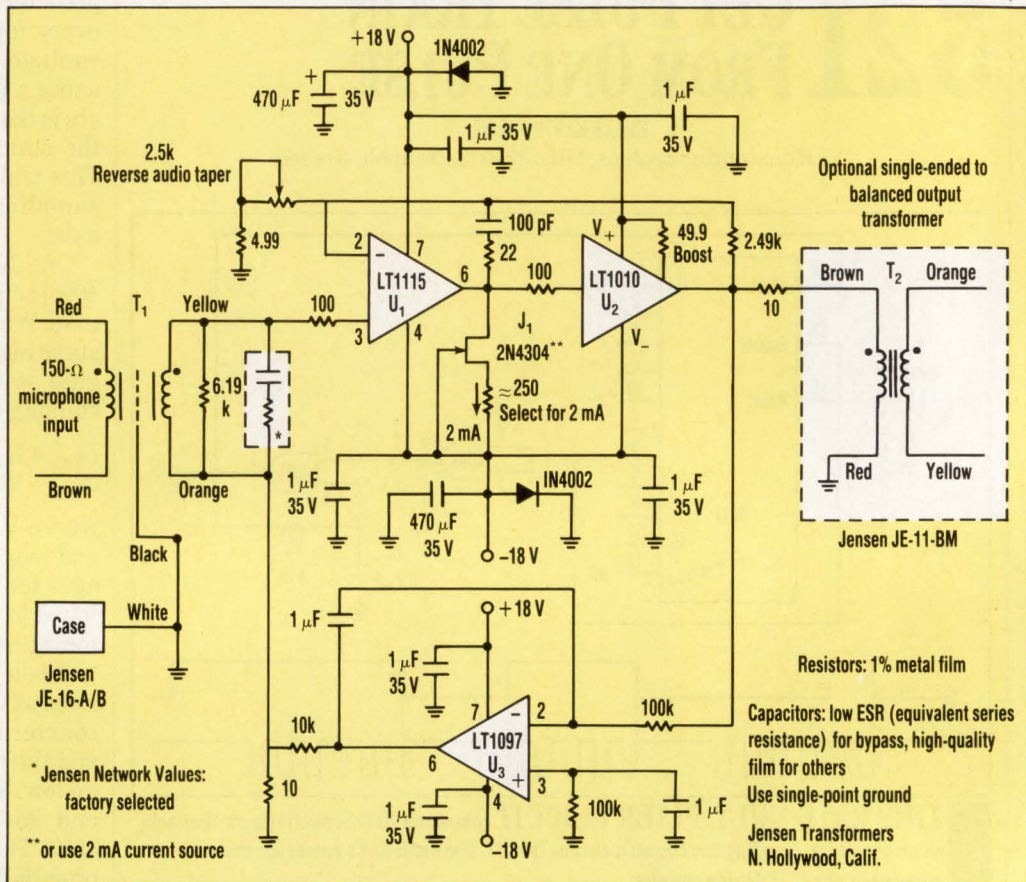

1. A LOW-INPUT NOISE AUDIO OP AMP (LT1115) is coupled with a class-A buffer amp (LT1010) to form a variable-gain, transformer-coupled microphone preamp. By altering the gain control, the circuit's overall gain can be adjusted from 12 to 50 dB.

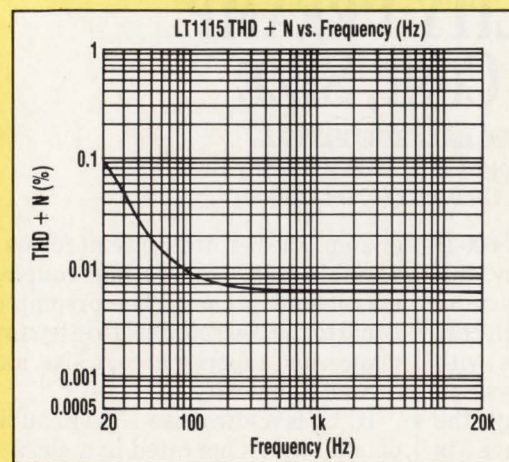

(a)

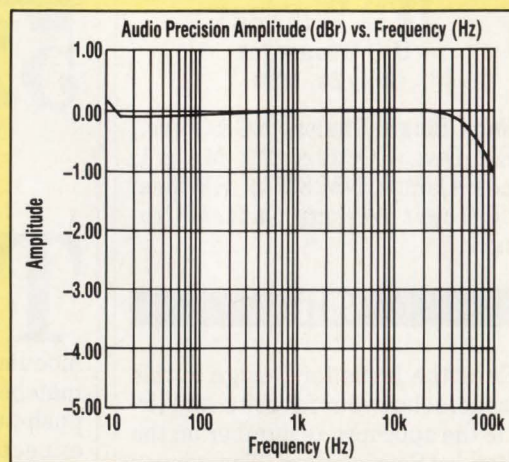

(b)

$V_s = \pm 18\text{ V}$
 $V_{in} = 0.95\text{ V rms}$
 $R_L = 600\ \Omega$
 $R_S = 150\ \Omega$
 $T_A = 25^\circ\text{C}$

2. THE CIRCUIT'S TOTAL HARMONIC DISTORTION (THD) plus noise is plotted against frequency (a). A second plot shows the circuit's frequency response (b). Both plots illustrate an operating gain of 20 dB with a balanced input-output.

New Low Distortion, Wideband Op Amp Keeps RF Signals Clean and Clear.

-80dBc IMD (5MHz)

OPA621 is a versatile new op amp for RF, video, and other high speed signal processing applications. It gives designers exceptional speed, precision, and output drive in an economical monolithic design.

problems of asymmetrical inputs and noisy, long settling tails associated with many current-feedback op amps. It has all the speed needed for RF/video buffering, PLL amplification, peak detecting, and signal

- Noise at 1MHz, 2.3nV/ $\sqrt{\text{Hz}}$
- Settling to 0.01%, 25ns max
- Output drive, 6Vp-p into 50 Ω
- Differential gain/phase error, 0.05%/0.05° (at 3.58MHz)
- 0/+70°C, -55/+125°C temp ranges
- $\pm 5\text{V}$ supply
- Plastic, ceramic, SOIC packages and die
- From \$8.25*

An internally compensated model, OPA620, is also available for unity-gain applications. Besides low distortion and high output drive, it settles to 0.01% in 25ns. Gain-bandwidth is 200MHz.

Design Tools

Burr-Brown makes it easy to put these parts to work in your system. The product data sheets include valuable charts and RF applications information. Contact your sales rep or call **1-800-548-6132** for immediate assistance.

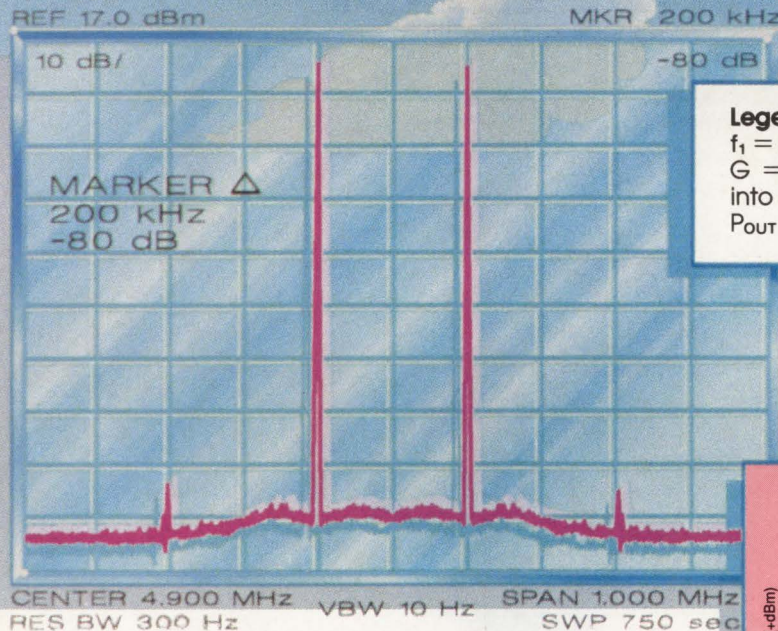

Legend:

$f_1 = 4.8\text{MHz}$, $f_2 = 5.0\text{MHz}$
 $G = 2\text{V/V}$, $V_{\text{OUT}} = 5\text{V}_{\text{p-p}}$ into 50 Ω .
 $P_{\text{OUT}} = 12\text{dBm/tone}$

For example, in gains of 2V/V and above, the uncompensated OPA621 can drive 5Vp-p into 50 Ω at 5MHz with a very low 3rd-order intermodulation ratio of -80dBc. This excellent low-distortion performance simplifies filtering tasks and improves signal purity. OPA621's classic op amp design also avoids the

distribution applications. Plus, its high current output lets you drive multiple cables and other heavy loads easily and economically.

Key OPA621 Features

- Bandwidth, 500MHz ($G = 2\text{V/V}$)
- 2-tone IMD at 5MHz, -80dBc

Burr-Brown Corp.
P.O. Box 11400
Tucson, AZ 85734

*USA OEM prices, in 1000s.

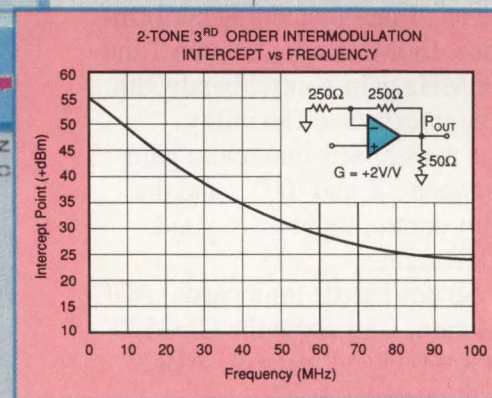

BURR-BROWN®

BB

**Because you're
thinking fast...**

you need responsive suppliers as well as fast parts. Comlinear is tuned in. With high quality, high-speed products. Assistance from R&D-level applications engineers to help develop your ideas quicker. Off-the-shelf MIL-STD-883 compliant monolithics and hybrids. Quality product documentation with guaranteed specs so you don't waste time. In your business, time is everything. Count on us for the speed you need.

Now, high-speed AGC is easier than ABC.

Until now, AGC amplifiers were only partial solutions to high-speed automatic gain control. You also had to find a high-performance op amp, numerous passive components and the board space to mount them all.

Now all you need is the new CLC520 AGC+Amp, $\pm 5V$ and two resistors. That's it.

You get a total high-speed AGC solution—with voltage-controlled gain and voltage output—in a single device. Plus outstanding performance: 160MHz signal-channel and 100MHz gain-control bandwidth. And unexpected flexibility... one resistor sets maximum gain between 2X and 100X, and the gain-control input gives you a 40dB range.

So don't settle for a partial AGC solution. Call about the CLC520 AGC+Amp and learn the ABCs of high-speed AGC.

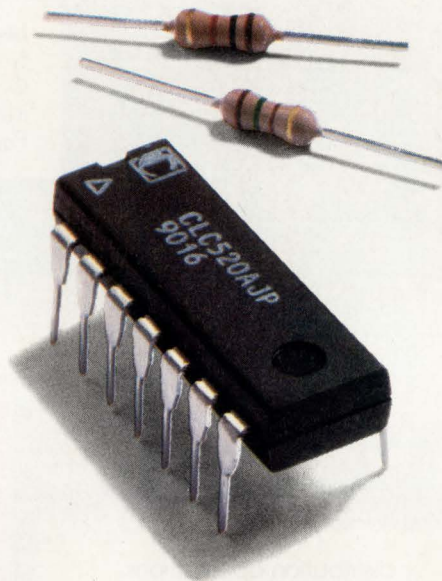

CIRCLE 157

 **Comlinear
Corporation**
Solutions with speed

4800 Wheaton Drive
Fort Collins, CO 80525
(303) 226-0500
1-800-776-0500 (USA)

More
easy-to-use
amplifiers...

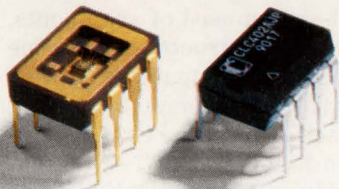

Op amps settle to 14 bits in 32ns max.

Extremely fast settling to 0.0025% and low 1.6mV max. offset make the CLC402 and CLC502 op amps ideal for high-accuracy A/D and D/A converters. Or in designs demanding high stability at low gain. Now you have extra design margins.

CIRCLE 158

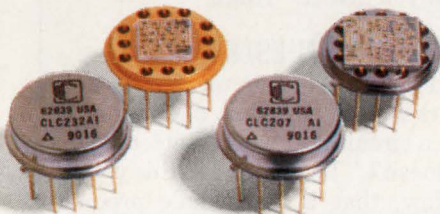

Low distortion for fast, wide-dynamic-range designs.

The 170MHz CLC207 and 270MHz CLC232 deliver ultra-low distortion. For high gain, choose the CLC207 with -80/-85dBc 2nd/3rd harmonics (2V_{p-p}, 20MHz, 200 ohms). And for low gain, the CLC232 with -69dBc harmonics (100 ohms).

CIRCLE 159

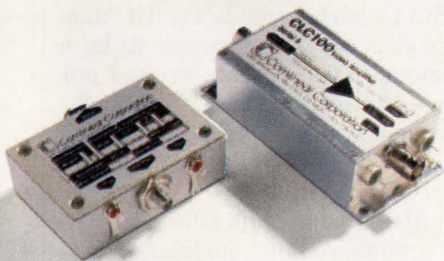

Modular amplifiers... ready to go.

For bench or system use, this family of dc-coupled modular amplifiers gives you complete amplifier solutions. Including PMT amps, cable drivers, post-amps, very-low-distortion amps, or amps with gain and I/O impedances that you can select.

CIRCLE 160

IDEAS FOR DESIGN

CIRCLE 523 GROUND LOAD WITH V/I CONVERTER

FRANTISEK MICHELE

Barvicova 17A, CS 60200 Brno, Czechoslovakia.

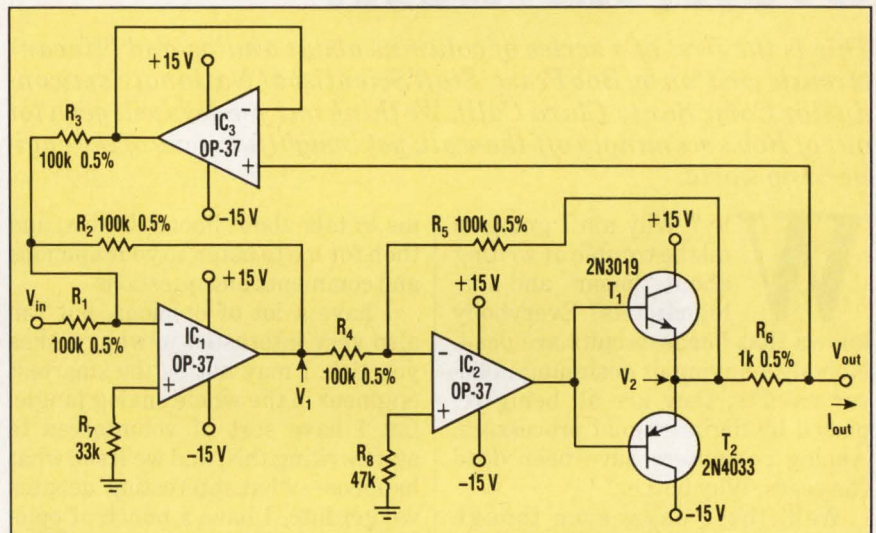

THIS VOLTAGE-TO-CURRENT CONVERTER has many advantages, such as working into a grounded load, high precision, and simple control of the I_{out}/V_{in} ratio.

This voltage-to-current converter circuit is beneficial in many analog applications. The circuit, which consists of three op amps, two medium-power transistors, and a few passive components, has many advantages over alternative circuits (*see the figure*). These include load-grounding possibilities, simple control of the I_{out}/V_{in} ratio, high precision, linearity, stability, bandwidth, and low noise. It also has an I_{out} range from about 1 μ A to the maximum I_C of T_1 and T_2 and an output resistance of about 50 M Ω .

Op-amp IC_1 inverts the sum of V_{in} and V_{out} :

$$V_1 = -(V_{in} + V_{out}).$$

IC_2 and T_1 and T_2 invert V_1 :

$$V_2 = -V_1 = -(-(V_{in} + V_{out})) = V_{in} + V_{out}.$$

Then, to calculate the output current I_{out} :

$$I_{out} = (V_2 - V_{out})/R_6 = (V_{in} + V_{out} - V_{out})/R_6 = V_{in}/R_6.$$

This formula shows that the value of I_{out} depends only on V_{in} and R_6 .

Voltage follower IC_3 reduces the current from the circuit's output to the input of IC_1 by a sufficient amount so that this current's influence can be neglected. □

THE VOTES ARE IN



We've tabulated all our readers' votes for the Annual Ideas For Design contest and have come up with a winner: Ricardo Jimenez's "Dc Voltmeter Speaks English." Mr. Jimenez, a test engineer with Shurgart/Kennedy Corp., holds a BS in electrical engineering. Mr. Jimenez receives a \$1500 honorarium as the annual award winner.

WHAT'S ALL THIS ANALOG STUFF, ANYHOW?

This is the first of a series of columns about analog and "linear" circuits written by Bob Pease, Staff Scientist at National Semiconductor Corp, Santa Clara Calif. We think our readers will get a lot out of Bob's seemingly off-the-wall, yet insightful views of the engineering world.

Why? Why am I going to all the trouble of writing about "linear" and analog circuits? Everybody knows that linear circuits are dead. Nobody's buying or designing in linear circuits; they are all being replaced by digital signal processors. Analog computers have been dead for years. Why bother?

Well, these days, even though there are trends to perform a lot of functions with digital computations, people are finding that there are still a huge number of things that cannot

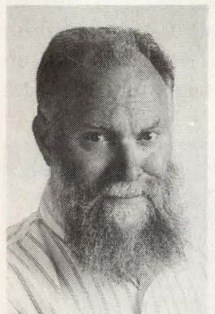

BOB PEASE
OBTAINED A BSEE FROM MIT IN 1961 AND IS STAFF SCIENTIST AT NATIONAL SEMICONDUCTOR CORP., SANTA CLARA, CALIF.

be done properly without analog circuits. It's true that some of the trendy new radios claim to use a lot of digital techniques, but even there, the receivers and amplifiers are analog circuits—even if the the receiver's frequency appears to be digitally controlled.

When people are designing digital computers, they need analog techniques to make good lay-outs for fast buses. They need power supplies— either linear ICs or switch-mode circuits (which use analog circuits internally). And, as for us analog designers, the old-timers and the rookie engineers—well— this column is intended as a soapbox for

me to talk about linear circuits, and then for me to listen to your opinions and comments and questions.

I have a lot of opinions, but I'm also very interested in what makes you tick. I may not be the smartest engineer in the whole analog jungle, but I have sort of volunteered to start writing this, and we'll see what happens—what interesting debates we get into. I have a bunch of opinions about ICs, data sheets, testing, computer simulation, education, troubleshooting, along with a whole slew of little topics.

In every darned issue of Electronic Design, I'll try to have some provocative or insightful topic. Some will be pretty technical, others will be more philosophical in nature. But one thing's for sure, I'll try not to bore you. For example: What's all this heuristic stuff, anyhow?

HEURISTICS?

The other day I was talking with a young college graduate from a prestigious Eastern engineering school. He explained that his specialty was analog synthesis. I perked up my ears—I hadn't heard much about that. Where could I read more about this? "Oh," he said, "in some of the IEEE journals." Hmm. He started to explain the approach. It's a heuristic approach, he said. Hmm. What's a heuristic? He said, "You don't know what a heuristic is? Really?" I explained no, that we didn't have any heuristics when I was in school.

(Note: Mr. Webster says that heuristic means "serving to guide, discover, or reveal; specif.: valuable for stimulating or conducting empirical

research but unproved or incapable of proof—often used of arguments, methods, or constructs that assume or postulate what remains to be proven or that leads a person to find out for himself.—from the Greek, heuriskein, to discover, find.")—Gee, that sounds like analysis or optimization to me—not synthesis.

The young man explained that when you make a lot of optimization experiments, heuristic refers to the starting place, the initial guess. H'mm. He said, "You feed in some requirements and some specifications, and it optimizes the performance." Hmm. Now, what circuit does it use? "Oh, it uses the circuit that you give it." Hmm.

THE KEY QUESTION

If you give it a circuit that doesn't work well enough, how does it generate a circuit that works better? "Oh, it doesn't." I explained to this young fellow, that in our whole product line, about 99% of the circuits are not optimized at all—at least not "optimized" in the sense he understands. If you really OPTIMIZED them, they would all be a little different than they are now. But each one has a different circuit that is a revolutionary—not just an evolutionary—change from any previous circuit. So there may be places in our company where optimization is useful and a good idea.

But I wish he wouldn't call it "analog synthesis," that seems to be a misnomer. The circuits around our area—the ones in the NSC Linear data books (and, I bet, in the PMI and Analog Devices data books, too), were not "synthesized" except by bright engineers who knew that the old circuits wouldn't cut it, and a new circuit was needed. Good luck, young fellow!

All for now. / Comments invited! /
RAP / Robert A. Pease / Engineer

ADDRESS:
Mail Stop C2500A
National Semiconductor
P.O. Box 58090
Santa Clara, CA 95052-8090

Want to see a precision narrowband sweep that usually takes about a minute?

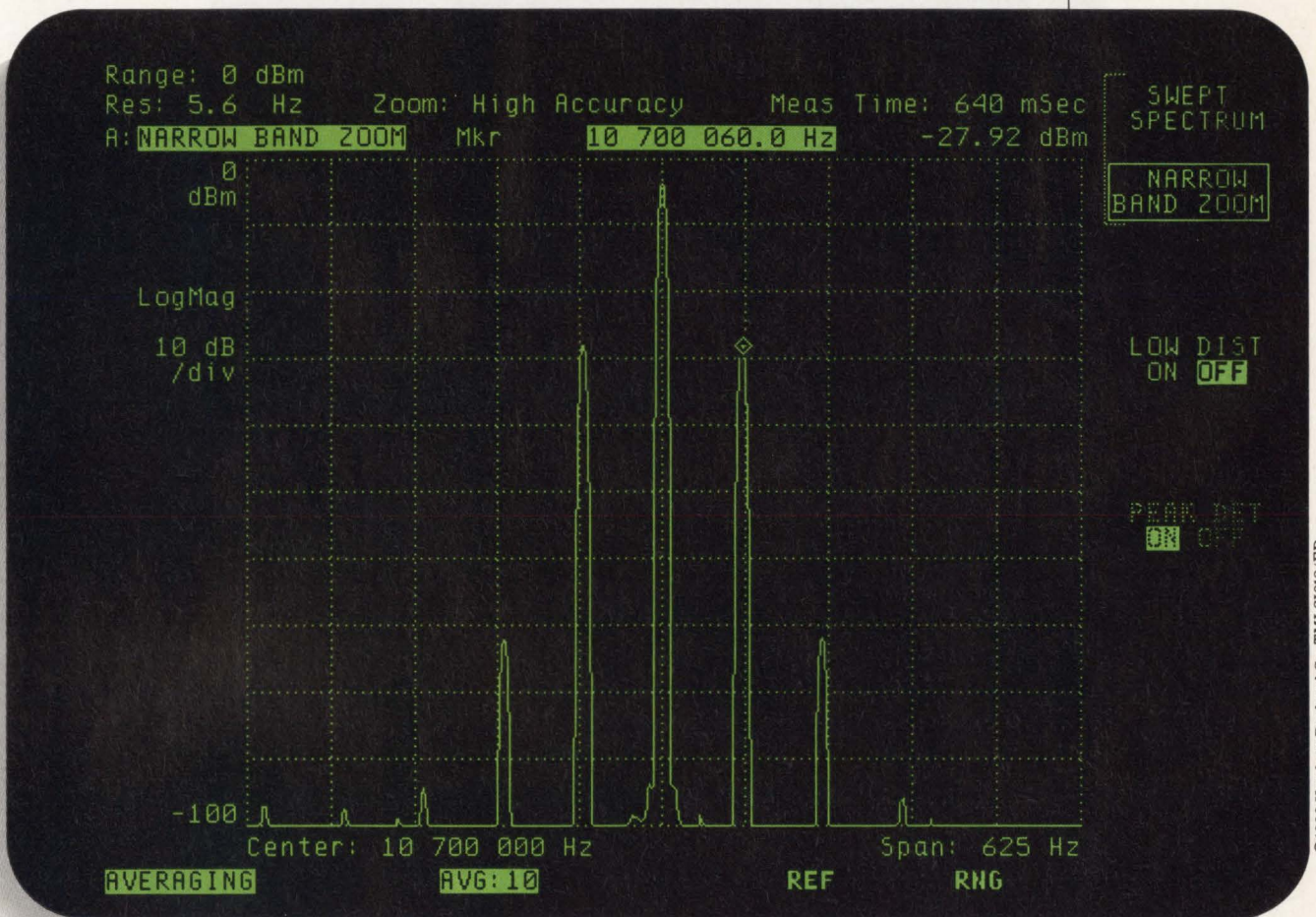

©1990 Hewlett-Packard Co. TMLSI018/ED

Oops, you blinked.

By blending digital-filter and FFT techniques with swept technology, the new HP 3588A spectrum analyzer makes this measurement in less than a second . . . with high resolution and ± 0.25 dB typical accuracy.

This analyzer offers unprecedented speed in two measurement modes. In the swept mode, you get a 10 Hz to 150 MHz range, RBW as narrow as 1.1 Hz and measurements up to 16 times

faster than previously available. The narrowband-zoom mode gives you a span of 40 kHz or less *anywhere* in the 150 MHz range, RBW to 0.0045 Hz and measurements up to 400 times faster than traditional swept analyzers.

So, call 1-800-752-0900 today. Ask for Ext. 1212, and we'll send a videotape demo so you can see these fast measurements for yourself. But don't blink.



There is a better way.

 HEWLETT
PACKARD

Are you missing the big picture in digital oscilloscopes?

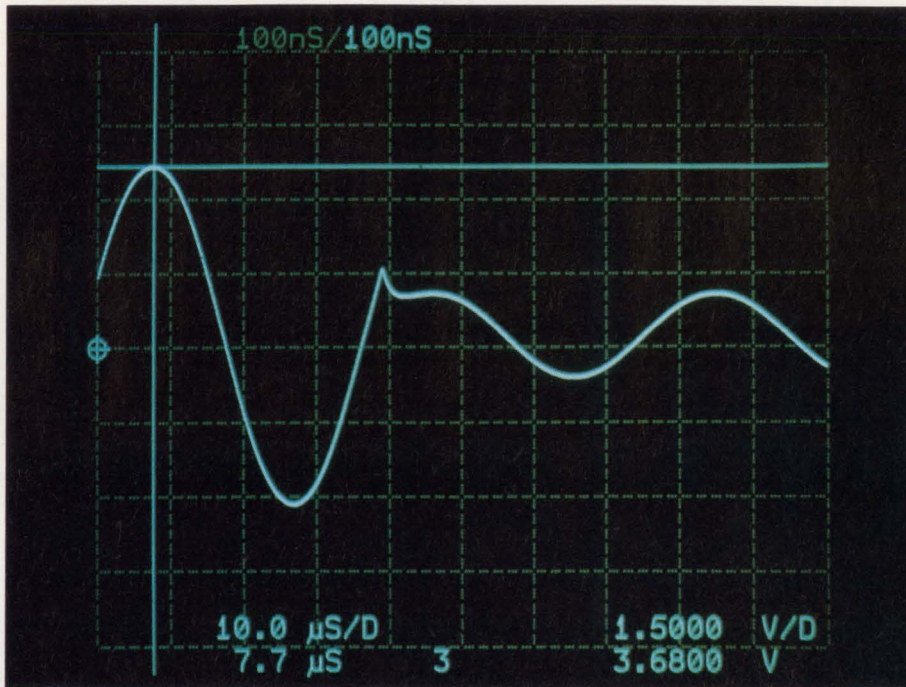

Nicolet 430E: 256K Memory/Channel, 12 bits vertical resolution.



LeCroy 9450:
80 times less resolution
(5 times less horiz.,
16 times less vert.)



Tektronix DSA602:
208 times less resolution
(13 times less horiz.,
16 times less vert.)



Hewlett Packard 54112D:
256 times less resolution
(4 times less horiz.,
64 times less vert.)



Fluke PM 3323:
256 times less resolution
(64 times less horiz.,
4 times less vert.)

There's more of everything with the Nicolet 400 Series.

Any way you look at it, competitors just can't touch the Nicolet 400 Series when you consider memory and vertical resolution.

The closest major competitor's per-channel memory is four times less. Vertical resolution—four times less again. And when memory and vertical resolution are combined, the nearest offering is 80 times less! Clearly no match.*

Now add other 400 Series advantages like the choice of two or four channels, with 64K to 256K memory in each. Single ended or differential inputs. A 3½" or 5¼" floppy drive. One to 200 MS/s digitizing rates. The unique 44 MB removable hard disk or 40 MB internal disk. Plus dual timebase, choice of 8 or 12 bit digitizing resolution (separate or combined); built in MS-DOS drive; LEARN mode for automated test sequences; FFT and averaging.

More individual features, more combined memory and vertical resolution, more of everything. Get the picture?

Call today about the Nicolet 400.

*Based upon known specifications as of 7/90.

Nicolet Test Instruments Division

5225 Verona Rd., Madison, WI 53711-4495, 608/273-5008 or 800/356-3090

Nicolet
INSTRUMENTS OF DISCOVERY

**SPEEDY FIFO MEMORIES
COME IN BY-9 WIDTHS**

Expanding its offering of 9-bit-wide FIFO registers, Mosel Corp., Sunnyvale, Calif., released a trio of units that access in as little as 25 ns. Now available are the MS7200, a 256-word by 9-bit register; the 7201A, a 512-by-9 device; and the 7202A, a 1024-by-9 memory. All three come in both a standard-power and a low-standby-power version. The low-power version has a power-down standby mode that drops the current drain to just 500 μ A. The standard-power version has a 5-mA standby-current rating. Active current for the highest-speed version is 125 mA, with slower versions (such as units with 50-ns access times) typically consuming about 50 mA. Each FIFO memory includes three status flag lines—Empty, Full, and Half-full. The memories come in 28-pin 300- or 600-mil DIPs, 330-mil gullwing small-outline packages, or 32-lead plastic leaded chip carriers. All are available from stock. Prices for the standard-power 25-ns versions of the MS7200, 7201A, and 7202A are \$12.80, \$14.30, and \$18.80, respectively. Contact Jeff Hall, (408) 733-4556. DB **CIRCLE 370**

**SYNTHESIZED GENERATOR
INCLUDES TRIGGER SOURCE**

A 20-MHz function generator, which features a built-in trigger generator, eliminates the need for an external trigger source in trigger, gate, or burst modes. The model 90, from Wavetek San Diego Inc., can also be phase-locked to an external source. In this case, the instrument acquires, calculates, and displays the locking frequency automatically. The synthesized generator supplies programmable sine, triangle, square, and dc waveforms. A GPIB interface is standard. Frequency range is 1 to 20 MHz with 0.001% accuracy. Output is up to 40 Vpk-pk, and burst count is up to 1 million cycles. The unit includes modulation and sweep modes, and a nonvolatile memory for front-panel set-ups. Model 90 pricing starts at \$3395, with delivery four weeks after receipt of an order. For more information, call (800) 874-4835. JN **CIRCLE 371**

**ENERGY IC COLD-STARTS
COMPUTER FROM KEYBOARD**

Featuring special circuitry, a new CMOS chip can turn a computer on or off using the keyboard instead of a circuit-breaker switch. By using the DS1239 from Dallas Semiconductor, Dallas, Texas, equipment can be cold-started with a kick from a 3-V lithium source. This eliminates the need to reach around the computer and fumble for the on-off switch. The chip also isolates 110/220-V ac power from the person activating the switch. A power-supply monitor sends a warning signal to the processor if power falls out of tolerance. The DS1239 is available from stock for \$3.50 each in 1000-piece quantities. JC **CIRCLE 372**

**SOFTWARE MEASURES
ANTENNA PATTERNS**

A new software package can automate far-field antenna-pattern measurements, including gain, beamwidth, side-lobe levels, polarization, axial ratio, and beam symmetry. Running on an HP model 9000 series 300 workstation, the HP 85361A software integrates an HP 8753B/C network analyzer and a positioner/controller for measurements in the 300-kHz to 3-GHz range. The package works with positioners from Flam & Russell and Orbit. Single- or dual-axis control are possible, and patterns may use either continuous-wave or multiple frequencies. Data can be presented in Cartesian, polar, or three-dimensional formats. The software identifies peak gain, half-power beamwidth, and a user-specified beamwidth automatically. The HP 85361A package costs \$12,000 and is available 6 weeks after ordering. Call (800) 752-0900. JN **CIRCLE 373**

**TOOLSET IMPLIFIES
MOTIF INTERFACE DESIGN**

By employing graphics rather than command descriptions, the Builder Xcessory allows designers to create Motif user interfaces graphically, thus reducing application development design. The toolset, from Integrated Computer Solutions Inc., Cambridge, Mass., is an interactive, paint-like software utility that eases the task of prototyping and testing Motif user interfaces for the X-window environment. With the Xcessory, designers can click on icons and move them within the interface, similar to a paint program. Overall development time is reduced considerably because the interface can be tested and modified without compiling. The tools include a Palette, which contains a large collection of Motif interface objects; a Resource Editor, which enables interface objects to be customized; and the Browser, which illustrates widget instance hierarchy. The Builder Xcessory program runs on all Sun workstations, DECstations running Ultrix, Aviiion platforms from Data General, workstations from Silicon Graphics and Sony, and the Apple Macintosh running A/UX. The company also plans to offer the software for VAX/VMS systems from DEC and the R6000-based systems from IBM. A single-platform version of the software sells for \$2500 and is available immediately. Call Peter Winston, (617) 547-0510. DB **CIRCLE 374**

BIG CHANGE.

FOR THOSE WHO KNOW THE WORLD IS HEADED FOR HIGH PERFORMANCE, MORE POWER TO YOU.

If you're among the leading-edge designers on a power trip to the future, consider this. Motorola's Microcontroller Division just cut your travel costs with an offer too good to miss:

*Act between September 4 and October 12, and you can get a computer-based learning program and a development kit for our 32-bit microcontrollers for just \$332. Plus, you could win a supercharged Macintosh® IIfx.**

This offer is the perfect way to learn about Motorola's 68332. The one microcontroller that delivers the 32-bit performance and integration you will need to be competitive in tomorrow's world. And it's available from Motorola today.

THE 68332. A BIG PART OF THE FUTURE.

The 68332 is simply the world's most powerful microcontroller. It contains a full 32-bit HCMOS CPU surrounded by smart, modular on-chip peripherals, including a *RISC-based Time Processor Unit*.

The 68332 is backed by the unsurpassed 32-bit software base of our 68000 microprocessors. And its modular architecture will keep your product designs evolving right along with our expanding portfolio of microcontroller peripherals.



BIG NEWS. NEW LOW COST.

Thanks to Motorola's aggressive production ramps, the price of power will be less than you might expect. To find out just how low prices will be by the time your applications reach volume production, check with your Motorola representative.

BIGGER NEWS. FOR JUST \$332, YOU CAN EXPLORE THE WORLD OF 32-BIT TODAY.

No matter where you are on your move toward higher performance, our 32-bit learning tools can be invaluable.

If you're at the 16/32-bit decision point, use them as a basis for immediate comparison. Or use them to prepare for future migration when you're ready to step up to 32-bit performance. (As you make your move up, be sure to mail in the attached coupon for details on our soon-to-be-announced compatible 16-bit Family.)

START OUT SMALL. END UP WITH BIG RESULTS.

This \$332 introductory offer, *available only through your Motorola distributor*, includes our \$32 68332CLP computer-based learning

SMALL CHANGE.

FOR THOSE WHO WANT TO KNOW MORE,
OUR 32-BIT LEARNING TOOLS ARE NOW JUST \$332.

program. As well as the \$300 68332KIT.

The 68332CLP learning program alone is the equivalent of a full-day instructional seminar. It features a MS-DOS® programmed learning disk and a complete set of manuals that teach you how to design the 68332 into your next system.

The 68332KIT development package has everything you need to learn hands-on operation of the 68332, including a Business Card Computer (BCC). With a surface mount 68332, 128K bytes of EPROM, 64K bytes of RAM, and a RS232 port, the BCC provides stand-alone evaluation of the 68332 on a board the size of a business card.

The 68332KIT also features a Platform Board for mounting the BCC in expanded development operations. As well as assembler software. And a variety of support literature.

Perform the exercise included in your 68332KIT or 68332CLP and send us your completed entry form by December 31, 1990. If you performed the exercise correctly, you become eligible for a drawing to win one of five Mac IIfxs. (The Mac IIfx can be awarded to you, your company, or your favorite charity.)

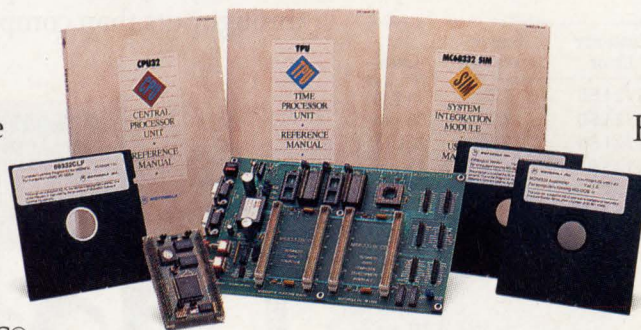

HURRY. WHILE THE POSSIBILITIES ARE ENDLESS, THIS OFFER IS NOT.

Our \$332 special offer is the perfect chance to

consider making a big change in power and performance for small change. To order, call your Motorola distributor today.

But hurry. Quantities are limited.** And this great price is good only through October 12.

All prices are manufacturer's suggested retail price.

**No purchase necessary. For entry details, write: Motorola, Inc., Dept. OE39/332 Promo, 6501 William Cannon Drive West, Austin, Texas 78735-8598*

***While supplies last. Limit 3 per customer.*

Macintosh is a registered trademark of Apple Computer, Inc.

MS-DOS is a registered trademark of Microsoft Corporation.

To receive a Technical Data Sheet for the 68332, plus news on our other 68300 Family products and our upcoming 16-bit high performance products, please complete and return this coupon to:

Motorola, Inc.
P.O. Box 1466
Austin, Texas 78767

ED9/13/90

Name _____
Company _____
Title _____
Address _____
City _____
State _____ Zip _____ Phone _____

THE PATHWAY TO PERFORMANCE.



MOTOROLA

SAMPLING A/D CONVERTERS

Model	Resolution (Bits)	Throughput (MHz)	Linearity Error	Power (Watts)	Case
ADS-111	12	0.500	±3/4 LSB	1.3	24-pin
ADS-112	12	1.0	±3/4 LSB	1.3	24-pin
ADS-193	12	1.0	±3/4 LSB	1.3	40-pin
ADS-132	12	2.0	±3/4 LSB	2.9	32-pin
ADS-131	12	5.0	±1 LSB	3.6	40-pin
ADS-130	12	10.0	±1 LSB	3.7	40-pin
ADS-924	14	0.300	±1 LSB	1.4	24-pin
ADS-928	14	0.500	±1/2 LSB	2.9	32-pin
ADS-941	14	1	±3/4 LSB	3.1	32-pin
ADS-942	14	2	±3/4 LSB	3.2	32-pin
ADS-930	16	0.500	±1 LSB	1.8	40-pin

SAMPLE-HOLDS

Model	Linearity	Acquisition Time (ns)	Gain	Bandwidth	Case
SHM-42	0.01%	50	+1	40 MHz	14-pin
SHM-43	0.01%	25	+1	40 MHz	14-pin
SHM-945	0.001%	500	-1/2, -1, -2	12 MHz	24-pin

A/D CONVERTERS

Model	Resolution (Bits)	Conversion Time (µs)	Linearity Error	Power (Watts)	Case
ADC-228	8	0.040	±1/2 LSB	1.25	24-pin
ADC-530	12	0.350	±1/2 LSB	2.10	32-pin
ADC-908	14	1.0	±1/2 LSB	2.70	32-pin
ADC-914	14	2.4	±1 LSB	1.20	24-pin

Superior Performance From one Complete Source.
DATEL's precision, high-speed data converters are the design advantage.

Just check the specs on the ADS-112 Sampling A/D, and you'll see why it's fast becoming the industry standard. Innovative designs in Sampling A/Ds deliver the best dynamic performance with some of the lowest power, smallest size and best pricing available.

Our High Performance A/D Converters are stand-alone units that let you design a data acquisition system with front-end configurations like those using simultaneous sample-holds.

Functionally complete, DATEL's Data Acquisitions Systems offer up to five times faster throughputs than competitive systems.



Data Converters

Innovative architectures make DATEL Multiplexers an industry first with guaranteed maximums and performance characterized for 14 and 16-bit applications.

New Sample Holds deliver the fastest maximum acquisition time at 12-bits in a 14-pin DIP, and a 16-bit differential input that truly delivers 16-bit performance. DATEL's innovative architectures are setting new limits of performance.

When your converter design demands peak performance at the best price, specify DATEL, the complete source. For more information call 1-800-233-2765. Or write DATEL, Inc., 11 Cabot Blvd, Mansfield, MA 02048.

DATA ACQUISITION SYSTEMS

Model	Resolution (Bits)	Throughput (KHz)	Power (Watts)	Channels	Case
HDAS-75	12	75	0.5	8 SE	40-pin
HDAS-76	12	75	0.5	4 DE	40-pin
HDAS-534	12	250	2.4	4 DE	40-pin
HDAS-538	12	250	2.4	8 SE	40-pin
HDAS-524	12	400	2.4	4 DE	40-pin
HDAS-528	12	400	2.4	8 SE	40-pin
HDAS-950	16	75	1.3	8 SE	40-pin
HDAS-951	16	75	1.3	4 DE	40-pin

MULTIPLEXERS

Model	Channels	Settling Time 20V to 0.01%	Input Range	Power (Watts)	Case
MX-826	8 SE	225 ns	±10.5V	0.370	24-pin
MX-850	4 SE	50 ns	±10.5V	0.210	14-pin



INNOVATION AND EXCELLENCE IN PRECISION DATA ACQUISITION

ENHANCED SCSI PROCESSOR PUSHES SYSTEM PERFORMANCE

SCRIPTS CHIP ADDS
MULTITHREADED I/O,
80-MBYTE/S DMA
TRANSFERS, AND MORE
FOR TOP SYSTEM DATA
THROUGHPUT.

DAVE BURSKY

Moving an environment from single-tasking to multitasking requires more than just a flexible CPU that can quickly switch between jobs. Once in a multitasking environment, the mass-storage subsystem usually becomes one of the main performance bottlenecks. Most mass-storage systems that include disk drives and other storage devices have access times in the tens of milliseconds. And their data-transfer rates are a fraction of the host-system's bus bandwidth.

To eliminate this bottleneck, designers at NCR Microelectronics have added new features to their previously released 53C700 Scripts processor (*ELECTRONIC DESIGN*, August 10, 1989, p. 37). The new features create a super-set CMOS device dubbed the 53C710. The C710 was designed specifically to execute, without processor intervention (except at the end of an I/O operation), multithreaded I/O algorithms—such as the ones found in workstation and file-server environments.

Another feature is a 32-bit bus-master DMA channel capable of 80-Mbyte/s data transfers (about 50% faster than the previous chip). In addition, the processor has a byte-ordering control pin that swaps the byte order to match the word structure of the processor that the chip

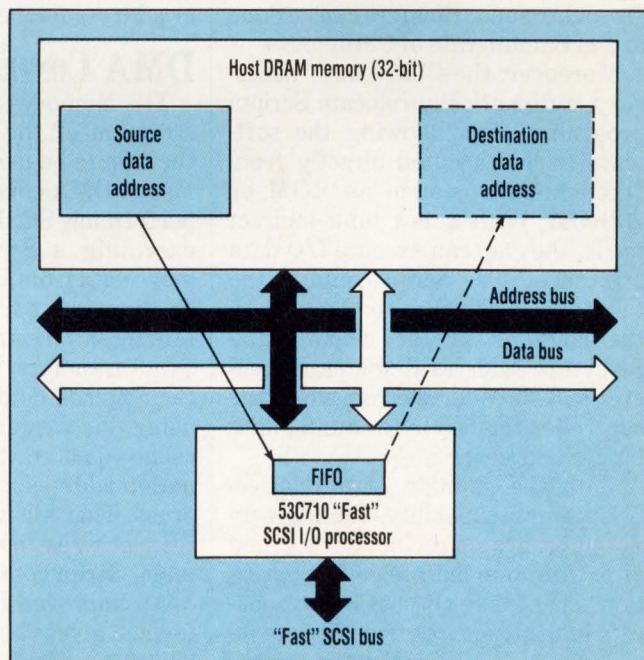

WHEN IT'S NOT performing SCSI transfers, the 53C710 SCSI Scripts processor from NCR can execute DMA requests at 40 Mbytes/s—half the speed of SCSI DMA operations. Data flows from the source location in main memory, through the 53C710's FIFO buffer, and back out from the FIFO register to its destination address, which is also in the main memory.

SMART SCSI CONTROLLER

connects to. Consequently, the controller can tie into either 80x86 or 680x0 buses with minimal circuitry.

An optional multiplexed address-and-data mode gives flexibility. This mode allows the chip to tie into low-cost host buses, such as Sun's SBus, with minimal support circuitry, or into more complex buses, with a few latches. Separate SCSI-bus and host-bus clock lines enable each bus to operate at its peak speed. System design requirements are thus simplified and each section of the system can be optimized for speed, cost, power, and other factors.

Furthermore, the glitches on the SCSI bus, which are typically generated when a SCSI device powers up or down, are also eliminated. Like the previous controller, the C710 can transfer data at 10 Mbytes/s in its synchronous mode. It can also implement a true "fast SCSI" subsystem with maximum cable lengths as specified by the SCSI-2 standard. Synchronous offsets from 1 to 8 bytes can be used. Most other chips that include a fast-SCSI option require significantly reduced cable lengths. Asynchronous transfers can be done at a maximum rate of 5 Mbytes/s.

Moreover, the C710 can, if necessary, automatically relocate Scripts programs, thus allowing the software to be executed directly from fixed memory, such as ROM or EPROM. With a new table-indirect mode, the chip can execute I/O data structures. The Script contains the table offset, which is combined with the contents of the chip's Data-Structure Address Register, to generate a 32-bit address from which the controller fetches byte counts, data buffer addresses, etc.

With the addition of a relative-Script-jump capability, the start-up Script program need not be modified at power-up to initiate an I/O operation. That makes it possible to separate data structures from Scripts instructions. It also assists in permitting the Script to be stored in nonvolatile memory. The C710 and 700 perform their control operations by executing the Scripts routines. Just 500 ns is required by either chip to decode the first command and start

implementing a Script.

Scripts is the programming concept NCR introduced with the 53C700. A Script program consists of modular SCSI control routines that are compiled—using an NCR development tool—and reside in the main system memory. To develop the Script program more easily, the company created a Script compiler that runs on any computer with a C compiler. The company also has a library of sample Script programs to simplify the creation of a custom Script.

The wide variance in bus latency from system to system requires that the C710 permit designers to locate SCSI Scripts and indirect data structures in either the main system memory or in a local memory on the host adapter card. A Fetch pin on the chip is brought high to indicate that the C710 is fetching Script instructions. With the availability of such a signal, external logic can steer a Script fetch locally, instead of causing a fetch from the main memory. Alternately, the chip can be set up to raise the Fetch pin during indirect data-structure fetches (for byte-count or buffer-address fetches).

DMA CONTROLLER

The Memory-to-Memory Move instruction of the controller enables the chip to be used as a high-performance DMA controller when it isn't performing SCSI operations. When executing a Script, the C710 can move data from a source address to a destination address at up to 40 Mbytes/s (see the figure). And, if SCSI transfers aren't being done, the chip can do data moves without using the system processor or its cache—just set the source or destination address to a chip register address. That allows the C710 to read from or write to the system memory under Script control.

An improved host-system bus interface gives the new controller the ability to burst data from a local memory to the host system at up to 66 Mbytes/s. Very fast cache-line refills or data-streaming operations can thus be performed. Burst lengths of 2, 4, or 8 bytes can be programmed by the user. To aid in the

transfer, a 64-byte FIFO register (16 words by 32 bits) is part of the chip.

Thanks to a Back-off control pin on the controller, the host system can force the C710 to relinquish the host bus, allowing a system to preempt a data burst for another high-priority task. To resolve bus deadlocks and eliminate system hardware lockups, the chip also includes a bus-retry capability that rearbitrates for the bus and retries data transfers.

To take control of the bus quickly, designers at NCR added a fast arbitration mode that removes one clock cycle from the host-bus arbitration time. That makes it easier to use host buses requiring extra address setup time and to more efficiently use the bus bandwidth of processor buses. Four programmable Status Output pins are active when the chip is a bus master. The pins can supply the host system with information about the current operation, or serve as user-programmable signal pins.

The C710's activity timer can be used to time all SCSI-bus activity, and interrupt the system after 250 ms if it detects a hang-up. Previously, the host adapter or host system provided this function. Another error-prevention aspect included on the chip consists of an Exclusive-OR register, which gives a vertical parity (checksum) value at the end of a data transfer.

The controller comes in a 160-lead quad-sided flat package. As with all NCR SCSI chips, it includes single-ended drivers/receivers that are engineered to withstand the harsh electrical realities of the SCSI cabling environment. □

PRICE AND AVAILABILITY

The 53C710 SCSI Scripts processor, sells for \$63 in quantities of 1000. The previously released 53C700 sells for \$51.95 in similar quantities. Delivery of C710 samples is from stock.

NCR Microelectronics Inc., 1635 Aero-plaza Dr., Colorado Springs, CO 80916; Brian Brown, (719) 596-5795. CIRCLE 537

HOW VALUABLE?	CIRCLE
HIGHLY	538
MODERATELY	539
SLIGHTLY	540

TEXAS INSTRUMENTS

A PERSPECTIVE ON DESIGN ISSUES:

Creating systems with an analog edge

IN THE ERA OF

MegaChip
TECHNOLOGIES



Advanced Linear can help you raise system performance levels.

A leadership family of analog circuits from Texas Instruments is helping designers meet difficult design challenges.

The evidence is strong. Throughout the design community, systems using the new breed of Advanced Linear functions from Texas Instruments are achieving the keener performance edges that can spell marketplace success.

TI's new analog devices are enabling design engineers to link digital brains to analog worlds more effectively and efficiently than ever before. Some offer new standards of accuracy or speed while others are highly integrated devices combining analog and digital functions on a single chip. The result is superior system performance and design flexibility.

These Advanced Linear functions are the result of leadership process technologies that we at TI firmly believe are the key to the advanced analog devices your future applications will demand.

Intelligent power for automobiles

Designers in the automotive industry face a tough challenge: Handle high reverse voltages and achieve rapid load turnoff while providing fault protection, detection, and reporting and efficient load management. To provide the needed intelligent power devices, we developed one of our newest process technologies, Multi-EPI Bipolar. It is unique because it can combine rugged power transistors with intelligent control functions.

The resulting circuits are now providing reliable, cost-efficient control of solenoids and valves in such automotive applications as antiskid braking systems, electronic transmission controls, and active suspension systems.

Other industry segments are also benefiting from TI's Advanced Linear process technologies. Here are a few of the winning designs to which we have helped add an analog edge:

Toledo Scale

Challenge: Improve the accuracy of point-of-purchase scales by eliminating drift over time and temperature.

Solution: The TI TLC2654 Chopper op amp. Our Advanced LinCMOS™ process makes possible chopping frequencies as high as 10 kHz, reducing noise to the lowest in the industry.



Pulsecom

Challenge: Develop a linecard capable of driving low-impedance loads with greater precision.
Solution: Our TLE206X family of JFET-input, low-power, precision operational amplifiers. These devices offer outstanding output drive capability, low power consumption, excellent dc precision, and wide bandwidth. Fabricated in our Excalibur process, they remain stable over time and temperature.

Leitch Video

Challenge: Design a compact, cost-efficient direct broadcast satellite TV descrambler for consumer use.
Solution: TI's TLC5602 8-bit Video DAC. Our LinEPIC™ process combines one-micron CMOS with precision analog to satisfy the demands of the application for video speeds and low-power operation.

U.S. Robotics

Challenge: Build a modem for high-speed data transmission between computers; allow flexible operation and minimize data errors.
Solution: Our TLC32040 Analog Interface Circuit (AIC). A product of our Advanced LinCMOS process, the AIC combines programmable filtering, equalization, and 14-bit A/D and D/A converters with such digital functions as control circuitry, program registers, and a DSP interface.

Xerox

Challenge: Cut component count and cost of copier systems while boosting reliability.
Solution: Our TPIC2406, a top-performance peripheral driver in a standard DIP package that is capable of driving heavy loads. It is fabricated using our Power BiDFET™ process which permits greater circuit density and incorporates CMOS technology for low total power dissipation.

Mr. Coffee

Challenge: Design an intelligent coffee maker that brews faster, maintains optimum temperature, shuts off automatically, and has a built-in cleaning cycle.
Solution: Our LinASIC™/LinBiCMOS™ capability permits us to combine both analog and digital library cells with custom analog cells. This results in cost-efficient integration of temperature monitoring, timing, and high-current outputs on a single control chip.

All of these examples point to one conclusion: TI's Advanced Linear functions are adding an analog edge to many system designs. They are contributing significantly to the enhanced system performance that marks a market winner.



WORLDWIDE MERCHANT IC MARKET

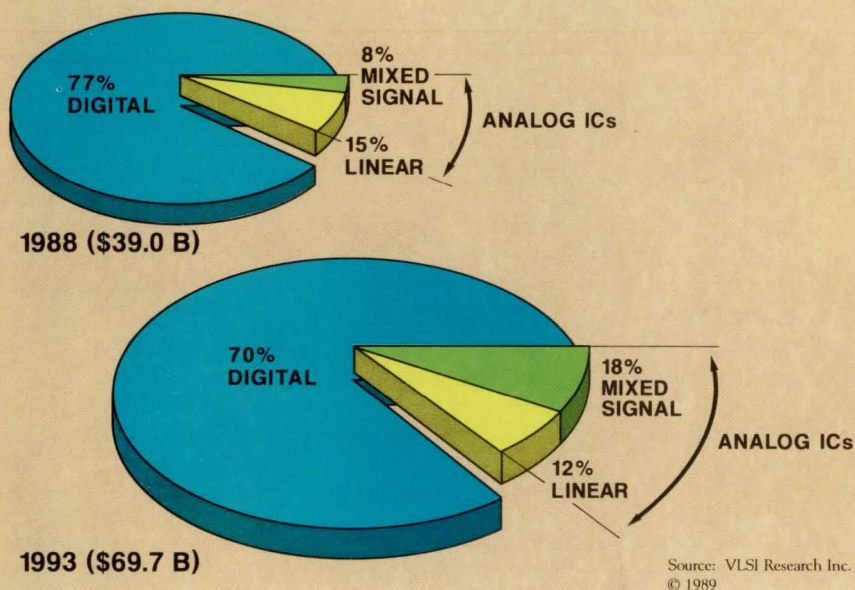

Helping you implement your designs in a changing world.

An increasing share of the total analog market is being captured by mixed-signal devices. As they gain more widespread acceptance, they are driving the expansion of the overall analog market (see above).

Changes such as this are the order of the day in the IC marketplace. Texas Instruments continues to provide not only the high-performance circuits you need but also the depth of experience, support, and service fundamental to successful completion of your designs.

Experience: Building on three decades in ICs

We at TI can successfully meet your requirements for mixed-signal devices because we have acquired the necessary knowledge from 30 years of experience in developing both analog and digital functions. We have also drawn upon our digital ASIC strengths in developing our LinASIC capabilities.

Support: Speeding our chips to you

The faster we move new products through our design cycles, the faster you can get through yours.

We employ a wide variety of design-automation tools and sophisticated software to speed our development process.

Service: Providing a surety of supply

However advanced our circuits may be, they are of little value if they are inaccessible to you. TI operates on the principle of global coverage, local service. We manufacture semiconductors in 13 countries and operate support centers in 22. We have product and applications specialists, designers, and technicians around the world. They are linked by one of the world's largest privately owned communications networks so that we can bring you our best — circuits and support — from wherever they may be to wherever you are.

Keeping our communications open

The relationship between you as customer and us as vendor is vital: You are our chief source for firsthand information that can help guide us in developing the circuits you will need for your future designs. We at TI welcome your comments and your suggestions.

TI's Leadership Analog Processing Technologies

LinBiCMOS — Combines Advanced LinCMOS, digital ASIC CMOS, and up to 30-V bipolar technologies to allow the integration of digital and analog standard cells and handcrafted analog components on a monolithic chip.

LinEPIC — One-micron CMOS double-level metal, double-level polysilicon technology, which adds highly integrated, high-speed analog devices to the high-performance digital EPIC process.

Advanced LinCMOS — An N-well, silicon-gate, double-level polysilicon process featuring improved resistor and capacitor structures and having three-micron minimum feature sizes.

Power BIFDET — Merges standard linear bipolar, CMOS, and DMOS processes and allows integration of digital control circuitry and high-power outputs on one chip. Primarily used for circuits handling more than 100 V at currents up to 10 A.

Multi-EPI Bipolar — A very cost-effective technology that utilizes multiple epitaxial layers instead of multiple diffusion steps to reduce mask steps by more than 40%. Used to produce intelligent power devices that can handle loads as high as 20 A and voltages in excess of 100 V.

Excalibur — A true, single-level poly, single-level metal, junction-isolated, complementary bipolar process developed for high-speed, high-precision analog circuits providing the most stable op amp performance available today.

If you would like a more detailed explanation of our Advanced Linear process technologies, please call 1-800-336-5236, ext. 3423. Ask for a copy of our *Advanced Linear Circuits* brochure.

™ Trademark of Texas Instruments Incorporated
©1990 TI

08-0082

**TEXAS
INSTRUMENTS**

AN HDL RAISES THE LEVEL OF ABSTRACTION FOR PROGRAMMABLE-LOGIC DESIGN

LISA GUNN

An enhanced hardware description language (HDL) helps to raise the level of design abstraction for engineers using Data I/O's newest version of the Abel software, Abel-4. The new software also features a window-based interactive user interface, increased device support, SmartPart intelligent device selection, automatic logic optimization, and a testing option.

The Abel HDL is optimized for field-programmable-gate-array (FPGA) and programmable-logic-device (PLD) designs. Because it is device- and architecture-independent, engineers can enter and verify designs without part specifications. Language features give engineers control over device characteristics such as buried flip-flops and configurable macrocells. As a result, engineers choose the level of detail required for their design. Input to the HDL can be in the form of high-level equations, state diagrams, truth tables, and schematics.

Other HDL enhancements include clearly-defined Pin and Node declarations, simplified signal attributes, and signal dot extensions for more complex language situations. The Abel synthesis software creates circuits for PLDs and FPGAs, or transfers the design information to other environments through standard-format transfer files.

Expanded FPGA support includes the Xilinx LCAs, Actel ACT 1 family, Altera Max, and Plus Logic devices. In total, the Abel-4 design software supports over 6000 devices and over 300 architectures.

SmartPart intelligent device selection automatically generates a list of candidate devices for every design by comparing the design's requirements with device resources. A design can then be tried in multiple architectures to determine the best fit. Users can define device technology, speed, manufacturer, and price.

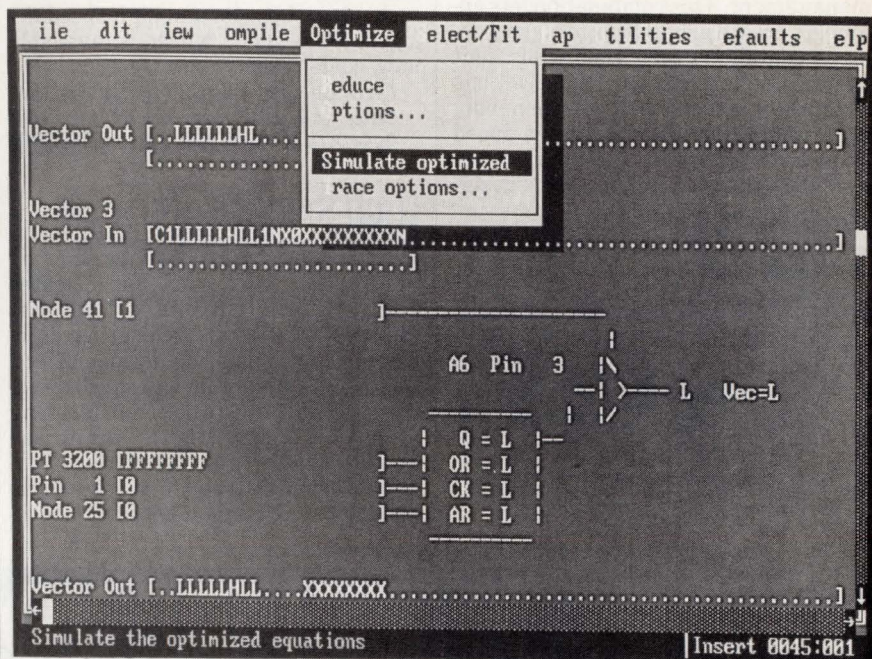

Abel-4 simulates a design at the device and system level for thorough verification. A design can be simulated at the functional level prior to device selection. Simulation results are given in both tabular and waveform formats. Device-level simulation allows for full verification before programming, including verifying that a design fits properly in the targeted device. Every fuse, node, and pin is fully debugged.

Multiple optimization techniques ensure an optimum device fit. Abel-4 algorithms contain device-independent synthesis features and device specifics. These specifics help to efficiently utilize complex device attributes such as multiple flip-flop types, exclusive OR gates, unique interconnect schemes, and folded arrays. Register synthesis, which lets users design independent of flip-flop type, automatically makes an intelligent decision based on the design. A reduction algorithm eliminates redundant circuitry.

Data I/O's recently announced Open-Abel is part of Abel-4. It lets users take advantage of a universal

design language without sacrificing device support or optimization. This is because with Open-Abel, semiconductor companies can write specialized device algorithms to fully optimize the silicon resources. The algorithms are termed fitters. Data I/O is licensing semiconductor vendors to write fitters for Open-Abel by means of the Abel-PLA format.

The PLDgrade testing option to Abel-4 performs automatic fault grading and testability analysis. It allows user-generated test vectors to be fault-graded by the design engineer, prior to the design entering production.

Abel-4 costs \$1995 for IBM XT, AT, and PS/2 computers and compatibles; \$2695 for Sun-3 and Sparcstation workstations; and \$4115 for VAX VMS workstations. The software is also available for site licensing. The PLDgrade option costs \$495. Abel-4 is shipping now with 2-4 week delivery after receipt of order.

Data I/O Corp., 10525 Willows Rd. N.E., P.O. Box 97046, Redmond, WA 98073-9746; (206) 881-6444.

CIRCLE 301

PCB DESIGN SOFTWARE USES VIRTUAL MEMORY

CAD Software Inc.'s top-of-the-line pc-board design system, called Pads-2000, runs on 80386- or 80486-based personal computers and uses virtual-memory management. This combination lets engineers create printed-circuit-board designs containing over 2000 equivalent 14-pin ICs. In addition, Pads-2000 has several features that have previously been found only in workstation-based pc-board tools. These features include a copper-pour routine that fills a design-

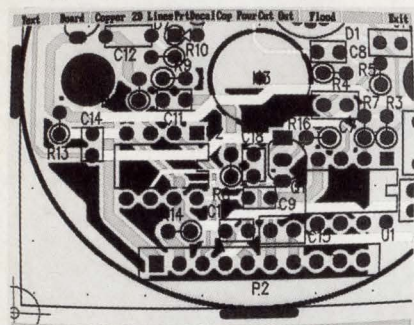

nated area with copper while leaving the included tracks and pads isolated, 1- μ m resolution, T routing, rotation of components and pads in 1/10th-degree increments, and five different autorouters. Engineers can design double-sided surface-mounted boards, mixed-technology boards, and high-speed designs. Pads-2000, which is available now, costs \$6995.

CAD Software Inc., 119 Russell St., Suite #6, Littleton, MA 01460; (800) 255-7814 or (508) 486-9521. CIRCLE 302

HIGH-SPEED SIMULATOR PREDICTS SKIN EFFECT

The newest release of Quad Design Technology's Crosstalk Tool Kit (XTK), XTK 2.0, can predict such high-frequency problems as the skin effect. This occurs when thin wires pick up extra resistance due to electron bunching at the wire surface. Thin wires are used in multichip designs. Version 2.0 simulates ultra-high-frequency, ultra-high-density printed-circuit boards. It calcu-

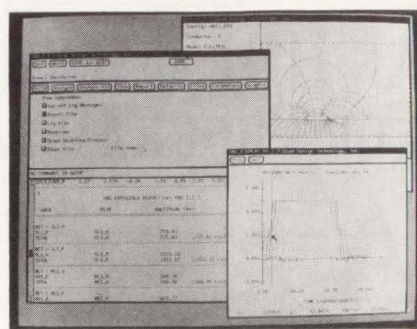

lates signal distortions and simulates their effects on system timing for boards with up to a 2-GHz operating frequency. Furthermore, it performs these tasks at both the board and net levels. XTK 2.0 is shipping now. It runs on Sun and HP/Apollo workstations, and memory-extended PCs. The Crosstalk Tool Kit software costs between \$27,000 and \$41,000, depending on the hardware platform.

Quad Design Technology Inc., 1385 Del Norte Rd., Camarillo, CA 93010; (805) 988-8250. CIRCLE 303

WHERE YOU MAKE THE RIGHT CONTACT.

Electronica is the world's largest trade fair for electronic components and assemblies. Here state-of-the-art technology is on display, and developments, trends, methods and solutions are showcased in a comprehensive, precise, clear and up-to-the-minute style.

Accompanying events at a glance

Congresses and lectures on the following subjects will take place during electronica 90:

- AVT - Layout and connector techniques
- PKO - Cost optimizing in testing
- Micro-electronic sensors
- 5th international power electronics conference
- PHA - Product liability
- MST - Microsystems engineering
- EMV - Electromagnetic compatibility
- DGQ/ZVEI Symposium: quality assurance agreements for assemblies



Munich
6-10 November 1990
electronica 90[®]

Information:

Gerald G. Kallman Associates,
5 Maple Court, Ridgewood, NJ 07450.
Tel. (201) 652-7070, Tfax (201) 652-3898.

MESSE MÜNCHEN INTERNATIONAL

CIRCLE 169

INCO SPECIALTY POWDER PRODUCTS RESEARCH AND DEVELOPMENT... NEW PRODUCTS FOR NEW TECHNOLOGIES



Victor Ettel, Director of Battery Powder Research, Sheridan Park, Mississauga, Ontario, Canada. His job is to find new uses for carbonyl technology.

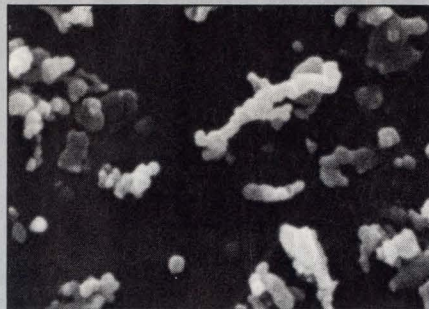

UFP, Ultra Fine Powder

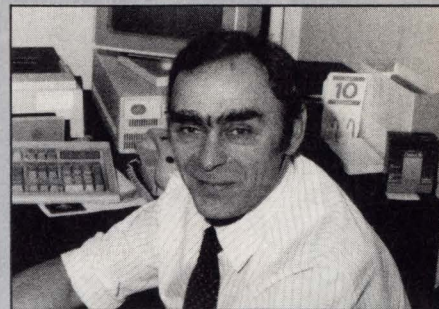

Eurof Rees, Pilot Plant Superintendent, Clydach Nickel Refinery, Wales, U.K. Eurof has been involved in carbonyl coating of substrates for more than twenty years.



Frank Heck, Technical Director, Novamet Specialty Products Corp. Wyckoff, New Jersey. Frank is always looking for new ways to produce a better powder.

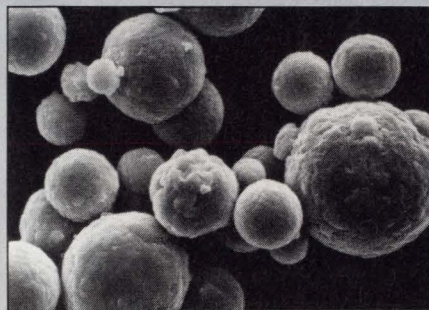

4SP Spherical Powder

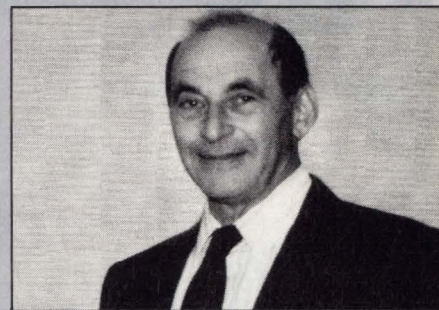

George Tyroler, Technical Superintendent, Copper Cliff Refinery, Sudbury, Canada. George likes working on the edge of developing nickel powder products.

INCO Specialty Powder Products is continuing to develop advanced powders and applications. Our mission is to develop new products for new technologies. INCO SPP personnel from marketing, manufacturing and research work together as a team, bringing to bear their disciplines to serve you and your needs.

NEW NICKEL POWDER PRODUCTS IN DEVELOPMENT

UFP, Ultra Fine Powder. A unique mixture of high nickel surface area, very fine particle size (0.8 microns) low density (0.07gm/cc) morphology and high purity. Surface area is 3 to 5 times that of other conventional carbonyl nickel powder. Surface resistivity in acrylics is at 10 ohms per square. It also presents possibilities for pasting in conductivity applications. This points to a greater range of resistivity with other agents, especially in thin film technology.

4SP Spherical Powder. Completely spherical and smooth in shape. Particle sizes of 8-9 microns. It has the potential to increase strength of P/M steel parts compared to other nickel powders. The particle shape presents opportunities for metal injection molding.

INTERNATIONAL RESEARCH GROUP

INCO Specialty Powder Products is conducting research and development at the Novamet Specialty Products Corp. in the US, at the Clydach Refinery in Wales, UK, and Sheridan Park Corporate Laboratory and Copper Cliff Refinery in Ontario, Canada. We are fortunate to have some of the leading powder technology researchers on our staff.

For more information write INCO Specialty Powder Products, Dept. 3-90, Park 80 West-Plaza Two, Saddle Brook, NJ 07662

INCO SPP

Park 80 West-Plaza Two, Saddle Brook, NJ 07662
Shin-Muromachi Building, 4-3 Nihonbashi-Muromachi 2-Chome,
Chuo-ku, Tokyo 103 Japan
1-3 Grosvenor Place, London SW1X7EA England
15/FI Wilson House, 19-27 Wyndham Street Central, Hong Kong

NEW PRODUCTS

COMPUTER-AIDED ENGINEERING

GENERATE VHDL FROM GRAPHICAL MODELS

Designers can produce VHDL code from graphical models with the Express VHDL software from i-Logix Inc. The resultant code can be used to drive any VHDL-compliant simulator. The behavioral models are created in

the company's Statecharts language, which extends state-transition diagrams with hierarchy, concurrency, and broadcasting. States and transitions are described with boxes and arrows. Labels on the transitions indicate when and under what conditions each transition will take place. Once a system's behavioral model is expressed

graphically, the equivalent VHDL code is automatically generated with the push of a button. Express VHDL will start shipping in the fall. Pricing for the software starts at \$32,500.

i-Logix Inc., 22 Third Ave., Burlington, MA 01803; (617) 272-8090. CIRCLE 304

DATABASE MEETS ENGINEERING NEEDS

ObjectStore is an object-oriented database management system (ODBMS) targeted at the electrical design-automation market. It supports object-oriented development in C++, and also supplies a migration path for applications developed in C to C++. In addition, ObjectStore applications are compatible with other subroutine libraries such as Fortran and Pascal. Development tools included with the DBMS are SchemaDesigner, an interactive graphical tool for creating database schemas; a browser; and a debugger. The database runs in any heterogeneous client-server environment of networked workstations and high-end PCs. Pricing for ObjectStore, which is on a per-seat basis, ranges from \$2000 to \$9000. Runtime license pricing is also available for independent software vendors. Shipment begins this month.

Object Design Inc., One New England Executive Park, Burlington, MA 01803; (617) 270-9797. CIRCLE 305

SIMULATE LARGE DESIGNS WITHOUT EXTRA MEMORY

Innovative simulation techniques and algorithms let a new simulator from Silicon Automated Systems run very large designs—those with over 100,000 gates—without additional memory. The company claims that the simulator runs ten times faster than other leading industry simulators. The X-Sim system simulation environment includes the X-Sim simulator executive and the X-Sim backplane bus. Various components, such as an HDL engine, VHDL engine, X-Sim control language, and test simulation server, communicate with each other through the backplane. The X-Sim control language has features for setting the simulation environment that eliminate the need for recompilation and linking. The system runs on Sun, IBM, and HP/Apollo workstations. Depending on the configuration, X-Sim costs between \$20,000 and \$70,000.

Silicon Automation Systems Inc., 1630 Oakland Rd., Suite #A104, San Jose, CA 95131; (408) 437-9161. CIRCLE 306

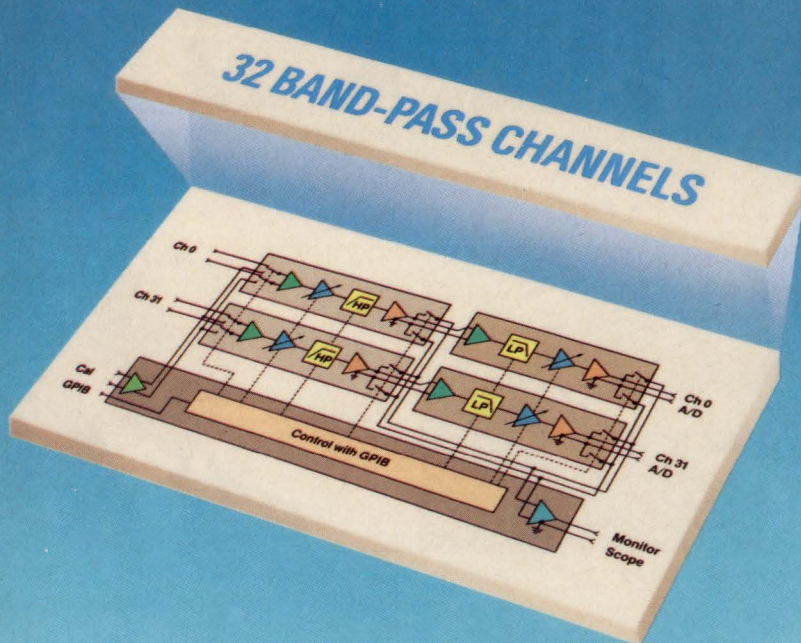

Only With System Friendly

Just one of hundreds of programmable hardware building block configurations possible with our operating system. Just one of hundreds of exclusive possibilities that make Precision 6000 truly System Friendly now and easy to update in the future. Call (607) 277-3550 for brochure. Or write.

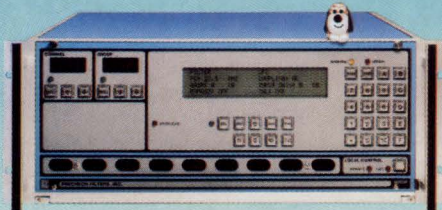

32 band-pass filter channels.
80 dB/octave.
1 Hz to 25.5 kHz.
1° phase match.
Pre and post gain.
Differential input.
Calibration input.
Signal monitor.
All in 7" mainframe.



PRECISION FILTERS, INC.

240 Cherry Street, Ithaca, New York 14850

CIRCLE 86

POWER SOLUTIONS THAT MAKE CENTS

50 to 200 Watts
Booster expansion to kilowatts
Up to 50 watts/in³



FOR
IMMEDIATE
DELIVERY CALL
VICOR EXPRESS
800-735-6200

EconoMods

If you thought component-level power was too expensive for your high volume, cost sensitive, applications . . . we've got good news. Vicor's new EconoMod™ family of component-level power converters offers the size and performance advantages of Vicor's megahertz power technology at prices that won't hog your budget . . . as low as \$0.33 per watt in OEM quantities.

Available in over 100 popular combinations of input voltage, output voltage and output power, and sharing Vicor's "industry standard" encapsulated package, EconoMods are the economical answer to contemporary power system requirements . . . from 50 watts to kilowatts. And EconoMods feature the high power density, high efficiency, "instant expandability" and component-level flexibility that make traditional power supplies obsolete.

By standardizing on EconoMod *you can bank on saving money, space and time.*



Traded on NASDAQ under "VICR"

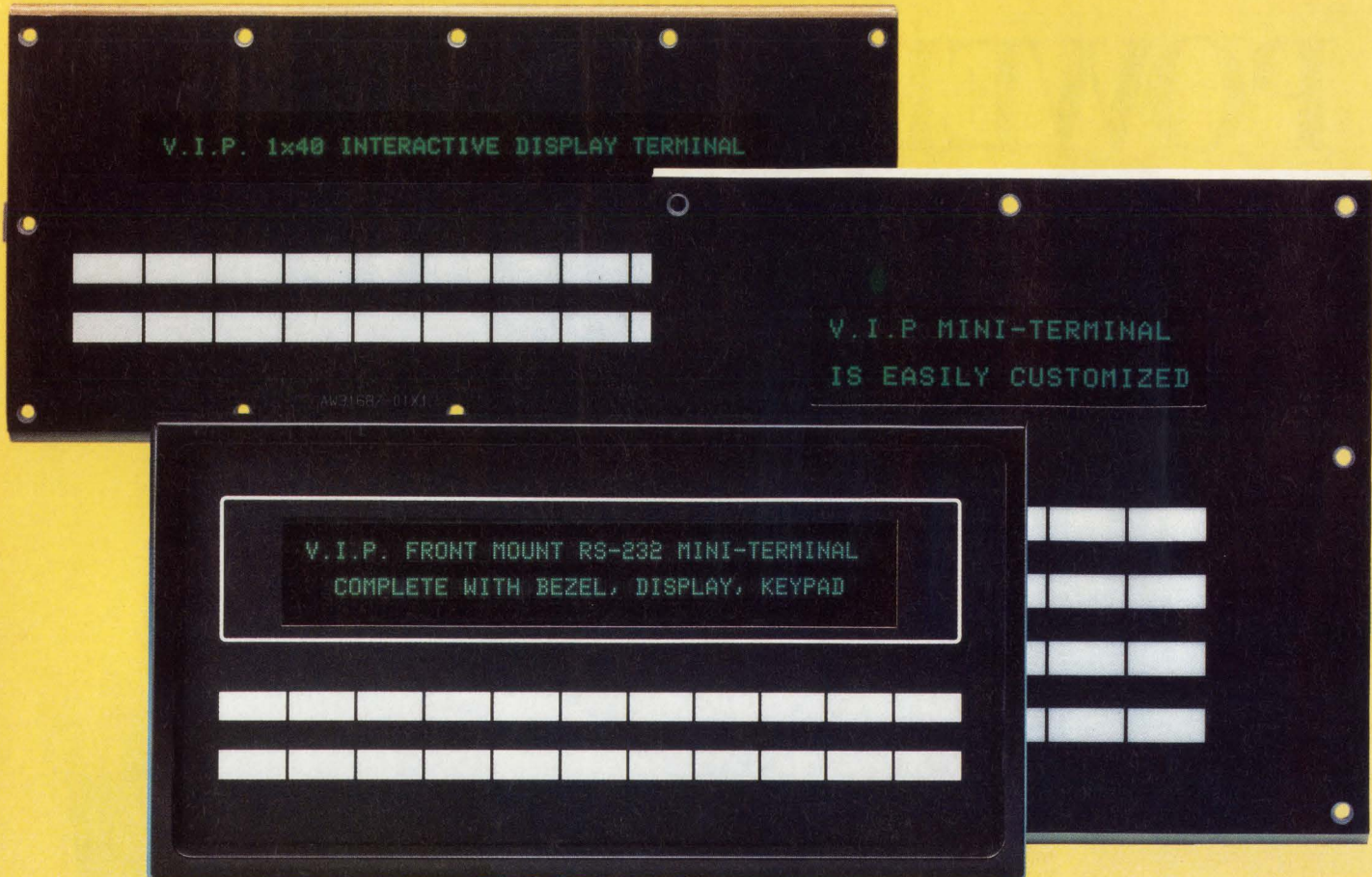

You have better things to do than reinventing the operator interface.

You **could** spend hours selecting displays, switches, and encoders for your operator interface. Of course, you'd still have to fabricate a wiring harness and individual panel cutouts for all those components. Then you'd be set, until the next configuration change meant redoing half your work.

But why do things the hard way, when you can choose a **V.I.P.**™ instead? This integrated display/keyboard system from IEE costs less than integrating "bits and pieces" yourself and also saves time. You see, **V.I.P.** is a ready-made "mini-terminal"—a

plug-in operator interface with lots of convenient features:

- Bright, easy-to-read vacuum fluorescent display.
- Operates on +5 VDC.
- Tactile dome membrane switches, with "slide-in" changeable legends. Ask about custom artwork and legends.
- One DB-25 RS-232C connector for display and switch I/O.
- On-board EPROM-based canned messages.
- Compact package easily seals to your front panel.

So what else is new? An optional front-mounted package—

with a die-cast bezel—for our popular two-line by 40-character model. And other new models are in the works.

Call today for ideas on how to use **V.I.P.** You'll have to come up with your own ideas for what to do with the time and money you'll save.

Industrial Electronic Engineers, Inc.
 Industrial Products Division
 7740 Lemona Avenue
 Van Nuys, CA 91405
 Tel. (818) 787-0311, ext. 418
 Fax (818) 901-9046



NEW PRODUCTS

SOFTWARE

REAL-TIME OS UPGRADE EXTENDS CONNECTIVITY, ADDS X-WINDOW SUPPORT

VxWorks version 5.0 is the latest release of Wind River Systems Inc.'s real-time operating system. Upwardly compatible with version 4.0.2, the software increases its kernel performance, I/O functions, connectivity support, debugging, and graphics.

The rewritten wind-kernel improvements include higher speed. Benchmarks on 25-MHz Motorola 68020-based target boards have clocked wind-context switches at 16 μ s and interrupt latency at 8 μ s. The software includes SLIP (serial-line interface protocol) and high-security login and remote login capabilities.

VxWorks 5.0 target configurations can range from a 60-kbyte, stand-alone, real-time kernel to a 465-kbyte full-scale development system including kernel, networking, file-system support, and development tools.

Device-independent SCSI support is combined with an MS-DOS media-compatible file system. Developers can use the ANSI C programming language in addition to a new set of internal system information utilities.

Options for VxWorks that weren't previously available include a remote

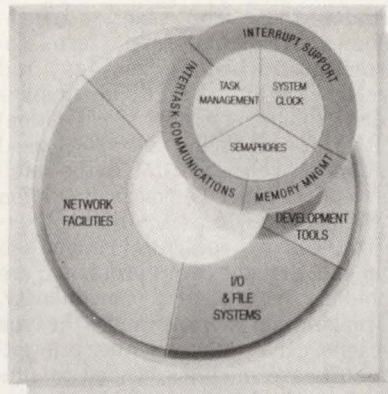

source debugger, and windX, client support for X-windows. The debugger, VxGDB, offers rehostable, retargetable source-code debugging that can simultaneously debug multiple tasks running on multiple targets.

Available now, a single-user development license costs \$15,000. VxGDB costs \$5000 and windX sells for \$2500.

Wind River Systems Inc., 1351 Ocean Ave., Emeryville, CA 94608; (415) 428-2623. CIRCLE 307
RICHARD NASS

OPEN-SYSTEM MODEL LETS DSP SYSTEMS SHARE PLATFORMS

By creating an open-system model that DSP hardware manufacturers can incorporate in their systems, Spectron Microsystems hopes to proliferate its SPOX real-time operating system for DSP chips such as the Texas Instruments TMS320C30, the Motorola 96002, and others. The open signal-processing architecture (OSPA) defined by Spectron is an extension of the company's SPOX operating system and permits a common software platform to be shared by multiple hardware and software vendors. Thus software developed for any of a dozen C30- or 96002-based DSP cards can run on any of the cards.

With OSPA DSP software, developers can isolate the end-user application from the hardware and the real-time DSP tasks. The underlying SPOX operating system handles the DSP tasks and program developed with the OSPA guidelines call tasks from SPOX. Able to run under Microsoft's Windows 3.0 environment (X-windows by the end of

this year), the OSPA model eases the development of application programs in multimedia, voice-response, process-control, and other systems. Spectron encourages three levels of third-party activity: first, DSP platform vendors must adopt the SPOX operating system; second, the independent software suppliers must "package" their DSP algorithms as SPOX applications; and third, system integrators must develop turnkey end-application programs.

To develop software for OSPA, designers must start with a DSP platform that runs the SPOX operating system and then add to it Spectron's Windows developers kit, as well Microsoft's Windows's developers kit. Depending on the DSP platform, price can range from about \$2500 to about \$5000. A porting package for SPOX is about \$18,000.

Spectron Microsystems Inc. 600 Ward Dr., Santa Barbara, CA 93111; Dave Wong, (805) 967-0503 CIRCLE 308
DAVE BURSKY

ULTRA-MINIATURE SURFACE MOUNT

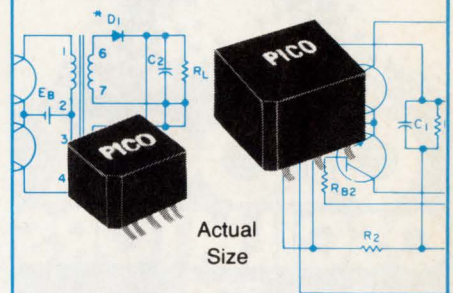

DC-DC Converter Transformers and Power Inductors

These units have gull wing construction which is compatible with tube fed automatic placement equipment or pick and place manufacturing techniques. Transformers can be used for self-saturating or linear switching applications. The Inductors are ideal for noise, spike and power filtering applications in Power Supplies, DC-DC Converters and Switching Regulators.

- Operation over ambient temperature range from -55°C to $+105^{\circ}\text{C}$
- All units are magnetically shielded
- All units exceed the requirements of MIL-T-27 ($+130^{\circ}\text{C}$)
- Transformers have input voltages of 5V, 12V, 24V and 48V. Output voltages to 300V.
- Transformers can be used for self-saturating or linear switching applications
- Schematics and parts list provided with transformers
- Inductors to 20mH with DC currents to 23 amps
- Inductors have split windings

Delivery—stock to one week

SEE EEM, THOMAS REGISTER OR SEND DIRECT FOR FREE PICO CATALOG

PICO Electronics, Inc.

453 N. MacQuesten Pkwy. Mt. Vernon, N.Y. 10552

Call Toll Free 800-431-1064

IN NEW YORK CALL 914-699-5514

CIRCLE 92

Your One-Stop
Source
for...

CLOCK OSCILLATORS and VCXOs

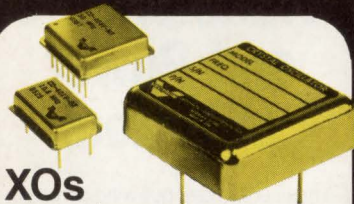

XOs

Logic

TTL: 16 kHz- 100 MHz
CMOS: 1 Hz- 15 MHz
HCMOS: 1 Hz- 125 MHz
*ECL: 5 MHz- 700 MHz
SINE: 5 MHz-1300 MHz

*10K, 10KH, 100K, MECLIII & ECLIPS

Accuracy (at 25°C) ± 10, 15, 25 or 50 ppm (± 1 ppm on some models)

Stability Standard ± 25 ppm over 0/+70°C
Optional ± 50 ppm over -55/+125°C
Optional ± 5 ppm over 0/+50°C

Available Class B or S screened per MIL-O-55310.

VCXOs

Frequency: TTL: 32 kHz- 70 MHz
HCMOS: 1 kHz- 70 MHz
ECL: 8 MHz-200 MHz
SINE: 8 MHz-750 MHz

Deviation: ± 30 ppm to ± 200 ppm

Stability: ± 10 ppm over 0/+50°C
± 50 ppm over -55/+85°C

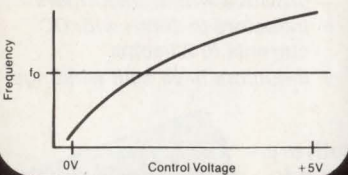

VECTRON

The Crystal Oscillator Company

VECTRON LABORATORIES, INC.
166 Glover Avenue, Norwalk, CT 06850.
Phone: (203) 853-4433. FAX: (203) 849-1423.

CIRCLE 106

NEW PRODUCTS

SOFTWARE

MODULAR BIOS FITS 80386-, 80486-BASED SYSTEMS

Release 3.1 of Award Software Inc.'s modular basic I/O system (BIOS) allows quick response to new chip sets, including those from Chips and Technologies, Headland, Intel, Texas Instruments, VLSI Technology, and Western Digital. The BIOS supplies EMS (Expanded-memory specification) in ROM for all 80486- and 80386-based systems as well as an LIM (Lotus-Intel-Microsoft) EMS 4.0 memory emulation in the same ROM as the BIOS. User-definable drive types, an expanded set-up menu, and password protection are included. Because of the modularity, PC makers can pick and choose the type of cache, drive, video, or other prewritten software modules needed to support specific hardware features. Release 3.1 is available now and costs from \$70 to \$80 in quantity one to upgrade from earlier versions, with significant discounts for large quantities.

Award Software Inc., 130 Knowles Dr., Los Gatos, CA 95030; (408) 370-7979. **CIRCLE 309**

SPREADSHEET ACCEPTS HIGH-LEVEL LANGUAGES

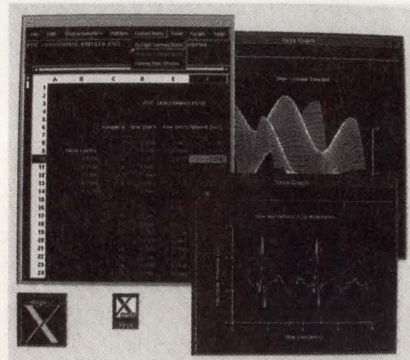

Engineers and scientists who require a level of computation beyond traditional spreadsheets can now turn to XESS (X-windows Engineering & Scientific Spreadsheet) from Applied Information Systems Inc. Running under Motif on Unix and VAX/VMS workstations, the software takes advantage of the speed, flexibility, and real-time data exchange that's possible in the X-windows environment.

In addition to standard spreadsheet functions, the program lets engineers quickly develop computational programs and interact with XESS by linking the XESS Connection Library to their C or Fortran programs. As calculation programs create new data, XESS can automatically incorporate the data,

recalculate the spreadsheet, and display a continuously updated report. While connecting to multiple remote programs, XESS can calculate matrix, vector, and Fourier transforms, plus mathematical and statistical operations. Surface, line, histogram, and bar graphs enhance data visualization. XESS can import and export spreadsheets in WKS and WK1 formats, so that current spreadsheets can be moved to XESS and expanded.

XESS runs on X-windows workstations running X11.3 or X11.4 with Motif. It sells for \$595 and will start shipping on Oct. 17.

Applied Information Systems Inc., 500 Eastoune Dr., Chapel Hill, NC 27514; (800) 654-2596 or (919) 942-7801.

CIRCLE 311

RUN WINDOWS 3.0 ON 34020 AND X-WINDOWS ON A PC

Version 3.0 of DGIS (Direct Graphics Interface Standard) offers support for Microsoft Windows 3.0 and Texas Instruments' TMS34020 graphics processor. This means that, using DGIS 3.0, from Graphic Software Systems (GSS), 34010 and 34020 system developers can support Windows 3.0. Other enhancements to Version 3.0 include support for DOS extenders and virtual color maps. Because DGIS 3.0 executes on a graphics coprocessor in parallel with the system CPU, its performance is up to ten times faster than VGA controllers.

More than 600 applications can run on DGIS 3.0, including AutoCAD, Microstation, WordPerfect, Harvard Graphics, and Ventura Publisher. In addition to Windows 3.0, other graphical user interfaces are accelerated, including X-windows. Many major system makers already incorporate the DGIS system into their hardware, including Compaq, Dell, HP, and NEC. Available now, DGIS 3.0 comes with the source code and is priced on a license and royalty basis.

XVision, also from GSS, is a Microsoft Windows application that enables PC users to display multiple X-window applications alongside multiple Windows 3.0 applications. Users gain the ability to cut and paste between the two environments. XVision can be networked to various X-window hosts simultaneously over a TCP/IP network. XVision is compatible with all versions of Microsoft Windows. It's available now for \$445.

Graphic Software Systems Inc., 9590 SW Gemini Dr., Beaverton, OR 97005; (503) 641-2200. **CIRCLE 312**

Fast 10-Bit Sampling A/D Converters Include Reference, DC and Dynamic Specs

Maxim's new 10-bit analog-to-digital converters come complete with internal voltage reference, track/hold, and clock - saving valuable board space. The MAX151 and MAX177 are ideal for applications such as digital-signal processing, audio and telecom processing, high-accuracy process control, electro-mechanical systems and high-speed data acquisition.

MAX151 - 300kHz/2.5 μ s 10-Bit Sampling A/D - \$11.50*

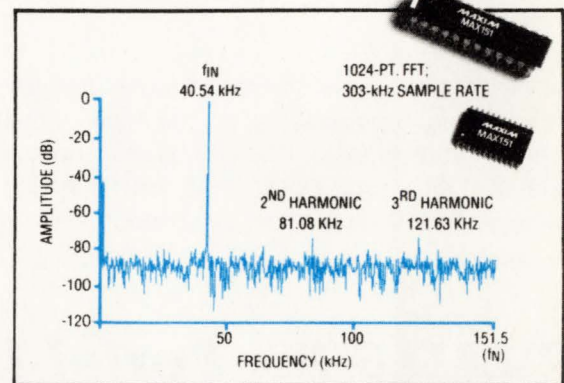
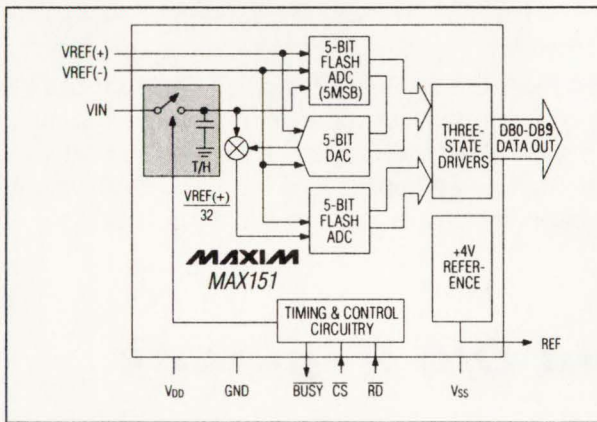

- ◆ 100% Tested for DC and Dynamic Accuracy
- ◆ ± 1 LSB Total Unadjusted Error
- ◆ Internal ± 60 ppm/ $^{\circ}$ C Voltage Reference
- ◆ No Missing Codes
- ◆ 0 to +5V Input Range with ± 5 V Supplies

- ◆ 5MHz Full Power Bandwidth
- ◆ ± 1 ppm/ $^{\circ}$ C Gain and Offset Drift
- ◆ Complete with Internal Track/Hold, Clock, Ref
- ◆ 275mW Power Consumption, Including Ref
- ◆ Small Footprint SO and DIP Packages

MAX177 - 100kHz/8.33 μ s 10-Bit Sampling A/D - \$7.90*

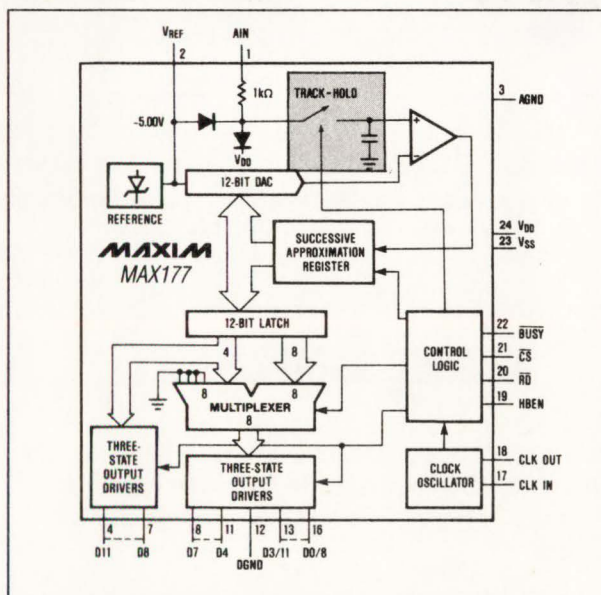

- ◆ 100% Tested for DC and Dynamic Accuracy
- ◆ Internal ± 40 ppm/ $^{\circ}$ C Voltage Reference
- ◆ No Missing Codes
- ◆ -2.5V to +2.5V Input Range
- ◆ 6MHz Full Power Bandwidth
- ◆ High Input Impedance (500M Ω)
- ◆ Complete with Internal Track/Hold, Clock, Ref
- ◆ 8- or 16-Wide μ P Interface
- ◆ 180mW Max Power Consumption, Including Ref
- ◆ Small Footprint SO and DIP Packages

For applications that don't need the track/hold function, Maxim offers the MAX173, essentially a MAX177 but with 5 μ s speed, +5V input range at \$7.00*.

* Price 1000-up FOB USA

8-Bit, 5 μ S A/D Converter with Track/Hold Accepts Differential Inputs - Only \$4.90*

- ◆ ± 1 LSB Total Unadjusted Error
- ◆ 50KHz Input Signal Bandwidth
- ◆ Single +5V Supply Operation
- ◆ Low 15mW Power Consumption
- ◆ 8-Bit μ P Interface
- ◆ 100ns Data Access Time
- ◆ Small Footprint DIP and SO Packages

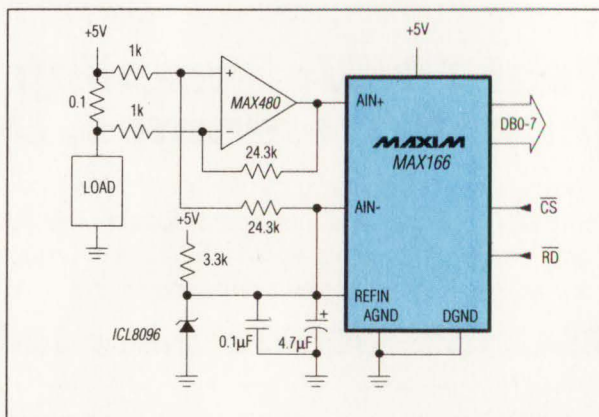

The MAX166 converts differential inputs from 0V to 2VREF using a single +5V supply. This reduces the output swing requirements on the input amplifier, and allows the converter to reject low-frequency common-mode signals. The high analog input impedance ($>10M\Omega$) allows use of lower cost amplifiers to drive this A/D. The MAX166 is ideal for high-speed, low-power applications such as digital-signal processing, data acquisition, servo loops, data logging, telecommunications, and audio systems.

* 1000-up FOB USA

QUAD 8-Bit Serial-Input D/A Replaces Trimpots for \$1.45*

- ◆ 16-Pin package reduces board space
- ◆ On-chip voltage output amplifiers ease drive requirements
- ◆ 5ppm/ $^{\circ}$ C drift improves stability
- ◆ Cascadable serial interface simplifies μ P connection
- ◆ Operates from single or dual supplies
- ◆ Small Footprint DIP and SO Packages

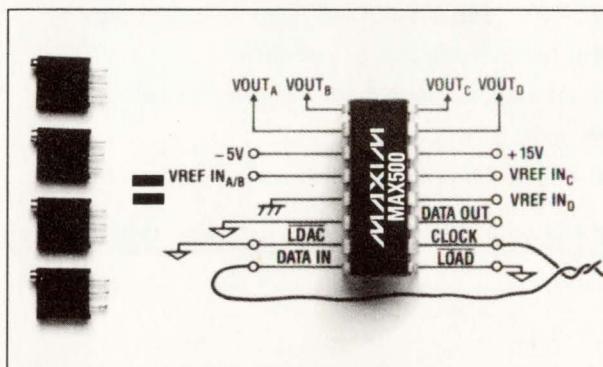

The MAX500 provides 256 digitally-programmable linear steps to digitally trim offsets, gain errors, and set trip-points. The low drift on-chip resistors and rugged latch-proof IC construction lets you free your system of trimpots. And, save both board area and cost. Applications include process control systems, automatic test equipment, and automatic calibration of system parameters such as gain and offset voltages.

* 1000-up FOB USA

★ FREE DATA SHEETS ★

MAX151 CIRCLE 71
 MAX173 CIRCLE 72
 MAX177 CIRCLE 73
 MAX166 CIRCLE 74
 MAX500 CIRCLE 75

★ FREE SAMPLES ★

For applications assistance, call (408) 737-7600, FAX (408) 737-7194 or write Maxim Integrated Products 120 San Gabriel Drive, Sunnyvale, CA 94086

14-BIT ADCs GRAB DYNAMIC SIGNALS AT 500 KHZ

A pair of high-speed 14-bit sampling and non-sampling a-d converters in 32-pin hybrid packages complement each other.

The ADS-928 can continuously sample and digitize 500-kHz signals at 1 MHz with no missed codes, while the temperature varies over the commercial range. Total harmonic distortion (THD) while sampling dc to 100-kHz signals reaches -83 dB (perfection is -86 dB), which drops to -78 dB at Nyquist. (All specifications are minimums or maximums.) Signal-to-noise ratio (SNR) with and without distortion runs 72 dB and 78 dB respectively at Nyquist; it is 5 dB better from dc to 100 kHz. This represents 12 effective bit performance at Nyquist. Two-tone intermodulation distortion while digitizing a mixture of 100-kHz and 240-kHz sinewaves is -92 dB.

Acquisition time, to 0.01% accuracy, is 750 ns. Aperture uncertainty, or jitter, is just 100 ps, which reflects the device's small-signal and full-power input bandwidths—6 and 1.75 MHz, respectively. Thus signals with frequency components over 10 times Nyquist can be under-sampled. Applications for this digitally corrected sub-ranging (two-step or half-flash) machine range from spectrum, transient, vibration, and waveform analysis to imaging in radar and sonar and medical applications. The ADS-928's non-sampling cohort, the ADC-908 converter, performs a 14-bit accurate, no-missing-code conversion in 1 μ s maximum over the commercial temperature range. For the military temperature range, that drops to 13 bits. Its dc specifications are similar to those of the 928. It is ideal in applications where a number of slowly varying signals must be digitized to 14-bit accuracy in a short period of time—for example, at the output of a high-speed multiplexer. Alternatively, it can be used with an external sampling amplifier and multiplexer for multiple higher frequency signals.

In quantities of 100, the commercial-grade sampling ADS-928 goes for \$399 each, the non-sampling ADC-908 for \$324 each.

Datel Inc., 11 Cabot Blvd., Mansfield, MA 02048; Call Bob Leonard (508) 339-3000. CIRCLE 313

■ FRANK GOODENOUGH

REGULATOR LIMITS DROPOUT TO 0.5 V

Whereas the input-to-output voltage of typical linear regulators may be as much as 2 or 3 V, that of National's LM2941 low-dropout (LDO) chip is typically 0.5 V at 1 A. In addition, unlike earlier fixed-output LDOs, the user can

set the LM2941's output between 5 and 20 V. The chip comes in a 5-pin TO-220 package; the fifth pin is used to turn it on or off with a logic voltage. In quantities of 100, the device is \$1.15.

National Semiconductor Corp. 2900 Semiconductor DR., Santa Clara, CA 95052-8090; Hugh Wright (408) 721-5856. CIRCLE 333

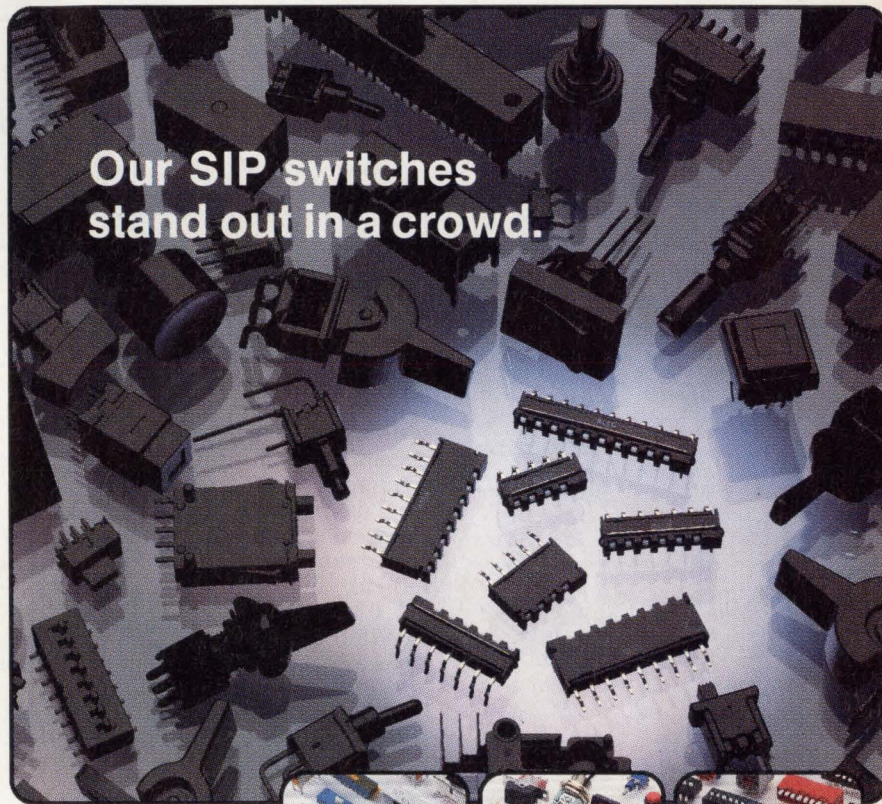

Our SIP switches stand out in a crowd.

Unique Space Saving Single In Line Switch

- 2, 4, 6, 8 or 10 position with common bus
- Vertical or right angle mounting options
- 2 SIP's require less board space than 1 DIP switch
- Compatible with pick & place equipment

AUGAT/ALCOSWITCH offers a full product line including...

Slides

Toggles, Rockers & Pushbuttons

DIPs

For your free catalog, product samples, applications help, or a quotation, call or write AUGAT/ALCOSWITCH, 1551 Osgood Street, No. Andover, MA 01845 USA.

Tel: (508) 685-4371, TLX: 275423, FAX: (508) 686-9545

AUGAT[®] ALCOSWITCH[®]

Quality and Innovation

AUGAT INTERNATIONAL SALES OFFICES

AUGAT LIMITED - ENGLAND	(011) 4490676655
AUGAT SA - FRANCE	(011) 33146683090
AUGAT GMBH - WEST GERMANY	(011) 49896129090
AUGAT AB - SWEDEN	(011) 468960270
AUGAT SRL - ITALY	(011) 3939654100
AUGAT ISRAEL	(011) 9723492173
AUGAT ELECTRONICS INC. - CANADA	(1) 4166771500
AUGAT RTV LTD. - AUSTRALIA	(011) 6129050533
AUGAT KK - JAPAN	(011) 810550897911

CIRCLE 167

VCXO's and PHASE-LOCKED-LOOP-VCXO

VCXO's Series M2000 1MHz to 67 Mhz



These VCXO's are used to replace a distorted incoming reference signal (e.g. 1.544 MHz, T1), with a stable crystal-controlled signal of the same or any multiple frequency, from 1 to 67 MHz.

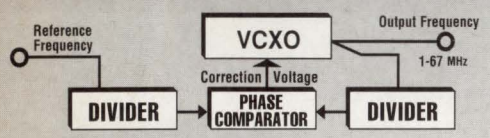

With MF VCXO's, since the specification is computer-tested over the full operating temperatures, you can be assured that the specified frequency- deviation is what you get for capture range.

	Control Voltage	Deviation
M 2001	0.3 to 10V	±175 ppm
M 2002	0.3 to 4V	± 75 ppm
M 2003	0.3 to 10V	±175-300 ppm
M 2004	0.3 to 4V	±125 ppm
M 2005	1.0 to 4V	± 75-300 ppm
M 2006	0 to 5V	±150 ppm
M 2007	0.5 to 4.5V	±125-250 ppm

PHASE-LOCKED LOOP-VCXO'S

Series M2010, M2015

This is the complete loop, including the phase-comparator and the VCXO, in just one package. Add the dividers to match the frequencies. Oscillators from 10 to 30MHz.

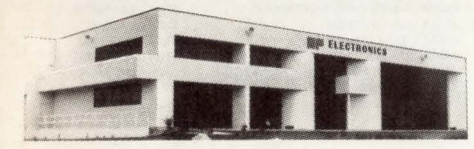
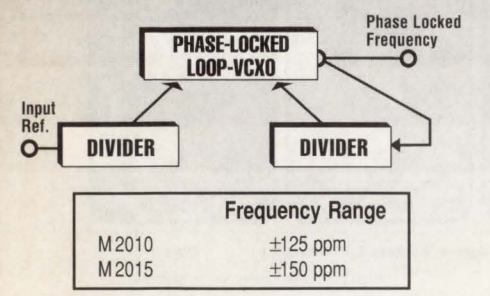

Headquarters and manufacturing plant: 36,000 sq. feet

NEW PRODUCTS

POWER

P-CHANNEL MOSFETS OFFER LOW RESISTANCE

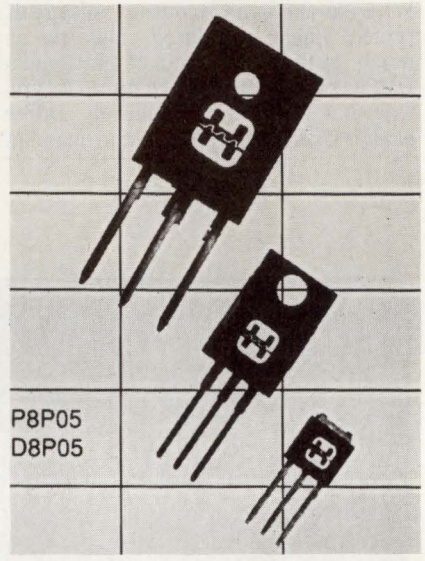

Until now, no p-channel power MOSFETs could match the low on-resistance of n-channel devices. However, this new family of MegaFETs brings low on-resistance in 50- and 60-V devices, using over two million cells/square-inch. Moreover, the devices are ruggedized: they are the first p-channel devices with unclamped inductive-switching avalanche ratings. The process puts 15-A, 0.3-Ω, 50-V devices in a D-Pak (and surface mount D-pak); 15-A, 0.15-μ devices in a TO-220; and 30-A, 0.075-Ω devices in a TO-247. Thousand-piece pricing ranges from \$0.69 each for D-Paks to \$7.10 for TO-247s.

Harris Semiconductor, P.O. Box 883, Melbourne, FL 32901; 1 (800) 4 HARRIS. CIRCLE 314

DC-TO-AC INVERTERS LIBERATE EQUIPMENT

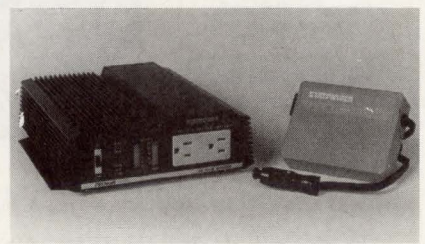

Two dc-to-ac inverters permit ac-powered equipment to be operated from any 12-V dc source, such as an automobile battery. The Model III Pocket-Power inverter produces 200 W peak and 100 W of constant power. It measures 4.5 by 3.5 by 1.2 in. and weighs 14 ozs. The PROwatt 600 devel-

ops 500 W of continuous power and 600 W for 30 minutes. It can deliver a surge of 1500 W to operate equipment with high starting currents. The larger-output device measures 10 by 9 by 3 in. and weighs 5.25 lbs. The smaller and larger units cost \$165 and \$499, respectively. Call for availability.

Statpower Technologies Corp., 7012 Lougheed Hwy., Burnaby, B.C., Canada V5A 1W2; (604) 420-1585. CIRCLE 315

150-W DC-DC CONVERTER OFFERS HIGH EFFICIENCY

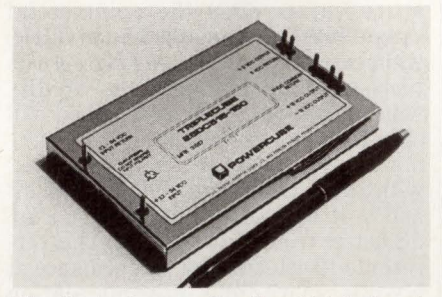

The first of a new family of high-density, multiple-output dc-dc switching regulator modules is available from Powercube. The 28DC515-150 features advanced integrated magnetics and control-circuit technology. It accepts a 28-V dc input per MIL-STD-704D and produces 150 W of output power at efficiencies of 80%. Other features include tight line and load regulation. In lots of 100, the converter costs \$12.83. Delivery is in 10 to 14 weeks.

Powercube Corp., 8 Suburban Park Dr., Billerica, MA 01821; (508) 667-9500. CIRCLE 316

MILITARY SUPPLY IS 0.6-IN. HIGH

A power density of 30 W/in.² and a 0.6-in profile mark the Powerboard military power supply. Two modules, which maintain component ratings within the NAVMAT-P4855 design guidelines, comprise the supply. The driver module converts an ac-input voltage to a high-voltage dc output. The device's 300-V dc output powers a triple-output dc-to-dc module. The output module delivers 5 V dc at 30 A and has two outputs rated at 15 V dc at 2 A. Typical overall efficiency is 75% under full load and nominal input voltage. The ac-to-dc module costs \$450 and the dc-to-dc section goes for \$1995, both in lots of 50. Delivery is in 12 to 14 weeks.

ATC Power Systems Inc., 472 Amherst St., Nashua, NH 03063; (603) 882-1366. CIRCLE 317



The Standard for Circuit Simulation Has Expanded

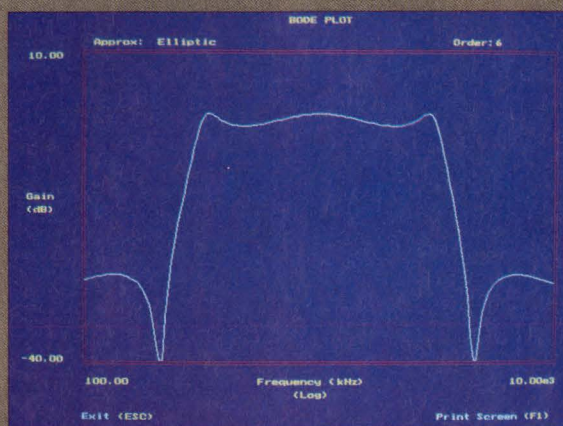

Advanced Filter Designer Bode Plot

Advanced Filter Designer: New Front End Design Tool

The PSpice family of products includes both the **Circuit Analysis and Circuit Synthesis packages**. The **Circuit Analysis package** contains our PSpice circuit simulator and its options, and the **Circuit Synthesis package** contains our filter synthesis products, **Advanced Filter Designer and Standard Filter Designer**.

Advanced Filter Designer is an interactive design aid giving you the ability to design and analyze active filters. Features include a menu-driven interface, hard copy report summaries and plots, cascading multiple designs, and interfaces to PSpice and SWITCAP.

Advanced Filter Designer uses a well established methodology in applying classical approximations to your filter specification. Available filter types include low pass, high pass, band pass, and band reject, all of which may be synthesized by Butterworth, Chebyshev, Inverse Chebyshev, and Elliptic (Cauer) functions. There is also the capability to synthesize arbitrary transfer functions and delay equalization filters.

A full editing capability allows you to insert, delete, and reorder stages, and modify coefficient values. These editing features allow a filter expert to fine tune a design, or quickly make a small modification to an existing design.

Advanced Filter Designer supports both active RC and switched-capacitor biquad filter structures. The components may be scaled or resized to center the values in preferred ranges.

Both Bode and pole-zero plots are available. Normally, you can determine the acceptability of your design by the inspection of its Bode plot. The Advanced Filter Designer plots gain, phase, and delay vs. frequency. For sampled data designs, you can plot your choice of the s - or z -domain transfer function. Pole-zero plots allow you to inspect the roots of the transfer function in either the s -domain or z -domain.

Filter Designer works with our PSpice circuit simulation package. PSpice and its options form an integrated package for the analysis of electronic and electrical circuits.

Each copy of our Circuit Analysis and Circuit Synthesis programs comes with our extensive product support. Our technical staff has over 150 years of experience in CAD/CAE, and our software is supported by the engineers who wrote it.

For further information about our Circuit Analysis or Circuit Synthesis packages, please call us at (714) 770-3022 or toll free (800) 245-3022.

20 Fairbanks • Irvine, CA 92718 USA • FAX (714) 455-0554

Coilcraft Designer's Kits

**First they save you time.
Then they save you money.**

These kits make it easier than ever to pick the right coils, chokes and other magnetics for your project.

Why waste hours calling around

for samples or trying to wind them yourself. Coilcraft's low-cost kits put dozens of values right at your fingertips!

You not only save time on engineering. You also save money when you go into production

because we stock just about all the parts in our kits at low off-the-shelf prices.

Call in today, and you can have your kit tomorrow!

To order, phone 800/322-COIL.

"Unicoil" 7/10 mm Tuneable Inductors

.0435 μ H - 1.5 μ H
49 shielded, 49 unshielded (2 of each)
Kit M102 \$60

"Slot Ten" 10 mm Tuneable Inductors

0.7 μ H - 1143 μ H
18 shielded, 18 unshielded (3 of each)
Kit M100 \$60

Surface Mount Inductors

4 nH - 33 μ H
48 values (10 of each)
Kit C100 \$125

Axial Lead Chokes

0.1 μ H - 1000 μ H
25 values (5 of each)
Kit F101 \$50

Horizontal Mount Inductors

Tuneable and fixed
Inductance: 31.5 - 720nH
33 Values (6 of each)
Kit M104 \$60

Common Mode Data Line Filters

Attenuation bandwidth: 15 dBm, 1.5-30 MHz
DC current capacity: 100 mA
2, 3, 4 and 8 line styles (4 of each)
Kit D101 \$65

Common Mode Line Chokes

Current: .25 - 9 amps RMS
Inductance: 508 μ H - 10.5 mH
8 styles (2 of each)
Kit P202 \$100

Current Sensors

Sensing range: 0.5-35 amps
Freq. resp.: 1 - 100 kHz, 50 - 400 Hz
Transformer and sensor-only versions
8 styles (15 total pieces)
Kit P203 \$50

Base/Gate Driver Transformers

Inductance: 1.5 mH Min.
Frequency: 10 - 250 kHz
2 single, 2 double section (2 of each)
Kit P204 \$50

Mag Amp Toroids

Current: 1, 5 amps
Volt-time product: 42 - 372 V- μ sec
6 styles (2 of each)
Kit P206 \$100

Power Filter Chokes

Current: 3, 5, 10 amps
Inductance: 5 - 300 μ H
18 styles (48 total pieces)
Kit P205 \$75

Axial Lead Power Chokes

Current: .03-4.3 amps
Inductance: 3.9 μ H - 100 mH
60 styles (2 of each)
Kit P209 \$150

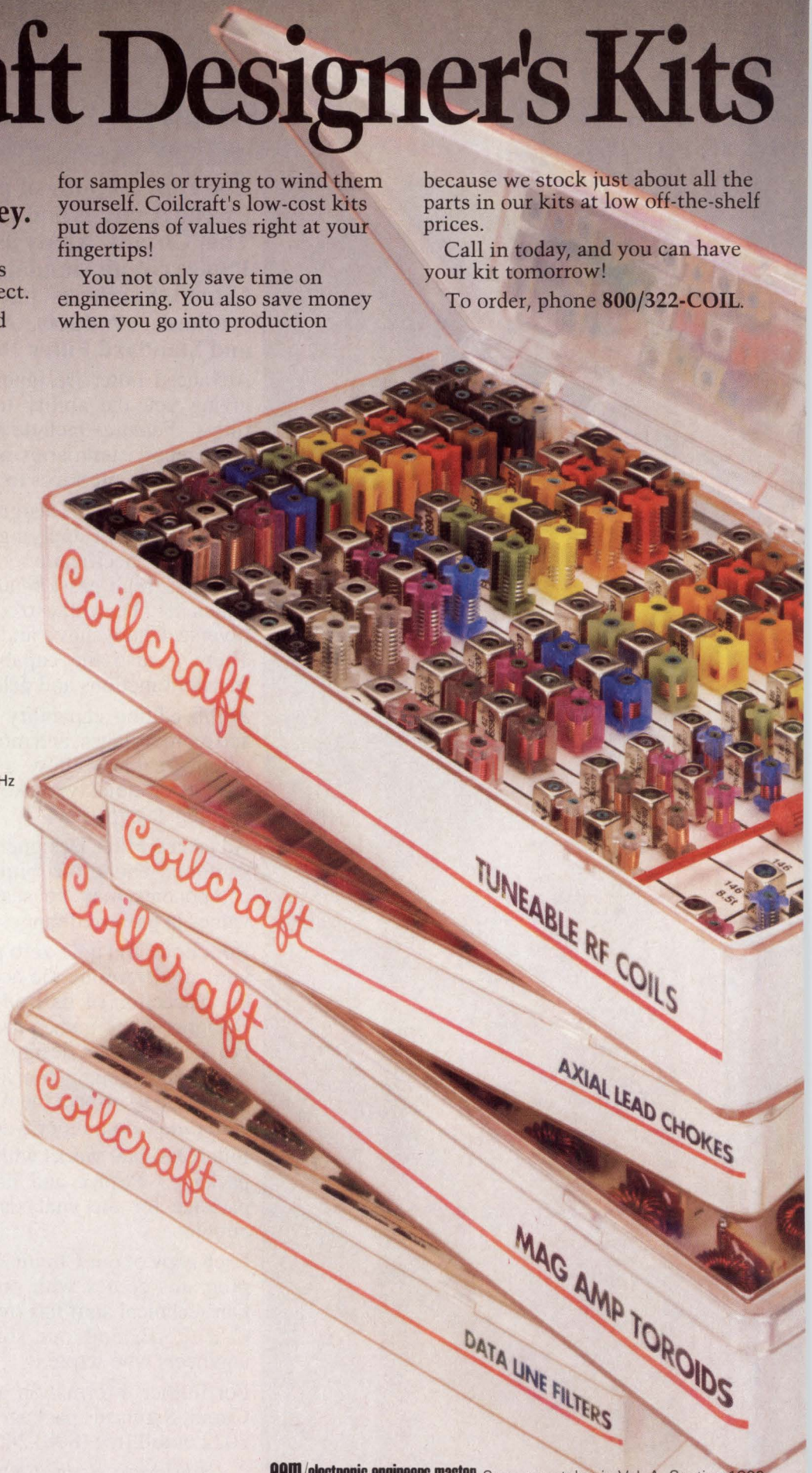

Coilcraft

EEM/electronic engineers master See our catalog in Vol. A, Section 1800

1102 Silver Lake Rd., Cary IL 60013 800/322-COIL Fax 708/639-1469

NEW PRODUCTS

COMPUTER BOARDS

FLOATING-POINT ARRAY PROCESSOR SUPPLIES 66 MFLOPS

Optimized for digital-signal-processing and imaging applications, the MSP-6C30 floating-point VME array processor from Analogic/CDA supplies up to 66 MFLOPS of peak processing power. The board, from Analogic/CDA, supports the company's extensive library of signal-

analysis, medicine, and graphics and imaging.

Single-unit prices start at \$4950 for the single-processor board. Prices for the board with dual processors start at \$8450. Production quantities are avail-

able now.

Analogic/CDA, 8 Centennial Dr., Centennial Industrial Pk., Peabody, MA 01960; (508) 977-3030.

CIRCLE 318

■ RICHARD NASS

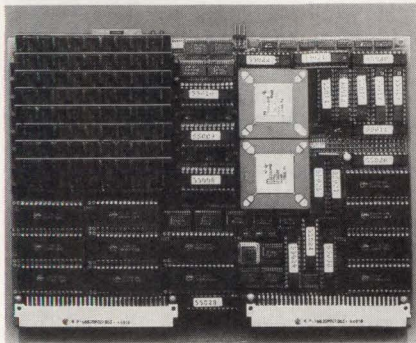

and image-processing functions. The board can operate as a standalone signal processor interfaced to external data-acquisition devices or as an array processor receiving control instructions from the host.

Designed in single- and dual-processor configurations, its Texas Instruments TMS320C30 32-bit digital-signal processors can function separately or together on computationally-intensive tasks, each performing simultaneous accesses on zero-wait-state memory. An optional SCSI port enables the board to connect to peripheral devices such as data-acquisition products and disk or tape drives.

Other external ports serve the VME-bus for system-wide data transfers, a general-purpose I/O that allows connection of multiple MSP-6C30 boards, and an RS-232C serial interface that's connected directly to the master processor.

Software support for the MSP-6C30 includes C and Fortran callable scientific signal-analysis and imaging subroutine libraries, an ANSI C compiler with an assembler, linker, and loader, a software simulator, and a hardware emulator with a C source-level debugger.

The standard 6U form-factor board can contain up to 1 Mbyte of static RAM and 32 Mbytes of dynamic RAM. The DRAM is configured in two banks, each with a dedicated crossbar switch. It's suited for applications requiring high throughput including communications, instrumentation, voice/speech

Introducing

MCXO*

- Power as low as 20 mW
- Stability to 3×10^{-8}
- Operating Temp. -55°C to $+85^{\circ}\text{C}$



Our innovative *Microcomputer Compensated Crystal Oscillator achieves compensation without the use of ovens or conventional temperature-compensating techniques. By doing so, it provides an order-of-magnitude improvement in frequency stability that's perfect for low-power, high-accuracy timekeeping and frequency control applications.

Call or write today for complete specifications.



FREQUENCY ELECTRONICS, INC.

55 Charles Lindbergh Blvd., Mitchel Field, NY 11553
516-794-4500 • FAX: 516-794-4340

CIRCLE 164

PICO DC-DC CONVERTERS

Wide Input Range
5 to 72V DC



Regulated
5 Watt to 30 Watt

- 386 Standard Models
- Single, Dual and Triple Output
- Output Voltages of 5, 9, 12, 15, 24, 28 and 48 Volts DC Standard
- Ambient Temperature Range -25°C to +70°C with No Heat Sink or Electrical Derating
- All Units Shielded
- 500V DC Isolation Input to Output
- New PLR Series Features .300" ht.
- New NR Series, up to 30 Watts-50 Models-30 Triple Outputs

OPTIONS AVAILABLE

- Expanded operating temp (-55°C to +85°C)
- Stabilization Bake (125°C ambient)
- Temperature Cycle (-55°C to +125°C)
- Hi Temp, full power burn in (100% power, 125°C case temp)

Delivery—
stock to
one week

SEE EEM,
THOMAS REGISTER
OR SEND DIRECT FOR
FREE PICO CATALOG

PICO Electronics, Inc.

453 N. MacQuesten Pkwy. Mt. Vernon, N.Y. 10552

Call Toll Free **800-431-1064**

IN NEW YORK CALL **914-699-5514**

PICO also manufactures over 700
standard DC-DC Converters, AC-DC
Power Supplies and over 2500 Miniature
Transformers and Inductors

CIRCLE 92

NEW PRODUCTS

COMPUTER BOARDS

SUPER VGA CONTROLLER ADDS DISK CONTROLLER, SERIAL, PARALLEL PORTS

Helping users reclaim their vanishing expansion slots, the MicroPAQ 452 is a highly-integrated VGA-multifunction board that combines a Super VGA controller, a floppy/hard disk controller, and serial and parallel ports. The board, from Monolithic Systems Corp., supplies high-performance VGA graphics with EGA, CGA, Hercules, and MDA compatibility using Chips & Technologies' 82C452 video-controller chip. The card's 1 Mbyte video memory supports 256 simultaneous colors at 640 by 480 resolution, and 16 simultaneous colors at flicker-free, noninterleaved resolutions of 640 by 480, 800 by 600, 960 by 720, and 1024 by 768.

The board's IDE hard-disk interface supports up to two hard disks equipped with an embedded AT-bus interface. Its dual floppy-disk drive controller comes with a standard 34-pin ribbon cable connector and can be disabled with a jumper switch.

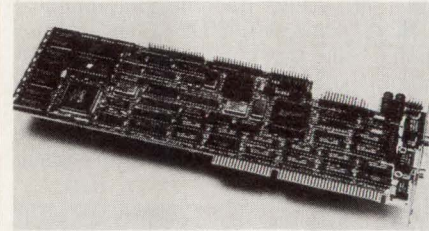

Two IBM-compatible serial ports and one bidirectional IBM PS/2-compatible parallel port are included. All three ports support printers and scanners. Three ribbon cable connectors on the 452 handle two DB9 nine-pin serial plugs and one DB25 25-pin parallel plug.

The 452 has a standard XT expansion-board form factor and can be used in any PC enclosure in 8-, 16-, and 32-bit slots with bus speeds up to 12.5 MHz.

**Monolithic Systems Corp., 7050
South Tucson Way, Englewood,
CO 80112; (303) 790-7400. CIRCLE 319**

■ RICHARD NASS

SBUS CARD ADDS DSP POWER TO WORKSTATION

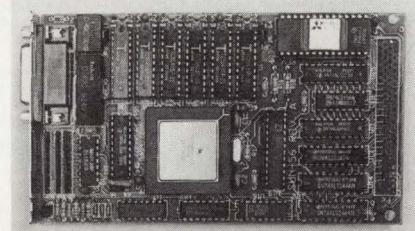

Occupying one SBUS option slot, the S-56 and S-56X DSP plug-in coprocessor cards add 13.5 MIPS of processing power to Sun SpareStation workstations. The cards are based on the Motorola DSP56001 digital signal processor and include up to 192 kbytes of zero-wait-state memory and a NeXT-compatible port for serial I/O transfers. A DSP port handles synchronous transfer rates up to 6.75 Mbits/s and can be directly connected to the Ariel's previously released DM-N digital microphone for CD-quality recording and signal analysis. The S-56X enhances I/O capabilities by adding a Xilinx 3042 RAM-based programmable gate array between the DSP chip and an option connector. The PGA can be reprogrammed for multiple specialized I/O tasks. The S-56 sells for \$1495; the S-56X for \$1995. Software development

tools include Bug-56, a symbolic debugger, the ASM-56 assembler-linker-librarian. Bundled, the software package sells for \$1295.

**Ariel Corp., 433 River Rd., Highland
Park, NJ 08904; Les Listwa, (201) 249-
2900. CIRCLE 320**

HALF-SIZE CARD LINKS 1553B, 1750A BUSES

Occupying a short expansion slot in an IBM PC AT, a MIL-STD-1553B interface board creates a hard-wired connection between MIL-STD-1750A avionics computers and the local area networks to which they are connected. The board, designated the Shuttle, works as an on-line bus tap and can be dynamically re-assigned as a bus protocol controller, remote terminal, or passive bus monitor. It is a doubly redundant LAN with 45 dB of common-mode noise rejection and a maximum bit-error rate of greater than 10⁻⁷. Program development tools supplied with the board include two sets of utilities for generating communication routines for the 1553 bus. The complete development system costs \$3495. Delivery is from stock to four weeks.

**Sabtech Industries Inc., 3910-B Pros-
pect Ave., Yorba Linda, CA 92686;
(714) 524-3299. CIRCLE 321**



The Emerging Standard in 574 Family 12-Bit A/D's

- **Monolithic construction**
- **Lowest power in the industry — 110mW**
- **No -15V power required**
- **25 μ s maximum conversion; 15 μ s maximum for 674**
- **Complete ADC — on-board SAMPLE/HOLD, reference, clock and tri-state output**
- **Available in surface-mount J-lead LCC and LCC**
- **Delivery from stock**

For a data sheet, pricing or samples, call **Sipex** direct at **1-800-272-1772**.



Sipex Corporation
6 Fortune Drive
Billerica, MA 01821
800-272-1772
508-663-9691
FAX: 508-670-9001

INPUT FLEXIBILITY AIDS DATA-ACQUISITION UNITS

A pair of data-acquisition instruments offer users the choice between a stand-alone unit and an instrument for use with PC-based systems. Both the 2620A data-acquisition unit and 2625A data logger accept

a wide variety of signals on 21 analog input and 12 digital I/O channels. They can be configured by front-panel controls or through a standard RS-232C or optional IEEE-488 interface. The stand-alone 2625A has a nonvolatile data memory for over 200 scans.

The instruments work with most sensors and transducers, including thermocouple, dc-voltage, ac-voltage (true-rms), frequency, and resistance types, with a maximum input of 300 V. No signal conditioning is needed as measurements are filtered and linearized at up to 18 reading per second. Both units feature alarm limits; linear scaling; minimum, maximum, and last memory; automatic print output; battery-backed clock and program; conditional scan triggers; and universal ac or 9-16-V dc operation.

Included software supplies setup instructions and monitors and stores readings on a PC in real-time, where it can be input into popular spreadsheet programs. The software also retrieves readings stored in the 2625A's memory. Also standard is Laboratory Technologies' Acquire data-collection software. Optional software includes Labtech Notebook for advanced data manipulation and analysis, a driver for National Instrument's LabWindows, Fluke's TesTeam for systems applications, and Fluke's QuickLog package.

Model 2620A costs \$1990 and model 2625A goes for \$2690. Both are available starting November 1 on a 4-week delivery schedule.

John Fluke MFG. Co. Inc., P.O. Box 9090, Everett, WA 98206-9090; (206) 347-6100. CIRCLE 322
■ JOHN NOVELLINO

Higher Performance Signal Conditioning

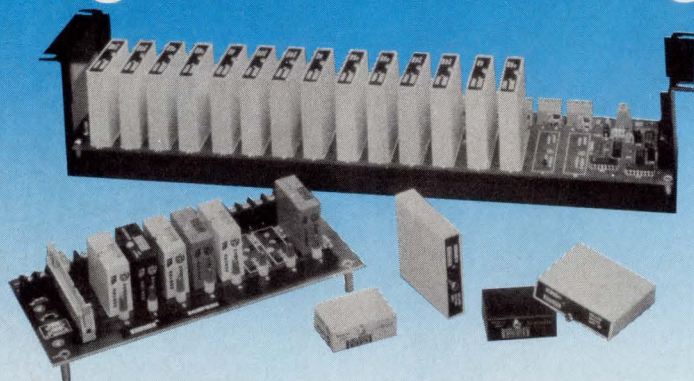

56 Times Better Noise Rejection, 8 Times Faster, and Competitively Priced!

If the amount of noise in your measured signal is too high, or if your access time is too slow, we can help. Our SCM5B Analog I/O Signal Conditioning Modules with their 95dB NMR at 60Hz offer 56 times better noise reduction than the Industry Standard 5Bs. And, they can switch onto a multiplexed analog bus 8 times faster. What we're offering then, is a broad line of higher performance products at very competitive prices. Come to think of it, that's a pretty good proposition.

And, if you're looking for a wide selection of Industry Standard Digital I/O Modules and accessories, we have those, too.

SCM5B Analog Modules

- Functions Include: Voltage Input/Current Input/Current Output/RTD and Thermocouple Inputs
- 1500V Transformer Isolation
- 160dB CMR/95dB NMR
- Backpanels for Mounting Up to 16 Mixed or Matched Modules

SCM Digital Modules

- Functions Include: AC Input/AC Output/DC Input/DC Output
- 4000V Optical Isolation
- UL, CSA Approved
- Fast Turn-On/Turn-Off Times
- 5V Logic/Control Voltage
- Backpanel for Mounting 8, 16, and 24 Mixed or Matched Modules.

For complete details or applications assistance, write Burr-Brown Corp., P.O. Box 11400, Tucson, AZ 85734. Or, call Toll Free 1-800-548-6132.



CIRCLE 153

ICE COMMUNICATES WITH HOST COMPUTER

An in-circuit emulator for ROM code development is built around an intelligent microcontroller that can communicate with the host processor, perform self-testing, and upload as well as download data. Called the PROMICE, the unit emulates any 24-, 28-, or 32-pin Jedec ROM of up to 8 Mbits using only standard cables. An optional Analysis Interface module allows bidirectional communication between the host computer and the software (debugger) running in the target system without the need to modify the target. Data signals downloaded to the PROMICE can be loaded over a serial RS-232-C link at baud rates of up to 57.6 kbaud or over an optional parallel link for even faster loading. Prices start at \$495 for a simple unit that emulates one 256-kbit ROM. Duplex units start at \$790.

Grammar Engine Inc., 3314 Morse Rd., Columbus, OH 43231; (614) 471-1113. CIRCLE 332

CIRCLE 83 →

NEW PRODUCTS

INSTRUMENTS

IEEE-488



Control any IEEE-488 (HP-IB, GP-IB) device with our cards, cables, and software for the PC/AT/386, EISA, MicroChannel, and NuBus.

PC-BASED ANALYZER DOES FFTS TO 250 KHZ

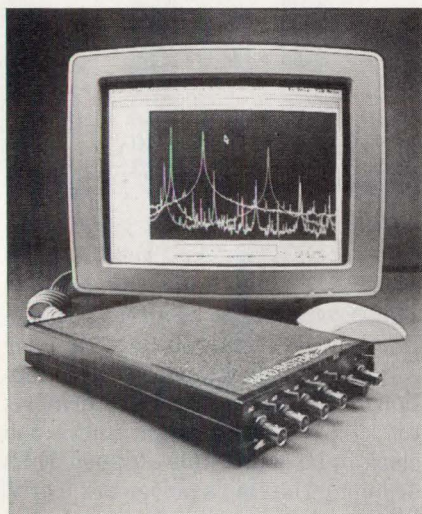

An IBM PC-based spectrum analyzer add-on offers real-time fast Fourier transform analysis up to 250 kHz on two channels simultaneously. The unit, an external box, supplies a split-screen display of both frequency and time representations. Users can average from two to 1024 waveforms on both channels simultaneously.

Sample rates from 1 Hz to 500 kHz are available, and the instrument has 32-kword/channel data buffers, full digital and analog triggering, and can be set with programmable gains. Gain ranges are from 10 mV to 50 V per division, and frequency and amplitude scaling can be either linear or logarithmic. Included is mouse-driven EGA/VGA color software. The R310 is priced at \$1995.

Rapid Systems Inc., 433 N. 34th St., Seattle, WA 98103; (206) 547-8311.

CIRCLE 323

ARBITRARY GENERATOR HAS INTERNAL TRIGGER

A synthesized 20-MHz arbitrary-waveform generator features a built-in trigger generator and up to 128 ksamples of waveform memory. The model 95 operates in noncontinuous modes (trigger, gate, and burst) and features burst counts to 1 million cycles. Range is 1 MHz to 20 MHz with 0.001% accuracy and automatic calibration. The model 95 prices start at \$4495, with 4-weeks delivery.

Wavetek San Diego Inc., 9045 Balboa Ave., San Diego, CA 92123; (800) 874-4835. **CIRCLE 324**

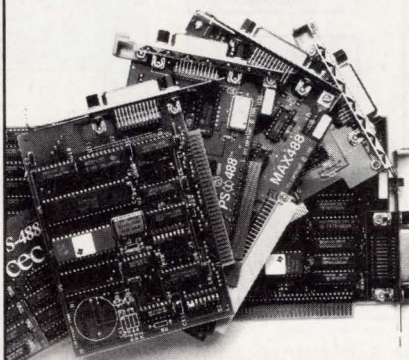

You get fast hardware and software support for all the popular languages. A software library and time saving utilities are included that make instrument control easier than ever before. Ask about our no risk guarantee.

COMMUNICATIONS TESTER HANDLES FDDI, SONET

Operating at up to 700 MHz, the CSA 907 bit-error-rate tester is designed to facilitate testing to both the fiber distributed data interface (FDDI) and synchronous optical network (SONET) standards. The unit supplies 32-kbit RAM words for FDDI/SONET pattern simulations, which meets pattern-length requirements of both standards. The CSA 907 consists of two portable units, the CSA 907T pattern generator and the CSA 907R error detector. The CSA 907 costs \$38,995 and is available 6 to 8 weeks after receipt of an order. Separately, the 907T pattern generator and 907R error detector go for \$21,995 and \$20,555, respectively.

Tektronix Marketing Communications Dept., P.O. Box 1700, Beaverton, OR 97077; (800) 426-2200.

CIRCLE 325

MEMORY TESTER CHECKS ACCESSES TO 300 NS

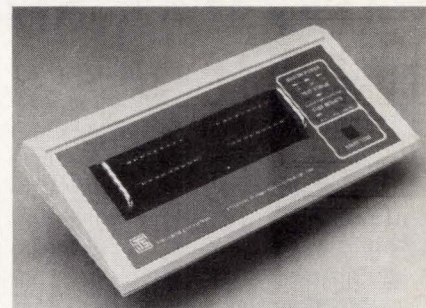

Even though it is simple to operate and easy to install, a PC-based memory tester is powerful enough to perform all the engineering tests needed to inspect dynamic and static RAMs, ROMs, EPROMs, and EEPROMs in any configuration from 16 kbits to 16 Mbytes. The Model 1000 checks access times ranging from 25 to 300 ns and uses industry-standard data and address test patterns. Even if the testing parameters for the memory device under test are unknown, the instrument's software can determine them automatically. The unit's test adapter handles up to eight devices at a time with programmable voltage cycling performed individually on each device. Adapters are available to accommodate virtually any memory device. The price of the Model 1000 is less than \$4000, including system software.

Integrated Test Systems, 21621 Kerry Ct., El Toro, CA 92630; (714) 586-0332. **CIRCLE 326**



Free: Informative catalog 800-234-4232
Applications help (617) 273-1818

cec

Capital Equipment Corp.
Burlington, MA. 01803

CIRCLE 98

EMBEDDED CONTROL VERSION OF 68000 PACKS DMA, SERIAL I/O, AND MORE

DAVE BURSKY

Designed to tackle many of the most demanding embedded-control applications, the 68340 microprocessor combines a 68000-family central processor core along with dual 32-bit DMA channels, dual serial channels, and a pair of counter-timers. Based on the same static CMOS logic processor core Motorola developed for the previously-released members of the 68300 family, the 68340 is upward object-code compatible with the 68000 and 68010 microprocessors.

Thus, although the core can execute existing 68000 and 68010 object code, several new instructions were added to simplify embedded-control applications. And, to simplify testing, a JTAG-compatible (IEEE 1149.1) test port is also included on the chip. Some of the main application areas envisioned for the 68340 include I/O processing such as in disk drives, networks, imaging systems (laser printers, fax cards, etc.), intelligent terminals (X-window, 3270), portable and handheld computers, and the control of multimedia systems such as compact-disk interactive systems.

In addition to the DMA, serial ports and timers, the processor contains another major block that handles many of the general system functions—clock generation, bus arbitration, system protection (watchdog timers and various signal monitors), and bus interface (control) logic. A programmable bus sizing capability permits both 8- and 16-bit peripherals to be attached to the host interface bus.

When operating at its maximum frequency of 16.78 MHz, the 68340 can deliver approximately three times the throughput of the original 68000 microprocessor running at the same clock frequency. Furthermore, the on-chip 32-bit DMA controllers can transfer data at rates of up to 33 Mbytes/s, thanks to the elimination of the overhead required by

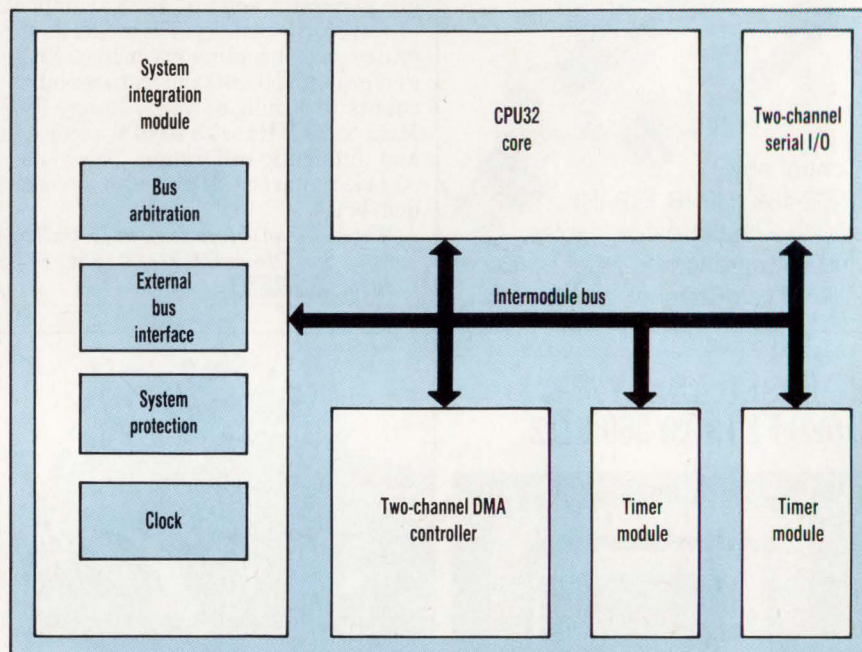

the CPU core to switch between the data-processing and data-transfer modes.

The twin serial channels on the chip are compatible with the popular 2681 full-duplex asynchronous/synchronous serial data communications chip. Each channel has a quadruple-buffered receiver and a double-buffered transmitter. Baud rates are independently programmable for each receiver and transmitter. There are 19 fixed rates from 50 to 76.8 kbits/s. By selecting a X1 clock instead of the standard X16 clock, data rates of up to 2 Mbits/s are also possible.

The dual programmable timers are 16-bits long, each with an 8-bit prescaler. Each timer can also be set to perform event counting, period and pulse-width measurement, input capture, output comparison, waveform generation, and pulse generation. Additionally, there are seven maskable interrupt conditions available for each of the programmable timers.

By using an on-chip phase-locked loop and a voltage-controlled oscillator, the 68340 can employ a low-fre-

quency (32-kHz) crystal to generate the 16.78-MHz on-chip clock frequency. The PLL permits the internal clock frequency to be altered on-the-fly, thus permitting the programmer to tailor the chip's power consumption to the application. Furthermore, the chip's static design allows the clock to be completely stopped, thus dropping the chip's power to 2.5 mW. When running at full speed, the 68340 microprocessor draws about 800 mW.

Also coming from Motorola's Austin-based operation is a stripped-down version of the chip that contains only the processor core. That chip, the 68331, will be sampled next quarter.

Samples of the 68340 processor, which can be obtained in either a 144-lead ceramic quad flat package or a 145-pin plastic pin-grid array, are immediately available. In 1000-unit lots, the chip will sell for less than \$50.

Motorola Inc., Microprocessor Products Group, 6501 William Cannon Dr. West, Austin, TX 78735-8598; (512) 891-2140.

CIRCLE 328



“To ensure our investment in quality products, Equipto Electronics invests in a quality publication: Electronic Design”

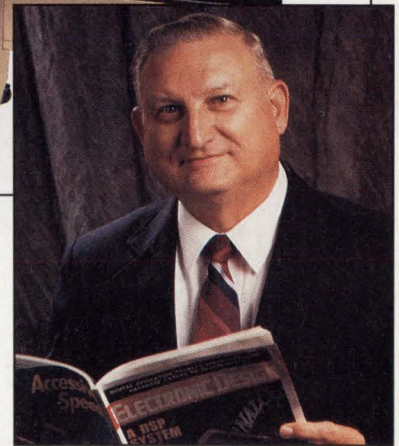

Robert L. Golz
President
Equipto Electronics Corporation

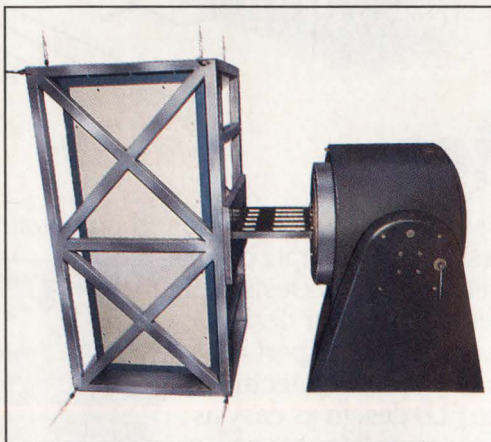

MIL-STD 810D shock and vibration test simulating a 20-year mobile application over rugged terrain.

“Increasingly difficult standards keep confronting today’s design engineers. That’s why Equipto Electronics keeps designing tougher enclosures. And we prove our engineering superiority through independent testing on both our standard product line and our EMI/RFI shielded products through TEMPEST. For example, our cabinets meet the demanding shock and vibration tests specified in MIL-STD 810D and 901. And recently one line of enclosures went through seismic testing and is approved for applications through Zone 4.

“Naturally, we want this engineering story to reach the key design engineers who must meet these tough standards. We know from the quality of responses we pull that *Electronic Design* is read by these important people. That’s why advertising in *Electronic Design* is a dominant part of our marketing program.”

Equipto Electronics Corporation
351 Woodlawn Avenue
Aurora, IL 60506-9988
Phone (708) 897-4691
FAX [708] 897-5314

Committed to Excellence Since 1960

EQUIPTO
Electronics Corporation®

NEW PRODUCTS

DIGITAL ICs

WIDE-INPUT PLDS DECODE ADDRESSES FAST

Designed specifically for address decoding, a very-wide-input decoder packs 36 input lines, 10 dedicated output lines and 12 additional programmable I/O lines. Fabricated in an advanced bipolar process the PHD48N22-

7 can decode up to a 48-bit bus pattern (by using the 12 I/O lines as additional inputs) in just 7.5 ns from input to output (through the AND logic), making the chip the fastest wide decoder available from any company. Four of the 12 bidirectional I/O lines also serve as OR logic outputs, and three of those four provide 7 product terms; the fourth line

has 12 product terms. The wide decoder is available in production quantities, and the plastic-housed leaded-chip-carrier version sells for \$22 in 1000-unit lots.

Philips-Signetics Corp., 811 E. Arques Ave., P.O. Box 3409, Sunnyvale, CA 94088; Paul Sasaki, (408) 991-2000. CIRCLE 329

PLDesigner V1.2 - Partitioning Solution Menu

System Name : CPU EXIT

Possible Solutions: Attempted : 35692 Found : 165

=> 1	2 x P300, P20RP6, 3 x P16R8	560ma	60ns	\$20.84
2	2 x P300, P20RP4, 3 x P16R8	560ma	60ns	\$20.84
3	2 x P300, P20RP8, P16R4, 2 x P16R8	560ma	60ns	\$20.84
4	2 x P300, P20R6, 3 x P16R8	455ma	60ns	\$21.29
5	2 x P300, P20R4, 3 x P16R8	455ma	60ns	\$21.29
6	2 x P300, P20XRP6, 3 x P16R8	530ma	60ns	\$21.36
7	2 x P300, P20XRP10, P16R4, 2 x P16R8	530ma	60ns	\$21.36
8	2 x P300, P20XRP4, 3 x P16R8	530ma	60ns	\$21.36
9	2 x P300, P320, 3 x P16R8	390ma	60ns	\$21.45
10	2 x P300, P320, P16R4, 2 x P16R8	390ma	60ns	\$21.45

Possible Devices:

P16R8 P16R6 P16R4 P16V0R P20RP8 P20RP6 P20RP4 P20RP10 P16RP8
P16RP6 P16RP4 P20X8 P20X4 P20X10 P20R8 P20R6 P20R4 P20XRP8
P20XRP6 P20XRP4 P20XRP10 P320 P20V0R P300 P300C PT19R6 PT19R4
PR19R8 PR19R6 PR19R4 PT19R8 P22V10R P600 P20RA10 P16RA8 P20RS8
P20RS4 P20RS10 P331 P32VX10R P900 P330X P330 S39V18X S39V18 ...

PLDesigner uses your design philosophy when scanning its library of over 2500 different parts. Possible devices have architectures appropriate to implement the design. Attempted solutions are the combinations of possible devices. Of these combinations, 165 viable solutions were found. You can then choose from the top ten implementations displayed. Power consumption, propagation delay and estimated cost given for each solution ensure that the final implementation you select is the most rigorous solution for your design problem.

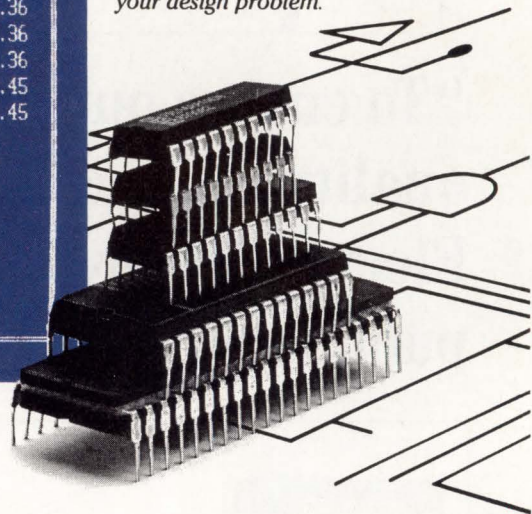

PLD Solutions - As Easy As Multiple Choice.

Only PLDesigner automatically generates multiple solutions for your design.

Whether you're new to PLD design or not, you'll benefit from PLDesigner's exclusive Architecture Mapping.

First enter, synthesize, and simulate your design using any combination of Minc's high-level language, schematic entry, or unique timing diagram entry. PLDesigner then automatically optimizes your design and selects the optimal device architectures, giving you solutions you may not have considered. Pick from the top ten solutions and PLDesigner will automatically

make pin assignments and, if required, automatically fit your design into multiple devices.

The intelligence of PLDesigner lets you concentrate on your design, without becoming an expert on hundreds of device architectures.

To make PLD design as easy as multiple choice, call for your free PLDesigner demo disk now.



minc

6755 Earl Drive
Colorado Springs, CO 80918
719-590-1155 FAX 719-590-7330

CIRCLE 89

Put LabWindows to Your Test



LabWindows® INSTRUMENTATION SOFTWARE **A+**

Data Acquisition

GPIB
 Plug-in Boards
 VXI
 RS-232

Data Analysis

Digital Signal Processing
 Statistics
 Curve Fitting
 Array Operations

Data Presentation

File I/O
 2D Plots
 Real Time Strip Charts
 Printer and Plotter Output

- True False
- Industry standard Microsoft C, QuickC, and QuickBASIC development tools for data acquisition and instrument control.
- Instrument drivers for over 100 GPIB, VXI, and RS-232 instruments.
- Integrated support for plug-in data acquisition boards.
- Powerful analysis library for real-time data processing.
- Extensive graphics library for creating full-color displays on printers and plotters.
- Code generation and debugging tools for faster program development.
- Software development tools for production test and ATE systems.

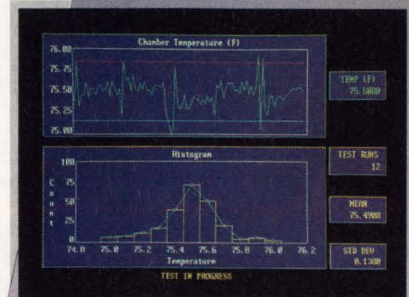
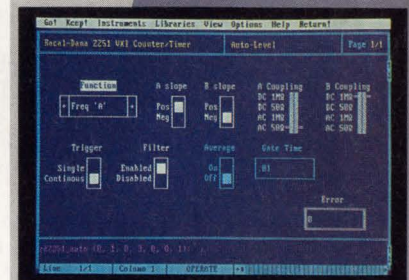

LabWindows...making industry standard programming languages work for you in data acquisition and instrument control.

NATIONAL INSTRUMENTS®
The Software is the Instrument®
6504 Bridge Point Parkway
Austin, TX 78730-5039

National Instruments Italy (02) 4830 1892
National Instruments France (1) 48 65 33 70
National Instruments Switzerland (056) 82 18 27
National Instruments United Kingdom (06) 35 523 545
Nihon National Instruments K.K. (Japan) (03) 788 1921

**Call for a FREE Demo Disk and Catalog
(512) 794-0100 • (800) 433-3488 (U.S. and Canada)**

NEW PRODUCTS

DIGITAL ICs

SIX-CHIP BICMOS GATE-ARRAY FAMILY OPERATES AT 210 MHz

A second-generation family of arrays, the Q24000 series from Applied Micro Circuits, includes six base chips that contain 800 to about 28,000 equivalent gates. Their maximum operating frequency of 210 MHz is the highest for a commercial biCMOS array family.

The arrays' internal logic cells contain 8 p- and 8 n-channel devices plus two pairs of bipolar totem-pole structures for use as line drivers. As a result, large macros such as multiplexers, flip-flops, and demultiplexers can fit in just one cell. Basic gates have a loaded propagation delay (fanout of 2 and 2 mm of wiring) of about 400 ps, with the delay increasing by 25 ps for each additional fanout.

I/O cells that surround the core can be configured for CMOS, ECL or TTL levels and can drive loads of up to 48

mA. The arrays contain 44 to 256 I/O pads. An additional 8 to 112 pads are available for power and ground connections. Power consumption ranges from 500 mW to about 9 W, depending on gate utilization, operating frequency, and package type.

Commercial- and military-temperature-range versions of the arrays are available. Design support for the arrays includes the company's MicroMatrix cell library and software tools. NRE charges range from \$5 to \$15/gate when the customer supplies a netlist. Production prices for commercial versions range from \$0.0075 to \$0.04/gate, depending on array size, package type, and screening level.

Applied Micro Circuits Corp., 6195 Lusk Ave., San Diego, CA 92121; Marc Friedman, (619) 450-9333.

CIRCLE 330

■ DAVE BURSKEY

RECORD AND PLAYBACK HIGH-QUALITY SOUND FROM A SOLID-STATE RECORDER

A solid-state tape recorder from Dallas Semiconductor can reproduce high-fidelity sound at bit rates as low as 8 kbits/s. The DS2270 Speech Recorder Stik decreases size and improves durability over mechanical tape-based techniques.

Telephone-grade speech normally consumes 64 kbits/s, a rate that's too costly to store in semiconductor RAM. Using digital compression techniques, the standard for quality sound reproduction has been 32 kbits/s. But Dallas Semiconductor has reduced that number by 75% with an advanced speech-compression algorithm. This lower bit rate makes it feasible to store speech in silicon rather than rotating magnetic media.

The DS2270 converts analog sound to digital data at a rate of 64 kbits/s. A second computer mounted on the same chip stores the data in nonvolatile SRAM and keeps track of the messages. Forty of the chip's 64 bytes of nonvolatile SRAM can store about 40 seconds of speech at 8 kbits/s. Extra memory can be attached to increase the amount of recordable speech. At 8 kbits/s, an hour-long conversation could be recorded and stored in less

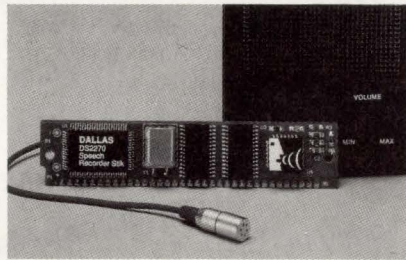

than 4 Mbytes of memory.

The key components of the recorder are available as a chip set specifically designed for incorporation into a PC. The chip set consists of a voice message processor for compressing speech, a dual digital potentiometer for adjusting volume settings, and a chip that interfaces directly to the computer's data bus. To complete the configuration, a small amount of EPROM or SRAM and a CODEC (for voice digitization) are needed. Available from stock, the DS2270 Speech Recorder Stick sells for \$96.25 in 500-piece quantities. The chip set containing the Stik's key components is priced at \$18 in quantities of 10,000.

Dallas Semiconductor, 4350 Beltwood Pkwy., Dallas, TX 75244.

CIRCLE 331

■ RICHARD NASS

CLASSIFIEDS

EMPLOYMENT OPPORTUNITIES

DIRECTOR OF QUALITY ASSURANCE: \$80,000 range. High/Low Voltage Power Supplies. Mil-Std 2000.
SALES/MARKETING/PRODUCT MANAGER: B.S.E.E. Passive Components with technical expertise in hybrids/thick/thin film. Automotive and Commercial Applications.

Contact: J.C. Banks, Excel Associates, P.O. Box 520, Cordova, TN 38018 or call (901) 757-9600 or FAX (901) 754-2986.

**Increase Your Profits
By Advertising Your
Consulting Services in**

ELECTRONIC DESIGN

RATES: 6x \$125 12x \$115

For more information, contact:

**Penton Classifieds at
(216) 696-7000,
ext. 2520.**

Looking for
**ELECTRONICS ENGINEERS &
ENGINEERING MANAGERS?**

165,000

Read

ELECTRONIC DESIGN

Twice Monthly

To reach them with a
recruitment ad in the
Professional Opportunities
section

Contact:
**Penton Classifieds
at 216-696-7000,
ext. 2520**

With a career at Motorola Cellular, we see no end in sites.

Stretching from the U.S. throughout the Far East, Latin America and Europe, Motorola cell sites cover the world. In fact, the company that pioneered cellular communications is now outdistancing all competitors combined. We're bringing the worldwide telecommunity closer and paving the way for even greater breakthroughs...like our patented four-cell reuse plan that supports more voice channels with fewer cell sites.

And with just 1% of the global cellular market developed, the opportunities at Motorola Cellular have just begun. We're developing the most advanced software, switching equipment and radio telephone exchanges. We're constantly modifying, updating and simplifying systems while enhancing RF sector-sharing capabilities.

Flexibility, capability and expandability...that's what Motorola Cellular can offer its customers...and your engineering career. If you want a career as dynamic as our growth, set your sites on one of the following opportunities:

• **Software Engineers** (positions also available at our Fort Worth, Texas facility) • **Hardware Engineers** • **Test Equipment Engineers** • **Mechanical Engineers** • **Manufacturing Engineers** • **Cellular Systems Engineers.**

We offer an attractive salary, a comprehensive benefits package and opportunities for professional growth. For immediate consideration, please send your resume to: Supervisor, Professional Recruitment, Motorola Inc., Cellular, 1501 West Shure Drive, Arlington Heights, IL 60004. Or FAX your resume to: (708) 632-5717 (our 24-hour FAX line). To access our On-Line Career Network from your PC,

dial (508) 263-3857, press return twice, and key in password LEGACY. For Software positions in Fort Worth, please send your resume to: Professional Staffing, Motorola Inc., P.O. Box 2931, Fort Worth, TX 76113. Or FAX your resume to (817) 232-6367 (our 24-hour FAX line). We are an equal opportunity/affirmative action employer.

1990
1991
1992
1993
1994



MOTOROLA

Cellular Subscriber Group

Radio Telephone Systems Group

Our breakthroughs are heard around the world.

ELECTRONIC DESIGN

DIRECT CONNECTION ADS

New Products/Services Presented By The Manufacturer.
To Advertise, Call JEANIE GRIFFIN At 201/393-6080

X.25 SDLC
QLLC HDLC
ADCCP PAD

- C source code
- ROM-able
- Full porting provided
- No OS required



GCOM, Inc.
41 E. University
Champaign IL 61820
(217) 352-4266

Specialists in Computer Communications
FAX 217-352-2215

GCOM

CIRCLE 273

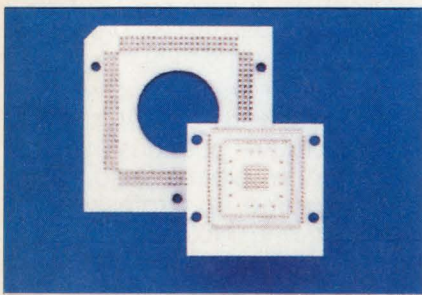

ISOCON™ SOLDERLESS CONNECTORS FOR HIGH DENSITY PAD PACKAGES

Compliant connection without package leads. Wiping action of conductors provides reliable gas-tight contact. Low inductance (<1 nH) and low total electrical resistance (<10 mOhms). High contact density, up to 400 I/Os per square inch at 50 mil pitch.

Rogers Corporation, One Technology Drive,
Rogers, CT 06263 203/774-9605.

ROGERS CORPORATION

CIRCLE 271



☆☆☆☆
"The Best 8051 Emulator"

NEW
30 MHz
REAL-TIME

8051

SEE EEM 89/90
Pages D 1324-1326

PC based emulators for the 8051 family

- 8031, 8032, 8051, 8052, 80C152/154/321/451/452/51FA/51GB/515/517/535/537/552/562/652/851, 80532, 83C451/552/751/752/851, 8344, 87C451/552/751/752, 8751, 8752, D85000 + CMOS ... more.
- PC plug-in boards or RS-232 box.
- Up to 30 MHz real-time emulation.
- Full Source-level Debugger w/complete C-variable support.
- 48 bit wide, 16K deep trace, with "source line trace"
- "Bond-out" pods for 8051, 83C552, 83C451, 83C652, 83C751, 80C515/80C517, 83C752.

Prices: 32K Emulator 8031 \$1790; 4K Trace \$1495*

CALL OR WRITE FOR FREE DEMO DISK!

Ask about our demo VIDEO

NOHAU CORPORATION
51 E. Campbell Avenue
Campbell, CA 95008
FAX (408) 378-7869
(408) 866-1820

*US only

NOHAU

CIRCLE 256

68HC11

PC-based emulator for 68HC11

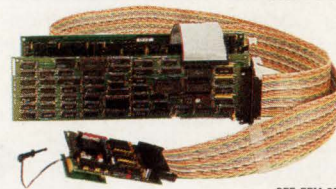

SEE EEM 89/90
Pages D 1324-1326

- PC plug-in or RS-232 box.
- Pull-down menus with full window support, combined with command-driven User Interface.
- Up to 16 MHz real time emulation.
- No intrusions to the 68HC11's resources.
- 48 bit wide 16K deep trace. All functions usable without disturbing emulation. Time stamping. Two level trigger.
- Symbolic and C Source Level Debugging, including in-line assembler and disassembler.
- Supports A, E, D and F parts.

Prices: 64K Emulator and pod \$2590; 4K Trace \$1995*

CALL OR WRITE FOR FREE DEMO DISK!

NOHAU CORPORATION
51 E. Campbell Avenue
Campbell, CA 95008
FAX (408) 378-7869
(408) 866-1820

*US only

NOHAU

CIRCLE 257

Design:

Industry-standard language for PLDs

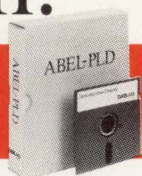

With new ABEL-PLD at just \$895*.

- 150 PLD architectures supported (over 4000 devices).
 - Uses ABEL™ Hardware Description Language (AHDL).
 - Intelligent synthesis and optimization.
 - Upgradable to full-featured ABEL.
- Call for your FREE ABEL-PLD demonstration diskette.
1-800-247-5700
*U.S. list price only.

DATA I/O CORPORATION

DATA I/O

CIRCLE 251

Program:

16L8, 20V8, 22V10, 27C020, and 450 other CMOS devices



PLDs and memories with the low-cost 212.

- Memory cards for easy updates.
 - Extensive editing capabilities.
 - Compatible with JEDEC standard programming files.
- Call for your FREE 15-day trial AND ABEL-PLD demonstration diskette.
1-800-247-5700

DATA I/O CORPORATION

DATA I/O

CIRCLE 252

YOUR AD HERE

Here's all you have to do:

- Send a B/W or 4C glossy photo.
- Include 13 lines of copy. (37 characters per line)
- Write a headline of 32 characters or less.

We do all the rest. No production charges.

We also accept camera-ready art. Ad size 2³/₁₆" wide × 3" deep.

CIRCLE 284

Little Giant™

C Programmable Controller

This shirt pocket sized computer interfaces directly to the outside world. Use it to control anything. Instantly programmable using your PC with Dynamic C. ROM and battery backed RAM to 1024k bytes. 8 Channel, 10/12 bit, A/D with conditioning. High voltage and current drivers. Battery backed time and date clock. Watchdog and power fail. 4 serial channels. 24 parallel I/O lines. Timers. Integral power supply. Terminations for field wiring. Expansion connector. Plastic or metal field packaging available. OEM versions from \$199.00.

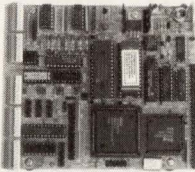

Z-World Engineering
1340 Covell Blvd., Davis, CA 95616
(916) 753-3722
Fax: (916) 753-5141

Z-WORLD ENGINEERING

CIRCLE 278

There is a Difference.

Lifetime Free Updates

PLD-1100
\$798



A programmer is not just another programmer. That is why BP Microsystems is committed to bringing our customers the highest quality programmers at an affordable price. The PLD-1100 Logic Programmer supports virtually every 20- and 24-pin logic device currently available. And, all of our programmers include free updates to support future chips as they become available and an unconditional money back guarantee.

BP MICROSYSTEMS
1-800-225-2102
(713) 461-9430

BP MICROSYSTEMS

CIRCLE 254



LOW COST INTERFACE CARDS FOR PC/XT/AT

RS-485/422 Card [PC485] \$95/125

- Serial Async. Communication up to 4,000ft; 2 or 4 wires; NS16450 UART;
- COM1-4; Max. Baud Rate 56Kb; High speed version (256KB) - \$165.
- Dual drivers/receivers; Handles 64 devices; Compatible with most comm. S/W.
- DB9 or phonejack. Sample programs included. Optional S/W (w/ source) - \$150

IEEE-488 Card [PC488A] \$145

- Includes DOS Device Driver and sample Communication program in BASIC.
- Additional libraries for C, Pascal, FORTRAN, Assembly available - \$50.
- Selectable IRQ (1-6). DMA channel 1 or 2. Up to four boards per computer.
- Compatible with most IEEE-488 Software packages for IBM-PC.
- I/O Addresses and Control registers compatible with NI's GPIB-PCIIA.

IEEE-488 Card [PC488C] With Built-in Bus Analyzer \$445

- Software Support for BASIC, QuickBASIC and GWBASIC.
- Additional libraries for C, Pascal, FORTRAN, Assembly available - \$50 (all)
- Powerful menu-driven BUS ANALYZER runs in the background while 488 programs or commands are executed. Features Program Stepping, Break points, real time bus data capture (4K buffer), instant screen toggling.
- Complete Controller/Talker/Listener capability. Based on NEC-7218.
- Compatible with NI's GPIB-PCII card. (TMS-9914 based card - \$345).

Stepper Motor Card [PCL738] \$395

- Capable of independent and simultaneous control of up to 3 stepper motors.
- Programmable speed from 3.3 PPS to 3410 PPS. Built-in acceleration control.
- Step Position Read-back; Opto-isolated outputs; Crystal based timing.
- Pulse/Direction or CW/CCW pulse output. Includes 8 bit digital I/O port.

MC / VISA / AMEX

Call today for datasheets!



B&C MICROSYSTEMS INC.
750 N. Pastoria Ave., Sunnyvale, CA 94086 USA
TEL: (408) 730-5511 FAX: (408) 730-5521

B&C MICROSYSTEMS

CIRCLE 264

Now, you can afford the high precision you really need.

With new YSI Precision Machine-Insertable Thermistors. Tape and reel packaging reduces manufacturing costs and YSI precision gives you the edge in circuit accuracy and reliability. Call 800 343-4357 for information. In Ohio, call 513 767-7241.

YSI Incorporated
Yellow Springs, Ohio 45387 USA



YSI, INC.

CIRCLE 253



UNIVERSAL PROGRAMMER IS DEPENDABLE AND SOFTWARE UPGRADABLE

Sailor-PAL is S/W driven by PC/XT/AT/PS2 or laptops; fast interface thru std parallel printer port; supports thousands of devices including CMOS and EE erasables:

- | | | |
|--------------|-----------|-----------------|
| • 5ns PALs | • EPLDs | • Test Vectors |
| • 10ns GALs | • PEELs | • 4-MEG EPROMs |
| • EP900/1200 | • ECLs | • Bipolar PROMs |
| • EP1800 | • 874X/5X | • CMOS PROMs |
| • 87C751/752 | • EEPROMs | • Xilinx PROMs |

Other models available.

ADVIN SYSTEMS, INC.

1050L East Duane Ave., Sunnyvale, CA 94086
800-627-2456; 408-243-7000 Fax: 408-736-2503
ADVIN SYSTEMS

CIRCLE 263



RS232 EE/EPROM, MICRO & MEMORY CARD PROGRAMMER \$345/495

- Programs EE/EPROMs, Flash EProms, ZPRams, Intel Micros, Memory Cards.
- Stand-Alone Mode for EE/EPROMs and Memory Card Duplication / Verify.
- All 24/28/32 pin EE/EPROMs to 8 Mbits (upgradable to 32 Megabits).
- Micros: 8741A/2/A-4,-8,-9,-51,-CS1FA/B,-52,-53,-55,-CS21,-CS41,9761.
- Accepts dedicated modules: Memory Card Programming Module (Seiko, Fujitsu) - \$145, Eraser/Timer Module - \$50, Gang Module (4 sockets) - \$145. Simultaneously duplicates up to 5 devices in stand-alone mode (with Gang).
- Can be operated with any computer containing an RS-232 serial port.
- User friendly Menu-Driven Interface Program for IBM-PC or Macintosh.
- Full 1 year warranty. Customer support via voice line, fax or dedicated BBS.

INTELLIGENT ROM EMULATOR \$395

- Emulates 2716 through 27512 EProms with a single unit. Access time 120ns.
- Connects to the standard parallel printer port via a standard printer cable.
- User friendly software. Command set includes: Load(data), Write(data), Display(memory), Type(of EPROM), Edit(memory), Fill(memory), Calculator, Reset(target system), Activate(debugging feature), Monitor(selected feature).
- Address Compare with Halt output, Address Snapshot, Trigger input.
- Fast data loading via parallel printer port (64k bytes in less than 10 sec).
- Cascadable up to 8 units. Includes target cable with Trigger/Reset/Halt chips.
- CMOS (stand-alone) model with rechargeable NiCad battery backup: \$495

MC / VISA / AMEX

Call today for datasheets!



B&C MICROSYSTEMS INC.
750 N. Pastoria Ave., Sunnyvale, CA 94086 USA
TEL: (408) 730-5511 FAX: (408) 730-5521

B&C MICROSYSTEMS

CIRCLE 265

68HC11 PC-based hardware test program

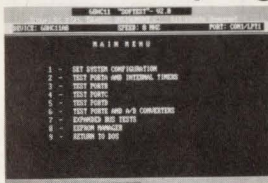

Test your 68HC11 boards from your computer.

Complete Hardware testing/debugging via the RS-232 port.

- No emulator required.
- Compatible with 68HC11A1/A2/E1/E2 and F1.
- Test "Single Chip" or "Expanded Bus" modes.
- Test all I/O ports.
- Exercise internal timers and timer I/O.
- Test A/D ports.
- Test external RAM and ROM.
- Complete EEPROM Management including config., Reg. and external EEPROM.
- Custom test program available for your board.

TIIC
Transic Instrument Co.
P.O. Box 26174
Salt Lake City, Utah 84126
(801) 468-6230

TRANSIC

CIRCLE 279

There is a Difference.

Lifetime Free Updates

EP-1140
\$895



A programmer is not just another programmer. That is why BP Microsystems is committed to bringing our customers the highest quality programmers at an affordable price. This commitment is evident in our EP-1140 E/EPROM programmer supporting thousands of 24-, 28-, 32- and 40 pin devices. A 32-pin model, EP-1132, is available also for \$895. And, all of our programmers include future chip support at no charge and an unconditional money back guarantee.

BP MICROSYSTEMS
1-800-225-2102
(713) 461-9430

BP MICROSYSTEMS

CIRCLE 255

Analog Circuit Simulation

Completely Integrated CAE from \$95

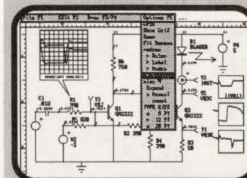

From Schematic Entry through SPICE Simulation to Post Processing

IsSPICE \$95, the complete SPICE program, runs on all PC's.

IsSPICE/386 \$386, The fastest PC based SPICE program available. Has virtually no circuit size limitations.

SPICE NET \$295, a schematic editor for any SPICE simulator. Generates a complete SPICE netlist.

INTUSCOPE \$250, a graphics post processor that performs all the functions of a digital oscilloscope.

PRESPICE \$200, extensive model libraries, Monte Carlo analysis, and parameter sweeping.



Please Write or Call
P.O. Box 6607 (213) 833-0710
San Pedro, CA 30 Day Money
90734-6607 Back Guarantee

INTUSOFT

CIRCLE 262

IEEE 488

**Easiest to use,
GUARANTEED!**

- IBM PC, PS/2, Macintosh, HP, Sun, DEC
- IEEE device drivers for DOS, UNIX, Lotus 1-2-3, VMS, XENIX & Macintosh
- Menu or icon-driven acquisition software
- IEEE analyzers, expanders, extenders, buffers
- Analog I/O, digital I/O, RS-232, RS-422, SCSI, modem & Centronics converters to IEEE 488

Free Catalog & Demo Disks
(216) 439-4091



IOtech • 25971 Cannon Rd. • Cleveland, OH 44146

IOTECH

CIRCLE 268

UNIPRO, the PC/XT/AT/386 based universal programmer/tester programs PROMs, EPROMs, EEPROMs, up to 4MB and 32-bit wide, PALs, PLDs, GALs, EPLDs, PEELs, and Micro Controllers. JEDEC file compatibility and Test Vector verification allow the use of most popular PLD compilers. The unit also tests TTL/CMOS Logic ICs and Dynamic/Static RAMs. 40-pin Gold ZIP socket, built-in protection for short circuit and over current, high speed parallel interface to the PC, and menu-driven software are included at \$585.

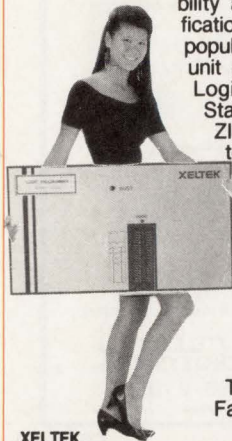

XELTEK

XELTEK

764 San Aleso Ave.
Sunnyvale, CA 94086
Tel: (408) 745-7974
Fax: (408) 745-1401

CIRCLE 260

Tango-PLD. The New Price/Performance Leader.

Tango-PLD, a universal PLD design tool with sophisticated features at an affordable price, creates complex designs with multiple PALs and GALs. Our top-down approach, emphasizing logic description first and part selection second, along with a "C-like" design language, makes Tango-PLD easy to use.

Tango™

Describe designs with Boolean equations, truth tables, state machines, high-level C expressions, or existing JEDEC files. Simulation with test-vector coverage checking guarantees no surprises. Rich functionality, one year's updates, free tech support and BBS, plus our 30-day guarantee. All this for just \$495. Call today.



FREE EVALUATION PACKAGE

800 433-7801 619 554-1000 619 554-1019 Fax

ACCEL™ Technologies ■ 6825 Flanders Drive ■ San Diego, CA 92121 USA
International prices may vary. Contact us for the distributor nearest you.

ACCEL TECHNOLOGIES

CIRCLE 270

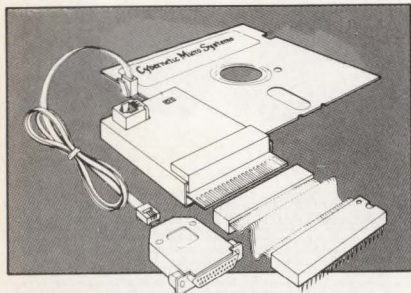

8051 Emulator - \$1250

d²ICE is a low cost, Full Speed, real time 8051 Emulator.. Powerful user interface for Hi-level multi-window source code debugging. Uses IBM-PC COM1/2. No Slots! Portable, fits in shirt pocket. Assembler and test bed included.



Cybernetic Micro Systems

PO Box 3000 • San Gregorio CA 94074
Ph: (415) 726-3000 • Fax: (415) 726-3003

CYBERNETIC MICRO SYSTEMS

CIRCLE 274

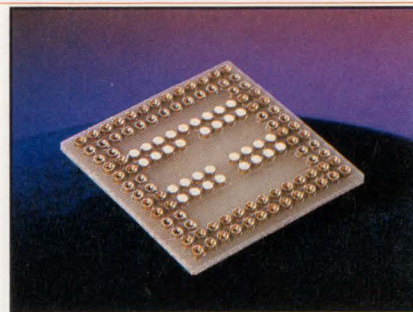

Over 150 Prototyping Adapters

- Adapt-A-Boards™ make it easy to adapt standard or high-density prototyping boards to a variety of packages.
- For all package types: LCC, PLCC, PGA, PQFP, SDIP (shrink DIP devices), SOIC and more!
- Bottom configurations adapt to wire wraps or solder tail pins. Boards conform to Mil-C-45204.
- Quick turnaround on custom engineering services, if needed. For a free catalog, contact:

Emulation Technology, Inc.
2368-B Walsh Ave. Santa Clara, CA 95051
Phone: 408-982-0660 FAX: 408-982-0664

EMULATION TECHNOLOGY



CIRCLE 258



FREE!
120
Page
Catalog

"Optics
for
Industry"

ROLYN OPTICS supplies all types of "Off-the-Shelf" optical components. Lenses, prisms, mirrors, irises, microscope objectives & eyepieces plus hundreds of others. All from stock. Rolyn also supplies custom products & coatings in prototype or production quantities. Write or call for our free 120 page catalog describing products & listing off-the-shelf prices. **ROLYN OPTICS CO.**, 706 Arrowgrand Circle, Covina, CA 91722, (818) 915-5707 & (818) 915-5717. TELEX: 67-0380. FAX: (818) 915-1379.

ROLYN OPTICS

CIRCLE 261

How To Get More Emulation for Less

ORION 8620 ANALYZER-EMULATOR

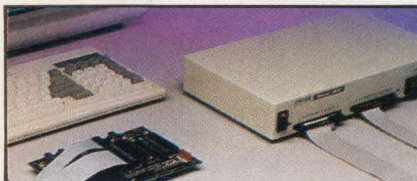

- High-Level language/Symbolic debug support
 - Over 170 processors supported with the same base hardware and software environment
 - Easy-to-use, powerful triggering
 - Extensive MACRO capabilities
 - Program Performance Analyzer
 - Built-In EPROM programmer
- Go ahead and compare. The 8620 Analyzer-Emulator gets your product to market faster and costs less. Base prices start at \$5080. Send for more information and free demo disk.

Toll Free 800/729/7700
or 415/327/8800



180 Independence Dr., Menlo Park, CA 94025

ORION INSTRUMENTS

CIRCLE 276

Interactive/Real-Time

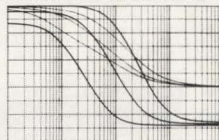

Analog Circuit Simulation

ECA-2 Electronic Circuit Analysis offers the best MonteCarlo and Worst-Case analyses with the capability to concurrently plot random samples or Min/Max/Nominal values.

- AC, DC, Transient, Fourier, and Temperature Analysis
- Interactive or batch modes
- Full nonlinear simulator
- Sine, Pulse, PWL, SFFM, and Exponential generators
- IBM PC/Mac/SUN
- Multiple plots
- On-line real time graphics - 2 to 50 times faster than SPICE
- Over 500 nodes
- Advanced component parameters
- Component Sweeping
- Full editing, built-in or external
- Detailed 525 page manual

Call for **FREE DEMO!**



TATUM LABS

CIRCLE 267



ELECTRONIC DESIGN AUTHOR'S GUIDE

Thinking of writing a technical article for publication in Electronic Design? This 12-page brochure contains just about everything you need to know about the process: submitting the outline, tips on writing the manuscript, preparing the artwork, and more.

ELECTRONIC DESIGN
611 Route #46 West
Hasbrouck Heights, NJ 07604

ELECTRONIC DESIGN

CIRCLE 281

Cross-Assemblers from \$50.00
Simulators from \$100.00
Cross-Disassemblers from \$100.00
Developer Packages
 from \$200.00 (a \$50.00 Savings)

Make Programming Easy

Our Macro Cross-assemblers are easy to use. With powerful conditional assembly and unlimited include files.

Get It Debugged--FAST

Don't wait until the hardware is finished. Debug your software with our Simulators.

Recover Lost Source!

Our line of disassemblers can help you re-create the original assembly language source.

Thousands Of Satisfied Customers Worldwide

PseudoCorp has been providing quality solutions for microprocessor problems since 1985.

Processors

Intel 8048	RCA 1802,05	Intel 8051	Intel 8096,196kc
Motorola 6800	Motorola 6801	Motorola 68HC11	Motorola 6805
Hitachi 6301	Motorola 6809	MCS Tech 6502	WDG 6502
Rockwell 65C02	Intel 8080,85	Zilog Z80	NSC 800
Hitachi HD64180	Mct. 58k & 10	Zilog Z8	Zilog Super 8

* All products require an IBM PC or compatible.

For Information Or To Order Call:

PseudoCorp

716 Thimble Shoals Blvd, Suite E
 Newport News, VA 23606

(804) 873-1947

FAX:(804)873-2154

PSEUDOCORP

CIRCLE 259

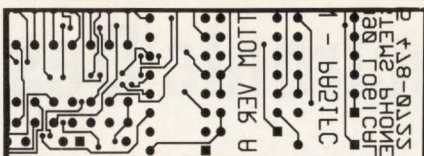

GerberJet V1.1F

CATCHES ERRORS BEFORE PHOTOPLOTTING

GerberJet plots Gerber data files on HP LaserJet-II and compatible printers at 300 dots per inch. With GerberJet you will be sure your files are correct BEFORE EXPENSIVE PHOTOPLOTTING.

Auto Scaling, Auto Tiling, EMS support, Auto Orientation, Plot AT card on one sheet Donut, Thermal, Oval, Round, Square Ap's Merge utility allows you to panelize files.

Call our BBS to download the demo file GJD.EXE. ONLY \$ 149.00 (thru 10/90)

CALL (315) 478-0722 FAX (315) 475-8460

BBS (315) 471-3961 (2400/1200,8,N,1)

Logical Systems Corporation
 P.O. Box 6184, Syracuse, NY 13217 USA

LOGICAL SYSTEMS

CIRCLE 282

Want to try this with your LCD display?

Call Planar to see the EL solution.

503/690-1100

PLANAR

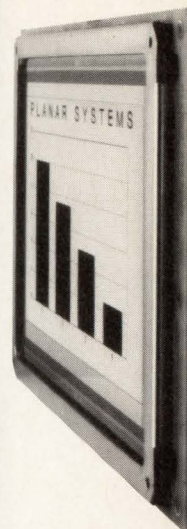

PLANAR SYSTEMS

CIRCLE 277

TESS PC Block Diagram Simulation

Modems, DSP, satcom, nav, controls...

Times are tough: shorter schedules, more complexity. TESS can help you:

- Detect gotchas before breadboarding.
- Find the best design alternatives fast.
- See the effects: filters on signals & loops, noise, multipath & adjacent channels.
- Simulate mixed-signal ASICs & systems.
- Put a lab on your desk for just \$695!

Demo disk: 404-751-9785 Fax: 404-664-5817
 TESOFTE Box 305, Roswell, GA 30077

TESOFT

CIRCLE 283

Cross Assemblers

Universal Linker, Librarian

PC/MS DOS, micro VAX, VAX VMS UNIX targeting 30 microprocessors

- ★ High speed
- ★ Compatible with chip manufacturer's assemblers
- ★ Powerful macros
- ★ Absolute or relocate code
- ★ Conditional assembly
- ★ \$295 up for MS DOS Packages



811 W. Fifth St.
 Lansdale, PA 19446 U.S.A.

telephone: 215-362-0966
 telex: 4948705 ENERTEC

CROSS ASSEMBLERS

CIRCLE 269

SMT QUARTZ CRYSTALS and CLOCK OSCILLATORS

WORLD'S SMALLEST
 212-505-4179

- 10kHz-32MHz
- ceramic & metal packages
- hermetically-sealed
- hi-temp mounting
- tape & reel
- thru-hole versions
- shock resistant

MCS MICRO CRYSTAL
 35 East 21st Street
 New York, N.Y.

FREE CATALOG

MICRO CRYSTAL DIV./SMH

CIRCLE 275

RESERVE SPACE IN 1990!

ELECTRONIC DESIGN'S

DIRECT CONNECTION ADS 1990 SCHEDULE

ISSUE	CLOSING	ISSUE	CLOSING	ISSUE	CLOSING	ISSUE	CLOSING
Jan. 11	12/15/89	Apr. 12	3/14/90	Jul. 12	6/15/90	Oct. 11	9/14/90
Jan. 25	12/28/89	Apr. 26	3/30/90	Jul. 26	6/29/90	Oct. 25	9/28/90
Feb. 8	1/12/90	May 10	4/13/90	Aug. 9	7/13/90	Nov. 8	10/12/90
Feb. 22	1/26/90	May 24	4/27/90	Aug. 23	7/27/90	Nov. 22	10/26/90
Mar. 8	2/9/90	Jun. 14	5/18/90	Sep. 13	8/17/90	Dec. 13	11/16/90
Mar. 22	2/23/90	Jun. 28	6/1/90	Sep. 27	8/31/90	Dec. 27	11/30/90



FOR MORE INFORMATION CALL (201) 393-6080

NEW NEW NEW NEW NEW

Telecom Design!

MF (R1) or MFC (R2)

TRANSCIVER



M-986 transmits and receives CCITT R1 or R2 forward and backward multifrequency signals. For trunk adapters, test equipment, and other applications.

- Single or dual channel versions available
- Versions for North American (R1) or International (R2) toll signals
- Binary or 2 of 6 input/output format
- Complete microprocessor interface
- 40 pin IC, 5 volt power, crystal time base

For more info call: 1-800-426-3926

TELSTONE



10801-120th Avenue NE, Kirkland, WA 98033
 Phone: 206-827-9626 Fax: 206-827-6050

TELSTONE

CIRCLE 272

Electronic Design

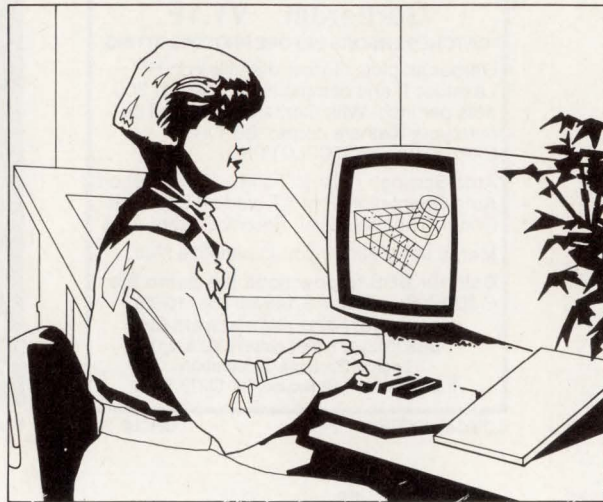

targets your mailings to 150,000 design and development engineers

Highly-educated engineers and managers in the
electronics original equipment market.

*Select by: Job function, type of industry, project responsibility, purchasing
influence, employment size, and geography.*

**Guaranteed 99% deliverable 100% BPA audited
circulation**

Ideal prospects for your next direct mail campaign

**Penton
Lists**

CALL LITA PATTON AT 216/696-7000
(ext. 2525) FOR YOUR FREE CATALOG.

If OEM sales are part of your business, Systems/USA is THE place to be.

Systems/USA is the OEM computer technology exposition for systems design and integration—the only show dedicated to the OEM computer technology market.

Systems/USA is the place to showcase products and expand OEM business, or find the solutions to systems design and integration requirements.

- **Technology Conference** will consist of a “hands-on” forum of nine separate tracks spanning three full days addressing these important categories:

- High-Performance ICs
- Power Sources
- Input Technology
- Buses & Boards
- Output Technology
- Government Defense
- Software Development
- Display Technology
- Storage Technology

- **Exhibits** will coincide directly with the topics being addressed within the technology program.
- **New Product Announcements** will be a key feature of the show, providing exhibiting companies the

opportunity to showcase their products and meet one-on-one with interested parties.

- **Management Issues Conference** will focus on business developments within the systems integration industry as told by the industry's leaders.

Systems/USA



Conference & Exposition

SYSTEMS/USA-West

**February 11-13, 1991
Anaheim Convention Center
Anaheim, California**

**For simple solutions to complex
problems... Systems/USA**

For FREE registration and more information, call (800) 873-1177 ext. 300.

Sponsored by the

American Electronics Association

5201 Great America Parkway, Santa Clara, CA 95054

ELECTRONIC DESIGN

Chairman and CEO: Sal F. Marino
President and COO: Daniel J. Ramella
Senior Vice President: James D. Atherton
Group Vice President: James W. Zaremba

Advertising Sales Staff

Publisher: Paul C. Mazzacano
 Hasbrouck Heights, NJ; (201) 393-6060
 San Jose, CA; (408) 441-0550

National Sales Manager:

Andrew M. Dellins
 San Jose, CA; (408) 441-0550

Hasbrouck Heights:

Judith L. Miller, Robert Zaremba
Sales Support Supervisor: Betsy Tapp
 611 Route # 46 West
 Hasbrouck Heights, NJ 07604; (201) 393-6060
 TWX: 710-990-5071

Boston: Ric Wasley

400 Fifth Ave.
 Waltham, MA 02154; (617) 890-0891
 FAX: (617) 890-6131

Colorado: Lou Demeter (408) 441-0550

Chicago/Midwest: Russell Gerches

Sales Assistant: Susan Johnson
 2 Illinois Center Bldg., Suite 1300
 Chicago, IL 60601; (312) 861-0880
 FAX: (312) 861-0874

Arizona: James Theriault (408) 441-0550

Los Angeles/Orange County/San Diego:

Ian Hill
Sales Coordinator: Debi Neal
 16255 Ventura Blvd., Suite 300
 Encino, CA 91436; (818) 990-9000
 FAX: (818) 905-1206

Pacific Northwest: Bill Gillier (408) 441-0550

San Jose:

Lou Demeter (408) 441-0550
 Bill Gillier (408) 441-0550
 James Theriault (408) 441-0550
Sales Administrator: Amber Hancock
 2025 Gateway Pl., Suite 354
 San Jose, CA 95110; (408) 441-0550
 FAX: (408) 441-6052 or (408) 441-7336

Texas/Southeast: Bill Yarborough

12201 Merrit Dr., Suite 220
 Dallas, TX 75251; (214) 661-5576
 FAX: (214) 661-5573

Direct Connection Ad & DAC Sales Representative:

Jeanie Griffin (201) 393-6080

Eastern Canada: Andrew M. Dellins (408) 441-0550

Holland: W.J.M. Sanders, S.I.P.A.S.

Oosterpark 6-P.O. Box 25
 1483 DeRyp, Holland
 Phone: 02997-1303
 Telex: 13039 SIPAS NL
 Telefax: (02997)-1500

Austria, Belgium, Germany, Switzerland:

Friedrich Anacker
 InterMedia Partners GmbH
 Katernberger Strasse 247
 5600 Wuppertal 1
 West Germany
 Phone: 02-02-711-091/92

Japan: Hirokazu Morita

Japan Advertising Communications
 New Gunza Building 3-13
 Gunza 7-chome
 Chuo-Ku, Tokyo 104 Japan
 FAX: 011-81-3-511-8710

Korea: Young Sang Jo

Business Communications Inc.
 K.P.O. Box 1916
 Midopa Building 146
 Dangju-Dong, Chongo-Ku
 Seoul, Korea
 Phone: 011-82-2-739-7840
 FAX: 011-82-2-732-3662

Taiwan: Tomung Lai

United Pacific International
 No. 311 Nanking E. Rd., Sec. 3
 Taipei, Taiwan R.O.C.
 Phone: 011-886-27-150-751
 FAX: 011-886-27-169-493

United Kingdom/Scandinavia/Israel:

John Maycock
 Huttons Buildings
 146 West St.
 Sheffield, England S1 4ES
 Phone: 742-759186

INDEX OF ADVERTISERS

A

ACCEL Technologies 140
 Actel 57-60
 Advin Systems Inc. 139
 Aerospace Optics 28
 Aldec 16
 American Electronics Assoc. 143
 AMP 34-35
 Ampro 80
 Analog Devices 44-45
 Ancot 42
 Apex 25
 AT&T 22, 75
 Atmel 69
 Augat Alcoswitch 117

B

B&C Microsystems 139
 BP Microsystems 139
 Burr-Brown 91, 124

C

Caddock Electronics 36
 Capital Equipment Corp. 131
 Comlinear Corp. 92-93
 Comtran Integrated Software 8
 Coilcraft 120
 Cybernetic Micro Systems 14, 140
 Cypress Semiconductor Cover IV

D

Data I/O 63, 138
 Datel 100

E

Emulation Technology 140
 Enertec 141
 Equipto 133

F

Frequency Electronics 121

G

G-Com, Inc. 138
 Gigabyte Logic 145

H

Hamilton Avnet 73
 Hewlett-Packard Co. 1, 9, 49, 65, 95
 Hyperception 146

I

IEE 112
 ILC Data Device 79
 Inco SPP 109
 Integrated Device Technology 31
 Intusoft 139
 IOtech 140
 ISDATA 56

L

Lambda Electronics 125-130
 LeCroy 55
 Logical Systems 141

M

Maxim Integrated Products 115-116
 Mentor Graphics 6-7
 MF Electronics 118
 Micro Crystal Div./SMH 141
 Micro Linear 50-51
 Microsim 119
 Mine, Inc. 134

Mini-Circuits Laboratory,
 a Div. of Scientific Components
 Corp. 15, 18-19, 88, Cover III
 Motorola Computer Group 82-84
 Motorola Semiconductor Products 2-3, 98-99
 Munich Trade Fair 108

N

National Instrument 135
 National Semiconductor 43
 NCR Microelectronics 10-11
 NEC 20-21
 Nicolet Instruments 96
 Nohau Corp. 138

O

Omaton 68
 Orion Instruments 140

P

Pico Electronics, Inc. 113, 122
 Planar Systems 141
 Pseudocorp 141
 Precision Filters 110

R

Rogers Corp. 138
 Rolyn Optics 140

S

Siemens Components 67
 Signetics 26-27
 Silicon Systems 39
 Sipex 123
 Sony Microsystems 70
 Standard Microsystems 17
 Stanford Research Cover II

T

Tatum Labs 140
 Teltone 141
 Tesoft 141
 Texas Instruments 32-33, 103-106
 Toshiba America 46
 Transic 139

U

UMTC 41

V

Vectron Laboratories 114
 Vicor 111

W

Wafios Maschinenfabrik 8
 Western Digital 12-13

X

Xeltek 140
 Xilinx 87

Y

YSI 139

Z

Zenith Data Systems 77
 Z-World 139

The advertisers index is prepared as an extra service. Electronic Design does not assume any liability for omissions or errors.

From OC-3 to OC-12...

Regenerate your SONET signals with our PLL clock and data recovery IC.

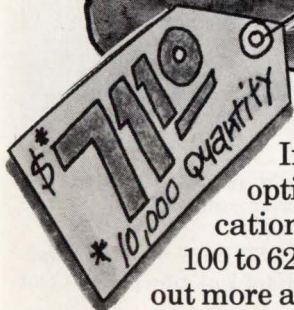

If you are designing a fiber optic receiver subsystem for applications requiring data rates from 100 to 625 Mbit/s NRZ, you should find out more about our PLL-based 16G041-H clock and data regenerator. It's a three terminal (data in, clock and data out) device in a compact 1.25 inch x 1.25 inch flatpack package.

The 16G041-H synchronizes an internal VCO directly to an incoming data stream and simultaneously retimes and regenerates the data, unlike SAW filter clock recovery circuits which first filter the clock signal from incoming data and then retime it. Moreover, the 16G041-H

generates a clock output in the absence of incoming data. The SAW filter does not.

To find out more about our PLL clock and data recovery circuit as well as the other members of our complete high speed fiber optic communications chip family including 16x16 crosspoint switch, limiting amplifier, transimpedance amplifiers, laser diode driver, LED driver, MUX and DEMUX, call us today. United States and Canada: (805) 499-0610, FAX (805) 499-2751; Europe: GIGA, at +45 4343 1588, FAX +45 4343 5967.

GBL GigaBit Logic

FOR MORE INFORMATION, CIRCLE 165
FOR REPRESENTATIVE CONTACT, CIRCLE 175

DSP for the Masses...

...well, maybe not yet. But if you are engaged in Digital Signal Processing, Hyperception can assist you with products from DSP Software to DSP/Acquisition Hardware to complete DSP Workstations. All of our products are designed to advance your efforts in Research and Development, Education, and Application in all areas of DSP today.

NEW!! HYPERSIGNAL-WORKSTATION DSP SOFTWARE VERSION 2.0 IS HERE!

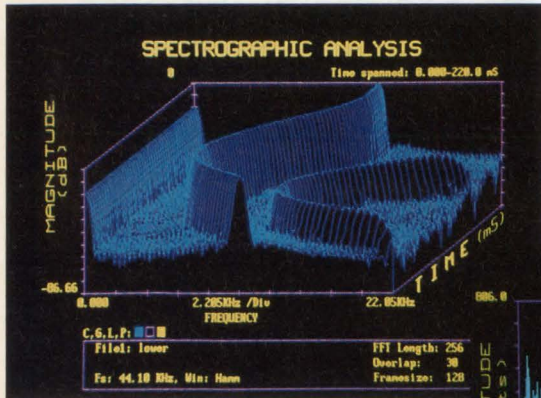

New instrumentation tools, including a Real-Time Map Analyzer ("Running Waterfall") for frequency domain analysis

New Audio/Acoustic analysis tools, including optional log-frequency axis in all frequency-domain displays

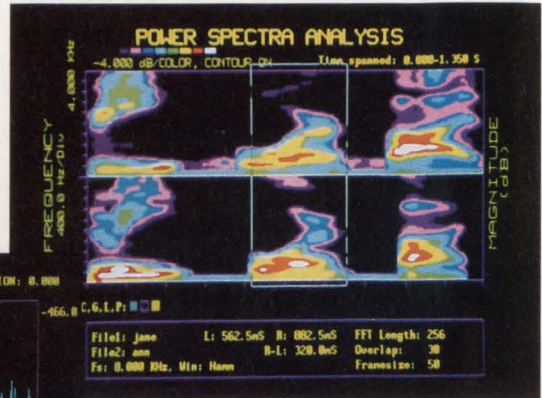

Publication-Quality output to over 150 printers including laserjet and paintjet color printer, and other Hi-Res printers

New high-resolution video display drivers capable of supporting 800x600, 1024x768, and 1600x1280 resolution. Support for standard Japanese NEC PC 98xx graphics modes

Built-In Mouse support

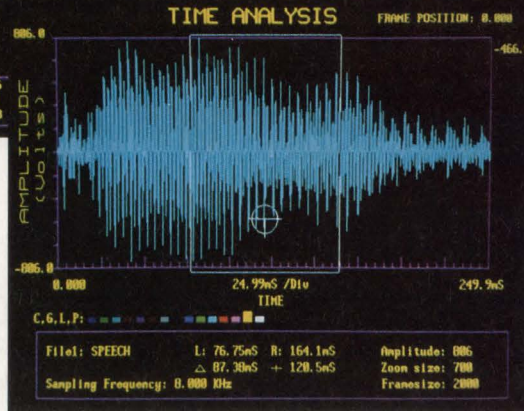

Many additional DSP/Acquisition board drivers for associated Real-Time processing functions

Enhanced waveform editing modes and advanced Difference Equation support

Improved Digital Filter design capability

Increased floating-point support

DSP AND ACQUISITION DEVELOPMENT BOARDS

Complete line of DSP Development/Application and Acquisition boards for Analog Devices, AT&T, Motorola, and Texas Instruments DSP's, all supported by high-level algorithm development software

Complete line of Acquisition boards, all supported by high-level data collection and PC-based instrumentation software

Technical support from veteran DSP engineering professionals

Software development support including assemblers, linkers, software simulators, DSP software libraries, high-level language compilers, and high-level DSP application support software, including Real-Time and non-Real-Time support for Analog Devices, AT&T, Motorola, and Texas Instruments DSP's

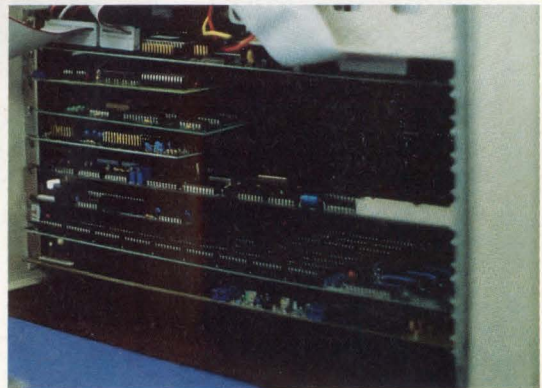

COMPLETE DSP WORKSTATIONS



High-Performance DSP 486 Workstation available, with many DSP Acquisition/Accelerator card options

Complete line of compatible DSP 386 Workstations available with up to 700 MByte Hard Disk storage and Color Printer option

Hi-performance disk controllers and I/O bus speeds

Hyperception

9550 Skillman LB125
Dallas, TX 75243
TEL (214) 343-8525
FAX (214) 343-2457

WEST GERMANY - Electronic Tools, phone: (02102) 841013, TLX 1631+BTX 02102841013 1+; fax: (02102) 841000 * UK, IRELAND - Loughborough Sound Images, LTD., phone: (0509) 231843, TLX 341409 LUFBRA G. fax: (0509) 262433 * FINLAND - ITI, phone: (90) 739 100, TLX 121450 MultiKomponent, fax: (90) 712 414 * FRANCE - BORES Technical Sales, phone: CC44 (0483) 740138, fax: (0483) 740136 * ITALY - Morra Ingegneri & Consulenti, phone: (172) 422577-422531, fax: (172) 431243 * DENMARK - Assenofte Electronics, phone: (06) 16 29 26, fax: (86) 16 20 12 * ISRAEL - IES Ltd., phone: (03) 7526333, fax: (03) 7510927

"your complete one-stop DSP shop"

**ULTRA-REL
MIXERS**
5-YR. GUARANTEE

WORLD'S SMALLEST SURFACE MOUNT MIXERS **JUST GREW!**

up to 1500 MHz LO up to 13dBm

For systems designs employing surface-mounting technology, Mini-Circuits now offers an expanded line of SMT mixers operating up to 1500 MHz with LO drive levels to +13dBm and RF input levels to +9dBm. The RMS-Series is the world's smallest double-balanced mixers, in a case only 0.25 by 0.30 by 0.2 in.

The tiny, non-hermetic package houses RF transformers, a ceramic-alumina substrate, and a four-diode assembly. A unique edge-plated design eases the job of making reliable solder connections to a printed-circuit board. A protective-barrier layer on top of the package's conductive layer retards the harmful effect of electromigration which may occur during soldering. The RMS can be attached to a pc-board by conventional manual soldering or with automatic equipment; mixers can be supplied in a tape-and-reel format for automated pick-and-place machines.

When you think SMT, think small, low-cost...
think Mini-Circuits RMS series.

finding new ways ...
setting higher standards

Mini-Circuits

A Division of Scientific Components Corporation
P.O. Box 350166, Brooklyn, New York 11235-0003 (718) 934-4500
Fax (718) 332-4661 Domestic and International Telexes: 6852844 or 620156

CIRCLE 115

WE ACCEPT AMERICAN EXPRESS

\$6.25

from

SPECIFICATIONS, typical mid-band response

MODEL	Frequency Range (MHz)		LO Level (dBm)	Conv. Loss (dB)	Isolation (dB)		Price \$ (1-9)
	LO, RF	IF			L-R	L-I	
RMS-1	0.5-500	DC-500	+7	5.5	33	30	6.25
•RMS-1LH	2-500	DC-500	+10	5.7	40	30	8.95
•RMS-1MH	2-500	DC-500	+13	5.7	40	30	10.45
•RMS-1R	0.5-500	DC-500	+7	5.5	33	30	14.45
RMS-2	5-1000	DC-1000	+7	6.5	35	30	6.95
•RMS-2LH	5-1000	DC-1000	+10	6.5	35	30	10.45
•RMS-2MH	5-1000	DC-1000	+13	6.5	35	30	11.45
•RMS-2U	10-1000	10-750	+7	6.5	40	35	11.45
•RMS-5	5-1500	DC-1000	+7	6.5	35	30	13.95

•new models
•hermetically sealed diodes

DAVE -
NICE DESIGN. I WRITE
DOWN SOME PARTS
THAT'LL MAKE IT A
REALITY. - J
P.S. KEEP YOUR DAY JOB!

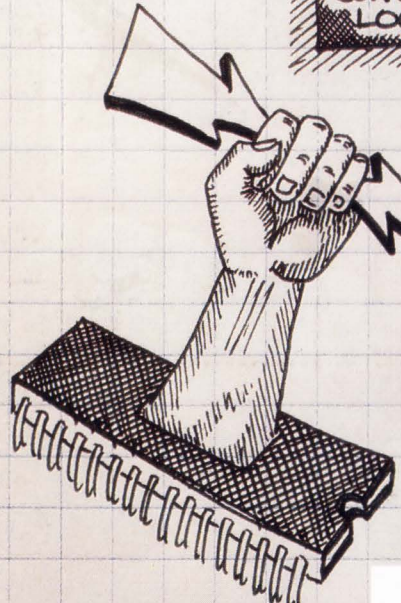
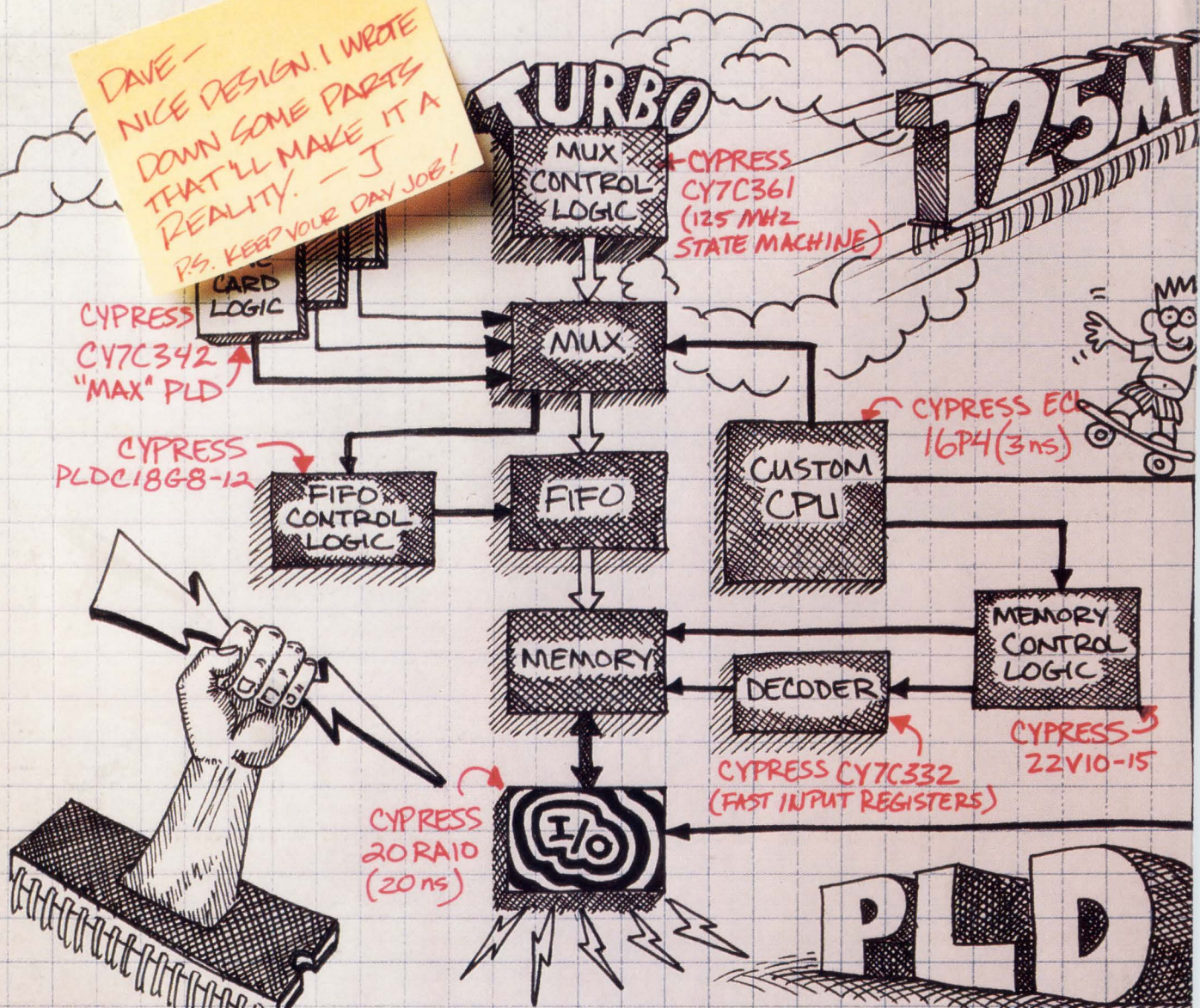

No matter where you're going, or how fast, we have the right PLD.

High Density Family: If you need density up to the level of small gate arrays, coupled with high performance and quick development times, our MAX™ family fills the bill. You get parts that can replace up to 50 TTL parts, or up to 15 PLDs, with performance to 50 MHz. Very flexible, very well supported.

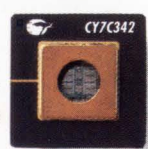

Functionally Specialized Family: We've created new architectures tailored to key functions, to give you maximum performance. For example, for state machine functions, our CY7C361 employs an innovative 'split-plane' architecture to cut feedback loop delay and enable 125 MHz performance.



Standard Enhanced Family: If you like the 'classics' but want state-of-the-art performance, you'll find plenty of solutions in our Standard Enhanced Family. Consider our CMOS 18G8 Universal PAL at 12 ns. Or our CMOS 22V10 at 15 ns. Or our 20RA10 at 20 ns. Our ECL 16P4 (10E302) at 3 ns. To name a very fast few.



Call for your free Data Book. Hotline: 1-800-952-6300.* Ask for Dept. C3J.

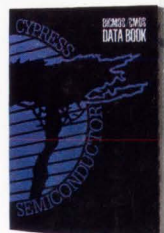

*1-800-387-7599 In Canada. (32)2-672-2220 In Europe.
©1990 Cypress Semiconductor, 3901 North First Street, San Jose, CA 95134. Phone: (408)943-2666, Telex 821032 CYPRESS SNJUD, TWX 910-997-0753. Trademarks: MAX - Altera Corporation.



CYPRESS SEMICONDUCTOR

