

**FUTUREBUS + GETS READY IN BUSCON'S BACKROOM
EMBEDDED CONTROLLER RUNS INSTRUCTIONS IN PARALLEL**

ELECTRONIC DESIGN

A PENTON PUBLICATION U.S. \$5.00

SEPTEMBER 14, 1989

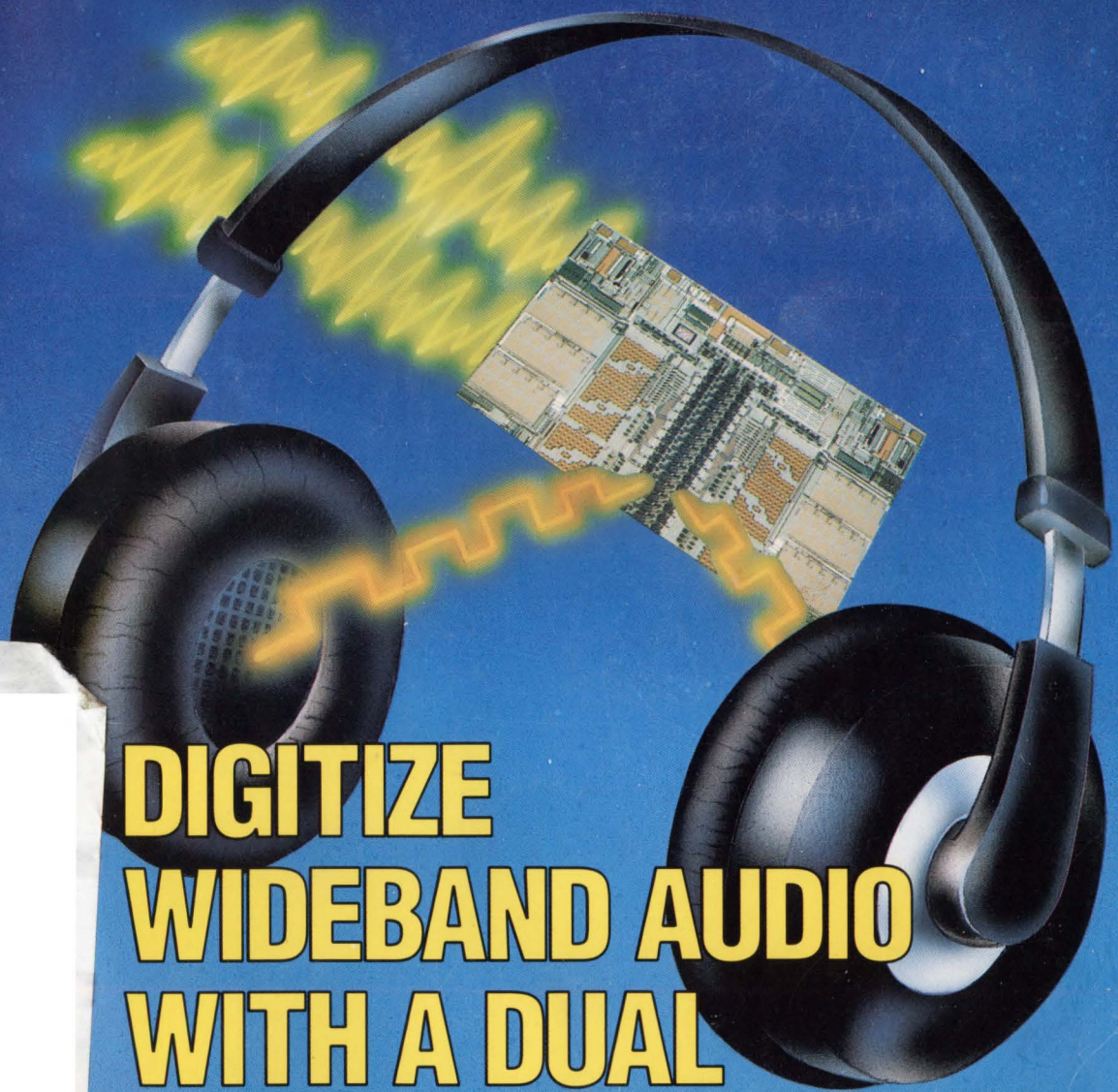

**DIGITIZE
WIDEBAND AUDIO
WITH A DUAL
18-BIT ADC CHIP**

SPECIAL REPORT: OP AMPS GROW IN VARIETY

The μ P-to-Peripheral Connection

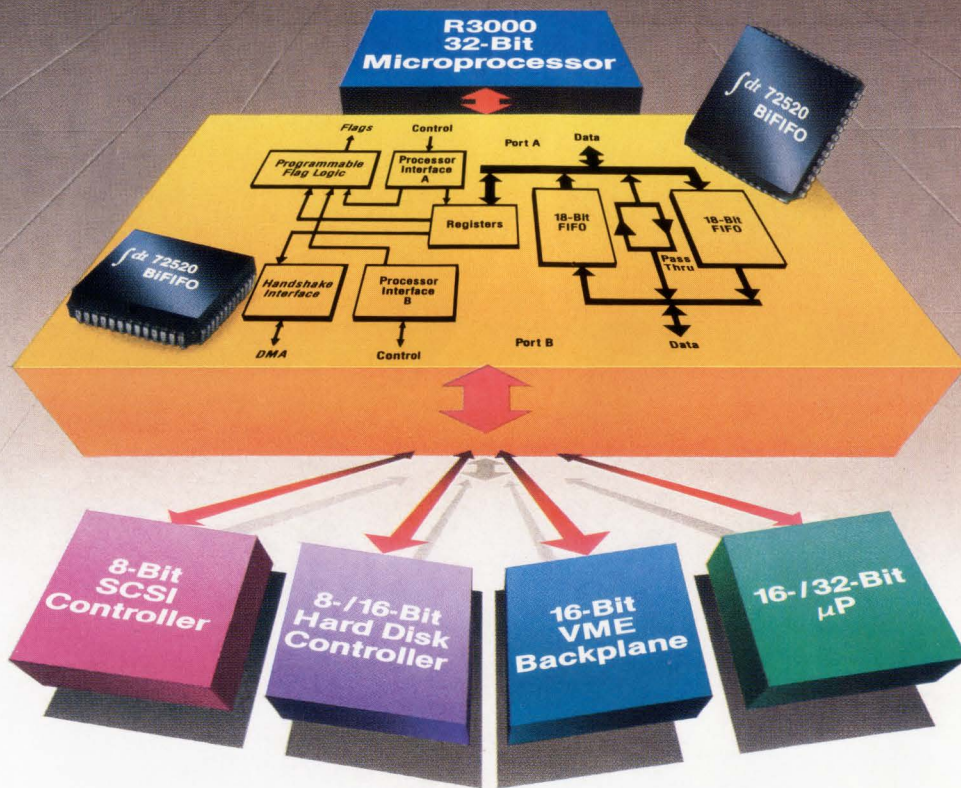

Introducing IDT's BiFIFOs

BiFIFOs bus match efficiently

Applications where a high-performance 32-bit RISC processor must talk to 8- or 16-bit peripheral controllers need IDT's new BiFIFO to minimize system chip count. IDT's bus matching bidirectional FIFOs make the ideal zero wait state connection between state-of-the-art processors and peripherals.

The BiFIFO integrates 18-bit to 9-bit bus matching logic and two full FIFO memories in one chip. Now for the first time a single chip can handle simultaneous communication in both directions. And at 35 ns the BiFIFO meets your processor performance needs.

Programmable configuration interface

Our BiFIFO has a microprocessor interface that gives you control over the BiFIFO's "personality". Ten registers configure features such as programmable flag offset, flag pin

assignment, DMA handshake, direct pass-through, and parity.

Flag offset can be programmed to any depth, giving you power over block transfer size and critical interrupts. The BiFIFO's DMA logic manages data block transfers, freeing your microprocessor for other crucial tasks. The pass-through path makes direct processor-to-peripheral command and status communication possible, eliminating external registers and reducing your board size.

Seamless interface for multiprocessing

Making two processors talk is not easy. But IDT's parallel BiFIFO makes the interface seamless, just like its bus matching brother. Multiprocessor arbitration is performed by the BiFIFO, simplifying your overall design. Since both of IDT's new BiFIFOs have the same architecture, whether you are using bus matching or parallel processing, we have the solution for you.

You can count on us

We know what you need. Call our Marketing Hotline at (408) 492-8675 to find out more about IDT's BiFIFOs. Or call (408) 492-8225 for a free copy of our 1989 Data Book Supplement with information on IDT's full range of high-performance system building blocks including RISC processors, SRAMs, multi-port and FIFO memories, standard and complex logic, and RISC subsystems and modules.

IDT, P.O. Box 58015, 3236 Scott Blvd., Santa Clara, CA 95052-8015, FAX 408-492-8674.

When cost-effective performance counts



**Integrated
Device Technology**

**Going
fast.**

Introducing ultra high-speed ECL logic packaged to meet your needs.

If the race belongs to the swift, then you're in fast company with Fujitsu Microelectronics. Because we'll give you all the high-speed ECL logic you need to win.

Whether you choose the 3GHz MB880 series, the 1.5GHz MB810 series, or our complementary 1-2.5GHz master slice series, the E128H, E32 and E128, you get the fastest UHECL logic available. And you get it packaged to go. Because it's on the shelf now.

You can even mix and match the MB880 and MB810 discrete logic series with the E128H, E32 and E128 master slice series for optimum system performance and cost.

Take the 3GHz MB880 discrete logic series and associated 2.5GHz E128 UHECL master slice array, for example. They were designed for ultra high-performance systems where speed is an absolute must.

Which makes them ideal for fiber-optics, telecommunications, video-graphics processing and high-speed computing applications.

When it comes to packaging for ultra-speed performance, we've got the MB880 and the master slice series all wrapped up in a compact, circular, ceramic flat package with radial leads.

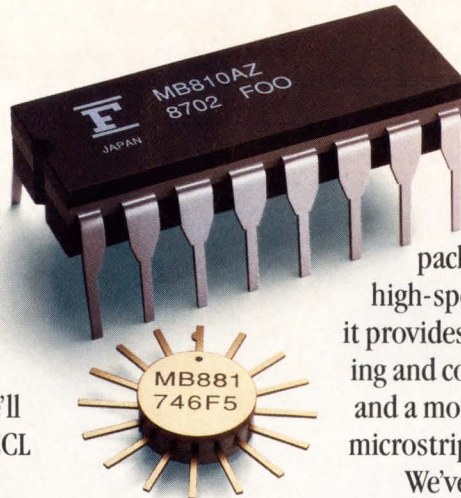

This unique package is designed for ultra high-speed applications. And it provides you with easier mounting and cooling, lower crosstalk and a more efficient interface to microstrip transmission lines.

We've even made it easy for you to check out our incredibly fast ECL process speeds for yourself. Our optional ECL test kit provides you with hardware to check out the performance of the circular ceramic flatpackage devices.

The 1.5GHz MB810 discrete logic series and 1.0GHz E128H and E32 master slice series are designed for use in high-speed test equipment, instrumentation and general logic applications. And they're conventionally packaged in 16-pin cerdip and ceramic flatpacks to provide performance at a lower cost.

What's more, you don't have to worry about compatibility, either. Because the MB880 and MB810 discrete logic series, and the E128H, E32 and E128 master slice array series are logic-level compatible with ECL 10K and 10KH series.

Best of all, they're from Fujitsu Microelectronics. The partner you can count on. Now and in the future. Providing you with the edge you need to always stay ahead.

If you'd like to know more about the UHECL series, call 800/642-7616. We'll show you how to fall in with a fast crowd.

FUJITSU

Every step of the way.SM

FUJITSU MICROELECTRONICS, INC.

Integrated Circuits Division

3545 North First Street, San Jose, CA 95134-1804. 1-800/642-7616.

© 1989, Fujitsu Microelectronics, Inc.

ELECTRONIC DESIGN

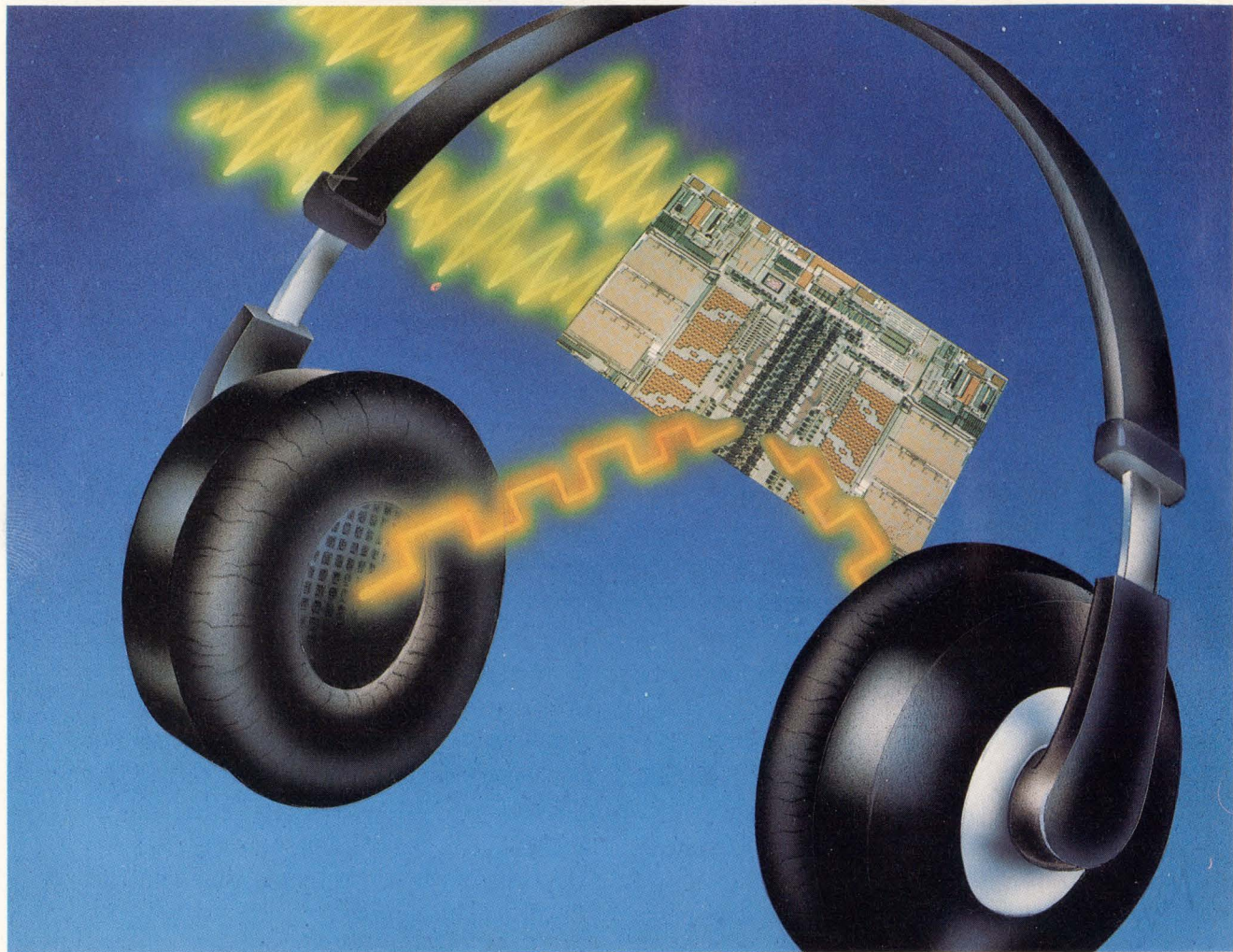

TECHNOLOGY ANALYSIS

37 FUTUREBUS APPROACHES FULL SPEC

Work groups are meeting at Buscon, which also features key VME, Multibus, and STD bus intros.

COVER FEATURE

49 DUAL 18-BIT ADC GRABS 20-KHz AUDIO

Aimed at digital-audio applications, this monolithic data converter offers 14 bits at 200 kHz for under \$1/bit.

ELECTRONIC DESIGN REPORT

57 PICKING IC OP AMPS: NO LONGER EASY

With improved process and circuit design, IC op amps challenge rivals.

DESIGN APPLICATIONS

73 BUILD A WIDE-BUS TEST SYSTEM

Designers face unique constraints when using off-the-shelf SCSI protocol chips in SCSI-2 systems

81 SHRINK RLL2,7 CODER'S DESIGN CYCLE

Develop and verify circuits in two weeks for an RLL2,7 coder with CAD on a PC/AT.

93 BRING PC COMPATIBILITY TO THE 80C186

A popular embedded control processor presents new opportunities for personal computer compatibility.

PRODUCT INNOVATIONS

115 MODIFY COMPONENTS TO CUSTOMIZE ICs

Large libraries plus tight tool integration equals simple analog and digital ASIC design.

119 PARALLELISM UPS PROCESSOR SPEED

Parallel instruction decoding and multiple execution units perform up to three multiple instructions per cycle to yield 66 MIPS.

12 EDITORIAL

18 TECHNOLOGY BRIEFING

Testing: Talking a better game

23 TECHNOLOGY NEWSLETTER

- Instrument CRT captures picosecond pulses
- Network and CPU get separate memory
- ASIC test approach clears hurdles
- Beta testing begins for graphics benchmark
- Modular architecture crafts custom boards
- Multiple write lines simplify byte parity
- Bipolar-circuits meeting promotes fast ICs

33 TECHNOLOGY ADVANCES

- Transputer modules ease parallel processing
- Expert software analyzes circuits, embeds test logic

105 IDEAS FOR DESIGN

- Upgrade with 1-Mbyte DRAMs
- Step driver delivers 0.1 to 9 A
- Switch-cap ICs filter transducers

111 PRODUCTS NEWSLETTER

- Op amps improve in price-performance
- Wide-band op amps come in tiny SO-8 package....
- ...Another sports precision and low noise
- 8-bit CPU chips feature embedded focus
- Network software ends memory conflicts
- I/O board boosts processing power
- Fiber-optic ethernet hooks directly to personal computer
- Graphics option boosts speed by as much as 500%
- Dual op amp runs off just 2 V; 40 μ A total
- 40-fA electrometer costs under \$1

NEW PRODUCTS

- 127 Instruments
Internal mass storage enhances fast digital scope
- 132 Computers & Peripherals
- 141 Analog
- 144 Digital ICs
- 148 Software
- 152 Computer Boards
- 154 Computer-Aided Engineering
- 155 Communications
- 156 Product News

165 NEW LITERATURE

171 UPCOMING MEETINGS

172 INDEX OF ADVERTISERS

173 READER SERVICE CARD

COMING NEXT ISSUE

- Special Report on DSP
- Latest developments in designing high-speed pc boards
- Special Reference Section: Interconnections & Packaging

ELECTRONIC DESIGN (USPS 172-080; ISSN 0013-4872) is published semi-monthly with one additional issue in March, June, September and December by Penton Publishing, Inc., 1100 Superior Ave., Cleveland, OH 44114. Second-class postage paid at Cleveland, OH, and additional mailing offices. Editorial, circulation, and advertising addresses: ELECTRONIC DESIGN Ten Holland Dr., Hasbrouck Heights, NJ 07604. Telephone (201) 393-6000. Facsimile (201) 393-6388; TWX-710-990-5071 (VNU BUSPUB UD), Cable (VNUBUSPUBS).

Title registered in U.S. Patent Office. Copyright © 1989 by Penton Publishing, Inc. All rights reserved. The contents of this publication may not be reproduced in whole or in part without the consent of the copyright owner.

Where necessary, permission is granted by the copyright owner for libraries and others registered with the Copyright Clearance Center (CCC), 21 Congress St., Salem, MA 01970, to photocopy any article herein for a fee of \$5.50. Payment should be sent directly to the CCC. Copying done for other than personal or internal reference use without the express permission of Penton Publishing, Inc. is prohibited. Requests for special permission or bulk orders should be addressed to the editor. ISSN 0013-4872 \$0.50+.25.

For subscriber change of address and subscription inquiries, call (216) 696-7000.

POSTMASTER: Please send change of address to ELECTRONIC DESIGN, Penton Publishing, Inc., 1100 Superior Ave., Cleveland, OH 44114.



Certificate of Merit
Winner, 1988
Jesse H. Neal Editorial
Achievement Awards

Cover illustration by Jim Kinstrey

Increasing Your System's Power Without Increasing Its Size?

See us at
Wescon '89
Booth 2253

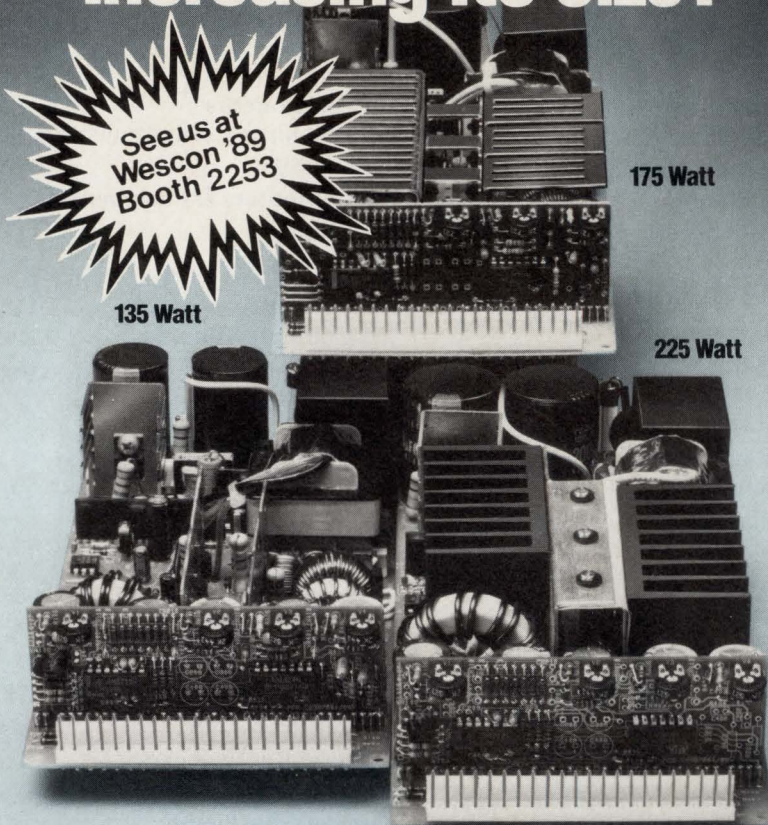

Three Power Levels... One Size: That Calls For The Interchangeable Standard Power Supply Family From Power Systems.

Family planning's at work here at Power Systems, developing an increasing range of PSI/STD convection-cooled, switch mode power supplies for data processing, instrumentation, and telecommunications applications. But here's the news: Now you can expand or contract the wattage in the same footprint.

If you've underestimated power requirements in the initial design, if you've over-specified, if market needs dictate more power for add-on boards... you'll find our PSI 135, PSI 175, and PSI 225 watt standard switching power supplies to be mechanically interchangeable. This allows you to use your existing chassis and harnessing, eliminating the need to redesign the system. That's because the PSI/STD

family has common mechanical interfaces. And with power densities up to 3 watts/in.³, convection cooled, we're going to provide the outputs and options you need. All PSI/STD supplies can be configured to operate in a redundant mode with our OR-ing board.

Write, call, TWX, or FAX today for full details, specs, options, and prices. This family of PSI/STD switching power supplies is ready and waiting for you.

Power Systems, Inc.

45 Griffin Road South, Bloomfield, CT 06002
(203) 726-1300 • TWX: 710-425-8778
FAX: (203) 726-1495.

© 1989, Power Systems, Inc.

ELECTRONIC DESIGN

Editor-in-Chief: Stephen E. Scrupski

Executive Editor: Roger Allan

Managing Editors:

Gil Bassak, *News and Products*
Bob Milne, *Design Applications*

Senior Editors: Frank Goodenough,
Milt Leonard, John Novellino

Technology Editors:

Analog & Power: Frank Goodenough
Computer-Aided Engineering: Bob Milne
Military & Industrial:
Milt Leonard (San Jose)
Microprocessor Systems: Lisa Gunn
Semiconductors: Dave Bursky (San Jose)
Test & Measurement: John Novellino

Associate Editors:

David Maliniak, Richard Nass

New Products Editor: Susan Nordyk

Field Bureaus:

West Coast Executive Editor:

Dave Bursky (San Jose)

Boston: Lawrence Curran

Dallas: Jon Campbell

Frankfurt: John Gosch

Chief Copy Editor: Clifford Meth

Copy Editor: Roger Engelke Jr.

Editorial Production Manager:

Donna A. Ullio

Associate Art Director: Alice Topf

Administrative Assistant: Janis Napolitano

Editorial Support Supervisor: Mary James

Editorial Assistant: Ann Kunzweiler

Editorial Secretary: Bradie Salazar

International Edition:

Executive Editor: Gil Bassak

Associate Editor: David Maliniak

Advertising Production:

(201) 393-6344 or FAX (201) 393-6452

Production Manager: Michael McCabe

Production Assistants:

Donna Bright, Doris Shiver

Traffic Clerk: Elaine Slavinsky

Circulation Manager: Elaine Brown

Subscription Inquiries: Mary Lou Allerton
(216) 696-7000

Reader Service: Paula Greenleaf

Reprints: Rita Gullotta (201) 423-3600

Group Art Director: Peter K. Jeziorski

Group Director, Editorial Production:

Anne Gilio Turtoro

Publisher: Paul C. Mazzacano

CIRCLE 100

99¢

from

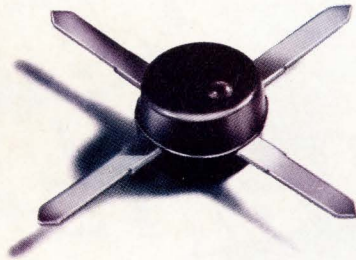

dc to 2000 MHz amplifier series

SPECIFICATIONS

MODEL	FREQ. MHz	GAIN, dB			Min. MHz	•MAX. PWR. dBm	NF dB	PRICE \$ Ea.	Qty.
		100 MHz	1000 MHz	2000 MHz					
MAR-1	DC-1000	18.5	15.5	—	13.0	0	5.0	0.99	(100)
MAR-2	DC-2000	13	12.5	11	8.5	+3	6.5	1.50	(25)
MAR-3	DC-2000	13	12.5	10.5	8.0	+8	6.0	1.70	(25)
MAR-4	DC-1000	8.2	8.0	—	7.0	+11	7.0	1.90	(25)
MAR-6	DC-2000	20	16	11	9	0	2.8	1.29	(25)
MAR-7	DC-2000	13.5	12.5	10.5	8.5	+3	5.0	1.90	(25)
MAR-8	DC-1000	33	23	—	19	+10	3.5	2.20	(25)

NOTE: Minimum gain at highest frequency point and over full temperature range.

- 1dB Gain Compression
- +4dBm 1 to 2 GHz

designers amplifier kit, DAK-2

5 of each model, total 35 amplifiers
only \$59.95

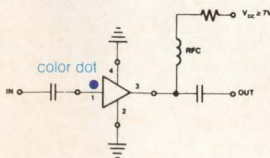

Unbelievable, until now... tiny monolithic wide-band amplifiers for as low as 99 cents. These rugged 0.085 in. diam., plastic-packaged units are 50ohm* input/output impedance, unconditionally stable regardless of load*, and easily cascable. Models in the MAR-series offer up to 33 dB gain, 0 to +11dBm output, noise figure as low as 2.8dB, and up to DC-2000MHz bandwidth.

*MAR-8, Input/Output Impedance is not 50ohms, see data sheet.
Stable for source/load impedance VSWR less than 3:1

Also, for your design convenience, Mini-Circuits offers chip coupling capacitors at 12 cents each.†

Size (mils)	Tolerance	Temperature Characteristic	Value
80 x 50	5%	NPO	10, 22, 47, 68, 100, 220, 470, 680, 1000 pf
80 x 50	10%	X7R	2200, 4700, 6800, 10,000 pf
120 x 60	10%	X7R	.022, .047, .068, .1µf

† Minimum Order 50 per Value

□ Designers kit, KCAP-1,
50 pieces of each capacitor value, only \$99.95

finding new ways ...
setting higher standards

Mini-Circuits

A Division of Scientific Components Corporation
P.O. Box 350166, Brooklyn, New York 11235-0003 (718) 934-4500
Fax (718) 332-4661 Domestic and International Telexes: 6852844 or 620156

FREE

*Making the change from
Analog to Digital scopes.*

**Scope Evaluation Guide
& Circuit Board instructions**

tronix 2440 500MS/s DIGITAL
OSCILLOSCOPE GPIB STATUS
LOCK SRQ ADDR



The Digital Scope Evaluation Kit

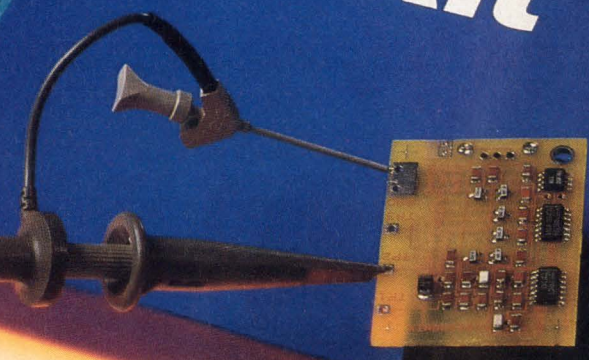

Do 3 simple tests you'd expect any digitizing scope to pass. And see why some don't.

Beware of bargain digitizing oscilloscopes that look good on paper but fall apart on the job.

Now, put any 100-500 MHz DSO to a true test of ability with Tek's *free* Scope Evaluation Kit.

All you need is a scope, ten minutes of your time, and this free kit.

You'll discover how well the scope you're testing stands up to the three challenges facing a digitizing scope buyer:

- Will the scope miss important events?
- Will it trigger on your signals?

- Will it accurately capture and measure your signals?

You can't safely assume that all scopes will meet these simple challenges.

See for yourself: The kit includes a compact, surface-mount circuit board with specially-designed signals that represent typical real-world measurements.

You'll be guided by an easy-to-follow, fully illustrated instruction manual. Even the battery is included.

Before you buy a DSO, you owe it to yourself to put any scope you're considering to the test. When you put Tek digitizing scopes alongside any other DSO, we're confident you'll see the difference.

To prove the point, Tek will *give* you the Scope Evaluation Kit — a \$20 value. **Free.**

Order your scope Evaluation Kit today. Return the reply card or call Tektronix toll-free: **1-800-426-2200**



Tektronix
COMMITTED TO EXCELLENCE

Who was the second person

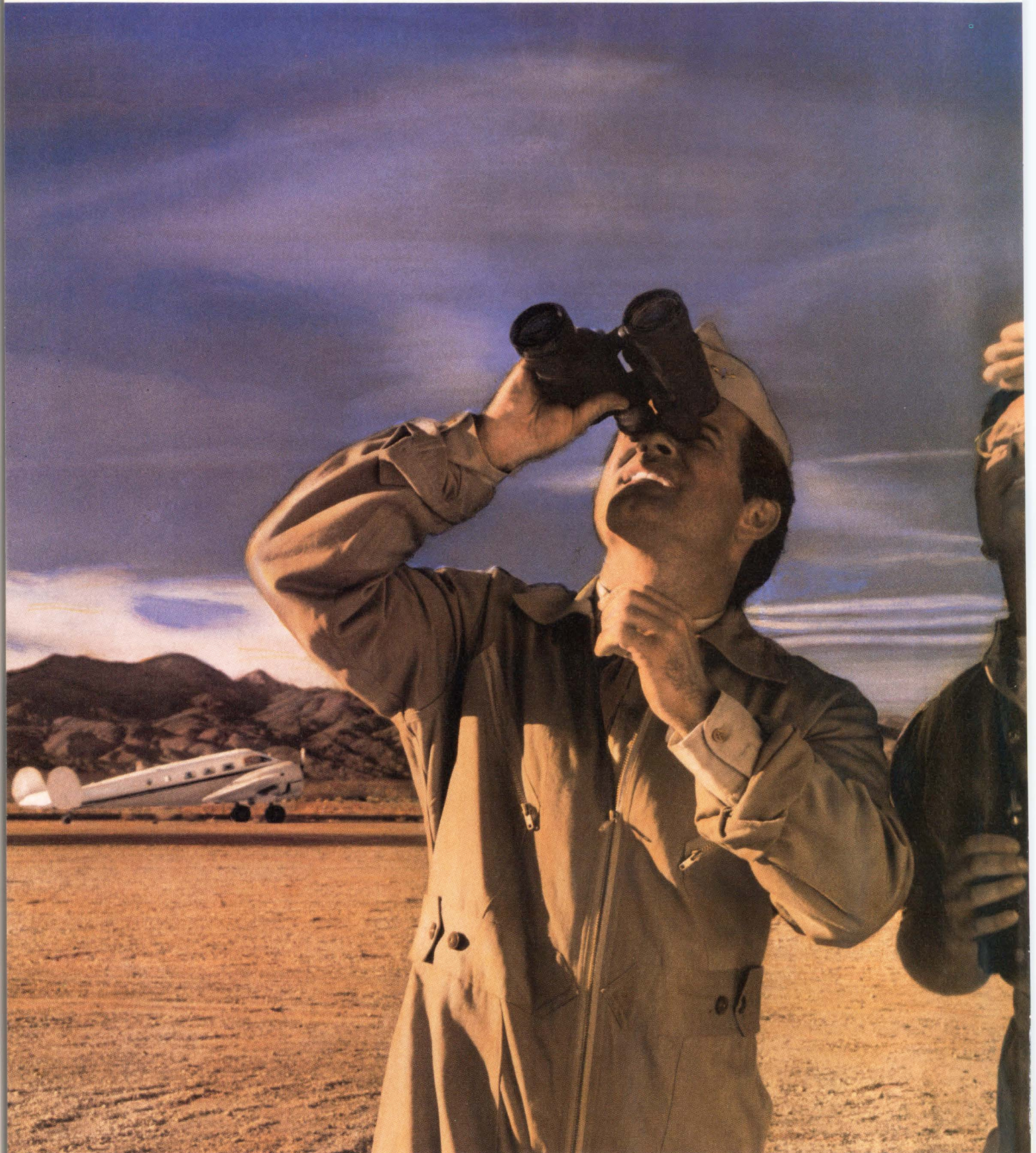

Captain James Fitzgerald was the second person to break the sound barrier at Muroc Dry Lake, on February 24, 1948.

to break the sound barrier?



Someone worked every bit as hard as Chuck Yeager and came in second. The sad truth is, no matter how fast you go, getting there second isn't fast enough.

The same holds true in the marketplace.

That's why AMD concentrates on complete design solutions that cut product development time. So your product won't be obsolete before it's shipped.

Take our 32-bit RISC microprocessor, the 29K™. At 17 MIPS, it's at the heart of some of the fastest, most powerful equipment now being built.

And everything you need to get to work is here. Today. From silicon to tools for hardware and software development. From AMD or any of 40 Fusion29K™ partners.

Which makes it easy for you to go out and get your share of the profits before anyone else gets off the ground.

Take your pick. You can work hard and produce anonymous products.

Or take AMD and fly to market.

Advanced Micro Devices 

901 Thompson Place, P.O. Box 3453, Sunnyvale, CA 94088.

For more information about the 29K, call (800) 222-9323.

© 1989 Advanced Micro Devices, Inc. 29K and Fusion29K are trademarks of Advanced Micro Devices, Inc.

CIRCLE 30

**New
CY545**

Only \$75 each
(\$25/1000s)



**Accelerate your
Stepper Motor
to 27,000
Steps/second!
Travel 16
Million Steps
and back!**

Is your motor earthbound by sluggish controllers that can't give you the performance you need? Look at what you get with the new CY545 single chip stepper motor controller:



- 40-pin, CMOS, +5v chip
- Speeds up to 27K Steps/sec
- 16 Million steps per motion
- Programmable start rate, accel/decel, slew rate
- Pulse and Direction Output
- Separate Limit Switches
- Jog operation
- Home seek command
- ASCII or binary commands
- Parallel or Serial interface
- 8 General Purpose I/O lines
- External memory control
- LCD & LED Display interface
- Thumbwheel Switch interface

Break the single chip *speed* barrier and the high performance *price* barrier. You can't afford to pass up this latest innovation from the company that, ten years ago, brought you the first stepper motor controller on a single chip! Order by Fax or phone or call today for free info.



Cybernetic Micro Systems
Box 3000, San Gregorio, CA 94074
Tel: 415-726-3000 Fax: 415-726-3003
Telex: 910-350-5842



THE SHOCKLEY-ROSE SYNDROME

Sometimes, you can take self-confidence too far. In recent weeks we have been reminded of this by two events: the lifetime ban from baseball placed on Pete Rose, and the death of transistor co-inventor William Shockley. Both men needed an abundance of self-confidence to accomplish what they did in their respective fields. Consistently hitting a baseball requires extreme confidence in one's ability, as does applying emerging principles of solid-state physics to a new class of electronic devices. Though Rose and Shockley might both make excellent role models in their fields, each one also took his self-assurance slightly beyond what's proper.

In Rose's case, his arrogance in flouting the rules of baseball is an extrapolation of his supreme self-assurance in his athletic skills. Similarly, Shockley was blessed with great intelligence and keen scientific analytical ability, but he also crossed the line when he stepped away from his knowledge of semiconductor physics and entered the realm of genetics. It's unfortunate that both giants of their respective fields will be remembered not only for their herculean achievements but also for their lapses.

If what we've read is true, Rose wasn't blessed with an outstanding amount of natural talent, but he developed his skill through intense practice—taking hundreds of ground balls a day in fielding practice, hours of extra batting practice, and the like. And he continued practicing his profession long after the time when others couldn't keep pace with the hot new rookie phenoms who sought to take the jobs of older players. Most over-40 engineers can identify with such dedication to the profession, as well as the problems of having to outperform new graduates with a more modern engineering education. Consequently, as a role model, Rose is in some ways a better example for engineers to follow than Shockley was.

Of course, semiconductor technology is one of the cornerstones of the electronics industry. And we all owe a big debt to William Shockley. Let's simply remember him as a pioneer whose work at Bell Laboratories has made life better for all of us.

Stephen E. Scrupski
Editor-in-Chief



value-packed
filters **\$11⁴⁵**
 from

dc to 3GHz

- less than 1dB insertion loss over entire passband
- greater than 40dB stopband rejection
- 5 section, 30dB per octave roll-off
- VSWR less than 1.7 (typ)
- over 100 models, immediate delivery
- meets MIL-STD-202
- rugged hermetically sealed package (0.4 x 0.8 x 0.4 in.)
- BNC, Type N, SMA available

finding new ways...
 setting higher standards

Mini-Circuits

A Division of Scientific Components Corporation
 P.O. Box 350166, Brooklyn, New York 11235-0003 (718) 934-4500
 Fax (718) 332-4661 Domestic and International Telexes: 6852844 or 620156

LOW PASS	Model	*LP-	10.7	21.4	30	50	70	100	150	200	300	450	550	600	750	850	1000
Min. Pass Band (MHz) DC to			10.7	22	32	48	60	98	140	190	270	400	520	580	700	780	900
Max, 20dB Stop Frequency (MHz)			19	32	47	70	90	147	210	290	410	580	750	840	1000	1100	1340
Prices (ea.): Qty. (1-9) P \$11.45, B \$32.95, N \$35.95, S \$34.95																	

HIGH PASS	Model	*HP-	50	100	150	200	250	300	400	500	600	700	800	900	1000
Pass Band (MHz)	start, max.		41	90	133	185	225	290	395	500	600	700	780	910	1000
	end, min.		200	400	600	800	1200	1200	1600	1600	1600	1800	2000	2100	2200
Min. 20dB Stop Frequency (MHz)			26	55	95	116	150	190	290	365	460	520	570	660	720
Prices (ea.): Qty. (1-9) P \$14.95, B \$36.95, N \$39.95, S \$38.95															

*Prefix P for pins, B for BNC, N for Type N, S for SMA
 example: **PLP-10.7**
 CIRCLE 31

An idea this small

This is the AMPMODU System 50 connector.

Definitely worth getting close enough for a good look.

It comes in a comprehensive system. Everything you need for a 0.050" x 0.100" grid. Board-to-board, stacking, or mother/daughter. FFC to board. 0.050" CL flex etched circuitry to board. 0.025" CL ribbon cable to board.

Special design innovations (such as putting the latch hardware on the *cable* side) shrink our System 50

line to the least board space of any connector in this class. Even 0.050" x 0.050" types.

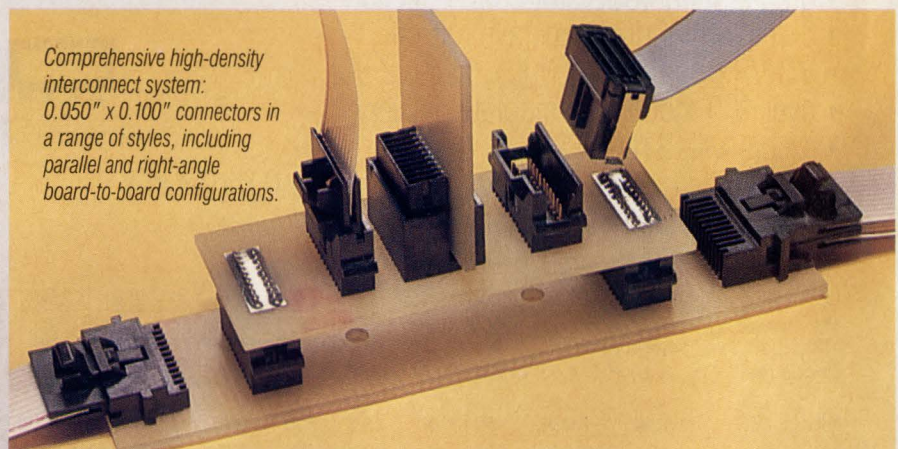

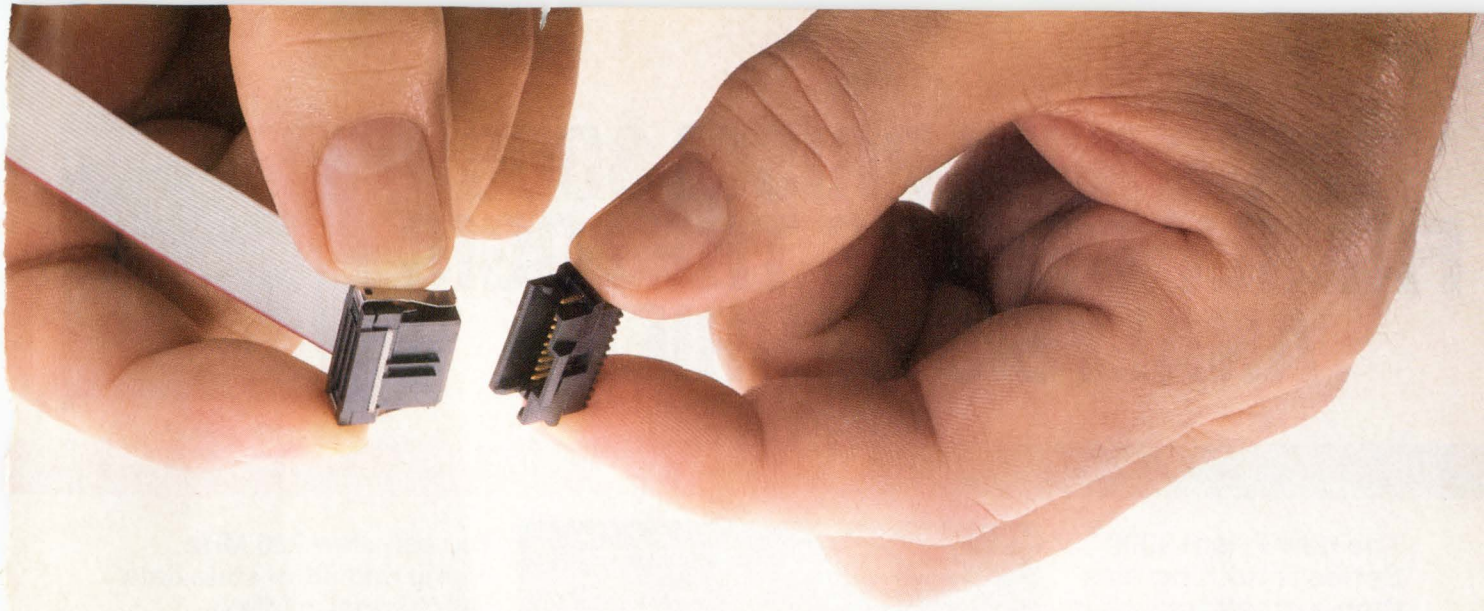

is no small idea.

Example: 2x25 position shrouded headers occupy 1.5" x 0.284" of board surface. And parallel boards mount with inside faces a mere 0.450" apart.

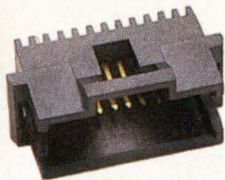

Along with density, you also get the productivity you expect from AMP: simple mass termination, robotic handling features, high-temp housings, selective gold plating.

And of course, outstanding quality and reliability.

AMPMODU System 50 connectors are available in selected sizes of 4 through 30 single row positions, 8 through 100 in dual row, with shrouded or unshrouded headers. With all those variations, you could do almost anything your design requires.



Which is our whole idea.

Call the AMP Information Center at 1-800-522-6752

to ask about our AMPMODU System 50 line. For characterized backplane assemblies, contact AMP Packaging Systems Inc., P.O. Box 9400, Austin, Texas 78766, (512) 244-5100, or your AMP Sales Engineer. AMP Incorporated, Harrisburg, PA 17105-3608.

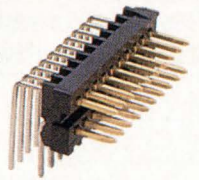

AMP Interconnecting ideas

TEK'S NEW PRISM 3000 FAMILY BREAKS THE LOGIC ANALYSIS BARRIER.

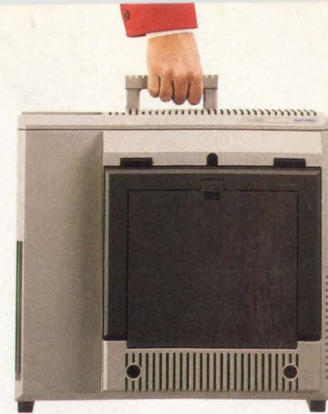

The new Prism 3000 Series is nothing less than a breakthrough in the evolution of logic analysis: once you see what it can do, you may scarcely imagine doing without it.

Now digital designers and integrators can start with all the speed, channels and memory depth they need — without tradeoffs. They can mix-and-match tools for their specific needs, including 8, 16 and 32-bit microprocessor debug modules brimming with features never before possible in a logic analyzer. They can add other modules, such as for high-speed timing and waveform analysis, later.

The new dimension of hardware/software integration.

- Microprocessor control
- Real-time performance analysis
- 200 MHz timing
- 8K deep state analysis
- Multiple microprocessor support



You can view 200 MHz timing and 8K of state data per channel, all time-correlated and integrated on the same display.

Observe data from multiple microprocessors or time-bases simultaneously. Set up



(Above, left) Real-time performance analysis as displayed on the Prism color monitor. (Left) The Prototype Debug Tool provides easy access to microprocessor control and debug functions, including the ability to set hardware and software breakpoints, and to patch registers and memory.

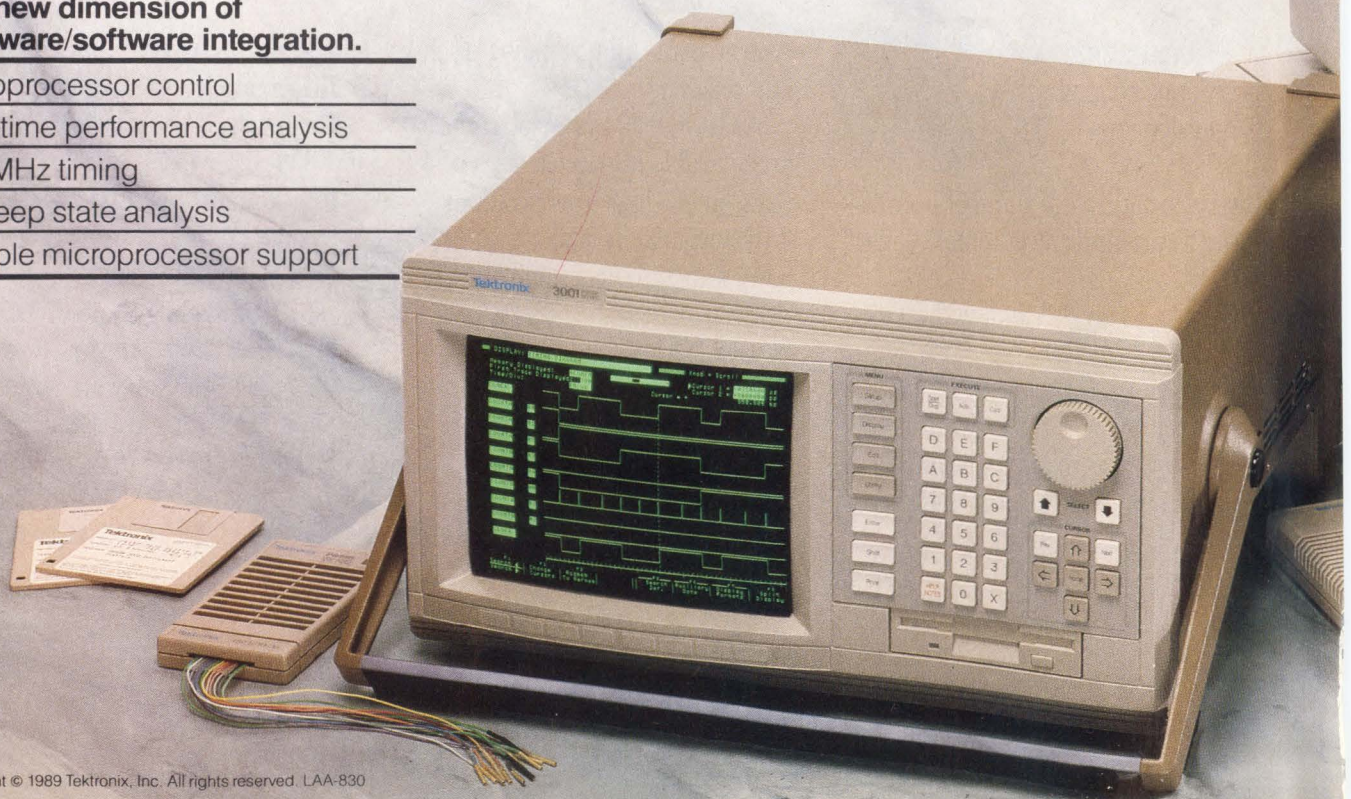



The Prism 3002P configuration features a slide-away keyboard and a 640x400 flat panel display that folds against the mainframe when not in use.

state and timing sections to cross-trigger, synchronize and arm each other, so you know exactly when and in what time relationship events occur.

Push beyond microprocessor observation into emulator-like microprocessor control.

With its unprecedented Prototype Debug Tool, Prism is the first logic analyzer to let you set breakpoints, patch registers and memory, restart

the system, and more — without an emulator's intrusiveness (or the long wait for new emulator availability).

Use real-time performance analysis to get a true, non-statistical view of system performance.

Designers of embed-

Complete front panel controls are included on the Prism keyboard, enabling users to move easily from one Prism mainframe to another.



ded control systems will especially benefit from histograms of uncompromising accuracy.

Choose from a stand-alone version, expandable mainframe-and-monitor, even a portable model with fold-up flat panel screen.

Features like auto-load, split-screen displays, smooth scrolling, automatic timestamping and on-line help notes make Prism refreshingly simple to learn and use.

The clincher? You can step into this new generation of logic analyzers at prices starting at \$8600.

Call 1-800-426-2200 for our free video demo and literature packet. Prism breaks so much new ground and offers so much to build on, you owe yourself a look. For a hands-on introduction, call your Tek sales engineer soon.

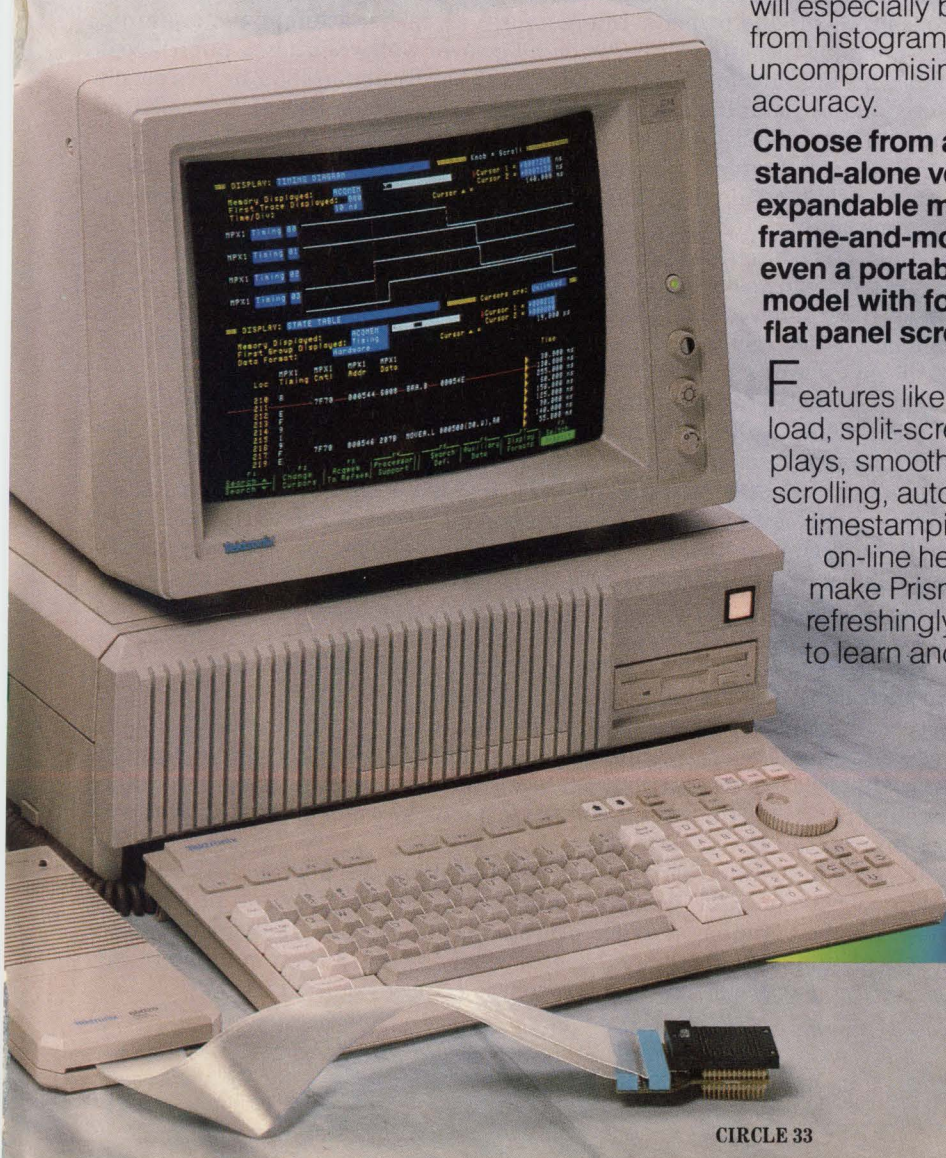

Tektronix
COMMITTED TO EXCELLENCE

Keystone

LOW-COST GLASS ENCAPSULATED THERMISTORS



sense
temperature
quickly

These NTCs—hermetically sealed in glass—are well protected from hostile environments to temperatures beyond 200°C. They protect themselves while reliably sensing air or surface temperatures either exposed or within probe housings. Resistance values @ 25°C: 1K to 5 megohm. Response time: 3 seconds. Price: Well below glass bead designs in any quantity.



Also available
in tape and reel
for automatic insertion.

Send for data bulletin.

Keystone

CARBON COMPANY

Thermistor Division • St. Marys, PA 15857
Phone 814-781-1591 • Telex No. 91-4517

Keystone Thermistors are distributed by

Allied Electronics 1-800-228-6705 Newark Electronics 312-638-4411
Digi-Key Corp. 1-800-344-4539 SIN-TEC Electronics 1-800-526-5960

CIRCLE 102

TECHNOLOGY BRIEFING

TESTING: TALKING A BETTER GAME

An encouraging trend is developing in the test-and-measurement industry—people are starting to talk to each other. Discussions are being held among instrument manufacturers as well as between manufacturers and users. And these aren't just the off-hand comments made at trade shows or during sales pitches—they're formal, useful talks that are positively affecting the way test-and-measurement people do their jobs.

First came the VXIbus standard for instruments on a card. The U.S. Air Force had asked the Modular Automated Test Equipment users group to write an open standard for its own use, but five manufacturers instead decided to develop a standard for both military and commercial users. The standard was completed in 1987, and several development systems and instrument modules were available within the next few months. At ATE & Instrumentation East in June, at least a dozen booths displayed VXIbus products.

Next came an update to the venerable IEEE-488 standard for the general-purpose interface bus, published in June, 1988. Document IEEE-488.2 simplified instrument programming and control by creating a layer of communications protocols and formats. Interestingly, an earlier attempt at standardizing codes and formats, IEEE-728, didn't go over well when it was published in 1981. This time around, though, the ink was hardly dry on 488.2 before people were talking about the possibility of standardized higher-level, device-based commands—an IEEE-488.3.

An eager volunteer in the battle for standardization is Hewlett-Packard. Last month, the Palo Alto-based company opened its test-and-measurement systems language (TMSL) to the public. The language uses one command to perform a specific function, regardless of the type of instrument or model. Hewlett-Packard, whose HP Instrument Bus served as the basis for IEEE-488 in 1975, believes that TMSL would make an excellent 488.3. In fact, the company is actively seeking an organization willing to manage the adoption of the language as a standard.

Talks between test-equipment manufacturers and users are also starting to bear fruit. At the International Test Conference in Washington last month, Integrated Measurement Systems Inc. introduced a scan test module for its Logic Master XL series of ASIC test-and-verification systems. Much of the product definition work on the new module resulted from the efforts of the Scan Technical Advisory Group (ScanTAG), which IMS formed with key users in August, 1988 to address scan-test issues. The company also participated in the Joint Test Action Group (JTAG), sent out detailed questionnaires to important users, and conducted one-on-one meetings with customers.

IMS learned that users want a system that supports a number of design-for-testability scan techniques besides that in the JTAG IEEE P1149.1 proposed standard. Consequently, the module also accommodates scan path, scan set, random-access scan, boundary scan, and level-sensitive scan design. Other ScanTAG contributions were the need for optimal serial/parallel memory depth and for ways to convert test data into meaningful and easy-to-use information.

It's easy to see how this trend will help test-equipment users do a better job less expensively. R&D costs too much to spend the effort on proprietary buses and test languages to perform standard functions. Instead, manufacturers should compete on the basis of what functions their equipment can perform and with what accuracy, resolution, speed, and so forth.



JOHN NOVELLINO

TEST & MEASUREMENT EDITOR

LEADER

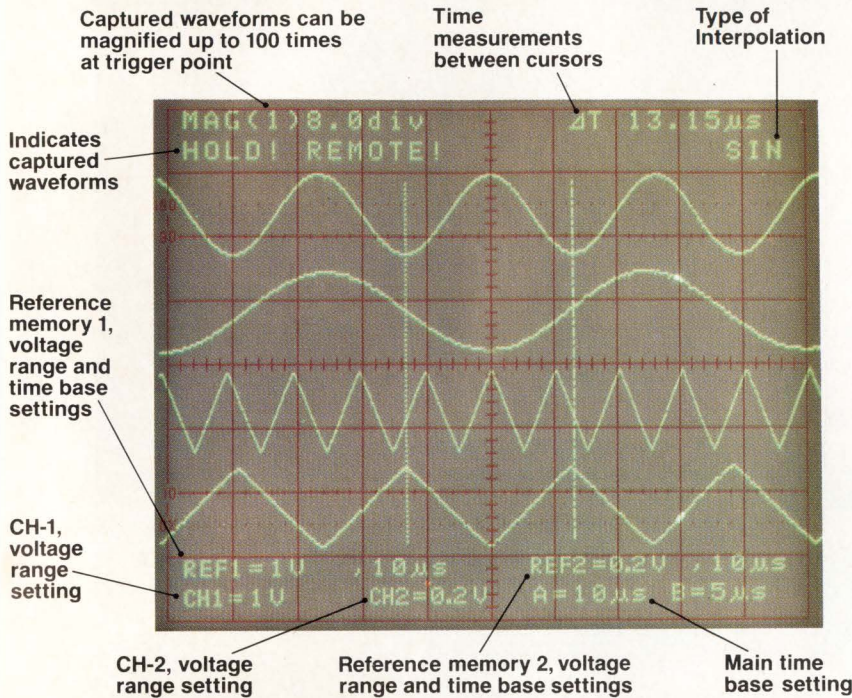

New full-time digital storage oscilloscope grabs fast events!

Perfect for freezing fast and slow events, the Model 3060D performs as a 40MS/s digital storage oscilloscope and 60-MHz real-time scope.

With high-speed digitizing and CRT readout with cursors, you can capture and easily analyze single-shot events, fast transients and slowly occurring phenomena.

Expand captured waveforms up to 100 times and interpolate them; store four waveforms in the 2k word/2-channel memory for immediate or later evaluation, and send fully documented waveforms to a plotter.

Plus, calibrated delay sweep, pre-trigger functions, p-p auto triggering, sine and pulse interpolation, autoranging time base... etc. And for computer control, GPIB is standard.

The 3060D is backed by a TWO-YEAR WARRANTY, and factory service depots on both coasts.

Look at Leader and see the difference. Phone now for our catalog, an evaluation unit, and the name of your nearest "Select" Leader Distributor.

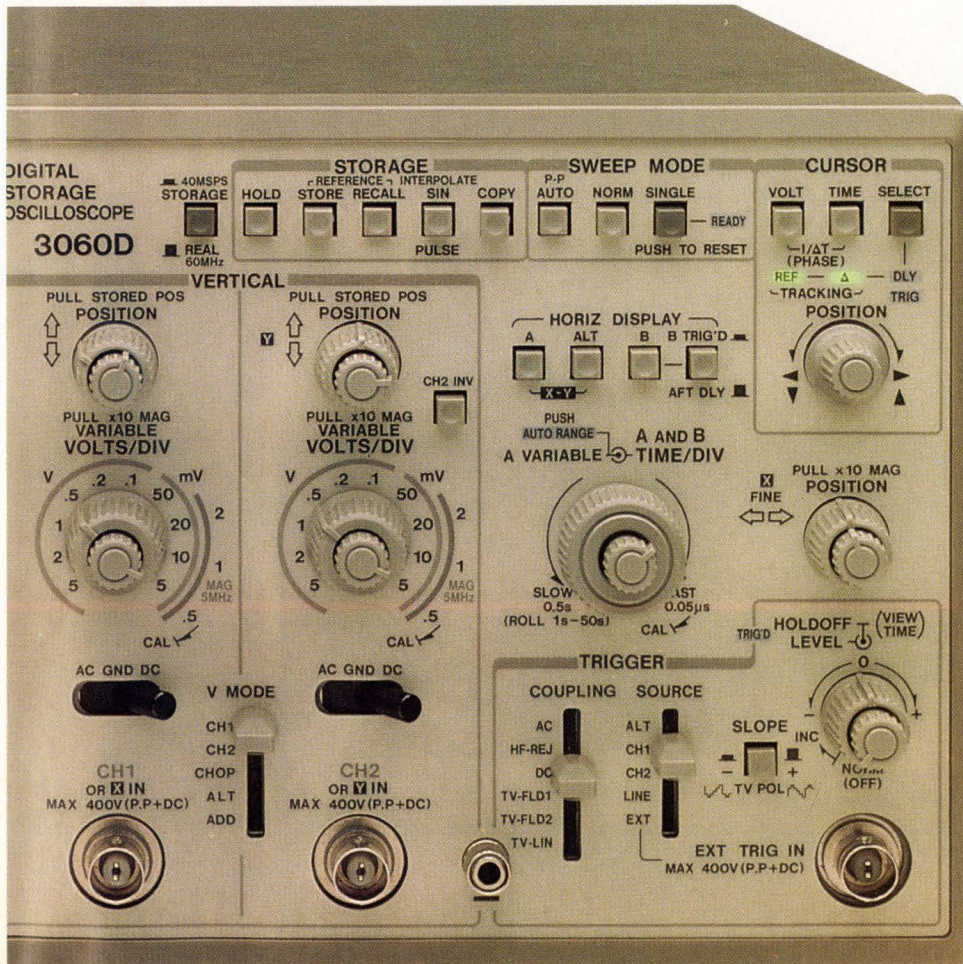

Call toll-free
1 800 645-5104
 In NY State
516 231-6900

Leader Instruments Corporation
 380 Oser Avenue, Hauppauge, New York 11788
 Regional Offices:
 Chicago, Dallas, Los Angeles, Boston, Atlanta
 In Canada call Omnitrion Ltd. 416 828-6221

LEADER
 FOR PROFESSIONALS WHO KNOW
 THE DIFFERENCE

For Product Information Circle 34
 For Product Demo Circle 35

WHAT EXACTLY
CAN THE WORLD'S
MOST POWERFUL AND
EXPANDABLE PC DO?



INTRODUCING THE COMPAQ DESKPRO 386/33 PERSONAL COMPUTER.

Never before has so much performance, expandability and storage been put into one desktop PC. And never before has one PC been capable of so much.

Inside its new system unit, you'll find that our engineers have redesigned just about every component to deliver a minicomputer level of power with unmatched PC flexibility.

So you can use it as a stand-alone PC, putting its power to work on the most demanding CAD/CAE, financial analysis, database management and personal productivity applications.

Or you can spread the power around, using the COMPAQ DESKPRO 386/33 as the driving force for a network or multiuser system.

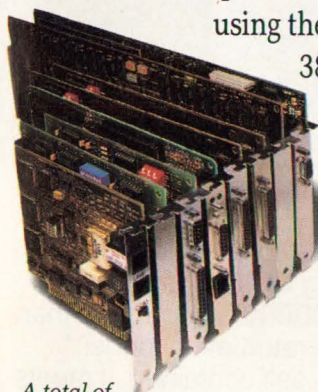

A total of eight expansion slots let you customize the system to your needs by expanding memory and choosing from thousands of industry-standard expansion boards.

At the heart of the system is the Intel 386™ microprocessor. Running at a blazing 33 MHz, it works in concert with a series of technological advancements. Like a 33-MHz cache memory controller with 64K of high-speed static RAM. Interleaved memory architecture. And the exclusive COMPAQ Flexible Advanced Systems Architecture.

This high-performance combination delivers a 35% performance improvement in CPU-intensive applications over 25-MHz 386 cache-based PC's.

Or said another way, nothing will slow you down. No matter what you want to do. You can expand the 2 MB

of standard RAM up to 16 MB using the high-speed 32-bit slot. That leaves up to six industry-standard slots free to customize the system to the demands of the application you're using.

If your job is particularly demanding, you can

use up to five high-performance internal storage devices to hold up to 1.3 gigabytes of data. And if that's not enough, bring total system storage to 2.6 gigabytes with the optional

COMPAQ Fixed Disk Expansion Unit.

There's more. You can run MS-DOS®, MS® OS/2, Microsoft® Windows/386 and the XENIX® and UNIX® operating systems.

Access memory over 640K under DOS with the COMPAQ Expanded Memory Manager that supports Lotus/Intel®/Microsoft (LIM) 4.0.

And speed through

calculations with 33-MHz Intel 387™ and Weitek 3167 coprocessor options.

All the new advancements engineered into the COMPAQ DESKPRO 386/33 deliver an unmatched level of power, expandability and storage. To do anything you want.

To find out more, please call 1-800-231-0900, Operator 97. In Canada, 1-800-263-5868, Operator 97. We'll send you a free brochure and give you the location of your nearest Authorized COMPAQ Computer Dealer.

COMPAQ® It simply works better® Registered U.S. Patent and Trademark Office. Intel®, Intel 386 and Intel 387 are trademarks of Intel Corporation. Microsoft®, MS®, XENIX® and MS-DOS® are trademarks of Microsoft Corporation. MS® Windows/386 and MS® OS/2 are products of Microsoft Corporation. UNIX® is a registered trademark of AT&T® *Registered U.S. Patent and Trademark Office. Product names mentioned herein may be trademarks and/or registered trademarks of other companies. ©1989 Compaq Computer Corporation. All rights reserved.

ANYTHING IT WANTS.

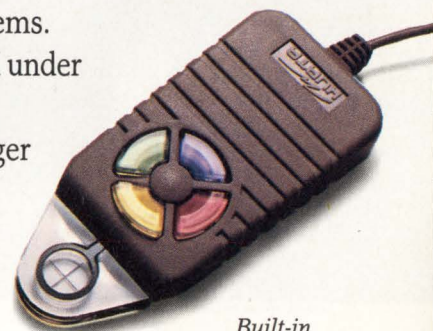

Built-in interfaces make it easy to connect pointing devices, printers, plotters or other peripherals without using an expansion slot.

At the heart of the system is the Intel 386™ microprocessor. Running at a blazing 33 MHz, it works in concert with

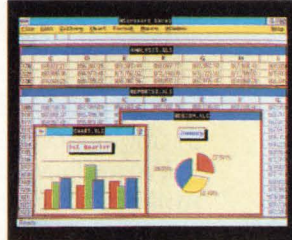
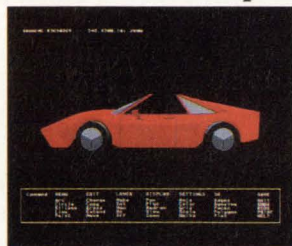

High-speed VGA graphics are built in. And for greater graphics capabilities, add the optional COMPAQ Advanced Graphics 1024 Board.



It simply works better®



GENERAL DYNAMICS LAND SYSTEMS

Generations from now, when today's state-of-the-art fighting systems have taken their place in armament history books, today's Abbott power supplies will still be operating reliably.

Outfitted for Enhanced Reliability, for example, our new 60 Watt triple-output switching DC-DC converter achieves an MTBF rating up to 600,000 hours; more than 68 years. A single-output model is rated even longer.*

Yet this compact package is fully self contained. It meets the tough EMI limits of MIL-STD-461C. And the punishing environmental specs of MIL-STD-810C and MIL-S-901C.

While the BC60 is brand new, this is no "developmental" power supply. Its topology is identical to our field proven BC100 and BC200 models. Its design integrity is verified through rigorous ESS testing.

We're delivering power supplies for projects critical to America's defense, including MILSTAR, the EH101 helicopter, the TOW missile, INEWS and the F/A-18 Hornet.

For a copy of our 1988 Military Power Supply Product Guide, write us at 2721 S. La Cienega Boulevard, Los Angeles, CA 90034. (800) 556-1234 XT9; CA (800) 441-2345 XT9.

*MTBF FIGURES CALCULATED PER MIL-HDBK-217E GROUND.

Versatile new 60 Watt switcher measures 5 x 4 x 1.5 inches. Provides outputs of 5, 12, 15, 24 or 28 V dc, from inputs of 18 to 36 V dc. Operating temperature from -55°C to +100°C. Overvoltage protection & short circuit protection standard.



**Our power supply
is built to
outlast the tank.**

abbott

WHEN RELIABILITY IS IMPERATIVE.™

CIRCLE 60

INSTRUMENT CRT CAPTURES PICOSECOND PULSES

An oscilloscope tube from the Components Division of Philips N.V., claims to capture nonrepetitive, narrow pulses faster than any other oscilloscope tube in the world. Developed at the company's Paris research labs, the D3-120KA/N boasts a bandwidth of 7 GHz, compared with 3 GHz for existing ultra-fast CRTs. The result is a giant leap forward in single-shot electronic imaging. The high bandwidth makes the tube suitable for applications in high-speed digital communications, particle physics, and high-power laser research. The 7-GHz bandwidth corresponds to a 50-ps pulse rise time. The bandwidth comes from the tube's vertical-deflection system, which consists of a tiny helix line. The horizontal-deflection system, which is built around a symmetrical meander line, has a 3-GHz bandwidth. As a result, fast deflection signals of linear, sinusoidal, or mixed types can be used. For timing, the D3-120KA/N uses 100-ps marking pulses, which can be superimposed on the signal by an independent deflection system. JG

2-A TRIAC-OPTOCOUPLER HANDLES RECORD POWER

Representing a virtual powerhouse in the triac-optocoupler field, the IL428 from Siemens AG handles 2 A—almost ten times the current-handling capability of conventional couplers. According to the company, this ability makes the chip the most powerful triac-optocoupler to date. Developed at Siemens Components Inc.'s Optoelectronics Division, Cupertino, Calif., the coupler comes in a new single-in-line package that needs no cooling, even for 2-A operation at up to 55°C. It consists of a GaAs infrared light-emitting diode optically coupled to a photo-triac. The photo-triac is so sensitive that control currents of less than 8 mA will switch the 2-A maximum current, and for resistive, inductive, and capacitive loads of 120 V, 230 V, and 380 V. Besides having applications in semiconductor relays, industrial controls, office equipment, and consumer electronics, the coupler opens up new applications for current switching in line-powered systems. JG

ASIC TEST APPROACH CLEARS HURDLES

Roadblocks on the path from simulation to test can often hinder successful ASIC designs. These obstacles include logic simulation; incorporation of tester-specific limitations, which means knowing what stimulus will be produced; and simulation verification and translation. The DesignTest approach offered by NCR, Ft. Collins, Colo., contains several key elements that team up to clear these hurdles. A central database contains complete and consistent data for both the design and test environments. A high-level simulation language adds portability across popular simulators, and built-in tester knowledge increases tester compatibility. Because an expected device response is included, the verification can also be performed at several stages within the design cycle. A paper on the DesignTest approach is one of many concerning all aspects of ASICs to be presented at the Second Annual IEEE ASIC Seminar and Exhibit in Rochester, N.Y., September 25 to 28. RN

MODULAR ARCHITECTURE CRAFTS CUSTOM BOARDS

Creating custom versions of standard board families can run up high non-recurring engineering charges. A better way to create application-specific boards is to have a "base" board with a minimal set of functions, a local bus, and optional peripheral modules. The Corebus architecture from Heurikon, Madison, Wis., consists of a CPU bus extension and optional plug-over modules. The local bus isn't easy to design: It must be fast enough to support a high-bandwidth link between the base board and the modules, yet flexible enough to satisfy the requirements of a broad range of memory and peripheral devices. Heurikon's Corebus is a standard 50-MHz, synchronous extension of a CPU card's internal bus that burst-transfer up to 200 Mbytes/s. In addition, it supplies flexible, multimaster arbitration and is compatible with both RISC and CISC processors. For board customization, application-specific options like specialized memory, DMA, Ethernet, and graphics are added through Corebus modules. LG

8051 MICROCONTROLLER RUNS FROM 1.5-V SOURCE

Thanks to a low-power, self-aligned CMOS process technology, power-saving operating modes, and specific design measures, engineers at Philips International N.V., Eindhoven, the Netherlands, have readied an 8051-based microcontroller that works from supplies as low as 1.5 V. Philips claims that this operating voltage is the lowest for any microcontroller to date. The PCF84C410 opens up many new markets for one-cell-battery applications, including pocket telephones and portable telecom equipment (cordless and cellular phones, facsimile systems, and answering machines). The device also fits general-purpose jobs in instrumentation, industrial control, intelligent computer peripherals, portable consumer products, and smart cards. The 16-MHz controller typi-

cally draws 1 mA from a 3-V supply at a 3.58-MHz clock frequency. Its idle- and power-down modes cut current drain to 0.5 mA and 1 μ A, respectively. The chip's own oscillator circuits work down to 32 kHz. With external oscillators, the controller operates down to dc, which means the clock can be turned off. When it's turned back on, the 84C410 resumes the operation it was performing. The result is even lower current drain because the controller lies dormant until the clock stream resumes. JG

NETWORK AND CPU GET SEPARATE MEMORY

The Full Throughput (FXP) architecture that CMC, Santa Barbara, Calif., uses in its network-interface processors allocates separate memory locations for host and interface processors. This improves network speed by eliminating competition for resources. With memory dedicated for programs, the CPU's instructions are executed from a private memory instead of a common one. Only the host can access the program memory directly, so it doesn't compete with network or VMEbus controllers for processing time. In addition, while most other products use plain DRAM, the FXP architecture uses video DRAM as global data memory. Video RAM gives users two ways to access data memory: the DRAM port and the sequential-access-memory (SAM) port, which has 32-bit parallel access at 800 Mbits/s. Examples of computer systems that can benefit from the FXP architecture include 3D workstations, such as those available from Silicon Graphics. The architecture will be the basis for many future CMC products, including the company's fiber-distributed data interface (FDDI) line. LG

MULTIPLE WRITE LINES SIMPLIFY BYTE PARITY

To check byte-wide parity, computer designers usually add bit-wide memories to long words formed with 4- or 8-bit-wide RAMs. But because each byte-parity bit needs its own write-control line, 32-bit word lengths need four separate bit-wide chips. Now, however, a 64k-by-4-bit static RAM from Motorola Semiconductor Inc., Austin, Texas, offers four write-control lines, eliminating the need for four separate chips. The four asynchronous lines make it possible to write to each bit position individually: Each bit's write cycle is completed only if its own strobe line is asserted within the specified setup time after a rising clock edge. Conversely, write cycles can be aborted by negating the write line before the clock goes low. Surrounding the forthcoming chip's 64k-by-4-bit core are positive-edge-triggered registers on address and synchronous-write enable lines. The synchronous design keeps data access down to 20 ns and cycle time to 25 ns. Such short access times let the novel RAM keep pace with a high-speed memory system. DB

CIRCUITS MEETING PEEKS AT TOMORROW'S ICs

The 4th annual IEEE Bipolar Circuits and Technology Meeting in Minneapolis, Minn. this month will give a glimpse of what the next few years should see in fast, wideband analog and digital ICs. Topics to be discussed include 30-GHz f_T transistors in silicon ECL, rather than GaAs; a liquid-cooled ECL gate array; 200-GHz f_T GaAs heterojunction bipolar transistors (HBTs); 10-bit 40- to 60-MHz a-d converters; a wideband JFET-input op amp with lower noise than most bipolar-junction-transistor (BJT) input op amps; trade-offs needed to run silicon BJTs at 70K; and a handful of complementary and biCMOS processes yielding 13-GHz npn transistors and 5-GHz pnps. The meeting will be held at the Marriott Hotel in Minneapolis on Sept. 18 and 19. For last minute registration call the conference office at (612) 934-5082. FG

BETA TESTING BEGINS FOR GRAPHICS BENCHMARK

Software for a picture-level benchmark (PLB) that will compare the performance of workstation graphics is now in beta test and will be released in early 1990. The benchmark is the fruit of efforts by the Graphics Performance Characterization (GPC) group and 11 companies working under the supervision of the National Computer Graphics Association (NCGA) (*ELECTRONIC DESIGN*, Feb. 9, p. 22). The NCGA plans to release the PLB source code to the public in March, 1990, so that any hardware vendor can port the code to its platform. Users will port geometry from their graphics applications to PLB software through a Benchmark Interface Format (BIF), which is based on a superset of elements from the Programmer's Hierarchical Interactive Graphics Standard (PHIGS+). The application can then be run for performance comparison on any hardware that supports the PLB program. BIF specifications are available from the NCGA for a nominal fee. Future plans for the GPC group include software that will grade graphics, windowing, I/O operations, and operating-systems. LG

TEXAS INSTRUMENTS

A PERSPECTIVE ON DESIGN ISSUES:

New ways to link digital brains to advanced analog worlds

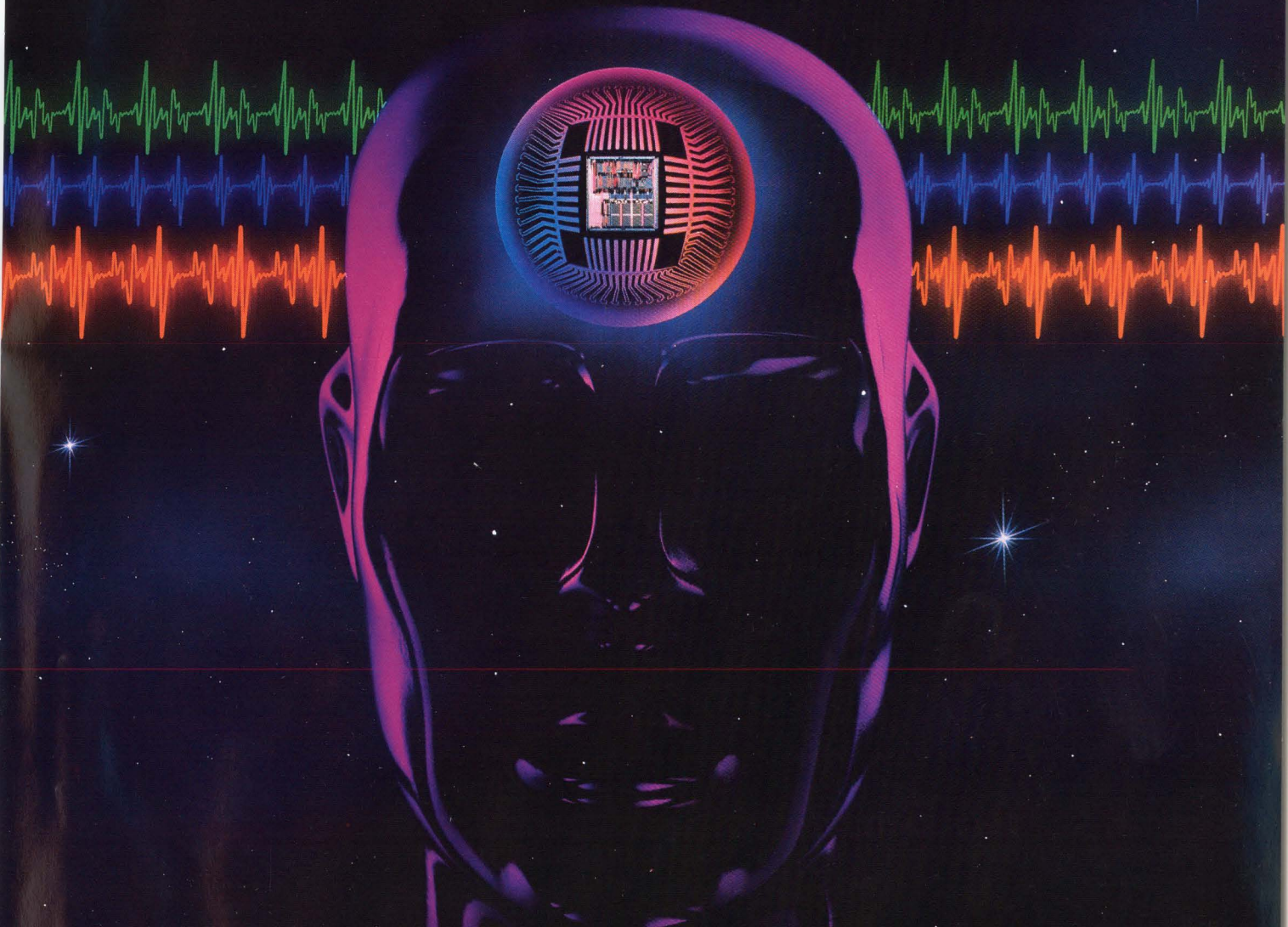

IN THE ERA OF

MegaChip
TECHNOLOGIES



Next-generation analog: Advanced Linear ICs

A new breed of linear chips, born of leadership processing at Texas Instruments, can help you design superperformance systems.

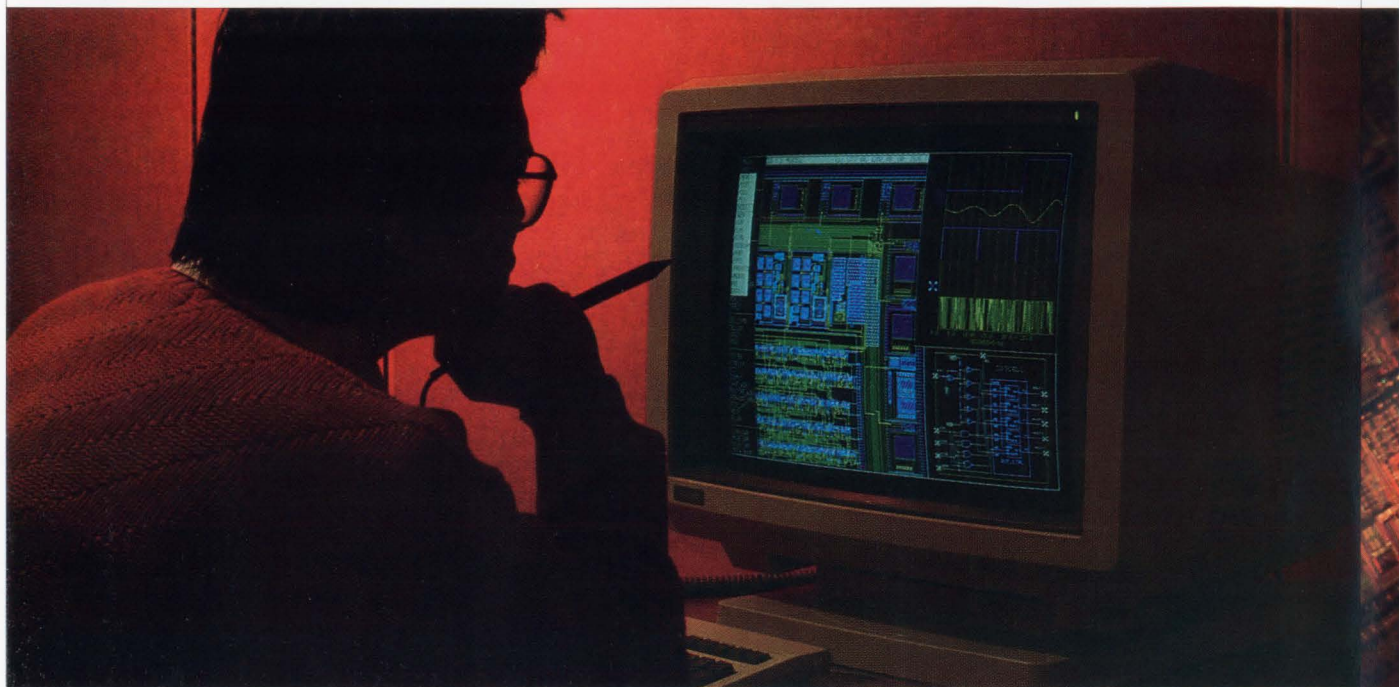

The human brain has separate but dependent left and right sides. Similarly, an electronic "brain" or system has separate but dependent parts, one digital, one analog. Designers accustomed to the spectacular performance gains made in digital chips are now demanding comparable improvements in analog devices so that both parts of their systems can function to full potential. Leading the analog evolution: Advanced Linear circuits from Texas Instruments.

These new chips are called *advanced* for one or more reasons. They are more highly integrated than ever before, often combining digital and analog functions on a single chip. They offer higher performance and greater flexibility.

Sophisticated design and simulation tools shorten development cycles of TI's Advanced Linear ICs, helping you get to market faster. By using these tools, TI can offer as standard circuits many designs that previously would have had to have been customized.

They are often the result of advanced processing that may merge two or more technologies.

Better parameters from better processing

Because advanced analog system requirements for performance and flexibility vary greatly, a single workhorse technology typically can't do the job any longer. Nor can creative circuit designs alone. We at TI are convinced the key to driving the linear evolution lies in the excellence of our processing technologies.

TI is committed to developing and implementing a range of leadership wafer-fabrication processes (see descriptions on back page). The

result: TI's Advanced Linear devices are already helping system designers link digital brains to advanced analog worlds more efficiently and with greater ease in many applications. Here are a few examples.

Advanced Linear: Displaying greater brilliance

Out of our pacesetter LinEPIC™ processing comes our high-performance Color Video Palette, operating at 125 MHz with a very high-resolution 1024 x 1024 pixel count. Because of one-micron CMOS processing, power consumption is reduced more than 40% compared to other CMOS implementations. Additionally, the device is pack-

...the key to driving the linear evolution lies in the excellence of processing technologies.

aged in reliable, economical plastic.

LinEPIC has also produced such high-speed, high-density interface chips as our Flash A/D and our Video DAC for use in graphics displays, imaging systems, monitors,

chips are ideal for use in automotive antilock braking systems, electronic transmissions, and active suspension systems.

Either technology can produce devices with low-side drive, high-side

to design with—it is available in our LinASIC™ cell library for integration with digital ASICs.

A new family of Analog Interface Circuits (AICs) is emerging from our Advanced LinCMOS™ processing. The voice-band AICs, designed for modems and fax equipment, combine high-performance analog functions—14-bit A/D and D/A converters and switched capacitor filters—with digital functions such as control circuitry, program registers, and DSP interface. The usual clutter of resistors, capacitors, and pots is eliminated.

High-speed AICs are available for use in servo controllers and hard-disk-drive applications.

These AICs are also high-performance members of our LinASIC standard-cell library. Based on TI's proven digital ASIC methodologies, the LinASIC library has allowed us to develop complex, semicustom chips in as little as 16 weeks.

Advanced Linear: Boosting instrumentation accuracy

Even one of the most basic analog building blocks, the operational amplifier, is benefiting from TI's Advanced Linear technologies. Our Excalibur op amp family combines low power consumption with a 5X speed improvement while retaining low offset voltages. Offset-voltage drift has been cut from 300 μV to 60 μV to reduce your calibration, test, and measurement expenses.

For high-accuracy applications, Advanced LinCMOS is making possible Chopper Stabilized Op Amps with chopping frequencies 10 times higher than previously available (10 kHz). Noise levels are the lowest on the market.

The evolution in analog devices has only begun. Dramatic progress lies ahead throughout the 1990s. As the Advanced Linear leader, Texas Instruments is pledged to remain at the forefront, supplying you with new ways to link digital brains to advanced analog worlds.

For suggestions on choosing a linear supplier, turn the page.

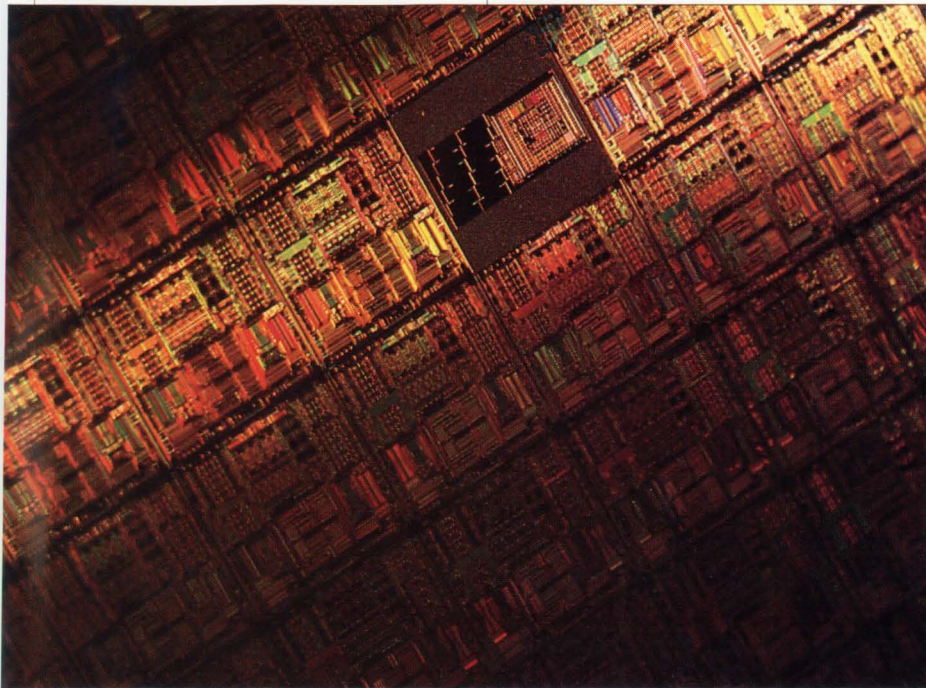

High-density Analog Interface Circuit chips demonstrate the greater integration achieved by TI's innovative linear processing technologies. These DSP interfaces allow you to alter circuit configuration under software control without external adjustments.

and cameras. Both devices require about five times less power than bipolar equivalents.

Advanced Linear: Intelligent power for every car

Chips fabricated with our Power DMOS-based BIFET™ processing are replacing electromechanical relays in many automotive applications, such as driving headlamps and motors. Power BIFET allows us to minimize power loss in the switch and add high-complexity logic functions.

Multi-EPI bipolar processing, a very cost-effective technology, is used to produce chips having inherent reverse battery protection and high operating voltages. Such

drive, or H-bridge configurations.

In the future, these developments may lead to multiplexed systems for cars, replacing bulky wiring harnesses.

Advanced Linear: Enhancing modems and facsimiles

TI's dual driver/receiver is a good example of the integration achieved with advanced processing technologies. LinBiCMOS™ processing has enabled us to put the drivers and receivers needed for RS-232 voltage levels on the same chip with the charge pump required to generate the necessary split rails from a single 5-V supply. You eliminate external power supplies and get a device that's easier

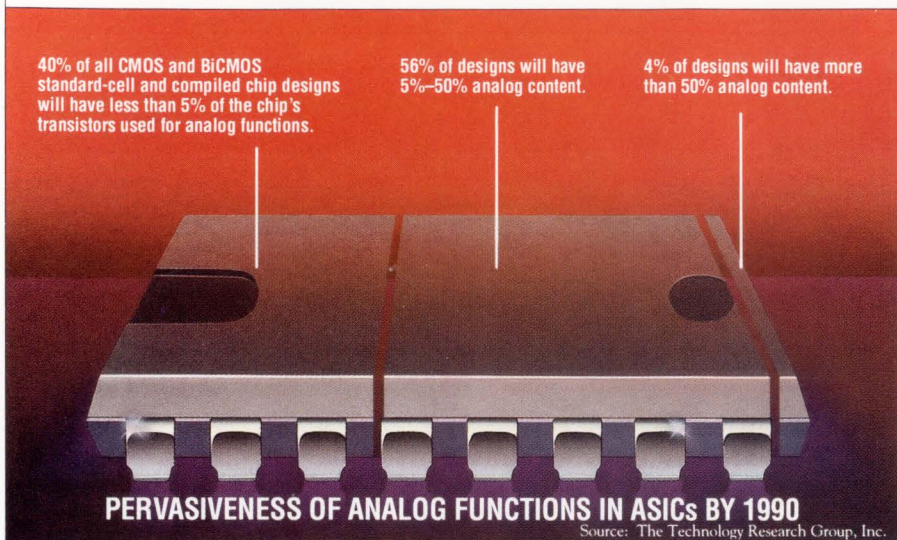

Circuits combining analog functions with digital logic will soon be widespread in ASIC chip designs. TI is taking a leadership role with the development of its LinASIC methodology.

Checkpoints for choosing an analog supplier in the 1990s.

Questions and answers with Tom Engibous, Vice President, Semiconductor Group, and Manager, Linear Products, Texas Instruments Incorporated.

Q. What is the first thing to look for in choosing a linear supplier?

A. Product performance is definitely the first priority. Our customers are asking for ever-increasing linear device performance. At TI, we believe creative circuit designs alone won't meet the challenge. Advanced process technologies—note the plural—are becoming the keys to success in linear device performance of the '90s.

Q. What else should a designer look for?

A. Whether or not the supplier has experience with digital as well as analog devices. These two worlds are merging (see chart above). Functions once performed by analog are now done digitally, and a growing percentage of our Advanced Linear devices combines analog and digital circuitry on one chip.

At TI, we've leveraged our 30 years of digital expertise into the development of our Advanced Linear products and processing with highly satisfactory success. This has been especially noticeable with our LinASIC methodology.

Q. Do you expect ASICs to play a major role in your linear future?

A. Very definitely, as they already do today. Cell-based designs will be the rule in both user-specified functions and highly integrated stan-

ard products. Digital ASIC methodologies are also the key to cutting system design cycles. As our digital experience proves, suppliers who have advanced process technologies and fast, accurate design-automation tools will be the best equipped to deliver single-chip solutions.

Today, we have customers doing their own LinASIC designs using our advanced processes and design-automation tools.

Q. What role does manufacturing capability play in picking a supplier?

A. It is always a factor, and the need for efficient worldwide manufacturing facilities such as TI has in place will become even more important. Today's semiconductor market is global in nature. You can't serve worldwide customers from a single plant—you have to be "multilocal." This is particularly true with ASICs.

Q. Any other important factors?

A. Yes, I'd suggest that, in choosing a linear supplier, the designer find one he can live with for a long time. Close supplier-customer relationships are essential to the development of products that will provide the highest performance and lowest cost systems.

TI's Leadership Linear Processing Technologies

LinBiCMOS—Combines Advanced LinCMOS, digital ASIC CMOS, and up to 30-V bipolar technologies to allow the integration of digital and analog standard cells and handcrafted analog components on a monolithic chip.

LinEPIC—One-micron CMOS double-level metal, double-level polysilicon technology which adds highly integrated, high-speed analog to the high-performance digital EPIC process.

Advanced LinCMOS—An N-well, silicon-gate, double-level polysilicon process featuring improved resistor and capacitor structures and having three-micron minimum feature sizes.

Power BIFET—Merges standard linear bipolar, CMOS, and DMOS processes and allows integration of digital control circuitry and high-power outputs on one chip. Primarily used for circuits handling more than 100 V at currents up to 10 A.

Multi-EPI Bipolar—A very cost-effective technology that utilizes multiple epitaxial layers instead of multiple diffusion steps to reduce mask steps by more than 40%. Used to produce intelligent power devices that can handle loads as high as 20 A and voltages in excess of 100 V.

Excalibur—A true, single-level poly, single-level metal, junction-isolated, complementary bipolar process developed for high-speed, high-precision analog circuits providing the most stable op amp performance available today.

Our just-published *Advanced Linear Circuits* brochure examines more fully the changes taking place in analog system design and their impact on linear devices. The brochure also describes TI's leadership processing technologies and explains the performance improvements that result. **For your copy, call 1-800-232-3200, ext. 3407, today.**

™ Trademark of Texas Instruments Incorporated
© 1989 TI 08-8459

**TEXAS
INSTRUMENTS**

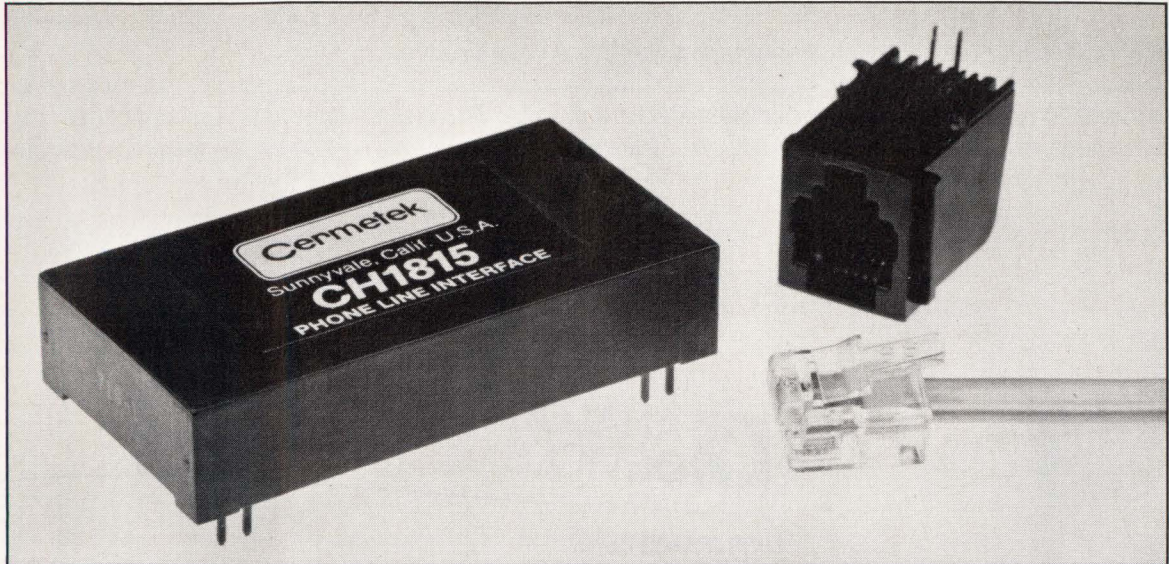

SELECTING A MODEM CHIP SET IS ONLY PART OF THE SOLUTION.

When considering a modem design, selecting the proper modem chip set is only part of the solution. You must consider the type of telephone interface used, what method of error control and agency approval needed, either domestic or international. Determining these factors is time consuming, costly and complex. The solution? Cernetek!

Our family of modem components allows the design engineer to surround a modem chip set, making it a complete modem, quickly and economically.

So when you need part of a solution, or the whole

modem solution, Cernetek has the expertise and the right answers for you. Find out how Cernetek can enhance your existing or future modem design. Call Cernetek today for more information or write us at:

Cernetek Microelectronics, Inc.
1308 Borregas Avenue
Sunnyvale, CA 94088
Tel: (408) 752-5000
Fax: (408) 752-5004

Call Toll Free: (800) 444-6271



MODEM COMPONENTS

189X Data Module Features

X.25 LapB, MNP Class 4 and 5, error correcting and data compression, autobaud speed conversion, flow control, RS-232 interface, AT compatible command format driven—1890, 1891, 1892.

MNP is a registered trademark of Microcom, Inc.

18XX DAA's Features

Telephone interface, Data Access Arrangement (DAA)—pre-approved domestic/international, voice data switch, 2- to 4-wire converter, surge protection, isolation, dialing feature, low cost and small size. 1810, 1811, 1812A, 1813, 1814, 1818, 1828.

Analog Devices' new BiCMOS DACs offer the best of both worlds – the speed and precision of Bipolar, combined with the low power of CMOS logic.

Our new BiCMOS DAC family is the most complete offering of full function DACs available anywhere – nine high performance, cost effective models with resolutions ranging from 12 to 18 Bits.

Each DAC features a precision output amplifier and high-speed bus interface, and most models include a stable on-chip reference. Which means there's no need for external amplifiers, references or glue logic. And no need to analyze stacks of data sheets or fuss with messy error budgets. Quite simply, our DACs are so easy to use, you just plug them in and apply power.



SELECTION GUIDE

	AD662	AD664	AD7245	AD7248
Resolution	12 Bits	12 Bits	12 Bits	12 Bits
Power Dissipation (mW)	55	400	65	65
Power Supply Voltage	+5 V	+5 V, ±12 V or ±15 V	+15 V or ±15 V	+15 V or ±15 V
Bus Interface	Parallel	Nibble, Byte, Parallel	Parallel	Byte
Priced From (\$ 1000s)	6.10	46.80	8.40	8.40
Comments	12-Bit DACPORT™	Four DACs, Multiplying Capability	12-Bit DACPORT	12-Bit DACPORT

DACPORT is a trademark of Analog Devices, Inc.

BiCMOS DACs. YOU READ ABOUT

Whatever your application need – small size, low power, fixed reference or multiplying – our family of BiCMOS DACs offers a solution. And it'll be an affordable solution, since these DACs start for as little as \$6.10 (1000s).

If you'd like to read more about how our complete function BiCMOS DACs can simplify your design process, call Applications Engineering at 1-800-ANALOGD. Or write to Analog Devices, P.O. Box 9106, Norwood, MA 02062-9106.



Analog Devices, Inc., One Technology Way, P.O. Box 9106, Norwood, MA 02062-9106; Headquarters: (617) 329-4700; California: (714) 641-9391, (619) 268-4621, (408) 559-2037; Colorado: (719) 590-9952; Maryland: (301) 992-1994; Ohio: (614) 764-8795; Pennsylvania: (215) 643-7790; Texas: (214) 231-5094; Washington: (206) 575-6344; Austria: (222) 885504-0; Belgium: (3) 237 1672; Denmark: (2) 845800; France: (1) 4666-25-25; Holland: (1620) 81500; Israel: (052) 911415; Italy: (2) 6883831, (2) 6883832, (2) 6883833; Japan: (3) 263-6826; Sweden: (8) 282740; Switzerland: (22) 31 57 60; United Kingdom: (932) 232222; West Germany: (89) 570050.

BiCMOS Complete D/A Converters

AD7845	AD7840	AD1856	AD7846	AD1860
12 Bits	14 Bits	16 Bits	16 Bits	18 Bits
210	70	110	100	110
± 15 V	± 5 V	± 5 V to ± 12 V	± 15 V	± 5 V to ± 12 V
Parallel	Serial, Byte, Parallel	Serial	Parallel	Serial
6.30	8.93	10.70	16.20	13.95
Multiplying Capability	AC and DC Specifications	Audio Applications	Multiplying Capability	Audio Applications



THEM HERE FIRST.

NEWS



SEPTEMBER 1989

ILC DATA DEVICE CORPORATION

ABOUT SYNCHRO-CONVERSION • A/D & D/A CONVERSION • 1553 BUS DEVICES • POWER & CUSTOM HYBRIDS

All You'll Ever Need In 1553!

MONOLITHIC BC/RTU/MT PROVIDES COMPLETE 1553 BUS TO SUBSYSTEM INTERFACE

The BUS-65610 (and BUS-65612 PGA) is a complete dual-redundant Bus Controller (BC), Remote Terminal Unit (RTU), and Bus Monitor Terminal (MT). This small 1.9" x 2.1" hybrid contains 2 encoder/decoders; 2 bit processors; BC, RTU, and MT protocol; and complete interface logic. When used with a low power transceiver, such as DDC's BUS-63125, and (optionally) the BUS-66300 II Interface Unit, the BUS-65610 provides a complete intelligent MIL-STD-1553B interface. The BUS-65610 hybrid and BUS-65612 PGA version are available screened to MIL-STD-883.

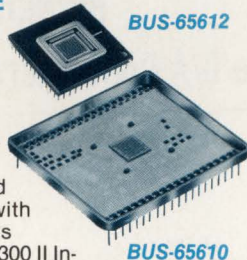

FOR SALES CONTACT CIRCLE 40

FOR LITERATURE CIRCLE 41

1553B RTU/BC/MT MODULE FOR GRiD™ 1530 LAPTOP

The BUS-65555 plug-in expansion module offers full, intelligent interfacing between the serial dual redundant MIL-STD-1553B Data Bus and the GRiDcase 1520, 1530, and 1535 laptop XT/AT compatible computers. It's software controls operation as a 1553 Remote Terminal Unit (RT), Bus Controller (BC), or Bus Monitor (MT) and is fully compliant with MIL-STD-1553B. Small size, high performance, low power requirement, and low cost make the BUS-65555 and GRiDcase combination an excellent choice for dynamic simulation in the lab or for flight line applications.



TM GRiD and GRiDCASE are a registered trademark of GRiD SYSTEMS CORPORATION.

FOR SALES CONTACT CIRCLE 42

FOR LITERATURE CIRCLE 43

LOW COST 1553B REMOTE TERMINAL HYBRID

The new, low cost BUS-65142 MIL-STD-1553B Dual Redundant Remote Terminal Hybrid features a single chip CMOS/SOS monolithic RTU protocol and Bipolar low power Mark II transceivers. It supports 13 mode codes for dual redundant operation and performs continuous on-line wraparound self-test. The BUS-65142 has radiation tolerance to Tactical Levels as well as excellent Single Event Upset tolerance. Incorporating small size (1.9" x 2.1") with low power, high reliability, and low cost makes this ideal for most MIL-STD-1553 applications requiring hardware or microprocessor subsystems.

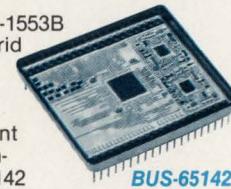

FOR SALES CONTACT CIRCLE 44

FOR LITERATURE CIRCLE 45

MONOLITHIC 1553 TO CPU INTERFACE HYBRID OR PGA REDUCES CPU OVERHEAD

DDC's BUS-66300 II Interface Unit simplifies interfacing the MIL-STD-1553 terminal to a MIL-STD-1750 or other standard microprocessor. This small 2.1" x 1.9" 78-pin hybrid frees the host CPU by assuming terminal control, data transfer timing/control, and response handling responsibilities. The BUS-66300 II (and BUS-66312 PGA) manages up to 64K x 16 of RAM, provides double buffering and uses standard control and memory I/O. When matched with a DDC intelligent Terminal Unit, the BUS-66300 II completes a truly stand-alone, bit-mapped 1553 interface. (Available screened to MIL-STD-883).

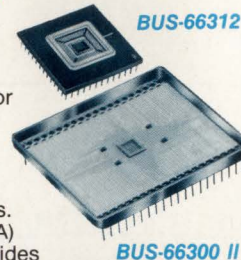

FOR SALES CONTACT CIRCLE 46

FOR LITERATURE CIRCLE 47

IBM PC® CARD PROVIDES 1553 TEST/SIMULATION

The BUS-65517 integrated, single-slot IBM-PC card and software provide a complete MIL-STD-1553 development package. Utilizing 2 on-board processors, the BUS-65517 requires little PC processing power to simulate up to 31 Remote Terminal Units, an assignable Bus Controller, an intelligent Monitor (event-triggerable command reconstruction), error injection/detection, and a MIL-STD-1553 port. User-friendly, intuitive menus and graphics (color or monochrome) provide integrated development, emulation, and analysis (IDEA) capabilities without lengthy training. The BUS-65517's Real Time Display provides complete real-time information.



* IBM PC is a registered trademark of International Business Machines Corporation.

FOR SALES CONTACT CIRCLE 48

FOR LITERATURE CIRCLE 49

1553 INTEGRATED BC/RT/MT TERMINAL

The BUS-61553 is an Advanced Integrated MUX (AIM) Hybrid which minimizes CPU overhead by assuming host interface maintenance and memory management. It contains dual low power transceivers, complete protocol logic, an 8K x 16 shared RAM, on-line and off-line Self Test, is compatible with MIL-STD-1750 and other standard CPUs, and is SEAFAC Tested. It comes as a 2.1 x 1.9 x 0.25" (DDIP) or a 2.2 x 1.6 x 0.17" (Flatpack). Also available as a single +5V only supply. MIL DWG TO BE ANNOUNCED.

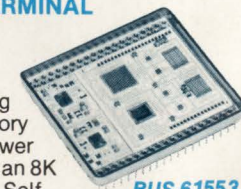

FOR SALES CONTACT CIRCLE 50

FOR LITERATURE CIRCLE 51

FOR ADDITIONAL PRODUCT INFORMATION CONTACT DATA BUS APPLICATIONS 1-800-DDC-1772.



HEADQUARTERS AND MAIN PLANT: ILC Data Device Corporation, 105 Wilbur Place, Bohemia, N.Y. 11716, (516) 567-5600, TLX-310-685-2203, FAX: (516) 567-7358
WEST COAST (CA): WOODLAND HILLS, (818) 992-1772, FAX: (818) 887-1372;
SAN JOSE, (408) 236-3260, FAX: (408) 244-9767; GARDEN GROVE, (714) 895-9777
WASHINGTON, D.C. AREA: (703) 893-7989, FAX: (703) 893-7954
NORTHERN NEW JERSEY: (201) 785-1734, TLX: 130-332
MASSACHUSETTS: (617) 341-4422 or 3128, FAX: (617) 344-1040
JAPAN: (03) 814-7688, FAX: (03) 814-7689
UNITED KINGDOM: 635-40158, TLX: 851-848826; FRANCE: (1) 4-333-5888, TLX: 842-630609
WEST GERMANY: (08191) 3105, TLX: 841-527128; SWEDEN: 8-920-635, TLX: 854-10952

TRANSPUTER MODULES EASE PARALLEL PROCESSING

Engineers can build a parallel computer that delivers about 100 MIPS and 12 MFLOPS on a standard VMEbus card for less than \$10,000 and in the time it takes to plug eight small modules into a board. Moreover, the modules can be mixed and matched to achieve various processor, memory, digital-signal processing, peripheral and graphics controller, and I/O-interface combinations. Designers can tailor the optimum embedded or standalone processor based on a range of standard-bus system boards, such as a PC XT/AT, PS/2, GPIB, Futurebus, or VXI.

This system extends beyond a set of parts for breadboarding prototypes. It includes more than 40 fully engineered modules and motherboards intended for full-production runs. Known as the IQ System, the modules from Inmos Ltd., Bristol, U.K., are now being produced and they will be formally introduced on September 12 at Buscon East in Boston.

The intention of the IQ Systems Division is to offer a catalog of modules and motherboards that will help designers build complete systems. Ian Pearson, Inmos' newly appointed director of Systems Products, divides system functions into seven layers, each defined as a class of functionality.

The first layer assumes that a system needs to communicate with other systems. The IQ first-layer modules will then connect

with various local-area networks. The first modules to be included in this category are Ethernet controllers. Modules that can drive 20-m, 20-Mbit/s Transputer serial-communications links are currently under development. Next will come modules to connect with high-speed, fiber-optic networks.

Within a system, second-layer modules will encompass what Pearson describes as "general-purpose I/O modules." These will offer interfaces to such standards as RS-232-C and IEEE-488 (GPIB), as well as analog-to-digital conversion and other functions.

Processors—the third layer in Inmos' strategy—are next. They consist of a series of computing modules, including 16- and 32-bit integer and floating-point scalar processors and vector processors. All modules in this category will contain memory.

Peripheral controllers and interfaces, such as graphics modules and controllers to drive the standard SCSI interface, define the fourth layer. This is followed by a more advanced set of application-specific modules, which constitute the fifth layer.

As an example, Pearson cites a module containing an Inmos A121 image-compression chip. This device compresses dynamic video information, reducing the bandwidth needed to send high-definition moving images, and then decompresses them on reception.

According to Pearson, a module that employs this

device could be teamed with others to build a high-capacity video store. The subsystem would compress signals for storage on various media, and then decompress them for subsequent processing and display.

Up to this level, individual modules conform to a credit-card-sized layout adopted as the basic standard. Because of the Transputer's architecture, modules need just 16 pins to communicate with the outside world. In fact, the Transputer was designed from the outset to be totally self-contained, incorporating such functions as local-memory management, clock generation, and synchronization.

In addition, though its internal structure uses either a 16- or 32-bit bus, depending on the part number, all external communication with other Transputers and peripherals apart from local memory is carried out with a fast serial link. Each Transputer has four such links that transmit data from 10 to 20 Mbits/s. These links are designed for direct connection to other Transputers. Consequently, any Transputer can be linked to the other four.

Furthermore, each module needs just four pins for the Transputer links. Others are used for power supply, ground, clock, and system services. This arrangement eases motherboard design, which is the sixth level in Pearson's system-architecture model. Motherboards contain little else than circuitry, which is required to deliver the proper signals to a particular system bus, and two rows of sockets to receive the mod-

ules' pins.

The other motherboard device is an Inmos C004 crossbar switch, a 32-by-32 matrix that sets up the motherboard configuration. The switch serves as a programmable and reconfigurable patch panel for the Transputer communications links.

Pearson also maintains that system design is eased by the Transputer's external clock requirements. Though the T800-G25S Transputer operates with an on-chip 25-MHz clock, it requires only a 5-MHz input. And 5 MHz doesn't require difficult pc-board fabrication or layout techniques.

If designers don't know exactly how much computing power is needed for a particular application when using the IQ System's modules, a modular system can be built by picking and choosing from other various modules.

"While most people are on a steep learning curve concerning parallel computing, we can introduce them to the shallow end of the pool," says Pearson. "For \$5000, they can get a respectable system to gain experience and then add modules and motherboards until they get it right. They don't have to invest \$50,000 or more just to experiment."

Prices of the IQ TRAM and motherboards vary with function. The VME motherboard costs around \$2000; a module with a 12.5-MIPS T800, 2 Mbytes of dynamic RAM, and 128 kbytes of static RAM costs goes for about \$1000. A 100-MIPS VME board made up of eight modules is \$10,000.

PETER FLETCHER

EXPERT SOFTWARE ANALYZES CIRCUITS, EMBEDS TEST LOGIC

By helping designers pin down and solve testability problems, a program developed at the Microelectronics and Computer Technology Corp. (MCC), Austin, Texas, promises to produce more testable chips and systems without requiring designers to be versed in test techniques.

The Testability Insertion Guidance Expert System—Tiger for short—assesses a circuit's testability and design-for-test (DFT) aspects early in its design cycle. Using "what-if" techniques, it evaluates various trade-offs of DFT solutions, and then helps embed the necessary logic.

The program builds on a testable-design expert system first proposed in 1985 by Magdy Abadir as a PhD thesis at the University of Southern California. Abadir now manages MCC's Tiger project.

Within the program are mechanisms for analyzing the accessibility of various design components. It identifies the characteristics of various data-flow paths using functional and structural design information. Designs are subdivided by the software into blocks referred to as kernels. Each kernel can be independently tested by exploiting functional, architectural, and structural partitioning to come up with the best way or ways to test the design. Data-flow paths uncovered by an accessibility analysis give insight into the design's bottlenecks and point to locations that require partitioning.

Thanks to the software's expert knowledge, more than one approach can be used to evaluate each kernel. According to Abadir, Tiger might suggest 50 possible test solutions with five possible techniques. Each is ranked and scored, and then the numbers are normalized and weighed against such factors as test time, chip area, pin count, fault coverage, performance degradation, software cost and code generation, and so forth.

The design goals and constraints, which are specified by the user, are used by Tiger to dynamically adjust the weights of the solution-ranking process as it searches for a feasible design that satisfies the testability goals with-

out violating the design constraints.

Taking matters further, the software helps compose test plans associated with the embedded solutions. Those plans contain the information required by the test-generation routines. Also, the plans describe the necessary on-chip test controller, which can be synthesized either as an individual module or as part of an existing controller.

Tiger can accept a hardware description at several levels. At the highest level, it can accept a register-transfer logic description or a model defined in a hardware-description language such as VHDL, or a circuit-description file such as EDIF. Net lists from some popular schematic-capture packages can also be input as the design nears completion. The

Tiger program ties into fault-coverage estimators, test-pattern generators, fault simulators, and other analysis tools that help designers wring out a circuit.

After analysis, the final logic synthesis can be performed manually or automatically. Trials on circuits with from 1000 to 27,000 gates yielded computation speeds for Tiger of as little as 3 seconds to about 120 seconds (using a Sun 3/60 workstation with 8 Mbytes of RAM). Only a 4% area penalty was incurred by embedded test circuitry in the 27,000-gate chip. The software selected a combination of built-in self-test and scan techniques.

Though the software is already available to MCC's CAD-program participants, MCC isn't sure when it might reach the commercial market.

DAVE BURSKY

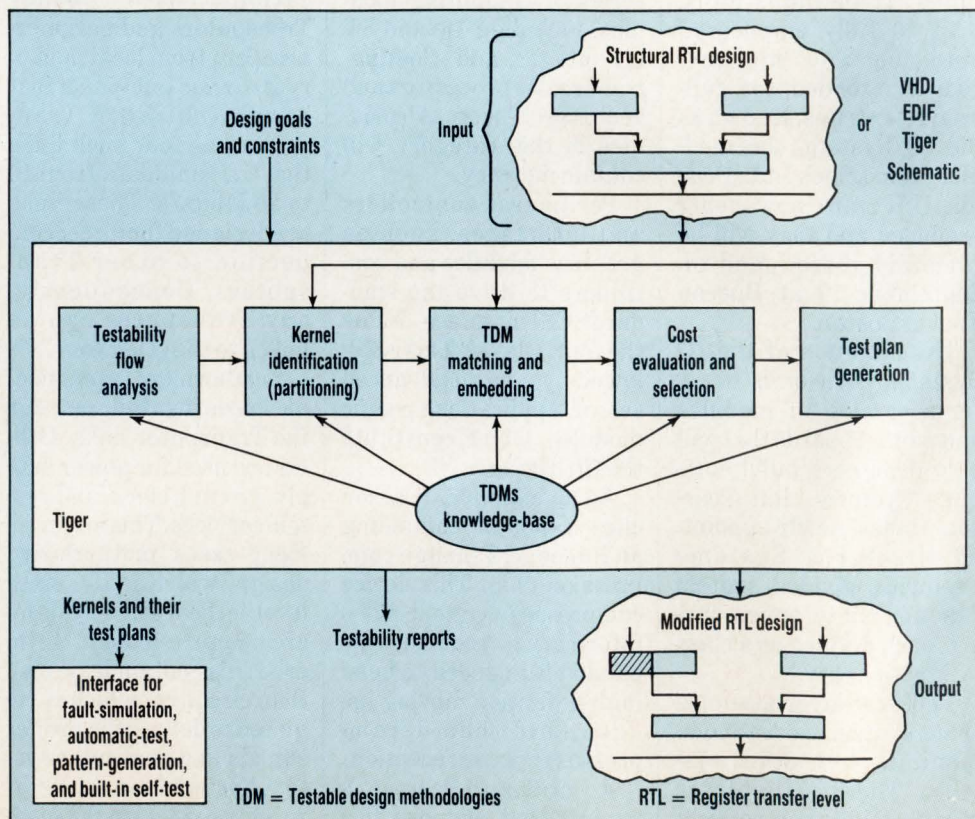

THE FIRST



4 × 350 MHz 4-channel Portable Digital Oscilloscope

- * Long 50K Memories per Channel
- * Fastglitch, Interval, TV and Logic Triggers
- * Spectrum Analysis, Advanced Processing and Pulse Parameters
- * Familiar Front-panel Operation

LeCroy's new Model 9424 is the first 4-channel digital oscilloscope to combine quality 8-bit Flash ADCs (12-bit with averaging), 350 MHz bandwidth and 50K acquisition memories. Independent ADCs sample repetitive signals at up to 10 gigasamples per second and transients at up to 100 megasamples per second.

Timing information is preserved by simultaneous acquisition on all channels. With these unique features the 9424 provides the best accuracy and resolution in any portable 4-channel digital oscilloscope on the market.

An extensive array of trigger capabilities such as Fastglitch, Interval, TV, Logic and Sequence modes ensures you'll catch the most elusive events. And, once you've caught them, they can be analyzed instantly with the most accurate processing and parameter measurement capabilities available in an oscilloscope. With LeCroy oscilloscopes it's all built in — no external boxes, no computers, and no time wasting. For more information call 1-800-5-LeCroy

700 Chestnut Ridge Road, Chestnut Ridge, NY 10977-6499

CIRCLE 52 FOR INFO ON 9424
CIRCLE 53 FOR A COPY OF OUR FREE DSO VIDEO

LeCroy

Innovators in Instrumentation



—Fred Molinari, President

When it comes to high performance data acquisition for the PS/2, we're the only act in town.

A bold claim that happens to be true. It's our all new DT2901 Analog and Digital I/O Board for the IBM PS/2. We say "all new" because we developed our board from scratch, unlike other developers who have been content to simply modify their "old designs."

So, how does that make our I/O board better?

We built our board around two custom-designed chips. Our data transfer chip permits A/D, D/A and Digital I/O operations to occur simultaneously and

without data gaps. Our custom MCA Interface Chip does the work of several conventional chips, permitting high performance operation while saving valuable space and power.

Add to this its *fast* 50kHz throughput, flexible channel and gain selection, and you've got yourself performance like no other data acquisition board on the market today.

You can get all of this, including our FREE ACQUIRE software, for under \$1,000! Think about it, and we think you'll

agree... our *all new* high performance I/O board isn't just the only act in town, it's also the best.

So act now.

Call (508) 481-3700

In Canada, call (800) 268-0427

FREE 1988/89 Data Acquisition Handbook.



Model	Analog In	Resolution	Programmable Gains	Throughput	Analog Out	Resolution	Throughput	DIO	Pacer Clock	Price
DT2901	16SE/8DI	12 bits	1,2,4,8,16	50kHz	2 chans.	12 bits	50kHz/chan.	16 lines	2	\$1,095
DT2905	16SE/8DI	12 bits	1,2,10,20 100,200, 500,1000	50kHz 2.6kHz	2 chans.	12 bits	50kHz/chan.	16 lines	2	\$1,195

DATA TRANSLATION®

World Headquarters: Data Translation, Inc., 100 Locke Drive, Marlboro, MA 01752-1192 USA, (508) 481-3700 Tlx 951646

United Kingdom Headquarters: Data Translation Ltd., The Mulberry Business Park, Wokingham, Berkshire RG11 2QJ, U.K. (0734) 793838 Tlx 94011914

West Germany Headquarters: Data Translation GmbH, Stuttgarter Strasse 66, 7120 Bietigheim-Bissingen, West Germany 07142-54025

International Sales Offices: Australia (2) 662-4255; Belgium (2) 735-2135; Canada (800) 268-0427; Chile (2) 25-3689; China (408) 727-8222, (1) 868-721; Denmark (2) 274511; Finland (90) 372-144; France (1) 69077802; Greece (1) 951-4944, (31) 527-039, (1) 361-4300; Hong Kong (5) 448963; India (22) 23-1040; Israel (3) 5401524; Italy (2) 82470.1; Japan (3) 348-8301, (3) 502-5550, (3) 355-1111; Korea (82) 756-9954; Morocco (9) 30-4181; Netherlands (70) 99-6360; New Zealand (9) 504759; Norway (2) 53 12 50; Peru (14) 31-8060; Philippines 818-0103; Portugal 545313; Singapore 7797621; South Africa (12) 8037680/93; Spain (1) 455-8112; Sweden (8) 761-7820; Switzerland (1) 723-1410; Taiwan (2) 918-4740; United Kingdom (0734) 793838; West Germany 07142-54025.

Data Translation is a registered trademark of Data Translation, Inc. All other trademarks and registered trademarks are the property of their respective holders.

FUTUREBUS WORK GROUPS CLOSE IN ON FINAL SPEC

THEY'RE MEETING AT BUSCON,
WHICH ALSO FEATURES KEY VME,
MULTIBUS, AND STD BUS INTROS.

LAWRENCE CURRAN

Most of the throngs of engineers attending the Buscon East show this week won't be aware of the backroom committee activity aimed at honing the specifications for Futurebus+. More likely, they'll focus on the exhibits and some key new product announcements intended to make some of today's buses—Multibus II, the VMEbus, and the STD bus—more effective until Futurebus+ becomes widely used in tomorrow's computers.

Buscon East, which takes place at the Royal Plaza Trade Center, Marlborough, Mass., Sept. 12-14, will see IEEE working groups gathered together to bring the specifications for their respective Futurebus+ projects closer to final form. The timetable calls for the Futurebus+ specification to become an IEEE standard by September, 1990. The logical layer (P896.1) of the Futurebus+ specification was essentially completed in July. Still to be finished are elements of the systems layer (P896.2), physical layer (P896.3), and system con-

figuration layer (P896.4).

At the same time, numerous new products introduced at the show make it easier for designers to get more mileage out of today's bus structures, and to bridge the gap between 16- and 32-bit systems as well as the coming generations of Futurebus+ systems. Among the hottest developments at the show, RISC-based single-board computers will be introduced by Force Computers and Heurikon.

Futurebus+, which encompasses an advanced bus architecture intended to serve into the late 1990s, will accommodate high-performance computers—including those to be implemented with the RISC wave of microprocessors needing higher-performance buses—whose data will range in width from 32 to 256 bits. In contrast, most of today's computers are at 32 bits or less. One of the bus's main appeals is that systems built to the specification will transfer data internally substantially faster than today's systems do, with near-term transfer rates of 200 Mbytes/s within systems.

Later on, speeds as great as 400 Mbytes/s will be possible when semi-

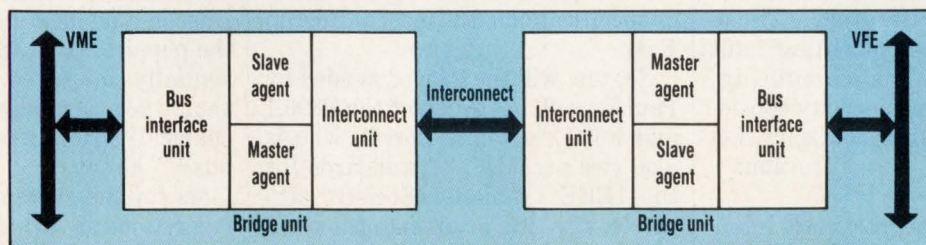

1. A VME-TO-VFE BRIDGE shows logic required to interface between the two buses.

BUSCON EAST PREVIEW

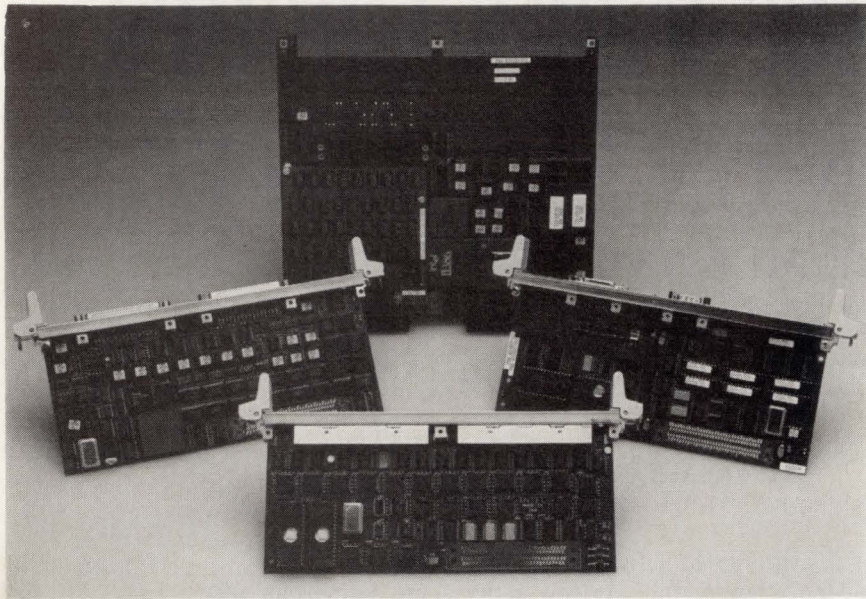

2. INTEL'S MIX EXTENSION for Multibus II uses a baseboard and one to three stackable modules.

conductor transceiver technology catches up with the Futurebus. Those numbers compare with about 40 Mbytes/s as the best possible with VMEbus systems, for example. The IEEE working groups have met just about monthly this year to sharpen the specifications for both Futurebus+ and bridges that link currently used buses with the coming Futurebus generations.

Late last year, working groups planning the Futurebus, the Rugged Bus, and the Next Generation Architecture (NGA) of the VMEbus, came to an important agreement: Each would back Futurebus+ as the structure most appropriate for high-performance, 32-to-256-bit computers (*ELECTRONIC DESIGN*, Feb. 9, p. 31).

The IEEE Computer Society-sponsored Futurebus and Rugged Bus committees merged and are incorporating Rugged Bus needs into the Futurebus specification. Those needs include accommodating fault tolerance, real-time computing, maintainability, and security considerations in the system configuration layer (P896.4) of the Futurebus+ specification.

At the same time, the VME International Trade Association (VITA) selected the Futurebus as its basis

for the VMEbus' so-called Next Generation Architecture. VITA then worked to hammer out a VME-to-Futurebus bridge specification.

Achieving an agreement among these working groups about a common hardware bus architecture was a major milestone. Paul Cook, chairman of the IEEE P896.3 and P896.4 working groups, noted that having Futurebus as a single hardware interface means that the industry can create common hardware modules for it, "just as Unix enables software modules to be created for a common software interface."

Cook is a member of the technical staff at Ameritech Services Inc.'s Applied Technology and Development Organization, Schaumburg, Ill. His two P896 working groups, which are tasked with incorporating the former Rugged Bus needs into the Futurebus+ specification, as well as working out the physical layer specifications, will meet at Buscon East.

So, too, will the groups headed by Paul Borrill, chairman of the P896.1 and P896.2 groups. Borrill, who is also vice president of standards for the IEEE Computer Society, also carries the title of distinguished engineer at Sun Microsystems Inc., Mountain View, Calif., where he

manages the S-bus architecture and development group.

Borrill is pleased that the 896.1 group handling the logical layer produced a draft Futurebus+ specification on schedule in July after reviewing the suggested revisions and comments that surfaced at the June meetings. He points out that provisions of the original 896.2 systems layer were incorporated into 896.1, and that a new 896.2 task will determine what is now called the profile and physical layer of the Futurebus+ specification.

The new group is addressing such considerations as board sizes and connector configurations. Eventually, this part of the specification may include, for example, a large industrial-size board, a smaller workstation board, and a ruggedized board for military applications.

Recent developments that are under consideration by Cook's 896.3 working group include a proposal from Hewlett-Packard that a desktop-computer-sized board that supports both an EISA bus and a 64-bit Futurebus+ be included as one of the Futurebus mechanical standards. Another proposed mechanical standard would have pure metric packaging and metric connectors for use in Europe, which is expected to go fully metric in 1992. The current Eurocard format is a mixed English-metric system.

In response to those proposals, the 896.3 working group recommended to the IEEE Computer Society's Microprocessor Standards Committee that study groups be created to investigate the need for those suggested standards. These study activities may later necessitate new project authorizations from the committee and some reorganization of 896.3.

Cook says that after this week's Buscon East meetings, he hopes that the physical layer (896.3) draft is essentially completed. "The document should be at a point where it's the mechanical specification for Futurebus+," he says.

As for the systems configuration layer, Cook says that the 896.4 working group will continue writing a draft at this week's Buscon East

BUSCON EAST PREVIEW

meeting. The draft will specify how to use boards that meet the provisions of 896.1 and 896.2, and which boards accommodate fault-tolerant and real-time computing, as well as maintainability and security considerations. The draft will be circulated for official working group ballot and comments at a December meeting.

Putting it all together, Borrill notes that he plans to have an overall IEEE Computer Society Futurebus+ draft document ready by October. For six months, this document would be available for public comment by interested parties.

Borrill points out that the International Standards Organization, like the IEEE, requires a six-month comment period for its standards, and that this period for the Futurebus+ specification for both organizations coincides. He looks forward to having the Futurebus+ specification as an approved IEEE standard next September. But achieving this will be no small feat, considering how large the working group meetings have become. "Just about every major company is sending representatives to our meetings," Borrill says, "but we've got top-notch people in

the groups, and they've remained essentially on schedule." He expects 32-bit system designers to hop on the Futurebus in the next two years; 64- and 128-bit Futurebus architectures should follow, beginning in 1991.

BRIDGING THE GAP

Wayne Fischer, director of marketing at Force Computers Inc., Campbell, Calif., is keenly interested in the eventual Futurebus+ provisions, but his near-term attention is focused on how today's VMEbus-based systems will link to Futurebus when it arrives. Toward that end, Fischer is chairing a working group charged with coming up with a bridge specification that will enable a hardware/software migration path from VME to the Futurebus.

The effort is called the VME-to-VME Futurebus+ Extended (VFE) bus bridge; the IEEE working group is P1014.2. In addition to offering a migration path, such a bridge will also accommodate the coexistence of two bus architectures in the same system, so that the VME segments might handle I/O functions, for example (*Fig. 1*).

Fischer points out that the VME-

to-VFE bridge is best understood in the context of a local-area network. "Both VMEbus and VFE can be considered as high-speed, parallel LANs in which a variety of CPUs, memory, and I/O boards can be plugged into the backplane," he says. Each board becomes a communication node on its respective backplane.

As a result, when two different systems—each with a different kind of backplane and associated protocols—must talk to each other, a mechanical and electrical bridge must be established to enable the movement of information between them. "The networking community calls this a gateway," Fischer explains, "but in both the Futurebus+ and VFE Bridge working groups, it was mutually decided to use the term 'bridge' to encompass the total activity of specifying the interface between the two buses."

Besides promoting easy migration to VFE (Futurebus+) systems and coexistence of these two buses in one system, there are other goals for the VFE bridge specification. It's also intended to help the VMEbus be used as a secondary bus for I/O operations in VFE systems. Furthermore, the bridge specification should make it possible for software to reach into the other buses for I/O and memory accesses while executing on either the VMEbus or VFE.

Fischer says that the assumption is that the bridge will be implemented as two boards (*Fig. 2*). His group was to complete the definition of the interface between the two buses by the end of last month. He hopes to have a final version of the bridge specification for the Oct. 30 meeting of the Futurebus+ working groups.

PRODUCT INTRODUCTIONS

Although systems are being designed for Futurebus+ ahead of the specification's completion, the effects of this new bus architecture won't be widely felt for several years. In the meantime, both board and device vendors continue to find ways to extend some of today's bus architectures, to improve the performance of systems implemented on those buses, or to make it simpler to

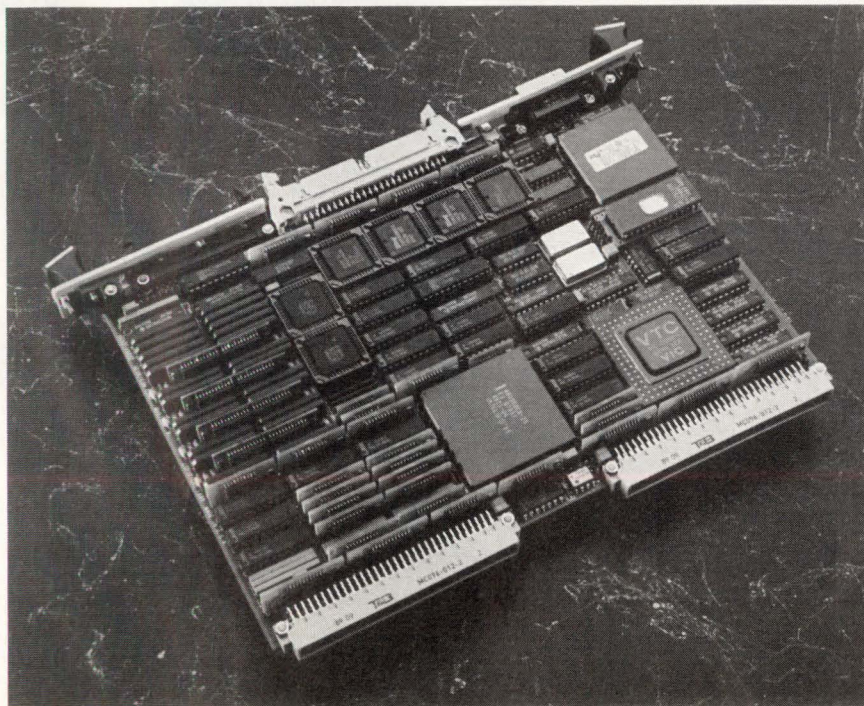

3. HEURIKON'S SINGLE-BOARD COMPUTER is the first to use the Intel 960 RISC microprocessor.



**“In design automation,
my worry is not which tools,
it’s which company.”**

**“HP understands it’s a
long-term partnership. With
HP DesignCenter, choosing
the right tools is just the
beginning.”**

HP’s philosophy on partnership is simple. Commitment...backed by the right team at the right time. Expert teams dedicated to making good design automation tools work for you.

To begin with, that means a team that consults instead of sells. A team that specializes in the design process. One that works with you and value-added-business partners to apply the tools to your business.

It means a team that’s experienced in getting design automation systems up and running. Quickly. One that’s also prepared to tough it out to the last little detail.

Then there’s training. The right team not only cuts the time to get designers on board, they also make sure designers are tapping the last ounce of system potential.

Finally, it means expert support. In software, hardware and networking. To make sure you get maximum up time.

DesignCenter. Not just the right tools. But the right team...at the right time. Call your local HP sales office today and find out how a partnership with HP can work for you.

There is a better way.



CIRCLE 17

BUSCON EAST PREVIEW

interface with some of those buses.

Several of the products bowing at Buscon East are intended to help designers achieve those ends. Some of the companies unveiling products or making other significant announcements are Concurrent Technologies, Force Computers, Heurikon, Intel, WinSystems, and Ziotech.

Intel's OEM Modular Systems Operation, Hillsboro, Ore., has two new Multibus II developments: an interface device and a Modular Interface

Extension architecture. Products using both will be introduced at Buscon East. The CMOS device, scheduled for October delivery, is the Multibus II Peripheral Interface (MPI). It's intended for I/O boards and subsystems, and it supplies a compatible subset of the Intel Message Passing Coprocessor (MPC).

The MPC, which offloads the on-board CPU by handling various bus-management tasks (timing, interrupts, data packetizing, and so forth)

is priced at more than \$100, depending on quantities. The new MPI will sell for less than half that because it's a "replier-only" device for the Multibus II Parallel System Bus (PSB). Like the MPC, the MPI communicates across the PSB at a full 32 bits, but supports only 8- and 16-bit data at the application level because few I/O operations need 32 bits. Unlike the MPC, the MPI doesn't require the use of an on-board microprocessor or microcontroller. All of this adds up to significant cost savings for I/O board designers.

The Multibus II Modular Interface Extension (MIX) architecture also comes from Intel's Hillsboro operation. The architecture, which helps designers build high-performance I/O subsystems, is featured on various boards shown for the first time at Buscon East. MIX is a 32-bit asynchronous I/O bus designed for on-board I/O expansion by using a baseboard-plus-modules approach optimized for Intel 80386 microprocessor-based Multibus II systems.

A typical MIX I/O subsystem would consist of an intelligent Multibus II MIX baseboard and one to three interconnected, stackable MIX modules that use a special connector (Fig. 3). MIX uses the baseboard-and-modules scheme to physically decouple the CPU of the baseboard from the I/O function of the module.

The 80386-equipped baseboard can perform memory as well as I/O and DMA transfers on the MIX bus, keeping the host system's main 386/Multibus free for higher-priority processing tasks. The first three I/O modules offered as part of MIX are a 12-channel terminal controller; a two-channel, 64-kbit/s wide-area network controller; and an Ethernet controller. More modules will come from Intel, and the company is encouraging other firms with I/O expertise to develop MIX modules by making the specs available without licensing or royalty fees.

The chief benefit of MIX is that its modularity gives designers flexibility. The baseboard can be tailored quickly because of the various interchangeable I/O modules that are available.

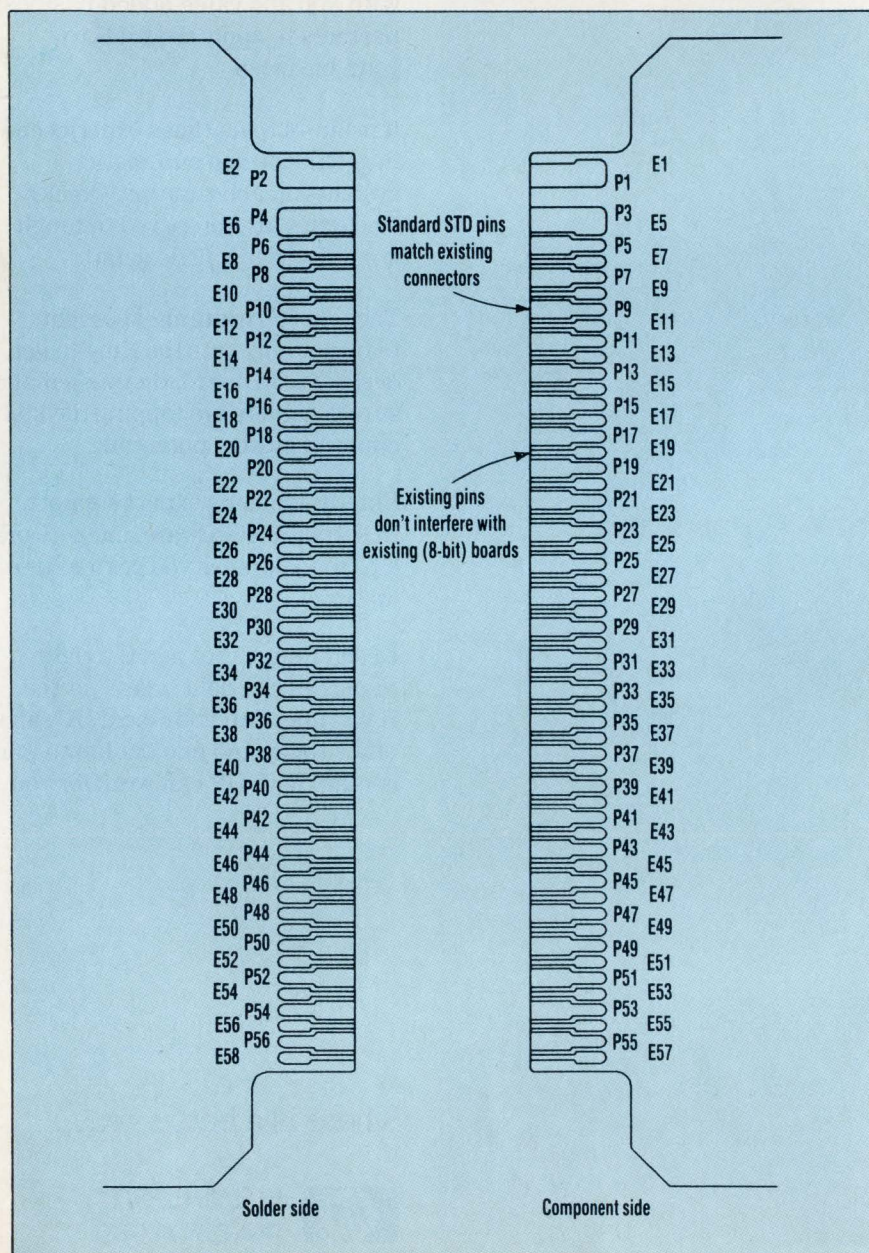

4. ZIATECH'S CONNECTOR CONFIGURATION is associated with the company's proposed STD 32 specification.

MODULAR HIGH POWER FROM POWER-ONE!

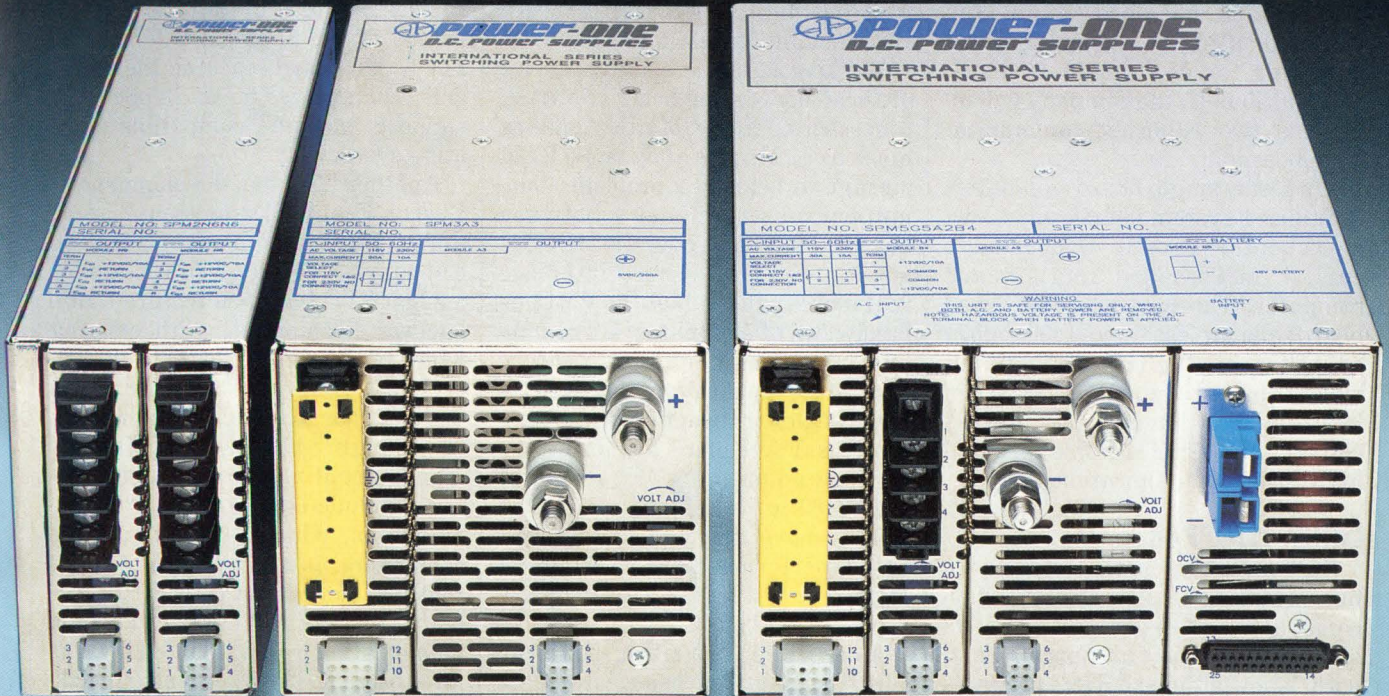

**500 WATTS
MODEL SPM2**
Up to 6 DC Outputs
5X3X11 Inches

**1000 WATTS
MODEL SPM3**
Up to 9 DC Outputs
5X5.5X11 Inches

**1500 WATTS
MODEL SPM5**
Up to 15 DC Outputs
5X8X11 Inches

Full-Featured Modular High Power Switchers. 1990's Technology... Here Today!

ANOTHER FIRST FROM POWER-ONE. A complete line of modular high power switchers offers 500 through 1500 watts of dependable DC power. Each power system features exclusive design innovations that guarantee a perfect combination of POWER-ONE quality, performance and cost-effectiveness.

FULLY MODULAR DESIGN. Allows the user to tailor a proven multiple output power system from a wide selection of single, dual and triple output power modules. Delivery from stock...no more costly R&D delays.

BATTERY BACK-UP UPS CAPABILITY. Optional fully automatic uninterruptible power system module provides battery back-up of up to 1000 watts of DC output power.

POWER SYSTEMS FOR THE WORLD MARKET. Designed and certified to meet the world's toughest safety agency and EMI requirements. The clear choice for products marketed in the U.S. and internationally.

Call Today For
New 1989 Catalogs.

**TOLL-FREE
LITERATURE HOT-LINE:
(800) 235-5943
In California:
(800) 421-3439**

"Innovators in Power Supply Technology"

**1 POWER-ONE
D.C. POWER SUPPLIES**

POWER-ONE, INC.
740 Calle Plano · Camarillo, CA 93010-8583
Phone: (805) 987-8741 · (805) 987-3891
TWX: 910-336-1297 · FAX: (805) 388-0476



BUSCON EAST PREVIEW

Other Multibus developments at Buscon East come from Concurrent Technologies, Champaign, Ill., in the form of boards using the Intel 80386 and 80386SX microprocessors. One is the CP1386/16X, a single-board computer for Multibus I systems. For Multibus II, the company will introduce two Ethernet communications boards.

With the single-board computer, Multibus I system users gain a lower-cost alternative to Concurrent's earlier 80386-based single-board computer. The new 80386SX-based board sells for less than \$1900 each in quantities of 100. The existing unit, which is priced at about \$3500 each in lots of 100, is intended for process control, industrial automation, and high-speed communications.

SHOW STOPPERS

Still a leading high-performance bus until and even after Futurebus+ comes along, the VMEbus will get its share of attention at Buscon East, with "show-stopper" RISC products from Force Computers and Heurikon Corp. Force made will make a splash with a Motorola 88000 RISC-based single-board computer family, while Heurikon will unwrap the first board-level computer to feature Intel's 66-MIPS RISC microprocessor, the 960, which was officially introduced on Sept. 12.

Force believes that its CPU-8X family with up to 340 MIPS per card cage thrusts the company into the domain served by multiprocessing systems. That's achieved by closely coupling 10 pairs of boards, with each pair delivering 34 MIPS.

Three boards make up the series: The CPU-80 contains a 20-MHz 88100 RISC CPU and two 88200 cache memory management units (CMMU), as well as 4 Mbytes of shared dynamic RAM. The board supports the VMEbus interface and also has a SCSI disk-drive interface. The CPU-81 is identical to the CPU-80, except that it replaces the SCSI interface with a VME Subsystem Bus (VSB) interface. VSB represents a local bus that can be used for I/O expansion.

The CPU-82 acts as a "dyadic" or

closely-coupled companion processor to either of the other two. It has an 88100 CPU, two or three 88200 CMMUs, 8 Mbytes of shared dynamic RAM, and a VSB interface. An Ethernet interface is optional.

Working in tandem, a dyadic pair of these boards can bring two RISC processors, five CMMUs, and as much as 12 Mbytes of dynamic RAM storage to bear on a problem. Communications to memory between boards takes place over the MBUS, a 100-Mbyte/s interboard interface that more than doubles the VMEbus bandwidth of 40 Mbytes/s. The family is intended for high-end, real-time computing applications, as well as large-scale, transaction-processing systems. Force plans to improve the series by adding a 25-MHz version of the 88100 in the second quarter of 1990, a move that will boost single-board performance from 17 to 21 MIPS—or to 420 MIPS for 10 dyadic pairs in a card cage.

Meanwhile, Heurikon, Madison, Wis., will impress show attendees with the HK80/V960E, a VMEbus single-board computer believed to be the first product to incorporate Intel's 960CA 32-bit RISC microprocessor (Fig. 4). The board offers peak performance of 66 native MIPS and 30 VAX MIPS. Heurikon claims that at its \$2795 price, the board offers the best price/performance ratio of any RISC or CISC single-board computer on the market. It's intended for real-time applications, including intelligent I/O, communications, embedded control, and image processing. The 40-MHz 960 chip includes a 1-kbyte instruction cache, 1 kbyte of static data RAM, and a four-channel 32-bit DMA controller.

A product billed as the first 20-MHz single-board computer for the STD bus will be shown for the first time by WinSystems, Arlington, Texas. The MCM286AT-20-2M is a 16-bit board that the company says is the fastest 80286 CPU board for that bus. WinSystems' previous 286-based STD product, introduced a year ago at Buscon, runs at 16 MHz. That board—the STD-AT—offers performance that's 19 times better than an IBM PC/XT, as measured by

the Norton SI benchmark. In contrast, the new board runs 23 times faster than the XT on the same benchmark. It all adds up to the new board's ability to top the performance of the IBM PS/2 Model 80. The \$1995 board features the Chips and Technologies Neat ChipSet and supports most AT-compatible operating systems.

Another STD bus development at Buscon East will come from Ziatech Corp., San Luis Obispo, Calif. The company produced specifications for a 32-bit STD bus architecture that's backward-compatible with existing 8-bit standards. Called STD 32, Ziatech will offer the specifications without charge to the STD community through STD MG, the STD Bus Management Group. The specifications include edge-connector tab dimensions, which match available connectors, as well as the use of pins that don't interfere with existing 8-bit boards. With STD 32, users could plug existing 8- and 16-bit STD cards into the STD-32 bus extension backplane. They could also plug new STD-32 bus extension cards into the backplane of existing 8- and 16-bit STD bus systems.

Ziatech undertook development of STD 32 after the firm's market research indicated that system designers would stay with the STD bus if they were assured that it offered a growth path to 32 bits. One 16-bit STD specification was proposed to STD MG but has not yet been accepted. STD 32 would leapfrog to 32 bits, but also accommodate 16-bit designs with a growth path.

Rob Davidson, Ziatech product manager, says that refinements are still needed before STD 32 can be put into production. "But in conversations with suppliers of connectors and other portions of STD technology, we've determined that every specification is producible," he says. Ziatech is already developing products using the new architecture. □

HOW VALUABLE?	CIRCLE
HIGHLY	559
MODERATELY	560
SLIGHTLY	561

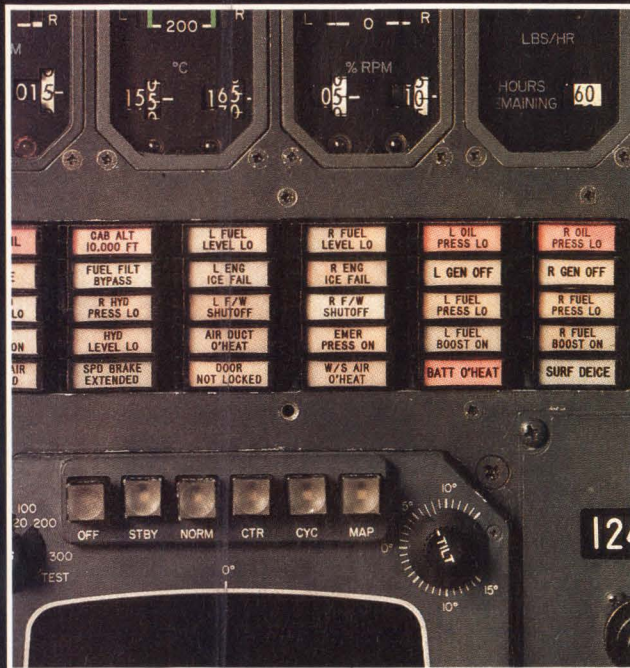

Before

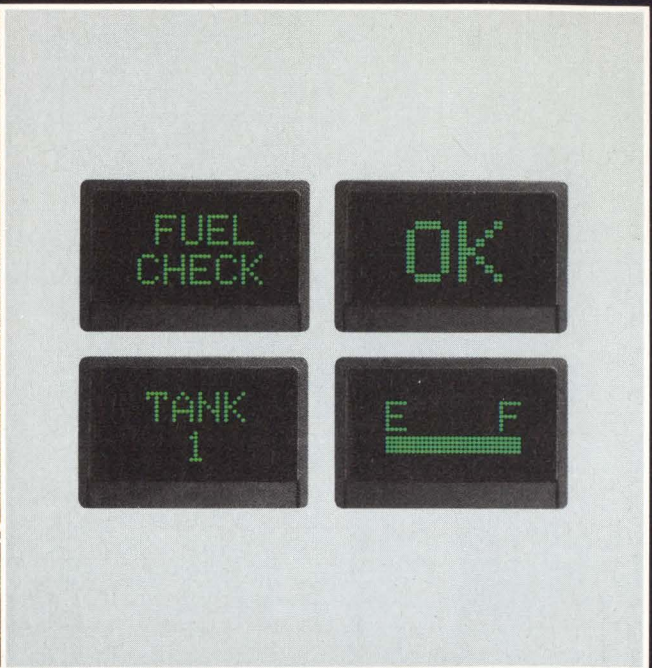

After

Fewer switches. More control.

Now you can reduce control panel clutter. Introducing Vivisun Series 2000, the programmable display pushbutton system that interfaces the operator with the host computer. The user friendly LED dot-matrix displays can display any graphics or alpha-numeric and are available in green, red or amber. They can efficiently guide the operator through any complex sequence, such as a checklist, with no errors and no wasted time.

They also simplify operator training as well as

control panel design. Four Vivisun Series 2000 switches can replace 50 or more dedicated switches and the wiring that goes with them. In short, Vivisun Series 2000 gives you more control over everything including your costs.

Contact us today.



AEROSPACE OPTICS INC.

3201 Sandy Lane, Fort Worth, Texas 76112
(817) 451-1141 • Telex 75-8461 • Fax (817) 654-3405

CIRCLE 19

SERIES
VIVISUN 2000™



Programmable display switches. Making the complex simple.

The Transputer. The Guide.

Send for the Transputer Guide, the definitive reference for the 16-bit and 32-bit transputer family. Find out how easy and economical it is to go from 25 MIPS and 3.6 MFLOPS with a single T800 chip to 250 MIPS and 36 MFLOPS with ten T800 chips. Read how the transputer can switch between tasks in less than $1\mu\text{s}$. Get the Guide and get complete information on the numerous software languages and toolsets now available for the transputer — the low-risk, low-cost path to increased computing performance.

TRANSPUTER GUIDE

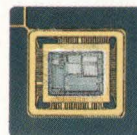

Multiprocessing
Made Simple.

Get The Guide.

Please rush me a free copy of the Transputer Guide.

Name _____ Title _____

Company _____ Phone _____

Address _____

City _____ State _____ Zip _____

Return the coupon to SGS-THOMSON
Microelectronics, 1000 East Bell Road,
Phoenix, Arizona 85022, or circle the bingo
number. For faster service call 602/867-6259.

Multiprocessing Made Simple.

ED 9/14/89

Performance-minded embedded control manufacturers refuse to wait on 'next-generation' processors.

Manufacturers designing embedded systems with scalability in mind have discovered that they can linearly increase product performance simply by adding extra transputers. Unlike conventional devices, transputers do not have the bus communication and shared memory problems that set a limit on the number of processors that can be tied together for multiprocessing applications.

The transputer's straight-line performance expandability allows manufacturers to introduce a wide range of products at one time.

Today, transputers alone offer a performance enhancement path that is not dependent on "next generation" microprocessor developments.





IR announces a new direction for Schottkys.

As power supply frequencies go higher and higher, power diodes need faster and faster recovery times.

International Rectifier is there with a new family of high-voltage, high-frequency Schottky diodes, from 100-160 volts with virtually no recovery time.

As efficiency demands go higher and higher, forward voltage drop must go lower.

And International Rectifier is there with a new family of ultra-low V_f Schottky diodes with forward voltage drops as low as 0.25 volts.

Whatever your application,

now you can pair up HEXFET[®] power MOSFETs with IR Schottkys. With the quality and reliability that are benchmarks of the industry.

Talk Schottkys with IR. Higher or lower, we have some pretty far reaching ideas about the future.

IR INTERNATIONAL RECTIFIER

WORLD HEADQUARTERS: 233 KANSAS ST., EL SEGUNDO, CA 90245, U.S.A. (213) 772-2000, TWX 910-348-6291, TELEX 472-0403 • EUROPEAN HEADQUARTERS: HURST GREEN, OXTED, SURREY RH8 9BB, ENGLAND TELEPHONE (0883) 713215, TELEX 95219

CIRCLE 58

AIMED AT DIGITAL-AUDIO APPLICATIONS,
THIS MONOLITHIC DATA CONVERTER OFFERS
14 BITS AT 200 KHz FOR UNDER \$1/BIT.

DUAL 18-BIT ADC CHIP GRABS 20-KHz AUDIO

FRANK GOODENOUGH

When designing mixed analog-digital systems, large numbers of dc-to-audio-band analog channels must be digitized to at least 14-bit accuracy. Now there's the PCM1705P, the first monolithic a-d converter with more than 16-bit resolution that can handle signals of more than a few hertz. Available from Burr-Brown, it runs at 200 kHz and gives 14-bit, no-missing-code accuracy for under \$14. In addition, two of these converters are contained on one chip.

The PCM1705P, a dual 18-bit CMOS a-d converter, was developed for high-end consumer digital-audio applications and is currently specified for only those jobs. When oversampling 20 kHz audio by a factor of four at 192 kHz, total harmonic distortion plus noise runs a maximum of -92 dB. It's used in digital-audio tape (DAT) player/recorders and various consumer applications, which include the front end of stereo systems that employ digital-signal processors for special effects, and digitizing stereo audio for video recorders (camcorders).

After discussing the PCM1705P with traditional system designers, Burr-Brown found a high level of interest in many applications, such as medical imaging, telecommunications, and various systems with DSPs at their heart. For instance, in virtually any DSP application the processor can up the a-d converter's signal-to-noise (S/N) ratio by 9

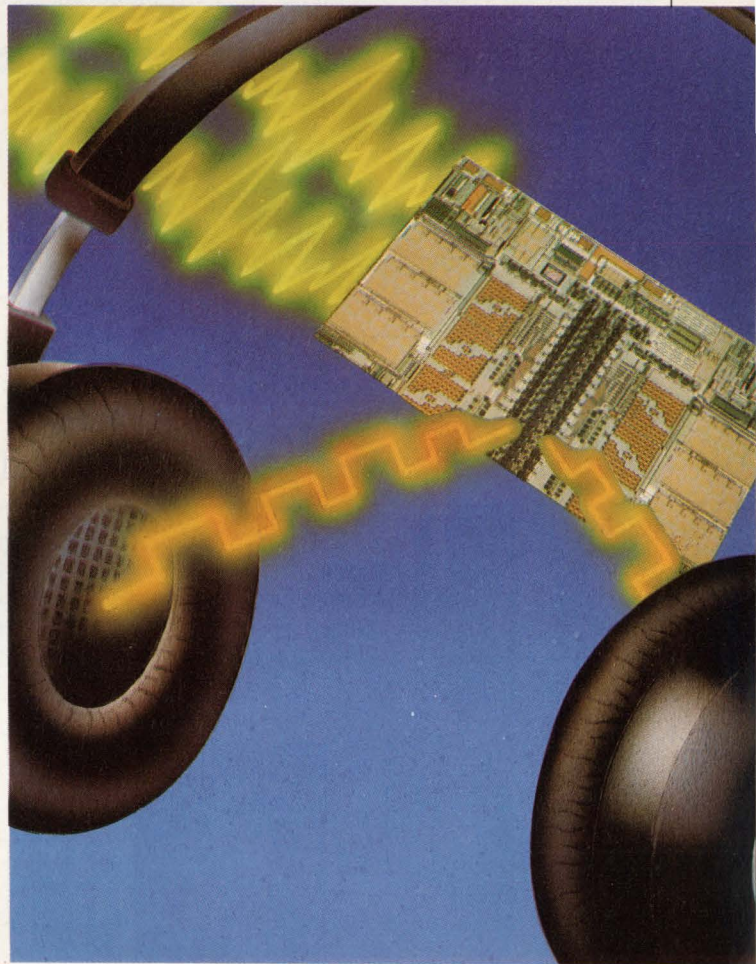

or 10 dB just by averaging.

This machine, with its two disparate sets of specifications, has two complete 18-bit, successive-approximation register, switched-capacitor a-d converters on one chip (*Fig. 1*). The digital-audio requirement demands two serial outputs that minimize die size and conveniently put the chip into a reasonably-sized 28-pin DIP (imagine working with

COVER: DUAL 18-BIT ADC IC

36 output lines from a 64-pin package). Some system designers may still employ parallel outputs, but most of them try to cut the number of bus lines on a board. In addition, if you need the data in parallel form, registers (which are usually inexpensive) can be used. The serial bits are clocked out by the master clock, with each bit available one clock cycle after a bit decision.

The converter pair employs a classic, binary weighted, switched-capacitor architecture to minimize chip size (160 by 160 mils). Segmentation, which would require additional ca-

pacitors, isn't employed. Like most a-d converters using switched capacitors, the architecture offers inherent sampling. Moreover, because the two converters run in synch, designers can simultaneously sample two dynamic signals. Typical jitter (aperture uncertainty) is just 50 ps, translating into a full-power bandwidth of 25 kHz, and an equivalent noise between channels of just 20 μ V.

Running in synch also ensures that the digital switching noise from one converter doesn't pollute the sampling of the signal, or effect critical bit-decisions by the auto-zeroed

comparator in the other converter. In the stereo application, minimum noise is crucial in reaching the -92 dB signal-to-noise ratio. The simultaneous sampling eliminates the phasing error found in systems that alternately sample and convert one channel and then the other.

The chip also has its own 2.75-V voltage reference, with separate fast-settling buffer amplifiers driving each of the capacitor d-a converters. The reference employs a low-noise band-gap circuit, but the circuit isn't low-drift. Consequently, the resulting gain temperature coefficient of the two converters can be as great as 250 ppm/ $^{\circ}$ C. Gain accuracy at 25 $^{\circ}$ C runs a maximum of \pm 5%.

An internal reference is fine for audio applications, but it doesn't always suffice for other applications where greater precision is needed. By using the REF-Out and REF-In pins that are supplied for each channel, a higher-precision reference can be used. Because the reference voltage to the d-a converter determines the maximum value of the input signal (\pm 2.75 V), changing its value alters the full-scale input voltage.

Burr-Brown is currently only supplying typical (but conservative) specifications for non-audio applications. However, accurate characterization for more traditional applications is underway. As noted, basic accuracy (no missing codes) is 14 bits, while differential nonlinearity (DNL) and integral nonlinearity run \pm 0.002% and \pm 0.003% of full scale, respectively. Power consumption, which is important to all potential users, is just 300 mW maximum for the PCM1705P; 28 mA from a +5-V rail; and a mere 13 mA from a -5-V rail.

There are diverse nonconsumer applications for the PCM1750. Today, the front end of a typical, multi-channel, medical imaging system consists of an expensive, true 16-bit a-d converter with a throughput rate in the neighborhood of 500 kHz. Between the converter and the signals lie signal-conditioning circuitry for each channel, a high-speed analog multiplexer, and a high-speed, 16-bit-accurate, sample-and-hold amplifier (or often a buffer amplifier or a sam-

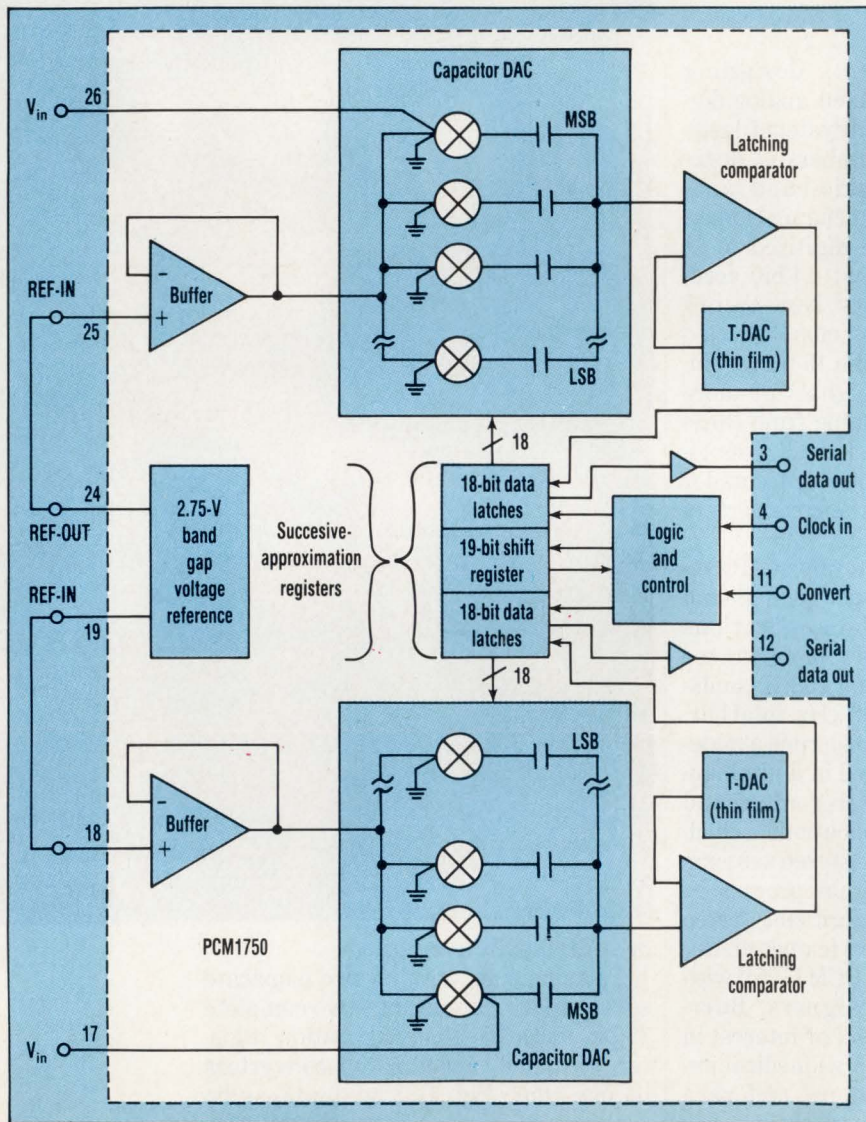

1. SWITCHED-CAPACITOR TECHNOLOGY and a successive-approximation architecture are employed by Burr-Brown's PCM1750 dual 18-bit a-d converter to achieve a 92-dB signal-to-noise ratio while sampling a 20-kHz signal at 200,000 kHz.

PRESSURED BY HIGH-SPEED ASICs?



INSIST ON SOLID GaAs.™

At speeds above 100 MHz, it's easy to exceed your comfort level. You have to reappraise the technologies. The risks. The costs. You want an ASIC resource with a solid track record of success.

As the first and most experienced GaAs ASIC vendor, TriQuint has earned the confidence of many of the largest and most demanding customers in telecommunications, instrumentation, computers and military systems.

Count on TriQuint to tell you if

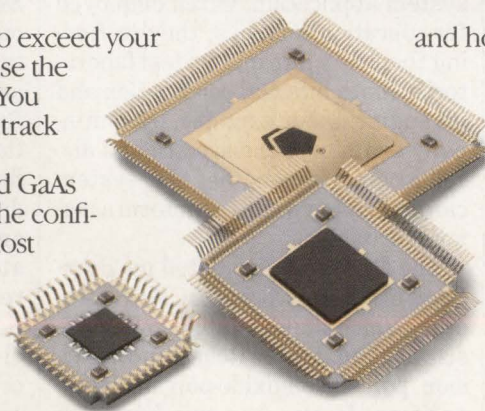

and how GaAs makes sense for your system.

We give you the facts on performance. Yield. Delivery. Reliability. We offer LSI-level macros for efficient design... flexible packaging... the option to mix analog cells with digital designs. We can show you credentials that stretch through hundreds of jobs.

Call TriQuint at 1-800-344-7641 (in Oregon, 644-3535) to learn how safe and solid high-test GaAs can be.

TriQuint 
SEMICONDUCTOR

S O L I D G a A s™
DIGITAL/LINEAR PRODUCT DIVISION • MICROWAVE PRODUCT DIVISION • MLC PRODUCT DIVISION

CIRCLE 22

COVER: DUAL 18-BIT ADC IC

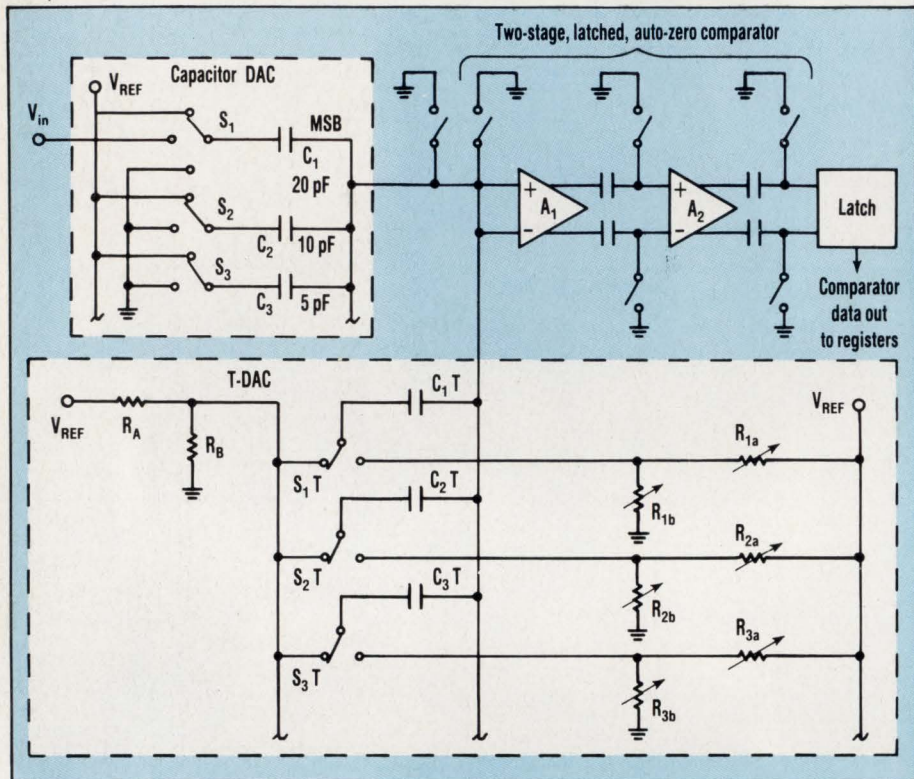

2. THE PCM1750 DUAL 18-BIT a-d converter employs trimming or T-DACs that use laser-trimmed thin-film resistors to trim its 18-bit switched-capacitor d-a converter.

ple-and-hold amplifier per channel ahead of the multiplexer). Switching to one-half of a PCM1750P per channel (though only 14 bits accurate) can actually produce a better image, and in some applications, a lower-cost system. Eliminating the multiplexer and sampling amplifier(s) significantly reduces timing jitter, resulting in nearly 1 bit less blur in the image.

Telecommunications applications range from digital-cellular telephones to echo cancellation in high-end (V.32, 9600-baud) modems. Both represent forms of DSP applications. The extra (14-bit) resolution

and accuracy eliminate the need for compression and/or gain-ranging circuits. The processor only uses the bits it needs. Low-cost instruments or systems that can run a fast Fourier transform on signals from dc to over 20 kHz represent another DSP system application. Often employed for vibration analysis, they're finding their way into engine test laboratories (both internal-combustion and jet engines). For example, by continually examining the spectra of a diesel locomotive engine, the system can determine when to perform a major overhaul.

The PCM1750 is created on Burr-Brown's 3- μ m, p-well, CMOS process, which builds stable, low on-resistance analog switches and precision, polysilicon-oxide-polysilicon capacitors. It also has two layers of metal, and builds laser-trimmable nichrome film resistors. In each converter, the capacitors are used in the two-stage, auto-zeroed, latched comparator; the main capacitor a-d converter; and in a trimming d-a converters. The resistors are used exclu-

sively in the trimming d-a converters.

Polysilicon plate capacitors have stability and matching characteristics equal to or superior to other precision components, such as thin-film resistors. On a well-controlled process, ratio matching typically runs 0.1%, which is a respectable number for an untrimmed component. Even more impressive, the capacitors ratio-track over temperature to about 0.1 ppm/ $^{\circ}$ C; drift overtime is similar.

Achieving a DNL error of better than 1 least-significant bit (at 18 bits) requires ratio matching of the "more significant bits" to better than 0.001%, or 100 times better than the process offers. Therefore, some form of calibration of the "upper bits" is mandatory. On the other hand, ratio tracking over temperature is so superb that DNL changes less than 1 LSB at 18 bits over a 50 $^{\circ}$ C temperature change. As a result, factory calibration rather than field (on-chip) calibration or trimming makes sense, further reducing die size, power, and cost.

Both converters, which are trimmed at the wafer-probing stage with their own on-chip, T-DACs, are built with polysilicon capacitors and thin-film resistors (Fig. 2). Instead of changing the capacitor's value, (ELECTRONIC DESIGN, Feb. 9, p. 26), the reference value is changed.

This is how it works for one bit: Switch S_{1T} (in the T-DAC) switches one plate of capacitor C_{1T} between two different voltage levels; a "reference" level is set by a fixed divider formed by R_A and R_B ; and a correction level is set by laser trimming the divider formed by R_{1a} and R_{1b} . The difference between these two voltages is coupled by C_{1T} to the comparator's minus input to generate a correction voltage for bit 1. The correction voltage changes a reference level for bit 1 at the minus input to the comparator. If C_{1T} is too large, the correction voltage is raised; if it's too small, the voltage is lowered. □

PRICE AND AVAILABILITY

The Burr-Brown PCM1750 dual 18-bit a-d converter, in a 28-pin double-width plastic DIP, goes for \$26.90 in quantities of 1000. Small quantities are available from stock.

Burr-Brown Corp., P.O. Box 11400, Tucson, AZ 85734; Randy Skinner, (602) 746-7270.

CIRCLE 512

HOW VALUABLE?

HIGHLY
MODERATELY
SLIGHTLY

CIRCLE

556
557
558

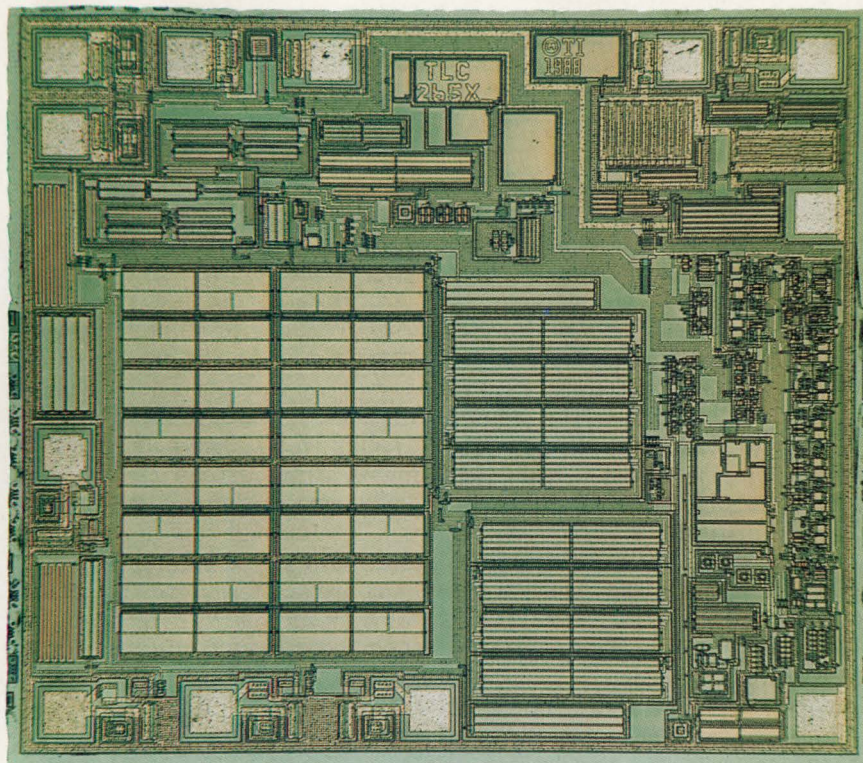

PICKING IC OP AMPS: IT'S NO LONGER EASY

Over the last few years, the IC op-amp jungle has come to resemble the Amazonian rain forest in the number and diversity of its species. This diversity stems from advanced processing and trimming techniques coming on-stream. Op-amp chip designers have had a field day defining and designing new families of op amps with greater performance—at lower prices. Developments continue, with each new design from each company optimizing one or more of the 40 plus performance specifications carried by every quality op amp.

Continued developments in junc-

FRANK GOODENOUGH

WITH IMPROVED PROCESS AND CIRCUIT DESIGN, IC OP AMPS CHALLENGE RIVALS.

tion-isolated-complementary-bipolar (JICB) and CMOS processes are the driving forces behind the op-amp explosion. Complementary bipolar processes build fast vertical npn transistors and fast vertical pnp transistors rather than slow lateral pnps, such as the ± 15 -V, standard, analog, bipolar process. TTL and ECL processes usually don't even build pnp transistors.

Both JICB and CMOS processes demand different design techniques or architectures. Furthermore, skilled designers have taken existing analog and digital bipolar and MOS processes and stretched the performance of the op amps built on them to new highs through innovative circuit techniques. While complementary processes of all types have made linear IC design simpler, op amp designers have taken full advantage of the processes to offer price-performance peaks.

Because of their process and architectural differences, members of each new op-amp family tend to be different from members of all the other families—it matters little that they're from the same company. In contrast, virtually all IC op amps that were bought a few years ago, with the exception of chopper-stabilized and dielectrically isolated (DI) devices, were built on essentially identical bipolar processes with very similar designs. Most op amps, such as the 741, 324, and 355, and logic ICs were multiple-sourced with identical specifications. But today, we find a multitude of models representing an

IC OP AMPS

impressive array of processes and designs. In fact, designers can find devices from processes as disparate as standard bipolar and CMOS aimed at the same application. With few exceptions, nothing is standard from one new op amp to another except for their basic pinouts.

PRODUCT PERMUTATIONS

General-purpose IC op amps (unity-gain stable devices for which speed or bandwidth aren't prime specifications) range from less than \$0.25 each to more than \$25. Their guaranteed maximum offset voltages go from less than $15 \mu\text{V}$ to more than 15 mV . Offset voltage (V_{OS}) drift spans a similar two decades. Bias current (I_B) sweeps a far greater savanna, from less than 100 fAs to hundreds of nAs —a ratio of $10,000,000$ to one. In addition, the temperature coefficient (TC) of these static specifications can differ radically from device to device.

Dynamic specifications are just as diverse as static specifications. Open-loop gain (A_{OL}) runs from 40 to 140 dB , unity-gain bandwidths run from hertz to gigahertz, minimum supply voltages span from 1 V to 12 V or more, and quiescent currents vary from $15 \mu\text{A}$ to over 15 mA . Other widely varying specifications, each important for many applications, include common-mode and power-supply rejection ratios, common-mode voltage range, settling time, full-power bandwidth and slew rate, distortion, and phase and gain margin. Moreover, most of these specifications aren't only a function of temperature, they're also a function of supply voltage and load impedance—the test conditions for the specification. Change any one of the conditions and it's often a whole new ball game. For example, some of the low-supply-voltage op amps have higher offset voltages at low supply voltages rather than at high supply voltages.

To further exacerbate the IC op amp inflation, the "big three" (National Semiconductor, Motorola, and Texas Instruments) and others are bringing out each new device in single, dual, and quad versions; in three

temperature ranges; and often in one or more performance grades. Finally, op-amp package types extend from TO-8 cans and plastic or ceramic DIPs to nearly any surface-mounted design.

And if product proliferation is a problem for designers, consider what it must be like for manufacturers. One Motorola op-amp family, the MC33071, has 42 models. However, several of Motorola's latest families have just two or four. One Analog Devices' op amp, the ultra-low-drift AD707, has 18 models in single-op-amp versions. A dual version, the AD708, adds nine more. Raytheon's ultra-low-drift RC4077/4277 has 26 models (5 duals). Precision Monolithics (PMI), however, has kept its ultra-low entry, the OP-177, to 11 models—there are no duals yet.

Precision (non-chopper-stabilized) low-offset-voltage and low-offset-voltage-drift op amps generally run

off $\pm 15\text{-V}$ supply rails with several exceptions (Fig. 1). They have offset drifts of less than $3 \mu\text{V}/^\circ\text{C}$ and offset voltages at 25°C below $300 \mu\text{V}$. The best come in at $0.1 \mu\text{V}/^\circ\text{C}$ and $10 \mu\text{V}$. Note that all specifications for individual devices are guaranteed maximums or minimums unless noted as typical (t) in Table 2.

Op amps that operate with 10 V or less between their supply pins (half with 3 V or less) and need a quiescent current (I_Q) equal to or less than $300 \mu\text{A}$. Some operate from as low as 3 V drawing $15 \mu\text{A}$. There are even 1-V units drawing just $270 \mu\text{A}$ (Fig. 2).

High-speed op amps will be covered in a second report early next year; however, some high-speed op amps are scattered over the charts (for another look at IC op amps, see ELECTRONIC DESIGN, May 14, 1987, p. 39; Sept. 3, 1987, p. 81; and Feb. 4, 1988, p. 127).

Today, process advancements are

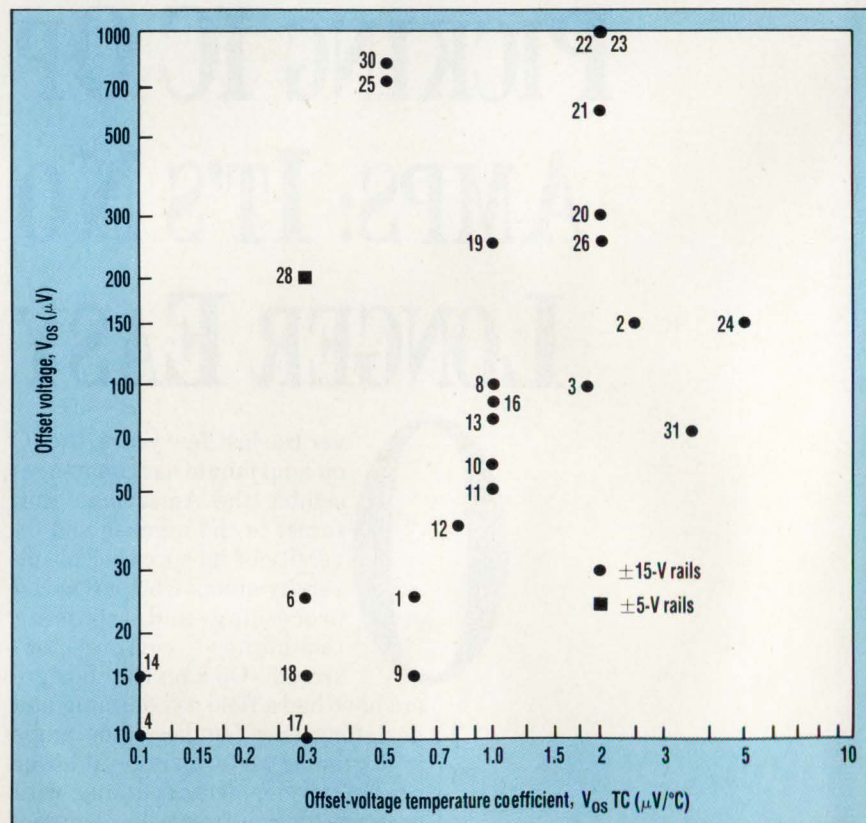

1. PICK THE PRECISION op amp you need from this chart (numbers refer to devices listed in Table 1). First, select the maximum offset drift you can stand along the horizontal axis, then go vertically into the chart until you reach the maximum initial offset voltage. Finally, pick up additional data about your selection in the Table 1.

IC OP AMPS

as important to the vitality of an analog IC supplier as published papers are to a professor. While much attention is given to the move toward JICB processes due to their speed, more designers will probably use op amps from one or more of the new silicon-gate CMOS processes.

Of the five companies marketing op amps built on these JICB processes (Analog Devices, AT&T, National

Semiconductor, PMI, and TI), only TI has used the process to build low-power ($230\text{-}\mu\text{A } I_Q$) general-purpose devices. The op amps are members of the recently announced TLE2021/22/24 device family (see opening figure and Tables 1 and 2, items 20 and 21). Moreover, their fast pnp input stage ensures single-supply operation (common-mode voltage can include the minus rail). They also ap-

pear to be the fastest single-supply op amps, and the fastest with a supply current below $500\text{ }\mu\text{A}$.

Although a dual, single-supply op amp swinging 75 V across a $1000\text{-}\Omega$ load is hardly general purpose, AT&T's LB1013AD comes close to the TLE2022 in many of its specifications. Operating with 85 V between its supply pins, the AT&T part will run off as little as 5 V ; supply current runs a total of 1.1 mA ($550\text{ }\mu\text{A}/\text{op amp}$). The LB1031AD goes for $\$5.25$ each in hundreds.

TLE20xx op amps can't touch the best precision op amps found in the lower left quadrant of figure 1. The BC grade with a guaranteed maximum offset voltage of 200 mV and a typical drift of $2\text{ mV}/+C$ certainly puts them in the precision class. Moreover, its offset voltage over temperature (including the military range) is a maximum of 300 mV . Consequently, your maximum expected error can be known even if the drift specification is given as typical. These specifications are for operation from one 5-V rail, which results in the low quiescent current. When operating from split 15-V supplies, I_Q increases by 70 mA —but maximum offset voltage drops in half. And, as might be expected, dynamic specifications improve: Open-loop gain improves by 10 dB .

Interestingly, two more CB op amps make figure 1, Analog Devices' AD844D and AD846B (Table 1, items 24 and 31). While employing a current-feedback design and aimed at speed, they still come in with an OP-07 class specification. Because the op amps current-feedback devices, their open-loop gain is expressed in megohms. Consequently they are not displayed for simplicity.

OTHER STROKES

Harris, which has DICB as its longtime trademark for its high-speed devices, recently entered the fray with a pair of precision devices, the single HA-5177 and the single/dual HA-5121/5122. The former has the lowest offset drift of the CB op amps, the latter is the fastest precision op amp that's not using current feedback (Table 1, items 16a and

TABLE 1: 15-V LOW-OFFSET-VOLTAGE PRECISION OP AMPS

No.	Company	Model	Unit price (100s)	Open-loop gain (dB)	Comments
1a	Precision Monolithics	OP-07A	\$12.65	110	
1b	Precision Monolithics	OP-27E	\$3.53	120	
1c	Burr-Brown	OPA27E	\$6.80	120	
1d	Harris Semiconductor	HA-5127A	\$6.75	120	
2a	Precision Monolithics	OP-07D	\$1.20	101	
2b	National Semiconductor	LM607C	\$0.93	123	
3a	Precision Monolithics	OP-27G	\$1.54	117	
3b	National Semiconductor	LM627C	\$1.13	132	
3c	Burr-Brown	OPA27G	\$3.00	117	
4a	Precision Monolithics	OP-177E	\$14.95	134	
4b	Raytheon Semiconductor	4077B	\$14.21	134	
5a	Precision Monolithics	OP-177G	\$1.00	126	
5b	Raytheon Semiconductor	RC4097F	\$2.45	116	
6a	Precision Monolithics	OP-77E	\$3.00	134	
6b	Precision Monolithics	OP-50E	\$8.10	140	
6c	National Semiconductor	LM627A	\$4.53	134	
6d	Linear Technology	LT1007AC	\$5.00	137	
6e	Linear Technology	LT1012AC	\$6.50	110	
6f	Raytheon Semiconductor	RC4097E	\$3.65	120	
6g	National Semiconductor	LM607AC	\$2.60	134	
7	Precision Monolithics	OP-77G	\$1.25	126	
8a	Precision Monolithics	OP-50F	\$6.00	138	$I_o = 50\text{ mA}$
8b	Burr-Brown	OPA21E	\$6.70	120	$I_o = 230\text{ mA}$
8c	Burr-Brown	OPA627B	\$15.80	110	$I_b = 20\text{ pA}$
9a	Linear Technology	LT1001AM	\$3.40	113	
9b	Raytheon Semiconductor	LT1001AM	\$27.00	113	
10a	Linear Technology	LT1001C	\$1.35	112	$I_b = 150\text{ pA}$
10b	Linear Technology	LT1007C	\$3.70	134	
10c	Raytheon Semiconductor	LT1001C	\$1.16	112	$I_b = 150\text{ pA}$
10	National Semiconductor	LM607BC	\$1.20	126	
11	Linear Technology	LT1012C	\$2.75	106	
12	Linear Technology	LT1028AC	\$7.55	137	Low noise
13	Linear Technology	LT1028C	\$4.95	134	
14	Analog Devices	AD707C	\$16.00	138	
15a	Analog Devices	AD707J	\$1.25	130	
15b	Raytheon Semiconductor	RC4077B	\$14.21	120	
16a	Harris Semiconductor	HA-5177	\$4.73	126	
16b	Raytheon Semiconductor	RC4077F	\$1.37	126	
17a	Raytheon Semiconductor	RC4077E	\$2.63	134	
17b	Maxim	MAX400E	\$7.62	114	
18a	Raytheon Semiconductor	RC4097A	\$21.00	120	
18b	Maxim	MAX400C	\$6.00	114	
19	Burr-Brown	OPA111BM	\$12.65	120	$I_b = 1\text{ pA}$
20	Texas Instruments	TLE2021AC	\$2.56	110	
21	Texas Instruments	TLE2021C	\$1.76	110	
22	Motorola Semiconductor	MC33078	\$1.05	90	Dual
23	Motorola Semiconductor	MC33077	\$1.91	104	Dual
24	Analog Devices	AD844B	\$7.00	NA	Current feedback
25	Harris Semiconductor	HA-5221	\$6.68	106	
26	Burr-Brown	OPA627A	\$7.50	104	
27	Motorola Semiconductor	MC33272	NA	94	
28	Texas Instruments	TLC2201B	\$7.49	104	$I_b = 1\text{ pA}$
29	Linear Technology	LT1077C	\$1.65	NA	
30	Texas Instruments	TL031AC	\$1.15	74	
31	Analog Devices	AD846B	\$7.45	NA	Current feedback

ЖЕКАР



ЖЕКАР

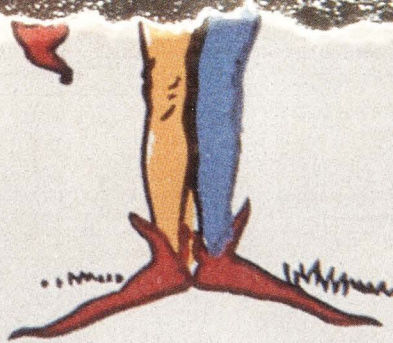

Where speed meets precision... the Harris op amp family.

One-chip Solutions That Won't Slow You Down.

Precision op amps aren't so slow anymore. In fact, Harris makes them downright fast.

Our precision op amps offer you low offset voltages that make further signal adjustments unnecessary. And their high speed broadens system band-

width and drives up throughput.

Select from proven workhorses like the HA-5147A and HA-5134, or tap the benefits of new entries like the unity gain stable HA-5221, four-channel programmable HA-2410, and HA-5177 with lowest offset voltage.

Available in many functional configurations, our op amps' low noise

yields higher resolution while their low supply currents reduce system power needs.

Best of all, they're all monolithic, all fast and all available now in the packages and quantities you need. Across the full temperature spectrum: military, industrial and commercial.

Use them to replace costly hybrids and boost

performance in instrumentation, automatic test equipment, active filters, low-noise sensors, voltage-controlled oscillators, and more.

For data sheets and more information, call 1-800-4-HARRIS, Ext. 1785. In Canada: 1-800-344-2444, Ext. 1785.

KEY FEATURE		HA-5221	HA-2410	HA-5177	HA-5134	HA-5170	HA-5147A
Max Offset Voltage	μV	700	200	25	100	300	25
Settling Time	μSec	1.5	2.0	14.0	13.0	1.0	0.4
Offset Drift	$\mu\text{V}/^\circ\text{C}$	0.5	3.0	0.1	0.3	2.0	0.2
Gain	$\text{V}/\mu\text{V}$	2.5	5.0	30.0	3.0	0.6	1.8
Noise	nV/Hz	3.4	6.0	3.8	7.0	10.0	3.0
Slew Rate	$\text{V}/\mu\text{Sec}$	20.0	8.0	0.8	7.0	8.0	35.0
Bandwidth	MHz	35.0	8.0	1.4	4.0	8.0	10
Supply Current	mA	8.0	4.0	1.2	6.5	1.9	3.0
Packages	LCC	•	•	•	•	•	•
	Cerdip	•	•	•	•	•	•
	TO-99	•	•	•	•	•	•

All specs typical.

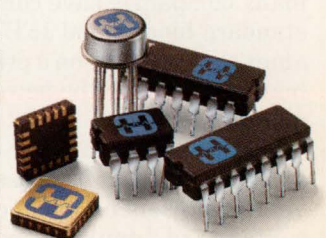

What your vision of the future demands. Today.

HARRIS
SEMICONDUCTOR
HARRIS · RCA · GE · INTERSIL

IC OP AMPS

25). In most applications, V_{OS} TC or maximum V_{OS} over temperature is more important than initial V_{OS} —and that's where the HA-5177 shines.

Harris isn't alone with precision DICB op amps. Burr-Brown's upcoming OPA627B (Fig. 1, center) has a V_{OS} of 100 μ V and a TC of 1 μ V/ $^{\circ}$ C (Table 1, item 8c). It's also fast, and it includes JFETs on the input that give it a bias current of 20 pA, putting it in a class with Burr-Brown's OPA111 and the Harris HA-5180-5. Both of these are 1-pA-bias-current chips aimed at electrometer applications where femtoampere bias currents aren't needed. Comparable to virtually all Harris op amps, the HA-5180 employs their DICB process; however, the OPA111 is built on an earlier Burr-Brown process. While employing DI, the OPA111's pnps are laterals (Table 1, item 19).

Elantec and Sipex are also building op amps on DICB processes, but both have limited their product lines to speedy devices. Furthermore, a JFET input device is expected from TI's complementary process in the near future. The TI chip will claim a mix of specifications for general-purpose JFET op amps that were previously unavailable.

Don't give up on the well-proven, standard bipolar processes yet. They dominate today's ultra-precision devices, such as the PMI OP-177E, with just 10 μ V of V_{OS} and 0.1- μ V/ $^{\circ}$ C drift, (Table 1, item 4). In addition, 20 other devices boast offsets equal to or below 50 μ V with TCs at or below 1 μ V/ $^{\circ}$ C. Many of them are available as duals, and some can be found as quads. A quick look at both tables indicates that innovative designers at many companies have come up with standard bipolar and JFET-input op amps that compete on a price-performance basis with the newer complementary units.

Eight op amp families developed at Motorola over the past several years represent excellent designs on a standard bipolar process. The newer families also contain members that are excellent examples of what can be done with advanced trimming techniques. The newest also show one company's effort to

slash product proliferation. As a reminder, both TI and National have bipolar and JFET-input op amp families containing devices with similar levels of performance.

"To Boldly Go..."

Op amps in Motorola's families range widely in performance—from low-power, single-supply all-bipolar devices to high-speed JFET-input units. All the bipolar-input devices run from one supply. The families have dual and quad versions; some also come as singles. The bipolar-input families include the single-version MC33171 units with low power of 250 μ A, a 1.6-V/ μ s slew rate, and V_{OS} of 4.5 mV; and the MC33071 with an 8-V/ μ s slew rate and V_{OS} of 3 mV. Both feature a V_{OS} TC of 10 μ V/ $^{\circ}$ C. In dual bipolar-input families, there are the MC33078, MC33077, and MC33272 with slew rates of 5, 8, and 10 V/ μ s, and a V_{OS} of 2, 1, and 1 mV, respectively. All three families have a V_{OS} IC of 2 μ V/ $^{\circ}$ C.

In JFET-input, single-version families, there's the high-speed MC34081 family with slew rates up to 20 V/ μ s, I_B of 200 μ A, V_{OS} of 0.5 mV, and V_{OS} TC of 10 μ V/ $^{\circ}$ C. Then there's the MC33181 family with a low bias current I_B of 100 μ A, a 7-V/ μ s slew rate, V_{OS} of 2 mV, and V_{OS} TC of 10 μ V/ $^{\circ}$ C. Also included is the MC33282 JFET-input dual-input family with a 7-V/ μ s slew rate, V_{OS} of 2 mV, V_{OS} TC of 5 μ V/ $^{\circ}$ C, and I_B of 200 μ A.

An all-npn output stage, common to these eight op amp families, gives them their speed-power product that's in a class

with many CB devices. This technique dominates Motorola's op amps. Linear Technology (LTC) uses it in its LT1028 and PMI uses it in its OP-50, which features a V_{OS} of 25 μ V, a V_{OS} TC of 0.3 μ V/ $^{\circ}$ C, and puts out 50 mA.

The secret behind any producible IC op amp with an offset voltage below a few millivolts is good control of the process and a superior production trimming technique. Analog Devices specializes in laser trimming thin-film resistors, while most of the others employ some variation of zener zapping—the blowing of on-chip zener diodes to cut fixed resistors in or out of the circuit. Both techniques must be used before packaging. However, stress induced during molding can cause permanent changes in offset voltage. Zapping can be done after packaging but it requires extra pins.

Motorola developed a technique that makes in-package trimming

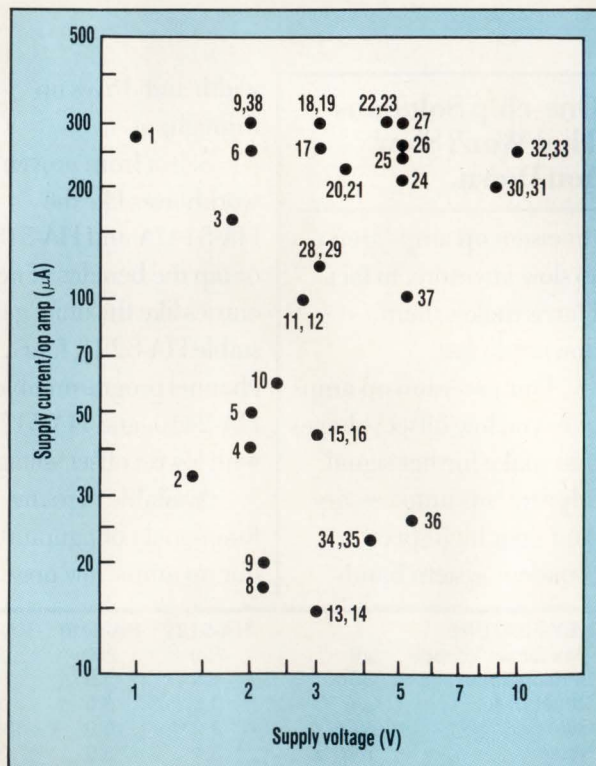

2. TO SELECT THE low-supply-voltage or quiescent-current op amp, you need to first choose your maximum supply voltage from the horizontal axis (numbers refer to devices listed in Table 2). Then go vertically into the chart until you reach your maximum allowable supply current. Finally, get other data about your choice in Table 2.

The Analog ASIC Solution

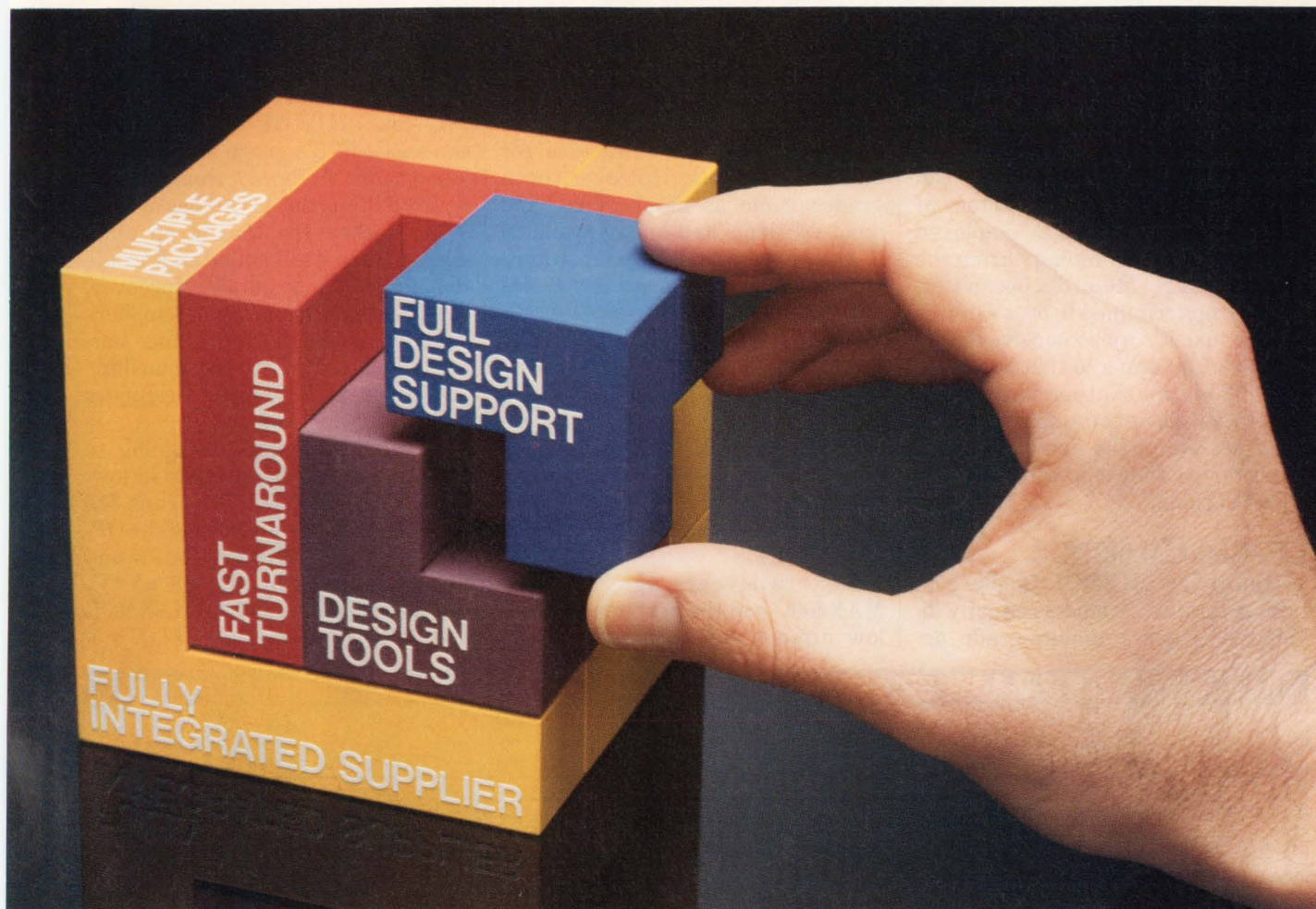

All the pieces—from Raytheon, your development partner:

Raytheon's RLA Linear Array Family of user-configurable macrocell arrays—and full design support. (RLA 40, 80, 120, and 160)

□ **Configurable macrocells:** 4, 8, 12 or 15 gain blocks that can be configured into a variety of analog functions to achieve your system's needs.

□ **Design support:** Raytheon offers a comprehensive design kit containing applications and design documentation, 200X plots, a printed circuit board, and 23 macrocell kit parts.

Software includes SPICE¹ model data files that can run on PCs and various workstations.

Application engineers provide personalized service and full support from design conception through product delivery. Take advantage of Raytheon's extensive experience in custom and semicustom products.

□ **And more:** Choose from a wide variety of packages including plastic and ceramic DIPs, SOICs, PLCCs, and LCCs in commercial, industrial and military temperature ranges.

Analog ASICs need not be a puzzle. Not with Raytheon's RLA Family. And the support we provide with more than 15 years' experience as a supplier of high-volume commercial custom and semicustom devices.

Call us for complete RLA program information and details on the RLA Macrocell Array Design Kit.

Raytheon Company
Semiconductor Division
350 Ellis Street
Mountain View, CA 94039-7016
(415) 966-7716

Raytheon

Where quality starts with fundamentals.

¹ SPICE developed by University of California

IC OP AMPS

possible by passing pulses of current through on-chip resistors via paths from signal pins to the power pins. Called "zipper-trimming" because the resistors look like zippers, it can rapidly trim offsets to within tens of microvolts. It can also be employed for prepackage trimming during the probing stage. Motorola doesn't offer op amps trimmed to 50 μV of offset because it's too expensive to test zillions of op amps to that specification. Their marketing philosophy says to sell a lot of op amps with 1 mV of offset—with the knowledge that every device they ship will meet that specification.

CUTTING CALORIES

Motorola's MC33071 family contains a total of 42 models equally divided between premium-grade de-

vices with initial maximum offsets of 3 mV, and non-premium-grade units with maximum offsets of 5 mV. All other specifications are identical for all other models. However, both grades come as single, dual, and quad versions, and all are available in the three standard temperature ranges. Each also comes in a choice of three packages.

The more recent MC34081 family dropped to 26 models, again equally divided between premium and non-premium devices. Finally, if designers want an MC33077, they can have it any form as long as it's a dual version for the extended-industrial-temperature range and it's in an SO-8 or an 8-pin DIP.

Just two years ago, Maxim's MAX400C had the best mix of ultra-low offset-voltage and offset-drift

devices, with a V_{OS} of 15 μV and a V_{OS} TC of 0.3 $\mu\text{V}/^\circ\text{C}$ (Table 1, item 18). Now PMI's OP-177 and Raytheon's RC4077B come in at 10 μV and just 0.1 $\mu\text{V}/^\circ\text{C}$ (Table 1, items 4a and b). In addition, the AD707 has a lower V_{OS} TC than the Maxim op amp, while Maxim itself added an E grade that drops V_{OS} to 10 μV . Moreover, other devices from other suppliers have encroached into this once barren field. Is this just "specsmanship" or is there a difference? Designers will have to decide.

To start, designers are going to have to pay for the ultimate in low-drift devices. The AD707C runs \$16 each in quantities of 100, and the OP-177E and the RC4077B go for \$15 and \$14.21, respectively. At 0.3 $\mu\text{V}/^\circ\text{C}$, the RC4097A, MAX400C, MAX400E and RC4077E cost \$21, \$6, \$7.62 and

TABLE 2: LOW-SUPPLY-VOLTAGE LOW-QUIESCENT-CURRENT OP AMPS

No.	Company	Model	Single supply	Min. rail voltage (V)	Max. I _Q (mA)	Unit price (100s)	I _B (max)	V _{OS} (mV/°C)
1	Genum	GC810	Y	1	270	\$1.49	160 nA	2 (t)
2	Texas Instruments	TLC1078 (d)	Y	1.4	34	\$2.31	0.6 pA (t)	1 (t)
3	Signetics	NE5230	Y	1.8	160	\$1.00	60 nA	5
4	Advanced Linear Devices	ALD1706A	Y	2	40	\$4.34	30 pA	7 (t)
5	Advanced Linear Devices	ALD1706G	Y	2	50	\$1.89	50 pA	10 (t)
6	Advanced Linear Devices	ALD1701A	Y	2	250	\$3.97	30 pA	7 (t)
7	Advanced Linear Devices	ALD1701G	Y	2	300	\$1.55	50 pA	10 (t)
8	Linear Technology Corp.	LT1178AC (d)	Y	2.2	17	\$5.15	8 nA	1.8
9	Linear Technology Corp.	LT1178C (d)	Y	2.2	20	\$2.80	10 nA	2.5
10	Linear Technology Corp.	LT1077C	Y	2.3	60	\$1.65	10 nA	0.4
11	Linear Technology Corp.	LT1006AC	Y	2.7	100 pA	\$2.80	15 nA	1.3
12	Linear Technology Corp.	LT1006C	Y	2.7	100 pA	\$1.60	25 nA	1.8
13	Precision Monolithics Inc.	OP-90E	Y	3	15	\$6.50	15 nA	NA
14	Precision Monolithics Inc.	OP-90G	Y	3	15	\$1.65	25 nA	NA
15	Texas Instruments	TLC27L7C	Y	3	42	\$1.18	0.6 pA (t)	1.1 (t)
16	Texas Instruments	TLC27L2C	Y	3	42	\$0.57	0.6 pA (t)	1.1 (t)
17	Motorola	MC331171	Y	3	250	\$1.34	0.1 mA	10 (t)
18	Texas Instruments	TLC27M7C (d)	Y	3	280	\$1.18	0.6 pA (t)	1.7 (t)
19	Texas Instruments	TLC27M2C (d)	Y	3	280	\$0.57	0.6 pA (t)	1.7 (t)
20	Texas Instruments	TLE2021AC	Y	3.2	230	\$2.56	50 nA	2 (t)
21	Texas Instruments	TLE2021C	Y	3.2	230	\$1.76	50 nA	2 (t)
22	Precision Monolithics Inc.	OP-80E	Y	4.5	300	NA	250 fA	30 (t)
23	Precision Monolithics Inc.	OP-80G	Y	4.5	300	\$1.95	2 pA	30 (t)
24	Burr-Brown	OPA21E	N	5	210	\$6.70	40 nA	1
25	Precision Monolithics Inc.	OP-21E	N	5	230	\$6.35	0.1 mA	1
26	Burr-Brown	OPA211G	N	5	250	\$3.30	75 nA	5
27	Precision Monolithics Inc.	OP-21G	N	5	300	\$1.88	0.15 mA	5
28	National	LPC662AI d	Y	3	120	NA	0.1 pA (t)	1.3 (t)
29	National	LPC662I d	Y	3	120	\$0.90	0.1 pA (t)	1.3 (t)
30	Analog Device Inc.	AD548C	N	9	200	\$4.95	10 pA	2
31	Analog Device Inc.	AD548J	N	9	200	\$0.75	20 pA	20
32	Texas Instruments	TL031AC	N	10	250	\$1.15	100 pA	25
33	Texas Instruments	TL031C	N	10	250	\$0.48	100 pA	7 (t)
34	Texas Instruments	TLE2021BC	Y	4	230	\$2.56	50 nA	2 (t)
35	Texas Instruments	TLE2021C	Y	4	230	\$1.76	50 nA	2 (t)
36	Motorola	MC34181	N	5	250	\$0.79	100 pA	10 (t)
37	Harris	CA5130A	Y	5	100	\$1.39	10 pA	NA
38	Harris	CA3420A	Y	2	300 t	\$2.81	0.02 pA	4

d = dual t = typical

HARRIS FROM HAMILTON/AVNET... WE HAVE INSIGHT INTO YOUR SIGNAL PROCESSING NEEDS



**HELPING TO
MAKE YOUR VISION
A REALITY**

If you give a hoot about quality products and service, call Hamilton/Avnet for Harris linear/analog ICs—in stock and ready to ship.

Harris' wide selection of high-performance op amps range from precision and low-noise circuits, to high gain bandwidth amplifiers for high-speed instrumentation and video applications. Harris' broad line of dielectrically-isolated switches and MUXes not only eliminate latchup, but also dramatically reduce power drain. Complete your data acquisition system with a full line of Harris A/D converters, D/A converters and sample-and-hold amplifiers.

And, with Harris' broad variety of telecom ICs, you're assured a product that meets the exact requirements of your phone, fax or PBX system.

Don't fall prey to the competition. For Harris' total line of signal processing products, call Hamilton/Avnet. For the location nearest you, call toll free, **1 (800) 442-6458**.

Hamilton  **Avnet**
ELECTRONICS  AN AVNET COMPANY

CIRCLE 10



A SAMPLING OF IC OP AMP SUPPLIERS

AT&T

Reading, Pa.
(800) 372-2447 USA
(800) 553-2448 Canada
CIRCLE 451

Advanced Linear Devices

Sunnyvale, Calif.
(408) 720-8737
CIRCLE 452

Analog Devices

Norwood, Mass.
(800) ANALOGD
CIRCLE 453

Apex Microtechnology

Tucson, Ariz.
(602) 742-8600
CIRCLE 454

Burr-Brown

Tucson, Ariz.
(602) 746-7347
CIRCLE 455

Comlinear

Fort Collins, Colo.
(303) 226-0500
CIRCLE 456

Datel

Mansfield, Mass.
(617) 339-3000
CIRCLE 457

Elantec

Milpitas, Calif.
(408) 945-1323
CIRCLE 458

Gennum

Burlington, Ontario
(416) 632-2996
CIRCLE 459

Harris Semiconductor

Melbourne, Fla.
(407) 729-5310
CIRCLE 460

Intersil Division

Santa Clara, Calif.
(408) 996-5000
CIRCLE 461

Hycomp

Marlborough, Mass.
(508) 485-6300
CIRCLE 462

Linear Technology

Milpitas, Calif.
(408) 432-1900
CIRCLE 463

Maxim Integrated Products

Sunnyvale, Calif.
(408) 737-7600
CIRCLE 464

Motorola

Phoenix, Ariz.
(602) 897-3840
CIRCLE 465

M.S. Kennedy

Clay, N.Y.
(315) 699-8023
CIRCLE 466

National Semiconductor

Santa Clara, Calif.
(408) 721-2274
CIRCLE 467

Optical Electronics

Tucson, Ariz.
(602) 625-8358
CIRCLE 468

Precision Monolithics

Santa Clara, Calif.
(408) 562-7384
CIRCLE 469

Raytheon Semiconductor

Mountain View, Calif.
(415) 966-7757
CIRCLE 470

**SGS-Thomson
Microelectronics**

Phoenix, Ariz.
(602) 867-6100
CIRCLE 471

Signetics

Sunnyvale, Calif.
(408) 991-2000
CIRCLE 472

Silicon General

Garden Grove, Calif.
(714) 898-8121
CIRCLE 473

Sipex

Billerica, Mass.
(508) 667-8700
CIRCLE 474

Sprague Semiconductor

Worcester, Mass.
(508) 795-1300
CIRCLE 475

Texas Instruments

Dallas, Texas
(214) 995-2011
CIRCLE 476

Teledyne Philbrick

Dedham, Mass.
(617) 329-1600
CIRCLE 477

Teledyne Semiconductor

Mountain View, Calif.
(415) 968-9241
CIRCLE 478

VTC

Bloomington, Minn.
(612) 851-5000
CIRCLE 479

Consider this a guide rather than
a definitive list.

\$2.63 each, respectively.

Open-loop gains, mandatory for high-precision circuits running at high gain, range from 114 to 134 dB: The low value (114 dB) is sufficient for all but the most critical circuit; the \$2.63 unit hits 126 dB. Early precision op amps had open-loop gains of about 100 dB, but the gain nonlinearity of many was poor. The result was nonlinear errors or distortion in wide-dynamic-range signals, particularly when driving low-impedance loads. Though unspecified, most current designs have eliminated the problem—both PMI and Analog Devices show typical gain nonlinearity plots (in any case, be cautious of precision op amps with open-loop gains much below 120 dB). Bias currents of

all units are similar in the 1-to-2-nA region. Maximum voltage noise between 0.1 and 10 Hz runs 0.35 μ Vpk-pk for the AD707, and 0.6 μ Vpk-pk for the RC4077 and Maxim units.

There are a half-dozen others to consider when in the market for this breed of op amp: the PMI OP-77E, National's LM627A and LM607AC, Linear Technology's LT1007AC and LT1012AC, Raytheon's RC4097E, and PMI's OP-50E. All have offset TCs of 0.5 μ V/ $^{\circ}$ C and 25 μ V of offset. Prices range from \$3 to \$6.50, except for the \$8 OP-50E. The OP-50E can put out 50 mA and has open-loop gain of 140 dB, but it's only stable at closed-loop gains of five or above. In a 14-pin hermetic DIP, the fast OP-50E shuts down when the die reaches

165 $^{\circ}$ C.

An anomaly lies in 0.5- μ V/ $^{\circ}$ C 200- μ V—the TI TLC2201BC, which is located in a square (*Fig. 1 and Table 1, item 28*). It's the only device on the figure that can't handle \pm 15-V rails. It's a CMOS op amp that outperforms many bipolars, albeit with an offset voltage that's specified as typical. And with a bias current of 1 pA (again typical), it beats out the JFETs, OPA111BM, and OPA627A (*items 19 and 8c*) and its drift is lower than the JFET OPA627B (*Table 1, item 26*).

When looking at the voltage noise of the low-bias-current devices, it's important to consider the ultra-low drift units: They usually have impressive noise specifications. From 0.1 to 10 Hz, voltage noise of the OPA111, OPA627, and TLC2201BC runs 2.5, 2.5, and 0.5 μ Vpk-pk typical, respectively. Their respective spot noise at 10 Hz runs 60, 60, and 25 nV/ \sqrt Hz. At 10 Hz, the voltage noise of LTC's LT1028 (the lowest voltage-noise IC op amp) is 1.7 nV/ \sqrt Hz, and that of the AD707 is 13 nV/ \sqrt Hz.

How did a TI designer take a process infamous for building noisy op amps (CMOS) and come up with a device that could challenge some of the best bipolars and beat out the lowest-noise JFETs? It took close work between circuit design, layout, and process engineering. In any process, low-noise input stages are obtained by using big transistors—in CMOS, they must be gargantuan. In fact, the input devices take up 45% of the die (*see opening figure*). The largest block in the lower left corner forms two p-channel MOSFETs, and the two large blocks to their right form two n-channel MOSFETs.

The move to CMOS IC op amps, begun by TI in 1983, appears to be gaining momentum. The second-generation field now has six players: TI, National, Advanced Linear Devices, Maxim, and PMI—all of them with proprietary product lines—and SGS-Thomson, which second-sources the TI devices.

There are a myriad of driving forces behind the move to CMOS and various reasons for its apparent success. One reason is the advantages



Improve your vision

High-performance PC-based image processing from Imaging Technology

PCVISION^{plus}

The PCVISION name has stood for quality in low-cost image processing since 1983. Providing RS-170 video digitization, on-board image storage, look-up tables, and pseudocolor display, the PCVISION^{plus} Frame Grabber is supported by more third-party software packages than any other frame grabber available today.

Series 100

Two versions — one for RS-170 input, the other for **variable-scan** input — make the Series 100 one of the most popular single-board image processors. In addition to high resolution and digital video input capabilities, the Series 100 adds a 1024 × 1024 × 12-bit image memory for nondestructive overlays, and a feedback processing path for averaging, subtraction, and other real-time operations.

Series 151

The Series 151 is the most powerful PC-based image processor available today. Housed in a separate chassis with an interface to the PC AT bus or PS/2 Micro Channel Architecture, the Series 151 is a modular, multi-board subsystem for performing real-time noise reduction, convolutions, histograms, feature extraction, and many more high-level functions. A programmable 32-bit floating-point processor ensures accuracy and adaptability to new requirements.

Extensive Software Tools

Our leading-edge software development library, called ITEX, contains *hundreds* of high-level image processing subroutines. A built-in interactive command-line interpreter accelerates application development. Our programmable processors have "C" language compilers for quick development of new or proprietary image processing techniques. Also, dozens of third-party software packages are available through the **Vantage Compatible Products Program**. We even support MS-DOS-based applications running on the VMEbus!

Imaging Technology is your best choice in PC image processing!

If you're serious about performance PC-based image processing, contact the company that leads the industry with hardware, software, service, and support. Imaging Technology Incorporated. Contact our technical sales team today.

Eastern United States

800-532-3500

Central, Mountain, and Pacific United States

800-356-4216

(714-960-7676 in California)

Imaging Technology Incorporated
600 West Cummings Park, Woburn, Massachusetts 01801-6343
FAX: 617-938-1757 TELEX: 948263

IMAGING Technology Inc.

International: Australia (3)-8734455 □ Benelux (76)-710144 □ Canada (604)-273-8655 □ Denmark (1)-156800 □ Eastern Europe [49]-(61)-8227338 □ Finland (0)-674191 □ France (14)-5347535 □ Germany (89)-809020 □ Greece (1)-9421176 □ Hong Kong/P.R.C. (5)-731183 □ India (91)-244771 □ Ireland (1)-450921 □ Israel (3)-9644114 □ Italy (2)-4817930 □ Japan (3)-4199190 □ Korea (2)-6333547 □ New Zealand (3)-798740 □ Norway (2)-555977 □ Portugal (2)-666501 □ Singapore 2780011 □ Spain (3)-2042099 □ Sweden (8)-830980 □ Switzerland (55)-951212 □ Taiwan (2)-3923170 □ United Kingdom (273)-608331

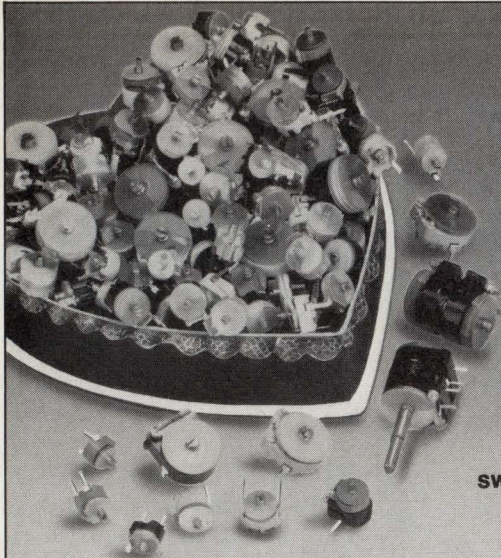

Who says nobody loves trimmer capacitors?

When it comes to commercial and industrial applications, engineers develop a sweet tooth for Sprague-Goodman's Plastic Dielectric Filmtrims®.

And there are plenty of good reasons why they savor these Filmtrims. Our tempting assortment of 4 dielectrics features low loss at low cost, high temperature capability, cost effectiveness, compact size, broad capacitance ranges, and the most stable TCC for single turn trimmers. Call or write for Engineering Bulletin SG-402E, plus data on other trimmers for virtually every variable capacitor requirement.

**SPRAGUE
GOODMAN**

The World's Broadest Line Of Trimmer Capacitors
134 FULTON AVENUE, GARDEN CITY PARK, NY 11040-5395
TEL: 516-746-1385 • FAX: 516-746-1396 • TELEX: 14-4533

CIRCLE 115

Creative Circuit Protection

Heinemann's newly introduced TX circuit protectors offer options previously available only on costly alternatives. They've been styled for use on panels where attractiveness is a must. They serve as a lighted on-off switch. They provide overload protection at ratings from 2 to 20 amperes. And they can be supplied with a built-in auxiliary switch for triggering alarms or controls when an overload occurs. Heinemann's TX circuit protectors carry a full complement of agency approvals.

Express your creativity by specifying a TX circuit protector for an existing application or your new design.

For more information, call or write for Bulletins TX and TX2.



When your reputation's on the line

HEINEMANN ELECTRIC COMPANY

P.O. Box 6800, Lawrenceville, NJ 08648-0800
(609) 882-4800 • EasyLink 62886238 • FAX (609) 882-2183

First in Features, First in Quality

CIRCLE 104

CMOS offers: low cost, low power-supply voltage, high density, a good power-speed product, and inherent sub-picoampere bias currents that turn a CMOS op amp into a poor-man's electrometer op amp. Furthermore, CMOS op amps can operate from one supply and deliver a virtual rail-to-rail output swing. Finally, analog system designers are now ready to give up split ± 15 -V rails.

Essentially all of the CMOS op amps announced over the past few years can be classified as low-power, low-supply-voltage types. The lone exception is the previously described low-noise TLC2201, which needs 1.5 mA from the rails (Table 2). With bias currents that peak at 50 pA and offset that drifts below $15 \mu\text{V}/^\circ\text{C}$, all of these CMOS op amps would make a low-bias-current list. While they can't take 30 V between their supply pins, they work well from ± 5 -V supplies—most only need about 3 V.

National's LPC662I, at just \$0.90, has a typical bias current of just 40 fA. It runs off 3 V and needs only 120 μA from one lithium cell (Table 2, item 29). Bias current is typical because designers can't test for that kind of current in production and sell it for \$0.90.

Another interesting micropower op amp, the all-bipolar dual LT1178AC, is a true precision device with a V_{OS} of 70 μV and a V_{OS} TC of $1.8 \mu\text{V}/^\circ\text{C}$. It needs just 17 μA of supply current per op amp from a 2.2-V battery (Table 2, item 9). As with all LTC single-supply op amps, its output swings to within a few millivolts of ground while sinking current, without the need for a pull-down resistor that draws power when sourcing current. The Advanced Linear Devices CMOS op amps and Signetics' bipolar NE5230 both offer a unique feature that's made possible by a complementary input stage: The common-mode voltage can include both supply rails (Table 2, items 3 through 7). □

HOW VALUABLE?	CIRCLE
HIGHLY	550
MODERATELY	551
SLIGHTLY	552

C11
AS.



OHAI

IN-CIRCUIT

The EMUL-PC is a series of microcontroller hardware for fast file transfer. An on-board trace function with software support. The POD, which plugs into a flexible operating range.



SUPPORT

EMUL51-PC

Intel
8051, 8031, 8032,
8344, 80C152, 80C

OKI
80C31, 80C51, 80C

Siemens
8051, 8031, 8031A

Philips, Signetics
8051, 8031, 80C45,
83C751, 87C751



CALL OR WRITE FOR YOUR
FREE DEMO DISKETTE!
(408) 866-1820

Ask about our 20 minute video presentation.



BUSINESS REPLY MAIL

FIRST CLASS MAIL PERMIT NO. 233 CAMPBELL, CA

Postage will be paid by addressee

NOHAU CORPORATION

51 East Campbell Avenue
Campbell, CA 95008-9884

NO POSTAGE
NECESSARY
IF MAILED
IN THE
UNITED STATES



NOHAU

NOHAU CORPORATION

51 East Campbell Avenue
Campbell, CA 95008
Fax (408) 378-7869
Phone (408) 866-1820

BUILD A WIDE-BUS TEST AND DEVELOPMENT SYSTEM

DESIGNERS FACE UNIQUE CONSTRAINTS WHEN USING OFF-THE-SHELF SCSI PROTOCOL CHIPS IN SCSI-2 SYSTEMS.

One of the key improvements in the proposed SCSI-2 standard is a wider data bus—16- and 32-bit capability in addition to the current SCSI standard's 8-bit data width. But the way that data is sent—over two cables that don't need synchronization—leads to potential problems in debugging new designs. One solution to these problems is a test-and-development system that displays bus phases, data-bus and control-line content, and timing information. With such a system, designers wouldn't need to decode ones and zeros to understand what's happening on the bus. Instead, they could concentrate on *why* a condition occurs rather than how to test for it.

Such SCSI test-and-development systems are usually based on protocol chips specifically designed to interface with the SCSI bus. These devices contain state machines that automatically handle all bus phases and the accompanying data transfers. The protocol chips currently available, however, were designed to conform with the SCSI-1 standard. To build a SCSI-2 test system with these devices, designers must add hardware and software that support the features embodied in SCSI 2.

A board that adds wide-bus capability to the Adaptec SDS-3 SCSI test and development system illustrates some of the problems SCSI-2 system designers must face. The wide-bus option board, as it's called, employs the Adaptec AIC-6250 SCSI protocol chip. The system consists of cards that plug into an IBM PC/XT, AT, or compatible, and the software to control the cards.

The 6250, a high-performance SCSI interface protocol controller,

supports both synchronous and asynchronous SCSI bus transfers. As either a target or an initiator, the device handles arbitration, selection, and reselection, as well as all other SCSI-bus phases. DMA transfers between the SCSI bus and a buffer memory are accommodated. Although a 16-bit bus is available to connect to the buffer RAMs, an 8-bit data bus is used on the SCSI bus side. As a result, a wide-bus system needs two or more devices, one on the 8-bit SCSI-2 bus A cable and one or three on the bus' B cable, depending on whether the bus is 16- or 32-bits wide.

In addition to the wide-bus option board, the SDS-3 links up with the SCSI bus through an SDS-3 test adapter board. This board connects to the A cable and consequently handles the lower 8 bits of data and all control signals. The wide-bus option board connects to the B cable and to the test adapter board. The design example that's discussed has a 16-bit bus, so only one 6250 is needed on each board. The example also exclusively covers the wide-bus option board design.

ON-BOARD MEMORY

Besides the AIC-6250, the wide-bus option board holds an on-board data buffer (OBB memory), which stores up to 64 kbytes of data coming from or going to the SCSI bus (*Fig. 1*). Fast DMA logic (OBB management logic) automatically performs the handshake on the OBB memory bus. This circuitry also ensures that the OBB on the wide-bus option board and the OBB on the test adapter board are synchronized so that they can transfer the correct number of bytes and locate these bytes in the buffer properly. The address and control signals from the PC bus transmit to the OBB through the

MICHAEL NGUYEN

Adaptec Inc., 691 S. Milpitas Blvd.,
Milpitas, CA 95035; (408) 945-8600.

MARK S. GORDON

Digital Finesse Inc., 355 W. Olive Ave.,
Suite 105, Sunnyvale, CA 94086; (408)
737-9156.

DESIGN APPLICATIONS
**WIDE-BUS
 TEST SYSTEM**

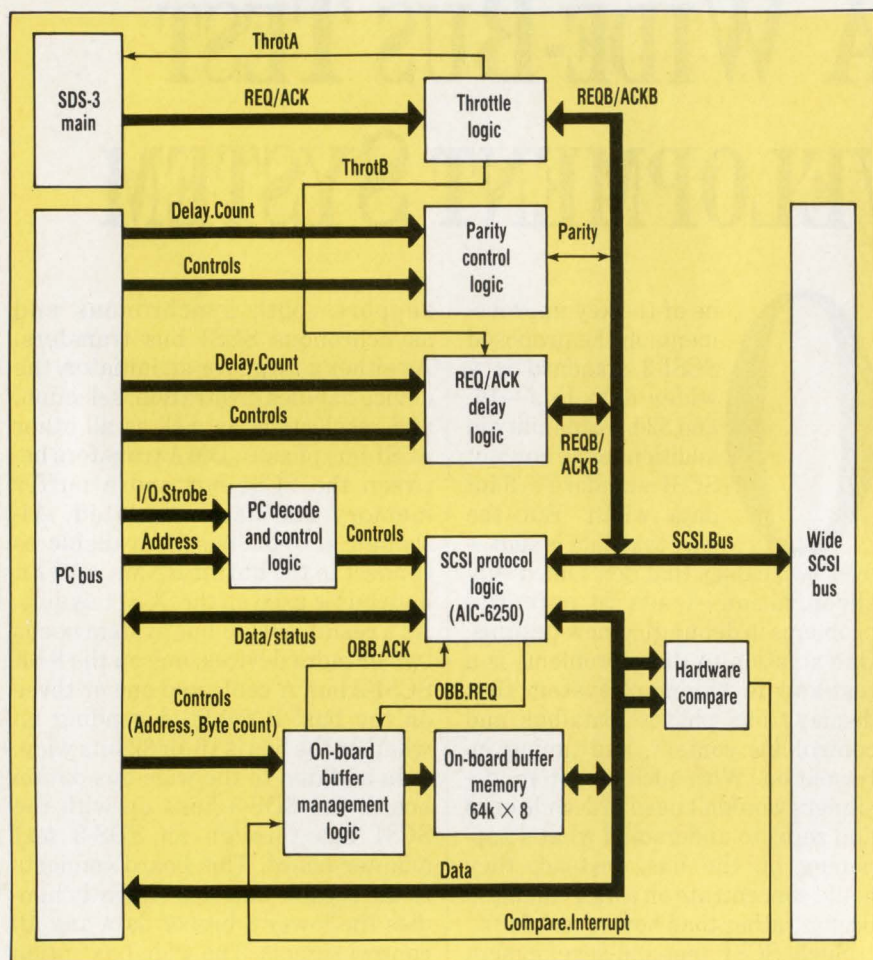

1. THOUGH THE AIC-6250 SCSI protocol chip was designed to conform to the original SCSI specification, designers can use the device in systems for the proposed SCSI-2 standard, such as this SDS-3 wide-bus option board.

OBB management logic.

The hardware compare block contains circuitry that compares data at high speeds. This capability makes possible on-the-fly comparisons of data that's written to a device on the SCSI bus. It works by comparing what's stored in the OBB with data that's read back from the bus (which is only compared, not stored). This feature is particularly useful when large volumes of data are transferred, making visual comparison inefficient.

The parity control logic makes controlled parity generation possible. If enabled, it generates parity for writes to the SCSI bus and checks parity on reads from the bus. With this parity logic, users can also force a parity error after from 1 to 256 byte

transfers.

Because it resides on the PC bus, the board also has PC decode and control logic, which is contained in a PAL16R4, a register-type programmable logic array (Fig. 2). Proper synchronization is ensured by clocking the array with the same 20-MHz on-board oscillator that the 6250 uses. The PAL translates PC bus address and control lines \overline{IOW} , \overline{IOR} , and AD_4 , and address decoder output \overline{BDSEL} to the \overline{WR} , \overline{RD} , ALE , and CS control lines required by the 6250.

The board has 32 (decimal) addresses: 16 for the 6250's internal registers and 16 for other logic. AD_4 chooses between the two sets, and the \overline{BDSEL} line supplies access to any of the 32 locations.

Two three-state buffers, $TSBUF_1$

and $TSBUF_2$, isolate the address bus lines from the multiplexed address/data bus lines, PD_{7-0} , of the 6250. Three more three-state buffers ($TSBUF_3$, $TSINV_1$, and $TSINV_2$) connect the $\overline{SCSI.I/O}$, $\overline{Pseudo.C/D}$, and $\overline{Pseudo.BSY}$ lines to the device.

ADAPTING TO SCSI-2

The $\overline{Pseudo.C/D}$ and $\overline{Pseudo.BSY}$ signals are needed because the 6250 is a SCSI-1 type device working in a SCSI-2 wide-bus system. This is because the 6250 is designed to handle all of the SCSI bus phases, expecting to see them occur in a particular order. Because all control signals are transmitted on the A cable, the 6250 on the adapter board monitors and handles the phases that these signals specify.

On the other hand, the 6250 on the wide-bus option board handles only B cable data transactions, so it doesn't see \overline{BSY} , \overline{SEL} , or any of the phase lines carried on the A cable. The $\overline{Pseudo.BSY}$ and $\overline{Pseudo.C/D}$ signals make the 6250 on the wide-bus option board believe that those SCSI-bus phases preceding the data phase are complete.

As a result, the 6250 on the B cable can arbitrate, select (or reselect), watch for a response to its selection (or reselection), and detect phases other than the data phase (a command, status, or message phase) so it can properly proceed to and from the SCSI data phase. Control software that's part of the SDS-3 manages the $\overline{Pseudo.BSY}$ and $\overline{Pseudo.C/D}$ signals.

It must be remembered that the \overline{BSY} , \overline{SEL} , and phase control lines ($\overline{C/D}$, $\overline{I/O}$, and \overline{MSG}) of the 6250 on the wide-bus option board aren't actually connected and this device doesn't control or respond to bus phases. The 6250 on the SDS-3 test adapter board handles bus phases.

A look at the arbitration and selection/reselection phases shows how the process works. Acting as an initiator, the 6250 on the wide-bus option board believes it's commencing arbitration when bit 6 in its interrupt mask register 0 is set to 1. The initiator raises \overline{SEL} (if arbitration is won), drops \overline{BSY} , and waits for the target

DESIGN APPLICATIONS
WIDE-BUS
TEST SYSTEM

to respond to being selected by raising BSY.

The SDS-3 control software responds when the SCSI SEL signal appears by polling SCSI signal register 09 on the 6250—this determines when BSY is dropped. It then raises the Pseudo.BSY signal at the appropriate time. This particular action fools the 6250 into believing that a SCSI target responded.

No Handshake Needed

The control software then asserts the Pseudo.C/D signal to simulate a change to command phase by a target. The 6250 matches this new phase, which is reflected in the SCSI C/D bit (bit 7 of the device's SCSI signal register 09). Next, the control software drops Pseudo.C/D, forcing a change in value of the SCSI C/D bit. Note that a handshake isn't needed for the 6250 to proceed to the SCSI data phase.

Similarly, when the board acts as a target, the control software watches for SEL being raised and BSY being dropped, then asserts and deasserts the Pseudo.BSY signal. This action makes the 6250 believe that it successfully completed the arbitration and reselection phases and gained control of the SCSI bus by asserting BSY. As a target, the 6250 can be switched to the command phase by writing SCSI signal register 09, bit 7. Data phase is entered when this bit is deasserted. This series of actions places the device in the data phase so that it can transfer data properly. The SCSI control signals are different for a target and an initiator, so the Target/Initiator signal is required to differentiate between the two roles.

The SCSI.I/O signal (a buffered version of the SCSI bus I/O signal) forces the 6250 to see the data phase direction (in or out) on the SCSI bus. The SCSI.RST.Detect signal resets the 6250 and then deasserts the Pseudo.BSY and Pseudo.C/D signals when a reset occurs on the SCSI bus.

As noted, the proposed SCSI-2 standard doesn't supply synchronized data transfers on the A and B cables. In the case of a 16-bit data

bus, even bytes (0, 2, 4, and so on) pass along the A cable, and odd bytes (1, 3, 5, and so on) along the B cable. If the cables are of different lengths, which is permitted by the proposed standard, skewed transfers can occur. For instance, bytes 0, 2, and 4 may pass along the A cable before the transfer of byte 1 is completed on the B cable.

A buffer, however, must hold the bytes in their proper order (0, 1, 2, and so forth), even though that may

differ from the order of receipt if transfers on one cable operate faster than those on the other. Consequently, unsynchronized cables can make it difficult to debug firmware that, for example, moves data into a disk buffer on reads. If the system enforces the synchronization of the two cables—a process called throttling—designers can turn the synchronization on and off to determine if skewed transfers cause improperly ordered buffers.

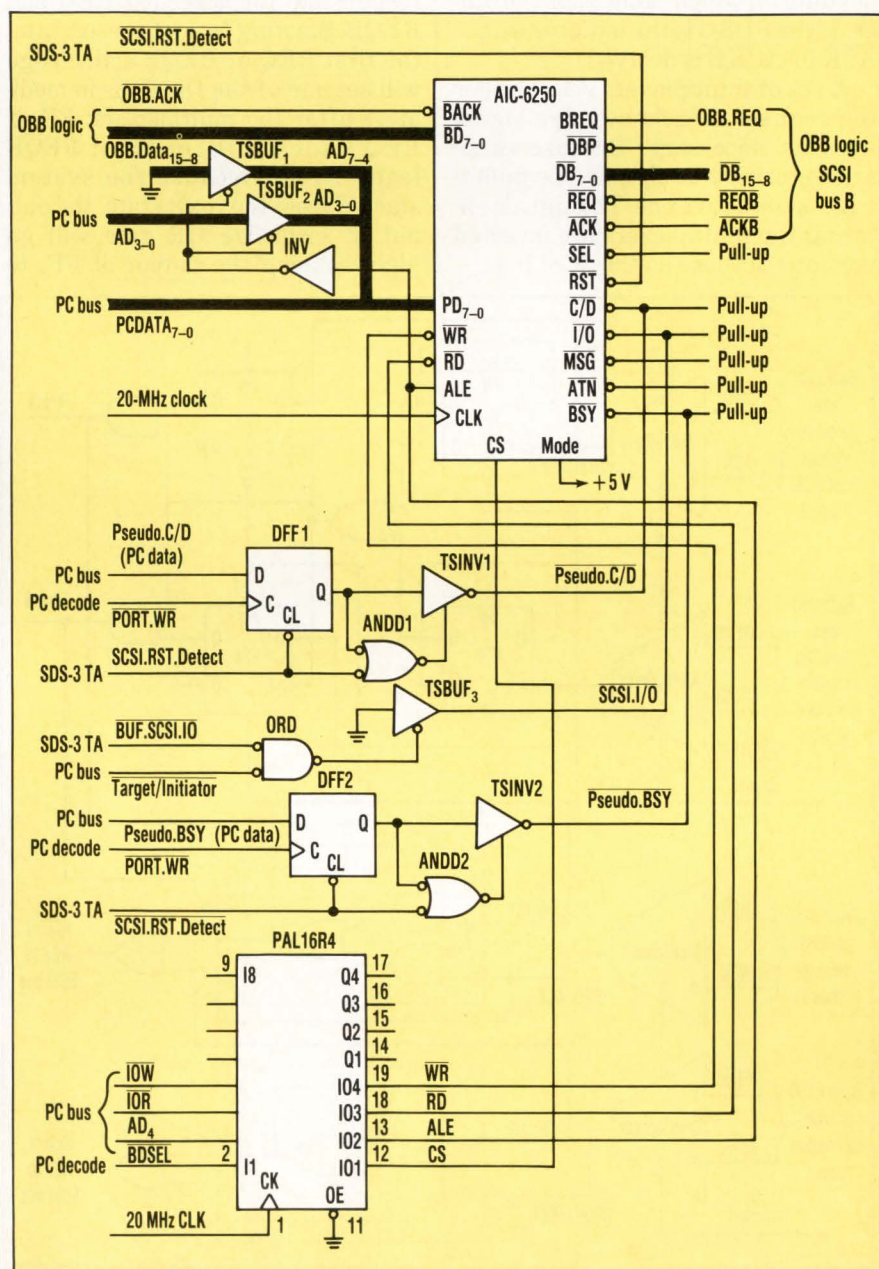

2. A PROGRAMMABLE LOGIC ARRAY, the PAL16R4, translates PC bus address and control lines into the control signals required by the SCSI protocol chip.

WIDE-BUS TEST SYSTEM

Fortunately, SCSI 2 includes separate REQ and ACK lines on each cable to accommodate possible different cable lengths. Therefore, it's conceptually easy to throttle transfers on either the A or B cable so that they're within one byte of each other.

To enforce synchronization, a throttle logic circuit generates two signals, ThrotA and ThrotB, that delay the appropriate REQ or ACK signal (Fig. 3). If the SDS-3 is the target, either REQ or REQ \bar{B} is delayed, depending on which cable leads the other. If the SDS-3 is the initiator, either ACK or ACK \bar{B} is delayed.

A set of multiplexers select either the request or acknowledge signal lines as necessary. Because these are negative true signals, the falling edge is the active one. The signals entering the multiplexers are inverted versions of those on the SCSI bus.

Four D flip-flops then determine which line (A or B) leads the other by more than one active edge. The Throttle signals pass through AND-OR logic that delays assertion on the SCSI bus of the appropriate handshake signal from the 6250 until it's less than one active edge ahead of its counterpart.

THROTTLING ACTION

For example, assume that the SDS-3 is the target and is therefore responsible for asserting REQ and REQ \bar{B} . Starting from the reset state, the first REQ or REQ \bar{B} active edge will set one of the flip-flops immediately after the multiplexers: FF $_1$ if REQ leads REQ \bar{B} , or FF $_2$ if REQ \bar{B} leads REQ. Because the system started from the reset state, the output of exclusive OR gate will go high, causing the output of FF $_3$ to

also go high. This output, combined with the inclusive OR gate's output, activates the ThrotA signal.

ThrotA, in turn, is an input to the AND-OR circuit that throttles the A cable. Working as a latch, this circuit waits until the current handshake transaction is completed, which occurs when REQ in the example goes high or inactive. This high signal combines with the high ThrotA to drive DelayA high, preventing REQ from being asserted at the OR gate's output.

Because DelayA is fed back into the AND-OR network, the circuit is latched until ThrotA goes low, regardless of the state of REQ. And ThrotA can't go low or inactive until an active edge occurs on the REQ \bar{B} line. The result is the desired throttling: REQ can't have two active edges without an intervening active REQ \bar{B} edge.

When the next REQ \bar{B} edge does occur, it triggers flip-flop FF $_2$. The exclusive OR gate's output then goes low and negates ThrotA. With ThrotA negated, another REQ edge can be gated onto the SCSI bus, making it possible for another data transfer on the A cable.

A similar series of events occurs if the REQ \bar{B} signal attempts to precede the REQ signal by more than one active edge. In that case, the ThrotB signal is activated and the B cable transfer throttled. The same situation applies if the SDS-3 is the initiator. The only difference between these situations is that the ACK or ACK \bar{B} signal is throttled.

By blocking another REQ active edge generation, this technique prevents more data transfers from occurring. As a result, the REQ/ACK handshaking ensures that transfers occur in lock step. This method is used only with asynchronous SCSI transfers.

The affect of throttling is easily seen on a set of typical REQ/ACK signal timing diagrams. With the throttling circuit disabled, byte N-1 is an "overrun byte," which means that its transfer begins before the transfer of byte N-2 begins (Fig. 4a). Debugging this situation can be difficult.

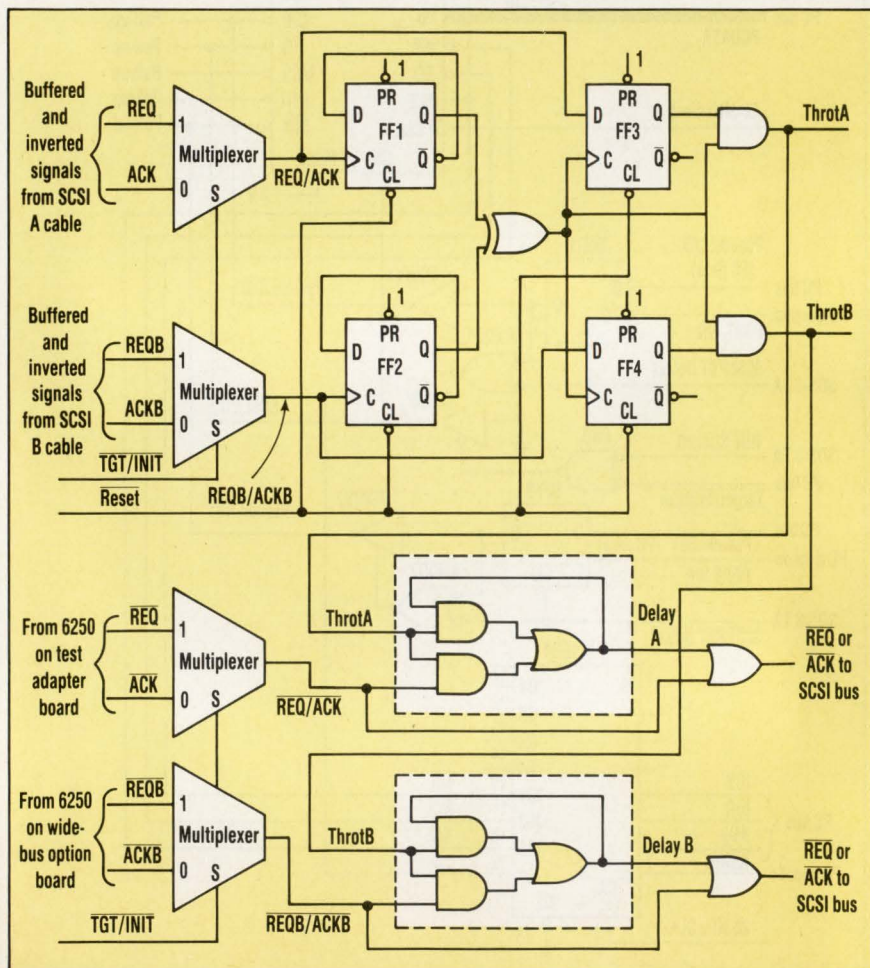

3. BY ADDING THROTTLING LOGIC on the wide-bus board, designers can synchronize A and B cable operation for easier debugging of SCSI 2 designs.

VSB RAM Dual-Ported Memory

Reliability Beyond EDC



Featuring Clearpoint's new proprietary error detection and correction chip set, with "Extra-Bit" functionality.

Clearpoint, Of Course!

For the sophisticated system that demands the highest performance and reliability, Clearpoint offers VSB RAM, intelligent memory for VME/VSB available in 2 to 16 MB modules. Unlock your system's potential with these advanced features:

- ❑ "Extra-bit" functionality designed into Clearpoint's channel-less 1.5-micron CMOS chip set. After 16 consecutive errors in a bit location, the VSB RAM automatically writes to a spare on-board DRAM.
- ❑ Flexible upgrade path. Choose the 2 or 8 MB VSB RAM now, then upgrade later with a 2 or 8 MB add-on daughter card. Or take advantage of Clearpoint's liberal trade-in credits and upgrade to a higher density board, or any other Clearpoint memory product.
- ❑ Dual-ported VME/VSB memory with dual 64-bit caching. Conforms to VSB Revision C specifications, and VME Revision C1 specifications.

No-Strings Lifetime Warranty

Clearpoint offers an unconditional lifetime warranty. Our 24-hour repair/replacement policy means no return-to-factory hassle or run around. Technical Support is provided 24 hours a day ... and is backed by an unequalled commitment to quality – minimum 72-hour dynamic and environmental testing, and a 100% static-free workplace.

VMElabs-Certified VMERAM

Increase system throughput with high-density VMERAM. Available on a single-slot dual-height card, VMERAM offers EDC, block mode and unaligned transfers. Discover maximum flexibility with 2, 4, 8 or 16 MB configurations. Conforms to VMEbus Revision C1 specifications.

Call for Our OEM Package

Find out what the leading supplier of add-in memory has to offer –

- 1989 edition of *The Designer's Guide to Add-in Memory*
- VSB RAM Product Update
- "Memory Tales," a video offering an inside look at add-in memory
- *Memory Pointers*, featuring *Pointers 5*, "Is It Worth the RISC?"

1-800-CLEARPT



Clearpoint Research Corporation
35 Parkwood Drive
Hopkinton, MA 01748
1-800-CLEARPT (508) 435-2000
EUROPE Clearpoint Europe B.V. 023-273744
Clearpoint UK Ltd. 0628-66-7823
Clearpoint Germany 064-30-2222
CANADA Clearpoint Canada 416-620-7242
JAPAN Clearpoint Japan KK 03-221-9726

BUSCON
THE BUS-BOARD USERS
SHOW AND CONFERENCE
SEPTEMBER 12-14, 1989
ROYAL PLAZA TRADE CENTER
MARLBOROUGH, MASSACHUSETTS

CLEARPOINT

Clearpoint is a registered trademark of Clearpoint Research Corporation.

CIRCLE 1

WIDE-BUS TEST SYSTEM

With the throttling circuit working, the active edges of the REQ/ACK and REQB/ACKB signals control the state of ThrotA. The ThrotA and DelayA signals delay the byte

N-1 transfer (Fig. 4b). ThrotA goes high when the REQ/ACK signal associated with byte N-3 goes high. DelayA goes high when REQ/ACK goes in active. The DelayA signal

prevents the REQ/ACK signal, gated onto the SCSI bus by the OR gate in the throttling circuit, from going active until the next active edge of REQB/ACKB arrives. That next active edge of REQB/ACKB causes ThrotA to go low, which forces DelayA low. □

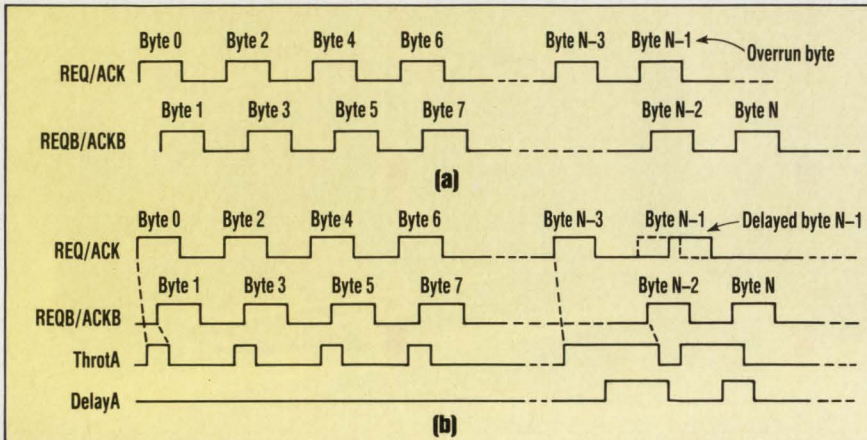

4. WITH THE THROTTLING FEATURE OFF, the transfer of byte N-1 may begin before the transfer of N-2 (a). Enabling the throttling circuit makes it possible for the REQ/ACK lines to control the Throttle and Delay signals in a way that delays the transmission of N-1 until N-2 begins transmitting (b).

Michael Nguyen, an engineer in the Development System Operations group at Adaptec, previously developed hardware at Link Flight Simulation.

Mark S. Gordon, founder and president of Digital Finesse, a consulting-management company, designed ICs at Zilog and helped found Verticom Inc.

HOW VALUABLE?	CIRCLE
HIGHLY	544
MODERATELY	545
SLIGHTLY	546

Contact-free soldering and de-soldering

of SMD, DIP and pin grid components and connectors in a matter of seconds with the Leister-Labor "S" hot-air tool. Electronic control of temperature and air supply. Over 400 special nozzles available.

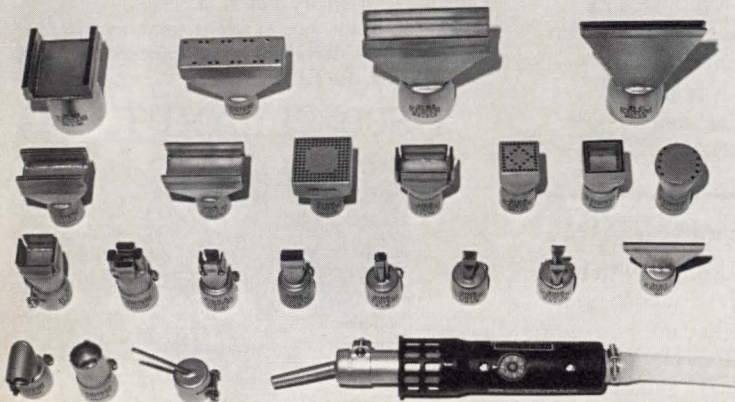

Ask for free brochure UW 169

Brian R. White Co. Inc., 313 Henry Station Road
 Ukiah, CA 95482 phone: (707) 462-9795
 Farmingdale, NJ 07727 phone: (201) 938-2700

CIRCLE 105

BYTEK 135H

Universal MultiProgrammer™

DATA I/O 288* Performance
PLUS PLD Support !!

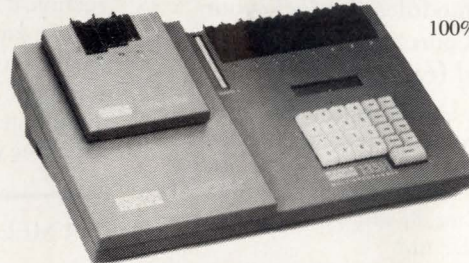

100% USA Made.

Model Shown:
 135H-U
 with optional
 LOGICel.

- ★ Model 135H is a GANG & SET (E) EPROM Programmer.
- ★ Programs virtually all EPROMs & EEPROMs up to 2048K.
- ★ Universal support includes Bipolar PROMs & EPROM Emulation.
- ★ **GANG Options for 40-pin MICROS & 40-pin EPROMs !!**
- ★ Stand-alone or Computer Remote Control operation.
- ★ 12 Month WARRANTY & 12 Month FREE Field Device Updates.
- ★ Supports OrCAD™'s new PLD Tools Software.

BYTEK

1-800-523-1565

In Florida: (407) 994-3520

BYTEK Corporation • 508 N.W. 77th St, Boca Raton, FL 33487
 FAX: (407) 994-3615 • Telex: 4998369 BYTEK

* DATA I/O is a registered trademark of DATA I/O Corporation.

CIRCLE 106

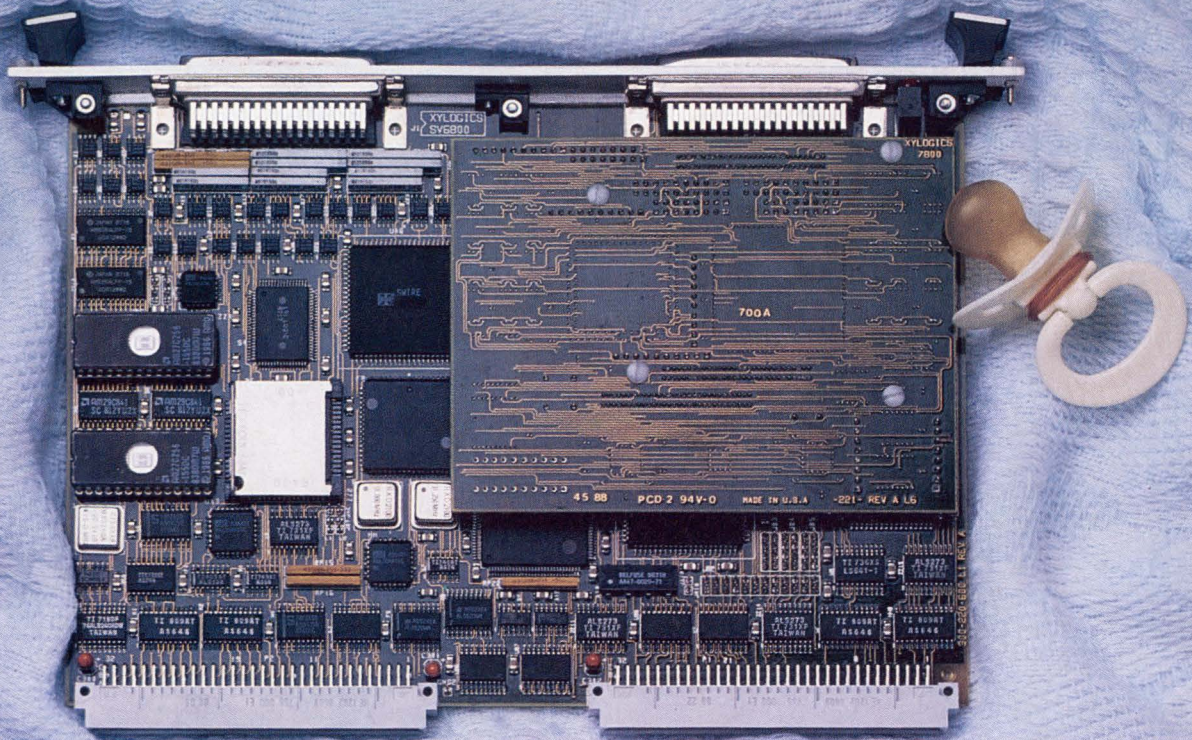

Born yesterday, and already talking 20 megabytes a second.

The new SV Series IPI-2 VME disk controllers from Xylogics... a prodigy of data rate performance.

Xylogics announces the SV7800 and SV6800 single-board disk controllers for VMEbus systems that will more than triple the disk data transfer rate currently available. With internal data paths up to 80 MB/sec, the SV Series controllers can sustain a data rate across the VMEbus of more than 35 MB/sec. This more than doubles the rates of current controller solutions. And our SV Series features a new "Universal Bus Silicon" architecture that sets the stage for future generations of controllers.

Addressing a critical market need for faster, higher capacity disk storage at an affordable price, the SV7800 and SV6800 IPI-2 controllers are the new standard for data-intensive applications such as supercomputing, real-time data acquisition, graphics,

imaging and electronic publishing. And RISC users will find the SV Series eliminates major disk I/O bottlenecks.

For a complete list of features and specifications on the newest, most remarkable members of the Xylogics family, the SV7800 and SV6800 controllers, call or write today.



Your Partner For Performance

Corporate Headquarters:
Xylogics, Inc.
53 Third Avenue
Burlington, MA 01803
(617) 272-8140

International Subsidiary:
Xylogics International Ltd.
2A Cofferridge Close
Stony Stratford
Milton Keynes MK11 1BY
United Kingdom
(908) 569444

**Our SMD's stand out
in a crowd.**

**Industry's Largest
Surface-Mount Selection**

- Toggles, pushbuttons, slides, DIPS
- High-temperature plastic construction
- Withstands infrared and vapor phase reflow, soldering processes
- Competitively priced

AUGAT/ALCOSWITCH offers a full product line including...



Pushwheel,



Industrial Controls &



Rotaries/Knobs

For your free catalog, product samples, applications help, or a quotation, call or write AUGAT/ALCOSWITCH, 1551 Osgood Street, No. Andover, MA 01845 USA,
Tel: (508) 685-4371, TLX: 275423, FAX: (508) 686-9545

AUGAT[®] ALCOSWITCH[®]

Quality and Innovation

AUGAT INTERNATIONAL SALES OFFICE

AUGAT LIMITED - ENGLAND	(011) 4490676655
AUGAT SA - FRANCE	(011) 33146683090
AUGAT GMBH - WEST GERMANY	(011) 49896129090
AUGAT AB - SWEDEN	(011) 468960270
AUGAT SRL - ITALY	(011) 3939654100
AUGAT ISRAEL	(011) 9723492173
AUGAT ELECTRONICS INC. - CANADA	(1) 4166771500
AUGAT PTY LTD. - AUSTRALIA	(011) 6129050533
AUGAT KK - JAPAN	(011) 810550897911

DEVELOP AND VERIFY CIRCUITS
IN TWO WEEKS WITH CAD ON A PC/AT.

CAD SHORTENS DESIGN CYCLE FOR RLL2,7 CODER

The total development effort, from design to working unit, for a fairly complex VLSI device can take just several weeks with schematic-capture and simulation tools, plus automatic-placement-and-routing software. A semicustom design, however, could take up to eight months, and a full custom design may consume years. An illustration of a computer-aided design-to-device cycle is the development of an RLL2,7-coding circuit for an optical-disk-interface encoder/decoder intended for high-density storage.

Less than two weeks of design effort went into developing and verifying the coding circuit on an IBM PC/AT. The schematic-design tools from OrCad Systems Corp. (OrCad/SDT III), together with Advanced Micro Devices' supported logic-cell-array (LCA) libraries, supplied the design software. Similarly, OrCad's verification and simulation tools (OrCad/VST) and the AMD PGA simulator-interface library offered unit-delay and full timing-delay simulation (*see "Logic cell arrays"*).

After partitioning the design with the software's auto-logic reduction and partitioning program (XNF2LCA) and routing with automatic-placement-and-routing (APR) software (AmPGA23), the circuit was temporarily hardwired in an Am3020 logic-cell-array (LCA) device for final checking. XACT editor software was also used to manually route some of the wiring nets that couldn't be APR routed.

The LCA device's primary advantage is fast turn-around design time—an advantage also extendible to other applications where time-to-market is critical. The RLL2,7-coding circuit was subsequently programmed into a larger Am3020 LCA device for full hardware verification. Finally, it was transferred into a still larger AM3090 as part of the entire optical-disk encoder/decoder system.

The encoding circuit in the LCA converts serially clocked nonreturn-to-zero (NRZ) digital data—the data format used inside most computers—into an RLL2,7 data stream for write operations to the disk. During data-read operations, the circuit converts the RLL2,7 coded data back to NRZ data. In addition to coding and decoding, the circuit checks for code-length violations of the

CHRISTOPHER JAY AND THY-HIEN LE

Advanced Micro Devices Inc., 901 Thompson Pl., P.O. Box 3453, Sunnyvale, CA
94088-3000; (408) 732-2400.

DESIGN APPLICATIONS
CAD FOR RLL2,7

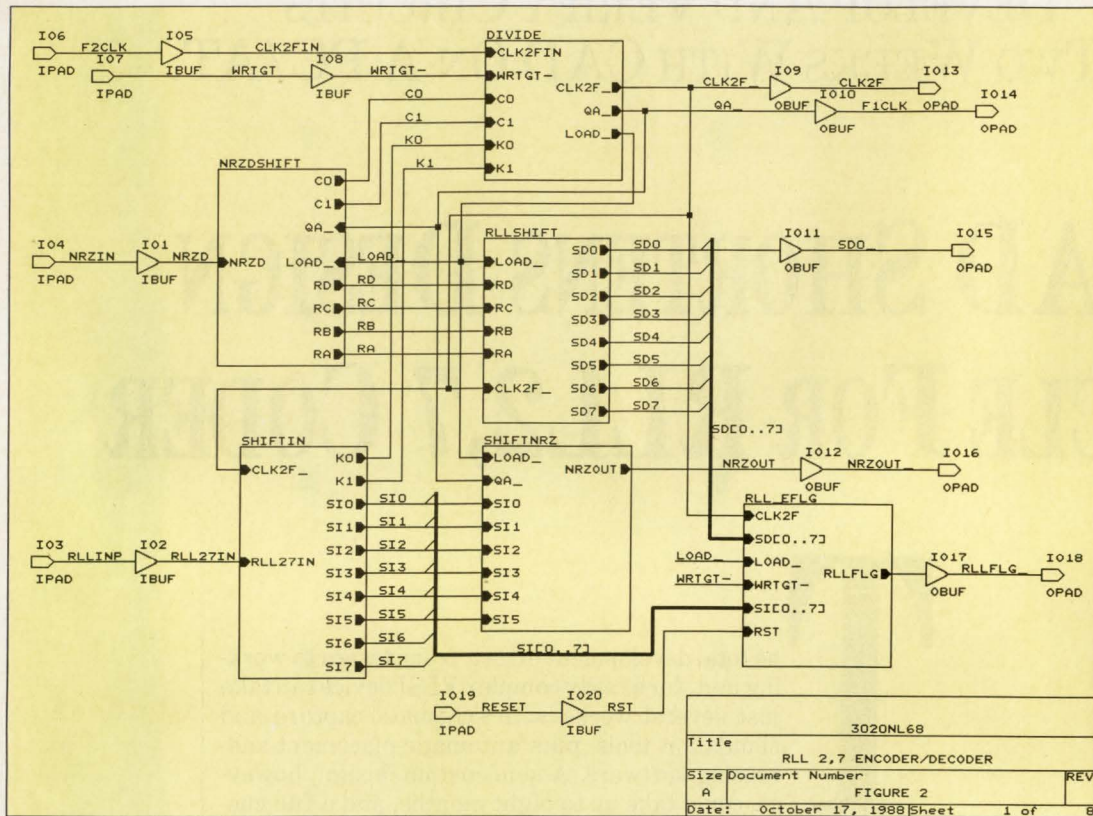

1. CREATED with OrCad/SDT III on a PC/AT, the overall block diagram of the RLL2,7 encoder/decoder is a hierarchical design. Each of its six blocks fit on separate sheets at a lower hierarchical level.

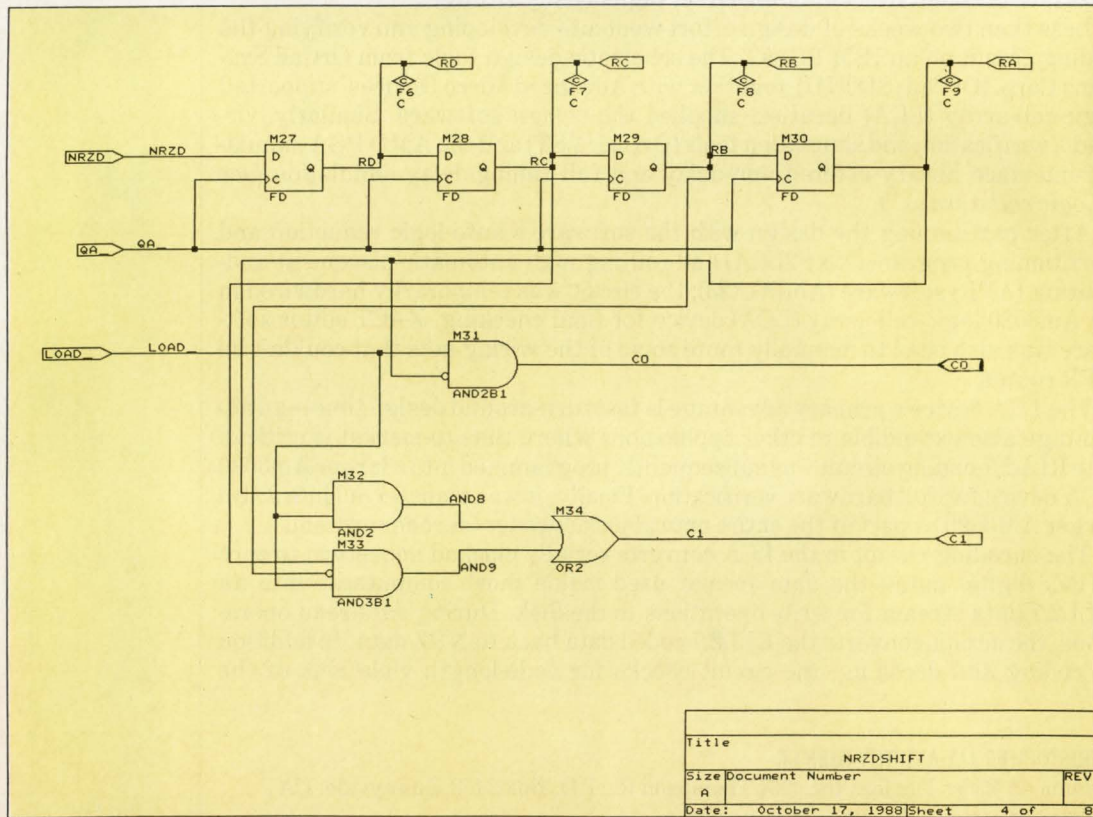

2. THE 4-BIT shift register in the NRZDSHIFT circuit receives serial NRZ data from the host computer.

DESIGN APPLICATIONS CAD FOR RLL2,7

3. THE RA through RD signals feed into the RLLSHIFT circuit.

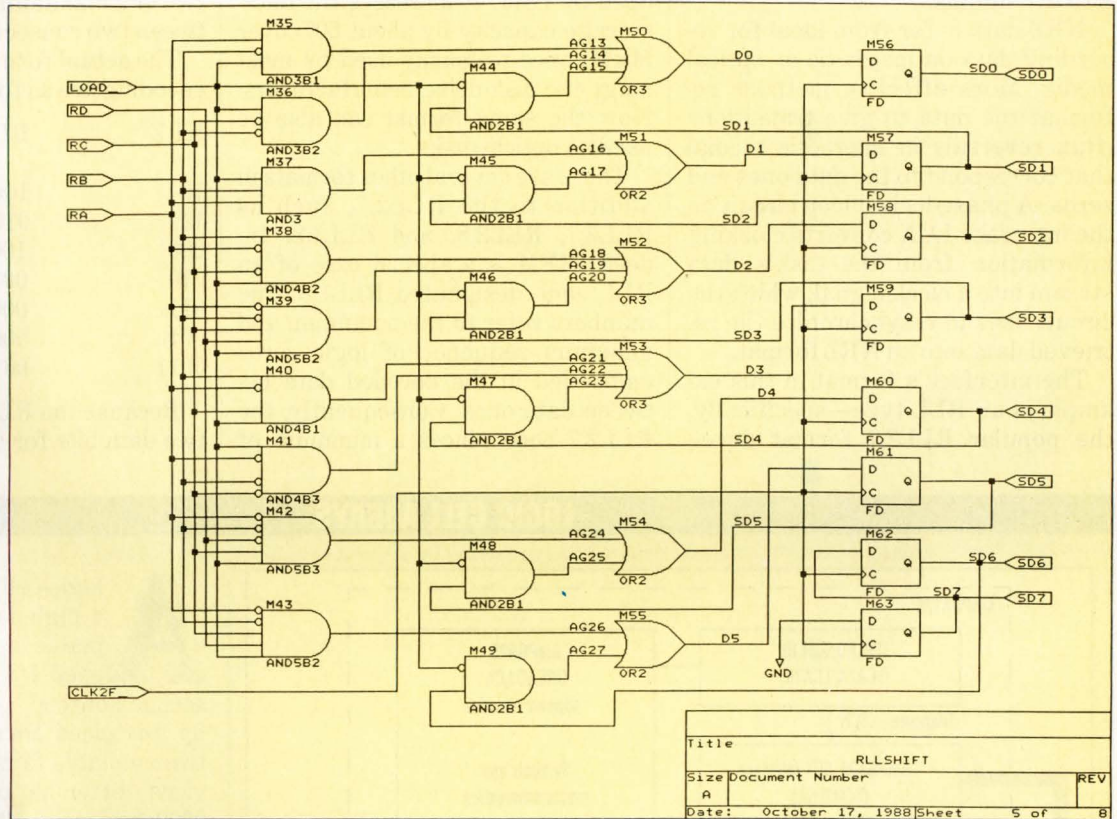

4. RLLSHIFT register loading takes place at a zero count of the counter in the Divide circuit.

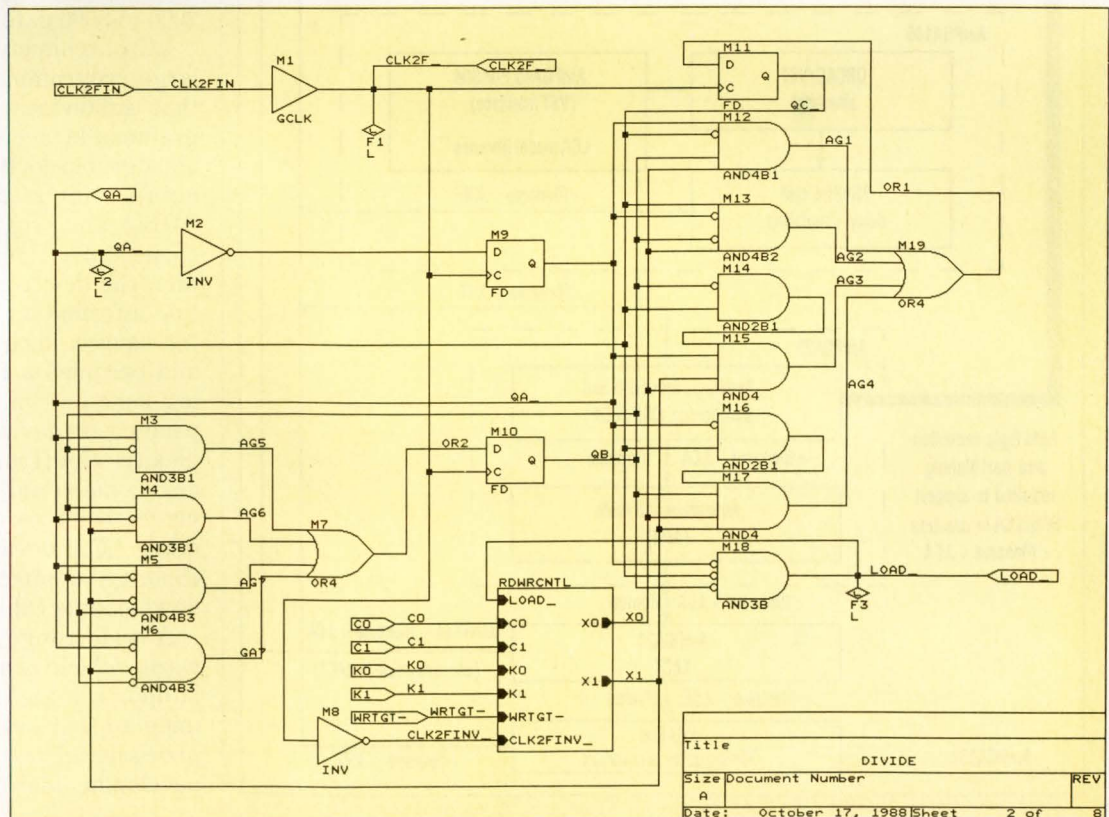

DESIGN APPLICATIONS
CAD FOR RLL2,7

RLL2,7 signals.

NRZ data is far from ideal for recording data on magnetic or optical media. More effective methods reformat the data to give transitions (flux reversals in magnetic media) that correspond to the data ones and zeros. A phase-locked loop circuit on the interface LCA converts clocking information from the disk's data stream into a clock signal, which the circuit uses to resynchronize the retrieved data into an NRZ format.

The interface's format in this example is an RLL type—specifically, the popular RLL2,7 format devel-

oped by IBM. It increases the data-storage capacity by about 50% over MFM, once primarily used by most magnetic disk-drive manufacturers. Now the same format can also be used on optical disks.

There are several other formats in addition to the RLL2,7, such as RLL2,7, RLL2,8, and RLL1,8. Indeed, MFM is a special case of an RLL code designated RLL1,3. The numbers refer to the maximum and minimum sequence of logic zeros embedded in the encoded data between data ones. Consequently, the RLL2,7 code places a minimum of

two or a maximum of seven zeros between two consecutive ones.

The actual formatting rules of the encoding are as follows:

NRZ	RLL	Shifts
10	1000	4
11	0100	4
000	100100	6
010	001000	6
011	000100	6
0010	00001000	8
0011	00100100	8

Because the RLL2,7 code supplies two data bits for each NRZ data bit,

LOGIC CELL ARRAYS

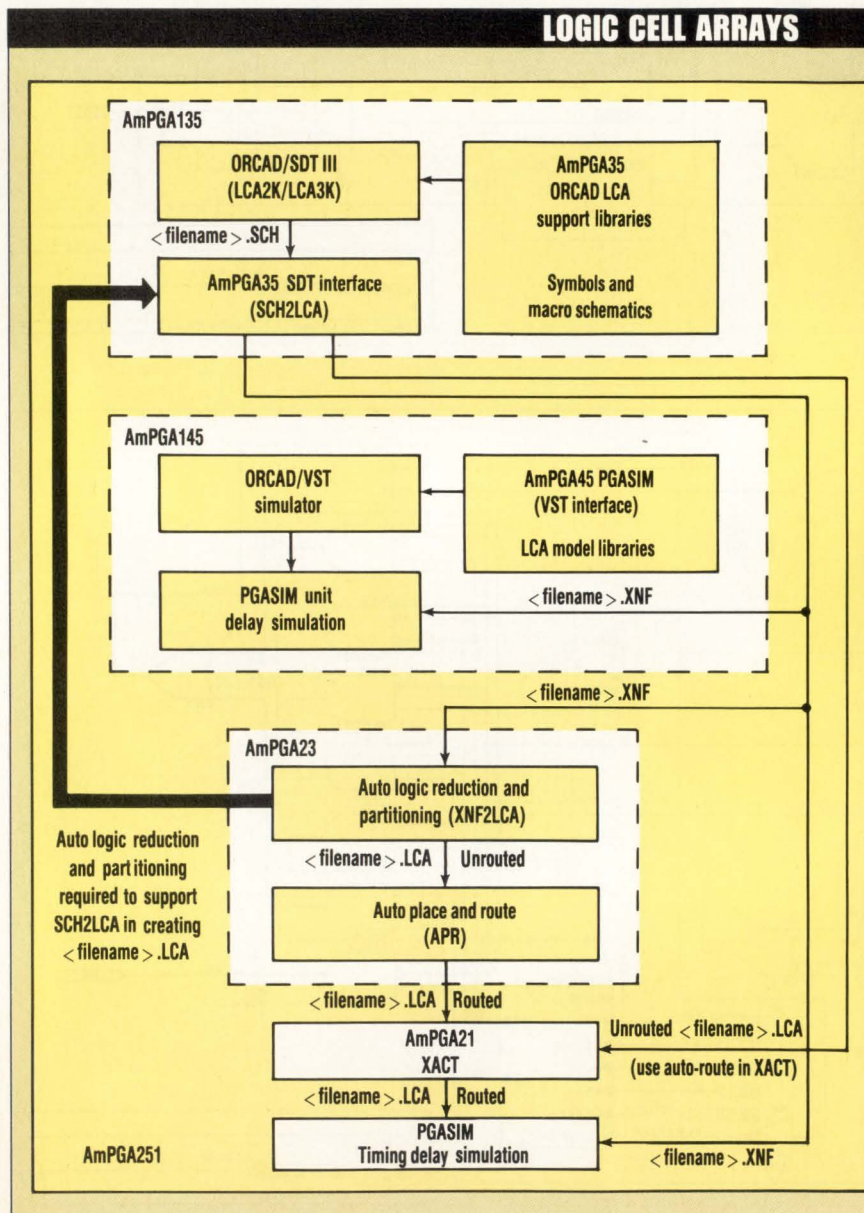

A logic-cell array (LCA) is a high-density programmable logic circuit developed by Xilinx Inc. and second-sourced by Advanced Micro Devices. The two available families of LCA devices differ in complexity—the 2000 series of 1200-to-1800 gate equivalency and the recently introduced 3000 series that offers 2000-to-9000 gate complexity.

LCA architecture is based on a large programmable RAM array that subdivides into three programmable sections: configurable logic blocks (CLBs), programmable input/output blocks (IOBs), and programmable interconnections. Upon power application, the device reads configuration information from a nonvolatile source, such as an EPROM, and becomes a functional working logic unit in 17 to 80 ms, depending on device type and complexity. Configuration data can also come serially from a microprocessor, a serial EPROM, another LCA device, or a PC/AT through a specially designed downloading cable.

A wide range of design software, which runs on a PC/AT, supports logic array programming so that designers can complete and fully test a design in the development lab (see the figure).

"Static can kill our circuitry.
And the front panel LEDs
can provide the path.
Now what?!"

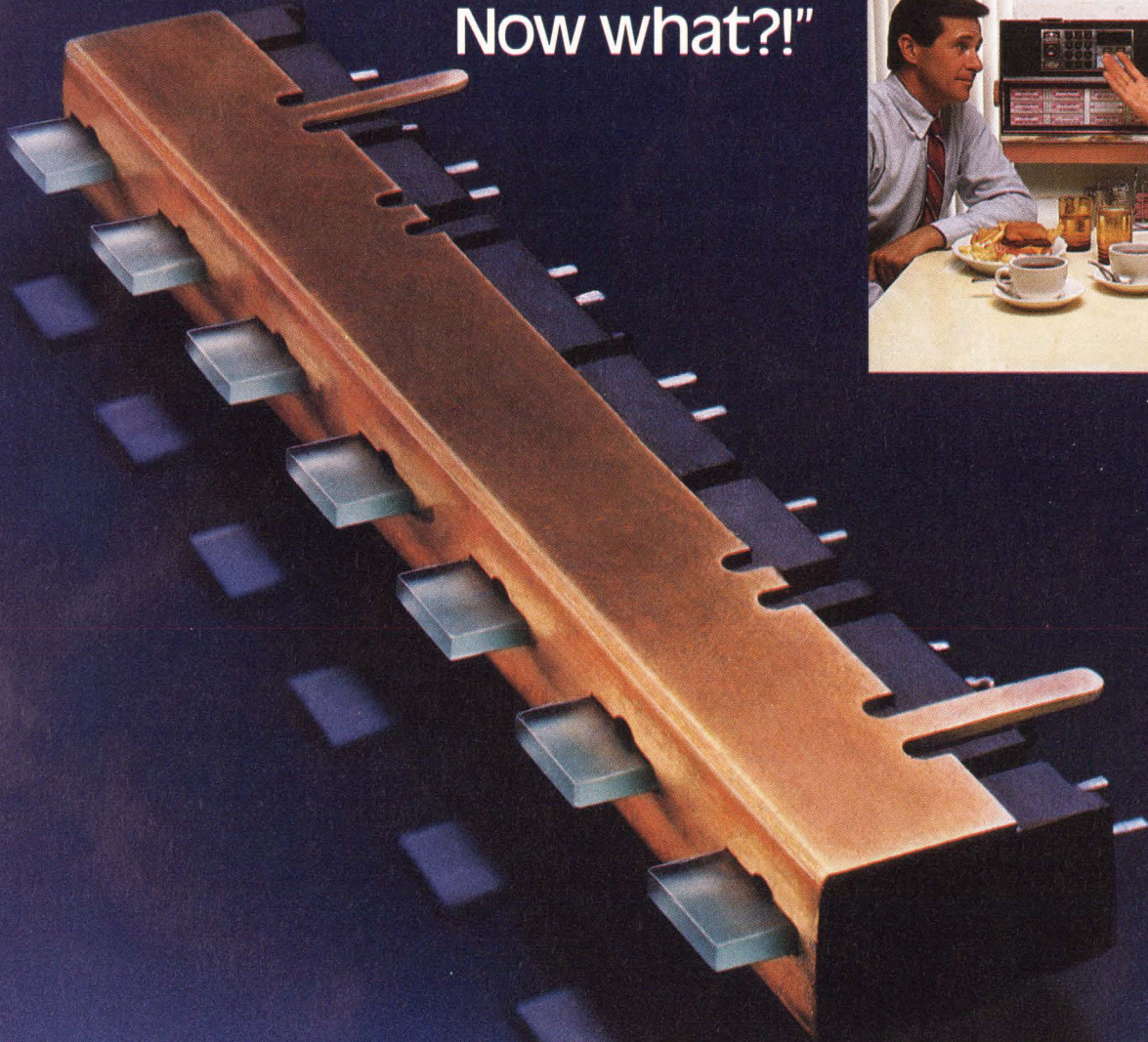

All indications are Dialight.

It was a problem grounded in the laws of electrical energy. And it could have caused real havoc. But the customer took the smart step of calling Dialight.

As the leader with over half a century of experience in every type of indicator light, for Dialight solving problems is standard operating procedure. Applying our engineering expertise in optoelectronics and utilizing state-of-the-art CAD equipment, our model shop quickly developed and prototyped a housing and grounding plate for the LEDs. Upon customer approval, our 100% internal tool fabrication and molding facilities provided quick turn-around on production quantities.

Saving costs while solving problems is something we've long done with our panel mount and circuit board LEDs. Over the years customers have asked us to pair, gang, piggyback, right angle mount, recess, bicolor, tricolor, slant, standoff, snap-mount, bin, do whatever you can imagine to them and we haven't been stumped yet!

So, when an indication design issue has you ground to a halt, remember that no one has more solutions than Dialight.

DIALIGHT CORPORATION

A Cambridge Electronic Industries Co.

1913 Atlantic Avenue, Manasquan, NJ 08736 201-223-9400

DESIGN APPLICATIONS
CAD FOR RLL2,7

shift registers for RLL2,7 data must have twice the clock rate of NRZ data. Accordingly, the encoder/decoder circuit needs two synchronous clock signals: CLK2F and QA.

The overall block diagram of the RLL2,7 encoder/decoder in the AM3020 LCA, created with OrCad/

SDT III on an IBM PC/AT, is a hierarchical design (Fig. 1). Each of its six blocks fit on separate sheets at a lower hierarchical level. OrCad offers two design-entry methods: flat file and hierarchical. Unless the design can fit on one sheet, the software doesn't support the flat-file

structure.

For easy identification, the sheets have the following labels: NRZDSHIFT, RLLSHIFT, SHIF-TIN, RDWRCNTL, RLL_EFLG, SHIFTNRZ, and DIVIDE. The 4-bit shift register in the NRZDSHIFT circuit receives serial NRZ data (NRZIN) from the host computer (Fig. 2). Shift-register outputs RA, RB, RC, and RD (where RA is from the last register in the 4-bit chain) drive a sum-of-products decoder circuit, which generates condition signals C0 and C1. The RA through RD signals also feed into the RLLSHIFT circuit (Fig. 3).

Then, within the RLLSHIFT circuit, the signals drive the six register inputs of the 8-bit shift-register chain—SD0 through SD7. Loading the RLLSHIFT registers takes place at a zero count of the counter in the DIVIDE circuit (Fig. 4).

The C0 and C1 condition signals load into a 2-bit register in the DI-VIDE circuit's RDWRCNTL section and control its counter (Fig. 5). Depending on the state of C0 and C1, the counter counts through one of the following three sequences: 0 to 3, 0 to 5, or 0 to 7. In this method, the Di-verse circuit generates the four, six, or eight shift cycles consistent with the code combinations in the encoding-rule table.

For example, if the data was 0011 from RA, RB, RC, and RD of the NRZDSHIFT register, then the Di-verse circuit would deliver a count of 0 through 7 to clock out the RLL2,7 data stream 00100100.

Accordingly, the RLL2,7 output bits must occur at twice the rate of NRZ input bits. The clock frequency (F2CLK) for shifting the RLL data is twice the clock frequency (QA) for shifting the NRZ data into the NRZDSHIFT register.

With the signal on the WRTGT line enabled, condition signals C0 and C1 pass through to lines OR1 and OR2 into flip-flop inputs that load when the LOAD signal is active—that is, when the Divide circuit counter contains a count of zero. The CLK2FINV clock signal strobes the condition signals into these flip-flops. When the counter's contents

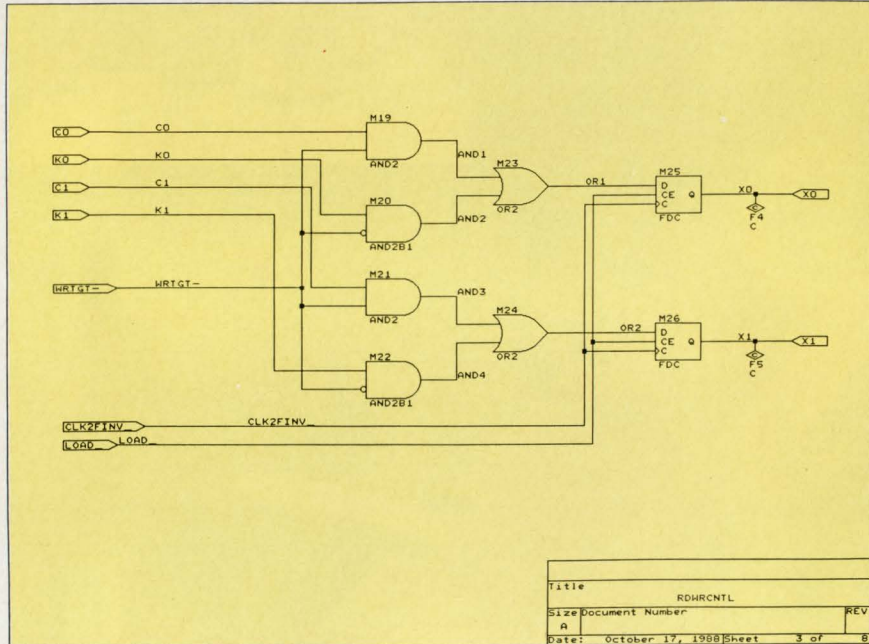

5. THE C0 AND C1 condition signals load into a 2-bit register in the Divide circuit's RDWRCNTL section and control its counter.

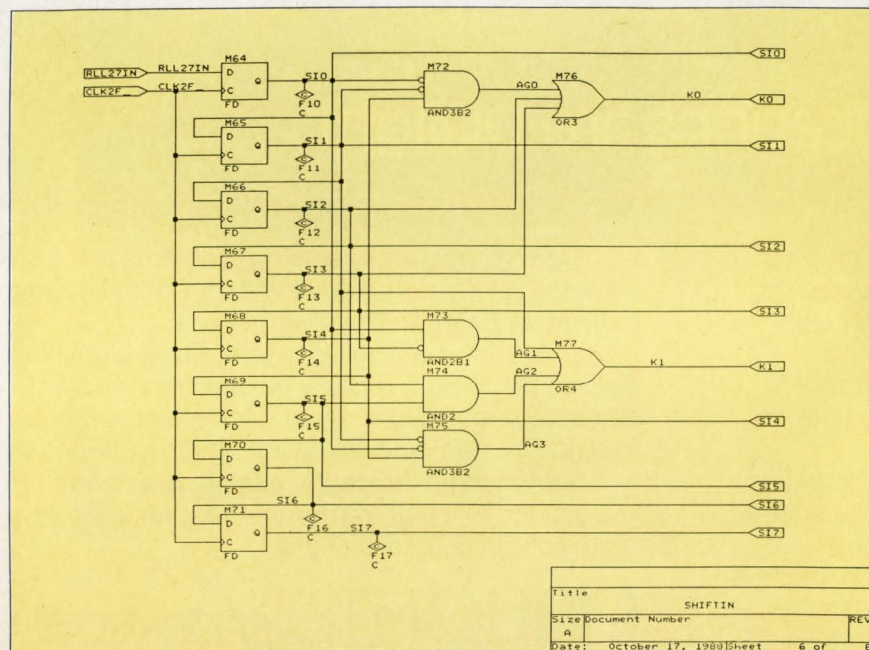

6. THE SHIF-TIN CIRCUIT generates the K0 and K1 control signals.

Three isolated Power MOSFET packages and up to 1000 volts give you the Power to Win.



SGS-THOMSON Microelectronics, the leader in isolated Power MOSFETs, gives you the packaging power to race well ahead of your competition.

We cover you with a winning lineup of 7 voltages that range from the high voltage TSD5MG40 (13A, 1000V, 0.7 Ω) to the TSD4M150 (135A, 100V, 14m Ω), all in the ISOTOP™ power package — now an emerging industry standard.

Replaces 4 to 5 devices. You would need 4 or 5 standard devices to equal one ISOTOP, plus all the isolating hardware, plus the heatsink space for mounting, plus the added assembly time. The bottom line? Measurably lower costs with ISOTOP.

Same heatsink space as TO-204 (TO-3). ISOTOPs take up no more heatsink real estate than a standard TO-204, yet they offer advantages that leave TO-204 high and dry:

2.5 kVRMS internal insulation

J-C thermal resistance <0.25°C/W

Internal parasitic inductance <5nH

Improved reliability

Reduced EMI and RFI

High current connections all on the top of the device

Screw terminals allow parallel bus connections

Easy assembly without external isolation hardware

New standards for TO-218 and TO-220. SGS-THOMSON also offers replacements for the standard TO-218 and TO-220 packages. These fully encapsulated packages eliminate the need for additional isolation hardware. Not to mention the cost.

Get the facts and get the Power to Win. Call or write for data sheets from the industry's leading manufacturer of isolated Power MOSFET packages: SGS-THOMSON Microelectronics, 1000 E. Bell Road, Phoenix, Arizona 85022. 602/867-6259.

 **SGS-THOMSON**
MICROELECTRONICS

ISOTOP is a trademark of SGS-THOMSON Microelectronics. SGS-THOMSON Microelectronics is a registered trademark of SGS-THOMSON Microelectronics Group. © 1989 All rights reserved SGS-THOMSON Microelectronics.

CAD FOR RLL2,7

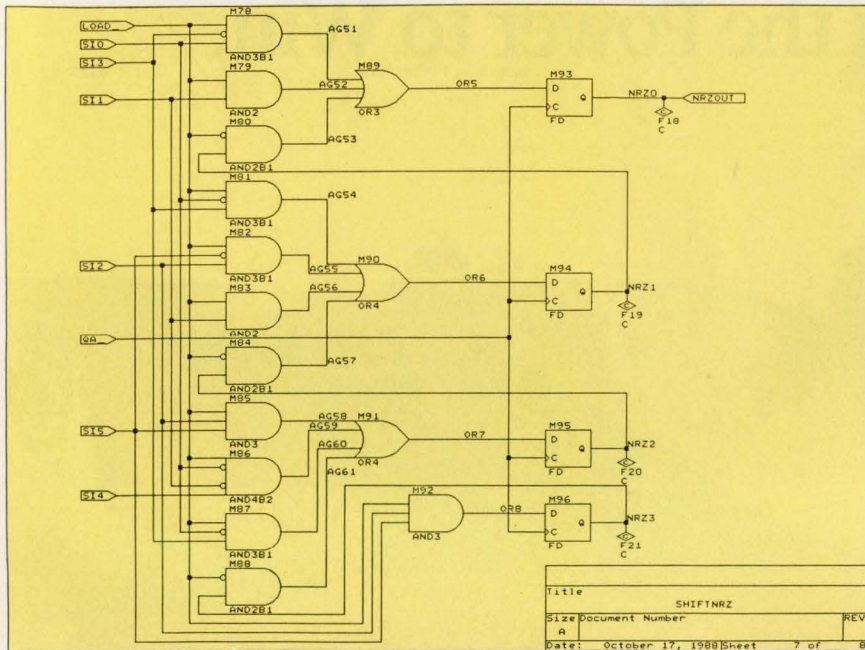

7. WITH AN ACTIVE LOAD signal, the SHIFTRNZ register's sum-of-products circuit decodes the RLL2,7 data signal to generate registered outputs NRZ0-3.

reach a count of three, the condition signals cause the counter either to reset, count to five and reset, or count to seven and reset. The same counter serves both read and write operations and the \overline{WRTGT} input selects either the C0 and C1 pair of signals or the K0 and K1 pair. The SHIFTRNZ circuit generates the K0 and K1 control signals (Fig. 6).

The decoding philosophy for the SHIFTRNZ's register's contents—using combinatorial logic and loading up a second register file with 4 bits of NRZ data—is the same for both the decoder and encoder. Consequently, the SHIFTRNZ circuit also decodes the RLL2,7 data output from the disk. The CLK2F signal clocks the encoded RLL27IN data into the first register of an 8-bit shift register. As in the NRZDSHIFT circuit, a sum-of-products circuit decodes the shift register's contents to supply the condition signals K0 and K1. The first six registers in the shift-register chain generate the sum-of-products. Just as the C0 and C1 signals control the count sequence in the write operations, K0 and K1 control the counter's behavior during a read.

The total set of conditions for selecting the three counting sequences

are as follows:

To shift out RLL2,7 data:

\overline{WRTGT}	C0	C1	K0	K1	Count
H	L	H	X	X	0-3
H	H	L	X	X	0-5
H	H	H	X	X	0-7

To shift in NRZ data:

L	X	X	L	H	0-3
L	X	X	H	L	0-5
L	X	X	H	H	0-7

(Note: An input code of C0 = C1 = K0 = K1 = 0 gives a count of 0 to 3, but it's a redundant code in the design.)

With an active \overline{LOAD} signal, the SHIFTRNZ register's sum-of-products circuit decodes the RLL2,7 data signal to generate registered outputs NRZ0, NRZ1, NRZ2, and NRZ3 (Fig. 7). When \overline{LOAD} is inactive, the NRZ data shifts through the register file at a rate synchronized to QA, half the CLK2FIN rate. Furthermore, the condition-code registers decode the same count sequence 0 to 3, 0 to 5, and 0 to 7, depending on the contents of the data shifted into the RLL input register. The same counter can encode and decode because read and write operations are

mutually exclusive.

After decoding, the SHIFTRNZ circuit passes the data to the host system as either a 4-bit, 6-bit, or 8-bit data stream. For a 4-bit count, registered outputs NRZ0 and NRZ1 load with the decoded data and shift through the register file to the NRZOUT output. For a 6-bit count, NRZ0, NRZ1, and NRZ2 load and shift to the output, and for an 8-bit count NRZ0, NRZ1, NRZ2, and NRZ3 load and shift.

Moreover, the RLL_EFLG circuit detects corrupted RLL2,7 data (Fig. 8). A $\overline{WRITEGT}$ command sets up the RLL_EFLG circuit in accordance with the condition code that controls the counter's behavior for writing or reading operations. When low, the $\overline{WRITEGT}$ signal selects the NRZ-to-RLL2,7 encoder condition-control signals C0 and C1; when high, the RLL2,7-to-NRZ condition-control signals K0 and K1 are selected. Only the specific cases of one zero, no zeros, or more than seven zeros between two consecutive logic ones in the data stream set registers and supply an error flag (RLLFLG) until cleared by the host system.

The OrCad/VST is a menu-driven simulator with a stimulus editor that makes it possible to initialize signals, and generate pulse signals and repetitive clocks cycles to drive a design's inputs in a PC/AT environment. An input signal can be added, deleted, or edited from the stimulus file. VCC and GND signals in this file represent high and low signal inputs, respectively. The trace editor controls the display of signal waveforms.

By invoking PGASIM (a program written by AMD), an external net list or LCA file can be translated into the OrCad verification and simulation tool's (OrCad/VST) net list and delay back-annotation files to run the simulation. The PGASIM menu offers either a unit-delay or timing-delay simulation. To check the design's logic functioning exclusively requires unit-delay simulation, which needs just the external net list file as an input source. Timing simulation, however, requires the routed timing parameters available from the LCA

NEW SOLUTIONS FROM MILLER-STEPHENSON



Miller-Stephenson introduces new
CFC-Free SAFEZONE Solvent & Flux Remover

Now by special formulation and in the interest of a better environment, Miller-Stephenson presents **SAFEZONE** CFC-Free Solvent & Flux Remover offering a "new solution" no rinse, quick cleaning action; so expedient for field service, so perfect for prototype and production work. For sample fill out coupon below or call (203) 743-4447. For technical service call **1-800-992-2424** (8-4 Eastern Time). In Canada call 1-800-323-4621 (8-4 Eastern Time).



miller-stephenson chemical co., inc.

CALIFORNIA
12261 Foothill Blvd.
Sylmar, Cal. 91342
818 896-4714

ILLINOIS
6348 Oakton St.
Morton Grove, Ill. 60053
312 966-2022

CONNECTICUT
George Washington Hwy.
Danbury, Conn. 06810
203 743-4447

CANADA
514 Carlingview Dr.
Rexdale, Ontario M9W 5R3
416 675-3204

COMPLETE COUPON BELOW

PLEASE
SEND FREE

AEROSOL
SAMPLE
MS-195CO²

BULK
SAMPLE
MS-197

Mail to:

miller-stephenson chemical co., inc.
George Washington Highway
Danbury, Connecticut 06810 U.S.A.

NAME _____

DEPT./TITLE _____

COMPANY _____

ADDRESS _____

1113-6H
ED/9H

CIRCLE 91

DESIGN APPLICATIONS

CAD FOR RLL2,7

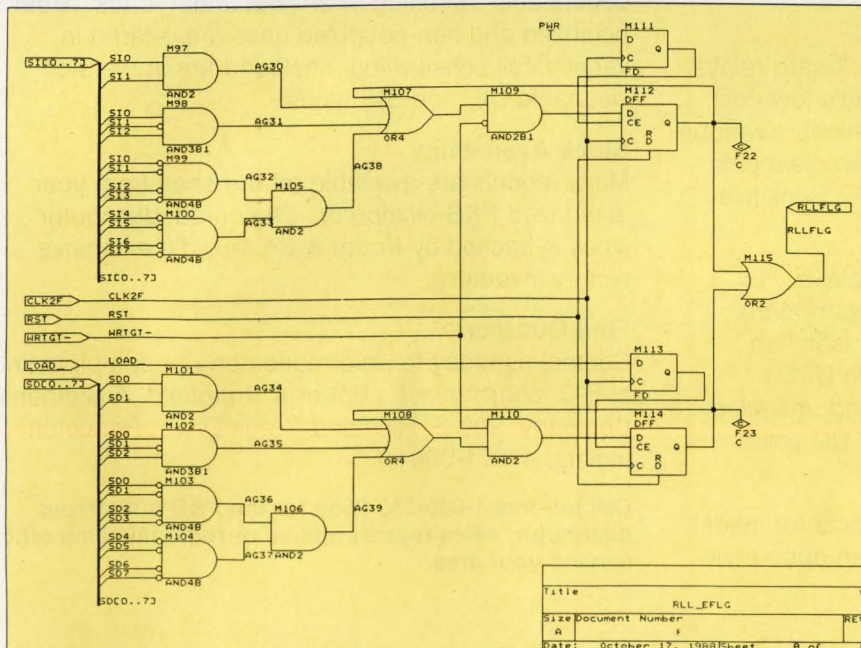

Title	RLL_EFLG	1
Size	Document Number	REV
A	F	
Date:	October 17, 1988	Sheet 8 of 8

8. THE RLL_EFLG CIRCUIT detects corrupted RLL2,7 data and supplies an error flag (RLLFLG) until cleared by the host system.

file. It can be done at the configurable logic-block level, which needs only the support of the routed-LCA file, or at the gate level, which requires both the routed-LCA file and the unrouted external net-list file. □

Christopher Jay is currently applications manager at Waferscale Integration. Prior to joining WSI, he worked at AMD as application manager for the LCA products. He holds a BSEE from the University of Essex.

Thy-Hien Le, a senior applications engineer working in AMD's Programmable Gate Array Division, has a BSEE from Santa Clara University.

HOW VALUABLE?

HIGHLY
MODERATELY
SLIGHTLY

CIRCLE

541
542
543

Specify P&B for dry circuit to 30A load switching on your P.C. board.

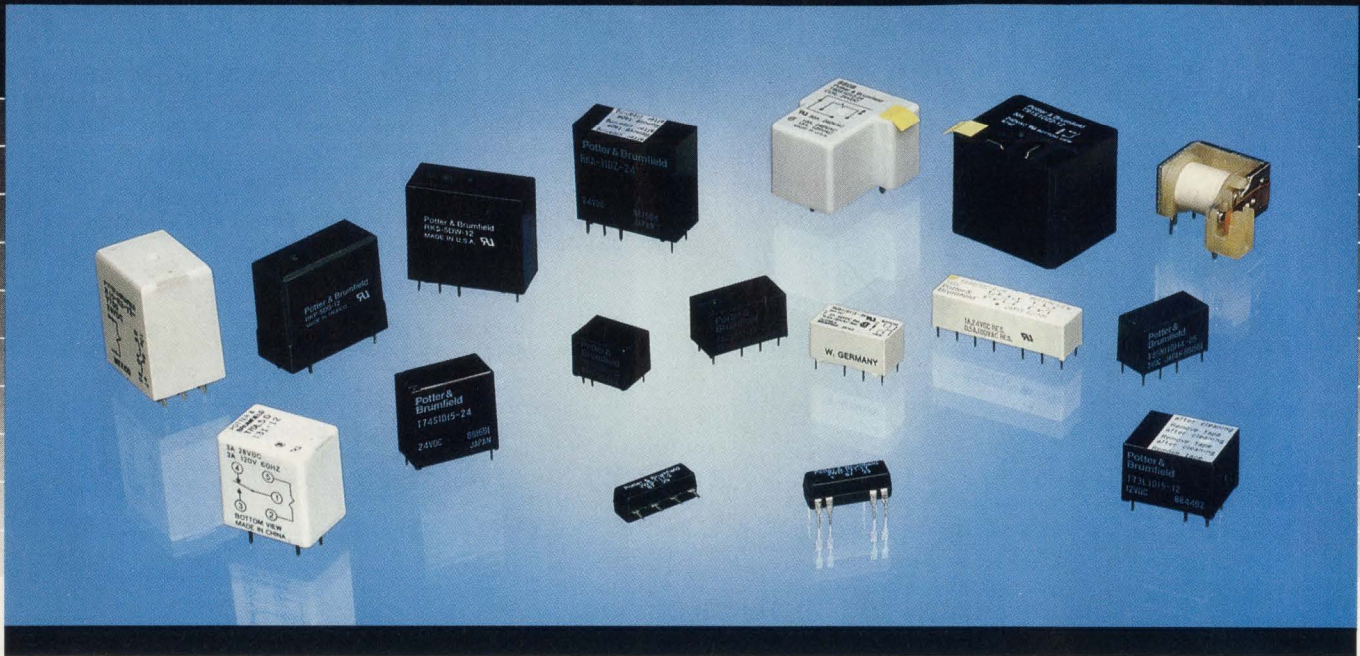

New Models Expand Offering

Potter & Brumfield's expanded line of printed circuit board relays provides the features you need – whether you're switching dry circuits or 30A loads. New products, traditional P&B quality and unbeatable service combine to help solve your toughest relay design-in problems in telecommunications, appliance, industrial control and other applications.

Miniature Relays Switch 1mA to 10A

New T73 and T74 series miniature P.C. board relays join the T70 series as Potter & Brumfield's low-cost SPDT units for general purpose applications. Various contact materials permit these immersion cleanable relays to switch from 1 mA through 10A. Sensitive coil models are available.

Expanded Line of 4,000V Isolation Relays

Extensions to the line of RK series relays feature 8mm coil-to-contact spacing for 4,000V isolation. SPDT models switch loads to 20A, while DPDT models switch up to 5A. Both sealed and unsealed types are now offered with either AC or DC coils.

T90 & T91 – 30A Workhorses

T90/T91 series relays have SPDT contacts for loads to 30A. The DC coil T90 is offered as an open-style

or sealed relay. The T91 is available with a DC coil, and it's offered with quick connect terminals for load connections. An AC coil T91 will be available soon.

More Models for Low Signal Switching

The growing line of P&B low-signal relays features units with single or multiple contacts to provide dependable switching of 2A and under loads. Both polarized and non-polarized units are offered in various coil sensitivities. Included are immersion cleanable DIP and SIP types.

Stock Availability

Many models are available off-the-shelf from your authorized P&B distributor. Of course, distributor stock is backed by Potter & Brumfield's extensive factory inventory.

Find Out More

Contact us today for information on our complete line of P.C. board relays. Potter & Brumfield, A Siemens Company, 200 S. Richland Creek Drive, Princeton, Indiana 47671-0001.

Call toll-free 1-800-255-2550 for the P&B authorized distributor, sales representative or regional sales office serving your area.

Potter & Brumfield A Siemens Company

A POPULAR EMBEDDED CONTROL PROCESSOR
PRESENTS NEW OPPORTUNITIES FOR PERSONAL
COMPUTER COMPATIBILITY.

BRING PC COMPATIBILITY TO THE INTEL 80C186

Many equipment manufacturers are considering moving the PC architecture from desktop to traditional embedded processor applications. There's a wide range of potential uses: consumer electronic devices, point-of-sale terminals, vending machines, industrial controllers. The architecture can also be used in such diverse areas as medical instrumentation, telecommunication systems, and electronic testing and measuring (see "PC architecture for embedded systems").

However, the 80186 (or 80C186), the most popular embedded 16-bit processor, isn't fully PC compatible. Until now, designers were forced to use either the less powerful 8080/8086 processor or the more complex, costly 80286 (or even the 80386). With the new VG-501/502 chip set, the popular embedded-system processor can now take full advantage of the PC's architecture with true PC compatibility. Simultaneously, the chip set supplies a substantially reduced component count and lower power consumption than the 80286/386 microprocessors, and also better performance than the 8088/8086 microprocessors.

The 80186 includes many peripheral components found in the PC, such as a direct-memory-access (DMA) controller, programmable-interrupt controller, programmable timers, clock generator, bus controller, and wait-state generator. Nevertheless, although the CPU is fully PC compatible, the architecture of the peripherals on the 80186 chip is different (Table 1).

PC architecture requires four DMA channels as supplied by the 8237 DMA controller. The 80186 only offers two, and they aren't 8237 compatible. The 8237 also uses a 16-bit address register and a 16-bit counter register for each channel. The 80186 has the same 16-bit counter register but uses 20-bit source and destination registers for

TABLE 1. 80186 vs. PC ARCHITECTURE

Feature	80186	PC
DMA	Two channels proprietary	Four channels (8237)
Timers	Two proprietary timers	Three timers (8253)
Interrupts	Single-level internal vector	Eight-level (8259A) external vector
Bus Cntrl	None	8288
Refresh	Internal (C186 only)	DMA channel 0

PAUL ROSENFELD AND RALPH WOODARD

Vadem, 1885 Lundy Ave., Ste. 201, San Jose, CA 95131; (408) 943-9301.

PC-COMPATIBLE 80C186

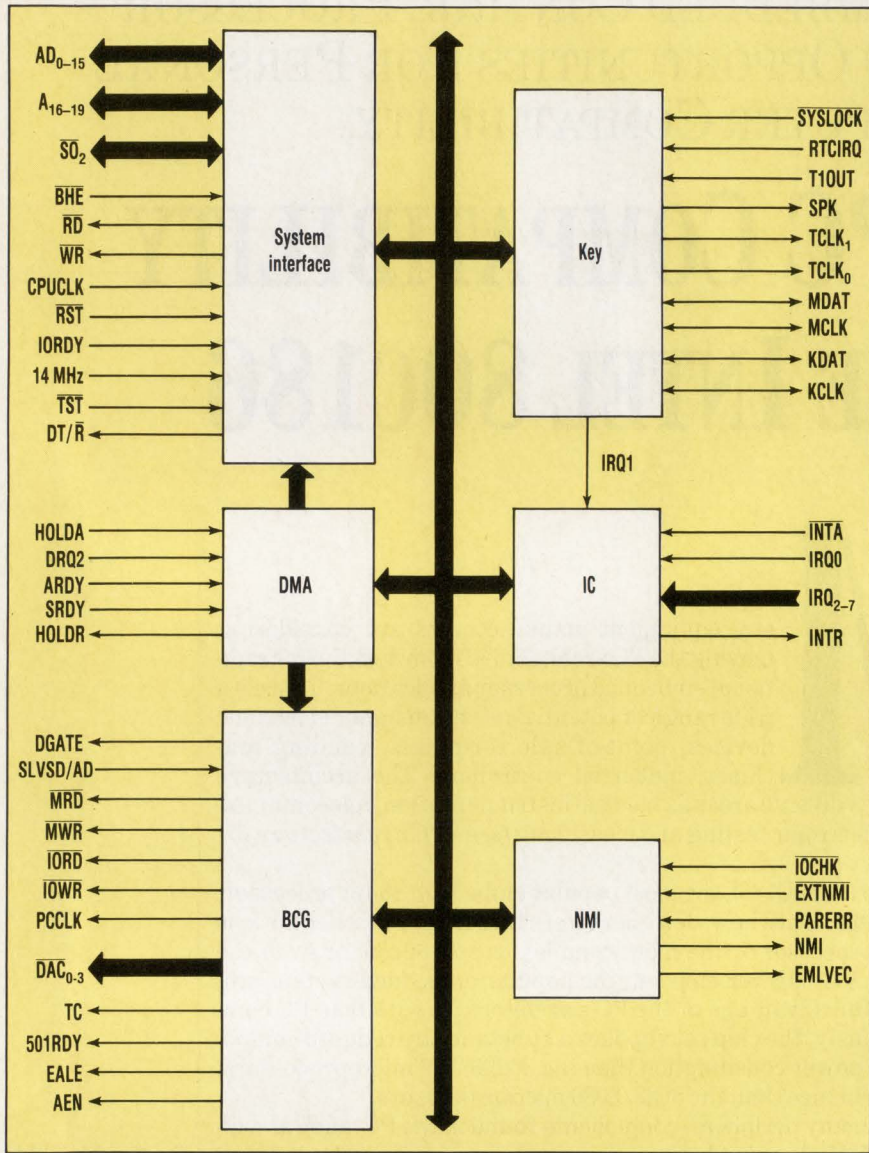

DMA. In addition, the 8237 generates TC and DACK signals when DMA is complete; the 80186 doesn't.

Also, where the PC uses the eight-level 8259 priority-interrupt-controller chip, the interrupt controller integrated in the 80186 offers little more than one 8086 type of interrupt facility in the mode of operation closest to the PC. Consequently, for the 80186, the full capability of the 8259 must be externally duplicated. Furthermore, the two timers on the 80186 set up in different ways than the three timers on the 8253 timer chip used for the PC. A third timer must be added externally.

A COMPATIBLE 80186

Two critical elements bring PC compatibility to the 80186. The first element is extra hardware that supplements the on-board 80186 peripherals to match the configuration of the PC. Secondly, there's intercepting (trapping) and converting (if necessary) the way PC application software and hardware access peripheral components. If the PC application software is well behaved and performs all peripheral accesses through the BIOS, a special PC-compatible BIOS for the 80186 is all that is required to access the hardware with appropriate commands. But problems arise when ill behaved programs bypass the BIOS and go directly to the hardware to access the peripherals.

The PC software makers are notorious for supplying programs that wring every possible bit of performance from PCs by directly interfacing the hardware. Nevertheless, some early PC suppliers tried to supplement the 80186 hardware and use a special PC BIOS to hide the hardware differences. The few PC products released to the market that used this approach with the 80186 failed.

Fortunately, the PC architecture makes it possible to define a precise list of all possible incompatible peripheral accesses. Because the PC accesses peripherals with I/O addresses, hardware can be used to intercept the critical I/O addresses for correction (Table 2). Accordingly, a hardware-based trapping mecha-

1. THE NEW VG-501/502 chip set lets the popular 80C186 take full advantage of the PC's architecture with true PC compatibility. The VG-501 chip acts as an external eight channel interrupt controller that is functionally compatible with the Intel 8259A.

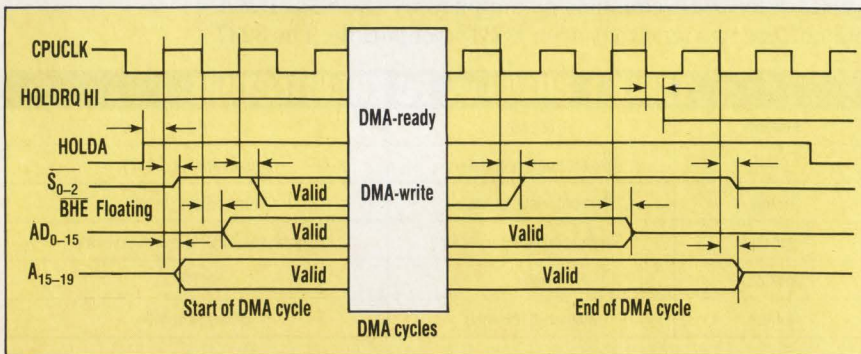

2. WHEN THE CONTROLLER in the VG-501 is ready to do a DMA transfer, it issues a Hold-Request signal. Once the 80186 releases the bus and returns a Hold-Acknowledge signal, the VG-501 becomes a bus master and can perform the DMA activity.

PC-COMPATIBLE 80C186

nism in the VG-501/502 chip set saves the state of the machine in a FIFO register. It also delivers a nonmaskable interrupt (NMI) signal to the 80186 processor. Upon receiving this signal, the processor executes a short interrupt-service routine, which interrogates the FIFO register to determine the type of CPU cycle that was in progress.

Upon identifying the cycle type, the NMI-interrupt routine passes control to specific customized routines in the 80186's special BIOS. The special BIOS procedures extract the parameters of the operation in progress. The BIOS then executes a functionally equivalent operation for the trapped command in a manner acceptable to the 80186/501/502

TABLE 2. CRITICAL I/O ADDRESS FOR PERIPHERAL ACCESSES

Peripheral	I/O Address
Interrupt	20
Interrupt	21
DMA	00-0F
DMA Page	80-83
Timer	40-43
Model 30 RTC	B0-BF, E0-EF

configuration. Afterwards, control returns to the application program. Using the NMI to trap doesn't affect the normal PC use of NMI for parity-error reporting.

Though this sequence may seem complex and slow, few instructions are needed to trap and execute an equivalent operation. Moreover, the chip-set hardware reduces the required software. Less than 1% of the

overhead is used when the code is executed to correct peripheral setup. A typical operation takes less than 40 μ s. Furthermore, because most PC applications employ relatively few peripheral accesses, overall performance degradation is barely noticeable.

Given the ability to detect and correct all accesses to the peripherals either through the BIOS or directly to the hardware, the next step is adding the necessary supplemental hardware to configure 80186 systems as a PC. This hardware is divided into three areas: interrupt control, DMA control, and timers.

INTERRUPT CONTROLLER

The 80186 internal interrupt controller operates in several modes. All but one force the use of fixed, internal interrupt vectors. The VG-501 chip acts as an external eight-channel interrupt controller, which is functionally compatible with the Intel 8259A (Fig. 1). The 80186 then operates in a mode functionally equivalent to the 8088/8086 interrupt system. Accordingly, the VG-501 typically receives interrupts intended for the 8259A in a PC-compatible system.

The VG-501 passes those interrupts on to the 80186, which is in a cascade mode. The 80186 doesn't generate internal interrupt vectors in the cascade mode, but it uses external vectors generated by the 8259A-like circuit contained in the VG-501. Of course, the 80186 requires proper initialization to enter this mode.

Seven of the VG-501 interrupt-controller channels (numbers 0 and 2 through 7) are externally accessible, and the remaining channel (number 1) connects to the VG-501's internal keyboard-mouse controller. The interrupt controller's output connects to the 80186's INT0 pin.

When the 80186 receives the interrupt, it carries out an Interrupt-Acknowledge (INTACK) cycle absorbed by the VG-501, which responds externally the same way as the 8259A. Consequently, PC-type software interrupt routines execute

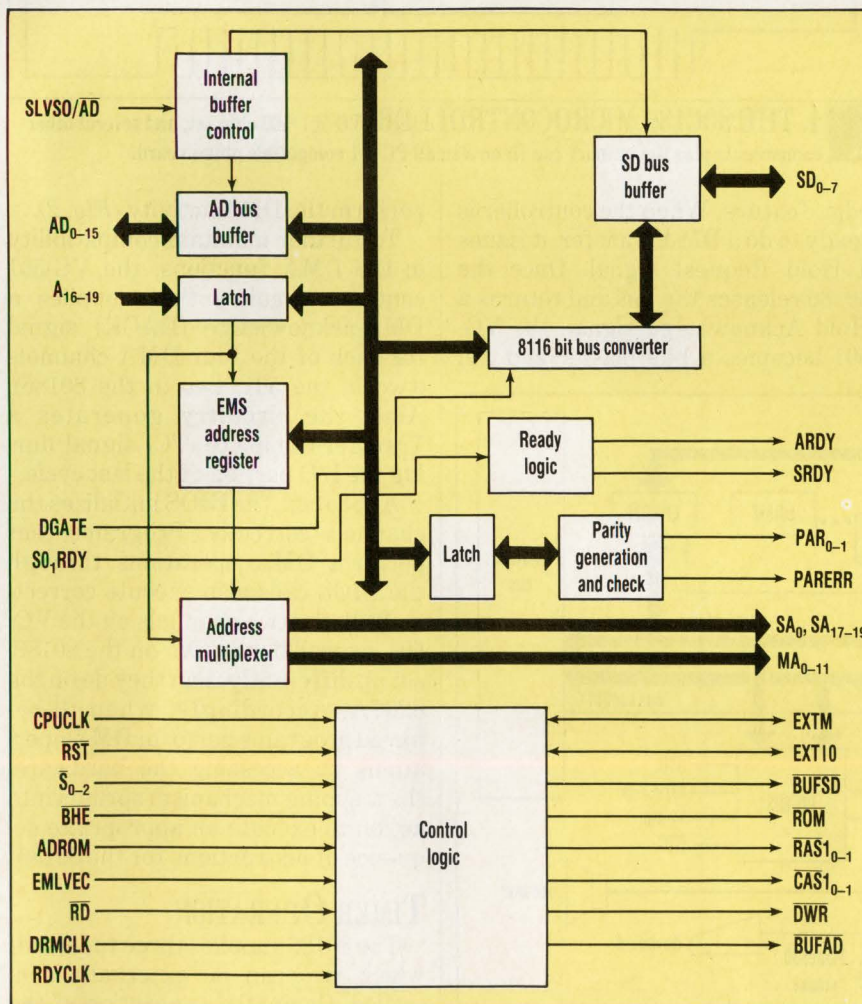

3. HARDWARE SUPPORT for extended memory is built into the VG-502 chip, making it possible for transparent access to a memory space of 32 Mbytes.

PC-COMPATIBLE 80C186

without change.

Although the interrupt controller in the VG-501/80186 functions identically with the 8259A in the PC, the VG501 interrupt controller is initialized differently. Ill-behaved programs, which attempt to access the interrupt controller directly through I/O address 20 and 21, are trapped in the hardware and corrected through the NMI structure. The BIOS handles the initialization at boot up in a normal fashion. Also, the application program, which interrogates or alters the interrupt controller operation by calls to the BIOS, operates in a normal fashion.

DMA CONTROLLER

The 80186 supplies two independent DMA channels, yet the PC architecture calls for four. Therefore, to make the 80186 PC compatible, the VG-501 chip includes the two additional channels. One channel transfers floppy-disk data, and is programmable in a single transfer mode compatible with the 8237A. The second channel serves refresh cycles. Though nonprogrammable, it's functionally compatible with channel 0 of the 8237A in the single transfer mode.

The VG-501's DMA controller uses the 80186 Hold Request/Acknowl-

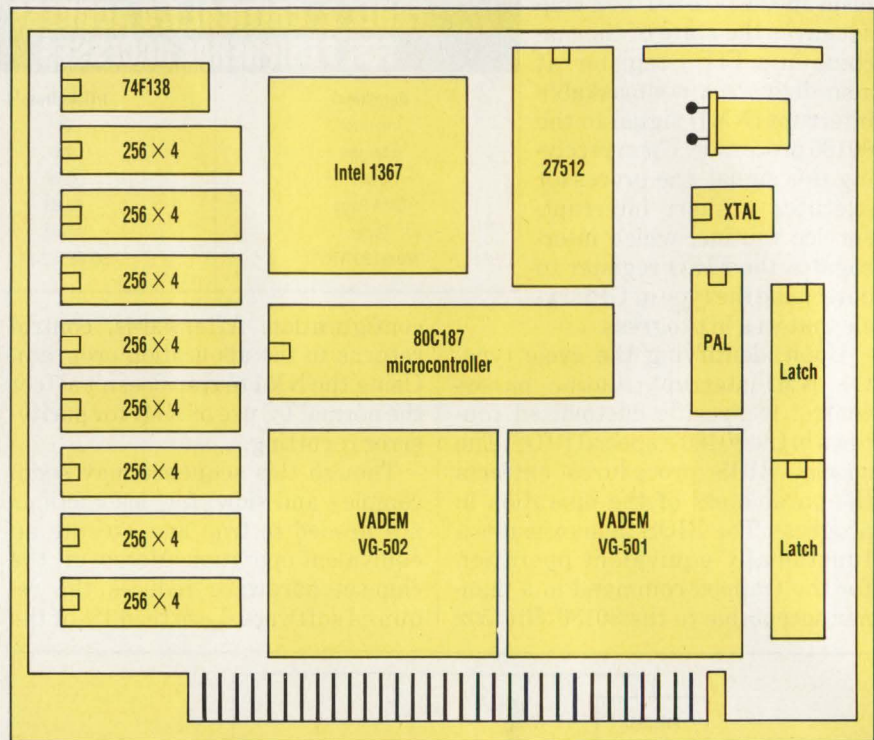

4. THE 80C186 MICROCONTROLLER, VG-501/502 chip set, and several other components plus the memory can fit on a small PC/XT compatible plug-in card.

edge feature. When the controller is ready to do a DMA transfer, it issues a Hold Request signal. Once the 80186 releases the bus and returns a Hold Acknowledge signal, the VG-501 becomes a bus master and can

perform the DMA activity (Fig. 2).

To further maintain compatibility in the DMA functions, the VG-501 contains circuitry that supplies a DMA-acknowledge (DACK) signal for each of the four DMA channels (two in the 501, two in the 80186). Also, the circuitry generates a Transfer-Complete (TC) signal during the I/O portion of the last cycle.

At boot up, the BIOS initializes the channels correctly. Programs that perform DMA operations through the BIOS calls also execute correctly. Still, the two channels on the VG-501, as well as the two on the 80186, set up differently than they do on the 8237A. Accordingly, when ill-behaved programs perform DMA operations by accessing the hardware, the trapping mechanism springs into action to execute an appropriate sequence of instructions for the 80186.

TIMER OPERATION

The 80186 supplies three timers, of which two can be externally controlled. Compatible operation of the on-board 80186 timers was perhaps the most challenging problem. The

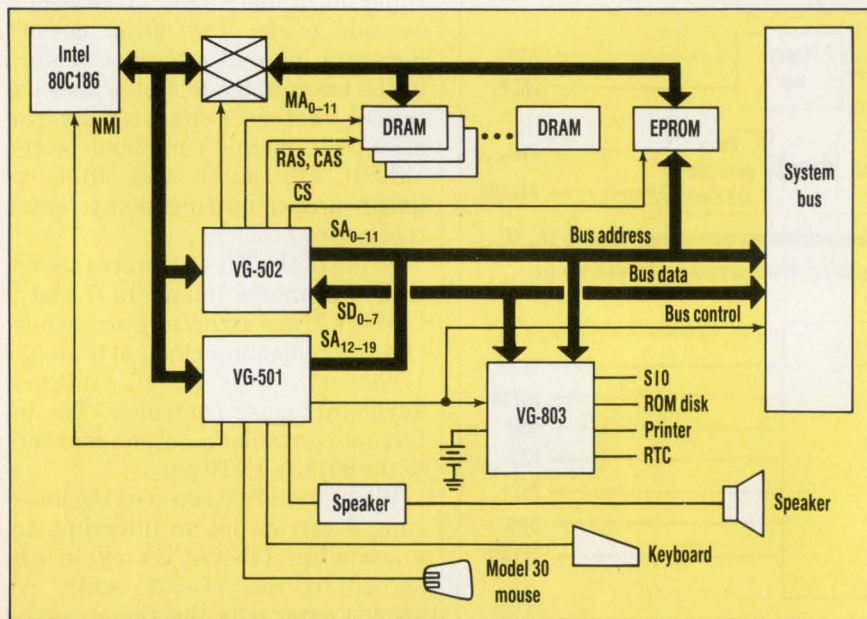

5. THE 80C186/501/502 chip combination can also serve in a PS/2 Model 30 compatible system.

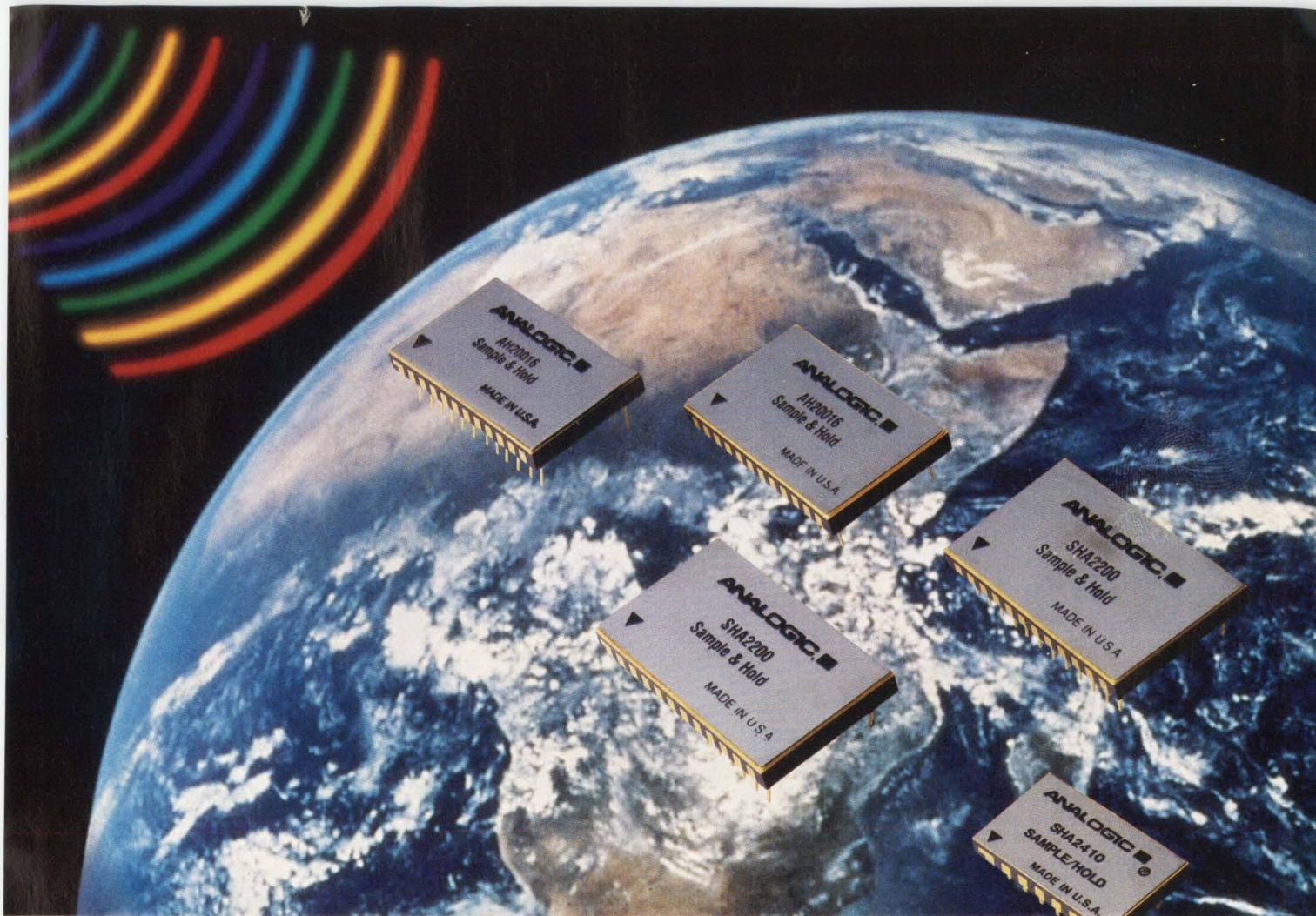

Analogic Introduces The World's Quietest S/H Amplifiers

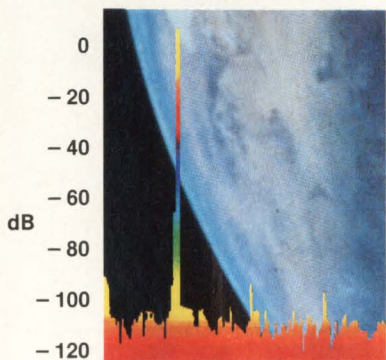

*High Speed and
Precision in
Industry Standard
Hybrid Pinouts*

Analogic, the world resource for precision signal technology, brings you the quietest, fastest precision sample-and-hold amplifiers available. With noise levels as low as $20 \mu\text{V rms}$, Analogic's new family of S/H amplifiers surpasses all others for high speed, high resolution signal processing applications.

Just look at these features. For high performance, the AH20016 offers 500 ns acquisition time, low aperture jitter of 10 ps rms, and $\pm 0.0015\%$ linearity. The SHA2200 is ideal for use with fast, high resolution A/D converters, digitizing signals up to 2 MHz with a low noise of only $30 \mu\text{V rms}$. Low cost applications are easily supported by the SHA2410 with excellent linearity of $\pm 0.0015\%$, acquisition time of only 2.5 μs and the lowest noise — $20 \mu\text{V rms}$. We offer standard pinouts to ease system integration, off-the-shelf delivery, and the high reliability you only get from hybrids!

The speed and accuracy of Analogic's S/H amplifiers will meet the most demanding OEM applications—wide-band data acquisition systems, professional audio encoding, digital telecommunications, automatic test equipment, industrial process control, or nuclear research.

And we put our promises in writing. Every Analogic S/H amplifier is tested on proprietary automatic test systems. The test data shipped with each product guarantees that it meets or exceeds the published specifications. Surprised? Anything less is just a lot of noise.

For Applications Assistance: Richard Lentini
Analogic Corporation, 360 Audubon Road,
Wakefield, MA 01880 (508) 977-3000 x2170
Telex: 466069, Fax: (617) 245-1274

ANALOGIC ■
The World Resource
for Precision Signal Technology

First the TQ and now . . .



the T-Series.

Only from Aromat!

NEW! TN Relay
Vertical TQ...
the Ultimate Space Saver.

Again, Aromat breaks through in technology, with new relays that are ideal extensions of the TQ, for a wider variety of demanding applications.

First, the TQ2, introduced in 1986 as "the world's smallest polarized relays."

Second, the TQ-4, a 4-pole version of the TQ, ideal for special applications and critical board layouts.

Third, the TF, the highly sensitive version of the TQ, offering 80mW nominal power consumption, direct drive possible by TTL or CMOS logic, available for use with 48V coil.

Fourth, the TF-SMD, a surface mount configuration of the TF, with all the features plus surface mount capability.

Micro-Balance Armature Design, the secret behind the T-Series.

- Excellent in vibration/shock resistance
- Destructive shock — 100G
- Destructive vibration — 30G

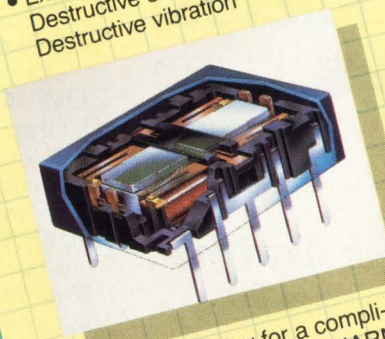

- Capable of high density board mounting without affecting the adjacent relays' operating characteristics.
- High speed performance is due to the low mass and small size of the moving components
- Operate Time: 2mSec
- Release Time: 1mSec
- Special hinge construction of the Armature block reduces friction. Consistent movement offers minimal variation in operating characteristics.

Call or write today for a complimentary copy of the 1987 NARM's Charles Schneider Best Paper Award (1st Place Prize) on the TQ relay's micro-balanced armature design.



CIRCLE 12 CALL ME I'M INTERESTED
CIRCLE 13 SEND LITERATURE

Advanced switching technology.

- For further information, contact your nearest Aromat sales office:
- New Providence, NJ**
Tel: (201) 464-3550
 - Marlboro, MA**
Tel: (508) 481-1995
 - Orlando, FL**
Tel: (407) 855-1075
 - Elk Grove Village, IL**
Tel: (312) 593-8535
 - Richardson, TX**
Tel: (214) 235-0415
 - San Jose, CA**
Tel: (408) 433-0466

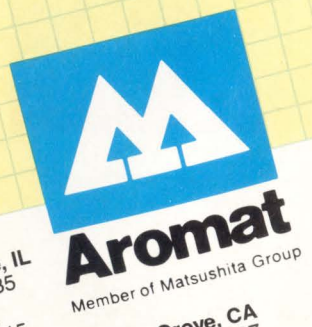

- Garden Grove, CA**
Tel: (714) 895-7707
- Aromat Canada Inc.**
Mississauga, Ontario
Tel: (416) 624-3777

DESIGN APPLICATIONS

PC-COMPATIBLE 80C186

code sequences that set up the 80186's timers differ from the 8253's timers used in the PC. As with the DMA, the BIOS handles initialization of the 80186 timers at boot up. Consequently, well-behaved programs that access the timers through BIOS calls operate correctly. Again, the NMI-trapping logic corrects the access to the timer hardware from ill-behaved PC applications that access the timer hardware directly. This underscores the importance of trapping-logic performance for the timers.

The 80186 timer channel 0 handles the system clock—the equivalent of the PC timer channel 0, and the 80186 timer channel 1 handles the speaker clock—the equivalent of the PC timer channel 2. The VG-501 supplies the inputs for these 80186 timer channels 0 and 1 by dividing the system's 14-MHz clock by 12. PC timer channel 1 normally serves as the refresh timer, a function handled completely within the VG-501.

Full control over the PC BIOS is a key element for successfully implementing an 80186-based PC. A standard off-the-shelf PC BIOS won't give the appropriate

PC ARCHITECTURE FOR EMBEDDED SYSTEMS

PC architecture isn't an obvious choice for embedded systems. PCs are generally associated with the MSDOS operating system and floppy or hard-disk drive usage. Embedded systems, however, are usually ROM based and diskless. Also, PCs don't require fast interrupt response times for handling external events. Furthermore, PC applications are single-threaded and generally deal with only one task at a time. PCs contain few elements to increase the reliability or maintainability of the system.

Nevertheless, the PC architecture isn't as bad a choice for embedded systems as it might appear. ROMable code can be written for PCs. New chip sets, BIOS developments enable existing PC applications to be based in ROM (or EPROM), whether or not the application was originally written for ROM. This capability even extends to DOS. The PC's interrupt architecture and response times are adequate for all but the most performance-intensive data gathering and control applications, and the higher speed processors now available for the PC architecture supply coverage of several of these applications.

Furthermore, a host of software companies now offer real-time multitasking operating systems for the PC architecture. They're either DOS compatible, run together with DOS, or take over the system completely. The fundamental underlying standard is the well-known PC architecture.

Because it's known that PC architecture deficiencies can be addressed for embedded applications, what are the advantages of the PC architecture? The most overwhelming gain may be the great wealth of off-the-shelf PC software and

You've wanted
HP quality...

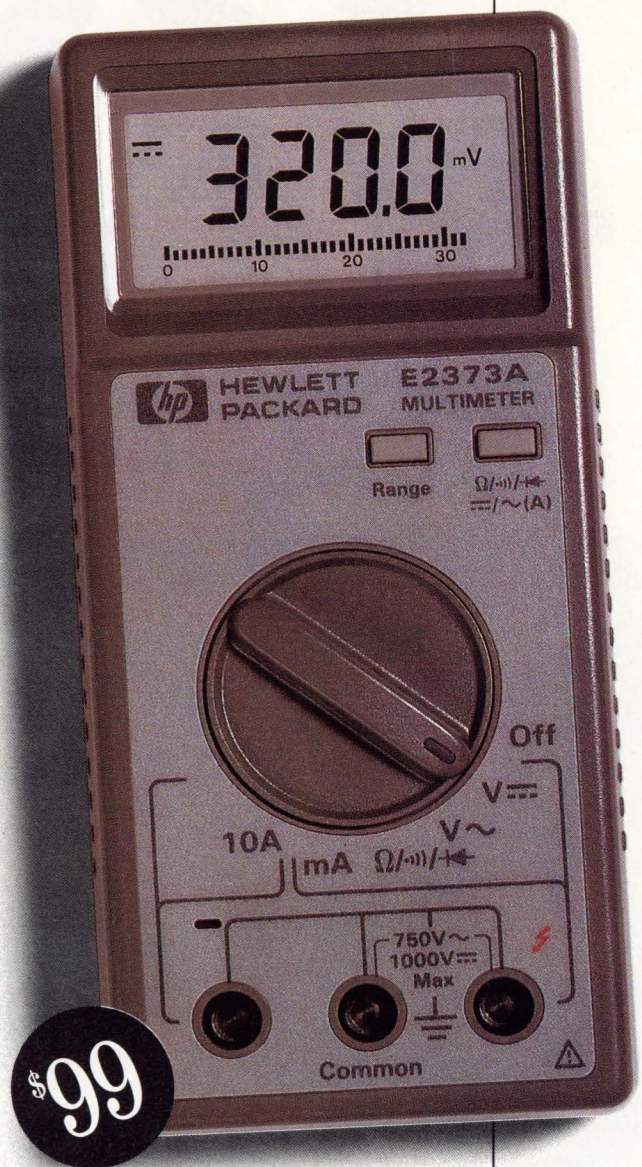

©1989 Hewlett-Packard Co. TML1D925/ED

Call HP DIRECT, 800-538-8787, Dept. A293.

We can't make buying HP quality in a handheld multimeter any easier or faster. Our toll-free line gives you fast access to the HP E2373A, above. It combines seven functions with 500 Hz AC bandwidth, accuracy of 0.7% in DCV and 2% in ACV, in a \$99.00* package. Call today to order.

*U.S. list price.

CIRCLE 107

120dB RANGE

FOR PRECISE EVALUATION OF HIGH-QUALITY COMPONENTS

Improve your dynamic range and resolution to match today's high-performance filters, tuners and other components.

Anritsu's MS3606A Network Analyzer now offers you an amazing 120 dB dynamic range for a clear picture around peak and cutoff frequencies. The fully synthesized signal source provides 1 mHz resolution and dramatic increases in phase/delay-time measurement resolution to give you the best sensitivity and precision for advanced video and mobile-communications components.

With the MS3606A, you can measure at a super-high speed of just 400 μ s. The Personal Test Automation (PTA) option gives you faster signal processing and ATE capability to improve productivity. You'll even have the flexibility to transplant program assets from other equipment.

Scalar analysis for complicated tests involving different input and output frequencies is also available, along with conventional vector analysis.

The MS3606A gives you all these features over a wide frequency range of 10 kHz to 1 GHz, for a broad spectrum of applications. And of course, a full selection of peripherals, including equipment for testing analog ICs, is also available.

For R&D or mass production, you'll get the greatest capabilities from Anritsu.

NETWORK ANALYZER MS3606A

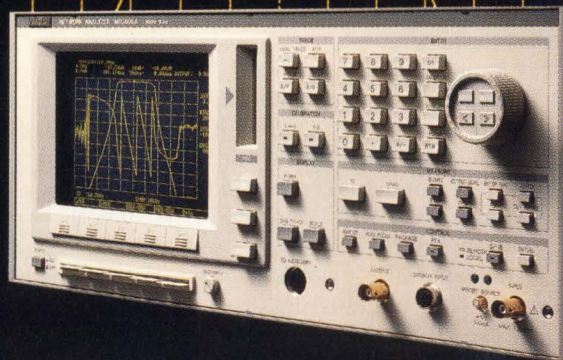
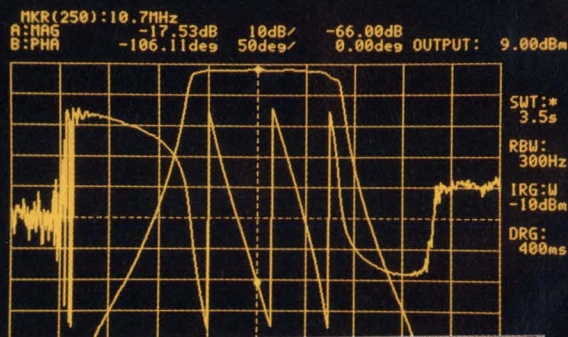

Anritsu

ANRITSU CORPORATION 10-27, Minamiazabu 5-chome, Minato-ku, Tokyo 106, Japan Tel. 03-446-1111
 U.S.A. ANRITSU AMERICA, INC. 15 Thornton Road, Oakland, N.J. 07436 Tel. 201-337-1111 Sales & Service 1-800-255-7234
 U.K. ANRITSU EUROPE LIMITED Capability Green, Luton, Bedfordshire LU1 3LU Tel. (STD0582) 418853
 F.R. Germany ANRITSU ELEKTRONIK GmbH Grafenberger Allee 54-56, 4000 Dusseldorf 1 Tel. 0211-679760
 Brazil ANRITSU ELETRONICA S.A. Av. Passos, 91-Sobrelas 203/205-Centro, 20.051-Rio de Janeiro-RJ Tel. 021-221-6086

•Argentina IQTA S.A. Tel. 431-0911 •Australia STANDARD TELEPHONES AND CABLES PTY. LTD. Tel. 03-615-6671 •Austria WIEN SCHALL GmbH Tel. 0222-832224 •Belgium C.N. ROOD S.A. Tel. 02-7352135 •Bulgaria ELSINCO GmbH Tel. 0222-871751 •Canada ATELCO INC. Tel. 416-479-8590 •Chile PARKER Y CIA. Tel. 231-9976 •Colombia RADIOCOM S.A. Tel. 218-2054/218-4606 •Costa Rica ELECTRONIC ENGINEERING S.A. Tel. 0-755-7711 •Cyprus CHRIS RADIOVISION LTD. Tel. 02-466121 •Czechoslovakia ELSINCO GmbH Tel. 0222-871751 •Denmark INSTRUTEK A/S Tel. 05-611100 •Egypt ALKAN Tel. 3490140 •Finland INTO OY Tel. 0-755-7711 •France SALIES S.A. Tel. 1-69-204010 •Greece KOSTAS KARAYANNIS Tel. 3230303, 3237731 •Guatemala ELECTRONICA OSRO Tel. 314966, 61552 •Hong Kong SCHMIDT & CO. (H.K.) LTD. Tel. 5-8330222 •Hungary ELSINCO GmbH Tel. 0222-871751 •Iceland GEORGI AMUNDASON & CO. Tel. 687620, 681180 •India PHOTOPHONE LTD. Tel. 582493, 582498 •Indonesia PT. SUBUR SAKTI PUTERA Tel. 359163 •Italy VIANELLO S.p.A. Tel. 02-89200162, 02-89200170 •Korea HAN-IL COMMERCE & COMPANY Tel. 783-6391-5 UTO TRADING COMPANY Tel. 785-18001 •Malaysia RANK O'CONNOR'S (M) SDN. BHD. Tel. 7566599 •Mexico ELECTRONICA 2000, S.A. DE CV Tel. 548-5049/548-0630 •Netherlands C.N. ROOD BV Tel. 070-996360 •New Zealand WM SCOLLAY & CO., LTD. Tel. 04-722-961 •Norway TELEINSTRUMENT AS Tel. 02-901190 •Pakistan ASSOCIATED ELECTRIC TRADING CORP. Tel. 042-56351/66635 •Papua New Guinea STANDARD TELEPHONES AND CABLES PTY. LTD. Tel. 256933 •Peru ESTEMAC PERUANA S.A. Tel. 45-5530 •Poland ELSINCO GmbH Tel. 0222-871751 •Portugal OMNITECNICA Tel. 905517, 905617 •Saudi Arabia ELECTRONIC EQUIPMENT MARKETING CO. Tel. 4771650 •Singapore RANK O'CONNOR'S (PTE.) LTD. Tel. 473-7944 •Spain UNITRONICS, S.A. Tel. 2425204, 4480162 •Sri Lanka INFOTECHS LTD. Tel. 580088, 500817 •Sweden TELEINSTRUMENT AB Tel. 08-380370 •Switzerland GMP S.A. Tel. 021-6348181 •Taiwan CHA WEI ELECTRIC TRADING CO., LTD. Tel. 522-1295 PHIN-KOW ELECTRIC TRADING CO., LTD. Tel. 736-3276 •Thailand P&P TELECOM CO., LTD. Tel. 2712397, 2710057 •Turkey burc ELECTRONICS AND MACHINERY INDUSTRY AND TRADE CORP. Tel. 1-1495788/1495789 •Uruguay GTE TELECOMUNICATIONS INC. Tel. 92-0301071

PC-COMPATIBLE 80C186

hardware.

Many portions of an embedded system can be purchased directly, as opposed to developed from scratch. This reduces time to market, which usually translates to higher prices, better margins, and a greater market share for the resulting product. Other factors that affect time to market include the availability of PC-compatible solutions at the box, board, and chip level. Board-level PC-compatible solutions are available for various popular bus architectures, such as the Multibus, VME, S-100, STD, and Eurocard, as well as the PC Bus. Such vendors as Ampro make a small form-factor bus-less single-board PC.

Even at the chip level, designs are simpler than ever due to the highly integrated chip sets available from various vendors. Embedded software can be prototyped on the ubiquitous desktop PCs before committing to EPROM for the embedded system prototyping.

Other factors favoring the PC architecture are the pricing for PC-compatible boards and chip sets that are driven by the high volume of PC sales themselves. These 10-million plus units per year bring down the manufacturing cost for PC-compatible components. Finally, the increasing attention on portable and laptop PCs is driving higher levels of integration for PC components, shrinking the size of PC implementations, and reducing power consumption to new low levels.

peripheral initialization for the 80186 and the necessary trapping code. Therefore, a special BIOS for the 80186 is needed. Without extensive PC-BIOS experience, the system designer would do best to steer clear of this task. The 80186 PC BIOS from Vadem designed to work with the VG-501/502 chip set offers full IBM PC/XT and PS/2 Model-30 compatibility.

Once the architectural approach to supplying PC compatibility with the 80186 is clear, the most difficult task is to supply adequate system performance. At initialization during boot up, and for well-behaved programs, the VG-501/502 chips' performance doesn't differ from the standard PC architecture. Ironically, those programs that access hardware directly to increase performance are the ones that impact the overhead of the trapping logic. With the timers integrated on the 80186, this is most difficult area of trapping logic.

Moreover, timer performance is most critical at slow processor-clock speeds, because the time to execute trapping code is most significant at this point. The timer adjustment for the trapping code must include the time consumed by the trapping logic, the decode logic, and the setup code. But the timers may not supply the accurate fine resolution needed at slow processor clock speeds with this VG-501/502 and 80186 approach. This problem has most impact on some game program sound effects.

...in a handheld
multimeter...

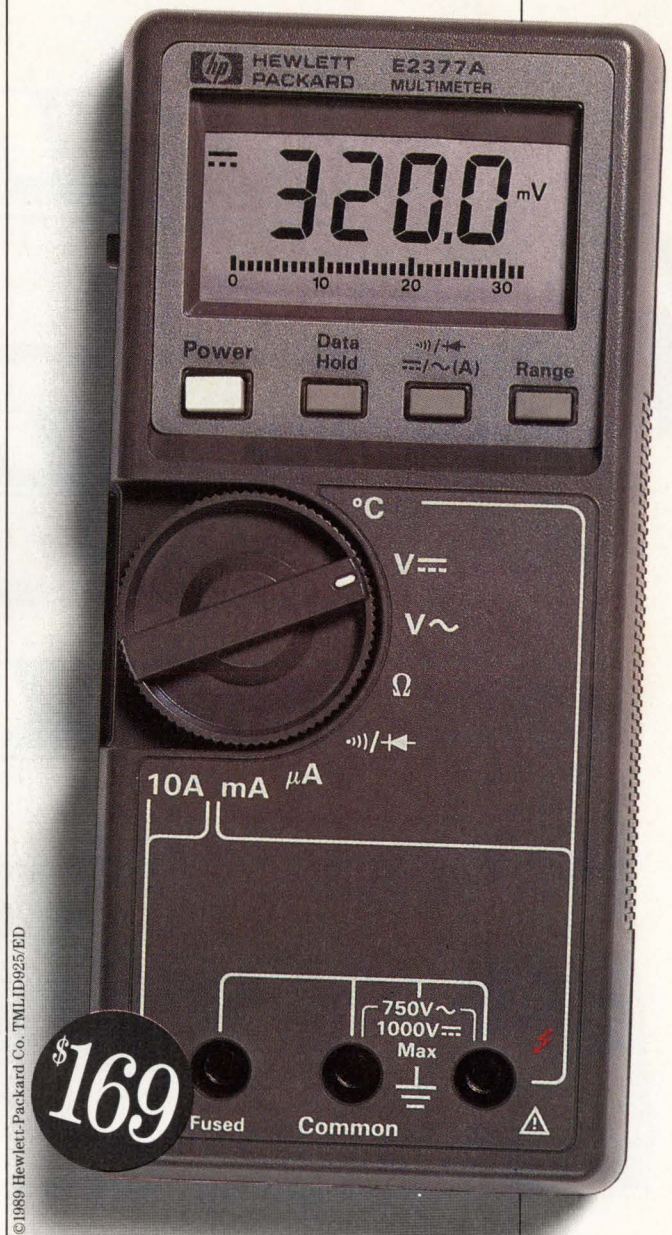

©1989 Hewlett-Packard Co. TMLD925/ED

Call HP DIRECT, 800-538-8787, Dept. A293.

For more exacting tasks, consider the HP E2377A. With basic accuracy of 0.3% in DCV, 1% in ACV, 1 kHz bandwidth, plus temperature function and data hold. All for \$169.00* Call and order now.

*U.S. list price.

CIRCLE 108

Your next Custom Power Supply is 50% Complete

WE MANUFACTURE

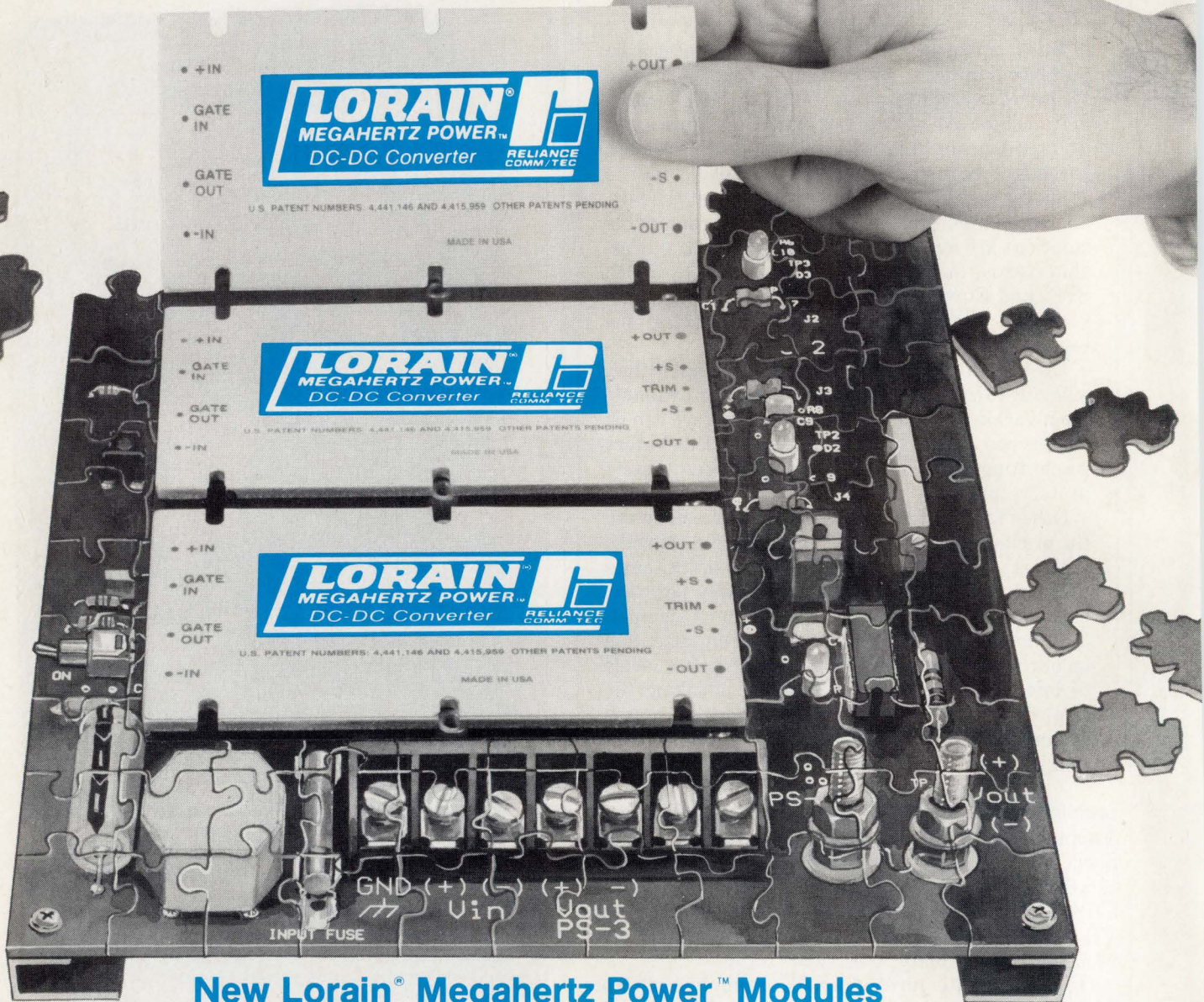

New Lorain® Megahertz Power™ Modules

When you are putting the pieces together for your next prototype custom power supply, Lorain Product's new Megahertz DC-DC converter modules will save you an incredible amount of time and money. With these compact, low cost, pin-connect modules, you need only provide input and output circuitry and peripheral components.

Over 170 standard master and booster modules accurately meet your specific requirements. Megahertz technology offers high efficiency for

easy cooling, zero-current switching for easy filtering, greater reliability, and agency compliance.

Once your power supply parameters are finalized, Lorain will again help you cut costs. Our engineers will assist you in developing the most cost-efficient production power supply utilizing this same benefit-packed megahertz technology. Call or write today for a free 6 page catalog detailing this revolutionary new product.

Working Ahead To Keep You On Line

AVAILABLE FROM STOCK

LORAIN PRODUCTS

1122 F Street
Lorain, OH 44052-2293
(216) 288-1122

CIRCLE 15

**RELIANCE
COMM/TEC**

PC-COMPATIBLE 80C186

Nevertheless, it hasn't affected the correct operation of any of the hundreds of PC application programs tested to date.

In addition to the timer problem, the memory controller offered several special challenges. First, the 80C186 can operate at speeds up to 16 MHz. No other PC/XT or PS/2 Model-30 compatible processor performs at that level. While higher performance systems built around the 80286 and 80386 require 80 ns or faster dynamic RAMs, use of such expensive DRAMs with a lower cost microcontroller, such as the 80186, would defeat one purpose in selecting the 80186. Consequently, the VG-501/502 chip set highly optimizes the memory controller to work at 16 MHz, with zero wait states and DRAMs operating at 100 ns. Furthermore, the memory controller can support either 256-kbits, 1-Mbit, or 4-Mbits DRAMs in either the by-1 or by-4 configurations.

Finally, the original PC architecture systems are based on an addressable memory space of 1 Mbyte. In the DOS-compatible environment, only 640-kbytes of this space was available to application programs. Many current embedded systems seek to go beyond this 640-kbyte limitation and find the traditional DOS environment constraining. The PC system designers have evolved several extended-memory alternatives to solve the problem. The most recent, and perhaps the most popular, is the LIM (Lotus, Intel, Microsoft) standard known as EMS 4.0. Hardware support for this extended memory standard is built into the VG-502 chip, making it possible for transparent access to an extended-memory space of 32 Mbytes (Fig. 3).

Accordingly, the task of supplying a full solution for 80186 usage in embedded PC-compatible systems is only slightly more difficult than supplying it for the 8086. The 80186, VG-501/502 chip set, and a few other components plus the memory can fit on a small PC/XT compatible plug-in card (Fig. 4). Similarly, this chip combination can serve in a PS/2 Model 30 compatible system (Fig. 5). The remaining tasks are for design engineers working on embedded systems to evaluate the opportunities presented by PC compatibility for the processor, which has proven to be the most popular for embedded control applications. □

Paul Rosenfeld, Vadem's chief operating officer, has an extensive background in systems and component marketing, including seven years at Intel Corp. He holds a BA in Math from the University of California, Berkeley.

Ralph Woodard, a design engineer at Vadem, has experience both as an electronic technician and engineer. He is currently designing ASICs for PC compatible systems.

How VALUABLE?
HIGHLY
MODERATELY
SLIGHTLY

CIRCLE
547
548
549

...here's a case
for buying today.

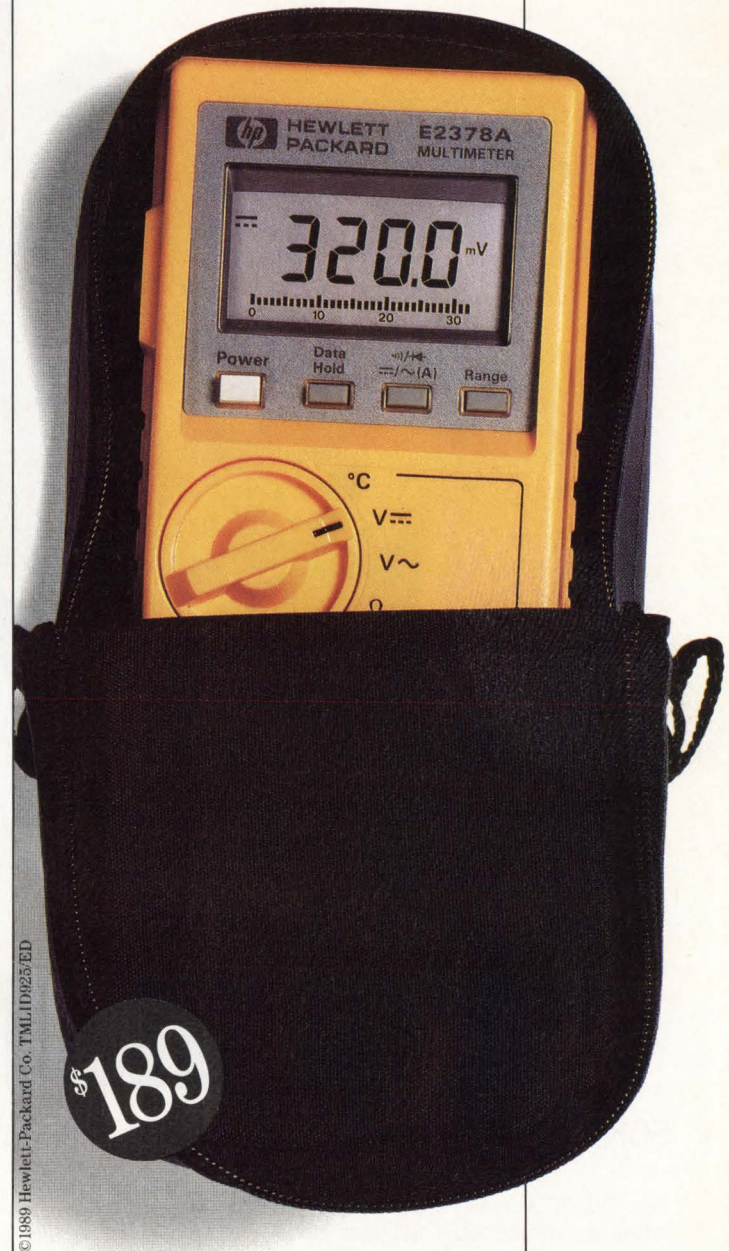

© 1989 Hewlett-Packard Co. TML1D025/ED

Call HP DIRECT, 800-538-8787, Dept. A293.

By calling this line, you get a free \$19.00* case with each meter. And you can get same-day shipping on all meters. Including the HP E2378A, which has the same specs as the HP E2377A in a ruggedized case. \$189.00* Order today.

*U.S. list prices. Offer expires October 31, 1989.

There is a better way.

 **HEWLETT
PACKARD**

CIRCLE 109

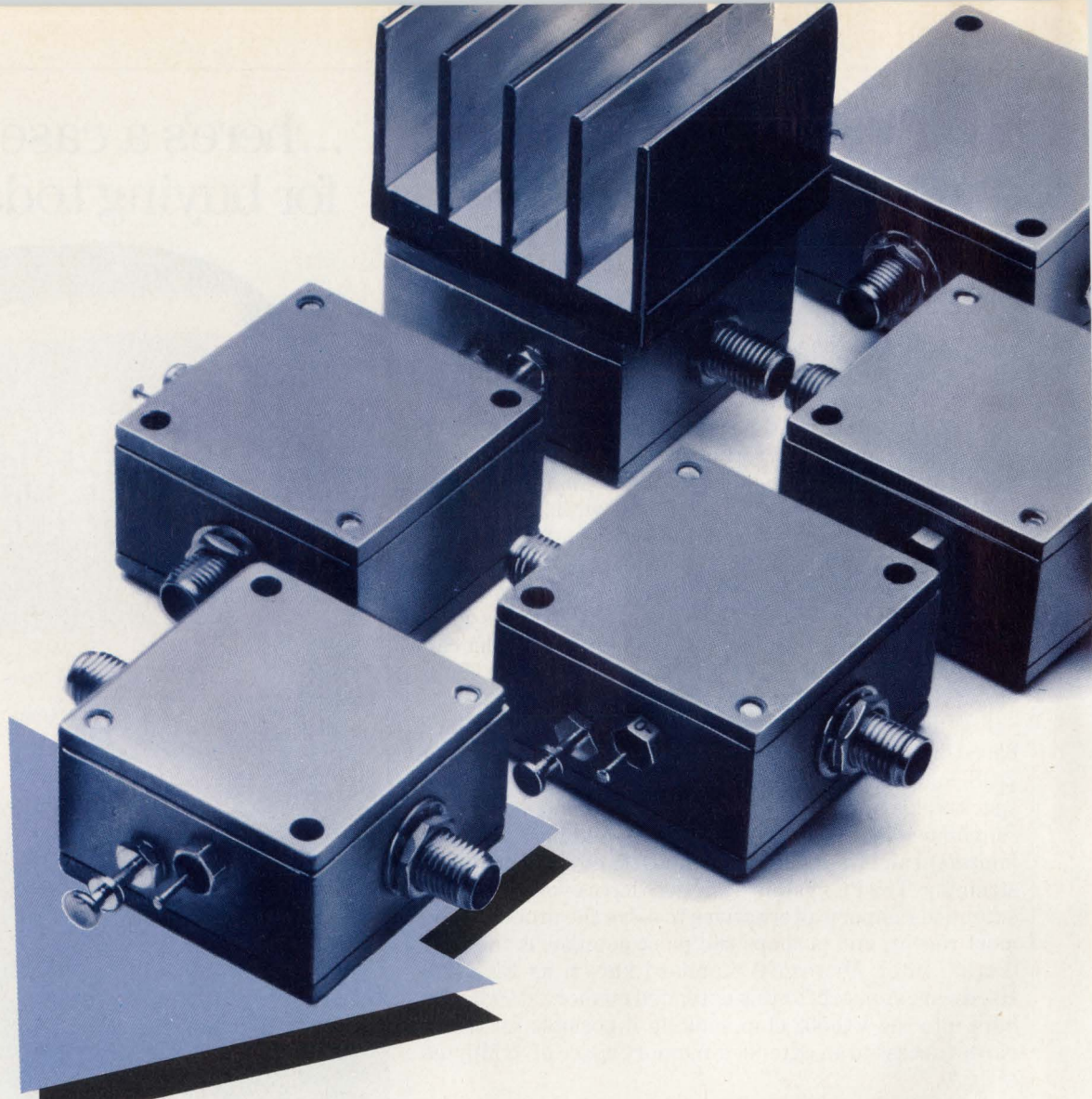

Amplifier Arsenal

50KHz—2000MHz, Low Noise 250mW output Gain Controlled from **\$69.95**

Our ZFL-2000 miniature wideband amplifier hit a bulls-eye when we introduced it last year. Now we've added more models to offer you a competitive edge in the continuing battle for systems improvement.

The ZFL-2000, flat from 10 to 2000MHz, delivers +17dBm output and is priced at only \$219.

Need more output? Our ZFL-1000H, flat from 10 to 1000MHz, delivers +20dBm output.

Is low noise a critical factor? Our ZFL-500LN and 1000LN boast a 2.9dB NF.

Variable gain important? Our ZFL-1000G, flat from 10 to 1000MHz, delivers +3dBm output with 30dB gain control while maintaining constant input/output impedance. The ZFL-1000GH spans 10-1200 MHz, has 30 dB gain control, and +9dBm output.

Searching for a high-quality, low-cost amplifier? Our ZFL-500 flat from 50KHz to 500MHz, delivers +10dBm output for the unbelievable low price of only \$69.95. Need to go higher in frequency? Consider the ZFL-750, from 0.2 to 750MHz, for only \$74.95. Or the \$79.95 ZFL-1000, spanning 0.1 to 1000 MHz. One week delivery...one year guarantee.

SPECIFICATIONS

MODEL	FREQUENCY MHz	GAIN, dB (min.)	MAX. POWER OUTPUT dBm(typ)	NF dB(typ)	PRICE \$ Qty. (1-9) Ea.
ZFL-500	0.05-500	20	+9	5.3	69.95
ZFL-500LN	0.1-500	24	+5	2.9	79.95
ZFL-750	0.2-750	18	+9	6.0	74.95
ZFL-1000	0.1-1000	17	+9	6.0	79.95
ZFL-1000G*	10-1000	17	+3	12.0	199.00
ZFL-1000GH*	10-1200	24	+9	15.0	219.00
ZFL-1000H	10-1000	28	+20	5.0	219.00
ZFL-500HLN	10-500	19	+16	3.8	99.95
ZFL-1000LN	0.1-1000	20	+3	2.9	89.95
ZFL-1000VH	10-1000	20	+26	4.5	229.00
ZFL-2000	10-2000	20	+17**	7.0	219.00

* 30dB gain control ** +15dBm below 1000MHz

Mini-Circuits

A Division of Scientific Components Corporation

P.O. Box 350166, Brooklyn, New York 11235-0003 (718) 934-4500
Fax (718) 332-4661 Domestic and International Telexes: 6852844 or 620156

WE ACCEPT AMERICAN EXPRESS

C101 REV.G

CIRCLE
521 **UPGRADE WITH**
1-MBYTE DRAMS

DON MACADAM

Annulus Technical Industries Inc., P.O. Box 7407, 1296 Osprey Dr., Ancaster, Ontario, Canada L9G 4G4; (416) 648-8100.

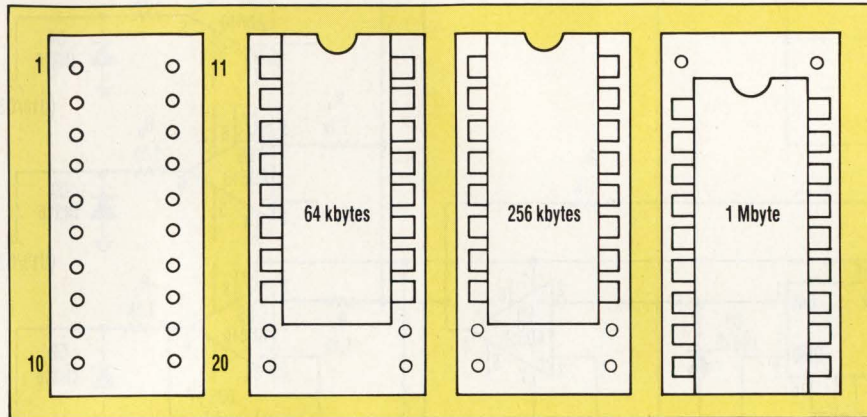

■ A 64- OR 256-KBYTE DRAM sits in the upper portion of a 20-pin socket, while a 1-Mbyte part is placed in the socket's lower section.

Today's designers are more apt to upgrade dynamic RAMs because they're less expensive. Upgrading is an easy task with 16-, 64-, and 256-kbyte DRAMs, which come packaged in 16-pin DIPs and have compatible pin-outs. Unfortunately, 1-Mbyte chips are packed in 18-pin DIPs and have an entirely different pinout configuration.

One solution to this problem is to

use a high density switch to reconfigure the source and destination of the pc-board traces between the DRAM array and the rest of a system. In an array of 32 DRAMs, organized as four banks of eight chips each, there are 41 traces to be reconfigured between the array and the rest of a system.

The problem is further simplified with 20-pin IC sockets that offer the maximum number of matches be-

tween the 16- and 18-pin formats. When the array is populated with 64- or 256-kbyte DRAMs, the parts are seated in the upper portion of the sockets. 1-Mbyte parts, however, are seated in the lower position (see the figure).

In this arrangement, only 21 circuit traces must be reconfigured. When the high density switch is in its "A" position, signals are sent to the IC sockets in the pattern required by 64- and 256-kbyte DRAMs. But when placed in its "B" position, signals are presented in the 1-Mbyte DRAM pattern. □

CIRCLE
522 **STEP DRIVER**
DELIVERS 0.1 TO 9 A

JAMES C. SMITH

NASA/Goddard Space Flight Center, Laboratories for Oceans, Greenbelt, MD 20771; (301) 286-5185.

Here's a straight-forward technique to build a closed-loop driver for a stepper-motor servo system that can deliver a wide current range. The range is a regulated current of 100-mA-to-9.9-A per stepper-motor phase (see the figure).

Components U1, U2, U3, and thumbwheel switches (TWS) S1 and S2 establish a programmable volt-

age reference. A stable -10-V output from voltage regulator U1 feeds into the digital attenuator U2 and U3. This attenuator's output (pin 6 of U3) ranges from 0.0 to +9.9 V, which corresponds with the settings of switches S1 and S2. The lowest nonzero setting is 0.1 V. Adjusting R₁ to establish the desired programmable output-voltage relationship between the TWS settings and the output voltage

range calibrates this function.

The programmable reference voltage then goes to the positive sense of each closed-loop servo reference comparator, U5 through U8, one for each stepper-motor (SM) winding. The SM winding current-sensing resistors R₁₉ through R₂₂ and op amps U9 through U12 supply a 1-V/A feedback signal. That signal then feeds the negative sense of the comparators. Each comparator output-error signal (A_v = 101) then passes through analog switches (U13) for current amplification via transistors Q1 through Q4 and Q5 through Q8.

Servo-loop control adjusts the current through each SM winding to equal the programmable output-ref-

IFD WINNERS

April 27, 1989

Jeff Barrow, Craven Hilton, and Frances Lucas, Analog Devices, One Technology Way, P.O. Box 9106, Norwood, MA 02062-9106. His idea: "Eliminate Oscillator From A Loop."

May 11, 1989

Michael A. Wyatt, Space and Strategic Avionics Div., Honeywell Inc., 13350 U.S. Hwy. 19 South, Clearwater, FL 34624-7290. His idea: "Phase Meter Uses Just Two Chips."

May 25, 1989

Warren Schultz, Motorola, SPS, 5005 E. McDowell Rd., Phoenix, AZ 50008. His idea: "Drive Brush Motors With Brushless IC."

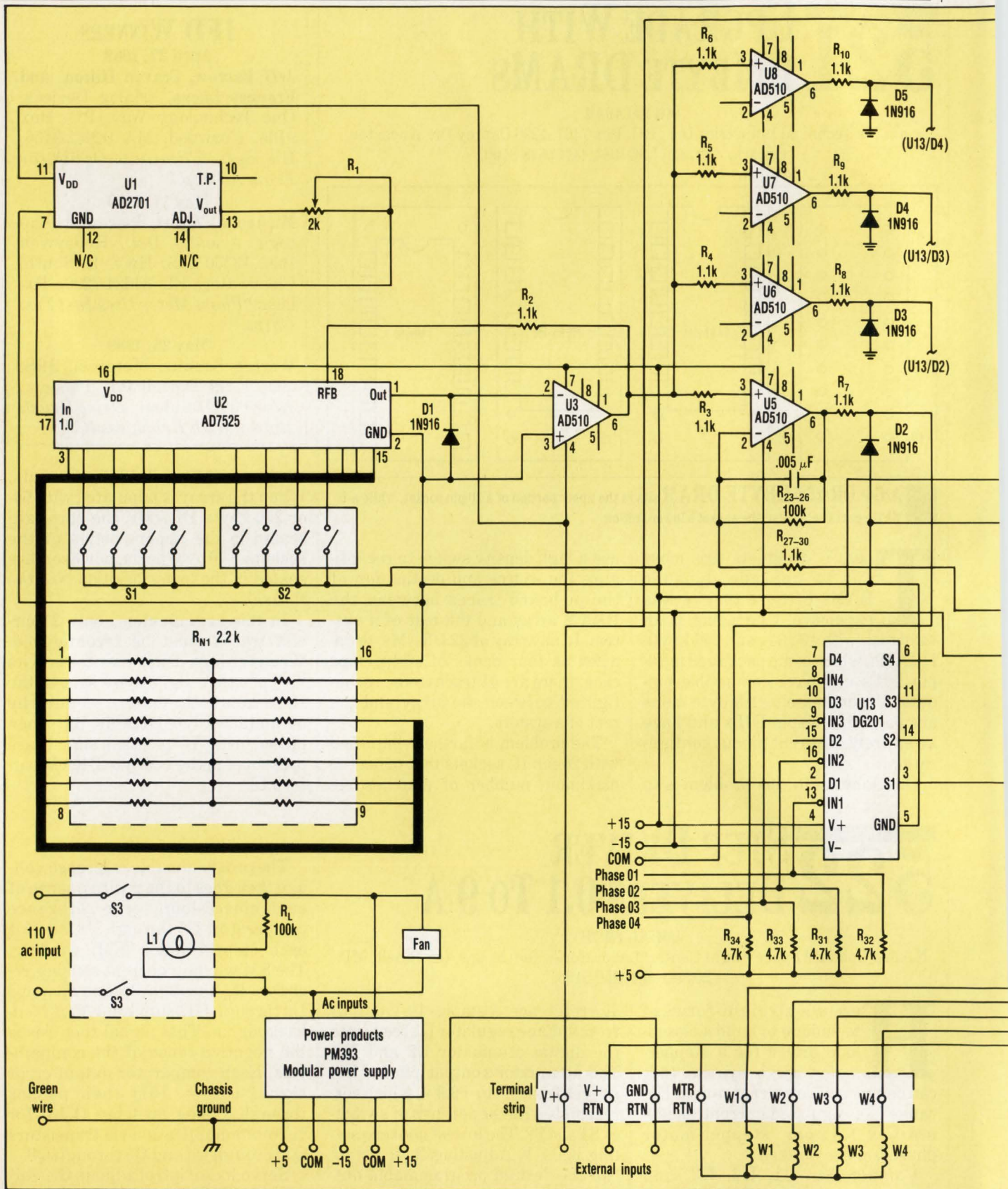

THE OUTPUT RANGE of this stepper motor's drive circuit is a regulated current of 100 mA to 9.9 A per phase.

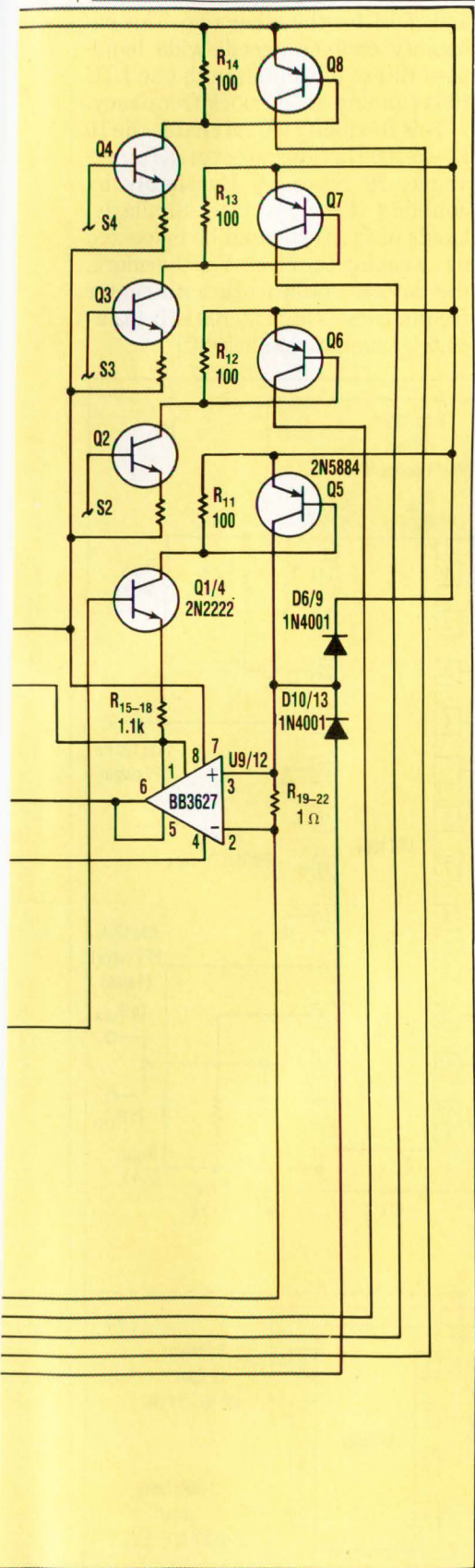

erence voltage (1 A/V). Consequently, the TWS settings correspond to the desired SM winding control current value range of 0.1 mA to 9.9 A.

The analog switches (U13) supply correct phases for the closed-loop servo operation. In other words, when the appropriate SM phase signal is active, it closes the corresponding analog switch to complete the servo-loop feedback path and to establish the programmed drive cur-

rent in the SM winding. When the SM phase signal is inactive, the analog switch is open and the closed-loop control servo becomes disconnected. This condition doesn't offer drive current to the emitters of Q5 through Q8. The voltage rating of Q1 through Q8 limits the maximum value of V+. S1 and S2 determine the maximum current supplied to the motor, and the subsequent control servo regulates the current. □

CIRCLE 523 SWITCH-CAP ICs FILTER TRANSDUCERS

RICH MARKELL

Linear Technology Corp., 1630 McCarthy Blvd., Milpitas, CA 95035; (408) 432-1900.

Sophisticated filter-system designs frequently need expensive printed-circuit boards that are replete with op amps and precision capacitors. Digital filters require fewer yet more expensive devices and a great deal of software. But help is on the way with advances in switched-capacitor filters that make the design of elegant filter systems cheaper, easier to operate, and much smaller. Determining resistor values for setting the filter frequency is the chief design problem with switched-capacitor filters. It's a minor problem, though, after considering the advantages.

Signals covering a dc-to-10 kHz range into a typical switched-capaci-

tor system for filtering transducers can be divided into three bandpass-frequency areas (Fig. 1). Filter 1 is a 400 Hz-to-10 kHz filter with a passband noise of 200 μ Vrms; filter 2 is a 10 Hz-to-100 Hz filter with a passband noise of 500 μ Vrms; and filter 3 is a 10 Hz-to-1 kHz filter with a passband noise of 390 μ Vrms. All of the bandpass outputs have 1-dB ripple in the passband.

This implementation uses two LTC 1064s and one LTC 1062 switched-capacitor ICs, and one LT 1007 op amp (Fig. 2). The LTC 1064s are quad switched-capacitor filters that can implement up to 8th-order filters. Filters 2 and 3 consist of one half of a four-section LTC1064—a 10-Hz

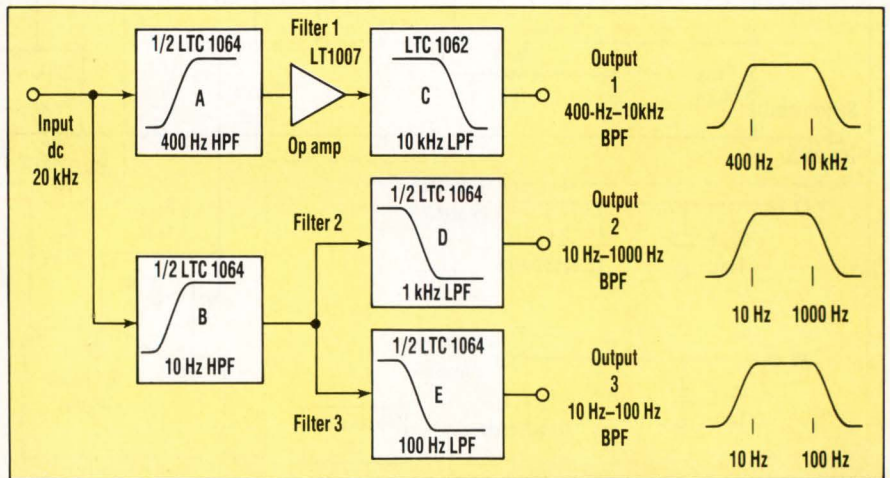

1. SIGNALS covering a dc-to-kHz range are split into three bandpass-frequency areas.

IDEAS FOR DESIGN

high-pass 4th-order elliptic filter—that feeds two separate low-pass 4th-order elliptic filters each made with half of an LTC1064. One cuts off at 100 Hz, the other at 1 kHz. In filter 1, a 400-Hz high-pass 4th-order elliptic filter feeds a 5th-order low-pass Butterworth filter set at 10 kHz.

Resistors R_{11A} to R_{H2A} , with R_{G2A} and the LT1007 op amp, implement the 400-Hz high-pass filter in device A. Resistors R_{13A} to R_{44A} , also in device A, implement the 1-kHz low-

pass filter. In Device B, resistors R_{11B} to R_{42B} implement the 10-Hz high-pass filter, and resistors R_{13B} through R_{44B} implement the 100-Hz low-pass filter. Lastly, R_{50} and C_{50} program the LTC 1062 for 10 kHz.

The LTC 1064 devices make it possible for two sections to operate in a 100:1 clock-to-center frequency mode while two others run in a 50:1 mode. Thus, resistor programming can change the clock-to-center frequency range to 25:1 for two sections

and 250:1 for the other two. This capability enables decade-wide bandpass filters to be built with one LTC 1064 running at one clock frequency.

This flexibility would enable the 10 Hz-to-100 Hz filter to cover, as an example, 20 Hz-to-200 Hz simply by doubling the clock rate. Similarly, bands of interest could be inspected by sweeping the clock. Furthermore, the devices could work with center frequencies as high as 100 kHz in circuits of similar simplicity. □

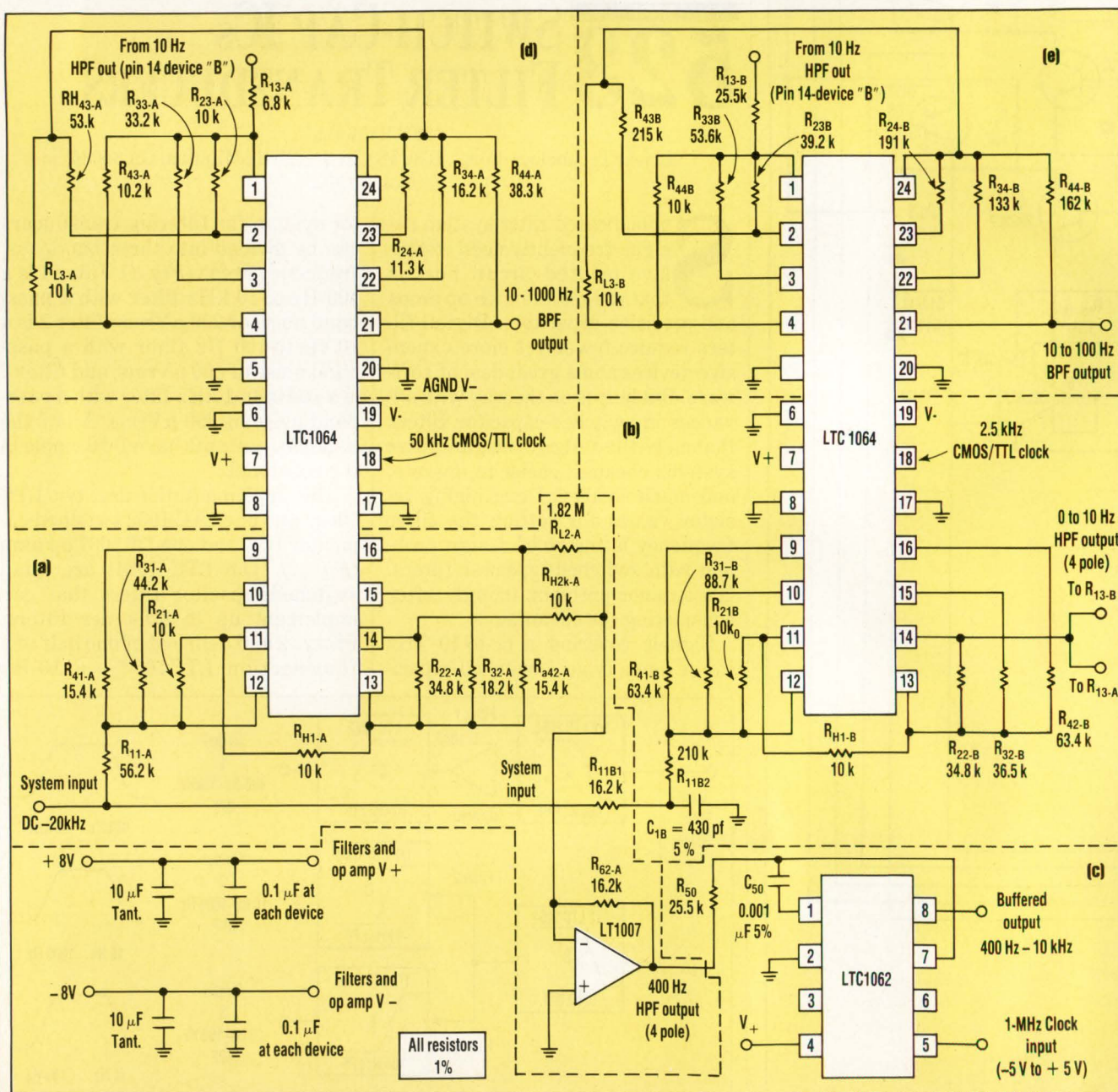

2. THE BANDPASS FILTERING system uses two LTC 1064 and one LTC 1062 switched-capacitor ICs, and one LT 1007 op amp.

“Vroom!”

Turbocharge your memory for zero wait state design with Signetics fast 7.5ns PAL[®]-type devices.

Vroom! Now you can get the zero wait state performance that will allow memory to keep pace with the new ultra-fast microprocessors. And you won't have to pay top price for your memory to do it!

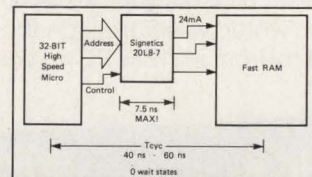

7.5ns PAL-type device improves system performance.

Vroom! Boost system speed, lower memory cost. Signetics offers the fastest (7.5ns) PAL-type devices for high-speed decoding. Now you can design with slower, less expensive, more available memory devices and still enhance system speed. And all Signetics PLDs are easily supported by ABEL, CUPL or our powerful AMAZE design software.

7.5ns 20-pin		7.5ns 24-pin	
PLUS16L8-7	PLUS16R6-7	PLUS20L8-7	PLUS20R6-7
PLUS16R4-7	PLUS16R8-7	PLUS20R4-7	PLUS20R8-7

Vroom! We've got the guts! That's right, we have those essential PLDs you need to improve total system performance. Programmable Macro Logic, Logic Arrays, Logic Sequencers and our PAL-type products that cut system cost while boosting system speed.

Turbocharge your memory now! Call Signetics at (800) 227-1817, ext. 985C, for a free High-Speed Decoder Handbook. For surface mount and military product availability, contact your local Signetics sales office.

PAL is a trademark of AMD/MMI. ©1988 NAPC

Signetics

Philips Components



PHILIPS

Unleash the infinite memory power of Hitachi's digital oscilloscopes

Slide a pocket-size IC card with a three-year memory into the front-panel slot and store up to 15 waveforms (4K each). Retrieve historical data on prototype designs, reconfigure test workstations quickly and at low cost, and create comparison waveforms to speed equipment maintenance.

Memory is unlimited. Use as many cards as you wish to store as much information as you wish, to distribute to as many associates as you desire. Using an optional card reader/writer, waveforms on the PC card can be transferred to/from an IBM PC or compatible; with an

optional high-speed interface, signals can be transferred to the PC for data analysis.

An external clock permits sampling in units other than time base (angle, rotation speed, displacement, etc.). Or sampling synchronization with the operational clock of the device being measured. Other usual functions include: four sampling modes, three interpolation modes, and GPIB, as well as plotter outputs. Also, any model can be used as a 100MHz bandwidth two-channel real-time oscilloscope.

This new, cost-effective way to communicate data quickly and error-free is only possible with Hitachi's Card Series DSOs available in three sampling speeds: the VC-6275 at 200MS/s, the VC-6175 at 100MS/s, and the VC-6075 at 50MS/s. Units are available on GSA contract GS00F03461.

For an informative 20-minute VHS video tape, send a business card or company letterhead to Dept. ED Div. at the address below.

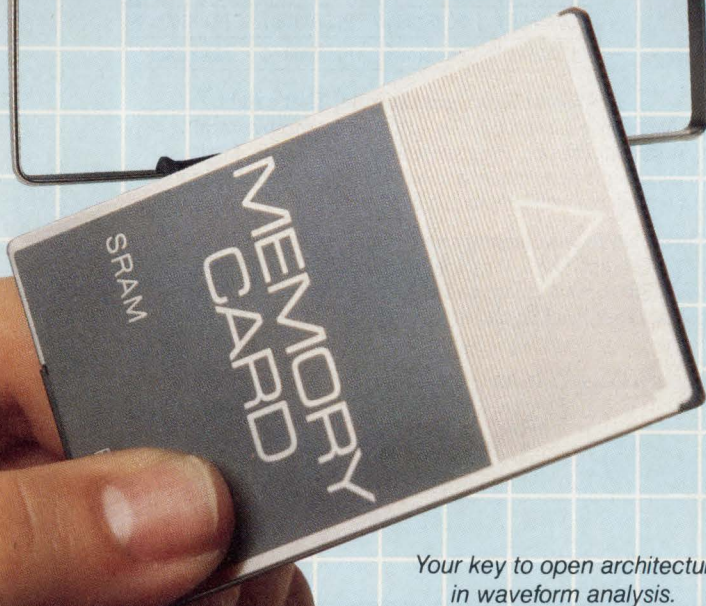
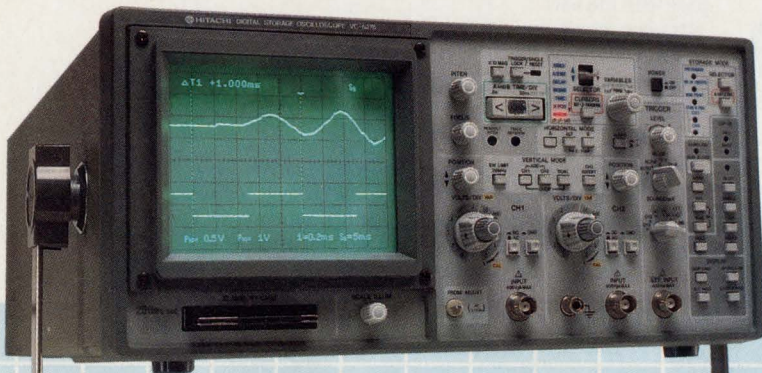

Your key to open architecture in waveform analysis.

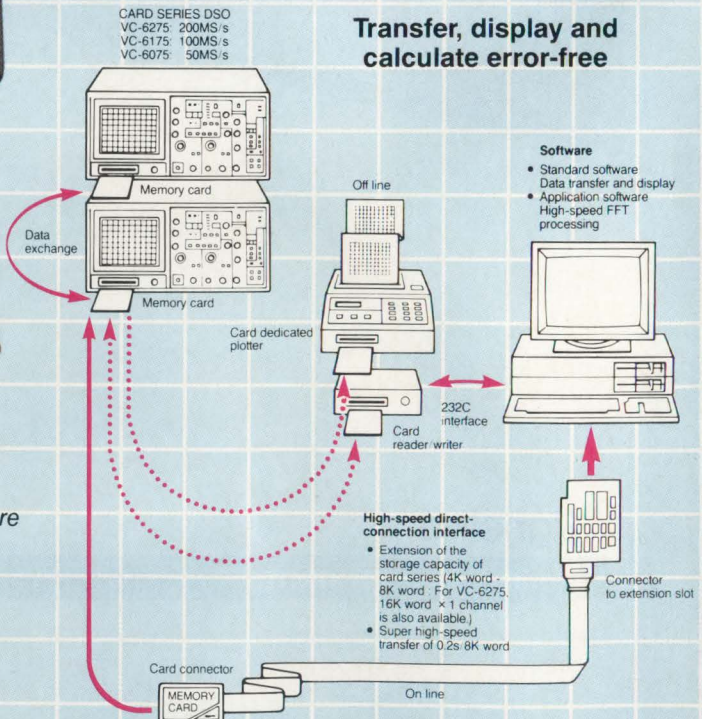

HITACHI

Hitachi Denshi, America, Ltd. • 175 Crossways Park West, Woodbury, NY 11797
 516-921-7200 • LA area 213-328-6116 • Dallas area 214-233-7623.

**OP AMPS IMPROVE
IN PRICE-PERFORMANCE**

A joint development-manufacturing-marketing agreement between Maxim, Sunnyvale, Calif., and VTC (a subsidiary of Control Data), Bloomington, Minn., should result in future innovations in high-speed, wide-bandwidth IC op amps, comparators, digital-to-analog converters, and analog-to-digital converters. Initially, Maxim will broaden the linear marketing base of VTC's current line of high-speed op amps and comparators. Down the road, new products will take advantage of both Maxim's design expertise and VTC's process technology. This technology is a complementary, ± 5 -V process that builds npn transistors with a cutoff frequency of 6 GHz; the cutoff frequency of the pnps runs 1.2 GHz. These transistors in turn build IC op amps, such as the VTC VA708 (Maxim's MAX 408) that slew at 90 V/ μ S (minimum), which translates to a full-power bandwidth of 4.8 MHz. And the op amps settle in 200 ns (maximum) to 0.1% for a 2-V step. Moreover, they can drive 50- Ω loads. Dual and quad versions are also available. Contact Jerry Thimsen at VTC, (612) 851-5200, or Brian Gillings at Maxim, (408) 737-7600. FG **CIRCLE 301**

**WIDE-BAND OP AMPS COME
IN TINY SO-8 PACKAGE . . .**

Comlinear, Fort Collins, Colo., will introduce all of its wideband IC op amps and buffers in small-outline packages. The first three devices, in SO-8s, are the 200-MHz (3-dB bandwidth at a gain of 2) CLC400, the 150-MHz CLC401 (3-dB bandwidth at a gain of 20), and the closed-loop unity-gain buffer, the 730-MHz CLC110 (3-dB bandwidth). All settle to 0.02% in under 15 ns for a 2-V output step. The combination of small size, low cost (\$9.25 each in 1000s), and low power (150 mW) makes them attractive for high-volume commercial applications. Call Scott Evans, (303) 226-0500. FG **CIRCLE 302**

**. . . ANOTHER SPORTS
PRECISION, LOW NOISE**

The OP-61 fast precision op amp from Precision Monolithics Inc., Santa Clara, Calif., has a typical gain-bandwidth product of 200 MHz, and at a frequency of 1 MHz, it's stable at gains of 10 or above. With that kind of ac performance, the premium OP-61A still offers a maximum offset voltage of just 500 μ V and maximum offset drift of 5 μ V/ $^{\circ}$ C. Input-voltage noise at 1 kHz is typically a low 3.4 nV/ $\sqrt{\text{Hz}}$. And it will typically settle a 10-V output step in under 330 ns. PMI is offering the model free to designers doing Spice simulation. In quantities of 100, the extended industrial-grade units start at \$4.25 each. Small quantities are in stock. Contact Al Neves, (408) 562-7181. FG **CIRCLE 303**

**8-BIT CPU CHIPS
FEATURE EMBEDDED FOCUS**

Zilog is still updating its Z80 microprocessor family, putting microcontroller-like features on the CPU chip. The latest implementation adds 2 kbytes of static RAM and a clock generator. As a result, time-critical data or instructions held in the new Z84C50 chip's static memory can be accessed with no wait states. This enables the processor to execute even faster than if the memory was off the chip. The new on-chip clock generator gives the processor four operating modes to save power: There are run and stop modes and two intermediate idle modes—one stops the clock and CPU; another stops the CPU but keeps the clock running. Contact Jim Magill, (408) 370-8000. DB **CIRCLE 304**

**NETWORK SOFTWARE
ENDS MEMORY CONFLICTS**

Users can run large, memory-hungry applications while still accessing network data with the VM/386 NetPak from IGC, Santa Clara, Calif. The software overcomes the 640-kbyte RAM limitation encountered with most computers. VM/386 NetPak extends IGC's VM/386 multitasking program for 80386-based computers. With the software, users can run multiple DOS applications simultaneously and access network data and peripherals from any one of those applications. Data is accessed from the file server without the need to first download it to a local hard disk. Each application runs on a virtual machine that contains DOS and compatible programs. To overcome the 640-kbyte memory limitation, users can load all network drivers into one virtual machine, while applications are loaded into their own virtual machines. Networks supported by the software include IBM Token Ring, Novell, and 3COM. Requiring a 80386-based computer running VM/386, NetPak costs \$150 and is shipping now. Contact Steve Rogaway, (408) 986-8373. LG **CIRCLE 305**

**I/O BOARD BOOSTS
PROCESSING POWER**

The ZT 8832 I/O control processor (ICP) board from Ziatech Corp., San Luis Obispo, Calif., modularly increases the processing power of an STD bus-based system. One or more ICP boards can be added to a STD-bus system in a multiprocessing configuration to handle real-time I/O tasks and to offload the main processor. The number of ICP boards in a system is only limited by the number of slots available in the card cage. The board is a surface-mounted, V40-based computer. Its features include 800 kbytes of memory, a numeric data-processor socket, two serial ports, three parallel ports, and

an SBX expansion socket. Software support for the board includes a DOS Multiprocessing Extension (DOS EXP) program, which is an operating and development environment for multiple ZT 8832 boards running DOS-based software. The control processor is available now for \$785 in single quantities. The DOS MPX development software costs \$650. Quantity discounts are available. Call (805) 541-0488. LG **CIRCLE 306**

FIBER-OPTIC ETHERNET HOOKS DIRECTLY TO PC

Most fiber-optic Ethernet local-area networks require costly external transceivers and interfaces to connect with personal computers. But the FiberStar Ethernet network from Zenith Electronics Corp., Glenview, Ill., has a transceiver right on the PC adapter card, so the fiber network connects directly into the computer. The FiberStar Z-LAN10F network is the newest addition to Zenith's Z-LAN product line. It transmits data at 10 Mbits/s with 100% collision detection, and spans 4 km on one network without magnetic or radio interference. FiberStar conforms to IEEE 802.3 Ethernet standards. The Z-LAN10F system consists of an Ethernet adapter card that fits in any PC/XT/AT or compatible-bus computer, a FiberStar hub coupler that connects 8 or 14 devices, and an external transceiver with an Attachment Unit Interface (AUI) that connects the system with other Ethernet networks. Prices for the interface card, 8-port hub, 14-port hub, and external AUI transceiver are \$895, \$4175, \$5975, and \$595, respectively. Delivery is 90 days after receipt of order. Contact Robert Dranter, (312) 391-8000. LG **CIRCLE 307**

GRAPHICS OPTION BOOSTS SPEED BY UP TO 500%

The 4G graphics board from Tektronix Inc., Wilsonville, Ore., accelerates the graphics speed of the Tektronix XD88 workstation by 500%. Redraw rates top 1 million 2D and 3D vectors/s and 65,000 shaded polygons/s. This performance increase results from a pipelined design, a separate clipping engine that runs at 13 million operations/s, and more bit-slice and transform engines. XD88 workstations equipped with the upgrade easily handle large databases for scientific visualization, molecular modeling, and animation. Because the board is transparent to application software, users need not recompile or relink existing programs. Tek 4230 Series netstations and 4330 Series workstations can also be upgraded. The 4G board, which ships this month, costs \$6000 as an installed option in a XD88 workstation; \$8000 when purchased with a Tek 4230/4330 Series netstation or as an upgrade for any compatible Tektronix graphics system. Call (800) 225-5434. LG **CIRCLE 308**

DUAL OP AMP RUNS OFF JUST 2 V; 40 μ A TOTAL

A true micropower op amp, the ALD2706, from Advanced Linear Devices, Sunnyvale, Calif., runs off a mere 2 V (or ± 1 V). Moreover, this dual CMOS chip typically needs only 20 μ A for each op amp (40 μ A total). Maximum supply voltage is 12 V, making possible reliable operation from split ± 5 V rails. In addition, a complementary p-channel/n-channel input stage allows the common-mode voltage to include both rails. Bias current typically runs 1 pA. Open-loop gain typically runs 100 dB—if driving at least 1 M Ω —but is still over 90 dB when driving 10 k Ω . Running off ± 2.5 -V rails, unity-gain bandwidth is 400 kHz; off ± 1 V rails, 300 kHz. Slew rate is 0.17 V/ μ s for either. With ± 2.5 -V supplies and driving 100 k Ω , the op amp's outputs will typically swing from 0.1 to 4.9 V. The ALD2706 comes in three grades with offset voltages of 2, 5, and 10 mV. In quantities of 100, the 10 mV device starts at \$3.84 each. Call Mike O'Neal, (408) 720-8737. FG **CIRCLE 309**

40-fA ELECTROMETER COSTS UNDER \$1

A dual CMOS IC op amp delivers micropower operation and femtoampere bias currents at the dramatically low cost of under \$1—op amps with this performance have cost \$15 to \$25 each in the past. The LPC662 from National Semiconductor, Santa Clara, Calif., has a typical bias current of 40 fA (guaranteed minimum bias current is 20 pA). Of course, no one can afford to sell an IC for under \$1 and still test for 90 fA. Bias current is actually checked at maximum temperature (either 85° or 125°C) and the room temperature value is calculated (bias current about doubles every 10°C). The ultra-low bias current goes with an offset voltage and an offset temperature coefficient of 3 mV and 1.3 μ V/°C coupled with one 5-V supply operation while drawing less than 60 μ A per op amp. When driving a 5000- Ω load from a 5-V rail, the output typically swings from 0.04 to 4.94 V (a swing from 0.15 to 4.85 V is guaranteed). In quantities of 100, prices range from \$0.90 to \$1.95 each. Small quantities are available from stock. Call Bettina Briz, (408) 721-2274. FG **CIRCLE 310**

EDITED BY CLIFFORD METH

New 10.000V Reference Lowers The Price Of Precision

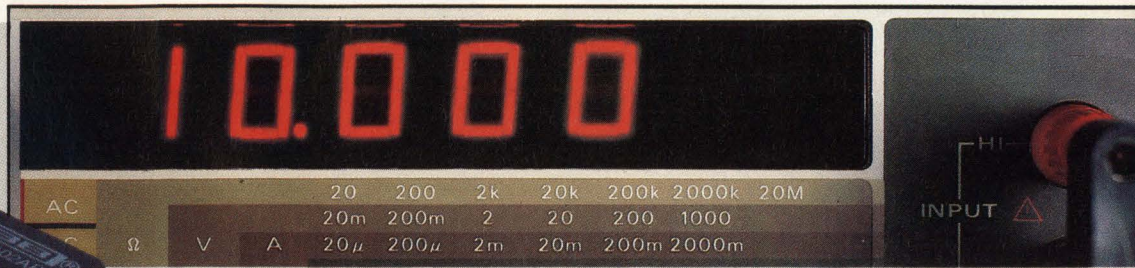

Highest Performance, Lowest Cost

REF102 is Burr-Brown's newest voltage reference. It outperforms the competition and costs less! Try it for transducer excitation, data acquisition system referencing, and a wide variety of test and measurement applications.

Accurate And Stable

REF102 provides a precision +10.000V output which is extremely stable over both time and temperature. Drift is laser-trimmed to 2.5ppm/°C, and the device's 5ppm/1000hrs long term stability sets a new standard for monolithic references.

Key REF102 Specifications

- Output, 10.00V ±2.5mV max
- Drift, 2.5ppm/°C max
- Stability, 5ppm/1000hrs
- Noise (0.1 to 10Hz), 5μVp-p
- Supply Range, 11.4V to 36V
- Quiescent current, 1.4mA max
- TO-99, plastic DIP, SOIC, and die
- \$2.55*

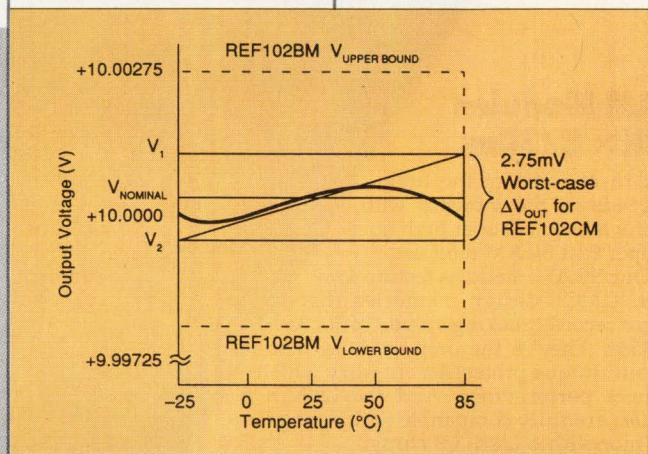

Superior Line And Load Regulation

The output is insensitive to both line and load variations. Maximum line and load regulation specifications are 1ppm/V and 10ppm/mA respectively.

Get the most precision for your system. . .and your money. Ask your sales rep for the data sheet and samples, or call **1-800-548-6132** toll-free for immediate assistance.

Burr-Brown Corp.
P.O. Box 11400
Tucson, AZ 85734

*USA OEM prices, in 1000s.

BURR-BROWN®

BB

CLOCK IN AT

SRAM Modules 128K X 8/30ns

Clock in at some of the highest speeds in the industry with Micron's family of super high quality, super Fast SRAM modules.

Our SRAM modules feature low-power, CMOS-design memories that produce record-breaking speeds of 30, 35 and 45ns. They're the only modules that offer our unique protection circuitry which enhances performance. And the 128K X 8 modules are fully compatible with next-generation monolithic 128K X 8 chips.

We offer a variety of SRAM and DRAM modules manufactured to industry-standard and custom specifications. So, no matter what your application, Micron can help you design and develop a solution.

For more information about Micron SRAM and DRAM modules, call us today at 1-208-386-3900. And discover how we can help you beat the clock.

Micron. Working to improve your memory.

ORGANIZATION	PACKAGES	SPEED
SRAM MODULES		
128K X 8	32-PIN DIP	30, 35, 45
64K X 16	40-PIN DIP	30, 35, 45
32K X 16	40-PIN DIP	30, 35, 45
64K X 32	64-PIN ZIP	25, 30, 35, 45
16K X 32	64-PIN ZIP	25, 30, 35, 45
DRAM MODULES*		
512K X 36	SIMM/ZIP	80, 100, 120
256K X 36	SIMM/ZIP	80, 100, 120
1MEG X 8/9	SIMM/SIP	80, 100, 120
256K X 8/9	SIMM/SIP	80, 100, 120, 150
64K X 8/9	SIMM/SIP	80, 100, 120, 150
64K X 4/5	SIMM/SIP	80, 100, 120, 150

* Micron offers a variety of packages configured in both standard and low profile versions. Access Cycles offered are Fast Page Mode, Page Mode, Static Column and Nibble Mode.

MICRON

TECHNOLOGY, INC.

2805 E. Columbia Road, Boise, Idaho 83706 208-386-3900

CIRCLE 21

LARGE LIBRARIES PLUS TIGHT TOOL
INTEGRATION EQUALS SIMPLE ANALOG
AND DIGITAL ASIC DESIGN.

MODIFY CHIP COMPONENTS TO FULLY CUSTOMIZE ICs

RICHARD NASS

Designers can hurdle the ASIC design obstacle course by switching to the Fastrack, a new system from Harris Semiconductor that eliminates the numerous stumbling blocks incurred when designing an ASIC from scratch. Now designers can leap over the task of integrating available toolsets, jumping from workstation to workstation, and figuring out just which direction to proceed in.

Fastrack was developed with a combination of libraries from Harris and GE Solid State, a result of Harris' recent acquisition of the GE division. The libraries contain bipolar and CMOS analog circuits and CMOS digital circuits.

The system takes advantage of the Cadence framework. Its open architecture allows the best available CAE tools to be integrated. These tools were developed by Harris and other third-party software suppliers. The open architecture could also integrate system simulation with IC simulation tools.

Another advantage of the Cadence framework is a unified database, which keeps a design's physical and electrical representations in one database. This simplifies the user interface and allows all phases of the design to be completed on the same workstation.

The tools support complete front-to-back design. The mouse-driven menus, windows, and on-screen help force users to go in the right direction along a step-by-step path—even first-time users

will find it simple to operate (Fig. 1). Moreover, error-prone tasks, such as generating a net list from a schematic, are automated with one command.

Most analog designers associate transistor-level design with the painstaking task of defining diffusion regions and interconnects within the ground-rule boundaries of a process. But designing transistors using Harris' Device Design, one of the Fastrack tools, can remedy some of that headache. The library has npn and pnp transistors optimized for specific applications, such as low noise, high current, or low collector resistance.

Once analog designers choose a device, four circuit parameters must be entered: minimum collector voltage, maximum collector current, maximum

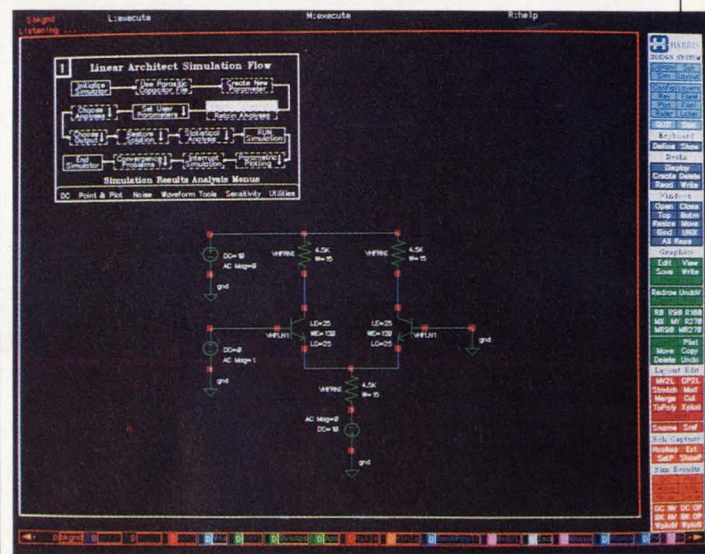

1. AFTER THE SCHEMATIC entry is complete, the design flow menu prompts users to the next step in the sequence.

CUSTOM ASIC DESIGN

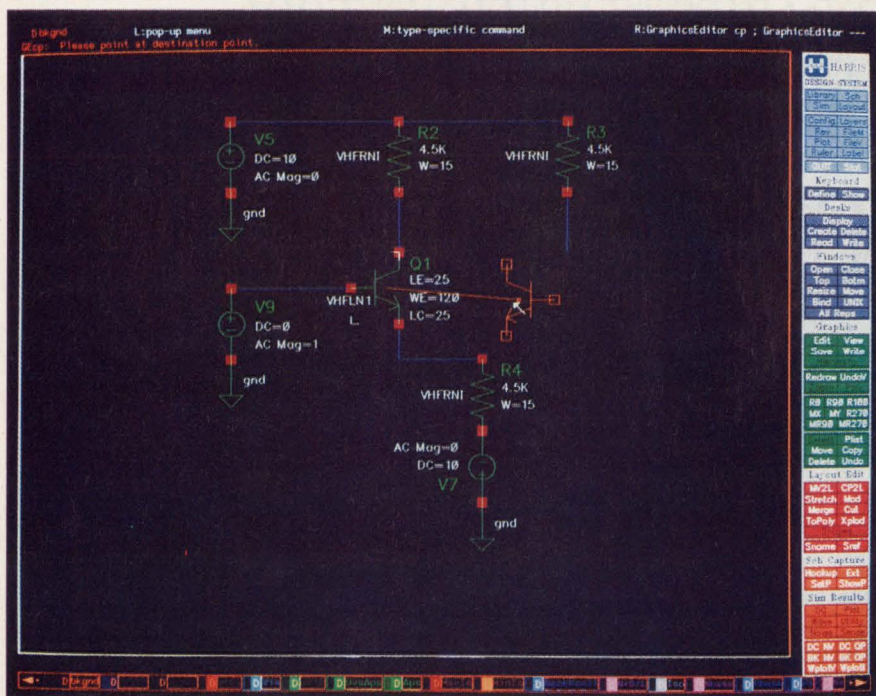

2. THIS ALMOST-COMPLETE SCHEMATIC shows all the devices with their parameters. A wire-entry tool is now used to interconnect the devices.

operating temperature, and the condition to be optimized for (low noise, matched emitter resistance, etc.). By doing this, designers create a custom device made to their own specifications, rather than using a "prefab"

model. Given this information and a prior knowledge of the process layout ground rules, the Device Design runs a device simulation to determine the transistor dimensions that comes up with custom-device geome-

tries for each design.

A Spice circuit file, or net list, is next created by the Readin Schematic. This schematic-capture tool eliminates manually entering the file. From this point, a preliminary electrical simulation can be run to make sure there aren't any problems with circuit performance. Users can next proceed to the physical design.

Harris' Slice (Simulation Language with Integrated Circuit Emphasis), the circuit simulator used by Fastrack, is an interactive, high-level programming language. It contains over 50 built-in mathematical functions and uses various simple high-level commands. These commands can perform ac, dc, transient, sensitivity, noise, and Monte Carlo analyses. The results of these analyses can be displayed in textual or graphical form. An interactive keyboard makes it easy for users to do complex calculations involving node voltages and branch currents. By simply pointing to a transistor node, users can obtain the operating conditions and model parameter values.

Three tools are used in the physical-design stage. First, the Automatic Device Generator, or Autogen, lays out the "correct-by-construction" device—a device that meets all of the electrical ground rules, such as minimum spaces between devices or minimum sizes for isolation. The second tool is the Automatic Preplacement tool, which preplaces the devices as they appear on the schematic (Fig. 2). Because this may not be the optimal layout as far as thermal or parasitic effects are concerned, alternate layouts can be attempted. In this case, some interactive layout tools can be used to assist designers, such as the Graphics Editor.

Certain features of the system are included to make it as error-free as possible. The system prompts designers to enter a needed parameter when it's required. By using multiple windows, designers can simultaneously view the circuit schematic, the physical layout, and a frequency response. Plots, histograms, and scatter plots can be created on-screen or sent to a plotter at different points in the design process.

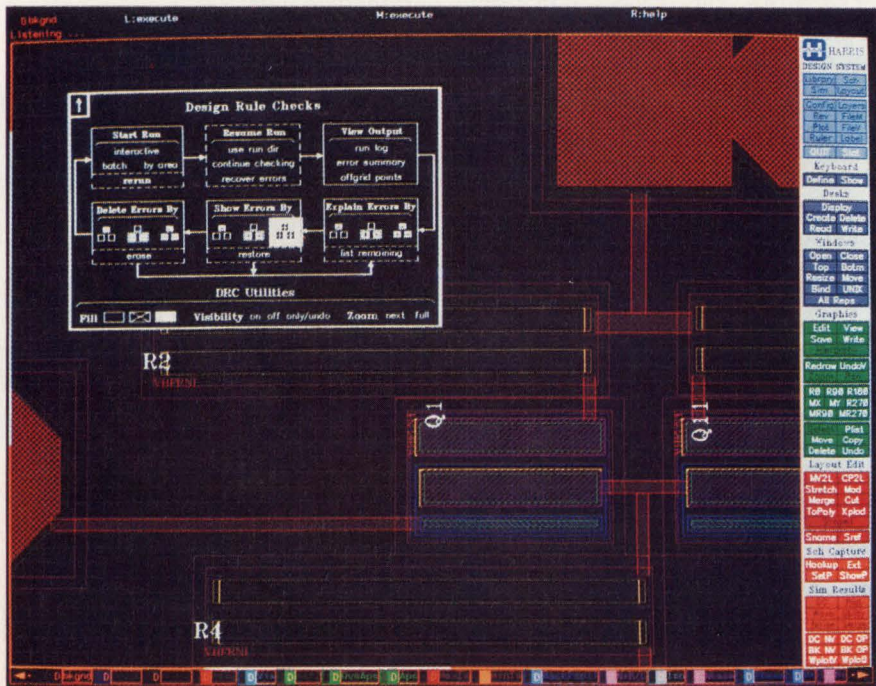

3. ONCE THE LAYOUT IS COMPLETE, the Design Rule Checker goes through its list of over 900 rules to be certain that none were violated.

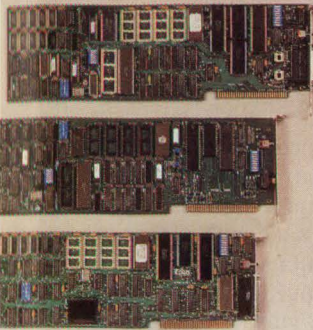

Y88, B88 and R188 PC Bus CPUs

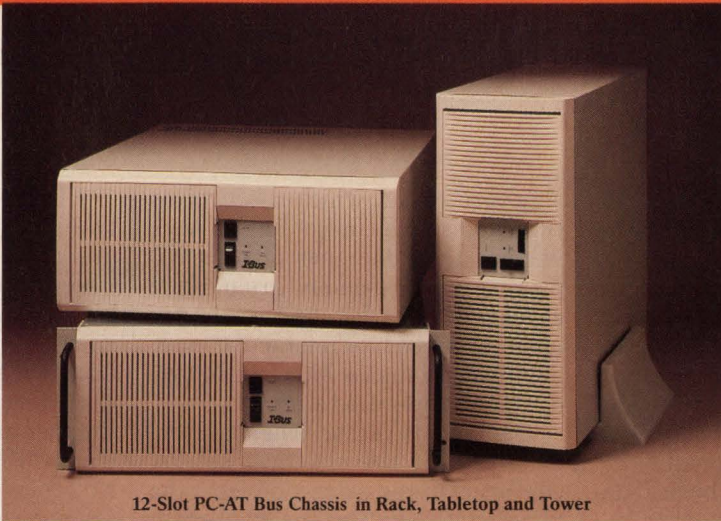

12-Slot PC-AT Bus Chassis in Rack, Tabletop and Tower

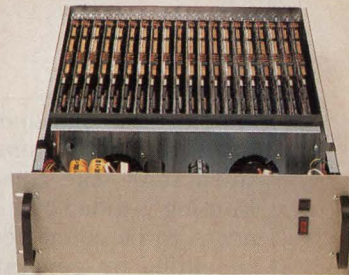

20-Slot PC-AT Bus Chassis
Holds Multiple Computer Systems

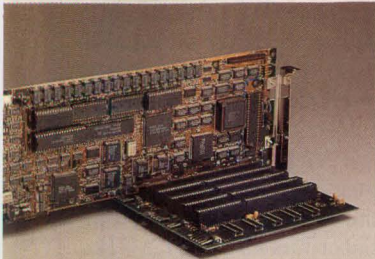

K286 PC-AT Bus 10 MHz CPU

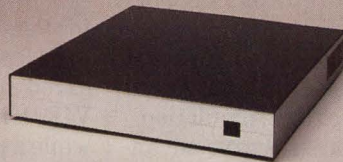

Slim Line 4-Slot PC-AT Bus Chassis

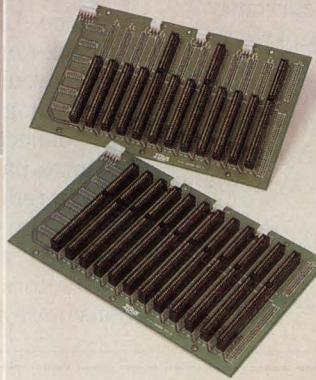

PC-AT and PC Bus
Passive Backplanes



6-Slot PC-AT Bus Expansion Chassis

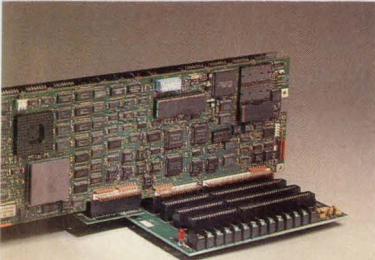

H386 PC-AT Bus 16 MHz CPU with
2-8 Meg Zero Wait State Memory

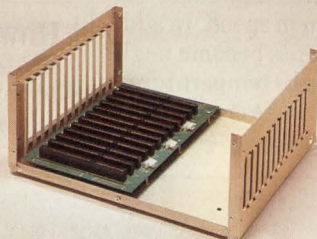

12-Slot PC-AT Bus Card Cage

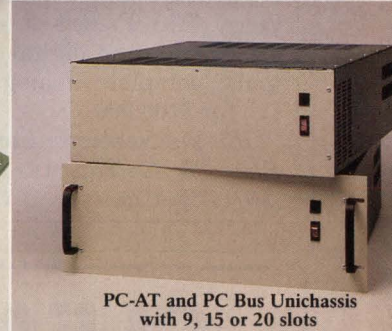

PC-AT and PC Bus Unichassis
with 9, 15 or 20 slots

If You're Into PC Bus Systems, I-Bus Speaks Your Language.

Only I-Bus builds PC-AT and PC Bus hardware that's designed specifically for dedicated OEM system applications.

Ours are board-level: the CPU is on a card, just like the PC expansion cards. The mother board is just a backplane with the connectors interconnected. That's best for serviceability and ease of upgrading.

If you don't need a keyboard you don't have to use one. Or a display, either. Or even a disk. You don't even have to produce

ROMable code to run an I-Bus processor from its ROMs. Ask us about PROMDISK, that lets any PC program run from ROM.

Choose from a host of compatible components. Five CPU cards topped by the powerful 16MHz, zero wait state H386. Rack mount, tabletop and tower enclosures holding up to 20 PC-AT cards—you can put five 4-board computer systems in a single chassis only 7" high!

Every enclosure comes complete with power supply and backplane. All you need to add are the PC expansion cards for your application.

Best of all, when you call I-Bus you'll talk to people who know the PC systems business, ready to answer questions and help with your unique requirements.

Call us today TOLL FREE (800) 382-4229 (except CA: 619-569-0646). If you're into systems, we speak your language.

I-BUS
The Full Service PC Bus Company

9596 Chesapeake Drive, San Diego, CA 92123 (619) 569-0646 TLX: 910 240 0290 FAX: 619-268-7863

CUSTOM ASIC DESIGN

After the placement is set, the routing is done manually using the third tool—the Graphics Editor. Routing is aided by highlighting the nodes to be connected, and further simplified by generating hierarchical symbols and multiple windows. During this process, any device modification is automatically back-annotated into the original schematic.

The final step is the physical-de-

sign verification, which also involves three tools. The Design Rules Check verifies the adherence of over 900 process and assembly ground-rule checks (*Fig. 3*). This check can be run in either a batch or interactive mode and can encompass either the entire circuit or a specified area.

The Layout Versus Schematic tool ensures that the electrical net list conforms to the extraction from the physical layout. The Layout Parasitic Extractor tool draws out any non-negligible parasitic capacitance or resistance from the interconnects and back-annotates the parasitics into the circuit file for resimulation.

The analog processes take advantage of dielectric isolation (DI) which eliminates parasitics that cause latch-up or a reduction in speed. In addition, leakage currents become negligible even at high temperatures. These factors also make circuit simulations more accurate.

With the DI process, vertical pnp transistors can react almost as quickly as the npns. In other words, the npns can be used in the same signal path as the npns. Previously, designers had to pull out their bag of tricks to find a way to achieve the same result without using the npns. Furthermore, the DI process supports JFETs and laser-trimmable Nichrome thin-film resistors. There are two complementary DI processes, one for high frequency, and one for very-high frequency (VHF). The high-frequency process is 40 V compared to the VHF's 20 V. An npn VHF transistor has an f_T of 1.2 GHz, while a pnp transistor from the same process has an f_T of 1.0 MHz. □

PRICE AND AVAILABILITY

The Fastrack system is currently available on Sun 3 and Sun 4 workstations. Volume shipments will begin in the fourth quarter of this year. The Fastrack starts at \$20,000 for the digital front-end tools; complete analog systems sell for \$100,000.

Harris Semiconductor, P.O. Box 883, Melbourne, FL 32901; (407) 724-3739. **CIRCLE 513**

HOW VALUABLE?

HIGHLY
MODERATELY
SLIGHTLY

CIRCLE

562
563
564

CLEAN UP...

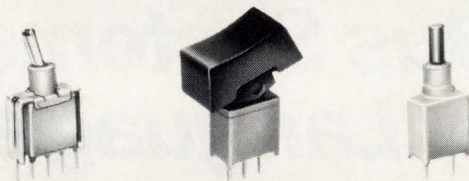

Shown Actual Size

with our new ET/EP Series sealed tiny toggle, rocker and pushbutton switches.

No contamination worries here. Cleaning and processing won't touch our new miniature switches. No special steps. Just solder and clean. Sweep up our options too: Many switching functions, terminal styles, and contact materials. Welded construction with epoxy terminal seals and internal actuator seals are standard.

Ratings from dry circuit to 3 amps at 120 V AC or 28 V DC. Call or write for literature and a free sample (617) 964-6400.

SEE US AT MIDCON, BOOTH #630-634

C&K C&K Components, Inc.
15 Riverdale Avenue
Newton, MA 02158

The Primary Source Worldwide[®]

CIRCLE 110

RAF hands you a choice line of handles and ferrules ... just in time.



Give your cabinets a distinctive high-tech look with our handsome assortment of round, oval and round-offset handles and matching ferrules. Precision-made and dimensionally accurate, they are available in a wide variety of sizes, materials and finishes.

With more than 35,000 items in stock, all orders get prompt attention. Your order can be filled and shipped the same day — *just in time delivery* arranged to suit your future requirements.

For the high quality you need, when you need it, you can depend on RAF's more than 50 years of manufacturing experience and reliable service.

Call or write today for our fully illustrated catalog, or additional information on specific products.



FREE designer's catalog

RAF
Electronic Hardware, Inc.
95 Silvermine Road • Seymour, CT 06483
(203) 888-2133 • FAX (203) 888-9860

CIRCLE 111

PARALLELISM INCREASES PROCESSOR SPEED

PARALLEL
INSTRUCTION
DECODING AND
MULTIPLE
EXECUTION
UNITS PERFORM
UP TO THREE
MULTIPLE
INSTRUCTIONS
PER CYCLE TO
YIELD 66 MIPS.

LISA GUNN

Generating higher speeds for processors is getting harder as conventional architectures and process technologies are pushed to the limit. But designers at Intel Corp. tackled this formidable task by incorporating parallelism—a technique that executes several instructions at once—into the newest member of their 80960 family of embedded processors, the i960CA. The inclusion of parallelism into the i960CA boosts performance three to five times while the processor remains software compatible.

The i960CA, a 32-bit reduced-instruction-set computer (RISC) processor optimized for data control, consists of numerous peripheral support functions built around the C-series core. Intel is also offering many i960CA support products (see *"In support of a fast processor,"* p. 122).

The C-series core implements the 80960 core RISC architecture, which is optimized for embedded-control applications. The core executes a sustained speed of 66 native MIPS, a speed that it owes to several innovative features that work together to issue and execute instructions in parallel (see the figure). These features include parallel instruction decoding, which can initiate two to three instructions in every clock cycle. Multiple, independent execution units perform overlapped instructions, and a multiport register file enables multiple registers to be accessed simultaneously. Register and resource scoreboarding manage the parallel execution, while a branch

look-ahead feature makes it possible for branches to execute in parallel with other instructions. Other factors contributing to the chip's high speed are the 33-MHz internal clock, the on-chip register cache, wide internal buses, the efficient instruction pipeline, and the numerous single-cycle instructions.

At 66 native MIPS, Intel claims that this device is the fastest embedded controller and the fastest microprocessor on the market today. Moreover, Intel says that the i960CA has the highest degree of parallelism of any single-chip integer device. Applications that can benefit from the processor's extremely fast data-handling ability include communications systems, such as network controllers and file servers, and office equipment, such as laser printers and scanners.

PARALLEL DECODING

Parallel instruction decoding is done by the instruction sequencer, which also handles prefetching and issuing instructions in parallel. The instruction decoder's task is simplified because of the machine-level instruction format. The instruction decoder basically supplies the pipe sequencer with enough instructions to maximize performance.

The parallel instruction sequencer fetches from the internal cache microcoded ROM and the queue. It also manages the instruction-prefetch requests. The pipe sequencer examines up to four instructions each clock cycle, and performs parallel decoding of up to three of them.

The pipe sequencer manages the parallel instruction flow and the parallel issuing of instructions; the core maintains three parallel pipelines. Parallel instructions are issued to the register (REG), memory (MEM),

EMBEDDED PROCESSOR

or control (CTRL) portions of the architecture. The pipelines can maintain two instructions per clock cycle at sustained execution.

The branch and condition branch instructions are executed by the instruction sequencer. Parallel branching, or branch look-ahead, is a pipe sequencer feature that attempts to execute a parallel branch before the branch condition is stable. If the attempt fails, the processor has time to abort the branch and redirect program flow. This redirection takes one to two clock cycles once the new target is cached.

The execute stage of the pipeline is handled by the execution units. Instruction execution typically takes only one clock cycle. However, some instructions, such as multiply, take multiple clock cycles.

All execution units operate in parallel. The multiply and divide unit, the address-generation unit, and the integer-execution unit make up the CPU core architecture. Execution units unique to the i960CA include the interrupt controller, bus controller, and DMA controller.

The register file and the wide data paths between the register file and the execution units reduce many potential internal bottlenecks. With the 128-bit internal buses, it's possible to move the contents of four 32-bit registers in one clock cycle.

Resource scoreboarding manages instructions that are issued to the execution units. An internal instruction cache decouples the instruction stream from the external bus, which minimizes the external-bus bottlenecks. The two-way set-associative

cache has a 1-kbyte by 4-word line size. Loops in the cache can execute at a sustained rate of two instructions per clock.

Another part of the i960CA implementation is a six-port register file that eliminates contention for register-set access by the independent execution units. One REG-format, one MEM-format, and one address-calculation instruction can read register operands simultaneously. Results from a REG and MEM coprocessor can be written to the register file concurrently.

The local register cache and data RAM are located internally on the processor's MEM-bus portion. These two units are actually part of the same on-chip memory array. The local register cache supports fast calls and returns for context switching.

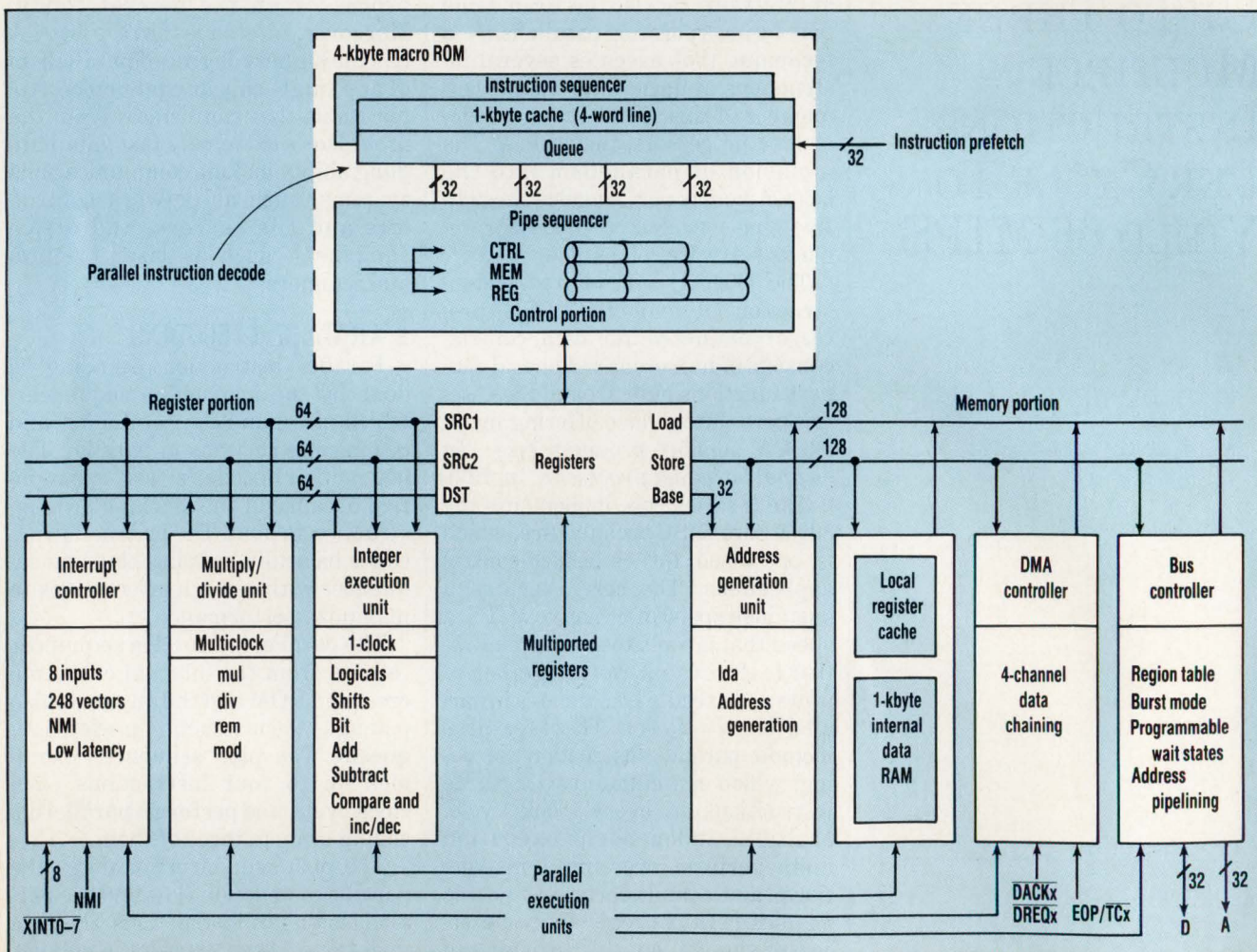

PARALLEL INSTRUCTION EXECUTION gives the i960CA processor its high speed of 66 MIPS. Divided into three portions, the chip is made of a C-series core in addition to interrupt-, DMA-, and bus-controller units.

PSpice

The Standard for Circuit Simulation

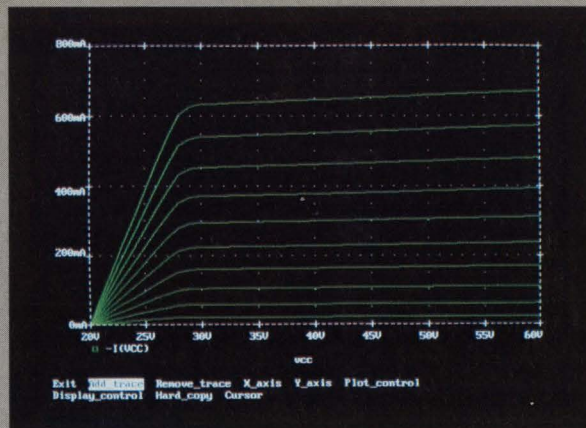

I-V curves of a triode vacuum tube

Analog Behavioral Modeling

The Analog Behavioral Modeling option for PSpice allows one to describe analog components, or entire circuit blocks, using a formula or a look-up table. For linear blocks, the description can be either a Laplace transform or a table of frequency response. Once defined, PSpice can simulate circuits including such blocks.

The ability to model entire blocks of circuitry is a powerful aid in designing a system from the top down. A functional block can be described by its behavior without worrying about how that function will be implemented. Later, the block can be replaced by the actual circuitry.

Another application is the modeling of electronic components which are not built into PSpice. The photo above shows an example of simulating the DC characteristics of a 3/2-power-law device.

Since its introduction over five years ago, MicroSim's PSpice has more copies sold than all other commercial Spice programs combined. Here are some of the features which have made PSpice so popular:

- Standard parts libraries of over 2200 analog models: diodes, bipolar transistors, small-signal JFET's, power MOSFET's, opamps, voltage comparators, transformer cores, and opto-couplers.
- GaAs MESFET devices, BSIM MOS model.
- Non-linear transformers modeling saturation, hysteresis, and eddy current losses.
- Ideal switches for use with, for example, power supply and switched capacitor circuit designs.

Besides Analog Behavioral Modeling, these other PSpice options are also available:

- **Digital Simulation**, which allows one to simulate mixed analog/digital circuits with feedback between the analog and digital sections.
- **Monte Carlo** analysis to calculate the effect of parameter tolerances on circuit performance. This includes statistical, sensitivity, and worst case analyses.
- **The Probe** "software oscilloscope" provides an interactive viewing environment for simulation results (see photo above).
- **The Parts** parameter extraction program, allowing one to extract a device's model parameters from data sheet information.

PSpice is available on these computers:

- The PC family, including the PS/2, running DOS, Protected Mode DOS, or OS/2.
- The Macintosh II.
- The Sun 3, Sun 4, and SPARCstation families.
- The Apollo DN3000 and DN4000 workstations.
- The VAX/VMS family, including the MicroVAX.

Each copy of PSpice comes with our extensive product support. Our technical staff has over 100 years of experience in CAD/CAE and our software is supported by the engineers who wrote it. With PSpice, expert assistance is only a phone call away.

For our free information packet, including a PSpice demo diskette, call us **toll free** at (800) 826-8603 or, in California, (714) 770-3022. Find out for yourself why PSpice is the standard in circuit simulation.



MicroSim Corporation

20 Fairbanks • Irvine, CA 92718 USA • Telex 265154 SPICE UR

EMBEDDED PROCESSOR

IN SUPPORT OF A FAST PROCESSOR

It's not enough to offer fast silicon these days: Customers also need support products in the form of development tools and external hardware. Intel Corp. addresses this need with a collection of products designed with the i960CA embedded RISC processor.

Development tools are important for getting maximum performance from an embedded processor. Intel's suite of development tools, for use in 80960-based systems design, include an in-circuit emulator, a system generator to set up data structures, and a software-execution vehicle for architecture evaluation and running a benchmark. Also included is a software debugger, a simulator, a macro assembler, and a C compiler. All the tools run on DOS-based PC/AT systems, and some also operate with VAX, MicroVAX, and Sun-3 systems.

Intel also offers hardware designed specifically for 80960-based designs. Though EPROMS

generally can't keep up with 32-bit speed, a new 1-Mbit EPROM utilizes a burst interface to give near zero-wait-state operation. The 27960 EPROM device supports the specific requirements of the 80960 processor family. A 85C960 function-specific programmable logic device (PLD) is also being introduced. The burst-mode memory PLD supplies address decoding and wait-state and ready generation.

Moreover, some of Intel's previously announced products support 80960-based designs. Its 85C508 PLD is a programmable address decoder with an on-board latch. With a maximum delay time of 7.5 ns, the PLD speeds the microprocessor-to-memory interface. The 82596 family of 32-bit local-area-network coprocessors operates independently of the i960CA system processor, which frees the system bus. The coprocessor transmits data at 100% of both the system- and serial-bus bandwidths.

The entire local register set is saved or restored in only four clock cycles. The on-chip RAM is available for frequently-accessed program data.

Exclusive features of the i960CA processor are the multimode bus, internal DMA, and interrupt controllers. The bus controller reads at 132 Mbytes/s and writes at 106 Mbytes/s. The processor has demultiplexed,

32-bit address and data buses. Loads, stores, and instruction fetches are queued by the bus controller.

The DMA controller is tightly coupled to the core. DMA transfers execute simultaneously with users' programs because core resources are shared between the program and the DMA operation. Quad-transfer modes can exploit the processor's burst mode.

Up to 248 interrupts from external sources are handled by the interrupt controller. It boasts a typical latency of less than 750 ns, an average time for a high-end RISC processor. The interrupt unit, a REG coprocessor, performs hardware-interrupt detection and priority mapping independently of the core. □

PRICE AND AVAILABILITY

Samples of the i960CA embedded processor are available, with volume production scheduled for the fourth quarter of this year. The chip comes packaged in a 168-lead ceramic pin-grid array. In quantities of 1000, the 16-, 25-, and 33-MHz versions of the processor cost \$273, \$303, and \$379, respectively.

Intel Corp., 5000 W. Chandler Blvd., Chandler, AZ 85226; (602) 554-8051. CIRCLE 511

HOW VALUABLE?

HIGHLY	553
MODERATELY	554
SLIGHTLY	555

CIRCLE

SALE!

INTERNATIONAL SWITCHER

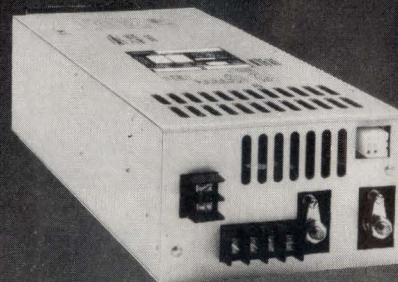

MODEL CV405B

\$399.^{ea.}

Qty. Discounts Available

FEATURES

- VDE, UL, CSA Safety and Emissions
- 5 Outputs
- 400 Watts
- HI-REL All purpose switcher

OUTPUTS

- No. 1: 5V @ 50A
- No. 2: +12V @ 8A
- No. 3: -12V @ 8A
- No. 4: +24V @ 4A - 6A pk.
- No. 5: 5V @ 10A

OUTPUTS 1 and 5

±0.4% total regulation

OUTPUTS 2, 3, and 4

±2.5% total regulation

DIMENSIONS

MODEL CV405B
15.45" x 5.10" x 3.15"

Deltron inc.

Call Toll Free 1-800-523-2332;
in PA 215-699-9261.

FAX: 215-699-2310 TWX: 510-661-8061
P.O. Box 1369, Wissahickon Avenue,
North Wales, PA 19454
CIRCLE 114

INTERNAL MASS STORAGE ENHANCES FAST DIGITAL SCOPE

JOHN NOVELLINO

As signal-analysis tasks grow in complexity, personal computers become an important adjunct to the oscilloscope. Recognizing this synergy, LeCroy Corp. designed the 7200 Precision Digital Oscilloscope not only as a high-performance scope, but also to be easy to use and program with PCs.

With a 1-GHz sampling rate, 400-MHz bandwidth, and 50-ksample acquisition memory, the model 7200 ranks high among digital scopes. The instrument accepts two model 7242 plug-in units, which contain the digitizing circuitry. Each plug-in offers the full 1-GHz, 8-bit-resolution sampling rate on two channels. As a result, the user can upgrade from two to four channels without losing performance. The large waveform memory lets users maintain the scope's maximum digitizing rate on slower timebase settings.

Additionally, the 7200 contains a 3.5-in. floppy drive and a hard disk. This internal mass-storage capability makes the scope easier to use. The MS-DOS floppy drive eliminates the need for GPIB programming and special instrument drivers to transfer data to a PC for analysis. Also, because front-panel settings can be stored on floppy disks, operators can maintain a file of frequently used set-ups.

On the hard disk, users store waveforms and front-panel set-ups. An on-line help manual and the 7200-series programs and operating system are also stored there. The hard disk is activated by the scope's Record Trace mode, which time-stamps each new screen of waveforms and stores it in a 2-Msample buffer.

The buffer holds any combination of waveforms adding up to 2 Msamples—for example, 1000 waveforms with 2000 points each. Storing the unit's operating system on the hard disk means that upgrades in module technology can be handled through the floppy disk rather than firmware

changes.

The 7200 does have GPIB and RS-232-C ports, however, and users can program the instrument through them. Bus commands can set up the unit, control its cursors, and read out data. The scope transfers waveform data blocks at up to 600 kbytes/s over the GPIB.

TRIGGER CAPABILITIES

LeCroy's Smart Trigger capability includes edge, logic, glitch, interval, and tv triggering, singly or in combination. For example, a user can capture a particular data or address condition in a microprocessor-based system by setting logic-threshold levels for the inputs and logic conditions to trigger on. Pulse-width triggering lets users find a dropout glitch in a clock signal or a missing bit during a disk-drive read. The scope will even wait for a specified number of events before triggering.

Up to eight waveforms can be displayed at once, and the scope can perform more than 20 mathematical functions on all displayed signals simultaneously. Or, the analysis functions can be chained so that 16 cascaded calculations can be made on one signal. To speed calculations and maintain near-real-time updates,

both the mainframe and plug-in module contain microprocessors.

Time-domain functions include automatic readout and statistical analysis of more than 40 pulse characteristics, X-Y plots, waveform math, and signal averaging. On single waveforms, the scope determines absolute value, square, square root, log, antilog, integral, derivative, 1/X, smoothing, averaging, and maximum/minimum. Multiple-waveform math includes sum, difference, multiply, and divide. The user can select the scientific units and define labels so the readouts are in the desired format.

In the frequency domain, the 7200 can calculate 100- to 50,000-point fast-Fourier transforms and inverse FFTs. Displays include phase, magnitude, power spectrum, cross spectrum, and other functions. The amplitude, frequency, and phase of the fundamental and harmonics are automatically read out.

The 7200 oscilloscope mainframe costs \$16,000, and the 7242 two-channel digitizing plug-in costs \$16,900. Delivery is in eight to 10 weeks after receipt of order.

LeCroy Corp., 700 Chestnut Ridge Rd., Chestnut Ridge, NY 10977-6499; (800) 553-2769.

CIRCLE 311

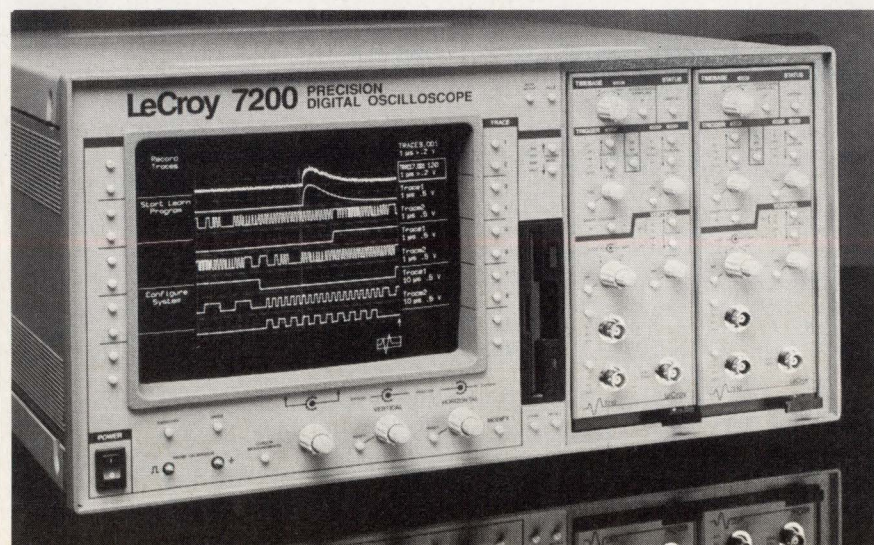

NEW PRODUCTS

INSTRUMENTS

MIXED-SIGNAL VERIFICATION SYSTEM BOASTS APPLICATIONS FLEXIBILITY

Featuring a low-noise system for distribution of analog signals, the Logic Master XL Mixed-Signal Verification System from Integrated Measurement Systems has the flexibility to perform prototype verification, device characterization, and even low-volume production testing. In addition to 176 digital-I/O channels operating at 60 or 100 MHz, the system includes 16 analog-I/O channels.

The distribution system's low-noise environment smooths out the signal noise and crosstalk problems inherent in mixed-signal ICs. The tester also has a mixed-signal switching matrix and mixed-signal fixturing that isolates analog and digital signals at the device under test to eliminate distortion. As a re-

sult, users can connect GPIB analog instruments to the fixturing to create a customized test set.

Designers can develop and execute tests interactively using the windowing environment. The interactive capability is helpful for making critical measurements during prototype verification. But the system can also execute automatic tests when the designer wants to collect data on a large sampling of devices during characterization or low-volume production testing.

Prices for the Logic Master XL Mixed-Signal Verification System start at \$120,000, depending on configuration. Upgrades for existing Logic Master XL systems start at \$60,000.

Integrated Measurement Systems Inc., 9525 SW Gemini Dr., Beaverton, OR 97005; (503) 626-7117.

CIRCLE 312

JOHN NOVELLINO

64-PIN PRODUCTION TESTER FEATURES BIG-SYSTEM PERFORMANCE

Although most ICs being developed these days have relatively low pin counts, many are taking advantage of the new fast device technologies. Designers who must test these fast ICs no longer need to use large, expensive VLSI testers just to get the needed speed. For such applications, Tektronix' Semiconductor Test Systems Division has introduced the LT-1201.

The LT-1201 can be configured with two 64-pin test heads, each capable of multisite (parallel) testing. With this scheme, the system can work with dual or quad handlers for high-volume production testing. Retaining the performance of Tektronix' 256-pin LT-1001, the smaller unit handles 100-MHz test speeds, creates 16 timing sets, and has an operating voltage range of -2.5 to +7.5 V. Throughput is enhanced by the inclusion of one parametric measurement unit for each eight I/O pins.

With its 100-MHz speed, the LT-1201 can test advanced CMOS logic and CMOS TTL-compatible ICs, as well as fast TTL and ECL logic families. The unit's 290-ps edge-placement accuracy allows tighter guard bands for increased yields.

Critical to the system's performance and reliability is its second-generation IC pin electronics. Three VLSI ASICs house the system's drivers, timing generators, active loads, front-end pin support circuitry, and analog- and digital-comparator circuitry. The result is a dramatically lower parts count for each pin card, which in turn lowers the test head's operating temperatures and minimizes thermal drift.

The LT-1201 starts at \$290,000 for a 32-pin system capable of testing two devices simultaneously. A typical 64-pin, one-head system costs \$370,000.

Tektronix Inc., Semiconductor Test Systems, P.O. Box 4600, MS-94-441, Beaverton, OR 97076; Alan Whiteside, (503) 629-1035.

CIRCLE 313

JOHN NOVELLINO

IEEE-488

'488 (GP-IB, HP-IB) control for your PC/XT/AT

Control instruments, plotters, and printers.

Supports BASIC, C, FORTRAN, and Pascal.

Fast and easy to use. High-speed DMA.

Software library included so you spend less time programming.

Thousands sold. Risk free guarantee.

Hardware and software - \$395.

Product literature 1-800-234-4CEC

Technical assistance 617-273-1818

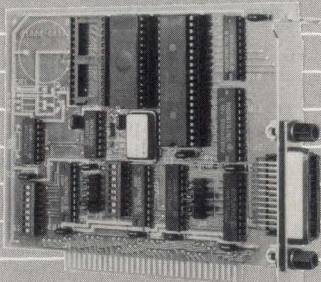

Capital Equipment Corp.
Burlington, MA. 01803

CIRCLE 116

NEW PRODUCTS

INSTRUMENTS

B- AND C-SIZE MODULES GIVE VXIBUS LINE PERFORMANCE FLEXIBILITY

A line of VXIbus products from Hewlett-Packard includes both B- and C-size modules, affording users a wide performance range. The HP 75000 family contains mainframes and controllers in both sizes, as well as instrument and switching modules.

The products are part of HP's measurement-system architecture, which includes software-development tools, controllers, HP-IB (GPIB) instruments, and the VXIbus, as well as modular measurement-system products that connect to a user's device under test. As part of this architecture, the HP 75000 series products share a common user interface, HP's interactive test generator, and a common command set, the HP test-systems language.

Modules available include digital multimeters, counters, a function generator, a power meter, multiplexers, a digital-to-analog converter, a 16-channel form-C switch, and a 4-by-4 relay matrix. A C-size controller

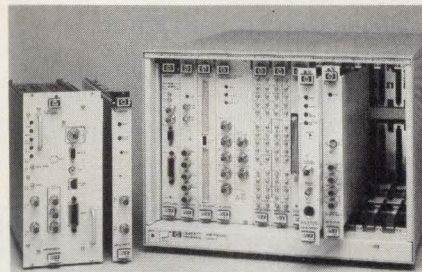

consists of an HP 9000 model 360 system-processing unit and associated I/O interfaces. The B-size mainframe contains a Motorola 68000-based controller that handles VXI slot-0 and resource-manager duties.

Most HP 75000 Series B and Series C products can be ordered now with an estimated delivery of eight to 15 weeks after receipt of order. The HP E1416A power meter, HP E1440A function/sweep generator, and HP E1480A V/360 controller will be available for order December 1.

Hewlett-Packard Co., 1920 Embarcadero Rd., Palo Alto, CA 94303; (800) 752-0900. **CIRCLE 314**

JOHN NOVELLINO

PROGRAMMABLE POWER SUPPLIES' TIMING MODE EASES STRESS-TESTING TASKS

Designed mainly for ATE users, the PPS series of programmable power supplies features an internal-timer program that eases stress-analysis testing, component testing, and evaluation of modules such as voltage-controlled oscillators. In addition, GPIB capability is built into each model.

Both research and development and bench-top applications benefit from the PPS supplies' versatility. The units offer full rated power from 100 to 1000 W for a wide range of test capabilities. Their modes of operation include ΔV , ΔT , and manual.

An important feature of the units is the ability to use their internal memory to store up to 200 preprogrammed voltage and current levels. These can then be stepped through

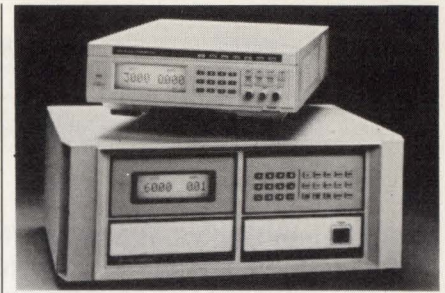

automatically without need for an external computer or controller. For instance, the supply can be programmed, for specified intervals, to deliver 24 V dc at 1 A, then go to 26.4 V dc (+10%) at 1 A, return to 24 V, switch to 21.6 V dc (-10%), and return again to 24 V.

The PPS series programmable power supplies start at \$995. Delivery is from stock.

Beckman Industrial Corp., 3883 Ruffin Rd., San Diego, CA 92123-1898; (619) 495-3200. **CIRCLE 315**

DAVID MALINIAK

IEEE-488

'488 (GP-IB, HP-IB) control for the Micro Channel

- Control instruments, plotters, and printers.
- Supports BASIC, C, FORTRAN, and Pascal.
- High-speed DMA,
- shared interrupts, and
- switchless installation.
- IBM approved ID.
- Risk free guarantee.
- Hardware and software - \$450.

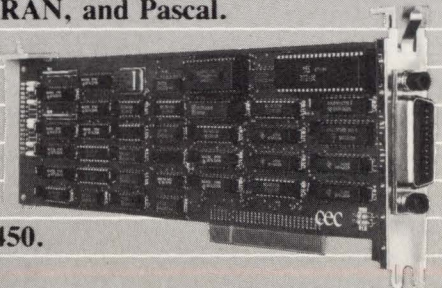

Product literature 1-800-234-4CEC
Technical assistance 617-273-1818



Capital Equipment Corp.
Burlington, MA. 01803

Micro Channel is a trademark of IBM

CIRCLE 117

CADDOCK's Precision and Ultra-Precision Resistor Networks provide a designer's choice of performance that will optimize solutions in precision analog circuit designs.

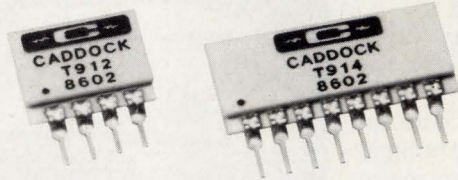

Precision and Ultra-Precision Resistor 'Pairs' and 'Quads' deliver a selection of Ratio Tolerance to as tight as $\pm 0.01\%$ and Ratio Temperature Coefficient to 2 PPM/ $^{\circ}\text{C}$ combined with exceptional long-term stability.

Standard Type T912 and T914 Precision and Ultra-Precision Resistor Networks.

Standard models of the Type T912/T914 Precision and Ultra-Precision Resistor Networks combine all of these performance characteristics:

- **Absolute Tolerance:** 0.1% for all resistors.
- **Ratio Tolerances:** 0.1%, 0.05%, 0.02% and 0.01%
- **Ratio Temperature Coefficients:** from 10 PPM/ $^{\circ}\text{C}$ to 2 PPM/ $^{\circ}\text{C}$.
- **Absolute Temperature Coefficient:** 25 PPM/ $^{\circ}\text{C}$ from 0 $^{\circ}\text{C}$ to +70 $^{\circ}\text{C}$.
- **Ratio Stability of Resistance at Full Load for 2000 Hours:** within 0.01%.
- **Shelf Life Stability of Ratio for Six Months:** within 0.005%.

The standard part number below provides a selection of over 500 in-production models of Type T912/T914 precision and ultra-precision 'pairs' and 'quads':

T912 - A 10K - 010 - 10

Model Number: _____

Ratio Code Letter: _____

Ratio Temperature Track: (0 $^{\circ}\text{C}$ to +70 $^{\circ}\text{C}$)
 -10 = 10PPM/ $^{\circ}\text{C}$ -05 = 5PPM/ $^{\circ}\text{C}$
 -02 = 2PPM/ $^{\circ}\text{C}$

Ratio Tolerance:
 -100 = 0.1% -020 = 0.02%
 -050 = 0.05% -010 = 0.01%

Standard Resistance Values (R_i):
 1K 10K 40K 200K 500K
 2K 20K 50K 250K 1 Meg
 5K 25K 100K 400K

No Letter = T912 with R₁ = R₂
 No Letter = T914 with R₁ = R₂ = R₃ = R₄

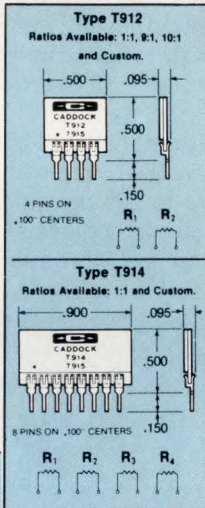

Custom Type T912 and T914 Precision and Ultra-Precision Resistor Networks.

Custom models of these precision 'pairs' and 'quads' can include these special performance features:

- **Resistance Values:** from 1K to 2 Megohms with maximum ratios of 250-to-1.
- **Absolute TC:** as low as 15 PPM/ $^{\circ}\text{C}$.
- **Ratio TC:** as low as 2 PPM/ $^{\circ}\text{C}$.
- For Type T912/T914 data, circle Number 201.

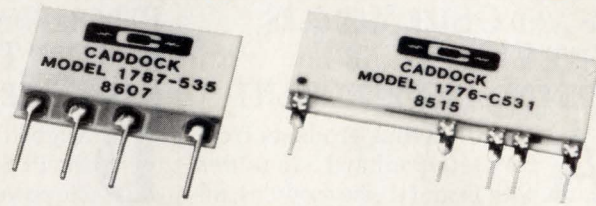
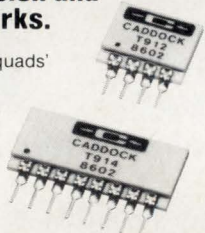

Precision Decade Resistor Voltage Dividers and Current Shunt Resistor Networks deliver many optimum combinations of precision and temperature coefficient performance for high accuracy range-switching circuitry.

Standard Type 1776 Precision Decade Resistor Voltage Divider Networks.

The Type 1776 Precision Decade Resistor Voltage Dividers provide a family of networks that includes 3, 4 and 5-decade voltage dividers with ratios from 10:1 to 10,000:1. Standard performance includes a wide range of specifications in particular combinations that meet the most often requested requirements.

- **Absolute Tolerances:** from 0.25% to 0.1%.
- **Ratio Tolerances:** 0.25%, 0.1% or 0.05%.
- **Absolute TC:** from 50 PPM/ $^{\circ}\text{C}$ to 25 PPM/ $^{\circ}\text{C}$.
- **Ratio TC:** from 50 PPM/ $^{\circ}\text{C}$ to 5 PPM/ $^{\circ}\text{C}$.
- **Voltage Coefficient:** As low as 0.02 PPM/Volt.

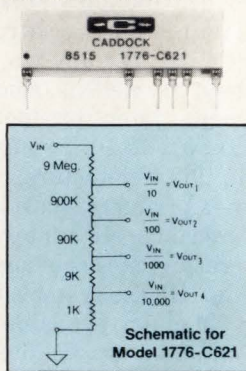

With 36 standard models to choose from, each circuit designer can specify the exact levels of performance required by each application.

- For Type 1776 data, circle Number 202.

Standard Type 1787 Precision Current Shunt Resistor Networks.

The Type 1787 Current Shunt Resistor Networks achieve the combination of performance requirements necessary to meet the demands of precision current measurement circuits, including laboratory and bench-type instrumentation:

- **Resistance Values:** 1 ohm, 10 ohms, 100 ohms and 1000 ohms.
- **Absolute Tolerances:** 0.25%, 0.1% or 0.05%.
- **Absolute TCs:** 100 PPM/ $^{\circ}\text{C}$, 80 PPM/ $^{\circ}\text{C}$ or 50 PPM/ $^{\circ}\text{C}$.

There are now 12 standard models of the Type 1787 Current Shunt Resistor Networks available for 3 and 4-decade applications, and prototype quantities of many models are normally available from factory stock.

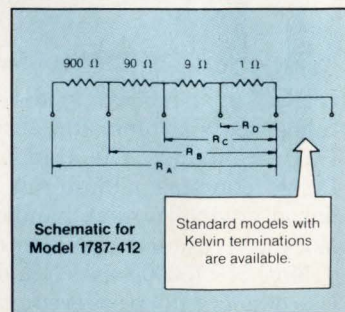

- For Type 1787 data, circle Number 203.

Caddock's new 28-page General Catalog describes over 200 models of both standard and custom precision and ultra-precision resistors and resistor networks. For your personal copy, call or write our main offices at - Caddock Electronics, Inc., 1717 Chicago Avenue, Riverside, California 92507 • Phone (714) 788-1700 • TWX: 910-332-6108

NEW PRODUCTS

INSTRUMENTS

COUNTER MODULE SPANS 0.1 HZ TO 150 MHZ

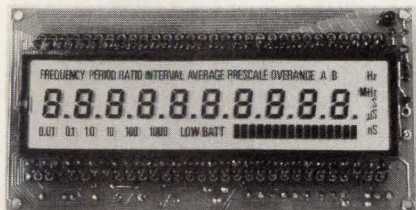

A 10-digit universal counter-timer in a digital panel-meter configuration offers performance equivalent to that of a laboratory counter. The UTC 150 has a direct frequency response from 0.1 Hz to over 150 MHz with up to 9 digits of resolution per second. Its dimensions of just 1.8 by 3.55 by 0.6 in. make it suitable for use in custom instrumentation, as well as digital panel meters. The unit offers such measurement functions as frequency, period, period average, time interval, time interval average, ratio, prescale, overrange. It also features a 16-segment bar graph and a high-accuracy (1-ppm) 10-MHz crystal time base with a calibration adjustment trimmer. In single quantities, the UTC 150 sells for \$225; \$149 in hundreds.

Optoelectronics Inc., 5821 N.E. 14th Ave., Fort Lauderdale, FL 33334; (800) 327-5912 or (305) 771-2050. **CIRCLE 332**

CLIPS PERMIT TESTS ON SOLDERED PLCCS

With the Adapt-A-Clip line of test accessories, users can run emulation and test programs on soldered PLCC devices. The adapters clip onto the outside of the soldered PLCC and present the emulator or testing device with alternate pinouts, such as as PGA, DIP, LCC, and others, for easy insertion of male emulator pods. The device-specific clips can be manufactured to adapt to any of the popular PLCCs currently available. They can also be custom ordered to transform one device into another by permitting different pinout configurations.

Emulation Technology, 2368B Walsh Ave., Bldg. D, Santa Clara, CA 95051; (408) 982-0660. **CIRCLE 361**

UNIT DETECTS AC WITHOUT CONTACT

Nonintrusive testing for the presence of 110 to 480 V ac is performed by a pocket-sized instrument called the Volt Stick. The unit distinguishes between live and neutral wires without having to contact the wire or its insulation. It operates by detecting the electric-field created by the 60-Hz cycle in alternating current. The instrument can detect single- and three-phase circuitry, as well as return loops. When the tip of the Volt Stick is within 1/8 in. of the wire insulation, it glows brightly indicating the presence of voltage. Current flow isn't needed for operation. The device costs \$24.98.

MBD International Inc., P.O. Box 870596, Dallas, TX 75287; (214) 250-6424. **CIRCLE 333**

PATTERN GENERATOR COVERS MANY STANDARDS

In addition to color pattern-generation capabilities that meet TV standards worldwide, the PM 5518 TXI offers full remote control via an IEEE-488 interface. It supports such standards as NTSC, PAL, and SECAM, as well as PAL N and M stan-



dards used in South America. What's more, the instrument permits simple user selection among standards. Over 70 test patterns and carrier frequencies between 32 and 900 MHz can be selected by direct entry on a numeric keyboard or over the 488 bus. Special test patterns are available to meet the changing requirements of NTSC and PAL, including a 250-kHz multiburst and a demodulator pattern. The PM 5518 TXI pattern generator sells for \$5150 and has an eight-week delivery time.

John Fluke Manufacturing Co. Inc., P.O. Box C-9090, Everett, WA 98206; (800) 443-5853. **CIRCLE 334**

Your Custom Precision and Ultra-Precision Resistor Networks from Caddock:

- Can be delivered in only 6 weeks ARO
- With total NRE charges typically under \$950⁰⁰
- Includes 10 prototype networks for your in-circuit evaluation.
- Thin-Profile, Single-In-Line package design.

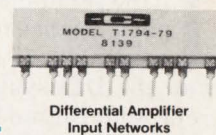

Differential Amplifier Input Networks

Type T1794 Custom Low TC Precision and Ultra-Precision SIP Resistor Networks.



Gain Setting Networks

Caddock's Tetrinox[®] resistance films provide a wide choice of Absolute TCs, Ratio TCs and precision tolerance specifications. Select the performance of your custom network from the following:

- Resistance Values: from 500 ohms to 50 Megs.
- Absolute Tolerances: 1.0%, 0.50%, 0.25%, 0.20%, 0.10%, 0.05% and 0.025%.
- Ratio Tolerances: 1.0%, 0.50%, 0.25%, 0.20%, 0.10%, 0.05% and 0.025%.
- Absolute Temperature Coefficients: 50 PPM/°C, 25 PPM/°C and 15 PPM/°C from 0°C to +70°C.
- Ratio Temperature Coefficients: 50 PPM/°C, 25 PPM/°C, 10 PPM/°C and 5 PPM/°C from 0°C to +70°C.
- For Type T1794 information, circle Number 204.

Type 1789 Custom Low Resistance Value Precision SIP Resistor Networks.

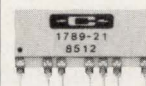

Current-Sensing Networks

Using Caddock's Micronox[®] resistance films, your low resistance custom networks can now include:

- Resistance Values: from 0.5 ohms to 10,000 ohms.
- Absolute Tolerances: 1.0%, 0.50%, 0.25%, 0.20%, 0.10% and 0.05%.
- Ratio Tolerances: 1.0%, 0.50%, 0.25%, 0.20%, 0.10% and 0.05%.
- Absolute Temperature Coefficients: 100 PPM/°C, 80 PPM/°C and 50 PPM/°C from 0°C to +70°C.
- Ratio Temperature Coefficients: 80 PPM/°C, 50 PPM/°C, 25 PPM/°C and 15 PPM/°C from 0°C to +70°C.
- For Type 1789 information, circle Number 205.

Caddock's high thru-put manufacturing capabilities provide cost-effective, on-time delivery of your custom resistor network requirements. Custom network designs are now in-production in quantities from 500 networks per year to as high as 500,000 networks per year.

For fast solutions to your custom resistor network needs, call our Applications Engineers at Telephone No. (714) 788-1700.

CIRCLE 81

CADDOCK
HIGH PERFORMANCE FILM RESISTORS

NEW PRODUCTS

COMPUTERS & PERIPHERALS

RISC-BASED WORKSTATIONS AND SERVERS SET NEW PRICE-PERFORMANCE LEVELS

In the scramble to deliver the best performance for the lowest price, the DECstation 2100 workstation and the DECsystem 5400 and 5800 represent Digital Equipment Corp.'s latest effort. The machines deliver from 10.4 to 36 MIPS, thanks to CPUs based on the R2000 and R3000 processors from Mips Computer Systems Inc.

The workstation delivers the 10.4 MIPS of integer throughput and 2.7 MFLOPS of floating-point computer power while running the R2000 chip set at 12.5 MHz. At \$7950 for a monochrome system, the DECstation 2100 represents the lowest-priced RISC-based Unix workstation.

The basic workstation configuration includes 8 Mbytes of RAM and a video subsystem that displays 1024 by 864 pixels (monochrome or eight color planes) on a 15- or 19-in. monitor. The system's SCSI port accepts up to seven SCSI-compatible peripherals. Optional SCSI peripherals from DEC include 332- or 104-Mbyte disk drives (the RZ55 or RZ23), a 95-Mbyte SCSI tape drive (TZK50), and a 600-Mbyte CD ROM drive. Both thick and thin Ethernet ports are included as are serial and parallel ports, a keyboard, and a mouse.

The more general-purpose DECsystem 5400 incorporates the DEC Q-bus interface for peripheral and I/O expansion and the higher-performance R3000 chip set. The system delivers 16.6 MIPS and has a starting price of \$49,900. DEC's top-of-the-line RISC-based system, the 5800 series computers, are powered by the R3000 CPU. These come in either a single- or dual-processor configuration, and are dubbed the 5810 and 5820, respectively. The 5810 cranks out 18.7 MIPS of computing power, while the 5820 ups the ante to 36 MIPS. These systems start at about \$100,000.

Digital Equipment Corp., Four Results Way, Box 1022, Marlborough, MA 01752-9122; (508) 467-5111.

CIRCLE 316

DAVE BURSKY

HIGH-VOLUME TEXT AND GRAPHICS SCANNER CONVERTS FILES TO CALS STANDARD

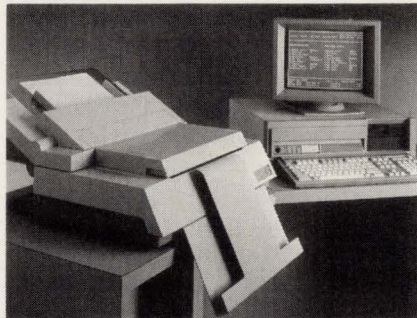

Thousands of type styles and sizes can be read by Xerox Imaging Systems' top-of-the-line Kurzweil K-5100 scanning system. The K-5100 heavy-duty scanner and 50-page automatic document feeder work with a PC/XT/AT or compatible in high-volume text and graphics scanning applications. In addition, a bundled system with special application software converts scanned documents to the Federal computer-aided acquisition and logistics support (CALS) standard output.

The K-5100 system uses Kurzweil's artificial-intelligence-based intelligent character recognition. It can read text created by typesetters, laser printers, typewriters, photocopiers, fine-line fonts, and draft-quality dot-matrix printers. Using the system's interactive text-verification feature, the user helps the system learn to recognize special symbols, and difficult characters found in poorer-quality documents. The learned characters can be stored and recalled as needed to expedite future recognition sessions.

The system features recognition spooling, which means that documents can be scanned as images and recognized for text at a later time.

The K-5100 scanning system is available now at a price of \$17,950. An 5100 upgrade kit for K-5000 systems costs \$3000. The K-5100 CALS-conversion system is also shipping now for \$22,950.

Xerox Imaging Systems Inc., 1215 Terra Bella Ave., Mountain View, CA 94043; (415) 965-7900.

CIRCLE 317

LISA GUNN

SECURE COMPUTERS OPTIMIZED FOR NETWORK APPLICATIONS

Extra security and remote-management capabilities are featured in the WGS series, an extension to AT&T's 6386 family of 80386-based computer systems. The machines gain their remote capabilities running under Unix System V/386 release 3.2.2 for distributed networking applications. All are PC-AT-bus compatible and run MS-DOS, OS/2 or Unix operating systems. Additionally, the systems support AT&T's Simul-task 386 software as well as the X-window and Microsoft Windows/386 utilities.

Besides the usual keyboard lock-switch, all of the systems have a software-based password-protection scheme to keep unauthorized users out of the system or network. The server models also have a lockable cover that secures the openings for removable media (floppy disks or tape).

The low-end 6386/SX WGS base machine comes with the 80386SX processor and 2 Mbytes of RAM on the motherboard (expandable to 8 Mbytes). All other peripheral support is found on the motherboard as well. This includes super-VGA video (800 by 600 pixels, 16 colors) and floppy-disk controllers, real-time clock, controllers for the 101-key keyboard and a mouse, hard-disk drive interface, two serial ports, and one parallel port. The higher-performance 6386/25 uses the 32-bit 80386DX, doubles the RAM to 4 Mbytes, and adds a 64-kbyte cache.

At the top of the line is the 6386E/33, an ESDI-based floor-standing system, and the 6386E/33 Model S, an SCSI-based version of the same system. Running at 33 MHz, they come with either a 135- or 300-Mbyte ESDI or SCSI disk drive and 125-Mbyte tape drive as standard equipment. Prices start at \$2995 for the 6386/SX WGS and surpass \$15,000 for the 6386E/33 systems.

AT&T Computer Systems, 1 Speedwell Ave., Morristown, NJ 07960; (800) 247-1212.

CIRCLE 318

DAVE BURSKY

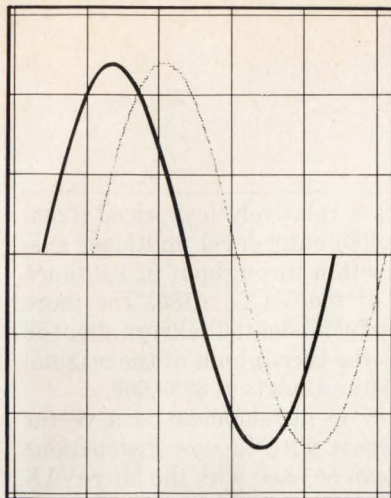

PHASE SHIFTING? ANALOG SIGNAL ALIGNMENT? DESKEWING?

Control them all **DIGITALLY!!**

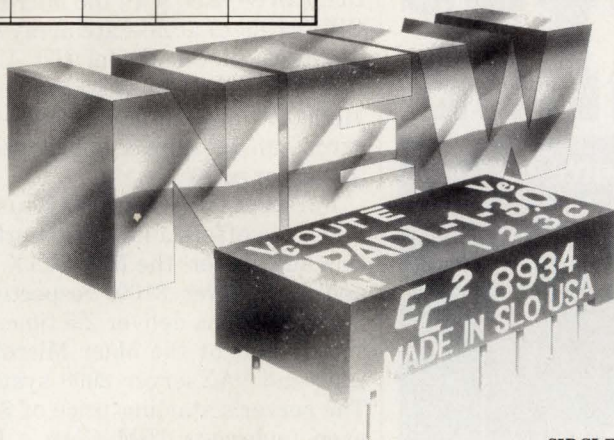

PROGRAMMABLE ANALOG DELAY LINE
(14-pin DIP)

EC-2 available only from
engineered components co.
P.O. Box 8121
San Luis Obispo, CA 93403-8121

CALL TOLL FREE (800) 235-4144
CIRCLE READER CARD NUMBER FOR FREE TECHNICAL SHEETS

PADL-001

CIRCLE 120

NOTEBOOK PC IS JUST OVER 1 IN. THICK AND WEIGHS UNDER 6 LBS.

Doubts about the portability of PCs should be eliminated with the introduction of the MiniPort notebook PC from Zenith Data Systems. This laptop-like computer measures only 1.3 in. in thickness and weighs just 5.9 lbs., including the removable battery.

The full-featured PC achieves its small dimensions by incorporating a 2-in. floppy-disk drive. These innovative disks hold 720 kbytes of data, equal to a standard 3.5-in. disk. Other features include an 8-MHz 80C88-2 microprocessor, switchable to 4.77 MHz; a full-size 80-key keyboard; and an optional internal modem.

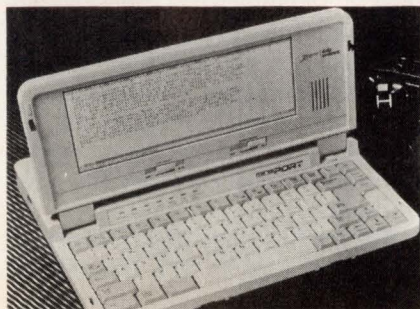

Also, MS-DOS 3.3 is permanently stored in the system's 832 kbytes of ROM.

The MiniPort contains a silicon disk that can store and retrieve data much faster than a standard hard disk. This disk can be expanded up from 360 kbytes to 1.36 Mbytes with an optional upgrade package.

A 25-line-by-80-character Day-Bright liquid-crystal screen combines the technologies of transmissive-backlit displays with reflective displays. The 9-1/2-in.-diagonal screen is illuminated by ambient light in normal lighting conditions and by an adjustable electroluminescent backlight in a dark or dimly-lit setting.

MiniPort's nickel-cadmium battery can operate for a minimum of three hours and recharges in four to six hours. The computer comes with serial and parallel ports in addition to an external floppy-drive and an external color-monitor port.

Two versions are available. Model 1 contains 1 Mbyte of RAM and sells for \$1999 while Model 2 contains 2 Mbytes of RAM and costs \$2299. This version also contains the upgraded silicon disk. The optional mo-

dem costs \$199.

Zenith Data Systems, 1000 Milwaukee Ave., Glenview, IL 60025;
(800) 553-0331.

CIRCLE 319

RICHARD NASS

PC LINK, MEMORY CARDS EXPAND ORGANIZER'S USES

Applications for Sharp Electronic's hand-held electronic organizer—the Wizard—are increased with a computer link that transfers data from the organizer to a PC, and vice versa. The Organizer Link includes all the hardware and software (3.5-in. or 5.25-in. floppy diskettes) needed for file exchange between the Wizard and an IBM-compatible PC. The link hardware includes a level converter, an interface cable, and an ac adaptor. In addition, the electronic organizer's memory can be expanded with removable 32- and 64-kbyte RAM cards. The Organizer Link retails for \$149.99. The suggested retail prices for the 32-kbyte and 64-kbyte RAM cards are \$79.99 and \$129.99, respectively.

Sharp Electronics Corp., Sharp Plaza, Mahwah, NJ 07430; (201) 529-9542.

CIRCLE 335

NEW PRODUCTS

COMPUTERS & PERIPHERALS

UPGRADED MICROVAX SYSTEMS DOUBLE TO TRIPLE CPU THROUGHPUT

Delivering throughput improvements of from 1.85 to 2.8 times that of earlier VAX-compati-

ble systems, the VAX 6000 Model 400, the MicroVAX 3100 workstation, and VAXserver 3100 bring the performance levels of Digital Equipment's latest systems to new highs. In the large-systems area, the VAX 6000 series gains two models. The

210 is a relatively low-priced (from \$129,000) entry-level multiuser system with a throughput of 2.8 times that of the VAX-11/780. The more powerful Model 400 delivers about 36 times the throughput of the original 11/780 and starts at \$239,000.

Now in development is a vector processor with 63 new instructions that can be used with the MicroVAX CPU cards to accelerate array computations in the Model 400. Up to four CPUs can be installed in the Model 400, and one or two of the CPU cards can be replaced with vector-processor cards.

For cost-conscious VAX users, DEC also offers a low-cost workstation and server: the MicroVAX 3100 and VAXserver 3100, respectively. These systems deliver 2.5 times the throughput of the older MicroVAX 2000 and VAXserver 2000 systems. The server's starting price of \$6680 even undercuts IBM Corp.'s PS/2 Model 80 PC. The 3100 Model 10 low-end workstation configuration, which costs \$8480, adds to the base system a 104-Mbyte hard disk drive, a 1.4-Mbyte 3.5-in. floppy drive, and a five-user VMS operating-system software license.

Digital Equipment Corp., Four Results Way, Box 1022, Marlborough, MA 01752-9122; (508) 467-5111.

CIRCLE 320

DAVE BURSKY

ADD-IN MEMORY FITS HP WORKSTATIONS

Two low-cost memory boards help users boost the performance of their Hewlett-Packard 9000 Model 340 and 360 workstations. The EM340 is a 4-Mbyte RAM board, while the EM360 is available in 4-, 8-, and 12-Mbyte configurations. Priced lower than their HP counterparts, these memory products are of particular benefit to HP users who are entering the Unix environment. The boards are completely compatible with any HP memory installed in the computer and come with an extended five-year warranty.

Infotek Systems, 1045 S. East St., Anaheim, CA 92815; (714) 956-9300.

CIRCLE 359

TUSONIX

If you're looking for a reliable source for EMI Filters and Custom Filter Assemblies . . .



Tusonix, as a QPL source, is proud of its JIT performance

Miniature EMI/RFI ceramic filters and filter capacitors attenuate most frequency ranges in a wide variety of QPL approved styles. Most are available from stock in production quantities, ready for immediate shipment.

When it comes to custom packaging EMI/RFI feed-thru filters and/or filter capacitors, Tusonix offers a complete in-house custom assembly capability. Every assembly is 100% tested in Tusonix' quality assurance laboratories. The result is a reliable, economic assembly that satisfies your unique needs.

So let Tusonix supply your filter requirements in discrete filters and assemblies. Write for literature TODAY . . . or please call us at:
Phone: 602-744-0400

TUSONIX

P.O. Box 37144, Tucson, AZ 85740-7144
Phone: 602-744-0400 Telex: (RCA) 299-640
FAX: 602-744-6155

CIRCLE 121

NEW PRODUCTS

ANALOG

FAST, LOW-NOISE JFET OP AMPS DON'T DRIFT; BIAS CURRENT RUNS 20 pA

A pair of JFET-input IC op amps, Burr-Brown's OPA627 and OPA637, boast a mix of precision and speed not available until now. The devices are built on a dielectrically isolated (DI) complementary process that builds fast vertical pnps as well as fast npn transistors. They offer the lowest noise of any JFET-input op amp.

The OPA627 is unity-gain stable with a typical unity-gain bandwidth of 16 MHz. The decompensated OPA637 has a typical gain-bandwidth product of 80 MHz at a gain of 5, which is its minimum stable gain. All other specifications match.

The rest of the specifications are minimums or maximums unless noted typical (t). For the B and A grades, slew rates run 45 and 40 V/ μ s, respectively. Both devices offer a settling time of 600 ns (t) to 0.01 % for a 10-V output step. Open-loop gain is 110 dB for the B grade and 104 dB for the A. With their bias currents of just 5 pA for the B grade and 50 pA for the A grade, these op amps are just right for high-speed sample-and-hold amplifiers and current-to-voltage converters.

But if a fast, low-offset-voltage op amp is called for, these chips fill the bill. Offset voltage for the B and A grades runs 100 and 500 μ V, respectively, while offset drift is 1 and 1.2 (t) μ V/ $^{\circ}$ C. Now for noise: between 0.1 and 10 Hz, voltage noise of the B-grade is just 2.5 μ V pk-pk, with a similar typical value for the A-grade. At 1 and 10 kHz B-grade voltage noise runs 6 nV/ \sqrt Hz.

Although both speed and low-noise operation demand current, these op amps draw no more than 7 mA from their \pm 15-V supply rails. Nonetheless, they can typically put out 30 mA. In quantities of 100, the A-grade OPA627/637AP costs \$7.50 each and the B-grade goes for \$15. Delivery is from stock.

Burr-Brown Corp., P.O. Box 11400, Tucson, AZ 85734; Bruce Trump, (602) 746-7347. CIRCLE 321
FRANK GOODENOUGH

SINGLE, DUAL, AND QUAD OP AMPS OFFER HIGH SPEED AT LOW POWER

With typical unity-gain bandwidths of 2 MHz and slew rates of 0.9 V/ μ s, the TLE2021 single, TLE2022 dual, and TLE2024 quad op amps provide a three-to-five-times improvement over other premium op amps, yet dissipate no more power. The devices operate from a single supply of 4 to 40 V, or a split supply, and have a common-mode input-voltage range that includes the negative rail. Each device incorporates phase-reversal circuitry to eliminate unexpected changes in output states when one of the inputs goes below the negative-supply rail.

The amplifiers' current consumption—230 μ A maximum at 5 V—changes only 44 μ A over the full military temperature range at a typical rate of 0.08 μ A/ $^{\circ}$ C. Texas Instruments credits this stable current consumption over the devices' operating-temperature range to its Excalibur process characteristics and advances in operational-amplifier circuit design.

These new op amps are the first devices TI has fabricated using the Excalibur process, a complementary bipolar technology that incorporates isolated vertical-pnp transistors. According to the company, the Excalibur process is the first high-volume manufacturing technology to combine these high-performance pnp transistors with p-channel JFETs, super-beta npn transistors, and metal-nitride-polysilicon capacitors.

The single, dual and quad op amps are characterized for operation over commercial, industrial, and military temperature ranges. Devices come in five package types: plastic and ceramic DIPs, small-outline packages, leadless chip carriers, and metal cans. MIL-STD-883C, Class B versions are planned for later this year. Prices begin at \$1.76 in quantities of 1000. Delivery is from stock.

Texas Instruments Inc., P.O. Box 809066, Dallas, TX 75380-9066; (800) 232-3200, Ext. 700. CIRCLE 322
JON CAMPBELL

SAVE TIME, \$\$\$

Simulate with SUSIE™
XILINX
PLD's, etc.

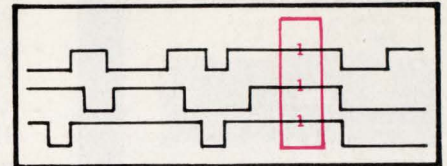

Benchmark proven, SUSIE outperforms workstation based CAE's by 10:1. SUSIE is resold by P-CAD and other major CAE vendors.

The world's fastest
PCB Simulator

- multiple **PLDs**
- multiple **MPUs**
- TTL/ECL/CMOS**

Since SUSIE is interactive, you can operate switches, load JEDEC and hex files and modify design on-the-fly without losing a single second on any compilation. SUSIE displays automatically all bus conflicts and timing violations.

- **EASY TO LEARN**
- **FULLY INTERACTIVE**
(No Compilations)
- **DISPLAYS BUS CONFLICTS**
- **SHOW TIMING VIOLATIONS**

TRY SUSIE!!!

**UNCONDITIONAL 30-DAY
MONEY BACK GUARANTEE**

Ask for a **FREE** sample!

(805) 499-6867

ALDEC

Automated Logic Design Co.
3525 Old Conejo Rd., #111
Newbury Park, CA 91320

© 1989 by ALDEC Company

CIRCLE 112

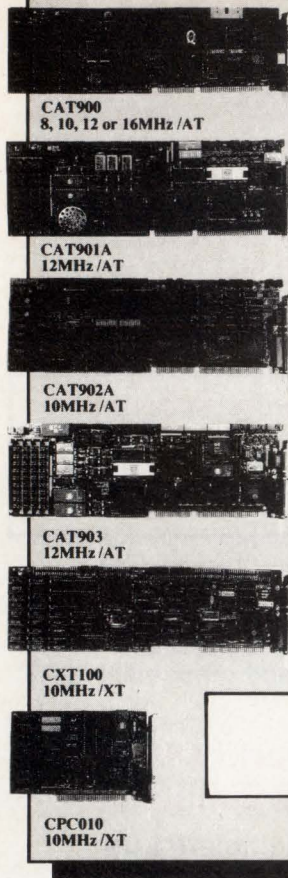

Complete Computer On A Single Card

With a DTI Single Board Computer, you eliminate the need of the "old motherboard". Just plug the "Single Board" into a passive backplane and you have a complete computer on a single card. Many models and features to choose from.

- /XT and /AT Single Board Computers
- 80386, 80386SX, 80286 or 8088 Processors
- ST506, SCSI or IDE Hard Disk Interfaces
- VGA, EGA, CGA, MDA, HDA or Hercules Video
- Phoenix, Award or Faraday BIOS
- Optional Co-Processors
- Ports Available:
Serial, Parallel, Speaker,
Turbo/Reset, Mouse & Keyboard

25 MHz with CACHE in
286 & 386 Models - Coming Soon
(20 MHz with CACHE shipping now)



Diversified Technology

An Ergon Co.

1-800-443-2667 CIRCLE 122

Faraday is a tradename of the Faraday Corp.

/XT & /AT are tradenames of IBM Corp.

NEW PRODUCTS

ANALOG

PRECISION SINGLE AND DUAL WIDEBAND OP AMPS SPORT LOW NOISE AND DRIFT

WWith a unity-gain bandwidth of 35 MHz and a gain-bandwidth product of 100 MHz (below 100 kHz), the Harris HA-5221 single and HA-5222 dual op amps offer a mix of low noise, low offset voltage, and low drift combined with high output drive and open-loop gain. Moreover, the dual devices are as good as the singles. These unity-gain-stable op amps slew at 15 V/ μ s, representing a full-power bandwidth of 238 kHz. Settling time for a 10-V output step to 0.01% is typically 1.5 μ s, and settling to 0.1% runs about 0.4 μ s. Closed-loop gain for both specs is -1.

Offset voltage is less than 750 μ V and offset drift is less than 0.5 μ V/ $^{\circ}$ C. Offset-voltage match between the two channels of the dual amplifier is within a maximum of 750 μ V at 25 $^{\circ}$ C, and twice that over the operating-temperature range. Common-mode rejection ratio is a minimum of 100 dB at 25 $^{\circ}$ C.

Input-voltage noise from 0.1 to 10 Hz is a maximum of 0.37 μ V pk-pk; spot-voltage noise at 1 kHz is 4.5 nV/ $\sqrt{\text{Hz}}$ and is just over twice that at 10 Hz. Total harmonic distortion plus noise, a specification vital for high-performance audio applications, is less than 0.005%. The op amps are tested at a closed-loop gain of 10 with an output swing of 5 V rms and a 600- Ω load. Test frequency is 1000 Hz.

Open-loop gain is a minimum of 106 dB while putting ± 10 V across 1000 Ω . However, the chips can put that voltage across 200 Ω , often eliminating the need for an additional buffer amplifier. On the dual HA-5222, channel separation at 10 kHz is typically 110 dB.

The chips draw a maximum of 11 mA/op amp from split ± 15 -V rails. In quantities of 100, unit prices for the HA-5521 start at \$6.68. The prices for the HA-5222 start at \$11.14. Delivery is from stock.

Harris Semiconductor, P.O. Box 883, Melbourne, FL 32901; Wes Kilgore, (407) 729-5310.

CIRCLE 323
FRANK GOODENOUGH

POWER SUPPLIES shipped in 3 days

Send for this 52-page catalog...

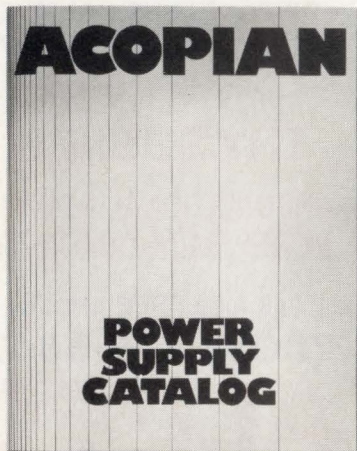

containing detailed information on single, dual and triple output power supplies including: Mini modules (for PC board and chassis mounting). DC-DC converters. General-purpose modular supplies with outputs to 200 Vdc, current ratings to 32A. Narrow profile supplies only 1.68" thin. Plug-in supplies. Unregulated supplies for economically driving relays and displays. Voltage programmable supplies. All shipped in 3 days. Rack mounting power supplies and systems, and redundant output systems shipped in 9 days. Complete pricing information is included.



P.O. Box 638, Easton, PA 18044
Call toll free (800) 523-9478
P.O. Box 2109, Melbourne, FL 32902
Call toll free (800) 327-6817

CIRCLE 123

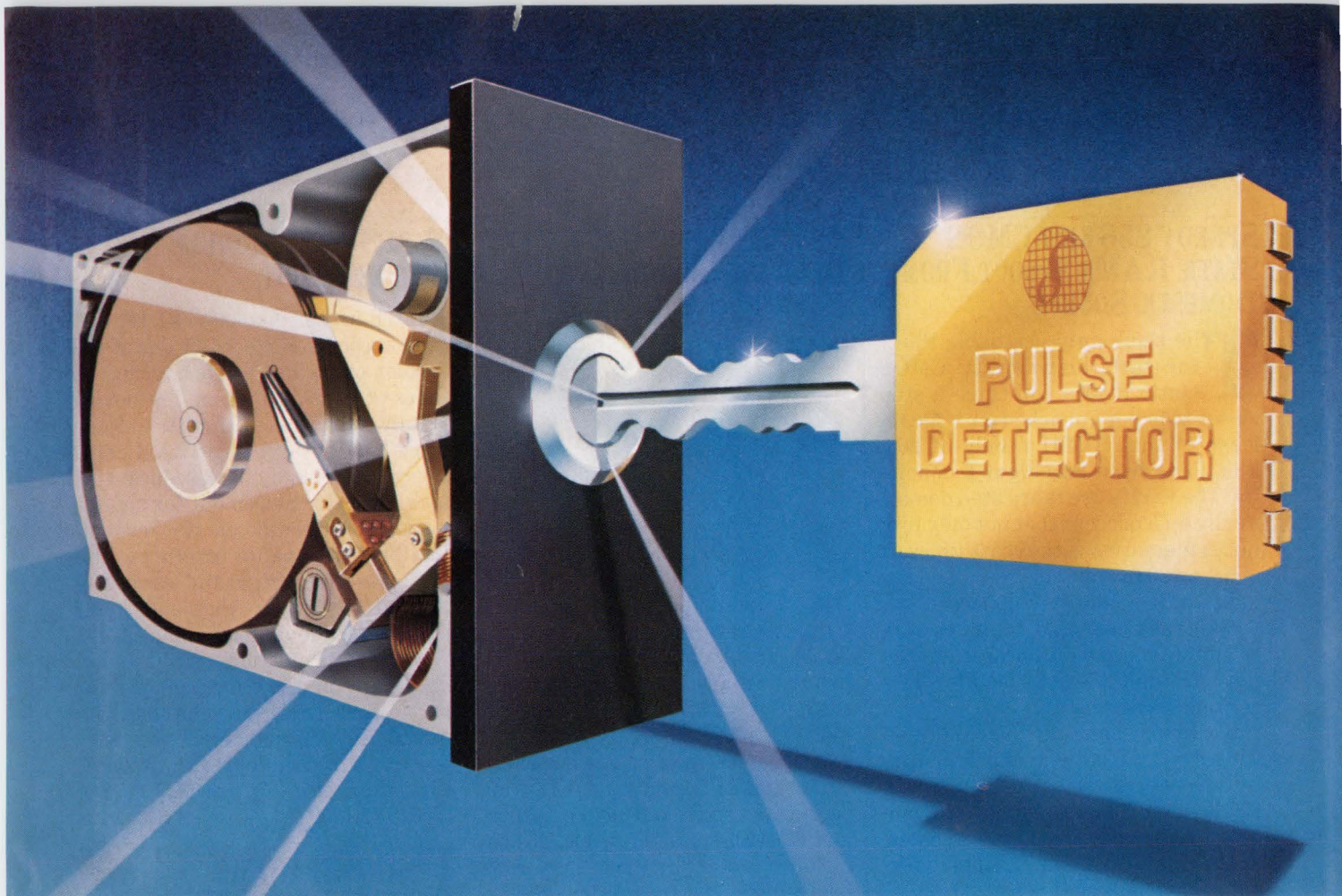

Unlock your drive's full potential...

With Silicon Systems Pulse Detectors

Now you can achieve greatly improved performance from your disk drive designs with the most complete family of Pulse Detector ICs. Choose from a wide range of off-the-shelf pulse detection products or specify a custom. Either way, Silicon Systems provides you with many performance options, advanced features, and packaging styles to meet even your most demanding needs.

Performance parameters such as window margin, system recovery time, and data security are greatly enhanced

with low pulse pairing, fast write-to-read recovery times, and innovative pulse qualification control. New advanced system requirements are also supported by features for zone bit recording, pulse equalization and embedded servo. Products are offered in a variety of surface mount package styles for reduced footprint and systems costs.

With a high level of integration, these unique Silicon Systems Pulse Detectors could be the very key you need to unlock the full potential of your

disk drive's performance.

CALL NOW!
(714) 731-7110, Ext. 3575

For more information on this Pulse Detector Family and other advanced disk drive IC families, contact Silicon Systems, your local representative or distributor today.
Silicon Systems, Inc.,
14351 Myford Road, Tustin, CA 92680.
Ph: (714) 731-7110, FAX: (714) 669-8814.
European Hdq. U.K. Ph: (44) 7983-2331.

silicon systems[®]

NEW PRODUCTS

DIGITAL ICs

SPEEDY 256-KBIT CMOS STATIC RAMS SPROUT FROM DOMESTIC SOURCE

The seemingly insatiable thirst for fast, high-density CMOS static RAMs will come a step closer to being quenched with the release of the PDM41 family of 256-kbit chips from Paradigm Technology. The RAMs are fabricated domestically on a process that not only produces memories with access times as short as 20 ns, but also results in the industry's smallest chip areas for 256-kbit devices. Also, the chips easily slip into small-outline J-lead, 300-mil DIP, and 28- or 32-lead leadless ceramic packages.

Six chips make up the family—a 256k-by-1, a 32k-by-8, and four 64k-by-4 devices. Besides the 20-ns chips, 25-, 35-, and 45-ns versions are available for operation over the commercial temperature range. Military versions have access times of 25, 35, 45 and 55 ns. All operate from a 5-V supply and consume about 400 mW when active and 400 μ W during standby. Low-power versions shave the active power by 50 mW and cut the standby power to just 100 μ W.

Four 64k-by-4 versions are being readied—the PDM41258, 41298, 41251, and 41252. The first uses the standard multiplexed data input and output lines and has a Chip Enable input. The 41298 adds an Output Enable line while the 41251 and 52 have separate data inputs and outputs but have only the Chip Select line. On the PDM41251, the outputs track the inputs during a write operation; on the 41252, the outputs go to a high-impedance state during a write. The PDM41257 is the 256k-by-1 memory, while the 41256 is organized as 32k-by-8.

Prices for the 20- and 25-ns options of PDM41258 are \$147.05 and \$113.12, respectively, for ceramic-DIP versions in quantities of 100. Samples are available now for the 41258; all others can be had in October.

Paradigm Technology Inc., 71 Vista Montana, San Jose, CA 95134; (408) 954-0500 **CIRCLE 324**

DAVE BURSKY

PROGRAMMABLE SEQUENCER DELIVERS SUPERSSET OF PLS105, 405 FEATURES

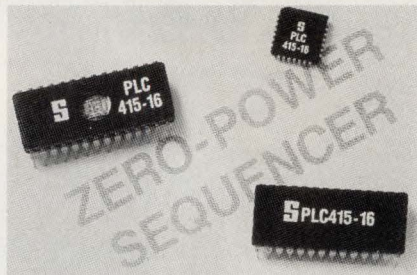

Although it drops right into the sockets now holding the popular bipolar PLS105 and 405 programmable logic sequencers, Signetics' CMOS PLC415-16 sequencer packs more features and consumes less power. The 28-pin circuit crams in 17 inputs, eight buried registers, eight output registers, and 68 AND product terms. It also includes a standby mode that trims operating power from its 300-mW active level to just 2.5 mW. In comparison, the bipolar chips consume more than twice the active power and have no reduced-power standby mode. The bipolar chips, however, run at more than double the clock frequency of the new CMOS chip.

Besides all the features of the PLS105 and 405, the 415 has programmable asynchronous initialization and output-enable functions that can be controlled from the internal AND array or from an external source. As a result, the state machine implemented in the array can be asynchronously initialized to start in any desired pattern.

Because the chip carries multiple clock inputs, more than one Mealy-type state machine can be implemented on a chip. The programmable elements of the PLS415-16 use UV EPROM memory cells, and when sold in windowed packages, the sequencer can be erased and reprogrammed. Prices range from \$12 to \$15 in quantities of 1000, depending on packaging.

Signetics Co., 811 E. Arques Ave., P.O. Box 3409, Sunnyvale, CA 94088-3409; (408) 991-2000.

CIRCLE 325

DAVE BURSKY

FAST SRAM MODULE STORES 1 MBIT

Housed in a 32-pin 600-mil DIP, a 1-Mbit static RAM module is one of the fastest of its kind, offering access times of 30, 35, and 40 ns. The device is fully compatible with future monolithic 128k-by-8-bit static RAM chips to prevent design obsolescence. It is also a direct replacement for similar products currently on the market. Unlike comparable products, the part uses a more rigid and less costly printed circuit board that lends itself to stringent industrial applications. A built-in protection circuit using both high- and low-frequency filter capacitors further enhances the module's performance.

Micron Technology Inc., 2805 E. Columbia Rd., Boise, ID 83706; (208) 383-4000. **CIRCLE 336**

4-KBIT EEPROMS OPERATE FROM 3 V

Organized at the user's option as 256 by 16 bits or 512 by 8 bits, two CMOS EEPROMs can be operated and programmed with a 3-V supply. The 4-kbit devices, designated the CAT33C104 and CAT33C204, require only two 1.5-V batteries, making them ideal solutions for a wide range of low-power, battery-backed applications. Each provides a serial interface, can endure 10,000 erase-write cycles per bit, and retains data for a minimum of 10 years. The CAT33C104 is designed for use with

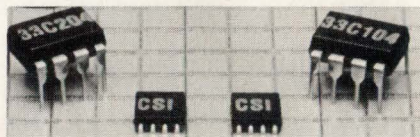

the COPS family of microcontrollers or other standard microprocessors such as the 8048 or 8051. It is Microwire-compatible and provides software data polling. Packaging options include 8-pin plastic DIPs and small-outline configurations. In quantities of 100, the commercial DIP version of either device sells for \$5.54.

Catalyst Semiconductor Inc., 2231 Calle De Luna, Santa Clara, CA 95054; (408) 748-7700. **CIRCLE 337**

We're standard, but we stand apart...

With Integrated Application Solutions

Intergraph®, the leading total solutions company, offers the broadest range of integrated applications in the industry, including AEC, utilities, plant design, mechanical, industrial engineering, mapping, energy exploration, electronic publishing, and electronic design.

With Third-Party Software

Intergraph's RISC-based CLIPPER® platform allows us to offer hundreds of third-party software products. Additionally, a full suite of development tools provides an ideal platform for third-party vendors.

With Binary Compatibility

Intergraph goes a step beyond the source compatibility of other vendors. We offer binary compatibility. So software

running on any CLIPPER system will run on all future CLIPPER systems without modification. This protects your investments in software, training and databases.

With Number 1 Standing In Customer Satisfaction

We rank Number 1 in customer satisfaction. This is due to 20 years of commitment to total systems solutions and our worldwide sales, training, and support. To learn more about our workstations and systems solutions, call us today: 1-800-826-3515 in the United States, 31-2503-66333 in Europe, or 852-5-8661966 in Asia.

INTERGRAPH

Intergraph and CLIPPER are registered trademarks of Intergraph Corporation.

Standards	Intergraph	Sun	DEC	Apollo
UNIX-based os	X	X	X	X
C, Fortran	X	X	X	X
X-Windows	X	X	X	X
PHIGS	X	X	X	X
GKS	X	X	X	X
Ethernet	X	X	X	X
TCP/IP	X	X	X	X
DECnet	X	X	X	X
NFS	X	X	X	X
RS232	X	X	X	X
SCSI	X	X	X	X
VME	X	X	X	X
Binary Compatible	X			

NEW PRODUCTS

DIGITAL ICs



School of American Ballet student performance: Merrill Ashley. Copyright: Martha Swope, 1967.

Thanks to the Library, American dance has taken great leaps forward.

American dance is more popular than ever, and one of the reasons is The New York Public Library's Dance Collection.

Choreographer Eliot Feld says the Library at Lincoln Center is "as vital a workroom as my studio." Agnes de Mille says, "the revival of any work is dependent on access to the Library's Dance Collection."

And they're not the only ones. For dancers and choreographers everywhere, over 37,000 volumes, 250,000 photographs, and an enormous film archive have been essential elements in the renaissance of American dance.

That's just one way The New York Public Library's resources serve us. The Library offers plays and puppet shows for children, programs for the elderly and disabled, extensive foreign language and ethnic collections, and scientific journals vital to the business community.

Again and again, the Library enriches our lives.



The New York Public Library
WHERE THE FUTURE IS
AN OPEN BOOK

CIRCLE 124

LOGIC DEVICES ARE FAST, LOW-POWER

Three CMOS PEEL (programmable electrically erasable logic) devices rival the speeds of comparable bipolar parts while offering the additional benefits of reprogrammability and low power consumption. The 24-pin 22CV10 and 20CG10 operate at 25 ns and consume just 55 mA and 45 mA, respectively, in standby mode. The 20-pin 18CV8-15 runs at 15 ns and consumes 90 mA on standby. Fabricated in CMOS, all three devices provide up to 12 independently programmable input-output macro cells, enabling them to emulate most 24-pin or 20-pin bipolar PLDs. The 22CV10 has 132 product terms and up to 22 inputs and 10 I/O pins. The 20CG10 has 92 product terms, up to 22 inputs, and 10 I/O pins. The 18CV8-15 offers 74 product terms, up to 18 inputs, and 8 I/O pins. In lots of 1000, prices are as follows: the 22CV10 costs \$7; the 20CG10, \$4.50; and the 18CV8-15, \$5.

Gould AMI, 2300 Buckskin Rd., Pocatello, ID 83201; (208) 234-2796. CIRCLE 338

MIL MICROCONTROLLER HAS EXPANDED I/O

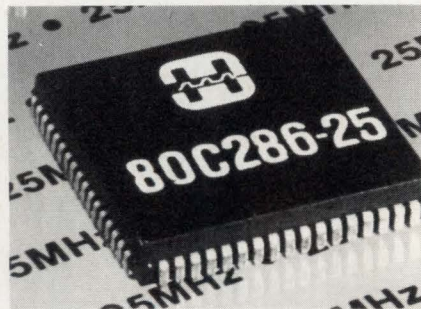

The 83C451 is one of the first mil-standard expanded input-output microcontrollers currently available. The single-chip device adds three 8-bit I/O ports and four I/O control lines. It reduces the requirement for external I/O ports, allowing for more inputs and outputs without having to add external hardware. The I/O central line facilitates inter-processor communication. Offered in two reduced-power modes, the 83C451 has full functional power dissipation of 1.25 mW (at 12 MHz, 6 V)

in the active mode. In the idle mode, power dissipation is reduced to 25 mW (12 MHz, 6 V), and is cut still further to 250 μ W in power-down mode. The processor can use the same software and code as earlier versions that had fewer I/O pins. Packaging options include 64-pin ceramic DIPs and 68-pin LLCCs. The DIP price is \$125 in lots of 100 units. Shipments are from stock.

Signetics Co., 811 E. Arques Ave., Sunnyvale, CA 94088; (408) 991-2000. CIRCLE 339

CHIP DRIVES PC CLOCK DISPLAY

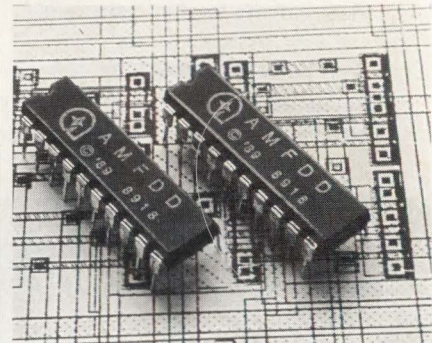

With one chip, the Frequency Display Driver (FDD), designers can drive seven segment LEDs used to indicate the CPU operating speed in personal computers with multiple system-clock frequencies. The auto-switching chip is a reference source-gated frequency and pulse counter, the output of which can drive a two-digit floating-point display unit from 0.1 to 39 MHz. The display unit need only consist of two common anode LEDs, two resistor packs, and an FDD chip. The display driver continuously samples the system clock and automatically reconfigures itself to display the correct frequency at all times. Thus, it eliminates the use of jumper settings to set the high and low system frequencies. The latter method also does not address situations where there are more than two operating frequencies on the system board. The FDD comes in a standard 20-pin plastic DIP and sells for \$4.95 in lots of 100.

Amaz Applied Technology Inc., 3001-A W. Mission Rd., Alhambra, CA 91803; (818) 300-8828. CIRCLE 340

At CARE, The Money You Give To Starving People Doesn't Get Eaten Up Somewhere Else.



At CARE, we don't let the cost of running a charity run away from us. 95% of every dollar we receive goes to help impoverished people overseas.

We've become the best run, best managed charity in America by adhering to a

simple philosophy.

If you want to help starving people, you have to take smaller bites yourself.

CARE | We're Helping People
Learn To Live Without Us.

1-800-242-GIVE

Piezoelectric Ceramics

Design engineers have relied upon Vernitron electronic components and shapes for more than 45 years. Specify Vernitron for your commercial, industrial or military applications.

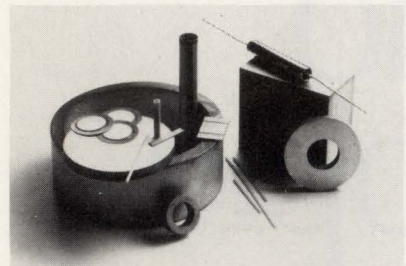

- lead zirconate titanate
- lead titanate
- lead metaniobate
- special compositions

Ceramic Shapes

- disks, cylinders
- rings, tubes
- blocks, plates
- special shapes, sizes

Typical Applications

- ultrasonic
- audio transducer
- sonar
- hydrophonic
- accelerometer
- high-voltage generator

Capabilities

- design/consultation
- MIL spec
- prompt delivery

(216) 232-8600



**Vernitron
Piezoelectric
Division**

232 Forbes Road
Bedford, OH 44146
TWX: 810-427-2274
FAX: 216-232-8731

CIRCLE 125

NEW PRODUCTS

SOFTWARE

REAL-TIME OPERATING SYSTEM SUPPORTS RISC AND CISC PROCESSORS

A real-time operating and development environment that supports a wide range of Intel and Motorola RISC and CISC microprocessors is now available with the introduction of OS-9000, from Microware Systems Corp. The OS-9000 operating system, of which 95% is written in C to maximize portability, is upwardly compatible with the company's popular OS-9 operating system.

Initially, the operating system will support Motorola's 68020, 68030, and 68040, as well as Intel's 80386. Support for the Intel 80486, Motorola's 88000, and a variety of other RISC processors and will be available early next year. Also planned for early 1990 is support for ISDN as well as a variety of loosely- and tightly-coupled VMEbus multiprocessor architectures.

Among OS-9000's more powerful features is its scalable, modular architecture. By selecting appropriate kernel, file-management, utility, and development modules, designers can take advantage of an assortment of operating-system configurations from a standalone kernel that can reside in ROM to a full-blown multi-user development system. In addition, it can run on networks, using Ethernet, Arcnet, and serial communications with TCP/IP and SLDC protocols. Users can also build their own library functions if they want to add to the existing library.

The operating system is available immediately in both industrial and professional versions. The industrial version includes the real-time kernel, interprocess communication, and console managers. In OEM quantities, it sells for \$350. The professional version starts at \$650, also in OEM quantities. This version adds disk and tape support, over 70 utility commands, and a C compiler to the industrial package.

Microware Systems Corp., 1900 N.W. 114th St., Des Moines, IA 50322; (512) 224-1929.

CIRCLE 326
RICHARD NASS

PROGRAMMING ENVIRONMENT LINKS MIDDLE-TO BACK-END ADA DEVELOPMENT TOOLS

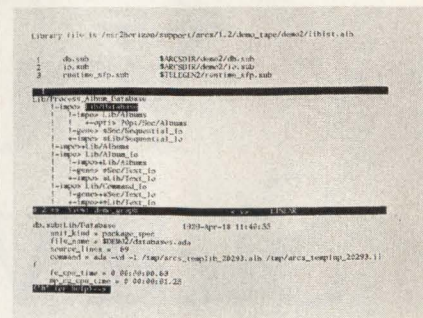

TeleArcs, a programming environment for the TeleGen2 Ada Compilation System, tightly integrates the Ada-sensitive tools needed for the detailed design, development, and test stages of the software lifecycle. TeleArcs, from TeleSoft AB, runs with the TeleGen2 Ada program library, using its inherent database facilities to accumulate information about the user software. It lets the developer view, access, and maintain the software at many different levels.

The toolset consists of an Ada language editor, an Ada library with browsing capabilities, a program debugger, and interactive cross-referencing features. With the browsing feature, users can view program units and import certain relationships.

The interactive system emphasizes its user-friendliness. For example, if the programmer changes a particular variable, TeleSoft will let him know what else must be changed to maintain the correct syntax. This enables quick and easy changes to the software. The user can also customize this interface.

The built-in editor processes the code with syntax checking, error feedback, Ada code formatting, and hierarchical text presentation.

Available for the VAX/VMS and Sun-3 platforms, prices range from \$4500 to \$37,500, depending on configuration.

TeleSoft AB, 5959 Cornerstone Court West, San Diego, CA 92121; (619) 547-2700.

CIRCLE 327
RICHARD NASS



School of American Ballet student performance: Merrill Ashley. Copyright: Martha Swope, 1967.

Thanks to the Library, American dance has taken great leaps forward.

American dance is more popular than ever, and one of the reasons is The New York Public Library's Dance Collection.

Choreographer Eliot Feld says the Library at Lincoln Center is "as vital a workroom as my studio." Agnes de Mille says, "the revival of any work is dependent on access to the Library's Dance Collection."

And they're not the only ones. For dancers and choreographers everywhere, over 37,000 volumes, 250,000 photographs, and an enormous film archive have been essential elements in the renaissance of American dance.

That's just one way The New York Public Library's resources serve us. The Library offers plays and puppet shows for children, programs for the elderly and disabled, extensive foreign language and ethnic collections, and scientific journals vital to the business community.

Again and again, the Library enriches our lives.



The New York Public Library
WHERE THE FUTURE IS
AN OPEN BOOK

ELECTRONIC DESIGN

Advertising Sales Staff

Publisher

Paul C. Mazzacano
Hasbrouck Heights, NJ; (201) 393-6000
San Jose, CA; (408) 282-7080

National Sales Manager

Andrew M. Dellins
San Jose, CA; (408) 282-7052

Hasbrouck Heights

Judith L. Miller, Stan Tessler
Sales Support Supervisor: Betsy Tapp
Ten Holland Dr.
Hasbrouck Heights, NJ 07604; (201) 393-6000
TWX: 710-990-5071

Boston:

Ric Wasley
400-2 Totten Pond Road, Suite 200
Waltham, MA 02154; (617) 890-0891

Colorado:

Lou Demeter (408) 282-7050

Chicago/Midwest:

Russell Gerches
Sales Assistant: Susan Johnson
2 Illinois Center Bldg., Suite 1300
Chicago, IL 60601; (312) 861-0880

Arizona:

James Theriault (408) 282-7074

Los Angeles/Orange County/San Diego

Ian Hill, Robert Zaremba
Sales Coordinator: Debi Neal
16255 Ventura Blvd. Suite 301
Encino, CA 91436; (818) 990-9000

Pacific Northwest:

Bill Giller (408) 282-7049

San Jose:

Lou Demeter (408) 282-7050
Bill Giller (408) 282-7049
James Theriault (408) 282-7048
Sales Administrator: Amber Hancock
1625 The Alameda, Suite 900
San Jose, CA 95126; (408) 282-7040

Texas/Southeast:

Bill Yarborough
555 Republic Dr., Suite 200
Plano, TX 75074; (214) 422-9775

Eastern National Accounts Manager:

John French
400-2 Totten Pond Road, Suite 200
Waltham, MA 02154; (617) 890-9775

Western National Accounts Manager:

Eric Singer
1625 The Alameda, Suite 900
San Jose, CA 95126; (408) 282-7002

Direct Connection Ad & DAC Sales Representatives:

Jeanie Griffin (201) 393-6382

Eastern Canada:

Ric Wasley (617) 890-0891

Austria, Belgium, Holland, Switzerland, Germany:

W.J.M. Sanders, S.I.P.A.S.
Oosterpark 6-P.O. Box 25
1483 ZG DeRyp, Holland
Phone: 02997-1303
Telex: 13039 SIPAS NL
Telefax: (02997)-1500

France:

Gerard Lasfargues
32 rue Desbordes Valmore
75116 Paris, France
Phone: (1) 45 04 97 94

Japan:

Hirokazu Morita
Mizuno Bldg., 1-2-3,
Kanda Jimbo-cho,
Chiyoda-Ku, Tokyo 101 Japan
Phone: (03) 219-5381

Korea:

O Kyu Park
World Marketing Inc.
C.P.O. Box 4010, Seoul, Korea
Phone: 776-5291-3, Telex: WLDKMG K25209

Taiwan:

Owen Wang, Ace Media Agency, Inc.
Rm. 503, 1, Fu Hsin S. Rd, Sec. 1
Taipei, 10587, Taiwan, R.O.C.
Phone: (02) 751-3636, Telex: 14142 ACEGROUP

United Kingdom/Scandinavia/Israel:

Paul D. Dimmock
Intergroup Communications
286 West Barnes Lane
New Malden, Surrey KT3 6LU, England
Phone: 01-949-0354, Telex: 291561

your    

POWER Specialists

AC LINE FILTERS

EMISSION LEVELS
FCC A & B
VDE A & B



- *POWER ENTRY MODULES..... 3-10 Amp
- *THREE-PHASE..... 3-70 Amp
- *MEDICAL/PATIENT CARE..... 3-20 Amp
- *SINGLE-PHASE, HIGH CURRENT.. 15-45 Amp
- *CUSTOM DESIGN..... 3-100 Amp

SWITCHING POWER SUPPLIES

LOW COST
SMALL SIZE



UNIVERSAL INPUT	SWITCHABLE INPUT
95-260 Volt	115-220 Volt
UV330 Series/30W	MF330 Series/30W
UV340 Series/40W	MF339 Series/40W
UV365 Series/65W	BM Series/150,220W
UV385 Series/85W	TABLETOP 30W,40W

*CUSTOM DESIGN

DC/DC CONVERTERS

LOW COST
CUSTOM DESIGN



- *200Z Series
-DISPLAY APPLICATIONS
- *949Z,950Z Series
-TELECOMMUNICATIONS
- *TDA,TDB Series
-LOCAL NETWORK



TRI-MAG, Inc.

CIRCLE 128

8210 W. DOE AVE.
VISALIA, CA 93291
(209) 651-2222

ITT TELEX NUMBER:4994462
CABLE ADDRESS:TRIMAG
FAX 209-651-0188

NEW 1.8 WATT INDUSTRY STANDARD DC/DC CONVERTERS

• Low Cost • Low Noise • High MTF

We've just introduced a low-cost version of *Industry Standard* 1.8 Watt regulated single- and dual-output DC/DC converters. At just \$31.75* each in 100s, our new PWR60XX series is *setting new standards* for price and performance, and buyers are beating a path through our doors. Maximum ripple and noise for these 1" x 2" x 0.4" devices is just 25mVp-p, and line/load regulation is 1%. Best yet, the series offers a calculated MTF of over 106 years. (MIL-HDBK-217, Rev. E, +25°C, ground benign, circuit-stress analysis method).

The series also features a voltage accuracy of $\pm 2\%$ max and a temperature range of -25°C to $+70^{\circ}\text{C}$ with no derating. When you add 500VDC isolation, short circuit protection, internal input/output filtering, a low EMI transformer design, and thermal shutdown protection, you have a real price/performance bargain that can't be beat.

For complete details, write Burr-Brown Corp., P.O. Box 11400, Tucson, AZ 85734. Or, call toll-free 1-800-548-6132.

*USA OEM price in 100s.



CIRCLE 126

NEW PRODUCTS

SOFTWARE

PROGRAM FOR MACINTOSH ANALYZES IMAGES

A software package provides powerful image processing when used with the QuickCapture frame grabber board and a Macintosh II. The Image Analyst program measures areas within an image, analyzes shapes, counts objects, and measures angles and distances. It also filters images to enhance them and analyzes the gray level content of images by performing histograms. Image Analyst supports all QuickCapture functions, including its 256 gray levels and 1:1 pixel aspect ratio. Its powerful functions are accessed with the standard Macintosh interface of pull-down menus, windows, and icons. Image Analyst sells for \$1995; the QuickCapture board is priced at \$1595.

Data Translation, 100 Locke Dr., Marlboro, MA 01752; (508) 481-3700.

CIRCLE 341

MATH SOFTWARE BREAKS 640-KBYTE RAM BARRIER

The latest version of PC-Matlab, an interactive software package for scientific and engineering numeric computation, breaks the 640-kbyte memory barrier for 80286-based personal computers. Version 3.5 runs in PC AT protected mode to support up to 15 Mbytes of installed extended memory. It also provides new functions for digital signal processing, filter design and analysis, and spectral analysis. Additional functions introduced in PC-Matlab V3.5 include solution of ordinary differential equations and systems of nonlinear equations, numerical function integration, unconstrained nonlinear optimization, complete elliptic integral of the first kind, Jacobi elliptic functions, and other numeric techniques. The interpreter itself has been optimized to perform scalar operations 2 to 10 times faster than the previous version of PC-Matlab. It is available immediately and sells for \$695.

Math Works Inc., 21 Eliot St., South Natick, MA 01760; (508) 653-1415.

CIRCLE 342

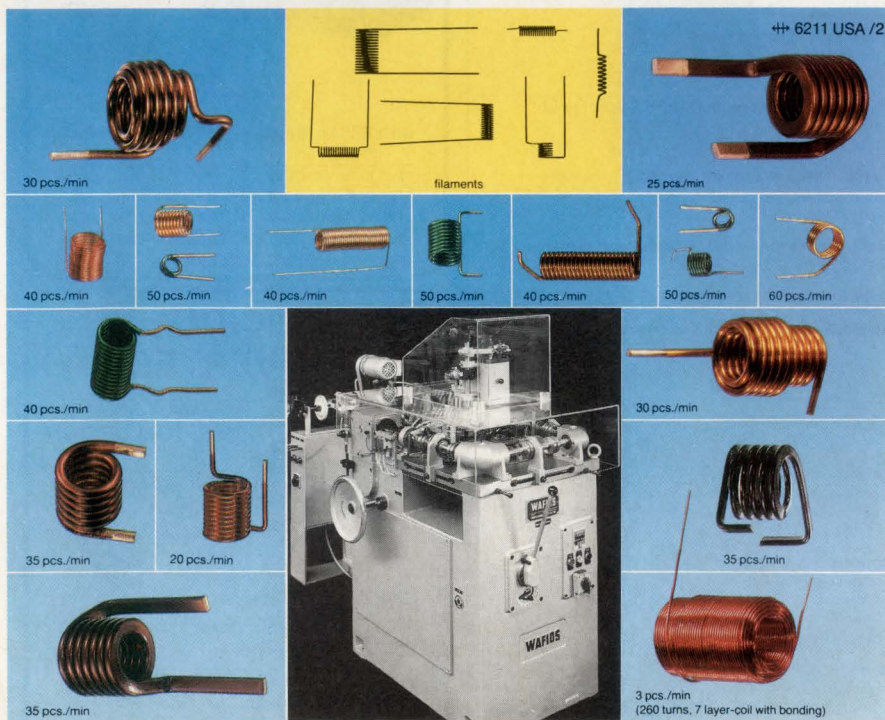

**For manufacture of single- and multi-layer coils and chokes:
WAFIOS Series FTU-97: \varnothing 0.3–3.5 mm (.012"–.138")**

Insulation stripping at the ends of the legs. Automatic bonding and soldering.

WAFIOS

Also with CNC-Control!
Any number of coils!

MACHINERY CORPORATION · P.O. B. 148, BRANFORD, CT 06405 · TEL. 203/481-5555 · TX 963556
CIRCLE 127

Coilcraft Designer's Kits

**First they save you time.
Then they save you money.**

These kits make it easier than ever to pick the right coils, chokes and other magnetics for your project.

Why waste hours calling around

for samples or trying to wind them yourself. Coilcraft's low-cost kits put dozens of values right at your fingertips!

You not only save time on engineering. You also save money when you go into production

because we stock just about all the parts in our kits at low off-the-shelf prices.

Call in today, and you can have your kit tomorrow!

To order, phone 800/322-COIL (in Illinois 312/639-6400).

"Unicoil" 7/10 mm Tuneable Inductors

.0435 μ H - 1.5 μ H
49 shielded, 49 unshielded (2 of each)
Kit M102 \$60

"Slot Ten" 10 mm Tuneable Inductors

0.7 μ H - 1143 μ H
18 shielded, 18 unshielded (3 of each)
Kit M100 \$60

Surface Mount Inductors

4 nH - 33 μ H
48 values (10 of each)
Kit C100 \$125

Axial Lead Chokes

0.1 μ H - 1000 μ H
25 values (5 of each)
Kit F101 \$50

Horizontal Mount Inductors

Tuneable and fixed
Inductance: 31.5 - 720nH
33 Values (6 of each)
Kit M104 \$60

Common Mode Data Line Filters

Attenuation bandwidth: 15 dBm, 1.5-30 mHz
DC current capacity: 100 mA
2, 3, 4 and 8 line styles (4 of each)
Kit D101 \$65

Common Mode Line Chokes

Current: .25 - 9 amps RMS
Inductance: 508 μ H - 10.5 mH
8 styles (2 of each)
Kit P202 \$100

Current Sensors

Sensing range: 0.5-35 amps
Freq. resp.: 1 - 100 kHz, 50 - 400 Hz
Transformer and sensor-only versions
8 styles (15 total pieces)
Kit P203 \$50

Base/Gate Driver Transformers

Inductance: 1.5 mH Min.
Frequency: 10 - 250 kHz
2 single, 2 double section (2 of each)
Kit P204 \$50

Mag Amp Toroids

Current: 1, 5 amps
Volt-time product: 42 - 372 V- μ sec
6 styles (2 of each)
Kit P206 \$100

Power Filter Chokes

Current: 3, 5, 10 amps
Inductance: 5 - 300 μ H
18 styles (48 total pieces)
Kit P205 \$75

Axial Lead Power Chokes

Current: .03-4.3 amps
Inductance: 3.9 μ H - 100 mH
60 styles (2 of each)
Kit P209 \$150

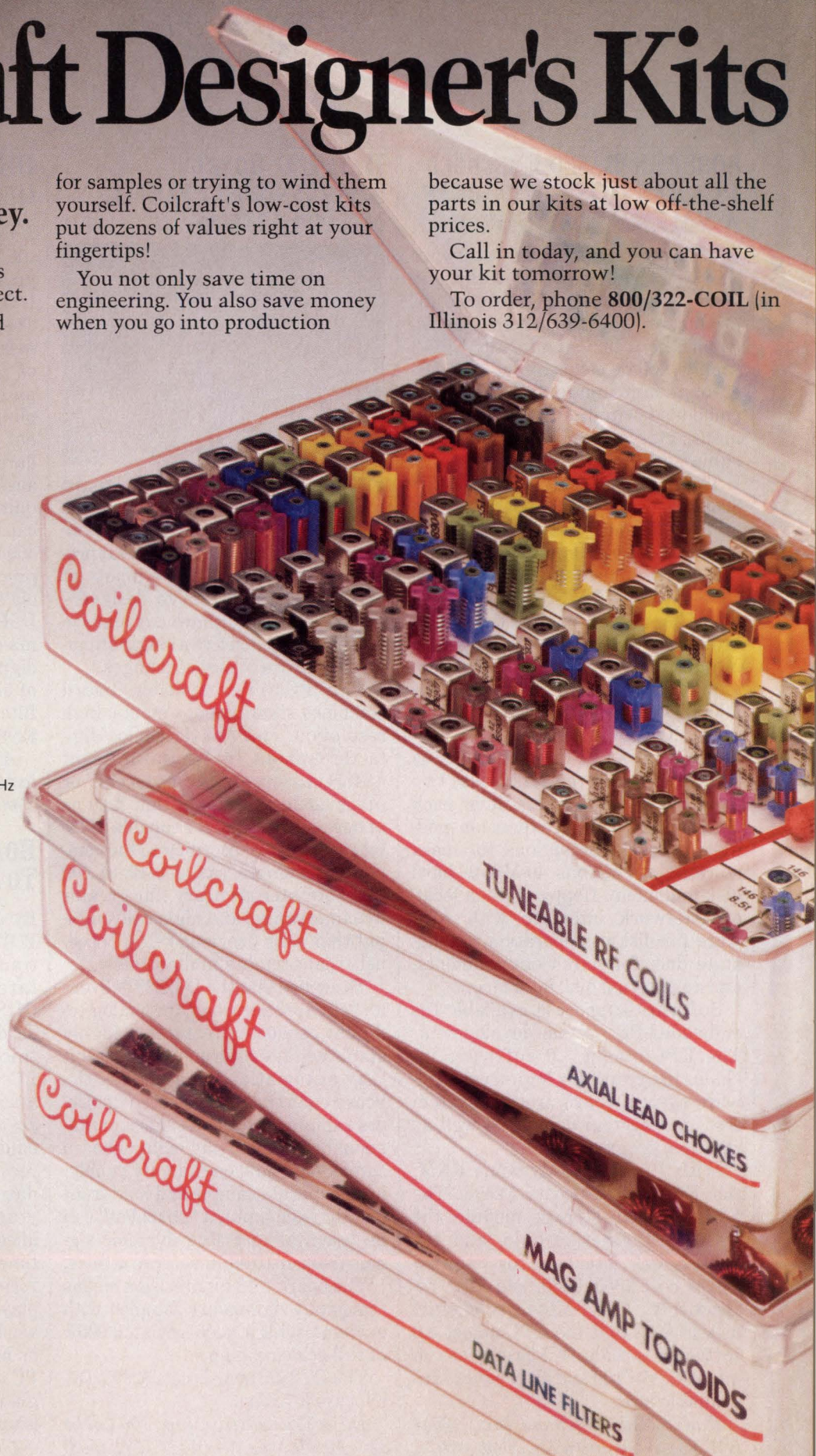

Coilcraft

OEM/electronic engineers master See our catalog in Vol. A, Section 1800

1102 Silver Lake Road, Cary IL 60013 800/322-COIL Fax 312/639-1469

NEW PRODUCTS

COMPUTER BOARDS

80386SX-BASED EMBEDDED PCs RUN DOS SOFTWARE IN A VMEBUS FORM FACTOR

Users can run their PC software in a rugged VMEbus system with a family of embedded-PC products from Radix Microsystems. Applications targeted for the EPC-3 family include a controlling computer or a human-interface computer embedded within automated equipment, medical systems, and test equipment.

The EPC-3 family includes the 80386SX-based CPU board, disks, and an assortment of expansion modules. High-density packaging made it possible to squeeze the entire CPU into one VME slot. The CPU board handles all the functions of an ordinary PC, and includes up to 4 Mbytes of dynamic RAM, an optional math coprocessor, serial and parallel I/O ports, a keyboard interface, and a VGA controller.

Thanks to an EPC-module sub-bus structure called the EXM bus, two expansion modules can fit in each VMEbus slot. EPC-3 expansion modules include four options for mass storage: a VMEbus 40-Mbyte hard disk and 3.5-in. floppy drive, a local-area-network interface with software for diskless operation, a solid-state disk for harsh environments, and an external disk interface.

Software support is available for embedded-PC system development. The EPCconnect 3.0 software includes programs for high-level hardware system configuration, system test, and system debug, as well as run-time programs.

With 1 Mbyte of dynamic RAM, the EPC-3 CPU costs \$2595. The EXP-MS mass-storage module, the EXM-1 Ethernet module, and the EXM-3 disk interface for external drives cost \$850, \$380, and \$260, respectively. The 1-Mbyte solid-state disk is \$590 and the EPCconnect 3.0 software is \$300. All prices are in quantities of 100 and all products are available now.

Radix Microsystems Inc., 19545 NW Von Neumann Dr., Beaverton, OR 97006; (503) 690-1229. CIRCLE 328

LISA GUNN

DATA-I/O BOARD SIMULTANEOUSLY SAMPLES MULTIPLE INPUTS

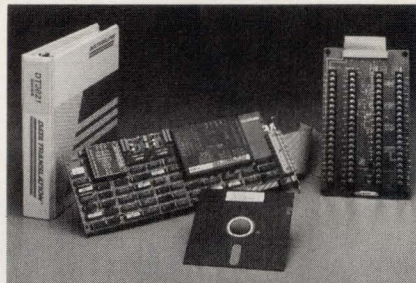

The DT2829 data-I/O board from Data Translation makes it possible to sample several inputs at the same time with great precision. Sampling multiple inputs at one time is important to designers who need to simultaneously analyze multiple responses to a single stimulus despite rapid signal changes.

The PC/AT-compatible board combines simultaneous inputs, high resolution, and 30-kHz analog-digital throughput. It can measure eight different sensors, transducers, or other analog signals within ± 20 ns of one another, and it's capable of 16-bit resolution. According to the company, designers can get 10 to 100 times greater accuracy, far greater dynamic range, and higher throughput than with previous PC/AT products that sample simultaneously.

To assure that the DT2829 delivers its full rated accuracy, the analog-to-digital converter features a highly stable voltage reference and a circuit that automatically calibrates the board each time it's powered up. Users sample multiple signals simultaneously by employing eight onboard sample-and-hold circuits. By supplying a separate sample-and-hold front end for each input, a "snapshot" can be taken of incoming dynamic signals from up to eight sensors at once.

The board's 16-bit precision means that input signals are sampled with extremely high accuracy ($\pm 0.006\%$ of full-scale reading).

The DT2829 board costs \$2995. Delivery is in 5 days.

Data Translation Inc., 100 Locke Dr., Marlboro, MA 01752-1192; (508) 481-3700. CIRCLE 329

CLIFFORD METH

DSP CARD PROVIDES QUALITY AUDIO I/O

A digital signal processing card for the IBM PC provides dual-channel professional-audio-quality analog I/O, as well as advanced digital I/O. The DSP-56's two 16-bit input channels permit simultaneous sampling of full audio bandwidth stereo signals with software-selectable sampling rates of up to 100 kHz per channel. Crystal-generated audio standard rates of 32, 44.1, and 50 kHz are also provided. For applications requiring higher sampling, the DSP-56 can acquire a single channel at up to 400 kHz while maintaining 12 bits of precision. The board employs Motorola's DSP56001, a 24-bit, 10.25-MIPS DSP chip, and the DSP56ADC16 sigma-delta oversampling analog-to-digital converter. In addition, a pair of ninth-order elliptic reconstruction filters are included. It is priced at \$2995.

Ariel Corp., 433 River Rd., Highland Park, NJ 08904; (201) 249-2900. CIRCLE 343

BOARD SYNCHRONIZES PC TO ATOMIC CLOCK

By decoding time information from WWV and WWVH radio signals transmitted by the National Institute of Science and Technology (NIST), the Computer Time Standard, or CTS-10, provides reliable, traceable, and accurate time for IBM PCs and compatibles. These signals are synchronized to the NIST atomic standard, allowing any CTS-10-equipped PC to incorporate the correct time. It automatically accommodates daylight-saving time, leap years, leap seconds, and other anomalies. The plug-in board also permits time zone selection, 12- or 24-hour formats, adjustable on-screen display, and color selection. The CTS-10 works on any PC running DOS 2.10 or higher. It plugs directly into the PC and maintains the PC clock. Single unit pricing, including software, is under \$200.

Coordinated Time Link, 921 Bluebonnet, Sunnyvale, CA 94086; (408) 738-2862. CIRCLE 344

**NOW! STOCK TO
6 WEEK DELIVERY ON**



MEGABIT MEMORIES



...in a 32-pin DIP!!

We've just packed a lot of CMOS memory into a single 32-pin DIP. You can now have 1 megabit (128Kx8) or 2 megabit (256Kx8) in SRAM or EEPROM with industrial or military temperatures. Our new high-density hybrid memories give you a choice. You'll also find that they'll lower your costs, save you board space, and conserve power, too.

Our rugged 1.6" x 0.6" ceramic package with JEDEC standard pinouts is brand new. Its welded metal cover and co-fired construction assures maximum integrity and hermetic seal, and lends itself to the most demanding industrial and military applications. MIL-STD-883 screening is available.

Want more? The EEPROMs offer a 10 Year Data Retention after write, and automatic page write option with internal address and data latches for up to 512 bytes, and 1 to 64 bytes/pages, up to 8

pages. Page write only 3.0mSec/page. And, there's data polling for end of write detection, and hardware and software data protection, too. Read access time is 150nSec.

The SRAMs include data retention with voltages down to 2.0 volts, read/write cycle compatibility with almost all microprocessors, and read access and write cycle times of 120nSec.

If 1 or 2 Megabit isn't enough, our 4 Megabit (512x8) will be out soon in the same 32-pin DIP. We also offer a range of access times down to speeds less than 50nSec, and memory capacities into the terabit region. Or, if you want to talk about products like a complex single-package system, a supercomputer array, or a totally defined multi-package management information system, give us a call. Your design or ours, we'll make it happen.

**CERTIFIED TO
MIL-STD-1772**

CIRCLE 66

White Technology, Inc.

A wholly owned subsidiary of Bowmar Instrument Corporation
4246 E. Wood Street • Phoenix, Arizona 85040 • (602) 437-1520
FAX 602-437-9120 • TWX 910-951-4203

NEW PRODUCTS

COMPUTER-AIDED ENGINEERING

AUTOMATED MULTILAYER-BOARD DESIGNS NOW INCLUDE HYBRID CIRCUITS

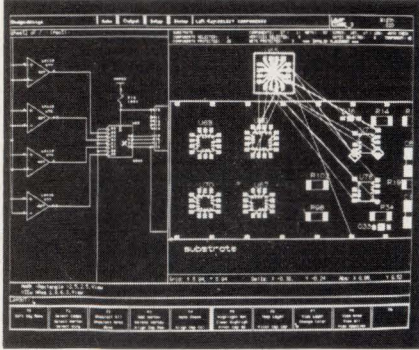

Hybrids are found in almost every aspect of electronic circuitry. They are seen in computers, automobiles, and in the aerospace, military, ATE, and medical industries. For this reason, Mentor Graphics, Beaverton, Ore., has developed the Hybrid Station, a fully automated system for the design of

thick-film hybrid circuits. This includes single-layer, multilayer, and cofired ceramic boards.

Because the Hybrid Station is fully integrated with Mentor's set of electronic-design-automation tools, engineers can design and simulate an entire system containing hybrids within one environment. The tools offer schematic entry, simulation, thermal analysis, packaging, and post-layout functions.

Some unique features of the tools include blind, buried, and staggered vias, automatic resistor generation, chip and wire bonding, up to 255 process layers, and dielectric checking.

Shipment of the Hybrid Station will begin in October for Apollo DN3500, DN4500, and DN10000 platforms. Pricing begins at \$102,000.

Mentor Graphics Corp., 8500 S.W. Creekside Pl., Beaverton, OR 97005; (503) 626-7000. **CIRCLE 330**

RICHARD NASS

SIMULATOR HANDLES 65,000 EVENTS/S

Version 1.2 of the OrCAD/VST PC-based logic simulation package is capable of performing 65,000 events/s running on a 20-MHz 80386 machine. Other enhancements to the simulator include a 20% increase in library parts (bringing the total device count to 1750) and more efficient tracing of internal and logic nodes. OrCAD/VST can also work with OrCAD's simulation modeling program, OrCAD/MOD. This optional product accepts an industry-standard Jeduc file and allows VST to simulate multiple PLDs within the design environment. VST is priced at \$995, with free updates to all registered users of VST 1.1 under warranty.

OrCAD Systems Corp., 1049 S.W. Baseline St., Suite 500, Hillsboro, OR 97123; (503) 640-9488.

CIRCLE 360

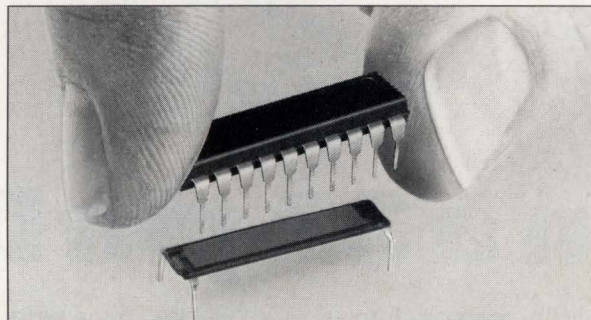

NO MORE NOISE!

Rogers' Micro/Q®1000 decoupling capacitors mated with your IC dramatically reduce voltage noise spikes and EMI/RFI.

The close proximity of the capacitor to the IC maximizes noise suppression. Same holes. Same space. No redesign.

Low inductance means low impedance over a wide frequency range. Makes the Micro/Q 1000 capacitor super effective at decoupling a wide bandwidth of frequencies with the following types of ICs: DRAMs, SRAMs, Video RAMs, EPROMs, MPUs, Bus Drivers/Buffers, and various logic families. Available on 0.3", 0.4", and 0.6" body widths with various pinouts and lengths.

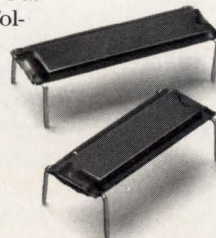

Micro/Q® is a registered trademark of Rogers Corporation. Another MEKTRON® Interconnection Product.

A quiet relationship. That's making a lot of noise around the industry. Micro/Q 1000 and you.

For all the facts on the Micro/Q 1000 capacitors call a Rogers' Product Specialist today at (602) 967-0624. (Fax 602-967-9385). And ask for a free sample.

Technology for tomorrow built on TQC today.



ROGERS

Rogers Corporation
Circuit Components Division
2400 S. Roosevelt Street
Tempe, AZ 85282

CIRCLE 103

NEW PRODUCTS

COMMUNICATIONS

CHIP LINKS DATA-COMMUNICATION EQUIPMENT TO T1, CEPT ISDN LINES

An efficient, cost-effective means of connecting data-communication equipment to either domestic T1 (1.544 Mbits/s) or European CEPT (2.048 Mbits/s) transmission facilities for ISDN service is now available from AT&T Microelectronics. The T7115 synchronous protocol data-formatter IC serves as the ISDN primary-rate interface in various hardware, such as front-end processors, host computers, PBXs, T1 multiplexers, cluster controllers, and high-end workstations.

The chip can be used in any application where many high-level data-link-control (HDLC) channels must be terminated. According to the company, the chip is the only one of its kind that enables ISDN-network operators or T1-multiplexer vendors to dynamically allocate the amount of bandwidth to customers, depending on their needs. As a result, equipment vendors can easily implement and offer fractional and full T1 capability.

All HDLC functions are performed by the chip, including the generation and checking of flags, CRC, and abort and idle codes. These functions are provided for 24- or 32-time-slot transmissions modes.

In addition, the device offers full memory management and DMA capability for each active channel, of which there can be 32. Multiple receive and transmit packets are queued in separate linked lists for each channel, which relieves much of the overhead on the resident CPU. This eases implementation of the upper layers of the Open System Interconnect protocol stack.

The T7115 IC comes in a 68-lead plastic leaded chip carrier. It costs \$75 each in small volumes and \$55 each in lots of 10,000. Small lots are delivered from stock.

AT&T Microelectronics, Dept. 52AL330240, 555 Union Blvd., Allentown, PA 18103; (800) 372-2447.

CIRCLE 331

DAVID MALINIAC

MODEM COMPRESSES DATA THREE-TO-ONE

In addition to CCITT V.25 bis and V.42 capabilities, the MultiModem 224EH7 provides users with MNP Class 7 data compression. When operating in the V.42 MNP mode, 3:1 data compression can be achieved. The 2400-bps modem performs V.25 bis dialing and V.42 error correction. By combining MNP Class 7 data compression with MNP Class 4 error correction (part of V.42), accurate data throughput is increased dramatically. MNP Class 7 data compression adds a run-length encoding technique to the compression algorithm that takes into account the recurrences of character sequences in transmissions and adjusts the code accordingly. This technique is similar to what the proposed V.42 bis standard will eventually incorporate, but is available now in the 224EH7.

Multi-Tech Systems Inc., 2205 Woodale Dr., Mounds View, MN 55112; (612) 785-3500. CIRCLE 345

TWO-SPEED MODEM PLUGS INTO PS/2

Designed for the IBM PS/2, a plug-in board combines the functions of three separate boards: a 2400-bps Bell-201-compatible synchronous modem, a 4800-bps Bell-208-compatible synchronous modem, and an SDLC communication adapter supporting multiple SNA protocols. With the AdaptModem/2 Model 4800, users can dial up host mainframes and other PCs or PS/2s which have either 201- or 208-compatible modems. The dual-speed modem eliminates the need to install two separate modems, as well as an SDLC board. It can be used with Network Software Associates' AdaptSNA software to achieve PS/2-to-host connectivity across all major SNA protocols. The board carries a price tag of \$1195; software ranges from \$245 to \$785.

Network Software Associates Inc., 39 Argonaut, Laguna Hills, CA 92656; (714) 768-4013.

CIRCLE 346

Over 600 standard
PICO Ultra-Miniature
DC-DC Converters
DELIVERY—STOCK TO ONE WEEK



from .3" ht.
1 to 20 Watts

- Input Voltages of 5, 12, 24, 28 and 48V DC Std.
- 129 New Wide Input Range Units (5 to 60V DC)
- Single and Dual Output
- 1 to 30 Watts Output Power
- Isolation, 500V DC input/output
- New High Voltage Models 100–250 Volt Output
- Over 100 Models with 28 Volt Inputs and Outputs
- 180 Regulated Models
- Ultra-Miniaturized Encapsulated Package (.3" height)
- Ambient Temp. Range –25°C to +70°C with No Heat Sink or Electrical Derating
- Optional Environmental Screening per MIL-STD-883
- Expanded Operating Temperature Range Available (–55°C to + 85°C ambient)

New M Series-Single and Dual Outputs. Up to 1.25 Watts. All JAN/TX Military Components.

Delivery—stock to one week

SEE EEM, GOLD BOOK OR THOMAS REGISTER FREE PICO CATALOG

PICO
Electronics, Inc.

453 N. MacQuesten Pkwy. Mt. Vernon, N.Y. 10552

Call Toll Free 800-431-1064
IN NEW YORK CALL 914-699-5514

CIRCLE 129

**HIGH-DEFINITION GRAPHICS
ICS GET MIL-SPEC RATING**



Five graphics ICs from **Brooktree Corp.** (San Diego, Calif.) now comply with MIL-STD-883C specifications. Included in the new monolithic CMOS offerings are two video d-a converters, two RAM d-a converters, and a clock generator. The two video d-a converters are the 30-MHz, triple 8-bit Bt101/883 and the 50-MHz, single 8-bit Bt102/883. Both devices have pipelined operation with extremely low differential and integral linearity-error levels. The two RAM d-a converters are the Bt453/883 40-MHz, 256-by-24 color palette and the Bt458/883 125-MHz, 256-by-24 color

palette. These pipelined products support up to 259 simultaneous colors from a 16.8-million color palette. The Bt438/883 125-MHz clock-generator chip is designed for the RAM d-a converters.

CIRCLE 347

**ASIC DESIGN TOOLS RUN
ON DEC WORKSTATIONS**

The Modular Design Environment (MDE) software from **LSI Logic** (Milpitas, CA) now runs on Digital Equipment Corp.'s RISC-based workstations. The MDE is a set of software tools used to design ASICs, from system definition, architectural design, and design implementation to chip verification. The tools ease the design of array- and cell-based ASICs ranging from single, low gate-count devices to complex, multi-ASIC systems. The price per node starts at \$35,000.

CIRCLE 348

**CAE/CAD TOOLS MERGE
IN OEM AGREEMENT**

Thanks to an agreement with EDA Systems Inc., **Harris Scientific Calculations Division** (Fishers, N.Y.) is now incorporating EDA's framework software into its integrated automation toolset for printed circuit board design. With it, Harris SC can offer a common design and data-base environment for its schematic capture and simulation tools as well as its Scicards layout, thermal analysis, and drafting and documentation tools. The company also made an agreement with Viewlogic Systems Inc. to sell Workview Series I and II design capture and simulation software. Viewdraw, a design capture system, and Viewsim/SD, a simulation tool for mixed analog and digital circuits, have been integrated with the Harris Scicards system for pcb layout.

CIRCLE 349

**At half the price,
our current limiting diodes have
few limitations.**



Designing in our high reliability current limiting diodes makes a lot of sense.

They offer superior circuit performance, superior lot-to-lot consistency, and superior thermal characteristics . . . in a space-saving, hermetically sealed glass case. Motorola-equivalent leaded or SMD versions are available at about half the price. Special selections also available.

Available Types:

- 1N5283 THRU 1N5314 (leaded).
- CCL0035 THRU CCL5750 (leaded).
- CMCL1300 THRU CMCL 1304 (leaded).
- CCLM0035 THRU CCLM5750 (SMD).

Pencil in Central. For more information, write or call.

Central Semiconductor Corp.

Central: We make the difference.
145 Adams Avenue, Hauppauge, NY 11788
Phone (516) 435-1110 FAX (516) 435-1824

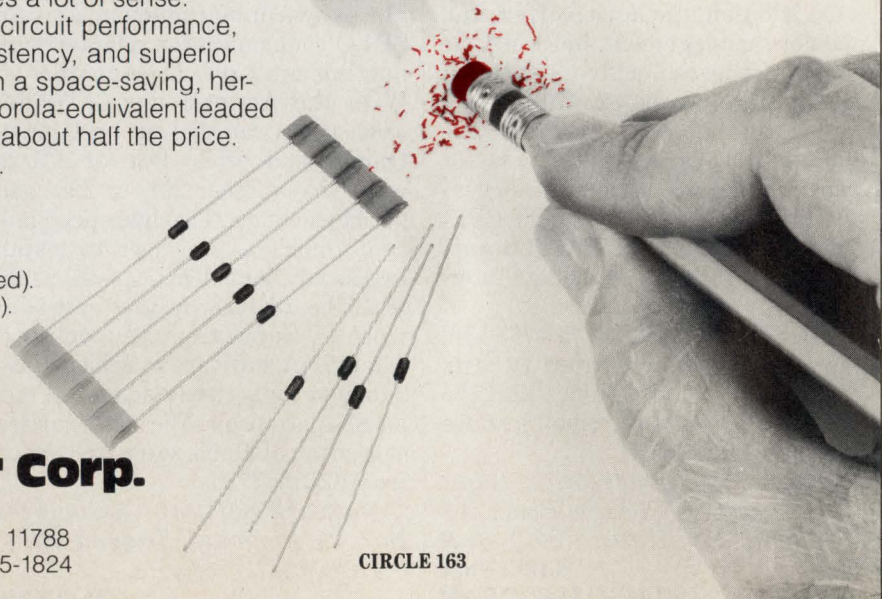

CIRCLE 163

DATA BOOK DESCRIBES 883B ANALOG ICs

Containing over 500 pages of technical information, Burr-Brown's *Military Products Data Book, Vol. 1*, provides a look at the company's broad line of 883B, SMD, and DESC (Defense Electronics Supply Center) analog microcircuits. Devices are offered in both packaged and die forms and include more than 80 high-performance op amps, power amps, data converters, multiplexers, instrumentation amps, multipliers, and voltage-to-frequency converters. The book also describes the company's DESC-certified facilities, monolithic and hybrid process flows, and quality assurance programs.

Burr-Brown Corp., P.O. Box 11400, Tucson, AZ 85734; (800) 548-6132 or (602) 746-1111. CIRCLE 350

SELECTOR GUIDE LISTS PROGRAMMABLE DEVICES

Updated quarterly, Logical Devices' *Spring 1989 Master Device List* features over 2000 programmable devices organized by manufacturer and device architecture. The 50-page booklet supplies information on device technology, including number of pins, array size, and voltage. Additionally, the listing specifies the Logical Devices' programmer that supports each device (or if future support is planned). The selection guide can also be obtained on 5-1/4-in. disks.

Logical Devices Inc., 1201 N.W. 65th Pl., Fort Lauderdale, FL 33309; (800) EE1-PROM or (305) 491-7404. CIRCLE 351

GLOSSARY DEFINES VISION, IMAGING TERMS

A 19-page glossary of microcomputer vision and imaging terms provides nearly 230 definitions. These include such areas as image capture, manipulation and analysis, microcomputer systems, and imaging software.

MetraByte Corp., 440 Myles Standish Blvd., Taunton, MA 02780; (508) 880-3000. CIRCLE 352

DETECTION AND SENSING COMPONENTS

A 14-page brochure provides an overview of Baumer Electric's line of electric sensors. It discusses the company's latest detection techniques and sensing solutions, including photoelectric sensors, incremental and absolute encoders, electronic and electromechanical switches, and inductive proximity sensors.

Baumer Electric Ltd., 122 Spring St., Southington, CT 06489; (203) 621-2121. CIRCLE 353

NON-CONTACT VIDEO INSPECTION SYSTEM

A full-color brochure presents the capabilities, benefits, and complete specifications of the Videoscope 3-D, a non-contacting video inspection system. Using system diagrams, inspection software menus, and other informative visuals, the literature outlines how the Videoscope addresses the dimensional inspection and flaw-detection requirements of quality control, manufacturing, production, and design departments. The vision system provides fully automatic measurements with accuracies from ± 0.0002 to ± 0.000001 in. and greater in a fraction of the time required with manual methods.

Videometrix Inc., an Agfa-Matrix Co., 5321 Sterling Center Dr., Westlake Village, CA 91361; (818) 707-0423. CIRCLE 354

COAXIAL CABLE SELECTION GUIDE

A brochure presents a line of coaxial cables engineered in a wide selection of materials, sizes, and shieldings. The cables are available in many configurations, including fiber-optic types and special hybrid LAN cables which include both fiber and copper components. All products are UL-listed and classified to conform to the National Electric Code for installation in air-handling plenums without conduit.

NEK Cable Inc., 2150 Fifth Ave., Ronkonkoma, NY 11779; (516) 588-0200. CIRCLE 355

IDC INTERCONNECTS ARE MILITARY-QUALIFIED

Military designers can now refer to a single catalog when specifying 3M military-qualified IDC components. The 35-page document lists components qualified under MIL-C-83505 and MIL-C-49055. The latter addresses round conductor flat cable used for IDC systems, while the former is the military specification for insulation displacement sockets and headers. All components appear on the qualified parts list. Cross references of military part numbers and national stock numbers are included.

3M, Department 89-57, P.O. Box 2963, Cedar Rapids, IA 52402; (512) 984-6708. CIRCLE 356

PIN AND SOCKET POWER CONNECTORS

A 24-page handbook on pin and socket connectors serves as a guide to choosing the right power connector for the application at hand. The booklet covers such factors as current rating, connector, wire, and circuit size, operating voltage, and materials and plating. Power connectors are cataloged along with their associated crimp tooling.

Molex Inc., 2222 Wellington Ct., Lisle, IL 60532; (312) 969-4550. CIRCLE 357

COAX INTERCONNECTS AND COMPONENTS

Technical data and pricing on more than 2000 standard items is provided in this informative catalog (# 1989a) of coaxial cable, switches, adapters, detectors, connectors, attenuators, terminations, and cable assemblies. The document also covers twinax adapters and connectors, as well as amplifiers, breakouts, cutting and stripping tools, programmable attenuators, push-button attenuators, and waveguide adapters. New products include adapters and connectors that utilize 3.5-mm, 7-mm, HN, N, SMB, SC, and SMA formats.

Pasternack Enterprises, P.O. Box 16759, Irvine, CA 92713; (714) 261-1920. CIRCLE 358

ELECTRONIC DESIGN'S DIRECT CONNECTION ADS

Can Be Colorful

Now, your ads in this section can be in eye-catching color*.
In Full Color In Two Colors

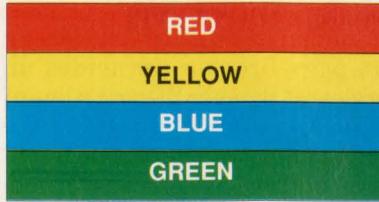
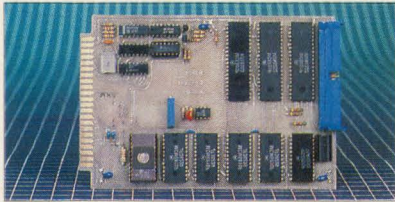

* Color Premiums: Full Color, \$250; Two Color, \$150

To get your ad in full color, just supply a color print, slide, or transparency and your copy. Or highlight your ad with one of the four colors above.

To place your order:
Call Jeanie Griffin at (201) 393-6382.

ANALOG CIRCUIT SIMULATION

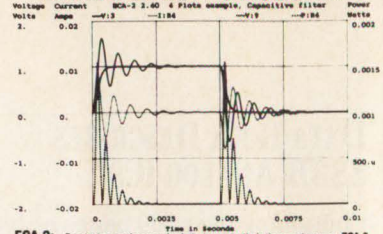

ECA-2: For design engineers who hate to waste their time and money, ECA-2 Electronic Circuit Analysis is a high performance, low cost, interactive analog circuit simulator. It reduces equipment expenses by eliminating the need for temperature chambers, signal generators, etc. Cuts weeks out of the design cycle time by simulating instead of prototyping. Available for a wide range of computers and operating systems.

- AC, DC, Transient Fourier, Temperature Worst-case, Monte Carlo
- Sine, Pulse, PWL, SFFM, and Exponential generators
- ECA-2 Offers
 - Built-in real time graphics
 - Multiple plots
 - Interactive or batch models
 - Online help
 - Full nonlinear simulator
- Frequently updated
- Over 500 nodes
- Money back guarantee
- SPICE compatible models
- 2 to 50 times faster than SPICE

ECA-2 2.40 IBM PC \$775

Turn-key Systems Available Call for more info and FREE DEMO disk

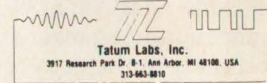

Tatum Labs, Inc.
3017 Research Park Dr. B-1, Ann Arbor, MI 48106, USA
313-963-8810

TATUM LABS

CIRCLE 251

ARE YOU STILL DRAWING FLOWCHARTS BY HAND?

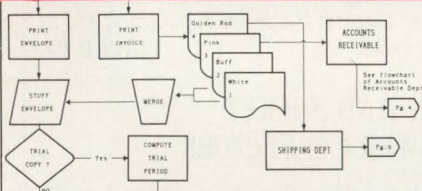

FLOW CHARTING II+

Flow Charting II+ will amaze you with its speed, power and simplicity.

- Update and print charts as fast as the situation changes
- See your revisions right away—no long wait for charts to be hand drawn
- Select 26 standard shapes; 10 text fonts
- Tutorial manual makes learning easy
- Runs on IBM or compatibles
- Produces excellent organizational charts!
- Only \$229!

PATTON & PATTON
Software Corporation

Excellence in charting the flow of ideas

For more information, see your local retailer or call
1-800-525-0082, ext. 43 (outside Calif.) 408-629-5376 (Calif./Int'l.)
81 Great Oaks Blvd., San Jose, CA 95119

PATTON & PATTON

CIRCLE 252



"The Best 8051 Emulator"

NEW 8XC751
support available now!

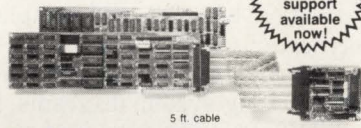

8051

See EEM 88/89
Page D-1304

PC based emulators for the 8051 family

- (8051/51FA/52/31/32/44/52/451/452/535/552/8XC751 + CMOS + more ...
- PC plug in boards or RS-232 box
- Pull-down menus combined with Command-Driven User Interface
- Context sensitive help and On-Screen Editing of data
- 20 MHz real time emulation
- 128K emulation memory
- 48 bit wide, 16K deep trace buffer with loop counter
- Program Performance analyzer
- Powerful Macros with IF-ELSE, REPEAT-WHILE structures
- Source Level debug for PLM-51 and C-51
- Symbolic debugging with in-line assembler and disassembler
- Execution time counter
- Trace can be viewed during emulation!

PRICES: 32K Emulator for 8031 \$1790; 4K Trace \$1495*

CALL OR WRITE FOR FREE DEMO DISK!

*U.S. only Ask about our demo VIDEO!

NOHAU
CORPORATION

51 E. Campbell Avenue
Campbell, CA 95008
FAX (408) 378-7869
(408) 866-1820

NOHAU CORP.

CIRCLE 253

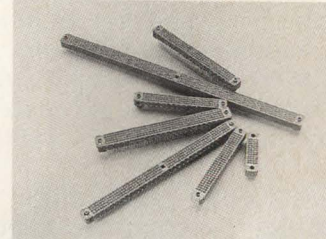

HIGH DENSITY - LOW INSERTION FORCE 48-490 POSITION HIGH REL PC CONNECTORS

KA/254 Printed Circuit Board Connectors are available with 4 row models with from 48 to 392 positions and 5 row models with from 230 to 490 positions. These connectors meet D55302 performance requirements. Crimp, flow solder, wirewrap®, and solder cup terminations are available on .100" x .100" grid spacing.

HYPERTRONICS CORPORATION

16 Brent Drive
Hudson, Massachusetts 01749
800-225-9228
(In Mass. & Canada (508) 568-0451)
FAX: 508-568-0680

HYPERTRONICS

CIRCLE 254

JDR Microdevices
2233 BRANHAM LANE, SAN JOSE, CA 95124

UNIVERSAL PROGRAMMER

PART OF OUR EXPANDABLE MODULAR SYSTEM. ALL MODULES USE THE SAME HOST ADAPTOR CARD. **\$499.99**

- PROGRAMS EPROMS, EEPROMS, PALS, BI-POLAR PROMS, 8748 & 8751 SERIES DEVICES; 16V8 AND 20V8 GALS FROM LATTICE, NS, SGS
- TESTS TTL, CMOS, DYNAMIC & STATIC RAMS
- LOAD DISK, SAVE DISK, EDIT, BLANK CHECK, PROGRAM, AUTO, READ MASTER, VERIFY AND COMPARE
- TEXTUOL SOCKET FOR .3" TO .6" IC'S (8-40 PINS)

MOD-MUP

MOD-MAC	HOST ADAPTOR CARD	\$29.95
MOD-MIC	DIGITAL IC TESTER MODULE	\$129.95
MOD-MPL	PAL PROGRAMMER	\$249.95
MOD-MMP	MICRO PROCESSOR PROGR.	\$179.95
MOD-MBP	BI-POLAR PROM PROGR.	\$259.95
MOD-MEP	1-EPROM PROGRAMMER	\$119.95
MOD-MEP-4	4-EPROM PROGRAMMER	\$169.95
MOD-MEP-8	8-EPROM PROGRAMMER	\$259.95
MOD-MEP-16	16-EPROM PROGRAMMER	\$499.95

Toll Free 800-538-5000
Call for a free catalog!

JDR MICRODEVICES

CIRCLE 255

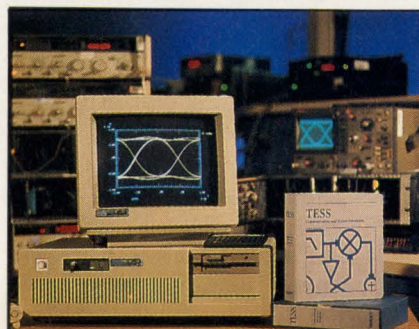

Communications Block Diagram Simulator for PCs

- TESS® simulates modems, radios, and other systems
- Built-in FFT spectrum analyzer, plus over 55 models: filters, mixers, VCOs, logic, A/D and lab equipment
- Capture schematics graphically with OrCAD® & PCAD®
- Add your own models to TESS easily using MODGEN
- Call for demo disk
- TESS is not copy protected

TESS Simulator \$495
MODGEN™ Model Generator \$245
OrCAD/SDT II® Part Library \$145
P-CAD® Part Library \$225

TESOFT
Roswell GA 30077-0305
404-751-9785 FAX 404-664-5817
VISA, MasterCard, PO's accepted

SYSTEM SIMULATION

CIRCLE 256

RS-422

- RS-422/485
- Selectable Address/IRQ
- Two/Four Wire Operation
- One/Two/Four Port Versions
- Delivery From Stock

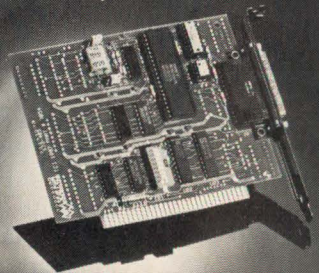

SEALEVEL

SEALEVEL SYSTEMS INC.
PO BOX 1808
EASLEY, SC 29641
(803) 855-1581

SEALEVEL SYSTEMS

CIRCLE 257

960 DIGITAL I/O LINES ON A SINGLE VME SLOT

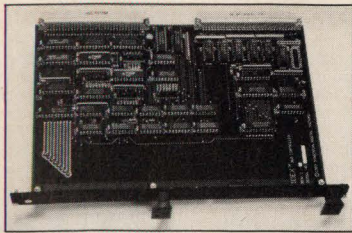

NEW! IOEX™ BUS CONTROLLER

- * I/O expansion bus highly immune to EMI/RFI noise.
- * Extends up to 50 feet on unshielded ribbon cable.
- * 20 card slots with geographic addressing.
- * Efficient slot vectored interrupts.
- * Compatible with most Eurocard card cages.
- * Components are available for complete sub-systems.



INDUSTRIAL DIGITAL SYSTEMS

2108 W. Freeway — Fort Worth, TX 76102
Phone (817) 332-2241

IOEX™ BUS CONTROLLER

CIRCLE 258

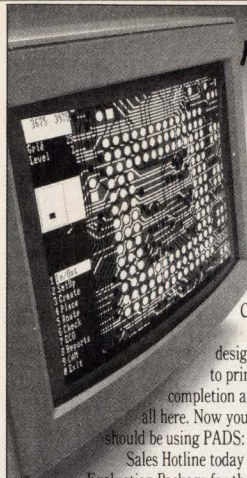

presenting PADS SUPERSTATION for TOTAL INTEGRATION

Obtain complete cradle-to-grave performance from your personal computer CAD system when performing electronic packaging design. From schematic capture to printed circuit design, to 100% completion autorouting capabilities, it's all here. Now you have one more reason you should be using PADS: Total Integration. Call our Sales Hotline today to receive a free Integrated Evaluation Package for the PADS-SUPERSTATION.



Software, Inc.
119 Russell St.
Littleton, MA 01460

Call Your Local Authorized Dealer

In MA: (508) 486-8929
Outside MA: (800) 255-7814

30 day money-back guarantee. MasterCard, Visa, American Express accepted.
CAD SOFTWARE CIRCLE 259

FINE-TUNE that TIMING CIRCUIT!!

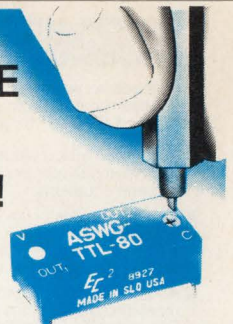

Our NEW ADJUSTABLE SQUARE WAVE GENERATOR MODULE is frequency trimmable $\pm 1\%$. Available in 25 models with output frequencies from 5 to 80 Mhz.

14-Pin DIP package (.260 high).

E² engineered components co.
P.O. Box 8121, San Luis Obispo, CA 93403-8121
CALL TOLL FREE (800) 235-4144
Circle Reader Card No. for FREE Technical Sheets

ENGINEERED COMPONENTS

CIRCLE 260

Optimize Filter Response to Fit Your Design Target with COMTRAN - PC

- Designs filters with custom-shaped responses
- Magnitude, Phase, Zin, Zout, or combinations
- Fits any precision response using available capacitor values (by recalculating resistors)
- Derives equivalent circuit from measured data
- Cuts opamp count in half (4 poles per opamp)
- FAST — Less than 1 second per point typical

Requires AT compatible w/ HP 82300B BASIC Language Processor card w/1 MB RAM, & HP 9122 floppy drive. This card adds HP Rocky Mountain BASIC, w/ HP-IB interface, to your PC. Lets your PC run HP 200/300 BASIC software. COMTRAN previously ran only on HP computers.

COMTRAN® Integrated Software

A Division of Jensen Transformers, Inc.
10735 BURBANK BOULEVARD, N. HOLLYWOOD, CA 91601
FAX (818) 763-4574 • PHONE (213) 876-0059

COMTRAN® INTEGRATED SOFTWARE

CIRCLE 261



NEW, GRIDLESS, 100% AUTOROUTING

HiWIRE-Plus® lets you quickly create and revise schematics and PCBs on your IBM PC. With the new, gridless, multilayer autorouter (AR) for HiWIRE-Plus, creating printed-circuit layouts is even faster. AR and HiWIRE-Plus are each \$895 and come with thirty-day money-back guarantees. Credit cards are welcome.

WINTEK CORPORATION
1801 South St., Lafayette, IN 47904
(800) 742-6809 or (317) 742-8428

HiWIRE-PLUS®

CIRCLE 262

PC BASED UNIVERSAL DEVICE PROGRAMMER \$595-895

- Programs EE/EPROMs, PALs, GALs, IFLs, EPLDs, MICROS, BIPOLARS.
- Software driven pin drivers. D/A generated programming voltages.
- Upgradeable for virtually any future programmable devices up to 40 pins.
- Self-sustaining operation. No additional modules or plug-in adapters required.
- Includes user friendly MEMORY BUFFER FULL SCREEN EDITOR.
- Friendly Menu-Driven interface. Device selection by P/N and manufacturing.
- Supports 8/16/32 bit word, Intelligent I & II, Quick Pulse programming.
- Functional testing, Register-Preload, PUSEMAP EDITOR for logic devices.
- File formats accepted: Intel Hex 86/88, Tetronix Hex, Motorola S, JEDEC.
- Customer support via voice line, dedicated BBS or fax. Full 1 year warranty.
- Base price includes Interface card, cable, Memory device library and 1 year free updates. Additional Device Libraries (Logic, Micros, Bipolars) \$95 ea.
- Libraries updates available every 6 mo. and can be received via floppy or BBS.

PC BASED 8-SOCKET GANG PROGRAMMER \$595

- Handles all memory devices to 32 pins. (Upgradeable up to 8 megabit parts).
- FULL SCREEN BUFFER EDITOR plus all applicable features from above.
- Customer support via voice line, dedicated BBS or fax. Full 1 year warranty.
- Includes PC Interface card, Memory device library and 1 year free updates.

MC / VISA / AMEX

Call today for datasheets!



B&C MICROSYSTEMS INC.

355 WEST OLIVE AVE., SUNNYVALE, CA 94086
TEL: (408) 730-5511 FAX: (408) 730-5521

B&C MICROSYSTEMS

CIRCLE 263

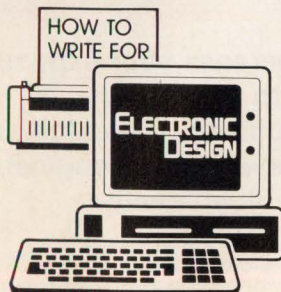

ELECTRONIC DESIGN AUTHOR'S GUIDE

Thinking of writing a technical article for publication in Electronic Design? This 12-page brochure contains just about everything you need to know about the process: submitting the outline, tips on writing the manuscript, preparing the artwork, and more.

ELECTRONIC DESIGN
Ten Holland Drive
Hasbrouck Heights, NJ 07604

ELECTRONIC DESIGN

CIRCLE 264

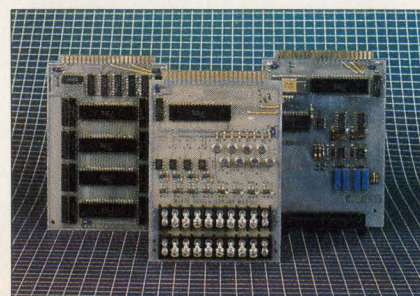

6800/6809 MICRO MODULES.

OEM 6800/6809 MICRO COMPUTER MODULES for dedicated control and monitoring. Interfaces for sensors, transducers, analog signals, solenoids, relays lamps, pumps, motors, keyboards, displays, IEEE-488, Serial I/O, floppy disks.

WINTEK CORPORATION
1801 South Street. Lafayette, IN 47904-2993.
(317) 742-8428 or (800) 742-6809

MICRO MODULES

CIRCLE 265



UNIVERSAL RS-232 PROGRAMMER \$345-595

- Programs EE/EPROMs, Flash EPROMs, ZPRams, Intel Micros, Memory Cards.
- Stand-Alone Mode for EE/EPROM and Memory Card Duplication. Verifies.
- All 24/28/32 pin EE/EPROMs to 4 Mbits (upgradeable to 32 megabits).
- Micros: 8741 A, 2/A, 4, 8, 9, 51, CS1, CS1A/B, 52, 53, 55, C21, C54, 1, 9761.
- Memory Cards: Seiko, Epson, Fujitsu, Mitsubishi (Integrated Adapter included).
- Modular design: Firmware easily upgradeable; 4 socket Gang module available.
- On-Board Programming capability. Custom interface modules available.
- User friendly Menu-Driven Interface Program (w/ IBM PC and Macintosh).
- Can be operated with any computer containing an RS-232 serial port.
- Optional built-in Eraser/Timer module (\$50); Top cover conductive foam pad.
- OEM open board programmer configurations available (from \$245).
- Customer support via voice line, dedicated BBS or fax. Full 1 year warranty.

INTELLIGENT PC ROM EMULATOR \$195

- Emulates 2716 through 27512 EPROMs (2k to 64k bytes) with a single unit.
- Connects to the standard parallel printer port. Uses standard printer cable.
- Intelligent features include: Reset Output, Address Compare, Address Snapshot, Trigger Input, Memory buffer editing capability. Selectable word sizes.
- User friendly software: Command set includes: Load, Write, Display, Run, Type, Edit, Fill, Run-Command-Fill, Monitor, Port, Reset, Help, Calculator.
- FAST data loading via parallel printer port (65k bytes in less than 10 seconds).
- Cascadable up to 8 units. Includes interface cable with Trigger and Reset clips.
- CMOS version with standard 9V battery backup available (\$495). After downloading the program from the host computer, the CMOS emulator version can be disconnected and used in stand-alone mode for firmware testing.
- File formats accepted: Binary, Intel Hex, Motorola S.

MC / VISA / AMEX

Call today for datasheets!



B&C MICROSYSTEMS INC.

355 WEST OLIVE AVE., SUNNYVALE, CA 94086
TEL: (408) 730-5511 FAX: (408) 730-5521

B&C MICROSYSTEMS

CIRCLE 266

Logic Synthesizer

Whether you design with gate arrays, programmable logic or random logic, you need **BOOL™** to tackle tight designs.

- **BOOL** converts a behavioral description of combinatorial logic or state machines into boolean equations.
- Extracts the don't care set from the input description for use in minimizing the hardware - a feature unique to **BOOL** which guarantees the most optimal implementation.
- Accepts as input: Behavioral descriptions, state machine specifications and boolean equations. Supports bus arithmetic, function calls, flow control statements, indexed variables and more.
- State of the art minimization algorithms, including absolute minimization and Espresso - can handle complex designs with hundreds of product terms in minutes.
- Built in simulator.

BOOL is just \$390 for the IBM/PC/XT/AT/PS2. 30 day money back guarantee.

 Cornell Design Tools,
761 Cornell Drive, Santa Clara, CA 95051
Phone: (408) 984-0777 Fax: (408) 748-1826

CORNELL DESIGN TOOLS

CIRCLE 267

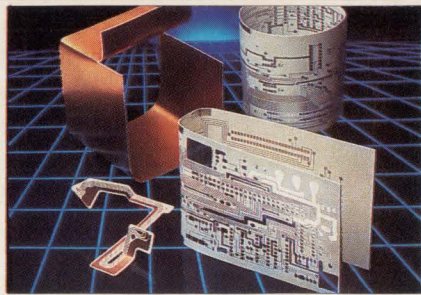

WE'RE BENDING THE RULES FOR CIRCUIT DESIGNERS

BEND/FLEX™, the bendable circuit board material that's flexible enough to bend into any multi-plane shape. Eliminates stiffener boards, flexible hardboard connectors, and may reduce the cost of two - and three - plane interconnection systems by as much as 30%!

**ROGERS CORP.
PORON & COMPOSITES DIVISION,**
One Technology Drive, Rogers, CT 06263

BEND/FLEX™

CIRCLE 268

No Waiting for Zero-wait Access

The **WACOM DMTC™** (W4006F-16/20/25) dedicated i80386 DRAM controller combines dynamic memory peripherals controller circuits for multiplexer, counter, and comparator, all on a single chip. Supports DRAM address control and refresh timing, too. The **DMTC™** recognizes the state of the i80386 via the control signal, that's why it can achieve zero wait access. Of course, putting all these circuits on a single chip means high speed performance, low power consumption, more compact memory boards, and lower cost, too.

● For the 16MHz, 20MHz, and 25 MHz i80386. ● Controls a maximum memory area of 256 MB (when used with 16 Mb per bit). ● Controls 256K x 1, 256K x 4, 1M x 1, 1M x 4, 4M x 1, 4M x 4, 16M x 1, or 16M x 4 bit DRAM. ● Automatically controls CPU access and refresh timing using the CAS before RAS refresh method. ● Ensures 2 bank interleaved cycle timing synchronized to the i80386 CPU clock, to achieve zero wait access.



WACOM—Your Link to ASIC

WACOM has the ASIC for your every application, from gate arrays to full custom chips. Let us be your link to ASIC.

WACOM

WACOM ASIC Center
4-29-11, Ikebukuro, Toshima-ku, TOKYO, 171 Japan

WACOM CO., LTD.

CIRCLE 269

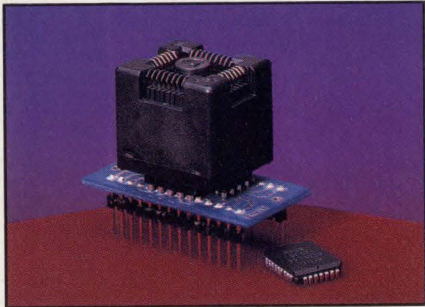

PAL/PROM Programmer Adapters

- Any EPROM programmer designed for DIPs can be converted to accept LCC, PLCC, and SOIC sockets in seconds!
- To program, just insert an **Adapt-A-Socket™** between the programmer's DIP socket and the circuit to be programmed.
- Designed to fit all types of EPROM programmers, including Data I/O 120/121A, Stag, Logical Devices, etc.
- Quick turnaround on custom engineering services, if needed. For a free catalog, contact:

Emulation Technology, Inc.
2368-B Walsh Ave. Santa Clara, CA 95051
Phone: 408-982-0660 FAX: 408-982-0664



EMULATION TECHNOLOGY

CIRCLE 270



Free MµShield Magnetic Shielding Catalog

For customized shielding, MµShield materials from stock, and consultation services, contact MµShield Products Division, Bomco, Inc., Route 128, Blackburn Circle, Gloucester, MA 01930. Phone 508/283-9000. Fax 508/283-2882.

bomco
Excellence in Metal Forming

FREE CATALOG

CIRCLE 271

IEEE-488

Complete Hardware and Software Solutions

Platforms: PC/XT/AT, PS/2, 386, RT PC, Macintosh Plus/SE/II, Sun, DEC, Apollo, MASSCOMP, 3B2, Q-BUS, UNIBUS, VMEbus, MULTIBUS, STD Bus, S-100, and SBX Bus

Operating Systems: DOS, OS/2, XENIX, UNIX, 386/ix, AEGIS, SunOS, AIX, RT, RSX, RSX, VMS, ULTRIX, VAXELN, PDOS, VERSAdos, RMX-86, Z-DOS, STD-DOS

Support Products: Extenders, Expanders, Converters, Controllers, Buffer, Analyzer

Call for **FREE** Catalog
(800) IEEE-488 • (512) 794-0100

NATIONAL INSTRUMENTS®
The Software is the Instrument™

12109 Technology Blvd. Austin, Tx. 78727

NATIONAL INSTRUMENTS

CIRCLE 272

SCSI

Analysis and Emulation



PED-4000 SCSI Analysis and Emulation System

DEVICE EMULATION

- Target or Initiator
- User Defined Device Descriptions
- SCSI II Disk and Tape Prototypes
- Interactive or Program Emulation Modes
- Menu Driven Edit, Configure and Run

PASSIVE STATE ANALYSIS

- Transition Time Record to 100 nsec
- Synchronous or Asynchronous Operation
- User Programmed, Event Driven Data Capture
- Display of Time, Bus State, Phase and Condition
- Menu Driven Setup, Capture and Display

PACIFIC ELECTRO DATA ‡

14 Hughes, Ste. B205, Irvine, CA 92718
(714) 770-3244

PACIFIC ELECTRO DATA

CIRCLE 273

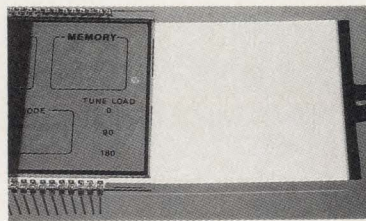

EL LCD BACKLIGHTING.

To backlight or not to backlight? With BKL's EL lamps, the answer is simple, inexpensive and fast! BKL's extremely thin (.012" to .024") quality lamps are made from Kard-O-Lite®, a patented electroluminescent material that makes them fit OEM needs. For the fastest turnaround in the industry, at affordable costs, call Eric Light, 215-277-2910 or Fax us your specs: 215-277-2956.

BKL, Inc.

421 Feheley Drive
King of Prussia, PA 19406

BKL, INC.

CIRCLE 274

Increase your exposure to the **most qualified** audience of design and development engineers with

Electronic Design INTERNATIONAL

For Details Call:

Jeanie Griffin (201) 393-6382
FAX: (201) 393-6388

CIRCLE 275

RELIABILITY PREDICTION SOFTWARE

ARE YOUR PRODUCTS RELIABLE?

The RelCalc 2 Software Package predicts the reliability of your system using the part stress procedure of MIL-HDBK-217E, and runs on the IBM PC and full compatibles. Say goodbye to tedious, time consuming, and error prone manual methods! RelCalc 2 is very easy to use, and features menu windows, library functions, global editing for what-if? trials, and clear report formats. Try our Demo Package for \$25 plus postage.

T-CUBED SYSTEMS, 31220 La Baya Drive # 110, Westlake Village, CA 91362. (818) 991-0057 • FAX: (818) 991-1281

AUTOMATE MIL-HDBK-217E

CIRCLE 276

Analog Circuit Simulation

Completely Integrated CAE from \$95

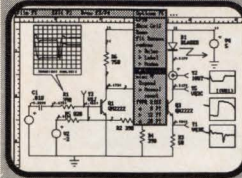

From Schematic Entry through SPICE Simulation to Post Processing

IsSPICE \$95, the complete SPICE program, runs on all PC's.

IsSPICE/386 \$386, The fastest PC based SPICE program available. Has virtually no circuit size limitations.

SPICENET \$295, a schematic editor for any SPICE simulator. Generates a complete SPICE netlist.

INTUSCOPE \$250, a graphics post processor that performs all the functions of a digital oscilloscope.

PRESPICE \$200, extensive model libraries, Monte Carlo analysis, and parameter sweeping.



Please Write or Call
P.O. Box 8607 (213) 833-0710
San Pedro, CA 30 Day Money
90734-6607 Back Guarantee

INTUSOFT

CIRCLE 277

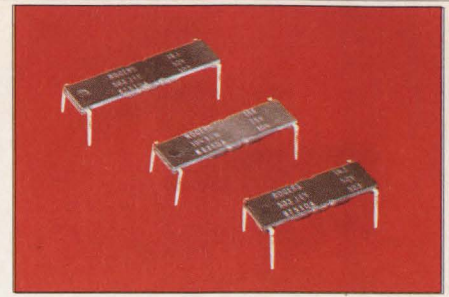

FOR A DECOUPLING CAPACITOR THAT SAVES SPACE, DEFEATS NOISE, IS SUITABLE FOR MILITARY APPLICATIONS AND BEATS HUMIDITY, HEAT AND COLD:
ROGERS MICRO/Q@2000

Rogers Corp., 2400 S. Roosevelt, Tempe, AZ 85282. 602/967-0624

ROGERS CORP.

CIRCLE 278

IEEE 488 Solutions.

- Hardware & software interfaces for PC, AT, 386, PS/2, Macintosh, SUN, HP & DEC
- IEEE converters to SCSI, RS-232, RS-422, modem, Centronics, digital I/O & analog I/O
- IEEE extenders, expanders & buffers
- IEEE drivers for DOS, UNIX®, Lotus 1-2-3, Symphony & Quattro.

Call or send for your FREE Technical Guide

Demo disks and application notes available



(216) 439-4091

Telex 6502820864 • Fax (216) 439-4093
IOtech, Inc. • 25971 Cannon Road
Cleveland, Ohio 44146

IOTECH

CIRCLE 279

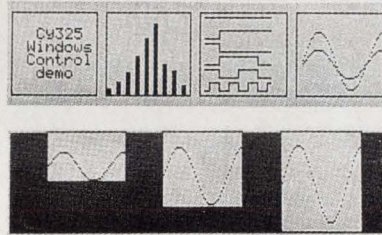

LCD WINDOWS CONTROLLER

The CY325 supports LCDs up to 128x240 pixels (16x40 char) with easy-to-use high-level commands and Parallel or Serial interface to host computer. The 256 built-in windows (or make your own) support window-relative text, graphics, plotting, bargraphs, waveforms, scroll/wrap/clip, etc. Read from an A/D and Write into Window! Separate text and graphic planes can be written or erased in any window. Eight pins support a variety of functions (soft-keys, waveforms) or can be used for GP I/O. Icons or special fonts can be user defined. Giant character mode, etc. Save months of design time with the CY325. \$75 CMOS \$20/1000s.



Cybernetic Micro Systems Inc.

P.O. Box 3000 • San Gregorio, CA 94074 • USA
Phone: (415) 726-3000 • Telex: 910-350-5842

CYBERNETIC MICRO SYSTEMS

CIRCLE 280

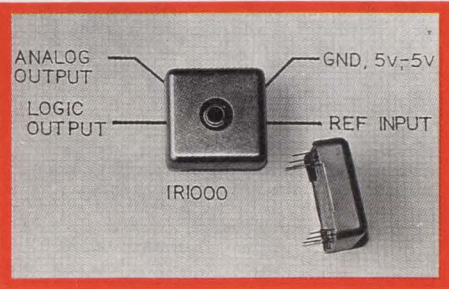

IR1000 DIGITAL INFRARED SIGNAL

- Printed circuit board components
- Responds to thermal radiation
- TTL or CMOS compatible logic output
- Accurate 90-60 Db gain low noise signal conditioner
- Threshold voltage reference input
- Current drain 200 uA available, 7ma standard
- Optical components for infrared systems available
- Complete infrared systems design available

INFRARED, INC. PO Box 47, PARLIN, NJ 08859
(201) 536-4455

INFRARED SENSOR

CIRCLE 281

YOUR AD HERE

Here's all you have to do:

- Send a B/W or 4/C glossy photo.
- Include 13 lines of copy. (37 characters per line.)
- Write a headline of 32 characters or less
- We do all the rest. No production charges.
- We also accept camera-ready art. Ad size: 2³/₁₆" wide x 3" deep.

CIRCLE 282

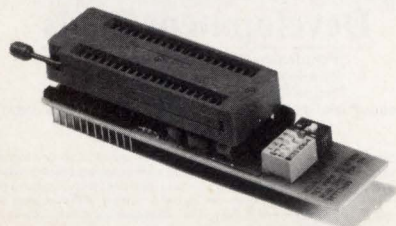

787C51 PROGRAMMER \$125.

Logical Systems brings you support for the Intel 87C51. The UPA87C51 programs this popular microcontroller on general purpose programmers that support the 2732A. With the UPA87C51 you can program the 8751 and 87C51 security bits and the 87C51 encryption array. Logical Systems, helping you get the most out of your programming equipment with our growing line of adapters. OEM inquiries welcome.

ADAPTER	PROGRAMS	PRICE
UPA8751	C8751, 8751H, AMD8753H, 8744	\$ 95.00
UPA87C51	C8751, 8751H, AMD8753H, 8744 87C51, 87C51FA	125.00
UPA83701V	Hitachi HD63701V0	65.00
UPA451N	Signetics SC87C451 (64 pin DIP)	125.00
UPA83701X	Hitachi HD63701X0 (64 pin shrink dip)	95.00
	Low insertion force socket	149.00
UPA83701Y	Hitachi HD63701Y0 (64 pin shrink dip)	95.00
	Low insertion force socket	95.00
	Textool ZIF socket	149.00
UPA83705V	Hitachi HD63705V0	65.00

CALL (315) 478-0722 or FAX (315) 475-8460

LOGICAL SYSTEMS CORPORATION

P.O. Box 6184, Syracuse NY 13217-6184 USA, TLX 6715617 LOGS

LOGICAL SYSTEMS

CIRCLE 283

Telecom Design!

TELEPHONE/COMPUTER INTERFACE

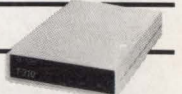

T-310 Telephone Access Unit with 2-way Touchtone/ASCII conversion:

- Intelligent dialer for PCs and other DTE devices. Responds to call progress tones, voice, and other calling signals. ASCII controlled DTMF and audio input.

- Intelligent answering device reports incoming rings for auto or commanded answer. Answer tone, audio port, and DTMF to ASCII conversion for remote phone data entry.

For more info call: **1-800-426-3926**
(In Washington State: 206-827-9626)



10801-120th Avenue NE, Kirkland, WA 98033

TEL TONE

CIRCLE 284



**DATA I/O : GREAT, H/W FLEXIBLE
SAILOR : GREAT, S/W FLEXIBLE**

Sailor-PAL is S/W driven by PC/XT/AT/PS2 or laptops; powerful, reliable and S/W upgradable.

Certified by IC manufacturers. Supports:

- 7ns PALs
- 12ns GALs
- EP900
- EP1800
- PLAs
- PLSs
- PEELs
- ECLs
- 8751s
- EEPRoMs
- Test Vectors
- 2-MEG EPROMs
- Bipolar PROMs
- New high speed CMOS PROMs

Please call for a free demo disk. **ADVIN SYSTEMS INC.**, 1050 East Duane Ave, Sunnyvale, CA 94086. (800) 627-2456 FAX (408) 736-2503

ADVIN SYSTEMS

CIRCLE 285

E/EPROM PROGRAMMER

\$895



- EP-1140 includes: software, cable, manual, 2 free updates, toll-free tech support, 1-year warranty
- Unconditional 30-day money back guarantee
- Programs 24-, 28-, 32- & 40-pin E/EPROMs
- Supports 874X & 87(C)5X series microcontrollers
- Connects to a standard parallel printer port
- Hardware to support future parts to 8 Megabit
- Software updates on floppy disk
- 32-pin model, EP-1132, available for \$695

The Engineer's Programmer™

CALL TODAY 800-225-2102

BP MICROSYSTEMS

10681 Haddington, #190, Houston, TX 77043
713/461-9430 FAX 713/461-7413

BP MICROSYSTEMS

CIRCLE 286

**Quartz Crystals
Oscillators
212-505-5340**

- World's Smallest
- SMT & Thru-hole
- 10kHz - 35 MHz
- Ceramic & Metal Pkgs
- Free Catalog

Micro Crystal Division/SMH

OSCILLATORS

CIRCLE 287

**C for the 8051
Compare:**

Benchmark Results — Sample program: Eratosthenese sieve Program from BYTE (1/83), expanded with I/O and interrupt handling.

	Archimedes		
	ICC51 v2.20A	MCC51 v1.2	FRANKLIN C51 v2.1
Compilation time	12 sec ✓	18 sec	17 sec
Linkage time	29 sec	9 sec	6 sec ✓
Execution time	11.45 sec	9.00 sec	0.88 sec ✓
Total code size	5318 bytes	3798	1726 ✓
Sieve module size	736	1021	541 ✓

Call now for your free DEMO disk.



888 Saratoga Ave. #2 • San Jose, CA 95129
(408) 296-8051 • FAX (408) 296-8061

FRANKLIN SOFTWARE

CIRCLE 288

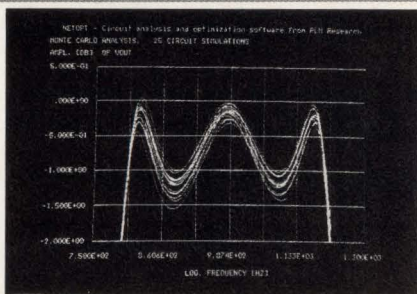

**NETOPT / NETSIM
ANALOG CIRCUIT ANALYSIS AND
OPTIMIZATION SOFTWARE**

NETSIM analyzes circuits in both time and frequency domains, performs Monte Carlo, tolerance/worst case analysis and extracts poles/zeros and transfer functions • Produce yield estimates and sensitivity analysis of your analog designs • **NETOPT** includes all features of **NETSIM** and adds sophisticated optimization capabilities • Compensate for circuit/device parasitics, generate non-standard responses and center designs for maximum yields. • **NETSIM** is available for IBM PC® (\$850) and VMS®/UNIX® (\$1700.00)/NETOPT is \$1995.00 for the PC and \$3995.00 for the VMS/UNIX version.

RLM Research

P.O.Box 3630, Boulder, CO 80307-3630 • (303) 499-7566

SOFTWARE

CIRCLE 289

**FREE UV ERASER
WITH DATA I/O'S 280
SET PROGRAMMER.**

For \$1595 the 280 gives you:

- 8 sockets for gang/set programming,
- Support for EPROMs and EEPROMs up to 512K,
- Full after-sale support from Data I/O®.

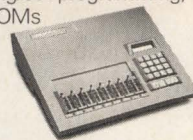

Order a 280 today and get a FREE UV eraser—a \$40 value. The Datarase II erases up to 4 EPROMs in 3 minutes.

**1-800-247-5700
Ext. 890**

DATA I/O
Corporation

DATA I/O

CIRCLE 290



**FREE!
120
Page
Catalog**

**"Optics
for
Industry"**

ROLYN OPTICS supplies all types of "Off-the-Shelf" optical components. Lenses, prisms, mirrors, irises, microscope objectives & eyepieces plus hundreds of others. All from stock. Rolyne also supplies custom products & coatings in prototype or production quantities. Write or call for our free 120 page catalog describing products & listing off-the-shelf prices. **ROLYN OPTICS CO.**, 706 Arrowgrand Circle, Covina, CA 91722, (818) 915-5707 & (818) 915-5717. TELEX: 67-0380. FAX: (818) 915-1379.

FREE CATALOG

CIRCLE 291

Development Tools

- PseudoSam Cross-assemblers \$50.00
- PseudoMax Cross-simulators \$100.00
- PseudoSid Cross-disassemblers \$100.00
- PseudoPack Developer's Package \$200.00(\$50.00 Savings)

POWERFUL

- PseudoCorp supports an extensive line of professional cross-development tools. Tools that speed development of microprocessor based products. Fast, sophisticated macro assemblers to generate your program code. Versatile simulators that allow testing and debugging of the program even before the hardware exists. Easy to use disassemblers to help recover lost source programs.

AFFORDABLE

- Until now, powerful tools like these have been priced from 5 to 10 times our price. No more waiting for system time, at these prices every Engineer can have a personal development system on an IBM PC or compatible.

BROAD RANGE OF SUPPORT

- PseudoCorp currently has products for the following microprocessor families (with more in development):
- | | | | |
|-----------------|------------------|-----------------|---------------|
| Intel 8048 | RCA 1802,05 | Intel 8051 | Intel 8096 |
| Motorola 6800 | Motorola 6801 | Motorola 68HC11 | Motorola 6805 |
| Hitachi 6301 | Motorola 6809 | MOS Tech 6502 | WDC 65C02 |
| Rockwell 65C02 | Intel 8080,85 | Zilog Z80 | NSC 800 |
| Hitachi HD64180 | Motorola 68000,8 | Motorola 68010 | |

- For more information call, write or use the reader service number below.
- To place an order, call or write:

PseudoCorp

Professional Development Products Group

716 Thimble Shoals Blvd, Suite E

Newport News, VA 23606

(804) 873-1947

PSEUDOCORP.

CIRCLE 292

**DIRECT
CONNECTION ADS**

**We'll Make Up
Your Ad For Free**

*And put it in front of over
150,000 design and devel-
opment engineers.*

**NO PRODUCTION
CHARGES!!!**

**Call now for details
(201) 393-6382**

CIRCLE 293

UPCOMING MEETINGS

SEPTEMBER

1989 ASIC Seminar and Exhibit, September 25-28. Rochester Riverside Convention Center, Rochester, NY. William Bush, 2530 Parker Rd., Palmyra, NY 14522; (716) 244-5830.

Autotestcon '89, September 25-28. Philadelphia, PA. Fred Liguori, Autotestcon '89, P.O. Box 1185, Browns Mills, NJ 08015; (201) 323-2842.

Advanced Composites Conference and Exposition, September 26-28. Hyatt Regency, Dearborn, MI. ASM International, (216) 338-5151.

21st International SAMPE Technical Conference, September 26-28. Atlantic City, NJ. Holly Barnett, R.L. Couch Public Relations, (714) 474-9111.

OCTOBER

IEEE International Conference on Computer Design (ICCD '89), October 2-4. Hyatt Regency, Cambridge, MA. Gail Clanton, Computer Society of the IEEE, (202) 371-1013.

CAM-I's 18th Annual International Conference, October 2-4. Royal Sonesta Hotel, New Orleans, LA. Roger Lewis, CAM-I, 1250 E. Cope land Rd., Ste. 500, Arlington, TX 76011; (817) 860-1654.

Electronic Imaging East '89, October 2-5. Hynes Convention Center, Boston, MA. MG Expositions Group, 1050 Commonwealth Ave., Boston, MA 02215; (617) 232-3976.

4th Annual PC EXPO, October 3-5. McCormick Place North, Chicago, IL. PC Expo, 385 Sylvan Ave., P.O. Box 1026, Englewood Cliffs, NJ 07632; (201) 569-4147.

IEEE 1989 Ultrasonics Symposium, October 3-6. Montreal, Quebec, Canada. Narendra Batra, Naval Research Laboratory, Washington, D.C. 20375; (202) 767-3505.

FASTEC '89 Conference and Exposition, October 4-5. Sheraton CentrePark Hotel, Arlington, TX. Carol Anderson, Society of Manufacturing

Engineers (SME), One SME Dr., P.O. Box 930, Dearborn, MI 48121-0930; (313) 271-1500.

1989 Quality In Electronics (QIE), October 5-7. Red Lion Inn, San Jose, CA. Dawn Onalfo, 1989 QIE Conference, P.O. Box 33015, San Jose, CA 95152; (408) 742-2472.

1989 Linear Applications Seminar, October 16. Red Lion Inn, Bellevue, WA. Dianne Sheppard, National Semiconductor, 2900 Semiconductor Dr., P.O. Box 58090, Santa Clara, CA 95052. For additional dates and locations: (408) 721-5000 or (800) 548-4529.

SCAN-TECH '89 International Show and Seminar, October 16-19. New San Jose Convention Center, San Jose, CA. Donald Anderson, Automatic Identification Manufacturers (AIM USA), 1326 Freeport Rd., Pittsburgh, PA 15238; (800) 338-0206 or (412) 963-8588.

Northcon/89, October 17-19. Portland Memorial Coliseum, Portland, OR. Natalie Perlin, Northcon/89, 8110 Airport Blvd., Los Angeles, CA 90045; (213) 772-2965.

Supercomputing World Conference, October 17-20. San Francisco Civic Center, San Francisco, CA. MG Expositions Group, 1050 Commonwealth Ave., Boston, MA 02215; (800) 223-7126 or (617) 232-3976.

International Society for Hybrid Microelectronics (ISHM '89), October 24-26. Baltimore Convention Center, Baltimore, MD. ISHM, P.O. Box 2698, Reston, VA 22090; (703) 471-0066 or (800) 232-4746.

NOVEMBER

DEXPO West '89, November 7-9. Disneyland Hotel, Anaheim, CA. Expoconsul International Inc., 3 Independence Way, Princeton, NJ 08540; (609) 987-9400.

Wescon '89, November 14-16. Moscone Convention Center, San Francisco, CA. Alexis Razevich, IEEE, 8110 Airport Blvd., Los Angeles, CA 90045; (213) 772-2965.

ULTRA-MINIATURE SURFACE MOUNT

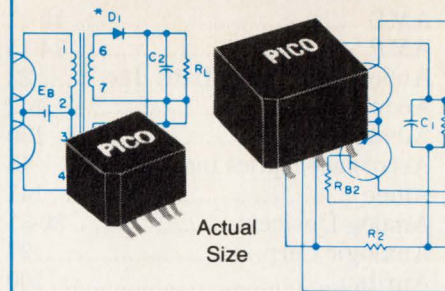

DC-DC Converter Transformers and Power Inductors

These units have gull wing construction which is compatible with tube fed automatic placement equipment or pick and place manufacturing techniques. Transformers can be used for self-saturating or linear switching applications. The Inductors are ideal for noise, spike and power filtering applications in Power Supplies, DC-DC Converters and Switching Regulators.

- Operation over ambient temperature range from -55°C to $+105^{\circ}\text{C}$
- All units are magnetically shielded
- All units exceed the requirements of MIL-T-27 ($+130^{\circ}\text{C}$)
- Transformers have input voltages of 5V, 12V, 24V and 48V. Output voltages to 300V.
- Transformers can be used for self-saturating or linear switching applications
- Schematics and parts list provided with transformers
- Inductors to 20mH with DC currents to 5.4 amps
- Inductors have split windings

Delivery—
stock to
one week

SEE EEM, GOLD BOOK
OR THOMAS REGISTER
OR SEND DIRECT FOR
FREE PICO CATALOG

**PICO
Electronics, Inc.**

453 N. MacQuesten Pkwy. Mt. Vernon, N.Y. 10552
Call Toll Free 800-431-1064
IN NEW YORK CALL 914-699-5514

CIRCLE 129

INDEX OF ADVERTISERS

A

AMD 10-11
 AMP 14-15
 Abbott Transistor Labs. Inc. 22
 Acopian 142
 Advin Systems 170
 Aerospace Optics Inc. 45
 Aldec 141
 Analog Devices 30-31
 Analogic Corp. 97
 Anritsu 100
 Aromat Corp. 98
 Augat Alcoswitch 80

B

B&C Microsystems 167
 BKL Inc. 168
 BP Microsystems 170
 Bomco 168
 Burr Brown 113, 150
 Bytek 78

C

CAD Software 167
 C & K 118
 Caddock 130, 131
 Capital Equipment 128, 129
 Central Semiconductors 156
 Cermetex 29
 Clearpoint 77
 Coilcraft 151
 Compaq 20-21
 Comtran Integrated
 Software 167
 Cornell Design Tools 168
 Cybernetic Microsystems 12, 169
 Cypress Semiconductor Cover IV

D

Data I/O 170
 Data Translation Inc. 36
 Deltron Inc. 122-126
 Dialight 85
 Diversified Technology 142

E

Emulation Technology 168
 Engineered Components
 Corp. 133, 167

F

Franklin Software Inc. 170
 Fujitsu 2-3

ELECTRONIC TECHNICIAN: To fabricate, diagnose and repair circuitry for racing industry. Must be thoroughly knowledgeable and trained in electronic components, circuit diagrams, scopes, and light circuit design. Quality control and automotive experience a plus. Upward mobility to technical manager. Near Glendale, CA for 18 years. Up to \$15/hr to start depending on skills. Ask for Ed. (213) 254-5108.

H

Hamilton Avenet 65
 Harris Semiconductor 60-61
 Heinman 68
 Hewlett-Packard1, 40-41, 99, 101, 103
 Hitachi 110
 Hypertronics 166

I

I-Bus Systems 117
 ILC Data Devices 32
 Imaging Technology 67
 Industrial Digital Systems 167
 Infrared Inc. 169
 Integrated Device
 Technology Inc. Cover II
 Intergraph 145
 International Rectifier 48
 Intusoft 169
 IOtech 169

J

JDR Microdevices 166

K

Kepeco Inc. 89, 90
 Keystone Carbon Co. 18

L

Lambda Semiconductor 157-164
 Leader Instruments 19
 LeCroy Corp. 35
 Karl Leister 78
 Logical Systems Corp. 169
 Lorain Products 102

M

Micro Crystal Div./SMH 170
 Micon Technology 114
 MicroSim 121
 Miller Stephensen 91
 Mini-Circuits Laboratory,
 a Div. of Scientific Components
 Corp. 7, 13, 104, Cover III

N

National Instruments 168
 Nohau Corp. 69-72, 166

P

Pacific Electro Data 168
 Patton & Patton 166
 Philips Components 53-56
 Pico Electronics 155, 171
 Potter & Brumfield 92
 Power One Inc. 43
 Power Systems 6
 Powertec 135-140
 PsuedoCorp. 170

R

RAF Electronics 118
 RLM Research 170
 Raytheon 63
 Rogers Corp. 154, 168, 169
 Rolyn Optics 170

S

SGS-Thomson
 Microelectronics 46-47, 87
 Sealevel Systems 166
 Signetics 109
 Silicon Systems 143
 Sprague Goodman 68

T

Tatum Labs 166
 T-Cubed Systems 169
 Tektronix Inc. 8-9, 16-17, 51
 Teltone 169
 Tesoft 166
 Texas Instruments 25-28
 Tri-mag Inc. 149
 Tusonix 134

V

Vernitron 148

W

Wacom Co. Ltd. 168
 Wafios 150
 White Technology 153
 Wintek Corp. 167

X

Xylogics Inc. 79

The advertisers index is prepared as an extra service. Electronic Design does not assume any liability for omissions or errors.

SPDT & SP4T SWITCHES

WITH BUILT-IN DRIVERS



10 to 3000MHz from \$39⁹⁵

Now, high-speed, high-isolation switches with built-in drivers, tough enough to pass stringent MIL-STD-202 tests. There's no longer any need to hassle with the complexities of designing a TTL driver interface and then adding yet another component to your subsystem... it's already included in a rugged, low-cost, compact assembly.

Available in the popular hermetically-sealed TO-8 package or a small EMI-shielded metal connectorized case, these tiny PIN-diode reflective switches, complete with driver, can operate over a 10 to 3000MHz span with a fast 2μsec switching speed.

Despite their small size, these units offer isolation as high as 40dB(typ), insertion loss of only 1.1dB(typ), and a 1dB compression point of +27dBm over most of the frequency range. All models are TTL-compatible and operate from a dc supply voltage of 4.5 to 5.5 V with 1.8mA quiescent current.

Switch to Mini-Circuits for highest quality innovative products... and leave the driving to us.

SPECIFICATIONS

	TOSW-230 ZFSW-230DR		TOSW-425 ZFSW-425DR	
	typ.	max.	typ.	max.
Freq. Range(MHz)	10-3000		10-2500	
Insert. Loss (dB)	typ.	max.	typ.	max.
10-100MHz	1.3	1.9	1.3	1.7
100-1500MHz	1.1	1.9	1.1	1.7
1500-3000MHz	1.8	2.7	1.8	2.5
Isolation(dB)	typ.	min.	typ.	min.
10-100MHz	60	40	60	40
100-1500MHz	40	28	40	30
1500-3000MHz	35	22	35	22
1dB Compression(dBm)	typ.	min.	typ.	min.
10-100MHz	17	6	17	6
100-1500MHz	27	19	27	19
1500-3000MHz	30	28	30	28
VSWR(ON)	typ.	max.	typ.	max.
	1.3	1.6	1.3	1.6
Switching Time (μsec) (from 50% TTL to 90% RF)	typ.	max.	typ.	max.
	2.0	4.0	2.0	4.0
Oper. Temp.(°C)	-55 to +100		-55 to +100	
Stor. Temp.(°C)	-55 to +100		-55 to +100	
Price (10-24) (1-9)	\$39.95 \$89.95		\$59.95 \$109.95	

finding new ways...
setting higher standards

Mini-Circuits

A Division of Scientific Components Corporation
P.O. Box 350166, Brooklyn, New York 11235-0003 (718) 934-4500
Fax (718) 332-4661 Domestic and International Telexes: 6852844 or 620156

WE ACCEPT AMERICAN EXPRESS

20ns
CY7C291A
2K x 8
PROM



15ns
CY7C245A
2K x 8
Registered
PROM

**On one hand,
we're the fastest.**

**On the other
hand, we're the
densest.**

30ns
CY7C277
32K x 8
Registered PROM

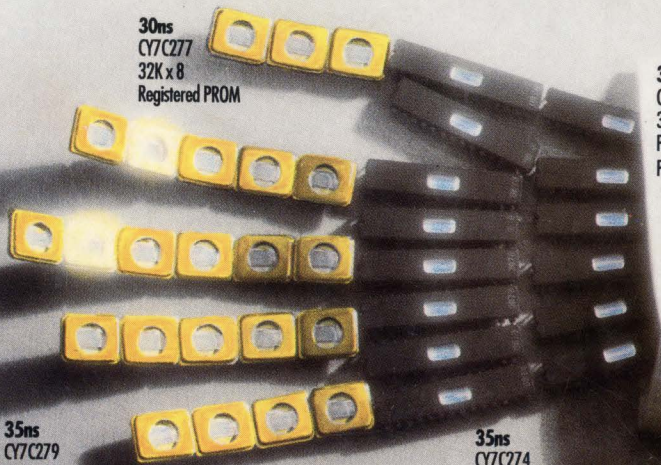

35ns
CY7C271
32K x 8
Power Down
PROM

35ns
CY7C279
32K x 8
Latched PROM

35ns
CY7C274
32K x 8
EPROM Pinout

If you need speed in a PROM, call us.

We have the world's fastest CMOS reprogrammable PROMs, from 4K to 256K.

Our new 20ns 16Ks, 7C291A and 7C293A, can improve system performance by running high speed programs straight from PROM without downloading to RAM. Yet using the 7C293A you can power down to 30mA. Save board space, cost, power.

For high-speed pipelined applications, our 16K 7C245A registered PROM accesses data in just 10ns, and requires only 15ns setup.

If you need the densest PROM, call us.

We have four 256Ks that can pack the maximum available high speed storage into a space-saving 300 mil DIP, or PLCC that requires just .3 square inches, all at a record setting 35ns.

**512 x 8. 1K x 8. 2K x 8.
8K x 8. 16K x 8. 32K x 8.**

We have registered versions. Registered diagnostic versions.

PROM.

EPROM pinouts. Power switched versions. We have the PROM you need with the speed and features you want.

Reprogrammable PROM.

Our CMOS floating-gate memory means you can order windowed versions of almost every part. You get the high speed of a PROM, with the benefits of reprogrammability.

Cool, low power CMOS.

So you don't use a lot of power, even when you need a lot of memory. Many parts power down even further when deselected.

Call. Get your hands on our data book.

**Data Book
Hotline
1-800-952-6300*
Ask for dept.
C3E**



**CYPRESS
SEMICONDUCTOR**

*1-800-387-7599 In Canada. (32)2-672-2220 In Europe.
©1989 Cypress Semiconductor, 3901 North First Street, San Jose, CA 95134
Phone: (408)943-2666, Telex 821032 CYPRESS SNJUD, TWX 910-997-0753.