

Electronic Design[®] 9

VOL. 26 NO.

FOR ENGINEERS AND ENGINEERING MANAGERS — WORLDWIDE

APRIL 26, 1978

A synthesizer/function generator sets a new standard for sources with 13 decades of sine output. This 11-digit unit even sweeps all waveforms — sines, squares,

triangles and ramps — over its full frequency range: 21 MHz for sines, 11 MHz for squares, and 11 kHz for triangles. And it undersells all others. See p.165.



This is your LAST issue
Your FREE subscription
has expired!
(See card inside cover for
re-entry application)



Bourns resistor networks

... for the "discreet"
design engineer.

Sure, you've already made a smart decision, choosing networks over discrete resistors. After all, the cost per resistor in a network package can be 40% less; they require only 10-15% of the P.C. board space needed by discretes; and component count is reduced as much as 95% with resistor networks.

But, when choosing a network supplier, you should also consider these points:

1. Bourns has the broadest network product line in the industry — over 1000 part numbers in all. And our standard DIP circuits range from simple pull-up configurations to Thevinin-equivalent ECL terminators and memory interface circuits.
2. Bourns Krimp-Joint™ offers both a mechanical and electrical bond that lap or butt joint construction doesn't provide. The lead is crimped onto the network element and a high-temp, reflow-resistant solder is used to prevent failure during wave soldering and in circuit thermal cycling and vibration.
3. Bourns was the first manufacturer to offer a complete line of off-the-shelf, super low profile SIPs with demonstrated automatic insertion capability.

These are the facts. So, now you can be even more "discreet". We're sure you'll specify Bourns Resistor Networks — direct or through your local distributor.

Send today for our new 1977 Resistor Networks Catalog.

TRIMPOT PRODUCTS DIVISION, BOURNS, INC., 1200 Columbia Avenue,
Riverside, CA 92507, Telephone 714 781-5415 — TWX 910 332-1252.

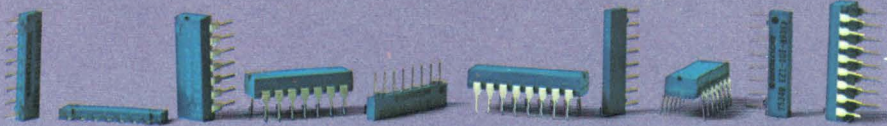

International Marketing Offices: European Headquarters — Switzerland 042/23 22 42 • Belgium 02/218 2005 • France 01/2039633 • Germany 0711/24 29 36 • Italy 02/32 56 88 • Netherlands 70/87 44 00 • United Kingdom 01/572 6531 • Norway 2/71 18 72 • Sweden 764/20 110 • Japan 075/921 9111 • Australia 02/55-0411 03/95-9566 • Israel 77 71 15/6/7

For Immediate Application — Circle 130

For Future Application — Circle 230

SURPRISE!



Sundial courtesy of Frank's Antique Clock Shop, San Jose, California.

The World's First LED Displays You Can View in Bright Sunlight.

Now available from Hewlett-Packard are displays designed for high ambient conditions. These seven-segment displays optimize the contrast between the digit segments and the background. A specially designed P-N junction and larger top contact metallization permit operation at high peak currents. This feature enhances display light output and permits strobed operation of long display strings. Combined with proper filtering these displays can be used under high ambient lighting as bright as 10,000 footcandles!!!

Available in High Efficiency Red and Yellow, the HDSP-3530/4030 series are designed for use in outdoor terminals, gas pumps, airplane cockpits, instruments, weighing scales, agricultural instrumentation and point-of-sale terminals.

The High Efficiency Red (HDSP-3530/3730 Series) displays are priced at \$2.05* (7.6mm/0.3") and the Yellow (HDSP-4030/4130 Series) displays are \$2.25* (10.9mm/0.43") in quantities of 1000.

For immediate delivery, call any franchised HP distributor. In the U.S. contact Hall-Mark, Hamilton/Avnet, Pioneer-Standard, Schweber, Wilshire or the Wyle Distribution Group (Liberty-Elmar). In Canada, call Hamilton/Avnet or Zentronics, Ltd. *U.S. Domestic Prices Only.

01803

CIRCLE NUMBER 2

HEWLETT  PACKARD

1507 Page Mill Road, Palo Alto, California 94304

For assistance call: Washington (301) 948-6370, Chicago (312) 255-9800, Atlanta (404) 955-1500, Los Angeles (213) 877-1282

MIL-SSR UPDATE

Another SSR first from Teledyne!

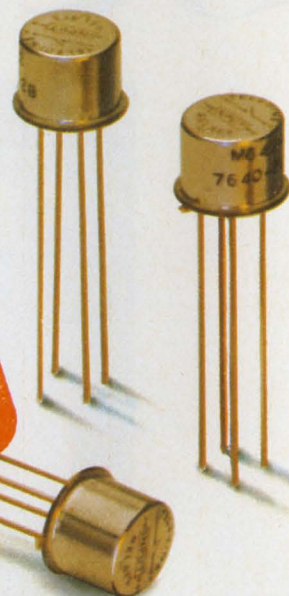

Experience, design know-how, and advanced solid state relay technology bring you another industry milestone with Teledyne's M640 Series — the first solid state relays to receive QPL approval to MIL-R-28750:

M28750/5 (Teledyne P/N M640-1W)

M28750/6 (Teledyne P/N M643-1W)

M28750/7 (Teledyne P/N M643-2W)

These SSRs have already established a high reliability record that spans a broad spectrum of switching applications for both airborne and ground support equipment. Our M640 Series features all-

solid-state circuitry utilizing hybrid microcircuit techniques in a hermetically sealed TO-5 package. And they're available with bipolar output for AC or DC loads up to 60mA/40V and DC outputs for loads up to 300mA/40VDC or 100mA/250VDC.

For complete specification data, contact your nearest Teledyne Relays sales office listed in EEM, Gold Book or Electronics Buyers' Guide. You'll find we have the experience, products, and technical support to meet all your SSR needs — including a quick reaction capability to design SSRs specifically for your application.

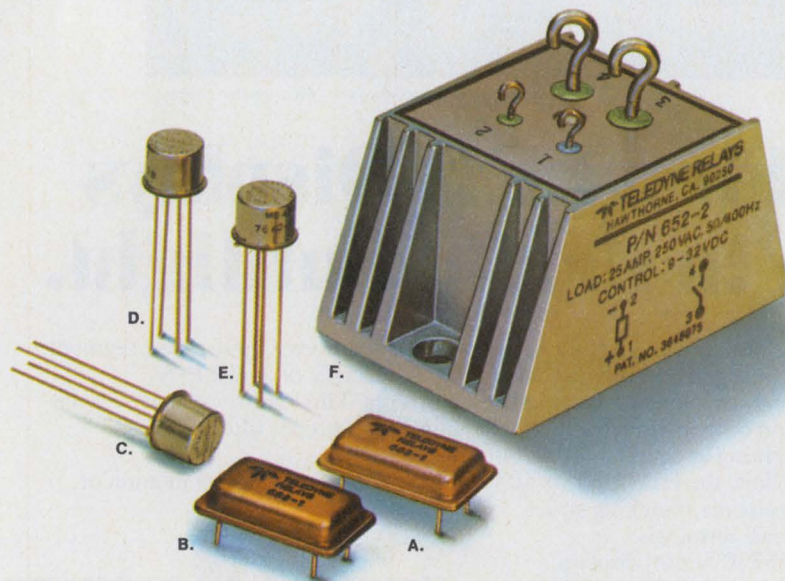

TELEDYNE'S MILITARY SSRs

- A. P/N 683-1 DC SSR
DIP package, with output rated at 600mA/50VDC
- B. P/N 682-1 AC SSR
DIP package, with output rated at 1A/250VAC
- C. P/N M640-1W Bi-polar SSR
Mil P/N M28750/5. TO-5 package, with bi-polar (AC/DC) output rated at 60mA/40V
- D. P/N M643-1W DC SSR
Mil P/N M28750/6. TO-5 package, with output rated at 300mA/40VDC
- E. P/N M643-2W DC SSR
Mil P/N M28750/7. TO-5 package, with output rated at 100mA/250VDC
- F. 652 Series AC Power SSR
Output rated at 25A/250VRMS

TELEDYNE RELAYS

3155 West El Segundo Boulevard, Hawthorne, California 90250
Telephone (213) 973-4545

CIRCLE NUMBER 3

NEWS

- 37 **News Scope**
- 42 **Integrated circuits are pushing into data communications**, relieving processors and cutting software—A special report.
- 50 **What's happening in microwave tubes?** A lot, particularly in traveling wave tubes.
- 65 **Washington Report**

TECHNOLOGY

- 72 **Specify low-speed modems properly** for distributed computer systems. A model spec sheet plus test schematics will help pick the modem you want.
- 78 **Optical-fiber links** help you sidestep communications problems. Neither cable capacitance, nor water, nor power lines will stop your signal.
- 84 **Memory Technology: Part 4.** Keep the memory interface simple between dynamic RAMs and a μ P. Use the right timing and refresh.
- 96 **Improved microprocessor interrupts** give you easy and efficient access to peripherals and let the μ Ps handle I/O like a mini.
- 104 **Tailor-make your own μ P power supply.** Selecting the proper rectifier, filter and regulator takes almost all the guesswork out of the transformer hunt.
- 112 **Build your own stepping motor tester.** Then you can try out different motor-control options, while your design is still in the breadboarding stage.
- 118 **Matching small ac motors** to a load for efficient operation is a compromise of speed, torque and duty cycle. You can't optimize them all.
- 124 **Wirewound precision and power resistors** fulfill design demands other resistors can't—like tolerance lows of ± 0.002 and power ratings of 2000 W.
- 130 **Don Alstadt of Lord** speaks on educating your managers.
- 136 **Ideas for Design:**
Transistor protects floating regulator in high-voltage applications.
Save your batteries with a motion-sensing switch for delayed turn-off.
Microprocessor talks to 'dumb' peripherals, using minimal address space.
Positive feedback speeds up low-cost opto-isolator response.
- 145 **International Technology**

PRODUCTS

- 165 **Instrumentation:** Synthesizer/function generator does more than 'just' up resolution to 11 digits.
- 176 **ICs & Semiconductors:** Monolithic circuit converts voltage to frequency with tightest wide-range tempco.
- 168 Modules & Subassemblies
- 192 Micro/Mini Computing
- 212 Components
- 220 Data Processing
- 226 Packaging & Materials
- 230 Power Sources

DEPARTMENTS

- 69 **Editorial:** The oldest profession
 - 7 Across the Desk
 - 147 Top Ten Winners
 - 232 Design Aids
 - 232 Application Notes
 - 232 New Literature
 - 240 Employment Opportunities
 - 249 Advertisers' Index
 - 250 Information Retrieval Card
- Cover:** Photo by Allen Howe, courtesy of Hewlett-Packard, Loveland Instrument Div.

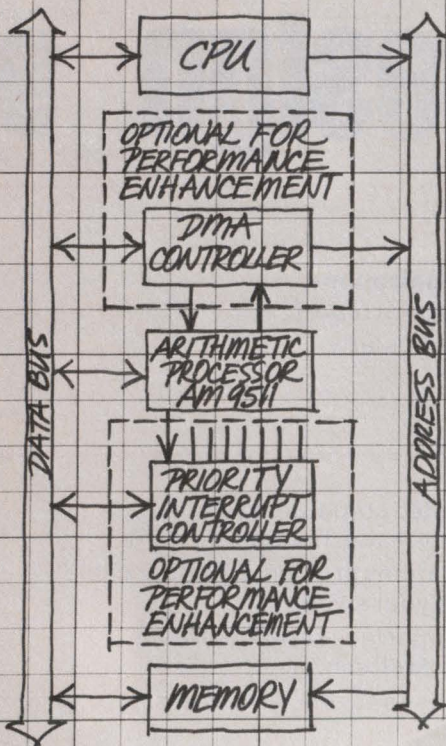

COMMAND IS ENTERED.
 OPERATES INDEPENDENTLY UNDER
 INTERNAL MICROPROGRAM CONTROL.
 REQUIRES NO CPU INTERVENTION.
 INTERNAL ARCHITECTURE HAS
 MANY FEATURES THAT EN-
 HANCE THE COMPUTA-
 TIONAL SPEED!

- ✓ DATA & STACK MANIPULATION COMMANDS.
- ✓ 16-BIT INTERNAL BUS
- ✓ VALIA & STACK STRUCTURE
- ✓ HARDWARE ARITHMETIC SEQUENCING
- ✓ TWO-PORT STACK ORGANIZATION
- ✓ WORKING REGISTER SPACE.

J.B.-
 Saw a whole board
 of TTL! MIL-STD-883
 for free too.
 This one's a
WINNER!

The weakest link in your micro-processor-based system has always been software development. It's always taken weeks and dollars and headaches. But that's going to be different now.

MICROPROCESSING: THE WEAK LINK REMOVED.

Advanced Micro Devices announces the Am9511 Arithmetic Processor.

It implements the following functions in high speed hardware, two orders of magnitude faster than the standard MPU software approach.

Simple: addition, subtraction, multiplication and division.

Complex: logarithms, square roots, powers, exponentiation, trigonometry and inverse trigonometry.

(The basic functions can be performed in 16-bit or 32-bit fixed point and 32-bit floating point format.)

As if that weren't enough, you pick the microprocessor. That's right. Not only is our Am9511 amazing, it's also compatible with all of the most com-

monly used microprocessors on the market—including the industry standard 8080/8085.

Increase your system throughput. Save weeks and months of software development. Reduce your chip count.

Remove the weak link. Call Advanced Micro Devices and ask for the data sheet and application note on the Am9511 Arithmetic Processor.

Advanced Micro Devices



Multiple technologies. One product: excellence.
901 Thompson Place, Sunnyvale, California 94086
Telephone (408) 732-2400

CIRCLE NUMBER 4

I want to show you our reliable system for removing flux

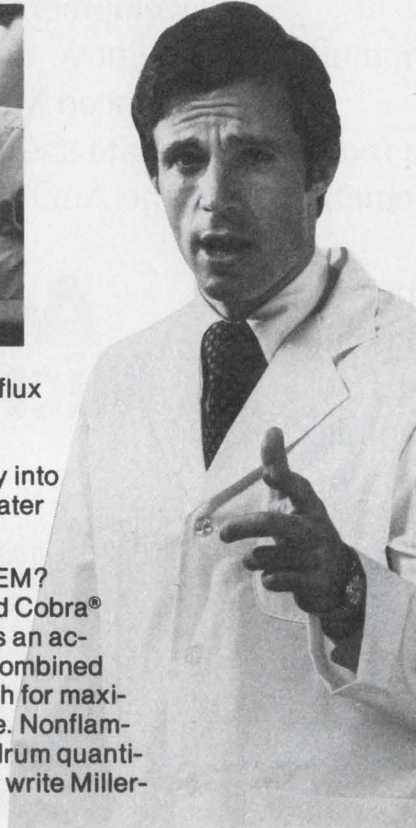
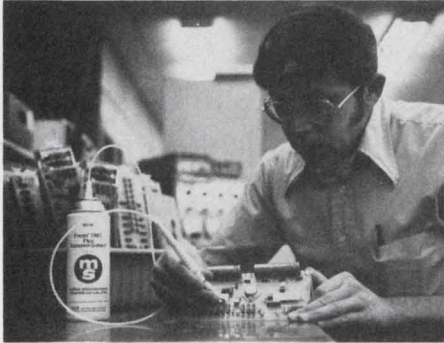

MS-190 and MS-190HD removes flux quickly, efficiently, economically without harm to components. Flux does not migrate by etching its way into critical parts causing failures at a later date.

WHAT'S NEW ABOUT THE SYSTEM?
The M-S system utilizes a patented Cobra® Solvent Spray Brush, the solvent is an accurately directed, metered spray combined with a scrubbing action of the brush for maximum cleaning with minimum waste. Nonflammable. Available in gal., 5 gal and drum quantities. For further information, call or write Miller-Stephenson.

**ms miller-stephenson
chemical co., inc.**
Danbury, Connecticut 06810 (203) 743-4447

----- ED-4W
miller-stephenson chemical company, inc.
Danbury, Connecticut 06810, (203) 743-4447

_____ Write our Technical Director for application information of MS-190, MS-190HD and MS-226 Cobra Solvent Spray Brush.

_____ Enclosed is \$5 for Trial Pack —
MS-190/MS-190HD/MS-226 Cobra Brush

_____ Send Literature and prices.

Name _____ Title/Dept. _____

Company _____

Address _____

City _____ State _____ Zip _____

*Registered trademark.

For Industrial Use Only. Trial Units must be sent to Company address.

LOS ANGELES • CHICAGO • DANBURY, CONN. • TORONTO

CIRCLE NUMBER 5

Publisher
William Maass

Editors
Editorial Offices
50 Essex St.
Rochelle Park, NJ 07662
(201) 843-0550
TWX: 710-990-5071
(HAYDENPUB ROPK)
Cable: Haydenpubs Rochellepark

Editor-in-Chief George Rostky

Managing Editors:
Ralph Dobriner
Michael Elphick

Senior Associate Editor
Stanley Runyon

Associate Editors:
Sid Adlerstein
Nicholas Bodley
Dave Bursky
Morris Grossman
Gene Heftman
Andy Santoni
Max Schindler

Contributing Editors:
Peter N. Budzilovich, Jules H. Gilder,
Sidney Moskowitz, Nathan Sussman

Editorial Field Offices
East

Jim McDermott, Eastern Editor
P.O. Box 272
Easthampton, MA 01027
(413) 527-3632

West

Dick Hackmeister, Western Editor
8939 S. Sepulveda Blvd., Suite 414
Los Angeles, CA 90045
(213) 641-6544
TWX-1-910-328-7240
Dave Barnes, Western Editor
465 S. Mathilda, Suite 302
Sunnyvale, CA 94086
(408) 736-6667

Editorial Production

Marjorie A. Duffy, Production Editor
James Keane, Copy Editor

Art

Art Director, William Kelly
Richard Luce, Anthony J. Fischetto

Business Manager

Thomas E. Vachon

Production

Manager, Dollie S. Viebig
Nancy Hurey

Circulation

Director, Barbara Freundlich
Senior Assistant, Gail Stone

Information Retrieval

Paula Greenleaf

Advertising Promotion

Director, William Hussey
Assistant, Judith Nappo

Reprints

Maxine Sassano

Across the desk

Paperwork records, doesn't make, history

Regarding your editorial on paperwork (ED No. 7, March 29, 1977, p. 73): I loved the editorial and have a copy of it on my bulletin board to remind me at all times that the computer never really makes things happen. It merely records the history of what some action person or persons made happen in the successful companies and what the paper shufflers did not do in the unsuccessful companies.

I could only imagine the things that might have been. Frank Jarman, my fraternity brother at MIT, died in an auto accident years ago. He abhorred paperwork and loved everyone. What a difference he would have made at Genesco after Max Jarman bowed out.

Dick Wynne
National Distributor Sales
Manager

RACAL-DANA Instruments Inc.
18912 Van Karman Ave.
Irvine, CA 92713

Eschewed out

Possessed of the same motive that is the theme of your editorial, "Concepting an Idea" (ED No. 3, Feb. 1, 1978, p. 53), I boldly posted a sign in my office exhorting all to ESCHEW OBFUSCATION. I thought it was cute and challenging. The reaction however, was enlightening.

One visitor stated angrily that it is not funny but foolish to post notices that others can't understand. Another didn't think he was hungry enough to chew anything, much less something new and strange. A third visitor announced haughtily that Latin wasn't something taught at his school, as though Latin were something of which to be ashamed.

Obviously obfuscated, I felt compelled to make the sign read
ESCHEW OBFUSCATION
means
KISS
(Keep It Simple Stupid!)
G. Robt. Mezger

RD2, Box 72
Miller Drive
Boonton, NJ 07005

Misplaced Caption Dept.



You call this a structured program?

Sorry. That's Thomas Eakins' "The Dean's Roll Call," which hangs in the Museum of Fine Arts in Boston.

(continued on page 14)

Electronic Design welcomes the opinions of its readers on the issues raised in the magazine's editorial columns. Address letters to Managing Editor, Electronic Design, 50 Essex St., Rochelle Park, NJ 07662. Try to keep letters under 200 words. Letters must be signed. Names will be withheld upon request.

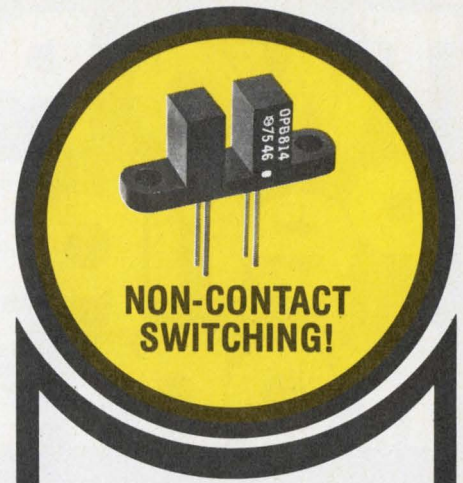

OPTICALLY COUPLED INTERRUPTER MODULES

OPTRON OFFERS IMMEDIATE DELIVERY OF NEW, LOW COST SERIES

OPTRON's new, low cost optically coupled interrupter module series combines non-contact switching and solid state reliability for applications requiring sensing of position or motion of an opaque object such as motion limit, paper edge or shaft encoding.

The new OPB 813, OPB 814 and OPB 815 consist of a gallium arsenide infrared LED coupled with a silicon phototransistor in an economical molded plastic housing. With a LED input of 20 mA, the OPB 813 and OPB 815 have typical unblocked current outputs of 2.0 mA and 3.0 mA, respectively. Typical output of the OPB 814 is 3.0 mA with a 10 mA input. The entire series is available from stock.

Background illumination noise is eliminated by a built-in infrared transmitting filter and dust cover in each device type. The OPB 813 also is available with a 0.010 inch aperture for high resolution applications.

New OPTRON optically coupled interrupter modules are interchangeable with similar products as follows:

| OPTRON | GE |
|---------|-------|
| OPB 813 | H13A1 |
| OPB 813 | H13A2 |
| OPB 814 | H13B1 |
| OPB 814 | H13B2 |

Detailed technical information on these and other OPTRON standard interrupter and reflective modules, as well as versions for specific applications is available on request.



OPTRON, INC.

1201 Tappan Circle
Carrollton, Texas 75006, U.S.A.
214/242-6571 • TELEX-73-0701
TWX-910-860-5958

Two Powerful Peripherals from Zilog:

The Z80™ Serial Input/Output

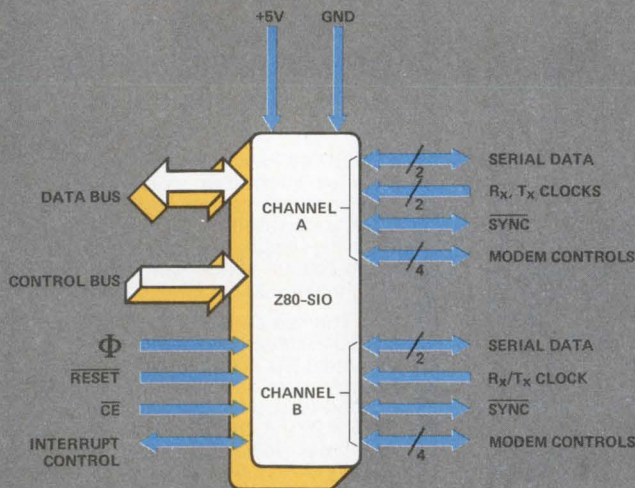

The Z80-SIO is the world's first dual-channel, multi-protocol serial communications interface circuit. It represents a significant technological advance in LSI microcomputer peripherals by supporting all common serial data communication techniques with a single, N-channel (+5V) 40 pin device. The Z80-SIO achieves unheard-of levels of logic density and functional integration.

(Over 10,000 transistors on a 200 mil chip.)

As with all Zilog Z80 peripheral components, the Z80-SIO supports the "Daisy-Chain" interrupt structure of the Z80-CPU for fast, powerful interrupt processing with no additional hardware overhead. The Z80-SIO can also be easily interfaced to other 8-bit and 16-bit microprocessors.

- Two independent, full-duplex channels with modem controls.
- Data Rates—0-550k bits/second (2.5 MHz Z80) • 0-880k bits/second (4.0 MHz Z80A)
- Asynchronous Modes • Programmable bits/character, stop bits • clock factor • Break detection/generation • Parity, overrun and framing error detection
- Synchronous Modes • Internal or external sync • One or two sync characters • CRC generation/checking
- SDLC/HDLC Modes • Comprehensive frame-level control • I-field residue handling • CRC generation/checking

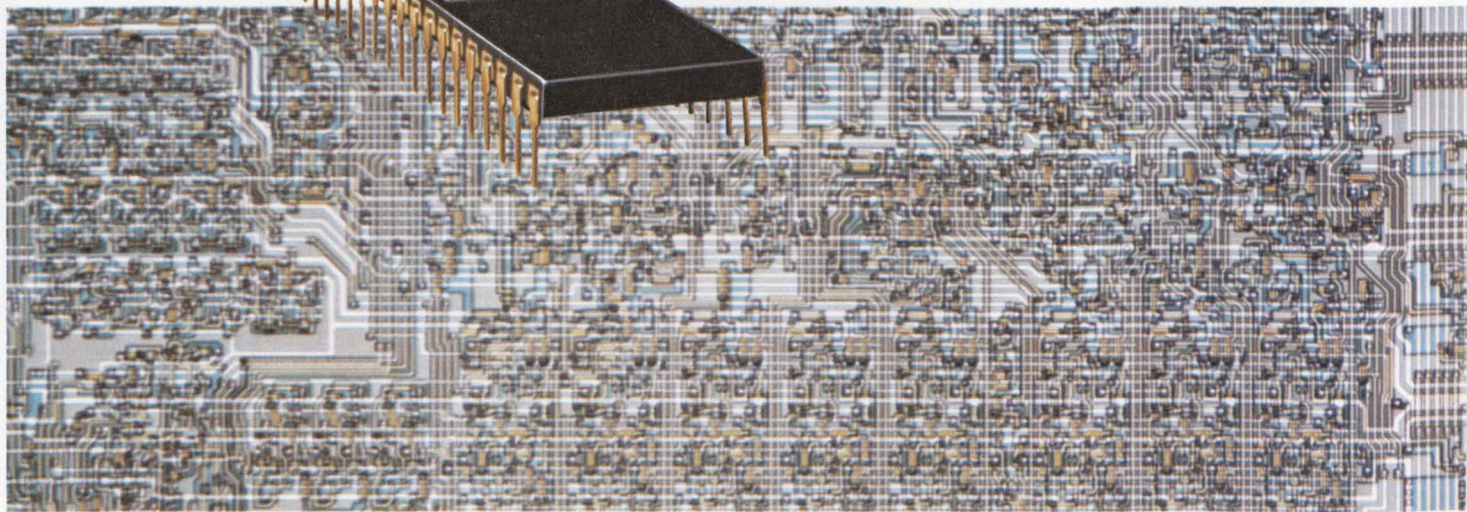
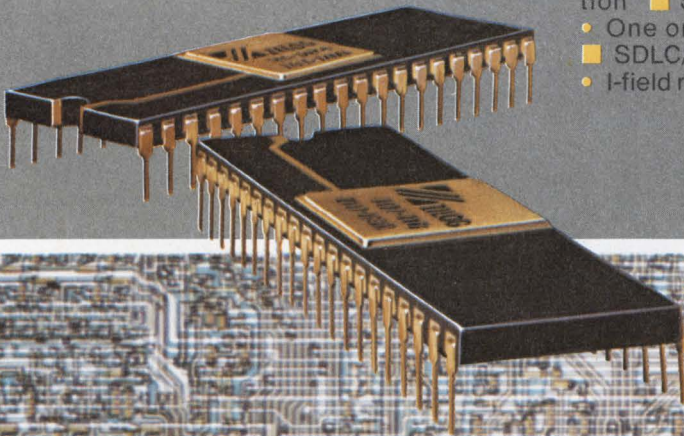

The Z80™ Direct Memory Access

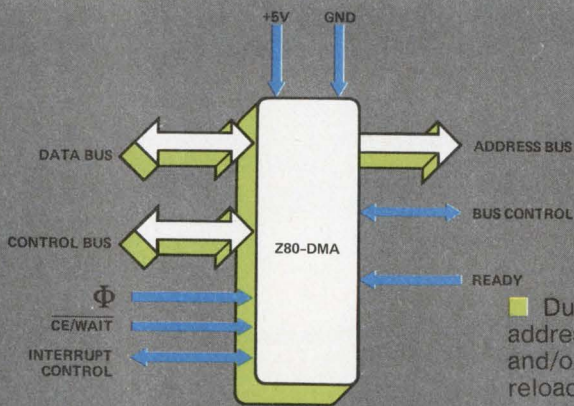

The Z80-DMA is designed to optimize the efficiency and speed of data transfers within microcomputer systems. Its unique, dual address operation provides the systems designer with features and flexibility far beyond that of any other type of DMA controller. The Z80-

DMA functions as a high-speed transfer processor, assuming complete system bus control in its "master" role. The Z80-DMA can be easily cascaded by on-chip features, operates off a single +5V supply and is packaged in a 40 pin DIP.

- Dual-address, single-channel
- Programmable operating modes, starting addresses, block lengths, port timings, increment/decrement/fix
- Transfer and/or byte search operation (up to 1.25 Mbyte/Sec)
- Automatic parameter reload
- Complete status read operation
- No additional hardware overhead

Total Systems Support from Zilog

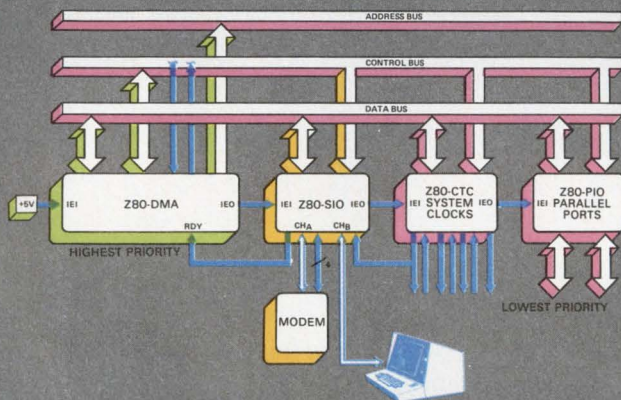

This diagram illustrates the power, functional integration and ease of interface of Zilog's Z80 peripheral component family that dramatically reduces the number of chips you need. It represents the peripherals section of a high speed communications processor.

The system bus is common throughout with memory, Z80-CPU and peripherals sharing as a common resource. The interface between all peripherals and the bus is direct with no additional logic required.

Interface to "outside" communications is through a MODEM device to the Z80-SIO. All necessary Modem controls are provided directly by the Z80-SIO and data is transferred under Z80-DMA control for message-structured buffering. The second channel of the Z80-SIO is devoted to an asynchronous CRT terminal.

Note the baud rate generation for the terminal interface comes directly from the Z80-CTC and is completely software programmable. Other system clocks are generated by the remaining channels of the Z80-CTC. Parallel interfaces to other input sources or

indicators are interfaced via the Z80-PIO.

All this from Zilog, the company that's pledged to stay a generation ahead. Zilog provides you with all the LSI circuitry necessary for you to build high-performance microcomputer systems with an absolute minimum of outside logic and memory elements.

Contact your local Zilog sales office or distributor for complete information and pricing.

10460 Bubb Road
Cupertino, California 95014
(408) 446-4666
TWX 910-338-7621

EASTERN REGION:
(617) 667-2179

MIDWESTERN REGION:
(312) 885-8080

SO. WESTERN REGION:
(714) 549-2891

NO. WESTERN REGION:
(408) 446-4666

EUROPE (ENGLAND):
(0628) 36131/2/3

An affiliate of
EXON ENTERPRISES INC.

CIRCLE NUMBER 7



We want you to know more about
Microcomputer Peripherals

HP Makes it Easy and Economical to Design Your Own Process Control System



with a **MULTIPROGRAMMER**

Now you can quickly design a process control system using the HP MULTIPROGRAMMER main-frame and plug-in cards to interface your analog and digital input/output signals ... at a price as easy as the system design itself. Start building your process control system

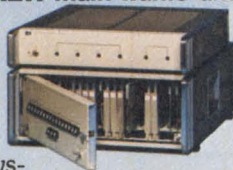

with the HP Multiprogrammer combined with a COMPUTING CONTROLLER. To

help you, HP offers a variety

of proven design aids including ... The MULTIPROGRAMMER TECHNICAL BROCHURE complete with capabilities, applications, typical system layouts, specifications, and more ... A USERS GUIDE that gives you sample programs, test routines, and I/O interface data for all 36 Multiprogrammer plug-in cards ...



We even have a UTILITY CARTRIDGE, that's ready to use in the HP 9825A computing controller, to aid you in writing your own application software for your specific application ... A SYSTEM



THROUGH-PUT ANALYSIS

allows you to accurately determine the measurement and control speed you can expect...even before you build your system. And, to make you a Multiprogrammer expert, we have

a hands-on TRAINING COURSE. For details on how HP makes it easy to economically build your process control system, write for our free Multiprogrammer Technical Brochure.

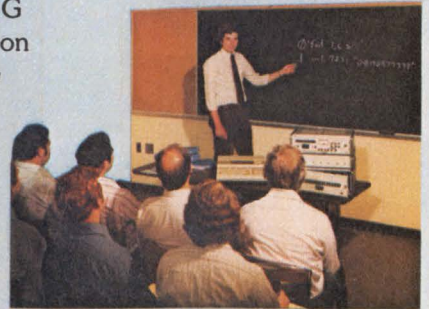

1507 Page Mill Road, Palo Alto, California 94304

For assistance call: Washington (301) 948-6370, Chicago (312) 255-9800, Atlanta (404) 434-4000, Los Angeles (213) 877-1282

CIRCLE NUMBER 8

21702

National and Lambda prove Fairchild regulators give you more for your money.

Compare our high current voltage regulators to the leading competitors.

You'll see we come out on top across the board.

Our unique Hybrid technology allows us to overcome the limitations

| 3 AMP, 5 VOLT REGULATORS | | | | |
|--|----------------------|-------------------|------------------|-------------------|
| PARAMETER | CONDITIONS* | FAIRCHILD SH323SC | LAMBDA** LAS1405 | NATIONAL** LM323K |
| Available Peak Current (typ) | $V_{IN}-V_{OUT}=10V$ | 6 A | 4.2 A | 4.2 A |
| | $V_{IN}-V_{OUT}=20V$ | 6 A | 2.3 A | 3.2 A |
| Available Average Output Current (typ) | $V_{IN}-V_{OUT}=10V$ | 5 A | 3 A | 3 A |
| | $V_{IN}-V_{OUT}=20V$ | 2.5 A | 1.5 A | 1.5 A |
| Minimum Input Voltage (typ) | $I_{OUT}=3A$ | $V_{OUT}+1.8V$ | $V_{OUT}+2.2V$ | $V_{OUT}+1.9V$ |
| Max Power Dissipation | — | 50 W | 30 W | 30 W |
| Price | 100 pieces | \$5.00 | \$6.75 | \$5.35 |

* $T_C=25^\circ C$
**Based upon published data sheet specifications

HI-CURRENT REGULATORS

| 5 AMP, 5 VOLT REGULATORS | | | | |
|--|----------------------|---------------------------|------------------|-------------------|
| PARAMETER | CONDITIONS* | FAIRCHILD $\mu A78HO5ASC$ | LAMBDA** LAS1905 | NATIONAL |
| Available Peak Current (typ) | $V_{IN}-V_{OUT}=10V$ | 7 A | 5 A | NO AVAILABLE PART |
| | $V_{IN}-V_{OUT}=20V$ | 7 A | 1.5 A | |
| Available Average Output Current (typ) | $V_{IN}-V_{OUT}=10V$ | 5 A | 5 A | |
| | $V_{IN}-V_{OUT}=20V$ | 2.5 A | 1.5 A | |
| Dropout Voltage (typ) | $C I_{OUT}=5A$ | 2 V | 2.4 V | |
| Price | 100 pieces | \$5.50 | \$11.25 | |

* $T_C=25^\circ C$
**Based upon published data sheet specifications

of monolithic designs. Which means you get better specs at a lower cost.

How our 3 Amp regulators stack up.

Our SH323SC 3 Amp, 5 Volt regulator is a perfect example of the value of applying Hybrid know-how to regulator designs.

This side-by-side comparison based on published data sheets should leave no doubt.

How our 5 Amp regulators stack up.

Our $\mu A78HO5ASC$ is a new, enhanced 5 Amp, 5 Volt regulator that's pretty much in a class by itself. As you can

see by this chart, one leading competitor doesn't even offer the part. And the one that does isn't much competition.

For more details on our voltage regulators, just contact your Fairchild sales office, distributor or representative today. Or use the direct line at the bottom of this ad to reach our Hybrid Division. Fairchild Camera and Instrument Corporation, 464 Ellis Street, Mountain View, California 94042. Telephone: (415) 962-3903. TWX: 910-379-6435.

FAIRCHILD

**Call us on it.
(415) 962-3903**

PMI announces the first, fast precision bi-FET op amps

pin-for-pin replacements for the 155, 156, and 157.

No question about it, the bi-FET op amp was quite an achievement. Speed combined with acceptable input performance for the first time. The Miracle of Silicon Gulch was a great step forward.

But there was room for improvement. In several areas. So we went to work on it.

First, we second sourced it. And made it better.

We set about to improve idling current control, reduce second-stage TCV_{OS} and improve the first stage balance. The results were PMI's PM155A, 156A, and 157A, with specs, yields, and delivery far superior to the Miracle's maker. But we didn't stop there.

We were convinced that the basic design could be improved. It could be made faster. And more precise. So we designed a completely new proprietary series of op amps that would perform the way bi-FET op amps should.

And now, meet the Miracle of Miracles!

PMI's OP-15, OP-16, and OP-17 are the first precision pin-compatible versions of the 155A, 156A, and 157A, respectively. They give you three major improvements in performance:

1. Higher speed—by a factor of two.
2. Reduced offset voltage, thanks to our production-proven zener zap trimming technique. TCV_{OS} is well-behaved.
3. High-temperature bias current drastically reduced—by an order of magnitude—by means of a FET leakage current cancellation circuit (patent pending).

Let's look at that last point for just a moment. Although FET input current is picoamperes at room temperature, it doubles with every ten-degree rise. It can be several nanoamperes at 70°C ambient and **hundreds** of nanoamps at 125°C—worse than many bipolar op amps. The fact that the chip temperature is 20° to 30° higher than the ambient doesn't help. FET bias current is important. We think it's misleading to specify it at junction

temperature, so we specify it warmed up—the way you'll use it.

Consider the specs:

OP-15/LF155, OP-16/LF156 and OP-17/LF157 Comparison Chart

| Parameter* | LF155A LF355A | OP-15A OP-15E | LF156A LF356A | OP-16A OP-16E | LF157A LF357A | OP-17A OP-17E | Units |
|---|------------------|------------------|-------------------|------------------|-------------------|------------------|---------|
| Offset Voltage, Max. | 2.0 | 0.5 | 2.0 | 0.5 | 2.0 | 0.5 | mV |
| Bias Current, Max. (warmed-up) 0 to 70°C | 8.0 | 0.75 | 9.0 | 0.9 | 9.0 | 0.9 | nA |
| -55 to 125°C | 100 | 9 | 180 | 11 | 180 | 11 | nA |
| Slew Rate, Min. | 3 | 10 | 10 | 18 | 40 | 45 | V/μsec. |
| Gain-Bandwidth Product Typ. | 2.5 | 6.0 | 4.5 | 8.0 | 20 | 30 | MHz |
| Supply Current, Max. | 4 | 4 | 7 156A 10 356A | 7 | 7 157A 10 357A | 7 | mA |
| Voltage Gain, Min. | 50 | 100 | 50 | 100 | 50 | 100 | V/mV |

*All other parameters are more or less equivalent; in the case of TCV_{OS} , however, the OP-15/16/17's **really do** meet the spec—and our typicals are typical of what you get.

A quick look tells us that the OP-15 has the speed of the 356A, but not the **power dissipation**, which is the same as the 355A. The OP-16 is twice as fast as the 356A.

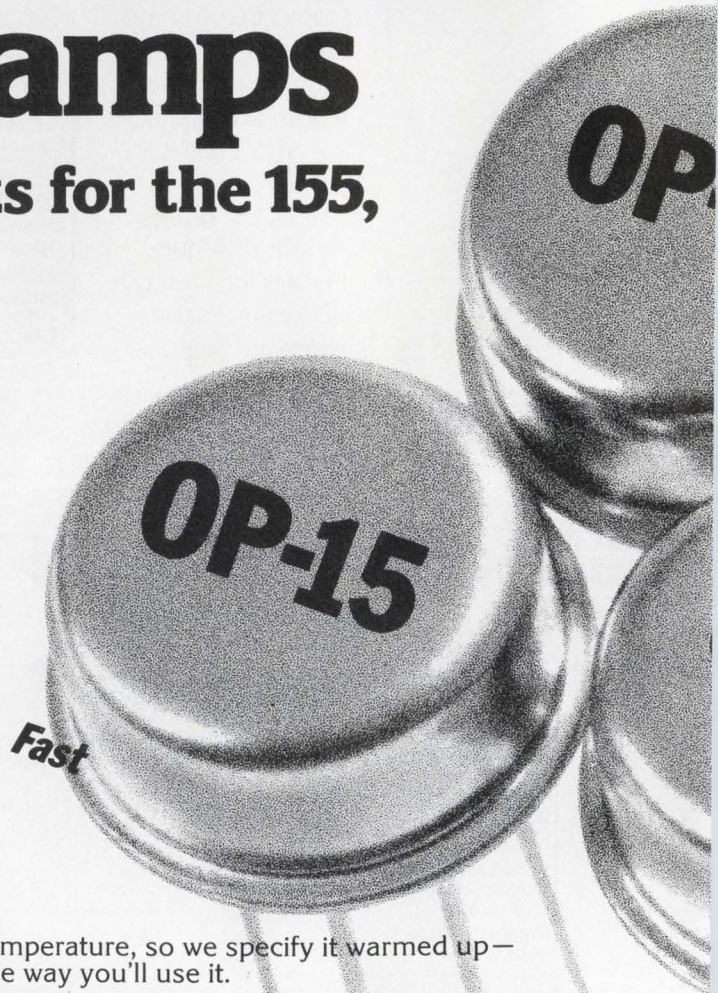

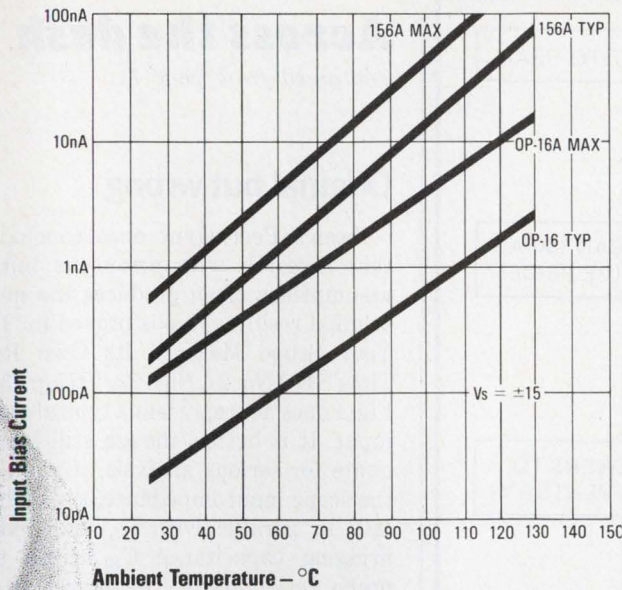

Input Bias Current vs. Ambient Temperature
(Units are warmed-up in free air)

And cost. What about cost?

There's no basis for comparisons, since nobody else is delivering "A" grade bi-FETs anyway. For sure nobody is delivering anything that comes close to the OP-15/16/17 specifications. But we would like to make something clear:

We do not consider a bi-FET op amp to be a substitute for a 741. With its larger chip area and extra ion-implant step, the bi-FET will always cost more; and the OP-15, 16, and 17 are **precision**, high-speed, low-bias-current op amps designed to give you high performance and high speed over the full operating temperature range. They cost more than 741's.

On the other hand, they cost **less** than LF-155/6/7A's—even though they outperform them.

| Model | Temp. Range | Price (100-999) |
|--------------|--------------|-----------------|
| OP-15/16/17A | -55°C/+125°C | \$18.00 |
| OP-15/16/17B | -55°C/+125°C | \$ 9.00 |
| OP-15/16/17C | -55°C/+125°C | \$ 6.00 |
| OP-15/16/17E | 0°C/+70°C | \$10.00 |
| OP-15/16/17F | 0°C/+70°C | \$ 3.50 |
| OP-15/16/17G | 0°C/+70°C | \$ 2.50 |

Lower price. Better performance. And we actually deliver them.

When you get right down to it, our miracle is a lot more dazzling than their miracle.

So what's the bottom line?

Offset voltage improved four-fold. Circuit balanced for low TCV_{OS} . Bias current over temperature reduced ten times. And the OP-15/16/17 fits all 155/156/157 sockets. Plus:

The **OP-15's** supply current is low like the 155's, yet it gives you the speed of the 156.

The **OP-16** gives you the best power/speed compromise you can find—twice as fast as the 156, but with the same moderate power dissipation.

The **OP-17** gives you ultra-high speed (70v/μsec. typical in a gain of five)—high enough to challenge costly dielectrically-isolated devices.



PMI's OP-15, OP-16, and OP-17. The next industry standard.



Precision Monolithics Incorporated
1500 Space Park Drive
Santa Clara, California 95050
Telephone: (408) 246-9222
TWX: 910-338-0528
Cable: MONO

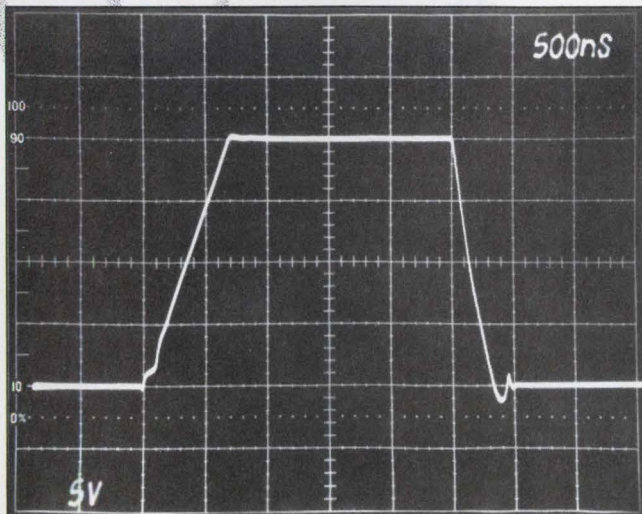

OP-16 Typical Slew Rate

Mail to:
Precision Monolithics, Inc., 1500 Space Park Drive
Santa Clara, CA 95050
I'm interested in the following:
 OP 15/16/17 data sheets Full Product Catalog
 Have a Sales Engineer call () _____

Name _____
Title _____
Company _____
Address _____
City _____ State _____ Zip _____

OH JOHN, TELL ME WHAT I WANT TO HEAR.

CAPAR HAS OVER 50 MILLION CAPACITORS AND OVER 40 MILLION CARBON FILM RESISTORS IN STOCK.

JOHN DEAR, TELL ME, CAN CAPAR DELIVER AT COMPETITIVE PRICES?

YES MY LOVE, NOT ONLY IS CAPAR THE MOST COMPETITIVE IN PRICE, BUT OUR QUALITY IS SECOND TO NONE.

CAN WE GET IMMEDIATE ANSWERS TO INQUIRIES ON AVAILABLE INVENTORY?

WHY DON'T YOU CALL US TOLL FREE TO FIND OUT. WE SHIP 80% OF OUR ORDERS THE SAME DAY.

OH JOHN, DEAR JOHN, YOU'VE TOLD ME ALL I WANT TO HEAR.



Yes, it's true. Capar, the people who give you the best service available, give you the best prices available, too. With our large inventory, we can take care of most of your company's needs. And we now have two warehouse locations, so we can ship to you faster. In fact, we give you immediate delivery on all of our devices.

When you order from Capar, you get top quality components, and at the best competitive prices. So if you want to get the maximum for your money, give Capar a call. We're waiting to serve you, and our service is the best.

See us at Newcom, Booth P9. See us at Electro, Booth 612.

303 Crossways Park Drive. Woodbury. New York 11797; Telephone (516) 364-2610; (800) 645-7474; Telex No. 144678



CIRCLE NUMBER 11

Across the desk

(continued from page 7)

Original but wrong

Ibsen's Peer Gynt once concluded that research with erroneous initial assumptions often produces the most original results. This is proven in "Let Your Scope Measure Its Own Rise Time" (ED No. 24, Nov. 22, 1977, p.130). Fig. 1 does not represent a typical scope input. It is better, though still inadequate for serious analysis, if you add the scope input impedance, typically $1\text{ M}\Omega$, in parallel with C_2 , and add a bridging capacitance C_B across the probe resistance R . A typical $10\times$ probe has $R = 9\text{ M}\Omega$ and $C_B = C_2/9$. When these corrections are made, it becomes obvious that the probe and input circuit no longer determines the bandwidth of the scope, only how the probe tip loads the circuit under test. This, unfortunately, leaves the whole analysis and measuring scheme meaningless.

Einar Traa

Tektronix, Inc.
P.O. Box 500
Beaverton, OR 97077

Dear Mr. Traa:

Upon reading your comments with respect to my article, I was surprised to learn that somehow the main text of the article had escaped you. Permit me to clarify some points of issue.

The equivalent circuit you described for a scope with a probe attached is correct and can be drawn as follows:

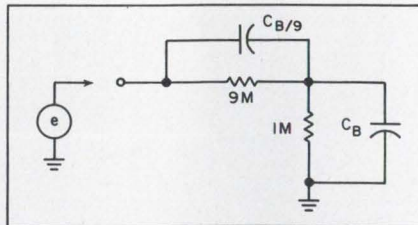

The transfer function of this circuit can be calculated to show that when the probe is matched properly, the scope offers no delay and the input impedance is resistive and capacitive.

However, the C_2 that I talked about does not relate to a physical capacity; C_2 by itself does not exist, it only exists in the product RC_2 , which represents the oscilloscope time constant. Let us

(continued on page 22)

One dynamic reason to buy Mostek's 4K static. Delivery.

Delivery's fast and that's good news, but there are more dynamic reasons to buy the Mostek 4104 4K X 1 static RAM. For one, it offers the industry's best speed/power product. Using our own widely-copied Edge-Activated™ design concept, Mostek engineers developed the 4104 offering the best features of static and dynamic RAMs. Power is extremely low— just 150mW active and 28mW standby. It's directly compatible with TTL. It operates on a single +5 Volt power supply with a tolerance of ±10%. And you can get it in the industry-standard 18-pin configuration.

| | ACCESS TIME | CYCLE TIME | ACTIVE POWER (MAX) | STANDBY POWER (MAX) | BATTERY BACKUP POWER (-3X Series) |
|--------------|-------------|------------|--------------------|---------------------|-----------------------------------|
| MK4104-4/-34 | 250ns | 385ns | | | |
| MK4104-5/-35 | 300ns | 460ns | 150mW | 28mW | 10mW |
| MK4104-6 | 350ns | 535ns | | | |

The new 4104-3X series offers the capability of retaining data in a reduced power mode. When Vcc is lowered to 3V, maximum power dissipation is only 10mW. This allows complete data retention during battery operation.

There's a lot of dynamic reasons for Mostek's 4104 static RAM. To get the

complete story, call a Mostek distributor or sales representative now. Or contact Mostek at 1215 W. Crosby Road, Carrollton, Texas 75006; telephone (214) 242-0444. In Europe, contact Mostek GmbH, West Germany; telephone (0711) 701096.

MOSTEK.

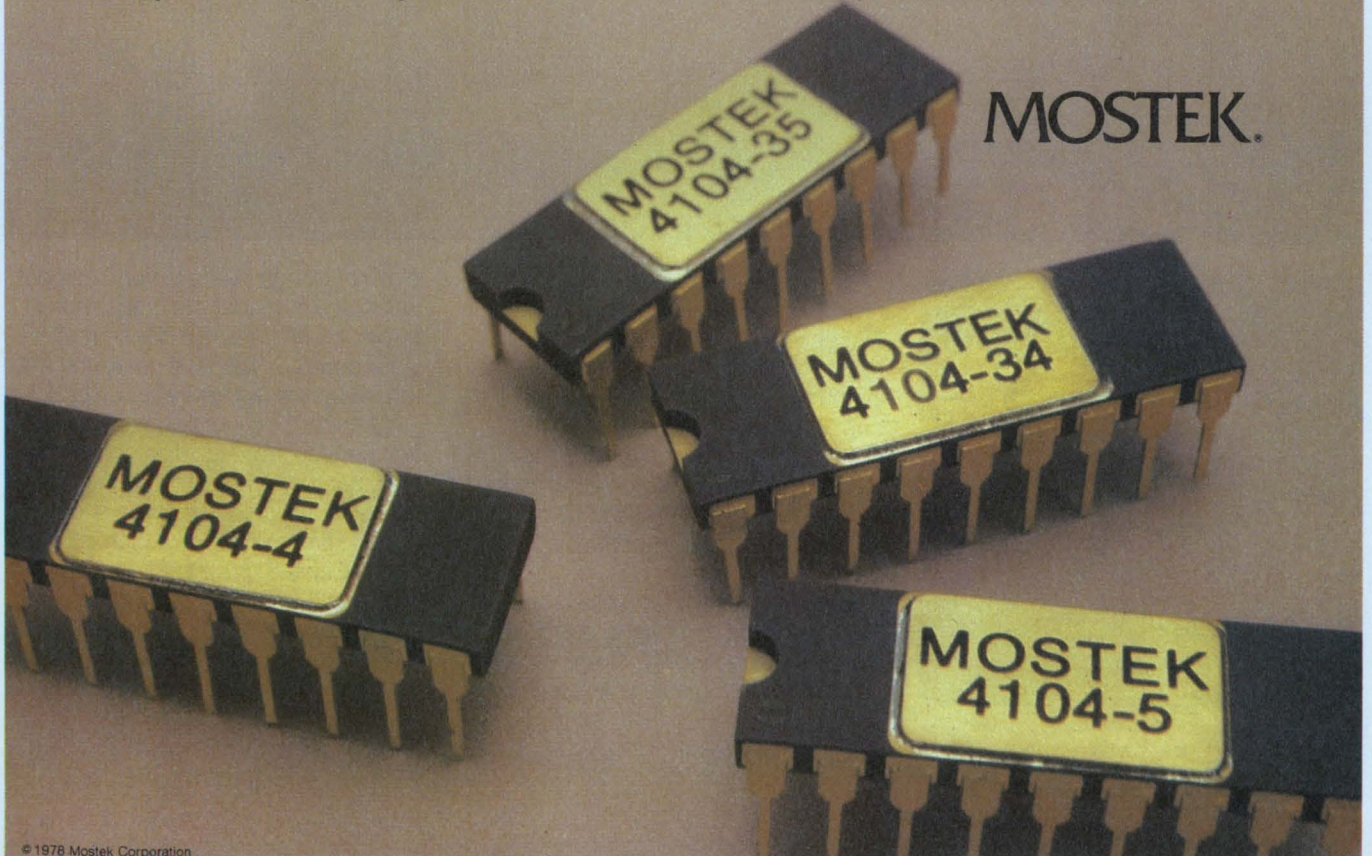

© 1978 Mostek Corporation

Multiwire[®] reliability: 99 percent.

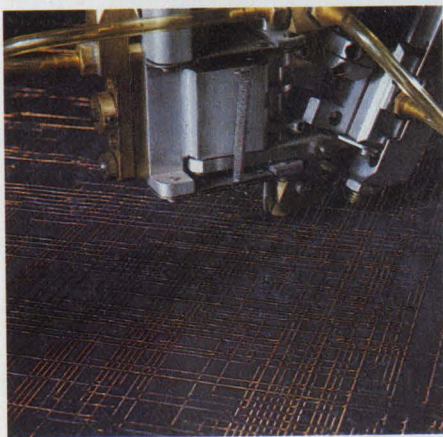
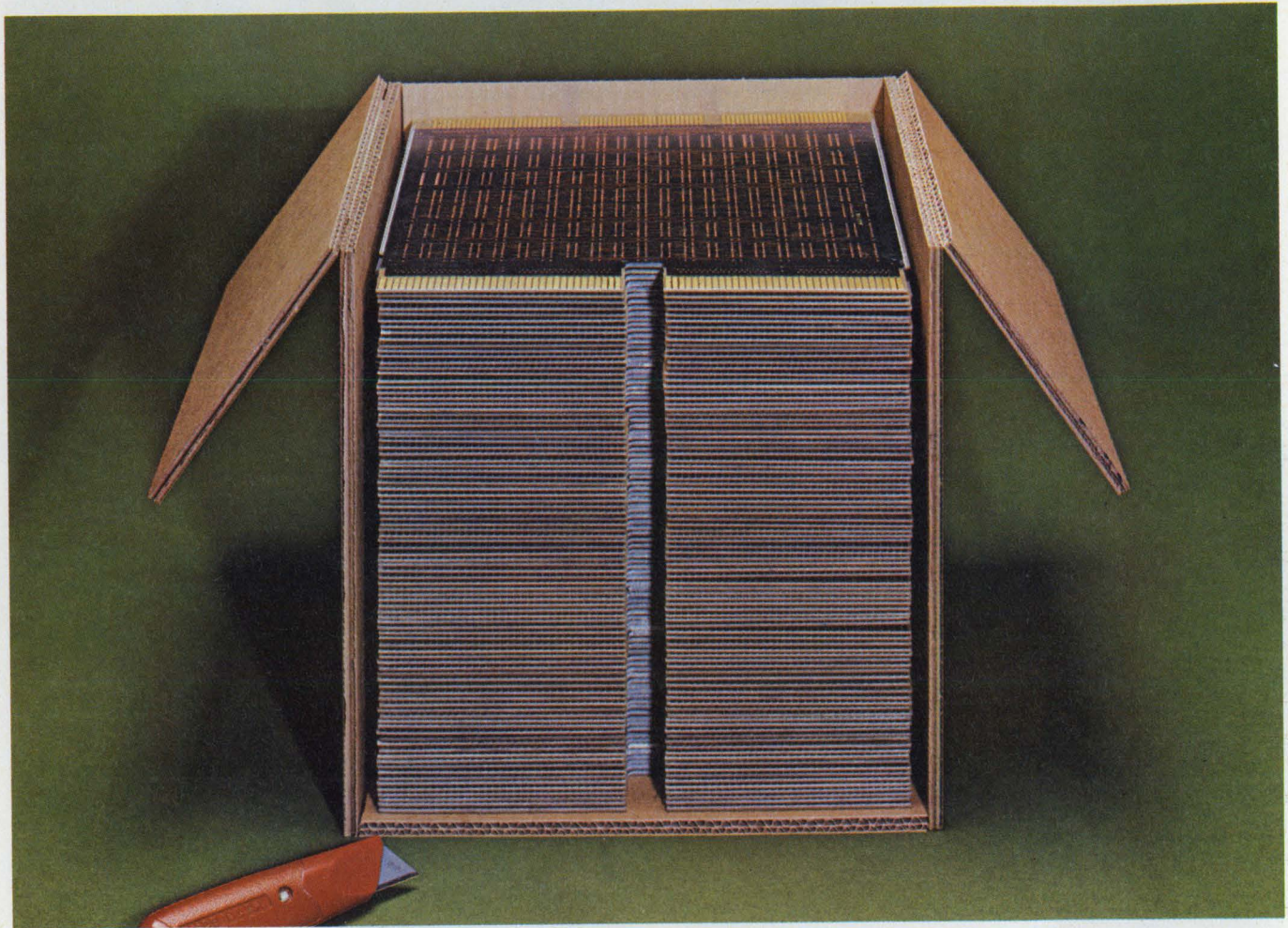

Until recently multilayer boards have been unchallenged in providing highest density interconnection systems. Their disadvantages, including lack of reliability, have been accepted as unavoidable by the user. Now Multiwire boards provide the same high density with several major advantages over multilayer boards. For many the most important is greater reliability.

Here is what one defense program manager says, "... multilayers have a questionable reliability. The interconnections in the middle layers to the

plated-through hole are very suspect when you consider the thousands of such connections in a dense multilayer board... we have not found any failures in the (Multiwire) boards."

After carrying out accelerated life tests on Multiwire, a large computer manufacturer had zero failures. To avoid assigning perfect performance to Multiwire, they assumed one failure and projected a real life failure rate of 0.01%/1000 hours.

In most military and commercial thermal shock specs a minimum of 36 interconnections are put through 5

Multilayer reliability: _____ percent.



cycles. To find any faults, an independent testing laboratory put 12,240 Multiwire interconnections through 200 cycles. Only one Multiwire connection opened.

Multiwire consists of a high-density grid of insulated wire laid down by numerically-controlled machines. All intersections typically have a 2000-4000-volt breakdown. The wires connect far more reliably to the plated-through holes than do the multilayer connectors, due to the inherent characteristics of the process.

Now consider other advantages of

Multiwire over multilayer: Multiwire offers much shorter lead times. No artwork except for the basic ground planes and connections. From there on, you need supply only an interconnection list . . . and we prepare the input data for our N/C machines. Or, from the software we offer, you can prepare your own input data. Our N/C machines do the rest. Result: Multiwire design and tooling costs are much lower and first-piece delivery is much faster.

Changes on wired or assembled boards? You have much higher

accessibility to connections throughout a Multiwire board.

Multiwire manufacturing automatically produces impedance control that requires sophisticated multilayer design to match.

It's no stroke of luck that 139 Multiwire boards are in one military vehicle already. Design, development, production and reliability advantages are too overwhelming to ignore.

Write Multiwire Marketing Department or call 516-448-1117. In New England, call 603-889-0083. In California, 213-999-1710.

Multiwire[®] from Photocircuits.

Division of Kollmorgen Corporation, Glen Cove, New York 11542

CIRCLE NUMBER 13

IT TOOK UNITRODE TO DELIVER A WHOLE POWER CIRCUIT FOR LESS THAN THE PRICE OF ITS PARTS.

Unitrode's Power Output Switching Regulator Circuits.

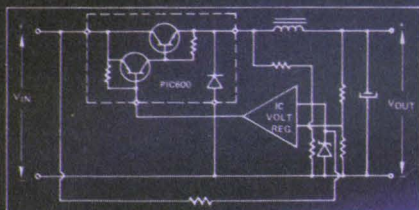

Typical Schematic for Positive Voltage Switching Regulator:

\$2 and up.

If you've ever designed a switching power supply, you already know how tricky it is. Especially when you're trying to mate the driver and output transistor with the catch diode.

But you could always argue that you were saving the company money.

Well, Unitrode has just priced that argument out of existence.

Because now, in high volume, you can get that power output circuit already designed and built for less than the price of the individual components. And you not only save design time, you also save breadboarding and debugging time.

You can also look forward to a switching circuit that will probably have greater efficiency and superior noise performance than the one you were thinking about building. Because our circuits switch faster, you can reduce the size and the cost of other components and operate at frequencies up to 100kHz.

Our power switching circuits (PIC600 through PIC656) are available, off-the-shelf, with both positive and negative outputs, from 5 to 20A and up to 80V.

Discover what more and more design engineers are discovering in applications ranging from microprocessor memories to instrumentation—that you might be able to build as good a power switching circuit as Unitrode, but you won't be able to do it for less.

To get more detailed information about our specs, along with our application notes on buck, boost and flyback regulator design, circle the reader service number or call or write: Unitrode Corporation, 580 Pleasant Street, Watertown, MA 02172. Tel. 617-926-0404.



UNITRODE

IN SEMICONDUCTORS, UNITRODE MEANS POWER.

© Copyright Unitrode Corporation 1977

Oliver Germanium.

Oliver O. Ward,
President,
Germanium Power Devices Corporation.
Sometimes known as
Oliver Germanium.



Still growing.

Germanium Power Devices Corporation is rapidly becoming the world's No 1 source for Germanium semiconductors.

We make all the well known JAN and EIA Germanium 2N numbers.

We make most of the PRO-ELECTRON families; AD, ADY, ADZ, ASZ, AU, AUY, and ASY.

And we can now replace practically all the Germanium products you used to buy from Motorola (MP500-506, 2N4276-4283, 4048-4053), Delco (DTG110, 2N1100, DTG2000-2400A), GE (2N319-324, 524-526, 1370-1381, 1413-1415, 1924-1926), Siemens, Mullard, SGS-ATES, and Thomson.

Our range goes from 150mW small signal to 100A power, in packages of all shapes and sizes.

Germanium is here to stay.

We'll be making Germanium devices as long as you, the customer want them.

Send for our latest catalogue or let us know your specific problem.

GPD, Box 65, Shawsheen Village Station, Andover, Mass, 01810.

Tel: (617) 475-5982.

Telex: 94-7150 GPD Andr.

**Germanium Power
Devices Corporation**

The Germanium Manufacturers

CIRCLE NUMBER 15

When it comes to quality control



we're years ahead of the competition.

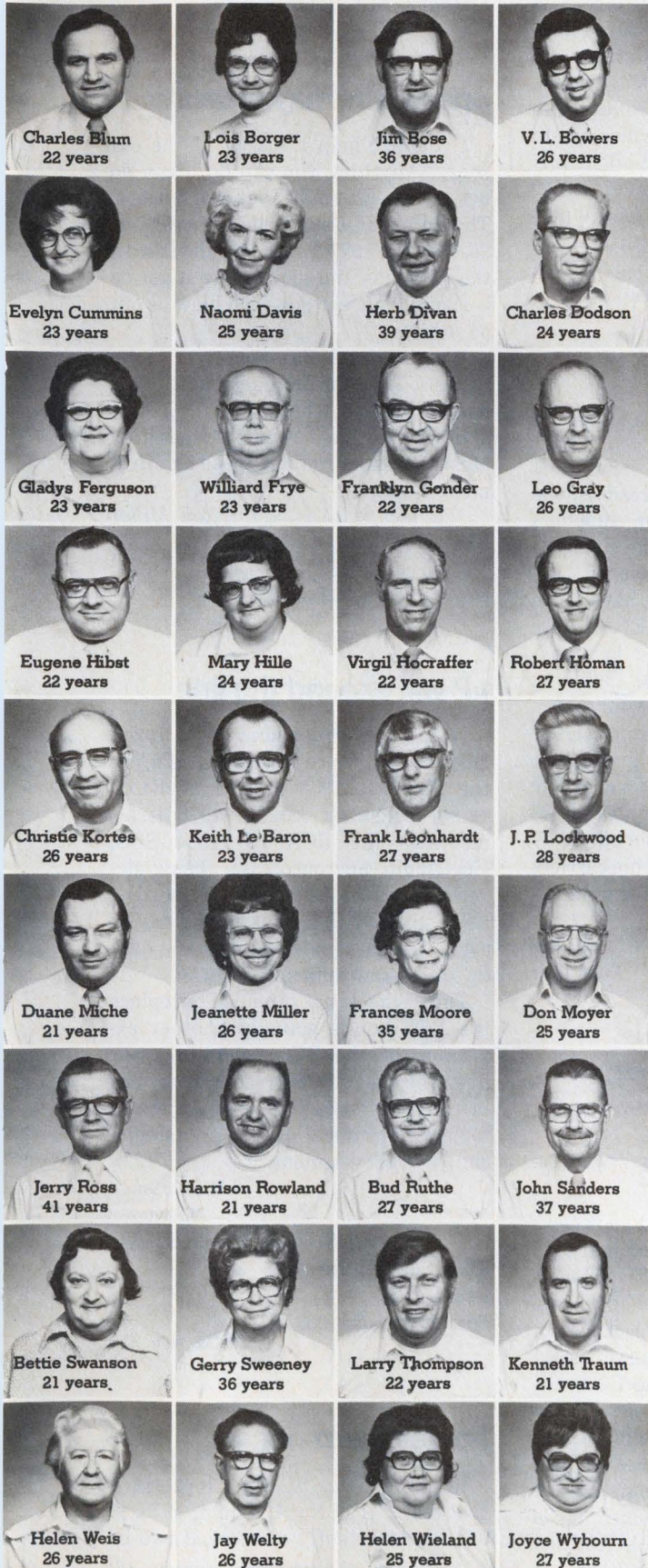

2775.

That's the total number of years these Quality Assurance employees have been on the job. And it's a figure that speaks for itself.

Because they use that experience to help make sure every MICRO SWITCH product meets the toughest performance standards in the business. Ours.

That's the MICRO SWITCH commitment to quality. A commitment made by every department. Every day. It adds up to the kind of products your money can't buy anywhere else.

We team our fine people with the very latest equipment. They use everything from simple, hand-held ring gauges to ultra-sophisticated electronic devices. Plus an evaluation lab that duplicates almost any environmental condition.

And it's all used with the same thought in mind. To see to it every MICRO SWITCH product is exactly what our designers intended it to be.

You see, when you buy a MICRO SWITCH product, whether it's a keyboard, a position sensor or a manual control, you're buying more than just a component. You're buying a company.

A company with capabilities to help solve your problems. Whether through research and development. Innovation. Availability. Reliability. Or Quality Assurance.

MICRO SWITCH. Consider what it would cost to have anything less.

For more information, write for our Quality Assurance booklet. MICRO SWITCH, Freeport, Illinois 61032. Or call 815/235-6600.

MICRO SWITCH products are available worldwide through Honeywell International.

MICRO SWITCH

Can you afford anything less?

CIRCLE NUMBER 109

Multiple-Output, UL-Recognized 750-watt Switchers!

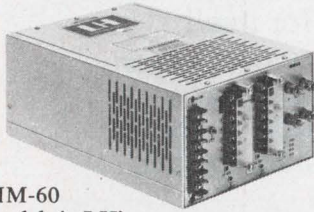

MM-60 models in LH's Mighty MITE Series are now UL-recognized. Choose among three-, four-, or five-output units producing 750 watts total. All models are compact and lightweight. Sized to fit into tight places — and tight budgets, too. Priced as low as \$750.00.* Major specs:

- Two high-current primary outputs: choice of 2V, 75 amps; 5V, 75 amps; 12V, 31 amps; 15V, 25 amps.
- 3rd, 4th and 5th output voltages — 2-28V, 3-12 amp ratings. Contact factory for detailed specifications (all outputs fully regulated).
- Efficiency up to 80%.
- 0.4% line reg. over input range.
- 0.4% load reg. from no load to full load.
- 1% or 50 mv peak-to-peak ripple and noise.
- 0°C to 70°C operating temp., derated to 60% at 71°C.
- Forced air cooling.
- Power fail detection and remote on/off capability.
- Thermal protection switch.

*10 to 24 pieces.

**World's largest
switcher
manufacturer!**



UL-recognized MM-60 switchers typify units offered by LH. And nobody packs more power in smaller packages or offers more desirable features including 1 through 7 outputs, up to 2.45w/in.³, 80% efficiency, 2-year guarantee. At less than 60¢/w in quantity.



LH RESEARCH, INC.

1821 Langley Avenue, Irvine, CA 92714
(714) 546-5279 • TWX 910-595-2540

CIRCLE NUMBER 16

Across the desk

(continued from page 14)

assume the scope has infinite bandwidth and that some limiting factor (a frequency corner at $\omega = 1/RC_2$) is cascaded with the oscilloscope to represent the real world. The article described a technique used to determine RC_2 , the limiting time constant. The article does assume the oscilloscope to have a 6-dB frequency roll-off; this is very close to being true according to laboratory measurements I have performed.

Raymond Pizzi
Electronics Engineer

Maintenance Directorate
Fort Monmouth, NJ 07703

Where are we?

For the benefit of your readers, one of the several connector suppliers listed in your article on the changing shape of IC packages (ED No. 26, Dec. 20, 1977, p. 30) should have been Azimuth Electronics, Inc. Even before JEDEC became interested in standardization, Azimuth was building sockets on a prototype basis for manufacturers and users of the chip carrier.

The 28 Pad General Instrument Mini-Pak mentioned in your article was socketed by the Azimuth 6040-28 G.I. This design concept is employed by Azimuth to accommodate chip carriers from 14 to 84 pads on 50 and 40-mil centers.

Kenneth C. Johnson
President

Azimuth Electronics, Inc.
2377 S. El Camino Real
San Clemente, CA 92672

CIRCLE NO. 315

Packaging impasse

I read with great interest your news report relating to IC packaging design changes proposed by JEDEC (ED No. 26, Dec. 20, 1977, p. 30). The change from long rectangular IC packages to multilead square packages could eliminate the impasse the PC-board layout designer currently encounters. We refer to it as the "Maginot Line" impasse when multiple use of rectangular packages prevents direct circuit-path interconnections. It is almost like encountering a fortified border; you need multilayer PC boards

to make interconnections blocked by two long lines of leaded IC packages.

John Elkizian
Senior Design Engineer

Electronics For Medicine Inc.
56 Union Ave.
Sudbury, MA 01776

Speed war may escalate

I couldn't help thinking of the old song, "Anything you can do, I can do better" when I read "Speeders Beware: The Cops Can Fake You Out" (ED No. 26, Dec. 20, 1977, p. 19). We did it with the Russians and look where it got us — enough nuclear power to blow us out of orbit.

What's next? Jammers for John Citizen? Then antijammers for the police? And then what?

In view of this, how about Operation Maser: Missiles against Speed Enforcement Radars.

Ron Miller

RFD 3
1 Monroe Drive
New Milford, CT 06776

μ P will expand the line

"Improved Processing Will Boost High-Performance Memories, μ Ps," in the Forecast 1978 section of ELECTRONIC DESIGN's Jan. 4, 1978 issue, mentions the RCA CDP1804 SOS, single-chip microprocessor being developed by the RCA Solid State Div. As of this writing, it is in the design cycle. We anticipate samples and data by the fourth quarter of 1978.

The device is not intended to replace the 1802 but is actually another expansion of the RCA microprocessor line. The use of SOS processing results in characteristics that will serve the high-performance/low-power, single-chip market segment.

M.S. Fisher
Manager

MOS OEM MARKETING

RCA Solid State Div.
Route 202
Somerville, NJ 08876

CIRCLE NO. 316

Forget them not

In my article, "IC Op Amps Have Evolved..." (ED No. 1, Jan. 4, 1978, p. 94), I inadvertently overlooked two IC
(continued on page 26)



RELAX...it's amazing how an easy mind helps build a home.

We're the easy mind people. TRW Capacitors.

We can solve your problems connected with reliability in ultra-miniature capacitors. Our X463UW metallized polycarbonates are designed to do just that.

The X463UW gives you "Space Age" performance in circuits demanding the smallest possible size. Capacitances range from .001 to 10 mfd, at 50, 100, 200 and 400 vdc—with less than 1.5% capacitance change from -55°C through 125°C . IR is 60,000 megohm x mfd minimum at 25°C . DF is less than 0.3% at 25°C and 1 KHz. And stability? In humidity and shelf life tests the stability of the X463UW is actually two to three times better than polysulfone.

You get all that because we've applied the latest in component technology to combine the improved electrical performance of polycarbonate with dramatic size and weight reductions made possible by the use of our exceptionally reliable metallized dielectric.

We also put the same kind of effort into our engineering services and our field support. Try us. We can help reduce the tension. Give us a call, or write: TRW capacitors, An Electronic Components Division of TRW, Inc., 301 West "O" St., Ogallala, Nebraska 69153. Tel: (308) 284-3611.



TRW CAPACITORS
ANOTHER PRODUCT OF A COMPANY CALLED TRW

CIRCLE NUMBER 17



STORE

ERASE

VIEW TIME

ERASE (PUSH)

MAX

BRIGHTNESS

MAX

WRITE

STORE

DISPLAY

1741A STORAGE OS

For one easy-to-use scope that: Captures single-shot events... Displays low-duty-cycle signals clearly... Provides three channels for the price of two...

HP's the Answer.

And the new 1741A is your scope. It gives you a unique combination of features for a moderately priced 100 MHz storage scope: Variable persistence for clear viewing of glitches and low-duty-cycle traces; storage for studying single-shot events; and third-channel trigger view for convenience in making simultaneous three-channel timing measurements.

Excellent variable persistence means a bright, sharp trace you'd expect only on a nonstorage scope. The result is an easy-to-read display of fast, low-duty-cycle repetitive signals. And the ability to see leading edges and glitches you'd otherwise miss.

Auto erase/Auto store. In Auto erase you adjust the display rate up to 2.5 per second. After that, it's all automatic, which means you simplify set-ups and eliminate smeared displays of digital data. It's a powerful tool for capturing those elusive glitches in data streams. In Auto store, your 1741A is armed, and as long as the instrument is fully operational and powered, will wait indefinitely, ready to store a random, single-shot event when it occurs.

Third-channel trigger view, selected at the push-of-a-button, lets you observe an external trigger signal along with channel A and B—three traces in all—so you can easily make timing measurements between all three channels. In most applications, that means three-channel capability for the cost of a two-channel variable persistence/storage scope.

For measurement convenience, the

1741A has a selectable 50 ohm input in addition to the standard 1 megohm input. A 5X magnifier permits two-channel measurements as low as 1 mV/div to 30 MHz, without cascading. You can even select a special modification (TV Sync) to tailor this scope for TV broadcast and R&D applications. Priced at \$4250*, the 1741A is an exceptional storage scope value.

Call your local HP field engineer today for all details. And for low-cost variable persistence/storage in a 15 MHz scope, ask him about HP's new 1223A.

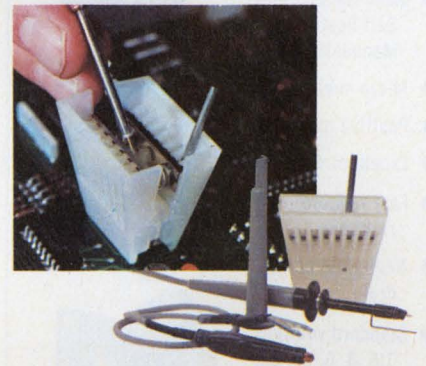

And here's something NEW for scopes. HP's EASY-IC PROBES. A new idea for probing high-density IC circuits that eliminates shorting hazards, simplifies probe connection to DIP's and generally speeds IC troubleshooting. Ask your HP field engineer about them.

*Domestic U.S.A. price only.



086 11B

HEWLETT  PACKARD

1507 Page Mill Road, Palo Alto, California 94304

For assistance call: Washington (301) 948-6370, Chicago (312) 255-9800, Atlanta (404) 955-1500, Los Angeles (213) 877-1282

CIRCLE NUMBER 18

Fail-Proof Miniature BITE Indicators

BUILT-IN TEST
EQUIPMENT

- Complete selection from one source!
- Mil-spec or commercial quality
- Ball or Flag Indicators and Annunciators
- Magnetic Latching, Self-Restoring and Manual-Reset models
- Micro-miniature sizes
- Positive indication
- Excellent visibility
- Fast reliable response
- Negligible power drain
- Standard voltages 1.5, 3, 6, 12, 24, 28 VDC
- Off-shelf delivery
- Write or phone for catalog

Sudden Service on Small Quantities!



PROTOTYPES

available on phone or letterhead request

MINELCO

a **TALLEY INDUSTRIES** Company

135 South Main Street
Thomaston, Conn. 06787 203-283-8261

CIRCLE NUMBER 19

Across the desk

(continued from page 22)

vendors in the chart on p. 101. They are:

Typical part no.

Silicon General
7382 Balsa Ave.
Westminster, CA 92683 **CIRCLE NO. 317**

Sprague **ULN-4036A**
Semiconductor Div.
115 Northeast Cutoff
Worcester, MA 01606 **CIRCLE NO. 318**
Walter Jung

Pleasantville Laboratories
Forest Hill, MD 21050

The question won't quit

I didn't know that I was an *old timer*, but I want to respond to Norm Andrews' letter in your November 22 issue (ED No. 24, p. 8).

There was a Capitol recording (I believe), in the 78-rpm era, of "Who's Yehudi?" by Jerry Colonna. This novelty song was based on a character who ran through comedy routines that Colonna did for many years on the Bob Hope radio show. Yehudi was sort of "the little man who wasn't there."

Belden Menkus

Box 85
Middleville, NJ 07855

More than a typewriter

Hats off to Charlie and his typewriter (see ED No. 5, March 1, 1978, p. 37). It's even worse if you are a female engineer (even if you *can* type 85 wpm on an electric!).

On my first job, I hid the fact that I could (and needed to) type for three years—for fear that they thought I *should* be typing! Following my promotion to group leader, I requested a typewriter—and all hell broke loose. The dialog was very similar to that in your editorial. We finally compromised on an old manual that was older than I was at the time.

On my second job, I only waited six months and, upon promotion to senior scientist, asked for a typewriter. They told me (in horror) that "If you get a typewriter, all the engineers will want one." I doubted it, and settled for a portable electric to be shared, upon demand, with the occasional Kelly Girl.

Finally, 12 years into my career, I

have reached the stage where I request a typewriter upon joining a company, and they "give the lady what she wants."

Meanwhile, I keep fighting systems that say that my secretary is only allowed *two* partition walls (no matter what that does to my office layout) and other such "organizational structures" that impede rationality, humanity, and getting things done.

Lita Nelson

97 Cambridge St.
Winchester, MA 01890

8080 is 00FF

John Robertson in the Feb. 1 Across the Desk (ED No. 3, p. 120) asked processor manufacturers to include both 00 and FF as NOP codes in their instruction sets to simplify PROM/EPROM programming. The ubiquitous 8080 is already such a processor! True, the FF code for an 8080 is an RST, a 1-byte call instruction to location 38 hex. However, if interrupt level 7 is not used in the 8080 application of interest, a return instruction, RET or C9, may be stored in location 38H, to make FF effectively a NOP.

Dr. Thomas L. Gabriele
Microprocessor System
Design Center

Bendix
Communications Div.
East Joppa Rd.
Baltimore, MD 21204

NOP isn't all

John Robertson proposes in your Feb. 1 issue to use both 00 and FF (base 16) as NOP codes. A CMOS processor for control systems—the MC14500B "ICU" already has this feature. The ICU has 4-bit instructions, NOPO (0000) and NOPF (1111), which in addition to calling for "No Operation" produce clock-cycle-length pulses on dedicated output pins.

For an added twist, these NOPs will inhibit the output pulse if the result register is empty and a Skip If Zero precedes the NOP. Thus, there is a state of "greater nullity" than NOP.

Vernon C. Gregory
Controls System Engineer
Subsystem Products

Motorola Inc.
Discrete Products Div.
P.O. Box 29023
Phoenix, AZ 85038

HIGH VOLTAGE CHAMP

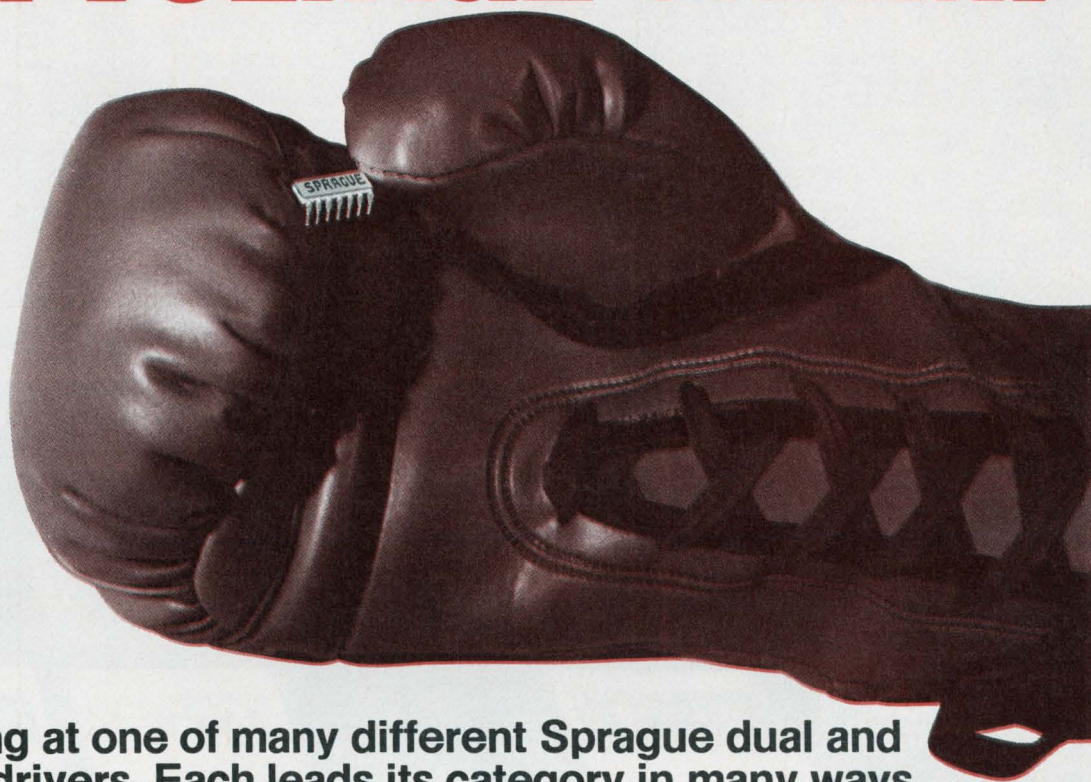

You're looking at one of many different Sprague dual and quad power drivers. Each leads its category in many ways.

Sprague pioneered the quad power driver for peripheral loads. Sprague was first to integrate transient suppression diodes for clamping inductive loads. Sprague led the way to lower supply currents and better noise margins, lower junction temperatures, higher breakdown voltages, and higher package dissipation.

SERIES UHP-400/500 Quad Power Drivers: These original Sprague power drivers contain the four logic functions: AND, NAND, OR, NOR. Transient-protected and open collector types are available. Also featured is the choice of three voltage ratings: 40 V, 70 V, and 100 V. All types come in plastic DIP, ceramic DIP, and flat pack. The ceramic DIP and flat pack meet all requirements for high-temperature, high reliability military and aerospace programs.

SERIES UDN-5700A Quad 2-Input Power Drivers and UDN-5700M Dual Power Drivers: These recently introduced drivers include the four basic logic functions and come with an 80-volt output rating. All are compatible with MOS logic. The input logic "0" (low) current is 100 μ A (max), and the logic "1" (high) current is 10 μ A (max) at an input voltage of 30 V. This allows interface directly from most CMOS and PMOS. Recommended V_{CC} operation is 5 V \pm 5%. Transient-suppression diodes are integrated.

SERIES UDN-3600M Dual 2-Input Power Drivers: These dual drivers complement the UDN-5700 Series and are compatible with MOS logic. They are pin-for-pin replacements for Series LM3600N. Sprague types offer reduced I_{CC} (on) currents for lower power, reduced noise problems, lower junction temperature, and higher package dissipation capability, plus 80 V breakdown.

UDN-5790/5791 Quad Drivers for PIN Diodes: These new devices have a 120 V maximum output voltage! Each output is capable of switching 300 mA. These units are available in both plastic and ceramic DIP packages. They permit users of discrete or hybrid PIN interface drivers to replace present components with a reliable monolithic design. Both inverting (5790) and non-inverting (5791) types are available.

For application engineering assistance, write or call George Tully or Paul Emerald, Semiconductor Division, Sprague Electric Company, 115 Northeast Cutoff, Worcester, Mass. 01606. Tel: 617/853-5000.

For Engineering Bulletins on the types in which you are interested, write to: Technical Literature Service, Sprague Electric Company, 347 Marshall Street, North Adams, Mass. 01247.

FOR FAST INFORMATION, CALL YOUR NEAREST SPRAGUE SALES OFFICE:

ALABAMA, Sprague Electric Co. 205/883-0520 • ARIZONA, Sprague Electric Co. 602/279-5435 • CALIFORNIA, Sprague Electric Co. 213/649-2600
Wm. J. Purdy Co. 415/347-7701 KCE Corp. 714/278-7640 • COLORADO, Wm. J. Purdy Co. 303/777-1411 • CONNECTICUT, Sprague Electric Co.
203/261-2551 • DIST. OF COLUMBIA, Sprague Electric Co. (Govt. sales only) 202/337-7820 • FLORIDA, Sprague Electric Co. 305/831-3636 • ILLINOIS,
Sprague Electric Co. 312/296-6620 D. Dolan Sales, 312/286-6200 • INDIANA, Sprague Electric Co. 317/253-4247 • MASSACHUSETTS, Sprague
Electric Co. 617/899-9100 Sprague Electric Co. 413/664-4411 • MICHIGAN, Sprague Electric Co. 517/787-3934 • MINNESOTA, HMR Inc. 612/920-
8200 • MISSOURI, Sprague Electric Co. 314/781-2420 • NEW JERSEY, Sprague Electric Co. 201/696-8200 Sprague Electric Co. 609/795-2299
Trinkle Sales Inc. 609/795-4200 • NEW MEXICO, Wm. J. Purdy Co. 505/266-7959 • NEW YORK, Sprague Electric Co. 516/549-4141 Wm. Rutt Inc.
914/698-8600 Sprague Electric Co. 315/437-7311 Mar-Com Associates 315/437-2843 • NORTH CAROLINA, Electronic Marketing Associates, 919/
722-5151 • OHIO, Sprague Electric Co. 513/869-2170 Electronic Salesmasters, Inc. 800/362-2616 • PENNSYLVANIA, Sprague Electric Co. 215/467-5252,
Trinkle Sales Inc. 215/922-2090 • TEXAS, Sprague Electric Co. 214/235-1256 • VERMONT, Ray Pennon & Co. Inc. 617/762-8114 • VIRGINIA, Sprague
Electric Co. 703/463-9161 • WASHINGTON, Sprague Electric Co. 206/632-7761 • WISCONSIN, D. Dolan Sales, 414/482-1111 • CANADA (Ontario),
Sprague Electric of Canada, Ltd. 416/766-6123 • CANADA (Quebec), Sprague Electric of Canada, Ltd. 514/683-9220

4SS-714BR2



a
**General
Cable**
subsidiary

... and you thought we only make great capacitors.



DATA I/O PROGRAMS

You can program every commercially available PROM on a Data I/O Programmer. What does that mean to you? First of all, it means design freedom. You can incorporate state of the art micro-processor and PROM technology in your designs with the assurance that the Data I/O PROM Programmer will meet your needs.

Second, it means security. You'll be able to designate second and third source PROM suppliers and know that you can program their devices.



THEM ALL.

Third, it means money. You won't have to purchase, or build, a new programmer every time you use a new PROM. You'll also be able to shop for best supplier prices.

If you'd like more good reasons for selecting a Data I/O universal PROM Programmer, send for our free PROM Programming Handbook. Simply contact Data I/O Corporation, P.O. Box 308, Issaquah, WA 98027. Phone 206/455-3990.

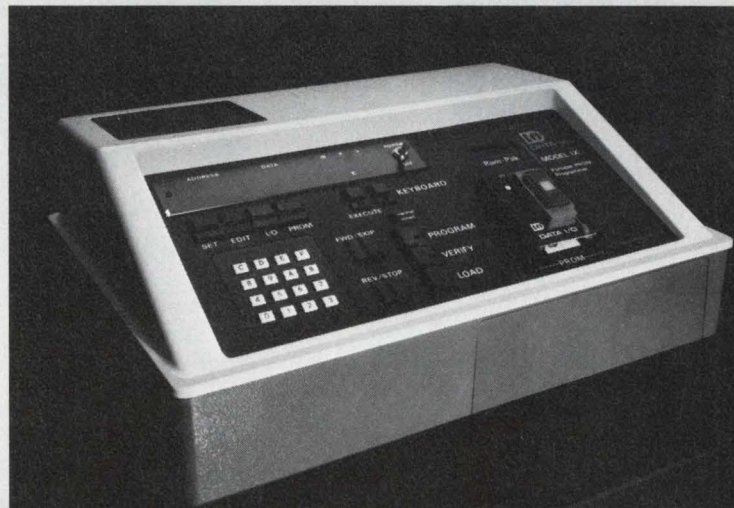
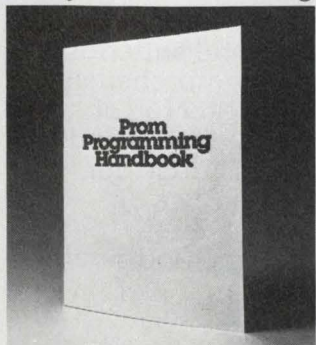

DATA I/O

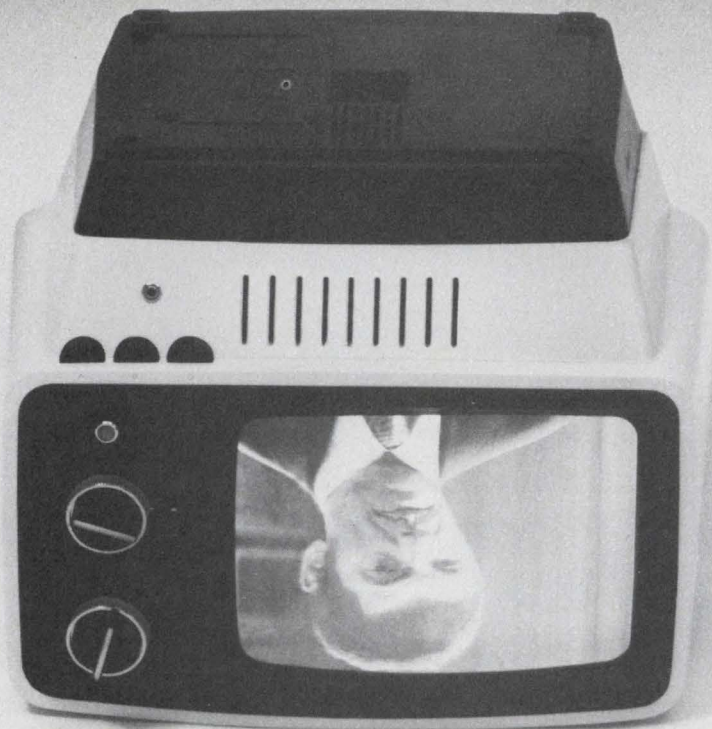

WHO IN HIS RIGHT MIND WOULD PUT A LEAD-ACID BATTERY IN A TV?

Lead-acid batteries leak. And gas. And corrode. And, traditionally, have all sorts of bad habits.

So, who'd ever design one into a portable television, or any other critical application, where it could do its worst?

Designers who know about Gates Energy, that's who. Because we've developed the sealed lead-acid cell to the point where it's almost faultlessly safe and reliable.

Our cells operate in any position without leaking. They're safe and predictable in temperatures ranging from -65°C to $+65^{\circ}\text{C}$.

Performance, frankly, is outstanding.

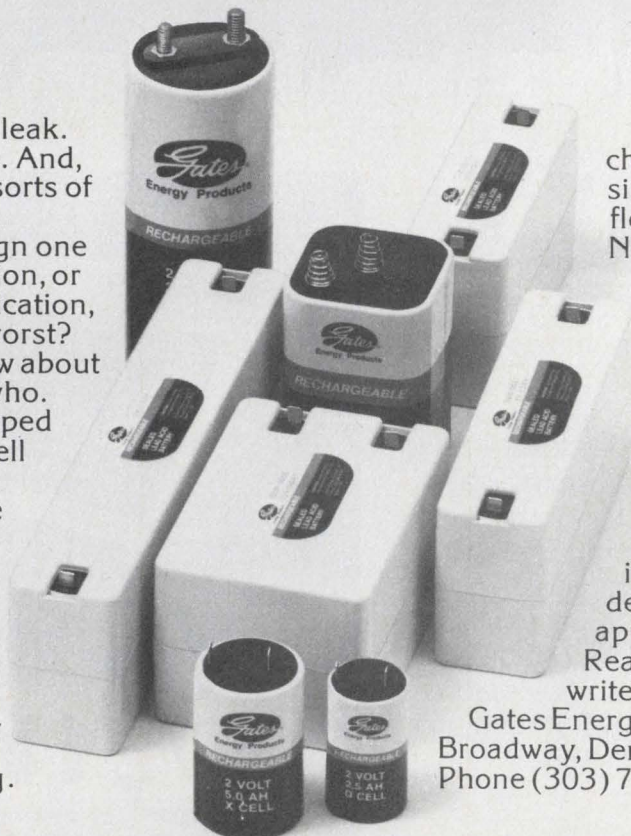

Expect hundreds of discharge cycles. Dependable, simple charging for both float and cyclic applications. No memory problems.

It all adds up to overall product reliability.

Just what every designer in his right mind has in mind when he tackles a new product's design.

Learn more about Gates Energy cells and batteries. Send for our comprehensive information packet full of design data, spec sheets and application notes. Circle our Reader Service number, or write us directly.

Gates Energy Products, Inc., 1050 South Broadway, Denver, CO 80217.
Phone (303) 744-4806. EDS-4

GATES ENERGY

CIRCLE NUMBER 22



Few industries have a more complicated data communications problem than the airlines. Reservations, weather, fuel management, maintenance, catering and a horde of other activities must be coordinated among a huge number of locations.

The complexity of the problem is one reason why so many major airlines choose modems from Universal Data Systems. The other reasons are latest CMOS technology (available in 103s, 201s, 202s and ACUs), multi-channel capability (available in the 16-channel RM-16) and economy (full-duplex 1200 bps communication with only two wires via the UDS 12 • 12, and FCC approved DAAs).

Technology, reliability and economy add up to communications confidence. If you need it, as a datacomm user or an OEM, ask UDS about your modem needs. Universal Data Systems, 4900 Bradford Drive, Huntsville, Alabama 35805. Phone 205/837-8100; TWX 810/726-2100.



Confidence In Communications

Universal Modems Accelerate Airline Activities

CIRCLE NUMBER 23

When it comes to resistor mountings: **THERE IS A DIFFERENCE.**



It costs money to mount an axial lead resistor. It has to be cut, bent, formed and oriented. And that's true whether it's done by hand or by machine.

Ohmite has better ways: the PC-58 radial lead resistor, for instance. With leads designed to fit 0.1" matrix boards, it enables you to choose a "perfect fit" for your PC board, chassis or other mounting base and avoid all the costly preparation. And not only can you save steps and increase productivity, you can also save space on crowded boards. What's more, the built-in stand-off helps in cleaning and heat dissipation.

But our PC-58 offers just one of the many mounting configurations available through Ohmite. We offer a comprehensive range of options to give you the optimum mounting for your needs.

For instance, for a given core size, Ohmite



can provide more than 20 different mountings. Axial leads, radial leads, weldable lugs, flexible leads, quick-connect terminals—and more. And most are available at your local Ohmite distributor.

There are many other advantages to Ohmite's complete selection in resistors and mounting configurations. But the point is, before choosing one resistor over another, talk to the people who know resistors best: Ohmite.

We can show you the options; explain why one product might work better than another; and make knowledgeable recommendations based on over 50 years of experience.

Write for our Catalog 100 today. We'd like to tailor a complete package to your overall resistive product requirements.

Ohmite Manufacturing Company, 3601 Howard Street, Skokie, IL 60076; 312-675-2600.

OHMITE®

A NORTH AMERICAN PHILIPS COMPANY

makes the difference

CIRCLE NUMBER 24

0-78-1



**MOTOROLA INC.**

RAMs

MOS DYNAMIC RAMs

| Organization | Part Number | Access Time (ns max) | No. of Power Supplies ¹ | No. of Pins |
|--------------|---------------|----------------------|------------------------------------|-------------|
| 4096 x 1 | MCM4096C-6† | 250 | 3 | 16 |
| 4096 x 1 | MCM4096C-16† | 300 | 3 | 16 |
| 4096 x 1 | MCM4096C-11† | 350 | 3 | 16 |
| 4096 x 1 | MCM4027C-2† | 150 | 3 | 16 |
| 4096 x 1 | MCM4027C-3† | 200 | 3 | 16 |
| 4096 x 1 | MCM4027C-4† | 250 | 3 | 16 |
| 4096 x 1 | MCM6604AC | 350 | 3 | 16 |
| 4096 x 1 | MCM6604AC-2 | 250 | 3 | 16 |
| 4096 x 1 | MCM6604AC-4 | 300 | 3 | 16 |
| 4096 x 1 | MCM6605AL | 300 | 3 | 22 |
| 4096 x 1 | MCM6605AL-2 | 200 | 3 | 22 |
| 8192 x 1 | MCM4108C-20*† | 200 | 3 | 16 |
| 8192 x 1 | MCM4108C-30*† | 300 | 3 | 16 |
| 16,384 x 1 | MCM4116C-15*† | 150 | 3 | 16 |
| 16,384 x 1 | MCM4116C-20† | 200 | 3 | 16 |
| 16,384 x 1 | MCM4116C-25† | 250 | 3 | 16 |
| 16,384 x 1 | MCM4116C-30† | 300 | 3 | 16 |
| 16,384 x 1 | MCM6616C-20† | 200 | 3 | 16 |
| 16,384 x 1 | MCM6616C-25† | 250 | 3 | 16 |
| 16,384 x 1 | MCM6616C-30† | 300 | 3 | 16 |

CCDs

| | | | | |
|------------|---------------|----|---|----|
| 65,536 x 1 | MCM0464L-50*† | 50 | 3 | 16 |
| 65,536 x 1 | MCM0464L-60*† | 60 | 3 | 16 |
| 65,536 x 1 | MCM0464L-70*† | 70 | 3 | 16 |

*To be introduced.

†Second source.

Heavy black type denotes industry standard part numbers.

Operating temperature ranges

| | |
|------|------------------------------------|
| MOS | 0° to 70°C |
| CMOS | -40°C to +85°C and -55°C to +125°C |
| ECL | Consult individual data sheets. |
| TTL | -55°C to +125°C |

¹MOS power supplies:

| | |
|---|-----------|
| 3 | +12, +5 V |
| 1 | +5 V |

All MOS outputs are 3-state except the 6570 and 6580 Series which are open-drain.

²Character generators include shifted and unshifted characters, ASCII, alphanumeric control, math, Japanese, British, German, European and French symbols.

MOS STATIC RAMs

| Organization | Part Number | Access Time (ns max) | No. of Power Supplies ¹ | No. of Pins |
|--------------|---------------|----------------------|------------------------------------|-------------|
| 1024 x 4 | MCM2114P-20† | 200 | 1 | 18 |
| 1024 x 4 | MCM2114P-25† | 250 | 1 | 18 |
| 1024 x 4 | MCM2114P-30† | 300 | 1 | 18 |
| 1024 x 4 | MCM2114P-45† | 450 | 1 | 18 |
| 1024 x 4 | MCM2114P-20† | 200 | 1 | 18 |
| 1024 x 4 | MCM2114P-25† | 250 | 1 | 18 |
| 1024 x 4 | MCM2114P-30† | 300 | 1 | 18 |
| 1024 x 4 | MCM2114P-45† | 450 | 1 | 18 |
| 4096 x 1 | MCM6641P-20† | 200 | 1 | 18 |
| 4096 x 1 | MCM6641P-25† | 250 | 1 | 18 |
| 4096 x 1 | MCM6641P-30† | 300 | 1 | 18 |
| 4096 x 1 | MCM6641P-45† | 450 | 1 | 18 |
| 4096 x 1 | MCM66L41P-20† | 200 | 1 | 18 |
| 4096 x 1 | MCM66L41P-25† | 250 | 1 | 18 |
| 4096 x 1 | MCM66L41P-30† | 300 | 1 | 18 |
| 4096 x 1 | MCM66L41P-45† | 450 | 1 | 18 |
| 4096 x 1 | MCM2147C-55*† | 55 | 1 | 18 |
| 4096 x 1 | MCM2147C-70*† | 70 | 1 | 18 |

CMOS STATIC RAMs

| Organization | Part Number | Access Time (ns max) | No. of Power Supplies | No. of Pins |
|--------------|---------------|----------------------|-----------------------|-------------|
| 64 x 1 | MCM14505 | 300 | 1 | 14 |
| 256 x 1 | MCM14537 | 1500 | 1 | 16 |
| 64 x 4 | MCM14552 | 1600 | 1 | 24 |
| 256 x 4 | MCM145101† | 650 | 1 | 22 |
| 256 x 4 | MCM145101-1† | 450 | 1 | 22 |
| 256 x 4 | MCM145101-3† | 650 | 1 | 22 |
| 256 x 4 | MCM145101-8† | 800 | 1 | 22 |
| 1024 x 1 | MCM146508*† | 460 | 1 | 16 |
| 1024 x 1 | MCM146508-1*† | 300 | 1 | 16 |
| 1024 x 1 | MCM146518*† | 460 | 1 | 18 |
| 1024 x 1 | MCM146518-1*† | 300 | 1 | 18 |

ECL BIPOLAR RAMs

| Organization | Part Number | Access Time (ns max) | Output | No. of Pins |
|--------------|-------------|----------------------|------------|-------------|
| 8 x 2 | MCM10143 | 15 | ECL output | 24 |
| 256 x 1 | MCM10144† | 26 | ECL output | 16 |
| 16 x 4 | MCM10145† | 15 | ECL output | 16 |
| 1024 x 1 | MCM10146† | 29 | ECL output | 16 |
| 128 x 1 | MCM10147† | 15 | ECL output | 16 |
| 256 x 1 | MCM10152† | 15 | ECL output | 16 |

TTL BIPOLAR RAMs

| Organization | Part Number | Access Time (ns max) | Output | No. of Pins |
|--------------|-------------|----------------------|----------------|-------------|
| 1024 x 1 | MCM93415† | 45 | Open collector | 16 |
| 1024 x 1 | MCM93425† | 45 | 3-state | 16 |

ROMs

MOS STATIC ROMs

Code Converters

| Organization | Part Number | Access Time (ns max) | No. of Power Supplies ¹ | No. of Pins |
|----------------------|-------------|----------------------|------------------------------------|-------------|
| 1024 x 8 or 2048 x 4 | MCM6560P† | 350 | 3 | 24 |
| 1024 x 8 | MCM6561P† | 350 | 3 | 24 |
| 1024 x 8 | MCM6562P† | 350 | 3 | 24 |
| 2048 x 8 | MCM6590P† | 800 | 3 | 24 |
| 2048 x 8 | MCM6591P† | 800 | 3 | 24 |

Character Generators²

| | | | | |
|---------------|------------|-----|---|----|
| 128 x (9 x 7) | MCM6570P† | 500 | 3 | 24 |
| 128 x (9 x 7) | MCM6571P† | 500 | 3 | 24 |
| 128 x (9 x 7) | MCM6571AP | 500 | 3 | 24 |
| 128 x (9 x 7) | MCM6572P† | 500 | 3 | 24 |
| 128 x (9 x 7) | MCM6573P† | 500 | 3 | 24 |
| 128 x (9 x 7) | MCM6573AP | 500 | 3 | 24 |
| 128 x (9 x 7) | MCM6574P† | 500 | 3 | 24 |
| 128 x (9 x 7) | MCM6575P† | 500 | 3 | 24 |
| 128 x (9 x 7) | MCM6576P† | 500 | 3 | 24 |
| 128 x (9 x 7) | MCM6577P | 500 | 3 | 24 |
| 128 x (9 x 7) | MCM6578P | 500 | 3 | 24 |
| 128 x (9 x 7) | MCM6579P | 500 | 3 | 24 |
| 128 x (7 x 9) | MCM6580P† | 400 | 3 | 24 |
| 128 x (7 x 9) | MCM6581P† | 400 | 3 | 24 |
| 128 x (7 x 9) | MCM6583P† | 400 | 3 | 24 |
| 128 x (7 x 5) | MCM6670P | 350 | 1 | 18 |
| 128 x (7 x 5) | MCM6674P | 350 | 1 | 18 |
| 128 x (9 x 7) | MCM66700P† | 350 | 1 | 24 |
| 128 x (9 x 7) | MCM66710P† | 350 | 1 | 24 |
| 128 x (9 x 7) | MCM66714P† | 350 | 1 | 24 |
| 128 x (9 x 7) | MCM66720P† | 350 | 1 | 24 |
| 128 x (9 x 7) | MCM66730P† | 350 | 1 | 24 |
| 128 x (9 x 7) | MCM66734P† | 350 | 1 | 24 |
| 128 x (9 x 7) | MCM66740P† | 350 | 1 | 24 |
| 128 x (9 x 7) | MCM66750P† | 350 | 1 | 24 |
| 128 x (9 x 7) | MCM66760P† | 350 | 1 | 24 |
| 128 x (9 x 7) | MCM66770P† | 350 | 1 | 24 |
| 128 x (9 x 7) | MCM66780P† | 350 | 1 | 24 |
| 128 x (9 x 7) | MCM66790P† | 350 | 1 | 24 |

Binary ROMs

| | | | | |
|----------|--------------|-----|---|----|
| 1024 x 8 | MCM68A30P8 | 350 | 1 | 24 |
| 1024 x 8 | MCM68A308P7 | 350 | 1 | 24 |
| 2048 x 8 | MCM68A316P91 | 350 | 1 | 24 |
| 1024 x 8 | MCM68B30AP† | 250 | 1 | 24 |
| 1024 x 8 | MCM68A30AP† | 350 | 1 | 24 |
| 1024 x 8 | MCM68B308P† | 250 | 1 | 24 |
| 1024 x 8 | MCM68A308P† | 350 | 1 | 24 |
| 2048 x 8 | MCM68A316EP† | 350 | 1 | 24 |
| 2048 x 8 | MCM68A316AP† | 350 | 1 | 24 |
| 2048 x 8 | MCM6832P† | 550 | 3 | 24 |
| 2048 x 8 | MCM6832P91 | 550 | 3 | 24 |
| 4096 x 8 | MCM68A332P† | 350 | 1 | 24 |
| 8192 x 8 | MCM68A364P*† | 350 | 1 | 24 |

CMOS ROM

| Organization | Part Number | Access Time (ns max) | No. of Power Supplies | No. of Pins |
|--------------|-------------|----------------------|-----------------------|-------------|
| 256 x 4 | MCM14524 | 1200 | 1 | 16 |

PROMs

MOS PROM

| Organization | Part Number | Access Time (ns max) | No. of Power Supplies ¹ | No. of Pins |
|--------------|-------------|----------------------|------------------------------------|-------------|
| 1024 x 8 | MCM2708P | 450 | 3 | 24 |

ECL PROMs

| Organization | Part Number | Access Time (ns max) | Output | No. of Pins |
|--------------|-------------|----------------------|------------|-------------|
| 32 x 8 | MCM10139† | 25 | ECL output | 16 |
| 256 x 4 | MCM10149† | 30 | ECL output | 16 |

TTL PROMs

| Organization | Part Number | Access Time (ns max) | Output | No. of Pins |
|--------------|---------------|----------------------|----------------|-------------|
| 64 x 8 | MCM5003/5303† | 125 | Open collector | 24 |
| 64 x 8 | MCM5004/5304† | 125 | 2K pull-up | 24 |
| 512 x 4 | MCM7620*† | 50 | Open collector | 16 |
| 512 x 4 | MCM7621*† | 50 | 3-state | 16 |
| 512 x 8 | MCM7640† | 70 | Open collector | 24 |
| 512 x 8 | MCM7641† | 70 | 3-state | 24 |
| 1024 x 4 | MCM7642† | 70 | Open collector | 18 |
| 1024 x 4 | MCM7643† | 70 | 3-state | 18 |
| 1024 x 8 | MCM7680*† | 70 | Open collector | 24 |
| 1024 x 8 | MCM7681*† | 70 | 3-state | 24 |
| 2048 x 4 | MCM7684*† | 80 | Open collector | 18 |
| 2048 x 4 | MCM7685*† | 80 | 3-state | 18 |
| 1024 x 8 | MCM82707*† | 70 | Open collector | 24 |
| 1024 x 8 | MCM82708*† | 70 | 3-state | 24 |

EPROMs

MOS EPROMs

| Organization | Part Number | Access Time (ns max) | No. of Power Supplies ¹ | No. of Pins |
|--------------|-------------|----------------------|------------------------------------|-------------|
| 1024 x 8 | MCM2708L† | 450 | 3 | 24 |
| 1024 x 8 | MCM27A08L† | 300 | 3 | 24 |
| 1024 x 8 | MCM68708L† | 450 | 3 | 24 |
| 1024 x 8 | MCM68A708L | 300 | 3 | 24 |
| 2048 x 8 | MCM2716L† | 450 | 3 | 24 |
| 2048 x 8 | MCM2717L | 450 | 3 | 24 |
| 2048 x 8 | MCM2716AL*† | 450 | 1 | 24 |

Motorola Memories

Motorola has developed a very broad range of MOS and bipolar memories for virtually any digital data processing system application. And for those whose requirements go beyond individual components, Motorola also supplies Memory Systems and Micromodules.

New Motorola memories are being introduced continually. **This selector guide lists all those available as of April 1978.** For later releases, additional technical information or pricing, contact your nearest authorized Motorola distributor or Motorola sales office.

Data sheets may be obtained from your in-plant VSMF Data Center, distributors, Motorola sales offices or by writing to:

Literature Distribution Center
 Motorola Semiconductor Products Inc.
 P.O. Box 20912
 Phoenix, AZ 85036.



MOTOROLA INC.

MOTOROLA MEMORIES Selector Guide

RAMs ROMs PROMs EPROMs



MOTOROLA INC.

A whole new connector series for I/O applications

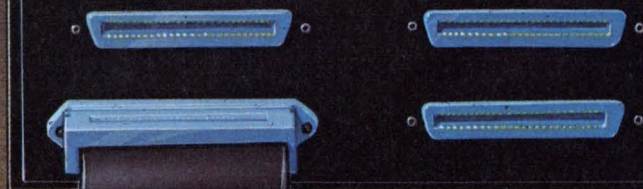

The introduction of our new BLUE MACS® Ribbon Connectors, designed in accordance with IEEE Standard 488, represents another Ansley engineering breakthrough in lower installed cost mass termination technology.

Ansley's BLUE MACS Ribbon Connector series terminates to standard 50 mil pitch cable which provides complete compatibility with all the other connectors in the system.

The Ribbon Connector incorporates all the BLUE MACS benefits, including the 4-point TULIP® contact for maximum termination reliability, and a one-piece design for fast, low cost assembly and positive cable-to-contact alignment.

This line is added to our complete family of "D" Series connectors now available from stock in 9, 15, 25 and 37 pin configurations. In addition, we offer a wide variety of UL listed jacketed cable for external use with these connectors.

This allows you more freedom when selecting connectors for future design.

All connectors are available with a broad selection of mounting hardware to various strain relief configurations. For the full reliability/cost effectiveness story and technical data, call or write:

T&B / Ansley

The mass termination company.

T&B/Ansley Corporation • Subsidiary of Thomas & Betts Corporation
3208 Humboldt St. • Los Angeles, CA 90031 • Tel. (213) 223-2331
TELEX 68-6109 • TWX 910-321-3938

CIRCLE NUMBER 25

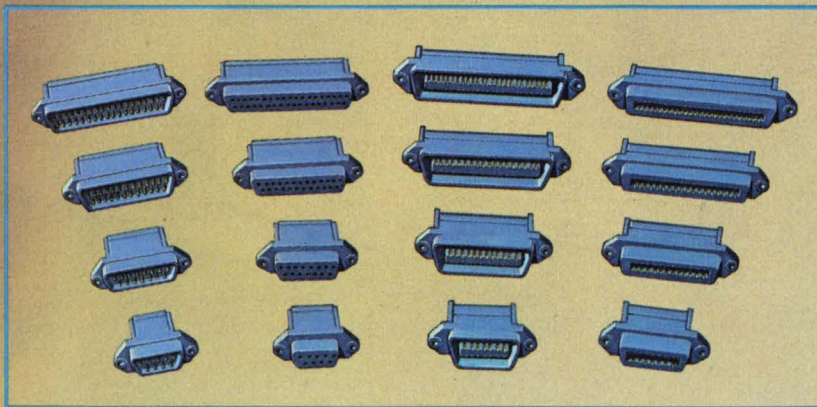

STOCKED AND SOLD THROUGH AUTHORIZED ANSLEY DISTRIBUTORS.

International T&B/Ansley Offices: AUSTRALIA, Brookvale, (02) 938-1713 • AUSTRIA, Vienna, (222) 6232365 • CANADA, Iberville, Quebec, (514) 658-6611 • ENGLAND, Luton, (0582) 597-271 • FRANCE, Rungis, 687-23-85 • HOLLAND, Zoetermeer, (79) 214688 • ITALY, Milano, 02-4986451 • JAPAN, Tokyo, 03-354-9661 • SINGAPORE (65) 2923711 • SOUTH AFRICA, Benrose 24-8134 • SPAIN, Barcelona, (93) 212-8607 • SWEDEN, Upplands Vasby, 0760-86140 • SWITZERLAND, Hombrechtikon, (04155) 422791 • WEST GERMANY, Dreieich bei Frankfurt, 06103-8 20 21 •

Coming through...

with a vital part in product design

It's what's up front that counts. That's why it pays off to involve Belden in the early stages of a project.

We know the codes, specs and electrical/environmental parameters you're faced with. We've come through with answers to some extraordinary new applications.

As much as any component, wire, cable and cord, can make a critical difference in your product's performance. And your costs. By drawing on thousands of high-quality standards—and a wealth of custom engineering knowhow—we can tailor an answer to fit your needs. Exactly.

We can even help you cope with the economics of wire processing, assembly and installation. Our problem solving experience ranges from innovative

packaging to total manufacturing analysis.

Whether you need cord sets, special harnesses, shielded cable construction, flat cable—or help putting it all together, involve a Belden Wire Specialist. He'll come through with everything we've got. For answers right now, phone:

317-966-6661 Electronic Division or mark 400 on reader service card.

312-986-1600 Electrical Division or mark 401 on reader service card.

312-887-1800 Transportation Division or mark 402 on reader service card.

Or write Belden Corporation, 2000 S. Batavia Ave., Geneva, IL 60134

BELDEN



Coming through...
with new ideas for moving electrical energy

Low-power CMOS/SOS types of NMOS μ Ps are on the way

Two NMOS microprocessors will soon be available in SOS versions that promise to cut power consumption by 90%. RCA's Solid State division (Somerville, NJ) is developing CMOS-on-sapphire editions of the 8048 and 8085, originally designed by Intel Corp. (Santa Clara, CA). And Intersil Inc. (Cupertino, CA) is developing a bulk-silicon CMOS version of the 8048.

NMOS versions of the 8085 and 8048 consume about 850 and 675 mW, respectively. The CMOS versions are expected to consume about 50 and 65 mW (see table), which should lead to new applications in portable and battery-operated equipment.

The tradeoff will be cost. The CMOS parts will be treated as premium editions, with correspondingly higher prices than the standard NMOS versions (see table for projected prices). But right now, both prices and CMOS specifications are estimates based on comparing the characteristics of NMOS, CMOS and SOS processing.

With CMOS and NMOS processing, circuitry is built on a silicon substrate. CMOS uses less power because its basic circuitry consists of N and P-channel transistors in series. In the quiescent state, almost no current flows because one or the other transistor is always off. With SOS, the silicon is built on a sapphire substrate, which should result in lower capacitance and therefore higher speed and even lower power consumption. But final specifications will not be set until designs are com-

plete and manufacturing begins.

Parts will become available from the new suppliers later this year: RCA expects to have sample quantities of the SOS 8085 in the fourth quarter of this year or the first quarter of next. Samples of the SOS 8048 are scheduled for the second quarter next year. Production will begin a few months later.

The RCA parts will be designed under an agreement signed with Intel late last month. Intel will supply RCA with information to design SOS versions of the 8085A and 8048, as well as two peripheral chips for the 8085A—the 8155 RAM I/O and 8355 ROM I/O. In exchange, Intel will receive information that will allow it to make the CMOS SOS versions RCA develops.

The agreement does not require that Intel become an alternate source to RCA and supply CMOS SOS parts. The firm has not yet decided if it will do so, and says a decision is probably still a year away.

Intersil's parts will be developed under an earlier agreement with Intel.

The CMOS SOS microprocessors will complement RCA's existing CDP1800 CMOS family, says Carl Turner, division vice-president-integrated circuits at RCA. He says the firm will continue to support the CDP1802, and still plans to introduce the CDP1804, a CMOS SOS single-chip microcomputer, later this year.

For Intel

CIRCLE NO. 501

For Intersil

CIRCLE NO. 502

For RCA

CIRCLE NO. 503

Choose your process

| Device | Process | Clock rate (MHz) | Power (mW) | Die size (mil x mil) | Price (\$) |
|--------|----------|------------------|------------|----------------------|------------|
| 8048 | NMOS | 4 | 675 | 200 x 200 | 20 |
| | CMOS | 3-4 | 65 | 240 x 240 | 20-25 |
| | CMOS/SOS | 3-5 | 50 | 240 x 240 | 25-30 |
| 8085 | NMOS | 5 | 850 | 164 x 222 | 20 |
| | CMOS/SOS | 4-6 | 50 | 225 x 225 | 25-30 |

CMOS promises lower power dissipation at the expense of chip size and, therefore, price. That's the basis for the estimates above.

μ C future looks rosy to μ P makers and users

Microcomputers will continue to replace minis, and 16-bit and even 32-bit micros will become commonplace. Not only that, but once the capabilities of LSI and VLSI become better appreciated, the sky will be the limit on applications.

These sweeping predictions, shared by microprocessor manufacturers and users alike, enlivened a panel session on new devices for industrial controls at the recent Conference on Industrial Applications Of Microprocessors in Philadelphia. Panelists included representatives from American Micro Devices, Intel, Leeds & Northrup, Motorola Semiconductor and SMC.

Indeed, microcomputer predictions abounded. Pin congestion in the denser micros? No problem. Serial input-output will be used. And bit-slice processors will continue the trend to fast, microprogrammable processors. Two-bit chips have been around for some time, and 1-bit chips are reportedly under development.

Moreover, as distributed processing expands, specialized μ C chips with input-output control, memory management, arithmetic and so on will replace the 8080-type architecture now used in these applications, according to the panelists. As for chip prices, they will not depend as much on function or word length as on production volume. Any chip, be it 1-bit or 32-bit, I/O or arithmetic, will cost only a few dollars if it sells well.

In μ C memories, the prevailing outlook was that bubble devices will replace mechanically driven magnetic media not only for smaller on-line storage, but also for ROM and non-volatile RAM functions, such as core. Magnetic tape, however—including cassette—will remain the most cost-effective, off-line medium for large data volume. And as memory prices keep declining, charge-coupled technology should corner cache applications.

Standardized instruction sets, an elusive goal, will remain so, some felt. But they also believed that extended use of higher-level languages will eventually render mnemonics obsolete, anyway.

Finally, the panelists concluded that because most microcomputer applications will involve control rather than data-processing functions, transducer and a/d converter markets will be huge. Combining linear and digital

circuitry on the same chip, however, will prove more expensive than using separate chips.

Low-cost printer works 'expensively' with μ P

A low-cost impact line printer has a single, vertical, 7-pin matrix array that can produce up to 20 fonts of type, mix type faces in the same line, and produce high-quality characters typical of much more expensive ink-jet and laser printers. The reason? The Media 12/7, developed by Royden C. Sanders of Sanders Technology Systems (Derry, NH) incorporates a Z-80 microprocessor. The μ P accesses 28 ROMs, whose data produce the varying character sizes and type fonts.

With the Z-80 and the ROMs, the Media 12/7 is rather simple, mechanically, for its high performance. As the 7-pin matrix moves back and forth across paper, the printer accepts ASCII characters and automatically controls the dot structure for a desired type face.

One key to the Media's versatility is its precise control of the dot structure. Dots can be created along the horizontal axis to a precision of 0.001 in. and along the vertical to 0.0035 in.

The Sanders printer operates at 120 to 216 characters per second for conventional matrix computer-printer output in a single-pass mode. For different type faces, it operates in two or four-pass modes. In the four-pass mode, 36 to 50 characters are produced per second, and the output can be controlled to look like that of an IBM Selectric typewriter.

In either multiple mode, the Media 12/7 prints portions of all characters on one pass across a single line. It then sweeps back and forth to print bidirectionally, interlacing the dots from the second, third and fourth passes to fill in the characters.

The first 100 evaluation units are expected to be shipped by early May, with complete assemblies, including case and power supply, going for \$2010 in 100 quantities, and \$1805 in 500.

'Beep beep' means 'Look out'

Highway and road workers can be warned of approaching traffic and its speed by the beeps from a small, portable radar system. Radar Alert comes in a 4 x 4 x 6-in. package that can be

clamped magnetically onto the side of a truck or placed inside a rear window. The system works off the cigarette lighter.

Radar Alert picks up approaching cars 400 ft away, according to James Campbell, president of Digitrol, Inc. (Nashua, NH), who developed the radar. Radar contact actuates the beeper. The faster the speed of the oncoming cars, the faster the beeping rate. What's more, it triggers radar detectors in oncoming autos, which should slow them down.

The Radar Alert system sounds a warning at vehicles approaching at over 30 mph. The microwave-horn antenna and transceiver are provided by Microwave Associates (Burlington, MA). The system is being submitted to the Federal Communications Commission for acceptance tests.

Scaling will increase RAM capacity to 64 k

A cost-effective 64-k dynamic RAM that can be produced in volume will be available within a year, says Richard H. Lee of Mostek Corp. The four-times increase in density will result from scaling device geometries, not from innovations in memory-cell circuits, Lee says in a paper prepared for Electro '78, to be held in Boston next month.

The Carrollton, TX firm is developing a 64-k (actually, 65,536-bit) RAM using the Scaled Poly 5 process, in which all physical dimensions, horizontal and vertical, of the transistor geometry have been reduced by a scaling factor, as has the substrate doping concentration and the operating voltage of the device. The chip is small enough to fit into standard packages.

The resulting memory operates from a single 5-V supply. The process should yield NMOS memories with access times under 100 ns, and RAMs with access times under 50 ns should be possible in three or four years, says Lee.

"There is available today photolithographic equipment that will permit design-rule reductions of the order necessary to make a 64-k RAM feasible," says Lee. Electron-beam imaging equipment will become necessary when device geometries shrink further, he notes, but the 64-k RAM is feasible without such equipment, which is still very expensive. That's fortunate, he adds, because cell complexity has already fallen to a single active device.

Says Lee, "It certainly appears that

we may have reached our limit in reducing cell size by reducing the number of components per cell—the major contributing factor in cell size reduction and four-times density increases in the past."

Flat, wide-screen TV projects from the rear

The first one-piece, rear-projection TV set with a large, flat screen has been unveiled by General Electric. The 45-in.-diagonal Widescreen 1000 has three times the screen area of conventional 25-in. sets. What's more, the brightness of the color picture is enhanced by a 13-in. CRT equipped with improved phosphors and a new shadow mask and electron gun.

The picture is projected by an f/1.6 three-element acrylic lens through two highly reflective (94%) mirrors onto the viewing screen—a one-piece acrylic design with a fresnel-lens pattern

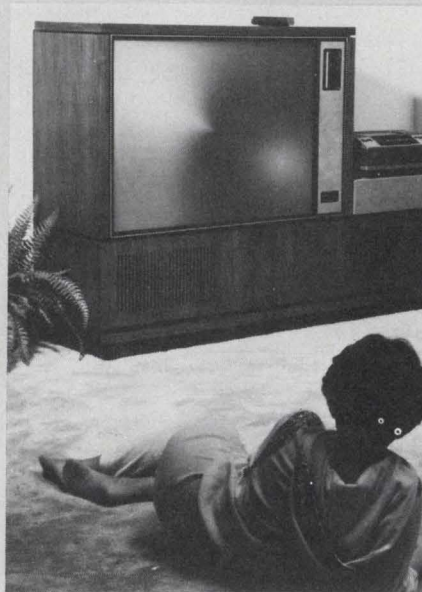

GE's wide-screen TV includes remote control and electronic tuning.

molded into the rear surface. The front surface is treated with an abrasive resistant material, and the lens, mirrors and screen are sealed against dust. No adjustments are needed—just plug in the 1000, and attach the antenna.

The Widescreen 1000 is expected to be available in June for about \$2800. Included in the price are electronic tuning and random-access remote control of all functions. The 1000 measures 50 in. high, 70 in. long and 24 in. deep. Power consumption is 235 W.

Semtech Transient Voltage Suppressors

**LOWEST
DYNAMIC
IMPEDANCE**

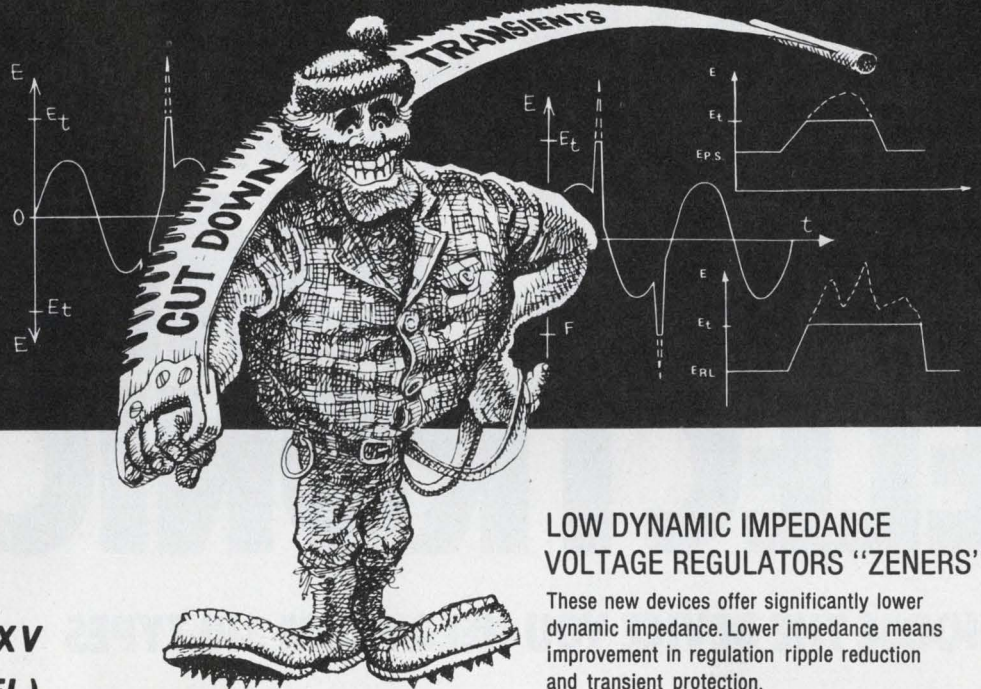

**Can be supplied as
JAN, JANTX or JANTXV
to MIL-S-19500/516 (EL)**

This new series of silicon bi-polarity transient suppressors is unique in that a single device will provide voltage transient protection symmetrically (i.e., provide protection for A.C. signals in addition to D.C.). This new series of devices has peak pulse power ratings of 500 to 1500 watts for 1 millisecond and its response time is effectively instantaneous (less than 1×10^{-12} sec.). Therefore, these versatile devices have many protection applications where large voltage transients can permanently damage voltage-sensitive components. The devices are encased in Semtech's Metoxilite, fused directly to the high temperature metallurgically bonded assembly. For use in commercial, industrial, military and space programs.

500 Watt

Peak Pulse Power

Types: IN6102 through IN6137
Break down Voltage V(BR):
From 6.8 to 200Vdc $\pm 10\%$
Peak Surge Voltage (Vsm): 11.0 to 286.0V
Peak Surge Current (Ism): 45.4 to 1.7A
Temperature Coefficient of (VBR): .05 to .11%/°C
Case Size (Max.): .140" D x .165" L

1500 Watt

Peak Pulse Power

Types: 1N6138 through 1N6173
Breakdown Voltage V(BR):
From 6.8 to 200Vdc $\pm 10\%$
Peak Surge Voltage (Vsm): 11.0 to 286.0V
Peak Surge Current (Ism): 136.4 to 5.2A
Temperature Coefficient of V(BR): .05 to .11%/°C
Case Size (Max.): .180" D x .165" L

LOW DYNAMIC IMPEDANCE VOLTAGE REGULATORS "ZENERS"

These new devices offer significantly lower dynamic impedance. Lower impedance means improvement in regulation ripple reduction and transient protection.

3 & 5 watt SX6.8 thru 120

Nominal Voltage: 6.8 to 120 V ($\pm 5\%$)
Low Reverse Leakage
Dimensions (max.): Body .140" D x .165" L
Lead .040" D x 1.10" L

5 watt 1N4954 thru 4984

Nominal Voltage: 6.8 to 120 V ($\pm 5\%$)
Low Reverse Leakage
Dimensions (max.): Body .140" D x .165" L
Lead .038" D x 1.10" L

10 watt SY6.8 thru 120

Nominal Voltage: 6.8 to 120 V ($\pm 5\%$)
Low Reverse Leakage
Dimensions (max.): Body .165" D x .165" L
Lead .040" D x 1.10" L



652 Mitchell Road, Newbury Park, California 91320
(805) 498-2111 • (213) 628-5392 • TWX: 910-336-1264
CHICAGO: (312) 352-3227 • DALLAS: (214) 234-6523
DAYTON: (513) 274-8356 • FLORIDA: (305) 644-5404
MARYLAND: (301) 937-0070 • NEW YORK/NEW JERSEY: (201) 964-9305
SAN FRANCISCO: (415) 494-0113 • SEATTLE: (206) 455-4807
CANADIAN SALES: Avotronics, Ltd. (416) 493-9711
EUROPEAN SALES: Bourns AG Zug, Switzerland (042) 232-242

OUR EXPANDING UNIVERSE OF LIGHT-EMITTING ELECTRONICS

CHOOSE THE DEVICE YOU NEED FROM 310 TYPES

Now Litronix offers an opto-electronic device for virtually every application. Over 300 LED displays, LED lamps, opto-isolators, IR emitters, photo-detectors and photo-voltaic cells. And more are coming every month.

You will find advanced products not available anywhere else. As well as widely-used standard devices at highly competitive prices.

Some highlights:

ALPHANUMERIC LED DISPLAYS.

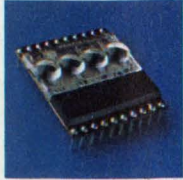

Character sizes from 0.16" to 0.50" in end-stackable arrays of 1 to 4 red characters — including an intelligent display that interfaces just like a RAM to μ P buses.

DIGITAL LED DISPLAYS.

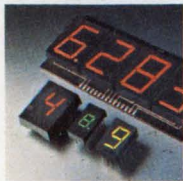

Green, yellow and red digits. Nine sizes from 0.1" to 1" high. In DIPs of 1 and 2 digits. On PCBs of 2 to 6 digits with edge connectors. Both light-pipe displays with

very wide viewing angle and low-cost reflector displays. 70 different types.

LED LAMPS.

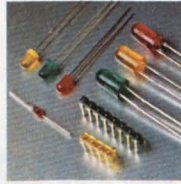

Red, orange, yellow and green lamps. T-1, T-1 $\frac{3}{4}$ and axial packages. Arrays of 2 to 10 lamps. With panel mounting clips. Lamps that flash on/off. Constant brightness lamps. Voltage-indicating lamps. 58 different types.

OPTO-ISOLATORS.

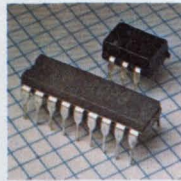

One, two and four-channel opto-isolators. Current transfer ratios up to 320%. Isolation voltages up to 5000v. Transmission rates as high as 4 megabits/sec. 15 JEDEC types. 25 different types in all.

IR EMITTING DIODES.



From medium to very high power. Beam widths from 6° to 60°. Hermetic and non-hermetic TO-18

size. Miniature with axial or radial leads. 30 different types.

PHOTO-DETECTORS.

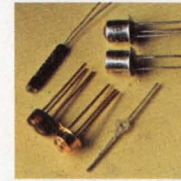
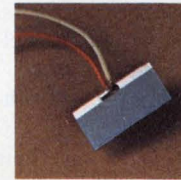

Photo-transistors and photo-diodes with acceptance angles from 6° to 73°. Hermetic high-reliability devices and low-cost non-hermetic devices. TO-18 packages, ceramic packages and miniature radial lead configurations. Arrays of 2 to 10 detectors. 47 different types.

PHOTO-VOLTAIC CELLS.



Silicon solar cells. Sensitivity from .04 micro-amperes to 2.8 microamperes. Twelve different types available.

SEND FOR FULL CATALOG.

Contains 32 pages on all devices in the product categories above. Phone your local distributor or contact Litronix at 19000 Homestead Road, Cupertino, CA 95014. Phone (408) 257-7910.

litronix
AN AFFILIATE OF SIEMENS

THE LIGHTS FANTASTIC

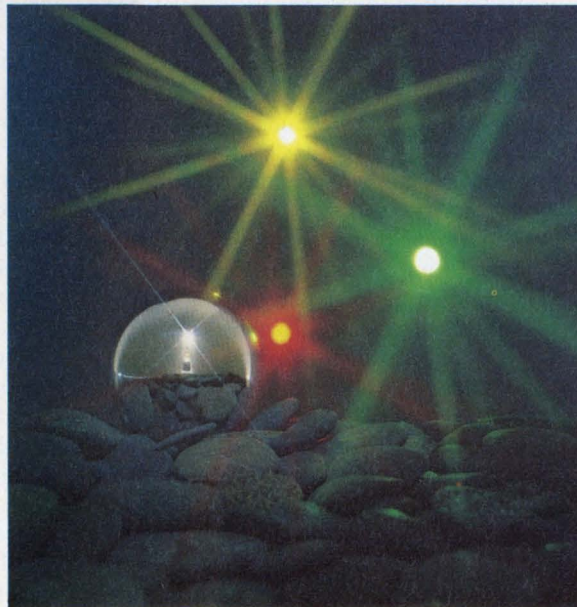

IC push into data communications relieves processors, cuts software

Integrated-circuit chips are mounting a full-scale invasion into all types of data-communications systems. What's more, the chips are being welcomed in large part as liberators:

- In tabletop systems and instrumentation networks, smart, μ P-companion chips are relieving their host processors of much of the responsibility for managing a parallel data port. They also reduce the cost and complexity of system software.

- In midrange systems with data terminals connected to a large, central processor, chips to drive and detect serial-data lines are being upgraded to the newer EIA standards for serial data links, RS 422/423. As a result, data rates are increasing, and so are line lengths.

- In far-flung data communications networks that span the globe, new LSI devices are assuming much of the management responsibility for serial data links. Here too, the ICs are replacing software. They are also ensuring the integrity of information and protecting it from eavesdroppers.

- Newly available IC chips are intensifying pressure to shift telephone systems from analog to digital.

Help for small systems

The big data-comm news in the lab is that bused (parallel) data communications has found a home in the IEEE-488 bus. Also known as the Hewlett-Packard Interface Bus (HPIB) or the general purpose interface bus (GPIB), the 488 is easy to implement with chips designed just for it.

For example, a 40-pin DIP from Motorola, the MC 68488, bridges the company's 6800 μ P bus and the 488. Motorola also supplies a modular ap-

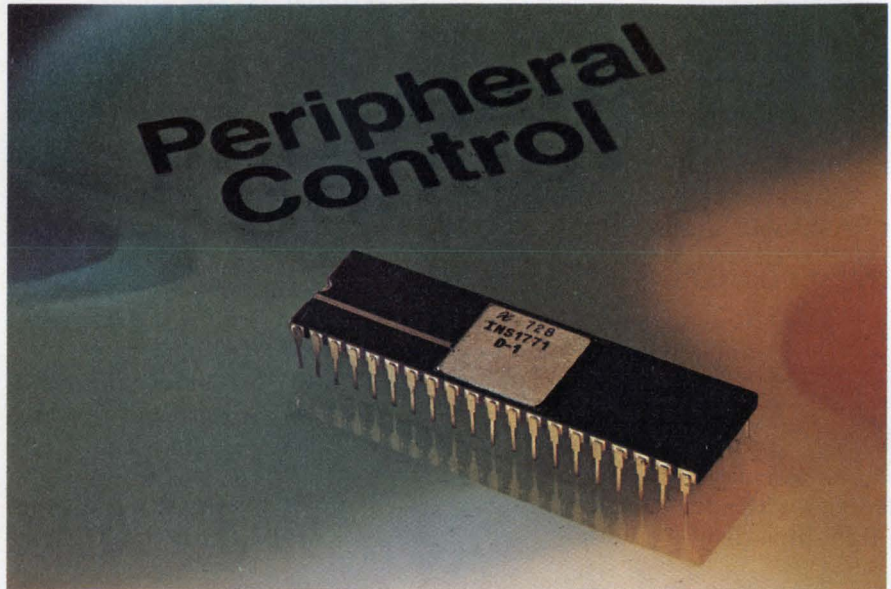

Microprocessor companion chips are simplifying the short-haul data-communications link between μ Ps and their system peripherals. This is National Semiconductor's INS-1771, a floppy-disc controller-on-a-chip.

proach for general TTL logic; MC 3448 is a 16-pin, four-line transceiver designed for 488 bus applications. Since the instrument bus needs 16 lines (eight data, five management, three handshake), four 3448s are required. Other data-comm interfaces from Motorola include the MC 3487 quad driver for RS-422 balanced lines and a mating receiver, the MC 3486. More devices support the older, slower, RS-232C standards.

National Semiconductor has a new way to unify its diverse line of μ Ps, memories and peripherals: the Microbus. It's used in small systems for byte-wise data transfer, and has all the standard bus elements—data, address and control. Up to 10 chips can be connected into the system.

For serial-data lines interconnecting terminals, computers and modems, National offers a wide range of devices to accommodate RS-232C and RS-422 EIA standards. The DS 1488 for in-

stance, is a quad line driver that converts four individual TTL signals to RS-232C output levels. At the other end of the line, National's DS 1489 receives the signals and reconstructs the original TTL data stream.

Double-ended (balanced) lines conforming to EIA's RS-423 standards can be driven with National's DS 1688 quad differential line drivers and terminated with its counterpart, DS 1689.

Another family of integrated circuits for line drivers and receivers, the SN 55107 series, is available from Texas Instruments.

Meanwhile, inside a computer, data bits are normally handled in 8-bit groups, or bytes. So data are transferred in and out in bytes, which is usually the way it's done in small systems of instrumentation and data processing. But when networks are spread over more than a mile or so, parallel data transfer becomes uneconomical. (Leasing eight parallel

phone lines would never do, much less eight parallel satellites.)

UARTs, USRTs and ASTROs

For this reason, long-haul data-comm information gets transmitted bit-serially. Devices such as UARTs, USRTs and ASTROs disassemble the computer's parallel data, and transmit the information serially over a single communications link. On the other end, a mirror circuit reconstructs the parallel data.

The basic chip providing bit-serial interfaces between computers and anything from office fax machines to data acquisition systems is a UART—for "universal, asynchronous receiver-transmitter." Like a modem, a UART has both a transmitter section and a receiver section; unlike a modem, it is entirely digital in operation.

A UART's transmitter section accepts parallel data bits and converts them into a serial word. In accordance with established protocols, the UART generates start, parity and stop bits, then incorporates them into each character, which may be 5 to 8 bits long.

A UART's receiver section accepts the incoming bit-serial characters, reconstructs them into their original, parallel form and verifies correct transmission by checking for parity and valid stop bits. Special flags are available to the host computer to indicate parity, framing and overrun errors at the receiver.

Most UARTs come in 40-pin DIPs and provide a number of programmable features, including character length, even or odd parity, parity inhibit and stop-code length.

Nine variations of silicon UARTs are available from Western Digital in both plastic and ceramic packages. Data rates are up to 50 kilobaud. SMC Microsystems offers the 2502 and 2017, which feature start-bit verification to reduce transmitted errors.

Because of the huge front-end investment required to manufacture ICs of this complexity, two firms often share the initial cost through licensing agreements, then multiple-source the same part; Hughes and RCA, for example, are multiple sources for a CMOS UART that is billed as a companion to the 1800 μ P and is suitable for use in portable data systems.

Harris and Intersil both offer a (6402) UART that features low power (10 mW) and high data rates (250

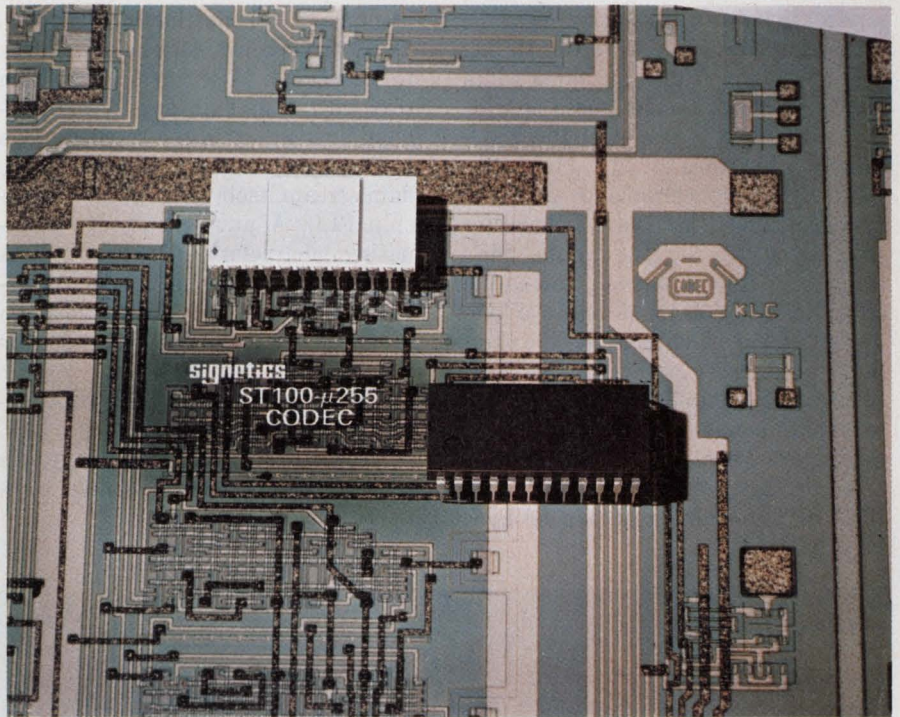

A codec is a monolithic modem. Advances in LSI technology now make it feasible to integrate all the circuitry of a modem (modulator/demodulator) onto a single chip. The new generic name represents coder/decoder, as shown in the metal mask of this Signetics codec, the ST-100.

kbaud). Synertek and Rockwell multiple-source a UART (6551-AICA) that offers two chip-select pins for multiple-line systems.

Versatile companion

A UART is driven typically from 50 baud to 9600 baud, thanks to companion chips called baud-rate generators. (The term "baud rate" holds true for

purely digital systems, too.) Any one of a dozen standard baud rates can be obtained by having one of these integrated circuits count down a high-frequency clock. The resulting subfrequency clock then drives the UART.

Most manufacturers provide UARTs and baud-rate generators as sets, but National puts the two into a single package. The 8250 asynchronous-communications element (ACE) is a UART with a built-in baud-rate generator. It divides the input clock by any selected integer up to 65 k to produce a data rate from dc to 56 kbaud. A Signetics UART has an on-chip baud-rate generator in a 28-pin package. The 2651 is a programmable communications interface (PCI) that provides modem control, supports IBM's BiSync protocol and has an asynchronous "echo back" mode for processor self-test. TTL compatible, it requires only +5 V and is the only such device that needs no clock.

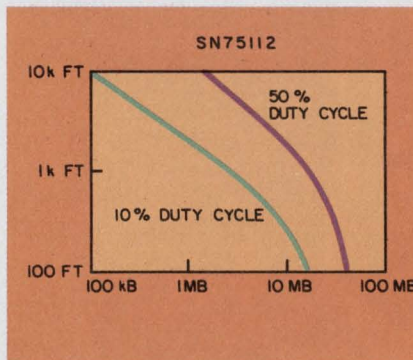

1. Balanced lines carry serial data streams between system components. Data drivers on one end and receivers on the other work well in-house, but are speed and distance-limited. Shown here is the data rate vs line length for TI's SN75112, a dual, long-line driver.

Sync and resync

Most *asynchronous* data-comm ICs operate at low speed—1200 baud or less. They resynchronize transmitter and receiver at the start of each character. At rest (between characters), the UART's transmitter section holds the

communications line to a ONE (marks the line), and then drops it to a ZERO (space) to indicate the beginning of the next character. The receiver timing system follows the incoming data stream, accepts the serialized character and returns to rest when the transmitter is finished.

All this synchronizing and re-synchronizing for each character weighs heavily on the comm line's efficiency. Synchronous data-comm chips on the other hand, improve line-use efficiency by eliminating the overhead time between characters. These devices burst data through the channel in a continuous message stream, many characters long.

According to established protocol, the USRT (for universal, synchronous

receiver-transmitter) sends out a receiver-synchronizing preamble, which identifies the destination address, alerts the receiver and locks its clock to the origin. The message is then transmitted at high speed—250 kilobaud or more—and the receiver stays in step by deriving its clock from the data stream itself, usually with an on-chip PLL. A unique, message-terminating character follows the data stream along with one or more error-checking characters. (For more on synchronous-data protocols, see ED No. 12, June 7, 1977, p. 36.)

One USRT, the 2601 from SMC Microsystems, comes in a 40-pin DIP. Moreover, it's suitable for floppy-disc I/O as well as long-haul data communications.

Both synchronous and asynchronous transmissions can be supported by combining UARTs and USRTs in a single chip and user-programming them to operate in one mode or the other. The combination chip is called an ASTRO—a loose acronym for "asynchronous, synchronous transmitter-receiver."

The "standard" ASTRO is the 1671 developed by Western Digital and now alternate-sourced by National Semiconductor and SMC Microsystems. The 1671 operates from dc to 1 Mbaud and features 5-bit addressability, a chip-select pin for multiple-line systems and receiver flags that indicate parity, overrun and framing errors to the host processor.

Like UARTs and USRTs, ASTROs are double-word buffered before and after the parallel-serial-parallel conversion process, and provide I/O-port diagnostics for the host computer.

Software assailed

The IC onslaught into data communications has taken its toll on software. With the trend toward higher-efficiency synchronous communications, designers are faced with having to devote more and more software to the support of attendant protocols than ever before. To help out, semiconductor manufacturers have developed very large-scale ICs (multiprotocol chips) to function as entire blocks of otherwise-expensive software. For less than \$50, these chips execute multiple data-comm protocols with almost no in-

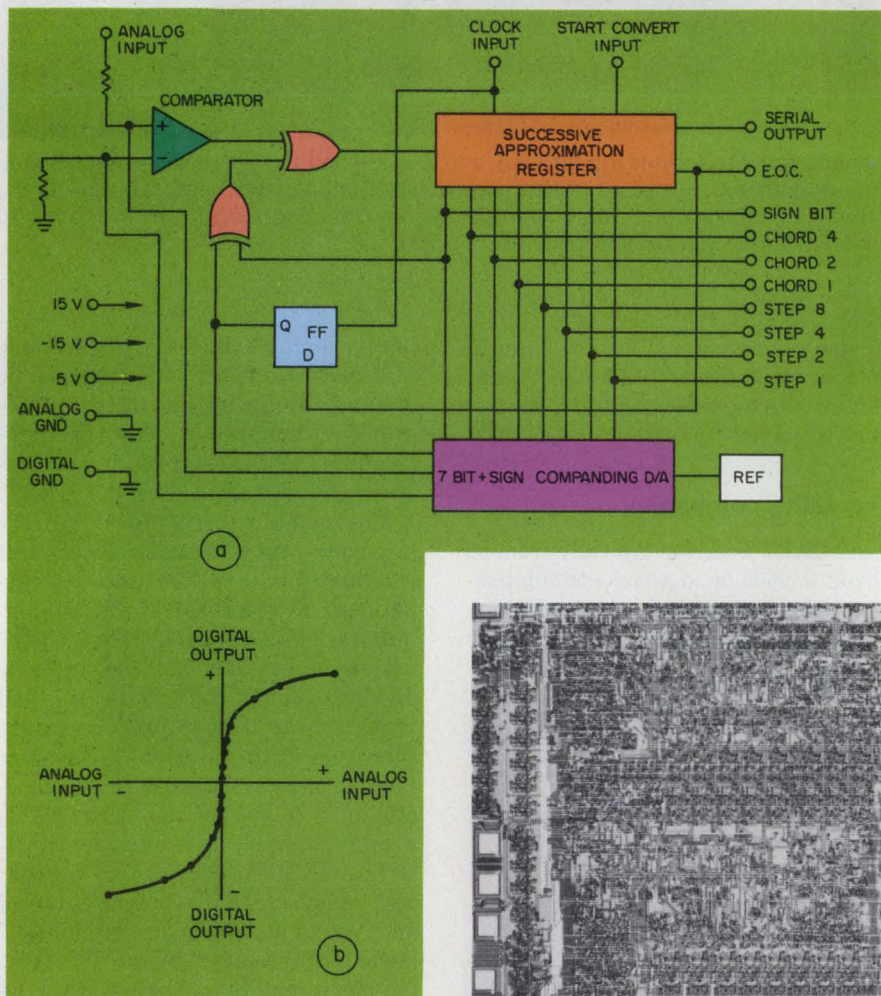

2. **Companding a/d-conversion** is the most popular method of digitizing voice for telephone transmission. By compressing the speech input, digitizing it, and then expanding it at the receiver, an 8-bit digital code can represent ± 72 dB of dynamic range. Micro Networks' companding ADC is a hybrid in a DIP.

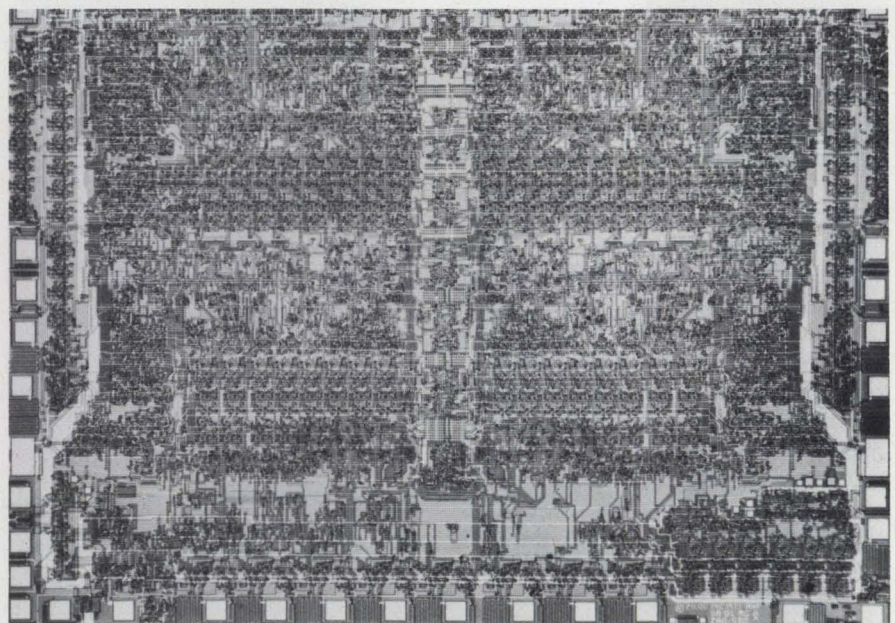

The first dual-channel, multiprotocol data-comm support chip is Zilog's SIO. It uses depletion-mode FETs to pack 10,000 transistors on a single substrate.

tervention by the host processor.

Mostly 40-pin devices, they are used for mutual interface among computers, modems, terminals and peripherals. They support all the popular, bit-oriented synchronous protocols—SDLC, HDLC, ADCCP—and the two byte-oriented protocols as well, BiSync and DDCMP.

Just one of these multiprotocol chips accepts parallel data from a computer's 16-bit data bus and formats it into a synchronous data stream. It generates vertical and cyclical-redundancy-check characters as well as adds destination addresses and automatically stuffs ZEROs into the data stream as required.*

With a multiprotocol chip, the data will be transmitted in a high-speed burst—2 Mbaud. An identical chip will recognize the receiving station's address and accept the data. It will strip away embedded ZEROs from the data stream, use parity and redundant check characters to ensure the data's integrity, then reconstruct the original format and present it to the receiving computer in parallel words.

The entire data-transfer process, transparent to both the sending and receiving processors, is scarcely more involved than an ordinary direct-memory-access operation.

The VLSI whiz chips are available from National (the 2652), Signetics (the 2652), SMC Microsystems (the 5025), and Zilog, whose SIO is the first *dual-channel* multiprotocol chip. These NMOS parts are all available in standard 40-pin DIPs.

Analog and digital together

Meanwhile, both analog and digital techniques are being combined into single data-comm products. The way to do it is with modems, frequency-shift keying—and integrated circuits.

A modem—for “modulator-demodulator”—connects digital equipment via telephone lines and communicates digital data. But a modem uses analog signals to do it. The technique involved is frequency-shift keying (FSK). (Because a modem has both analog frequency and digital-bit rate, the speed of information transfer is called the *baud rate* which defines the number of line signal elements per second.)

In FSK, an analog carrier signal is

Common line driver/receiver interface standards

| Interface area | Application | Standard | Origin | Comments |
|--|----------------------------------|--|--|---|
| Data communications equipment to data terminal equipment | U.S.A. Industrial | RS 232 C | EIA | Unbalanced, short lines Balanced, long lines Unbalanced, RS 232 upgrade System standard covering use of RS 422/423 |
| | | RS 422 | EIA | |
| | | RS 423 | EIA | |
| | | RS 449 | EIA | |
| | International | C.C.I.T.T. Vol VIII V. 24 C.C.I.T.T. #97 X. 26 C.C.I.T.T. #97 X. 27 | International Telephone & Telegraph Consultative Committee | Similar to RS 232 |
| | | | | Similar to RS 423 |
| | | | | Similar to RS 422 |
| | U.S.A. Military | MIL-STD-188C | D.O.D. | Unbalanced, short lines |
| | | MIL-STD-188-114 | D.O.D. | Similar to RRS 22/423 |
| | | MIL-STD-1397 (NTDS-slow) | Navy | 42 Kbits/S |
| MIL-STD-1397 (NTDS-fast) | | Navy | 250 Kbits/S | |
| U.S. Gov non-military | Fed-STD-1020 Fed-STD-1030 | GSA GSA | Identical to RS 423 Identical to RS 422 | |
| Computer to peripheral | IBM 360/370 | System 360/370 channel I/O | IBM | Unbalanced bus |
| | DEC mini-computer | DEC Unibus | DEC | Unbalanced bus |
| Instrument to computer | Nuclear instrumentation | CAMAC | NIM (AEC) | Uses RS 232-C or RS 422/423 and IEE 488 |
| | Laboratory instrumentation | 488 | IEEE | Unbalanced bus |
| Numerical control equipment to DTE | Numerical controlled equipments | RS 408 | EIA | Short lines (< 40 ft.) |
| Facsimile equipment to DTE | Facsimile transmission | RS 357 | EIA | Incorporates RS 232 |
| Automatic calling equipment to DTE | Impulse dialing multitone keying | RS 366 | EIA | Incorporates RS 232 |
| Microprocessor to interface devices | Micro-processor circuits | Microbus | National Semiconductor Corp. | Short line 8-bit parallel, digital transmission |

*SDLC protocol requires that no more than six contiguous ONEs be permitted in the data stream.

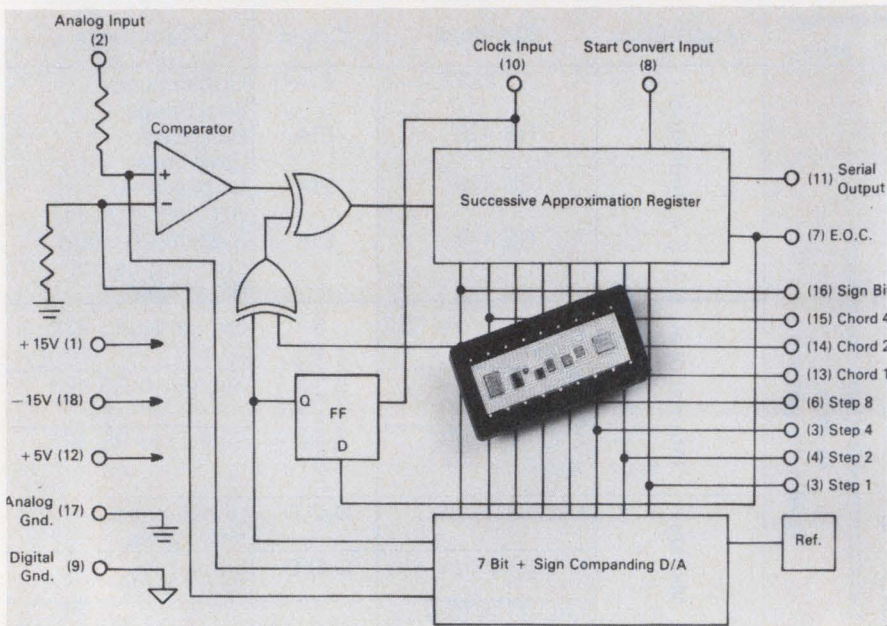

Long-haul data-communications systems are simplified with LSI devices that format data streams according to protocol. This ASTRO (asynchronous-synchronous transmitter/receiver) chip from National Semiconductor is one of several available. The device type was introduced by Western Digital.

shifted between two preselected frequencies (at the baud rate) to represent a ONE or a ZERO (mark or space, in modem terms). The integrated circuits that provide this facility are phase-locked loops.

Typically, a PLL consists of a voltage-controlled oscillator (VCO), a phase comparator, an amplifier, and a low-pass filter—all on a monolithic substrate. The mark-space frequency shift is generated by driving the chip's VCO with the binary data to be transmitted.

On the receiving end, a PLL's phase comparator locks onto the signal and tracks it between mark and space. An

RC ladder filter then strips away the carrier component, and the amplifier reconstructs the digital data stream.

Seven PLLs are available from Signetics. Their latest, the NE564, operates up to 50 MHz and uses standard TTL supplies.

Plessey's SL 1001 modem features 50-dB carrier suppression for the receiver. Motorola's MC 14412 is a 600 baud FSK modem.

The human side

Integrated circuits have even brought a new element into data com-

munications: the human voice. Today, there are more than half a dozen types of ICs for digitizing voices. Some can even be used for data acquisition, but their real purpose is to support digital telephone systems.

Digitally-encoded telephones show great promise, especially now that optical fibers have been successfully integrated into commercial phone systems (see ED No. 2, Jan. 18, 1978, p. 40).

The aim is to break the human voice into bits. The IC most semiconductor firms are trying to perfect for phone systems are companding codecs (for "compressing-expanding coder-decoder").

The first hybrid companding a/d converter is housed in an 18-pin DIP and comes from Micro Networks. The MN 5110 compresses a ± 5 V analog signal into an 8-bit binary code (see Fig. 2). The weight of the bits and the resulting shape of the transfer curve adheres to the Bell Telephone Labs μ -255 speech-compression law, or μ -law.

Two systems for voice-band digitizing from National Semiconductor both require a set of two IC packages. They are the TP3001/3002 and MM48100/LF2700. These two systems typify the way most companding codecs work: The system samples band-limited (300 Hz $< f < 3.4$ kHz) voice signals and digitizes them at an 8 kHz rate.

Each analog sample is converted into one digital byte according to either the μ -law or the A-law. Then it is buffered and transmitted serially at up to 2 Mbaud. At the receiving end, another companding codec simply reverses the process and reconstructs the filtered voice.

Five telecomm chips are being offered by Siliconix, a μ -law companding codec in a single, 14-pin DIP (the DF331) and an A-law codec that requires no external components (the DF341). The firm's DF320 is a telephone dialer chip that uses a common (3.58-MHz) crystal to allow pushbutton telephones to be used with dial-telephone switching centers. The DF321 and 322 are conventional dialer chips, but feature "interdigital listening." The most expensive of these devices goes for only \$18.

Nitron second-sources Siliconix' DF-320 and DF321 dialer devices.

Mostek provides six different tone dialers and hopes soon to introduce four new telecomm chips—a pulse dialer, a pushbutton tone-detector chip

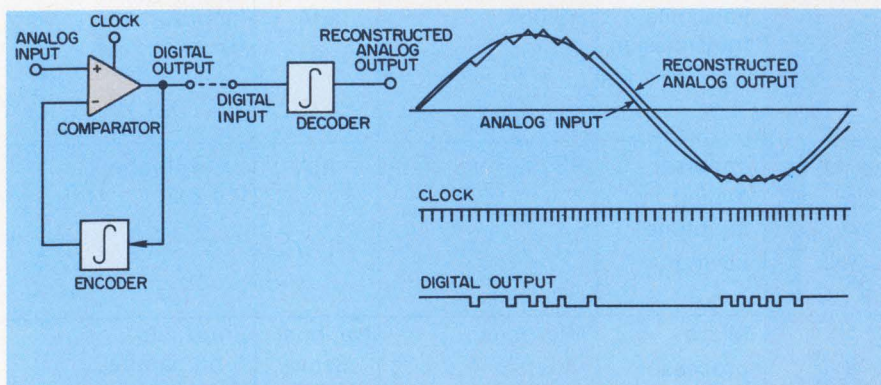

3. **The human voice is digitized** by this Motorola IC for binary telephone systems by using a clock to sample the instantaneous slope of the signal. ONEs indicate rising slopes, ZEROs falling slopes. At the receiver, the bit stream is integrated to reconstruct the original voice.

PEOPLE WHO KNOW RELAYS COUNT ON STRUTHERS-DUNN FOR TIME DELAY

- New Design Concept** 1
- Broad Selection** 2
- Design Flexibility** 3
- Reduce Costs** 4
- Standard Voltages & Sockets** 5
- Timing & Setting Range** 6
- Reliability** 7
- Transient & Polarity Protection** 8
- False Contact Protection** 9
- Total Relay Capability** 10

The Struthers-Dunn line of standard tdrs was achieved by combining a proven hybrid solid state timing module with the entire line of standard general purpose relays. In most cases the module fits within the existing relay cover, and therefore does not affect unit size or ease of mounting.

Imagine, more than 6000 combinations of timing, voltage, contact arrangement and mounting. New concept permits any standard general purpose relay to be equipped with built-in time delay function. Standard off-the-shelf models are U. L. recognized. Hermetically sealed models meet the requirements of MIL-R-83726. It adds up to the most complete line available anywhere.

The versatility of these timing modules offers a wide variety of alternatives when the control circuit must include time delay. Instead of searching for a timer to fit the circuit, simply choose the type of relay you want with the assurance that it is available with time delay capability.

The new tdrs will cut costs in many applications. If, for example, a system now uses a conventional electromechanical timer and a separate relay as many circuits do, the designer may substitute a single tdr and cut his component cost in half. Cost of mounting and wiring the component is also reduced.

Forget previous voltage limitations. Our tdrs are available for all standard voltages from 12 VAC to 240 VAC and from 12 VDC to 125 VDC. Plug-in models available for most common sockets: Octal, square base, miniature or 12 pin rectangular plugs with quick connect, solder, printed circuit or front connect terminals.

Standard off-the-shelf models offer seven different timing ranges with adjustable setting: 0.1-1 second, 0.2-2, 1-10, 3-30, 6-60, 18-180 and 30 to 300 seconds. Settings are available three ways: Fixed (factory preset), knob adjustable or remote adjustable from a central control panel.

These tdrs incorporate two time-tested components—electromechanical relays and solid state timing modules. Thus there is no weak link to cause premature failure. Repeatability of $\pm 3\%$ at 20 to 25°C and $\pm 10\%$ accuracy within voltage and temperature range is assured. Life expectancy is 50 million mechanical operations or 500,000 operations minimum at full load.

Time delay operation is protected for transient voltages as long as 5ms duration with exponential slope from 0 volts to 20 microsecond peaks of ± 2000 volts. DC models are inverse polarity protected. Tdrs will not operate with polarity reversed, but will function normally once wiring is corrected.

Another added operational protection. With our on-delay relays, false transfer of contacts is prevented should the voltage be interrupted during timing cycle. With off-delay relays, if control switch closes during delay period, timing resets to zero and contacts do not transfer. Full timing is assured when control switch opens again.

Dependability and know-how, that's what you get from more than 50 years experience. You, too, can count on a relay line-up with unmatched diversification. We provide solutions to control problems with ten key relay functions: General Purpose, Latch Sequence, Sensitive, Reed, Solid State & Hybrid, Motor Control, Military, Special Assemblies and, of course, Time Delay.

...we're in TOTAL CONTROL

STRUTHERS-DUNN, INC.

PITMAN, NEW JERSEY 08071

Manufacturers of Relays and Solid State Controls

Telephone: 609-589-7500 TWX: 510-686-7510



CIRCLE NUMBER 29



NEWCOM'78

Las Vegas Convention Center, May 2, 3, 4
See our diversified line of relays at Booth G31

Available Through 140 Stocking Distributors
Canada: Struthers-Dunn Relay Div., Renfrew Electronic Marketing, Ltd.

for remote data entry, a 24-channel companding codec in a single package, and a repertory dialer with a 100-phone number capacity.

General Instrument currently supplies a 10-number repertory dialer, the AY5-9200, and has been offering a number of pulse telephone dialers for several years.

Complexity simplified

But the problem with companding codecs is that they are overly complex—a great deal of engineering effort goes into designing the wafer masks. Motorola, however, has announced a breakthrough in voice coding-decoding—the MC 3471 “continuously variable slope delta modulator (CVSD).”

With this simple approach, the voice-encoding bits do not represent discrete analog “weights,” but, rather, the instantaneous slope of the voice signal. A ONE defines a rising slope, a ZERO a falling slope. The frequency of the bits defines the rate of the slope going up or down (see Fig. 3).

By applying the CVSD data stream to an integrator, Motorola reconstructs the original, band-limited voice. Offering a similar product, Harris Semiconductor does its implementation in CMOS.

Thomson-CSF markets a 300-baud modem-on-a-chip (ESM-501), as well as five other integrated circuits that defy simple classification.

The company's SFF-9364 converts an ordinary TV receiver into a data terminal. The SFF-26303 is an eight-channel multiplexer for PABX equipment. The SFF-26310 is a 4 x 4 crosspoint matrix with controlling RAM (RCA offers a similar chip, in its CD 22100). The ESM-536 and TBD-146 are both telephone-channel amplifier chips. The latter chip is programmable for gain-band-width product, slew rate, supply current, input-bias and offset currents as well as input noise.

And, for designers of military systems using the two-wire, transformer-coupled, serial data bus of MIL STD 1553A, Harris Semiconductor has announced a Manchester II encoder-decoder in a 28-pin DIP (HD 15530). The CMOS device encodes 16-bit words (with sync and parity), operates at 1 Mbaud and requires just a +5 V supply.

Intel markets an integrated circuit

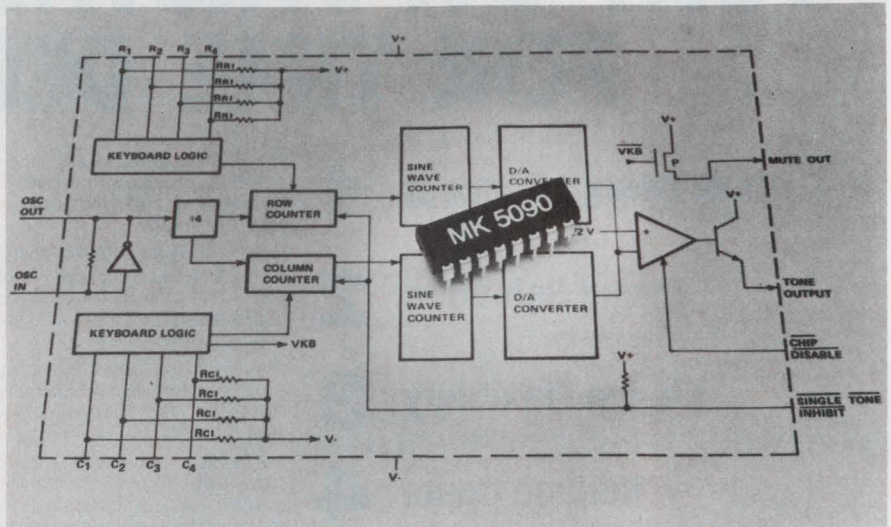

This telephone-dialer chip from Mostek uses a color-TV crystal to derive eight different audio tones. The tones are then mixed on-chip to provide standard dual-tone, multifrequency (DTMF) dialing.

for government-owned data terminals called the 8294 data encryptor unit. This device enciphers data in a secret code that is approved by the National Bureau of Standards.

Finally, a pair of high-speed

monolithic multipliers from TRW are especially suitable for telecomm filtering applications. The TDC-1008 is an 8 x 8 accumulator/multiplier; MPY-16 is a 16 x 16 A/M. The latter is second-sourced by Monolithic Memories. ■■

Need more information?

The following IC manufacturers may offer products and features not mentioned in this report. To get details on products mentioned and data on other IC devices, circle the appropriate reader-service-card numbers, or consult ELECTRONIC DESIGN'S GOLD BOOK.

- Fairchild Semiconductor**, 464 Ellis St., Mountain View, CA 94042. (415) 962-5011. J. Duffy. **Circle No. 541**
- General Instrument**, 600 John St., Hicksville, NY 11802. (516) 733-3107. John Wunner. **Circle No. 542**
- Harris Semiconductor**, P.O. Box 883, Melbourne, FL 32910. (800) 528-6050. S.R. Zepp. **Circle No. 543**
- Hughes Aircraft**, 500 Superior Ave., Newport Beach, CA 92663. (714) 548-0671. Gary Des Rochers. **Circle No. 544**
- Intel**, 3065 Bowers Ave., Santa Clara, CA 95051. (408) 246-7501. H.M. O'Hara. **Circle No. 545**
- Intersil**, 10710 N. Tantau Ave., Cupertino, CA 95014. (408) 996-5000. E.J. Turney. **Circle No. 546**
- Micro Networks**, 324 Clark St., Worcester, MA 01606. (617) 852-5400. Chuck Sabolis. **Circle No. 547**
- Monolithic Memories**, 1165 E. Arques Ave., Sunnyvale, CA 94086. (408) 739-3535. Schlomo Wasser. **Circle No. 548**
- Mostek**, 1215 W. Crosby Rd., Carrollton, TX 75006. (214) 242-0444. Don Ward. **Circle No. 549**
- Motorola Semiconductor**, P.O. Box 20912, Phoenix, AZ 85036. (602) 244-3465. Bob Hirschfield. **Circle No. 550**
- National Semiconductor**, 2900 Semiconductor Dr., Santa Clara, CA 95051. (408) 737-5000. Robert Culicover. **Circle No. 551**

- Nitron**, 10420 Bubb Rd., Cupertino, CA 95014. (408) 255-7550. Steven Pollock. **Circle No. 552**
- Philips (N.V.)**, Gloeilampenfabrieken, Eindhoven, The Netherlands. **Circle No. 553**
- Plessey Microsystems**, 1674 McGaw Ave., Santa Ana, CA 92714. (714) 540-9945. Dennis Chant. **Circle No. 554**
- Plessey Semiconductors**, Swindon Wilts, SN2 2QW, England. **Circle No. 555**
- RCA**, Route 206, Somerville, NJ 08876. (201) 658-6000. Dick Santilli. **Circle No. 556**
- Rockwell International**, 3310 Miraloma Ave., P.O. Box 3669, Anaheim, CA 92803. (714) 632-2860. Ron Eufinger. **Circle No. 558**
- Signetics**, 811 E. Arques Ave., Sunnyvale, CA 94086. (408) 739-7700. Ron Aubish. **Circle No. 559**
- Siliconix**, 2201 Laurelwood Rd., Santa Clara, CA 95054. (408) 246-8000. Art Fury. **Circle No. 560**
- SMC Microsystems**, 35 Marcus Blvd., Hauppauge, NY 11787. (516) 273-3100. A. Sidorsky. **Circle No. 561**
- Synertek**, 3050 Coronado Dr., Santa Clara, CA 95051. (408) 984-8900. George Rigg. **Circle No. 562**
- TRW LSI Products**, One Space Park, Redondo Beach, CA 90278. (213) 535-1831. Bill Koral. **Circle No. 563**
- Texas Instruments**, 13500 N. Central Expressway, Dallas, TX 75222. (214) 238-5711. Steven Howard. **Circle No. 564**
- Thomson-CSF Semiconductors**, 50 Rue Jean-Pierre Timbaud, Courbe-voie 92, France. 788-5001. M. Eliaers. **Circle No. 565**
- Western Digital**, 3128 Red Hill Ave., Newport Beach, CA 92663. (714) 557-3550. George Gregoire. **Circle No. 566**
- Zilog**, 10460 Bubb Rd., Cupertino, CA 95014. (408) 446-4666. Ken McKenzie. **Circle No. 567**

Ford uses General Instrument

SUPERECTIFIER™



...Quality Cars Start with Quality Parts.

At Ford Motor Company, quality is a lot more than something to talk about in TV commercials—it's a *rule* that applies to every aspect of building fine cars and trucks.

So when Ford needs rectifiers, the choice is quality—General Instrument Superectifier.

Not only does Superectifier assure Ford owners of long dependable service, but it eliminates costly failures due to the stresses of automated assembly techniques, *helping Ford to keep costs down.*

It's easy to see why Ford selected Superectifier, just look at its patented construction.

- Metallurgically Bonded, at greater than 600°C, at both the leads and the junction.
- Hermetically Sealed, glass passivated junction.
- Flame Retardant, UL Listed epoxy encapsulation.

Not everyone needs the kind of quality Ford requires, but everyone can afford it—because with Superectifier the premium is on quality not price.

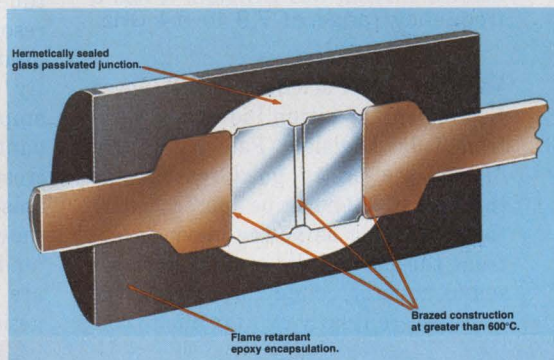

WIN THIS NEW FORD PINTO!

You may win this 1978 Ford Pinto or one of the other Super prizes in the General Instrument Superectifier Sweepstakes. Just send in this literature request coupon and we'll send your entry form with your Superectifier catalog.

Official Rules and Regulations Apply. Void Where Prohibited.

OK, GI. Send My Superectifier Catalog and Sweepstakes Entry Form and Official Rules.

Name _____ Title _____

Company _____

Address _____

City _____ State _____ Zip _____

Phone _____

GENERAL INSTRUMENT CORPORATION
DISCRETE SEMICONDUCTOR DIVISION
600 West John Street, Hicksville, New York 11802 (516) 733-3333

ED04



Microwave power tubes are more than just around—they're getting better

Microwave power tubes are enjoying the fruits of continuing design and development: higher power output (in some types of tubes), wider bandwidth, and better efficiency. Improvements are coming from new material and process technology as well as computer-aided design. As a result, not only are traveling-wave tubes, klystrons, magnetrons and crossed-field amplifiers being upgraded, they are being joined by two newcomers fresh from the lab—gyrotrons and electron-bombarded semiconductor devices.

Most radars and all microwave ovens use microwave power tubes; so do microwave relay, satellite, and troposcatter communication links. More exotic applications are found in electronic warfare and particle accelerators. All this is for a good reason. Only microwave power tubes can provide power outputs from tens of kilowatts to tens of megawatts, and they appear to be the only devices capable of doing so in the foreseeable future.

"The combination of power and bandwidth that tubes are capable of isn't approached by solid-state devices," explains Dr. J. Rodney M.

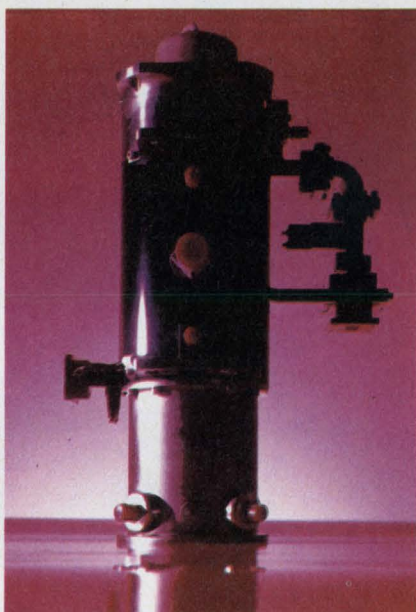

This traveling-wave tube has a gain of 37 dB at 5 kW cw. Made by Hughes Electron Dynamics Division, it has a frequency range of 7.9 to 8.4 GHz.

Vaughan, chief scientist in the Linear Beam Dept. of Litton Industries' Electron Tube Division (Palo Alto, CA). "There are pretty good reasons for thinking it will never be approached by them. As long as you're moving electrons through a solid-state material—semiconductor, conductor, or whatever—losses are relatively high due to col-

lisions. And when you get up to high power, it's only when you can get the electrons out into a vacuum, where the motion in itself is essentially lossless, that you can handle [large] amounts of power."

Dr. Vaughan also points out that in a tube, the rf interaction area and the collector are in different places, so the cooling at the collector is isolated from the rf area. In a solid-state device, on the other hand, the heat is generated in the rf interaction area, and cooling problems are much more difficult. The material isn't the best for heat transfer, and its shape isn't optimum for that, either.

Microwave power tubes can be classified rather simply as linear-beam devices and crossed-field devices. Both groups may have either essentially-resonant, or essentially-nonresonant rf interaction structures. Traveling-wave tubes are linear-beam types with non-resonant structures, which are also used in the crossed-field amplifier family. Klystrons are linear-beam amplifiers and oscillators with resonant structures, while magnetrons are crossed-field oscillators. (For historical reasons, linear-beam tubes are sometimes called O-type, from the French "ondes"—waves. Crossed-field types are likewise called M-type, for "magnetic." Magnetic fields are an integral

Nicholas Bodley
Associate Editor

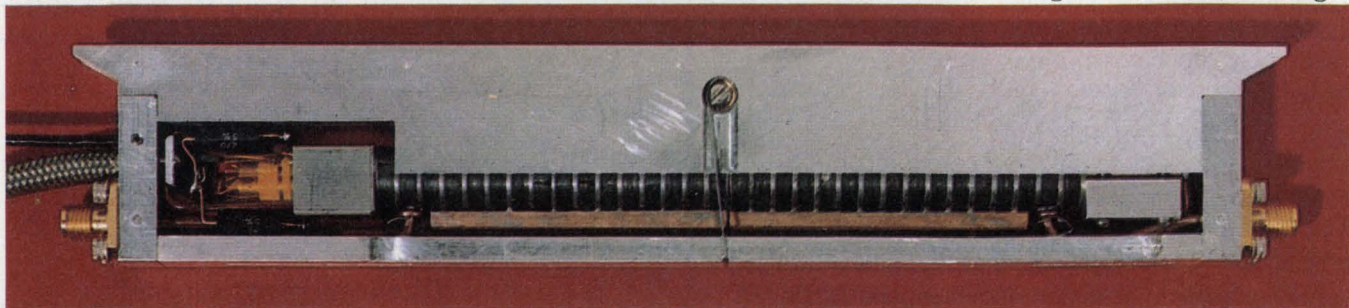

This prototype mini-TWT, shown almost actual-size, was originally designed by RCA for phased array. It has an output of 25 to 50 W cw between 8 and 18 GHz. The electron gun is to the right, and the collector is at the left end. In between is the periodic permanent-magnet

focusing structure. The magnets, made of samarium cobalt, are the dark rings seen edge-on. The lighter-colored pole pieces between the magnets not only shape the focusing field, but also carry heat to two copper bars (one is visible above the magnets), and the aluminum sink.

THE WIDEBAND RMS VOLTMETER ONLY FLUKE COULD CREATE.



You're probably accustomed to using analog meters for audio-to-rf measurements. Maybe you've given up hope of going digital at a reasonable price.

Good news!

Fluke's new 8920A wideband true rms DMM is loaded with features—some you can't buy anywhere at any price, and it sells at an analog price: \$995*!

For starters, 8920A bandwidth is 10 Hz to 20 MHz for sub-audio to video AC measurements. Mid-band accuracy is 0.5%, compliments of an exclusive Fluke designed (and built) micro-electronic rms chip. Accurately measuring noise and non-sinusoidal waveforms is easy since the chip responds only to the heating effect of the waveform. You can select the AC + DC function for non-symmetrical waveforms like pulses that have a DC component.

We gave the 8920A dynamic range from 180 μV to 700 volts, to measure from low noise levels to the output of powerful amplifiers. And, fast auto-ranging relieves you of the knob twisting chores!

Put the 8920A into dBV mode and measure from -75db to +57db (132db range), with 0.01db resolution. If you want your dBV reference somewhere else beside 1V, Fluke's

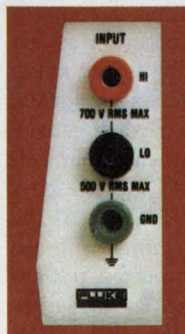

8921A's Isolated Banana Jack Input.



"Dial-An-Ohm"

exclusive *relative reference* lets you store any voltage as the 0-db point. Imagine how simple your gain measurements can be!

To make the 8920A all things to all people, we've included a "dial-an-ohm" feature for dbm measurements. Instead of laboriously correcting each of your readings from a 600 ohm reference, simply dial 50, 75, 300, or one of nine *other* impedances up to 1200 ohms, and be right on every reading. There are several selections for broadcast, telephone, TV and RF applications.

An analog meter is standard, for convenient peaking/dipping/nulling, as is a linear analog output for continuous recording. Optional are logarithmic analog output and an isolated output to drive a counter. Soon, IEEE 488 interface will be available for systems use.

If you prefer an isolated banana jack input with full floating capability, specify the 8921A (also only \$995*). *U.S. Price

For more information, contact one of the more than 100 Fluke offices or representatives, worldwide. In the U.S., CALL (800) 426-0361, TOLL FREE. Residents of the U.S. and all countries outside of Europe, contact: John Fluke Mfg. Co., Inc., P.O. Box 43210, Mountlake Terrace, WA 98043, U.S.A. Telex: 32-0013.

In Europe, contact: Fluke (Nederland) B.V., P.O. Box 5053, Tilburg, The Netherlands. Telephone (013) 673973. Telex: 52237.

FLUKE[®]

2504-8018

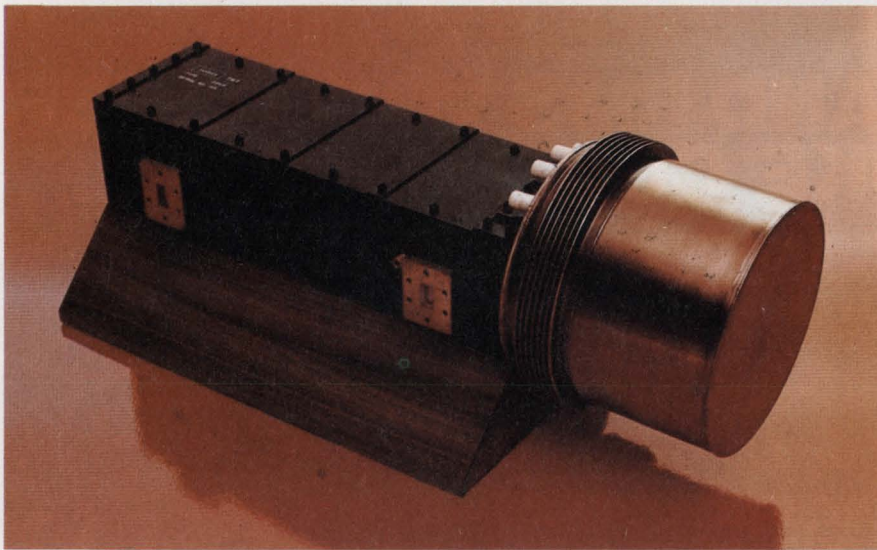

High-efficiency spacecraft TWT by Hughes is cooled primarily by radiation from the cylindrical collector cover. Power output is 100 W cw at 12.0 GHz. Gain is about 47 dB, efficiency 53%, and design life over 30,000 h.

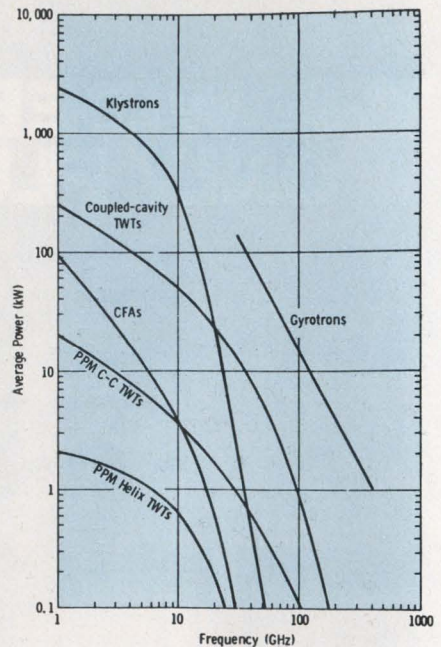

Average power capability of microwave tube is shown as a function of frequency. From A. Staprans, Varian.

Microwave letter-frequency designations

| IEEE Microwave Radar | | Tri-Service | |
|----------------------|------------|-------------|-------------|
| L | 1.0 - 2.0 | A | 0 - 0.25 |
| S | 2.0 - 4.0 | B | 0.25 - 0.50 |
| C | 4.0 - 8.0 | C | 0.50 - 1.0 |
| X | 8.0 - 12.0 | D | 1.0 - 2.0 |
| Ku | 12.0 - 18 | E | 2.0 - 3.0 |
| K | 18 - 27 | F | 3.0 - 4.0 |
| Ka | 27 - 40 | G | 4.0 - 6.0 |
| mm | 40 - 300 | H | 6.0 - 8.0 |
| | | I | 8.0 - 10 |
| | | J | 10 - 20 |
| | | K | 20 - 40 |
| | | L | 40 - 60 |
| | | M | 60 - 100 |

NOTE: All frequencies are in GHz.

part of crossed-field tube operation; they only focus the beam in linear-beam tubes, however.)

CAD helps improve performance

One major tool for improving existing designs and creating new ones is computer-aided design. The push for improved tube performance calls for more sophisticated designs, which would be impossible without CAD. In fact, computer-aided design has been instrumental in the further development of traveling-wave tubes, and is proving quite helpful in gaining better understanding of crossed-field amplifiers.

CAD has, typically, helped select the optimum helix pitch profile for a TWT. (The helix turns aren't uniformly spaced in this tube.) In another TWT design, the electron gun and periodic-permanent-magnet focusing structure

have been designed and optimized by computer. In still another, a coupled-cavity type of rf structure was optimized through CAD by trying many designs through a modeling program.

Coupled-cavity slow-wave structures are permitting much higher output power (about 300 kW peak, roughly 10 kW average, up to 15 GHz). At the other end of the scale, mini-TWTs are creating interest, with output powers in the 10 to 100-W range. The latter are for phased-array radar and ECM; there's a push to cut their cost and keep a good match in characteristics from tube to tube.

However, according to Dr. Vaughan, the most important recent TWT development is that engineers have learned how to successfully operate the collector of a TWT at a reduced ("depressed") voltage, which improves efficiency quite a bit. Even with the collector voltage depressed, the current col-

lected is the same, so there's less power dissipation. For still greater efficiency, typically 50% or better, the collector is made as a multistage "stack" of several stages, connected to a progression of supply voltages. One such tube, the Litton L-5678, has four stages and reaches 82% efficiency at the collector.

There are several other noteworthy TWT developments. For example, some newer pulsed TWTs use electron guns with grids to turn the beam on and off. Pulsing the grid is much easier than pulsing the full power of the beam itself. In such tubes, the grid is positive when the beam is on, and it collects part of the beam current. To avoid this, some gridded gun designs include a shadow grid, which is positioned between the cathode and the control grid.

This shadow grid is aligned precisely behind the control grid. It is connected to the cathode, and blocks the electrons from the control grid. Some recently developed tubes have the shadow grid bonded to the cathode surface. Work is being done to bond the control grid as well, which avoids tight tolerances in manufacturing and improves reliability.

TWTs are noted for their wide bandwidth—up to two octaves in some instances—which makes them vital to ECM systems.

But both ECM and military radar applications need a TWT that not only can run continuously but also can be pulsed up to a higher power level by



**Only
Hamilton/Avnet
delivers so many
microcomputer
system-segments
off-the-shelf!**

**WE
HAVE
LOCAL
SYSTEMS
STOCK.**

| | |
|-------------------------|-------------------|
| System Components | Intel |
| Floppy Disk Systems | Shugart |
| System Components | National |
| System Components | Motorola |
| Video Display Terminals | Hazeltine |
| Printers | Centronics |
| Analog Peripherals | Burr-Brown |

Hamilton  **Avnet**
ELECTRONICS  A DIV. OF AVNET, INC.

World's largest local distributor with 35 locations stocking the world's finest lines of system components

SOUTHERN CALIFORNIA
Hamilton, L.A. (213) 558-2121
Avnet, L.A. (213) 558-2345

NORTHWEST
Mountain View (415) 961-7000
Seattle (206) 746-8750

SOUTHWEST
San Diego (714) 279-2421
Phoenix (602) 275-7851

ROCKY MOUNTAIN
Salt Lake City (801) 972-2800
Denver (303) 534-1212
Albuquerque (505) 765-1500

NORTH CENTRAL
Chicago (312) 678-6310
Minneapolis (612) 941-3801
Detroit (313) 522-4700
Milwaukee (414) 784-4510

SOUTH CENTRAL
Dallas (214) 661-8661
Houston (713) 780-1771
Kansas City (913) 888-8900

INTERNATIONAL
Telex 66-4329
Telephone (213) 558-2441



MID CENTRAL
St. Louis (314) 731-1144
Dayton (513) 433-0610
Cleveland (216) 461-1400

CANADA
Toronto (416) 677-7432
Montreal (514) 331-6443
Ottawa (613) 226-1700

NORTHEAST
Boston (617) 933-8000
Syracuse (315) 437-2641
Rochester (716) 442-7820

METROPOLITAN
Georgetown (203) 762-0361
Westbury (516) 333-5800
Cedar Grove (201) 239-0800

MID-ATLANTIC
Baltimore (301) 796-5000
Mt. Laurel (609) 234-2133
Raleigh (919) 829-8030

SOUTHEAST
Miami (305) 971-2900
Atlanta (404) 448-0800
Huntsville (205) 533-1170

**System-
Segments from Hamilton/Avnet**

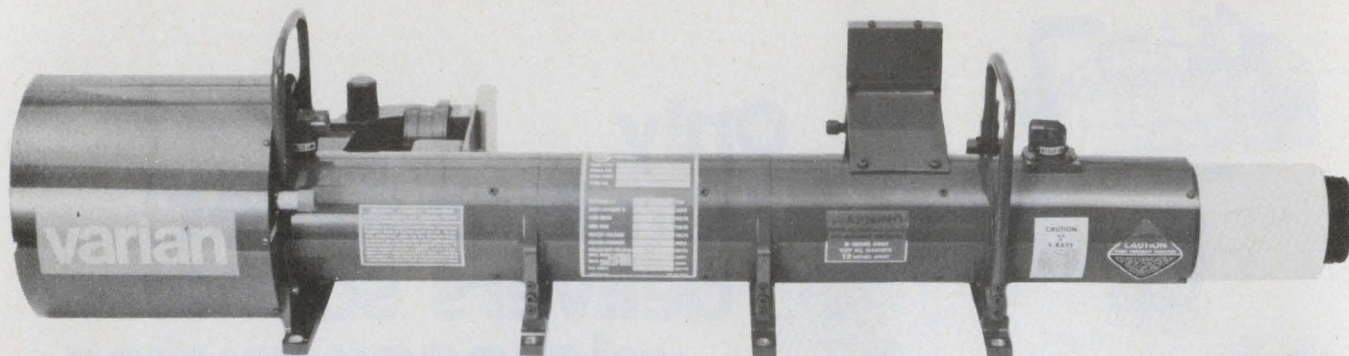

Grid-pulsed TWT for radar serves as a driver for a crossed-field amplifier or as a final output stage. Peak output is

120 kW min. The tube's gain is 47 dB; it operates in the 3-GHz range. Length is about 4 ft, and weight 110 lb.

a factor of 10 dB. Doing this is not easy, for the beam must stay focused. But it has been done by Varian and Hughes, at least.

Many new TWT designs use periodic permanent-magnet (PPM) focusing with samarium cobalt magnets. These magnets are extremely powerful for

their weight and size, which makes possible a compact, relatively lightweight tube and higher power at higher frequencies.

If power is increased too much in a TWT, the helix can overheat, even if the beam is aimed and focused properly. Indeed, it's quite possible for the

helix to be destroyed if it intercepts much of the beam current. One tube, the Siemens RW 3010, has a beam-current density of 5 MW/cm².

Keep your helix cool

Progress has been made with helix-support materials such as boron nitride and beryllium oxide, which are electrical insulators with excellent thermal conductivity. Even diamond has been tried, by Raytheon, with really encouraging results. Diamond has thermal conductivity superior to copper at moderate temperatures.

One problem remains. Helix supports don't make good, large-area contact with either the helix or the surrounding tubular sleeve, so conduction cooling doesn't work too well. Thomson-CSF is now making brazed helix assemblies, using copper for both the helix and the sleeve. The helix supports are beryllium oxide, which is brazed to the helix and the tube. (In-

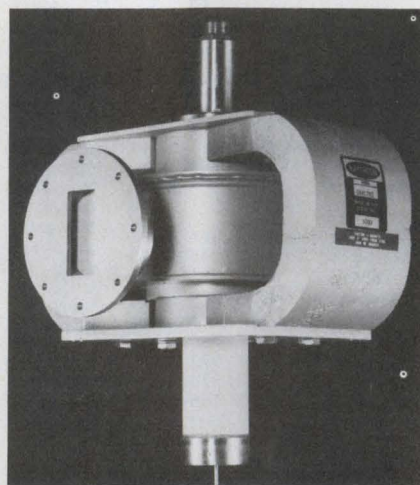

Coaxial magnetron from Raytheon has a higher efficiency and better frequency stability than regular magnetrons but is more expensive.

Microwave power tubes

All widely used microwave power tubes operate by the interaction of electrons with rf fields inside a steady magnetic field. Broadly classed, tubes are either crossed-field types or linear-beam types.

Crossed-field types have magnetic (B) and dc electric (E) fields at right angles to each other. In the illustration, the magnetic lines of force are perpendicular to the plane of the paper. In (a), the magnetic field is strong enough to redirect the electrons back to the cathode when no rf is present. So there's no significant anode current.

Applying an rf field slows down some electrons, which then move with a larger radius of curvature and come closer to the anode. In doing so, they transfer energy from the dc electric field to the rf field. Faster-moving electrons catch up with the slow ones until the "cloud" of electrons develops spokes, as in (b). The "teeth" on the inside of the anode couple the spokes to the rf field as the "wheel" of electrons moves past them.

The magnetron, which is a power oscillator, looks like (b) in general. The anode teeth are resonant cavities, which determine the output frequency.

Other types of tubes have teeth that don't extend all the way

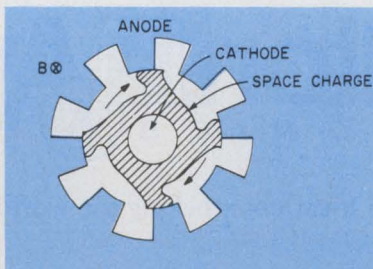
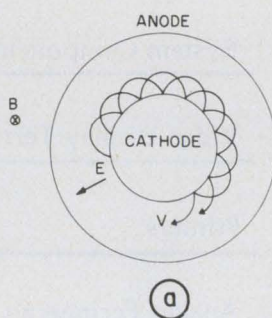

around the anode. The teeth behave like a bandpass filter and the device amplifies. Not surprisingly, it is called a crossed-field amplifier. A CFA has moderate bandwidth, and very high efficiency.

Linear-beam tubes use the magnetic field to keep an electron beam focused as it travels from an electron gun through a structure where it interacts with the rf energy. For more on these types, see the box about TWTs and klystrons.

Drawing from Radar Handbook, by Merrill I. Skolnik. © 1970 McGraw-Hill.

Now you can solve your data communications problems at super-high baud rates.

These two new 2650 LSI peripherals interface with any microprocessor, and offer on-chip performance which shrinks hardware/software costs.

Whether you're designing data communications systems for a byte-control protocol like BISYNC, or for one of the newer bit-oriented disciplines like SDLC, you won't find a more cost-effective, higher performance interface capability than you get with the newest LSI additions to the Signetics 2650 family.

These two data communications ICs can satisfy virtually every interface requirement. They help speed data flow between CPUs or between CPU and terminals. The 2651 Programmable Communications Interface (PCI) combines USART functions with an on-chip baud-rate generator, modem controls and BISYNC support. The 2652 Multi-Protocol Communications Controller (MPCC) handles many popular line protocols and can interface with either a microprocessor or mini-computer data bus. Both devices are TTL-compatible and operate from a single +5V power supply.

Move Data at 800,000 Baud. With the 2651 PCI, you can serialize and deserialize data at rates up to 800,000 baud. Interfaced with any microprocessor, this versatile IC can be used in a polled or interrupt-driven system—count on it to support many serial data disciplines, both synchronous and asynchronous, in the full- or half-duplex mode.

Moreover, the 2651 PCI can be programmed either to accept an external clock or to generate an internal transmit/receive clock. In the internal mode, you can program any of 16 different baud rates, from 50 to 19,200 baud.

Link With 8- or 16-Bit Bus. The 2652 MPCC works with either an 8-bit or 16-bit data bus, and handles both bit-oriented and byte-control protocols. That means you can use it with microprocessors or minis, and with almost any discipline, including SDLC, HDLC, ADCCP and DDCMP.

When you design in the 2652 MPCC, you design in flexibility. It gives you high-speed operation — up to 1,500,000 baud — plus on-chip features which reduce hardware and software costs. This LSI device contains programmable circuitry for performing CRC generation/checking and zero insertion/deletion, as well as SYNC or secondary address comparison.

If you're designing data communications systems, you need to know all about the new 2651 PCI and 2652 MPCC circuits from Signetics. To get the full story, use the coupon below or contact your local Signetics Distributor.

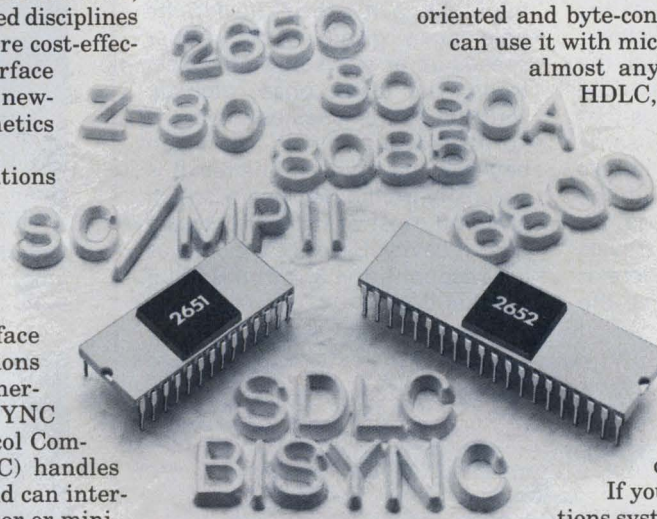

signetics

a subsidiary of U.S. Philips Corporation

Signetics Corporation
811 East Arques Avenue
Sunnyvale, California 94086
Telephone 408/739-7700

| 2651/2652 SELECTION GUIDE | | |
|---------------------------|---|---|
| Feature | 2651 (PCI) | 2652 (MPCC) |
| Rcv/Xmt Modes | Synchronous and Asynchronous | Synchronous |
| Protocol Compatibility | BISYNC, DDCMP | SDLC, HDLC, ADCCP, DDCMP, BISYNC (limited). |
| Baud Rate | DC to 800,000 baud | DC to 1,500,000 baud, typical |
| Baud Rate Generation | External or On-chip (16 internal rates) | External |
| Data Bus Compatibility | Microprocessor (8-bit tri-state) | Microprocessor or Minicomputer (8- or 16-bit tri-state) |
| Modem Controls | Many | None |
| Error Controls | Odd/Even VRC | Odd/Even VRC, CRC-16, CRC-CCITT |
| Self-test | Local/Remote Loop Back | Local Loop Back |
| Package | 28-pin DIP | 40-pin DIP |
| Price (100 Qty) | \$13.70 | \$24.90 |
| Availability | Immediate | Immediate |

To: Signetics Information Services, 811 East Arques Avenue
P.O. Box 9052, MS 27, Sunnyvale, CA 94086

Please send data sheet(s) for 2651 PCI 2652 MPCC
 Also send application note which describes how the 2651 PCI can interface to any microprocessor.

I have an urgent requirement. Please have a PCI/MPCC specialist phone me at once: () _____

Name _____ Title _____

Company _____ Division _____

Address _____ MS _____

City _____ State _____ Zip _____

ED426

CIRCLE NUMBER 32

Traveling-wave tubes and klystrons

Traveling-wave tubes and klystrons are linear-beam amplifiers with some similarities. Both have electron guns that send an electron beam through an rf interaction structure, where the rf is amplified. The used electrons are then absorbed by a collector.

In a TWT, an electron gun squirts a beam down the center of a slow-wave structure, which is often a helix, shaped like a common spring. The beam is kept from contacting the helix by the magnetic focusing field, which has lines of force parallel to the axis of the tube.

The rf input traveling along the helix and down the length of the tube, moves much more slowly than the speed of light—thus, the term "slow-wave structure." The key to the tube's operation is that the electrons travel at the same speed as the rf. As the rf travels down the tube, it interacts with the beam and becomes amplified. An attenuator absorbs rf that travels back toward the input, where it would cause instability. Once the

electron beam passes through the helix, it is absorbed by the collector.

Many new TWT designs use the ppm focusing structure basically like that shown, which has magnets shaped like thick washers. Most new designs use samarium-cobalt magnets.

A klystron is a relatively narrow-band linear-beam tube with a different rf interaction structure. A klystron has at least two cavities, one for input, another for output. The cavities are like stacked doughnuts, with the electron beam passing through the "holes."

When the beam passes through the input cavity, the rf field in the hole at a given instant either speeds up or slows down the electrons. The faster ones catch up with the slower ones as the beam "drifts" through a field-free region between the cavities. The result is a density-modulated beam, which gives up most of its energy to the output cavity. Because the cavities are resonant, the klystron is not a wideband tube.



Experimental pulsed gyroklystron amplifier is used for plasma heating at 28 GHz. The rf output is at bottom.

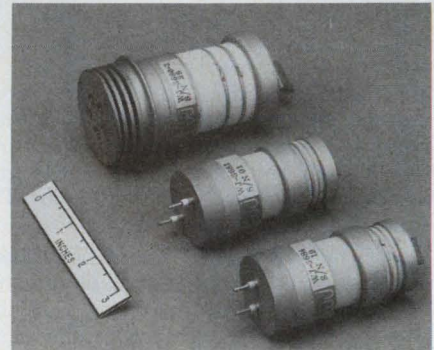

Unpackaged EBS devices from Watkins-Johnson are video amplifiers. The middle tube has 750-V, 7-A peak output.

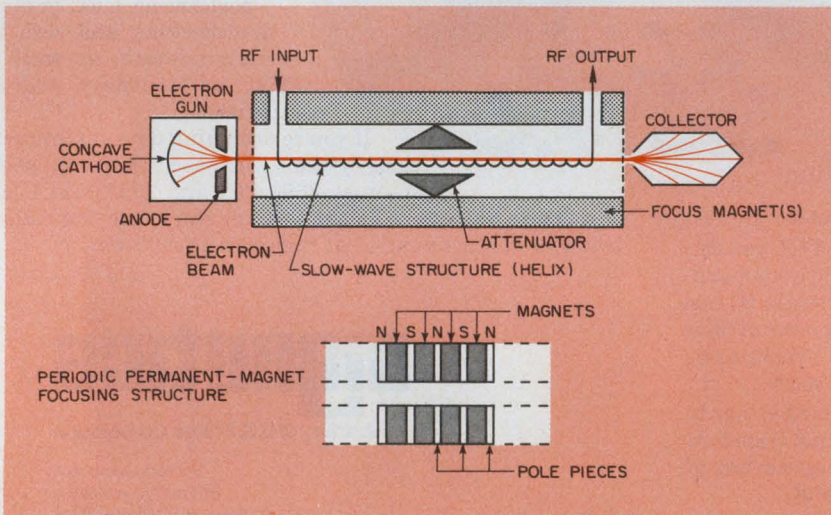

cidentally, both diamond and BeO can be brazed.)

Numerous newly developed TWTs have been described in the past few years. Here are a few highlights:

- A 2 to 8-GHz TWT from Hughes, with a minimum output of 1.25 kW peak, a gain of about 50 dB, a duty cycle of 10%, a gridded gun and PPM/ SmCo_5 focusing. Bandwidth is notably wide, presumably for ECM.

- The 9.6 to 9.8-GHz VTX5788 from Varian with outputs of 1.1 and 11 kW,

both peak. Operating in a dual-power mode, this tube has PPM/ SmCo_5 focusing, a shadow grid on the cathode surface, and a three-section coupled-cavity rf structure. This tube, liquid-cooled, is used for airborne multimode radar.

- The 11-GHz TH3535 from Thomson-CSF, with three levels of output power—20, 8, and 4 W—for constant input power. It also has a three-stage depressed collector and weighs 450 grams. INTELSAT uses it.

- A 30-GHz device from NEC, with 800-W cw output and a 2.5-GHz instantaneous bandwidth. The rf structure is a coupled-cavity type, with 71 cavities for about 45-dB gain. The tube is air-cooled, and has integral, finned heat pipes. It uses solenoid focusing, and has a very high beam-convergence ratio of 175:1. The TWT is used for satellite-communication earth stations.

- A 40 to 50-GHz TWT from Siemens with over 400-W cw output power, PPM/ SmCo_5 focusing and liquid cooling.

Because of their heating problems, TWTs can't be used in very-high power

(continued on page 60)



Our new mini/micro computer printers... "the easy ones."

Features:

- Three popular ASCII input configurations
- Forty characters per line
- Internal data storage
- Double-width character selection
- Power line filter
- Optional tally-roll and/or fast paper feed

EASY TO INTERFACE

The new DP-1000 Series Printer family fits right into most mini-micro computer and modem applications - thanks to three popular ASCII formats available in four different basic models.

Standard Baud rates from 110 to 2400 Baud, and internal storage of up to 104 characters (more optionally) with "hand-shake" control signals, let you pick from a variety of off-the-shelf configurations to fit your specific application.

EASY TO USE

A time-proven, dot matrix impact printing element can print 64 alpha-numeric and special symbols in 40 characters/line at 50 CPS on single or multiple-copy paper rolls. Options such as Tally Roll take-up and Fast Paper Feed, make the printers easy to fit point-of-sale and related fields.

Combining form and function, the modern package blends with virtually any surroundings, while

its flip-top design allows convenient access for paper replacement and servicing.

EASY ON BUDGETS

Best of all, single-unit prices for the DP-1000 Series start at under \$600, with substantial Dealer and OEM quantity discounts.

Want to see a demonstration in your office, or more details? That's easy too. Just contact Ken Mathews at Anadex; 9825 DeSoto Avenue; Chatsworth, CA 91311; Telephone (213) 998-8010; TWX 910-494-2761.

CIRCLE NUMBER 105

MICRONOVA. ALL THE INGRED

HIGHER LEVEL LANGUAGES

Fortran IV
Basic-single/multiuser
Business BASIC

RUN TIME I/O SOFTWARE SUPPORT

Communications Access Manager (CAM)
Sensor Access Manager (SAM)
RJE/80 (2780, 3780), HASP II
DG/L Programming Language

MICRONOVA PROCESSOR

Single chip 16-bit NOVA computer,
Integral MUL/DIV,
RTC, DMA, hardware stack, and
memory refresh
Available as a chip, board microcomputer
or packaged minicomputer

INTERFACING/PACKAGING

Card Cage/Power Supply
General Purpose Interface
High Speed DMA
Cabling
Prom Programmer

COMMUNICATIONS

Synchronous with CRC
Asynchronous
4-line Asynchronous Mux

SENSOR I/O

A/D, D/A, Digital I/O
DG/DAC Sensor I/O Subsystem

MENTS TO MAKE YOU A HERO.

OPERATING SYSTEMS

Diskette Operating System (DOS)
Real-Time Operating System (RTOS)
Extensive Program Development Utilities

SYSTEM PERIPHERALS

Dasher Displays and Printer Terminals
Single and Dual-Diskette Subsystems
Line Printers, Paper Tape

AVAILABLE MEMORIES

Expansion to 64K bytes with:
8KB and 16KB RAM
4KB and 8KB PROM



Our microNOVA line is now of heroic proportions. 17 new enhancements make it the broadest line of 16-bit microcomputer products available. Here are all the basics so the design engineer can bite into the real challenge. Without having to waste time developing the tools he needs. Call 800-225-7282. Or write for free brochure.

 **Data General**
We make computers that make sense.

Data General Ltda., Sao Paulo, Brazil, 543-0138. © Data General Corporation, 1978 microNOVA and DASHER are trademarks, and NOVA is a registered trademark of Data General Corporation.

Keystone CHIP THERMISTORS



...WORTH TAKING
A CLOSER LOOK.

Keystone Chip Thermistors with silver contact pads can be easily soldered directly to PC boards and hybrid substrates.

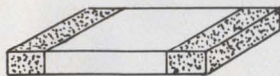

The tiny, low cost NTC Chip Thermistors also can control ambient temperature on MSI and LSI packages.

Low thermal mass . . . fast response time . . . Keystone quality.

Send for
Bulletin 782
on Chip
Thermistors
today.



Keystone
CARBON COMPANY
Thermistor Division
St. Marys, PA 15857
814/781-1591 • Telex 91-4517

CIRCLE NUMBER 35

(continued from page 56)

Electron-bombarded semiconductor devices

EBS devices combine vacuum-tube and semiconductor technologies. Containing an electron gun and a semiconductor-diode target, an EBS is used as an amplifier. The beam is modulated by the input signal, which can be video or rf up to a few GHz, and bombards the diode target, which is back-biased. Each electron in the beam (at 10 to 12 kV) generates about 2000 carriers, so the device has considerable gain. Output power comes from the diode's bias supply, not from the electron beam.

The beam can be either density-modulated or deflection-modulated, as shown in the figures. Representative operating voltages for a density-modulated device are

shown; rf matching networks are omitted for clarity. The deflection structure resembles that used in some wideband scope CRTs.

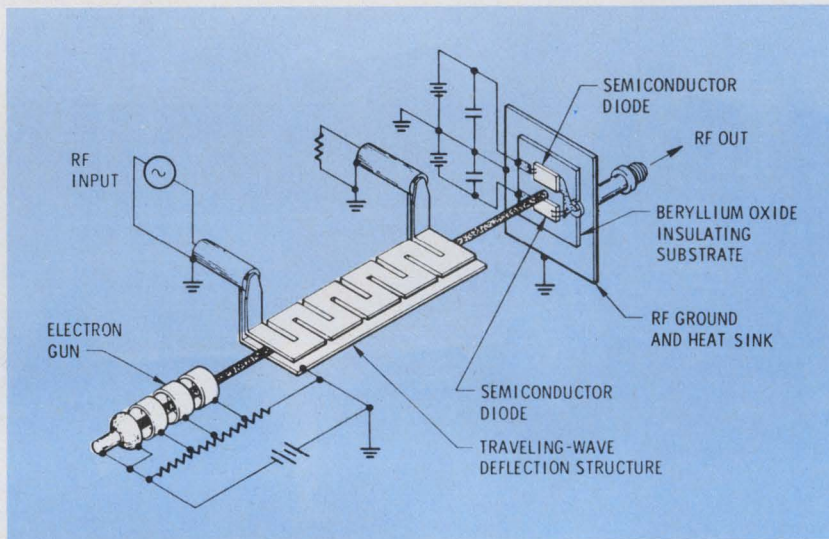
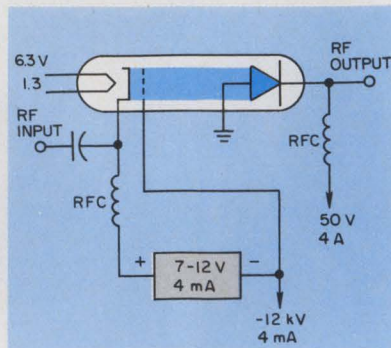

applications. Here, other types of tubes have to be used. The most-common type is the klystron, and a new tube still being developed, the gyrotron, has still-unknown limits on power output at frequencies of 20 GHz and above.

Klystrons—power champs

For powers of 1 MW and above and bandwidths of up to a few percent, klystrons are the best bet. In fact, klystrons have reached 50-MW peak output, and some linear accelerator klystrons are rated at 30 MW peak. Efficiency is no problem. Nearly all recent designs have better than 50%, with some close to 70%. By way of contrast with TWTs, klystron design is

relatively "mature," with emphasis on second-order effects such as phase and amplitude linearity.

Tubes that are somewhat like klystrons, called extended-interaction oscillators, generate medium-high power (100 W cw at 100 GHz, for instance) at frequencies above 20 GHz, and can go up to 300 GHz. An output of 40 W cw at 140 GHz is considered routine by EIO manufacturer Varian. EIOs have long life, good spectral purity and frequency stability, and efficiencies to 15%.

The real efficiency champs are crossed-field amplifiers, which are something like amplifying magnetrons. One type reaches 80%. Work on

CFA's is directed toward improving gain and noise. Some tubes have gain as low as 6 dB, with perhaps 10 to 15 dB being typical. The goal is 30 to 45 dB. Intraspectral noise is also being improved; 60 dB down is considered excellent.

Microwave-tube improvements are significant in their own right, but fundamentally different classes of microwave electron devices are also a big part of the tube story.

The new waves

Certainly the most remarkable new type of microwave tube in many years is the gyrotron, which is really a family of tubes. Practical versions of electron-cyclotron masers, gyrotrons have outputs of hundreds of kW at millimeter wavelengths, and there's lots of room for development. Some idea of their potential is given by the 900 megawatt output at 7.5 GHz obtained in the lab by a pulsed electron cyclotron maser.

One of the most important things about the gyrotron is that its output frequency is determined by the strength of the magnetic field used by the tube, rather than by the physical dimensions of a resonant structure. The power limitations of the tiny structures characteristic of other types of mm-wave tubes simply don't apply any more. There's a new problem, though: Even at this relatively early stage of development, gyrotrons put out so much power that the components that handle the tube's output can't deal with the power. New designs are needed.

Corkscrew relativity

In an electron cyclotron maser, a hollow, tubular beam of electrons is injected into a metal "pipe", with the axis of the beam coincident with the pipe. The electrons take a helical path down the pipe, because there's a magnetic field with its lines of force parallel to the axis. As the electrons travel, any microwaves present at the tube's frequency start to bunch the electrons. The process is unstable, which makes the bunching become stronger, and in turn amplifies the rf field in the tube. The process is relativistic: the mass of the electrons changes as their speed changes.

The gyrotron principle has been applied to power-oscillator designs as well as klystron and TWT structures. Following some years of purely lab work with electron-cyclotron masers,

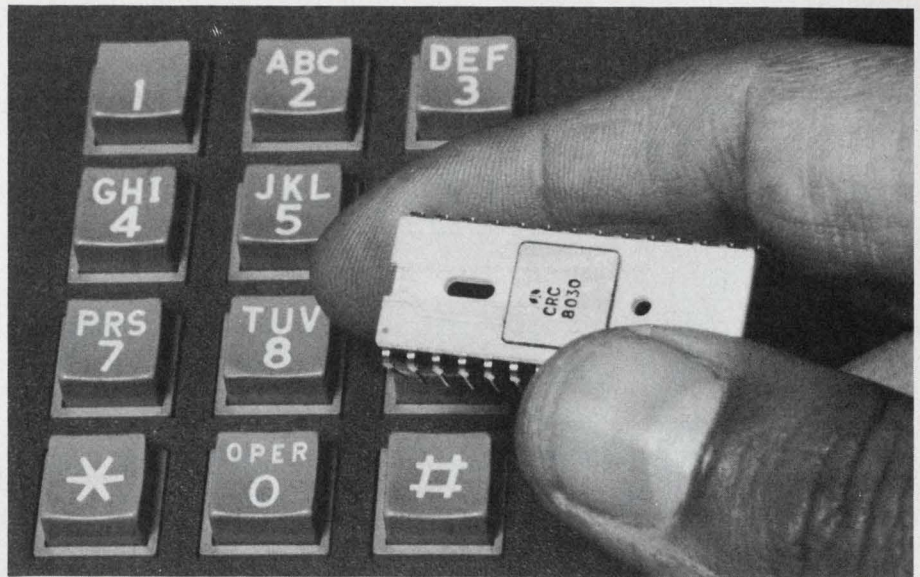

Rockwell MOS/LSI Touch Tone® detection can get you into more products.

CRC-8030, Rockwell's MOS/LSI digital Touch Tone® detector, can open up new markets for your products by providing a low cost, high performance solution for dual tone multi-frequency (DTMF) detection.

A product of Collins high-technology telecommunications experience coupled with Rockwell's extensive MOS/LSI production capability, CRC-8030 has been in quantity production for over a year. Besides traditional telephony systems, it can be used in a growing number of applications including computer signaling and control systems.

CRC-8030 reduces costs versus conventional systems (in some cases as much as one fifth the cost) and offers the size and reliability benefits of MOS/LSI. You get: detection in 22-39 MS; on-chip oscillator operating at 3.579545 MHz color burst crystal frequency; binary or 2-of-8 coded outputs; operation with single or dual power supply.

The CRC-8030 performs the key critical functions of DTMF detection. To implement a complete DTMF receiver, a number of front-end band-split filters are available. And, if you need DTMF-to-dial pulse conversion, use the CRC-8030 in conjunction with Rockwell's MOS/LSI Binary-to-Dial Pulse Dialer, the CRC-8001.

For more information on telecommunications devices and applications services, contact your nearest Hamilton/Avnet distributor. Or use the coupon below.

Touch Tone is a registered trademark of AT & T.

Get the full story.

ED-4/26

Microelectronic Devices
Rockwell International
P.O. Box 3669, Anaheim, CA 92803
Attn: Marketing Services D/727 RC55 • (714) 632-3698

I want information on CRC-8030 CRC-8001
 Send it by mail Have a salesman call me.

Name _____ Title _____

Company _____

Address _____ City _____

State _____ Zip Code _____ Telephone _____



Rockwell International

...where science gets down to business

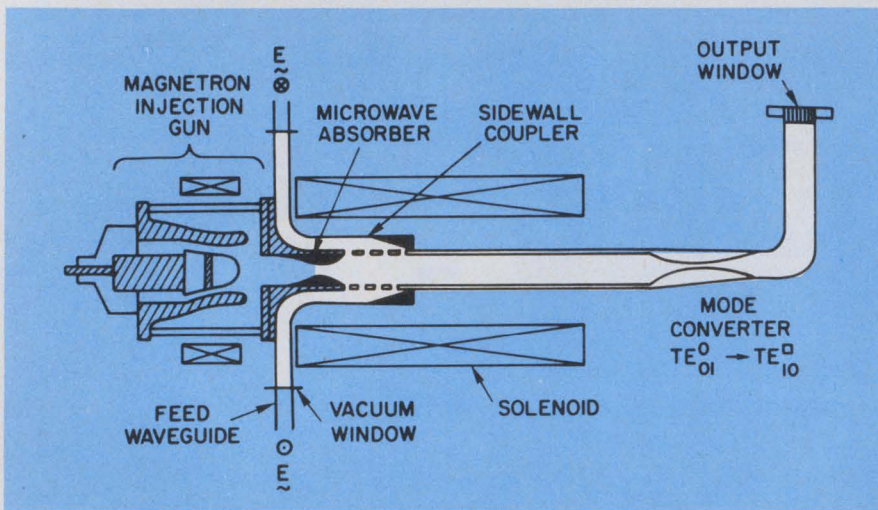

Gyro-traveling-wave amplifier under development at the Naval Research Lab operates at 35 GHz.

the Soviets began developing practical tubes. Their success inspired the Naval Research Lab and Varian to develop tubes here in the U.S. Principal applications for gyrotrons are rf plasma heating for experiments in controlled thermonuclear fusion, and high-powered mm-wave radar. The latter is still in the very early stages. One such radar being discussed would have 10,000-mile range and an angular resolution equivalent to 6 in. at that range. The radar's receiver would use a Josephson junction, and—what else—a gyrotron transmitter.

Varian has made a gyrotron oscillator tube for rf plasma heating, and delivered it to the Oak Ridge National Laboratory. Output is 248 kW peak at

Take a good look around this 2-

Calibrated Meter & Function Display.

Reads % AM, FM peak deviation, or output level in dBm. Indicates modulation output ranges and ALC.

Versatile Modulation.

External AM or FM, metered, calibrated. AM: 10 Hz to 100 kHz; FM: 50 Hz to 10 MHz. Simultaneous AM and FM possible.

The HP 8672A

A look around HP's 8672A Synthesized Signal Generator will show you just how versatile this instrument really is. Its multi-band frequency coverage makes it ideal for a wide variety of applications including satellite communications, EW, automated test systems as well as serving as a bench replacement for multiple signal sources. All this capability at a price of \$28,600*

For local oscillator applications, the HP 8671A Synthesizer covers 2-6.2 GHz, programmable with FM but no level control. Price: \$17,600*. To find out more, contact your nearby HP field sales office, or write.

*Domestic US Prices only.

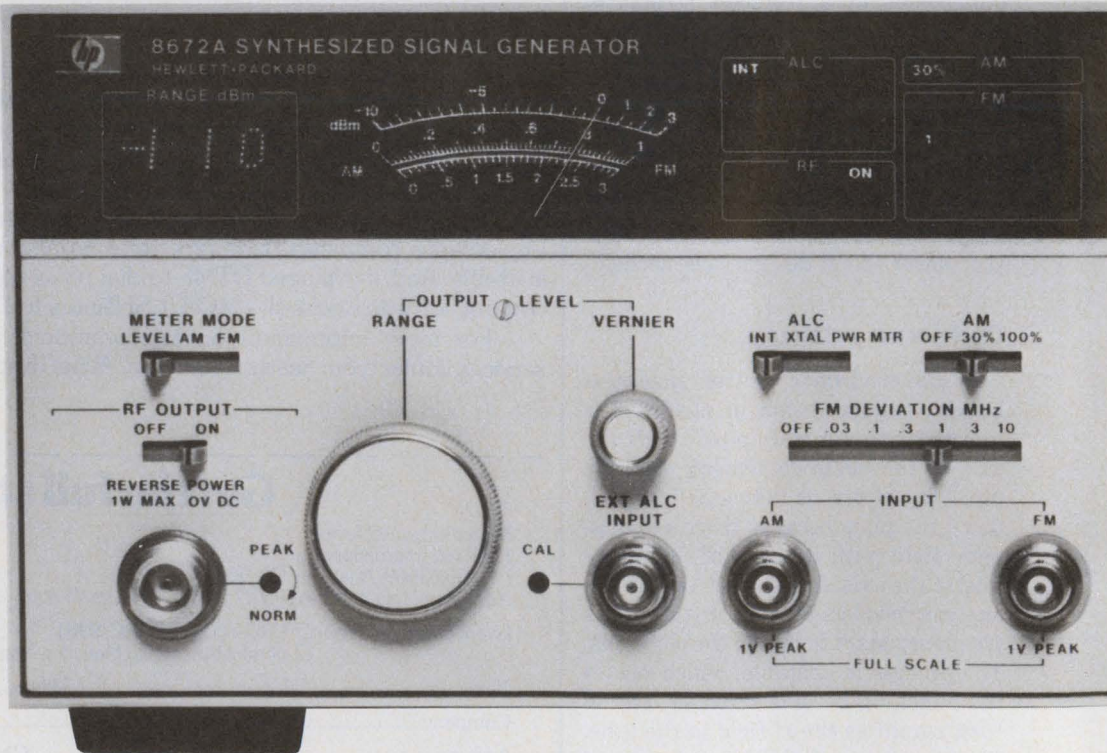

Remote Programming.

Ideal for automatic test systems or simulators. All front panel functions programmable. HP Interface Bus format.

Wide Dynamic Range.

+3 to -120 dBm for tests on receiver AGC and sensitivity. Very low leakage to permit sensitivity tests at the lowest output of 0.3 μ V.

Fast Switching Time.

Indirect-type synthesizer settles within 1 kHz in 15 ms. (2-6 GHz). Precise and fast enough for automated test systems and many signal simulators.

28 GHz. Another tube, a gyro-TWT, is being built for Rome Air Development Center to be used for a 94-GHz radar. Target specs are 100-kW peak output, about 5% bandwidth, and a 5% duty cycle. A superconducting magnet will be needed to provide enough flux for that frequency.

Another new family of devices is actually a cross, in a sense, between electron tubes and semiconductors. There are called electron-bombarded semiconductor devices (for more, see box). Practical EBSs are available from Watkins-Johnson; both video amplifiers and rf amplifiers are offered. A typical rf device is the WJ-3620, which has a bandwidth of 40 MHz in the 500 to 1200-MHz range, and a peak output of 1 kW with a 1% duty cycle. ■■

Need more information?

For further information on microwave tubes, readers may consult the manufacturers listed here by circling the appropriate numbers on the reader-service card. More vendors and information may be found in **ELECTRONIC DESIGN'S GOLD BOOK and MICROWAVES' PRODUCT DATA DIRECTORY.**

AEG-Telefunken Corp., 570 M. Sylvan Ave., Englewood Cliffs, NJ 07632. (201) 568-8570. **Circle No. 481**

Hughes Aircraft Co., Electron Dynamics Div., 3100 W. Lomita Blvd., Torrance, CA 90509. (213) 534-2121. **Circle No. 482**

Litton Industries, Electron Tube Div., 960 Industrial Rd., San Carlos, CA 94070. (415) 591-8411. **Circle No. 483**

Microwave Associates Inc., South Ave., Northwest Industrial Park, Burlington, MA 01803. (617) 272-3000. **Circle No. 484**

Raytheon Co., Microwave & Power Tube Div., Foundry Ave., Waltham, MA 02154. (617) 899-8400. **Circle No. 485**

Siemens Corp., 186 Wood Ave. S., Iselin, NJ 08830. (201) 494-1000. **Circle No. 486**

Teledyne MEC, 3165 Porter Dr., Palo Alto, CA 94303. (415) 493-1770. **Circle No. 487**

Thomson-CSF Electron Tubes, 750 Bloomfield Ave., Clifton, NJ 07015. (201) 779-1004. **Circle No. 488**

Varian Electron Device Group, 611 Hansen Way, Palo Alto, CA 94303. (415) 493-4000. **Circle No. 489**

Watkins-Johnson Co., 3333 Hillview Ave., Palo Alto, CA 94304. (415) 493-4141. **Circle No. 490**

18 GHz synthesized generator

Wide Frequency Range— Wide Application Range.

2000 to 18000 MHz in 1, 2, or 3 kHz steps, covers the important microwave applications of satellite receivers, electronic warfare, and automatic test.

High Resolution Tuning & Display.

Human-engineered, continuously tuned rotary pulse generator with selectable tuning resolution of 1 kHz, 10 kHz, 1 MHz, 100 MHz. Ideal for bench use.

Operational Status Display.

Shows condition of phase lock loops, oven temperature, remote-local, internal reference, etc. Also interfaces with system controller.

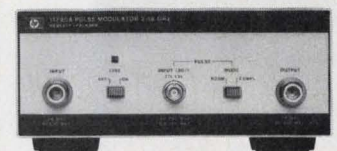

Add Pulse Modulation.

HP's 11720A Pulse Modulator eliminates the need for several narrowband modulators. Freq. Range: 2-18 GHz. Rise/Fall Times: 10 ns. On/Off Ratio: 80 dB. Insertion Loss: 10 dB to 18.0 GHz. Price: \$2500*

2-18 GHz

FREQUENCY MHz

18 000 000

STATUS

FREQUENCY RESOLUTION

HOLD

TUNING

PRESET (3 GHz)

LINE ON

STANDBY

Superior Spectral Purity.

SSB phase noise, -89 dBc/Hz @ 10 kHz offset, non-harmonic spurious -70 dBc, 2-6 GHz. Harmonics and sub-harmonics -25 dBc to 18 GHz. Ideal for local oscillator and upconversion applications.

Excellent Long-term Stability.

5×10^{-10} /day internal standard hold button stores display, battery-operated frequency memory.

HEWLETT  **PACKARD**

1507 Page Mill Road, Palo Alto, California 94304

For assistance call: Washington (301) 948-6370, Chicago (312) 255-9800, Atlanta (404) 955-1500, Los Angeles (213) 877-1282

CIRCLE NUMBER 36

ELECTRONIC DESIGN 9, April 26, 1978

APH

high voltage power supplies

for your LAB BENCH or ATE SYSTEM

from

KEPCO

The Kepco APH is a well-behaved, highly stabilized, fully programmable group of high voltage power supplies. They'll stabilize voltage and current for you in one continuous sweep from zero to maximum output. No step switches.



0- 500V @ 40 mA
0-1000V @ 20 mA
0-2000V @ 10 mA

Call your Kepco rep for a demonstration or write Dept. ACF-05.

KEPCO®

KEPCO, INC. • 131-38 SANFORD AVENUE • FLUSHING, N.Y. 11352 U.S.A. • (212) 461-7000 • TWX #710-582-2631 • Cable: KEPCOPOWER NEWYORK

CIRCLE NUMBER 37

Particle-beam weapons run into snags, need more \$\$

For now, a plan to begin advanced development of particle-beam weapons has been scrapped by the Defense Department. Instead, basic research will be accelerated in problem areas like power switching, generation and storage.

Charged-particle-beam weapons have been considered particularly attractive to counteract hostile spacecraft in the vacuum of space—even more so than high-energy laser weapons—and the Pentagon had planned to begin defining possible missions and hardware configurations next year. But major technical uncertainties have led to a reappraisal of the whole program, according to Dr. Ruth M. Davis, deputy undersecretary of defense for research and advanced technology, in testimony before the Senate Armed Services Research and Development Subcommittee.

The Defense Department plans to spend another \$6-million on top of the \$5.6-million already requested for particle-beam research next year to tackle what Dr. Davis calls “areas of critical deficiency,” including fusion-plasma heating, inertial fusion, advanced simulation, laser pumping, radiation-core electronic countermeasures, microwave generation and beam projection.

Particle-beam weapons are more valuable than conventional missiles or artillery because they can reach the target at the speed of light and destroy within milliseconds, either in the form of material particles (electrons, protons, heavy ions or neutral atoms) or, after conversion, as photons (X-ray, infrared or microwave radiation).

The Navy, which has pioneered charged-particle-beam technology, is expected to get the bulk of any additional funding approved by Congress. While the Air Force is apparently going down a blind alley with its aircraft-mounted gas dynamic laser, the Navy is stressing charged particles under its ultrasecret Chair Heritage program, which is investigating a ship-mounted, high-energy particle accelerator to neutralize incoming missile warheads. A much smaller Army laser-weapon program involves both antitank applications and antiballistic-missile (ABM) applications.

Defense procurement off for quarter, but ahead of last year

Defense procurement dipped during the second quarter—Jan. 1 to March 31, 1978—of the government fiscal year, but is still running well ahead of last year's pace.

Prime contracts of \$1-million or more each were awarded during the quarter to the total tune of \$8.37-billion—down from the \$10.76-billion of the first quarter (Oct. 1 to Dec. 31, 1977), according to Washington Communications Service, an independent market research firm in Vienna, VA. For the previous fiscal year, however, the firm recorded \$9.52-billion for the first quarter and \$5.99-billion for the second, well behind this year's quarterly totals so far.

For the entire fiscal 1977, WCS recorded military prime contracts totaling \$31.92-billion. The quarter to look for is the fourth, which typically garners the highest amount as defense agencies rush to spend their funds rather than lose

them when the fiscal year ends.

Meanwhile, the Defense Department's Comptroller's Office has issued its summary for fiscal 1977. With a minimum of \$10,000 per contract, a total of \$50.38-billion worth of prime contracts was recorded for the fiscal year.

New light source to study gases

A new source of very short wavelength light has just undergone preliminary tests at Stanford University in Palo Alto. The source is aimed at increasing the understanding of the basic atomic structures of gases and crystals. The research may benefit air pollution studies, according to the National Science Foundation, which is funding the project.

The apparatus uses what is known as vacuum ultraviolet (VUV) radiation, so called because it can travel only in a vacuum. To begin the process, Stanford's linear accelerator produces high-energy electrons. As each electron moves through the material to be studied, it emits a cone of light the same way a supersonic aircraft emits a sonic boom. This form of light emitted by the fast-moving electrons is called Cerenkov radiation and is rich in VUV.

The Stanford test cell is 22.1 feet long and contains rarified helium gas. A set of platinum-coated mirrors causes the light to appear at a small focus about 24 yards away. The focus is 0.12 inch in diameter. The light flashes in microsecond bursts in time with electron bursts from the accelerator.

The absorption of the VUV is expected to permit scientists to infer many of the properties of atoms in gases or crystals.

British win share of Navy fighter-electronics gear

A British-American team has won a major subcontract on the F-18 Navy fighter being developed by McDonnell Douglas, St. Louis. The subcontract, which is expected to end up being worth \$60-million, covers an electronic horizontal-situation display to be installed in the fighter cockpit.

The award, to be shared by the Bendix Corp. of the United States and Ferranti of England, is an important step, industry sources say, towards implementing a 1975 Memorandum of Understanding between the two countries to establish a "two-way street" in arms sales and technology.

Capital Capsules: The Department of Energy and the National Park Service have agreed on a joint project to demonstrate the use of **solar cells to generate electric power**. The project is slated to begin in the summer of 1979 at the National Bridges National Monument near Blanding, UT. Under the program, to be managed by Lincoln Laboratory of MIT, about 18,000 square feet of solar cells will be installed on a 1.3-acre site to supplement diesel generators at the remote site. Solar cells currently cost about \$11 per peak watt of output, according to the DOE, down from \$21 a year ago. But the department's goal is to reduce that price to 50 cents per peak watt by 1986. . . . The National Bureau of Standards' Boulder, Colorado Laboratories will stress research on electromagnetic interference in its exhibit at the IEEE-sponsored Electro' 78 scheduled for Boston, May 23 to 25. Featured will be NBS's **transverse electromagnetic (TEM) cell, developed to measure electromagnetic radiation from electronic devices placed within it**.

Ready for automatic insertion?

Our Radial Capacitors are

That's right. Our radial leaded ceramic capacitors — both disc and monolithic — are now available in reel packaging for your automatic insertion equipment. That means whichever type you need, you can now use the most efficient production method for lowest installed cost. For price, delivery, and technical information, contact Centralab, El Paso about the discs, and Centralab, Los Angeles about the MonoKaps™.

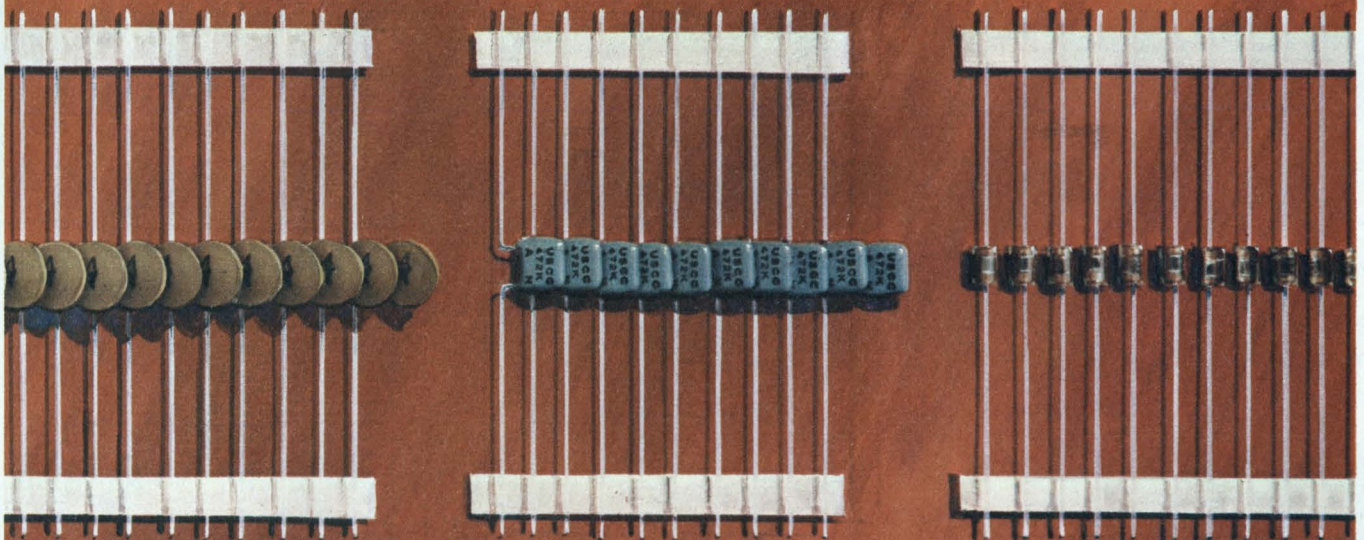

So are our Axial Capacitors

If board space and weight are your critical concerns, consider our miniature Mono-Glass ceramic capacitors. Also reel packaged for automatic insertion, they feature glass encapsulated construction in an axial leaded configuration, and a variety of dielectrics, in both precious and base metal electrodes. Contact Centralab, Los Angeles for complete price and delivery information.



CENTRALAB
Electronics • GLOBE-UNION INC.

4561 Colorado Blvd., Los Angeles, CA 90039 (213) 240-4880
7158 Merchant Ave., El Paso, TX 79915 (915) 779-3961

CERAMIC CAPACITORS • FILTERS • POTENTIOMETERS • SWITCHES
THICK FILM CIRCUITS • TRIMMER RESISTORS

When you need LEDs or more than LEDs...



Dialight is the first place to look. We can help you do more with LEDs... because we've done more with them.

Discrete LEDs come in a variety of sizes, shapes, colors (red, yellow, green in clear or diffused), with or without built-in resistors.

Low cost logic state fault indicators for trouble shooting complex circuits. Designed for close density PC board mounting.

High-brightness bi-color LEDs (red/green) suitable for go/no-go situations. Designed with unique

lenses for the extra visibility you'll want for your most critical applications.

Snap-in mounting LED indicators reduce labor cost. Available in red, yellow or green with or without built-in resistors.

Whatever you need in LEDs, Dialight's probably got it already. For your free 60-page selector guide and listing of our nationwide stocking distributors, contact us today.

DIALIGHT
A North American Phillips Company

Dialight meets your needs.

Dialight, 203 Harrison Place, Brooklyn, N.Y. 11237 (212) 497-7600

CIRCLE NUMBER 39

The oldest profession

A doctor, an engineer and a spec writer were arguing over which belonged to the oldest profession. "You may recall," the doctor began, "that the Lord created Eve from the rib of Adam. This was clearly a surgical activity, well within the province of medicine. So medicine is the oldest profession."

"Wait a minute," the engineer challenged. "Just before that, the Lord created the heavens and the earth and the firmament. He made order out of chaos—an engineering job." "Hold it," the spec writer interjected. "Where do you think the chaos came from?"

Well, I wasn't there, so I can't swear that spec writers originated primordial chaos. But they do contribute more than their share today. Yet it's not really their fault. The fault lies in the widespread notion that a well-written data sheet can make up for a product's deficiencies. This idea, in turn, stems from the notion that engineers aren't quite sure of what they need, so they'll buy the best spec sheet—and never test to those specs anyway. Indeed, there's a widespread belief that most engineers aren't even equipped to measure conformance to many specifications they pay for.

Some years ago, an old buddy confided: "Nobody in his right mind needs a power supply with 0.01% regulation. But we make them. We're not psychiatrists." He pointed out, further, that it's devilishly hard to measure 0.01% regulation. But it doesn't matter, he said, as a blur of other specs can blind an engineer to the effects of line-voltage or load-current changes.

Now, if this is true—if engineers will really shell out extra dollars for performance they can't measure and performance that might be illusory—then who can blame the spec writer for creating such performance on paper? And if the spec writer plies his art by manufacturing better specs for engineers who don't need them, and engineers buy on that basis, then the engineers are making chaotic specs profitable. They may belong to the oldest profession after all.



GEORGE ROSTKY
Editor-in-Chief

**THE WORLD'S
MOST IMITATED
OEM COMPUTER
JUST PULLED
A FAST ONE.**

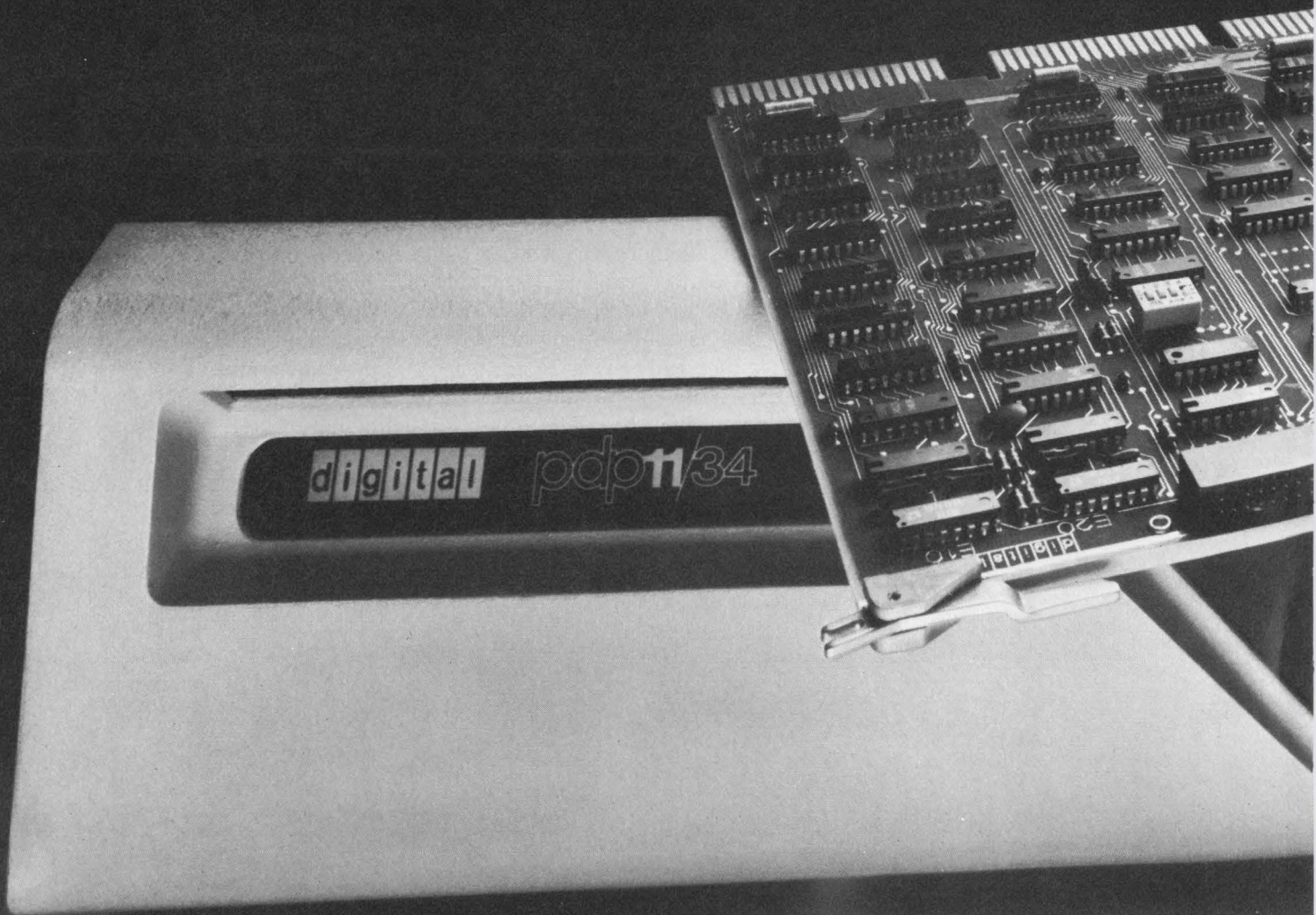



INTRODUCING THE PDP-11/34 WITH HIGH-SPEED CACHE.

The new direct-map cache memory for the PDP-11/34.

2K bytes of high speed RAM. A hit rate of almost 90%. It all adds up to make the fast, powerful PDP-11/34 up to 60% faster. Our new high-speed cache is available in a system now or as a field enhancement.

Deliveries in May.

Will the competition ever cache up?

Call or write: Digital Equipment Corporation, PK3-1/M-86, Maynard, MA 01754. (617) 493-4237. In Europe: 12 av. des Morgines, 1213 Petit-Lancy/ Geneva. Tel. 93 33 11. In Canada: Digital Equipment of Canada, Ltd.

digital
OEM PRODUCTS
GROUP

CIRCLE NUMBER 40

Specify low-speed modems properly

for distributed computer systems. A model spec sheet plus test schematics will help you pick the modem you really want.

More and more, computers are communicating over telephone lines. But telephone systems have evolved to transmit analog voice signals, not digital ZEROS and ONES. So you need a device to modulate and demodulate the data stream. "Modems" are needed in computer terminals, multiplexers, and a host of other equipment. And over a direct-distance-dialed or a leased line you'll most probably want modems that transmit at 1200 bits/s or less. But do you know how to specify them? Especially since manufacturers can't agree on common specs?

Low-speed modems use frequency-shift-keyed (FSK) modulation for (typically asynchronous) encoding of binary information. The advantages of this technique are its low cost and low error rate even under severe amplitude distortion.

As the name implies, frequency-shift keying uses two frequencies, one called "mark" the other "space." Usually, the mark state designates a ONE and the space a ZERO. As the data reach the modem in binary-coded serial form, the modem's sine-wave output shifts between the mark and the space frequency. At the receiving modem, the procedure is reversed (Fig. 1).

Low-speed modems are usually either compatible with Bell 103s or 202s, the major low-speed modems available from Western Electric. A 103 can transmit and receive simultaneously (full-duplex) over a 2-wire

circuit at up to 300 bits/s. It uses two sets of frequencies, one set per channel. A filter accepts the proper channel while rejecting the adjacent one (Fig. 2).

The 202 operates at 1200 bits/s (Fig. 3). Because binary FSK needs 1 Hz of bandwidth for 1 bit/s, a type 202 modem uses most of the available channel bandwidth and thus usually operates in half-duplex mode over a two-wire circuit. In half-duplex, the modem can either send or receive over one pair of wires, but not simultaneously.

Watch for noise and distortion

When choosing a modem, the first things you should check are signal-to-noise (s/n) ratio, bias distortion and isochronous distortion.

The s/n ratio is a standard measure of modem performance in the presence of circuit noise. But you must understand the test conditions under which the ratio is measured. It's important that the modem adhere to the s/n ratio spec over its entire dynamic range, from "back-to-back" (transmitter output connected directly into receiver input) to the worst-case combination of line length and line mismatch. Modems also suffer from phase jitter and impulse noise, but these defects are proportional to the signal-to-noise ratio.

To check the s/n ratio of the modem, add noise to the transmitter output of a reference modem and feed the result into the receive port of the modem under test. Read the noise power with a true-rms power meter through a fourth-order, 300 to 3300-Hz

Tony Mazarini, Manager of Custom Products Engineering, Vadic Corp., 222 Caspian Drive, Sunnyvale, CA 94086.

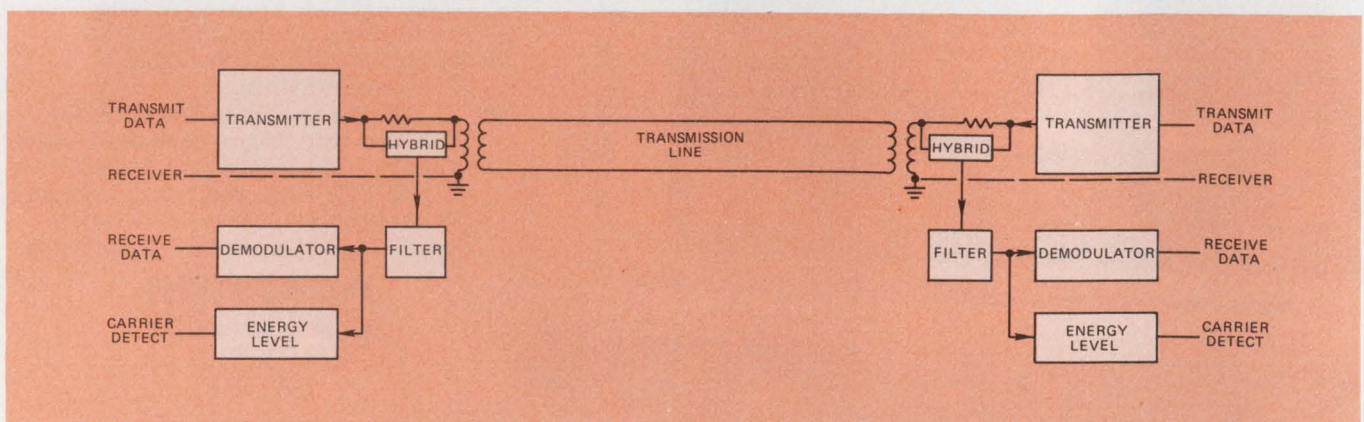

1. To transmit data over a telephone line, you need a modem as the interface at each end of the line.

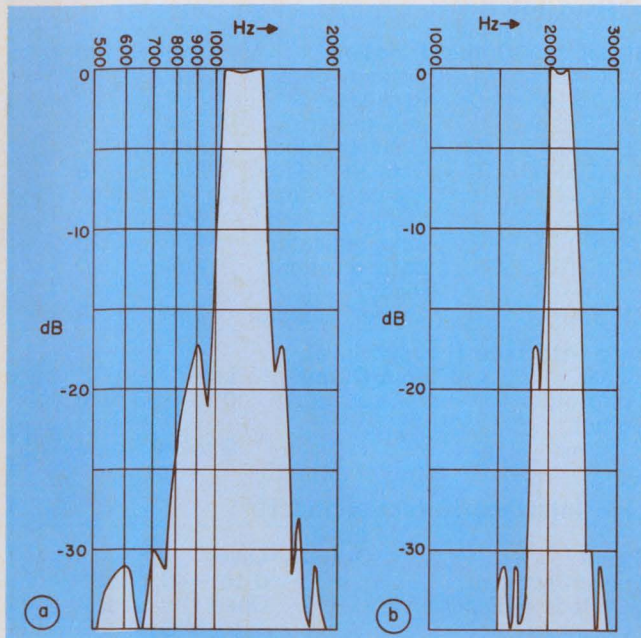

2. Bell 103-compatible modems transmit messages in the bands 1020 to 1320 Hz (a), and 1975 to 2275 Hz (b).

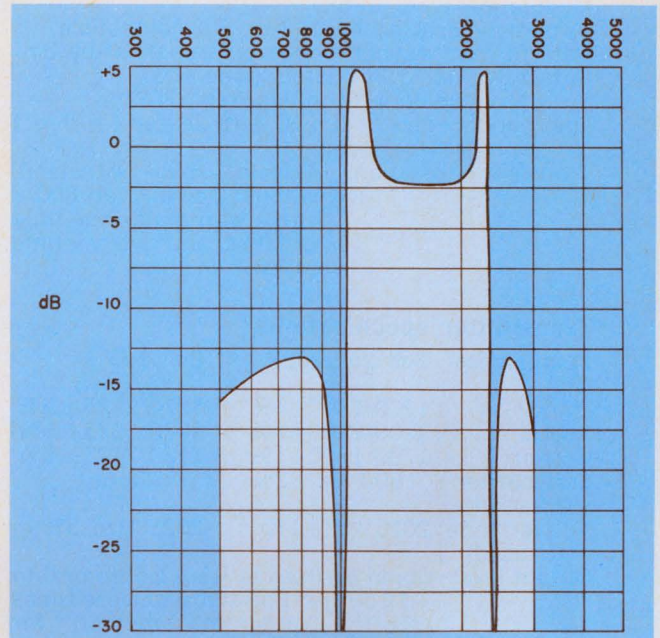

3. Bell 202-compatible modems have a transmitter spectrum with two peaks centered at 1200 and 2200 Hz.

bandpass filter (Fig. 4). The noise bandwidth at the receiver port is 50 kHz wide to check the effectiveness of the input receive filter. Good 202-type modems have an s/n ratio of 10.5 dB at an error rate of 1 in 10^5 bits, and suffer a 3-dB degradation with the worst-case line. The true test of a 202-type modem is at the lowest receive level with a worst-case line in the circuit. As a termination, use the impedance of a typical local loop at 1 kHz.

Bias distortion measures the error, in percent, of a receiver's tuning to the center of the channel, it is measured with a pattern of alternating ONES and ZEROS. The received data are monitored, and the difference between the actual and the measured bit-period determines bias distortion.

The narrower the FSK channel, the more sensitive the system becomes to frequency offset. But the ensuing bias distortion should never exceed 5%, and it shouldn't change much with shifts of input level or changes in power-supply voltage.

Isochronous distortion is a measure of a modem's dynamic operation. Although mainly of interest in synchronous systems, it provides a popular yardstick because it can be measured easily with a data generator and a storage scope (Fig. 5).

Use the transmit clock from the data generator to trigger a scope that is set up to store and superimpose the transition regions of 10^5 bits. The isochronous distortion is the result of dividing total deviation from the ideal point by the bit period, and expressing the result in percent. Good 202 or 103-type modems shouldn't have more than 20 to 25% isochronous

distortion, either back-to-back, or with a worst-case line.

Now you know the most important characteristics to look for in modems. But to spec modems properly, you must watch other things as well.

Writing the whole spec

When you set out to specify a 103 or 202-compatible modem, use the format of Table 1 as you work your way through the following considerations:

Modulation type

You know that FSK (frequency-shift-key) modulation is standard for low-speed modems. However, note that the output must be phase-continuous when shifting between mark and space frequencies. If the phase changes at the instant of switching, distortion will increase and the s/n ratio will deteriorate. So specify modulation as continuous-phase FSK (CPFSK).

Data format

The format of the transmitted data is typically asynchronous binary and serial by bit.

Data rate

You know that 103-type modems can transmit at any rate from 0 to 300 bits/s and 202-type modems from 0 to 1200 bit/s. If you want, you can specify the 202-type modem with a reverse channel that can handle a data rate of 5, 75 or 150 bits/s. However,

Table 1. Model specifications for custom modems

General specifications

Modulation type: CPFSK
 Modem type: (Specify 103 or 202-compatible)
 Data format: Asynchronous binary, serial by bit
 Data rate: up to 300 bits/s (type 103)
 up to 1200 bits/s (type 202)
 Line connection: 2- (or 4) wire; leased (or direct connect)
 Transient protection: Modem shall withstand, without damage, an 800 V surge with a max rise time of 10 μ s, and a decay time to 50% of 2 ms

Transmitter specifications

| Frequencies (Hz) | Bell 202/202R | Bell 103 (Orig./Ans.) |
|------------------------|--------------------|-----------------------|
| Mark | 1200/1300 \pm 1% | 1270/2225 \pm .5% |
| Space | 2200/2100 \pm 1% | 1070/2025 \pm .5% |
| Carrier | 1700/1700 \pm 1% | 1170/2125 \pm .5% |
| Soft carrier (if used) | 900 Hz \pm 2% | None |
| Answer tone (if used) | 2025 Hz \pm 1% | 2225 Hz \pm .5% |

Output level: Could be fixed at -1 \pm 1 dBm or 0 to -12 dBm in 1 dB steps for leased lines (specify "program" method for direct-connect)
 Spurious outputs: Meets FCC Tariff 261 for leased lines (or Part 68 for direct connect)
 Clear to send delay: Varies for leased lines; for direct connect, -200 \pm 20 ms
 Soft-carrier length: 25 \pm 5 ms (for 202-type)
 Answer tone length: 2.5 to 4 s (for 202-type)

Receiver specifications

| Frequencies (Hz) | Bell 202 | Bell 103 (Orig./Ans.) |
|------------------|----------|-----------------------|
| Mark | 1200 | 2225/1270 |
| Space | 2200 | 2025/1070 |

Receiver dynamic range: 0 to -35 dBm (for leased line)
 -12 to -50 dBm (for direct connect)
 Bias distortion: 5% max
 Isochronous distortion: 25% max back-to-back or worst-case line
 Signal-to-noise ratio: 14 dB back-to-back or worst-case line (for 202-type) 3.5 dB (for 103-type)
 Carrier detector: on at -30 dBm, off by -36 dBm for leased line
 on at -45 dBm, off by -52 dBm for direct connect
 Carrier detector timing:
 202-type 103-type
 Off to on delay 40 \pm 10 ms 265 \pm 50 ms
 On to off delay 12 \pm 4ms 50 \pm 25 ms
 Turnaround delay (202 only): 150 \pm 30 ms

Power requirements

\pm 12 V at 80 mA max with 300 mV max peak-to-peak ripple
 \pm 5 V at 50 mA max

Interfaces

System Interface:

| Signal | Input/Output | Function | Level | Pin |
|----------|--------------|---------------------|-------|-----|
| BA (TXD) | I | Transm data | EIA | 2 |
| BB (RXD) | O | Rec data | EIA | 3 |
| CA (RTS) | I | Req to send | EIA | 4 |
| CB (CTS) | O | Clear to send | EIA | 5 |
| CC (DSR) | O | Data set ready | EIA | 6 |
| AA (FG) | - | Frame ground | - | - |
| AB (SG) | - | Signal ground | EIA | 7 |
| CE (RI) | O | Ring indicator | EIA | 22 |
| CD (DTR) | I | Data terminal ready | EIA | 20 |
| CF (CXR) | O | Carrier detector | EIA | 8 |

Line Interface (Leased-line):

| Signal | Input/Output | Level |
|-------------|--------------|--------------|
| Transmitter | O | 0 to -12 dBm |
| Output | | |
| Receiver | I | 0 to -35 dBm |
| Input | | |

Line Interface (Direct-connect):

| Signal | Input/Output | Level |
|---------------------------|--------------|------------------------|
| Transm/rec pair | I/O | 0 to -45 dBm |
| MI (Mode indication) | I | Open (or close) to MIC |
| MIC (Mode indication com) | I | Open (or close) to MI |

Interface logic

Auto-answer logic

Ring to RI delay: 50 to 300 ms
 Modem goes off hook with DTR on and with RI going off
 Mode indication: Modem will go off hook 500 ms after MIC closes to MIC with DTR on
 Data set ready: Turns on when modem is off hook (103-type) and has completed sending answer tone (202-type)

Additional Logic

Clear to send: Turns on after delay following RTS going on
 Transmit data: Clamped to the mark frequency until CTS goes on
 Received data: Clamped to the mark frequency until CXR goes on

Test functions

Specify analog or digital loopbacks as needed

Environment

Operating temperature range: 0 to 60 C
 Storage temperature range: -20 to +70 C
 Relative humidity: 0 to 95% (noncondensing)

Physical dimensions

Modem layout per customer board drawing
 Give maximum height available above board

75 and 150 bits/s are not Bell-compatible.

Line connection

For leased-line (LL), the connection is either 2 or 4-wire at an impedance of 600 Ω . The modem input

impedance must be 600 Ω \pm 10% resistive. For private hardwired lines with additional drops between the two end points, you can specify a high termination impedance, typically 5 k Ω .

If the modem is to be connected to a direct-distance-

Modem specification checklist

1. Can timing be done on the system side instead of in the modem, e.g. clear-to-send delay, ring-to-RI delay, etc.?
2. Can logical functions be implemented in the system instead of the modem, like clamping BA to mark unless CTS is on?
3. Is the maximum component height above the board realistic? Although clearance can go as low as 0.36 in. for leased line (LL) operation, 0.55-in. height is generally needed for direct distance dialing (DDD).
4. Is the interface logic clearly specified? Is a flow diagram or timing chart included? What happens in the test mode?
5. Will the customer wash the modem board in chlorinated hydrocarbons? These solvents attack commonly used polystyrene capacitors, and you should specify other capacitor types.
6. Did you specify a "gold-plated" modem that will accommodate every possible configuration? Maximum cost savings come with modems that are tailored to your application.
7. Did you give the modem maker all available board space? If you have not allowed enough room, now is the time to find out!

dialing (DDD) network, the phone company can supply data-access arrangements for \$3 to \$5 a month. But under Part 68 of FCC regulations you can now integrate the equivalent of this coupling device into the modem, and save both cost and space. Part 68 requires that your coupler be tested by a "cognizant" engineer and that the test results be submitted for approval and certification. This procedure, as stipulated by the FCC, takes about 60 days.

Under Part 68 you connect to a standard RJ41S or RJ45S data jack (Fig. 6), which sets the transmitter output so the phone company central office receives the proper signal level.

Transient protection

How much protection the modem will need is determined by the greatest energy that the modem must withstand at its transmission-line interface. Western Electric states that the worst-case transients measured on a standard telephone line are about 600 V peak with a 50% decay time of 2 ms.

Transmit frequencies

Mark and space frequencies determine the logic state of the signal; the mark-space frequency difference divided by the bit rate is called the modulation index. For binary FSK, the optimum modulation index is about 0.7.

Carrier frequency, the arithmetic average of the mark and space frequencies, determines the channel center.

At the end of a transmission the receiver's carrier

detector must be turned off in one of two ways, depending on which modem type you prefer: "Soft carrier" works with 202-type modems and uses a 900-Hz tone sent from the transmitter at the end of each transmission. This tone forces the receiver to the mark frequency and causes the carrier detector to turn off. As a result, there is no chance of receiving false bits.

The second method is often used in low-cost systems where an end-of-transmission character is sent to instruct the receiving terminal to ignore all data until carrier-detect turns on again.

An answer tone used with both 202 and 103 modems disables the switched-network echo suppressors (if reverse channel is used), and tells the originating end that a proper connection has been made.

Output levels

The required transmitter output depends on the line. Leased-line drops are usually specified for 0 dBm (1 mW into 600 Ω) max. So, specify -1 ± 1 dBm, and the limit won't be exceeded. Some common carriers set other maximum levels, so it's a good idea to provide a variable attenuator. But if you work under Part 68 of FCC rules, the jack takes care of transmit levels.

Spurious outputs

How much out-of-band energy the modem transmitter may produce depends on the maximum levels that won't affect the telephone company's signaling functions. It's enough to specify that spurious outputs meet Parts 68 or 261 of the FCC regulations.

Timing functions

Clear-to-send delay, soft-carrier length, answer-tone length and turnaround delay are all simple timing functions that can be set outside the modem.

Receiver dynamic range

Defining the range of input levels over which the modem must operate ensures that s/n ratio and isochronous distortion specs are met even at the lowest receive levels.

Carrier detector

At a point where the received energy becomes so low that data cannot be reliably received, the received data are clamped to the mark logic level, and carrier detect turns off.

Interface levels

The levels at which data and control signals pass between the system and the modem are defined here. Values in Table 1 are typical for an EIA RS232 interface. If you specify other interface levels (e.g. TTL or CMOS), you may be able to reduce the modem's cost.

In a direct-connect interface, observe spacing requirements of the transmitter/receiver lead pair. To avoid voltage breakdown, spacing between the leads should be at least 0.1 in., and between the leads and

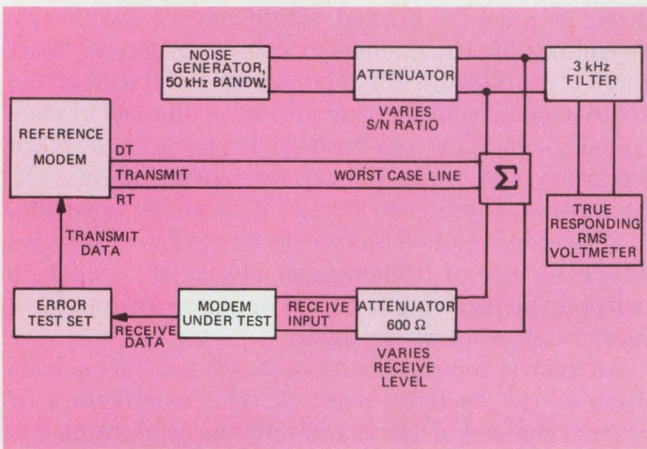

4. To measure a modem's signal-to-noise ratio, add noise to the output from a reference modem. Then check the modem under test over its full dynamic range.

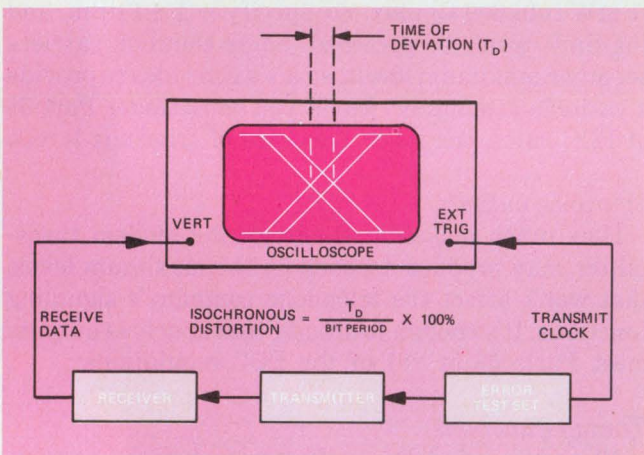

5. **Isochronous distortion** is a measure of the dynamic operation of the modem. The oscilloscope is set up to examine the leading and trailing edges of a bit stream.

any other conductive path (e.g. ground) at least 0.15 in.

Interface logic

This section of the spec defines how the system handshakes with the modem. The sample spec in Table 1 illustrates this protocol conventionally, but it would be even better to define the logic with a flow diagram or timing chart.

Test functions

The sophistication of a modem's built-in diagnostics depends on how much performance is required of the data-transmission system. Looping back is a common diagnostic technique in which signals are "looped back" toward their origins at various points in the system. Loopbacks on the transmission-line side of the modem are analog loopbacks, and those on the digital side of the modem are digital loopbacks. Since loopbacks of both forms operate either towards or away from the modem, as many as four loopbacks are possible at any operating site in the system. In a low

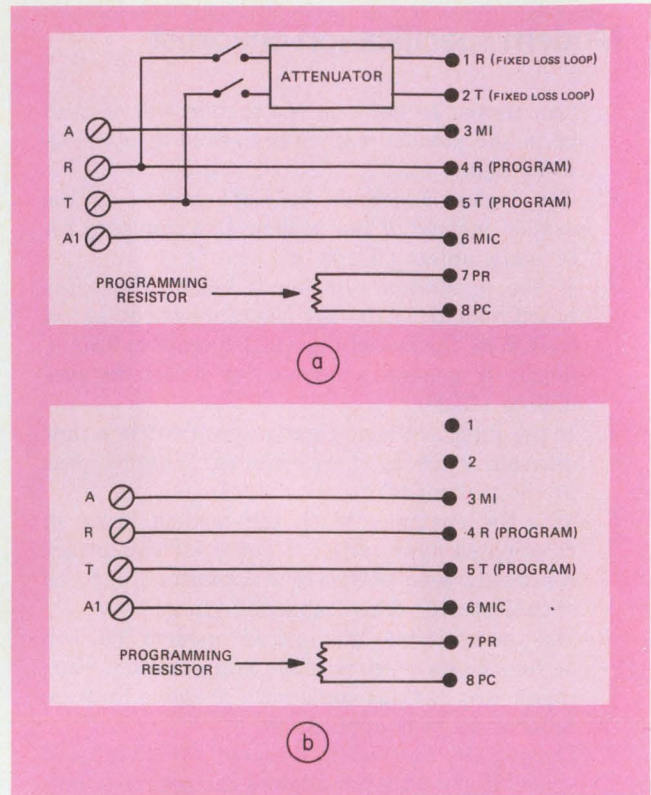

6. The "data access arrangement" from the phone company can be replaced by these "Standard RJ41S and RJ45S" data jacks.

cost system, few if any diagnostics would be required, and loopbacks are rarely used.

Power requirements

Check how much power is available to the modem. The requirements shown in the sample spec are for a typical direct-distance-dialing modem. Simpler modems without control logic or diagnostics need only about 200 mW.

Operating temperature range

Although the general industrial requirement is 0 to 60 C, modems can be designed, for more money, to operate from -40 to +85 C if your application requires it.

Storage temperature and relative humidity

The sample spec covers most applications. However, if a modem is exposed to extreme environmental conditions, special designs are available.

Physical dimensions

Modems can usually be built on about 20 to 30 in² of PC board. Be sure to specify the maximum component height on the board and consider the actual card area available for components.

While you should try to write as comprehensive a spec as you can, don't overspecify. If you tell the manufacturer all you can about your specific applications, he may be able to save you not only money, but also time and frustration.■

Smart pros count faster—and spend less.



80 MHz
\$295*

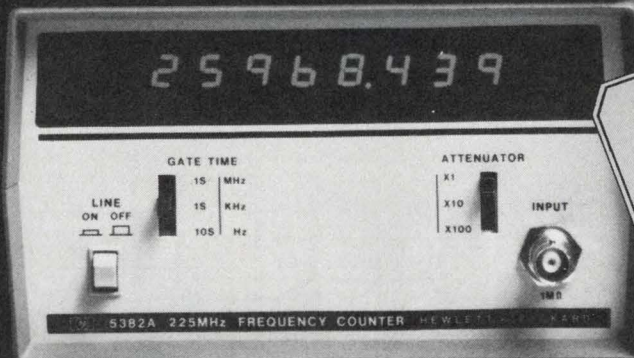

225 MHz
\$395*

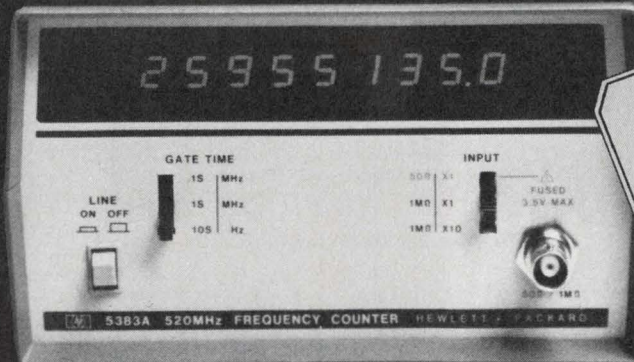

520 MHz
\$650*

It can be downright aggravating to wait longer for a reading than it takes you to make the adjustment.

The direct counting professional grade HP 5380 "Frequency-Only" Series solves this problem by giving you 1 Hz resolution in just one second. Every time, all the way up to 520 MHz. No more waiting for pre-scalers to prescale.

You'll like the new 20% lower prices for the HP 5382 and HP 5383, too.

Using state-of-the-art components common to HP's most sophisticated counters, this "frequency-only" series also offers high accuracy, high input sensitivity, input attenuators, a rugged metal case and a temperature-compensated crystal oscillator for improved measurement accuracy.

Each instrument is tested and calibrated to the industry's most precise frequency standards before shipment.

The same high quality that's built into every HP instrument.

To find out more about the HP 5380 "Frequency-Only" Series and the entire family of sophisticated and versatile HP electronic counters call your nearest HP field office or write for our new electronic counter brochure.

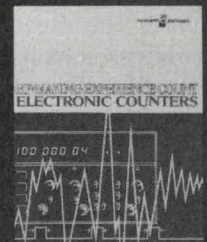

HEWLETT **hp** PACKARD

1507 Page Mill Road, Palo Alto, California 94304

For assistance call: Washington (301) 948-6370, Chicago (312) 255-9800, Atlanta (404) 955-1500, Los Angeles (213) 877-1282



HP: MAKING EXPERIENCE COUNT.

*U.S. Domestic price only.

CIRCLE NUMBER 41

02806

Optical-fiber links help you sidestep communications problems. Neither cable capacitance, nor water, nor power lines will stop your signal.

Though fiber-optical communications links were developed primarily to pack more bandwidth into less space, they also offer ready solutions to very different problems. For example, you can run glass-fiber "cables" through water. Or you can put it in electrical power conduits, without having to fret about interference. And you never need worry about bandwidth or hum pickup if you hook up a microphone fiber-optically.

These fiber-optic systems are easy to design because they use basic, readily available components (Fig. 1). At the transmitter, electrical signals modulate a LED whose light output is focused into an optical fiber. At the receiving end, the light emerging from the fiber falls on a photodetector that reproduces the original input signal.

In one application, a simple 50 kHz digital system transmits the output of a remote temperature sensor to a digital readout over a 500-ft link (Fig. 2). The temperature sensor—a silicon diode in a bridge op amp—converts the measured temperature to a voltage, which drives a voltage-to-frequency converter. The output pulses from the converter are then fed to a TTL inverter (two 7400 gates) to drive a high-output red LED. This narrow-beam emitter is mounted close to an optical fiber bundle in a specially designed fixture that minimizes loss.

You can count on fiber-optics

Once you've aligned the fiber bundle, most of the pulsed LED output enters the fiber and travels to the far end where a standard phototransistor serves as the receiver. A few gates then reshape the pulses, and a counter displays the temperature reading. A printer, driven by the counter, provides a permanent record. You can, of course, use the same approach to measure pressure, acceleration, physical position, or any other quantity, remotely.

A completely different digital challenge is solved in Fig. 3: How to interconnect two teleprinters in a local sales office and a warehouse. Since this system operates at less than 100 kHz, you can again use phototransistors in the receiver. The 170-V output of

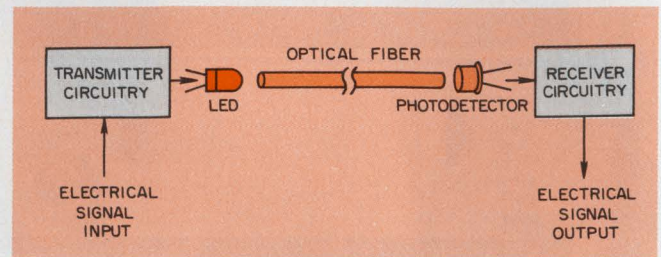

1. In the basic fiber-optical data link, light is modulated at the transmitter, sent through optical fibers, and demodulated by the receiver.

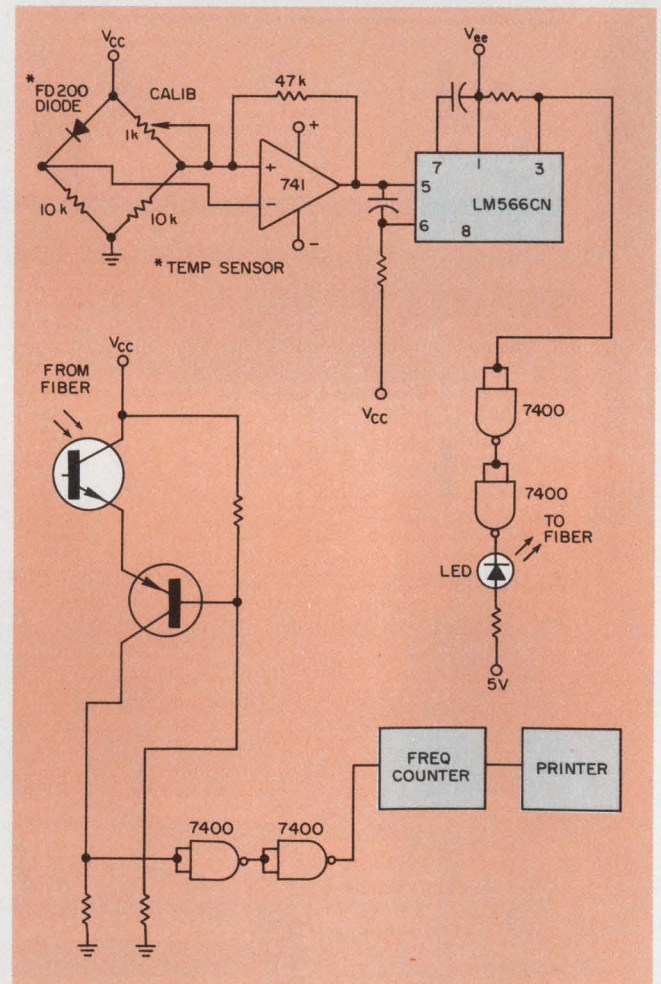

2. A temperature-transmitting link converts the temperature reading into light pulses, and at the remote end demodulates them to drive a counter.

Irwin Math, President, Math Associates, 376 Great Neck Rd., Great Neck, NY 11021

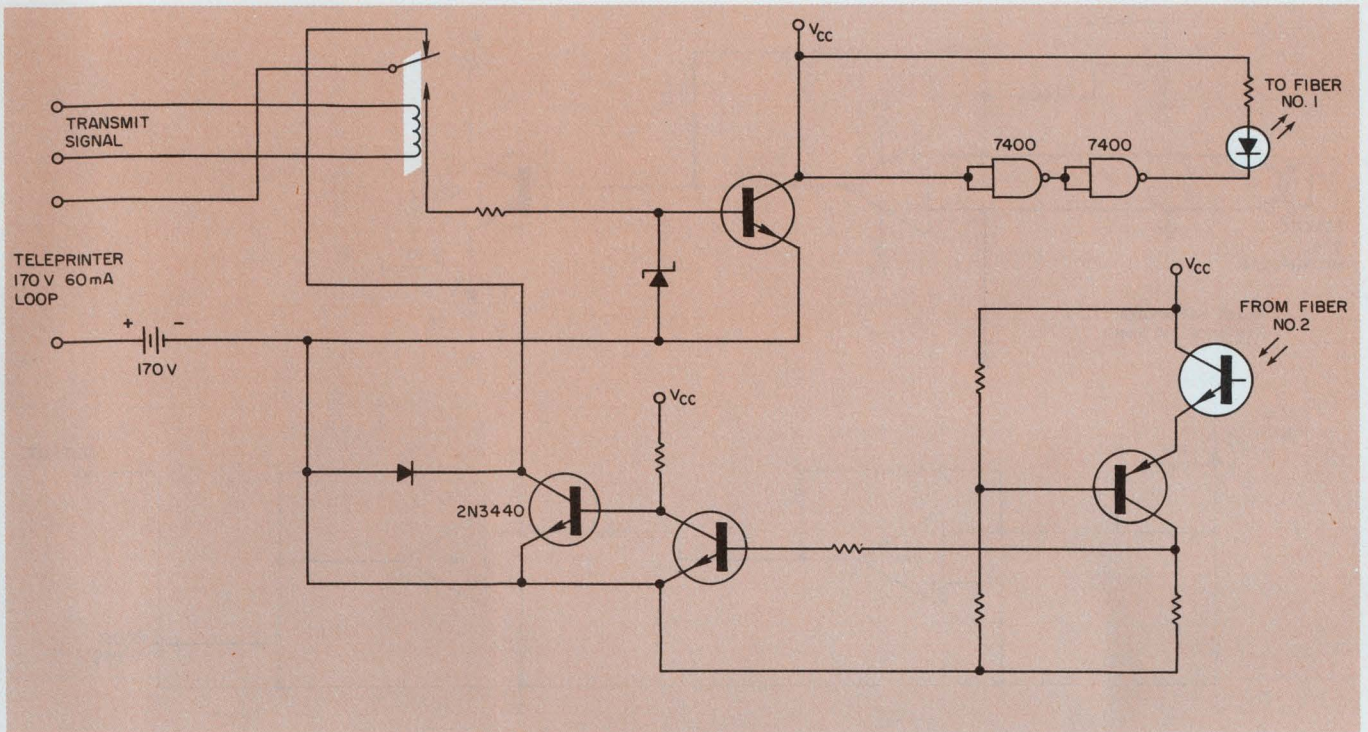

3. Teleprinters can be connected fiber-optically in full-duplex with this simple circuit.

the terminal drives the same LED circuit as in the previous example through a simple transistor converter. On the receiver side, the TTL output pulse drives a high-voltage transistor which in turn operates the teleprinter's 170-V loop. A relay keeps each station in the receive mode until the send key on the teleprinter activates the relay, turning on the LED transmitter.

But wouldn't it be much cheaper simply to hook up the two TTYs over a coax cable instead of optical fibers? In this particular application, the only ac-

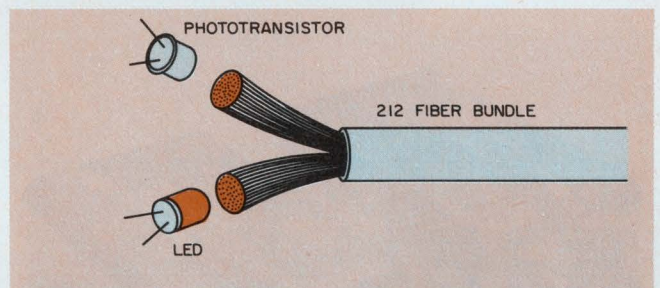

4. When two channels are needed, a 212-fiber bundle can be separated into two smaller bunches as shown.

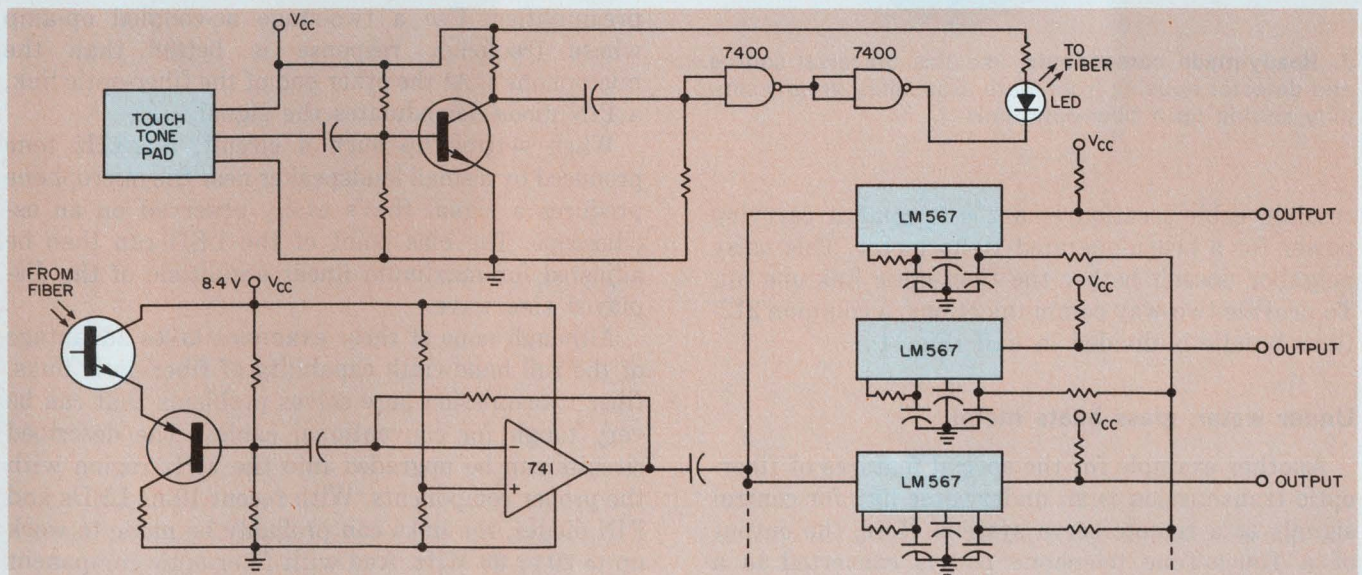

5. This remote-control system uses a Touch-Tone pad in the transmitter and nine LM-567s in the receiver to provide

nine independent control functions. And salt water does no harm to the fiber-optical cable.

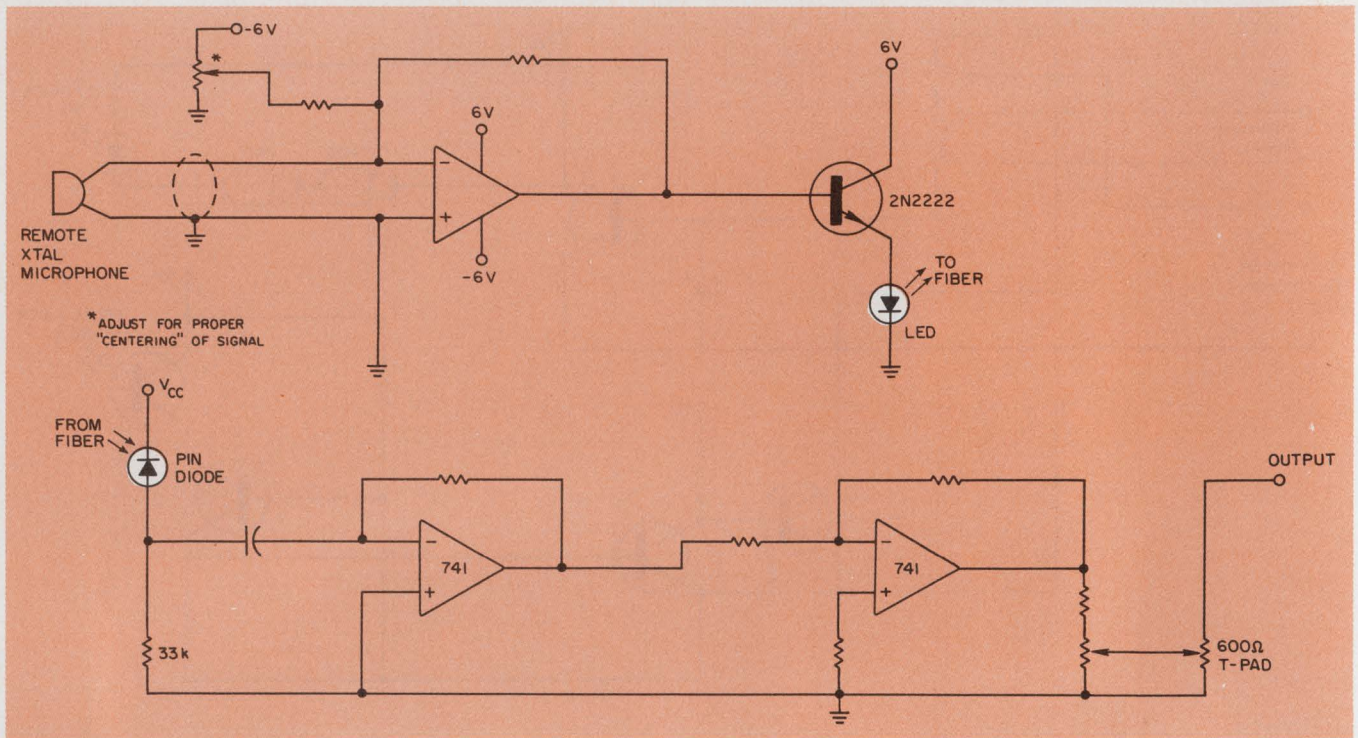

6. A microphone link uses fiber-optics to retain high fidelity and avoid interference pickup.



7. Ready-made components, like this universal source and detector housing from Math Associates, greatly simplify setting up a fiber-optic link.

cessible cable location is a 250-ft conduit carrying power for a brush-operated 10-hp motor. This noisy neighbor doesn't bother the fiber-optic link one bit. To provide two-way communications, a common 212-fiber bundle is divided in half (Fig. 4).

Under water, glass beats metal

Another example for the special features of fiber-optic transmission is an underwater link for control signals to a remote servo system. Here, the output of a Touch-Tone telephone pad is converted to a "digital tone" by the circuit shown in Fig. 5. After transmission over 1000 ft of 400- μ m-diameter glass

fiber, the signal tone is fed to a touch-tone decoder, and used to control the servomechanism. For such an underwater path—especially through salt water—optical fibers are much safer than coaxial cable.

Finally, fiber-optics solve the problem of temporarily sending high-fidelity sound from a theater stage to a sound-mixing console behind the orchestra pit. A 700-ft run of shielded microphone cable not only loses the high frequencies, but also risks picking up extraneous signals.

The solution: an amplitude-modulated LED circuit (Fig. 6) and a PIN-diode detector. A PIN diode, unlike a phototransistor, has a linear response, but needs a preamplifier. Use a two-stage ac-coupled op-amp whose frequency response is better than the microphone's. At the other end of the fiber-optic link, a PIN diode demodulates the signal.

When setting up such a circuit, a 1-kHz tone produced by a small loudspeaker near the microphone produces a signal that's easily observed on an oscilloscope. The bias point of the LED can then be adjusted for maximum linear amplitude of the displayed sine wave.

Although none of these examples takes advantage of the full bandwidth capability of fiber-optic links, fiber transmission here solves problems that can be very tough for conventional cables. The described circuits can be upgraded into the MHz region with the proper components. With recent 10-ns LEDs and PIN diodes, the links can probably be made to work up to 20 or 30 MHz. And with fiber-optic component kits and hardware readily available (Fig. 7), you may want to try a fiber-optic link yourself. ■■

FAMOUS
FIRSTS.

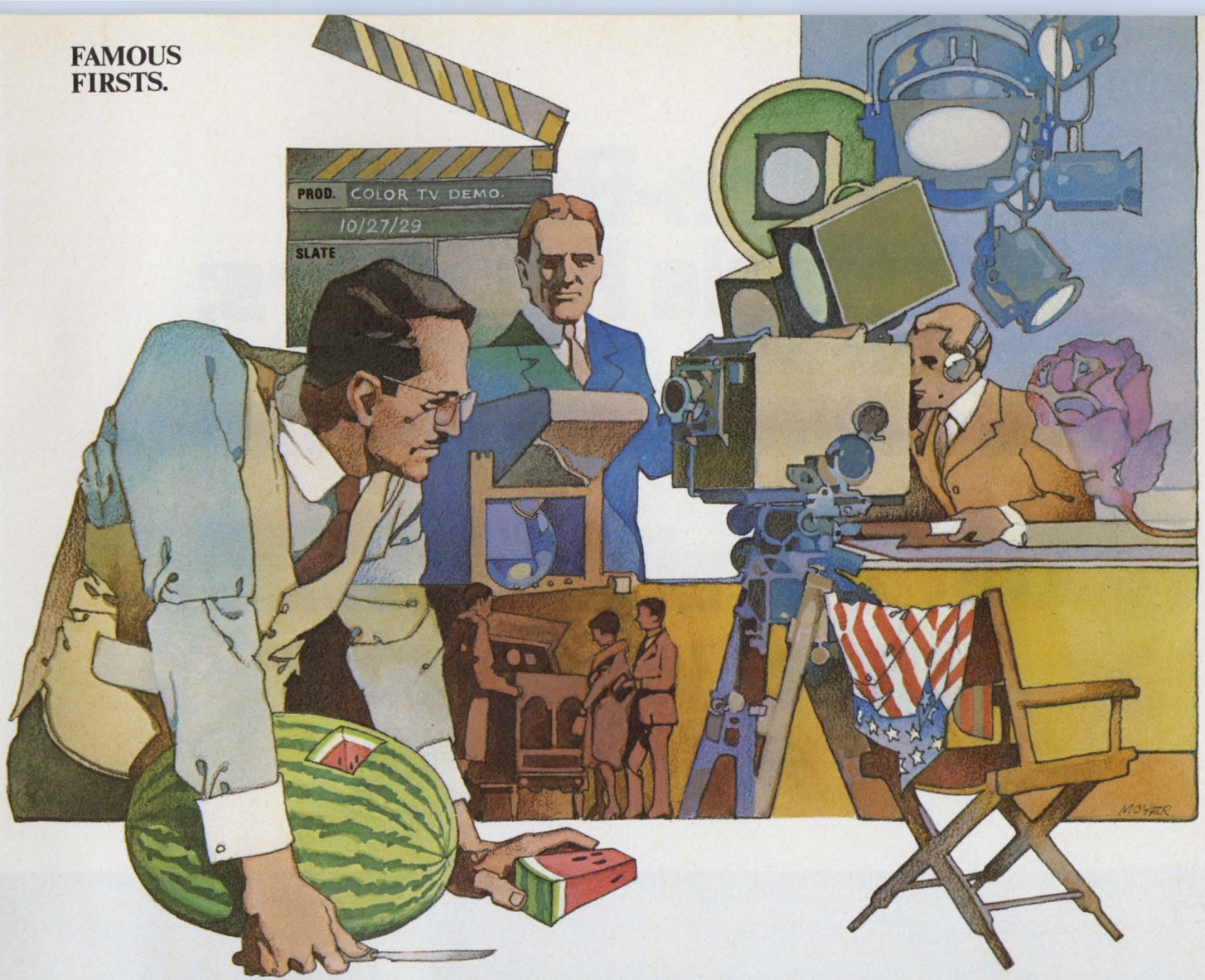

On an October day in '29, a watermelon was plugged as a TV star.

It, an American flag and a bunch of roses shared top billing in the first public color television demonstration in New York City, October 27, 1929. It was primitive, but it was a beginning. And as Bud has proven since its founding in 1928, small beginnings based on good ideas trigger growth.

In fact, today Bud holds the prime spot in offering, and making immediately available, the industry's largest selection of enclosures. And whichever of the over 2,500 styles and sizes you specify, that Bud enclosure will add to your product's value, function, styling -- add to its marketability. That's why we're in business, to help you in yours. And that's why we've grown.

Bud Industries, Inc., 4605 East 355th Street, Willoughby, Ohio 44094. Bud West, Inc., 3838 North 36th Avenue, Phoenix, Arizona 85019.

BUY BUD

FAMOUS...AND FIRST.

For information,
phone toll free: (800) 321-1764;
in Ohio, (800) 362-2265.

FOR FULL DETAILS CIRCLE NUMBER 42
TO HAVE SALESMAN CALL CIRCLE NUMBER 43



*Choose your enclosures from over
2,500 styles and sizes, all immediately
available from Bud.*

Allen-Bradley Variable Resistors:

We have what you need.

**Our distributors have
them when your
need is now.**

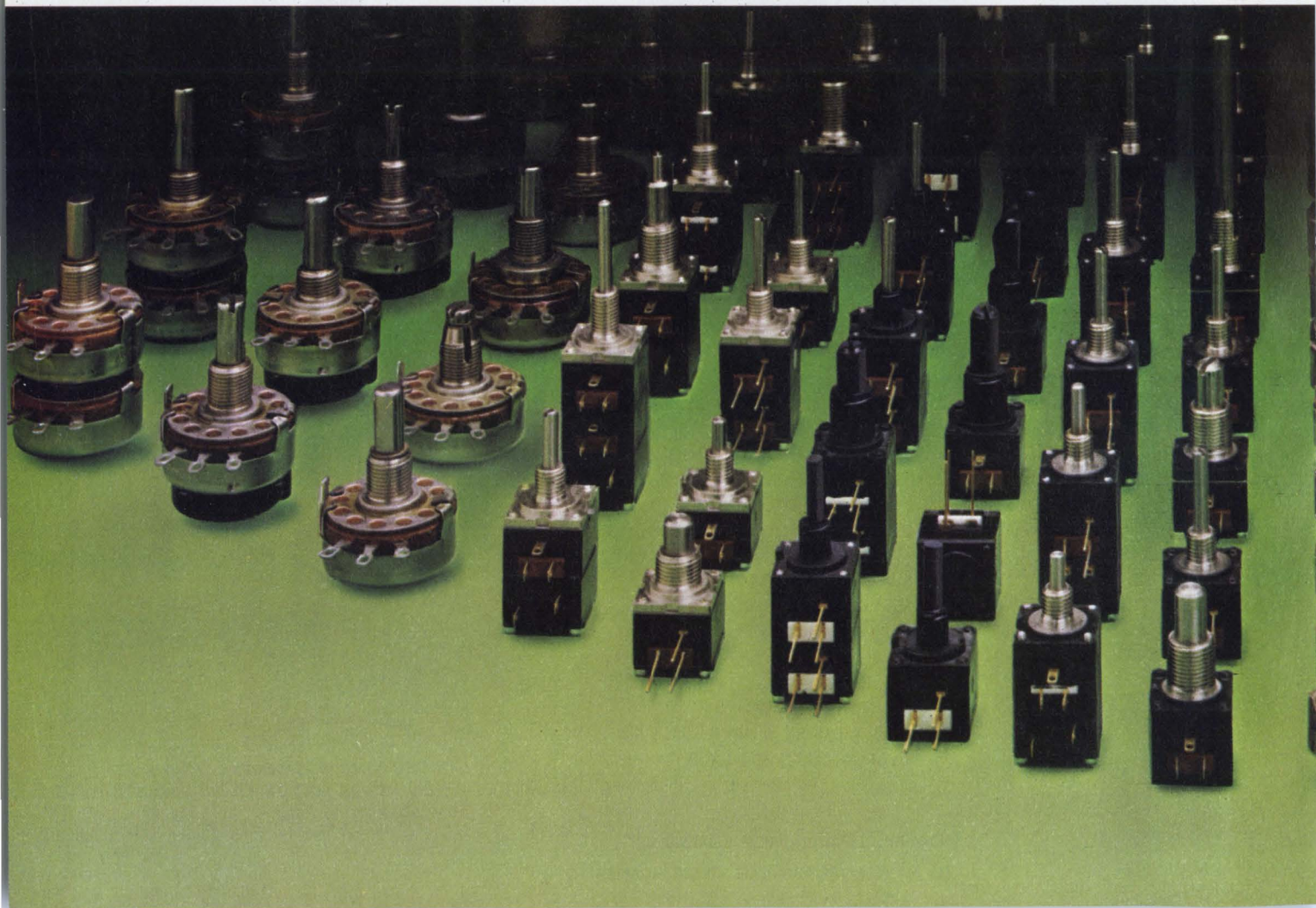

ALLEN-BRADLEY VARIABLE RESISTORS



Type J: $1\frac{1}{32}$ " diameter. Hot-molded carbon composition. 50 ohms to 5.0 megs. 2.25W at 70°C. 100M cycle rotational life. Single, dual, triple sections. SPST switch optional. Many other options. Publication 5200. **500 piece price \$1.27 (single).**



Type EJ: $1\frac{1}{32}$ " diameter. Hot-molded carbon composition. 50 ohms to 5.0 megs. 2.25W at 70°C. 1 MILLION cycle rotational life. Single and dual sections. Slip clutch optional. Many other options. Publication 5230. **500 piece price \$1.50 (single).**



Series 70: $\frac{3}{8}$ " square MOD POT.[®] Hot-molded composition, cermet, conductive plastic. 50 ohms to 10.0 megs. 100M cycle rotational life. Single, dual, triple sections. Switches optional. Many other options. Publication 5217. **500 piece price \$1.19 (single).**



Series 72: Case, bushing and shaft are non-metallic (for double insulation). Otherwise, same as Series 70. Singles and duals only. Publication 5217. **500 piece price \$0.90 (single).**



Series 73: A lower priced version of Series 70. Singles and duals only. Publication 5217. **500 piece price \$1.04 (single).**



Type G: $\frac{1}{2}$ " diameter. Hot-molded composition. 100 ohms to 5.0 megs. 0.5W at 70°C. 50M cycle rotational life. SPST switch optional. Many other options. Publication 5201. **500 piece price \$1.72.**



Type GD: Dual section version of Type G. Well suited for attenuator applications. Publications 5213 and 5221. **500 piece price \$3.67.**



Type W: A lower priced version of Type G. Publication 5212. **500 piece price \$1.19.**



Type WR: Radial lead version of Type W. SPST switch optional. Publication 5220. **500 piece price \$1.30.**



Type SP: $\frac{3}{8}$ " diameter. Cermet element. 50 ohms to 1.0 megs. 1.0W at 70°C. 25M cycle rotational life. Publication 5216. **500 piece price \$2.00.**



Type M: 10.0 MM (.394") cube. Conductive plastic element. 100 ohms to 1.0 megs. 25M cycle rotational life. Single and dual sections. Switches optional. Other options. Case, bushing and shaft are non-metallic. Publication 5239. **500 piece price \$2.12 (single).**

Quality in the best tradition.



ALLEN-BRADLEY

Milwaukee, Wisconsin 53204

CIRCLE NUMBER 44

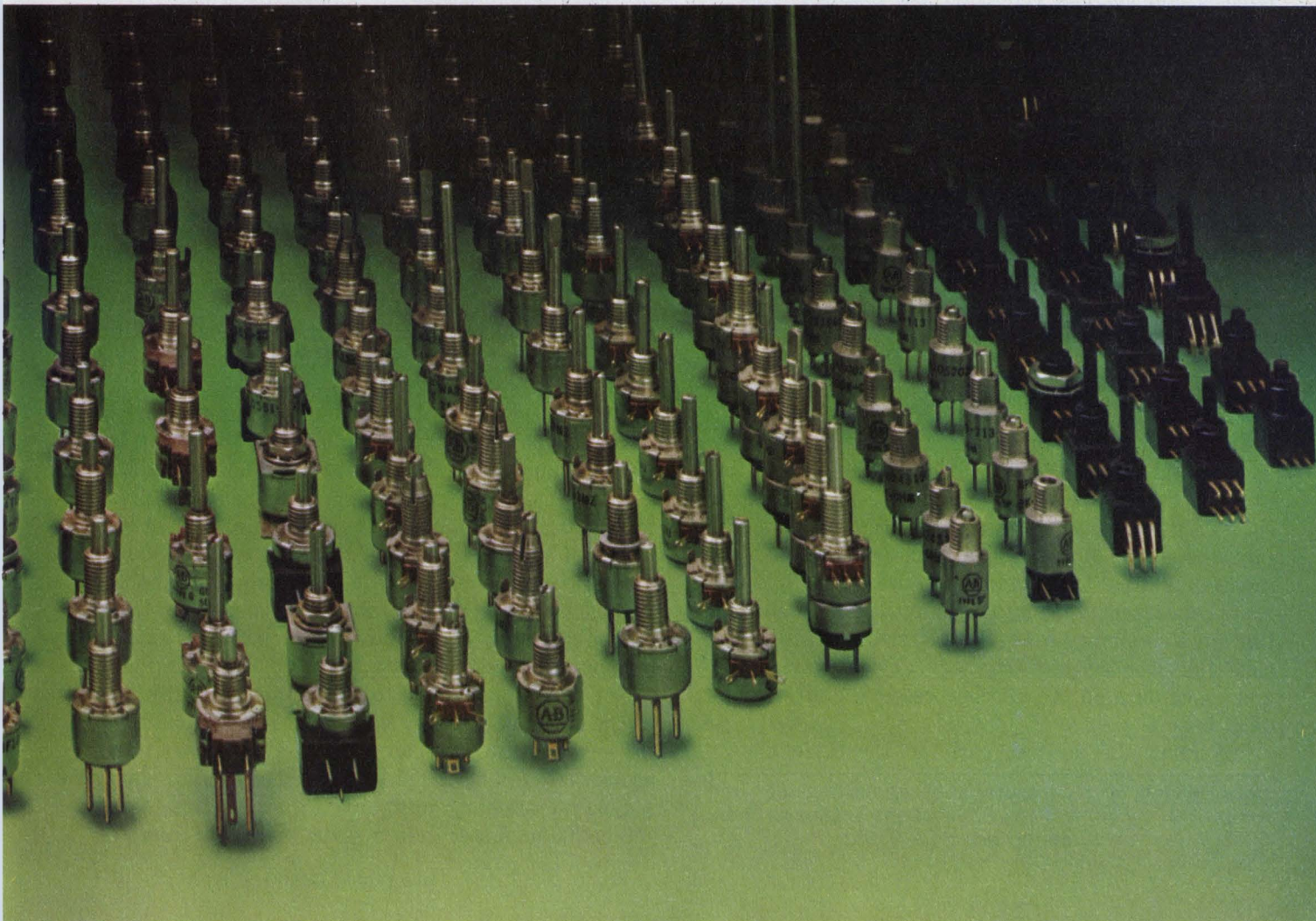

Keep the memory interface simple

between dynamic RAMs and a μ P. Use the right timing and refresh, and you won't have to trade off much performance for cost.

Dynamic random-access memories, which offer about four times the density of static memories, are prime candidates for many microprocessor-system designs. With the increased use of programmed logic, the pervasiveness of high-level languages, the rising power of the microprocessors themselves, and the dropping costs of RAMs, system memories are increasing in size at an almost unbelievable pace.

But a dynamic RAM isn't as easy to design into a microprocessor system as a static unit. Not only do you have to worry about special access timing requirements, but you also have to decide which form of memory-refresh system will work best with your application. And, depending on the size of your memory system, it may be more economical to use static devices. For systems requiring less than 8 kbytes of memory, static devices are probably the better alternative. For systems above 16 kbytes, dynamic RAMs are more economical, even with the cost of the refresh circuitry. In between the two ranges, the choice depends on many factors—cost, ease of design, parts count, familiarity, etc.

There is no RAM component easier to use than the static device. Still, you can design a dynamic-memory system that is every bit as reliable and perhaps, more cost-effective. One of the biggest challenges you'll encounter, though, is to determine the minimum access time needed by the RAMs.

Understand memory speed requirements

Memory speed, or access time, for either static or dynamic RAMs is a fairly complex characteristic. Considering a typical microprocessor memory read cycle (Fig. 1a) will help bring the term "access time" into focus. A typical microprocessor presents its memory address to the memory address bus, followed some time later (typically 100 ns to allow for stabilization) by its memory-read (MEMR) strobe. This strobe asks that the selected memory device provide the addressed data on the microprocessor's bidirectional data bus.

Providing the address early in the cycle allows

Gary Fielland, Microcomputer Applications Engineer, and **Ken Oishi**, Dynamic RAM Applications Engineer, Intel, 3065 Bowers Ave., Santa Clara, CA 95051.

address decoding and module selection to be performed before the MEMR strobe occurs, and heads off any bus conflicts. Some time (typically 350 ns) after the MEMR strobe is issued, the processor expects valid data at its input port. If the data are not available in the allotted time, the processor can be forced to wait by having its Ready input (assuming an 8080A processor) pulled to the inactive state. As long as the Ready is false, the processor will wait an integral number of processor clock periods (wait states).

To meet the "no-wait-state" timing for the processor, the memory system must be no slower than the processor's required read access time. One of them, t_{ACA} , is the time between a stable processor-supplied memory address and the arrival of valid data at the processor's input port—typically 450 ns. Another read access time is t_{ACR} , the period, after a processor-supplied read strobe, during which the processor can expect valid data at its input port—typically 350 ns.

Read access time, t_{ACS} , for a static memory component (Fig. 1b) is the delay between a stable address input and valid data at the RAM output. A static memory will begin accessing the addressed bit cell(s) the moment the address becomes available. If there are multiple banks of static memory, each bank will access the addressed bit cell(s), though only one bank will be selected by the high-order address-bits decoder. So by ignoring bus and bus-buffer delays, a static memory with $t_{ACS} \leq t_{ACA}$ will satisfy the no-wait-state criterion.

On the other hand, the read access time t_{ACD} (Fig. 1c) for a dynamic-memory component is the time from its clock input until the data at the RAM output are valid. Assume that the address is set up at the address inputs of the dynamic RAM some time, t_{ASU} , before the clock input is activated—typically 0 to 10 ns. For a simple system design, the clock input can be activated by the MEMR strobe. This means that the dynamic memory doesn't have as much time as a static memory to access its data.

Not only that, but 50 to 100 ns are typically lost in the dynamic-memory controller itself. To satisfy the no-wait-state criterion, a dynamic memory must provide a $t_{ACD} \leq t_{ACR}$ (typically 50 to 100 ns less). Thus, a dynamic memory must have an access time some 150 to 200 ns faster than a static memory to satisfy

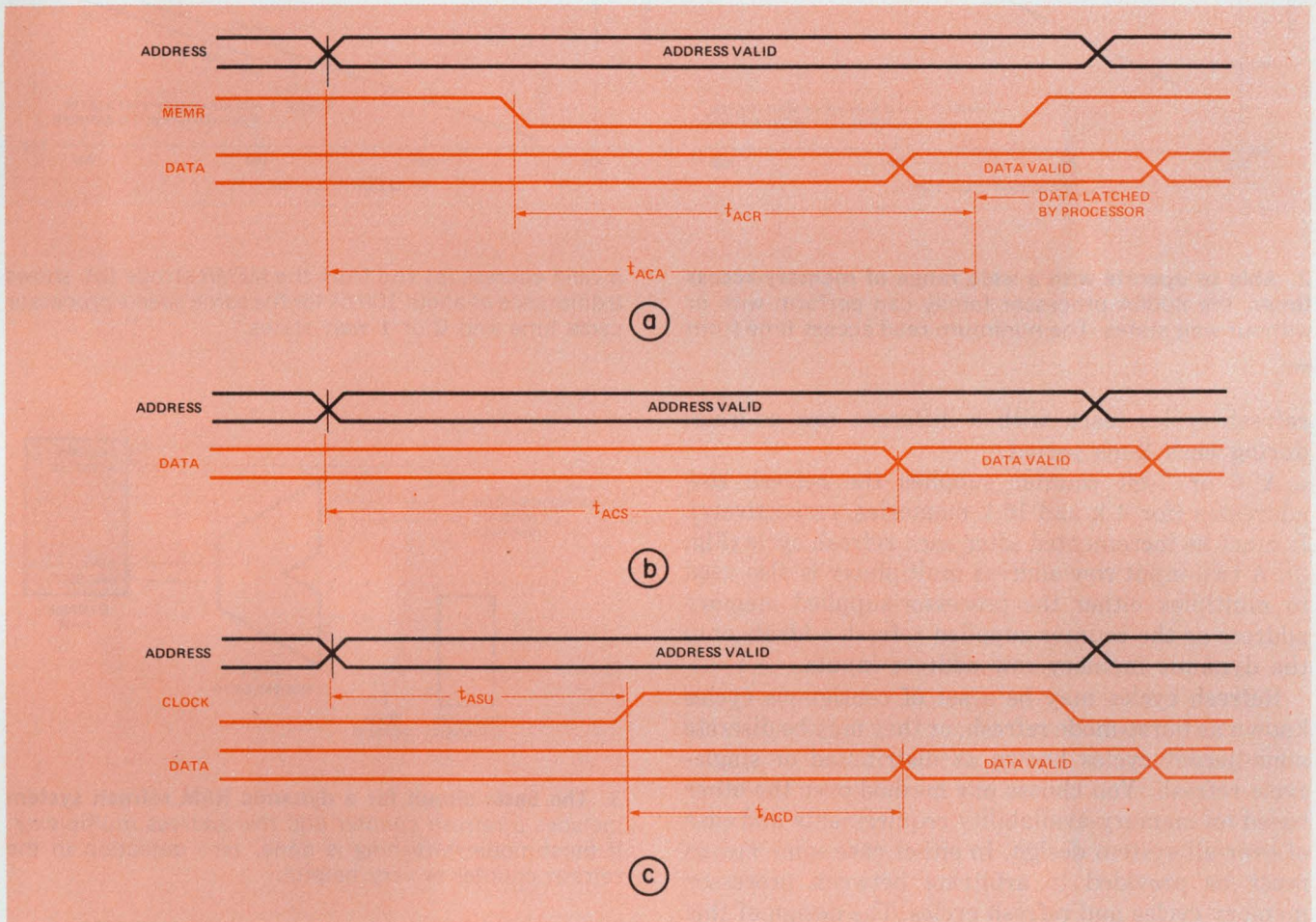

1. **A typical microprocessor no-wait-state memory Read cycle (a)** shows the memory-system access time required from address (t_{ACA}) and Read strobes (t_{ACR}). For a static memory system, access time (t_{ACS}) is measured from

a microprocessor's no-wait-state access requirement. Fig. 2 graphically depicts the memory access time requirements for an 8080A microprocessor.

Memory refresh: crucial for data retention

Another crucial requirement is that the dynamic RAM be refreshed so that none of the data held inside will be lost. Most of the 4 and 16 k dynamic RAMs available today specify that each bit cell within the

address valid to data valid (b). Access time in a dynamic memory system (t_{ACD}) is measured from the start of the clock to the beginning of the data valid, with an implied address set-up time, t_{ASU} (c).

array be refreshed every 2 ms.

A dynamic RAM has its cells organized in arrays—4096-bit memories have a cell array of 64 rows and 64 columns. All columns in a single row are refreshed simultaneously so that you need only provide 64 refresh cycles (each with a different row address), each 2 ms. The 16,394-bit memories have two identical cell arrays each with 64 rows and 128 columns. Again, all columns in a single row in an array are refreshed simultaneously. This means that you must supply 128

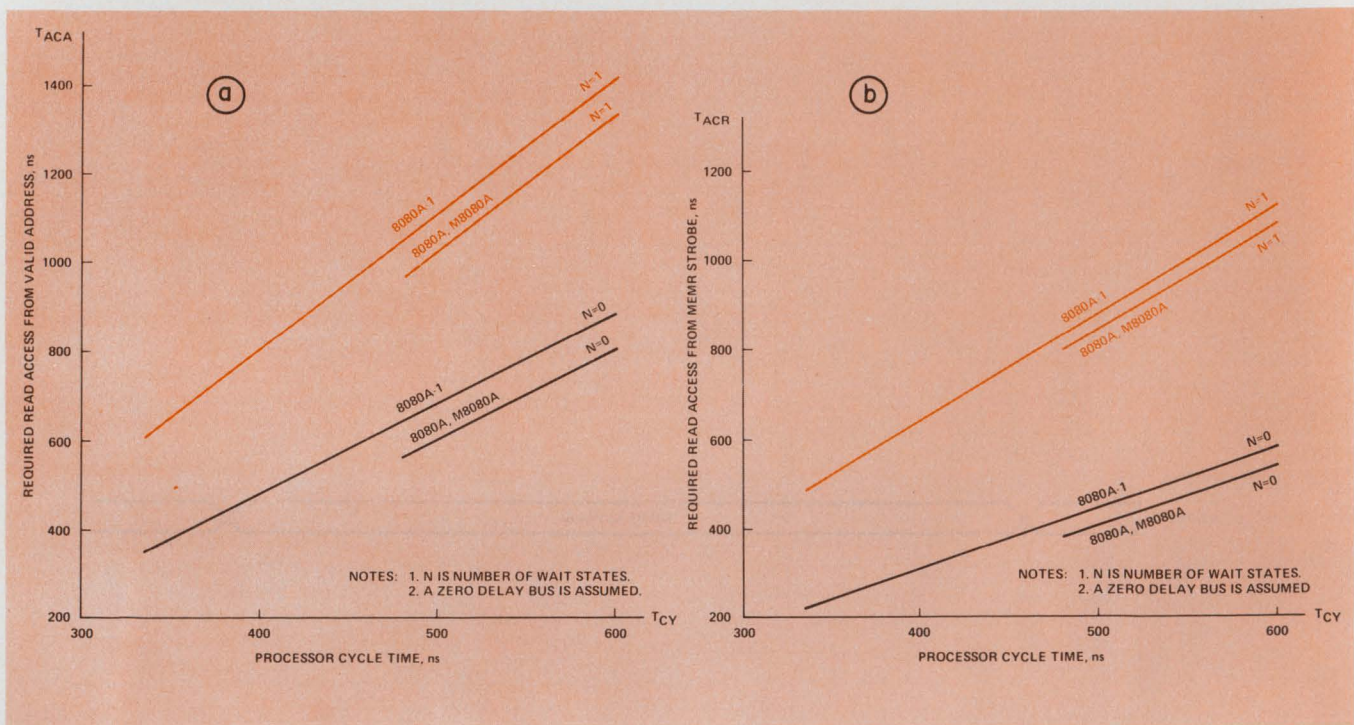

2. **Able to operate with a wide range of memory-access times**, the 8080A processor family can perform with or without wait states. The minimum read access time from

a valid address (a) and from the MEMR strobe (b), shows a difference of about 100 ns for the same speed/processor cycle time and 0 or 1 wait states.

refresh cycles (each with a different row address) during each 2-ms period.

A 6 or 7-bit counter supplies the refresh row addresses (for 4 k and 16 k memories, respectively). It must be incremented after each refresh cycle (Fig. 3). A two-input row-address multiplexer is also used to multiplex either the processor-supplied memory address or the counter-supplied refresh address onto the dynamic memory row address inputs.

Refresh cycles may be a set of contiguous cycles known as burst-mode refresh, or they may be discrete nonadjacent cycles known as distributed or single-cycle refresh. You choose one method over the other based on memory-availability requirements and ease of over-all system design. In either case some means must be provided to arbitrate between processor memory cycles and refresh cycles. The design of this refresh arbiter can be simpler or complex, depending on the method chosen.

More than one way to refresh

There are three ways to refresh dynamic RAMs. Each differs slightly in complexity, generality, and memory availability (Table 1).

The *asynchronous* method assumes that refresh is inherently a real-time event—one refresh cycle every 31 μ s (64 cycles every 2 ms)—and is independent of the state of the processor. This popular approach yields the most flexible system since it is very loosely coupled. The asynchronous memory system normally has its own dedicated control logic and may run independently of the microprocessor. The local control

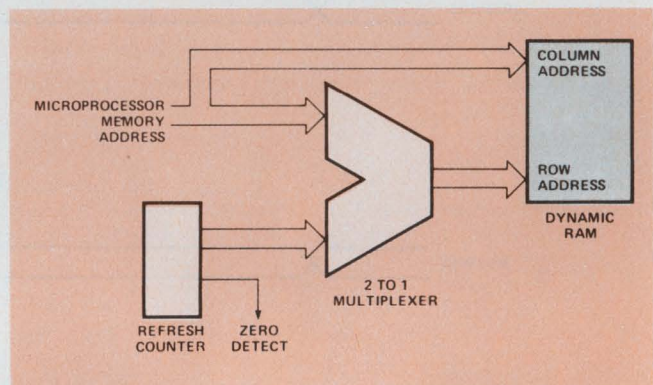

3. **The basic circuit for a dynamic RAM refresh system** includes a refresh counter and row-address multiplexer. If burst-mode refreshing is done, zero detection in the refresh counter is very helpful.

logic supplies refresh as needed and couples with the processor only to provide Read or Write cycles.

In most implementations, the memory system is unaware of the processor state or any other processor particulars. Indeed, an asynchronous-refresh memory system may be designed to operate with just about every microprocessor. At the other end, the asynchronous-refresh memory appears no different than static memory to the microprocessor, except that the processor may occasionally have to wait for service if the memory is busy performing refresh.

While an asynchronous-refresh memory system offers the most modular approach to design, it frequently suffers from a high degree of complexity, which degrades performance. One big reason is that

Three ways to refresh

| | | |
|-----------------|---|--|
| Asynchronous | — | Refresh is performed asynchronously with respect to the microprocessor. |
| Synchronous | — | Refresh is performed in synchronism with microprocessor events. |
| Semisynchronous | — | Refresh is performed in synchronism with the microprocessor clock, but asynchronously with respect to microprocessor events. |

you have to design a reliable, high-speed memory controller that arbitrates between asynchronous-refresh requests and microprocessor memory requests—a demanding job (Fig. 4). This problem is further complicated since the beginning of the memory cycle must now be delayed until the requests have been definitively resolved and appropriate address, data, and control set-up times have been supplied. So this request resolution adds time directly to the system access time for each cycle.

Synchronize the μ P and the refresh

The *synchronous* method of refresh, on the other hand, can improve the performance and apparent availability of a memory system. Refresh cycles are forced to occur synchronously with microprocessor events, and the event usually chosen is a cycle in which the microprocessor won't be using the memory. Hence, there is no contention for the memory and the refresh cycles do not detract from apparent memory availability. This hiding of the refresh cycles when the memory would otherwise be idle is often called Invisible Refresh since the processor sees no delay due to refresh.

As a result, the memory is available to the processor without conflict every time the memory is requested. This absence of contention leads to a not-so-obvious but significant performance improvement. The memory address and data multiplexers may select the microprocessor bus before the cycle begins. Then, once the microprocessor issues a request, the cycle begins. The processor can provide sufficient address and data lead time to satisfy all address decoding, propagation delay, and memory device set-up times.

Synchronous system-access time is determined only by the memory and timing-generation circuitry, with no time added for arbitration or multiplexer settling. Thus, with today's dynamic memories, you can guarantee memory cycles that require no microprocessor wait states. Dispensing with wait states yields a significant performance improvement—about 500 nanoseconds' worth for each state.

The heart of an efficient synchronous refresh microprocessor memory system is the refresh scheduler accepts status inputs from the refresh timer and the microprocessor, and based on its knowledge of that processor, schedules the refresh cycles into idle portions of the processor cycle.

Obviously, construction of the scheduler is depend-

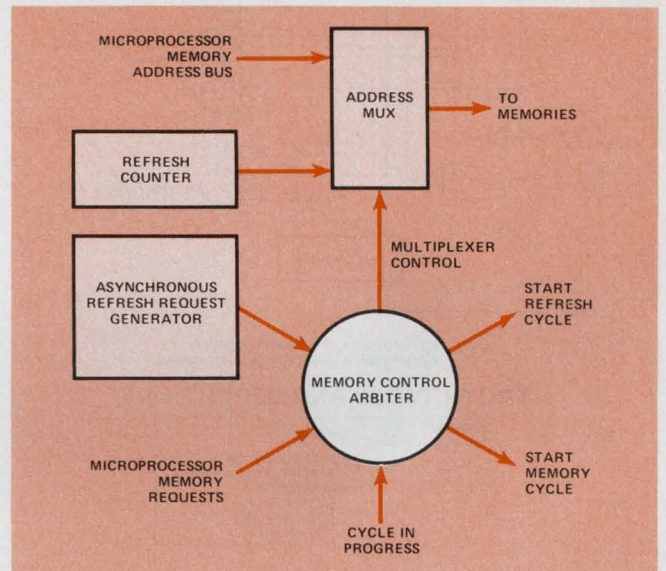

4. An asynchronous memory system requires that you design a very complex controller that must be able to resolve contention problems.

ent on the particular microprocessor used and its application.

An override must be provided to guarantee refresh, should the microprocessor be detained from reaching the normal refresh event—such as when the microprocessor enters the Halt, Reset, Wait, or Hold states. But this override will introduce some asynchronism back into the system, for the processor may begin again at any time.

Semisynchronous refresh is a combination of asynchronous and synchronous refresh. For one thing, it simplifies an asynchronous system's request arbiter. Moreover, the memory requests initiated are synchronous with a clock edge. Thus, if the refresh request is synchronous with the opposite clock edge, the two request transitions will never occur simultaneously.

Except for the synchronization of refresh requests to the microprocessor clock, semisynchronous refresh is very similar to asynchronous refresh. There must still be memory-cycle-vs-refresh-cycle arbitration since one cycle may already be in progress when the other is requested. However, this arbitration can be made much simpler.

Using a microprocessor other than an 8080A might require a slight modification to ensure the mutual exclusion of refresh and processor request transitions.

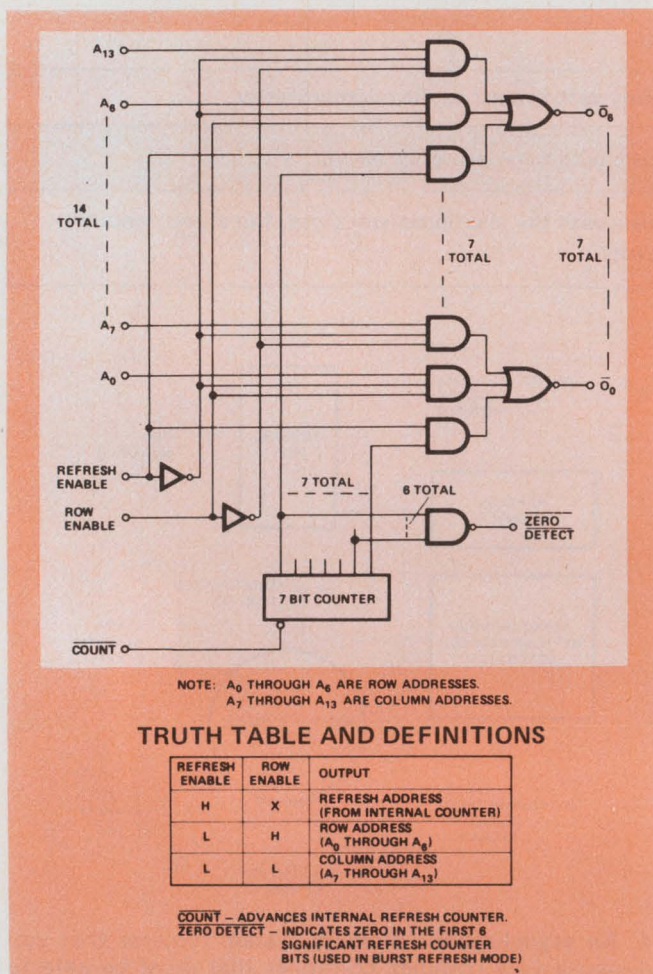

5. Containing both the refresh counter and the address-row multiplexer, the Intel 3242 helps simplify the circuitry needed to build a refresh controller for a dynamic memory system. It comes in a 28-pin DIP.

The memory controller must still arbitrate between requests and lock out the tardy one. Hence, refresh is still visible, and the processor may have to wait for the refresh cycle to be completed before gaining access to the memory.

Which refresh method do you choose? If you select the synchronous refresh methodology, your next question might be whether or not to perform invisible refresh. First, consider the loss due to visible refresh. Assuming a nominal memory cycle time of 500 ns, 4000 memory cycles will be available in each 2-ms refresh interval. During an interval, 64 refresh cycles must be provided, which causes a loss of almost 2% in memory availability.

Looking at the same numbers from the processor's point of view, the situation is similar. A typical processor machine cycle takes 2 μ s, so assuming instant memory availability and no loss due to refresh, 1000 machine cycles can be performed each refresh interval. Now if 64 of those machine cycles were delayed one memory cycle (500 ns) for visible refresh, only 984 machine cycles could be executed each refresh interval, for a processing loss of about 2%.

To maximize performance, you can improve per-

formance about 2% by using invisible refresh. But then you get penalized by the added cost and complexity of the refresh-scheduler design. In some implementations this cost may not be much. There are some LSI devices that can reduce system package count in a dynamic memory controller by providing a major portion of the necessary control logic.

The 3242 refresh controller from Intel, for example, contains an address multiplexer and refresh counter (Fig. 5), and is designed for use with 16-k dynamic RAMs. It multiplexes 14 bits of system-supplied address onto 7 output pins. The 7-bit refresh-counter outputs can be multiplexed onto the refresh controller's output. Since they are externally controlled, either distributed or burst-mode refresh may be used.

Now that you're ready to design a microprocessor/dynamic-RAM interface, be prepared to make tradeoffs. The first involves system requirements. Do you want, for example, a dedicated memory system where low cost is more important than generality, or do you want a system where generality is critical? But if cost and performance are your key objectives, choose the synchronous method of refresh, and don't even try to make the refresh invisible.

Design a dedicated system

When trying to decide how to design the synchronous refresh scheduler, consider this: Clearly, the scheduler must have intimate knowledge of the processor state and be able to predict the appropriate moment to perform refresh. Conveniently, an 8080A already has an inherent scheduling function under another name; and what has better knowledge of the processor state than the processor itself?

Two pins in the 8080A, HOLD and HLDA (Hold Acknowledge), indicate internal processor states. HOLD is an input used by the memory to request that the 8080A suspend its use of the bus as soon as possible, and HLDA is an output that the 8080A uses to signal that it is about to yield the bus.

In an 8080A system, HLDA is commonly delayed until the trailing edge of the ϕ 2 clock, which yields HLDAD (Hold Acknowledge Delayed), which in turn is used to gate off the 8080A bus drivers.

So actually you've got a scheduler without any design work. All you have to do is rename the signals generated by the basic processor configuration shown in Fig. 6: HOLD becomes RFRQ (Refresh Request); HLDA becomes RFAK (Refresh Acknowledge); and HLDAD becomes RFAKD (Refresh Acknowledge Delayed).

Before going any further, however, examine the system limitations stemming from your choice of scheduler. First, there are several conditions under which refresh will not be provided due to the use of the 8080A HOLD feature. Refresh will not be provided while the 8080A RESET pin is active, so don't maintain RESET for too long if you want to preserve your dynamic memory's integrity. Similarly, refresh will

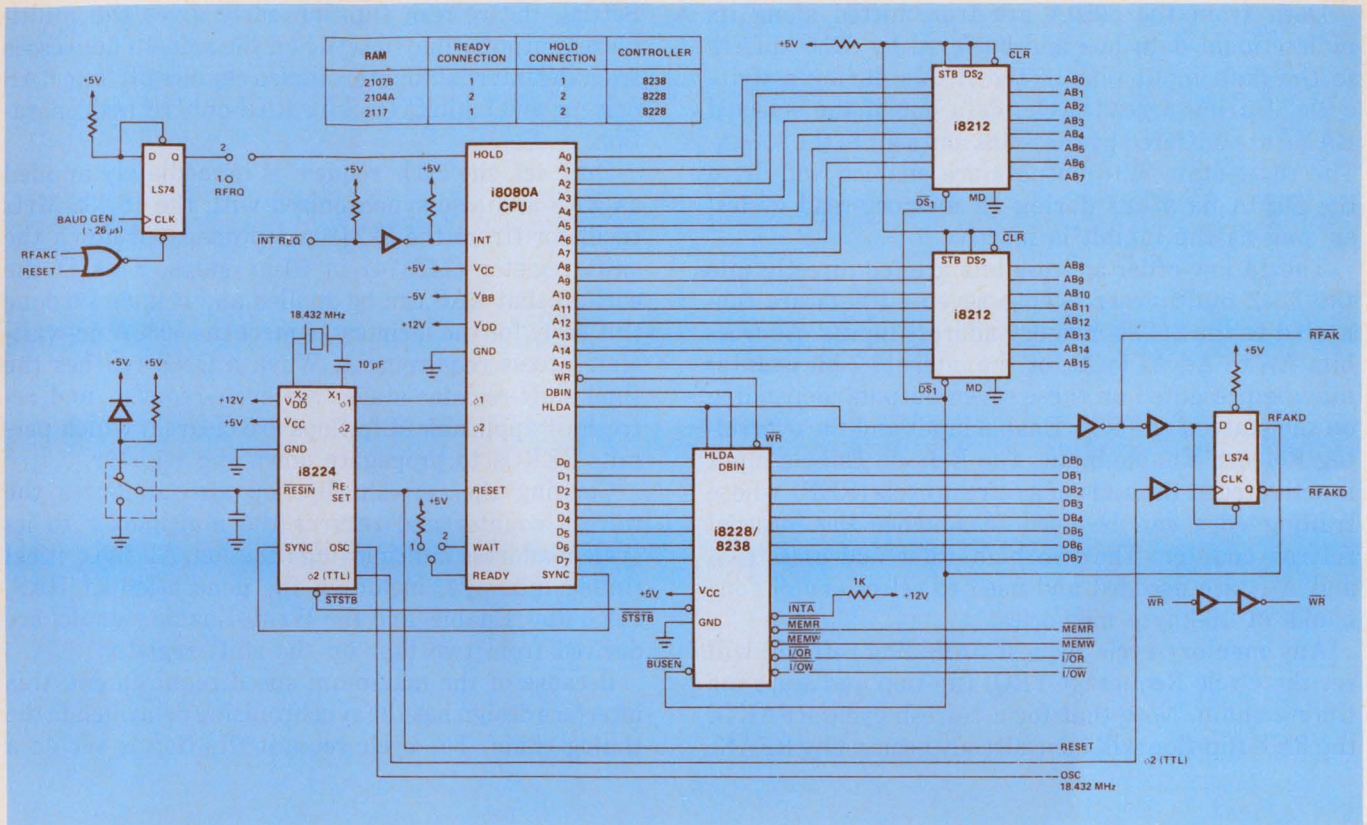

6. To design a dedicated memory controller, you must assume a certain processor configuration. This 8080A-

not be provided while the 8080A is in the Wait state; that is, READY is false. This should be no problem unless READY is being used to single-step the processor.

Finally, refresh will not be provided while in the interrogation mode if you're using the Intel 8080A in-circuit emulator on a system under development. While in that mode, the user system is virtually without a processor, so it obviously will not respond to requests.

With the scheduler design completed all that remains is to provide a source of refresh requests and an interface to the dynamic RAM or RAMs.

Take advantage of 16-k dynamics

With the 16-kbit dynamic RAMs in 16-pin packages, you can build a 64-kbyte memory array on a printed-circuit board area of 16 square inches.

The use of the 16-pin package is made possible by multiplexing the 14 address bits onto seven address input pins. The two 7-bit address words are latched into the RAM by two TTL clocks—Row-Address Strobe (RAS) and Column-Address Strobe (CAS). No chip select is included on the 16-k RAMs; however, the output is brought to a high-impedance state by the positive transition of CAS.

Refreshing can be accomplished every 2 ms by either of the following methods:

1. RAS-only cycles on 128 addresses A₀ to A₆.
2. Normal read or write cycles on 128 addresses,

based CPU structure provides all the signals needed by a dynamic-RAM system.

A₀ to A₆. Remember, when using a write cycle for refresh, 127 cells are refreshed, but the selected cell will contain the data written based on the state of the data input pin.

A 64-kbyte RAM's synchronous-controller-refresh memory system can be built using 2117s, a 3242 controller (Fig. 7), and the 8080A processor group (using the 8228 bus controller). An output ($\leq 15 \mu\text{s}$ period) from a baud-rate generation chain is used to set the refresh request (RFRQ) flip-flop. This RFRQ is applied to the 8080A's HOLD input, while HLDA is used as refresh acknowledge (RFAK).

This design emphasizes maximum performance, in spite of the consequent cost increase. All 64 kbytes are available to an 8080A system (488-ns clock) without any wait states. The primary cost penalty is the need for high-speed RAMs.

System interface is simple

In the system, accurate timing is generated via a shift-register technique. The register is built from 74LS174 D flip-flops. Since the 2117 dynamic RAM doesn't have a chip-select pin, the devices are selected by decoding some of the addresses to generate separate RAS inputs for each row of the memory array, while all devices receive common CAS. A device receiving CAS but no RAS performs no memory operations. Its output remains in the high-impedance state. Only the group of devices receiving both RAS and CAS are enabled to perform memory operations.

Data from the 8080A are transmitted along its bidirectional data bus and buffered by 8216 buffers to the data input pins of the RAMs during a write cycle. During a read cycle, data out of the selected RAMs are buffered by the 8216s and sent to the 8080A. The three-state 8216 outputs are enabled and drive the 8080A data bus during all memory-read cycles, as long as the inhibit is inactive.

The 14 low-order address bits are fed directly into the 3242 multiplexer, whose seven outputs are connected to the 2117's memory-address inputs. Address bits A₁₃ to A₇, A₆ to A₀, or the internal 7-bit counter may be presented on these seven outputs, depending on the state of the Row Enable input and the overriding Refresh Enable input. The Refresh Enable input is activated at the start of a refresh cycle (REF), whose trailing edge can be used to advance the internal refresh counter. The two high-order addresses (A₁₄ and A₁₅) are decoded and used to select one of four banks of 16-kbyte memories.

Any memory-cycle request (including refresh) will set the Cycle Request (CYRQ) flip-flop and start the timing chain. Note that for a refresh cycle RFAKD, the REF flip-flop will have already been set by RFAK.

Setting the refresh flip-flop early gives the multiplexer outputs time to settle on the refresh addresses from the internal counter. It also enables all four RAS drivers, and inhibits CAS for RAS-only refresh operation.

Once set, the cycle request is immediately applied as RAS and also synchronized with the 18.432-MHz oscillator (from the 8224) and propagated down the shift register (74S174) in 54-ns steps. This is the earliest that RAS can be applied and it must be done this early for the memory to meet the 8080A no-wait-state access requirement. When a ONE reaches the final shift-register stage, the cycle-request, and refresh (if applicable) flip-flops are cleared, which permits ZEROs to propagate down the register.

Clearing the refresh flip-flop also advances the refresh counter and returns the multiplexer to its system-address multiplexing function. All the critical timing intervals, including the generation of RAS, CAS, Row Enable, and the Write-Enable signals, are derived from two taps on the shift register.

Because of the maximum speed requirement, this interface design has the synchronizing delay inside the timing chain. The cycle-request flip-flop is set on a

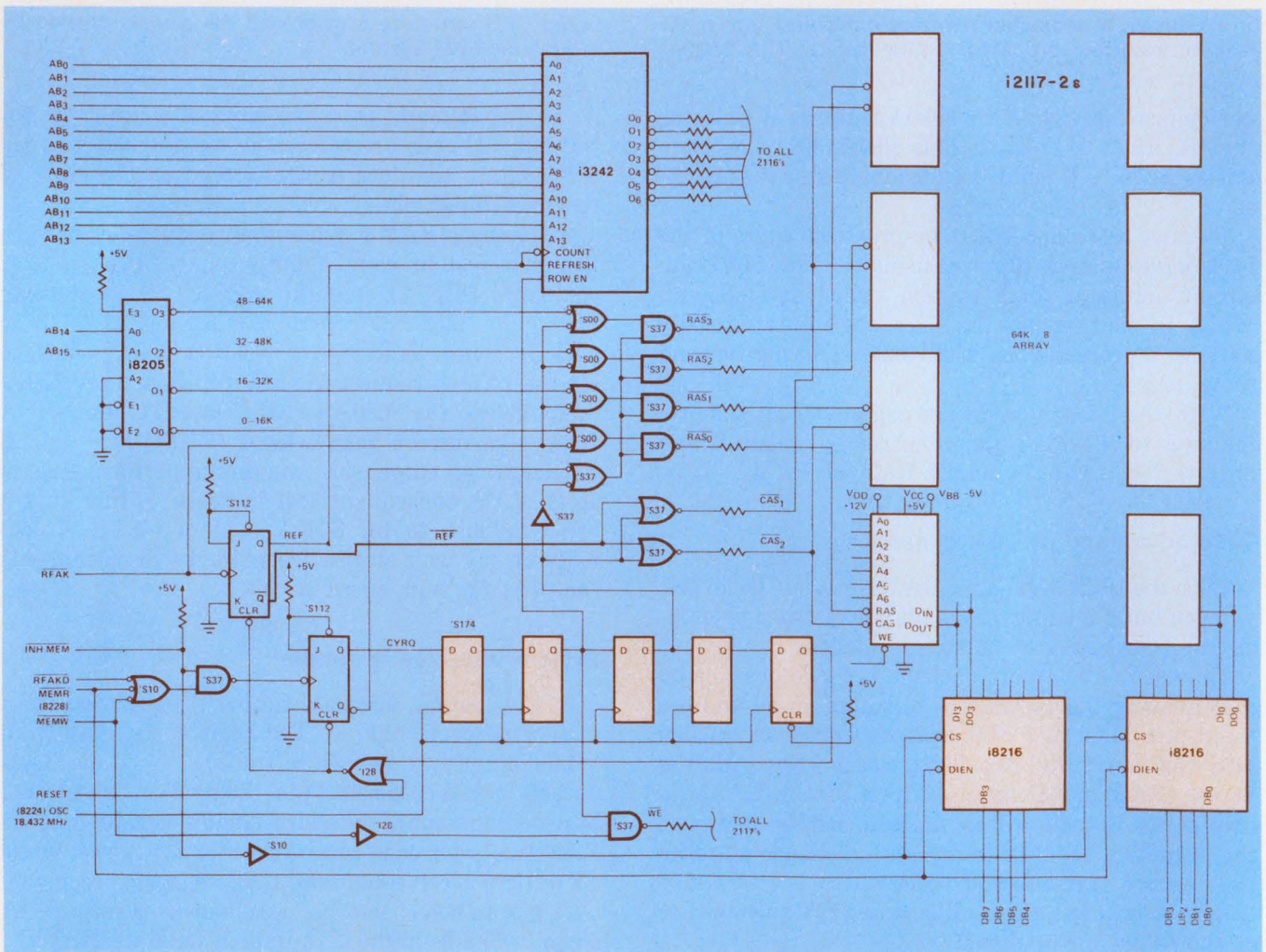

7. A 64-kbyte dynamic memory system, built using 16-k RAMs, requires less than a dozen ICs in addition to the

memory chips and the 8080A-based processor array described in Fig. 6.

valid cycle request, which immediately applies the row-address strobe (RAS).

One advantage is that the memory access may start as soon as possible, rather than after a synchronizing delay. The disadvantage is that now the time ambiguity is a part of the RAS pulse. This is inconvenient but not insurmountable. Just ensure that all memory set-up and hold times will be met for either extreme of the ambiguous synchronizing interval. Keep the ambiguity in mind when you calculate the worst-case system access time.

Too much memory? Try overlapping

By now you will have realized that a processor system with 64 k of dynamic RAM as its only memory is virtually useless. Two techniques will help circumvent this problem. Both involve overlapping a ROM or PROM into the memory-address space and require an inhibit feature on the dynamic RAM system.

Because semiconductor memories are available in discrete sizes, you may have to have two memories overlap in address space. For instance, if you have a system with 4 kbytes of ROM in addresses 0 to 4095 and 60 kbytes of RAM in addresses 4096 to 65,353, you can implement the system very economically with 16-k RAMs. But then this 64-kbyte RAM would also occupy the first 4 kbytes where you would like to place the ROM.

Mapping the ROM into the first 4 kbytes would essentially discard the first 4 k of RAM by preventing the RAM from ever functioning while in that address range. You can do that with an address-decoding network and memory-inhibit (INH MEM) line as shown in Fig. 8a.

Another thing you might want to do is put the ROM in the address space and inhibit the overlapped RAM only at system start-up. Then, once the system reaches steady state, the bootstrap program can perform an output, which inhibits the bootstrap ROM and enables the overlapped RAM. Thus, the overlapped RAM is not discarded forever; it is simply switched out while the ROM is being used to bootstrap the system and possibly load new programs into the remaining RAM. This allows an easy start-up while retaining the flexibility to later exchange the ROM for RAM. Such a system could be implemented with an address-decoding network, an output port and RAM memory-inhibit line (Fig. 8b).

A slight modification of such a bootstrap technique inhibits the RAM only during start-up for Read cycles. The read inhibit (INH RD) in the RAM module simply keeps the data-bus drivers in their high-impedance state (Fig. 8c). Then, all Reads in that address range will be from ROM, but all Writes will be to both. In effect, the Writes are directed only to RAM since a Write to a ROM is a no-op. As a result, a bootstrap ROM can load a program into RAM—even in locations currently occupied by the bootstrap ROM itself.

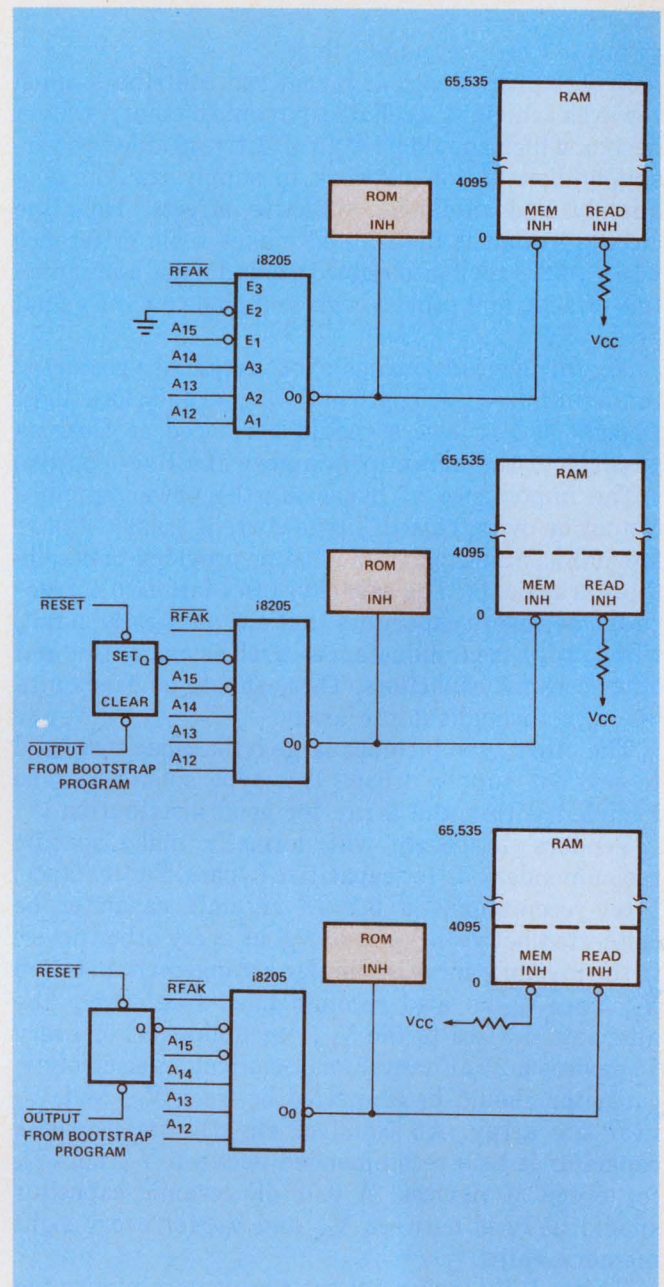

8. Memory can be overlapped by any of three methods: permanently disabling specific RAM locations (a); inhibiting the RAM only during start-up (b); or inhibiting only RAM read operations during start-up (c).

In fact, a bootstrap ROM can even copy itself into corresponding RAM locations. Of course, after steady state has been achieved, the ROM may be completely disabled, which would allow both Reads and Writes from the RAM.

Watch out for circuit bugs

A dynamic RAM is a highly complex analog and digital system. It contains differential sensing amplifiers that must detect decivolt signals buried in noise and must operate in tens of nanoseconds. When the device is deselected (RAS and CAS High), the power dissipation is minimal. However, when the memory receives a RAS signal a high current transient is

generated on the supply lines.

Proper printed-circuit layout can contribute much towards achieving a reliable dynamic memory system design, which should have an effective gridded power-supply-distribution network to supply current adequately and minimize inductive effects. How the circuit ground is distributed makes a big difference when you're trying to reduce ground noise and inductive offsets, and provide a ground plane for the signal lines.

Another concern during layout is to find a geometry that minimizes the length of the signal and clock lines. Drivers and receivers should be placed as close as possible to the array to minimize the line lengths.

The importance of bypassing the power supplies cannot be overstressed. Large current transients are inevitable, and capacitors must be provided to handle these transients. The capacitors fall into two categories. One covers capacitors that are physically small, with low inherent inductance—such as monolithic and other ceramic capacitors. These should be used quite liberally throughout the array.

The other type includes large-bulk capacitors used to prevent supply droop. This type should also be included within the array for good distribution.

Vendors' literature will normally make specific recommendations for capacitive bypass. For instance, Intel recommends a 0.1 μF ceramic capacitor be connected between V_{DD} and V_{SS} at every other device in the memory array. A similar arrangement between V_{BB} and V_{SS} is also recommended (preferably the alternate devices to the V_{DD} decouplings). For every 16 devices a 25 μF tantalum or equivalent electrolytic capacitor should be connected between V_{DD} and V_{SS} near the array. An equal or slightly smaller bulk capacitor is also recommended between V_{BB} and V_{SS} for every 32 devices. A 0.01 μF ceramic capacitor should be used between V_{CC} and V_{SS} for every eight memory chips.

By carefully laying out the circuit to minimize the length of the signal path, you can reduce the detrimental effects due to the transmission-line properties of a printed-circuit line. Most clock drivers, for instance, include clamps that help minimize over and undershoot. Another frequently used and recommended technique is to put a series resistor in the line to help match impedances and damp out reflections.

The optimum value of the series resistor depends very much on layout and driver and receiver characteristics, and is normally determined empirically. A value of 20 to 30 Ω is a fairly good starting value. When using a series resistor, you must also ensure that the voltage drop across it does not severely degrade the logic level noise margins.

Crosstalk is usually not a severe problem, but you must allow for it during layout. Avoid the temptation of running two or more signals very close together for long distances.

If your system design uses asynchronous refresh,

Asynchronism and bistable hang-up

Though most activities of a computing system are synchronous, occasionally asynchronous events must be introduced. Handle this introduction with great care. Bistable devices are normally designed with an input set-up and hold-time requirement with respect to the "clock" input (see Fig. A). This timing requirement ensures that the bistable won't be forced into its astable state. Thus, knowing the normal delay paths, you may specify the delay time required to change state. This delay time, however, is only valid so long as the required set-up and hold times are honored.

Whenever the data input occurs asynchronously to the clock input, it's possible the set-up time will be violated. If this happens, the bistable may "hang" in its astable state for an indeterminate amount of time and extend the specified delay. This hang-up, under forced conditions, has been observed to last as long as 20 ns with a 74S74 flip-flop (Fig. B). Furthermore, during this hang-up time, the outputs are undefined. Depending on the circuit design, they may do nothing, exhibit a slow transition, or even oscillate (Fig. C).

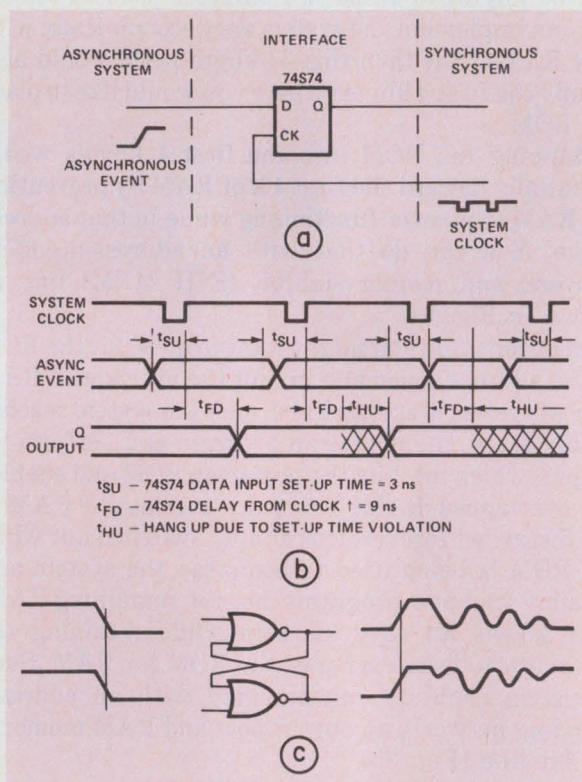

be very careful with the refresh arbiter. It's quite tricky to design, and can arbitrate between asynchronous requests very rapidly (see box above). Most circuit-design problems in asynchronous-refresh memory systems are found to be linked with refresh interference—an extremely annoying problem because it occurs infrequently and unexpectedly. ■■

Why you should use switching regulators. And why you should use ours.

Why switching regulators?

To save power. To reduce part count. To improve efficiency. To increase design flexibility.

A switching regulator can be used for step-up, step-down or inverting switching regulators

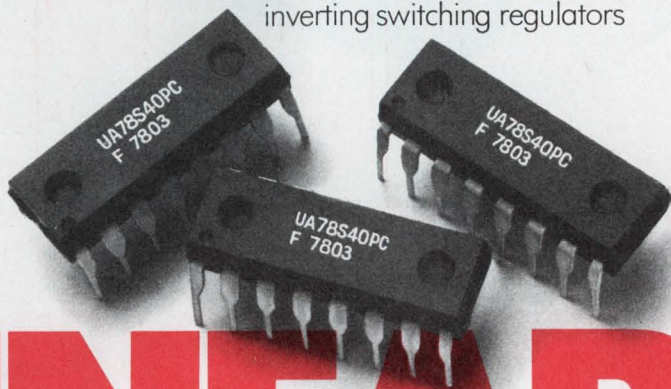

It also happens to be made by the world's leading manufacturer of regulators.

| FAIRCHILD μA78S40 SWITCHING REGULATOR | |
|--|-------------|
| Input Voltage Range | 2.5 to 40 V |
| Power Switching Current | 1.5 A Max |
| Supply Current | 2.5 mA Max |
| Typical Efficiency | 75% |
| Adjustable Output Voltage | 1.3 to 40 V |
| Switching Saturation | .7 V @ 1 A |
| Reference Voltage | 1.2 V |
| 100-Piece Price | \$2.10 |

LINEAR

as well as series pass or DC-DC conversion. It is especially efficient in battery operated systems which require low input voltage and low supply current.

Why Fairchild's switching regulator?

Our new μA78S40 is simply the very best switching regulator on the market.

It has the widest input voltage range (2.5 to 40 V).

It has the highest output current capability (1.5 A switching current).

It has extremely low supply current (2.5 mA max).

It's the only one with an independent on-chip op amp.

It has the kind of prices that make switching to switching regulators a smart move.

Which applications benefit the most?

We'd like to send you an application note that demonstrates the incredible versatility of switching regulators. Specifically the μA78S40. Contact your Fairchild sales office, distributor or representative today. If you have a question that can be answered on the telephone, please use the direct line at the bottom of this ad. Linear Products Division, Fairchild Camera and Instrument Corporation, 464 Ellis Street, Mountain View, California 94042. Telephone: (415) 962-4903. TWX: 910-379-6435.

FAIRCHILD

**Call us on it.
(415) 962-4903**

THE FIRST

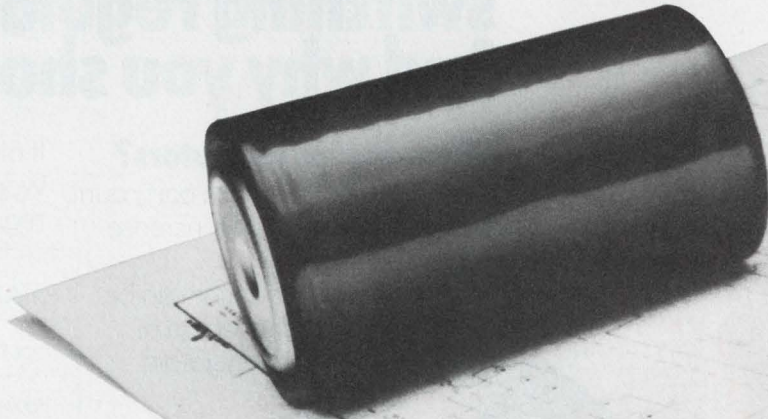

Now, all you need
is a battery and an idea.

ALL THE ADVANTAGES OF CMOS TECHNOLOGY IN A UV ERASABLE PROM.

- 10 mW Total Operating Power at 1 MHz
- Single +5V power supply
- Supply voltages
 V_{DD} : 4 to 11V
- Operating temperature range:
-40°C to +85°C

PROTOTYPE YOUR SYSTEM IN CMOS.

If you're prototyping a digital system requiring fast programming turnaround, low power and a wide operating temperature range, the ultra low power UV erasable IM6603/4's are designed to fit your application. IM6603: 1024 x 4. IM6604: 512 x 8.

CMOS MEANS LOW POWER.

Whether you're prototyping a system or building production systems, CMOS means energy savings, increased reliability, and lower system cost.

You not only reduce the cost of the power supply system but the associated development costs.

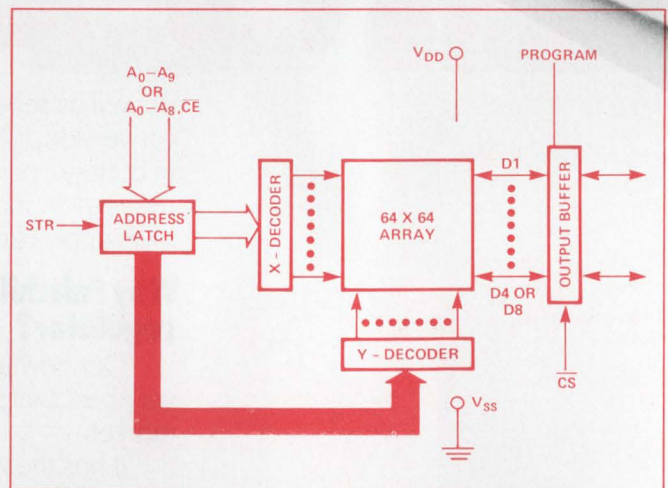

SINGLE +5V POWER SUPPLY.

In addition to low power advantages of CMOS, Intersil's leading technology produces the industry's only CMOS EPROM that can operate from a single +5V power supply. This combination of low power and a single +5V power supply allows the design of EPROM based systems that offer maximum flexibility in a multitude of applications.

MULTI-PURPOSE APPLICATIONS.

The IM6603/4's low power, low system cost,

CMOS EPROM

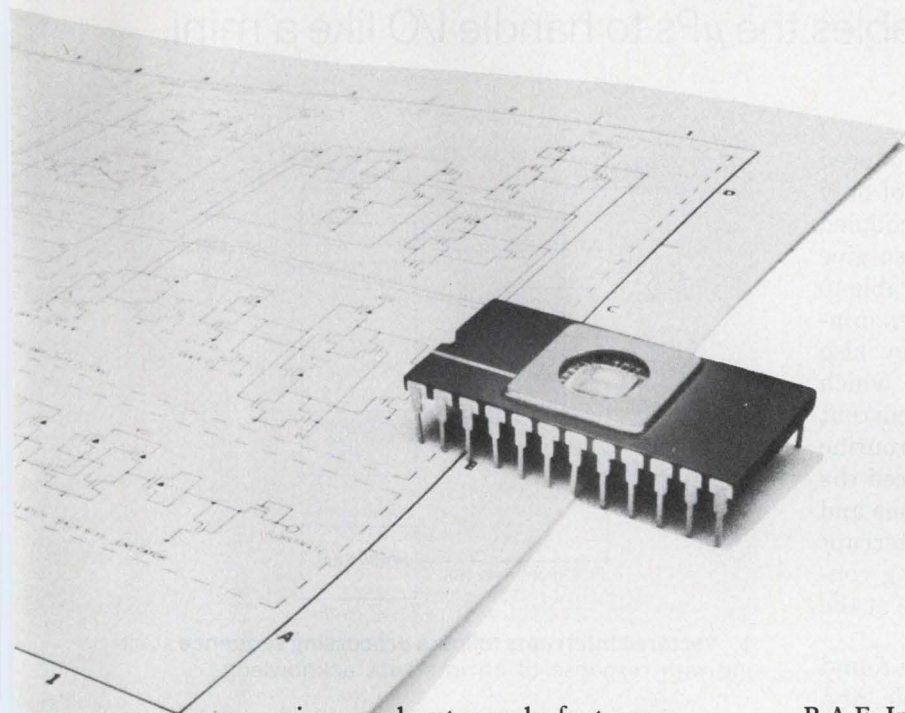

easy programming, and extremely fast reprogrammability make it ideal for all kinds of portable applications: portable data acquisition terminals, medical instrumentation, military computers, telemetry instrumentation, and, any other applications requiring low power consumption, portability, and flexibility.

DELIVERY NOW.

Intersil's UV erasable CMOS PROM's are available now.

DESIGNERS, IF YOU HAVE AN IDEA AND A BATTERY, CALL US.

Your Intersil Sales office or Stocking Intersil Distributor is listed below. They'll be happy to make the IM6603/4 available in prototyping or production run quantities. If you'd like to receive the IM6603/4 Application Notes and Data Sheet, fill in the coupon below.

INTERASIL FRANCHISED DISTRIBUTORS:

Advent/Indiana • Alliance Electronics • Arrow Electronics
CESCO • Century Electronics • Component Specialties
Components Plus • Diplomat/IPC • Diplomat/Southland
Elmar Electronics • Harvey/Binghamton • Intermark Electronics
Kierulff Electronics • LCOMP • Liberty Electronics

CIRCLE NUMBER 46

R.A.E. Ind. Elect. Ltd. • RESCO • Schweber Electronics
Sheridan • Zentronics

INTERASIL SALES OFFICES:

CALIFORNIA: Sunnyvale (408) 744-0618, Carson (213) 532-3544 • COLORADO: Denver (303) 750-7004
FLORIDA: Fort Lauderdale (305) 772-4122 • ILLINOIS: Hinsdale (312) 986-5303 • MASSACHUSETTS: Lexington (617) 861-6220 • MINNESOTA: Minneapolis (612) 925-1844
NEW JERSEY: Englewood Cliffs (201) 567-5585 • OHIO: Dayton (513) 866-7328 • TEXAS: Dallas (214) 387-0539
CANADA: Brampton, Ontario (416) 457-1014

INTERASIL

Digital Products—Memory
10710 North Tantau Avenue
Cupertino, CA 95014
For literature: (408) 996-5403
TWX: 910-338-0171
(800) 538-7930 (outside California)

I have an idea for the industry's first CMOS EPROM.

- Send me your literature on the IM6603/4. Send me your new 20 x 24 Shakespeare poster.

Name _____

Company _____

Address _____

City _____ State _____ Zip _____

Improved microprocessor interrupt capability gives you easy and efficient access to peripherals, and, with proper instructions, enables the μ Ps to handle I/O like a mini.

Interrupt systems designed into recently introduced microprocessors like the Z80, 8085 and 9900 not only give peripherals easy and efficient access, but, coupled with an enhanced set of I/O instructions, also give the processors I/O-handling capability comparable to that of a minicomputer. These interrupt modes minimize response time (interrupt latency). They also reduce overhead time spent in recognizing which device is requesting service, in saving the current status of the CPU, in getting to the service routine for the interrupting device and—having serviced the device—in restoring the pre-interrupt conditions and returning to the interrupted program. The interrupt structures also establish protocol for resolving conflicts when two or more devices request service at the same time.

Two major types of interrupt modes can be found in the newer microprocessors: the nonmaskable, and the maskable. The maskable types fall into three subgroups: instruction jamming, automatic restart and vector.

The nonmaskable interrupt is useful in microcomputer systems because it allows absolute external control of CPU operations. In addition, it cannot be disabled under program control and will be honored once the current instruction is completed (unless a bus request is pending in a Z80 system).

A nonmaskable interrupt, called the "trap" interrupt in an 8085, causes a restart to be executed internally to an 8085's location 24H, and in a Z80 CPU, to location 66H. In a 9900 system, the level 0 vectored interrupt (power restored) is nonmaskable.

Nonmaskable interrupts are fast

All nonmaskable interrupts have priority over any maskable interrupt and are normally dedicated to functions that require a rapid response, such as a power failure.

A maskable interrupt can be selectively enabled or disabled by the programmer. In a Z80 or 8085 system, the enable interrupt (EI) instruction will allow any

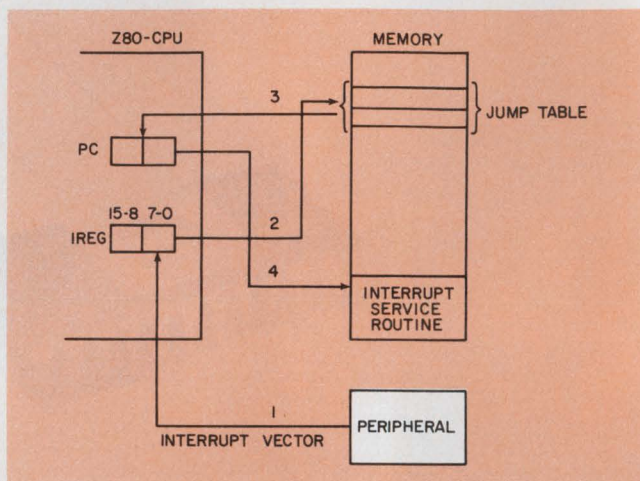

1. Vectored interrupts follow a processing sequence starting with response to an interrupt acknowledge.

maskable interrupt to be recognized. The disable interrupt (DI) instruction in Z80 and 8085 systems won't. In a 9900 system, each of 15 vectored interrupts can be individually masked by programming four bits in the status register.

In an instruction-jamming mode, a maskable interrupt, the interrupting device places an instruction on the data bus for execution by the CPU. This instruction in Z80 and 8085 systems is normally a restart (RST), since this is an efficient one-byte call to any one of eight subroutines located in the first 64 bytes of memory (each subroutine is eight bytes long). However, any instruction may be given to the CPU. The first byte of a multibyte instruction is read during the interrupt-acknowledge cycle. Subsequent bytes are read into Z80 systems by a normal memory-read sequence. An 8085 issues additional interrupt-acknowledge cycles. A 9900 doesn't support instruction jamming.

Automatic restart, another maskable interrupt, gives a microprocessor interrupt access to minimally complex peripherals such as printers or process controllers. The mode is similar to the nonmaskable interrupt in Z80A and 8085 systems except that the call location is 38H for the Z80A CPU. For an 8085 CPU, three prioritized interrupts cause an automatic restart to locations 2CH for RST 5.5 (highest priority), 34H for RST 6.5 and 3AH for RST 7.5 (lowest priority).

A set interrupt mask (SIM) instruction selectively enables any of the three restart interrupts. These interrupts then have a higher priority than the jammed instruction interrupt.

A vectored-interrupt mode, yet another maskable interrupt, allows a peripheral device, or logic outside of a peripheral device, to identify the starting location of the interrupt service routine. An 8085 uses the 8259 programmable interrupt controller to prioritize eight levels of interrupts and present the address vector to the CPU. A 9900 supports up to 15 peripherals and

uses a 4-bit input from a TIM 9907 priority encoder to vector to a table of 16 addresses in lower memory.

A Z80 accomplishes the same tasks but requires no external logic since it allows an indirect call to any memory location by a single 7-bit vector supplied from the peripheral device itself. As a result, the Z80 can accommodate up to 128 I/O devices.

In general, the peripheral generating a vectored interrupt places the vector on the data bus in response to an interrupt acknowledge. This vector then becomes the least significant eight bits of the indirect pointer, while the I register in the CPU provides the most significant eight bits. The complete address, in turn, points to an address in a vector table that contains the starting address of the interrupt routine.

Interrupt processing starts at an arbitrary 16-bit address to allow any location in memory to be the beginning of the service routine. Fig. 1 shows the sequence of events for processing vectored interrupts.

Interrupts have a pecking order

The acceptance and service of any interrupt depends on the CPU status at the time of the interrupts and the occurrence of the interrupt within an instruction cycle. Fig. 2 details the standard interrupt processing sequence for the Z80 microprocessor in a flow diagram. The order of priority for processing these interrupts is bus request, nonmaskable interrupt (NMI) and maskable interrupt (INT).

A bus request is used to request the CPU to change address, data and control lines to a high impedance state, usually in response to a pending direct-memory-access (DMA) transfer. This line, BUSRQ, will be sampled (internal CPU bus-request flip-flop set) if active—low—and granted priority at the end of each machine cycle. If the last machine cycle is also the end of the instruction, the CPU will recognize an interrupt, either nonmaskable or maskable, by setting appropriate internal flip-flops, but will then service a pending bus request.

When a bus request is completed, the CPU checks the status of the NMI flip-flop. If set, the CPU executes the NMI interrupt routine as indicated in Fig. 3. If the NMI flip-flop is not set, the CPU checks the status of the maskable interrupt flip-flop (INT F/F), which, if set, causes the CPU to execute any one of the three interrupt modes as indicated in Fig. 4. If the INT F/F is reset, the CPU returns to main-line program processing.

In a 9900 system, the CPU continuously compares the 4-bit interrupt code from the priority chip with the interrupt mask contained in the status register. When the level of the pending interrupt is higher than or equal to the current interrupt status, the processor recognizes the interrupt when the current instruction is completed. Each level is uniquely associated with a two-word location in memory (trap address) that directs the CPU to the start of the interrupting program.

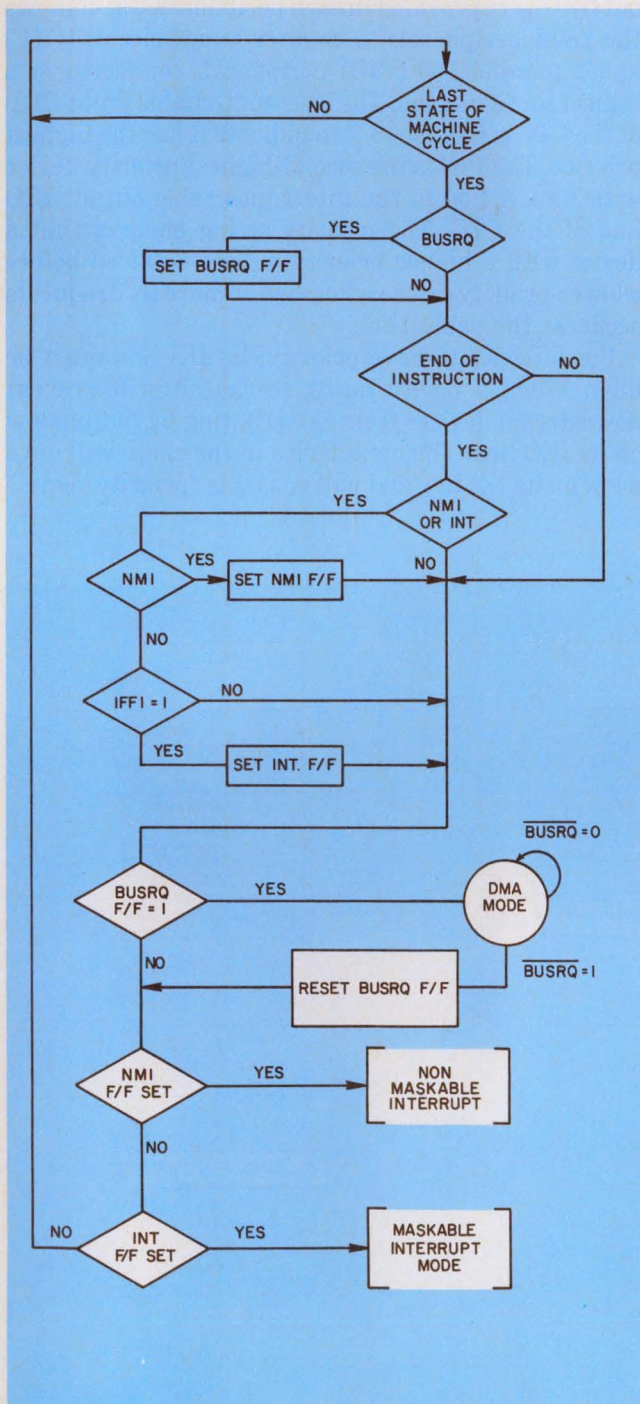

2. The standard interrupt processing sequence for a Z80 μ P is detailed here. The order of priority is bus request, nonmaskable interrupt and maskable interrupt.

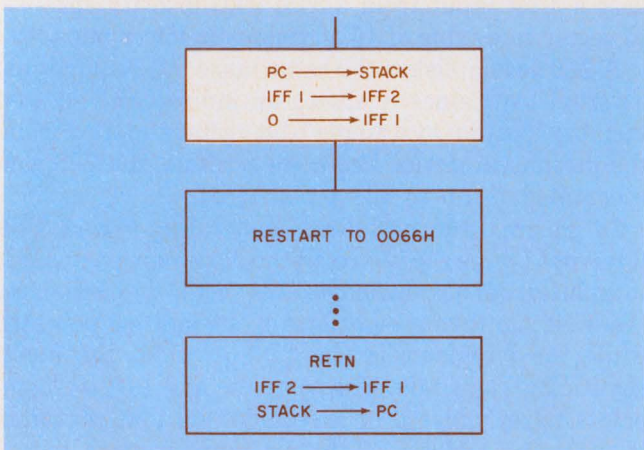

3. The Z80's NMI sequence is followed if, after a bus request, the CPU finds the NMI flip-flop set.

Now you know the interrupt priority structure within each microprocessor. But what happens when two or more peripheral devices demand service—at the same time?

CPU determines priority

Establishing peripheral priority can be resolved in Z80, 8085 and 9900 systems several ways. The most common is to “poll” each peripheral to find the ones needing service. For more than one interrupt at any

given time, a software program can resolve conflicts. But this is time-consuming—so much so that if there are many sources of interrupt requests, the time needed for polling can exceed the time available.

The CPU could determine priority by having a number of interrupt request lines, as in the 8085 with its three priority restart lines. But a special device, the 8529 programmable interrupt controller, can do the same job using just one 8085 pin.

In a Z80 system, priority is set by putting peripherals in a daisy-chain configuration, with each device tied to the interrupt line without additional logic. Two lines, interrupt enable in (IEI) and interrupt enable out (IEO), are provided in each peripheral. Fig. 5 shows the Z80A peripherals, a counter/timer circuit (CTC) and a parallel I/O (PIO) peripheral, connected in a typical configuration. The interrupt-enable input (IEI) of the CTC is tied to +5 V to indicate it has the highest priority. The PIO is the second-highest priority device with its IEI tied to the interrupt-enable-output IEO line of the CTC. The priority string ensures that a device with a higher priority will be serviced before a lower-priority device when two or more \overline{INT} requests occur at the same time.

For a device to have priority, its IEI line must be high. When a device needs service, it will prevent downstream devices from interrupting by pulling low on its IEO line. The next device in the chain will have a low on its IEI line and will pass this “priority signal”

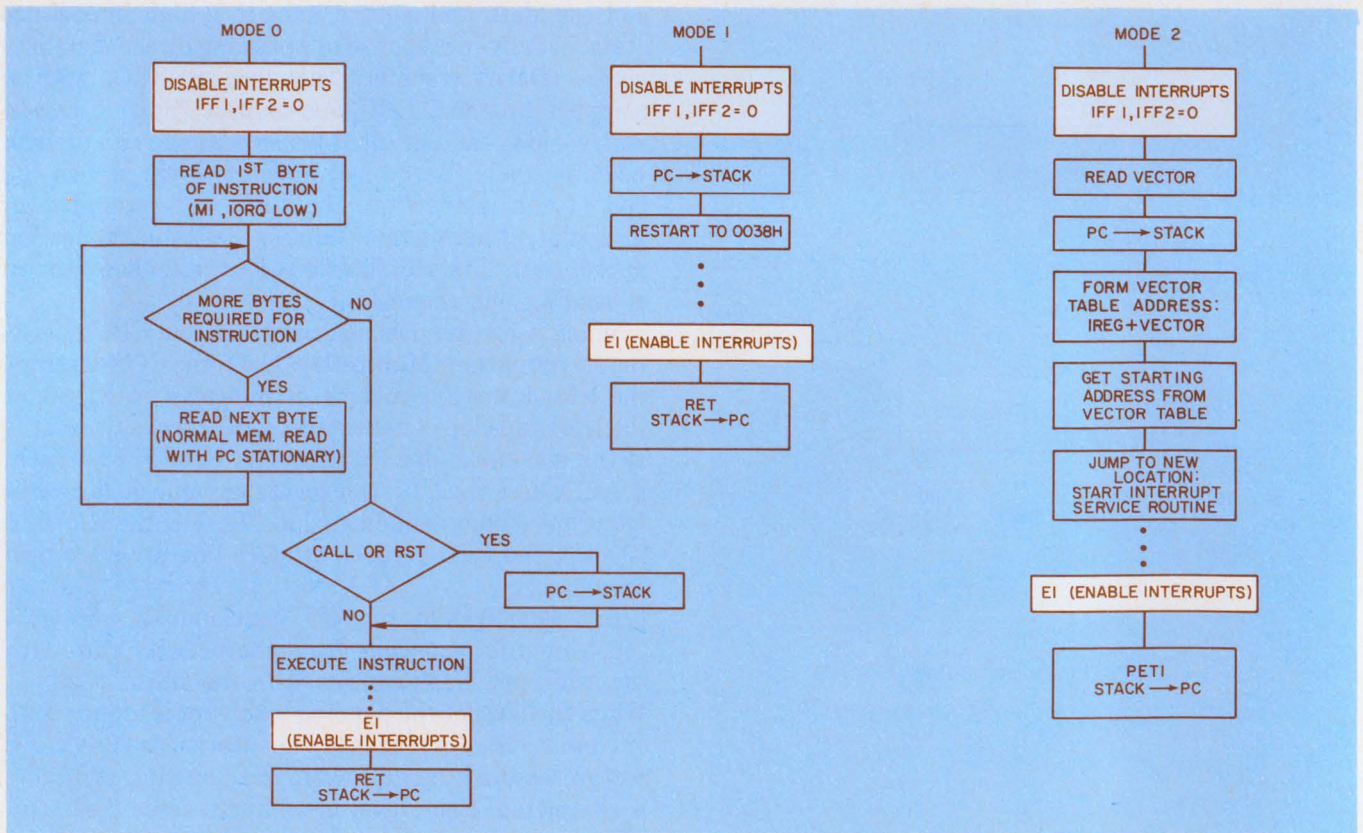

4. Any one of three interrupt modes can be executed by a Z80 after checking the status of the INT flip-flop. An

interrupt mode is executed if the flip-flop is set. If the flip-flop is reset, the CPU returns to processing.

on to the next device by pulling low on its IEO line. The IEO line, therefore, of any given peripheral will satisfy the following relationship:

$$IEO = IEI \cdot \overline{HELP}$$

where \overline{HELP} is an internal peripheral signal indicating that the device needs service.

In a 9900 system, the 4-bit interrupt mask stores the level number of any interrupt being executed and prevents interrupts from the same or lower levels from interrupting. Such a priority structure can be changed with software.

Nesting lets top priority take over

Enabling interrupts during a particular device's service routine, establishes a priority structure that allows higher-priority devices to interrupt the current service routine. This "nesting" gives a high-speed device interrupt access and temporarily suspends the interrupt service of a slower device. After this device is serviced, the slower device's service routine is returned to automatically. To see how nesting works, check the timing relationships of a typical interrupt processing routine detailed in Figs. 6a and 6b.

The PIO peripheral requests interrupt service by setting its \overline{HELP} logic and pulling the \overline{INT} and IEO lines low. Assuming interrupts have been enabled, the Z80 CPU finishes the current instruction and responds with an interrupt acknowledge ($\overline{M1}$ and \overline{IORQ} low).

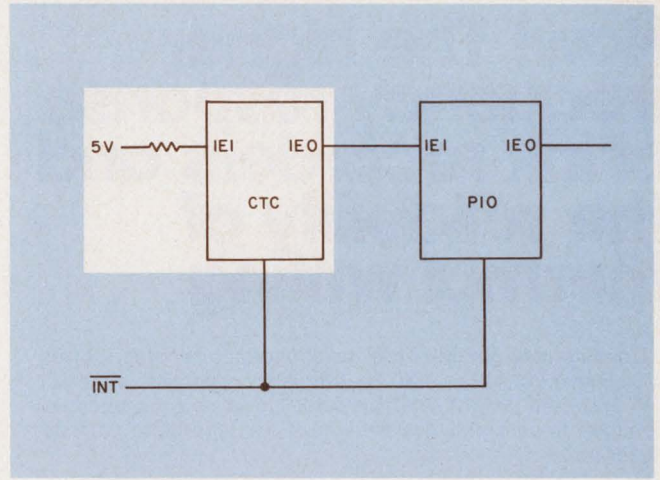

5. In this priority chain of peripherals, the counter/timer circuit gets serviced first because its IEI is tied to +5 V.

The interrupt vector is read and the contents of the program counter (PC) are stored in the external stack. Interrupts automatically disable whenever an interrupt is acknowledged and must be subsequently re-enabled (via an EI instruction) so that future higher-priority interrupts can be detected and handled.

While in the service routine for the PIO peripheral (with interrupts enabled), the CTC peripheral generates an interrupt (\overline{INT} , \overline{HELP} and IEO all go low). The IEO of the PIO now low-blocks any downstream

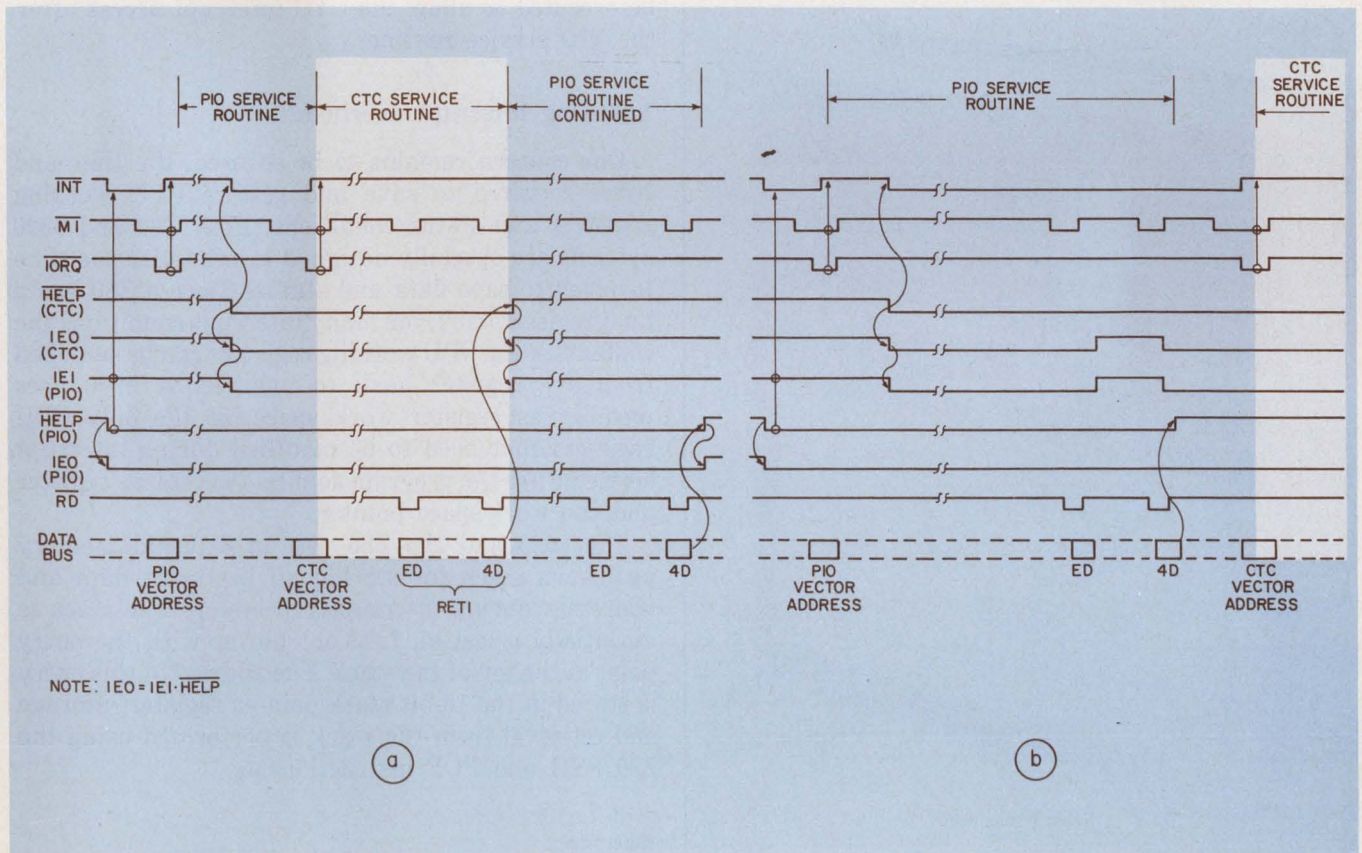

NOTE: $IEO = IEI \cdot \overline{HELP}$

6. CTC/PIO interrupt timing with interrupts enabled (a) shows nesting mechanism that establishes priorities.

When interrupts are disabled (b), the routine allows the CTC access after the PIO has been serviced.

Now! The higher frequency response of ink recorders and the reliability of thermal writing

Gulton's new generation of oscillographic recorders gives you clear crisp traces, 140 Hz frequency response, compact size and light weight. And they don't give you the puddles, smudged fingers and aggravation of ink recorders. Or their higher price.

Now all Gulton recorders have an eight speed pushbutton chart drive. Sturdy coaxial styli are standard, and nearly indestructible ceramic tip styli with two year guarantees are available. Automatic stylus heat compensation varies the stylus heat in proportion to the chart speed to maintain constant trace density.

With one Gulton recorder, and your choice of plug-in signal conditioners (30 are presently available), you can record volts, amps, temperature, strain, ac to dc, frequency to dc, EKG, watts, log to dc, current to dc, ac to log . . . and more.

Two, four, six and eight channel models are available for lab or field use, or rack mounting.

Write or call today for our fact-filled 16 page recorder catalog!

gulton[®]

Measurement & Control Systems Division
Gulton Industries Inc., East Greenwich, Rhode Island 02818
401-884-6800 • TWX 710-387-1500

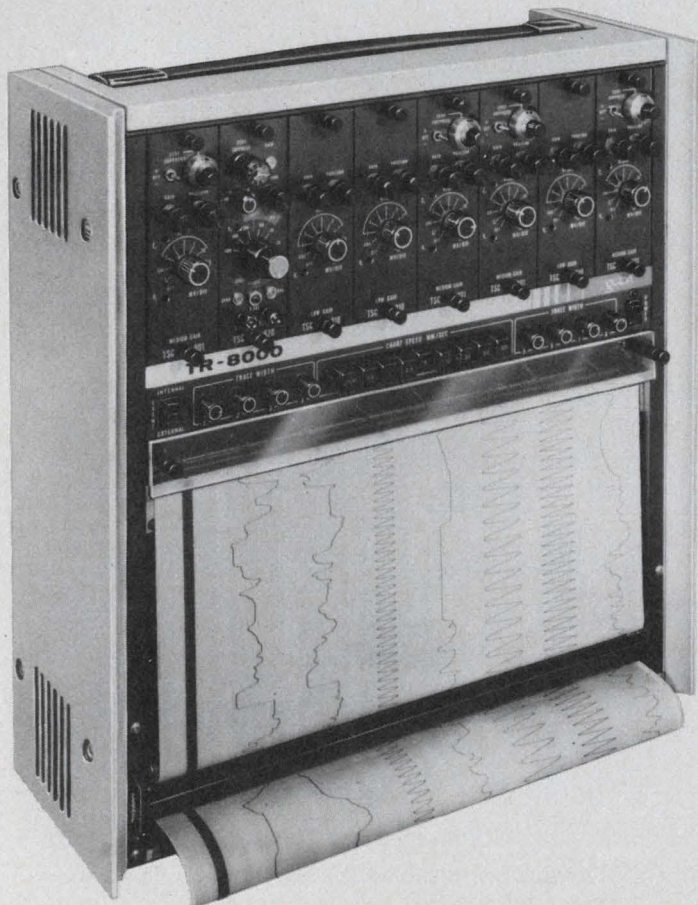

CIRCLE NUMBER 47

devices. The Z80 CPU finishes the current instruction of the PIO service routine, responds with an interrupt acknowledge and reads in the interrupt vector. The contents of the PC are stored in an external stack and interrupts are once again disabled.

Once the CTC service routine is completed, the RETI (return from interrupt ED 4D) instruction restores the contents of the PC to that of the PIO service routine and resets the CTC's HELP logic. The CTC's IEO line goes high, and the PIO's IEI, now high, indicates that the PIO can finish its service routine. Before the RETI instruction is executed, an EI instruction should be executed to enable interrupts for the remaining segment of the PIO service routine. The PIO service routine is then completed, and another RETI instruction resets the HELP logic and the IEO line. The stack is popped, which restores the program counter to the main-line program.

This sequence varies when interrupts are disabled during the PIO service routine. Then, if the CTC needs service (HELP logic low with PIO low), the INT line pulls low; but the CPU doesn't respond. However, when a RETI is issued for the PIO routine, the CTC's HELP logic must not be reset. Therefore, the CTC allows its IEO line to go high for one M1 cycle during the RETI instruction (see Fig. 6b). In other words, if an interrupt acknowledge is not given to a device requesting service, its IEO line will be forced high for one M1 cycle after decoding the first byte of RETI (ED) to allow downstream devices to decode RETI. Again, prior to the RETI, an EI instruction should be executed to allow the CTC interrupt access after the PIO service routine.

Lowering interrupt overhead

One concern remains to be covered: the time and bytes required to save and restore CPU working registers and status conditions. Both Z80 and 9900 systems are specially designed to minimize the time involved to save data and status. Since a Z80 has a dual-register bank, for many interrupt conditions the contents of the CPU working registers can be switched from one register bank to another. A 9900 uses memory as register work space, so the only CPU registers that need to be modified during interrupt servicing are the program counter, the status register and the work-space pointer.

The 8085 and the Z80 use an external memory pushdown stack for storing all pertinent data and addresses during interrupt processing. The stack is essentially a last-in, first-out buffer with the entry point at the top of the stack. The address of this entry is stored in the 16-bit stack pointer register. Storage and retrieval from the stack is performed using the Z80 PSH and POP instructions.■

Reference

1. Ungermann, R., and Peuto, B., "Get Powerful Microprocessor Performance by Using the Z80," *Electronic Design*, July 5, 1977, pp. 54-63.

Smart buy.

The world's best 5½ digit DMM
got on the bus to save you more.

The Dana 5900 has been the most accurate, most reliable 5½ digit multi-meter on the market for over four years. It still is. Now we've added an IEEE-STD-488 GPIB option, which gives you microprocessor control for less than any comparable system.

The 5900 costs less to buy. You don't need continuous GPIB interface for every DMM in your laboratory. The GPIB microprocessor interface is a separate module that piggybacks on any 5900. You only pay for what you need.

The 5900 costs less to own. It's so simple to use it doesn't require highly skilled technicians. Its specifications are guaranteed for one full year. This means an annual savings of about \$150 in calibration costs and four weeks of downtime over competitive instruments.

The 5900 gives you more. It takes 120 readings a second. It's so accurate (0.001% of scale) it can compensate for possible errors in the rest of your system. And it's now available with optional AC/AC ratio.



See for yourself why the 5900 is not only a smart buy. It's the best buy.
Call or write Dana Laboratories, Inc.
18912 Von Karman Avenue, Irvine, CA 92715, 714/833-1234

DANA[®]
Others measure by us.

TEKTRONIX
thinks your logic analyzer
should be as versatile
as you are. _____



1

I need to
see logic
the way I
think logic

2

I need to
have con-
fidence in
my meas-
urements

3

I need to
identify my
problem in
one pass

4

I need to
do the en-
tire design
job—
timing
and logic

5

I need to
know my
design
works
everytime
— not just
some of
the time

So Ours Let You Change Applications . . . Without Changing Your Logic Analyzer

The logic analyzer . . . it's become *the* essential measurement tool for digital designers like you. But just a logic analyzer isn't enough. Because your logic analyzer should be as versatile as you are.

Our dictionary calls versatile "capable of turning with ease from one to another of various tasks." And versatile is exactly what you have to be in your day to day digital design work. Versatile in the tasks you perform, and versatile in your role as part of the design team.

And so you need a logic analyzer every bit as versatile as you are. One that lets you "turn with ease." From hardware to software analysis. Or from microprocessor to non-microprocessor design.

TEKTRONIX LOGIC ANALYZERS: THE VERSATILE ONES

VERSATILE CONFIGURATIONS:

Concentrate on new applications — not on learning a new logic analyzer. Modules that plug in to any Tektronix 7000

Series oscilloscope let you "build" the logic analyzer you need.

VERSATILE FEATURES:

You — not the logic analyzer — decide how you'll look at logic. Go from state tables to mapping to timing — without going to another logic analyzer. Touch a button and select binary, hex, octal, mapping, timing, GPIB, or ASCII.

You need confidence in your measurements. So you want the best possible resolution. And that means you need to sample faster than the system under test — the faster the better. So Tek Logic Analyzers let you sample asynchronously up to 100 MHz at a resolution of 15 ns.

You're looking at a lot of information in digital systems — yet you want to find your problem in one pass. Our large, formattable 4K memory can deliver up to 1024 bits per channel.

You need to see what's on — and off — the bus. Synchronous and asynchronous operation in the *same* logic analyzer lets you perform software and

hardware analysis.

Your design has to work right every time. Automatic Data Comparison will verify it for you. Or identify any fault. While you're busy elsewhere.

VERSATILE APPLICATIONS:

Tektronix Logic Analyzers stay with you. For design; debugging; and troubleshooting. For hardware and software analysis. For timing and state applications. For *whatever* job is at hand.

Versatile — so you can do today's job and tomorrow's. So you can change applications without changing your logic analyzer.

Contact Tektronix Inc., P.O. Box 500, Beaverton, OR 97077. In Europe, Tektronix Ltd., P.O. Box 36, St. Peter Port, Guernsey, Channel Islands.

Tektronix
COMMITTED TO EXCELLENCE



1
Look at logic in your language: choose binary, hex, octal, mapping, timing, GPIB, or ASCII



2
The faster your measurements, the better the resolution. Sample up to 100 MHz at 15 ns resolution



3
See all the information you need to see with our large 4K formattable memory



4
Get the whole picture: verify logic on the bus synchronously; verify timing sequences asynchronously



5
Concentrate on other work while Automatic Data Comparison verifies operation — or identifies faults

FOR TECHNICAL DATA CIRCLE #147 ON READER SERVICE CARD

FOR DEMONSTRATION CIRCLE #148 ON READER SERVICE CARD

Tailor-make your own μ P power supply.

Selecting the proper rectifier, filter and regulator takes almost all the guesswork out of the transformer hunt.

Rather than buy a linear power supply for relatively small systems like microprocessor-based equipment, design and build one yourself. By "rolling your own" supply, you can often save money and avoid delivery problems—especially for high volume. Build one yourself, and you can package the supply to fit your requirements, which can be important in a μ P-based system that needs small dedicated PC-board-mounted supplies. Moreover, by mounting a small, separate supply close to the circuitry it services, you get better isolation and noise immunity than with large centralized sources of dc power.

Once you've decided to do it yourself, think of a power supply as being organized into four major functional blocks as shown in Fig. 1:

- Transformer.
- Rectifier.
- Filter.
- Regulator.

The transformer will probably be the hardest part of the supply to select, because transformer manufacturers are only just beginning to offer "standard" power transformers for microprocessor-based equipment. These pass 5 to 50-W totals from their multiple-secondary windings.

Due to their newness, mystery still surrounds these small multiple-output transformers. Don't expect the same high level of documentation for these transformers as for the supply's other major components.

A rectifier circuit is most often one of the four types shown in Fig. 2:

- Half-wave (one diode).
- Full-wave, center-tapped (two diodes).
- Full-wave bridge (four diodes).
- Dual full-wave complementary (four diodes).

Usually, a half-wave rectifier (a) is a good choice only for low-power output (up to 1 W).

The one advantage of low component count aside, the half-wave circuit suffers from current spiking and inefficient use of the transformer core. A current spike occurs every line-frequency cycle, i.e., 60 per second.

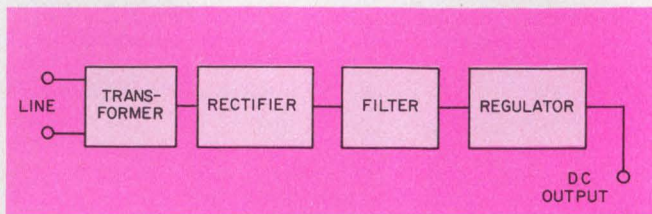

1. A linear dc power supply is composed functionally of transformer, rectifier, filter and regulator. The transformer is surely the most difficult to specify for multi-output low-power microprocessor supplies. IC regulators take the pain out of selecting this block.

These are high-current spikes, limited only by transformer impedance and diode forward resistance. So, half-wave rectifiers require high surge-current diodes. Half-wave rectification also causes high rms currents in the transformer secondary.

Furthermore, the transformer-secondary current is unidirectional. This one-way current flow biases the transformer core. So, half-wave rectification requires a large core to prevent transformer saturation.

Full wave means compromise

Choosing from the full-wave rectification schemes in Fig. 2 involves trade-offs. The bridge configuration (c) uses its transformer efficiently and needs no center tap. But bridge rectifiers do use four diodes as opposed to two for the full-wave, center-tapped circuit (b). And the two additional diodes cause a larger voltage drop. Bridge rectifiers are usually a good choice except for those low-voltage outputs where any extra voltage drop at all is intolerable.

A dual full-wave-complementary configuration (d) is a combination of the two-diode and four-diode full-wave circuits. This circuit develops opposite polarity outputs using only one secondary winding—but the winding must be center-tapped.

The filter in your supply is the easiest section to design. Don't even consider choke-input filters—they're too large, heavy and dissipative for small linear supplies. Furthermore, IC regulators make inductive filters unnecessary. They reduce ripple and hold output-voltage constant in the face of load

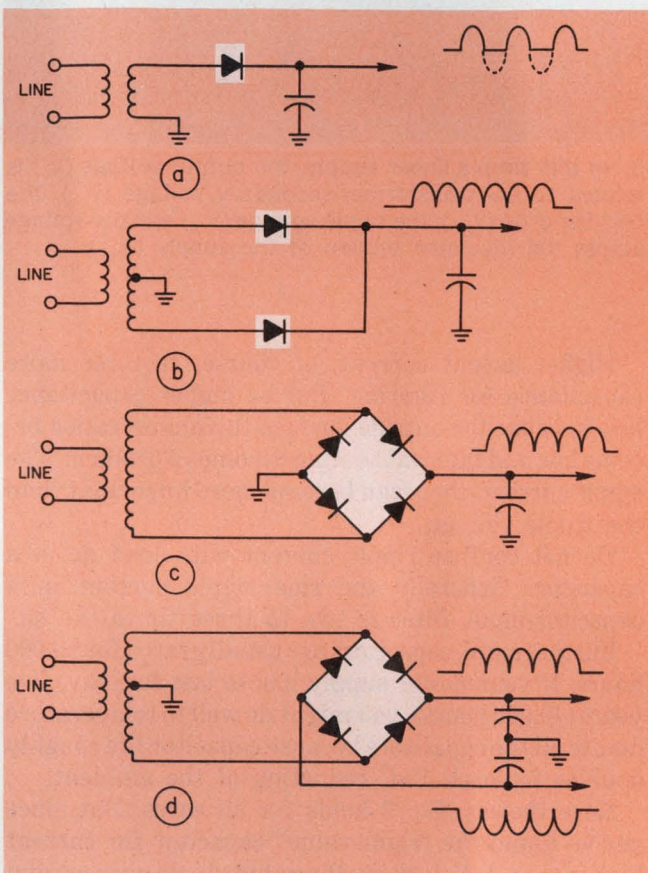

2. **Popular rectifier circuits** each have advantages. A half-wave rectifier (a) is simplest. Though the two-diode full-wave circuit (b) inefficiently uses the secondary winding only half the time, it has a low voltage drop. A bridge (c) is efficient with its transformer but develops large voltage drops. The dual full-wave complementary scheme (d) provides two opposite-polarity outputs from only one center-tapped secondary winding.

changes. So, all you need is a capacitor-input filter.

But a capacitive filter draws high-amplitude short spikes of current after each off period of the rectifiers. Therefore, *peak* current is high in the transformer secondaries. However, the *average* VA rating of the transformer is the same with either an inductive or capacitive filter because of the capacitive filter's higher output voltage. So, capacitive filters impose only one restraint on the rectifiers—their ability to

withstand high current surges.

The regulator section, once the ogre of linear power supplies, has been tamed. IC linear regulators are available from many sources. They're small, reliable, stable and inexpensive. And, unlike transformers for microprocessor supplies, IC regulators come with all the data you need.

Derive the transformer voltages

After choosing configurations for the filter and rectifier, derive the transformer's "unknowns" from its "knowns." To this end, suppose you need 5 V dc at 2 A. And say you know that the supply must operate from a 115-V nominal ac line that can go as high as 130 and as low as 95 V ac. Then, using the terms defined in Fig. 3, calculate the required transformer-secondary voltage from

$$V_{ac} = \frac{V_o + V_{reg} + V_{rec} + V_{rp}}{0.92} \times \frac{V_n}{V_{ll}} \frac{1}{\sqrt{2}} \quad (1)$$

Two of the variables in Eq. 1 aren't defined by Fig. 3. These are V_n , the nominal line voltage (115 V ac), and V_{ll} , the low extreme of the line voltage (95 V ac). The constant, 0.92, is a typical rectifier's efficiency. Values of 5 V dc for V_o , 1.25 for V_{rec} , 3 V for V_{reg} and 0.5 V (10% of V_o) for V_{rp} , when "plugged into" Eq. 1, give 9.07 V ac for the voltage across each half of the secondary winding, V_{ac} . The total potential across the secondary is then 18 V ac.

This value for the secondary voltage obviously depends on the type of rectifier circuit you use. If you replace the two-diode full-wave circuit in Fig. 3 with a four-diode-bridge circuit (Fig. 2c) you double V_{rec} —from 1.25 to 2.5 V. Then you increase the V_{ac} to make up for the increased rectifier drop. So, with a bridge rectifier, the transformer secondary must deliver approximately 10 V ac.

So far, calculating the transformer-secondary voltage for the 5-V dc output has been straightforward—even with the line as low as 95 V ac. But what happens at 130 V ac (high-line)? Also, Eq. 1 assumes that the transformer is operating under a full load. But what happens when the line goes high—to 130 V ac—and the load is very light?

Under these conditions, the transformer-secondary voltage increases by the ratio of high-to-low line (130/95). That is, for a high line,

$$V_{ac} = (130/95) \times 9 \\ = 12.3 \text{ V.}$$

The additional 3.3 V must be absorbed by the regulator IC. So, when selecting a regulator stress the high-line condition of the input.

Find the current

Now that you know the transformer-secondary voltages for both the center-tapped-two-diode and four-diode-bridge circuits, you can determine the secondary current.

Fortunately, empirically determined secondary-current values give solid designs for practical transformers—especially at the low power levels required by many microprocessor-based systems. With capacitor filters, the required secondary current (rms) is 1.2 times the dc output for the two-diode center-tapped rectifier and 1.8 times the dc for the full-wave bridge.

The complete transformer-output specification becomes 36 VA (10 V at 3.6 A) with the bridge rectifier, and 43.2 VA (18 V at 2.4 A) with the two-diode, center-tapped rectifier. These rms secondary-winding ratings can now be matched to transformer-catalog values.

But these transformer-secondary calculations take care of only one voltage, 5 V, that a typical microprocessor power supply might be required to deliver. But many microprocessors and their associated circuits also require either ± 15 V dc or ± 12 V dc at about 100 mA.

Using a two-diode center-tapped rectifier circuit with

$$V_{ac} = 15 \text{ V,} \\ V_{rec} = 1.25 \text{ V,} \\ V_{reg} = 3 \text{ V, and} \\ V_{rp} = 0.75 \text{ V (1.5 V pk-pk)}$$

gives you 18.6 V ac for the potential from one end of the secondary to the center tap. The full secondary then must provide approximately 37 V ac. The transformer-secondary current then becomes

$$1.2 \times 100 = 120 \text{ mA rms.}$$

Up to now, your transformer secondary calculations have hinged on a second assumption—the filter has enough capacitance. But you do have to check that the capacitor is large enough. Fortunately, that's simple to calculate.

For supplies whose output currents are lower than 1 A, the filter-capacitor value is determined from

$$C = (I_L / \Delta V) (6 \times 10^{-3}) \quad (2)$$

where I_L is the total dc and ΔV is the peak-to-peak ripple voltage at 120 Hz.

Plugging data-sheet information into this simple formula gives you the minimum-capacitance values. These are usually good for outputs that deliver less than 1 A. However, in most practical cases, you must use two or three times the minimum capacitance—especially as the current gets higher.

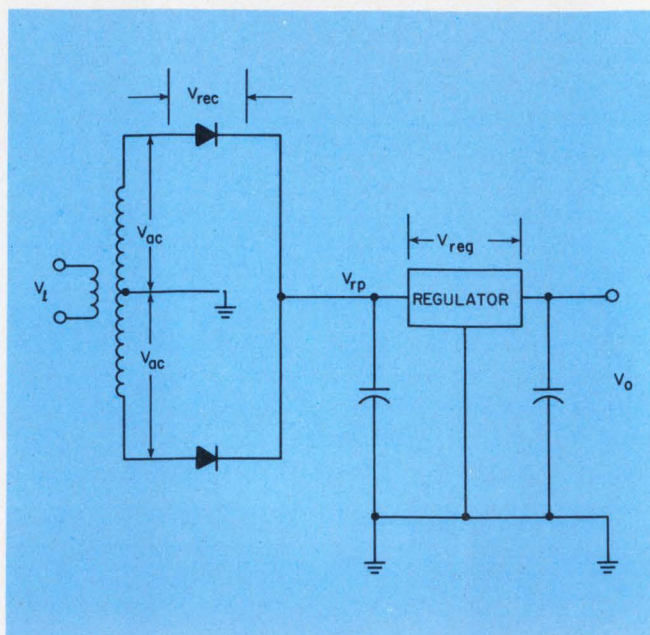

3. In this simple linear supply, the output voltage (V_o) is related to the transformer-secondary voltage (V_{ac}), the rectifier drop (V_{rec}), the ripple voltage (V_{rp}) and the voltage across the regulator section of the supply (V_{reg}).

Higher output current, of course, requires more capacitance for filtering. But at higher capacitance levels, capacitor outside surface-to-volume ratios become low and internal heating becomes a problem. The ripple current, then, can become more important than the ripple voltage.

Do not confuse ripple current with load dc in a capacitor. Generally the rms ripple current in a capacitor-input filter is two to three times the dc.

Furthermore, capacitors are usually rated for 10,000 hours. If your power supply has to last for, say, five years (40,000 hours), you might do well to temperature derate all the capacitors because capacitor life roughly doubles for each 15-C reduction of the ambient.

Nevertheless, Eq. 2 holds for all cases. But, once you've found the "right-value" capacitor for current higher than 1 A, look up the rated ripple current and select your capacitor accordingly.

For instance, consider a supply with an I_L of 3 A and a ΔV of 4 V pk-pk. Eq. 2 tells you that the capacitor should be 4500 μF minimum. Then, suppose you find, in a catalog, a 4600- μF , 20-V dc capacitor. (Your circuit requires only 12 V dc).

On the surface, this unit looks like a perfect fit. But, looking deeper, you find the unit's maximum ripple current at 65 C is 3.1 A rms. After dividing by 2.5 to convert from rms ripple current to load dc, you get a rude awakening—the capacitor is good for a maximum of only 1.24 A dc. So, the unit is far from perfect—and you must either derate the temperature or use a larger capacitor.

Take additional care, when looking at capacitor-data sheets. Are the ratings for still or moving air? A capacitor can, of course, handle more energy in moving

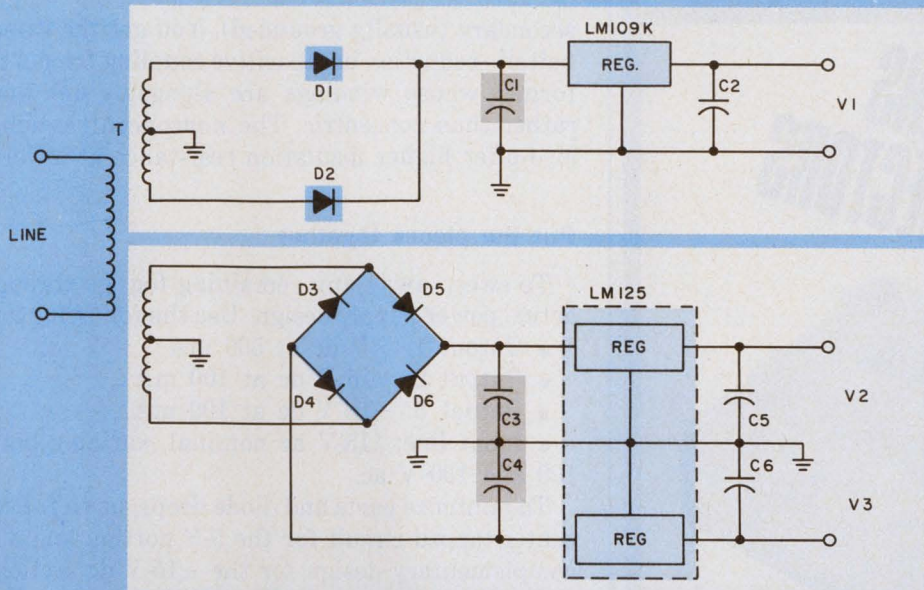

C1: 4000 μ F, 15 V DC
 C2: 2.7 μ F, 20 V DC
 C3, C4: 1000 μ F, 50 V DC
 C5, C6: 2.7 μ F, 20 V DC
 D1, D2: 1N4001
 D3, D4, D5, D6: 1N4002
 T: MPC-Y-15
 SIGNAL TRANSFORMER CO.

4. This microprocessor power supply delivers 5 V dc at 500 mA (V_1), and ± 15 V dc at 100 mA each (V_2 , V_3).

Capacitors C_2 , C_5 and C_6 improve the transient response. One IC packs the regulators for both V_2 and V_3 .

air—and computer-grade capacitors are most often rated for moving air. So be careful.

Filter loads the rectifier

No matter how carefully you choose the capacitor, a capacitor-input filter reflects current-handling burdens onto the rectifier diodes. The current into capacitor-input filters usually comes in short, high-amplitude pulses. Though each diode conducts these high-amplitude current pulses only on alternate half-cycles of the input ac, it's good practice to select diodes that can carry the full dc-output current.

Furthermore, for safety, and to ensure adequate surge-handling capability during turn-on, make sure that the diode's surge-current rating is at least twice the direct current available at the output.

Finally, you have to solve the ever-present problem of removing the heat generated by even the most efficient rectifier diodes. In an axial-lead diode heat flows through the leads. So, use short leads—soldered to large metal contacts, such as large PC pads.

Once you've nailed down the rectifier diodes, you can go on to select the IC regulator. The actual regulator you choose will depend on such diverse variables as packaging considerations and the results of temperature analysis. But, you can make a preliminary selection by pinning down four major requirements:

- Output voltage.
- Output current.
- Unregulated input voltage (filter output).
- Ambient temperature.

After choosing a few regulator candidates determine the actual junction temperatures your regu-

lator will have to withstand, with detailed heat-flow calculations. This should boil down your choice to one. Then, make the associated heat-sink calculations.

Sometimes you may need more output current than an IC alone can supply. Simply add a discrete power transistor or Darlington to your IC regulator.

IC regulators are usually easy to incorporate into microprocessor power supplies. One reason is that manufacturer's handbooks give you all the information you need. Unfortunately, the same isn't true for the transformers in microprocessor supplies.

Here, a lack of standards accounts for the wide variations of the data in, and the formats of, electronic-transformer catalogs. For instance, some catalogs don't specify the load for the secondary voltages. Fortunately, others give full-load ratings.

Suppose, because a transformer's 16-V ac secondary potential isn't clearly defined, you assume the potential is for full load when actually it is a no-load voltage. At a 2-A load, what was 16 could easily become 14.5 V ac. Conversely, a 16-V ac, 2-A output at 115-V ac line input goes up to about 17.5 V ac under no-load.

This fluctuation of a transformer's output voltage under changing loads is an example of transformer-load regulation—the percent change in voltage output from no-load to full-load. That is, if a 20-V output rises 1 V, under a full load-to-no-load change, the load regulation is 5%. Obviously, transformer-load regulation is different from power-supply regulation.

Another hazy area in transformer selection is electrostatic shielding. Before you get involved with this costly parameter, decide if you really need it. Chances are good the answer will be no. After all, electrostatic shielding is just a copper sheet between primary and

BATTERY HOLDERS CLIPS & CONNECTORS

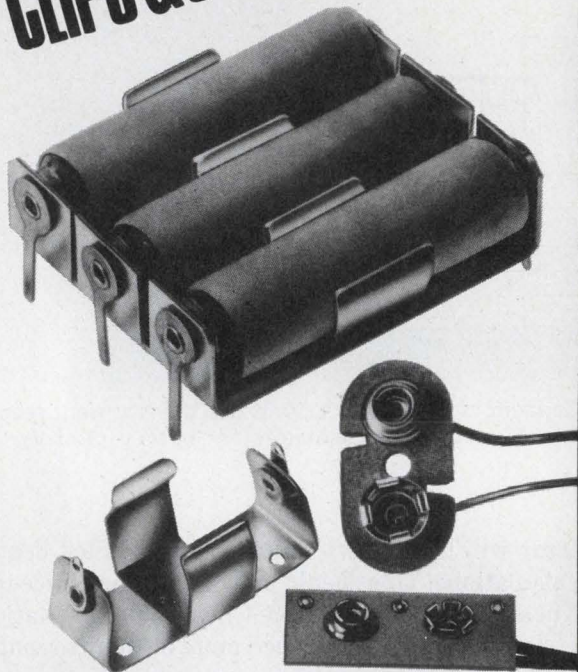

Keystone has parts nobody else makes: Like our new battery holders for printed circuit boards.

And of course we continue to have our unsurpassed line of standardized battery holders and snap-on straps, clips and connectors. On top of which, we can design and make for you any non-standard units you may need.

We do everything ourselves: both designing and manufacturing. All of which is reflected in our low prices. We do it right here in the United States. And it shows in the quality of our products.

Our battery holders, clips and connectors are ruggedly built of aluminum or nickel plated steel — and they're for use with all types of batteries. We make both single and multiple holders. We're proud of our immediate delivery from stock.

We offer a FREE engineering service for your special requests.

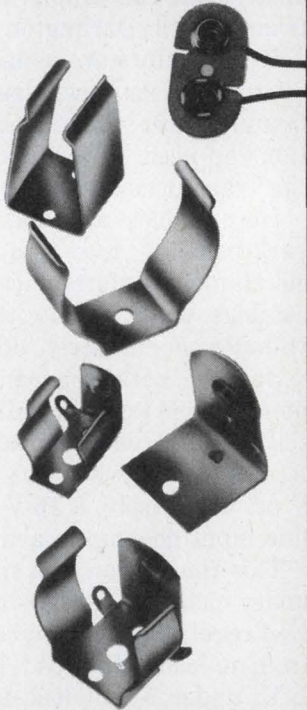

secondary (usually grounded). You get the same—or better—reduction in capacitive coupling from a transformer whose windings are alongside one another rather than concentric. The nonconcentric windings also offer higher insulation resistance at lower cost.

Put the pieces together

To sweep away any remaining fog, go through an actual power-supply design. Use the following values:

- Output 1: 5 V dc at 500 mA
- Output 2: +15 V dc at 100 mA
- Output 3: -15 V dc at 100 mA.
- Input line: 115-V ac nominal, variable between 100 and 130 V ac.

To minimize parts and diode drops, use a full-wave, center-tapped circuit for the 5-V portion and a dual-complementary design for the ± 15 -V dc sections, as shown in the supply of Fig. 4.

Choose a simple capacitor-input filter and follow it with a straightforward three-terminal IC regulator as shown in Fig. 4. From the previous calculations, you know that a transformer whose output is approximately 10 V ac will be satisfactory. Also, multiply the maximum power-supply output current by 1.2 to get the required secondary current:

$$500 \times 1.2 = 600 \text{ mA.}$$

The transformer, then, must provide a minimum 10 V at 600 mA. From Eq. 2, the minimum capacitance in the filter must be $4000 \mu\text{F}$ and the capacitor must be capable of withstanding 15 V dc.

The diodes for the 5-V section must be rated for at least 2 A. Accordingly, the 1N4001 is a good choice. A series-type regulator, like the LM109, can handle the required output.

Next, turn your attention to the dual 15-V outputs. Start with the transformer and use the results of previous calculations. Each half of the secondary should deliver approximately 17.7 V ac, or a total of about 35.5 V. Here the required potential is 17.7 instead of the 18.6 V ac you obtained before because the low line in this case is 100, not 95 V ac.

Now multiply the output current required by 1.8 to get the figure for the secondary current:

$$1.8 \times 100 = 180 \text{ mA rms.}$$

Your transformer, then, must be able to deliver 35.5 V rms at 180 mA rms.

Now, using Eq. 2 again, you find that a $1000\text{-}\mu\text{F}$ capacitor is large enough for the filter. To be on the safe side, however, use a 50-V dc unit. For the bridge, use diodes rated at 500 mA (load current times four).

For the regulators, you can use just one LM125 chip to regulate both the ± 15 -V outputs at 100 mA. Also, the regulator's TO-110 package is well-suited for mounting on a printed-circuit board.

You now have selected all the components for the power supply, except the transformer. But you do have its required ratings. It's now only a matter of going through catalogs until you find the right unit.■



NEW FREE CATALOG ON REQUEST

KEYSTONE

ELECTRONICS CORP.

TWX 710-581-2861 CABLE-KEYELCO

49 BLEECKER STREET, NEW YORK, N.Y. 10012 212-475-4600

CIRCLE NUMBER 50

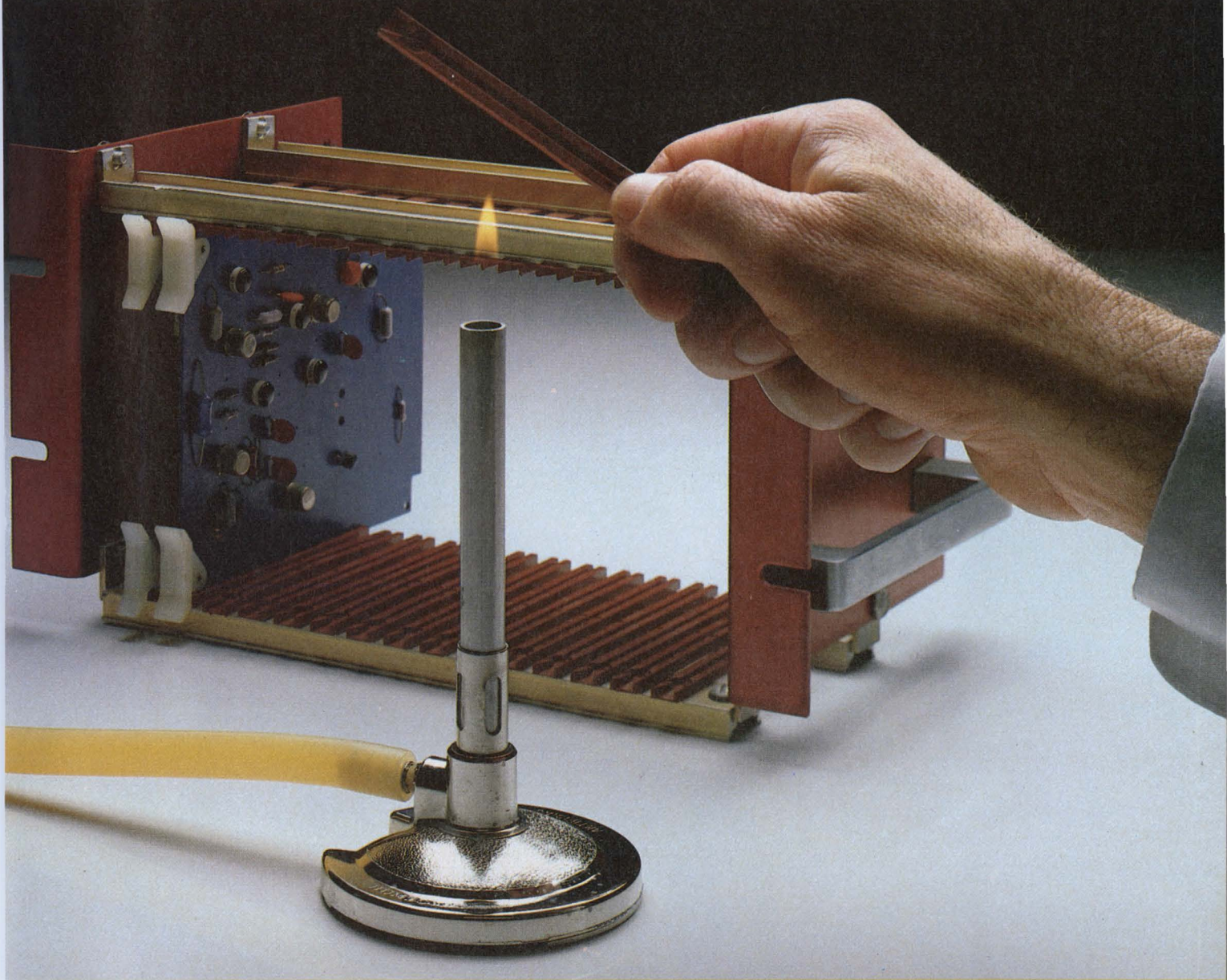

Vydyne® M-340 nylon. It meets UL standards for fire-retardancy.* And Bivar's standards for performance.

When Bivar, Inc., of Santa Ana, California, wanted to introduce a new line of PC board card guides, they looked into Monsanto's line of Vydyne® nylon resins. They required a material with good fire-retardant characteristics for the computer and instrumentation fields. Good enough to meet UL standards. Rigid enough for the application. Yet flexible enough for the required snap-in insertion feature.

Vydyne M-340 by Monsanto was the answer. It has a UL rating of 94V-0 down to 1/64 of an

inch, 94-5V down to 1/32 of an inch. Vydyne M-340 also offers natural lubricity for easy card insertion and a distinct color for easy identification as a fire-retardant.

The fact is, Monsanto standards for Vydyne M-340 are high enough to meet UL standards, and high enough to meet yours.

For information, write: Monsanto Plastics & Resins Co., an operating unit of Monsanto Co., Dept. 804, 800 N. Lindbergh Blvd., St. Louis, Mo. 63166.

VYDYNE
NYLON RESIN BY MONSANTO

CIRCLE NUMBER 51

Monsanto

*These UL numerical flame spread ratings are not intended to reflect hazards presented by this or any other material under actual fire conditions.

Someone has developed a more efficient resistor.

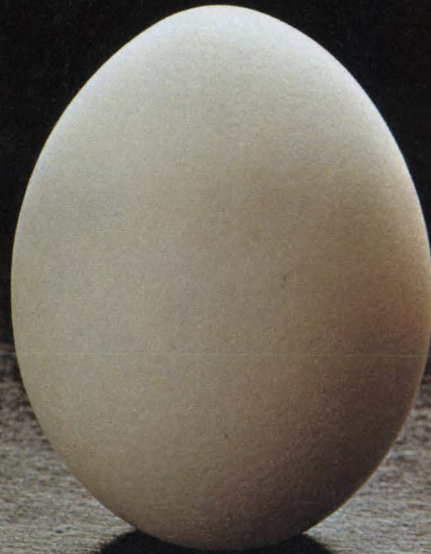

THE new Dale resistors are more efficient to buy. A network of computer terminals throughout our three resistor plants gives you more useful production information than you've ever been able to get—from anyone.

Place an order and in seconds we can tell you whether it can be shipped from stock. Inquire about an existing order and we can tell you its exact production status equally as fast. Discover a need for earlier delivery and we can instantly mark your order for expediting. That's

resistor efficiency you can use. It's part of an expansion program that has seen our floor space devoted to resistors grow from 300,000 square feet in 1970 to more than 400,000 square feet today. And much of this expansion has been devoted to automated facilities. Multistation winders let you specify the stability and power of wirewounds at a lower cost than ever...and batteries of laser spiralling machines turn out RN-style metal film parts at machine-gun speed. We're making the most efficient resistors you can buy—and we're ready to prove it.

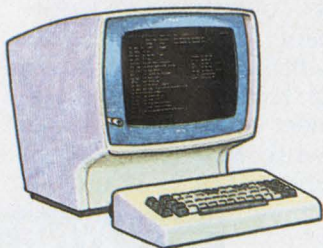

The new Dale resistors are made from more efficient materials than ever. Sophisticated equipment, like this scanning electron microscope, gives us state of the art capability for analyzing, identifying and specifying component materials. It's part of an integrated materials improvement, performance testing and quality control program we initiated 15 years ago in the early days of the Minuteman High Reliability Development Program. Today, one out of every 10 Dale employees is directly involved with Quality Control. Tangible results include: More than 100 separate QPL listings for wirewound and metal film resistors; the world's most reliable wirewound resistor (proven failure rate .000021%/1000 hours). The new Dale resistors will give you less trouble—before and after purchase—than any others you can buy—and that's efficiency! Call 402-564-3131 for wirewound and 402-371-0080 for metal film.

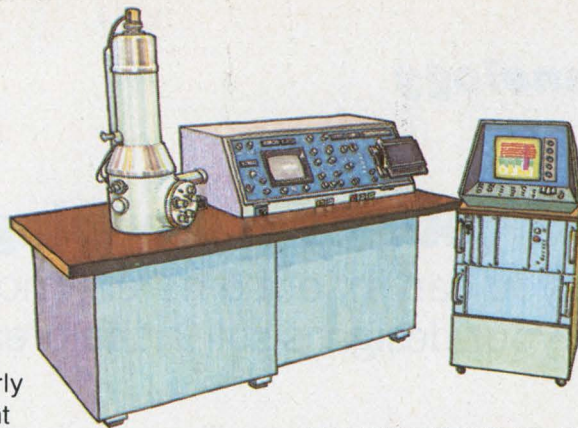

DALE ELECTRONICS, INC.
1300 28th Avenue, Columbus, Nebraska 68601
A subsidiary of The Lionel Corporation
In Canada: Dale Electronics Canada Ltd.
In Europe: Dale Electronics GmbH,
8 München 60, Falkweg 51, West Germany

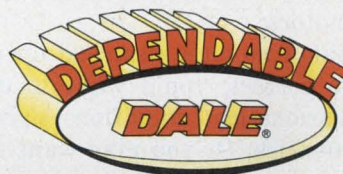

Our complete product line can be found in Electronic Design's GOLD BOOK.
CIRCLE NUMBER 52

Dale!

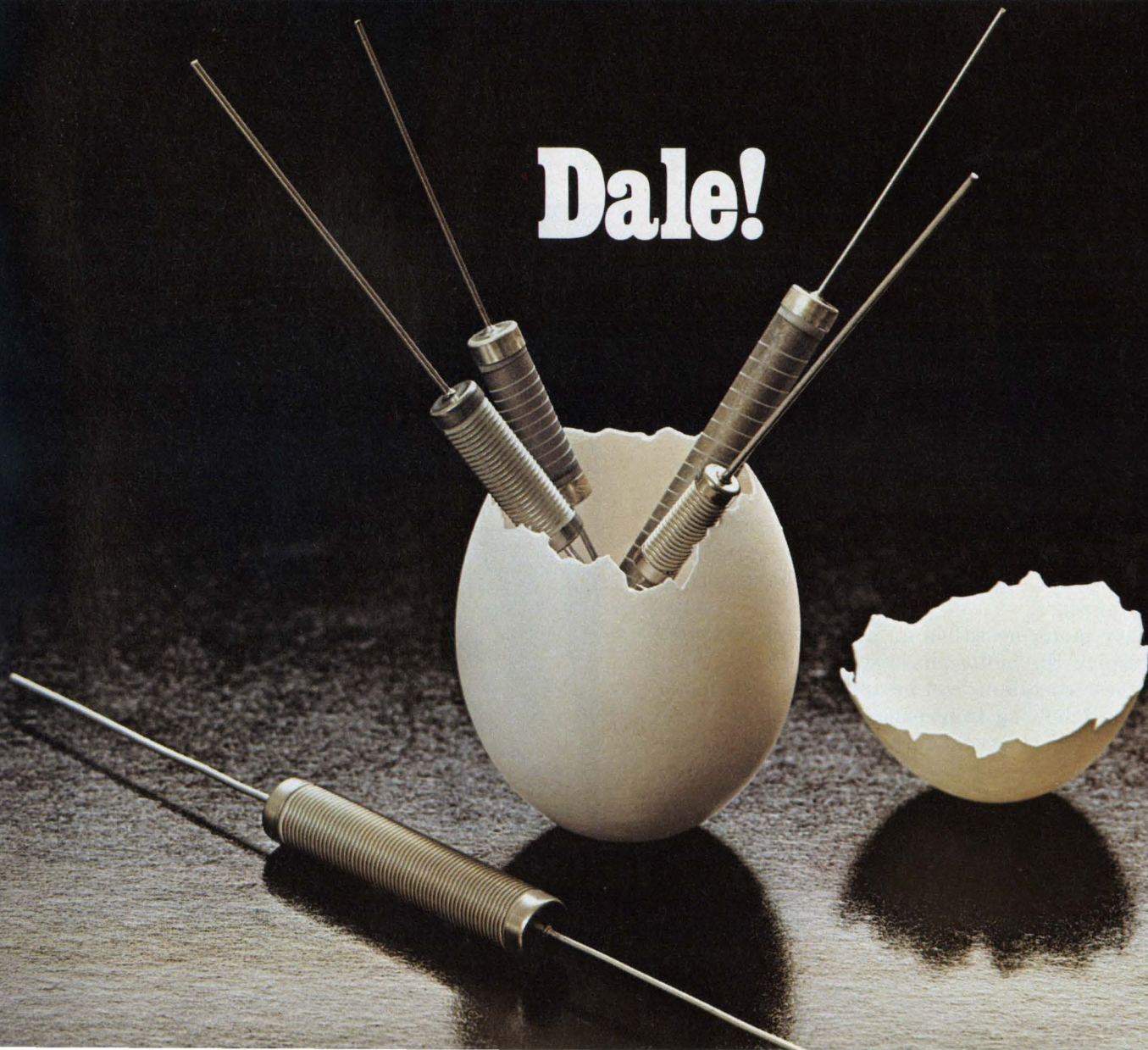

Build your own stepping motor tester.

Then you can try out different motor-control options, while your design is still in the breadboard stage.

Test your pet theories on controlling a stepping motor before carving your design in stone—connect a motor-test box to your electromechanical system breadboards. With a stepping motor tester you get several options for powering and controlling small and medium-size motors.

To verify that a motor's electrical operation and positioning are correct, you'll want to check your design under various load conditions, drive voltages and clock frequencies. Or you may want to test and evaluate how a motor performs with a number of different gear heads. At any rate, you'll probably have to test manufacturers' specifications on quite a few stepping motors before choosing the one that suits your system requirements.

All this and more can be done with a motor tester that you can build with readily available TTL digital ICs, transistors, diodes, switches and passive components. Not only that, but the test box will enable you to find out what makes your motor tick.

Many ways to test your stepper

To test a stepping motor in a simulated operating environment, you should be able to apply a variety of control and load conditions to the motor. Here's what the stepping motor tester in Figs. 1 and 2 allows you to do:

- Select the step count (0 to 9999) via thumbwheel switches.
- Verify the count via a numeric LED display.
- Operate the motor bidirectionally.
- Select either high or low-torque operation.
- Select either count or free-running operation.
- Supply holding current to brake the motor and lock it in place.
- Vary motor speed via an external clock source.
- Display the motor-phase state via LEDs.

All these conditions can be applied to your motor using the following front-panel switches:

Fwd/Rev, which sets the direction of rotation of the motor.

Clock—Int/Ext, which can be an internal 400-Hz clock signal, or any external clock you choose to apply.

Torque—Hi/Lo, which selects the number of bits



1. Building a stepping-motor tester like this one gives you a convenient method for breadboard testing before constructing production hardware.

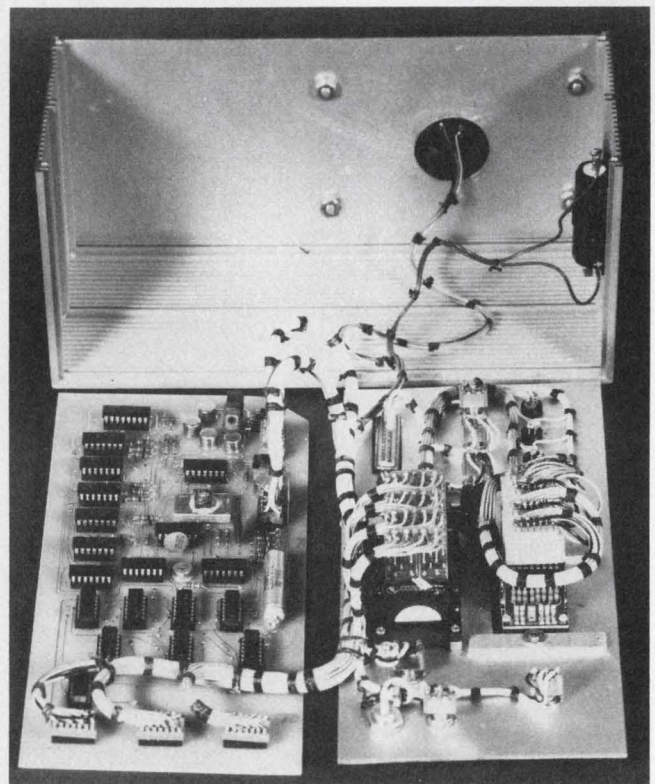

2. Just two PC boards house all the tester components. And there's nothing unusual about the parts; they're readily available digital ICs, semiconductors, switches and passive components.

John A. Glaab, Electronic Systems Engineer, National Aeronautics and Space Administration, Goddard Space Flight Center, Greenbelt, MD 20771

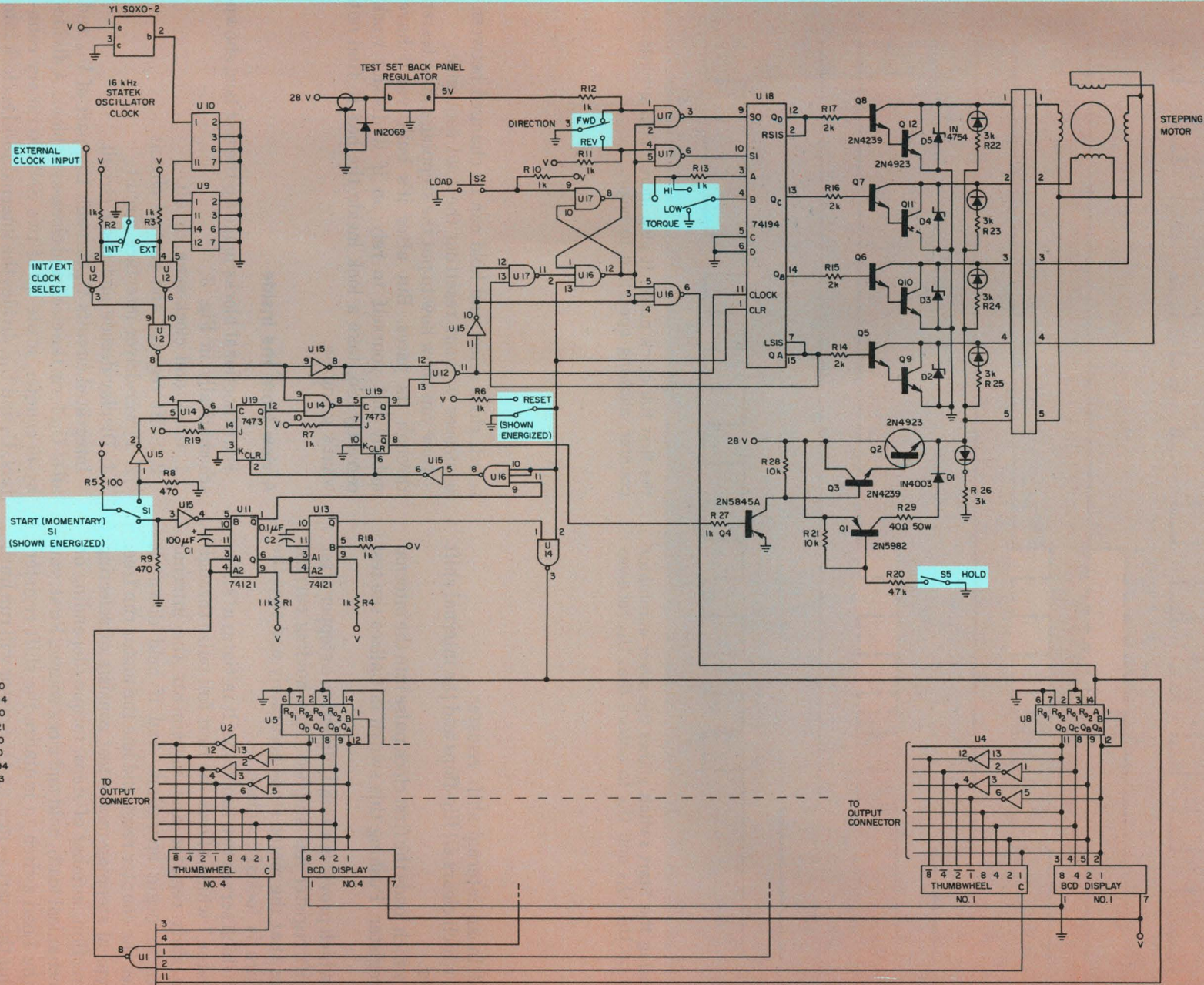

COMPONENTS

| | |
|-------------------------|-------|
| U1 | 7430 |
| U2, U3, U4, U15 | 7404 |
| U5, U6, U7, U8, U9, U10 | 7490 |
| U11, U13 | 74121 |
| U12, U14, U17 | 7400 |
| U16 | 7410 |
| U18 | 74194 |
| U19 | 7473 |

3. Four functional blocks make the tester schematic easier to understand. The motor under test can be driven

by the internal 400-Hz clock or by any frequency you select with your own pulse generator.

SLIVER ELIMINATOR

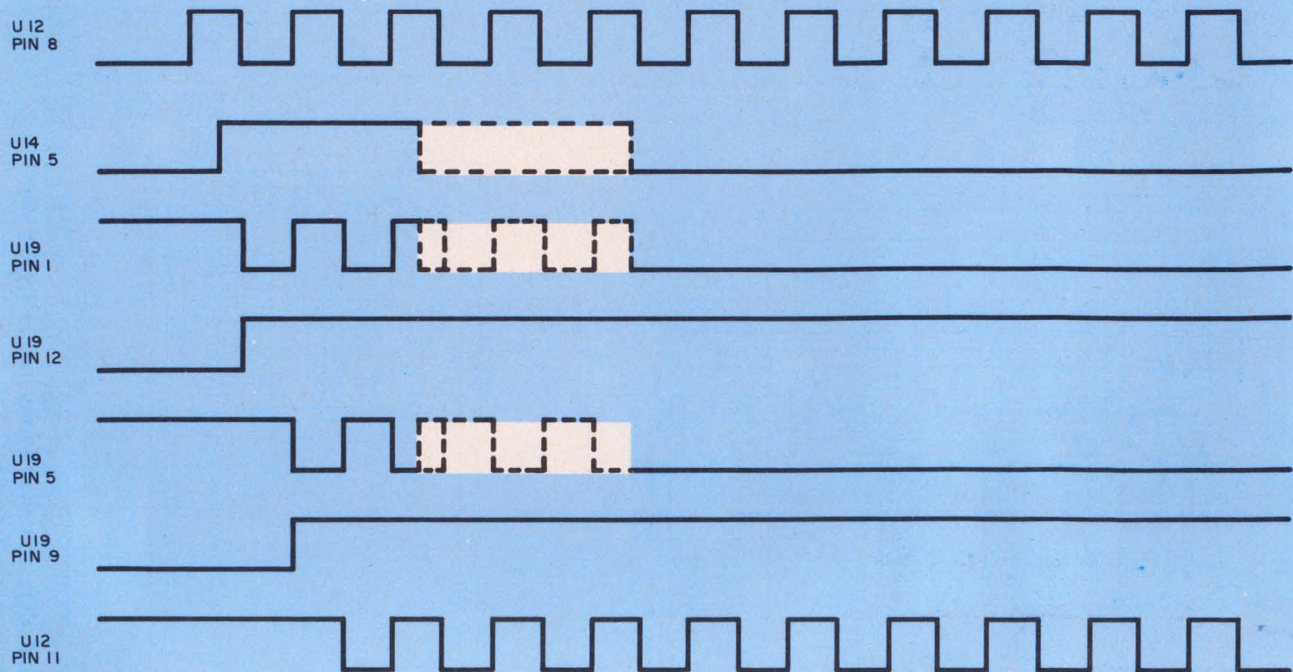

4. Pressing the Start switch allows the sliver eliminator formed by U₁₄, U₁₅ and U₁₉ to ensure that U₁₈ receives

the first full clock pulse. It also increments an internal counter, allowing operation to begin.

shifted in an internal shift register.

Reset, which clears all flip-flops and the internal shift register.

Load, which loads the first clock pulse into the internal shift register. Pushing this switch initializes the test box.

Hold, which provides a small current to a stepper after the shift register has stopped. This holding current ensures that the motor stops accurately and that the armature is locked in place.

Start, which serves two functions. It initiates a "sliver eliminator," which allows the first full pulse through to the shift register and increments the internal counter to begin operation. And if held down, it disables the counter reset and lets the motor run free.

A typical stepping-motor test consists of selecting the direction, number of steps, torque (depending on the mechanical load), hold and clock source. First, you push the Load switch to initialize the shift register. Next, hit the Start switch, and the motor will run until the number of steps you've selected with the thumbwheels has been reached. If you want to repeat this sequence, push the Start switch again. Push Load only when the system is powered-up or has been reset.

If you goof or get a mechanical malfunction, hit Reset, which stops the motor and resets the shift register, counters and flip-flops. Direction, count

select, clock select and hold can be changed between sequences without resetting the load sequence.

Now you know how to put the stepping motor tester through its paces. But after it's built you'll have nobody but yourself to rely on if it doesn't work correctly. So, take a look inside the box to find out what's going on.

A view from the inside

Four functional blocks make up the test box, shown schematically in Fig. 3:

1. Clock and clock-sync circuit.
2. Shift register and control circuit.
3. Power-driver-interface circuit.
4. Display-decode and reset circuit.

Integrated circuits U₉ through U₁₅, part of U₁₆ and all of U₁₉ form the clock and clock-sync block. A divide-by-40 counter, made up of two SN7490 binary counters, U₉ and U₁₀, divides the internal 16-kHz clock into a 400-Hz square wave for operating a stepper. Of course, you can use the external clock input to provide your own clock source from a separate TTL-compatible pulse generator.

To ensure that shift register U₁₈ receives the first full clock pulse after the Start switch is thrown, U₁₄, U₁₅ and U₁₉ form a sliver eliminator (see Fig. 4).

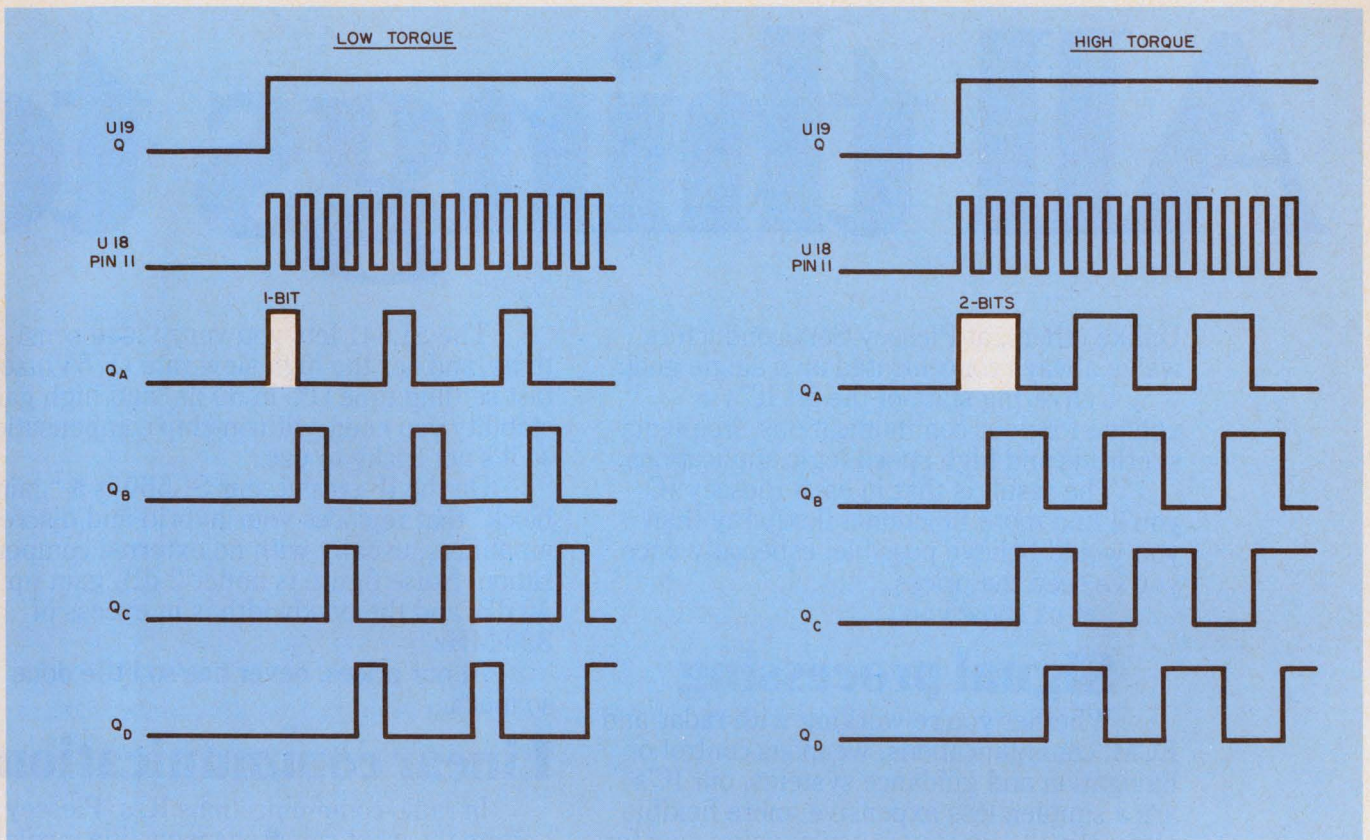

5. You can run your motor in either a high or low-torque mode. The difference is in the number of bits that

propagate through the tester's shift register. Low-torque uses one bit and high-torque, 2 bits.

Besides a clock input, the shift register and its associated control gates, U₁₆ and U₁₇, receive direction, load and torque inputs from the corresponding front-panel switches. Both the Load and Fwd/Rev switch inputs control the shift-register mode-control lines, S₀ and S₁. And the Torque—Hi/Lo switch determines whether one bit (low-torque), or two adjacent bits (high-torque) will propagate through the register as shown in Fig. 5.

Before initializing the tester, select the direction of motor rotation (Fwd or Rev); then push the Load switch. Mode-control lines S₀ and S₁ on the register come up to ONE, which allows the device to be loaded. Depending on where you previously set the Torque switch, either one or two bits are loaded into U₁₈, on its A and B inputs. The first bit always appears on the Q_A output, and that bit is immediately fed back as an enable signal to the U₁₆, U₁₇ latch. When the second half of the first clock pulse arrives at U₁₆, pin 2, the latch is reset, and allows data from the Fwd/Rev switch to dictate the counting direction via the mode-control inputs. Succeeding clock pulses are fed only to the shift register, whose outputs circulate from Q_A through Q_D in the Fwd mode, or Q_D through Q_A in the Rev mode of operation.

The power-drive circuitry of the tester consists of transistors Q₁ through Q₁₂ and their associated re-

sistors and diodes. Four power Darlingtonts, made up of discrete pairs of transistors Q₅ through Q₁₂, translate the logic outputs of the shift register into 0 to 28-V levels for operating a stepping motor. And transistors Q₂, Q₃ and Q₄ operate as a power switch, which is actuated by the second stage of the clock sync sliver eliminator, U₁₉, pin 8, in the schematic diagram of Fig. 3. The function of the power switch is to apply 28 V to the stepper, then turn it off when the maximum count is reached. To lock the stepper in place, the Hold switch provides a small current of about 0.20 A to the motor via Q₁ and R₂₉. If you must test different types of steppers, make R₂₀ a potentiometer, so you can vary holding current to fit the requirements of your motor.

The final block is a four-stage BCD select, readout and reset. Clock drive for the U₅-through-U₈ counter chain is the 400-Hz signal from U₁₆, pin 6, which appears on the BCD displays. Four BCD thumbwheels, in parallel with the displays, provide the input count, and examine the BCD code. When the count you dial in is reached, U₈, pin 1 goes low, firing one-shot U₁₁. This immediately resets the sliver eliminator, and inhibits any further counting. The period of U₁₁ is about 3 seconds, during which the display holds the count. At the end of 3 s, U₁₃ fires, and resets the count/display section. ■■

All things to

Unlike others, at Plessey Semiconductors we've always concentrated on a single goal:

Delivering state-of-the-art IC's in volume for your communications, frequency synthesis and high speed logic applications.

The result is that in each Plessey IC you'll find more functional flexibility than you would believe possible, especially once you've seen the prices.

Let us show you.

Signal processing

Whether you're working with radar and ECM, communications, weapons control or navigation and guidance systems, our IC's are a simpler, less expensive, more flexible alternative to whatever you're using now for any IF strip up to 240 MHz.

The log IF strip shown, for example, uses only five devices and a single interstage

The SL541 lets you vary video sensitivity, and has the high slew rate (175V/ μ sec), fast settling time (1% in 50 ns) and high gain stability you need, with on-chip compensation so it's not tricky to use.

On the IF output, our SL560 is a "gain block" that replaces your hybrid and discrete amplifiers, usually with no external compensation. Noise figure is under 2 dB, gain up to 40 dB, and the bandwidth is in excess of 320 MHz.

At our prices, never has so little done so much.

Linear communications

In radio-communications IC's, Plessey offers the most comprehensive line available. IC's that will cut the costs, reduce the size and increase the reliability of your designs for everything from commercial CB sets to manpack radios.

Typical is our SL660, a monolithic IC that contains a complete IF amplifier, phase-locked loop and squelch system. Power consumption is a meager 1.5 mA at 6V, S/N ratio is 20 dB, dynamic range is 120 dB, THD is just 2% for 5 kHz peak deviation, and it can be used up to 25 MHz and with deviations up to 10 kHz.

Our SL664 and SL665 are similar but go a bit further, adding dc volume control and an audio output stage to the on-chip preamp, amp, detector and carrier squelch. The SL664 drives low impedances, while the SL665 drives high impedances.

In addition to these, we offer a large family of RF and IF amplifiers, limiters and detectors.

The circuits are unique, performance superb.

Frequency synthesis

Plessey IC's offer a quick and easy way to lower synthesizer costs while increasing loop response and channel spacing all the

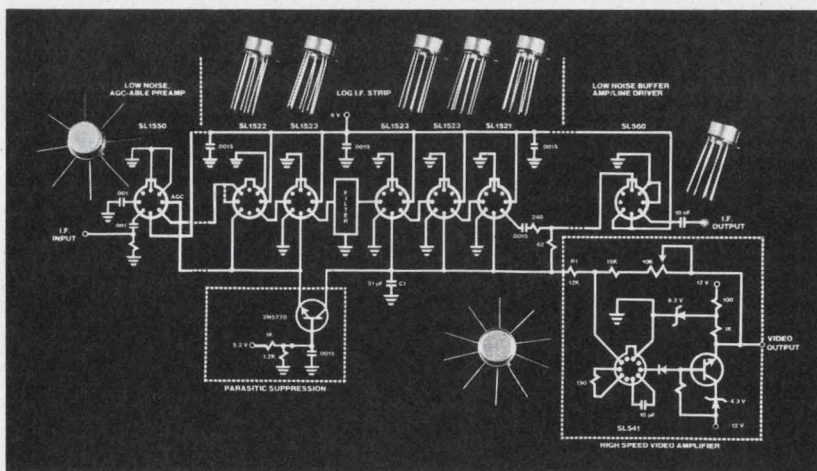

filter to achieve a logging range of 90 dB, ± 1 dB accuracy, -90 dBm tangential sensitivity and a video rise time of 20 ns or less.

The devices shown are all based on the Plessey SL1521, the simplest, easiest-to-use and least expensive wideband amplifier you can buy. It has a 12 dB gain and upper cut-off frequency of 300 MHz. The SL1522 is two 1521's in parallel with a resistive divider for increasing the IF strip's dynamic range, while the SL1523 is two 1521's in series.

The AGC-able SL1550 on the front end improves noise figure, dynamic range and sensitivity, with 2 dB NF, 38 dB gain, and a 320 MHz bandwidth.

some people

PLESSEY HIGH-SPEED DIVIDERS/PRESCALERS

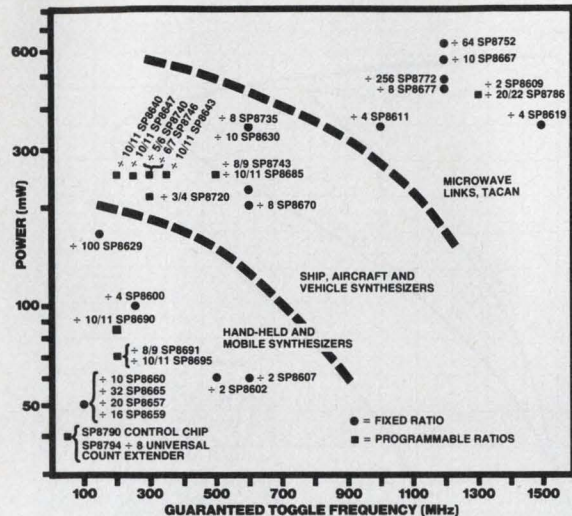

way from dc through the HF, VHF, UHF and TACAN bands.

Start with one of our IC prescalers. They feature input ports for VHF and UHF, self-biasing clock inputs, TTL/MOS-compatible and are all guaranteed to operate from dc to at least the frequencies shown.

Then add one of our two-modulus dividers. All of them provide low power consumption, low propagation delay and ECL-compatibility.

Finally, to make things even simpler, add the Plessey SP8760 control chip and phase lock your synthesizer to any crystal up to 10 MHz. All the stability you need with none of the usual headaches and hassle.

We wouldn't have it any other way.

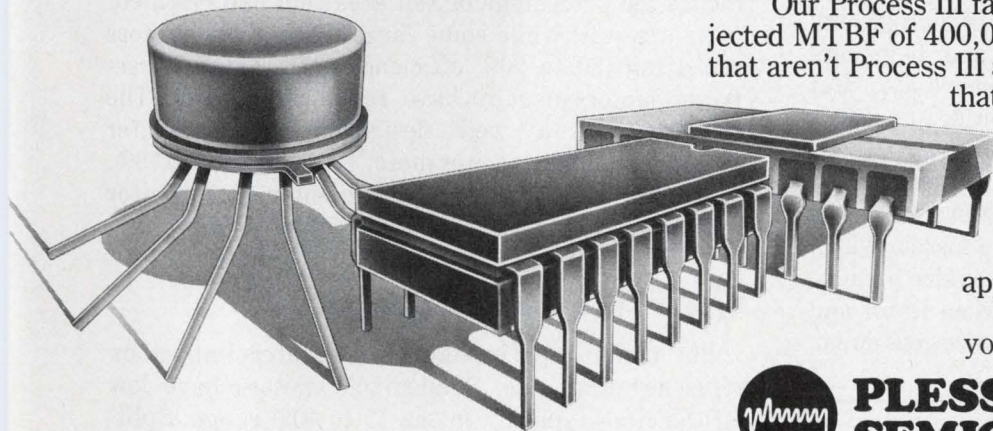

Me-too, only better

The ECL III parts you've been waiting for are available now.

From Plessey Semiconductors.

You can get our ECL III devices as identical "me-too" plug-ins, including the lo-Z parts you can't get anyplace else.

Or you can get Plessey ECL III with lower delays and much higher operating speeds. Our SP16F60, for example, is the world's fastest

Dual 4-input OR/NOR Gate, with a switching speed of just 500 picoseconds. And all our other products

are available with typical values as good as MECL's maximums, and maximums that have to be experienced to be believed.

We can select for certain specifications (such as threshold voltage or slew rate on our SP1650/1, toggle rates or delays on our SP1670).

And perhaps best of all, we're delivering now.

And more

Most of our IC's are available in full MIL-temp versions.

We'll screen most to 883B, and some to 883A, if you need it (including our ECL III).

Our Process III fabrication has a projected MTBF of 400,000 hours. (The parts that aren't Process III are Process I, and that's even more reliable.)

And we'll provide what you need when you need it, so contact us for details and application notes today.

You'll find that we're your kind of people.

PLESSEY'S ECL III IN STOCK:

| | |
|---------|---------------------------------------|
| SP1648 | Voltage controlled oscillator |
| SP1650 | Dual A/D comparator, Hi-Z |
| SP1651 | " " Lo-Z |
| SP1658 | Voltage controlled multivibrator |
| SP1660 | Dual 4-I/P OR/NOR gate, Hi-Z |
| SP1661 | " " Lo-Z |
| SP1662 | Quad 2-I/P NOR gate, Hi-Z |
| SP1663 | " " Lo-Z |
| SP1664 | Quad 2-I/P OR gate, Hi-Z |
| SP1665 | " " Lo-Z |
| SP1666 | Dual clocked R-S Flip-Flop, Hi-Z |
| SP1667 | " " Lo-Z |
| SP1668 | Dual clock latch, Hi-Z |
| SP1669 | " " Lo-Z |
| SP1670 | Master-slave D Flip-Flop, Hi-Z |
| SP1671 | " " Lo-Z |
| SP1672 | Triple 2-I/P exclusive-OR gate, Hi-Z |
| SP1673 | " " Lo-Z |
| SP1674 | Triple 2-I/P exclusive NOR gate, Hi-Z |
| SP1675 | " " Lo-Z |
| SP1690 | UHF prescaler type D Flip-Flop |
| SP1692 | Quad line receiver |
| SP16F60 | Dual 4-I/P OR/NOR gate |



PLESSEY SEMICONDUCTORS

1641 Kaiser Ave., Irvine, CA 92714. (714) 540-9979

CIRCLE NUMBER 53

Matching small ac motors to a load for efficient operation is a compromise of speed, torque and duty cycle. You can't optimize them all simultaneously.

Properly matching small ac single-phase electric motors to loads is much more complicated than matching, say, a line driver to a communications line. With a line driver you're usually interested in merely getting maximum power into the line. But with a motor you must consider not only power output, but also starting and running torques, and duty cycle and efficiency, all of which vary with motor speed in "strange," nonlinear ways (Fig. 1). With the new energy-conservation consciousness, efficiency is particularly important.

Unfortunately, however, you can't get a practical single-phase ac motor design that has peak efficiency over a wide range of torques and speeds. So you have to optimize for a particular use. In an application such as a teletypewriter, the motor may merely idle at almost no load for many hours, perhaps most of the business day. Clearly, to save energy, the motor's efficiency should be as high as possible at a point near idle, no-load speed. The motor characteristics curves in Fig. 1 provide a maximum efficiency of 70% at 1100 rpm. This speed, therefore, would be a good idle-speed design point for this application.

But maximum power output is attained at 1000 rpm, which, therefore, would be a good design speed for operation under full load. Note, however, that efficiency at this maximum-power point is down to 60%.

Efficiency costs money

Efficiency itself is expensive. To be highly efficient, a motor must be made with a great deal of active high-grade electrical steel and copper. Not only is this expensive, but as a result, the motor gets large. Furthermore, ball bearings and precision-ground shafts, which reduce drag slightly and help considerably to raise efficiency, are expensive also. But even if you pull out all the stops, you soon reach a limit.

Small motors are generally less efficient than integral-horsepower-sized motors. Moreover, the smaller a motor gets, the greater the losses, which become increasingly difficult to control as size shrinks. One big reason is that the air gap between stator and rotor remains about the same as motor size goes down.

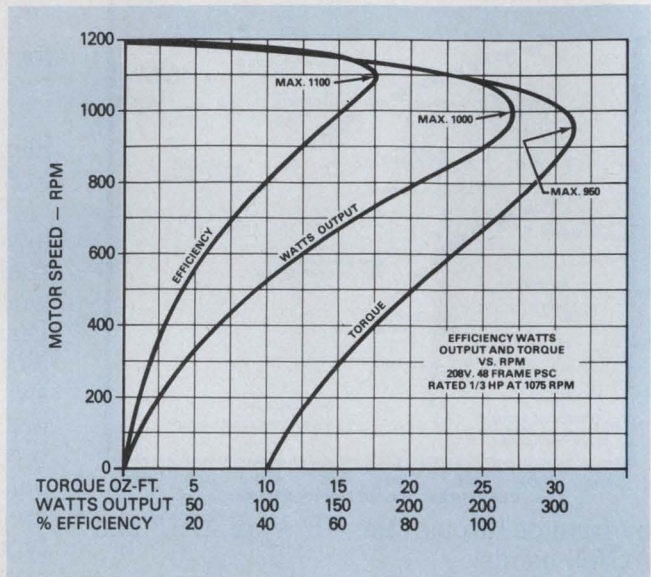

1. The efficiency, torque and power output of small single-phase motors peak at different speeds. This complicates matching a motor to its load for the greatest effectiveness in a particular application.

Thus the gap becomes a larger percentage of the total flux-path length. Consequently, a greater proportion of the motor's field ampere-turns and power is used in overcoming the air gap.

Furthermore, since wire space must be scaled down in small motors, wire I²R losses get boosted by the higher current densities. Also, mechanical wire-interference problems are greater in small slot spaces. And wire insertion is more difficult, which tends to reduce the percentage of slot area that can be filled.

As a result, while some large three-phase motors can attain 80 to 90% efficiencies, fractional-horsepower motors usually have substantially less. The efficiency of a well designed 5.5-in.-diameter permanent-split capacitor motor typically is 65 to 70%. A 3¼ to 4½-in.-diameter permanent-split capacitor motor typically has only 55 to 65% efficiency.

Type is more important than size

But motor type has an even greater impact on efficiency than size. Shaded-pole motors have low efficiencies—typically in the 15 to 40% range. Split-phase motors have 40 to 60% efficiencies. And capacitor-start motors are about as efficient as split-

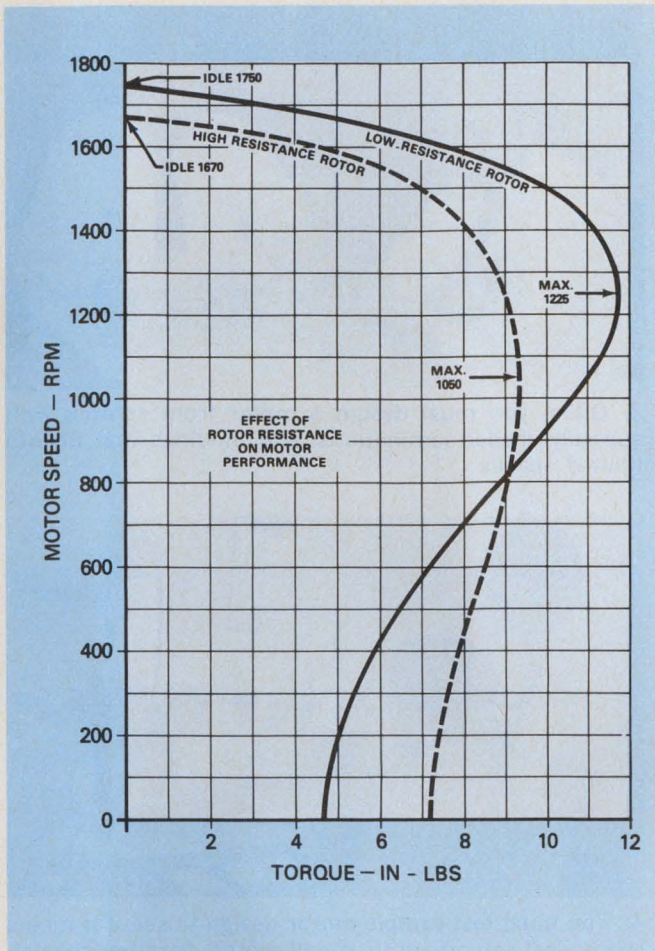

2. Many motor applications require a high starting torque. But to attain it requires relatively high rotor resistance—which lowers motor efficiency at operating speeds above the “knee” of the speed-torque curve.

phase, but provide much higher starting torques.

Permanent-split capacitor motors easily attain 60 to 70% efficiencies. And 56 frame and larger three-phase motors are the most efficient with 80 to over 90% efficiencies. Permanent-split capacitor motors, however, tend to be the quietest and smoothest-running of all the other types.

Nevertheless, to achieve the maximum efficiency that each ac motor type can attain, the motor manufacturer must reduce losses as much as possible. In the order of their importance, the major losses are as follows:

- *PR stator-winding loss.* Large-diameter wire, which keeps current density (amperes/circular mil) as low as possible will reduce it. The problem is getting the required number of turns into the stator slots.

- *PR rotor-winding loss.* You might assume that the aim is to use the largest possible conductors in the rotor for maximum efficiency. However, starting-torque requirements force you to retain a certain minimum resistance level.

Rotor resistance greatly affects the motor’s speed-torque relationship. Note in the curves of Fig. 2 that a so-called high-resistance rotor, whether wound or constructed with rotor bars, has a higher starting

torque than a low-resistance rotor. Also, note that with a high-resistance rotor, efficiency is greater and line current lower at *low* speeds—that is, at all speeds below the speed-torque curve’s “knee.”

On the other hand, a low-resistance rotor is better if you don’t need the extra starting torque. With low rotor resistance, efficiency and torque are greatest above the speed-torque curve’s “knee.” Also, the motor runs faster at idle, drawing less current.

Most squirrel-cage motors use high-quality electrical-grade aluminum for rotor conductor bars. Rotor resistance is usually controlled by changing the bar cross sections or varying end-ring thicknesses. For very low slip motors (speeds near synchronous) and highest possible rotor efficiency, rotor resistances must be low and copper bars could be used. But copper is more expensive than aluminum, and the small increase in performance usually isn’t worth the added expense. Thus copper is rarely used in modern motors.

- *Eddy-current rotor and stator core losses.* Cores made from high-grade electrical steels are laminated to break up unwanted eddy currents. The thinner the laminations, the more effective they are in reducing eddy-current losses. But, of course, the thinner they are, the more expensive the core structure becomes. Also, material and physical problems limit thinness.

- *Hysteresis core loss.* Rotors and stators made from special silicon steels—for which impurities are carefully controlled and precision stress annealing is used—can lower hysteresis losses. However, the small loss improvement is usually not worth the cost increase. In most applications, ordinary high-quality electrical-grade carbon steel, properly heat-treated, does an adequate job.

Carbon-steel core loss is about 3 W/lb against about 2W/lb for silicon steel. In small motors, it’s cheaper to increase the motor’s stack height or use somewhat larger laminations to get the equivalent improvement in efficiency. But if cost is not a prime factor, motor manufacturers will supply silicon steel.

- *Friction and windage losses.* These losses are only a small percentage of the total loss. Available excellent bearings and lubricating systems materially reduce friction loss. And fine turbine-grade lubricants and precision-ground shafts can further reduce it to a minimum. Shafts are routinely ground to 15- μ in. finishes, and 8 to 10- μ in. is common in some special motors. Fortunately, the small diameter of fractional-horsepower motors makes windage a minor factor.

Sometimes you start from scratch

But designing a motor for minimum losses sometimes means you have to start from scratch. In most small “standard” single-phase induction motors, the maximum horsepower output occurs at about 80% of the synchronous speed, and the maximum efficiency occurs at 90%. However, these points can be controlled within limits for specific applications to produce maximum power output and efficiency at other desired loads or speeds.



Three ways
to get a
good CRT yoke



Call
Syntronic
(312) 543-6444



Write
Syntronic

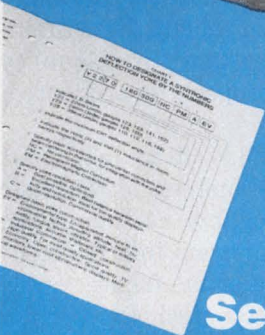

Use
our Yoke
Selection Guide

It shows a simplified way to specify the best yoke for your CRT display. Our engineers have developed a unique concept—the yoke energy constant—as a way to estimate yoke inductance and current. From there, it's an easy step to specify a yoke "by the numbers". Try it. Call or write for your copy. See for yourself how Syntronic's years of experience can add up to getting a better yoke for your display.



syntronic

Syntronic Instruments, Inc.
100 Industrial Road, Addison, IL 60101
(312) 543-6444

CIRCLE NUMBER 54

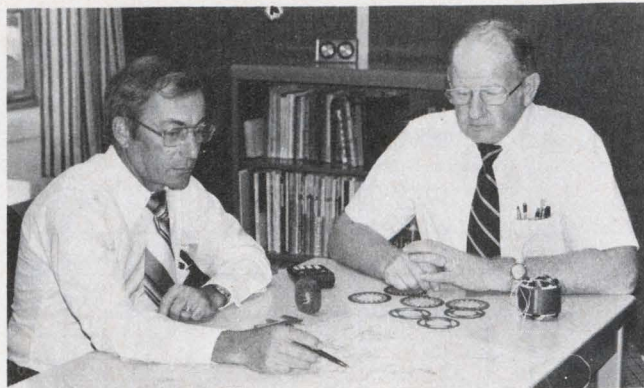

3. Often, you must design a motor from scratch with specially shaped laminations, and windings that fit into limited spaces.



4. You must test sample-motor design to see if it meets specs. Test equipment for small motors is rather specialized, and usually requires specially fabricated test fixtures and instruments—and the know-how to use them.

Some applications—such as medical and dental—call for extra-low leakage current. But less demanding use, say, a garage-door opener, can get away with as high as 0.5 mA of leakage. When necessary, leakage currents can be controlled down to 100 μ A or less with double-insulation systems.

Other applications require that a motor be UL-approved—which means passing rain-spray, high-humidity and other tough environmental tests. Rooftop ventilator motors must withstand drenching water before they can get approval. And home-appliance and portable power-tool motors must, in particular, pass stringent anti-shock-hazard tests.

Often a motor must have a special shape and fit into a tight space. Square, elongated and oval shapes are frequently needed. Of course, then, new lamination shapes, and dies to punch them, must be designed (Fig. 3). And when special spacing requirements are imposed on built-in motors, wire and coil configurations must be arranged to suit. Sometimes, special low-noise specifications must often be met, which imposes additional tough design problems.

Needless to say, a standard catalog motor, if it can meet your needs will cost you the least. But standard or special, the motor must be carefully tested. Testing motors requires specialized fixtures and test equipment (Fig. 4) and the knowledge to use them.■

Fast Relief

for digital troubleshooting headaches

Banish those troubleshooting headaches with signature analysis, the new technique from Hewlett-Packard that lets you troubleshoot microprocessor products right down to the faulty component. In production. In the field.

With signature analysis, that enormous floating inventory of expensive boards and modules moving in and out of service can be cut dramatically.

Signature analysis is positive. There is no hit or miss about it. Conceivably you could even eliminate the need to partition your product for modular service.

A simple concept.

The HP 5004A Signature Analyzer converts lengthy bit streams at any node in the circuit into short, four-digit, hexadecimal "signatures"

Just activate a digital exercise routine in the circuit under test and compare the bit stream signature at each data mode with the known good signatures previously written into your manual.

Digital signal tracing



becomes as simple as analog tracing used to be. But more accurate. So accurate that it catches almost every possible fault, including many that can be detected in no other way. It once again becomes realistic to think of field or production troubleshooting to the component level by technicians.

Design it in or retrofit.

The savings in service costs and inventory are well worth the effort of designing with signature analysis in mind. In some cases, it could even pay you to "retrofit" by developing a signature manual for your existing equipment.

It's a fascinating—and very workable—concept. Amazingly the price of the HP 5004A Signature Analyzer that makes all this possible is a low \$990*

To help you take advantage of this breakthrough we've prepared Application Note 222 — "A Designer's Guide to Signature Analysis." It's yours for the asking. Just contact your nearest HP field sales office or write.

*Domestic U. S. price only.

HEWLETT  PACKARD

1507 Page Mill Road, Palo Alto, California 94304

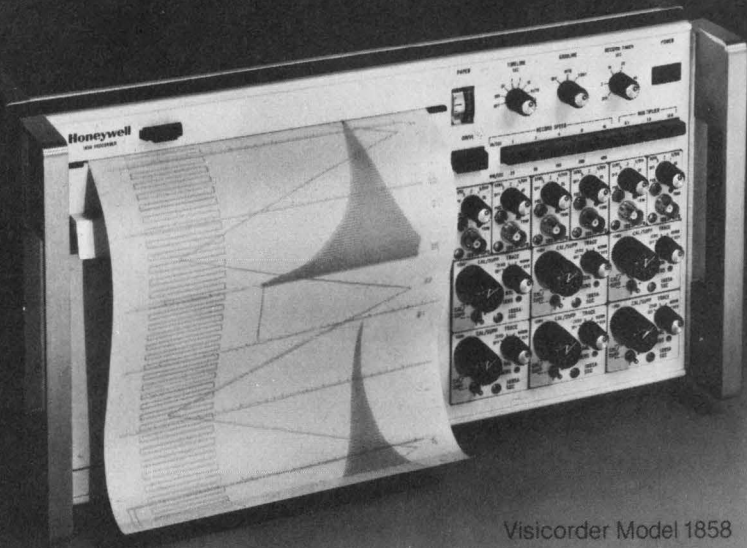

Visicorder Model 1858

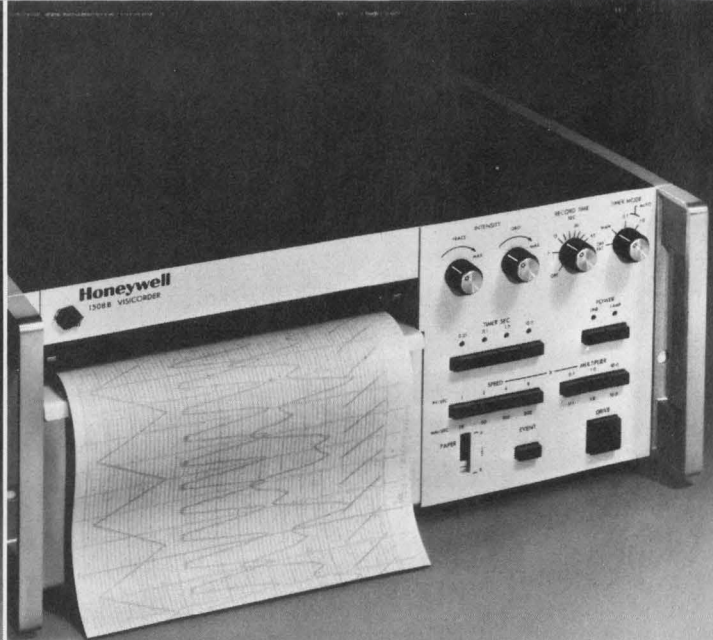

Visicorder Model 1508B

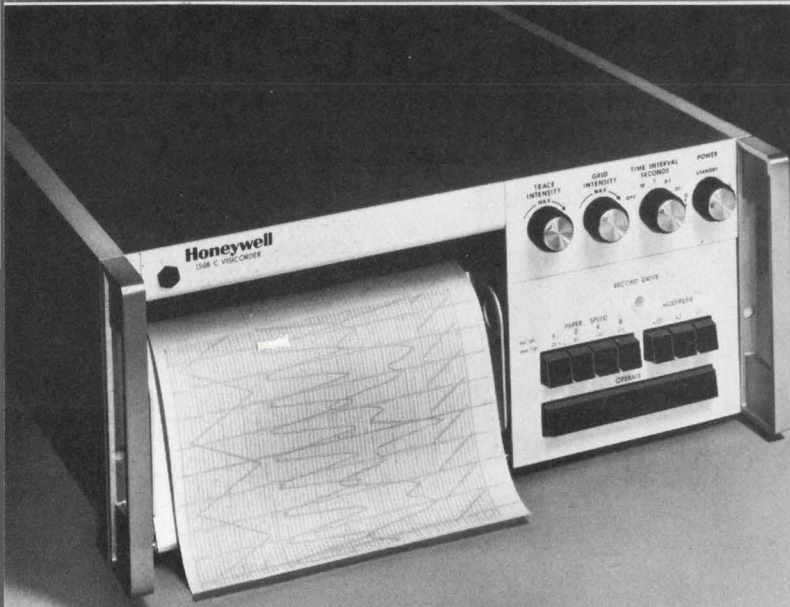

Visicorder Model 1508C

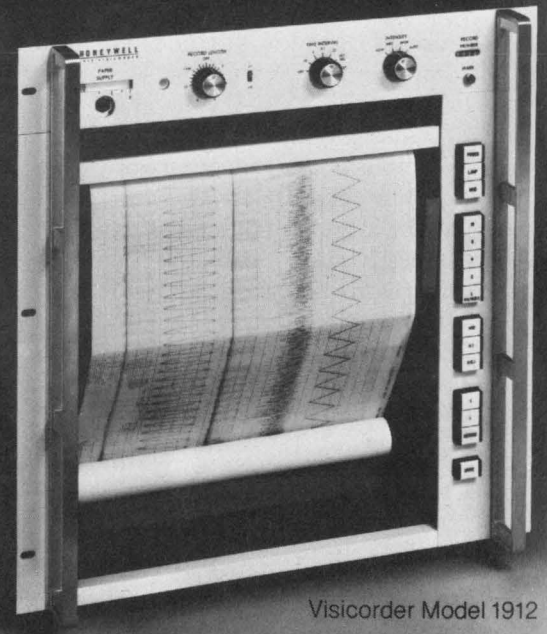

Visicorder Model 1912

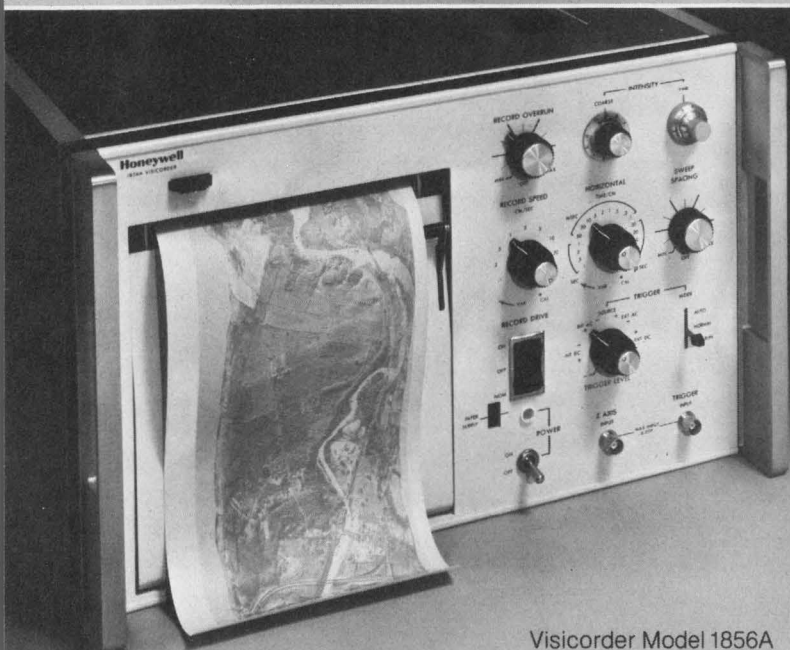

Visicorder Model 1856A



Visicorder Model 1806A

MEET SIX TOP RECORD MAKERS.

Perhaps the data you need can best be obtained by a high-performance oscillographic recorder with excellent trace resolution. Or you may require a linescan image recorder having very fast scan rates and a broad gray scale. Whatever it takes to get your data, chances are you will get it faster and easier with one of the recorders shown here.

These Visicorder oscillographs set the standard for high-performance graphic recording.

Visicorder Model 1858 is a completely self-contained system with up to 18 channels, yet it stands less than nine inches high. This unexcelled portability, enhanced by a wide selection of miniature, plug-in signal conditioners, makes the Model 1858 ideal for field or mobile use. And its dc to 5 kHz response, wide chart speed range, 100 μ V-300V input sensitivity, and the ease with which it expands to 32 channels also make it a favorite in the lab. A fiber-optic CRT assures sharp traces of high resolution across the entire 8-inch record.

Visicorder Models 1508B and 1508C offer dc to 25 kHz response, wide chart speed range and writing speeds greater than 50,000 inch/sec. Both combine

high-linearity optical systems with sensitive galvanometers to produce extremely accurate 8-inch-wide recordings. The Model 1508B has 24 data channels plus 4 for event recording; Model 1508C has 12 data channels plus 2 for event recording.

Visicorder Model 1912 offers the most data channels, widest recording paper, and widest transport speed range of all Honeywell galvanometer-type oscillographs. This versatile recorder can handle up to 36 channels of data, in addition to 6 channels of event recording. It accommodates 12-inch-wide paper at speeds from .005 to 200 inch/sec.

Do you need 4-axis recording capability? Our linescan image recorders give you the kind of record quality you can only get with a direct writing fiber-optic CRT.

Visicorder Model 1856A produces 6-inch-wide records that have exceptionally high resolution and wide gray scale. This makes the recorder particularly suited for such applications as facsimile, spectrum analyzer readouts, IR mapping and echocardiography. Z-axis response is dc to 8 MHz, Y-axis is dc to 75 kHz, and the X-axis is capable of scan rates to 18,000/sec. Accessories are available for film records.

Visicorder Model 1806A can record, on 6-inch-wide paper,

high-frequency signals that would otherwise require magnetic tape or oscilloscope camera techniques. It offers Y-axis response from dc to 1 MHz, Z-axis to 10 MHz, X-axis to 1 MHz and writing speeds greater than 1,000,000 inch/sec. The Model 1806A also accommodates accessories for film records.

Honeywell's Accudata signal conditioning modules speed most recording and measurement tasks.

Whether you need to control and amplify strain-gage signals, drive oscillograph galvanometers or magnetic tape recorders, or amplify low-level signals where relatively high common mode voltages are encountered, we have the modules to do the job easily and economically. Just give us your requirements and we'll show you an Accudata signal conditioner than can meet them.

For detailed information on any of these recorders or Accudata modules, call Lloyd Moyer at (303) 771-4700. Or write for our technical data sheets and a free brochure that describes all of Honeywell's Visicorders, magnetic tape systems and Accudata modules. Honeywell Test Instruments Division, Box 5227, Denver, CO 80217.

WE'LL SHOW YOU A BETTER WAY.

Honeywell

CIRCLE NUMBER 56

Wirewound precision and power resistors

fulfill many design demands other resistors can't meet, like tolerance lows of $\pm 0.002\%$ and power ratings of over 2000 W.

Wirewound resistors can provide lower temperature coefficients (1 ppm/ $^{\circ}\text{C}$), attain greater stability (0.003%/yr) and accuracy ($\pm 0.002\%$), and dissipate more power (over 2000 W) than composition and film resistors. And even though film resistors are making great strides, and may eventually supersede wirewounds both in cost and performance,¹ wirewounds still have the edge at the extreme ratings.

Resistors—whatever the type—that have better than $\pm 1\%$ initial tolerances are classified generally as precision resistors. The typical precision wirewound, however, is rated with a $\pm 0.1\%$ absolute-value initial tolerance. Moreover, wirewound resistors are available in large power ratings (1 to 15 W), not attainable with film units. Most other precision-resistor types are limited to less than 1-W ratings.

And large power wirewound units can handle far more power (to over 2000 W) with greater stability than most other available types of resistors.

Precision wirewounds come in many styles

Precision wirewound resistors come in a large variety of body sizes and shapes with axial, radial or PC-mounting leads (Fig. 1). Resistance wire (usually a nickel-chromium alloy) in various diameters, together with size limitations determines specific resistance ranges. Typical production units range from 0.1 Ω to 20 M Ω , but the low resistance end of the range, generally, must be larger than 0.1 Ω for very high precision units, because of lead-resistance errors.

Obviously, resistor value is affected by winding tension during manufacture, and stresses developed during mechanical placement. Moisture and chemicals also can affect the resistance. Clearly, resistor manufacturers must control these factors to make tight-tolerance resistors, which, of course, cost more the tighter tolerances are made. And spools of supposedly the same raw resistance wire often have slightly different resistivity from spool to spool, which further increases control difficulty.



1. Wirewound precision and power resistors come in a large variety of body sizes and shapes. Axial, radial, PC-mounting and multilead-network types are all available as precision units. And power units often have ceramic bodies, through-tab mounting and vitreous coatings. Special units come with lamp bases or water cooling.

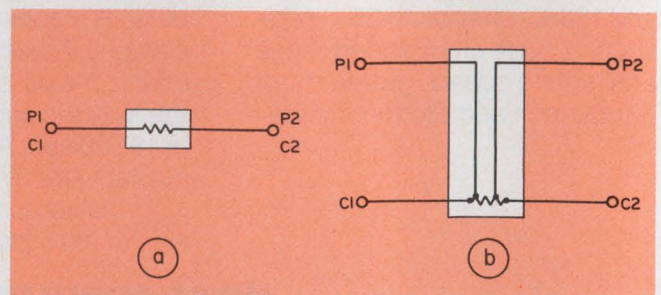

2. In low-valued high-precision resistors, leads can contribute substantially to poorer tolerances, because of lead resistance. In such cases, the usual two-lead resistor (a) often is replaced by a four-lead configuration (b), where the current flows through one pair of leads (C₁ and C₂) and voltage is tapped off a second pair (P₁ and P₂).

Roy Kampmeyer, Chief Engineer, Charles T. Gamble Industries, 605 Perkins Lane, Delanco, NJ 08075.

Normal initial tolerances for high-volume production units can be controlled to $\pm 0.002\%$. However, $\pm 0.005\%$ is a more common "best" initial tolerance, and costs less than $\pm 0.002\%$ units.

Unfortunately, a precision-wirewound's tolerance-error band increases with age, handling and storage. And absolute resistance values will drift with age, temperature and use, but these changes are small—typically 0.003% per year. This drift more than satisfies MIL-R-39005C, which allows a maximum drift of $\pm 0.1\%$ after 2000 h with rated power at an ambient temperature of 125 C.

Clearly, resistor values and tolerances are easy to define. If only the tempco characteristics of wirewounds were that easy.

An elusive parameter

Tempco, probably the most elusive property of a wirewound resistor, is expressed in parts-per-million resistance change per degree centigrade (ppm/ $^{\circ}$ C), or in % change/ $^{\circ}$ C, at specific reference temperatures and resistances. Mathematically, tempco is expressed as follows:

$$\frac{(R_1 - R_2)/R_1}{\Delta T} \times 100 = \% \text{ change } / ^{\circ}\text{C}$$

$$\frac{(R_1 - R_2)/R_1}{\Delta T} \times 10^6 = \text{ppm} / ^{\circ}\text{C}$$

Resistances R_1 and R_2 are absolute resistance values at two temperatures of concern, and ΔT is the temperature change. The tempco can be positive or negative, depending upon the wire material and how it's treated.

Temperature change, however, must include both external, or ambient, changes and the effects of self-heating—a point often overlooked. Self-heating combined with nonlinear tempcos makes it difficult to calculate exact resistance changes.

Furthermore, tempcos generally specified by a manufacturer are measured in a temperature-controlled oil bath, which keeps the resistive element at a fixed temperature, despite current flow through the resistor. However, on a circuit board with power applied, self-heating raises the resistor-element temperature above the body temperature. Thus, a manufacturer's tempco rating isn't of much help, unless you can determine the temperature rise of the resistor element when under power. To account for self-heating, have the manufacturer supply the tempco with an applied voltage and at a given ambient temperature in air.

Table 1. Wirewound-resistor lead materials

| |
|--|
| Tin-plated copper |
| 180 Alloy (22% Ni, 78% Cu) |
| Nickel A (99.45% pure Ni) |
| 46 Alloy (46% Ni, 54% Fe) |
| Dumet (1% Mn core, 42% Ni, 57% Fe, Copper covered) |
| Gold-plated Dumet |
| Copperweld (Cu over steel—40% Cu, 60% steel by weight) |

Over-all tempco is affected by several different factors. First, the resistance-wire material has a basic tempco as spooled, usually with a value within the range of ± 10 ppm/ $^{\circ}$ C for nickel-chromium alloys. The value can remain always negative, always positive, or it can go from negative to positive as the temperature changes over the usual range for precision resistors—from -65 to 125 C.

Tempco, also, is affected by stresses induced by winding the resistive element and additional stresses from differential contraction and expansion of the bobbin and wire with temperature changes. A heat soaking above 100 C for stabilization can relieve these stresses. Of course, selecting special wires and special treatment of the wire to get low tempco increase costs.

Tempcos of production precision wirewound resistors are typically ± 10 to ± 25 ppm/ $^{\circ}$ C, but can be as low as ± 1 ppm/ $^{\circ}$ C or as high as $+6000$ ppm/ $^{\circ}$ C (with pure-nickel wire). Copper has a tempco of $+3930$ ppm/ $^{\circ}$ C at 25 C. Tempco-spec reference-temperature ranges usually come in two classes: -65 to 25 C or 25 to 125 C. However, manufacturers' oil baths are mostly set between 0 and 60 C when making measurements for specs. MIL-R-39005C calls for tempcos of less than ± 10 ppm/ $^{\circ}$ C for resistors 100Ω or larger, and all the way to ± 90 ppm/ $^{\circ}$ C for 1Ω or smaller.

You should keep dissipated power in precision wirewounds well below the resistors' rated value, unless you can cope with or are unaffected by related self-heating tempco effects. Design loads for military applications are usually 25% of rated and commercial ones about 50% of rated.

But maximum allowable resistor temperatures can be higher than those at which the tempco is specified. The maximum temperature is determined by limitations of the bobbin and other resistor materials. Some epoxies and insulating tapes can't be used above 150 C. MIL-R-39005C has set the standard for the industry

Table 2. Power-resistor core materials

| Material | Cost factor | Core conductivity |
|-----------------|-------------|----------------------------------|
| | | BTU-ft. ft ² -h-°F |
| steatite | low | 1.5 |
| aluminum oxide | medium | 8.0 |
| beryllium oxide | high | 64.0 |

at 125-C maximum ambient with rated power in the resistor. And some manufacturers go a bit higher, but derate their units 5% per °C of rated power above 125-C ambient.

Watch out for inductance

Tempco isn't the only tricky spec for wirewounds. Watch out for inductance, too. Most precision resistors are wound "noninductively," but they still have some inductance. And some are supplied inductively wound for use in circuits of over-all low Q, where additional inductance matters little.

Low inductance is obtained with bifilar windings or with two or more (even number) pi-windings wound in series opposition. Of course, complete inductance cancellation is impossible. Thus, at frequencies over 1 MHz, even though the residual inductance is small (less than 1 μH), it can have an appreciable effect. And the problem becomes greater with high resistor values, because more turns and longer wire lengths result in higher residual inductances.

In addition, stray capacitance between turns and between layers of the wire gives a wirewound resistor a resonant frequency. Consequently, in some applications the resistor can appear more capacitive than inductive.

Well made "noninductively" wound resistors commonly have residual inductances of less than 1 μH in the high ranges; low resistive values can be easily wound with only 0.01 to 0.1-μH inductances.

Leads make a difference

If inductance doesn't bother your application, perhaps the resistor leads will—especially if you're using a close-tolerance resistor. Dissimilar lead and resistive-element metals create a thermocouple; consequently, tempco is affected by small thermocouple voltages, which vary with temperature. Fortunately, copper leads with nickel-chromium resistance wire produce the lowest thermocouple voltage of currently used lead materials—typically about 0.3 μV/°C. Other popular lead materials are listed in Table 1.

Leads are soldered or welded to the resistive element. Lead-wire diameter usually depends on the resistor's body style, and is typically 0.02 to 0.032 in. Lead placements are either axial or radial, and lugs are also often used.

But precision wirewounds often need more than the usual two-wire lead set (Fig. 2a). A four-wire set is more accurate (Fig. 2b). In a four-wire set, the current path is through separate terminals, C₁ and C₂, not through measurement terminals P₁ and P₂. The measurement terminals merely sample the voltage between their attachment points. Thus, the current-path lead resistance can be considerable, yet not affect the voltage between P₁ and P₂, particularly if the external current in the measurement loop of P₁ and P₂ is kept small. Four-wire lead sets are especially suited for low-value, very accurate resistors, where only a few milliohms of contact or lead resistance can have a major influence.

For two-wire lead sets, manufacturers guarantee the resistor value at a particular measurement point

Table 3. MIL-spec wirewound power resistors

| Type | MIL-R-26E | | MIL-R-18546D | MIL-R-39007D | MIL-R-39009B | MIL-R-19365C |
|--------------------------------|--------------------------------------|-------------------------------------|--|---|--|---------------------------------------|
| | RW series | | RE series (metal-body chassis mount) | Established reliability type RWR series. Axial lead, precision, inductive and noninductive. | Established reliability type RER series. Metal-body, chassis mount, inductive & noninductive | RX Series adjustable |
| Char "V" Gen'l. Purpose | Char "U" Precision | Tolerances (± %) | | | | |
| | 5 | 0.1 0.5 1.0 | 1 | 0.1, 0.5, 1.0 | 1 | 5 |
| Wattage ratings @ 25 C ambient | 3-240 W derated to zero at 350 C amb | 1-10 W derated to zero at 275 C amb | Characteristic G: 5-120 W. derated to zero at 275 C amb Characteristic N: noninductive version of "G" | 1-10 W derated to zero at 275 C amb | 5-30 W (mounted) derated to zero at 275 C amb | 11-210 W derated to zero at 350 C amb |

on the leads, especially in low-valued resistors. For example, MIL-R-39005C calls for measurements at 3/8 ±1/16 in. from the body for 10-Ω, or lower, resistors.

Matching can solve many problems

But if special leads or noninductive windings aren't your problem, perhaps you need specially matched resistors in your voltage-divider network application. Precision wirewound resistors allow absolute-value matching to be held to ±0.004% without selection, based on available ±0.002% single-resistor tolerances. With selection and, of course, higher cost, sets can be matched to within ±0.001%.

Indeed with care, manufacturers can hold tempco matching to ±0.5 ppm/°C at 25 C, but at reduced yield. As a result, tracking from 0 to 60 C can be kept to ±1 ppm/°C. Needless to say, with such close matching and tracking specs, you get a very expensive resistor pair. Film resistors produced monolithically, however, can give nearly perfect tempco match, because they are on the same substrate.

But if you want individual resistors that can attain the ultimate precision and stability, and also carry appreciable power, wirewounds are still hard to beat. Commercial-quality wirewounds typically offer ±25 ppm/°C tempcos at 25-C ambient. Thermal-stress removal processing is minimal in such commercial units, and yield is close to 100%. For better-quality units, MIL-R-39005 (which replaces MIL-R-93) covers

the so-called RBR series of wirewounds, and MIL-STD-202 defines the testing procedures used on them.

But if catalog-listed precision resistors don't meet your application requirements, contact the manufacturer directly. You'll get application assistance, design recommendations, valuable suggestions and even samples of specially made resistors.

Wirewound-resistors, however, aren't confined to precision applications.

Power wirewounds are resistor workhorses

Power wirewounds can safely dissipate large amounts of energy and handle body temperatures to 275 C (you can cook on them). They are the workhorses of the resistor world. And they come in a great variety of styles—fixed, fixed-tapped adjustable, etc. Some are silicon and others are vitreous coated. Many have metal cooling fins and mounting ears.

Power ratings are limited by the maximum permissible hot-spot temperatures that can develop in the resistive element or core. Wirewound units as large as 2000 W and with surface temperatures near 500 C are fairly common. Of course, it's best to keep them as cool as possible. Accordingly, a ceramic core provides good thermal conduction for heat removal.

Also, a vitreous or silicon coating over the wire element transforms the surface of a wirewound resistor into a better and more uniform heat radiator. Since leads often serve to conduct heat from the core,

Table 4. Comparison of MIL-spec ratings

| Parameter | MIL-R-26E | MIL-R-18546D | MIL-R-39007D | MIL-R-39009B | MIL-R-19365C |
|---------------------------------------|---|---|--|--|--|
| Max. Tempco (±ppm/°C) | U char.: 30 for R>10Ω 50 for 1<R<10Ω 90 for R<1Ω V char.: 260 for R>20Ω 400 for R<20Ω | 30 for R>2kΩ 50 for R<2kΩ | 30 for R>10Ω 50 for 1<R<10Ω 90 for R<1Ω | 30 for R>20Ω 50 for 1<R<19.6Ω 100 for R<1Ω | 260 for R>ρ 400 for R<ρ where ρ = 0.25Ω/in. ² of winding area |
| Max. ΔR with life (25 C, rated power) | ± (3% + .05Ω) for RW 20-69. ± (0.5% + .05Ω) for RW 70-81) time: 2000 h | ± (1% + 0.05Ω) time: 1000 h | ± (0.5% + 0.05Ω) time: 2000 h | ± (1% + 0.05Ω) time: 2000 h | ± 5% time: 1000 h |
| Max. ΔR with short-time overload | ± (0.2% + 0.5Ω) for RW 70, 81. ± (2% + .05Ω) for others. 10-times rated pwr for 5 s. | ± (0.5% + .05Ω) 5-times rated pwr for 5 s | ± (0.2% + .05Ω) 5-times rated pwr for 5 s (RWR71, 80-82, 89). 10-times rated pwr for 5 s (others) | ± (0.3% + .05Ω) 5-times rated pwr for 5 s. | ± 2% 10-times rated pwr for 5 s. |

easily melted soft-soldered terminals shouldn't be used in high-wattage units.

The core must be durable and low cost. It must withstand very high temperatures and have high dielectric strength. Furthermore, it must be inert and stable, and should be extrudable into many shapes. A ceramics core can meet all these requirements.

Table 2, lists the ceramic materials commonly used in power wirewounds. As core heat conductivity increases, resistor physical size can be decreased for a given power rating. But of course, the heat must have somewhere it can go, when it leaves the core; thus, adequate heat sinking must be provided.

Power resistors usually are wound in a single layer to take advantage of the heat-sinking capability of the core. But a single layer limits the maximum resistance attainable, although values as high as 275 k Ω can be obtained. In addition, MIL specs establish minimum wire size, which further restricts high resistance values. Also, the requirement for noninductively wound units cuts the practically attainable upper limit by about one half that of ordinary inductive types.

At the low end of the resistance range—at about 0.1 Ω —MIL specs also impose limitations. According to the MIL-specs, "no more than 20% of the over-all body length shall remain uncovered by the winding." However, commercial parts don't have to meet this spec, and values down to 5 m Ω can be achieved.

Resistance changes with age

But whether your resistors are high or low-valued units, the resistance of most wirewounds will shift with time—unless pre-aged before shipment. MIL specs (Table 4) spell out pre-aging conditions and limits. Also, the specs provide criteria for testing and allowed resistance-change limits after wirewounds are subjected to high transient power pulses.

Overloads greater than 10-times rated generally can be accommodated for intervals less than the five seconds specified in the MIL specs. For a pulse of less than 16.6 ms, a 25-W unit can handle as much as 1000 W. If the pulse is faster than the resistor core's time constant, no heat can be drawn off by the core, and the wire is effectively in free space. The manufacturer can tell you the wire temperature achieved for a given pulse time and overload, as well as advise you how it affects the unit.

Another important specification for wirewound power resistors is dielectric breakdown, which generally occurs between the resistor element and its mounting. The breakdown often is to a through-bolt or to the metal housing of chassis-mounted resistors. Although an allowable current leakage should be specified at the breakdown-voltage value, it rarely is. Breakdown test voltages are usually 60-Hz sine waves specified in rms volts.

The MIL spec for dielectric breakdown is 1000 V rms, except 500 V for RW70, 80, 81 and RWR80, 81, 82 types, and as follows for MIL-R-18546 and MIL-

R-39009 chassis-mounted types:

RE60, 65, 70..... 1 kV.

RE75..... 2 kV.

RE77, 80..... 4.5 kV.

Testing for breakdown is done at 25 C and at sea-level pressure. If desired, you can specify high humidity and reduced atmospheric pressure, since both conditions reduce dielectric breakdown voltage.

But one spec you usually don't have to worry about with power wirewounds is inductance. Wirewound power resistors generally have much lower inductance values than precision units, because fewer turns of wire are required. Moreover, you easily can get noninductive power units with less than 0.5 μ H. The RWR series (MIL-R-39007) carries a spec of 0.25 to 1.2 μ H at 1 MHz for values above 50 Ω , and about half this inductance below 50 Ω .

Though inductance usually isn't a serious problem with wirewound power resistors, resistance change with temperature can be. How do you get an accurate resistance with power wirewounds when they're run at rated power? Even in a constant ambient temperature, the resistor element often experiences a change of 250 C from power off to rated-power on. With an over-all tempco of ± 50 ppm/ $^{\circ}$ C, you would get a $\pm 1.25\%$ resistance change. So how can you specify a $\pm 1\%$ resistor, when merely turning it on changes it by 1.25%?

Fortunately the primary job of power resistors is to waste power, not drop voltages accurately. You can get tempcos less than 10 ppm/ $^{\circ}$ C, but a tempco of only ± 10 ppm/ $^{\circ}$ C would produce $\pm 0.25\%$ resistance change with a 250-C warm-up.

To get an accurate resistance under full power in a specific ambient temperature, specify the resistance you want under the conditions you want, including the maximum hot-spot temperature. Of course, ask for a low over-all tempco to limit resistance change.

It's wise to use MIL specs as a guide to environmental and quality ratings. If you have a particular set of conditions in mind, try to pick the nearest MIL spec that most completely describes them and call your favorite resistor manufacturer. This will give him a good starting point from which to put together your requirements.

To get more control over the resistors you buy, follow established reliability specs, such as in MIL-R-39009B and MIL-R-39007D. Such resistors must endure exhaustive testing by the manufacturer, and guaranteed failure rates of 0.001 to 1% per 1000 h at rated power and 25 C ambient with a 60% confidence factor. Failure may simply mean an out-of-spec resistance change. For example, a resistance change of $\pm(2\% + 0.05 \Omega)$ and $\pm(1\% + 0.05 \Omega)$ constitutes a failure for MIL-R-39009B and 39007D, respectively, over a 10,000-h period.■

Reference

1. "Mass-Produced Precise and Stable Resistors Surpass Wirewound Units," *Electronic Design*, Jan. 18, 1978, p. 115.

THE NEW TALLY T-2000 LINE PRINTER

Added Value Lower Prices

Tally's made a good thing better. Put Tally's 1978 Model T-2000 Line Printer next to a 1976 version, and it's easy to see the improvements have been made under the hood. Instead of experimenting with unproven technologies, we've concentrated on improving the proven performance of comb matrix printing.

Call Tally today.

TALLY®

OEM SALES OFFICES

Boston (617) 272-8070
New York (516) 694-8444
Chicago (312) 325-9788
Los Angeles (213) 378-0805
Miami (305) 665-5751
San Jose (408) 247-0897
Washington, D.C. (703) 471-1145
San Antonio (512) 733-8153
Seattle (206) 251-6730

CIRCLE NUMBER 57

BUSINESS SYSTEMS SALES

Orinda, CA (415) 254-8350

Here's a sampling of what's new: Simplified power supply consumes less power. The unit is structurally stronger, yet lighter in weight. Improved air flow lets the unit run cooler. Service accessibility has been improved again. In fact, the mean time to repair has been cut in half. Improved reliability and longer life. Increased MTBF with no preventive maintenance; no other line printer can match it! All these benefits have been achieved at lower cost which means lower prices. Now you can afford Tally quality.



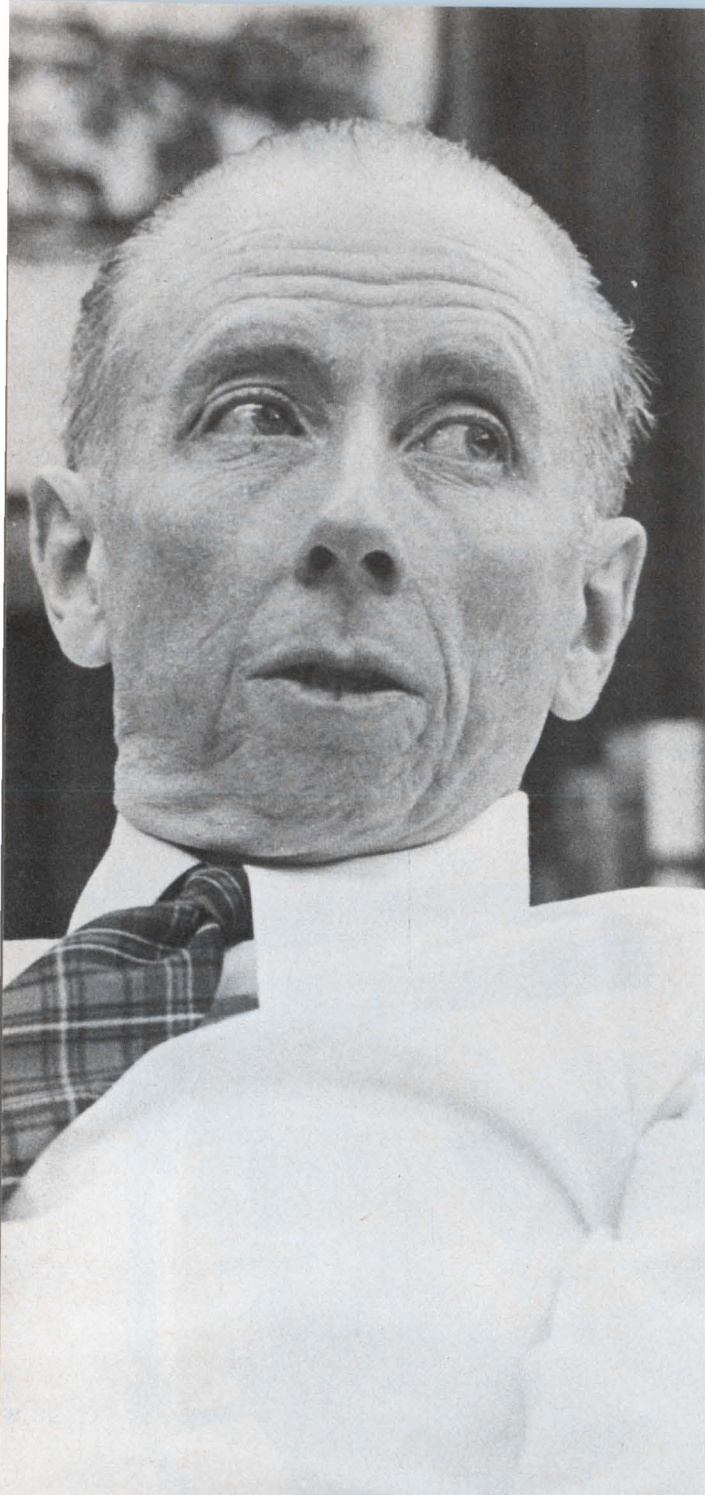

Don Alstadt of Lord Speaks On Educating Your Managers

by people whose knowledge of science and technology is practically nil. Many of them see basic science as a form of witchcraft, as an unknown and awesome thing. This fact threatens the entire process of innovation. And without innovation, the continued growth of wealth is not possible. Of course there are exceptions. Organizations like Hewlett-Packard, Beckman Instruments and Polaroid, and the people who run them, are the exceptions in our society.

The problem is even worse than it seems because even the people originally possessed with technical backgrounds aren't equipped to understand current technology. Look at what happens.

Say a person comes out of engineering school and works in the lab for many years. At some point in his career, he finds himself in general management.

In the time between his leaving the lab and his intense involvement in management, he is probably exposed to all kinds of training in finance, human-resources management, law, and what have you. Perhaps he goes to business school. However it happens, he gets continued refurbishment in the management arts.

When he gets to be a manager, he learns a lot about management and forgets a lot about technology. He isn't familiar with the technology that is now running the business. If it's been 20 or 25 years since he left the laboratory, he might just as well not have gone to engineering school at all.

The biggest threat to the growth of America is the fact that our institutions are more and more under the control of people who can't understand what the innovation process is all about. Their backgrounds don't prepare them for understanding that growth comes from research and development or, if you will, from science and engineering.

That comment was made to me many years ago by Irving Langmuir, a Nobel laureate who was the dean of American industrial scientists. His idea is more valid today than it was then.

The great bulk of American corporations and the great bulk of our governmental institutions are run

Let me tell you about Langmuir again. When we met, I asked about a paper he had written that I had recently read. He remembered almost nothing about that paper.

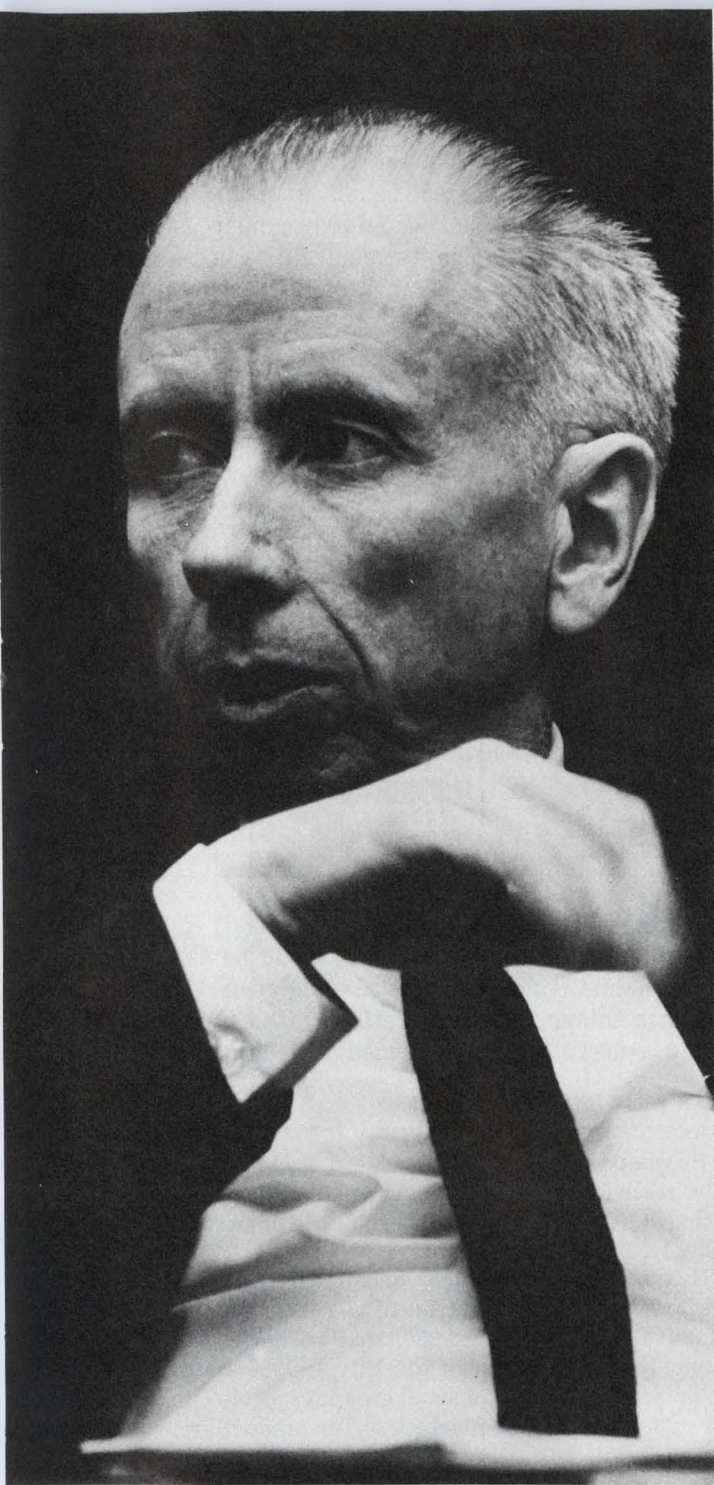

Langmuir was honest enough to admit that he remembered almost nothing about that paper; he had written it 20 to 25 years earlier. But we have many managers of engineering companies who forgot almost all the engineering they learned 20 years ago. Most won't admit that they forgot so much.

Unfortunately, many of these former engineers think the technology in their business is what it was when they were back in school. That can be even more unfortunate than the situation with a manager who was trained in finance, human resources or law. The man with no technical training may, at least, have some humility. But he, too, might believe that you

can lead, as contrasted to manage, a business without understanding the technology that drives it. I don't believe this is possible.

One of our greatest problems is that the continuing education of the management and leadership talent of our corporations does not include continual exposure to technology. Yet technology is changing so rapidly that familiarity with it is almost essential for someone to have a continued entrepreneurial attitude.

Successful operation of a business requires three different functions—to innovate, to entrepreneur and to manage. But our business schools are oriented only to the third function. As far as I can see, they have no ability to influence the first two. Yet the man who gets to the top of an American corporation who has not been exposed to technology education since he got out of school—or ever—can't understand the innovation process and is uncomfortable with the entrepreneurial process. If he lacks such understanding, his organization is very much inhibited in its ability to make changes needed to keep that business viable in a technologically changing world.

The steel industry is probably a classic example. Some years ago, the director of research of a major steel company told me of breakthroughs in the labs that could remake the steel industry. But the concept of a breakthrough depended on whom you spoke to.

The marketing manager thought a breakthrough was a new process that would allow him to undersell his competition. The manufacturing manager didn't care what the breakthrough was, as long as he didn't have to change the plant. The president's attitude was: "When you fellows can agree, come back and see me."

This shows what I'm talking about. There's a top-level lack of comfort in dealing with innovation and the entrepreneurial process.

What can we do about it? Well, for several years I've been trying to get business and engineering schools to develop curricula to refurbish 30-to-50-year-old executives. I'd like these people exposed, not only to "the management arts," but to the world of science and technology. And I'd like them to develop some sense of comfort with the innovation processes. I can't say I've been very successful.

The deans of the engineering schools are somewhat more tolerant to the idea than the management deans (though two business schools, in fact, are trying to "engineer" such curricula). By and large, though, the management deans feel that if you can manage one kind of company you can manage any kind.

Maybe that's true. Maybe you can manage any kind of company. But you can't lead it.

There's a marked difference between managing and leading a company because leading involves an understanding of not only the management process but also the innovative and entrepreneurial processes. These

are not things you can pick up or be exposed to in our business schools.

While I'm trying to get schools to do something for these executives, I'm bringing the mountain to Mohammed in our own organization. We're starting a series of lectures and training programs conducted by people who are particularly knowledgeable in various branches of science and technology. We're bringing these people in to talk—not to our laboratory people, our science people, our director of research, but to our general managers, our vice-presidents, our senior vice-president and some of our board members. We want our executives to develop an appreciation of the technology that's going to change our company in the next five to ten years.

Our first session, on high-polymer chemistry, was given by Professor Herman Mark. He's Professor Emeritus of the Polytechnic Institute of New York. Directly or indirectly, this lively 82-year-old man trained the great bulk of American polymer chemists.

Over the next months we plan to cover subjects like magnetics, radiation interaction with materials, metallurgy and materials science, active feedback systems, advanced mechanics, process control and decision-making techniques that involve mathematical systems.

I should point out that it doesn't make any difference if our managers have engineering backgrounds. Once a man has been out of engineering school for 25 years or so it doesn't make a heck of a difference if he hasn't kept up to date. Then he's

no more equipped to understand today's technology than is our finance vice-president.

There's something interesting here. Nontechnical managers expect technical people to learn their language. The engineer is expected to become reasonably conversant with financial terms, legal terms, and the terms used by specialists in human-resources.

But nobody seems to expect the nontechnical manager to extend the same degree of effort to the field of technology so that he can participate in what I call the TPM decisions of the corporation—moving Technology into Products and moving Products into Markets. Incidentally, moving technology into products into markets is the basic mission of a corporation—any corporation.

That's why we exist. If we were here primarily to make money, most American corporations ought to liquidate their assets and put them in tax-exempt bonds because many companies most of the time don't make 6% after taxes.

Making money is like good health habits. If you don't have them, you don't stay alive. But having good health habits is not why you're alive. You're here to do other things. The corporation's basic function is to move useful human knowledge (technology) into

Who is Don Alstadt?

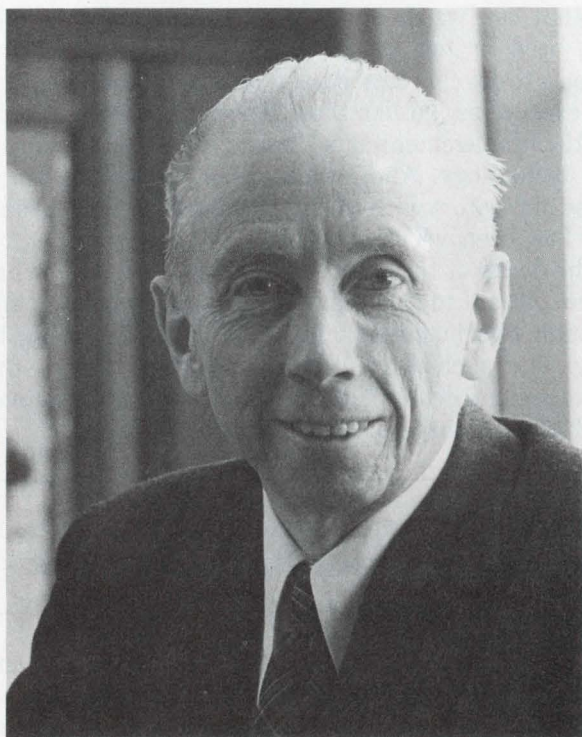

He was born in Erie, PA. He joined Lord in 1943 and later received his bachelor's in chemistry and physics from The University of Pittsburgh (a little over 100 miles from Erie).

He started in the laboratory, and his early work saw the development and patent of a rubber-to-metal adhesive (1953), Chemlok 220, that permitted successful bonding even in high humidity. In 1956 Alstadt was placed in charge of a small group responsible for its manufacturing and marketing. The product grew and so did Alstadt.

In 1959, Lord created Hughson Chemicals and, one year later, Alstadt was named general manager. That same year he was named vice-president. Don was named vice-president and general manager for both Lord Manufacturing Company and Hughson Chemicals Company in 1964. Two years later he was tapped as executive vice-president. And in 1968 he was named president, Lord Corporation, the first non-Lord to be so selected, and has since served in that capacity of this privately held company whose recent sales volume was about \$75 million.

Professionally, Alstadt derives his greatest pleasures from seeing concepts move from the drawing board to the marketplace. To promote this pleasure, he spends lots of time on academic campuses and serves on the board of trustees or advisory committee of eight universities.

products and to move these products into markets. When it does that, it automatically creates wealth for all of society.

I personally feel that the standard of living throughout the world is related to how effectively technology is put into products that are put at the doorstep of Joe Doakes. In fact, there's more relationship between how well Joe lives and how well that process is performed than there is to the form of government under which he lives.

I certainly prefer our form of government to any other, but I think most people probably live better in the Soviet Union than they do in India, because India has not successfully developed technology into products, despite the fact that it's a democracy.

So I feel it urgent that the people who lead business and government become comfortable with technology and the entrepreneurial and innovative processes.

I think one of our problems is that so many of our corporations and government bodies are dominated by a legalistic mentality. This is an adversary mentality, geared to investigate, defend or prosecute—or to judge in terms of tradition, history or law. The legal mind is not trained to understand the broad concepts involved in economics, technology, medicine or any of the other disciplines that drive our society.

There's another problem. Over the past 30 years or so we have tended to put into control of our corporations people with disciplines aimed at coping with specific problems. After the war, the notion existed that a corporation would be successful if it developed products the market was yelling for. So we placed marketers in charge of our companies.

Then we went through a financial crunch, so we put accountants and finance people in charge. Now we're having legal problems with the government, so we're putting legal people in charge.

It seems to me that scorekeepers and umpires are running the ball team. Yet the name of the game is neither scorekeeping nor umpiring.

The name of the game is playing ball—which is moving technology into products into markets. We need more broad-gauge people who have a feel for the technology-product-market process and who are equipped, when it's needed, to obtain marketing, financial or legal advice.

The name of the game is moving technology into products into markets—and not panicking every time an environment of the moment seems to suggest that we have some marketing, financial or legal problems. We're working on pimples instead of the real body. We need people who understand the basic processes and people can't understand these processes unless they have a feel for technology in addition to the management arts. ■■

Dialight LEDs

The widest choice for your every application.

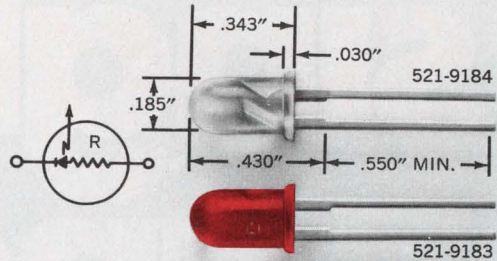

Available in red or clear LED packages with or without a built-in current limiting resistor. Red LED is also made without resistor. Suitable for circuit status indication, alpha-numeric displays and visual indicators. Features long wire-wrappable leads. IC compatible with solid state reliability. High luminous intensity, low power consumption, low cost.

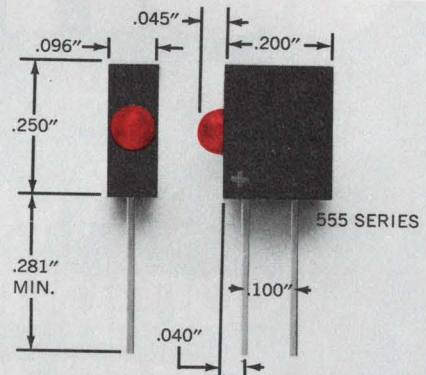

LED logic state fault indicators available in 14 models with voltage ratings from 1.7 to 14. Suitable for dense packaging on printed circuit boards—up to 10 units to the inch—IC compatible. With built-in series resistor. Polarity identified. Low power consumption.



Dialight, the company with the widest choice in switches, LEDs, indicator lights and readouts, looks for needs . . . your needs . . . and then they develop solutions for your every application. No other company offers you one-stop shopping in all these product areas. And no other company has more experience in the visual display field. Dialight helps you do more with these products than any other company in the business, because we are specialists that have done more with them. Talk to the specialists at Dialight first. You won't have to talk to anyone else. Send for your free new copy of Dialight's current catalog.

DIALIGHT

Dialight, A North American Philips Company
203 Harrison Place, Brooklyn, N. Y. 11237
(212) 497-7600

See Dialight.

CIRCLE NUMBER 58

The single chip analog computer.

A versatile, new
computational IC that's
accurate and easy
to use,



The AD534 Analog Multiplier,
from \$16 in 100s.

The Analog Devices' AD534 Analog Multiplier. A new, monolithic, laser-trimmed, four-quadrant analog multiplier destined to smash the myth that analog multipliers are more complex than the computing function they solve.

The AD534 has a guaranteed maximum multiplication error of $\pm 0.25\%$ without external trims of any kind. This level of accuracy you'd normally expect to find only in expensive hybrids or bulky discrete modules. Excellent supply rejection, low temperature coefficients and long-term stability of the on-chip thin film resistors and buried zener reference preserve the AD534's accuracy even under the most adverse conditions.

The AD534 is the first general purpose, high performance analog multiplier to offer fully differential high impedance operation on all inputs. And that's what gives the AD534 its amazing flexibility and ease of use.

The AD534 is a completely self-contained, self-sufficient multiplier which can generate complex transfer functions very close to theoretical. Our active laser trimming of thin film resistors on the chip to adjust scale factor, feedthrough and offset allow you to plug in the AD534 and run it virtually without adjustment.

In addition to straightforward implementation of standard MDSSR functions (multiplication, division, squaring and square rooting), the AD534 simplifies analog computation (ratio determination, vector addition, RMS conversion); signal processing (amplitude modulation, frequency multiplication, voltage controlled filters); complex measurements (wattmeters, phasemeters, flowmeters) and function linearization (transducers, bridge outputs, etc.) You can set up the AD534 to perform complex calculations by using various feedback arrangements to manipulate the AD534 transfer function of $(X_1 - X_2)(Y_1 - Y_2) = 10(Z_1 - Z_2)$.

and use,

In Frequency Multiplication.

Nonlinear circuits which accept sinusoidal inputs and generate sinusoidal outputs at two, three, four, five or more times the input frequency make use of trigonometric identities which can be implemented quite easily with the AD534 as shown. For this frequency doubling circuit the output should be AC-coupled to remove the DC offset resulting from the trigonometric manipulation.

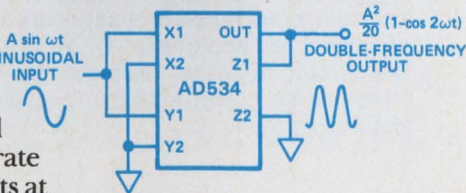

In Ratio Computing. The percentage deviation function is of practical value for many applications in measurement, testing and control. The AD534 is shown in a circuit that

computes the percentage deviation between its two inputs. The scale factor in this arrangement is 1% per volt although other scale factors are obtainable by altering the resistor ratios.

and use,

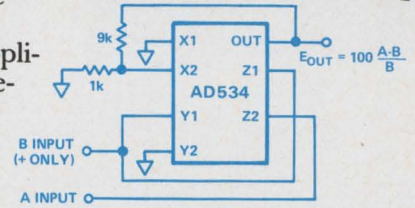

and use,

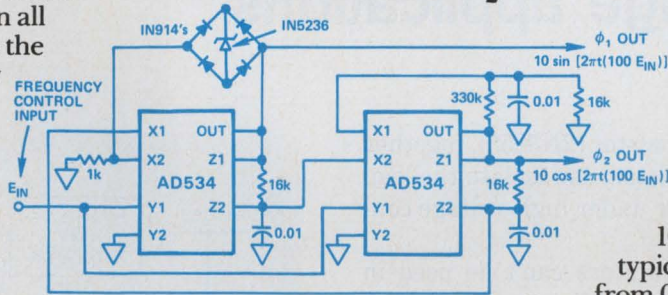

In Sine Wave Function Generation.

The voltage controlled 2-phase oscillator uses two AD534's for integration with controllable time constants in a feedback loop. The frequency control input, E_{IN} , varies the integrator gains, with a sensitivity of 100Hz/V and frequency error typically less than 0.1% of full scale from 0.1V to 10V.

In a Voltage Controlled Filter.

The output voltage, which should be unloaded by a follower, responds as though E_s were applied directly to the RC filter but with the filter break frequency proportional to the input control voltage (i.e. $f_0 = \frac{E_c}{20\pi RC}$). The frequency response has a break at f_0 and a 6dB/octave rolloff.

These uses of our new Single Chip Analog Computer, the AD534, are only the beginning. For the big picture call Doug Grant at (617) 935-5565. Or write for a copy of our new Multiplier Application Guide and the data sheet on the AD534.

and use.

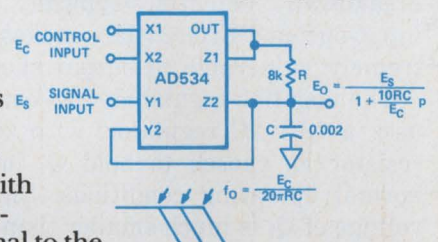

ANALOG DEVICES

The real company in analog computation.

Transistor protects floating regulator in high-voltage applications

An inexpensive power transistor (2N3055), together with a zener diode and a resistor, can isolate the load on a three-terminal regulator under high-voltage conditions.

Available low-voltage regulators can't be used in high-voltage (>40 V) power supplies unless they're floated. And then the ability of IC regulators to both limit current and to protect against thermal overload is usually lost in floating operation. Moreover, the low breakdown potential—typically 30-V maximum input-output differential—makes the devices extremely vulnerable to output short circuits.

The negative regulated -50-V supply in the figure uses a 12-V IC regulator, with zener diode D_1 and resistor R_1 chosen to hold Q_1 in saturation under normal operating conditions. Since the saturation voltage of Q_1 is much smaller than output voltage V_o , changes in $V_{ce(sat)}$ have negligible effect on the output. Under thermal or current overload, Q_1 acts as a buffer between the load and regulator. And D_1 allows the regulator to control the output current from zero to its maximum, with output voltage variations of only -40 to -50 V.

Suppose a fault shorts the power supply to ground. Under this condition, the current limit of the regulator, I_2 is 1 A, the dc current gain (H_{fe}) of Q_1 is 49, and V_{be} is 1 V. The output voltage of the regulator, V_2 , adjusts internally to provide a base current to Q_1 :

$$I_b = I_2 / (H_{fe} + 1) = 1.0 / (49 + 1) = 20 \text{ mA.} \quad (1)$$

With an I_b of 20 mA,

$$V_2 = - (V_z + I_b R_1 + V_{be}) = - [39 + 20 \times 10^{-3} (200) + 1.0] = -44 \text{ V.} \quad (2)$$

If the output remains shorted, Q_1 dissipates 44 W and the regulator 16 W. When the regulator's junction temperature exceeds safe limits, the internal thermal protection circuitry reduces the output current, and

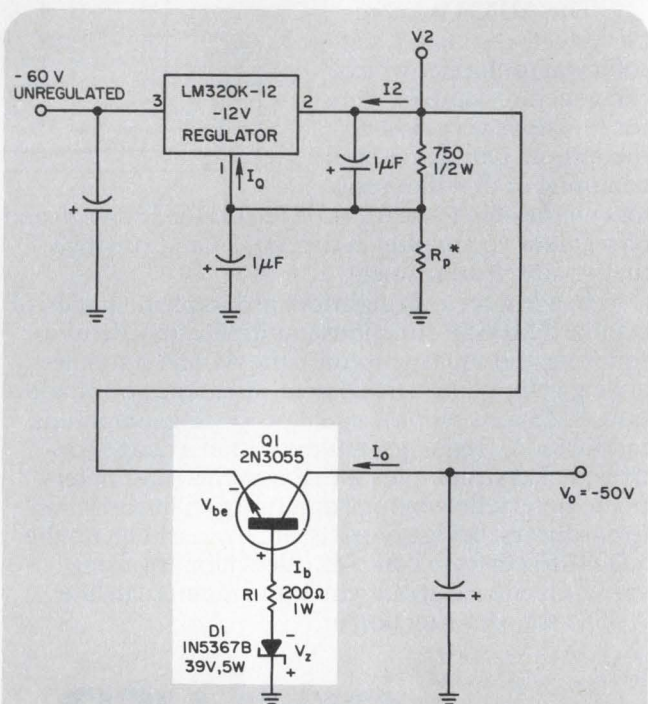

* THE VALUE OF R_p DEPENDS ON I_Q . FOR THIS CIRCUIT, ASSUMING $I_Q = 1 \text{ mA}$, $R_p = 2.26 \text{ k}$

Low-voltage IC regulators can work in high-voltage supplies if you add this Q_1 , D_1 , R_1 protection circuit. The circuit not only protects the regulator, but preserves its current-limit and thermal shutdown features as well.

allows V_2 to become more positive. But not more positive than -40 V, because at that point Q_1 would cut off, and output current I_o would go to zero.

To protect Q_1 from overheating, mount it close to the IC on a common heat sink, and let the thermal overload circuitry protect the transistor as well.

Jay Seaver, R & D Engineer, Hewlett-Packard Inc., P.O. Box 1550, Fort Collins, CO 80522.

CIRCLE NO. 311

If you need
top-quality
panel
instruments
 with a clean,
 modern look...

Buy
Triplett's
Series GL
 or **GL/B**

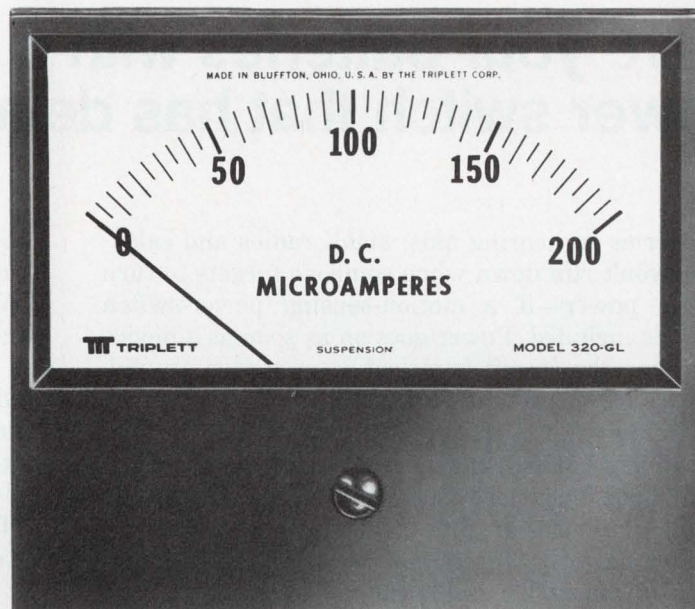

GL

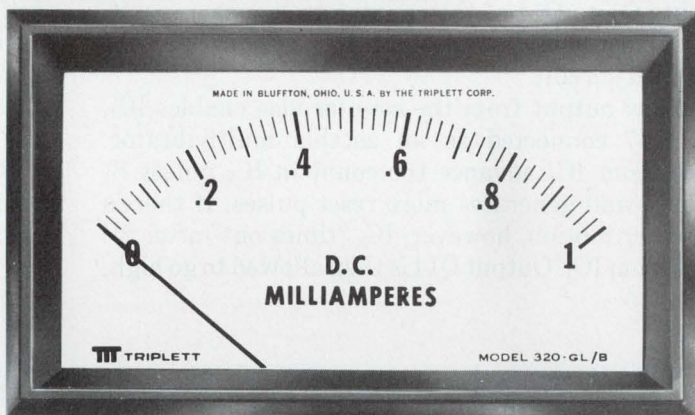

GL/B (mounted appearance)

Triplett's newest panel instruments, the Series GL and GL/B, feature glass windows, matte-finish phenolic cases and a dial design that can readily accommodate multiple scales. They are available in 3½", 4½" and 5½" sizes.

The GL Series features a standard 2-stud mount with 3- and 4-stud mounts available.

The feature of the GL/B Series is behind-the-panel mounting with a bezel which is an integral part of the case.

CIRCLE #60 FOR INFORMATION

There's a choice of more than 275 stock sizes and ranges — in DC microammeters, milliammeters, ammeters, millivoltmeters and voltmeters; AC milliammeters, ammeters, and voltmeters; RF thermoammeters; dB meters and VU meters. For those who need special instruments . . . custom dials, pointers, scales, accuracy, tracking, resistance, response time or practically any combination of unusual specs can be put into these new cases. For quick, dependable delivery

CIRCLE #61 FOR FREE DEMONSTRATION

of small quantities of these adaptable new instruments, contact your Triplett Sales/Service/Modification Center or distributor. For prototypes or production quantities, contact your Triplett representative. Triplett Corporation, Bluffton, Ohio 45817.

TRIPLETT
 BLUFFTON, OHIO 45817
 Manufacturers of the World's
 most complete line of V-O-M's

Save your batteries with a motion-sensing power switch that has delayed turn-off

Batteries in hearing aids, small radios and calculators won't run down when someone forgets to turn off the power—if a motion-sensing power-switch circuit is included. Power goes on as soon as a device containing the circuit is picked up or moved around, and goes off again when it is set down and left alone—but only after a selectable time delay.

Moving the device makes a mercury switch in the circuit open and close (see figure). Two CMOS ICs provide the turn-off time delay, and transistor Q_1 switches power to the rest of the equipment (represented in the figure as the controlled circuit). When mercury switch S_1 closes, it sends a reset pulse to IC₂, which is a CD4020 14-stage binary ripple counter. Outputs Q1 to Q14 of the counter go low as a result, and transistor Q_1 is turned on to feed power to the controlled circuit.

The low output from the counter also enables IC₁, a CD4047 connected as an astable multivibrator. Pulses from IC₁ advance the count in IC₂ unless S_1 is moved and generates more reset pulses. If there's no further motion, however, IC₂ "times out" after 2¹³ pulses from IC₁. Output Q14 is then allowed to go high,

which turns off the controlled circuit and stops IC₁ from oscillating.

With the component values shown, the "on" time is about one hour, which is the time delay obtained by using all stages of the counter. Connecting pin 4 and the base of transistor Q_1 to the Q13 output of the counter cuts the "on" time in half. Using other counter outputs gives you the option to reduce the "on" time by further powers of two.

The standby current drain of this circuit is determined by R_2 and the position of the mercury switch S_1 , and is less than 1 μ A with a 5-V supply. As designed, the circuit will switch more than 100 mA. To drive heavier loads, the counter's output can be buffered with a CD4050 noninverting hex buffer, and resistor R_4 can be made less than 100 k Ω . To prevent power from being turned on by unintentional movement, you can add a mechanical switch in series with the batteries.

John A. Porter, Design Engineer, Hughes Aircraft Co., Space and Communications Group, Bldg. 377, M/S C209, El Segundo, CA 90009

CIRCLE NO. 312

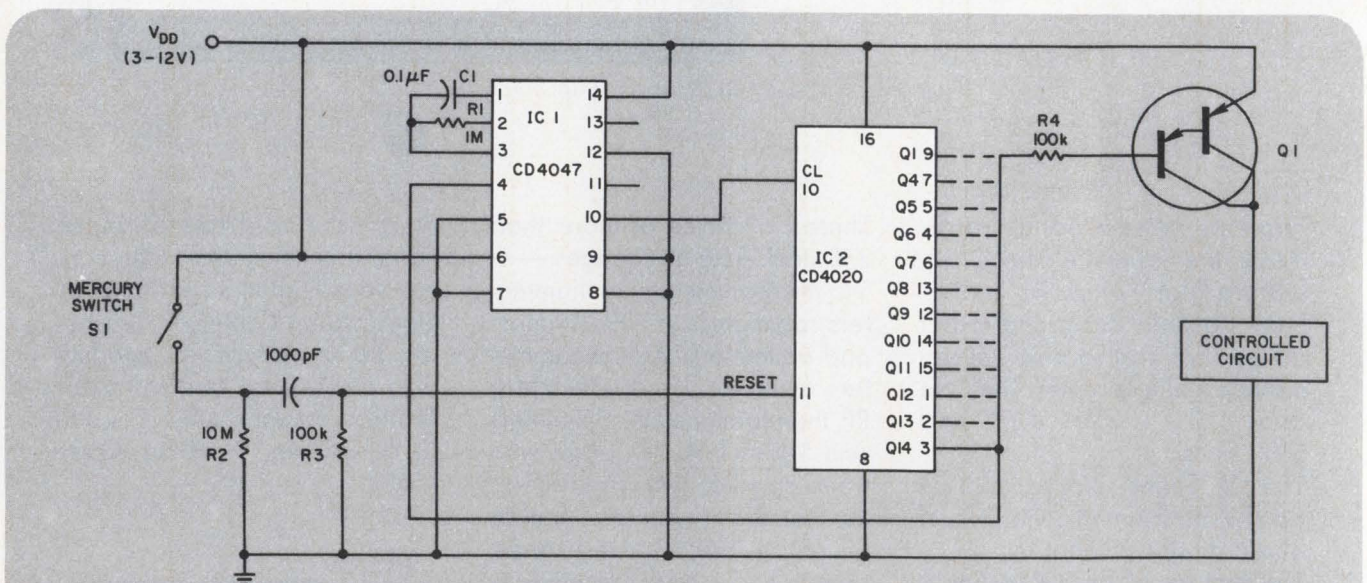

This power-control circuit for battery-operated equipment turns on power when the equipment is picked up or moved. Power turns off again after a

delay determined by the two ICs. As a result, the battery won't be discharged if you forget to turn off the power.

Analog Multiplydivide-squaresquarerootrms-to-dc-conversionagcmmodulate-demodulate function with .1% maximum nonlinearity for only \$3.75

Raytheon now has the first analog multiplier to have complete compensation for nonlinearity, the primary source of error and distortion.

The Raytheon 4200 is the first analog multiplier to have three on-board operational amplifier designed specifically for use in multiplier logging circuits. This means superior AC response in comparison to other analog multipliers.

The Raytheon 4200 is ideally suited for use in low-distortion audio modulation circuits, voltage-controlled active filters, and precision oscillators.

The 4200 is designed to multiply two input currents (I_1 and I_2) and to divide by a third input current (I_4) yielding an output current (I_3).

Think of the advantages to you the circuit designer. Multiple function capability, high-accuracy (0.1% maximum nonlinearity) a temperature coefficient of 0.005%/°C and a wide bandwidth of 4 MHz.

For the complete details about Raytheons' new 4200 Analog Multiplier, fill in the coupon or call Raytheon Company, Semiconductor Division, 350 Ellis Street, Mountain View, CA 94042. (415) 968-9211.

Another first from Raytheon.

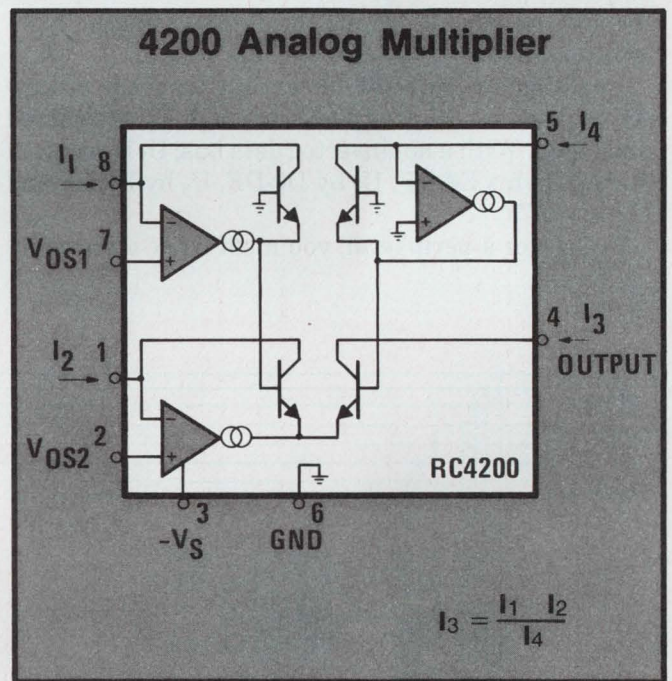

Tell me more. . .

- Send me your complete 4200 data sheet.
- Send me your full product Selection Guide.

Name _____

Title _____

Company _____

Address _____

City, State, Zip Code _____

Have a salesman call, I need help ASAP! My phone number is _____

Microprocessor talks to 'dumb' peripherals with minimal use of address space

With inputs from only two locations of address space, the logic scheme in the figure can establish communications between a microprocessor and peripherals that can't talk back. Basically, 64 dumb peripherals can be serviced, but you can access 256 devices by adding more logic.

Inputs to the SN74154 4-line-to-16-line decoders (U_1 through U_4) come from the low-order nibble—least-significant four bits—of the data bus. The high-order 4-bit nibble provides the input to \overline{G}_1 , one of two select input lines on the decoders. For a decoder to generate an enable pulse (i.e., \overline{EN}_1), it must be selected by both the address bus via U_6 and the data bus via the high-order nibble.

Enabling a peripheral allows data from the processor to enter the selected device through U_5 , the shared data latch. With a noninverted data bus, U_1 is accessed by data bytes $E0-EF$, U_2 by $D0-DF$, U_3 by $B0-BF$ and U_4 by $70-7F$.

To service a peripheral, you must write an instruc-

tion sequence to move data from memory to the selected device. For example, with a Motorola MC6800 microprocessor, to transfer data from memory location MEM to peripheral 22, the instruction sequence would be:

```
LDA A MEM (get data into accumulator)
LDA B #$D5 (set accumulator to pulse line 22)
STA A PERH (store data byte in shared data latch)
STA B ENAB (output peripheral 22 enable)
```

With this logic scheme 64 peripherals are serviced without decoding the high-order nibble. However, decoding each of the 16 high-order nibble combinations (0 through F) with four-input gates and inverters gives you 16 \overline{G}_1 enables. And with 16 decoders, each having 16 output lines, you can access a total of 256 peripherals.

M.S. Rogers, MTS, Sandia Labs, Box 5800, Albuquerque, NM 87115.

CIRCLE NO. 313

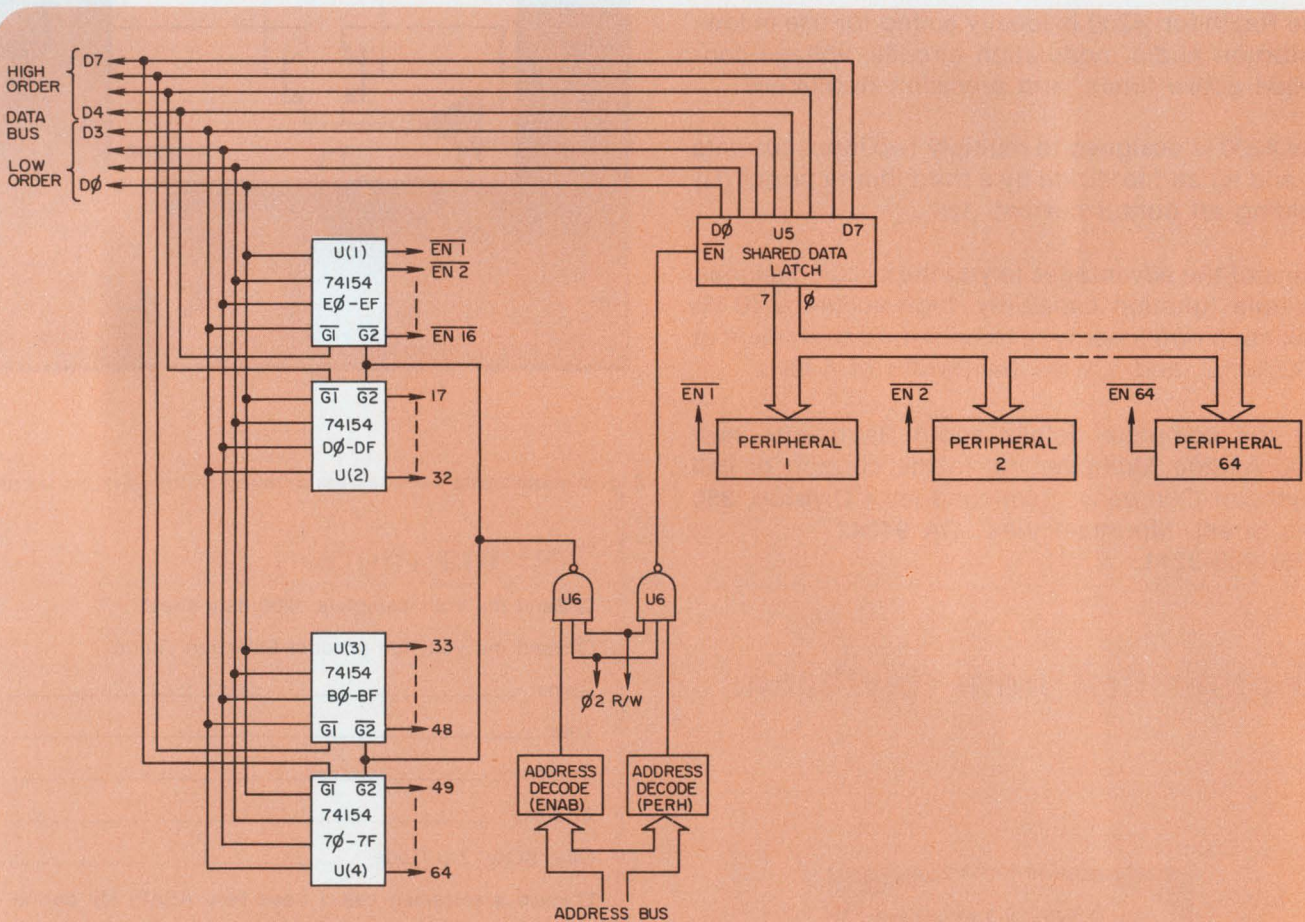

"Dumb" peripherals can be serviced with this logic circuit, which can talk to 64 units while using only

two locations of microprocessor space. But 256 units can be serviced with more logic.

The minifloppyTM from number 1

Used in 50,000 installations
for a number of very good reasons.

When we introduced our minifloppy, we frankly didn't expect the revolution that was about to happen. We've now delivered more than 50,000 minifloppys to OEM's and the demand is still increasing. Naturally, we are flattered by the acceptance the little drive has received (and by all the imitations). There are a lot of good reasons why our minifloppy has been accepted as number 1.

35 Tracks. A format with a future. The minifloppy provides fast, random access to the industry accepted 35 recording tracks. This format will help you grow compatibly into double-density and double-sided recording when you are ready. The compact minidisketteTM media carries 100 KB of information.

Reliable Storage. The Shugart minifloppy drive has the proven mechanical reliability and data integrity of standard flexible disk drives. It reads and writes with the same glass bonded ferrite/ceramic head used in Shugart's standard-sized SA800 flexible disk drives. Die cast construction offers high mechanical integrity.

A DC drive motor with an integral tachometer eliminates AC power requirements. The unique stepping motor actuator uses a direct drive spiral cam with ball bearing V-groove positive indent. This assures perfect head registration every time.

Data Integrity. The Shugart minifloppy drive improves error rate by two orders of magnitude compared to cassettes. Soft errors are only one in 10⁹, and seek errors, one in 10⁶. Write protect circuitry prevents loss of recorded information. It's standard with every Shugart SA400.

The minidiskette media is recorded at 20% less density than our standard floppy. This generous safety margin is your assurance of data integrity and the lowest possible media

costs. **Maintainable Performance.**

Simple modular components reduce Mean-Time-To-Repair to minutes. The self-aligning head eliminates the need for head alignment

tools in the field. **Inexpensive Storage.** Applying affordable floppy technology in a compact size reduces OEM and end user cost. Small drive size (5.75" wide, 3.25" high, and 9.0" deep) reduces total system cost. Low unit weight of three pounds.

Low power consumption. **The SA4400 ministreakerTM Controller.** The SA4400 ministreaker controller controls up to three minifloppy drives, providing up to 241.8 kilobytes of on-line data storage.

Support. Shugart has made the floppy smaller and product support bigger. We give you more support—systems design, technical service, documentation, and applications help. Two out of three OEM's specify Shugart. They get more experience, more technology, more support. So talk to number one in low cost disk storage. Talk to Shugart.

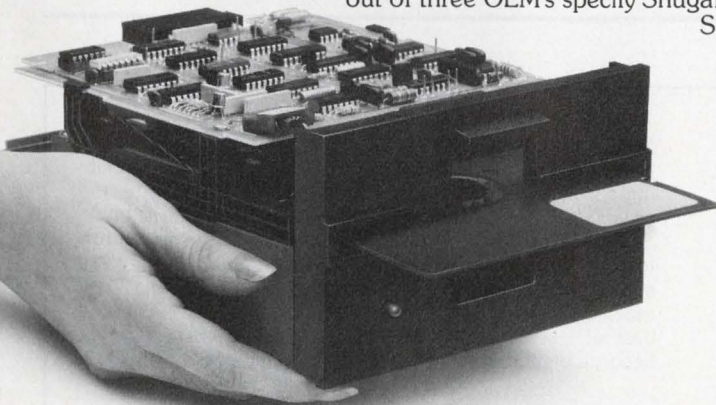
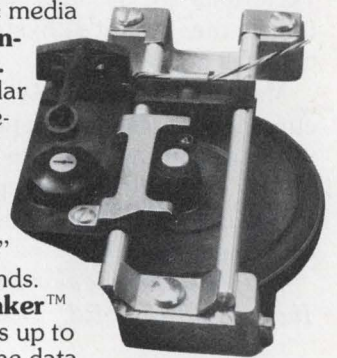
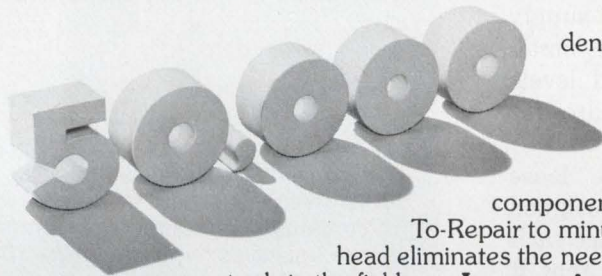

Shugart Associates

435 Oakmead Parkway, Sunnyvale, California 94086
Telephone: (408) 733-0100
West Coast Sales/Service: Telephone: (408) 252-6860
Midwest Sales: Telephone: (612) 786-4430
East Coast Sales/Service: Telephone: (617) 890-0808
Europe Sales/Service: 3, Place Gustave Eiffel, Silic 311
94588 Rungis, France Telephone: (1) 686-00-85

Positive feedback speeds up low-cost opto-isolator response

You can greatly increase the switching speed of a low-cost opto-isolator by putting in a circuit that provides positive feedback to the light-sensitive base of the device's phototransistor. Low-cost isolators (Fig. 1a) have relatively slow switching speeds, especially for wide voltage swings. But their high-speed counterparts are often very expensive.

For the small price of one transistor, five resistors and a capacitor, you can modify the basic low-cost circuit (see Fig. 1b) and improve its response from 2 to 3 kHz to at least 30 kHz for a square-wave output. The collector of transistor Q_1 swings to almost the full supply voltage, with rise times faster than 200 ns and fall times less than 2 μ s. Current-switching thresholds for the light-emitting diode remain relatively constant, and there's an added advantage of Schmitt-trigger action in response to slow ramp functions.

Capacitor C_1 is required for correct ac loop gain, with a value of 180 pF giving the proper compensation for best switching speed. You can omit resistor R_1 , but only if your power bus is adequately bypassed, and good circuit-layout techniques have been followed. The value of R_2 is directly related to power-supply voltage, and ranges from about 390 k Ω for a 5-V supply to 680 k Ω at 12 V. At a given supply voltage, small variations in R_2 shift the current-threshold levels (vary the circuit's hysteresis) to compensate for changes in devices.

Many garden-variety opto-isolators have loose current-transfer-ratio specs, and must be designed with current overdrive to compensate for device variability. But the advantage of this circuit is that it minimizes device-dependent performance while increasing speed.

Ralph Tenny, Senior Designer, PAVCO Electronics Inc., 12810 Coit Rd., Dallas, TX 75251

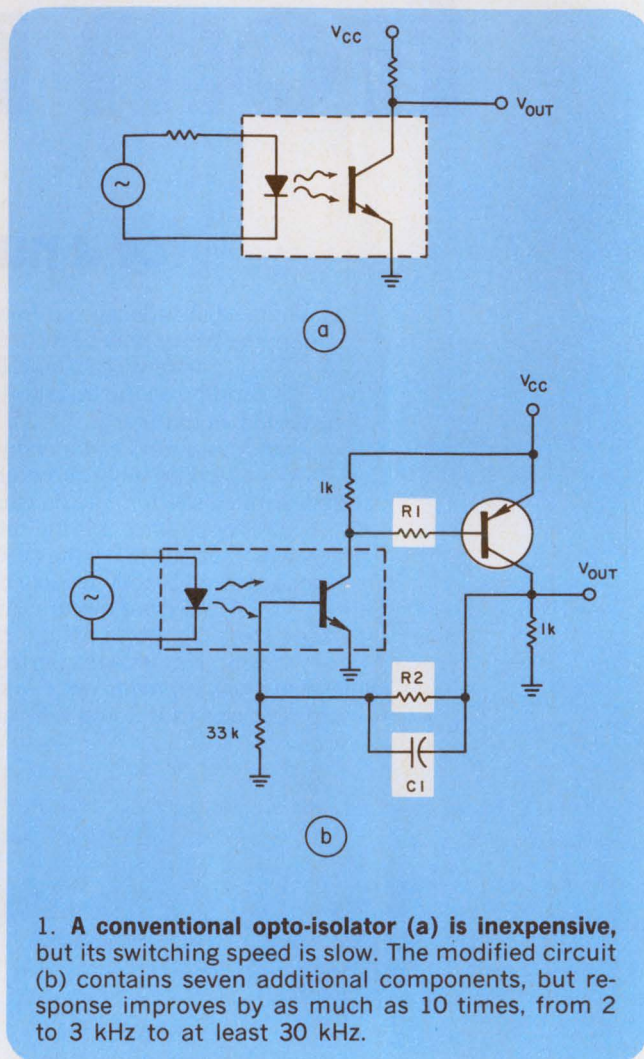

CIRCLE NO. 314

IFD Winner of December 20, 1977

R. S. Viles, Technical Specialist, Xerox Research (UK) Ltd., 99 Bridge Rd. E., Welwyn Garden City, Hertfordshire AL7 1LQ, England. His idea "Upper and Lower Thresholds Can Be Set Independently in Latching Comparator Circuit" has been voted the Most Valuable of Issue Award.

Vote for the Best Idea in this issue by circling the number of your selection on the Reader Service Card at the back of this issue.

SEND US YOUR IDEAS FOR DESIGN. You may win a grand total of \$1050 (cash)! Here's how. Submit your IFD describing a new and important circuit or design technique, the clever use of a new component or test equipment, packaging tips, cost-saving ideas to our Ideas for Design editor. Ideas can only be considered for publication if they are submitted exclusively to ELECTRONIC DESIGN. You will receive \$20 for each published idea, \$30 more if it is voted best of issue by our readers. The best-of-issue winners become eligible for the Idea of the Year award of \$1000.

If we didn't solve so many of your coax problems we wouldn't be number one.

When it comes to solving knotty coaxial cable problems, it's not surprising that so many design engineers come to Times. We're number one in coax. Which means that there is an excellent chance we have a standard cable to meet your needs perfectly. Times cables are uniform up to 22 GHz and we have constructions suitable for virtually any environmental conditions. We even have cables to meet the new MIL-C-17E specifications, plus Fiber Optic cables.

If you need something unusual, nobody builds as many special cables as Times. Whatever your requirements, Times

can design and produce it: ultra-low noise; high frequency; phase tracking over a broad range of frequencies and temperatures; extra strength; super flexible; buoyant; radiating; you name it.

Times also produces more than 25,000 cable assemblies per year, to exacting specifications. With Times broadband cable assemblies, you're assured of maximum RFI integrity; clean, low resistance connections and exceptionally low VSWR, even at frequencies in the double digit gigahertz range.

To reduce lead time, most cables are readily available from your local Times distributor.

Send for your free copy of the Times coax "Bible".

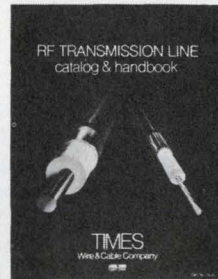

Times Wire & Cable

The #1 Coaxial Cable Company

358 Hall Avenue, Wallingford, CT 06492

(203) 265-2361, TWX: 710-476-0763

In Canada: 290 Benjamin Hudon, Montreal (514) 331-2860
DIVISION OF TIMES FIBER COMMUNICATIONS, INC.

CIRCLE NUMBER 79

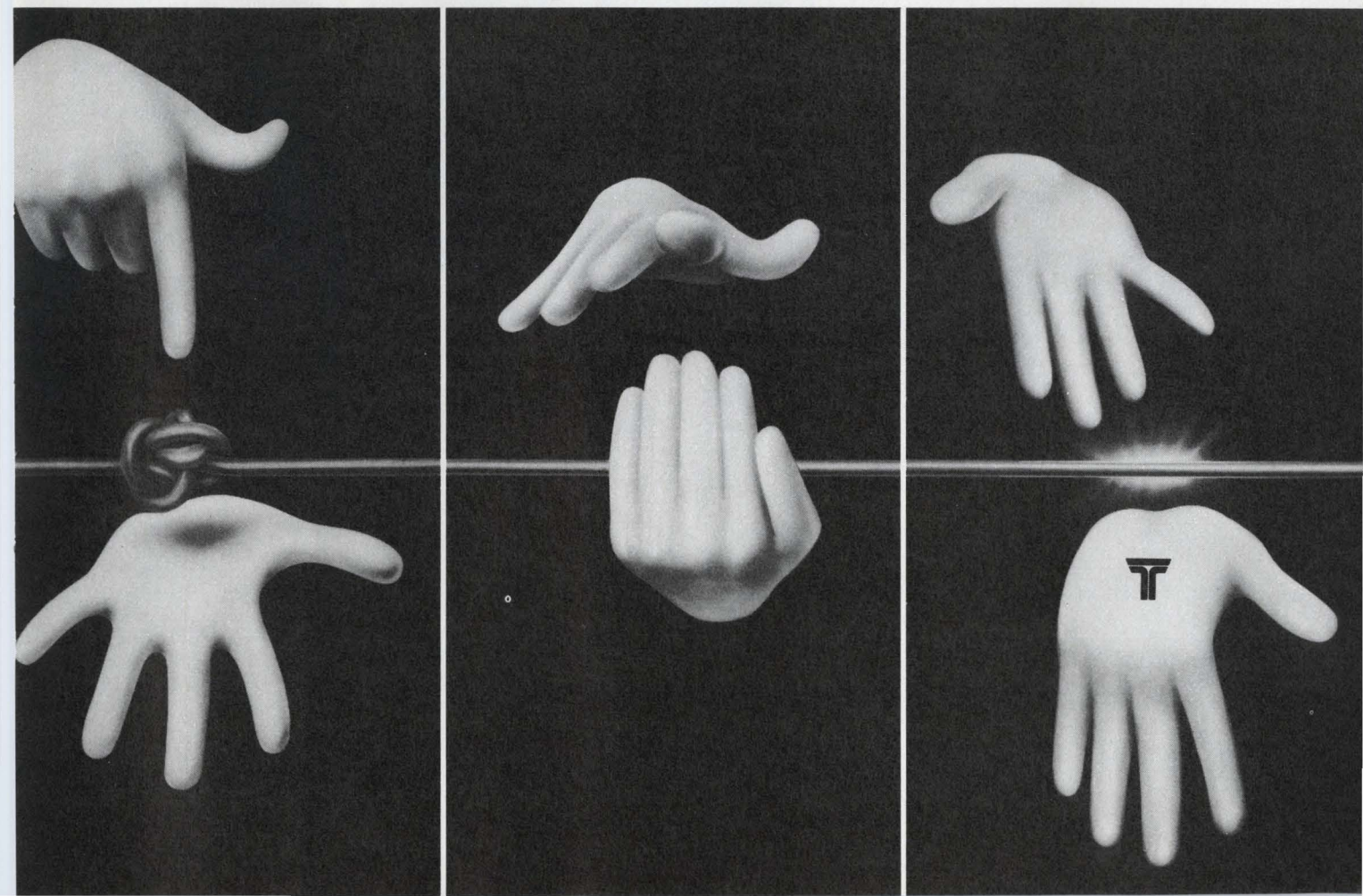

PROGRAMMABILITY!

Exclusive with SABRE X

IRIG tape recorder/reproducer

What puts SABRE X IRIG Tape Recorder/Reproducer above and beyond all others? ... Programmability.

With SABRE X you get keyboard-programmable (and re-programmable) microprocessor control of tape speeds, operating modes, end-of-tape, shuttle and search functions, even monitor/alarm and other diagnostic testing functions. It lets you set up your entire protocol in a fraction of the time needed for manual controls. A standard peripheral keyboard is all that's required. The SABRE X is also programmable from a complete computer system with peripherals such as mag tape, disc, etc. . . . a standard feature no other IRIG tape recorder/reproducer provides. And that's just the start.

Another SABRE X exclusive is a tape transport with ten speeds electrically switchable from 240 through 15/32 ips for both record and reproduce, High Density Digital (HDR) Direct, or FM. As the only 4.0 MHz/track direct record and reproduce system available, SABRE X offers the most extended frequency range . . . plus the industry's longest record time of 88.8 hours per tape reel . . . plus the engineering capable of housing a full system's 32 record and reproduce channels in a single cabinet. We could go on . . . but you get the idea: SABRE X is the state-of-the-art. For more information, call or write: Sangamo Weston, Inc., Sangamo Data Recorder Division, P.O. Box 3041, Sarasota, FL 33578 TEL: (813) 371-0811

SANGAMO WESTON
Schlumberger

CIRCLE NUMBER 64



SABRE X

RMS speech power boosted by feed-forward method

A level-control technique using a feed-forward configuration to control speech-signal peak amplitudes quadruples RMS speech power for a given peak power. It also improves speech intelligibility when the transmission signal-to-noise ratio falls below 28 dB.

The technique, developed at the University of Swansea, Wales, samples each half-cycle of an input waveform and determines the peak amplitude in that period. The peak value sets the gain of the channel to which the speech signal is then fed, after a suitable delay. The gain is adjusted to amplify the peak of each half-cycle to a constant maximum value.

The channel delay must be long enough for the longest half-cycle ex-

pected to be sampled. For example, a lower-frequency limit of 100 Hz requires a 5-ms delay.

To prevent channel noise from being amplified, a gain threshold is incorporated, and unity gain set in the channel is always below the threshold. A noisy signal would require a higher threshold and reduce the useful range of the system. For a noise-free speech input, the output remains constant for a 60-dB change in input level, using an 8-bit compressor-expander.

This level-control process reduces the peak-to-RMS ratio of speech from about 12 to 6 dB. It can be used at the input of CW transmission equipment. Full-modulation depth can be achieved at all times, with a 6-dB increase in speech power. The main effect on the speech quality is an increase in sibilance.

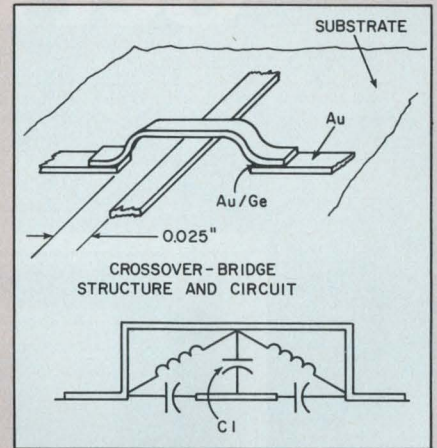
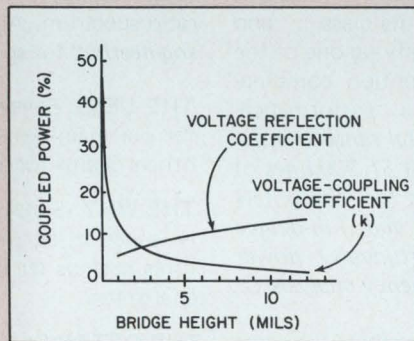
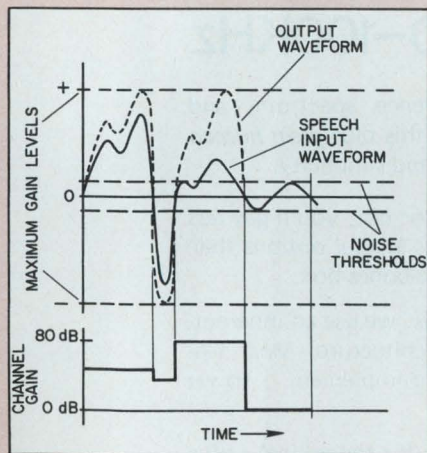

Ω lines and is joined to them by a gold-germanium (AuGe) sandwich-preform thermo-compression bond.

Bridging the lines at right angles to each other ensures that the coupling between the lines is capacitive. A 0.025-in. spacing of the terminated lines from the one crossed over means that the coupling is mainly due to C_1 in the equivalent circuit, as shown in the figure. Without the bridge, the isolation between the two circuits is 55 dB.

The foil, 0.001 in. thick, is compressed into shape in a machined slot of the correct depth. Various heights of bridges have been tried and found reproducible down to 0.001 in., with corresponding variations in the value of C_1 and hence in the coupling between lines. Power coupled bidirectionally is given by $20 \log_{10} k$ where k is the voltage-coupling coefficient.

The results obtained at 4 GHz are shown in the graph, for both k and for the loop-line reflection coefficient. By varying the height of the loop, the crossover can be adjusted to give either a desired isolation or a given amount of coupling.

Bridge of gold simplifies microstrip crossovers

With microstrip construction, complex transmission circuits can be formed on a single substrate. But as packing densities increase, the need grows to cross striplines over each

other. One answer, devised by Australian researchers, joins one stripline perpendicularly across another with a bridge of gold. The bridge connects the two ends of the open sections of the 50-

Trade Shows

Israel High Technology Industry Exposition (IsraTech '78)—Jerusalem, Israel, June 4-8.

Contact: Government of Israel Investment Authority, 641 Lexington Ave., New York, NY 10022.

Get it all. For less.

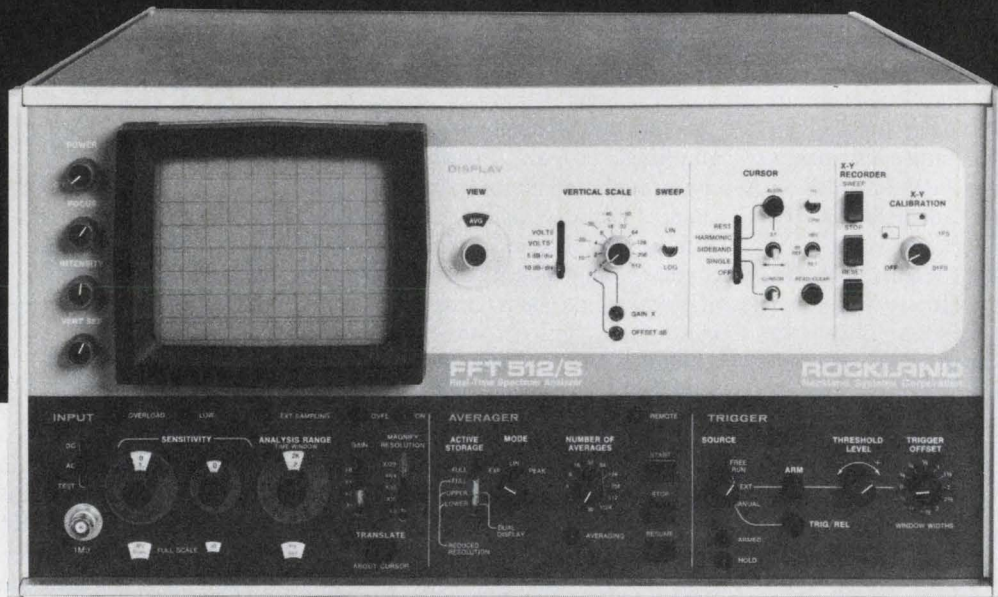

Real-Time Spectrum Analyzer: 0-100KHz

THE ALL. Rockland's Model FFT 512/S is the most versatile design in its class . . . and the most advanced. By specifying one of the dozens of mainframe-plus-option combinations, you get all these performance-optimizing features: *all-digital range translation* ("frequency zoom") for 51,200 lines of resolution; *digital interfaces* for computers or calculators; *1/3-octave and full-octave bandwidths*; *narrowband (tunable) power readout*; and *ultra-low-frequency analysis* (2, 5, 10 Hz ranges).

And *before* you add options, you get standard mainframe features that others provide as options (if at all): *the most advanced readout system* in the field . . . everything can be measured, displayed and recorded, in absolute or engineering units.

The most modal flexibility, too: input time function (continuous or captured), instantaneous power spectrum, averaged power spectrum, two averaged power spectra

(dual display), difference spectrum, and ratio spectrum. All of this plus *great human engineering*, for speed and simplicity.

THE LESS. Believe it or not, you'll pay *less* for our mainframe plus several options than others charge for a bare-bones box.

THE WHY. Simply this: we use an inherently superior circuit architecture. Most features cost us far less to implement — so we charge less.

THE DETAILS: Yours for the asking — plus a bonus: a FREE 48-PAGE "MINI-TEXTBOOK" on SPECTRUM ANALYSIS. Use the inquiry number, or write:
Rockland Systems Corporation
 230 West Nyack Road
 West Nyack, NY 10994
 (914) 623-6666
 TWX 710-575-2631

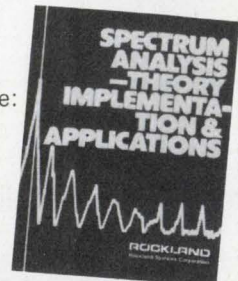

ROCKLAND

CIRCLE NUMBER 65

Electronic Design Announces "Top Ten" Winners.



On the following pages you will see the advertisements from the January 4th issue of *Electronic Design* which won this year's "Top Ten" contest. In 1978, as in the past, thousands of *Electronic Design* subscribers around the world tried to match wits with our Reader Recall survey in picking the winners. The highest percent "Recall Seen" scores determined the winners. Look at the following pages and find out how well you rated. You may be a winner, perhaps of the Grand Prize—a ten-day Acapulco holiday for two and \$1,000 in cash.

As you will see, the winning advertisements combine well-written copy with superior design to achieve impact and memorability. Here are the winners:

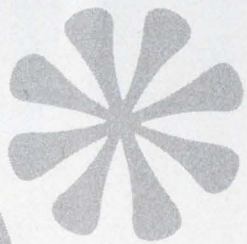
- 
- 
1. Hewlett-Packard
 1. Tektronix
 3. Precision Monolithics
 4. Intel
 5. Vactec
 5. Anadex
 7. Hewlett-Packard
 8. Mostek
 8. Dow Corning
 10. National Semiconductor

Meet HP's new Logic Analyzer that captures state, timing and glitch information simultaneously.

Now you can approach logic debugging from a timing or state point of view.

HP's new 1615A Logic Analyzer now gives you unmatched capability for system logic analysis. Use it as a 24-bit state analyzer for real-time monitoring of program execution. Use it as an 8-bit timing analyzer for locating problems on control lines or other asynchronous system elements. Or, with its cross triggering and arming capability between timing and state modes, use it as a combination of state and timing analyzers to debug interaction problems between synchronous and asynchronous system elements.

This powerful new logic analyzer lets you perform many tasks such as evaluating system performance at the time of a glitch; verifying I/O data stability prior to reading a port; monitoring handshake sequences at specific points in a program where a problem exists; and more. Using simple keyboard entries to pinpoint areas of interest in system activity you save both development and debugging time of synchronous and asynchronous digital systems.

If you're designing digital systems, this combination state and timing analyzer, priced at \$6800*, will help you reduce development costs and troubleshooting time. Your local HP field engineer has all the details. Give him a call today.

* Domestic U.S.A. prices only.



Timing Analysis—The hardware approach

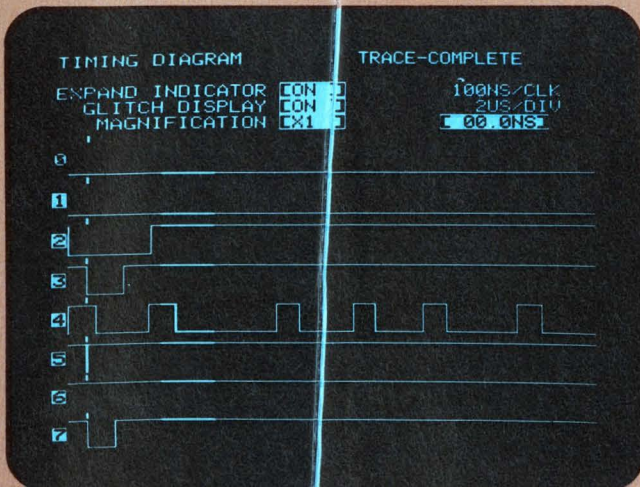

Trigger on glitches. A glitch on an input to a one shot (channel 5) is causing a false interrupt (channel 7). This glitch (which is intensified to distinguish it from data) can be used to trigger state as well as time displays.

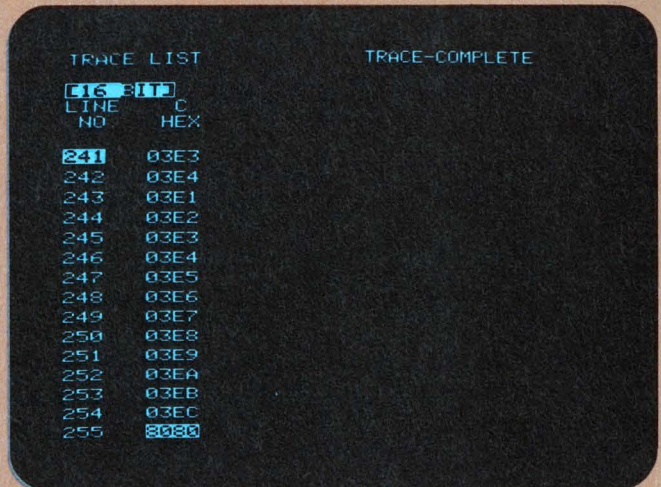

Observing state display shows address flow at the moment the glitch occurs and reveals that the I/O port address 8080 always occurs at the same time. This would lead you to observe I/O related signals for transitions occurring simultaneously with the glitch.

State Analysis—The "Software" approach

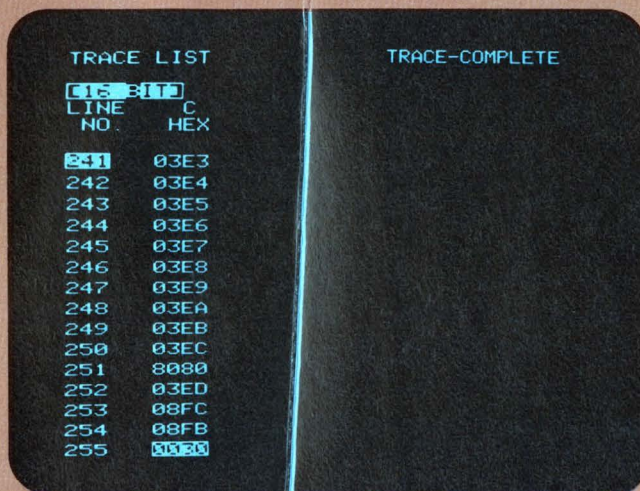

Trigger on state. The interrupt vector (0030) can be used as the trigger point to observe address flow prior to the false interrupt. Evaluation shows that the I/O port address 8080 always appears four machine cycles prior to the interrupt vector.

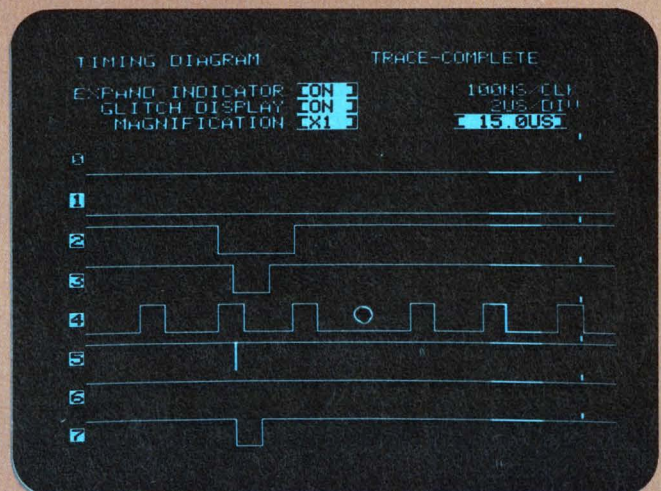

Observing timing display of signals on I/O and one-shot shows that the glitch on the input to the one shot (channel 5) occurs four machine cycles before the trigger point and is coincident with the transition on I/O read (line 3) indicating possible capacitive coupling.

HEWLETT  PACKARD

1507 Page Mill Road, Palo Alto, California 94304

For assistance call: Washington (301) 948-6370, Chicago (312) 255-9800, Atlanta (404) 955-1500, Los Angeles (213) 877-1282

CIRCLE NUMBER 211

We've combined refresh with storage in a new modular graphics display.

You build from there.

Suddenly state-of-the-art display technology comes built for the OEM.

Tektronix' new GMA display modules let you integrate into your system our most impressive display capabilities ever. Including refresh and storage graphics in one tube. Complete character and vector generators. Big 19" screen and fine resolution.

It's exactly what you need, because you can specify exactly what you want. Order CRT and power supply only, or select from a range of performance and packaging options in our extensive product line.

You can integrate other products from our graphics family, like hard copy modules. Or talk to us about other special product configurations, like our 11" storage-only components.

No other package lets you pick such comprehensive graphic display capability at anywhere near the price.

It figures, because Tektronix has been the worldwide low-cost graphics leader for years. No matter what unique and unusual systems you're working with, we can help with manufacturing flexibility, engineering assistance, and a passion for excellence.

Get capability you can build with. From a supplier you can work with. Get your Tektronix OEM Sales Engineer on the phone today. Or write us for more information.

Tektronix, Inc.
Information Display Group
OEM Components
P.O. Box 500
Beaverton, OR 97077



Tektronix
OEM components:
the perfect fit.

Tektronix[®]
COMMITTED TO EXCELLENCE
CIRCLE NUMBER 212



**PMI's
COMDAC™ companding
D/A converter. When
you think about what
it can do, nothing
seems very far-fetched.**

Not long ago, we ran a little contest in one of the electronics magazines. We asked engineers to come up with the most creative ideas they could think of to put PMI's unique COMDAC—the first and only companding D/A converter—to work. We got lots of responses with exciting ideas. But the interesting part is that no less than **five** engineers said they'd had terrific ideas—but they couldn't submit them because their corporate attorneys were starting patent searches.

That's the kind of brainstorming that COMDAC has generated since we first introduced it.

The reason is simple: nature is nonlinear. People, plants, animals, water, wind—we don't live in a straight-line world. We live in a world of curves, slopes, and human response systems (ears, eyes, touch) that do not follow straight-line paths. In trying to reduce these things to digital data, or to imitate them, we've always fallen short.

Until COMDAC.

With the help of COMDAC you **can** linearize analog signals. COMDAC **can** supply the shades of grey, the sweeping curves, the "vive la différence!" of the natural world. COMDAC uses logarithmically companded digital techniques for D/A conversion; with just eight bits, it provides the dynamic range of a 12-bit DAC—72dB or 4096:1. With that range, it can produce a convincing facsimile of the human voice, for example. Your watch radio can awaken you gently, with soothing, motherly tones, or shake you out of bed with a drill sergeant's scream—whichever is called for in your case.

It's six-forty — rise and shine. Squash at eight. Board meeting at ten.

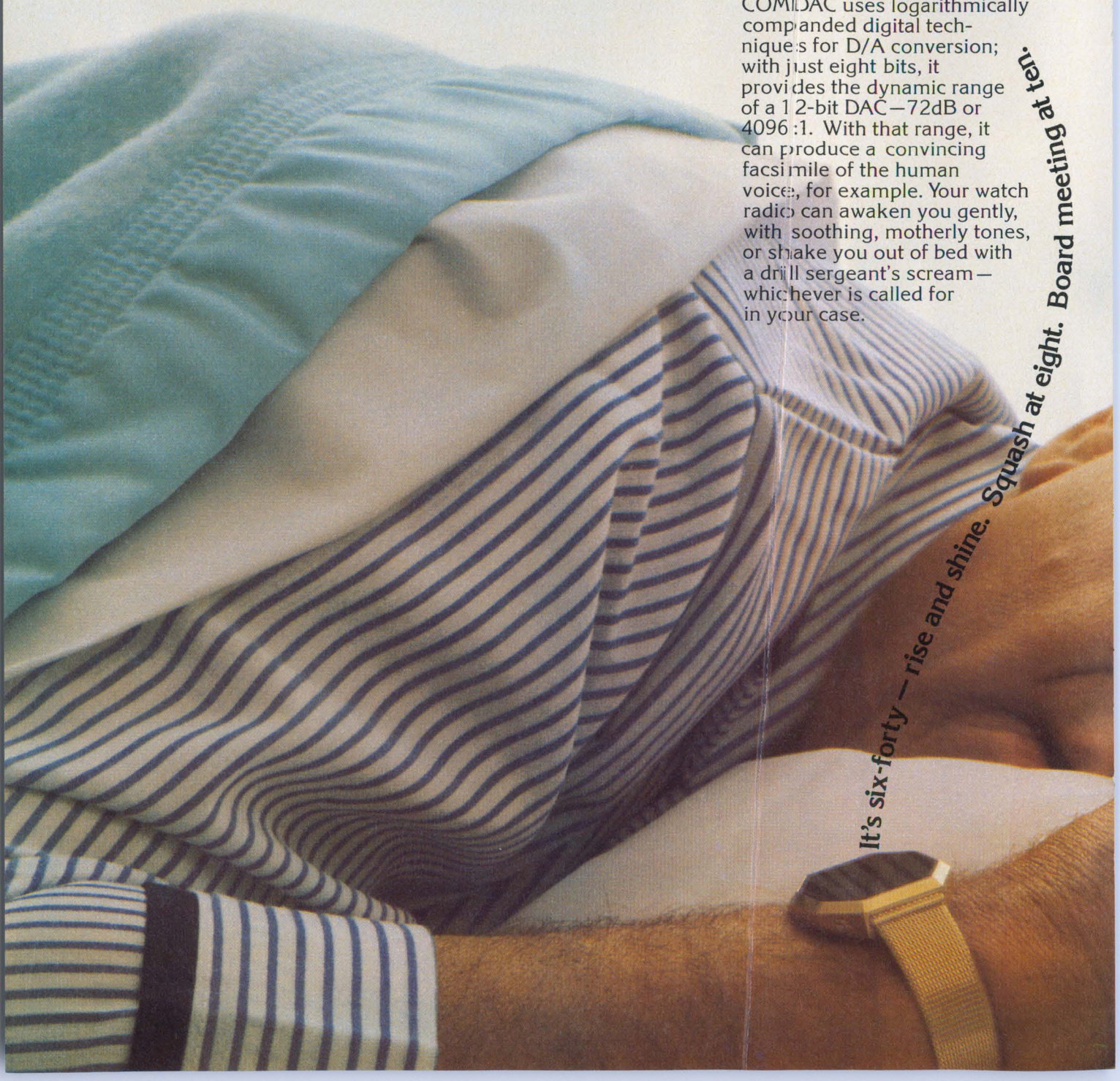

Consider these applications—some of which are already a reality:

- Digitized audio—music, sound effects, voice (μ P controlled)
- XYZ positioning (automated drill presses, for example)
- Motor controls
- Echo/reverb devices (for electronic guitars, electronic organs, synthesizers)
- Voltage-controlled oscillators and filters
- Servo motor controls
- Altimeters
- Waveform generation (with PROM)
- VU meters (for better response)
- Voice recognition (imagine a typewriter you could dictate letters to!)
- Tone generators
- Voice encryption
- Voice warning systems (they're already using them in aircraft)
- LOG sweep generators
- Data acquisition
- Recording studios
- Verbal response systems (like, your car could give you the word when it's overheating)

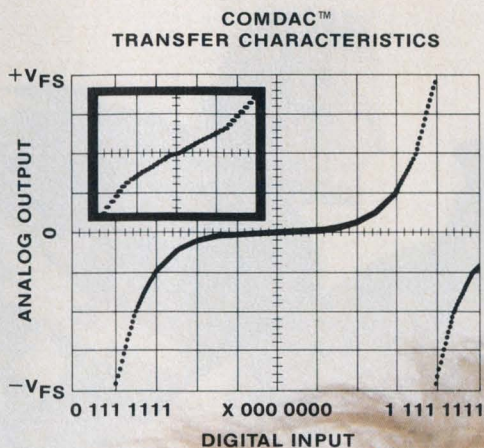

Keep in mind that COMDAC is not just a concept. It's a working reality. In the last two years, we've delivered half a million and cut the price in **half**. And since the 8-bit COMDAC can do many things a

12-bit DAC can do, think of what you will save by using a low-cost 8-bit system to do the job of the expensive 12-bit approach.

With a little bit of thought, a creative engineer—that's you—can come up with some really dazzling ideas. The surface has just been scratched. If you'd like a copy of all our contest entries, circle the bingo number below. We'll send technical literature that will help you with your application. Want a sample COMDAC? Send us a request on your letterhead.

Precision Monolithics, Incorporated
1500 Space Park Drive, Santa Clara, CA 95050 (408) 246-9222.
TWX: 910-338-0528 Cable MONO



CIRCLE NUMBER 213

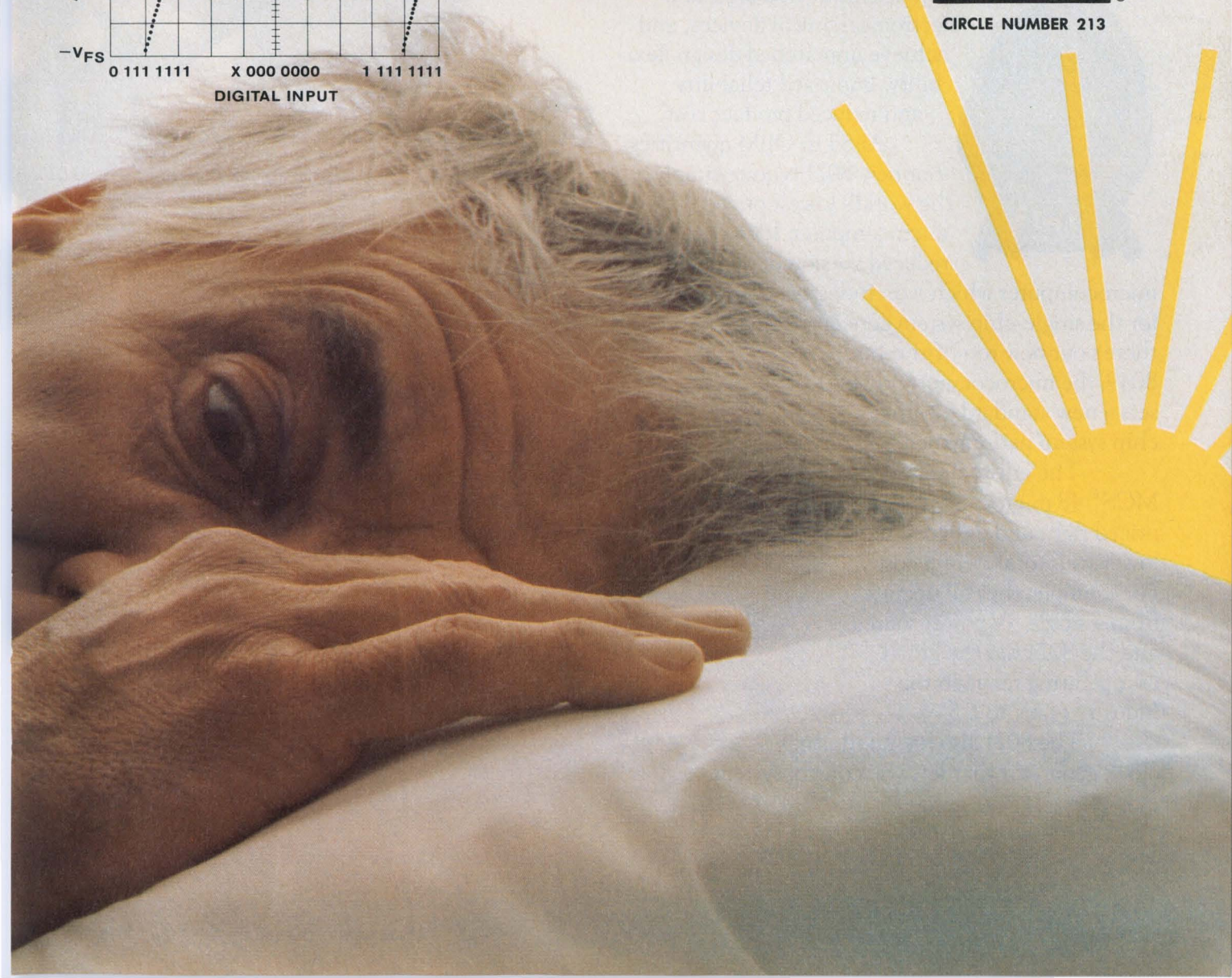

Intel delivers six single that provide economy

Intel leads the way with both the lowest cost and the highest performance single-chip microcomputers available. We now deliver the industry's broadest and most complete selection of compatible economy microcomputers. So there's no need to compromise your standards when your application requires low cost intelligence.

That's good news if you're designing for home appliances, automobiles, communications equipment, vending machines or any price-sensitive product.

Now you can take advantage of microcomputer power to replace hardwired logic and electromechanical devices, and achieve unmatched design flexibility, improved reliability and reduced product cost.



At \$3 in OEM quantities, our new 8021 is quite simply the world's lowest priced 8-bit microcomputer. It's a cost reduced version of our 8048, the

microcomputer which won industry acceptance for the single-chip system concept. Then there's our new top-of-the-line 8049, the microcomputer that sets a new standard for single-chip system performance.

The entire line of MCS[®]-48 microcomputers is priced right and designed to lower your total system cost. For example, they all operate from a single 5V power source, and the 8021 has the broadest operating range in the industry (4.5V to 6.5V).

The 8021 also has an internal clock generator that lets you control system

timing with a single 2 Ω resistor. Built-in zero cross detection enables the 8021 to accurately control system



chip microcomputers without compromise.

timing operations and perform time-of-day accumulation.

For sheer performance, there's not a single-chip microcomputer anywhere that can catch our new 8049.

With twice the on-chip memory of the 8048, the 8049 enables you to economically perform complex functions that previously required more costly multi-chip systems. And it's a drop-in replacement for the 8048, so you can upgrade 8048-based products with no redesign.

We've made MCS-48 microcomputers the easiest to use, too. Our 8748, for example, provides on-chip erasable and reprogrammable EPROM. That enables you to beat the ROM turnaround cycle during design and field testing. And its 100-piece prices start at just \$39, making the 8748 economical for low to medium volume production. To ensure maximum flexibility, all members of the MCS-48 family are software compatible.

If you've taken advantage of our high performance multi-chip microcomputers, the 8080 and 8085, you know that Intel delivers the most in-depth and advanced development support. Now you don't have to go without that support, even for your most

MCS-48 Microcomputers

| Model | Program Memory | Data Memory | I/O Lines | Instructions | Package Size |
|-------|----------------|-------------|-----------|--------------|--------------|
| 8021 | 1K Bytes ROM | 64 Bytes | 21 | 65 | 28 Pin |
| 8048* | 1K Bytes ROM | 64 Bytes | 27 | 96 | 40 Pin |
| 8748* | 1K Bytes EPROM | 64 Bytes | 27 | 96 | 40 Pin |
| 8035* | (External) | 64 Bytes | 27 | 96 | 40 Pin |
| 8049* | 2K Bytes ROM | 128 Bytes | 27 | 96 | 40 Pin |
| 8039* | (External) | 128 Bytes | 27 | 96 | 40 Pin |

*Designed for easy expansion of program/data memory and I/O.

budget-minded applications. It starts with our PROMPT™ 48 Design Aid. Then there's Intellect®, the industry's most powerful microcomputer development system, with resident MCS-48 Macro Assembler and ICE™ In-Circuit Emulation with symbolic debugging. Plus applications assistance worldwide, full documentation, training classes, design seminars and a rapidly expanding users' software library.

The more important economy is to you, the more important it becomes for you to evaluate the 8021, 8049 and other members of Intel's MCS-48 economy microcomputer family. They're all available now through your nearest Intel distributor: Almac/Strom, Component Specialties, Cramer, Hamilton/Avnet, Harvey Electronics, Industrial Components, Pioneer, Sheridan, L.A. Varah, Wyle/Elmar-Liberty and Zentronics. For complete technical information use the reader service card or write: Intel Corporation, 3065 Bowers Avenue, Santa Clara, CA 95051. Telephone: (408) 987-8080.

intel® delivers.

CIRCLE NUMBER 214

VACTEC Couplers

**For putting it together, VACTEC
is second only to RODIN*.**

Vactec Optical Couplers (T.M. Vactrols) put together incandescent lamps, neon lamps or LEDs with photoconductors in a wide variety of packages and capabilities.

Couplers using photoconductive cells are useful for isolation where speed requirements are in the order of milliseconds. Applications include noiseless switching, noiseless potentiometers, signal modulators for audio.

For hospital beds, an LED Vactrol gates a triac for forward and reverse motor operation. A neon Vactrol is used to sense telephone ringing for automatic answering or computer interface — offers light line loading ($< 300 \mu\text{A}$, $> 200 \text{K}\Omega$ input). A very low cost *true* RMS sensor using an incandescent Vactrol as a sense and feedback element — to control constant wattage for heater or *true* RMS voltage regulator.

VACTEC really does put them together — we make our own photoconductive cells, phototransistors, photodiodes, silicon solar cells, CMOS and bipolar camera controls, selenium cells, and couplers at our only factory near St. Louis. Write for bulletins of interest.

*Reproduction of The Kiss by Rodin.

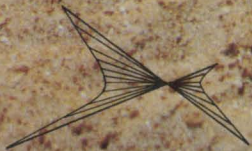

VACTEC, INC.
2423 Northline Industrial Blvd.
Maryland Heights, Mo. 63043 U.S.A.
(314) 872-8300 TWX 910-764-0811

CIRCLE NUMBER 215

We're hot for your BAUD!

And we've got the models to prove it - the Anadex DP-750A Series of alpha-numeric printers working at Baud rates from 110 to 4800, with 8 lines of storage.

They're complete, self-contained drum printers that can print, in red or black, 42 alpha-numeric characters and symbols in 21 columns at 25 characters/second.

With three models, you have a choice of synchronous or asynchronous ASCII compatible inputs with appropriate internal storage and control signals. Input circuitry meets EIA standard RS232-C for easy interfacing to your minicomputer or modem.

Reliability? Underneath that classy package there's a unit with an MTBF of over 10 million print cycles...the result of conservative design, a microprocessor, and a few tricks like turning off the drum motor when not actually printing.

A complete selection of options lets you tailor the 750A Series to your system. For example, there's a Form Feed option to automatically position pre-printed paper or gummed labels.

OEM/quantity discounts are available, and special configurations are our specialty.

To find out how our hot little models perform, contact us at 9825 De Soto Ave.; Chatsworth, CA 91311; phone (213) 998-8010; TWX 910-494-2761.



Write for your free, "Hot for your BAUD" poster...add a little glamour to your office.

CIRCLE NUMBER 216

The Mostek 3872.

Double the ROM.* Double the RAM.

Mostek's 3870 family means easy system upgrade and minimum investment in new designs.

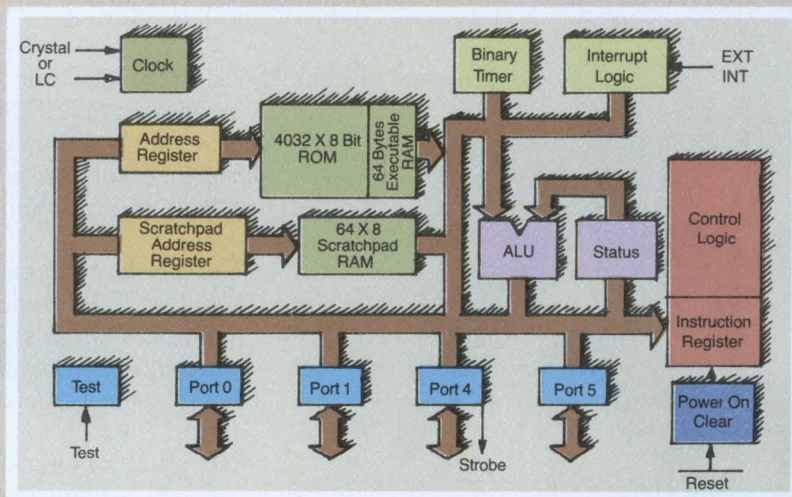

Mostek does it again! Mostek's 3870 single-chip microcomputer has led the industry in capability and performance for over a year. Now Mostek introduces another industry standard with double the 3870's ROM and RAM. Called the MK 3872, it is second in a growing family of single-chip microcomputer products from Mostek.

*The 3872 features include 4032 x 8 bytes of mask programmable ROM; 64 bytes of scratchpad RAM and an additional 64 bytes of executable RAM. Supporting the executable RAM is a stand-by power mode for easy battery backup.

These characteristics enable the 3872 to control sophisticated mechanical devices and instruments. Or the 3872 may be used to combine several programs into one system,

thereby lowering manufacturing costs. In applications that require non-volatile data storage, the stand-by power mode makes expensive CMOS memories unnecessary. No extra components are required to trickle charge standby batteries.

Family design means system compatibility. When designing a microcomputer system, engineering time is one of your largest investments. The 3870 family design concept protects that investment by allowing system expandability while maintaining hardware and software compatibility.

You can start with the 3870's 2K of ROM and upgrade to the 3872's 4K of ROM. Or begin with 4K and then substitute 2K for lower cost applications. This versatility, while retaining a common system base, means new applications with faster development and lower costs.

When Mostek engineers expanded the 3870, they retained all of its important features. Like 32 bits (4 ports) of bi-directional I/O; a programmable binary timer; external interrupt; low power (285 mW typ.); and single +5 volt \pm 10% power supply. Pinouts, of course, are unchanged. The best simply got better.

Coming in '78. The Mostek 3870 family will continue to grow, giving you the flexibility and expandability required for new applications. The 3873 Serial I/O version will interface to serial devices such as shift registers and CCD memories, and allow implementation of an asynchronous serial I/O port making low cost multi-processing

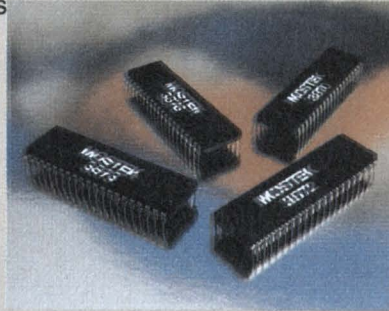

applications practical. The 3876 version will have the same ROM as the 3870 but with double the 3870's RAM, plus a standby power mode.

Complete Development Support. A full array of development aids is available from Mostek. This includes hardware/software support, complete documentation, field application engineers and 3870 microcomputer workshops.

The Mostek 3870 family. A total system with total support. From the source, Mostek. For more information, contact Mostek; 1215 West Crosby Road; Carrollton, Texas 75006. Telephone: (214) 242-0444. In Europe, contact Mostek GmbH, West Germany. Telephone: (0711) 701096.

MOSTEK

SURPRISE!

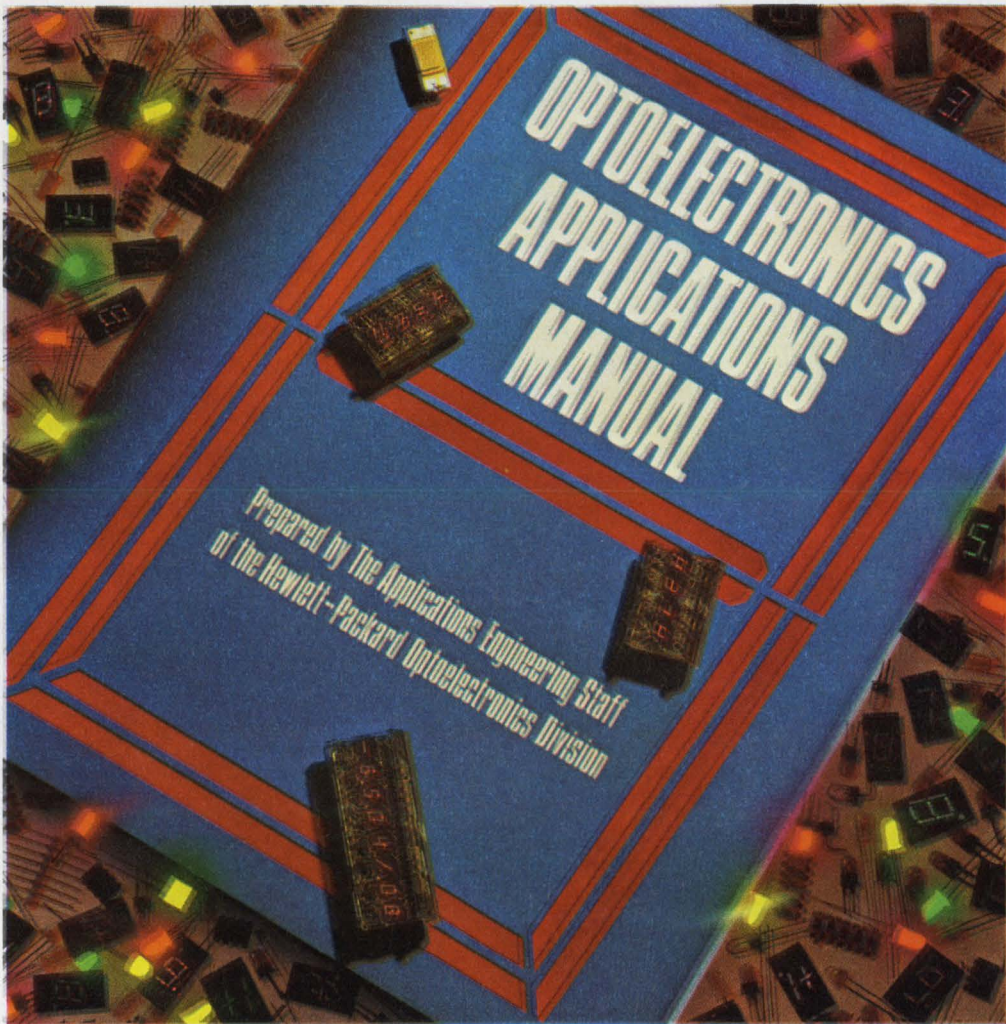

A Treasury of Opto Applications from HP.

Just published by McGraw-Hill and authored by the Applications Engineering Staff of Hewlett-Packard, this 279 page hardcover book is a practical guide to the use of optoelectronic devices and a foundation for the development of new design ideas. This volume demonstrates the broad potential for optoelectronic components and how to take full advantage of optoelectronics in your design.

In nine chapters you'll explore everything from theory of LED operation, design, packaging, contrast enhancement — even practical insights into photometry and radiometry.

You'll find this book not only invaluable, but will find it can save you time, effort and costs. Contact any HP franchised distributor for your copy — only \$19.25* ask for HPBK-1000, Optoelectronics Application

Manual. They're in stock right now. In the U.S., contact Hall-Mark, Hamilton/Avnet, Pioneer Standard, Schweber, Wilshire or the Wyle Distributon Group (Liberty-Elmar) for immediate delivery. In Canada, just call Hamilton/Avnet or Zentronics, Ltd. *U.S. Domestic price only

HEWLETT  PACKARD

1507 Page Mill Road, Palo Alto, California 94304



Strong, yet gentle.

That's why you should use Dow Corning® 3145 silicone rubber adhesive/sealant for your critical bonding and sealing jobs on electrical/electronic equipment.

Because it's strong, Dow Corning 3145 sealant easily withstands extended exposure to harsh environments. It's stable from -65 to 250 C. Has excellent tear strength. Resists moisture. Protects against high-voltage leaks. And virtually never needs maintenance.

Because it's gentle, you can safely use Dow Corning 3145 sealant on any material. Its noncorrosive cure won't affect copper or corrosion-sensitive equipment.

Besides meeting Mil Spec MIL-A-46146, Dow Corning 3145 is also recognized under the Component Program of U.L. up to 180 C for elongation, and up to 200 C for adhesion and dielectric strength.

When your application demands high performance—from mounting resistors to sealing or gasketing high-temperature electrical components—choose the sealant that's tough but doesn't hurt. Dow Corning 3145 sealant.

For complete facts, write Dow Corning Corporation, Dept. A-7540, Midland, Michigan 48640. Tell us about your application and we'll send a free sample.

DOW CORNING



CIRCLE NUMBER 219

Presenting our 32-

In four parallel 8-bit chips. Our 8060 microprocessor allows common memories and common I/O to be shared by multiple processors strung together like Christmas lights via a common bus.

In a word...

Multiprocessing.

This unique feature allows one 8-bit microprocessor application to be split into more easily manageable parts. So the whole job is easier.

Software development is easier. And cheaper.

What makes all this possible is built-in control circuitry and cycle interleaving.

The result is a machine more powerful than any single CPU system. (And even

if there *were* a single CPU system this powerful, it would cost an arm and a leg compared to the 8060.)

You get flexibility through modularity. Features can be added to your system by just adding on an additional CPU rather than rewriting the whole program.

And serial I/O facilities allow several self-contained 8060 systems (with memory) to be bussed together.

But multiprocessing is just one of the appealing features of the 8060 (a member of the SC/MP family.)

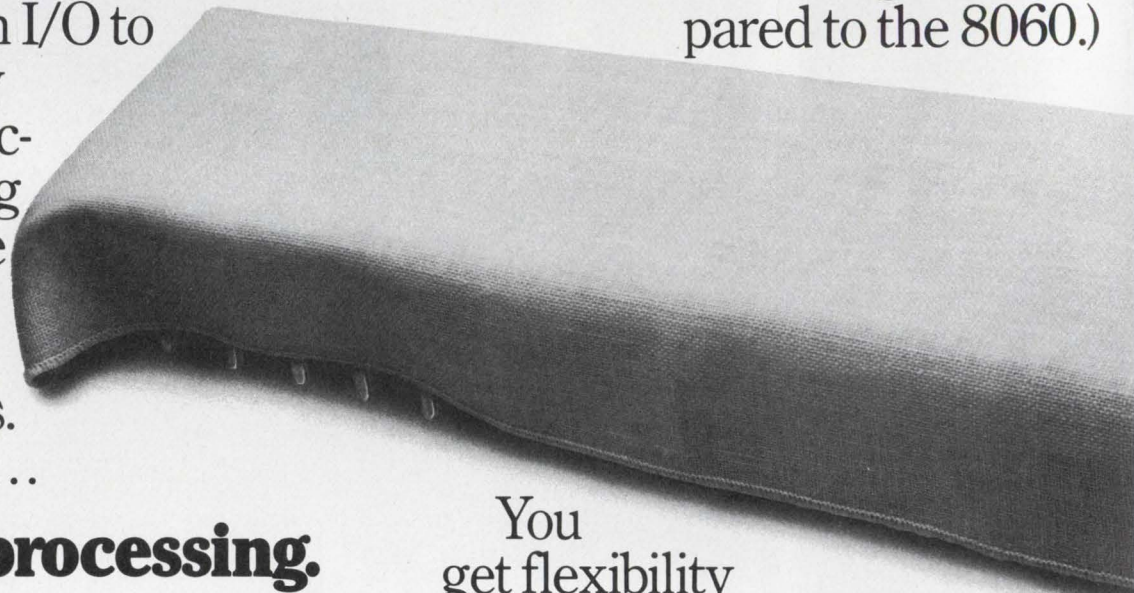

bit microprocessor.

High level language.



The 8060 uses NIBL BASIC language. In one 8K x 8 ROM. This chip interprets English-like commands. Instead of a complex program, you can write simple Dick-and-Jane instructions such as $A \times B = C$, which also reduces software costs.

Since NIBL is an interpreter, there's no expensive development system needed. All you need is the 8060 and the NIBL ROM.

A complete system in two chips.

To turn the 8060 into a system just add one chip.

This results in a system more powerful than a one-chip system, but at a price competitive with a one-chip system. The chip is INS8356, which combines a 2K x 8 ROM, 128 x 8 RAM, and I/O.

This basic 5-volt system is bus expandable, and compatible with standard memories and our arsenal of 8080A peripherals.

The 8060.

Multiprocessing. High level language. And a minimum system that works like gangbusters.

National Semiconductor
2900 Semiconductor Drive
Santa Clara, CA 95051

Gentlemen:

Please fill me in on your 8060 microprocessor.

Name _____ Title _____

Company _____

Address _____

City _____ State _____ Zip _____

ED1/4

 **National Semiconductor**

You Get Much More When You Rent Test Instruments From General Electric:

Application Assistance



**Quick-rental
instruments**

Call General Electric with your testing requirements. Our Rental Specialists are application experts trained on the equipment in our large rental inventory. When you need test instruments, a GE Rental Specialist can help you select the right instrument or instrument system to do the job. Because we stock equipment made by many manufacturers, we are able to give you the best value for your rental dollars.

General Electric has over 38 rental sales offices and six stocking inventory centers; you are never more than a phone call away from the instruments you need. And all are available for rent by the week or month.

For your FREE Rental catalog Call Collect (518) 372-9900 or your nearest sales office listed below or write General Electric Company, Apparatus Service Division, Building 4, Room 210, Schenectady, N.Y. 12345.

ALA. BIRMINGHAM (205) 925-9449 • ARIZ. PHOENIX (602) 278-8515 or 8516, TUCSON (602) 294-3139 • CAL. LOS ANGELES (213) 642-5350, SACRAMENTO (916) 383-4986, SAN FRANCISCO (415) 436-9260 • COL. DENVER (303) 320-3255 • CONN. SOUTHINGTON (203) 621-4059 • FLA. JACKSONVILLE (904) 751-0615, MIAMI (305) 696-0811 • GA. ATLANTA (404) 457-5563 • ILL. CHICAGO (219) 933-4500 or (312) 854-2994 • IND. INDIANAPOLIS (317) 639-1565 • KY. LOUISVILLE (502) 452-3311 • LA. NEW ORLEANS (504) 367-6528 • MD. BALTIMORE (301) 332-4713 • MASS. BOSTON (617) 396-9600 • MICH. DETROIT (313) 285-6700 • MINN. MINNEAPOLIS (612) 522-4396 • MO. KANSAS CITY (816) 231-4377 or (816) 231-4620, ST. LOUIS (314) 965-7115 • NEW JERSEY CLIFTON (201) 471-6556 • N.Y. BUFFALO (716) 876-1200, SCHENECTADY (518) 385-2195 • N.Y.C. CLIFTON, N.J. (201) 471-6556 • N.C. CHARLOTTE (704) 525-0311 • OH. CINCINNATI (513) 874-8512, CLEVELAND (216) 523-6382, TOLEDO (419) 691-3501 • ORE. PORTLAND (503) 221-5101 • PA. PHILADELPHIA (609) 424-4450, PITTSBURGH (412) 462-7400 • S.C. GREENVILLE (803) 277-4093 • TENN. MEMPHIS (901) 527-3709 • TEX. BEAUMONT (713) 842-4514, DALLAS (214) 357-7341, HOUSTON (713) 672-3570 • VA. RICHMOND (804) 232-7886 • WASH. SEATTLE (206) 854-0211 • W.V. CHARLESTON (304) 345-0920 • WISC. MILWAUKEE (414) 744-0110 • PUERTO RICO PONCE (809) 843-4225 or 4625

GENERAL  **ELECTRIC**

New products

Synthesizer/function generator does more than 'just' up resolution to 11 digits



Hewlett-Packard, 1501 Page Mill Rd., Palo Alto, CA 94304. (415) 856-1501. P&A: See text.

For a startling \$3000, the Hewlett-Packard 3325A synthesizer/function generator puts together performance and features you can't get in any other single instrument. Just for starters, you'll have 11 digits of resolution. But you'll also get, among other things,

- Phase-continuous frequency switching.
- Phase-continuous linear and log sweep.
- Ultralinear triangles.
- Full HP-IB (IEEE-488) remote control.
- Store and recall of up to 10 settings.

As a synthesized source of precision sine waves, the 3325A ventures down to a crawling 1 μ Hz and up to a breezy 21 MHz (a rear auxiliary output soars even higher—to 60 MHz). Below 100 kHz, you get 1 μ Hz of resolution; above, you get 1 mHz.

As a function generator, the 3325A delivers square waves from 1 μ Hz to 11 MHz and ultralinear (0.2%) triangles and precision (0.6%) ramps from 1 μ Hz to 11 kHz. Square-wave rise time is less than 20 ns, and symmetry is under 0.1% of the period +3 ns.

As a sweeper, the HP source varies all waveform frequencies linearly or logarithmically over each full frequen-

cy range, while keeping phase continuity. You can choose single or continuous sweeps at 0.01 to 99.99 s. However, the fastest log sweep is two seconds, and the single log covers an integral number of decades. A TTL pulse marker is also available.

As a systems source, the 3325A wears two hats: it can be either a programmable synthesizer or a programmable function generator that talks and listens via the standard HP interface bus. Program commands can change almost all functions and parameters: frequency, amplitude, phase (720° of control with 0.1° resolution and $\pm 0.2^\circ$ increment accuracy), dc offset, waveform selection, sweep settings, self-test, amplitude calibration, and even store-and-recall operations.

Frequency-switching and settling time stay under 2 ms to get within 1 Hz for a 1-MHz span or 50 ms for a 20-MHz span. In phase, it takes less than 75 ms to get within 1° for a 20-MHz span.

The HP source delivers 1 mV to 10 V pk-pk of 50- Ω output, with four digits of resolution for any waveform, and with an amplitude flatness between ± 0.1 and ± 0.5 dB. The dc level can be offset up to ± 5 V with dc alone (no ac signal) or to ± 4.5 V with dc plus ac at highest range or down to ± 4.5 mV at the lowest.

Spectral purity—a prime item in a

signal source—stacks up as follows: For the sine wave up to 50 kHz, harmonic components are 65 dB down—which makes the 3325B a good audio source. Beyond 50 kHz, harmonics (in dB) are -60 to 200 kHz, -40 to 2 MHz, -30 to 15 MHz, and -25 to the top.

Spurious components stay below 70 dB, and phase noise (integrated 30-kHz signal-to-phase) under 54 dB. Square-wave overshoot is less than 5% of the peak-to-peak amplitude at full output.

On top of all this, there are other features that make the HP source even more attractive. Like external amplitude and phase modulation. Like amplitude readout in pk-pk, rms or dBm at the touch of a button. Like a phase-lock input that enables you to hook up two 3325s for dual channels with variable-phase offset.

But what did HP trade off to fit in all those goodies for \$3000? Not much.

Other synthesizers are faster—the Rockland Systems 5100, for instance, settles in 1.5 μ s. Other synthesizers offer similar convenience features, like the 10 storage registers in the Fluke 6011A. There are even function generators that offer things the HP doesn't—such as trigger, gating and burst modes. And there are synthesizer/function generators that are flatter, like the Interstate Electronics SPG800, or provide FM or VCO operation—for example, the Wavetek 172.

But except for most function generators—which are really a different class of signal source—the 3325A undersells all competition. And no single competing synthesizer or synthesizer/function generator comes close in frequency resolution, or offers the HP source's sweep capabilities, or combines its other features in one box.

Like one? Delivery takes 90 days.

| | |
|------------------|-----------------------|
| Hewlett-Packard | CIRCLE NO. 320 |
| Fluke | CIRCLE NO. 321 |
| Interstate | CIRCLE NO. 322 |
| Rockland Systems | CIRCLE NO. 323 |
| Wavetek | CIRCLE NO. 324 |

INSTRUMENTATION

Digital meter reads watts or rms I and V



Valhalla Scientific, 7707 Convoy Ct., San Diego, CA 92111. Kevin Clark (714) 277-2732. \$495; stock.

The Model 2000 digital watt-ammeter simultaneously displays either watts or true-rms current and actual rms line voltage. The wattmeter portion of the meter provides autoranging from 1-mW resolution to 2 kW full scale, with an accuracy of $\pm 0.1\%$. Circuit-breaker-protected true-rms current can be measured from 100 μA to 20 A with the same accuracy. A separate 4-digit display is provided for line voltages from 90 to 140 or 180 to 280 V ac.

CIRCLE NO. 308

Data comm test set boasts of versatility

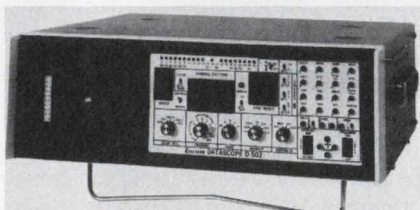

Spectron, P.O. Box 620, Moorestown, NJ 08057. Boyce Adams (609) 234-5700. \$10,800; 8 wks.

Datascope D-502B data communications test set can be used as a data monitor, a data analyzer and an interactive data simulator and tester. The instrument features a time-correlated full-duplex display of 375 characters; switch selection of program listing, output buffer contents, timers, counters and display; switch control of framing, code level, languages, markers, idle suppress, synchronization and speed. Also provided are composite video output and a printer option. The unit can be extended by a series of options that include an alphanumeric keyboard, digital tape unit and a program storage adapter.

CIRCLE NO. 309

Frequency counters operate to 520 MHz

Philips Test & Measuring Instruments, 85 McKee Dr., Mahwah, NJ 07430. (201) 529-3800. \$545/\$645; stock.

A compact lightweight automatic frequency counter, the PM6664-01 and its companion PM6664-02, with a temperature compensated crystal oscillator, operate up to 520 MHz. The counters have an 8-digit LED display with resolution of 1 Hz up to 80 MHz and 10 Hz above 80 MHz. A wide range of automatic input sensitivity from 20 mV rms to 1 V rms is provided. Input attenuation is automatic and continuously variable. The size is 5.75 \times 1.75 \times 8.7 in.

CIRCLE NO. 310

Automatic tester checks ECL devices

Tektronix, P.O. Box 500, Beaverton, OR 97077. Mike Bonham (503) 644-0161.

A fully automated means of testing emitter-coupled logic (ECL) LSI devices is provided by the S-3280 system. A pin driver and sampling head is included for each pin, and up to 64-pin units can be tested. Devices as complex as microprocessors can also be handled. Pulse rise time for the pin drivers is 1 ns or less for a 2-V swing and a 50- Ω load. Positions of drive-pulse leading and trailing edges can be set under program control in 100-ps increments. Programmable circuitry capable of controlling drive-pulse amplitude, width and delay is provided for each pin of the device under test.

CIRCLE NO. 325

Temperature module plugs into DVM

Kurz Instruments, P.O. Box 849, Carmel Valley, CA 93924. (408) 659-3421. \$125.

A portable solid-state temperature measuring system, Model 601, plugs directly into the input terminals of conventional digital voltmeters. A +1-V reading indicates 100 C and 0 V is 0 C, resulting in a 10-mV/ $^{\circ}\text{C}$ sensitivity. The temperature range is -50 to 150 C. The stainless-steel probe is 0.125-in. diameter \times 8-in. long with a 15-ft vinyl cable. The electronics is powered by a self-contained battery and is housed in a case measuring 3.25 \times 2.125 \times 1.125 in.

CIRCLE NO. 326

Dual-trace scope uses fixed delay line

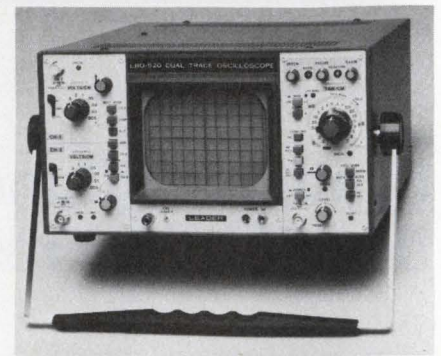

Leader Instruments, 151 Dupont St., Plainview, NY 11803. Pat Redko (516) 822-9300. \$1000.

A 120-ns, built-in delay line permits viewing of the leading edge of a pulse on the dual-trace Model LBO-520 oscilloscope. The instrument has 5-mV/cm sensitivity, one-shot trigger on both channels and a 20-ns/cm sweep combined with a rise time of 11.7 ns. Display modes include Ch-1, Ch-2, alternate, add, subtract and X-Y.

CIRCLE NO. 327

Logic-state analyzer handles 32 channels



Paratronics, 800 Charcot Ave., San Jose, CA 95131. (408) 263-2252. \$1500; 6 to 8 wks.

Using an ordinary oscilloscope, the Model 532 logic-state analyzer captures and displays up to 250, 32-bit words in hexadecimal or binary. The channels operate together or functionally split into A and B groups, each 16-bits wide and each separately clocked. The basic unit uses a calculator-type keyboard for entering the trigger word and selecting one of 21 available triggering modes. Also included are a 5-MHz data memory, pretrigger and posttrigger data collection, trigger and clock qualifiers, up to 9999 steps of digital delay for program paging and loop analysis, a signature-like summary of data memory contents in hexadecimal and an automatic self-test each time the instrument is turned on.

CIRCLE NO. 328

Suppose someone with no axe to grind designed practical one-card microprocessor systems.

Pro-Log sifts through manufacturer's claims, selects the best parts, and designs them into simple, reliable systems...

... systems flexible enough to use in a wide variety of applications. Systems easy to build, easy to service. Systems in which every part—the microprocessor, every semiconductor, every connector, every miscellaneous component—is or soon will be a second-sourced industry standard.

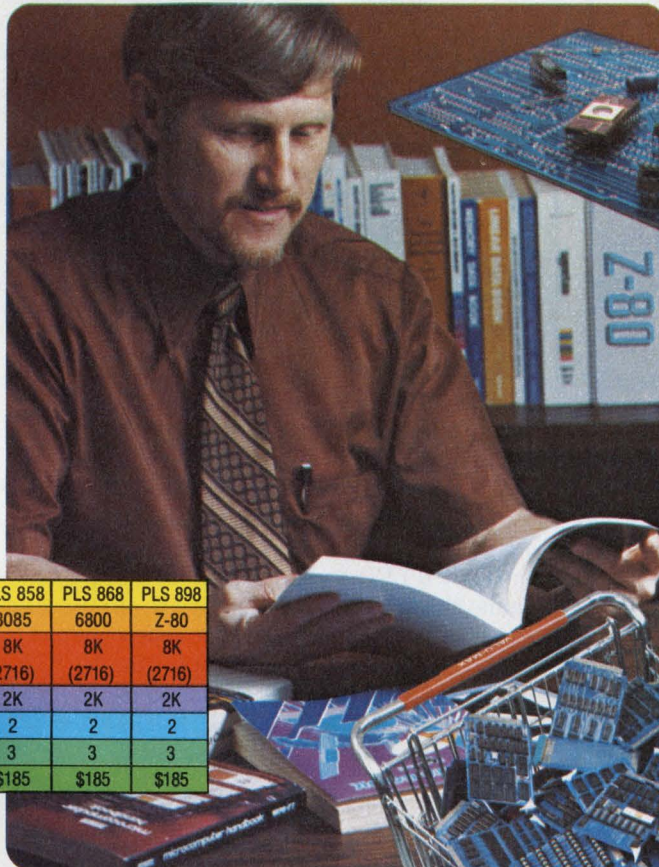

Our comparison guide helps you avoid the pitfalls of microprocessor design.

Send for your copy today.
Pro-Log Corporation, 2411
Garden Road, Monterey, CA
93940. Phone (408) 372-4593.

| Card | PLS 881 | PLS 888 | PLS 858 | PLS 868 | PLS 898 |
|------------------------|--------------|-----------------|--------------|--------------|--------------|
| Processor | 8080A | 8080A | 8085 | 6800 | Z-80 |
| PROM* Capacity | 4K (2708) | 8K (TMS2716) | 8K (2716) | 8K (2716) | 8K (2716) |
| RAM** Capacity | 1K | 2K | 2K | 2K | 2K |
| Input Ports (8 lines) | 2 | 2 | 2 | 2 | 2 |
| Output Ports (8 lines) | 3 | 3 | 3 | 3 | 3 |
| 100 Piece Price | \$165 | \$185 | \$185 | \$185 | \$185 |

*PROM not included. **1K of RAM included.

Pro-Log builds 8080A, 8085, Z-80, and 6800 microprocessors into one-card systems.

We use standard 4½-inch by 6½-inch 56-pin edge-connected cards. We've refined each system to fewer than 100 parts. To make sure our systems work when you get them, we test each system before and after power-on burn-in. We supply

complete documentation with every card. Buy 250 of any one card and we give you free the plans for that card and non-exclusive manufacturing rights. You can build cards yourself and use us as a second-source. Need more capability later? Upgrade to one of our equally well-designed multiple card systems.

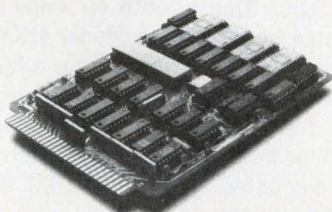

PRO-LOG
CORPORATION

Microprocessors at your fingertips.

MICROPROCESSOR ANALYZERS for

6800 - 6802
8080 - 8085

FUNCTIONAL • EASY TO USE
INTERACTIVE • PORTABLE
• CLIP-ON-CONNECTION •

WE OFFER THE PERSONALIZED
ANALYZER, DEDICATED TO THE IN-
DIVIDUAL μ P FAMILY. IT DOES
WHAT YOU NEED WHEN YOU NEED
IT MOST.

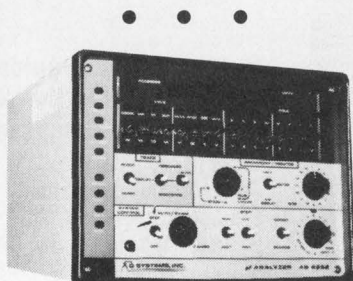

- For the Design Engineer
- For Production Testing
- For Quality Control
- For Field Service Engineer
- For the Beginner
- For the Expert

Your **BEST** Source
for μ P Analyzers for ALL
Your Requirements

Call: (914) 962-4264

AQ SYSTEMS, INC.

1736 FRONT STREET
YORKTOWN HEIGHTS, N.Y. 10598

CIRCLE NUMBER 68

MODULES & SUBASSEMBLIES

Scanners combine LEDs and photocells

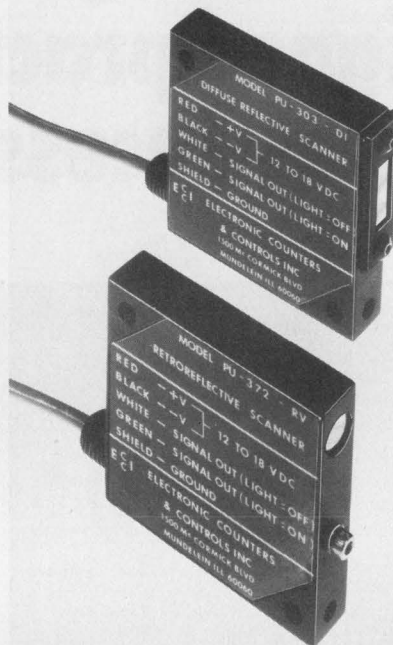

Electronic Counters & Controls, 1500
McCormick Blvd., Mendlemin, IL 60060.
(312) 362-8910. \$129.

The reflective scanners, Model
PU372-RV (retroreflective) and Model
PU303-DI (diffuse reflective), have a
modulated LED and a photocell in the
same housing. The sensing speed of
these units is 6000/min and both operate
on 12 to 18 V dc at 60 mA. The
output is complementary transistors
with an I_{sink} of 250 mA max. Housings
are sealed and supplied with shielded
6-ft cable.

CIRCLE NO. 329

Digital angle converter has 14-bit resolution

Transmagnetics, 210 Adams Blvd.,
Farmingdale, NY 11735. Fred Haber
(516) 293-3100. \$250; stock to 4 wks.

The Model 1500 converts digital
angles to simultaneous sine and cosine
outputs with 14-bit resolution. Conversion
time is 2 μ s. The input to the device
is a digital natural-binary-coded angle
representing 0 to 360°. The digital
outputs are represented by 12-bit-sine
and 12-bit-cosine coded angles and the
sign for each output is represented by
a logic level 1 for minus and 0 for plus.
Input registers allow many units to be
connected to one computer.

CIRCLE NO. 330

S/d converters provide jitter-free output

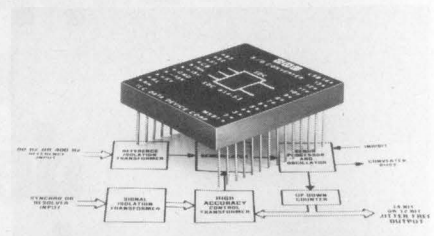

ILC Data Device, Airport International
Plaza, Bohemia, NY 11716. (516)
567-5600. \$345/\$395; stock to 8 wks.

Two low-profile 14-bit and 12-bit
synchro-to-digital tracking-converter
modules use a control-transformer
algorithm to provide inherently higher
accuracy and jitter-free output. The 14-
bit SDC-634 has two accuracy options,
either $\pm 4 \text{ min} \pm 0.9 \text{ LSB}$, or $\pm 2.6 \text{ min}$.
The 12-bit SDC-632 has an accuracy of
 $\pm 8.5 \text{ min}$. The output is natural-binary
angle and logic is TTL and CMOS
compatible. A Converter Busy output
and an Inhibit input are provided for
synchronization. The size of the module
is 3.125 \times 2.625 \times 0.42 in.

CIRCLE NO. 331

Op amps mount on breadboard kit

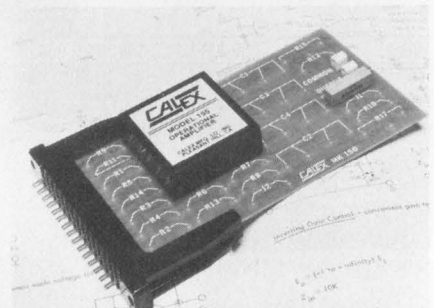

Calex Mfg., 3305 Vincent Rd., Pleasant
Hill, CA 94523. Ron Kreps (415)
932-3911. See text; stock.

A family of modular op amps and a
breadboard mounting kit provide a
quick way to set up analog circuits. The
Model 152 op amp has such character-
istics as 200-pA input current, $10^{12}\text{-}\Omega$
input impedance, 3-MHz unity-gain
frequency and $\pm 10\text{-V}$ output capabili-
ty. The Model 155 offers a drift of ± 3
 $\mu\text{V}/^\circ\text{C}$ and an input impedance of $4\text{M}\Omega$.
Both op amps can be put to use with
the Model MK150 breadboard mounting
kit on which a large number of
standard op amp circuits can be con-
nected. The Model 152 is priced at \$19
and the Model 155 is \$38. The MK150
mounting kit is \$16.

CIRCLE NO. 332

The Portable Data Logger

10 Analog Channels • Thermal Printer • 4-1/2 Digit DPM • 99 Min/Sec Timer

Datel has it, Model PDL-10—the portable approach to measuring, scanning and logging analog signals. Its small size allows it to be positioned near sensors and test apparatus. That means less cabling, lower noise, and lower cost. And the convenience of operating your data logger right next to laboratory equipment. Weighing only 12 lbs. (5,5 Kg), the PDL-10 is easily carried to different measurement sites.

But Datel hasn't sacrificed performance for portability. Ten input channels are provided, along with a 4-1/2 digit panel meter, a 7-column thermal printer for instant hard copy printout, scan electronics, and a 99 Min/Sec Scan Interval clock. Other features include multirange capability for each channel (± 200 mV, ± 2 V, ± 20 V), relay-switched differential inputs, and for further flexibility, individual SKIP controls for each channel.

Thus, the user may monitor any desired number or combination of channels.

The high performance and versatility of the PDL-10, together with its small size and weight, make it ideal for bench-top operation in laboratory and industrial applications where slowly varying signals from bridge transducers such as thermocouples, strain gages, and pressure sensors are to be monitored and recorded. In addition, the excellent common-mode rejection of the PDL-10 provides high noise immunity in industrial applications.

Input connections are made through convenient screw terminals on the rear panel. Operation requires no special training or knowledge and will usually be mastered within a matter of minutes.

Send today for the free 12-page brochure detailing PDL-10's capabilities.

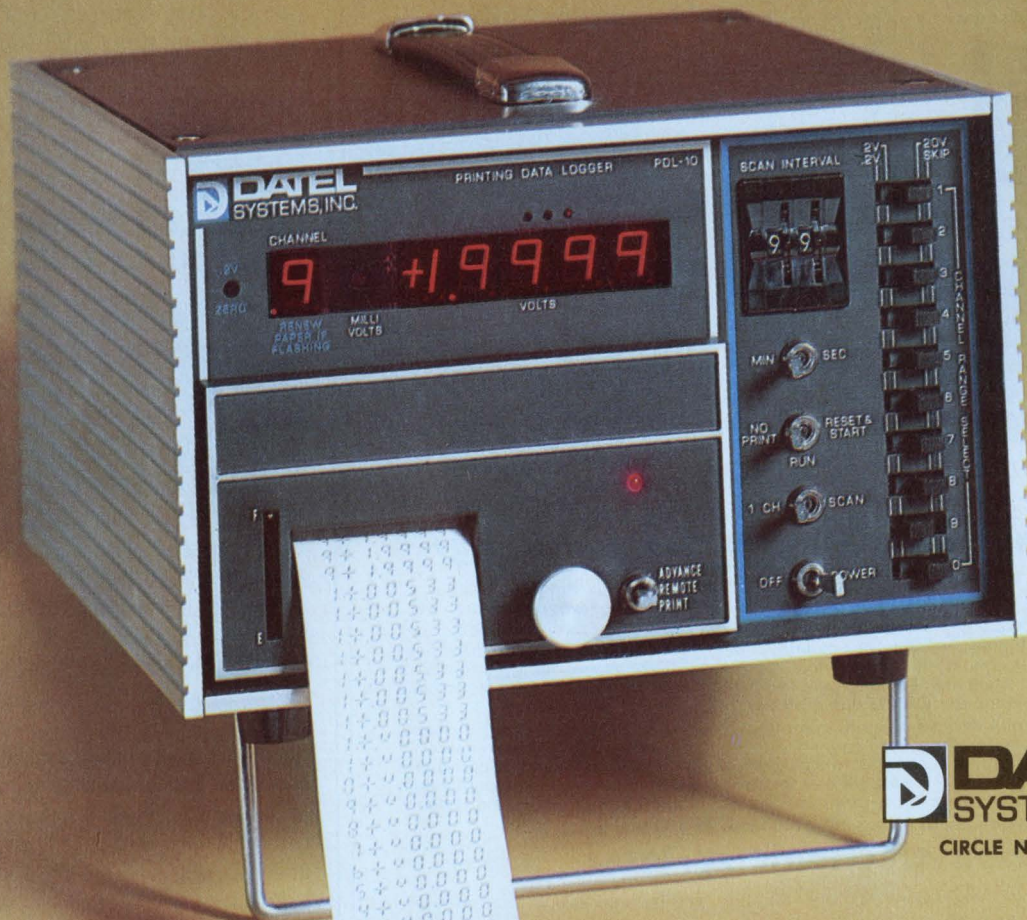

D **DATEL**
SYSTEMS, INC.

CIRCLE NUMBER 69

1020 TURNPIKE STREET, CANTON, MASS. 02021 / TEL. (617) 828-8000 / TWX: 710348-0135 / TELEX: 924461
Santa Ana, (714) 835-2751, (L.A.) (213) 933-7256 • Sunnyvale, CA (408) 733-2424 • Gaithersburg, MD (301) 840-9490 • Houston, (713) 932-1130 • Irving, TX (214) 256-4444
OVERSEAS: DATEL (UK) LTD—TEL. ANDOVER (0264) 51055 • DATEL SYSTEMS SARL 620-06-74 • DATELEK SYSTEMS GmbH (089) 77-60-95

TKC[®] Custom Connectors

with the famous 'CONE POINT'[®]

Some companies just offer you what they've got. We give you custom design at off-shelf prices—connectors for PCB's and displays (LED, LCD and gas discharge) with contacts and spacing tailored to your exact requirements.

Solderless connectors with gold or tin-plated contacts and exclusive, positive "CONE POINT" design • Solder posts for through-board mounting or bolt-on models for stacking PCB's as deep as needed • Rugged, glass-filled polyester bodies. Tell us what you need!



410 S. Cedros Ave.
Solana Beach, CA 92075

(714) 755-1181
TWX (910) 322-1135



Every One a Special,
and we love the challenge!

CIRCLE NUMBER 70

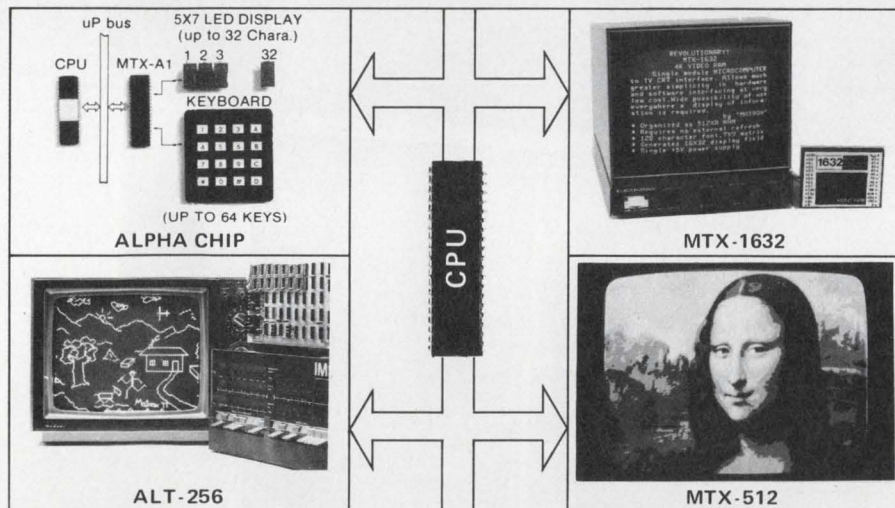

matrox microprocessor displays

- VIDEO RAMS: A family of alphanumeric CRT controllers. Wide range of display formats.
 - GRAPHICS: A family of versatile CRT controllers. Resolutions from 256 x 256 to 512 x 512.
 - ALPHA CHIP: A family of single chip LED alphanumeric keyboard/display controllers.
- Matrox offers you a highly diversified line of innovative display controllers. Our products have proven themselves in almost every imaginable application; from ground control displays for the Viking mission to Mars to hobby displays. You can choose from one of the most complete lines of micro-mini-computer CRT and display controllers in the industry.

These state of art OEM devices come as complete off the shelf, ready to use sub-systems. (Single chips, modules, PCB's). They connect directly to any uP and can drive standard TV monitors. We offer many products which are plug-in compatible with industry standard buses including DECSI-11, Intel SBC-80, S100 bus and Prolog. Matrox also offers a unique custom design capability which ranges from complex single chip controllers to complete systems.

If you need a display for your uP, let us know. We are ready to help you.



matrox electronic systems TLX 05-825651

P.O. BOX 56, AHUNTSIC STN., MONTREAL, QUE. H3L 3N5 TEL. (514) 481-6838 or (514) 735-1182
U.S. ONLY, TRIMEX BUILDING, MOOERS, N.Y. 12958

CIRCLE NUMBER 71

MODULES & SUBASSEMBLIES

Two pulse preamps boast low cost

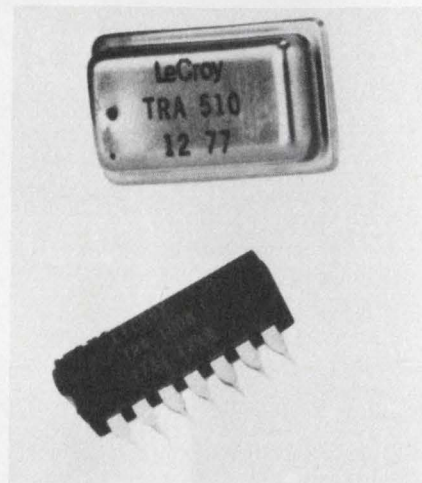

LeCroy Research Systems, 700 S. Main St., Spring Valley, NY 10977. Alan Michalowski (914) 425-2000. \$6.00/\$12.00.

Two high-performance, low-cost pulse preamplifiers are the monolithic Model TRA1000 and the hybrid TRA510. The units give open-loop voltage gain of up to 5000, bandwidth of 20 MHz, power dissipation of 80 and 160 mW respectively and inverting and noninverting outputs. The Model TRA510 contains a FET input stage in the hybrid to provide low-noise amplification. 16-pin DIP.

CIRCLE NO. 333

0.5-in. LED display reads out for DVMs

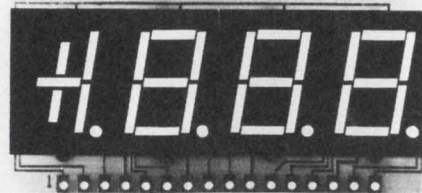

National Semiconductor, 2900 Semiconductor Dr., Santa Clara, CA 95051. (408) 737-5000. \$6.50 (100 qty); stock.

The common-cathode multiplexed GaAsP LED display, NSB5388, is compatible with the ADD3501 and other digital voltmeter chips. It connects by PC-type terminals on the edge of the display. The display features separate access to its plus-minus sign and decimal points. Digit light intensity is rated at 1.6 mcd at 10-mA/segment and all digits are prematched for brightness.

CIRCLE NO. 334

New, 16 Bit Microcircuit D/A Converter

Datel has it...



Two versions to choose from:

DAC-HP16BMC

- ▶ 16 Bit Binary Resolution
- ▶ 15 ppm/°C Max. Tempco
- ▶ ±0.003% Linearity
- ▶ 0 to +10V, ±5V Output
- ▶ 35 μsec. Settling Time

DAC-HP16DMC

- ▶ 4 Digit BCD Resolution
- ▶ 15 ppm/°C Max. Tempco
- ▶ ±0.005% Linearity
- ▶ 0 to +10V Output
- ▶ 15 μsec. Settling Time

\$7750*
(100's)

Price, both versions: \$119.00* (1-24)

*U.S.A. domestic prices only

When high resolution and stability are demanded, Datel's DAC-HP series provides the performance — applications such as precision signal reconstruction, automatic test systems, and ultra-linear ramp generation. DAC-HP's excellent performance results from special low tempco nichrome thin-film resistors, laser trimmed for optimum linearity, and a low tempco zener reference circuit. Operating temperature range is 0 to 70C, with models available for -25 to +85 and -55 to +125C operation.

DATEL
SYSTEMS, INC.

1020 Turnpike Street, Canton, MA 02021
TEL: (617) 828-8000 TWX: 710-348-0135

Santa Ana, (714) 835-2751, (L.A.) (213) 933-7256 • Sunnyvale, CA (408) 733-2424 • Gaithersburg, MD (301) 840-9490 • Houston, (713) 932-1130 • Irving, TX (214) 256-4444
OVERSEAS: DATEL (UK) LTD—TEL: ANDOVER (0264) 51055 • DATEL SYSTEMS SARL 620-06-74 • DATELEK SYSTEMS GmbH (089) 77 60 95

CIRCLE NUMBER 72

TRW L-Band Transistors

- broadband output
- reliability of gold
- and priced right

960-1215MHz
1 microsecond
10% Duty Factor

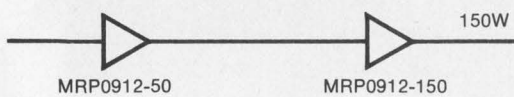

\$73.14*

960-1215MHz
1 microsecond
10% Duty Factor

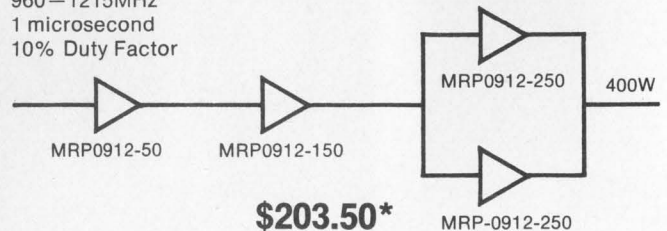

\$203.50*

960-1215MHz
1 microsecond
10% Duty Factor

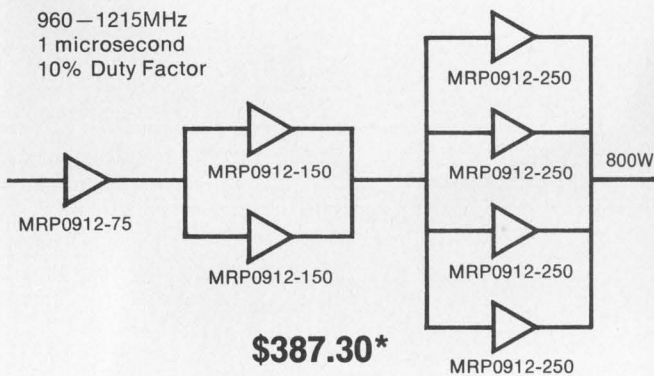

\$387.30*

1200-1400MHz
2 millisecond
20% Duty Factor

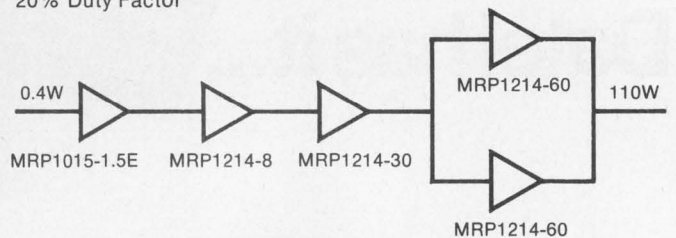

\$502.62*

*1K Level Pricing U.S. Only

TRW RF Semiconductors make a full line of 960-1215 and 1200-1400MHz, transistors, with power outputs from 1.5W to 250W, for DME, TACAN, IFF, or phased array radar.

All of TRW's L-Band devices feature TRW's patented silicon diffused ballast resistors and refractory gold passivated metallization process, for long-life reliability. And they all cover the specified bandwidth at their rated power outputs.

Great performance at great prices at TRW. For details, send the coupon or phone RF Sales Department, at TRW RF Semiconductors, (213) 679-4561.

TRW RF Semiconductors

An Electronic Components Division of TRW Inc.
14520 Aviation Boulevard,
Lawndale, California 90260

Please send information on your new priced right L-Band Transistors.

Name _____
Position _____
Company Name _____
Address _____
City _____ State _____ Zip _____ ED

TRW

RF SEMICONDUCTORS

ANOTHER PRODUCT OF A COMPANY CALLED TRW

CIRCLE NUMBER 73

Dial-A-Voltage



SHOWN ACTUAL SIZE

0.005% Calibrator only \$450 (SINGLES)

Datel's Digital Voltage Calibrator, DVC-8500 comes in a mini-benchtop package, at a mini-price (\$450 in singles*), but provides very big performance. DVC-8500 offers 4½-digit resolution and a ±19.999 volt full scale output range with ±1 millivolt accuracy (±0.005% of full scale.)

Use your DVC-8500 to calibrate A/D and D/A converters, DPM's, DVM's, Op Amps, V/F converters, and Data Acquisition Systems. A short-proof, buffered output gives up to ±25mA output current with an LED overload warning signal. The ±1.5 millivolt front panel vernier allows fine tuning of A/D and D/A bit steps.

Included are rear PC sense terminals and a choice of 100, 115, or 230 VAC inputs. A panel mounting kit is optional.

Contact Datel, or your nearest Datel Representative listed in Gold Book or EEM.

* U.S.A. Domestic Price only.

 **DATEL**
SYSTEMS, INC.

1020 TURNPIKE STREET, CANTON, MASS. 02021
TEL. (617) 828-8000 / TWX: 710-348-0135
TELEX: 924461

Santa Ana, (714) 835-2751, (L.A.) (213) 933-7256 • Sunnyvale, CA (408) 733-2424 • Gaithersburg, MD (301) 840-9490 • Houston, (713) 932-1130 • Irving, TX (214) 256-4444
OVERSEAS: DATEL (UK) LTD—TEL: ANDOVER (0264) 51055 • DATEL SYSTEMS SARL 620-06-74 • DATELEK SYSTEMS GmbH (089) 77-60-95

CIRCLE NUMBER 74

ELECTRONIC DESIGN 9, April 26, 1978

173

MODULES & SUBASSEMBLIES

Keyboard programs to exact need

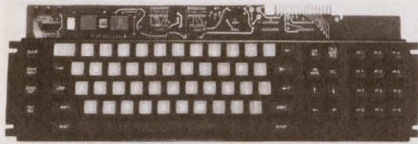

C.P. Clare, 3101 W. Pratt Ave., Chicago IL 60645. (312) 262-7700.

Full-function keyboards quickly program to the exact application requirements. The keyboard includes a single-chip 8-bit microprocessor with a ROM, RAM and erasable PROM. The microprocessor permits automatic repeats, multiple programming of a single board, program changes in the field, serial and parallel I/O and 3-key roll-over.

CIRCLE NO. 335

Quiet tape punch uses concentric spooling

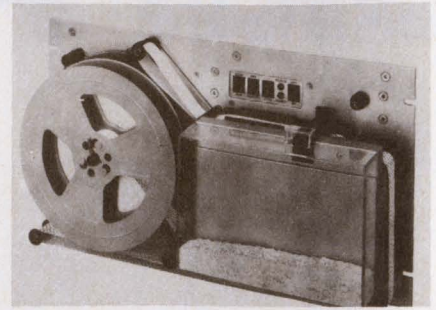

Data Specialties, 3455 Commercial, Northbrook, IL 60062. (312) 564-1800. \$1860; 6 wks.

The RP-75 is a rack-panel-mounted tape-punch system that features concentric spooling and whisper-quiet operation. The system is provided with a front-panel-mounted supply and take-up spool as well as a high-capacity chad container. The punch receives data at speeds up to 75 char/s asynchronously or when in the serial configuration at 300, 600 or 750 baud. The unit interchangeably punches Mylar, Mylar laminates and oiled or unoled tape. A tape sensor provides tape-out, low-tape and tight-tape indication.

CIRCLE NO. 336

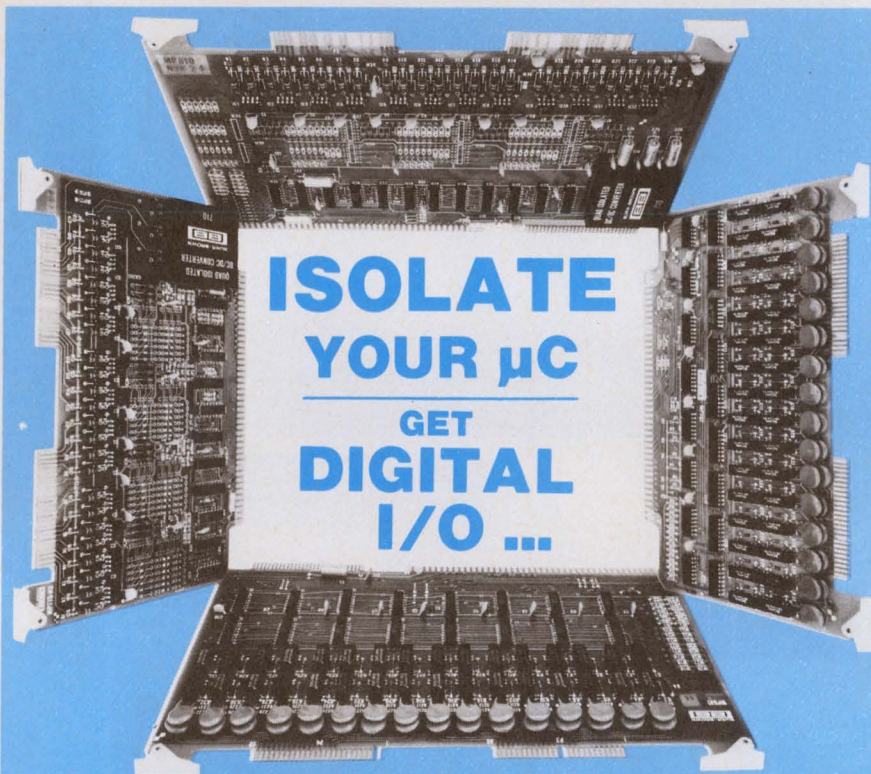

**ISOLATE
YOUR μ C**
**GET
DIGITAL
I/O ...**

... AND INTERFACE WITH CONTACT CLOSURES

Protect your Motorola Micromodule®, Intel SBC80 or National BLC80 μ C from the electrical violence of the industrial world!

Totally compatible isolated digital input/output microperipheral boards provide contact closure or voltage operation. Unique design features assure predictable-reliable operation in electrically noisy, physically dirty environments. Up to 600 VDC isolation.

Request complete technical data on these problem solving Burr-Brown microperipherals offering 16/32 channel relay output, 24 channel contact closure/voltage inputs.

Burr-Brown-P.O. Box 11400-International Airport Industrial Park
Tucson, Arizona 85734 Phone: (602) 746-1111.



Putting Technology
To Work For You

CIRCLE NUMBER 95

Dual-channel filter tunes digitally



Krohn-Hite, Avon Industrial Park, Avon, MA 02322. (617) 580-1660. \$2000; 4 wks.

The Model 3343 dual-channel filter is digitally tuned over the range of 0.01 Hz to 99.9 kHz and has a 48-dB slope per octave. A slope of 96 dB per octave can be achieved when both channels are operated in the same mode, at the same cutoff-frequency setting and cascaded. Channels operate in a high-pass or low-pass mode. Frequency response is an 8-order Butterworth with maximum flatness for cleanest filtering in the frequency domain. A front-panel switch changes frequency response to RC optimum for transient filtering. Switch tuning permits cutoff-frequency calibration accuracy of $\pm 2\%$ and 3-digit resolution.

CIRCLE NO. 337

Four very small ways to improve on your PC design.

With four types of switches—rockers, pushbuttons, toggles and DIPs—Cutler-Hammer offers one of the industry's broadest and most unique selections of PC subminiatures.

Each of the hundreds of available styles provides the reliability you've come to expect from Cutler-Hammer. With ratings to 6 amps, each conforms to standard circuit board mounting requirements.

PC switches, along with accessories and decorative hardware, are distributor stocked for local availability. And since most are manufactured in the United States, we offer fast reaction time on solder lug and wire wrap terminal variations, as well.

To improve your next design in any number of small ways, contact your Cutler-Hammer Sales Office or Switch Distributor.

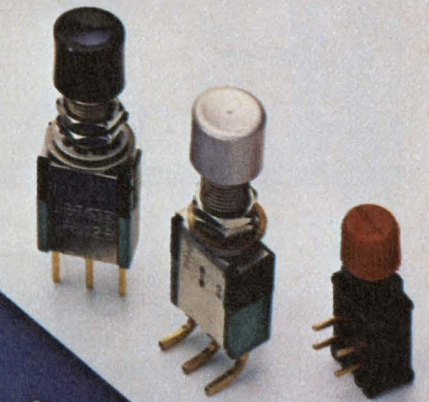
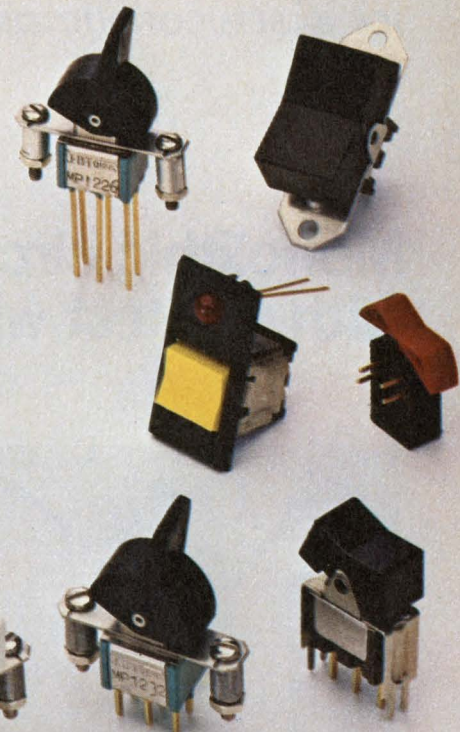

 Switch to No.1

CUTLER-HAMMER
SPECIALTY PRODUCTS DIVISION, Milwaukee, Wis. 53201
CIRCLE NUMBER 76

Monolithic circuit converts voltage to frequency with tightest wide-range tempco



National Semiconductor, 2900 Semiconductor Dr., Santa Clara, CA 95051. (408) 737-5000. P&A: See text.

Until now, if you wanted temperature stability of gain in a monolithic voltage-to-frequency (v/f) converter, the best maximum tempco you could get over -55 to 125 C, was ± 150 parts per million per $^{\circ}$ C (ppm)—no matter what price you were willing to pay. But things have changed, thanks to National Semiconductor's high-stability monolithic v/f converter, the premium LM 131AH. For \$12 (100 qty), this IC holds its voltage-to-frequency transfer function to a tight 50 ppm, and guarantees this maximum tempco from -25 C to both -55 and 125 C.

National feels that specifying the tempco from room temperature to the extremes describes the device better than just the T_{\min} -to- T_{\max} tempco specs that others like Analog Devices (Norwood, MA) use for, say, the ± 150 ppm AD 537S. Apparently, Burr-Brown Research (Tucson, AZ) agrees that the three-point "butterfly" tempco specification is more informative—its VFC 32SM's ± 150 ppm is also guaranteed

from room temperature to the operating-temperature extremes.

The National LM 131AH is the most stable and expensive member of an extensive family of v/f converters. Other versions operate over narrower temperature ranges and, naturally, cost less. The LM 231AN and LM 331AN guarantee their 50 ppm's from -25 to $+85$ C and 0 to $+70$ C, respectively; they sell for \$4.50 and \$3.90 (100 qty). The most loosely specified member of the series, the LM 331, will soon be available in a plastic mini-DIP for \$3.00 (100 qty).

LM 131/231/331 converters offer more than just good tempco. Maximum nonlinearity from 1 Hz to 11 kHz is 0.01% at 25 C and increases to only 0.02% over the full temp range. No IC v/f converter guarantees better linearity. And thanks to a temperature-compensated, band-gap-reference circuit, the entire family holds its accuracy even when operating with supplies as low as 4 V.

Another reason for the LM 131's remarkable performance with low-voltage input power is that it uses a $Q = I \times T$ type charge dispenser instead

of the conventional $Q = C \times V$ type. The latter dispenser's time may have past: Saving transistors is no longer the overriding concern in ICs.

Other IC v/f converters are more stable than the LM 131AH—but over a smaller temperature range. The 9400 from Teledyne Semiconductor (Mountain View, CA) offers a 40-ppm maximum tempco from -40 to $+85$ C at \$4.95 (100 qty). Another ± 40 -ppm device, the VFQ-1R from Datel Systems (Canton, MA), operates from -25 to $+85$ C.

Although not in the same stability class as the LM 131AH, the RM 4151 from Raytheon Semiconductor (Mountain View, CA) has one feature that makes it hard to pass over—the 8-pin mini-DIP version costs \$0.95 (100 qty). But Raytheon hasn't thrown in the sponge on tempco. The RM 4152 has 150 ppm guaranteed from -55 to $+125$ C and, in plastic, costs only \$1.40 (100 qty). This summer, look for a further update of the 4152—this one should take the present 0.5% nonlinearity at 25 C down to 0.1%.

Another interesting series of converters is the 100-ppm (0 to 70-C) 8400 and its looser cousin, the 8402, both from Intech/FMI (Santa Clara, CA). Not only do they convert a voltage input to a proportional frequency, they also can be reversed to convert frequency to voltage.

All this activity, in what was for a long time a rather prosaic field, may be the harbinger of a long-awaited development, the digital transducer. An IC v/f converter—with just a sensing element added, perhaps even on the chip itself—could be the answer.

| | |
|---------------------|----------------|
| National | CIRCLE NO. 301 |
| Analog Devices | CIRCLE NO. 302 |
| Burr-Brown Research | CIRCLE NO. 303 |
| Datel Systems | CIRCLE NO. 304 |
| Intech/FMI | CIRCLE NO. 305 |
| Raytheon | CIRCLE NO. 306 |
| Teledyne | CIRCLE NO. 307 |

FOR RENT...NOW...

the truly universal PROM Programmings from Data I/O that enable you to program any of the more than 200 PROMs now available.

A single Data I/O programmer—the Model V or Model IX—can be used to program every single commercially available PROM.

Data I/O programmers are universal. You can use them to program any PROM, and more than 200 PROMs are currently available. This means you don't have to get a separate programmer to accommodate different PROMs. With either the Model V or Model IX and the appropriate personality card, you can program any PROM or its second source equivalent. Moreover, one personality module can be used to program all PROMs within a generic family and keep your yield at the maximum.

ROM emulation and editing capabilities are built-in, making software development a breeze and virtually eliminating PROM waste.

All the Data I/O programmers save lab time and slash your development expense. These are

portable, rugged, human-engineered and easy to use units. They're ideal for field service. Both the Model V and Model IX offer a direct display readout of PROM or RAM data at any address and offer unlimited data editing capabilities. Operation is totally automatic, and you can enter data manually through the keyboard or load it automatically from a preprogrammed master PROM. There are built-in error checking routines to insure accurate and correct data transfers, and serial or parallel I/O are standard. These unique PROM programmers and their personality cards are available now.

Rental Electronics, Inc.

Another of the **AMERICAL** companies

More than 12,871 state-of-the-art instruments . . . off-the-shelf, throughout North America.

| | |
|--|--|
| <input type="checkbox"/> Tell me more about the Data I/O PROM Programmings now! Call me at _____ | <input type="checkbox"/> Send me a copy of your free illustrated Rental Catalog. |
| <input type="checkbox"/> Send me your Equipment Sales Catalog—I might be interested in buying some of your great "previously owned" equipment on a money-back guarantee. | Name _____ |
| <input type="checkbox"/> I have a pressing need right now for the following: _____ | Title _____ |
| | Company _____ |
| | Address _____ |
| | City _____ |
| | State _____ Zip _____ |
| | Phone No. _____ Ext. _____ |
| Please phone me immediately at _____ | GSA #GS-04S-21963 Neg © 1978 Rental Electronics, Inc. |

Complete this coupon and return it today to the world's oldest and largest electronic equipment rental firm, REI, 19347 Londelius St., Northridge, California 91324

Anaheim, CA (714) 879-0561
Mountain View, CA (415) 958-8845
Fort Lauderdale, FL (305) 771-3500
Des Plaines, IL (312) 827-6670
Burlington, MA (617) 273-2770
Gaithersburg, MD (301) 948-0620 • Oakland, NJ (201) 337-3757
Cleveland, OH (216) 442-8080 • Dallas, TX (214) 661-8082
Houston, TX (713) 780-7218 • Seattle, WA (206) 641-6444
Northridge, CA (213) 993-RENT (7368)
Rexdale (Toronto), Ontario (416) 675-7513
Montreal, Quebec (514) 681-9246 • Vancouver, B.C. (604) 684-6623

CIRCLE NUMBER 77

Precision Film Capacitors

for High Temperature Applications

Standard Series Balco capacitors made of DuPont TEFLON are available in two internal construction styles ideally suited for critical circuits at operating temperatures up to 200°C.

TFHT (extended foil) — for use in high power resonant and pulse circuits.

TMHT (metalized film) — for resistor coefficient matching and for use in subminiature circuits.

Performance Features:

- Insulation Resistance 10^{10} ohms to 10^{12} ohms @ 25°C.
- Dissipation factor to 0.02% @ 25°C
- High Retrace Stability
- Low Dielectric Absorption

For complete specifications, write for FREE Product Bulletin T-1.



CUSTOM ELECTRONICS, INC.
4 Browne Street, Oneonta, NY 13820
PH: 607-432-3880 TWX: 510-241-8292

CIRCLE NUMBER 78

ICs & SEMICONDUCTORS

Schottky diode operates at 175 C junction temp

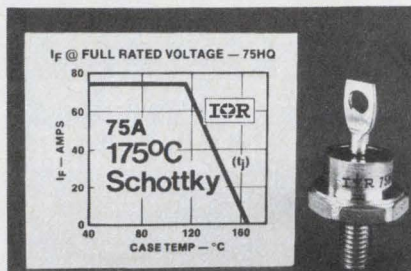

International Rectifier, 233 Kansas St., El Segundo, CA 90245. (213) 322-3331. \$6.00 (100 qty); 2 to 4 wks.

Compared to 150-C rated devices, this 175-C Schottky diode family can yield an additional 25-W output. The higher junction temperature rating is a result of lower reverse current leakage. With a 45-V reverse bias at 125 C, the diodes have a 50-mA max leakage. The forward current rating is 75 A at 115 C. Type 75HQ030 has a reverse-voltage rating of 30 V and the 75HQ045 is rated at 45 V. Packaging is in DO-5 cases.

CIRCLE NO. 338

4-k RAMs take only 40 mA max current

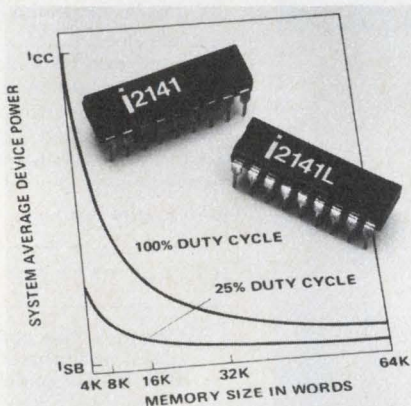

Intel, 3065 Bowers Ave., Santa Clara, CA 95051. Rob Walker (408) 249-8027. From \$18.75 (100 qty).

Seven types of HMOS 4096 × 1-bit fully static RAMs are included in the 2141 family. The family provides four speed versions and three low-power selections. For example, the L series operates with only a 40-mA max supply current. Current drops to 5 mA when the device is deselected. The RAMs operate at max access times down to 55 ns and they allow data throughput to be maximized by the use of equal access and cycle times. The 200-ns version runs at a 5-MHz data rate.

CIRCLE NO. 339

High-power SCRs are rated to 1200 A

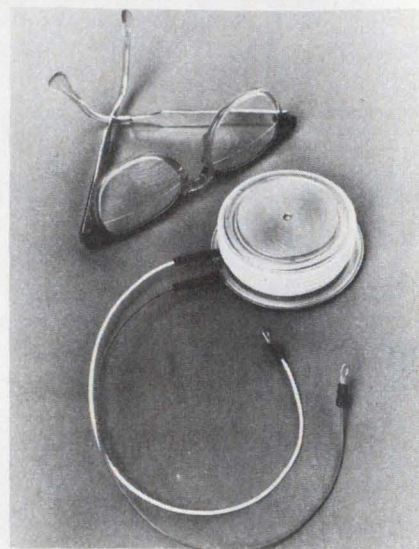

Westinghouse Semiconductor, Youngwood, PA 15697. (412) 925-7272. See text; 4 to 6 wks.

Maximum ratings of 800, 1000 and 1200 A at 3, 2.2 and 1.6 kV are offered by the T9GO SCRs. Surge ratings are up to 27,000 A. The device's power-disc packaging allows for single or double-sided cooling. Units can be matched for series or parallel operation and they are available with factory assembled air or water-cooled heat exchangers. The 1000-A, 2.2-kV SCR is priced at \$258 each for 100 pieces.

CIRCLE NO. 340

PWM control IC suits HV designs

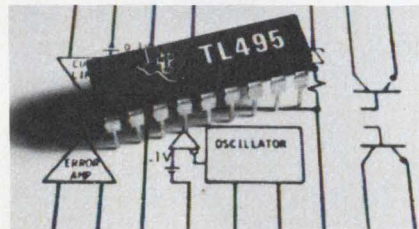

Texas Instruments, P.O. Box 5012, M/S 308 (Attn: TL495), Dallas, TX 75222. Dale Pippenger (214) 238-5908. \$3.60 (plastic), \$4.03 (ceramic); stock.

A pulse-width modulation circuit, TL495, includes an on-chip 39-V zener for high-voltage applications. The chip contains a 5-V regulator, error amplifier, current-limit-sense amplifier, programmable oscillator, dead-time control comparator, pulse-steering flip-flop and output control circuitry. Uncommitted output transistors provide either common emitter or emitter-follower output. Units come in either 18-pin plastic or ceramic DIPs.

CIRCLE NO. 341

FOR FURTHER INFORMATION ON ITT CANNON CONNECTORS
CIRCLE READER SERVICE NUMBER 101 ▶

**When you need small
connectors, and dense
packaging, who can solve
your biggest problems?**



Cannon can!

Six decades on the leading edge of interconnect technology.

CANNON ITT

Cannon's Small World

PRODUCT OFFERING

CANNON'S GOT IT

CANNON'S TWIST PIN CONTACTS* SYSTEM IS COMMON TO ALL CONNECTORS IN THE MICROMINIATURE SERIES.

Heart of the Twist Pin Contacts system, from ITT Cannon Electric, is a multi-element male twist pin recessed within an insulating housing. The rugged, cylindrical sockets are mounted in the exposed half of the connector. When connector halves are mated, the chamfered sockets guide the twist pins into proper and positive alignment, even under worst case tolerance conditions.

The multiple twist pin spring elements, then under compression, form a multi-point contact of high mechanical and electrical integrity. This tried and true system is designed for fail-safe reliability over thousands of cycles of unplugging. We've made millions of Twist Pin contacts, and have seen them go many places ... like the moon.

THE BASIC SYSTEM INTERCONNECTION.

The system interconnections shown below are common elements in complete system assembly; a few examples of such system intercon-



Seeing is believing

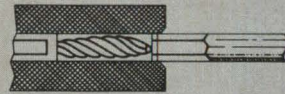

Ideal mating configuration

*Licensed by New Twist

nections are seen on the page to the right. These interconnection systems offer virtually unlimited flexibility in connector system harnessing and encompass printed circuit boards, flex circuitry and standard wire and cable.

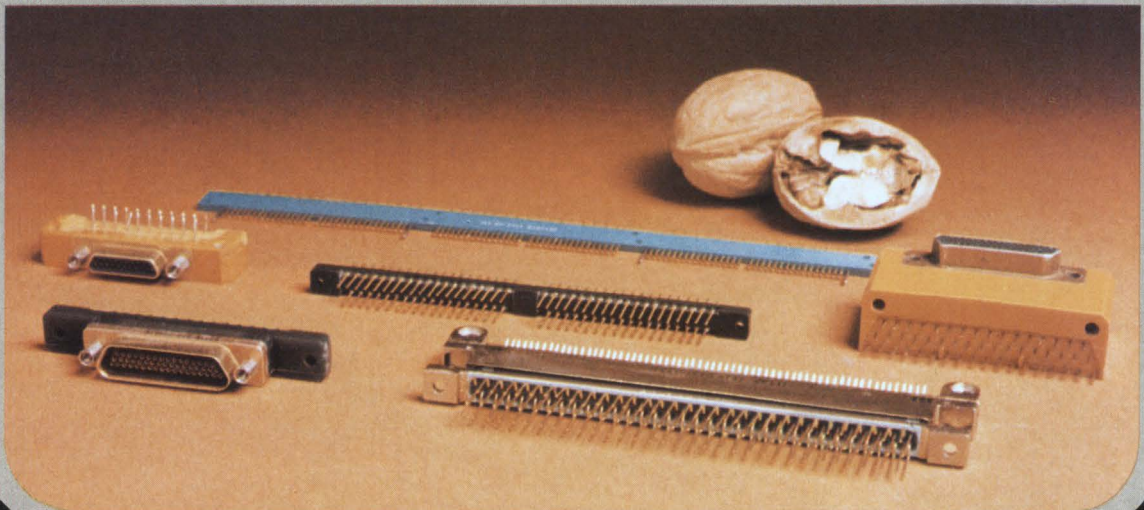

ALWAYS INNOVATIVE

CANNON'S GOT IT

COMPLETE SYSTEM INTERCONNECTION

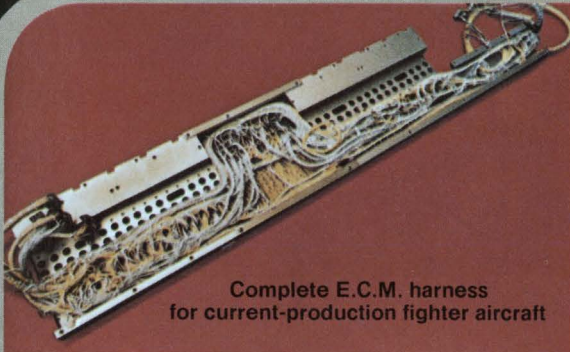

Complete E.C.M. harness
for current-production fighter aircraft

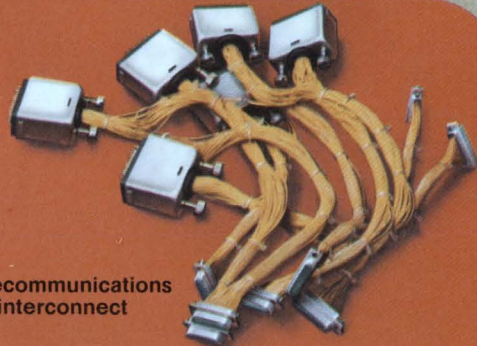

Telecommunications
interconnect

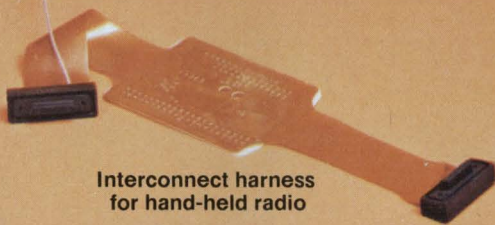

Interconnect harness
for hand-held radio



Black box interconnect harness

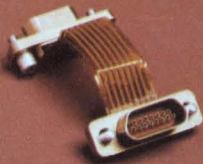

Space saver harness
with flex circuitry



Terminal interconnect,
PCB maintainability



Modular stacking interconnection devices



Interconnect harness for inertial navigation platform

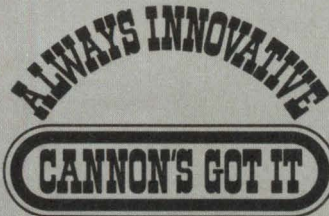

CIRCULAR CONNECTORS



Threaded coupling plastic circulars (MIK) for use in space saving requirements where severe environmental conditions do not prevail. These micro connectors provide twice the number of contacts in shell sizes similar to our miniature circular connectors.

Threaded coupling metal shell circulars (MIKM) for use in rugged,



hostile environments where space is at a premium and high reliability is a must.



Quick disconnect metal shell circulars (MIKQ) for use where space & physical volume are at a premium. And where there is a high frequency of connect/disconnects with minimum effort required, as in medical instrumentation.

All miniature circular connectors are designed to meet MIL-C-38999.

NANO CONNECTORS

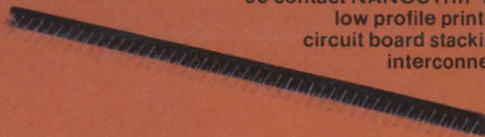

90 contact NANOSTRIP for low profile printed circuit board stacking interconnect.



Center jack screw inline plugs and receptacles on .025" centers used in inertial navigation systems and medical electronics implants (May be polarized to prevent cross-mating).



NANOSTRIP and metal shell connectors on .025" centers.



72 contact circular center jack screw inline configuration.

QUICK ACTION GETS YOU ALL THIS...

In these pages we've shown you a few examples of components and systems from over 40,000 microminiature interconnect configurations available, including complete lines of standard MICRO-D's, 50 MIL STRIP, CENTI-STRIP, Double Density D, plus custom designs.

Send today for our new total line micro products catalog and a Cannon Quick Action card. It contains an application sketch form that lets you show us your particular needs. Once you've completed the Quick Action card and returned it to us, we'll send you a free, old-fashioned apothecary jar filled with Cannon candy. ITT Cannon Electric, 666 E. Dyer Rd., Santa Ana, CA 92702. Toll-free, 24-hr. (800) 854-3573; in CA, (800) 432-7063. (And be sure to check the EEM Directory for all your Cannon Connector needs.)

Cannon can!

Six decades on the leading edge of interconnect technology.

CANNON ITT

What's new about GE's Optically Isolated Bilateral FET?

Linear low level output.

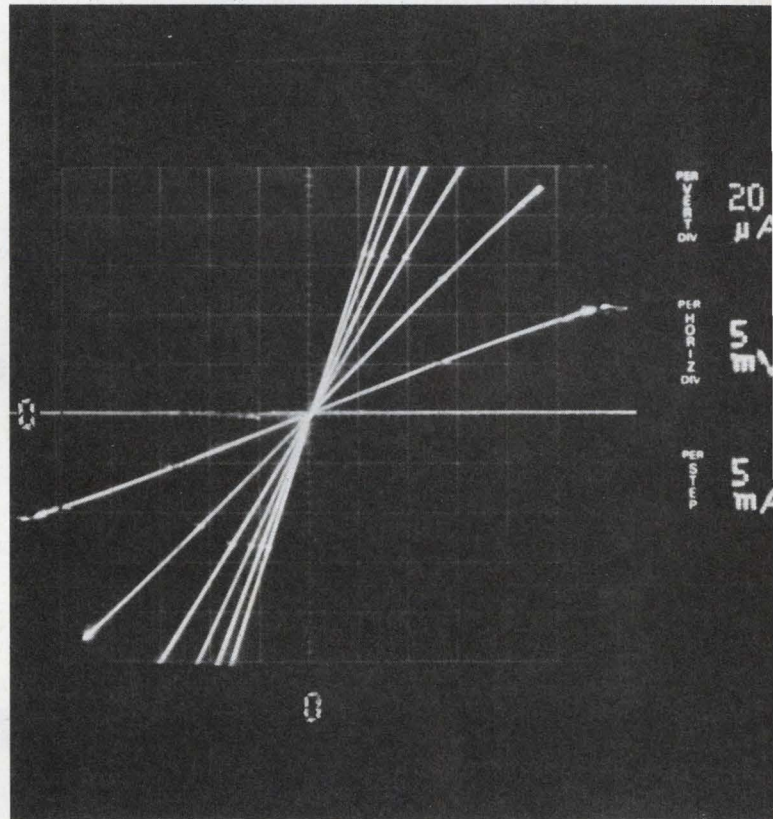
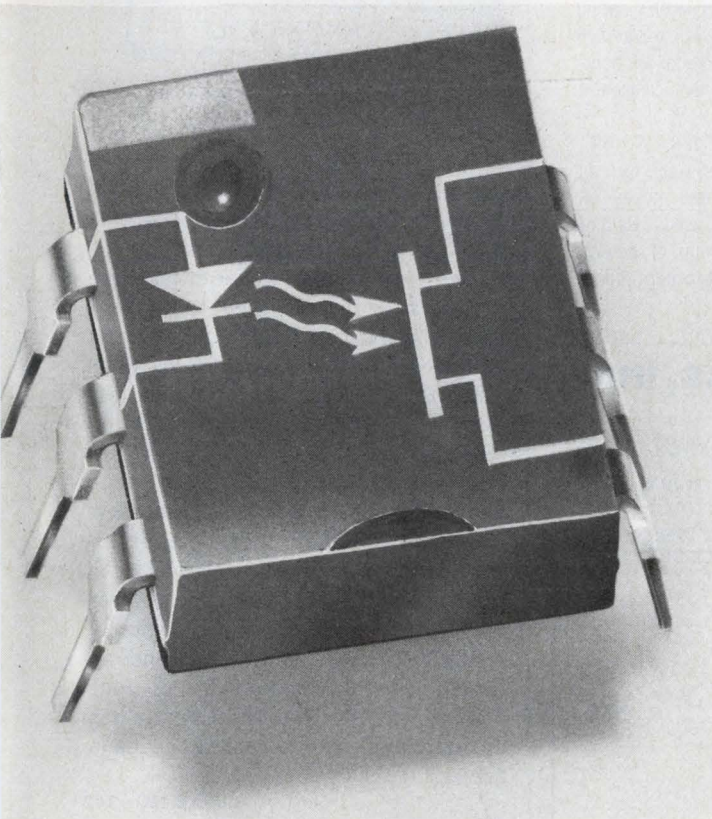

General Electric continues to innovate in Optoelectronics with the new H11F, that optically combines the dependable, efficient GaAs IRED with a Silicon Bilateral Analog FET. The H11F can be used either as a linear variable resistor output with $<200\Omega$ "on" resistance, $>300\text{ M}\Omega$ "off" resistance — or as a fast ($<15\mu\text{ sec}$) bilateral analog switch featuring 60-volt peak-to-peak output and extremely low offset voltage.

A typical application of the H11F as a variable resistor yields distortion free attenuation of low level 10KHz signals over a 70 db range.

Another unique application of the H11F is in an isolated sample and hold circuit where signal polarity is undefined and cost is critical. H11F series coupler prices start at 98¢ in 1,000 lot quantities.

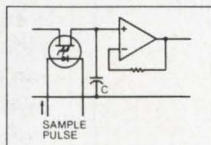
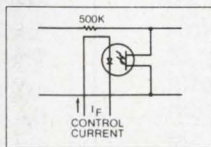

Other applications include automatic gain control, active filter fine tuning, multiplex A/D conversion.

The H11F series, like other General Electric opto couplers, features patented glass dielectric isolation for uniformity, performance and reliability.

The H11F is another example of GE innovative leadership in Optoelectronics. For a design specification sheet and free sample, write to General Electric, Electronics Park 7-42, Syracuse, N.Y. 13221, (315) 456-2715 or contact your authorized distributor.

In Europe, contact Electronics Trading Company, Dundalk, Ireland. (042) 32371, TELEX: 6500. 222-09

**There's more to
any GE semiconductor
than meets the eye**

GENERAL  ELECTRIC

TIME SAVER

FOR
OEM PARTS

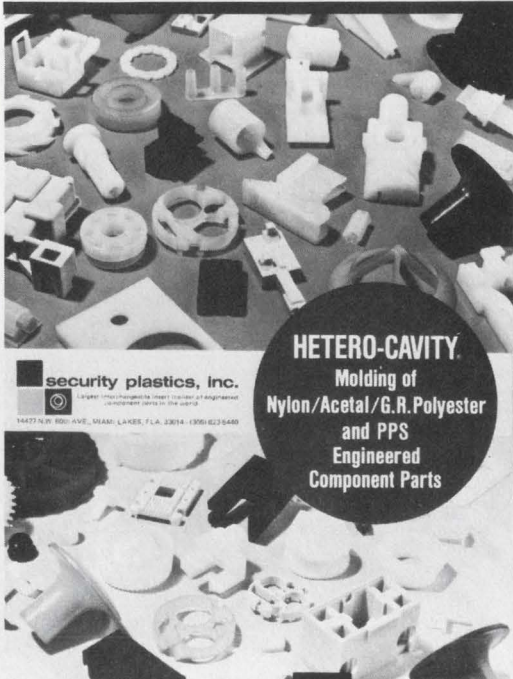

What it is...

How to design for it...

HETERO-CAVITY
Molding of
Nylon/Acetal/G.R. Polyester
and PPS
Engineered
Component Parts

security plastics, inc.
14427 N.W. 60th Ave., Miami Lakes, FL 33014 • (305) 823-5440

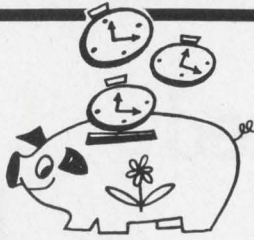

FREE DESIGN GUIDE

gives full details on faster tooling and production plus MONEY-saving advantages of Hetero-cavity® molding of nylon/acetal/GR polyester/PPS engineered component parts.

Now molding OVER TWO BILLION parts a year, Security can save YOU time and money on your small parts needs. Call or write for free copy of newly-revised full color brochure today!

security plastics, inc.

14427 N.W. 60th Avenue,
Miami Lakes, FL 33014 / (305) 823-5440

Largest interchangeable insert molder of engineered component parts in the world
CIRCLE NUMBER 80

NEW! INSTANT FREQUENCY DIFFERENCE!



Tracor Model 527A measures frequency difference instantly, precisely. For precisely \$3,150.

Front-panel meter reads directly to parts per 10¹¹. Allows adjustment of two oscillators to the same frequency, adjustment to a specific offset, determination of offset — all instantly. Plus both short-term and long-term stability analysis. Internal oscilloscope extends precision to 1 x 10⁻¹². Reference and signal frequencies need not be the same. Write or call for full technical and application information.

Tracor Industrial Instruments

6500 Tracor Lane • Austin, Texas 78721 • AC 512/926-2800

CIRCLE NUMBER 81

ICs & SEMICONDUCTORS

Line drivers meet EIA RS-422 spec

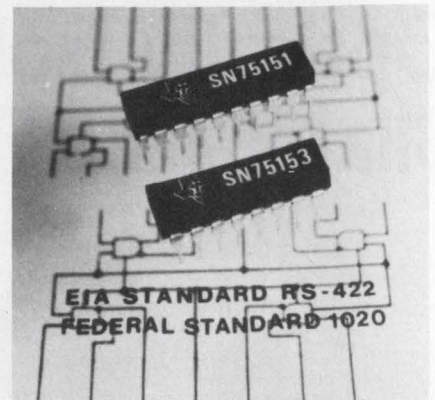

Texas Instruments, P.O. Box 5012, M/S 308 (Attn: SN75151-153), Dallas, TX 75222. Dale Pippenger (214) 238-5908. \$1.87 to \$3.02 (100 qty); stock.

Two quadruple differential line drivers with three-state outputs meet EIA standard RS-422 and federal standard 1020 requirements. The SN75151 and SN75153 provide differential output signals for driving balanced lines. Output stages are totem-pole outputs with 40-mA sink and source capability. Schottky-clamped transistors allow 16-ns (typical) switching speed and 400-mW (max) power dissipation. The devices provide a common input logically ANDed with the data input and an enable control common to all four drivers. The SN75151 additionally has an individual enable control for each driver.

CIRCLE NO. 342

Monolithic d/a has 10-bit resolution

Datel Systems, 1020 Turnpike St., Canton, MA 02021. Eugene Murphy (617) 828-8000. \$10.95; stock.

Model DAC-IC10BC is a monolithic d/a converter with 10-bit resolution. It settles in 250-ns for a full scale output change. The converter's digital inputs accept positive true logic. Linearity is $\pm 1/2$ LSB typical and ± 1 LSB max. The gain tempo is -20 ppm/ $^{\circ}$ C. An external reference current programs the scale factor and may be varied over a 4 to 1 range. Output current is 0 to 4 mA with an output voltage compliance of -2.5 to $+0.2$ V. The output can either drive a load resistor directly or the summing junction of an operational amplifier. Converters come in 16-pin ceramic DIPs.

CIRCLE NO. 343

The HP 2649A is what you make it.

A controller. It's a natural. Just program the built-in 8080 microprocessor to do your thing, and get it into your system. The HP 2649A has a variety of synchronous, asynchronous, serial and parallel interfaces (including HP-IB, our IEEE Interface Standard 488). This makes it easy to hook up with instruments and peripherals. In short, it's a complete controller system in a single package.

A terminal. Terrific! Great editing ability, a choice of keyboards, flexible data communications, and a variety of baud rates make it an excellent fit in an RJE situation. Preprogrammed firmware is available to get you off to a head start.

You can really make a lot with the HP 2649A.

You start with the basics — a CRT, power supply, backplane, I/O cards, MPU, and versatile, modular architecture.

You program

it to do your specific job, and pick only the memory, keyboard, I/O, breadboard, and other modules you need. These include RAM (up to 32K bytes on one module), ROM, and PROM boards, which all simply slip into the chassis.

(There are slots for your own boards as well.) You can also add 220K bytes of mass storage on dual plug-in cartridges.

To top it off, we have documentation, development tools, and a one week training course in programming and customizing the HP 2649A.

So whatever you call it, call your nearest Hewlett-Packard office

listed in the White Pages and ask for complete details. Or send us the coupon. We'll help you make it any way you want it.

A microcomputer. Why not? The microprocessor gives you a lot of power. Then you can add ROM memory, interface with a disc, control peripherals, and access other systems via a modem. So the HP 2649A acts like a small computer, even if it doesn't look like one.

A graphics display station. Sure. You can put a window in your system and see exactly what's going on. Alphanumerics, auto-plot, and full graphics, including Area Shading, Pattern Definition and Rubber-band line, give you the whole picture.



HEWLETT  PACKARD

42802HPT6

CIRCLE NUMBER 82

I'm interested in your microcomputer/controller/graphic display station/terminal.

- Have your representative contact me.
- Send me technical literature.
- Send me OEM information.

Name Title

Company

Address

City/State/Zip

Mail to: Ed Hayes, Marketing Manager,
Hewlett-Packard Data Terminals Division,
19400 Homestead Road, Dept. 1418, Cupertino CA 95014.

Imagine what you could do with an RF link so small and yet so versatile.

**Imagine
the size...** Repco's transmitters and receivers measure only 3.32" square, so no matter how tight the packaging requirement, we've got your link!

**Imagine
the low cost...** In almost any telemetry application you may consider Repco beats the cost of hard wire hands down. In fact, Repco's low cost RF links could probably be saving money on a job you're designing right now. Why not find out?

**Imagine
the versatility...** How could any link so small and so low cost offer so many performance features—Frequencies of 25-50 Mhz, 72-76 Mhz, 132-174 Mhz, 450-470 Mhz • voice, low-speed digital or tone operation • 0.4 to 25 watt Tx output • unique modular circuit design for easy maintenance and design flexibility.

Versatility of applications? We wrote the book on it. And we'll send you a copy free of charge. Write today for Repco's brand new RF links applications book, and we'll also include our latest performance specifications and price list.

 **Repro** Inc.

A subsidiary of Scope, Inc.
P.O. Box 7065
Orlando, FL 32854
(305) 843-8484
TWX 810-850-0120
Telex 56-6536

CIRCLE NUMBER 83



Take a chance on a power supply and win an airline trip.



Red Eye Flights to Customer Sites

A chancy power supply's bottom-line cost doesn't show up on a price list. It shows up in increased emergency service calls, total aggravation, and catastrophic downtime costs to the customer. Our Switching Regulated Power Supplies - the Dependables - can minimize such worries.

Time Proven Winners: the Dependables

For over 19 years, the Dependables have proved their reliability in OEM digital applications where superior line and dynamic load regulation are needed. And their low RFI/EMI and low output ripple (less than 3 mV peak-to-peak at line frequencies) make them ideal for sensitive analog applications.

Brownoutproof: These Days a Must

The Dependables can supply their specified regulated outputs **at full load** over input variations from 92 to 138 or 184 to 250 VAC. And they'll keep it up for several minutes even if the input drops to 70 or 140 VAC. If AC fails completely, the supplies will hold up for at least 30 mSec., allowing orderly shutdown or shift to optional DC backup. **Catalog DP-27** gives details on our single output supplies and brownoutproof features.

The tables at the right list our standard single and multiple output supplies. Other configurations can be provided. Standard DC input voltages are 48, 120 or 220 VDC.

Multiple Output Supplies

| AC Input - Model Number | PM2675 | PM2676 | PM2677 | PM2678 |
|--------------------------|---------------------------------|--------|--------|--------|
| DC Input - Model Number | PM2775 | PM2776 | PM2777 | PM2778 |
| Total Power | 375W | 600W | 750W | 850W |
| Main Channel Max Power | 250W | 500W | 600W | 750W |
| Second Channel Output | 10 amperes or 150 watts | | | |
| Third Channel Output | 10 amperes or 150 watts | | | |
| Fourth Channel Output | 4 amperes or 75 watts | | | |
| Standard Output Voltages | 2, 3, 5, 12, 15, 18, 21, 24, 28 | | | |

Single Output Supplies

| AC Input - Model Number | PM2496 | PM2497 | PM2498 | |
|-------------------------|--------|--------|--------|------|
| DC Input - Model Number | PM2721 | PM2722 | - | |
| Outputs: | Volts | Amps | Amps | Amps |
| | 2 | 100 | 200 | 400 |
| | 3 | 60 | 100 | 200 |
| | 5 | 50 | 100 | 200 |
| | 5 | - | 150 | 300 |
| | 12 | 25 | 60 | 120 |
| | 15 | 25 | 50 | 100 |
| | 18 | 22 | 45 | 90 |
| | 21 | 18 | 38 | 76 |
| | 24 | 16 | 33 | 66 |
| | 28 | 13 | 27 | 54 |

To find out how the Dependables can keep your system on the air and your maintenance people out of it, call or write Pioneer Magnetics, Department B, today.



**Pioneer
Magnetics**

1745 Berkeley Street • Santa Monica, CA 90404
Telephone (213) 829-6751 • TWX 910-343-6249

ICs & SEMICONDUCTORS

SRT chip handles Bi-sync or SDLC in μ Cs

NEC Microcomputers, 5 Militia Dr., Lexington, MA 02173. (617) 862-6410. \$16 (100 qty).

A synchronous receiver/transmitter (SRT) chip, uPD379, handles either binary-synchronous (Bi-sync) or syn-

chronous data link control (SDLC) protocols in microcomputer systems. The uPD379 operates in full or half-duplex mode at 800 kb/s and is directly TTL compatible. It also has three-state data outputs, a programmable synchronous word, and contains circuitry for detection/rejection of flag, abort and idle patterns, zero insertion and rejection, and an indication of overrun and underrun errors. The circuit is housed in a 42-pin ceramic DIP.

CIRCLE NO. 344

Analog level detector operates in 5 steps

Texas Instruments, P.O. Box 5012, M/S 308 (Attn: TL489), Dallas, TX 75222. Dale Pippenger (214) 238-5908. \$0.65 (100 qty); stock.

The TL489 uses five comparators to digitize analog input signals. The five comparators and a reference voltage source detect the level of an analog input signal. Output 1 is switched to a low logic level at a typical input of 200 mV. After each additional 200-mV step, the subsequent outputs are switched to low logic levels. All outputs are switched to low logic levels at a typical input voltage of 1000 mV. The open-collector outputs sink currents up to 80 mA and operate up to 18 V. Packaging is an 8-pin plastic DIP.

CIRCLE NO. 345

Sequence controller handles 4096 words

Advanced Micro Devices, 901 Thompson Pl., Sunnyvale, CA 94086. E. Sopkin (408) 732-2400. \$25.95 (100 qty); stock.

The Am2910 address sequencer controls up to 4096 words of microprogram-stored microinstructions. In addition, the chip provides conditional branching to any instruction within its 4096-word range. An on-chip loop counter keeps count of how many times a single microinstruction or loop of microinstructions has been executed. This loop counter also automatically controls the repetition. Packaging is in a 40-pin ceramic DIP and a 42-pin flat pack.

CIRCLE NO. 346

Data-acquisition system is packed on single chip

National Semiconductor, 2900 Semiconductor Dr., Santa Clara, CA 95051. (408) 737-5100. \$19.95 (100 qty); stock to 4 wks.

A CMOS device, INS8292, is a complete data-acquisition system on a single chip. The chip contains a 16-channel multiplexer, a chopper-stabilized comparator, an 8-bit a/d converter, a three-state latched output buffer and all control logic. The device requires a single 5-V supply and consumes 15 mW, worst case. Conversion time, using a 640-kHz clock, is typically 100 μ s and the multiplexer delay time is less than 2.5 μ s.

CIRCLE NO. 347

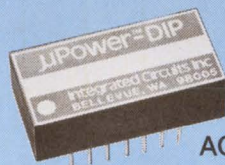

it's
sanforized®

ACTUAL
SIZE

As hard as we tried, we couldn't shrink our new line of micro-miniature DC-to-DC converters any smaller than we've shown above...actual size. So, if you've been trying to fit one of those maxi-sized converters onto your PC board, then take a look at our new μ Power™DIP converters!

The specifications are excellent, by anyone's standards...and conservative, too. μ Power™DIP converters are available with input voltages of 5, 12, 24, 28, 48 or 50. Dual Tracking Regulated Outputs with isolation >100 Megohms @ 500VDC and Non-isolated Dual Regulated/Unregulated Outputs are available in voltage ranges of 5, 12 and 15 with up to 1.5 Watts out. Efficiencies range from 55 to 80%, to keep you ahead of the game!

But, you say your circuit runs off a battery supply? μ Power™DIP converters are also available with an input variance of +3 to +7VDC...just perfect for those battery applications and they can provide up to 1.25 Watts out at an efficiency up to 80%. And they're not expensive, either.

Thick-film hybrid micro-electronics, made in the U.S.A. No short-cuts and they're practically fool-proof.

If you've got a converter need...
We've got a converter for you!
Write or call and ask for data sheets...



Integrated Circuits Incorporated

(206) 747-8556 • 13256 NORTHUP WAY • BELLEVUE, WA 98005 • TWX 910-443-2302

SANFORIZED® IS A REGISTERED TRADEMARK OF CLUETT, PEABODY & CO., INC., NYC 10036

CIRCLE NUMBER 85

Multiple choice

1,700 answers
to electrical enclosure needs
by Hoffman.

Quick answers too. Hoffman offers you "off-the-shelf" shipment on most of over 1,700 standard electrical/electronic enclosures.

Each of them is built to meet the quality standards that made Hoffman's reputation. They include:

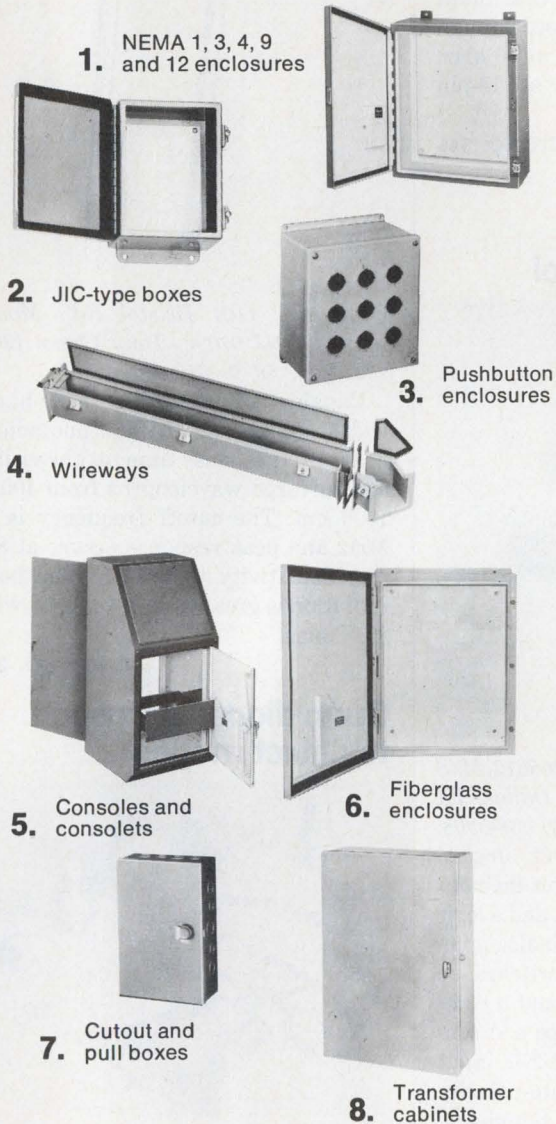

If you have a need that isn't met by one of our over 1,700 standard enclosures, we can modify them or custom engineer and fabricate per your specifications. Our free catalog gives details on quality Hoffman enclosures and is available on request. Put Hoffman to the test.

Hoffman® **ELECTRICAL ENCLOSURES**
HOFFMAN ENGINEERING COMPANY
Division of Federal Cartridge Corporation
ANOKA, MN 55303 DEPT. ED525

CIRCLE NUMBER 86

CIRCLE NUMBER 87 ▶



JOSEPH HENRY

I wish I could have had a Digibridge™



\$1160

GR 1657 μ P-based 1 kHz RLC Digibridge™

- Measures R, L, C, D and Q.
- 0.2% accuracy for R, L, and C.
- Fast testing time of three measurements per second, unqualified.
- Microprocessor-directed ranging takes the guesswork out of setting the correct range.
- Five full-digit LED display for R, L and C. Four full digits for D and Q. All numbers go to 9.
- Wide measurement ranges allow you to test a greater number of component values.
- Automatic decimal point positioning provides measurement on the lowest possible range, so maximum resolution is always achieved.
- Selectable test frequencies of 1 kHz or 120 Hz (100 Hz) are switched by the operator.
- Selectable series or parallel measurement modes are operator specified across the full measurement range of every test parameter.
- Hi-Rel Kelvin test fixture accommodates axial and radial lead components.

U.S.A. price only

 **GenRad**

300 BAKER AVENUE, CONCORD, MASSACHUSETTS 01742 • ATLANTA 404 394 5380 • BOSTON 617 646 0500 • CHICAGO 312 864 6900
DALLAS 214 234 3351 • DAYTON 513 234 1500 • LOS ANGELES 714 340 9830 • NEW YORK 909 212 864 2722 (N.J.) 201 791 8990
SAN FRANCISCO 408 985 0662 • WASHINGTON, DC 301 948 7071 • TORONTO 416 252 3395 • BOURNE END (UK) (06285) 2 66 11



The only total Logic Analyzer you'd enjoy as your traveling companion.

- Get 50-MHz performance plus portability—weighs less than 20 pounds.
- Choose from 8- and 16-channel logic analyzers.
- Fast glitch capture available.
- Selectable time domain, data domain and mapping displays.
- Compare our unmatched price/performance—fully featured models priced from \$3,375.

BPI offers the only lab-quality logic analyzers you can really call portable. They're becoming the constant traveling companions of more and more field engineers. In the field or in the lab, our logic analyzers provide all the features for digital design, development and repair.

There's a lot more to know about logic analyzers. Give us a call today...

(408) 446-4322

Data Domain

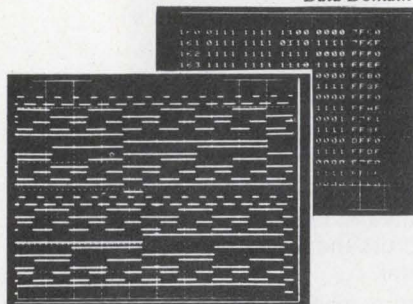

Timing Domain



The Giant Killers
B P INSTRUMENTS

10601 S. De Anza Blvd. Cupertino, CA 95014
CIRCLE NUMBER 88

ICs & SEMICONDUCTORS

D/a gives 4-quadrant multiplication

Analog Devices, 829 Woburn St., Wilmington, MA 01887. Jeff Riskin (617) 935-5565. \$12 (1000 qty); stock.

A true 12-bit monolithic CMOS d/a converter, the AD7541, features full four-quadrant multiplication. The converter is available in 0.01% and 0.02% accuracy versions. Six versions offer 0.02% or 0.01% linearity for operation over the 0 to 70 C, -25 to 85 C or the -55 to 125 C ranges. The maximum settling time is 1 μ s and feedthrough error is less than 1/2 LSB at 10 kHz. The device is packaged in an 18-pin ceramic or plastic DIP.

CIRCLE NO. 348

Chip set includes a/d and logic control

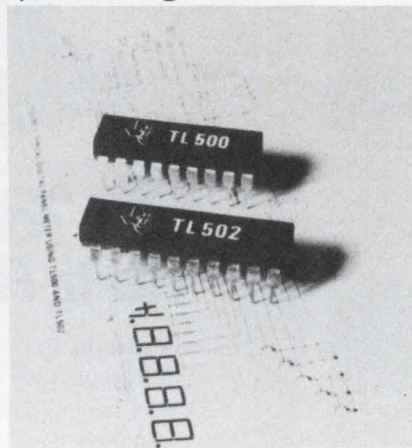

Texas Instruments, P.O. Box 5012, M/S 308 (Attn: TL500, TL502), Dallas, TX 75222. Dale Pippenger (214) 238-5908. \$5.04 (TL500), \$7.20 (TL502); stock.

The a/d converter chip set includes an analog processor, TL500, and a logic control device, TL502. The analog processor incorporates analog switches, op amps, a voltage reference and a comparator to form a dual-slope a/d converter. Features include: 10^8 - Ω input impedance, auto-zero, auto-polarity and a conversion rate of 200 samples/s. The logic control device interfaces with the analog processor in digital panel meter applications up to 4-1/2 digits. The chip provides base drive for external pnp digit drivers and drives LED segments through external limiting resistors. The control device performs inter-digit blanking, and is compatible with 7-segment common-anode displays.

CIRCLE NO. 349

Photodiode detects wideband signals



Centronic, 1101 Bristol Rd., Mountaintown, NJ 07092. Tony Green (201) 233-7200. \$3 to \$10; stock.

Capable of detecting wide-bandwidth signals, the BPX65 photodiode has a 1-ns response time for the visible and infrared wavelengths from 400 to 1000 nm. The cutoff frequency is 50 MHz and peak response occurs at 850 nm. Sensitivity to 2856 K blackbody radiation is greater than 4 nA/Lx with 20-V bias.

CIRCLE NO. 350

Gunn diodes are used to detect motion

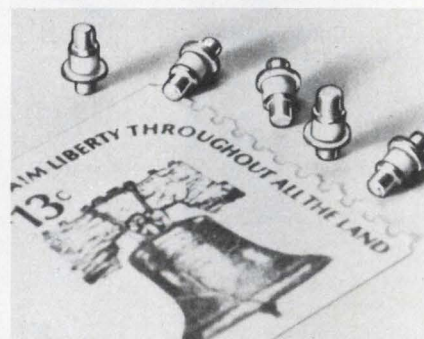

GHZ Devices, 16 Maple Rd., Chelmsford, MA 01824. (617) 256-8101.

The GC-5900 series of Gunn diodes for motion detection applications are GaAs bulk-effect devices that convert dc power to microwave energy. Power output levels range from 5 to 10 mW with typical efficiencies of 1%. Operating frequencies are 9.475 and 10.525 GHz.

CIRCLE NO. 356

WE KNOW A LOT ABOUT A LITTLE.

550 Mu powder cores, for instance.

Our 550 Mu powder cores bridge the gap between 300 Mu cores and nickel laminations. Compared to 300 Mu cores, they pack 1.8 times more inductance into the same space. These toroids offer you less d.c. copper resistance, minimum distributed capacity, greater temperature stability than laminations and economies in assembly.

Samples are available upon request. 550 Mu is just one of 10 permeabilities, starting at 14 Mu, which will meet all your filter needs. Write Magnetics, Components Division, Butler PA 16001.

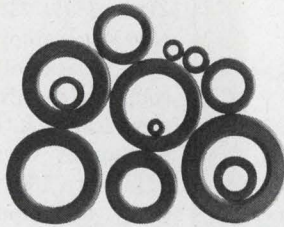

Available in 12 sizes from .250" to 1.50" OD.

Very special specialists in powder cores.



CIRCLE NUMBER 89

WE KNOW A LOT ABOUT A LITTLE.

Photoetched parts. Lead frames and magnetic head frets, for instance.

For openers, we're big enough to take on any photoetch job, regardless of quantity. And we have the expertise to etch all standard materials. In short, we're a one-stop shop, geared to save you time and money. We compound, melt and roll our own metal alloys. So if you call for a special composition or thickness, we have the capability—in house—to meet your exacting specs. Need artwork? We do that, too. Want your magnetic head frets stacked and bonded? Our process will give you absolute uniformity and precise thickness batch after batch. Put us to the test—send your drawings and let us quote. Write Magnetics, Components Division, Butler PA 16001.

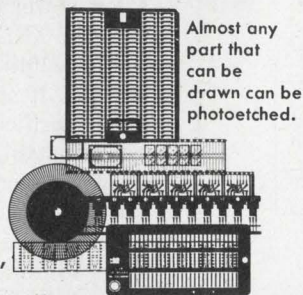

Very special specialists in photoetched parts.



CIRCLE NUMBER 90

CIRCLE NUMBER 87 ►



GEORG SIMON OHM

I wish I could have had a Digibridge™



\$2320

GR 1658 μ P-based 1 kHz RLC Digibridge™

- Measures R, L, C, D, Q.
- 0.1% accuracy for R, L, and C.
- Autoranging.
- IEEE 488 bus option.
- 10 bins for sorting.
- Hi-Rel Kelvin test fixture accommodates axial and radial lead components.
- Five full-digit display for R, L, and C. Four full digits for D and Q. All numbers go to 9.
- Wide measurement ranges allow testing a greater number of component types.

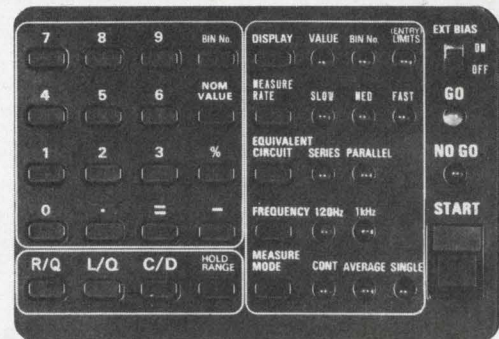

U.S.A. price only



GenRad

Opto couplers provide 1-kV isolation

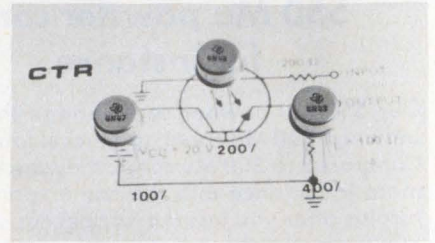

Texas Instruments, P.O. Box 5012, M/S 308 (Attn: 4N47), Dallas, TX 75222. Elo Zinke (806) 747-3737. \$6.25 to \$10.63 (100 qty); stock.

A series of three JEDEC opto couplers, the 4N47, 4N48 and 4N49, has electrical isolation rated at 1 kV. The minimum current transfer ratios (CTR) are 100, 200 and 400%, respectively, and input current is 1 mA for any model. Units are housed in TO-5 hermetic metal cans and operate over the full military temperature range of -55 to 125 C.

CIRCLE NO. 357

Timer chip reduces power dissipation

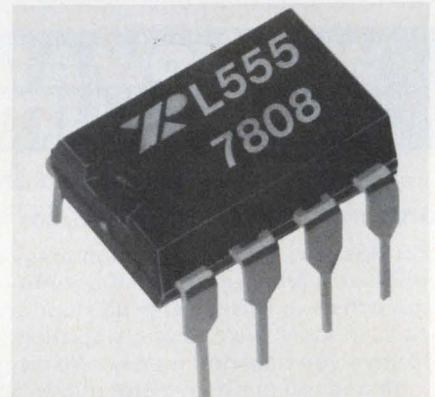

Exar Integrated Systems, P.O. Box 62229, Sunnyvale, CA 94086. (408) 732-7970. \$0.90 (100 qty); stock.

A low-power version of the popular 555 IC, the XRL555 micropower timer has only 1/15th the power dissipation of the 555. It operates down to 2.7 V without sacrificing timing accuracy or frequency stability. Some of the features of the circuit are pin compatibility with the standard 555, power dissipation of less than 1 mW, timing from μ s to minutes, 1000-h operation with two NiCd batteries and compatibility with CMOS, TTL and DTL. The chip can be used in both monostable or astable modes.

CIRCLE NO. 358

Plastic Power Coolers

New low profile heat sinks save board space
 The 6073B requires only .750" x .750" board space and is just .375" tall — the right heat sink for .500" centerline PC board applications. Cools SCR's and transistors in TO-220, Motorola Case 70 and Case 90 packages. Dissipates 21°C/watt in natural convection. Cost (5,000 pc. quantity): Black Anodize < 5¢, Pre-Black Anodize < 4¢.

Number one in Semiconductor Accessories

Thermalloy, Inc.
 Post Office Box 34829
 2021 West Valley View Lane
 Dallas, TX 75234 • (214) 243-4321

Free sample and new 1978 catalog with your response

CIRCLE NUMBER 91

RF detectors fast delivery

Quantities to 200 from stock

You get fast delivery on WILTRON's quality RF detectors whether your needs are large or small.

And with discounts of up to 15% in quantity.

These are WILTRON's time-proved quality detectors with field-replaceable diodes. Diodes are field-replaceable even in 18.5 GHz models.

Call Walt Baxter at WILTRON now for details.

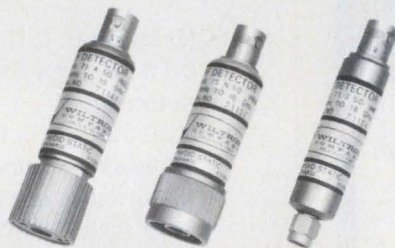

| Model | Range | Connectors In | Connectors Out | Flatness | Price \$ |
|-------|-----------------|---------------|----------------|----------|----------|
| 71B50 | 100 kHz-3 GHz | BNC Male | BNC Fem. | ±0.5 dB | 70 |
| 73N50 | 100 kHz-4 GHz | N Male | BNC Fem. | ±0.2 dB | 75 |
| 74N50 | 10 MHz-12.4 GHz | N Male | BNC Fem. | ±0.5 dB | 145 |
| 74S50 | 10 MHz-12.4 GHz | SMA Male | BNC Fem. | ±0.5 dB | 165 |
| 75A50 | 10 MHz-18.5 GHz | APC-7 | BNC Fem. | ±1 dB | 190 |
| 75N50 | 10 MHz-18.5 GHz | N Male | BNC Fem. | ±1 dB | 170 |
| 75S50 | 10 MHz-18.5 GHz | SMA Male | BNC Fem. | ±1 dB | 170 |



930 E. Meadow Drive • Palo Alto, Ca. 94303 • (415) 494-6666 • TWX 910-373-1156

CIRCLE NUMBER 92

Lowest Phase Noise...
 Highest Short-Term Stability...
 Lowest Cost...

Austron Model 1120 Crystal Oscillators

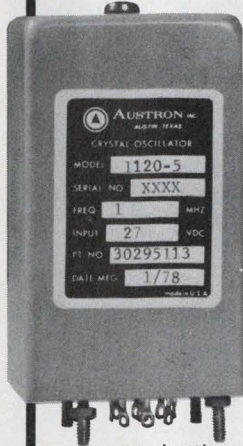

- Enclosed in solid state proportional control oven
- Frequencies in 1-10 MHz range
- Extremely high short term stability
- 1×10^{-9} / day aging
- Designed for critical phase-lock applications

Typical Applications: digital frequency synthesizers, doppler & synthetic aperture radars, spectrally conservative microwave radio and satellite communications systems; time/frequency control and measurement instrumentation.

Send today for complete information.



AUSTRON INC.
 1915 Kramer Lane, Austin, TX 78758
 Tel. (512) 836-3523

CIRCLE NUMBER 93

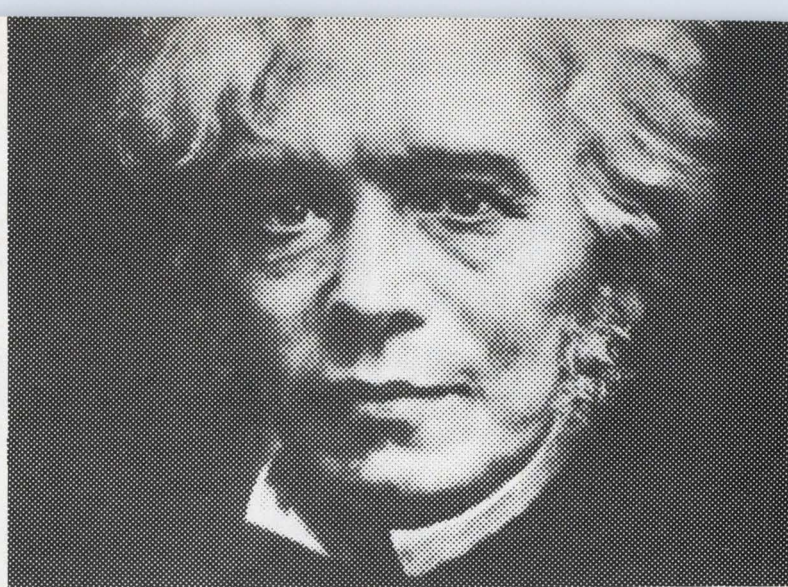

MICHAEL FARADAY

I wish I could
 have had a Digibridge™



\$2965

GR 1687 μ P-based 1 MHz LC Digibridge™

- Measures Ls & Q, Cs & D, Cs & Rs, Cp & Gp.
- 0.1% accuracy for C, 0.2% for L.
- Autoranging.
- IEEE 488 bus option.
- 10 bins for sorting.
- Automatically compensates for stray C or L.
- Optional Kelvin test fixture tests radial and axial lead components.
- Automatic self-check/diagnostics on power-up.
- Five full-digit display for L and C. Four full digits for Q, D, R and G. All numbers go to 9.

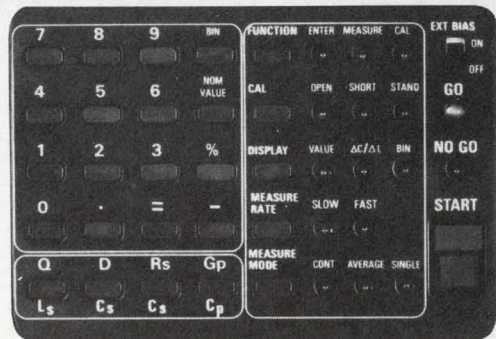

U.S.A. price only

 **GenRad**

HAVE A FERRITE DELIVERY PROBLEM?

LOOK TO PERMAG

... for application-rated Indiana General Corp. Ferramics.™ Complete fabricating facilities. Prototype quantities available. Plus, engineering assistance, field testing. Prompt 24-hour delivery. Extensive stock of ferrite parts at all locations. New catalog available.

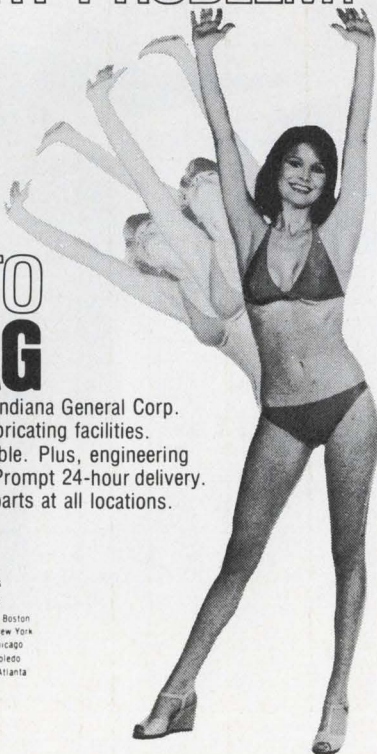

YOUR NO. 1 SOURCE
 FOR ALL MAGNETIC MATERIALS



ALL ACROSS THE COUNTRY

Consult your Yellow Pages for address and telephone number of Permagn near you

CIRCLE NUMBER 94

CIRCLE NUMBER 87

**Dow Corning[®] silicone
elastomers perform
from one extreme
to another.**



When you're designing a component that has to go to extremes—especially temperature extremes—it's nice to know that Dow Corning silicone elastomers will get you there. And help reduce total design costs at the same time. They perform consistently and stay flexible from -55 to +200 C. Or better.

Take a look at some of Dow Corning's electrical/electronic design problem solvers.

Flame-retardant potting compound. For general potting and deep section encapsulation, try our two-part Sylgard® 170 A and B encapsulant. It has excellent flame retardancy and provides outstanding electrical insulation on modules, relays, power supplies, transformers, ferrite cores and other devices. Sylgard 170 encapsulant is recognized under the Component Program of U.S. Labs, Inc. up to 170 C. Its cost is very competitive with less effective organics.

Durable, flexible conformal coating. For a tough, clear, shock-insulating conformal coating on circuit boards, you can't beat Dow Corning® 3140 RTV silicone coating. This flowable, one-part silicone coating is the only conformal coating that has UL component recognition to 180 C and also meets the requirements of Mil Spec MIL-I-46058-C and MIL-A-46146.

Tough adhesive sealant. For those critical bonding and sealing jobs, high-tear-strength Dow Corning® 3145 RTV adhesive sealant is a must. It stands up to the toughest jobs and virtually never needs maintenance. As with all of these products, it's noncorrosive to sensitive electronics. Two colors are available. The gray-colored sealant has UL component recognition to 200 C; clear has UL component recognition to 180 C.

If you're looking for reliability and reduced design costs, specify the products that go to extremes for you—Dow Corning silicone elastomers. Our technical support group will also go to extremes to help. For more information, write Dow Corning Corporation, Dept. A-8554, Midland, Michigan 48640.

Cost-cutting silicone elastomers.



DOW CORNING

DOW CORNING Cost-cutting
silicone
elastomers.

CIRCLE NUMBER 75



MICRO/MINI COMPUTING

Mini-diskette system stores over 200 kbytes



Techtran Industries, 200 Commerce Dr., Rochester, NY 14623. (716) 334-9640. \$1395; 6 wks.

Storing over 200 kbytes, the Model 950 mini-diskette system records in either file or batch modes. File names are automatically entered into the directory for total random access. Switch-selectable data rates handle up to 9600 baud. A binary mode provides for code transparent applications.

CIRCLE NO. 359

Single-board μ C holds 8-k PROM plus 8-k RAM

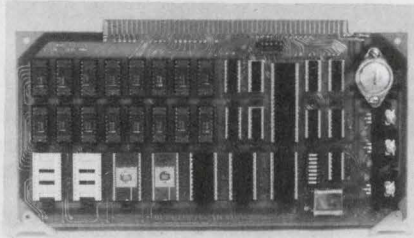

BPI Electronics, 4470 S.W. 74 Ave., Miami, FL 33155. (800) 327-2252. See text.

Little Brain I is a 6802-based S-100 type single-board microcomputer that includes as much as 8 kwords of UV-erasable PROM and 8-kwords of fully static RAM. An RS-232C channel is also built into the board. The unit has on-board voltage regulators, fully buffered address, data and control buses along with a 128-word scratchpad memory. A fully socketed version with a 2-k monitor/debug program and 1 kwords of RAM sells for \$395.

CIRCLE NO. 360

Portable real-time unit emulates 8080 μ P

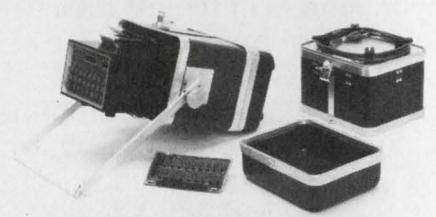

Mupro, 424 Oakmead Pkwy., Sunnyvale, CA 94086. Don Pantle (408) 737-0500. \$4495; 3 wks.

A portable real-time in-circuit emulator, the 80FS, is for 8080 microprocessors. The unit contains 8 kbytes of static RAM, a carrying case and a card ejector. The computer includes the capability to use a full 64-k memory plus a general-purpose parallel and serial I/O. The carrying case provides space for the emulator/computer, memory and I/O cards, spare 40-pin headers, power cord and an optional 2708 PROM programmer. The size is 22 x 7.5 x 10 in.

CIRCLE NO. 361

Custom Services for the Device You Need

When your vendor parries your request for a transistor, diode or microcircuit of peculiar constraints, or refuses to modify the standard device you need to meet tough military requirements, give us a call.

Our special services—including special processing, special testing, and special packaging—let you design exactly the device you need.

No need to compromise. Call (617) 491-1670.

TELEDYNE
CRYSTALONICS

147 Sherman Street, Cambridge, MA 02140
Tel: (617) 491-1670 • TWX 710-320-1196



CIRCLE NUMBER 96

NEW LOW PROFILE LSI SOCKETS FROM SMK

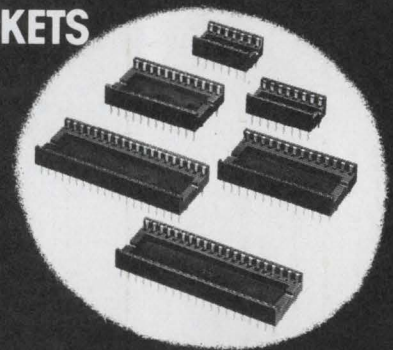

The SI-2440 Series complete line of new LSI Sockets, including 14, 16, 24, 28, 40 and 42 pin versions on 0.1" centers are designed so that they can be flush mounted end-to-end maintaining the 0.1" center-to-center pin spacing. For example, two 24 pin LSI Sockets can be mounted end-to-end to accommodate the latest 48 pin ROM.

The glass-filled Nylon bodies (66% Nylon) are designed to withstand soldering temperatures to +350°C for 3 seconds and are available with either tin plating, selective gold contact plating or gold flash.

Typical 100 piece price for the fourteen pin unit, tinned plated, is \$311 each.



SMK Electronics Corporation
of America

118 East Savarona Way Carson, California 90746
Tel: (213) 770-8915

CIRCLE NUMBER 97

ELECTRONIC DESIGN 9, April 26, 1978

Meet the *real* OEM display

It's easy to design in... it gives you a good system image.

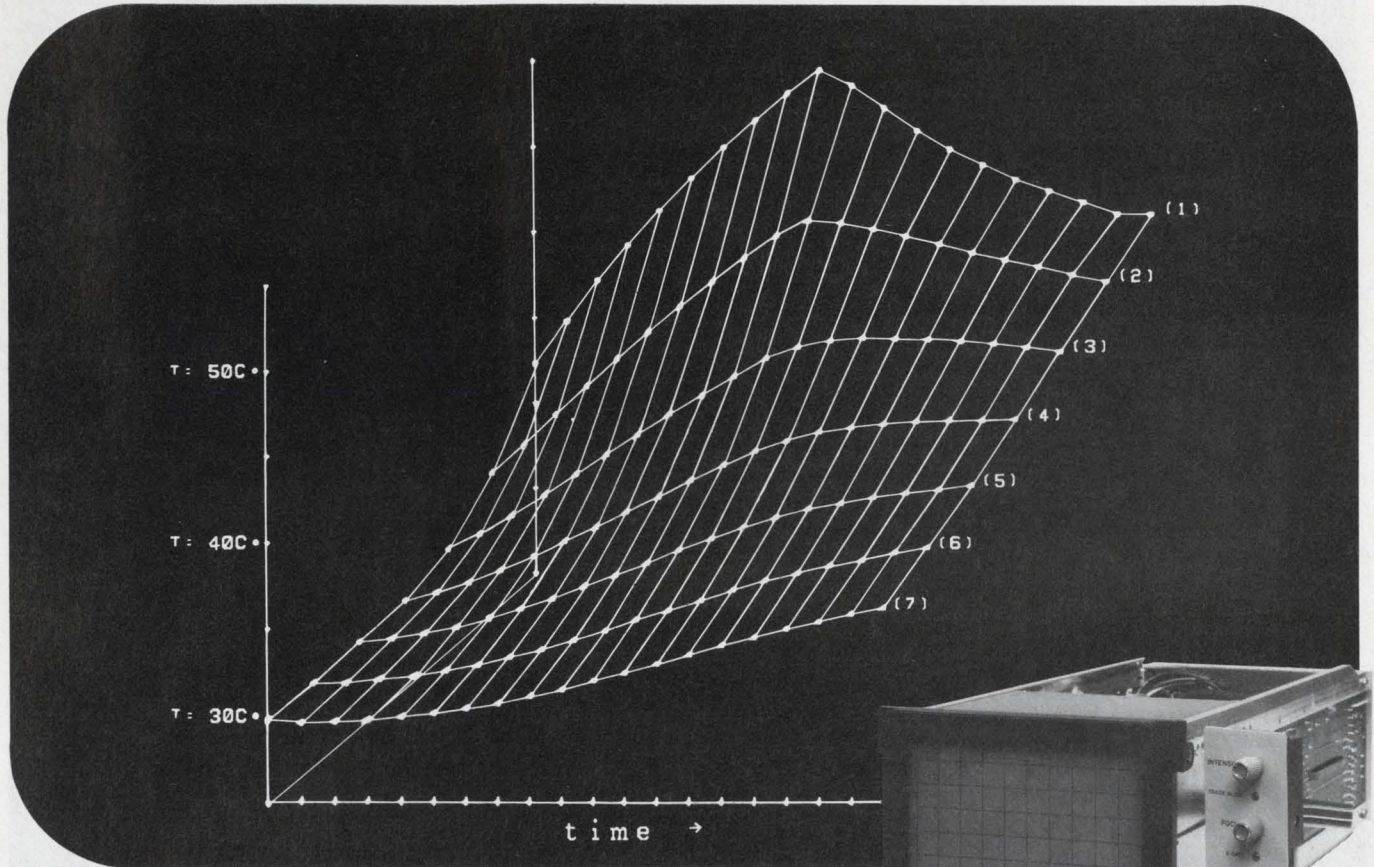

Easy viewing, even in high-ambient light, is provided by HP's new 1340A with post-accelerator CRT. You get a bright image on the 114 cm² (17.7 in²) screen for easy evaluation of intricate presentations.

Crisp displays of complex graphics and alphanumeric data is assured by a 0.46mm (0.18 in.) spot that focuses uniformly over the entire viewing area, regardless of intensity level.

HP's new 1340A is a true OEM display component. And to accommodate most OEM requirements, options such as different phosphors and TTL blanking as well as a choice of packaging schemes are available. For only \$1,000*, you get a cost-effective display that easily adapts to almost any instrumentation system.

So for a better image of your system's performance, look into HP's new OEM display. For further details, ask your local HP field engineer.

* Domestic U.S.A. price only.

Versatile interface is the result of a set of internal switches that let you select input impedance, input sensitivity, polarity and bandwidth. One display model can be used with a variety of different instruments and systems.

Flexible location of controls is possible with the 1340A's separate control panel. You can locate intensity, focus, gain and trace-alignment controls to suit your particular system. Or, with Option 001 you can use your own controls.

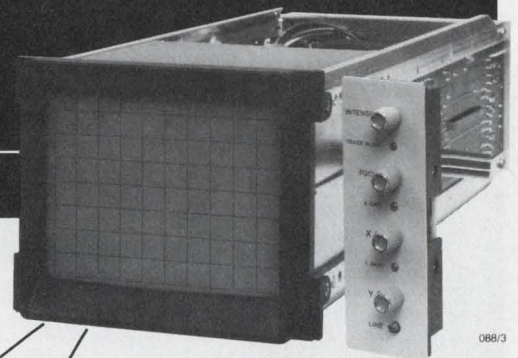

Easy system integration is the result of the 1340A's packaging flexibility. Open frame, desk top, vertical stack and rack mount versions easily adapt to nearly any system configuration.

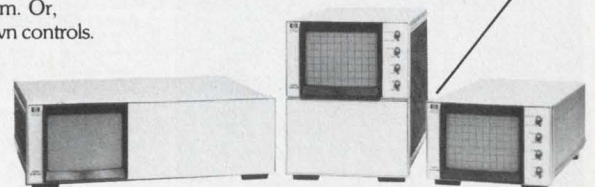

HEWLETT  **PACKARD**

1507 Page Mill Road, Palo Alto, California 94304

For assistance call: Washington (301) 948-6370, Chicago (312) 255-9800, Atlanta (404) 955-1500, Los Angeles (213) 877-1282

Single-board memory expands PDP-11 capacity

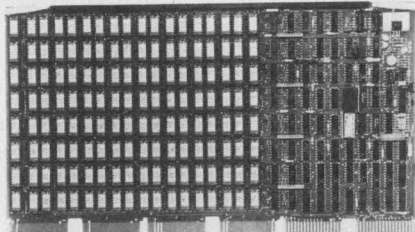

Dataram, Princeton-Highstown Rd., Cranbury, NJ 08512. John Gilligan (609) 799-0071. \$7920; 4 to 6 wks.

Using 16-k chips, the Model DR-114S single-board semiconductor memory packs 128 kwords \times 18 to expand DEC's PDP-11 minicomputers. The memory is completely compatible with DEC's MS11-JJ 16 k \times 18 board. Access and cycle times are 525 ns. On-board refresh and provision for battery backup are provided.

CIRCLE NO. 362

CPU board employs 6800 processor



Micro Data Systems, P.O. Box 36051, Los Angeles, CA 90036. (213) 939-6764. \$198 (kit).

Compatible with the S-100 bus, the MD-690 CPU board makes use of the Motorola 6800 processor. The CPU uses an MC6802 that combines the instruction set of the 6800 with an internal RAM and crystal-controlled clock. The card has an interrupt driven keyboard input, ROM monitor, and an on-card 2400-baud Manchester cassette interface. In addition, there are 1 kbytes of available RAM on the card and provision for a second expanded monitor.

CIRCLE NO. 363

64-channel a/d-d/a slides into PDP-11

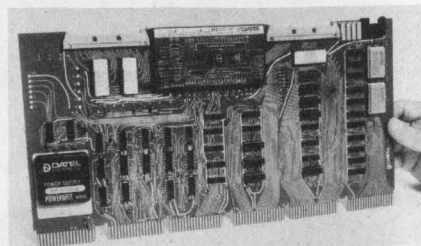

Datel Systems, 1020 Turnpike St., Canton, MA 02021. Ron Petrelli (617) 828-8000. \$1235; 4 to 8 wks.

The ST-PDP series is a complete 64-channel a/d-d/a data acquisition peripheral built on a single DEC BB-11 connector block that loads directly inside the PDP-11 minicomputers. The system accepts 64 single-ended or 32 differential input channels and digitizes them to 12-bit binary data words. These data samples are then placed on the Unibus under software control. Input voltages of -10 to $+10$ V may be accepted. The a/d conversion speed is 20 μ s. Effective channel throughput rates of 45,000 samples/s are possible using optional DMA logic.

CIRCLE NO. 364

Vector

PLUGBORDS OFFER MORE...

- Unique time saving bus patterns
- Press-fit wrap-posts & solder terminals
- Many board and contact sizes



- Easy to wire hole and pad patterns
- .042" diameter holes on .1" grid
- P.C. plug or flexcable connections

4493-1 ANY DIP, \$14.95. Accepts all DIPs. Offset power and ground planes. 36/72 contacts. 4.5" \times 9.6" (6.5" also available). 22/44 contacts also offered in both sizes.

8804 ANY DIP, \$19.95. Accepts all DIPs. Offset power and ground planes, 50/100 contacts spaced .125". S-100 size.*

4112-5 PAD BOARD, \$12.23. Pad per 3 holes. Ground plane on back-side. 4.5" \times 4.5" or 4.5" \times 6.5" or 4.5" \times 9.6". 22/44 contacts spaced 0.156".

8802-1 PAD BOARD, \$19.95. Pad per 2 holes, each side, peripheral buses. 50/100 contacts spaced at .125". S-100 size.*

8801 PAD BOARD, \$19.95. Pad per each hole, each side, peripheral buses. 50/100 contacts at .125". S-100 size.*

8801-1, \$14.95. No pads — just holes. 50/100 contacts at .125". S-100 size.

*S-100 size is 5.3" high by 10" wide.

VECTOR ELECTRONIC COMPANY
12460 Gladstone Avenue
Sylmar, California 91342

Phone (213) 365-9661
TWX (910) 496-1539

Send for new data.

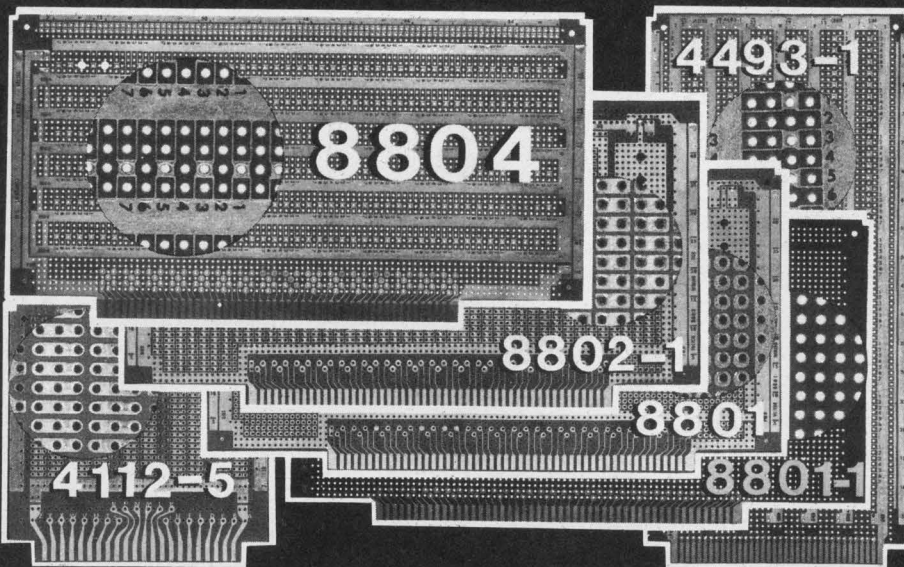

FULL LINE OF SUPPORTING PRODUCTS: Card cages and enclosures for all Plugboards, mating receptacles, interconnect products.

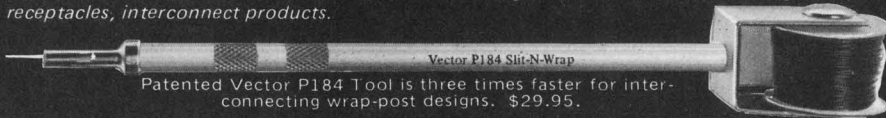

Patented Vector P184 Tool is three times faster for interconnecting wrap-post designs. \$29.95.

600278

The 2114. It's old hat to us



Most 2114s are new products with new product problems. Not ours. The SEMI 2114 is a member of the Royal Family of Static RAMs. It is, in fact, a new pin-out of an 18-pin, 5V, 1Kx4 static RAM that we've been delivering in production quantities for a year and a half.

The SEMI 2114 features low power (only 300 mw), TTL compatible I/O,

and all the speed you need for microprocessor applications.

If you'd like complete information on the SEMI 2114, or any other members of the Royal Family of static RAMS, see your local EMM/SEMI distributor, or contact us directly.

Memory at Work

EMM SEMI, INC.

A subsidiary of Electronic Memories & Magnetics Corp., 3883 N. 28th Ave., Phoenix, Arizona 85107 (602) 263-0202

ALABAMA: Gentry Associates, Huntsville 205/534-9771 • **ARIZONA:** EMM, Phoenix 602/263-0202 • **CALIFORNIA:** EMM, Hawthorne 213/644-9881; EMM, Los Alamitos 213/598-8705; EMM, Burlingame 415/692-4251; Varigon, El Segundo 213/322-1120 • **FLORIDA:** Gentry Assoc., Orlando 305/894-4401 • **GEORGIA:** Gentry Assoc., Atlanta 404/455-1206 • **ILLINOIS:** EMM, Des Plaines 312/297-7090 • **MASSACHUSETTS:** EMM, Lexington 617/861-9650 • **MINNESOTA:** EMM, Hopkins 612/933-7115 • **NEW JERSEY:** EMM, Cherry Hill 609/779-7911 • **NEW YORK:** EMM, Melville 516/423-5800 • **TEXAS:** EMM, Dallas 214/231-2539; Young Sales, Dallas 214/341-2900 • **WASHINGTON:** The Thorson Co., Bellvue 206/455-9180 • **CANADA:** Cantec, Ottawa 613/255-0363

NOW WITH BUS CONTROL: S-D's NEW 4½-DIGIT DVM



Check the outstanding features of Systron-Donner's new 4½-digit Model 7244A multimeter:

- IEEE-488 Interface
- Front Panel Address indicators
- Front Panel Function indicators
- True RMS
- 20,000 count display
- D.C. Accuracy ±0.02%
- Autoranging
- Optional rear inputs
- Price \$945

Model 7244A is but one of a complete new family of S-D's 4½-digit DVM's. Be sure to ask us about our classy new portables and new "thin-line" systems models.

Contact your local Scientific Devices office or Systron-Donner at 10 Systron Drive, Concord, CA 94518. Phone (415) 676-5000.



SYSTRON DONNER

CIRCLE NUMBER 102

MICRO/MINI COMPUTING

DMA interface board plugs into LSI-11

Computer Technology, 6043 Lawton Ave., Oakland, CA 94618. (415) 451-7145. \$495; 4 wks.

Model DMA-L11 is a flexible, general purpose direct-memory-access interface board for the LSI-11 and the PDP-11/03 computers. The board handles byte or word transfers at rates up to 400-k transfers/s. Programmed I/O is allowed between the CPU and five 16-bit registers in the user's device for control of complex devices. Three 16-bit registers include command/status, memory address, and byte count. Extended memory addressing is supported. Up to 32 kwords or 65 kbytes may be transferred in a single operation.

CIRCLE NO. 365

Tape drive transfers data at 2000 char/s



General Micro-Systems, 12369 W. Alabama Pl., Lakewood, CO 80228. Bob Smith (303) 985-3423. \$595; 6 wks.

The SYS I tape drive records biphasic Manchester code at 1600 bits/in. on ANSI-specified data cassettes with a transfer rate of 2000 char/s at 10 in./s. The tape record (block) is variable length and a 10-byte record may be followed by a 32-kbyte record. The user program may dynamically load the next record and operate the unit as a batch data processing system, with an unlimited amount of data. Over 700 kbytes may be recorded on one side of a cassette using large records. Rewind time is less than 30 s at over 120 in./s. Search can be at over 120 in./s by counting inter-block gaps, getting to any record in less than 15 s.

CIRCLE NO. 366

Software provides μ P program development

Virtual Systems, 1500 Newell Ave., Walnut Creek, CA 94596. (415) 935-4944.

Microbench software operates with PDP-11 and LSI-11 computers to provide program development capability for popular microprocessors. Featured in the software are relocating assemblers and linking loaders for the 8080/8085, Z80, 6800 and equivalent microprocessors. Coded in Macro-11 for high throughput, these assemblers and loaders operate under the RT-11 operating system in 16 kwords of memory. Also included are a system macro library, optional cross-reference listings, object file library maintenance, and ROM/RAM alignment at load time.

CIRCLE NO. 367

Disc cartridge drive yields data from 2 discs

Fujitsu America, 2945 Oakmead Village Ct., Santa Clara, CA 95051. (408) 985-2300. \$3900.

All the data contained on two discs within a cartridge are available from the M2201 disc cartridge drive. The need for data staging is thereby eliminated. The removable disc contains four times as much data as other single-disc units with no requirement for fixed discs inside the drive. The drive stores 50 Mbytes of unformatted data and has a transfer rate of 819 kbyte/s. Track to track access time is 6 ms and average access time is 30 ms.

CIRCLE NO. 368

Microcalculator operates with 8-bit μ Ps

Artisan Electronics, 5 Eastmans Rd., Parsippany, NJ 07054. Alan Seman (201) 887-7100. \$189; stock to 3 wks.

Microcalculator, Model 85, operates with 8-bit microprocessors and interfaces through an 8-bit bidirectional I/O port. Each entry that would normally be made by a key is replaced with an 8-bit instruction from the microprocessor. The Model 85 accepts instructions, provides a means to detect busy status and outputs the full 14-digit display back to the microprocessor for storage or display. An advanced programmable scientific calculator system is achieved with the aid of the unit and the microprocessor.

CIRCLE NO. 369

If You're Creating Products for

- TELECOMMUNICATIONS
- BUSINESS EQUIPMENT
- CONSUMER ELECTRONICS
- COMPUTERS AND PERIPHERALS

Here's A Better
Way To Get From
Breadboard To
Functional Circuit...

CENTRALAB THICK FILM NETWORKS



TYPICAL CIRCUITS

ACTIVE FILTERS

Centralab's thick film hybrid capability includes custom active filters for band pass, low pass, high pass and band reject applications. Many are available in multiple pole configurations.

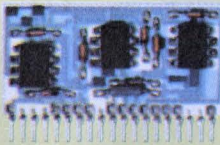

LOW VOLTAGE REGULATORS

Functional network trimming provides voltage tolerances to within $\pm 0.2\%$. When trimmed networks are added to voltage regulator IC's, it enhances their performance and stability.

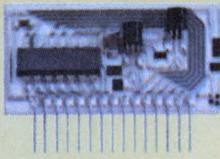

SQUELCH CIRCUIT

This cost-effective thick film hybrid circuit includes 10 resistors, 7 Centralab monolithic chip capacitors, 2 transistors and 2 diodes in a space-saving package.



ECL TERMINATOR

This thick film R/C network incorporates cermet resistors and a Centralab monolithic chip capacitor in a unique layout to minimize signal cross talk requirements in high speed ECL applications. Use of these SIP networks increases packaging density and reliability.



Why have so many designers and buyers switched to Centralab thick film networks? The reasons are many. Compared to chip and wire hybrids, Centralab discrete hybrids are the most economical to buy...with lower start up costs. Compared to discrete components, our networks require less board space...help to minimize noise...and can reduce overall costs for equivalent circuitry. But some other reasons include...faster delivery...reduced assembly costs...higher yield...computer-aided design...automated production...five separate worldwide facilities...and over 30 years of Centralab experience in customized circuitry.

Why should you investigate Centralab thick film networks? Well, until you do, you won't know how our computer-aided design service optimizes layout, minimizes human error and, incidentally, speeds service. Or how our design engineering services — including worst-case analysis, component selection, thick film processing and 100% functional testing — produce reliable circuits. Until you investigate, you won't know how much you can gain using Centralab's cost-effective CERBON™ and Cermet thick film technology. To find out the ways that Centralab service can help your product, send for our new Thick Film brochure. Use the reader service card or call us at 414/228-2874.

*Products you need
from people who care.*

CENTRALAB

ELECTRONICS DIVISION
GLOBE-UNION INC.
5757 North Green Bay Avenue
Milwaukee, Wisconsin 53201

CIRCLE NUMBER 103

Ceramic Capacitors • Filters • Thick Film Circuits • Switches • Potentiometers • Trimmer Resistors.

“All we got for our connector dollar were connectors.

Until we used AMP Latch-and AMP”

Too many times you may select a connector that does the job—but that's all it does. You can't expand with it. With AMP Latch connectors we make sure that won't happen.

The complete approach. Every AMP Latch connector is designed as part of a larger approach to packaging. For example, AMP Latch is available in cable-to-cable, edge card, DIP and receptacle connectors. And it works with twisted pair cable, round conductor ribbon cable and round conductor bonded cable. In addition, it mates with the full range of AMPMODU headers including standard right angle and feed-thru types, as well as header barriers for mixing a variety of connector families.

The quality approach. AMP Latch connectors are built to meet extra-ordinary requirements. They incorporate extra features such as redundant, duplex-plated contacts and heavy-duty strain relief covers for reliable electrical and mechanical performance. Polarization and positive latching assure accurate mating to headers. They have built-in inspection ports to facilitate inspection, test and repair. And they are quickly terminated by AMP Latch tooling so you have the capability of using virtually all popular types of round conductor flexible cable as efficiently as possible.

The AMP approach. Of course, AMP Latch connectors, and all AMP products, are backed by AMP technical service. Not just ordinary service, but the kind that says we'll help you with system design. Application tooling. Training your people. And more.

We invite you to find out more about AMP Latch and the AMP approach. Just call Customer Service at (717) 564-0100. Or write AMP Incorporated, Harrisburg, PA 17105.

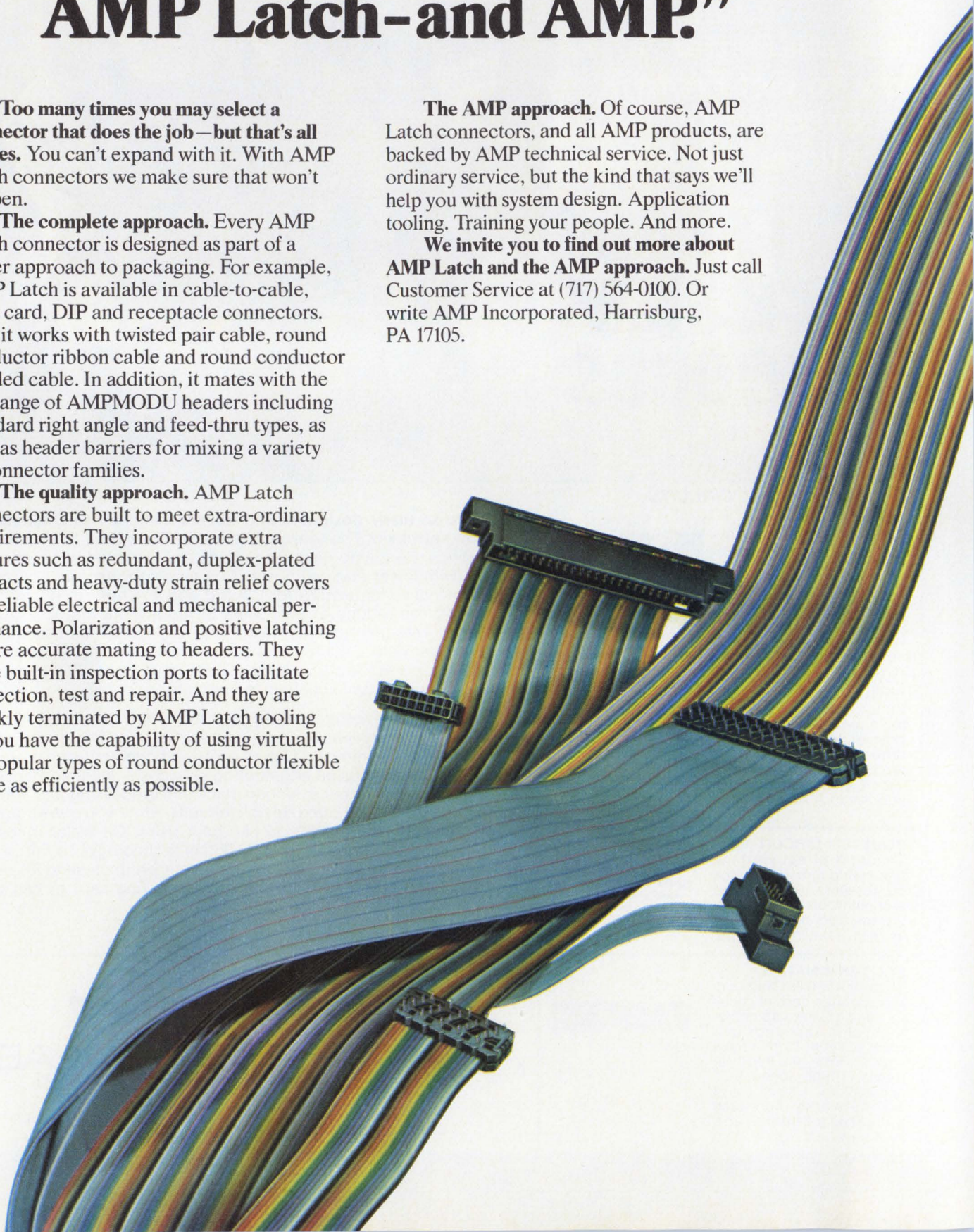

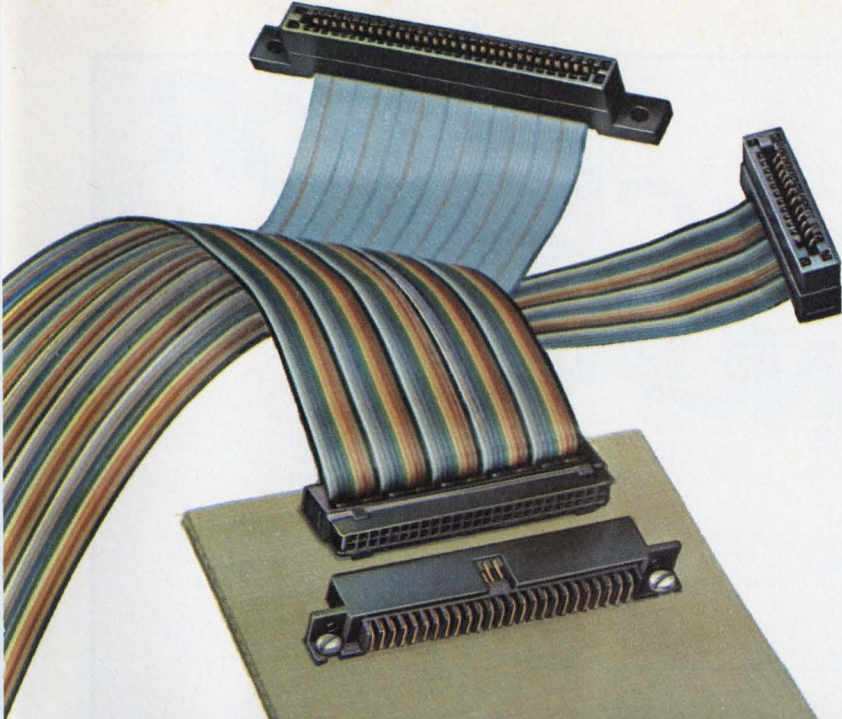

**AMP has a better way...
Mass Termination.**

AMP pioneered the concept and today is the acknowledged leader with the industry's widest range of application experience.

We have mass termination connectors for discrete wire and virtually any type of cable: ribbon coaxial, flat etched, twisted pair, round conductor, flat flexible. All have preassembled contacts, eliminate costly wire preparation and offer productivity savings and benefits never before possible.

If you would like details on any of our Mass Termination ideas, call Customer Service at (717) 564-0100.

AMP and AMPMODU are trademarks of AMP Incorporated.

AMP
INCORPORATED

CIRCLE NUMBER 104

Due to popular demand

MICROPROCESSOR DATA MANUAL

is now in book form!

**ALL THE INFORMATION
ON MICROPROCESSOR
SELECTION AND
SOFTWARE IN ONE
CONVENIENT SOURCE!**

- First appeared in **Electronic Design Magazine!**
- Over 30 manufacturers represented!

**MICROPROCESSOR
DATA MANUAL**
Edited by Dave Bursky

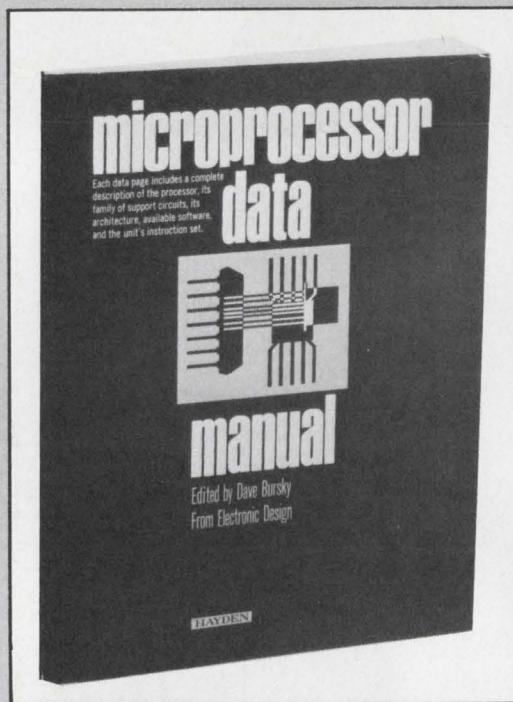

The manual includes a complete data page for each microprocessor or family of processors, with a complete description of the processor, its family of support circuits, architecture, available software, and the unit's instruction set.

Other sections include:

- the pitfalls to avoid when choosing a specific model;
- micro fundamentals and a glossary of terms;
- a report on floppy-disc drives;
- background information on micro selection and software.

Send to: **HAYDEN BOOK COMPANY, INC.**

50 Essex Street, Rochelle Park, N.J. 07662

Please send me MICROPROCESSOR DATA MANUAL (#5114-X, \$7.95) on 15-day examination. At the end of that time, I will send payment, plus postage and handling, or return the book and owe nothing.

Name _____

Firm _____

Address _____

City/State/Zip _____

78-009

SAVE MONEY! If you send cash with order, publisher pays postage and handling. Same return guarantee. Price subject to change without notice. Offer good in U.S.A. and Canada only.

**Make your micro
decisions easier! Order
your copy today!**





What a time for a tone receiver to quit.

Next time, specify hybrid microcircuits for MF and DTMF tone-signalling systems by North Electric.

Because your customers don't want to leave anything to chance.

Designed with an unique modular concept, our microsystems tone receivers are ideal for central office, PBX, key system, data transmission and similar applications.

Available as individual hybrid microcircuit modules or complete tone receiver assemblies.

Perfect for U.S. telephone systems and CCITT No. 5 and R2 systems. Compatible with CEPT specifications.

So visit us when you're in Florida, or write for our brochure. 700 Hillsboro Plaza, Deerfield Beach, Florida 33441. Phone: (305) 421-8450. TELEX & TWX 510-953-7523.



ITT North

Microsystems Division

THE GO-EVERYWHERE MICROPROCESSOR NOW HAS A DO-EVERYTHING DESIGN AID.



New RCA Micromonitor helps you debug designs and software, production-test and field-test RCA 1800 microprocessor systems.

Now you can quickly and economically prove out the RCA 1800...our cost-effective, environmentally rugged, CMOS microprocessor.

Our new COSMAC Micromonitor CDP18S030 is a complete portable μ P system diagnostic tool. The best

tool, in fact, to perform breadboard debugging *and* factory checkouts *and* field tests without additional diagnostic equipment. The Micromonitor can take instructions

electronically, supply hard-copy or CRT display through your terminal, and become more powerful via our COSMAC Development system with floppy disk — all useful features in automated testing.

Prototype debugging

Simply plug the CPU of your system under test into the Micromonitor. You now have control of both hardware interfaces and program execution. Using the keyboard and display, you can start/stop, examine any portion of the system, and make changes. An optional RAM or ROM card lets you evaluate your system before building memory and finalizing ROM.

Unique automated testing

The Micromonitor can be

used with any of its configurations to provide the factory test system you require.

Field service

Its self-contained package is designed to be carried easily to any place RCA 1800 microprocessor systems are in operation.

Operation software

An optional Micromonitor Operating System (MOPS) CDP18S831 gives you an extended set of commands. You can execute command programs from files on a floppy disk. During debugging you can dump a status report at any time. So you don't have to keep starting over. MOPS, on the COSMAC Development System with floppy disk option, helps the Micromonitor do everything from simple terminal-Micromonitor dialog to fully automated system testing.



**RCA Solid State, Box 3200
Somerville, NJ 08876**

Tell me more about why the Micromonitor is one more reason to go RCA 1800. My microprocessor application is:

Name _____

Title _____

Company _____

Address _____

ED-1

RCA 1800. Our systems are go.

RCA

A NEW STAR IS BORN THE DIPPER!®

DIPPER® stands for
Dual-Inline-Package
Power Relay.

Have you ever heard of a DIP component that can conservatively switch 2 amps at 28 VDC or 120 VAC? How about a full 2 PDT set of gold alloy contacts as well! And less than 0.420 inches high, with a range of input voltages from 5-24 VDC.

A new star is born! The Midtex Type 190 relay, affectionately referred to as the DIPPER®.

The DIPPER® offers excellent isolation between input and output circuits. And lamp or wiring capacitance surges that destroy DIP reed relays will not even faze the DIPPER®.

THE TOTAL RELAY COMPANY

MIDTEX 

INCORPORATED
1650 TOWER BLVD. / 507 625-6521
N. MANKATO, MN 56001

Our goal was real power in a Dual-Inline package, good speed and a commercially attractive price. We have succeeded!



CIRCLE NUMBER 108

Save Your Copies of Electronic Design in handsome library files or binders



Keep your valuable copies neat and organized for ready reference. Each rugged case or binder holds half a year's issues. Richly covered in dark green leatherette and embossed with 16K gold lettering — a handsome and practical addition to your bookshelf or desk.

Mail to: Jesse Jones Box Corp., Box 5120, Philadelphia, Pa. 19141

Please send me: _____ Library Cases at \$4.95 each; 3 for \$14; 6 for \$24, postpaid. ED

_____ Binders at \$6.50 each; 3 for \$18.75; 6 for \$36, postpaid.

(Add \$1. each outside U.S.A. to cover additional postage and handling)

Check or money order (U.S. funds) for \$_____ enclosed.

Name (Print) _____

Title _____

Company _____

Address _____

City/Province _____

State/Country _____

Zip or Postal Code No. _____

Satisfaction guaranteed or money refunded. Allow 5 weeks for delivery.

CIRCLE NO. 371

MICRO/MINI COMPUTING

A/d multiplexer expander slides inside 8080 μ Cs

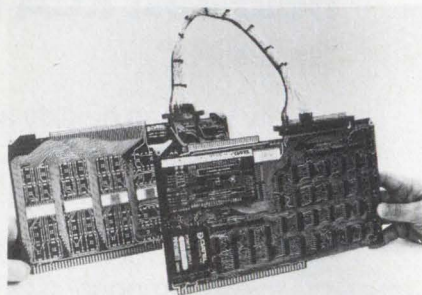

Datel Systems, 1020 Turnpike St., Canton, MA 02021. Ron Petrelli (617) 828-8000. \$395; 6 to 8 wks.

An analog multiplexer board system, ST-800AD32S, acts as a slave to control from a master a/d converter board, Model ST-800-32S, and slides directly into the MDS-800, SBC-80 and BLC-80 series card guides. The board is electrically compatible to the backplane pinouts and is controlled by 8080 assembly language instructions. The system digitizes analog inputs to 12-bit binary resolution with 0.025% accuracy. Together, the two boards accept 64 single-ended a/d channels. Over-all speed of the system is high, with the CMOS LSI multiplexers taking only 1 μ s to settle. Channel-to-channel a/d throughput is 20 μ s.

CIRCLE NO. 370

Core RAM for 8080 μ Cs stores 16 kbytes

Amper, 200 N. Nash St., El Segundo, CA 90245. Clyde Cornwell (213) 640-0150. \$885; stock.

Fully compatible with SBC 80 single-board computers, the MCM-8080 provides nonvolatile storage for 16,384 bytes and data access within 325 ns. The read and write cycle times are 780 and 1240 ns. Each memory board includes circuitry to detect input dc power conditions and inhibit operation when out of tolerance. Switches select 16-k contiguous addresses beginning at locations 0000, 4000, 8000 or C000. Other features include honoring the INH/1 signal transmitted by the SBC 416 or equivalent PROM and generating the advanced acknowledgement signal used by 80/10 and 80/20 type processors.

Floppy Disk triple output power Under \$1 per watt

UL-RECOGNIZED

The field-proven AED 101. A high-efficiency power supply designed to provide the special DC power range required to operate floppy disk subsystems with one to four drives. Extremely compact and lightweight in design, the AED 101 provides the correct power for floppy disks. Triple output (5V @ 12 Amps, -12V @ .7 Amps, +24V @ 3.5 Amps) for four drives, drive electronics, formatter and interface circuitry. Other features include OVP, foldback current limiting, 5V switching regulator, and superior cost/efficiency ratio. Contact us today for detailed specifications and our low prices. Delivery from stock in production quantities \$137.50.

**ADVANCED
ELECTRONICS
DESIGN, INC.**

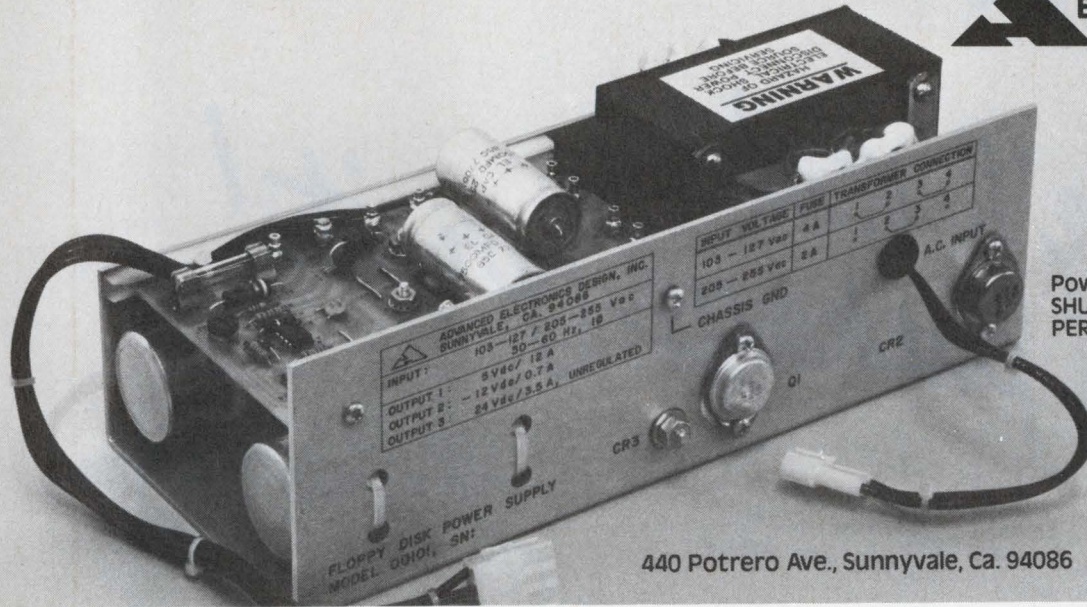

Power for
SHUGART, MEMOREX,
PERTEC AND OTHERS

440 Potrero Ave., Sunnyvale, Ca. 94086 Phone 408-733-3555

CIRCLE NUMBER 110

we did it again!

**18% MORE
STAND-BY POWER**
in the same space

we introduced the world's smallest,
maintenance free battery . . . now,
we present a big battery with greater
power in conventional space.

- Needs no memory conditioning
- No cell reversal
- Better float life
- Spill-proof
- Rechargeable
- Maintenance free

WITH IMMOBILIZED ELECTROLYTE



6.25" length, 3.35" width, 6.5" width, 12.2 pounds

CIRCLE NUMBER 111

You name
your interconnection.
We'll make
the package for it!

You say you need a flat package with 180 leads — or more — for digital circuitry?

Or a plug-in package, with pins on .050" centers, instead of the usual .100", for high density — that can also be sealed on a standard flatpack sealer?

Or a package with ground pins, for low-noise, low-resistance connection to the case?

Or DIPs, in single, double or triple widths, that can be sealed by seam welding, resistance welding, or stitch welding? Or by any of a half dozen soldering techniques?

Or a power package, with copper-cored leads for low electrical resistance, that can also dissipate 100 watts without "glowing in the dark?"

Or a microwave package offering 50-ohm impedance for the X-band and above?

Or a package specially made for fiber optics interconnections? Whatever your packaging and interconnection needs, call Isotronics. We're already making them.



Isotronics

A SUBSIDIARY OF AUGAT INC.

Isotronics, Inc. 12 Coffin Avenue, New Bedford, Mass., 02746 • (617) 997-4575 • TWX 710 344 1961 • CABLE— ISOTRONICS

CIRCLE NUMBER 133

From a single CPU board



to a half million word super computer

That's the selection you get from ROLM's AN/UYK-19 family. It's the most complete line of Mil-Spec computers in the industry. And every piece is backed by extensive, updated, upward compatible software.

Delivery? 30 days or less because they're all standard products in continuous production. Plus they follow a modular concept for interchangeability, compatibility and upgrading.

RoIm completes the package with full nomenclature and an integrated line of both military and commercial peripherals.

In just seven years we've been able to put together a family plan that lowers your programming costs, reduces hardware costs, cuts out your risk and gives you quicker reaction time.

That's Why We're #1 in Mil-Spec Computer Systems

ROLM

MIL-SPEC
Computers

4900 Old Ironsides Drive, Santa Clara, CA 95050. (408) 988-2900. TWX 910-338-7350.

In Europe: 645 Hanau, Muehlstrasse 19, Germany, 06181 15011, TWX 418-4170.

CIRCLE NUMBER 112

At last. The 2901A, one upped.

Announcing a faster, fully spec'd 2901A
4 Bit microprocessor slice.

It's a unique blend of ECL and Schottky,
fully pin-compatible, and faster than any other
2901A in the world.

Here are the numbers.

| | Typical | Commercial | Military |
|---------------------------|---------------|--------------------------|---------------------------|
| Our data: | 25° C (5V) | 0°-70° C (4.75-5.75V) | -55-+125° C (4.5-5.5V) |
| A, B Inputs → Y Output | 37ns | 65ns | 80ns |
| C _n → Y Output | 18 | 30 | 35 |
| D Input → Y Output | 20 | 40 | 45 |
| Clock → Y-Output | 35 | 60 | 65 |
| Minimum Clock Period | 45 | 60 | 75 |
| Read-Modify-Write Cycle | 45 | 60 | 75 |

And if you think those are hot specs,
wait'll you see our 2901A-1 coming soon.

Specs like this really shouldn't come as a
big surprise to you.

After all, we're the industry leader in
bipolar technology. And we invented Bipolar
Tri-State™ (which is used with the 2901A).

And another nice thing is all the parts we support the 2901A with.

First off, a family of 16 products, all fully spec'd.

Our family:

| | |
|-----------|--|
| IDM2901A | 4-Bit Microprocessor Slice |
| IDM2902 | Carry Look-Ahead Generator |
| IDM2909A | Microsequencer |
| *IDM2911A | Microsequencer |
| IDM29702 | 16 x 4 Bit RAM (open collector) |
| IDM29703 | 16 x 4 Bit RAM (Tri-State) |
| IDM29750 | 32 x 8 Bit PROM (open collector) |
| IDM29751 | 32 x 8 Bit PROM (Tri-State) |
| IDM29760 | 256 x 4 Bit PROM (open collector) |
| IDM29761 | 256 x 4 Bit PROM (Tri-State) |
| IDM29803 | 16 Way Branch Controller |
| IDM29811 | Next Address Controller |
| *IDM29901 | Octal Tri-State |
| IDM29902 | Priority Encoder |
| IDM29903 | 16x4 Edge-Triggered Register (Tri-State) |
| *IDM29908 | Quad Gated Flip Flop (flag control) |

*Available soon.

Also, we supply a complete line of low-power Schottky MSI, MOS static and dynamic RAM's, as well as all the other parts you need to build a complete, high-performance processor.

So if you need to know who to go to for everything you need, now you know.

National Semiconductor
2900 Semiconductor Drive
Santa Clara, CA 95051

Gentlemen:

Please send more information on your 2901A and its support products.

Name _____ Title _____

Company _____

Address _____

City _____ State _____ Zip _____

 **National Semiconductor**

Video display board interfaces S-100 bus

Technical Design Labs, 1101 State Rd., Princeton, NJ 08540. Judy Goodman (609) 921-0321. \$369.

A video interface for S-100 bus microcomputers is provided by the VDB (video display board). The unit consists of two piggybacked boards and it occupies one edge connector on the bus. The VDB contains its own display buffer memory and provides two pages of display, each with 25 rows of 80 characters. The display buffer memory does not use any memory address, leaving the entire computer memory address intact for user programs. The product displays, in addition to ASCII characters with descenders, 64 unique display symbols, permitting a graphic resolution with 160 horizontal by 75 vertical elements. The display can accept data at 400,000 char/s.

CIRCLE NO. 372

Data-acquisition card mates with LSI-11/2

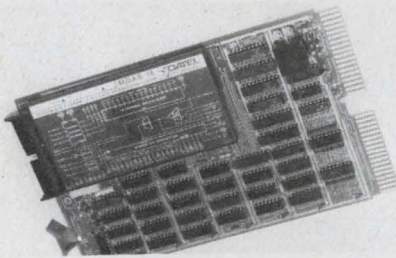

Andromeda Systems, 14701 Arminta St., Panorama City, CA 91402. Les LaZar (213) 781-6000. \$850; stock to 4 wks.

A data-acquisition card, the ADC11, provides a 12-bit analog-to-digital converter with 16 multiplexed inputs. The card is compatible with the LSI-11/2 computer and has a conversion rate of 20 μ s/channel. In auto-sequence mode, the input channel is automatically incremented. A burst mode enables up to 16 conversions at the full rate from a single start command and truncation mode enables automatic reset of the input channel number following the conversion of any programmed last channel. A 16-word FIFO data buffer allows full rate conversions independent of the CPU program speed.

CIRCLE NO. 373

Disc system increases μ C storage capacity

System Integration, Little Conestoga Rd. & Adams Dr., Glenmore, PA 19343. (215) 286-5136. \$5783; 4 wks.

The SIA-2000 disc system interfaces with most microcomputers to increase storage capacity. The data storage capacity of the system ranges from 12 to 48 Mbytes. The system performs record blocking, directory maintenance, sorting, searching and indexing of files. The unit contains 16 kbytes of RAM with DMA interface, an 8080A microprocessor and disc interface logic. The firmware for the system is contained in 15 kbytes of PROM.

CIRCLE NO. 374

Module interfaces μ P to transducers

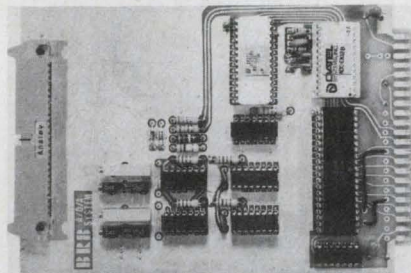

Wintek, 902 N. 9th St., Lafayette, IN 47904. (317) 742-6802. \$99.

The analog interface module makes it easy to interface thermocouples and other transducers to a microprocessor. Options include a 16-channel multiplexer, an 8, 10, or 12-bit analog-to-digital converter and one or two 8-bit digital-to-analog converters.

CIRCLE NO. 375

Graphics board mates with any S-100 bus

Vector Graphic, 790 Hampshire Rd., Westlake Village, CA 91361. Yvonne Beck (805) 497-6853. \$235 (assembled), \$195 (kit); stock.

This high-resolution graphics board operates with any microcomputer that has an S-100 bus. The board operates in one of two modes; digital output or 16-level gray scale. It requires +8 V dc, a minimum of 8-k of RAM, and produces digital graphic displays of 256H \times 240V screen elements or gray scale 128H \times 120V elements. The video output conforms to RS-170 and interfaces to standard raster-scan monitors.

CIRCLE NO. 376

8-channel serial I/O plugs into M6800 μ P bus

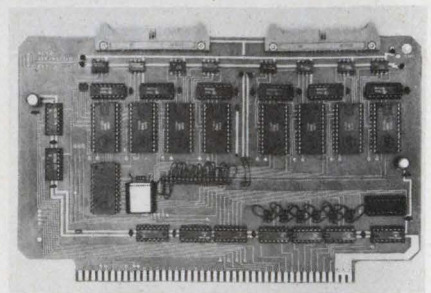

Micro Systems, 6773 Westminster Ave., Westminster, CA 92683. (714) 892-2859. \$237 (100 qty).

The 9650 asynchronous serial interface module is compatible with the M6800 microprocessor bus. The module provides full address decoding and fully buffered data, address and control lines. The I/O unit uses eight MC6850 asynchronous communications interface adapters (ACIA) with full RS-232C signal conditioning. An on-board bit rate generator simultaneously provides 14 standard rates individually strappable to each ACIA. The 9650 occupies 16 consecutive memory addresses. The standard configuration is fully populated to eight channels.

CIRCLE NO. 377

μ C has five system configurations

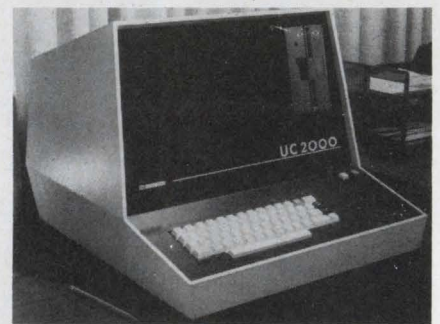

Infinite, 1924 Waverly Pl., Melbourne, FL 32901. (305) 724-1588. From \$995.

Model UC2000 is an S-100 bus computer available in five system configurations ranging from an empty mainframe card rack to a complete system with CPU, memory, multiple floppy discs and printer. The basic console contains a 12-MHz 12-in. CRT, eight card-slot mainframe, 18-A power supply, axial blower and various keyboard options. All subsystem modules are plug connected for easy maintenance. Although the complete systems are supplied with an 8080-based CPU card, any S-100 compatible CPU can be used in the empty mainframe.

CIRCLE NO. 378

SEND FOR AN **ACOPIAN**

... and get detailed information on an expanded line of single, dual, and triple output power supplies including: Mini modules (both PC-mounting and chassis-mounting types). General purpose modular supplies with outputs to 200 Vdc, current ratings to 32A. Narrow profile supplies only 1.68" thick. Plug-in supplies. MIL-tested supplies. Unregulated supplies, for economically driving relays and displays. Laboratory benchtop supplies. Rack-mounting power supplies, multiple-output power systems, and redundant-output power systems.

The catalog also includes pricing information and details Acopian's long-standing policy of "shipment 3 days after receipt of order."

**POWER
SUPPLY
CATALOG
1978**



Corp., Easton, PA 18042 Toll free number: (800) 523-9478

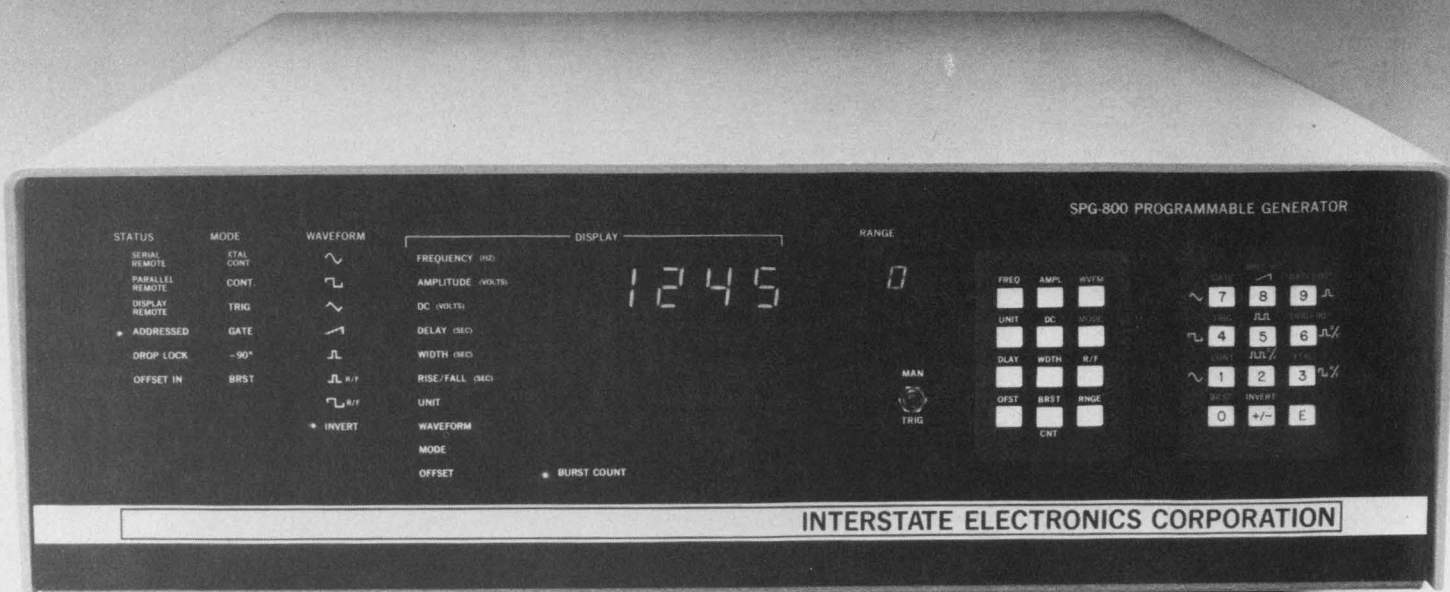

See the SPG-800 at Electro 78, Booth 2303.

SPG-800.

The best performance you can get from an ATE programmable signal generator.

Anywhere.

No matter who you are—large-scale ATE user, OEM, or small system user—the Interstate Electronics SPG-800 brings you more money saving performance features at less cost than any similar instrument anywhere. Here's why:

High-technology, high-performance design from the Interstate Electronics heritage of 22 years of instrumentation. The SPG-800 is the best.

Faster programming and faster settling times mean more measurements per second. And that means dollars saved.

Versatility of functions and interfacing lets you plug in instruments, four in a box, with

your choice of interfaces.

Less than \$4,000 buys the basic SPG-800.

The SPG-800 gives you 1.2 microseconds per character on the IEEE bus. That's the fastest programming time you can get. And it comes with an analog settling time that's from 4 to 20 times faster than any other.

ASCII interface is standard, but you can get optional plug-ins for **IEEE 488 bus** or the **RS-232-C with 20-mA loop**. Combine those features with plug-in functions, and that's versatility.

Use the SPG-800 with our new, low-cost, simple A-1000 Programmable Controller. You can, with a DVM and

printer, build small special-purpose test systems for under \$10,000 that can save you up to \$1,000 per month.

Talk's cheap. So's a phone call or a stamp. For full information on what we think is the world's best, contact Interstate Electronics Corporation, Department 7000, P.O. Box 3117, Anaheim, CA 92803. (714) 772-2811.

**INTERSTATE
ELECTRONICS
CORPORATION**

SUBSIDIARY OF **ATO**

**Information Processing and Display.
Systems. Products. Services.**

C.P. CLARE'S μP KEYBOARD WITH REEDS. THE BEST OF THEM ALL.

Best μP.

Here's why. Its second-generation microprocessor has EPROM capability — real smarts. It gets us from your keyboard concept to a prototype design in record time. It enables completely customized software control of all key functions. You can program in automatic repeats, multiple program a single keyboard, program changes in the field. You can have 8-bit serial and/or parallel I/O. Three-key rollover is built in with N-key rollover possible. There are no compromises and the options are unlimited.

Best of both worlds.

Couple this μP with the unique low-profile reed switches we manufacture and you've got the best of two technologies — an unbeatable keyboard system. You know reed contacts are sealed against hostile environments. You know reeds are extremely dependable and stable. They'll switch faultlessly over 10^8 times. They are low in power consumption. And zero in power drain. Another key point: they've got the feel operators like, so speed and accuracy increase.

Best keytops.

C. P. Clare's keytops are non-glare, 2-shot molded. The legends sharp and clear for life. The colors lab-quality, 3-dimensionally controlled. Yes, 3-dimensionally controlled.

Best advice.

C. P. Clare's μP keyboard is the best of them all. But is it best for you? Call the C. P. Clare sales office nearest you and arrange to talk to a keyboard expert. He'll tell you honestly if it is, or if you'd be better off with another C. P. Clare keyboard design. Talk to him today. Or, if you prefer, write C. P. Clare and Company, 3101 W. Pratt Avenue, Chicago, IL 60645. Or call 312-262-7700.

We help you compete

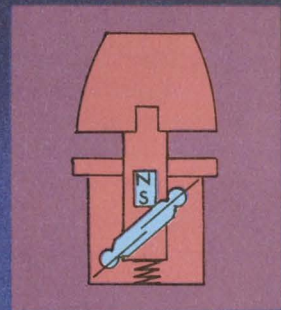

Height with keytop: $1\frac{1}{16}$ "



C. P. CLARE & COMPANY
GENERAL INSTRUMENT CORPORATION



CIRCLE NUMBER 153

SHORT-TIMERS!

I/O Terminal Rentals: From a day to a decade.

Renting gives you a real choice

Now you can rent the latest CRT terminals, teleprinters and protocol monitors by the day, week, month or longer.

Choose the datacomm equipment you need from the world's largest rental inventory of telecommunications equipment.

Top manufacturers like Teletype, Texas Instruments, Lear Siegler, DEC, and Hewlett-Packard—we've got them all!

Immediate availability makes renting an obvious answer to most emergency equipment problems. Renting offers you both the operating and financial flexibility you can't get when you buy or lease. Renting is "non-obsolescent."

Renting is leveling out demand peaks and valleys. Renting is low-cost. You get what you need—when you need it—for as long as you need it!

Only one monthly charge
When you rent from

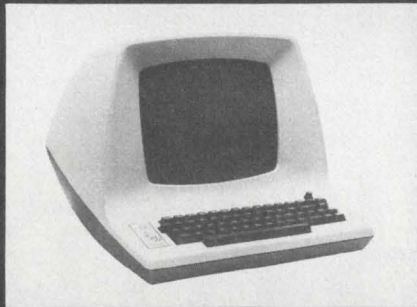
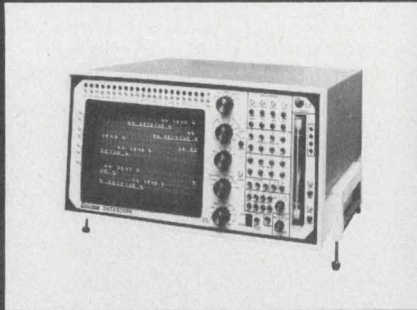
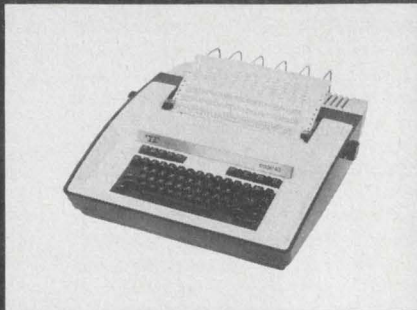

Leasametric you pay just one low monthly rate. There's no extra installation/take out fee, no add-ons, no monthly maintenance or repair costs. We take care of everything.

Service is our business

All equipment is inventoried and serviced by experienced professionals at Leasametric's 20 Regional Inventory Centers across the U.S. and Canada.

In the event of a failure, we'll replace malfunctioning equipment with a fully-operational unit within hours. You deal directly with Leasametric's applications specialists and technicians who are geared to respond to your emergency problems quickly and efficiently.

Call your nearest Leasametric Inventory Center today for immediate delivery of the latest CRT terminals, teleprinters and protocol monitors. Ask for your FREE EDP Equipment Rentals Brochure outlining our many services.

 **Leasametric**

Division of Metric Resources Corporation 822 Airport Blvd., Burlingame, CA 94010

INVENTORY CENTERS: San Francisco, CA (415) 342-7111; Los Angeles, CA (213) 768-4200; Anaheim, CA (714) 634-9525; San Diego, CA (714) 565-7475; Houston, TX (713) 988-1000; Chicago, IL (312) 595-2700; Boston, MA (617) 272-6520; Midland Park, NJ (201) 444-0662; Long Island, NY (516) 293-5881; Washington, D.C. (301) 881-6700; Orlando, FL (305) 857-3500; Dayton, OH (513) 898-1707; Philadelphia, PA (215) 583-2000; Denver, CO (303) 429-7900; Minneapolis, MN (612) 854-3426; Dallas, TX (214) 661-9193; Atlanta, GA (404) 491-1155; Seattle, WA (206) 455-3080; Baltimore, MD (301) 444-5144; Toronto, Ontario (416) 676-1897.
TOLL FREE NUMBERS: Outside California 800-227-0280; Outside New Jersey 800-631-7030; Outside Maryland 800-638-0838; Outside Illinois 800-323-2513.

If you think logic analyzers, recorders or scopes are the only way to debug digital circuitry, you're wrong.

We'll show you.

You'd like to take the guesswork out of debugging the complex circuitry you've designed. Make it less of an art and more of a science.

You'd like to have a known, stable signal to input to your circuit, so you can tell whether its output is on target. But the multiple pulse or wave generators, flip flops, logic gates or other gear you've been using to generate your word and timing patterns just aren't enough. You can't program them easily or with any guarantee they're accurate.

You'd rather have a single instrument that has multiple channels and is easily programmed. So you can input *exact* duplicates of the real programs your circuit will be handling. So you can tell at a glance whether your output is right.

But nobody makes a single unit like that, right? Wrong!

Interface Technology is going to show you.

We'll show you a self-contained, low-cost, small digital debugging tool for \$2,500 and up. A multi-channel, microprocessor-controlled data and timing generator that's programmable with only 16 instructions. A general purpose tester that can generate large amounts of digital data, that's interactive, can respond to external stimuli and make decisions. A benchtop instrument that can be used rack-mounted as part of a computer-driven system, or as the core of a low-cost, stand-alone digital test system.

We'll show you how our multi-channel programmable digital systems can lower your design time. We'll show you how you can be *sure* about your final product. And we'll show you how we're already working for people like General Dynamics, Rockwell and Hughes and how we can work for designers like you.

We'll put the whole show on the road and demonstrate our digital test systems for you in person. And all you have to do is call collect: (213) 966-1718. Or write to the address below.

interface
TECHNOLOGY

852 North Cummings Road • Covina, California 91724 • (213) 966-1718

CIRCLE NUMBER 155

DESIGN BECKMAN TRIMMERS IN. DESIGN PROBLEMS OUT.



Presenting the 93P. Our new half-inch trimmer with its built-in dial is a turn for the better.

For the first time, you can have a cermet half-inch single-turn, with dial setting capabilities. A variable resistor that's somewhere between trimmer and precision pot, designed to save labor costs with screwdriver position adjustability, and high-resistance capabilities.

Now you can write your manuals, and specify fast setting instructions. Using the 93P means reduced labor. It'll take less time to make that initial setting, less time to check the board. Calibration time is minimized. And the

93P has custom dial setting capabilities, too. Cermet technology has many advantages over wire wound. With 10% tolerance, and 100 ohms to 2 meg

ohms resistance range, it wins hands-down at high resistances. Inductive problems are eliminated. And the 93P is sealed for environmental stability.

Why a larger cermet part? The longer the element, the more the power dissipation. And it stands to reason, you can get more marking and more adjustability.

Design in a trimmer that's not a trimmer as you've known it until now. The 93P.

Call your local Beckman Helipot distributor for free evaluation samples. To get his number, or immediate technical literature, call (714) 871-4848, ext. 1776. Start designing problems out today.

BECKMAN®

CIRCLE NUMBER 156

Now Philips offers alternate time base display in a 100MHz as well as in a 25MHz scope.



Since its introduction the Philips 25 MHz dual trace oscilloscope has been hailed as the ideal digital service oscilloscope. Now it is joined by a Philips 100 MHz dual trace universal oscilloscope which is light enough for use in the field and yet can handle just about every measurement problem in computers, communications and process control.

The two oscilloscopes have these features in common:

- Alternate time base display eliminates back and forth switching
- Composite triggering gives full selection of display modes
- Bright display
- Light weight

25 MHz/2 mV dual trace oscilloscope with alternate time base display—PM 3214—has all the triggering facilities found on the latest, most expensive oscilloscope available—only \$1425.00*

100 MHz/(2 mV at 35 MHz) dual trace oscilloscope with alternate time base display and third channel trigger display—PM 3262—reflects the state-of-the-art in oscilloscope design. Will trigger to frequencies

over twice its rated bandwidth—only \$2345.00*
*U.S. Domestic Price only

For immediate information, use our toll-free Hotline number: (800) 631-7172. New Jersey residents, please call collect (201) 529-3800. Or contact Philips Test & Measuring Instruments, Inc.

In the U.S.:
85 McKee Drive
Mahwah, New Jersey 07430
Tel. (201) 529-3800

In Canada:
6 Leswyn Road
Toronto, Canada M6A 1K2
Tel. (416) 789-7188



Test & Measuring Instruments

CIRCLE NUMBER 157

PHILIPS

The big switch

...is to energy saving switchers.

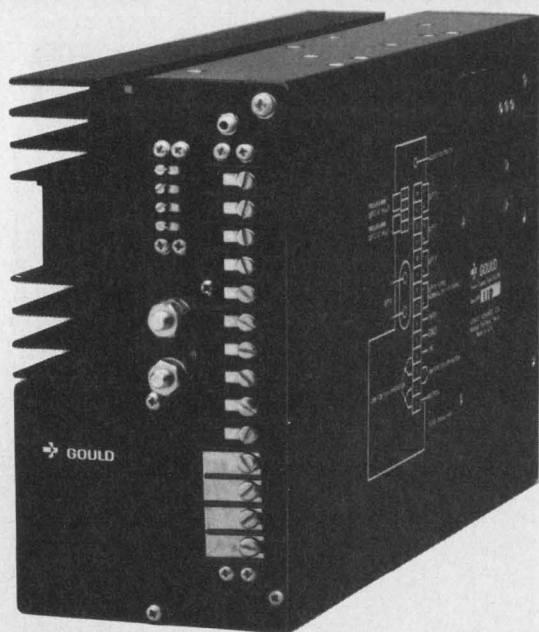

300 watt, quad output MGQ 300: 75% energy efficient.

Switching power supplies are more efficient than linears.

To produce a 200 watt output, a linear supply needs 400 watts coming in. A Gould switcher needs only 270. The switcher saves the 130 watts that the linear throws off in the form of heat.

Since the switcher dissipates less heat, your system operates at a lower temperature. This improves overall reliability and can reduce the need for external cooling.

But energy efficiency isn't the only advantage switchers offer. They're 1/3 the size and 1/4 the weight of linears. And they offer far better holdup and brownout protection.

Gould offers single and multiple output switchers with power levels from 8 to 2,250 watts. And custom designs can be provided to meet your exact specifications. You'll be backed by a high volume production capability and worldwide service network that only a \$1.5 billion company like Gould could offer.

For more information contact Gould Inc., Electronic Components Division, 4601 North Arden Dr., El Monte, CA 91731. Phone (213) 442-7755.

Gould.
The power in switching power supplies.



NEW X-Y RECORDER

**MORE RELIABLE
LESS EXPENSIVE
BECAUSE...**

"THE POT IS NOT"

- No more slidewire cleaner
- No more slidewire lubricant
- No more slidewire

*U.S. Domestic Price only

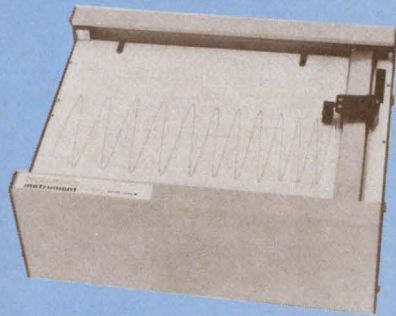

SERIES 100

Prices start at \$895.*

A capacitance feedback transducer replaces the potentiometer and slidewire - Neatly eliminating the most troublesome components in X-Y servo systems

Send today for complete information on the Series 100 - a new concept in low cost X-Y recorders.

houston instrument | DIVISION OF BAUSCH & LOMB 
"The recorder company"

A HIGH-SPEED, LOW-COST LINE PRINTER THAT'S GREAT FOR USE IN SOFTWARE DEVELOPMENT. IN MANY APPLICATIONS THE PRINTER CAN LITERALLY PAY FOR ITSELF AND ITS SUPPLIES WITH THE TIME IT SAVES. THE MODEL 8210 RENTS FOR LESS THAN \$175 PER MONTH AND CAN PRINT A 30 PAGE LISTING IN ONE MINUTE. AT THIS SPEED AND PRICE YOU CANNOT AFFORD TO CONTINUE WASTING DEVELOPMENT TIME WAITING FOR NECESSARY PROGRAM LISTINGS, ETC. THE MODEL 8210 HAS 80 PRINT COLUMNS AND WILL PRINT AT SPEEDS UP TO 2400 LINES PER MINUTE. A 132 COLUMN VERSION IS ALSO AVAILABLE WHICH CAN PRINT AT SPEEDS UP TO 1400 LINES PER MINUTE. THE LINE-TO-LINE SPACING IS 6 PER INCH WHILE THE COLUMN-TO-COLUMN SPACING IS 10 PER INCH RESULTING IN LARGE, EASY-TO-READ OUTPUT. THE INTERFACE SIGNALS FOR THE PRINTER HAVE BEEN ARRANGED TO ASSURE COMPATIBILITY WITH MOST KNOWN MINICOMPUTER AND MICROPROCESSOR DEVELOPMENT SYSTEMS. THE PRINTERS USE AN ELECTROSTATIC NON-IMPACT PRINTING METHOD THAT IS EXTREMELY QUIET, YET THE COST OF THE SPECIAL PAPER IS LESS THAN 90 CENTS PER 30 PAGE LISTING. THE PAPER DOESN'T FEEL OR LOOK FUNNY. FURTHERMORE, IT WON'T TURN BLACK WITH AGE. ABCDEFGHIJKLMNOPQRSTUVWXYZ 1234567890ABCDEFGHIJKLMN0PQRSTUVWXYZ1234567890ABCDEF

Print a 30 Page Listing in 1 Minute

- Extremely quiet
- High speed - low cost
- Interfaced to most mini's & micro's
- Easy to read 7" x 9" dot matrix
- High reliability
- \$3450* and \$3785*

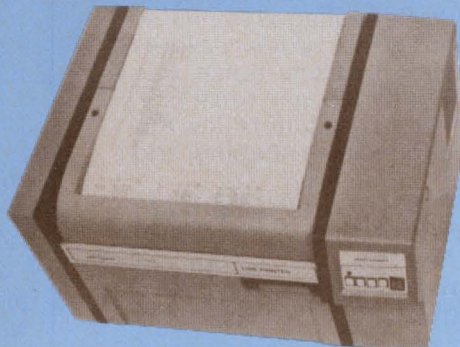

Actual output in less than one second.
Actual reproduction of printing quality.

*U.S. Domestic Price only

houston instrument | DIVISION OF BAUSCH & LOMB 
"The recorder company"

ONE HOUSTON SQUARE (at 8500 Cameron Road) AUSTIN, TEXAS 78753
(512) 837-2820 TWX 910-874-2022 cable HOINCO
TELECOPIER
EUROPEAN OFFICE Rochesterlaan 6 8240 Gistel Belgium
Phone 059/277445 Telex Bausch 81399

DIGITAL PLOTTER

for use

**ONLINE
OFFLINE
REMOTE BATCH
TIME SHARING**

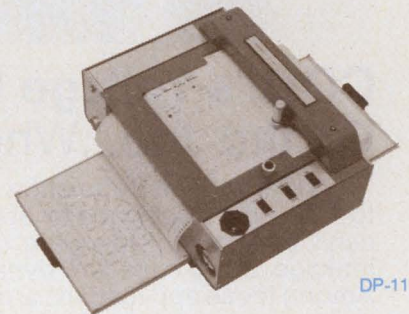

DP-11

- Plots at up to 4000 steps/sec
- Unique "Micro Drive" introduces "super quiet" to digital plotting
- 4 switch selectable step sizes
- Bi-directional paper movement
- Plots on 11" X 144" fan fold chart
- Price \$3995*

*U.S. Domestic Price only

houston instrument | **THE RECORDER COMPANY** | DIVISION OF BAUSCH & LOMB 

Visit us at the FACEB Show, booth B-32
CIRCLE NUMBER 115

COMPONENTS

Membrane switches made to most any pattern

Duralith, P.O. Box 804, Millville, NJ 08332. (609) 825-6900.

Press-Flex and Duraswitch are pressure-activated membrane switches in custom configurations that meet most any shape or layout pattern. The switches are available with graphic

overlays that can incorporate back lighting and display filters. Both of these low-profile switches have gold-to-gold contacts and are suitable for low-voltage logic circuits. The Press-Flex switch is environmentally sealed and has a thickness of 0.02 in. The Duraswitch is a half-switch with a polyester insulator that is bonded to the rear side to provide insulation and actuation travel when mounted on a PC board.

CIRCLE NO. 379

Mini dc motors have low inertia

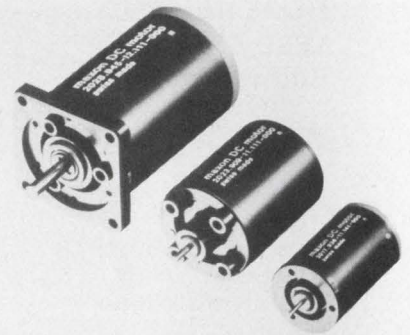

Horizons International, 716 Willow Rd., Menlo Park, CA 94025. Steve Buller (415) 328-1111. \$10.53 to \$15.31.

Miniature dc motors, Series 2300, have low inertia and are supplied in 17, 23 and 28-mm diameters. The low inertia and efficiencies up to 81% are achieved by the use of an ironless balanced rotor with crossed windings. Specs include nominal voltages from 3 to 24 V dc, starting torques of over 4 oz-in., no-load speeds to 8700 rpm and starting time constant from 16 ms. The starting voltage is about 0.3 V and torque ripple is about 2% rms.

CIRCLE NO. 380

Mini solid-state relays plug into sockets

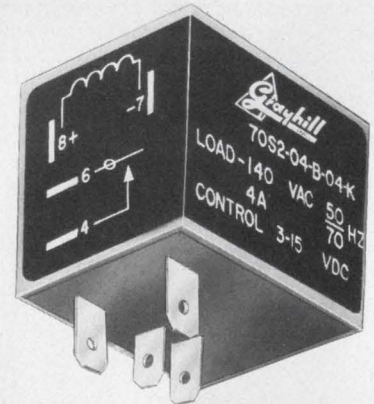

Grayhill, 561 Hillgrove Ave., La Grange, IL 60525. (312) 354-1040. \$9.48 (100 qty); stock.

Mini Cube solid-state relays have plug-in terminals that are compatible with standard relay sockets. The relays are 1 x 1.2 in. and about 1-in. high above the socket. The load current switching capability is 0.1 to 4 A at 120 or 240 V ac. No additional heat sinking is required for operation at rated load. Optical coupling and zero-voltage turn-on are standard features. The input circuit is logic compatible and is available in operating ranges of 3 to 15 or 14 to 30 V dc.

CIRCLE NO. 381

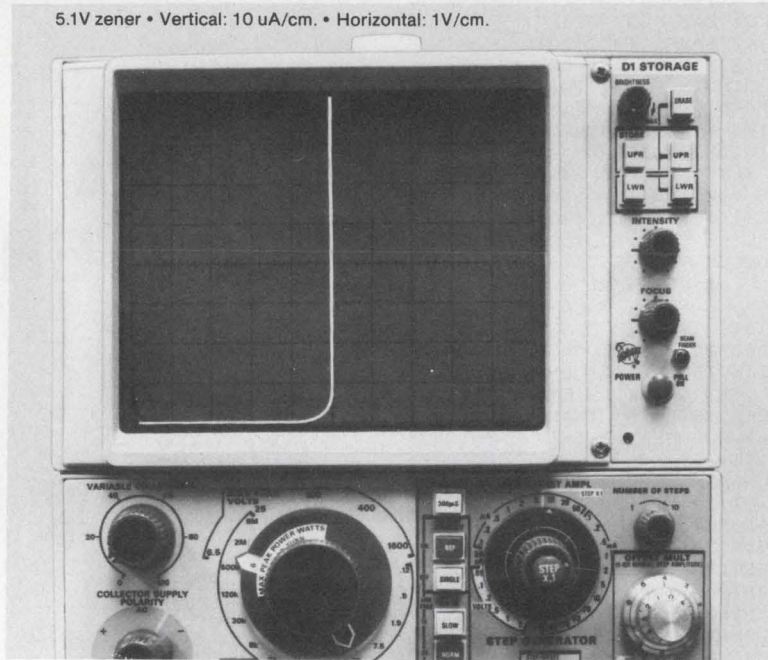

CODI's Voltage Regulator Diodes Do the Job...Where Zeners Can't

CODI's Voltage Regulation Diodes offer voltages from 3.3V to 10V and are designed for applications where ordinary zeners can't provide an adequate combination of low noise, low leakage, sharp knee, low dynamic impedance, and reliability. Among these applications are ultra-stable regulators, low ripple series regulators, Op Amp regulators, wave shaping, and comparator references.

This CODI series of diodes from IN5518B to IN5528B are available in JAN and JANTX versions providing up to 8.2V where MIL reliability is required. They can also be supplied with 100% internal visual inspection. All diodes are supplied in hermetically-sealed glass packages. Higher voltage units are available on special request.

To find out how CODI Voltage Regulator Diodes can solve your circuit problems, call Bill Henderson, CODI Corporation, Pollitt Drive South, Fair Lawn, N.J. 07410; telephone: 201-797-3900; TWX: 710-988-2241.

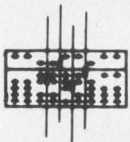

CODI CORPORATION

Semiconductor Products

See us at Electro/78 Booth No. 1724

CIRCLE NUMBER 116

Add a Burroughs Microprocessor Display



...it's as easy as B.C.D.

Now Burroughs makes it easier than ever to add an alphanumeric display to your product. Microprocessor control has been built into our popular SELF-SCAN® panels, so all you do is plug them in and input BCD signals for display of a full 64-character ASCII subset. The microprocessor eliminates 95% of the input circuit design normally required and minimizes the load on your system's microprocessor.

You get all the brightness, legibility and sales appeal of the popular SELF-SCAN display (more than a quarter-million in operation worldwide). SELF-SCAN displays are rugged yet lightweight and have a thin cross section. All this is yours at a very affordable price — as little as \$315 in 100 quantities.

Our new brochure contains all the information you need to start saving design time, weight, space, and big dollars as well. Get your copy today; call or write Burroughs Corporation, Electronic Components Division, P.O. Box 1226, Plainfield, NJ 07061. (201) 757-5000. Overseas, contact Burroughs ECD International, Langwood House, High Street, Rickmansworth, Hertfordshire, England. Telephone Rickmansworth-70545.

the first name in displays
the last word in displays

Burroughs



FOR GENERAL INFORMATION CIRCLE NUMBER 117
FOR DETAILED SPECIFICATIONS CIRCLE NUMBER 118

INTREX[®] TRANSPARENT ELECTRO- CONDUCTIVE FILM

APPLICATIONS:

**ELECTRO
PHOTO
GRAPHY**

**X-RAY
IMAGING**

**MICRO
GRAPHICS**

**TOUCH
PANELS
(CRTs)**

**RFI/EMI
SHIELDING**

**ELEC
TRONIC
CIR
CUITS**

**HEATED
ANTI
FOGGING
EYE
WEAR**

← This line represents Intrex film .003" thick

Intrex coated polyester films are available in thicknesses from .003" to .007"

Intrex coated polyester films are uniquely both transparent and electrically conductive. They are manufactured by a continuous high-volume process and are economically practical for use as a product component or as a consumable product.

Intrex products include Intrex-G gold-coated film and Intrex-K indium tin oxide-coated film. Other coatings and combinations are available.

We'd like to send you samples of Intrex so you can see for yourself how clear it is that we have the right material for your application.

Please call or write:



**Sierracin/
Sylmar**
12780 San Fernando Road
Sylmar, CA 91342
213/367-6184
Telex 167122
Attention: Intrex Film Marketing

CIRCLE NUMBER 119

COMPONENTS

Label keyboard can save a bundle

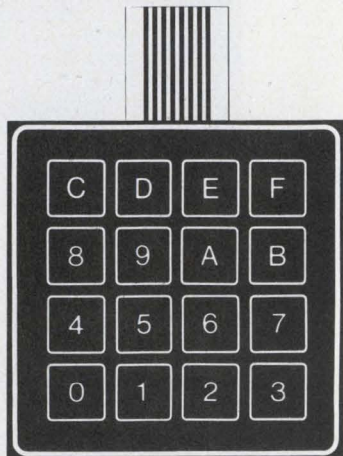

Computronics Engineering, 7235 Hollywood Blvd., Hollywood, CA 90046. J.B. Stanton (213) 876-3326. \$3.95; stock.

The hexadecimal label keyboard is less expensive than a mechanical keyboard. Stuck on to any panel by its self-adhering backing like any label, this micro-profile keyboard (0.03 in. thick) also eliminates the cost and installation of mounting hardware. The labels produce matrix coded output and interface with the type 74C922 IC for binary code. Because the labels do not bounce, debounce electronics is not required. Life is estimated at 10⁸ operations. A self-contained flex cable plugs into a 100-mil spacing socket or allows soldering of wires.

CIRCLE NO. 382

Inductors fit into 20-kHz switcher designs

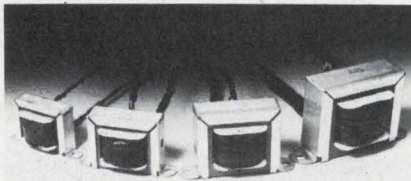

Pulse Engineering, P.O. Box 12235, San Diego, CA 92112. (714) 279-5900. \$4.50 to \$6.90; stock.

A line of inductors includes four inductance values for use in the most popular ratings of 5-V, 20-kHz switching power supplies. The types are 50742, 8 μ H at 100 A; 50738, 19 μ H at 50 A; 50734, 32 μ H at 25 A; 50730, 65 μ H at 12.5 A. All units have wire leads and channel-frame mounting.

CIRCLE NO. 383

Solid-state relays are rated at 1.5 A

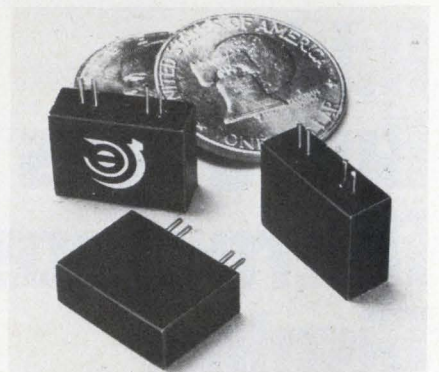

Theta-J Relays, 1 DeAngelo Dr., Bedford, MA 01730. Allan Mowatt (617) 275-2575. \$3.40 (100 qty).

A series of miniature solid-state relays, MX-100, are rated at 1.5 A in a 40-C ambient at load voltages up to 280 V ac. Encased in a plastic single-in-line package (SIP), the units employ photoisolation of 3750 V rms or 5500 V pk between input and output. All units withstand 100% overload for a full minute. The relays can be driven from any dc or full-wave rectified ac input above 1.5 V as long as a series input resistor limits the drive current to between 7 to 25 mA. The response time is 16 to 32 ms.

CIRCLE NO. 384

Tiny synchro converter employs Scott T

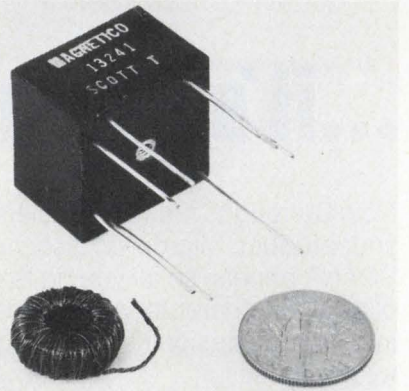

Magnetico, 182 Morris Ave., Holtsville, NY 11742. H.G. Eicher (516) 654-1166. \$27 (1000 qty); 12 wks.

Part number 13241 is a Scott-T synchro-to-resolver converter that has a volume of only 0.43 in³. The encapsulated device mounts on PC boards, weighs about 0.75 oz and has a size of 0.85 × 0.85 × 0.6 in. The unit converts an 11.8-V-rms, 400-Hz synchro signal to 5-V rms sine and cosine information. The worst-case accuracy is 60 arc-sec over a range of -55 to 125 C.

CIRCLE NO. 385



The Intecolor 8080 Development System Gives You Total In-House Control. You probably already realize that an in-house development system would give you a lot more control, flexibility and efficiency.

You may not realize that now you can afford one. Our new low-cost 8080 development system features a 19-inch, 8-color data entry terminal with an Intel 8080 micro computer. A 110 CPS bi-directional desk top printer. A dual mini disk drive and our 2708/2716 PROM programmer. It also includes a sophisticated ROM-based Text Editor and Assembler. And as an option, a FORTRAN compiler with double precision by Microsoft.®

Call today 800/241-9888 toll-free for a demonstration.



Color Communicates Better

Intelligent Systems Corp.®

5965 Peachtree Corners East/Norcross, Georgia 30071
Telephone 800/241-9888 TWX: 810-766-4584

CIRCLE NUMBER 120

FREE!

EDMUND SCIENTIFIC

**ELECTRONICS
OPTICS**

**SOLAR
ENERGY**

**MAGNETS
LASERS**



**O.E.M.
COMPONENTS
LABWARE
MIRRORS
SURPLUS**

164 PAGE CATALOG

- Over 4,000 unusual bargains for science and industry
- In-stock supplies for engineers, experimenters, research labs, hobbyists, etc.
- Order direct and save—buy with complete confidence ... every item carries the famous Edmund 30-day money-back guarantee.
- Simply mail this coupon for the newest Edmund catalog.

RUSH LATEST FREE EDMUND CATALOG

EDMUND SCIENTIFIC CO.
Dept. DA08, Edscorp Building, Barrington, N.J. 08007

Name _____

Address _____

City _____ State _____ Zip _____

CIRCLE NUMBER 121

CIRCLE NUMBER 122 ►

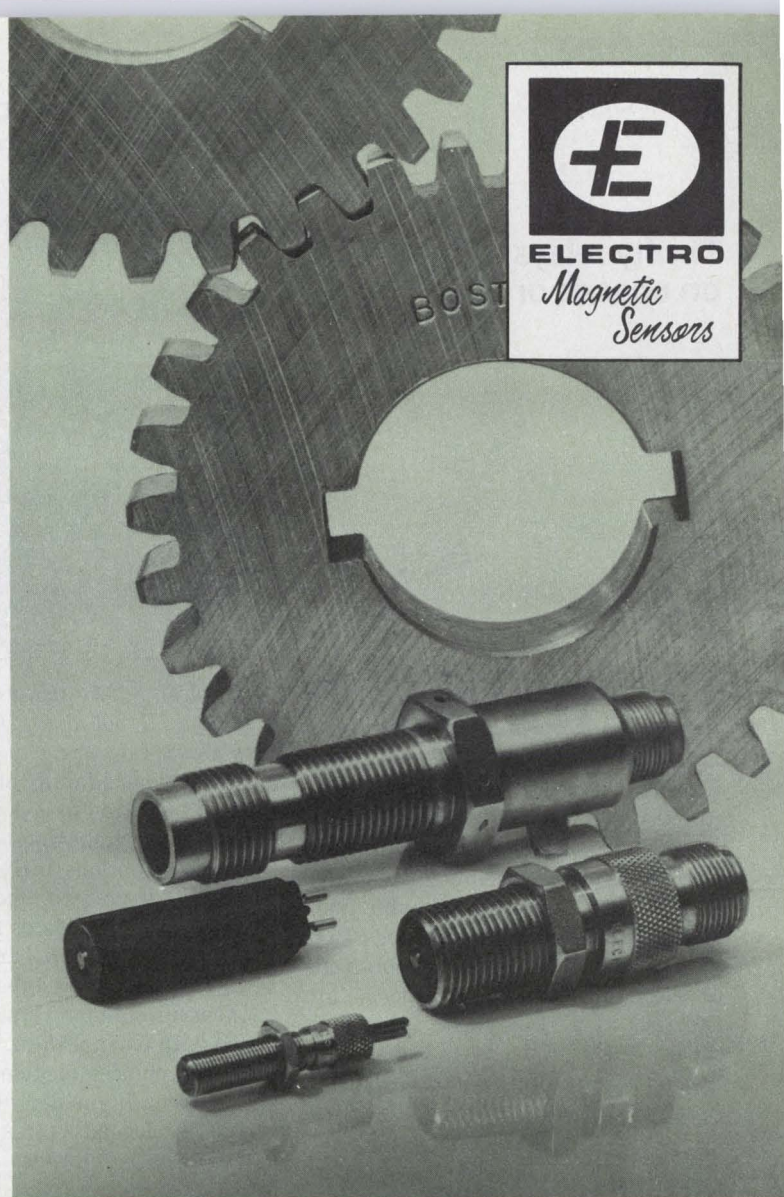

**For sensing motion
... there's only ONE!**

ELECTRO gives you the complete capability ... from prototype designs to high-volume production. We have pioneered in the development of magnetic sensors for more than 35 years and currently produce industry's most complete line of sensors including:

- **General-Purpose Sensors For Instrumentation**
- **High-Reliability Designs For The Transportation Industry**
- **Low-Cost, Molded-Plastic Sensors For Computer Peripheral, Appliance And Automotive Applications.**

Our sensor designs have been copied and imitated ... but never duplicated. We suggest the reason lies in our experience ... we've been at it longer than anyone else.

If you want to know more about the proven advantages of ELECTRO sensors write or call Electro Corporation, P.O. Box 3049, Sarasota, Florida 33578, 813-355-8411.



COMPONENTS

Thrifty relays mount on chassis or PCs

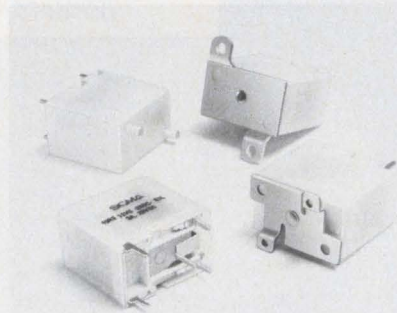

Sigma Instruments, 170 Pearl St., Braintree, MA 02184. R. Didriksen (617) 843-5000. \$1.86 (100 qty); stock.

In addition to having printed-circuit terminals, the Series 49 low-cost relay can also be provided with any of three alternate brackets for chassis mounting. The relays come in versions rated to 5 A, yet occupy only 1 cubic inch. They are available as SPST, or SPDT with fine-silver, silver-cadmium-oxide or palladium contacts. All models are enclosed in a glass-filled nylon dust cover.

CIRCLE NO. 386

Metal-film resistors meet Mil specs

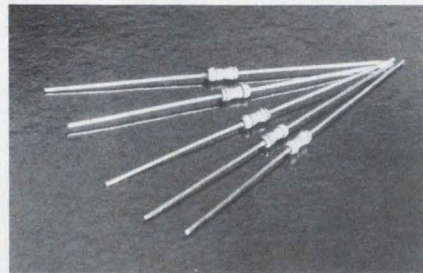

R-Ohm, P.O. Box 4455, Irvine, CA 92716. (714) 546-7750. \$0.05 (1000 qty); stock.

CRB Series metal-film resistors meet the requirements of both RN55D and RL07 precision and semi-precision specifications of MIL-R-10509F and MIL-R-22684. Units are available with a 1% tolerance and tempo of 100 ppm/°C. Resistors are supplied with EIA-standard color-code markings that are impervious to industrial cleaning solvents. Multiple epoxy coatings protect the devices against adverse environmental conditions.

CIRCLE NO. 387

Keyboards let you choose from many types

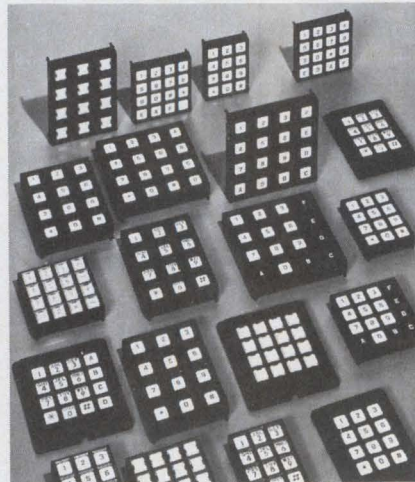

Grayhill, 561 Hillgrove Ave., La Grange, IL 60525. (312) 354-1040. \$6.30 to \$8.05.

A keyboard family offers a choice of 12 or 16-button arrays plus a choice of circuitry, mountings and legends. Circuitry options include matrix coding, single-pole/common bus switching, 2-out-of-7 code or 2-out-of-8 code. Either a 3 × 4 or 4 × 4 array is available with post or screw-type flange mount. The post-mounted version can be specified with 0.5 or 0.75-in. button centers. Legend choices include standard keyboards with molded-in legends, hot-stamped legends and snap-on caps to self-legend prototypes.

CIRCLE NO. 388

Cermet trimming pots indicate slider position



Beckman Helipot, P.O. Box 3100, Fullerton, CA 92634. (714) 871-4848. \$1.54 (100 qty); stock.

An arrow and dial indicate the slider position on the Model 93 cermet trimming potentiometers. The 0.5-in. diameter pots have a voltage adjustability of better than ±0.05%. Power is rated at 1 W at 70 C. The operating temperature range is -55 to 125 C.

CIRCLE NO. 389

Reed and triac make good relay pair

C.P. Clare, 3101 W. Pratt Ave., Chicago, IL 60645. (312) 262-7700. \$5.60 to \$7.92 (1000 qty); stock.

This ac hybrid has a reed-relay input that operates from a 5-V DTL or TTL source without the need for relay-driving buffers. A triac output handles loads of 10 and 25 A at 120 or 240 V ac. The relay is housed in an industry-standard package made from high-temperature thermoset plastic, V-0 flame rated, and highly resistant to most chemicals. Minimum life is 20 × 10⁶ operations for 120-V and 10 × 10⁶ for 240-V models.

CIRCLE NO. 390

LEDs come with bi-pin bases

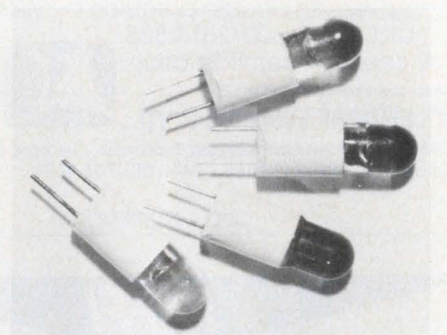

Industrial Electronic Engineers, 7740 Lemona Ave., Van Nuys, CA 91405. (213) 787-0311. \$0.75 (500 qty); stock.

A series of bright LED Jupiter lamps are packaged in T-1-3/4 incandescent lamp bi-pin bases. The lamps are available in ultra-high intensity colors of orange, green, yellow and red and are compatible with DTL and TTL circuits.

CIRCLE NO. 391

Metallized capacitors serve HV designs

TRW Capacitors, 301 West O St., Ogallala, NE 69153. (308) 284-3611. \$1.10 (500 qty); 6 wks.

Metallized-polyester capacitors, X675HV, are designed for voltage multipliers and high-voltage filters. The rated working voltage is 16 kV and capacitance values range up to 0.68 μF. Dissipation factor is less than 1% at 1000 Hz and 25 C. With a plastic-film case and epoxy end fills, the capacitors operate from -55 to 65 C.

CIRCLE NO. 392

SIMPSON 260[®] VOM

Choice of Professionals for Over 40 Years!

- Fast accurate measurements on 27 popular ranges
- Rugged taut-band varistor-protected movement
- Optional 5 KV probe
- External access battery and fuse compartment
- Multi-purpose color-coded test leads with combination and screw-on alligator clips



COMPLETE LINE OF PROBES, LEADS, CARRYING CASES AND OTHER ACCESSORIES AVAILABLE
SEE THEM AT YOUR LOCAL SIMPSON DISTRIBUTOR



Audio, TV and Communications Service



Electrical Maintenance



Production and Quality Control

- 260-6VOM — \$83.50
- 260-6M with mirror scale — \$86.60
- 260-6P overload protected — \$124.95
- 260-6PM overload protected with mirror scale — \$128.10
- 260-6RT in roll top case — \$94.00
- 260-6PRT overload protected in roll top case — \$135.45
- 260-6MRT with mirror scale in roll top case — \$97.15
- 260-6XL with extra ranges and features — \$97.50
- 260-6XLM with mirror scale — \$101.00
- 260-6XLP overload protected — \$134.50
- 260-6XLPM overload protected with mirror scale — \$137.50

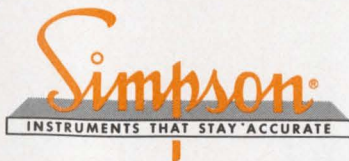

SIMPSON ELECTRIC COMPANY

853 Dundee Avenue, Elgin, Illinois 60120
(312) 697-2260 • CABLE SIMELCO • Telex 72-2416
IN CANADA: Bach-Simpson, Ltd., London Ontario
IN ENGLAND: Bach-Simpson (U.K.) Ltd., Wadebridge, Cornwall
IN INDIA: Ruttonsha-Simpson Private, Ltd., Vikhroli, Bombay



Make light of your toughest problems.

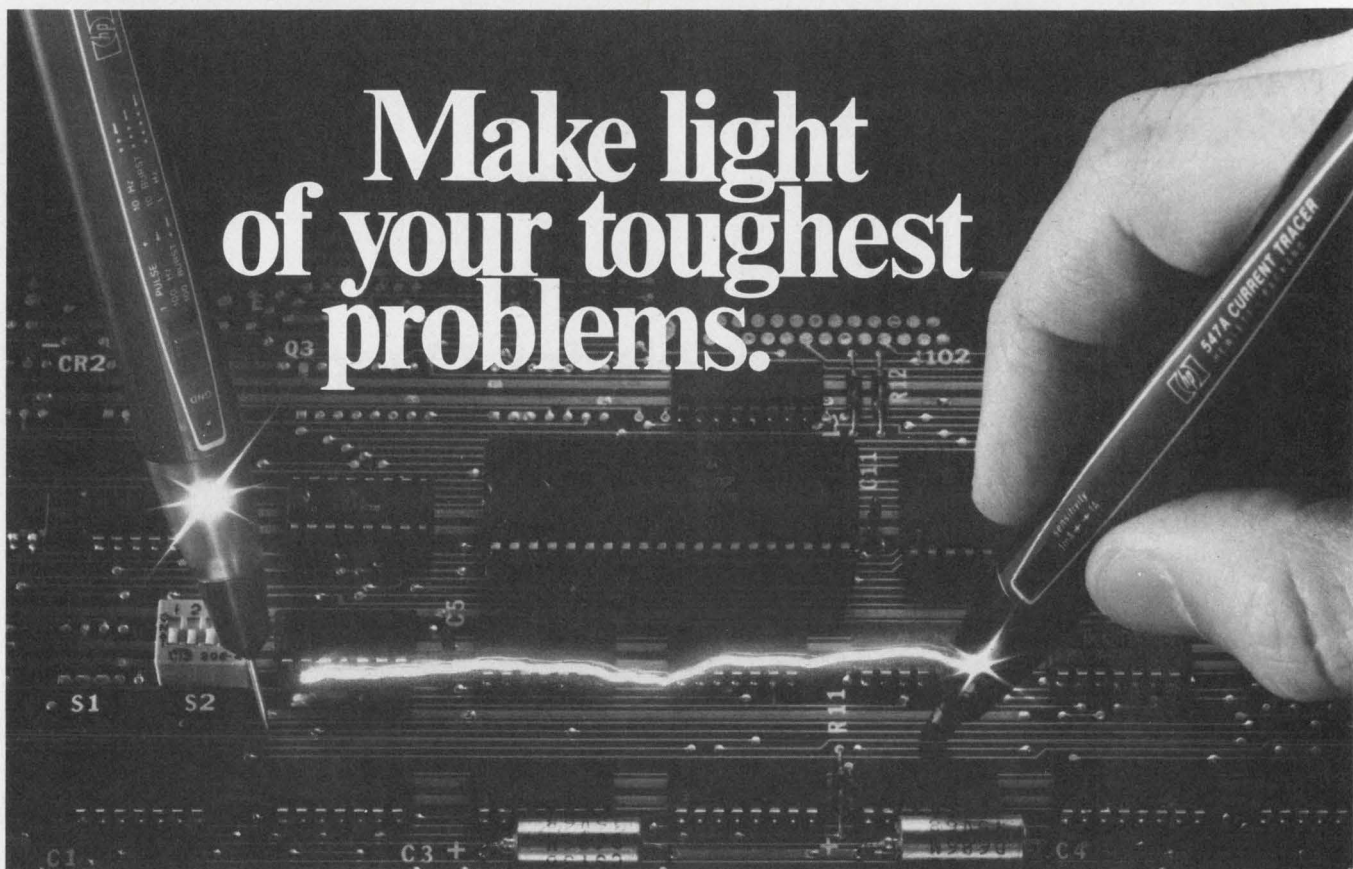

Those aggravating stuck node digital troubleshooting problems won't leave you in the dark anymore. Light has arrived in the form of Hewlett-Packard's 547A Current Tracer.

The vast majority of digital troubleshooting faults can be tracked right down to the component level by HP's 5004A Signature Analyzer or an HP Logic Probe. However, zero voltage situations like the microcomputer example at right in which line D2 is stuck low always present special difficulties. No voltage based tool will take you further unless you're prepared to start cutting board traces and unsoldering components in an attempt to isolate the faulty circuit element.

Enter the HP 547A Current Tracer.

It responds inductively to current pulses in the circuit from 1mA to 1A by lighting up. Just follow the light down the circuit path and it will

lead to the exact component or wiring fault that is sinking the current (in this case, RAM 1).

The 547A does it without risky circuit trace cutting or hit or miss component replacement. It's just a very straightforward and simple procedure.

No usable test current on the circuit trace you're working with? That's no problem either. Use the 547A in conjunction with the HP 546A Logic Pulser to inject current pulses into your circuit for equally simple, equally fast results.

Compact, simple and affordable enough to use when you need them: \$350 for 547A Current Tracer, \$175 for 546A Logic Pulser, \$125 for 545A Logic Probe, \$990 for the powerful 5004A Signature Analyzer.

**HP MAKES
DIGITAL TROUBLESHOOTING
EASIER THAN EVER**

Call your nearest Hewlett-Packard Field Office today, or write. We'll send full details on all these illuminating tools. All prices are domestic USA only.

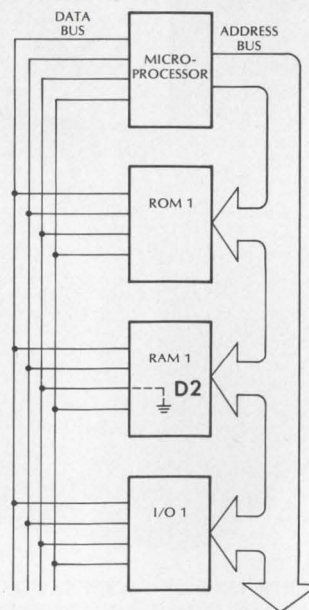

HEWLETT  PACKARD

1507 Page Mill Road, Palo Alto, California 94304

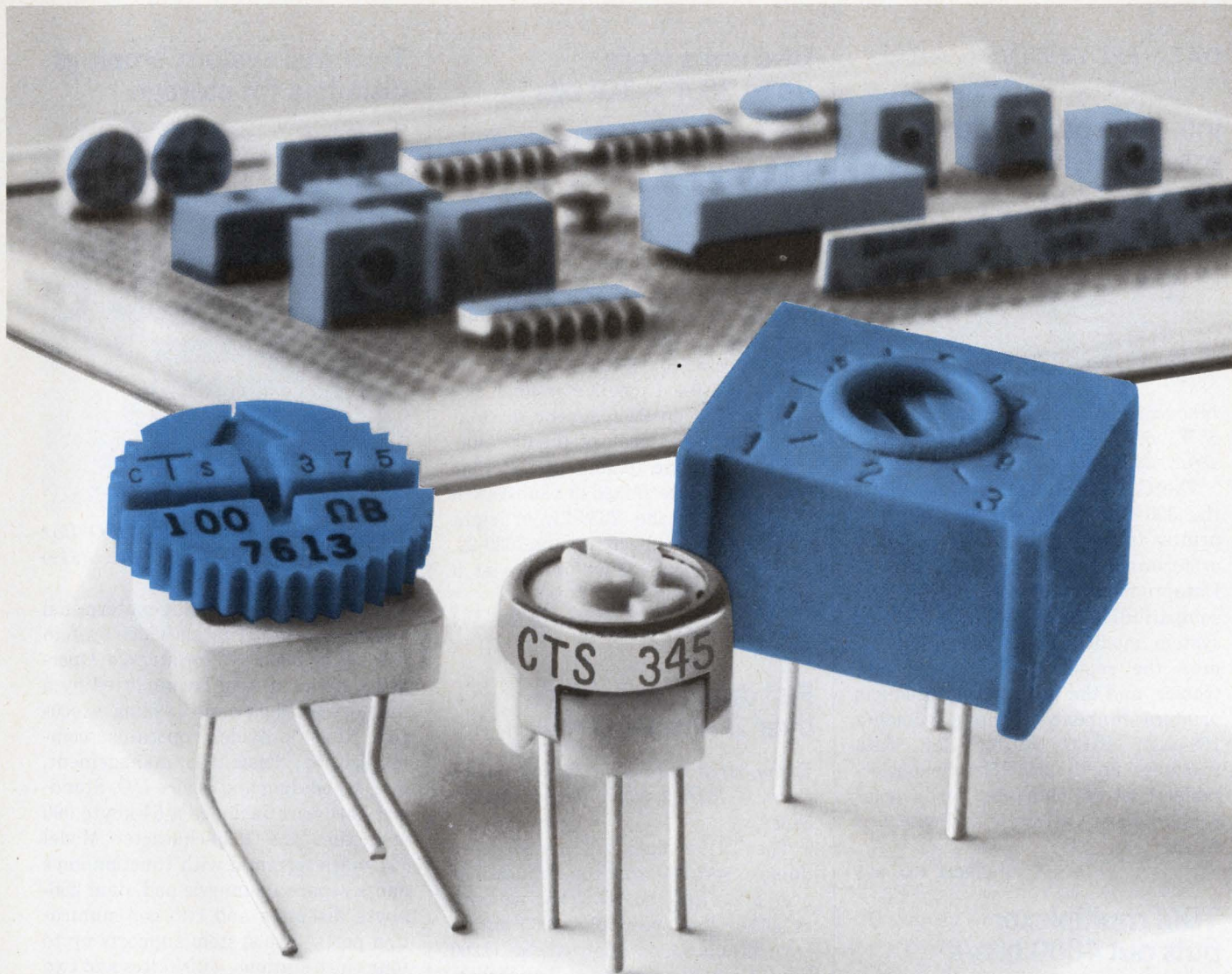

Overspecifying your cermet trimmer needs?

Why use multiturn trimmers when CTS single turns provide settability accuracy of .03%...approaching that of a 20-turn trimmer. Compactness, economy and excellent performance add up to a lot of efficiency in product design. You get all these benefits when you rely on CTS *single turn* cermet trimmers.

For example, the $\frac{3}{8}$ " diameter Series 375 is available in six popular terminal styles. And they're priced as low as 25¢ each in production quantities.

The CTS Series 345 is a "mini" $\frac{1}{4}$ " round design featuring low .180" profile, sealed construction and production priced at just 70¢ each.

The $\frac{7}{16}$ " square Series 360 satisfies a wide range of critical OEM applications. Eleven popular grid spacings include both top and side adjust .100", .125", .150" and TO-5 centers. Low priced, too. Under 40¢ each in production quantities.

All available off the shelf from CTS Industrial Distributors. CTS single turns handle nearly every trimmer application...economically! You be the judge. Call for your *Free Sample*. **CTS of West Liberty, Inc., 6800 County Road, West Liberty, Ohio 43357. Phone (513) 465-3030.**

CTS CORPORATION

A world leader in cermet and variable resistor technology.



CIRCLE NUMBER 124

DATA PROCESSING

Interface board allows printer interchange

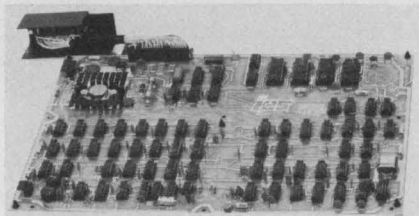

Innovative Electronic Systems, 15200 N.W. 60th Ave., Miami Lakes, FL 33014. (305) 558-1591. \$795; 4 wks.

The C/D-40 interface board allows the 300 line/min Teletype Model 40 printer to connect to a host computer or terminal that has a Centronics or Dataproducts interface. Plug-to-plug compatibility exists without making system modifications. The C-40 permits the replacement of any Centronics, and the D-40 of Dataproducts printers. Standard features include a 160-char FIFO buffer for data transfers up to 250 kHz, field-selectable control character code conversion, parity selection and extended ASCII.

CIRCLE NO. 393

TDM multiplexer puts out 4800 bits/s

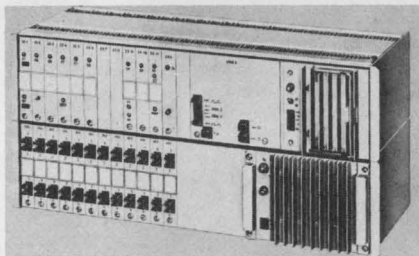

Siemens, 186 Wood Ave. S., Iselin, NJ 08830. (201) 494-1000. See text; 13 wks.

The ZD 1000-CI time-division multiplexer (TDM) system provides a total bit stream of 2400 or 4800 bits/s at the output. The system can be used in a stand-alone mode or can be linked to a parent TDM system for a total bit stream of 64 kbits/s. Transmission is either by CCITT A or CCITT B standards. The speed of the unit ranges from 50 to 300 baud at 7.5 to 11-unit elements. With a bit rate of 2400 bits/s, the maximum system capacity is 46 channels at 50 baud. The individual channel programming is done with a pre-programmable PROM that provides four different programs per system.

CIRCLE NO. 394

Disc units store up to 38.4×10^9 bits

Control Data, 6003 Executive Blvd., Rockville, MD 20852. (612) 853-4656. \$53,550 to \$75,000.

Two high-capacity disc subsystems provide up to 38.4 gigabits of data storage for users of the CDC Cyber 176-class computer systems. The subsystems use 819-21 disc storage units and Model 7639-21 and -22 single or dual access controllers. The Model 819-21 is a fixed media storage device that records on 22 magnetic discs at 6000 bits/in. on each of the disc surfaces. From one to four disc storage units can be intermixed in a subsystem that includes the 7639-21, or eight drives can be connected to the 7639-22. Both subsystems transfer data at a rate of 37.2 Mbits/s.

CIRCLE NO. 395

Full duplex provided over 2-wire DDD net

Rixon, 2120 Industrial Pkwy, Silver Spring, MD 20904. (301) 622-2121. Stock.

The T212A data set provides full duplex serial data communications over a 2-wire DDD switched network at either low speed (0 to 300 bits/s) asynchronous, or high speed (1200 bits/s) synchronous, as well as character asynchronous. Speed selection is made by a front-panel switch, or the terminal interface. At the answering station, the T212A automatically adjusts to the speed of the originating data set. The set operates with most automatic calling units.

CIRCLE NO. 396

Receive-only terminal is in compact case

Ann Arbor Terminals, 6107 Jackson Rd., Ann Arbor, MI 48103. Sarah Freeman (313) 769-0926. \$950 to \$1200; 8 wks.

Model 400E smart monitor terminals are available in a receive-only configuration packaged in a compact desktop case. The terminal is the size of a standard 15-in. monitor, measuring $15 \times 14 \times 13.6$ in. The unit displays 24 lines by 80 characters. As the screen fills with data, the top line rolls off for display of new data. Users may specify a single data rate from 110 to 9600 baud.

CIRCLE NO. 397

Terminal system employs diskettes for storage



Texas Instruments, M/S 784, P.O. Box 1444, Houston, TX 77001. (512) 258-7305. \$12,950.

The Model 774/1 intelligent terminal system is a multistation video system employing diskettes for storage. Operation of the system is supported by a memory-resident multitasking executive that provides operator communication, basic file management, task scheduling and device I/O. Standard hardware includes a 64-kbyte 990 processor, the 1920-character Model 911 video terminal with function keys and a separate numeric pad, dual 256-kbyte diskettes and two communication ports. The system supports up to four video stations, 4 diskettes and two 150-char/s Model 810 impact printers.

CIRCLE NO. 398

High-density storage transfers data fast

Bell & Howell, 300 Sierra Madre Villa, Pasadena, CA 91109. (213) 796-9381.

A high-density digital storage and retrieval system, with error detection and correction electronics provides error-free recording at high data rate transfers. The System 100 operates at up to 100 Mb/s on 28 tracks with a packing density of 33 kbit/in on one transport. Multiple transports may be synchronized and run in parallel to increase I/O data rates to 300 Mb/s. The system achieves bit error rates of 1×10^{-10} to 1×10^{-12} . The system is modular in design and operates at tape speeds of 1 to 135 in/s, offering bidirectional data address search capability at a tape speed of 270 in/s with a resolution of 0.2 in. Model 100 has built-in test functions for rapid fault isolation.

CIRCLE NO. 399

Infinite EMI/RFI Shielding Possibilities from Metex

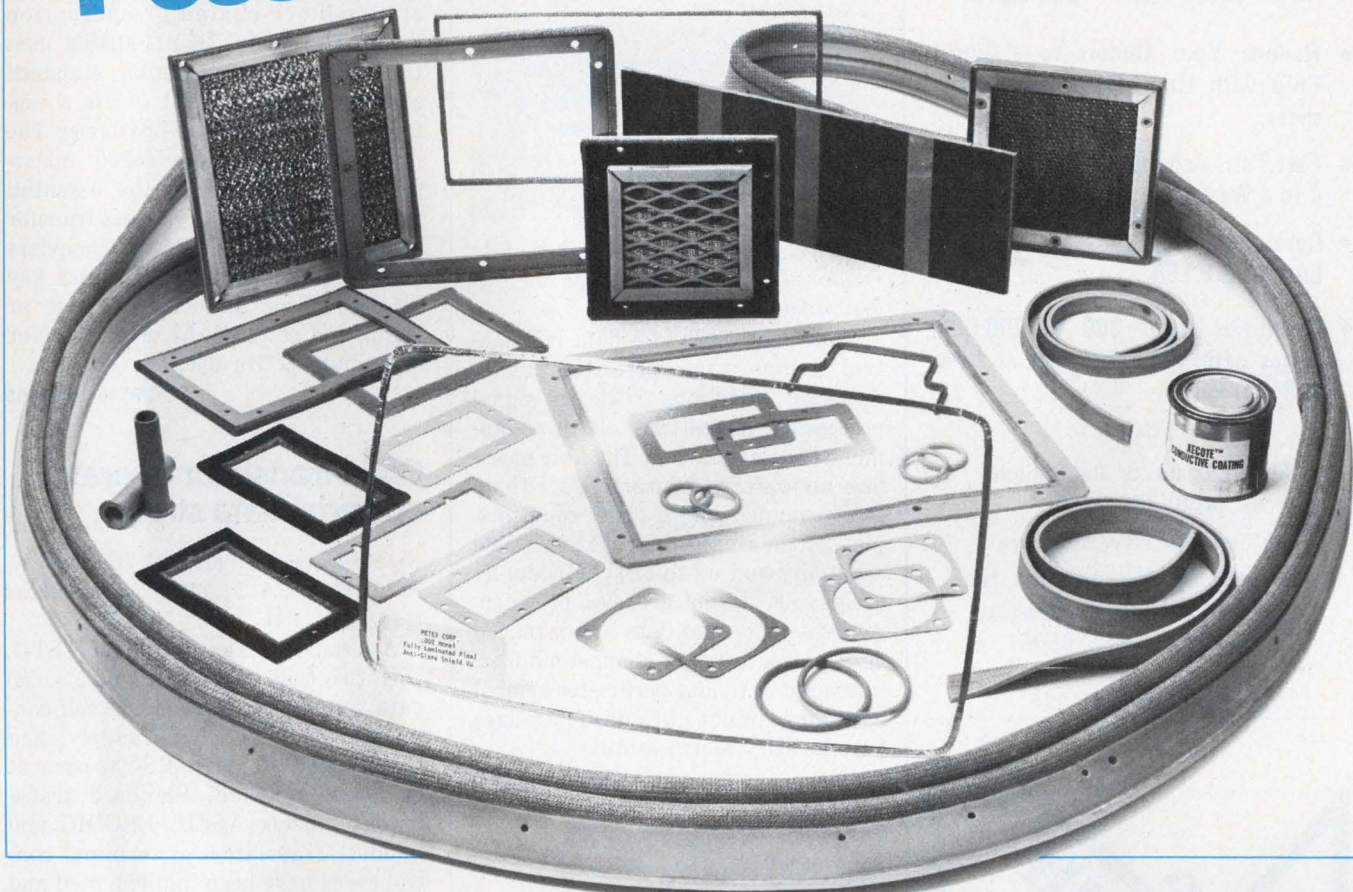

Metex EMI/RFI shielding comes in an infinite assortment of shapes and sizes for every conceivable electronics application, from sophisticated mobile communications and radar systems to fluorescent lighting fixtures. Fact is, we're the most experienced company in the business, worldwide.

That's why, when you get hung up on an interference problem, call your Metex representative. No matter what kind of shielding your application requires, the chances are Metex has a design for it. If not, we'll create one, just for you.

Part of our problem-solution technology is the use of knitted metal. Another is our Xecon® Conductive Elastomer. When we combine the two, the result is Metex Armored Xecon® Gasketing. The most advanced EMI/RFI shielding available. Anywhere.

Metex Shield Vu™ Windows allow you

to see clearly (98% visibility) into any cabinet, chamber or digital display without EMI/RFI leakage. Again, we use knitted metal – between panes of acrylic or glass.

Omni Cell® Panels, with our transverse-oriented honeycomb configuration for ventilation shielding, are opaque to all electrostatic polarization vectors.

Metex Combo® Gaskets can be designed to accommodate any pressure differential application regardless of joint unevenness. They're available in combinations of six different standard elastomers and two different knitted metals. The knitted metal strip comes with or without an elastomer core.

Metalex® Shielded Frames are a combination of knitted metal gasketing mounted within an extruded aluminum cross section.

So, whether you can best use custom designed Combo® or Pola® Shielding

Gaskets in sheets, rings or strips, or conductive coatings, Metex should be your first thought when it comes to EMI/RFI shielding.

And, to help you realize the infinite possibilities of Metex shielding, we want you to have, free of charge, our 124 page EMI/RFI Shielding Handbook, acclaimed the world over as the "textbook" of the field. Write to us on your company letterhead, at 970 New Durham Road, Edison, N.J. 08817, or on the west coast, 20437 S. Western Ave., Torrance, Ca. 90501.

Or, if you need an answer right away, talk to one of our applications engineers in N.J. at 201•287-0800, or in California on 213•320-8910. Also ask about samples and our free video seminars, offered periodically.

METEX
ELECTRONIC SHIELDING GROUP
A Unit of Metex Corporation

semi CUSTOM CMOS LSI

- Reduce Your Circuit to a Single Chip with One of Our 14 Master-slices.
- Fast Turn Around – Prototypes in 4 to 6 Weeks.
- Development Cost – As Low As \$ 2,150.
- Quantities from 200 to 200,000 Pieces with Volume Prices as Low as \$1.50 Each.

Call

Orhan Tozun or Joe Puhich
(408) 735-9370

Or Send for New Brochure:

International Microcircuits, Inc.
3004 Lawrence Expressway
Santa Clara, CA. 95051

CIRCLE NUMBER 126

the better source

Electronics Ltd.

Temtron

a major supplier of
electron tubes and
semi-conductors
features:

- KLYSTRONS
- MAGNETRONS
- TRIODES
- TETRODES
- POWER TRANSISTORS
- MICROWAVE DIODES

Supplying manufacturers include: Sylvania, Rheaon/Machlett, RCA, Eimac/Varion, Amperex, GE, EEV & many others

TEMTRON ELECTRONICS, LTD.
138-69 Francis Lewis Blvd.
Rosedale, New York 11422
Toll Free 800-221-8376
In N.Y. State (212) 978-5896
Telex 125237



CIRCLE NUMBER 127

DATA PROCESSING

Data logger performs μ P functions



United Systems, 918 Woodley Rd., Dayton, OH 45403. (513) 254-6259. Under \$3000; 4 to 6 wks.

Datalogger 2000 is a data information center that performs micro-processor functions such as signal processing, formatting, alarm assignment and interfacing. The unit measures up to 4 mixed parameters with up to 20 channels and $\pm 25,000$ -count display of measured data. Skip-channel capability and up to 1200 individually assignable alarms are also provided. Accurate time and data are displayed and recorded, as are channel number, measured data and parameter symbol with the printout of English messages that identify alarm status.

CIRCLE NO. 403

Impact printer spews out 100 char/s

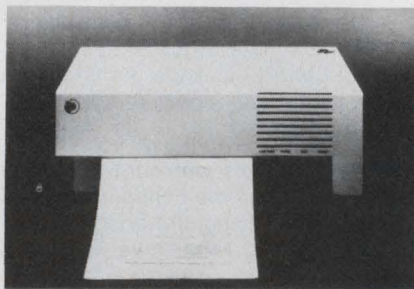

Integral Data Systems, 5 Bridge St., Watertown, MA 02172. N. Lamade (617) 926-1011. \$799.

The μ P-controlled IP-125 impact printer uses a 256-char multiline buffer to achieve an instantaneous print rate up to 100 char/s with a sustained throughput of 50 char/s at 80 columns/line. The printer has an RS232C serial interface, parallel TTL-level interface, and the full 96-character ASCII set. Multiple copy printing is on 8 1/2-in. roll, fanfold or sheet paper. The size of the printer is 17.25 \times 7 \times 11.5 in.

CIRCLE NO. 404

Data security unit goes into PDP-11

Motorola, 8201 E. McDowell Rd., Scottsdale, AZ 85252. (602) 949-3578. \$1995.

This product, for DEC's PDP-11 computer, is a module that enciphers data using the cipher-feedback or cipher-block-chaining encryption mode. The Model DES1100DSM uses the NBS data encryption standard algorithm implemented within a custom, single-chip NMOS LSI device. The module includes an M6800 micro-processor and handles the essential tasks of direct memory access transfer and encryption. The device enciphers and deciphers data and handles key loading, either immediate active or major and restores the major key for immediate active use.

CIRCLE NO. 405

Code translator operates on serial data stream

Sigma Data Systems, 715 Torrey Ct., Palo Alto, CA 94303. Cliff Kirkhart (415) 494-1138.

A serial data translator, Model ST-1, performs code translations on a serial data stream. The device is self-contained, including power supply, and communicates via two RS-232 ports at up to 19.2 kbaud. Standard translations include ASCII, EBCDIC and Baudot. Translation of terminal control codes have been implemented and other translations are available. The unit contains an Intel 8035 micro-processor with up to 1 k of EPROM and since the unit communicates via serial ports, it is compatible with any host computer.

CIRCLE NO. 406

Add-on memory mates with IBM systems

California Computer Products, 2411 W. La Palma Ave., Anaheim, CA 92801. (714) 821-2541. \$41,000.

The Model 4135/4145 memory system uses an interface that allows complete hardware and software compatibility with any IBM 135 and 145 processors. The interface module can be field upgraded, permitting the system to adapt easily to type 138 and 148 processors. The system includes a 4-k static RAM, and the memory is expandable in 256-kbyte increments to a maximum of 2 Mbytes.

CIRCLE NO. 407

OUR COMP KILLERS ARE ON THE "MOST WANTED" LIST.

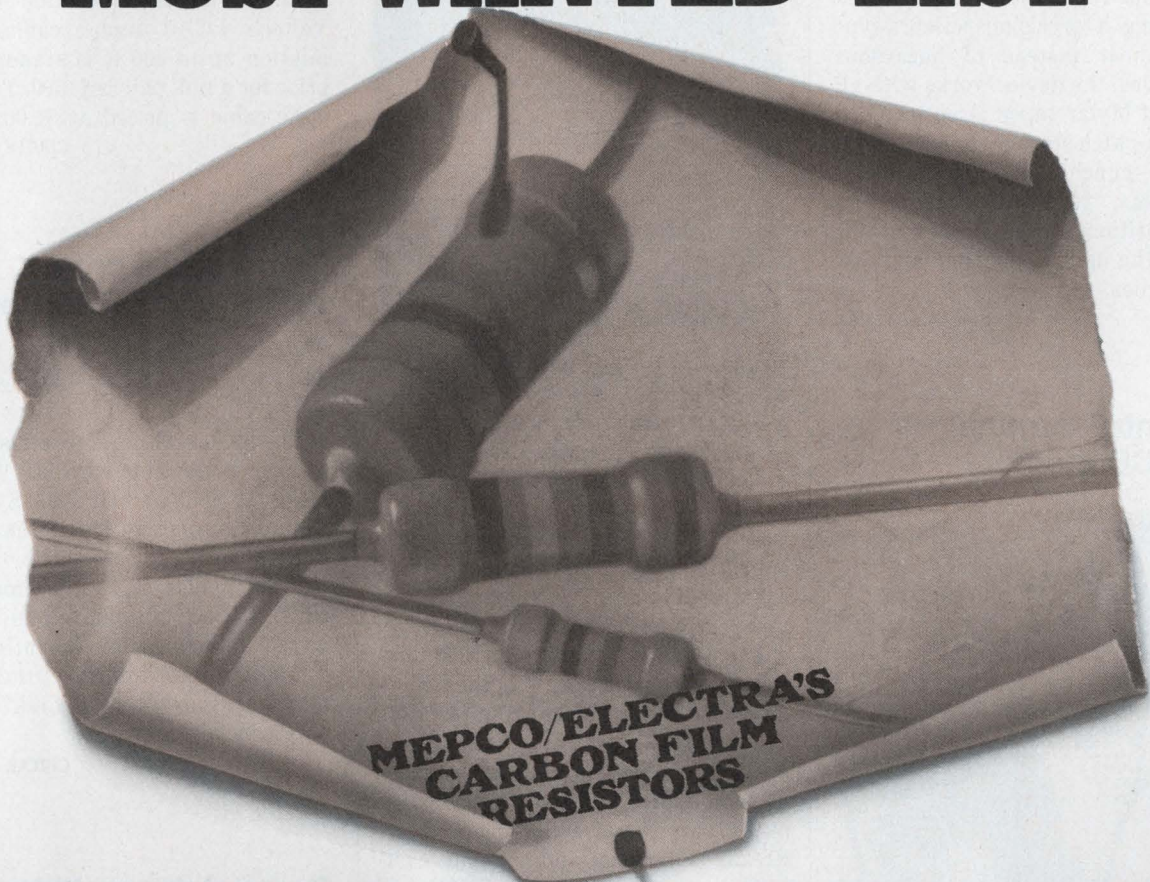

PERFORM BEST • COST LESS AVAILABLE EVERYWHERE

We're on the "Most Wanted" list because of better performance and lower unit cost. Talk to the leading Design Engineers who have made this move from carbon comp to carbon film resistors. It's the way the industry is going.

MEPCO/ELECTRA CR Series resistors can broaden your design capabilities quickly.

Choose from 1/8, 1/4, or 1/2-watt power ratings. In tolerances of 2 or 5 percent. And in the widest resistance range ever offered in a high-performance low-cost film resistor.

You can get immediate deliveries in quantity from an authorized distributor in your local buying area.

The CR Series carbon film resistors feature a low negative temperature coefficient, lower power and voltage coefficients, plus higher initial accuracy, long-term stability and much greater moisture resistance than carbon comps.

The industry's going to carbon film resistors. Come on over to the "Most Wanted" Comp Killers from Mepco/Electra. Write or CALL M/E for technical data and samples. MEPCO/ELECTRA, INC., Columbia Road, Morristown,

NJ 07960
(201) 539-2000.



CIRCLE NUMBER 128

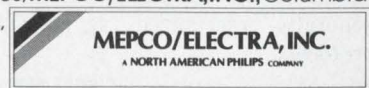

Splicer repairs punched tapes

Telex Marketing, 6464 Sunset Blvd., Los Angeles, CA 90028. Ron Carboy (800) 421-0506. \$169.50.

A splicer-punch-gauge for all 8, 7, 6 and 5-channel perforated tapes makes splices, and repairs tears up to 8 in. long. Using a precision scissors-type cutting shear instead of hazardous razor blades, the device works with all paper and Mylar tapes. Also included are a data-patch storage compartment, code-hole punch, tape gauge, hold-down arms, registration pins and punch position guide. A starter kit includes the splicer/puncher and 300 data patches.

CIRCLE NO. 408

Data entry terminal uses CCD memory

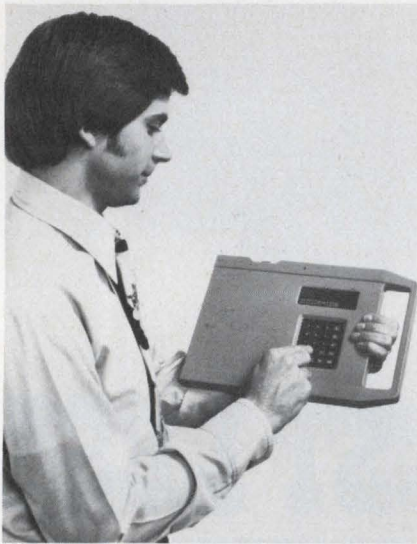

Azurdata, P.O. Box 926, Richland, WA 99352. Nina Martin (509) 946-1683.

"ScorepadLC" is a portable data entry terminal that uses a CCD memory interfaced with a single-chip micro-computer. The terminal is available with 4 to 8 kchar of memory. Besides allowing for a normal product-code field of 4 to 12, and a quantity field of 0 to 8 char, the terminal permits any line or field to be opened up to accommodate free-form comment lines. Transmissions are compatible with all generally recognized asynchronous protocols.

CIRCLE NO. 409

Modem is controller for entire network



Penril, 5520 Randolph Rd., Rockville, MD 20852. (301) 881-8151. \$1600 (master), \$1300 (remote); 8 wks.

A diagnostic-controlled modem, Model 2400 DCM, provides controller functions for the entire communications network and handles 2400 synchronous bits/s. The diagnostics, contained within the master and remote modems, provide a secondary channel with command-mode procedures. Test and control of the remote modems are performed over this secondary channel without interference to mainstream transmission. Other features include built-in test pattern generator and detector, RS-232 interface and on-line compatibility with Bell 201B and 201C data sets.

CIRCLE NO. 410

TTY serial I/O mates IBM Series/1 computer

MDB Systems, 1995 N. Batavia St., Orange, CA 92665. Gene Sylvester (714) 998-6900. \$560.

A serial I/O that interfaces with the IBM Series/1 computer is provided by the MBI-49-TTY/RS232 module. The unit features an 8-bit buffer to minimize data overrun. Switch-selectable baud rates, parity, word length and stop bits are standard. The module has clear-to-send and request-to-send protocol and also transmits in serial fashion using TTL levels.

CIRCLE NO. 411

Fiber-optic data link handles 20-kbits/s

Valtec, West Boylston, MA 01583. Morris Weinberg (617) 835-6082. See text; 4 wks.

The fiber-optic data link, Model RSH-D1, is an asynchronous full-duplex link that handles data rates to 20 kbits/s. A standard 25-pin computer-type connector feeds input and output signals. Power is obtained from a wall outlet. Fiber-optic connectors are mounted on the link and mate to Valtec's PC-10 duplex cable. Transmission up to 300 ft is standard. The price for a link pair is \$1000. The fiber-optic cable is priced at \$1.00/ft.

CIRCLE NO. 412

Matrix serial printer mates with HP computers

Hewlett-Packard, 1507 Page Mill Rd., Palo Alto, CA 94304. (415) 856-1501. \$3150.

The Model 2631 matrix serial printer is fully compatible with HP 9825, HP 9830, HP 9831 and HP 9800 System 45 desktop computers. The 180 char/s dot-matrix printer has three different printing modes, fast-replacement cartridge ribbon, automatic underlining and smart bidirectional printing. With the appropriate interface, the printer may be used with HP desktop computers now in use.

CIRCLE NO. 413

Drum plotter gets to high speed fast

California Computer Products, 2411 W. La Palma Ave., Anaheim, CA 92801. (714) 821-2541. \$36,400; 13 wks.

The use of dc servo-drive motors and linear pen actuators in the Model 1055 drum plotter provides quicker acceleration to top plotting speed and reduced pen up/down times. The plotter has a speed of 30 in/s, an acceleration of 4 g and a pen-down time of 10 ms. Resolution is 0.0005 in. Other features include a plot-time meter, Y-axis limit switches and a vacuum column buffer. A scale factor adjustment compensates for the expansion and shrinkage of plot media. The unit is free standing, has four pens and a 34-in. wide drafting area.

CIRCLE NO. 414

Sprague Input Capacitors combine many plus factors to improve power supplies...

More capacitance per case size. Higher ripple current capability. Lower ESR. Plus more ratings to choose from.

You can get input filter capacitors with capacitance values as high as 390,000 μF in a 3" dia. x 8.625" case. You can also get capacitors to handle up to 39.6 amperes of ripple current at 65°C and 120 Hz.

You should have no problem in meeting your power supply requirements without paying for costly specials that necessitate slower delivery.

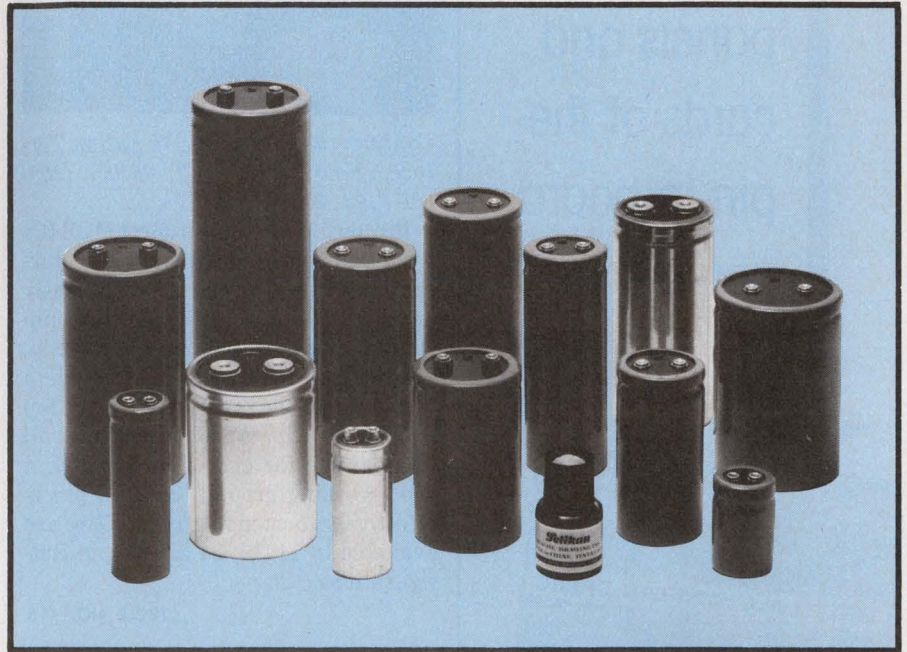

CHECK THIS MINI-TABLE FOR THE SPECS YOU NEED.

| | TYPE 602DX Extralytic® ALUMINUM ELECTROLYTICS 150 Standard Ratings | | TYPE 32DR Compulytic® ALUMINUM ELECTROLYTICS 132 Standard Ratings | | TYPE 32DX Compulytic® ALUMINUM ELECTROLYTICS 132 Standard Ratings | | TYPE 36DX Powerlytic® ALUMINUM ELECTROLYTICS 132 Standard Ratings | |
|--|--|--------|---|-------|---|-------|---|-------|
| Case Size Range (D. x L.) | 1.375" x 2.125" to 3.000" x 5.625" | | 1.375" x 2.125" to 3.000" x 8.625" | | 1.375" x 2.125" to 3.000" x 8.625" | | 1.375" x 2.125" to 3.000" x 8.625" | |
| Operating Temperature Range | -55°C to +85°C | | -40°C to +85°C | | -40°C to +85°C | | -40°C to +85°C | |
| WVDC Range | 5 to 250 | | 7.5 to 150 | | 10 to 200 | | 10 to 450 | |
| Capacitance Range (μF) | 150 to 330,000 | | 410 to 310,000 | | 180 to 320,000 | | 80 to 390,000 | |
| Max. ESR (ohms) at 120 Hz | 330,000 μF at 5 WVDC | 0.0062 | 310,000 μF at 7.5 WVDC | 0.010 | 320,000 μF at 10 WVDC | 0.017 | 390,000 μF at 10 WVDC | 0.012 |
| Max. RMS Ripple Current (Amperes) at 120 Hz and 85°C | | 36.0 | | 23.9 | | 18.3 | | 15.3 |
| Terminal Styles | Low or High Screw-Insert, or High Current | | Low or High Screw-Insert, or Solder Lug | | Low or High Screw-Insert, or Solder Lug | | Low or High Screw-Insert, or Solder Lug | |

For complete technical data, write for Engineering Bulletins 3431D, 3441E and 3457B to Technical Literature Service, Sprague Electric Company, 347 Marshall Street, North Adams, Mass. 01247.



a
General Cable
subsidiary

THE BROAD-LINE PRODUCER OF ELECTRONIC PARTS

for those
who specify
or buy
wire wrap
panels and
cards of the
pin-in-board
persuasion...

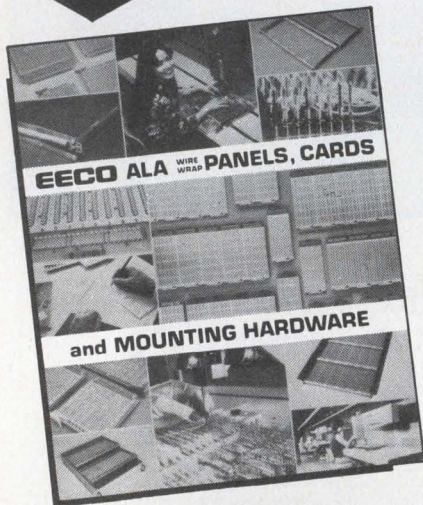

**FREE
BROCHURE**
28 pages...panels, cards,
frames, drawers, prices...

EECO

1441 E. Chestnut Avenue • Santa Ana, California 92701
(714) 835-6000 • TWX 910-595-1550/Telex 67-8420

DISTRIBUTED BY
MARSHALL INDUSTRIES
CIRCLE NUMBER 146

PACKAGING & MATERIALS

Test clips protect MOS devices from static

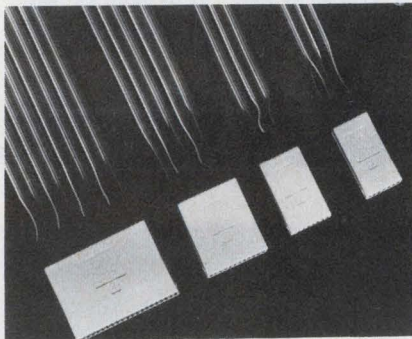

Continental Specialties, 70 Fulton Terrace, New Haven, CT 06509. (203) 624-3103. \$7.75 to \$21.75.

Proto-Clip test clips protect MOS ICs from damage by static electricity during handling. The device clips gently onto DIP units and brings their pin connections to the top end of the clip. Cabled versions of the tool include a connecting cable preattached to the top end of the clip. And by attaching all leads at the far end of the cable to a good working ground, each IC pin is effectively shorted to ground. Clips are available in 14, 16, 24 and 40-pin configurations.

CIRCLE NO. 415

Conductive foam protects static-sensitive devices

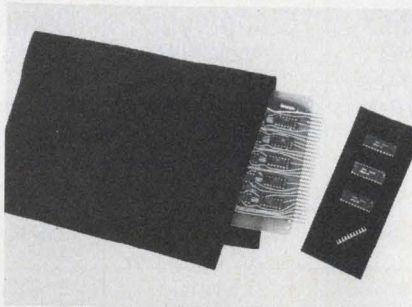

Charleswater Products, 3 Walnut Park, Wellesley, MA 02181. (617) 237-5942. From \$18.50; stock.

CP105 Statfree conductive foam is an electrically conductive packaging material that protects devices affected by both physical shock and discharge. Available in low density for cushioning and high density for directly inserting leads, the foam is unaffected by relative humidity. The conductive foam is available in thicknesses from 1/8 to 2-1/4 in. in 25 x 75-in. sheets. Volume resistivity is less than 3×10^3 ohm-cm.

CIRCLE NO. 416

Mini shock absorber reduces damaging forces

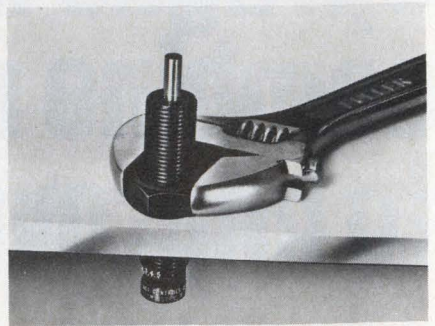

Ace Controls, P.O. Box 71, Farmington, MI 48024. (313) 476-0213.

Micro-Cushions reduce damaging impact forces generated in relatively small, high-speed equipment. The shock absorbers have 1/4-in. bores and 1/2-in. strokes and handle impact forces up to 100 in.-lb/cycle and 400,000 in.-lb/h. Spring-back force is 2 lb which permits the deceleration of very light objects to a fast, smooth stop. Deceleration, speed and degree of cushioning are controlled by a lockable adjusting knob.

CIRCLE NO. 417

Splitter prepares flat-cable ends

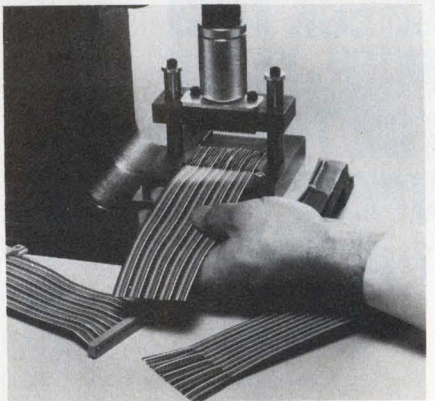

3M, P.O. Box 33600, St. Paul, MN 55133. (612) 733-1110. \$135/\$182.

Two splitters separate the conductors of 0.0425 or 0.05-in.-spaced flat cables, so they can be individually terminated or fitted into connectors of other center spacings. The splitting is accomplished with precision, so that the insulation of each conductor is undisturbed. The Model 3520 splitter employs a shearing action effected by offset ridges in mating dies. The Model 3540 uses closely spaced blades to cut between conductors. Both models operate in an assembly press and split the cable at its point of termination or in mid span.

CIRCLE NO. 418

THE BEST VALUE IN OSCILLOSCOPES COMES IN MANY MODELS.

When you choose a Gould oscilloscope — regardless of the model — you get reliability, versatile performance and a modest price tag. All of which adds up to true value. Over the years, Gould has earned a well-deserved

reputation for building reliable instruments. Prompt, efficient service is available through a worldwide network of service centers. And all Gould oscilloscopes carry a full two-year warranty covering all parts and labor exclusive of fuses, calibration and minor maintenance. Look to Gould for your best value in oscilloscopes.

For more information contact Gould, Instruments Division, 3631 Perkins Ave.,

Cleveland, OH 44114. In Europe contact Gould Instruments, Roebuck Rd., Hainault, Essex, CB10 1EJ England.

For brochure call toll-free (800) 325-6400, Ext. 77. In Missouri: (800) 342-6600.

 **GOULD**



Gould OS 245A

- DC to 10 MHz
- Dual trace
- 4 inch CRT
- 5 mV/div sensitivity
- Only 11 pounds

Circle No. 141

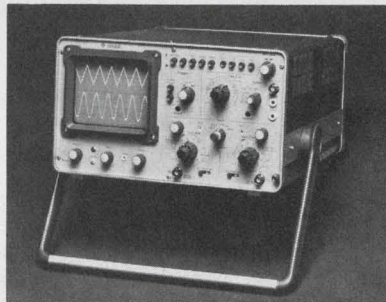

Gould OS 1100

- DC to 30 MHz
- Dual trace
- 1 mV/div sensitivity
- Delayed timebase
- Channel Sum and Difference

Circle No. 143

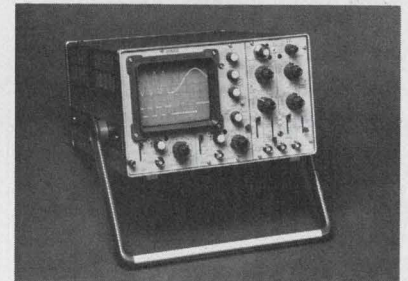

Gould OS 3300 B

- DC to 50 MHz
- Dual trace
- Two independent timebases
- Mixed sweep
- 1 mV/div sensitivity
- Channel Sum and Difference

Circle No. 144



Gould OS 260

- DC to 15 MHz
- True dual beam
- High brightness CRT
- 2 mV/div sensitivity
- Single Sweep
- Switched X—YY

Circle No. 142

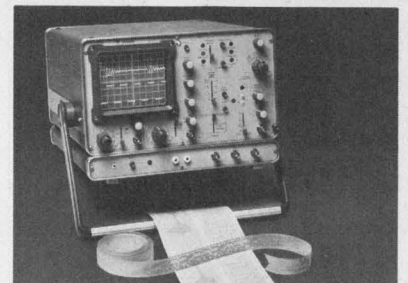

Gould OS 4000

- DC to 10 MHz—dual trace—digital storage (RAM)—no deterioration of stored trace—pre-trigger viewing—output to analog and digital recorders—simultaneous stored and real time viewing.

Circle No. 145

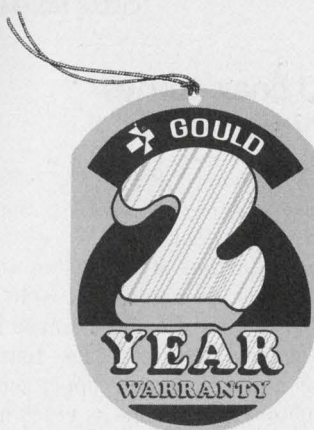

Rack assembly enhances design flexibility

Mupac, 646 Summer St., Brockton, MA 02402. Art Largey (617) 588-6110. \$400 to \$500 (rack assemblies), \$100 to \$500 (panels); stock.

Mupac Mixer is a modular packaging system that lets you integrate a variety of panel sizes, IC densities and selectable voltages into one rack assembly. Logic can be subdivided into multiple-sized functions. Three independent backplanes permit the modular separation of analog and digital grounds and voltage-supply requirements for optimum noise immunity. Multilayer panel construction allows high-frequency use. Panels with 32 to 192 ICs ranging in size from 4.5 x 6 to 8 x 14.9 in. can be accommodated. Panels contain from 108 to 540 I/O pins.

CIRCLE NO. 461

Board assembly stations put together easily

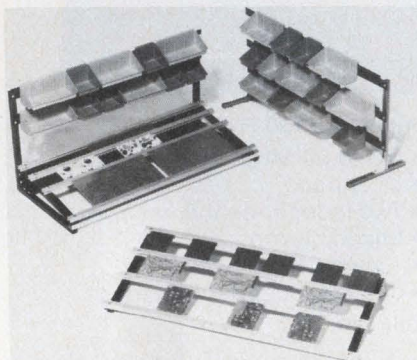

Production Systems, 1670 N. Main St., Orange, CA 92667. (714) 948-7120. See text; stock to 4 wks.

A series of PC-board work stations, for portable or fixed installations, is easily put together with a screwdriver. The series consists of Para-Trak II, Para-Trak III and Parts Cup Racks made of anodized aluminum frames. In use, the shorter-length Parts Cup Racks and Para-Trak II racks function as single-position assembly stations, while longer racks provide in-line assembly stations, where work slides from position to position. The Para-Trak III combines parts racks and a lift-out transfer rack for finished boards. All systems are available in lengths of 36, 48 and 60 in. Parts Cup Racks are priced from \$24; Para-Track II is priced from \$38; Para-Track III is priced from \$70.

CIRCLE NO. 462

Component carriers handle wrapped wire

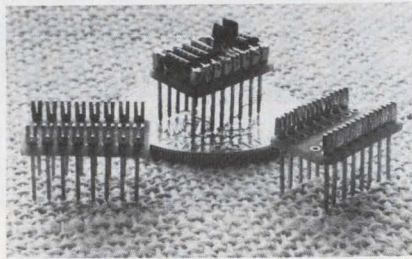

Hybricon, 410 Great Rd., Littleton, MA 01460. D.F. Murphy (617) 486-3174. \$1.05; stock.

Wrapdip is a series of wire-wrapable discrete component carriers that can be installed in boards with 0.042-in. holes on centers of 0.4 or 0.6 in. The carriers permit the pre-assembly of axial-lead components with lead diameters up to 0.03 in. The carriers then insert into boards for direct wire wrapping. Where additional heat sinking is desired, the carrier pins can be soldered in plated-through holes, providing better heat dissipation from component to board.

CIRCLE NO. 463

Epoxy adhesive stakes heat-sensitive parts

Tra-Con, 55 North St., Medford, MA 02155. Jim Hart (617) 391-5550.

Tra-Bond 2153 is a two-part thermally conductive epoxy adhesive system recommended for staking heat-sensitive electronic components to PC boards, radiators and heat sinks. The epoxy mixes to a putty-like paste and cures overnight at room temperature, or in a few hours at 65 C. It cures to a hard, rigid product that adheres to metals, glasses, ceramics and plastics.

CIRCLE NO. 464

RG8/U coax comes in mini size

AVA Electronics, P.O. Box 338, Lansdowne, PA 19050. (215) 284-2500. \$39.50 (500 ft); stock.

The miniaturized RG8M cable replaces RG8/U type cables and is 40% smaller. It is more flexible because it has 95% copper braid coverage, foam insulation and a 19-strand copper center conductor. RG8M adds as much as 2-dB gain over average RG58/U antenna lead. The attenuation is 1.35 dB/100 ft at 27 MHz.

CIRCLE NO. 419

IC sockets are only 1/8-in. high

Samtec, 810 Progress Blvd., New Albany, IN 47150. (812) 944-6733. \$0.60 up.

Low-profile IC sockets with 0.6-in. row spacing and with 10, 14, 16 and 18 contacts are only 1/8-in. high. Contacts are precision-machined brass with beryllium-copper contacts in gold or tin finish. Terminations are solder or wrap-wire types. The sockets' glass-filled polyester bodies are UL rated 94V-O, have pin-1 orientation and through-mounting holes molded in.

CIRCLE NO. 420

Strong soldering flux is clean and safe

M.W. Duntton, P.O. Box 6205, Providence, RI 02940. (401) 331-3600.

Nokorode Spec-Master soldering flux is used where a clean and safe residue is necessary after only a mild water wash. The flux is available in strengths able to solder stainless steel, yet safe enough to yield electronically clean surfaces after only water washing. The flux is nonflammable, nontoxic, nonirritating and nonfuming. Liquid, cored solder, paste solder and soldering pastes are available.

CIRCLE NO. 421

Hand tool dispenses wire solder

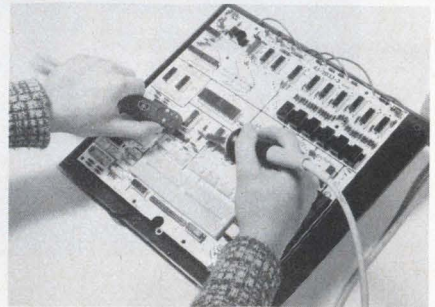

Micro Electronic Systems, 8 Kevin Dr., Danbury, CT 06810. (203) 746-2525. \$8.65; stock.

Hand-Y-Feed is a hand tool that dispenses wire solder in sizes of 0.015 to 0.06 in. Rewinding solder in the magazine is done on a core, fed from the bottom up through the center. The tool can be used either left or right handed and cannot be picked up incorrectly. A metal nozzle protects the unit from being burnt should an iron get too close.

CIRCLE NO. 422

these two Panel Meters ...
can become 93 different measuring instruments ...

count'em.

| | |
|---------------------------|-----------|
| DC and AC Volts | 23 models |
| DC and AC Current | 20 models |
| DC Autoranging | 2 models |
| True rms | 8 models |
| Thermocouple C or F | 16 models |
| RTD C or F | 4 models |
| Thermistor C or F | 8 models |
| Offset and Scaled | 4 models |
| Process Monitors | 8 models |

and the best part is ...

You can change to any one of these models anytime. It is as simple as reprogramming the rear connector or adding one of DigiTec's exclusive adapters. Call or write for complete specifications.

These instruments are available under GSA Contract, GS-00S-27741.

DigiTec: Precision Measurements to count on



918 Woodley Road, Dayton, Ohio 45403
(513) 254-6251, TWX (810) 459-1728

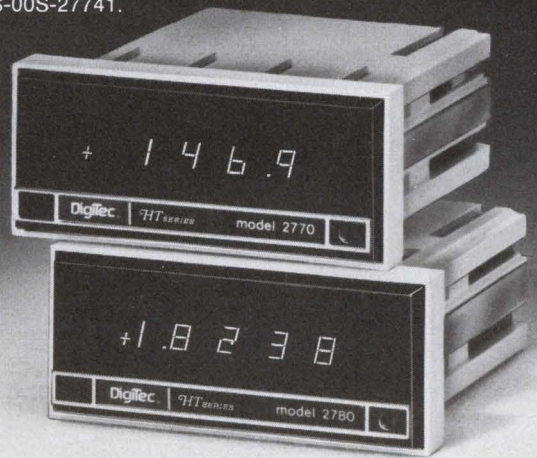

FOR INFORMATION ONLY CIRCLE NUMBER 132

FOR DEMONSTRATION ONLY CIRCLE NUMBER 150

An 8½ inch Microprocessor Controlled Impact Printer for just \$345*

Now that's what we call
Practical!

Laugh all the way to the bank, OEM's. With both matrix impact print head and built-in microprocessor controller, our DMTP-6uP is a budget printer in price only. In practice, it's one of the greats.

You can print 80-96 columns of both data and text at a fast 110 cps. Turn out up to four copies at once on regular 8½ inch roll paper, even on fan-fold forms and labels. Not only are all needle drivers and diagnostic routines included with the microprocessor, but you can choose the interface function you want — parallel ASCII, RS-232C/1-Loop, or switch-selectable baud rates from 110 to 1200. You even get the economy of easily-replaceable ink rollers and a self-reversing 10-million character life ribbon.

* \$345 in 100 qts.; single units \$472

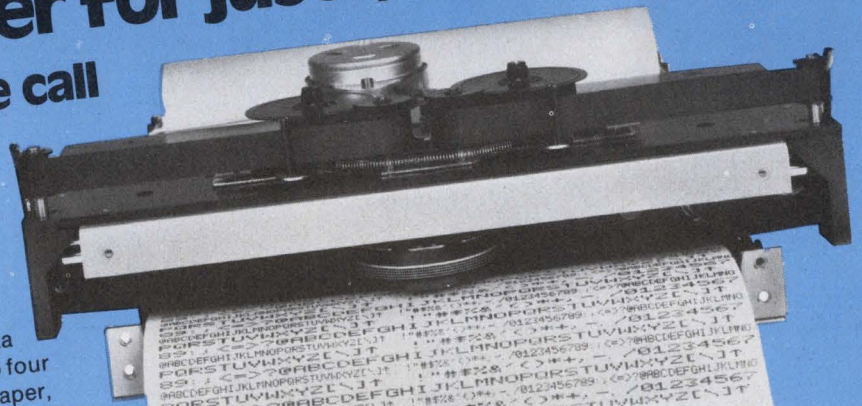

All that for \$345*? It's phenomenal...
and it's also very Practical.



PRACTICAL AUTOMATION, INC.
Trap Falls Road, Shelton, CT. 06484
Tel: (203) 929-5381

CIRCLE NUMBER 134

Bliley

first name in frequency control



Our best is typical of our entire line



Regardless of price—and there is a wide range at Bliley—each of our components is designed and made for total reliability in its intended application.

Think about that the next time your budget threatens your design parameters.

Then, tell Bliley about your requirements. Meantime, update your files with our new catalog C/AR. It's yours for the asking.

Quartz Crystals • Crystal Oscillators

BLILEY ELECTRIC COMPANY

2545 West Grandview Boulevard,
P.O. Box 3428, Erie, PA. 16508
Tel. (814) 838-3571 TWX 510-696-6886

CIRCLE NUMBER 135

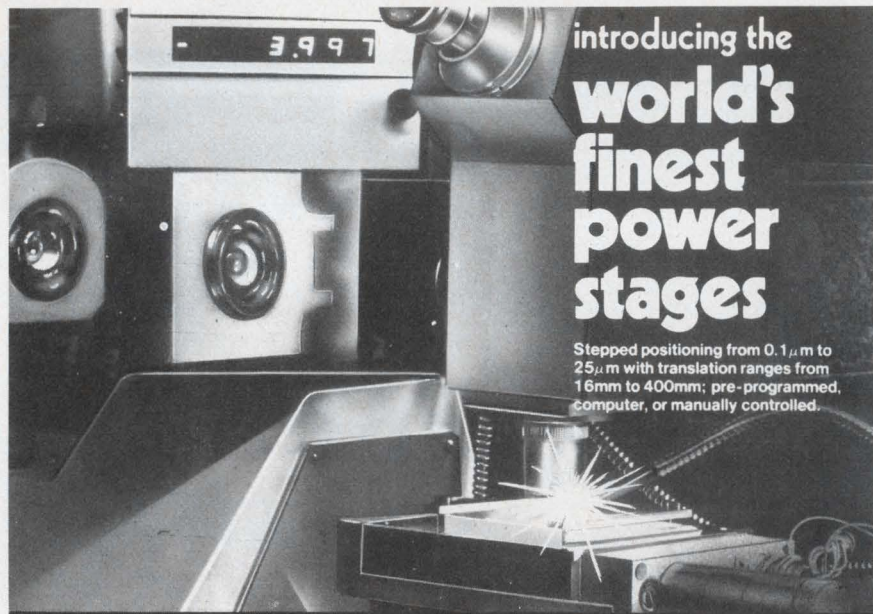

introducing the world's finest power stages

Stepped positioning from 0.1 μ m to 25 μ m with translation ranges from 16mm to 400mm; pre-programmed, computer, or manually controlled.



Translation Stages



Rotation Stages



Goniometric Cradles

Send for Catalog 408

KLINGER
SCIENTIFIC CORP.

83-45 Parsons Blvd.,
Jamaica, N.Y. 11432 (212) 657-0335

CIRCLE NUMBER 136

POWER SOURCES

Mini switchers deliver 25 W at up to 24 V

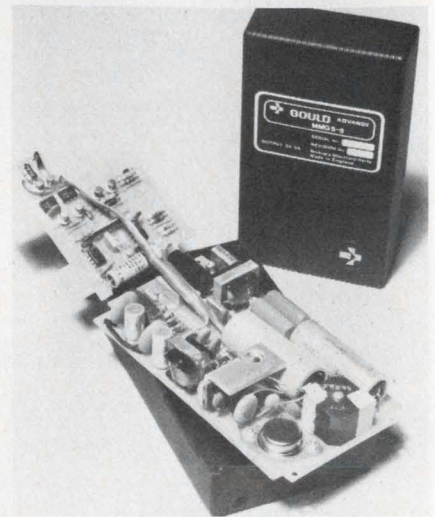

Gould, 4601 N. Arden Dr., El Monte, CA 91731. (213) 442-7755. \$135; stock.

Three 12, 15 and 24-V units with efficiencies of 75 to 85% have been added to the MMG line of 25-W switching power supplies. The units operate from 110/220 V or 220/240 V, 50 or 60 Hz and deliver currents from 1.4 to 2.5 A. Optical coupling provides 4-kV rms (5.7-kV pk) isolation between input and output. The output regulation is 0.1% max for the worst-case combination of 0 to 100% load change and $\pm 10\%$ line change. Ripple does not exceed 10 mV rms or 50 mV pk-pk over a 30-MHz bandwidth. Dimensions are 6.3 \times 3.5 \times 1.3 in.

CIRCLE NO. 423

Dc/dc converter fits in 0.4-in. height

Tecnetics, P.O. Box 910, Boulder, CO 80306. (303) 442-3837. \$60 (single output), \$75 (dual output).

The type 100 regulated 6-W dc/dc converter is only 0.4 in. high. Input voltages are 5, 12, 24 and 28 V dc. The converter is available with single outputs of 5, 9, 10, 12 or 15 V dc and dual outputs of ± 12 , ± 15 , +12 and -5, and -12 and +5 V dc. Efficiency is rated at up to 60%. Regulation is 0.4% (line plus load) and the case operating temperature is -25 to 71 C. The size is 2.35 \times 2.125 \times 0.4 in.

CIRCLE NO. 424

odds·on choice



in trimming potentiometers

Take the gamble out of "set and forget" circuit adjustments in both consumer and industrial applications with our new RVA/RVG subminiature carbon and cermet trimming potentiometers.

All standard resistances in 1/5, 1/3, 1/2 and 1 watt ratings with either vertical or horizontal mountings, are included in the line. Manufactured on a stable alumina base these pots stay put and have an extremely high resistance to adverse environments, shock, vibration, humidity and solder flux.



Odds are these new tiny trimmers are just what you require. Write for complete catalog to: Murata Corporation of America, 1148 Franklin Road S.E., Marietta, Georgia 30067. Phone: 404-952-9777. *first in ceramics*

CIRCLE NUMBER 137

THE SUPERIOR PROM PROGRAMMER

PRICED AT \$1695
Personality
Modules \$330



IM 1000 PROGRAMMER UNIT INCLUDES:

- Capacity to program any PROM
- Microprocessor Controller
- Sixteen Key Data Entry Keyboard (0-9, A-F)
- Fourteen Digit Alph-numeric Display
- 32,000 Bits of Internal RAM Memory
- Selectable Baud Rates (110 to 9600)
- Parity Checking (Even, Odd, None)
- TTY Interface (20 MA. Loop)
- EIA RS 232C Interfaces (Two I/O Ports)

FOR FURTHER INFORMATION:

IM International Microsystems, Inc.
638 Lofstrand Lane
Rockville, Maryland. 20850
or call: (301) 340-7505

CIRCLE NUMBER 138

ELECTRONIC DESIGN 9, April 26, 1978

900 STANDARD PERMANENT COMPONENT MOUNTS/SPACERS

PROTECT.
SUPPORT.
REDUCE LABOR
AND REWORK.
FROM STOCK.

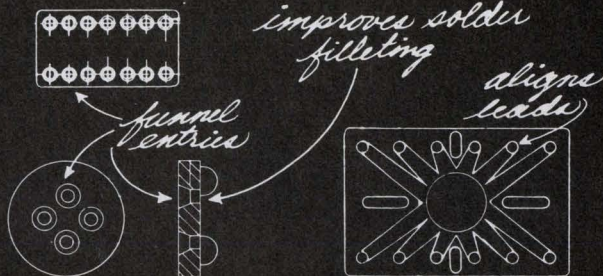
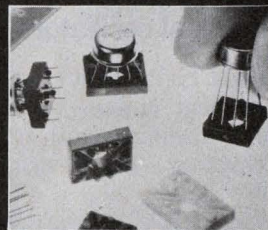

Guards components from shock, vibration and heat damage during assembly. Transistor and Capacitor mounts. Universal spacers, I.C. pads and spreaders. Molded from U.L. rated 94 V-2 material. Free catalog and prices. BIVAR, INC., 1617 E. Edinger Avenue, Santa Ana, CA 92705. (714) 547-5832.

Bivar

CIRCLE NUMBER 139

400 STANDARD WASH-AWAY COMPONENT SPACERS

SAVE ASSEMBLY
TIME.
REDUCE REJECTS
& REWORK.
FROM STOCK.

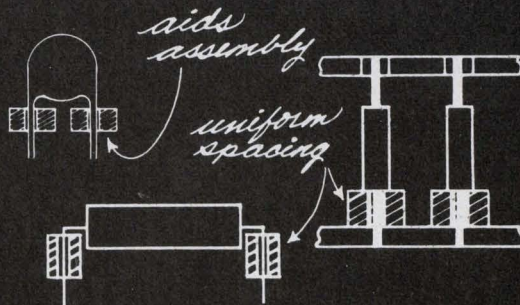
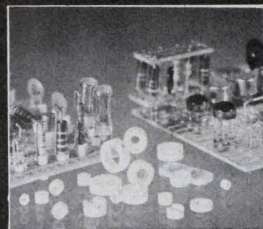

Accurately position components, protect leads, wash-away in hot or warm running water without a trace of residue. Available from stock in over 400 standard sizes. Free catalog and prices. BIVAR, INC., 1617 E. Edinger Avenue, Santa Ana, CA 92705. (714) 547-5832.

Bivar

CIRCLE NUMBER 140

Application notes

IC crystal oscillators

"IC Crystal Oscillators" is a general treatment of how crystal oscillators can be combined with semi-custom IC technology. Interdesign, Sunnyvale, CA

CIRCLE NO. 425

Computer interconnections

"Computer Interconnections" describes methods with which the HP 1000 computer systems and HP 9825 desktop computers can be interconnected to serve together in a wide range of instrument-control, measurement and analysis applications. Hewlett-Packard, Palo Alto, CA

CIRCLE NO. 426

Nomograms

A series of nomograms simplifies the design of switched-mode-converter power transformers. Each of the three basic transformer designs, push-pull, forward and flyback, have a separate set of design nomograms. Brief instructions and a typical design example are given for each nomogram. The nomograms are bound in three ring-binders and reproduced on sturdy reinforced paper. Single copy price is \$8.95. Ferroxcube, Linear Ferrite Marketing, 5083 Kings Highway, Saugerties, NY

CIRCLE NO. 427

Multipliers

Many ideas on using multipliers, dividers, squarers and square rooters to solve analog problems with simplicity and low cost are shown in a 40-page guide. In addition to over 30 applications, the book includes a section on theory and a bibliography. Analog Devices, Norwood, MA

CIRCLE NO. 428

TWTs, TWT amplifiers

A 32-page handbook on traveling-wave tubes and TWT amplifiers features articles on the history of the device, its uses, design considerations and terminology. Hughes Electron Dynamics Div., Torrance, CA

CIRCLE NO. 429

Design aids

Display sheet

A 9 × 12-in. adhesive-backed sheet allows designers to simulate full-size planar gas-discharge displays for clock and front-panel readouts. Printed in neon orange on a black background, the PGD letters, numbers, and symbols, in several font styles for 1/2 and 1-in. characters, are practical aids for mock-ups. Beckman Helipot Division, Santa Ana, CA

CIRCLE NO. 430

Command reference

Descriptions and functions of more than 300 commands for Computer Automation's CAPABLE 4000 series of automatic-test equipment are featured in a booklet. Commands and subcommands are written in TOPS (Test-Oriented Programming System). Computer Automation.

CIRCLE NO. 431

Templates

General-purpose templates, including metric circles, squares, sketch aid and pocket aid, are shown in a guide. Bishop Graphics.

CIRCLE NO. 432

Thermocouple wire

A guide for selecting thermocouple wire, covering temperature from -300 to +2800 F, provides information on color codes and standard and special limits of error. Havg Industries.

CIRCLE NO. 433

Buzzword guide

"Sherry's Guide to Data Communication Buzzwords," a 24-page pocket-sized booklet, defines 183 data-communications and data-processing terms. Racal-Milgo.

CIRCLE NO. 434

Switches and keyboards

Characteristics of nine digital switches and low-profile keyboards are highlighted in a product guide. Digitran.

CIRCLE NO. 435

New literature

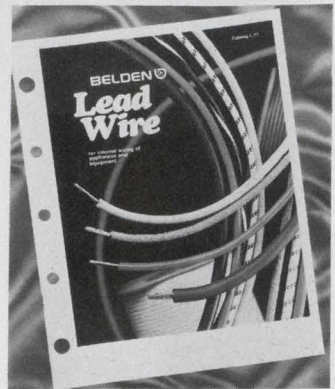

Lead wire

Fourteen basic lead-wire constructions covering over 150 products are featured in a 16-page catalog on lead wire for internal wiring of appliances and equipment. Belden, Oak Brook, IL

CIRCLE NO. 436

Power transistors

A 28-page condensed catalog covers more than 1000 types of transistors, including npn and pnp planar power transistors (2 to 60 A), fast-switching power transistors, triple-diffused transistors (low and high voltages), power Darlingtons (monolithic and discrete), diodes (fast-recovery), hybrids, and chips (standard and custom types). Kertron, Riviera Beach, FL

CIRCLE NO. 437

Test equipment

Specifications and operating characteristics for insulation and dielectric-breakdown testers, high-voltage Schering bridges, megohmmeters, liquid power-factor testers and high-voltage power supplies are provided in a four-page brochure. Beckman Instruments, Cedar Grove Operations, Cedar Grove, NJ

CIRCLE NO. 438

Satellite modems

A six-page booklet introduces communications engineers to the features and applications of microprogrammed modems for digital satellite communications. Linkabit, San Diego, CA

CIRCLE NO. 439

No more square tails in round holes.



Introducing the wave solder PC connector.

What an electronic design engineer will make-do with in a pinch is astonishing. For example — converting wire wrap* PC connectors to wave solder.

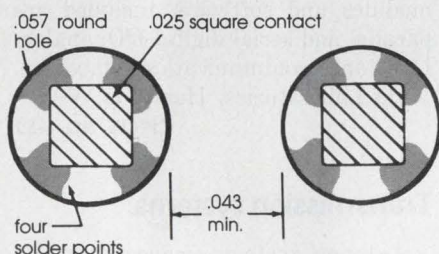

How it's done: you saw off the square .025" tail and push it through a .057" round hole in the PC board. You get only 4 contact points for solder. And there's room for only one tracing between holes. But, so what...it works.

At last — The obvious answer

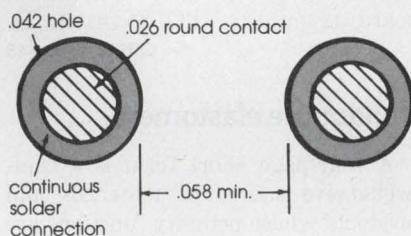

Our own design engineers, not afraid of doing the obvious and simple thing, have done just that. They've taken a series of our PC wire wrap connectors — and given them .026" round tails. Everything else stays the same: the insulator, semi-bellows contacts, pin and row spacing.

So what?

So — the .026" round pin slips into a .042" round hole in your PC board for an excellent solder connection. So — you can now get multiple tracings between rows.

We have two tail lengths: a .200" short one and a .250" longer one to take the AS400 Solderpak** System. These are available in connectors with contacts on .100", .125" and .156" centers, and in layouts from 6 to 50 positions.

Use our coupon and we'll send you all the details.

There's more. There are some things we haven't told you — including materials and other details you need to know. Ask us for the literature.

NAME _____

TITLE _____ TELEPHONE _____ EXT. _____

COMPANY _____

ADDRESS _____

CITY _____ STATE _____ ZIP _____



Viking Industries, Inc. / 21001 Nordhoff Street, Chatsworth / CA 91311 U.S.A.

(213) 341-4330 / TWX: 910-494-2094

*A registered trademark of the Gardner-Denver Company. **A registered trademark of the Raychem Corporation.

CIRCLE NUMBER 233

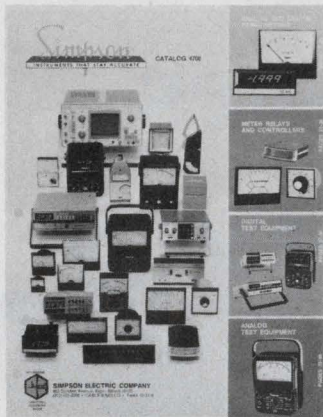

Panel meters

A 60-page catalog lists analog and digital panel meters, meter relays, controllers and test instruments. Simpson Electric, Elgin, IL

CIRCLE NO. 440

Thick-film materials

A product guide to thick-film-material systems for hybrid microcircuits, resistor networks, cermet trimmers, potentiometers and gas-discharge displays permits easy selection of a complete, proven system of thick-film materials to meet performance, processing and cost requirements for a specific application and end-use market. DuPont, Wilmington, DE

CIRCLE NO. 441

Indicator lights

Indicator Lighting Guide No. 1077 is completely revised and covers solid-state LEDs, Tineons (neon or incandescent), integral housing, midget-screws, snaplites, rear mounts, rectangular neons and incandescents, flashers, lighted switches and lampholders. Leecraft, Long Island City, NY

CIRCLE NO. 442

Coaxial cable

A Catalog and Handbook lists all RG/U coaxial cable, with specs and dimensions. The handbook section presents formulas common to all coaxial cable, properties of insulating materials, detailed explanations of all cable parameters and graphs of the most important cable characteristics. Times Wire & Cable, Wallingford, CT

CIRCLE NO. 443

Rf power transistors

An RF Data Manual is packed with data sheets, practical application notes and cross-references. The 736-page volume describes rf power transistors, linear hybrid amplifiers, power hybrid amplifiers and small-signal rf transistors. The book costs \$3.50. Motorola, P.O. Box 20912, Phoenix, AZ 85036

CIRCLE NO. 444

Soldering spec

A new specification, IPC-S-815, "General Requirements for Soldering of Electrical Connections and Printed Board Assemblies," defines the approved materials, methods and inspection criteria for producing the quality of workmanship necessary for soldering electrical connections and printed-board assemblies. IPC, Evanston, IL

CIRCLE NO. 445

Conductive elastomers

A four-page short form is a comprehensive source of materials and products whose primary functions are electrical conductivity or control of radiated energy. It presents a brief description of both conductive-elastomer connectors and EMI-shielding products. Tecknit, Cranford, NJ

CIRCLE NO. 446

Test accessories

Hundreds of test accessories are listed in an 86-page catalog, covering molded patch cords, cable assemblies, test-socket adaptors, spaced molded accessories, molded test leads, connecting leads, banana plugs and phone plugs. ITT Pomona Electronics, Pomona, CA

CIRCLE NO. 447

Relays and accessories

Over 1500 stock relays and accessories are contained in a 40-page catalog. List prices are shown for each item. Potter & Brumfield, Princeton, IN

CIRCLE NO. 448

Microcomputers

A 52-page catalog details a full line of microcomputers and accessories, software packages, parts and literature. Tandy Computers, Fort Worth, TX

CIRCLE NO. 449

Ceramic capacitors

Technical information on reduced barium-titanate disc ceramic capacitors is given in an eight-page bulletin. Sprague Electric, North Adams, MA

CIRCLE NO. 450

Computer-on-a-chip

An overview of the S2000, single-chip μ C, its architecture, special operating modes, specifications, instruction set and the design-support tools available for program development, emulation, testing and analysis is given in a catalog. American Microsystems, Santa Clara, CA

CIRCLE NO. 451

Industrial-control μ C

An eight-page brochure describes a line of microcomputers, digital-logic modules and software. Included are parallel and serial digital-I/O, analog-I/O, and communications modules. Wyle Laboratories, Hampton, VA

CIRCLE NO. 452

Transmission systems

Antenna systems, waveguides and coaxial cables are featured in a 148-page catalog. Cablewave Systems, North Haven, CT

CIRCLE NO. 453

Motors, fans, blowers

Specifications and performance data for precision miniature motors, fans, and blowers are condensed in a 24-page catalog. TRW Globe Motor Div., Dayton, OH

CIRCLE NO. 454

Power supplies

A new product catalog includes complete specs, prices, photos and mechanical drawings of 83 specific power-supply models. Single, dual and triple outputs are available as well as models for floppy-disc/microprocessor applications. Power One, Camarillo, CA

CIRCLE NO. 455

PC-board switches

Features and options of PC-board switches are given in an eight-page catalog. EECO, Santa Ana, CA

CIRCLE NO. 456

LIGHTED INSTRUMENT SWITCHES



Request
Bulletin MIN-1

- Space Savings — Mount on 3" centers
- Switch Ratings — Up to 600V-20A
- Available with 2 or 3 Lights
- All lights have push-to-test feature
- All lights removable from front of panel



ELECTRO SWITCH

Weymouth, Massachusetts 02188

Telephone: 617/335/5200 • TWX: 710/388/0377

CIRCLE NUMBER 222

How do you resolve two signals spaced 1 Hz apart at 2 MHz?

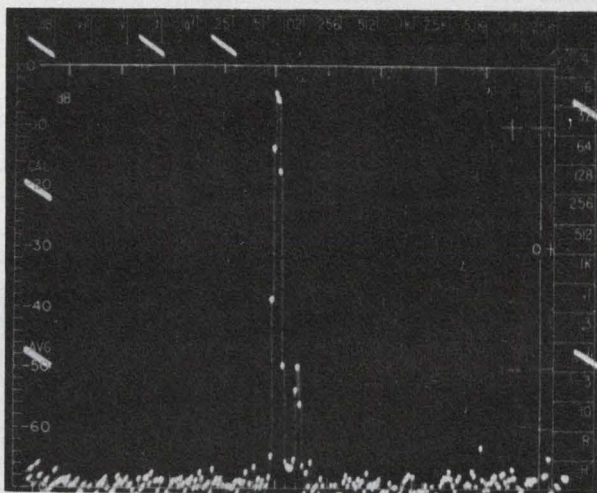

With an EMR Model 1510 Digital Real-Time Spectrum Analyzer and EMR Model 1520 Digital Spectrum Translator. Simply add the optional EMR Model 1521 Range Extension Module to the 1520 Translator, and you have real-time spectrum analysis at frequencies up to 2 MHz!



The CRT photograph illustrates the result. The input signal consisted of two discrete frequencies spaced 1.0 Hz apart, with a 50 dB difference in amplitude. The frequency range covered is 25.6 Hz centered about 1.99000 MHz, and the frequency resolution is 0.1 Hz!

Only EMR offers that much resolution at frequencies up to 2 MHz in real time.

So if you have an analysis problem requiring high-resolution/high-frequency real-time spectrum analysis, contact EMR... we will arrange for a demonstration or detailed information.

Sangamo Weston, EMR Telemetry Division
P.O. Box 3041, Sarasota, FL 33578
813-371-0811

SANGAMO WESTON

Schlumberger

CIRCLE NUMBER 224

235

PLENTY OF POWER PACKS

Small size, hermetically sealed. Promise long life, low ripple, withstand vibration and shock. AC input, DC output. Wide variety of electrostatic and solid state applications. Standard and custom designs available. Off the shelf delivery up to 75 KVDC. Just send your specs.

Write for Technical Data.



Plastic Capacitors, Inc.
2623 N. Pulaski Road
Chicago, Illinois 60639
(312) 489-2229

"Serving industry
for 25 years"

CIRCLE NUMBER 223

ELECTRONIC DESIGN 9, April 26, 1978

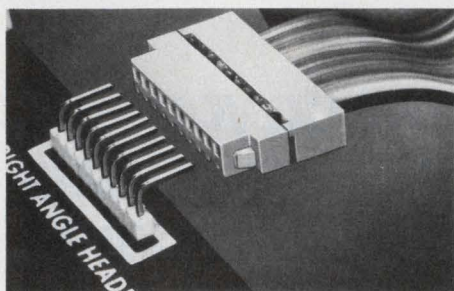

METHODE MASS TERMINATION CONNECTORS FOR CABLE-TO-BOARD RIBBON CABLE ON .100" CENTERS. An industry first, "TERM-APIERCE®" connectors eliminate rejections caused by shorts to adjacent conductors, a major cause for rejects when terminating on .050" centers. 1300-200 Series available in straight-on and right angle versions. 10 to 28 contact positions (22-26 AWG). Tin plated brass contacts. 94V-0 housings. Methode Electronics Inc., 1700 Hicks, Rolling Meadows, IL. 60008 (312) 392-3500.

.100" CENTERS CONNECTORS

181



MAGNETIC SHIELDING Take advantage of Eagle's 23-year background in shield design and production. Custom and standard models. Full service includes design, engineering, fabrication, heat treating, finishing, testing. Also wide selection of sheet and foil so you can form your own shields. For helpful design and cost data, request Bulletin E-77. Eagle Magnetic Co., Inc., Box 24283, Indianapolis, IN 46224, 317-297-1030.

MAGNETIC SHIELDING

184



FREE 16-PAGE BROCHURE ON CONVERTER/CHARGERS from Dormeyer's Coach. Describes plug-in power converter/chargers (filtered & unfiltered DC output), Ni-CAD battery chargers and AC low voltage step-down transformers. Catalog CC-75A has complete data on electrical output, duty cycle, input watts and plug-in case size for each application. Load curves also included. All units described are U/L listed or recognized. DORMEYER INDUSTRIES, 3418 N. Milwaukee Ave., Chicago, IL 60641 (312) 283-4000.

CONVERTER/CHARGERS CATALOG

187



PORTABLE MEGOHMMETERS. Measure leakage on semis, capacitors, wire/cable, printed circuit cards and other insulating materials. GenRad's megohmmeters provide a wide resistance range from 50 k Ω to 200 T Ω ($2 \times 10^{11} \Omega$) with up to 200 test voltages from 10 to 1090 V. Flip-tilt cover protects front panel when transported. The GR 1863 and GR 1864 can be your solution for precise high-resistance measurements. GenRad, 300 Baker Ave., Concord, MA 01742, Tel. (617) 369-8770

MEGOHMMETERS

182



NEW '78-'79 GOLD BOOK OFFERED AT 25% PRE-PUBLICATION DISCOUNT. Upcoming set will contain more than 2,500 pages of information for quickly locating and specifying products used by the electronics industry. Complete with Product, Trade Name, Manufacturers, Distributors Directories and Catalog Compendium. Published in July. Reserve your copy NOW at Pre-Publication Rate of \$22.50 US, Canada and Mexico (Regularly \$30) or \$30 in all other countries (Regularly \$40).

THE GOLD BOOK

185

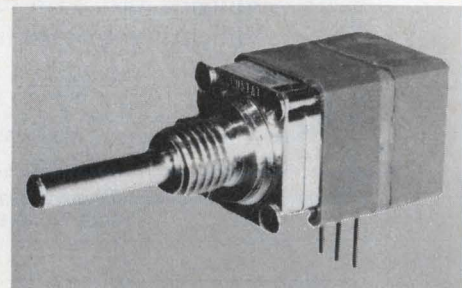

Series 388 Conductive Plastic, Series 389 Cermet Push Drive Potentiometer. Single shaft must be pushed in to operate. Free wheeling in extended position. Prevents accidental changes in critical settings. Various terminal configurations available. Cost per 1,000 series 388 \$1.95 each; series 389, \$2.10 each. Further information available from your local representative or Clarostat Mfg. Co., Inc., Washington Street, Dover, N. H. 03820.

SERIES 388/389

188

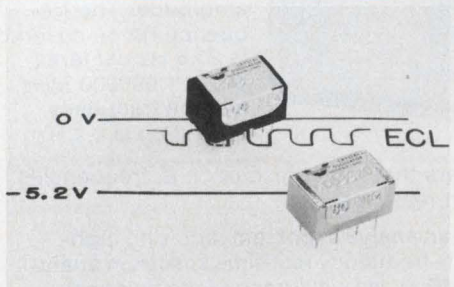

ECL COMPATIBLE DIP CLOCK OSCILLATOR Operates from -5.2 VDC and provides stability of ± 25 ppm over 0-70°C at any frequency in 5-125 MHz range, extended to 300 MHz in a larger package. Improved stability and -55/+125°C operation are both available. CMOS, TTL and sinewave types also included in broadest available line of crystal oscillators. Vectron Laboratories, Inc., Norwalk, CT. Call applications engineering department at 203-853-4433.

ECL CLOCK OSCILLATOR

183

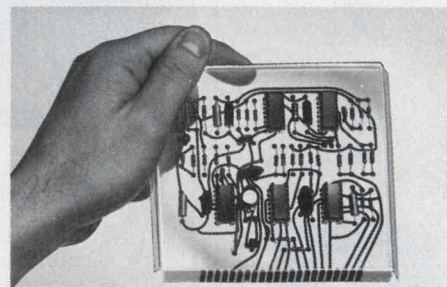

NEW PC DESIGN FREEDOM with Rogers Mektron® circuits now enable use of any insulator down to .015" with metal foils from .001" to .015" of anything from stainless steel to lead. Certain post-formable insulation can convert into complete chassis. Patterns mechanically generated. Call or write Rogers Corporation, 5259 Minola Drive, Lithonia, Georgia 30058 (404) 981-9830

MEKTRON PC's

186

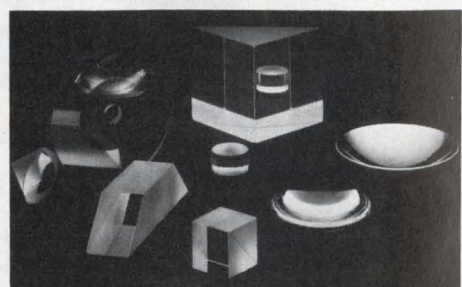

ROLYN OPTICS CO. supplies all types of "Off-the-Shelf" optical components. Lenses, prisms, mirrors, irises, microscope objectives and eyepieces and many others. All from stock. We also supply custom products and coatings in prototype or production quantities. 75 page catalog describes products and prices. ROLYN OPTICS CO., 300 Rolyne Place, Arcadia, CA 91006. (213) 445-6550 - TELEX: 67-5312

OPTICS

189

Electronic Design

ELECTRONIC DESIGN's function is:

- To aid progress in the electronics manufacturing industry by promoting good design.
- To give the electronic design engineer concepts and ideas that make his job easier and more productive.
- To provide a central source of timely electronics information.
- To promote communication among members of the electronics engineering community.

Want a subscription? ELECTRONIC DESIGN is circulated free of charge to those individuals in the United States and Western Europe who function in design and development engineering in companies that incorporate electronics in their end product and government or military agencies involved in electronics activities. For a free subscription, use the application form bound in the magazine or write for an application form.

If you do not qualify, paid subscription rates are as follows: \$30.00 per year (26 issues) U.S./Canada/Mexico, \$40.00 per year (26 issues) all other countries. Single copies are \$2.50 U.S. and all other countries. The Gold Book (27th issue) may be purchased for \$30.00 U.S./Canada/Mexico, and \$40.00 all other countries.

If you change your address, send us an old mailing label and your new address; there is generally a postcard for this in the magazine. You will have to requalify to continue receiving ELECTRONIC DESIGN free.

The accuracy policy of ELECTRONIC DESIGN is:

- To make diligent efforts to ensure the accuracy of editorial matter.
- To publish prompt corrections whenever inaccuracies are brought to our attention. Corrections appear in "Across the Desk."
- To encourage our readers as responsible members of our business community to report to us misleading or fraudulent advertising.
- To refuse any advertisement deemed to be misleading or fraudulent.

Individual article reprints and microfilm copies of complete annual volumes are available. Reprints cost \$6.00 each, prepaid (\$5.00 for each additional copy of the same article), no matter how long the article. Microfilmed volumes cost \$23 for 1976 (Vol. 24); \$30 for 1973-75 (Vols. 21-23), varied prices for 1952-72 (Vols. 1-20). Prices may change. For further details and to place orders, contact Customer Services Dept. University Microfilms, 300 N. Zeeb Rd., Ann Arbor, MI 48106. (313) 761-4700.

Want to contact us? If you have any comments or wish to submit a manuscript or article outline, address your correspondence to:

Editor
ELECTRONIC DESIGN
50 Essex St.
Rochelle Park, NJ 07662

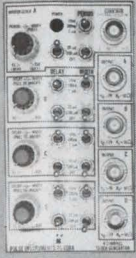

4-CH., 50MHZ CLOCK GENERATOR plug-in for Tektronix TM-500 series power modules. The PI-100A replaces 4 synchronized pulse generators in timing set up applications. Master Clock A variable from 50MHz to 500Hz. Ch. B, C & D each delayable from 10ns to 1ms w.r.t. Ch. A. All widths variable from 10ns to 1ms. 2V min., 50Ω outputs drive TTL's and unterminated lines. Ext. Trig./Gate. \$695. Pulse Instruments Co., 1536 West 25th St., San Pedro, Ca. 90732. Tel: (213) 541-3204

4 CH. CLK GENERATOR 190

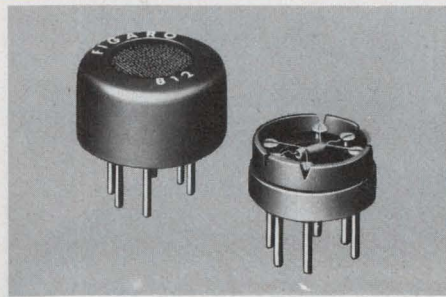

FIGARO GAS SENSOR TGS is a gas sensitive semiconductor. When combustible gas is absorbed on the sensor surface, a marked decrease of electrical resistance occurs. Major features of the sensor include high sensitivity, long term reliability and low cost. The applications are: GAS-LEAK ALARM, AUTOMATIC FAN CONTROL, FIRE ALARM, ALCOHOL DETECTOR, etc. Figaro Engineering Inc., North America Office-3303 Harbor Boulevard, Suite D-8, Costa Mesa, Calif. 92626 Tel: (714) 751-4103 Telex: 6783396

GAS SENSOR 193



POCKET-SIZED RESISTANCE SUBSTITUTION UNIT OFFERS 1% ACCURACY. A slide-switch unit that combines pocket size convenience with a range of over 11 million resistance steps. An excellent tool for circuit design, development, instrument repair and trouble shooting. This model features three binding posts, one to ground case. And, its rugged aluminum construction assures reliability. Available now from stock at a price of only \$58, from Phipps & Bird, Inc., Richmond, Virginia 23261.

RESISTANCE SUB UNIT 191

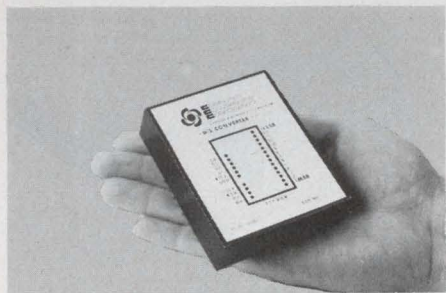

DIGITAL TO SYNCHRO CONVERTERS— 14, 12 or 10 bit input, 11.8/90V, 400 or 60Hz transformer isolated output, accuracy ±4, ±15 or ±30 min. Driving 1VA, 2VA (2.6" x 3.1" x 82"H module) or 5 VA loads (4½" x 9¼" PC card). Price from \$350 in qty. Other CCC products are Synchro to Digital or DC, and DC to Synchro Converters, Solid State C.T.'s or CDX's, and Absolute Encoders. Send for Free Catalog & Application Notes. Computer Conversions Corp., East Northport, N.Y. 11731 (516) 261-3300.

DIGITAL TO SYNCHRO 194

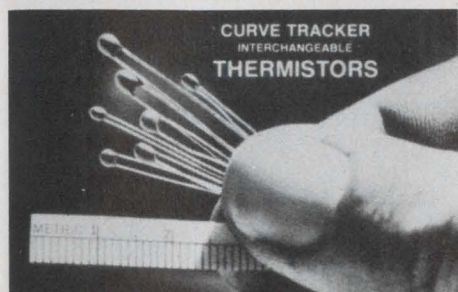

CHIP THERMISTORS combine small size with reliability and low cost. R @ 25°C 50Ω to 500Ω ±10% to ±1%. INTERCHANGEABLE tolerances ±1°C, ±.5°C or ±.2°C. Point matched interchangeables to ±1%. HYBRID CHIPS and PROBES to your specs. WESTERN THERMISTOR CORP., 354 Via Del Monte, Oceanside, CA 92054. (714) 433-4484. TWX 910-322-1983

THERMISTORS 192

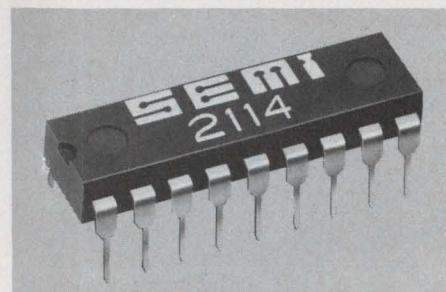

The experienced 2114 4K static RAM. From EMM — the industry's largest supplier of 4K static RAMs — a 2114 with a year and a half of delivery behind it. Not a new part. Just a new pin-out of a proven part. 1K x 4 organization. 5V only. Standard 18-pin DIP. It draws only 300 mw, has all the speed you need for microprocessor applications. EMM/SEMI, Inc., 3883 N. 28th Ave., Phoenix, AZ 85017. (602) 263-0202.

4K STATIC RAMS 195

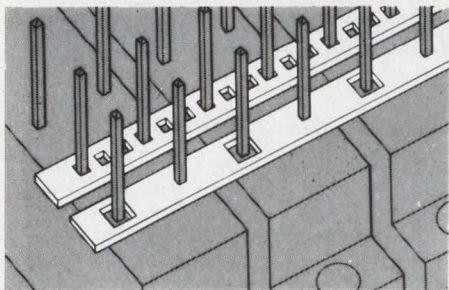

STRIP/BUS BY ROGERS. Low Cost Busing Systems; easy installation, reliable solder joints; greater pin exposure. Write or call for details. Rogers Corporation, Chandler, AZ 85224. Phone (602) 963-4584. (EUROPE: Mektron NV, Ghent, Belgium; JAPAN: Nippon Mektron, Tokyo)

STRIP/BUS

196

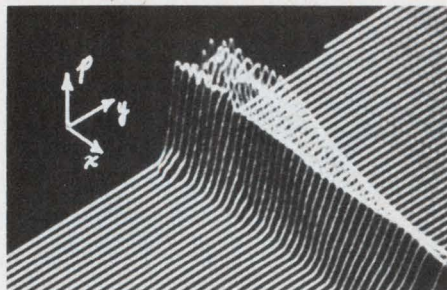

ELECTRONIC ISOMETRIC PROJECTOR generates 3D images of data applied to X, Y, Z inputs. Single-wide plug-in fits the Tektronix TM500 system. Image can be rotated, tilted, and magnified with front panel controls for optimum view. Image may be presented on CRT display, recorder, etc. Input and output offset controls are incorporated. Applications include ultrasonic field mapping and imaging, infrared imaging, eddy current testing, scanning electron microscopy. METROTEK, INC. (509) 946-4778

ISOMETRIC PROJECTOR

199



MINI-STEPS . . . MAXI-STEPPERS PM and VR steppers — responsive and precise — with slewing rates to 20,000 steps/sec and higher. EAD offers an unlimited range of step angles, frame sizes and configurations. High torque/size ratios. Options: dampers, heat sinks, encoders, pulse sources, drivers, present indexers, gear-heads and more. Send for catalog. Eastern Air Devices, Holtzer-Cabot Motors, Dover, N.H. 03820, 603-742-3330. Syn & Ind Motors • Gearmotors • Fans • Blowers

STEPPING MOTORS

202

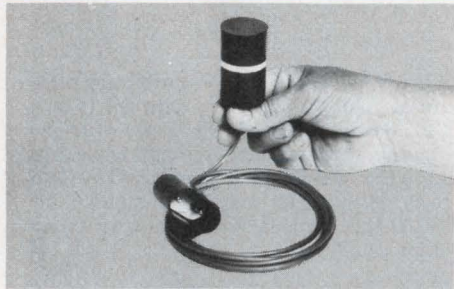

A. C. MAGNETIC FIELD EVALUATOR PROBE accurately measures field intensity. Sensitivity is 60 mV/gauss. Either axial (shown) or transverse pickup coil positions are available. The shielded banana plus on 3/4" centers fit typical input jacks of a V.T.V.M. or oscilloscope. Magnetic Shield Div., Perfection Mica Co., 740 N. Thomas Dr., Bensenville, Ill. 60106. Tel: (312) 766-7800.

MAGNETIC FIELD PROBE

197

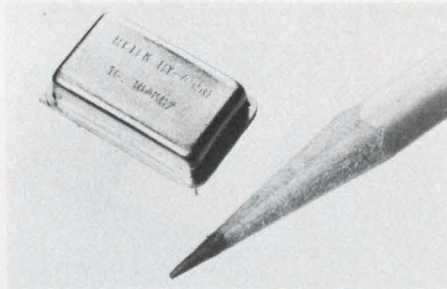

CRYSTAL CLOCK OSCILLATORS Hytek Microsystems, now offers its crystal clock oscillators in an all metal D.I.P. The low power CMOS HY 4560 operates on +5 to +15vdc power drawing only 20mW and is available in frequencies from 600KHZ to 5MHZ. The TTL compatible HY 4550 operates from 250KHZ to 50MHZ and requires +5vdc. Both units measure only 0.815 x 0.515 x 0.200" and offer +0.01% frequency stability. Hytek Microsystems, Inc., 16780 Lark Ave., Los Gatos, Calif. 95030 (408) 358-1991

CRYSTAL CLOCK OSCILLATORS

200

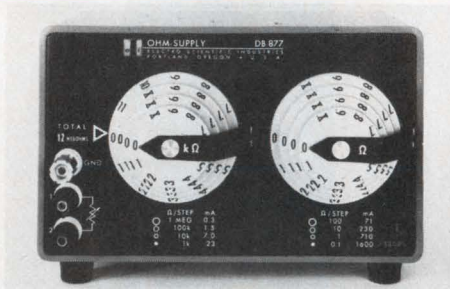

PRECISION DECADE RESISTOR for dc, audio frequency testing. Handy 8-decade DEKABOX® provides .02% accuracy long-term 0.1 ohm through 12 megohms. Features proprietary ESI wirewound resistors, silicone-treated ceramic switch wafers, solid silver-alloy contacts, front terminals. Patented coaxial dials hold 8 decades of fixed resistors with low temp. and power coefficients, providing up to 120 million divisions of resolution. Switching repeatability: ±1mΩ typical. \$575. Electro Scientific Industries, 13900 N.W. Science Park Drive, Portland OR 97229, (503) 641-4141. 203

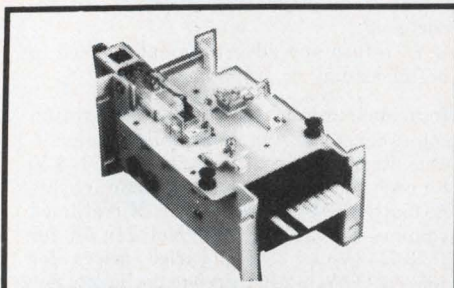

MULTI-TRACK MAGNETIC CARD READER The Model 210/211, from AMP, with multi-track capability. Reads, writes 210 bits per inch, up to 650 bits across card. Adaptable to IATA, ABA, THRIFT tracks. Convenient behind-panel mounting. Special-purpose models for high-density and paper media applications. Write AMP Incorporated, Capatron Division, Elizabethtown, PA 17022.

AMP CAPITRON DIVISION

198

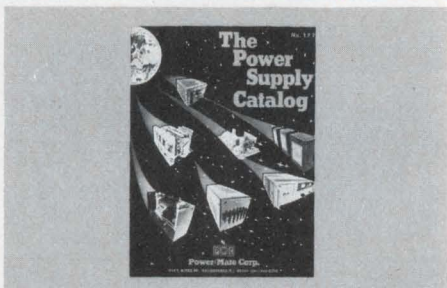

Free New catalog contains over 34,500 quality power supplies from the world's largest manufacturer, Power/Mate Corp. Power Supplies for every application including submodulars, open frame, variorated, encapsulated, laboratory & system. All units UL approved and meet most military and commercial specs for industrial and computer uses. Power/Mate Corp., 514 S. River St., Hackensack, NJ 07601 (201) 343-6294

POWER SUPPLIES

201



FREE new 24-page catalog contains complete specifications and prices on 94 standard models of switching power supplies. Input voltages range from 12Vdc to 115Vac; output voltages from 5 to 48Vdc. Includes single and multiple outputs in modular or PCB configuration. Featured are Industry's lowest cost DC/DC converters and 5-year warranty. ETATECH, INC., 187-M W. Orangethorpe Avenue, Placentia, California 92670. (714) 996-0981.

POWER SUPPLIES

204

Electronic Design

Advertising Sales Staff

Susan G. Apolant
Sales Coordinator

Rochelle Park, NJ 07662

Robert W. Gascoigne
Thomas P. Barth
Stan Tessler
Constance McKinley
50 Essex St.
(201) 843-0550
TWX: 710-990-5071
(HAYDENPUB ROPK)

Philadelphia

Thomas P. Barth
(201) 843-0550

Boston 02178

Gene Pritchard
P.O. Box 379
Belmont, MA 02178
(617) 489-2340

Chicago 60611

Thomas P. Kavooras
Berry Conner, Jr.
200 East Ontario
(312) 337-0588

Cleveland

Thomas P. Kavooras
(312) 337-0588

Los Angeles 90045

Stanley I. Ehrenclou
Burt Underwood
8939 Sepulveda Blvd.
(213) 641-6544

Texas

Burt Underwood
(213) 641-6544

San Francisco

Robert A. Lukas
465 S. Mathilda, Suite 302
Sunnyvale, CA 94086
(408) 736-6667

United Kingdom-Scandinavia

Constance McKinley
50 Essex St.
Rochelle Park, NJ 07662
Phone: (201) 843-0550

Europe

W. J. M. Sanders
S.I.P.A.S.
Raadhuisstraat 24 - P.O. Box 25
1484 EN Graft-de-Ryp, Holland
Tel: 02997-1303 and 3660
Telex: 13039 SIPAS NL
Telegrams: SIPAS-Amsterdam

G. Nebut
Promotion Presse Internationale
7 ter Cour des Petites Ecuries
75010 Paris, France
Telephone: 5231917, 1918, 1919

Dieter Wollenberg
Erikastrasse 8
D-8011 Baldham/Muenchen
Germany

Telephone: 0 8106/4541
Robert M. Saidel
Technimedia International
Via G. Fara, 30
20124 Milan, Italy
Tel: 65.72.765
Telex: 25897 Utdioma

Tokyo

Haruki Hirayama
EMS, Inc.
5th Floor, Lila Bldg.,
4-9-8 Roppongi
Minato-ku, Tokyo, Japan
Phone: 402-4556
Cable: EMSINCPERIOD, Tokyo

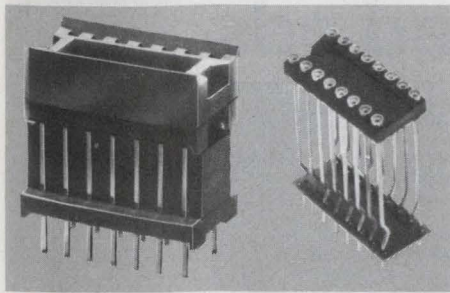

Elevator Sockets. Useful to bring display device to level required. Standard heights available from stock from 1/4" to 1-1/4". Series 8000 with Aries bifurcated contacts available in 14 pin on .300 centers. Also available is complete line of elevator sockets with collet contacts mounted in FR-4 base material, 2 to 64 pins. Specials for any alpha-numeric display. Aries Electronics, Inc., P.O. Box 231, Frenchtown, NJ 08825. (201) 996-4096 TWX 510-235-3391

ELEVATOR SOCKETS

205

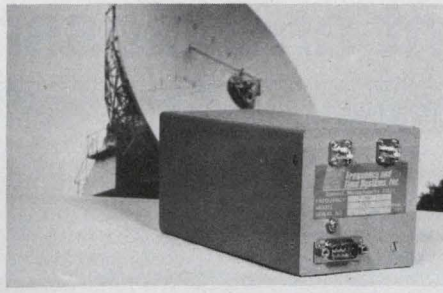

WHY USE A RUBIDIUM? $< 5 \times 10^{-11}$ /DAY AVAILABLE IN RUGGED OCXO from people who delivered the first cesium atomic clocks in space. Model 1000 can meet your needs at 1/2 cost offering lowest phase noise (< -118 db at 1 Hz) close to the carrier. Can be radiation hardened. Excellent short term stability $< 8 \times 10^{-12}$ /100s (σ_T). LINEAR VCO. Dual 1 VRMS (50 Ω) outputs. 5 (stock), 5.115, 10, 10.23 MHz available. Frequency and Time Systems, Inc., 182 Conant St., Danvers, MA 01923 (617) 777-1255 Telex: 94-0518

RUGGED OSCILLATOR

208

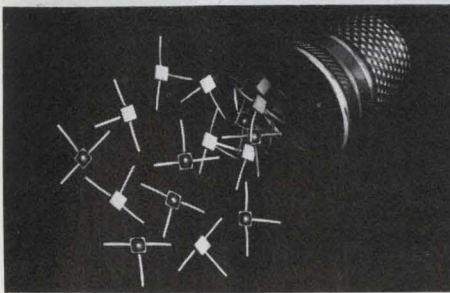

TaNFilm™ precision subminiature resistor networks from TRW, the world's smallest 1/4-watt resistor, has proven its performance, reliability and space-saving design in ultra-high-speed computers, line terminations and microwave attenuation. Useful at frequencies up to 2 gigahertz, the network offers low noise and excellent high-frequency characteristics for RF or high-speed switching operations. TRW/IRC Resistors, an operation of TRW Electronic Components, 4222 S. Staples St., Corpus Christi, TX 78411. (512) 854-4872.

RESISTOR NETWORKS

206



For Sale . . . Now . . . more than 2,471 state-of-the-art instruments and this Intellec MDS-800 Microcomputer Development System, for only \$3,600.00, is just one of them. (Plus, ICE-80 for only \$1,375.00). Immediate worldwide delivery. Call (617) 273-2777 or (212) 993-7368 TODAY, or write for a free catalog to REI SALES COMPANY, 19347 Londe-lius Street, Northridge, CA 91324

FREE SALES CATALOG

209

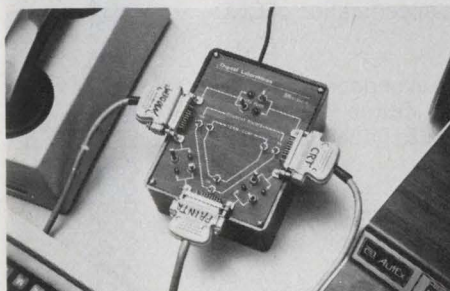

UNIVERSAL JUNCTION UNIT . . . for three devices, RS232C or current loop.

. . . Six switches provide all 63 interconnects that are possible between three I-O devices. LED's indicate data flow. . . .

. . . Designed to provide circuit compatibility and easy data routing between different manufacturer's devices. . . .

. . . \$350 (1-4) from DIGITAL LABORATORIES, 600 Pleasant St., Watertown, MA 02172 (617) 924-1680

3 PORT RS232 & 20 MA LOOP

207

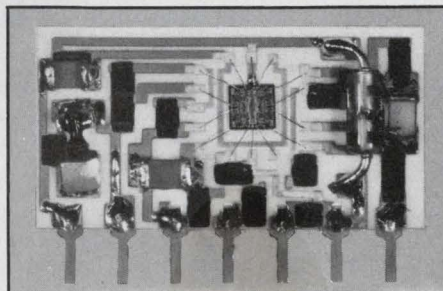

ULTRA SMALL ACTIVE BAND PASS FILTER fabricated using OP Amp incorporated Hybrids Circuit. Operating Voltage 1-2.5V/4-15V, Frequency Range 288.5-2800Hz, Q 180+20, 35+5 and etc. .788" x .138" x .433". By adding Feed Back Circuit of extra Diode and Capacitor, it does the job of small but reliable Oscillator. Active Filters can be tailor-made to customer's specifications. IWATA ELECTRIC CO., LTD. Mansei Bldg., 1-1-16 Sotokanda, Chiyoda-ku, Tokyo, Japan.

ACTIVE FILTER

210

★ABP

BPA

Electronic Design

recruitment and classified ads

PLACE YOUR AD AT ONLY \$55 PER COLUMN INCH IN

Electronic Design

— GET A REPEAT AD FREE!

With our 2 for 1 plan, your net cost in *Electronic Design* is only \$27.50 per column inch, lowest among all the national newspapers and electronics media. You get a total of 165,418 exposures to OEM engineers and engineering managers (not counting 11,668 more among general or corporate managers) at only 33¢ per thousand! You can't beat the price. You can't beat the coverage and you can't beat the quality.

YOU REACH ENGINEERS WITH TITLES LIKE THESE:

- Chief Engineer • Development Engineer • Design Engineer • Project Engineer • Electronic Engineer • Engineer-Supervisor • Section Leader • Staff Engineer • Systems Engineer • Test Engineer • Standards Engineer • Master Engineer

Electronic Design RECRUITMENT ADVERTISING RATES

15% commission to recognized agencies supplying offset film negatives. 2% 10 days, net 30 days. Four column makeup. Column width 1-3/4" x 10".

| SPACE | DIMENSIONS | | COST |
|----------------------|--------------------|------|---------|
| | Wide | Deep | |
| One column inch | 1-3/4" x 1" | | \$55. |
| 2 col. in. | 1-3/4" x 2" | | \$110. |
| 1/16 page (1/4 col.) | 1-3/4" x 2-1/2" | | \$130. |
| 1/8 page (1/2 col.) | 1-3/4" x 5" | | \$275. |
| 1/4 page (1 col.) | 1-3/4" x 10" Vert. | | \$550. |
| | 3-1/2" x 5" Hor. | | |
| 1/2 page (2 cols.) | 3-1/2" x 10" Vert. | | \$1100. |
| | 7" x 5" Hor. | | |
| 3/4 page (3 cols.) | 5-1/4" x 10" | | \$1650. |
| 1 page | 7" x 10" | | \$2200. |

NOTE: EACH RECRUITMENT AD YOU PLACE WILL BE REPEATED FREE OF CHARGE!

LATE CLOSING DATES

Electronic Design is mailed every two weeks. Because of its timeliness, personnel recruitment advertising closes only two weeks before each issue's mailing date.

| Issue Date | Recruitment Closing Date | Mailing Date |
|------------|--------------------------|--------------|
| May 24 | April 28 | May 12 |
| June 7 | May 12 | May 26 |
| June 21 | May 26 | June 9 |
| July 5 | June 9 | June 23 |
| July 19 | June 23 | July 7 |



HOW TO PLACE YOUR AD

CALL THE RECRUITMENT HOT LINE 201-843-0550

Camera-ready film (right reading negatives, emulsion side down) or camera-ready mechanicals must be received by deadline. Or, if you wish us to set your ad (typesetting is free) simply pick up the phone and call our RECRUITMENT HOT LINE — (201) 843-0550. Ask for:

Constance McKinley
RECRUITMENT ADVERTISING MANAGER
ELECTRONIC DESIGN

50 Essex Street, Rochelle Park, New Jersey 07662

CCD/LSI Engineers

The opportunities you're looking for are with us in Orlando, Florida.

The Microelectronics Division of Martin Marietta Aerospace has several engineering openings in an expanding advanced technology environment. Ground has been broken on our new 50,000 square ft. microelectronics facility, which will contain the latest design, fabrication and test equipment. Individuals with the following experience are encouraged to respond.

CCD Design Engineer—You should have experience in the design of CCD circuits, with a basic working knowledge of CCD fabrication techniques. Experience with focal plane array is especially desirable. Your involvement will include ground-floor responsibilities for the design and specification of CCD arrays for I.R. Detectors.

CCD Process Engineer—The hands-on process engineer we seek should have experience in PMOS and NMOS CCD processes, utilizing polysilicon, ion implantation, and planar structures techniques. You will be involved in equipment procurement and the installation of a new pilot line. Experience in fabricating large area focal plane arrays is highly desirable.

Bipolar LSI Design Engineer—This opportunity for an experienced engineer requires a knowledge of bipolar processing and fabrication techniques. Experience with linear and/or ¹L is very desirable. Your responsibilities will involve designing custom LSI circuits for advanced military systems.

Explore these career opportunities in greater detail by sending your resume in confidence to: Dr. David Meyer, Deputy Director of Microelectronics, Martin Marietta Aerospace, P.O. Box 5837—MP#9, Orlando, Florida 32855.

We are an equal opportunity employer, m/f.

MARTIN MARIETTA

MARTIN MARIETTA AEROSPACE

Come join me at Hughes and be part of the new world of electronics.

It's a good feeling to be in the vanguard of technology with employment stability through dynamic growth and diversification!

For Immediate Openings In:

Circuit Design Engineers

Experienced in RF, IF, Video, and A/D circuit design for use in Signal Processing in both airborne and space applications.

Digital Logic Design Engineers

Experienced in design and development of digital circuits using TTL, STTL, ECL and CMOS technologies.

Software Development Engineers

Experienced in the development of software for special purpose digital processors. Digital hardware background experience desired.

Product Design Engineers

Experienced in extremely high density physical and thermal designs for airborne and spaceborne signal processing.

Project Engineers

Experienced in the management of all aspects of a project including management of subcontracts and remote manufacturing facilities.

Digital Module Test Engineer

Experienced in developing software for automatically testing digital modules.

Digital Associate Engineer (Non MTS)

Having good rapport with digital logic design, logic schematics and the conversion of these to a computerized interconnect data base.

Actual Hughes Scientific and Engineering Manpower Growth Curve
This chart indicates the Company's extraordinary record of growth with stability in the dynamic electronic technology industry.

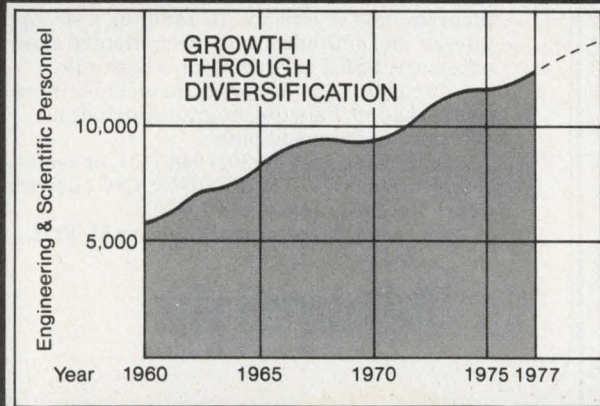

Call now—call collect: Richard Fachtmann, Assistant Manager, Signal Processing Laboratory, (213) 391-0711, Ext. 3904.

Or send resume (referencing this ad) to: Professional Employment C, Aerospace Groups, 11940 W. Jefferson Blvd., Culver City, Ca 90230.

HUGHES

HUGHES AIRCRAFT COMPANY
AEROSPACE GROUPS

U.S. citizenship required. Equal opportunity M/F/H/C employer

SCIENTIFIC SYSTEMS ENGINEERS

McDonnell Douglas, St. Louis is seeking individuals with degree in Industrial Engineering or Computer Science and with experience in FORTRAN programming. Must have background in one or more of the following areas:

Geometric Modeling Computer Graphics
Simulation Models Data Base Systems
Distributed Processing

Explore the possibility of joining our team of skilled professionals in the expanding Computer Aided Manufacturing area developing advanced systems and technology by sending your resume to:

W. B. Kellenberger
Section Manager,
Professional Employment
Department EDN-78SE
P.O. Box 516
St. Louis, Missouri 63166

MCDONNELL DOUGLAS

CORPORATION

An Equal Opportunity Employer m/f

AMP INCORPORATED

Internationally known, ranking among the top 500 publicly held U.S. industries, and with major product lines in commercial fields, has opportunities for:

ENGINEERS (ELECTRONIC PACKAGING)

To work with engineering team in the continued development of a premolded chip carrier and automatic assembly process which will produce finished electronic devices on strip. Should have knowledge of plastic materials, metals, stampings, plating, cleaning, testing, wirebonding. Experience in designing, building and operation of semiconductor packaging line helpful.

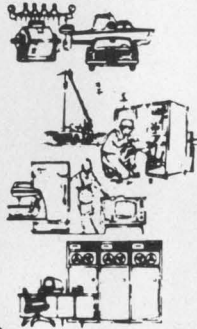

Please send resume in confidence to:
Thomas J. Sullivan
Area Personnel Manager

**AMP
INCORPORATED**

P.O. BOX 3608
Harrisburg, PA 17105

We Are An Equal Opportunity Employer M/F

MARKETING MANAGERS ... PRODUCT MANAGERS ... SALES ENGINEERS ...

Who have had successful track records and are ready for greater challenges and rewards.

Advertising space sales and marketing counseling at Hayden Publishing can offer you those challenges and rewards. A career filled with challenges—a new and different one with each of hundreds of clients—one in which the personal and monetary rewards are high—it's not just a job—it demands a highly self-motivated individual with a strong desire for personal recognition who's willing to use every ounce of energy, experience and education—are you ready for this career?

If you are ready, Hayden Publishing's **Electronic Design**, **Computer Decisions** and **MicroWaves** are expanding and want the brightest and the best. Ideal candidates would have demonstrable sales and marketing successes and engineering and business management education.

Send resume with salary history and requirements to:

V. Daley, Hayden Publishing Company, Inc.,
50 Essex Street, Rochelle Park, NJ 07662.

Equal Opportunity Employer M/F

Sales Engineer Microprocessor Development Systems

Experience as a design engineer, applications engineer or sales engineer working with minicomputers, minicomputer systems or microprocessor systems will provide you the opportunity to join the Tektronix sales team.

We need professionals with hardware, software and microprocessor experience. Product and sales training will be provided for you.

Applicants should have a current knowledge of digital hardware systems and assembly language programming experience. In addition, a strong interest and aptitude in customer oriented sales is necessary. BSEE or equivalent is desirable.

Competitive salary program includes incentive compensation. Benefits programs include a substantial retirement plan.

Call Mike Jones at (301) 948-7151, or send a complete resume to TEKTRONIX, INC., 2 Research Court, Rockville, Maryland 20850.

An Equal Opportunity Employer M/F/H.

Tektronix
COMMITTED TO EXCELLENCE

CONSOLE COMMUNICATIONS SALES

Due to market potential and rapidly increasing sales in Communications Division of diversified electronics manufacturer (music amplification/P.A. systems, law enforcement radar, communications products), a new position exists for person with some or all of the following qualifications: electronics-related or technical degree; comprehensive knowledge of (FM 2-way) land mobile communications and/or telephone switching systems; familiarity with D.P. language and logic; demonstrated success in sales of electronics products and systems; experience in dealing with law enforcement and government agencies. Moderate to heavy travel. Salary, draw, commission, bonus, car, expenses. Position will be on East Coast. Relocation may or may not be necessary, depending on location of person hired. Please send resume, including earnings history and expectation in confidence to:



Kustom
Electronics
Inc.

Mr. Bruce Keeton
Personnel Director
1010 W. Chestnut
Chanute, KS 66720

"World Leader In Traffic Safety Radar"

An Equal Opportunity/Affirmative Action Employer

RF Engineers

Enter a challenging, creative, energetic small but expanding company. Massa Products Corporation is a rapidly expanding manufacturer of sophisticated commercial electronics equipment.

Our growth has created a need for a creative individual with a minimum of two years' experience in RF circuit design in the VHF and UHF frequency bands. Some knowledge of FCC regulations would be helpful.

Salary is commensurate with experience and qualifications. We offer an excellent benefits package, including profit-sharing. We firmly believe in promotions from within.

Please send resume in confidence, or call Dick Carpenter at 963-6363.



Massa Products Corporation
61 Teed Drive, Randolph, Mass.

An Equal Opportunity Employer

ELECTRONIC SALES

Because of new product lines and expansion of sales, marketing positions available for persons with successful background in sales of sophisticated electronic products or systems. Prefer electronics-oriented degree but will consider persons with comprehensive electronics sales background who have non-technical degree or at least 2 years college. Would consider persons who have been in middle management positions with large police department or highway patrol and have technical and sales aptitude or experience. Experience in dealing with government agencies and law enforcement personnel highly desirable. Draw, commission, bonus, car, expenses. Moderate to heavy travel. Positions available in Southeast Central, West Central U.S. and East and West Coasts. Resumes, with earnings history and requirements, may be sent confidentially to:

Box #9 RLC

CSC

ENGINEERS

**We're Seeking Engineering Talent,
And We're Rewarding It As Well!**

Computer Sciences Corporation, Systems Division, is seeking qualified communications professionals. Individuals with a desire to learn more and to contribute more to their field. And for these people, CSC Systems Division is providing outstanding opportunities for continued professional accomplishment and for personal growth within our organization. We also are offering highly competitive incomes and more than generous benefits. Investigate immediately if you meet the requirements listed below ...

ENGINEERS to analyze antenna system performance and power budgets and analyze and interpret antenna patterns. Qualifications include BSEE, 4-8 years experience in VLF to HF antenna systems, preferably submarine antennas — buoyant cables, mast mounted, towed buoys.

ENGINEERS to provide technical, engineering and management support to Navy SSN communications program. Qualifications include BSEE or Naval Sciences, experience in submarine communications and/or command systems.

ENGINEERS to manage Coordination Drawing program to support Navy Special Communications project, design system interface, prepare coordination drawings. Qualifications include BSEE, 1-4 years coordination drawings, mechanical or engineering drafting experience.

ENGINEERS to provide engineering and management support to Customer's VERDIN and Cesium Beam Frequency Standard Programs. Qualifications include BS, 2-5 years background in engineering, configuration management or logistics.

Please send resume to:

William E. Penn
Professional Staffing Representative

We aggressively support
equal opportunity and
affirmative action.

Systems Division
6565 Arlington Boulevard
Falls Church, VA 22046

**COMPUTER
SCIENCES
CORPORATION**

Major Offices and Facilities
throughout the World

Constance McKinley
RECRUITMENT ADVERTISING MANAGER
ELECTRONIC DESIGN
50 Essex Street, Rochelle Park, New Jersey 07662
(201) 843-0550

**I'm interested in placing recruitment
advertising in *Electronic Design***

Issue _____ Size of ad _____
 My copy is enclosed I need more information
 Name _____
 Title _____
 Company _____
 Address _____
 City _____ State _____ Zip _____
 Telephone _____



Engineers

Our Hunt Valley complex, located in the northern suburb of Baltimore, has immediate openings in two engineering departments.

The Nuclear Instrumentation Control Department has requirements for engineers with experience in analog and digital circuit design. Responsibilities include the development and design of instrumentation and control equipment and systems for commercial and naval nuclear programs.

Requirements:

- BSEE with minimum of 5 years design experience.
- Ability to analyze designs and present results.
- Desire to apply innovative solutions to complex engineering problems.

The Integrated Logistics Support Engineering Department is involved in a variety of long-term automated test projects and has needs in the following areas:

Software

Applicants should have BSEE and major specialization in computers or with BS in Computer Science and a knowledge of digital and analog circuit design and at least 2 years experience in one or more of the following areas:

- Design and generation of analog/digital test application software
- Design and generation of ATE executive and support software.

Logistics and Maintenance

Applicants should have BSEE with advanced statistics and/or numerical analysis courses with a minimum of 2 years experience in one or more of the following: logistics models, simulation models, logistic support analysis, support equipment requirements, maintenance planning.

Digital Hardware Design

Responsibilities include systems specifications and design utilizing advanced microprocessors and microcomputers as applied to sophisticated electronic test problems. Minimum of 2 years experience and BSEE degree.

Electronic Design

Requires capability in solid state electronic design. Should have at least 2 years experience in analog and digital testing of military avionics sub-assemblies. BSEE required.

IF or RF Electronic Design

At least 2 years design experience involving very stable oscillators and other RF circuitry operating at X-band. BSEE degree.

For consideration, please send resume, stating present salary, and indicating department of interest, to:

R.A. Richmond, Dept. 401
Westinghouse
P.O. Box 1693
Baltimore, MD 21203

An Equal Opportunity Employer

Westinghouse

PROJECT SUPERVISOR Microprocessor Based to \$37,000

Will supervise engineers and programmers developing this State-of-the-Art electronic system. Key position with high visibility. Must have previous supervisory experience and a BS/MSEE. The essential technical skills are logic design, systems architecture and microprocessor applications.

We also seek design engineers for this project. Minimum one year experience. Salary to high \$20's.

For additional information contact Steve Ford or George Winton at (617) 426-4180. Please include salary history when submitting resume. Our client company assumes all fees.

ROGERS & SANDS

100 Federal Street
Boston, MA 02110

Member of
Mass. Professional Placement Consultants

ENGINEERS

The needs of our client firms, nationwide, for EE's, ME's, ChE's continues to expand and our recruitment program for 1978 is actively underway. Twenty years of successful engineering placement assures motivated, career conscious professionals a vehicle to realize the growth they desire. We provide personalized, confidential service and invite calls or letters of interest to be directed to: E. LUTTINGER

**J.W. Willard
Associates, Inc.**

One Lincoln Center, Syracuse, N.Y. 13202
(315) 422-5111

Fee Paid/EEO Employer M/F National Affiliates

SEMICONDUCTOR PROCESS ENGINEER

Must have thorough knowledge of semiconductor process technology. Silicon rectifier manufacturing experience preferred. Excellent opportunity for right person to take charge of all process engineering. Send resume including salary history to: Mr. H. Kolokowsky, V.P. Manufacturing.

ELECTRONICS DEVICES, INC.

21 GRAY OAKS AVENUE
YONKERS, NEW YORK 10710

An Equal Opportunity Employer M/F

7 OPENINGS

PICK YOUR STATE AND POSITION. Critical needs exist in FL, GA, AL, MS, LA, TX, NC, SC, KY, & TN. We have 192 affiliates in the U.S. to help. Confidential and no fees.

LANDRUM PERSONNEL ASSOCIATES
P.O. Box 1373, Pensacola, FL 32596; 904/434-2321

SALES ENGINEER

We are a medium size Electronic Manufacturer with a challenging opportunity for an aggressive Degreed Sales Engineer who has 2 to 3 years experience in sales preferably in selling Machine Control Equipment.

This position involves sales to machine builders nationwide and some travel is required. Salary commensurate with experience.

Please submit complete resume to,

J. R. Mueller
Stewart-Warner Electronics
1300 N. Kostner
Chicago, Ill. 60651

an equal opportunity employer m/f

CLASSIFIED

PRINTED CIRCUIT BOARD GRAPHICS

Precision artwork films produced from your schematic and layout requirements.

- Guaranteed Accuracy
- Fast Service
- Full Documentation

RODRIGUEZ APPLIED SYSTEMS

1312 Pacific Coast Highway
Hermosa Beach, CA 90278
(213) 372-8103

ISOLATED-PAD-DRILL-MILL

or - Professional Breadboards, add to/modify existing etched boards. Complete set of (3) tools with replaceable No. 60 Carbide Drill IP6003C, \$30.00. A.F. Stahler Co., P.O. 354, Cupertino, CA 95014 (408) 252-4219

ETCHING MACHINE WANTED

for printed circuits. 1 chamber, min. sheet size 12 in. x 16 in.

American I.D., 145 58th St.,
Brooklyn, N.Y. (212) 492-3400

KEEP
ELECTRONIC DESIGN'S
GOLD BOOK
HANDY
WHEN YOU
CALL

DIVISION SALES MANAGER

Sale of Solid State

Power Conversion Systems

We are an international electronic firm on the move ... stocks traded on the NYSE. We need a pace-setter Sales Manager looking for an opportunity to organize and develop an ongoing dynamic multi-million dollar division into a \$50 million operation. This individual will possess personal initiative, drive, organizational and sales ability.

The individual we seek will be technically educated with a degree and a minimum of 5 years progressive experience in budgeting, product planning and development, and marketing. This person will have supervisory experience and may presently be employed in a sales management capacity of a \$100 million corporation. A primary requirement will be the capacity to develop strategy and sustain diverse marketing activities in both commercial and defense markets. Approximately 30% air travel required.

We offer challenge, a chance to pull out the stops and show what you can do. And, of course, our salary is commensurate with experience, and complemented by a salary incentive program. You will love our location near a large metropolitan city in the Southwest. For the right person we have a lot to offer.

If you are ready for a move up, send your resume with salary history in strict confidence to:

Mr. Bob Williams

Varo, Inc., P.O. Box 401426, Garland, TX 75040

Electronics

COMMUNICATION SALES ENGINEER (ELECTRONICS)

Due to rapidly increasing sales in Communications Division of diversified electronics manufacturer (music amplification, law enforcement radar, console communications products), an important position exists for person with electronic-related degree who has comprehensive knowledge of land mobile communications and/or telephone switching systems and equipment.

Requires some experience in sales and/or sales support function. Duties include customer interface, proposal preparation, and technical support. Potentially moderate travel. Position based in Kansas City area. Interview and relocation expenses paid.

Please send resume, including earnings history and expectation, in confidence, to:



Kustom
Electronics
Inc.

Bruce Keeton
Personnel Director
1010 W. Chestnut
Chanute, KS 66720

"World Leader In Traffic Safety Radar"
An Equal Opportunity/Affirmative Action Employer

Sales

ELECTRONIC SALES ENGINEER

Due to expansion of sales and product lines, position available for person experienced in electronic communications equipment sales. Prefer electronic-related or technical degree. Will call on both established and new accounts, requiring moderate overnight travel. Draw, commission, bonus, company car and expenses. Salary potential limited only by individual performance. Earnings of employees in this position average app. \$32,000. Positions available in San Francisco, Memphis, and Chicago.

Please send resume including earnings history, and expectations, in confidence, to:

HAYDEN PUBLISHING CO., INC.
BOX 8RR, 50 ESSEX ST.
ROCHELLE PARK, N.J. 07662

An Equal Opportunity/Affirmative Action Employer

Schlumberger

MICROWAVE DESIGN ENGINEER

Industry leader has an immediate need for experienced engineer with working knowledge of microwave systems. The position involves the conception and design of sophisticated high temperature instrumentation to be used in our worldwide logging operations.

Advanced degree required — MS or Ph.D in electronics or Physics. Experience in analog and digital circuits, electromagnetic theory, and communications is desired. Applications involve development of systems for measuring propagation characteristics in earth formations at high temperatures.

Outstanding facilities provided, high-caliber supporting personnel, exceptional benefits and working conditions. Permanent positions — no term contracts.

Send resume to:

T. E. Holmes

We Are An Equal Opportunity Employer M/F

Schlumberger Well Services

P.O. Box 2175 Houston, Texas 77001

We Are an Equal Opportunity Employer M F

Constance McKinley
RECRUITMENT ADVERTISING MANAGER
ELECTRONIC DESIGN

50 Essex Street, Rochelle Park, New Jersey 07662

(201) 843-0550

Recruitment Ads Pull

IC Test Engineer S. Florida

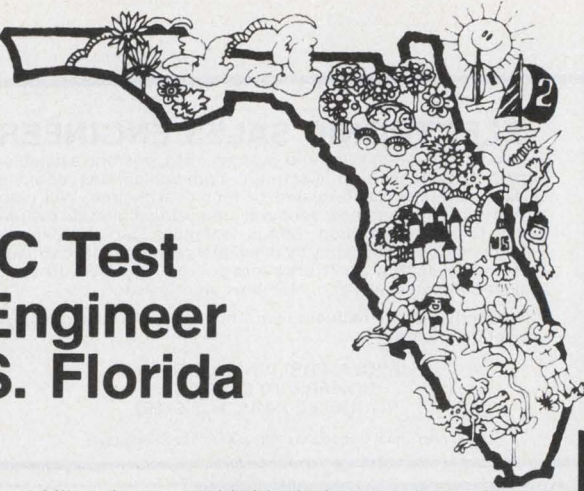

Racal-Milgo, Inc., a worldwide designer and manufacturer of data communication equipment, is looking for an IC test engineer with programming experience on the Fairchild "Sentry" system, the Tektronix System or the Macrodata System.

Qualified individual must have a strong background in State of the Art semiconductor technology. Experience in device design or component evaluation of LSI technologies helpful. BSEE or MSEE desired.

The successful applicant must be able to communicate and interface well with others in order to effectively administer program development and characterization testing on a "Sentry VII" system. Position includes both technical and supervisory responsibilities.

We offer excellent salary and a complete benefits package. If you are looking for a challenging, rewarding career in the communications industry and can meet these requirements, we welcome your reply. Send your resume in complete confidence to Laura Jack, Employment Manager, or call collect (305) 591-5214.

Racal-Milgo —the new name for ICC

8600 N.W. 41st St., Miami, FL 33166 (305) 592-8600



Equal Opportunity Employer

ENGINEERS— MANAGERS

\$18,000 to \$35,000

FREE PROFESSIONAL CONSULTING

Nationwide opportunities with client firms in:
**Telecommunications, RF/Microwave, Computer Software/Hardware,
Military & Commercial Communications Circuits/Systems Design.**

Is the flood of recruiting ads too much? Then leave the work to us—
at **NO COST TO YOU!!**
Call **COLLECT**. Send your resume, and you will receive **FREE
CONSULTING SERVICE** including:

- Critique/modification, if necessary, of your resume.
- Control of who gets your resume.
- Detailed information on client firms.
- Economic advice on geographical areas.

OLIVER Associates

401 Broad Hollow Rd, Melville, NY 11746
(516) 249-0202

YOU REACH ENGINEERS WITH TITLES LIKE THESE:

- Chief Engineer • Development Engineer • Design Engineer • Project Engineer
- Electronic Engineer • Engineer-Supervisor • Section Leader
- Staff Engineer • Systems Engineer • Test Engineer • Standards Engineer
- Master Engineer

ENGINEERS

Challenging Career
Opportunities
in An Aviation
Environment
\$21,883-\$28,444

- **AEROSPACE**—Survivability/
Vulnerability, Propulsion
- **ELECTRONICS**—EW, ASW, Navigation,
Computer/Software, Weapons Control,
Communications
- **GENERAL**—R&M, Specs and Stds.
- **MATERIALS**—Metals, Non-metals, NDTI

Interested, qualified candidates
send SF-171 (Application for Federal
Employment) to:

Civilian Personnel Division
Code AIR-9402
NAVAL AIR SYSTEMS COMMAND
Washington, D.C. 20361
Attn: Kelly D. Turbeville
An Equal Opportunity Employer

ELECTRONIC ENGINEERS

We have several client companies located in Danbury, Connecticut, seeking degreed electronic engineers in any one of the following fields: Microprocessor design in the telecommunications field; computer-controlled test equipment design; systems design for NDT; radar signal processing; power supply design (A/D and magnetic circuits); airborne radar systems design and display systems engineering.

The area provides fine recreational facilities (Lake Candlewood) and has good connections to the New York Metropolitan area. It is an ideal locale for family life.

Send your resume, or call Uni/Search, 203-792-8500. We are at 85 West Street, Danbury, Conn. 06810. George Field is handling these opportunities. Never a fee to the applicant.

— GET A REPEAT AD FREE!

With our 2 for 1 plan, your net cost in *Electronic Design* is only \$27.50 per column inch, lowest among all the national newspapers and electronics media. You get a total of 165,418 exposures to EOEM engineers and engineering managers (not counting 11,668 more among general or corporate managers) at only 33¢ per thousand! You can't beat the price. You can't beat the coverage and you can't beat the quality.

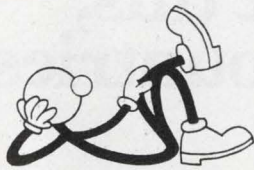

EFFORTLESS . . .

If you're ready to move on with your career, it can be a lot easier than you expect.

We are the members of



who work extensively with electronics industry leaders. The companies we service have many openings and pay for us to search you out.

Send your resume to the office nearest you. Then sit back and relax while we do the work.

BRENTWOOD PERSONNEL ASSOCIATES

Electronics Division
1280 Route 46
Parsippany, New Jersey 07054
(201) 335-8700

STAFF DYNAMICS, U.E.

26 Sixth Street
Stamford, Connecticut 06905
(203) 324-6191

ANDERSON-TAYLOR

P.O. Box 21
Exton, Pennsylvania 19341
(215) 363-1600

THE PERSONNEL CENTER

405 Loew Building
Syracuse, New York 13202
(315) 472-4551

RIKER PERSONNEL

834 Circle Tower
Indianapolis, Indiana 46204
(317) 632-5422

WESTERN PERSONNEL EMPLOYMENT

3800 North Central Ave., Suite 1007
Phoenix, Arizona 85012
(602) 279-5301

190 associates internationally

Engineering

NORTHROP DESIGN ENGINEERING

*great purposes...
greater achievements*

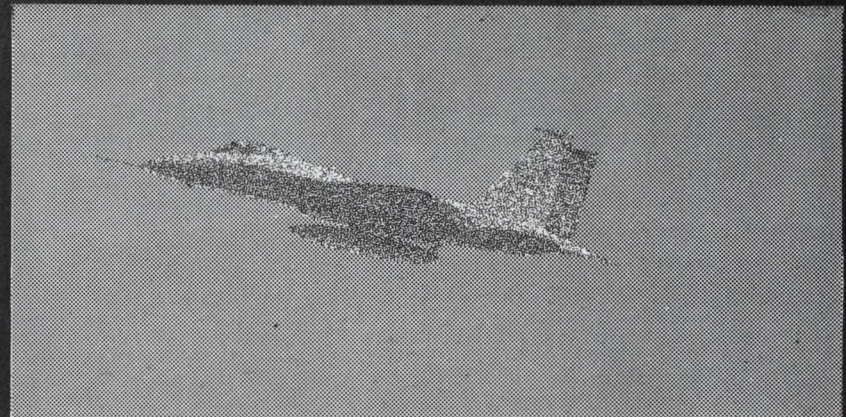

Establishing goals that challenge your ability. . . creates a sound beginning. Advancing beyond those objectives. . . instills pride.

At Northrop Defense Systems Division, a leader in advanced Electronic Countermeasure technology, we provide the guidance and professional freedom necessary for creative problem-solving and maintaining our leadership in the state-of-the-art.

If you are a Design Engineer with the following qualifications and possess a strong drive toward self-fulfillment, we invite you to consider an exciting career at Northrop.

- *BSEE, familiar with design for AGE test equipment.
- *Minimum of 5 years experience in Digital Design, using TTL-DTL, MOS and micro-processor in designing and testing computers.
- *Design of Tuning Unit Analog and digital circuits. Familiarity with RF component interface circuits.
- *Minimum 5 years experience in analog and/or digital design. Familiarity with microwave components preferred.
- *PROJECT ENGINEER with analog/digital circuits and microwave components experience.

In addition to the opportunity to join one of the finest engineering teams in the nation, we offer an excellent salary/benefits program. Qualified individuals are invited to send brief letter or resume in confidence, to:

Director—Design Engineering
Department EM
NORTHROP CORPORATION
Defense Systems Division
600 Hicks Road, Rolling Meadows, Illinois 60008
An equal opportunity employer m/f

NORTHROP

**HOW TO PLACE YOUR AD
CALL THE RECRUITMENT
HOT LINE 201-843-0550
OR
USE OUR TELECOPIER
EXT. 212**



To get overseas trade leads like this, you could open offices in 127 countries.

Or use our computer.

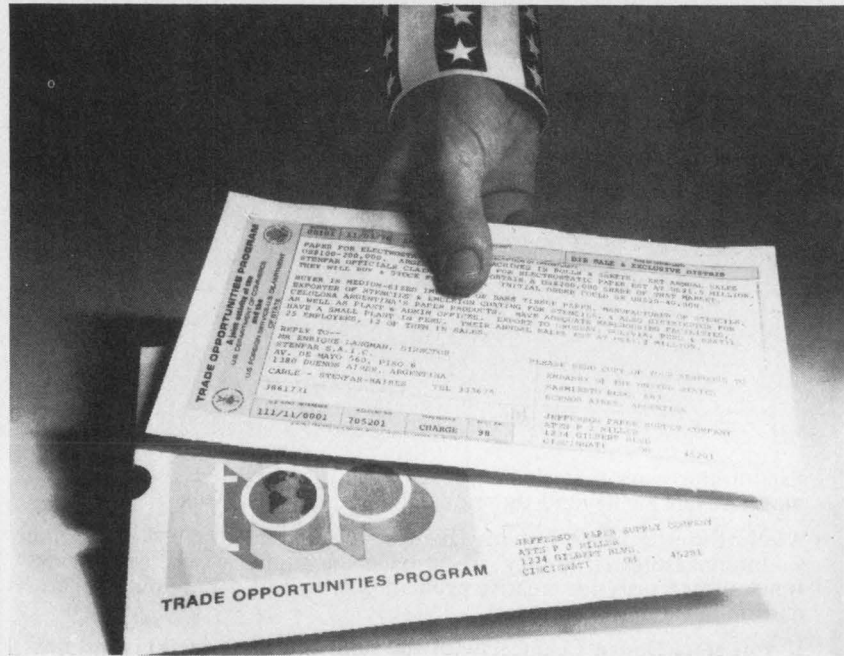

The U.S. Commerce Department's computer-operated Trade Opportunities Program (TOP) can supply you with immediate, continuing, specific leads tailored to your sales objectives for any of 127 countries. So if you can't be all over the world at one time, we've got the answer. To learn more, write Secretary of Commerce, U.S. Department of Commerce, BIC-9B, Washington, D.C. 20230.



A Public Service of This Magazine & The Advertising Council

Engineer

ELECTRICAL ENGINEER (Console Communications)

Due to rapidly increasing sales in Communications Division of diversified electronics manufacturer (music amplification, law enforcement radar, console communications products), key position available for B.S.E.E.-degree person with experience in land mobile 2-way radio (FM-police band) communications systems and equipment. Duties include designing special engineering features on consoles. Some travel. Based in Kansas City. Interview and relocation expenses paid.

Please send resume, including earnings history and expectations, in confidence, to:



Mr. Bruce Keeton
Personnel Director
1010 W. Chestnut
Chanute, KS 66720

"World Leader In Traffic Safety Radar"
An Equal Opportunity/Affirmative Action Employer

ELECTRONIC TECHNICIAN (Communication Console)

Newly created position available with diversified electronics manufacturer for person with electronics school certificate or degree. Requires some experience with 2-way FM radio, police band, UHF/VHF communications equipment. Prefer field installation experience. Moderate travel. Excellent salary, benefits, and environment. Based in Kansas City area. Interview and moving expenses paid by Company.

Inquiries held in confidence. Please send detailed resume including job references, earnings history, and earning requirements to:



11700 W. 85th St.
Lenexa, KS 66216

An Equal Opportunity/Affirmative Action Employer

N/C SYSTEMS ENGINEERS

McDonnell Douglas, St. Louis, has openings for individuals with BS or MSEE with experience in digital logic & computer programming to work in Computer Aided Manufacturing (CAM), particularly in area of real-time monitoring and control. Areas of responsibility will include advancing technology in area of N/C and other machine tool related applications. If you meet the above requirements, explore the possibility of joining our creative team by sending your resume to:

W. B. Kellenberger
Section Manager,
Professional Employment
Department EDN-78N
P.O. Box 516
St. Louis, Missouri 63166



An Equal Opportunity Employer m/f

Advertiser's index

| Advertiser | page |
|--|--------------------------------|
| AMP, Incorporated..... | 198,199 |
| AMP, Incorporated, Capatron Division..... | 238 |
| AQ Systems, Inc..... | 168 |
| Acopian Corp..... | 210A |
| Advanced Electronics Design, Inc..... | 205 |
| Advanced Micro Devices..... | 4,5 |
| Allen Bradley Co..... | 82,83 |
| Anadex, Inc..... | 57,157 |
| Analog Devices, Inc..... | 134,135 |
| Aries Electronics, Inc..... | 239 |
| Austron, Inc..... | 189 |
| BP Instruments..... | 186 |
| Beckman Instruments, Inc. Helipot Division..... | 210F |
| Belden Corporation..... | 36 |
| Bivar, Inc..... | 231 |
| Bliley Electric Co..... | 230 |
| Bourns, Inc., Trimpot Products Division..... | Cover II |
| Bud Industries, Inc..... | 81 |
| Burr-Brown Research Corporation..... | 174 |
| Burroughs Corporation..... | 213 |
| CTS Corporation..... | 219 |
| Capar Components Corporation..... | 14 |
| Centralab, The Electronics Division of Globe-Union, Inc..... | 197 |
| Centralab/USCC..... | 67 |
| Clare & Co., C. P..... | 210C |
| Clarostat Mfg. Co..... | 236 |
| CODI Corporation..... | 212 |
| Computer Conversions Corp..... | 237 |
| Continental Specialties Corporation..... | Cover III |
| Custom Electronics, Inc..... | 178 |
| Cutler-Hammer, Specialty Products Division..... | 175 |
| Dale Electronics, Inc..... | 110,111 |
| Data General Corporation..... | 58,59 |
| Data I/O Corporation..... | 28,29 |
| Datel Systems, Inc..... | 169,171,173 |
| Dialight, A North American Philips Company..... | 68,133 |
| Digital Equipment Corporation..... | 70,71 |
| Digital Laboratories..... | 239 |
| Dormeyer Industries, Inc..... | 236 |
| Dow Corning Corporation..... | 161,190,191 |
| EECO..... | 226 |
| *EMI Ltd. SE Labs..... | 82,83 |
| EMM Semi, a subsidiary of Electronic Memories & Magnetics Corporation | 195,237 |
| EMR Telemetry, Weston Instruments, Inc..... | 235 |
| Eagle Magnetics, Inc..... | 236 |
| Eagle-Picher Industries, Inc..... | 205 |
| Eastern Air Devices..... | 238 |
| Edmund Scientific Company..... | 215 |
| Electro Corporation..... | 215 |
| Electro Scientific Industries..... | 238 |
| Electro Switch Corp..... | 235 |
| Electronic Design..... | *146E,*146H,*175,*190,*191,204 |
| Etatech, Inc..... | 238 |
| Fairchild Semiconductor, Operations Division..... | 11,93 |
| Figaro Engineering, Inc..... | 237 |
| Fluke Mfg. Co., Inc., John..... | 51 |
| *Fort, SA..... | 175 |
| Frequency & Time Systems, Inc..... | 239 |
| Gates Energy Products, Inc..... | 30 |
| GenRad..... | 185,187,189,236 |
| General Electric Company, Instrument Rentals..... | 164 |
| General Electric Company, Semiconductor Products Department..... | 179 |
| General Instrument Corporation, Semiconductor Division..... | 49 |

| Advertiser | page |
|---|---|
| General Magnetics Inc..... | 250 |
| Germanium Power Devices Corp..... | 19 |
| Gold Book, The..... | *197,200,236 |
| Gould, Inc., Instrument Division..... | 227 |
| Gould Inc., Electronic Components Division..... | 210H |
| Gulton Industries, Inc., Measurement & Control System Division..... | 100 |
| Hamilton/Avnet Electronics..... | 53 |
| Hayden Book Company, Inc..... | *177 |
| Hewlett-Packard..... | 1,10,24,25,62,63,77, 121,148,149,160,181,193,218 |
| Hoffman Engineering Company..... | 185 |
| Honeywell Test Instruments Division..... | 122,123 |
| Houston Instrument, The Recorder Company..... | 211 |
| Hytek Microsystems, Inc..... | 238 |
| ITT Cannon Electric, International Telephone and Telegraph Corporation..... | 178A-D |
| ITT-North, Microsystems Division..... | 201 |
| Intel Corporation..... | 154,155 |
| Intelligent Systems, Inc..... | 215 |
| Interface Technology..... | 210E |
| Integrated Circuits, Incorporated..... | 184 |
| International Microcircuits, Inc..... | 222 |
| International Microsystems, Inc..... | 231 |
| Intersil..... | 94,95 |
| Interstate Electronics Corporation..... | 210B |
| Isotronics, Inc..... | 206 |
| Iwata Electric Co., Ltd..... | 239 |
| Kepeco, Inc..... | 64 |
| Keystone Carbon Company..... | 60 |
| Keystone Electronics Corporation..... | 108 |
| Klinger Scientific Corp..... | 230 |
| Kollmorgen, Photocircuits Division..... | 16,17 |
| LH Research, Inc..... | 22 |
| Leasametric..... | 210D |
| Litronix, Inc..... | 40,41 |
| Magnetic Shield Division, Perfection Mica Company..... | 238 |
| Magnetics, Inc..... | 187 |
| Matrox Electronic Systems..... | 170 |
| *Mektron..... | 164 |
| Mepco/Electra, Inc..... | 223 |
| Metex Corporation..... | 221 |
| Methode Electronics, Inc..... | 236 |
| MetroTek, Inc..... | 238 |
| Microswitch, A Division of Honeywell..... | 20,21 |
| Midtex, Inc..... | 204 |
| Miller-Stephenson Chemical Co., The..... | 6 |
| Minelco, A Tally Industries Company..... | 26 |
| Monsanto Electronic Materials..... | 109 |
| Mostek Corporation..... | 15,158,159 |
| Motorola Semiconductor Products, Inc..... | 33,34 |
| Murata..... | 231 |
| National Semiconductor Corporation..... | 162,163,208,209 |
| Ohmite Manufacturing Company..... | 32 |
| Optron, Inc..... | 7 |
| Permag..... | 189 |
| *Philips Electronic Components and Materials..... | 81 |
| Philips Industries, Test and Measuring Instruments Dept..... | 210G |
| Phipps & Birds, Inc..... | 237 |
| Pioneer Magnetics, Inc..... | 183 |
| Plastic Capacitors Inc..... | 235 |
| *Plessey Optoelectronics..... | 177 |
| Plessey Semiconductors..... | 116,117 |

*Advertisers in International Edition

| Advertiser | page |
|---|------------------|
| Power/Mate Corp..... | 238 |
| Practical Automation Inc..... | 229 |
| Precision Monolithics, Incorporated..... | 12,13,152,153 |
| Pro-Log Corporation..... | 167 |
| Pulse Instruments, Inc..... | 237 |
| RCA Solid State Division..... | 202,203,Cover IV |
| REI Sales..... | 239 |
| Racal-Dana Instruments, Inc..... | 101 |
| Raytheon Semiconductor..... | 139 |
| Rental Electronics, Inc..... | 177 |
| Repeco, Incorporated..... | 182 |
| Rockland Systems Corporation..... | 146 |
| Rockwell International..... | 61 |
| Rogers Corporation..... | 236,238 |
| Rolm Corporation..... | 207 |
| Rolyn Optics..... | 236 |
| SMK Electronics Corporation of America..... | 192 |
| Sangamo Weston, Sangamo Data Recorder Division..... | 144 |
| Security Plastics Inc..... | 180 |
| Semtech Corporation..... | 39 |
| Shugart Associates..... | 141 |
| Sierracin/Sylmar..... | 214 |
| Signetics Corporation..... | 55 |
| Simpson Electric Company..... | 217 |
| Sprague Electric Company..... | 27,225 |
| Struthers-Dunn, Inc..... | 47 |
| Syntonic Instruments, Inc..... | 120 |
| Systron-Donner..... | 196 |
| T & B/Ansley Corporation..... | 35 |
| TRW Capacitors, an Electronic Components Division of TRW, Inc..... | 23 |
| TRW/IRC Resistors, an operation of TRW Electronic Components..... | 239 |
| TRW RF Semiconductores, an Electronic Components Division of TRW, Inc..... | 172 |
| Tally Corporation..... | 129 |
| Tektronix, Inc..... | 102,103,150,151 |
| Teledyne Crystalonics..... | 192 |
| Teledyne Kinetics..... | 170 |
| Teledyne Relays, A Teledyne Company..... | 2 |
| Temtron Electronics Ltd..... | 222 |
| Thermalloy Company..... | 188 |
| Times Wire & Cable Company..... | 143 |
| Tracor, Inc..... | 180 |
| Triplett Corporation..... | 137 |
| United Systems Corporation..... | 229 |
| Unitrode Corporation..... | 18 |
| Universal Data Systems..... | 31 |
| Vactec, Inc..... | 156 |
| Vector Electronic Co., Inc..... | 194 |
| Vecron Laboratories..... | 236 |
| Viking Industries, Inc..... | 233 |
| Western Thermistor Corporation..... | 237 |
| Wiltron Company..... | 188 |
| Zilog..... | 8,9 |

RECRUITMENT

| | |
|---------------------------------|---------|
| Ad Council..... | 248 |
| AMP..... | 242 |
| Computer Sciences Corp..... | 243 |
| Hayden Publishing..... | 242 |
| Hughes..... | 241 |
| Kustom Electronics Inc..... | 248 |
| Martin Marietta..... | 240 |
| McDonnell Douglas..... | 242,248 |
| Naval Air Systems Command..... | 246 |
| Northrop Corp..... | 247 |
| Racal-Milgo..... | 246 |
| Schlumberger Well Services..... | 245 |
| Varo, Inc..... | 245 |
| Westinghouse..... | 244 |

Solid State D.C. To Synchro Converter

PROVIDES A THREE WIRE AC OUTPUT PROPORTIONAL TO A DC VOLTAGE INPUT

FEATURES:

- Develops a fully isolated 3-wire AC output proportional to a DC signal
- Maintains accuracy with tracking speeds as high as 720°/SEC
- Isolated reference input
- Accuracy is not affected by reference voltage or power supply variations
- Provides 0.5 VA output drive
- Three wire AC output developed with 15 minute accuracy
- Hermetically sealed metal package
- Package size and terminal configuration may be altered at no extra cost
- Units can be altered to meet your exact voltage and frequency requirements—in most cases at no extra cost
- Output remains constant for $\pm 10\%$ reference voltage variations
- Low output distortion (<0.5%)
- Infinite resolution

SPECIFICATIONS: MAC 1562-1

- **Input signal** — 0 to $\pm 10V$ DC
- **Input signal resistance** — 10K minimum
- **Reference input** — 26V RMS $\pm 10\%$
- **Operating frequency** — 400 HZ $\pm 10\%$
- **DC power** — $\pm 15V \pm 1\%$
 $\pm 50MA$ no load
 $\pm 100 MA$ full load (139 Ω L-L)
- **Full scale output** — 11.8V AC line to line $\pm 2\%$
- **Power output** — 0.5VA max.
- **Transfer function**

$$S1-S3 = 11.8V \times \sin\left(\pi \times \frac{EIN}{10V}\right)$$

$$S2-S3 = 11.8V \times \sin\left(\pi \times \frac{EIN}{10V} + 120^\circ\right)$$

$$S2-S1 = 11.8V \times \sin\left(\pi \times \frac{EIN}{10V} + 240^\circ\right)$$

- **Accuracy***
 15 minutes of ARC (Max) at 20°C $\pm 10^\circ$ C
 30 minutes of ARC (Max) over the operating temp. range

*Accuracy is based on the following equation:

$$\theta = \tan^{-1} \left[\sqrt{3} \frac{(1-K)}{(1+K)} \right]$$

Where K is the measured ratio (S3-S2)/(S1-S2)

- **Tracking speed** — 720°/SEC
- **Operating temperature range** 0°C to 70°C
- **Distortion** 0.5% max.

For units to meet wider temperature range and other specifications please consult the factory.

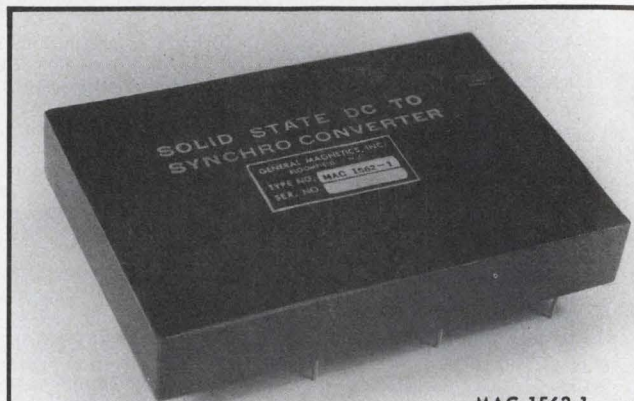

MAC 1562-1

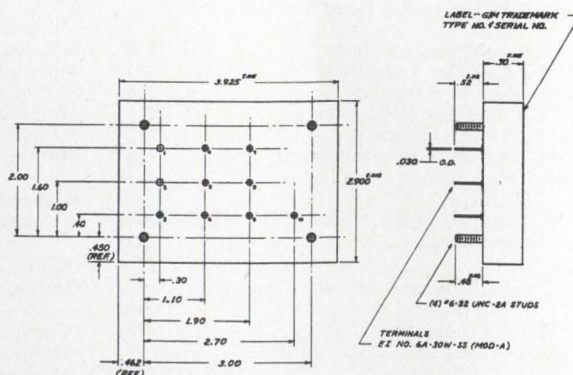
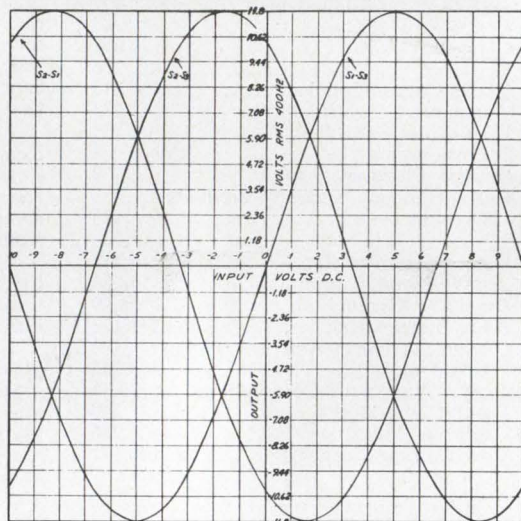

There is No Substitute for Reliability
GENERAL MAGNETICS, INC.
 211 GROVE STREET
 BLOOMFIELD, N. J. 07003

\$44.95 KNOW-IT-ALL

CSC's multi-family Logic Probe 1 with memory.
Already the industry standard for performance and value.

This compact, enormously versatile test and troubleshooting aid is like a pencil-sized scope at your fingertips. Simply connect its clip leads to the circuit's power supply, set a switch to the proper logic family, and touch the probe tip to the node under test.

LP-1's unique circuitry does the work of a level detector, pulse detector, pulse stretcher and memory. HI LED indicates logic "1," LO LED, logic "0," and all pulse transitions—positive and negative, as narrow as 50 nanoseconds—are stretched to 1/3 second and displayed on the PULSE LED. One-shot, low-rep-rate narrow pulses—nearly impossible to see even with a fast scope, are easily detectable and visible. And you can indefinitely store single-shot as well as low-rep-rate events.

At frequencies above 1 MHz, there is an additional indication with unsymmetrical pulses: duty cycles of less than 30%, light the LO LED; over 70%, the HI LED. In all modes and circuit states, LP-1's high input impedance virtually eliminates loading problems. The unit also features overvoltage and reverse-polarity protection, interchangeable probe tips, cables and other optional accessories.

Order today. Call 203-624-3103 (East Coast) or 415-421-8872 (West Coast): 9 a.m.-5 p.m. local time. Major credit cards accepted. Or see your CSC dealer. Prices slightly higher outside USA.

Logic Family Switch—TTL/DTL or CMOS matches Logic "1" and "0" levels; CMOS position also compatible with HTL, HiNIL and MOS logic.

PULSE/MEMORY Switch & LED—PULSE position detects and stretches pulses as narrow as 50 nanoseconds to 1/3 sec.; MEMORY stores single-shot and low-rep-rate events indefinitely; HI/LO LED's remain active.

HI/LO LED's—Display level (HI-logic "1", LO-logic "0") of signal activity.

Interchangeable probe tips—Straight tip supplied; optional alligator clip and insulated quick-connecting clip available. Optional input ground lead.

Plug-in leads—36" supplied, with alligator clips. Virtually any length leads may be connected via phono jack.

*Mfr.'s rec. resale. Slightly higher outside U.S.

© 1978 Continental Specialties Corporation

Specifications

Input impedance: 100,000Ω

| Thresholds (switch selectable) | DTL/TTL | HTL/CMOS |
|--------------------------------|--------------|---------------|
| logic "1" thresholds (HI-LED) | 2.25V ± .15V | 70% Vcc ± 10% |
| logic "0" thresholds (LO-LED) | 0.80V ± .10V | 30% Vcc ± 10% |

Min. detectable pulse width 50nsec, guaranteed

Pulse detector (PULSE LED) in PULSE position of PULSE/MEMORY switch, 1/3-sec. pulse stretcher makes high-speed pulse train or single events (+ or - transitions) visible; in MEMORY position, first transition lights and latches LED

Operating temperature 0-50°C

Physical size (l x w x d)

5.8 x 1.0 x 0.7" (147 x 25.4 x 17.8mm)

Weight 3oz. (.085Kg)

Power leads removable 36" (914mm) with color-coded insulated clips; others available

Input protection overload, ± 500V continuous; 117 VAC for less than 15 sec.; reverse polarity, 50V; power leads reverse-voltage protected.

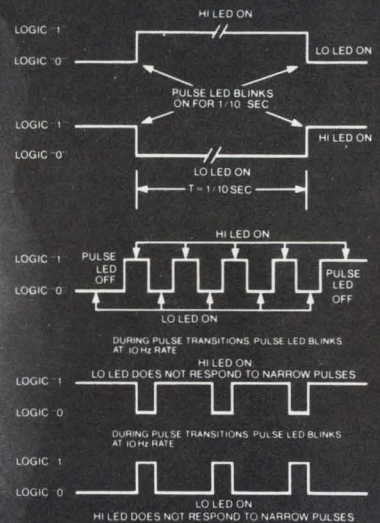

CONTINENTAL SPECIALTIES CORPORATION

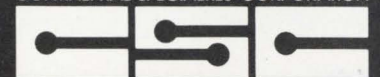

70 Fulton Terrace, Box 1942, New Haven, CT 06509
203-624-3103 TWX 710-465-1227
WEST COAST: 351 California St., San Francisco, CA 94104,
415-421-8872 TWX 910-372-7992
GREAT BRITAIN: CSC UK LTD.
Spur Road, North Feltham Trading Estate,
Feltham, Middlesex, England.
01-890-8782 Int'l Telex: 851-881-3669

CIRCLE NUMBER 231

NEW LP-1!

RCA. Newsmaker in Linear.

New A/D makes low-cost readout as easy as **1 2 3**

Our new CA3162 A to D converter lowers the cost of three-digit readout. So you can go digital in more places. Or in new places. Our new driver (CA3161) and our circuit layout make it easy as well as economical.

1 Super accurate A/D Converter.

Our CA3162 uses dual slope integration, which means high noise rejection. Freedom from long-term drift and changes due to temperature. It has an ultra-stable on-chip bandgap reference. On-chip clock. And much more.

2 Companion driver IC.

The CA3161 BCD to 7-Segment Decoder from RCA has a 25 mA current per LED segment for brighter, larger displays.

3 Circuit board layout.

The whole circuit design is right there, ready for you to drop in the actual components for a complete 3-digit readout.

Send for our new brochure on the 3162 A to D system.

For more information, contact your local RCA Solid State distributor. Or contact RCA Solid State headquarters in Somerville, N.J.; Sunbury-on-Thames, Middlesex, England; Quickborn 2085, W. Germany; Ste. Anne-de-Bellevue, Quebec, Canada; Sao Paulo, Brazil; Tokyo, Japan.

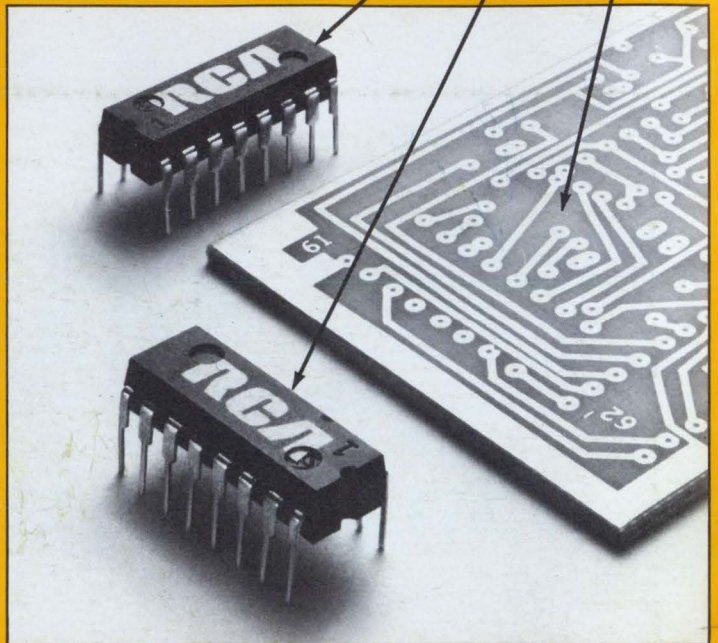

RCA Linear IC experience is working for you.

RCA