

# Electronic Design<sup>®</sup> 9

VOL. 25 NO.

FOR ENGINEERS AND ENGINEERING MANAGERS

APRIL 26, 1977

**The flat, flexible cable spectrum** ranges from conventional wires woven into a ribbon to flexible circuit boards. Choose the right cable and you can save time,

money, weight and space. But you must choose correctly from hundreds of different kinds and interpret some "flexible" specs. Make the connection on p. 60.





# Highest Honors for Mil-Spec Trimmers



**Only Bourns is qualified to all 18...**

A medal to Bourns from Bourns — slightly arrogant, but well deserved. We examined all competitive Mil-Spec Trimmer capabilities and found that no one even came close to the sheer number of approvals we've achieved... eighteen in all! And they're manufactured with the same dedication to quality, service and value that has made Bourns Number One in trimmers for twenty-five years!

**... and at a new level of reliability**

Not only did we invent the trimming potentiometer in 1952, but we're reinventing it all the time. Patented design innovations incorporated into our Mil-Spec line have brought a new level of reliability unequalled in the industry:

**NEW DRIVE SYSTEM** — Substantial reductions in material wear and increased rotational life are derived from this "pin-free, lock-free" construction.

**SWAGE BOND**—High energy "sonic swaging" transforms the cermet element and the termination into an integral one piece unit, providing a connection that is electrically and mechanically more reliable.

**CHEVRON SEAL**—This unique shaft-to-housing environmental seal is "O-ringless," resulting in uniform torque without any springback.

**WRAP-AROUND WIPER** — With this feature, wiper pressure is consistent, allowing for better "setability" and lower CRV.

Find out for yourself why we're number one, send for complete technical information from the award winner — Bourns, direct or through your local distributor.

**TRIMPOT PRODUCTS DIVISION, BOURNS, INC.** • 1200 Columbia Ave. Riverside, CA 92507 • Phone: (714) 781-5050. TWX 910 332-1252.

## WIREWOUND

Style	Characteristics	Qualified Terminals	Description
-------	-----------------	---------------------	-------------

### MIL-R-27208

RT10	C2	L, P	1" long
RT12	C2	L, P, Y	1 1/4" long
RT22	C2	L, P, W, X	1/2" square
RT24	C2	L, P, W, X	3/8" square
RT26	C2	W, X	1/4" square

### MIL-R-39015

RTR12	D	L, P, Y	1 1/4" long
RTR22	D	L, P, W, X	1/2" square
RTR24	D	P, W, X	3/8" square

## CERMET

Style	Characteristics	Qualified Terminals	Description
-------	-----------------	---------------------	-------------

### MIL-R-22097

RJ12	C, F	L, P, Y	1 1/4" long
RJ22	C, F	L, P, W, X	1/2" square
RJ24	C, F	L, P, W, X	3/8" square
RJ26	C, F	P, W, X	1/4" square
RJ50	C, F	P	1/4" round

### MIL-R-39035

RJR12	C, F	L, Y	1 1/4" long
RJR24	C, F	P, W, X	3/8" square
RJR26	F	P, W, X	1/4" square
RJR28	C, F	P	1/2" long
RJR32	C, F	D	3/4" long DIP



International Marketing Offices: European Headquarters — Switzerland 042/23 22 42 • Belgium 02/218 2005 • France 01/2039633 • Germany 0711/24 29 36 • Italy 02/32 56 88 • Netherlands 70/87 44 00 • United Kingdom 01/572 6531 • Norway 2/71 18 72 • Sweden 764/20 110 • Japan 075/921 9111 • Australia 02/55-0411 03/95-9566 • Israel 77 71 15/6/7

CIRCLE NUMBER 245



# SURPRISE!



## Our New Display Can Say A Lot For You

Our new HDSP-2000 Alphanumeric Display can spell it out for you in bright, crisp LED characters. The full 5x7 dot matrix can display ASCII or custom character sets including lower case and symbols.

Compact and complete with on-board electronics, the HDSP-2000 dramatically reduces display system size and complexity. Each 12 pin DIP contains 4 characters with row drivers and storage. End stackable and easy to interface, they're ideal for "smart" instruments, medical systems or business terminals, military applications, and almost any mobile, portable or hand-held device.

The price is \$47.00\* per 4-character cluster in quantities of 125 clusters. They're in stock today at HP's franchised distributors. In the U.S. contact

Hall-Mark, Schweber, Wilshire or the Wyle Distribution Group (Liberty/Elmar) for immediate delivery. In Canada, contact Zentronics, Ltd. \*U.S. Domestic price only.

**HEWLETT**  **PACKARD**

Sales and service from 172 offices in 65 countries.  
1507 Page Mill Road, Palo Alto, California 94304



## SSR UPDATE

# Our International Connection

The European market demanded a high voltage AC solid state relay with a challenging combination of performance features such as:

- 3750VRMS optical input/output isolation to meet VDE and IEC specs
- 800 volts peak blocking voltage for high overvoltage transient immunity
- 480VRMS output voltage rating for reliable 3-phase switching
- 200V/ $\mu$ sec min. off-state dv/dt rating
- Steady state load current ratings up to 40 Amps

We met that challenge with our all-new 621 Series. Fact is, Teledyne designed it from the ground up to achieve all of the above—from pc board layout with wide tracking distances for high voltage isolation to a highly functional case configuration with deep recessed terminals. Other features include logic compatible input drive circuitry, and zero voltage turn-on to reduce EMI.

For complete specification data, contact your local Teledyne Relays sales office. You'll find we have the experience, products, and technical support to meet all your SSR needs.

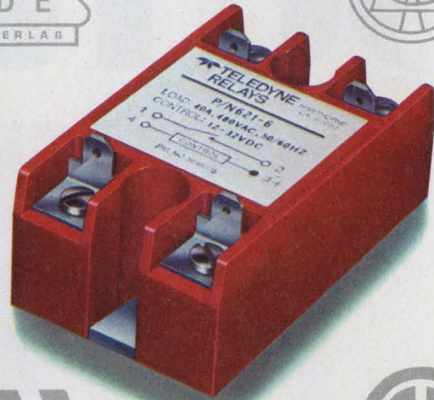

### OTHER TELEDYNE AC SSRs

- A. 601 Series\***  
5 and 10A (to 600V peak). Optically isolated, zero voltage turn-on. Screw terminals, quick disconnects, and pcb pin options.
- B. 611 Series\***  
10, 15, 25 and 40A (to 600V peak). Optically isolated, zero voltage turn-on. Dual purpose screw/quick disconnect terminals.
- C. 675 Series\***  
Low profile (0.5" max.) pc board SSRs. Output rating 3A, up to 600V peak. Optically isolated, zero voltage turn-on.
- D. 671 Series**  
I/O Converter Modules. Special purpose SSRs for use in programmable controllers, machine tool controls, etc. Mounting panel available.
- E. SerenDIP® Series\***  
TO-116 DIP package. Output rating 1A/280VRMS. Logic compatible 3.8 to 10VDC input.
- F. 970 Series MOVs**  
High voltage transient suppressors designed specifically for use with all Teledyne AC SSRs.

\*UL recognized/CSA certified.

 **TELEDYNE RELAYS**

3155 West El Segundo Boulevard, Hawthorne, California 90250  
Telephone (213) 973-4545

CIRCLE NUMBER 3



---

## NEWS

- 27 **News Scope**
- 36 **Electronic television games** are continuing to sell big, but EMI/RFI proofing is a problem.
- 42 **Safety standards for test and measuring instruments** may come true on the fourth try.
- 49 **Washington Report**

---

## TECHNOLOGY

- 60 **FOCUS on flat flexible cables:** Thanks to mass termination, flat cables can save you time and money, increase reliability, and improve performance. But only if you know how to pick the right one for your need.
- 70 **The design of a home security system** lets you apply the concepts of 'top-down' programming. The assembly code is written for an 8080-based microcomputer.
- 86 **Cut a/d conversion costs by using** software and d/a converters. Memory-mapped I/O helps eliminate the interface circuits normally needed.
- 96 **Exchange data between digital systems** simultaneously with a simple full-duplex interfacing circuit. Echo the message back or scramble it, in a half-duplex mode.
- 102 **Power-switch ROMs and PROMs quickly** and safely with a simple circuit that reduces turn-on and turn-off delays and keeps your data intact.
- 111 **International Technology**
- 114 **Ideas for Design:**  
Alarm circuit guards a guarding-camera system.  
Wide-frequency-range clock source needs few discrete components.  
Active zener circuit provides clipping adjustable down to almost zero.  
Low-cost integrator multiplies 555 timer's delay range 100 times.

---

## PRODUCTS

- 123 **ICs & Semiconductors:** D/a offers tenfold speed boost over competition.
- 124 **ICs & Semiconductors:** DVM chips include 7-segment decoder and LED drivers.
- 128 **Modules & Subassemblies:** Tiny companding a/d crams 72 dB into 8 bits.
- 132 **Micro/Mini Computing:** Line printers handle alphanumeric characters.
- 146 **Data Processing:** Two headed floppy accesses twice the data in half the time.
- |                     |                           |
|---------------------|---------------------------|
| 136 Instrumentation | 142 Power Sources         |
| 139 Components      | 144 Packaging & Materials |

---

## DEPARTMENTS

- |   |                                |
|---|--------------------------------|
| 55 <b>Editorial:</b> Outguessing the boss |                                |
| 7 Across the Desk                         | 158 Advertisers' Index         |
| 150 Application Notes                     | 160 Product Index              |
| 150 Vendors Report                        | 160 Information Retrieval Card |
| 152 New Literature                        |                                |

**Cover:** Photo courtesy of AMP Inc., Harrisburg, PA



**Buy  
none.**

**Get two  
free.**

Just write us a note on your letterhead. Our quad differential line driver and receivers are so good we're going to give you one of each — free — to prove it.



We make two quad receivers and one driver. The Am26LS32 receiver meets the EIA RS-422 specs; the Am26LS33 receiver

meets military needs, and the Am26LS31 driver meets both.

### Us and them.

First us. All three parts are in 16-pin packages. (The old duals were also in 16-pin packages, so our quads give you twice the electronics for the same space.)

All three parts are three-state output; they all work off a 5-volt power supply and they're all TTL compatible. Wow!

Now them. One competitor makes duals but no quads. Another makes quads but no military quads. And the third makes neither.

### Why are we giving things away? Have we lost our senses?

No. Here's what we figure: You decide to check out our parts. We send you a free pair. You look over the data sheets. You test the parts. And you're absolutely amazed. You take out your order book and write down "One Car-load of AMD's Terrific Quad Line Drivers and Receivers."

## Look:

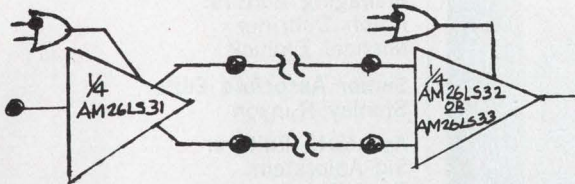

#### **Am26LS31**

1. Low output skew rate 2ns typical.
2. Input-to-output delay 12ns typical.
3. Outputs won't load the line when  $V_{cc}$  equals 0.
4. High output drive capability for 50 Ohm-transmission lines.

#### **Am26LS32**

1. The EIA RS-422 driver – the spec is  $\pm 200\text{mV}$  threshold over  $\pm 7\text{V}$  common mode range.

#### **Am26LS33**

It has  $\pm 500\text{mV}$  threshold over  $\pm 15\text{V}$  common mode range over the military temperature range.

#### **Am26LS32/33**

1. 6K Ohm minimum input impedance.
2. High-speed 17ns typical propagation delay.
3. Failsafe mechanism that notifies the machine of transmission difficulties.
4. 30mV input hysteresis.

# Advanced Micro Devices

Bipolar LSI. N-Channel, silicon gate MOS. Low-power Schottky.  
Multiple technologies. One product: excellence.



Advanced Micro Devices • 901 Thompson Place, Sunnyvale, California 94086 • Telephone (408) 732-2400 •  
Distributed nationally by Hamilton/Avnet, Cramer and Schweber Electronics, and regionally by Arrow, Bell and Century Electronics.



# A SMART WAY TO BEAT YOUR POWER SUPPLY SIZE PROBLEM

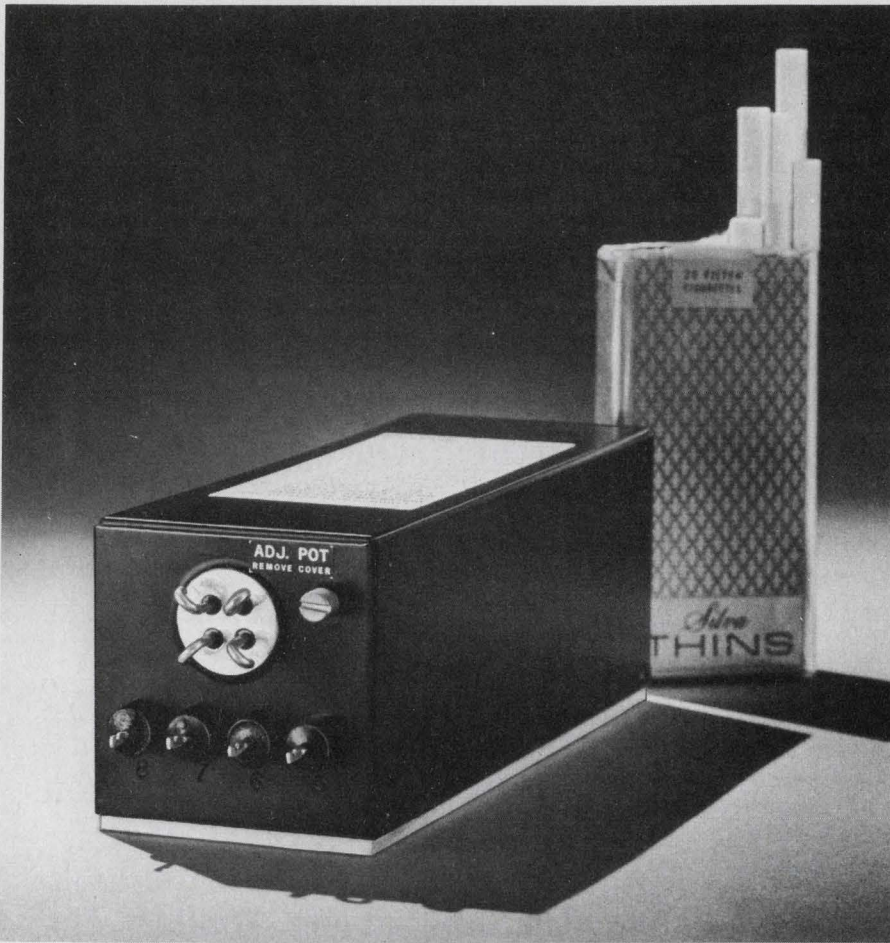

**2 1/2" thin, 2 3/8" narrow, 6 1/4" short**

yet this converter produces 50 watts of regulated DC power from an input of 20-32 VDC! It weighs less than 2 pounds. This is only one of our wide variety of many small lightweight converters, inverters and power supplies — there are over 3500 models listed in our newest catalog, including size, weight, and prices. If you have a size problem, why not send for an Abbott catalog?

**MIL SPEC ENVIRONMENT** — All of the hermetically sealed power modules listed in our new catalog have been designed to meet the severe environmental conditions required by modern aerospace and military systems, including MIL-STD-810C. They are hermetically sealed and encapsulated in heavy steel containers. New high performance units meet MIL-

STD-461A for conducted and radiated electromagnetic interference.

**RELIABLE** — Highest quality components are used in Abbott power modules to yield high MTBF's (mean time between failure) as calculated in MIL-HDBK-217. Typical power modules have over 100,000 hours MTBF — proving that the quality was built in from the beginning.

**WIDE RANGE OF OUTPUTS** — Any voltage from 5 volts DC to 740 VDC is available by selecting the correct model you need from our catalog with any of a variety of inputs including:

60  $\approx$  to DC  
400  $\approx$  to DC  
DC to DC  
DC to 400  $\approx$   
DC to 60  $\approx$

Please see pages 1836-1848 of your 1976-77 EEM (ELECTRONIC ENGINEERS MASTER Catalog) or pages 676-682 Volume 2 of your 1976-77 GOLD BOOK for information on Abbott Modules.

**Send for our new 60 page FREE catalog.**

**abbott transistor**  
LABORATORIES, INCORPORATED

GENERAL OFFICES  
5200 W. Jefferson Blvd.  
Los Angeles, CA 90016  
(213) 936-8185  
Telex 69-1398

EASTERN OFFICES  
1224 Anderson Ave.  
Fort Lee, NJ 07024  
(201) 224-6900  
Telex 13-5332

CIRCLE NUMBER 4

**Sr. Vice President, Publisher**

Peter Coley

**Editors**

Editorial Offices  
50 Essex St.  
Rochelle Park, NJ 07662  
(201) 843-0550  
TWX: 710-990-5071  
(HAYDENPUB ROPK)  
Cable: Haydenpubs Rochellepark

**Editor-in-Chief** George Rostky

**Managing Editors:**

Ralph Dobriner  
Michael Elphick

**Senior Associate Editor**  
Stanley Runyon

**Associate Editors:**

Sid Adlerstein  
Dave Bursky  
Morris Grossman  
John F. Mason  
Andy Santoni  
Max Schindler

**Contributing Editors:**

Peter N. Budzilovich, Jules H. Gilder,  
John Kessler, Alberto Socolovsky,  
Nathan Sussman

**Editorial Field Offices**

**East**

Jim McDermott, Eastern Editor  
P.O. Box 272  
Easthampton, MA 01027  
(413) 527-3632

**West**

Dick Hackmeister, Western Editor  
8939 S. Sepulveda Blvd., Suite 414  
Los Angeles, CA 90045  
(213) 641-6544  
TWX: 1-910-328-7240

Dave Barnes  
844 Duncardine Way  
Sunnyvale, CA 94087  
(408) 736-6667

**Editorial Production**

Marjorie A. Duffy, Production Editor  
James Keane, Copy Editor

**Art**

Art Director, William Kelly  
Richard Luce, Anthony J. Fischetto

**Production**

Manager, Dollie S. Viebig  
Helen De Polo, Nancy Hurey

**Circulation**

Director, Barbara Freundlich

**Information Retrieval**

Paula Greenleaf

**Advertising Promotion**

Susan G. Apolant

**Reprints**

Maxine Correal



# Across the desk

## Monolithic? 12 bits? A DAC?

I was delighted to see, in the February 15 issue (p. 36) that I have been "immortalized by deposition" in having my initials appear, under a slightly eroded heart, on Precision Monolithics' 12-bit current-switching DAC. It was also pleasing to learn that they remember my oft-repeated statement that "there are no (current-switching) monolithic 12-bit DACs on the market . . . and there never will be." Despite PMI's development, I remain convinced of the validity of my statement.

Before explaining further, let me point out that the engineering staff at Analogic has the highest regard for the technical competence of the people at Precision Monolithics. Indeed, Analogic is a substantial customer for its products. And its latest development, though not yet in production, confirms our high opinion of the company—but in no way controverts my original statements.

First, the new DAC is *not*, strictly speaking, a monolithic device. It has thin-film resistors, and they are deposited (like my initials and the bitten heart) on the substrate in a separate operation. It is my understanding, and both Webster and technical dictionaries seem to agree, that the term "monolithic" means to be composed of a single material. Thus, a silicon substrate with diffused impurities may be considered monolithic, but a silicon substrate with added thin-film resistors cannot.

I was further pleased to read that the PMI people agree with statements I have made on many occasions and have themselves concluded that laser-trimmed, thin-film resistors may not be stable enough for precision converters. As a matter of fact, the new PMI device isn't even a complete DAC. It is a circuit from which a DAC may be made; that is, it does not contain a

reference or an output amplifier or bypass capacitors, etc. Therefore, its specifications, whatever they ultimately may be on the basis of production experience, are not "self-contained." We might call this device, at best, a "DAC circuit."

Now then—what about the "unattainability" of a 12-bit monolithic DAC? For a device to qualify as a 12-bit DAC, it is not sufficient that the device be capable of accurate 12-bit conversions merely at the moment of manufacture, or on shipment, or at incoming inspection, or even at the moment of installation in the host equipment. A *real* 12-bit device must *maintain* its accuracy over an extended period of time, over a reasonable operating temperature range, and after many on/off cycles. If we examine the parametric constraints involved in creating such a 12-bit device, we discover certain fundamental technical problems.

Let's assume that the happy day will come when a manufacturer of DACs or DAC circuits will supply a histogram of the probability of shift as a function of time, temperature, further manufacturing procedures, even environment. Such a histogram would take into account the fact that the initial trimming procedure cannot be perfect because of the finite number of trim operations, which were described in the PMI article.

So initially there will be a nonlinearity error of an eighth, a quarter or a half a bit, depending on the fortuitous combination of initial condition and trim capabilities. Furthermore, initial errors will stem from the fact that the trimming equipment, like any other instrument, has a certain amount of random and systematic noise and is not based at the NBS.

(continued on page 11)

Electronic Design welcomes the opinions of its readers on the issues raised in the magazine's editorial columns. Address letters to Managing Editor, Electronic Design, 50 Essex St., Rochelle Park, NJ 07662. Try to keep letters under 200 words. Letters must be signed. Names will be withheld upon request.



## OPTICALLY COUPLED INTERRUPTER MODULES

OPTRON OFFERS IMMEDIATE DELIVERY OF NEW, LOW COST SERIES

OPTRON's new, low cost optically coupled interrupter module series combines non-contact switching and solid state reliability for applications requiring sensing of position or motion of an opaque object such as motion limit, paper edge or shaft encoding.

The new OPB 813, OPB 814 and OPB 815 consist of a gallium arsenide infrared LED coupled with a silicon phototransistor in an economical molded plastic housing. With a LED input of 20 mA, the OPB 813 and OPB 815 have typical unblocked current outputs of 2.0 mA and 3.0 mA, respectively. Typical output of the OPB 814 is 3.0 mA with a 10 mA input. The entire series is available from stock.

Background illumination noise is eliminated by a built-in infrared transmitting filter and dust cover in each device type. The OPB 813 also is available with a 0.010 inch aperture for high resolution applications.

New OPTRON optically coupled interrupter modules are interchangeable with similar products as follows:

OPTRON	GE
OPB 813	H13A1
OPB 813	H13A2
OPB 814	H13B1
OPB 814	H13B2

Detailed technical information on these and other OPTRON standard interrupter and reflective modules, as well as versions for specific applications is available on request.



OPTRON, INC.

1201 Tappan Circle  
Carrollton, Texas 75006, U.S.A.  
214/242-6571 • TELEX-73-0701  
TWX-910-860-5958



# Stretch your mind. Think Amphenol® connector systems.

Don't back off from your big idea. We can help you make it work. And work right.

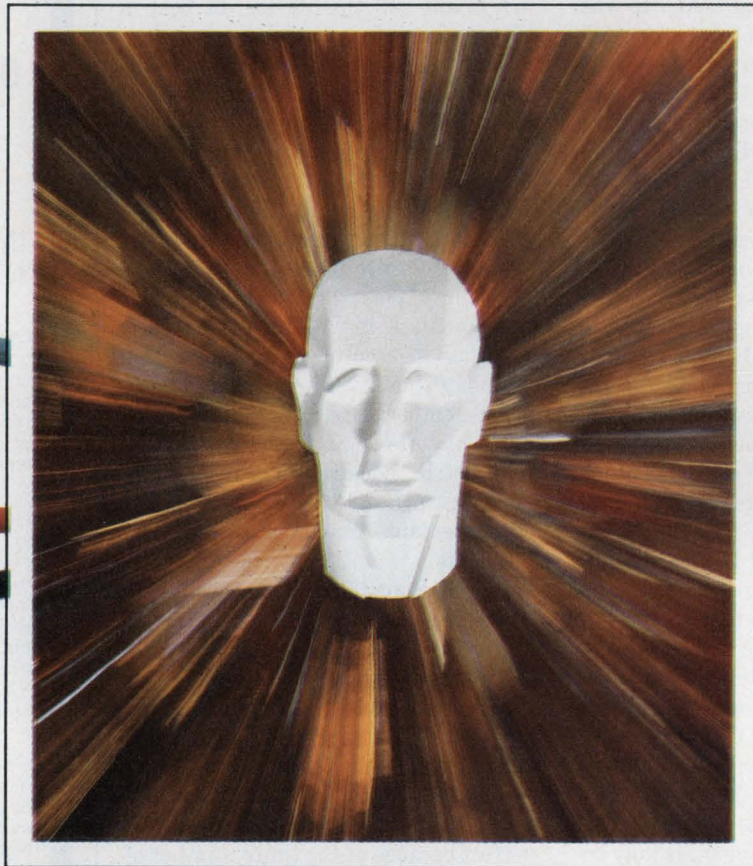

Dare to be different. We'll back you up with Amphenol connectors. We may already have the kind that'll make your big idea work.

But if we have to create something totally new to match your idea, we'll go all out—even to designing the required termination tooling. Our connector design specialists are known for the way they tackle the unknown. With a spirit that yields the answers.

Think of it this way: we can help you avoid a lot of false starts. And give you measurable quality and economy. The people who use the Amphenol con-

nectors shown here know that's true. They think of us first when they need connectors for consumer and business products, data and word processing equipment, aerospace and military applications, telephony, and more.

Got a mind-stretching idea? Then include Amphenol connectors in your thinking. To get started on the right track, just write to us: Amphenol Connector Systems, Bunker Ramo Corporation, Dept. C47B, 900 Commerce Drive, Oak Brook, Illinois 60521. Or call: (312) 986-2320.



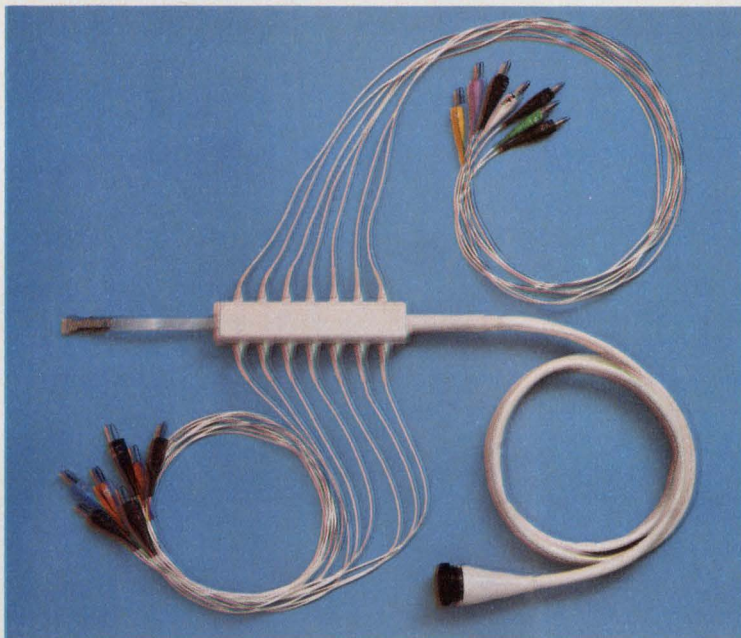

**Medical interface cables for critical applications.** Provide reliable patient monitoring and medical electronics interface. Custom-made for reliability, good looks.

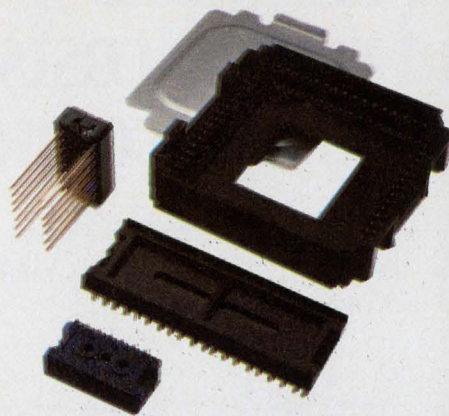

**No more unsoldering for IC replacement.** Dual-inline IC's or planar leadless MOS/LSI's plug right into 800 Series devices.



**Connectors that go beyond waterproof.** Self-sealing, low-cost 44 Series shrugs off water. And fuel, road salt, ozone and more. For automotive, transportation, and marine uses.

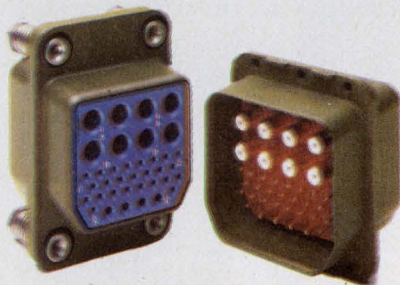

**Rack-and-panel connectors that advance the state of the art.** 94 Series environmental connectors utilize polymer-retention discs to retain the 20, 16 and shielded size contacts.

**A way to slash telephone key-set installation costs.** System 66 connectorized blue-field panels are pre-wired. No cables to punch-down.

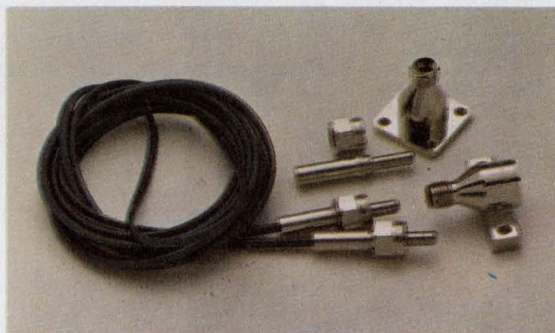

**Precision optical connectors from stock.** Optimum components for emitter-to-cable, cable-to-detector, and cable-to-cable junctions. All with standard SMA size mating.

The right idea  
at the  
right time.

**AMPHENOL** Connector Systems **BUNKER RAMO**<sup>®</sup>



# You eliminate short circuits and reduce costs with these AMP connectors.

## Unique, low-cost, all-plastic AMP straight posted and right-angle headers.

Now circuit paths can be located directly under the connector without shorting. Because AMP 94V-O rated AMPLIMITE headers are of all-plastic construction. These low-cost high-density headers intermate with standard AMPLIMITE connectors, other similar designs and those meeting EIA specification RS-232-C. Housings have built-in stand-off relief and are available in 5 popular right-angle versions, and a new 25-position low profile straight posted version.

## A better way to terminate flat-cable fast.

We put teeth in low-cost mass termination with 25-position HDF AMPLIMITE plugs and receptacles. A simple, miniature press is all that's needed. Fork-like teeth penetrate the cable, make electrical contact with each conductor and interlock with the housing.

Accommodate any 26-position solid or stranded round-conductor flexible cable on 0.050" centers—with no preparation other than

squaring the end. The HDF connector is the one to use for highest production rates and lowest applied cost.

And AMP's unique technical service is the one to use, too. It's in-depth help that's yours for the asking even if you are only in the product planning stage. In fact, we prefer to be involved early. Because it lets you take full advantage of the capabilities and willingness of AMP people to search out better ways for better products.

For further details on the unique AMPLIMITE all-plastic or HDF connectors, call Customer Service at (717) 564-0100. Or write AMP Incorporated, Harrisburg, PA 17105.

AMP has a better way.

# AMP

INCORPORATED

CIRCLE NUMBER 8



## Across the desk

(continued from page 7)

Therefore, we must accept the fact that there will be initial errors. We must also accept the fact that the resistors will drift with time. It is not a question of whether they will drift or not—it is only a question of *how much*. And once the zeners are zapped and the resistors drift, the zeners cannot be zapped again a year later. Indeed, for a device of this type, it may be impossible, once a unit has drifted out of specification, to bring it back again. We will then have to face failure—not a failure to function, but a failure to meet specifications. Presumably, if a 12-bit DAC is needed to begin with, it will be needed a year later. Now we see why so much money is spent on engineering rework, debugging and warranty service for analog-to-digital and digital-to-analog converters.

More problems will crop up. Other parameters will drift. The  $V_{BE}$  offsets of the current-switching transistor will change some finite amount. The reference will change. The offset in the servo amplifier will change as well as the offset in the output amplifier. All of these changes—some small, some large—must be constrained to within a fraction of a bit, including the effects of differential variations in resistor values over temperature. For a unit to be called a 12-bit DAC legitimately, there must be some means of recalibrating the device after some reasonable time of operation.

Now suppose we intend to purchase a substantial number of DACs—say, a thousand—and put them into equipment that we manufacture. Let us also assume that the requirements *demand* 12-bit-DAC performance; otherwise, the whole discussion is meaningless. After a reasonable time (say, a year) in the hands of our customer, and after exposure to even a modest operating temperature range (let's say  $\pm 20$  C), and after several hundred on/off power cycles, what percentage of the units we have installed will still be 12-bit DACs?

An experienced and conscientious manufacturer might allow himself a failure rate of perhaps 3% per year from *all* sources, and the DAC would be only *one* source. But let us be even more generous, and stipulate that, after one year, 970 DACs remain accurate to 12 bits. When someone can meet that criterion with a *truly monolithic device*, one may indeed be forced to "eat one's heart out."

What are the realities? We have already discussed the fact that all resistors drift with time. It would indeed be an excellent set of resistors, by any standard, that could be counted on, in quantity, to track to within 30 to 60 ppm per year. Indeed, to accomplish this today would require either premium-grade, wirewound resistors or the highest-quality bulk-film resistors. Resistors alone would account for a quarter of a bit of drift.

Let's assume that  $V_{BE}$  changes account for another tenth or two-tenths of a bit, and allow some reasonable change for leakage variations, and for changes in the reference. Then, to maintain a linearity of  $\pm \frac{1}{2}$  bit, the over-all temperature coefficient of the unit would have to be constrained to some fraction of a ppm/ $^{\circ}$ C. Maybe some of our assumed 1000 monolithic (or quasimonolithic) 12-bit DACs will do all this, but I think PMI, and more experienced readers, would agree that *too many of them won't*. And that's why I remain unconvinced.

Additional insight into this problem can be obtained by reviewing the excellent article on amplifiers, starting on page 72 of the same issue. It's a most needed article, for it points out the limitations and deficiencies of available operational amplifiers, both from a functional point of view and with respect to the manufacturers' specifications. Analog-to-digital and digital-to-analog converters are much more complex than operational amplifiers *per se*.

Thus, it is not necessary to fall back on semantic definitions to protect the technical honor of the 12-bit DAC. We must realize that 12-bit devices, let alone those with 13, 14, 15 or 16 bits, require more attention to detail than may be available in semiconductor processing.

Nevertheless, we wish to acknowledge Precision Monolithics' dedication to the advancing semiconductor-converter art and to thank them—dare I say "wholeheartedly"?—for associating me so intimately with its efforts.

Bernard M. Gordon  
Chairman

Analogic Corp.  
Wakefield, MA 01890

### Sure it is

Let me confirm the mutual respect that Precision Monolithics' engineering staff has for Mr. Gordon and Analogic. We do not consider modules

(continued on page 16)

### AMP EUROPE

**Austria** — AMP Austria. Branch of AMP Deutschland GmbH. Markgraf-Ruediger Str. 6-8, 1150 Vienna. Phone: 924191/92

**Belgium** — AMP Belgium. Branch of AMP-Holland B.V., Rue de Brabant 62-66, Brussels. Phone: 322.17.55.17

**Finland** — AMP Finland OY Postilokero 3, 00401 Helsinki 40 Phone: 90/584122

**France** — AMP de France. 29 Chaussée Jules-César. Boite Postale No. 39. 95301 Pantaise France. Phone: 030 82 20, 030 92 30

**Germany** — AMP Deutschland GmbH. Ampéstrasse 7-11, 607 Langen, B. FFM., West Germany. Phone: (06103) 7091

**Great Britain** — AMP of Great Britain Limited, Terminal House, Stanmore, Middlesex, England. Phone: 01-954-2356

**Holland** — AMP Holland B.V., Papierstraat 2-4 's-Hertogenbosch, Holland. Phone: (04100) 25221

**Italy** — AMP Italia S.p.A., Via Fratelli Cervi 15, 10093 Collegno (Torino), Italy. Phone: 785-656

**Spain** — AMP Española, S.A., Apartado 5294. Pedro IV, 491, 495, Barcelona 5, Spain. Phone: 307-75-50

**Sweden** — AMP Scandinavia AB, Datavägen 5, 17500 Jakobsberg, Sweden, Mailing Address: Fack S-175 20 JARFALLA 1, Sweden. Phone: 0758/10400

**Switzerland** — AMP AG, Haldenstrasse 11, 6006 Luzern, Switzerland, Phone: (414) 235421, 235422, 235423

### AMP NORTH AMERICA

**Canada** — AMP OF CANADA LTD., 20 Esna Park Drive, Markham, Ontario, Ph: 416-499-1251

**Mexico** — AMP de Mexico, S.A., Apartado Postal 179, Naucalpan de Juarez, Edo. de Mexico, Phone: Mexico City 576-41-55

**Puerto Rico** — AMP OF CANADA LTD., 677 Calé de Diego, Rio Piedras, Puerto Rico 00924, Phone: (809) 766-2346

**United States** — AMP Incorporated, Harrisburg, Pa. 17105, Phone: 717-564-0100

### AMP SOUTH AMERICA

**Argentina** — AMP S.A. Argentina 4 de Febrero, 76 Villa Zagla — SAN MARTIN, Buenos Aires, Argentina, Phone: 752-4612

**Brazil** — AMP do Brasil Ltda., AV Comendador Martinelli 185, Lapa, Sao Paulo, Phone: 262-4353

### AMP PACIFIC

**Australia** — Australian AMP Pty. Limited, 155 Briens Road, Northmead, N.S.W. 2152 Australia, Mailing Address: P.O. Box 194, Baulkham Hills, N.S.W. 2153 Aus. Ph: 630-7377

**Japan** — AMP (Japan), Ltd., No. 15-14, 7-Chome, Roppongi Minato-Ku, Tokyo, Japan, Ph: 404-7171

Products and services for many specialized industries are provided by the AMPLIVERSAL Division. In the United States, this division is known as AMP Special Industries.

For Amp products and services in other countries, write: AMP International Division, Harrisburg, PA 17105, USA.





# BIPOLAR MEMORIES

## WE JUST SET THE LAND SPEED RECORD FOR RAMs.

If you thought our 45ns TTL RAM was hot stuff, you haven't seen anything yet.

The TAA for our newest TTL RAM clocks in at 30ns. Making it the fastest TTL RAM ever made. And it's just one of six new speed records turned in at our latest time trials for Bipolar RAMs.

And if that doesn't impress you, wait until you hear this: While we were increasing our speed, we also reduced our prices.

### WATCH OUR DUST.

How fast is fast?

We took six of our most popular RAMs (four TTLs and two ECLs) and improved the specs across the board.

We also added a brand new TTL device that's no slouch in the speed department itself.

The line looks like this:

MAXIMUM ADDRESS ACCESS TIME (TAA) IN NS Over a temperature range of 0-70° C					
TTL	Organization	Old Spec	New Spec	100 Quantity Old Price	100 Quantity New Price
93L415*	1024 X 1	95	60	\$16.89	\$ 9.10
93L412*	256 X 4	70	60	\$30.67	\$17.03
93412*	256 X 4	NEW	45	—	\$17.75
93415*	1024 X 1	70	45	\$13.00	\$ 9.75
93415A*	1024 X 1	45	30	\$15.60	\$11.70
<b>ECL</b>					
10415	1024 X 1	60	35	\$29.82	\$15.60
10415A	1024 X 1	35	20	\$34.08	\$18.20

\*All TTL parts are available in a 3-state version with the same specs as above.

### GENTLEMEN, START YOUR RAMs.

Right from the start, our RAMs have outperformed the competition because of advanced Fairchild processing techniques. All our latest product improvements are the result of a process improvement called *Walled Emitter Isoplanar™*

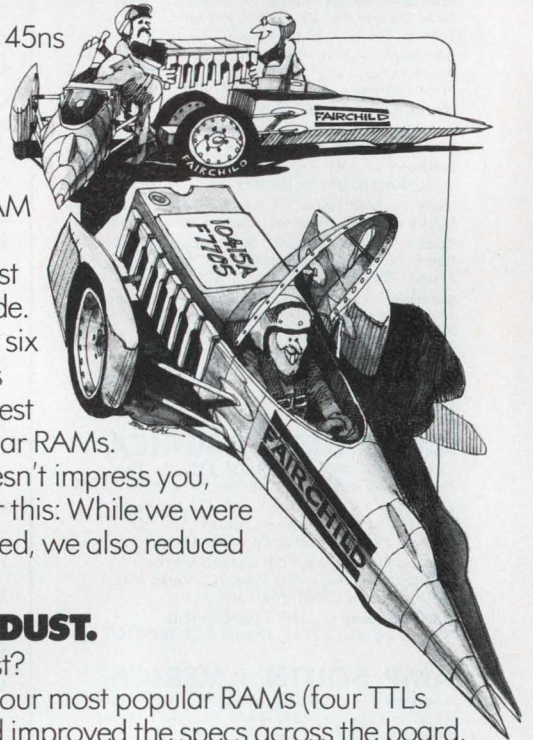



technology which, as you might suspect, is a patented Fairchild process.

The new process not only allows us to turn out faster parts for less cost, but also enables us to reduce die sizes from 20% to 50%.

And, if the initial results with the WEI process are any indication, you haven't seen anything yet.

### SO WHAT ELSE IS NEW?

How about a 35ns 4096 X1 static TTL RAM? Or a 256 X 1 ECL RAM with a T<sub>AA</sub> of 6ns typical? Both of these products and more are way beyond drawing board status at Fairchild. In fact, we should be announcing quantity production and distributor availability any day now.

### THE DYNAMIC DUO.

What about dynamic RAMs? Glad you asked.

Fairchild also makes the fastest dynamic 4K RAM in the industry. The 93481 boasts a T<sub>AA</sub> of 120ns and a cycle time of 280. The 93481A has an impressive T<sub>AA</sub> of 100ns and a cycle time of 240.

Both of these dynamic devices owe their performance specs to the I<sup>3</sup>L™ process. Which stands for Isoplanar™ Integrated Injection Logic.

### WAIT TILL YOU SEE HOW FAST WE DELIVER.

Making the world's fastest RAMs is one thing. Delivering them is another. As luck would have it, we also excel in another.

Our whole line of speedy TTL and ECL RAMs are waiting for you on distributor shelves. In quantity.

If you're somewhat surprised that we not only have the best RAMs on the market, but can also deliver them in whatever quantity you need, don't be. Fairchild has delivered more large Bipolar RAMs than all our competitors combined.

For fast information and delivery, write or call your Fairchild sales office, distributor or representative today. For an even faster response, use the direct line at the bottom of this ad to call our Bipolar Memory Division. Fairchild Camera & Instrument Corp., 464 Ellis Street, Mountain View, CA 94042. Tel: (415) 962-3951. TWX: 910-373-1227.



**FAIRCHILD**

**CALL US ON IT.  
(415) 962-3951**



# Our IC Converter class.

Ten years of leadership in signal conversion design, manufacture and application support has put Analog Devices at the head of the class in IC Converters. We pace the field in every aspect: in innovation, quality, pricing and shipments. As a result we can deliver more than 20 different kinds of IC Converters today. As well as give you the strongest technical and application support. Our production capability is what really enables us to step out ahead of the rest.

Take our high density CMOS processing technique. It increased circuit packing density, made higher breakdown voltages feasible and produced unusual stability and reliability. And enabled us to give the world its first precision CMOS monolithic D/A converters.

And look what our bipolar expertise plus innovations in thin film processing and laser trimming technology ultimately led to. The first monolithic laser wafer trimmed bipolar converters with unmatched accuracy and stability.

AD572—complete 12 bit successive approximation A/D converter can guarantee no missing codes over the full  $-55^{\circ}\text{C}$  to  $+125^{\circ}\text{C}$  temperature range.

AD7522—first monolithic CMOS 10 bit multiplying D/A converter with input buffer and holding register, allowing direct interface to microprocessors.

AD7550—13 bit monolithic CMOS integrating A/D converter using our revolutionary "Quad Slope" conversion technique for extremely high precision and stability. Tri-state data output and byte control for direct interface to microprocessors.

AD7570—monolithic CMOS 10 bit successive approximation A/D converter with tri-state data output and byte control for direct interface to microprocessors.

AD563—12 bit complete D/A converter with monotonic performance, over the full  $-55^{\circ}\text{C}$  to  $+125^{\circ}\text{C}$  temperature range.

AD7520—first monolithic CMOS 10 bit multiplying D/A converter.

AD561—10 bit complete monolithic D/A converter, the new DAC Standard.

 **ANALOG  
DEVICES**

The real IC converter company.



# Your IC Converter class.

## Program

### I. A/D and D/A Converters:

D/A Converter Function and Selection Factors  
Deciphering the Specification Page  
A/D Conversion Techniques  
Error Sources and Testing

### II. Analog Signal Handling for High Speed and Accuracy

D/A Converter Output Signal Interface  
Converter Dynamics and Compensation  
Finding and Preserving the Signal Path in Operational Amplifiers  
Analog and Digital Grounding and Decoupling

### III. Application Versatility of Bipolar and CMOS Converters

IC Converter Components and Designs  
The Complete Single-Chip Bipolar D/A  
Application Strengths of the Multiplying CMOS Converter  
Bipolar A/D's for Speed and Accuracy  
Low Power Systems A/D's with CMOS  
Peripheral Components

### IV. Converter/Microprocessor Interface Techniques

Hardware Techniques for the Standard Converter  
Simplifying the Interface with Peripheral Adapter Chips  
Converter Components for Direct  $\mu$  Processor Bus Connection  
Configurations of Complete Data Acquisition Systems

One of our Application Seminars is a perfect opportunity to learn from the head of the class more about today's IC Converters and data acquisition systems and their potential. You will also get a glimpse of what the future holds in store for conversion components. You can expect an intensive, stimulating all-day program put on by some of the best engineering brains in our company.

Which means some of the best brains in the industry. A look at the program will give you an idea of the scope of each seminar. And how much richer in knowledge you'll be at the end of it. Check the schedule below for the one you would like to attend. Then send the coupon to the sales office listed or telephone them. We will contact you with specific details.



The real IC converter company.

#### United States

- Los Angeles<sup>o</sup>  
May 3
- Palo Alto<sup>o</sup>  
May 5
- Boston<sup>oo</sup>  
May 11
- Metropolitan N.Y.<sup>oo</sup>  
June 7
- Houston<sup>o</sup>  
June 9
- Detroit<sup>ooo</sup>  
June 14

#### International

- Tokyo  
April 7 and 8
- Osaka  
April 11
- Munich  
May 24
- London  
May 26
- Copenhagen  
May 31
- Paris  
June 2

Send coupon or telephone:

<sup>o</sup>Analog Devices, Inc., 2225 28th Street, Suite 500, Long Beach, CA 90806. Tel: (213) 595-1783

<sup>oo</sup>Analog Devices, Inc., Route #1 Industrial Park, Norwood, MA 02062. Tel: (617) 329-5043

<sup>ooo</sup>Analog Devices, Inc., 123 East Lake Street, Suite 200, Bloomingdale, IL 60108. Tel: (312) 894-3300

For international seminars, contact: Denmark: 02/84 58 00, England: 01/94 10 46 6, France: 686-77 60, Germany: 089/53 03 19, Japan: 03/26 36 82 6.

ED426

Yes, I want to attend your class.

I'm interested in the seminar in

\_\_\_\_\_ on \_\_\_\_\_  
location date

Name \_\_\_\_\_

Title \_\_\_\_\_

Company \_\_\_\_\_ Department \_\_\_\_\_

Address \_\_\_\_\_ Phone \_\_\_\_\_

City \_\_\_\_\_ State \_\_\_\_\_ Zip \_\_\_\_\_



# Gulton's New Quiet Non-Impact Thermal Numeric Printer



Featuring . . . ultra quiet operation . . . seven columns of numbers or six columns of numbers with  $\pm$  sign . . . fast paper roll loading . . . up to four line per second print rate . . . complete with interface electronics . . . compatible with all popular digital panel meters.

Introducing Gulton's answer to noisy, complicated mechanical printers. The NP-7 panel-mounting printer requires only one moving part, the paper advance motor, which sends the paper silently beneath a non-impact thermal print head. You'll be pleased at the price, too.

Write or call for detailed catalog.

**gulton**<sup>®</sup>

Measurement & Control Systems Division  
Gulton Industries Inc., East Greenwich, Rhode Island 02818  
401 884 6800 • TWX 710 387 1500

NOW AVAILABLE WITH  
SPECIAL DATA IDENTIFICATION  
CHARACTERS

21098.76	K <sup>2</sup>
109876.5	9#
0987654	8#
9876543	7-
8765432	6+

## Across the desk

and monolithics competitive, and we value Analogic as a good customer for many of our products.

Mr. Gordon's treatise on our DAC-12 seems to focus on two points: definition of "monolithic," and definition of "DAC."

1. Mr. Gordon is misinformed about the definition of "monolithic." *The IEEE Standard Dictionary of Electrical and Electronics Terms* says that a monolithic integrated circuit is "an integrated circuit whose elements are formed in situ upon or within a semiconductor substrate with at least one of the elements formed within the substrate." By Mr. Gordon's definition, there is no such thing as *any* monolithic circuit, since every one of them has thin-film metal interconnects.

2. "Complete" should be defined by the buyer. High-speed multiplying DACs *do not need* a reference, and an output op amp just slows them down.

The success of PMI's 8-bit DAC-08, which is also a current-output, multiplying DAC (recently second-sourced by four major semiconductor companies), calibrates what the market is buying, if not what Mr. Gordon is selling. We probably have more DAC-08s in final test or distributor stock than all the 8-bit modules ever produced.

The rest of Mr. Gordon's letter expounds on manufacturing techniques and the theoretical aspects of long-term stability.

I don't think we have to apologize for using the standard IC-production method of "yielding," "culling" or sorting by performance grade. Further, the zener-zap trimming technique is quite analogous to "tweaking up" a module.

Regarding long-term stability, PMI's 6, 8, and 10-bit DACs have been qualified to "Level A" reliability on virtually every military/aerospace program since 1970. Such qualifications include the most stringent AQLs and PDAs on all performance parameters during accelerated life tests at 125 C and higher. We will qualify the DAC-12 as soon as production units are available.

Rather than debate semantics and theory, let's wait for the results. If the DAC-12 does not meet Mr. Gordon's criteria for stability, we will, at that time, remove the chewed-up heart from the metal mask.

Earl Rogers  
President

Precision Monolithics, Inc.  
Santa Clara, CA 95050



# Interested in network variety? Select from a spectrum of 540 standards.

Allen-Bradley has the popular configurations you need. Pull-ups, Pull-downs. Line Terminators. Networks to complement Core Memory Sense Amplifiers. TTL to ECL Translators. O-Pad Attenuators. All styles available from your Allen-Bradley *Electronic Distributor*. Call for specs or check your EEM Catalog. If you need specials, contact your local Allen-Bradley district office for fast turn-around. Ask for Publication 5840. A-B is an experienced twin-film manufacturer, i.e. precision thin film and thick film.

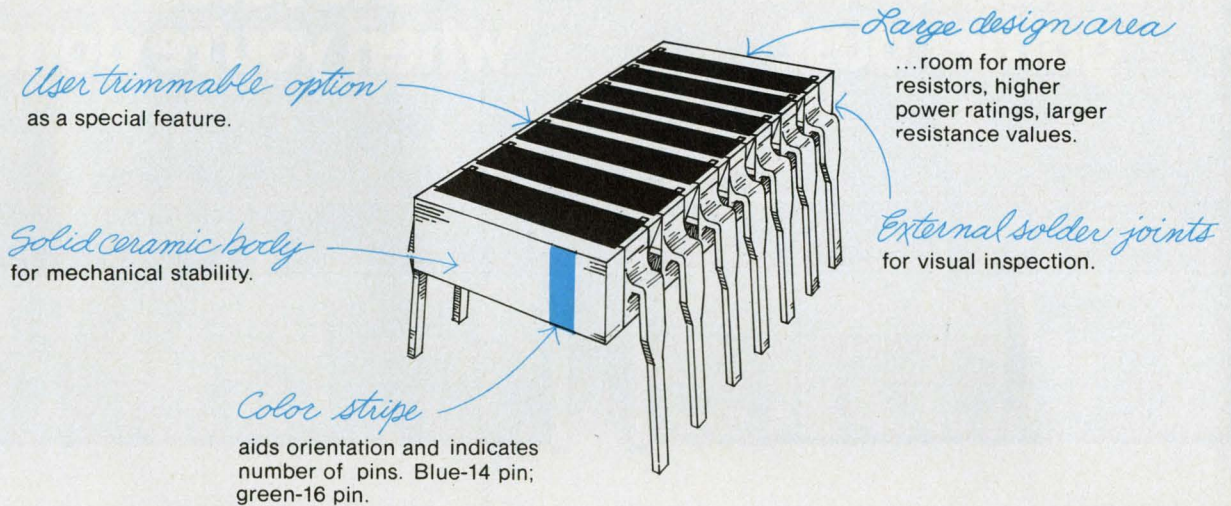

0540

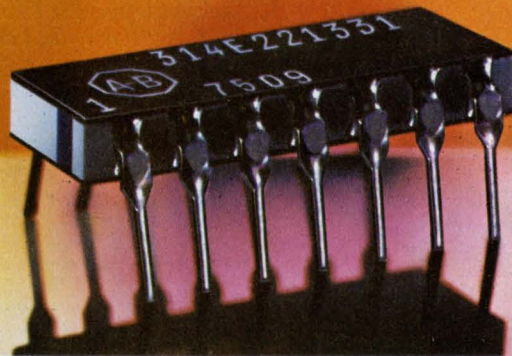

## Quality in the best tradition.



**ALLEN-BRADLEY**  
Electronics Division  
Milwaukee, Wisconsin 53204

CIRCLE NUMBER 13

EC149



**You can buy  
this signal generator  
for a 3-month job,  
and then let it  
gather dust.**

**You can rent  
this signal generator  
for a 3-month job,  
and return it  
when you're done.**

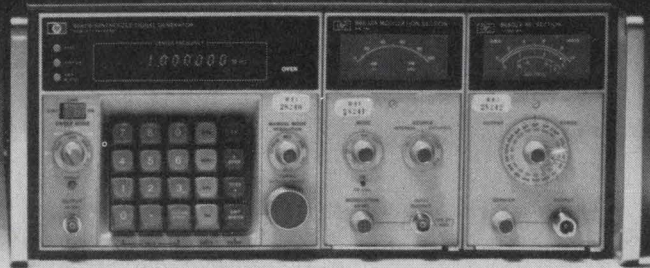
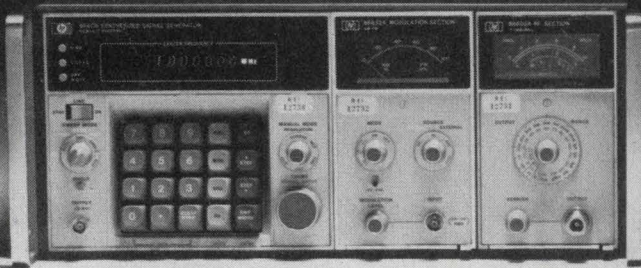

When you buy electronic test equipment for a short-term project, you're stuck with the equipment after the project is completed. Maybe it'll sit around gathering dust and costing you money. Or maybe you could sell it at a loss.

Or maybe, you should have rented it from REI.

When you rent equipment from us, you keep it only as long as you need it. When you're through with it, you send it back. Since you pay only for the time you have your instruments, you never have to spend your money on idle equipment. Short-term needs are just one reason for renting. Immediate delivery is another. Because we maintain over \$10 million in inventory in fully stocked instant inventory centers around the country, you can get delivery within hours.

REI stocks over 8,000 fully checked-out test instruments. And they're ready whenever you are. For the full story on renting as well as our low prices, send in the coupon for prompt delivery of our free illustrated catalog. Or call us now for your immediate requirements.

Rental Electronics, Inc.,  
99 Hartwell Avenue, Lexington, Mass. 02173.  
Please send me your free instrument rental catalog:

Name \_\_\_\_\_ Title \_\_\_\_\_

Company \_\_\_\_\_

Address \_\_\_\_\_

City \_\_\_\_\_ State \_\_\_\_\_ Zip \_\_\_\_\_

Tel. Number \_\_\_\_\_

**Rental Electronics, Inc.** 

Burlington, MA (617) 273-2770 • Gaithersburg, MD (301) 948-0620 • Oakland, NJ (201) 337-3757 • Ft. Lauderdale, FL (305) 771-3500  
Des Plaines, IL (312) 827-6670 • Dallas, TX (214) 661-8082 • Mountain View, CA (415) 968-8845 • Anaheim, CA (714) 879-0561  
Rexdale, Ontario (416) 677-7513

CIRCLE NUMBER 14



# TAKE A CLOSE LOOK AT THESE BURROUGHS PLASMA DISPLAY BREAKTHROUGHS.

Easier to read

Greater brightness

Improved contrast

Larger matrix dot

Broader horizontal  
viewing angle

Lower power  
requirements

Cost effective  
design

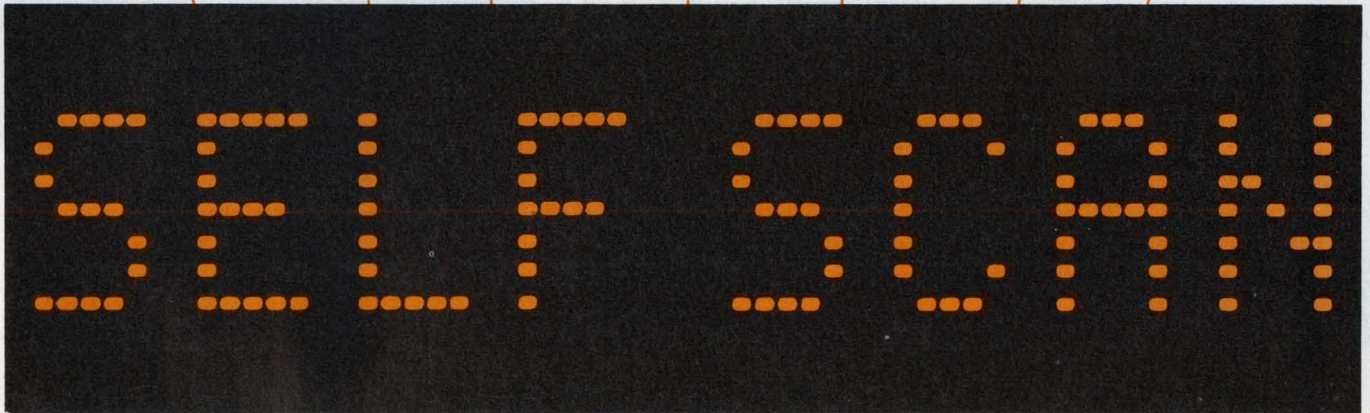

The new Burroughs SELF-SCAN® II single register gas plasma panels are breakthroughs in visibility and readability, making them ideal for all types of applications — from audience information displays to instrumentation applications. They are digitally addressed to interface easily with microprocessors and computers.

Only 15 connections are required. These new units complement Burroughs' standard line of single register 16 and 32 character plasma displays.

The Burroughs SELF-SCAN II 1 x 20 and 1 x 40 displays. Certainly worth looking into.

Burroughs Corporation, Electronic Components Division, P.O. Box 1226, Plainfield, New Jersey 07061. Telephone (201) 757-5000. SELF-SCAN displays are available nationwide through our distributors, Hamilton/Avnet and Cramer Electronics.

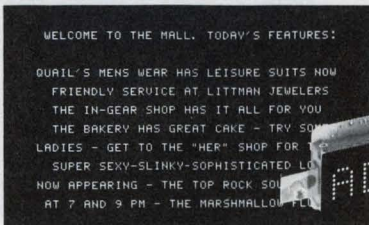

New 1 x 20 panel can be stacked and butted together to give a contiguous large audience information display of any number of characters.

New 1 x 40 panel for instrumentation, data terminals, computers and hundreds of other applications.



You can see the difference

## Burroughs



SELF-SCAN is a registered trademark of Burroughs Corporation.



# The Only Full Performance

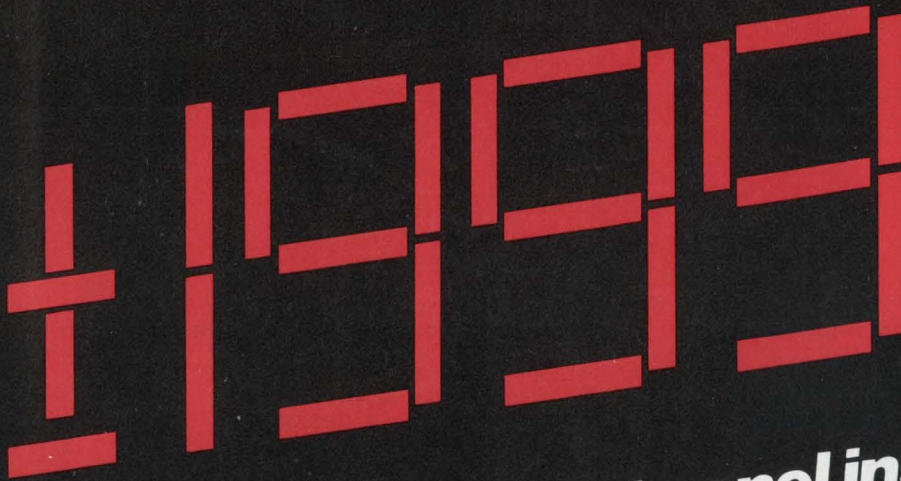

# COUNT

( $\pm 3\frac{1}{2}$  Digits)

**\$39<sup>00</sup>\*** digital panel instrument

More than just a \$39.00 Digital Panel Meter, our new AN2570 Digital Panel Instrument combines full performance with low cost. It features a full  $3\frac{1}{2}$  digit ( $\pm 1999$  count) LED display. It offers accuracy of  $\pm 0.05\%$  of reading  $\pm 1$  count, a bipolar differential input, a built-in signal enhancement filter, and input protection of  $\pm 300$  volts DC or AC RMS. Bias current is a very low 50 picoamps, input resistance  $> 1000$  megohms, range tempco is  $\pm 35$  ppm of reading/ $^{\circ}\text{C}$ , and the auto zero holds zero drift to just  $\pm 1\mu\text{V}/^{\circ}\text{C}$ . Operating temperature range is from  $-10^{\circ}\text{C}$  to  $+65^{\circ}\text{C}$ . And, to add to its value, the AN2570 has a low parts count, is extremely cool running, has a calculated MBTF in excess of 100,000 hours, and a 24-month warranty. But that's just half the story.

You have the choice of either a  $\pm 1.999\text{V}$  or  $\pm 199.9\text{mV}$  full scale input range. Four power options are available, too. Depending on your application you may choose either  $+5\text{Vdc}$   $\pm 5\%$  @  $170\text{mA}$ ,  $+8\text{Vdc}$  to  $+28\text{Vdc}$  @  $90\text{mA}$ ,  $110\text{ Vac}$   $\pm 20\%$  @  $1.6\text{ Watts}$ , or  $220\text{ Vac}$   $\pm 20\%$  @  $1.6\text{ Watts}$ . Standard is a DIN/NEMA high impact plastic case, but if you have an EMI/RFI problem, you can order a metal case. To further simplify installation, a rear screw-terminal connector is available for solderless connections. Also available is a latched and buffered parallel BCD output option for driving long data lines.

And, when you get ready to hook it up to the real world, the AN2570 has provisions for that, too. Standard display and conversion control signals include HOLD, BLANK, DISPLAY TEST, EOC, and OVERLOAD. Also standard are such features as Automatic Zero, Automatic Overrange Indication, Automatic Polarity, 3 or 4 wire ratiometric operation, and externally programmable decimal points.

That's full performance! Can you afford anything less for your \$39.00? For complete technical information and off-the-shelf delivery, contact your nearest Customer Interface Center, or Analogic's Marketing Department, Analogic Corporation, Audubon Road, Wakefield, Massachusetts 01880. Telephone (617) 246-0300.

\*\$39.00 each in 100's (+5V unit)  
Even less in larger quantities

## ANALOGIC

...The Digitizers



#### CUSTOMER INTERFACE CENTERS

#### E.I.L. INSTRUMENTS

Baltimore Area  
(301) 252-1260  
Los Angeles  
(213) 685-7020  
Chicago Area  
(312) 430-2292

Burlington, MA  
(617) 272-9450  
Norfolk, VA  
(804) 855-4241  
Alexandria, VA  
(703) 354-4330  
Pittsburgh  
(412) 731-5230  
Dayton  
(513) 435-2134

Indianapolis  
(317) 545-1373  
North Kingstown, RI  
(401) 885-1773

**TROTT ELECTRONICS**  
Clarence, NY  
(716) 634-8500  
Rochester, NY  
(716) 473-8010

**AMPOWER ELECTRONIC INSTRUMENT**  
Paterson, NJ Area  
(201) 742-3215  
Farmingdale, NY  
(516) 752-1078

**METERMASTER**  
Los Angeles  
(213) 685-4340

Palo Alto  
(415) 968-0313  
San Diego  
(714) 560-4841  
Chicago Area  
(312) 593-8650  
Garland, TX  
(214) 271-5671  
Phoenix, AZ  
(602) 243-4111

**CMP DISTRIBUTOR**  
Detroit Area  
(313) 477-7700  
Cleveland  
(216) 333-5650

**THERMO ELECTRIC (CANADA) LTD.**  
Brampton, Ontario  
(416) 451-0813



Welded terminations for superior resistance stability.

All-plastic case guards against shorts.

Cemented front and rear casing guards against solder flux.

Metal slotted shaft and metal bushing.

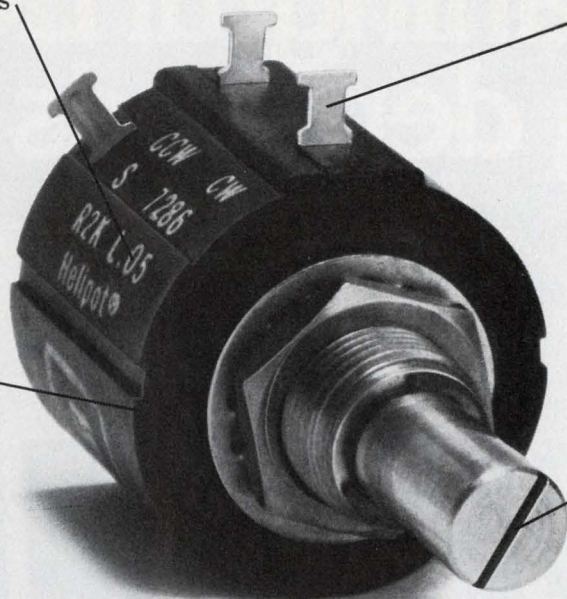

The Beckman 7/8" 10-Turn Model 7286

## Pay less for a better-quality precision potentiometer.

Look at more of the specific features of the 100%-inspected Model 7286:

- Operating temperature of 125°C (max).
- Independent linearity well within 0.25%.
- Separate contact position guide to decrease coil wear.
- Power rating: 2 watts at 70°C.
- Resistance range: 11 standard wirewound versions from 100 ohms to 100K ohms.
- Excellent setting stability.

One of the fine Beckman Helipot® family of standard pots, in sizes from 7/8" to 3-5/16". All available in wirewound; many available with conductive plastic, cermet, or hybrid resistance elements.

Available for delivery now. To order, or for more information, call your nearest Beckman Helipot distributor, or call (714) 871-4848, Extension 1776.

And the price: just \$4.68\*

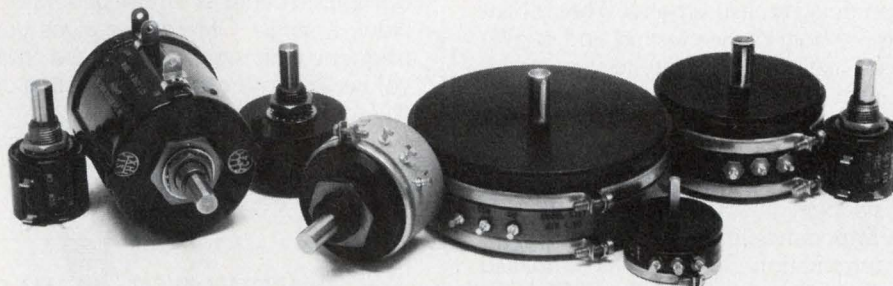

# BECKMAN®

\*In the 100-piece quantity.



# Meaningful ECL testing demands both:

Rep rates  
to  
250 MHz.

Variable  
transition  
times to 1 nsec.

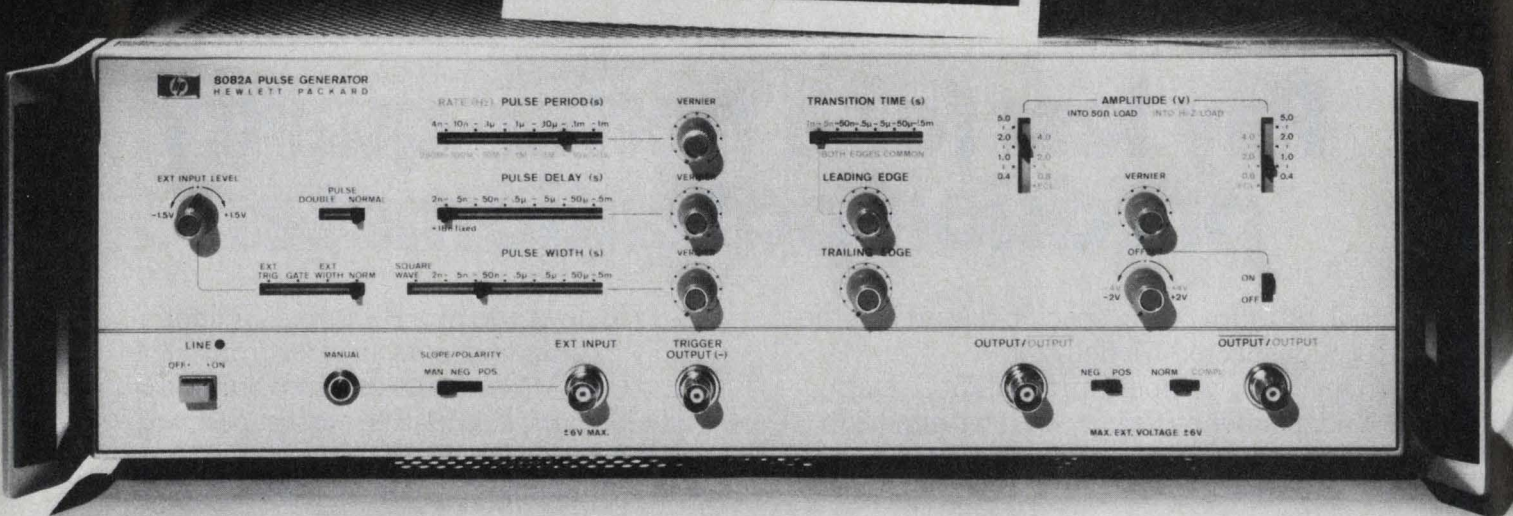
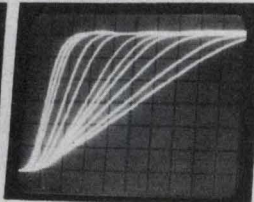
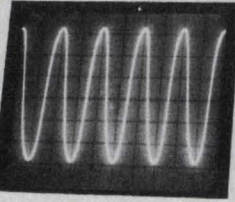

Instrument is shown with optional handles

## Only HP's 8082A Pulse Generator delivers both.

In ECL testing, high rep rates and fast transitions aren't enough. You also need variable transition times to 1 nsec for meaningful results. And, HP's 8082A Pulse Generator gives you variable transition times and more.

Now you can match the manufacturer's specified conditions for propagation delay measurements. That means more accurate results for both device testing and qualification, and breadboard testing. The ability to vary transition time between 1 nsec and 0.5 msec also gives you a way to test for worst-case conditions. And it lets you use this pulser for Schottky TTL and general-purpose TTL testing too.

What's more, HP's 8082A gives you a precise 50 ohm, low-reactance source impedance for excellent pulse shape without an external termination. That means simplified setups. And, to further simplify operation, the 8082A has an ECL output switch that automatically sets amplitude and offset to specified ECL levels; complementary outputs; and switch selectable polarity.

The 8082A also provides variable pulse delay for easy scope triggering at the right instant; a double-pulse mode

with variable spacing to 2 nsec for measuring data set-up times or simulating radar pulses; and external triggering which extends the rep rate range to dc. Priced at \$3675\*, the 8082A is the logical choice for both meaningful and convenient ECL testing.

And for the designer doing *state-of-the-art* logic development, HP has a new 300 MHz to 1 GHz pulse/word generator system, the 8080. This modular system can be configured either as a pulse generator or a word generator. Now, a single GHz pulser gives you dual outputs with frequency division and precise inter-channel delay for convenient and economical testing of the fastest available IC logic families.

For complete details on these versatile pulse generators, contact your local HP field engineer.

\*Domestic U.S.A. price only.

HEWLETT  PACKARD

1507 Page Mill Road, Palo Alto, California 94304

For assistance call: Washington (301) 948-6370, Chicago (312) 255-9800, Atlanta (404) 955-1500, Los Angeles (213) 877-1282

CIRCLE NUMBER 18

087/6



# What this country needs is a good \$39 DPM.

And we've got it. The AD2026 from Analog Devices. Priced at \$39 in hundreds\*, it's the first real alternative to the measurement grade analog panel meter. And the first to give you all the advantages of a DPM at a practical price. Advantages like visual appeal, accuracy, resolution, small size and reliability.

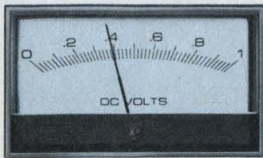

The AD2026 is a three digit, logic powered DPM that measures and displays voltages from -99mV to +999mV on 0.5" LEDs. It consumes only 3/4 Watts of 5V power. And because the AD2026 can be scaled with a simple resistive divider on its input pins, you can get direct readout in any engineering unit with equal or better resolution than APMs.

With an accuracy of 0.1% of reading  $\pm 1$  digit, the AD2026 is again far superior to conventional APMs, where their inherent inaccuracy usually limits the total performance of the instrument.



The AD2026 conserves on space, too. Its small front panel size of 3.4" x 2.0" and only 0.64" needed behind the panel makes it smaller than 3 1/2" scale APMs. But its performance outclasses 4 1/2" APMs.

When it comes to reliability, the AD2026 is unsurpassed. Its I<sup>2</sup>L technology combines most of the active analog and digital circuitry on *one* chip. The AD2026 has only 14 components and a MTBF of 250,000 hours at 25°C. In a 24-hour-a-day application, you shouldn't expect a failure for 28 years.

A new commercial tester automatically tests all AD2026's for defects such as bad components and solder shorts. It also fully tests both the LSI chip and the complete DPM. Following 168 hours of failure free burn-in, the units are again 100% tested.

The AD2026. Its low price (\$39/100s), small size, superior performance, and remarkable reliability make it the only sensible alternative to APMs. Which is just what this country needed.

Check it out. Return the coupon with your check or money order today to order an evaluation sample at the low 1-9 quantity price of \$62. And when you receive your evaluation samples you will also receive a Credit Certificate for \$23 redeemable when you place your order for the first hundred or more AD2026's.

## ANALOG DEVICES

The real DPM company.

Box 280, Norwood, MA 02062  
 Telephone: East Coast: (617) 329-4700,  
 Midwest: (312) 894-3300,  
 West Coast: (213) 595-1783,  
 Texas: (214) 231-5094.



- Please send me \_\_\_\_\_ AD2026 for testing and evaluation at the low (1-9) price of \$62. (Enclose check or money order.)
- Enclosed is my purchase order for 100 AD2026 DPMs at the unbelievably low price of \$39 in 100s.
- I'm not ready to order my AD2026 DPM for testing and evaluation, but I would like to receive all available technical information.

ED 4/26  
 P.O. # \_\_\_\_\_  
 Name \_\_\_\_\_  
 Company \_\_\_\_\_ Telephone \_\_\_\_\_  
 Address \_\_\_\_\_  
 City \_\_\_\_\_ State \_\_\_\_\_ Zip \_\_\_\_\_

\*Substantial quantity discounts available.



# Intel delivers micro ahead of the fast

In 1971, Intel invented the microcomputer and quickly became the world's largest supplier of microcomputers and microcomputer support products. We still are.

Over the past six years we've invested millions of dollars to make the microcomputer even more useful and more economical. Today there are over 195 Intel® microcomputer hardware and software products available to help people like you keep ahead of costs, ahead of the competition and ahead of the fast changing world.



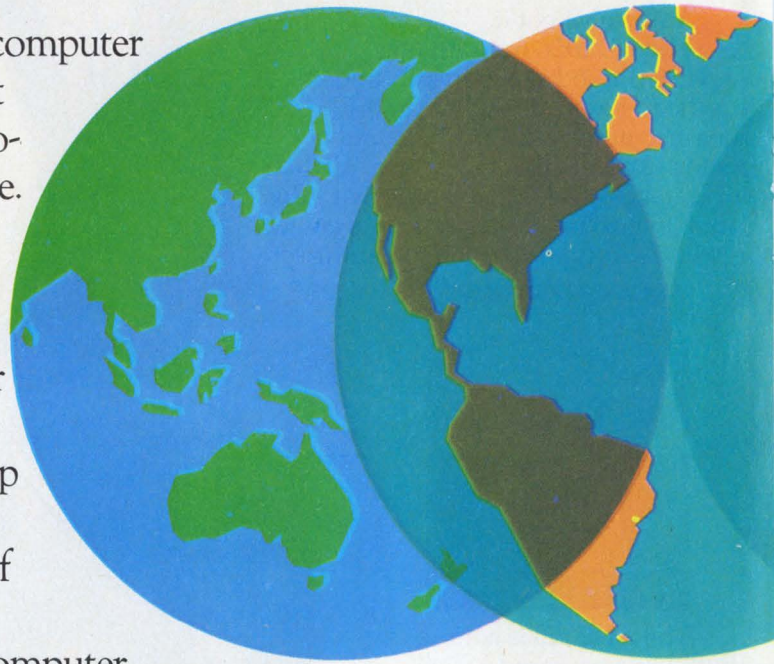

We're now offering seven microcomputer families. Including the newest high performance 8085 and the single chip 8748 with resident PROM. And 81 LSI peripheral, memory and I/O support circuits to help you cut design time, do more and get to market first. To reduce design time even further, choose one of our SBC80 Single Board Computers or System 80

packaged microcomputer systems.

But a wide selection of microcomputer components and systems is only half the story. We also provide programming support, including the PL/M high level microcomputer language to help you cut months off those big software development jobs. And Intellec® microcomputer development systems with ICE™ in-circuit emulation

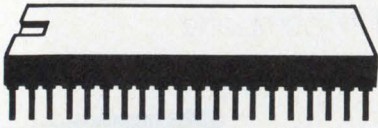

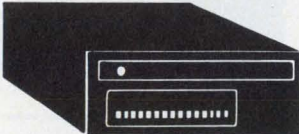
ix

<p>7 microcomputer families</p> 	<p>81 LSI peripheral, memory and I/O support products</p> 
<p>33 software products, users' library with 235 programs</p> 	<p>Intellec Development System with 42 options and accessories</p> 
<p>30 SBC 80 Single Board Computer products</p> 	<p>2 System 80 packaged microcomputer systems</p> 



# computers to keep you changing world.

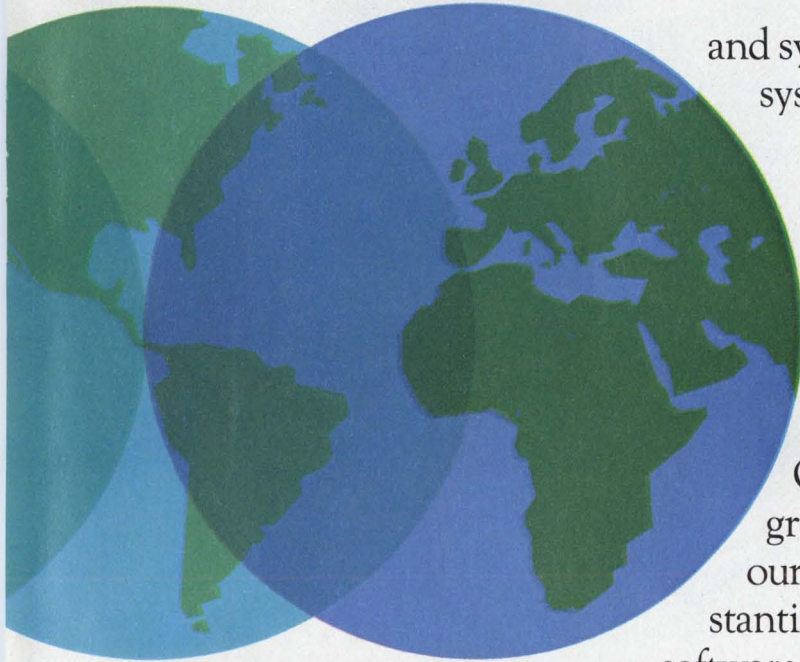

and symbolic debugging to help reduce system integration and debug time.

Then there's application assistance, training classes and regularly scheduled seminars available worldwide. A users' library with 235 programs and still growing.

Intel's investment protects your investment. Here are a few examples. Our new 8085 microprocessor offers greatly improved performance over our industry standard 8080, with substantial cost savings. Yet you use the same software, the same peripheral, memory and

I/O circuits as the 8080. You don't have to go through a new learning experience or re-invest in software to upgrade your system to 8085 performance. And that same kind of protection comes when you invest in an Intel development system. Last year's investment in an Intellec system is preserved even when we introduce a new microcomputer. Our newest 8085 and 8748 microcomputers are now fully supported with development software for your present Intellec system.

And you will soon be able to add low cost ICE-85 and ICE-48 in-circuit emulation modules.

Let Intel help you stay ahead.

Get started now by asking for our new microcomputer product line brochure describing the full line of Intel microcomputer products, systems and software. Use the reader service card or write: Intel Corporation, 3065 Bowers Avenue, Santa Clara, CA 95051.



## intel® delivers.

CIRCLE NO. 161 FOR TECHNICAL INFORMATION  
CIRCLE NO. 162 FOR TECHNICAL INFORMATION AND DEMONSTRATION





# All our memories are worth remembering.

Everybody knows NEC Microcomputers makes the fastest and most reliable 4K MOS RAMs on the market.

But that's just the start of our state-of-the-art memories.

We've got both static and dynamic types. In NMOS, CMOS and bipolar technologies. All made with the same care and quality control we give to our more famous products.

And we can deliver them in the quantity you need, when you need them.

At prices that are very competitive.

So if you are in the market for memory components, remember everything we have.

And remember us.

NEC Microcomputers, Inc., Five Militia Drive, Lexington, MA 02173. 617-862-6410.

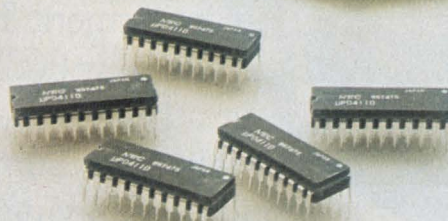

Product	Description	Organization	Access Times (Max) (ns)
2101AL	NMOS Static RAM	256 x 4	250-450
2102AL	NMOS Static RAM	1K x 1	250-450
2111AL	NMOS Static RAM	256 x 4	250-450
5101	CMOS Static RAM	256 x 4	450
2205	Bipolar TTL Static RAM	1K x 1	45
403	Bipolar PROM (A.I.M.*)	256 x 4	60
405/25	Bipolar PROM (A.I.M.)	512 x 8	70
406/26	Bipolar PROM (A.I.M.)	1K x 4	80
2308	NMOS ROM	1K x 8	450
2316A	NMOS ROM	2K x 8	450

\*Avalanche Induced Migration

## NEC microcomputers, inc.

REPS: East—C&D Sales 301-296-4306, Contact Sales 617-273-1520, Harry Nash Assoc. 215-657-2213, Tech-Mark 607-748-7473, 716-223-1252, 315-652-6229, Trionic Assoc. 516-466-2300; South—Perrott Assoc. 305-792-2211, 813-585-3327, 305-275-1132, Wolfs Sales Serv. Co. 919-781-0164; Midwest—Electronic Innovators 612-884-7471, W. Pat Fralia Co. 817-640-9101, 817-649-8981, 713-772-1572, K-MAR Eng. & Sales 816-763-5385, R. C. Nordstrom & Co. 313-559-7373, 616-429-8560, Technology Sales 312-438-3300; West—Mike Duffy Assoc. 303-934-7392, Electronic Component Marketing 714-524-9899, 213-649-5374, Spedden Assoc. 714-295-6122, Summit Sales 602-994-4587, Trident Assoc. 408-734-5900, Tri-Tronix 206-232-4993, 505-265-8409; Canada—R.F.Q. Ltd. 416-626-1445, 514-626-8324.

DISTRIBUTORS: Century Electronics (Albuquerque, Salt Lake City, Wheatridge CO), Diplomat (Chicopee Falls MA, Clearwater FL, Elk Grove Village IL, Farmington MI, Minneapolis, Mt. Laurel NJ, Salt Lake City, St. Louis, Sunnyvale, Totowa NJ, Woodbury NY), Future Electronics (Montreal, Ottawa, Rexdale, Canada), Harvey Electronics (Fairfield NJ, Lexington MA, Norwalk CT, Woodbury NY), Intermark Electronics (San Diego, Santa Ana, Sunnyvale), Lionex (Burlington MA), G.S. Marshall (Sunnyvale), Micro Electronics (Phoenix), Resco (Raleigh), R-M Electronic (Kentwood MI, Madison Hgts MI), Semicomp (Newport Beach CA), Semiconductor Specialists (Burlington MA, Chicago, Dallas, Dayton, Farmington MI, Hazelwood MO, Indianapolis, Kansas City, Milwaukee, Minneapolis, Pittsburgh, St. Louis; Malton Canada), Sterling Electronics (Albuquerque, Dallas, Houston, New Orleans, Phoenix, San Diego, Seattle, Sun Valley CA, Watertown MA), Technico (Columbia MD, Roanoke VA), Zeus Components (Elmsford NY).



APRIL 26, 1977

## Liquid-crystal panels put car functions on display

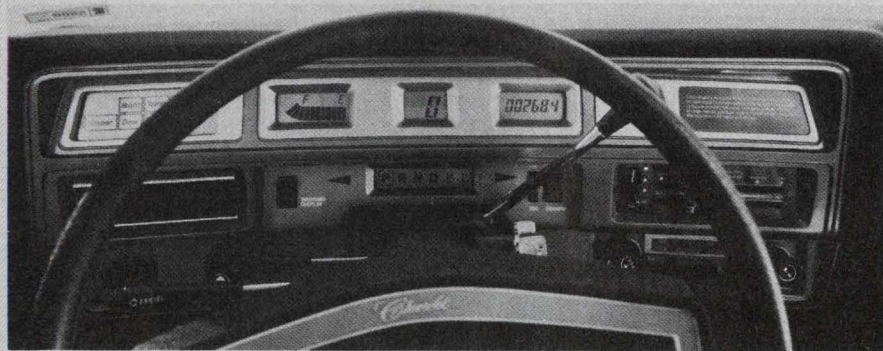

A liquid-crystal displays like this one may be used in future cars.

The first full panel of liquid-crystal displays to be installed in an auto draws less power and takes up much less space than conventional gauges and indicators. In addition, the low power and voltage needed by these displays—which are being tested in a General Motors' Research car—make them compatible with CMOS circuits that convert sensor inputs into digital voltages to drive digital or analog-display elements.

The entire panel consumes just 1/3 W. The individual displays are insulated from the panel ground and driven by CMOS circuits that convert car-battery voltage to 256-Hz pulses with a 50% duty cycle. The circuit uses the inherent capacitance of such cells to provide voltage doubling, so that a nominal 12 V is boosted to 24-V peak-to-peak across the cells. Indeed, the cells can even operate with 8-V pk-pk.

The displays are the reflective type with twisted nematic crystals. Indicators show speed, mileage, time of day, fuel level and gear (drive, neutral, etc.). Colored polarizing filters, used in this type of display for the first time, present such operating functions as "CRUISE" control and "BRIGHT" lights in blue letters. Warning indications for alternator, oil pressure and radiator temperature appear in red. Figures and elements for the other displays are black or gray.

Both the speed and odometer dis-

plays are tied to the digital clock so that the time base of the clock can be fed to circuits that compute the speed from distance and time. For distance, an optical sensor driven by a LED keeps track of wheel rotation. The CMOS processing circuits convert this rotation to distance traveled. This distance is divided by time to give the vehicle speed, which is then displayed as two large digits.

Since one LCD shows either the odometer reading or the time of day, a driver can select one or the other with one dashboard switch.

The output of the fuel-level sensor (a 0-to-90- $\Omega$  variable resistor) is processed to light up the bar-graph-type fuel display progressively towards "F" or "E." The warning sensors are switches that are grounded when a warning condition exists, which turns on the proper red display.

### Chips replace software in data-comm systems

Two LSI chips—a multiprotocol communications controller and a programmable interface chip—should go a long way toward simplifying data communications. The former can be used to send and receive digital data over common telephone lines, and can manipulate data streams into either

bit-oriented protocols (SDLC, ADCCP) or byte-oriented protocols (BISYNC, DDCMP). The latter can be used to serialize data transmission over telephone lines and, once the data are received, can reconstruct them into a parallel format.

Designated the 2652 by Signetics Corp., Sunnyvale, CA, the MPCC/SDLC chip assumes many of the tasks previously done in software: It generates and compares error-checking characters, inserts and deletes zeroes for the SDLC protocol, and detects short characters. Operating from dc to 500 kbits/s, the 2652 has local and remote loop-back for self-testing, is TTL-compatible and requires only a single, 5-V supply. Price ranges from \$27 to \$34, depending on quantity.

Its companion device, the 2651 programmable communications interface (PCI), is also implemented in MOS technology. Furthermore, it is interruptible. Should an incoming message arrive while the PCI is serializing an outgoing message, the device will suspend its outgoing operation to accept and reconstruct the incoming message. Then it can pick up where it left off.

Even though the PCI works only in BISYNC protocol, it can support full and half duplex operation, synchronous and asynchronous modes, and even, odd or no parity. Any of 16 different baud rates can be programmed by the host microcomputer. Like the 2652, the PCI is TTL-compatible and requires a single 5-V supply. The cost is \$16 to \$18, depending on the quantity ordered.

CIRCLE NO. 319

### 16-bit microprocessor can run the lights, too

Replacing a minicomputer with a 16-bit microprocessor produces a stage-lighting memory system with the same capabilities but half the cost. Exhibited at the National Association of Broadcasters Convention in Washington, DC, the Performance by Kliegl Bros. stores the levels of the stage spotlights for each lighting cue during a production. In addition, the cues can be recalled by pushbutton, and the lighting set to fade from one cue to the next.

Depending on the configuration, the Performance is priced from \$25,000 to \$50,000.

The microprocessor, a Texas Instruments TMS 9900, manages the system's memories, performs the mul-



tuplications necessary to calculate fade levels, and interfaces to such peripherals as a CRT display, a Shugart floppy disc, and a hard-copy printer for written records of lighting programs.

"We selected the TMS 9900 because the system must perform a large number of multiplications, and the 9900 has hardware multiply facilities," says Gordon W. Pearlman, design leader for the Long Island City, NY, theatre-equipment supplier, best known for its Klieglight spotlights. Operating software is stored in EPROMs, and "soft" data such as present lighting levels are stored in 4096-bit static MOS RAMs. The user's lighting program is stored in CMOS RAMs that can be powered either from the line or from back-up batteries—which prevents losing a complex lighting program to a power outage, Pearlman explains.

Lighting levels can be programmed into the Performance with either a rolling-tape mechanism attached to a shaft encoder or slide-wire potentiometers that feed the microprocessor through analog-to-digital converters. In addition, triac dimmers are driven by digital data from the microprocessor that are converted to analog form.

## Color monitors can be adjusted on sight

With a color-bar test signal, a technician can use his own eyes to adjust the color saturation and hue as well as the black level on CRT monitors. Developed by CBS Technology Center, Stamford, CT, the technique eliminates costly instruments that measure light levels off the screen, and is aimed at studio color monitors and CRTs such as those used in some automatic test-equipment systems.

"Small chroma drifts can be easily identified at a glance, which encourages their correction before the errors become objectionable," says A.A. Goldberg, who described the system for CBS at the Broadcast Engineering Conference, part of the National Association of Broadcasters Conference in Washington, DC.

Seven color bars—gray, yellow, cyan, green, magenta, red, and blue—are displayed on the monitor screen, along with four color patches—blue below the gray color bar, magenta under the cyan bar, and vice versa. For black-level adjustments, there are two

additional patches, one a shade lighter and one a shade darker than the darkest shade normally reproduced on a TV screen, which are set in a black surround.

First, the red and green electron guns are extinguished, leaving only the blue gun energized. Since gray, cyan, and magenta have some blue-light content, they appear as blue—resulting in a test pattern of four blue bars interspersed with black.

Color saturation is correct when the two outer blue bars are equally bright; hue is correct when the blue inner bars are equally bright. Equality is determined by adjusting until the boundary between the color bar and the patch beneath disappears.

Brightness is properly adjusted when the lighter black-level patch is visible and the darker patch invisible against the black surround.

Another system, a digital noise reducer developed jointly by CBS Technology Center and Thomson-CSF Laboratories (also in Stamford) improves the signal-to-noise ratio of color-TV picture transmissions by 15 dB.

An adaptation of a frame-to-frame recursive filter, this noise reducer contains a motion detector that scans every element of a TV picture and decides whether the filter should operate.

Input and output data from the filter are fed into an arithmetic logic unit and compared with data from the previous frame. To avoid smearing the picture, filtering occurs only when there is no motion.

## Small computer uses micro, multiprogramming

The newest small computer from Data General features a user-micro-programmable control processor. In addition, it incorporates multiprogramming for users with complex, multifunction applications.

Microprogramming is a technique for writing special instructions into a computer's CPU to obtain high processing speeds for dedicated applications. The microprogramming store of the Eclipse S/130 from Data General, is based on a 56-bit word length with 15 independent control fields. Currently, Hewlett-Packard's 21 MX has a 24-bit word length (which is effectively larger with encoding) and Digital Equipment's 11/60 has a 48-bit word length.

Multiprogramming is a software

technique that supports concurrent time-sharing, batch operations and real-time operations under the control of Data General's recently announced Advanced Operating System.

Accelerated processing speed, fast execution of specialized instructions and most-used algorithms, and generating and debugging of extensions to the computer's own instruction set can all be achieved with the user-micro-programming features. For example, the S/130—the smallest member of the Eclipse family that includes the S/230 and C/330—can execute a microcoded, 32-bit floating-point multiply in less than 14  $\mu$ s, about one-fifth the time it would take if simulated in software. A microcoded character-handling instruction set produces a similar increase in processing speed.

The fast processing is due to several factors: the 15-field microword that allows a number of parallel operations to take place in a single microcycle; a fast 200-ns microcycle; a high-speed scratchpad of 256 16-bit registers; and an unusually powerful arithmetic logic unit.

With its Eclipse architecture, the S/130 can be expanded up to 256 kbytes of MOS, core, or mixed main memory. The semiconductor memory modules have 64 kbytes and a cycle time of 500 ns. The semiconductor memories have error correction and optional battery backup. A memory allocation and protection unit provides program and data protection in multi-user environments.

System software includes Data General's AOS and its real-time disc-operating system. High-level languages include globally optimized Fortran 5, Fortran IV, single and multi-user Basic and Algol.

## Intel's advanced 80/20 has twice the memory

An advanced version of its SBC 80/20 single-board  $\mu$ C, with double the memory capacity will be announced by Intel, Santa Clara, CA. The four 2708 DIPs in the current version have been replaced by four 2716 EPROMs, while eight new 2114 static RAMs take the place of the 2113s now used. Meanwhile, current 80/20s can be upgraded merely by plugging in the new double capacity chips and by making jumper changes on the board. RAM capacity becomes 4 kbytes and EPROM goes to 4 kbytes.



# This semiconductor plant ain't exactly two guys in a garage.

It takes a lot of research, development, design, and production know-how to turn out a good line of semiconductor devices . . . it also takes a lot of sophisticated equipment . . . plus a lot of specially-educated and skillfully-trained people mutually striving for product excellence.

At Sprague Electric's Semiconductor Division, we have accumulated over fifteen years of intensive experience in the manufacture of *innovative* semiconductor devices . . . devices making special contributions to technology . . . devices manufactured under the most exacting QAR program . . . devices that assure total customer satisfaction.

We have built the kind of operation it takes to produce semiconductors compatible with today's as well as tomorrow's requirements.

We proudly invite customers and prospects to tour our plant, the nation's finest semiconductor facility of its type. Here you will see the magnitude of effort that goes into properly designed and manufactured devices. You'll be pleasantly surprised!

Write or call George Tully or Bob Milewski to arrange a visit. You can reach them at the Semiconductor Division, Sprague Electric Co., 115 Northeast Cutoff, Worcester, Mass. 01606. Tel. 617/853-5000.

#### FOR FAST INFORMATION, CALL YOUR NEAREST SPRAGUE SALES OFFICE:

ALABAMA, Sprague Electric Co., 205-883-0520 • ARIZONA, Sprague Electric Co., 602-279-5435 • CALIFORNIA, Sprague Electric Co., 213-649-2600. Wm. J. Purdy Co., 415-347-7701. KCE Corp., 714-278-7640 • COLORADO, Wm. J. Purdy Co., 303-777-1411 • CONNECTICUT, Sprague Electric Co., 203-261-2551 • DIST. OF COLUMBIA, Sprague Electric Co. (Govt. sales only), 202-244-6006 • FLORIDA, Sprague Electric Co., 305-831-3636 • ILLINOIS, Sprague Electric Co., 312-678-2262 • INDIANA, Sprague Electric Co., 317-253-4247 • MASSACHUSETTS, Sprague Electric Co., 617-899-9100. Sprague Electric Co., 413-664-4411 • MICHIGAN, Sprague Electric Co., 517-787-3934 • MINNESOTA, HMR Inc., 612-920-8200 • MISSOURI, Sprague Electric Co., 314-781-2420 • NEW JERSEY, Sprague Electric Co., 201-696-8200. Sprague Electric Co., 609-795-2299. Trinkie Sales Inc., 609-795-4200 • NEW MEXICO, Wm. J. Purdy Co., 505-265-7959 • NEW YORK, Sprague Electric Co., 516-549-4141. Wm. Rutt Inc., 914-699-8600. Sprague Electric Co., 315-437-7311. Mar-Com Associates, 315-437-2843 • NORTH CAROLINA, Electronic Marketing Associates, 919-722-5151 • OHIO, ElectronicSalesmasters Inc., 800-362-2616. Sprague Electric Co., 513-278-0781 • PENNSYLVANIA, Sprague Electric Co., 215-467-5252. Trinkie Sales Inc., 215-922-2080 • TEXAS, Sprague Electric Co., 214-235-1256 • VERMONT, Ray Perron & Co. Inc., 617-762-8114 • VIRGINIA, Sprague Electric Co., 703-463-9161 • WASHINGTON, Sprague Electric Co., 206-632-7761 • CANADA (Ontario), Sprague Electric of Canada Ltd., 416-766-6123 • CANADA (Quebec), Sprague Electric of Canada Ltd., 514-683-9220

4SS-6139RI

**SPRAGUE**  
THE MARK OF RELIABILITY

... and you thought we  
only make great capacitors.



CIRCLE NUMBER 22



# When your job calls for a microcomputer,

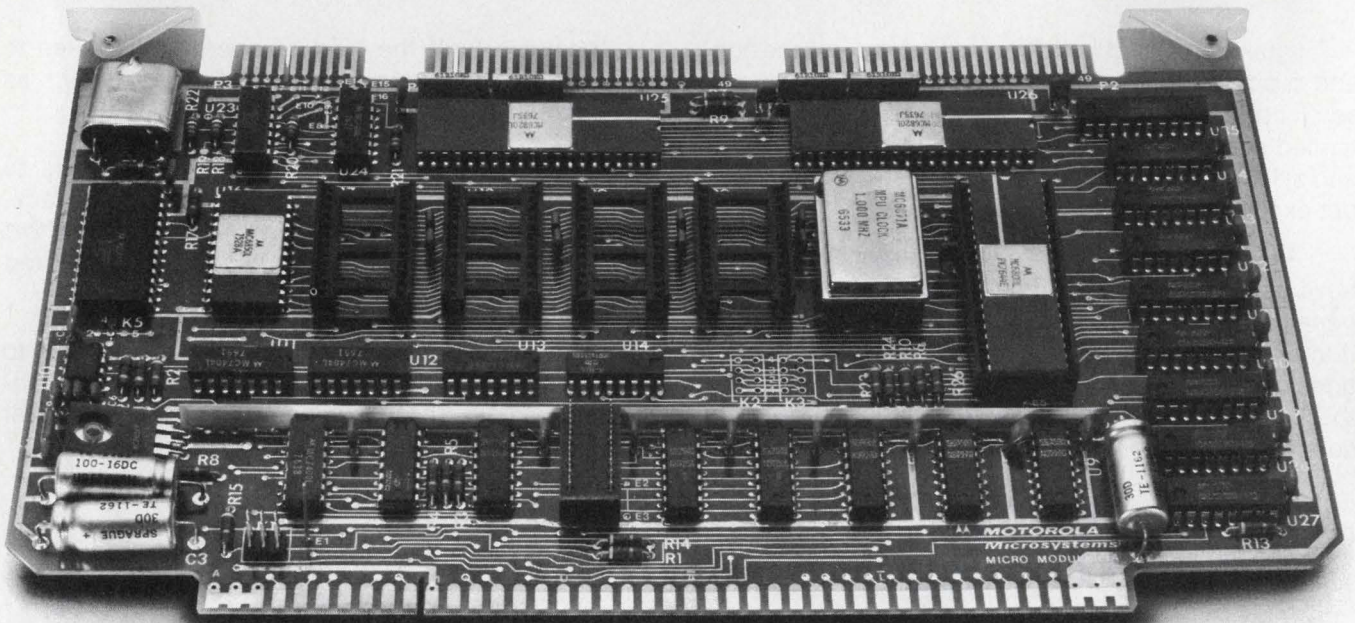

Motorola's newest Monoboard microcomputer-  
M68MM01A. \$285.00, 100-Up. (US)

Controls? Medical instruments? Communications preprocessors? Yes, for these and countless other new and imaginative applications, the rush to microcomputers is on.

Some users can and do design and build their own, from scratch. Many others, however, would rather buy than build: to speed start-up, to avoid the hassles of in-house design and production, to hasten market entry, or simply to employ the lowest cost approach.

Motorola's Micromodule\* Family responds to these requirements, and more, with your choice of Monoboard microcomputers or the mix 'n match modular building block board set.

## Monoboard microcomputers, everything on a single compact board

Call them instant microcomputers if you wish, but whatever you call them, all you have to add is the power supply and you're ready to

go. The original M68MM01 is designed with all parallel I/O, and the newer M68MM01A features both serial and parallel I/O.

**M68MM01A** — An Asynchronous Communications Interface Adapter and two Peripheral Interface Adapters provide both programmable serial and parallel I/O

**M68MM01** — Three MC6820 Peripheral Interface Adapters for all parallel programmable I/O

- MC6800 microprocessor for processing and control power
- 1K x 8 of RAM
- Four 1K x 8 EROM/ROM sockets
- RS232 interface
- 1MHz crystal controlled clock
- Bus compatible with EXOR-ciser\* and all Micromodule Family modules
- Powerful, easy to use instruction set
- Expandable memory and I/O
- Refresh for external memory



# answer with Micromodules.

Mix'n Match, custom microcomputers from standard family Micromodules

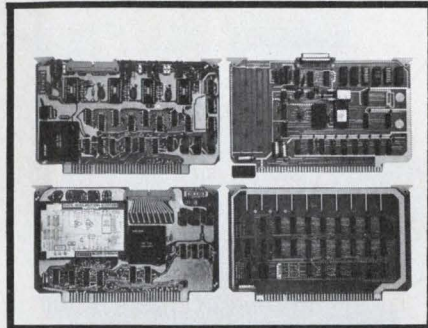
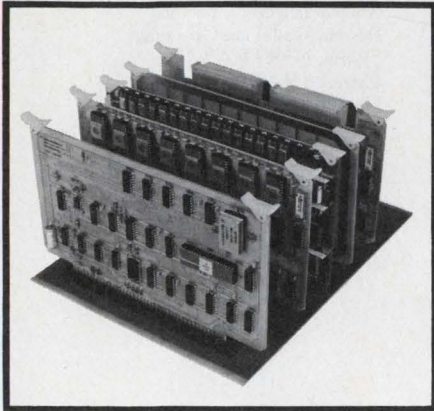

## New support modules available

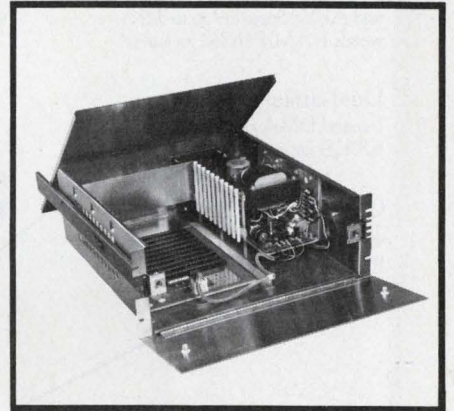

## Chassis, card cages and power supply wrap up the system

Talk about flexible. This is the modular building block approach to your customized system...with standard boards. The heart of this plan is the CPU module, M68MM02, which comes equipped with the M6800 microprocessor, clock, timing and control signals for DMA, three-state control, halt, dynamic memory refresh, etc. System expansion modules previously available include the M68MM03, 32/32 I/O module, and the M68MM04, 8K/16K EROM/ROM module. All micro-modules are EXORciser Bus compatible.

Now five recently introduced additional family modules are also available, increasing the mix 'n match flexibility of the Micromodule Family. M68MM05A is an 8-Channel Differential 12-Bit A/D module, the 05B is a Single-Ended 16-Channel 12-Bit A/D, and the 05C is the analog output module, a Quad 12-Bit D/A.

They are joined by a new 2K RAM module, M68MM06, and the M68MM08 Microbug, a debug module with a firmware monitor program and provisions for communication with either an RS232 terminal or a 20 mA current loop.

We offer two different rack mount chassis complete with card cage, motherboard and power supply, the short one with a 5-card cage, and the long, with a 10-card cage. For applications which don't require a rack mount chassis, fully equipped short and long card cages are available with provisions for a wide variety of mounting positions.

The Micromodule Family is backed by the total resources of Motorola's system development tools, including EXORciser, EXORdisk\*, EXORprint\*, and the full complement of software.

Contact your authorized Motorola distributor or Motorola sales office, or send for our Micromodule data brochure. Motorola Semiconductor Products Inc., P.O. Box 20912, Phoenix, AZ. 85036.

\*Trademark of Motorola Inc.

## The Micromodule Family

### Available Now

#### Monoboard Microcomputers

M68MM01 Monoboard Microcomputer 1  
M68MM01A Monoboard Microcomputer 1A

#### Micromodule CPU

M68MM02 CPU Module

### To be Introduced

#### System Expander and Support Modules

M68MM09 CMOS RAM Battery  
M68MM10 Programmable Timer  
M68MM12 GPIB

### Available Now

#### Applicable EXORciser Modules

ACIA, EROM/ROM, 16K RAM, System Analyser

#### System Expander and Support Modules

M68MM03 32/32 I/O  
M68MM04 8K/16K EROM/ROM  
M68MM05A 8-Ch. Differential 12-Bit A/D  
M68MM05B 16-Ch. Single-Ended 12-Bit A/D  
M68MM05C Quad 12-Bit D/A  
M68MM06 2K RAM  
M68MM08 Microbug



# MOTOROLA Microsystems

-making it happen in microcomputers



# Here's how Data General's microNOVA system stacks up against the competition.

**microNOVA Processor:**  
Fully packaged 9-slot micro-computer, 16K words MOS memory, 2.4-microsecond arithmetic operations, hardware stack facility, multiply/divide, DMA capability. Includes RTC, PF/AR and APL. Supports up to 32K words RAM/PROM memory.

**Dual-diskette subsystem:**  
Integral DMA controller, compact 630KB capacity.

**Cabinet:**  
37 inches high, holds all rack mounted components.

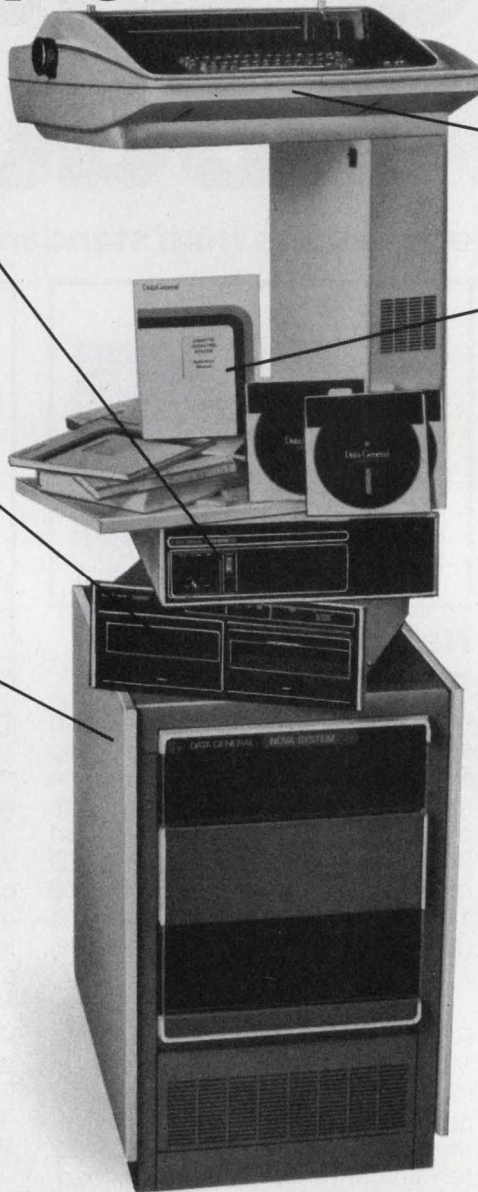

**DASHER**  
terminal printer:  
30 cps, 132-columns, typewriter keyboard, upper/lower case.

**Systems Software:**  
Multitasking Disc Operating System, Real-Time Operating System, FORTRAN IV, Extended BASIC, Macro Assembler, Utilities.

**\$10,970**  
List\*

The facts speak for themselves. For **\$10,970**, Data General's new microNOVA gives you more system, software availability and support than any other comparable computer. And we deliver in 60 days.

Any way you look at it, it all stacks up in your favor. For more information and our brochure, call our toll free number, 800-225-9497, or, fill out and return the coupon.

\*Additional software fees apply to first system only. Quantity and OEM discounts available.

Data General, Westboro, MA 01581  
Sounds like smart business. Send me more information.

NAME \_\_\_\_\_  
TITLE \_\_\_\_\_  
COMPANY \_\_\_\_\_  
ADDRESS \_\_\_\_\_ TEL. \_\_\_\_\_  
CITY \_\_\_\_\_ STATE \_\_\_\_\_ ZIP \_\_\_\_\_

NOVA is a registered trademark of Data General Corporation.  
DASHER is a trademark of Data General Corporation.



**Data General**  
It's smart business.

Data General, Westboro, MA 01581, (617) 485-9100. Data General (Canada) Ltd., Ontario. Data General Europe, 15 Rue Le Sueur, Paris 75116 France. Data General Australia, Melbourne (03) 82-1361.

CIRCLE NUMBER 24



# We did it. Cheaper.

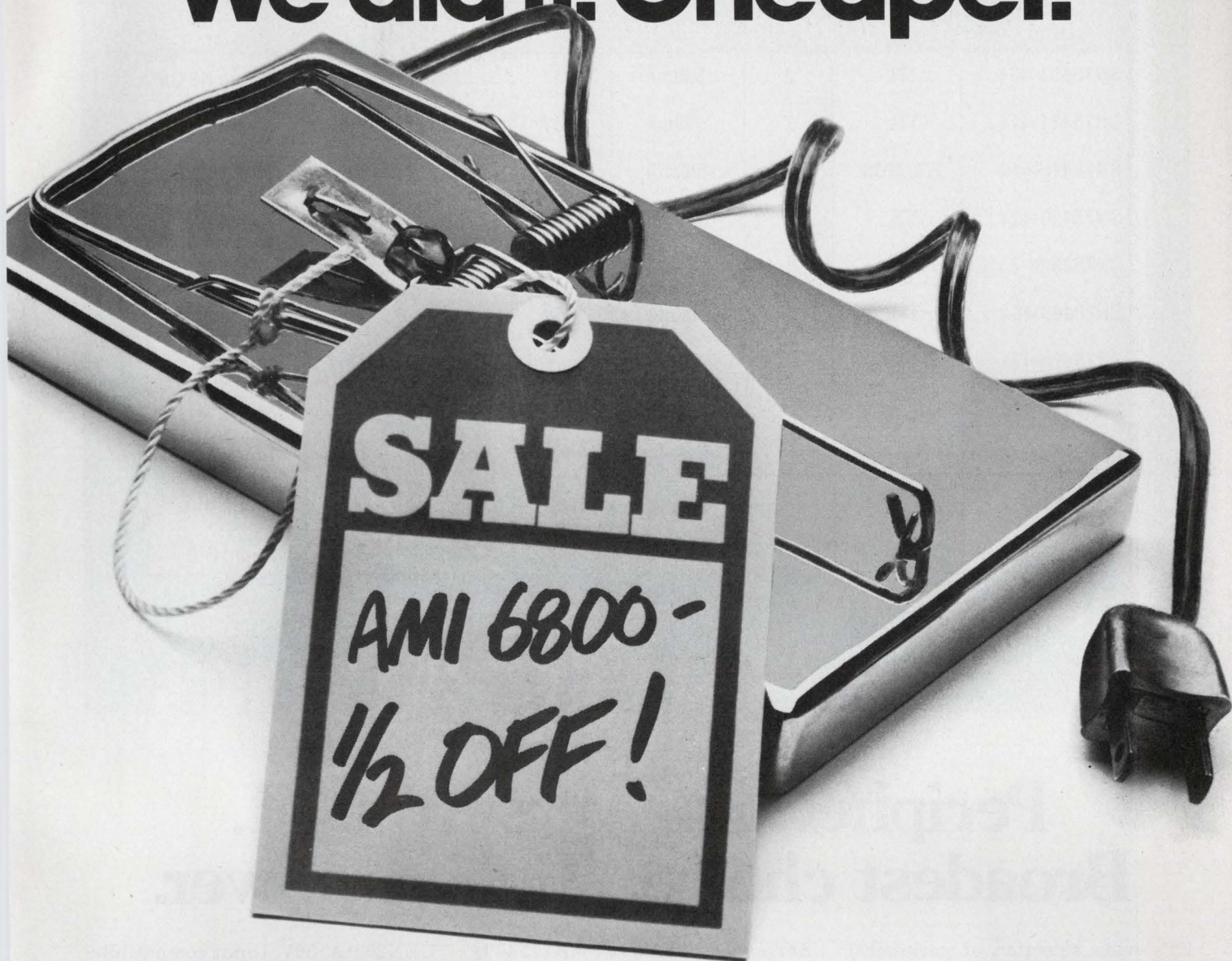

Here's fantastic news for you cost-conscious perfectionists. Now you can buy the better microprocessor for about the same price as the 8080 or even less.

We've just cut the price of the AMI 6800 to \$15 at 100 up. And you know how much easier it is to design your system around the 6800 microprocessor. So by the time you count your savings in power supplies and TTL, you should be way ahead—with a better product, too.

The rest of the AMI 6800 family has also gone on a reducing diet. That includes our RAM, ROM, PIA, ACIA, MODEM, and USRT. And our 4K EPROM is down to a slim \$9.95 in 100 up quantity, a lower

cost per bit than an 8K EPROM.

The better Microcomputer Development Center, which can cut programming time from hours to minutes, has also been cut by \$900—down to \$9,600.

That buys you a very smart CRT, a dual floppy disk, an EPROM programmer, a firmware debug package, and complete software, including file manager, editor and assembler.

People like Hewlett-Packard, Tektronix, TRW, Memorex and Conrac have chosen the AMI 6800 because of its superior architecture. Now it's possible for you to

do the same—because of its price.

You'll find the whole AMI 6800 family at our distributors. Give them a call, or phone your local AMI sales office. Or contact AMI, 3800 Homestead Road, Santa Clara CA 95051, (408) 246-0330.

REDUCED  
\$900



**AMI**  
AMERICAN MICROSYSTEMS, INC.



DEVICES	INPUT	DRIVERS PER PACKAGE	OUTPUT CURRENT	OUTPUT VOLTAGE	TYPICAL SPEED	CLAMPED DIODES	PACKAGE
SN75401-404	TTL	2	500mA	35V	33ns	No	14-pin NE DIP
SN75411-414	TTL	2	500mA	70V	33ns	No	14-pin NE DIP
SN75416-419	TTL/MOS	2	500mA	70V	100ns	Yes	14-pin NE DIP
SN75430-434	TTL	2	300mA	15V	15ns	No	8-pin DIP*
SN75450B-454B	TTL	2	300mA	30V	21ns	No	8-pin DIP*
SN75460-464	TTL	2	300mA	35V	33ns	No	8-pin DIP*
SN75470-474	TTL	2	300mA	70V	33ns	No	8-pin DIP*
SN75476-479	TTL/MOS	2	300mA	70V	100ns	Yes	8-pin DIP
ULN2001A-4A	**	7	500mA	50V	1 $\mu$ s	Yes	16-pin DIP
SN75466-469	**	7	500mA	100V	130ns	Yes	16-pin DIP
SN75441	ECL	2	100mA	30V	22ns	No	14-pin DIP

\*SN75431-434/451B-454B/461-464/471-474 (AND, NAND, OR, NOR functions) are 8-pin devices. SN75430/450B/460/470 (AND function with externally connected output transistor bases) are 14-pin devices.

\*\*Input capabilities include TTL; CMOS (5V and 6V-15V); and PMOS (5V, 6V-15V, and 14V-25V).

## INTERFACE ICs

# Peripheral drivers from TI. Broadest choice. Highest power.

TI's wide selection of peripheral drivers makes it easier to implement your most demanding designs. Easier to match optimum current/voltage/speed combinations to your specific requirements.

Check the chart above. In it you'll find specs on the industry's best selection of peripheral drivers: Series SN75401/SN75411/SN75416 — two-watt power dual drivers with 500mA output current. The special 14-pin NE package has copper-clad silver-plated lead frames, with eight active pins and the six center pins used for heat dissipation. Inserts easily into standard 14-pin pc board mounting holes.

The 401 series has a 35V off-state output voltage; the 411 and 416 series, 70V. The 416 series features output clamped diodes.

Series SN75430/75450B/75460/75470 — general-purpose duals with 300mA output current. These series offer a broad choice of voltage/speed combinations.

Series SN75476 — dual drivers with 70V off-state output voltage and output clamped diodes on the chip. No longer are external clamped diodes required to drive inductive loads.

These monolithic linear ICs deliver the specs you need. Within each series you have a complete choice of logic functions — AND, NAND, OR, NOR.

In addition to these dual drivers, TI also offers two series of seven-channel Darlington transistor array inverting buffers. The SN75466 series has an off-state output voltage of 100V; the

ULN2001A, 50V. Input compatibilities include TTL; CMOS (5V and 6V-15V); and PMOS (5V, 6V-15V, and 14V-25V).

And there's also the SN75441 dual driver with positive OR logic, compatible with Series 10K ECL inputs.

Take stock of your peripheral driver needs today and place your order with Texas Instruments or your local authorized TI distributor.

**Free data book.** For your personal copy of the new 120-page Peripheral Driver Data Book, circle the reader service number indicated below or write Texas Instruments Incorporated, P.O. Box 5012, M/S 308, Dallas, Texas 75222.



## TEXAS INSTRUMENTS

INCORPORATED

CIRCLE NUMBER 26



# You design the system. We'll display your solutions.

**Together we make each other look better than ever.** Because our specialty is taking your system's output and displaying it as concepts that any user quickly understands.

Tektronix has made graphics desirable and affordable

worldwide. Our components can give your system the same universal acceptance and versatility. Our capabilities complement your needs: including graphic and alphanumeric terminals and monitors. Plotters. Hard copiers. Combined refresh and storage technology.

**We'll work as your partners.** We'll provide modular display components you can stake your reputation on, with prices and quantity

discounts that put it all together. You've got high standards for your OEM suppliers: we stack up to them. Give us a call soon.

Tektronix  
Information Display Group  
OEM Components  
P.O. Box 500  
Beaverton, Oregon 97077

**Tektronix  
OEM components:  
the perfect fit.**

CIRCLE NUMBER 27

**Tektronix**  
COMMITTED TO EXCELLENCE

copyright © 1977, Tektronix, Inc. All rights reserved



## Video games continue to sell big, but EMI/RFI proofing is a problem

The consumer impact of TV video games, besides overshadowing advances in other electronic games, is turning out to be far greater than originally envisioned. For one thing, more than 10-million of these sophisticated electronic products—most of them using dedicated game chips—are expected to be sold this year. And for another, toy and game manufacturers, whose expertise is in mass production and distribution, are turning out products by designers whose electronics expertise doesn't include the one area most critical to marketing the games—EMI/RFI measurements and proofing. As a result, a sizable headache has been created for the manufacturer, who must gain FCC approval before he can even demonstrate, much less market, his video game.

This problem is a fairly recent one. The first-generation TV games, produced by Magnavox in 1972, use a number of bipolar IC chips to generate, control and present the game information on TV screens. Sales were limited by the relatively high cost of such games.

But a standard low-cost game-chip circuit by General Instrument opened the way to mass production of video games by toy and game manufacturers with limited electronics expertise. By the end of 1976, more than five-million of GI's first-generation game chips—the AY-3-8500 for the 625-line European TV system and the AY-3-8500-1 for the 525-line U.S. TV receivers—had been shipped, with U.S. manufacturers clamoring for more.

The 8500-series GI chip—Ball and Paddle I—contains six games: Tennis, Hockey, Squash, Practice, Skeet Shooting and Target Shooting. Each ball-and-paddle game can be played at either fast or slow ball speeds, with



**The first microprocessor-based video game to be marketed** was this Fairchild Channel F system with programs in plug-in ROM cartridges.

high or low ball angles, and large or small paddles. Automatic scoring and realistic sounds are also provided.

Today, GI's lead in the game-chip field is being challenged by both National Semiconductor and Texas Instruments. And games from all three suppliers have acquired considerable sophistication.

GI's Paddle I has been followed by Ball and Paddle IA (six games), Ball and Paddle II (eight games) and Ball and Paddle III (16 games). Nine other game-chip circuits totaling 40 new games are also being produced by GI.

A series of competitive game chips are being sold by National Semiconductor. These include its first-generation MM57100, a full-color MOS/LSI game chip with six games, including Hockey, Tennis and Handball. Nine combinations of handi-

capping can be implemented simply by adjusting the paddle size, along with sound effects, ball speed-up and ball spin, or English.

Extensive background color is designed into the MM57100. Tennis has a green court with a blue border, a yellow net, orange paddles and a light green ball. A low-cost black and white equivalent of the M57100 is also available, the MM5789.

The MM57106, being prepared for sale in June, has six action fields: Tennis, Handball, Hockey, Soccer, Pinball and Wipeout. Twenty-three different games are possible.

Pinball displays 16 rectangles, a moving bonus bumper and four pockets to catch the ball. In Wipeout, 256 dots appear on the screen. After the first 100 dots are eliminated, the remaining dots change in point value.

Texas Instruments has a different chip approach to video games. A set of TTL and CMOS-compatible bipolar ICs called "Universal Game Circuits" provides the basic functions to design a broad range of video games. These chips include the following basic ICs:

- Sync generator—SN76425N.
- Character generator—SN76426N.
- Wall and ball generator—SN76427N.
- Video logic—SN76428N.
- Digital scoring—SN76460/62N.
- Random "English"—SN76423N.

The basic game functions for a simple black-and-white-TV game are shown in Figure 1. These functions are common not only to TI's video games but to all video games.

### Video games have common roots

No matter who makes them, video games have the same basic features. A composite video-game signal, which is modulated and fed to the TV antenna, produces the game characters, players



and game field viewed on the TV screen. The character may be a simple rectangular paddle or, in the more sophisticated games, a complex figure representing a man or auto or tank. The video-field information consists of a game format, which includes whatever walls and balls are a part of the game as well as goals or fixed obstacles. Interface circuitry for both player and game-action control are included with the circuits generating the character and field information.

The game-playing rules are established with logic circuits that may be dedicated for a single game, designed for a series of similar games, or implemented with programmable logic to expand variations in the types of games and other rules applied.

Basic scoring displays are produced by bar generators or numeric-character generators. The scoring circuit also presents the totals during the game.

Sounds can be inserted at any appropriate point in the game by pulse-detection gating. Changes of state can trigger a sound generator or external device, such as a piezoelectric beeper. The sync generator provides both the vertical and horizontal sync signals needed to generate and time the correct composite signals. In general, voltage-sensitive sync and logic circuits get their power from a regulated dc supply.

The composite video signal that makes up the game field as well as the paddles, players and balls is obtained at the output of a video summing network. In all games, including those using single-chip devices, this composite signal is fed to a vhf oscillator-modulator combination that is usually provided by the game manufacturer, not the game-IC supplier.

Set for channels 3 or 4, the oscillator output provides the input signal to the TV antenna terminals, through a special isolation switch.

### EMI-proofing is a headache

Video games have one big problem. Radio-frequency that is delivered to the antenna terminal, and undesired radiation from both connecting cables and the oscillator(s) on the games' PC board can interfere with televisions in the vicinity. So manufacturers must submit their games to the Federal Communications Commission for Type Approval under part 15 as "a Class I TV device that is coupled to a TV set with a modulated rf oscillator" (see "FCC Swamped with Complaints as Sources of RFI/EMI Increase," ED No.



Four games are contained in this Odyssey 500 unit by Magnavox: Tennis, Hockey, Smash and Soccer. In these games—originated by Magnavox in 1972—the players are represented by on-screen figures.

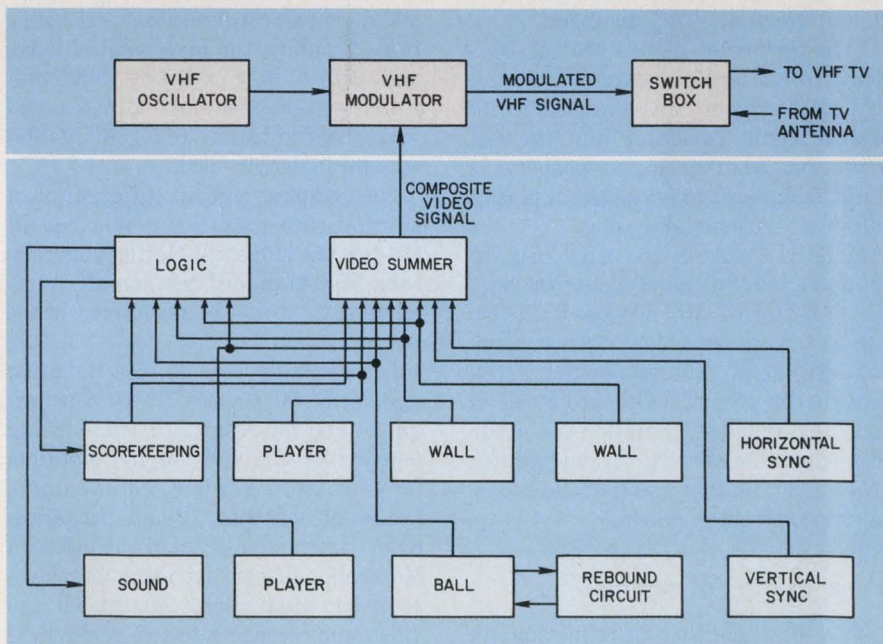

1. TV games consist of game circuits (lower section) designed by semiconductor manufacturers and interfacing circuits (upper section) supplied by game producers. The latter convert game video signals to vhf-TV inputs. These functions are common to all TV games.





**Making EMI/RFI measurements to check the levels of radiation from TV games** is only part of the problem of getting video games to pass FCC standards. Here, Dan Norton at Sanders Associates checks on a design fix.

20, Sept. 27, 1976, p. 24).

Many video games fail the FCC test because their design engineers are not experts in EMI measurements and analysis. Or the manufacturer doesn't want to invest a minimum of \$200,000 for an EMI test facility.

Whichever the reason, many of the game producers have turned to rf-testing laboratories, like that of Sanders Associates, Nashua, NH. Although Sanders has tested all sorts of military and commercial equipment, EMI-proofing video games has been one of its most challenging measurement and design problems, says Daniel Norton, EMC engineer.

"The new color games are very difficult to EMI-proof because there are two oscillators on the board, the 3.579-MHz chroma oscillator and the vhf oscillator. Another major problem is that the games are packaged in plastic cabinets, without shielding."

Moreover, cables are often used to connect remote hand controls and, when batteries are not used, the ac supply. Another cable connects the game to the TV-antenna switch. Even though the game's PC board itself is carefully shielded, radiation can occur from the cable shields, without careful grounding and bypassing of the cables as they leave the board.

### It's a matter of pennies

Two other conflicting requirements make the job tough, says Norton. First, these games are turned out in the millions by the toy and game manufacturers who are concerned about spend-

ing even a few cents a game for added shielding and filtering. For this reason, suggestions that the insides of plastic housings be sprayed with low-cost shielding silver, copper or other conductive particles in a resin binder—produced, for example, by Acheson Colloids, Port Huron, MI—are frequently rejected (see "Focus on Adhesives and Coatings," ED No. 23, Nov. 8, 1976, p. 40). "On the other hand," says Norton, "we are faced with the stringent requirement of keeping radiation from these games to less than 15  $\mu\text{V}/\text{m}$ ."

Another problem is the lack of a standard test configuration. According to FCC policy, the placement of wires and cables is completely random—which makes sense since no one can tell what configuration the game cables will be in when used.

Nevertheless a good configuration of a worst-case condition would benefit the testing industry, Norton suggests. Like MIL-standard testing, all video-game tests would be performed in the same fashion.

Interestingly enough, the radiation standards for Class I TV Devices originated as the result of a rule-making petition by Cartrivision and Motorola for videotape recorders, whose outputs can be attached to TV-antenna terminals. Cartrivision is out of business and Motorola canceled its plans for video-recorder production. Almost all the videotape recorders tested by the FCC are Japanese sets.

But because of their design and high-volume production, the FCC at least acknowledges that video games are in

a class distinct from the tape recorders. In addition, the emerging growth of the home-computer industry makes it apparent that standards will soon have to be set for home-computer/TV interfaces. Because of their different end uses, says an FCC spokesman, the Commission will probably issue a rule-making proposal in the coming months to at least distinguish all of these devices.

Even though getting the video game type-approved by the FCC is the game manufacturer's problem, chip suppliers are beginning to help. For example, a small, standard game-board design from National minimizes not only the number of discrete components that radiate, but also the shielding requirements. An 18-pin IC substitute—the LM 1889N—replaces the usual oscillator/modulator's discrete elements. The game video, the audio, and the chroma-oscillator signals are all fed to it. The vhf outputs produced are suitable for channels 3 or 4 (Fig. 2).

A vestigial sideband filter aids RFI suppression even more. The entire circuitry, including game chip, clock driver and regulated power supply, fits on a 2-1/2  $\times$  4-1/2-in. PC board.

### Suddenly, another problem

An unexpected problem has shaken up the video-game producers recently—fear of picture-tube damage. According to a consumer-alert bulletin issued by the Canadian Government's Consumer and Corporate Affairs Bureau, "Prolonged use of the games may cause the game pattern to remain as a ghost during regular TV viewing." The alert followed a warning from a Canadian TV dealer that games used over long periods for demonstrations had shown phosphor burns.

The U.S. Federal Trade Commission has been investigating the situation for

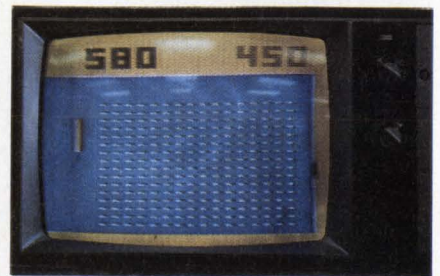

**Wipeout**, one of the games in National Semiconductor Consumer Products Div.'s Adversary 600, puts on the screen 256 dots that must be eliminated by striking with the players' balls.



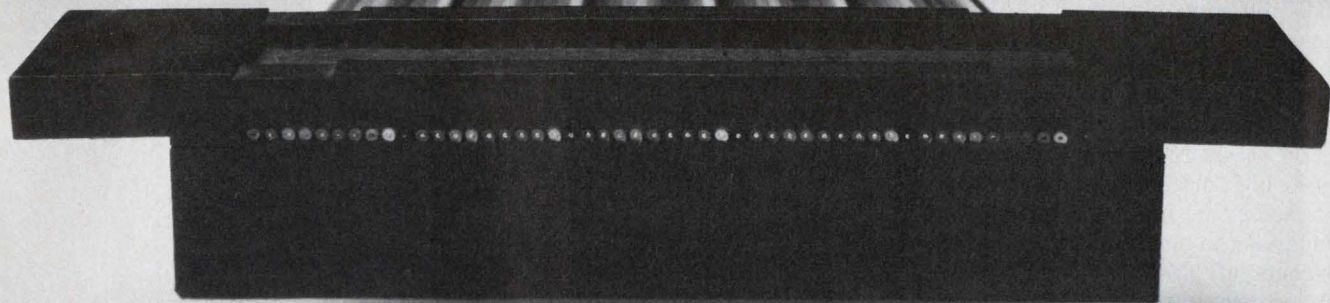

# MULTI-TERM: HAPPY ENDING

Putting together a system that uses flat flexible cable? Watch out for these five key factors.

## 1. Cable Contacts

Insulation displacement requires a sharp edge. Any roughness or irregularity can nick the conductor and weaken it. Only SAE uses precision coining to produce a perfect contact surface.

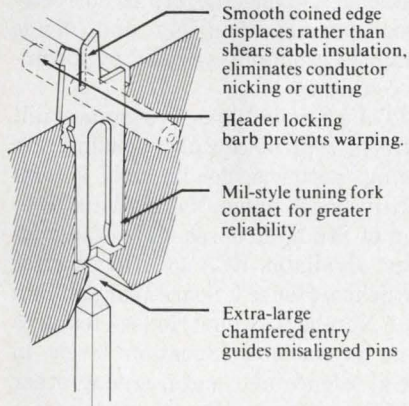

Smooth coined edge displaces rather than shears cable insulation, eliminates conductor nicking or cutting

Header locking barb prevents warping.

Mil-style tuning fork contact for greater reliability

Extra-large chamfered entry guides misaligned pins

## 2. Mating Contacts

A lot of systems use a beam-type contact. SAE uses a military-type tuning fork configuration. It grabs the pin and produces maximum electrical reliability.

## 3. Header Security

Only MULTI-TERM™ contacts have locking barbs that bite into the header at every conductor position. Built-in pre-retention keeps header, contact and conductor securely mated. Vibration resistance is superior, and headers won't warp or bow.

## 4. Cable Quality

The best termination system in the world can't overcome irregular cable. Specify SAE ribbon cable as part of your system and you'll get more than just economy. You'll get dimensional stability.

## 5. Production Tooling

MULTI-TERM tooling speeds

production. Alignment is automatic, cuts and terminations are square, and the final result is as pleasing to the eye as it is effective and reliable.

SAE manufactures all the parts. PC connectors, header connectors, I/O headers, 14 and 16 pin DIP connectors and socket connectors. Tooling. Fixtures. Cable. You can buy any component you need.

Better yet, call SAE during your design phase. Let our engineers help work out a complete MULTI-TERM System for your flat cable runs. Your project, and your cable, will have a happy ending.



The OEM Connection

Stanford Applied Engineering, 340 Martin Avenue, Santa Clara, CA 95050. (408) 243-9200. TWX 910-338-0132







## Save Space. Save Weight. Increase Reliability.

Paralleling transistors doesn't pay —not when an inherently rugged single device can do the job far more reliably, using much less space, weight, and at lower total system cost. That's why PowerTech's unique single-chip NPN silicon high-power transistor is the one way to go.

Used alone, our space-saving single-chip device eliminates multiple failure sources while reducing the environmental testing costs inherent in parallel arrays. Because of their simplicity they're available off-the-shelf pre-rated, pre-tested and inventoried to meet virtually any hi-rel JAN and JAN-TX hi-current requirements without custom prices and long custom waits.

For information, application assistance, and free design guide call Sales Engineering. PowerTech, Inc., 0-02 Fair Lawn Avenue, Fair Lawn, New Jersey 07410; Tel. (201) 791-5050.

Type #	(pk.) $I_c$	$V_{ce0}$	( $h_{fe} = 10$ ) $V_{ce} (sat) @ I_c$
JAN-TX 2N5926	90A	120V	0.6V @ 50A
PT-7511	90A	200V	0.6V @ 50A
JAN-TX 2N5927	120A	120V	0.6V @ 70A
PT-6502	200A	80V	0.7V @ 100A
PT-9502*	500A	80V	0.5V @ 300A

350 Watt Power Rating  
\*625 Watt Power Rating  
Guaranteed SOAR

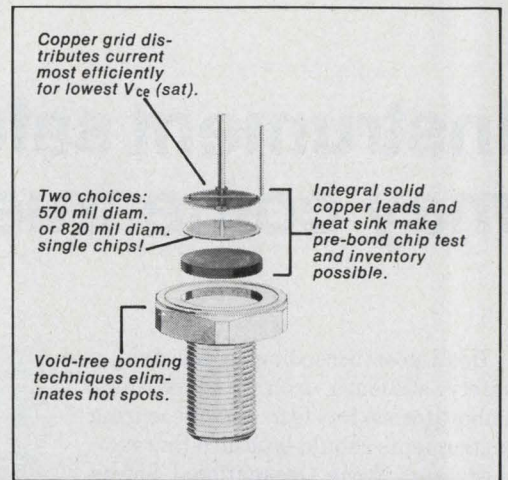

# TO UNPARALLEL IS TO SAVE:

Silicon transistors  
to 500 amps with  
lowest  $V_{CE} (sat)$



**PowerTech, Inc.**  
"BIG IDEAS IN  
BIG POWER"



# Instrument safety standard may come true on the fourth try

If all goes according to schedule, a safety standard from Underwriters' Laboratories for test and measuring instruments should be issued this summer. And if the Occupational Safety and Health Administration endorses this fourth draft of UL 1244 as a consensus industry standard, manufacturers may not be able to sell new instruments without first obtaining a UL label, or certification from a testing lab acceptable to OSHA.

Right now, in Los Angeles and Chicago, among other cities, electrical and electronic equipment that doesn't bear a UL label must be tested by the local product-safety agency before it can be sold. So the standard by which UL might officially examine instruments becomes even more important to instrument manufacturers, who would much prefer a single listing from UL to submitting their products to various city agencies.

What's more, this prospective standard, which is being circulated this week for manufacturers' comments, is certain to affect instrument buyers as well.

## Clearer tests

"The latest version of UL 1244 makes requirements more clear," says Richard Nute, manager of product-safety engineering at Tektronix Inc. in Beaverton, OR. "For example, UL has traditionally defined 'recognized components' as parts 'suitable for the application.' In the latest draft, that has been changed to refer specifically to component ratings."

UL 1244 now requires that a capacitor have a rated working voltage high enough to withstand foreseeable levels, and that switches have voltage and current ratings consistent with the application. Criteria in earlier versions

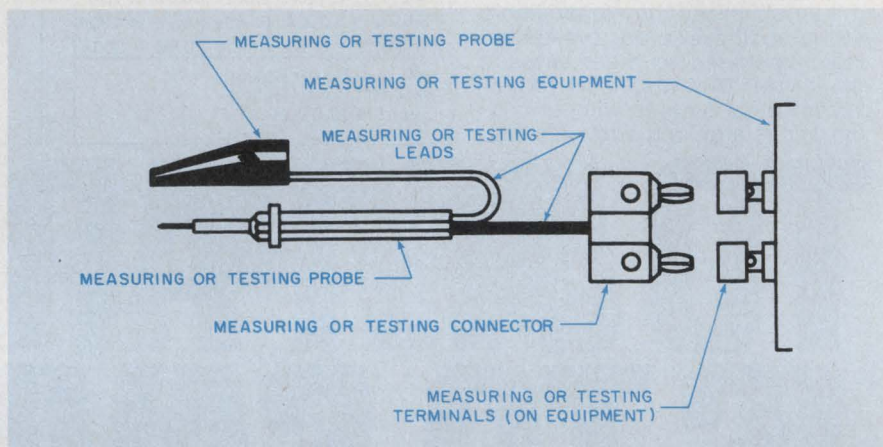

Even test probes come under the scrutiny of UL 1244, the safety standard for test and measuring instruments. Each part—the probes, leads, and connectors—has to meet detailed requirements to ensure safe instrument operation.

are much less specific, referring only to "suitability."

In some cases, the latest draft places even fewer burdens on the manufacturer than its predecessors. For example, printed-circuit boards don't have to undergo testing of specific parameters like peel strength. Now UL will accept the manufacturer's word that a PC board meets the standard, but reserves the right to spot-check for compliance.

## Probe terms defined

The standard also defines terms that apply to parts of a measuring probe, and sets up requirements for each part. For example, the probe end of the assembly must be insulated to prevent accidental contact with live parts.

On an instrument itself, test terminals that are not connected to the instrument's metal enclosure must be insulated to prevent contact with potentially live parts. The terminal can be adjusted to any possible position when determining accessibility. This requirement may sound simple, but in many designs, standard BNC connec-

tors don't follow the rule.

In its fourth draft, UL 1244 follows the margins, indexing, indenting and printing style of IEC 348, a safety standard for test equipment already drafted by the International Electrotechnical Commission. "Because of the large volume of international business, it becomes costly for U.S. manufacturers to produce and distinguish between domestic production and international production," explains Donald Mader, associate managing engineer in the Electrical Department at UL's office in Melville, NY.

Since the International Electrotechnical Commission had already drafted a safety standard for test equipment, notes Mader—and many U.S. instrument makers were applying this standard to products destined for sale in Europe—"it was reasonable that the requirements in UL 1244 not contradict the international standard in any major way." So when some of the test-equipment makers suggested that UL 1244 be drafted into the same format as IEC 348, Underwriters' Laboratories agreed.

But now there are complaints about

Andy Santoni  
Associate Editor



# Burr-Brown announces the lowest cost Analog I/O Systems for Intel and Motorola microcomputers.

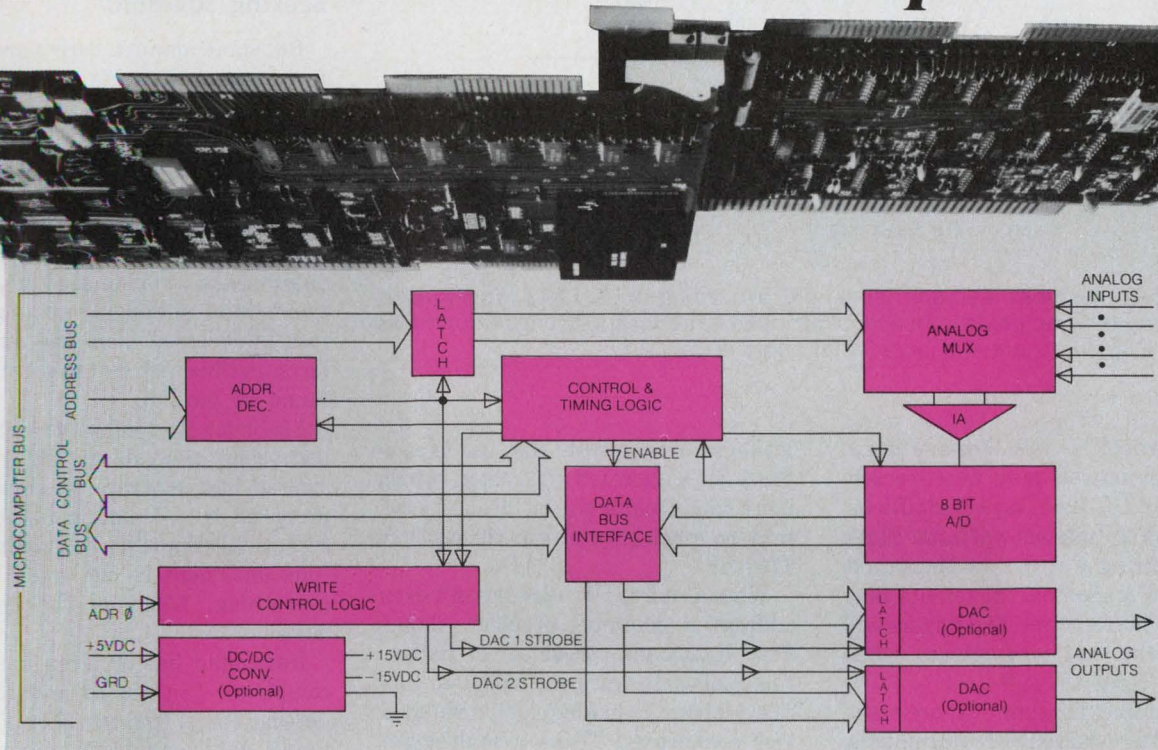

**Prices start at \$198 in 100's.** These new additions to Burr-Brown's growing family of Analog I/O Systems are designed specifically for Intel and Motorola microcomputer users. They're the only complete 8-bit systems available, and the lowest priced plug-compatible I/O systems offered for these microcomputers. Here's the complete hardware solution to your analog input and output interface problems. And it's a solution that simplifies system software too.

For the Intel SBC80 or Intellec® MDS user, our MP8600 series offers input and output on a single board which mates to either memory or I/O slots. These systems can provide up to 32 differential or 64 single-ended input channels. And they're adjustable from  $\pm 10$  mV to  $\pm 5$ V full-scale to handle low or high-level signals directly. The two optional output channels have strap selectable full-scale outputs ranging from  $\pm 2.5$ V to  $\pm 10$ V.

Motorola Micromodule or EXORciser® users can choose the MP7400 series and get up to 24 differential or 48 single-ended input channels. Like the MP8600 series, input and output levels

are field adjustable to meet your application needs.

All of Burr-Brown's Analog I/O Systems (including our 12-bit systems previously introduced for Intel and Motorola microcomputers and our new 8-bit Pro-Log compatible systems) can be treated as memory by the CPU. New versions offer you the options of interfacing in the interrupt mode and of conversion without halting the CPU. This means essentially unlimited channel expansion capability plus easy software implementation.

These I/O interfaces are system engineered and specified to ensure compatibility with your microcomputer. That means big savings for you in development time, in system debugging and in production start-up.

If you're using a microcomputer from Intel, Motorola or Pro-Log, it will pay you to find out about Burr-Brown's 8 and 12-bit Analog I/O Systems.

For more information, contact Burr-Brown, International Airport Industrial Park, Tucson, Arizona 85734. Phone (602) 294-1431.

Intellec® is a trademark of Intel Corp.

Micromodule and EXORciser® are trademarks of Motorola Semiconductor Products, Inc.

**See us at Electro 77,  
Booth Nos. 2824 & 2826.**

**BURR-BROWN**



*Leaders in  
microcomputer I/O*





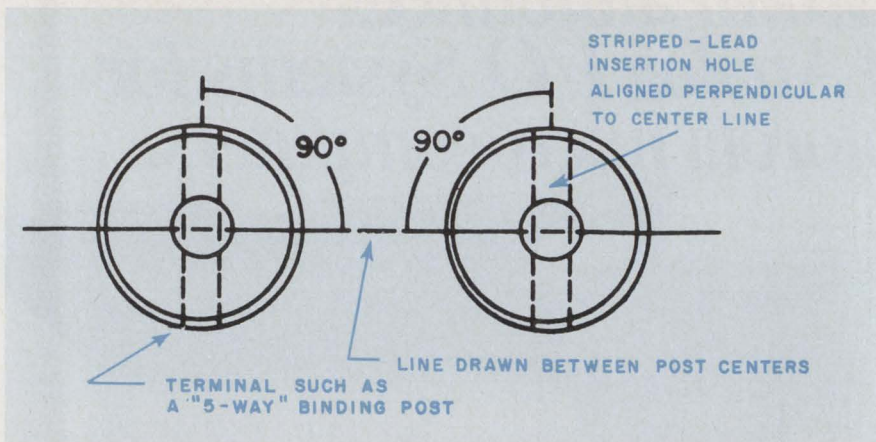

**Mounting simple jacks** isn't all that simple, according to UL 1244. Where jacks, like five-way binding posts, can accept stripped conductors, the insertion holes must be aligned to prevent accidental short circuits.

the fourth draft as well. For one thing, instrument buyers may be adversely affected by UL 1244, says Walt Riebe, product safety manager at John Fluke Manufacturing Co. Inc. in Mountlake Terrace, WA. Some instruments may have to be made larger, and buyers will have to take that into account when designing systems.

For example, because of more stringent leakage-current requirements, such instruments as digital voltmeters may grow in size. According to UL 1244 the capacitance between a voltmeter's input terminals and ground will have to be less than 900 pF to pass the

leakage-current test. But the capacitance in a guarded voltmeter, which has a shield inside the metal outer case, may be much greater—on the order of 1700 pF.

What's more, UL 1244 doesn't even address a common problem, claims Fred Katzmann, president of Ballantine Laboratories Inc., Boonton, NJ. The problem is inadequately insulated test connectors. "Take a multimeter with a 1000-V range and connect it to a high-voltage line," Katzmann explains. "Often, the banana plug pulls out of the front of the instrument just as you make the connection. That

## A changing story

The real saga of UL 1244 began three drafts ago after instrument makers approached Underwriters' Laboratories to find out how test and measuring instruments could obtain a UL listing. UL drafted a standard and submitted it to a group of instrument makers for comment.

The response to the first draft was quick and loud: Unnecessarily complicated and severe.

"We were a bit off target," admits Robert W. Seelbach, managing engineer in the Electrical Department at Underwriters' Laboratories' Chicago headquarters.

"We had adopted a lot of the requirements out of UL 492 for television-receiving devices, thinking that the circuitry was somewhat comparable," Seelbach explains. But instrument makers convinced UL that test equipment is different

enough from consumer-electronic products to demand a different approach to safety testing. So UL made a second attempt.

The second draft of UL 1244, industry representatives agreed, was a step in the right direction. So after relatively minor changes, a third draft was written.

"One of the major comments we then received from industry was that safety should be an international, not a national, concern," says Donald Mader, associate managing engineer at UL's Melville, NY, office. The standard should agree with International Electrotechnical Commission documents.

UL took on the task of rewriting their standard to make it international in scope. They produced a fourth draft, the version now ready for another round of industry comments and fine-tuning.

leaves a high voltage accessible on a bare banana plug."

UL 1244 does not require that the test connector be fully insulated.

## Seeking solutions

But some manufacturers are looking for ways to provide this protection anyway. A recessed banana plug is used on the face of some instruments from Triplett Corp. in Bluffton, OH, and the mating connector is a fully insulated banana jack. Designs from other instrument makers are being developed to provide the same protection without shifting to a configuration that is reversed from the norm, and incompatible with test leads commonly found in the lab.

Problems and solutions concerning test-probe assemblies will be considered in a separate document being prepared by UL and industry representatives. Explains Tektronix's Nute, "one document is not going to cover everything." There is work yet to be done.

Katzmann has an even more basic complaint. "In this standard, we're looking for a consensus of manufacturers, not of engineers, and that's bad. The specifications should have been generated by a society like the IEEE, not by UL and company representatives."

Nute disagrees: "Maybe industry is to be chided for not immediately going to the IEEE, but it really doesn't make a lot of difference." Furthermore, says Nute, the IEEE didn't step up and take on the task of writing the standard, and UL was willing to commit funds to the project. Since most of the industry comments on UL's drafts were coming from the West Coast, the Western Electronics Manufacturers Association was chosen to coordinate industry efforts. But Nute wouldn't have objected to some other coordinating body.

In any case, says Katzmann, "safety is not a matter of consensus, it's an absolute. I think good things will come out of all this, but I wish it had been done in a more professional manner."

At any rate, indications are that instrument designers and buyers will finally have a definitive safety standard. After this round of industry discussion, UL 1244 will have moved one step closer to taking its place alongside the IEEE-488 and Camac interface standards, the EIA/IEC rack and cabinet standards, and the many other documents that determine how instruments are built. ■■



New from Centralab...

# IMPS PUSHBUTTON SWITCHES

A new miniature modular building block system that offers microprocessor control designers more of what they need.

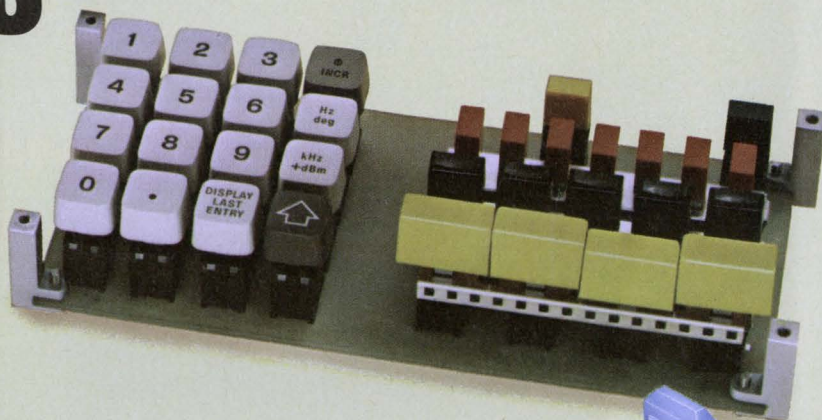

To meet the special digital and analog needs of today's  $\mu$ P-based controls, Centralab offers design engineers a whole new system of modular pushbutton switch building blocks. We call it IMPS — Integrated Modular Panel System. IMPS saves PC board and panel area and simplifies front panel design, cuts assembly costs, reduces back-panel space requirements, and meets the digital-analog needs of  $\mu$ P-based controls. Check these space saving, cost-cutting features.

## Simplify front panel interface.

All IMPS switches regardless of function, are uniform in size, simplifying design and selection of front panel hardware. They have high volumetric efficiency, occupying .505" x .388" PC board area and require only .608" of space between PC board and front panel.

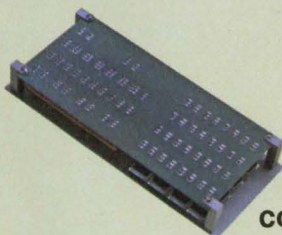

Cut  
assembly  
costs.

IMPS switches may be mounted on the front panel, and are designed for automatic wave soldering installation and PC board cleaning. Insert molded terminals prevent flux and solder wicking and contact contamination. Integral PC board stand-offs provide for efficient board cleaning.

## Meet analog and digital needs.

IMPS switches are available with momentary, push-push and interlocking actions, with a long-life contact system that switches both digital and analog signals. To accommodate critical signal requirements, housings are high-insulation molded plastic with UL 94V-0 rating.

## Available options.

Optional installations include ganged assemblies, front-panel mounting and wire-wrapping.

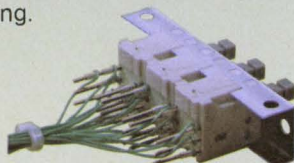

All IMPS pushbutton switches are built to Centralab's highest quality standards (see specifications at right). They're priced as low as 41 cents in 1,000 quantity. For full technical details, samples and quotation, call (515) 955-3770, or write to the address below.



CENTRALAB

Electronics Division

GLOBE-UNION INC.

P.O. BOX 858

FORT DODGE, IOWA 50501

CIRCLE NUMBER 31

## Built To Centralab Quality Specs.

IMPS Pushbutton Switches combine compact size, low cost and highest quality throughout.

- Silver or gold inlay wiping contacts for long-life and low-contact resistance.
- Less than 2 milliseconds contact bounce.
- SPST, SPDT, DPST, and DPDT switch contacts.
- Printed circuit, DIL socket or wire-wrap terminations available.
- 2.5 to 3.5 oz. actuation force (momentary).
- Choice of button interface — square or blade shaft (shown) — permits use of a variety of Centralab and industry standard buttons and keycaps.
- 10, 15, 20 or 25mm center-to-center spacing.

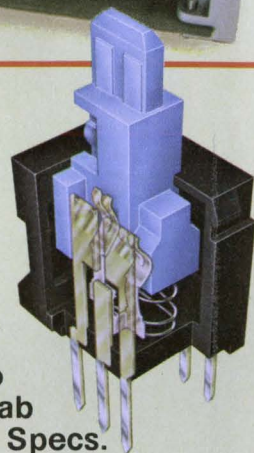



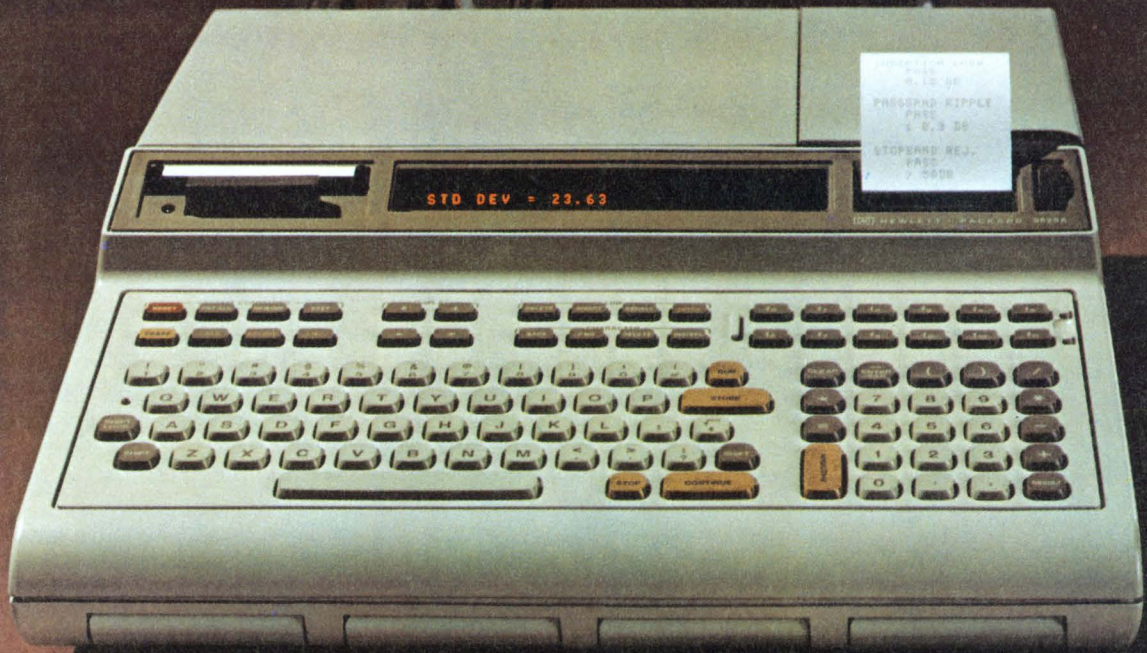

STD DEV = 23.63

STOPWATCH MODE  
PRESS 0.10 00  
PRESS AND KIPPLE  
PRESS 1 0.3 00  
STOPWATCH RES.  
PRESS 7 0000

- 0998

00.00 0774

+0600755

43

3.168



# HP computing controllers.

## 12 reasons why they're ready-made for interfacing.

1. Direct memory access (DMA)
2. Vectored priority interrupt
3. Buffered I/O
4. High-level language
5. Plug-in interface cards
6. High-speed tape cartridge
7. Built-in printer
8. Preprogrammed I/O drivers
9. Keyboard programming
10. 32 character display
11. Live keyboard
12. Editing keys

An HP 9825 computing controller provides minicomputer-like performance in one complete easy-to-interface, easy-to-program, easy-to-use package. I/O is built-in. Software for the operating system, which includes high-level language and I/O drivers, is built-in. Interface cards just plug in. You get a cost-effective solution to instrument interfacing.

**I/O cards and simplified programming make interfacing easy.** You can choose off-the-shelf interfaces for BCD, bit parallel, bit serial, or HP-IB (HP's implementation of IEEE Standard 488-1975).

For many applications, interfacing can be just this simple. You plug the correct I/O card in the back of the computing controller that fits your needs. Then connect your instrument to the other end of the card. After programming the controller with a few simple commands, your automated system is ready for work.

Vectored priority interrupt, DMA (direct memory access), and buffered I/O allow the 9825 to do multiple interfacing jobs routinely.

**The HP 9815 provides low cost interfacing.** For applications that don't need interrupt and DMA, the HP 9815

computing controller offers a ready-made solution for data-logging and instrument control. It, too, has a self-contained printer, tape storage, display, easy-to-use language, and integrated keyboard. Auto Start allows your program to begin executing automatically when power is turned on. It provides a lot of performance for its low price.

### **Improve your system and become more productive.**

No matter what kinds of instruments you use—scanners, counters, spectrometers, meters, converters, chromatographs, or what have you—an HP computing controller can greatly enhance their performance—now. Find out more. Send for our interfacing brochure today.

407/3

*From computers-on-a-board to general-purpose systems,  
HP can meet your interfacing needs.*



P.O. Box 301, Loveland, Colorado 80537

For assistance call: Washington (301) 948-6370, Chicago (312) 255-9800, Atlanta (404) 955-1500, Los Angeles (213) 877-1282

CIRCLE NUMBER 171

FOR INFORMATION OEM APPLICATIONS CIRCLE 172



# COME-

# talk to our power supplies

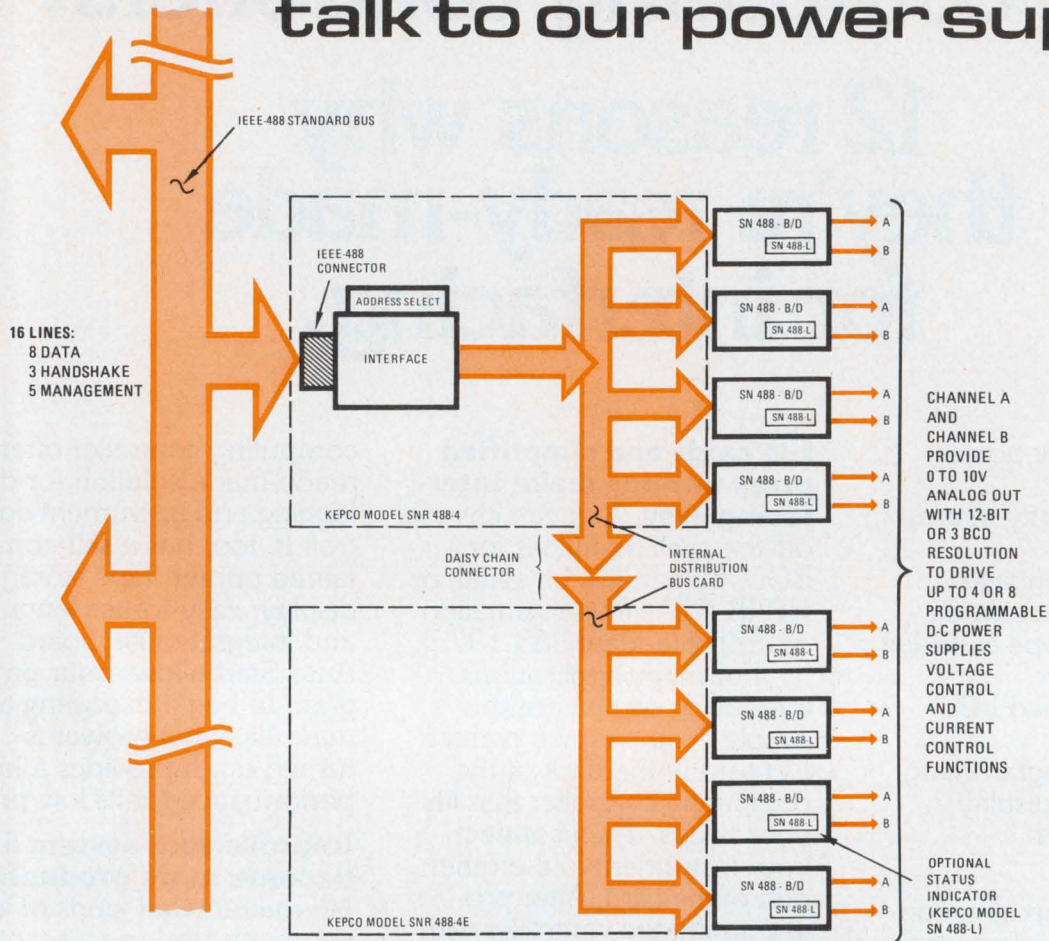

**KEPCO**  
**SN-488**  
 programming  
 system

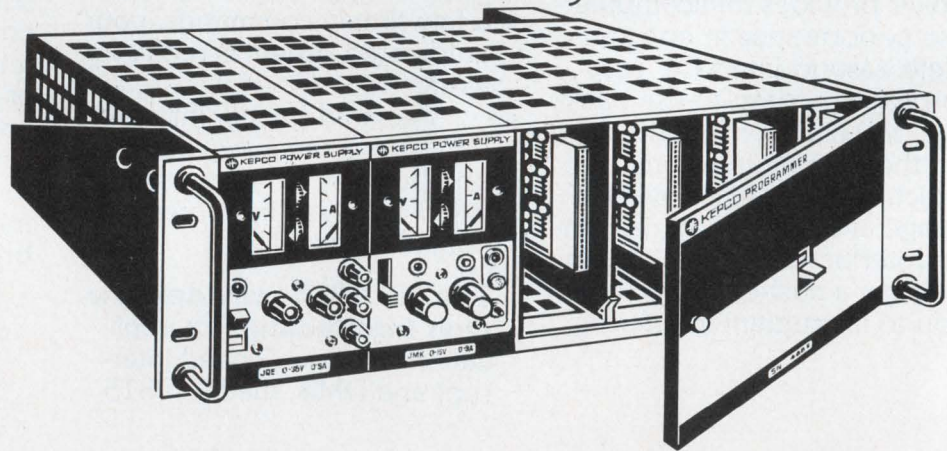

Kepeco's new SN-488 digital interface provides you with a convenient way to put our programmable power supplies on your General Purpose Interface bus. The model SN-488 responds to the "listen" instruction, provides the "handshake" interaction and gives you two addressable channels on each card. Up to eight cards can be addressed through a single bus connector.

Each channel provides 12 bits resolution with programmable range (10:1) and programmable polarity (for use with bipolar power supplies). Kepeco makes hundreds of power supplies that can listen on your bus through the SN-488 interface: fast models, slow models, high voltage and low; unipolar, bipolar, voltage stabilizers and current stabilizers . . . power supplies designed for today's automatic test equipment.

For complete specs,  
 write Dept. BYF-05

**KEPCO**® 131-38 SANFORD AVENUE • FLUSHING, N.Y. 11352 U.S.A. • (212) 461-7000 • TWX #710-582-2631

See them in action during ELECTRO '77. Our Hospitality Suite is Room 1802. Holiday Inn, 440 W. 57th St., N.Y.C.

CIRCLE NUMBER 33



# Washington report

---

## NASA's future depends on a space station

The National Aeronautics and Space Administration's space program will reach a critical crossroads within the next two years. The Space Shuttle will essentially have been developed, and a decision will be needed on whether to proceed to the next logical step, a permanent manned station in space. "Yes" could touch off a new space boom. "No" could lead to another depression in the industry—like the one that followed the Apollo project.

A decision is essential because in two years funding will begin to decline for the reusable Space Shuttle. The Ford Administration increased the proposed fleet of orbiting Shuttle spacecraft from two to five—a decision that the Carter Administration has endorsed. Although shuttle spending is currently running at \$1.3-billion a year, it is due to dip to \$1.1-billion in fiscal 1979 and slide sharply to just over \$100-million by fiscal 1982.

The major hope for the future, the space station, is the main ingredient of a five-year plan prepared by NASA earlier this year, the first such plan in the agency's 19-year history. That blueprint calls for a steady buildup of spending from the \$4-billion requested for next year to \$4.7-billion in fiscal 1982. The Pentagon is projecting similar growth over the same period for its military space activities—from \$1.5-billion to at least \$2.2-billion.

## Electronics share would be high

If the Carter Administration does not overturn these plans—both agencies must update their five-year forecasts every year—there should be \$32-billion available for space over the next five years. The electronics industry's share may be as high as \$14-billion: The Electronic Industries Association estimates that 44% of all space spending goes into electronics (39% of procurement and 55% research and development). All sums are expressed in constant 1978 dollars to eliminate the impact of inflation.

But regardless of any buildup in spending for the space station—hence, the space agency—spending for the Shuttle will decline. So NASA must spell out for Congress and the public the economic benefits of a permanent facility in space. At the moment, the leading candidates for useful projects to be carried out in a space station are orbiting-manufacturing facilities that use the inherent zero-gravity and hard-vacuum properties of space, and solar-energy collectors that would beam electrical power to earth via microwave links. Both projects are in the early planning stage.

## Work is already under way

Meanwhile, NASA is optimistic enough to have two study contractors at work defining what the space station should be: Grumman Aerospace Corp., builder of the Apollo lunar module, and McDonnell Douglas Astronautics, the space agency's study contractor on an earlier ill-fated space station attempt known



as the Manned Orbiting Research Laboratory. In their preliminary reports, the firms estimate that a basic station accommodating a crew of four to six and costing \$1-billion can be flying by 1985, and that the mission payloads would cost another \$2-billion ("Washington Report," ED No. 5, March 15, 1977, p. 43).

## **Military space spending is up**

Lurking beneath the surface, however, is the space application nobody talks about officially: military operations in space. The Soviet Union last year conducted four tests of "hunter-killer" spacecraft with its own satellites as targets ("Washington Report," ED No. 5, March 1, 1977, p. 35). In response, the Pentagon has doubled its defense development program from \$61-million this year to \$126-million for fiscal 1978. Another doubling, to \$265 million, is projected for fiscal 1979.

As a result, NASA and Air Force participation in the Space Shuttle program has become intertwined. The Air Force has begun to build a launch complex of its own, and is developing a new rocket stage to be used from the Shuttle to place military payloads in higher orbits. The new complex at Vandenberg Air Force Base, CA, will permit Air Force missions to achieve polar orbits that can pass over the Soviet Union several times a day. The rocket, known as the Interim Upper Stage, will place 5000-lb payloads into synchronous orbits.

But without a space station, the NASA budget will start declining by 1980—just as it did in 1966, when Apollo spending peaked at more than \$6-billion a year even though the manned lunar landing was still three years away. NASA missed a golden opportunity to capitalize on the Apollo success—partly because the war in Vietnam was draining national resources and partly because the NASA management and Congress could never agree on what the agency's follow-on mission should be.

## **Government attitude looks encouraging**

So far the Carter Administration has supported the space program. While slicing the Pentagon budget by \$2.8-billion for fiscal 1978, the administration has tacked on another \$15-million to the \$4-billion request by NASA—an extra \$10-million for the next Viking mission to Mars in 1984 and another \$5-million to build a backup satellite for the Landsat-D earth resources survey program. What's more, none of the cuts in the Pentagon budget affect its military-space efforts.

Congress has also lent its support to the space program—thus far. The House passed the full \$4-billion NASA authorization request, including President Carter's amendments, by 338 to 44. The bill now goes to the Senate, which in the past has treated the NASA request even more favorably. However, both houses still have to appropriate the funds, and traditionally appropriations fall slightly below the authorization level.

The other ingredients in NASA's five-year plan will advance scientific knowledge to some extent, but won't, unfortunately, do much for business. The projects include: a spacecraft to rendezvous with Halley's Comet in 1982, a Venus orbiter with an imaging radar in 1983, infrared and ultraviolet space telescopes in 1983 and 1985, and orbiter/probes of Saturn and Uranus in 1985 and 1986.





## Configurability at a price you didn't figure on

Here's a really multi-functioned digital multimeter: Six functions—dc and ac voltage, dc and ac current, resistance and dB (both dBV and dBm)—in one compact, 3½-digit DMM for just \$250\*. It's called the DM 502 (Option 2) and it has the configurability to interface with a full range of test and measurement instruments in the TEKTRONIX TM 500 line.

If you need to measure temperature—perhaps you're aware how quickly you can isolate faulty semiconductors with a digital thermometer—the DM 502 (with temperature measurements from -67°F to +200°F, or -55°C to +150°C) costs just \$375\*, complete with temperature probe.

Combine either DMM with compatible TM 500 plug-in instruments and you can

create unique performance configurations within a single mainframe. Select a packaging configuration to fit your job site: TM 500 mainframes come in benchtop, rackmount, rollabout and portable models, with spaces for one to six plug-ins.

One typical configuration, the Audio Travel Lab\*\*, combines the DM 502 (or the DM 502, Option 2) with an SG 502 Audio Oscillator, a DC 504 five-digit Counter/Timer, and an SC 502 15-MHz Dual-Trace Oscilloscope within a TM 515 Traveler Mainframe. This lab-quality instrument configuration looks like carry-on luggage and provides comprehensive audio measurement capability which you can take anywhere.

So the next time you're looking for a 3½-digit DMM with all the functions you need

and with the configurability to work with the rest of your test equipment, select the DMM that is also priced right for you: DM 502. Or, for similar functions and 4½-digits, look into the configurable DM 501; you'll be pleased with its price, too.

For more information on configurable instruments, call your local Tektronix Field Engineer or write Tektronix, Inc., P.O. Box 500, Beaverton, OR 97077. In Europe, Tektronix Limited, P.O. Box 36, St. Peter Port, Guernsey, Channel Islands.

\*\*Audio Travel Lab .....\$2720\*

\*U.S. Sales Prices, FOB Beaverton, OR.

**Tektronix**  
COMMITTED TO EXCELLENCE

For Technical Data Circle 291  
For Demonstration Circle 292

## TM 500...designed for configurability.





# International Rectifier "Function Fit" Power Transistors will enhance your circuit design and increase its reliability.

It's unlikely that you'll find a Power Transistor line with as many types as ours, or with functional characteristics that fit specific applications so well . . . to improve reliability.

For example, for **Switching Power Supplies**, our 2N6542-2N6547 and IR6002's will switch up to 600V  $V_{CEX(sus)}$  with optimum  $t_f$  and  $E_s/b$ .

For **Display Terminal** horizontal and vertical deflection, you can get up to 900V  $V_{CBO}$  with a sharp breakdown (from hard-glass passivation) for added reliability . . . coupled with low  $V_{CE(s)}$ .

For **Automotive Ignition**, count on higher  $V_{CEO(sus)}$  and higher inductive energy capability with the reliability you need. Clamped or unclamped performance in a TO-3 package, on a chip, or a chip on a Beryllia substrate.

For **High Current Applications** our BUX-20 not only switches 125V and 50A at 20KHz, but does it at commercial prices. Also try our 2N6274-2N6277.

For **Amplifiers**, try our high energy EPI base discretes and Darlingtons. You'll get the SOA you need plus better frequency response than you'll find in other companies' diffused types.

For **Motor Drives**, our rugged Darlingtons will provide the inductive energy, high  $V_{CEO(sus)}$ , and high gain needed for reliability in these tough applications.

Whatever your application, chances are good that we have a "Function Fit" Power Transistor that will give you extra-margin reliability without changing your circuit . . . or costs!

Contact your local IR Sales Office or Distributor for data or write to  
 International Rectifier,  
 233 Kansas Street,  
 El Segundo, CA 90245  
 (213) 322-3331, Telex 67-4464

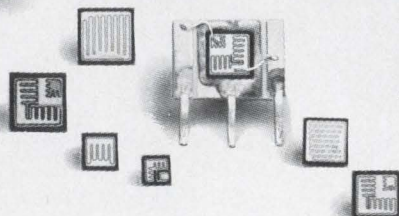

## International Rectifier

... the innovative semiconductor people





# HOW DO YOU WANT YOUR FLAT CABLE?

**In Bulk.** TAPE CABLE® for signal transmission, control and power distribution applications is available with 1 to 200 round or flat conductors of the same or different sizes; with any desired conductor spacing; with many types of insulation; unshielded or shielded on one or both sides.



**Jumper cables.** We'll cut TAPE CABLE to any length you want and strip and tin it at both ends. Brand-Rex jumper cables are instantly ready to interconnect printed circuit boards, connectors, electrical circuits, etc. with reflow or wave soldering.

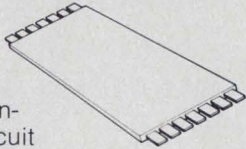

**Plug-in jumper cables.** We'll form the ends of our TAPE CABLE to mate with printed circuit connectors— with no external connectors or contacts. Plug-in jumper cables are minimum cost, flexible interconnectors for multiple circuits.

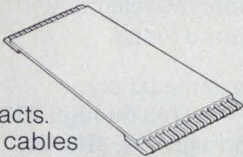

**PC Board Harnesses.** We can also bond TAPE CABLE to printed circuit boards. When you get it, the whole assembly is ready to go. All you have to do is plug it in.

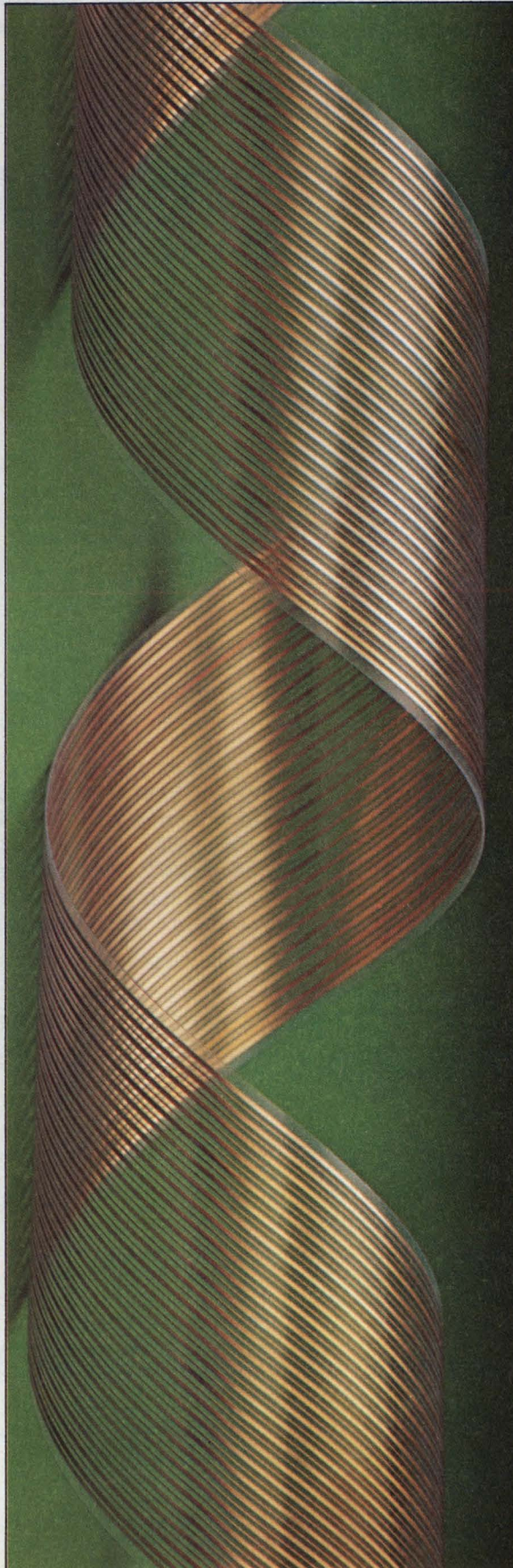
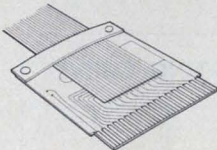

**Connector Harnesses.** We can terminate TAPE CABLE with two types of connectors—the insulation piercing type or those requiring soldered connections. Using standard off-the-shelf hardware where appropriate, or special connectors where required. Brand-Rex can recommend suitable connectors for any application.

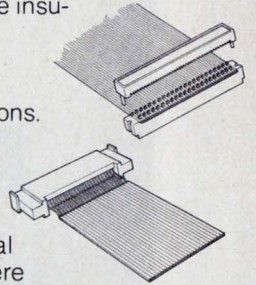

**Self-retracting cables.** We can form polyester insulated TAPE CABLE into spiral coils, helical coils or accordions. They're the perfect devices for interconnecting units that move in relation to each other.

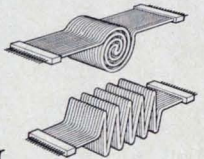

You can order Brand-Rex TAPE CABLE in any form—from bulk to custom assemblies—to solve your interconnect problems. No matter what your electrical, mechanical or termination requirements are, there's a Brand-Rex TAPE CABLE that's right for the job. For more information ask for Technical Bulletin BR-740. Or contact Brand-Rex directly or your nearest Brand-Rex sales engineer. Brand-Rex Company, Electronic & Industrial Cable Division, Willimantic, Connecticut 06226, Phone (203) 423-7771.

## BRAND-REX

ELECTRONIC & INDUSTRIAL CABLE DIVISION  
 Other Brand-Rex Divisions:  
 Abbott & Co., wiring harnesses  
 Nonotuck Manufacturing Co., copper wire  
 Pyle-National Co., electrical connectors  
 Telecommunications Cable Division  
 Teltronics, Inc., telephone equipment and components  
 Brand-Rex, Ltd. (Scotland), wire and cable



# OUR ZENERS HAVE BEEN PART OF EVERY MAJOR HI REL PROGRAM FOR 17 YEARS.

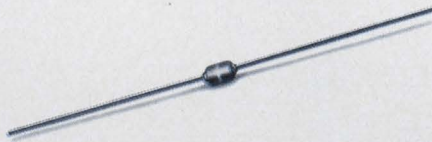

Our 400 mW zeners have been integral to Hi Rel programs ever since we started building them 17 years ago. You'll find them on Hawk, Minuteman, Trident, F-14 to name just a few. But they make up only a small part of our total zener line. Others range from 250 mW to one watt, from 2.4 volts to 100 volts, include a wide range of T.C. types, and are competitively priced for commercial applications.

Our popular one-watt zener is shown here. It features the PowerStud DO-41 package design

with extra large 55 mil studs for improved heat transfer from the die. The rugged, hermetically sealed glass body provides improved reliability over the full operating temperature range.

The following zener diodes are immediately available: **1N702 through 732, \*1N746 through 759, 1N957 through 961, \*1N962 through 984, 1N3506 through 3534, 1N4099 through 4123, \*1N4370 through 4372, 1N4725 through 4764.** All are contained in hermetically sealed glass packages. The entire line is also available in dice form.

\*Military types also available.

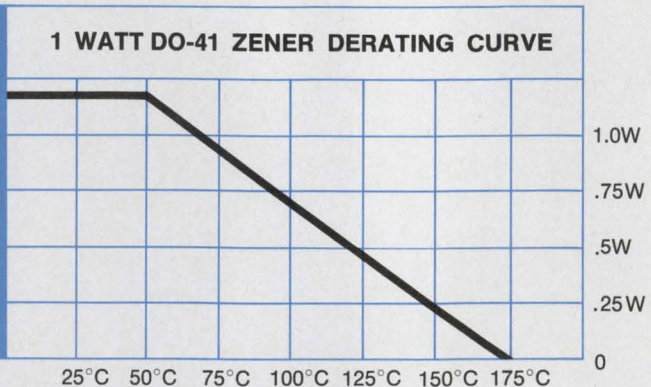
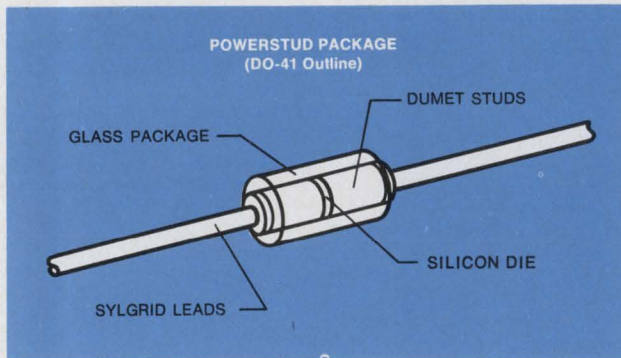

**TELEDYNE SEMICONDUCTOR**

1300 Terra Bella Avenue, Mountain View, California 94043 Tel: (415) 968-9241 TWX: 910-379-6494 Telex: 34-8416

SALES OFFICES:

DOMESTIC: Salem, N.H. (603) 893-9551; Stony Brook, N.Y. (516) 751-5640; Des Plaines, IL (312) 299-6196; Los Angeles, CA (213) 826-6639; Mountain View, CA (415) 968-9241 • INTERNATIONAL: Hounslow, Middlesex, England (44)-01-897-2503; Tiengen, West Germany 7741-5066; Kowloon, Hong Kong 3-240122; Tokyo, Japan 03-405-5738.

CIRCLE NUMBER 37



## Outguessing the boss

Charlie felt that it wasn't his job to make decisions for his staff. It was up to his engineers to decide what specs to build into their instruments, how to organize the front panels, and even what colors to use. But there was great unpleasantness if their ideas didn't coincide with his.

If the engineers designed a grey front panel with toggle switches, Charlie let them know how stupid they were for not making it powder blue with rocker switches. If they used LED displays, he let them know that liquid crystals consumed less power.

But Charlie was a reasonable man. His engineers could always defend their choice; they could point out that they had already evaluated the relative merits of LED and LCD, grey panels and blue ones, and toggles and rockers. Why, then, did they make the wrong choices, Charlie challenged.

Very quickly, the engineers, who were quite willing to cater to Charlie's inclinations, learned that it saved time and anguish if they could find out what Charlie liked. Unfortunately, Charlie wouldn't tell. It was, after all, *their* job to make these decisions.

Since Charlie wouldn't tell them if he preferred grey or blue, LED or LCD, toggles or rockers, they were forced to guess. So they spent lots of design time—not designing to satisfy customers, but guessing what Charlie would prefer.

That didn't work either. Charlie, it's sad to say, was a poor barometer of customer preferences. So when the engineers designed for *him*, they weren't necessarily designing for the customers. To add to the sadness, it turns out that one of the reasons Charlie wouldn't disclose his preferences in advance is that he really didn't know. He would never admit it, even to himself, but he wasn't sure of what he wanted until the engineers completed their design. He knew he didn't like *that*.

So the engineers would redesign to please Charlie. But the product wouldn't sell because the customers didn't like it, engineering and rework costs drove up the price, and the product reached the market late. This was proof again Charlie knew, that his engineers weren't very bright.

"But we made it the way you wanted it," they would point out. "I don't remember any such thing," Charlie would scoff. Clearly, Charlie's memory was superior, as was his design sense. After all, he was the boss.



GEORGE ROSTKY  
Editor-in-Chief



**I F**  
**YOU**  
**CAN'T SEE**  
**THE MOTOROLA**  
**BRIDGE YOU WANT HERE,**  
**BETTER HAVE YOUR I<sub>0</sub>'s EXAMINED**



**MOTOROLA**



MDA920A2 1A 50V	MRA363 650A 300V	MDA970-5 4A 400V	MRA163 600A 300V	MR3004CT# 30A 400V	MDA3504* 35A 400V
MDA980-2 12A 100V	MDA302# 3A 200V	MDA3508* 35A 800V	MDA980-3 12A 200V	MDA920A7 1A 600V	MR3002CT# 30A 200V
MDA310# 3A 1000V	MRA333B 300A 300V	MDA920A3 1A 100V	3N258 2A 800V	MR3000CTF† 30A 50V	MDA970-1 4A 50V
3N246 1A 50V	MDA980-1 12A 50V	MR3006CT# 30A 600V	MDA3506* 35A 600V	3N248 1A 200V	MBR3545CT‡ 35A 45V
MR3010CT# 30A 1000V	MDA920A4 1A 200V	MDA301# 3A 100V	MR3001CT# 30A 100V	MDA980-5 12A 400V	3N255 2A 200V
MRA333 300A 300V	3N247 1A 100V	MRA163B 600A 300V	3N256 2A 400V	MDA970-3 4A 200V	MDA3510* 35A 1000V
3N257 2A 600V	MR3008CT# 30A 800V	MDA306# 3A 600V	MRA133B 300A 300V	MR3000CT# 30A 50V	MDA304# 3A 400V
MR3001CTF† 30A 100V	MDA3500* 35A 50V	MR3002CTF† 30A 200V	MDA920A6 1A 400V	MDA2501* 25A 100V	MDA3502* 35A 200V
MDA2506* 25A 600V	MR3004CTF† 30A 400V	3N253 2A 50V	MDA3501# 35A 100V	3N254 2A 100V	MRA133 300A 300V
3N250 1A 600V	MDA2500* 25A 50V	MDA2504* 25A 400V	MRA363B 650A 300V	MDA2510* 25A 1000V	3N259 2A 1000V
MDA980-6 12A 600V	MDA970-2 4A 100V	MDA2508* 25A 800V	3N251 1A 800V	MDA 300# 3A 50V	MR3006CTF† 30A 600V
MBR3535CT‡ 35A 35V	3N252 1A 1000V	MDA308# 3A 800V	MBR3520CT‡ 35A 20V	MDA2502* 25A 200V	3N249 1A 400V

‡Schottky †Fast Recovery # 3rd Quarter Introduction \* Fast Recovery Available

## Motorola bridges. Make the whole world dc.

Motorola Semiconductor Products, Inc., P.O. Box 20912, Phoenix, AZ 85036.

# Semiconductors

-still the production house



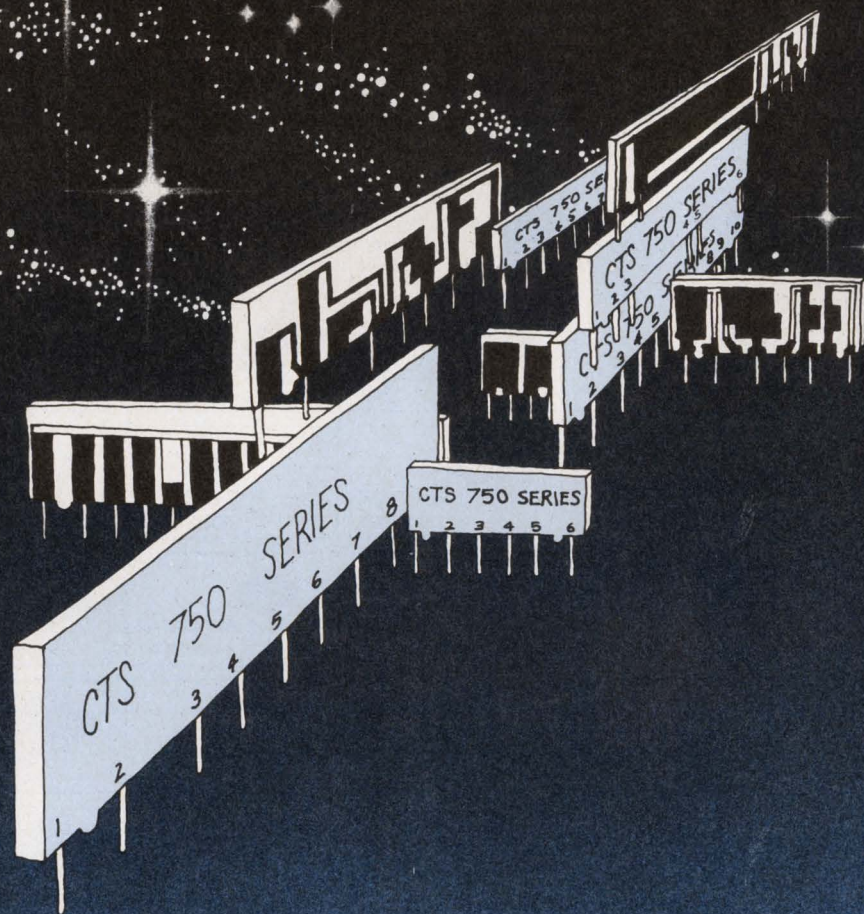

# CTS conquers space.

And has for *well over a decade* with space saving Series 750 SIP cermet resistor networks. And with space a very important commodity in modern systems, you'll want to make CTS a very special source for your network needs.

You conserve valuable PCB space, enjoy greater system reliability, use fewer components, install easier—automatically, cut handling costs and derive faster inspection. CTS experience, technology and production capacity insure the highest quality, fastest delivery available.

Where one of our more than 130 *standard* off-the-shelf SIP's won't meet your circuit require-

ments, we'll custom design the resistor network you need in either conventional or low profile package configurations.

Be assured of ultra-high stability and reliability. Over 900 million hours of test data prove CTS reliability with an established failure rate of only 0.00051% per 1000 hours @ 95% confidence level—considerably superior to military failure level S of established reliability specs.

For your copy of our reliability report or complete resistor network data, write: **CTS OF BERNE, INC.**, 406 Parr Road, Berne, Indiana 46711. Phone (219) 589-3111.

**CTS CORPORATION**  
Elkhart, Indiana

A world leader in cermet variable resistor technology.





# RF TRANSFORMERS

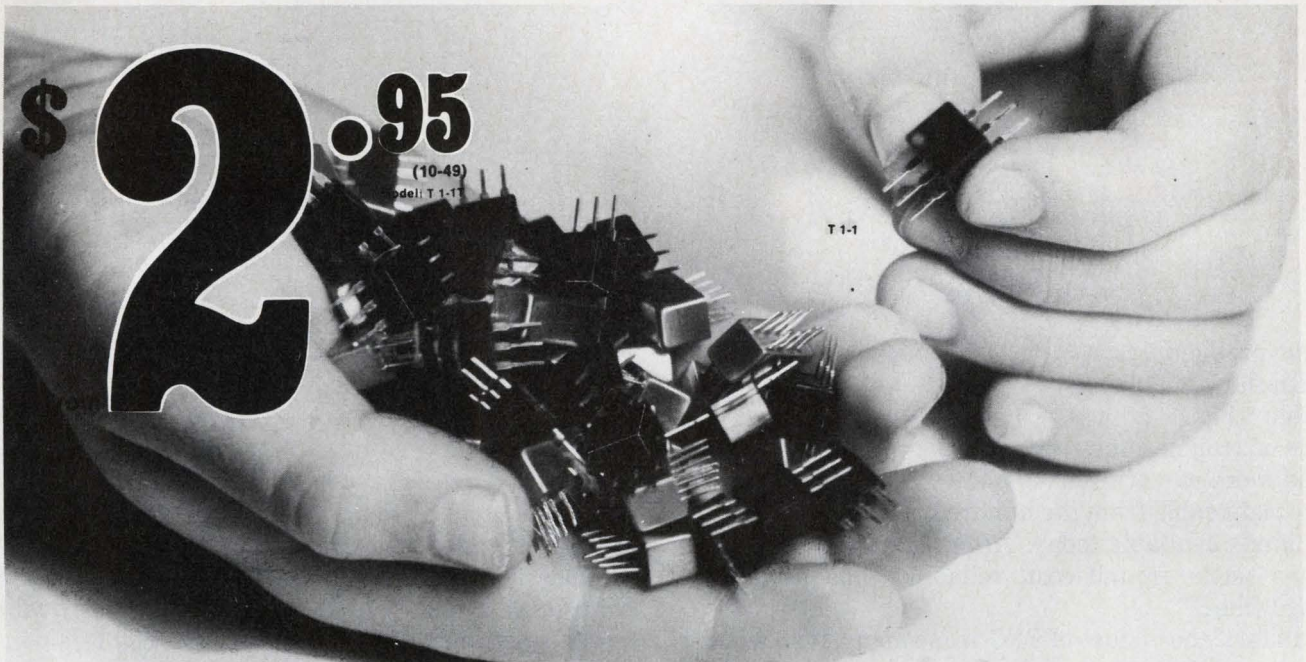

## Have it your way! 36 models to choose from, 10KHz-800MHz

It costs less to buy Mini-Circuits wideband RF transformers. The T-series (plastic case) and TMO series (hermetically sealed metal case) RF transformers

operate with impedance levels from 12.5 ohms to 800 ohms and have low insertion loss, 0.5 dB typ. High reliability is associated with every transformer. Every

production run is 100% tested, and every unit must pass our rigid inspection and high quality standards. Of course, our one-year guarantee applies to these units.

DC ISOLATED PRIMARY & SECONDARY						DC ISOLATED PRIMARY & SECONDARY CENTER-TAP SECONDARY							
Model	TMO 1-1	TMO 1.5-1	TMO 2.5-6	TMO 4-6	TMO 9-1	TMO 16-1	TMO 1-1T	TMO 2-1T	TMO 2.5-6T	TMO 3-1T	TMO 4-1	TMO5-1T	TMO 13-1T
Metal Case	T 1-1	T 1.5-1	T 2.5-6	T 4-6	T 9-1	T 16-1	T 1-1T	T 2-1T	T 2.5-6T	T 3-1T	T 4-1	T 5-1T	T 13-1T
Plastic Case	T 1-1	T 1.5-1	T 2.5-6	T 4-6	T 9-1	T 16-1	T 1-1T	T 2-1T	T 2.5-6T	T 3-1T	T 4-1	T 5-1T	T 13-1T
Freq. Range, MHz	.15-400	.1-300	.01-100	.02-200	.15-200	.3-120	.05-200	.07-200	.01-100	.05-250	2-350	3-300	.3-120
Impedance Ratio	1	1.5	2.5	4	9	16	1	2	2.5	3	4	5	13
Max. Insertion Loss	3 dB	2 dB	1 dB	3 dB	2 dB	1 dB	3 dB	2 dB	1 dB	3 dB	2 dB	1 dB	3 dB
Price, Model TMO	\$4.95	\$6.25	\$5.95	\$5.95	\$5.45	\$5.95	\$3.95	\$4.25	\$4.25	\$3.95	\$2.95	\$4.25	\$4.25
(10-49) Model T	\$2.95	\$3.95	\$3.95	\$3.95	\$3.45	\$3.95							
UNBALANCED PRIMARY & SECONDARY													
Model	TMO 2-1	TMO 3-1	TMO 4-2	TMO 8-1	TMO 14-1								
Metal Case	T 2-1	T 3-1	T 4-2	T 8-1	T 14-1								
Plastic Case	T 2-1	T 3-1	T 4-2	T 8-1	T 14-1								
Freq. Range, MHz	.015-600	.5-800	.5-600	.15-250	.2-150								
Impedance Ratio	2	3	4	8	14								
Max. Insertion Loss	3 dB	2 dB	1 dB	3 dB	2 dB								
Price, Model TMO	\$5.45	\$6.25	\$5.45	\$5.45	\$6.25								
(10-49) Model T	\$3.45	\$4.25	\$3.45	\$3.45	\$4.25								

### Designers Kit Available

(TK-1) — 2 transformers of each type T1-1, T2-1, T4-1, T9-1, T16-1 **\$32.00**  
 (TMK-2) — 2 transformers of each type TMO1-1, TMO2-1, TMO4-1, TMO9-1, TMO16-1 **\$49.50**

**International Representatives:**  **AUSTRALIA:** General Electronic Services, 99 Alexander Street, New South Wales, Australia 2065.  **ENGLAND:** Dale Electronics, Dale House, Wharf Road, Firmley Green, Camberley Surrey.  **FRANCE:** S.C.I.E. - D.I.M.E.S. 31 Rue George, Sand 91120 Palaiseau, France.  **GERMANY, AUSTRIA, SWITZERLAND:** Industrial Electronics GMBH, Klüberstrasse 14, 6000 Frankfurt/Main, Germany.  **ISRAEL:** Vectronics, Ltd. 69 Gordon Street, Tel-Aviv, Israel.  **JAPAN:** Densho Kaisha, Ltd. Eguchi Building 8-1 1 Chome Hamamatsucho Minato-ku, Tokyo.  **EASTERN CANADA:** B. D. Hummel, 2224 Maynard Avenue, Utica, NY 13502 (315) 736-7821.  **NETHERLANDS, BELGIUM, LUXEMBOURG:** Coimex, Veldweg II, Hatteren, Holland.  **NORWAY:** Datamatik AS, Ostensjoveien 62, Oslo 6, Norway.

**U.S. Distributors:**  **NORTHERN CALIFORNIA:** Cain-White & Co., Foothill Office Center, 105 Fremont Avenue, Los Altos, CA 94022 (415) 948-6533.  **SOUTHERN CALIFORNIA, ARIZONA:** Crown Electronics, 11440 Collins Street, No. Hollywood, CA 91601 (213) 877-3550.

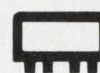

World's largest manufacturer of Double-Balanced Mixers

**Mini-Circuits**  
 Mini-Circuits Laboratory A Division Scientific Components Corp

837-843 Utica Avenue, Brooklyn, NY 11203  
 (212) 342-2500 Int'l Telex 620156 Domestic Telex 125460



# Focus on Flat Flexible Cable

The problem with flat, flexible cable (FFC) is less one of troublesome specs and more one of filtering out the right cable from the hundreds of kinds available today. After that, most FFC problems settle around cost, reliability and production headaches.

In fact, the virtues of FFC are so many, it's a wonder that conventional round cable is not yet a distant memory—especially after you've listened to the FFC manufacturer's claims.

There's no doubt that the FFC can save weight and space. It can carry more current per cross-section, and it has lower propagation delay than conventional wiring. It's usually easy to clean, to install, to inspect. And it's as tough as it is flexible.

But . . .

No one FFC can improve on round cables in every

respect. And test methods for FFCs are not yet standardized. Nevertheless, FFC users are enthusiastic and show little quarrel with specs, quality, even price—once they've chosen the right cable.

Just five years ago, FFCs were largely custom-made. Now, the shelves of dozens of vendors are heavily laden with hundreds of styles. Five years ago, specifications were often vague and many characteristics unknown. Today, vendors are happy to supply reams of test data to support published specs.

Yet, the explosive growth of FFC applications did not come about because FFC technology improved dramatically. Rather, it was the development of the mass termination that brought FFC into its own.

As long as FFC had to be interfaced with round connectors, it remained largely an aerospace curiosity. The tedious stripping and soldering of each conductor

**Max J. Schindler**  
Associate Editor

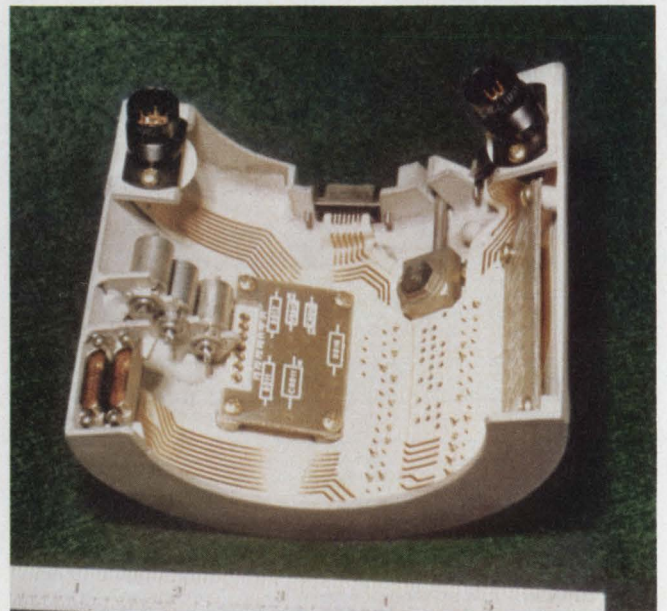
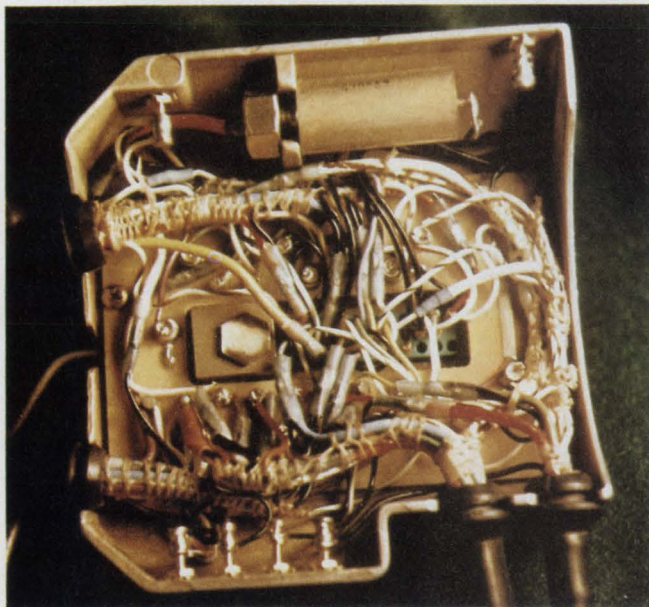

Flexible circuit boards convert a tangled mess into a neat assembly as in this example from Teledyne.



to either the connector or a special interface device negated much of the labor-saving potential, and wiring errors remained.

In mass-termination systems, the connector makes contact with all the conductors of the FFC in one single operation. Two major approaches are available. In the crimping technique the usually flat conductor is pressed into a U-shaped channel that cuts through the insulation, and is then bent inward until its upper edges dig back into the conductor.

The other technique is used with both round and flat conductors. Contact is established on the inner edges of a fork that actually cuts into a round conductor, and deforms a flat conductor into a U. A variant of this technique is Ansley's Tulip contact in which the fork is transformed into a slotted, hollow cylinder, so that the number of contact points is doubled to four.

Shielded flat-conductor cable is not as easily mass-terminated. But Ansley will come out shortly with a shielded 25-mil-pitch FFC and a connector that will automatically tie all ground lines to the shield. Thus the signal lines can be mass-terminated with the standard FFC conductor spacing of 0.050 in.

Before FFCs came of age, a connector known as "D Subminiature" was developed to terminate up to 50 conductors. This still popular connector, unfortunately, requires 52-mil spacing, and is therefore incompatible with the standard FFC configuration. Recently special D-Subminiature connectors have become available that permit mass-termination of cables with a 50-mil pitch.

### All FFCs are not alike

Construction techniques for flat, flexible cable are as diverse as the applications. Many varieties were developed specifically to optimize certain characteristics. Nevertheless, the profusion of FFCs evolve from two distinct technologies.

At one end of the spectrum are bonded "ribbon" cables; at the other extreme, flexible cable board.

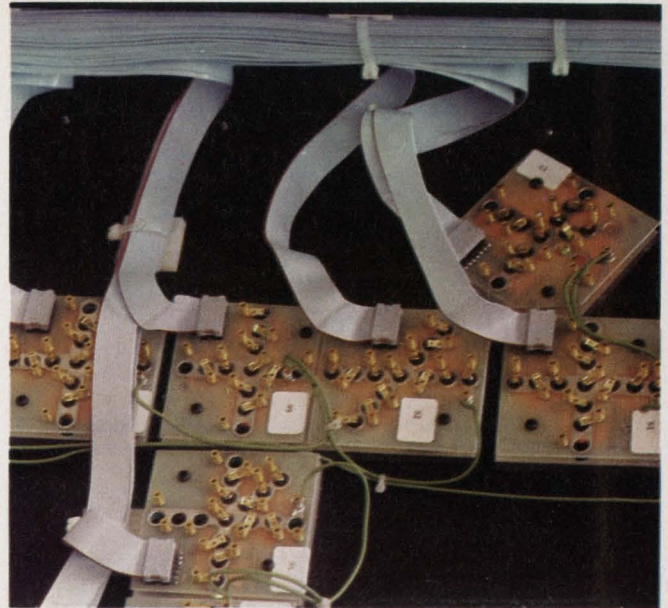

The 3M Scotchflex cable harness in this equipment simplifies routing to a multitude of terminal boards.

Ribbon cables simply consist of regular round "hook-up" cable with stranded conductors. Laid side by side, the cables are held together either by fusing or bonding of the insulation.

Flexible circuit board is produced by etching, and it is often used to carry components as well as provide interconnections. After the conductors are etched, a "coverlay" is applied to provide insulation on the top side of the circuit. When used for interconnection alone, the etched FFC is often called "flectape" and is rarely used in lengths over 20 in. Etched flexible circuits are usually more expensive than other FFCs, but when connecting points are widely scattered and distances between groups of connecting points are small, flectape offers the only alternative to conventional wiring.

FFC insulation comes not only in a rainbow of colors, but also in a wide spectrum of materials. Vinyl is the least expensive, but has a limited temperature

## Table 1. Insulating-material characteristics

Characteristic	Polyimides (Kapton)	Polyesters (Mylar)	Fluoroethyl (Teflon)	Polyvinylchloride	Polyethylene
Min service temp. (°C)	-60	-60	-60	-40	-20
Max service temp. (°C)	400	150	250	85	80
Specific gravity	1.42	1.40	2.15	1.25	0.91
Dielectric constant	3.5	3-3.5	2.1	3.6-4	2.2
Dielectric strength (kV/mil)	7	7	2.8	0.8	0.6
Tensile strength (psi)	25,000	20,000	3000	3000	2000
Water absorption (% in 24 h)	3	0.8	0.01	0.1	0.01
Flammability	self-extinguishing	poor	inflammable	self-extinguishing	flammable
Bondability	good	good	Note 1	good	good

Note 1: good after special treatment



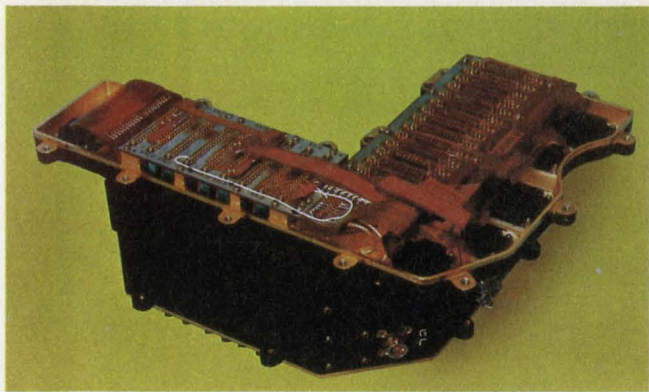

An interconnection box with hundreds of terminal points, such as this one made by Hughes, would be impractical with conventional wiring methods.

**Table 2. Substrates for flexible printed circuits**

Material	Service temperature (°C)	Dielectric constant	Bondability to itself
TFE plastic	-200 / 250	2.2	good
TFE glasscloth	-70 / 250	2.5 to 5	poor
FEP plastic	-200 / 200	2.1	good
FEP glasscloth	-70 / 200	2.5 to 5	good
Polyimide film	-200 / 300	3.5	poor
PCTFE	-70 / 125	2.5	good
Epoxy Dacron	-20 / 100	2.5 to 4	good
Polypropylene	-55 / 100	2.0	good
Polyester film	-60 / 105	2.8 to 3.7	poor
Polyvinylchloride	-30 / 85	3.6 to 4.0	good
Polyethylene	-20 / 60	2.2	good

range of 2 to 60 C. The costliest of the common insulations is Kapton, which can tolerate as much as 400 C. Silicone rubber is also excellent at high temperatures, but rarely used because of its softness. At very low temperatures, Viton (polyester and synthetic rubber) retains flexibility the best.

Depending on your requirements, you can choose the most suitable insulator from Table 1. Use the table only as a guide, because jacket materials are constantly being improved. Not included are less popular materials like polyamide, fluorocarbons and polyvinylfluoride. If you plan to use cable with dual insulation, make sure you get full specs for both insulating materials from the manufacturer. Extruded flat cables have the advantage that groups of wires can easily be separated when breakouts are required.

For flexible circuits and other bonded FFCs, the service temperature range is given in Table 2. Because of its poor flexibility, glass-epoxy is no longer used very much for FFCs—even though it has the best dimensional stability of all flextape substrates and tolerates temperatures from -55 to 150 C.

For bonded construction, the service temperature may well be determined by the adhesive. Mylar, for

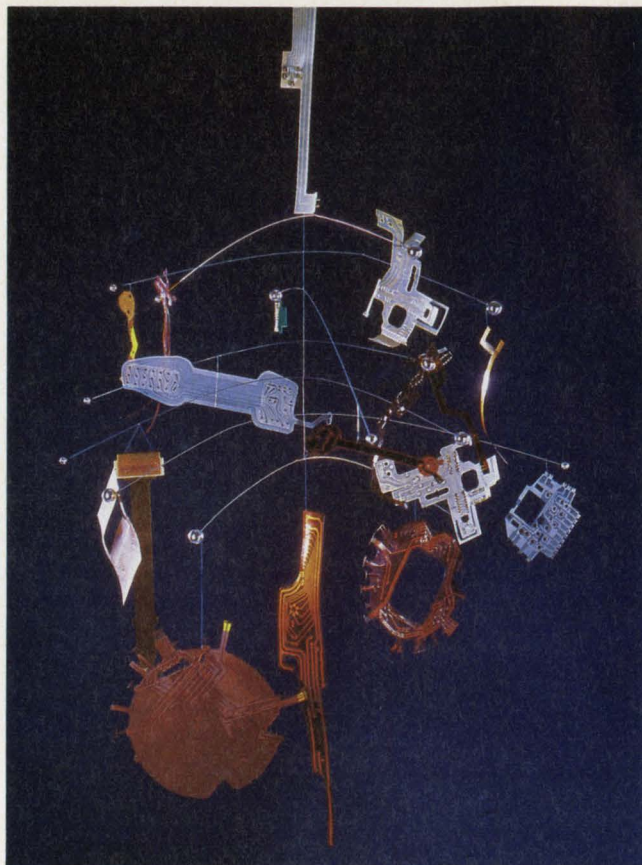

Striking a balance between PC boards and flat cables, etched flexible circuit boards, like these made by Rogers Corp., fit diverse applications.

instance, can be bonded by brush-on adhesives like 3M's EC1099 (-160 to 120 C), a paste adhesive like Dow-Corning's Silastic 140 (-160 to 100 C), or adhesive films like Fasson's S-277 (-25 to 100 C). None of these however, attains the full temperature range of Mylar (-60 to 150 C), and thus the adhesive becomes the limiting factor.

### Flat conductors have the edge

Flat cables with round conductors can turn a tangled mess into a neat harness, but electrically they act pretty much like any cable with round conductors. Flat-conductor cable, on the other hand, has some impressive advantages. In flexible circuits, flat conductors are produced by etching. If rolled stock is used, the insulation can be bonded or extruded.

Because of the large surface area available for cooling, flat-conductor cable can carry more current for the same cross-sectional area. When carrying 3 A per conductor, a flat cable with 25 conductors of 4 x 40-mil cross section (corresponding to AWG 27) heats up to 50 C in air, and 110 C in vacuum. Under the same conditions a bundle of AWG 27 round cables heats up to 110 C in air, and well over 250 C in vacuum.

Because flat-conductor cables require less copper, weight savings are possible that range from 5 to 30% for AWG 20 and reach 60 to 70% for AWG 30. In a missile or fighter plane, such savings are quite signifi-



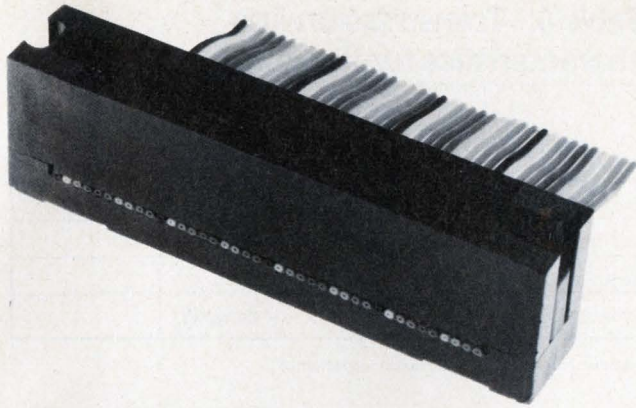

**Insulation-displacement connectors** (IDCs), such as this one from Stanford Applied Engineering, make contact through the insulation. The flat cable simply ends in a straight cut, flush with the connector.

cant. Interestingly, the space-saving feature of flat-conductor cable led to the first flat-conductor patent—in 1884! Table 3 permits you to convert flat-conductor cross sections to equivalent AWG at a glance. Design curves are available from NASA (see bibliography).

Even though a flat-conductor cable is usually wider than a round harness, as you add more conductors, the safe current per conductor still diminishes—although less than for round conductors. A typical flat-conductor derating curve, setting the rated current of a single conductor at 100% for one conductor, declines to 75% for 10, 65% for 20, and 60% for 30 conductors.

**Table 3. AWG equivalent for flat conductors**

Thickness (mils)	Width (mils)			
	25	50	75	100
2	31	29	27	26
4	29	26	24	23
6	27	24	23	21

Chances are, however, that you will want to carry signals rather than power in your wiring. Of course, any flat cable allows you to separate interfering signals by placing the signals on the two edge conductors. But how do flat-conductor cables stack up as transmission lines?

Since only the narrow edges of the conductors face each other in flat-conductor cable, the capacitive loading is relatively small, and the impedance somewhat higher than for round-wire cables. So the flat-conductor cable's propagation delay ranges from 1.1 to 1.3 ns/ft, compared with 1.8 ns/ft for a typical 0.2-in. coaxial cable.

Flat-conductor losses are lower too. Attenuation at 200 MHz for AWG 31-equivalent flat conductors is 2.2 dB for 10 feet, whereas a ribbon cable with round AWG 31 conductors measures 5 dB and a twisted pair, even with AWG 26 conductors, shows a loss of 7 dB.

When crosstalk is a major problem, flat-conductor cable again has the edge over conventional and ribbon

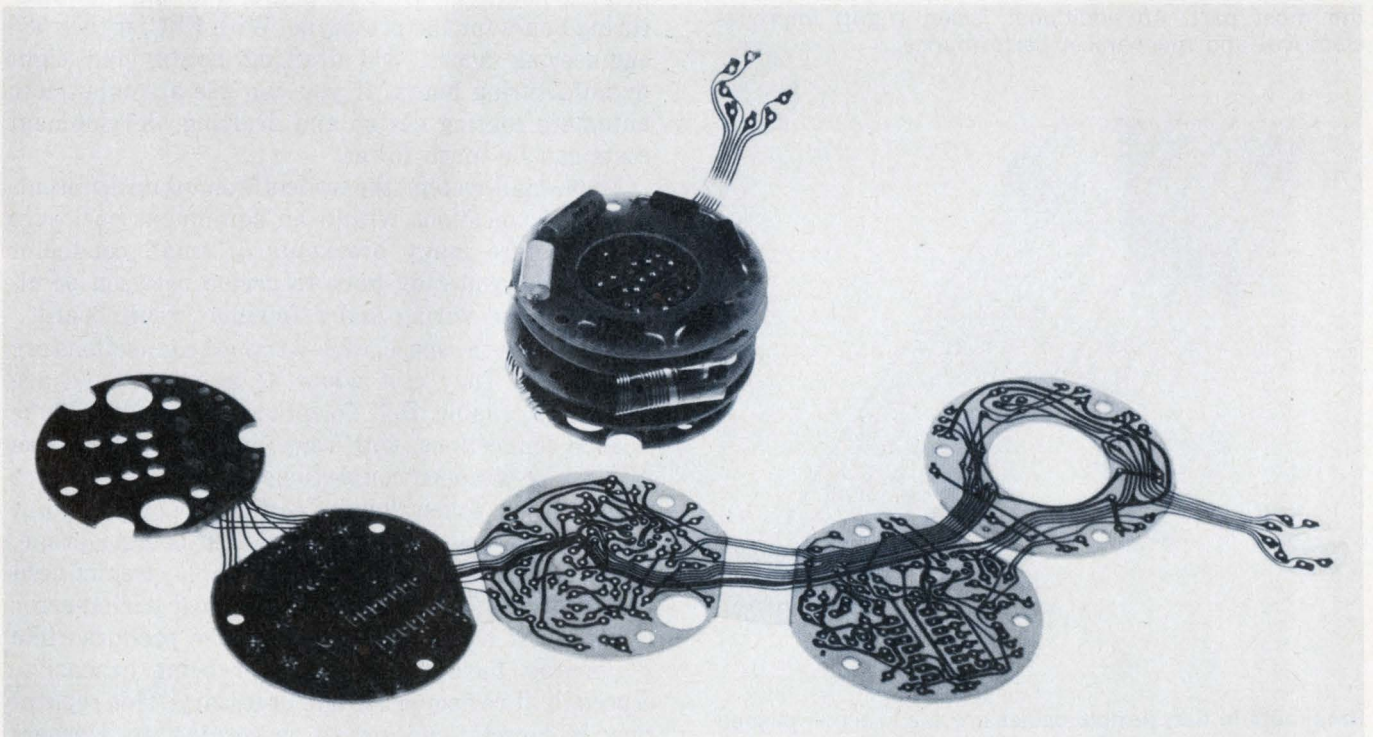

**Design flexibility is the "fourth" dimension** of flexible cables and circuits. This Parlex component is used in a

projectile, and greatly simplifies assembly. It replaces five PC boards, jumpers and connectors.



cable because of its lower capacitance. A  $4 \times 40$ -mil flat-conductor cable with 35-mil spacing measures only 6.5 pF/ft, which can be reduced to 0.05 pF/ft by applying a shield on both sides. However, the shield capacitance,  $C_s$ , is high—190 to 290 pF. Why such a large range? Because  $C_s$  is very sensitive to the conductor-shield spacing, which has a tolerance of  $\pm 0.5$  mil. If the tolerance is doubled,  $C_s$  could range from 160 to 360 pF/ft.

The high shield capacitance can, however, be reduced. Ansley's Signaflow cable, for instance, is available with alternating flat and round conductors, which reduces the signal-line capacitance, and crosstalk with it, but keeps ground capacitance low.

A further improvement is achieved with the application of a PVC jacket over a polyethylene core. The

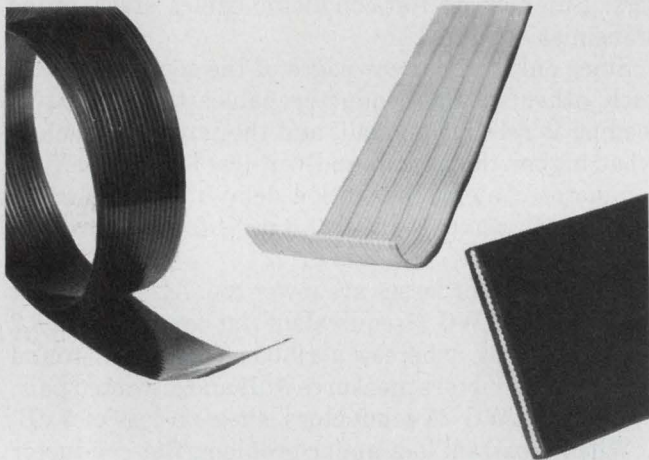

**Flat-cable constructions differ widely**, as demonstrated by these Ansley cables. Flat-conductor cables (left) are often laminated, round-conductor cables (center) extruded for the most part. An additional jacket (right) improves electrical and mechanical performance.

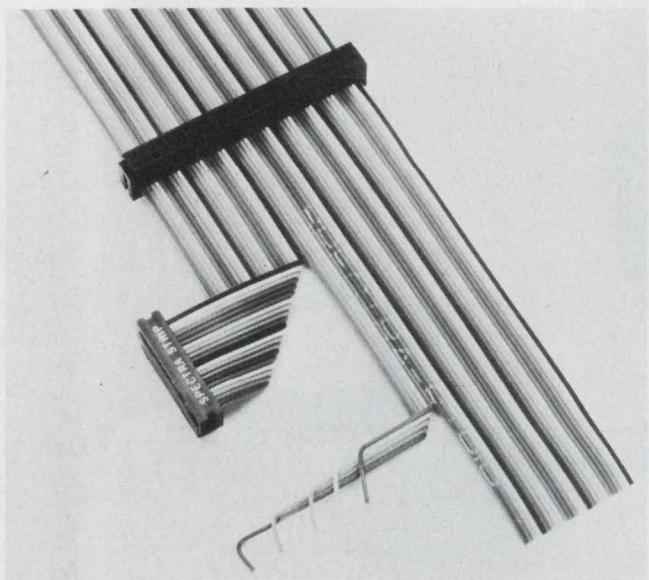

**Breakouts in flat, flexible cables** are easily accomplished in this harness from Spectra Strip. Insulation-displacement connectors can be placed in the middle as well as at the ends of a harness.

**Table 4. Transmission-line characteristics for flat-conductor cable**

Action	Result			
	impedance	capacitance	propagation velocity	inductive loss
Increase pitch	decreases	decreases		increases
Add insulation	increases		decreases	
Widen conductor	increases	decreases		
Increase $\epsilon$	increases		decreases	

Example: Increased pitch decreases capacitance

jacket reduces the crosstalk 80%, compared with that of unjacketed flat cable; compared with bundled, twisted pairs, crosstalk is reduced nearly an order of magnitude. Some of the major transmission-line parameters for flat-conductor cable are summarized in Table 4.

#### But can you afford it?

When you decide between FFC and conventional wiring, cost is a major factor. A few years ago, FFCs cost substantially more per foot of conductor than regular round cable. Today, thanks to the large selection off the shelf, cost per foot is no longer the decisive factor. The important figure is installed cost, and that depends on your application. If you are working on a large system, FFC will cost you much more than round cable in the design stage. But you quickly cash in on direct labor.

For example, a weapons-system harness with 300 wires developed by Westinghouse required 120 engineering hours, 60 drafting hours, and 632 manufacturing hours for the prototype. With FFC, it took 180 engineering hours, 360 drafting hours, and eight manufacturing hours. If you can use a computer to automate routing design and drafting, development costs can be much lower.

For a small system, the tradeoffs shape up differently. Interconnections within an equipment enclosure often require many breakouts of small conductor groups. So, you may have to decide between point-to-point hand wiring and a flexible circuit board.

If you have the space, wire-wrapped connections are a good bet. They cost about 4¢ per point and are extremely reliable. Bell Telephone has made billions of such connections, with very few failures. Bell has found wire-wrapped connections to be 34 times more reliable than solder joints. Although point-to-point hand wiring is often less expensive, it is error-prone.

In contrast with hand wiring, flexible circuits need practically no space and eliminate most wiring-error rework. But these circuits, which are produced like PC boards, have a reputation for being expensive, especially if revisions become necessary. This reputation is largely undeserved, according to Herbert Pallade, President of Parlex.

Pallade states that jumper wires can be used for



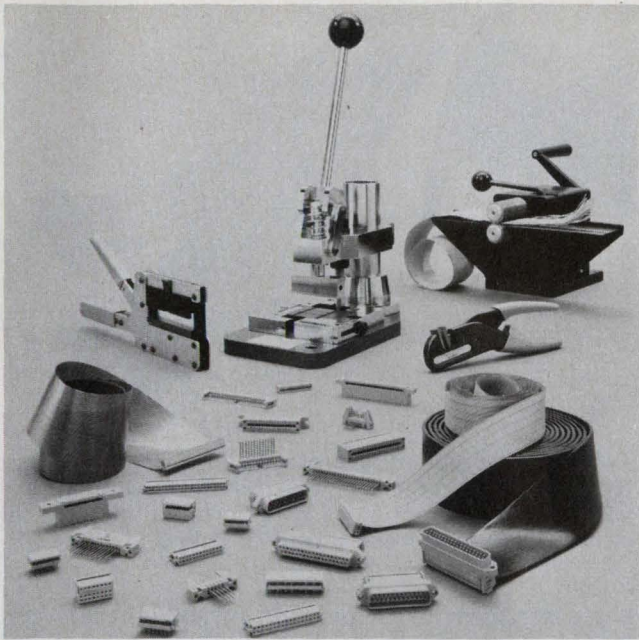

The system concept for flat, flexible cables is typified by Ansley's Blue Macs line. You can buy a complete harness, or make your own from the large selection of available connectors, cables and tools.

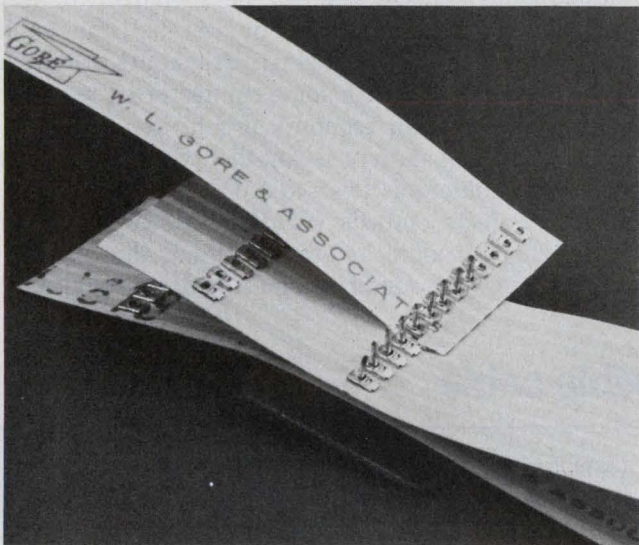

Jumper cables without connectors are possible by attaching the contact pins directly to this flat-conductor cable assembly made by AMP.

modifications, just as in regular PC boards. Tooling costs can be kept low by more generous tolerances, and a competent manufacturer can make a flexible circuit competitive for as few as 10 units. Nevertheless, some aerospace engineers have misgivings based not only on the greater cost, but also on the reliability of flexible circuits.

If crossovers can't be avoided, double-sided circuits are necessary. But on thin substrates, plated-through holes are a problem. If you must stack several flexible circuits, the problem is compounded. Eyelets improve reliability, but add to the cost. One company, Tele-dyne, solves the problem by soldering rather than

plating through the hole.

Recent improvements in flexible-circuit technology let you mount some components directly on the circuit. And you can design complex circuits in such a way that all solder joints are on the same side, then fold the circuit over several times to give you high packaging density. Such stacks are inexpensive to produce because all the solder joints are made at once.

Belling-Lee (Enfield, England) offers some hints to keep flexible-circuit costs down, and reliability up:

- Make conductors at least 25 mils wide, and give profiles a  $\pm 25$ -mil tolerance.
- Leave as much copper as possible on the "board," and blend the track into your terminal pads.
- Use 12-mil stiffening rather than rigid boards.
- Make autopositive copies of your artwork to avoid distortion problems.
- Above all, work closely with your vendor, and avoid the "overs" and "unders" of specifying.

### Striking the proper balance

Overspecification can cost you a bundle, not only on etched flexible circuits, but also on other types of flat, flexible cables. For instance, a few more degrees in maximum operating temperature can force the vendor to use a dielectric or construction that doubles or triples the price.

Insist on an over-all width tolerance of  $\pm 0.010$  in. on a 50-conductor cable, and you'll pay for a lot of measuring and sorting at the vendor's plant. By the time you get the cable, temperature and storage will have changed that critical width anyway.

Use a grooved cable with a matching connector, and the individual wires will self-center. For 12 to 36 conductors,  $\pm 0.015$  in. width tolerance is reasonable, and for 40 to 60 conductors  $\pm 0.02$  in. Another costly mistake is to specify 500-ft lengths of bonded cables, which are normally made in 100-ft runs. In production, such a cable then often gets chopped into 10-ft pieces.

If you specify all the mechanical dimensions as well as the materials, then you have tied down the electrical characteristics as well. Specify impedance or crosstalk also and you place the vendor—and yourself—right on the horns of a dilemma, because you have already determined impedance with your dimensions. When you select an FFC from a catalog, consider the given characteristics as a guideline only, and work out the details with the vendor.

Underspecification, on the other hand, is even more fraught with danger. The surest candidate for disaster is a product designed at one end of a tolerance range and manufactured at the other end. That product is usually never shipped. It's usually best to define all the electrical characteristics and the environmental constraints realistically, and let the vendor propose the most cost-effective solution, in terms of materials and dimensions.

Don't forget to include such "incidentals" as the termination or potting to be used, chemical resistance



to solvents, flex radius and tension, folding requirements, shielding (be specific about frequency range and pulse shape) or flammability. If your vendor assumes you are planning to use insulation-displacing connectors, but you decide to solder instead, you may wind up with a cable that curls under the heat. What looks like a good connection suddenly opens during vibration.

If you need 100-million flexes, you may think that only stranded cable can do the job—only to find out later that flexible circuits have been improved to take the same punishment and save you assembly labor. Don't preclude alternate designs just because your first vendor prefers his own approach. Table 5 can get you started to find the best source.

Be specific. If you specify only a 600-V rating, the vendor may give you a cable that's satisfactory under MIL-W-16878, type B. But should it turn out that you need UL approval, you will need twice the insulation thickness for the same 600-V rating.

Above all, don't let your cable design drag on until everything else is cast in concrete. The more sophisticated the wiring, the earlier its details must be taken into account. Otherwise, you may paint yourself into an expensive corner.

### There's one in every crowd

In addition to flexible circuits, extruded flat cable and laminated flat-conductor cable, some "specialty" constructions may be of interest in your application. The oldest family in the specialty group—the woven cable—is itself as diverse as the FFC.

The woven hangs on because it is flexible not only in space, but also in another sense: You can specify

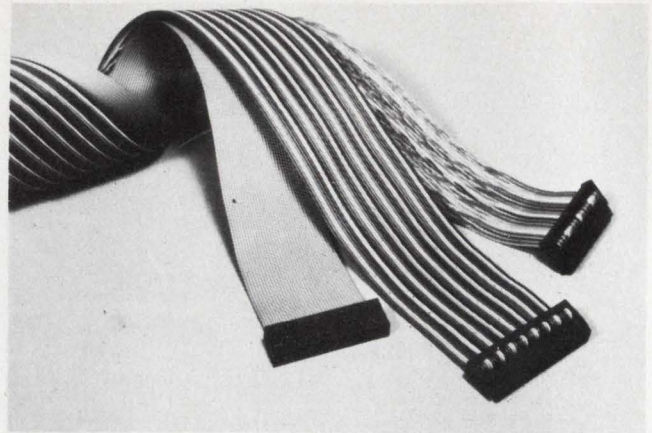

**Twisted wires minimize crosstalk**, but are difficult to terminate. By alternating twisted sections with flat sections, this cable from Alpha Wire Corp. (right cable) can be mass-terminated like other flat cables.

any assortment of single-wire, stranded, coax—and even no-conductor lines—and get them woven into a ribbon. While conventional FFC is limited to the AWG-26-to-30 range, woven cables can accommodate as heavy a power line as AWG 10 or as fine a wire as AWG 40.

Conductor-less spacers can be included to keep sensitive circuits separated or to fold the cable lengthwise, like a pleated skirt. Breakouts are made automatically, and, with some connectors, the woven harness presents an economical solution.

An insulating matrix is another way to combine different conductors (down to AWG 46) into a ribbon. Storm Products embeds wires in silicone-rubber to form a super-flexible, low-torque ribbon that's almost totally limp, with conductor spacing down to 0.025 in.

**Table 5. Who makes what in flat flexible cable**

Company	Round conductors		Flat conductors	Etched conductors	Connectors	Harness assemblies	Comments
	solid	stranded					
Alpha Wire	✓				✓		Twisted w. flat sections
Ansley	✓	✓	✓	✓	✓	✓	Shielded, twisted/flat
AMP			*	✓	✓	✓	*only as part of harness
Belden		✓					extruded and laminated
Belling-Lee	✓	✓				✓	
Burndy					✓	✓	
Daburn	✓	✓					
Electroweave	✓	✓				✓	woven, incl. shielded
Haveg	✓	✓					woven
Huber & Suhner			✓				
Hughes	✓		✓	✓		✓	
3M		✓		✓	✓	✓	
Parlex	✓	✓	✓	✓		✓	
Rogers				✓		✓	
Stanford	✓	✓			✓	✓	
Storm					✓	✓	silicone rubber, coax, twisted



If your application requires inches, rather than feet of FFC, then silicone ribbon may provide a high-temperature solution despite its higher cost.

Although FFC can be made with very low crosstalk, under some conditions that parameter can be reduced even further by assembling twisted pairs into a ribbon. The catch: such a cable is hard to terminate. Spectra Strip offers a solution by providing flat sections every 18 in. With this geometry, mass termination is a cinch.

### Get a running start

If you are just getting into flat, flexible cable, here is a list of helpful design aids, both software and hardware:

- A "Design Questionnaire" from Ansley helps you write a comprehensive FFC specification.
- A design guide from Minco Products designated FC300 helps you with flexible circuits.
- A cable-connector system from Alpha, which permits inspection of the connectors before covering and crimping, is available in kit form.
- A kit from Rogers Corp. helps you prototype flexible circuits (\$25).
- A Blue Macs design kit from Ansley offers \$500 worth of cables and connectors for \$395.
- A universal arbor-press fixture (and a press) from Vector Electronics works with Alpha, AMP, Ansley, Berg, CW, JAE, 3M, SAE, and of course, Vector's own connector systems.

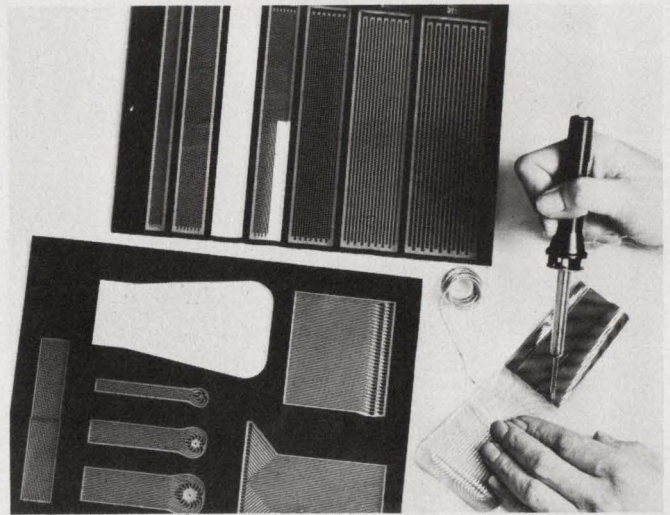

**Judge for yourself** if this kind of wiring suits your application, with Rogers' flexible-circuit kit.

■ MIL-Specs 55543 and 55544 are indispensable to most engineers working with flat-conductor cables and connectors. ■■

### Bibliography

"Flat Conductor Cable Design, Manufacture, and Installation," NASA Technical Memorandum TMX-53975, George C. Marshall Space Flight Center, AL 35812.

"Printed Wiring Design Guide," Institute of Printed Circuits, 1717 Howard St., Evanston, IL 60202.

"Survey of Flat Conductor Cable Technology," Report A951795, Lockheed Missile and Space Co., 6201 E. Randolph St., Los Angeles, CA 90040.

## Need more information?

For further information on flat, flexible cables, readers may consult the manufacturers listed here by circling the appropriate numbers on the reader service card. More vendors and information may be found in electronic Design's GOLD BOOK.

Alpha Wire Corp., 711 Lidgerwood Ave., Elizabeth, NJ 07201. (201) 925-8000. (M. Klakis) **Circle No. 501**

AMP Inc., Harrisburg, PA 17105. (717) 564-0101. (J.T. Pletcher) **Circle No. 502**

Ansley Electronics Corp., Old Easton Rd., Doylestown, PA 18901. (215) 345-1800 (J. Rocks) **Circle No. 503**

Augat Inc., 34 Perry Ave., Attleboro, MA 02703. (617) 222-2202. (R. Grubb) **Circle No. 504**

Belden Corp., P.O. Box 1100, Richmond, IN 47374. (317) 966-6661. (M. La Porte) **Circle No. 505**

Belling & Lee Ltd., Great Cambridge Rd., Enfield, Middlesex, England EN1 3RY. 01-363-5393. (H. Pinkus) **Circle No. 506**

Brand-Rex Co., P.O. Box 498, Willimantic, CT 06226. (203) 423-7771. (G. Graeber) **Circle No. 507**

Buckbee-Mears Co., 245 E. Sixth St., St. Paul, MN 55101. (612) 228-6371. **Circle No. 508**

Burndy Corp., Richards Ave., Norwalk, CT 06856. (203) 838-4444. (J.F. Bradley) **Circle No. 509**

Calmont Engineering & Electronics Corp., 420 E. Alton St., Santa Ana, CA 92707. (714) 549-0336. (V. George) **Circle No. 510**

Cicoil Corp., 9324 Topango Canyon Blvd., Chatsworth, CA 91311. (213) 882-2021. (A. Hershkovitz) **Circle No. 511**

Daburn Electronics & Cable Corp., 2360 Hoffman St., Bronx, NY 10458. (212) 295-0050. (B. Danziger) **Circle No. 512**

Electroweave Inc., 27 Foundry St., Central Falls, RI 02863. (401) 724-4000. (R. Planchet) **Circle No. 513**

Flexible Circuits Inc., Paul Valley Industrial Park, Warrington, PA 18976. (215) 343-2300. (J. Hannun) **Circle No. 514**

W. L. Gore & Associates, Inc., 555 Paper Mill Rd., Newark, DE 19711. (302) 738-4880. (R. S. Kauffman) **Circle No. 515**

Haveg Industries Inc., Wire Div., Box 7, Winoosik, VT 05405. (802) 655-2121. (J. Brooks) **Circle No. 516**

Huber & Suhner AG, Degersheimerstr 14, 9100 Herisau, Switzerland. 071 531515. (M. C. Capps) **Circle No. 517**

Hughes Aircraft Co., Connecting Devices Div., 17150 Von Karman Ave., Irvine, CA 92714. (714) 549-5701. (W. D. Morris) **Circle No. 518**

ITT Wire & Cable Div., 172 Sterling St., Clinton, MA 01510. (617) 365-6331. (C. Genre) **Circle No. 519**

Methode Electronics, Inc., 7447 W. Wilson Ave., Chicago, IL 60656. (312) 867-9600. (M. Andrei) **Circle No. 520**

Minco Products Inc., 7300 Commerce Lane, Minneapolis, MN 55432. (612) 786-3121. (L. G. Hanson) **Circle No. 521**

3M Co., Electronic Products Div., 3M Center, St. Paul, MN 55101. (612) 733-1110. (R. Barker) **Circle No. 522**

New England Electric Wire, 365 Main St., Lisbon, NH 03585. (603) 833-6628. (C. McKenzie) **Circle No. 523**

Parlex Corp., 145 Milk St., Methuen, MA 01844. (617) 685-4341. (M. Kotler) **Circle No. 524**

Philips Cable Div., P. O. Box 26, Delft, Holland. Telex 31024/31051. **Circle No. 525**

Rogers Corp., 77 Main St., Rogers, CT 06263. (203) 774-9605. (H. Brooks) **Circle No. 526**

Sanders Associates, Grenier Field, Manchester, NH 03103. (603) 669-4615. (L. Travis) **Circle No. 527**

Spectra-Strip Inc., 7100 Lampson, Garden Grove, CA 92642. (714) 892-3361. (D. Ebling) **Circle No. 528**

Stanford Applied Engineering, 340 Martin Ave., Santa Clara, CA 95050. (408) 245-2910. (M. Austin) **Circle No. 529**

Storm Products Co., 112 S. Glasgow, Inglewood, CA 90301. (213) 776-8141. (G. E. Heisler) **Circle No. 530**

Teledyne Electro-Mechanisms, 29 Crown St., Nashua, NH 03060. (603) 889-6191. (V. St. Amand) **Circle No. 531**

TRW Co., Holyoke Div., 775 New Ludlow Rd., South Hadley, MA 01075. (413) 533-3961. (G. Miles) **Circle No. 532**

Woven Electronics, P.O. Box 189, Mauldin, SC 29662. (803) 963-5131. (J. W. Burnett) **Circle No. 533**



hp 1741A STORAGE

STORE



ERASE



OR  
VIEW  
TIME  
ERASE  
(PUSH)  
MAX

BRIGHTNESS



MAX

WRITE



STORE



DISPLAY

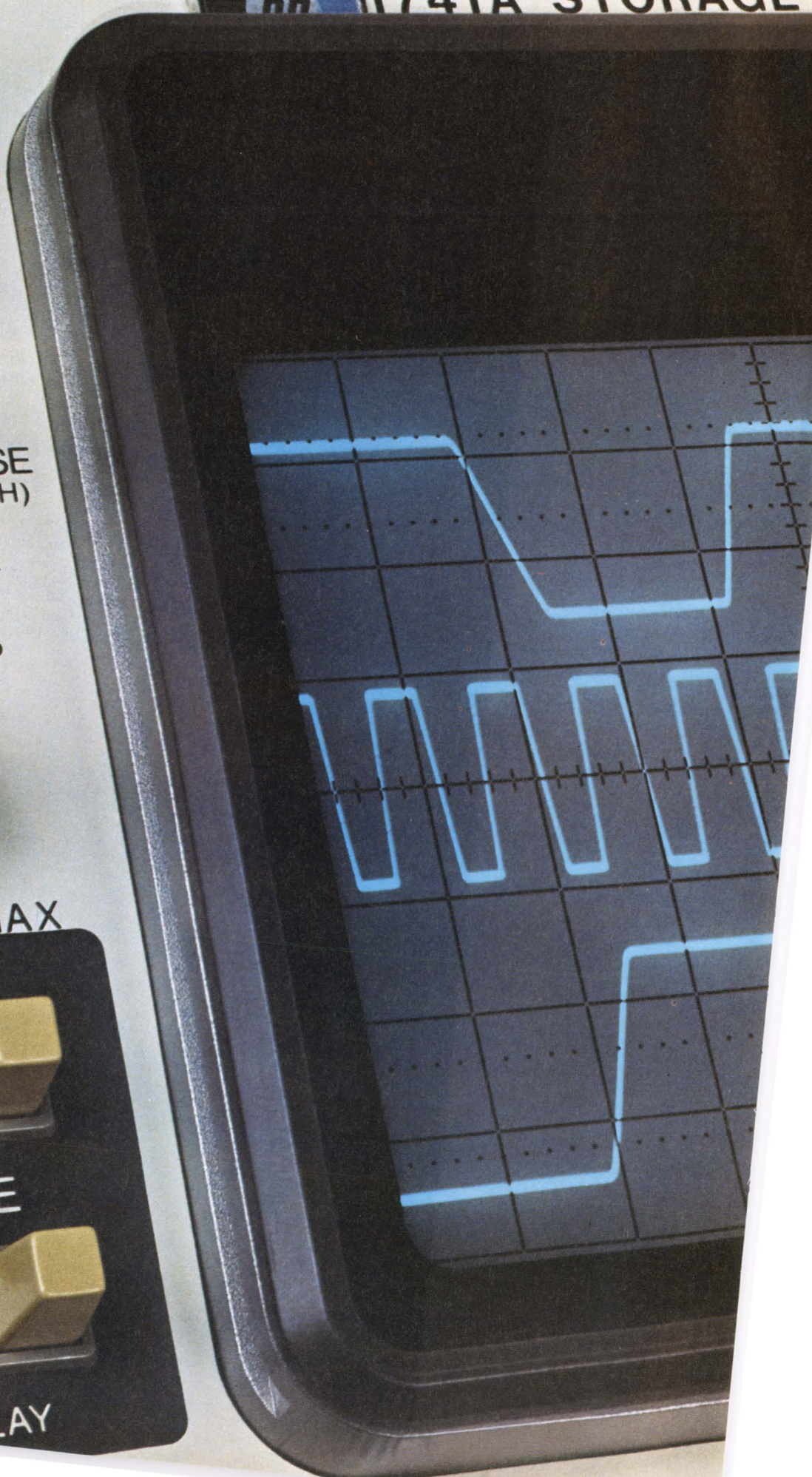



# For one easy-to-use scope that: Captures single-shot events... Displays low-duty-cycle signals clearly... Provides three channels for the price of two...

## HP's the Answer.

And the new 1741A is your scope. It gives you a unique combination of features for a moderately priced 100 MHz storage scope: Variable persistence for clear viewing of glitches and low-duty-cycle traces; storage for studying single-shot events; and third-channel trigger view for convenience in making simultaneous three-channel timing measurements.

**Excellent variable persistence** means a bright, sharp trace you'd expect only on a nonstorage scope. The result is an easy-to-read display of fast, low-duty-cycle repetitive signals. And the ability to see leading edges and glitches you'd otherwise miss.

**Auto erase/Auto store.** In Auto erase you adjust the display rate up to 2.5 per second. After that, it's all automatic, which means you simplify set-ups and eliminate smeared displays of digital data. It's a powerful tool for capturing those elusive glitches in data streams. In Auto store, your 1741A is armed, and as long as the instrument is fully operational and powered, will wait indefinitely, ready to store a random, single-shot event when it occurs.

**Third-channel trigger view,** selected at the push-of-a-button, lets you observe an external trigger signal along with channel A and B—three traces in all—so you can easily make timing measurements between all three channels. In most applications, that means three-channel capability for the cost of a two-channel variable persistence/storage scope.

For measurement convenience, the

1741A has a selectable 50 ohm input in addition to the standard 1 megohm input. A 5X magnifier permits two-channel measurements as low as 1 mV/div to 30 MHz, without cascading. You can even select a special modification (TV Sync) to tailor this scope for TV broadcast and R&D applications. Priced at \$3950\*, the 1741A is an exceptional storage scope value.

Call your local HP field engineer today for all details. And for low-cost variable persistence/storage in a 15 MHz scope, ask him about HP's new 1223A.

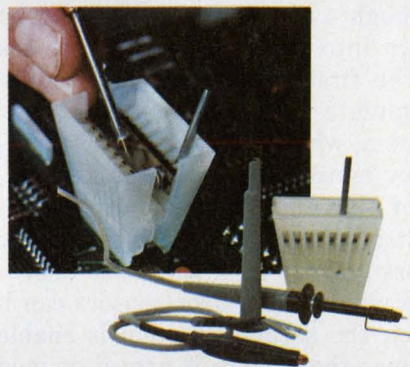

And here's something NEW for scopes. HP's EASY-IC PROBES. A new idea for probing high-density IC circuits that eliminates shorting hazards, simplifies probe connection to DIP's and generally speeds IC troubleshooting. Ask your HP field engineer about them.

\*Domestic U.S.A. price only.



08611A

HEWLETT  PACKARD

1507 Page Mill Road, Palo Alto, California 94304

For assistance call: Washington (301) 948-6370, Chicago (312) 255-9800, Atlanta (404) 955-1500, Los Angeles (213) 877-1282

CIRCLE NUMBER 41





## The design of a home security system

lets you apply the concepts of 'top-down' programming.

The assembly code is written for an 8080-based microcomputer.

Most microcomputers are used in dedicated control operations: The computer reads a number of sensors, manipulates the inputs according to the program instructions, and as a result activates output devices. A practical example of such an operation is a home security and alarm system, which employs many I/O techniques. You can develop a program to implement this system with an 8080-based microcomputer.

The complete program is fairly complex, but by using a "top-down" design procedure, and the structured programming techniques described in Parts 1 through 4 of this series, you can break the problem down into small blocks that are easy to implement.

The first step in top-down software design is to formulate a complete specification for the security system, which serves a typical three-bedroom, single-story house with a two-car garage. Fig. 1 shows the floor plan and the location of fire or smoke detectors, control panels and sensors that monitor two entry doors (garage door and patio door) and 13 windows. The window and door sensors can be activated only when the security system is enabled.

Once the system is armed, it monitors all sensors continuously. If it detects an entry, the alarms are activated.

### One for fire, two for intrusion

The output devices of the system are one fire alarm and two intruder alarms. The fire alarm is loud enough to awaken family members sleeping anywhere in the house. The first intruder alarm is large and noisy. If the system is armed, the alarm is activated by any entry violation. Or you can press the Alarm Test button on the main console.

The second intruder alarm is part of the main control panel, and designed to wake you without setting off the general alarm. If the security system has been armed from the main control panel, the second alarm is activated by an intruder; what's more, you can check the status board to decide whether to call the police, activate the main alarm, or take other action.

Remote-control points at the front and garage doors

allow you to activate the entry-detection part of the system when you leave the house, and deactivate it when you re-enter. Each remote site has an indicator to show when the system is active, and a mechanical keyboard. Activate the system by pressing a single key, and deactivate it by punching a user-selected five-digit code.

A remote-control unit (Fig. 2) consists of two control buttons, a 10-key keyboard, and two indicator lights. Press the Arm button when leaving the house. The system then checks to make sure all doors and windows are closed and turns on the System Armed indicator. If a door or window is found open, the System Fault indicator turns on. You can then check the main control panel to find the open door or window.

The master control panel (Fig. 3) consists of several control buttons and an outline of the house perimeter, with an indicator light for each sensor. The Arm button performs the same function as the Arm buttons on the remote units. The Disarm button deactivates the intruder sensors and turns off all active alarms except for the fire sensors, which are always active. The Test button turns on all the panel lights until the Disarm switch is pressed.

The Status button permits you to check for any open door or window. When you press "Status," the system turns on the proper indicator light(s) and keeps them on until the Disarm button is pressed. The Alarm button activates the system alarms, which remain on until deactivated by the Disarm button.

### Off to the corner byte shop

The hardware design for this system is straightforward, because many 8080-based microcomputers have enough parallel I/O ports, and several new versions will soon be available. So most of the hardware design is taken care of. You just have to wire the sensors, control panels and alarms.

To minimize the number of wires running around the house, use scanned-input operations (see box). All fire or entry sensors must be identifiable so that they can be properly displayed on the status display. All key entries must be decoded to check them against the valid entry code. The Arm, Disarm, Test, Status, and Alarm inputs, on the other hand, are detected only



1. The floor plan of a typical home shows three fire sensors and 13 windows to be monitored. The security system's main control is in the master bedroom, and two doors have remote panels.

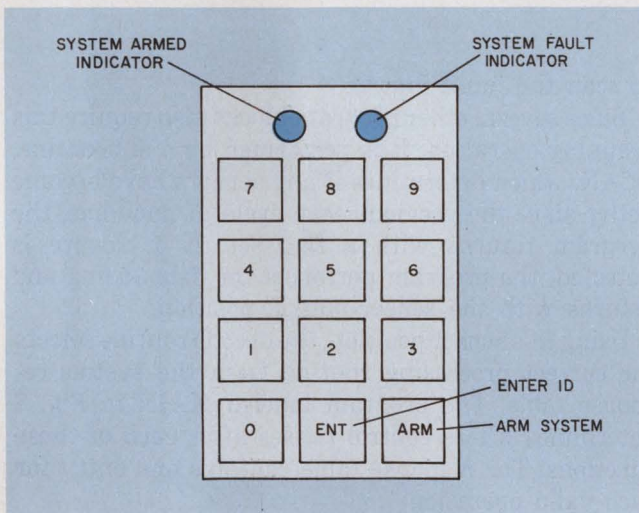
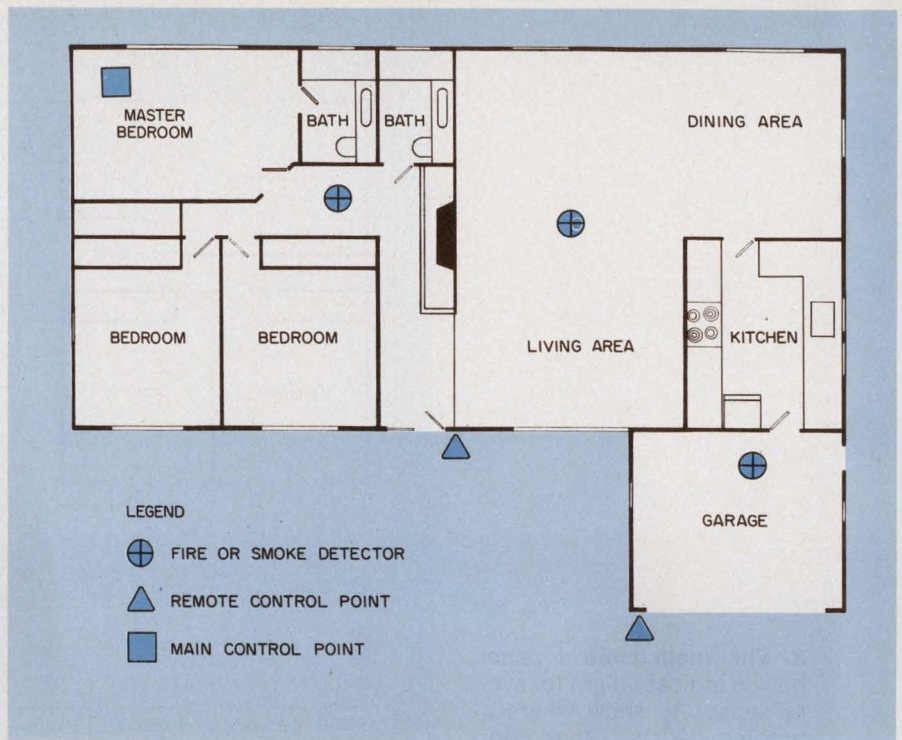

2. Remote-control panels permit you to arm the security system when you leave, and disarm it by entering an identification code.

to initiate a control sequence.

The output system requires enough output ports to energize the indicators on the main control panel and drive the Arm and Fault indicators at the remote sites. Each indicator is a single device driven directly from the output port.

The input detectors are organized as a scanned matrix; each system input is assigned a position in the matrix. All remote control stations are wired in parallel.

Fig. 4 shows the matrix layout for the system. Note that not all the matrix positions are used. The fire and entry sensors are located in blocks to permit easy expansion. Each indicator light is a single LED.

The low-volume intruder alarm has adjustable volume, and can be made from an inexpensive radio. A good high-volume external alarm would be a surplus crash alarm from a World War II destroyer.

The basic output hardware is shown in Fig. 5, using an 8-bit microcomputer. The system's Arm and Fault indicators, alarm actuators, and entry indicators are all on separate output ports. Sufficient output ports for expansion are included.

To complete the hardware design, assign the I/O ports to be addressed in your 8080-based microcomputer as follows:

INPUT PORT NAME	I/O ADDRESS, BITS	FUNCTION
COLUMN	10H, BITS 0-7	SWITCH MATRIX COLUMN INPUTS
ROWS	10H, BITS 0-7	SWITCH MATRIX ROW OUTPUTS
STATUS	11H, BIT 0	SYSTEM ARMED INDICATOR
	BIT 1	SYSTEM FAULT INDICATOR
ALARM	12H, BIT 0	FIRE ALARM ACTUATOR
	BIT 1	OUTSIDE INTRUDER ALARM
	BIT 2	INSIDE INTRUDER ALARM
IND 0	13H, BIT 0	FIRE SENSOR 25 (GARAGE)
	BIT 1	FIRE SENSOR 25 (LIVING ROOM)
	BIT 2	FIRE SENSOR 26 (BEDROOMS)
	BITS 3-7	OTHER FIRE SENSORS FOR LATER USE SENSORS 32-39
IND 2	15H, BITS 0-7	STATUS INDICATORS FOR SENSORS 40-47

(continued on page 72)



3. The main control panel has an indicator light for every sensor to show where a problem exists. Other controls permit you to check out the system.

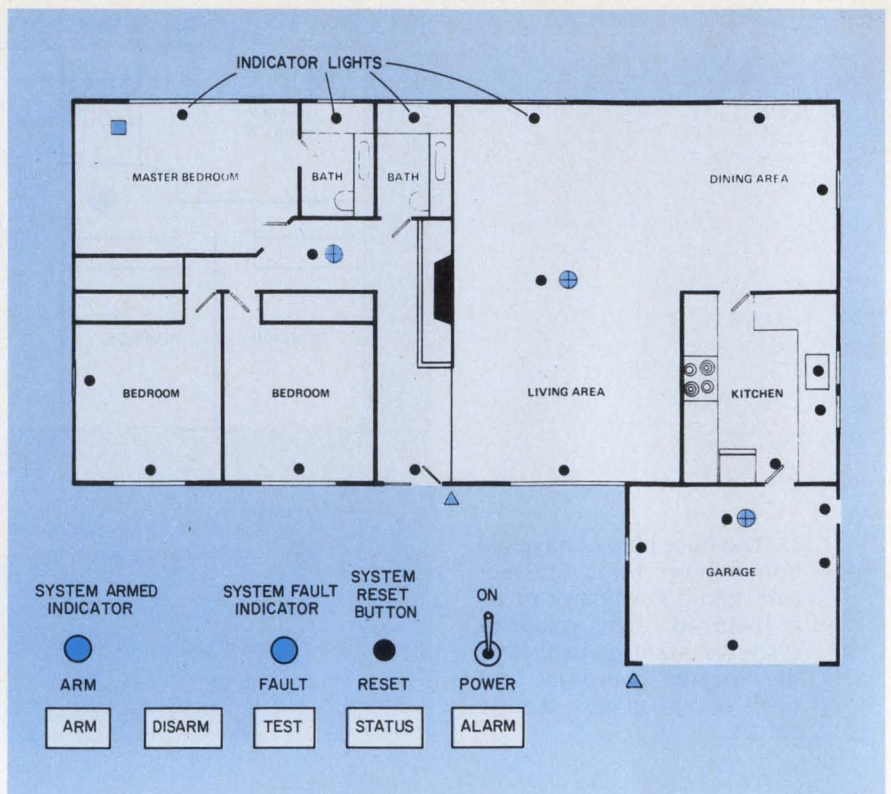

(continued from page 71)

IND 3	16H, BITS 0-7	STATUS INDICATORS FOR SENSORS 48 AND 49 (50-55 AVAILABLE FOR LATER USE)
IND 4	17H, BITS 0-7	STATUS INDICATORS FOR SENSORS 56-63 AVAILABLE FOR LATER USE

### Block out the software

Continuing with the top-down design procedure, you must now define the major software blocks (Fig. 6) After initialization, the program continually scans the sensor matrix for any closure transitions. Because several sensors may be active at the same time (e.g., several open windows) and because you want the system to respond to the most recent change, you must keep an image of each sensor position.

Once a closure transition is detected and debounced (see box), it is decoded and control transferred to the appropriate response routine. This is a good application for a table-driven Select Operation structure, where the key position code determines which process to execute. You can develop, code, and debug the major software blocks individually, then integrate them and debug the whole system.

Fig. 7 shows the logic for beginning the program, in more detail. The reset button clears all indicators in the status display, deactivates all alarms and initializes all status flags to indicate that the system is disarmed and quiescent. The program then begins

to scan the input matrix.

Since several other program blocks also require this scanning operation, it is performed by a subroutine, SCAN, which determines if any sensors have become active since the previous scan cycle. If none has, the program returns with a flag set. If a closure is detected, the program performs the debouncing and returns with the sensor-matrix position.

Using this sensor position, the decode routine selects the correct processing routine from the system-response table. The program labeled MAIN in Fig. 7 determines where control passes after each of these functions. The response table contains one entry for each valid operation:

- \* ARM SYSTEM FROM MAIN PANEL
- \* ARM SYSTEM FROM REMOTE PANEL
- \* DISARM SYSTEM FROM MAIN PANEL
- \* DISARM SYSTEM FROM CODE ENTERED BY REMOTE PANEL
- \* CONTROL FIRE ALARMS
- \* CONTROL INTRUDER ALARMS
- \* TEST ALL ALARMS
- \* DISPLAY SYSTEM STATUS
- \* TEST DISPLAY

Because the program is meant to run in a small, dedicated system, it is primarily stored in ROM. The ROM will contain 512 bytes from 0-1FFH. Assume there are also 256 bytes of RAM from 200-2FFH. When all sensors are inactive, all image bytes are ZERO. And if the system is armed from the master panel, the panel flag is ZERO. The storage is allocated by, and the temporary-storage locations defined in, the following part of the program:



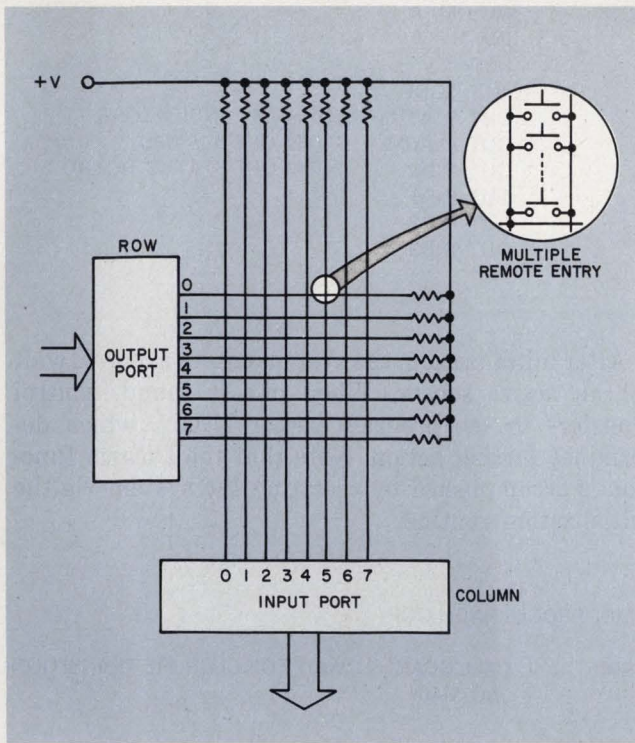

4. A matrix for sensors and keyboards minimizes the amount of wiring and the number of I/O ports the system requires. The table indicates matrix assignments.

Matrix position assignments		
Matrix point	Switch number	Function
0,0	0	Arm
0,1	1	Disarm
0,2	2	Test
0,3	3	Status
0,4	4	Alarm
0,5	5	Remote arm
0,6	6	Remote entry
0,7	7	Unused
1,0	8	Code key 0
1,1	9	Code key 1
1,2	10	Code key 2
1,3	11	Code key 3
1,4	12	Code key 4
1,5	13	Code key 5
1,6	14	Code key 6
1,7	15	Code key 7
2,0	16	Code key 8
2,1	17	Code key 9
2,2-2,7	18-23	Unused
3,0	24	Garage fire input
3,1	25	Dining area fire input
3,2	26	Bedroom fire input
3,3-3,7	27-31	Available for other fire sensors
4,0-6,1	32-49	Sensor inputs
6,2-7,7	50-63	Available for other sensors

```

ORG 200H
;
;:FLAGS
;
ARM:      DS 1      ;:SYSTEM ARMED FLAG
PANEL:   DS 1      ;:REMOTE/MAIN PANEL ARMED
;
;:MATRIX
;:IMAGES
;
SWITCH:  DS 8      ;:SENSOR IMAGES FOR CONTROL
;:BUTTONS
KEYS:    DS 10     ;:KEY SWITCH INPUTS
NULL:    DS 6      ;:UNUSED
FIRE:    DS 8      ;:FIRE SENSORS
SENSOR:  DS 32     ;:ENTRY SENSORS

```

The 8080 instruction set was discussed in Part 1 of this series (ED No. 1, Jan. 4, 1977, pp. 95-96) and in Part 2 of  $\mu P$  Basics (ED No. 10, May 10, 1976, pp. 85-89). "ORG" and "DSxx" are pseudo-instructions. All entries following a semicolon are merely comments, and the 8080 disregards them.

The initialization program follows the flow chart of Fig. 7. The jump at location 0 to location 40H leaves some locations available for the 8080 interrupts (RST1-7).

```

ORG 0      ;:RESET VECTOR
JUMP INIT

INIT:      ORG 40H
MVI A, 0   ;:INITIALIZE SYSTEM
LXI H, ARMS ;:START OF SWITCH IMAGES
MVI C, 64

```

(continued on page 74)

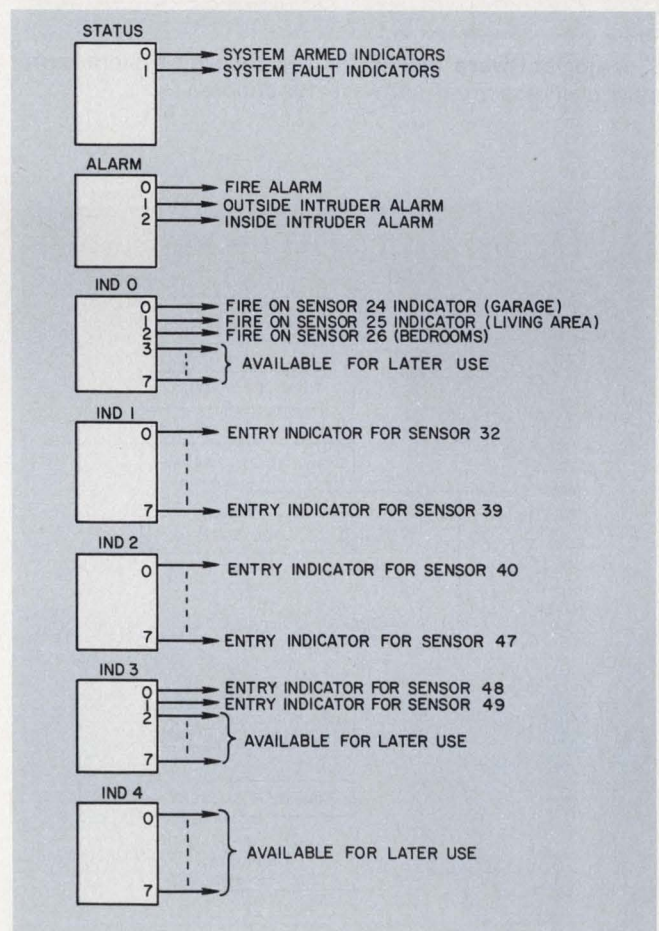

5. Seven output ports are required for the security system, which includes space for possible expansion.



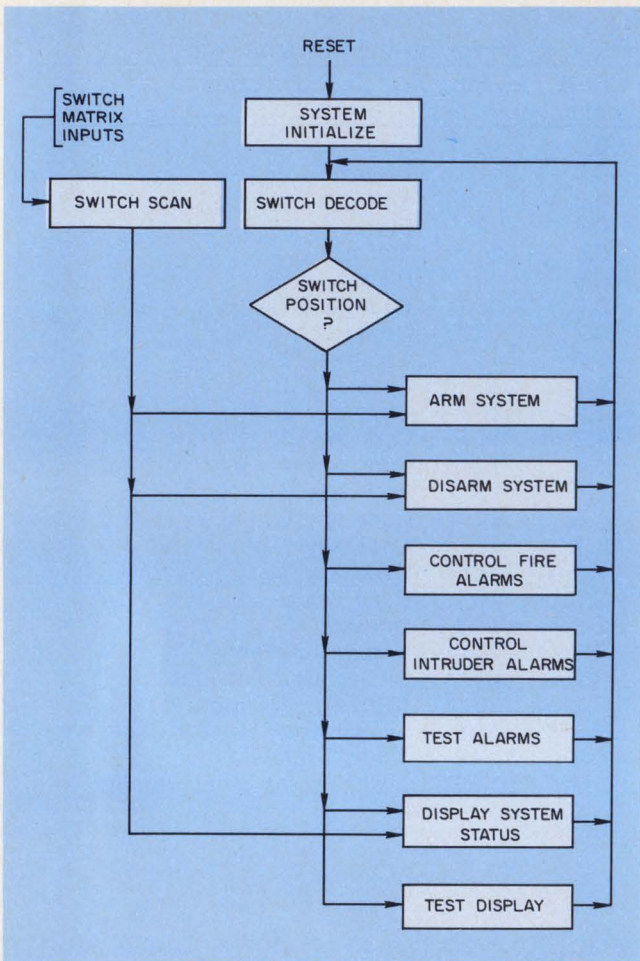

6. Major software blocks for the security system summarize all essential software functions.

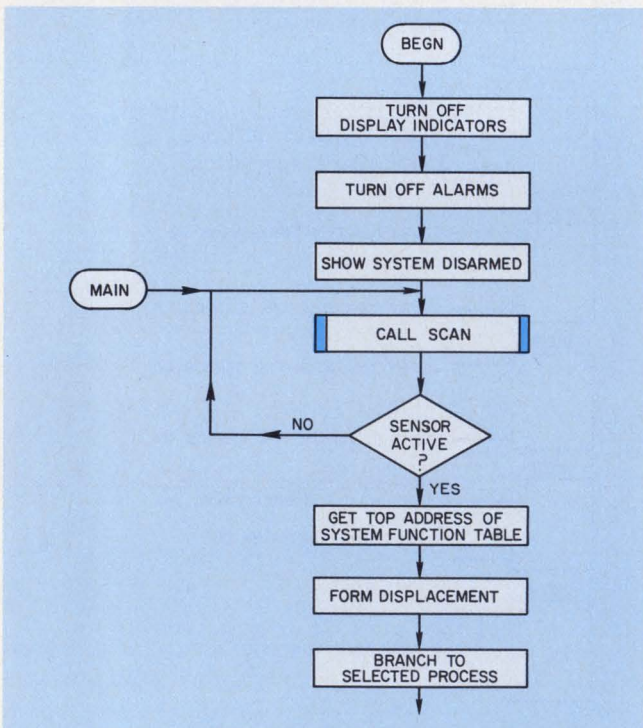

7. The logic for system initialization and command decoding is expressed in a standard flow chart.

```

ILOOP:  MOV M, A
        INX H
        DCR C
        JNZ ILOOP
        OUT STATUS ;TURN OFF INDICATORS
        OUT ALARM  ;TURN OFF ALARMS
        OUT INDO   ;TURN OFF STATUS BOARD
        OUT IND1
        OUT IND2
        OUT IND3
  
```

After initialization, the system enters a loop to wait for an active sensor. When one is found, control transfers to the program sector MAIN, which determines further action. Note that the Disarm function is accomplished by resetting the system via the initialization routine.

```

;MAIN PROCESSING LOOP
;
MAIN:   CALL SCAN ;WAIT FOR CLOSURE TRANSITION
        JNC MAIN
;
;CLOSURE CODE NOW IN A
;
        CPI 32    ;SENSOR?
        JP SENSOR ;YES, IF A ≥ 32
        CPI 24    ;FIRE?
        JP FIRE   ;YES, IF A ≥ 24
        CPI 7     ;OTHERS?
        JP MAIN   ;IGNORE THOSE BETWEEN
                  7 AND 23
;
;A = 0-6. FORM TABLE DISPLACEMENT
;
        MOV H, A ;SAVE A
        ADD A    ;A = A * 2
        ADD H    ;A = 3 * A
        LXI H, CTBLE ;GET TABLE ADDRESS
        ADD L
        MOV L, A ;ADD 3 * A TO ADDRESS
        JNC HERE ;SKIP INR H IF NO CARRY
        INR H
HERE:   PCHL ;JUMP TO JUMP TABLE
;
;COMMAND TABLE
;
CTBLE:  JMP MARM ;MASTER ARM
        JMP INIT ;DISARM
        JMP TEST ;TEST DISPLAY
        JMP STATUS ;SHOW SYSTEM STATUS
        JMP ALERT ;TEST/ACTIVATE ALARMS
        JMP RARM ;REMOTE ARM
        JMP RENT ;REMOTE ENTRY
  
```

### SCAN walks the beat

The SCAN routine tests the sensor matrix to determine which sensors have changed from open to closed, or closed to open, since the last scan. The current state of each sensor must be saved in memory. If a sensor goes active, the matrix position is computed and a flag set before control returns to the main program for appropriate action. If there are no transitions, SCAN continues through the matrix until all rows and columns have been scanned, then returns



## Develop a routine for scanned I/O devices

Scanned I/O devices are all around you. Take a simple keyboard, consisting of a matrix of wires with a normally open pushbutton switch at each intersection. The matrix reduces 64 individual key inputs to eight inputs and eight outputs—only two I/O ports on an 8-bit microcomputer.

A program to accept keyboard entries must determine whether a key has been depressed and, if so, which one. The problem is complicated by the fact that most keys bounce for several milliseconds before the closure is complete. Another problem is multiple key depressions (N-key rollover), which you can solve by forcing the program to wait for all keys to be open between key closures.

To develop the scan logic, start by setting all the output port bits LOW. Until a key is depressed, the input port bits are all HIGH. You can detect a key closure by looking for a LOW on the input port. After detecting a key closure, your program requires a delay that is longer than the bounce time of the switch. Then you can scan the matrix to determine which key is closed.

A simple scan algorithm drives the first row low and all others high, then reads the input port representing the column lines. If there is a zero in the input, its location tells you which key is depressed. If no zero is found, you drive the next row low and repeat until you find the closed key.

After exit from the scan routine, you know the row number and the column bit pattern. The combination of these two values identifies the closed key with the help of a table that has one entry for each key. Search the table for a match with the I/O port images, and

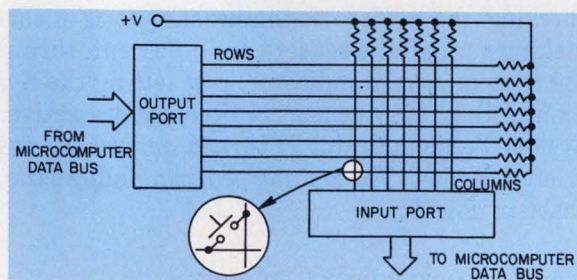

exit with the proper key code, which can then be used in the program. The logic diagram shown is general enough to be used with matrix keyboards of almost any size.

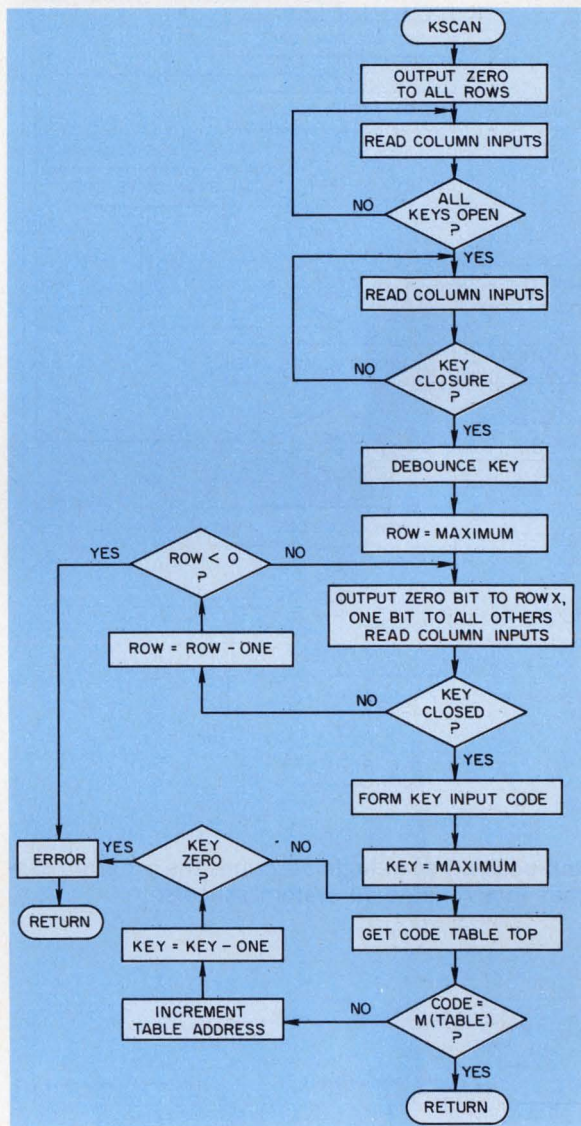

with the transition flag cleared. The program logic for SCAN is shown in Fig. 8.

To implement this flow chart in 8080 assembly language, make the carry bit the transition flag. The row and column counters are stored in BC, and the input and output port images in DE. The delay subroutine DBOUNCE tests for true switch closure.

```
PUSH H
PUSH D
PUSH B
CALL DBOUNCE
```

```
LXI H, SWITCHES + 63 ;LAST SWITCH IMAGE
MVI B, 7 ;ROWS = 7
MVI D, 7FH
MOV A, D ;SET UP ROW IMAGE
OUT ROWS
MVI E, 80H ;SET UP COLUMN MASK
MVI C, 7 ;COLUMNS = 7
CLOOP: IN COLUMN
ILOOP: ANA E
JZ CLOSED ;IF 0, CLOSURE
```

(continued on page 76)



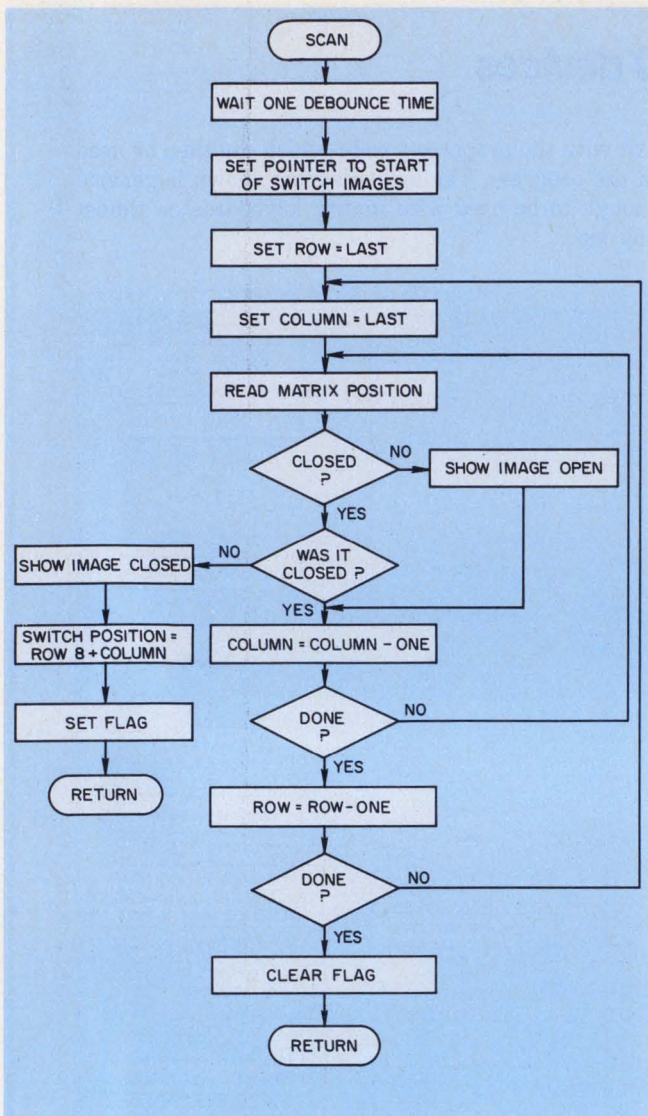

8. Switch-position scan logic describes the program segment that interrogates all system sensors.

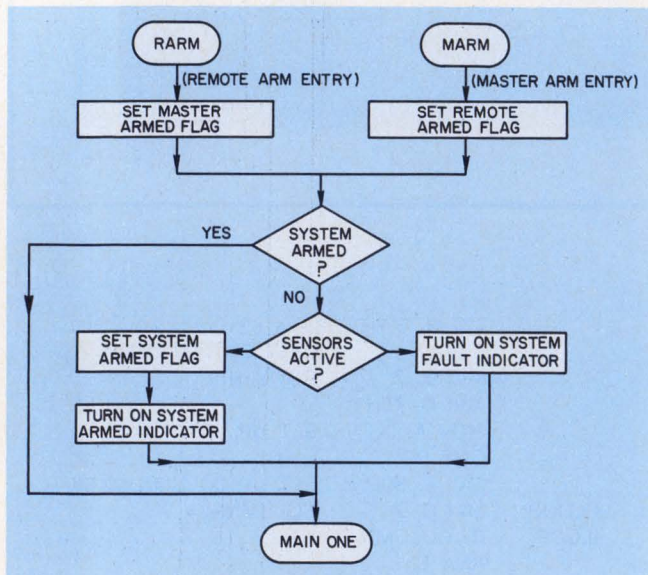

9. The intruder-detection subsystem is armed by the routine outlined in this flow chart.

```

MVI M, 0 ;SHOW IMAGE OPEN
JMP NEXT C
CLOSED: MOV A, M ;GET IMAGE
ORA A
JNZ NEXT C ;ALREADY CLOSED
MVI M, A ;SHOW CLOSED
MOV A, B ;GET ROW NUMBER
RLC ;ROW * 2
RLC ;ROW * 4
RLC ;ROW * 8
ANI 38H ;MASK OFF EXTRA
ADD C ;ADD IN COLUMN
STC
POP B
POP D
POP H
RET
NEXTC: DCR C ;NEXT ROW
JM NEXT R ;NEXT IMAGE
DCX H
MOV A, E
RRC ;NEXT BIT
MOV E, A
JMP JLOOP
NEXTR: DCR B ;IF MINUS, ALL DONE
JM DONE ;NEXT IMAGE
DCX H
MOV A, D
RRC
OUT ROWS
MOVE D, A
JMP OLOOP
DONE: ORA A ;CLEAR FLAG
POP B
POP D
POP H
RET

```

### Arming your electronic watchman

The arming logic (Fig. 9) consists of saving a flag for the remote-input panel or the master control panel, checking the system to make sure it is disarmed, making sure all the sensors are quiescent, turning on the System Armed indicator, and setting the System Armed flag. If a sensor is detected as active, the System Fault indicator is turned on and the system is left disarmed. The arming program follows the flow chart of Fig. 9:

```

;
;SYSTEM ARMING CONTROL
;
MARM: MVI A, 0 ;SHOW ARMED FROM MAIN PANEL
JMP TESTS
RARM: MVI A, 1 ;SHOW ARMED FROM REMOTE PANEL
TESTS: STA PENL ;SAVE ARMING FLAG
LDA ARMS
ORA A ;ALREADY ARMED?
JNZ MAIN1 ;IF SO, IGNORE SWITCH
LXI H,
;SENSOR ;START OF SENSOR IMAGE AREA
MVI C, 32 ;CHECK SENSOR IMAGES
TLOOP: MOV A, M ;GET IMAGE
ORA A ;TEST FOR ZERO
JNZ TERR ;IF NOT ZERO, ACTIVE SENSOR
INX H
DCR C ;CONTINUE
JNZ TLOOP
;
;SYSTEM CLEAR. ACTIVE

```



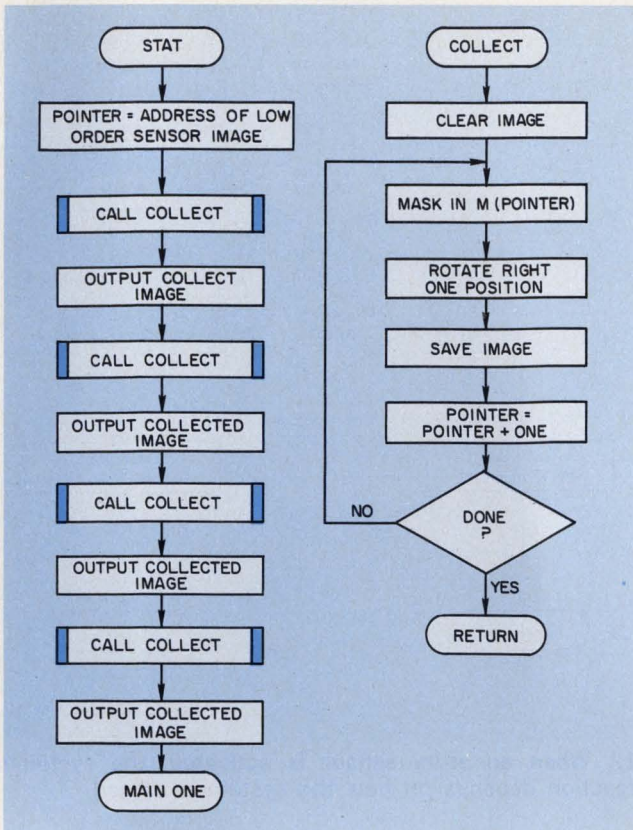

10. Testing for display and system status is straightforward, as indicated by these logic diagrams.

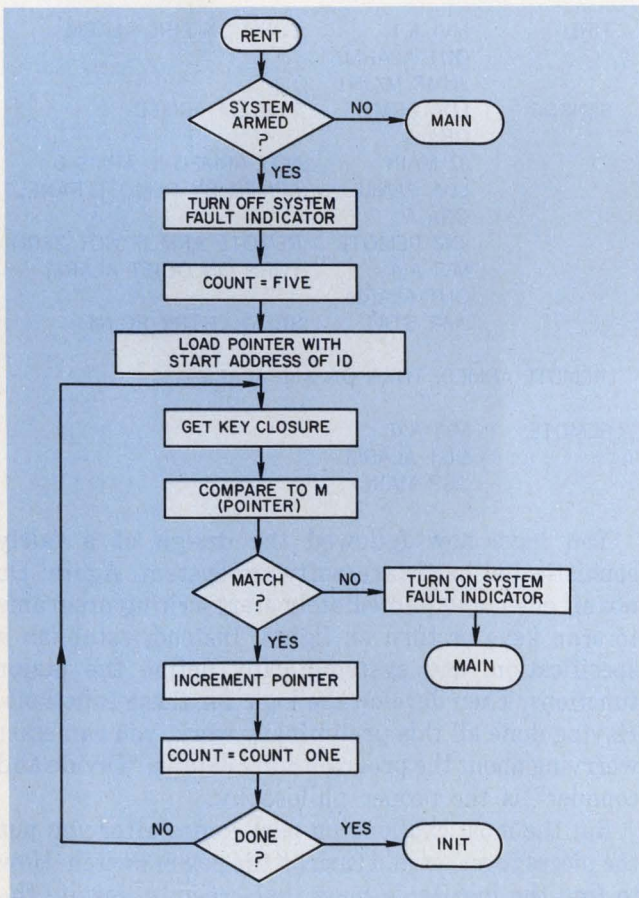

11. To disarm the system from an entrance, the program compares five punched-in digits with "pointer M."

```

MVI, A, 1
STA ARMS
OUT STATUS ;TURN ON ARMED INDICATOR
JMP MAIN1

;SYSTEM HAS ACTIVE SENSOR

MVI A, 2
OUT STATUS ;TURN ON FAULT INDICATOR
JMP MAIN1
  
```

Testing the display status is simply a matter of turning on all the panel's indicator lights so that you can detect and replace any bad ones. The lights stay on until the system's Reset or Disarm inputs are activated. Use the same procedure to turn on the alarms, when the Alarm button is pressed, by outputting ONEs to all the bits in the alarm output port. The alarms remain on until the system is disarmed.

Testing system status is also fairly simple. Just scan through the sensor images and turn on the indicator for any active sensor. But there is one problem: The output indicators are controlled by parallel output ports (eight indicators per output port) while the sensor-input images are saved as sequential one-bit flags. So you collect eight sensor images into a single byte and output the value to the appropriate port.

The logic for the status output is shown in Fig. 10 and the program segments for display test (subroutine TEST), alarm actuator (subroutine ALERT), and status display (subroutine STAT) follow.

```

TEST:  MVI A,OFFH
        OUT IND0
        OUT IND1
        OUT IND2
        OUT IND3
        OUT IND4
        JMP MAIN
  
```

```

ALERT: MVI A,OFFH
        OUT ALARM
        JMP MAIN
  
```

```

STAT:  LXI H,SENSOR ;ADDRESS OF LOW ORDER
        CALL COLLECT ;SENSOR IMAGE
        OUT IND1 ;OUTPUT TO INDICATORS 32-39
        CALL COLLECT
        OUT IND2 ;OUTPUT TO INDICATORS 40-47
        CALL COLLECT
        OUT IND3 ;OUTPUT TO INDICATORS 48-55
        CALL COLLECT
        OUT IND4 ;OUTPUT TO INDICATORS 56-63
        JMP MAIN
  
```

;COLLECT BITS INTO OUTPUT PORT IMAGE

```

COLLECT: MVI C,0
          MVI B,8
CLOOP:  MOV A,M ;GET BIT
          ORA C ;MASK INTO IMAGE
          RRC ;ROTATE TO NEXT PLACE
  
```

(continued on page 78)



(continued from page 77)

```

MOV C,A      ;RE-SAVE IMAGE
INX H
DCR B
JNZ CLOOP
RET

```

### Is that you, dear?

To get into the house when the system is armed, press the Ent key, and enter a five-digit entry code. If the punched code matches that stored in the computer, the system is deactivated, and the System Armed indicator light goes off. If the code does not match, the System Fault indicator comes on, and the system remains armed. The entry code allows 100,000 combinations. At one try per second, that's 28 hours of punching. Prowlers rarely have that much time. You can program the system to set off the alarm after a certain number of incorrect attempts to match codes.

The logic in Fig. 11 first verifies that the system is armed, turns off the System Fault indicator, sets a pointer to the start of the ID code string, and sets a counter to five. It then enters a loop, which picks up key closures and compares them to the position saved in the string. If the entire string matches, the system is disarmed via the initialization routine. If the string doesn't match, the System Fault indicator goes on, and the system remains armed.

```

;REMOTE ENTRY DISARM
;
RENT:  LDA ARMS      ;TEST FOR ARMED
      ORA A
      JZ MAIN       ;IF 0 NOT ARMED
      MVI A,1       ;TURN FAULT OFF
      OUT ISTATUS
      MVI C,5       ;SET COUNTER
      LXI H,KEY ID  ;START OF KEY STRING
RELOOP: CALL SCAN
      JNC RELOOP    ;WAIT FOR CLOSURE
      CMP M         ;COMPARE CLOSURE TO STRING
      JNZ ERROR
      INX H         ;NEXT KEY
      DCR C         ;DECREMENT COUNTER
      JNZ RELOOP
      JMP INIT      ;MATCH. RE-INITIALIZE
;
;ERROR. TURN ON FAULT INDICATOR
;
ERROR: MVI A,2
      OUT STATUS
      JMP MAIN

```

The system's response to a fire-sensor HIGH is simple: It turns on the fire alarm. But what happens if the system finds an intruder? Fig. 12 has the answer. If the system is armed from the main panel, the wake-up alarm is activated, and the status board shows the entry point. You can then decide on the appropriate action. If the system is armed remotely, the old destroyer horn goes off as well.

Note that the correct indicator is activated in Fig. 12 simply by jumping to the status subroutine after turning on the alarm. The SCAN routine has saved

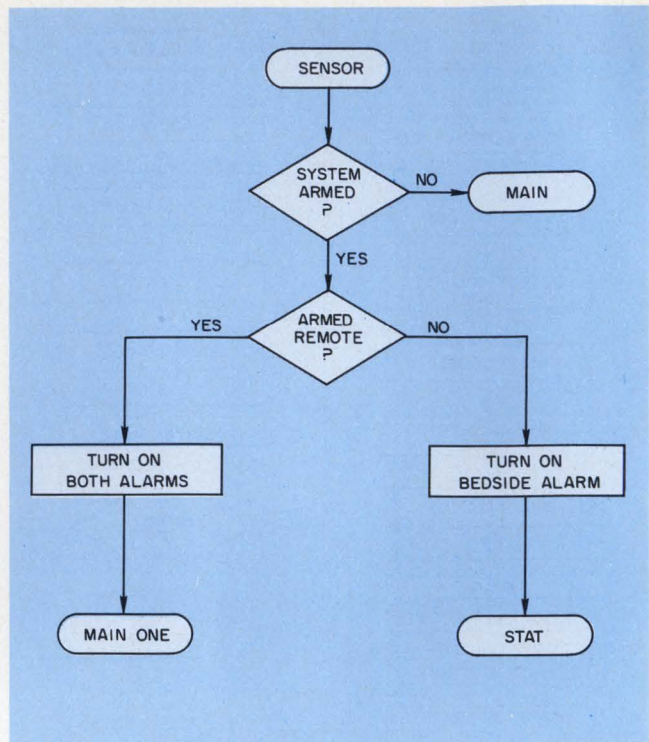

12. When an entry sensor is activated, the system's reaction depends on how the system is armed.

the image of the active sensor, which can now be sent to the display. The program for this segment follows:

```

FIRE:  MVI A,1      ;TURN ON FIRE ALARM
      OUT ALARM
      JUMP MAIN1
SENSOR: LDA ARMS    ;SYSTEM ARMED
      ORA A
      JZ MAIN       ;NOT ARMED IF ARMS 0
      LDA PANEL     ;ARMED BY REMOTE PANEL?
      ORA A
      JNZ REMOTE    ;REMOTE ARM IF NOT ZERO
      MVI A,4       ;TURN ON QUIET ALARM
      OUT ALARM
      JMP STAT      ;SHOW ENTRY POINT
;
;REMOTE ARMED. TURN ON ALL ALARMS
;
REMOTE: MVI A,6
      OUT ALARM
      JMP MAIN

```

You have now followed the design of a fairly sophisticated hardware/software system. Again: Do not sit down and immediately start writing programs to scan keys or turn on lights. Instead, establish a specification, and systematically define the major functions. Then develop the logic for these functions. Having done all this preliminary work, you can start worrying about the programming details. "Divide and conquer" is the proper philosophy.

But the most challenging part comes after you put the pieces together and turn on the power switch. How to find the inevitable bugs that creep in despite the most systematic and consistent design procedure will be a future topic. ■■



# After you look at the specs, look how long they're guaranteed.

The accuracy specs for the Dana 5100 5½ digit multimeter are guaranteed for a full year. Not 90 days. Not 6 months. That means you only have to calibrate it once a year.

All other multimeters have to be calibrated an average of three times a year. At about \$75 a pop. Which makes their \$995 units a lot more expensive to own than the Dana 5100 at \$1145\*.

Instead of sitting in the shop for six weeks over the course of the year, the Dana 5100 will stay right where you are. Measuring AC, DC, Ohms and frequency

(yes, frequency too) with very high accuracy. Just like the specs say. For a year at a time.

When you look at it that way, one thing becomes obvious. The cost of owning a multimeter is a lot more important than the price.

Write Dana Laboratories, Inc., 2401 Campus Dr., Irvine, CA 92715 for all the specs. And take a good look. With specs that good, you'll be glad you only have to give it up once a year.

**DANA**®

**Others measure by us.**

\*U.S. domestic prices

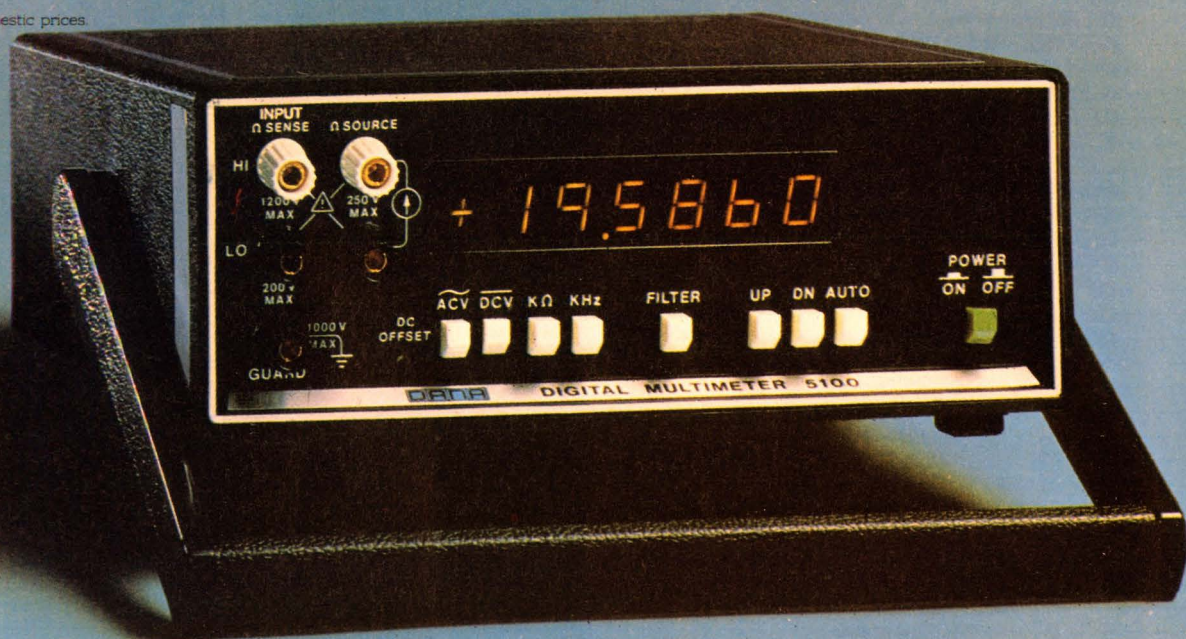

**Dana 5100.**  
**Ask for a free demonstration**  
**before you consider anything less.**

See us at Electro '77 Booths 1219, 1221 and 1223.

FOR PRODUCT DEMONSTRATION, CIRCLE 42

FOR LITERATURE ONLY, CIRCLE 43



# MEMORY AT WORK

## Diagnostics Memory for medical

diagnostic equipment must be reliable. Human lives are involved. It must be fast; dynamic imaging calls for high speed CRT refresh. Those are two reasons our MICRORAM static RAM memory systems are chosen so often. Cycle speeds are sufficient for CRT refresh. Our metal-gate technology is inherently reliable. And the support circuitry needed by static RAMS is very simple. That adds up to an overall system reliability you just can't beat.

You can't beat our 15-year experience in the memory business, either. Give us a call today and tell us what you need.

**EMM**

**COMMERCIAL MEMORY PRODUCTS**

A Division of Electronic Memories & Magnetics Corp.  
12621 Chadron Ave., Hawthorne, Calif. 90250  
(213) 644-9881





# Berg Quickie Connectors are the logical cable interface for Digital minicomputers

Berg Quickie™ Connectors rapidly, reliably terminate multi-lead, flat, round conductor cable—without pre-stripping. Quickie designs allow for visual inspection before and after assembly.

Digital Equipment Corporation likes the Quickie connector's ease of termination and how its askewed tines strip away insulation to assure positive electrical contact. They like the way Quickie Headers latch to maintain connection integrity through vibration and impact. Digital has found it can rely on Berg... to supply the products and the application

machines that precisely meet its demanding interconnection needs.

Berg is experienced. We read interconnection needs like Digital computers read data. We have the products, the background, and the back-up to do the job. Your job. Let's work on it, together. Berg Electronics, Division E. I. du Pont de Nemours & Co., New Cumberland, Pa. 17070—Phone (717) 938-6711.



**BERG ELECTRONICS**

CIRCLE NUMBER 45

We serve special interests—yours!

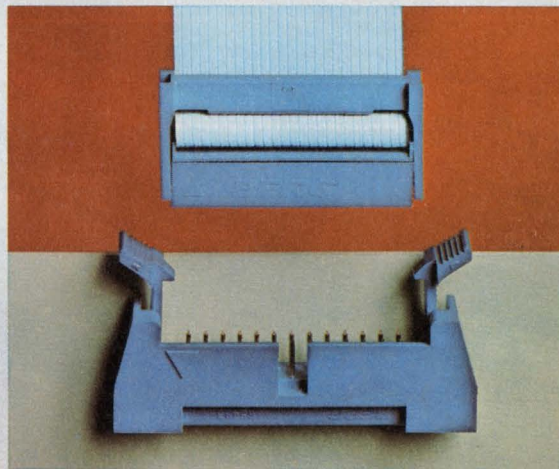







**When you're  
designing microprocessors  
into your products...  
our 990 computer products  
can give you a head start.**

# TEXAS INSTRUMENTS.

Start with the TMS 9900 microprocessor.

It delivers surprising power, speed and flexibility in a low-cost, single-chip 16-bit package. Its repertoire of versatile instructions and high-speed interrupt capabilities provide computing power usually associated with a 16-bit TTL minicomputer.

Hardware multiply and divide is standard and the software you develop for the TMS 9900 is upward compatible with any other member of the 990 computer family.

When your application calls for a microcomputer—start with the 990/4 microcomputer on a board.

It offers all the advantages of the TMS 9900, plus flexible memory and CPU options ideally suited to manufacturers' applications: up to 8K bytes of dynamic RAM memory, up to 2K bytes of RAM and/or PROM, real-time clock input, eight vectored interrupts, expansion interface and optional ROM utilities. It's our off-the-shelf answer for many production needs.

The 990/4 microcomputer is also available in a low-cost three-slot OEM chassis... or housed in a 6- or 13-slot rack-mount chassis with programmer's panel... or in a 6-slot

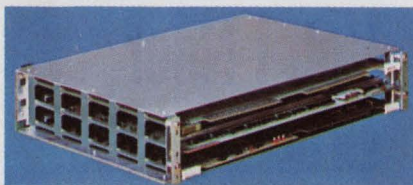

tabletop chassis. And, the 990/4 is available as a complete computer system supported by your choice of performance options and peripherals.

For applications requiring greater speed, we offer the most powerful member of the 990 computer family... the 990/10 minicomputer. It uses a TTL implementation of the 990 architecture and features TILINE\*, an asynchronous, high-speed 16-bit parallel I/O data bus which links the CPU, memory, and high-speed peripheral devices.



Rack-Mount 990 Computer

And to help you get on line faster and surer, there's a prototyping system using 990 computer hardware and software packages.

In addition, the 990 family is well supported by a substantial library of software development packages.

Whatever your needs... the TMS 9900 microprocessor, the 990/4 microcomputer, or the 990/10 minicomputer... you'll be working with some of the most attractive



990/9900 Prototyping System

computer component values on the OEM market. Price/performance leadership you expect from Texas Instruments.

You can start today by getting more information on the entire 990 computer family. Contact your nearest TI sales office, or phone (512) 258-5121, Computer Equipment Marketing, for your local distributor. Write Texas Instruments Incorporated, P.O. Box 1444, M/S 784, Houston, Texas 77001.



\*Trademark of Texas Instruments

©1977, Texas Instruments Incorporated

©Copyright 1977, Texas Instruments Incorporated

See Texas Instruments products at Computer Caravan.

**TEXAS INSTRUMENTS**

INCORPORATED

CIRCLE NUMBER 46



# What makes The faster and easier?

## ...Rapidograph, Rapidometric, Rapidograph SL

Finest precision, highest quality Technical Pens offer the most complete range of line widths. Points available in hard chromed stainless steel, sapphire jewel and tungsten carbide.



## ...Pelikan and Koh-I-Noor Drawing Inks

Specially formulated for the most exacting requirements.



## ...Rapidraw Drafting Film

A virtually indestructible film with a fine-toothed surface for maximum precision and reproducibility in engineering drawings.

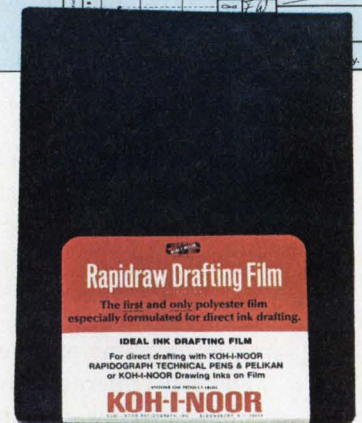
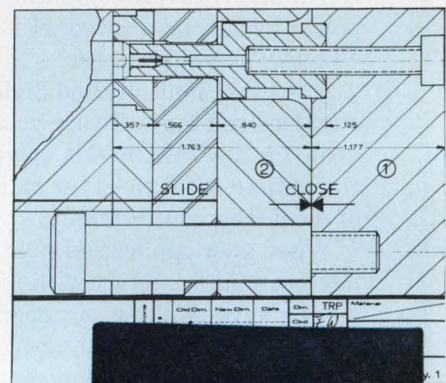



# "RAPIDDRAW" System

To learn how The "Rapiddraw" System can help you save money and achieve highest quality engineering drawings, call Koh-I-Noor on our toll-free number 800-631-7646 or collect 201-479-4124.

## ...Koh-I-Noor Ink Erasing System

Erasures can be made on the film with confidence and ease without marring the film surface, as often as required.

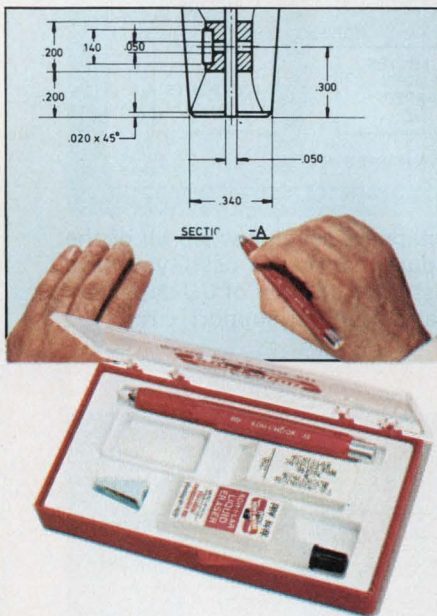

## ...System accessories

Designed to make drafting with ink on film even easier than you might suppose.



## What makes us the authority?

Koh-I-Noor has developed Rapiddraw, a System of totally integrated instruments and materials, providing a remarkable simplification of drafting techniques. This System makes direct ink drafting on film the most practical method to achieve precision engineering drawings, as confirmed by leading industries. We would like to give you a free manual completely describing our System.

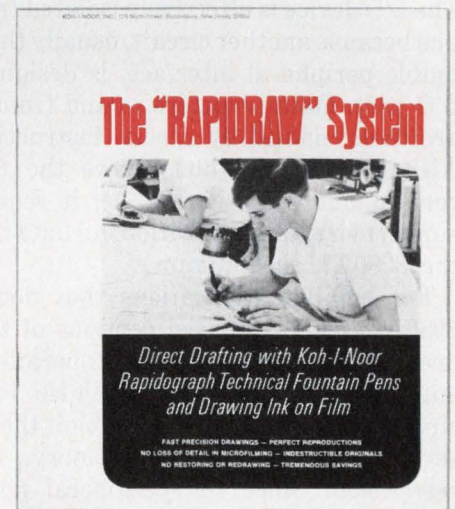

YOU GET MORE FROM  
**KOH-I-NOOR**<sup>®</sup>  
The "Breakthrough" Company

Koh-I-Noor Rapidograph, Inc., 100 North Street, Bloomsbury, N.J. 08804  
In Canada: Koh-I-Noor/Canada/Ltd., 4180 Ave. de Courtrai, Montreal, Quebec H3S 1C3.

CIRCLE NUMBER 47



## Cut a/d conversion costs by using software and d/a converters. Memory-mapped I/O helps eliminate the interface circuits normally needed.

Although the microprocessor is usually considered a flexible replacement for discrete logic, most  $\mu$ P-based instruments still use numerous isolation and support packages to convert from analog to digital. But now you can create a software-controlled a/d converter input for your  $\mu$ P system—with software, a processor and a digital-to-analog converter.

An 8080A  $\mu$ P and a DAC-08 eight-bit d/a converter can be used to build an 8-bit a/d converter that doesn't need any 8080A peripheral isolation circuits. And you can easily expand this technique to 10 or 12 bit converters or to other  $\mu$ Ps that have separate address and data buses.

### Know the $\mu$ P interface requirements

To communicate with any peripheral circuit, the 8080A must first be able to distinguish between its normal memory array and the particular I/O device. There are two basic techniques that can be used by the 8080—and each has its own pros and cons.

For most large systems with 32 k or more of memory, each peripheral is assigned to an I/O port. The I/O device is effectively isolated from the memory bus because another circuit, usually the 8255 programmable peripheral interface, is designed to act as an I/O port. Data transfers to and from the peripheral are then enabled by special instructions, In or Out. Although this method allows the full memory to remain undisturbed (Fig. 1), it requires additional support circuits. In addition, all data must go through the 8080A's accumulator.

For smaller applications that don't use the full 8080A memory, unused portions of the memory address space can serve for I/O operations (Fig. 2). Not only does this scheme minimize extra peripheral circuits, but it also lets you exploit the full instruction set used to control the memory. But there is a restriction: Since the peripheral now looks like a memory, it must conform to memory-bus signals and timing.

Conventionally, you establish memory-mapped I/O by assigning address line  $A_{15}$ , the most significant

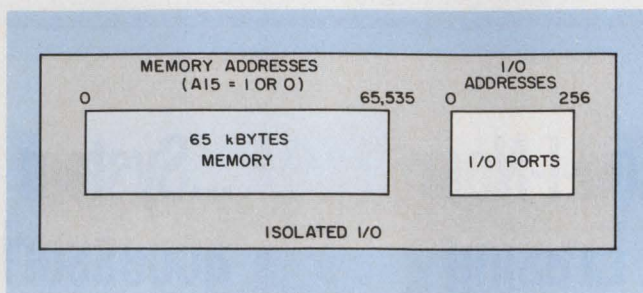

1. When peripheral support circuits are used to provide the I/O in a  $\mu$ P system, the entire memory can remain undisturbed and available for storage.

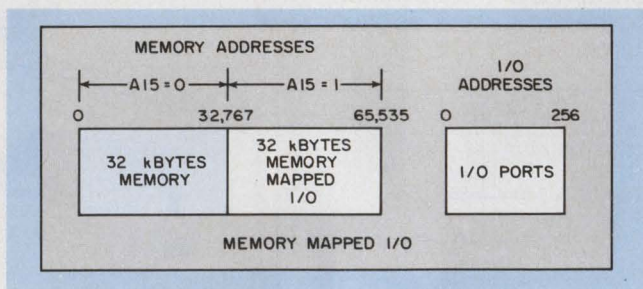

2. By using a memory-mapping scheme when all of the main memory of a computer isn't being used, you have available an almost unrestricted amount of I/O capability that doesn't need special peripheral support circuits.

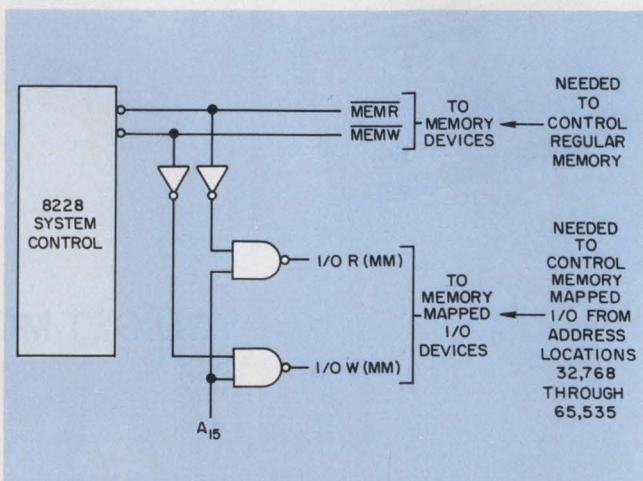

3. You can tap all the a/d-converter control signals directly from the 8228 system controller. Only two signals are needed to control the memory-mapped I/O devices.

Wes Freeman, Senior Technician, and Will Ritmanich, Senior Application Engineer, Precision Monolithics, 1500 Space Park Drive, Santa Clara, CA 95050.



address bit, as the I/O control flag— $A_{15}$  permits full addressing of 32 kilowords of main memory. So if  $A_{15}$  is Zero, the memory is active; if  $A_{15}$  is One, the I/O is active.

To manipulate the mapped I/O, you must generate appropriate control signals. Gating the  $\overline{\text{MEMR}}$  and  $\overline{\text{MEMW}}$  signals with  $A_{15}$  creates the I/O read and write signals (Fig. 3). This scheme has no effect on the bus and permits manipulation by all instructions.

### Use the $\mu\text{P}$ to do the conversion

For the best tradeoff involving speed, hardware and software complexity, apply the successive-approximation a/d conversion scheme. Operation is similar to the pan balance, as shown in Fig. 4.

To measure an unknown weight, place the weight in one of the balance pans. By successively applying binarily weighted counterweights to the other pan, you can effectively "balance" the scale. The number of "trials" is equal to the number of counterweights available, and starts with the heaviest counterweight. The weight is retained or rejected, depending on how it compares with the unknown weight—if less than, it is retained; if more than, rejected. Continue this process for the next heaviest weight until all weights have been tried.

This measurement can be simulated electrically by sequentially comparing the output of a d/a converter and some analog input (Fig. 5). A conversion begins with the MSB of the d/a converter being turned on by the successive-approximation register (SAR), which produces an output from the d/a equal to one-half the full-scale value. The converter's output is then compared to the analog input by a comparator, and if the d/a converter's output is greater than the unknown input, the MSB is turned off and the next bit tried.

If the converter output is less than the unknown input, the next bit is still tried but the MSB remains on. This process repeats itself, much like the three-bit decision tree shown in Fig. 6, until all bits are determined.

When the 8080 doesn't have to operate at full speed for other jobs, it can often replace the SAR. The eight lowest-order address bits control the data-bit inputs to the d/a converter, and the comparator controls the 8228 system controller (Fig. 7). The entire conversion requires only two decisions, and the program only 16 lines of assembly code (Fig. 8).

The d/a converter is accessed like a  $256 \times 1$  ROM, which minimizes conversion time, hardware-interface circuitry and program length. Combined, the settling times of the DAC-08 and CMP-01 are shorter than the processor-cycle time (Fig. 9). No-wait states or no-operation instructions are required for the program to execute.

The d/a converter's input code is established when instruction  $\text{MOV L,A}$  moves the test value to the L register (memory-address register), which controls

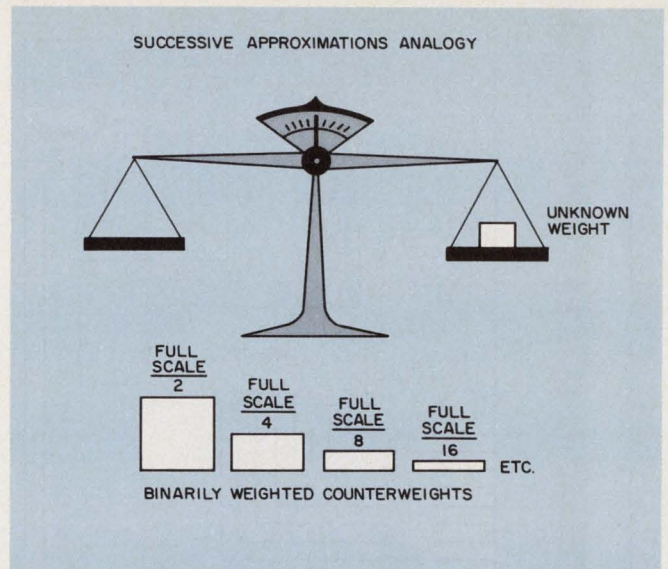

4. The basic successive-approximation conversion scheme can be likened to a simple scale balance that uses binarily related weights.

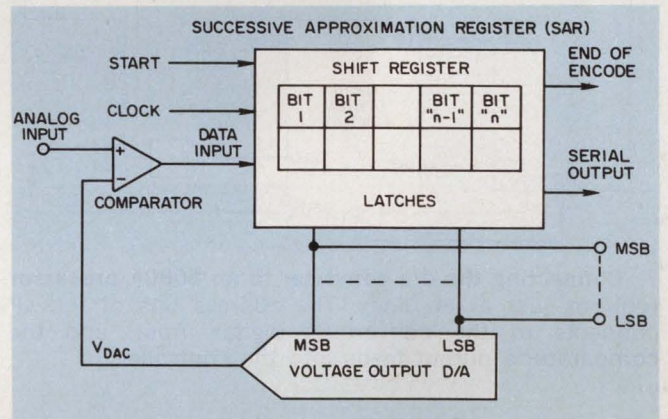

5. To make a successive-approximation a/d converter, the output of a d/a converter must be fed back through a comparator. The comparator, in turn, controls a special register that turns the d/a converter bit inputs on or off.

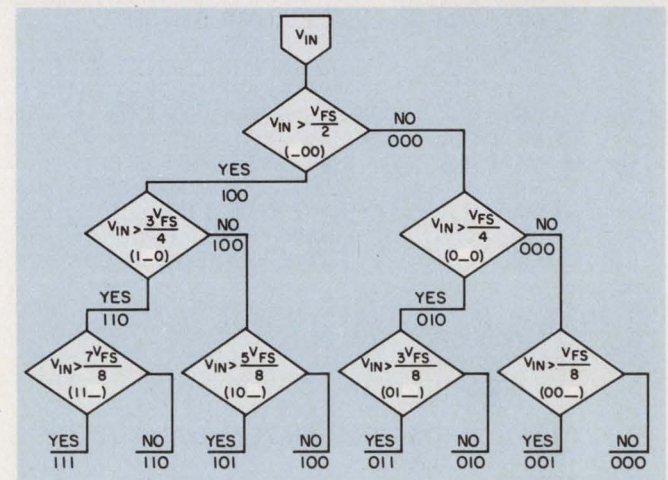

6. The conversion sequence can be broken down into a flow diagram and simplified so that it becomes a sequence of decision points.







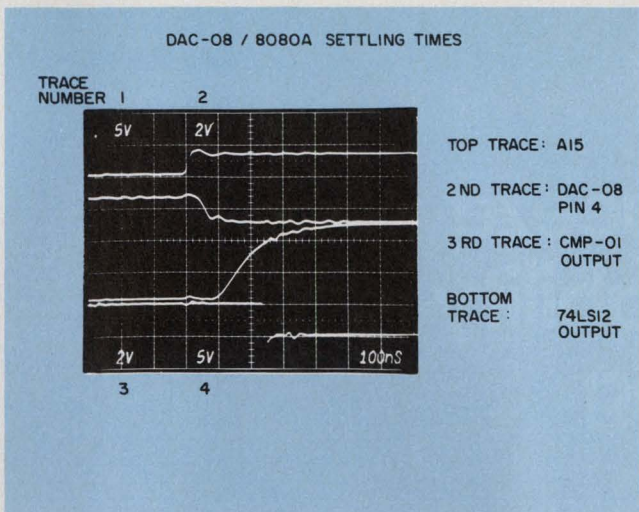

9. When an 8-bit conversion is performed, the settling time of the d/a converter is less than 500 ns—shorter than the cycle time of the 8080 processor for a 2-MHz clock. Thus the  $\mu$ P doesn't have to waste time with no-ops.

the eight lowest-order address bits. Then the comparator compares the d/a converter's output with the analog input, and a MOV A, M instruction gates the comparator's output into the 8080A's accumulator.

### Time and memory demand little

After the processor receives the input, it completes the conversion by continuing to perform the logical operations and to modify the contents of the address bus. Only 21 bytes of memory are needed for an 8-bit a/d conversion, and a time requirement of 235 to 285  $\mu$ s (for a 2-MHz clock). The time depends on the analog input because saving the trial bit, if necessary, requires extra program steps. Quantizing is done over an analog input range of 0 to 10 V, but you can set the converter for other ranges.

Expanding the technique to 10 or 12-bit a/d conversion simply requires you to employ a 10 or 12-bit d/a converter and connect the MSB inputs to the corresponding address lines. Since multiple latches and byte-moving operations are eliminated, the savings in hardware and software are significant. For a 10-bit a/d converter, the d/a converter "looks" like a 1024  $\times$  1 ROM and a 12-bit d/a looks like a 4096  $\times$  1 ROM. In general, the settling time of the 10 or 12-bit d/a converters is greater than the cycle time of the 8080A. However, with an 8080A Ready line to insert wait states, you can accommodate the settling time of any d/a converter. ■■

### Bibliography

- Aldridge, D., "A/d Conversion Systems: Let Your  $\mu$ P Do the Working," *EDN*, May 5, 1976, pp. 77-80.
- "Low-Cost, High-speed Analog to Digital Conversion with the DAC-08," Precision Monolithics, Santa Clara, CA, Application Note AN-16.
- Nichols, A. J. and McKenzie, K., "Build a Compact Micro-computer," *Electronic Design*, May 10, 1976, pp. 84-92.
- "8080 Microcomputer Systems Users Manual," Intel Corp., Santa Clara, CA, September, 1975.

# Dialight LEDs

The widest choice for your every application.

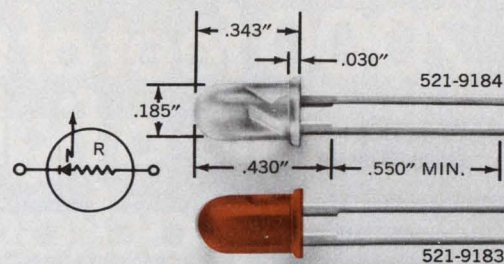

Available in red or clear LED packages with or without a built-in current limiting resistor. Red LED is also made without resistor. Suitable for circuit status indication, alpha-numeric displays and visual indicators. Features long wire-wrappable leads. IC compatible with solid state reliability. High luminous intensity, low power consumption, low cost.

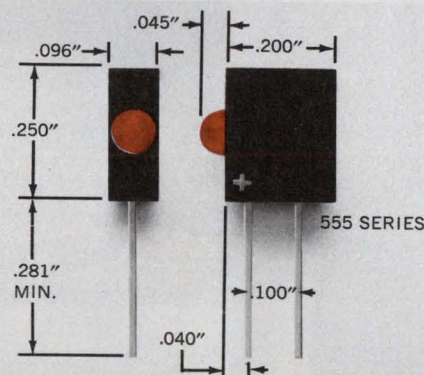

LED logic state fault indicators available in 14 models with voltage ratings from 1.7 to 14. Suitable for dense packaging on printed circuit boards—up to 10 units to the inch—IC compatible. With built-in series resistor. Polarity identified. Low power consumption.



Dialight, the company with the widest choice in switches, LEDs, indicator lights and readouts, looks for needs . . . your needs . . . and then they develop solutions for your every application. No other company offers you one-stop shopping in all these product areas. And no other company has more experience in the visual display field. Dialight helps you do more

with these products than any other company in the business, because we are specialists that have done more with them. Talk to the specialists at Dialight first. You won't have to talk to anyone else. Send for your free new copy of Dialight's current catalog.

## DIALIGHT

Dialight, A North American Philips Company  
203 Harrison Place, Brooklyn, N. Y. 11237  
(212) 497-7600

# See Dialight.

"Visit our Booth 2130, 2132 at Electro 77"

CIRCLE NUMBER 48



How do you squeeze  
7000 feet of reliability  
into a fighting  
package?

Ask Hughes.





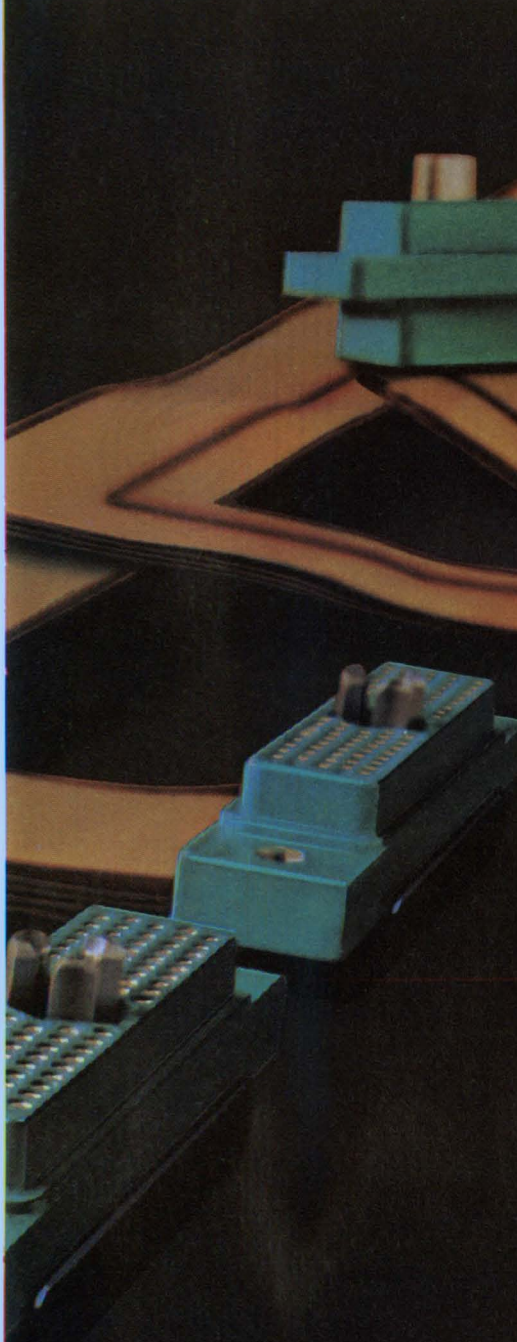

## Total interconnection technology.

When it's a complex fighting machine like the Navy's A-6E and its TRAM target-sensing system's highly sophisticated avionics, you connect with Hughes capability. Hughes, because of our deep involvement in high-technology military and aerospace programs: Phoenix, Maverick, Lance, Minuteman, AWACS, F-14, F-15, Space Shuttle, Viking, Sonobuoy, F-4, A-7, Condor, Standard Missile, F-8, Trident, Hobo, Sprint, and many more.

With all that experience, we've developed not only the hardware and the circuitry, but also the concepts and design capability to solve the toughest interconnection problem. And the techniques to make it work. Aside from our design-to-system advanced packaging, we also offer umbilical and special connectors and off-the-shelf connectors.

**Umbilical and other special connectors.** Our umbilical on the new laser-guided Maverick is typical of our specials; we also have connectors on many of the country's airborne missiles where sure-fire operation is critical to national defense. Meeting your requirements is the challenge to us. We give priority to your special-connector problems. Solutions are just part of what we offer.

**Off-the-shelf connectors.** The new C-21 (MIL-C-85028) is another typical example of Hughes hi-rel technology. For high-altitude applications the C-21 has individual seals for up to 250 psi on the contacts, preventing altitude breathing and consequent contamination. It's a Hughes exclusive.

Our standard line also features subminiature rectangulars, standard size, subminiature circulars, and miniature rectangulars—better because they're super hi-density connectors. Our exclusive PolarHex™ Center Jackscrew coupling device makes it all possible. Another Hughes first is our HAC PAK™ connector (MIL-C-28804), the simplest way to connect round to flat cables.

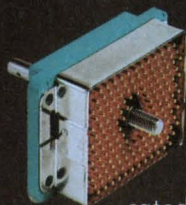

**Ask Hughes.** Squeezing reliability into any sophisticated machine is no problem for you. Just ask Hughes Connecting Devices, 17150 Von Karman Avenue, Irvine, CA 92714, or call (714) 549-5701.



# HUGHES

HUGHES AIRCRAFT COMPANY  
CONNECTING DEVICES

**Total interconnection technology:  
the hardware, the circuitry, and the concepts.**



# COMING IN

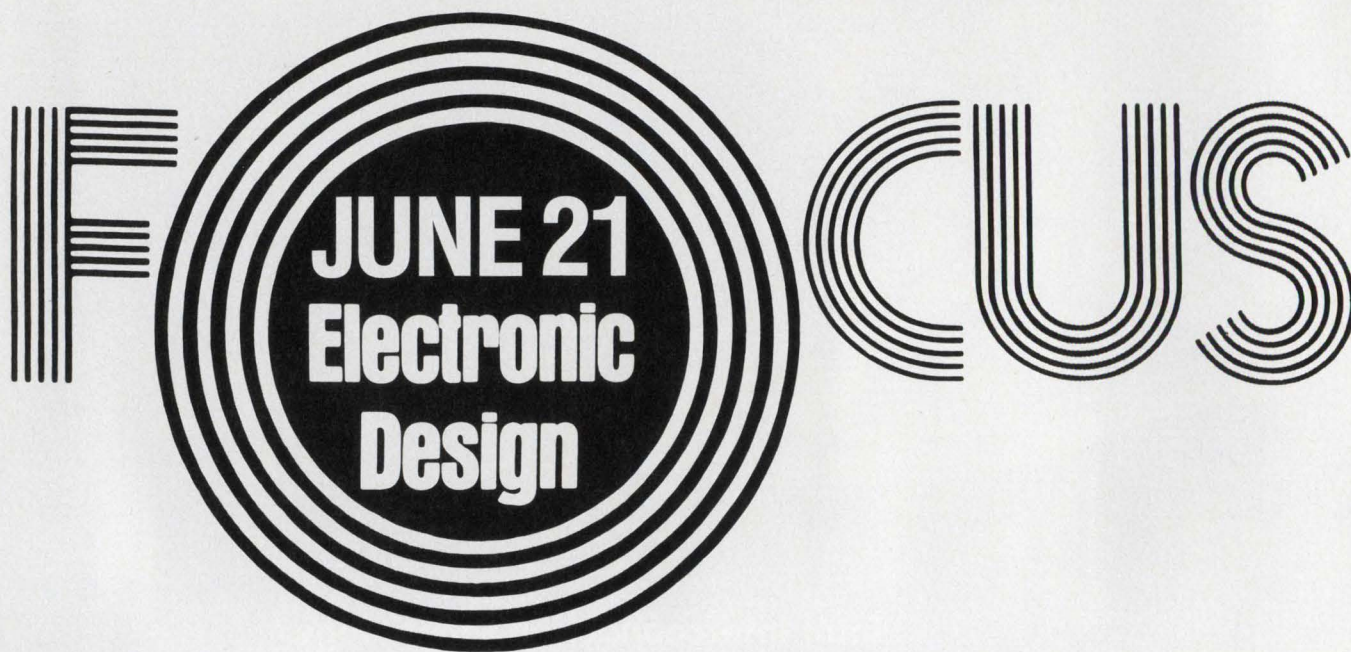

## ROUND AND RACK/PANEL MULTIPIN CONNECTORS

The sixth installment of *Electronic Design's* 1977 FOCUS series will appear in the June 21 issue. The topic: Multipin Connectors.

Connectors are as crucial to a successful electronic system as the more exotic components. Associate editor Morris Grossman takes an in-depth look at round and rectangular multipin units, including rack/panel types. The report examines zero-insertion-force (ZIF) connectors, mass-termination connectors, and multiple-lead fiber-optic connectors.

As with all FOCUS reports, emphasis is placed on the significant specs readers should watch for and how to avoid pitfalls in connector selection and use. More than 61,000 *Electronic Design* subscribers specify or authorize purchase of connectors. If you're one of them... mark June 21 on your calendar. It's a report you'll want to keep for months to come.

### FOCUS ON MULTIPIN CONNECTORS

**ANOTHER REASON ELECTRONIC DESIGN IS THE BEST  
READ ELECTRONICS PUBLICATION IN THE WORLD!**





# Attention Inductor Users:

Read how Dale can  
boost your quality and  
cut your lead time.

## 1. Chokes

**Faster delivery on these Mil-Spec. equivalents.**



MS-75083	MS-75085	MS-18130
MS-75084	MS-14046	MS-90538

Expanded finished goods stock expedites shipment of both molded (IM) and coated (IR) styles. Delivery is off-the-shelf to a maximum of eight weeks. Inductance range: 10  $\mu$ H to 1,000  $\mu$ H. Tolerance:  $\pm$ 10% standard. Includes popular sizes

interchangeable with Delevan (1025, 1537, 2307 and 2500 Series) and Nytronics (SWD and DD Series). IR models feature Dale's special flame retardant epoxy coating which provides mil. level protection at a cost savings.

## 2. 11Z Style Transformers

**Immediate delivery on many styles.**



Forget about long lead time. Dale has built a solid capability for supplying 11Z styles to meet your needs in low-cost triac-controlled SCR power supplies. Bobbin and printed circuit configurations available fast! For cost savings in printed circuit applications, check Dale's new PT 50 Series. Provides 11Z spacing and performance at significant savings.

### CROSS REFERENCE CHART

Dale Style	11Z Style	Dale Style	11Z Style
PT10-101	11Z12	PT20-103	
PT10-106	11Z13	PT50-103	11Z2001
PT10-112	11Z14	PT20-105	
PT10-117	11Z15	PT50-105	11Z2002
PT10-120	11Z16	PT20-112	
PT20-101		PT50-107	11Z2003
PT50-101	11Z2000	PT20-120	
		PT50-110	11Z2004

## 3. Low Power Transformers

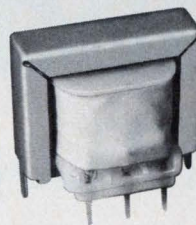

Laminated construction for low-cost industrial use... including *microprocessor* applications. Precision-spaced PC terminals. Transformer secondaries may be series or parallel connected for twice the voltage or twice the current rating for individual windings. Includes dual primary models for 115V/230V operation. Designed to meet U.L. specifications.

### SPECIFICATIONS

**Wattages:** .75, 1.5, 4.5, 10  
**Output Voltages:** 4-115V (parallel); 8-230V (series)  
**Output Current:** 10-2000 MA (parallel);  
 10-1000 MA (series)

Contact your Dale  
Representative or phone  
the factory: 605-665-9301.



DALE ELECTRONICS, INC.  
East Highway 50, Yankton, S.D. 57078  
A subsidiary of The Lionel Corporation  
IN CANADA: Dale Electronics Canada, Ltd.



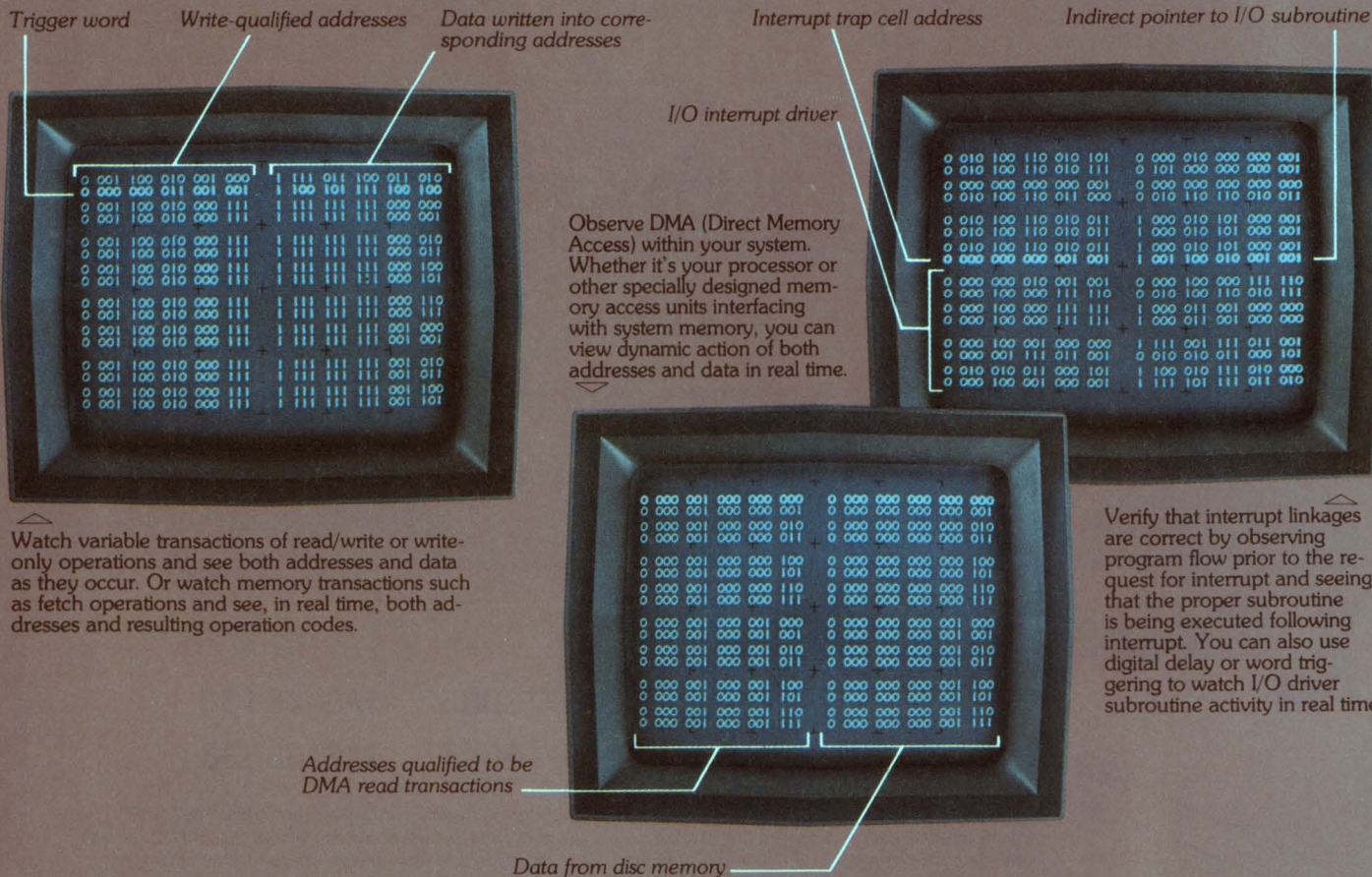

If you're designing

# minicomputer based systems,

only HP Logic State Analyzers show you real time like this.

Logic State Analyzers effectively put you inside your operating minicomputer system for faster design and debugging. Here's the difference HP's real-time view makes.

HP's 1600S Logic State Analyzer (priced at \$7100\*) plus 10254A Serial-to-Parallel Converter (priced at \$975\*) gives you a better way to spot and diagnose intermittent system operation. They give you greater insight for better understanding of your system's capability. The combination can mean earlier product introduction, lower development costs, a faster return on the development investment.

Your local HP field engineer has all the technical details. Give him a call today. And also ask him about HP's FREE seminars—An Introduction to the Data Domain.

\*Domestic U.S.A. prices only



Cursor

Dynamic real time photograph (time exposed) of incrementing counter used as system clock

Get a system overview with this memory map. It shows how your memory is being utilized in an operating program. If you know how your memory is organized, the map tells you at a glance what your program is doing and the relative time being spent in any one memory location. That makes it easy to spot things that shouldn't be happening, or to determine that part of your program isn't being implemented.

Disc address (cylinder, head, sector)

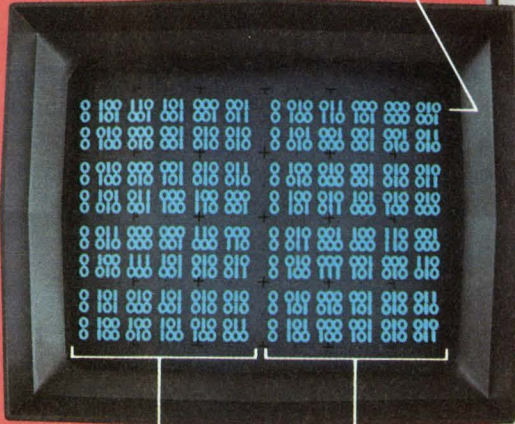

Parallel data inside computer

Serial data from 10254A

ASCII code

View I/O transactions in real time. Straddle an interface with the 1600S and you can evaluate handshake signals and compare input and output data directly—even if the clock rates differ and you're comparing serial data to parallel.

**Qualifiers**, digital delay and various local or bus-triggering modes give you pinpoint selection of data flow for effective program tracing.

**Output triggers** drive your scope—at the right instant—for making electrical measurements in the time domain.

**Up to 32 channels** let you see all the action on a 16-bit system main bus plus 16 bits in the control section, I/O, or any other logic section in your minicomputer system.

**Dual clock** means you can easily relate bus activity to events occurring elsewhere at a different clock rate—in system peripherals, for example.

**Serial-to-Parallel Converter** (HP's 10254A) lets you directly view serial data in relation to parallel data on the system bus.

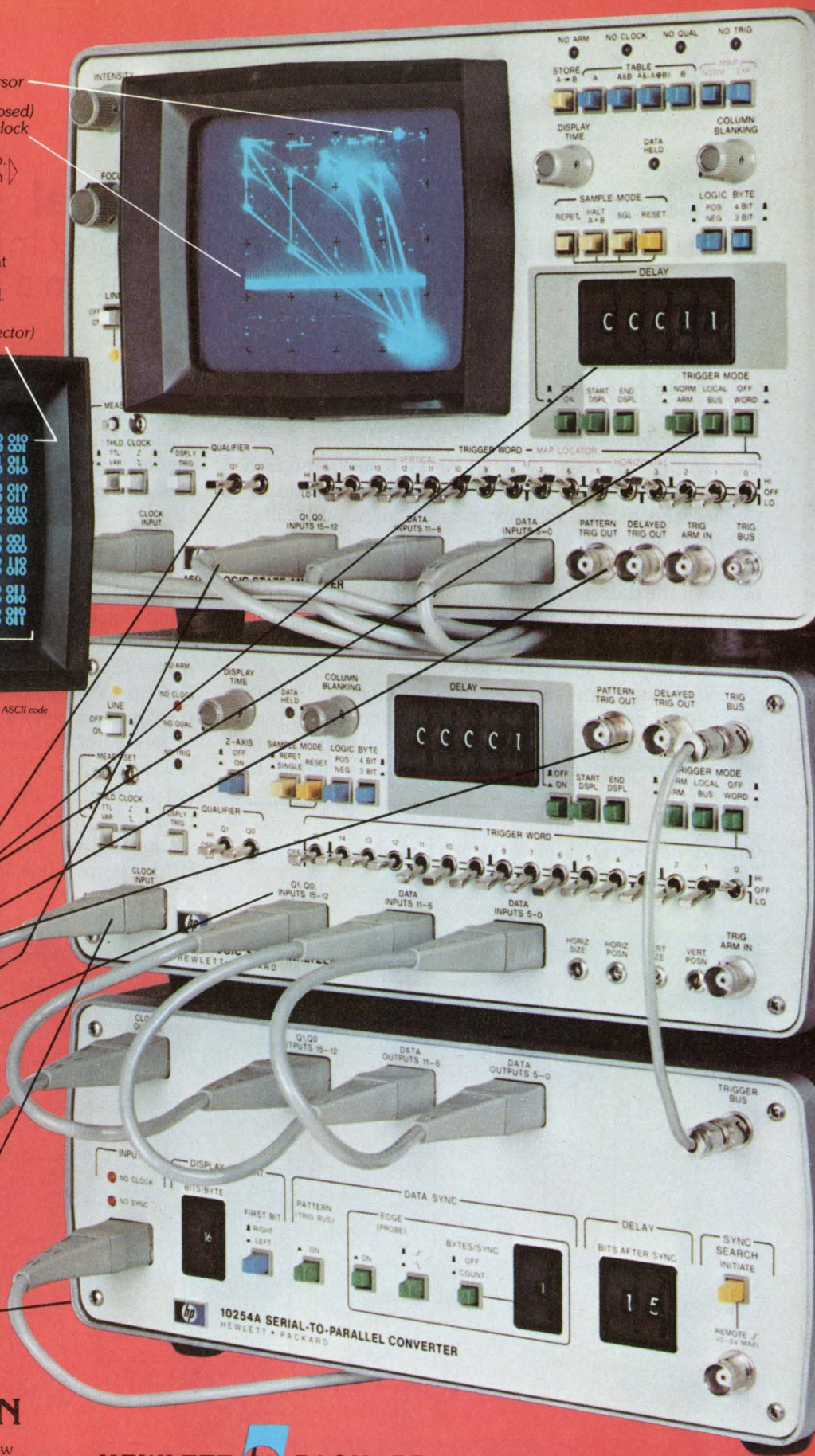

# FREE DATA DOMAIN SEMINAR

Find out for yourself how HP Logic State Analyzers can broaden your view of the data domain and speed digital design and debugging.

Seminars are scheduled in a number of cities throughout the country. Ask your HP field engineer about specific details on seminars in your area.

HEWLETT  PACKARD

1507 Page Mill Road, Palo Alto, California 94304

For assistance call Washington (301) 948-6370, Chicago (312) 255-9800, Atlanta (404) 955-1500, Los Angeles (213) 877-1282



## Exchange data between digital systems

simultaneously with a simple full-duplex interfacing circuit. Echo the message back or scramble it, in a half-duplex mode.

For data rates to 300 baud at distances up to one mile, or 4800 baud at up to 500 feet, there's little need to connect data systems with elaborate data modems. The simple interface circuit of Fig. 1 does a superb job. Even for very short distances, you can profitably replace the bundle of wire needed for an RS232-C interface with the same circuit. And there's no need for synchronous or special frequency relationships between the data terminals. An RG 59-U coaxial cable with low-cost BNC connectors is all you need. And for short distances in relatively noise-free environments, you can use a twisted pair.

Two data systems can "talk" simultaneously to each other—full-duplex operation without fancy hybrids or balancing circuits. Or, the receiving end can use its transmitter section to supply a masking signal to

"scramble" the message on the line and protect it from unauthorized monitoring. Another useful operating mode of the circuit retransmits, or echoes, the received message back to the originating end, where the message can be monitored immediately for accuracy.

### The line voltage has three states

The cable between two data systems forms a summing junction and can have three signal states: +5, -5 and 0 V. One system's transmitter, station A, drives the line to -5 V for a ONE input to its circuit, and the other, station B, drives it to +5 V. When both transmitters send a ONE simultaneously, the line is at zero volts. The combination of the cable's state and the transmitter's input state,  $T_X$ , at each data terminal determines the state of the received bit at the terminal's output,  $R_X$ . For data,  $R_A$ , received at station A from the transmitter signal,  $T_B$  at station B, the truth table is the following:

Charles R. Smiley, Senior Project Engineer, Interdyne, 14761 Califa St., Van Nuys, CA 91411.

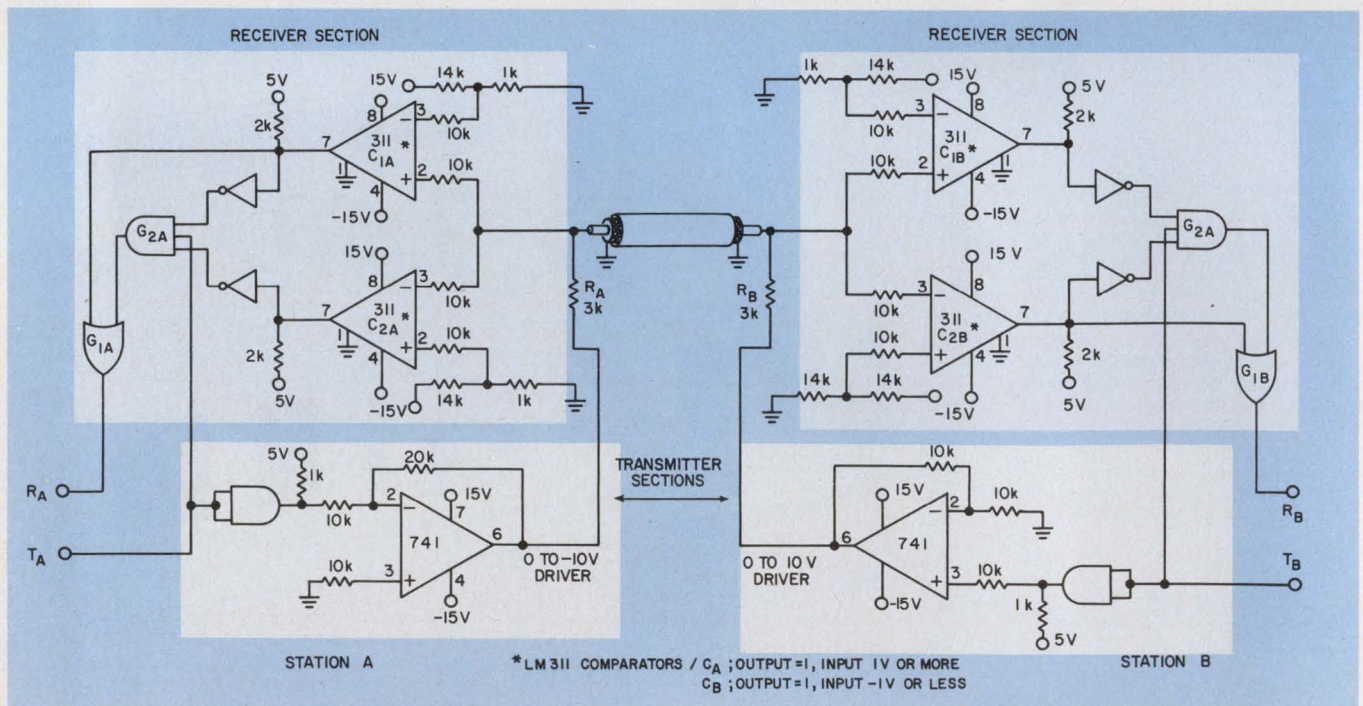

1. This simple bidirectional communications interface allows the simultaneous transmission of 300-baud data between two data terminals up to 1 mile on a coaxial cable.

Even better performance can be achieved with more powerful line drivers than the 741 op amps to allow use of lower-valued summing resistors.



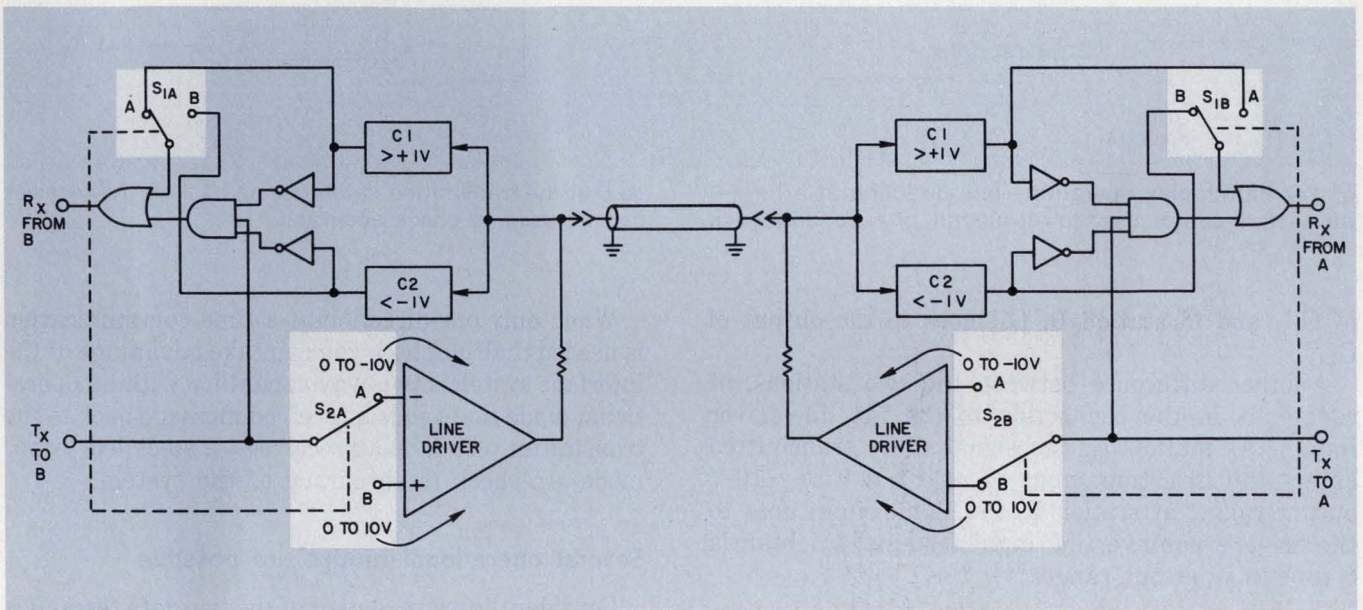

2. Selecting the station configuration—type A or B—becomes necessary in a network of terminals.

$T_B$	$T_A$	Cable	$R_A$
0	0	0 V	0
1	1	0	1
0	1	-5	0
1	0	+5	1

The table for the receiver at B is similar:

$T_A$	$T_B$	Cable	$R_B$
0	0	0 V	0
1	1	0	1
0	1	+5	0
1	0	-5	1

Note that at station A, the  $T_A$ /cable-volts combinations for ZERO and ONE outputs at  $R_A$  are 1/-5 V and 0/+5 V, respectively; at station B, the  $T_B$ /cable-volts combinations are different, 1/+5 V and 0/-5 V. The circuit differences in Fig. 1 between stations A and B that accommodate this signal difference are determined by whichever of the two input voltage comparators of the receiver section,  $C_{1X}$  or  $C_{2X}$ , connects to the output-OR gate,  $G_{1X}$ .

Comparator  $C_{1X}$  provides a ONE output when the transmission-line voltage is greater than +1 V, and  $C_2$  provides ONE when the voltage is less than -1 V. Therefore, in station A,  $G_{1A}$  connects to the output

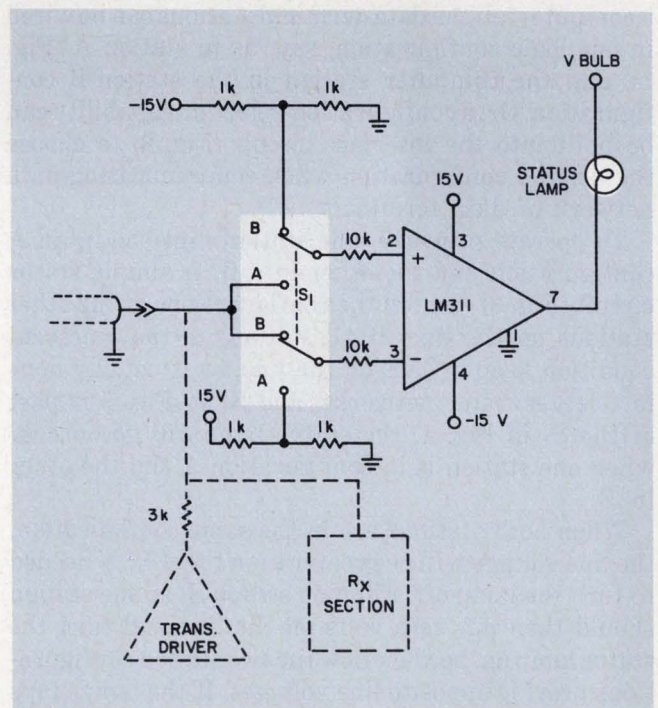

3. A station-configuration status indicator is convenient to have when the interface system is used with several data terminals in a network.



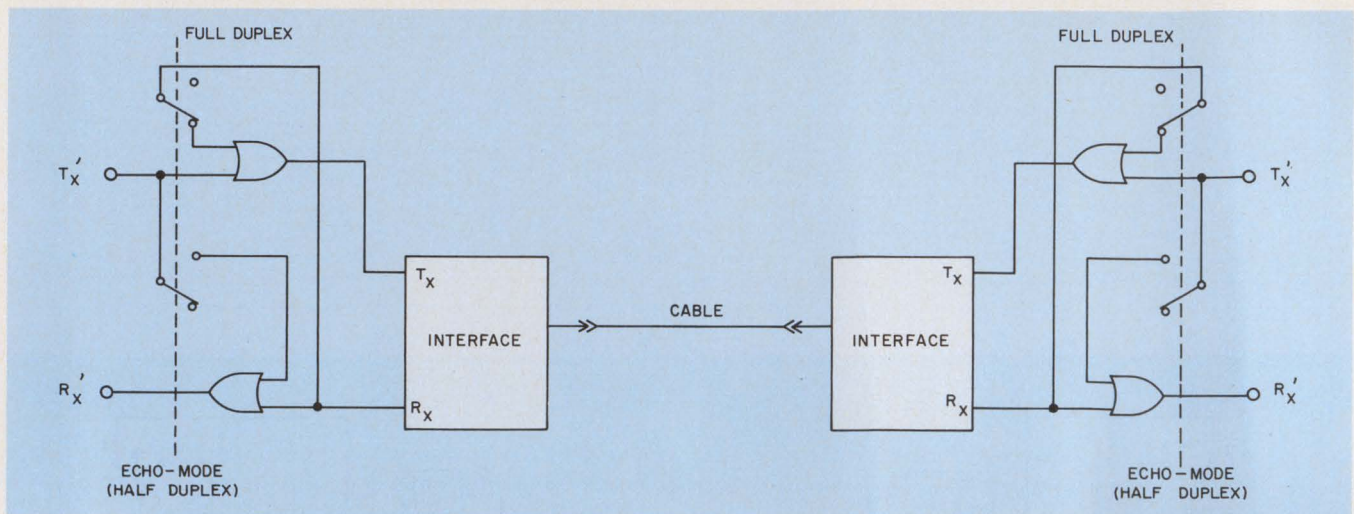

4. **For half-duplex operation**—one direction at a time—the system can be used to retransmit, or echo, data back

so that the transmitted data arriving back at the receiver can be used to check accuracy.

of  $C_{1A}$ , and in station B,  $G_{1B}$  goes to the output of  $C_{2B}$ .

Another difference between the two stations, of course, is in the connection to the 741 line-driver inputs. At station A, the signal to be transmitted enters the inverting input to obtain a 0 to  $-10$ -V output range; at station B, the signal input goes to the driver's noninverting input terminal to obtain a 0 to  $+10$ -V output range.

### Selecting a station configuration

When several data terminals are time-shared with a computer, all the data-terminal stations can be wired in one logic configuration, say, as in station A (Fig. 1), and the computer station in the station-B configuration. Or, a configuration-selection capability can be built into the interface circuit (Fig. 2) to choose the desired configuration when communicating on a network of data terminals.

To operate properly, one station must be in an A configuration and the other in a B. A simple status circuit (Fig. 3) can tell the configurations of the other stations on the line. If all stations in the quiescent condition keep a ONE on the line, as is usually done in teletypewriter networks, and  $S_1$  in Fig. 3 is part of the  $S_1$  in Fig. 1, the status light will go on only when one station is in configuration A and the other in B.

When both stations are in the same configuration, the line voltage will be greater than the  $\pm 7.5$  V needed to turn the lamp off. Flipping switch  $S_1$  at one station should then put zero volts on the line and turn the status lamp on, because now the two station configurations provide opposite line voltages. If the lamp stays off in both positions of  $S_1$ , then at least one of the terminals is in a disconnect state or lacks a ONE at its transmit input.

When only one-direction-at-a-time communication is needed (half-duplex), you can take advantage of the interface system's two-way capability with an operational mode that sends a received message back to the transmitter as it's being received—a so-called "echo" mode—to check the accuracy of the system.

### Several operational modes are possible

Consider the arrangement of the two data terminals in Fig. 4. Both terminals have a keyboard and printer. If A sends a message to B, and B retransmits, or echoes, the message back to A, then A can check the message as it is being sent, with only microseconds delay. The message prints out at both stations; if correct at A, most likely the message has been received correctly at B.

The echo mode is particularly useful in computer time-sharing systems. The computer can determine whether to echo back received material or send new material, depending on the priorities of the moment.

Note that in the echo mode, the cable appears always to be at zero volts, except for narrow spikes caused by the system delays.

Another useful mode of operation scrambles messages to protect them from clandestine monitoring. For example, if station A is sending data to B, B can send meaningless bit patterns to A during this transmission. Thus, the cable carries a composite signal that is difficult to decode without the key. The receiver doing the scrambling, of course, has the key: It is merely the jamming signal that is going to the input of its transmitter driver.

The jamming signal can be simply a square wave at some frequency near the bit rate of the correct data or, better, a random bit pattern. For best results, no synchronous relationship should exist between the data and jamming signals. ■■



# The snap action switch

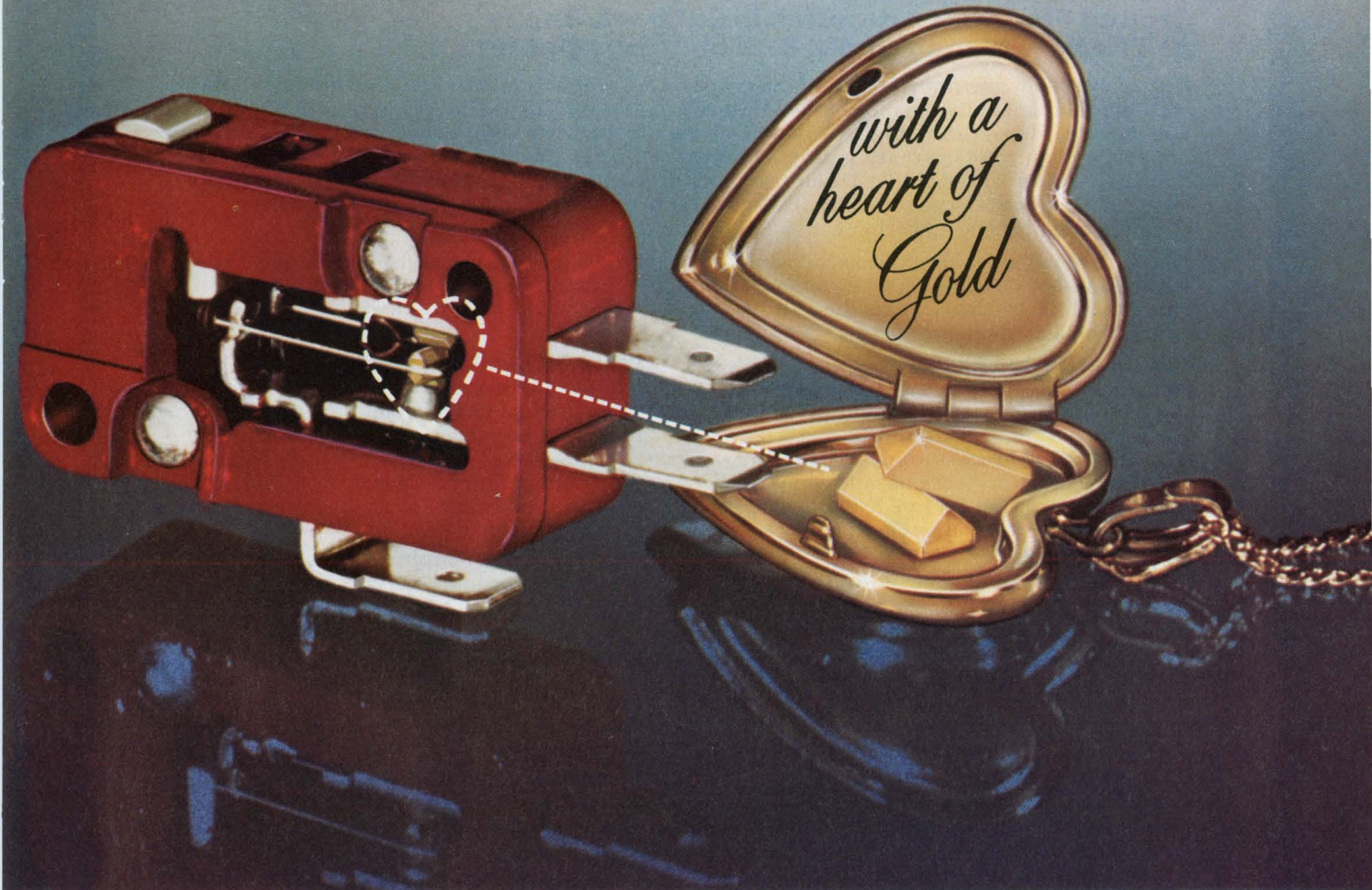

...for **POSITIVE** switching in low energy circuits

Now your 4 to 100 milliamperere, 4 to 30 volt circuits can have the same high reliability you've learned to love in Cherry snap action switches. Because, our "heart of gold" snap action switches have the same long life coil spring mechanism, the same large overtravel as all of our snap action switches.

**They also have gold crosspoint contacts.** A configuration with knife-edge contact area so small (9 millionths of a square inch)... with contact force so great (about 5,000 psi)... and gold alloy so pure and film-free... you are absolutely assured of positive contact every time. For 50 million operations and beyond.

Cherry Gold Crosspoint Contact Switches are available in virtually every snap action design in

Cherry's big catalog. And you *know* what a wide variety of switch types, sizes and mounts *that* is. Choose any switch design from a basic open or general purpose to a panel mount pushbutton, low torque, miniature, subminiature or subminiature module. Chances are 99 to 1 that the switch you have chosen is available with gold crosspoint contacts. Which will make designing low energy circuits a whole lot easier... and a whole lot *better*. (No love letters, please.)

**For free test sample and complete catalog, just TWX 910-235-1572... or PHONE 312-689-7700.**

**CHERRY** 

Cherry switches now available locally from distributors.

**CHERRY ELECTRICAL PRODUCTS CORP., 3609 Sunset Avenue, Waukegan, IL 60085**

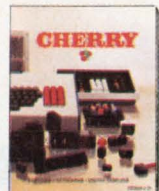
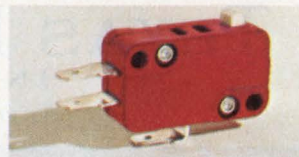





# Engineers for Calculators, Watches, & Other Consumer Products

## Ground Floor Opportunities in Lubbock, Texas At TI's New Management & Technology Center

With the establishment of TI's new Management & Technology Center for Consumer Products in Lubbock, immediate openings offer engineers and technical people exceptional opportunities. You'll get the opportunity to prove how good you are. In a close-knit, creative environment, you can play a major role in creating product innovations. You'll be in good company with the company that invented the "calculator-on-a-chip" IC and the MOS technology used in calculators. You'll work with the company respected for price and product leadership in digital watches, helping pioneer these and other consumer products.

You'll feel good in Lubbock, Texas. At an altitude of 3,000 feet, it's got high, dry air, and cool nights. Lubbock also has civic symphony, ballet and theatre. Its museum has a planetarium. This city of 190,000 boasts a leading university, Texas Tech, and has built a \$35 million facility for its School of Medicine.

### Electrical Design Engineer

Component development with primary emphasis on circuit development. Responsibilities include specification, characterization, design and process analysis, systems interfacing, cost projections, and competitive analysis. Requires a BS in EE or Physics, and 1-2 years semiconductor experience.

### EE or Physicist

Conceive, design and develop, and phase into production consumer products. This broad scope of responsibility includes new concept development, system analysis, component analysis, schedule and cost control, tooling and test equipment, testing and qualification, and engineering improvements. Requires a BS/MS in EE or Physics, and 2-5 years experience in IC's, Optics, and Displays.

### Programmable Calculator Engineer

Responsible for advanced programmable product design. Requires insight to digital systems of the future, the ability to conceptualize market implications of product and price. Requires a BS/MS in engineering, and 3-5 years experience.

### Applications Engineer

Develop applications and software libraries for card programmable calculators. Requires a BS in Engineering or CS, and 3 or more years directly related experience.

### Mechanical Design Engineer

Mechanical design of metal and plastic consumer products and associated hardware, with strong experience in labor-effective high volume designs. Requires a BSME, and 3 years applicable experience. A MS is preferred.

### Process Sustaining Engineers

Sustain engineering responsibility including yield, product improvement packages and follow-up. Requires a BS in EE or ME, and 2 or more years experience in high volume consumer products support, including digital electronic circuitry and/or mechanical assembly of small products.

### Product Design Engineers

Technical coordination and support from product inception to production release. Design to cost, cost reduction plans, and product qualification experience required. Openings in both electrical and mechanical areas. A BS in EE or ME is required. Must be able to direct the activities of designers and technicians.

### Electrical Designer/Programmer

Design and fabricate sophisticated electronics equipment used to test calculators/calculator components. Develop computer programs/software. Requires a BSEE and 5-8 years experience in electronic equipment design. Must have working knowledge of computer programming.

### Field Sales Engineers

For major Eastern and Midwestern cities. Responsible for the development and achievement of a territory sales plan for major accounts selling digital watches, calculators, and other consumer products. Requires a BS or BA (MBA preferred), and 2-3 years related experience.

If you qualify, send your resume in complete confidence to: Staffing Manager/P. O. Box 10508/Lubbock, Texas 79408.

**TEXAS INSTRUMENTS**  
INCORPORATED  
An equal opportunity employer



# Coming through...



with wire, cable and cord  
that delivers quality,  
performance, economy...

Belden has it: a total service capability. Extensive design and application know-how. What it takes to deliver complex cable configurations, special harnesses, cords, lead wires, and even special packages to fit your requirements.

Our specialists and engineers will meet with your people at your plant to discuss problems in processing, assembly, installation, ordering, human engineering, color coordination, physical and electrical parameters, opportunities for cost reduction. And when we can't help you using standard products, we'll innovate a solution to your problem.

Talk to a Belden specialist about your new applications, product ideas, processing problems—all your wire, cable and cord needs. He has thousands of standard items to draw from. And standard or special, he'll come through with the best wire buy around. For answers right now, phone:

317-966-6661 Electronic Div. or mark No. 400 on reader service card  
312-986-1600 Electrical Div. or mark No. 401 on reader service card  
312-887-1800 Transportation Div. or mark No. 402 on reader service card,  
or write Belden Corporation, 2000 S. Batavia Ave., Geneva, IL 60134.



**Coming through...**

*with new ideas for moving electrical energy*



## Power switch ROMs and PROMs quickly and safely with a simple circuit that reduces the turn-on and turn-off delay and keeps your data intact.

Most TTL-based ROMs and PROMs can be operated by applying power only when you actually want to access the information they hold. But you must take some precautions if you want to operate successfully in this mode.

Examine the power switch in Fig. 1. If the input is taken to ground either through a switch or through the output of a TTL gate, base current flows through  $R_1$  to turn on the pnp transistor. If the input is allowed to float or be pulled high by a TTL output, resistor  $R_2$  turns the transistor off.

When the pnp transistor turns on, the  $V_{CC}$  terminal of the ROM rises rapidly to a voltage just below that of the  $V_{CC}$  supply. The difference is determined by the  $V_{CE}$  (SAT) of the pnp transistor. When the transistor is turned off, the  $V_{CC}$  for the ROM decays to a low value (Fig. 2). Turn-on time is how long it takes for the input signal to propagate through the switch and raise  $V_{CC}$  to the 4-V level, at which most ROMs and PROMs are fully functional—even though not all the device specs may be met.

### Now it's time to propagate

Once the device's  $V_{CC}$  has reached 4 V, time is required for all inputs to propagate through the device and establish the correct output state. This is true regardless of whether the inputs are stable before  $V_{CC}$  is switched on, or whether  $V_{CC}$  and the inputs are switched at the same time.

The required propagation time is approximately  $t_{AA}$ , the address-access time given in the data sheets. Typically, ROMs and PROMs reach the correct state within 20 ns of the specified  $t_{AA}$ . So the "worst-case enable time" of a power-switched device is given as follows:

$$t_{enable} = t_{on(pnp)} + t_{AA} + 20 \text{ ns.} \quad (1)$$

Notice that the turn-off time for the power switch in Fig. 2 is specified at 1.5 V, where most TTL PROMs are "off," and their outputs floating. If  $V_{CC}$  is dropped instantly to 1.5 V, the outputs will be "off" and floating within 10 ns. The worst-case disable time is thus given

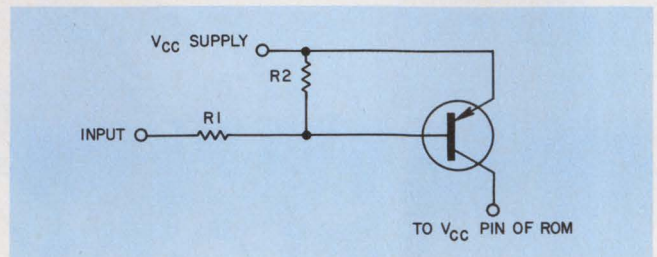

1. ROMs and PROMs are power-switched with a simple pnp transistor circuit in the  $V_{CC}$  line.

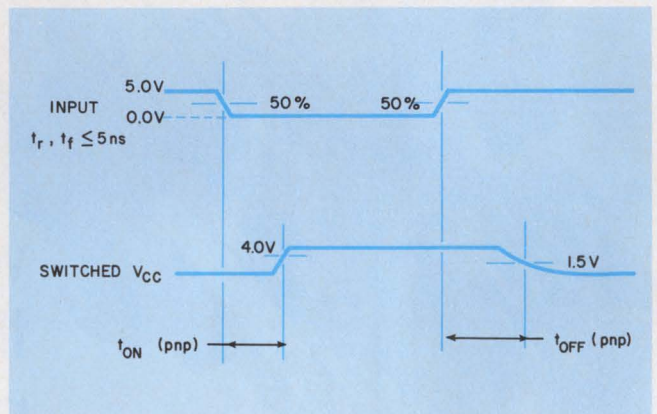

2. The output waveform of a pnp switch lags the input wave by  $t_{on}$  at the start, and by  $t_{off}$  at the end of the switching period.

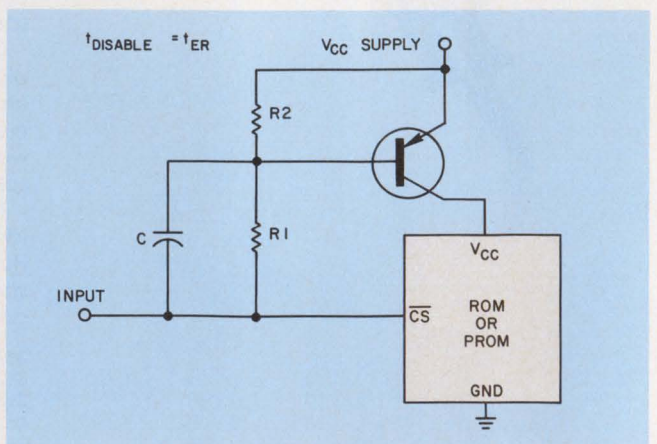

3. Switching performance is improved with a speed-up capacitor, and in addition by feeding the switching input to the ROM's  $\overline{CS}$  pin.



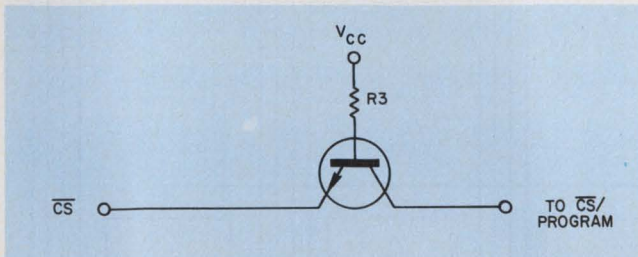

4. PROMs require an npn transistor at the  $\overline{CS}$ /Program input to avoid excessive loading of the input wave.

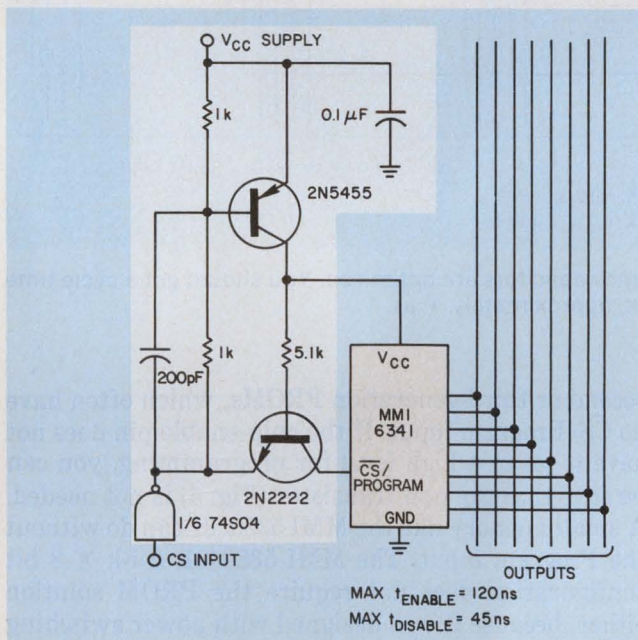

5. The complete schematic for a PROM switch is developed for the 6341 PROM from Monolithic Memories.

**Table 1. Suitable pnp switching transistors**

No. of ROMs/PROMs	Some suitable pnp transistors
1	2N5455, 2N3467, 2N4402
2	2N3467, 2N3244
4	2N3467, 2N5023
8	2N3467

by the following equation:

$$t_{\text{disable}} = t_{\text{off(pnp)}} + 10\text{ ns.} \quad (2)$$

The actual disable time can be quite long because  $t_{\text{off(pnp)}}$  consists of two components: the turn-off time of the pnp transistor, and the decay time for  $V_{CC}$ . Because pnp transistors with good current-handling ability often have lousy turn-off times, you must be very careful to choose the right transistor for a pnp power switch. Several recommended transistors are listed in Table 1.

The decay time for  $V_{CC}$  depends on the current,  $I_{CC}$ , of the ROM or PROM. As  $V_{CC}$  approaches 1.5 V,  $I_{CC}$  drops very rapidly, and all or part of the current may turn on the output of the ROM. Accordingly, the  $t_{\text{off(pnp)}}$  specified for the power switch may be quite high.

You can improve the performance of a pnp power switch in several ways. But two of the most effective are the following:

1. Use a speed-up capacitor in parallel with  $R_1$  of the basic power switch in Fig. 1. This capacitor provides overdrive for turning the transistor on and off. The value should be such that the time constant,  $R_1C$ , is approximately equal to the fastest cycle time at which the power switch will be used. This technique, however, does not improve the decay time of  $V_{CC}$ .

2. Tie the input of the power switch to a  $\overline{CS}$  (chip enable) input of the ROM or PROM being switched. You thereby force the outputs into the OFF state as soon as the input to the power switch goes high. This means that while  $V_{CC}$  is decaying to 1.5 V, the outputs are held off, because the  $\overline{CS}$  input is high. The internal  $\overline{CS}$  buffer becomes ineffective when the outputs are turned off by  $V_{CC}$ .

With this second technique, the disable time is no longer represented by Eq. 2, but rather given by the  $t_{ER}$  time specified on the ROM or PROM data sheet:

$$t_{\text{disable}} = t_{ER}. \quad (3)$$

### PROMs have special needs

What sets PROMs apart from ROMs is the fact that a  $\overline{CS}$  input is also used as a programming input. The  $\overline{CS}$ /Program input is designed in such a way that voltages higher than  $V_{CC}$  provide the internal currents necessary to program the device. Even at 5 V, this current can be very high. Consequently, when  $V_{CC}$  is



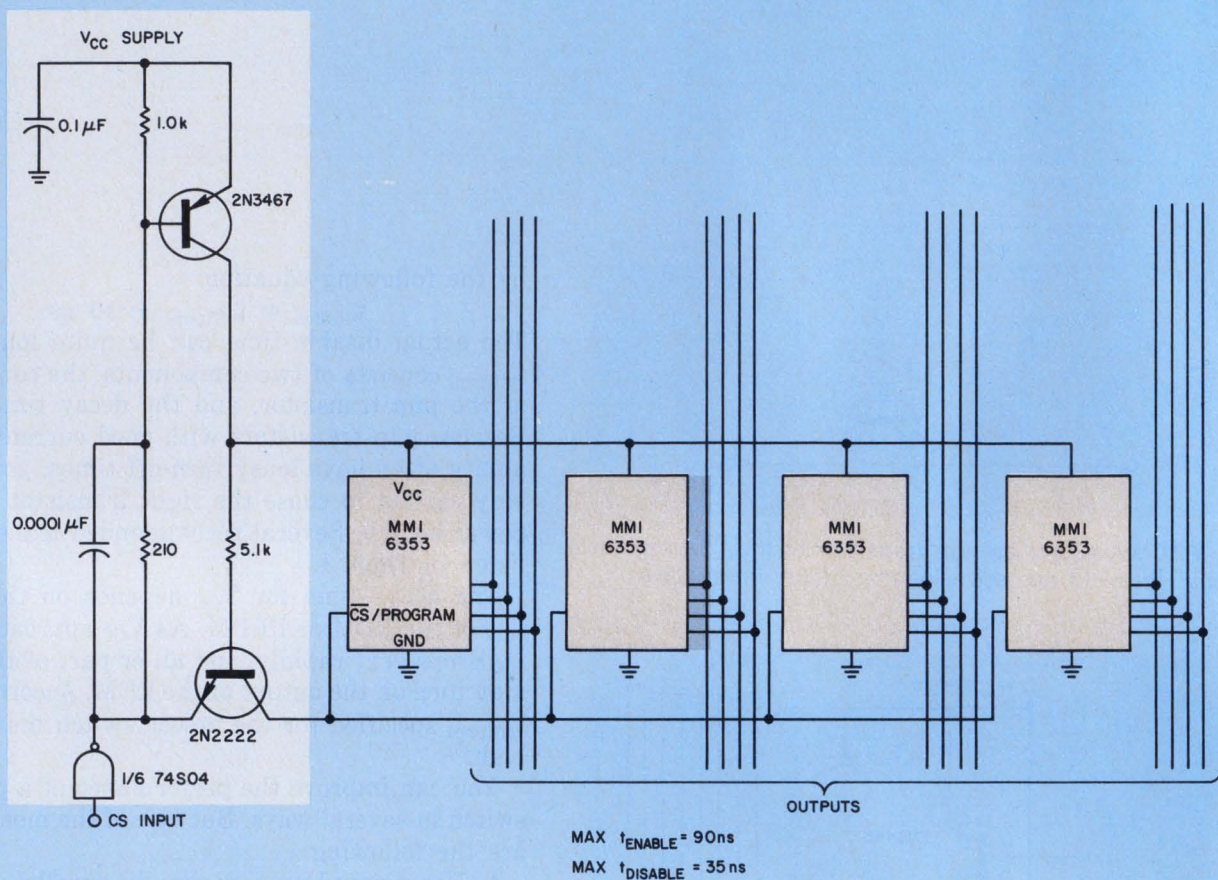

6. This example for power-switching a PROM array uses four MMI 6353 PROMs, for which the values of resistors

and capacitors are optimized. You should get a cycle time of approximately 1  $\mu$ s.

reduced by the power switch, the normal input-current spec does not apply. Instead, the  $\overline{\text{CS}}$ /Program input and all signals tied in parallel with it are loaded down; while you expect a logic "1," it may be a "0."

This peculiarity can cause you headaches if you choose the  $\overline{\text{CS}}$ /Program input in the improved switching scheme of Fig. 3. The loading of the  $\overline{\text{CS}}$ /Program input is normally high enough to keep the input at a low level, and the pnp transistor remains on. Sometimes the whole system oscillates.

Fortunately, the following solution is simple, and works regardless of whether the  $\overline{\text{CS}}$ /Program input is tied to a signal lead, or to the input of the power switch (Fig. 4): An npn transistor is used as a one-way switch to ensure that no current flows from the driver to the  $\overline{\text{CS}}$ /Program pin. The small delay through the npn transistor can be ignored.

### Here comes the new generation

The solution shown in Fig. 4 effectively changes the  $\overline{\text{CS}}$ /Program input into a  $\overline{\text{CS}}$ -only input. But you don't necessarily have to apply this solution in the case of

second or third-generation PROMs, which often have no  $\overline{\text{CS}}$ /Program input. If the chip-enable pin does not have to go to a high level for programming, you can be sure that the npn transistor (Fig. 4) is not needed. A small memory like the MMI 5330/31 can do without the Program input. The MMI 5380/81, a 1-k  $\times$  8 bit configuration does not require the PROM solution either, because it was designed with power switching in mind: Zeners prevent the input circuit from being loaded down. If you want to power-switch PROMs, you really must know their design.

Even if your PROM turns out to be of an earlier variety, the outlined remedies work well. In Fig. 5, only one PROM is being switched with the concept described, while in Fig. 6, four PROMs are being switched. In both cases, the components give good operation in a system with a cycle time of 1  $\mu$ s.

The worst-case enable time in both cases is the  $t_{AA}$  from the data sheet, plus 30 ns. The worst-case disable time is  $t_{ER}$  from the data sheet. While the 2N2222 is used in Figs. 5 and 6, other transistors with fast turn-off time—like the 2N3444, 2N4275, and 2N5134—work just as well. ■■



# The Ansley "D" Connector...

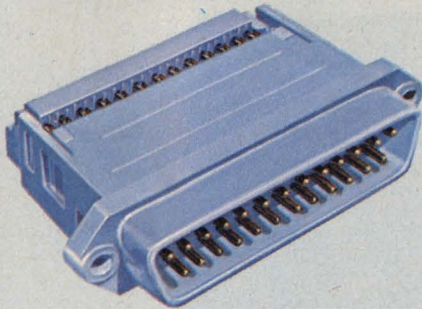

Our new series of male and female "D" connectors offer you a cost effective external mass termination cable and connector system second to none. Its uniqueness begins with a one-piece "D" connector package that meets industry standards for size, pin spacing, and contact reliability. With no loose parts to match up, positive cable-to-contact alignment is assured. Conductors are mass terminated in seconds with our standard BLUE MACS™ hand or bench tools. The results? Faster installation, higher reliability.

Contact pins are spaced on .0545" centers — a perfect fit for any standard inter-cabinet "D" type connector application. Our new "D" connectors are designed to mate with standard .050" pitch flat cable as well as our new, improved jacketed cable — the only flexible flat cable engineered specifically for out-of-cabinet use.

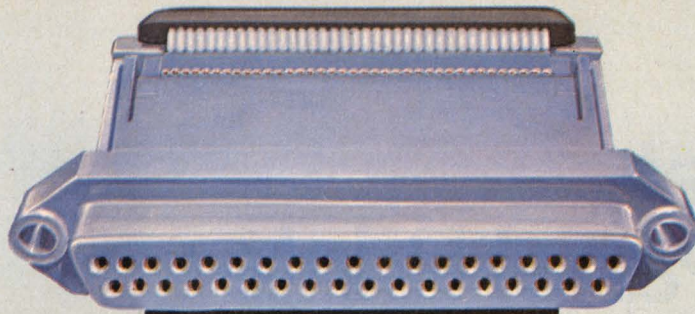

# a new meaning to cost effectiveness.



The Ansley BLUE MACS™ jacketed cable is U.L. listed for external interconnection of electronic equipment. Electrically, it outperforms standard jacketed twisted pairs in typical I/O applications. And there's no special zipper lock tubing required — reducing the need for an extra cable accessory. Installation is faster, easier. And like all Ansley connectors, you can daisy chain our "D" types anywhere in the cable — along with our DIP socket, card edge, or pc board connectors.

Cable alignment and high contact reliability is assured — because both cable and connector are grooved for absolute alignment. Our patented TULIPTM 4-point insulation-displacing contacts are permanently fixed and sealed-in to provide a reliable, gas-tight, corrosion-free mass termination.

For the full reliability/cost effectiveness story and technical data, call or write:

## T&B / Ansley

The mass termination company.

T&B/Ansley Corporation • Subsidiary  
of Thomas & Betts Corporation  
3208 Humboldt St. • Los Angeles, CA  
90031 • Tel. (213) 223-2331 •  
TWX 910-321-3938

Available through authorized  
Ansley distributors

In Canada: T&B/Ansley, Ltd.  
700 Thomas Ave.,  
Industrial Park  
Iberville, P.Q.

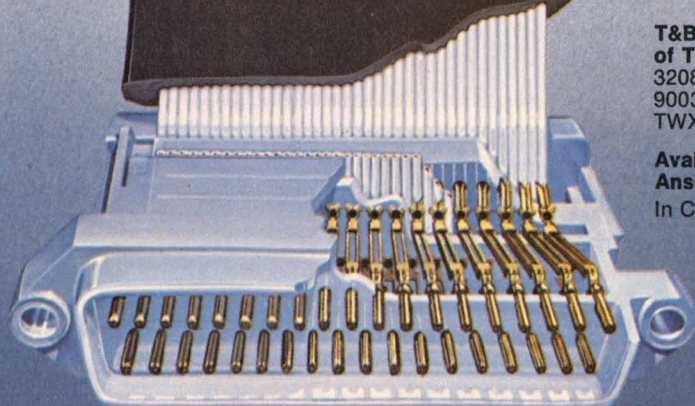



# Datel's Low Cost, Digital Panel Printer

## MODEL DPP-7

- Thermal 7-Segment Printhead uses no ink, hammers, or printwheels.
- Panel-mounting, featherweight 2.3 lb. (1,1 kg)
- 6-Digit and polarity sign formats available with optional hexadecimal.
- AC line power or +5, +12 or +28 VDC
- Includes all BCD TTL full parallel electronics plus input storage register for multiplexed bussing.
- Selectable positive/negative true data and controls logic coding.

COVERED BY GSA CONTRACT



You'll find complete specifications on this product and more than 300 data conversion circuits and systems in Gold Book.

Just check Gold Book's Volume 3. That's Datel's complete Engineering Product Handbook, in its own separate volume. More than 290 pages of D/A & A/D Converters, Multiplexers, Sample-Holds, Op Amps, Power Supplies, Digital Panel Meters, and Printers, Digital Panel Instruments, Data Loggers, Digital Cassette Recorders, and Data Acquisition Systems. Each fully detailed on individual data sheets.

And it's available to you in Gold Book.

**DATEL**  
SYSTEMS, INC.

1020 Turnpike St., Canton, MA 02021  
Phone: (617) 828-8000

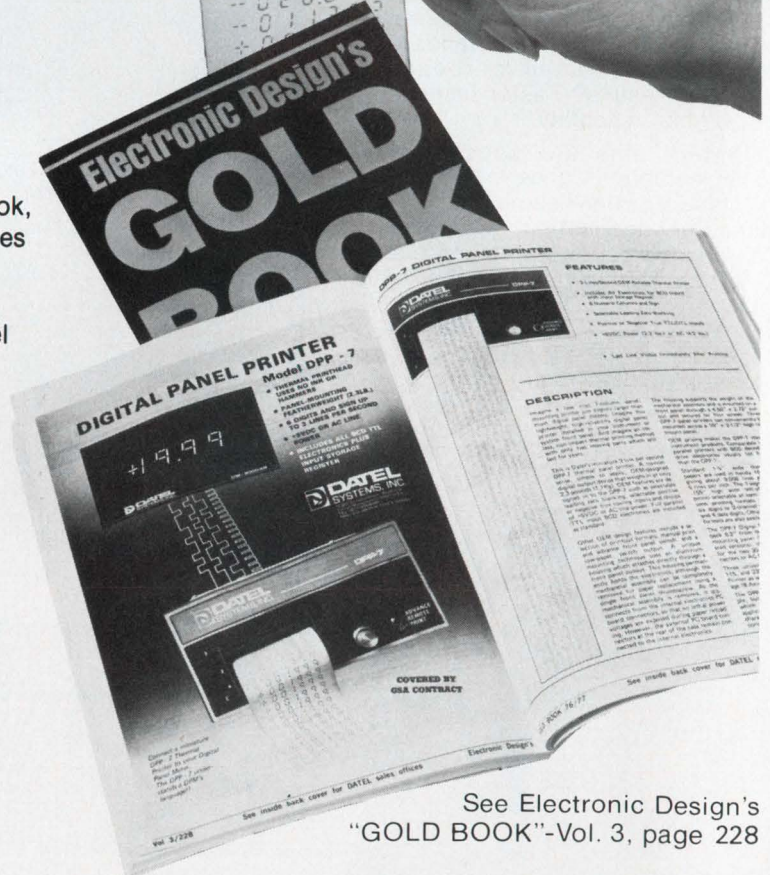

See Electronic Design's  
"GOLD BOOK"-Vol. 3, page 228

• Santa Ana, CA (714) 835-2751, (L.A. Exchange) (213) 933-7256 • Sunnyvale, CA (408) 733-2424 • Gaithersburg, MD (301) 840-9490

CIRCLE NUMBER 57



# We'll flip you over your ceramic capacitor specs... **heads you win tails you win**

Heads are our standard line of MONO-KAPS™. Radial-leaded, epoxy-coated monolithic ceramic capacitors with noble-metal electrodes whose proven formulation has not been modified or compromised. They meet MIL requirements, and are available off-the-shelf in a broad range of capacitances and voltage ratings to meet your specific needs.

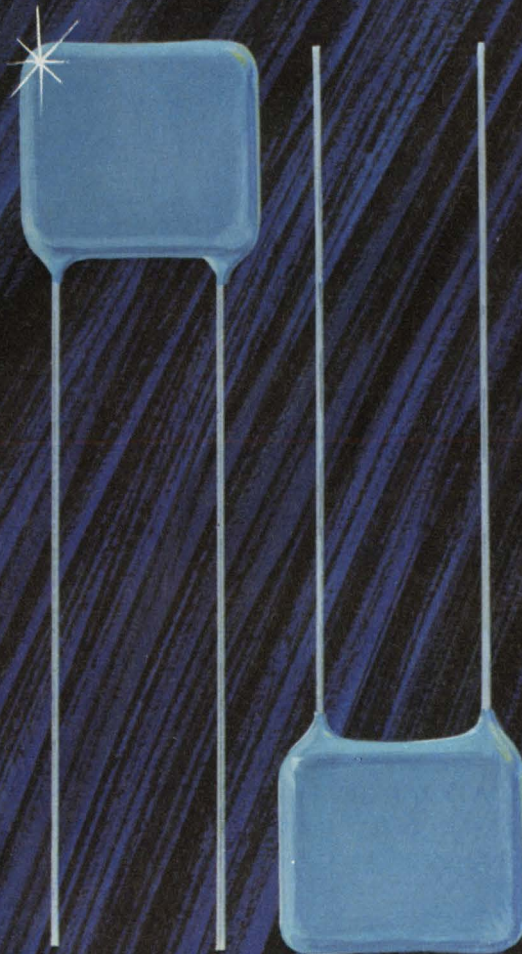

Tails are our BME-Radials™. They protect you from the noble metal cost spiral, and save you money right up front. They are the product of our unique BME capacitor technology which eliminates noble metal entirely from electrodes and terminations. But they'll meet most of the same circuit requirements with no sacrifice.

So you see, it's up to you — MONO-KAPS or BME-Radials. Both are immediately available in quantity from the only people who give you the choice. Either will do the job without compromise. Call or write for all the details today.



**CENTRALAB/USCC** 4561 Colorado Blvd. • Los Angeles, CA 90039 • (213) 240-4880  
Electronics • GLOBE-UNION INC.

SEE OUR COMPLETE CATALOG IN EEM: PAGES 317 TO 335, AND GOLD BOOK PAGES 103 TO 121; OR contact us directly.



# Here is the updated 1977-1978 MicroWaves Product Data Directory to help you make better buying decisions and locate sources of supply ...

## THE NEW, UPDATED 1977-1978 EDITION of the MICROWAVES PRODUCT DATA DIRECTORY

will be the most current and comprehensive compilation of microwave product information you can find anywhere at any price. The objective of this Directory is to assist the design engineer/engineering manager/purchasing agent in his search for product information and sources of supply. The Directory will contain more than 500 pages of fingertip information including:

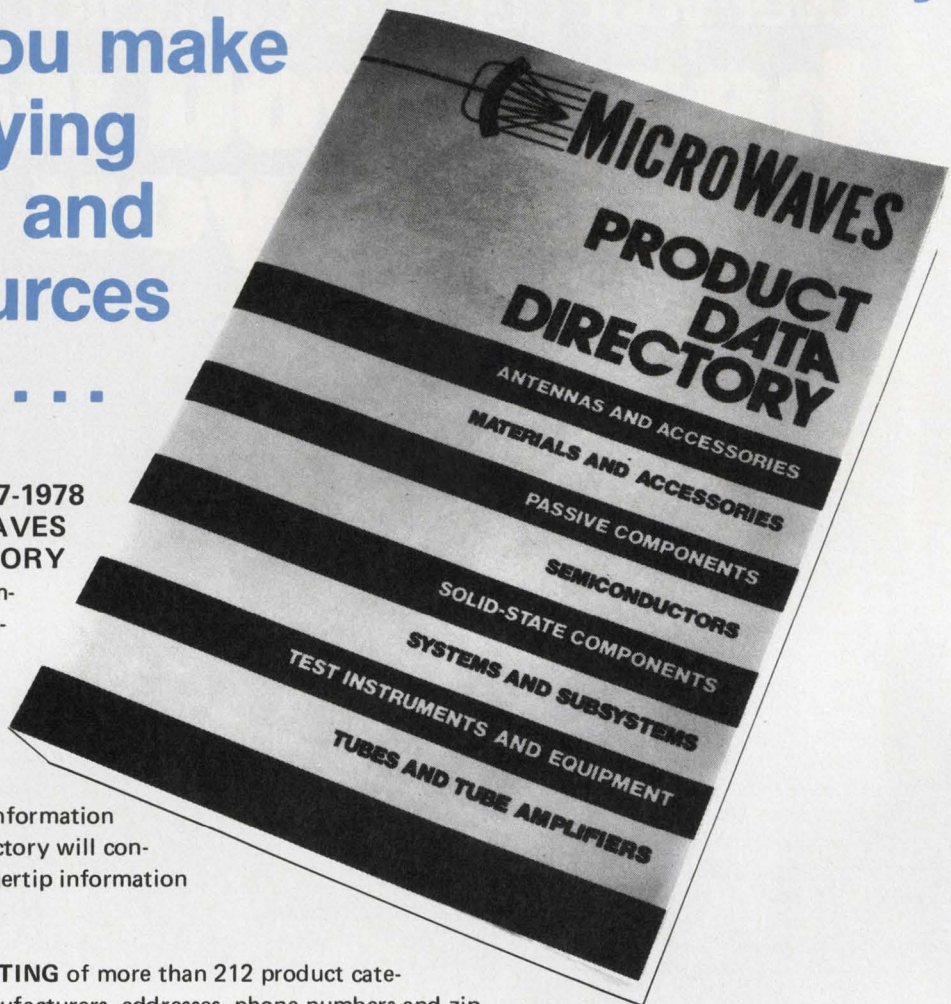

- **PRODUCT CATEGORY LISTING** of more than 212 product categories with the names of manufacturers, addresses, phone numbers and zip codes. Under each product category is an alphabetical listing of manufacturers who supply those products.
- **MANUFACTURERS' PRODUCT DATA INFORMATION SECTION** with specifications, outline drawings, schematics, pricing information. The 8 major product areas in this section include: Antennas; Materials & Processing; Equipment; Passive Components; Semiconductors; Solid State Components; Systems & Subsystems; Test Instruments & Equipment; Tubes & Tube Amplifiers.
- **MANUFACTURERS AND SALES OFFICES SECTION** with more than 2,500 names and addresses of manufacturers supplying the microwave industry. Also phone numbers and representative and sales office listings.

### MAIL COUPON TODAY TO RESERVE YOUR COPIES

DEPT. 301R. MICROWAVES PRODUCT DATA DIRECTORY – Hayden Publishing Co. Inc., Box 13801, Philadelphia, Pa. 19101. U.S.A.

Ship us \_\_\_\_\_ copies\* of the updated 1977-1978 MICROWAVES PRODUCT DATA DIRECTORY as soon as it comes off press. Rates: \$15 per set in U.S.A. All other countries: \$27.00 per copy – payable in U.S. funds.

NAME (Print or type) \_\_\_\_\_ JOB TITLE \_\_\_\_\_

COMPANY \_\_\_\_\_

MAILING ADDRESS \_\_\_\_\_

CITY \_\_\_\_\_ COUNTRY \_\_\_\_\_ POSTAL CODE # \_\_\_\_\_

Company purchase order # \_\_\_\_\_ is enclosed.

Check in U.S. funds enclosed in full payment.

Bill company.  Bill me.

\*Copies will be available for shipment at the end of June, 1977.



# Want simpler backplane connections? Come to the source.

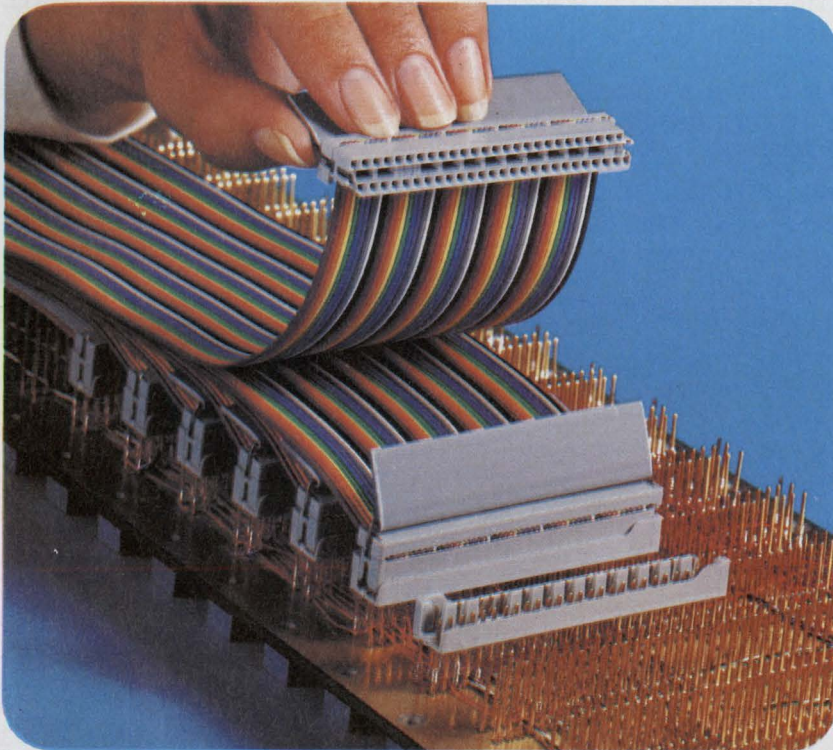

Now, a unique Scotchflex brand Socket Connector and Keying Header system lets you interface directly with backplane wire wrap pins and provides for easy, positive polarization and keying. The header design allows for thousands of unduplicated polarizing combinations without loss of backplane pins. The 50-position connector mates with .025" square pins on .100" x .200" grid spacing. Header allows space for and protects two layers of wrap below it. System also provides polarizing keys and strain relief handles.

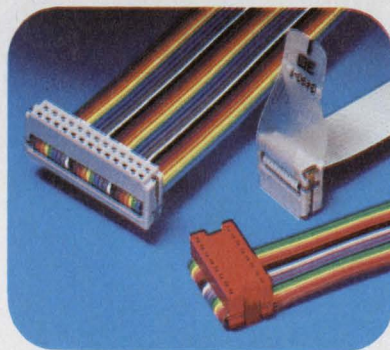

Need some other ways to simplify wiring and increase circuit density? 3M's Scotchflex line offers you a broad choice of mass terminating socket connectors, plus wire wrap or solder tail headers to suit your specific design problem. Keying capability is also provided.

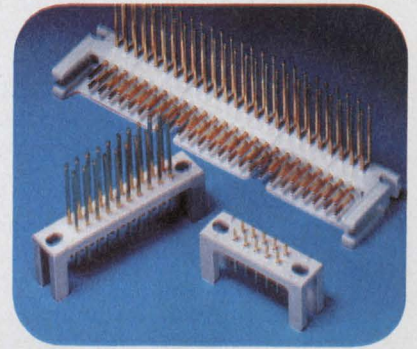

There are several more things you can get only from 3M. The broadest range of flat cables and complete system components. Best off-the-shelf availability. Proven performance. And the unmatched experience of the people who pioneered this reliable mass termination system.

"Scotchflex" is a registered trademark of 3M Co.

## Scotchflex<sup>®</sup> systems from 3M. The source.



See our  
catalog in EEM,  
page 1056



# HP quality, convenience and low prices mean big value in DMM's.

**\$225\***—The **HP 3476A**—3½ Digits—Autoranging, automatic polarity and automatic zero make the 3476 a big value. It's a convenient size to hold in your hand or carry in your briefcase. Just \$225\* for the "A" version for AC line operation in your lab or \$275\* for the portable "B" version (with built in batteries and recharging circuit).

**\$375\***—The **HP 970A**—3½ Digits—Handheld, autoranging, automatic polarity and zero, the 970 is totally self-contained and totally convenient. And the readout can be inverted with a flick of your thumb for easy reading. On the job measurement has never been easier.

**\$400\***—The **HP 3435A**—3½ Digits—Autoranging or manual operation and wide-range operation, plus built-in batteries and recharging circuits bring you laboratory

accuracies and portability in the same unit. If you don't need battery operation, option 001 gives you line operation only for just \$335\*.

**\$500\***—The **HP 3465B**—4½ Digits—1μV sensitivity gives you performance you'd normally expect from a 5½-digit multimeter. Fully portable too, with its own nickel-cadmium batteries and recharging circuit. Dry-cell operation and a rack-mount version are available in the 3465A for as low as \$425\*.

**Confidence** in low-cost DMM's comes from knowing you've made the right decision. HP's quality and service give you assurance. Contact your local HP field sales engineer or write today for more information.

\*Domestic U.S.A. price only.

**HP DMM's...  
the right decision.**

097/42



HEWLETT  PACKARD

Sales and service from 172 offices in 65 countries.

1507 Page Mill Road, Palo Alto, California 94304  
For assistance call: Washington (301) 948-6370, Chicago (312) 677-0400  
Atlanta (404) 434-4000, Los Angeles (213) 877-1282

CIRCLE NUMBER 61



## IC fluid-flow sensor gauges fluid rate and direction

Based on the principle that a heated body is cooled by a passing fluid flow at a rate that depends on the fluid velocity, an integrated-circuit fluid-flow sensor has been fabricated that can measure both the direction and the rate of fluid flow. Three transistors in the chip structure sense the direction of the flow (Fig. 1). Transistor  $Q_1$ , located in the center of the chip, acts as a heat source. Transistors  $Q_2$  and  $Q_3$ , at opposite ends of the chip, act as temperature-sensing transistors. If fluid is flowing from left to right and parallel to the surface,  $Q_2$  will measure a lower temperature than  $Q_3$ , because the fluid is heated by  $Q_1$  before reaching  $Q_3$ . The temperature difference between  $Q_2$  and  $Q_3$  is proportional to the square root of the fluid velocity. The sign of the difference output indicates the direction of flow.

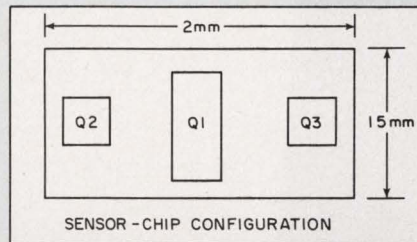

For the fluid sensor to operate properly as a transducer, a fourth transistor,  $Q_4$ , is mounted in the fluid and thermally isolated from the chip. Its base-emitter voltage indicates the fluid temperature.

Current efforts by the device's developers at the Delft Technical University in the Netherlands are aimed at combining two differential transistor pairs at right angles to each other to produce a true velocity-vector output.

## Implanting sulphur ions produces super GaAs FET

GaAs field-effect transistors without a mesa structure have been successfully fabricated by selectively implanting sulphur ions into a GaAs substrate doped with chromium. Not only does this process pave the way for reduced production costs, but as a result, transistors have been produced at the Electrical Communications Laboratories in Tokyo whose oscillation frequency is a very high 30 GHz.

Thin n-type layers of high uniformity, which are necessary to the production of GaAs FETs, are produced by covering a CR-doped (100) semi-insulating GaAs substrate with a 500-Å layer of sputtered  $\text{SiO}_2$  and selectively implanting the sulphur ions.

The sulphur ions are implanted

with the aid of a 0.9- $\mu\text{m}$  thick mask of aluminum, which is made with photolithographic techniques.

The aluminum mask protects the underlying substrate because the 200 keV sulphur ions penetrate only about 0.2  $\mu\text{m}$  of the aluminum layer.

Following the implantation, the wafer is annealed at 800 C for 3.5 hours.

The annealing process activates the implanted sulphur ions and removes the damage to the lattice caused by the ion bombardment. After annealing, the wafer is etched.

Source and drain contacts are constructed by evaporating gold-germanium and nickel and alloying for 30 s at 460 C in a hydrogen atmosphere.

The gate uses a Schottky-barrier structure, formed by evaporating

aluminum—a simple process because the devices don't have a mesa structure. The gate is 1.4  $\mu\text{m}$  long and 400  $\mu\text{m}$  wide.

## Miniprograms to be run on any microcomputer

Now programs developed on a mini-computer can run on any micro-computer board for which a "cross-translator" has been written. A universal microprocessor-development system called MicroAde develops programs that can be run on micro-computer boards linked to the mini-computer by a single cable. Based on the PDP-11, MicroAde has been developed by CAP MicroSoft, Reading, England.

Like cross-assemblers, cross-translators are hosted on the development computer and produce object code for the target microcomputer. Although a cross-translator must be written for each microcomputer, all translators share the same facilities, such as loaders, linkers and program management.

As a result, a given program can be run on all the supported micro-computers without rewriting any part of the program. And since the framework of the new cross-translator already exists, new microprocessors can be supported quickly.

Cross-translators invented by CAP's chief software designer, Esmond Hart, for the 8080 and 6800 microprocessors reside on floppy discs. Other cross translators are being developed for the 9900, the F8 and the 2650.

MicroAde has a unique high-level language capability known as MicroCobol, which may cause microprocessors to be used in data processing. As yet, microprocessors aren't used in such applications because usually these applications are software-intensive.

An interactive debugging system that provides a complex test-sequence facility, I/O simulation and randomly generated interrupts is included in MicroAde as well as conventional debug facilities.





**“THE GOLD BOOK HAS HELPED ME LOCATE SOME OF THE UNUSUAL PRODUCTS THAT ARE HARD TO FIND IN OTHER BOOKS”**

Gary McIntyre is Test Supervisor for Moore Systems, Sunnyvale, California. Moore produces communications alarm controls, data loggers, computer monitoring systems and digital telemetering systems. McIntyre supervises final unit and systems testing, also in-house computer systems check out.

His directory? *Electronic Design's* GOLD BOOK.

**“I refer to the GOLD BOOK two or three times a week. It allows for quick reference for many electronic products. By using the GOLD BOOK I can readily see what and where things are available for purchase. It's extremely useful, superior in all aspects.”**

Moore Systems purchases equipment worth several thousand dollars per two-month period through the GOLD BOOK. The GOLD BOOK is working for advertisers because it's working for users — like Mr. McIntyre — throughout the U.S. and overseas.

**IF IT'S ELECTRONIC...IT'S IN THE GOLD BOOK**



# Designing with Ferrites?

## Here comes help

**PERFORMANCE**—We have the best specs available anywhere because our ferrite materials are developed to match your circuit requirements. For example, we're the people who control temperature characteristics to give you low loss components in three temperature ranges, TC matched to inexpensive capacitors, or an inductance factor that's stable from  $-30$  to  $+75^{\circ}$  C.

**PRICE**—But you may not need the hottest specs. Our help also includes a new *Cost Saver*<sup>™</sup> line that can give you the hottest price. We do it with high volume runs of popular shapes and materials.

**BOTH**—Our new Catalog 209 describes the higher performance you can get with our products—and the lowest prices in town if your standard requirements can be met in a popular size. For your copy of Catalog 209, please call, write, bingo, or contact your local Permag distributor.



**EMM** indiana general

a division of Electronic Memories & Magnetics Corp.

Keasbey, N.J. 08832 • (201) 826-5100

CIRCLE NUMBER 63



## Alarm circuit guards a guarding-camera system

A system such as a surveillance camera needs an independent alarm system to ensure that the power cord is properly plugged in, and vibration and cover-open sensors to detect unauthorized entry into or movement of the device. The alarm circuit is composed of three major sections (see figure).

One section, the noise maker, consists of two CMOS oscillators wired so that the one controls the frequency of the other. The oscillator formed by  $G_5$  and  $G_6$  operates at about 1 Hz and changes the resistance in the second oscillator,  $G_7$  and  $G_8$ , with a 4016 analog switch. The second oscillator swings about 2 kHz and sounds like an English siren—repeated high-to-low notes.

Another section detects whether or not the 117-V-ac plug is properly inserted into the outlet. When properly inserted, there is continuity between the neutral and ground conductors. If someone tries to disable the alarm by removing the plug, capacitor  $C_1$  charges through  $R_1$  and  $R_2$ . After 1 to 3 s, the potential across  $C_1$  ex-

ceeds the threshold of the CMOS gate,  $G_1$ , and the alarm sounds. The alarm doesn't latch; reinserting the plug resets the alarm. And if the line power is shut down—say, over a weekend, the circuit doesn't respond: The neutral and the ground remain connected.

The third part of the circuit is the alarm logic. Gates  $G_3$  and  $G_4$  form an R-S latch. When one of the  $S_2$  switches opens or one of the  $S_3$  switches closes, the latch sets and activates the alarm. The bypass key,  $S_1$ , forces the alarm off when closed and resets the R-S latch.

A 1.7-Ah Gel/Cell can provide an alarm for at least 2 h. This battery is trickle-charged from the camera's power supply, which ensures that the alarm is continuously powered and ready for operation. The entire circuit draws only microamps in stand-by operations.

*John Harrison, Technical Consultant, Northeast Electronics, Airport Rd., Concord, NH 03301.*

CIRCLE NO. 311

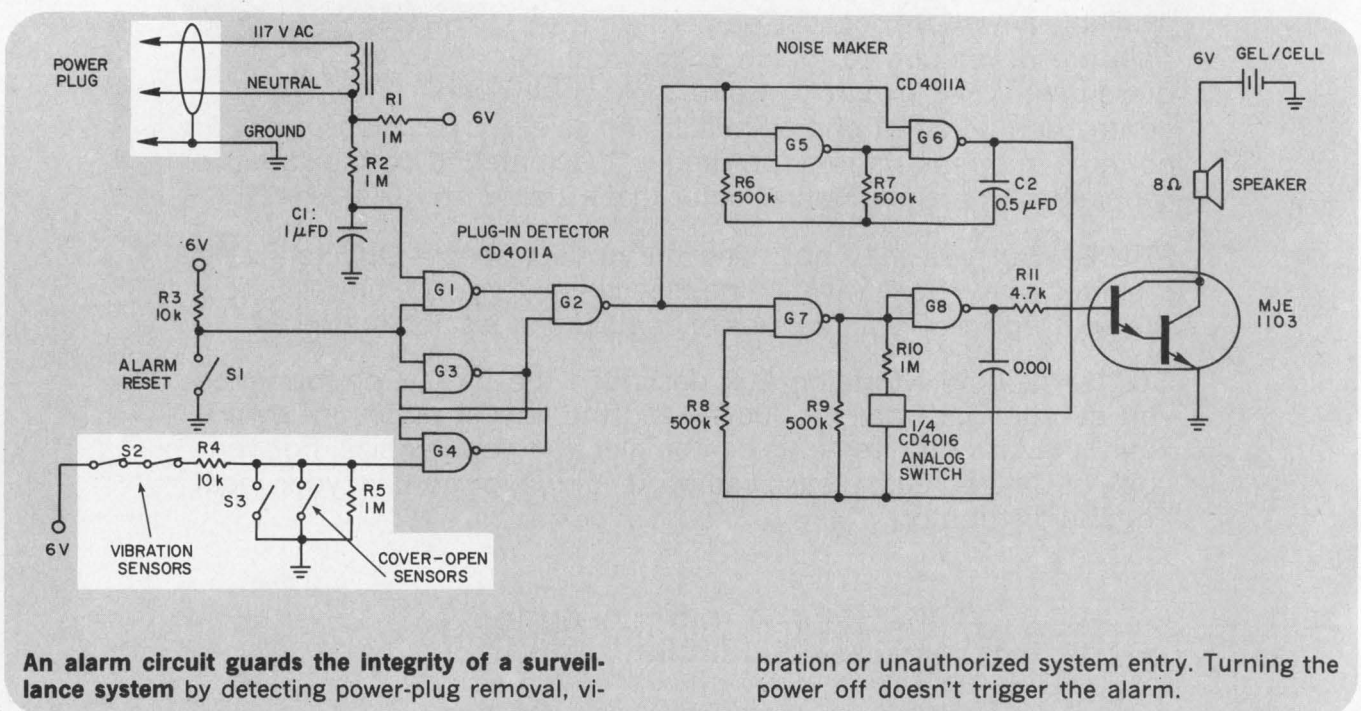



**Triplett  
310 mini-VOM's  
fit your hand  
and your  
wallet...**

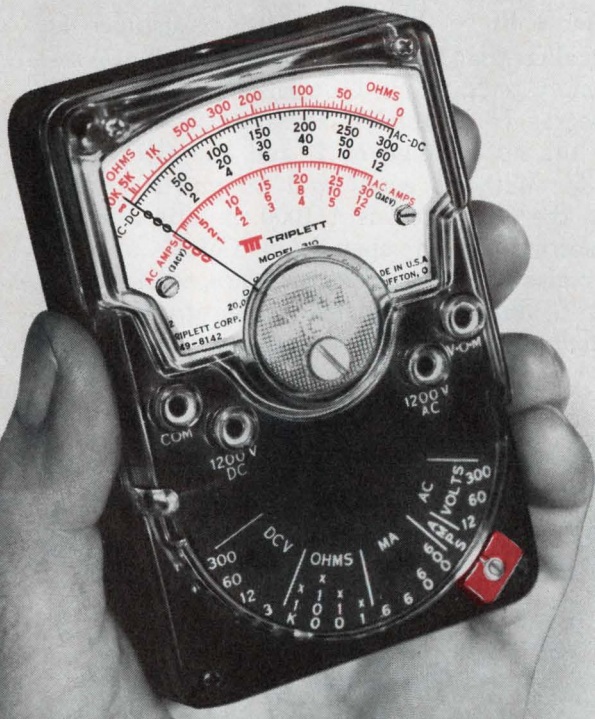

**only \$53**

The high quality Triplett 310 is a little all-in-one VOM. This made in the U.S.A. VOM gets around a lot for half fare. It packs most of the features you'd expect to find only on a meter twice the size and price. It fits in your shirtpocket easily. The small size and its versatility is a boon to field servicemen as well as circuit designers, technicians, electrical maintenance engineers, and the price is right for vocational and hobbyist use.

A newly designed high impact, drop resistant case makes it practically indestructible . . . 20K ohms/volt DC and 5K ohms/volt AC ranges provide plenty of sensitivity for most applications . . . and, there's diode overload protection with a fused R X 1 ohm range. The single range selector switch is a real time saver for reading 0 - 1200 DC or AC volts, 0 - 20 megohms, and 0 - 600 micro-amps or 0 - 600 milliamps at 250 millivolts.

Comes complete with 42" leads, alligator clips, batteries and instruction manual. Accessories triple the versatility of a 310. Adding the Model 10 clamp-on ammeter allows you to measure AC currents easily with one hand.

Visit your local distributor or Mod Center and shake hands with a real bargain.



**TRIPLETT**  
BLUFFTON, OHIO 45817

**Triplett. The easy readers**

CIRCLE NUMBER 64 FOR INFORMATION  
CIRCLE NUMBER 65 FOR FREE DEMONSTRATION



# Wide-frequency-range clock source needs few discrete components

Need a wide-range clock source operable from 100 Hz to 100 kHz? When operated as a simple clock source, the circuit in Fig. 1 easily covers this range, features an inherently square-wave output and uses a minimum of discrete parts with an AD537 v/f converter in a DIP. And the frequency-determining components,  $R_t C_t$ , can have small values because of a multiplying factor of 10 in the circuit's frequency equation—of particular importance at low frequencies.

The frequency expression, which has an initial maximum calibration error of 7%, is

$$f_0 = \frac{1}{10 R_t C_t},$$

with pins 5 and 7 directly connected to each other.

A timing current,  $I_t = 1/R_t$ , which can be varied from 1 mA to less than 1  $\mu$ A, appears as a linear-charging current in the timing capacitor,  $C_t$ . This timing current is the same for both the HIGH and LOW parts of the output waveform; therefore, the output waveform is square. For the many applications that need a square wave, this circuit has an advantage over other oscillatory sources, such as 555 astables or charge-balancing v/f converters.

As a manually tunable "lab source,"  $R_2$  divides a reference voltage from pin 7 and introduces a fractional multiplier,  $K$ , into the frequency equation. Factor  $K$  is proportional to the fractional rotation of  $R_2$ . The frequency varies directly with

$R_2$ , allowing convenient dial calibration and operation over more than three decades of frequency range.

Resistor  $R_3$  (shown dotted) can be included in the circuit to track the calibration at the low-frequency end of the range. Capacitor  $C_1$  filters possible noise pickup at  $R_2$ 's arm, especially when  $R_2$  is at mid-range.

The output at pin 14 comes from an open-collector npn, so a load resistor,  $R_1$ , is required. Load-reference voltages for pin 14 can be up to 36 V, independent of the voltage level to the chip at pin 13.

Although basically a square-wave source, the circuit can be modified for asymmetric waveform operation as well (Fig. 2). The timing resistor,  $R_t$ , is replaced by a switching function with a p-channel FET,  $Q_1$ . When  $Q_1$  is OFF, the timing resistance is  $R_{t1} + R_{t2}$ . If  $Q_1$ 's ON resistance is much smaller than  $R_{t2}$ , the timing resistance reduces simply to  $R_{t1}$  when  $Q_1$  turns ON.

The degree of attainable asymmetry is limited only by the span range of  $I_t$  and the ON-resistance of  $Q_1$ . With  $R_{t1}$  equal to 1 k $\Omega$  and  $R_{t2}$  equal to 1 M $\Omega$ , the duty cycle is 1/1000. A 4016 analog-switch section or an open-drain CMOS buffer/converter also can be used as switches across  $R_{t2}$ .

Walter G. Jung, Pleasantville Laboratories, 1946 Pleasantville Rd., Forest Hill, MD 21050.

CIRCLE NO. 312

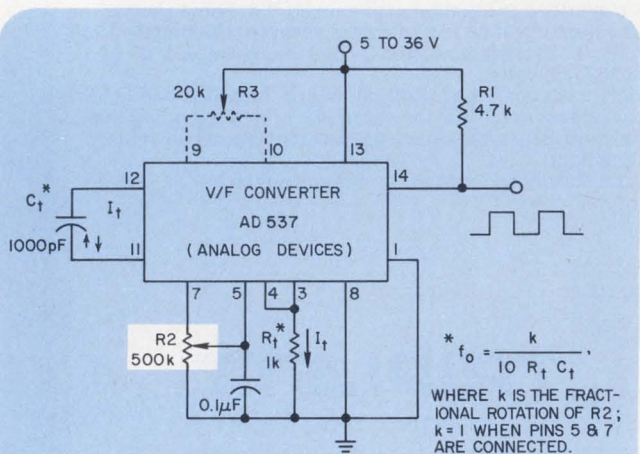

1. This square-wave clock source can be adjusted from at least 100 Hz to 100 kHz, where the frequency output is proportional to the fraction of rotation of a linear potentiometer,  $R_2$ .

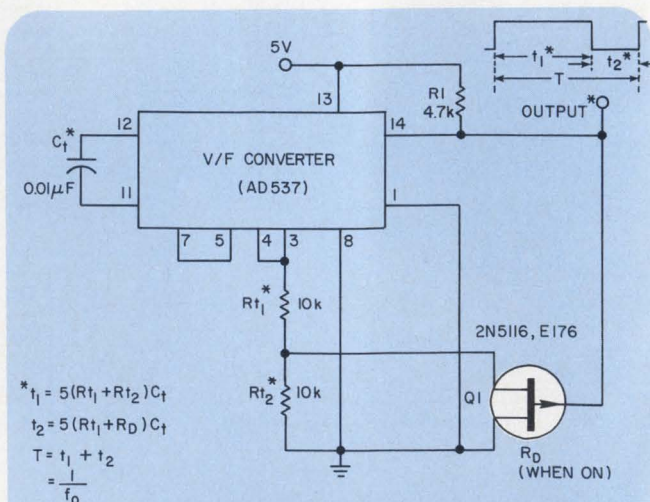

2. The basic square-wave circuit can be modified with a switching FET,  $Q_1$ , to generate asymmetrical outputs with duty-cycle ratios as large as 1:1000.



# DURACELL GIVES YOU THE POWER OF IMAGINATION.

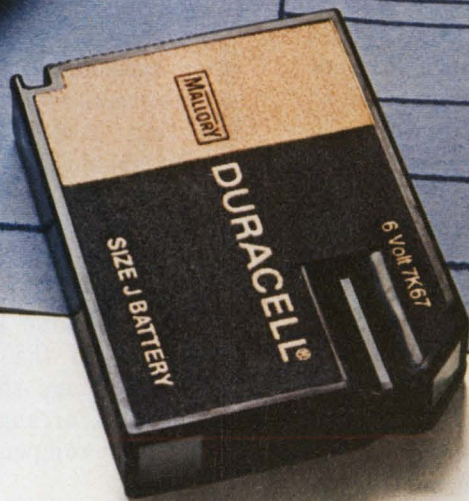

## FLAT-PAK® CARTRIDGE BATTERIES FROM DURACELL GIVE YOU NEW FREEDOM FOR INNOVATIVE DESIGN.

We used *our* imagination in designing a thinner, more compact power source so you can use *yours*...in designing miniaturized electronic equipment that was never possible before.

Duracell FLAT-PAK® cartridge batteries are specifically designed to meet your miniaturized power requirements. And they're already being utilized by some of the nation's leading electronic innovators.

For example, KODAK's new instant picture cameras use a FLAT-PAK® cartridge battery, as does VIVITAR's® Model 50 Electronic Flash Unit and NOVUS "Checkbook" Pocket Calculator.

But to really appreciate the endless applications of

FLAT-PAK® cartridge batteries, you've got to see them for yourself. So we're making you a simple, no gimmick offer: call any time, night or day, toll free at 800-243-5000 (from U.S. except Conn.) or 1-800-882-5577 (Conn. residents only), or use the coupon below. Either way, we'll send you a complete set of FLAT-PAK® cartridge batteries, so you can get your ideas off the drawing board and into prototype



**MALLORY DURACELL®**

**Send me my free  
FLAT-PAK® Kit today.**

**Mail to:** Mallory Battery Company  
Department 314  
So. Broadway & Sunnyside Lane  
Tarrytown, New York 10591

Name \_\_\_\_\_

Address \_\_\_\_\_

City \_\_\_\_\_

State \_\_\_\_\_ Zip \_\_\_\_\_

Title \_\_\_\_\_

Company \_\_\_\_\_



# Active zener circuit provides clipping adjustable down to almost zero

Voltage limiting can be extended to well below 0.1 V by combining conventional zener diodes with an operational-amplifier stage. The circuit is simple and allows precise adjustment of clipping level, even when wide-tolerance components are used. The figure shows both conventional clipping circuits and the active-circuit concept.

The conventional arrangement clips at a level that corresponds to the sum of the forward and reverse voltages of the two series-opposing zener diodes. With this configuration, clipping levels as low as about 2.3 V can be obtained with units such as the National Semiconductor LM103 devices. Lower voltages, down to about 0.5 V, can be obtained with the forward-breakdown characteristics of multijunction reference diodes from Codi Corp., when connected in parallel opposition. But in either case, the breakdown voltage can't be conveniently trimmed to a desired value.

However, the active circuit achieves any desired clipping level down to nearly zero. An inverting op amp boosts the voltage applied to the zener from  $E_o$  to  $E_o(1-\bar{A})$ , where  $\bar{A}$  is the gain of the amplifier circuit. The Limiting action then occurs at

$$E_o(1-\bar{A}) = V_z + V_f,$$

or

$$E_o = \frac{V_z + V_f}{1 - \bar{A}},$$

where  $V_f$  and  $V_z$  are the forward and reverse voltages of the zeners.

For example, a 4.5-V zener with a 0.5-V forward drop can be combined with a gain of  $-19$  stage to obtain  $\pm 0.25$ -V clipping action.

For high frequencies, the adverse effects of zener capacitance, increased by the Miller effect, can be reduced by using a two-stage amplifier. The first stage, a noninverting adjustable-gain circuit, should have a trimmer capacitance from its output to terminal A of the voltage-limiting element. The second stage, a unity-gain inverting amplifier, will then provide the necessary drive to terminal B. The trimmer capacitance is adjusted to a value lower than the low-signal-level capacitance of the zeners, and the bandwidth of the second stage should be wide compared to the first. This arrangement ensures good shunt-capacitance compensation and an oscillation-free circuit.

*Eugene R. Schlesinger, Senior Staff Engineer, Perkin Elmer Corp., Norwalk, CT 06852.*

CIRCLE NO. 313

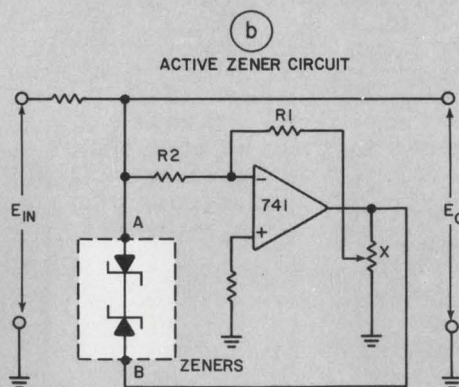
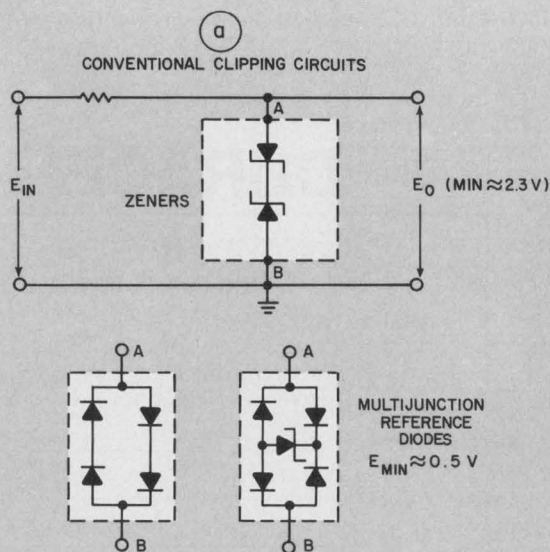

$$E_o \leq \left| \frac{V_z + V_f}{1 - \bar{A}} \right| \quad \text{WHERE } \bar{A} \approx - \left( \frac{R_1}{X R_2} \right)$$

X = POTENTIOMETER TRANSFER FUNCTION— BETWEEN ZERO AND 1

$V_f$  AND  $V_z$  = FORWARD AND REVERSE VOLTAGES OF ZENERS

Adjustable clipping levels to very low voltages can be achieved by placing the voltage limiting elements

in the feedback circuit of an op amp. Varying the setting of potentiometer X changes the level.



**Need standard transformers, inductors,  
electric wave filters and High Q Inductors  
that are something special?  
TRW/UTC has a stock answer.**



We have in continuous production the most complete line of standards for immediate delivery from the factory or an authorized distributor.

So our products get to you fast — when you need them.

But fast is not enough. All products that carry the TRW/UTC name have a quality background.

In engineering, all designs are fully laboratory proved before being released for production. In quality control, all incoming materials are subjected to exhausting test-

ing, and continuous surveillance.

In product testing, each individual transformer or filter is tested for performance at least three times during successive stages of manufacture.

The end result is a level of quality and reliability unmatched in the industry.

We're proud our products are available when you need them. But, we're even prouder of what we do to them before they reach the shelf.

**TRW UTC TRANSFORMERS**

ANOTHER PRODUCT OF A COMPANY CALLED TRW

CIRCLE NUMBER 67



# Low-cost integrator multiplies 555 timer's delay range 100 times

With the circuit in Fig. 1, the maximum practical delay of a 555 timer can easily be increased to 100 times that of a conventional circuit. The C and R delay elements form part of an integrator, with a CA3140 op amp the active element.

In a conventional circuit, the input-bias current to pin 6 limits the resistance of R to a maximum of about 10 M $\Omega$ , so a practical maximum delay is about 1 min. An hour's delay would require impractically large capacitors.

After the 555 is triggered, capacitor C charges at a rate equal to  $V_{ref}/RC$ . With  $V_{ref}$  at 0.1 V, a time equal to 100 RC is needed for C to charge to 10 V, which is  $2/3 V_{cc}$ . At this voltage, the CA3140 output is strobed low and C discharges through diode D.

For high R values, diode D must have low leakage such as provided by the gate-channel diode of a Siliconix E202 FET. The E202's maximum leakage current is only 100 pA at 20 V; maximum forward current is 50 mA.

Since  $V_{ref}$  varies with  $V_{cc}$ , the timing is nearly independent of supply voltage. At  $V_{cc} = 5$  V, however, the CA3140's output can't reach the level of  $2/3 V_{cc}$ . But the 555's triggering point can be lowered with external resistors.

Fig. 2 shows the charging-time curves of capacitor C both without an integrator, and also with an integrator whose  $V_{ref}$  equals 0.5 V. Note that the starting point of the integrator's timing cycle contains a step change equal to  $V_{ref}$ .

*William Olthoff, Euratom, Petten 1724, the Netherlands.*  
CIRCLE NO. 314

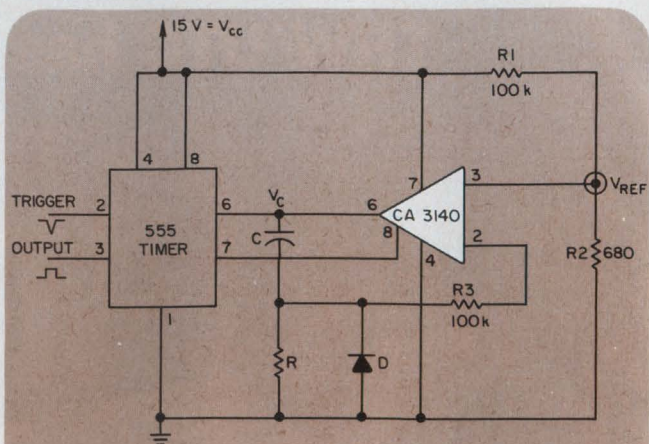

1. Long delay times can be derived from a 555 timer with reasonably sized capacitors, if an integrator circuit is used.

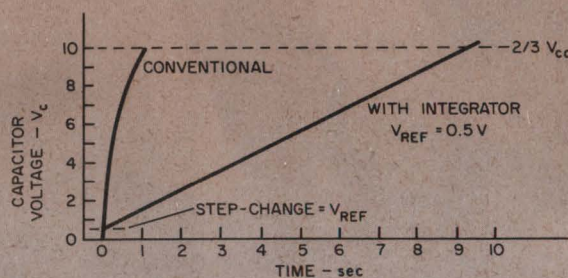

2. The capacitor's charging time with an integrator circuit can be much longer than with a conventional 555-timer configuration.

## IFD Winner of December 20, 1976

**Donald C. Elmore**, Principal Engineer, Electronic Communications, Inc., P.O. Box 12248, M/S 22, St. Petersburg, FL 33733. His idea "Diodes Act As Temperature Sensor in Remote Temperature-Measuring Circuit" has been voted the Most Valuable of Issue Award.

**Vote for the Best Idea in this issue** by circling the number for your selection on the Reader Service Card at the back of this issue.

**SEND US YOUR IDEAS FOR DESIGN.** You may win a grand total of \$1050 (cash)! Here's how. Submit your IFD describing a new or important circuit or design technique, the clever use of a new component or test equipment, packaging tips, cost-saving ideas to our Ideas for Design editor. Ideas can only be considered for publication if they are submitted exclusively to ELECTRONIC DESIGN. You will receive \$20 for each published idea, \$30 more if it is voted best of issue by our readers. The best-of-issue winners become eligible for the Idea of the Year award of \$1000.



# Opening new frontiers with electro optics

## PMT with big new "teacup" dynode gives scintillation counters better PHR.

We expect quite a tempest over this teacup. It's a radically different RCA approach to large-diameter PMT's: The teacup is a large, cup-shaped first dynode that is an improvement over conventional venetian-blind types. It has better spatial uniformity and better off-axis uniformity. As a result, PHR (Pulse Height Resolution) is improved by 0.3% for Cs<sup>137</sup> [NaI (TI)] and 0.7% for Co<sup>57</sup> [NaI (TI)].

RCA 4900 is the first in a whole new family of 2" to 5" circular and hexagonal face PMT's with teacup first dynodes. It has a 3" diameter, 10 stages, and "blue" cathode responsiveness of 10  $\mu$ A/blue 1m minimum, 10.5  $\mu$ A/blue 1m typical. Available with voltage divider network.

### High performance in exacting applications

Besides scintillation counting, the teacup PMT can also be useful in gamma ray spectroscopy

for medical applications. Several leading manufacturers of medical diagnostic equipment recently conducted their own tests on these gamma-camera type tubes, and pronounced them a giant step forward in improving camera performance.

If electro optics can solve your problem, remember: EO and RCA are practically synonymous. No one offers a broader product spectrum. Or more success in meeting special needs. Call on us for design help or product information. RCA Electro Optics, Lancaster, Pennsylvania 17604. Telephone 717-397-7661. Sunbury-on-Thames, Middlesex TW16 7HW, England; Ste.-Anne-de-Bellevue, Quebec, Canada; Belo Horizonte, Brazil; Hong Kong.

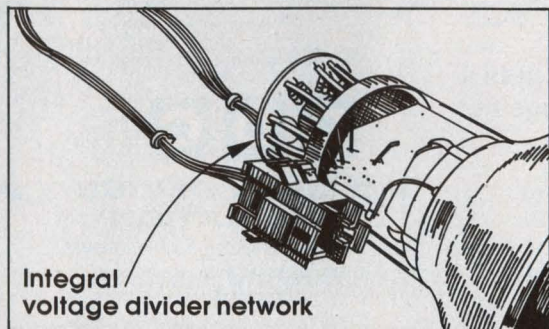
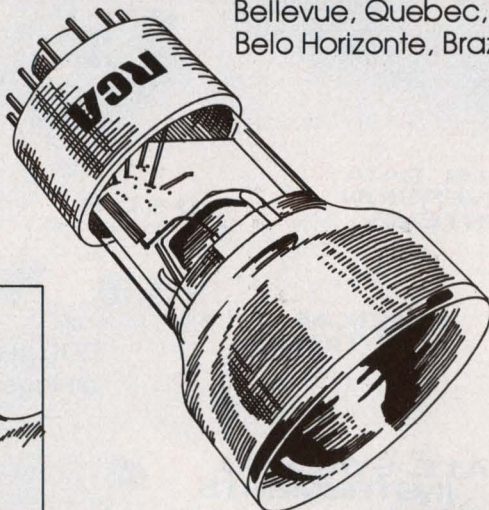
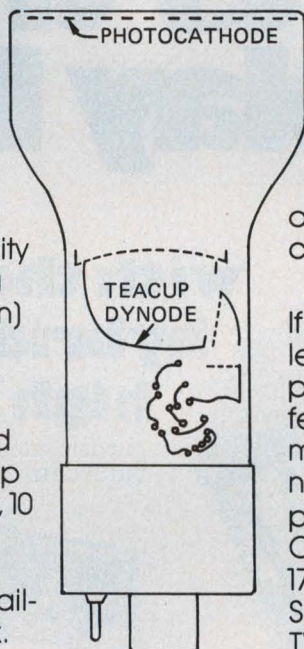

# RCA



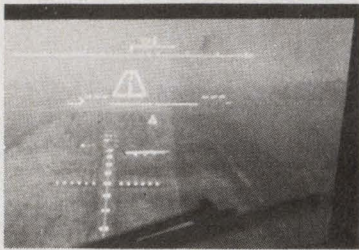

HEAD-UP DISPLAY SYSTEM

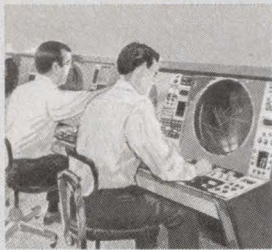

GROUND STATION DISPLAY SYSTEM

**DDC has done it again . . .** putting together a series of high reliability, ultra low-glitch display DACs that out-perform any others.

These low-noise, high-quality thick-film D/A converters are all processed in accordance with the exacting requirements of MIL-STD-883 . . . and are actively at work in such demanding environments as

head-up display systems, ground station displays, video processing systems and others where ruggedness and reliability are important! All are proven performers.

If your requirements are for the best possible display DACs, let us send you full details on these perfect problem solvers.

- ADH- 030 — high-speed 50MHz 12-bit thick-film hybrid in a 24-pin DDIP configuration. Features include current output with a settling time of 50ns for full-scale changes and 20ns for 1 LSB changes. Input is ECL logic compatible.
- DDAC — Ultra-low glitch available as two DDIP packages, plus TO-3 case with 13-bit output, programmable  $\pm 2.5$ ,  $\pm 5$  or  $\pm 10V$  outputs with 500 mA coax drive capability. 25ns one LSB settling, internal or external reference with short circuit protected output.
- SDAC — Compact 13-bit, 24-pin DDIP with settling times to  $\pm 0.1\%$  500ns at  $\pm 2.5V$ , 1 $\mu$ sec. at  $\pm 5V$  and 1.6  $\mu$ sec. at  $\pm 10V$ .

# DDC sets the pace in display DACs...

with the first hybrid, low glitch <sup>(500 mV•ns)</sup>, high performance <sup>(update rates to 50MHz)</sup> converters.

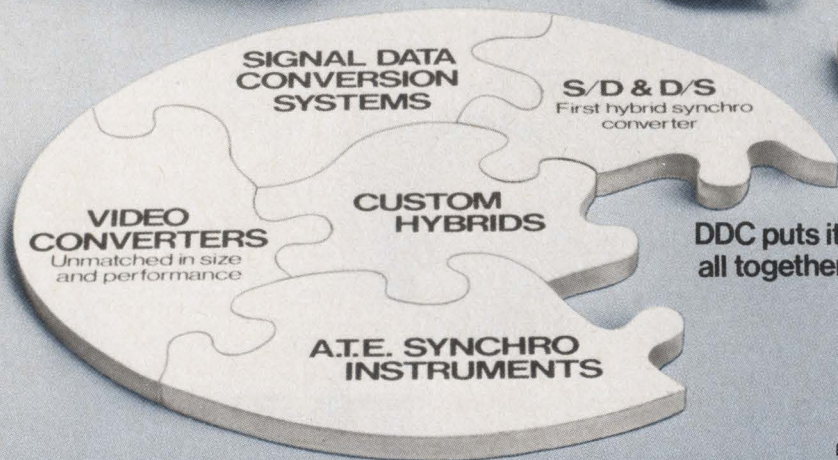
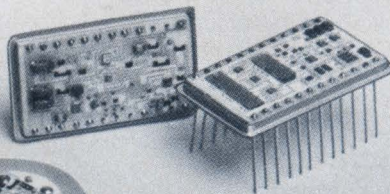
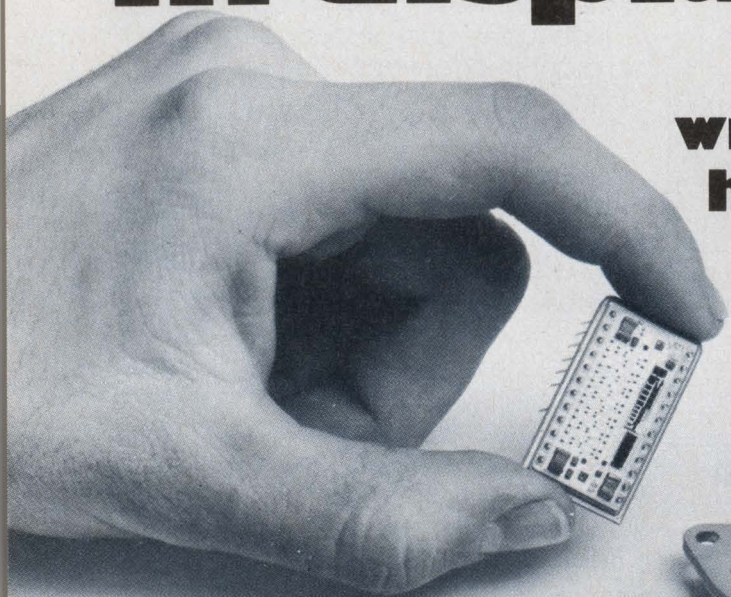

DDC puts it all together

ILC DOVER is the sole designer and manufacturer of the Apollo, Skylab and Space Shuttle space suits.



**ILC DATA DEVICE CORPORATION**

A Wholly Owned Subsidiary of ILC Industries, Inc.

AIRPORT INTERNATIONAL PLAZA  
BOHEMIA, LONG ISLAND, N.Y. 11716 • (516) 567-5600

West Coast: 7337 Greenbush Ave., N. Hollywood, CA 91605 • (213) 982-6454  
Interested engineers, write or call Harry Lewis or request data sheets.



# New products

## D/a offers tenfold speed boost over competition

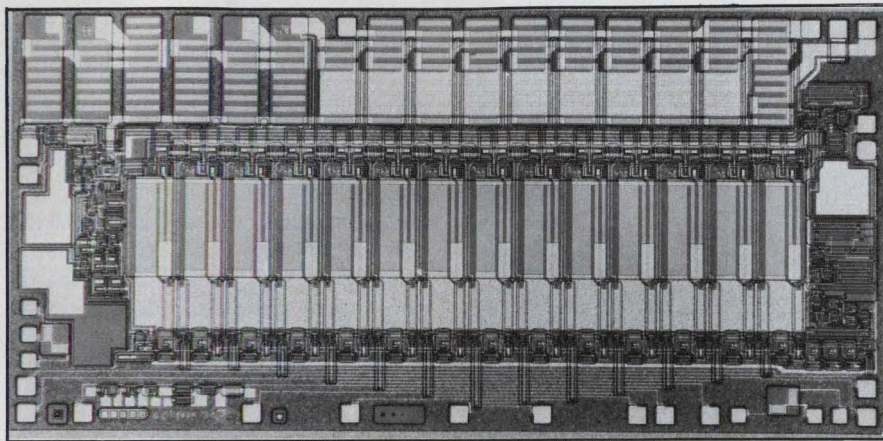

Harris Semiconductor, P.O. Box 883, Melbourne, FL 32901. Ernie Thibodeaux (305) 724-7407. P&A: See text.

Offering a settling time less than a tenth that of competing 12-bit "monolithic" d/a converters, the HA-562A reaches its final value in just 100 ns, maximum. The single-chip converter, developed by Harris Semiconductor, is pin-compatible with the dual-chip AD562 made by Analog Devices, Norwood, MA. But the HA-562A also includes internal high-frequency compensation, which must be added externally to the AD562.

The Harris circuit has a maximum nonlinearity of  $\pm 1/4$  LSB at 25 C and  $\pm 1/2$  LSB over the full temperature range of the particular model. At 25 C, the differential nonlinearity error is  $\pm 1/4$  LSB for the HA-562A-2 version and  $\pm 1/2$  LSB for the 562A-4 and 562A-5. As well as settling to within  $\pm 1/2$  LSB in 100 ns, the converter takes only another 50 ns to settle with  $\pm 1/10$  LSB.

Untrimmed gain error at 25 C is 0.3% of full scale, while offset error is kept to less than  $0.5 \mu\text{A}$ . Both gain and offset errors can be trimmed to zero at 25 C with external pots. However for all models, gain will drift by  $\pm 2$  ppm/ $^{\circ}\text{C}$  and offset by  $0.5$  ppm/ $^{\circ}\text{C}$  (unipolar mode) and  $\pm 3.5$  ppm/ $^{\circ}\text{C}$  (bipolar

mode). Differential nonlinearity drifts by  $\pm 2$  ppm/ $^{\circ}\text{C}$ .

Since it doesn't have an internal reference the converter can operate in a two-quadrant multiplying mode. Feedthrough for a 2-kHz reference source fed into the 7.2-to-8.8-k $\Omega$  input is typically  $\pm 1/2$  LSB. The converter current output has a  $\pm 0.75$ -V compliance and presents a 900-to-1100- $\Omega$  resistance. When used with an external op amp, the converter can deliver 0 to 5, 0 to 10,  $\pm 2.5$ ,  $\pm 5$  or  $\pm 10$  V.

Just like the AD562, the Harris circuit accepts TTL or CMOS-input levels, but delivers an output current of 0 to 5 mA for unipolar operation and  $\pm 2.5$  mA for bipolar operation—double that of the AD562. An external reference greater than +3 V or less than -3 V must be used in addition to the supplies of up to  $\pm 20$  V.

Active circuitry on the Harris d/a converter requires only 15% of the chip area. The rest of the 103- $\times$  209-mil chip is used to hold large R-2R ladder resistors; the large size of the resistors permits precise laser trimming.

Drawing approximately +15 and -20 mA from its supplies, the HA-562 dissipates 400 mW, maximum, in its 24-pin ceramic DIP. The operating temperature ranges are -55 to 125 C for the 562A-2; -25 to +85 C for the 562A-4; and 0 to 70 C for the 562A-5.

Faster than the AD562 but slower than the HA-562A is the DAC-12, a 12-bit d/a converter developed by Precision Monolithics, Santa Clara, CA. It settles in 300 to 500 ns and it is trimmed with a zener-zap technique instead of laser trimming of the resistor network. Exact prices for the converter have not yet been determined but are expected to start in the \$20 to \$30 range in 100-up quantities. Prices for the Analog AD562 range from \$39 for the 0-to-70-C model to \$100 for the -55 to +125-C version, in 100-unit quantities.

Prices for the Harris converters start at \$29 for the 562A-5 and increase to \$43 and \$108 for the -2 and -4, respectively, all for units in 100-up quantities. Delivery is from stock. Harris Semiconductor **CIRCLE NO. 303**  
Analog Devices **CIRCLE NO. 304**  
Precision Monolithics **CIRCLE NO. 305**

## Wideband op amp offers 320-MHz bandwidth

Plessey Semiconductors, 1674 McGaw Ave., Irvine, CA 92714. Dennis Chant (714) 540-9945. P&A: See text.

The SL1550 wideband amplifier has a bandwidth of 320 MHz and a typical noise figure of 2 dB or less at 100 MHz. A voltage-controlled agc range of 25 dB and an external gain control characteristic of  $\pm 1$  dB from -55 to +125 C are also available. The amplifier has an over-all gain of 38 dB, an output of 0.5 V rms, and requires only a single supply voltage between 6 and 9 V. Available in an eight-lead TO-5 can, the SL1550 costs \$25.25 in 100-unit quantities.

**CIRCLE NO. 320**

## Power Darlington's boost operating temp to 200 C

Motorola Semiconductor Products, P.O. Box 20924, Phoenix, AZ 85036. Lothar Stern (602) 244-6900. \$2.75 (100-up); stock.

Designed specifically for the high-voltage, high-current and harsh environmental requirements, the MJ10012 Darlington transistor operates over a -65 to +200-C range. Breakdown voltage,  $BV_{CEO}$ , is 400 V and the continuous collector current is 10 A. The Darlington has a safe operating area of 3.5 A at 50 V and can dissipate 100 W at 100 C. Gain of the TO-3 housed transistor at an  $I_C$  of 3 A is 300.

**CIRCLE NO. 321**



# DVM chips include 7-segment decoder and LED drivers

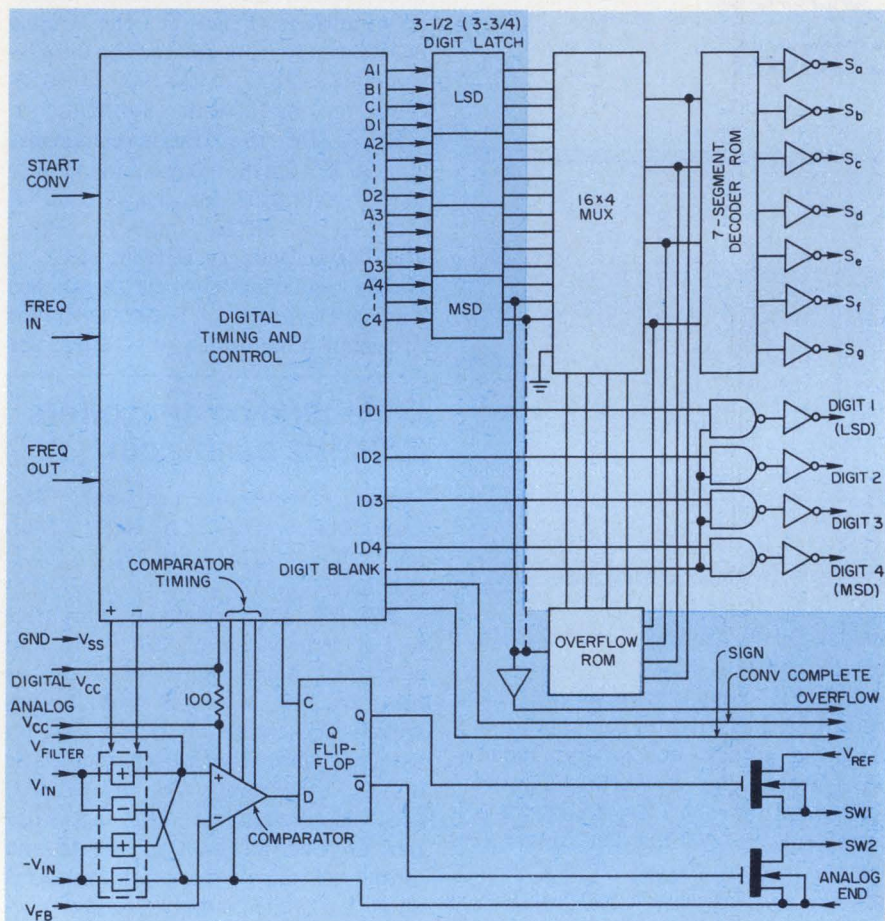

National Semiconductor, 2900 Semiconductor Dr., Santa Clara, CA 95051. Dennis Dauenhauer (408) 737-5000. From \$9.95 (100-up); 30 days.

Requiring just an external reference, some digit drivers and a LED display, the ADD3500 DVM chip includes all other conversion and drive circuitry for a 3-1/2-digit DPM. Housed in a 28-pin DIP, the chip contains a 3-1/2-digit a/d converter, seven-segment decoder and drivers, and clock circuits. A higher-resolution version, the ADD3700, provides a 3-3/4-digit display (3.999 instead of 1.999).

The accuracy is the same for both circuits: 0.05% +0, -1 count. Up to 10 conversions per second can be performed. Maximum converter-input currents have been kept to  $\pm 1$  nA.

If the converters' power supply isn't isolated, only one polarity of input

voltage can be converted. If the supply is isolated, either polarity of the input signal can be handled. A +2-V reference, also isolated from input ground, must be used, for dual-polarity measurements. It can be derived from the chip's power supply.

Both the 3500 and 3700 have definitive outputs to indicate overflow—the displays show +OFL or -OFL. This output feature "came for free" when the decoder ROM was designed.

Pulse-duration modulation is employed to perform the a/d conversion (see "CMOS Puts New a/d Technique Ahead of Dual-slope Method," ED No. 8, April 12, 1977, p. 36) and takes advantage of the nonlinear circuit performance of CMOS.

Except for the reference voltage only a +5-V power supply is required by the DVM chips. On the other hand, compet-

ing chips such as the LD110/111 from Intersil (Cupertino, CA), the MC14433 from Motorola (Austin, TX), and the LD130 from Siliconix (Santa Clara, CA) require at least two supplies—and external decoders and drivers if LED displays are used.

Both National chips can handle switched LED currents and maintain full-rated accuracy—if special care is taken. The converters can deliver 50-mA peak currents per segment, thus peak output currents as high as 350 mA flow in the chip. This current must be timed so that it doesn't influence the conversion section of the circuit. To prevent errors from degrading accuracy to 0.1%, a fast-recovery power supply must be provided for the LEDs so that switching transients are kept short. An inexpensive three-terminal regulator readily does the job.

National Semiconductor **CIRCLE NO. 306**  
Intersil **CIRCLE NO. 307**  
Motorola **CIRCLE NO. 308**  
Siliconix **CIRCLE NO. 309**

## Analog comparators have dual-channel control

Signetics, 811 E. Arques Ave., Sunnyvale, CA 94086. Robert Lanford (408) 739-7700. 100-up prices: \$6.33 (570), \$5.88 (571); stock.

Dual gain-control circuits, containing a complete compressor and expander in one linear IC, the NE570/571 provide a dynamic range of 110 dB. Either channel of the dual comparators can be used as a dynamic-range compressor or expander. Each channel has a full-wave rectifier to detect the average value of a signal, a linearized, temperature-compensated variable gain cell, an operational amplifier, and a bias system. The comparator section includes a THD trim terminal to permit offset voltages to be trimmed out. Other features include operation from a 6-to-16-V supply, a maximum power dissipation of 400 mW, and an operating temperature range of -40 to +70 C. The NE570/571 come in 16-pin DIPs.

**CIRCLE NO. 322**



# Insert components, wavesolder & test while flat...

**FLEXIBLE CIRCUIT COMBINED WITH HARDBOARD** is a Parlex specialty. One high-density homogeneous circuit and its built-in interconnection system replace individual PC boards and their associated connectors and discrete wiring. This example of advanced packaging geometry was designed, fabricated and automatically electrically tested at our 40,000 square foot modern plant in Methuen, Massachusetts.

## ...then fold to assemble.

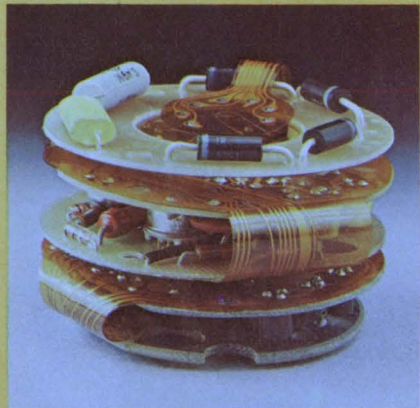

High-density flex-hardboard combinations of varied shapes that fold into small volumes are only one of Parlex's capabilities. We have dozens of ideas that solve interconnection and packaging design problems. And we handle everything from prototype to high volume production. Whether you are starting a design from scratch, redesigning, or simply want more information, consider Parlex.

For flex-circuits, flex-circuit hardboard combinations, multi-layers, flat cable and our many other interconnection products, call Dick Blais at 617-685-4341, or write Parlex Corp., 145 Milk St., Methuen, Massachusetts 01844

**Parlex**  
CORPORATION

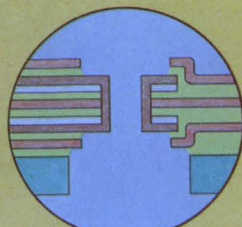
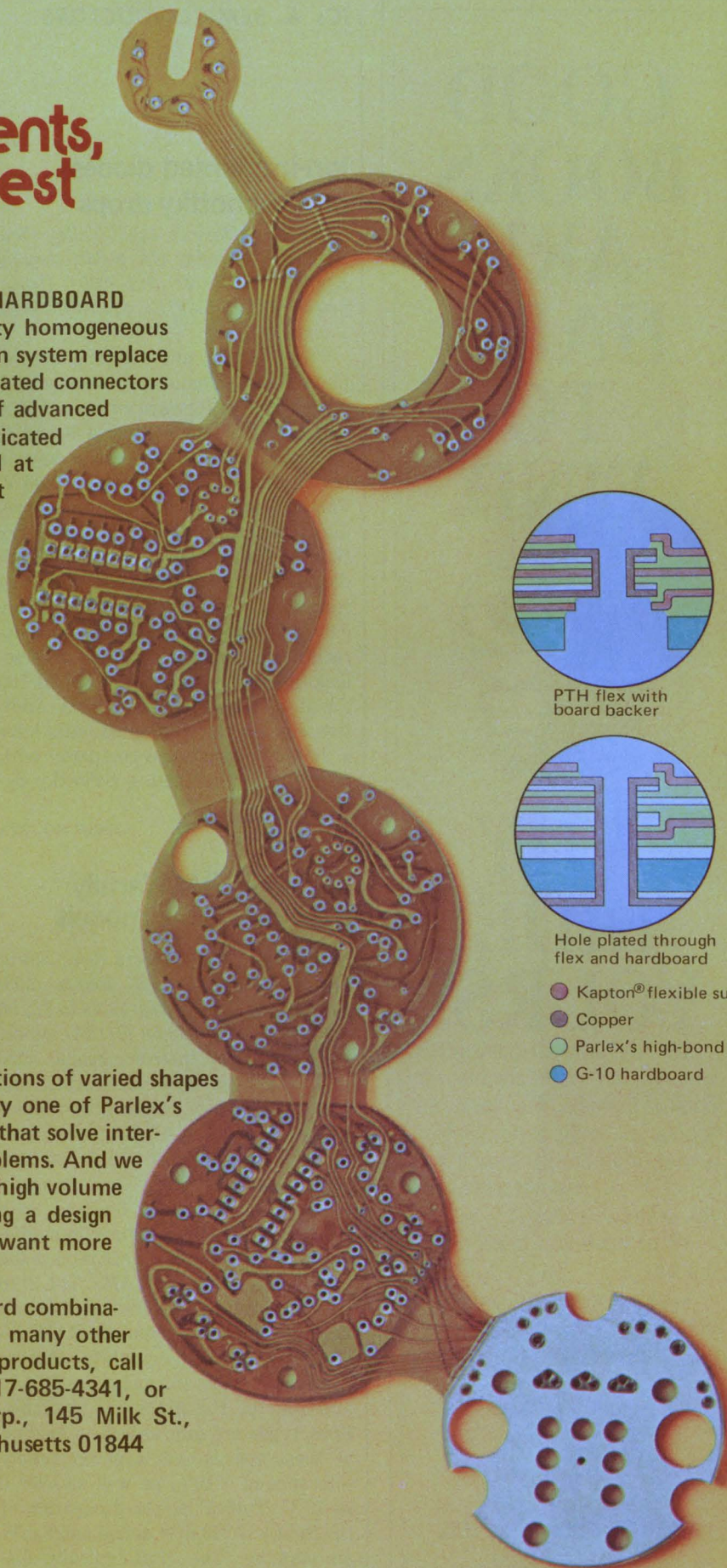

PTH flex with  
board backer

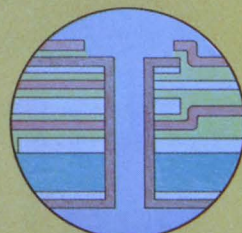

Hole plated through  
flex and hardboard

- Kapton® flexible substrate
- Copper
- Parlex's high-bond adhesive
- G-10 hardboard

*Actual size of circuitry*



# GOOD BOOKS ARE HARD TO FIND.



# WHY HIDE YOURS?

We are always looking for well-written manuscripts, or book proposals, for works on topics of interest to professional engineers that will advance their understanding of the state of their art.

What have you been working on?

What can we do for each other?

Let me know.

**S. WILLIAM COOK**  
EDITORIAL DIRECTOR



**Hayden Book Co., Inc.**  
50 ESSEX STREET  
ROCHELLE PARK, N.J. 07662

## ICs & SEMICONDUCTORS

### Ion-implanted diodes offer Schottky drops

*Solid-State Devices, 14830 Valley View Ave., La Mirada, CA 90638. Arnold Applebaum (213) 921-9660. 100-up prices: \$11.25 (6097E), \$13.90 (6098E); 4 wks.*

The 1N6097E and 1N6098E ion-implanted diodes handle an average half-wave rectified forward current of 50 A with a dc blocking voltage of 30 and 40 V, respectively. Both devices have a maximum forward voltage of 0.86 V. The ion-implantation technique produces a maximum reverse-recovery time of 75 ns with 50 ns typical. Both diodes have a -65 to +175-C operating range and a thermal resistance of only 0.8 C/W. There is no temperature derating up to 125 C while reverse-leakage current at rated voltage is 100  $\mu$ A at 25 C and 2 mA at 125 C. Additionally, the ion-implanted units have a 700-pF capacitance compared with 7000 pF for competing Schottky devices.

CIRCLE NO. 323

### Dynamic RAM family has 4 and 16-k models

*Intel Corp., 3065 Bowers Ave., Santa Clara, CA 95051. Bill Regitz (408) 246-7501. 100-up prices: \$9.95 to \$14.95 (2104A), \$47 to \$62.50 (2116A); stock.*

A family of interchangeable 4096 and 16,384-bit dynamic RAMs, the 2104A/2116 units, can directly replace many of the 16-pin, 4-k RAMs now used in many systems. The 2104A and 2116 series are electrically and logically compatible, allowing 4-k and 16-k RAMs to be easily combined in memory systems. The 2104As can replace the 2104 and similar 4-k RAMs. The 2116 types are improved versions of Intel's 2116 16-pin, 16-k dynamic RAM introduced in January, 1976. Access times as short as 150 ns for the 2104As and 200 for the 2116s are available. Both types are guaranteed to operate at these speeds over a power supply tolerance of  $\pm 10\%$ , as well as over 0 to 70 C. Typical power dissipation of the 2104A is 240 mW active and 8 mW on standby. The 2116 typically dissipates 588 mW active and 14 mW on standby.

CIRCLE NO. 324

### CCD memory chip holds 65 kbits in 16 pin DIP

*Texas Instruments, P.O. Box 5012, Dallas, TX 75222. (214) 238-2011. \$195 (unit qty); stock.*

Able to hold 65,536 bits of data, the TMS3064 charge-coupled device memory is organized externally as 65,536 one-bit words. Internally the CCD chip has 16 addressable 4096-bit serial-parallel-serial loops. The two non-overlapping clocks and the chip-enable inputs can be driven by standard MOS-level drivers. All other inputs have 200 mV of dc noise immunity when interfacing with standard TTL. No pull-up resistors are required. The three-state output will drive at least two standard series 74, 74S or 74LS loads without the use of pull-up resistors. The maximum data rate is 5 Mbits/s and access time is 800  $\mu$ s, minimum. The TMS3064 has a typical operating power dissipation of 300 mW at 5 MHz and a standby power dissipation of less than 30 mW. The memory comes in a 16-pin ceramic DIP package with pin rows on 400-mil centers and is designed for operation over a 0-to-70-C range.

CIRCLE NO. 325

### Power transistors switch fast and handle 70 A

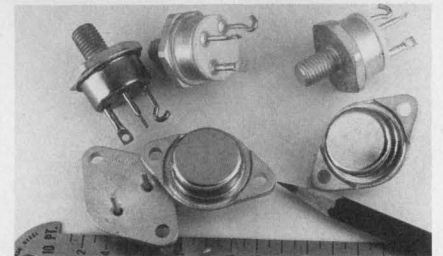

*Semicoa, 333 McCormick Ave., Costa Mesa, CA 92626. Robert Boughan (714) 979-1900. 100-up prices: from \$33 (TO-3 cases); stock.*

Double-diffused npn power transistors designed for switching applications offer only a 0.01- $\Omega$  resistance with a 70-A collector current. The devices have a 0.5  $\mu$ s  $t_{on}$  and  $t_{off}$  and a 1- $\mu$ s storage time. Their  $E_{S/B}$  is guaranteed at 200 millijoules, which is claimed to be two to five times the guaranteed ratings of competitive devices. The  $I_{S/B}$  is rated at 25 A and the saturation voltage is a low 0.7 V at rated collector current. Maximum  $f_t$  is 30 MHz with an  $I_C$  of 10 A; beta is typically 10 at 70 A. The family of available transistors is available with  $V_{CEO}$ 's of 80 to 150 and comes in TO-3, TO-59, TO-61, and TO-63 packages.

CIRCLE NO. 326



## Compensated amps mix MOSFETs and bipolars

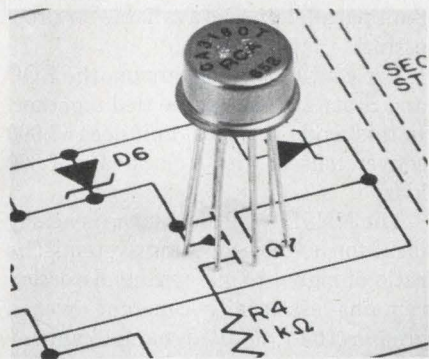

RCA Solid State Div., Box 3200, Somerville, NJ 08876. (201) 685-6423. From \$0.80 to \$9.95 (1000-up); stock.

Complete with on-chip frequency compensation, the CA3160 series of BiMOS op amps combine MOSFET inputs, CMOS outputs and bipolar devices. The CA3160, CA3160A, and CA3160B are frequency-compensated versions of the older CA3130 op amps. The input stage has an input impedance of  $1.5 \times 10^{12} \Omega$ , typical, and an input current of 5 pA at 15 V typical. The output stage can swing the voltage to within 10 mV of either supply-voltage terminal. Other CA3160 features include a bandwidth of 15 MHz, a slew rate of 10 V/ $\mu$ s (unity-gain follower) and a strobing capability to reduce standby power consumption. The three versions operate over the temperature range of  $-55$  to  $+125$  C, and are available in 8-lead TO-5 packages with either straight or dual-in-line formed-leads.

CIRCLE NO. 327

## Digital multipliers offer MIL temp ranges

TRW, One Space Park, Redondo Beach, CA 90278. Bill Koral (213) 536-1500. 100-up prices for MIL versions: \$115, \$170, and \$225 for the MPY 8, 12 and 16, respectively; stock.

The 8, 12 and 16-bit bipolar multipliers, the MPY 8, 12 and 16, are now available in military-temperature-range versions in addition to the previously announced commercial range versions. Both 12 and 16-bit multipliers come in 64-pin ceramic flat packages with built-in heat studs. They will also be available in 64-pin ceramic DIPs that have integrated heat sinks for  $-55$  to  $+125$  C. The MPY-8 will be supplied only in a 40-pin ceramic DIP. In addition to the full MIL-temp units, devices fully qualified to level B of MIL-38510 will be available.

CIRCLE NO. 328

# CCPD

## WHAT IS CCPD?

It is the ultimate image sensor just introduced by RETICON. It takes advantage of the best features inherent in both CCD and RETICON's long-established photodiode array technology. It uses a CCD register for readout, providing a low capacitance, low-noise output—and diffused photodiode sensors for uniform response, high quantum efficiency, and freedom from blooming. Our CCPD™ image sensors are available with 256 to 1728 elements on 16  $\mu$ m centers.

## COMPARE THESE FEATURES.

	CCD	CCPD*
● Low Noise, Low Light Level Performance (Low Output Capacitance)	Yes	Yes
● Low Dark Current (allows operation up to 40 msec integration time).	No	Yes
● Smooth Spectral Response (No Interference Pattern)	No	Yes
● Full Silicon Spectral Response (Including Blue and UV)	No	Yes
● High Resistance to Blooming	No	Yes
● High-Volume Production Process	No	Yes

\*Charge Coupled PhotoDiode

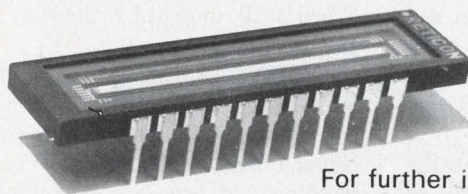

For further information, write or call:

# RETICON®

AN EG&G COMPANY

910 Benicia Ave. • Sunnyvale, California 94086 • (408) 738-4266



# Tiny companding a/d crams 72 dB of input into 8 bits

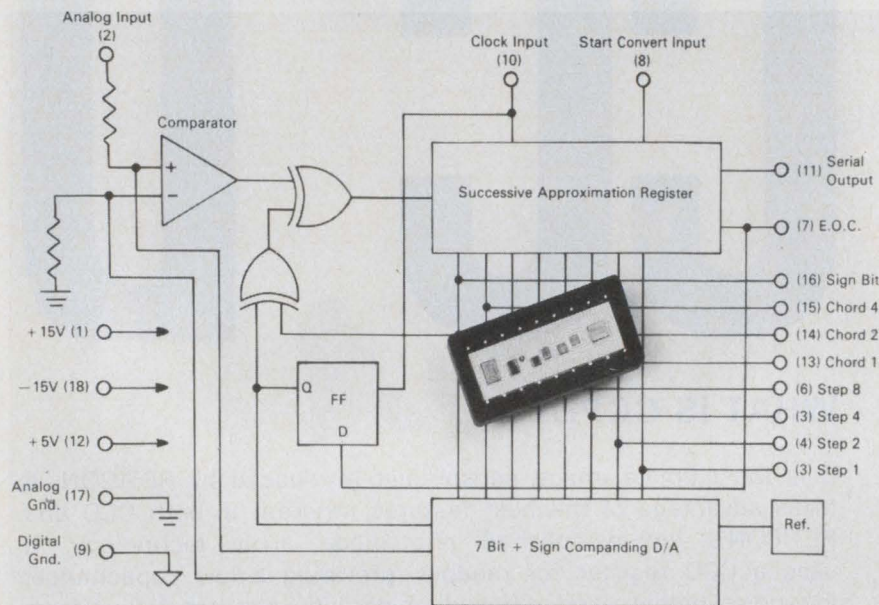

Micro Networks, 324 Clark St., Worcester, MA 01606. J. Munn (617) 852-5400. \$69 (1-24 qty); stock to 2 wks.

Signals with wide dynamic ranges can now be resolved with up to 12-bit accuracy using an 8-bit output a/d converter in an 18-pin DIP. The MN 5110, a companding converter, compresses analog inputs into a 7-bit-plus-sign output code, which covers a 72-dB dynamic range.

Micro Networks' thin-film hybrid a/d circuit is a companion to Precision Monolithics' COMDAC chip—an 8-bit companding d/a converter. In fact, the MN 5100 uses PMI's IC as a component.

To get an approximately logarithmic transfer function (Bell  $\mu$ -235 law), the analog range is broken up into eight binarily related "chords." Each chord is divided in turn into 16 linearly related steps.

Two waveforms (see photo) show the increased resolution at low voltages of the companding a/d (top trace) with respect to a linear a/d (bottom trace).

The finest step size occurs in chord 0. Here each step represents 1.25 mV (based on  $\pm 5$ -V full scale). The accuracy and resolution in chord 0 is equivalent to those of a sine-plus-12-bit a/d converter.

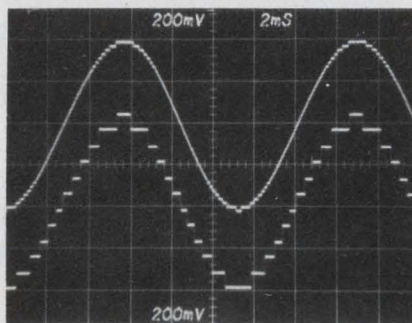

In chord 1, the step size is doubled to 2.50 mV and is equivalent to an 11-bit-plus-sign converter. Doubling the step size proceeds for each successive chord until, in chord 7, the step size is 150 mV.

The MN5110 operates like a standard 8-bit successive-approximation a/d converter. But instead of a conventional binary-weighted d/a, the companding a/d uses a companding d/a (described in ED No. 9, April 26, 1976, p. 111). In addition, logic for initial input-polarity determination is included.

Conversion begins when the Start line is low during a low-to-high transition of the Clock. After the sign bit is determined, the three bits that select

the chord are successively latched in. Then the four step-bits follow. When End of Conversion (EOC) goes low, the 8-bit parallel word is available for processing.

For continuous conversion, the EOC and Start signals can be tied together. In this mode, a typical unit does 67,000 conversions/s, with a clock rate of 600 kHz.

The MN5110's performance is nearly ideal for a voice-encoding system. The ratio of signal to quantizing distortion remains essentially constant over a greater than 40-dB dynamic range.

Signal compression or expansion has been widely used to optimize signal-to-noise ratios in information transmission. The best example is in the telecommunications industry, where a large dynamic range of voice signals is compressed into 8-bit digital words to be transmitted by pulse-code modulation. At the receiver, the words are converted and expanded back to the full analog range.

Since the converters are most accurate near the zero point, they are well-suited for servo loops—where signals must be nulled. The 8-bit units, of course, interface neatly with 8-bit  $\mu$ P data buses.

In many instances, the MN5110 can replace a complex system that uses a conventional converter and gain-ranging amplifiers.

CIRCLE NO. 302

## Load cells stretch range down to 10 lb

Interface, Inc., 7401 E. Butherus Dr., Scottsdale, AZ 85260. (602) 948-5555. From \$150 (unit qty); stock.

Two low-range models of strain-gauge load cells, the SM-10 and SM-25, add 10 and 25 lb (45N and 111N) capacities to the Super-Mini line of 50, 100, 250, 500 and 1000 lb (222N, 445N, 1112N, 2225N and 4450N) capacities. The entire series boasts tempcos for zero and sensitivity of 8 ppm/ $^{\circ}$ F. Additional features include 0.03% nonlinearity, 0.02% hysteresis and 0.01% nonrepeatability. Creep is less than 0.03% after 20 min. The series' 3-mV/V output signal simplifies interfacing and a 5-ft four-conductor shielded cable is provided.

CIRCLE NO. 329



# Same great name. Same great color.

## And now a neat new way to definitive display performance.

# DOT MATRIX

Consider the new Noritake-Ise dot-matrix line-up—  
9, 10, 16, 20 and 40-character line displays.  
Variety aimed at giving you more design potential.  
Or consider our unique 400-dot graphics display  
with 17m/m depth and low 35V drive rating.  
It's aimed at helping you think low voltage,  
portability and economy all at the same time.

In short, consider Noritake-Ise period  
for dot matrix (or segmental) displays.  
Itrons always help you design more competitively.

**itron**®



**DC209A2**

Dimension: 41(H)×208(W)×10.5(D)mm Character Size: 9.0(H)×6.3(W)mm

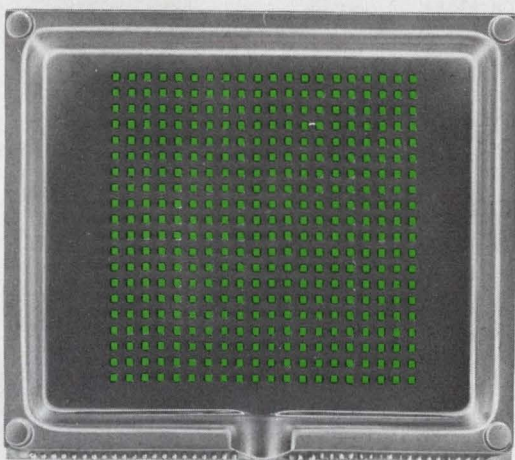

**FG400DA1**

Dimension: 114(H)×130(W)×17(D)mm



**DC95A2**

Dimension:  
24(H)×75(W)×7.2(D)mm  
Character Size:  
5.05(H)×3.55(W)mm



**FG48D6**

Dimension:  
25.5(H)×56.5(W)×7(D)mm  
Character Size:  
8.0(H)×4.2(W)mm

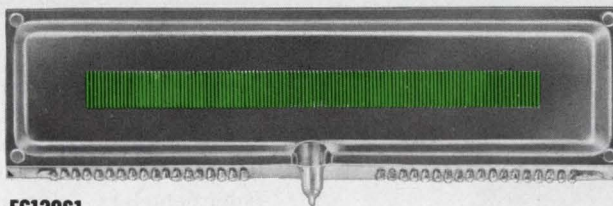

**FG120S1**

Dimension: 39(H)×138(W)×12.5(D)mm



**FG209M2**

Dimension: 41(H)×208(W)×10.5(D)mm Character Size: 9.0(H)×5.4(W)mm

## NORITAKE CO., LTD.

### Electronics Division

1-1, Noritake-Shinmachi, Nishi-ku,  
Nagoya-Shi, Japan  
Phone: NAGOYA (052) 561-7111  
Telex: J59738 NORITAKE

### Electronics Office (U.S.A.)

22410 Hawthorne Blvd.  
Torrance California 90505, U.S.A.  
Phone: (213) 373-6704  
Telex: 230674910

### F.R. Germany

NEUMULLER GmbH 8 Muenchen 2,  
Karlstrasse 55, F.R. Germany  
Phone: 592-421  
Telex: 522106

### U.K.

### ITT Component Service

Refuge House, River Front,  
Enfield, Middx, England  
Phone: 01-363 7459  
Telex: 21637

### Hong Kong

Room 1403 Shing Loon Bldg,  
24-26 Stanley Street, Hong Kong  
Phone: 5-232420 Telex: HX83151  
**Taipei**  
72-9 SEC 2, JEN AI RD., Taipei  
Phone: 351-0293 Telex: 11176

### Manufacturer:

### ISE ELECTRONICS CORP.

P.O. Box 46, Ise-shi,  
Mie-Pref., Japan  
Phone: (05963) 5-2121 to 4  
Telex: 4969523

CIRCLE NUMBER 73



## MODULES & SUBASSEMBLIES

### Small amp blasts out 10W of clean audio

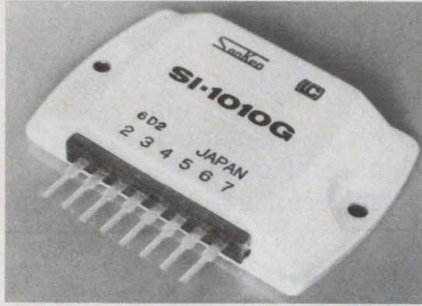

Energy Electronic Products, 6060 Manchester Ave., Los Angeles, CA 90045. T. Nixon (213) 670-7880. \$5.20 (100 qty); stock.

You get 10 W of linear output from the hybrid SI-1010G made by Sanken in Japan. The module features less than 0.5% total harmonic distortion at 10-W output. The class-B, quasi-complementary circuit uses flip chip transistors and passivated-chip power transistors with high secondary-breakdown strength. The amp operates from single or split input power.

CIRCLE NO. 331

### Digitize 4096 levels over full temp range

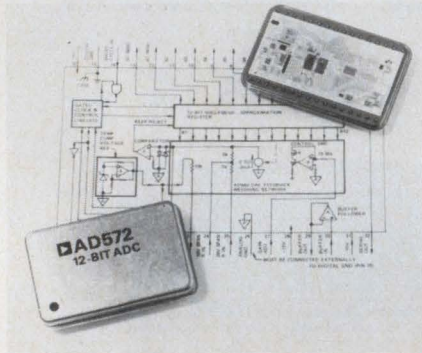

Analog Devices, Route 1 Industrial Park, P.O. Box 280, Norwood, MA 02062. J. Mills (617) 329-4700. \$250 (1 to 24); stock to 4 wk.

Because of its mere 900-mW dissipation, the 12-bit AD572S a/d converter operates from  $-55$  to  $+125$  C with no missing codes. The successive-approximation unit features the following maximum specs: nonlinearity of  $\pm 0.012\%$ , conversion time of  $25 \mu\text{s}$ , and tempcos of  $\pm 25$ -ppm/ $^{\circ}\text{C}$  (gain) and  $\pm 10$ -ppm/ $^{\circ}\text{C}$  (reference). Lower cost A and B versions operate with no missing codes over  $0$  to  $70$  C and  $-25$  to  $+85$  C, respectively. Processing to meet MIL-STD-883, Method 5004, Class B is available for these dual-in-line devices.

CIRCLE NO. 332

### Chopperless high-gain op amp nails drift

National Semiconductor, 2900 Semiconductor Dr., Santa Clara, CA 95051. L. James (408) 737-6523. From \$7.60; stock.

Featuring max noise of  $(0.7\text{-}\mu\text{V pk-pk})$  and min gain of 120 dB the LH0044 op amp family is intended to replace chopper-stabilized amps. The devices boast max initial offsets of  $25 \mu\text{V}$ , max offset drift of  $0.5\text{-}\mu\text{V}/^{\circ}\text{C}$  and min CMRR of 120 dB. Models are specified from  $-55$  to  $+125$  C, or  $-25$  to  $+85$  C. The T0-5 device is pin compatible with LM108A, LH725, and LM741 op amps.

CIRCLE NO. 333

### Unit gauges analog voltages

Calex Mfg., 3305 Vincent Rd., Pleasant Hill, CA 94523. R. Kreps (415) 932-3911. \$68; stock to 2 wks.

You can monitor precisely low-level signals with the 546 Multi-function Voltensor. The module has: a triple op-amp instrumentation amplifier; two comparators; logic to provide HI, Lo and GO signals; and three high-level output stages capable of sinking 100 mA or sourcing 20 mA. The device features a differential impedance of  $1000 \text{ M}\Omega$  and input ranges of  $\pm 100$  mV,  $\pm 1$  or  $\pm 10$  V that are pin selectable. The set points can be externally adjusted using potentiometers. Both the HI and LO comparators can be made to latch or to have variable hysteresis by means of pin selection. Four different mounting kits are available for the  $2 \times 2 \times 0.6$ -in. module that provide potentiometers, output relays, or jumpers as required.

CIRCLE NO. 334

### Sharp-cutoff filters span wide range

T T Electronics, Inc., 2214 Barry Ave., Los Angeles, CA 90064. (213) 478-8224. From \$80; 3 wks.

Series-Q bandpass filters feature bandwidth ratios of 2:1 for 3-to-40-dB bandwidths. The 40-to-3-dB cut-off-frequency ratio is 1.05 for some models. You can get center frequencies ( $f_c$ ) from 10 kHz to 50 MHz and any bandwidth from 5 to 20% of  $f_c$ . These hermetically sealed filters come in both chassis-mounting and PC-board cases.

CIRCLE NO. 335

### I/O boards open $\mu\text{C}$ to analog signals

Burr-Brown, International Airport Industrial Park, P. O. Box 11400, Tucson, AZ 85734. G. Athey (602) 294-1431. From \$120; stock.

Both the 4216 (16-channel input board) and 4102 (2-channel output board) mate with 4 or 8-bit Pro-Log  $\mu\text{Cs}$ . The boards can be treated as memory by the CPU—each channel requires one 8-bit memory location. Each board's address block is strap selectable, so a board can be located anywhere in memory. Alternatively, the systems can be treated as I/O. An input board is a 16-channel differential-input system with full-scale input ranges between  $\pm 10$  mV and  $\pm 10$  V. Analog inputs are converted with 8-bit resolution. Throughput accuracy ranges from  $\pm 0.5\%$  of full-scale reading on the  $\pm 10$ -V range, to  $\pm 0.7\%$  of full-scale reading on the  $\pm 10$ -mV range. Conversion time is  $60 \mu\text{s}$ . Output boards contain two channels, each with 8-bit resolution and a throughput accuracy of  $\pm 0.4\%$  of full scale.

CIRCLE NO. 336

### Single board gives $\mu\text{C}$ 8 analog outputs

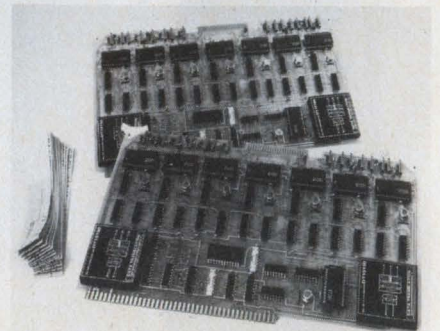

Data Translation, 23 Strathmore Rd., Natick, MA 01760. F. Molinari (617) 655-5300. See text; stock.

An 8-channel d/a converter system is mechanically, electrically and software compatible with Intel's SBC-80  $\mu\text{C}$ . Two single-board models are available: the 12-bit DT1842, priced at \$995 for 8 channels or \$695 for 4 channels; and the 8-bit DT1843, costing \$795 for 8 channels or \$495 for 4 channels. On-the-board 4-to-20-mA current-loop outputs are optionally available at \$30 per output. Features of these systems include  $\pm 1/2$ -LSB linearity and  $3\text{-}\mu\text{s}$  settling time to 0.01% of full scale.

CIRCLE NO. 337



# 8080 Core

**non-volatile • high reliability**

Dataram introduces the industry's widest range of byte-designed single-board core systems for 8080 and other byte-oriented applications.

And when Dataram says "byte," we mean true byte systems — with 1K to 32K bytes, 8 to 10 bits/byte, not 16 or 18 bits/word systems that simulate byte systems.

What that means to you is less power and fewer components... and that means more for less. More reliability and more performance with smaller size... and lower product costs.

8080 Core. For people who think small.

Find out more about 8080 Core today. Return this coupon at once, or call us at 609-799-0071.

SYSTEM	CAPACITY	CYCLE/ ACCESS	DIMENSIONS	VOLTAGES	TYPICAL POWER	COMPATIBILITY
DR-180	4K x 8 8K x 8	750/250 ns 750/250 ns	9.2" x 6.3" (233.4 mm x 160 mm)	+5V, +12V	30 Watts	8080 Microprocessor
DR-121	1K x 10 2K x 8 2K x 10	900/350 ns 900/350 ns 900/350 ns	11.7" x 11.5" (297 mm x 292 mm)	+5V, -12V	25 Watts	Cambridge Memories' 1K x 9 Unicore
DR-104	4K x 9 8K x 9 16K x 9 32K x 9	750/350 ns 750/350 ns 750/300 ns 800/300 ns	13.5" x 8.3" (343 mm x 211 mm)	+5V, -12V	32 Watts	National Semiconductors' MOSRAM 104

In addition to standard systems, Dataram offers impressive custom design capabilities.

- I'd like to learn more about 8080 Core.
- Please send information
  - Please have a salesman contact me
  - Please have a technical type call me.

Name \_\_\_\_\_  
 Title \_\_\_\_\_ Phone \_\_\_\_\_  
 Company \_\_\_\_\_  
 Address \_\_\_\_\_  
 City \_\_\_\_\_ State \_\_\_\_\_ Zip \_\_\_\_\_

- Please send me information about BULK CORE:  
256K byte memory system on a single board
- Please send me information about mini-memories for  
minicomputers

See  
8080 CORE  
at the  
'77 NCC  
Booths  
1025-1029



PRINCETON-HIGHTSTOWN ROAD  
CRANBURY, NEW JERSEY 08512  
TEL: 609-799-0071 TWX: 510-685-2542



# let's calibrate

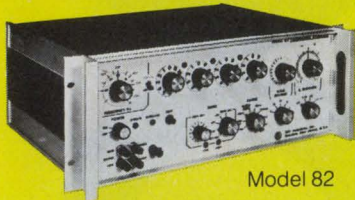

Model 82

## PRECISION STANDARD for AC/DC Voltage and Current

- Tests a wide range of analog and digital meters
- AC and Bipolar DC voltage ranges of 100mV, 1V and 10V
- AC and Bipolar DC current ranges of 100uA, 1mA, 10mA and 100mA
- Nominal accuracies of 0.01% DC and 0.05% AC
- Percent error deviation dial
- Frequency variable from 40Hz to 1kHz
- Four fractional scale division ranges



Model 829G

## Measure or supply with one instrument

- AC or DC voltages from 10 mV to 1400V
- Current from 10 uA to 14A
- 10 cardinal resistance values from 0.01 ohm to 10 megohms
- 5-digit readout



## COMPLETE VOLTAGE, CURRENT & WATTMETER CALIBRATOR

- For calibration of wattmeters from 0.05 watt to 14 kilowatts
- Consists of two Model 829G's and a Model 5058A Wattmeter Calibration Module
- Available as individual units or, as shown, in an attractive customized enclosure with work table.



Call or write for full information  
**RFL Industries, Inc.**  
Instrumentation Division  
Boonton, N.J. 07005

EST. 1922

Tel: (201) 334-3100 / TWX: 710-987-8352  
Cable: RADAIRCO, N.J.

CIRCLE NUMBER 75

## MICRO/MINI COMPUTING

### Line printers handle alphanumeric characters

*C. Itoh Electronics, 280 Park Ave., New York, NY 10017. Floyd Makstein (212) 682-0420. See text; 7022T; stock; 7080, 4 months.*

Able to print 22 or 80 characters per line, two printers, the 7022T and 7080, respectively, use a dot-matrix approach. Both units are impact printers and print at 1.58 and 1 line per second, respectively. The 7022T has a maximum print line of 1.86 in., a top of form sensor option and can handle form thicknesses of up to 0.015 in. It includes a print element of seven solenoids and requires external circuit-

ry to drive the solenoids. The printer measures 6.4 × 6.85 × 4.62 in. and costs \$125 in 500-unit quantities. The 7080 has two printheads, dividing a page into two 40 column halves and has a print line capability of 6.67 in. and a character height of 0.123 in. It costs just \$250 (not including electronics) when purchased in 500-unit lots and measures 5.22 × 12.438 × 4.415 in.

CIRCLE NO. 338

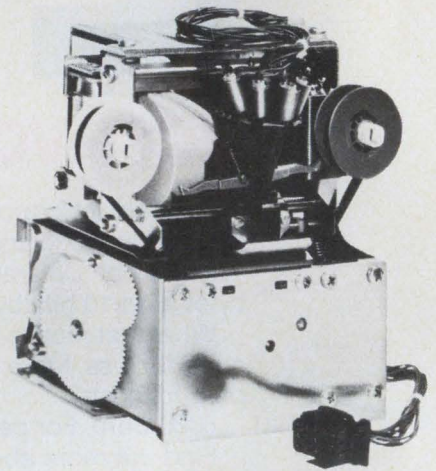
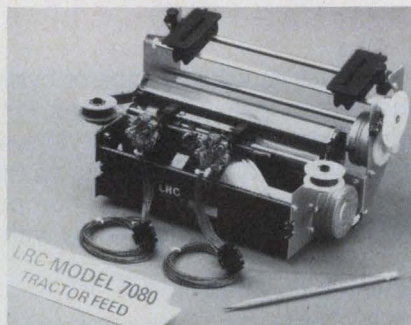

### 6800 text editor offers many features

*Technical System Consultants, Box 2574, West Lafayette, IN 47906. Dave Shirk (317) 742-7509. See text; stock.*

Developed to support the 6800 microprocessor, the SL68-24 text editing program is claimed to be the most extensive 6800 editor available. It includes commands such as Print, Insert, Delete, Find, Replace and Verify as well as pointer movers for file Top, Bottom, as well as commands for tabs, line numbers, renumbering, overlaying, headings, zoning and for reading, writing and saving programs. The editor requires approximately 5 k of RAM. For \$23.50 the company provides a complete source listing, hex dump listing, sample output and users manual. An additional \$6.95 buys a cassette listing and \$8 buys a paper tape.

CIRCLE NO. 339

### Compact microcomputer slips into briefcase

*Cybersystems, 4306 Governors Dr. West, Huntsville, AL 35805. (205) 837-2080. From \$525; stock.*

Ready to plug into the line and operate, the MicroCyber 1000 microcomputer is compact enough to fit in a briefcase. The 14 × 11 × 2-in. computer is based on the MOS Technology 6502  $\mu$ P and includes 1024 bytes of RAM and 2048 bytes of ROM. In the ROM is the operating system for the cold-start bootstrap, TTY handlers, keyboard and display handlers, and audio-cassette handlers. The computer comes with a full hex keyboard and six-digit LED display for address and data. For further expansion, a 72-pin I/O and memory expansion bus connector is included.

CIRCLE NO. 340



## Compiler program accepts assembly or PL/M codes

*Intermetrics, 701 Concord Ave. Cambridge, MA 02138. Mary Allard (617) 661-1840. \$1000 (mag tape).*

PL/M6800, a high level programming language for the 6800 microprocessor, permits the user to intersperse assembly code between PL/M6800 statements. The compiler is accessible via the NCSS time-sharing network, or can be purchased directly from the company for in-house installation on IBM 360 or 370 computers. PL/M6800 has a one-pass compiler that produces optimized directly loadable object code. It offers a user-controlled switch that determines whether the emitted code is in the AMI or Motorola loader format. Other user controlled features include listings of source code, object code, and/or assembler code; as well as symbol table dumps. About 300 kwords of memory space are needed to hold the program.

CIRCLE NO. 341

## Expansion boards flex SBC/System 80 muscles

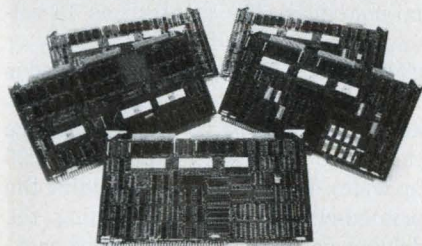

*Intel Corp., 3065 Bowers Ave., Santa Clara, CA 95051. George Adams (408) 246-7501. Single-unit prices: \$775, \$875, \$1375, \$425 and \$395 for the SBC 104, 108, 116, 517 and 519, respectively.*

Designated the SBC 104, 108, 116, 517 and 519, five memory expansion boards have been added to the SBC 80 single board and System 80 microcomputer systems. Each board interfaces directly with any SBC 80 or System 80 via the system bus. The SBC104/108/116 series are combination RAM, EPROM and serial and parallel I/O expansion boards containing 4, 8 and 16 kbytes of RAM, respectively. The SBC517 is a combination I/O expansion board containing 48 programmable parallel I/O lines and a full RS-232-C programmable serial channel, with addressing and connectors directly compatible with the SBC 104/108/116 series. The SBC519 provides 72 programmable I/O lines which can be expanded via direct bus interface.

CIRCLE NO. 342

## Processor board uses Z80 but runs SBC 80/10 code

*Mini Micro Mart, 1619 James St., Syracuse, NY 13203. Maury Goldberg (315) 422-6666. From \$199.95 (kit); stock.*

Software compatible with the Intel SBC 80/10 board, the RM Z80 single-board  $\mu$ P system, provides space for three on-board 2708 PROMs, 1 k of static RAM, two 8255's (providing nine parallel ports), and an 8251 USART for a serial interface. Both a 20-mA cur-

rent loop TTY and an RS-232-C interface are also on the board. Provisions for baud rates from 110 to more than 9600 are available. Full address decoding is provided for both the on-board memory and the I/O devices. With minor modifications the RM Z80 will also run Altair, Imsai, and Processor Technology software. The board measures 7 x 10.5 in. and has gold connector fingers on a dual 43 (0.156 in. centers) format.

CIRCLE NO. 343

# Pinpoint The Problem

## HP's Current Tracer locates low impedance logic faults.

By tracing current to sources or sinks, it can find the one bad component on a bus, pinpoint hairline solder bridges or backplane shorts. It quickly troubleshoots wired AND/OR and 3-state busses in all logic families. No cutting circuit traces or removing good circuit elements. Sensitive only to AC currents with fast transitions; adjustable sensitivity of 1 mA to 1 A; single lamp readout displays relative current levels. Model 547A, \$350\*. Also available are HP's 546A Programmable Logic Pulser for single pulse or streams (\$150\*) and HP's Logic Probes and Clip for voltage based problems. \*Domestic U.S. prices only.

Northeast, contact Schweber: Westbury, NY; Somerset, NJ; Danbury, CT. West, contact Wyle-Elmar: Denver, CO; Mt. View, CA. Wyle-Liberty: Seattle, WA; Phoenix, AZ; San Diego, CA; El Segundo, CA. Elsewhere, contact your nearby HP sales office, or write.

HEWLETT  PACKARD

1507 Page Mill Road, Palo Alto, California 94304





MILITARY  
APPLICATIONS

# AD CONVERTERS

by

## MSK

Accuracy

Speed

Size

Repairability

Military

Temp. Range

-55° C to +125° C

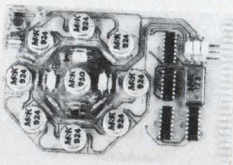

- 4 Bit/50 nSec; Low Cost
- Ideal for Radar Scan Converters
- Holds Absolute Accuracy Over Temperatures
- Tracks a 10 MHz Analog Input

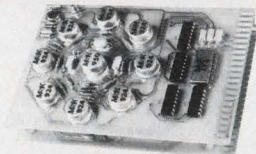

- 9 Bit/200 nSec.
- < 2 Bit Drift Over Temperature
- Insensitive to Clock Frequency

For Further Information Call or Write

**M.S. Kennedy Corp.**

Pickard Drive, Syracuse, New York 13211

Tel. 315-455-7077

CIRCLE NUMBER 77

## MICRO/MINI COMPUTING

### Controller handles incremental plotters

*Logic Sciences, 6420 Hillcraft #317, Houston, TX 77081. William Hyche (713) 777-5744. \$3500; 45 to 60 days.*

A microprocessor-controlled plotter interface, the MPC-11, accepts input from either an 8-bit parallel or RS-232-C data source. Devices compatible with the MPC-11 include almost all popular incremental plotters as well as the Tektronix Model 4014 graphics CRT. Software on the MPC-11 includes the following features: Generation, rotation and scaling of a LeRoy lettering set plus special symbols, generation of circles and arcs, vector generation including dashed lines, switch selectable baud rate (75 to 9600 baud), input and output buffers and the ability to interface to modems for remote plotting at up to 9600 baud.

CIRCLE NO. 344

### Hardcopy terminal talks or listens at 1200 baud



*Digital Equipment Corp., Digital Components Group, One Iron Way, Marlborough, MA 01752. (617) 481-7400. \$2270 (100-up); stock.*

The LS120 DECwriter III, a keyboard terminal, can be used for interactive communication with a computer and as a unit in a data or message-communication network. It operates at 1200 baud and prints at 180 cps. Inside, a 1-k character buffer helps maximize throughput and the unit has an EIA interface, an automatic "paper out" switch, a last-character visibility and a self-test capability. The terminal is compatible with full duplex and half-duplex protocols. Optional features include a forms handling package, a communications package, an APL alternate character set, a compressed font, and a 300-baud integral acoustic coupler.

CIRCLE NO. 345

### Printer does 10<sup>6</sup> lines between service calls

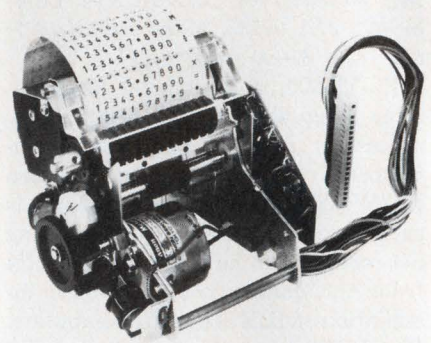

*Canon USA, 10 Nevada Dr., Lake Success, NY 11040. Mike Yoshikawa (516) 488-6700. \$30 (large qty.).*

The CMP-1, an impact numeric printer, can print over a million clear, sharp lines without any servicing. Designed for calculators, data loggers, point-of-sale equipment and other numeric output devices the CMP-1 uses a pre-inked roller in a removable cartridge to achieve the long print capability. The ink cartridge can be changed without tools and without smudging fingers. Printer MTBF is 7.5-million lines. The printer has 13 columns (wheels) with 12 numbers or characters per wheel. Printing speed is 2.8 lines/s. Character height is 0.106 in. and width is 0.067 in. Standard office calculator paper rolls can be used (2.25 in. wide). The entire unit, including the printed-circuit board containing the driving circuit, is a self-contained package measuring 4.25 x 5 x 3.35 in. and weighing 1.5 lb. Power required is 20 V ±10% and the code input is 5-bit phase-shift parallel.

CIRCLE NO. 346

### Floppy-disc system operates with M6800 $\mu$ Ps

*Electronic Product Associates, 1157 Vega St., San Diego, CA 92110. (714) 276-8911. See text: 2 wks.*

Designed to mate with a 6800 micro-computer system, the Micro-68 floppy-disc system comes complete with a single or dual-disc drive, drive electronics and controller. Each IBM compatible disc holds 256,000 bytes of data. Housed in a rugged aluminum cabinet, the system, complete with EXORciser interface for the 6800 costs \$2595 for a single drive with power supplies. A dual system costs \$3295. Included with either system is the floppy disc operating system and assembler and editor software.

CIRCLE NO. 347



# .050 Centers EDGE CARD Connector

Terminals for Soldering,  
Welding and Conductive  
Adhesives.

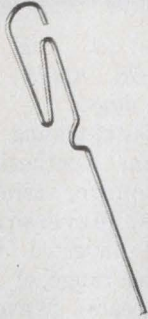

Available  
in 4-132  
Bellowform  
Contacts  
for Micro-  
Miniature  
Series



Our engineering dept. personnel are ready to consult with you on your connector applications, new product development and product modification problems.

Write for free sample.  
Specify contact  
quantity

6050-075  YA

For our nearest sales office or distributor,  
see your electronic directory



CONTINENTAL CONNECTOR CORPORATION  
WOODSIDE, NEW YORK 11377 PHONE: (212)899-4422

CIRCLE NUMBER 78

## SWITCHES FOR KEYBOARDS

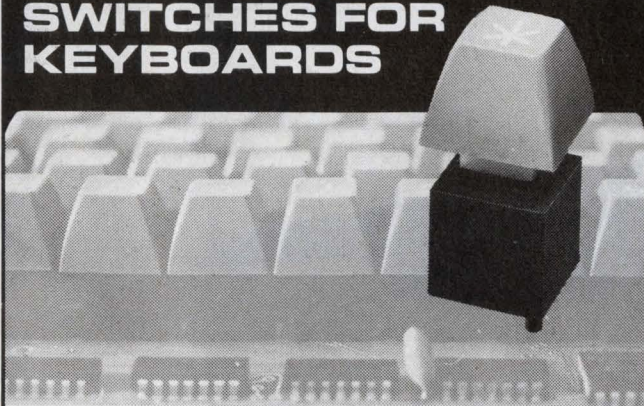

We offer the following for OEM's producing their own keyboards.

- Keyswitch sizes for 5/8" or 3/4" centers
- Gold Bar mechanical contacts or sealed contacts
- Front panel relampable lighted models
- Single and double pole contacts including NC
- Alternate action models
- Doubleshot molded keytops for 3/4" or 5/8" mounting
- Easy change legend systems
- 100,000 pc. quantity prices as low as \$0.21 each

Letterhead request or phone call brings  
free sample switch w/keytop.

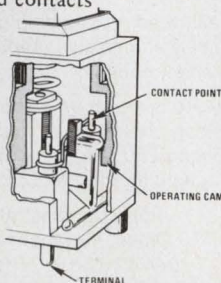

MECHANICAL ENTERPRISES, INC.  
8000 Forbes Place Springfield, Virginia 22151  
(703) 321-8282 TWX 710-832-0942

In Germany - NEUMÜLLER GMBH, MUNICH  
In U.K. - TEKDATA Ltd., STOKE-ON-TRENT

CIRCLE NUMBER 79

# GEOMETRY PROBLEMS?

Pincushion distortion on CRT displays can be solved by the Syntronic problem solvers when electronic circuit correction is out of reach.

A Syntronic yoke with carefully calibrated and accurately positioned magnets will "push" in the corners and "pull" out the sides for near-perfect geometry. Any remaining distortion or defocusing is corrected with Syntronic's stator core design combined with special coil turns distribution.\*

To see the difference 28 years experience makes, let Syntronic solve your geometry problem.

\* Write for  
Syntronic Instruments  
AP Note No. 1 "Pincushion  
Distortion, a Significant Factor in  
CRT Displays"

SYNTRONIC INSTRUMENTS, INC.  
100 Industrial Road  
Addison, IL 60101  
Phone (312) 543-6444

CIRCLE NUMBER 80



## INSTRUMENTATION

### Small 3-1/2-digit DPM spans 2 to 1000 V ac



Non Linear Systems Inc., P.O. Box N, Del Mar, CA 92014. (714) 755-1134. \$136; stock.

Full scale ac values of 2, 20, 200 or 1000 V—all with 0.5% accuracy—are yours with the Model PM-3.5 ac. The 3-1/2-digit unit weighs 4 oz, and occupies  $0.94 \times 2.5 \times 4.19$  in. Power consumption is less than 1.3 W at 5 V dc. The LED display has a programmable decimal point. Input impedance is 1 M $\Omega$ , except for the 900-k $\Omega$  1000-V-ac meter. Zeroing is not necessary. An optional 5-V power supply is available for 115-V-ac line operation.

CIRCLE NO. 348

### Recorder loads fast with cartridge paper

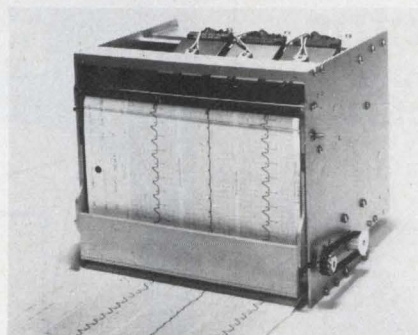

Astro-Med, Atlan-Tol Industrial Park, West Warwick, RI 02893. (401) 828-4000. \$1500; 30 days.

A new 3-1/2-channel recorder incorporates cartridge chart loading. Model W302 XL provides three 50-mm-wide channels as well as a wide margin for three or more columns of alphanumeric information. Standard 8-1/2-in.-wide chart paper is preloaded into a cartridge outside the recorder, and the cartridge is simply snapped into the unit for immediate inkless thermal writing.

CIRCLE NO. 349

### Materials test source spans w-i-d-e range

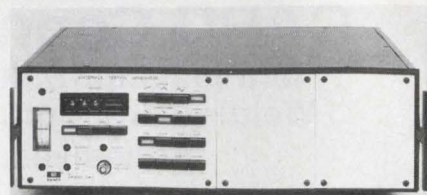

Exact Electronics, 455 S.E. 2nd Ave., Hillsboro, OR 97123. (503) 648-6661. \$1200; 45 days.

Model 340 material-testing generator uses digital synthesis to generate sine, square, triangle, ramp, haversine, haversquare, havertriangle, and inverted waveforms over a period range of 1 ms to 99,900 h (11.4 years). Waveform period can be selected in milliseconds, seconds, minutes, or hours with three-digit resolution for each range. The digits can also be multiplied by factors of 10 and 100. For ramp mode of operation, the ramp step amplitude is resolved down to 50  $\mu$ V per step at maximum signal amplitudes of 20 V pk-pk.

CIRCLE NO. 350

# Landing Lights to LEDs

The TEKTRONIX J16 Portable Digital Photometer/Radiometer makes a wide variety of light measurements, in the lab or in the field. Landing lights, lasers, fiber optics, crts, and LEDs are just a few.

Eight precalibrated probes help give the J16 versatility. Each probe snaps quickly and easily into place. Or it may be operated remotely with an extender cable.

The J16 is tough as well as versatile. An aluminum extrusion case, silicon photodiodes, and the extensive use of ICs make it rugged enough for field measurements. And it's small (2.4 x 4.6 x 8 in.), light (3.3 lb.) and battery operated, so it's easy to take along.

For a demonstration, contact your nearest Tektronix Field Office. For applications assistance, call Peter Keller, (503) 644-0161 ext. 7769. For a free brochure describing the J16 Photometer, circle the number below, or write Tektronix, Inc., P.O. Box 500, Beaverton, Oregon 97077. In Europe, write Tektronix Limited, St. Peter Port, P.O. Box 36, Guernsey, Channel Islands.

**Tektronix**  
COMMITTED TO EXCELLENCE

The J16 measures the full range.

CIRCLE NUMBER 81



## 1800-MHz synthesizer offers AM/FM/PM

Ailtech, 815 Broadhollow Rd., Farmingdale, NY 11735. (213) 965-4911. Starting at \$11,000; 16 weeks.

Model 360 direct frequency synthesizer now covers the range of 0.01 to 1800 MHz with the addition of new optional plug-in modules. Complete programmable frequency, modulation and output level plus 20- $\mu$ s switching time are featured.

CIRCLE NO. 356

## DMM comes with analog peaking meter



Systron-Donner Corp., Ten Systron Dr., Concord, CA 94518. (415) 676-5000. \$350; stock.

Model 7003M 3-1/2-digit multimeter includes an analog meter for making nulling and peaking measurements. The 7003M offers five complete functions: dc voltage, dc current, ac voltage (true rms), ac current (true rms), and resistance. It can also include an optional internal battery pack for complete field portability. The 7003M features a resettable circuit breaker for current overload protection.

CIRCLE NO. 357

## Signal generator boasts low noise

Marconi Instruments, 100 Stonehurst Court, Northvale, NJ 07647. (Longacres, St. Albans Hertfordshire AL4 0JN, United Kingdom). (201) 767-7250. About \$16,000.

Model TF 2020 synthesized signal generator offers one of the best sideband noise performance available. Sideband noise is at least 130-dB/Hz down at 20-kHz offset. All functions of the 50-kHz-to-520-MHz unit can be controlled from the front panel or remotely through parallel BCD inputs. Stability is better than 1 part in  $10^8$  per day, and spurious signals are better than 90-dB down.

CIRCLE NO. 358

# Still chained to wire?



## Break the wire habit with Repco's modular RF links and discover new design freedom.

Repco's modular RF links are used in hundreds of applications including remote and supervisory control, voice communications, alarm and reporting systems... all become more versatile and effective through the use of Repco's rugged, reliable RF transmitters and receivers.

Repco's RF links are packed with performance features: multiple transmission modes designed to carry tone, voice or low-speed digital data; a wide VHF/UHF frequency range; all units meet FCC and DOC requirements.

Best of all, Repco's RF links are economical. They beat hard wire system costs over the long haul, thus affording you maximum performance at minimum expense. Now is the time for you to link up... with Repco's versatile RF links! Write or call today for free specs brochure, application booklet and special evaluation offer.

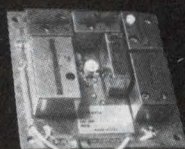

TX

# Repco Inc.

A subsidiary of Scope, Inc.  
1940 Lockwood Way  
Orlando, FL 32804  
(305) 843-8498



RX

World's leading manufacturer of modular communication products.

CIRCLE NUMBER 82



# New Minelco MIN-Lites

# LED Indicators

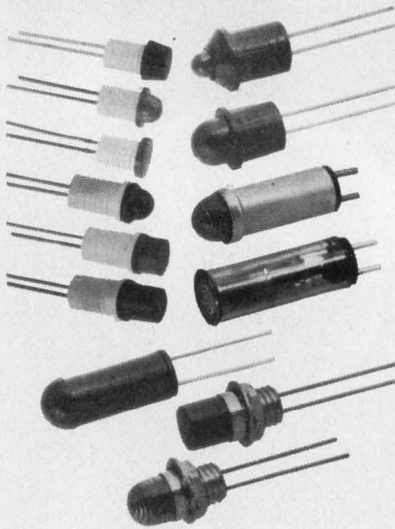

- MM, LM, M, RCM, RCP, UN
- Interchangeable with standard modules and lamp holder assemblies
- Wide choice of configurations, lens styles and colors
- High luminous intensity, wide viewing angle
- Long life, low cost, highest reliability
- Small size, low power, fast switching
- Available from stock, under \$1.00 ea. in quantity. Specials to suit

## Sudden Service on Small Quantities!

### PROTOTYPES

available on phone or letterhead request

### MINELCO

A  TALLEY INDUSTRIES COMPANY

135 South Main St., Thomaston, Conn. 06787  
Phone 203-283-8261

...from **Minelco**

CIRCLE NUMBER 83

## INSTRUMENTATION

### 30-MHz counter uses batteries or ac



B&K Precision (Dynascan Corp.), 6460 W. Cortland Ave., Chicago, IL 60635. (312) 889-9087. \$120.

Not much larger than a pocket calculator, Model 1827 autoranging, portable frequency counter offers a six-digit LED display and guaranteed operation to 30 MHz with 1-Hz resolution and 0.25-ppm stability. The input circuitry is sensitive enough to display a 100-mV sine-wave signal, but is protected against an input signal of up to 200 V. The 1827 can be powered for more than 8 h by AA or rechargeable NiCd batteries. Including optional batteries, the 1827 weighs less than 1 lb. Size is only 4.4 × 9.5 × 16.8 cm.

CIRCLE NO. 359

### Meter reads 3- $\phi$ true-rms E/I, watts

Yokogawa Corp. of America, 5 Westchester Plaza, Elmsford, NY 10523. (914) 592-6767.

Model 2505 3-phase, 4-wire digital instrument provides readings of true-rms, volts and amps as well as watts with an accuracy of  $\pm 0.25\%$  rdg  $+0.05\%$  of range. The compact unit covers voltage ranges of 100 to 600 V ac, current ranges from 2 to 20 A and power from 200 W to 12 kW (all per phase). Typical input characteristics include an input impedance on voltage ranges of from 50 k $\Omega$  to 1.5 M $\Omega$  and a power consumption on ampere range of from 0.1 VA to 2 VA. Size is 5-7/8 × 9 × 14-3/8 in. and weight is 35.3 lb.

CIRCLE NO. 360

## Interface links CAMAC and GPIB

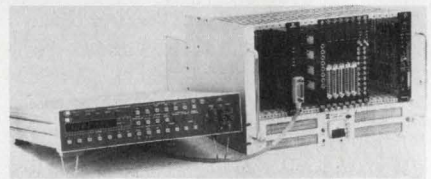

Kinetic Systems Corp., 11 Maryknoll Dr., Lockport, IL 60441. (815) 838-0005. \$850; stock-6 wks.

Model 3388 GPIB Interface is a double-width module that provides the interface between a CAMAC system (IEEE Standard 583) and the General Purpose Interface Bus (also called "GPIB" or "ASCII Bus"), IEEE Standard 488. This module allows digital multimeters, counters, printers, calculators, display terminals or other devices that meet the GPIB standard to be connected to a CAMAC system. With Model 3388, up to 14 other GPIB-interfaced instruments can be connected via the standard GPIB cables.

CIRCLE NO. 361

## Tough meter demands no hazard pay



Ballantine Laboratories Inc., P.O. Box 97, Boonton, NJ 07005. (201) 335-0900. \$995; 30 days.

Model 9601A claims to be the first ac rms responding voltmeter and amplifier designed to conform to OSHA and UL safety requirements. The instrument operates on its own rechargeable batteries or the ac power line. The solid-state, ruggedized, explosion-proof, general-purpose instrument provides operator safety and instrument protection in making voltage measurements to 500 V in high-hazard applications. The instrument has internal electronic protection against overload and recovers within seconds after removal of an overload.

CIRCLE NO. 362



## COMPONENTS

### Tiny toggle switches sealed against water



Alco Electronics Products Inc., 1551 Osgood St., North Andover, MA 01845. (617) 685-4371. \$1.45:TTE-13D-3T, SPDT (100 up).

Single and double-pole 3-A toggle switches of the TTE Series incorporate a new method of providing a watertight seal in the bushing and are supplied with an O-ring for sealing to the panel. Designed to be operable under 2 in. of water, the toggles are well suited for outdoor miniaturized equipment and wherever panels are subject to splashes or brief engulfment. Groups of TTE switches can be spaced on  $\frac{3}{8}$ -in. centers.

CIRCLE NO. 363

### Indicator lights dimmed mechanically

Dialight, 203 Harrison Pl., Brooklyn, NY 11237. (212) 497-7600. \$2.57 to \$2.91 (1000 up); stock.

Operator-actuated mechanical dimming to suit ambient illumination conditions is an available feature of subminiature indicator lights. Rotating a knurled portion of the lens cap operates the dimming feature, which can be either a mechanical shutter or a Polaroid filter. The shutter varies the size of an opening in the lens cap. It is available in two styles: one ranges from full opening with full intensity to complete closure; the other closes from full open to only a small opening so that indicators having a safety or other alarm function can't be completely blacked out. The optional Polaroid dimmer involves some loss of lamp intensity, even at its maximum setting, but maintains a fully illuminated lens diameter throughout its intensity range. All use T-1-3/4 lamps and offer a choice of unfrosted or back-frosted convex lenses with a variety of color options.

CIRCLE NO. 364

### Voltage-divider network stable to 0.01%/6 mo

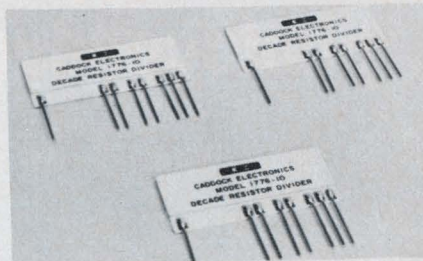

Caddock Electronics Inc., 3127 Chicago Ave., Riverside, CA 92705. (714) 683-5361. \$4.50 (2500 up); stock to 2 wks.

Edge-mounted precision decade voltage drivers, type 1776, come in customer-selected resistor values in the range from 10 k $\Omega$  to 10 M $\Omega$ . Ratio stability of 0.01% per six months and ratio temperature coefficients as low as 5 ppm/ $^{\circ}$ C over the temperature range from 0 to 70 C are provided. The decade voltage dividers are fully encapsulated under a solid ceramic cover. Terminals are arranged on multiples of standard 0.1-in. spacing for single-in-line connectors and sockets.

CIRCLE NO. 365

# PYROFILM MAKES IT!

## HIGH VOLTAGE RESISTORS

- Up to 40,000 Volts
- 10 sizes
- Up to 1,000M Ohms
- Temp. Coef. as low as  $0 \pm 100$  PPM/ $^{\circ}$ C
- Up to  $5\frac{1}{4}$  Watts

Setting New Standards in Reliability

# PYROFILM

60 S. Jefferson Road • Whippany, N. J. 07981 • (201) 887-8100

CIRCLE NO. 84



# Type 9 CdS photoconductive material

offers:

- Stability with temperature
  - Fast response time
  - Low light memory
  - Available in three packages: TO-5, TO-8, TO-18
- Call (914) 664-6602

**TYPE 9 MATERIAL**

- LOW TEMPERATURE ERROR
- LOW LIGHT HISTORY EFFECT
- HIGH LINEARITY
- FAST RESPONSE TIME
- RESISTANCE TOLERANCE AT 2 F<sub>1</sub>C: ± 3%
- TEMPERATURE RANGE: 50 °C to +175 °C

**RESPONSE TIME VERSUS LIGHT**

Light Intensity (μW/cm²)	0.1	1.0	10	100
Fast Coalesc.	0.1	0.2	0.2	0.2
Slow Coalesc.	0.1	0.2	0.2	0.2
Steady State	1.2	0.2	0.2	0.2

**CLAIRES ELECTRONICS**  
A DIVISION OF CLAIRES CORPORATION  
560 South Third Avenue, Mount Vernon, N.Y. 10550 • (914) 664-6602

**CLAIRES ELECTRONICS**  
A Division of Claires Corporation

CIRCLE NUMBER 85

## COMPONENTS

### Pull solenoids available in two versions

Regdon Corp., 3713 Grand Blvd., Brookfield, IL 60513. (312) 485-5152. \$1.25 (1000 up); stock to 2 wks.

Miniature pull-type solenoids are available both in box-frame and tubular versions. The Mini Twins incorporate an efficient magnetic structure for maximum efficiency in a small size. Both units are made with glass-filled nylon bobbins and other class A insulation materials. The tubular version, part number R6X6, has a diameter of 0.375 in. and a length of 0.8 in. The box-frame style, part number 3U3, is 0.36 W × 0.43 H × 0.825 L in. Both models are available with 6, 12 and 24-V-dc coils in both continuous and intermittent-duty versions.

CIRCLE NO. 366

### Variable chip inductors side or top tuned

Vanguard Electronics Co., Inc., 930 W. Hyde Park, Inglewood, CA 90302. (213) 678-7161. About \$2 (1000 up); 4 to 6 wks.

Variable chip inductors in side-tuned and top-tuned configurations are available in values from 0.018 through 150 μh. They are completely transfer molded with all-welded internal construction built to meet MIL-C-15305, Grade 1, Class B, and MIL-I-83446. Operating temperature range is -55 to 125 C.

CIRCLE NO. 367

### Visible LEDs deliver high-intensity light

Texas Instruments, P.O. Box 5012, MS-308, Dallas, TX 75222. (214) 238-3940. \$0.46: T-1, \$0.49: T-1-3/4 (1000 up).

A series of high-intensity, gallium-phosphide visible light-emitting diodes (VLEDs) is available in red, amber or green. The small T-1-diameter VLEDs are designated TIL212 (amber), TIL216 (red) and TIL232 (green). The larger T-1-3/4-diameter devices are designated TIL224 (amber), TIL228 (red) and TIL234 (green). The VLEDs in molded epoxy packages are direct replacements for many other types currently being used. They feature brightness outputs of up to 25 mcd at 50 mA, low-power consumption and long life.

CIRCLE NO. 368

# AUTHOR'S GUIDE

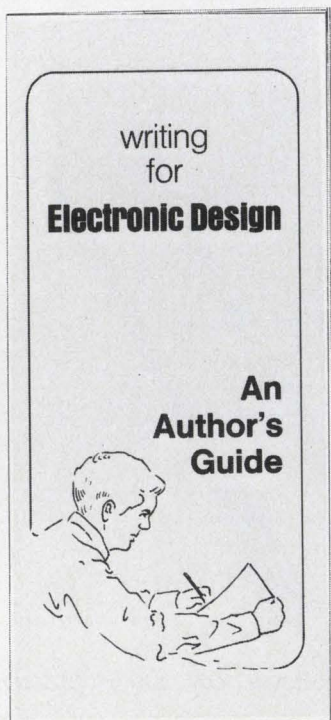

If you've solved a tricky design problem, if you have developed special expertise in a specific area, if you have information that will aid the design process... share it with your fellow engineers-readers of *Electronic Design*.

Articles you have authored not only raise your own professional status, but help build your company image as well. The readers benefit, your company benefits.

To help you prepare material that meets *Electronic Design's* high editorial standards, our editors have prepared a special author's guide entitled "Writing for *Electronic Design*." It covers criteria for acceptability, form, length, writing tips, illustrations, and payment for articles published. It's available without cost.

It's easy to write for *Electronic Design*, but it's often hard to get started. Send for your copy of our Author's Guide today.

**Circle No.**  
**250**



## Thick-film resistors in low-profile SIP

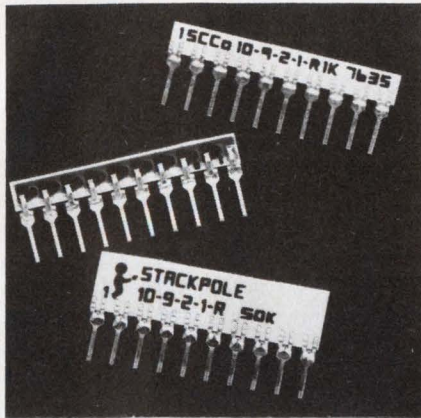

Stackpole Components, P.O. Box 14466, Raleigh, NC 27610. (919) 828-6201. Average under \$0.15; (low qty); 4 to 6 wks.

A line of thick-film resistor networks, the Mini-SIP, has only a 0.175-in. height above its standoff; in standard SIPs the height is 0.35 in. The 1/8-W units are offered with four, six, eight, 10 or 12 pins, and in 64 standard resistance values ranging from 33  $\Omega$  to 10 M $\Omega$ . Stackpole's omega-shaped resistance path, called the Top Hat design, is laser-trimmed to provide long paths on the same amount of real estate as the usual L-cut configurations. Also, hot spots, current crowding and high capacitance common with conventional designs are eliminated. Ratings of 200 W/in.<sup>2</sup> are very realistic. With packing densities to 100 resistors per square inch on a PC board, Mini-SIPs are applicable to all logic, memory and linear ICs. Standard resistance tolerance is  $\pm 2\%$ .

CIRCLE NO. 369

## Thumbwheel switch mounts without tools

ECCO, 1441 E. Chestnut Ave., Santa Ana, CA 92701. (714) 835-6000. \$2 (1000 up); 6 wks.

The 1800 Series thumbwheel switch features a front-mount snap-in design eliminating the need for tools, panel-mount holes, screws, nuts or washers. The manufacturer states that the slim 0.315-in. switch module solves panel density problems by being able to mount more switches in a smaller space. Contacts are gold in a self-extinguishing nylon housing with a glass-epoxy circuit board. A wide variety of 10-position, BCD and decimal codes are available.

CIRCLE NO. 370

## Solid-state relay provides time delay

Guardian Electric Manufacturing Co. of California, 4030 W. Spencer St., Torrance, CA 90503. (213) 542-8651.

A series of 7 and 10-A solid-state relays, called the SSRT, for time-delayed control of large loads is available in three time ranges, 0.1 through 50 s. The SSRT combines a time-delayed dc input stage

optically coupled into a line-synchronized triac output. This feature minimizes RFI/EMI, while reducing inrush current by 60% to protect other circuit components. Ac reactive loads are switched regardless of power factor, and arcing caused by inductors is eliminated because of zero-current turn-off by the triac. The relays are housed in a nylon cover with an isolated-metal base for easy mounting and efficient heat sinking.

CIRCLE NO. 371

**No. 1**  
IN A SERIES  
**LOW NOISE**  
MICROWAVE TRANSISTOR  
UPDATES FROM AVANTEK

**$G_{NF}$ : 7.5 dB**  
 **$NF_{opt}$ : 3.5 dB**  
**Frequency: 4.0 GHz**  
**Avantek AT-4641**

### Guaranteed Specifications

Type	$NF_{opt}$ dB (max)	$G_{NF}$ dB (typ)	$I_C$ mA	$G_{max}$ dB (min)	$I_C$ mA	$f_{Test}$ GHz	$f_T$ GHz (typ)
AT-4641	3.5	7.5	5	8	15	4.0	8.0

### Built-In Reliability

The AT-4641 features a superior gold metallization system and hermetic packaging. All Avantek transistors are manufactured under the most stringent quality controls, assuring the designer of high MTBF's.



### Fast Delivery

Concerned about a supplier located halfway around the globe? Avantek is just a phone call away. Orders placed by noon will normally ship the same day.



### OUTLINE DRAWING

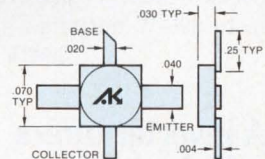

### Dependable Performance

The AT-4641 is a proven performer in critical military and space applications with HI REL screening available as a standard option. It features a very high dynamic range among its impressive specifications. Reliability, performance, and immediate availability — Avantek's AT-4641 is your solid choice.

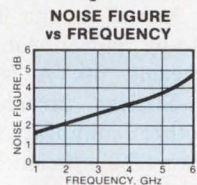

Contact: Avantek Transistor Applications Engineering (408) 249-0700

3175 Bowers Ave., Santa Clara, CA 95051  
TWX 910-339-9274 Cable: AVANTEK

SEM photo of AT-4641 (1000X magnification).

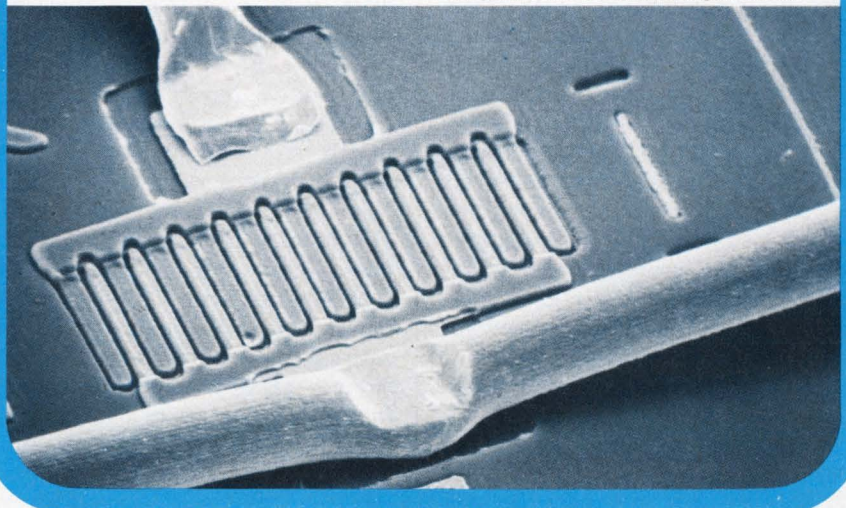

CIRCLE NUMBER 86



## POWER SOURCES

### PWM dc/dc's outperform two-stage inverters

*Bikor Corp., 1228 253 St., Harbor City, CA 90710. R. Pizer (213) 325-2820. \$340 (1-25 qty); stock to 4 wks.*

Pulse-width modulated (PWM) power inverters of the DOS series provide higher efficiency, lower cost and smaller size than the company's DDR single-output high-power dc/dc converters. The new units switch power in one stage as opposed to the separate power-inverter and switching-regulator stages of the previous design. Standard units deliver outputs from 5 V at 25 A to 28 V at 5 A from a choice of 12, 28, 48 or 115-V inputs. Regulation is 0.2% for line and load, while efficiency varies from 70 to 87% depending on input and output voltages. The 4-lb units measure 4 × 4.63 × 15 in. Special models are available with up to 800-W outputs.

CIRCLE NO. 372

### 5-kVA inverter offers high efficiency

*Nova Electric, 263 Hillside Ave., Nutley, NJ 07110. K. Niovitch (201) 661-3434. \$2995; stock to 30 days.*

First model in the Taurus series of dc-to-ac power converters is a 90%-efficient 5-kVA sine-wave inverter. Similar inverters available from other manufacturers are in the 82 to 85% efficiency range. The unit converts 48 to 54 or 105 to 150 V dc to 117 or 220 V ac at 50, 60 or 400 Hz. The device boasts voltage regulation of ±1% from no-load to full-load and frequency regulation of ±0.15% with 0.005% available as an option. Additional features include distortion of less than 5% and power-factor range of ±0.5 lead or lag. The converter is rated for continuous operation at full load. The unit also features the following protection as standard: short-circuit protection, automatic current limiting, reverse-input-polarity protection, thermal protection, undervoltage and overvoltage protection. Another standard feature is frequency-and-phase synchronization.

CIRCLE NO. 373

### Open triple-outputers power micros, etc.

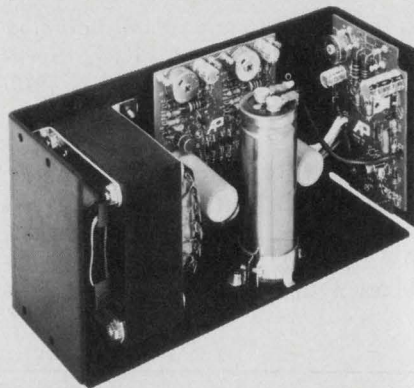

*Adtech Power, 1621 S. Sinclair St., Anaheim, CA 92806. K. Nelson (714) 634-9211. From \$75.90 (100 qty); stock.*

Four models, TAPS 1, 2, 3 and 4, provide triple dc outputs for  $\mu$ Cs, mixed-logic and other uses. You get a single 5-V output at 4 to 12 A and ±12 to ±15-V outputs at 0.5 to 3 A. Dual outputs can be ±9 to ±12 V as an option. The units feature regulation of ±0.1% for line and load with 115/230-V ±10%, 47-to-63-Hz input power; ripple of 5-mV pk-pk max; and stability of ±0.2%. These open framers deliver full power from -20 to +50 C and operate derated up to +65 C.

CIRCLE NO. 374

### Switchers conform to a total-error band

*Pioneer Magnetics, 1745 Berkeley St., Santa Monica, CA 90404. A. Hagiwara (213) 829-6751. From \$695; 45-90 days.*

Outputs of the PM 2675, 6 and 7 series of multiple-output switchers remain in a ±2% total-error band for all effects of line changes, static-and-dynamic-load changes, ripple, noise, temperature and drift. Primary output of these supplies is 250, 500 and 600 W, respectively. Each unit provides three additional outputs: two channels of 150-W or 10-A capacity and a fourth output of 75 W or 5 A. All outputs have a range of 2 to 48 V. Normally operating from either 115 or 208/220-V inputs, the supplies continue to operate for several minutes with 60% of nominal input. When the input voltage fails entirely, the outputs hold up for 30 ms. These switchers operate at full rating from 0 to 50 C and derated to 80% at 70 C. They measure 5 × 8 × 11 in.

CIRCLE NO. 375

### Plug-in unit cleans your power line

*Dyma Engineering, 213 Pueblo Del Sur, P.O. Box 1697, Taos, NM 87571. (505) 758-2686. \$14.95; stock.*

Near-capacity loading of power systems is causing increases of potentially destructive line-voltage surges and spikes. To protect your sensitive equipment from line transients, plug Dyma's ac line surge protector into a 20-A, 117-V, two-or-three-pin outlet. Then plug in your equipment. The unit, which fits into the palm of the hand, contains a suppressor coupled to a ferrite filter.

CIRCLE NO. 376

### Open modules pack big wattage in small case

*Abbott Transistor Laboratories, 5200 W. Jefferson Blvd., Los Angeles, CA 90016. A. Hilbert (213) 936-8185. \$61 (1-24 qty); stock.*

Type-NL dc power supplies provide single outputs of 5, 12, 15, 24 and 28 V at up to 84 W in C-size cases. Standard ac input is either 115 or 220 V, 47 to 440 Hz. Dual primaries are also available. All units feature tight regulation, low ripple and full-load operation up to 50-C ambient with derating to 40% at 71 C. Overvoltage protection is standard on 5-V outputs and optional on the higher voltages. Three-surface mountable cases are 7 × 4.875 × 2.75 in. The line also includes single, dual and triple-output models with power ratings from 15 to 170 W.

CIRCLE NO. 377

### Converter powers $\mu$ P plus four memory chips

*Datel Systems, 1200 Turnpike St., Canton, MA 02021. E. Zuch (617) 828-8000. \$89 (1-9 qty); 4 wks.*

You get all the necessary outputs to power an 8080  $\mu$ P plus four 2107A RAMs or four 1702A ROMs from the Model 1200, a dc/dc converter. Mounted locally on a circuit board, the module transforms 5-V-dc power into isolated triple-output voltages of +12, -5 and -9 V dc. The unit features line-and-load regulation of 0.05%, a max. rms output-ripple of 1 mV and max. recovery time of 50  $\mu$ s.

CIRCLE NO. 378



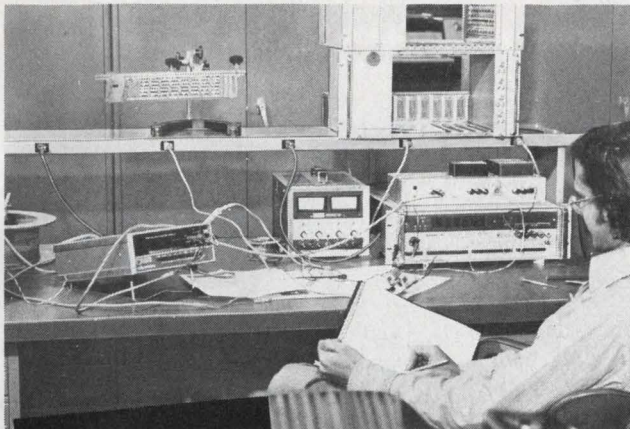

## THE QUIET BUNCH

Specify Plugmold® multioutlet strips with noise reducing insulated/isolated grounding receptacles for your lab or test bench and eliminate problems with electromagnetic noise and spurious signals.

Easy to install, easy to use. Available in various lengths and receptacle centers.

For free information contact



**THE WIREMOLD COMPANY**  
West Hartford, Connecticut 06110

CIRCLE NUMBER 87

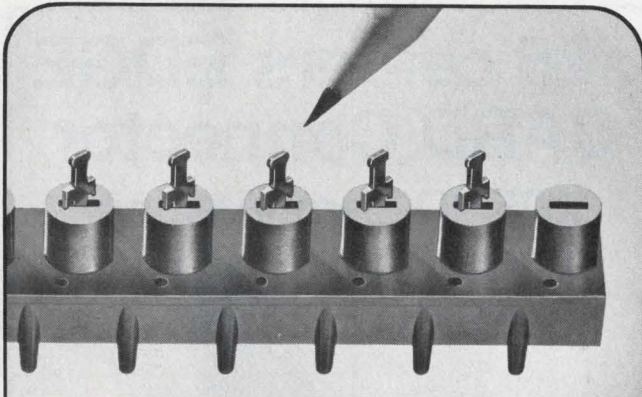

## NEW TWIST

The electrical "Thru-Air" path has been increased on Kulka's Feed-Thru terminal boards by twisting the bottom terminals 45 degrees to the longitudinal axis. This design improvement is just one of the many that Kulka is constantly making to insure quality.

# Kulka®

A NORTH AMERICAN PHILIPS COMPANY

520 S. Fulton Ave., Mt. Vernon, NY 10551 Tel: 914 664 4024

CIRCLE NUMBER 88

ELECTRONIC DESIGN 9, April 26, 1977

# VIBRATION!

## IC's Backing Out?

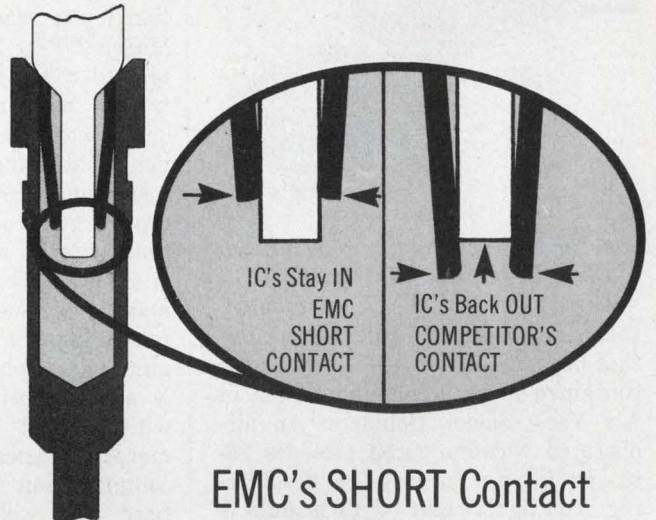

## EMC's SHORT Contact for SHORT Leads

Many newer IC's have shorter or highly tapered leads. If plugged into longer standard terminal contacts, lateral pressure caused by the angle of the contacts vector into a constant potential ejection force. Add a little vibration from nearby equipment, and out they come. EMC's new four-finger Short Contacts move the lateral pressure well up onto the body of the lead . . . grab and hold leads even .095 inches long. Specify Short Contacts in EMC's full line of sockets and packaging panels . . . field-proven for over a full year in actual usage. Phone or write Electronic Molding Corp., 96 Mill St., Woonsocket, R.I. 02895. (401) 769-3800.



**EMC®**  
Interconnection Specialists

CIRCLE NUMBER 89



## PACKAGING & MATERIALS

### Solder-gobbling module fits atop workbench

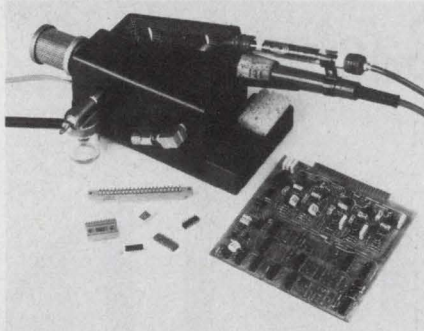

Air-Vac Engineering Co., 100 Gulf St., Milford, CT 06460. (203) 874-2541. \$134.

The Model SSVM-147 vacuum desoldering module is a bench-top unit that occupies only 5 x 8 in. The self-contained holder accommodates any of Air Vac's Solder Gobblers. An air-operated vacuum pump provides 28-in.-Hg vacuum for clog-free desoldering. The lightweight (4 lb) module is available with either electrical or mechanical controls, and can be set up in 10 seconds.

CIRCLE NO. 379

### $\mu$ P-controlled system positions tools

Cambridge Thermionic Co., 445 Concord Ave., Cambridge, MA 02138. W. G. Nowlin (617) 491-5400.

By simply mounting the special tooling required for your application, you can convert the new Model GP-1 X-Y Positioning System to a complete numerically controlled machine that will handle such work as drilling, assembly, light machining as well as test and inspection. The unit permits either tape control or full manual operation. Block and pattern repeats, automatic step, tool override and manual jog modes are possible. The microcomputer also provides LED numeral displays showing relative X and Y positions. The X-Y table with a full 18 x 12-in. travel moves on linear ball bushings. The complete unit is mounted on a unitized and welded steel frame designed to achieve the highest rigidity to weight ratio possible.

CIRCLE NO. 380

### All-plastic connector is a snap to install



AMP, Harrisburg, PA 17105. Jim Pletcher (717) 564-0100. Stock.

The "audio" connector consists of a one-piece, all-plastic receptacle housing, which can be panel-mounted without screws or other mounting hardware, and an all-plastic two-piece plug housing. To further reduce assembly time, the insulation-piercing crimp/snap-in contacts can be machine-applied without stripping the wire. The tinned, brass contacts can be used with wire having insulation diameters up to 0.055 in. A four-contact size is now available, with 2, 3, 5, 6, and right-angle versions to follow shortly.

CIRCLE NO. 381

## CONTROL SWITCH/RELAY



- Combines the features of manually-operated switch with remote-operated relay
- For all Instrument & Control Applications
- Bi-directional service for breaker control . . . automatic synchroscope timing
- Continuous rating: 30A/600V

Request CSR Specification Sheet



**ELECTRO SWITCH**

Weymouth, Massachusetts 02188

Telephone: 617/335/5200 • TWX: 710/388/0377

CIRCLE NUMBER 90

## .125 centers EDGE CARD Connector .025 SQ. Terminations



with Semi Bellows bifurcated contacts. Available from 4-130 contacts for wire-wrapping or flow soldering.

Our engineering dept personnel are ready to consult with you on your connector applications, new product development and product modification problems. Just give us a call at (212) 899-4422.

Write for free sample. Specify contact quantity.

6125-250  WA

For our nearest sales office or distributor, see your electronic directory.



**CONTINENTAL CONNECTOR CORPORATION**  
34-63 56TH Street Woodside, N.Y. 11377

CIRCLE NUMBER 91

ELECTRONIC DESIGN 9, April 26, 1977



## Instrument feet double as cord holder

Buckeye Stamping Co., 55 Marion Rd., Columbus, OH 43207. James Willcox (614) 445-8433.

The Cord-Wrap is designed for handy storage of power cords. It consists of a pair (or two) of 1-in.-high black-plastic pieces mounted on the back panel of an instrument, or on the bottom as feet for portable instrumentation. The power cord is wound around several of the plastic shapes and the two or three-prong plug can be "plugged" into one of them. A sample pair is available from any area Buckeye representative.

CIRCLE NO. 382

## Pin-line sockets save space and money

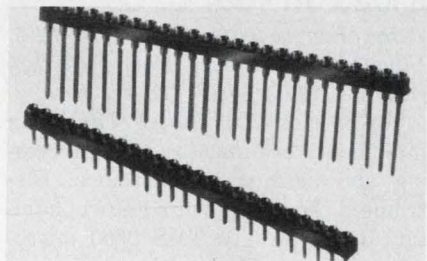

Aries Electronics, Inc., P.O. Box 231, Frenchtown, NJ 08825. (201) 996-4096. 12¢ to \$1.92; stock.

Collet-type pin strips are available in lengths from one pin to twenty-five pins, with either wire-wrapping or solder tails. The sockets can be used for low-cost, compact modular applications, and fit end-to-end or side-by-side on 0.1-in. centers.

CIRCLE NO. 383

## Machinable magnet is stronger than Alnico

Matsushita Electric Industrial Co., Ltd., Kadoma, Osaka 571, Japan. (06) 908-1121. See text.

Made from manganese, aluminum and carbon, a new anisotropic magnet material has been developed that combines the best of three worlds. The maximum energy product of the new magnets is 5 to 7 MGOe, exceeding that of many Alnicos; the coercivity of over 2000 Oe betters that of barium ferrites; the mechanical characteristics are superior to those of Alnicos and ferrites, permitting machining and drilling. Because only inexpensive materials are used for the new magnets, the manufacturer expects them to be competitively priced. Samples will be available in June, 1977.

CIRCLE NO. 384

# MEET OUR family of ELECTRONIC TEST ACCESSORIES

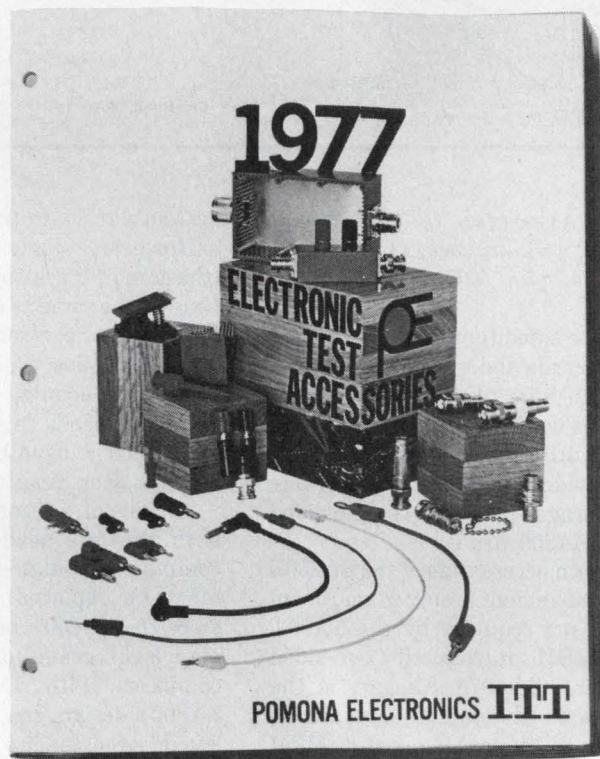

The 1977 edition of our family album of electronic test accessories (illustrated above) is yours for the asking.

Our new general catalog has grown to 82 pages. It describes and illustrates every one of the 600-plus members of the ITT Pomona Electronics family, including 28 new items that have been added for the first time this year.

You'll find this comprehensive catalog will be your best single source for high quality test accessories in every phase of electronic testing. For your free copy, circle the reader service number listed below, or write:

## ITT POMONA ELECTRONICS

1500 East Ninth St., Pomona, Calif. 91766  
Telephone (714) 623-3463, TWX: 910-581-3822



CIRCLE NUMBER 92



## Two-headed floppy accesses twice the data in half the time

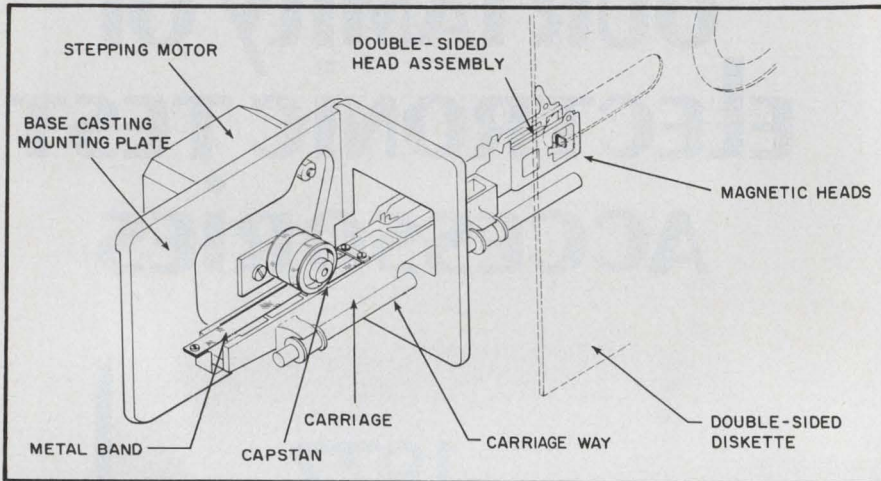

Shugart Associates, 415 Oakmead Parkway, Sunnyvale, CA 94086. George Sollman (408) 733-0100. See text.

A double-sided floppy-disc drive, the SA850, records and reads data on both sides of an 8-in. Mylar diskette. Two read heads come into contact simultaneously with the diskette. Thus the drive provides twice as much on-line data storage as the single-sided Shugart SA800 drive.

Maximum access time of the SA850's 25-track movement is only 91 ms, down from 208 ms required by the SA800. Though IBM introduced two-sided floppies in mid-1976, Shugart is the first to make the technique available for OEMs. With double-density M<sup>2</sup>FM recording, the diskette holds 1600 kbytes unformatted, or 1200 kbytes formatted. The SA850 drive also permits single-density recording (600 or 800 kbytes).

The drastic improvement in access time (which includes settling time, but not rotational latency) comes from a new head actuator with 3-ms track-to-track time, and 15-ms settling time. The actuator replaces the lead-screw/stepping-motor method of the SA800 drive with the system shown in the illustration. The head carriage is moved by a metal band driven by a stepping motor. Whereas the lead-screw/stepping-motor method has a track-to-track time of 8 ms, the new

system's track-to-track time is 3 ms.

However, single-track seek time, (the sum of track-to-track and settling time) is the same as the SA800's, 18 ms, because the lead-screw actuator has a shorter settling time. Also unchanged is the head-loading time (the time to move the heads into disc contact), 35 ms, which is usually absorbed by the average seek time of 91 ms.

The use of a second head does away with the felt head-load pad that is common to single-sided drives, and must be replaced periodically. And since the SA850's head assembly uses only eight grams of head-load force, compared with 15 grams for the SA800's design, the life of each floppy should be extended from the SA800's 3.5-million loaded passes to at least 5-million passes.

The double-sided unit has many other characteristics of the SA800 and other standard floppy drives. Like the SA800, the SA850 has a data-transfer rate of 250 kbits/s, a packing density of 3400/6800 bpi, and 77 tracks per side, which are packed at 48 tracks/in.

Using a dual-index sensor to differentiate between single and two-sided floppies, the SA850 can also read and record single-sided media. It is also plug-compatible with the SA800 and can use the same media as IBM's 3740 and S/32 single-sided floppy drives, and the IBM 4964 and 3600-series two-sided drives. However, the IBM format

specifies 128-byte sections, limits capacity to 250 kbytes per side, and uses only single density.

Although the SA850 has the same dimensions as the SA800 (4.62 × 8.55 × 14.25 in.), it uses 20% less power. The electronics includes read/write amplifiers and all circuits for control, write-protect, data/clock separation, and programmable diskette-door lock. Aside from its double-head capability, the SA850 is mechanically and electrically interchangeable with the SA800. At a base price of \$750, the single-unit price of the SA850 is about 25% higher than the SA800. Delivery takes eight weeks.

CIRCLE NO. 310

## Bright terminal takes a load off your CPU

Texas Instruments, P.O. Box 1444, Houston, TX 77001. Dan Fullerton (713) 494-5115. \$6400 (1); see text.

The Series 700, Model 770 is an intelligent terminal for data processing and data communications. Distributed processing is its natural habitat. Based on TI's TMS 9900 micro-processor, the Model 770 can reduce mainframe computing and communications costs by placing data checking, validating and preprocessing at the local site. The compact desktop unit includes ROM and RAM memory, dual minicartridge magnetic tape drives, a 1920-character video display and a full ASCII keyboard with separate numeric, cursor control and programmable-function key clusters.

CIRCLE NO. 385

## Low-cost unit boosts data rate

Western Telematic, 3001 Red Hill Ave., Costa Mesa, CA 92626. Steven Tatum (714) 979-0363. \$399; 4-8 wks.

The Model 1200 data rate converter accepts up to 256 char/s from one I/O device at its operating rate, and passes the string on to another device with a different speed. The unit thus permits you to interact from a slow (10 or 30 char/s) terminal with the host computer over a fast (1200 baud) full-duplex modem. When the program is ready to run, you simply press a switch, bypassing the converter, and you can transfer the bulk data from on-site storage (disc, tape) to the computer, or vice versa, at the higher rate.

CIRCLE NO. 386



# .100 centers Connector

EDGE  
CARD

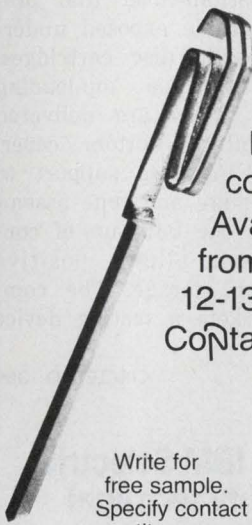

The only connector with Bellowform contacts. Available from 12-130 Contacts



Write for free sample. Specify contact quantity. WA 6100-200-

For nearest sales office or distributor, see your electronic directory.



CONTINENTAL CONNECTOR CORPORATION  
34-63 56th Street, Woodside, N.Y. 11377

PHONE: (212) 899-4422

CIRCLE NUMBER 93

## Now mount any width flat or ribbon cable

WITH NEW NYLON ONE SIZE CLIP

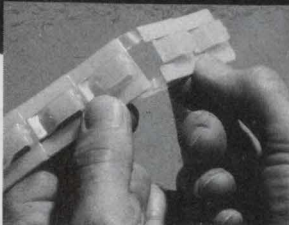

Peel off . . . press into place!

### FREE SAMPLES

Write for sample packet, literature and prices.

With Weckesser Molded Nylon FCA-15 Press Clip, one size is all it takes for any width flat or ribbon cable you use. Used along edges, provides unlimited flexibility in mounting arrangements, including stacking of cables having varying widths and thicknesses. Adhesive-backed for flat, press-on mounting.

**Weckesser COMPANY, Inc.**

4444 West Irving Park Road • Chicago, Illinois 60641 • 312/282-8626

CIRCLE NUMBER 94

ELECTRONIC DESIGN 9, April 26, 1977

## With MINI BUS<sup>®</sup>

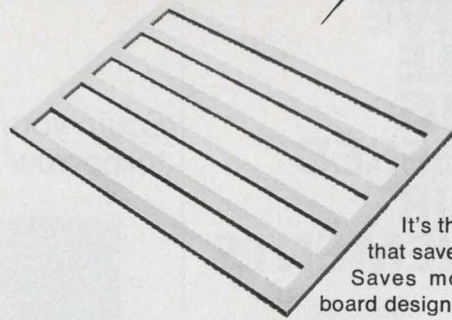

It's the PC card bus bar that saves space on a PCB. Saves money too. Makes board design and layout easier.

## all these DIPs

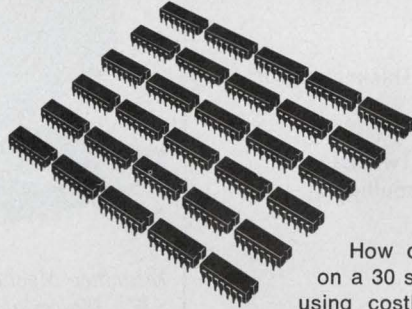

How can you put 30 DIPs on a 30 sq. inch board without using costly multi-layer PCBs?

## go on a 5" x 6" 2-sided PCB

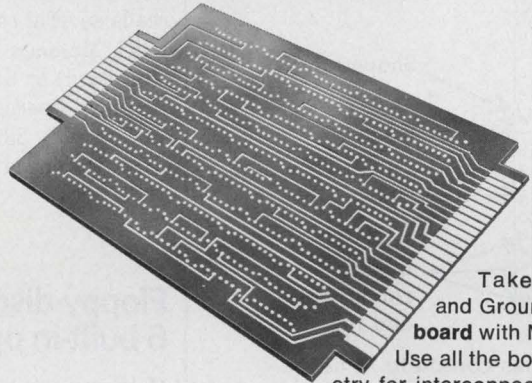

Take Voltages and Grounds off the board with MINI/BUS. Use all the board geometry for interconnecting DIPs.

## like this

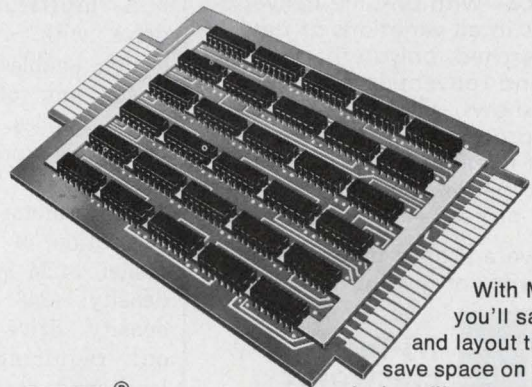

With MINI/BUS, you'll save design and layout time. You'll save space on the board.

And you'll save money — up to half the cost of a typical 4-layer PCB.



Rogers Corporation Chandler, Arizona 85224

Phone: (602) 963-4584

EUROPE: Mektron NV, Ghent, Belgium JAPAN: Nippon Mektron, Tokyo

CIRCLE NUMBER 95



# COST EFFECTIVE FLEXIBLE CABLING ENGINEERED TO YOUR REQUIREMENTS

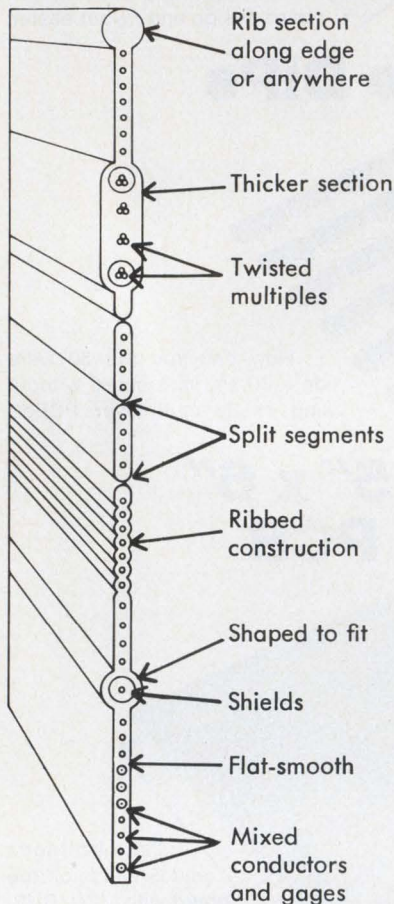

Tri-Tech has complete in-house capability to handle your job from design through tooling, assembly, encapsulation, testing, and final acceptance—with on-time delivery. Specialists in all variations of flat ribbon—etched, polyurethane, silicone and conventional. As diagram shows, unique proprietary molding procedures permit a wide variety of linear and cross-sectional controlled geometry to be designed into your project—all cost effective.

If you have a project under consideration, write or give us a call.



**Tri-Tech  
Electronic  
Corporation**

9480 E. Colonial Dr.  
Orlando, Fla. 32814  
Phone: (305) 277-2131

A subsidiary of Schiller Industries Inc.

CIRCLE NUMBER 96

## DATA PROCESSING

### Equip your system with tomorrow's input device



*Interface Mechanisms, 5503 232nd St. SW., Mountlake Terrace, WA 98043. (206) 774-3511. \$875; 4-8 wks.*

If you equip your system with a scanner, it can read "print" directly and cheaply in the form of bar codes. The  $\mu$ P-based light pen Model 9210 reads several codes: 39, 2 out of 5, and UPC. Message length is 32 characters (standard) or 64 (optional). The Model 9210 can operate in parallel with any on-line RS 232C-equipped terminal. Scanning speed ranges from 3 to 5 in/s.

CIRCLE NO. 387

### Floppy-disc drive has 6 built-in options

*CalComp, 2411 W. La Palma Ave., Anaheim, CA 92801. Russ Paquette (714) 821-2544. \$625; 8 wks.*

A multifunctional floppy-disc drive with a built-in six-position switch enables the user to switch-select any of six built-in operational modes. These include hard or soft sectoring, gating of "write protect" or "ready" with select, stepper motor power control, and separation of data and clock. The Model 142M performs as a single-density (243 kbytes) or double-density drive (650 kbytes)—without requiring additional control logic, and at the price of a single-density unit. The Model 142M is plug-compatible with CalComp's two other floppy disc products, the Models 140 and 142.

CIRCLE NO. 388

### Inexpensive cover protects your discs

*Innovative Computer Products, 18360 Oxnard St., Tarzana, CA 91356. (213) 996-4911. \$5 to \$7.50.*

The PC-15 Protector is a heavy-duty Lexan bottom-cover that protects the vulnerable exposed underplate of 2315-type disc cartridges. Unlike the 5440-type top-loading cartridge, the 2315s are delivered without a built-in bottom cover. The Model PC15 gives support to the armature plate and cone assembly, minimizes the build-up of contaminants, and allows positive stacking during storage. The company also markets a testing device for discs.

CIRCLE NO. 389

### Converted IBM Selectric is heavy-duty terminal

*CPT Corp., 1001 S. 2nd St., Hopkins, MN 55343. (612) 935-0381. \$1700 (25-50); stock-4 wks.*

What looks like an IBM Selectric and types like an IBM Selectric, but isn't? The Rotary II I/O typewriter has an IBM 735 chassis, but many of the innards have been replaced to produce a heavy-duty I/O terminal with a speed of 15 characters/s. The electronic keyboard features four extra keys for special functions or control signals. The interface is available with ASCII characters and RS-232C emulation, including a range of options.

CIRCLE NO. 390

### Line printers mated with DEC, DG minis

*Rianda Electronics, 2535 Via Palma, Anaheim, CA 92801. Les Alberts (714) 995-6552. \$1000 (1); 4 wks.*

Line printer controllers compatible with PDP-11 and Nova computers are available for Data Products, Centronics, Printronix, Tally or equivalent printers. The package consists of one PC board that installs in the computer chassis, a 15-ft cable to the printer, a diagnostic routine (paper tape) and an instruction manual. Inquire for OEM and quantity discounts.

CIRCLE NO. 391



## This $\mu$ C's configuration is mostly up to you

Communication Network Systems, Box 1087, Minnetonka, MN 55343. (612) 933-3420. See text.

A microcomputer consisting of a 63-key keyboard, dual cassette interface, video display of 16 lines by 32 characters from a 128-character set, 4-k bytes of RAM, and 4-k bytes of ROM is priced under \$1000 in small quantities. Assembler, Basic interpreter and scientific calculator mode comprise the software. Other configurations are available: Call CNS for a worksheet to identify your needs.

CIRCLE NO. 392

## Impact printer offers versatility, low price

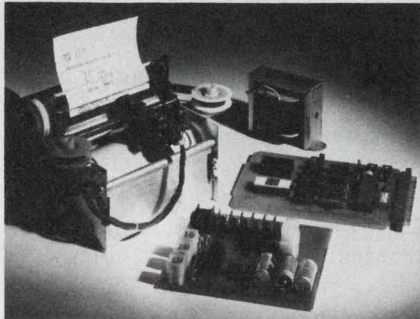

Syntest, 169 Millham St., Marlboro, MA 01752. Curtis Hoffman (617) 481-7827. \$310 (100); stock - 8 wks.

If a 40-column matrix printer satisfies your requirements, the Model SP300 offers much for little. You get the following: a 64-character ASCII subset, with both parallel and series inputs; RS232-C or current loop option; selectable internal/external bit rate clock; print speed of 50 char/s; front and top paper exit, and more. The price includes power supply and all electronics, as well as the compact printer mechanism (9 x 6 x 10 in.).

CIRCLE NO. 393

## Mini disc controller is second-source

Xcomp, 7571 Convoy Ct., San Diego, CA 92111. J. Costello (714) 560-4415. From \$2800; 2-4 wks.

The Model-DC10 disc controller is both hardware and software-compatible with Interdata minicomputer systems, and can be used to replace the M46-444. The controller is installed in one standard I/O slot and operates up to four 2400 rev/min disc drives with 2200 bits/in.

CIRCLE NO. 394



electrocube solutions...

## POLYSULFONE



## WHEN THINGS GET HOT

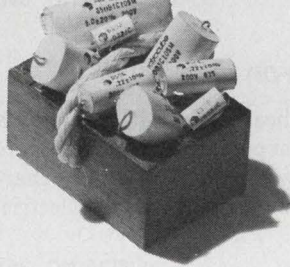

When your application specifies 150°C, specify ElectroCUBE's new Polysulfone capacitors. You have a wide choice of extremely stable units in six case styles ... capacitances from 0.0010 to 50 mfd, and standard ratings to 600 VDC. Get more information today on this miniature series from ElectroCUBE, 1710 So. Del Mar Ave., San Gabriel, California 91776; Tel. (213) 573-3300; TWX: 910-589-1609

CIRCLE NUMBER 97

## NEW! INSTANT FREQUENCY DIFFERENCE!



**Tracor Model 527A measures frequency difference instantly, precisely. For precisely \$2,950.**

Front-panel meter reads directly to parts per 10<sup>11</sup>. Allows adjustment of two oscillators to the same frequency, adjustment to a specific offset, determination of offset — all instantly. Plus both short-term and long-term stability analysis. Internal oscilloscope extends precision to 1 x 10<sup>-12</sup>. Reference and signal frequencies need not be the same. Write or call for full technical and application information.

**Tracor** Industrial Instruments

6500 Tracor Lane • Austin, Texas 78721 • AC 512/926-2800

CIRCLE NUMBER 98



# Available Now!



## MICROPROCESSOR

**BASICS**, edited by Michael S. Elphick. Here's the nitty-gritty on design selected from *Electronic Design* for the eight currently popular microprocessors: 8080, 6800, F8, PACE, IMP, 2650, 1802, and 6100. Each chapter discusses one model, detailing its advantages, disadvantages, architecture, capabilities, and includes many illustrations of its applications. #5763-6 paper 224 pp., \$9.95

## ORGANIZING AND DOCUMENTING DATA PROCESSING INFORMATION,

by Thomas R. Gildersleeve. Write sharp, precise DP documents that command attention. This book will show you how to... prepare a first draft... shape your sentences for reading ease... organize a document for quick study. Filled with examples of great DP writing and scores of exercises for practice. #5739-3 paper, 160 pp., \$7.95

Please send the book(s) checked on 15-day examination. At the end of that time, I will send payment, plus postage and handling, or return the book(s) and owe nothing. On all prepaid orders, publisher pays postage. Prices are subject to change without notice. Offer good in U.S.A. and Canada only.

NAME \_\_\_\_\_

COMPANY \_\_\_\_\_

ADDRESS \_\_\_\_\_

CITY \_\_\_\_\_

STATE/ZIP \_\_\_\_\_

Send to:

**Hayden Book Company, Inc.**  
50 Essex Street, Rochelle Park  
New Jersey 07662

#77-62

## Application notes

### Capacitance measurements

The problems, precautions, and the principle of three-terminal capacitance measurements are contained in a 21-page applications note. Boonton Electronics, Parsippany, NJ

CIRCLE NO. 395

### Computer plotting

Seven case histories documenting computerized mapping applications are presented in a six-page note. Versatec, Santa Clara, CA

CIRCLE NO. 396

### SCR turn-on techniques

An application note provides a thorough explanation of SCR gate terminology, trade-offs and characteristics. Westinghouse Electric, Youngwood, PA

CIRCLE NO. 397

### Laser rangefinder systems

"Laser Rangefinders—Today's Military and Industrial Systems" summarizes the use of laser systems for precision measurement of distances in commercial and military applications. The theory of operation, system constraints and comparison of Nd:YAG to GaAs laser rangefinders are explained and illustrated with graphs and diagrams. International Laser Systems, Inc., Orlando, FL

CIRCLE NO. 398

### Solid-state relays

The theory, performance capabilities and applications for various classes of hybrid and all-solid-state relays are provided in a 48-page handbook. The handbook includes 28 pages of comprehensive reference material, illustrated with typical applications circuits, comparative performance graphs, and parameter diagrams, as well as a comprehensive glossary of special terms. Gordos/Grigsby-Barton Inc., Rogers, AR

CIRCLE NO. 399

## Vendors report

Annual and interim reports can provide much more than financial position information. They often include the first public disclosure of new products, new techniques and new directions of our vendors and customers. Further, they often contain superb analyses of segments of industry that a company serves.

Selected companies with recent reports are listed here with their main electronic products or services. For a copy, circle the indicated number.

**LRC.** Matrix-related printers and printer-related subsystems.

CIRCLE NO. 427

**Information International.** Image analysis, text processing and information recycling.

CIRCLE NO. 428

**The Plessey Co.** Consumer electronics; components; microsystems; radar, avionics and communications; and telecommunications.

CIRCLE NO. 429

**Lloyd's Electronics.** Consumer electronics.

CIRCLE NO. 430

**Ampex.** Audio/video products; magnetic tape; data and memory products.

CIRCLE NO. 431

**Varian.** Electronic devices; instruments; information systems; industrial equipment and medical electronics.

CIRCLE NO. 432

**On-Line Systems.** On-line computers and software.

CIRCLE NO. 433

**Coherent Radiation.** Lasers; laser systems; optics; optical systems, and related accessories and components.

CIRCLE NO. 434

**Hydrometals.** Consumer electronics and hand tools.

CIRCLE NO. 435



# .156 & .200 Centers EDGE CARD Connector .045 SQ. Terminations



Available  
in 4-100  
Bellowform  
Contacts  
for .156 spacing  
4-86 Bellowform  
Contacts for .200 spacing

Write for free sample.  
Specify contact  
quantity

6200-200  WA  
(.156 centers)  
6156-200  WA  
(.200 centers)

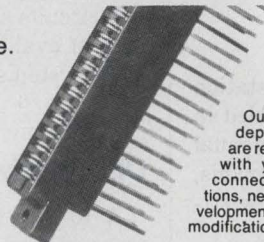

Our engineering  
dept. personnel  
are ready to consult  
with you on your  
connector applica-  
tions, new product de-  
velopment and product  
modification problems.

For our nearest sales office or distributor, see your electronic directory



CONTINENTAL CONNECTOR CORPORATION  
WOODSIDE, NEW YORK 11377 PHONE: (212)899-4422

CIRCLE NUMBER 99

# 19¢\*

ea.

## An integrated bridge rectifier in a miniature dual in-line package

# D I B

## DUAL IN-LINE BRIDGE

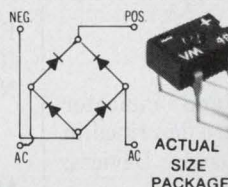

- 4-pin, low-profile DIP
- Leads on standard .10" (2,54 mm) grid
- Compatible with automatic testing, handling and inserting
- 1 Amp at 40°C (I<sub>o</sub>)
- 25V to 1000V (V<sub>RRM</sub>)
- 25A Peak One-Half Cycle Surge (I<sub>FSM</sub>)
- Two devices will fit into standard 14-pin DIP socket
- Moisture resistant epoxy package
- Call Lee Miller 214/272-4551, Ext. 206 for more information.

\* 100V; 100,000 qty.



Design us in . . . we'll stay there  
**VARO SEMICONDUCTOR, INC.**

P.O. BOX 676, 1000 N. SHILOH, GARLAND, TEX. 75040  
(214) 272-4551 TWX 910-860-5178

EUROPEAN OFFICE: UK: VARO SEMICONDUCTOR INTERNATIONAL, INC.  
Deepdene House, Bellegrave Road, Welling, Kent, England DA163PY, 01-304-6519/0

CIRCLE NUMBER 101

FOR HOME AND INDUSTRY  
**EDSYN**  
PRODUCTS

WORLD'S MOST PRACTICAL SOLDER HANDLING TOOLS  
SOLDERING +  
DESOLDERING +  
RESOLDERING =  
**SOLDER Ability** ELEMENTARY  
TO ELITE

## ATMOSCOPE™ DIP EXTRACTOR DE180

**QUADRAMATIC Action**  
allows YOU to remove a DIP  
from SIDES or ENDS with the  
skill of a Surgeon!



Used with the LONER Soldering Instrument to remove 14-16 point DIP (Dual Inline Pin) components from circuit boards. Several types and shapes can be easily removed in seconds, depending on type of tip being used. The DE 180 DIP Extractor can also be used separately as dual axis hand tongs.

contact your local **DISTRIBUTOR** inquiries invited

Covered by U.S. and Foreign Patents and Pending Applications

**EDSYN** 144 PAGE TRAINING MANUAL  
1555 ARMINTA ST. VAN NUYS, CALIF. 91406  
24 HR. PHONES Local (213) 989-2324 L.A. (213) 973-5115  
CABLE EDSYNEX VAN TELEX 65-1469

**NEW! OVER 1,000** ILLUSTRATIONS

**FANVISION**

CIRCLE NUMBER 100

ELECTRONIC DESIGN 9, April 26, 1977



# New literature

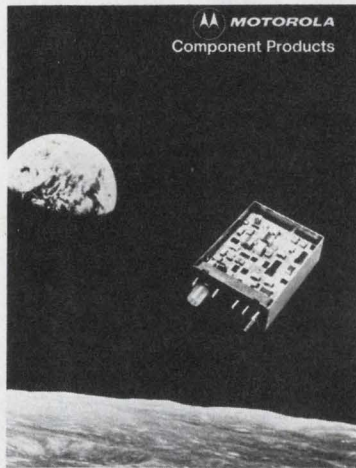

## Components

A booklet outlines the company's frequency-sensitive components and other sophisticated electronic devices. Motorola Component Products, Schaumburg, IL

CIRCLE NO. 409

## Indicator lights

Off-the-shelf pilot and indicator lights and accessories are described in a 12-page catalog. Industrial Devices, Edgewater, NJ

CIRCLE NO. 410

## Keyboard pads

Two bulletins describe the company's keyboard code outputs and legend capabilities. Grayhill, La Grange, IL

CIRCLE NO. 411

## 5-1/2-digit multimeter

Detailed information on the Model 5100 5-1/2-digit multimeter's capabilities and functions are contained in a brochure. Dana Laboratories, Irvine, CA

CIRCLE NO. 412

## Circuit breakers

Photographs, dimensional drawings, delay curves, charts, specifications, and typical applications of magnetic circuit breakers are contained in a 12-page bulletin. Airpax Electronics, Cambridge, MD

CIRCLE NO. 413

## Instruments

A condensed catalog is prefaced by a selection chart, summarizing the instruments offered by listing their various ranges—resistance, capacitance, and inductance—together with their test frequencies and basic accuracies. Electro Scientific Industries, Portland, OR

CIRCLE NO. 414

## Coil winding equipment

A complete compilation of coil winding equipment is featured in a 52-page catalog. Geo. Stevens Mfg., Chicago, IL

CIRCLE NO. 415

## CRT display station

The HP 2654A CRT display station and its many features are detailed in an 84-page user's manual. The manual is illustrated with photos, diagrams, tables and sample displays. Hewlett-Packard, Palo Alto, CA

CIRCLE NO. 416

## CMOS ICs

A 24-page product guide describes RCA's B series of CMOS high-voltage ICs. RCA Solid-State Div., Somerville, NJ

CIRCLE NO. 417

## Motors, gearmotors

A 32-page catalog groups more than 425 motors and gearmotors by frame size (output capabilities), and then within each group—according to electrical type. Bodine Electric, Chicago, IL

CIRCLE NO. 418

## All-metal packages

A 125-page catalog contains photographs, engineering drawings, and specifications for the company's flat-packs, plug-ins, dual in-lines, automatic insertion dips, standard headers, and microwave modules. Isotronics, New Bedford, MA

CIRCLE NO. 419

## Specialty materials

"Advanced Materials for Electronics," a 126-page catalog, features specialty materials for the electronics industry. Transene Co., Rowley, MA

CIRCLE NO. 420

## Data-conversion products

Data-conversion products are highlighted in a 20-page short-form catalog. Micro Networks, Worcester, MA

CIRCLE NO. 421

## Relays

Specifications, selection data, dimensional drawings and wiring diagrams on the company's relays are included in a 56-page catalog. Magne-craft Electric, Chicago, IL

CIRCLE NO. 422

## MOS/LSI microcircuits

A 16-page catalog describes MOS/LSI circuits and includes a cross-reference of available second sources. SMC Microsystems, Hauppauge, NY

CIRCLE NO. 423

## OEM hardware, software

A 16-page brochure with four processor product bulletins describes products for OEMs. Interdata, Oceanport, NJ

CIRCLE NO. 424

## Tracking pedestals

Applications and specifications for tracking pedestals and servo-control products are described in a 44-page brochure. A glossary of tracking-system definitions, formulas and wind-loading charts for various sizes of antennas are also included. Scientific-Atlanta, Atlanta, GA

CIRCLE NO. 425

## Instrument rentals

A 52-page catalog contains full specifications, monthly rental rates and model numbers on more than 800 instruments. Continental Rentals, Bedford, MA

CIRCLE NO. 426

## $\mu$ P Bibliography

Looking for a reference of major articles about microprocessors? Search no more. Technical Index Services has just started a publication called "A Microprocessor Bibliography" that provides over 275 articles and paper references in its first issue. The bibliography costs \$5 and can be ordered directly from Technical Index Services, Dept. ED, 2635 Merrywood Rd., Charlotte, NC 28210.

INQUIRE DIRECT



## Ing./Cand. real./ Sivilingeniører

Norsk Data A.S. utvikler, produserer og markedsfører NORD-datamaskiner. Vi er 200 ansatte.

Utviklingsavdelingen har som oppgave å utvikle ny hardware og software for Nord datamaskinsystemer. Vi har ansvaret for utviklingen fra systemspesifikasjon frem til de første leveransene til kunder.

Vi søker ingeniører, cand. real. og sivilingeniører til

### HARDWARE UTVIKLING

Våre nye medarbeidere vil få utviklingsoppgaver innen et eller flere av følgende områder:

- datamaskin sentralenheter
- datakommunikasjon
- masselagersystemer
- testprogrammer

Vi har fleksibel arbeidstid, og synes selv at vi har et hyggelig miljø.

Ring Bård Sørbye for mer informasjon, eller send oss en søknad.

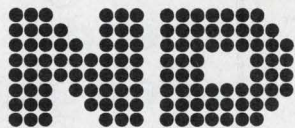

**NORSK DATA A.S.**

Lørenveien 57, Postboks 163 Økern, Oslo 5. Tlf. 21 73 71

CIRCLE NUMBER 102

# Free!

## Aluminum Electrolytic Computer Grade Catalog

Here's the 18-page catalog that lists what we feel are the finest quality computer grade capacitors available today. Find out yourself. You'll be glad you did.

### OTHER PRODUCTION ITEMS

INCLUDE: Ceramic capacitors, electrolytic capacitors, film capacitors, oil-filled capacitors—without P.C.B., and metallized-paper capacitors.



NICHICON AMERICA CORPORATION  
Division of NICHICON CAPACITOR LTD., Kyoto, Japan  
6435 N. Proesel, Chicago, Ill. 60645 (312) 679-6530

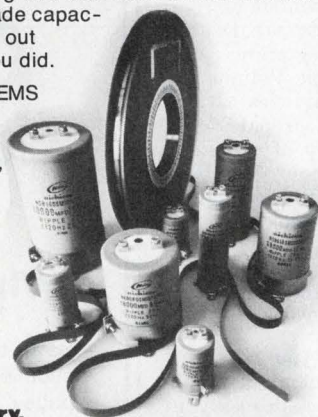

CIRCLE NUMBER 103

ELECTRONIC DESIGN 9, April 26, 1977

## Want A Safer Product And Lower Manufacturing Costs Too?

On the one  
hand choose the  
**MICROTEMP®**  
thermal cutoff

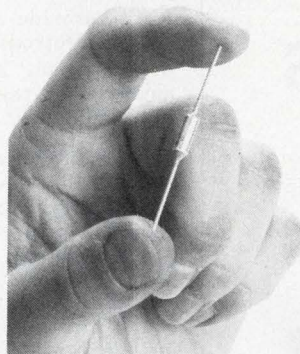

On the other  
hand, don't  
overlook the new  
**PICOTEMP**  
thermal cutoff

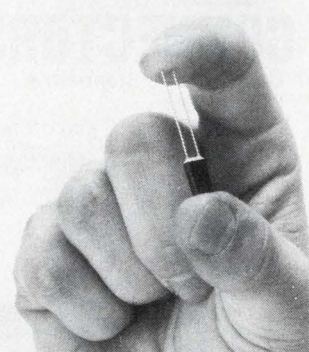

A reliable, accurate easy to install, "one shot" thermal limiter.

- temperature tolerance— $\pm 1.7^{\circ}\text{C}$ .
- temperature ratings— $58^{\circ}$  to  $242^{\circ}\text{C}$ . ( $136^{\circ}$  to  $468^{\circ}\text{F}$ .)
- current capacity—up to 30 amps at 240 VAC.
- compact—diameter, .157"; length, .457" (exclusive of leads).
- economical
- easy to install—assorted terminations, mounting packages and insulations available.
- Recognized under the Component Program of Underwriters' Laboratories, Inc. UL File #E40667A. CSA approved. BSI Certificate #5041 approved. Recognized by MITI and VDE. Military approval.

Used where installation or space restrictions rule out MICROTEMP® thermal cutoffs.

- temperature tolerance— $+0^{\circ}\text{C}$ .— $-3.3^{\circ}\text{C}$ .
- temperature ratings— $63^{\circ}$  to  $150^{\circ}\text{C}$ . ( $146^{\circ}$  to  $300^{\circ}\text{F}$ .)
- current capacity—to 5 amps. at 120 VAC. Will hold this rating up to and including 240 VAC.
- compact—.236" x .389" x .087/.104" (exclusive of leads).
- economical
- Package is completely insulated, leads are 26 gauge silver plated wire.
- Recognized under the Component Program of Underwriters' Laboratories, Inc. UL File #40667A. MITI approved. CSA approved.

Both devices are completely sealed against the atmosphere. Because of their unique design and construction, they won't derate. And they're unaffected by age or extended use. You not only get positive, yet low cost protection against malfunctions in circuits and components caused by equipment failure or user abuse, but you eliminate costly and unnecessary service calls caused by nuisance tripping.

PICOTEMP or MICROTEMP? Which is best? Depends on your needs. Tell us about them.



**MICRO DEVICES**

DIVISION OF EMERSON ELECTRIC CO.  
1881 SOUTHTOWN BLVD.  
DAYTON OH 45439 513-294-0581

See us in Booth 1344 at the Design Engineering Show

CIRCLE NUMBER 104



# USC's UMI most compact ULTRA MINIATURE CONNECTORS

7 UMI Series -- Standard &  
Closed-Entry  
MIL-C-28748/7, 8 and others.

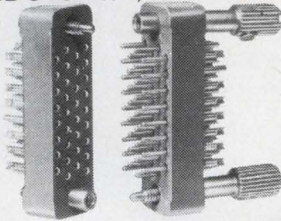

Highest reliability -- proved in Gemini/Apollo flights! 1 of over 20,000 types of connectors. Write or phone for UMI Series catalog -- today!

## U.S. COMPONENTS, INC.

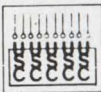

Leader in advanced engineering & design  
1320 Zerega Avenue, Bronx, N.Y. 10462  
(212) 824-1600 TWX: 710-593-2141  
Cable: COMPONENTS, NYK

CIRCLE NUMBER 105

# Sabor presents the **NEW** SONY® Instrumentation Cassette Recorder

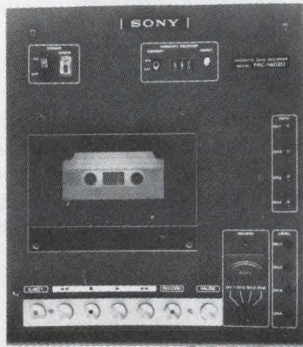

The new Sony FRC-1402 D provides 4 FM data channels with a frequency response of DC to 625 Hz. S/N ratio has been increased to 50 dB! Remote control is available.

Price \$2,250

12597 Crenshaw Blvd.  
Hawthorne, CA 90250  
(213) 644-8689

## Sabor corporation

CIRCLE NUMBER 106

# Electronic Design

ELECTRONIC DESIGN's function is:

- To aid progress in the electronics manufacturing industry by promoting good design.
- To give the electronic design engineer concepts and ideas that make his job easier and more productive.
- To provide a central source of timely electronics information.
- To promote communication among members of the electronics engineering community.

**Want a subscription?** ELECTRONIC DESIGN is sent free to qualified engineers and engineering managers doing design work, supervising design or setting standards in the United States and Western Europe. For a free subscription, use the application form bound in the magazine. If none is included, write to us direct for an application form.

If you do not qualify, paid subscription rates are as follows: \$30.00 per year (26 issues) U.S., \$40.00 per year (26 issues) all other countries. Single copies are \$2.00 U.S., \$3.00 all other countries. The Gold Book (27th issue) may be purchased for \$30.00 U.S. and \$40.00 all other countries.

**If you change your address,** send us an old mailing label and your new address; there is generally a postcard for this bound in the magazine. You will have to requalify to continue receiving ELECTRONIC DESIGN free.

**The accuracy policy** of ELECTRONIC DESIGN is:

- To make diligent efforts to ensure the accuracy of editorial matter.
- To publish prompt corrections whenever inaccuracies are brought to our attention. Corrections appear in "Across the Desk."
- To encourage our readers as responsible members of our business community to report to us misleading or fraudulent advertising.
- To refuse any advertisement deemed to be misleading or fraudulent.

Microfilm copies are available of complete volumes of ELECTRONIC DESIGN at \$19 per volume, beginning with Volume 1, 1952 through Volume 20. Reprints of individual articles may be obtained for \$3.00 each, prepaid (\$.50 for each additional copy of the same article) no matter how long the article. For further details and to place orders, contact the Customer Services Department, University Microfilms, 300 North Zeeb Road, Ann Arbor, Michigan 48106 telephone (313) 761-4700.

**Want to contact us?** If you have any comments or wish to submit a manuscript or article outline, address your correspondence to:

Editor  
ELECTRONIC DESIGN  
50 Essex Street  
Rochelle Park, N.J. 07662

## classified ad

### Sr. CB Design Engineer

Excellent opportunity with progressive consumer electronics corporation. Design complete receiver and transmitter circuits. Must have PLL and IC Circuitry design exp. Prefer 3 to 5 years in the CB field. Send resume or call personnel collect.

Fanon/Courier Corporation  
990 South Fair Oaks  
Pasadena, CA 91105  
213/441-3101

## Help your Heart... Help your Heart Fund

American Heart Association



## KEEP

Electronic Design's

# GOLD BOOK HANDY

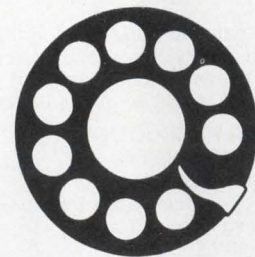

## When You Call

Save time when you contact suppliers. Check their catalog pages first in *Electronic Design's* GOLD BOOK. Maybe the information you need is right at your fingertips.



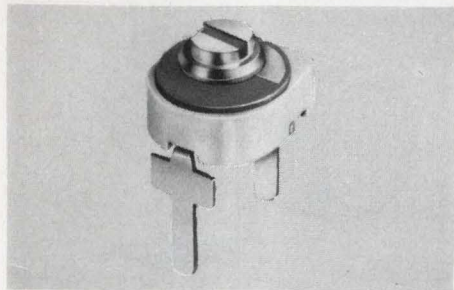

**MINIATURE CERAMIC TRIMMER CAPACITORS** 9371 series of ceramic trimmer capacitors are compact, economical and rugged. They are 50% smaller than other trimmers of this type yet provide high capacitance values. Available in 4 capacitance ranges, 1.5 to 4, 3.0 to 10, 3.5 to 18 and 5.0 to 25 pf with Q's > 300 at 10 MHz. They have an overall diameter of .225" with .215" above board height. JOHANSON MANUFACTURING CORPORATION, Rockaway Valley Road, Boonton, N.J. 07005 201-334-2676  
TRIMMER CAPACITORS **181**



**MAGNETIC SHIELDING** Take advantage of Eagle's 23-year background in shield design and production. Custom and standard models. Full service includes design, engineering, fabrication, heat treating, finishing, testing. Also wide selection of sheet and foil so you can form your own shields. For helpful design and cost data, request Bulletin E-77. Eagle Magnetic Co., Inc., Box 24283, Indianapolis, IN 46224, 317-297-1030.  
MAGNETIC SHIELDING **184**

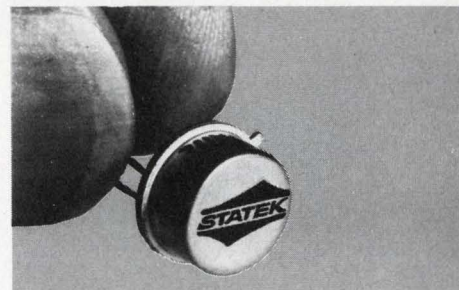

**Don't count down.** Use SX-1 10 kHz - 300 kHz Quartz Crystals \* 18 stock frequencies \* 0.185" high TO-5 \* 1000g shock \* \$2.00 ea. in 1000 qty. ( $\pm$  0.01% accuracy) \* Details in Gold Book & EEM \* STATEK CORP. \* 1233 Alvarez Ave. \* Orange, Calif. 92668 \* (714) 639-7810 \* Telex 67 8394  
QUARTZ CRYSTALS **187**



**Low-cost tape reader is fast**—up to 300 cps—and quality-built. Dual sprocket drive, a state-of-the-art fiber optic light source and photo transistor read head. Simplicity of design makes it easy to adapt to specific OEM requirements. Decitek, 250 Chandler Street, Worcester, MA 01602 (617) 798-8731  
SAM® TAPE READER **182**



**INTEGRITY AND RECOVERY IN COMPUTER SYSTEMS**, by T. K. Gibbons. Here is a step-by-step guidebook that places at your fingertips all the techniques and strategies you need for locating and correcting errors and failures and for re-establishing complete system integrity and reliability as quickly as possible. #5454-8, 144 pp., \$9.95. Circle the Info Retrieval Number to order your 15-day exam copy. When billed, remit or return book with no obligation. Hayden Book Co., 50 Essex St., Rochelle Park, N.J. 07662.  
INTEGRITY & RECOVERY **185**

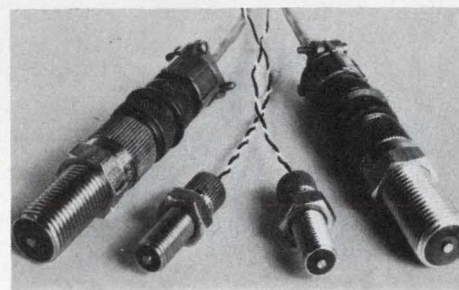

**Magnetic pickups, digital transducers & fast delivery.** Airpax manufactures a broad, standard line of high quality, magnetic pickups and digital transducers. So, we can deliver off the shelf. And because our designs are flexible, we can handle unusual applications fast and economically. For catalogs, tech specs and price information, write: Airpax, Controls Division, 6801 W. Sunrise Blvd., Fort Lauderdale, Fla. 33313  
MAGNETIC PICKUPS **188**

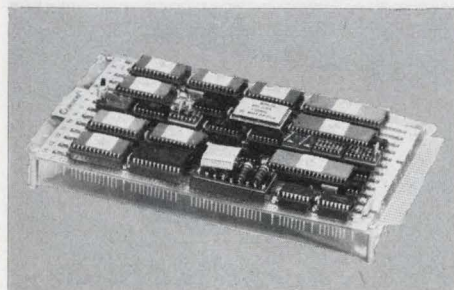

**MICROPROCESSOR BOARD FOR MOTOROLA M6800 EVALUATION CHIP SET.** \$197.50 from CAMBION distributors. Pre-wired board saves hours interconnecting M6800 evaluation kit. Wire-Wrap® tool and precut wires for circuit changes included plus circuitry and components to interface with teletype machine, pre-wired sockets for three more MC6810L, connections for 12 more IC's, instructions and hardware. Cambridge Thermionic Corp., 445 Concord Ave., Cambridge, MA 02138.  
MICROPROCESSOR BOARD **183**



**MEMODYNE INCREMENTAL LOW POWER DATA LOGGER Model 2221**, is ideal for remote or unattended collection of sporadic measurements. Features 16 channels, 0 to +10 volt analog input, 12 bit resolution, over 2 megabit capacity per 300 foot cassette. Standby current is less than 50 microamps. Available for line or battery operation. Unit price is \$1670.00. Memodyne Corporation, 385 Elliott Street, Newton Upper Falls, Massachusetts, 02164. (617) 527-6600.  
LOW POWER DATA LOGGER **186**

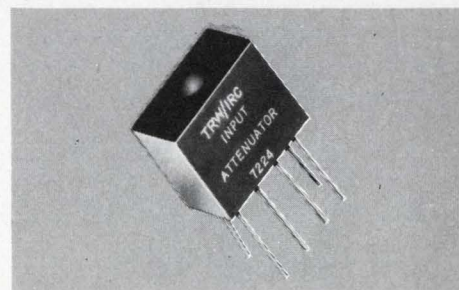

**AR Ultra-Precision Resistor Networks** from TRW provide maximum environmental protection. They feature lower effective cost, high density packaging, and all-welded construction. And, the AR Matched Resistor Sets provide ultra-precision performance at the lowest possible cost. TRW/IRC Resistors, an operation of TRW Electronic Components, 401 N. Broad St., Phila., Pa. 19108. (215) 922-8900.  
AR MODULES **189**



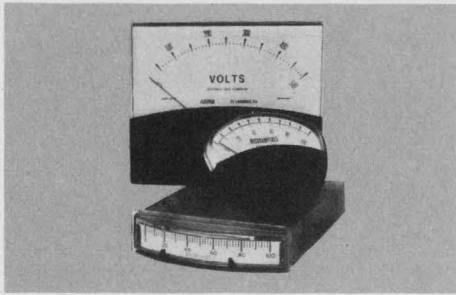

**Four week delivery on custom meters.** And even faster delivery on our standard line of dependable panel and edge reading meters. Variety of ranges, extremely compact design and easy mounting. Versatile enough to handle any number of function control applications. For catalogs, tech specs and price information, write: Airpax, Controls Division, 6801 W. Sunrise Blvd., Fort Lauderdale, Fla. 33313

INDICATING METERS

190

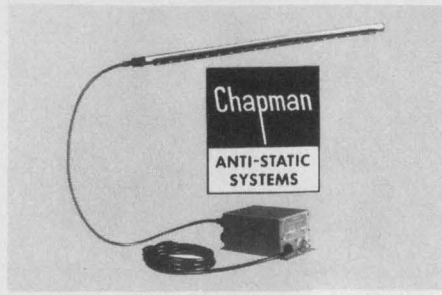

**ANTI-STATIC SYSTEMS FOR PRINTERS, OCR COM and other machines.** Static causes rapidly moving paper and film to jam. . . cause arc tracks on undeveloped film. . . attract and hold dust to photographic negatives causing imperfections on printed circuit boards. Numerous products, of interest to both OEM and user, are detailed in new 32 page catalog to solve these problems quickly, reliably and economically. Chapman Anti-Static Div., Portland Co., 58 Fore St., Bx 427, Portland, ME 04112. (207) 773-4726

ANTI-STATIC SYSTEMS

193

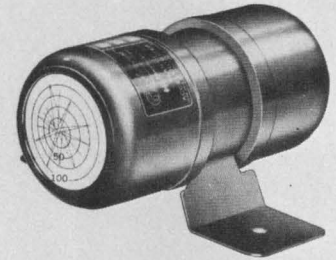

**RECORDS ACCELERATION AND SHOCK** . . . Low cost, sensitive Accelograph™ simultaneously monitors and permanently records acceleration and low frequency shock in all directions within a given plane. No power or electronics needed. Stylus traces acceleration on replaceable recording disc that can be resurfaced in field. Ranges of 1-50G. Ideal for shipping containers to record abuse in transit, monitor dynamic vehicle tests. Humphrey, Inc., 9212 Balboa Ave., San Diego, CA 92123. (714) 565-6631

SHOCK RECORDER

196

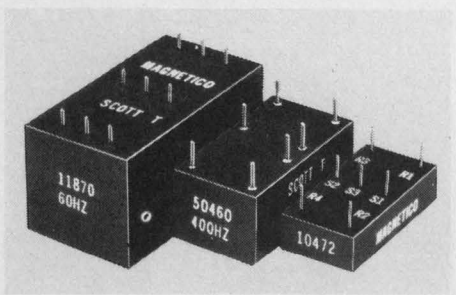

**Scott T Transformer.** 11870: 60HZ, 90v, L-L in. 1.1x2.1x1.1. 50460: 400 HZ, 90v, L-L in. 7/8x1.5/8x11/16. 50642: 400HZ, 11.8v, L-L in. 7/8x5/8-11/16. 10472: 400-HZ, 11.8v, L-L in. 3/4x1.1/2x3/8. All with 6v RMS sine & cosine output. MAGNETICO, INC., 182 Morris Ave., Holtsville, N.Y. 11742 516-654-1166.

TRANSFORMER

191

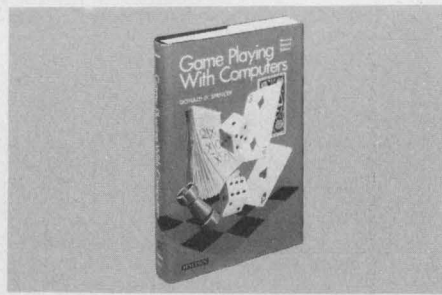

**GAME PLAYING WITH COMPUTERS, Revised Second Edition,** by Donald D. Spencer. This volume presents over 70 games, puzzles, and mathematical recreations for a digital computer. The reader will also find brand-new "how to" information for applying mathematical concepts to game playing with a computer. #5103-4, 320 pp., \$16.95. Circle the Info Retrieval Number to order your 15-day exam copy. When billed, remit or return book with no obligation. Hayden Book Co., 50 Essex St., Rochelle Park, N.J. 07662.

GAMES-PLAYING GUIDE

194



**FLUORESCENT PHOTOELECTRICS. TRAN-BAL INVERTER BALLAST;** allows designer to utilize fluorescent lamp for long photoelectric light source by eliminating flicker associated with 60 Hz Operation. Models available for all lamps through 40 watts. Input voltage 12 to 48 v.d.c. The Bodine Co., 236 Mt. Pleasant Road, Collierville, TN (901) 853-7211

FLUORESCENT PHOTOELECTRONICS 197



**Free New '77 catalog** contains over 34,500 quality power supplies from the world's largest manufacturer, Power/Mate Corp. Power Supplies for every application including submodulars, open frame, variorated, encapsulated, laboratory & system. All units UL approved and meet most military and commercial specs for industrial and computer uses. Power/Mate Corp., 514 S. River St., Hackensack, NJ 07601 (201) 343-6294

POWER SUPPLIES

192

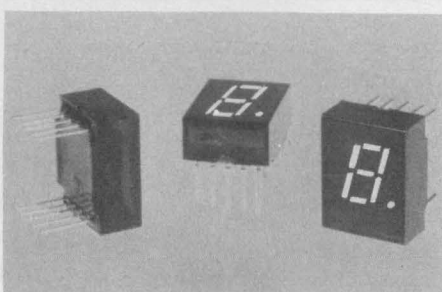

**NEW .5" HIGH LED DISPLAYS FROM IEE** Series 1786 thru 1789 consist of .5" (12.70mm) high, deep red characters, 0-9 with right hand decimal and ±1; available in common cathode and common anode with typical 600μcd/segment luminous intensity at 20mA/1.7V. Ten horizontal in-line pin connections on .1" spacing; socket or PC board mounting; Interchangeable with Fairchild Models FND500 and FND-507. Price \$1.15 ea in 500. quan. Shelf stocked. IEE, 7740 Lemona Ave., Van Nuys, CA 91405, (213) 787-0311, ext. 268.

.5" LED DISPLAYS

195

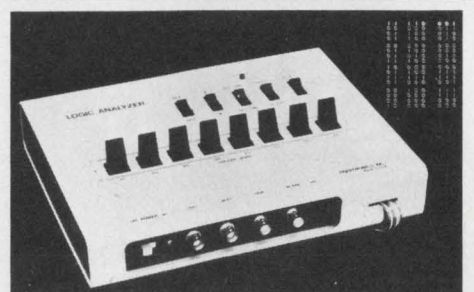

**LOW COST LOGIC ANALYZER.** The Model 100A offers the following advanced features: 8 x 16 truth table display • Pre-trigger & post-trigger data capture • Static and dynamic displays in HEX or OCTAL • Compatible with most oscilloscopes • Operates at data rates up to 8MHz • Expandable to 24 bits • Includes 100-page application manual. **PRICES: ASSEMBLED — \$259.00; KIT — \$189.00.** (Add 5% for U.S. shipping; 10% foreign.) Paratronics, Inc., Dept. ED, 800 Charcot Ave., San Jose, CA 95131. (408) 263-2252

LOGIC STATE ANALYZER

198



# Electronic Design

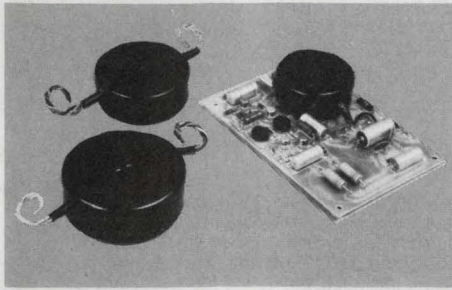

**AVEL-LINDBERG toroidal transformer** offers many electrical and mechanical advantages combined in attractive, uniform presentation in the range of standard power transformers. Toroids also have 50% less weight and volume; a lower height profile for slimline electronics and an incredible 8:1 lower radiated interference field. See Avel-Lindberg at Electro 77 Booth 2113 or circle distributor list.

VISIT OUR BOOTH #2113 AT IEE 199

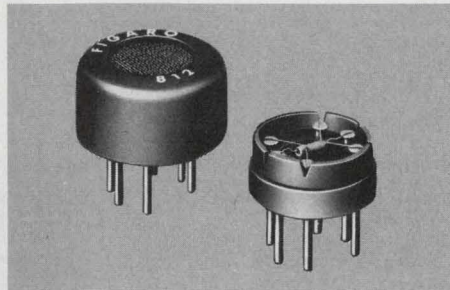

**FIGARO GAS SENSOR TGS** is a gas sensitive semiconductor. When combustible gas is absorbed on the sensor surface, a marked decrease of electrical resistance occurs. Major features of the sensor include high sensitivity, long term reliability and low cost. The applications are: GAS-LEAK ALARM, AUTOMATIC FAN CONTROL, FIRE ALARM, ALCOHOL DETECTOR, etc. Figaro Engineering Inc., North America Office-3303 Harbor Boulevard, Suite D-8, Costa Mesa, Calif. 92626 Tel: (714) 751-4103 Telex: 678396  
GAS SENSOR 202

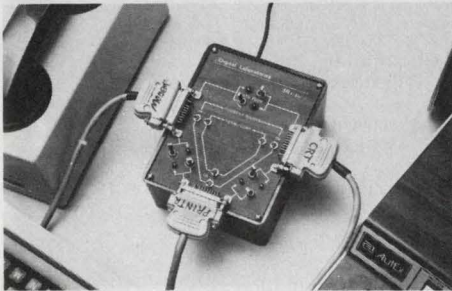

**UNIVERSAL JUNCTION UNIT . . .** for three devices, RS232C or current loop.

. . . Six switches provide all 63 interconnects that are possible between three I-O devices. LED's indicate data flow. . . . Designed to provide circuit compatibility and easy data routing between different manufacturer's devices. . . . \$350 (1-4) from DIGITAL LABORATORIES, 600 Pleasant St., Watertown, MA 02172 (617) 924-1680

3 PORT RS232 & 20 MA LOOP 200

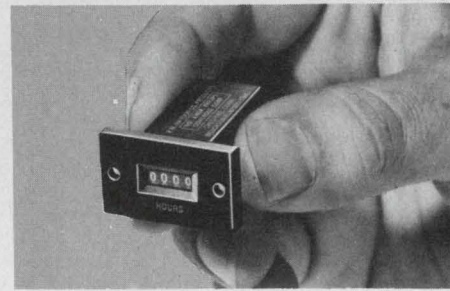

**ELAPSED TIME INDICATOR** Microminiature. Series 49200. One of smallest direct digital ETI's on the market. Only 37/64" sq by 1-1/2" long. 4-digit hourly readout clearly legible. Uses 1W synchronous motor, 115V ac, 60 Hz. Accuracy  $\pm 1\%$  or  $\pm 1$  hr., whichever is greater. Where size is important, one of your best buys anywhere. 7 standard mounting styles available. North American Philips Controls Corp., Cheshire, Conn. 06410. (203) 272-0301.

ELAPSED TIME INDICATOR 203

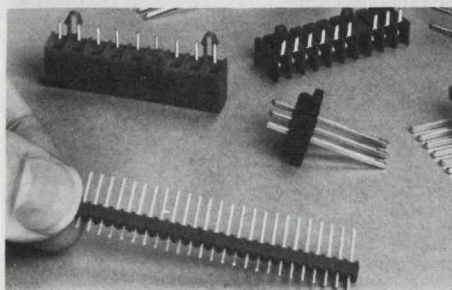

**NEW FAMILY OF MINIATURE TERM-ACON SERIES CONNECTORS** will solve majority of PC board interconnect problems. Moderately priced reliable designs for .100", .200" and .156" center pin spacings for hi-density to general purpose usage. U/L flame retardant Nylon material conforms to MIL-STD-202E. Polyester 94V-0 rated connectors are also available. METHODE ELECTRONICS, INC., 1700 Hicks Road, Dept. PR, Rolling Meadows, Illinois 60008. (312) 392-3500.

PC BOARD CONNECTORS 201

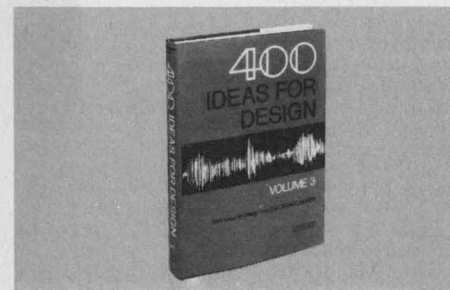

**400 IDEAS FOR DESIGN, Volume 3**, ed. by Morris Grossman. Brainstorm with the experts! Volume 3 of 400 IDEAS FOR DESIGN contains the best selections from *Electronic Design* that were published between 1971 and 1974. You'll find a wide range of ideas from very complicated to simple, but unique, approaches. #5111-5, 348 pp., \$13.95. Circle the Info Retrieval Number to order your 15-day exam copy. When billed, remit or return book with no obligation. Hayden Book Co., 50 Essex St., Rochelle Park, N.J. 07662.

IDEAS FOR DESIGN 204

## Advertising Sales Staff

Tom W. Carr, Sales Director  
Jean Bunfield, Sales Coordinator

## Rochelle Park, NJ 07662

Robert W. Gascoigne  
Daniel J. Rowland  
Thomas P. Barth  
50 Essex St.  
(201) 843-0550  
TWX: 710-990-5071

## Philadelphia

Thomas P. Barth  
(201) 843-0550

## Boston 02178

Gene Pritchard  
P.O. Box 379  
Belmont, MA 02178  
(617) 489-2340

## Chicago 60611

Thomas P. Kavooras  
Berry Conner, Jr.  
200 East Ontario  
(312) 337-0588

## Cleveland

Thomas P. Kavooras  
(312) 337-0588

## Los Angeles 90045

Stanley I. Ehrenclou  
Burt Underwood  
Neil Canavin  
8939 Sepulveda Blvd.  
(213) 641-6544

## Texas

Burt Underwood  
(213) 641-6544

## San Francisco

Robert A. Lukas  
3579 Cambridge Lane  
Mountain View, CA 94040  
(415) 965-2636

## England

Constance McKinley  
50 Essex St.  
Rochelle Park, N.J. 07662  
Phone: (201) 843-0550

## Europe

Sanders, W. J. M.  
Raadhuisstraat 24  
Graft-De Ryp, Holland  
Phone: 02997-1303  
Telegrams: Euradteam-Amsterdam  
Telex: 13039-SIPAS

## G. Nebut

Promotion Presse Internationale  
7 ter Cour des Petites Ecuries  
75010 Paris, France  
Telephone: 5231917, 1918, 1919

## Dieter Wollenberg

Erikastrasse 8  
D-8011 Baldham/Muenchen  
Germany  
Telephone: 0 8106/4541  
Telex: 5215532 auri d

## Tokyo

Haruki Hirayama  
Electronic Media Service  
5th Floor, Lila Bldg.,  
4-9-8 Roppongi  
Minato-ku, Tokyo, Japan  
Phone: 402-4556  
Cable: Electronicmedia, Tokyo









This year SONIMAG will be the hot spot for Electronics in  
BARCELONA (Spain) of



EUROPE, AFRICA AND AMERICA

## SONIMAG

In a splendorous place full of facilities for the purchaser and the visitor, offers to all companies devoted to electronics the wide possibilities for the opening of international markets.

30.000 sq. m of professional electronics exhibit, electronic components, consumer electronics, communication and audiovisual means are the sectors which form the big ensemble for the specialized show SONIMAG, and the new EQUIPTRONICA sector of equipment for electronics.

Information: Apply to SONIMAG, Av. M.<sup>a</sup> Cristina, Palacio n.º 1, Barcelona-4 (España)

CIRCLE NUMBER 107

**25 AMP.**  
50 to 1000 PRV

**.250**  
QUICK-CONNECTS

**edi** MINIBRIDGE<sup>®</sup>

**FREE SAMPLE**

# RECTIFIER BRIDGES

**PB Series!** 300 Amp. surge, 1,500V RMS dielectric strength  
U.L. Component Recognition. Lots of features. Competitively priced. Write or use Inquiry Number for O.E.M. application card for free samples and condensed catalog of bridges.

**edi**<sup>®</sup> Buy from the specialist  
**electronic devices inc.**  
21 GRAY OAKS AVE., YONKERS, N.Y. 10710  
(914) 965-4400, TWX 710 560-0021

For application information, call Toll Free: 800 431-1532

CIRCLE NUMBER 108

ELECTRONIC DESIGN 9, April 26, 1977

# Buzzzz.

(Write for new catalog.)

**REDUCED**  
Prices Reduced as of April 1, 1977

Solid state electronic MICRO-BUZZER from CITIZEN: High reliability, competitively priced with immediate delivery.

A complete range: **SMB** 1.5, 6, 12, 24, VDC  
**RMB** 3, 6, 12, 24, VDC  
**IMB** (Intermittent) 6, 12, VDC

## CITIZEN

CITIZEN AMERICA CORPORATION

Name \_\_\_\_\_  
Company \_\_\_\_\_  
Address \_\_\_\_\_  
City \_\_\_\_\_ State \_\_\_\_\_  
Zip \_\_\_\_\_ Phone \_\_\_\_\_

Toll Free (800) 421-6516  
In Calif. (213) 829-3541  
TWX: (910) 343-6450

CIRCLE NUMBER 109



# Product index

**Information Retrieval Service.** New Products, Evaluation Samples (ES), Design Aids (DA), Application Notes (AN), and New Literature (NL) in this issue are listed here with page and Reader Service numbers. Reader requests will be promptly processed by computer and mailed to the manufacturer within three days.

Category	Page	RSN	Category	Page	RSN	Category	Page	RSN
<b>Components</b>			bridges			connector, card-edge		
capacitor catalog	153	103	chip, DVM	124	306	connector, card-edge	135	78
capacitors	149	97	Darlington, power	123	321	connector, card-edge	147	93
contacts	143	89	diodes, ion-implanted	126	323	connector, ribbon-cable	111	246
display alphanumeric	1	2	dual-in-line bridge	151	101	connectors	9	6
gas plasma panels	19	15	electro-optics	121	68	connectors	154	105
indicator lights	139	364	IC converters	15	10	cord holder	145	382
LED, high-intensity	140	368	integrated circuits	31	23	DIP extractor	159	108
micro buzzers	159	109	LED indicators	138	83	desoldering tool	144	379
potentiometers	21	17	LEDs	89	48	drafting supplies	85	47
relay, ss time-delay	141	371	line drivers and receivers	5	11	ferrites	113	63
relays, solid-state	2	3	memory, CCD	126	325	flat cable	53	36
resistor	17	13	multipliers, digital	127	328	flexible cable	148	96
resistor networks	58	39	op amp, compensated	127	327	flexible circuits	125	70
resistor networks	139	365	peripheral drivers	34	26	interconnections	91	296
resistor networks	141	369	RAMs, family	126	324	magnetic material	145	384
resistors, HV	139	84	rectifier bridges	151	100	multi-outlet strips	143	87
solenoids	140	366	transistors, power	126	326	photoconductive material	140	85
switch/relay	144	90	transistors, silicon	41	29	ribbon cable	147	94
switches	135	79	zeners	54	37	terminal boards	143	88
switches, PB	45	31	<b>Microwaves &amp; Lasers</b>			wire, cable and cord	101	400
switches, snap-action	99	53	microwave transistors	141	86	X-Y positioner	144	380
switches, thumbwheel	141	370	<b>Micro/Mini Computing</b>			<b>Power Sources</b>		
switches, toggle	139	363	boards, expansion	133	342	batteries	117	66
thermal cutoff	153	104	board, processor	133	343	converter, dc/dc	142	372
transformers	119	67	cassette recorder	154	106	inverter, dc/ac	142	373
trimmers	11	245	computer products	83	46	line suppressor	142	376
yokes	135	80	controller, plotter	134	344	power supply, dc	142	375
<b>Data Processing</b>			language, development	133	341	power supplies	6	4
bar-code reader	148	387	memories	80	44	programmable power supplies	48	33
data printer	148	390	microcomputer	32	24	<b>new literature</b>		
data rate converter	146	386	microcomputer	149	392	all-meter packages	152	419
floppy disc	146	310	microcomputer, complete	132	340	CMOS ICs	152	417
floppy-disc drive	148	388	microcomputers	26	21	CRT display station	152	416
intelligent terminal	146	385	printers, line	132	338	circuit breakers	152	413
interface, printer	148	391	printers, line	134	346	coil winding equipment	152	415
40-column printer	149	393	program, editor	132	339	components	152	409
<b>Instrumentation</b>			system, floppy-disc	134	347	data-conversion products	152	421
DMM, 5-1/2-digit	79	43	terminal, hardcopy	134	345	indicator lights	152	410
DMMs	51	291	thermal numeric printers	16	12	instrument rentals	152	426
DMMs	110	61	MC-based systems	95	52	instruments	152	414
DPMs	20	16	<b>Modules &amp; Subassemblies</b>			keyboard pads	152	411
DPMs	23	19	a/d, companding	128	302	MOS/LSI microcircuits	152	423
DVM	137	357	amp, audio	130	331	motors, gearmotors	152	418
interface	138	361	analog I/O systems	43	30	OEM hardware, software	152	424
interface bus	47	171	converter, a/d	130	332	relays	152	422
OEM components	35	27	converter, d/a	130	337	specialty materials	152	420
photometer/radiometer	136	81	converters, a/d	134	77	tracking pedestals	152	425
pulse generator	22	18	filters, bandpass	130	335	<b>application notes</b>		
recorder	136	349	I/O system, analog	130	336	capacitance measurements	150	395
rental instruments	18	14	image sensor	127	72	computer plotting	150	396
scopes	69	41	interrupter modules	7	5	laser range-finder systems	150	398
signal generator	137	358	load cells	128	329	SCR, gate-turn-on	150	397
signal source	136	350	op amp	130	333	solid-state relays	150	399
synthesizer	137	356	rf links	137	82			
test accessories	145	92	<b>Packaging &amp; Materials</b>					
VOM	115	64	backplane connections	109	60			
VTVM	138	362	back	147	95			
3-phase E/I/W meter	138	360	connector	105	56			
<b>ICs &amp; Semiconductors</b>			connector	144	381			
amplifier, wideband	123	320	connector, card-edge	144	91			
bipolar memories	13	9						



# Molex Introduces...THE Insulation Displacement Ribbon Cable Connector.

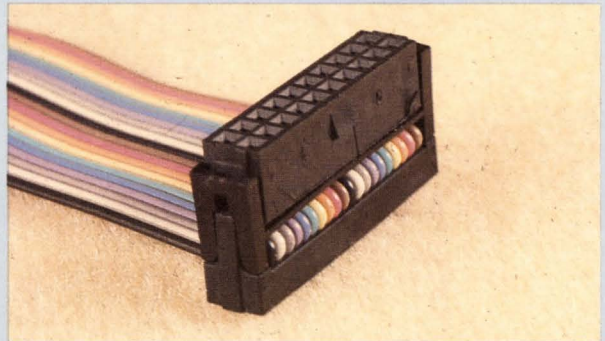

Strain Relief



Daisy Chain Applications

## MOLEX 4700 FEATURES

- High Reliability
- No Insulation Stripping
- No Soldering
- Simultaneous Termination Technique
- Gas Tight Connections
- Reduced Labor Costs
- Error Free Wiring
- Industry Compatible
- Terminate Either Side of Flat Cable
- Contacts Accept Cable on .050" Centers
- Positive Flat Cable Alignment
- Avoid Bends in Cable
- Consistant Electrical Characteristics
- Mates With .025" Square or Round Pins
- Probe Holes in Cover
- Visual Inspection
- UL 94V-O Rated Plastic
- Solid or Stranded Wire
- Recessed Cover and Strain Relief
- Dual Wiping Box Contact
- Snap On Strain Relief
- Industry Compatible Assembly Tooling
- Broad Line of Sizes
- Closed End Cover Available

For more information about Molex's "affordable technology", write *MOLEX Incorporated, 2222 Wellington Court, Lisle, Illinois 60532* or call *(312) 969-4550*.

**molex** ... *Affordable Technology*

CIRCLE NUMBER 246



With higher speeds and density ...

# Here are three new COS/MOS ideas, good buddy.

A new 40-channel CB synthesizer and two other circuits prove: RCA COS/MOS has really got the hammer down on the rip strip of hot new applications. In these circuits and more to come, you have improved speeds and density to work with. Plus the other COS/MOS advantages. All adding up to better performance and significant cost and space savings.

## 1 40-Channel CB: cut costs of ownership.

Our new synthesizer IC combines receiving and transmitting oscillator functions on a single chip. Result: lower CB manufacturing cost—and more. The low power requirements and environmental ruggedness of COS/MOS help reduce power-supply and operating costs, and make it a natural for use in vehicles. Operating between 15-20 MHz with no pre-scaler, TA10336 has a transmit-receive shift, 6-bit channel code, and a 10.24 MHz reference.

Circle 241

## 2 FIFO Register: simplify microprocessor interfacing.

On a single chip you get 4 independent FIFO registers that can be used in parallel. CD40105B is 4 bits by 16 bits long, is expand-

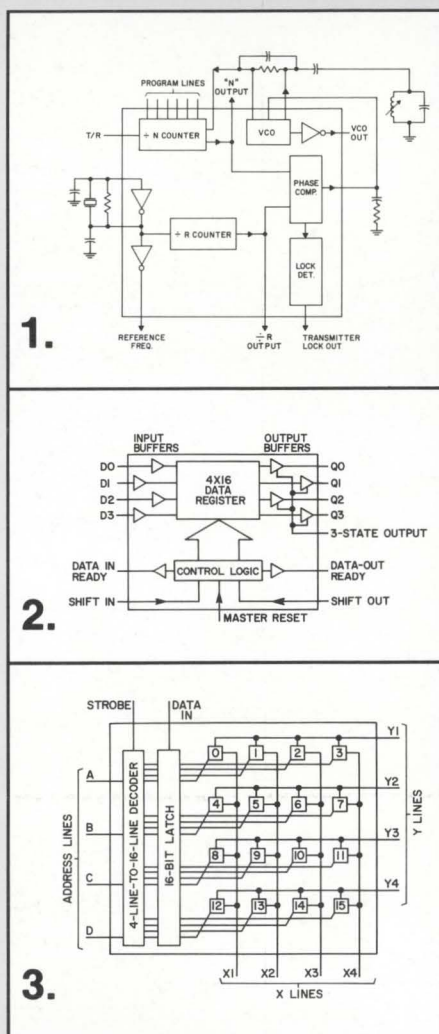

able, and features independent asynchronous inputs/outputs (outputs are 3-state). It really shines in microprocessor applications requiring input/output peripheral buffering.

Circle 242

## 3 4 x 4 Crosspoint Switch: lower the cost per crosspoint.

The CD22100 is 16 switches on a single chip, replacing 16 relays (at about 1/3 the cost) or 3 standard ICs. This can mean major space savings in in-house telephone and data communications systems, for example. And of course fewer connections means higher reliability. Coming soon: a 4 x 4 x 2 crosspoint switch.

Circle 243

For more information on these COS/MOS integrated circuits, contact your local RCA Solid State distributor.

Or write: RCA Solid State, Box 3200, Somerville, NJ 08876; Sunbury-on-Thames, Middlesex TW16 7HW, England; Ste.-Anne-de-Bellevue, Quebec, Canada; Fuji Bldg., Tokyo, Japan.

**RCA COS/MOS experience is working for you.**