

Improved snap-action switches abound. But switch load specs are still in the dark ages. High current and voltage ratings don't provide a safety factor for light

loads. And contact materials for light loads stick and erode at high-level loads. The resistance of contacts obeys complex laws. Match switch to load on p. 44.



There's a new dip store in town.



Dale ships standard resistor networks in less than a week.

Dale builds *and stocks* standard resistor networks compatible with your system. Automatic insertion. Hand insertion. All are quality-built with the same materials we use to make the industry's first thick film network qualified to MIL-R-83401.

Circuit Uses Include:

Pull-Up

- Power Gate
- Open Collector
- Parallel
- "Wired OR"
- MOS Memory
- TTL Unused Gate
- Power Driver

Pull-Down

- ECL Output
- TTL Input
- MOS Memory

Other Applications:

- Impedance Balancing
- Current Limiting
- Line Termination
- Pulse Squaring
- TTL to ECL Translator

Check this cross reference chart

DALE	BECKMAN	CTS
LDP14-02-XXXG	899-1-RXXX	760-1-R
LDP14-01-XXXG	899-3-RXXX	760-3-R
LDP16-02-XXXG	898-1-RXXX	761-1-R
LDP16-01-XXXG	898-3-RXXX	761-3-R

Phone 402-371-0080 for complete
price & delivery details.



DALE ELECTRONICS, INC.
Box 74, Norfolk, Nebr. 68701
In Canada: Dale Electronics Canada Ltd.
In Europe: Dale Electronics GmbH,
8 Munchen 60, Falkweg 51, West Germany
A subsidiary of The Lionel Corporation

INFORMATION RETRIEVAL NUMBER 252

Our complete product line can be found in *Electronic Design's GOLD BOOK.*

Our byte-size brain food for 'little' thinkers:

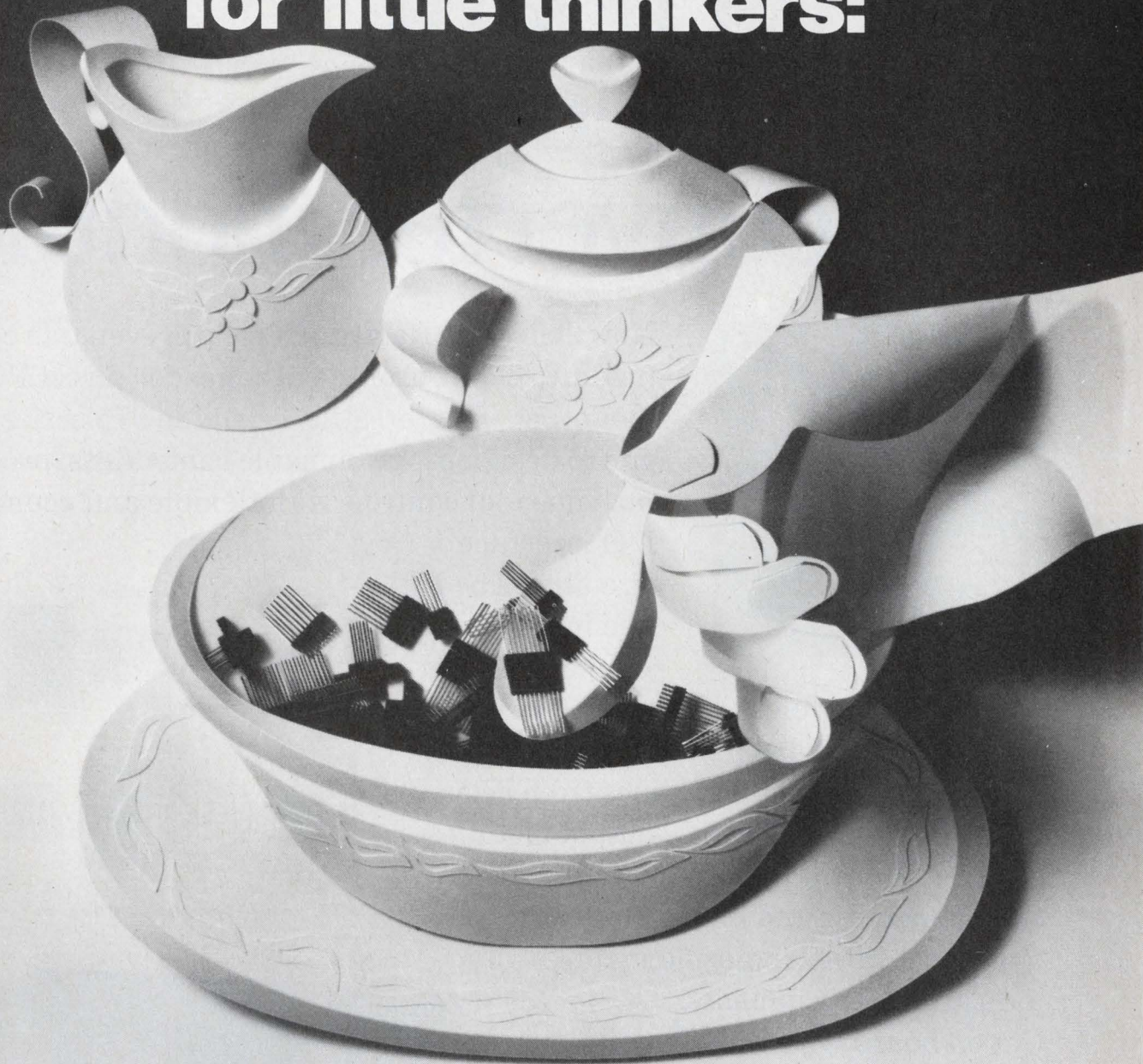

TRW/Cinch microminiature Dura-Con* connectors

No matter how large your byte, you still have to think "little" to reduce space and weight. That's why TRW/Cinch microminiature Dura-Con connectors offer so much food for thought.

The trim microminiature rectangular series of Dura-Con connectors is available in 9, 15, 21, 37, and 51 positions. Or consider the possibilities in stacking .075" thick Dura-Con strips. Only 33 grams of strips with .050" centers supplies 247 contact positions in a single square inch. Both types are available from TRW/Cinch distributors.

Besides high contact density, the unique Dura-Con design provides highly reliable connections. Each pin contact, formed from precision miniature spring cable of gold-plated 24 gauge copper alloy,

provides seven points of peripheral contact with the mating socket wall. Thus continuous mating is assured, no matter what radial forces are applied, from dry circuit to 3 amps.

Also available are TRW/Cinch Dura-Con connectors with #30 AWG contacts on .025" centers in custom configurations. That's up to 1521 contacts in a square inch for those who think much about "little."

For additional information, dial toll-free (800) 645-9201 for the name of your nearest TRW/Cinch sales office. Or write for technical bulletin CD-205 to TRW/Cinch Connectors, an Electronic Components Division of TRW Inc., 1501 Morse Avenue, Elk Grove Village, Illinois 60007; phone (312) 439-8800.

*Trade Name TRW Inc. CC-7502

TRW[®] CINCH CONNECTORS

Get on board with Teledyne I/O converter modules

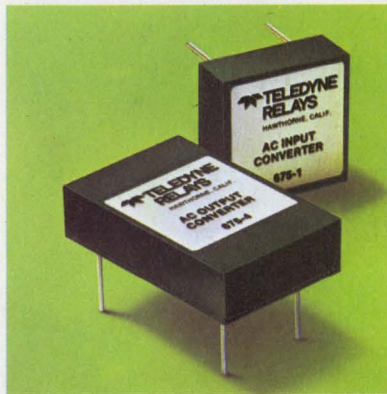

Now Teledyne Relays offers its proven I/O converter modules in low profile packages for direct PC board mounting. The versatile Teledyne 675 series allows you to design programmable controllers, process and machine tool controls with flexible and economical I/O interface circuitry. The full line includes both ac and dc, input

and output modules. All versions are optically isolated, with 1500 VRMS isolation, to protect logic lines from ac or dc power circuits. The AC output modules feature zero voltage turn-on to reduce switching noise and high dv/dt ratings to prevent false triggering in tough industrial environments.

Get on board with Teledyne Relays. We've got thousands of I/O modules at work in the field. Call your nearest Teledyne Relays office for location of your local representative or distributor.

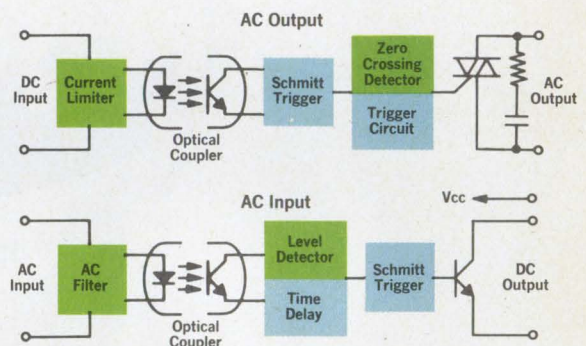

Typical Functional Diagrams

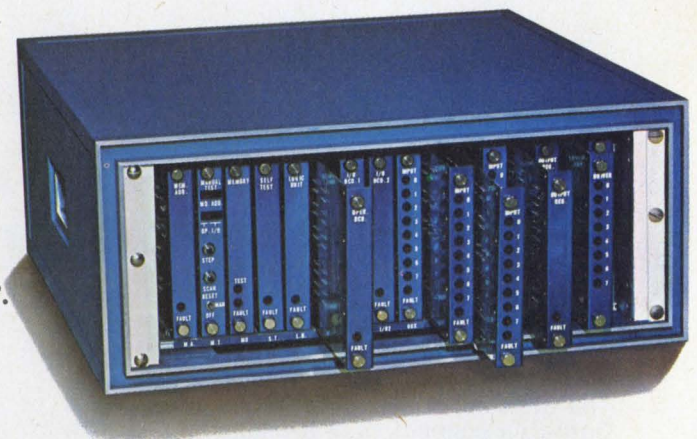

TELEDYNE RELAYS

3155 West El Segundo Boulevard, Hawthorne, California 90250
Telephone (213) 973-4545

Photo courtesy of Datametrics
a subsidiary of ITE Imperial Corporation.

Burgstrasse 6-8, 62 Wiesbaden, West Germany
Telephone: 06121-30231/2 Telex: 04-186851 (Trel-D)

Heathrow House, Bath Road, Cranford, Hounslow, Middlesex, U.K.
Telephone: 01-8972501 Telex: 935008

INFORMATION RETRIEVAL NUMBER 3

NEWS

- 19 **News Scope**
- 24 **Radiotelephones and specialized precision instruments** make a splash at the annual boat show.
- 26 **The insecure computer problem:** Researchers are seeking ways to foil unlawful entry by protecting both hardware and software.
- 33 **Broad-foil lead** increases p-i-n diode switch power.
- 35 **Washington Report**

TECHNOLOGY

- 44 **FOCUS on snap-action switches:** Guidelines to the subtleties of switch specs and contact behavior help the engineer avoid problems. And an update on the latest types allows him to make better selections.
- 52 **Join micros into intelligent networks** to perform dedicated tasks. Common-memory hardware and software pave the way to processor intercommunications.
- 60 **Switching contacts causing problems?** Look into the details of contact behavior. Maximum ratings don't tell what happens at your circuit's specific levels.
- 64 **International Technology**
- 66 **Ideas for Design:** Voltage-controlled music oscillator has linear control properties . . . Simple power-frequency meter built with only a few passive components . . . Display inverter circuit eliminates upside-down readout problems . . . Regulated power source drives low-power devices.

PRODUCTS

- 75 **Integrated Circuits:** 8-bit IC DAC settles fast and has adjustable threshold levels.
- 80 **Modules & Subassemblies:** A/d converter module keeps speed high but cuts cost by 50%.
- | | |
|------------------------|----------------------------|
| 76 Data Processing | 84 Discrete Semiconductors |
| 78 Microwaves & Lasers | 85 Components |
| 82 Instrumentation | |

DEPARTMENTS

- | | |
|---|-------------------------------|
| 39 Editorial: I'm sorry, sir, he's in conference | |
| 7 Across the Desk | 94 Advertisers' Index |
| 86 Design Aids | 96 Product Index |
| 86 New Literature | 96 Information Retrieval Card |

Cover: Photo by William Pittsley, courtesy of Micro Switch, a division of Honeywell, Freeport, IL

Put a complete your system for less

\$29⁹⁵ 4040

ROAD SENSORS → 4308 ↔ 4040 ↔ 4201

STOP GO

4040 CPU
4201 CLOCK GENERATOR
4308 1Kx8 ROM & I/O

GOOD FOR TRAFFIC CONTROLLERS, DIAGNOSTIC INSTRUMENTS VENDING MACHINES, PROCESS CONTROLLERS, LARGE SYSTEM PREPROCESSORS, ETC.

Cash in on the demand for economical intelligent products with Intel's inexpensive new 4040 CPU, 4201 integrated system clock, 4308 high density, low cost program memory and three new I/O components. Faster and more versatile than any other MOS 4-bit microprocessor unit, the 4040 can totally automate a smaller system or large portions of a big system. Yet an MCS-40 micro-

computer system with CPU, clock, memory and I/O costs as little as \$29.95.

Many equipment manufacturers are replacing hardwired logic and bulky electromechanical assemblies with MCS-40 systems. Most moderate speed control logic built with TTL can be replaced. The savings certificates show only a few 4040 applications. MCS-40 devices can be used with our 4004 central processor unit, too. The 4004, in production since June 1971, can lower system costs even more.

\$39⁹⁵ 4040

Cassette → 4002 ↔ 4040 ↔ 4201

4308 ↔ 4003 ↔ Key Board ↔ Display

4040 CPU
4201 CLOCK GENERATOR
4002 RAM
4003 SHIFT REGISTER
4308 1Kx8 ROM & I/O

Good For Data Collectors with Calculators, Distributed Intelligence Systems, Cassette Data Systems and Paper-Tape Equipment, Printer, Keyboard, Display and Control Panel Controllers, etc.

With either CPU, you'll save development time, lower component count and reduce assembly costs. You'll save even more as microcomputer costs decline while other system costs rise. And you'll gain valuable insurance against product obsolescence. Any design is easy to program and update

with Intel's total development support, assemblers and Intellec 4/MOD 40 development systems. Our training centers will even teach you how to use Intel microcomputers.

microcomputer in than \$30.

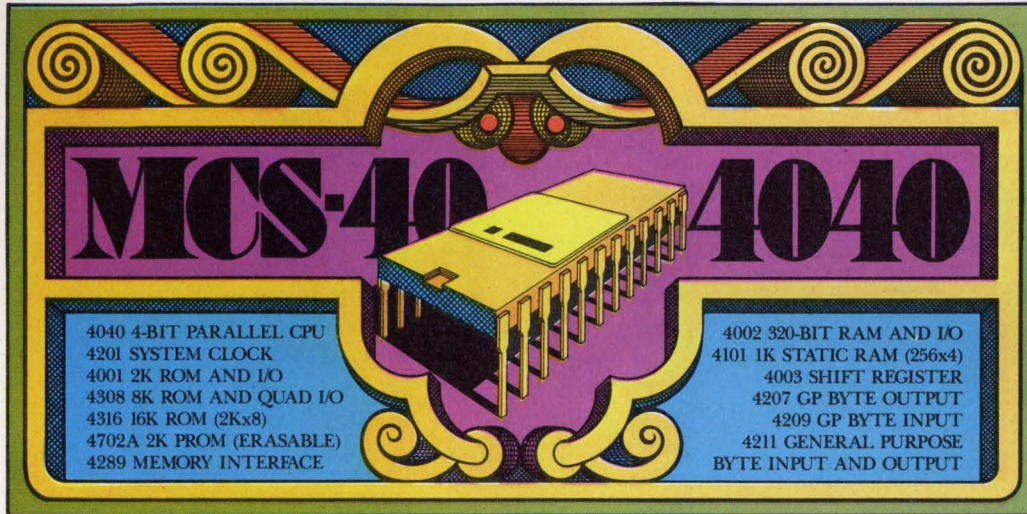

MCS-40 4040

4040 4-BIT PARALLEL CPU
4201 SYSTEM CLOCK
4001 2K ROM AND I/O
4308 8K ROM AND QUAD I/O
4316 16K ROM (2Kx8)
4702A 2K PROM (ERASABLE)
4289 MEMORY INTERFACE

4002 320-BIT RAM AND I/O
4101 1K STATIC RAM (256x4)
4003 SHIFT REGISTER
4207 GP BYTE OUTPUT
4209 GP BYTE INPUT
4211 GENERAL PURPOSE
BYTE INPUT AND OUTPUT

In high volume for just \$29.95, you can buy an MCS-40 system with the 4040 CPU, 4308 1Kx8 ROM with four independent I/O ports, and 4201 system clock generator. The 4040 itself has 60 instructions, 7-level subroutine

nesting, 24 index registers, interrupt processing, memory and index register bank switching, single-step operation and a low power standby mode.

A few dollars more buys extra computation flexibility. Use our 4289 interface, for example, to attach standard memory or I/O devices. And, at only \$99.95 in quantity of one, the system with the 4702 erasable PROM is ideal for prototypes and low volume production.

At these prices, you can even use several microcomputers in large systems. Knowledgeable designers are putting 4040 intelligence into new products at less cost than simple-minded electro-mechanical parts and single-minded logic cards. Write for details on the MCS-40 family and the industry's most extensive software support. Or call any Intel office for an appointment with our applications engineers.

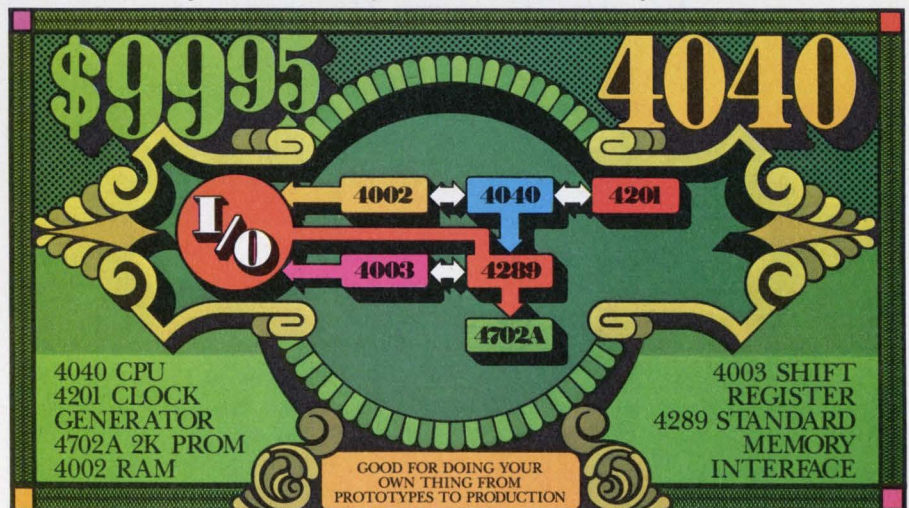

Intel Corporation, 3065 Bowers Ave., Santa Clara, Calif. 95051 (408) 246-7501.

intel® Microcomputers. First from the beginning.

INFORMATION RETRIEVAL NUMBER 4

A Smart Way to Beat Your Power Supply Size Problem

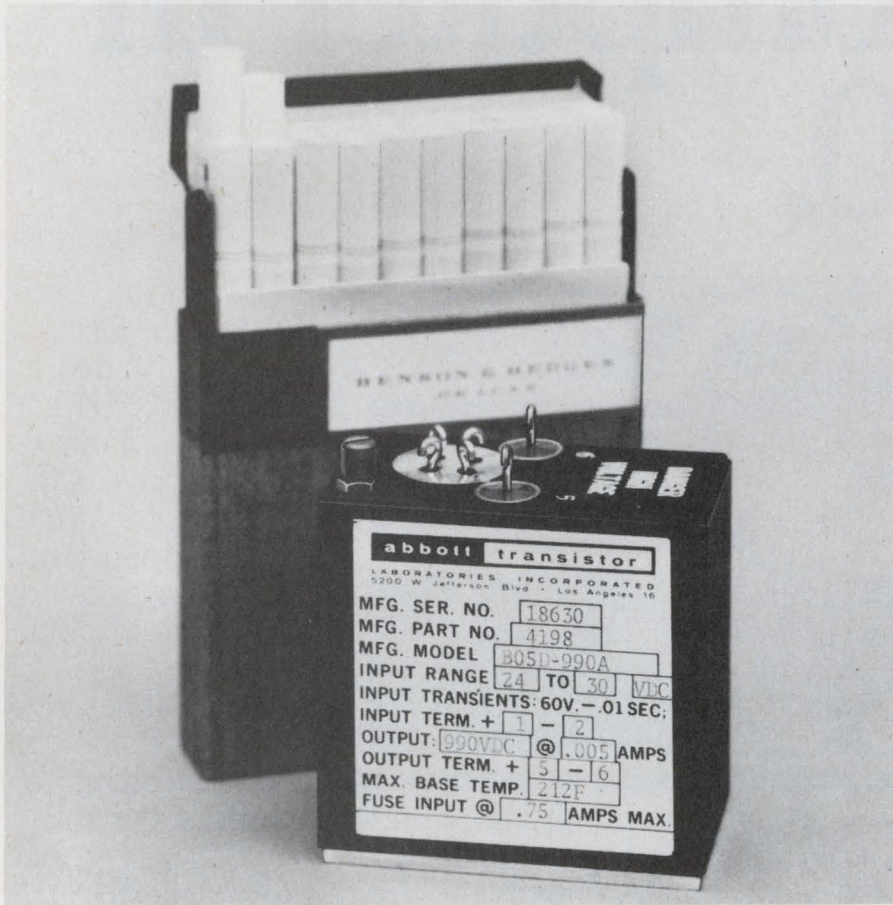

1½" thin, 2¾" narrow, 2¾" short

yet this converter produces 1000 volts DC, regulated, from a battery input of 28 VDC! It weighs less than 15 ounces. This is only one of our wide variety of many small light weight converters, inverters and power supplies — there are over 3000 models listed in our newest catalog, including size, weight and prices. If you have a size problem, why not send for an Abbott catalog?

MIL SPEC ENVIRONMENT — All of the hermetically sealed power modules listed in our new catalog have been designed to meet the severe environmental conditions required by modern aerospace systems, including MIL-STD-810B. They are hermetically sealed and encapsulated in heavy steel containers. New high performance units can meet MIL-STD-461A.

Please see pages 307-317 Volume 1 of your 1974-75 EEM (ELECTRONIC ENGINEERS MASTER Catalog) or pages 853-860 Volume 3 of your 1974-75 GOLD BOOK for complete information on Abbott Modules.

Send for our new 60 page FREE catalog.

RELIABLE — Highest quality components are used in Abbott power modules to yield the high MTBF (mean time between failure) as calculated in the MIL-HDBK-217 handbook. Typical power modules have over 100,000 hours MTBF — proving that the quality was built in from the beginning.

WIDE RANGE OF OUTPUTS — Any voltage from 5 volts DC to 740 VDC is available by selecting the correct model you need from our catalog with any of a variety of inputs including:

- 60 \sim to DC
- 400 \sim to DC
- 28 VDC to DC
- 28 VDC to 400 \sim
- 12-38 VDC to 60 \sim

Vice President, Publisher
Peter Coley

Editors

Editorial Offices
50 Essex St.
Rochelle Park, NJ 07662
(201) 843-0550
TWX: 710-990 5071
Cable: Haydenpubs Rochellepark

Editor-in-Chief George Rostky

Managing Editors:

Ralph Dobriner
Michael Elphick

Associate Editors:

Dave Bursky
Jules H. Gilder
Morris Grossman
Seymour T. Levine
John F. Mason
Stanley Runyon
Edward A. Torrero

Contributing Editors:

Peter N. Budzilovich
Alberto Socolovsky
Nathan Sussman

Editorial Field Offices

East

Jim McDermott, Eastern Editor
P.O. Box 272
Easthampton, MA 01027
(413) 527-3632

West

David N. Kaye, Senior Western Editor
8939 S. Sepulveda Blvd.,
Suite 510
Los Angeles, CA 90045
(213) 641-6544

Editorial Production

Marjorie A. Duffy

Art

Art Director, William Kelly
Richard Luce
Anthony J. Fischetto

Production

Manager, Dollie S. Viebig
Helen De Polo
Anne Molfetas
Christopher G. Hill

Circulation

Manager, Evan Phoutrides

Information Retrieval

Peggy Long

Promotion

Manager, Walter G. Salm
Karen Kerrigan (Reprints)

abbott transistor

LABORATORIES, INCORPORATED

general offices

eastern office

5200 W. Jefferson Blvd./Los Angeles 90016
(213) 936-8185 Telex: 69-1398

1224 Anderson Ave./Fort Lee, N.J. 07024
(201) 224-6900 Telex: 13-5332

INFORMATION RETRIEVAL NUMBER 5

Exceptions are taken to pulse-gen reports

I want to thank you for the articles on instrumentation (ED No. 24, Nov. 22, 1974, pp. 40-145). It is interesting to see a broad picture of what the industry is doing today.

However, there are some errors regarding our field. On p. 77, Tom Coates of HP is reported to have said that most programmable pulse generators don't have programmable pulse width. Our Model 1012, as well as the generators of the other companies mentioned on that page, provide control of pulse width, as well as all other pertinent pulse parameters. I might further point out the next sentence, which reports the unavailability of programmable pulse generators with ASCII, is contradicted in the article starting on p. 90.

On p. 92 there is a section on medium-priced pulse generators that do not have all the features, such as frequencies above 20 MHz, variable delay and dc offset. The author then includes the Chronetics Models PG-10 and PG-11A as representatives of this group. While the price is right, both of these generators provide pulses at frequencies up to and including 50 MHz. Both have variable delay as well as variable pulse width, amplitude, single and double pulse, etc. And the PG-10 also offers dc offset.

On p. 95, we are omitted from the list of manufacturers who make programmable pulse generators. Our Model 1012 was one of the earliest generators to provide digital programming capable

of all functions and has been one of the most widely used instruments of this type in the field.

Nevertheless, on balance, we found the articles informative and hope that you will keep up the good work.

*Sid Gordon
President*

Chronetics, Inc.
500 Nuber Ave.
Mount Vernon, NY 10550

Add W-J synthesizers to MW instrumentation

This letter is in response to the article in the Nov. 22, 1974, issue entitled "Microwave Instrumentation: It's a New World of Measurement at 1 GHz and Higher." Although you could not mention all companies that provide each type of microwave instruments, I feel that your omission of Watkins-Johnson in the discussion of microwave frequency synthesizers deserves a critical comment.

Watkins-Johnson has been a primary source of 1-to-12.4-GHz and 1-to-18-GHz synthesizers since 1971, with microwave synthesizer design and manufacture going back to 1966. The early standard multi-octave microwave synthesizers were members of the WJ-1154 series.

Since early 1974, Watkins-Johnson has been advertising and delivering a new microwave synthesizer family called the WJ-1250 series. Available WJ-1250 configurations can cover any standard band within the 0.5-to-18-GHz range, the full 0.5-to-18-GHz range, or any combination in be-

(continued on pg. 12)

Electronic Design welcomes the opinions of its readers on the issues raised in the magazine's editorial columns. Address letters to Managing Editor, Electronic Design, 50 Essex St. Rochelle Park, N.J. 07662. Try to keep letters under 200 words. Letters must be signed. Names will be withheld on request.



OPTRON OPTICALLY COUPLED ISOLATORS

LOW COST "DIP" SERIES FURTHER EXPANDS ISOLATOR LINE

OPTRON's addition of a new, low cost 6-pin plastic dual in-line isolator series further broadens its line to provide a coupler for every application.

The new "DIP" series includes six models offering complete interchangeability with popular industry types. It offers a wide range of capabilities to allow you to choose a device most suited to your circuit requirements at the best possible price. The "DIP" series has isolation voltages of 1500 or 2500 volts with a current transfer ratio of 2.0 to 50%.

OPTRON's broad selection of "DIP" and other packages with isolation voltages to 50 Kv now provides the versatility required for maximum electrical and mechanical design flexibility.

1.5 Kv isolation with 60% current transfer ratio. Phototransistor base lead available. Hermetic TO-5 package.

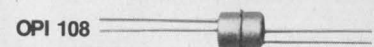

1 Kv isolation and 20% current transfer ratio. 5 μ sec switching time in a welded axial lead hermetic package.

Detailed technical information on these and other OPTRON optoelectronic products... chips, discrete components, assemblies, and PC board arrays... is available from your nearest OPTRON sales representative or the factory direct.



OPTRON, INC.

1201 Tappan Circle
Carrollton, Texas 75006
214/242-6571

We're very big on small

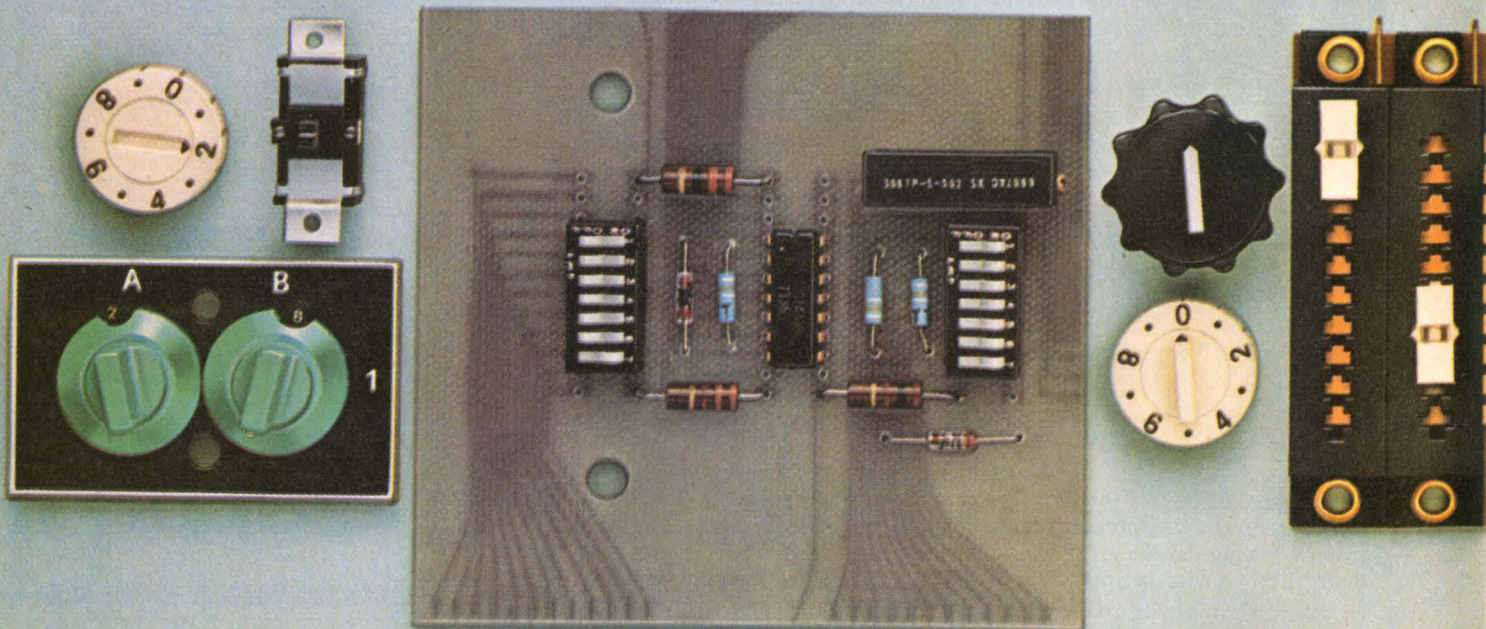

When it comes to miniaturized switches, you'll find true AMP innovation. And because they're made by AMP, you know you're getting economy and reliability.

Take our multipole switch for pc boards, a new addition to our dual in-line switch group. It increases our ability to give you an even wider variety of configurations in high-density DIP switches. From double-, triple-, 4- and 5-pole single-throw to single-pole double-throw 4-terminal form Z.

What else is new? Our 2-, 3- or 4-position switches, each having double-pole double-throw capability. In a single dual in-line enclosure. They're only .275" high, which includes the screwdriver-operated actuator.

For low-cost applications, consider AMP's unique pull-to-set slide switch. It's available as a module for mounting on pc boards. Or preassembled as a programmable matrix slide switch.

In addition, we have a complete line of matrix rotary switches and switch kits designed for panel mounting. They're simple and economical ways of manually programming various types of electrical/electronic equipment. Without external switch wiring.

Our pc board rotary switch gives you a wide choice of outputs. Plus truly versatile application possibilities. While our 5-position slide switch permits maximum slide positions in a minimum switch size.

So think small. Think AMP mini-switches. Call (717) 564-0101. Or write AMP Incorporated, Harrisburg, Pa. 17105.

AMP
INCORPORATED

AMP is a trademark of AMP Incorporated.
INFORMATION RETRIEVAL NUMBER 7



switches

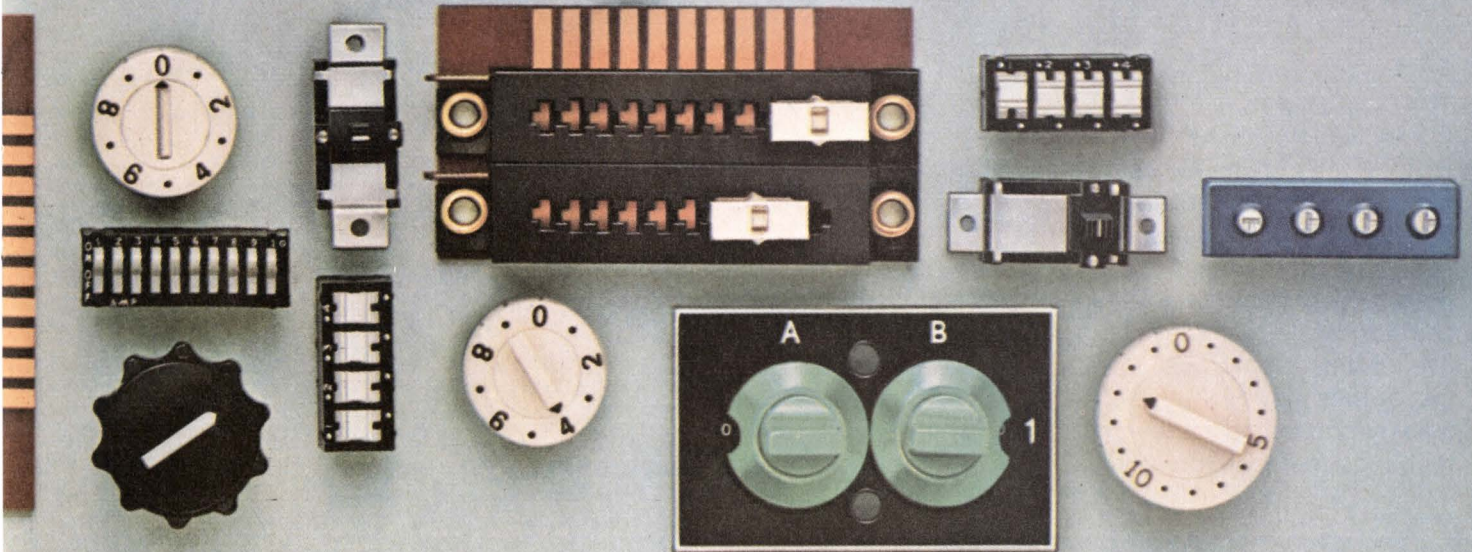

Zero Centurion™ cases. 59 better ways to protect your portable equipment.

Zero's rugged aluminum carrying cases provide complete protection for the most delicate portable equipment in virtually any environment. And there's a wide choice of styles, sizes and prices in the extensive Zero line.

Zero Centurion Elite offers the ultimate in distinctive styling, quality and reliability, plus two-week delivery. Valu-Line offers the same kind of reliability at a lower price. And the Economy Series puts Zero's high quality within the reach of any budget.

If you can't find exactly what you need in our 59 standard models, Zero can provide full custom modification capability. Aluminum carrying cases—one of the many ways Zero supports your world.

Write for your free catalog today.



Zero Manufacturing Co.

777 FRONT STREET · BURBANK, CALIFORNIA 91503
 Design and Manufacturing Facilities | ZERO WEST · BURBANK, CALIFORNIA · 213/846-4191
 ZERO EAST · MONSON, MASSACHUSETTS · 413/267-5561
 ZERO SOUTH · CLEARWATER, FLORIDA · 813/531-8991



FOR IMMEDIATE NEED, CIRCLE 181

FOR INFORMATION, CIRCLE 182

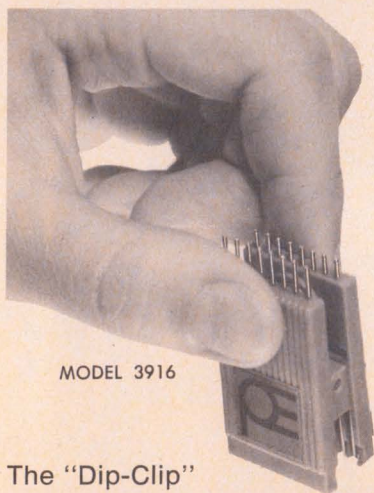

MODEL 3916

The "Dip-Clip" is specially designed to allow the attachment of test probes to 14 or 16 lead DIPs. The unique patented design greatly reduces the possibility of accidental shorting while testing live circuits. Numerous test probes may be quickly connected for hands-free testing.

dip clip

T.M.

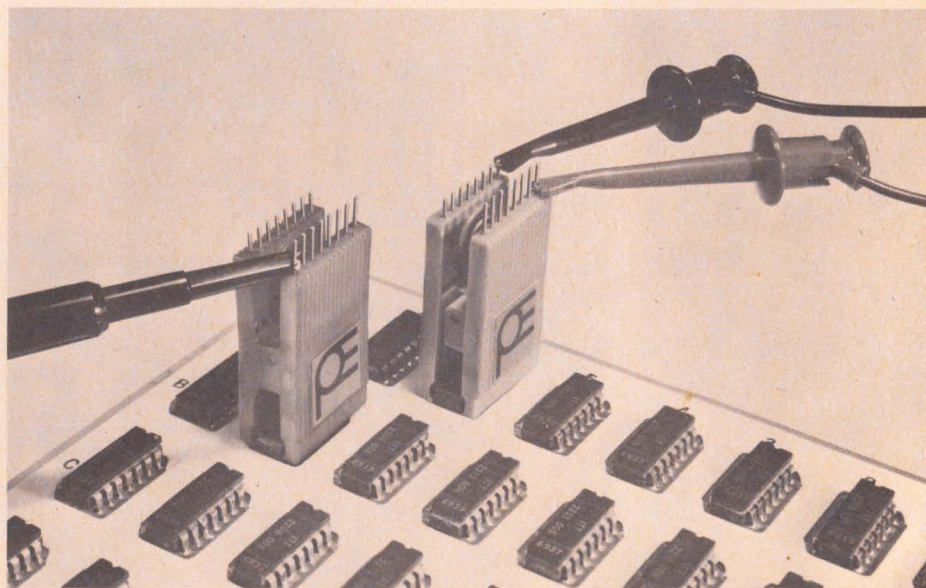

POMONA ELECTRONICS
A Division of ITT

1500 E. Ninth St., Pomona, Calif. 91766 • Telephone: (714) 623-3463

INFORMATION RETRIEVAL NUMBER 9

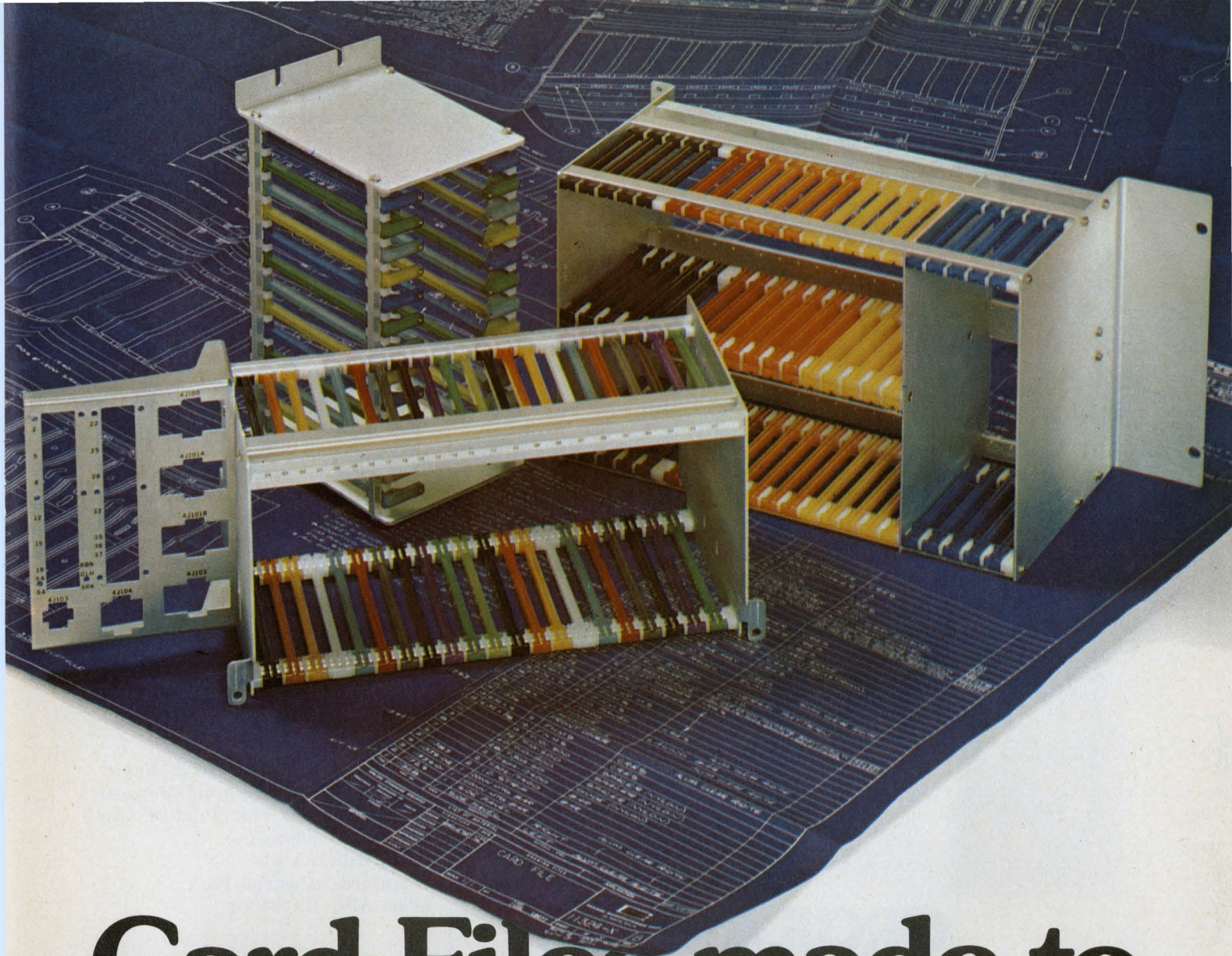

Card Files made to Order

Let us design and build card files to meet your card packaging demands. Whether you need a multi-row file, a drawer or a complex custom-made file... let us help.

We can make files for lots of cards or just a few. We can give you a connector mount right on the card guide, on aluminum bars or on separate nylon feet. We can punch, bend and cut sheet metal to meet any situation. We can provide mounting for I/O connectors, wire harnesses or any auxiliary components. We can make a card file to do just about anything.

The guides in our files are molded of high strength U.L. approved nylon and provide a strong durable holder for your cards. The nylon guides

protect cards and components from shock and vibration while their narrow profile allows for system cooling. Rigid extruded aluminum mounting bars hold guides in place and provide a rugged lightweight package. Aluminum or steel sheet metal designed for your particular need completes the system.

Before you start engineering your next card packaging system call us... let us help.

Scanbe Manufacturing Corp.
3445 Fletcher Ave. / El Monte, Ca. 91731
(213) 579-2300 / 686-1202 TWX (910) 587-3437



THE WORLD'S FIRST CIRCULAR IMAGE SENSOR.

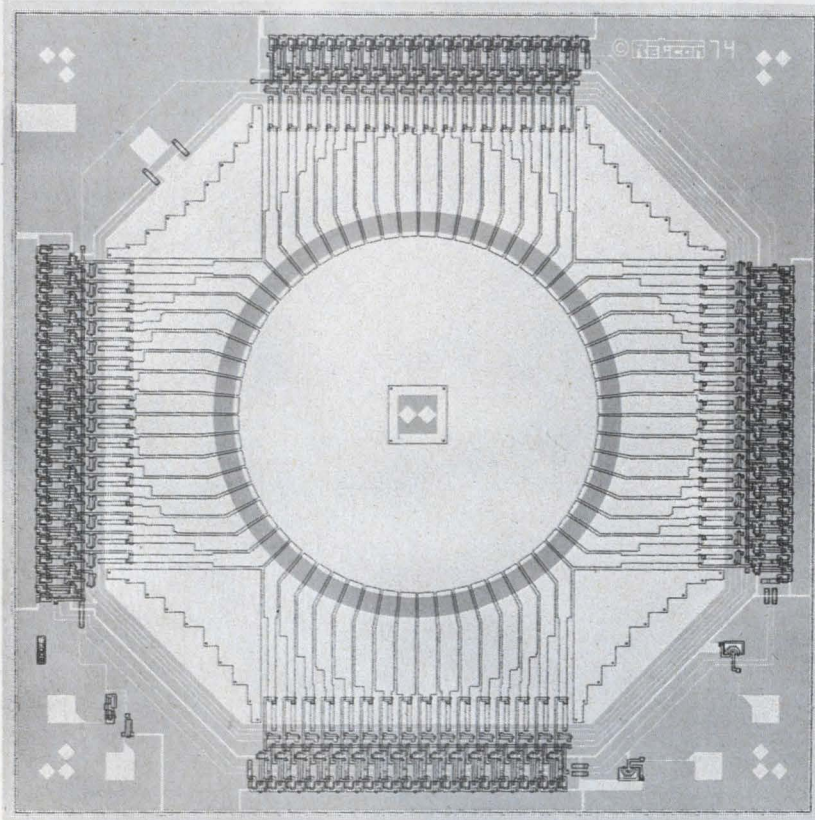

CIRCULAR?

YES. And with on-chip scanning to provide serial output on a single pin. The 64 sensors of the R0-64 are each 0.1 mm x 0.1 mm in size and are uniformly spaced on a 2 mm diameter circle. The array can be operated at scan rates as low as 30 scans per second or as high as 40,000 scans per second. The device is packaged in a 16 lead ceramic DIP and sealed with an optical quality quartz window. The R0-64 is designed for applications in tracking, automatic alignment, automatic focusing, pattern recognition and many others.

RETICON also continues to offer the most complete line of standard linear and matrix arrays in the industry. Our "C" series linear arrays provide from 128 through 1024 elements of resolution on a single monolithic chip and are considered the standard in facsimile, OCR, and industrial control applications.

Custom devices have been developed for a wide variety of applications from point-of-sale to spectroscopy.

In solid state image sensing, our technical leadership backed by over 60 salesmen and 14 distributors over the world makes RETICON the most viable source.

RETICON®

910 BENICIA AVENUE • SUNNYVALE, CA 94086
PHONE: (408) 738-4266 • TWX: 910-339-9343

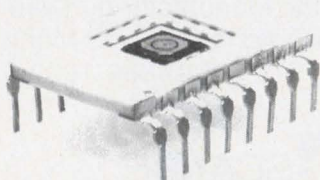

INFORMATION RETRIEVAL NUMBER 11

ACROSS THE DESK
(continued from pg. 7)

tween. This is made possible by modular rf sources that plug into the WJ-1250 mainframe or into one or two piggyback multisource chassis.

These configurations are digitally programmable, can switch between any two frequencies in the 0.5-to-18-GHz range within 100 ms or less, and they provide a minimum of 10-mW output power (unleveled) or 5 mW (leveled). Programmable attenuation, programmable pulse modulation and manual control over distances in excess of 1000 ft can be provided by use of additional units. W-J is also happy to provide special modifications and designs for unique requirements.

If your readers would like information about the WJ-1250, they may contact a W-J field sales office in their area or W-J Synthesizer Applications Engineering in Palo Alto at (415) 493-4141, Ext. 218.

*Richard S. Napier
Program Manager*

WJ-1250 Product Line

Watkins-Johnson Co.
3333 Hillview Ave.
Stanford Industrial Park
Palo Alto, CA 94304

Are you on our little list?

You can do your company a good turn if you check to see if it's listed in Electronic Design's GOLD BOOK.

If your company supplies products to the electronics industry, and, if it isn't listed in the Manufacturers Directory of the 1974-75 edition, be a hero. Circle No. 320 on the Information Retrieval card and we'll send you a questionnaire that you can turn over to your Sales Manager, Ad Manager, Marketing Manager, Public Relations Manager, or whoever gets stuck with the job of filling out such questionnaires. Remember:

CIRCLE NO. 320

Wrong sign shown for coordinate conversion

In "Don't Sweat Polar-to-Rectangular Coordinate Conversion"
(continued on pg. 16)

Heath scopes give you more than you bargain for.

The single trace 4530... a professional service scope



It's hard to find a better 10 MHz scope value than the Heath 4530. It features DC-10 MHz bandwidth, 10 mV sensitivity... trigger bandwidth guaranteed to 15 MHz, AC & DC coupled... TV coupling for service work... time bases from 200 ms/cm to 200 ns/cm... and true X-Y capability. The 4530 is easy to operate and offers a lot of performance for the money. Only \$420.00* for the factory assembled & calibrated SO-4530. Or order the easy-to-assemble Heathkit IO-4530, only \$299.95*

The dual trace 4510... a precision lab-grade scope

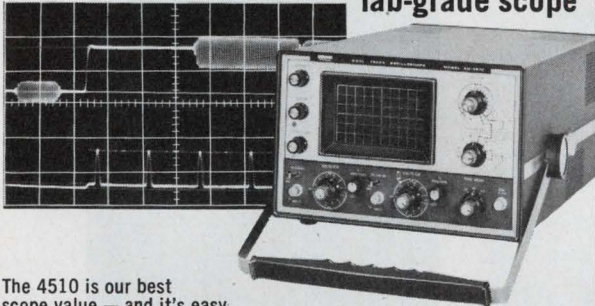

The 4510 is our best scope value — and it's easy to see why. With DC-15 MHz bandwidth... 1 mV/cm input sensitivity... 45 MHz typical triggering bandwidth, 30 MHz guaranteed... time base sweep 100 ns/cm... post-deflection accelerated CRT for high brightness... vertical delay lines for complete waveform display... X-Y capability... operates on any line voltage from 100 to 280 VAC. Assembled & calibrated SO-4510, only \$750.00*. Kit-form IO-4510, only \$549.95*.



For information on all the Heath scopes

... send for your free copies of our latest catalogs. The Heath/Schlumberger Assembled Instruments Catalog features a complete line of high performance, low cost instruments for service and design applications. Our '75 Heathkit Catalog describes the world's largest selection of electronic kits — including a full line of lab & service instruments.

HEATH COMPANY
Dept. 511-03
Benton Harbor, Michigan 49022

HEATH
Schlumberger

- Please send the latest Heath/Schlumberger Assembled Instruments Catalog.
- Please send the 1975 Heathkit Catalog.

Name _____
 Title _____
 Company/Institution _____
 Street _____
 City _____ State _____ Zip _____

*MAIL ORDER PRICES; F.O.B. FACTORY.
PRICES AND SPECIFICATIONS SUBJECT TO CHANGE WITHOUT NOTICE.

EK-451

INFORMATION RETRIEVAL NUMBER 12

ELECTRONIC DESIGN 5, March 1, 1975

Dialight sees a need:

(Need: The widest choice for your every application.)

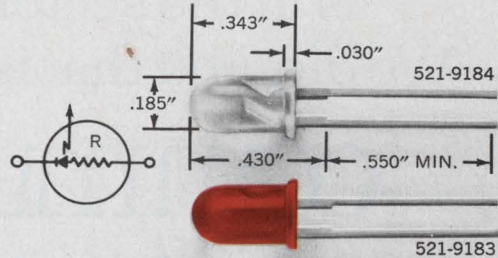

Available in red or clear LED packages with or without a built-in current limiting resistor. Red LED is also made without resistor. Suitable for circuit status indication, alpha-numeric displays and visual indicators. Features long wire-wrappable leads. IC compatible with solid state reliability. High luminous intensity, low power consumption, low cost.

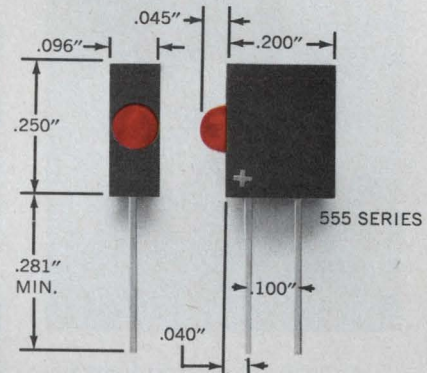

LED logic state fault indicators available in 14 models with voltage ratings from 1.7 to 14. Suitable for dense packaging on printed circuit boards—up to 10 units to the inch—IC compatible. With built-in series resistor. Polarity identified. Low power consumption.



Dialight, the company with the widest choice in switches, LEDs, indicator lights and readouts, looks for needs . . . your needs . . . and then they develop solutions for your every application. No other company offers you one-stop shopping in all these product areas. And no other company has more experience in the visual display field. Dialight helps you do more with these products than any other company in the business, because we are specialists that have done more with them. Talk to the specialists at Dialight first. You won't have to talk to anyone else. Send for your free new copy of Dialight's current catalog.

DIALIGHT

Dialight, A North American Philips Company
203 Harrison Place, Brooklyn, N. Y. 11237
(212) 497-7600

See Dialight.

INFORMATION RETRIEVAL NUMBER 13

IT'S REALLY NO SECRET-

But did you know that the greatest growth in the world's professional electronics industry is in the sector of communications?

We did, and that is why we have produced-

communications international

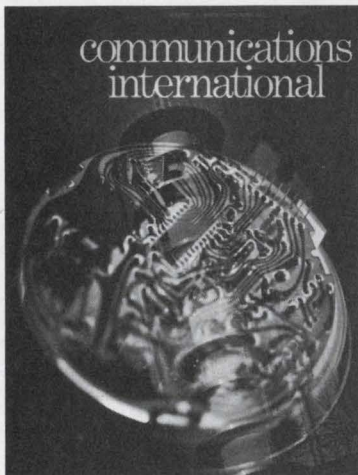

the new monthly journal for the world's manufacturers, designers & users of systems, equipment & components in the field of communications.

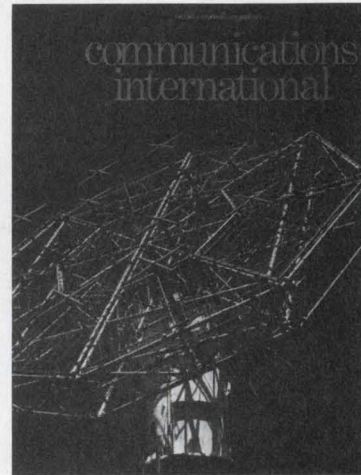
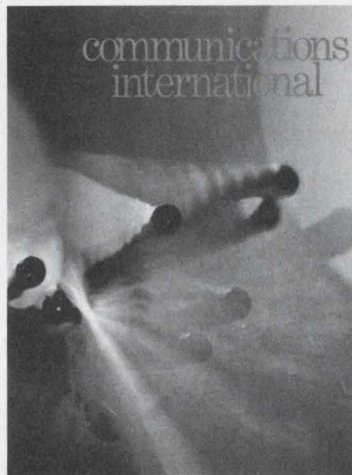

Circulation: Communications International has a circulation of 5,000 copies in the UK, 9,000 copies on the mainland of Europe and 4,000 copies are sent to countries throughout the rest of the world.

Advertising: The Publication offers highly competitive advertisement rates ranging from £340 for a whole page black and white to £94 for a quarter page in black and white. Series discounts are available and colour is charged extra. Communications International is published from the UK but its readership is global and its editorial coverage is carefully

selected from material provided by a worldwide network of foreign correspondents and articles from eminent international technologists. Communications International concerns itself with four broad editorial areas of communication and these are line and data, mobile radio, fixed radio and defence. Within these

areas it provides up-to-the-minute news of the world industry, its business aspects and in depth technical information aimed at aiding engineers to solve specific problems. Communications International also presents regular international features on the most technically efficient and economic options available to managers and purchasers of communications equipment and it includes a meticulously screened and researched section which every month is devoted to new products appropriate to the communications industry.

Mail this form today to: The Publisher, COMMUNICATIONS INTERNATIONAL
49-50 Hatton Garden London EC1N 8XS ENGLAND. Telephone: 01-278 6571

Please send:

- Advertisement Rates & Data
 Subscription Details

Name _____

Status _____

Company/Address _____

Country _____ ED

Compare TI's NEW SR-51....

- Mean, variance and standard deviation.
- Automatic linear regression. ● 20 programmed conversions. ● Percent and percent difference.
- Random number generator.
- 3 accessible memories. And much more for only

\$224.⁹⁵



More math power for the money. More than log and trig and hyperbolics and functions of x... the SR-51 has these and also has *statistical* functions... like mean, variance and standard deviation, random numbers, factorials, permutations, slope and intercept, and trend line analysis. Check the chart above—compare it. With the HP-45 or any other quality calculator. Then try it—at no risk. We're sure you'll agree that the SR-51 offers extraordinary value.

FUNCTION	SR-51	HP-45
Log, ln	yes	yes
Trig (sin, cos, tan, Inv)	yes	yes
Hyperbolic (sinh, cosh, tanh, Inv)	yes	no
Degree-radian conversion	yes	yes
Deg/rad mode selection	yes	yes
Decimal degrees — deg-min-sec	yes	yes
Polar-rectangular conversion	yes	yes
y^x	yes	yes
e^x	yes	yes
10^x	yes	yes
x^2	yes	yes
\sqrt{x}	yes	yes
$\sqrt[y]{x}$	yes	no
$1/x$	yes	yes
$x!$	yes	yes
Exchange x with y	yes	yes
Metric conversion constants	13	3
% and $\Delta\%$	yes	yes
Mean and standard deviation	yes	yes
Linear regression	yes	no
Trend line analysis	yes	no
Slope and intercept	yes	no
Store and recall	yes	yes
Σ to memory	yes	yes
Product to memory	yes	yes
Random number generator	yes	no
Automatic permutation	yes	no
Preprogrammed conversions	20	7
Digits accuracy	13	10
Algebraic notation (sum of products)	yes	no
Memory (other than stack)	3	9
Fixed decimal option	yes	yes
Keys	40	35
Second function key	yes	yes
Constant mode operation	yes	no

Test the SR-51 at no risk. Full refund if not satisfied. Master Charge or Bank Americard accepted.



TO: Texas Instruments Incorporated
P.O. Box 22013, M/S 358, Dallas, Texas 75221

Try it 15 days. Return with all accessories if not satisfied.
Enclosed is my check, money order, company purchase order for \$ _____ for the purchase of _____ SR-51(s).

Please add state and local taxes where applicable.*
Please charge this order to my Master Charge. Or, BankAmericard
My Card Number is:

With the expiration date: _____

E03

If Master Charge is used indicate 4-digit Bank Number appearing on card just above your name:

Name _____
Street _____
City _____ State _____ ZIP _____

Authorizing Signature (If billed to Credit Card Must be signed by card holder)

*AL, AZ, CA, CO, CT, FL, GA, IA, IL, IN, KY, MA, MD, MI, MN, MO, NC, NM, NJ, NY, PA, TN, TX, UT, VA, WA, WI. Offer good only in U.S.

TEXAS INSTRUMENTS
INCORPORATED

© 1975 Texas Instruments Incorporated
13500 North Central Expressway
Dallas, Texas

82016

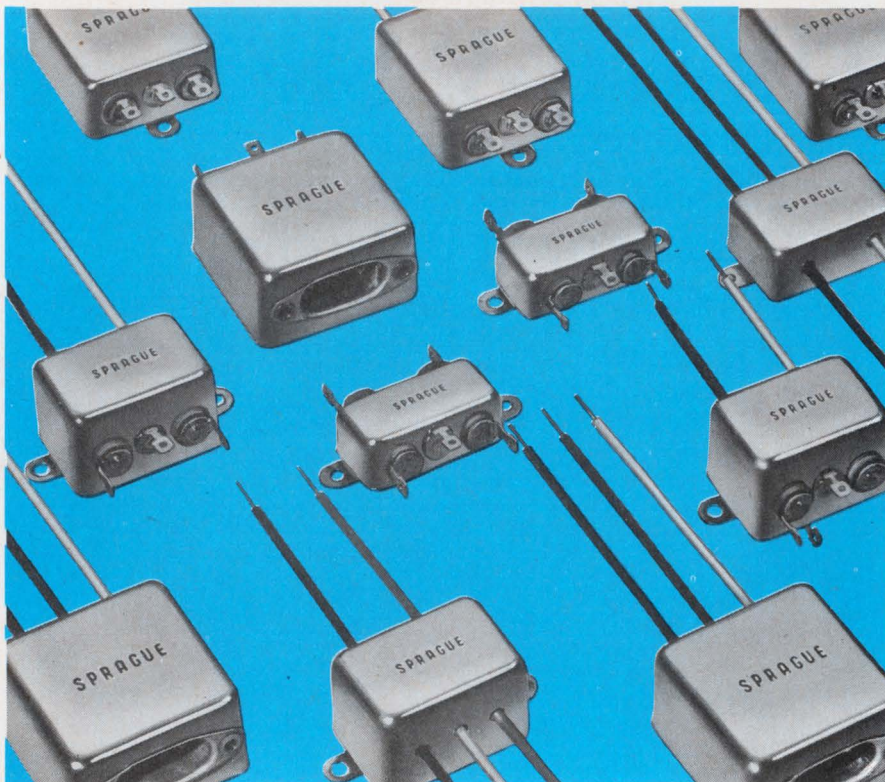

FILTERS THAT WORK. FILTERS THAT FIT. FILTERS YOU CAN AFFORD.

Sprague JX5100 Series EMI Powerline Filters give you the right blend of efficiency/size/cost.

The lower cost of these general-purpose filters makes them especially suitable for higher-volume production-assembled equipment such as computer peripherals, cash registers, credit card verifiers, electronic service instruments, etc.

Series JX5100 Filters are designed to protect equipment from line noise as well as to protect the line from equipment noise, particularly equipment with high impedance loads. Smaller in size than many filters with comparable performance, they control line-to-ground interference with a high degree of efficiency. Filtering both sides of the line, the need for two filters is eliminated.

Available in a wide variety of current ratings (1 to 30 amps) and several different terminal configurations, Series JX5100 Filters withstand a test voltage of 2100 VDC, assuring protection against high-voltage transients. Line-to-ground capacitance is only $.01\mu\text{F}$, and maximum leakage current (each line to ground, @115V, 60Hz) is 0.5mA.

Sprague maintains complete testing facilities for all commercial, industrial, and government interference specifications.

For complete technical data, write for Engineering Bulletin 8210.11 to: Technical Literature Service, Sprague Electric Company, 347 Marshall Street, North Adams, Mass. 01247.



THE BROAD-LINE PRODUCER OF ELECTRONIC PARTS

INFORMATION RETRIEVAL NUMBER 16

ACROSS THE DESK

(continued from pg. 12)

(ED No. 23, Nov. 8, 1974, p. 129) the sign for the susceptance of the circuit shown should be positive. Thus the admittance is $20 + j 44.6$ mmhos. Then in the conversion to polar notation, the phase angle of the network becomes -65.8° .

John R. Pandzik

Electronics Engineer

Department of the Air Force
Optical & Expendables CM Branch
Directorate of Avionics
Engineering
Wright-Patterson AFB, OH 45433

The author replies

Yes, Mr. Pandzik is correct. The problem arises when the admittance of 20 millimhos $+ j 44.6$ mmhos has a positive imaginary component, which will correspond to a negative phase angle when converted to impedance. This should have been obvious to me in the calculation, since one function is the reciprocal of the other and therefore the imaginary component should have experienced a sign reversal. However, the chart is still quite useful—unless you have an HP-45 to do the conversion for you!

Vaughn D. Martin

Senior Engineering Writer

Magnavox Co.
ASW Section
1415 Dividend Rd.
Fort Wayne, IN 46808

Keep it simple

With reference to the excellent article "Interface CMOS Logic with Switches," (ED No. 17, Aug. 16, 1974, p. 80), the formula for percentage of hysteresis reduces to $R_1/R_2 \times 100$. Let us not obscure a simple concept behind obscure mathematics.

R. B. Jordan

Biometrics Section

Ministry of Agriculture and
Fisheries
P.O. Box 2298
Wellington
New Zealand

ieee intercon proudly presents **Un-Flation**

(Most everything you need to know about electronics, for 6 cents an hour)

Almost anything you bought yesterday will cost something extra today. And even more tomorrow.

IEEE Intercon is proud to announce its countermeasure: More for your convention dollar instead of less. And darned few dollars at that.

This international convention and exposition offers more innovation, technical variety and depth, more special programs than ever before. They are calculated to provide an update on everything that's new in technological trends, new componentry and equipment, new systems and techniques.

There are, for instance, 144 hours of solid, applicable technical and professional programming. One registration fee covers all of them, and it works out to less than *six cents per hour* for expert and relevant technical information.

That same fee — \$8 for IEEE members and \$10 for non-members — also entitles you to three full days of a first-rate exposition, a continuing science film theater, special applications programs, a high-speed computerized registration system that gives you your own "literature credit card."

It also makes you eligible for some very exciting doorprizes — an HP-55 programmable scientific calculator to be given each day; and a grand prize of a Teradyne Circuit Analyzer (which sells for \$3500)! All you have to do is help us with an informal Intercon survey questionnaire.

In tight-budget times like these, Intercon really offers "un-flation!" 47 technical sessions. 400

brand-new electronics displays. Compact three-day show schedule. Full preprint session manuscripts available on the spot. The new "one-on-one" technical forum.

Intercon will produce literally hundreds of new ideas for improving performance and producibility, reducing costs, making products and systems more marketable. Any or all of them are available to you — at a few cents per dozen.

Come and get 'em at Intercon in New York.

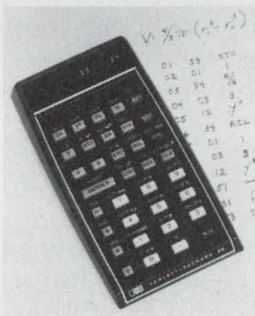

Daily doorprize: The HP-55 programmable calculator



Grand prize: The Teradyne J127 benchtop circuit analyzer

ieee intercon75

April 8-10, New York Coliseum/Hotel Americana



IEEE Intercon is the international convention and exposition of IEEE Inc., 345 East 47th Street, New York, N.Y. 10017

INFORMATION RETRIEVAL NUMBER 17

Here's why REI can rent you what you want when you want it.



Our inventory. It's the biggest in the industry, with over 8,000 items of electronic test equipment in stock and ready to go. And it's getting better all the time, because we add more state-of-the-art equipment every month. This means we can deliver one special instrument... or a dozen... within hours of the time you place your order.

Now, more than ever, renting makes sense... to stretch your equipment budget, to fill temporary needs, and to avoid the long delivery lead times associated with purchasing. And renting from REI makes even more sense... because we're better equipped to fill your needs than any other rental company.

REI is backed by the tremendous resources of the PepsiCo organization, which gives us the financial strength to keep on hand whatever test equipment you may need. And renting from us helps *your* financial strength,

too. Since you pay only for the time you have your instruments, you'll never have to spend your money on idle equipment.

Send for our catalog today for a description of our rental, rental/purchase and leasing plans, and for our low rental prices. Or call the instant inventory center nearest you for immediate assistance.

Rental Electronics, Inc.,
99 Hartwell Avenue, Lexington, Mass. 02173.
Please send me your free instrument rental catalog:

Name _____ Title _____

Company _____

Address _____

City _____ State _____ Zip _____

Tel. Number _____

Rental Electronics, Inc.

A PEPSICO LEASING COMPANY

Burlington, MA (617) 273-2770 • Gaithersburg, MD (301) 948-0620 • Oakland, NJ (201) 337-3757 • Ft. Lauderdale, FL (305) 771-3500
Des Plaines, IL (312) 827-6670 • Dallas, TX (214) 661-8082 • Mountain View, CA (415) 968-8845 • Anaheim, CA (714) 879-0561
Rexdale, Ontario (PLC Leasing Ltd.) (416) 677-7513

INFORMATION RETRIEVAL NUMBER 18

MARCH 1, 1975

Semi laser pulser delivers 1000 W from 27-V battery

A new semiconductor laser pulser that is only 1.5 in. long is reported to deliver more than 1000 W of peak power from a 27-V battery.

According to the developer, Adaptive Systems, Inc., Pompano Beach, FL, the pulser occupies less than 2 cubic inches of space and produces a 150-ns-wide pulse that can deliver up to 100 A to a low-inductance load.

Weldon Vlasak, president of Adaptive Systems, says the repetition rates of the pulser have been limited to less than 10 kHz by the heating effects of the injection laser, even though the pulser operates at efficiency as high as 90%. Cooling of the laser can increase the allowable repetition rate, he notes.

Until now the major problem with pulsing injection lasers has been the high self-inductance of the circuit path. Lasing is a function of drive current for the injection laser, and the self-inductance of the current path causes the current rise time to be slower than the voltage rise time.

The self-inductance in the new pulser has been reduced to less than 8 nH, Vlasak says, resulting in fast current rise times. Rise times as short as 5 ns have been measured, he reports.

To reduce the self-inductance, a special transistor array with short interconnecting leads had to be fabricated. It contains 40 transistor chips on a metal substrate that is 3/4 of an inch in diameter. The total path length from the energy source—a storage capacitor—to the transistors in the array is less than a half inch.

Vlasak notes that at first a monolithic transistor array was used, but current hogging resulting from the ballast resistors in the monolithic device caused hot spots near

the emitters of the transistors and the failure of the monolithic array.

Because of that, the discrete-chip array was used. This approach, Vlasak says, makes it possible to move the emitter ballast resistors away from the transistors, so that current hogging doesn't occur.

Vlasak says the new pulser can be used with a semiconductor laser chip as a sunsight illuminator, a night-viewing aid or a short-range radar. A commercial product is not yet available.

Prototypes cost \$1000 each, but once production starts, Vlasak sees the cost dropping to about \$300.

Laser printer transfers data to ordinary paper

A non-impact printer that uses the beam of a 4-W argon laser to transfer alphanumeric data onto ordinary paper has been developed for the Army. The system, known as the Tactical Line Printer, transfers messages by a process in which the laser beam is scanned across a dye-coated plastic ribbon. The dye is literally blasted onto the paper.

Developed by RCA Advanced

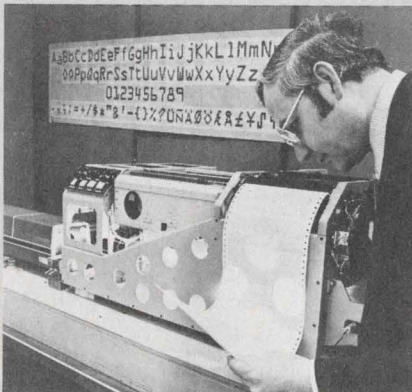

Non-impact tactical line printer is examined by engineer at RCA's Advanced Technology Laboratories.

Technology Laboratories, Camden, NJ, the printer forms characters by a series of dots that are generated as the laser scans the dye-coated ribbon. The laser scan is produced by a rotating mirror. To produce a complete line of copy, the laser beam makes 19 scans across the paper.

Seven operating speeds are available. For serial input, they are 55, 110, 220 and 440 lines per minute, while for parallel input operation, 273, 605 and 900 lines per minute can be obtained.

In operation the printer receives the digital data and decodes and stores them in a buffer memory, one line at a time. The buffered input is then restructured so that an electrical signal can be generated to drive the laser modulator and form the dot structure.

Use of the laser is expected to reduce the maintenance problems encountered with impact printers. And operating costs are reduced through the use of ordinary paper. The present system is a laboratory model developed for the Army Electronics Command at Ft. Monmouth, NJ.

Conference to feature offshore drilling aids

For electronics companies that would like to get their feet wet in the increasingly busy and lucrative field of offshore drilling, a good, four-day opportunity is coming up: the Offshore Technology Conference, to be held May 5-8 in Houston, TX.

Billed as the largest and most comprehensive technical meeting and exhibition in the organization's seven-year history, the conference is expected to play host to 40,000 visitors. Last year's audience came from 90 countries.

There will be 280 technical papers at 45 sessions this year, and 2800 exhibits provided by 1200 offshore service, supply and manufacturing companies from 13 countries. Many exhibits will feature electronic systems or complexes that include electronics.

Technical sessions of direct interest to electronics engineers include "Offshore Operations—Drilling" (Honeywell will describe acoustic re-entry concepts for sub-

sea exploration, drilling and production); "Navigation" (satellite, acoustic and hydrospheric); "Pollution," "Bottom Surveys" (side-scan sonar, a portable underwater videorecorder, slant-range sonar); "Offshore Operations—Production" (Transworld Drilling Co. will describe "Shirtsleeves Beneath the Ocean Surface"); and "Ocean Mining" (surveillance and survey systems).

U.S. weighs cutbacks at WWV and WWVH

In response to Government efforts to reduce operating costs and to conserve energy, the National Bureau of Standard is considering alternatives to operating radio stations WWV and WWVH.

The stations have provided standard-frequency and time-signal broadcasts to many users for decades. Station WWV is at Fort Collins, CO, and WWVH near Kekaha, Kanai, HI.

The bureau is asking listeners to these stations to provide information via questionnaire to "help set priorities and guide decision-making processes."

Last year a 50% reduction in power output at 5, 10 and 15 MHz was proposed by the bureau for WWVH. According to James Barnes, chief of the bureau's Time and Frequency Services Section, "We received so many objections to the proposal that we have decided to explore other possible means of cost and energy reductions."

Examples of possible changes, Barnes says, include eliminating some broadcast frequencies from WWV and WWVH or reducing transmitted power on some frequencies.

Users of these stations can get a postage-paid questionnaire by writing to the National Bureau of Standards, Time and Frequency Services Section, Boulder, CO, 80302. The deadline for returning the questionnaires is May 1.

Computer keeps tabs on 20 engine test points

A computerized system for testing gasoline car and truck engines

automatically has 15 types of sensors that measure more than 20 engine parameters. The parameters include oil temperature and pressure, fuel-flow rate, throttle position, spark advance, engine rpm and torque.

The system, being built for the Ford Motor Co.'s Dynamometer Laboratory in Dearborn, MI, by Hamilton Test Systems, Windsor Locks, CT, is designed to operate four independent test cells simultaneously.

The system will substantially increase the speed of test-data acquisition at the Ford laboratory, which houses 70 test cells for evaluation of engines.

The Hamilton System will automatically regulate the operation of both dynamometers and engines while monitoring each test sequence. Data will be available for review on a video monitor and on a computer printout at a central operator's station.

Fluorimeter detects lead in human blood

Lead poisoning, the killer that children ingest from paint chips and dust, can now be detected in one minute from a single drop of blood with a portable instrument developed by Bell Laboratories, Murry Hill, NJ.

Nomally tests for lead poisoning require a test tube full of blood and a long wait while it's analyzed in a medical laboratory. With the new instrument, a drop of blood is placed on a glass slide and inserted into a special fluorimeter, which measures the light emission, or fluorescence, of the blood when the sample is irradiated by a beam of blue light.

If excessive amounts of lead are present, the blood will give off red light of a specific frequency. The intensity of this red fluorescence, recorded on a digital meter, reveals the level of lead in the blood.

Near real-time imagery from side-looking radar

Very high-resolution imagery—25 line pairs at 36 Mb/s—is reported from an airborne sensor in the Army's In-flight Data Trans-

mission systems (AIDATS).

Arthur Gandy, AIDATS program manager at the Northrop Electronics Div., Palos Verdes Peninsula, CA, says: "We can transmit imagery sensed by an APS-94D side-looking airborne radar to a ground mobile station for near-real-time processing."

Robert G. Cooper, project engineer at Northrop, explains that an outstanding feature of the system is its low bit-error rate. "While the spec was a maximum bit error rate of 10^{-3} at a range of 150 km," he stresses, "we did 370 km and probably could have gone further."

The system contains a Ku-band transmitter on the aircraft with a 150-W TWT output amplifier. On the ground is a 7-ft parabolic antenna (0.7-degree beam width) connected to a low-noise microwave receiver and an image-processing system.

The receiver has a tunnel diode preamplifier, and the over-all noise figure of the receiver front end is better than 7 dB. The receiver is a triple converter down to an i-f frequency of 13.7 MHz. This signal is sent to a quadra-phase demodulator and from there to a demultiplexer.

Finally the signal goes to a delta demodulator, and the output video is fed to a moving window display.

UV erasable PROMs storing up to 8-k bits

After two years of relative inactivity, ultraviolet erasable PROMs are moving up to storage capacities of 4-k and even 8-k bits. Renewed interest in the erasable PROM area is a direct result of the increased use of microprocessors, semiconductor manufacturers note.

The 4-k unit, National Semiconductor's MM5204, is organized as a 512-by-8-bit array and features programming time of only 30 sec. Although it is twice as large as the popular 2-k device, the MM5204 reportedly uses one-third the power.

An 8-k erasable PROM, the 2708 from Intel, is scheduled for introduction in March. The chip design is similar to that of the 1702, a 2-k device. Access time for the 2708 is said to be 500 ns.

Surprise! \$2.95

(10-49)

Wideband Transformers

SURPRISE! Wide bandwidths, .015-600MHz
SURPRISE! Low insertion loss, 0.5 dB
SURPRISE! Microminiature, .230" x .270" x .300"
SURPRISE! One week delivery

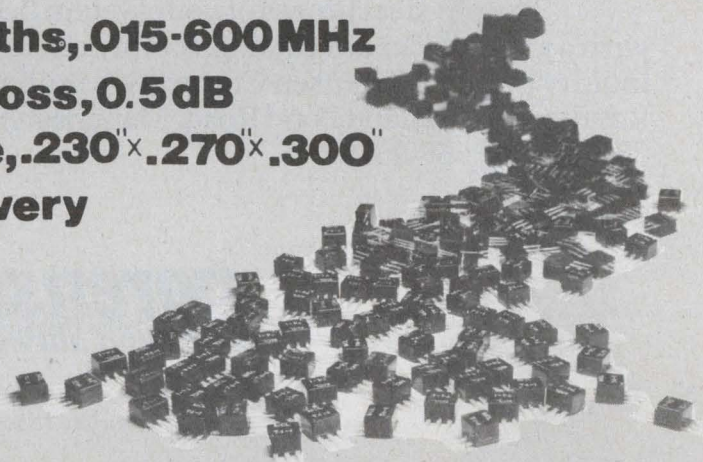

DESIGNERS KIT AVAILABLE:

2 TRANSFORMERS OF EACH TYPE
 T1-1, T2-1, T4-1, T9-1, T16-1
 KIT # TK-1 ... **\$32.00**

NO "MAKE OR BUY" DECISION HERE... it costs less to buy Mini-Circuits wideband transformers and there's no delivery delay. Impedance levels from 12.5 to 800 ohms with insertion loss typically less than 0.5 dB

MODEL	T1-1	T2-1	T4-1	T9-1	T16-1
Impedance Ratio (50 Ω pri. imp.)	1	2	4	9	16
Band-width (MHz)	1db loss	2-50	.05-200	2-100	2-40
	3db loss	.15-400	.015-600	.2-350	.15-200
Price (10-49)	\$2.95	\$3.45	\$2.95	\$2.95	\$3.45

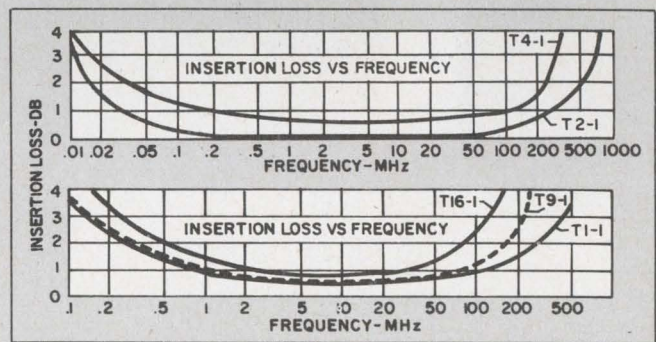

WE'VE GROWN

Customer acceptance of our products has been so overwhelming, we've been forced to move to larger facilities — THANKS.

Mini-Circuits Laboratory
A Division Scientific Components Corp.

MCL

**OUR NEW ADDRESS IS: 837-843 Utica Avenue,
 Brooklyn, NY 11203 (212) 342-2500
 Int'l Telex 620156**

Foreign Sales Representatives: AUSTRALIA General Electronic Services, 99 Alexander Street, New South Wales, Australia 2065; ENGLAND Dale Electronics, Dale House, Wharf Road, Frimley Green, Camberley Surrey; FRANCE S. C. I. E. - D. I. M. E. S., 31 Rue George - Sand, 91120 Palaiseau, France; GERMANY, AUSTRIA, SWITZERLAND Industrial Electronics GMBH, Klüberstrasse 14, 6000 Frankfurt/Main, Germany; ISRAEL Vectronics, Ltd., 69 Gordon Street, Tel-Aviv, Israel; JAPAN Densho Kaisha, Ltd., Eguchi Building, 8-1 1 Chome Hamamatsucho Minato-ku, Tokyo; EASTERN CANADA B. D. Hummel, 2224 Maynard Avenue, Utica, NY 13502 (315) 736-7821; ITALY Microel Italia s. r. l. via M. Loria 50, 20144 Milano & via Senafe 27, 00199 Roma; NETHERLANDS Coimex, Veldweg 11, Haltem, Holland

US Distributors: NORTHERN CALIFORNIA Cain-White & Co., Foothill Office Center, 105 Fremont Avenue, Los Altos, CA 94022 (415) 948-6533; SOUTHERN CALIFORNIA, ARIZONA Crown Electronics, 11440 Collins Street, No. Hollywood, CA 91601 (213) 877-3550

For complete U.S. Rep listing and product line see MicroWaves' Product Data Directory

The health of the system depends on the condition of the heart

We make sound hearts for systems — power supplies that are also twice as efficient, more than twice as compact, and price competitive with conventional series-pass types.

The 40 models in the Sorensen STM family are modular switching power supplies designed for OEM systems, 3.0 to 56 Vdc. Despite their compactness and efficiency, they retain all of the advantages inherent in the series-pass design.

The physical fitness of your system begins with a good look at our catalog. Simply circle the inquiry number. Sorensen Company, a unit of Raytheon, 676 Island Pond Road, Manchester, N.H. 03103. (603) 668-4500.

Sorensen
POWER SUPPLIES

INFORMATION RETRIEVAL NUMBER 20

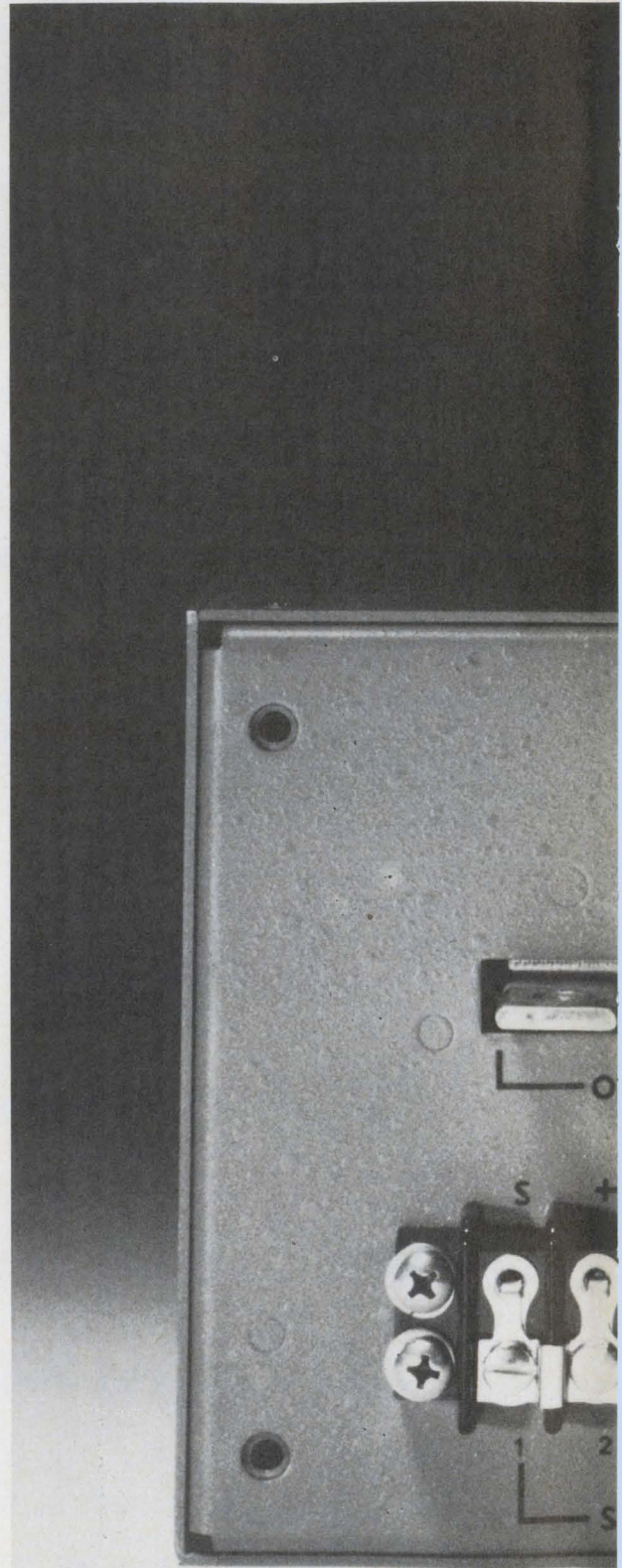

Sorensen
POWER SUPPLIES

STM

5-60

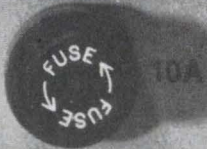

OVP
VOLT

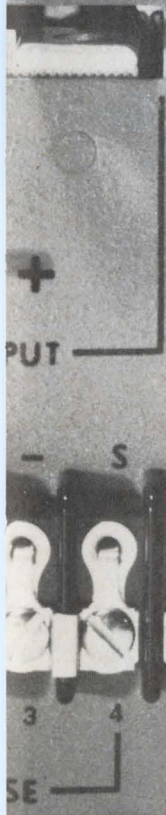

Radiophones and precision gear make a splash at boat show

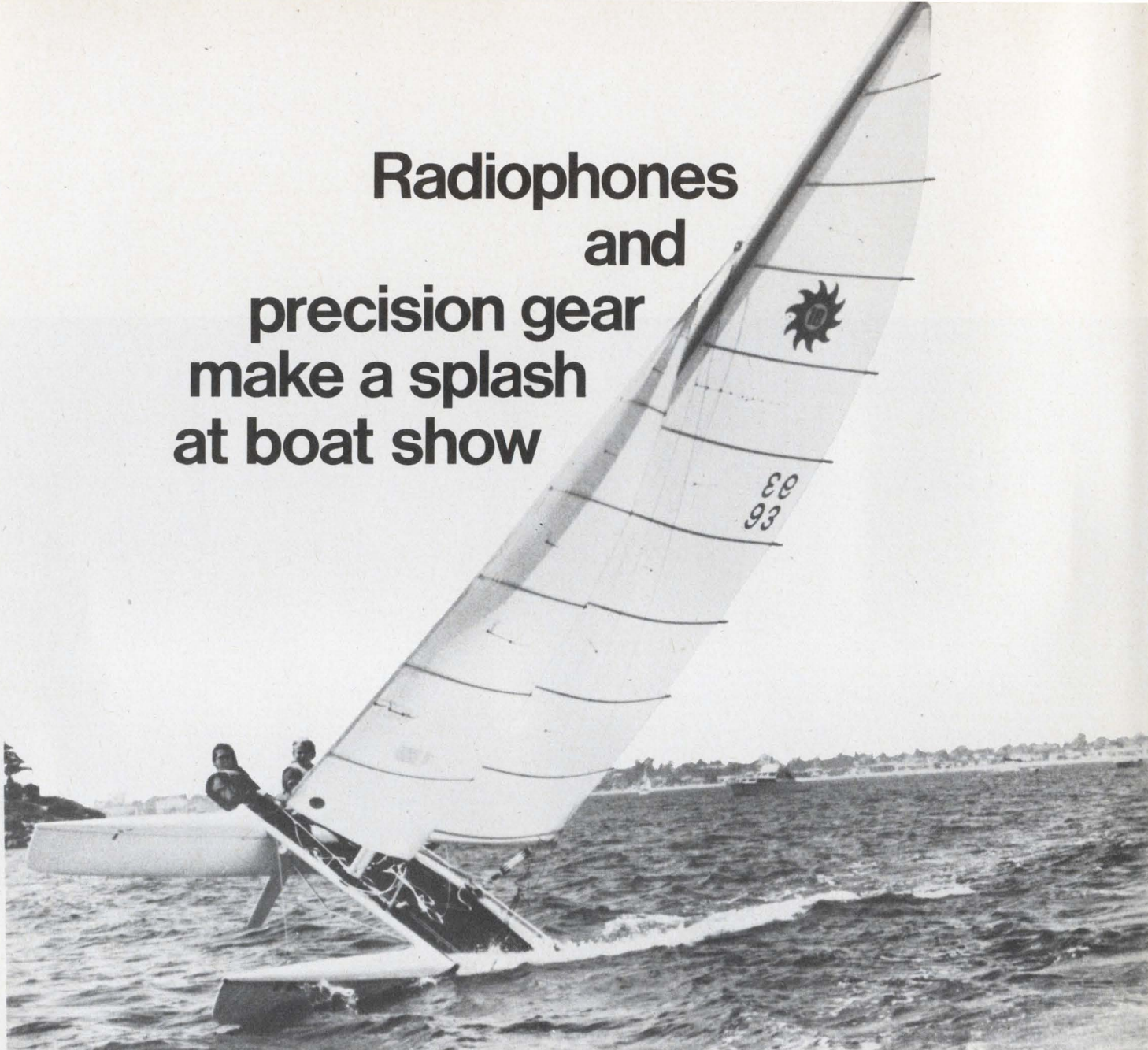

You'd never have known there was a recession going on outside New York City's Coliseum from Jan. 11 to 19. Record crowds spent \$63-million for the sleek boats and yachts on display and for the sophisticated electronic units to go with them. The occasion was the 65th National Boat Show, and attendance was up 15% over last year's.

Two trends were notable: radiotelephones are moving away from multiple-crystal oscillators toward frequency synthesizers controlled by a single crystal, thus offering cheaper, more compact units with more performance. And there are

more specialized precision instruments for the more sophisticated craft, such as racing sloops.

On the high-performance, low-price side, a new vhf/FM radiotelephone called Seacom 55 was shown by Unimetrics, Inc., Plainview, NY. The unit provides crystal-controlled operation on a 55-channel, phased-locked-loop circuit for operation over the entire 156-157.5-MHz marine band. With a choice of a 6-dB or sailboat antenna, it's priced at \$775.

Receiver sensitivity is 0.5 μ V. Audio output is 4 W into a 4- Ω load, at 10% distortion. The rf output of the transmitter is 25 W high power and 1 W low.

Emergency Beacon Corp., New Rochelle, NY, displayed its new \$895 synthesized vhf marine trans-

ceiver, which provides 67 channels plus four receive-only channels. As a safety feature, the unit automatically monitors the emergency channel, No. 16. An emergency battery pack for the EBC-RT-55M unit costs \$199 and a vhf marine direction finder \$895.

Several new, all-solid-state radiotelephones were shown by Konel Corp., South San Francisco. A vhf/FM unit guarantees 25 W at full power, 12 channels (expandable to 24) and two weather channels.

Called the KR-28VN, the unit uses an offset frequency design that enables a receiver crystal to control the transmit frequency as well. This eliminates the need for a second crystal and a synthesizer.

The basic unit with 12-channel capability costs \$539 plus \$8 per

John F. Mason
Associate Editor

channel. With remote switching, the basic price is \$819. The 24-channel set costs \$599, with the crystals extra. With remote switching, it sells for \$889.

Konel also showed a new ssb radiotelephone, the KR-100SB. The front of the unit is removable, so the set can be placed directly at the base of the antenna. This eliminates the need for an antenna coupler. The unit offers 17 simplex or 8 half-duplex channels.

The unit cost of the KR-100SB is \$1495. The dc power supply costs \$200 extra and the ac supply \$350. Each simplex A channel costs \$40 and each simplex B, \$15. A duplex channel costs \$55.

A vhf-FM radiotelephone was shown by ITT Decca Marine, New York City. Called the STR 24, the

unit uses one crystal and a frequency synthesizer to cover all channels and all modes of communication in the vhf range, including Channel 16. The unit costs \$1475.

Other new instruments include two all-solid-state depth recorders, which both record the voyage as one sails and give instant, flashing readings. The DC-1024 records depths to 180 feet and flashes depths to 240. The DC-1048 records and flashes to twice these depths. The units were built by Sonar Radio Corp., Brooklyn, NY.

What is described as the "world's first" digital radio direction finder, the Heathkit MR-1010, offers half-inch-high digits. It covers 190 to 410 kHz plus 535 to 1605 kHz, and it operates from the ship's 12 V dc power or its own built-in bat-

tery. Heathkit products are manufactured by the Heath Co., Benton Harbor, MI.

Simrad, Inc., Armonk, NY, displayed its new Internav 204 loran-C navigation unit. Selling for \$4850, the 12-V system offers automatic signal acquisition and automatic tracking of two lines of position at the same time.

Konel plans to bring out a manually operated A and C loran navigation unit that will cost about \$1700.

New radars shown included Raytheon Marine Co.'s Model 3900. The unit uses a four-foot slotted antenna that offers a data update rate of 30 rpm. Selectable ranges are from a half mile to 32 nm. The unit, which costs \$5590 complete, is being produced at Raytheon's plant in Manchester, NH. ■■



"World's first" digital radio-direction-finder readout can be read in sunlight on this Heathkit MR-1010.



Vhf transceiver with 67 channels, plus four more for receive-only, costs \$895 and is made by Emergency Beacon Corp.



Vhf/FM radiotelephone covers all channels, including 16 with a single crystal. Priced at \$1475 by ITT Decca.



Seacom 55, by Unimetrics, provides 55 channels on a crystal-controlled, phase-locked loop.

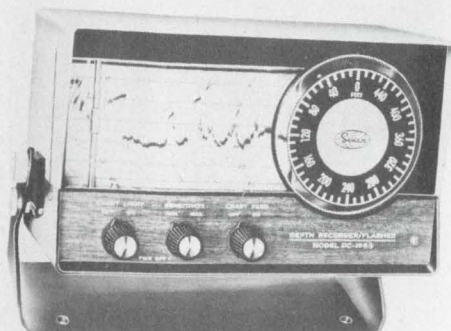

Solid-state depth recorder, the DC-1024 by Sonar Radio Corp., flashes and records readings to 480 feet.



Marine radar Model 3900, by Raytheon, uses a four-foot slotted antenna to provide high bearing resolution.

The insecure computer problem: Ways sought to foil unlawful entry



Computers are insecure.

According to Lindsay L. Baird Jr., a computer security consultant for Advanced Computer Techniques in New York City, "there is no such thing as a totally secure computer."

About a year ago the Oregon Dept. of Motor Vehicles decided to share its IBM 360 computer with the students at Oregon State University. Shortly after the computer was made available, one student called up the computer from his remote terminal, gained access to the machine's operating system and took over control.

He sent a signal to the computer, telling it to ignore data coming from the control console in the computer center and to make his terminal the control console. The student then put the system into a supervisory state where no programs could be executed. He let the system stand then for three hours—just to prove a point.

He could have stolen a lot of

data or even erased the data completely from memory. He didn't. He merely wanted to demonstrate that computers are insecure.

To overcome the machine's basic flaws, researchers are seeking to protect both hardware and software.

Baird points to several things that contribute to an insecure com-

puter system. For one, there is always strong pressure on computer designers and operators to keep the system running. So, the security consultant says, systems are being designed to work but not necessarily to work securely.

"You tell me something that's sensitive and requires protection," Baird asserts, "and if the system

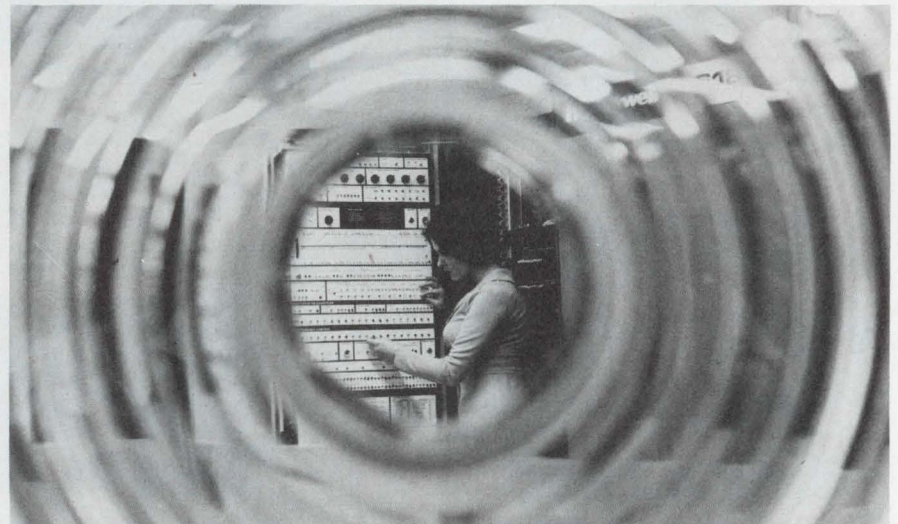

Rings of protection are a key element in Honeywell's Multics computer system. The rings help control shared access of files in the system.

Jules H. Gilder
Associate Editor

Want a prime source for all your components?

Consider the diversity in 50 electronic product lines from a company called TRW.



The fourteen Electronic Components Divisions of TRW, Inc. produce over 50 major product lines. Passive, active and electromechanical components—we can supply virtually any part you need. High volume, high technology, or both. We either already make it, or we can make it to your specifications. If you're looking for diversity in your prime source, you've just found it in a company called TRW.

TRW ELECTRONIC COMPONENTS

Headquarters: 10880 Wilshire Boulevard, Los Angeles, CA 90024

TRW.CAPACITORS

TRW.CINCH-MONADNOCK

TRW.GLOBE MOTORS

TRW.IRC POTENTIOMETERS

TRW.IRC RESISTORS

TRW.SEMICONDUCTORS

TRW.CINCH CONNECTORS

TRW.CONSUMER INTERNATIONAL

TRW.HOLYOKE WIRE & CABLE

TRW.SUPERMET PRODUCTS

TRW.CINCH-GRAPHIK

TRW.ELECTRONIC FUNCTIONS

TRW.IRC NETWORKS

TRW.UTC TRANSFORMERS

INFORMATION RETRIEVAL NUMBER 21

has a data-element dictionary, I can pull that item out of there any number of ways and never touch a protected file."

It's the bits and pieces that equal the sum, he explains. He notes that in the military, the worldwide inventory of certain munitions is a secret. But you can legitimately ask the computer what depots store these munitions, Baird contends, and you can ask how much the inventory at each depot weighs. That information is not protected, he says, because what is located at any one depot is not classified.

"I can sit at a terminal and ask a computer what depots have a certain item, and it will give me a list," he explains. "Then I can ask the computer how much is at depot A, depot B, etc. So now I've got the classified data, and I never touched a protected file."

Another way to get the same information, Baird says, is to ask what the dollar volume of the inventory is. With very few exceptions, money information is not classified by the military, he reports. After getting the total cost of inventory, it is only necessary to ask for the unit price and to do a little division.

"People just don't think when they design these systems," Baird says. "To make computers secure, you have to go back to basics."

While surreptitious penetration of computers is generally possible because of bugs or trap doors in the system's software, Baird points out that both hardware and software are necessary to make a computer more secure.

Hand identification used

Many pieces of hardware are being investigated for computer security, but only a few are commercially available at present. One is a hand-geometry identification and verification system designed by Identimation of Northvale, NJ.

According to Marvin Miller, president and chairman of Identimation the geometry of the human hand, like fingerprints, is unique to each person. When a hand is placed on a special Identimation console, the machine measures the hand's geometry, and these figures, along with an identification number, are recorded on a magnetical-



Magnetic cards can be used to control access to computer facilities.



Bank cash terminals, such as IBM's 3614, dispense money after a verified user inserts a cash card.

ly striped plastic identification card.

Whenever a person wants to use a computer terminal or to enter a restricted area in a computer center, he must insert his card into the reader and place his hand on top. If the measurements of the hand match those on the card, a minicomputer checks to see if the person is authorized to use the facilities.

According to Miller, the error rate of the standard Identimation system is less than one in 200, and for high security requirements,

They're tough to bug

Bugging a computer isn't easy, and as a result, it isn't often done. In general, the data in a computer are handled in parallel form. This speeds up the movement of the data and also causes problems for the would-be bug planter.

The reason is that to handle the 8 or 16-bit words in computers, a hidden transmitter would have to handle between 8 and 16 individual channels. Bugs like that aren't easy to come by, and even if they were, they'd be difficult to hide and connect.

According to Donn Parker, a computer security researcher at the Stanford Research Institute, not many cases of computer bugging have been reported.

But it's not always necessary to hide a transmitter in a computer to get the data out. In one incident, a miniature receiver was planted in the machine by a computer maintenance technician. The technician knew that the information he was interested in gathering would be in the computer on a certain day at a certain time. So he planted a receiver that would cause the computer to malfunction and go down. When this happened, the data-processing center called him in to fix the machine. While repairing the computer, he dumped all the information in memory onto a disc, and he walked out with all the data he wanted.

this can be increased to one in 2000.

Magnetic cards also used

In addition to hand geometry, magnetically encoded striped cards are available. Their use, both for access control and cash transactions, is increasing, though they can be compromised. Two examples are the magnetically striped cards used in San Francisco's BART railroad system and the magnetically coded plastic credit cards used

(continued on page 30)

Careful there . . .
you're likely
to start
something.

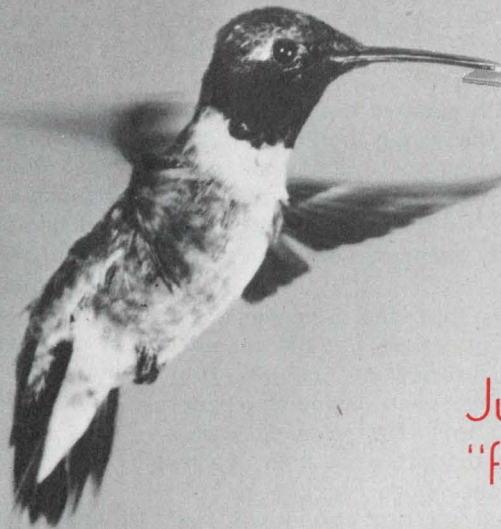

Just a
"flutter" of pressure
. . . and SNAP!

Less than 2 grams of force actuates this Cherry snap-action miniature switch. Outside, the external aluminum actuator is purposely $2\frac{3}{8}$ " long to provide this unusually low operating force. Inside, an extra internal actuator further reduces operating force while maintaining solid contact mating pressure for reliable performance.

The "flutter force" switch is only one of Cherry's E22 series of unique miniatures. All are rated 3 amps, 125 VAC. All are also available in gold "crosspoint" configuration for low energy solid state circuits.

A switch in your hand is worth two in the tree, so . . . SNAP UP A FREE SNAP-ACTION SAMPLE.

Just TWX 910-235-1572 . . . or PHONE 312/689-7704 and ask Frank to give you facts on miniature switches . . . or circle appropriate reader service number.

E22-75HX
5 grams LIGHT
FORCE actuation
Circle No. 101 for
Free Sample



E22-55HX
3.5 grams LIGHTER
FORCE actuation
Circle No. 102 for
Free Sample



E22-85HX
Less than 2 grams
"FLUTTER"
FORCE" actuation
Circle No. 103 for Free Sample



CHERRY 

CHERRY ELECTRICAL PRODUCTS CORP.
3609 Sunset Avenue, Waukegan, Illinois 60085



Cherry affiliates worldwide • Hirose Cherry Precision Co., Ltd., Tokyo • G. W. Engineering Pty. Ltd., Sydney
Cherry Electrical Products (U.K.) Ltd., St. Albans, Herts • Cherry Mikroschalter GmbH, Bayreuth, Germany



Data encoders can be used to protect information transmitted over phone lines. The Secre/Data encoder from Com Tech offers a million code settings.



Hand geometry can be used to identify personnel using terminals.

in bank cash machines.

Many ways have been found to duplicate the BART cards, which normally are good for \$20 in train rides. The system subtracts the cost of each ride when the card is inserted into a terminal.

Some counterfeiters have taken a new BART card and transferred the magnetically coded data to regular recording tape, by placing the tape over the stripe and applying heat from an iron. They then pasted the duplicate tape onto an old BART card.

Robert Courtney, IBM's manager of data security and privacy, notes that changes in the system were made as soon as this counterfeiting technique was discovered. Now the system requires a strong magnetic

The Schneider story: A quarter-million theft

Five years ago, Jerry Schneider, then a 19-year-old engineering student in Los Angeles, used a computer to steal equipment from Pacific Telephone & Telegraph. Before the law caught up with him three years later, he had stolen a quarter-million dollars worth of equipment.

It all started, Schneider told *ELECTRONIC DESIGN*, when he saw a truck drop off a box of equipment that had a computer-generated label on it. "Could it be," he says he asked himself, "that a computer 'sent' this equipment?"

That sparked his imagination, and the young engineering student, who was studying computer programming at the time, decided to find out all he could about computer-ordering systems.

As a first step, Schneider says, he sent letters to IBM requesting information on ordering systems. Then posing as a journalist and later as a customer, he found out what kind of system the phone company had. It turned out that the system was a standard one that was available from IBM.

"After a while, I found myself becoming a whole library of knowledge on that system and how it worked," Schneider says.

"And as a challenge, I went out to see if I could get things delivered to a particular location."

Schneider says he picked up his Touch Tone telephone, dialed the correct phone number and ordered equipment simply by punching in the correct beep tones from his phone. He then picked up the ordered equipment and sold it through a dummy company.

Schneider was able to continue this operation for three years while the unpaid bills on his dummy account accumulated. Finally he was caught. How? He refused to give the truck driver he had hired \$1 an hour more, and the driver squealed, Schneider says.

Schneider was charged with stealing a quarter million worth of equipment, sentenced to 40 days in jail and put on probation. The sentence was light, he notes, because he subsequently cooperated with the phone company in eliminating the holes in its computer system.

He has since set up his own computer security consulting concern, Jerry Schneider & Co. in Los Angeles. He now advises businesses on how to plug up loopholes in their computer systems.

field that is present only on the original card.

But that hasn't solved the problem; it only means that counterfeiters have to spend a little more money to buy recording equipment that can read and reproduce the stronger signal.

Bank cash cards pose a more serious problem. More money can be stolen.

Not too long ago Baird of Advanced Computer Techniques offered to do a survey for a large bank in New York to point out all of the weak points of its system. He would require no access to the computer center, and he guaranteed that no equipment would be damaged. He specified that whatever he used to defeat the system would be available to the average man on the street. The only thing he wanted stipulated was that the bank let

him keep half the money he could get from the machine.

Though he claimed that he could make the money machine dispense cash like a broken slot machine, the bank refused to take Baird up on his offer. His plan called for getting a group of "confederates" to apply for the cash card. After they got it, they were to phone the bank and indicate that they had never received it, or had lost it or wanted to cancel it. The number of the card would then go on the bank's hot list.

The practice of the bank that Baird had in mind was to keep the hot list in memory in its main computer but not in the back-up unit. So whenever the main computer was down for maintenance or other reasons, the backup computer would issue money to any money card,

(continued on page 32)

Signal has the answer...

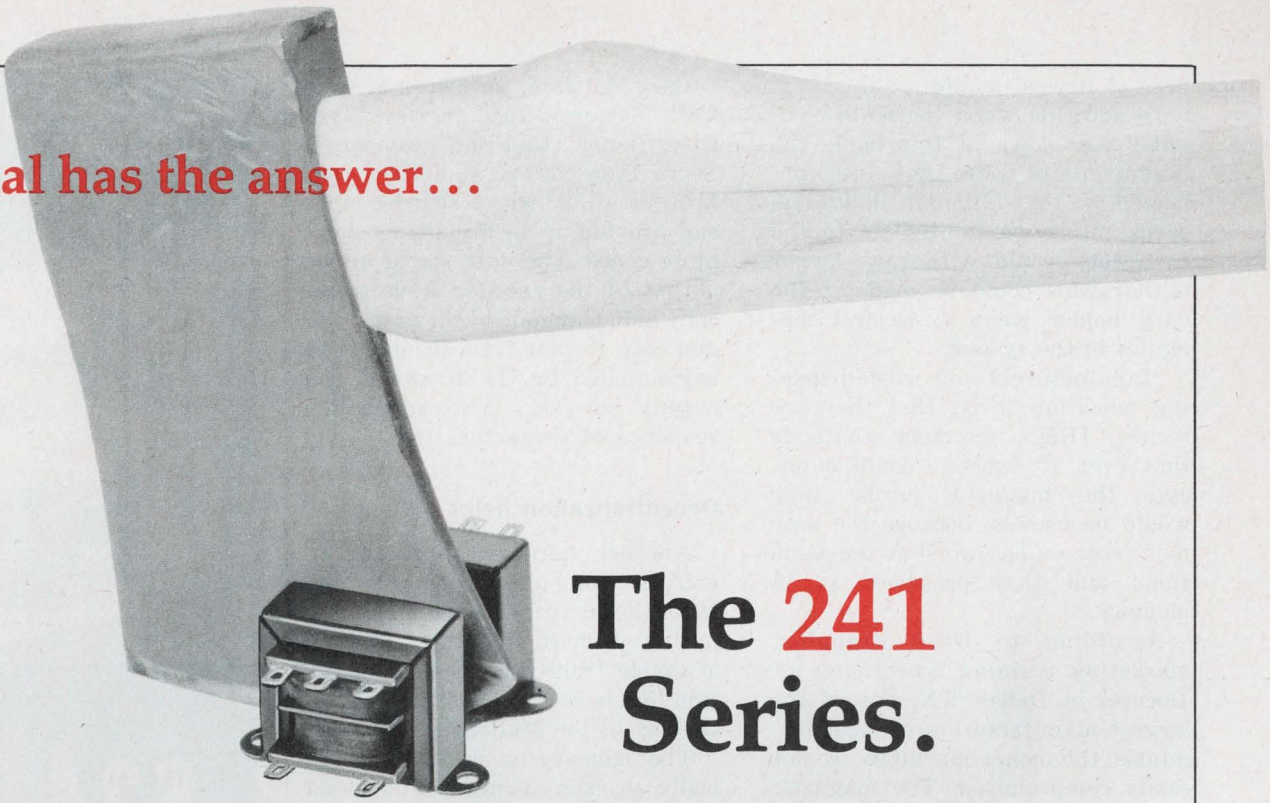

The 241 Series.

Cuts transformer weight, size and cost almost in half!

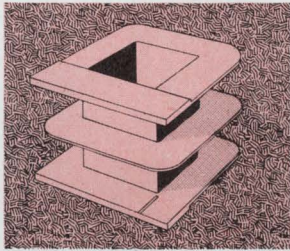

Special "split" bobbin (secondary wound alongside primary rather than over it) effectively isolates primary and secondary and reduces inter-winding capacitance. An electro-static shield

is not required in all but the most sensitive applications. Hipot rating of 2500V RMS is standard. Bobbin winding technique affords a 40-50% savings in winding space over conventional layer winding. "Split" bobbin eliminates the need for inter-winding insulation and cross-over of primary and secondary leads.

Grain-oriented steel core is used at higher saturation flux densities and results in about a 40% reduction in turns required. Although the cost per lb. of grain-oriented steel is higher than that

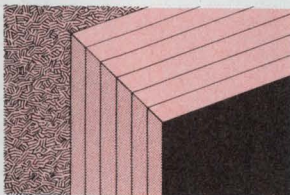

for ordinary silicon steels, the net cost is less, since less core weight is required and a significant reduction is made in copper weight.

Terminals, which are wedged into the bobbin wall, are designed so that they can be used as solder lugs or as 0.187" quick-connect types. Lead slots are incorporated in the bobbin wall leading to the terminals. It is not necessary to tape the start lead since it comes to the top of the coil through the slot and is thus separated from the winding. Separate lead wires or terminal boards and the extra assembly time to use them are eliminated.

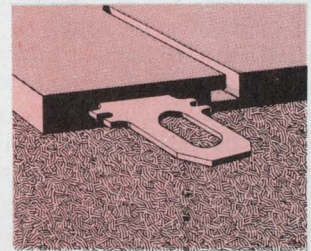

Fresh thinking in engineering design and material selection has reduced material and labor cost and results in a series of small power transformers which cut weight, size, and cost almost in half. Therefore, we named them the "2-for-1" series...



signal transformer co., inc.

1 Junius Street, Brooklyn, N.Y. 11212
Tel: (212) 498-5111 • Telex 12-5709

-and Signal has it in Stock!

even if it was invalid.

In addition when the main computer was down at this bank, the backup units were not interconnected, so that although individual cards might be limited as to the cash they could withdraw, larger withdrawals could be made if the card holder went to several machines in the system.

Manufacturers of cash-dispensing machines insist that they are secure. IBM's Courtney contends that even if someone could duplicate the magnetic cards, they would be useless, because the user must enter a password at the same time, and that password is in memory.

According to Dave Branning, marketing training coordinator of Docutel in Dallas, TX, one of the largest manufacturers of cash terminals, the money machines are not easily compromised. The magnetic cards in the Docutel system have the password encoded on the stripe in scrambled form. And each time the card is read, the data are re-scrambled. Only two people in the company have the key to the scrambling operation, he says.

Baird maintains that even though the encoded data are scrambled, with a dozen or so cards, a good mathematician and a digital computer can determine the scrambling algorithm without too much difficulty. It may take a little while but it can be done.

Abuses discovered by accident

Over 300 cases of computer-related crimes have been studied by Donn Parker, a researcher at the Stanford Research Institute, Menlo Park, CA. Almost all of them were discovered by accident.

According to Parker, the most vulnerable computers are those with some sort of teleprocessing capability. More people have access to this computer and there is more exposed hardware in the form of communications equipment, he explains. The problem is particularly bad in some of the new skyscrapers where all of the lines in the telephone junction boxes are identified with labels. This makes it easy for would-be wiretappers.

The more secure systems can protect against wiretapping by using data scramblers.

Carl Mangani, an owner of Com Tech Systems, Inc., in New York City, notes that his company's Secre/Data series of devices contain six thumbwheel switches that can provide up to a million scrambling codes. The data signal at the output of the encoder is electronically indistinguishable in waveshape and code format from the data signal supplied by the terminal. The output, however, is a random-like sequence of characters.

Decentralization helps

Another hardware approach to increase computer security is the Multiplexed Information and Computing Service (Multics) system available from Honeywell Information Systems. Virtual memory is the key to the Multics system.

The memory is segmented logically so each segment is accessed by name and accessed directly. Each segment contains its own list of authorized users of the system. The system contains eight concentric rings, or areas of operation.

Such decentralization makes the Multics system a big step forward in computer security, but the software is still vulnerable. Trap doors in operating systems, placed there by systems programmers to ease diagnosis, must be removed.

According to SRI's Parker even though Multics "is supposed to be the most secure commercially available system today," an Air Force study team is compromising it regularly in a hunt for remedies.

The big problem with computer systems today is that there is no way to prove system integrity. It's easy to test a system to see if it does what it's supposed to, but how do you know it doesn't do something else that you don't know about? How can you prove that the system hardware performs only according to specifications and that there is no "Trojan horse" in there that will make it perform differently under some special conditions?

Concern over exactly what a system does is so great that the Air Force Special Weapons Center in New Mexico is now worried about the integrity of the software used for nuclear missile guidance. The service has requested statements from the industry for a study of the software. ■■



\$24.95

1-9 pc
5V, 3A

- Overvoltage protection
- 115/230 VAC Input
- 0.05% Regulation
- 2 Year Warranty
- "Triple Test" with 2-hour burn-in on all units

SEE OUR CATALOG
FOR 58 OTHER MODELS

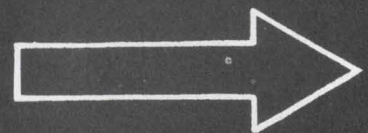

If you've been ripped off
circle reader service number
for your copy.



POWER-ONE, INC.
531 Dawson Drive
Camarillo, Calif. 93010
805-484-2806

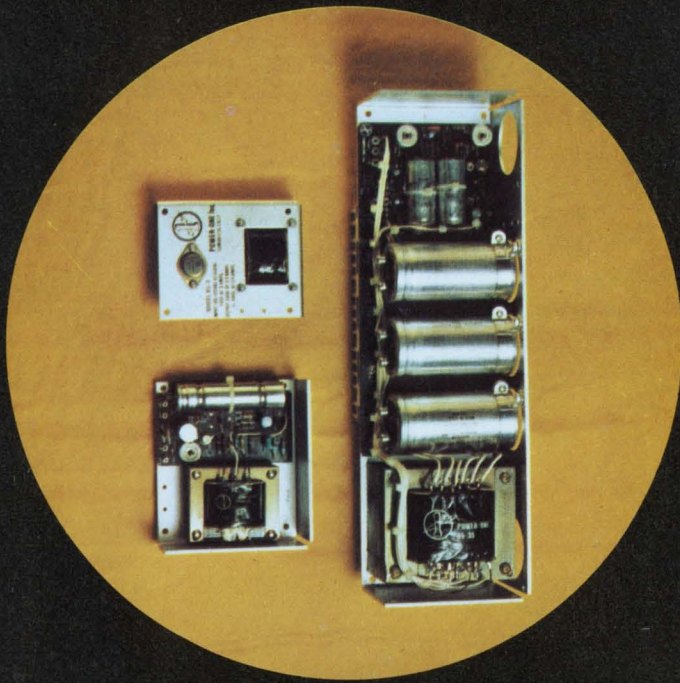

SINGLE OUTPUT

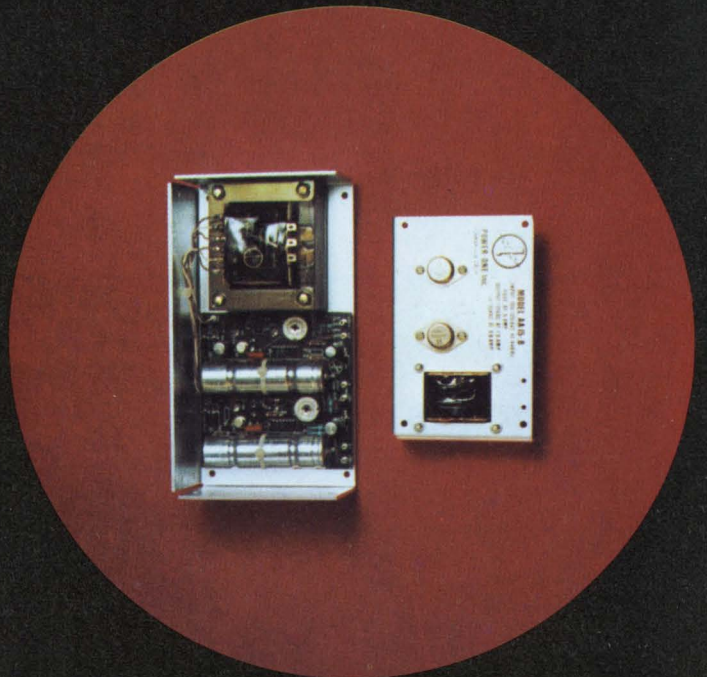

DUAL OUTPUT

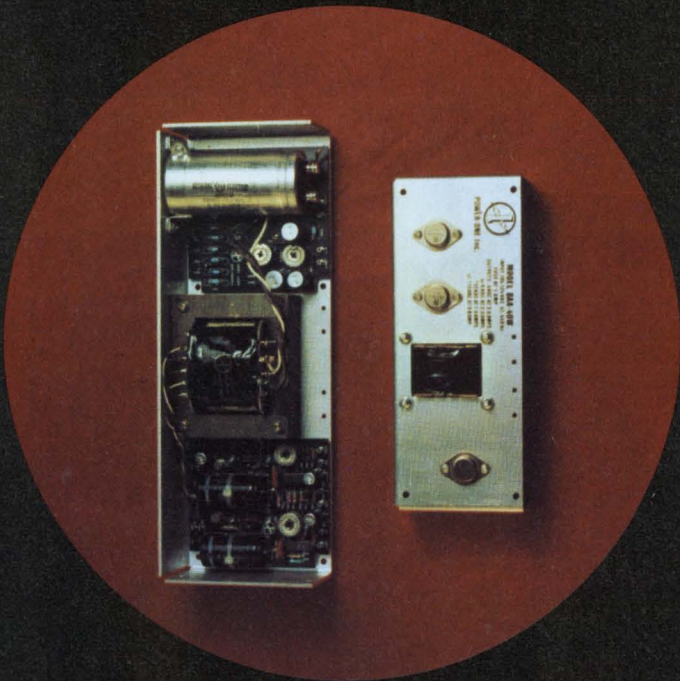

TRIPLE OUTPUT

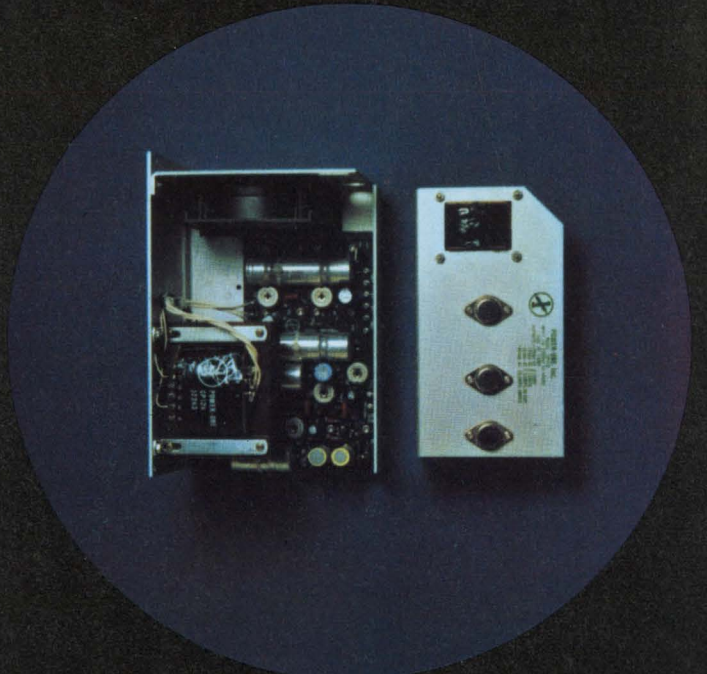

CUSTOM



**DC
Power
Supplies**

POWER-ONE, Inc.

531 Dawson Drive
Camarillo, Calif. 93010

QUALITY – ECONOMY – RELIABILITY

POWER-ONE'S commitment is to design and produce the finest OEM DC power supplies available.

A full time Research and Development Staff is continually improving the design and making changes that enhance the reliability and performance of our power supplies. We firmly believe that the OEM DC power supplies produced at our 15,000 sq. ft. Camarillo, California facility are superior to any OEM power supplies on the market.

We support this belief with our exclusive 2 year guarantee, which warrants any power supply unit we produce against defects in material or workmanship, with free replacement or repair. POWER-ONE provides:

- The lowest price and best performance available ANYWHERE
- 100% Testing of each unit including:
 1. Full functional test
 2. Minimum 2 hour burn in
 3. Full functional test
- All units are either recognized or built to conform to UL 478
- Full two year warranty, transferable to your customer
- Efficiency rated at 45%-65%. The absolute maximum efficiency available in a series pass design, comparable to many switching regulators.
- Ideally suited for computer, industrial and commercial applications through our uniquely balanced and proven design.
- I.C. Regulation – problems found in other units as pertain to regulation, oscillation, etc., are virtually eliminated.
- Only the finest quality hermetic transistors are used throughout all POWER-ONE units to enhance performance and reliability.
- Printed circuit board material is epoxy glass approved to UL 94VO.
- Aluminum heat sink and chassis are combined for optimum performance and packaging density.
- Foldback current limit protects against overload or accidental shorts, automatic recovery.
- All capacitors are computer grade, rated to 85°C operation.
- Balanced design provides for full rated operation at 50°C ambient temperature.
- 59 Standard Models—The most comprehensive selection available.
- All Models in stock – Call us for 1 day delivery.

Call your local POWER-ONE representative or our offices in Camarillo, California for a free, thirty day evaluation unit. Once you have compared POWER-ONE's features, reliability and performance with competitive units we are certain you will agree that POWER-ONE is NUMBER 1.

WARRANTY 2 YEAR GUARANTEE

POWER-ONE will repair or replace any power supply of its manufacture that does not perform to published specifications as a result of defective materials or workmanship for a period of 2 years from date of original purchase. No other obligations or liabilities are implied or expressed. Returns must be freight prepaid.

POWER SUPPLY SELECTOR

SINGLE OUTPUT UNITS	5 to 24V @ 15 to 170 Watts 1) 105-125 VAC Input 2) All with remote sense	P 4 & 5
	2 to 28V @ 6 to 170 Watts 1) 115/230 VAC Input 2) Built-in OVP on 5V Units	P 6 & 7
	5 to 28V @ 125 to 280 Watts 1) 115/230 VAC Input 2) Built-in OVP on 5V Units	P 12 & 13
DUAL OUTPUT UNITS	± 5 to ± 15 V @ 24 to 90 Watts 1) 105-125 or 115/230 VAC Input Models 2) Dual Tracking Models 3) Built-in OVP on 5V Models	P 8 & 9
TRIPLE OUTPUT UNITS	5V and ± 12 or ± 15 V @ 40 to 105 Watts 1) 105-125 or 115/230 VAC Input Models 2) Dual Tracking Models	P 10 & 11
OVERVOLTAGE PROTECTION	Adjustable (SCR) OVP Module 1) 12 Amp & 24 Amp Models	P 13
SPECIALS	Modified Versions of Std Products	P 14
CUSTOM DESIGNS	Custom-Designed Power Supplies to meet specific requirements	P 14
REPRESENTATIVES & DISTRIBUTORS	National Representatives & Distributors listed for your convenience.	P 15

SINGLE OUTPUT



B
\$24.95

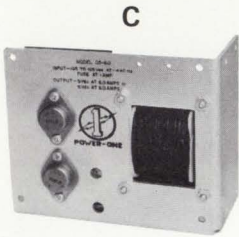

C
\$44.95

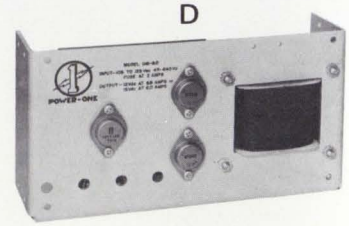

D
\$74.95

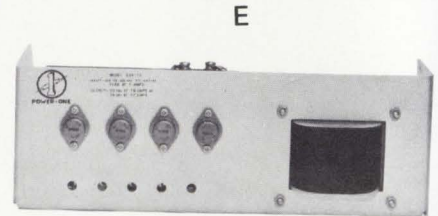

E
\$104.95

- .02% REGULATION
- REMOTE SENSING
- FOLDBACK CURRENT LIMIT
- POPULAR INDUSTRY SIZE
- FULL RATED TO 50°C
- I.C. REGULATOR
- REVERSE VOLTAGE PROTECTION
- REMOTE PROGRAMMING CAPABILITY
- REMOTE VOLTAGE ADJUST CAPABILITY
- TWO HOUR BURN IN
- TWO YEAR WARRANTY

SPECIFICATIONS

AC Input:	105-125VAC, 47-440 HZ (Derate current 10% for 50 HZ operation)	Remote Sensing:	Provided, open lead protection built-in
DC Output:	See table, $\pm 5\%$ output adjustment range minimum	Stability:	$\pm .05\%$ for 24 hours after warm up
Line Regulation:	$\pm .01\%$ for a 10% input change	Temperature Rating:	0 to 50°C full rated, derated linearly to 40% at 70°C
Load Regulation:	$\pm .02\%$ for 50% load change	Temp. Coefficient:	$\pm .01\%/^{\circ}\text{C}$ maximum, .002% typical
Output Ripple:	1.5 mv PK-PK, 0.4 mv RMS maximum	Efficiency:	5V units 45%; 12 & 15V units 55%; 20 & 24V units 60%
Transient Response:	30 μ seconds for 50% load change	Vibration:	Per Mil-Std-810B, Method 514, procedure 1, curve AB to 50 HZ).
Short Circuit & Overload protection:	Automatic current limit/foldback	Shock:	Per Mil-Std-810B, Method 516, Procedure V.
Reverse Voltage Protection:	Provided on output and pass element		

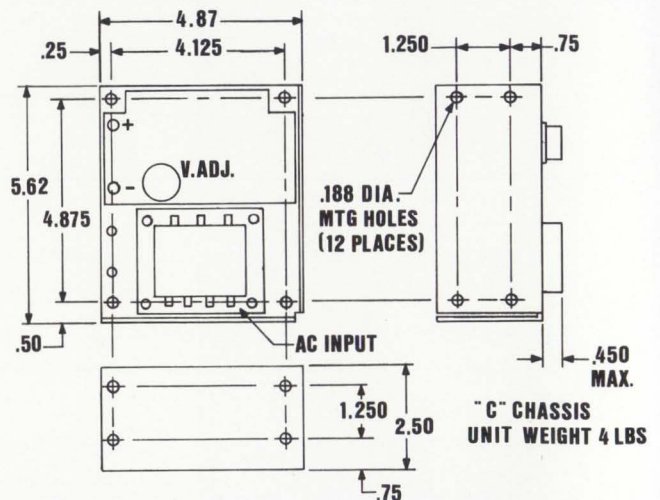
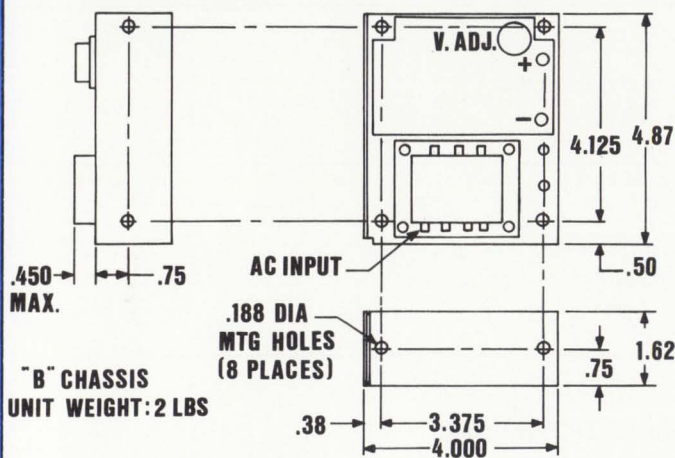

5V - 24V

MODEL	VOLTAGE ±5%	CURRENT (AMPS)	CASE SIZE	PRICE	
				1-9	100-249
5 VOLTS					
B5 - 3	5	3.0	B	\$ 24.95	\$20.00
C5 - 6	5	6.0	C	44.95	36.00
D5 - 12	5	12.0	D	74.95	60.00
E5 - 18	5	18.0	E	104.95	84.00
6 VOLTS					
B5 - 3	6	3.0	B	\$ 24.95	\$20.00
C5 - 6	6	6.0	C	44.95	36.00
D5 - 12	6	12.0	D	74.95	60.00
E5 - 18	6	18.0	E	104.95	84.00
12 VOLTS					
B15 - 1.5	12	1.7	B	\$ 24.95	\$20.00
C15 - 3	12	3.4	C	44.95	36.00
D15 - 6	12	6.8	D	74.95	60.00
E15 - 9	12	10.2	E	104.95	84.00
15 VOLTS					
B15 - 1.5	15	1.5	B	\$ 24.95	\$20.00
C15 - 3	15	3.0	C	44.95	36.00
D15 - 6	15	6.0	D	74.95	60.00
E15 - 9	15	9.0	E	104.95	84.00
18 VOLTS					
B24 - 1.2	18	1.3	B	\$ 24.95	\$20.00
C24 - 2.4	18	2.6	C	44.95	36.00
D24 - 4.8	18	5.2	D	74.95	60.00
E24 - 7.2	18	7.8	E	104.95	84.00
20 VOLTS					
B24 - 1.2	30	1.3	B	\$ 24.95	\$20.00
C24 - 2.4	20	2.6	C	44.95	36.00
D24 - 4.8	20	5.2	D	74.95	60.00
E24 - 7.2	20	7.8	E	104.95	84.00
24 VOLTS					
B24 - 1.2	24	1.2	B	\$ 24.95	\$20.00
C24 - 2.4	24	2.4	C	44.95	36.00
D24 - 4.8	24	4.8	D	74.95	60.00
E24 - 7.2	24	7.2	E	104.95	84.00

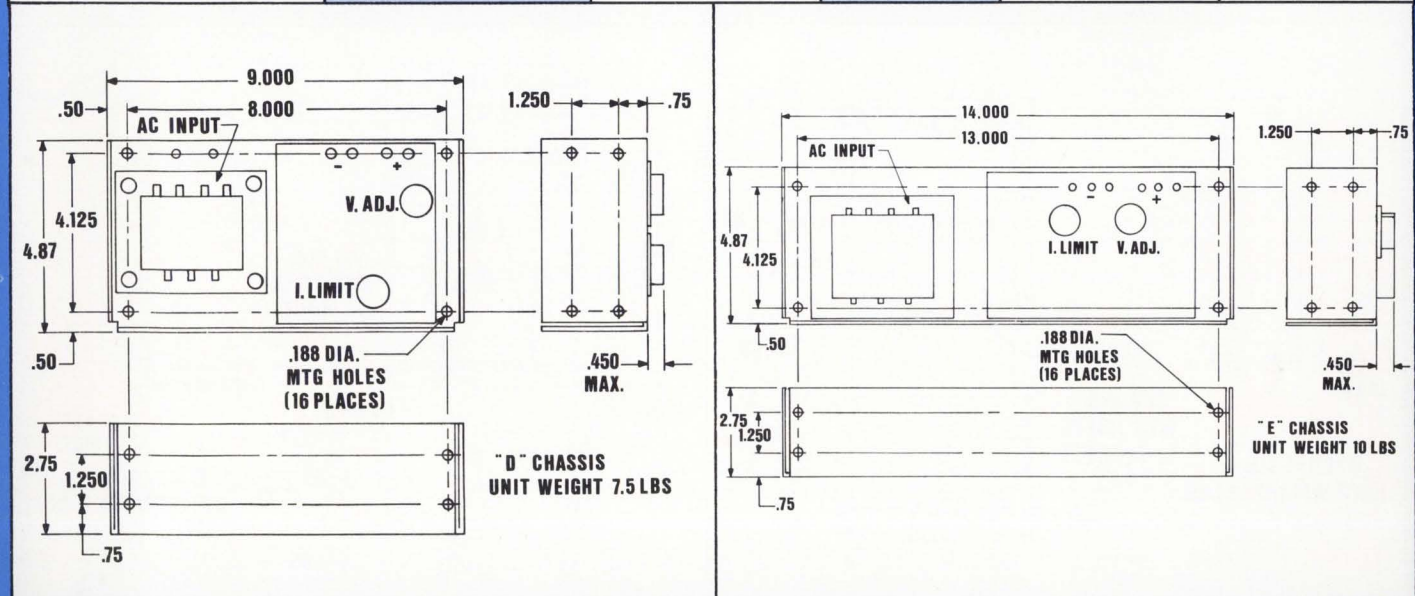

HI-VOL SINGLE OUTPUT

HB



\$24.95-\$29.95

HC



\$44.95-\$49.95

HD



\$74.95-\$79.95

HE

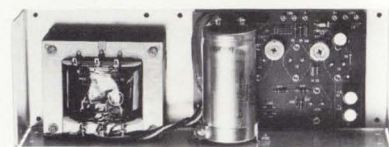

\$109.95-\$114.95

- 115/230 VAC INPUT
- OVP ON 5V OUTPUTS
- .05% REGULATION
- POPULAR INDUSTRY SIZE
- FOLDBACK CURRENT LIMIT
- I.C. REGULATOR
- TWO HOUR BURN IN
- TWO YEAR WARRANTY

SPECIFICATIONS

<p>AC Input: 115/230VAC \pm 10%, 47-440 HZ (Derate current 10% for 50 HZ operation)</p> <p>DC Output: See table, \pm 5% output adjustment range minimum</p> <p>Line Regulation: \pm .05% for a 10% input change</p> <p>Load Regulation: \pm .05% for a 50% load change</p> <p>Output Ripple: 2 to 15V-1.5 mv PK-PK, 0.4 mv RMS Maximum, 24 to 200V-.02% PK-PK, .01% RMS Maximum</p> <p>Transient Response: 30 μ seconds for 50% load change</p> <p>Short Circuit & Overload Protection: Automatic current limit/foldback</p>	<p>OVP: Built-in on 5V outputs at $6.2 \pm .4$ VDC</p> <p>Remote Sensing: Provided on all D & E models, open lead protection built-in</p> <p>Stability: \pm .3% for 24 hours after warm up</p> <p>Temperature Rating: 0 to 50°C full rated, derated linearly to 40% at 70°C</p> <p>Temp. Coefficient: \pm .03%/°C maximum</p> <p>Efficiency: 5V units 45%; 12 & 15V units 55%; 20 & 24V units 60%</p> <p>Vibration: Per Mil-Std-810B, Method 514, Procedure 1, curve AB to 50 HZ).</p> <p>Shock: Per Mil-Std-810B, Method 516, Procedure V.</p>
--	--

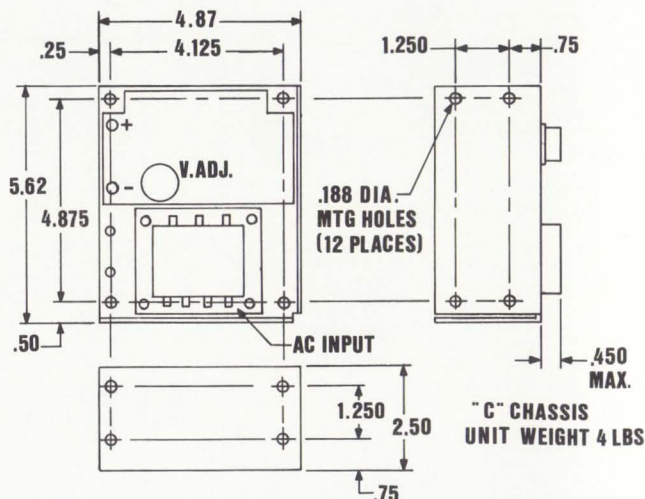
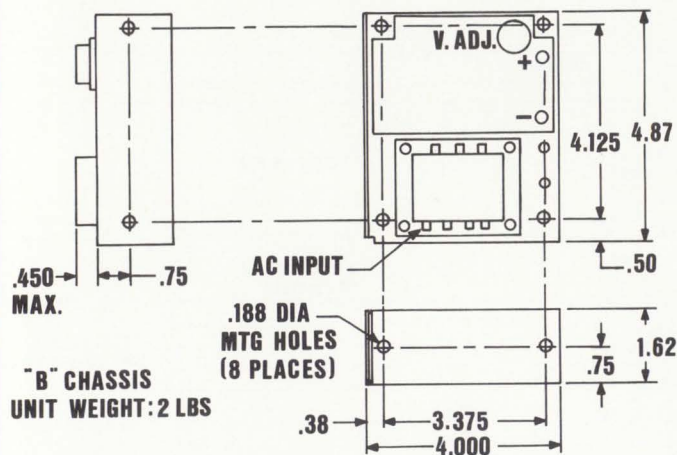

2V - 200V

MODEL	VOLTAGE ±5	CURRENT (AMPS)	CASE SIZE	PRICE	
				1-9	100-249
2 VOLTS					
HB 2 - 3	2	3.0	B	\$ 29.95	\$ 24.00
HC 2 - 6	2	6.0	C	49.95	40.00
HD 2 -12	2	12.0	D	79.95	64.00
HE 2 -18	2	18.0	E	109.95	88.00
5 VOLTS					
HB 5 - 3/OVP	5	3.0	B	\$ 24.95	\$ 20.00
HC 5 - 6/OVP	5	6.0	C	49.95	40.00
HD 5 -12/OVP	5	12.0	D	79.95	64.00
HE 5 -18/OVP	5	18.0	E	114.95	88.00
12 VOLTS					
HB12 - 1.7	12	1.7	B	\$ 24.95	\$ 20.00
HC12 - 3.4	12	3.4	C	44.95	36.00
HD12 - 6.8	12	6.8	D	74.95	60.00
HE12 -10.2	12	10.2	E	104.95	84.00
15 VOLTS					
HB15 - 1.5	15	1.5	B	\$ 24.95	\$ 20.00
HC15 - 3	15	3.0	C	44.95	36.00
HD15 - 6	15	6.0	D	74.95	60.00
HE15 - 9	15	9.0	E	104.95	84.00
24 VOLTS					
HB24 - 1.2	24	1.2	B	\$ 24.95	\$ 20.00
HC24 - 2.4	24	2.4	C	44.95	36.00
HD24 - 4.8	24	4.8	D	74.95	60.00
HE24 - 7.2	24	7.2	E	104.95	84.00
28 VOLTS					
HB24 - 1.2	28	1.0	B	\$ 24.95	\$ 20.00
HC28 - 2	28	2.0	C	44.95	36.00
HD28 - 4	28	4.0	D	74.95	60.00
HE28 - 6	28	6.0	E	104.95	84.00
48 VOLTS					
HB48 - 0.5	48	0.5	B	\$ 29.95	\$ 24.00
180 VOLTS					
HB200-0.15	180	0.15	B	\$ 29.95	\$ 24.00
200 VOLTS					
HB200-0.15	200	0.15	B	\$ 29.95	\$ 24.00

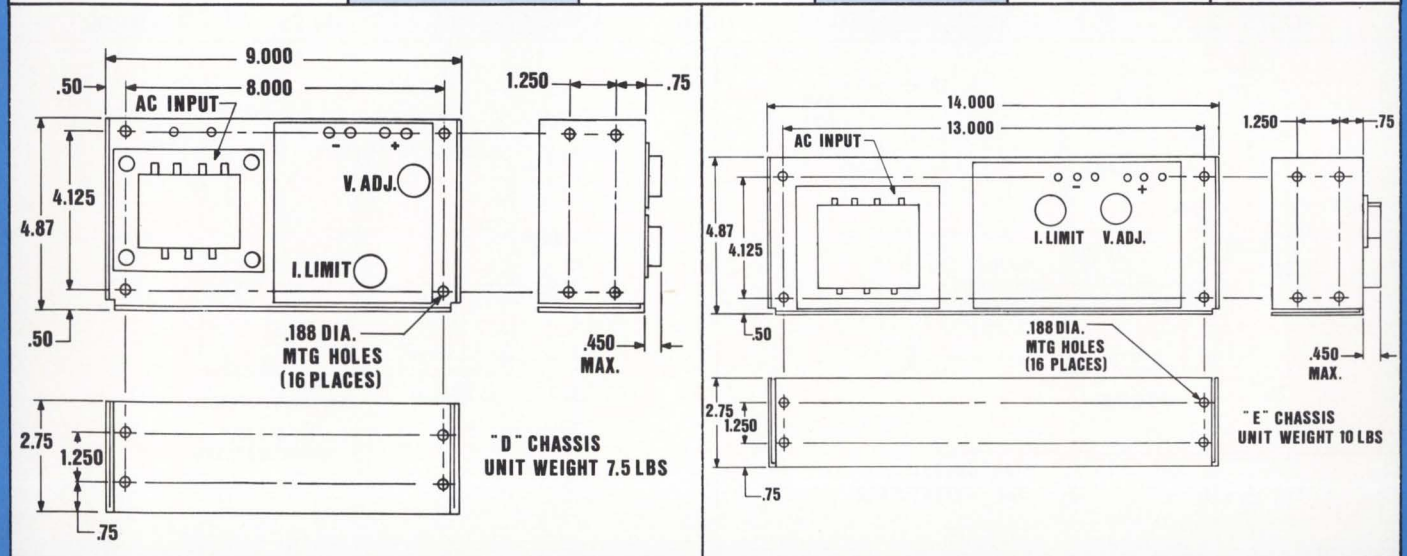

DUAL OUTPUT .1% TRACKING ACCURACY

AA

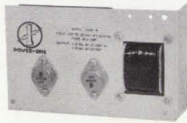

\$42.95

- TRACKING REGULATOR
- REMOTE SENSING
- .02% REGULATION
- FOLDBACK CURRENT LIMIT

BB

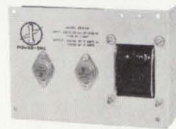

\$53.95

- IDEAL FOR OP AMPS
- I. C. REGULATOR
- TWO HOUR BURN IN
- TWO YEAR WARRANTY

CC

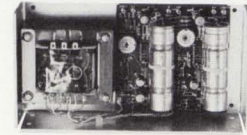

\$84.95

SPECIFICATIONS

AC Input:	105-125VAC, 47-440 HZ (Derate current 10% for 50 HZ operation)	Remote Sensing:	Provided, open lead protection built-in
DC Output:	See table, $\pm 5\%$ output adjustment range minimum	Tracking Accuracy:	$\pm .1\%$ when balance is preset to $\pm .01\%$
Line Regulation:	$\pm .01\%$ for a 10% input change	Stability:	$\pm .05\%$ for 24 hours after warm up
Load Regulation:	$\pm .02\%$ for a 50% load change	Temperature Rating:	0 to 50°C full rated, derated linearly to 40% at 70°C
Output Ripple:	1.5 mv PK-PK, 0.4 mv RMS maximum	Temp. Coefficient:	$\pm .01\%/^{\circ}\text{C}$ maximum, .002% typical
Transient Response:	30 μ seconds for 50% load change	Efficiency:	5V units 45%; 12 & 15V units 55%; 20 & 24V units 60%
Short Circuit & Overload Protection:	Automatic current limit/foldback	Vibration:	Per Mil-Std-810B, Method 514, Procedure 1, Curve AB to 50 HZ).
Reverse Voltage Protection:	Provided on output and pass element	Shock:	Per Mil-Std-810B, Method 516, Procedure V.

MODEL	VOLTAGE $\pm 5\%$	CURRENT (AMPS)	CASE SIZE	PRICE	
				1-9	100-249
± 12 VOLTS					
AA15 - 0.8	12/12	1.0/1.0	AA	\$ 42.95	\$ 34.00
BB15 - 1.5	12/12	1.7/1.7	BB	53.95	43.00
CC15 - 3	12/12	3.4/3.4	CC	84.95	68.00
± 15 VOLTS					
AA15 - 0.8	15/15	0.8/0.8	AA	\$ 42.95	\$ 34.00
BB15 - 1.5	15/15	1.5/1.5	BB	53.95	43.00
CC15 - 3	15/15	3.0/3.0	CC	84.95	68.00

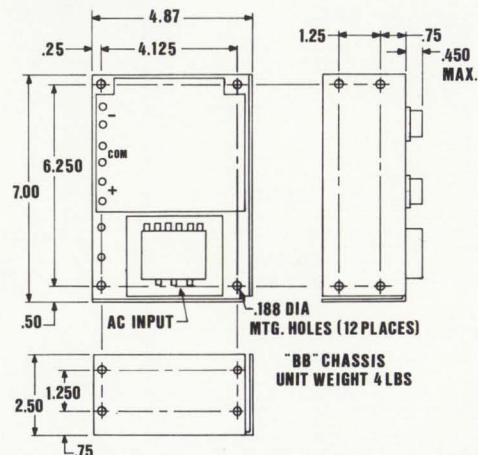
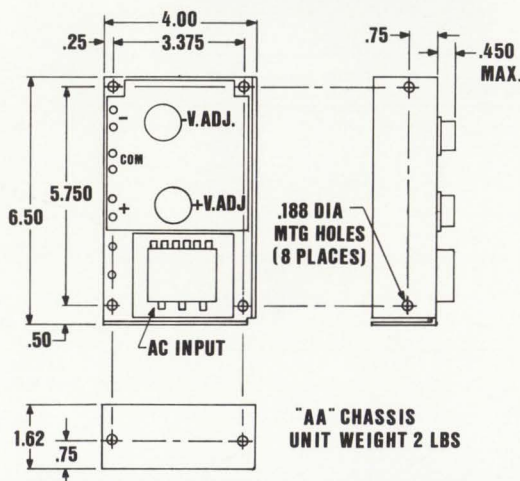

HI-VOL DUAL OUTPUT

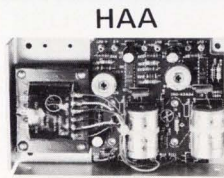

HAA
\$39.95

- 115/230 VAC INPUT
- OVP ON 5V OUTPUTS
- .05% REGULATION
- FOLDBACK CURRENT LIMIT

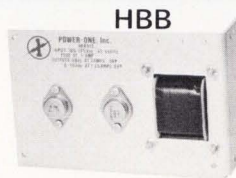

HBB
\$49.95-\$61.95

- USE FOR CMOS, ECCL, ETC.
- I.C. REGULATOR
- TWO HOUR BURN IN
- TWO YEAR WARRANTY



HCC
\$79.95-\$92.95

SPECIFICATIONS

AC Input:	115/230VAC \pm 10%, 47-440 HZ (Derate current 10% for 50 HZ operation)	OVP:	Built-in on 5V outputs at 6.2 \pm .4 VDC
DC Output:	See table, \pm 5% output adjustment range minimum	Stability:	\pm .3% for 24 hours after warm up
Line Regulation:	\pm .05% for a 10% input change	Temperature Rating:	0 to 50°C full rated, derated linearly to 40% at 70°C
Load Regulation:	\pm .05% for a 50% load change	Temp. Coefficient:	\pm .03%/°C maximum
Output Ripple:	1.5 mv PK-PK, 0.4 mv RMS maximum	Efficiency:	5V units 45%; 12 & 15V units 55%; 20 & 24V units 60%
Transient Response:	30 μ seconds for 50% load change	Vibration:	Per Mil-Std-810B, Method 514, Procedure 1, curve AB to 50 HZ
Short Circuit & Overload Protection:	Automatic current limit/foldback	Shock:	Per Mil-Std-810B, Method 516, Procedure V.

MODEL	VOLTAGE \pm 5%	CURRENT (AMPS)	CASE SIZE	PRICE	
\pm 5 VOLTS					
HBB 5 - 3/OVP	5/5	3.0/3.0	BB	\$ 61.95	\$ 50.00
HCC 5 - 6/OVP	5/5	6.0/6.0	CC	92.95	74.00
\pm 12 to 15 VOLTS					
HAA 15 - 0.8	12-15/12-15	1.0,8/1.0,8	AA	\$ 39.95	\$ 32.00
HBB 15 - 1.5	12-15/12-15	1.7,1.5/1.7,1.5	BB	49.95	40.00
HCC 15 - 3.0	12-15/12-15	3.4,3.0/3.4,3.0	CC	79.95	60.00
5 VOLTS and 9-15 VOLTS (ISOLATED OUTPUTS)					
HBB 512	5/9-15	3.0/1.25	BB	\$ 54.95	\$ 44.00
HCC 512	5/9-15	6.0/2.5	CC	86.95	70.00

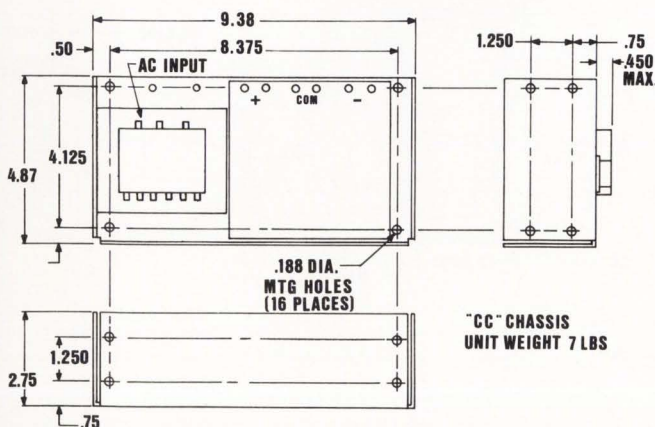

OVERVOLTAGE PROTECTION

Mounting holes are provided in all chassis for mounting an OVP-12 (PG 13). When used on \pm 12 or \pm 15V units, one OVP protects both outputs. On the HBB512 and HCC512, OVP is built in on the 5V output, use an OVP-12 to protect 9-15 volt output.

TRIPLE OUTPUT .1% TRACKING ACCURACY



BAA



CBB

\$91.95



DBB

\$126.95

- TRACKING REGULATOR
- REMOTE SENSING
- .02% REGULATION
- FOLDBACK CURRENT LIMIT
- IDEAL FOR OP AMPS + LOGIC
- I.C. REGULATOR
- TWO HOUR BURN IN
- TWO YEAR WARRANTY

SPECIFICATIONS

AC Input:	105-125VAC, 47-440 HZ (Derate current 10% for 50 HZ operation)	Remote Sensing:	Provided, open lead protection built-in
DC Output:	See table, $\pm 5\%$ output adjustment range minimum	Tracking Accuracy:	$\pm .1\%$ when balance is preset to $\pm .01\%$
Line Regulation:	$\pm .01\%$ for a 10% input change	Stability:	$\pm .05\%$ for 24 hours after warm up
Load Regulation:	$\pm .02\%$ for a 50% load change	Temperature Rating:	0 to 50°C full rated, derated linearly to 40% at 70°C
Output Ripple:	1.5 mv PK-PK, 0.4 mv RMS maximum	Temp. Coefficient:	$\pm .01\%/^{\circ}\text{C}$ maximum, .002% typical
Transient Response:	30 μ seconds for 50% load change	Efficiency:	5V units 45%; 12 & 15V units 55%; 20 & 24V units 60%
Short Circuit & Overload Protection:	Automatic current limit/foldback	Vibration:	Per Mil-Std-810B, Method 514, Procedure 1, curve AB to 50 HZ
Reverse Voltage Protection:	Provided on output and pass element	Shock:	Per Mil-Std-810B, Method 516, Procedure V.

MODEL	VOLTAGE $\pm 5\%$	CURRENT (AMPS)	CASE SIZE	PRICE	
				1-9	100-249
5 VOLTS and ± 12 VOLTS					
BAA - 40W	5/12/12	3.0/1.0/1.0	BAA	\$ 69.95	\$ 56.00
CBB - 75W	5/12/12	6.0/1.7/1.7	CBB	91.95	74.00
DBB - 105W	5/12/12	12.0/1.7/1.7	DBB	126.95	102.00
5 VOLTS and ± 15 VOLTS					
BAA - 40W	5/15/15	3.0/0.8/0.8	BAA	\$ 69.95	\$ 56.00
CBB - 75W	5/15/15	6.0/1.5/1.5	CBB	91.95	74.00
DBB - 105W	5/15/15	12.0/1.5/1.5	DBB	126.95	102.00

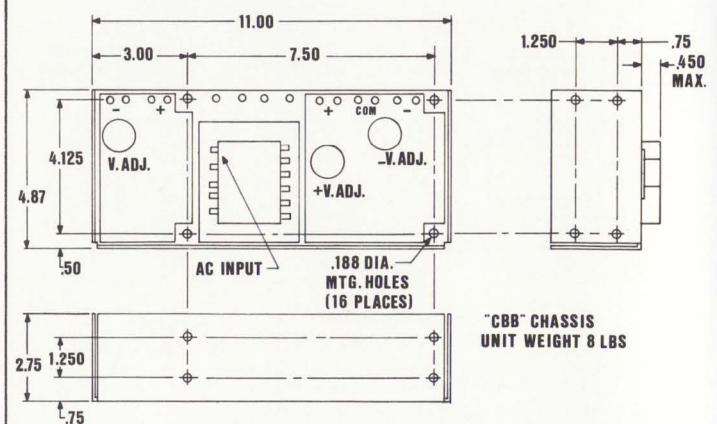
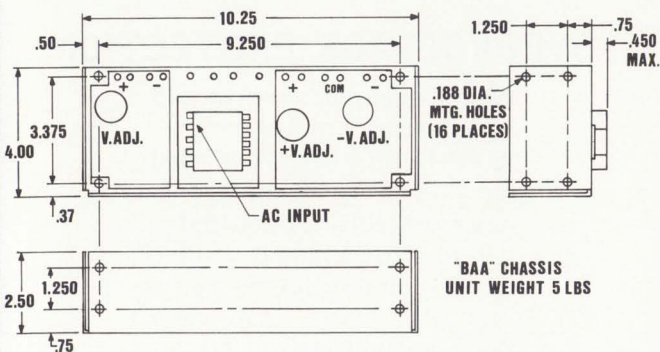

HI-VOL TRIPLE OUTPUT



HBAA

- 115/230 VAC INPUT
- OVP ON 5V OUTPUTS
- .05% REGULATION
- FOLDBACK CURRENT LIMIT



HCBB

- USE ON SMALL SYSTEMS
- I.C. REGULATOR
- TWO HOUR BURN IN
- TWO YEAR WARRANTY



HDBB

SPECIFICATIONS

AC Input:	115/230VAC \pm 10%, 47-440 HZ (Derate current 10% for 50 HZ operation)	Remote Sensing:	Provided on 5V, 12A output, open lead protection built-in.
DC Output:	See table, \pm 5% output adjustment range minimum	Stability:	\pm .3% for 24 hours after warm up
Line Regulation:	\pm .05% for a 10% input change	Temperature Rating:	0 to 50°C full rated, derated linearly to 40% at 70°C
Load Regulation:	\pm .05% for a 50% load change	Temp. Coefficient:	\pm .03%/°C maximum
Output Ripple:	1.5 mv PK-PK, 0.4 mv RMS maximum	Efficiency:	5V units 45%; 12 & 15V units 55%; 20 & 24V units 60%
Transient Response:	30 μ seconds or 50% load change	Vibration:	Per Mil-Std-810B, Method 514, Procedure 1, curve AB (to 50 HZ).
Short Circuit & Overload Protection:	Automatic current limit/foldback	Shock:	Per Mil-Std-810B, Method 516, Procedure V.
Overvoltage Protection:	Provided on 5V outputs at 6.2 \pm .4 VDC		

MODEL	VOLTAGE \pm 5%	CURRENT (AMPS)	CASE SIZE	PRICE	
				1-9	100-249
5 VOLTS and \pm 12 VOLTS					
HBAA - 40W	5/12/12	3.0/1.0/1.0	BAA	\$ 69.95	\$ 56.00
HCBB - 75W	5/12/12	6.0/1.7/1.7	CBB	91.95	74.00
HDBB - 105W	5/12/12	12.0/1.7/1.7	DBB	126.95	102.00
5 VOLTS and \pm 15 VOLTS					
HBAA - 40W	5/15/15	3.0/0.8/0.8	BAA	\$ 69.95	\$ 56.00
HCBB - 75W	5/15/15	6.0/1.5/1.5	CBB	91.95	74.00
HDBB - 105W	5/15/15	12.0/1.5/1.5	DBB	126.95	102.00

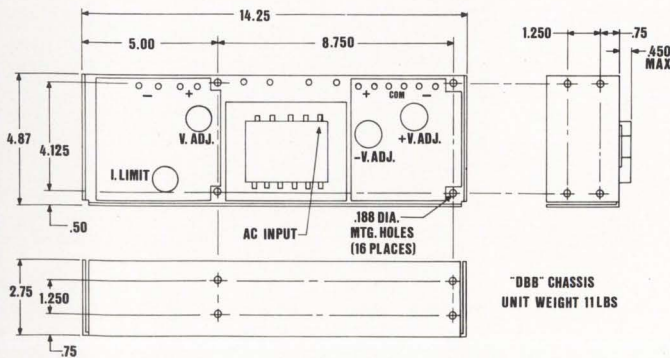

OVERVOLTAGE PROTECTION

Mounting holes are provided for 2 OVP-12 modules. Use one module to protect \pm 12 or \pm 15V outputs and one module to protect 5V outputs.

Note: OVP is built in on 5V output HBAA, HCBB and HDBB.

SINGLE OUTPUT

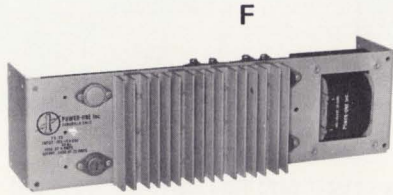

\$149.00

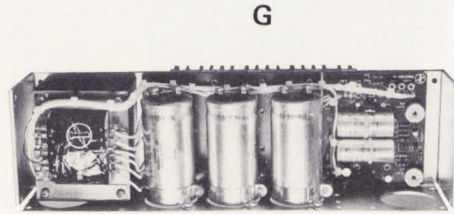

\$185.00

- 115/230 VAC INPUT
- 53%-66% EFFICIENCY
- MASTER/SLAVE COMPATIBILITY
- REMOTE PROGRAM AND VOLTAGE ADJUST
- FOLDBACK CURRENT LIMITING
- REMOTE SENSING
- OVP ON 5V UNITS
- INHIBIT BUILT-IN
- TWO HOUR BURN IN
- TWO YEAR WARRANTY

SPECIFICATIONS

AC Input:	115/230VAC \pm 10%, 47-440 HZ (Derate current 10% for HZ operation)	Remote Sensing:	Provided, open lead protection built-in
DC Output:	See table, \pm 5% output adjustment range minimum	Stability:	\pm .05% for 24 hours after warm up
Line Regulation:	\pm .01% for a 10% input change	Temperature Rating:	0 to 50°C full rated, derated linearly to 40% at 70°C
Load Regulation:	\pm .01% \pm 1 mv for a 50% load change	Temp. Coefficient:	\pm .01%/°C maximum, .002%/°C typical
Output Ripple:	1.5 mv PK-PK, 0.2 mv RMS maximum	Efficiency:	5V units 52 - 54%; 12 & 15V units 62 - 64%; 24 & 28V units 64 - 66%
Transient Response:	30 μ seconds for 50% load change	Vibration:	Per Mil-Std-810B, Method 514, Procedure 1, curve AB (to 50 HZ).
Short Circuit & Overload Protection:	Automatic current limit/foldback	Shock:	Per Mil-Std-810B, Method 516, Procedure V.
OVP:	Built-in on 5V outputs at 6.2 \pm .2 VDC	Master/slave:	Any unit may be master or slave. One master will drive up to 5 slaves.

5V - 28V to 280 WATTS

MODEL	VOLTAGE +5%	CURRENT (AMPS)	CASE SIZE	PRICE	
				1-9	100-249
5 VOLTS F5 - 25/OVP G5 - 35/OVP	5	25.0	F	\$149.00	\$119.00
	5	35.0	G	185.00	148.00
12 VOLTS F15 - 15	12	16.0	F	\$149.00	\$119.00
15 VOLTS F15 - 15	15	15.0	F	\$149.00	\$119.00
24 VOLTS F24 - 12	24	12.0	F	\$149.00	\$119.00
28 VOLTS F24 - 12	28	10.0	F	\$149.00	\$119.00

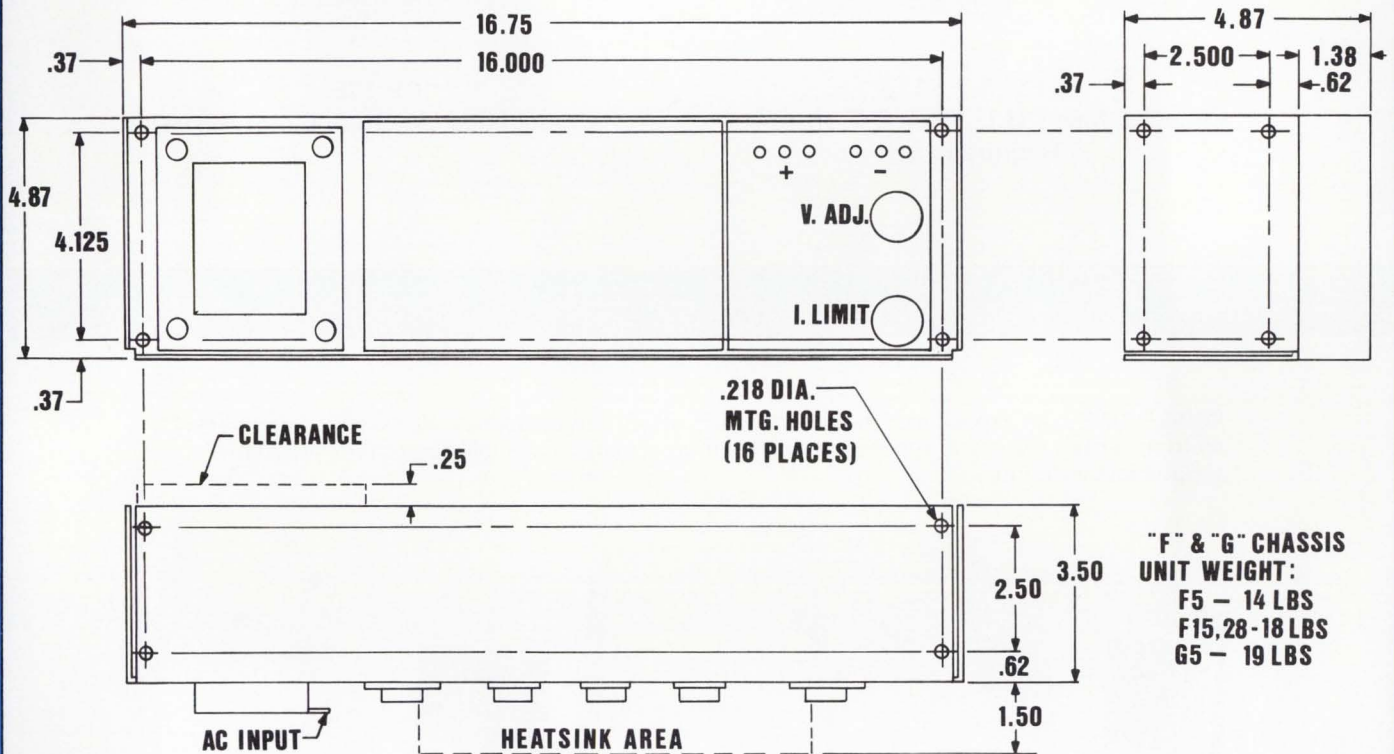

OVERVOLTAGE PROTECTION - SCR "CROWBAR" TYPE

OVP-12
1-9 \$7.95

OVP-12: Mounting holes are provided in all chassis for this add-on module which may be used on all outputs except "E & F" cases. This module is adjustable from 6.4 to 36V. When used on ± 12 or ± 15 dual output supply one OVP protects both outputs.

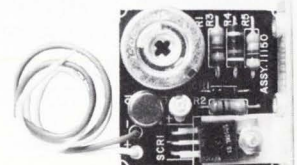

OVP-24
1-9 \$14.95

OVP-24: Mounting holes are provided in E & F cases for this module. Adjustment range 6.4 to 36VDC.



SPECIALS

Any of our standard power supplies can be modified to meet special requirements. These requirements may be AC input variations, chassis modifications, special output voltages, varied current levels, etc. Consult your local representative or the factory for more information.



B12 - 1.7 S113

Changes: Meets U.L. Class 2 Transformer Requirements



CP 115

Unregulated 7A @6.0, 6.4 or 6.8VDC

CUSTOM DESIGNS

POWER-ONE is an experienced manufacturer of custom power supplies. We excel at open frame multiple output DC power supplies, regulated or unregulated. Consult your local representative about a factory quote



CP 110

Input: 115/230VAC \pm 10% 47-63HZ
Output: -10VDC @2A, OVP @12V
 + 12VPC @ 0.1A
 - 12VPC @ 0.1A
 + 80VDC @ .25A unregulated



CP109-3

Input: 115/220/240 VAC \pm 10%, 47-63HZ
Output: +5 VDC @6A
 -12VDC @2.5 Amps
 +24VDC @.4 Amps unregulated

REGIONAL SALES OFFICES

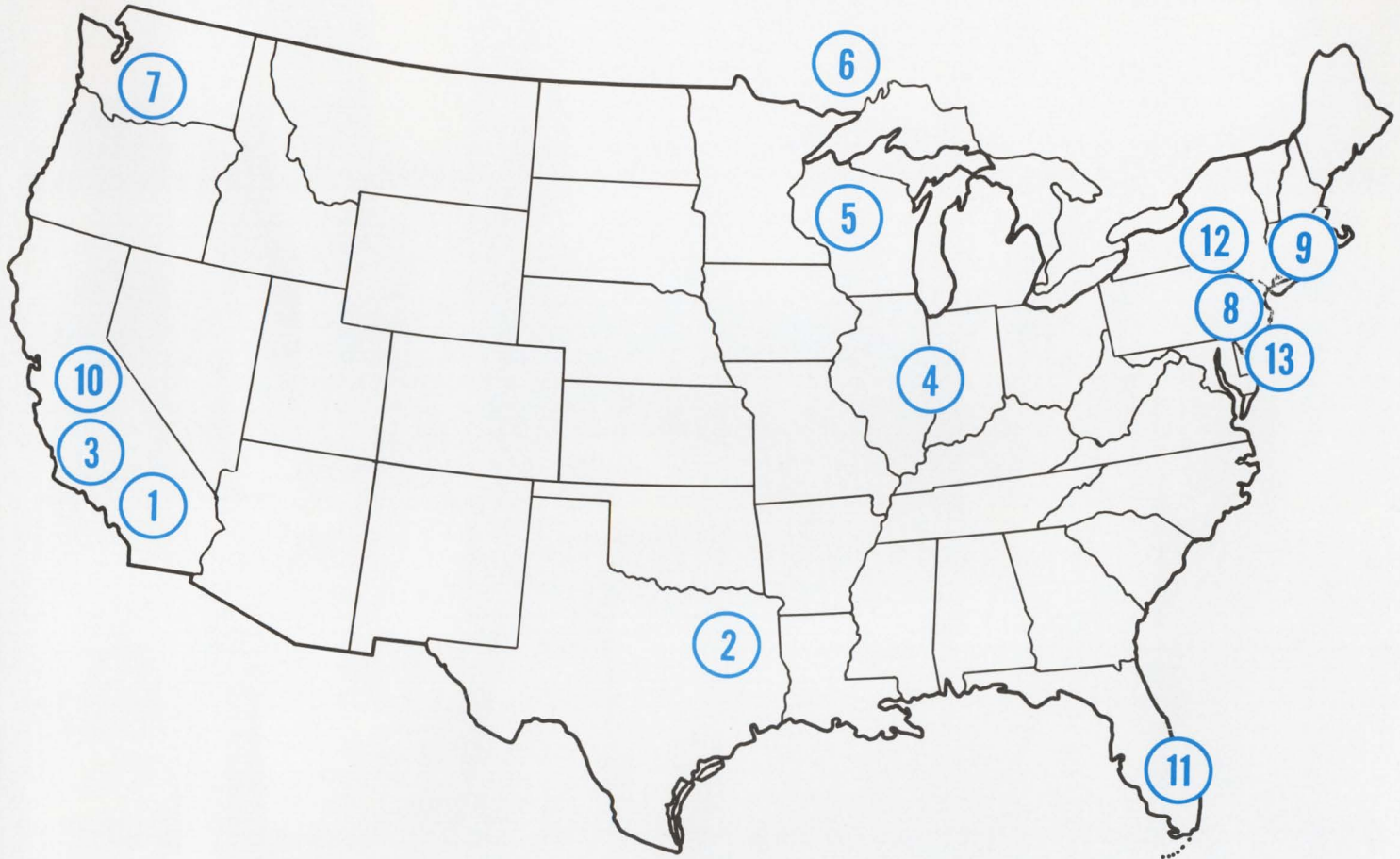

DIAL - A - SOURCE 800- 645-9200 (TOLL FREE)

- | | | | |
|--|--|--|---|
| <p>2 *William Reese Associates
Dallas, Texas
(214) 638-6575
Houston, Texas
(713) 621-3134</p> | <p>5 Engineering Products Associates
Minneapolis, Minn.
(612) 925-1883
Wheaton, Ill.
(312) 665-0061</p> | <p>8 *Livera - Polk Associates
Roslyn Hts. N. Y.
(516) 484-1276
Madison, N. J.
(201) 377-3220</p> | <p>11 Repronics, Inc.
Miami, Fla.
(305) 251-5478
St. Petersburg, Fla.
(813) 522-8220</p> |
| <p>3 *Burtis Instruments
Woodland Hills, Ca.
(213) 887-1360</p> | <p>6 *Duncan Instruments LTD
Weston, Ontario
(416) 742-4448</p> | <p>9 *Digital Sales Associates
Waltham, Ma.
(617) 899-4300</p> | <p>12 Ken Corsetti
Burnt Hills, N. Y.
(518) 399-9200</p> |
| <p>4 *Holsapple & Associates
Indianapolis, Ind.
(317) 889-2890</p> | <p>7 Jon B. Jolly, Inc.
Richland, Wa.
(509) 783-6523
Seattle, Wa.
(206) 938-4166</p> | <p>10 *Richards Associates
Santa Clara
(408) 246-5860</p> | <p>13 DENCO
Norristown, Pa.
(215) 279-8146</p> |

*Stocking Distributor

1 POWER-ONE, INC. (805) 484-2806

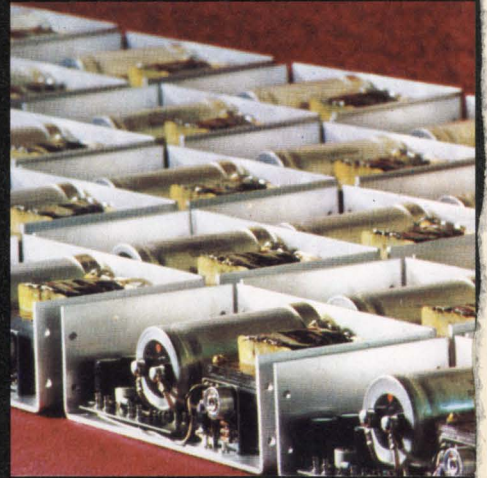
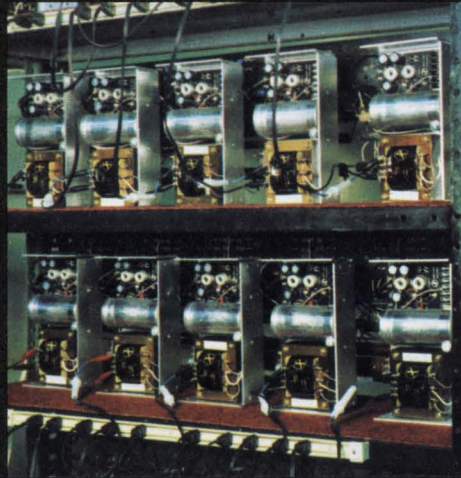
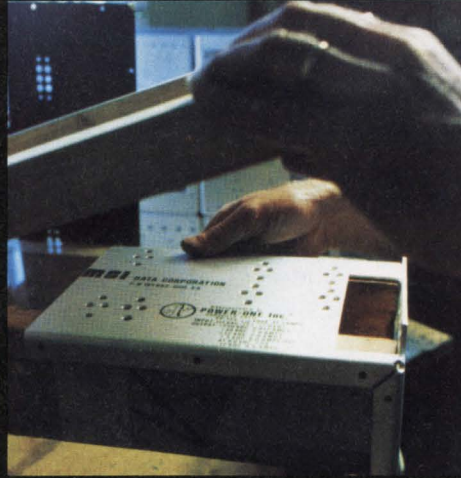
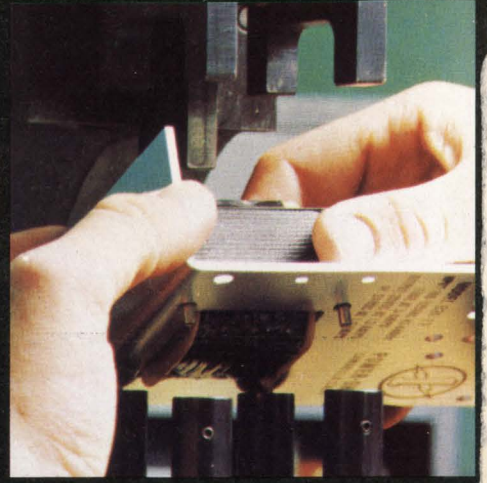
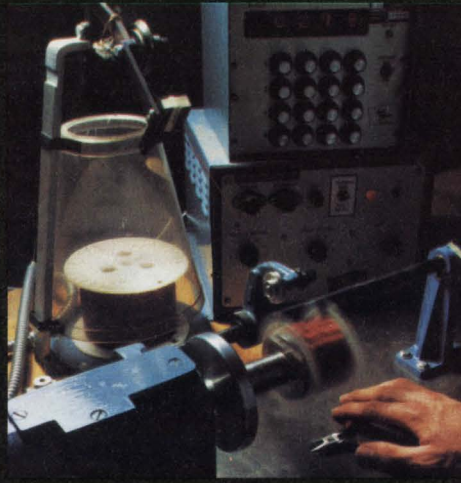

POWER-ONE, Inc.

531 Dawson Drive
Camarillo, Calif. 93010

Broad-foil lead increases p-i-n diode switch power

"It was wild. The diode was fine, but the package melted. It couldn't handle the required power of 600 W. So we decided to use unpackaged p-i-n diode chips and to design our own package around them."

That's the way Hugh R. Malone, a senior microwave engineer at Motorola's Government Electronics Div. in Scottsdale, AZ, describes the problem that led him and Michael L. Matson, another Motorola senior engineer, to a novel package. It contains a pair of microwave p-i-n diodes in parallel, connected to the outside through a broad strip of gold foil.

The application was a single-pole, 56-throw p-i-n diode switch matrix to feed signals to a 4.6-GHz cylindrical steerable beam antenna.

"Standard low parasitic packages," Malone notes, "have a Kovar lead which is unplated in the area of a glass feed-through. This lead cannot handle sufficient current at microwave frequencies to handle high power. Due to skin effect, the current density gets so high at 300 W and 4.6 GHz that the Kovar lead melts."

Since Kovar has 167 times the resistance of gold, the latter was selected for the new package. To reduce the current density, a 0.050-in.-wide, 0.005-in.-thick strip of

gold foil was used.

Tests were run with a single 0.5-pF, 0.5- Ω diode in the new package. This diode switch could block 600 W but could not pass 600 W. A 0.25-pF, 1.0- Ω diode passed 600 W but could only hold off 200 W.

"It is easier to parallel two diode chips and maintain low thermal resistance than it is to series them," Malone points out. Therefore two 0.25-pF, 1.0- Ω diode chips were paralleled in the new package.

The single strip of gold foil is attached at one end of the package to a plated beryllium copper substrate. From there, the strip loops over to the pair of diode chips sitting side by side. The strip touches both diodes to parallel them and then continues on to another beryllium copper substrate on the other side of the package. The strip of gold also provides a small amount of inductance in series with the diodes for impedance matching.

Diodes should pass 1 kW

Higher power testing of the dual diodes has shown that the diode will pass 800 W and block 1000 W. Malone believes that the design can be used to pass at least 1000 W at 4.6 GHz and that it should be good at even higher frequencies.

"We are hoping to build test diodes in Ku-band [12.4 to 18 GHz], using the same technique," Malone says.

With glass passivated chips from Microwave Associates, Burlington, MA, the dual diodes were tested over 4.0 to 5.2 GHz. Each diode has a 0.1-to-0.15-dB loss and approximately 1.2 to 1.35:1 VSWR over that band. Net thermal resistance of the chips was less than 3 C/W at 25 C.

The mounting configuration of the ultimate switch matrix was to have a coaxial (type N) input and waveguide outputs. The diodes are mounted on a stripline circuit, with quarter-wave ground-plane spacing and Teflon-fiberglass dielectric. The characteristic impedance of the circuit is 50 Ω . ■■

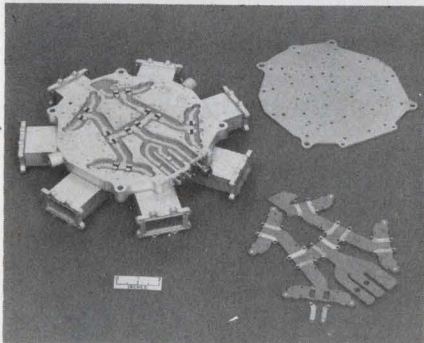

High-power dual p-i-n diodes are encased in novel packages to handle 600 W at 4.6 GHz. The diodes are mounted in a single-pole, seven-throw switch matrix with coaxial input and waveguide outputs. A single-pole, 56-throw switch will have each of the seven outputs attached to a single-pole, eight-throw switch.

Thin-Trim[®] capacitors



 Tucked in the corner of this Pulsar Watch is a miniature capacitor which is used to trim the crystal. This Thin-Trim capacitor is one of our 9410 series, has an adjustment range of 7 to 45 pf., and is .200" x .200" x .050" thick. The Thin-Trim concept provides a variable device to replace fixed tuning techniques and cut-and-try methods of adjustment. Thin-Trim capacitors are available in a variety of lead configurations making them very easy to mount.

 A smaller version of the 9410 is the 9402 series with a maximum capacitance value of 25 pf. These are perfect for applications in sub-miniature circuits such as ladies electronic wrist watches and phased array MIC's.

Johanson Manufacturing Corporation, Rockaway Valley Road., Boonton, N.J. 07005. Phone (201) 334-2676, TWX 710-987-8367.

Johanson

When you've got to power noise sensitive logic,
what do you want for the job?

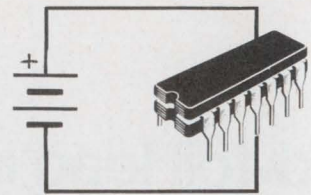

When your system draws a pulsating load current,
what do you want for the job?

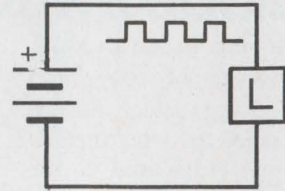

When your specs call for adjustable voltage,
what do you want for the job?

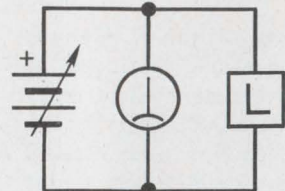

When your programmed level must be accurately reproduced, when the current limit must be adjustable and square (not folded back), when you want a power supply that doesn't lose half its current rating at +71°C (or at -20°C). . . .

the power supply you want for your job is the

KEPCO **JQE**



Quarter-rack
100 watts

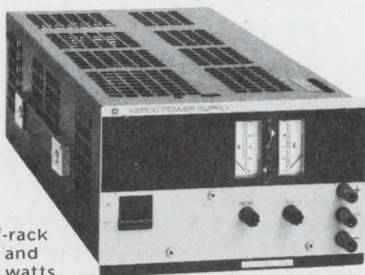

Half-rack
250 and
500 watts

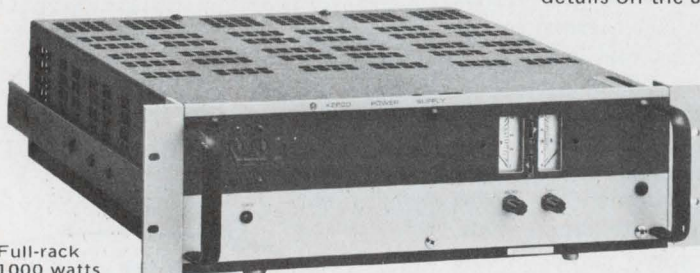

Full-rack
1000 watts

JQE Power Supplies are *linear* voltage stabilizers (not complex switching units). They can be adjusted or remotely programmed from true zero to maximum output with better than 0.01% linearity. They vary less than 0.0005% for .105–125V a-c source changes and have such low output impedance that a zero to full load change influences the stabilized output by less than 0.005%. Ripple and noise is well under 200 microvolts rms, 1 millivolt p-p.

31 JQE linear voltage stabilizers are manufactured in 4 sizes: 100 Watts, 250 Watts, 500 Watts and 1000 Watts in voltage ranges from 0–6V to 0–150V. Metered bench and rack-panel style and unmetred modular form for the OEM. Adjustable overvoltage protection available.

If *your* job needs a linear voltage stabilizer, call Kepco for the details on the JQE, or write Dept. V-5



KEPCO

washington report

\$8.7-billion defense rise asked

Defense spending is in for tough sledding in the Administration's proposed \$349.4-billion budget for fiscal 1976. President Ford is asking for an increase of \$8.7-billion in actual outlays for defense—from \$85.3-billion in 1975 to \$94-billion—to strengthen strategic forces, upgrade tactical forces and expand naval shipbuilding. The Army would add three divisions by realignment.

Defense procurement would rise \$1.8-billion to \$16.6-billion. The long-range projection for defense spending is that it will increase 7.6% annually to \$141.4-billion in 1980, at which time the total Federal budget is estimated at \$477-billion!

Navy procurement would rise to \$7.5-billion in the fiscal year beginning July 1—an increase of \$447-million. Air Force purchases would increase \$727-million to slightly over \$6-billion, and Army procurement would be up \$508-million to \$2.75-billion.

The new Energy Research and Development Administration, appearing for the first time in the budget, is scheduled to have a budget authority of \$3.3-billion. Its many programs would have outlays of \$2.98-billion in the new fiscal year, up nearly \$600-million.

FCC revises its fee schedule

A recent Supreme Court decision has caused the Federal Communications Commission to revamp its fee schedule. The theory of operation in the past held that the intent of Congress was that the fees help make the agency self-sustaining. The Supreme Court rejected that concept; so on March 1 annual license, assignment and transfer fees will drop, while fees for processing will rise.

The commission reviewed the way it was charging, and under new guidelines, it will get \$1.5-million less from annual license fees and \$900,000 less from assignment and transfer fees. On the other hand, the FCC concluded that it was undercharging on the costs of processing renewal and transfer applications and applications for construction permits. So \$4.5-million more will be taken in annually.

Shift in Federal R&D priorities continues

A continuing change in the nation's research and development priorities is reflected in the fiscal 1976 budget. Since 1967, civilian R&D obligations have grown 120%, from \$3.3-billion to \$7.3-billion.

Total R&D and related facilities outlays in the new budget are \$21.7-billion, an increase of \$2.3-billion. The obligations are up 15% over those

in the 1975 budget. Since 1967, space R&D has decreased 38% (\$1.8-billion) and defense has grown 33% (\$2.8-billion).

For the coming fiscal year, the Dept. of Defense R&D budget authority will, if Congress agrees, rise to \$10.6-billion, of which \$8.6-billion will be development and \$2-billion for research. Air Force R&D outlays are estimated at \$3.75-billion, up \$397-million. An increase of \$350-million over last year would give the Navy \$3.3-billion. The Army is allocated \$2-billion, a \$158-million hike, and defense agencies would spend \$560-million, a modest \$53-million increase.

Lasers, electron-device technology and night-vision technology are due to receive greater R&D emphasis. NASA, which is slated to gain \$2.6-billion for R&D, would only post a \$270-million increase despite rising costs. A total of \$200-million of this gain would be for the space-shuttle program.

GAO would cut electronics in port plans

If penny-pinchers at the General Accounting Office have any influence, sophisticated electronic surveillance won't be installed in the Coast Guard's vessel traffic plans for six U.S. ports. The service has been developing traffic systems at San Francisco, Puget Sound, Houston-Galveston, New York, New Orleans and Valdez, Alaska. About \$30-million is to be spent.

The San Francisco and Puget Sound systems are operating, and the GAO says it would cost about \$5-million to construct each of the basic systems at New York, Houston-Galveston and New Orleans. Each is designed to prevent 72 accidents annually. The addition of radar and other electronic surveillance might prevent 30 more accidents annually, the GAO says, but the cost would be from \$9.5-million to \$11.5-million more and the Federal office questions if it's worth it.

The Coast Guard is considering the GAO report, but is likely to want to go for more sophistication. There are, on average, some 2800 vessel accidents annually, resulting in about \$80-million in damages.

Capital Capsules: The Energy Research and Development Administration, which came into being Jan. 19 with the demise of the Atomic Energy Commission, is **looking for a permanent home**. Its temporary home is in the Reporters Building, Seventh and D Sts., S.W., Washington, DC 20545. . . . The Nuclear Regulatory Commission, also new, is at the former Atomic Energy Commission office at 1717 H St., N.W., Washington, DC 20555. . . . **Rumors that the Office of Telecommunications Policy in the White House was going to be abolished were soundly dispelled** by the new budget submitted by the President. It's to have an outlay of \$8.8-million this coming fiscal year, an increase of \$178,000. . . . The General Accounting Office has **again criticized the Advisory Group of Electron Devices** in the Dept. of Defense. In 1969 the GAO found the group's effectiveness impaired because other Government agencies do not participate and because in-house research projects are not reviewed. Recently the GAO took another look. It found little improvement. . . . The Navy's Electronic Systems Command is **in the market for 25 microwave relay equipment sets** for the Marine Corps. They're to be used for anti-air warfare operations. . . . **Competitive contract sources are being sought** by the Defense Communications Agency for the design, fabrication, installation and maintenance of a high-speed, packet-switched data network to augment the current Autodin system.

New snap-in rockers with Cutler-Hammer reliability.

Here's a completely new line of snap-ins, each engineered with the kind of solid dependability you expect in Cutler-Hammer Rockette® switches. Bright metal bezels, illuminated and non-illuminated, A-c and D-c capabilities up to 20 amps.

Sub-panel rockers in a variety of colors, rocker or paddle designs in standard, special, or proprietary models.

Switches snap in and stay in permanently. Speed up assembly time, cut costs.

Flush-mounted rockers in the same wide range of designer-oriented colors and styles. One- and two-pole models.

Illuminated single-pole rockers. Choice of red, green, amber, white, or clear. Hot-stamped legends indicate switch functions.

For more information, call your Cutler-Hammer Sales Office or Switch Distributor.

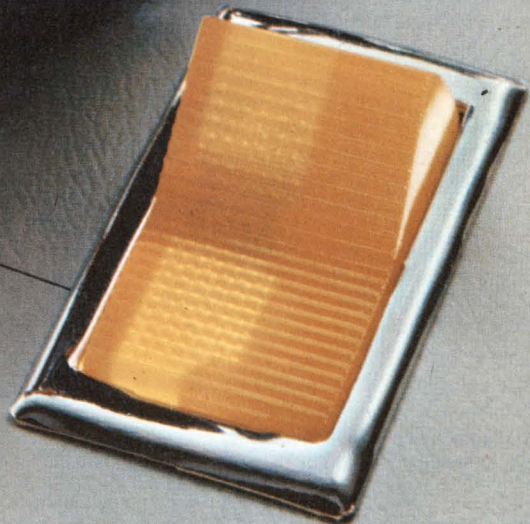

CUTLER-HAMMER
SPECIALTY PRODUCTS DIVISION, Milwaukee, Wis. 53201



Designing with Microprocessors: A 2-hour home TV special April 15-18...

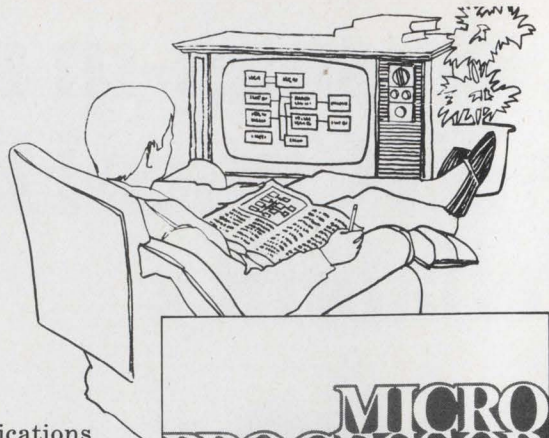

This is your chance to get authoritative answers to questions about today's hottest design topic: microprocessors. Read TI's Microprocessor Handbook. Then watch our 2-hour TV lecture series right in your own home. You'll learn what the microprocessor revolution is all about and how it can affect your designs. Plus you'll get valuable reference information on the leading edge of the technology.

Two hours of microprocessor information... on your TV set.

Tune-in your television to two hours of microprocessor technical lectures presented by the Texas Instruments Learning Center, April 15-18. You'll see four half-hour sessions—one each morning, Tuesday through Friday—timed so they won't interfere with your regular work day:

TUESDAY April 15: System architecture

A discussion of digital computer system architecture as a basis for understanding microprocessors. Evolution of microprocessors... peripheral controllers... parallel processors... Direct Memory Access.

WEDNESDAY April 16: Microprocessor logic—what type?

Chip fabrication technologies are reviewed—including most MOS forms, TTL, Schottky TTL and the new Integrated Injection Logic (I²L) which has the density and power dissipation of MOS and the speed and driving capabilities of bipolar.

THURSDAY April 17: Potential applications for microprocessors.

Guidelines for using microprocessors, including both advantages and limitations for certain types of equipments. Shows how microprocessors can lower costs, shorten design cycles, improve performance and reliability in practical applications.

FRIDAY April 18: Using microprocessors in communications systems.

Discusses problems of digital communications and typical hardware

solutions. In-depth applications guidelines show how microprocessors can be used economically within this broad field.

Don't miss this opportunity to explore this dynamic new technology—with only two hours of early morning television. Check TI's broadcast schedule for your city:

CITY	CHANNEL	TIME
Boston	7	6:20 AM
Chicago	9	6:00 AM
Cleveland	8	6:00 AM
Dallas	5	6:00 AM
Dayton	7	6:00 AM
Denver	4	6:30 AM
Detroit	2	6:00 AM
Houston	11	6:30 AM
Los Angeles	11	6:30 AM
Miami	4	6:00 AM
Minneapolis	11	6:30 AM
New York City	5	6:30 AM
Orlando	6	6:00 AM
Philadelphia	To be announced*	
Phoenix	5	6:00 AM
Rochester	10	6:00 AM
San Diego	6	6:30 AM
San Jose	11	6:00 AM
Seattle	11	6:30 AM
Washington, D.C.	5	6:30 AM

*See our ad on the TV page of your April 14 newspaper.

Order your Handbook now... before the TV presentation.

To: Texas Instruments Incorporated

Please send me _____ copies of the Microprocessor Handbook (LCB1761). I enclose check, money order, company purchase order for _____ (\$24.95 for each book ordered*)

Mail checks and money orders to:
P. O. Box 3640, M/S 84, Dallas, Texas 75285
Mail company purchase orders to:
P. O. Box 5012, M/S 54, Dallas, Texas 75222

Name _____

Company _____

Street _____ City _____

State _____ ZIP Code _____

*Texas residents please add 5% sales tax. ED

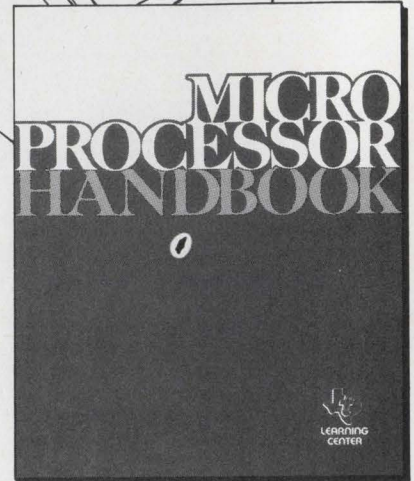

...and this fact-filled book.

200 pages of up-to-date design information... for only \$24.95.

The Microprocessor Handbook is your source for up-to-date microprocessor information—fully objective, concentrated, use-oriented data that might take you months to assemble on your own:

ALU's • Controllers • Memories • Timing • Microprocessor Selection Guide • Microprocessor Comparison Chart • In-depth discussion of I²L technology • Digital Computer System Architecture • Chip Architecture • Chip Fabrication Technologies • How to Use a Microprocessor • Potential Applications and Limitations • Microprocessors in Communications • Microprocessor Supplier Listing • Glossary of Microprocessor Terms • Bibliography

Microprocessors have the potential to revolutionize electronic system design and replace many mechanical and electro-mechanical systems. That's why TI's information-packed Microprocessor Handbook is a must for your personal library. Review it before you watch TI's TV presentation. Use it to jot down notes during the lectures. Then keep it as a permanent reference. Order your copy now to allow ample time for delivery before TI's April 15-18 telecast.



I'm sorry, sir, he's in conference

I finally got through to Owen Cooper. This was no mean accomplishment as he seems to spend most of his time at meetings. I called him one day to get some information about a new product his company had developed and learned that he was in conference. He later returned the call, but I was in conference.

We found ourselves working back and forth this way doing nothing more productive than enriching the telephone company. When I finally got to him, I asked if his conference had led to any decisions. "Hell, no," he said. "We never decide anything. We just have these interminable discussions about product philosophy and marketing philosophy. My boss just loves to chew up my time."

I think that's a dreadful waste. I've known Owen for many years and I know he's an extremely creative, extremely productive engineer. When a company immerses a guy like Owen in endless thrashing about in conferences, that's an unforgivable waste of a priceless resource. It's worse than throwing money away because you can always get more money. But once you've blown Owen's time, you can never get it back. It's gone.

Too many managers in our industry don't respect the time of the people working for them. They devour hours without making decisions. They call meetings without objectives. They seem to feel that profits come from meetings rather than actions. They hire people to get things done, then get in their way. These managers are the first to challenge their people, the first to demand, "Why isn't this project done? What have you been doing with your time?" And they won't accept the answer, "I've been spending my time meeting with you."

It's sad that many of these managers came from the ranks of engineering, where they should have learned discipline. Engineering is a hard taskmaster. It forces one to establish design objectives and to measure one's progress along the way. It demands of a person the ability to make choices and decisions. One would think that an engineering manager would be the best manager. Too often, he is as poor as a manager in any other field.

I've always admired Burt, a chief engineer at an instrumentation company. It seemed kind of nutty but he always kept a kitchen timer on his desk. Whenever he called a meeting, he announced the objectives of the meeting, set the timer, and demanded that the meeting end before the timer rang. Was it just luck that his engineers got a lot more done than the fellows at Owen's company?

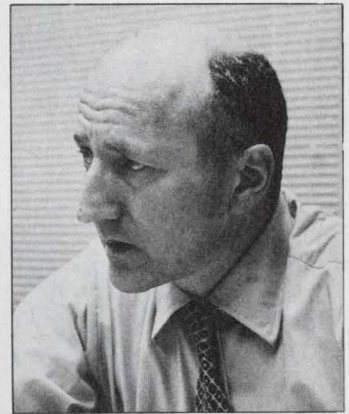

George Rostky

GEORGE ROSTKY
Editor-in-Chief



It also comes assembled.

If you need dials, we have dials. If you need handsets, we have handsets. If you need Touch Calling keysets, we've got 'em by the thousands. Ringers and hook-switches, too. Or, if you need complete telephones, we have them for you in all the latest styles and colors.

You get communications components faster from GTE Automatic Electric because, outside of the Bell System, we're the largest manufacturer of telephone equipment in the U.S. If you need it, we have it.

Use the coupon below for a complete

catalog. Or if you're in a real hurry, call John Ashby at (312) 562-7100, extension 250.

When it comes to quality components, call **THE SOURCE:**
GTE Automatic Electric.



- Please send your catalog of communications components.
- Please send more information and prices on _____ of _____
(Quantity) (Product)

Name _____ Title _____
 Company _____
 Address _____
 City _____ State _____ Zip _____
 Telephone _____

Mail to: Mr. J. D. Ashby, B-4, GTE Automatic Electric,
Northlake, Illinois 60164.

GTE AUTOMATIC ELECTRIC

Now. 1-Kilobyte CCD memory.

The first *production-proven* CCD memory is now here.

Fairchild's CCD450 is a 1024 x 9 byte-serial memory — with *built-in* NMOS input and output transition circuitry.

Compared with MOS memory, CCD simplicity means inherently higher chip densities — and ultimately, lower costs. Because it's fabricated with established NMOS technology, it's easy for the designer to use, too.

Developed by the leader in solid-state memory technology, the 1-Kilobyte CCD450 is the first in Fairchild's new family of CCD memory. And it's ideal for storage use in terminal buffers, display refresh and many other stand-alone terminal applications.

Complete specifications, a technical paper describing the CCD450 and a brief analysis of the projected economic impact of CCD memories are available now with *4-week sample delivery*.

For immediate opportunity to work with this major new memory technology, contact your Fairchild field office or distributor today.

Fairchild CCD450 Serial Memory:

- Solid-state monolithic.
- Very low power (250 mW max, 30 mW standby).
- TTL compatible.
- Standard 18-pin DIP.
- 4-mode operation: Read, Write, Read/Modify/Write, recirculate.

- 3 MHz data-rate capability.
- Hot Line for additional information: (415) 962-3941

Semiconductor Components Group, Fairchild Camera & Instrument Corp., 464 Ellis St. Mountain View, CA 94040
TWX: 910-379-6435

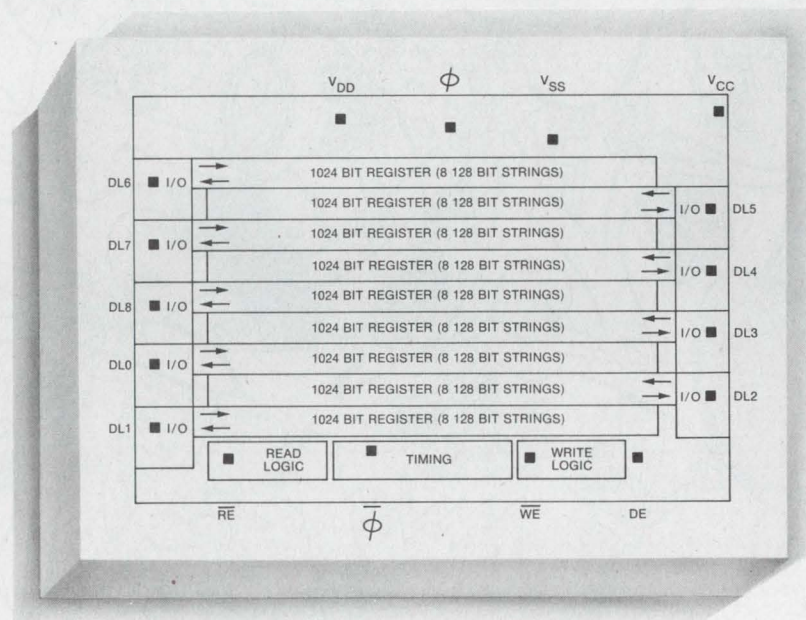

The first production CCD memory is Fairchild's CCD450, 1-Kilobyte serial storage device comprised of nine 1024-bit registers each organized in eight 128-bit strings. The CCD450 utilizes production proven Fairchild CCD buried-channel, ion-implanted barrier structure in the registers and Fairchild's Isoplanar N-channel MOS structure in on-chip timing, charge-detection and interface circuitry.

**MADE IN
FAIRCHILD
No.1 for memory.**

INFORMATION RETRIEVAL NUMBER 29

THE SENSOR TO COMPUTER INTERFACE:

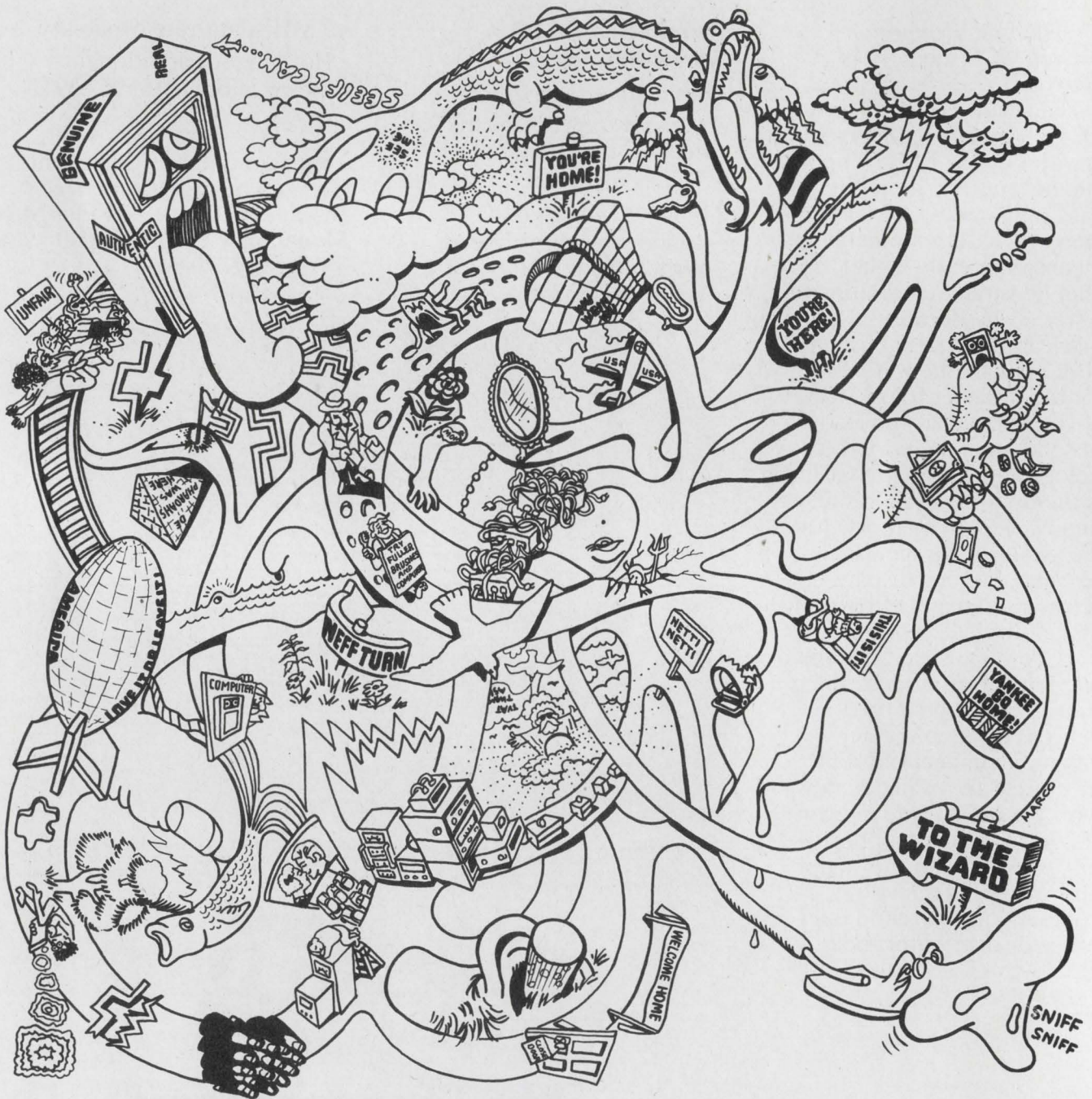

WHICH WAY IS BEST FOR YOU?

The data acquisition problem is as simple as getting from point A to point B. Just take the analog signals from your sensors and convert them to digital signals for your computer to process.

The solution is not so simple. There are a lot of different ways to go. A lot of potential pitfalls to be avoided. A lot of trade-offs to be judged. Which way is best for your particular needs?

Amplifier-per-channel vs. low-level multiplexers.

If you're not seriously concerned with performance, if the lowest possible price is your only criterion, low-level multiplexers make sense for you. If you're willing to invest a little more money, however, an amplifier-per-channel system offers significant performance advantages. A few of the benefits are signal isolation, lower noise, faster throughput, greater accuracy, continuous analog output, less crosstalk, overload protection, and low pass filtering.

Amplifier-per-channel vs. instrumentation amplifiers.

If you have a real need to maintain constant manual control, and if price is no object, then instrumentation amplifiers are the way to go. On the other hand, if you're geared for computer-control and don't mind saving a great deal of money, an amplifier-per-channel system is the only reasonable choice.

The Neff 620 amplifier-per-channel data acquisition system vs. building your own.

If your engineers are analog-oriented and have a great deal of time on their hands, you might try to build your own system. Lots of luck. If such is not the case, the Neff 620 analog signal processor was designed and built especially for you.

The Neff 620 is a compact box that contains differential amplifiers (Neff invented the original one 18 years ago!), low pass active filters, high level FET multiplexer, programmable gain amplifier, analog-to-digital converter, and control logic. In short, everything you need to get from point A to point B.

The Neff 620 is expandable all the way up to 2048 channels, popular minicomputer interfaces are designed and available, and the unit will not cost you more than about \$200 per channel.

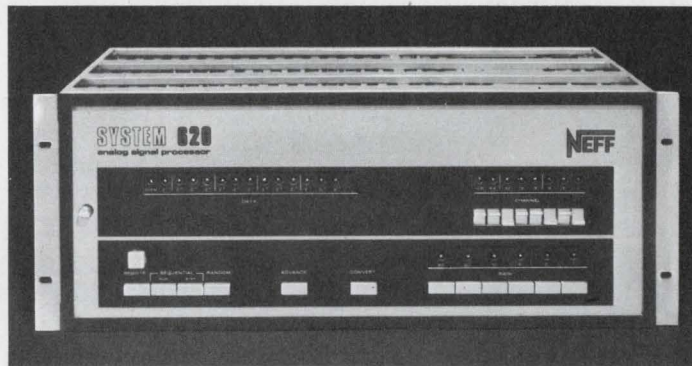

Your next step.

If you're still with us, you're beginning to get a pretty good idea of the way you should go. Your next step is easy. Give us a call. Or write. Ask for our thoroughly informative brochure on the Neff 620 amplifier-per-channel data acquisition system.

You win.

NEFF

Instrument Corporation
1088 East Hamilton Road
Duarte, California 91010
(213) 357-2281

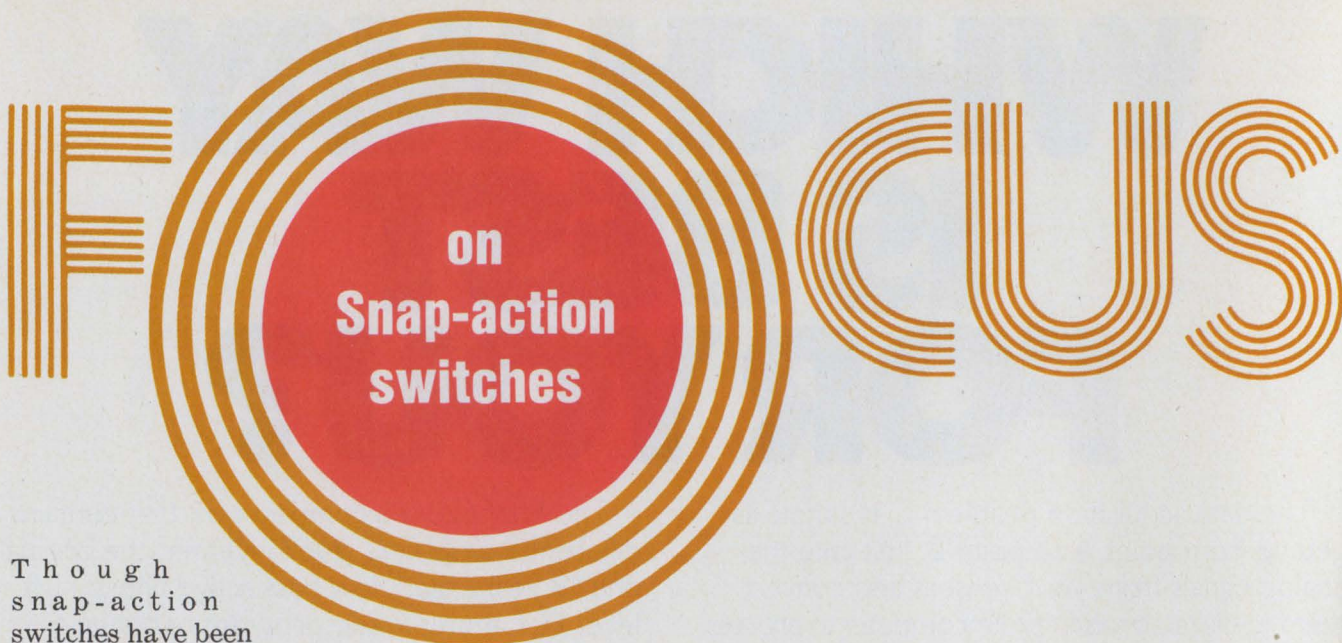

on Snap-action switches

Though snap-action switches have been around for 40 years, you can still make mistakes when you buy them.

Manufacturers' specification writing hasn't kept pace with improvements in reliability and pricing.

For example, most catalogs and data sheets still rate switches only by *maximum* load current and voltage. At first glance, one might believe that maximum ratings are all that's necessary to specify switch performance, since a conservatively loaded switch would appear to operate with a high safety factor. But this is debatable.

Maximum ratings may be satisfactory to specify switches at intermediate-level loads (0.25 V to 28 V dc and 50 to 100 mA) and for high-level loads.¹ For these loads, maximum ratings give the loads below which the contacts won't stick, weld, erode or do other unpleasant things.

But low-level and dry-circuit loads present other problems. Contacts that are perfectly satisfactory for intermediate and high-level loads, may have high contact resistance and provide noisy, erratic performance at low loads. Switch manufacturers rarely supply low-limit specifications. Circuit designers should be aware that most switches with only maximum ratings, also have a low, but unspecified limit.

Low-limit ratings?

Thus Martin Gaber, chief executive officer of Chicago Switch, says he would like to see switch specs written with both low and high ratings. He suggests that typical specs might be as follows:

- Reliability range—50 to 100 mA and 0.25 to 30 V.

- Load—resistive.
- Life 100,000 actuations under maximum load and 10 million under minimum.
- Initial contact resistance—10 m Ω max.
- End of life—in milliohms, as determined by application tolerances.
- Shelf life—in years.

Chicago Switch's catalog is one of the few that lists separate "low-energy" and "power range" versions for many of its switch lines. But still each type does not have high and low specs. So-called low-energy units usually have gold contacts and power-range types use silver.

Similarly, the Cherry Electrical Products catalog features a simplified contact-selection chart (see fig. p. 46) that shows the application range of its gold-alloy cross contacts. Maximums of only 30 V and 0.1 A are recommended for these contacts. Cherry advises the use of silver contacts above 30 V.

But J. P. Lockwood of Micro Switch in his "Applying Precision Switches—a Practical Guide" offers a contrary opinion. He writes: "Occasionally the suggestion is made that switches be provided with minimum voltage and current ratings. . . . This stems from the erroneous impression that a given switch will develop performance problems below specific levels of voltage and current. A clean switch usually can control micro-volt-microampere circuits without difficulty. There is no particular voltage or current levels at which problems begin, and there is no technically valid way to set minimum electrical ratings."

Lockwood contends that "if silver contacts are clean, there is no lower limit to the voltage and current that they will control reliably."

But it's hard to keep the silver clean. Silver tarnishes, forming oxides or sulfides all too easily. It tarnishes in unprotected atmospheres and even in hermetically sealed enclosures. Gold, however, is inert chemically. It doesn't form sulfides or oxides in unprotected atmosphere. And when sealed, gold contacts provide even more insurance for low-level performance.

However, high-purity gold contacts are susceptible to sticking. In addition gold and gold-alloy materials ordinarily are not suitable for currents above about 0.5 A because of their relatively fast erosion rate.²

Mel Fink, applications engineer for Seacor Inc., warns that gold-plated brass contacts, which are popular with several manufacturers, should not be used, even momentarily, for applications that exceed 0.4 VA or 20 V dc maximum.

"In many instances," he notes, "when these specs are exceeded by a transient pulse, the gold

is burned off and only the brass base is left. The life, voltage and current capabilities of the brass are not defined. Thus the original spec of the switch no longer applies."

However, when the base metal is a silver alloy or other transfer and erosion-resistant material, gold plating over the base may not disappear where a contact is first subjected to high-level switching. The gold may combine with the base material to form an area that is suitable for low-level switching, according to one theory. Some applications, such as synchro systems and bridge circuits, require the contacts to carry a load from high to low or low to high levels. And such circuits can be successfully switched with gold-on-silver contacts.

In general, however, switch designers agree that contacts designed for low-level switches should not be used for high-level loads, and vice versa. Nor should switches carry mixed loads. In

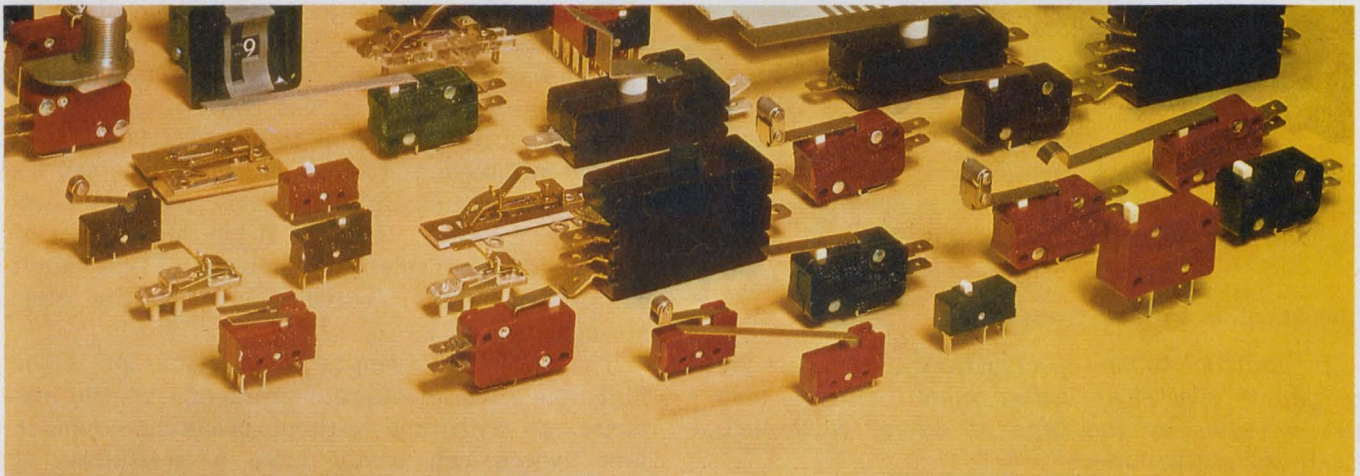

A large variety of snap-action switches is available, as illustrated by this selection from Cherry's switch lines.

And actuators of every imaginable form increase the switch's versatility.

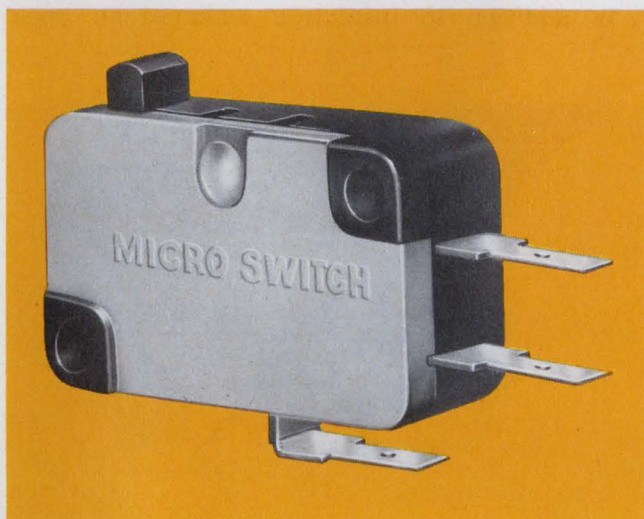

Micro Switch's V3 style is a venerable and widely duplicated housing configuration. Now Micro Switch announces an XL solid-state switch in a V3 shape.

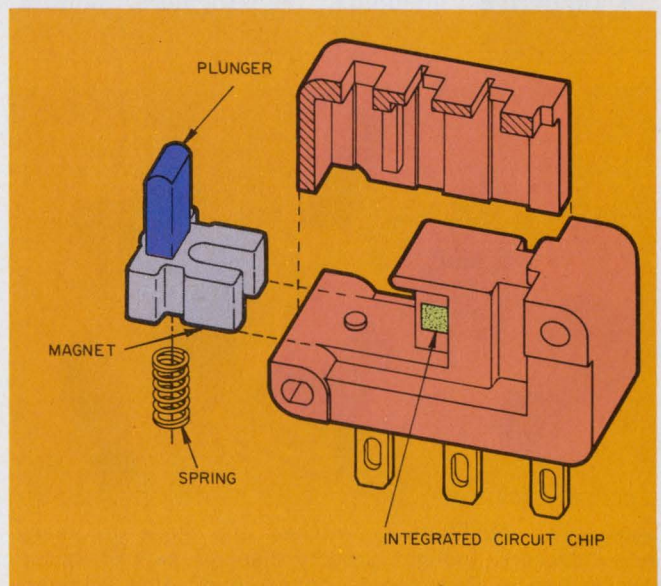

CHERRY'S GUIDE FOR CONTACT SELECTION

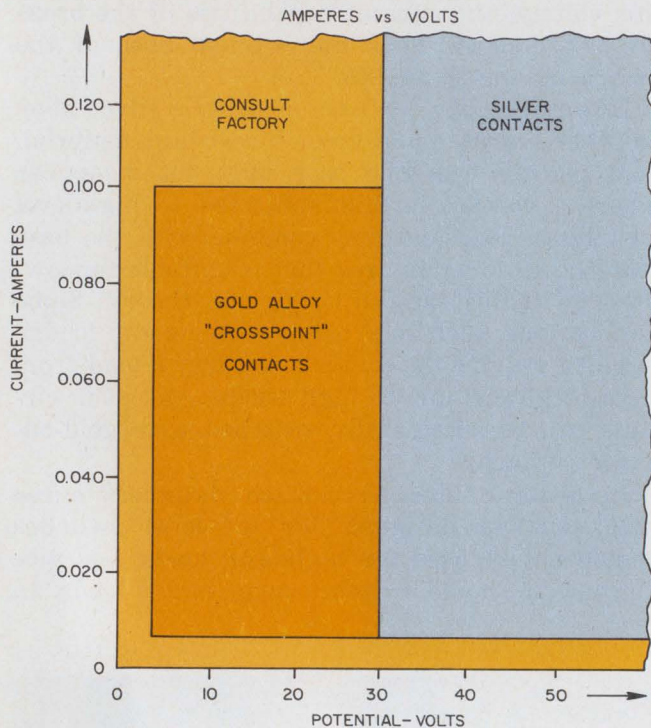

GENERAL GUIDE ONLY. CONSULT FACTORY FOR SPECIFIC APPLICATIONS.

fact, many military specs state that contacts tested to high-level characteristics are not recommended for low-level applications.

Classification by load types

In addition to the specification of switches by maximum electrical loads; manufacturers also list switches by the type of device controlled. Such devices include:

- Resistive—constant-valued resistance.
- Tungsten-lamp—characterized by a high initial current that tapers to a steady resistive load as the lamp attains operating temperature.
- Inductive—solenoids, transformers, motors



Snap-action pushbutton switches are made by many manufacturers. Dialight proudly displays part of its extensive line of illuminated and nonilluminated versions.

and other devices with coils in them. They often draw high in-rush currents when turned on. When turned off, the inductive loads can generate very high kickback voltages that can produce destructive arcs across opening contacts.

▪ Capacitive—some motor starter circuits, power-supply filters and many electronic circuits that have substantial capacitance. A discharged capacitor is almost a short-circuit at the instant voltage is applied. Since contacts of low melting-point materials are easily welded together by such loads, refractory metals, such as tungsten, or platinum and its alloys, should be used.

Ac loads are more easily handled by switches than dc, because any arcs struck across opening contacts tend to self-extinguish when the ac goes through zero voltage. Thus the contacts can usually handle four to five times more rms current and voltage than dc.

Contact resistance is complicated

The ideal switch would have infinite open resistance and zero closed resistance. In a practical snap switch, the snap of the mechanism can change the resistance across the switch's terminals from a few milliohms to over 100,000 MΩ in a few milliseconds—about as close to ideal as any switch can attain. The open-circuited resistance is, of course, determined by the leakage of the switch's insulating material. But don't confuse insulation resistance with dielectric strength.

The dielectric strength of an insulator is the highest electrical potential gradient that the material can withstand without breaking down. A new switch can easily have a resistance of 100,000 MΩ at normal operating voltages. But high voltages, usually in excess of 1000 V, can permanently damage the insulating material and allow a sudden increase in leakage current.

In addition to insulation leakage, an open

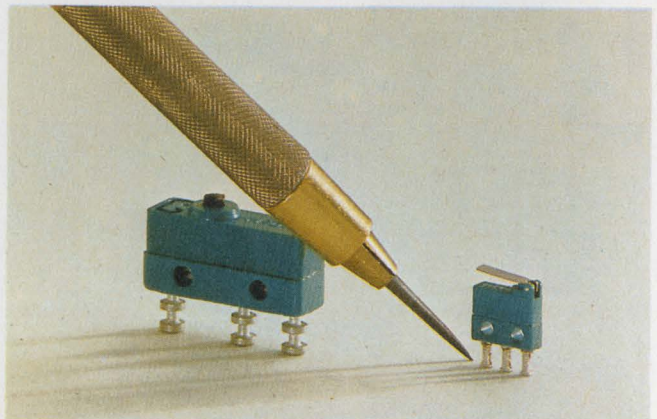

McGill compares the size of its subminiature 4900 series with the already tiny 4800 unit. McGill says the 4900 is the smallest available precision snap switch.

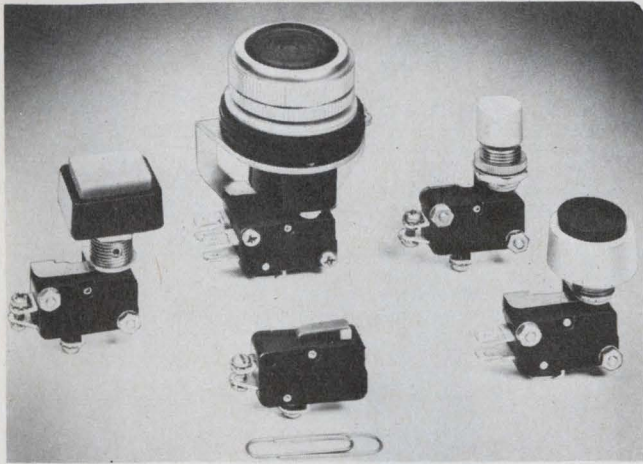

Many different superstructures attached to Cutler-Hammer's basic SS12 snap-action switch provide a flexible approach to pushbutton-switch design.

switch also has capacitance between its terminals. In high-frequency circuits, a switch's capacitance must be taken into account. Small snap-action switches may have between 1 and 10 pF. And the capacitance of the wiring to the switch also can easily reach or exceed these values.

But though the impedance of an open switch is easy to describe and understand, analysis of a switch's resistance when the contacts are closed is complicated.

Switch specifications often list a maximum "contact resistance." This is usually an erroneous use of the term. The value given, rarely clearly defined, is generally the resistance with closed contacts, measured at the switch's terminals. This resistance is more than just the resistance of the contacts. It also includes all the springs, joints and pivots that make up the conducting paths to and from the contacts. There is a vast difference between the characteristics of the resistance of the contacts and the rest of the switch's conducting parts. The resistance of the conductors to and from the contacts usually obey Ohm's Law, but the resistance of the contacts does not.

Studies of the behavior of contact resistance fill books.³ Contact resistance is affected by many variables. They include pressure between contacts, the current flowing through them, the type of contact material used, the condition of the contact surfaces and contaminants on the contacts. Thus test results are hard to repeat and difficult to interpret, and many often-conflicting theories abound to explain the discrepancies.

Snap action gives superior performance

Most snap-action switches are essentially butt-contact switches with a "mouse-trap" mechanism to control the movement of the contacts. The

mechanism stores energy in a spring as the switch actuator is moved. In a precision snap-action switch, the mechanism "releases," at a precise point, and uses the stored energy to swiftly snap the contacts to their opposite position.

Without snap action, a simple butt switch—for example, a cheap bell switch—has many limitations and problems that are overcome in snap switches. The problems with simple butt switches include:

- contact "teasing," which can cause excess arcing, shortened switch life and improper circuit operation;
- slow contact separation, which results in bad arcing;
- poor repeatability of the contact make and break positions, because contact wear and spring fatigue directly change the contact operating points.
- limited versatility, because of inherent restrictions in the ways actuator motion and forces can be controlled.
- no wiping action, which allows rapid build up of contaminants and short switch life.
- loose tolerance, which confines the use of butt switches to only the simplest, least-demanding applications.

Precision snap-switch designs, however, allow precise specifications for each movement and force involved in the operation of the switch. These include (see illustration):

- pretravel—the distance the actuator travels from its initial, or "free," position to the operating point.
- overtravel limit—the position beyond which the switch can be damaged.
- release point—the position at which the contacts snap back to their initial position.
- differential—the displacement of the operate point from the release point.

Each motion or position is associated with a predictable, toleranced force. They include: operating force, release force, differential force (between operate and release) and a safe overtravel "bottoming" force. Tolerances of the movements and positions are in thousandths of an inch and forces in fractions of an ounce.

And many snap mechanisms also provide for a small wiping action during overtravel of the plunger.

There are many types of snap mechanisms. Some use flat springs, others coiled springs. Some break and then make two contact pairs; others only one contact pair.

In most snap switches the spring that snaps the contacts also carries the current; in others the spring carries no current. And, of course, each vendor argues the good points of his design.

But snap-action switches have one serious

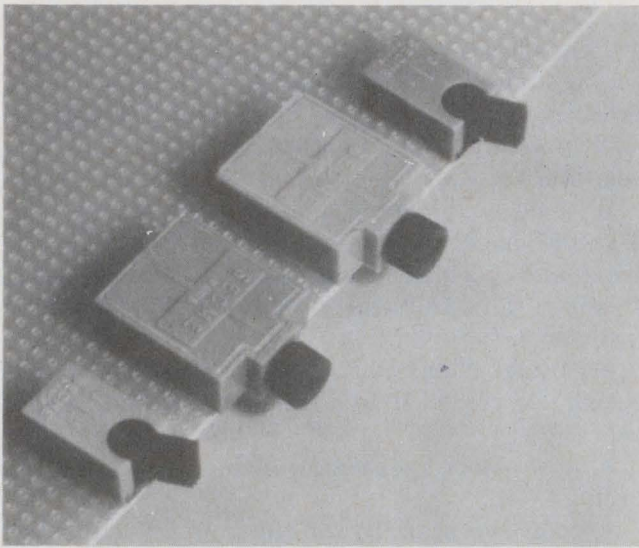

Centralab's line of PC mounted snap-action switches comes in either toggle or rotary-action styles. One and two-pole versions are available.

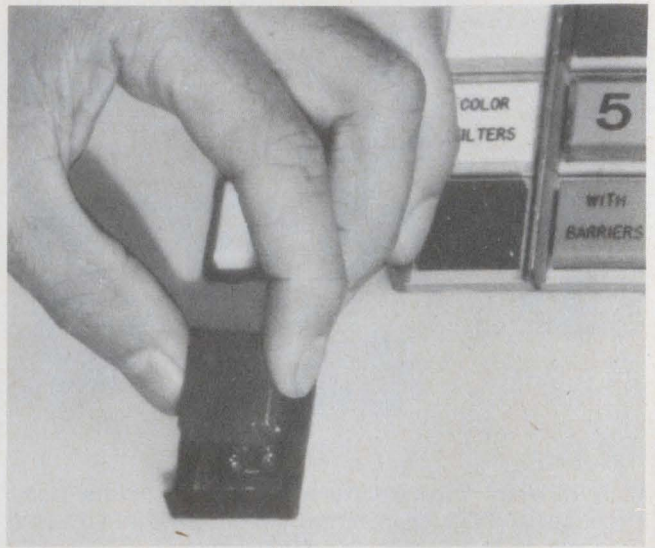

Snap-action modules with illuminated pushbuttons in Switchcraft's Push-Lite line can handle 8-A, 120-V-ac, noninductive loads, according to the manufacturer.

drawback: The high contact transit speed increases contact bounce. When the moving contact strikes the stationary contact, a series of make-and-break bounces result until the energy is dissipated in heat.

Snap-switch contacts bounce

For most power loads, bounce may not be a problem, other than some additional arcing and wearing of the contacts. But in fast-acting control circuits, even the fast relays—and certainly with solid-state logic—each bounce can be interpreted as a separate signal and thus provides false inputs.

Micro Switch states in its application book: "No attempt is made to control contact transit time or bounce characteristics during switch manufacture; in fact, they are only partially controllable. Furthermore, contact transit time and bounce are inherently variable. In practice, two successive actuations of a switch seldom produce the same transit time, bounce pattern or bounce duration, no matter how nearly constant the known variables are held."

Most other snap-action switch manufacturers are silent on this subject. Unless the designer can get the manufacturer to do something special to control bounce, he should expect nearly every off-the-shelf snap switch to produce bounce. The large variety of antibounce logic circuits available indicates that circuit designers are aware of the problem.

Death of a switch: many causes

A switch's life depends upon many variables. For this reason, few manufacturers publish life

figures. Subtle variations in the switch and test conditions can have large effects on the life values.

But life is an important design consideration. If the manufacturer doesn't publish his figures, ask for them. Most reputable manufacturers have tons of data, but the engineer may have to do a bit of arm-twisting to get the facts. A manufacturer may even be persuaded to run a test under mutually agreed-upon conditions.

The use to which the switch is put determines many of the failure criteria. In a mechanically tight-tolerance application, the drift of the operation point of a precision snap-action switch might cause system failure. Or, in a high-impedance circuit, reduced insulation resistance may make the switch unfit. Some of the more obvious modes of failure include these:

- Contact welding. Tiny welds continually occur during the normal life of a switch. They are broken by the normal forces on the contacts and don't affect the switch's performance. But with high currents and advanced switch age, a weld may finally cause the contacts to stick permanently.

- Contact erosion. Arcing, wear and mechanical pounding gradually erode the contact metal. Contact gaps widen and fail to meet, or eroded metal deposits on insulating barriers and reduce insulation resistance to the failure point.

- Contact-material migration. The complex phenomena of switching involve tiny bridges of molten contact metal that can form a cone on one contact face and a corresponding crater on the other, until the contact gap shorts.

- Insulation failure. Aging of insulation material, heat, vibration and other hostile environmental factors can cause high leakage, loss of strength and cracking, and thus the destruction

of the switch.

■ **Mechanical failure.** Any of the switch's mechanical members, such as pivots, springs and levers, may seize, fatigue or break. Sometimes a switch is rated by its mechanical life—without an electrical load. Such a figure is not very meaningful. A switch should be evaluated under conditions of actual use.

Fatigue of the spring is usually the limiting factor in a snap-action switch's mechanical life. Reduced overtravel or the use of external leaf or spring actuators to absorb overtravel can appreciably lengthen the snap-switch's life.

Of course, off-centered actuation of a switch, excessive forces, shock actuation, high-frequency switching and high temperatures can reduce a switch's mechanical life. Also, high altitudes increase the tendency to arcing and contact deterioration. Many varieties of sealed switches are available for high altitudes.

If the mechanical limits of the switch are respected, a well-designed snap switch will usually fail electrically before mechanical failure occurs. The published current and voltage rating of a switch represents only a single point on a switch's life-vs-electrical load curve. As might be expected, life increases as the voltage and current load are reduced (see typical life curves).

Some switches have agency ratings

Many snap-switch manufacturers obtain approval for their lines from rating agencies, such as Underwriters' Laboratories (UL). In international markets, they may get an OK from the Canadian Standards Association (CSA), Verband Deutscher Elektronika (VDE) and the new International Commission on Rules for Approval of Electrical Equipment.

But be aware that an agency label can have many meanings. Because a switch carries a UL marking does not mean it meets approval for all applications under all circumstances. The agencies have many ratings or listings.

For example, UL has "special" and "general-use" switch categories. Some switches have horsepower ratings; others don't. UL's "L" rating refers to a switch's ability to handle tungsten lamps on dc, and "T" rating to its ac lamp capability. And there are a large variety of voltage, current and leakage and endurance tests in each category. The manufacturer's listed maximum rating may not correspond to UL or CSA approved values.

And some switches also receive "pilot duty" approval from UL. Pilot duty means that the switch can control a contactor, relay or other electromagnetic device, and special tests must be passed for high in-rush-current capacity and performance under inductive loads.

A final word of caution: UL standards pri-

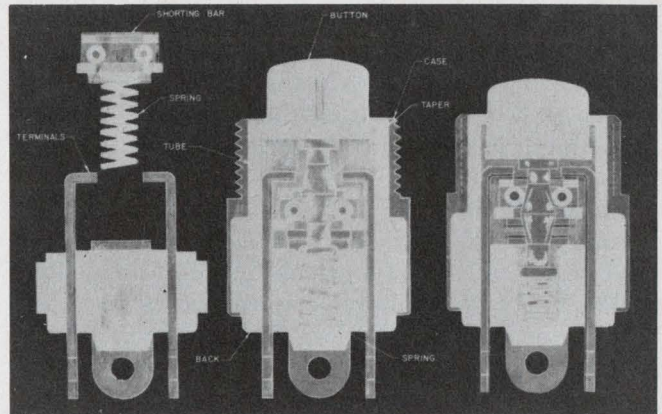

High contact pressure with minimum contact bounce is featured by Control Switch in its JR snap-action mechanisms. The series is available in a wide range of ratings, case styles and colors.

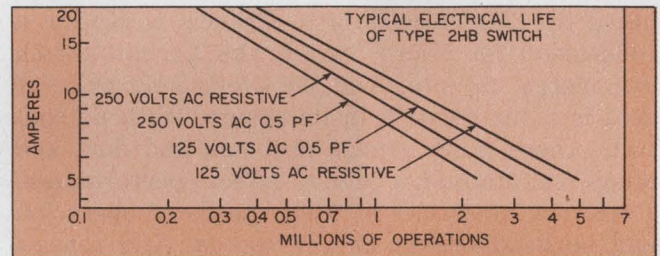

Contact wear is the primary limitation to the electrical life of a switch. This graph of Unimax's 2HB switch illustrates how life decreases with increased current and voltage and with lower power factor. The tests were made under atmospheric conditions with the switches operated 60 times a minute and with power on both the open and closed contacts.

marily cover safety from electrical shock and fire. A switch's reliability and life are not guaranteed by UL tests.

The variety is endless

Snap-action switches are made in an endless variety of styles. They include pushbutton styles and plunger types with levers of every imaginable shape and size, and many cam-actuated versions.

The most versatile class of snap-action switches is the so-called precision switch. This class was pioneered by the Micro Switch Corp., now a division of Honeywell. The ideas incorporated in many of today's precision snap-action switches were described in a 1933 patent filed by Philip K. McGall, a mechanic with the then C. F. Burgess Laboratories in New York. The patent became the property of the Micro Switch Corp. in the late 1930s.

Today several companies, including Cherry, Unimax, McGill, Cutler-Hammer and Control Switch, manufacture competing precision switch

designs. Many of these companies' styles are interchangeable dimensionally and electrically.

One very popular style is Micro Switch's V3 switch, introduced in the mid-40s. Now at about 35 cents apiece, it's an "international standard," the company says.

Cutler-Hammer's SS12, McGill's 4600 series, Unimax's 2TM and Cherry's E22 to E34 series have practically the identical external dimensions of the V3, with similar electrical ratings and offerings of actuator styles. The internal details, however, differ.

A variety of actuator accessories is available for most precision switches. They come with short and long levers, rollers, specially shaped cams, toggle-switch or pushbutton-adaptor assemblies and illuminated buttons.

To take advantage of the wide acceptance of the V3's case style, Micro Switch is now introducing a solid-state Hall-effect version, designated the XL. According to Francis L. Kafka, a spokesman for Micro Switch, the XL can switch low-energy circuits. And the ever-rising price of gold is of no concern in its design. With no contacts, there is no bounce problem, and dust and other contaminants can't affect performance. There are no misses at high speeds of operation and no dead breaks at low speeds. And repeatability of the operate, reset and differential movements is said to be much better than in the original V3.

Haydon Switch & Instrument offers the 6214 hermetically sealed switch, which can withstand temperatures to 600 F and even 800 F in some applications.

And Chicago Switch has its new intermediate-load CS 20-000-051 snap switch under test for life

expectancy. The switch sells for less than \$1. With six samples under a load of 0.1 mA at 6 V, one has failed after 325 million on-off operations, and five others are still going strong, the company says. An automotive version of this switch can handle 5 A at 14 V.

Traditional toggle switches, of course, represent an important category of snap-action switches. Companies such as Alco, Control Switch, Cutler-Hammer, JBT Instruments, Seacor and many others make them. Seacor's Series 5000 toggles are particularly rugged, its maker says, because of its pinned construction and solid-silver inlays for the contacts. Some versions use gold plating over the silver.

Centralab's entries in the snap-switch field include a miniature low-profile, one or two-pole snap switch with either toggle or rotary handles for PC-board mounting (Part No. 06-17631-19). But many toggle types are assembled from basic plunger precision snap switches and special toggle actuators.

An interesting example of a complex actuator for standard precision snap-switches is the line of rotary switches made by Precision Mechanism. Its CS-402 series provides externally adjustable cams for the snap switches.

Many snap switches are illuminated pushbutton varieties. Dialco features its 513 series, said to have a life of between 500,000 to 1 million operations. The series can handle 5 mA to 5 A, and many versions come with illuminated buttons. Switchcraft's Push-Lite illuminated units are available with switch modules that contain up to two form-C contacts, and they can handle up to 8 A at 124 V ac.

Compu-Lite has new "shorty" Series 849 and

Need more information?

We wish to thank the companies that provided information for this report. The products cited in the report have been selected for their illustrative, or in some cases, unique qualities. However, manufacturers not mentioned in the report may offer similar products. Readers may wish to consult manufacturers listed here and Electronic Design's GOLD BOOK for further details.

Alco Electronic Products Inc., 1551 Osgood St., North Andover, MA 01845. (617) 685-4371. **Circle No. 401**
Arcoelectric Switch Corp., P.O. Box 348, North Hollywood, CA 91603. (213) 985-3130. **Circle No. 402**
Arrow-Hart Inc., 103 Hawthorn St., Hartford, CT 06106. (203) 249-8471. **Circle No. 403**
Bryant Electric, 1421 State St., Bridgeport, CT 06602. (203) 334-5561. **Circle No. 404**
Centralab Electronics Div., Globe-Union Inc., 5757 N. Green Bay Ave., Milwaukee, WI 53201. (414) 228-1200. **Circle No. 405**
Cherry Electrical Products Corp., 3600 Sunset, Waukegan, IL 60085. (312) 689-7600. **Circle No. 406**
Chicago Switch Inc., 2039 W. Wabansia Ave., Chicago, IL 60647. (312) 489-5500. **Circle No. 407**
Clare-Pendar Co., Box 785, Post Falls, ID 83854. (208) 773-4541. **Circle No. 408**
Cole Hersee Co., 20 Old Colony Ave. S., Boston, MA 02127. (617) 268-2190. **Circle No. 409**

Columbus Electric Manufacturing Co., P.O. Box 289 AB, Piney Flats, TN 37686. (615) 968-3360. **Circle No. 410**
Compu-Lite Corp., 17795 Sky Park Circle, Irvine, CA 92707. (714) 546-9045. **Circle No. 411**
Control Switch Inc., 1420 Delmar Dr., Folcroft, PA 19032. (215) 586-7500. **Circle No. 412**
CTS Corp., 905 N.W. Blvd., Elkhart, IN 46514. (219) 293-7511. **Circle No. 413**
Cutler-Hammer, 4201 N. 27th St., Milwaukee, WI 53216. (414) 442-7800. **Circle No. 414**
Dialight Corp., 203 Harrison Pl., Brooklyn, NY 11237. (212) 497-7600. **Circle No. 415**
Eagle Electronic Manufacturing Co., 45-31 Court Sq., Long Island City, NY 11101. (212) 937-8000. **Circle No. 416**
Electro Mechanical Components, 1826 N. Floradale S., El Monte, CA 91733. (213) 442-7180. **Circle No. 417**
Elmwood Sensors Inc., 1655 Elmwood Ave., Cranston, RI 02907. (401) 781-6500. **Circle No. 418**
GC Electronics, 400 S. Wyman St., Rockford, IL 61101. (815) 968-9661. **Circle No. 419**
General Control Co., 1200 Soldiers Field Rd., Boston, MA 02134. (617) 782-7440. **Circle No. 420**
Hayden Switch & Instrument, 1500 Meriden, Waterbury, CT 06705. (203) 756-7441. **Circle No. 421**
IEE/Schadow, Inc., 8081 Wallace Rd., Eden Prairie, MN 55343. (612) 944-1820. **Circle No. 422**
Illinois Tool Works, Licon Div., 6615 W. Irving Park Rd., Chicago, IL 60634. (312) 282-4040. **Circle No. 423**
Illuminated Products Inc., P.O. Box 4011, Anaheim, CA 92803. (714) 535-6037. **Circle No. 424**
Janco Corp., 3111 Winona Ave., Burbank, CA 91504. (213) 845-7473. **Circle No. 425**

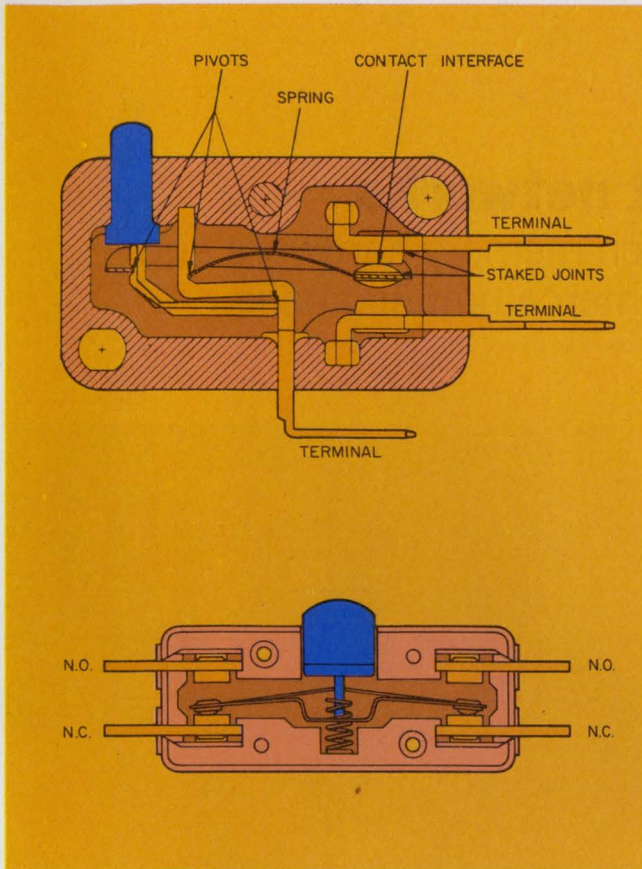

The inner details of snap-action mechanisms vary substantially among manufacturers, but case dimensions in many types are standardized.

852 illuminated pushbutton switches that are claimed to have the shortest behind-the-panel depth available today. These switches sell for less than \$2 in OEM quantities.

Nonilluminated one and two-legend actuators are featured by IEE/Schadow for its NE 15/F

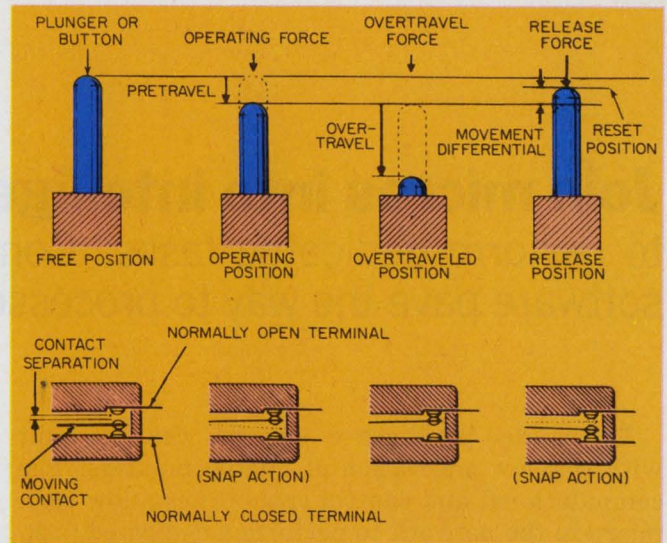

Every position and movement of a snap-action switch's plunger has a name and definition.

pushbutton switches. Push the button, and the legend on the two-legend unit automatically changes—ON to OFF, or any other suitable pair of designations. Visibility is excellent in ambient light because of the highly reflective legends.

And many others also make snap-action pushbutton switches, including Molex, Control Switch and Jay-EL Products. You can find a style to suit almost any need, but look before you leap. ■■

References

1. Adkins, R. M., "Intermediate Level Switching," 21st Annual National Relay Conference, Oklahoma State University, Stillwater, OK, May 1, 1973, pp. 15-1 to 15-12.
2. National Association of Relay Manufacturers (NARM), "Engineers' Relay Handbook," Revised Second Edition, Hayden Book Co., Rochelle Park, NJ, pp. 91-94.
3. Holm, Ragnar, "Electrical Contacts, Theory and Application," Fourth Edition, Springer-Verlag, NY.

Jay-EL Products, 1859 W. 169, Gardena, CA 90247. (213) 321-3260. **Circle No. 426**
 JBT Instruments Inc., 424 Chapel St., New Haven, CT 06508. (203) 772-2220. **Circle No. 427**
 Klockner Moeller Corp., 4 Strathmore Rd., Natick, MA 01760. (617) 655-1910. **Circle No. 428**
 Littelfuse Inc., 800 Northwest Hwy., Des Plaines, IL 60016. (312) 824-1188. **Circle No. 429**
 Machine Components Corp., 53 Werman Ct., Plainview, NY 11803. (516) 694-7222. **Circle No. 430**
 Master Specialties, 1640 Monrovia Ave., Costa Mesa, CA 92627. (714) 642-2427. **Circle No. 431**
 McGill Manufacturing Co., N. Campbell St., Vaparaiso, IN 46383. (219) 462-2161. **Circle No. 432**
 Micro Switch Div., Honeywell, 11 W. Spring St., Freeport, IL 60132. (815) 232-1122. **Circle No. 433**
 Molex Inc., 2222 Wellington Ct., Lisle, IL 60532. (312) 969-4550. **Circle No. 434**
 Namco Controls Acme-Cleveland, 170 E. 131 St., Cleveland, OH 44108. (216) 268-4200. **Circle No. 435**
 Nexus Inc., 50 Sunnyside Ave., Stamford, CT 06902. (203) 327-7300. **Circle No. 436**
 Otto Controls Div., 38 Main St., Carpentersville, IL 60110. (312) 428-7171. **Circle No. 437**
 Potter & Brumfield Div., AMF Inc., 1200 E. Broadway, Princeton, IN 47670. (812) 385-5251. **Circle No. 438**
 Precision Measures, 1220 Jones St., San Francisco, CA 94109. (415) 441-1827. **Circle No. 439**
 Precision Mechanisms, 44 Brooklyn, Westbury, LI, NY 11590. (516) 333-5955. **Circle No. 440**
 Ranco Inc., 601 W. Fifth Ave., Columbus, OH 43201. (614) 294-3511. **Circle No. 441**

Reed Switch Developments Co., 34 Lincoln Ave., Greenwich, CT 06830. (203) 661-9410. **Circle No. 442**
 Relay Specialties Inc., 1300 Plaza Rd., Fair Lawn, NJ 07410. (201) 797-3313. **Circle No. 443**
 Robertshaw Controls Co., P.O. Box 449, Columbus, OH 43216. (614) 875-2351. **Circle No. 444**
 Milton Ross Co., 511 Second St. Pike, Southampton, PA 18966. (215) 355-0200. **Circle No. 445**
 Seacor Inc., 598 Broadway, Norwood, NJ 07648. (201) 768-6070. **Circle No. 446**
 Shigoto Industries Ltd., 350 Fifth Ave., New York, NY 10001. (212) 695-0200. **Circle No. 447**
 Showa Musen Kogyo Co. Ltd., No 5-5 6-Chome Togoshi, Shinagawa-ku, Japan 03785 1111. **Circle No. 448**
 Sierra Electric Div., Sola Basic Ind., 15100 S. Figueroa, Gardena, CA 90247. (213) 321-1000. **Circle No. 449**
 Stackpole Components Co., P.O. Box 14466, Raleigh, NC 27610. (919) 828-6201. **Circle No. 450**
 Stettner-Trush Inc., 67 Albany St., Cazenovia, NY 13035. (315) 655-8141. **Circle No. 451**
 Switchcraft Inc., 5555 N. Elston Ave., Chicago, IL 60630. (312) 792-2700. **Circle No. 452**
 TEC Inc., 9802 N. Oracle Rd., Tucson, AZ 85704. (602) 297-1111. **Circle No. 453**
 Texas Instruments Inc., 34 Forest St., Attleboro, MA 02703. (617) 222-2800. **Circle No. 454**
 Unimax Switch Corp., Ives Rd., Wallingford, CT 06492. (203) 269-8701. **Circle No. 455**
 Waldon Electronics Inc., 4637 W. 53rd St., Chicago, IL 60632. (312) 585-1212. **Circle No. 456**
 Wilbrecht Electronics Inc., 240 Plato Blvd., St. Paul, MN 55107. (612) 222-2791. **Circle No. 457**

Join micros into intelligent networks

to perform dedicated tasks. Common-memory hardware and software pave the way to processor intercommunications.

Distributed-intelligence systems can be built with the new generation of microcomputers. The computational and control capabilities allow each micro in the network to perform a dedicated task. The over-all network can provide hardware and software redundancy at an attractive price—compared with a single large processor. Common-memory software and hardware techniques provide one of the newest ways to handle the necessary intercommunication between subsystems.

Microcomputer sets that include CPU, memory and I/O adapters can be purchased for less than \$30. In a distributed-intelligence system, each of these units or processors has a dedicated function, typically I/O oriented (Fig. 1). Since the system is oriented towards maximum I/O throughput, processor cross-communication is held to a minimum.

Join processors by I/O ports

Each processor can be viewed as having two I/O ports: one associated with external system activity; the other, for information exchange with other system processors. In practice, both ports are part of the I/O section of a processor. Low-cost microcomputers such as the Intel 4040 are particularly adaptable to communications via their I/O ports.

Because of the rapid real-time response possible with this setup, the multiprocessor system can be designed for functions such as these:

- Control of a common interprocessor bus.
- Interrogation and preprocessing of remote sensors.
- Packing and unpacking of control information to and from remote locations.
- Minimization of intersystem cabling by concentration of information.
- Performing automatic calibration at remote location.
- Support of multipartition systems.
- Pipelining of arithmetic or algorithmic cal-

Howard A. Raphael, Product Manager, Microcomputer Systems Group, Intel Corp., 3065 Bowers Ave., Santa Clara, CA 95051.

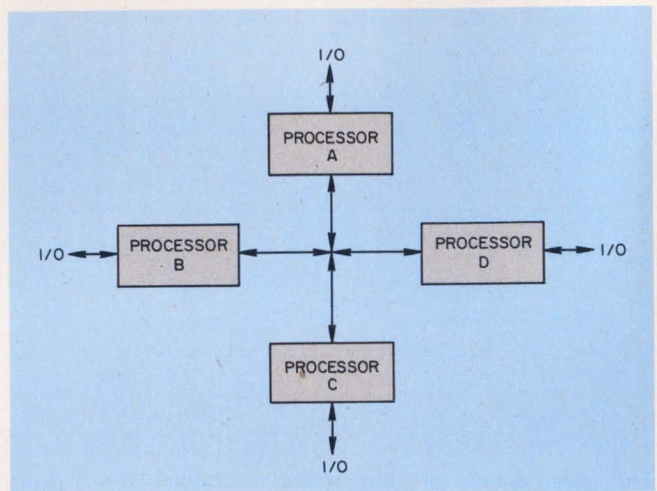

1. Each processor of a distributed-intelligence system performs an assigned function. Emphasis tends to be on the input-output operations with microprocessors.

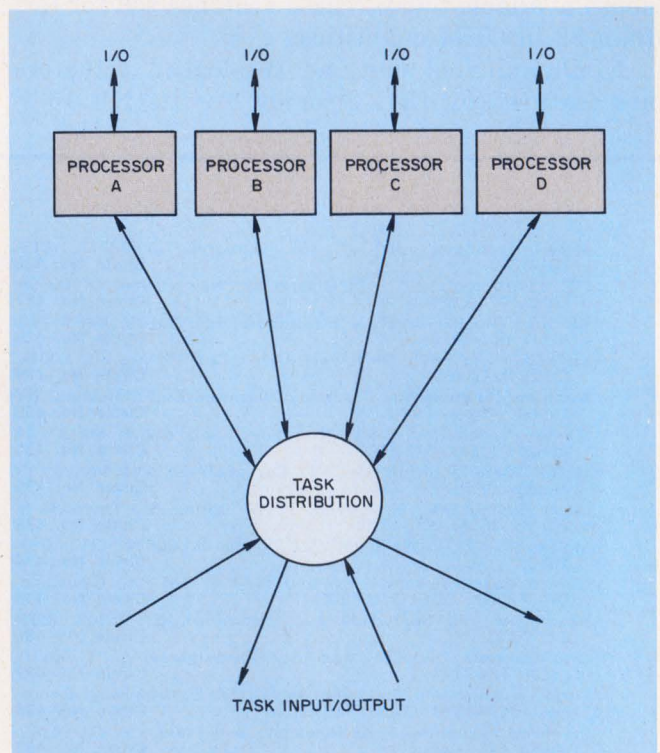

2. Multiprocessing systems also use multiple processors, but the processors share assignments rather than performing dedicated tasks.

culations in systems like FFT analyzers.

- Performing diagnostic monitoring.
- Control of security systems.

Distributed-intelligence systems differ from multiprocessing systems in the way that tasks are handled. Although both systems use multiple processors, the tasks assigned to a distributed system remain fixed. By contrast, in a multiprocessing environment, a continuous stream of assignments is fed to a single node and allowed to unburden the processors (Fig. 2). And the allocation of tasks is performed by complex algorithms present in the software operating system.

Each processor in a distributed-intelligence microcomputer system (DIMS) performs some combination of these four basic activity functions:

- Local input/output or hardware controller activity.
- Information concentration and temporary storage.
- Information processing.
- Remote input/output and communication.

The table lists typical combinations found in a variety of applications.

The different activities

The first activity, local functions, can be divided over several microcomputers or combined into one processor. The local interface may deal with a broad variety of contrasting I/O characteristics that includes: high-speed/low-speed; electromechanical/electronic; decimal/binary; analog/digital; interrupt/pollled DMA; unformatted/formatted; human/machine; simple/complex, and single-cycle/multicycle.

The type of interface and the I/O responsiveness of the microcomputer are factors in the organization of local I/O activity. (Evaluation of I/O responsiveness will be discussed in a future article.) One method is to assign a specific class of interface to each processor. For example, one processor can do all decimal interface operations; another can handle high-speed I/O. In this way the designer can choose the most suitable processor for each category. The Intel MCS-40 is suitable for low-speed I/O and man-machine interfaces. On the other hand, the Intel 3000, a bipolar unit, is a wise choice for high-speed applications or complex multiple-cycle interfaces. Many types of processors can be combined in a single DIMS.

Physical distribution of I/O should be considered. Placement of the processor near the source of the I/O reduces coupling costs and helps provide some isolation for each location. Some redundancy and simplified systems diagnostics are other benefits.

The second function, information concentration, improves efficiency—unlike the use of bytes or small records. Each data transfer requires less I/O software and the data are easier to handle. Any form of concentration, however, implies the use of storage.

Formatting of data is another aspect of information concentration. ASCII formatting of raw data for remote transmission to a host is one example. The numerical data can be packed into four bits per digit (a nibble) and two digits per byte. With this type of packing, memory usage is very efficient. Systems that process hexadecimal information make extensive use of packed data formats.

Typical applications for data concentration

Functions performed by DIMS

Local Input/Output ↔	I II III IV	↔ Remote Input/Output
Applications <ol style="list-style-type: none"> 1. Modular instruments. 2. Terminal (POS, data collection) system controller. 3. Network of remote sensors, interpretation and communication to larger host computer. 4. Modular data collection device with display. 5. Scientific computer network or minicomputer emulation. 6. General-purpose controller/processor applications. 7. Multiprocessing system or dedicated support system. 		
Combinations used <ol style="list-style-type: none"> 1. Local I/O (I) and processing (III). 2. Local I/O (I), concentration (II), and remote I/O (IV). 3. Local I/O (I), processing (III), and remote I/O (IV). 4. Local I/O (I), concentration (II). 5. Local I/O (I), concentration (II), processing (III). 6. Local I/O (I), concentration (II), processing (III), and remote I/O (IV). 7. Remote I/O (IV), concentration (II) and/or processing (III). 		

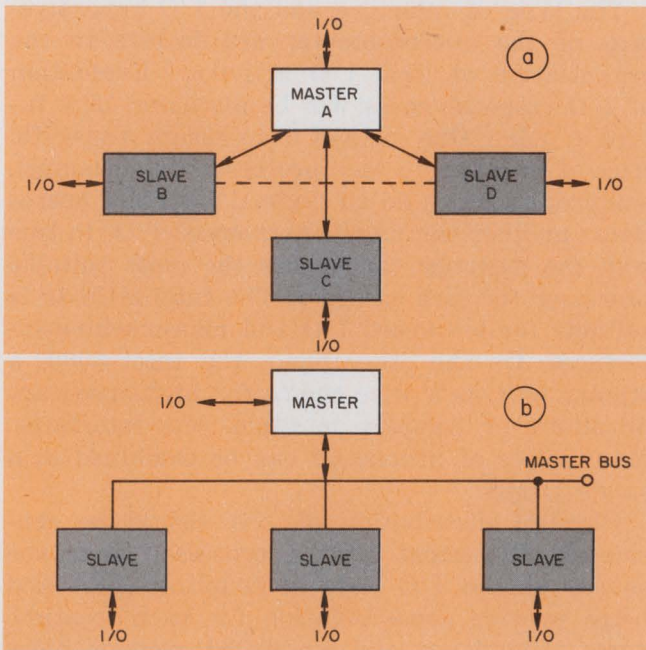

3. The master/slave system is an hierarchy in which slave processors communicate with one master. Polled or interrupt-driven systems tend to use radial busses (a); otherwise a common bus is the rule (b). Such systems emphasize high information transfer rates.

occur in line concentration for POS (point-of-sale) terminal devices, multiterminal key-to-tape and key-to-disc systems, and scientific data accumulators.

Information processing, the third activity, is a classic computer function. The processor accepts data, interprets it and outputs the final results. Typical activities include: information routing, arithmetic operations, and system diagnostics. The designer can split these tasks between processors to select the one best suited to each function. A single arithmetic processor with information routing split among several processors is quite common.

In larger systems, a separate processor can be used for system diagnostics. System testing can be performed during idle times at power-on or by an internal timer. Low cost ensures commercial acceptance. How low? The MCS-40, with 1 kbyte of program and a clock chip, sells for \$29.95 in quantity.

The fourth function, the remote-communications section of the system, disseminates information to destinations outside the system. These destinations can be another DIMS or a larger host computer. The communications link and message frequency determine the resources that should be dedicated. The communications function can be carried out either with a dedicated processor in the DIMS or combined with the concentration or processing activities.

Remote I/O considerations are as follows:

- Parallel or serial interface.

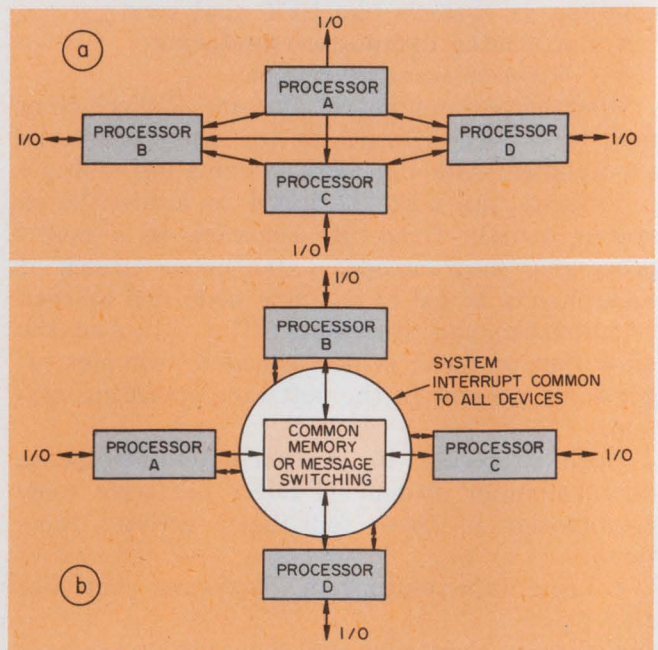

4. The master/master system affords a high degree of independence to each processor. Communications-based systems use individual links (a). Microprocessor-based systems are easy to design for common-memory message exchange (b).

- Single or multiple ports.
- Synchronous or asynchronous.
- Baud rate.
- Communication link.
- Information block size.
- Simplex, half-duplex or duplex.
- Dedicated or common bus.

The remote I/O interface can be treated just like any other I/O interface, in terms of activity-rate calculations.

Two basic configurations

Processor organization or configuration depends to some extent on factors like these: number of I/O ports and their location; type of I/O ports and activity rate; type of processing required, and microcomputer cost-performance characteristics.

Two basic organizations used are master/master and master/slave. Either organization (or any other) can perform the four basic DIMS functions.

The master/slave arrangement imposes a rigid hierarchy on subsystem components (Fig. 3). All slave processors communicate to a single master, which acts as either a concentrator or information switcher assigned to control the subsystems' communication activity. An instrument with several "plug-ins," all of which require the attention of the instrument mainframe, is a specific example. The mainframe is the master and the plug-ins are the slaves.

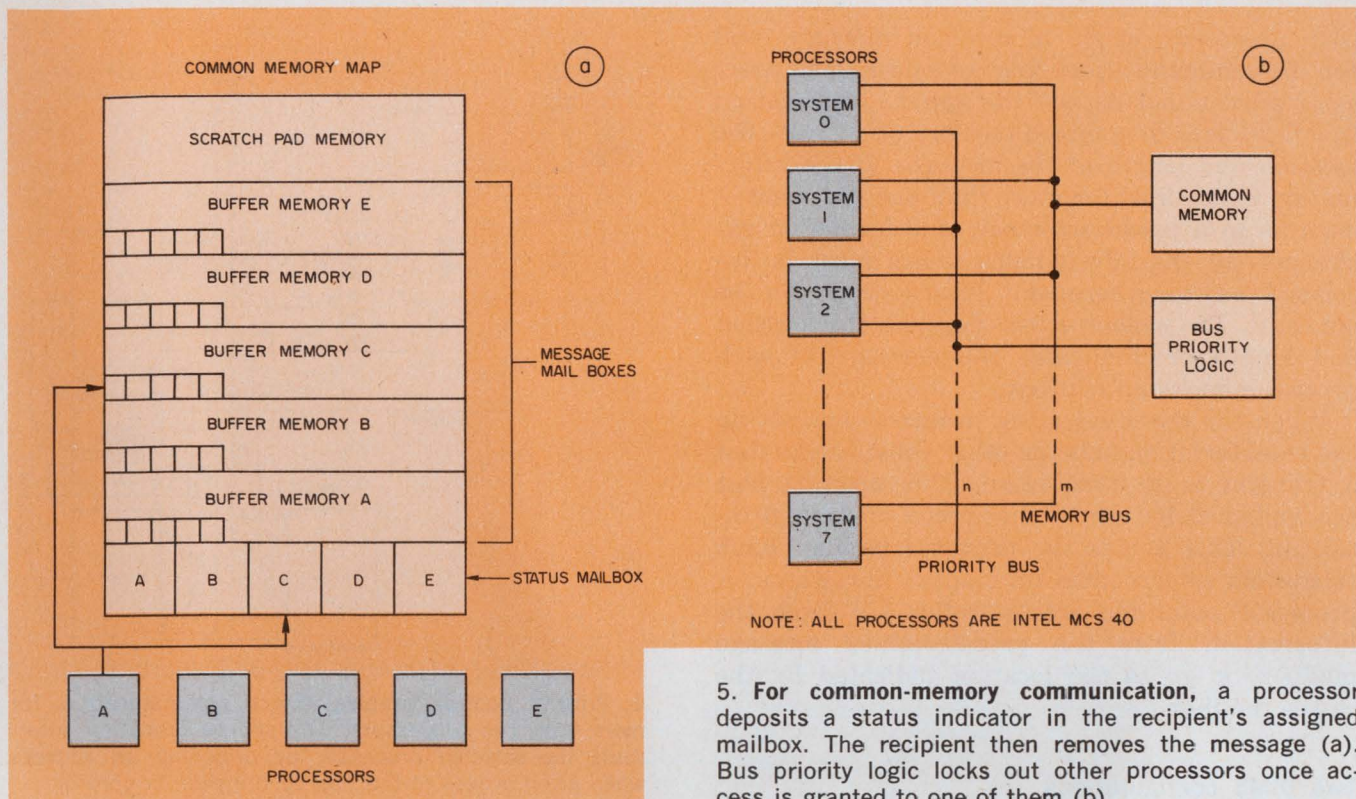

5. For common-memory communication, a processor deposits a status indicator in the recipient's assigned mailbox. The recipient then removes the message (a). Bus priority logic locks out other processors once access is granted to one of them (b).

The master/slave DIMS lends itself well to systems where there is a high degree of information transfer and I/O (Fig. 4). Data-collection networks, instruments with intelligent plug-ins, POS terminal networks and certain process-control systems are only a few applications that exhibit the high information transfer and high I/O activity level. In these applications, the slave microcomputers pass the I/O to and from the master. There the data are concentrated and/or processed and sometimes forwarded for external communication. Information can be transferred from microcomputer to microcomputer, either directly via a common bus or radially with a dedicated bus. The information flow is usually directly between elements, rather than through the common-memory scheme that is associated more closely with a master/master system. When a slave requests the attention of the master, the master—at some point based on a priority—grants the request. It then sets up the information route from the slave to the master or from the requesting slave to another destination slave.

The number of slave microcomputers per system is a function of the I/O capacity of the system and the distribution to maintain an efficient information throughput. Other considerations, such as the degree of physical integration desired and packaging cost of the microcomputer, are also relevant.

In a master/master system, communication between elements is less frequent and more formatted or refined than in a master/slave system.

Communication between elements is predetermined by each master. Each master is more inclined to perform a higher degree of dedicated activity associated with a particular system entity. A master processor contacts the other processor or processors with which it needs to communicate. This communication can be direct or via a common bus. Access to the communication bus is on a priority basis, arbitrated by a common logic tree usually located within the common memory or at some central location (Fig. 5).

Master/master systems are now becoming more popular than master/slave. They can be used in multi-instrument test systems where a separate processor controls each instrument but passes results to a central processor for final summarization.

Common-memory information transfer

Most commercially available microcomputers lend themselves to an arrangement where all information transfer proceeds through a common memory added to the I/O portion of the processor.

Each processor gains access to common memory by some fixed priority scheme to avoid bus conflicts. A processor that gains access to the common memory locks out all the principals. By depositing a status indication in the respective processor's mailbox, the sender indicates to which processor it wants to communicate a message. A "mailbox," or status, character, associated with

each processor, exists in common memory used for the communication. The communicating processor must either deposit the specific information in a fixed area of common memory or indicate the location and length of the message. If the information is destined for more than one processor—such as in a broadcast mode of information exchange—all the affected processors must be informed as to where the information can be obtained. The sender either deposits the location and length or duplicates the message in each processor message mailbox.

When the communicating processor has set up the transfer, it signals the other constituents that a transfer is to take place. This alert is best accomplished by use of a common on-system interrupt. This avoids the need for polling. Each subsystem interrogates its mailbox for status. A processor obtaining active status will fetch the information from the predetermined message mailbox or go to the location indicated by the status mailbox.

Two DIMS configurations

A distributed-intelligence microcomputer system (DIMS) can be fabricated with the MCS-40, as shown by two possible configurations.

A two-processor, direct-communications system is implemented just by connecting the I/O ports of the MCS-40 together. Each processor generates an interrupt when it wants to communicate. Control status and data are derived from the I/O ports. The I/O ports can be either those of the 4308 ROM, 4207, 4209, or 4211 general-purpose I/O device, or the 4225 programmable I/O device. This technique can be used to transfer words of any length. The length should be selected to minimize cabling and interface costs.

If more than two systems are joined with this technique, a bus-arbitrator scheme must be implemented (Fig. 6). This will allow one processor to be designated as the source, or sender, device. The source device will then select its destination. The destination selection can be accomplished by use of either a hardware or software technique. The hardware technique requires that the source device interrupt selectively the processor or processors with which it wants to communicate. The software approach requires that the source processor interrupt all system processors in a broadcast mode. Simultaneously the source processor places a destination address on the common bus. This address is interrogated by all system processors and compared with an internal programmed address. The processor with a successful match is designated to receive the data.

For common-memory communications, a block of memory is designated common to all system processors. Information is transferred via this

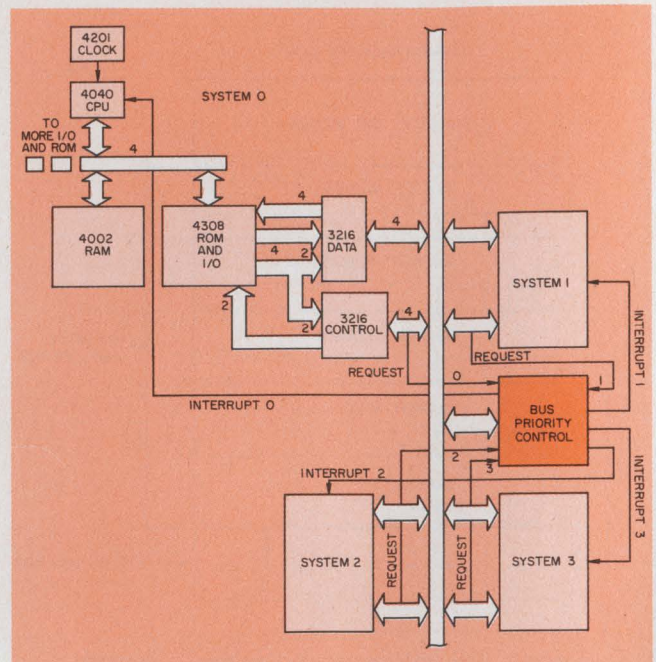

6. Priority control enables direct communication for more than two processors. The source processor interrupts the selected processor by providing an address when given access to the bus by the priority control.

memory from processor to processor. This technique allows the source processor to load the common memory with the information and inform the destination processor of the message. The destination processor obtains the information without the attention of the source processor. Hence, the transfer is more asynchronous than that of the previous technique.

All subsystems are attached to a common memory bus that consists of ten bits of address, four bits of bidirectional data and two control lines (Fig. 7a). Only one system is allowed to be active on the bus at any one time. Systems have access to the memory for a *block* transfer rather than a *word* transfer. Access to the memory is granted via fixed priority. Only when a system is given a bus grant will it attempt to access memory; all other systems are locked out. When a system is granted access to the bus, the 4265 will be removed from a floating output state to an active memory access state (Mode 0, Option 1). Information will be transferred.

The system granted will maintain the bus until the bus request is removed and a Clear Bus signal is generated. Limits on how long any one user can access the bus may be established. If a user hangs on to the bus past the limit, which indicates a failure, the system can be removed from the bus. This is accomplished with a reset that frees the bus. The reset does this by placing the 4265 into a floating mode. Hence other systems can access the memory. The Bus Priority Network prevents any higher priority devices from taking over the bus once it has been acquired.

The basic subsystem consists of a minimum of

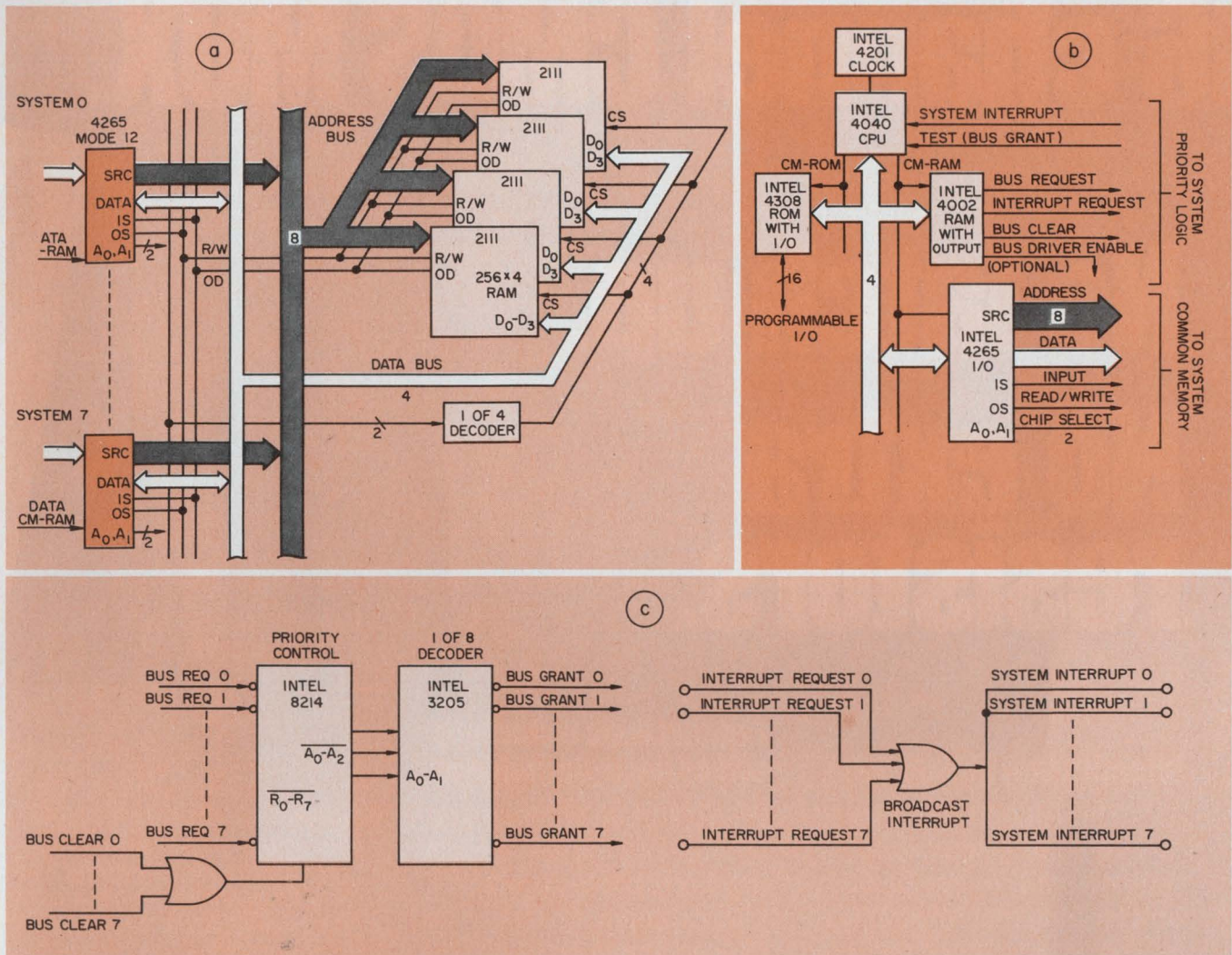

7. A common memory bus serves all processors in this common-memory hookup (a). Each processor consists of five packs (b) that connect to the memory system and to

an Intel 4201 system block, a 4040 CPU, a 4308 ROM (1 k × 8) with I/O, a 4002 RAM with outputs and a 4265 programmable I/O device (Fig. 7b). The 4265 is assigned as the common-memory interface. The 4002 output port is used to access the bus to provide interrupt activity.

The common memory consists of an array of 1024 × 4 bits, composed of four Intel 2111 RAMs. This memory is expandable with additional logic. All systems are attached to the memory on the common bus.

The Intel Priority Control Unit (8214) samples and holds the current request until it is cleared by a Bus Clear signal, which is generated by the bus-relinquishing subsystem. The bus request of the relinquishing subsystem must be reset prior to the Bus Clear (Fig. 7c).

When one processor wants to talk to another processor, it will first request access to the bus. Then it will load a status character in the mailbox associated with the processor to be communicated to. The communicating processor will place the message in a predetermined location in com-

mon memory. When common memory has been loaded, the communicating processor will generate an interrupt for a fixed length of time and relinquish the bus. All processors will eventually access the bus to check their mailboxes for status. The processor that finds an active status character will transfer the information to its local memory and extinguish the status character and relinquish the bus.

The scheme described above illustrates communication via a broadcast system interrupt to which all processors respond. With the addition of source and destination hardware, only the processor destined to receive the information need be interrupted. ■■

References

1. Farber, D. J., and Henrich, F. P., "The Distributed Computer System," CompCon '73, February, 1973, pp. 31-34.
2. Ravindran, V. K., and Tomas, T., "Characterization of Multiple Microprocessor Networks," CompCon '73, February, 1973, pp. 133-135.
3. Davidow, W. H., "General Purpose Microcontrollers," Computer Design, July, 1972.

16 channel CMOS MUX.

No latch up.

No extra resistors.

Intersil's new IH5060/5070.

The IH5060 multiplexer is a 16 channel plug-in replacement for the DG506 and HI-506A. The IH5070 is an 8 channel differential multiplexer, a plug-in replacement for the DG507 and HI-507A. Both new Intersil devices eliminate design headaches the others have.

Floating Body technology solves latch-up problems.

Latch up is eliminated by Intersil's exclusive Floating Body process, which also protects against over-voltages up to ± 25 volts minimum. It does this by electrically floating the bodies of the N-channel and P-channel MOS-FETs forming the analog gate of the multiplexer.

Lower ON resistance doesn't attenuate signals.

The Floating Body process does away with need for current-limiting resistors, either off- or on-chip. Result is far lower total ON resistance—400 ohms max for the mil-temp model, 450 ohms max for the commercial. So you get much less system signal attenuation.

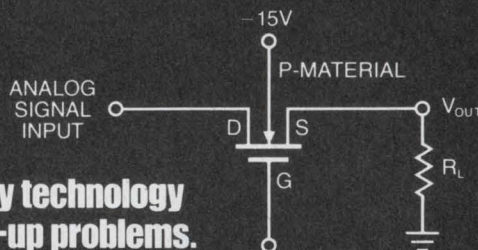

Figure 1. In other technologies, when either power supply is off (at ground), even momentarily, and there is an analog signal present, high current flows, causing latch up and possible destruction of the device.

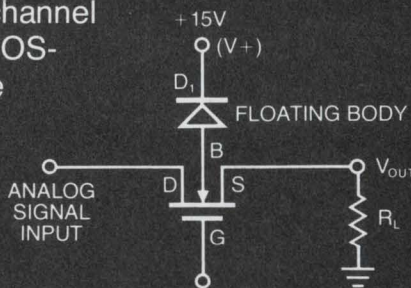
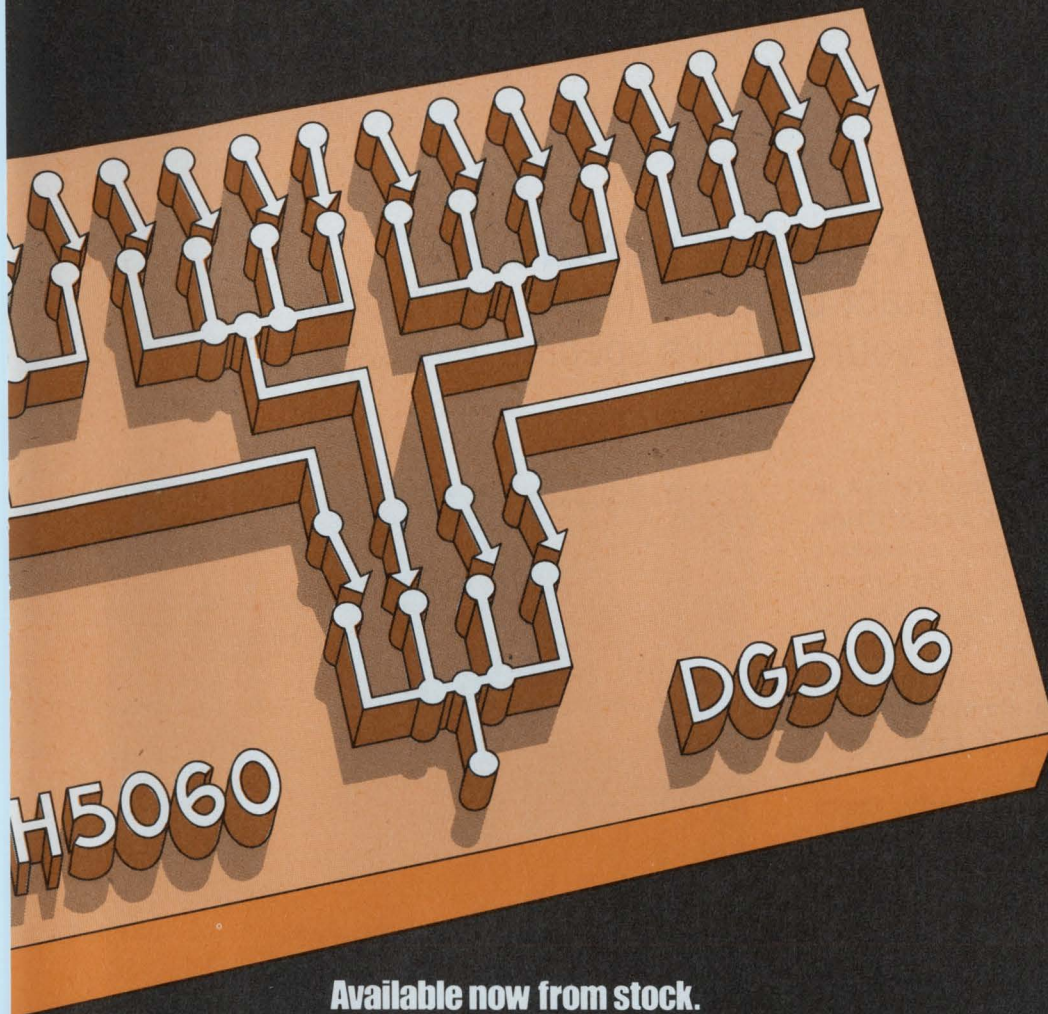

Figure 2. Intersil's Floating Body process, U.S. Patent pending, eliminates latch up with a diode between the FET bodies and their power supplies. For a detailed explanation, send for Application Note A006, "A New CMOS Analog Gate Technology."





Available now from stock.

MUX	Type	Package	Price (100+)	
			-55 to +125°C	0 to +75°C
IH5060	16 channels	28-pin DIP	\$55.00	\$28.00
IH5070	8 dual chs.	28-pin DIP	55.00	28.00

Because they're CMOS devices, supply current drain is the lowest available for this type of product: For mil-temp units, 100 μ A from the negative supply, 200 μ A from the positive; for commercial units, 1mA from each supply. And unique Intersil two-tier design reduces circuit output capacitance to less than 40pF, and makes expansion to 32, 64 or more channels very simple.

From the company that makes almost 200 separate types of semiconductor analog gates and over 25 different CMOS switches. Intersil, 10900 North Tantau Ave., Cupertino, CA 95014.

Part of the distinguished Intersil family of alternate source CMOS switches.

PART NUMBER	TYPE	R _{ON}
DG 181	Dual SPST	30 Ω
DG 182	Dual SPST	75 Ω
DG 184	Dual DPST	30 Ω
DG 185	Dual DPST	75 Ω
DG 187	SPDT	30 Ω
DG 188	SPDT	75 Ω
DG 190	Dual SPDT	30 Ω
DG 191	Dual SPDT	75 Ω

Intersil



Get 'em here.

Intersil stocking distributors.

Arrow Electronics,
N.Y., Minn., N.J.,
Conn., Md./D.C.
Elmar/Liberty Electronics.
Kierulff Electronics, Mass.
Schweber Electronics.
Semiconductor Specialists.
Weatherford.

Intersil area sales offices.

Boston (617) 273-2055.
Chicago (312) 371-1440.
Dallas (214) 387-0539.
Los Angeles (213) 532-3544.
Minneapolis (612) 925-1844.
New York (201) 567-5585.
San Diego (714) 278-6053.
San Francisco Bay Area
(home office) (408) 996-5000.
Upstate New York/Canada
(315) 463-3368.

Representatives in all major cities.

Switching contacts causing problems?

Look into the details of contact behavior. Maximum ratings don't tell what happens at your circuit's specific levels.

The metallic contact in switches and relays is much abused. The way most specs are written by manufacturers, you might expect a contact with a maximum rating of 28 V, 5 A dc to perform superbly at 30 mV and 10 mA. Not so. You might be misled into thinking that tarnish-resistant gold contacts, because they operate well at millivolt and milliamp levels should offer no problems at 28 V and 5 A. Wrong again. Gold erodes rapidly above about 0.5 A.¹

To apply switches and relays properly, users must understand how contacts conduct, the different modes of arcing, and material behavior under various electrical loads. Otherwise poor performance and short contact life are inevitable.

A first step in understanding the phenomena is to define the load levels that contacts carry. The available load energy—and hence the temperature of the contacts—ultimately determines the life of a pair of contacts. But, of course, other parameters such as contact material, spacing, size, speed of movement, and atmospheric pressure and cleanliness are involved.

Loads are usually referred to as dry, low, intermediate and high. Each can be defined in terms of the contact temperature. Let's look at them:

- Dry circuit—Frequently and erroneously used as a synonym for low level, to connote very-low-energy-level switching.¹ More precisely, a dry circuit denotes switching in which the dry contacts do not make or break a load of any kind. Thus no arc is drawn, and contact heating is minimal. Note, however, that there is no restriction in the definition on the amount of current carried by dry contacts. But because the current may be very low and contact operation is under zero-current switching, contacts—such as gold—that perform well under low-level loads must be used.

- Low level—Loading in which the energy at the contacts is insufficient to dissipate contact films or to change the contact geometry or chem-

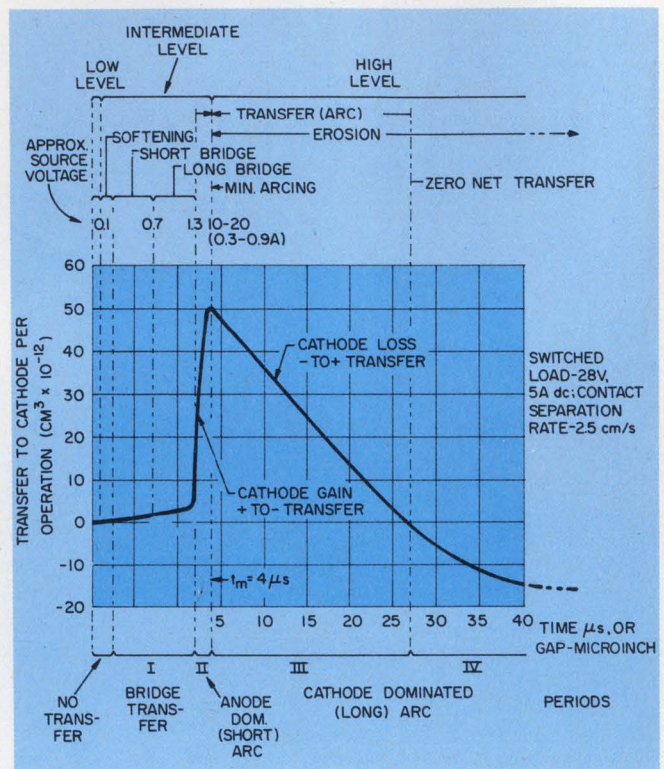

1. Material is transferred between contacts during switching. As the contacts separate and heat up, they first act as if they were carrying a low load, then an intermediate load and finally the full high-level load.

istry at the contact interface. There is no softening of the contact material. The softening-voltage limit for gold is about 0.08 V. Softening occurs when a temperature of roughly 100 C is generated. Current is conducted by a tunneling process. Dynamic contact resistance is usually about 30 Ω.

- Intermediate level—Energy levels that can raise the temperature of the contact material at the interface to soften and melt it.

- High level—Levels (also called power levels) at which contact material boils and produces long arcs, with heavy erosion of contact material.

Examination of switching phenomena

What happens when a relatively large resistive load—say 28 V dc, 5 A—is switched with a pair

R. Max Adkins, Engineering Manager, WABCO, Batesburg, SC 29006.

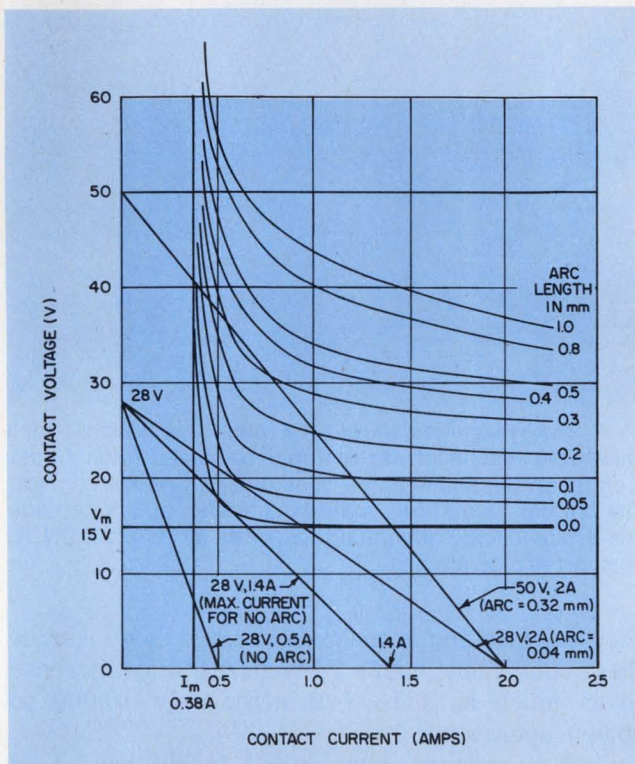

2. A family of arc-length curves for contacts helps establish the load limits for the intermediate/high-level load conditions. Voltage and current lines V_m and I_m , determine the maximum values for the zero, or short-arc mode.

of gold contacts? As the contact-pair parts, material is transferred from one contact to the other. The sequence of events illustrates contact behavior through all energy levels.

In Fig. 1, the contacts part at the rate of 2.5 cm/s. During the first few microseconds, there is almost no contact material transfer, as if only a low-level load—source voltage of less than 0.1 V—is being switched, because the contacts have not yet had time to heat up. Later in the switching cycle, contact temperatures rise and conform in sequence to values that would be generated first by intermediate and then by high-level loads. The top part of Fig. 1 shows regions equivalent to the different source-voltage loads, together with the corresponding physical state of the contact interface.

For source voltages between 0.1 and 0.4 V

temperatures of 100 to 1063 C are generated and the contact interface softens. Still little material is transferred between contacts; the metal is only softened, not melted.

Softening enhances the process called “fritting,” which produces minute quasimetallic contacts through tiny ruptures in any intervening contact film. In this voltage range, the electric field is then strong enough to force normal electron conduction across these metallic-contact interfaces. The over-all result of electron conduction is a much lower contact resistance—tens of milliohms instead of ohms—than at low source-voltage levels, where conduction is by the tunnel effect. In addition, the contact resistance tends to remain relatively constant over the life of the contacts, since transfer and erosion are minimal.

As the load energy region equivalent to 0.4 to 1.3 V is reached, the contact interface material melts and material, or “bridge,” transfer occurs. A very small amount of material transfers from the anode to the cathode contact each time the contacts part. A crater forms on the anode and a pip on the cathode.

Bridge transfer produces two detrimental effects: sticking or locking of pip and crater, and degradation of dielectric strength across the open contact—because of a narrowed gap. However, below 1.3 V, the rate of material transfer is still quite small and long contact life is usually obtained.

For still greater loads—in the 1.3 to 15.0 V range—boiling of gold contact material occurs, because temperatures of over 2800 C are built up.

Short arcs for intermediate loads

Arcs result from this intense heat at the contacts and consequent boiling of the material. Arc temperatures are typically about 3500 C.

When the source voltage exceeds approximately 1.3 V, but the load line does not intersect the contacts’ VI (voltage-current) characteristic curve for the material’s zero-arc length, a so-called short arc is formed at contact break (Fig. 2). The short arc, sometimes called a spark, is very small and nearly invisible.

The upper limit of the short-arc condition, or critical short arc, produces the maximum allowable rate of contact material transfer without causing significant erosion of the contacts to provide self-cleaning. Maintenance of this limit is most important with intermediate-level loads. Contact performance can be substantially altered after only a few operations if the load-line limit is exceeded, since at this critical point there is a tremendous increase in net anode-to-cathode material transfer for a small rise in source voltage.

The VI-characteristic hyperbola curve that constitutes the upper limit for the short-arc condition is the lowest curve in Fig. 2. This is the power-level curve for arc lengths equal to zero. Only short arcing occurs over most of the area below and to the left of this curve. Thus, for gold, only a short arc is produced when the load is to the left of the asymptotic current line, I_m (equal to 0.38 A dc or peak ac) regardless of the voltage, or when the source voltage is less than the V_m line (15 V dc or peak ac) regardless of the current.

In addition, the load line drawn for 28 V and 1.4 A produces only a short arc, since it is also tangent to the limiting curve for short arcing. But because there is always a small amount of inductance in any resistive load circuit, the 28-V and 0.5-A load line is more realistic as a short-arc limiting value.

To illustrate that the term "short arc" really means a very short arc consider the relationship²

$$S_{cr} = T + vt_m,$$

where S_{cr} is the critical arc length, T is the thickness of the cathode layer across which the limiting source voltage appears, v is opening velocity of the contacts and t_m is the time at which maximum cathodic material gain occurs after the contacts start to open (see Fig. 1).

Typical values are:

$$\begin{aligned} T &= 5 \times 10^{-8} \text{ m,} \\ v &= 2.5 \times 10^{-2} \text{ m/s (Fig. 1),} \\ t_m &= 4 \times 10^{-8} \text{ s (Fig. 1).} \end{aligned}$$

For these values, S_{cr} is about 15×10^{-8} m, or 5 microinches. This maximum short-arc length is extremely small.

The available energy at intermediate loads is sufficient to break down the initial volatile surface contaminants, which then combine with the contact material. Continuous build-up of this contaminated material results in high, erratic contact resistance.

The adverse effects are maximum when gold contacts switch between 0.1 and 0.5 A at 28 V dc. Also, the effects are aggravated when the switch or relay operates near its maximum rated temperature and in proximity to a second contact

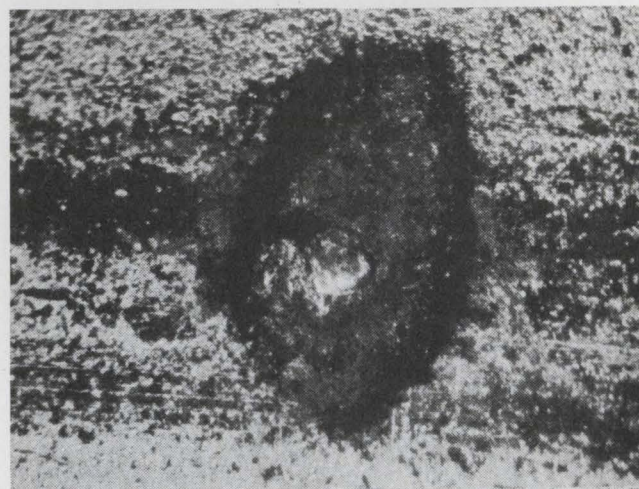
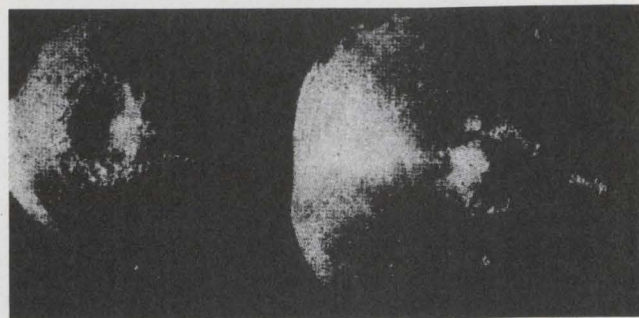

3. A 25 \times magnified view of a pair of contacts (top) shows the results of arc material transfer, which forms a crater on the anode and a cone on the cathode contact. The bottom view shows material transfer to the cathode and accumulated contaminant deposits at 28 V dc, 0.1 A, or short-arc conditions.

that is switching a maximum rated load. Under these conditions, contact resistance may increase to as much as 1 to 3 Ω after only 10,000 to 20,000 operations.

Gold is perhaps most suited to low-level load use. To ensure that gold contacts do not soften, and that they therefore operate in a truly low-level mode, test conditions are usually limited to approximately 30 mV dc, or peak ac, and about 10 mA. In general, test currents should be as low as possible within the capability of the monitoring equipment. And care should be exercised in testing so that stray inductances do not invalidate the test by creating appreciable peak voltages at a contact break.

Low-level tests are often used to detect particulate contamination of contacts. And in combination with the use of high and low temperature cycling, these tests also can determine the presence of moisture and other volatile contaminants in hermetically sealed relays.

High-level loads produce long arcs

An increase in voltage and current to high, or power, levels (10 to 20 V) produces long, or regular, arcs, intense boiling and supertempera-

tures in the order of 4000 C. This long arc now starts reverse material transfer—from cathode to anode—and a very rapid loss of material to the surroundings.

Though the chart ends at 40 μ s, the high-level load of 28 V dc and 5 A produces an intense arc that persists for several milliseconds. During this interval, rapid erosion and pitting of the cathode takes place with the gradual formation of a cone on the anode and a crater on the cathode contact (Figs. 3 and 4).

The family of curves above the zero, or critical-arc-length, curve (Fig. 2) represents high-level, or power, switching conditions. For example, the load line shown for a 28-V and 2-A resistive load produces an arc 0.04-mm long. The load line is tangent to the curve representing the 0.04-mm value. The arc length for the 50-V, 2-A load is about 0.32 mm. Of course, inductive loads can produce high voltages on contact break. This results in longer, more intense arcs. Therefore, as the inductance increases the current rating of the contacts must be reduced.

The arc length and intensity determines the rate of the contact material's dissipation to the surroundings. Some erosion is beneficial, because it produces self-cleaning and low, stable contact resistance. However, detrimental effects also eventually follow because of the gradual loss of contact pressure and wipe action. Also the dissipated material is deposited on insulators and causes a deterioration of their dielectric strength and resistance.

These undesirable effects can be minimized by the use of erosion and transfer-resistant materials such as silver-cadmium oxide, silver-magnesium-nickel, tungsten or silver-impregnated carbon (but not gold) as contact material for high-level loads. And the use of barrier structures in the insulator configuration can help block and absorb contact-material deposits.

However, when a transfer-resistant material like silver is coated with a substantial layer of gold, some recent experience indicates that both high and low levels can be handled. At low levels, the gold provides a proper set of contact interfaces. And at high levels, the gold may not disappear, but may combine with the base metal to form a gold enriched area, which should be suitable for subsequent low-level switching. But an intensive investigation into this area of high-low contact use is needed before firm data are available. ■■

References

1. National Association of Relay Manufacturers, "Engineers' Relay Handbook," Revised Second Edition, Hayden Book Company, Inc., Rochelle Park, NJ
2. Holm, Ragnar, "Electrical Contacts, Theory and Application," Fourth Edition, Springer-Verlag, New York.

A GOLD MINE OF INFORMATION & DATA

- **520 CATALOG PAGES ON ICs & SEMICONDUCTORS**
- **300 CATALOG PAGES ON INSTRUMENTS**
- **290 CATALOG PAGES ON POWER SUPPLIES**
- **210 CATALOG PAGES ON WIRE & CONNECTOR PRODUCTS**
- **150 CATALOG PAGES ON SWITCHES**
- **2800 CATALOG PAGES ALL TOLD IN 52 PRODUCT CATEGORIES**

Electronic Design's GOLD BOOK puts the entire electronics industry at your fingertips. Use it for product search, selection, specification and purchase. It's the most thorough industry master catalog & directory ever compiled.

When you need information . . .

**Electronic Design's
GOLD BOOK
IS THE PLACE
TO LOOK**

Temp control improved in Gunn oscillators

Two new techniques for the temperature compensation of Gunn oscillators are reported to provide mechanical stability and reliability even under heavy vibration conditions. The techniques were developed at the Allen Clark Research Center of the Plessey Co. in England.

Temperature compensation is required because when Gunn diodes are used in microwave oscillator cavities, it is difficult to obtain frequency stability simply by use of low-expansion material in a high-Q cavity. Transient temperature changes produce a "chirp" of the rf pulse in these diode-driven oscillators.

The research center's first compensation technique uses an Invar reactive tuning stub that enters the cavity at a region of maximum rf field. Invar does not expand significantly with temperature,

but the stub is supported externally by a high-temperature-coefficient material, such as Perspex. Expansion of the Perspex varies the amount the stub protruded into the cavity, thus retaining a stable frequency with temperature variation.

The second Clark technique compensates for large frequency changes, such as 100 MHz, over a 110-C swing. It is suitable for use with multidiode cavities. The cavity is formed from special rectangular waveguide with side-walls of metallized Perspex. The walls are free to expand inward as the temperature rises. These dimensional changes in the waveguide cross-section compensate for the effect of temperature change.

Experiments at 14 and 9.3 GHz, respectively, have confirmed the usefulness of the two methods of compensation, the Clark center says.

Flat cable reduces channel interference

Interchannel interference in a multiconductor cable has been substantially reduced at high frequencies by construction of the cable from flat strips.

The flat-cable design, developed by the Dept. of Electrical Engineering at Eindhoven University in the Netherlands, places the conductors in the same plane between the ground shields (see figure for cross-sectional view).

The coupling between neighboring strips is small, and between nonadjacent strips it is negligible.

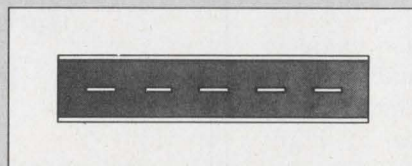

If the flat conductors are made as thick as the skin depth for the highest-frequency components of the signal, the cross-channel interference is reduced, the university reports.

Stored program control used for data switching

A new electronic Telex and data-switching exchange that uses stored-program control has been introduced by the L. M. Ericsson Telephone Co. of Sweden. The exchange, developed jointly by the Swedish Telecommunications Administration and L.M. Ericsson, features a new computer intended also for use in Ericsson's exchanges.

The switching method is based on time-division-multiplex techniques, which drastically reduce space and power requirements. All vital parts in the exchange are redundant for maximum reliability. Many maintenance functions are carried out automatically.

The exchange offers subscribers a variety of advanced features, such as automatic multi-address calls, abbreviated dialing and keyboard selection. The first exchange of the new type has been ordered by the Swedish Telecommunications Administration for installation in Malmö and will be put into service in 1977.

Schottkys prove stable in far-infrared ranges

Schottky diodes can be used as stable mixers for sources in the far-infrared ranges, according to experiments at the Universite Pierre et Marie Curie in Paris.

Detector performance was successfully checked in a setup using 100 gallium-arsenide Schottky diode elements with the following characteristics: 5- μm diam, an f_{co} in the region of 1000 GHz, capacity of 0.03 pF and resistance R_s of 6 Ω . The 100 diodes were integrated on a single substrate. The output contact was a 7- μm diam tungsten wire electrochemically tapered to a point.

Tests were carried out by directing the beams of two stabilized CO₂ lasers onto an individual Schottky diode. The beat-frequency voltage was stable and was easily observable. A CO₂ laser infrared beam was focused onto the diode array, and the fundamental infrared energy was detected. Detector output of 1 V per watt of incident power was obtained.



comp killers

**Our carbon film resistors knock composition dead.
On price...on performance...on delivery.**

Our 5% carbon film resistors priced at less than you pay for 10% carbon composition... on the shelf for immediate delivery. No wonder we call them the "Comp Killers."

Mepco/Electra CR series carbon films give you performance and reliability unmatched in any resistor at comparable low price. For example: temperature and time stability that's close to metal film. Low temperature coefficient. Low noise. Excellent immunity to environmental and electrical stress. They're compact, too, with a rugged design well suited for automatic insertion.

Take your pick of $\frac{1}{8}$, $\frac{1}{4}$ or $\frac{1}{2}$ watt power rating, 5% tolerance, 1 ohm to 1 megohm resistance range. Prices significantly lower than composition, plus

immediate delivery.

Start fighting inflation today/order today "The Comp Killers" from Mepco/Electra.

If it sounds too good and you want us to prove it, call or write the Carbon Film Marketing Department for the "Comp Killer Kit" from Mepco/Electra, Inc., Columbia Road, Morristown, New Jersey 07960 (201) 539-2000.

**Talk to the
man from
MEPCO/
ELECTRA**

M/E
MEPCO/ELECTRA, INC.
COLUMBIA ROAD, MORRISTOWN, N.J. 07960



Plant Locations:
Morristown, New Jersey; San Diego, California; Mineral Wells, Texas; Canandaigua, New York; Pleasant Hill, California.

INFORMATION RETRIEVAL NUMBER 75

Send for this new brochure
by the originators of Solid-State
Photo-Isolated Power Relays.

It details the widest line available
and how to apply them.



**Think
Crydom...
The Pacesetters.**
"First and widest line in the field"

INTERNATIONAL RECTIFIER



1521 Grand Avenue, El Segundo, CA 90245 • 213/322-4987

INFORMATION RETRIEVAL NUMBER 76

TO: International Rectifier CRYDOM Division • 1521 Grand Avenue, El Segundo, CA 90245
Please send your brochure on Solid-State Photo-Isolated Power Relays to:

Name _____
Title _____
Company _____
Address _____
City _____
State _____
Zip _____
Phone _____

All 10-turn pots look alike

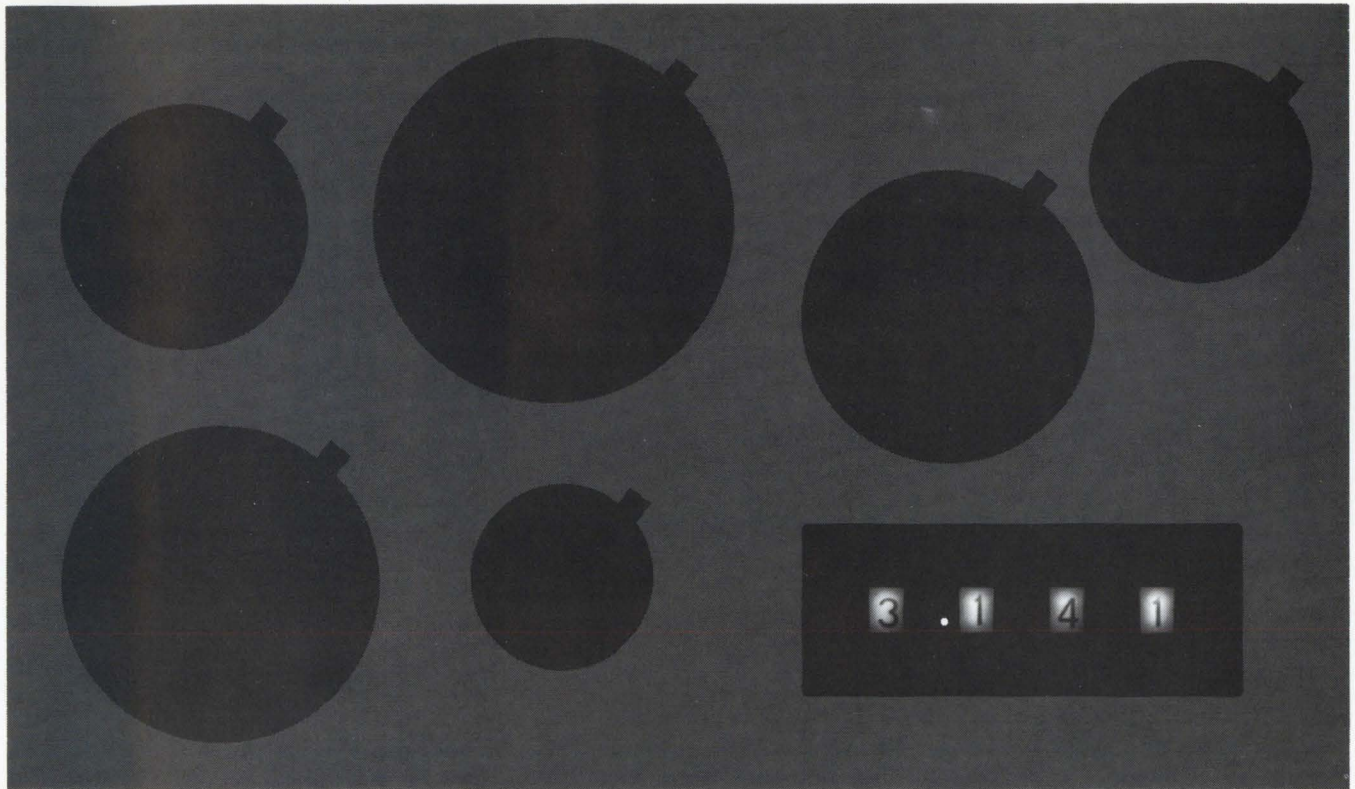

in the dark.

In the dark they're all unreadable. And if you're more than three feet away, you can't even read them in the light.

Ergo our new Thumbpot. It can be illuminated to read in the dark (above), and the numbers are large enough to read 10 feet away.

In addition you can set in those numbers rapidly with finger or thumb. And you can reset any number right on the button, exactly.

The reason for these superior features is that Thumbpot is not a pot. It is an incremental voltage divider. A switch. A switch specifically designed



to replace panel-mounted 10-turn pots.

Because Thumbpot is really a switch, it affords some other advantages. It is available in two sizes, with 1, 2, 3 or 4-digit readout, with or without a fixed or floating decimal point, in more than 400 standard versions. And its design is inherently more reliable and longer-lived than that of 10-turn pots.

There's much more to Thumbpot than we can cover here, however, so we urge you to request our brochure, by mail or telephone.

Thumbpot. No look-alike.

EECO

FOR SWITCHES

1441 East Chestnut Avenue, Santa Ana, California 92701
Phone 714/835-6000



Also available from Hall-Mark



G. S. Marshall



Schweber

INFORMATION RETRIEVAL NUMBER 77

HAYDEN BOOK COMPANY, INC.

50 Essex Street, Rochelle Park, New Jersey 07662



An Open Letter To Manufacturing Managers.

Are you putting off reliable and promising systems innovations because of the money involved? Or the time? Or maybe because of the painful "people problems" you can foresee?

You probably face these problems constantly because as systems technology expands, it demands radically new talents and skills from management.

Recently, professionals from industry, education and government met for the 10th annual symposium co-sponsored by Informatics and UCLA. Their goal? To bring *clarity* and *profitability* to today's new manufacturing methods—for you, the manager.

Now we have compiled the proceedings into a compact management handbook, called **MANUFACTURING MANAGEMENT SYSTEMS: New Challenges and Profit Opportunities**. As a manager, you couldn't ask for anything more.

This handbook is the symposium and *more*. We've cut away all the extras—the repetitions, the mumblers and the chit-chat—leaving you with the clear and uninterrupted essentials.

The result is an unparalleled, personalized handbook of guidelines, solutions and solid information from some of the nation's most successful industrial leaders.

You'll hear the vice-president in charge of technical affairs at Ford Motor Company tell how an American institution computerized its vast and complex production lines (and battled equally monstrous supplier foul-ups, record problems, etc. along the way).

An executive from a major R & D firm outlines what he has discovered to be the vital managerial skills and essentials for directing progressive operations.

One of Informatic's key men spells out some of the latest and most worthwhile computerized tools available to manufacturers.

The president of a manufacturing firm offers 16 pages of realistic guidelines for handling the sensitive problems of system implementation (without any of the current psycho-social jargon).

There's one corporation president whose share of this handbook is frankly titled "Making Sure You Really Get a Payoff From Your Manufacturing System." It amounts to nothing less than a proven master plan for doing just that.

There are ten sections in all, each one more helpful and informative than the next. Every page is sharp and direct, yet conversational, as if it were being spoken. For the manager, there's a perfect balance of technical information and the wisdom and common sense for using it.

You can now examine, read and use the handbook free, for 15 days, just by circling the information retrieval number shown below. At the end of that time, just send in a check for \$10.50, plus postage and handling, or return the book with no further obligation.

You won't run across many opportunities to hear this kind of straight talk. Try to imagine a symposium where you sit right up front and write down every single word because you know you can use it all.

P.S. Remember—it's easy to order. Just circle the *Information Retrieval No.* shown below!

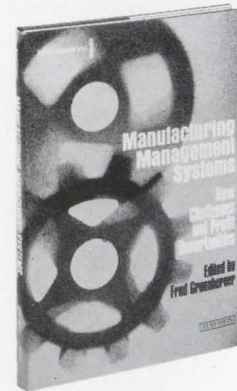

TO ORDER, CIRCLE 96

The Inner-Vator... there's one in every crowd.

You know the type . . . always into everything . . . making things happen. At Glowlite, we're proud of our Inner-Vators. That's what we call our circuit component neon lamps. They make things happen as arc suppressors, multivibrators, oscillators, photo-choppers, voltage



regulators, relays, SCR controllers, wave generators and lots of other things. The Inner-Vators are low-cost, have long-life, precise size and shape, and other versatile characteristics. Pick the one that stands out from the crowd — Glowlite's Inner-Vator. Write for our catalog.

ELT INC. **GLOWlite**
DIVISION

PAULS VALLEY, OKLAHOMA 73075
405/238-5541 • TWX 910-830-6590

INFORMATION RETRIEVAL NUMBER 35

DIGITAL SENSOR
improves resolution



Electro Corporation, 1845 57th St.
Sarasota, Fla. 33580. (813) 355-8411
\$49 list: Stock to 4 weeks.

Send for complete catalog

Model 58413 Di-Mag® Digital Magnetic Sensor is designed for applications requiring very high resolution. Geometrically matched sensing tip (pole-piece) allows maximum resolution when used with fine toothed gears. Unit has self-contained signal conditioning circuitry and produces outputs compatible with TTL, DTL or HTL logic.



YES... WE'VE BEEN BUSY!
This honey of a new product is but one of many — look for more in the New Product Sections of your favorite publications.

INFORMATION RETRIEVAL NUMBER 36

ELECTRONIC DESIGN 5, March 1, 1975

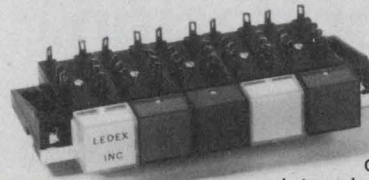

ganged switches

flexible, with up to 5 circuits per button and interrelated switching logic . . .

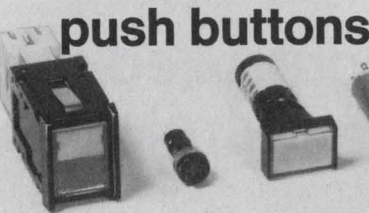

push buttons

all shapes and sizes, single or split lens, non-illuminated, built-in or replaceable lamps . . .



indicator lights

from 1/4" diameter indicators to 2" x 3" display panels . . .

LEDEX INC.
123 Webster Street
Dayton, Ohio 45401
(513) 224-9891

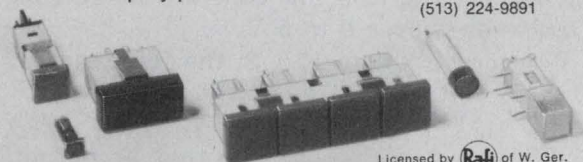

Licensed by **Rafil** of W. Ger.

To really appreciate the variety, beauty, and workmanship in the complete line of Ledex push buttons and indicators, it's best to see them. We'll be glad to arrange a personal demonstration. Just call this toll free number for the name of your Ledex representative: 800-645-9200.

INFORMATION RETRIEVAL NUMBER 37

PHOTO ETCH™ PRINTED CIRCUIT KIT

Makes circuits **THREE WAYS**

- 1 FULL SCALE ARTWORK MASTER
- 2 MAGAZINE ART ILLUSTRATION → FILM POSITIVE → NEGATIVE → DEVELOPED PHOTO RESIST IMAGE ON COPPER CLAD CIRCUIT BOARD → ETCHED CIRCUIT BOARD
- 3 DIRECT ETCH DRY TRANSFERS APPLIED TO COPPER CLAD BOARD

NO CAMERA DARKROOM FILM CUTTING TRACING

USES DATAK'S POS-NEG™ PROCESS
The revolutionary photographic way that makes **PERFECT** printed circuits from original art or a printed page.

KIT CONTAINS 5" x 6" steel printing frame, 4 sheets 5" x 6" photocopy film, yellow filter, chemicals for 1 pint film developer and 1 pint film fixer, 5" x 6" copper clad board, 3" x 4 1/2" copper clad board, spray can of photo etch resist, 1 pint resist developer, 2 sheets 8 1/2" x 11" layout film, 1 roll 1/16" printed circuit tape, 1 roll 1/32" printed circuit tape, 8 sheets dry transfer direct etch PC patterns including pads, transistors, round can and flat pack ICs, DIP ICs, edge card connectors, lines, circles, jogs, etc. 1/4 lb anhydrous ferric chloride to make 1 pint etchant, instructions.

- ER-4 COMPLETE PHOTO ETCH SET \$24.95
- ER-2 PC patterns and tapes — refill 3.39
- ER-3 1/4 pound dry etchant — refill 1.25
- ER-5 6 sheets photocopy film — refill 3.39
- ER-6 Film process chemicals — refill 1.79
- ER-7 Photo resist spray, 2.5 oz. — refill 2.95
- ER-8 Resist developer, 16 oz. can — refill 2.95

AT YOUR DISTRIBUTOR OR DIRECT

the **DATAK** corp.
65 71st St. • Guttenberg, N. J. 07093

INFORMATION RETRIEVAL NUMBER 38

Voltage-controlled music oscillator has linear control properties

A voltage-controlled oscillator for electronic music applications has a linear frequency-vs-control-voltage characteristic that passes through the origin (Fig. 1). The control-voltage range is standardized over 0 to 5 V.

For the circuit in Fig. 2, the frequency of the 8038 oscillator IC is given by

$$f = (1.5/RC) [1/(V_{cc} - V_{ee})] (V_2 - V_1).$$

The 741 op amp is biased so that its output, V_1 , equals V_2 when V_c is zero. The bias is set with resistor R_3 .

Since the op-amp output is unable to reach the value of V_{cc} , the value of V_2 is obtained by a reduction of about 1.4 V from V_{cc} to 13.6 V with two silicon-diode voltage drops. The minimum value of V_1 , which corresponds to the maximum control voltage—and thus the maximum output frequency—is specified for the 8038 to be no less than two-thirds of the total supply voltage. Two-thirds of the supply voltage of 30 V is 20 V. Thus V_1 minimum is +5 V above ground, since the low end of the supply is -15 V. This value of V_1 should correspond to the maximum $V_c = 8$ V to allow 60% overrange capability (Fig. 2). Therefore the full frequency-vs-voltage scale is set to 5 V by adjustment of the ratio

$$\begin{aligned} R_2/R_1 &= [V_2 - V_1 (\text{min})]/V_c (\text{max}) \\ &= (13.6 - 5)/8 = 1.075. \end{aligned}$$

If you choose $R_1 = 82$ k Ω and $R_2 = 91$ k Ω and substitute the values for the supply voltages, you get

$$f = (0.055/RC) V_c.$$

The best linearity is obtained when R lies between 10 k Ω and 100 k Ω . For the values in Fig. 2, $f = 6$ kHz for $V_c = 5$ V. The supply voltages should be well-regulated to minimize the drift of the zero frequency point. This point must correspond to zero control volts to preserve the harmonic relationships in a musical scale. The circuit can be easily modified, by proper choice of R_3 , to provide frequency modulation about a nonzero center frequency.

Paul Berkowitz, *Electronic Engineer, Vanguard Recording Society, 71 W. 23rd St., New York, NY 10010.*

CIRCLE NO. 311

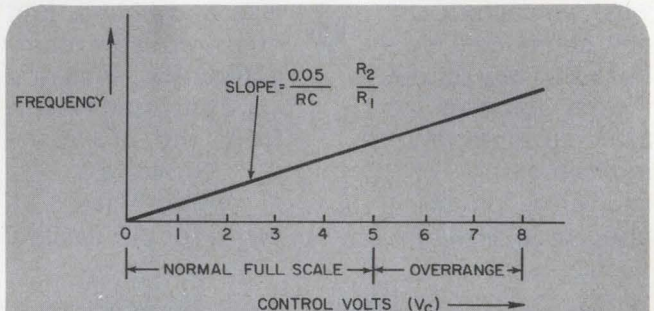

1. The frequency-vs-control-voltage characteristic for electronic music applications should be a slope that is proportional to the control voltage and that passes through the origin.

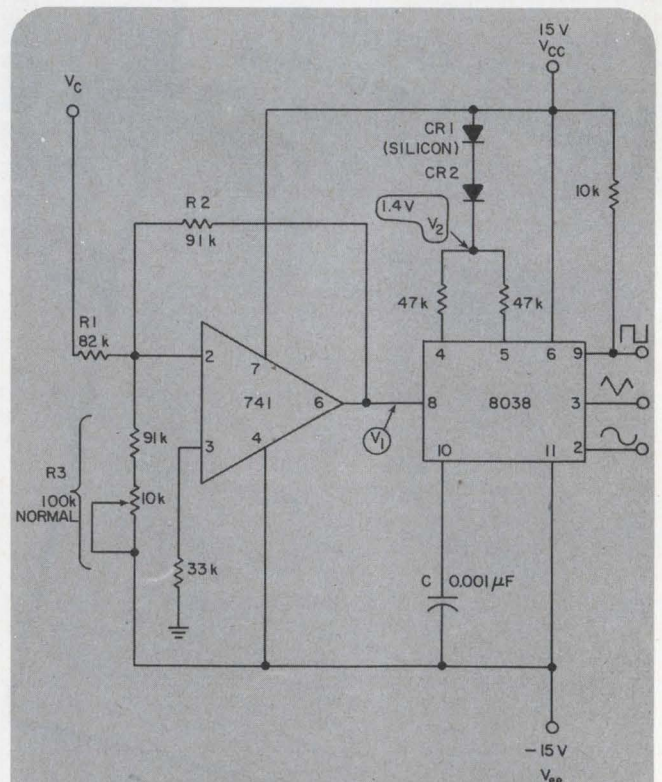

2. Voltage-controlled oscillator is adjusted to zero frequency for zero control voltage with resistor R_3 .

The 70-range circuit reader. 630-NA.

This versatile, general purpose V-O-M ideal for communications/computer circuits, Triplett Model 630-NA, is priced at just \$112.

The electronics equipment designer likes the 630-NA's 1½% DC accuracy, ease of operation, sensitivity, and reliability. So do the men who maintain communications equipment, computers, and satellite electronics. Still, it's no delicate flower. These strengths plus rugged dependability have put the 630-NA to work wherever a general purpose tester is needed: construction, electrical machinery, fabricated metal products, transportation systems, consumer electronic products, utilities, and radio, TV and appliance service.

You'll also like these features:

1. 70-range V-O-M with single range switch and DC polarity-reversing switch.
2. Accuracy 1½% DC and 3% AC; mirrored scale.
3. Diode overload-protected suspension movement with temperature compensation.

The 630-NA measures DC volts from 120 mV to 6,000 volts (10,000 or 20,000 ohms/volt). There are AC voltage ranges from 1.5 to 6,000 volts (5,000 or 10,000 ohms/volt). Six resistance ranges to 100 M Ω are provided.

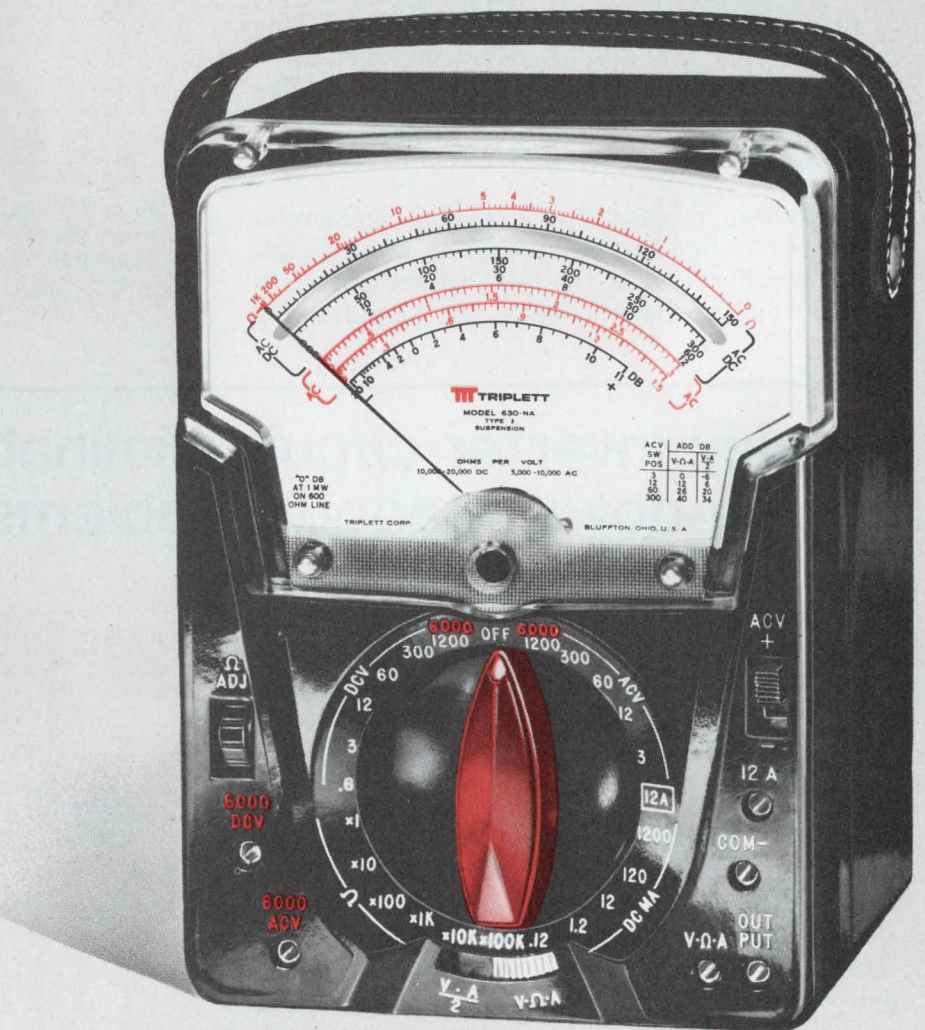

Need higher ohms per volt, greater sensitivity? Then you'll want Triplett's 630-NS at just \$134. Up to 200,000 ohms per volt DC and 20,000 ohms per volt AC; down to 150 mV at 60 microamperes.

For more information or a free demonstration, call your Triplett distributor or sales representative.

For the name of the representative nearest you, dial toll free (800) 645-9200. New York State, call collect (516) 294-0990. Triplett Corporation, Bluffton, Ohio 45817.

TRIPLETT
ALL YOU'LL EVER NEED IN V-O-M's.

Triplett. The easy readers.

Simple power-frequency meter built with only a few passive components

A simple frequency meter for power-line frequencies (50 to 60 Hz) can be built with only seven inexpensive passive components. It doesn't need a battery or any other power supply. Here's how it works.

Power-frequency sine waves are first converted to square waves by a 100-k Ω resistor and a 6.8-V zener, type BZ148. The square wave is then "differentiated" by a 0.22- μ F capacitor. The average of the pulsed current that results is almost exactly proportional to frequency. This current, with the aid of rectifying diodes, is averaged and read by a 100- μ A meter. The meter's 0-to-100 scale indicates frequency directly over the range from 10 to 100 Hz with good accuracy.

Calibration is easy. An accurate, commercial 60-Hz power line can be used as an input to adjust the calibration of the 5-k Ω potentiometer to read 60 on the meter's scale. The amplitude of

the square waves is stabilized by the zener. Therefore meter readings do not vary significantly with input voltage over a wide range. The circuit as shown reads correctly on the usual power-line voltages from about 110 V to 230 V.

M. C. Sharma, 5R-4, P.O. Charbatia Orissa, India. CIRCLE NO. 312

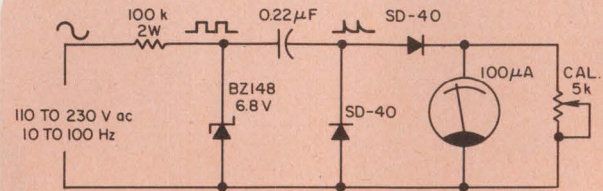

A power-frequency meter uses a zener diode to form square waves from input sine waves. After calibration with the 5-k Ω potentiometer, the 100- μ A meter reads directly in hertz.

Display inverter circuit eliminates upside-down readout problems

Using digital readout instruments to take measurements in hard-to-reach places may involve you in mild gymnastics: You could end up looking at the display upside-down (Fig. 1a). To avoid this, add "inverting circuitry" to the display (dotted box in Fig. 2). This will enable you to flip and reverse a four-digit display.

The typical multiplexing circuitry for a four-digit LED display consists of IC₁, IC₂, IC₃, IC₄, IC₅ and IC₈. It must be modified with the addition of IC₆, IC₇, IC₉ and IC₁₀ and two switches, S₁ and S₂, if you want to invert the display. A four-digit display requires, of course, that all four digits be transposed and inverted (Fig. 1a).

The multiplexer is driven by an external clock signal, whose frequency is selected for flicker-free display. With S₁ in the normal position, the display is strobed from left to right, and decoder outputs a through g are fed to the corresponding inputs of the LED displays. When the inverted mode is selected, outputs a through g are transposed (Fig. 1b), and the decimal point is shifted. The invert command also changes the scan direction to right-to-left.

V. Ramamoorthy and S. Murugesan, Indian Scientific Satellite Project, Peenya 562140, Bangalore, India. CIRCLE NO. 313

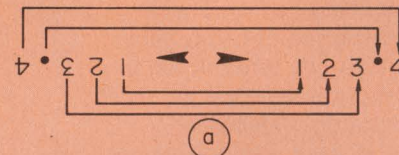

SEGMENT OUTPUT FROM IC 3	LED INPUT BUS (NORMAL DISPLAY)	LED INPUT BUS (INVERTED DISPLAY)	DECIMAL POINT INPUT	LED DECIMAL POINT INPUT	
				NORMAL DISPLAY	INVERTED DISPLAY
a	a	d	1d	1d	3d
b	b	e			
c	c	f			
d	d	a	2d	2d	2d
e	e	b			
f	f	c			
g	g	g	3d	3d	1d

1. To transpose a four-digit display (a), the digits on the left must be shifted to the right, as indicated by the arrows. To invert the numeral, the decoder outputs must be changed to follow the sequence in the table (b).

(continued on pg. 70)

NEW GE-MOV™ VARISTORS BETTER THAN ZENERS FOR TRANSIENT PROTECTION

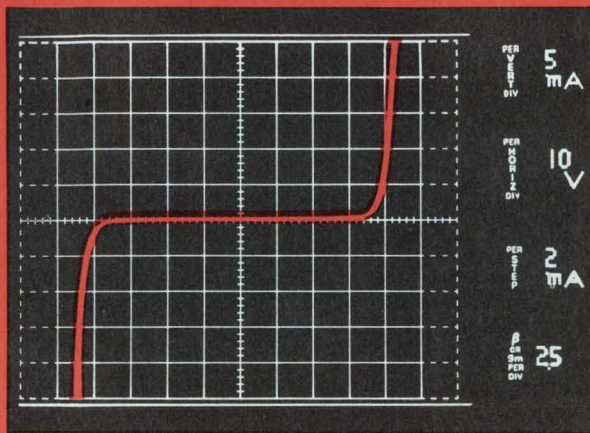

Actual photograph of V33ZA1 Characteristic

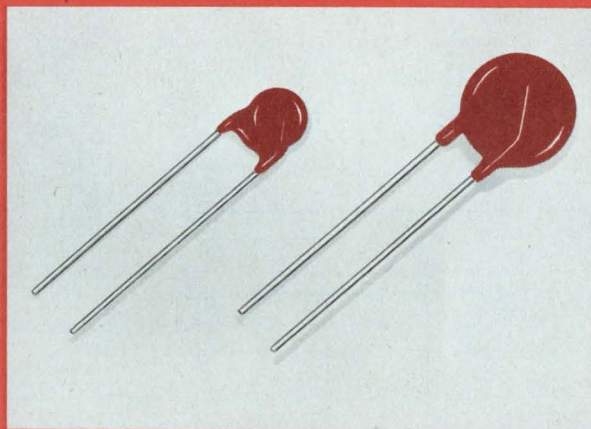

Actual Size

NEW "ZA" Series GE-MOV™ metal oxide varistors are voltage dependent symmetrical resistors which....

- Exhibit characteristics similar to back-to-back zeners when used for transient protection
- Offer up to 10X improvement in peak pulse current capabilities compared to zeners
- Are characterized to $\pm 10\%$ RETMA values at 1 mA DC
- Offer better characteristics than zeners, silicon carbide, selenium or R-C networks when used for transient protection
- 26-81V DC, 20-60V RMS
- Up to 250A peak pulse current
- 1-15 Joules energy absorption
- 14 Types, 2 package sizes
- 41¢ each, suggested resale 10,000 lot quantities
- New "ZA" Series complements over 100 other GE-MOV™ varistor types offering transient protection up to 1000V RMS, up to 2,000A peak pulse current
- Available now from any authorized GE Electronics Component Distributor
- For free sample, write on letterhead to: General Electric Semiconductor, Electronics Park, Bldg. 7-49, Syracuse, N.Y. 13201 stating desired voltage—AC or DC and application

GENERAL  ELECTRIC

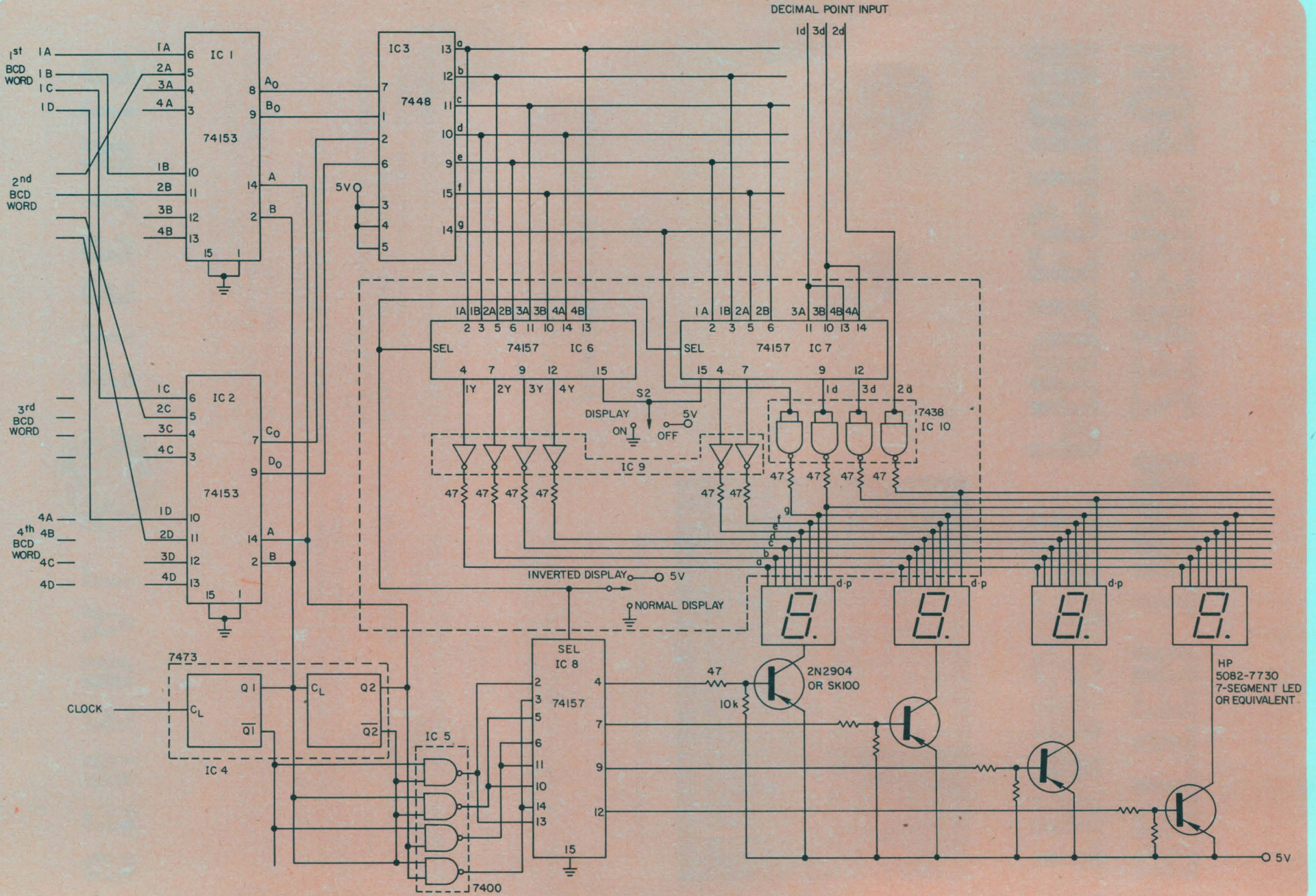

Fujitsu Quality on Sale in Reed Switches

The highly versatile Fujitsu reed switches combine sub-miniature size with reliability and superior performance.

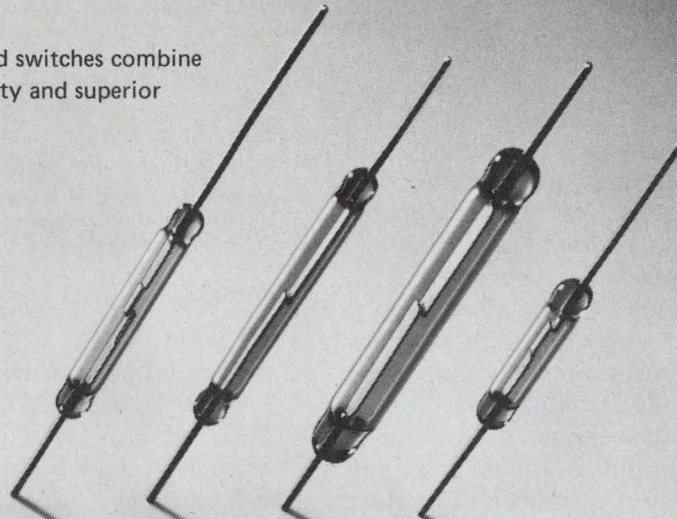

Select the most suitable reed switch for your requirements from the following:

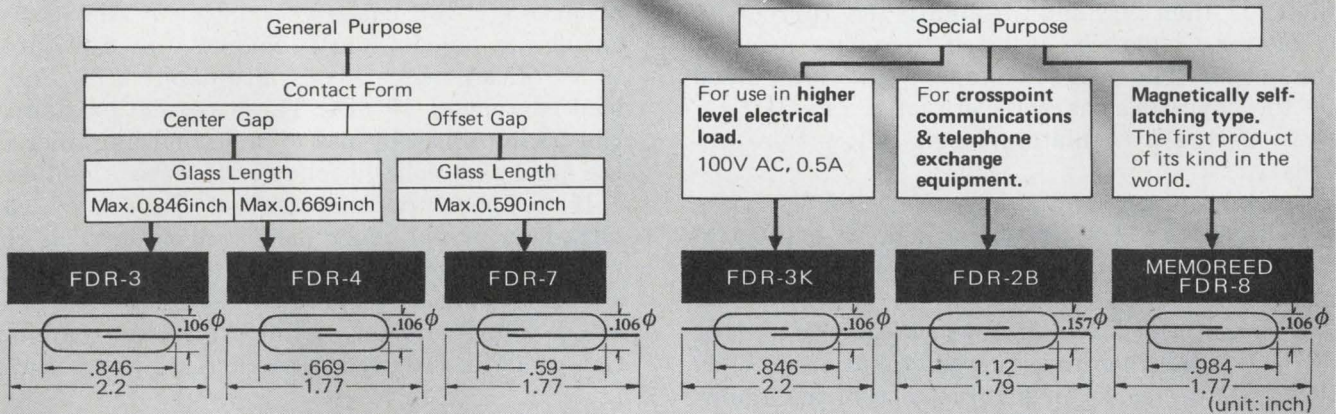

Reed Switch	Contact Form	Contact Rating	Pull-in Ampere-turns	Drop-out Ampere-turns	Operate Time	Release Time	Initial Contact Resistance	Dielectric Withstanding Voltage
FDR-3	A(make) Center Gap	10VA DC (0.5A DC max.) 100V DC max.)	20 ~ 60	8 min.	800μS max. (including contact bounce)	50μS max.	150mΩ max.	250/500V DC (1min.)
FDR-4	A(make) Center Gap							
FDR-7	A(make) Offset Gap		20 ~ 52	10 min.				
FDR-3K	A(make) Center Gap	30VA DC (1A max.) 50VA AC(0.5A max.)	20 ~ 60					250/350V DC (1min.) 250/500V DC (1min.)
FDR-2B	A(make) Center Gap	10VA DC (0.5A max.)	25 ~ 60	13 min.	1.5mS max. (including contact bounce)	0.2 mS max.	100mΩ max.	800V DC(1min.)
FDR-8	A B	Self-latching Type	5VA DC (0.5A max.)	85 ± 10 110 ± 15	-28 ± 6 -24 ± 10	0.1 mS max.		600V DC(1min.) 800V DC(1min.)

FUJITSU LIMITED
Communications and Electronics
Marunouchi, Tokyo, Japan

For further information, please contact:
Head Office: 6-1, Marunouchi 2-chome, Chiyoda-ku, Tokyo 100, Japan Telex: J22833
New York Office: 680 Fifth Avenue, New York, N.Y. 10019, U.S.A. Phone: (212) 265-5360
Fujitsu California Inc.: 1135 East Janis Street, Carson, California 90746, U.S.A. Phone: (213) 636-0858, (213) 537-8930

MAIN PRODUCTS □ Telephone Exchange Equipment □ Carrier Transmission Equipment □ Radio Communication Equipment □ Space Electronics Systems □ Electronic Computers & Peripheral Equipment (FACOM) □ Telegraph & Data Communication Equipment □ Remote Control & Telemetry Equipment □ Electronic Components

Regulated power source drives low-power devices

Small electronic devices that operate from a battery supply often need an inexpensive voltage regulator. It should be insensitive to large battery-voltage variations, and it should consume little power. If the battery is, say, a 9-V transistor type, a reasonable requirement would be that the regulated voltage be maintained even though the battery voltage drops from 9 to 6 V.

The regulator circuit in the figure provides these capabilities. It uses a National Semiconductor quad LM324, because its common-mode voltage range includes ground when it is operated from a single-ended supply and V^- on a dual supply. Further, it combines a relatively high current-drive capability with a low supply-current drain.

Instead of a zener, diode D_1 is used as the reference element; it is unnecessary to provide a start-up voltage. The amplifier input is a pnp current source of about 50 nA—sufficient to start the circuit's regenerative action.

Any voltage at the noninverting input of the amplifier, V_d , is amplified to give an output voltage $V_o = (1+q)V_d$, where the feedback ratio is $q = (R_2 + R_3)/R_1$. The driving voltage for the diode is then V_d , and R_d limits the current. A capacitor C_1 may be inserted to reduce noise at the output. The output voltage, V_o , is determined by the operating characteristic of the diode.

To design a regulator circuit follow this procedure:

1. For a given V^+ and $V_o < V^+ - 1.5$ V, choose q so that $V_o/(1+q) = V_d$ is in the range 0.4 to 0.7 V. With $V^+ = 9$ V, q usually ranges from about 5 to 10.

2. From the I_d -vs- V_d characteristic curve of diode D_1 , find the diode current that corresponds to V_d . If we neglect bias current from the amplifier, the resistance of the current-limiting resistor is $R_d = qV_d/I_d$.

3. To balance the amplifier input, as a start-

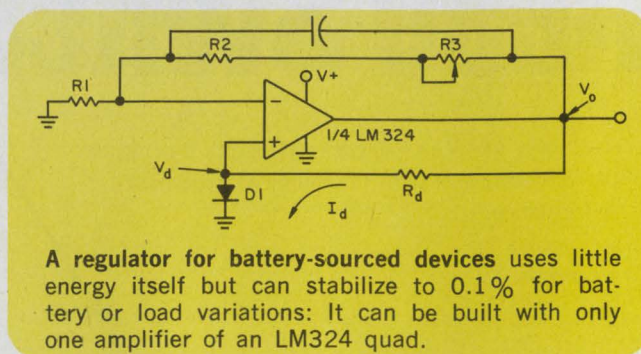

A regulator for battery-sourced devices uses little energy itself but can stabilize to 0.1% for battery or load variations: It can be built with only one amplifier of an LM324 quad.

ing point, let $R_1 = V_d/I_d$. The output voltage can then be trimmed with R_3 . For example: Let $V^+ = 9$ V and $V_o = 5$ V. D_1 is a 1N914. Choose $q = 10$. Then $V_d = V_o/(1+q) = 0.45$ V. For a 1N914, when $V_d = 0.45$ V, $I_d = 50 \mu\text{A}$. Then $R_d = qV_d/I_d = 90$ k Ω and $R_1 = V_d/I_d = 9$ k Ω . Choose standard values: $R_d = 91$ k Ω , $R_1 = 9.1$ k Ω , $R_2 = 82$ k Ω and $R_3 = 50$ k Ω . Finally fine-tune V_o with R_3 to give the desired output voltage in the range $V_d < V_o < V^+ - 1.5$ V.

The V_o voltage-regulated output is stable to about 0.1% for battery variations. This corresponds to about 1-mV change for 1-V drop in V^+ . Load regulation is also about 0.1% for a load current of 10 mA. These regulation figures can be improved by use of a second amplifier of the quad as a voltage follower to drive the diode.

If temperature-compensation is needed, an ultra-low-current zener diode can be used as the reference element. Then the minimum voltage available from the source would be about 6.5 V, and a voltage-divider, voltage-follower, combination would be required to provide a lower voltage.

Marc Damashek, Research Engineer, Clarke School for the Deaf, Northampton, MA 01060.

CIRCLE NO. 314

IFD Winner of October 25, 1974

Randy Young, CMOS Design Engineer, Motorola Semiconductor Products, Inc., P.O. Box 2953, Phoenix, AZ 85036. His idea "Low-Power CMOS Digital Voltmeter Built with Only Six Integrated Circuits" has been voted the Most Valuable of Issue Award.

Vote for the Best Idea in this issue by circling the number for your selection on the Information Retrieval Card at the back of this issue.

SEND US YOUR IDEAS FOR DESIGN. You may win a grand total of \$1050 (cash)! Here's how. Submit your IFD describing a new or important circuit or design technique, the clever use of a new component or test equipment, packaging tips, cost-saving ideas to our Ideas for Design editor. Ideas can only be considered for publication if they are submitted exclusively to ELECTRONIC DESIGN. You will receive \$20 for each published idea, \$30 more if it is voted best of issue by our readers. The best-of-issue winners become eligible for the Idea of the Year award of \$1000.

Topaz Ultra-Isolation Transformers will solve your power line noise problems. We guarantee it.

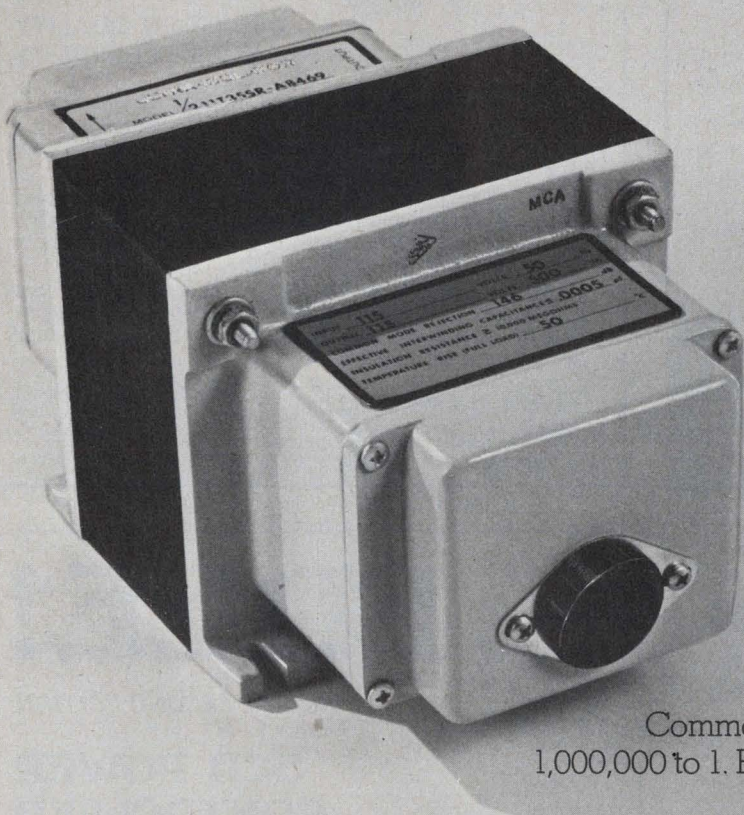

Pete Jorgensen, Magnetics Production Manager at Topaz, was asked recently why the performance of Topaz Ultra-Isolation Transformers is so exceptional. He answered by saying, "Because we have people who have been winding and shielding transformers for 10 years, and they do it unusually well."

Topaz Ultra-Isolation Transformers protect electronic equipment from noisy power lines and protect clean power lines from noise-generating equipment. The unique Topaz box shielding techniques and the meticulous care taken during manufacturing guarantee the effectiveness of Topaz transformers.

Common-mode noise is attenuated by more than 1,000,000 to 1. Effective capacitance between windings is less than 0.0005 picofarads.

So if power line noise is your problem, write or phone. We'll prove that Topaz Ultra-Isolation Transformers will solve your problem. We guarantee it — or your money back.

Or your money back.

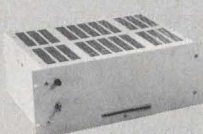

Other Products • Uninterruptible Power Systems • Inverters • Frequency Changers • AC Line Regulators

Topaz is also a major supplier of **custom** power conversion equipment. Contact us.

TOPAZ

ELECTRONICS 3855 Ruffin Road, San Diego, California 92123 • Phone: (714) 279-0831. TWX (910) 335-1526

INFORMATION RETRIEVAL NUMBER 42

NEW PROGRAMMABLE TIME DELAY RELAYS

For R&D, low volume & production requirements.

Featuring CMOS digital circuitry; DPDT contacts—10 amps resistive; no "false" operation on delay on make function; competitive pricing; low inventory requirements.

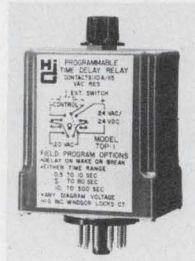

Model TDP-1: Each unit easily field selected for delay on make or break; for 24VDC, 24VAC, or 120VAC; and for delay ranges of 0.3 to 10, 3 to 80, or 10 to 300 seconds—adjustable to min/max of each range.

Low cost conventional, adjustable and fixed, single mode timers also available.



for further information contact
Hi-G, Inc./Windsor Locks, CT 06096
Area Code (203) 623-2481
see complete Hi-G line in EEM

INFORMATION RETRIEVAL NUMBER 43

Sturdilite ELECTRONIC WORK STATIONS

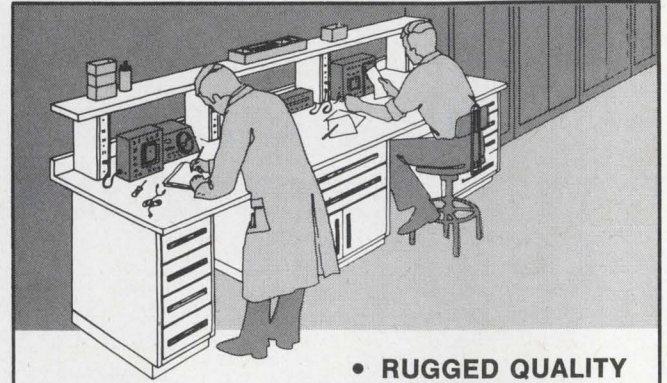

- RUGGED QUALITY
- PLANNED FLEXIBILITY

STURDILITE SYSTEMS combine the look of quality furniture with the ruggedness of industrial equipment . . . and provide *true economy* and *efficiency*, no matter how large or small your work area may be!

Unique combinations of work surfaces, riser shelves, electrical outlets, and pedestal bases with innumerable drawer/door arrangements, provide the maximum in *planned flexibility*.

STURDILITE engineers will gladly prepare detailed room layouts to meet your specific requirements . . . at *absolutely no cost to you!* Send for free catalog, or . . . better yet, call us at (616) 685-6400.

Sturdilite

ANGLE STEEL DIVISION
KEWAUNEE SCIENTIFIC EQUIPMENT CORP.
PLAINWELL, MICH. 49080 (616) 685-6831



INFORMATION RETRIEVAL NUMBER 45

75 OHM COAX SWITCHING

MICROWAVE CHANNEL PROTECTION, DELEGATE/ROUTING, RADIO DROP, CABLE AND ANTENNA SWITCHING FOR I.F.—R.F.

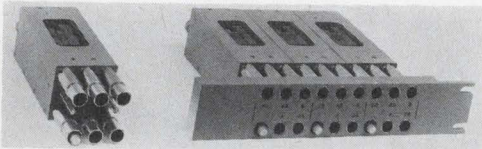

DC to 3GHz

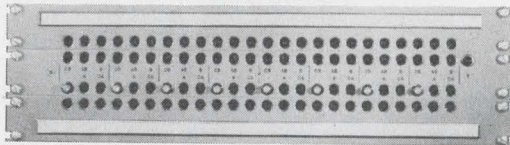

Trompeter Electronics has developed a NEW proprietary broadband switching relay. It is used in the manufacture of 75 OHM high frequency matrices and switches specifically designed for routing I.F. and R.F. signals where high isolation, high return loss and low VSWR are required.

The relays can be supplied in individual crosspoints so packaged that the user can change matrix configuration as needed or packaged in a fixed matrix for a specific function.

Trompeter Electronics, Inc.
8936 Comanche, Chatsworth, CA 91311

INFORMATION RETRIEVAL NUMBER 44

FREE!

8-PAGE SECOND EDITION

SCR POWER CONTROLLER APPLICATIONS GUIDE

The purpose of this guide is to assist the design engineer in selecting the proper SCR Power Controller for a specific application. It contains five pages of technical details including SCR firing, a comparison of on-off and proportional control modes, general design features, application consideration, performance options and a list of major parameters that must be considered when selecting a controller. Also included is an informative discussion on six-SCR versus three-SCR Hybrid models for three-phase systems. Vectrol power controllers are offered in 30 to 400 amp models.

SEND FOR YOUR FREE COPY TODAY



VECTROL INC.

1010 WESTMORE AVE., ROCKVILLE,
MD. 20850, U.S.A. (301) 424-6900

INFORMATION RETRIEVAL NUMBER 46

ELECTRONIC DESIGN 5, March 1, 1975

8-bit IC DAC settles fast and has adjustable threshold

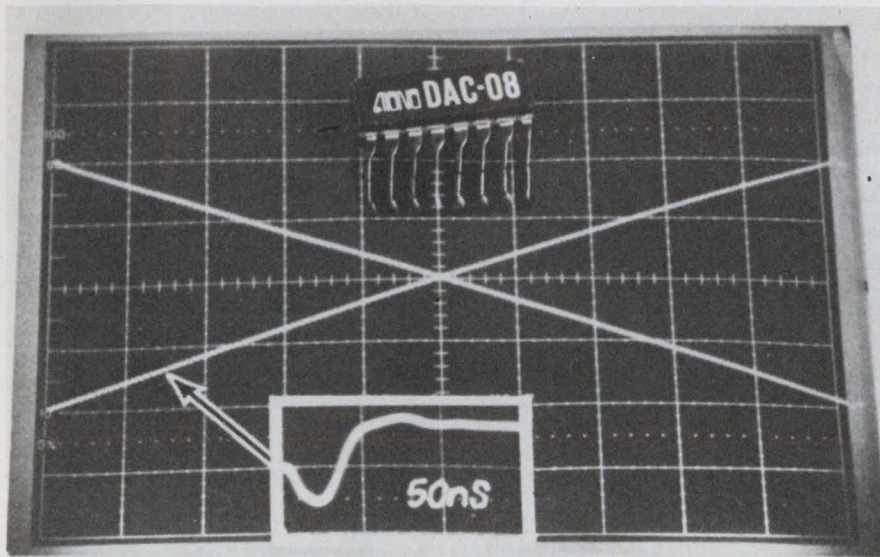

Precision Monolithics, 1500 Space Park Dr., Santa Clara, CA 95050. (408) 246-9225. P&A: See text.

Four monolithic, 8-bit, digital-to-analog converters not only settle to within 0.19% accuracy in 125 ns but have programmable threshold levels. The monoDAC-08 units made by Precision Monolithics, have a control pin that permits programming of the threshold voltage over a -10 to $+13$ V range.

These units can also handle any logic family that has logic swings within a -10 to 18 V range. Thus the converters are compatible with TTL, DTL, MOS, CMOS, HN1L and ECL and have full noise immunity. An input current of only $30 \mu\text{A}$ maximum ($3 \mu\text{A}$ typical) allows interfacing to logic families that have low current capabilities.

The converters have two output pins, for the normal and complementary output signals, respectively. Thus either normal or inverted logic systems can be used. Both outputs have a high compliance that permits the output to

float -10 to $+18$ V from ground with no effect on circuit linearity. Thus, the DAC-08 can drive a load resistor to produce an output voltage without the usually needed op amp.

There are four versions of the DAC-08 available, each with different linearity specs. But all have guaranteed 8-bit monotonicity. The prime commercial version, the DAC-08EZ, operates over the 0-to-70-C range, settles in 85 ns typical (125 ns max) and has a 0.19% maximum linearity error (± 0.5 LSB over 0 to 70 C).

The propagation delay for any bit, or for all bits changing at once, is 30 ns typical and 45 ns max. This delay time doesn't vary with either temperature or input current changes. The DAC-08EZ also has a low glitch—only 4 LSB at the major carry point.

Power requirements for any of the converters are flexible—both the V^+ and V^- supplies can range from 4.5 to 18 V—and the power consumption is low. Typical current drain for a 2-mA output is

only 2.5 mA from the V^+ supply and 6.5 mA from the V^- —provided they are set at $+5$ and -15 V, respectively. The total power consumption is only 110 mW and remains almost constant for any logic level input combination.

When purchased in 100-unit quantities, the DAC-08EZ costs \$7.95 and is housed in a 16-pin, hermetic, ceramic DIP. The 08CZ has 7-bit linearity and costs \$6.50. An 8-bit MIL version, the 08Z costs \$12.95 while another MIL unit, the 08AZ, has 9-bit linearity and costs \$20. All units have 8-bit monotonicity and are available from stock.

CIRCLE NO. 307

99-key encoder clocks itself

Electronic Arrays Inc., 550 E. Middlefield Rd., Mountain View, CA 94043. (415) 964-4321. EA2000: \$15 (100); 6-8 wks.

A full four-mode 99-key encoder—the EA2000—generates its own clock signal on the chip. It is completely programmable, generating a 10-bit output word for each of the 99 keys and four modes. On-chip circuitry also provides N-key rollover and key-bounce protection. The EA2000 interfaces with keyboards without requiring diode isolation for each key. The device is fully TTL-compatible without external components, and requires only $+5$ and -12 V power supplies. The EA2000 comes in a 40-pin ceramic or silicone-molded DIP. A pre-programmed version, the EA2007, provides encoding for standard ASCII and EBCDIC keyboards.

CIRCLE NO. 308

Green, Yellow, Amber, Red

Bi-Pin LED's

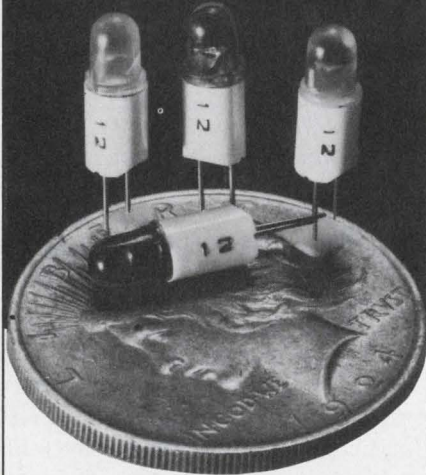

WITH BUILT-IN SERIES RESISTORS

- 5 to 28V models.
- Direct replacements for incandescent types.
- Lower power requirements.
- Faster signal monitoring.
- Clear lenses for dead front panel applications . . . diffused lenses for direct viewing.
- Offset terminals for easy insertion.
- Priced under \$1 (100 quantities).

And we've got more! LED, Incandescent and Neon sub-miniature panel lights . . . PCB lights. We're your "one-stop-shop" for indicator lights.

The "original" little light people!

DATA DISPLAY PRODUCTS

5428 W. 104th St., Los Angeles, Ca. 90045
(213) 641-1232

DATA PROCESSING

Buffered matrix printer has speed of 73 char/s

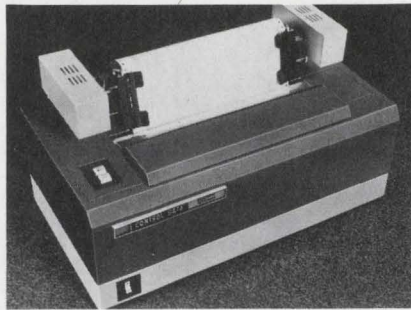

Control Data, Box O, Minneapolis, MN 55440. (612) 853-4096. \$2350; see text.

A dot-matrix printer, the Model 9316, offers speeds to 173 char/s, and up to 100 lines/min (for a 45-char. line). In addition the unit can print one to five-part forms (1st line visible to operator) of any width between 4 to 16.75-in. A line-buffer permits loading of up to 132 characters plus forms advance with asynchronous data. A ROM chip allows quick change of character sets—standard 64, optional 96 or 128. The print ribbon is changeable in 30s and a standard typewriter ribbon is usable. The 9316 conforms with U.S. Canadian and European Standards for safety and noise. Production began in February, '75 subsequent shipments are 90 days ARO.

CIRCLE NO. 309

Stripped fast CPU poised for new logic design

Scientific Micro Systems, 520 Clyde Ave., Mountain View, CA 94043. (415) 964-5700. See text.

Strip a microcomputer of most arithmetic capability, cut the instruction set to eight commands, use bipolar LSI and what's the result—a 300-ns programmable controller called the MicroController. This control-oriented device replaces sequential logic and can even be part of the control system of a large CPU or the controller for a mass-storage peripheral. The 8-bit processors are packaged on a PC board and range in price from \$370 to \$1460. An interface register provides up to 224 I/O points and 56 control signals to external devices. Program storage ranges from 512 to 4096 16-bit words.

CIRCLE NO. 310

Cassette system stores data and programs



Sykes Datatronics, 375 Orchard St., Rochester, NY 14606. (716) 458-8000. \$1500 (qty); 1 wk.

The Model 80 is a low-cost cassette system for minicomputers. The SYKES-tape is suited for program loading and sequential data logging. It includes off-the-shelf interfaces and software drivers for most popular minicomputers. The unit features a transfer rate of 9600 bit/s, rewind speed of 120 in/s and capacity of more than 30 (4k) programs per cassette (2.8 Mbits).

CIRCLE NO. 321

Programmer-processor loads and tests pROMs

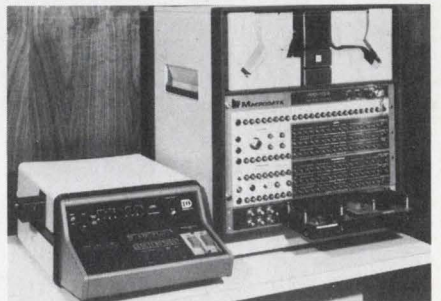

Macrodata Corp., 6203 Variel Ave., Woodland Hills, CA 91364. (213) 887-5550. \$16,000; 30 to 60 days.

Macrodata's MD-100 or MD-104 programmable microprocessor and Data I/O's Model III programmer, program and test pROMs with up to 2×16 organization. A paper tape input or standard pROM can be used. The bit pattern is loaded separately into the MD-100/104 RAM and the Data I/O memory. The programmer programs the pROM. The system then applies the write pulses to each pROM position and verifies the bit there. Control is automatically switched to the processor to perform functional tests.

CIRCLE NO. 322

PLL module helps build dense storage systems



Correlation Industries, P.O. Box 751, La Canada, CA 91011. (213) 790-3189. \$165.

Packing densities in excess of 40 k bpi/track are promised by the Model 114 data synchronizer. A narrow-band phase-locked loop and coherently clocked sample data detector, the module accommodates RZ, NRZ-L, M, or S, BI-phase L, M, or S, or Miller-encoded recording formats. All tracks may be fully deskewed for simultaneous parallel playback. The synchronizer is tunable over a 2 to 1 data rate range by means of an analog control input. Units are available from 7.8 kbit/s to 8 Mbit/s. Power requirements are ± 15 V, +5 V at 1.4 W. The dimensions are $3 \times 2.5 \times 0.625$ -in.

CIRCLE NO. 323

Acoustic coupler has automatic switchover

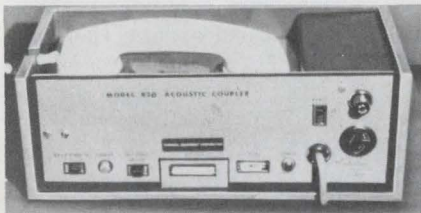

Tycom Systems Corp., 26 Just Rd., Fairfield, NJ 07006. (201) 227-4141. See text: stock to 30 days.

The Model 920 originate-only acoustic coupler comes with its own IC-regulated power supply and is contained in a wood-grained cabinet. The unit operates at rates from 0 to 300 baud and automatically switches between data and acoustic operations. It can be used with any terminal that has EIA RS-232 connector and can switch from full to half duplex. A carrier detect light is standard on all units, and each comes with a direct access arrangement (DAA). The PC board sells for \$99.50; the encased unit is \$199.50.

CIRCLE NO. 324

NEW NEW NEW STRIP CHART ADAPTER FOR X-Y RECORDER

Model 2000
Recorder
\$890
plus modules

Model SCA-1
Strip Chart
Adapter
\$765

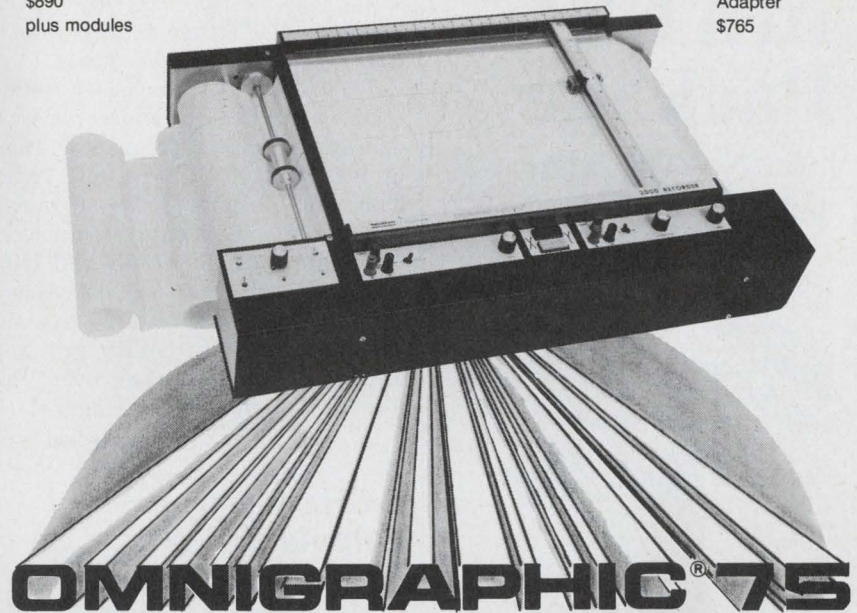

PRESENTS NEW VERSATILITY FOR YOUR 2000 X-Y RECORDER

- Converts any Omnigraphic 2000 X-Y into a Strip Chart Recorder.
- Provides single sheet advance (local or remote control) thus eliminating manual single sheet changing.
- Bi-directional chart drive
- Easily installed in the field
- Adapter only \$765 complete

Send for brochure today.

**houston
instrument**

**THE
RECORDER
COMPANY**

ONE HOUSTON SQUARE (at 8500 Cameron Road) AUSTIN, TEXAS 78753
(512) 837-2820 TWX 910 - 874-2022 cable HOINCO

EUROPEAN OFFICE Rochesterlaan 6 8240 Gistel Belgium
Phone 059/27445 Telex Bausch 19399

® A registered trademark of Houston Instrument

INFORMATION RETRIEVAL NUMBER 48

NOW!

Analog Computer in a DIP Package

$$E_0 = V_4 \left(\frac{V_z}{V_x} \right)^m$$

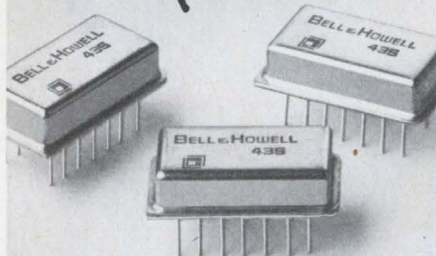

Bell & Howell Type 435 Polyfunctional Operator

Use this versatile analog operator for a wide range of applications in measurement and control as well as laboratory experiments and development projects. This miniature, hermetically sealed unit performs multiplication, division, squaring, square root and exponentiation. With the use of external components, it can generate trig functions of sine, cosine, arc tangent, and vector algebra. Using log/antilog techniques to perform all functions, the Type 435 Operator provides typical full scale accuracies of better than $\pm 0.25\%$.

Write for 6-page brochure containing complete specifications.

CONTROL PRODUCTS DIVISION
706 Bostwick Ave., Bridgeport, Conn. 06605 (203) 368-6751

 **BELL & HOWELL**
INFORMATION RETRIEVAL NUMBER 49

MICROWAVES & LASERS

Linear amp yields 1 W at 2.4 GHz



Microwave Power Devices, Inc., Adams Ct., Plainview, NY 11803. (516) 433-1400. 60-90 days.

The Model LWA 0824-1 solid-state amplifier provides class-A operation over the frequency range of 800 to 2400 MHz in one band. The amp outputs 1 W of linear power and 2 W of saturated power. Minimum gain is 27 dB and harmonics are at least -29 dB. Above 1400 MHz, harmonics drop to -50 dB. Input/output SWRs are 2:1 and the unit operates over the 0-to-70-C temperature range.

CIRCLE NO. 325

1-GHz klystron outputs 37 kW

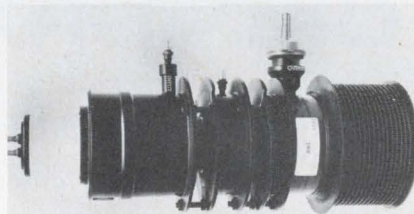

ITT Electron Tube Div., 3100 Charlotte Ave., Box 100, Easton, PA 18042. (215) 252-7331.

A klystron amplifier tube, type F-2912, covers the frequency range between 960 and 1215 MHz with a power output of 37 kW minimum. The metal/ceramic tube is an electrostatically focused, mechanically tuned device that operates in the pulse mode at a duty factor of 2.5%. Operating voltage is 24 kV at a peak beam current of 7.8 A. Maximum grid-cutoff voltage is -475 V and maximum rf drive power is 75 W. With a gaussian current pulse, the energy in each 500-kHz band, centered ± 800 kHz from the center frequency, is more than 45 dB down from the energy in the 500-kHz band centered on the carrier frequency.

CIRCLE NO. 326

Hf dipole handles four channels



Rohde & Schwarz, Pressestelle, 8000 Munchen 80, Muhldorfstrabe 15, Germany.

A high-frequency dipole, the HK003, transmits signals up to 1 kW in power. The HK003 measures 10 m in length and it permits preprogramming of four channels in the frequency range of 2 to 30 MHz by the use of suitable reactive components.

CIRCLE NO. 327

10-kW amp permits continuous sweep

N.V. Philips' Gloeilampenfabrieken, Elcoma Div., P.O. Box 523, Eindhoven, the Netherlands.

A single-tube 10-kW amplifier unit, type 40775, can be tuned continuously over its entire frequency range of 87.5 to 108 MHz. Only 70 W of input drive yields an output power of 11 kW. Thus a solid-state drive can be employed. A complete 10-kW transmitter, using the 40775, can be installed in one 19-in. rack. The grounded-cathode 40775 is designed around the company's YL1470 power tetrode.

CIRCLE NO. 328

Couplers span 0.2-to-18-GHz range



Norsal Industries, Inc., 34 Grand Blvd., Brentwood, NY 11717. (516) 231-4040. Stock to 8 wks.

A series of broadband directional couplers covering the ranges of 0.2 to 18 GHz, 1 to 12 GHz and 0.2 to 18 GHz provide coupling values of 10, 16 and 20 dB. Most units have directivities exceeding 20 dB. All models are available with SMA and Type N connectors per MIL-C-39012, and all units have been qualified for MIL environments. Typically the new couplers measure $2 \times 11/16 \times 1/2$ -in.

CIRCLE NO. 329

After all the noise, the quiet logic of HiNIL and 74C CMOS keeps you on the right track.



May 10, 1869. Promontory, Utah. The rumble of wheels, the hiss of escaping steam, the shouts of the celebrating crowd filled the skies with a deafening roar when they drove the golden spike that joined the Central Pacific and Union Pacific Railroads.

But today, when you link Teledyne's high noise immunity logic, HiNIL, and our 74C CMOS together in your digital or analog/digital control designs, you'll no longer have to worry about spikes or noise. Teledyne invented HiNIL to meet the need for high noise immunity found in practically all digital systems. The success of this large and still growing family has made Teledyne a leading supplier of logic for high noise applications.

Just put HiNIL on input-output lines to block heavy noise transients and drive high current peripheral devices. And use CMOS in the middle to minimize power dissipation and increase speed and circuit density. The combination of HiNIL's guaranteed 3.5V noise margin and 74C's low power dissipation lets them quiet almost any kind of system with high noise problems.

Our two logics interface directly, too. Standard 74C drives HiNIL directly and HiNIL drives more than 50 CMOS loads. Simply connect both to an inexpensive 12 or 15V $\pm 1V$ power supply. You can even connect linear circuits to the same supply for extra savings.

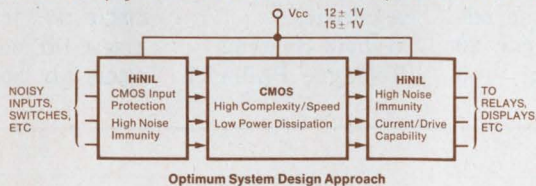

HiNIL eliminates the need for drivers because it sources up to 15mA and sinks up to 65mA. That's ample capability for display tubes, LEDs, lamps and relays.

And with HiNIL you save on filter capacitors, get the extra flexibility and economies of diode-expandable inputs, and have a choice of active or passive pullup and open collector outputs. There's plenty of board-shrinking MSI in both families, too.

So write or call Teledyne today to find out about our HiNIL and 74C CMOS lines. We'll show you how easy it is to block out all the noise and stay on the right track.

TELEDYNE SEMICONDUCTOR

1300 Terra Bella Avenue, Mountain View, California 94043 Tel: (415) 968-9241 TWX: 910-379-6494 Telex: 34-8416

ENGLAND: Heathrow House, Cranford, Hounslow, Middlesex, Tel: (44) 01-897-2503 Telex: 851-935008

FRANCE: 90, Avenue Des Champs Elysees, 75008 Paris, Tel: 2563069 Telex: 842-29642

WEST GERMANY: Albert Gebhardtstrasse 32, 7897 Tiengen, Tel: 7741-5066 Telex: 841-792-1462

JAPAN: Nihon Seimei-Akasaka Bldg. (3F), 1-19, Akasaka 8-chome, Minato-ku, Tokyo 107, Tel: 03-405-5738 TWX: 781-2424241

Additional offices in West Germany, Hong Kong and the United States. Representatives and distributors worldwide.

INFORMATION RETRIEVAL NUMBER 50

A/d converter module keeps speed high but cuts cost by 50%

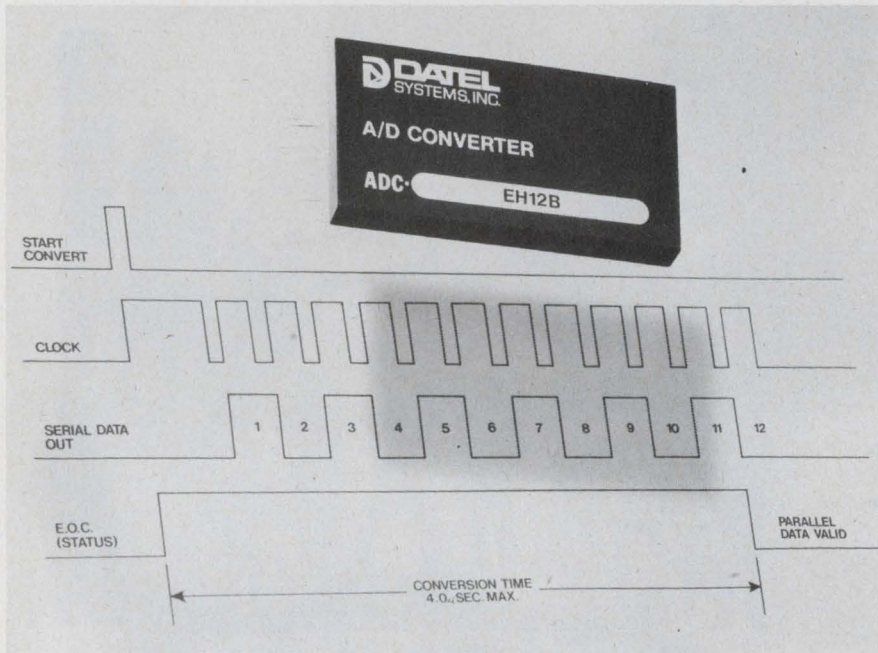

Datel Systems, 1020 Turnpike St., Canton, MA 02021. (617) 828-8000. P&A: See text.

Datel's ADC-EH12B 12-bit analog-to-digital converter halves the cost of high-speed conversion. The unit transforms an analog input signal into a 12-bit digital word in 4 μs or less. And, it costs only \$229 in unit quantities.

Other outstanding features of the modular converter are its small size and its power consumption. The unit measures only 2 × 4 × 0.4 in.—about half the height of many competing converters. The

power requirement of only 2 W is also about half that of the competition. Both of these improvements are due to the company's use of complex ICs that replace some older, less efficient circuits.

The a/d converter can operate either as a unipolar or bipolar unit, just by pin-strapping. Input ranges are 0 to 10 V or -5 to +5 V. For either input range the input has an impedance 4.4 kΩ.

Only two trims are required to adjust the converter gain and offset. The gain tempo is a low 20 ppm/°C max. Both serial and

parallel output data are available in either offset binary, 2's complement or straight binary, depending upon which input mode is selected.

Some competing units available include the ADC-1103 at \$495 from Analog Devices (Norwood, MA), the ADC-591-12A at \$425 from Hybrid Systems (Burlington, MA), the 4132 at \$485 from Teledyne Philbrick (Dedham, MA) and the MP2912A at \$595 from Analogic (Wakefield, MA).

All except the Analogic unit complete conversions in 3.5 μs. Both the Datel and Analogic units require 4 μs.

All four competing units require more power than the Datel, with Teledyne Philbrick the closest at 2.8 W.

Teledyne Philbrick, though, makes the smallest unit of the lot — 2 × 4 × 0.375 in.—an eighth of an inch thinner than the Datel converter. And the Analog Devices ADC-1103 has the best gain tempo — only 10 ppm/°C max.

Datel also has a lower-speed version of the ADC-EH12B, with conversion time of 8 μs for 12 bits. It costs \$169 in unit quantities.

The ADC-EH12B converters are offered for delivery in four weeks.

Datel	CIRCLE NO. 301
Analog Devices	CIRCLE NO. 302
Analogic	CIRCLE NO. 303
Hybrid Systems	CIRCLE NO. 304
Teledyne Philbrick	CIRCLE NO. 305



ANALOGY
ACE OUT THE COMPETITION WITH THE A-860 12-BIT DAC. YOUR SYSTEM WON'T NEED RIGGS FOR 100ns CONVERSION SPEED AT 0.0125% LINEARITY! SETTLES TO THE BOTTOM LINE IN LESS TIME THAN HOWARD CAN SAY "WOMAN'S LIB."

intech INCORPORATED
(408) 244-0500
1220 COLEMAN, SANTA CLARA CA. 95050

Motor drives handle 1/8 to 1 hp units

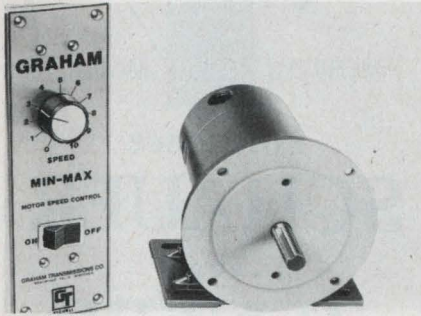

Graham Transmissions Co., P.O. Box 160, Menomonee Falls, WI 53051. (414) 251-1100. \$120; stock.

The Min-Max series of permanent magnet motor drives are available in ratings from 1/8 to 1 hp. Standard features include 4% regulation over a 30:1 speed range; maximum speed adjustment, adjustable torque limit, and a NEMA 41/12 oil and dust resistant enclosure. The units are compact, less than 11 in. high and 4 in. square. While the Min-Max series drives are offered in complete basic packages (including 1800 rpm motors), the control unit itself is available for use with other permanent magnet 90-V armature motors (with slight internal modification).

CIRCLE NO. 330

High speed follower handles 300-V signals

ILC Data Device Corp., Airport International Plaza, Bohemia, NY 11716. (516) 567-5600. \$250; 6 to 8 wk.

The high voltage, high speed, voltage follower, Model VF-666, is intended for deflection circuit buffering and other applications that require high voltage isolation. The Model VF-666 will track 300-V pk-pk signals from dc up through high frequencies with a unity gain accuracy of $\pm 0.01\%$. Its input parameters include an input offset voltage of ± 1 mV, an input bias current of 100 pA and an input impedance of $10^{11} \Omega$. The amplifier slew rate is 50 V/ μ s (min). The rated supply voltage is ± 175 V dc and the unit can supply ± 150 V at 3 mA. The VF-666 is packaged in a $2 \times 3 \times 0.5$ in. case and is rated for operation from 0 to 70 C.

CIRCLE NO. 331

NEW Continental Specialties Logic monitor

FASTER THAN A SCOPE! SAFER THAN A VOLTMETER! BRINGS ICs TO LIFE!

Made in USA



* Patent Pending

The amazing self-powered, self-contained, pocket-size Logic Monitor requires no adjustments or calibrations as it simultaneously displays static and dynamic logic states of DTL, TTL, HTL or CMOS DIP ICs. Now you can watch your signals work their way through counters, shift registers, timers, adders, flip-flops, decoders, even entire systems! High intensity LEDs turn on when lead voltages exceed the threshold (2V). **No power supply is needed!** The power-seeking gate network locates DIP supply leads and feeds them into the Logic Monitor. Forget about grounds, pin counting or sync polarity.

Simply clip the Logic Monitor to any DIP IC up to 16 pins. Precision plastic guides and a flexible plastic web insure positive connections between non-corrosive nickel/silver contacts and the IC leads. Logic levels appear instantly on 16 large (.125" dia.) high intensity LEDs. Logic "1" (high voltage)-LED ON. Logic "0" (low voltage or open circuit)-LED OFF. Yes, now you can see your designs come alive. Order your fast, versatile, accurate, indispensable Logic Monitor today!

ORDER TODAY! 84⁹⁵

Add \$2.50 postage/handling.
Foreign orders add 15%.
Prices subject to change.



Continental Specialties Corporation

Box 1942, New Haven, CT 06509 • 203/624-3103

W. Coast Off.: Box 7809, S. Fran., CA 94119 • 415/383-4207 Canada: Available thru Len Finkler Ltd., Ontario

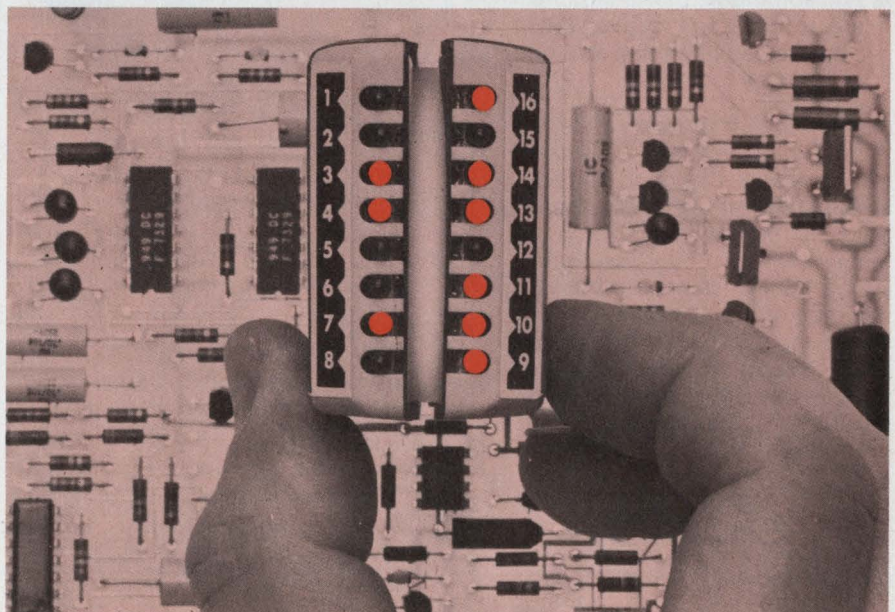

INFORMATION RETRIEVAL NUMBER 52

designed
by Grayhill
as the
world's
smallest
rotary switch



**10 positions, 1 or 2 poles,
diameter less than .300"**

- Non-shorting...wiping contacts
...rated to make or break 15,000
cycles minimum at logic loads.
- Now available with integral knob
...as well as screwdriver or
shaft operated.
- For communications circuits,
electronic stopwatches, and
other low voltage applications
where size is critical

As the pioneer in switch microminiaturization, we present our Series 75, designed as the smallest the state of the art permits. If you think that small switch means big price...guess again. Here's a lot of switch in a tiny package at a cost that's surprisingly low. Write for Bulletin #237 describing these miniature switches...and consult EEM for more information on Grayhill products.



561 Hillgrove Avenue • LaGrange, Illinois 60525
(312) 354-1040

INFORMATION RETRIEVAL NUMBER 53

INSTRUMENTATION
Voltage/Ω calibrator
offers 30 ppm/year

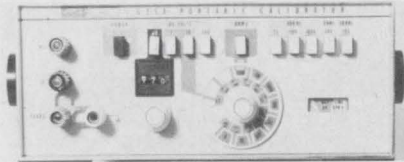

*John Fluke Manufacturing Co.,
Inc., Box 7428, Seattle, WA 98133.
(415) 323-2133. \$1995; stock to 45
days.*

A portable ac-dc voltage and resistance calibrator especially designed for use with digital voltmeters, Model 515A, offers a basic accuracy of 30 ppm per year over a wide temperature range of 18 to 28 C. Weighing only 13 lb. including the rechargeable battery pack (which provides up to 8 h off-line operation) the instrument is housed in a 3-1/2 × 8-1/2 × 16-in. case. Specs include dc volts from 9 to 999 μ V continuous with 0.2- μ V resolution, 0 to 1.0 V in 0.1-V steps, 0 to 10 V in 1-V steps, and a precise 100-V output. Ac voltage tests can be made at three frequencies, 400 Hz, 4 kHz and 50 kHz.

CIRCLE NO. 332

IC testers offer
100% functional tests

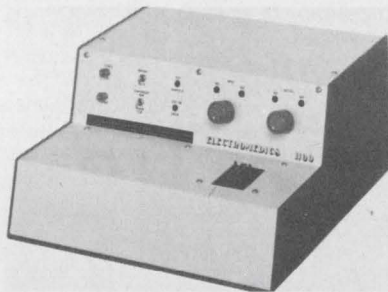

*Electromedics, 3295 Brookdale Dr.,
Santa Clara, CA 95052. (408) 243-
3119. Start at \$550.*

Models 1000 and 1100 digital IC testers feature 100% functional testing of DTL, TTL, and CMOS devices. Programmable cards and simple go/no-go fault indicators eliminate operator training or error. High productivity is assured with less than 0.1-s cycle times. Expandable options are available for 24 and 40-pin devices. Model 1000 provides pass/fail testing while Model 1100 incorporates failure analysis indicators.

CIRCLE NO. 333

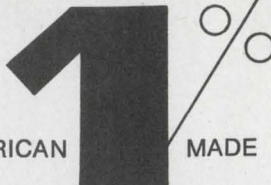
 AMERICAN MADE
Tolerance
SCHAUER
1-Watt
ZENERS

Immediate Shipment
Low Prices

ANY voltage from 2.0 to 16.0

Quantity	Price each
1-99	\$1.07
100-499	.97
500-999	.91
1000-4999	.86
5000 up	.82



Write for complete
rating data and other
tolerance prices.

Buy the kit-
Save
a lot

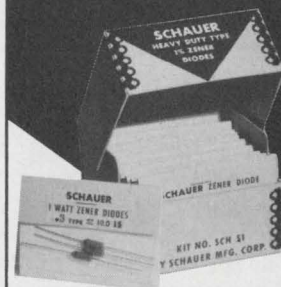

Kit contains a 51-piece assortment of SCHAUER 1% tolerance 1-watt zeners covering the voltage range of 2.7 to 16.0. Three diodes of each voltage packaged in reusuable poly bags. Stored in a handy file box. Contact your distributor or order direct.

A \$54.57 value for
ONLY \$24⁵⁰

Semiconductor Division
SCHAUER
Manufacturing Corp.

4511 Alpine Ave. Cincinnati, Ohio 45242
Telephone: 513/791-3030

INFORMATION RETRIEVAL NUMBER 54
ELECTRONIC DESIGN 5, March 1, 1975

Unit checks logic on 64-pin boards

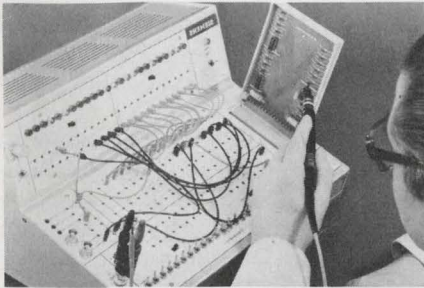

Siemens Corp., 186 Wood Ave., S., Iselin, NJ 08830. (201) 494-1000. Under \$1500; 60-90 days.

Log 38 tests PC boards (31 or 64 pins) and ICs (TTL, CMOS, LSI) with visual indication of static voltage conditions. The unit is equipped with a plug board which links the inputs of the boards under test to a word generator, and the outputs with a word indicator. This generates the required input bit sample. Selector sockets enable the operator to choose whether the indicator lamps should light up at ZERO or ONE.

CIRCLE NO. 334

6-channel recorder gives choice of modules

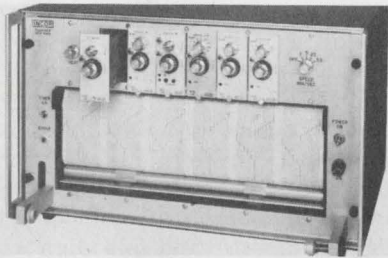

Incor Instrumentation, Inc., 144 Lamar St., West Babylon, NY 11703. (516) 643-7070. Basic 6-channel, single speed: \$2090; stock to 4 wks.

This six-channel recorder, Series 3000, offers over 10 types of standard plug-in modules that provide conditioning for: ac and dc voltages for $1 \mu\text{V}$ to 50 V per division; thermocouple inputs, frequency-to-voltage, log conversion; and to power most types of strain, load and pressure transducers. Each plug-in module contains its own fused transformer input power supply to provide complete signal and fault isolation between recording channels. The recorders are thermal writing type and provide dc to 110 Hz response on 50-mm wide analog channels.

CIRCLE NO. 335

10 MHz to 18 GHz detectors using field-replaceable diodes

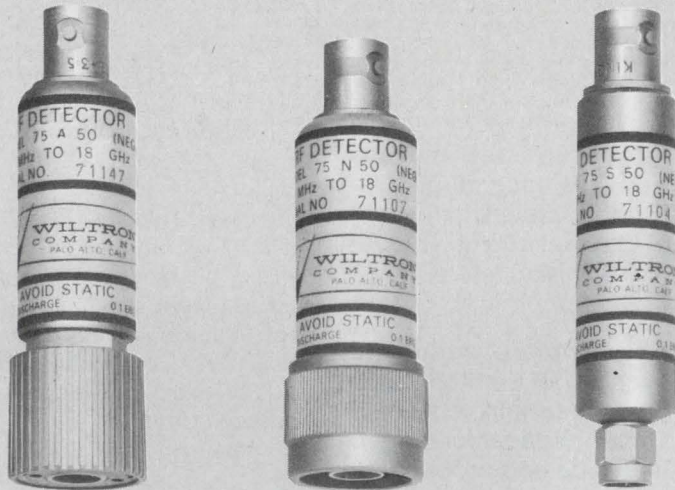

2-WEEK DELIVERY

You no longer need to sweat out long delivery cycles for crystal detectors, WILTRON can currently supply you with high-performance detectors on a 2-week basis. These are the same detectors that have been time-proven in WILTRON quality instrumentation.

What's more, WILTRON detectors have field-replaceable diodes—an exclusive advantage in the upper part of this frequency range. Replacement diodes are only \$50.

And note that either positive or negative polarities are available as are any of the three common connectors: N, APC, or SMA. No need for adapters.

Other performance parameters are also high. Swr, for example, is unsurpassed and flatness is ± 1 dB over the full range.

CALL NOW

Call Walt Baxter at WILTRON today and get these high-convenience detectors on their way to you.



930 E. MEADOW DRIVE • PALO ALTO, CA. 94303

(415) 321-7428 • TWX 910-373-1156

INFORMATION RETRIEVAL NUMBER 55

Check your total cost... then check ours

Stacoswitch's competitive purchase price plus ease of installation and quick, simple servicing from front of panel add up to **LOW TOTAL COST**. You save three ways.

And Staco's matrix mounted Series 1M and 1MR Lighted Push-button Switches help conserve precious panel space for added savings in design and production.

Choice of circuitry, switch action, and display style to meet your

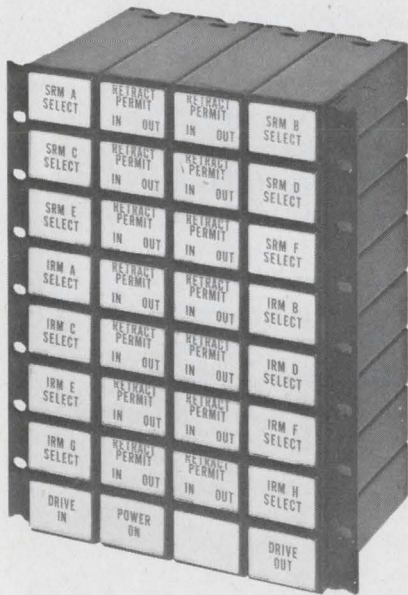

particular needs. Write today for General Catalog showing complete switch line. When you think switch...think **STACOSWITCH** and save!



1130 BAKER STREET, COSTA MESA, CALIF. 92626
(714) 549-3041 TWX: 910/595-1507

Other STACO Company products: Fixed Ratio Transformers, STACO, INCORPORATED, Richmond, Indiana; Variable Transformers, STACO, INCORPORATED, Dayton, Ohio.

INFORMATION RETRIEVAL NUMBER 56

DISCRETE SEMICONDUCTORS

Laser diodes deliver up to 20 W at room temp

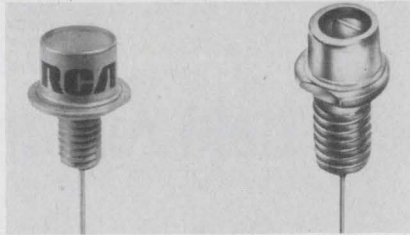

RCA, 415 S. Fifth St., Harrison, NJ 07029. (201) 485-3900. From \$10 (unit qty.); stock.

Ten GaAs single-diode injection lasers are designed for use in a variety of applications including intrusion alarms and industrial control equipment. These 10 devices, designated as the SG2000 series, have minimum power outputs ranging from 1 to 20 W at peak drive currents of 10 to 100 A. The peak wavelength of spectral radiant intensity at 27 C is 904 nanometers. The devices are supplied in coaxial OP-3 and OP-12 packages for simple mounting and good thermal dissipation capability.

CIRCLE NO. 336

Transient suppressors have JEDEC registration

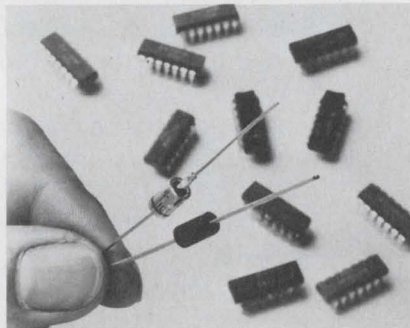

General Semiconductor Industries, P.O. Box 3078, Tempe, AZ 85281. (602) 968-3101. From \$0.90 (10,000-up); stock.

Two JEDEC registered Trans-Zorb transient voltage suppressors are intended for 5-V IC logic protection. The 1N5907 is a glass-to-metal, hermetically sealed device for military applications, and the 1N5908 is a molded version for commercial use. Both devices have a high energy suppression capability—15,000 W for 10 μ s and 1500 W for 1 ms. The theoretical response time is less than 1×10^{-12} s.

CIRCLE NO. 337

Npn power transistors handle up to 200 W

Kertron, 7516 Central Industrial Dr., Riviera Beach, FL 33404. (305) 848-9606. From \$8.60 (100-up); stock.

The 2N6338, 2N6339, 2N6340 and 2N6341 are npn power transistors housed in TO-3 packages. The devices feature high current gain at 10 A, with a minimum gain of 12 at 25-A collector current. The transistors can dissipate 200 W with a case temperature of 25 C. The transistors have a turn-on time of less than 300 ns and fall-time of less than 250 ns. All devices in the family are rated from 100 to 150 V BV_{CEO} .

CIRCLE NO. 338

High speed photodiodes made for optical guides

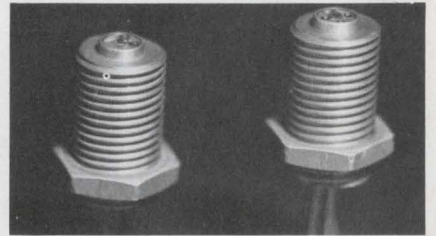

Texas Instruments, P.O. Box 5012, Dallas, TX 75222. (214) 238-3741. \$40 (471); \$175 (451); 3 wk.

Two high-speed diodes, the TIXL471 and 451, are designed for use in fiber optic applications. The GaAs diode light source and silicon avalanche photodiode can connect directly and self-align with Corning T-19H optical waveguide terminations. The TIXL471 infrared-emitting diode is a dome-shaped chip mounted in a threaded connector package. The 0.018 in. diameter chip is encapsulated in epoxy to provide a flat, clear window at the top of the case. Typical optical power coupled into the Corning T-19H optical waveguide is 15 μ W at 150 mA drive current. The TIXL451 photodiode is housed in an anodized-aluminum threaded case filled with clear epoxy. Light (up to 8° half angle) emitted from the attached fiber optic bundle will fall on the active area of the detector (4.5×10^{-3} cm²). Designed for dc to microwave frequencies, the TIXL451 has a minimum photocurrent gain of 100 and a typical gain-bandwidth product of 80 GHz.

CIRCLE NO. 339

COMPONENTS

Solid-state buzzer emits 76 dB of sound



Aristo-Craft Distinctive Miniatures, 314 Fifth Ave., New York, NY 10001. (212) 279-9034. \$1 (OEM qty).

The new electronic SSB series of solid-state buzzers is only 15/16 in. in diameter, 11/16-in. high and flange mounted. Low-current drain makes the SSB suitable for transistorized circuitry. Two models are presently available. Model SSB No. 612 operates on 6 to 12 V dc at a maximum current of 15 to 30 mA, and the SSB No. 30 operates on 3 V dc at a maximum current of 35 mA. The minimum sound-level output is 76 dB at 1 ft and its frequency is 400 Hz. The unit's temperature range is -10 to 55 C.

CIRCLE NO. 340

Neon 7-segment display provides high contrast

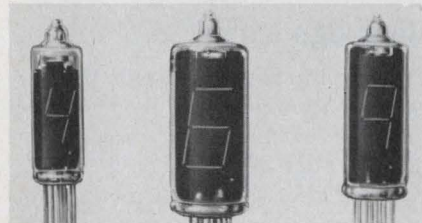

Industrial Electronic Engineers, Inc., 7720-40 Lemona Ave., Van Nuys, CA 91405. (213) 787-0311. \$1.75 to \$2.35 (unit qty); stock.

The IEE-Luna Series of seven-segment, neon-tube digital displays feature bright, amber and single-plane characters. The units are available in nominal 3/8-in. (NTD-11), 1/2-in. (NTD-21) and 5/8-in. (NTD-31) sizes, and they provide a high-contrast, low-power display with 120° viewing. Life expectancy is 100,000 h. The tubes require only 0.6 mA per segment at 130 V dc and they operate over temperature range of -10 to 55 C.

CIRCLE NO. 341

Make the big change-over to the new DMM from T.R.I.

High performance, low cost (\$279) and compact size, 10 μ V Resolution.

10 μ V resolution, \$279
Model 6355 is a portable DMM having a 10 μ V (DC voltage) resolution. It is comparable to DMM's for laboratory use, priced at an economical \$279, and sets a new standard of performance for portable DMM's.
Fully automatic
Operation is as simple as selecting the function and signal connection. The measured value is displayed

through the automatic selection of 5 functional modes: range selection, unit display, polarity, over-range indication and overload protection.

True portability
It measures 4-3/8" (W) x 2-7/8" (H) x 6" (D) and is a light-weight 1.8 lbs for complete portability. The shock-resistant design even protects the unit against accidental drop damage.

Rechargeable battery (Option)
Besides the AC power supply, the standard composition includes an alkaline battery. Optionally available is a rechargeable battery. Standard accessories include a battery charger.



505 West Olive Avenue
Sunnyvale, CA 94086
(408) 733-9080

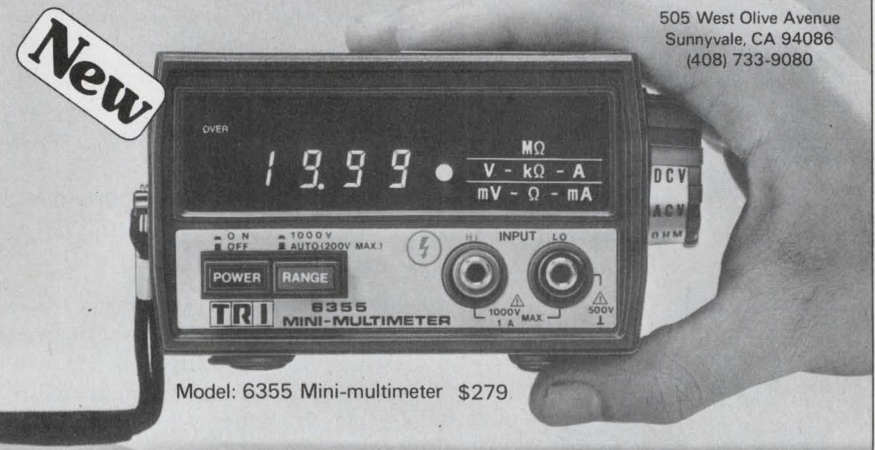

INFORMATION RETRIEVAL NUMBER 57

SHORTY

Illuminated Pushbutton Switches & Indicators

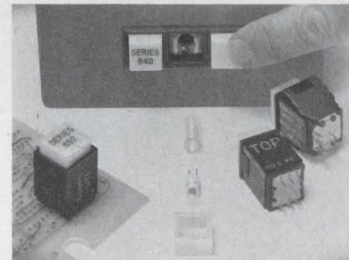

1" MAX. BEHIND PANEL

NEW ALTERNATE ACTION SPDT & DPDT FOR PANEL OR PRINTED CIRCUIT BOARD MOUNT

Short . . . But not on features. Full logic compatibility. Momentary or Alternate Action with Positive Latch Down. Front Relamping. Readily Available Lamps. Coin Silver contacts rated to 6 amps @ 125VAC

or Hard Gold Contacts rated to 1/2 amp @ 30VDC or 125VAC. Wide Variety of lens colors. Engraved legends. Terminals Accept Solder, Crimp Post Receptacles, or Printed Circuit Board.

AS LOW AS \$1.50* *IN QTY.



COMPU-LITE CORPORATION

17795 Sky Park Circle, Irvine, California 92707
(714) 546-9045

INFORMATION RETRIEVAL NUMBER 58

BIG POWER SUPPLIES



IN LITTLE PACKAGES

**AC-DC and DC-DC
miniaturized power converters
that deliver 3.9 watts
per cubic inch.**

- AC inputs: 115VAC, 50-500Hz
- DC inputs: 12, 28, 48 & 115VDC.
- 1 to 6 isolated and regulated DC outputs from 4.2 to 300VDC.
- Line and load regulation to 0.1%.
- Up to 120 watts per output.
- Efficiencies to 85%
- Design-As-You-Order construction from standard sub-modules . . . over 1200 possible configurations.
- Completed converters provided in tested and encapsulated, conduction cooled packages in just days.

See for yourself how we've packed the power and performance in . . . request our actual size "little black box" punch out kit and catalog today!

Call us collect . . . ask for Jim Dunn.



ARNOLD MAGNETICS CORPORATION

11520 W. Jefferson Blvd.
Culver City, Ca. 90230 ● (213) 870-7014

design aids

LED driver selector guide

Organized as a four-unit matrix—common-anode and common-cathode rows, segment driver and digit-driver columns—a LED driver selection guide lets its user select, at a glance, precisely the LED driver needed. For each driver, the guide shows the number of outputs, the current capability per segment or digit and indicates whether or not the driver is decoded. National Semiconductor, 2900 Semiconductor Dr., Santa Clara, CA 95051

INQUIRE DIRECT

Dielectric materials

Described in a dielectric materials selector chart are adhesives, casting and potting resins, conformal coating and varnish resins, electrically conductive resins and tooling resins. Formulated Resins.

CIRCLE NO. 342

Displays

Mock-ups of planar gas discharge displays represented in actual size and color are printed on an 8-1/2 × 11 in. adhesive-backed paper. Two character fonts (Series SP-350, 1/2 in. and SP-330, 1/3-in.) and two functions (clock and frequency) allow sampling two sizes and two configurations. Beckman Instruments, Helipot Div., Santa Ana, CA

CIRCLE NO. 343

Silicon bridges

A cross-reference guide lists 12 of the company's silicon bridges and corresponding competitors' bridges, ranging in current from 1.5 to 25 A. General Instrument, Semiconductor Products Div.

CIRCLE NO. 344

Zener wall chart

An updated zener diode wall chart covers low-cost commercial zeners to ultra-reliable military devices. Siemens.

CIRCLE NO. 345

new literature

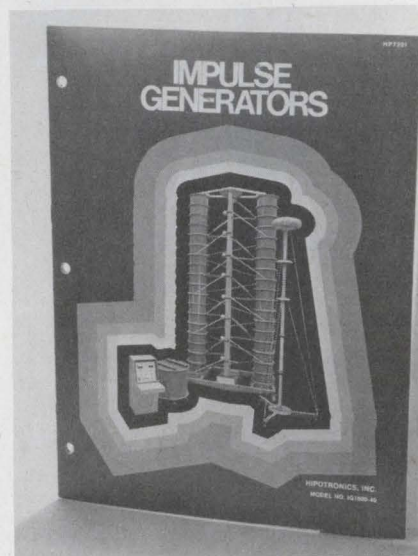

Impulse generators

A 12-page, four-color brochure covers 19 standard impulse generators. Performance features and safety features are described, along with descriptions of nine types of optical equipment. Five of the units are illustrated, and schematic diagrams and scope traces support the discussions on operation and theory. A chart supplies major specifications for each model. Hipotronics, Brewster, NY

CIRCLE NO. 346

Cartridge lamps

Two-pin cartridge lamps that insert easily from the front of the panel into matching holder assemblies are described in a 16-page catalog. Photographs, drawings and ordering information are included. Genisco Technology, Eldema Div., Compton, CA

CIRCLE NO. 347

Instrument rental

A comprehensive listing of over 5000 instruments available for short or long-term lease; 100 nationwide sales/service centers; ancillary services such as measurement and testing, calibration and maintenance, terminal services and instrumentation repair and calibration are covered in a 50-page catalog. General Electric, Quick-Rental Instruments, Schenectady, NY

CIRCLE NO. 348

No down-time in rotary switches



Unique 5-second wafer replacement obsoletes other switches. Simply lift out old wafer, slip in new wafer. No unsoldering . . . no disassembling . . . no wire removing.

CDI patented switches with dust covers are available in sizes 2" x 2", 3" x 3", and 4" x 4" with lengths to accommodate up to 36 wafers. Switches can be customized to your specifications.

Operation may be manual, motor or solenoid for use in any rotary selector switch application. Now supplied for numerous military and commercial applications.

Mfd. under Tabet U. S. Patents 2,841,660, 2,971,066, 3,015,000, 2,956,131, 2,988,607.

CHICAGO DYNAMIC INDUSTRIES, INC.



PRECISION PRODUCTS DIVISION

1725 Diversey Blvd., Chicago, Ill. 60614. Phone 312, WE 5-4600

INFORMATION RETRIEVAL NUMBER 60

Ⓢ SUBMINIATURE LAMP SPECIALISTS

Lamps for European Equipments
Get them quickly from
OSHINO

T-1

Bi-Pin



Actual size

3V to 28V
0.100 inch pin
spacing

T-1^{3/4}

Midg. Bayonet



Actual size

3V to 28V
Smallest bayonet
base

T-4.6

Telephone slide



Actual size

6V to 48V
Smallest slide
base

T-5.5K

Telephone slide



Actual size

6V to 60V
Shortest slide
base

T-5.5

Telephone slide



Actual size

6V to 72V
German standard
DIN 49838-B

Other European type subminiature lamps also stocked for quick delivery.

• Ask informations to:
WAMCO Technical Sales, Inc.
705 W. 16th Street, Costa Mesa, California 92627
TEL: (714) 642-5100 TELEX: 678459

Mid-West 12 states only
CIMCO International, Inc.
9037 Kenton Ave., Skokie, Illinois 60076
TEL: (312) 673-0262 TELEX: 724426

OSHINO ELECTRIC LAMP WORKS, LTD.
TOKYO, JAPAN

INFORMATION RETRIEVAL NUMBER 61

ELECTRONIC DESIGN 5, March 1, 1975

BERG Minisert™

. . . Low-Profile P.C. Socket provides repeated pluggability for IC's, DIP's, etc.

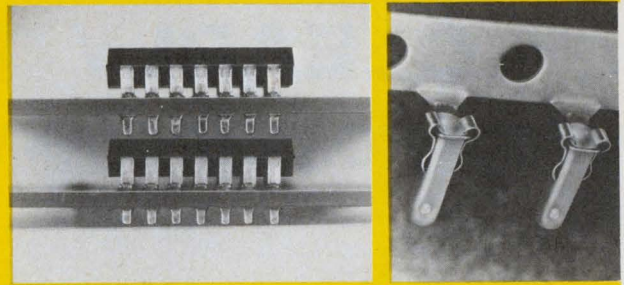

For use where space is restricted; extends just .030" above and .088" below board, allows .400" board-to-board spacing. One size MINISERT® socket fits wide range of hole sizes—.050" to .058" in diameter. Elastomeric seal keeps foreign matter out of socket. MINISERT socket accepts round or flat leads of DIP's, LED's and LSI's. Free-standing design can be used in any socket pattern. Semi-automatic machine inserts at rates up to 2000 per hour. Write for Bulletin 120, or call:



**BERG
ELECTRONICS**
Division, E. I. du Pont de Nemours & Co. (Inc.)

New Cumberland, Pa. 17070 Phone: (717) 938-6711

*Terminals sell for \$20 to \$30 per thousand in volume quantities.

INFORMATION RETRIEVAL NUMBER 62

Griplet® CONNECTORS

CUT COSTS
SPEED CIRCUIT ASSEMBLY

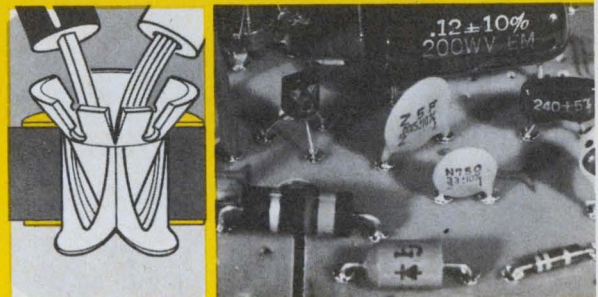

The Berg Griplet connector gives you reliable interfacial connections with no investment in plating facilities. Plated-through holes are eliminated, solderability is improved and mechanical interconnections are positive. With high-speed machines you keep complete in-house control of production and quality control, while reducing costs. Griplet connectors also allow field repairs without damaging interfacial connections, and they withstand repeated thermal shocks with out solder cracking. Write for Catalog 301, or call:



**BERG
ELECTRONICS**
Division, E. I. du Pont de Nemours & Co. (INCORPORATED)

New Cumberland, Pa. 17070 Phone: (717) 938-6711

INFORMATION RETRIEVAL NUMBER 63

87

IT'S CLEARLY THE CHOICE OF ELECTRONICS ENGINEERS – WORLDWIDE

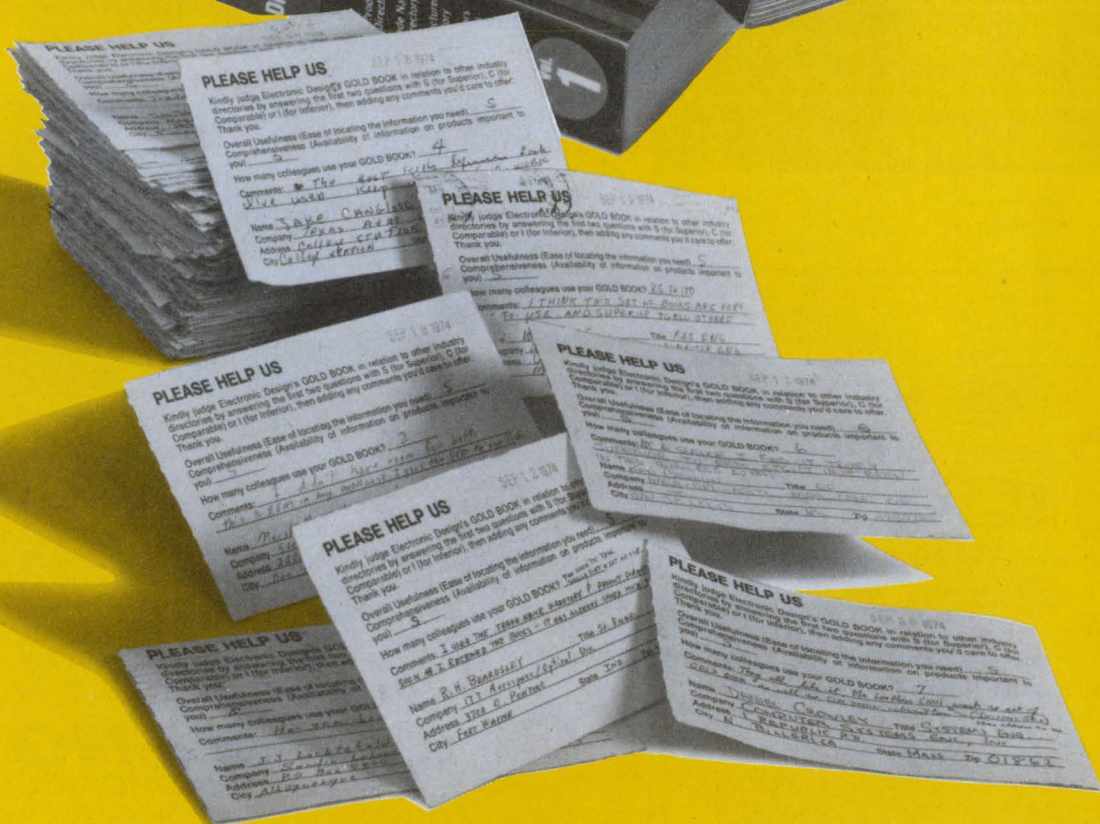
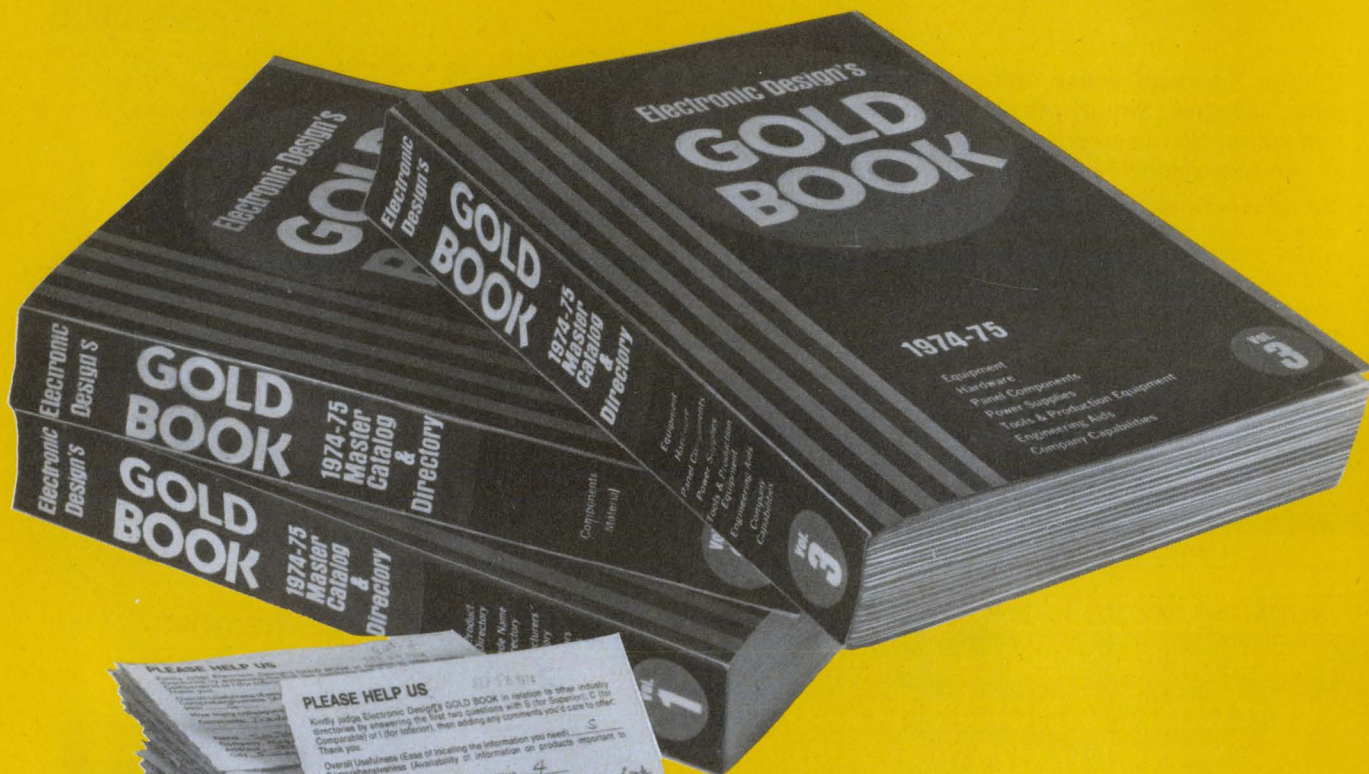

WHEN YOU HAVE Electronic Design's GOLD BOOK YOU DON'T NEED ANY OTHER INDUSTRY DIRECTORY

In just a few months, the first issue of *Electronic Design's* GOLD BOOK has become the leader among all directories used in this industry. Engineers have responded enthusiastically throughout the U.S. and from all over the world — especially in Europe where they've never seen anything like it before. The GOLD BOOK has become number one almost overnight.

HERE'S HOW YOUR FELLOW ENGINEERS RATE THE INDUSTRY ANNUALS

	Annuals Consulted Within Past Month	Annuals Preferred
Electronic Design's GOLD BOOK	85%	60%
Electronic Engineer Master (EEM)	63%	42%
Electronic Buyer's Guide (EBG)	32%	8%
Thomas Register	16%	7%
Conover-Mast Purchasing Directory	2%	1%

SOURCE: Study by Dr. Eugene D. Jaffe, Associate Professor of Marketing, St. John's University, Nov. 1974. Base: respondents using directories. Totals exceed 100% due to multiple mentions.

The GOLD BOOK has revolutionized directory use patterns in this industry. Here's why: The GOLD BOOK is by far the largest, most complete one-step electronics purchasing and reference tool ever produced. And it's far easier to use. Look at these comparisons:

COMPARISON OF ELECTRONICS INDUSTRY DIRECTORIES (1974-75 editions)

	EBG ELECTRONICS BUYERS' GUIDE	EEM ELECTRONIC ENGINEERS MASTER	ELECTRONIC DESIGN'S GOLD BOOK
Number of manufacturers listed	5,800	3,165	7,528
Total number of products listed	4,267	3,235	4,799
Number of direct products listed	2,479	2,250	2,925
Number of cross-reference products listed	1,788	985	1,874
Number of distributors listed in Distributors Directory — Alphabetic	0	1,720	5,780
Number of distributors listed in Distributors Directory — Geographic	0	1,720	5,780
Is complete mailing address given each time a company is listed in product directory?	No	No	Yes
Is telephone number given for each company listed in product directory?	No	No	Yes
Are distributors listed for each manufacturer?	No	Partial ¹	Yes
Does manufacturers listing include FSCM numbers?	No	No	Yes
Does manufacturers listing include facsimile equipment by make and call number?	No	No	Yes
Total Circulation	30,017 ¹	89,169 ¹	Over 90,000
Overseas Circulation ²	1,339 ²	0 ³	13,200
Number of ad pages	590 ⁴	2,752	2,820

¹ Paid listings only
² Includes Canada

³ Standard Rate & Data; Oct. 24, 1974
⁴ Includes fractionals

**MOST THOROUGH, MOST COMPLETE, EASIEST-TO-USE
ELECTRONICS INDUSTRY DIRECTORY IN THE WORLD**

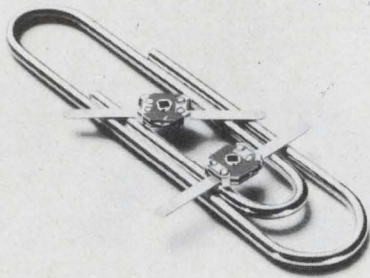

Thin-Trim variable capacitors provide a reliable means of adjusting capacitance without abrasive trimming or interchange of fixed capacitors. Series 9401 has high Q's and a range of capacitance values from 0.2-0.6 pf to 3.0-12.0 pf and 250 WVDC working voltage. Johanson Manufacturing Corporation, Boonton, New Jersey (201) 334-2676.

INFORMATION RETRIEVAL NUMBER 601

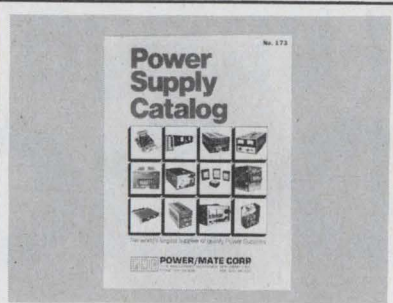

Free catalog of 34,500 power supplies from the worlds largest manufacturer of quality Power Supplies. New '74 catalog covers over 34,500 D.C. Power Supplies for every application. All units are UL approved, and meet most military and commercial specs for industrial and computer uses. Power Mate Corp. (201) 343-6294.

INFORMATION RETRIEVAL NUMBER 604

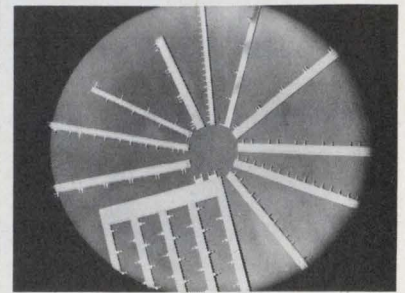

Mini/Bus® Evaluation Kit, \$25, in stock. Lets you try Rogers' low-cost, noise attenuating, high packaging density power distribution system for PC boards. Millions in use. Standard parts on 2 weeks delivery, or less! Customer parts 4 to 6 weeks delivery. Rogers Corporation, Chandler, Ariz. 85224. Phone (602) 963-4584

INFORMATION RETRIEVAL NUMBER 607



TECHNICAL EXCELLENCE at economical prices for Microcomputers, Machine Control Systems, Zero-Speed Transducers, Injection Laser Systems, High-Impedance Delay Lines, Filter Design, Engineering Analysis, New Product Design, Microcircuits. ADAPTIVE SYSTEMS, INC. P.O. Box 1481 Pompano Beach, Fla 33061 (305) 942-4000

INFORMATION RETRIEVAL NUMBER 602

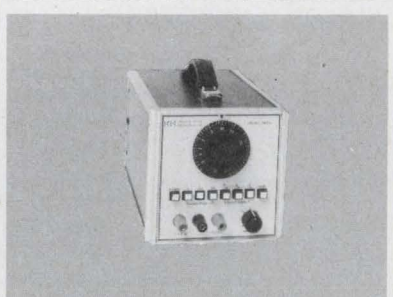

Low Cost Function Generator, Model 5800 provides sine, square and triangle waveforms from 0.2Hz to 2-MHz. 15 volts p-p outputs, 50 ohm output. Distortion typically less than .3%. 1000:1 tuning dial covers audio range on one band. Aux. output square wave. Krohn-Hite Corp., 580 Massachusetts Ave., Cambridge, MA 02139 (617) 491-3211.

INFORMATION RETRIEVAL NUMBER 605

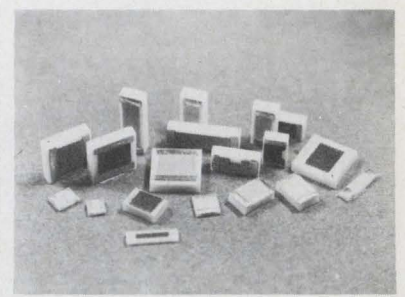

PRECISION THICK-FILM RESISTORS available in wide assortment of std sizes/types for reflow solder, epoxy or wirebound assembly techniques. All materials & mfg. processes carefully controlled & documented. In-depth inventories, efficient mfg. methods keep prices low & del. fast. Mini-systems Inc., 20 David Rd., N. Attleboro, MA 02761 617-695-0206

INFORMATION RETRIEVAL NUMBER 608

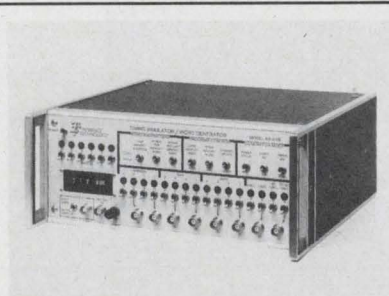

Unique New Programmable Generator features multiple function capability. Program as digital pulse or word generator. Programmable time from 50ns to .999 sec. External trigger, 8 or 16 output channels, ROM option, computer interface, expandable memory. Interface Technology, 627 Fremont Ave, South Pasadena, CA 91030 (213) 682-3705

INFORMATION RETRIEVAL NUMBER 603

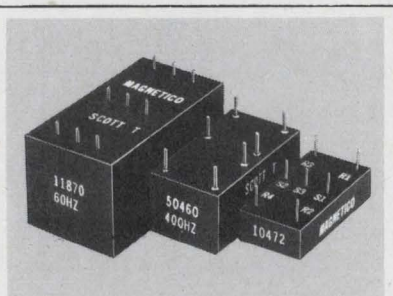

Scott T Transformer. 11870: 60HZ, 90v, L-L in. 1.1x2.1x1.1. 50460: 400HZ, 90v, L-L in. 7/8x1-5/8 x11/16. 50642: 400HZ, 11.8v, L-L in. 7/8x1-5/8-11/16. 10472: 400-HZ, 11.8v, L-L in. 3/4x1-1/2x3/8. All with 6v RMS sine & cosine output. MAGNETICO, INC., 182 Morris Ave, Holtsville, N.Y. 11742 516-654-1166.

INFORMATION RETRIEVAL NUMBER 606



Extra high voltage power transistor, V_{CB} & $V_{CE} = 1500V$, $I_C = 5A$, $P_d = 12.5W$, $I_B = 4A$. Field-tested reliability, rugged TO-3, quality product from Telefunken. Cost: 1-24: \$7.70, 25 up: \$6.93, 100 up: \$5.40. Also 5 other types to 1700V available from stock. Energy Electronic Products, 6060 Manchester Avenue, Los Angeles, CA 90045 (213) 670-7880.

INFORMATION RETRIEVAL NUMBER 609

Projection displays

Series 1100 projection display product profile is a technical and applications catalog, enabling users to evaluate and/or specify this series of low-cost message displays and their companion driver/decoders. IEE, Van Nuys, CA

CIRCLE NO. 349

Choppers and reed relays

Basic transformer-isolated and high-frequency choppers, microchoppers, chopper drivers, microreed, reed-power and light-isolated relays are featured in a 32-page catalog. Solid State Electronics, Sepulveda, CA

CIRCLE NO. 350

Edge connectors

Printed-circuit receptacles (edge connectors) are presented in a catalog. Full specifications, illustrations, schematic drawings, as well as ordering information, are given for each series. U.S. Components, Bronx, NY

CIRCLE NO. 351

Packaging cards and racks

Euro-Cards and Euro-Racks, a family of metric IC packaging cards and racks, are described in a four-page brochure. Cambridge Thermionic, Cambridge, MA

CIRCLE NO. 352

A/d converters

Direct digital conversion of i-f signal frequencies using the Model 7110 a/d converter is detailed in a series of data sheets. Computer Labs, Greensboro, NC

CIRCLE NO. 353

Materials test system

"Series 810 Materials Test Systems Catalog" describes features and capabilities of the system. MTS Systems Corp., Minneapolis, MN

CIRCLE NO. 354

High-voltage power SCRs

Series 420PA, 470PA and 470-PB high-voltage power SCRs in a Hockey-Puk package are described in a data sheet. International Rectifier, El Segundo, CA

CIRCLE NO. 355

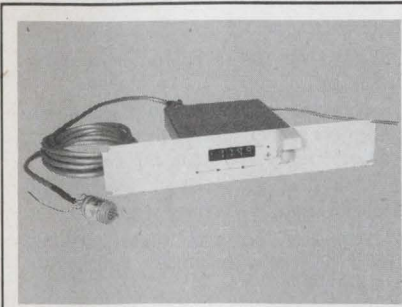

ABSOLUTE ENCODER—± 1 Part In 3600 System Accuracy, Electro-Magnetic Transducer + LED Display + BCD, Binary, and DC Output—Infinitely Adjustable Scale Factor (0 to 9999)—Hi Noise Immunity—Zero Offset—Single and Multi-Channel Units From \$375/Axis (1 pc.) Computer Conversion Corporation, East Northport, NY 11731 516-261-3300
INFORMATION RETRIEVAL NUMBER 610

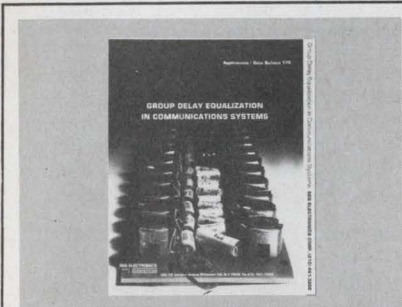

Free Applications Booklet—"Group Delay Equalization In Communications Systems". This comprehensive manual, prepared by SEG's Equalizer Design Dept., features useful applications information as well as tutorial look at the design of equalizers and their functions. SEG Electronics Corp. 120-30 Jamaica Ave., Richmond Hill, N.Y. 11418 (212) 441-3200.

INFORMATION RETRIEVAL NUMBER 611

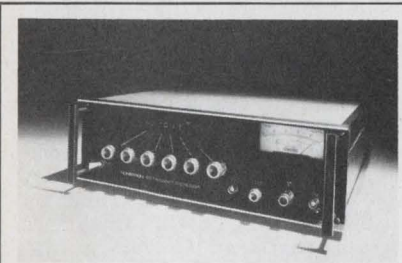

Comstron's 1013 costs only \$1595. It's a 5 digit, 0.1Hz to 13MHz Frequency Synthesizer for bench & systems applications. A metered, leveled output, up to 3V RMS, with a precision output attenuator adjustable in 10db steps with continuous level control, low phase noise & low harmonic distortion ensures signal purity. Comstron Corp, 120-30 Jamaica Ave, Richmond Hill, NY 11418 (212) 441-3200.

INFORMATION RETRIEVAL NUMBER 612

Advertisers wishing to reserve Quick Ad units should note the following mechanical requirements: Specs—Supply glossy photo of product and approximately 40 words which will set no more than 10 lines of 34 characters each. AFTER SUBMISSION NO COPY CHANGES CAN BE ACCEPTED. Quick Ads cost only \$300 per insertion, less for frequency advertisers.

RATES:

1x
\$325

7x
\$300

13x
\$275

19x
\$270

26x
\$265

39x
\$260

52x
\$255

104x
\$250

WHEN IT'S TIME FOR A SWITCH...

It's time for Shigoto. Because every Shigoto switch is backed by solid engineering know-how. A reliable piece of equipment you can count on. To perform every time. We've got toggle and rocker, lever and leaf, push button, panel, rotary, radio, knife, slide and snap action switches. All sizes, all ratings. Leaf through our Catalog and pick the switch that's compatible with your requirements. If we haven't already made it, we can, specially for you. And while you're at it, check out our other outstanding O.E.M. components, too.

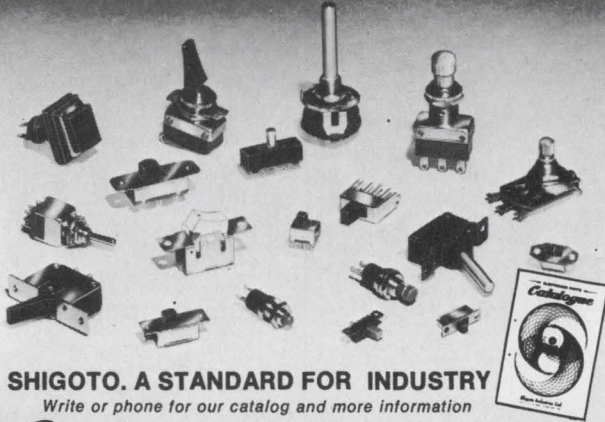

SHIGOTO. A STANDARD FOR INDUSTRY

Write or phone for our catalog and more information

Shigoto Industries Ltd.

350 Fifth Ave., N.Y., N.Y. 10001/(212) 695-0200/Telex 224219
One of the World's Largest Manufacturing Importers

INFORMATION RETRIEVAL NUMBER 64

The Ultimate in Ignition Systems!

★ **ELIMINATES BREAKER POINTS.**
Perfect Timing and Dwell never change!

★ **Eliminates Tune-ups.**
Never wears out or needs any Maintenance.

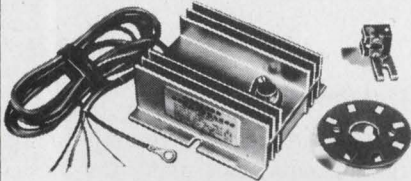

★ The Most Advanced "OPTO-ELECTRIC SYSTEM"

- The Allison Breakerless System eliminates the Points and Condenser, replacing them with an Opto-Electronic Trigger, using a Light-Emitting Diode and Phototransistor. Also completely eliminates wiper-arm "friction" wear. The only "TRUE" Electronic Ignition... that you can install for under \$100. Gives 40-times more Timing Accuracy than ANY system using mechanical Breaker-Points! Unlimited RPM. Smoother running (No timing fluctuation as with Magnetic units). Unaffected by Temperature, Moisture, or Vibration! All Solid-State Components. Easier Starting under any condition! Increased Horsepower. Sparkplugs last longer. Perfect timing increases engine Efficiency and Gas Mileage up to 30%!

● **Quick and Easy Installation!**

★ **Tested and Proven reliability.**

Only **\$49⁹⁵** ● **SATISFACTION GUARANTEED!**

● Complete. ● **1-YEAR FACTORY WARRANTY.**

(State Make, Year, Engine Size). (Calif. Res. add Tax).

● **CONVERT YOUR "C-D" UNIT TO BREAKERLESS!**
"TRIGGER-UNIT" ONLY \$34.95

★ **Send Postcard for FREE BROCHURE Today.**

ALLISON AUTOMOTIVE CO.

P.O. Box 881-F, TEMPLE CITY, CAL. 91780

INFORMATION RETRIEVAL NUMBER 65

SUBSCRIBER SERVICE For prompt service include the addressed label when writing about your subscription.

CHANGE OF ADDRESS

city	company address	division/department	company	name	NEW ADDRESS
state				title	
zip					

If you're moving, please let us know six weeks before changing your address. If you have a question, place your magazine address label here and clip this form to your letter.

MAIL TO: ELECTRONIC DESIGN Circulation Dept. Hayden Publishing Co., Inc., 50 Essex Street, Rochelle Park, NJ 07662

Electronic Design

ELECTRONIC DESIGN's function is:

- To aid progress in the electronics manufacturing industry by promoting good design.
- To give the electronic design engineer concepts and ideas that make his job easier and more productive.
- To provide a central source of timely electronics information.
- To promote communication among members of the electronics engineering community.

Want a subscription? ELECTRONIC DESIGN is sent free to qualified engineers and engineering managers doing design work, supervising design or setting standards in the United States and Western Europe. For a free subscription, use the application form bound in the magazine. If none is included, write to us direct for an application form.

If you do not qualify, you may take out a paid subscription for \$30 a year in the U.S.A., \$40 a year elsewhere. Single copies are \$1.50 each.

If you change your address, send us an old mailing label and your new address; there is generally a postcard for this bound in the magazine. You will have to requalify to continue receiving ELECTRONIC DESIGN free.

The accuracy policy of ELECTRONIC DESIGN is:

- To make diligent efforts to ensure the accuracy of editorial matter.
- To publish prompt corrections whenever inaccuracies are brought to our attention. Corrections appear in "Across the Desk."
- To encourage our readers as responsible members of our business community to report to us misleading or fraudulent advertising.
- To refuse any advertisement deemed to be misleading or fraudulent.

Microfilm copies are available of complete volumes of ELECTRONIC DESIGN at \$19 per volume, beginning with Volume 1, 1952 through Volume 20. Reprints of individual articles may be obtained for \$2.00 each, prepaid (\$.50 for each additional copy of the same article) no matter how long the article. For further details and to place orders, contact the Customer Services Department, University Microfilms, 300 North Zeeb Road, Ann Arbor, Michigan 48106 telephone (313) 761-4700.

Want to contact us? If you have any comments or wish to submit a manuscript or article outline, address your correspondence to:

Editor
ELECTRONIC DESIGN
50 Essex Street
Rochelle Park, N.J. 07662

ELECTRONIC DESIGN 5, March 1, 1975

Electronic Design

Advertising Sales Staff

Tom W. Carr, Sales Director

Rochelle Park, NJ 07662

Robert W. Gascoigne

Daniel J. Rowland

(Recruitment, Quick Ads, Classified)

50 Essex Street

(201) 843-0550

TWX: 710-990-5071

Philadelphia

Thomas P. Barth

50 Essex Street

Rochelle Park, NJ 07662

(201) 843-0550

Boston 02178

Gene Pritchard

P.O. Box 379

Belmont, MA 02178

(617) 489-2340

Chicago 60611

Thomas P. Kavooras

Berry Conner, Jr.

200 East Ontario

(312) 337-0588

Cleveland

Thomas P. Kavooras

(Chicago)

(312) 337-0588

Los Angeles 90045

Stanley I. Ehrenclou

Burt Underwood

8939 S. Sepulveda Boulevard

Suite 510

Los Angeles, CA

(213) 641-6544

San Francisco 94022

Jerry D. Latta

P.O. Box 1248

Los Altos, CA

(415) 965-2636

London, Amsterdam, Tokyo, Seoul

John Ashcraft

12, Bear St.

Leicester Square

London WC2H 7AS England

Phone: 01-930-0525

W. J. M. Sanders

John Ashcraft & Co.

Herengracht 365

Amsterdam C., Holland

Phone: 020-24-09-08

Haruki Hirayama

Electronic Media Service

5th Floor, Lila Bldg.,

4-9-8 Roppongi

Minato-ku, Tokyo, Japan

Phone: 402-4556

Cable: Electronicmedia, Tokyo

Mr. O-kyn Park, President

Dongbo Int'l Corp.—

World Marketing

C.P.O. Box 4010

Seoul, Korea

Tel: 76-3910/3911

Cable: DONGBO SEOUL

Telex: EBKOREA K27286

ABP

BPA

ELECTRONIC DESIGN 5, March 1, 1975

SWITCH DEPENDABILITY BEGINS ON THE INSIDE

LOOK INSIDE ONE OF OURS!

High contact pressure gives low contact resistance

Taper and shorting bar combination gives true over-center snap-action resulting in fast transfer of contacts independent of actuation rate

Fast transfer time reduces arcing effects

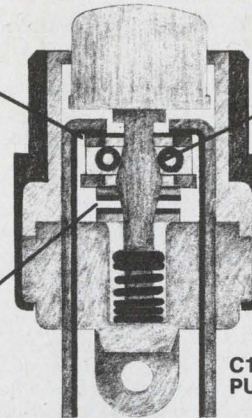

C100 SERIES PUSHBUTTON

Control Switch's unique taper mechanism results in dependable make and break... every time! The contacts go through maximum contact pressure at the snap point. This positive make and break with minimum arcing gives extended contact life.

This C100 Series of Control Switch pushbuttons features life to 125,000 cycles — Load to 10 amps — Bounce less than 1 ms — Low actuation force.

SEND FOR PORTFOLIO OF TECHNICAL BULLETINS.

CONTROL SWITCH

A CUTLER-HAMMER COMPANY



1420 DELMAR DRIVE, FOLCROFT, PA. 19032 215/586-7500

I-1

INFORMATION RETRIEVAL NUMBER 66

WHEN THE BLOCK READS "DIGITAL DISPLAY" ...don't get involved!

Let us fill the block for you.

When your lead time is short, our off-the-shelf PDC series display block modules can save you time *and* money on moderate volume or prototype applications. We have modules in a wide range of digit sizes. They include LED, incandescent, and seven-segment numeric as well as dot-matrix alphanumeric. They're pre-wired for BCD logic and are ready to mount to your panel with just two screws. Ask for our catalog.

In fact, contact us whatever the requirements of that digital display block may be; we also design and produce *custom* systems. We are digital display specialists and thrive on involvement.

Precision Dynamics Corporation
3031 Thornton Ave. • Burbank, CA. 91504
(213) 845-7606

INFORMATION RETRIEVAL NUMBER 67

PICTURE, PATTERN, OR PLOT

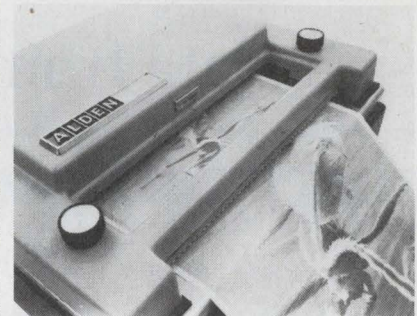

Now you can afford to add instant graphic hard copy output to your data terminals, storage tubes, computer outputs, SSTV, scanning sensors.

- Get low cost hard copy by instant graphic recording on ALFAX Type A electrosensitive paper where electricity is the ink.
- Interface ALDEN "Flying Spot" Component Recorders by simple synchronizing with your sweep circuit or scanning sensors and record directly from your target or cathode signal current.

Send for free brochure: "ALDEN Components to Picture, Pattern or Plot"

ALDEN
ELECTRONIC & IMPULSE RECORDING EQUIPMENT CO. INC.

Westboro, Mass. 01581 Tel: (617) 366-8851 TELEX: 94-8404

INFORMATION RETRIEVAL NUMBER 68

advertiser's index

Advertiser	Page	Advertiser	Page	Advertiser	Page
AMP, Incorporated	8, 9	Fairchild Semiconductor,		Pomona Electronics	10
Abbott Transistor Laboratories, Inc.	6	Components Group	41	Power/Mate Corp.	90
Adaptive Systems, Inc.	90	Fujitsu Limited	71	Power-One, Inc.	32, 32 P1—32 P16
Alden Electronic & Impulse		GTE Automatic Electric	40	Precision Dynamics Corporation	93
Recording Equipment Co., Inc.	93	General Electric Company	69	RCA Solid State	Cover IV
Allison Automotive Company	92	Glowlite Division, ELT, Inc.	65	Rental Electronics, Inc.	18
Amphenol RF Division, The		Gold Book, The	63, 88, 89, 95	Reticon	12
Bunker-Ramo Corporation	Cover III	Grayhill, Inc.	82	Rogers Corporation	91
Angle Steel/Division of Kewaunee		HiG, Inc.	74	S.E.G. Electronics	91
Scientific Equipment Corp.	74	Hayden Book Company, Inc.	64D	Scanbe Canoga Industries	Cover II
Arnold Magnetics Corp.	86	Heath Company,	13	Schauer Manufacturing Corp.	82
Bell & Howell, Control		Houston Instrument, The Recorder		Shigoto Industries, Ltd.	92
Products Division	78	Company	77	Signal Transformer Co., Inc.	31
Berg Electronics, Inc.	87	IEEE Intercon 75	17	*Sodeco	40
Cherry Electrical Products Corp.	29	Intech, Incorporated	80	Solartron/Schlumberger	*64E—64H
Chicago Dynamic Industries, Inc.	87	Intel Corporation	4, 5	Sorensen Company, a unit of	
Communications International	14	Interface Technology	90	Raytheon	22, 23
Compu-Lite Corporation	85	International Rectifier,		Sprague Electric Company	16
Computer Automation, Inc.	16A—16D	Crydom Division	64B	StacoSwitch, A Staco Inc. Company	84
Computer Conversions Corp.	91	Intersil	58, 59	T-Bar, Incorporated	96
Comstron	91	Johanson Manufacturing Corp.	33, 90	T.R.I. Corporation	85
Continental Specialties Corporation	81	Kepeco, Inc.	34	TRW Cinch Connectors	1
Control Switch, A Cutler Hammer		Krohn-Hite Corporation	91	TRW Electronic Components	27
Company	93	Ledex, Inc.	65	Teledyne Semiconductor	79
Cutler-Hammer, Specialty		Magneto	90	Teledyne Relays, A	
Products Division	37	Mepco/Electra, Inc.	64A	Teledyne Company	2
Dale Electronics, Inc.	Cover II	Mini-Circuits Laboratory, A		Texas Instruments,	
Data Display Products	76	Division of Scientific		Incorporated	15, 38
Data Corporation, The	65	Components Corp.	21	Topaz Electronics	73
Dialight Corporation	13	Mini-Systems, Inc.	90	Triplett Corporation	67
EECO	64C	Neff Instrument Corporation	42, 43	Trompeter Electronics Inc.	74
Edmund Scientific Company	94	Optron, Inc.	7	Vectrol, Inc.	74
Electro Corporation	65	Oshino Electric Lamp Works, Ltd.	87	Wiltron Company	83
*Electronic Design				Zero Manufacturing Co.	10
Energy Electronic Products Corp.	90				

*Advertisers in non-U.S. Edition.

Design Data from Manufacturers

Advertisements of booklets, brochures, catalogs and data sheets. To order use Reader-Service Card (Advertisement)

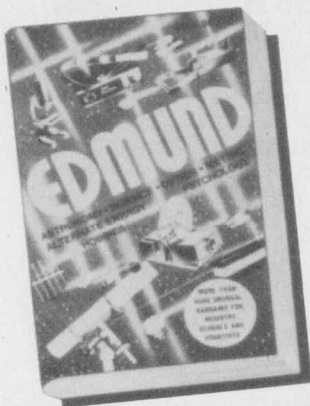

GIANT FREE CATALOG

New 180-page catalog! Packed with 1,000's of hard-to-find buys in Optics, Science, Electronics. Loaded with optical, scientific, electronic equipment available from stock. Rare surplus buys. Many "one-of-a-kinds". Ingenious scientific tools. Components galore: lenses, prisms, wedges, mirrors, mounts, accessories. 100's of instruments: pollution test equipment, lasers, comparators, magnifiers, microscopes, projectors, telescopes, binoculars, photo attachments, unique lighting. Shop, save by mail! Request free Catalog "DA".

CIRCLE NO. 171

Edmund Scientific Co.
America's Largest Science-Optics-Electronics Mart
300 Edscorp Bldg., Barrington, New Jersey 08007 (609) 547-3488

classified ads

STRETCH YOUR BUDGET!

Reconditioned Scopes, SS Power Supplies, Freq. Counters & Generators - Many others. Send for our: "Bargain Bulletin"

Lawrence Instruments, Sunbury PA

CIRCLE NO. 241

FREE ALARM CATALOG

Full line of professional burglar and fire alarm systems and supplies. 96 pages, 450 items. Off the shelf delivery, quantity prices.



mountain west alarm
4215 n. 16th st., phoenix, az. 85016

CIRCLE NO. 242

HERMETIC SEALING

Connectors • Headers • Relay Bases
Terminals • Custom Seals • Testing
Glass/Ceramic To Metal • Since 1959

DETORONICS CORPORATION

10660 E. Rush • S. El Monte, CA 91733
(213) 579-7130 • TWX 910-587-3436

CIRCLE NO. 243

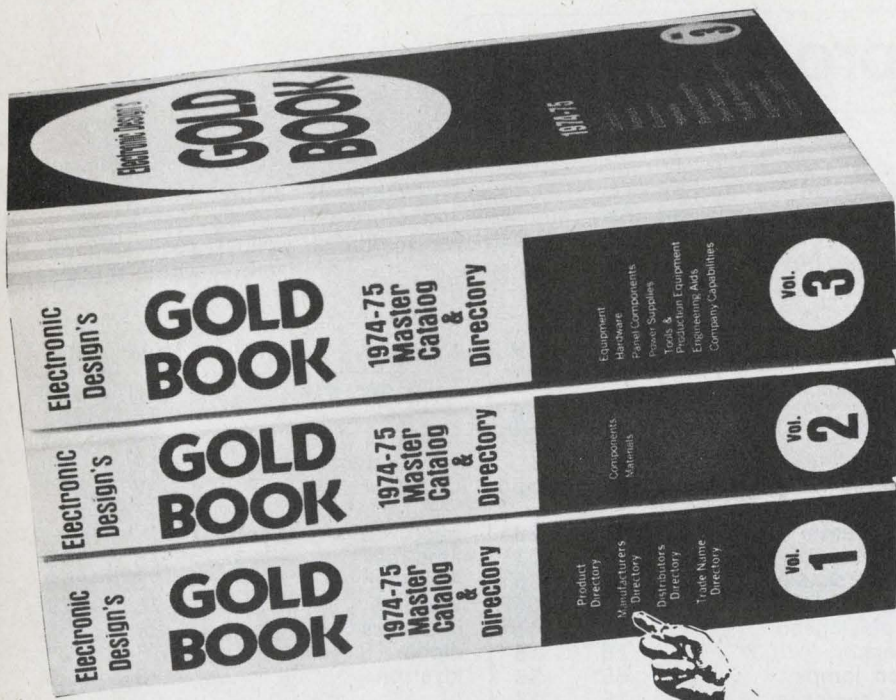

Are you there?

Don't get left out

If your company sells products to the electronics industry, and you can't find it listed in the Manufacturers Directory of Electronic Design's GOLD BOOK, here's your golden chance to be a hero and, perhaps, earn your company's undying thanks.

With pen in hand — or pencil — circle No. 306 on the Information Retrieval card along with any of the other numbers you might circle and return the card right quick.

We, in turn, will promptly send you one of our pretty GOLD BOOK questionnaires, which you can gloatingly turn over to the fellow at your place who fills these things out.

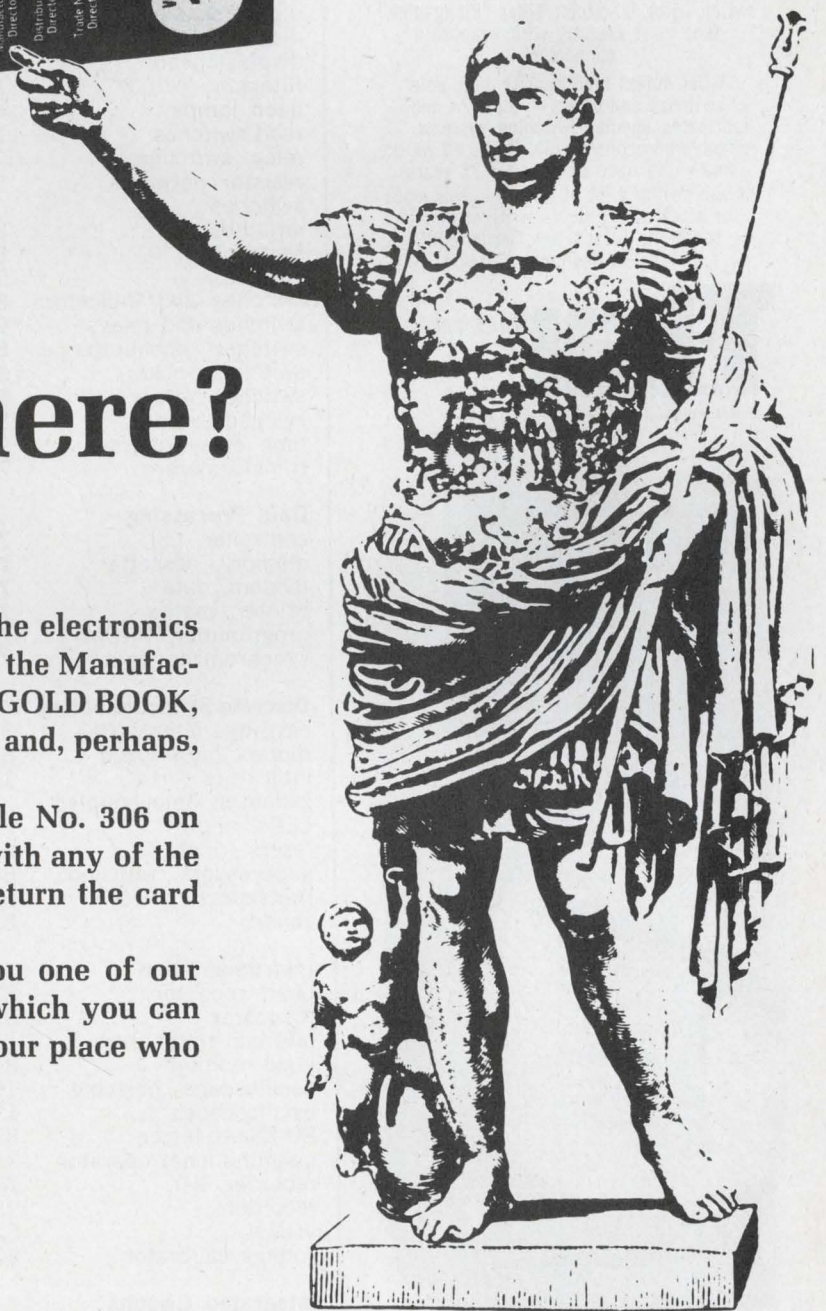

NEW! Systems Integration through Switching!

How do you reconfigure four data acquisition channels and 500-600 transducer leads from each of eight test stations — frequently, reliably, quickly, without distorting low level analog signals? Easy. Integrate your system with a matrix switch using 60-circuit T-Bar "Pluggables" that mate directly with wrappable connectors.

T-Bar makes high density multi-pole switches and relays — designs and fabricates special switching systems — reliably and economically. That's all we do. And we've been doing it for 15 years. If you switch a lot of lines — all at once or a few at a time — write or phone today for T-Bar's new Series 6900 Pluggable Switching Catalog.

T-bar INCORPORATED
SWITCHING COMPONENTS DIV.
146M Danbury Road Wilton, CT 06897
Phone: 203/762-8351

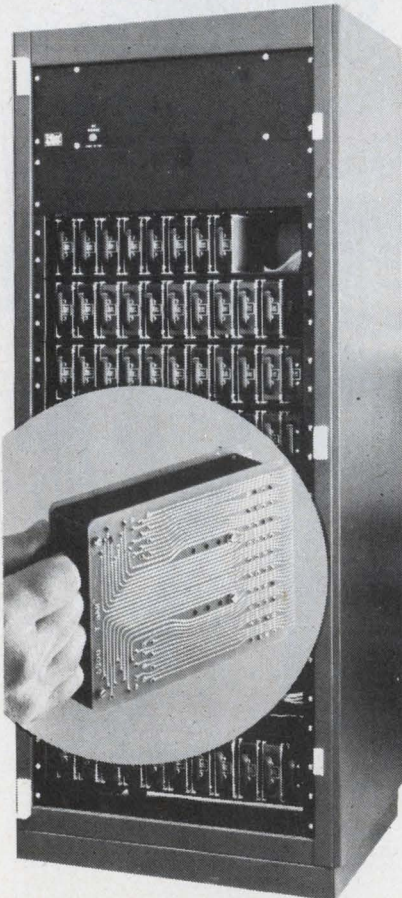

INFORMATION RETRIEVAL NUMBER 72

product index

Information Retrieval Service. New Products, Evaluation Samples (ES), Design Aids (DA), Application Notes (AN), and New Literature (NL) in this issue are listed here with page and Information Retrieval numbers. Reader requests will be promptly processed by computer and mailed to the manufacturer within three days.

Category	Page	IRN	Category	Page	IRN
Components			converter, d/a	75	307
buzzer, solid state	85	340	encoder	75	308
capacitors	33	24	hi-NIL & CMOS logic	79	50
chopper and reed relays (NL)	91	350	image sensor	12	11
communication components	40	28	op amp	IV	254
components	27	21	Microwaves & Lasers		
digital sensor	65	36	amplifier	78	325
display modules	93	66	amplifier	78	328
display, neon	85	341	couplers	78	329
filters	16	16	detectors	83	55
neon lamps	65	35	dipole	78	327
reed switches	15	15	klystron	78	326
relay, switching	74	44	Modules & Subassemblies		
resistor networks	11	252	a/d converters (NL)	91	353
switches	9	7	converter, a/d	80	301
switches	29	101	DAC, 12-bit	80	51
switches	65	37	drives, motor	81	330
switches	95	68	follower, voltage	80	331
switches and indicators	85	58	ignition systems	93	64
switches and relays	96	72	Packaging & Materials		
switches, pushbutton	84	56	bobbin	31	23
switches, rocker	37	26	clip	63	34
switches rotary	82	53	connector	11	10
switches, rotary	87	60	connectors	87	63
time delay relays	74	43	edge connectors (NL)	91	351
transformers	73	42	electronic work stations	74	45
Data Processing			enclosures	10	8
controller, LSI	76	310	PC kit	65	38
memory, cassette	76	321	socket, PC	87	62
modem, data	77	324	Power Sources		
printer, matrix	76	309	power supplies	6	5
programmer, PROM	76	322	power supplies	23	20
synchronizer, data	77	323	power supplies	86	59
Discrete Semiconductors			power supplies, dc	32	295
cartridge lamps (NL)	86	347	SCR power controller guide	74	46
diodes, high speed	84	339	new literature		
indicators	13	13	a/d converters	91	353
isolators, opto coupled	7	6	cartridge lamps	86	347
LEDs, bi-pin	76	47	chopper and reed relays	91	350
lasers, diode	84	336	edge connectors	91	351
suppressors, transient	84	337	high-voltage power SCRs	91	355
transistors, power	82	338	impulse generators	86	346
zeners	82	54	instrument rental	86	348
Instrumentation			materials test system	91	354
chart recorder	83	335	packaging cards and racks	91	352
IC tester	82	333	projection displays	91	349
Intercon trade show	17	17	design aids		
logic monitor	81	52	dielectric materials	86	342
oscilloscope, portable	10	9	displays	86	343
oscilloscopes	13	12	silicon bridges	86	344
PC-board tester	83	334	zener wall chart	86	345
polyfunctional operator recorder, X-Y	78	49			
recorders	77	48			
VOMs	93	65			
voltage calibrator	67	39			
Integrated Circuits					
CCD memory	41	29			
CMOS MUX, 16-channel	59	31			

Introducing the ALC-5.



The hardworking connector that's easy on your pocket.

Now you can truly reduce your cost of interconnecting by designing in the new ALC-5.* It represents a new concept in subminiature coaxial connector design that will yield the best cost-to-performance ratio of any connector available today.

Unshielded hookups can be risky.

The ALC-5 economically provides RF shielding in computer applications where high speed or close proximity prevent the use of unshielded, single conductor interconnects. Where the new FCC 900 MHz reallocations have put higher frequency demands on vehicle monitoring and communications systems, the ALC-5's hard working VSWR virtue shines (1.1:1 at 1GHz, 1.2:1 at 4GHz, 1.4:1 at 6GHz with RG-58 C/U cable).

Crimp-crimp assemblies assure the repeatable performance required for navigational equipment, biomedical monitoring systems and professional

broadcast and recording gear. Everything from marine radar systems to microwave ovens can use these tiny, low-cost, reliable RF connections. And crimp-crimp assembly also keeps your production costs low.

A fresh, new answer for today's interconnection needs.

The ALC-5 is a contemporary line designed around today's demands for lower price, better performance, smaller size and faster delivery and assembly. Rather than a revamp of one of yesterday's solutions, we've invented something totally new. We've taken the first bold step. Why don't you take the next. Specify ALC-5. Amphenol RF Division, Bunker Ramo Corporation, 33 E. Franklin Street, Danbury, Connecticut 06810, (203) 743-9272. *U.S. Patent No. 3,282,303



AMPHENOL

A major breakthrough in op amps...

MOS/FET, Bipolar and CMOS on the same chip.

It's the low-cost CA3130 from RCA. An accurate, easy-to-work-with op amp from the people who first combined PMOS and bipolar technologies in the CA3100T.

Even with three technologies on a single chip, the new CA3130 is simplicity itself. Which is why it costs only \$0.75 at 1K (premium versions are also available). Among its principal features (values shown are typical):

General Purpose

High open loop voltage gain: 110 dB
 Low input offset voltage: 8mV
 Low input current: 5pA
 Input offset current: 0.5pA

FET input

Very high input impedance: 1500 M Ω

Wideband

Unity gain crossover frequency: 15 MHz
 High slew rate: 10 V/ μ s
 Fast settling time: 1.2 μ s

Micropower

2.5 mW at 5V supply voltage

High current

22 mA output

A voltage swing to within 10 millivolts of either rail on a single power supply is now possible for the first time because of the CMOS output stage.

Available in 8-lead TO-5 ("T") or 8-lead dual in-line ("S") packages off the shelf from your RCA Solid State distributor. Call him or write RCA Solid State, Box 3200, Somerville, N.J. 08876. Phone (201) 722-3200, Ext. 3142.

RCA Solid State
 A full house in Linear ICs

