

# Electronic Design<sup>®</sup> 20

VOL. 22 NO.

FOR ENGINEERS AND ENGINEERING MANAGERS

SEPT. 27, 1974

**Wound up over rotary switches?** You can choose among twist, thumb, push and lever styles. Which should you pick? Twist types remain the workhorses,

thumbwheels dominate digital input uses and some types are designed for circuit-board use. But catalogs don't reveal enough. To help unwind, turn to page 56.

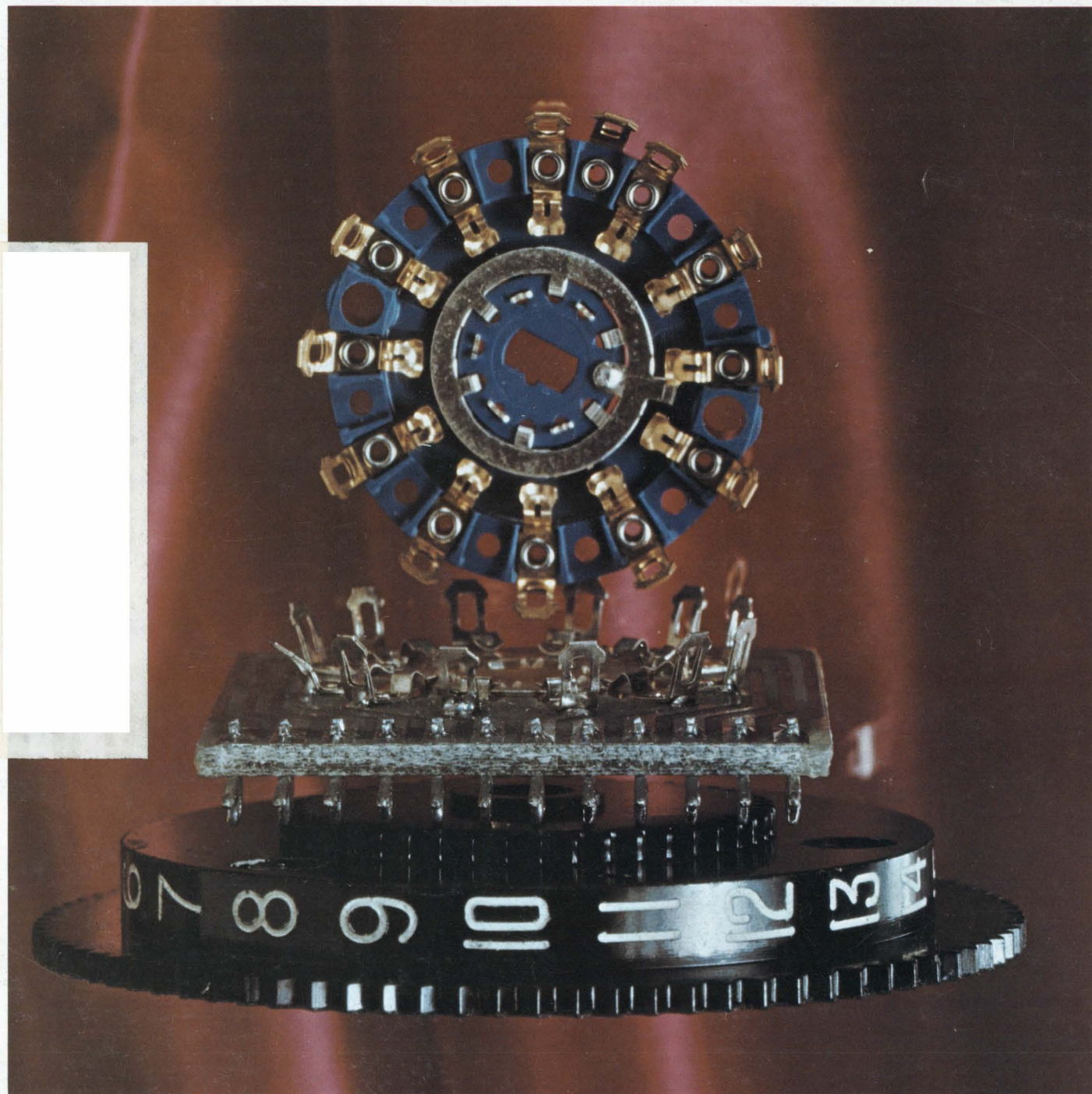





## Ultra reliability in ultra-miniature transformers...

### ...and they're off the shelf!

PICO Electronics' patented construction combines mass production with the utmost in reliability to produce the smallest possible transformer.

These little giants handle up to 600 milliwatts at 1 KHz and 1.5 watts at 10KHz. They cover the frequency range of 300Hz to 250KHz. Primary or Secondary impedances of 3.2 ohms to 250K ohms. Pulse applications .05 $\mu$ s to

100 $\mu$ s. Construction can be TO-5 plug-in, insulated flexible leads or flat pack ribbon style.

Size variations from 1/4" dia. x 1/4" ht. to 1 1/32" dia. x 1/2" ht. Special designs with 1/4" dia. and .180" ht.

Pico Electronics is a Q.P.L. source. All transformers are hermetically sealed in a metal case and in strict compliance with MILT-27 specifications. Every Pico device has the added reliability feature of being

guaranteed for 25 cycles of thermal shock (MIL-STD-202D, method 107C).

Industrial and Commercial designs are also available for maximum economy.

*Over 600 standard transformers to choose from... Delivery—stock to one week... specials take a little longer—9 days.*

**Send for free 36 page catalog.**

## PICO Electronics, Inc.

50 South MacQuesten Pkwy., Mt. Vernon, New York 10551 • Telephone 914-699-5514



# THE FIRST OF THE BIG COUNT TIMERS

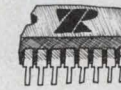
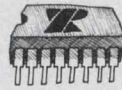
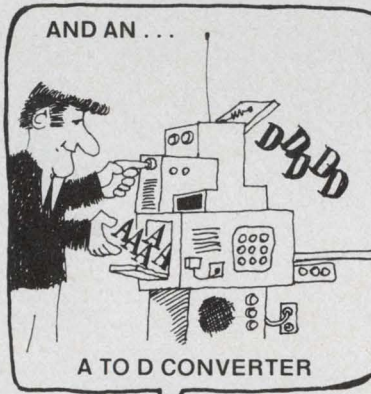
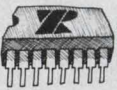
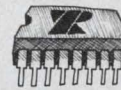
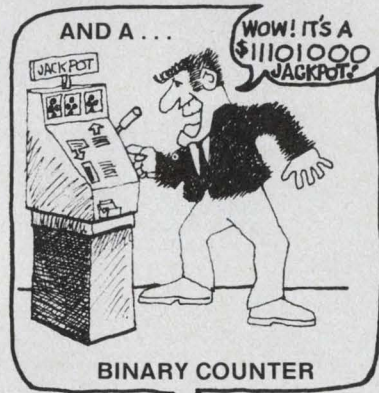
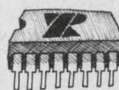
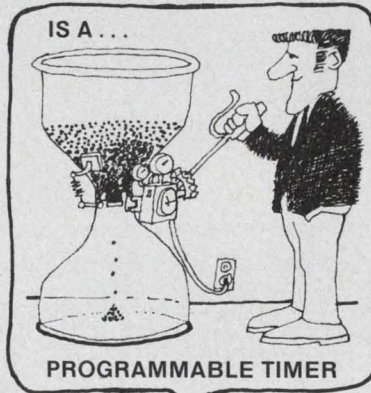
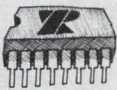
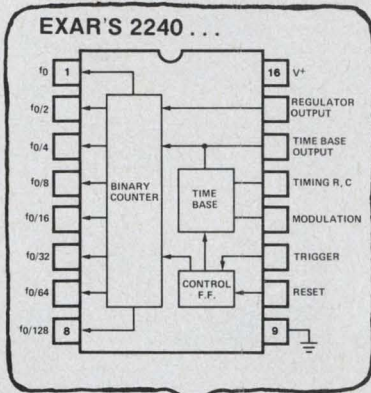

Exar's new XR-2240 counter/programmable timer solves so many tough problems that designers will unanimously agree that it's really the universal timer.

With its unique combination of analog and digital timing methods, you can now replace inadequate and complex assemblages of monolithic and electromechanical timers with the much simpler XR-2240. As a bonus, you get greater flexibility, precision operation, and a reduction in components and costs for most applications.

Because of built-in programmability, you can also use the XR-2240 for frequency synthesis, electronic music synthesis, digital sample and hold, A to D conversion, binary counting and pattern generation, and more.

With a single XR-2240 you can now generate

precision time delays programmable from  $1RC$  to  $255RC$ , a range of microseconds to 5 days. By cascading only two XR-2240 timers, you can extend the maximum delay by a factor of  $2^N$ , where  $N = 16$  bits, resulting in a total delay of 3 years!

The XR-2240 operates over a 4V to 15V supply range with an accuracy of 0.5% and an  $80 \text{ ppm}/^\circ\text{C}$  temperature stability. It's available in either a 16-pin ceramic or plastic dual-in-line package for military or commercial applications. Prices start at \$4.50 in 100 piece quantities.

For the more conventional timing applications, look to our other timers: the XR-320 timing circuit and the XR-2556 dual timers. Call or write Exar, the timer leader, for complete information.

## EXAR SPEAKS YOUR LANGUAGE

R-OHM CORPORATION  
 EXAR INTEGRATED SYSTEMS  
 P.O. BOX 4455, IRVINE CA 92664  
 TELEPHONE: (714) 546-8780  
 TWX: 910-595-1721



R-OHM ELECTRONICS GMBH  
 EXAR INTEGRATED SYSTEMS  
 MÜHLENSTRASSE 70  
 4051 KORSCHENBROICH  
 FEDERAL REPUBLIC OF WEST GERMANY

Members of the International R-OHM Group

INFORMATION RETRIEVAL NUMBER 2



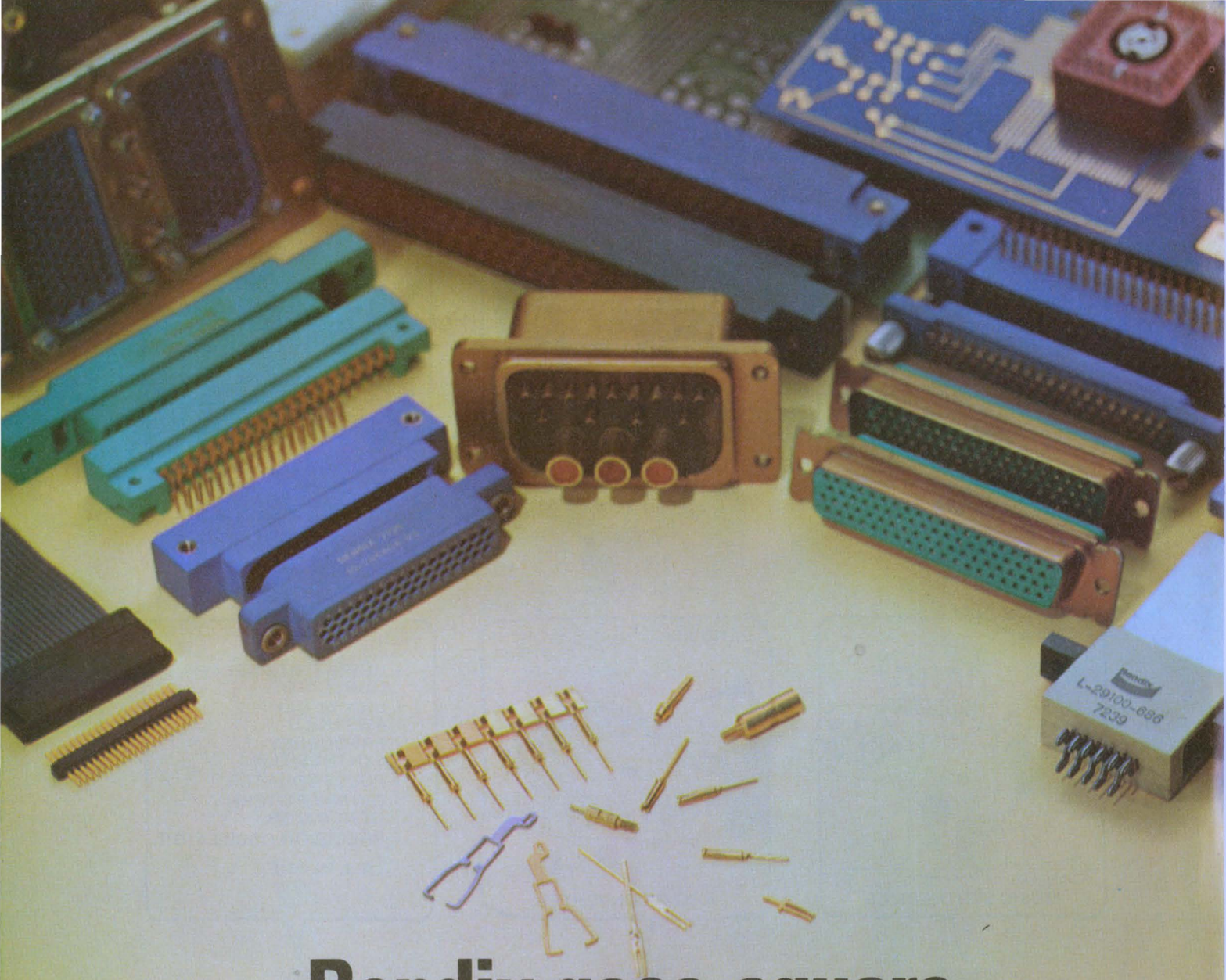

# Bendix goes square and rectangular, too.

Printed circuit board connectors. Mother/daughter PCB terminations. Center connectors. Miniatures. Subminiatures. ARINC. You name it and chances are Bendix has it. Because now, Bendix is a source for a wide range of square and rectangular connectors.

You can choose from a wide range of contacts as well. Crimp-type rear removable. Solderless wrap. Solder termination. Floating. Straight or right angle.

Choose from a wide range of connector styles and contact variations.

All this means if you're in computer main frame, communications equipment, avionics or automotive electronics, Bendix probably has just the connector you need.

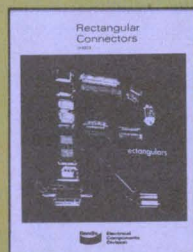

Fact is, we could write a book about our square and rectangular connectors so we've done precisely that. Why not send for it? It gives you over 70 pages of ways to go square and rectangular, too. Write: The Bendix Corporation, Electrical Components Division, Sidney, New York 13838.

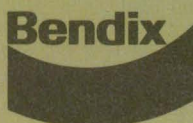



---

## NEWS

- 25 **News Scope**
- 30 **A unique and little known source of instant electrical power**, the thermal cell, bids for attention.
- 32 **An ultra-low-frequency electromagnetic direction-finding system** for miners passes tests at 1500-ft depth.
- 36 **Hand-held gas detector** promised, with 1-part-per-billion sensitivity.
- 49 **Washington Report**

---

## TECHNOLOGY

- 56 **FOCUS on rotary thumbwheel switches:** A special report that updates the engineer and pinpoints problems in specifying all types of rotary switches from conventional styles to pushbutton versions.
- 70 **Design of oscillators** from transistor data sheets. By using simple models you can easily compute the component values for sinusoidal oscillators.
- 76 **Convert two-port circuit parameters** from any form to any other. A short Fortran program handles all popular parameters in polar or rectangular form.
- 82 **Analyze TV noise performance** by correlating video signal-to-noise ratio with rf noise figure. Then use a spectrum analyzer to perform the measurements.
- 90 **ECL 10,000 interconnects economically.** Controlled edge speeds and low-voltage swings allow use of conventional boards for this popular logic.
- 98 **Look as asynchronous sequential logic** for best speed-power performance. Then add a self-clocking feature to obviate design constraints.
- 106 **Is a crowbar alone enough?** To reduce the risk of power-supply damage or even fires, an overcurrent interrupt element may also be needed.
- 114 **Servicing a high-technology product** means that engineering must provide a design capability that minimizes later problems with the customer.
- 118 **Ideas for Design:** Counter has symmetrical output though the input signal is asymmetrical . . . Simple tally system ranks events in the order of occurrence . . . Inexpensive AM modulator replaces clipping type and gives less distortion . . . Comparator detects volts in narrow window and accurately nulls to reference level . . . Counter resets itself reliably with one additional flip-flop.
- 128 **International Technology**

---

## PRODUCTS

- 131 **Integrated Circuits:** Analog-function array aids instrument designs.
- 138 **Data Processing:** First floppy disc peripheral made for microcomputers.
- 150 **Microwaves & Lasers:** 35-MHz rf amp outputs new high of 300 W.
- |                             |                             |
|-----------------------------|-----------------------------|
| 146 Discrete Semiconductors | 170 Modules & Subassemblies |
| 156 Power Sources           | 176 Components              |
| 162 Instrumentation         | 183 Packaging & Materials   |

---

## Departments

- |   |                                |
|---|--------------------------------|
| 53 <b>Editorial:</b> It's a fine first baby. Father's moderately pleased. |                                |
| 7 Across the Desk   | 196 Bulletin Board             |
| 188 Application Notes   | 204 Advertisers' Index         |
| 188 Vendors Report  | 206 Product Index              |
| 192 New Literature  | 208 Information Retrieval Card |

**Cover:** Photo by Fred Meyer, courtesy of OAK Industries Inc., Switch Div.



# “Think Hz for a

“A different point of view . . . that’s often the key to a problem solution. And that’s just what HP analyzers give you. A look at your problems in the frequency domain instead of the time domain.”

“HP high-frequency analyzers have a solid reputation for providing RF and microwave designers with accurate frequency-domain measurements. But what about analyzers to help engineers with low-frequency problems?”

“I’d like to tell you about HP’s broad line of low-frequency analyzers that can solve some of your tough measurement problems. Problems such as making low-level measurements in

the presence of noise, analyzing frequency components of a signal, determining the transfer function of a network, or making distortion measurements on analog circuits.”

“Take the narrow view. HP’s 3581A wave analyzer lets you home-in on a specific frequency for amplitude measurements. Look at a signal through a 3 Hz bandwidth. Monitor low-level signals to 30 nV over a 15 Hz to 50 kHz range. This ability to measure low-level signals in the presence of noise simplifies transducer signal monitoring. Helps you isolate ground-loop problems.”

“Look for a broad picture. Spec-

trum analyzers display your waveform’s Fourier components on a CRT. That’s an easy way to see your signal and its component relationships. It’s also an ideal way to characterize mechanical devices that have unique spectral ‘signatures.’”

“HP’s 3580A spectrum analyzer gives you a 5 Hz to 50 kHz range and the sensitivity to operate directly from the lowest level transducer outputs. Its digital memory lets you store traces for accurate comparison of two signals. And a narrow 1 Hz bandwidth allows you to resolve 60 Hz sidebands.”

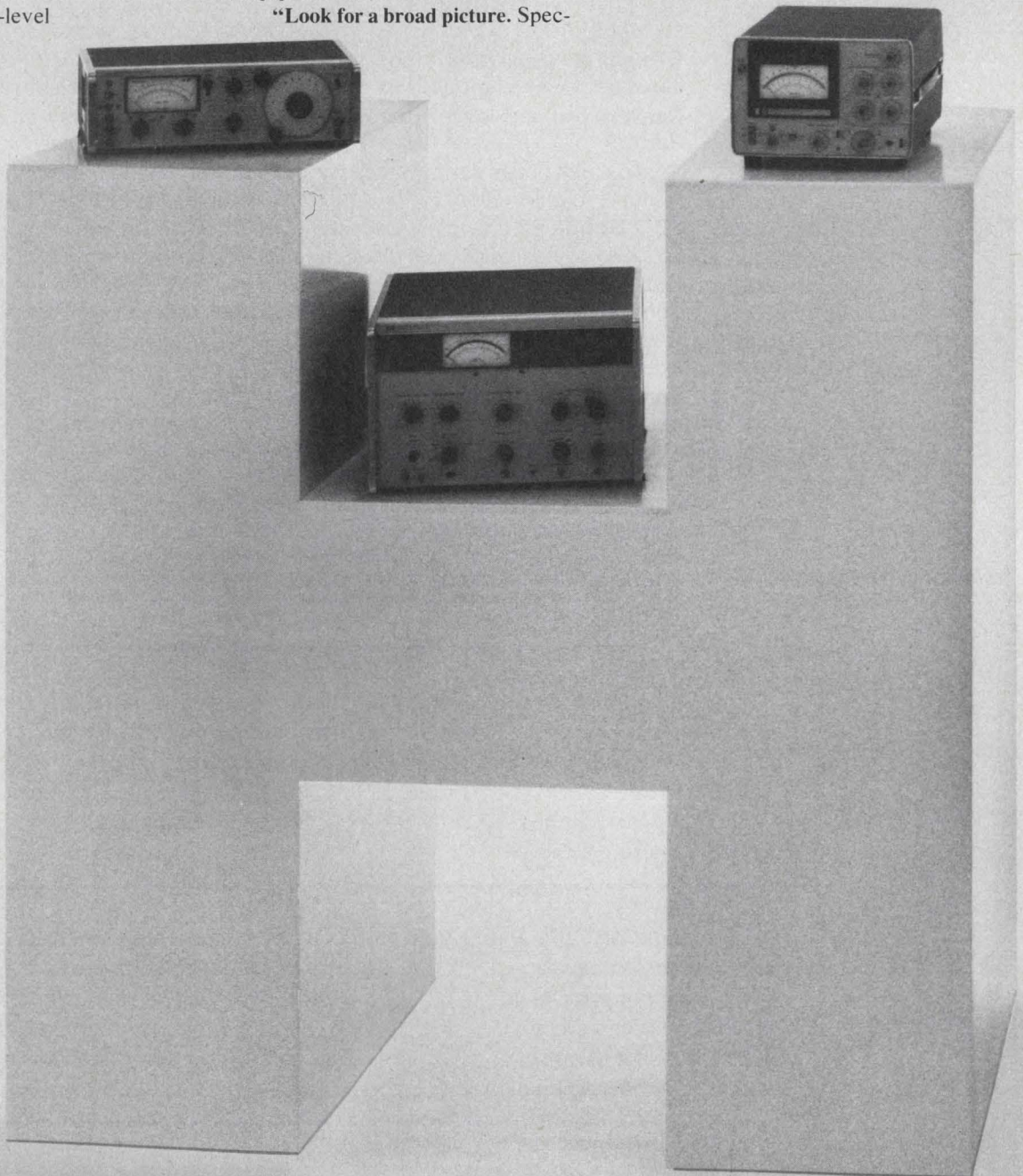



# different view™

“There’s also an in-depth view provided by HP’s network analyzers. These dual-channel analyzers provide amplitude and phase measurements as a function of frequency. This simplifies transfer-function measurements, speeds the location of poles on a Bode plot, and accurately determines resonant frequencies and phase margins in circuit design.”

“Our broadband 3575A gain-phase meter gives you a range of 1 Hz to 13 MHz and lets you select your own signal source to do low-cost network analysis.”

“For high-accuracy network analysis, plus optional group delay and offset determinations to 13 MHz, HP’s high-performance 3040 analyzer is the answer. By adding the computational power of a calculator

to either the 3575 or 3040 analyzers you can view the results of 108 tests in less than 20 seconds... and with greater precision.”

“And there’s a reciprocal view. HP’s distortion analyzers give you the reciprocal function of a wave analyzer. By rejecting the fundamental and monitoring the remaining harmonic and spurious components, distortion is measured and displayed on a meter. Our 331A to 334A series provides a wide range of 5 Hz to 65 MHz.

And automatic nulling speeds the measurement of total harmonic distortion.”

“So think hertz and get a different view... in design, in manufacturing, and in servicing. Think hertz and get a different view of everything from electronic components and networks to mechanical devices and systems. Think hertz for a different view and look to HP for help in applying analyzers to your measurement problems.”

“You’re local HP field engineer will be happy to give you additional details on our broad line of analyzers that operate from 1 Hz into the GHz range. Give him a call today.”

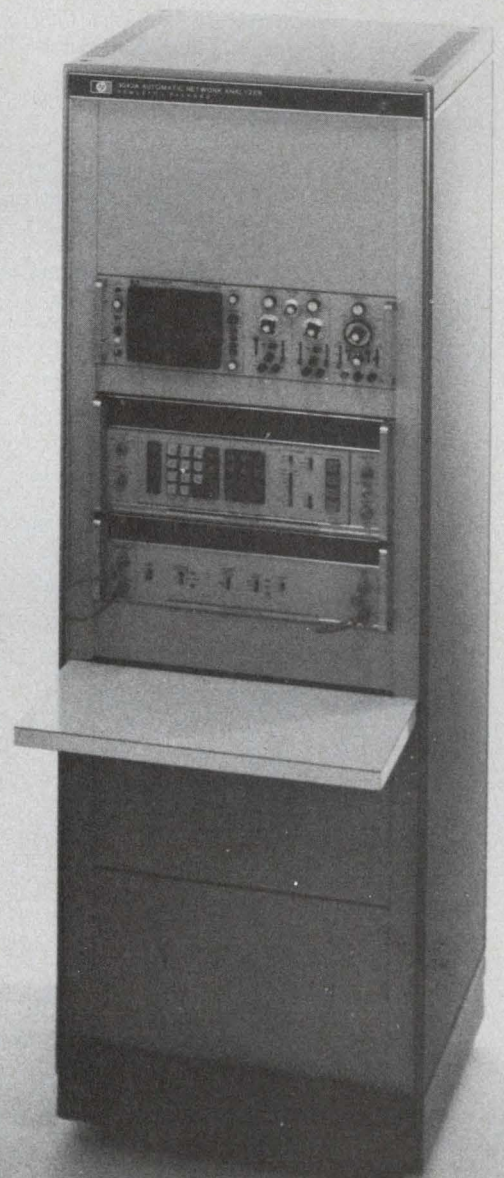
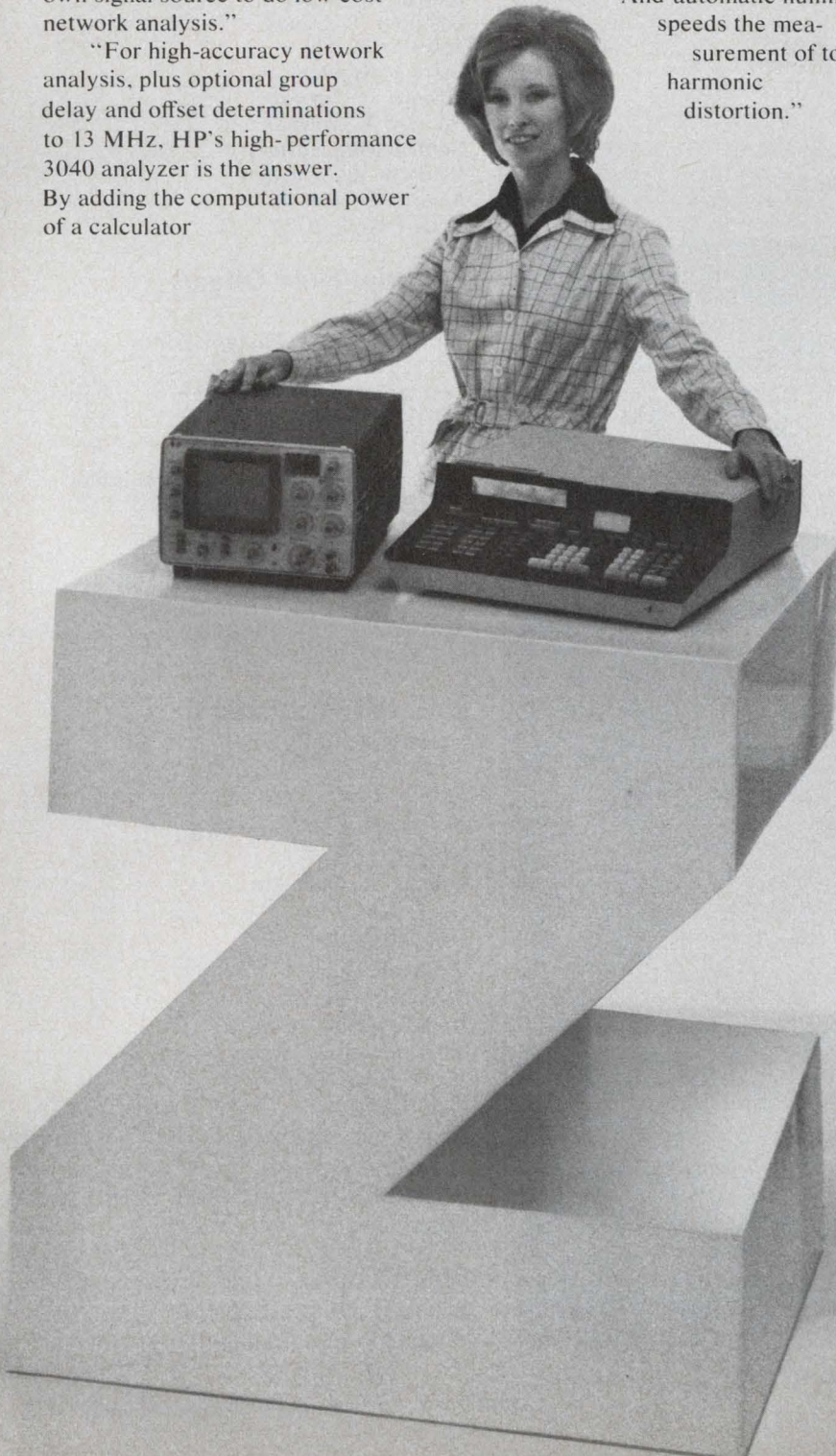

Measurement with a different view

HEWLETT  PACKARD

Sales and service from 172 offices in 65 countries.  
1501 Page Mill Road, Palo Alto, California 94306

INFORMATION RETRIEVAL NUMBER 4



# FLAT INTERCONNECTS YOUR COMPLETE SOURCE

Ribbon Cable / IC Interconnects / Custom Harnesses

You're sold on flat cable, now buy it at its best. Precise, compact cable packages to fit your specifications perfectly, computer-loomed for unmatched versatility by Woven Electronics.

Handling ease of independent non-bonded leads speeds production, cuts cost, while technical characteristics outrank other flat cable forms.

Make Woven your source for jumpers, continuous rolls, special harnesses, all your interconnect needs.

## WOVEN ELECTRONICS

P.O. Box 189 Mauldin, South Carolina 29622  
803/963-5131

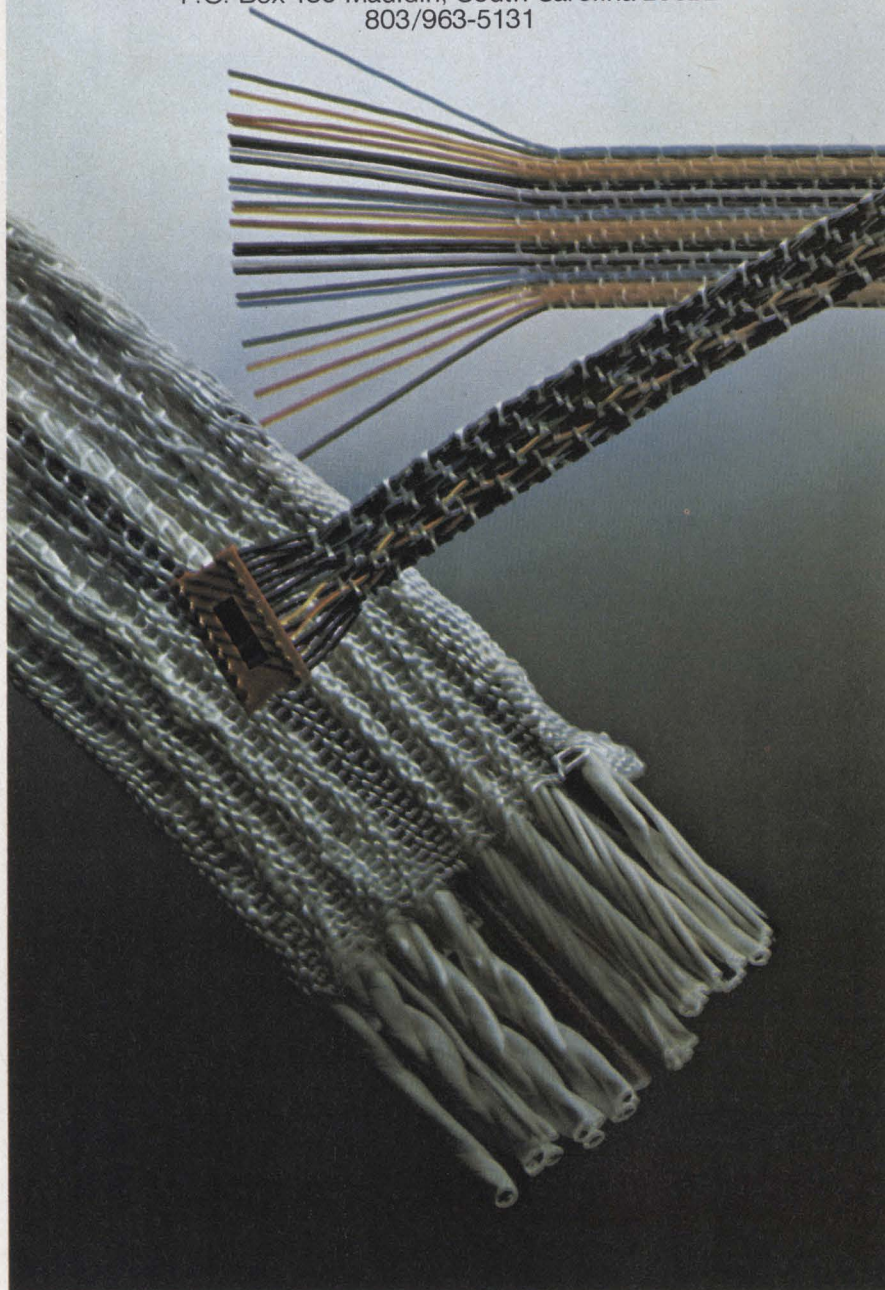

### Vice President, Publisher

Peter Coley

### Editors

Editorial Offices

50 Essex St.

Rochelle Park, N.J. 07662

(201) 843-0550

TWX: 710-990 5071

Cable: Haydenpubs Rochellepark

**Editor-in-Chief** George Rostky

### Managing Editors:

Ralph Dobriner

Michael Elphick

### Associate Editors:

Dave Bursky

Jules H. Gilder

Morris Grossman

Seymour T. Levine

John F. Mason

Stanley Runyon

Edward A. Torrero

Richard L. Turmail

### Contributing Editors:

Peter N. Budzilovich

Alberto Socolovsky

Robert Wollins

### Editorial Field Offices

#### East

Jim McDermott, Eastern Editor

P.O. Box 272

Easthampton, Mass. 01027

(413) 527-3632

#### West

David N. Kaye, Senior Western Editor

2930 West Imperial Highway

Inglewood, Calif. 90303

(213) 757-0183

Northe K. Osbrink, Western Editor

112 Coloma St.

Santa Cruz, Calif. 95060

(408) 426-3211

### Editorial Production

Marjorie A. Duffy

### Art

**Art Director**, William Kelly

Richard Luce

Anthony J. Fischetto

### Production

**Manager**, Dollie S. Viebig

Helen De Polo

Anne Molfetas

Christopher G. Hill

### Circulation

**Manager**, Evan Phourides

### Information Retrieval

Peggy Long

### Promotion

**Manager**, Walter G. Salm

Karen Kerrigan (Reprints)



## across the desk

### Engineers! Join IEEE for a new status!

If you're an IEEE member, there's a constitutional amendment in your future. In fact there are two constitutional amendments that will be up for approval on the 1974 ballot. Both have come up the hard way—by petition from the Professional Activities Committees (PAC) throughout the U.S.

In 1972 the constitution was amended to permit the IEEE to take action on behalf of the professional status of its members. To implement this policy, the headquarters encourages each section (of which there are about 260) to form a PAC to handle the professional activities of the section. The PAC studies engineers' professional problems and makes recommendations or takes action to ameliorate the problems.

The Long Island PAC has come up with a petition to pay the IEEE president a salary, to give him a three-year, full-time term of office—instead of one year—and to obligate him to disaffiliate completely from the electrical or electronics industry during his term of office. His salary would be competitive with executives of like responsibility in private industry. We feel that this is a way to make him responsive to the membership and would end any conflict of interest between the presidential office and an outside job. Our PAC chapter circulated this petition throughout the country. We received far more than the required 450 signatures to put it on the ballot.

A California PAC performed the same process with respect to another amendment, which would

lower the number of signatures needed on a petition to put a second candidate's name on the ballot for president. The constitution formerly required signatures of 2% of the voting membership (about 2700), but this amendment would lower it to 0.33% (about 450).

Notice how nicely our two amendments fit together. Considering that PACs have been in existence less than two years, this is quite an accomplishment. You ain't seen nothing yet!

Position papers will accompany the ballot and the amendments and will tell why members should vote yes—if it's not immediately obvious. Long Island's PAC urges all voting IEEE members to vote yes on both proposed amendments. Democratize the IEEE with your ballot. Also watch for further action from PACs around the country.

So you see, the IEEE is on its way to becoming responsive to the needs of the working engineer. PAC is the avenue. The message for non-IEEE members is: Join IEEE and participate in the changeover. In so doing, you'll strengthen IEEE and your professional stature.

*Robert Bruce*

*Chairman, L.I. Section PAC*  
15 Johnstone Rd.  
Great Neck, N.Y. 11021

### Clearly not clairvoyant

In these times of product and project planning, it is well to note that last month's meeting of the Southern California Clairvoyant Society was cancelled due to unforeseen circumstances.

# Thin-Trim<sup>®</sup> capacitors



 Tucked in the corner of this Pulsar Watch is a miniature capacitor which is used to trim the crystal. This Thin-Trim capacitor is one of our 9410 series, has an adjustment range of 7 to 45 pf., and is .200" x .200" x .050" thick. The Thin-Trim concept provides a variable device to replace fixed tuning techniques and cut-and-try methods of adjustment. Thin-Trim capacitors are available in a variety of lead configurations making them very easy to mount.

 A smaller version of the 9410 is the 9402 series with a maximum capacitance value of 25 pf. These are perfect for applications in sub-miniature circuits such as ladies electronic wrist watches and phased array MIC's.

Johanson Manufacturing Corporation,  
Rockaway Valley Road., Boonton, N.J.  
07005. Phone (201) 334-2676, TWX 710-  
987-8367.

Electronic Design welcomes the opinions of its readers on the issues raised in the magazine's editorial columns. Address letters to Managing Editor, Electronic Design, 50 Essex St. Rochelle Park, N.J. 07662. Try to keep letters under 200 words. Letters must be signed. Names will be withheld on request.



  
**BOURNS®**  
**PANEL**  
**POWER**





# BOURNS INTRODUCES THE FIRST INTEGRAL PUSHBUTTON POTENTIOMETER

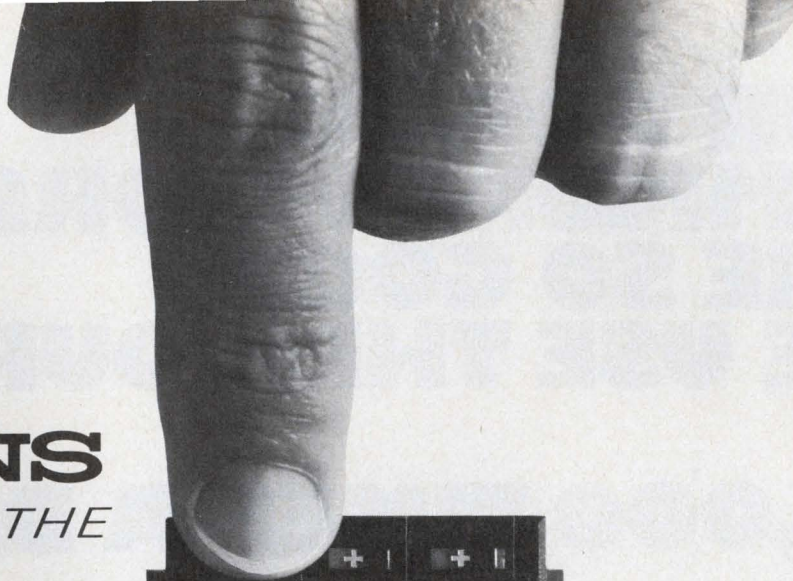

If you're designing panels with precision data entry or set-point controls, consider the BOURNS Model 3680 KNOBPOT® Digital Potentiometer . . . another innovative idea from Bourns. The 3680 integrates a precision incremental decade potentiometer with an easy-to-read digital display, AND a speedy pushbutton control action. It is handsome, extremely accurate, and a "snap" to install. Everything is INSIDE the Model 3680 . . . no resistors or mini-PC boards are required . . . nothing clutters the back of the unit to steal precious space.

## PUSHBUTTON ACTION

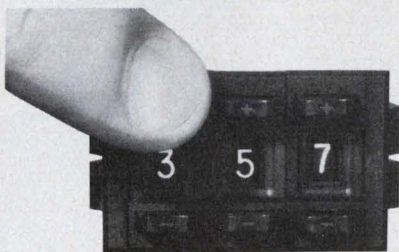

Simple, fast, precise. Push the PLUS button to increase; the MINUS to decrease. Rated life is 100,000 operations per decade.

## IN-LINE DIGITAL READOUT

Large, easy-to-read numbers enable fast, "squint-free" data entry and information readout.



## ACCURATE

You get what you set with the 3680 . . . every time. The unique Bourns design integrates precision laser-trimmed cermet resistor technology with a positive push-button detent action. The result is resolution of output of 1 part in 1000 discrete steps, and dependable repeatability of  $\pm 0.1\%$ .

## COSTS LESS TO INSTALL

Snap-in mounting cuts installation time, eliminates mounting hardware. Integral bezel covers irregular panel cut outs and minor edge blemishes. Terminals match the AMP Series 110 receptacle . . . or can be soldered in the standard fashion.

## FEATURES AND SPECIFICATIONS

- stable built-in cermet resistance elements
- 100 PPM/°C tempco
- 2 watts power rating
- standard resistance range (3 decade unit) 5K ohms to 1 megohm
- $\pm 1.0\%$  resistance tolerance
- resolution 0.1%.

## COMPACT SIZE

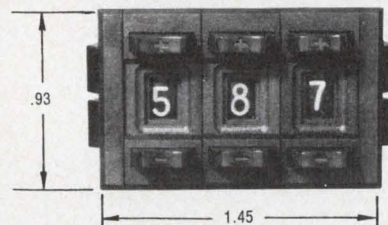
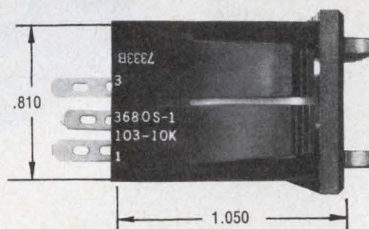

For the name and number of your nearest Bourns representative, dial EEM toll-free 800-645-9200.

when innovation counts, count on...



TRIMPOT PRODUCTS DIVISION • 1200 COLUMBIA AVE., RIVERSIDE, CALIF. 92507

INFORMATION RETRIEVAL NUMBER 7



**OUR POWER  
SEMICONDUCTORS  
ARE SO GOOD  
WE USE THEM OURSELVES.**

**20,000 TIMES A DAY.**

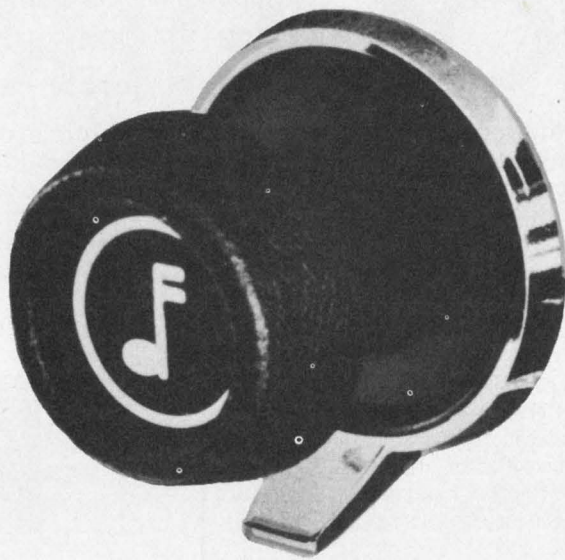



That's the rate at which Delco Electronics supplies a variety of products for GM cars.

Under one roof we design and manufacture complete systems, including the power semiconductors that help make those systems work. This can mean a lot to you. Here's why:

We know the requirements and standards that must be met to produce over 20,000 systems a day. We know what it means to deliver on time, to meet our own production schedules. And we know the importance of component quality in assuring reliability of the end product.

Our semiconductor devices are used

in the Delco AM radios, AM/FM radios and stereo tape systems we produce for GM cars. They are also used in the GM High Energy Ignition systems, I.C. voltage regulators, alternators, and in the new combination front seat/shoulder belt interlock systems you find in all the 1975 GM cars.

And all the capabilities that go into Delco semiconductors can work for you, too.

There are select distributors with stock on hand strategically located coast to coast. For the distributor nearest you, phone

your closest Delco Electronic regional sales office: Kokomo, Ind. (317) 459-2175, Van Nuys, Calif. (213) 988-7550, Union, N.J. (201) 687-3770.

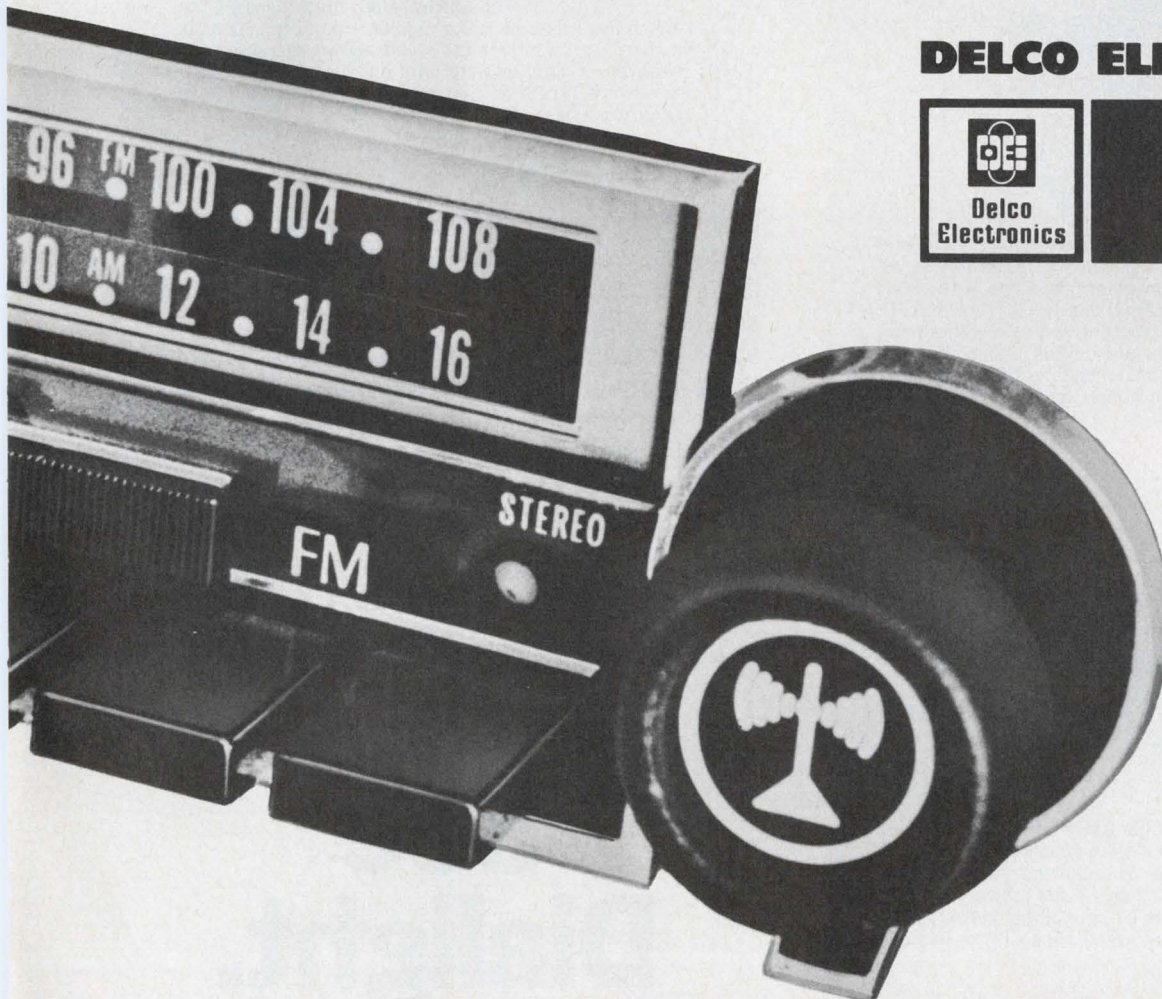
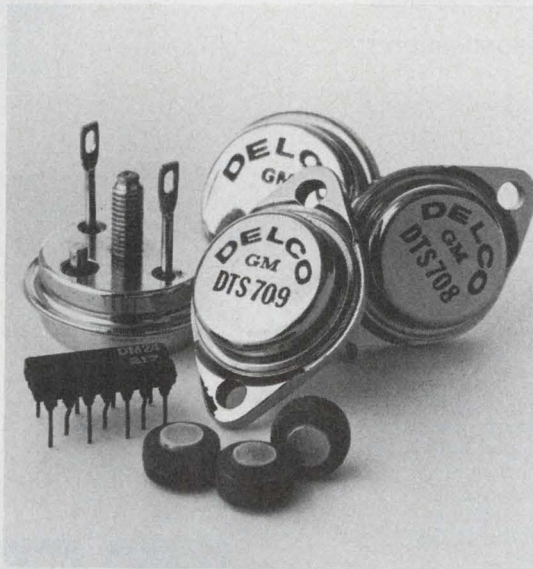

## DELCO ELECTRONICS





# Dialight sees a need:

(Need: The widest choice for your every application.)

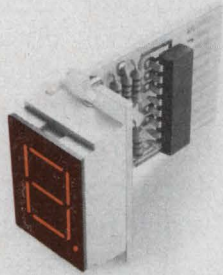

**730 SERIES** Your choice . . . a red or green LED readout with large 0.625" characters . . . low power, operates with standard IC power supply levels. Comes in plus-minus module. Display uses standard or high brightness LEDs for maximum light output arranged in a seven-segment format. Available with or without on-board decoder/driver. Unique lens design generates bright, highly legible characters.



**739 SERIES** Save design time and installation costs . . . this LED display assembly is attractively designed in a convenient package with bezel and is ready for instant panel mounting. Available in groups of one or more characters, with or without decoder/driver . . . characters are 0.625" and come with either green or red LEDs in seven-segment format. Readout offers lowest cost per character for comparable size.

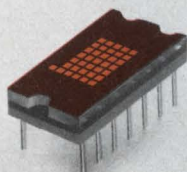

**745-0005** Dot matrix LED readout display produces a bright 0.300" high character or symbol display. Has wide angle visibility and is compatible with USASCII and EBCDIC codes. Low power requirements. Mounts into standard 14-pin DIP socket. The display is also available in bezel assemblies with or without code generator.

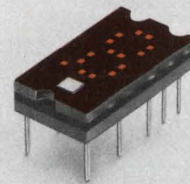

**745-0007** LED hexadecimal display with on-board logic operates from 5 to 6 volt supply, low power consumption. Integral TTL MSI chip provides latch, decoder and drive functions. 0.270" character display has wide angle visibility and mounts into standard 14-pin DIP socket.



**755 SERIES** High brightness planar gas discharge displays in a 0.550" character. Orange color gives high contrast ratio and allows readability to 40 feet even in high ambient lighting. Designed for interfacing with MOS/LSI, displays have an expected life of 100,000 hours or more.

Dialight, the company with the widest choice in switches, LEDs, indicator lights and readouts, looks for needs . . . your needs . . . and then they develop solutions for your every application. No other company offers you one-stop shopping in all these product areas. And no other company has more experience in the visual display field. Dialight helps you do more with these products than any other company in the business, because we are specialists that have done more with them. Talk to the specialists at Dialight first. **DIALIGHT** You won't have to talk to anyone else.

Dialight, A North American Philips Company  
203 Harrison Place, Brooklyn, N. Y. 11237  
(212) 497-7600

# See Dialight.







# Here's how we help jumbo jets get off the ground.

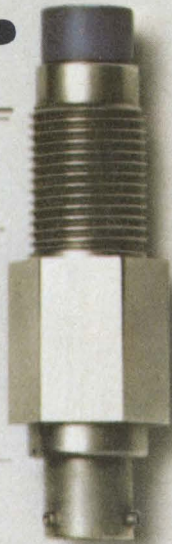
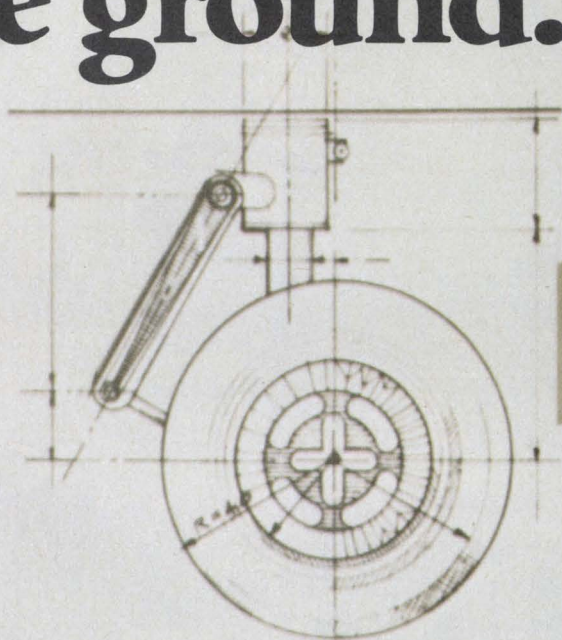

SOLID-STATE FW PROXIMITY HAS SWITCHING & SENSING ELEMENTS SEALED IN SINGLE UNIT. PROVIDES RELIABLE, NO-TOUCH SWITCHING FOR LANDING GEAR AND CONTROL SURFACE POSITION DETECTION. VARIATIONS OFFER SURFACE OR THRU-PANEL MOUNTING, HIGH-SPEED SENSING AND CIRCUITRY OUTPUT OPTIONS.

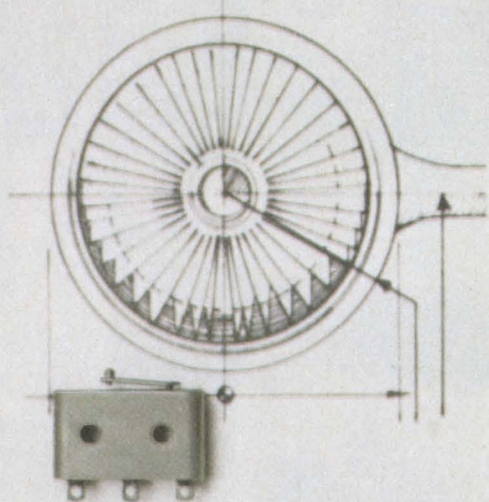

HERMETICALLY-SEALED HM FUNCTIONS IN PRESSURE SWITCH CONTROLS AND CONTROL VALVES. LARGER, HERMETICALLY-SEALED HS OPERATES IN TEMPERATURE RANGE FROM:  $-100^{\circ}$  TO  $+500^{\circ}$  F AND TO 25 AMP DC

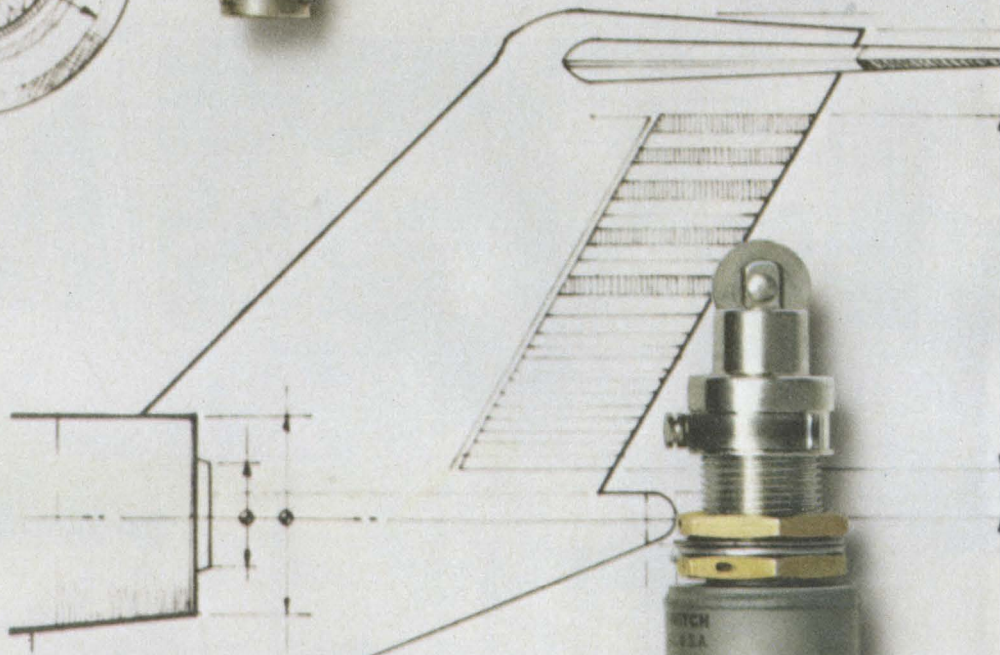

ENVIRONMENTALLY-SEALED EN'S CAN SENSE POSITION OF DOORS & CONTROL SURFACES, INDICATE STATUS OR INITIATE ACTUATOR CONTROL. OFFER WIDE ELECTRICAL RANGE, CHOICE OF TERMINATIONS & OPERATING CHARACTERISTICS. COMPLEMENTARY PRODUCTS OFFER HERMETIC SEALING AND TEMPERATURE RANGES TO  $+600^{\circ}$  F.



TL TOGGLES WORK AS COCK-  
 PIT CONTROLS AND IN MANUAL  
 INPUT PANELS. MEET MIL-S-3950.  
 AVAILABLE WITH UP TO FOUR SPDT  
 CIRCUITS & WITH  
 SCREW, SOLDER,  
 OR INTEGRATED  
 WIRING TERMINA-  
 TIONS. COMPLE-  
 MENTARY TOGGLES  
 OFFER VARIETY  
 OF ACTUATORS,  
 HERMETIC SEAL-  
 ING, UP TO 10  
 POLES, SPECIAL  
 CIRCUITRY AND  
 ROCKER ACTION.

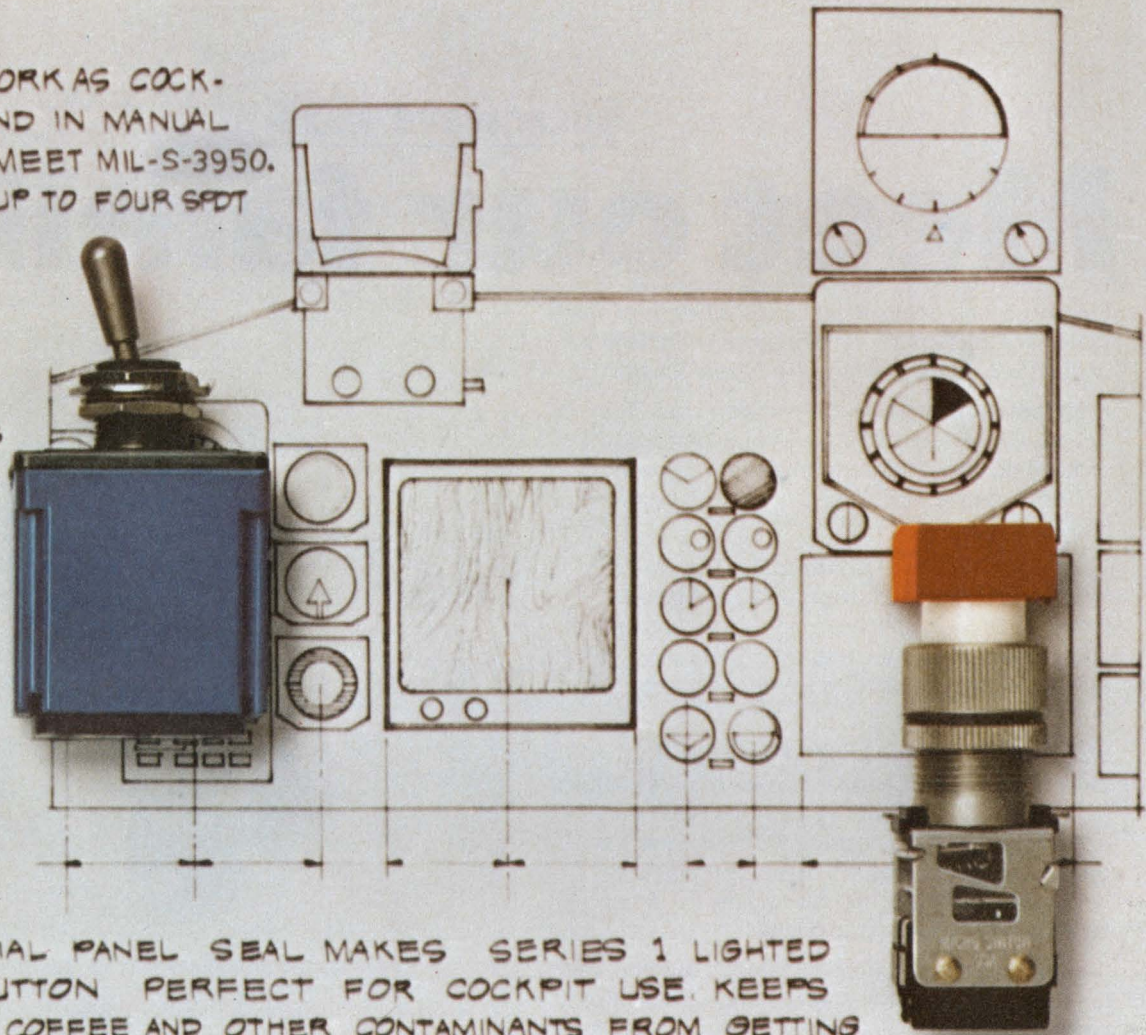

A SPECIAL PANEL SEAL MAKES SERIES 1 LIGHTED  
 PUSHBUTTON PERFECT FOR COCKPIT USE. KEEPS  
 WATER, COFFEE AND OTHER CONTAMINANTS FROM GETTING  
 THROUGH PANEL. MIL APPROVED UNDER M-22885-81. OTHER MIL  
 APPROVED PUSHBUTTONS OFFER MULTI-POLE,  
 MULTI-LAMP OPTIONS.

EXIT

ENVIRONMENTALLY-  
 SEALED SE AND  
 SE SWITCHES  
 HANDLE SENSING AND  
 MONITORING FUNCTIONS  
 AT LOW COST. APPLICA-  
 TIONS INCLUDE VALVE  
 MONITORING AND EMER-  
 GENCY EXIT CONTROL.  
 UNSEALED SM AND SX  
 OFFER GREATER COST  
 SAVINGS. UNSEALED  
 HT OPERATES TO  
 +1000°F. IDEAL FOR  
 THRUST REVERSERS  
 AND VALVE CONTROL  
 MONITORING.

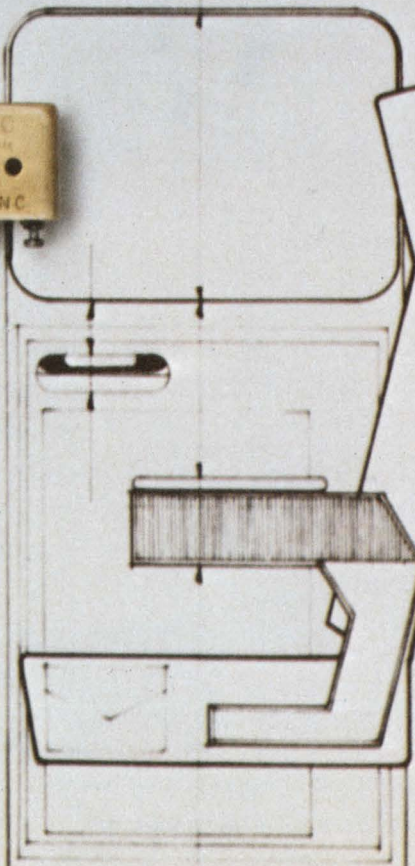
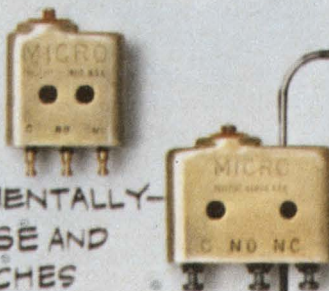

Aerospace applications present  
 special problems.

So MICRO SWITCH has  
 designed entire families of special  
 switches to handle them.

The result is one of  
 industry's most complete lines of  
 rugged high-performance  
 switches for both military and  
 civilian use.

A few examples are shown  
 here. But your MICRO SWITCH  
 Branch Office (Yellow Pages,  
 "Switches, Electric") can provide  
 the full story. Contact them today.

**MICRO SWITCH makes your  
 ideas work.**

**MICRO SWITCH**

FREEPORT, ILLINOIS 61032

A DIVISION OF HONEYWELL  
 INFORMATION RETRIEVAL NUMBER 11



## Microwave Mixers

# Meet our family.

Since one kind of mixer can't meet all kinds of needs, Watkins-Johnson has developed an entire family of double-balanced microwave mixers featuring:

**High Isolation and Low Conversion Loss.** The WJ-M14, M14A and M20 series provides  $>30$  dB of isolation and  $<6$  dB of conversion loss with  $+7$  dBm of local oscillator drive across C, X, and Ku-band.

**Very Wide RF and IF Bandwidths.** The WJ-M12, M12A and M19 series covers 2 to 14 GHz with IF response to 5 GHz allowing single step conversion down to S-band. This series also offers  $>+7$  dBm power output capability and superior spurious performance.

**Wideband Coverage in MIC Packages.** The WJ-M15, M16, M17 and M18 series features octave bandwidth coverage from 2.5 to 18.5 GHz in extremely small MIC packages. This unique "flat-pack" design features  $<5$  dB noise figure and  $<1.5:1$  R-port VSWR and is excellent for direct integration into microstrip circuits.

Another one of the W-J mixer family's exciting features is computer characterization. Each mixer is computer tested so you receive complete conversion loss and isolation data up to 12.4 GHz for each unit purchased.

For more information on Watkins-Johnson's computer characterized microwave mixers, and a copy of our Microwave Mixer Catalog, call the Watkins-Johnson Field Sales Office in your area or W-J Applications Engineering in Palo Alto, California at (415) 493-4141, ext. 638.

Pictured is an actual computer characterization print-out for a WJ-M12A Microwave Mixer.

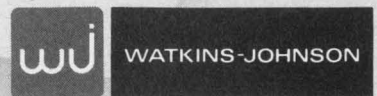
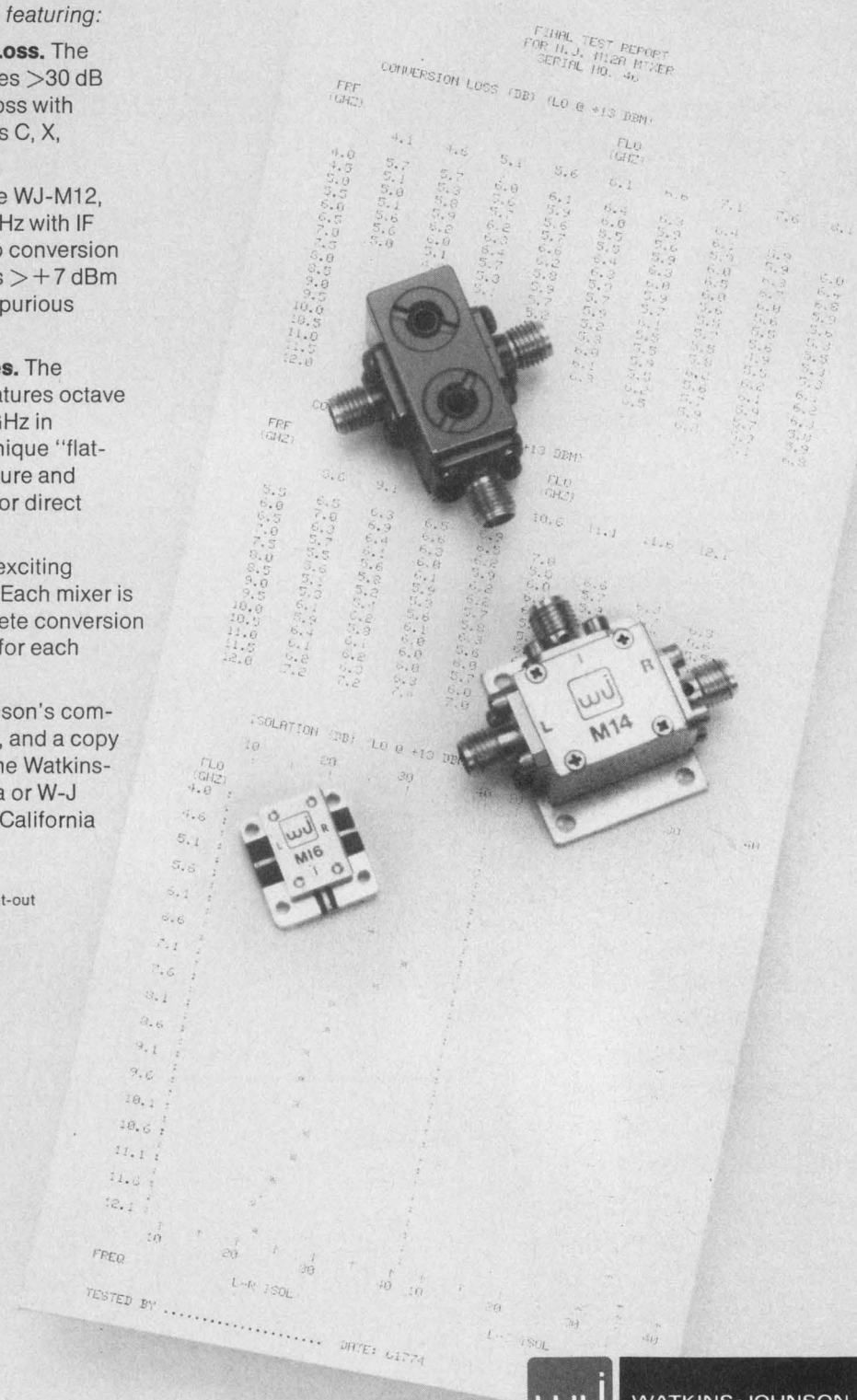

Watkins-Johnson—U.S.A.: 3333 Hillview Ave., Palo Alto, CA 94304 • (415) 493-4141 • TWX: 910-373-1253 • Telex: 34-8415 • Cable: WJPLA • 700 Quince Orchard Rd., Gaithersburg, MD 20760 • (301) 948-7550 • TWX: 710-828-0546 • Telex: 89-8402 • Cable: WJCEI • United Kingdom: Shirley Ave., Windsor, Berkshire SL4 5JU. England • Tel: Windsor 69241 • Cable: WJUKW-WINDSOR • Telex: 847578 • West Germany: 8033 Planegg, Muenchenerstr. 17 • Tel: (089) 859-9441 • Cable: WJDBM-Muenchen • Telex: 529401 • Italy: Piazza G. Marconi, 25 00144 Roma-EUR • Tel: 59 45 54 • Cable: WJROM-ROMA • Telex: 60117



# The inside story of the company inside your products.

AVX is the major supplier of ceramic capacitors and EMI filters. Components you use inside your systems and subassemblies.

Our inside story is quality. Quality built into all our components through technological leadership in ceramics and metal-

lization. Through advanced design in packaging. Through painstaking manufacturing and thorough testing at every stage of the production cycle.

Quality that lets you forget all about us once you've built our components into your products.

To remind you of all the components and subassemblies we offer, we've packed them into two new catalogs. Fill in the coupons on the following pages to order your catalogs and get the complete AVX story.

## AVX: The Insiders.

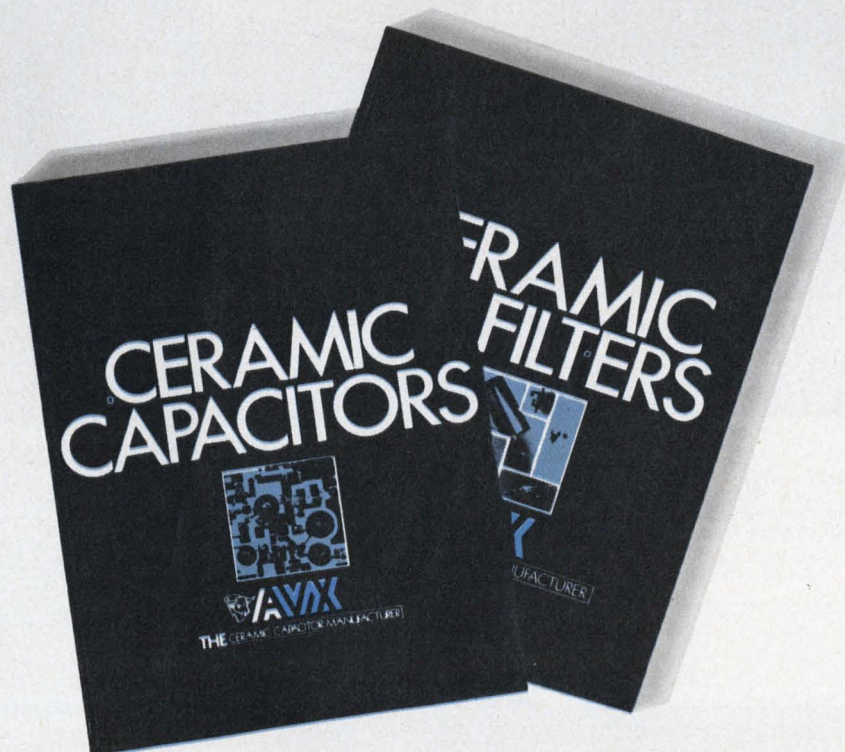

INFORMATION RETRIEVAL NUMBER 13



# SIEMENS

## Cost-Effective Solutions to Semiconductor Test Problems

### APPLICATION:

Verification of semiconductor memory performance from device to system level.

### WHAT TO LOOK FOR IN A TESTER:

High speed microprocessor.  
Independent X & Y addressing.  
Off-the-shelf device interface.

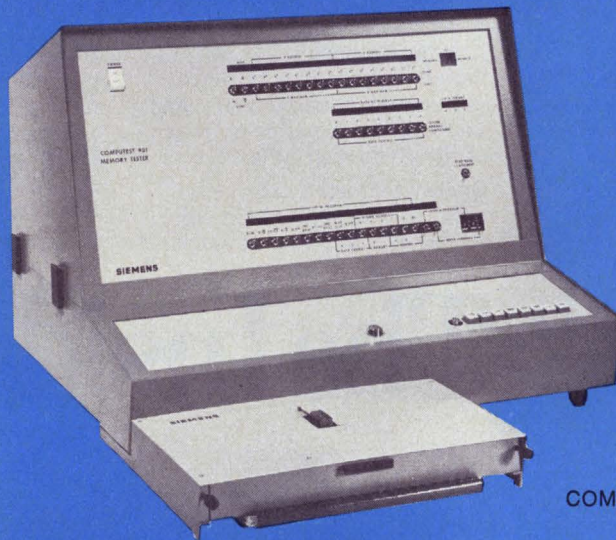

COMPUTEST MODEL 901

Semiconductor testing demands a practical low-cost solution. To check performance of semiconductor memory from the device through the system level requires memory-oriented addressing capability, a stable clock system, performance compatible device interface and real-time error detection. It's all found in the Computest Model 901 bench top memory tester.

The Computest 901 has an easy-to-use, 10 MHz microprocessor, independent X & Y address generator, and a flexible, multi-channel clock. A complete inventory of RAM/ROM interface modules puts the 901 to work for you immediately.

The Computest 901—flexible, versatile, tailored in price and performance for semiconductor memory testing from device to system level.

#### FREE!

Send for the Computest catalog of Semiconductor Test Equipment and our Semiconductor Program Library



NAME \_\_\_\_\_  
COMPANY \_\_\_\_\_  
ADDRESS \_\_\_\_\_  
CITY \_\_\_\_\_  
STATE \_\_\_\_\_ ZIP \_\_\_\_\_

**For applications assistance, contact:  
John Lalley, (609) 424-2400**

**Siemens Corporation  
Electronic Systems Division  
Computest Products**

3 Computer Drive, Cherry Hill, N.J. 08002 (609) 424-2400



# Inside AVX Capacitors.

We're the industry leader in ceramic capacitors. The volume leader in discs and tubes. In multi-layer radial, axial and chip capacitors. The quality leader in capacitors for consumer products. For critical military,

industrial and EDP applications. You know our Ni-Guard® multi-layer chip capacitors with the exclusive silver, nickel, gold terminations. You know our molded Ceralam® radials and axials. Our dipped Skycaps.

Now we'd like you to know our complete line of quality capacitors in all EIA characteristics and Military specifications. Send for the new AVX ceramic capacitor catalog. Get the inside story of the industry leader.

**AVX** CERAMICS  
DIVISION OF AVX CORPORATION



AVX Ceramics  
Department C-2  
P. O. Box 867  
Myrtle Beach, S.C. 29577

Rush me \_\_\_\_\_ copies of the  
new AVX Ceramics capacitor  
catalog at no cost to my company.

NAME \_\_\_\_\_

TITLE \_\_\_\_\_

COMPANY \_\_\_\_\_

ADDRESS \_\_\_\_\_

ZIP \_\_\_\_\_

TELEPHONE \_\_\_\_\_

For faster delivery call AVX Ceramics  
directly: 803-448-3191.  
TWX: 810-661-2252

INFORMATION RETRIEVAL NUMBER 15



**Finally, the tough little competitor designs the first quiet low cost, low frequency switching regulator power supply with no RFI-EMI headaches!**

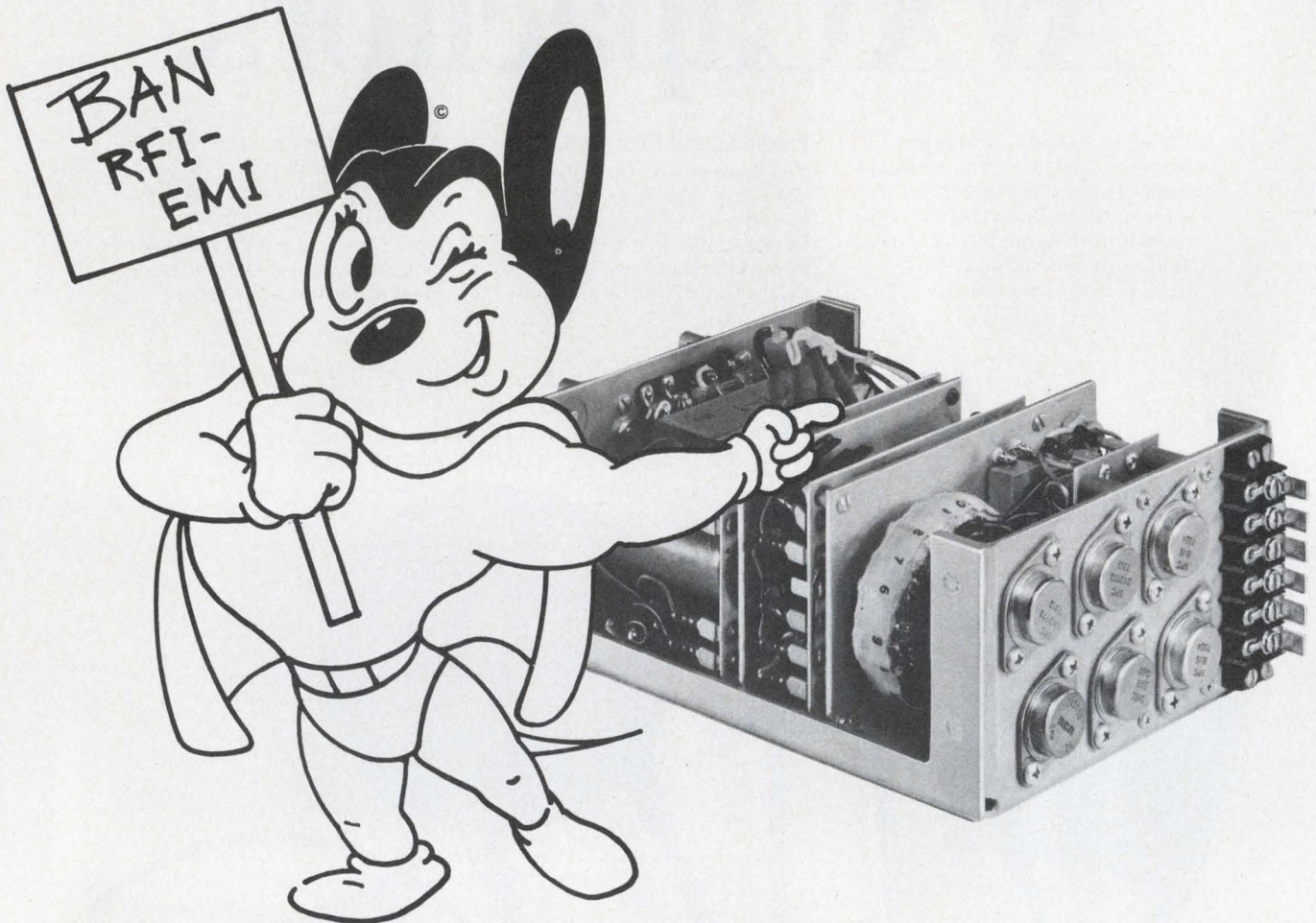

You've seen and heard switching power supplies: you haven't seen or heard any like AMPSCO's. They're new and different. Very different.

THESE SALIENT FEATURES PROVE IT:

- NO RFI-EMI PROBLEMS
- 80% EFFICIENT
- ALL SPECIFIED RATINGS @ 55°C. CONVECTION COOLING
- FORCED-AIR COOLING FOR 100% STATED CURRENTS @ 70°C
- LOWER RIPPLE — 40 MV PK - PK MAX

AVAILABLE IN BOTH CONVECTION AND FORCED-AIR COOLING FOR 100% OF STATED CURRENTS @ 70°C.

BATTERY BACKUP OPTION AVAILABLE TO PROVIDE FAIL-SAFE POWER.

Field-tested and proved over the past two years, the tough little competitor's switcher is available in two versions. The basic model is a bit audible. The super-silent model costs a little more. All models are competitively priced with series pass regulators.

Write or call us right now for full information. We have them now. Why shouldn't you?

Power Supplies by

**AMPSCO**  
**WVBSCO**

A Tough Little Competitor

American Power Systems Corporation 51 Jackson Street Worcester, Mass. 01608 (617) 753-8103

INFORMATION RETRIEVAL NUMBER 16



# Inside AVX Filters.

The nice thing about an AVX filter is what's inside. A quality, high performance AVX capacitor. Giving all our networks precision performance. Exact conformity to specification.

AVX offers a complete line of broadband, feedthru's and high

frequency filters. In addition, we're introducing a new modular design concept for multi-filters. Using our standard broadband eyelet line, it enables AVX or our customers to build custom filter packages in countless varieties with off the shelf speed. And at off the shelf prices.

Look through our catalog to find the AVX equivalent for filters you are now using. Or the new AVX design that meets your application. You'll find the parts you need. And you'll like the parts you get.

**AVX** FILTERS  
DIVISION OF AVX CORPORATION

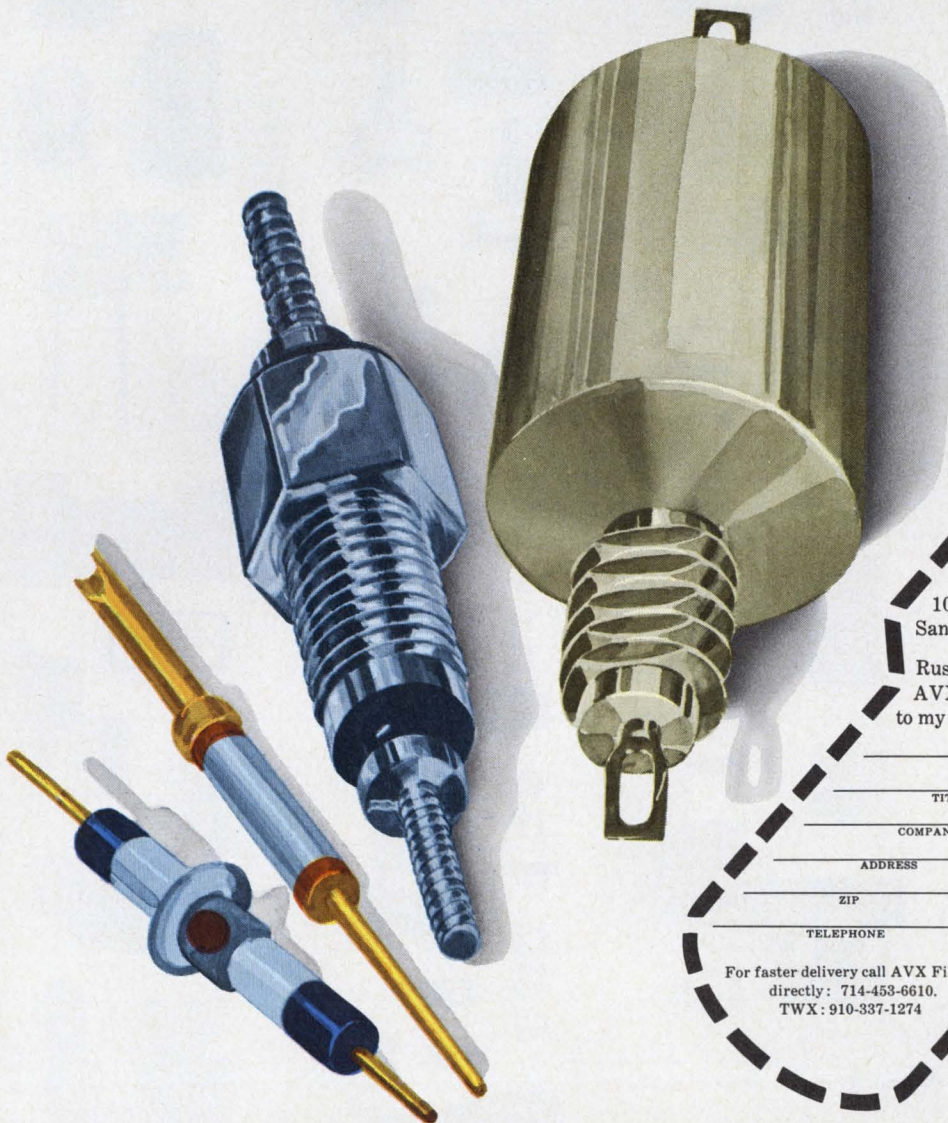

AVX Filters  
Department F-2  
10441 Roselle Street  
San Diego, Ca. 92121



Rush me \_\_\_\_\_ copies of the new  
AVX EMI filter catalog at no cost  
to my company.

NAME \_\_\_\_\_

TITLE \_\_\_\_\_

COMPANY \_\_\_\_\_

ADDRESS \_\_\_\_\_

ZIP \_\_\_\_\_

TELEPHONE \_\_\_\_\_

For faster delivery call AVX Filters  
directly: 714-453-6610.  
TWX: 910-337-1274



# Designers'

## Toggle Switches

Bat, lever lock, Designer Line, sealed. Big, broad choice.

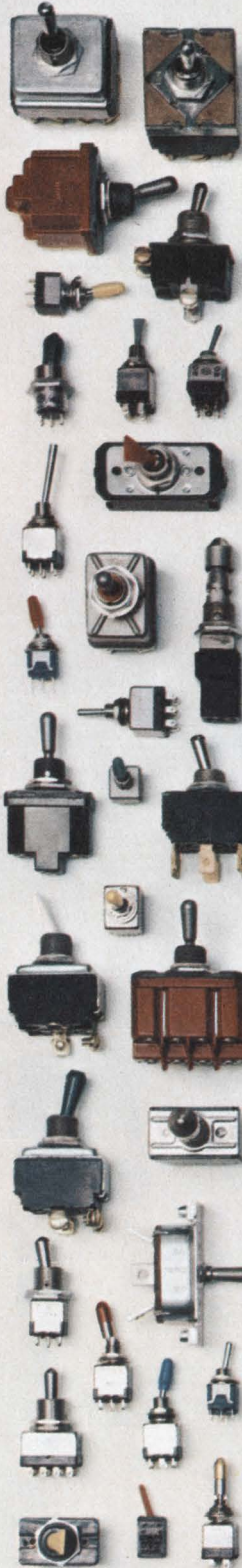

## Rocker Switches

Singles and multiples. Wide, colorful selection range. Legends, too.

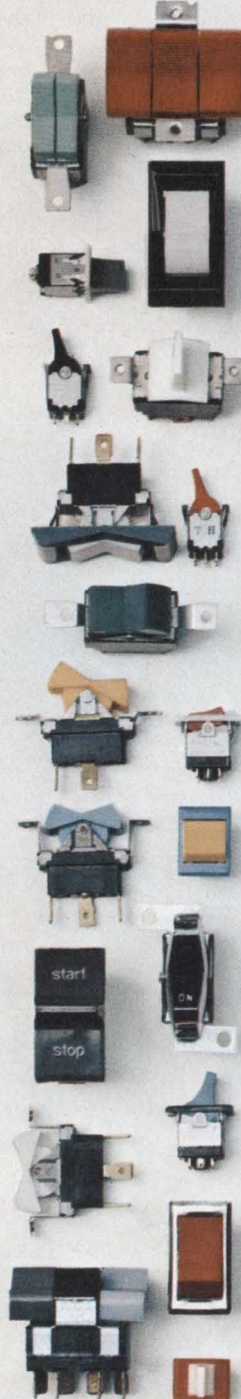

Cutler-Hammer, of course! The broadest line. Styled to meet today's and tomorrow's requirements. They're solid quality, look great, work long and hard. Carried in stock for local availability by Switch Distributors. Backed by Cutler-Hammer sales engineers who can deliver innovative design help for

## Pushbutton Switches

Choice of sizes, colors, circuits, ratings. Styled to "turn you on".

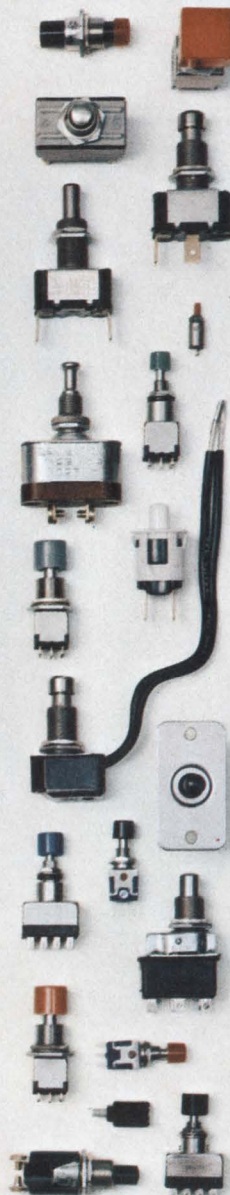

## Tool Handle & Slide Switches

Variable speed, reversing. Double insulated.

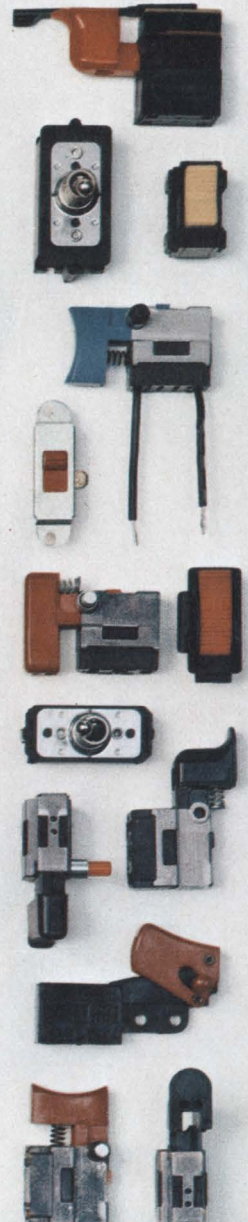

 **Switch to No.1**



# Choice.

the exact switch or relay you need—when you need it.

It's no wonder so many designers specify Cutler-Hammer. For quality, reliability, availability, and style. For commercial, industrial, and military applications.

We simply offer more—of everything!

## Snap Switches

Lever, roller, leaf, and pushbutton actuators. Four terminal styles.

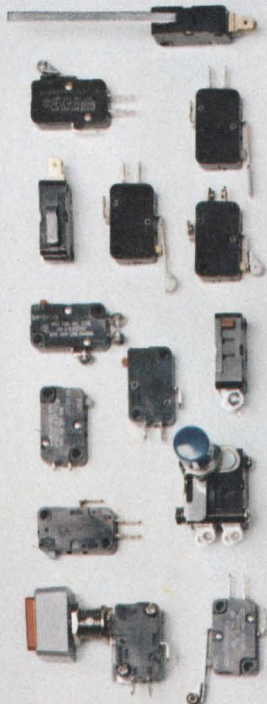

## Rotary Switches

Precision and general purpose. Single and multiple wafer.

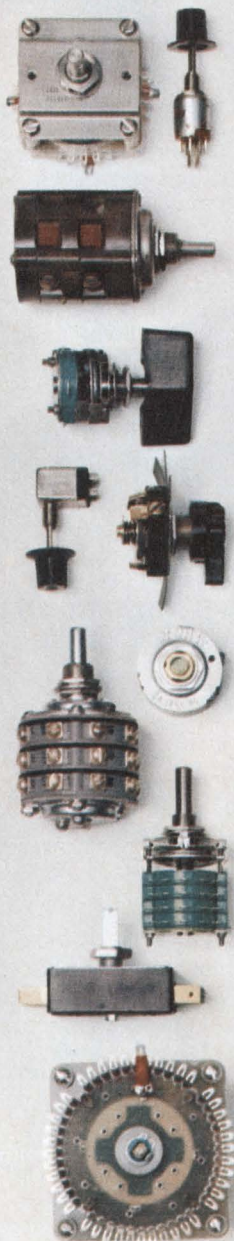

## Switch Accessories

Guards. Boots. Seals. Caps. Decorator facenuts. And much more to protect, code or customize.



## Illuminated Switches

Rockers, paddles, pushbuttons, indicators. Snap-in and bushing.

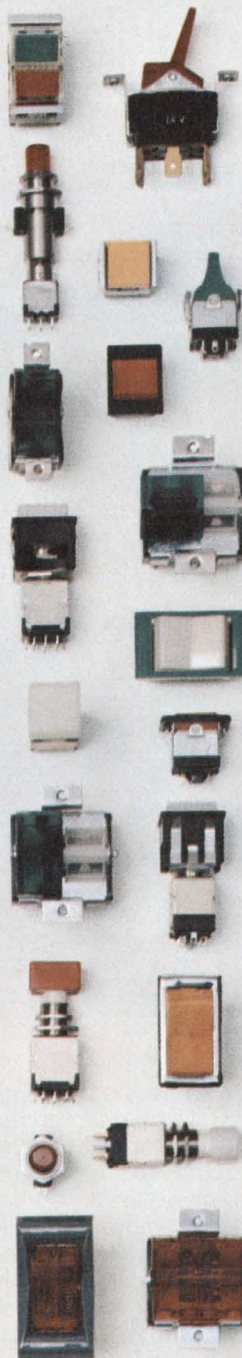

## Relays

Hermetics, non-sealed, potted. Power, latching, and timing functions.



**CUTLER-HAMMER**

SPECIALTY PRODUCTS DIVISION, Milwaukee, Wis. 53201



INFORMATION RETRIEVAL NUMBER 19



# OPEN WIDE AND SAY "Ahhh... Now that's what I call a THUMBWHEEL CATALOG!"

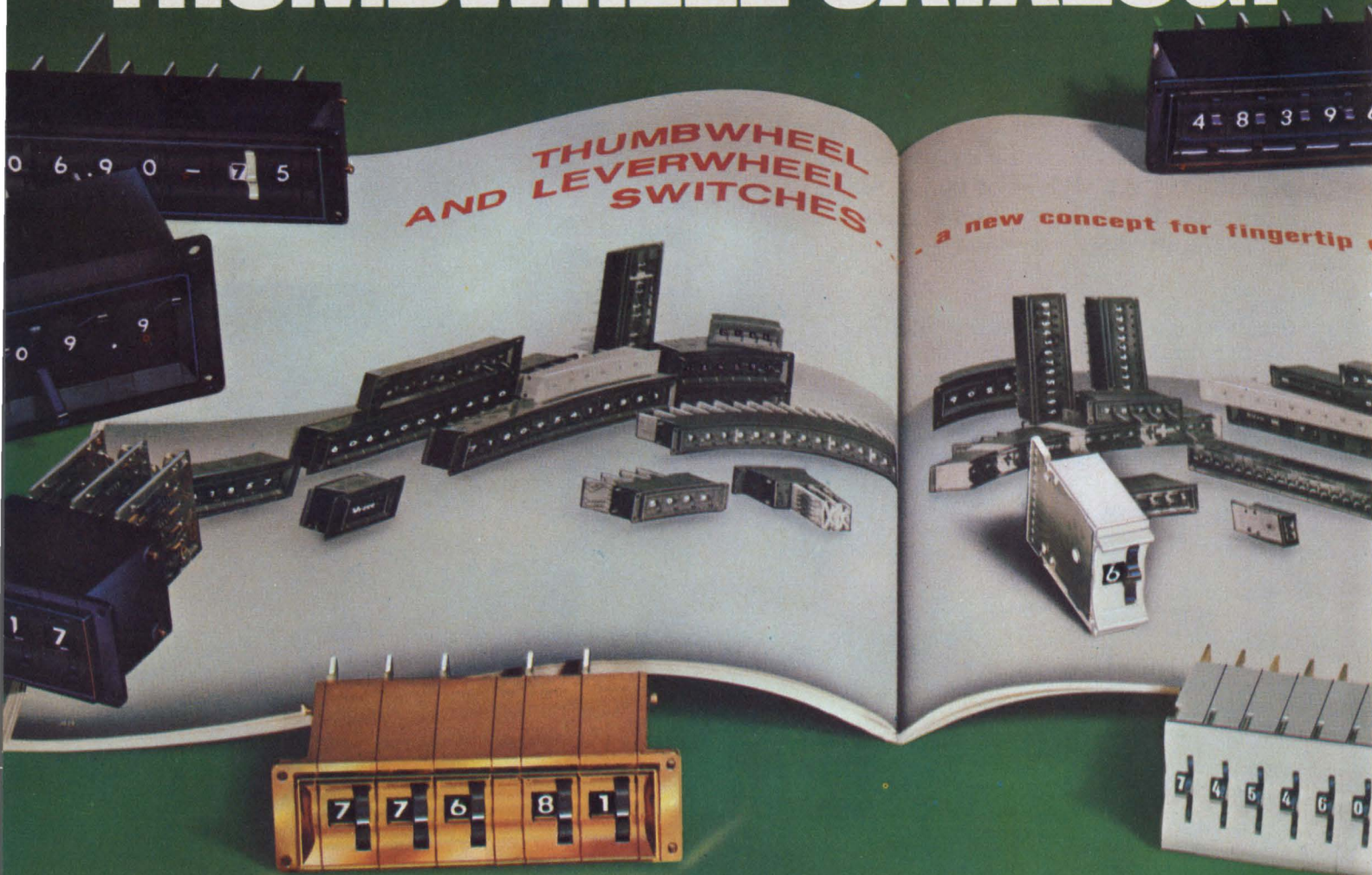

Send for this new Cherry Handbook and Guide

For everything you could possibly want to know about Cherry Thumbwheel and Leverwheel Switches, this new catalog is just what the doctor ordered. You'll find details and specs on nine series of Thumbwheels and Leverwheels—available in hundreds of variations. You'll find truth tables . . . cross-indexed product listings . . . application data . . . specials . . . and more. You'll also find never-before-published "inside" information on Cherry's Thumbwheel Switch total in-house manufacturing capabilities: Including printed circuit, precious metal plating, silk screening, metal stamping and plastic molding operations. All in a handsome, new, easy-to-use 72-page format. **And it's yours for the asking:** Just TWX 910-235-1572 . . . or PHONE 312-689-7700 . . . and ask for Frank.



# CHERRY



CHERRY ELECTRICAL PRODUCTS CORP.  
3609 Sunset Ave., Waukegan, Ill. 60085



Cherry affiliates worldwide • Hirose Cherry Precision Co., Ltd., Tokyo • G. W. Engineering Pty. Ltd., Sydney  
Cherry Electrical Products (U.K.) Ltd., St. Albans, Herts • Cherry Mikroschalter GmbH, Bayreuth, Germany

INFORMATION RETRIEVAL NUMBER 20



## Parley will offer solutions to defects in hybrid circuits

Solutions will be offered at a symposium in Boston to one of the most serious problems in hybrid microcircuits—the degradation or destruction of microchip semiconductors due to attack by chemicals in the epoxy adhesives that bond the chips to the substrate.

Thomas Gillis, engineering manager of microelectronics at Raytheon, Quincy, Mass., is technical program chairman of the meeting, which is being sponsored by the International Society for Hybrid Microelectronics. The meeting will be held Oct. 21 to 23 at the Sheraton Boston Hotel.

“Like it or not,” Gillis says, “two years from now, most hybrids will be fabricated with epoxies.”

To avoid disastrous consequences, he warns, “you’ve got to be exceptionally careful in selecting epoxies and in applying them.”

“We’ve done much work on hybrids at Raytheon,” Gillis says, “and we’ve concluded that 50% of the epoxies that are currently available attack aluminum. But aluminum is used to make contacts on the semiconductor chips. So if the corrosive type of epoxy gets on the chip, it eats away the aluminum pattern.”

In Session 6, “Polymers and Hybrids,” successful approaches and continuing problems in the use of epoxy for hybrid fabrication will be described by experts from six companies—Applied Technology, Raytheon, Autonetics, Airborne Instruments Laboratory, Analog Devices and IBM.

Substantial progress has also been made in reducing the size of microelectronic hybrid packages, according to Dr. Robert Mandal, staff scientist at Applied Technology, Sunnyvale, Calif., Mandal, chairman of Session 7, “Hybrid Packaging,” points out:

“Today we are doing a lot more

in a smaller volume. For example, we’re packaging very high-density memory modules.”

Important factors in size reduction, Mandal explains, have been improved methods of heat sinking, both within the microcircuit and between the hybrid package and environment. Greater reliability and reduced circuit cost result, he notes.

But Mandal points out that a big problem remains: the elimination of interconnections.

“Even though integrated microcircuit techniques have reduced interconnections for a given circuit by, say, 80%,” he says “we still have wirebonded interconnections within the hybrid package. And that’s something we want to get rid of.”

Computer control of hybrid microcircuit design and fabrication has produced improved circuit performance notes Daniel D. Zimmerman, physicist on the senior professional staff at Johns Hopkins University Applied Physics Laboratories, Silver Spring, Md.

Zimmerman, chairman of Session 5, “New Applications for Hybrids,” points out that computer-controlled laser-trimming techniques have produced a new concept in hybrid circuit production, called functional trimming.

“You no longer trim a resistor to a given value, but you trim the circuit to a desired transfer function,” he notes.

“This provides improved operating characteristics and is very cost-effective.”

### Built-in microprocessor available in scope

Automatic measurement and display of time interval, frequency, dc voltage, instantaneous ac volt-

age and relative amplitude expressed in percent are available on the first microprocessor-controlled oscilloscope.

Called the 1722A by its manufacturer, Hewlett-Packard in Colorado Springs, Colo., the scope is a dual-channel, 275-MHz laboratory model with 6 × 10-cm display. It sells for \$4500 without probes or other accessories.

“The microprocessor is the same chip set that runs the HP-35 hand-held calculator,” according to Walt Fisher, project manager. American Micro Systems [Santa Clara, Calif.] supplied the chips for the first production run. Mostek [Carrollton, Tex.] is an alternate source for the chips.”

Calculated results are displayed on a 3-1/2-digit LED readout with scientific notation. The exponents are always given as -3, -6 or -9. When used for time-interval measurements, these correspond to ms,  $\mu$ s and ns.

To make the time-interval measurement easier a dual delayed sweep function has been incorporated. This is a dual comparator that fires the sweep at one voltage and their again at another. The start and stop points of the desired time interval then appear as intensified markers on the scope face. A simple switch inverts a time-interval measurement to give a direct frequency readout on the LED display.

The new scope is expected to be the first of a family. Later products will probably have such features as user programmability and digital storage of a waveform for future reference. There might even be an HP-35 keyboard on the scope control panel.

### Amplifier tube claims ‘firsts’ in performance

A new jumbo low-light-level amplifier tubes for Air Force night photo reconnaissance missions is reported to set a number of firsts in performance. Developed for the Air Force Avionics Laboratory at Wright-Patterson AF Base, Ohio, by ITT, Fort Wayne, Ind., the single-stage, image-amplifier tube is focused electromagnetically and has an active aperture, or useful diameter, of 162 mm (6.4 in.).



A prime advantage of the tube, according to Frederick Farinet, Air Force project engineer, is that it permits use of a camera with standard 5-in. film and gives full area coverage. Previously, with the next largest tube (144 mm, or 365 in.), the image was clipped at the corners.

Compared with the 144-mm device, the 162 mm is said to have substantially improved optoelectronic characteristics:

- Cathode sensitivity is high across the operating band of 700 to 980 nanometer (nm). Response at 850 nm is 20 mA/W compared with 3 mA/W for the smaller device.

- Stage gain is 28 W/W, contrasted with 5 W/W for the 144-mm unit.

- Limiting resolution is 75 line-pairs per mm per stage, compared with 60 for the smaller tube.

- The tube can be efficiently gated on and off in less than 10  $\mu$ s, compared with 10,000  $\mu$ s required by the 144 mm tube. This gating feature permits a substantial reduction in atmospheric back scatter from the aircrafts gated light sources. Although 10- $\mu$ s gating has been achieved with photo multipliers, it is the first time that such rapid gating has been produced with large-image tubes.

- For mapping purposes, a reticle is incorporated in the cathode substrate. Earlier tubes did not have this feature.

Farinet points out that a major step has been taken toward achieving essentially uniform sensitivity over the full cathode area of the tube. The loss of sensitivity from the center outwards to the edge of such tube cathodes has been a problem for years.

Because of the increased gain of the new tube, an aircraft taking covert night pictures will be able to operate at higher altitudes than heretofore.

## C-Band landing system adopted by the FAA

An interim microwave landing system, compatible with the ILS avionics currently installed in aircraft, has been adopted by the Federal Aviation Administration.

Developed by Tull Aviation

Corp., Armonk, N.Y., the system operates at 5 GHz in the C band and has separate transmitters and scanning antennas for the localizer and the glide-slope functions. And it requires only a receiver-converter to change the pulsed C-band radiation to standard vhf/uhf ILS signals. The output of the converter is fed to conventional ILS receivers.

After competitive evaluation and flight tests were made with microwave equipment produced by Singer-Kearfott and Boeing, the Tull system was selected as the only one to pass all Category I landing-systems specifications.

The system is intended for use at locations where the standard ILS has reflection and interference problems, or where the needs for the low-approach service would be better met by installation of the newer system instead of the older ILS.

Under FAA contract terms, Tull will license companies wishing to build its system. Requests for data should be made directly to Tull.

An FAA spokesman says that limited application of the system will not affect the national microwave landing-system program. The FAA plans to amend its aviation regulations to provide financial aid under the Airport Development Program for the new installations.

Walter Barry, Tull's manager of installations, estimates that the cost will be about \$110,000 to \$125,000. Present costs of the receiver converter for the aircraft are projected at \$3000.

## FM stations reducing noise the Dolby way

"Dolbyize" has started in the wake of a public notice by the Federal Communications Commission that it has no objection to broadcasters combining the Dolby B-type noise-reduction system with a 25- $\mu$ s pre-emphasis curve.

The noise-reduction system, invented by Dr. Ray Dolby of Dolby Laboratories, New York City, selectively boosts the amplitude of the high-frequency components of audio material during low-volume music passages. This coded material is then recorded or broadcast. Upon playback or reception, the

process is reversed to return the audio response to normal. To the listener, the high-frequency noise produced by the tape or receiver is attenuated by about 10 dB during the quiet passages, where it is most objectionable.

A number of commercial radio stations, including WQXR in New York, have been broadcasting Dolbyized programs for some time. The problem that has prevented wider use is that a listener without decoding equipment hears the program is "overly bright" because of the boosting of the audio high frequencies.

By a change in the audio pre-emphasis (boost of high frequencies) in a transmitter from the standard 75  $\mu$ s to a less-severe 25  $\mu$ s, this problem is solved. Receivers of tuners without Dolby decoding hear the program with its normal proportion of high frequencies. Dolby-decoder-equipped receivers, provided with 25- $\mu$ s de-emphasis, receive the program normally, with a 10-dB better signal-to-noise ratio.

"So far we have delivered over 20 of the Type 324 encoder units incorporating the 25- $\mu$ s pre-emphasis," says Morely Kahn, Dolby's vice president and U.S. manager.

## Secure messages sent via phone by terminal

Through electronics the Air Force may turn a secretary into a communications center, provided she has, among her other assets, a security clearance.

The tool is a compact message terminal that contains a built-in electric typewriter connected to a cassette tape drive, which connects to a secure cryptographic processor in a safe. Incoming messages are automatically recorded, while outgoing messages are composed on the typewriter, transferred into digital format through the tape unit, processed by the cryptographic device and transmitted over ordinary telephone lines.

The Air Force envisions a number of terminals on each base that would tie into a computer-controlled automatic switch developed by the Air Force Communications Service's Communications Computer Programming Center.



# What's going in... in mainframes?

## MOSTEK's 16-pin 4K RAM.

Your mainframe memory system... MOSTEK's 16-pin 4K RAM. A perfect match. Because MOSTEK's 4K RAM gives you the performance, board density and ease of use your system demands. Plus it's available *now*.

Compare performance at the system level. MOSTEK's low capacitance, TTL compatible clocks, combined with superior output drive capability, provide the access time your system requires. Alternate 22-pin designs require high capacitance clocks and additional output buffering, causing system speeds to be lower. MOSTEK's 16-pin multiplexed design reduces the number

of address buffers required without affecting high speed access time. For small peripheral memory arrays the cost savings are substantial — even more so in the case of large mainframe arrays. So look to MOSTEK to meet the high speed requirements of your system.

Want board density? Of course. All memory users — from peripheral and minicomputer manufacturers to the big mainframe people — appreciate the increased density offered by MOSTEK's 16-pin design. (A 50% savings in memory board size over 22-pin alternates.) The result is a more compact, cost effective system.

Interested in ease of use? Again, compare the advantages of MOSTEK's MK4096. Readily available automatic insertion equipment can be used in

board assembly. Voltage pins are on the corners to simplify PCB layout. All inputs including clocks are directly TTL compatible with low capacitance. And the circuit is extremely tolerant of noisy system environments.

Your mainframe, minicomputer or peripheral memory and MOSTEK's 4K RAM. That's what's *going in*.

Want more details? Call your local MOSTEK distributor or representative or contact MOSTEK, 1215 West Crosby Road, Carrollton, Texas 75006, (214) 242-0444. In Europe contact MOSTEK GmbH, TALSTR. 172, 7024 Bernhausen, West Germany, Tel. 798038.

# MOSTEK<sup>®</sup>

INFORMATION RETRIEVAL NUMBER 24

**MOSTEK moves forward...in memories.**

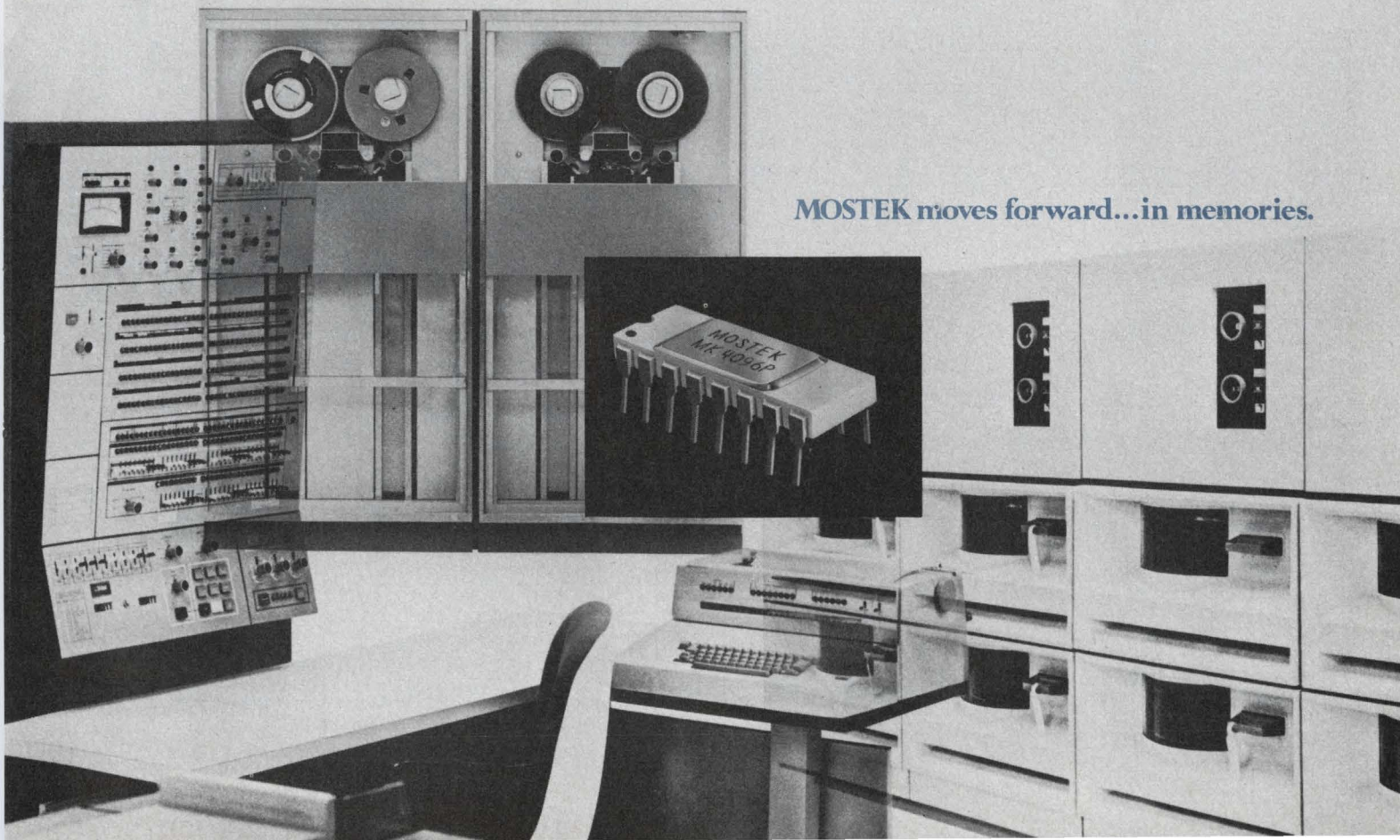



# We're shipping two million Which gives you a second

Not bad when you consider that after five years in the business we've become the world's second largest producer of CMOS. And rapidly gaining. In the last two years alone, our production capacity has increased 500%.

So it's a pretty sure bet we've got what you want. When you want it.

Because we're alternate-sourcing all of the big guy's most popular 4000-series. Plus a lot of the

other guys' standard CMOS devices. We're also turning out a lot of our own originals.

Actually, we're an alternate source that's better than equal. Because we *specialize* in CMOS. Nobody else does. And that's important to you in a number of ways.

We do all of our own development and process work, and plow more than 10% of our net income back into R & D. Nobody else does. We've got a





# CMOS circuits a month. source that's really prime.

brand new three-inch wafer facility; backed by ion implantation, automatic wire bonding, computer-controlled testing. That all adds up to high quality and high yield. Consistent availability. In volume.

In fact, volume is our whole thing. We already deliver one out of every five CMOS circuits bought today. Worldwide. And we've always

been the leading supplier of CMOS watch circuits.

So if you're thinking big numbers, please start with us. Meanwhile, let us send you our new catalog. Just write "CMOS" on your business card, and mail it to us.



**SOLID STATE SCIENTIFIC INC.**

Montgomeryville, Pa. 18936/(215) 855-8400/TWX 510-661-7267

**The alternate source that's better than equal.**

INFORMATION RETRIEVAL NUMBER 25





# A little-known source of power, the thermal cell, bids for attention

"Now that some of the military restrictions have been eased and more civilian designers are finding out what thermal batteries can do, the demand could lead to some very effective low-cost designs."

This is the view of Frederick Tepper, vice president and general manager of Catalyst Research Corp., Baltimore, and to back it, he points to advances that have been made in the thermal battery construction.

Representing a unique source of electrical energy, thermal cells can produce hundreds of watts of peak power in packages weighing less than a pound. However, once activated, they produce power for only a short time, ranging from milliseconds to perhaps half an hour for different versions.

## Can be stored for years

Thermal batteries have been used to power military ordnance, such as time fuses and missile electronics, since their invention in the late 1940s. But until fairly recently they have remained virtually unknown to designers of civilian electronics.

Present military thermal batteries have proved reliable sources of power for equipment that may be stored for years and then used at a moment's notice.

Not only is the battery ideal for weapons systems but for critical emergency equipment, such as aircraft ejection systems, emergency transmitters and signaling devices.

The military batteries range in

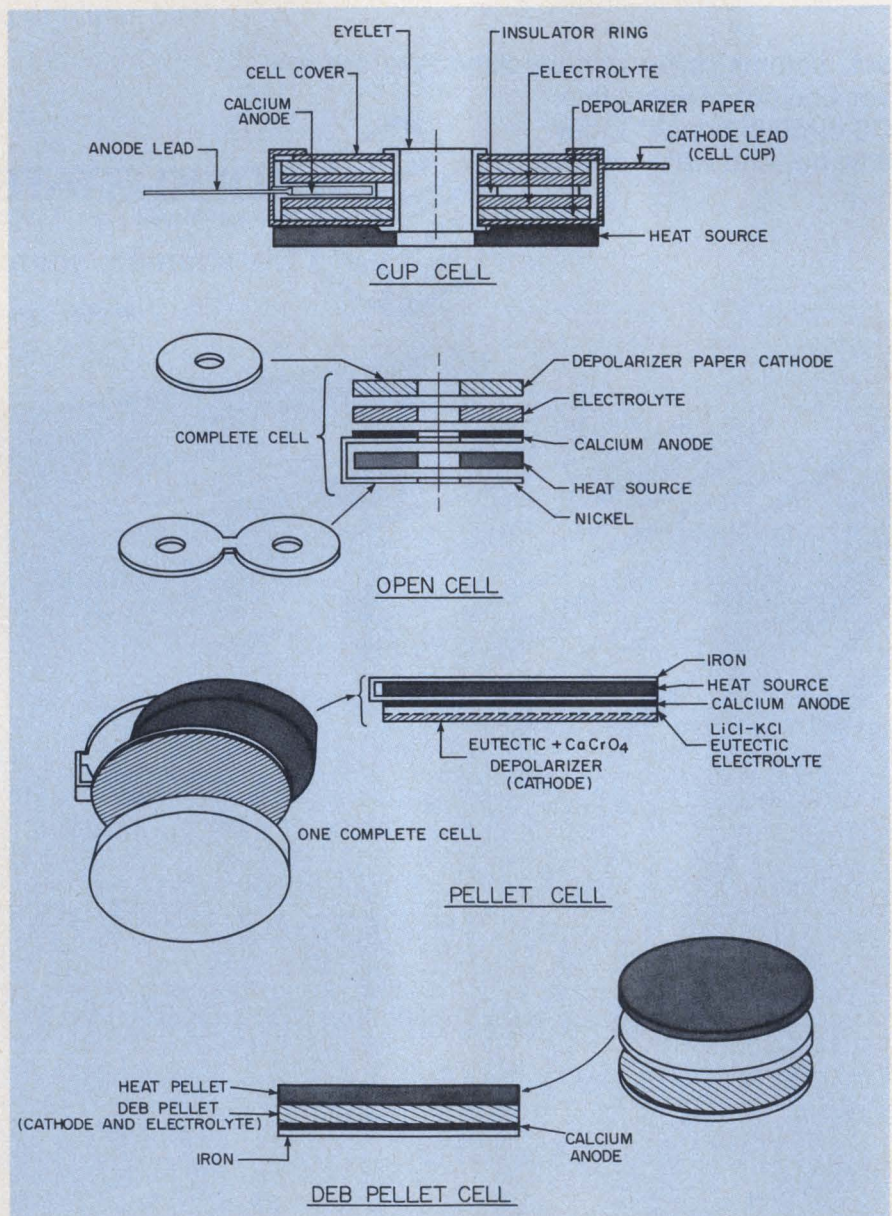

Most thermal battery cells are made of layers of a gasless pyrotechnic heat source, anhydrous metal salt electrolyte, calcium anode and metallic oxide, sulfide or chromite cathode. The older designs, cup and open cells, are made of paper-like layers of the materials, while the newer cells use pellets, which are mechanically stronger and easier to assemble. In the DEB (depolarizer, electrolyte, binder) cell, the cathode and electrolyte are combined in a single homogeneous pellet.

Northe K. Osbrink  
Western Editor



# Characteristics of some typical thermal batteries

Cell type	Volume (cc)	Weight (g)	Nominal voltage	Current (A)	Peak power (W)	Average life (sec)
Cup	450	850	7*	5.8	41	70
			126	0.47	60	70
Open cell	100	385	50**	0.36	15	70-100
Open cell	44	148	18	26	462	1.2
Open cell	1	5.5	10†	5.0	50	0.15†
High voltage array††	81	225	203	.02	4	45
			1.7	.32	0.5	45
Heat-DEB	2.9	7.5	20	0.045	0.9	25
Heat-DEB	105	307	28	1.2	34	150
			28	or 2.5	75	60
Heat-DEB	592	1560	28	2.8	78	800
Activated heat-DEB	83	250	45	6.0	385	25
Advanced pellet design	570	1485	28	5.5	158	720

\*Two-section battery.

\*\*Three sections totalling 58 V.

†Open circuit voltage is 33 V. Thermal life (light load, 28 V operation) is 2-3 seconds.

††Multisection battery with power and high voltage sections.

price from \$2 for some high-production units to \$200 or more, but civilian versions could be far less expensive, Tepper says.

"So far there have been no large production runs or automated assembly," he notes. "Even though over 10 million thermal batteries have been produced. We have been, in effect, job-shopping them and making a few for each contract—never more than two or three thousand a month."

The thermal cell is a primary cell, producing an electric current by the chemical action of oxidizing a metallic anode and reducing a cathode in the presence of an electrolyte. Unlike the more common primary cells—such as zinc-carbon or mercury, which are actively producing current immediately after assembly—the thermal cell is a reserve cell. The chemical activity does not start until an internal source of heat is activated. So the shelf life is virtually infinite.

The thermal battery uses an anhydrous salt electrolyte that operates at high temperature—usually molten. The high temperature is provided by inclusion of a non-gas-producing chemical heat source within the hermetically sealed battery case. Activating the battery requires that the heat source be ignited—with an electrical squib, firing pin or fuse.

According to Tepper, the most common thermal cells use a molten lithium and potassium chloride mixture for the electrolyte with a calcium metal anode. The active cathode material, called the depolarizer, may be oxides of iron, vanadium or tungsten and sulfides of copper or calcium chromate. Such cells require a temperature of 300 to 500 C to melt the electrolyte and to activate the battery.

The first practical thermal batteries were built with the cup-cell technique, and many current production batteries use the same construction. The active materials are contained in a metal cup, which also serves as the cathode connection. In the cup cell—and a later variation, the open cell, which eliminates the containing cup—the source of heat is a compound of zirconium and barium chromate manufactured in a paper-like sheet. It tends to be fragile and susceptible to accidental ignition.

## Pellet cells replace paper

The paper cells have largely been superseded by pellet cells. In these the heat source—electrolyte, anode and cathode—is manufactured in the form of round pellets, which are comparatively sturdy and easy to handle. The electrolyte—also barium-zirconium chromates—is mixed with a binder like kaolin,

which causes it to maintain its shape during the operating cycle.

In 1959, Catalyst Research Corp. and Sandia Laboratories, Albuquerque, N.M., developed independently two versions of a new type of thermal cell. Known as the DEB (depolarizer, electrolyte, binder), the cell is built like other pellet cells. But the depolarizer (cathode) and electrolyte are combined into a single homogeneous pellet, held together with a binder.

Tepper notes: "You theoretically could get some cell discharge, since the anode is placed directly next to the cathode—an ion short. However, in operation, the molten blobs of depolarizer are surrounded by extremely thin layers of pure electrolyte. So, in practice, there is no loss of efficiency in using the DEB pellet."

By combining the DEB construction with an improved heat source (iron-potassium perchlorate), the "activated heat DEB" cell is capable of longer operating life and more stable power production.

During combustion, Tepper explains, the perchlorate gives up its oxygen to the iron, leaving a pellet of potassium chloride when combustion is finished.

"The chloride acts as a thermal sink, melting and absorbing heat during combustion and giving it up as the cell cools," Tepper explains. ■■



# Ulf direction finder for miners passes tests at 1500-ft depth

An ultra-low-frequency electromagnetic direction-finding system that can pinpoint a transmitter 1500 ft. below the earth's surface is ready for operational use after more than three years of development and field-testing. It will be used to find miners who are trapped in underground disasters.

The system comprises a miner's keyed cw transmitter connected to a large loop antenna, which radiates at a discrete frequency in the 900-to-3100-Hz band. Above-ground receivers, with direction-finding loops, are designed to be carried by men on foot and by flying helicopter.

The system, developed by West-

inghouse for the United States Bureau of Mines, has proved capable of locating the position of underground transmitters to within one foot for shallow mines of 200-to-350-foot depths (see table). For a worst-case test, Westinghouse chose the Geneva Coal Mine, near Dragerton, Utah.

Here, the ground has relatively high conductivity and the overburden—the depth of the earth above the mine passageways—is deep. At the shallowest overburden location of 1150 ft., the signal from the mine could be picked up by the helicopter as it flew at 100 ft. The horizontal detection range was about 4000 ft. Signals were also detected by the helicopter at depths up to 1500 ft., but the horizontal detection range was limited to about 1000 ft.

The helicopter was used for quick scans over the mine area, to determine the presence or absence of transmitted signals in the mine and their approximate location. The man-pack receivers were used to zero in on the signal source.

The direction-finding system is being refined by Collins Radio Co. in light of the tests, and Collins will build the production models.

The original design of the ulf system made use of the fact that miners equipped with tone transmitters driving a large loop antenna could generate a vertical magnetic dipole moment that could be located by measurement of the magnetic fields on the surface. Directly above the dipole or source, is a null that provides the location.

The accuracy of the location depends upon the depth of the null, which is a function of signal level and background noise. Accuracy also depends on the orientation of the axis of the underground loop, as well as on the slope of the terrain on the surface. However, the tests have demonstrated that correction factors can reduce the slope error to a small one.

*(continued on p. 34)*

**Jim McDermott**  
Eastern Editor



Underground field strength measurements are being made by Westinghouse engineers in the Eagle Coal Mine in Colorado. Evaluation of the penetration depth of ulf radio transmissions was aided by these measurements.

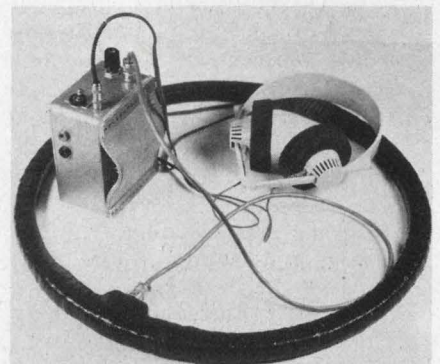

This prototype ulf receiver, by Westinghouse, uses a direction-finding loop to find the null in the pattern being radiated by underground transmitters.



# CERAMOLITHIC<sup>®</sup> EVOLUTION

U. S. Capacitor Corporations' monolithic ceramic EMI/RFI filters have evolved in phase with solid state technology. Increasingly higher frequencies in tiny LSI environments make tough demands on designers: better attenuation, in state-of-the-art sizes and at affordable prices.

We've met these challenges at USCC/Centralab by accelerating the filter evolution through research in dielectrics and high-productivity manufacturing techniques.

Here's what today and tomorrow look like.

The latest and smallest filters available from USCC — 9900 Series feed-throughs. Better than 70db insertion loss at 10 GHz. Used all the way from medical electronics to CATV.

Also today, MIL-STD-461 filters — the smallest ever offered for this use. For any relatively low source and load impedance job, the highest insertion loss at low frequencies.

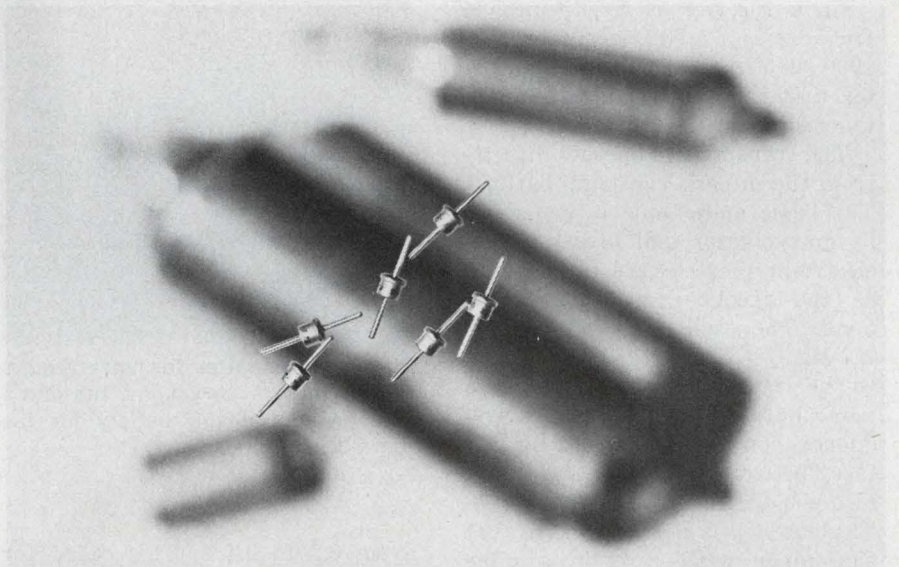
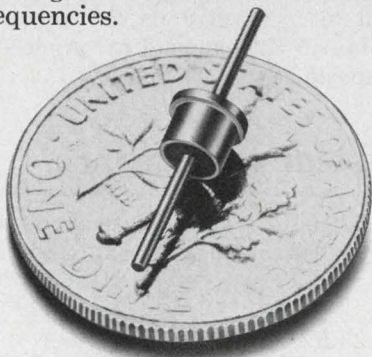

Above is USCC's smallest filter product — the 9900 series feed-thru pictured over larger more costly conventional types.

Buttons. High efficiency low pass "buttons" for data processing and MIL-F-15733 missile use. The best EMI/RFI filter job for the least money.

— a dielectric that serves as its own outer case — with obvious economics. Make the ceramolithic evolution work for you; contact us early in your design cycle.

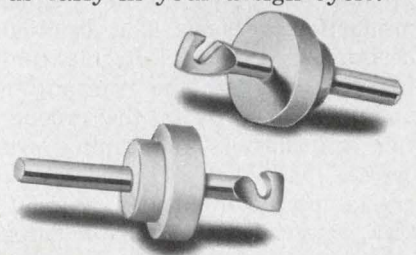
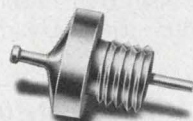

Tomorrow?  
CASELESS FILTERS. U.S. Capacitor has reached the next step in CERAMOLITHIC<sup>®</sup> evolution

Write or call Don Thommen (213) 843-4222 for evaluation samples or help with your filter application.



**USCC/Centralab**

Electronics Division ■ Globe-Union, Inc.



2151 North Lincoln Street ■ Burbank, California 91504  
(213) 843-4222 ■ TWX: 910-498-2222

INFORMATION RETRIEVAL NUMBER 26



Two types of prototype receivers were developed by Westinghouse: a portable, single-channel receiver with an aircore loop antenna tuned to one particular frequency (see photo) and a multichannel helicopter receiver with a broadband loop and preamplifier.

The Westinghouse manpack receiver is a tuned audio amplifier employing four bandpass filters and a sharply tuned, microelectronic piezoelectric tuning-fork filter with a Q of 500. The overall receiver bandpass is  $3 \pm 2$  Hz. Out-of-band interference  $\pm 300$  Hz away from the center frequency is attenuated about 70 dB.

Each receiver is fixed-tuned to frequencies of 922.5, 982.5, 1700, 1900, 2500 and 2900. The helicopter unit can receive all six simultaneously.

The transmitters operate directly from the miner's cap lamp battery. The basic audio tone is generated by an oscillator that uses a microelectronic piezoelectric tuning fork as the frequency-generating element. The oscillator's accuracy is  $\pm 2$ -Hz.

The transmitter output is a gated burst of the tuning-fork frequency—on for 0.2 s and off for 2 s. The output is 8 amperes, peak, into a  $0.4\text{-}\Omega$  resistive load at 70 F. The antenna is a loop of wire that the miner winds around a mine pillar.

It's possible to key the transmitter manually for coded communication, or it can be set for automatic burst operation.

Both the transmitter and receiver have been miniaturized for greater portability in the Collins production version. The original designs used microelectronic tuning forks in both the transmitter and receiver. But in the production transmitters the tuning-fork crystal has been replaced by a crystal oscillator in the 32-to-50-kHz range. This oscillator uses electronic-watch crystals.

The crystal output in the Collins transmitter has been divided down to provide a single basic frequency in the 900-to-3100-Hz range. Different frequencies will be assigned to different sites in a mine.

To reduce battery drain and provide 10 hours of minimum operation after the miner has used his cap lamp for eight hours, the transmitted burst has been reduced

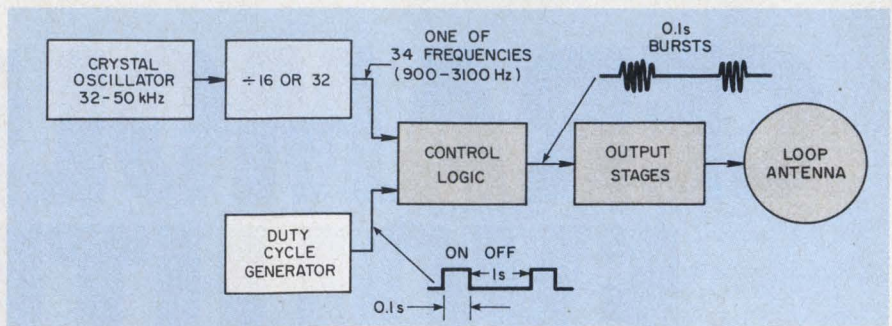

The production u/f Collins transmitter uses a watch-crystal oscillator that is counted down to give discrete frequencies in the basic audio range suitable for underground communication. Loop is spread out in mine.

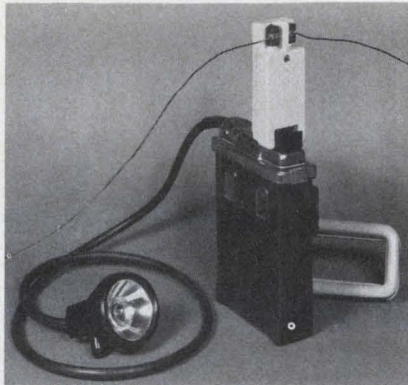

The u/f transmitter for underground use by miners, by Collins, fits into a clip on top of the battery for the miner's lamp.

from 0.2 to 0.1 s. This called for an increase in receiver bandwidth from about 2 Hz to 10.

Another battery-saving feature has been built into the transmitter, according to Dean Anderson, head of mine electronic product design for Collins. As the battery gets weaker, he points out, the voltage drops more and more with transmitted bursts. But it rises when the transmissions stop. To

keep the crystal oscillator in operation despite the drop in voltage, a capacitor is charged by the battery during the off portion of the transmitter cycle. During the on portion the oscillator runs off of the capacitor.

The transmitted output power into a typical loop, Anderson says, is about 10 W, average, during the sine-wave burst.

To eliminate 60-Hz interference in the receiver, the transmitter frequencies fall between the 60-Hz harmonics.

In field tests the microelectronic tuning-fork filter in the receiver proved to be microphonic. This noise interfered with reception by the manpack receiver. In Collins version, the fork has been eliminated. And the circuit, instead of being a tuned audio amplifier, has been redesigned as a superhet with an intermediate frequency of 50 kHz.

"We're translating the input signal upwards to 50 kHz and putting it through a 50 kHz i-f crystal filter to give us the required 10-to-15-Hz bandwidth," Anderson reports. ■■

### Prototype u/f locator system performance

Mine	Overburden thickness, ft	Hill slope, deg	Location accuracy, ft	
			Uncorrected	Corrected for hill slope
Inexco #1 Jamestown, Col.	350	23.5	43	1
Somerset Paonia, Col.	500	15	23	5.6
Copper Queen Bisbee, Ariz.	200	15	5	1
Geneva Dragerton, Utah	130 to 200	22	130 to 300	—



# BIG 3.

## SERIES JA.

Closest thing yet to a universal OEM circuit breaker. Any rating from 0.020 to 30 amp at 240V 60Hz or 400Hz, or 65V DC. Four time delays. Seven special-function internal circuits. One to four poles. Plastic or steel toggle handle, rocker, or pushbutton actuator. Optional colors. Optional snap-in installation (no hardware). Choice of quick-on or screw terminals. Five-year warranty. 16-page Bulletin J-3333.



## SERIES CF.

Most compact breaker in its class, offered in both front- and back-connected models. Any rating from 0.010 to 100 amp at 240V 60Hz or 400Hz, or 125V DC. Special 480V models. Four time delays. Seven special-function internal circuits. One to six poles. Five-year warranty. 14-page Bulletin CF-3104.

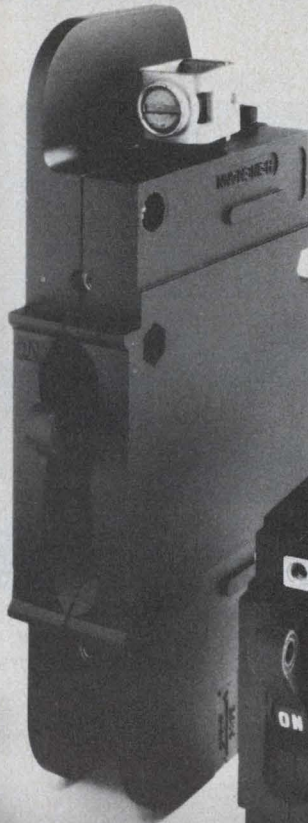

## SERIES AM1.

Direct replacement for Heinemann AM12 and similar breakers; costs less. Any rating from 0.020 to 60 amp at 250V 60Hz or 400Hz, or 65V DC. 70 and 100 amp ratings available in 120V 60Hz. Four time delays. Seven special-function internal circuits. One to four poles. Five-year warranty. 8-page Bulletin 3306.



## An easy way to find the right OEM circuit breaker (and the fastest delivery).

Heinemann Series JA, AM1, and CF are the Big 3—America's best-selling OEM circuit breakers.

And with good reason. These three product lines are broad enough and deep enough to handle almost any OEM application.

Remember that, and next time you want a circuit breaker (or power switch) for the equipment you manufacture, you'll be a step closer to knowing exactly what you need.

Your nearby Heinemann representative has complete information on the Big 3, as well as other Heinemann

breakers, and can assist in recommending specific models for your application. He'll also tell you about our new stock program, called Quick-Draw, through which you can generally get a reasonable quantity of standard breakers in a few days, sometimes even overnight.

The Big 3 breakers are described separately in detailed product bulletins packed with useful engineering information and application hints. We'd like you to have them all. Contact your nearby Heinemann representative or Heinemann Electric Company, Trenton, NJ 08602. Phone (609) 882-4800.



We keep you out of trouble.

INFORMATION RETRIEVAL NUMBER 27



# Hand-held gas detector promised, with 1-part-per-billion sensitivity

A gas-detecting system that could pinpoint air pollutants in concentrations of one part per billion may be one answer to a demand for hand-portable detectors to sniff out explosives and dope in packages and luggage at transportation and postal terminals. Present equipment used for this purpose requires a truck to carry it.

The new detector, developed at Massachusetts Institute of Technology under the sponsorship of the Advanced Research Projects Agency, is an opto-acoustic system. It produces acoustic signals by the rapid expansion of a pollutant gas as it absorbs energy from the chopped beam of a laser (Fig. 1). The laser wavelength is chosen to coincide with an absorption line of the gas.

The prototype model has a sensitivity of 200 ppb, but one of its developers, Roger Kamm, research assistant at MIT, says that with relatively simple modifications, the system would be able to detect as low as 1 ppb of an air contaminant.

The basic approach is not new, according to Associate Prof. C. Forbes Dewey Jr., who designed the improved version. Earlier systems, he points out, suffered from sensitivity losses, caused by absorption of energy by the test chamber walls and end windows. Consequently the pressure signal that activated a microphone inside the chamber was very low.

These problems were overcome with three new features in the MIT system design. First, the sample cell was designed as a resonant acoustic chamber, so that small pressure fluctuations produced by the chopped laser beam could be amplified by the Q of the acoustic chamber.

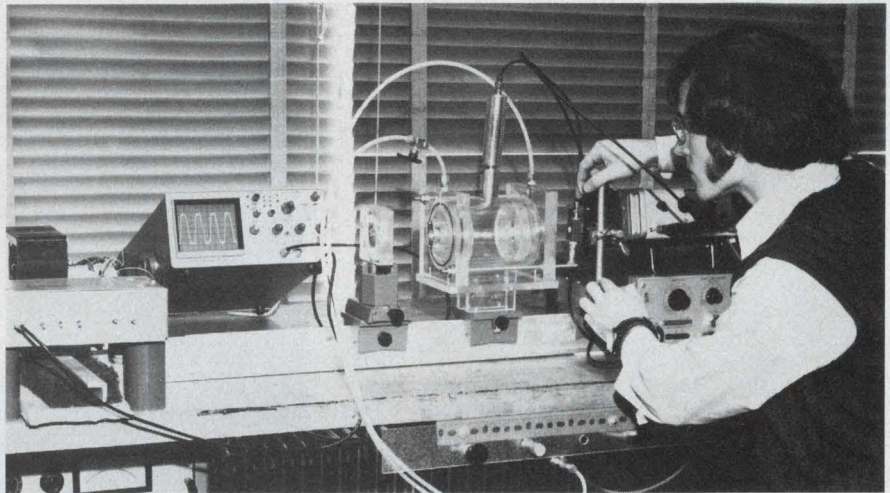

Acoustic chamber of MIT gas-detecting system is being aligned with laser beam by Roger Kamm, one of system developers. Output of the photodetector, used for alignment, appears on the screen of the scope. Laser is at left.

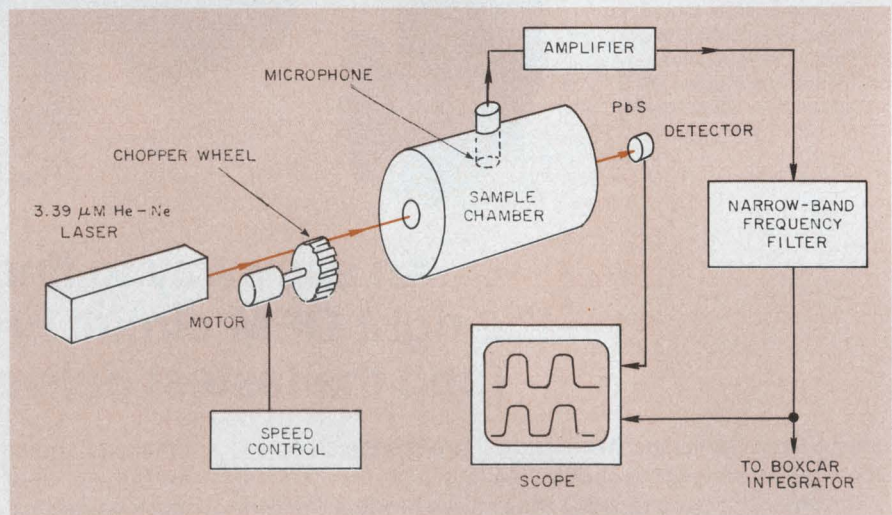

The infrared absorption of a gas sample is amplified by the acoustic resonance of the sample chamber. The chopped laser beam, in passing through the chamber, produces sonic pressure changes picked up by the microphone.

The maximum Q of the chamber approached 700, but the gain of the prototype system—due to other losses—was 100 times that of a nonresonant system.

To further enhance the acoustic signal gain, the laser beam was

chopped at the chamber's 3900-Hz resonant frequency. This is in contrast with earlier nonresonant systems using 100-Hz chopping rates.

The resonant-frequency chopping technique overcame another major  
(continued on page 38)



**WHAT THIS COUNTRY  
NEEDS IS A GOOD**

**4¢** ~~**5¢**~~  
**RECTIFIER\***



**HERE IT IS...GENERAL INSTRUMENT'S 1N4001**

**\*Conditions of Sale**

**Minimum Order Quantity: 1,000,000 units scheduled within 12 months**

**Delivery: Minimum Shipment 100,000 pcs.**

**Packing: Bulk Packing, 1,000 unit/box**

**Marking: Cathode Band, IN4001, GI, Date Code**

**AQL: 1%**

**Specifications: Per EIA**

**For complete information call toll-free 800-645-1247 (In New York State call 516-733-3235) or write, General Instrument Corporation, Semiconductor Components Division, 600 W. John St., Hicksville, N.Y. 11802.**

**GI'S GOT IT!**

**GENERAL INSTRUMENT CORPORATION  
SEMICONDUCTOR COMPONENTS**





problem of earlier systems—absorption of the laser radiation by the sample cell windows and walls. This produced pressure signals that were identical to those produced by the pollutant being measured.

Dewey points out that because the resonant gas-pressure waves are different from the waves triggered by window and wall absorption, the latter do not interfere with detection of the pollutant signal.

In the prototype experiments, a 2-mm beam from a 0.6-mW, 3.39- $\mu$ m helium-neon laser made a single pass through gas in a chamber. The sample chamber was 92 mm long and had a diameter of 102 mm.

To pick up the pressure waves, a 5-mm electret microphone, encapsulated with an impedance-matching FET, was suspended inside the chamber at the end of a small rod. And to increase the amount of energy absorbed by the gas internal concave spherical re-

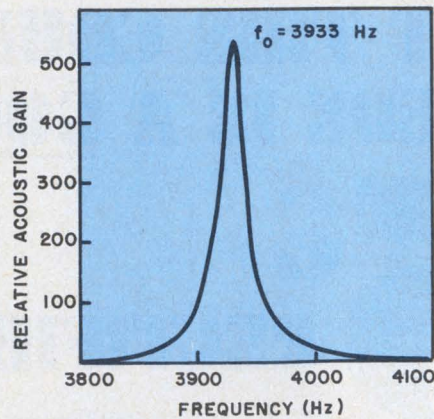

The measured acoustic gain of the sample chamber approaches 600.

flectors were added to both ends of the chamber.

Dewey estimates that the beam was reflected back and forth some 20 times with this arrangement. The mirror at the laser-entrance end was drilled with a small center hole to permit the beam to pass into the chamber.

Losses with this optical arrangement are about 5%, Dewey re-

ports. But this can be reduced, to 0.2%, he adds, by the use of anti-reflection coatings and the installation of external mirrors.

Experiments with n-butane as the trace absorbing gas have verified the soundness of the system concept, Dewey says. The output was demonstrated to be linearly proportional to the gas concentration.

While the prototype uses a helium-neon laser, Kamm sees the system eventually packaged into a suitcase, by substitution of a tunable solid-state laser for the helium-neon unit.

The system has been demonstrated to the Federal Law Enforcement Administration for detection of the minute amounts of vapor given off by explosives and heroin.

The Advanced Projects Agency sees another use of the technique: detection of atmospheric absorption of infrared laser beams used for communication and navigation systems. ■■

## Space antennas use quasar signals to predict earthquakes

Radio signals from outside our galaxy will soon be used to detect almost imperceptible movements in the Earth's crust that may eventually lead to the accurate prediction of earthquakes.

In a project dubbed ARIES, for Astronomical Radio Interferometric Earth Surveying, scientists from NASA's Jet Propulsion Laboratories in Pasadena, Calif., have taken instruments originally developed for space exploration and adapted them for use in an earth fault-monitoring system. By combining the experience they've gained from spacecraft navigation with current radio astronomy and geophysical research, JPL scientists hope to be able to measure movements as small as a few inches in the earth's crust.

According to Peter Mac Doran, the project director, the principal

instruments in the earthquake research project are a 30-ft. dish antenna located at JPL's Pasadena facility, and a 64-meter dish located in the Mojave Desert in Goldstone, Calif. According to Mac Doran, a sensitive radio receiver linked to the antenna listens to signals originating from quasars that are as much as one-billion light years away.

One of the space-communications stations of NASA's Deep Space Network in Goldstone will listen to the same signals, Mac Doran continues. Success of the project, he states, is linked to JPL's ability to measure the difference in the arrival times of identical quasar radio signals at the two dishes located about 125 miles apart.

Mac Doran is confident that the researchers will be able to make

these measurements without too much difficulty. In explaining why, he says that over the past three years, instruments originally developed for space navigation and communication have been developed that produce time measurements with a precision of 1/10 of a billionth of a second ( $1 \times 10^{-10}$  sec).

In explaining how the system works, the director notes that S-band signals from a quasar are received and heterodyned with a signal from a local oscillator to produce an output signal in the 0-to-2-MHz range. This signal is digitally sampled at a rate of 4 Mbits/sec, and then "tagged" with a time code, and recorded on a magnetic tape recorder. Tapes from the two stations are then fed into a computer, where a cross correlation is performed to get the difference in the time of arrival



# AIRPAX™

## TYPE 209 E-Frame Circuit Breakers

Airpax Type 209 molded-case circuit breakers are designed for use by the original equipment manufacturer. The hydraulic/magnetic principle provides stable trip points over a wide ambient temperature range. Typical applications include: refrigeration, air conditioning, power supplies, computers, and others.

**Features:**

U.L. listed for branch circuit protection.

Current ratings to 100 amperes.

Voltage: 125V dc 120/240V ac  
240V ac 277/480V ac

**Construction:** Series, relay, shunt, auxiliary switch.

**Terminations:** Solderless connector, screw or stud terminals.

**Time Delays:** Instant, short, medium, or long.

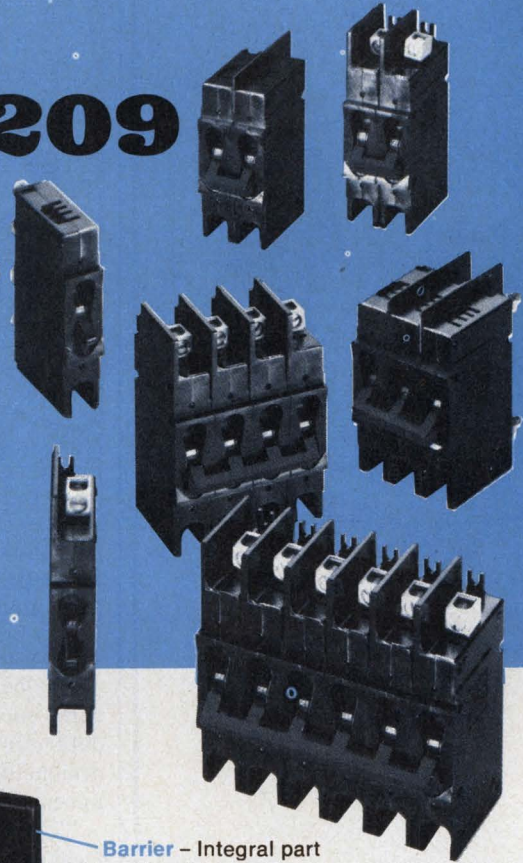

### Here's the inside story of the Airpax Type 209 Circuit Breaker:

**Solderless Connector** –

Accepts 14-0 copper and 12-0 aluminum wire. (Also available with back connected stud terminals)

**Mounting Foot** – Provides for versatility and ease in mounting.

**Contact Terminal** –

Self-cleaning contacts, sliding under pressure, insure low resistance and long contact life.

**Arc Plate** – Additional arc extinguishing feature.

**Hydraulic-Magnetic Unit** –

Accurate protection throughout ambient temperature range.

**Barrier** – Integral part of molded case.

**Arc Chamber** – Ten positioned metal baffles and screen to quickly diffuse and extinguish arc.

**Inertia Wheel** – Prevents nuisance tripping due to inrush currents of 20 times breaker rating without affecting delay curve.

**Handle** – Definite ON-OFF positions. Automatic reset.

**Mechanism** – Positive latching with trip-free construction. Balanced armature. Moisture-resistant finishes.

Airpax Electronics  
Cambridge, Maryland 21613  
Phone (301) 228-4600

# AIRPAX™

Cambridge Division

Want to know more about these compact, competitive Type 209 breakers? Write for Airpax Bulletin 2012.

INFORMATION RETRIEVAL NUMBER 29



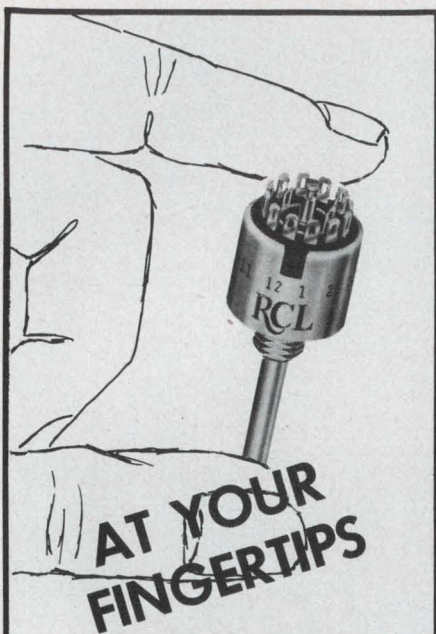

**AT YOUR FINGERTIPS**

*Industry's Best Delivery On Every*

# MINIATURE ROTARY SWITCH

*In Our Catalog*

Call our hotline for prompt service and delivery.  
(201) 374-3311

**RCL**  
**ELECTRONICS, Inc.**  
General Sales Office:  
700 So. 21st Street  
Irvington, N. J. 07111

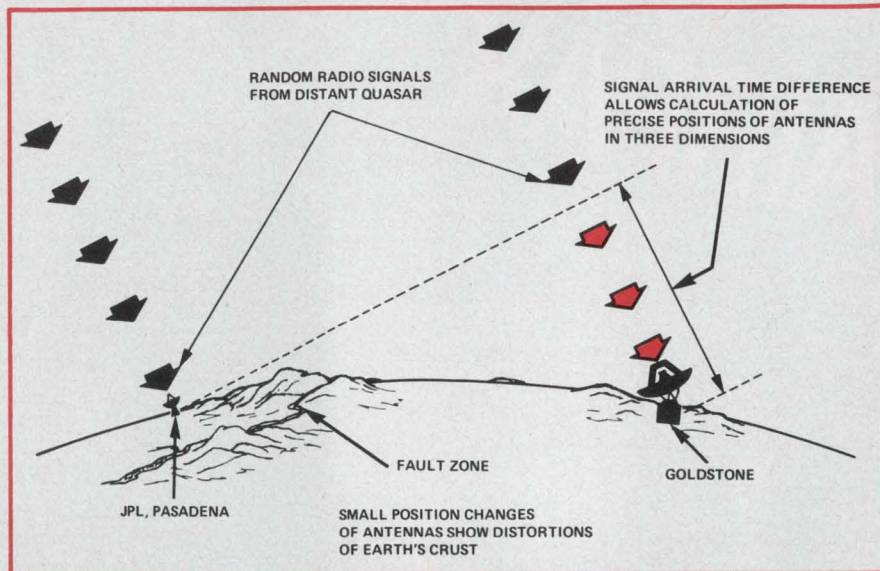

**Prediction of earthquakes** is the goal of Project ARIES, which uses signals generated by quasars to detect movement in the earth's crust.

of the signal at each location.

By looking at five or more quasars, enough data are generated to determine accurately the three-dimensional separation of the two antennas, Mac Doran says.

To make sure that the clock and local oscillator signals at both locations are the same, a rubidium atomic clock is used as a reference.

Commenting on the vast difference in size between the two dish antennas, Mac Doran notes that the results of this system depend on the geometric mean of the receiver sensitivity and the collecting area of the antennas. Thus the big Goldstone dish, with its maser amplifier, compensates for the smaller JPL dish with its parametric amplifier.

An initial distance measurement between JPL and Goldstone will establish a reference baseline. Subsequent measurements will indicate any change in the distance between the two dishes that might be caused by shifts in the earth's crust.

Explaining how the motion of the earth's crust is detected, Mac Doran notes that any deformation in the earth between these two antennas will cause them to shift in location with respect to each other. This shift from the reference positions, set up at the beginning of the experiment, will cause radio signals from the quasar to arrive a fraction of a second before or after the time they should have normally arrived. This fraction-of-a-second difference

in time is measured, and the amount of movement is calculated.

With the high-precision equipment available, changes in the distance between the two antennas can be determined in three dimensions to an accuracy of a few inches or less.

The Goldstone and JPL sites were chosen specifically because a straight line between the two intersects the St. Andreas fault, which is the main channel of the earth-fracture-system in California. And that area is the source of the state's most devastating earthquakes. Motion associated with this fault can be detected right away, and can be used as an early warning against earthquakes. The reason is that the motion creates a strain that must be relieved by a mild or sometimes violent earthquake.

In addition to the JPL location, the portable 30-ft. dish will be used in at least six other locations in southern California.

With its ability to measure motions of the earth's surface in three dimensions, the ARIES project may also be useful to confirm a new theory that some earthquakes are preceded by a swelling of the surface of up to 3 ft. over an area of hundreds of square miles. This rock-expansion theory is based on the belief that stresses in the crust cause minute cracking of rock on a vast scale. This tends to lift the earth's surface. If the theory is confirmed, earthquake predictions would be better. ■■



# “Rack in the box”

## THE PACKAGING SURPRISE FROM SCANBE

**A**vailable now! A complete card file system in a box . . . ready for assembly. Rapid Rack is the immediate solution to 8 out of 10 packaging problems . . . many for as little as \$20.20!

**B**uild your own customized card rack . . . *exactly* as you want it, *when* you want it. Up to 34 card positions — pre-assembled guide assemblies — spacers and mounting bars — pre-punched, slotted or blank end plates — drilled and tapped connector



mounting bars — single or double columns.

**C**ontact your Scanbe distributor

for complete details or descriptive brochure. Rapid Rack is on his shelf, ready for delivery. You'll save time, money, and worry. And you'll have everything you need to assemble the one rack that best meets your system requirements.

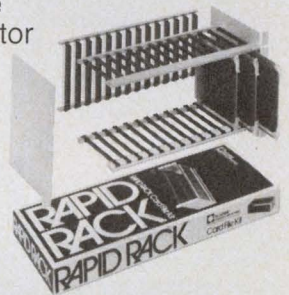

### CONTACT YOUR NEAREST SCANBE DISTRIBUTOR FOR IMMEDIATE DELIVERY OR COMPLETE DETAILS

#### WESTERN

**Almac/Stroum**  
Seattle, Washington  
(206) 763-2300

**Almac/Stroum**  
Portland, Oregon  
(503) 292-3534

**Electronic Parts**  
Denver, Colorado  
(303) 744-1992

**Moltronics of Arizona**  
Phoenix, Arizona  
(602) 272-7951

**Moltronics**  
San Diego, California  
(714) 278-5020

**Moltronics**  
Santa Clara, California  
(408) 244-7600

**Moltronics**  
South Gate, California  
(213) 773-6521

**Rose Electronics**  
Burlingame, California  
(415) 697-0224

#### EASTERN

**Car-Lac**  
Bohemia, New York  
(516) 567-4200

**Garden State Electronics**  
Roselle, New Jersey  
(201) 241-9000

**Pytronics**  
Montgomeryville, Pa.  
(215) 643-2850

**QPL Electronics**  
Waltham, Massachusetts  
(617) 891-0460

**Summit Distributors**  
Buffalo, New York  
(716) 884-3450

**Summit Distributors**  
Rochester, New York  
(716) 334-8110

**Time Electronics**  
Woburn, Massachusetts  
(617) 935-8080

**Treeko Sales**  
Beltsville, Maryland  
(301) 937-8260

#### CENTRAL

**Hall-Mark Electronics**  
Elk Grove Village, Illinois  
(312) 437-8800

**Hall-Mark Electronics**  
Houston, Texas  
(713) 781-6100

**Hughes-Peters, Inc.**  
Columbus, Ohio  
(614) 294-5351

**Hughes-Peters, Inc.**  
Cincinnati, Ohio  
(513) 351-2000

**Industrial Components, Inc.**  
Minneapolis, Minnesota  
(612) 831-2666

**Marsh Radio Supply**  
West Allis, Wisconsin  
(414) 545-6500

**Olive Electronics**  
St. Louis, Missouri  
(314) 863-7800

**Pioneer-Cleveland**  
Cleveland, Ohio  
(216) 587-3600

**Pioneer/Michigan**  
Livonia, Michigan  
(313) 525-1800

**Specialized Products**  
Dallas, Texas  
(214) 358-4663

**SOUTHERN**  
**Hall-Mark Electronics**  
Orlando, Florida  
(305) 855-4020

**Powell Electronics**  
Huntsville, Alabama  
(205) 539-2731

**SCANBE**  
**CANOGA INDUSTRIES**

3445 Fletcher Avenue/El Monte, California 91731  
Telephone: (213) 579-2300/TWX: (910) 587-3437



# We're very big on small

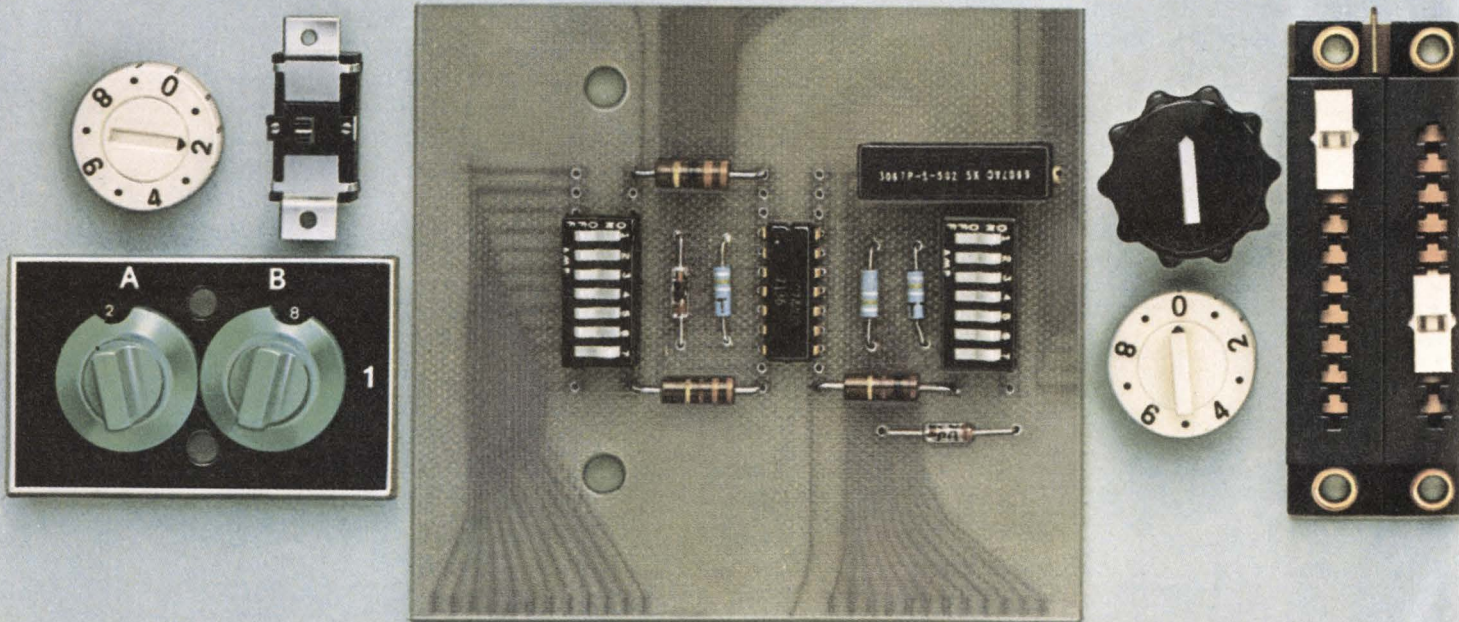







# A new autoranging multi-function counter using LSI/MOS from the "Counter House" the 1900A



## Fluke's new 1900A multi-counter offers you...

... a superb autoranging counter with outstanding features ...  
like leading zero suppression to end confusion ... autoreset, so  
your first reading is always correct no matter how often you  
change the function ... 5 Hz to 80 MHz dynamic range ...  
autoranging in both frequency and period measurement modes  
... signal input conditioning ... 25 mV sensitivity, typically 15  
mV ... event counting to  $10^6$  with overflow indication ... six  
digit LED display ... automatic annunciation ... and 20%  
hysteresis on autoranging to eliminate bothersome range  
switching. All this and more for \$349.

With the 1900A you get a rugged, compact and reliable instrument with all the performance and quality that Fluke is famous for. Including Fluke's full 12-month guarantee.

If you want battery operation we'll install an optional internal battery pack that gives you five hours of continuous operation between charges. Or if you need a data output we can provide it.

For fast, fast delivery order your 1900A from your local Fluke distributor - he has them in stock. Or write or phone us direct.

\$  
349

**FLUKE**  
COUNTER DIVISION

John Fluke Mfg. Co. Ltd.,  
Counter Division  
P.O. Box 1094, Station "D",  
Buffalo, N.Y. 14210  
Phone (716) 842-0311  
TWX 610-492-3214



# There's more to a Unimax product than meets the eye.

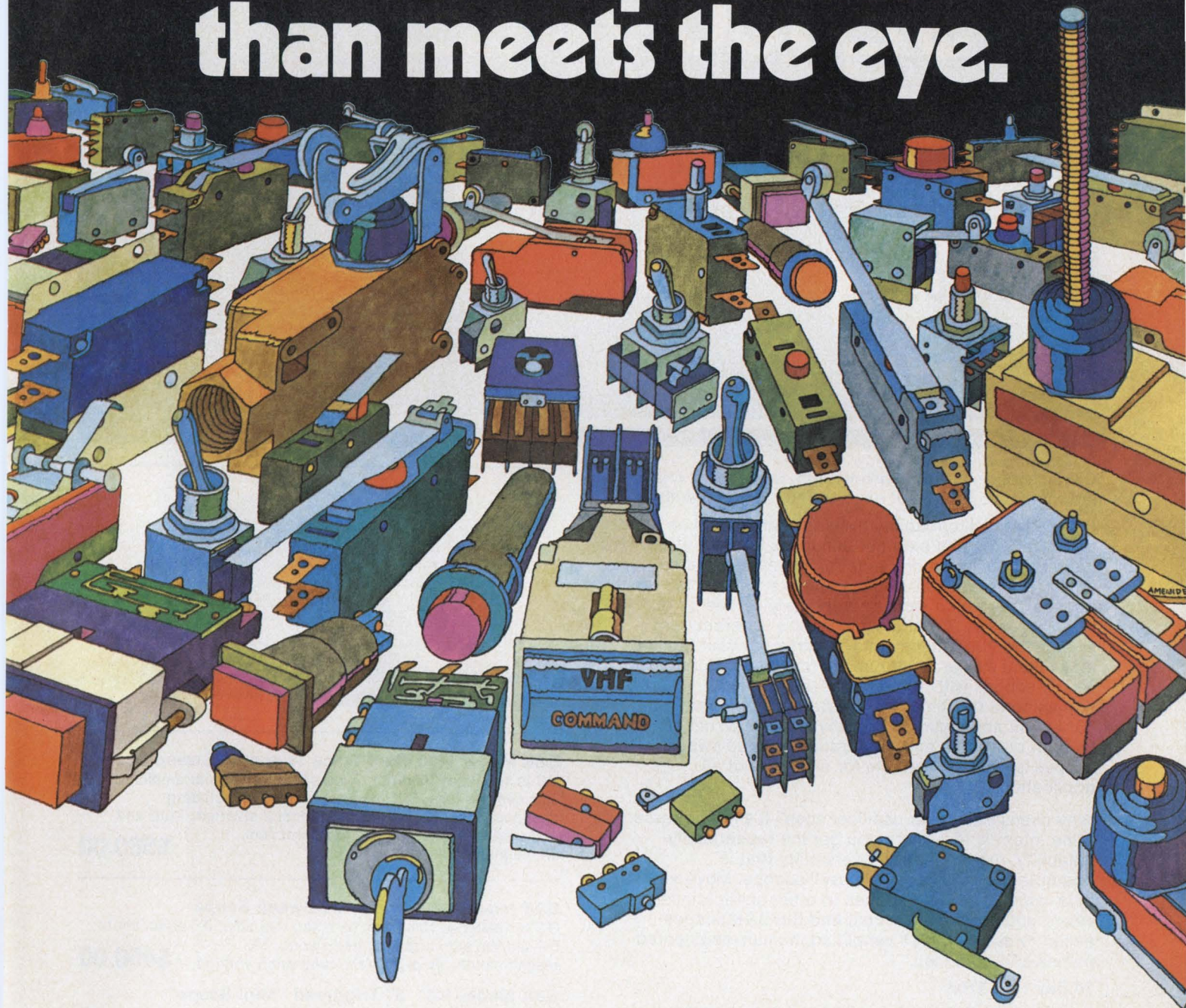

More quality. More reliability. More choice. More service.

When it comes to switches, you'll find that our models cover almost any conceivable snap-acting switch requirement.

BASIC PRECISION switches that are the first choice of the volume OEM users.

The most complete GENERAL PURPOSE line in the industry.

All styles of MINIATURE, SUBMINIATURE, and MINIATURE SUBMINIATURE types.

Big, rugged, METAL-CASED LIMIT

switches. Thousands of specials in minimum turn-around time, at minimum cost.

And to see the light, ask about our ILLUMINATED PUSHBUTTON CONTROLS. They offer you the broadest variety of styles in the business—in the widest choice of displays, colors, illuminations and actuations. From simple pilot light applications to the most

sophisticated multi lamp—multi switch—multi legend control, you'll find a Unimax LPB to meet your requirements. At a competitive price.

You'll also find special key lock or mushroom cap models. Mountings that are simplicity itself. Electrical and mechanical performances that are uniformly high.

Let us give you more. Write for detailed information concerning your applications to Unimax Switch Corporation, a Riker-Maxson Subsidiary, Ives Road, Wallingford, Conn. 06492. Or call (203) 269-8701.

 **Unimax**  
We give you more.

INFORMATION RETRIEVAL NUMBER 34



how 80%  
of \$2,000  
is only

\$580<sup>00</sup>

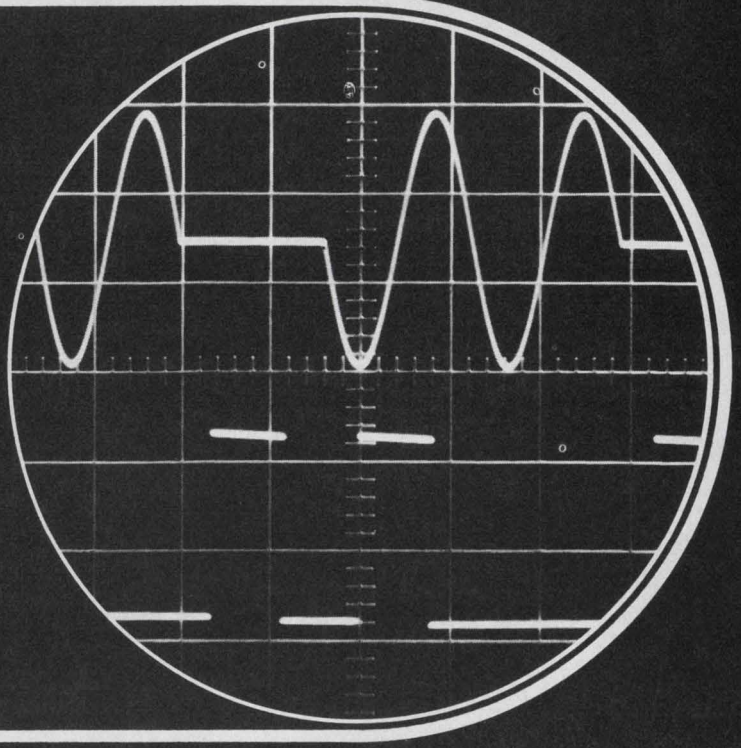

Oscilloscopes for most production, inspection, QC and lab applications are not used to their full capability.

In fact their full capability in bandwidth may even need to be limited by an external bandpass filter for easier trace readability. In one electronics manufacturing facility a survey of 22 applications discovered 19 applications which were appropriately served by our least expensive \$179.95 oscilloscope with recurrent sweep and 2MHz bandwidth. A survey of your facility may reveal similar opportunities for saving. Our triggered sweep scopes with 10MHz bandwidth and 35 nanosecond rise time answer the needs of more than 80% of all applications. Sensitivity of 10mV/cm offered by both our single and dual trace triggered sweep scopes is similarly suitable for over 80% of all applications.

Why overspecify your oscilloscopes? It's not necessary if the intent is to be sure you get the repeatability, reliability, ruggedness and versatility that is characteristic of every B&K oscilloscope. Move your ultra-wide bandwidth scopes to other applications where you need them. You'll find the B&K scopes easier to use with their simplified, human-engineered panels and controls.

#### 10 Day Free Trial

With more than 20 years successful experience in manufacturing fine test equipment at competitive prices, Dynascan has the confidence in its new B&K instruments to offer them on a 10 day free trial basis. Just properly identify yourself, your company and your application and we'll supply a new oscilloscope that will prove our claim to quality and value. Write on your letterhead for complete specifications and Free Trial.



Model  
1470

#### CONDENSED SPECIFICATIONS

#### B&K Model 1470 Dual Trace Triggered Sweep Scope

DC to 10MHz at 10mV/cm. Two separate vertical amplifiers. 35 n sec rise time. Six dual pattern modes including chopped, alternate, add and Channel 2 inverted. Auto and triggered sweep 1 usec/cm to 0.1 sec/cm. 5X magnification.

**\$580.00**

#### B&K Model 1460 Triggered Sweep Scope

DC to 10MHz at 10mV/cm. 35 n sec rise time. 0.5 usec/cm to 0.5 sec/cm auto and triggered sweep. 5X magnification. 5V p-p 1 KHz calibration voltage.

**\$450.00**

#### B&K Model 1431 3" Triggered "Mini-Scope"

As above, but 1/3 the size.

**\$399.00**

#### B&K Model 1403 Portable 3" "Mini-Scope"

3" solid state scope only 5 1/4" x 7 3/8" x 1 1/4". DC to 2MHz bandwidth and 20mV/cm sensitivity. Recurrent sweep 10Hz to 100kHz. Weighs only 8 1/2 pounds.

**\$189.00**



1801 W. Belle Plaine Ave. • Chicago, IL 60613 • Phone (312) 327-7270

Complete Line of Analog and Digital Multimeters, Oscilloscopes, Signal Generators, Semiconductor Testers, Power Supplies, Probes, Tube Testers and Substitution Boxes.





Stable Trimmers  
Small Duals  
Rugged Pots

If you're really  
serious about cost,  
be serious about quality.

Type FD trimmer. Type GD pot. Ideal variable resistors for CATV attenuators. Or any Bridged-T or L pad application requiring minimum size, stability and long life in severe environments. Exclusive hot-molded composition resistance elements permit peak set-ability. Diameter 1/2

inch (12,70 mm). Immersion-sealed (can be potted). Standard resistance values from 100 ohms to 5 megs and many popular impedance values. Single turn. For complete technical details request Publication 5231 (FD trimmer), Publication 5213 (GD potentiometer), Publication 5221 (FD/

GD attenuators). Allen-Bradley Electronics Division, 1201 South Second Street, Milwaukee, Wisconsin 53204. Export: Bloomfield, New Jersey 07003. Canada: Allen-Bradley Canada Limited, Cambridge, Ontario. United Kingdom: Jarrow, County Durham NE32 3EN.

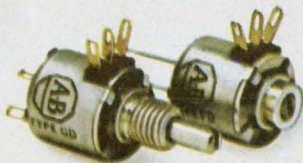

Actual Size

INFORMATION RETRIEVAL NUMBER 36



**Allen-Bradley**

Milwaukee, Wisconsin 53204



# How sweet it is.

LICON®  
Series 05 Lighted Switch.

Treat yourself to ultra reliable switching in a low cost, momentary LPB. See what pennies will buy with miniature Series 05 LPB switch priced near \$.60 in quantities. Wide LPB application. Plus designed for "Function enable" switching modes on computer/peripheral equipment. With Series 05, you get tactile feel upon contact closure, together with long (.030") contact wipe which assures reliable switching closures over an extended life. Plus the integral design—mounting legs and housing are unitized—eliminates extra hardware and minimizes installation time. And the single pole LPB accepts the new, low cost T-1 $\frac{3}{4}$  wedge base lamp. Also available in LED, neon lamp or an unlighted PB

switch version. How sweet it is. See for yourself. For information and complete specs, write:

LICON, Division  
Illinois Tool Works Inc.,  
6615 W. Irving Park Road,  
Chicago, Illinois 60634. Phone  
(312) 282-4040, TWX 910-  
221-0275.

**i t w LICON®**  
The Innovative Electronics Group of ITW  
LICON • EMCON • PAKTRON

© Illinois Tool Works Inc. 1974

INFORMATION RETRIEVAL NUMBER 37





# washington report

## **U.S. Pension Reform Act: A start, anyway**

President Ford's signing into law the Pension Reform Act was a milestone for some 30 million American employees but hardly the last shot for pension reformers, who won't be satisfied until pensions are portable from job to job and the pension plans are mandatory. Yet the bill made giant strides in stipulating acceptable vesting systems. It specified minimum funding and fiduciary standards, and it established a Pension Benefit Guarantee Corporation to insure pensions.

For the self-employed, contributions to the so-called Keogh type of private pension plan were raised to 15% of annual earnings or \$7500, whichever is less—up from the old \$2500 maximum. New in this category of plans is a provision that allows employees not covered by tax-qualified government or annuity pension plans to create their own retirement accounts. The annual limit is 10% or \$1500, whichever is less.

A possibility for portability is written into the new reform law. With a former employer's approval, an individual may transfer vested benefits, but he must do so within 60 days after leaving. Conceivably these funds could then be transferred to the new employer's pension plan, if he was agreeable. This and other provisions of the law are murky, and experts themselves aren't sure on many aspects. It will probably be months before the full impact of the bill is known.

## **Long-range study of microwave effects due**

The increasing use of microwave-generating devices—and the flap over microwave ovens—has prompted the National Institutes of Health to seek sources to investigate the effects of long-term, low-level pulsed and modulated microwave radiation. The focus is on the 1-to-10-GHz frequency range and possible impact on the functioning of the nervous system. Officials say the objective is to learn more about biological effects, which appear to be more pronounced with length of exposure.

## **U.S. calls metric conversion inevitable**

Although it was a backdoor operation, the U.S. does finally have a metric policy of sorts that indicates a recognition of the inevitable.

In an amendment to the Elementary and Secondary Education Act, recently passed by Congress, is an authorization for \$50-million to be used at the discretion of the U.S. Commissioner of Education for metric education through fiscal 1978. The amendment states that increased use of the metric system is inevitable and will become the dominant system of



weights and measures in the nation.

An added push for Congress to pass a metric bill that would coordinate conversion is coming from an agreement being implemented by the European Common Market. By 1978, U.S. exporters will be required to indicate dimensions in metric units.

## **Expansion for automatic vehicle location**

The Federal Communications Commission, in recognition of the dramatic developments in automatic vehicle location, is amending its rules to accommodate more users by opening new frequency bands. In general, narrowband base mobile data links in automatic vehicle monitoring (AVM) systems are being developed on uhf frequencies in the 450-MHz range. Various proximity sensing systems also use frequencies at 150 MHz or the 27-MHz band, but there has been a problem in meeting channel requirements because of the narrowband spectrum available.

To alleviate this condition, the FCC is reallocating 902 to 912 MHz and 918 to 928 MHz for wideband AVM applications employing pulse-ranging, multilateration techniques. This is where vehicle positions are determined by the difference in time of arrival, or phase difference, of signals received at fixed sensors or at the vehicle. Such systems are expected to handle up to 10,000 vehicles and be suitable for large or multiple users.

The FCC reports that AVM techniques are now being used in Chicago's bus transportation system and in police operations in St. Louis.

**Capital Capsules:** The Air Force is planning to evaluate reliability and associated failure mechanisms for complementary MOS transistors using silicon on sapphire technology. . . . The Air Force intends to conduct a comprehensive engineering study of electronic counter-counter-measures (ECCM) techniques applicable to digital tropospheric scatter radio communications systems. Included will be scatter and various means of line-of-sight jamming. . . . The Dept. of Defense is planning to issue a six-month contract for technical assistance to the National Military Command System Support Center for analysis, design, development and maintenance of selected data files and associated hardware. Bidders must have extensive knowledge and experience with IBM 360/67, HIS 6000, and CALCOMP plotter. . . . The Navy is seeking several-source production of OE-82B/WSC-1(V) shipboard antenna systems used for satellite tracking. The system uses two antennas and diplexers to give simultaneous transmission and reception, regardless of the ship's bearing in relation to the satellite. . . . The Air Force is looking for companies to develop a sophisticated damage-assessment system. Involved are theoretical and analytical investigation of remote-damage assessment of airborne vehicles by measurement of trajectory and by multispectrum signature analysis. . . . The U.S. Bureau of Mines has taken delivery on an electronic gas analyzer, "blue box," that will be used to detect dangerous concentrations of explosive methane gas or unusual accumulations of carbon dioxide in coal mines. The bureau is building a capability to determine electronically whether a mine's ventilation system is operating correctly, whether there is a fire or if a known fire has been extinguished. . . . The Atomic Energy Commission has issued a Request for Proposal for the design and construction of one or more Demonstration Centrifuge Enrichment Facilities, to be in operation by the late 1970s. The AEC concludes that small demonstration plants on private sites is Step 1 in luring private firms into the business.



# NO CASUAL CONTACTS.

We don't treat connectors casually. And neither should you.

With our connectors, the gold is exactly where you want it.

You can get a completely gold-coated contact or our reliable gold-dot type. Both types are available custom or off-the-shelf.

High quality connectors are our business. And business is something we don't treat casually.

GTE Sylvania, Parts Division, Warren, Pa. 16365

**GTE SYLVANIA**

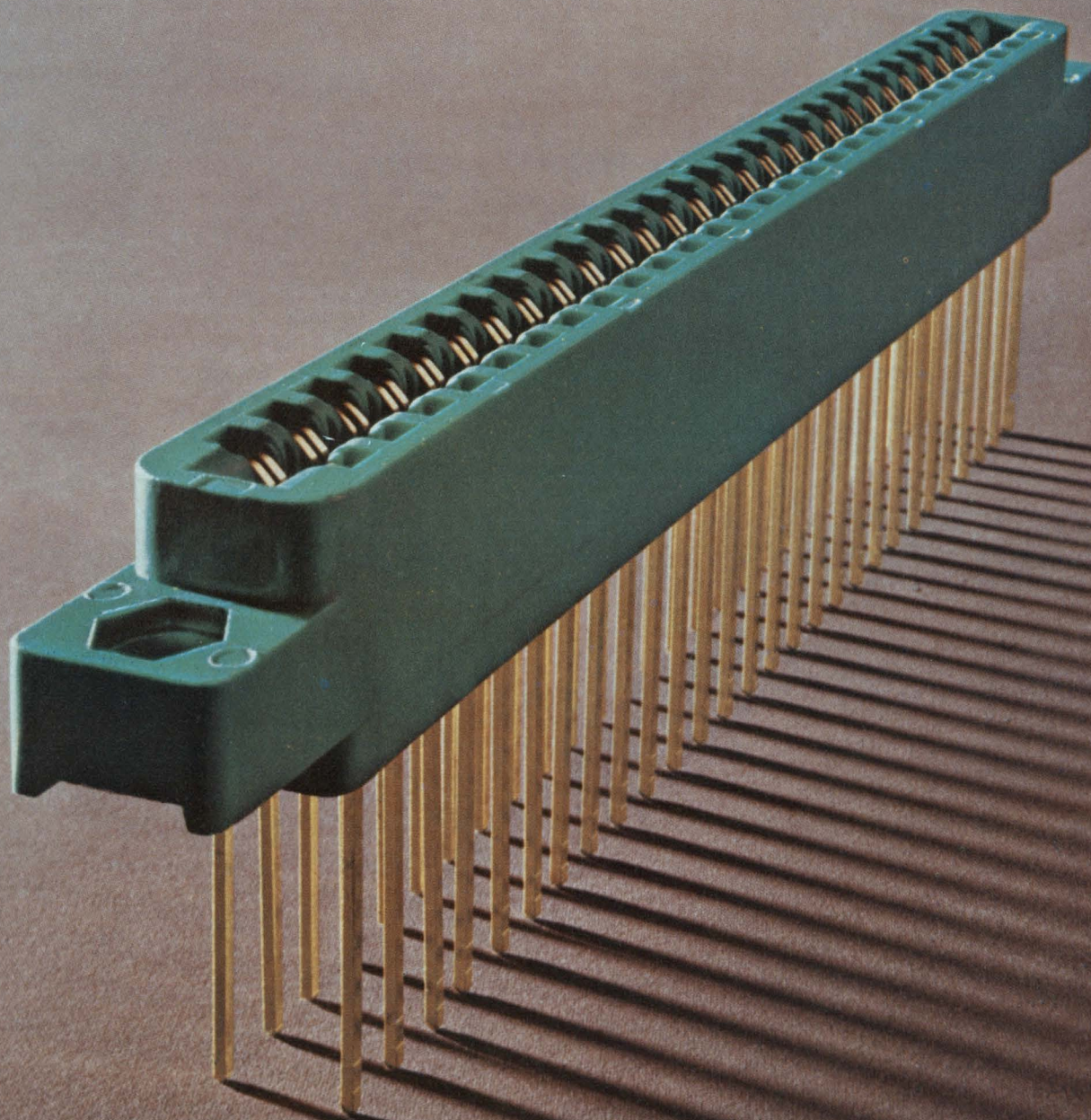



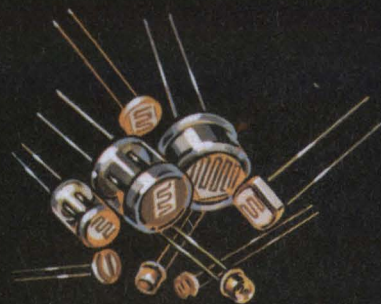

**New**  
**Photoconductive**  
**Material**  
**Rock Stable...**  
**Less Light Memory**

New Type 9 photoconductive material is now available in three photocell packages from Clairex — TO-5, TO-8, TO-18. Type 9 material is more stable at high temperatures and has less light memory than normal CdS materials. Type 9 material also has improved linearity and broader spectral response. Try Type 9 material if you have photocell stability problems.

Call (914) 664-6602 or write Clairex<sup>®</sup>, 560 South Third Avenue, Mount Vernon, New York 10550.

**CLAIREX ELECTRONICS**  
A DIVISION OF CLAIREX CORPORATION



## It's a fine first baby. Father's moderately pleased.

Many of you have been kind enough to let us know how useful you found Electronic Design's GOLD BOOK. We really appreciate those kind words, for directory editors rarely hear from their readers.

Frankly, we really worked at the GOLD BOOK. I use the word "we" loosely here. What I really mean is George Weingarten, the GOLD BOOK's editor. For a while, George spent so much time at the office that I'm sure his wife, on his rare visits home, had to re-introduce him to his kids.

The first edition was a mammoth undertaking. It has information on 7500 manufacturers, with sales outlets listed for 3100 of them. For some 3000 products, it lists the manufacturers with complete address, zip and phone number—not just the city and state. And for each product, it shows which manufacturers have provided verifying literature. It lists 5700 distributors and 4500 trade names—in addition to 2800 pages of catalog data. In every way we could conceive, it was designed to make it easy for a fellow to locate the sources of the products he needs.

Now that the first edition has been distributed, you'd think that Weingarten, his right arm, Editorial Assistant Edith Merker, and I would be overjoyed. We are, in fact, rather pleased—but not content. We've already found several errors and we're sure there are more. We didn't expect it to be perfect, though we tried to make it so. We already have some ideas for making it better next year. But we're annoyed with ourselves for not having thought of these for the first edition.

What really irks us, though, is that we're sure there are ideas that will come to us after we have put the second edition to bed, and plenty of other ideas that may never occur to us.

We would genuinely appreciate your help. As you use the GOLD BOOK, if you see some ways we can make future editions more useful, please drop us a note or use the card following page 160A. We'll probably never be completely satisfied. But we hope each year's edition will be better than the earlier one.

Thank you.

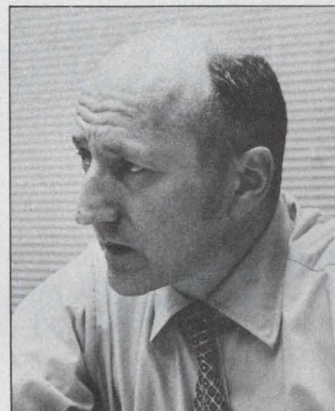

A handwritten signature in cursive script that reads "George Rostky".

GEORGE ROSTKY  
Editor-in-Chief



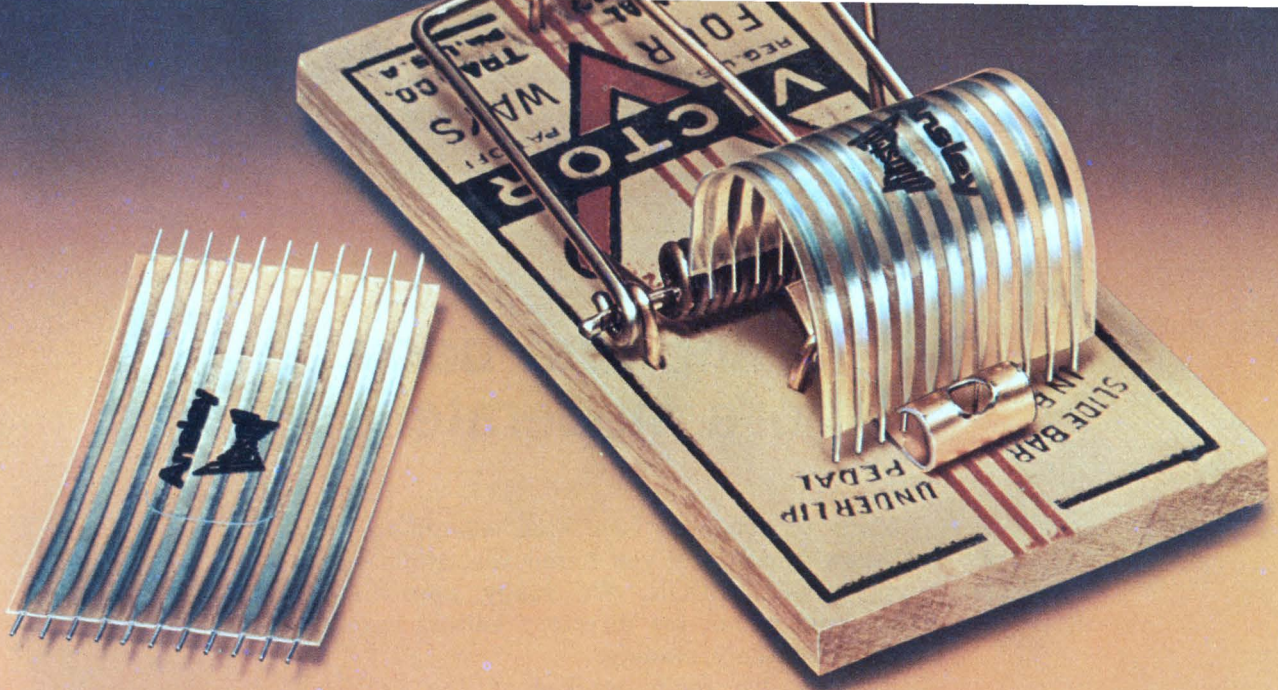

# "There is a better way" Contest

Ansley FLEX STRIP® jumpers may never be used to build a better mousetrap. But you've found so many ways to lower your installed costs by using our jumpers since we originally introduced them for board-to-board interconnecting, that we're sure there are thousands of applications not even heard or thought of yet — and we're willing to pay just to find out what some of them are.

Unlike wire, our FLEX STRIP jumpers are engineered components; so you can forget about expensive cutting to length, wire routing, stripping or tinning. For flexibility, we've made the conductors flat; to reduce the cost of terminating, we've made the contacts round for quick insertion into hole patterns or sockets.

Our FLEX STRIP jumpers do the same job as discrete wires, but at a fraction of the installed cost and with greater reliability.

We're also sure that you can see the immediate benefits of using these engineered components in different applications. So sure, that we are offering three first

place \$2,500 unrestricted engineering scholarships to any accredited university or engineering college of your choice. Use it yourself or transfer it to anyone you choose. Sound interesting? All you have to do to qualify is send us new design applications. We've even increased the chances of your winning by offering secondary prizes of four HP-45 calculators and a half a dozen T.I. SR-50 electronic slide rules — all that in return for well thought out applications. Your chances are pretty good!

Interested? Just circle the reader service number for your ANSLEY BETTER WAY CONTEST entry kit. It will detail the rules, provide complete technical information and FLEX STRIP® jumper samples, plus a list of typical applications. All we need are new ones! Even if you're not interested in our contest, send for the package, our application drawings may solve an interconnection design problem you're working on. (Employees of Thomas & Betts Corporation, its subsidiaries, agencies & distributor salesmen are not eligible for prizes.)

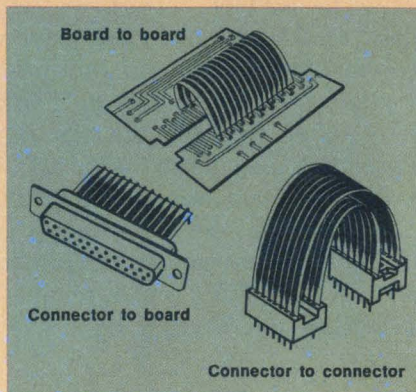

## Ansley

ANSLEY ELECTRONICS CORP.  
Subsidiary of Thomas & Betts Corporation

3208 Humboldt St., Los Angeles, Ca. 90031  
Tel. (213) 223-2331, TWX 910-321-3938

SOLD COAST TO COAST THROUGH AUTHORIZED ANSLEY DISTRIBUTORS.

INFORMATION RETRIEVAL NUMBER 44





## Our finest performer has come down to earth.

**"AMPHENOL 48."** Proven through more than 15 years of environmentally tough aircraft and aerospace applications, Amphenol's 48 Series connectors have come down to earth for use in communications, electric utility, automotive, rapid transit and construction applications. Ready availability with a wide choice of configurations and styles is the reason why.

48 Series connectors stand up to environmental assaults that put other connectors out of operation, like temperature extremes, physical shock, vibration, moisture and corrosion. They're your best buy for both standard and environmentally-demanding commercial and industrial applications.

Choose from standard power to coax contacts with semi-automatic/automatic crimp terminations.

Quick-disconnect bayonet or vibration-proof threaded coupling connectors are available in 30 different insert arrangements. Our 48 Series gives you the industry's broadest selection of environment-resistant connectors.

They're available from stock or from any one of more than 60 Amphenol distributors nationwide. Get them in a choice of finishes to dress up your product design.

Call or write Wayne Zimmerman for full information on the 48 Series connectors. The high-reliability, aerospace-quality connectors that make a lot of sense in tough, down-to-earth applications.

Amphenol Connector Division, Bunker Ramo Corp.  
2801 South 25th Avenue,  
Broadview, Illinois 60153. (312) 345-9000.



# AMPHENOL

To contact the Amphenol Sales Offices in your area, dial our hotline number toll free: 800 645-9200 (In New York State dial collect 516 294-0990).

INFORMATION RETRIEVAL NUMBER 45



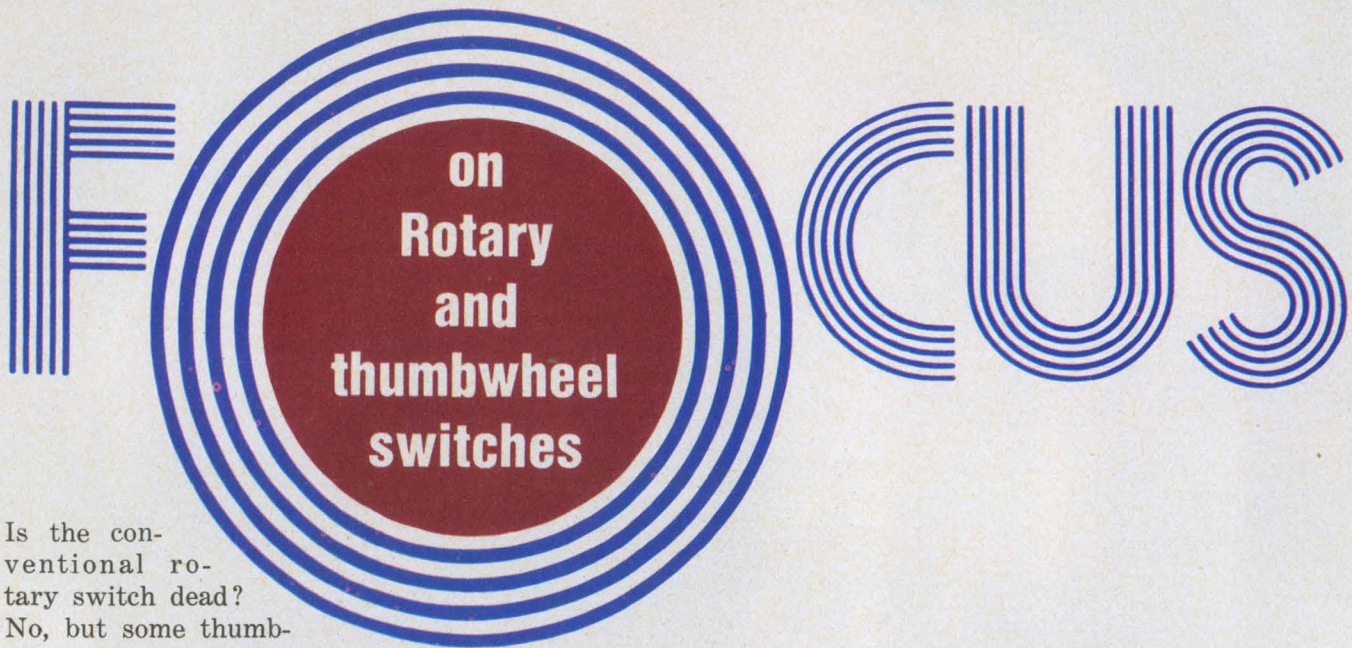

# on Rotary and thumbwheel switches

Is the conventional rotary switch dead? No, but some thumbwheel-switch manufacturers wish it were.

The rotary remains the workhorse of selector switches, while the thumbwheel has moved into more sophisticated applications.

And all types of selector switches—from conventional rotaries to the latest thumbwheel and level and pushbutton versions—are alive and well.

Straight thumbwheel switches are replacing the ordinary rotary in many uses. Meanwhile lever and pushbutton “thumbwheel styles” are making inroads into the market of the “straight thumbwheel.” With an over-all expanding electronics market, sales of all types are increasing.

The result: The designer has a wide, very competitive field from which to choose a selector switch. But he also has more ways to get stung. Manufacturers' catalogs are the first step into the hornets' nest.

## Catalogs can steer you wrong

Catalog listings for selector switches can be very misleading. In attempts to simplify spec listings, switch manufacturers compare switch designs in an arbitrary way. The criteria for their comparisons rarely match the needs of actual applications. If 49-m $\Omega$  contact resistance means that the switch is good, can 50 m $\Omega$  mean that the contact has failed? Some tests call for exactly this kind of end-of-life determination.

Most reputable switch manufacturers have compiled tons of data on their products. But the data are based upon accelerated life tests and arbitrary end-of-life criteria. They are difficult to relate accurately to the real world of applications. Fearing that their data will be misinter-

**Morris Grossman**  
Associate Editor

preted, manufacturers often go to the extreme of providing too little information in catalogs.

It is true that the many possible switch requirements, coupled with the many design solutions, can result in almost infinite permutations of ratings. The effects of load, duty cycle, environment, contact material, insulators and other factors on failure criteria are complicated. But most catalog listings show load and life ratings for so limited a range of conditions, that the data seldom are sufficient for a rational choice.

How do you determine which switch will perform reliably in your application?

## Decisions, decisions

First, decide on the style of selector—conventional rotary, thumbwheel or one of the “thumbwheel” variants. Rotary switches, in general, offer several advantages over nonrotary. They can control many circuits simultaneously—and in a tremendous variety of sequences. And most rotaries, except perhaps the lever, are more difficult to actuate accidentally than toggle switches. Because of this, equipment designers often use a two-position rotary instead of a toggle switch.

If the design calls for the handling of extremes in voltage, current and environment, the conventional rotary styles will fill the bill. At signal-power levels in the more complex circuit combinations—like encoding and decoding—most designers use the thumbwheel variety. For in-between applications—range and function selectors, for example—both rotaries and thumbwheels are used.

Conventional rotaries usually occupy more panel space than thumbwheel types to do the same job. And when rapid positioning is desir-



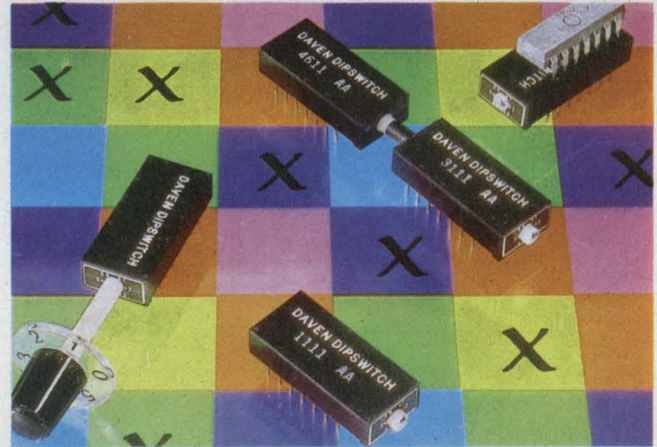
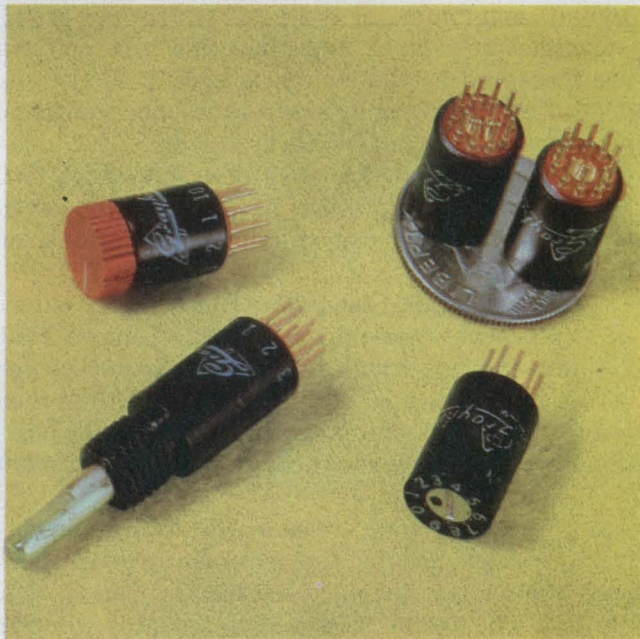
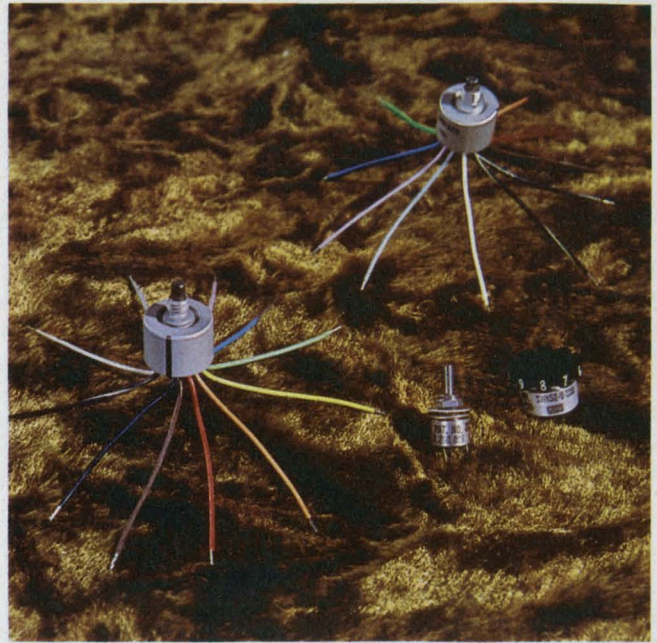

Miniature rotary switches for PC-board mounting include (upper left and clockwise) AMP 642-1 series units, the Minelco SW 37 and 67, the Edison, Daven Dip-switches and the Grayhill Series 75. Other rotary-switch manufacturers are turning out similar types in an almost endless flow.

able, variations on the thumbwheel style that use lever actuators are available. Operation of the switch with gloves might dictate a pushbutton or level variety. Finally, "human engineering" and esthetics—where visual, auditory and tactile considerations are of prime concern—might be the ultimate arbiter in the selection of a switch style.

After you've decided on the switch style and made an initial selection from the meager data in most catalogs, draw up the following list of requirements and submit them to several manufacturers:

- Application—type of equipment.
- Switch drive—manual or motor driven, and duty cycle, drive torque and stop limits.

- Load—voltage, current, frequency, power factor.

- Environment—temperature, altitude, relative humidity, shock and vibration, corrosive atmosphere, etc.

- Expected life—in number of cycles per agreed failure criteria.

- Failure criteria—contact resistance, insulation resistance, dielectric strength, etc.

A reputable manufacturer can then estimate whether a given switch selection is the right one for your application, or he may recommend a better one.

But before you can talk intelligently to the switch manufacturer, you must learn to specify in his language.



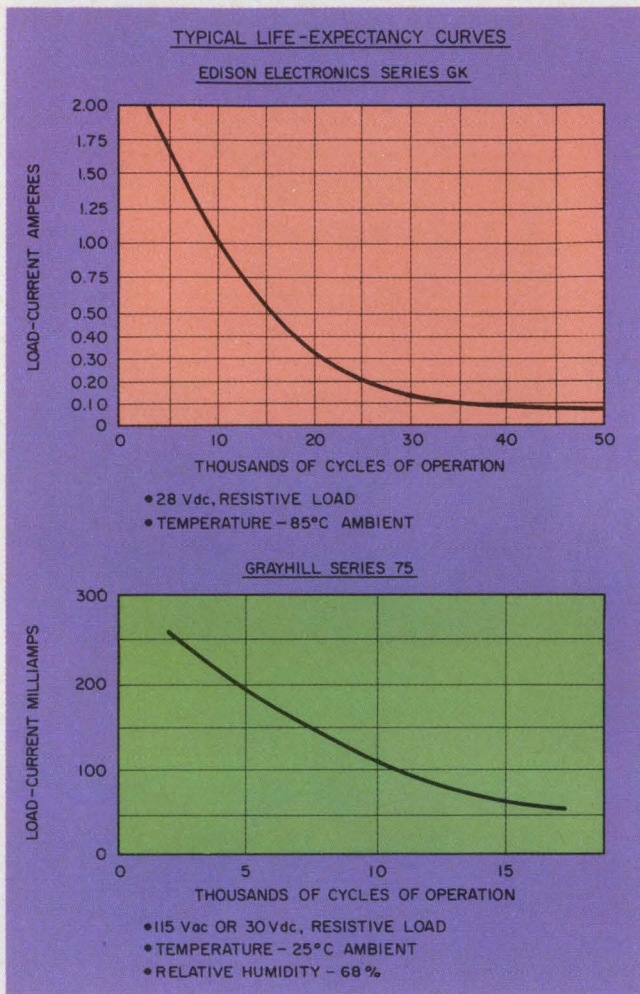

The "useful" life of a switch in your application depends upon the demands the circuit makes upon the switch's load-carrying ability, its contact resistance, insulation resistance, dielectric strength and detent mechanism.

#### A switch's life is hard to measure

What may be totally unacceptable in one instance may be perfectly suitable in another. For example, a contact resistance of  $0.1 \Omega$  might be unusable in the range switch of an ammeter. However, even  $1 \Omega$  would make no difference in most logic-circuit selector controls.

And don't make the common mistake of selecting a switch based only upon its performance

when new. Most switch characteristics deteriorate with use and time. Some switches die gracefully. Others drop dead without warning, as when a spring breaks in the indexing mechanism. More important than initial characteristics may be the performance of a switch after several years of use.

Let's examine some of the criteria that manufacturers use to determine "end of life."

Contact resistance, under correct electrical loading changes gradually. Low resistance is the prime requirement of a switch contact. Typical values for rotary switches lie in the milliohms range. For example, Grayhill's Series-75 rotary switch is specified at a maximum of  $10\text{-m}\Omega$  initial contact resistance and an end-of-life maximum of  $50 \text{ m}\Omega$ . Thumbwheel switches usually have higher initial and final values. Their field of applications—mainly in logic circuits—doesn't require extremely low contact resistance. Typical is EECO's 8000 series thumbwheels. They have an initial  $100 \text{ m}\Omega$  maximum and a specified end value of  $160\text{-m}\Omega$  maximum.

Contact resistance and the other life criteria are measured as the switch is cycled. A cycle is defined by most manufacturers as one complete rotation through all contact positions and a return through all switch positions. But watch out. Some vendors may wish to impress you with large numbers and use individual operations, or index steps.

Thus, on Edison Electronics' Series GK switch, the life curve (see plots) correctly shows that  $200 \text{ mA}$  can be switched for about 25,000 cycles before the contact resistance, or one of the other failure criteria, terminates the test. This 12-position switch then moves through  $2 \times 11 \times 25,000 = 550,000$  index steps.

A noncatastrophic reason for failure, arbitrarily established by the manufacturer or perhaps a MIL-spec, usually signals the "end" of a life test. The switch seldom disintegrates when it reaches this "failure" criterion. For a great many applications, it could still be quite satisfactory—its life continuing for many more cycles until some mechanical part breaks.

So-called "life-expectancy" data apply only to the narrow conditions of the test. The values obtained may be far too optimistic or pessimistic, to determine the actual useful life.

### Short table of MIL-Spec end-of-life criteria

	Contact resistance $\text{m}\Omega$	Insulation resistance— $\text{M}\Omega$		Dielectric strength $V_{\text{rms}}$
		dry	90-98% RH	
MIL-S-3786	20	1000 (plastics)	10 (plastics)	1000 (1-mA leakage max)
MIL-S-6807	20	no spec	3 (after drying)	600 (10-mA leakage max)
MIL-S-8805	40	1000	10 (plastics)	1000 + $2 \times \text{WV}$ (1 mA leakage max)



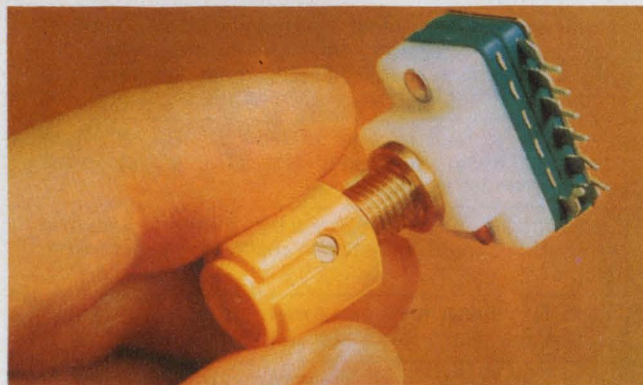
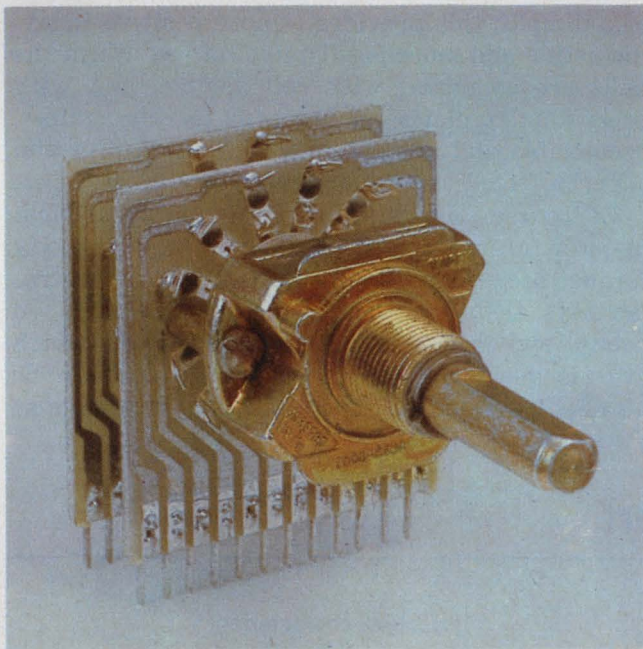
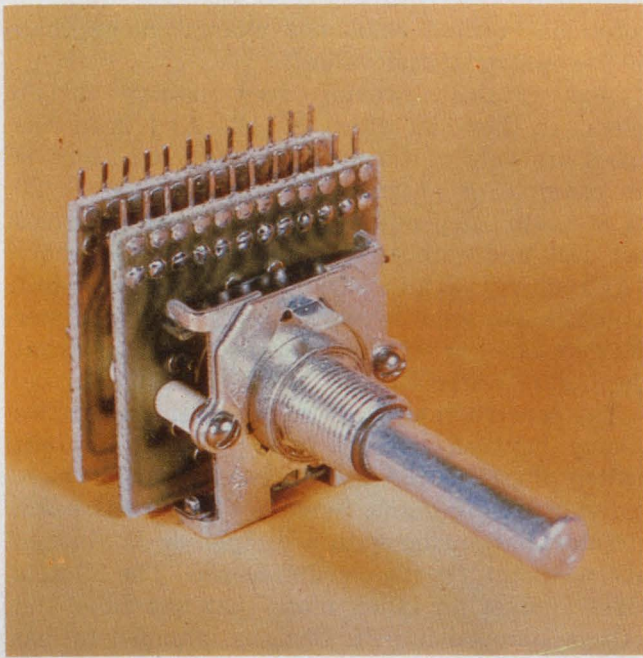

The popularity of printed-circuit wiring has prompted many conventional rotary-switch makers to convert some designs to PC styles. Centralab's Series 160 (top) and Oak's 12-position rectangular units have all terminations along one edge to facilitate PC soldering, and Stackpole (bottom) follows suit with a miniature, enclosed unit, the Series 80.

Thus the life-expectancy curve of the Grayhill Series 75 switch is only for 115-V ac or 30-V dc resistive loads. And the ambient conditions for the manufacturer's test were sea level, 25 C and 68% relative humidity. For other temperatures, altitudes, humidities and loads, most manufacturers advise: "Ask us."

#### Insulation a factor in failure

Reduction of insulation resistance or dielectric strength—which is frequently catastrophic—also signals what manufacturers and the military call end of life.

Insulation resistance is measured between any two insulated metal parts that may become part of a circuit. For new switches, typical values are in thousands of megohms. The resistance of an insulator, especially with surface contaminants, tends to be nonlinear; thus measurements are made at specific high dc potentials—usually 100 or 500 V for signal-level switches.

As an example, RCL's Series FC and RC commercial switches have an initial insulation resistance spec of 50,000 M $\Omega$ . When the resistance drops to a minimum of 10,000 M $\Omega$ , the switch, according to the specs, is at its end of life. But 10,000 M $\Omega$  may be more than adequate for low-impedance, low-voltage circuits, and many more cycles may be tolerated before the switch is dead.

The insulation resistance between contacts drops with use, mainly because of the buildup of surface contaminants from the environment and from metallic particles that rub off the contacts onto the insulation. Moisture also affects insulation resistance. A test condition commonly specified is the measurement of insulation resistance in high humidity (90 to 98% relative humidity). In this atmosphere there is usually condensation on the insulation. Some insulators absorb moisture, and reduced insulation resistance results.

Though surface contaminants can often be removed to restore the insulator's resistance, life-expectancy tests usually don't permit this procedure. Thus, again, the accelerated tests tend to provide more pessimistic data than actual use might justify.

In addition to reduced resistance, insulators also suffer from dielectric breakdown. But in an actual voltage breakdown the odds are high that the switch would be damaged. Thus so-called "breakdown" tests are only checks for "excessive" leakage current at some high ac voltage. A new selector switch might withstand 1000 V rms, with only microamperes of leakage current. But deterioration of the dielectric material with age and temperature can result in a typical end-of-life maximum leakage of over 1 mA (see MIL life table).



The selection of insulation material for commercial applications is often first based upon price and then personal preference. In military applications the MIL spec may dictate the insulator material (see selection chart). There is a broad overlap in characteristics among the choices. Phenolic insulation, because of its low cost, has been very popular for industrial use. However, diallyl phthalate, which as the chart shows offers superior qualities, is gaining in use.

### Torque specs are inadequate

Of the life criteria, rotational torque, or actuation force, is probably the more inadequately treated. Index mechanisms deteriorate with use and can end the life of a switch before anything else fails, though frequently mechanical life is longer than electrical life under full load.

A CTS 211 index assembly is rated for 250,000 cycles through 12 positions and return. This is perhaps five times the electrical life of some of the contact assemblies that could be used with it.

The mere listing of maximum and minimum torque is not enough to establish end of life. Two offsetting factors operate to change the initial torque values during the life of the switch. Wear and galling of the switch's mating surfaces tend to increase the force needed to turn the switch, and fatigue and relaxation of spring members lowers the forces.

Thus end-of-life criteria should call for a maximum allowed percentage change from the initial value. A typical spec might read: "The

rotational torque shall not change more than 50% from its initial value."

Most catalogs provide very skimpy torque specs, if they list them at all. And then the specs are only of the initial-value type. Here is an example of an inadequate torque spec: "20 to 80 oz-in., depending on the number of poles per deck and number of decks." Here's another: "As required within a range of 5 to 25 oz-in." You are not told what torque is required per deck or pole; what the tolerances are; or what the failure criteria are.

The construction of detent mechanisms varies widely between manufacturers. Even different switch lines of the same manufacturers have individualized designs. Some low-cost units use a circular, flat spring with a dimple, or V, formed at one point on its circumference. The dimple rides against an index plate that has hills and valleys stamped into it. Designs intended to last longer use a pair of steel balls or rollers instead of a dimple; this provides a more positive indexing action and more predictable torque. When the balls are combined with coil springs and with precise index plates for the balls to ride against, predictable and adjustable torques, long life and superior "feel" can be obtained.

Of course, you pay for these features. Most manufacturers prefer that you not specify torque, because it is difficult to control. Centralab says that its standard torque tolerance on rotary switches is 20% or  $\pm 10$  oz-in., which ever is greater. But 10% or  $\pm 5$  oz-in. can be attained on some of Centralab's index designs at

## Rotary switch insulator selection chart

Stator Insulation	MIL Spec	Usable temperature limit (°C)	Relative cost	Minimum insulation resistance M $\Omega$	Important characteristics
Phenolic	MIL-P-3115, type PBE-P	100	1	1,000	Most economical, most commonly used. Though nonnutrient to fungi, varnish impregnation per MIL-V-173 is available. Meets most military and commercial application requirements.
Diallyl Phthalate	MIL-M-14F	100	6	10,000	Excellent structural and dielectric strength. Low moisture absorption rate. Not affected by most solvents and flux cleaners.
Epoxy-Glass	MIL-P-18177, type GEB	125	4.5	10,000	Economical, excellent structural and dielectric strength. Lower moisture absorption rate than phenolic.
Silicone Glass	MIL-P-997C, type GSG	125	4.5	10,000	Good RF characteristics. Lower structural strength than epoxy glass, and slightly higher in cost.
Mycalex	MIL-I-10A, Grade L-411	150	10.5	10,000	Good structural and dielectric strength, lowest moisture absorption.
Kel-F	MIL-M-55028-A Grade 3	125	9	20,000	Excellent structural and dielectric strength. Low moisture absorption.
Ceramic	MIL-I-10A, Grade L-422	150	3	10,000	Very low dielectric loss and moisture absorption.

Courtesy of Ledex Inc.



a "considerable" cost increase.

Conventional rotaries can be specified with a large variety of shafts: round, single-flat, double-flat, knurled-slotted, insulated, etc. Of course, the dimensions and location of flats, if any, must be carefully specified by the user. Though a switch is an electrical component, the physical dimensions and mechanical details in catalogs are usually more adequately presented than are the electrical details.

### Watch the load

Though most switch specs distinguish between current-carrying and current-switching capabilities, some don't. Ask if the information is not clear. An example of a clearly rated switch is Ledex's Series 200 rotary. The switches are rated to make or break 0.5 A at 28 V dc or 0.25 A at 110 V ac, resistive, for silver-plated brass contacts. The contacts can carry 5 A.

The carrying capacity is higher than the switching capacity, because an electrical arc is drawn when a circuit is broken. And, of course, inductance in the circuit increases the arcing problem when a circuit is opened. On the other hand, a large capacitor with low series resistance can weld the contacts of a switch when a circuit is closed.

Often contacts are specified for handling inductive circuits, but rarely is an allowed value of inductance stated. A common standard, derived from MIL S-3786, is a value of 2.8 henries with an L/R ratio of 0.026.

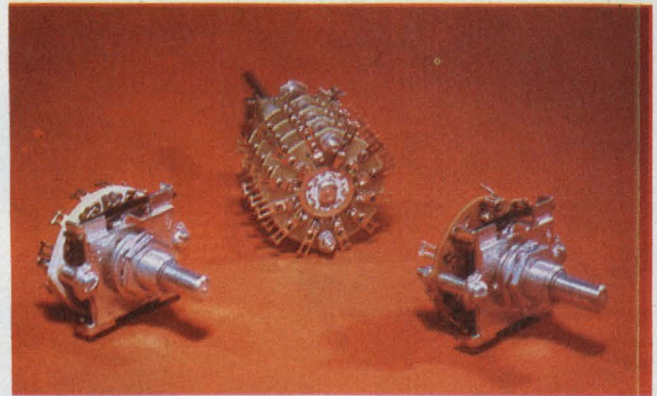

**Conventional rotaries are the workhorses** of the selector-switch world. These Centralab Series 500s are built with three different insulator materials. Many manufacturers allow a wide choice of insulator material for standard switch lines.

Resistive-load current capacities are generally five to 10 times larger than inductive. And resistive ac ratings are higher than dc, because an ac arc will extinguish itself when the current goes through its instantaneous zero, while a dc arc tends to maintain itself. The higher the frequency, the sooner the arc is extinguished, with less erosion of the contact.

A fast-acting index mechanism, which tends to snap the contacts open rapidly, can reduce arc damage. Conversely, a switch that can be "teased" is undesirable. In addition to arcing, teasing can cause improper, even dangerous circuit operation.

Reduced barometric pressure at high altitudes may worsen the arcing problems. Air at low pres-

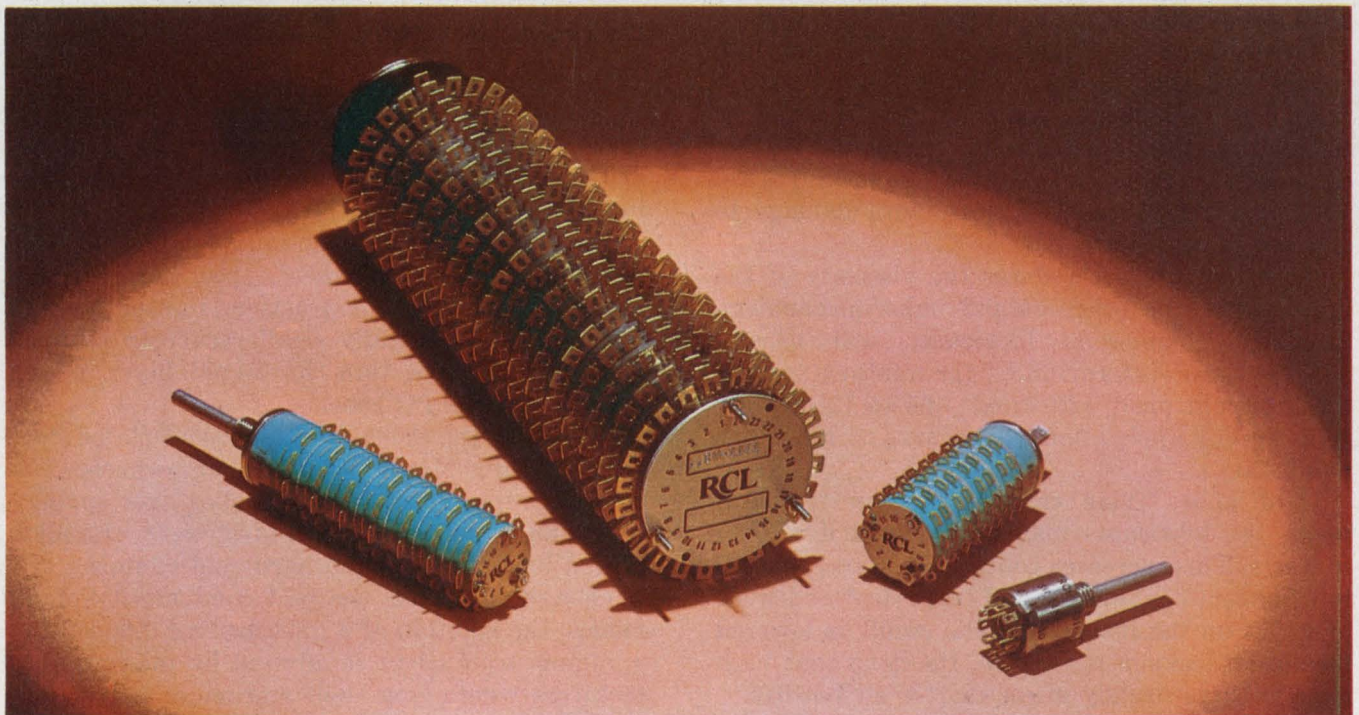

**Completely enclosed rotary switches** are protected against most environmental hazards. According to RCL,

enclosed rotaries are price-competitive with the conventional open-frame types.



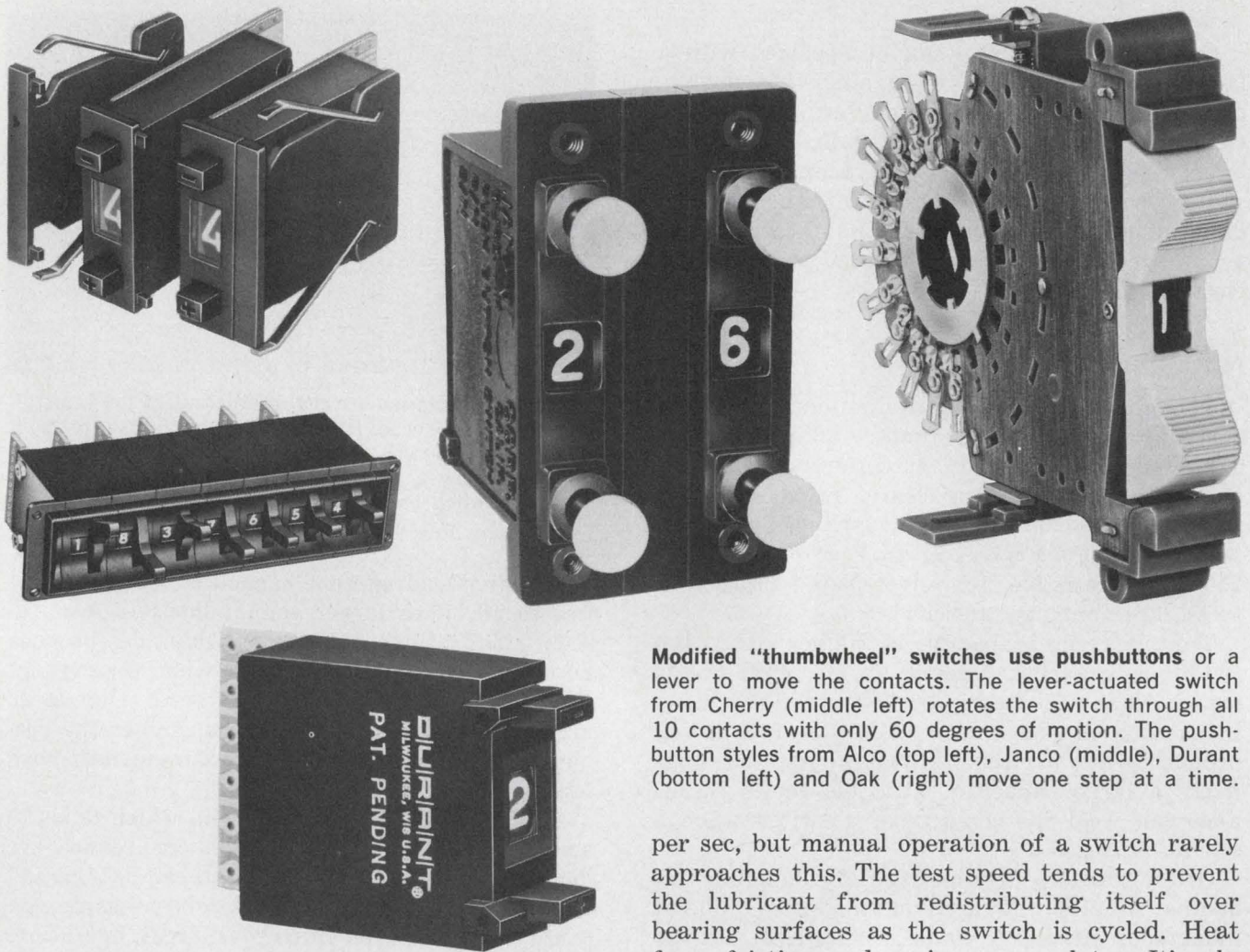

**Modified "thumbwheel" switches use pushbuttons or a lever to move the contacts. The lever-actuated switch from Cherry (middle left) rotates the switch through all 10 contacts with only 60 degrees of motion. The push-button styles from Alco (top left), Janco (middle), Durant (bottom left) and Oak (right) move one step at a time.**

sure ionizes at low voltage and maintains the arc longer. Thus current and voltage ratings must be derated at high altitudes.

The amount of lubricant initially put into rotary and thumbwheel switches during manufacturing is generally sufficient for the life of the switch under normal room temperatures. But continued operation at elevated temperatures results in gradual lubricant loss, with damage to the mechanical parts.

High temperature reduces the viscosity of the lubricant in the bearings, and index mechanism. Standard commercial lubricants will usually operate from  $-45$  to  $125$  C; for military service, the lubricant must withstand  $-65$  to  $125$  C. For some special applications, lubricants to  $175$  C are available.

Used above their rated maximum temperatures, the lubricants may liquefy and flow onto contacts. This increases contact resistance, causes intermittent connections and traps dust and wear particles on the insulation. The result is lowered insulation leakage resistance. It's clear that high temperatures usually mean shorter switch life.

Accelerated life tests may not be much help here either. The tests are run at about 10 cycles

per sec, but manual operation of a switch rarely approaches this. The test speed tends to prevent the lubricant from redistributing itself over bearing surfaces as the switch is cycled. Heat from friction and arcing accumulates. It's obvious that the switch runs hotter than it would under manual use.

#### Dry circuits need gold

For most applications, the self-wiping action of conventional rotary switches allows use of economical silver-plated brass for the contacts and wiper blades. Silver-plated brass with 0.0001-in. minimum plating will last for about 10,000 cycles, but a solid silver alloy can run over 200,000 cycles. Thumbwheel types, however, because of their PC construction, lighter contact pressures and generally smaller current ratings, frequently have a thin, hard-gold layer plated over the copper PC base.

Typical is the 0.0002-in.-thick gold-plated contacts on Inter-Market Type-I thumbwheels. The rotor pickups are a silver-gold alloy over springy beryllium-copper. To help control wear, the alloy pickup is softer than the hard-gold contact.

Though silver has the best conductivity of all metals, the addition of a gold flash of 0.00003 in., minimum over silver is advised by many manufacturers where long shelf storage or infrequent use of the switch is expected. This is to avoid oxide buildup on the silver. For switches that





**Thumbwheel switches** like these Digitran units stack readily and can squeeze a lot of control information

will see steady use, a 0.0005-in. hard gold alloy, rolled onto the contacts, will last for 50,000 to 100,000 cycles; for the balance of the switch's life the contacts will operate on silver-to-silver surfaces.

Gold plating is almost a must for so-called "dry" circuits. But what is a dry circuit? Everybody talks about it; nobody defines it.

One pragmatic, but tongue-in-cheek definition is: "When the switch doesn't work well, it's a dry circuit." This definition is hardly useful for specification purposes, but it's about the best that you can get out of most catalogs.

Other definitions range from "relatively small current in a relatively low-voltage circuit" to an attempt at numbers—"a maximum of 1 mA at 1 mV," or perhaps "generally below 0.5 A at 28 V dc." None of these is very authoritative, of course.

This is an area sorely in need of clarification. The National Association of Relay Manufacturers—in "Engineers' Relay Handbook," published by the Hayden Book Co.—defines a dry contact as one that "neither makes nor breaks current." The book states that the widespread use of "dry" is "erroneous" for circuits or contacts that handle low-level voltages and current. On p. 92 the book discusses "softening voltage" of contact materials, and it ends the discussion with this statement: "Circuits in which there is no possibility of applying to the contacts either a steady-state or a transient voltage as great as the softening voltage are known as dry, low-level, circuits."

In electrical contacts the metal of the mating surfaces meets only at microscopic high points, which concentrate any current flow into high current densities. When the voltage across the contacts is above a certain value—the "softening voltage"—heat is generated faster than it dissipates, and the contact material softens. At the softening voltage, the area in contact tends to increase, molecular films are vaporized, contact resistance drops, and the voltage drop tends

into a small space. And spacers between switch units blend a stacked assembly into a unified whole.

to remain constant as current is increased.

Perhaps a better definition for "dry" could be based on the softening voltage of gold. Gold, which is recommended most often for dry-circuit contacts, has the lowest softening voltage of commonly used contact metals. Its value of 80 mV, with a small safety factor—to, say 50 mV—could then be the upper limit for the open-circuit voltage in a dry-circuit. Since the voltage across the contacts must drop below the open-circuit voltage when the contacts close, no current limits need be included in the definition.

MIL specs are, of course, a valuable guide to contact specifications, and many catalogs refer to them.

### Know the MIL specs

MIL S-3786 is the primary standard for low-power rotary switches that carry less than 2 A. And MIL S-6807, 8805, 15473, 21604, 22710, among others, are applicable to other switches.

Many switches for severe industrial applications can be completely specified by reference to a military qualified-parts list (QPL) number. However, a QPL part will command a higher price than a commercial version. Though a commercial switch may be built to MIL designs, it doesn't come with the full testing, documentation and inspection certification that a full MIL-spec switch does.

Some manufacturers' catalogs reveal which types are MIL styles. Often you find out that commercial versions are available only by asking.

### Conventional rotaries are the workhorses

In spite of many advantages claimed for thumbwheel switches, the conventional rotaries still fill most selector-switch applications. They handle very high voltages and current. An example is Ross Engineering's line of 10-to-30-kV, 25-to-50-A rotary switches. And at the low-power end, the Dipswitch line of Edison Electronics,



the PC-board switches of AMP (Bulletin 642-1) or Minelco's SW line are straight rotary switches for circuit-board use. Some miniatures use small conventional knobs, some built-in serrated wheels, and some versions need a screwdriver to turn them. Many other companies also have miniature switch lines; EECO's Stripswitch and Beckman's Model 374 are examples.

Conventional rotaries come in three basic contact types. All wipe as they make and break contact. This tends to keep the mating surfaces clean and to expose fresh surface for low resistance contact.

The most popular contact uses a rotary blade that wipes between stationary contact clips—examples include Oak's JKN series, Centralab's many SA types, and the CTS 223 selectors. In better types the rotary blade wipes between a pair of clips. The two independent mating surfaces provide far more reliable performance than a single-clip contact does.

The blade and clip-contact design comes in shorting and nonshorting styles. Shorting designs have a wide rotor-blade pickup member that can bridge the gap between adjacent clips and short them together when the switch is moved from one contact clip to the next (make-before-break). This is desirable in some applications, such as audio work, where a momentary open-circuit can introduce clicks and other undesirable responses. By using a narrow rotor-blade pickup, nonshorting designs break the previous circuit before making the next. Be careful to specify the version required for your circuit.

Another type of contact uses multiple-spring leaves. They are used in Edison Electronics Daven Series B selector switches and the Ross units. The spring leaves make contact with fixed studs. Such construction is usually used on large switches that can handle amperes of current. Or the leaves can provide low contact resistances in precision decade boxes or low-resistance bridges.

The third type of contact is used in printed-circuit configurations. It uses one or more "brushes" that ride on the surface of the contacts. This type, though, is used mainly in thumbwheel switches. The pressure between the contacts is necessarily light—60 to 70 grams for standard Chicago Dynamics' switches—to limit the wear on plated contacts and allow a light touch in thumbwheel switches. Too light a contact pressure will, of course, produce erratic results.

In addition to contact construction, conventional rotaries also offer a choice between open and enclosed construction. The lower-cost, open types are receiving rough competition from the

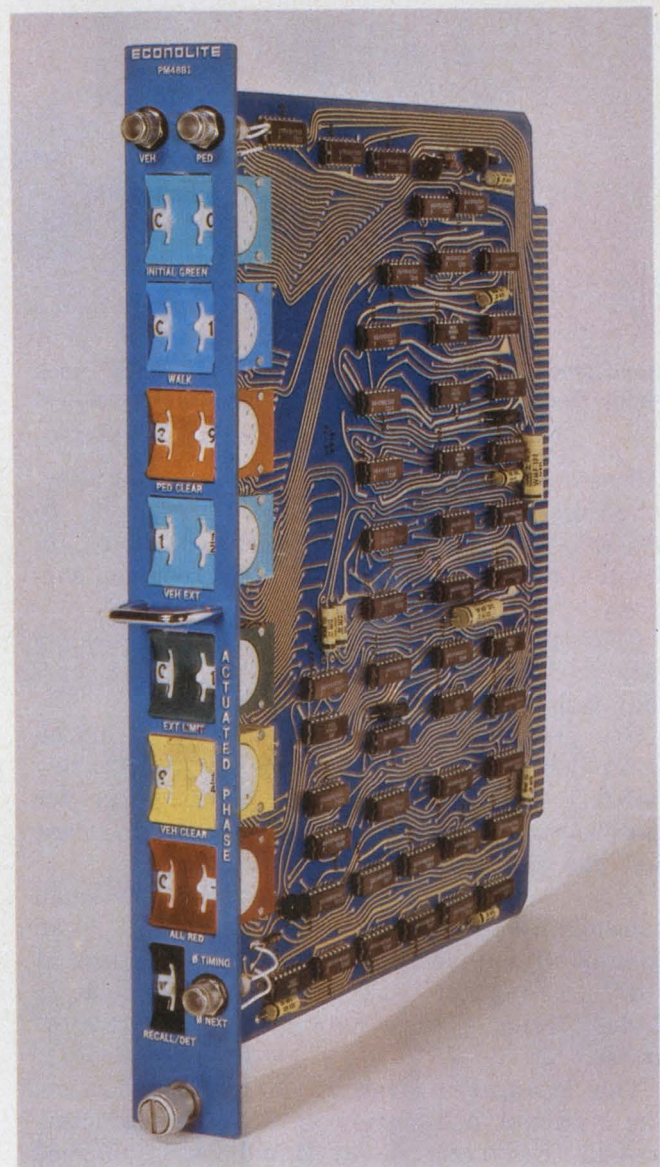

The color and PC compatibility of EECO's 800 series thumbwheel switches combine to make a compact traffic-control module.

enclosed. RCL says that it has reached the point where its commercial enclosed miniature switches are price-competitive with the older, open-frame wafer switches. RCL makes a complete line of enclosed rotaries—from 1/2-in. to 1-3/8-in. in diameter.

Some rotary switches have followed the trend to PC assembly techniques. Many traditional types have been redesigned to mount to PC boards, with terminations for automatic soldering. New switches have been specially configured for efficient PC mounting.

For example, Stackpole's Series 80 switch, announced for this fall, is rectangular. This shape allows all terminals to be in-line, with 0.1-in. centers. Special or BCD coding will be available with 30, 60 and 90-degree indexing, and up



to nine decks, with two modules per deck, will be offered.

Although we tend to think of rotary switches as wafers with shaft-driven wipers, there are other ways of constructing a rotary switch. In some the shaft rotates a permanent magnet, which actuates hermetically sealed reed switches—such as the Gordos GRS series, which is only 1 D × 1 H in. and weighs less than 1 oz.

### Thumbwheels are more than a sidewise rotary

When switch designers first thought of turning a conventional rotary switch sidewise and then added a thumbwheel actuator, they got more than they expected. A thumbwheel switch offers minimum panel space, highly readable and repeatable display; rapid low-fatigue switching; the ability to control complex circuits, and coding and decoding with a minimum of wiring.

The most important asset of a single thumbwheel is its one-digit-at-a-time display. A bank of thumbwheel switches can provide almost any kind of data input required by a computer or machine control. A 10-digit number with the digits spaced only 3/8-in. apart—as produced by stacked-thumbwheel modules—is far easier to read than a display from rotaries that might need 1-in. spacing.

And, of course, color and lighting are used extensively to further enhance the readability and identification of the thumbwheel display. Blank spacers to fit the style of the switch and some spacers with markings—decimal points, symbols or abbreviations for minutes, seconds, etc.—easily fit into a switch assembly.

### Sound and feel should be 'right'

A poorly designed switch scrunches into position with an annoying feel and sound. The feel and sound should be positive, distinct and pleasant. Human-factors engineers know that a reassuring audible click is needed to tell the user that the switch has snapped into place. Even when the construction of the switch does not require it, an audible snap is often built in by manufacturers to fill this psychological need.

In rotary switches, however, a positive detent is necessary for the switch's reliability. A good detent prevents the operator from teasing the switch and possibly setting it between valid positions.

Most thumbwheels require only 7 to 10 oz-in. of torque, in contrast with the 20 oz-in. and up for conventional rotaries. The touch of the thumb is lighter than the relatively powerful force of the wrist on a large knob.

But force is not the only measure of a good indexing mechanism. The shape of the thumbwheel is also important. Because the thumbwheel is used for frequent and rapid programming, the operating space on the wheel must fit the average operator's finger, provide a good, slip-free grip and avoid sharp tabs that can cause pain and fatigue. Thin, serrated edges wear on the operator's thumb and can be painful with constant use. Thumb-actuating wheels should be wide enough to fit most of an average thumb pad.

### Operating with a gloved hand

Many applications—in military aircraft, industrial environments and elsewhere—require the operator to wear gloves. For these applications, switch designers have come up with so-called thumbwheel versions that use levers, rockers and pushbuttons to move the dial back and forth.

The pushbutton is easy to locate and operate with gloves, but the push-release action required is a bit slower than that for a straight thumbwheel. Chicago Dynamic's Series MPB/AS 27000 switches, Digitran's Series 12000 and Alco's MICO/MHE series are examples of pushbutton switches.

To improve the speed of dial setting, you can use lever actuators. In most lever-actuated rotaries, a 90-degree lever motion translates into a 360-degree motion with a rack-and-pinion assembly. This gear-up action allows rapid setting and resetting of the switch. With a light touch by a gloved hand, an entire bank of switches can be reset to zero with one motion. Digitran's Series 28000 Minilever and Cherry's Series L Leverwheel types are examples of lever-actuated "thumbwheel" rotaries.

Oak makes a rocker switch with an actuator that is a cross between a lever and a pushbutton. However, the indexing action is like that of a pushbutton—step by step. Two rockers provide bidirectional motion. Digitran's Series 24000 is, however, actuated by a single rocker lever that has a mechanism for one-digit-at-a-time action. Here a single lever provides bidirectional operation, and it is mounted below the display, so the operator's finger does not obscure the number display.

But the lever presents its own set of human-engineering problems. If it is too long, it can interfere with the display's visibility. If too short, it's hard to grip, especially with gloves. In either case, the safety advantage of rotary switches is negated. The switch position is vulnerable to accidental change, like a toggle switch. ■■

*(continued on page 66)*



## Need more information?

We wish to thank the companies that provided information for this report. The products cited in the report have been selected for their illustrative, or in some cases, unique qualities. However, manufacturers not mentioned in the report may offer similar products. Readers may wish to consult manufacturers listed here for further details. Code letters listed after each company refer to switch types manufactured: rotary (R), thumbwheel (T).

AMP Inc., 449 Eisenhower Blvd., Harrisburg, Pa. 17105.  
(717) 564-0101. (R) (T) **Circle 400**

ASM Inc., 525 Truck Lane, Smithfield, N.C. 27577. (919) 934-3104. (R) **Circle 401**

Adgraphix Corp., 5940 Kester Ave., Van Nuys, Calif. 91401.  
(213) 781-1100. (T) **Circle 402**

Airflyte Electronics Co., New Hook Rd., Bayonne, N.J. 07002.  
(201) 436-2230. (R) **Circle 403**

Alco Electronic Products Inc., 1551 Osgood St., North Andover, Mass. 01845. (617) 685-4371. (R) (T) **Circle 404**

Allen-Bradley Co., 1201 South 2 St., Milwaukee, Wis. 53204.  
(414) 671-2000. (R) **Circle 405**

American Solenoid Co. Inc., 245 E. Inman Ave., Rahway, N.J. 07065. (201) 381-5100. (R) **Circle 406**

Amphenol RF Div. Bunker-Ramo Corp., 33 E. Franklin St., Danbury, Conn. 06810. (203) 743-9277. (R) **Circle 407**

Arrow-Hart, Inc., 103 Hawthorn St., Hartford, Conn. 06106.  
(203) 249-8471. (R) **Circle 408**

Astrosystems Inc., Nevada Dr., Lake Success, N.Y. 11040.  
(516) 328-1600. (R) (T) **Circle 409**

Beckman Instruments Inc., 2500 Harbor Blvd., Fullerton, Calif. 92634. (714) 871-4848. (R) (T) **Circle 410**

Bendix, Electrical Components Div., Sidney, N.Y. 13838. (607) 563-9511. (R) **Circle 411**

Bowmar/TIC Inc., Bowmar Inst. Corp., 850 Lawrence Dr., Newbury Park, Calif. 91320. (805) 498-2161. (R) **Circle 412**

C&K Components Inc., 103 Morse St., Watertown, Mass. 02172. (617) 926-0800. (R) **Circle 413**

CTS Keene Inc., 3230 Riverside Ave., Paso Robles, Calif. 93446. (805) 238-0350. (R) **Circle 414**

Carlingswitch Inc., 1428 Brickell Ave., Suite 800, Miami, Fla. 33131. (305) 358-5400. (R) **Circle 415**

Carson Mfg. Co. Inc., 5453 N. Rural, Indianapolis, Ind. 46220. (317) 257-3191. (R) **Circle 416**

Carter Mfg. Corp., 23 Washington St., Hudson, Mass. 01749.  
(617) 562-6987. (R) **Circle 417**

Centralab Div., Globe-Union Inc., 5757 N. Greenbay Ave., Milwaukee, Wis. 53201. (414) 228-1200. (R) **Circle 418**

Cetec Inc., 13035 Saticoy St., North Hollywood, Calif. 91605.  
(213) 875-1900. (R) **Circle 419**

Cherry Electrical Products Corp., Waukegan-Gurnee Ind. Park, Waukegan, Ill. 60085. (312) 689-7600. (T) **Circle 420**

Chicago Dynamic Industries Inc., Precision Products Div., 1725 W. Diversey Blvd., Chicago, Ill. 60614. (312) 935-4600. (R) (T) **Circle 421**

Chicago Lock Co., 4275 W. Belmont Ave., Chicago, Ill. 60641.  
(312) 282-7177. (R) **Circle 422**

Chicago Switch Inc., 2035 W. Wabansia, Chicago, Ill. 60647.  
(312) 489-5500. (R) (T) **Circle 423**

Cole-Hersee Co., 20 Old Colony Ave., Boston, Mass. 02127.  
(617) 268-2190. (R) **Circle 424**

Cole Instrument Corp., 2034 Placentia Ave., Costa Mesa, Calif. 92627. (714) 642-8080. (R) **Circle 425**

Connector Corp., 6025 N. Keystone, Chicago, Ill. 60646. (312) 539-3108. (R) **Circle 426**

Couch S. H. Div. 36 River St., Boston, Mass. 02126. (617) 298-4147. (R) **Circle 427**

Cutler-Hammer Inc., 4201 North 27th St., Milwaukee, Wis. 53216. (414) 442-7800. (R) **Circle 428**

Dension, R. B. Inc., 103 Broadway, Bedford, Ohio 44146.  
(216) 232-8200. (R) **Circle 429**

Dialight Corp., 60 Stewart Ave., Brooklyn, N.Y. 11237. (212) 497-7600. (T) **Circle 430**

Digitran Co., 855 S. Arroyo Parkway, Pasadena, Calif. 91105.  
(213) 449-3110. (T) **Circle 431**

Disc Instruments, Inc., 102 E. Baker St., Costa Mesa, Calif. 92626. (714) 979-5300. (R) **Circle 432**

Duncan Electronics, 2865 Fairview Rd., Costa Mesa, Calif. 92626. (714) 545-8261. (R) **Circle 433**

Durant Digital Instruments Div., Cutler-Hammer, 901 South 12th St., Watertown, Wis. 53094. (414) 261-4070. (T) **Circle 434**

(EECO) Electronic Engrg. Co. of California, Electronic Products Div., 1441 E. Chestnut Ave., Santa Ana, Calif. 92701.  
(714) 835-6000. (R) (T) **Circle 435**

Eagle Electric Mfg. Co., 45-31 Court Square, Long Island City, N.Y. 11101. (212) 937-8000. (R) (T) **Circle 436**

Edison Electronics Div., McGraw-Edison Co., Grenier Field Municipal Airport, Manchester, N.H. 03103. (603) 669-0940. (R) **Circle 437**

Electro-Mec Instrument Corp., 382 Main St., Yalesville, Conn. 06492. (203) 269-7711. (R) **Circle 438**

Electro Switch Corp., King Ave., Weymouth, Mass. 02188.  
(617) 335-5200. (R) **Circle 439**

Essex, 1601 Wall St., Fort Wayne, Ind. 46804. (219) 743-0311. (R) **Circle 440**

Fisher Controls Co., 205 S. Center St., Marshalltown, La. 50158. (515) 754-3011. (R) **Circle 441**

Full Linear Control Co., 417 Liberty St., Jackson, Mich. 49201. (517) 783-5343. (R) **Circle 442**

Furnas Elec. Co., 1197 McKee St., Batavia, Ill. 60610. (312) 879-3410. (R) **Circle 443**

GC Electronics, Div., Hydrometals Inc., 400 S. Wyman St., Rockford, Ill. 61101. (815) 968-9661. (R) **Circle 444**

General Control Co., 1200 Soldiers Field Rd., Boston, Mass. 02134. (617) 782-7440. (R) **Circle 445**

General Devices Inc., Instrumentation Div., P.O. Box 253, Princeton, N.J. 08540. (609) 924-2500. (R) **Circle 446**

General Elec. Co., 1 River Rd., Schenectady, N.Y. 12345.  
(518) 374-2211. (R) **Circle 447**

General Microwave Corp., 155 Marine St., Farmingdale, N.Y. 11735. (516) 694-3600. (R) **Circle 448**

Gordos Corp., 250 Glenwood Ave., Bloomfield, N.J. 07003.  
(201) 743-6800. (R) **Circle 449**

Grayhill Inc., 545 Hillgrove Ave., La Grange, Ill. 60525. (312) 354-1040. (R) **Circle 450**

Gunther America Inc., 9 Manee Rd., Holmdel, N.J. 07733.  
(201) 264-2488. (R) **Circle 451**

Hathaway Industries Inc., P.O. Box 45381, Tulsa, Okla. 74145. (918) 663-0110. (R) **Circle 452**

Haydon Switch & Instrument Inc., 1500 Meriden Rd., Waterbury, Conn. 06720. (203) 756-7441. (R) **Circle 453**

ITT Components Group, 1551 Osgood St. N. Andover, Mass. 01845. (617) 688-1881. (R) (T) **Circle 454**

Imlac Corp., 150 A St., Needham, Mass. 02194. (617) 449-4600. (T) **Circle 455**

Impact Electrical Products Inc., 333 Adams St., Bedford Hills, N.Y. 10507. (914) 666-8939. (R) **Circle 456**

Imtronics Ind. Ltd., 48 Commerce Dr., Farmingdale, N.Y. 11735. (516) 293-5282. (R) **Circle 457**

Industrial Devices, Edgewater, N.J. 07020. (201) 224-4700. (R) **Circle 458**

Inter-Market, Inc. 1920 Waukegan Rd., Glenview, Ill. 60025.  
(312) 729-5330. (T) **Circle 459**

Interswitch, 770 Airport Blvd., Burlingame, Calif. 94010.  
(415) 347-8217. (T) **Circle 460**

J-B-T Instruments Inc., Box 1818, New Haven, Conn. 06508.  
(203) 772-2220. (R) **Circle 461**

Janco Corp., 3111 Winona Ave., Burbank, Calif. 91540. (213) 845-7473. (R) **Circle 462**

LVC Industries Inc., 135-25 37 Ave., Flushing, N.Y. 11354.  
(212) 899-5588. (T) **Circle 463**

Langevin Precision Switches, 2030 Placentia Ave., Costa Mesa, Calif. 92627. (714) 642-8083. (R) **Circle 464**

Ledex Inc., 123 Webster St., Dayton, Ohio 45401. (513) 224-9891. (R) **Circle 465**

Leeds & Northrup Co., Sumneytown Pike, North Wales, Pa. 19454. (215) 643-2000. (R) **Circle 466**

Leviton Mfg. Co., 59-25 Little Neck Parkway, Little Neck, N.Y. 11362. (212) 229-4040. (R) **Circle 467**

Licon Div., Illinois Tool Works, 6615 W. Irving Park Rd., Chicago, Ill. 60634. (312) 282-4040. (R) **Circle 468**

Litton Systems Inc., Poly Scientific Div., 1213 N. Main St., Blackburg, Va. 24060. (703) 552-3014. (R) **Circle 469**

Mag-Con Inc., 85-2nd Ave., S.E., New Brighton, Minn. 55112.  
(612) 633-8820. (R) **Circle 470**

Mallory Controls, Box 327, Frankfort, Ind. 46041. (317) 654-5501. (R) **Circle 471**

Matrix Systems Corp., 9411 Lurine Ave., Chatsworth, Calif. 91311. (213) 882-2008. (R) **Circle 472**

Maurey Instrument Corp., 4559 West 60th St., Chicago, Ill. 60629. (312) 581-4555. (R) **Circle 473**

Microlab/FXR, 10 Microlab Rd., Livingston, N.J. 07039. (201) 992-7700. (R) **Circle 474**



Micro Switch Div., Honeywell, 11 W. Spring St., Freeport, Ill. 61032. (815) 232-1122. (R) **Circle 475**

Minelco Div., General Time Corp., 135 S. Main St., Thomaston, Conn. 06787. (203) 283-8261. (R) **Circle 476**

Mossman, DP Inc., Box 265, Brewster, N.Y. 10509. (914) 279-3725. (R) **Circle 477**

Mouser Electronics, 11511 Woodside Ave., Lakeside, Calif. 92040. (714) 449-2220. (R) **Circle 478**

Ney, JM Co., Maplewood Ave., Bloomfield, Conn. 06002. (203) 242-2281. (R) **Circle 479**

North American Philips Control Corp., Cheshire Industrial Park, Cheshire, Conn. 06410. (203) 272-0301. (R) **Circle 480**

Oak Industrial Switch Div., Crystal Lake, Ill. 60014. (815) 459-5000. (R) (T) **Circle 481**

Ohmite Mfg. Co., a North American Philips Co., 3601 Howard St., Skokie, Ill. 60076. (312) 675-2600. (R) **Circle 482**

Otto Controls Div., 38 Main St., Carpentersville, Ill. 60110. (312) 428-7171. (R) **Circle 483**

Precision Mechanisms Corp., 44 Brooklyn Ave., Westbury, N.Y. 11590. (516) 333-5955. (R) **Circle 484**

RCL Electronics, Inc., 700 S. 21st St., Irvington, N.J. 07111. (201) 374-3311. (R) **Circle 485**

Radio Switch Corp., State Hwy. 79, Marlboro, N.J. 07746. (201) 462-6100. (R) **Circle 486**

Ross Engrg. Corp., 559 Westchester Dr., Cambell, Calif. 95008. (408) 377-4621. (R) **Circle 487**

Rundel-Idex, P.O. Box 5126, Redwood City, Calif. 94063. (415) 365-1916. (R) **Circle 488**

Schrack Electrical Sales Corp., 1140 Broadway, New York, N.Y. 10001. (212) 683-0790. (R) **Circle 489**

Seacor Inc., 598 Broadway, Norwood, N.J. 07648. (201) 768-60780. (R) (T) **Circle 490**

Seaelectro Corp., 225 Hoyt St., Mamaroneck, N.Y. 10543. (914) 698-5600. (R) **Circle 491**

Shallco, Inc., Box 1089, Smithfield, N.C. 27577. (919) 934-3135. (R) **Circle 492**

Shallcross, Cutler-Hammer Co., E. Preston St., Selma, N.C. 27576. (919) 965-2341. (R) **Circle 493**

Shigoto Industries Ltd., Empire State Bldg., 350 Fifth Ave., New York, N.Y. 10001. (212) 695-0200. (R) **Circle 494**

Showa Musen Kogyo Co., Ltd., No. 5-5 6-chome Togoshi Shinagawa-ku, Japan **Circle 495**

Siemens Corp., 186 Wood Ave. S., Iselin, N.J. 08830. (201) 494-1000. (R) **Circle 496**

Signet Scientific Co., Box 6489, Burbank, Calif. 91503. (213) 849-6615. (R) **Circle 497**

Singer Co., Controls Co. of Amer. Div., 9655 W. Soreng Ave., Schiller Park, Ill. 60176. (312) 678-4150. (R) **Circle 498**

Sparton Corp., 2400 E. Ganson St., Jackson, Mich. 49202. (517) 784-9131. (R) **Circle 499**

Sparton Southwest, Inc., P.O. Box 1784, 9621 Coors Rd., N.W., Albuquerque, N.M. 87103. (505) 898-1150. (R) **Circle 500**

Specialties Mfg. Co., Inc., 23425 Harper, St. Clair Shores, Mich. 48080. (313) 771-2700. (R) **Circle 501**

Spectrol Electronics, 17070 E. Gale Ave., City of Industry, Calif. 91745. (213) 964-6565. (R) **Circle 502**

Square D Co., P.O. Box 472, Milwaukee, Wis. 53201. (414) 332-2000. (R) **Circle 503**

Stackpole Components, P.O. Box 14466, Raleigh, N.C. 27610. (R) **Circle 504**

Stacoswitch, Inc., 1139 Baker St., Costa Mesa, Calif. 92626. (714) 549-3041. (R) **Circle 505**

Standard Grigsby Co., 920G Rathbone Ave., Aurora, Ill. 60507. (312) 897-8417. (R) (T) **Circle 506**

Stanford Applied Engineering Inc., 340 Martin Ave., Santa Clara, Calif. 95050. (408) 243-9200. (T) **Circle 507**

Stettner-Trush, Inc., 67 Albany St., Cazenovia, N.Y. 13035. (315) 655-8141. (T) **Circle 508**

Subminiature Instruments Corp., 3147 Durahart St., Riverside, Calif. 92507. (714) 684-7133. (R) **Circle 509**

TEC Inc., 9800 N. Oracle Rd., Tucson, Ariz. 85704. (602) 297-1111. (R) **Circle 510**

Tech Labs, Inc., Bergen & Edsall Blvds., Palisades Park, N.J. 07650. (201) 944-2221. (R) **Circle 511**

Texas Instruments, Components Grp., Box 5012, Dallas, Tex. 75222. (214) 238-2011. (R) **Circle 512**

Thermo Electric Co., 1095 5 St., Saddle Brook, N.J. 07662. (201) 843-5800. (R) **Circle 513**

Tower Mfg. Corp., 158 Pine St., Providence, R.I. 02903. (401) 331-2380. (R) **Circle 514**

Veeder-Root, 70G Sargeant, Hartford, Conn. 06102. (203) 527-7201. **Circle 515**

Wilbrecht Elecs. Inc., 240 Plato Blvd., St. Paul, Minn. 55107. (612) 222-2791. (R) **Circle 516**

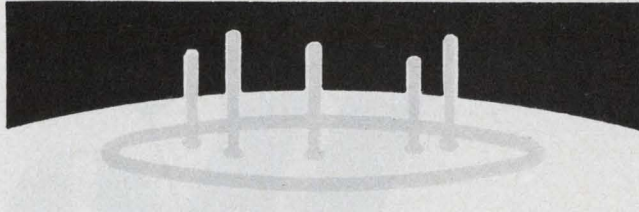

How can short-exposure X-ray images be created without film or processing?

How can industrial monitoring systems freeze and display transient images (such as flaws on steel strip)?

How can slowly scanned images (such as thermographs) be stored and displayed without film — and at lower cost?

How can high-resolution pictures be sent through narrow-bandpass facilities?

How can doctors obtain non-fading EKG records without paper or film?

WITH

# extra-vision™

THE UNIQUE

## Lithocon II™

IMAGE STORAGE SYSTEM AT WORK IN THE PEP SCAN CONVERTER

Now you can scan a frame once, at any speed from DC to megahertz. And store it for up to an hour with 64 levels of grey scale (or up to two hours in pure black and white). A fine, stable, high-resolution picture rivaling wide-band, closed-circuit television.

Extra-vision captures a transient or single-scan image and displays it in hard-copy quality without hard-copy cost and delay. You can selectively erase and rewrite a portion of an image. Or zoom in to magnify up to 36X without altering the stored image.

The image can be read out in any video format and at any scan rate, continuously refreshing as many monitors as required. In any mix of sizes.

If you have an image-processing application, you may be surprised at the techniques made possible by the Lithocon II silicon-target storage tube.

The five applications cited here are from a long list of actual systems. Please tell us about your image-processing activity. We may have some ideas for you.



**PRINCETON ELECTRONIC PRODUCTS, INC.**  
 P.O. Box 101, North Brunswick, N.J. 08902  
 (201) 297-4448



**We got  
the  
4K RAM  
in  
production  
NOW!**







# Design rf oscillators from transistor data sheets.

By using simple models and some easy math, you can compute the component values for sinusoidal oscillators.

Analyze the data on transistor spec sheets, and you'll be able to simplify rf oscillator design. By using the manufacturer's data and simple transistor models, you can design stable oscillators in the 1-to-100-MHz frequency range.

Many different circuit configurations are possible, but let's consider the Colpitt's oscillator with a sinusoidal output. This type of oscillator uses a tuned circuit but doesn't need a tapped inductor, as required in the Hartley oscillator.

If all designs are limited to the low-frequency region—say, below 1 MHz—internal transistor capacitances have very little effect on circuit operation. But as frequencies increase above 1 MHz, the internal effects play havoc with the basic equation for oscillator frequency:

$$f = 1/2\pi\sqrt{LC}.$$

In this equation L and C represent the discrete values of tank inductance and capacitance.

## A look at the Colpitt's oscillator

The basic Colpitt's oscillator (Fig. 1) provides sinusoidal outputs over a wide range of frequencies. As a typical example, let's design a circuit that provides sinusoidal oscillations at 30 MHz.

To start the design, the  $\pi$  model for the pnp transistor can be very useful when you analyze the circuit. Since the oscillator circuit uses a transistor with a grounded base ( $C_4$  is an ac short at 30 MHz), a simplified model can be used. Also, the output and feedback internal resistances are usually much greater than any load resistance that would be used for an oscillator and can thus be neglected. The simplified  $\pi$  model,<sup>1</sup> with appropriate conversion factors considered, minimizes calculations (Fig. 2) to determine component values.

The model is valid over a frequency range that has an upper limit<sup>2</sup> determined by

$$(f_t/3)(r_e/r_{bb'}).$$

If the external components shown in the schematic of Fig. 1 are added to the equivalent circuit (also allowing for  $C_4$  as an ac short at 30

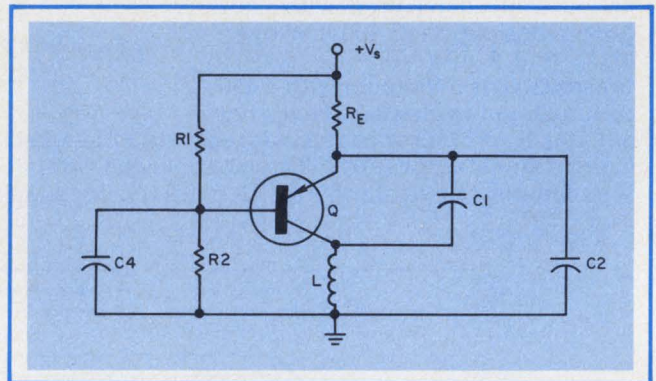

1. A simple Colpitt's oscillator uses a pnp transistor and produces sine-wave oscillations.

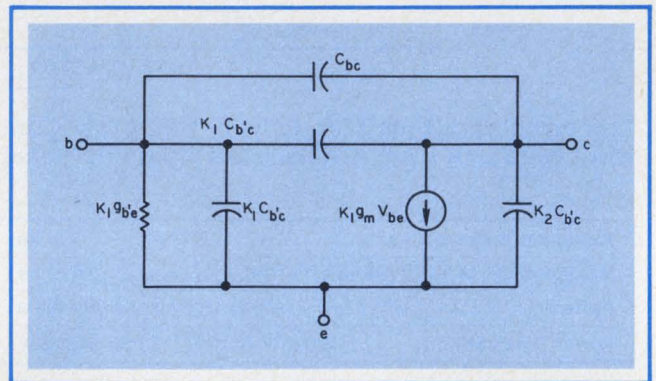

2. The simple pnp transistor  $\pi$  model can help reduce the number of calculations when you compute the values of the internal capacitances.

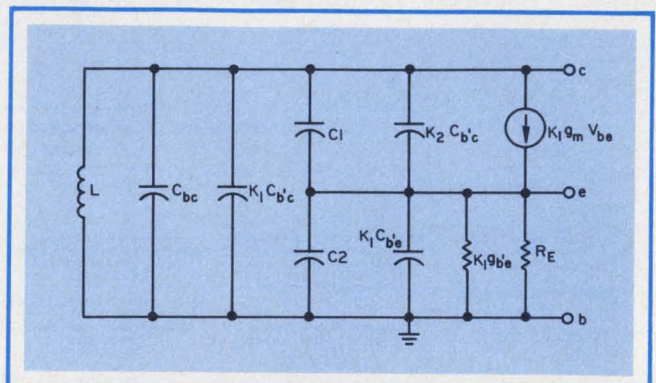

3. If the external components are added to the  $\pi$  model, the oscillator circuit becomes ready for analysis.

Fred Palenschat, Chief Electrical Engineer, Gamma Scientific, 3777 Ruffin Rd., San Diego, Calif. 92123



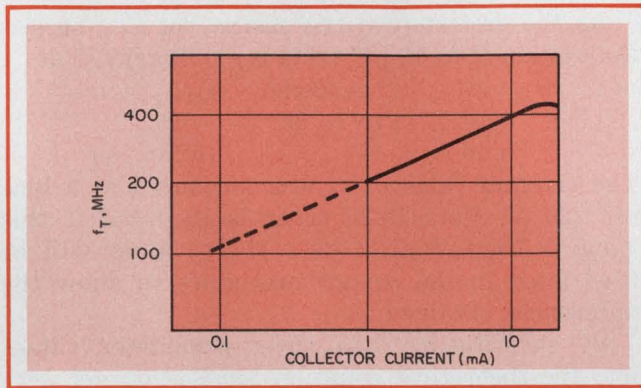

4. The transistor  $f_t$  decreases almost linearly with the decreasing collector current.

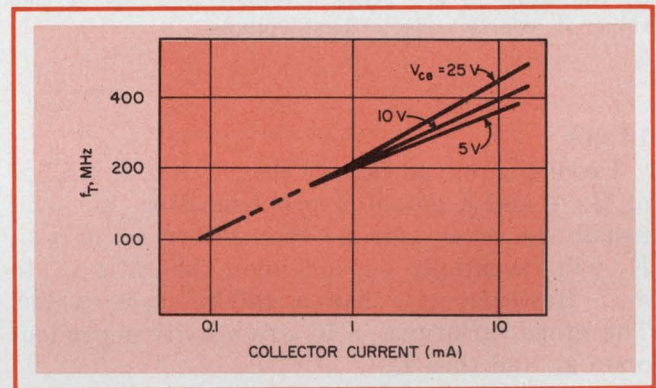

5. As the collector-emitter voltage varies over a 5-to-25-V range,  $f_t$  holds almost constant.

MHz), the schematic in Fig. 3 results. Resistors  $R_1$  and  $R_2$  are also neglected.

To ease circuit analysis, some of the parameters in the diagram of Fig. 3 can be defined (Table 1). All have some control over the capacitance that affects the oscillator performance.

From Table 1, it is obvious that  $g_m$  is directly proportional to the emitter current ( $r_e \approx 26 \text{ mV}/I_E$ ). Since  $C_{b'e}$  is itself directly proportional to  $g_m$  and inversely proportional to  $f_t$ , either  $I_E$  must

be kept fairly low or the transistor's  $f_t$  must be high. Usually a compromise between  $f_t$  and  $I_E$  is made (Fig. 4), but this causes complications, since  $f_t$  decreases as the emitter current decreases.<sup>4</sup> Over the same current range as in Fig. 4,  $f_t$  will remain nearly constant with variations in collector-emitter voltage (Fig. 5).

As a rule of thumb (if no curves are supplied on the data sheet),  $f_t$  is approximately halved for every decade of decrease in emitter current below

Table 1. Parameter definitions for transistor model

$g_m = \alpha/r_e$	where $\alpha$ (or $\beta/(1 + \beta)$ ) is the low frequency common-base current gain, and $r_e$ is the dynamic resistance looking in at the emitter.
$g_{b'e} = g_m/\beta$	where $\beta$ is the dc common emitter current gain.
$g_{bb'} = 1/r_{bb'}$	where $r_{bb'}$ is the base spreading resistance.
$C_{b'e} = C_{ob} - C_{bc}$	where $C_{bc}$ is the header capacitance and overlap diode capacitance <sup>3</sup> , and $C_{ob}$ is the collector-base output capacitance with the emitter open (usually specified).
$C_{b'e} = (g_m/2\pi f_t) - C_{b'e}$	where $f_t$ is the frequency at which $\beta = 1$ (the gain-bandwidth-product).
$K_1 = g_{bb'}/(g_{bb'} + g_{b'e})$ $K_2 = (g_m + g_{b'e})/(g_{bb'} + g_{b'e})$	



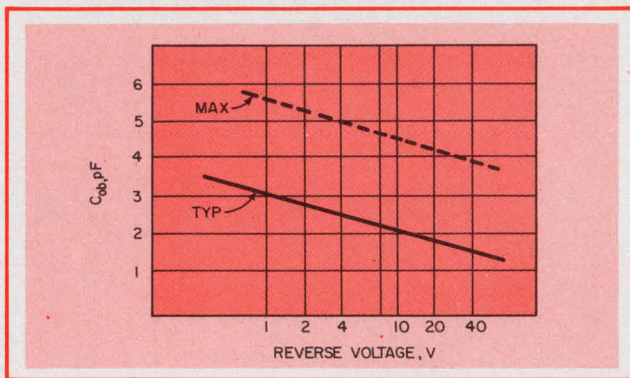

6. The value of  $C_{ob}$  varies inversely with the applied value of reverse collector-base voltage.

10 mA.

From Fig. 3, you can see that  $K_2$  is a multiplier of  $C_{b'e}$ —and a potential problem. Since  $g_{b'e}$  will usually be much smaller than either  $g_m$  or  $g_{bb'}$ ,  $K_2$  will essentially depend upon the ratio  $g_m$  to  $g_{bb'}$ . However,  $g_{bb'}$  has a fairly stable value. Therefore variations in  $K_2$  are heavily dependent upon  $g_m$  and thus  $I_E$ .

### Select the right transistor

From the analysis so far the most important factors to consider in transistor selection are the  $f_t$  and the emitter current. Note, though, in Fig. 6 that  $C_{b'e}$ , and thus  $C_{ob}$ , is fairly independent of current but varies inversely with reverse voltage.<sup>5</sup>

For the design example, a 2N4916 transistor was chosen because of its high  $f_t$ . However, the manufacturer's data sheet notes that the gain-bandwidth curves are typical composites. Thus to design for worst-case conditions, you can find the minimum  $f_t$  by first checking the minimum high-frequency value of  $h_{fe}$  on the data sheet. For the specific transistor selected, the  $h_{fe}$  minimum at 100 MHz is 4. Thus the gain-bandwidth product is 400 MHz.

Some of the other parameter values that will be

Table 2. Selected transistor parameters

$h_{FE}(\text{min}) = 50$
$h_{fe}(\text{min}) = 4$ at $I_E = 10$ mA, $V_{CE} = -20$ V, and $f = 100$ MHz
$\therefore f_t(\text{min}) = 400$ MHz at $I_E = 10$ mA and $V_{CE} = -20$ V
$C_{ob}(\text{max}) = 4.5$ pF at $I_E = 0$ , and $V_{cb} = -10$ V
$r_b \cdot C_c = 50$ ps at $I_c = 10$ mA, and $V_{CE} = -20$ V

used in the design example are shown in Table 2. The calculations can proceed if a supply voltage of 9 V and a  $V_{CE}$  drop of 5 V can be assumed. The chosen  $V_{CE}$  is quite arbitrary, but it was chosen to be high enough to prevent gross degradation of  $f_t$ .

From Table 2, you are given  $C_{ob}$  as equal to 4.5 pF at a  $-10$ -V bias. And from the data sheet, you can see that  $C_{ob}$  increases from 4.5 to 4.8 pF as the collector voltage is reduced to 5 V (Fig. 6). If a header capacitance and overlap diode capacitance of 2 pF is assumed, you can find that

$$C_{b'e} = 4.8 - 2 \text{ pF} = 2.8 \text{ pF.}$$

As the first step in the design, let  $C_{b'e}$  be less than or equal to 45 pF (this is arbitrary). But

$$C_{b'e} = (g_m / 2\pi f_t) - C_{b'e}$$

$$\therefore C_{b'e} = (\alpha I_E / 52\pi f_t) - C_{b'e}$$

$$\text{and } I_E = (C_{b'e} + C_{b'e}) (52\pi f_t / \alpha).$$

The original value of  $f_t$  was measured at a bias of  $-20$  V. Very little error is incurred if this value is used; typical data sheet values will be used later in the design procedure to show the differences obtained.

By substituting data sheet parameter values into the theoretical equation for  $I_E$ , you get

$$I_E = 3.174 \text{ mA.}$$

Since the calculated emitter current is closer to 1 mA, a lower  $f_t$  should be used—say, 200 MHz. Now if you recalculate the emitter current, you get  $I_E = 1.587$  mA.

### Determine the bias resistors

Once you know the emitter current, the base bias network can be designed. Start by redrawing the base circuit in Fig. 1 to that of Fig. 7. Let  $S$ , the stability factor, be equal to 2.2 (again quite arbitrary; good bias stability dictates that  $S$  should be between 2 and 10).

Since  $S = (R_B / R_E) + 1$ , the ratio of  $R_B$  to  $R_E$  can be computed to be 1.2. The  $V_{CE}$  was already stipulated at 5 V. Thus the value of  $R_E$  becomes  $(V_{\text{supply}} - V_{CE}) / I_E$  or 4 V / 1.587 mA, which equals 2.5 k $\Omega$ . To simplify the design, let  $R_E = 2.2$  k $\Omega$ , a standard component value. Since  $R_E$  is now known,  $R_B$  can be found:

$$R_B = 1.2 (2.2 \text{ k}\Omega) = 2.64 \text{ k}\Omega$$

From the circuit of Fig. 7,  $V_{th}$  can be calculated:

$$V_{th} = [I_E \cdot (1 + \beta)] [R_B + (1 + \beta) R_E] + 0.6 \text{ V}$$

$$= 4.16 \text{ V.}$$

Now the values of  $R_1$  and  $R_2$  can be calculated:

$$R_B = R_1 // R_2 \text{ and } (V_{\text{supply}}) \left( \frac{R_2}{R_1 + R_2} \right) = V_{th}$$

thus  $R_1 = 5.71$  k $\Omega$  and  $R_2 = 4.91$  k $\Omega$ .

If you let these resistors take on standard values, you get  $R_1 = 5.6$  k $\Omega$  and  $R_2 = 4.7$  k $\Omega$ . Using these new values, you can recalculate the value of  $I_E$  to find  $I_E = 1.564$  mA.

Once all these component values have been



found, the transistor model parameters can be determined:

$$g_m = (1.564) (60) / (260) (61) = 59.17 \text{ mmhos},$$

$$g_{b'e} = g_m / \beta = 0.986 \text{ mmhos},$$

$$r_{bb'} = r_b C_c (\text{max}) / C_{b'e} (\text{max}),$$

with  $r_b C_c$  given at 10 mA and -20 V. Capacitance  $C_{ob}$  is relatively constant with current but is reduced at 20 V to 4.2 pF (from manufacturer's data sheet).

Thus  $C_{b'e} = 4.2 \text{ pF} - 2 \text{ pF} = 2.2 \text{ pF}$  and, in turn,  $g_{bb'} = 2.2 \text{ pF} / 50 \text{ ps} = 44 \text{ mmhos}$ . From the formulas in Table 1, you can now find the values of  $K_1$ ,  $K_2$ ,  $C_{b'e}$ ,  $C_{bc}$  and  $C_{b'e}$ . Their values are 0.978, 1.337, 2.8 pF, 2 pF and 44.3 pF, respectively.

All these calculated values can now be substituted into the modeled transistor circuit of Fig. 3 (redrawn in Fig. 8). You can also select arbitrary values of  $C_1$  and  $C_2$ , although  $C_2$  is normally kept between the limits of  $C_1 \leq C_2 \leq 3C_1$ . Also, the values of  $C_1$  and  $C_2$  are chosen so as not to mask or swamp out the internal stray capacitance (to help illustrate this design procedure).

You can now compute the total capacitance by adding up the values of  $C_{bc}$ ,  $K_1 C_{b'e}$  and allowing for the series-parallel arrangement of  $C_1$ ,  $C_2$ ,  $K_2 C_{b'e}$  and  $K_1 C_{b'e}$ . Thus you get

$$C_t = C_{bc} + K_1 C_{b'e} + \frac{(C_1 + K_2 C_{b'e})(C_2 + K_1 C_{b'e})}{C_1 + K_2 C_{b'e} + C_2 + K_1 C_{b'e}}$$

$$C_t = 15 \text{ pF}.$$

From the basic formula for oscillation, you can substitute in the value of  $C$  and find the value of inductance needed for oscillation at a frequency of 30 MHz:

$$L = 1 / (2\pi \times 30 \times 10^6)^2 C_t = 1.88 \mu\text{H}.$$

As a check on the accuracy of the method, assume that a 2.5- $\mu\text{H}$  choke is used and the frequency recalculated and measured. The calculated worst-case frequency becomes 26 MHz and the measured frequency is 34.5 MHz.

Remember, the external capacitors should be selected so that internal capacitances in the final computations will have little or no effect on the oscillator frequency. This is not the case in the example so far—there is a wide disagreement between the calculated and measured frequencies.

### The procedure can be further improved

If the emitter current in the transistor is reduced by an order of magnitude, you can get closer agreement in the frequency. For example, when  $R_E$  increases to 33 k $\Omega$ ,  $I_E$  drops to 0.106 mA and  $\beta$  decreases by 30%. The other parameter values then change to the following:

$$g_m = 3.977 \text{ mmhos} \quad K_2 = 0.09$$

$$g_{b'e} = 0.099 \text{ mmhos} \quad C_{b'e} = 2.8 \text{ pF}$$

$$g_{bb'} = 44 \text{ mmhos} \quad C_{bc} = 2 \text{ pF}$$

$$K_1 = 1$$

Also, for the decrease in current,  $f_t$  drops by

**Table 3. Comparison of computed oscillator frequencies**

$I_E = 1.564 \text{ mA}$	$I_E = 0.106 \text{ mA}$
$h_{FE} = 100$	$h_{FE} = 70$
$f_T = 300 \text{ MHz}$	$f_T = 150 \text{ MHz}$
$C_{ob} = 2.5 \text{ pF}$	$C_{ob} = 2.5 \text{ pF}$
$r_{bb'} = 23 \Omega$	$r_{bb'} = 23 \Omega$
$g_{bb'} = 44 \text{ mmhos}$	$g_{bb'} = 44 \text{ mmhos}$
$g_m = 51.6 \text{ mmhos}$	$g_m = 3.48 \text{ mmhos}$
$g_{b'e} = 0.516 \text{ mmhos}$	$g_{b'e} = 0.0498 \text{ mmhos}$
$C_{b'e} = 0.5 \text{ pF}$	$C_{b'e} = 0.5 \text{ pF}$
$C_{bc} = 2 \text{ pF}$	$C_{bc} = 2 \text{ pF}$
$C_{b'e} = 26.9 \text{ pF}$	$C_{b'e} = 3.2 \text{ pF}$
$K_1 = 1$	$K_1 = 1$
$K_2 = 1.17$	$K_2 = 0.081$
$f(\text{calc}) = 31.5 \text{ MHz}$	$f(\text{calc}) = 35.2 \text{ MHz}$
$f(\text{meas}) = 34.5 \text{ MHz}$	$f(\text{meas}) = 35.2 \text{ MHz}$

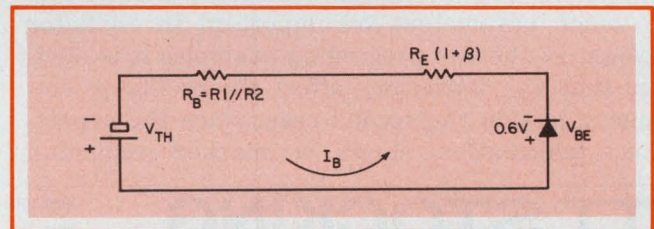

7. The simplified base circuit of the transistor can be used to design the bias network.

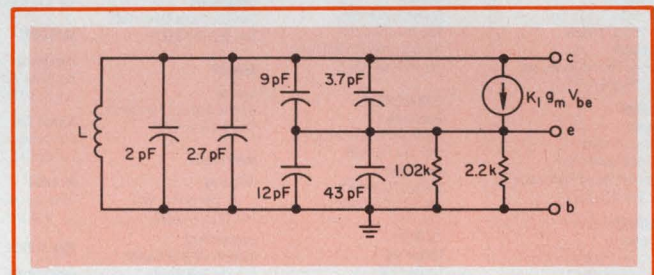

8. The completely calculated transistor model can now be simplified so that the inductor value can be found.

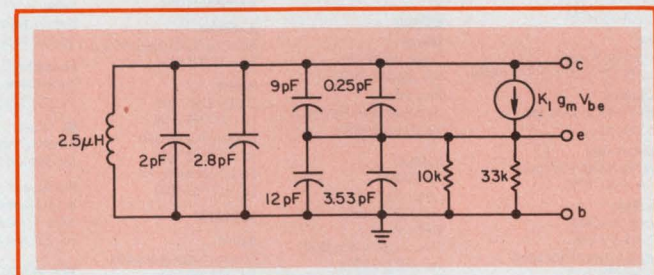

9. Recalculating the transistor model components with typical values from the data sheet, you can find the value of the tank inductor.



**Table 4. Worst-case & typical vs measured frequencies**

$I_E$ (mA)	$C_1$ (pF)	$C_2$ (pF)	$L$ ( $\mu$ H)	f(calc) worst case (MHz)	f(calc) (MHz)	f(meas) (MHz)
1.564	29	29	0.53	41.9	46.7	50.8
0.106	29	29	0.53	48.6	51.9	51.3
1.564	29	100	0.53	39	42.6	40.8
0.106	29	100	0.53	41.5	43.5	43.5
1.564	9	12	2.5	26	31.5	34.5
0.106	9	12	2.5	30.9	35.2	35.2

a factor of 2; thus  $f_t = 100$  MHz. And  $C_{b'e}$  then becomes 3.53 pF. All these values can now be substituted into the same circuit as before, and you can recompute and measure the frequency of oscillation. The values become 30.9 MHz (calculated) and 35.2 MHz (measured). The measured and calculated values are much closer than before, since  $C_1$  and  $C_2$  are more dominant.

This mathematical approach not only is in close agreement but also gives a strong indication as to which parameters are important in oscillator design. In the two preceding examples it is obvious that  $C_{b'e}$  variations affect the oscillator frequency less in the second case, since the capacitance calculation shows a marked reduction

(more than an order of magnitude). Therefore good design requires that  $C_1$  and  $C_2$  be selected to "swamp out," or at least be a large part of their parallel stray counterparts.

Let's do the same design example once more, using the typical parameters from the transistor data sheet. Table 3 has a comparison of all the calculated and given parameters for the two previous emitter-current levels.

To show the over-all effect of tank-capacitance selection, only the tank components have been changed, and the frequency again calculated and measured. Table 4 lists the previous examples as well as some other arbitrary values for comparison.

Thus if  $C_1$  and  $C_2$  are indeed selected to mask the inherent stray capacitances—say,  $C_2 = 2C_1$ ,  $C_2 > 2K_1C_{b'e}$ ,  $C_1 \geq 3C_{ob}$  and  $C_1 > 5C_{b'c}$ —the calculated and the measured values will agree. Even if the worst-case parameters at a given temperature are used, the results are still usable. ■■

**References**

1. Thornton, Searle, Pederson, Alder and Angelo, "Multistage Transistor Circuits," S.E.E.C., Wiley, 1965, Vol. 5; p. 57.
2. Ibid p. 57.
3. Searle, Boothroyd, Angelo, Grey, and Pederson, "Elementary Circuit Properties of Transistors," S.E.E.C., Wiley, 1964, Vol. 3; p. 102.
4. Millman and Halkias, "Integrated Electronics," McGraw-Hill, 1972, p. 358.
5. Data Sheet 2N4916; Fairchild Semiconductor.

# ITT STOCKING DISTRIBUTORS

**ALABAMA**  
 Birmingham  
 ACK Radio Supply Co.  
 Tel: 205-322-0588  
 Huntsville  
 Cramer/EW Huntsville, Inc.  
 Tel: 205-539-5722

**ARIZONA**  
 Phoenix  
 Cramer/Arizona  
 Tel: 602-263-1112  
 Hamilton/Avnet Electronics  
 Tel: 602-275-7851

**CALIFORNIA**  
 Chatsworth  
 Westates Electronics Corp.  
 Tel: 213-341-4411  
 Culver City  
 Avnet Electronics  
 Tel: 213-836-7200  
 Tel: 714-522-8220  
 Hamilton Electro Sales  
 Tel: 213-870-7171  
 Tel: 714-522-8200  
 Irvine  
 Cramer/Los Angeles  
 Tel: 714-979-3000 & 213-771-8300  
 Los Angeles  
 Radio Products Sales, Inc.  
 Tel: 213-748-1271  
 Mountain View  
 Hamilton/Avnet Electronics  
 Tel: 415-961-7000  
 San Diego  
 Cramer/San Diego  
 Tel: 714-565-1881  
 Hamilton/Avnet Electronics  
 Tel: 714-279-2421  
 Sunnyvale  
 Bell Electronic Corp.  
 Tel: 408-734-8570  
 Cramer Electronics  
 Tel: 408-739-3011

**COLORADO**  
 Denver  
 Cramer Electronics  
 Tel: 303-758-2100  
 Hamilton/Avnet Electronics  
 Tel: 303-534-1212

**CONNECTICUT**  
 Georgetown  
 Hamilton/Avnet Electronics  
 Tel: 203-762-0361  
 North Haven  
 Cramer Electronics  
 Tel: 203-239-5641

**FLORIDA**  
 Hollywood  
 Cramer/EW  
 Tel: 305-923-8181  
 Hamilton/Avnet Sales  
 Tel: 305-925-5401  
 Orlando  
 Cramer/EW Orlando  
 Tel: 305-894-1511

**GEORGIA**  
 Atlanta  
 Cramer Electronics  
 Tel: 404-448-9050  
 Norcross  
 Hamilton/Avnet Electronics  
 Tel: 404-448-0800

**ILLINOIS**  
 Des Plaines  
 Edmar Electronics Co.  
 Tel: 312-298-8580  
 Elmhurst  
 Semiconductor Specialists  
 Tel: 312-279-1000  
 Mt. Prospect  
 Cramer/Chicago  
 Tel: 312-593-8230  
 Schiller Park  
 Hamilton/Avnet Electronics  
 Tel: 312-678-6310

**INDIANA**  
 Indianapolis  
 Semiconductor Specialists  
 Tel: 317-243-8271

**KANSAS**  
 Lenexa  
 Hamilton/Avnet Electronics  
 Tel: 913-888-8900

**MARYLAND**  
 Baltimore  
 Arrow Electronics, Inc.  
 Tel: 301-247-5200

**Gaithersburg**  
 Cramer/EW Washington  
 Tel: 301-948-0110

**Hanover**  
 Cramer/EW Baltimore  
 Tel: 301-796-5790  
 Hamilton/Avnet Electronics  
 Tel: 301-796-5000

**MASSACHUSETTS**  
 Burlington  
 Hamilton/Avnet Electronics  
 Tel: 617-273-2120

**Newton**  
 Cramer Electronics  
 Tel: 617-969-7700  
 Cramer/International  
 Tel: 617-969-7700  
 Greene-Shaw Co., Inc.  
 Tel: 617-969-8900

**MICHIGAN**  
 Detroit  
 Semiconductor Specialists  
 Tel: 313-255-0300

**Livonia**  
 Cramer/Detroit  
 Tel: 313-425-7000  
 Hamilton/Avnet Electronics  
 Tel: 313-522-4700

**MINNESOTA**  
 Edina  
 Cramer/Bonn  
 Tel: 612-835-7811  
 Hamilton/Avnet Electronics  
 Tel: 612-941-3801

**Minneapolis**  
 Semiconductor Specialists  
 Tel: 612-854-8841

**MISSOURI**  
 Hazelwood  
 Hamilton/Avnet Electronics  
 Tel: 314-731-1144

**Kansas City**  
 Semiconductor Specialists  
 Tel: 816-452-3900

**St. Louis**  
 Olive Industrial Electronics  
 Tel: 314-863-7800

**NEW JERSEY**  
 Cedar Grove  
 Hamilton/Avnet Electronics  
 Tel: 201-239-0800

**Cherry Hill**  
 Cramer/Pennsylvania, Inc.  
 Tel: 609-424-5993

**Clifton**  
 Wilshire Electronics/New Jersey  
 Tel: 201-365-1150

**Moonachie**  
 Cramer/New Jersey  
 Tel: 201-935-5600

**Mt. Laurel**  
 Hamilton/Avnet Electronics  
 Tel: 609-234-2133

**Pennsauken**  
 Resco Electronics  
 A Div. of Astrex, Inc.  
 Tel: 609-662-4000

**NEW MEXICO**  
 Albuquerque  
 Cramer/New Mexico  
 Tel: 505-265-5767  
 Hamilton/Avnet Electronics  
 Tel: 505-765-1500

**NEW YORK**  
 East Syracuse  
 Cramer Electronics  
 Tel: 315-437-6671  
 Hamilton/Avnet Electronics  
 Tel: 315-437-2642

**Endwell**  
 Cramer Electronics  
 Tel: 607-754-6661

**Freeport**  
 Milgray Electronics  
 Tel: 516-546-6000

**Hauppauge, L. I.**  
 Cramer/Long Island  
 Tel: 516-231-5600

**Rochester**  
 Cramer Electronics  
 Tel: 716-275-0300

**Westbury L.I.**  
 Hamilton/Avnet Electronics  
 Tel: 516-333-5800

**NORTH CAROLINA**  
 Winston-Salem  
 Cramer/EW Winston-Salem  
 Tel: 919-725-8711

**OHIO**  
 Cincinnati  
 Cramer/Tri-States  
 Tel: 513-771-6441

**Cleveland**  
 Cramer/Cleveland  
 Tel: 216-248-8400

**Dayton**  
 Hamilton/Avnet Electronics  
 Tel: 513-433-0610

**Dayton-Cleveland**  
 Hamilton/Avnet Electronics  
 Tel: 216-289-0550

**TEXAS**  
 Dallas  
 Cramer/Texas  
 Tel: 214-350-1355  
 Texas WATTS 800-492-6940  
 Hamilton/Avnet Electronics  
 Tel: 214-661-8661

**Dallas-Ft. Worth**  
 Hamilton/Avnet Electronics  
 Tel: 817-275-6561

**Houston**  
 Hamilton/Avnet Electronics  
 Tel: 713-526-4661

**Richardson**  
 Altair Co., Inc.  
 Tel: 214-231-5166

**UTAH**  
 Salt Lake City  
 Cramer/Utah  
 Tel: 801-487-4131  
 Hamilton/Avnet Electronics  
 Tel: 801-262-8451

**WASHINGTON**  
 Bellevue  
 Hamilton/Avnet Electronics  
 Tel: 206-746-8750

**Seattle**  
 Cramer/Seattle  
 Tel: 206-762-5755

**WASHINGTON, D. C.**  
 Baltimore  
 Hamilton/Avnet Electronics  
 Tel: 301-953-7010

**WISCONSIN**  
 Oak Creek  
 Cramer/Wisconsin  
 Tel: 414-764-1700

**CANADA**  
 Downsview, Ontario  
 Cramer/Canada, Ltd.  
 Tel: 416-661-9222

**Halifax, Nova Scotia**  
 Consolidated Supply Co., Ltd.  
 Tel: 902-454-8581

**Mississauga, Ont.**  
 Hamilton/Avnet Electronics  
 Tel: 613-677-7432

**Montreal, Quebec**  
 Hamilton/Avnet Electronics  
 Tel: 514-735-6393

**Ottawa**  
 Hamilton/Avnet Electronics  
 Tel: 613-725-3071

**Vancouver, B. C.**  
 Cam Gard Supply, Ltd.  
 Tel: 604-291-1441

**Winnipeg, Manitoba**  
 Cam Gard Supply, Ltd.  
 Tel: 204-786-8481

**ITALY**  
 Roma  
 Cramer/Italia  
 Tel: 51-393-87 and 51-393-90

**PUERTO RICO**  
 De San German  
 Cramer/Puerto Rico  
 Tel: 809-892-1130

**San Juan**  
 ITT Caribbean Sales & Service  
 (P.R.) Inc.  
 Tel: 809-767-5050  
 809-766-2408





# Who's tuned in on consumer electronics?

Rate ITT by its accomplishments. Take a look at our 3701 — it's a complete monolithic 2-watt FM sound system for TV, radio and other FM sound communications. It is packaged in a 14-pin power DIP. It eliminates shielded volume control cables and is impervious to output short circuits. It drastically reduces your total component requirement while providing limiting with less than 100  $\mu$ V input. It's only one in a line of ITT devices that includes the popular 1330, 1352, 3064, 3065 (plus several proprietary circuits), as well as double-plug diodes, glass rectifiers, zeners and other consumer-oriented components. Tune in to ITT now!

## ITT...Logically

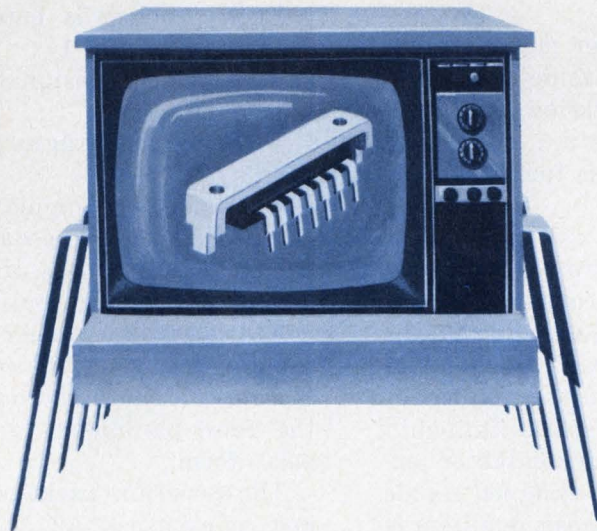

# semiconductors

ITT Semiconductors is a division of International Telephone and Telegraph Corporation, 3301 Electronics Way, West Palm Beach, Florida 33407. Phone 305/842-2411. Factories in West Palm Beach, Florida • Lawrence, Massachusetts • Footscray, England • Colmar, France • Freiburg, Germany • Cascais, Portugal • Taipei, Taiwan • Sydney, Australia.

# ITT



# Convert two-port circuit parameters

from any form to any other. A short Fortran program handles all popular parameters in polar or rectangular form.

Two-port parameter conversions are a time-consuming task to program or calculate. But the 140 equations required for these conversions can be reduced to less than 100 Fortran statements, if you take advantage of the redundancies inherent in the equations.

A compact Fortran program results, which performs all possible conversions between any pair of six two-port parameter systems. The user can input the four matrix elements for any of the six—z, y, h, g, ABCD and S—and select conversion to any other form. The subroutine also carries out impedance normalization for S-parameters, provides output in rectangular as well as polar form, and accepts inputs in either rectangular or polar form.

## Coding reduces program size

A coding scheme reduces the number of expressions programmed from 144 to 27 in the case of conversion, and from 24 to 7 for S-parameter normalization.

Conversion from one parameter matrix to another requires four equations—aside from possible normalizations. If we describe the input matrix in terms of four elements  $x_{11}$ ,  $x_{12}$ ,  $x_{21}$  and  $x_{22}$ , then the output matrix, R, has four elements. Each is given by an equation

$$r_{ij} = f_{ij}(x_{11}, x_{12}, x_{21}, x_{22}) \quad (1)$$

in which indices  $i$  and  $j$  range from one to two.

These functions  $f_{ij}$  contain considerable redundancy. Many simply require division by the determinant of the input matrix—regardless of which  $r_{ij}$  is to be calculated. And the number of possible numerator expressions is also limited.

All possible numerator and denominator expressions are calculated once and assigned a code number (Table 1). Then in each case, one item is selected for the numerator, another for the denominator, and the ratio,  $r_{ij}$ , is computed.

For simplicity, the actual program performs all 27 calculations on the input variables, then

stores them in array X with the subscript equal to the code number.

Five matrices of code numbers are formed to reference the pre-stored conversion computations (Table 2). The matrices  $N_{11}$ ,  $N_{12}$ ,  $N_{21}$  and  $N_{22}$  contain the locations of numerator terms for elements  $r_{11}$ ,  $r_{12}$ ,  $r_{21}$  and  $r_{22}$ . The common-denominator term location is stored in array D.

The use of the arrays is straightforward. For instance, to compute the element  $y_{12}$  in a S-to-y conversion, matrix  $N_{12}$  indicates the numerator code 30 and matrix D indicates the denominator code 13. And from Table 1, these codes show that

$$y_{12} = \frac{-S_{12}}{S_{11}S_{12} - S_{12}S_{21} + S_{11} + S_{22} + 1} = \frac{X(30)}{D(13)} \quad (2)$$

The computations for S-parameter normalization formulae are stored in array N, and the multiplicand or divisor is chosen for each of the four elements from array NORM (Table 3).

## How to use the program

Each problem is entered with the following information (Fig. 1):

- Numerical designation of input-parameter type.
- Numerical designation of output-parameter type.
- Polar or rectangular designation on input.
- Values for impedance-level normalizations on input and output—if S-parameters are specified for input or output.
- Appropriate numerical values for the four input elements (R,  $\theta$ ) or (x, y).

Data calculated and outputted are the values of the four parameters in both rectangular and polar form.

The program package consists of a mainline and subroutines AZCON, RECT and POLAR. AZCON performs all conversions, including the normalization/denormalization. RECT and POLAR provide polar-to-rectangular and rectangular-to-polar conversions. These function routines are used only by AZCON. The mainline program handles input and output to the user and passes parameters to AZCON.

Once AZCON, RECT and POLAR have been

---

Robert P. Arnold, Project Leader, Motorola Semiconductor Products, Inc., 5005 E. McDowell Rd., Phoenix, Ariz. 85008.



INPUT,OUTPUT (1=Z,2=Y,3=H,4=G,5=ABCD,6=S) ? 6 2  
 INPUT FORM(1=RECT,2=POLAR) ? 2  
 RO1,R02=? (DEFAULT=50) ?          ← IF NORMALIZATION REQUIREMENTS  
 ARE OTHER THAN 50Ω TYPE IN  
 DESIRED INPUT AND OUTPUT  
 IMPEDANCES.  
 S11 S21 S12 S22 ← NUMBERS ARE IN POLAR  
 ? .35 259,2.5 78,.092 56,.68 337 NOTATION  
 REAL IMAGINARY MAGNITUDE ANGLE  
 Y11= 0.1280E-01 0.1340E-01 Y11= 0.1853E-01 46.32  
 Y21= 0.1795E-01 -.5068E-01 Y21= 0.5376E-01 -70.49  
 Y12= -.8610E-04 -.1977E-02 Y12= 0.1978E-02 -92.49  
 Y22= 0.9715E-03 0.4188E-02 Y22= 0.4300E-02 76.94

(Y)

**Table 1. Code numbers assigned to conversion expressions**

Code No.	Computation
0	None
1	$X_{11}$ (A)
2	$X_{21}$ (C)
3	$X_{12}$ (B)
4	$X_{22}$ (D)
5	$\Delta_x = X_{11} X_{22} - X_{12} X_{21}$
6	1
7	$\Delta_x + X_{11} - X_{22} - 1$
8	$\Delta_x - X_{11} + X_{22} - 1$
9	$2 X_{21}$
10	$2 X_{12}$
11	$2 \Delta_x$
12	2
13	$\Delta_x + X_{11} + X_{22} + 1$
14	$\Delta_x - X_{11} - X_{22} + 1$
15	$X_{11} + X_{12} + X_{21} + X_{22}$
16	$X_{11} + X_{12} - X_{21} - X_{22}$
17	$-X_{11} + X_{12} - X_{21} + X_{22}$
18	Not used
19	Not used
20	Not used
21	$-X_{11}$
22	$-X_{21}$
23	$-X_{12}$
24	$-X_{22}$
25	$-\Delta_x$
26	-1
27	$-\Delta_x - X_{11} + X_{22} + 1$
28	$-\Delta_x + X_{11} - X_{22} + 1$
29	$-2 X_{21}$
30	$-X_{12}$

Note: These computations on the 4-input elements  $x_{ij}$  are stored by code number in the 30-element array X.

INPUT,OUTPUT (1=Z,2=Y,3=H,4=G,5=ABCD,6=S) ? 6 1  
 INPUT FORM(1=RECT,2=POLAR) ? 2  
 RO1,R02=? (DEFAULT=50) ?           
 S11 S21 S12 S22  
 ? .35 259,2.5 78,.092 56,.68 337  
 REAL IMAGINARY MAGNITUDE ANGLE  
 Z11= 36.05 11.46 Z11= 37.83 17.63  
 Z21= 302.8 353.4 Z21= 473.0 50.20  
 Z12= 15.34 8.225 Z12= 17.41 28.20  
 Z22= 158.9 -36.64 Z22= 163.0 -12.99

(Z)

INPUT,OUTPUT (1=Z,2=Y,3=H,4=G,5=ABCD,6=S) ? 6 3  
 INPUT FORM(1=RECT,2=POLAR) ? 2  
 RO1,R02=? (DEFAULT=50) ?           
 S11 S21 S12 S22  
 ? .35 259,2.5 78,.092 56,.68 337  
 REAL IMAGINARY MAGNITUDE ANGLE  
 H11= 37.27 -39.03 H11= 53.97 -46.32  
 H21= -1.309 -2.589 H21= 2.901 -116.8  
 H12= 0.8035E-01 0.7031E-01 H12= 0.1068 41.19  
 H22= 0.5977E-02 0.1378E-02 H22= 0.6134E-02 12.99

(H)

INPUT,OUTPUT (1=Z,2=Y,3=H,4=G,5=ABCD,6=S) ? 6 4  
 INPUT FORM(1=RECT,2=POLAR) ? 2  
 RO1,R02=? (DEFAULT=50) ?           
 S11 S21 S12 S22  
 ? .35 259,2.5 78,.092 56,.68 337  
 REAL IMAGINARY MAGNITUDE ANGLE  
 G11= 0.2519E-01 -.8008E-02 G11= 0.2644E-01 -17.63  
 G21= 10.54 6.730 G21= 12.50 32.56  
 G12= -.4524 -.8437E-01 G12= 0.4602 -169.4  
 G22= 52.55 -226.6 G22= 232.6 -76.94

(G)

INPUT,OUTPUT (1=Z,2=Y,3=H,4=G,5=ABCD,6=S) ? 6 5  
 INPUT FORM(1=RECT,2=POLAR) ? 2  
 RO1,R02=? (DEFAULT=50) ?           
 S11 S21 S12 S22  
 ? .35 259,2.5 78,.092 56,.68 337  
 REAL IMAGINARY MAGNITUDE ANGLE  
 A= 0.6740E-01 -.4305E-01 A= 0.7997E-01 -32.56  
 C= 0.1353E-02 -.1624E-02 C= 0.2114E-02 -50.20  
 B= -6.211 -17.53 B= 18.60 -109.5  
 D= 0.1555 -.3076 D= 0.3447 -63.19

(ABCD)

INPUT,OUTPUT (1=Z,2=Y,3=H,4=G,5=ABCD,6=S) ? 6 6  
 INPUT FORM(1=RECT,2=POLAR) ? 2  
 RO1,R02=? (DEFAULT=50) ?           
 S11 S21 S12 S22  
 ? .35 259,2.5 78,.092 56,.68 337  
 REAL IMAGINARY MAGNITUDE ANGLE  
 S11= -.6678E-01 -.3436 S11= 0.3500 -101.0  
 S21= 0.5198 2.445 S21= 2.500 78.00  
 S12= 0.5145E-01 0.7627E-01 S12= 0.9200E-01 56.00  
 S22= 0.6259 -.2657 S22= 0.6800 -23.00

(S)

1. You can perform any of six two-port conversions by supplying the underlined information to the program.



**Table 2. Arrays used as indices to numerator and denominator terms**

Four Numerator Arrays						
To	From					
	z	y	h	g	A	S
z	0	4	5	6	1	28
y	4	0	6	5	4	27
h	5	6	0	4	3	13
g	6	5	4	0	2	14
A	1	24	25	6	0	28
S	7	27	7	27	16	0

N 11

To	From					
	z	y	h	g	A	S
z	0	23	3	23	5	10
y	23	0	23	3	25	30
h	3	23	0	23	5	10
g	23	3	23	0	25	30
A	5	26	21	4	0	13
S	10	30	10	30	11	0

N 12

To	From					
	z	y	h	g	A	S
z	0	22	22	2	6	9
y	22	0	2	22	26	29
h	22	2	0	22	26	29
g	2	22	22	0	6	9
A	6	25	24	1	0	14
S	9	29	29	9	12	0

N 21

To	From					
	z	y	h	g	A	S
z	0	1	6	5	4	27
y	1	0	5	6	1	28
h	6	5	0	1	2	14
g	5	6	1	0	3	13
A	4	21	26	5	0	27
S	8	28	28	8	17	0

N 22

**Denominator Array**

To	From					
	z	y	h	g	A	S
z	0	5	4	1	2	14
y	5	0	1	4	3	13
h	4	1	0	5	4	27
g	1	4	5	0	1	28
A	2	2	2	2	0	9
S	13	13	13	13	15	0

D

Note: All numbers refer to results stored in array X.

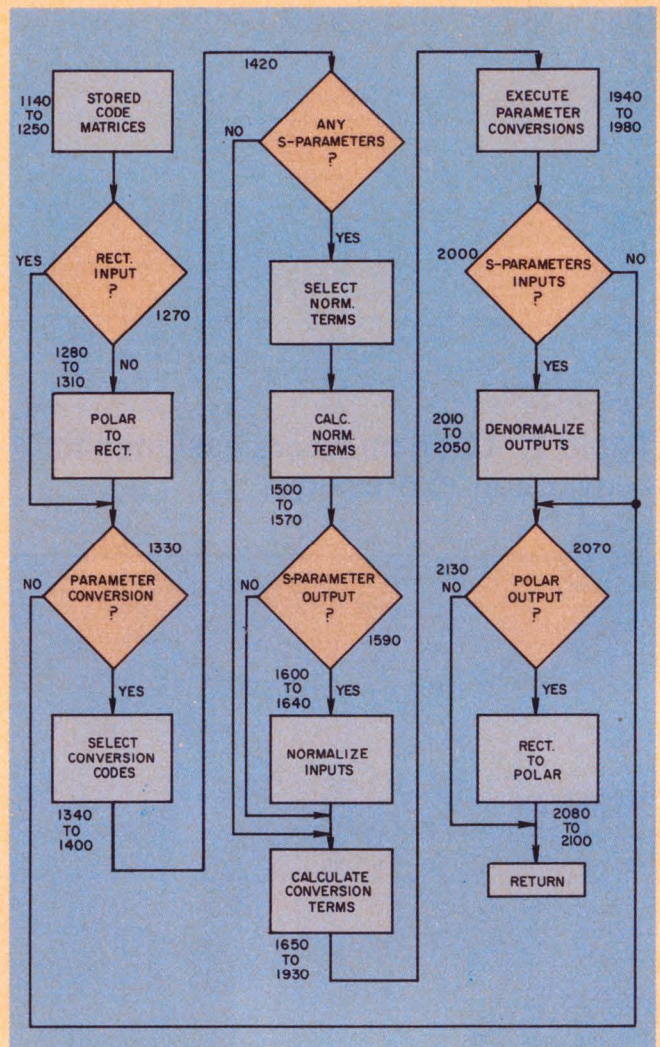

2. The subroutine AZCON performs the conversions with a coding technique that minimizes redundant calculations.

**Table 3. Normalization codes and addresses**

Code No.	Computation	Code No.	Computation
0	None	4	$\sqrt{R01 R02}$
1	1	5	$1/R01$
2	R01	6	$1/R02$
3	R02	7	$1/\sqrt{R01 R02}$

Element	Form of input or output					
	z	y	h	g	A	S
X <sub>11</sub>	5	2	5	2	1	0
X <sub>21</sub>	7	4	1	1	4	0
X <sub>12</sub>	7	4	1	1	7	0
X <sub>22</sub>	6	3	3	6	1	0

NORM

Note: The computations are stored in the one-dimensional array N by code number; the index of code numbers is stored in the array NORM.



saved, the subroutine may be called by any program as follows:

CALL AZCON (R, P, IC, OC, IF, OF, R01, R02)

where

R = Rectangular input/output, a complex 2 × 2 matrix (input in rectangular or polar; output in rectangular).

P = Polar form output, a complex 2 × 2 matrix (optional for OF = 2).

IC = Input Code } 1 = z, 2 = y, 3 = h,  
OC = Output code } 4 = g, 5 = ABCD, 6 = S.

IF = Input form } 1 = Rectangular,  
OF = Output form } 2 = Polar.

# Fortran program for two-port parameter conversion

## Mainline program for data input and control

```

100$NDM
110C***** A18: THIS EXAMPLE PROGRAM CONVERTS Z,Y,H,G,ABCD & S-
120C PARAMETERS INTO ANY OF THE ABOVE PARAMETERS USING THE SUB-
130C ROUTINE "AZCON". INPUT MAY BE IN RECTANGULAR OR POLAR FORM,
140C OUTPUT IS GIVEN IN BOTH FORMS. FOR CONVERSIONS TO/FROM S-
150C PARAMETERS, THE NORMALIZING RESISTANCES (R01 & R02) MUST
160C BE SPECIFIED. *****
170C-----
180 COMPLEX R(2,2),P(2,2)
190 INTEGER IC,OC,IF,OF,V(24)
200C-----VARIABLE LIST MATRIX FOR PRINTOUTS-----
210 DATA V /3HZ11,3HZ21,3HZ12,3HZ22,3HY11,3HY21,3HY12,3HY22,
220 3HH11,3HH21,3HH12,3HH22,3HG11,3HG21,3HG12,3HG22,
230 3H A,3H C,3H B,3H D,3HS11,3HS21,3HS12,3HS22/
240C-----INITIALIZE MATRICES R & P TO ZERO-----
250 DO 1 J=1,2
260 DO 1 I=1,2
270 1 R(I,J)=P(I,J)=(0.,0.)
280C-----START OF MAIN PROGRAM LOOP-----
290 2 CONTINUE
300C-----READ CONVERSION INSTRUCTIONS-----
310 R01=R02=50
320 PRINT," INPUT,OUTPUT (1=Z,2=Y,3=H,4=G,5=ABCD,6=S)",^*
330 READ,IC,OC
340 PRINT," INPUT FORM(1=RECT,2=POLAR)",^*
350 READ,IF
360C-----READ R01 & R02 IF ANY S-PARAMETERS-----
370 IF(IC.EQ.6.OR.OC.EQ.6) PRINT," R01,R02=? (DEFAULT=50)",^*
380 IF(IC.EQ.6.OR.OC.EQ.6) READ,R01,R02
390C-----SELECT CORRECT VARIABLES FOR INPUT HEADING-----
400 II=(IC*4)-3
410 I1=V(II)
420 I2=V(II+1)
430 I3=V(II+2)
440 I4=V(II+3)
450C-----READ INPUT SMALL-SIGNAL PARAMETERS-----
460 PRINT 4,I1,I2,I3,I4
470 4 FORMAT(3X,A3,5X,A3,5X,A3,5X,A3)
480 READ,R
490C-----CALL SUBROUTINE AZCON FOR CONVERSIONS-----
500 CALL AZCON(R,P,IC,OC,IF,2,R01,R02)
510C-----PRINT OUTPUT HEADING-----
520 PRINT 5
530 5 FORMAT(14X,"REAL IMAGINARY",11X,"MAGNITUDE ANGLE")
540C-----SELECT AND PRINT CORRECT OUTPUT VARIABLES-----
550 K=0
560 DO 7 J=1,2
570 DO 7 I=1,2
580 K=K+1
590 IV=(OC*4)-4+K
600 IV=V(IV)
610 PRINT 3,IV,R(I,J),IV,P(I,J)
620 3 FORMAT(3X,A3," = ",G10.4,IX,G10.4,5X,A3," = ",G10.4,IX,G10.4)
630 7 CONTINUE
640 PRINT 9
650 9 FORMAT(/,60(1H-),/)
660 GO TO 2
670C-----
680 END

```

## Subroutine for circuit parameter conversion

```

AZCON
1000C*****SUBROUTINE FOR CONVERSION OF Z,Y,H,G,ABCD & S-PARAMETERS*****
1010C R=INPUT/OUTPUT COMPLEX MATRIX
1020C (INPUT IN RECTANGULAR OR POLAR; OUTPUT IN RECT.)
1030C P=POLAR FORM OUTPUT MATRIX (OPTIONAL FOR OF=2)
1040C IC=INPUT CODE; OC=OUTPUT CODE(1=Z,2=Y,3=H,4=G,5=ABCD,6=S)
1050C IF=INPUT FORM; OF=OUTPUT FORM (1=RECT,2=POLAR)
1060C R01 & R02 MUST BE SPECIFIED FOR S-PARAMETER NORMALIZATION
1070C-----
1080 SUBROUTINE AZCON(R,P,IC,OC,IF,OF,R01,R02)
1090 EXTERNAL RECT,POLAR
1100 COMPLEX R(2,2),P(2,2),X(30),DET,RECT,POLAR
1110 INTEGER N11(36),N21(36),N12(36),N22(36),D(36),NORM(24)
1120 INTEGER IC,OC,IF,OF,N1,N2,N3,N4,DD,NM1,NM2,NM3,NM4
1130 REAL N(7)
1140C-----CONVERSION & NORMALIZATION CODE MATRICES-----
1150 DATA N11 /0,4,5,6,1,28,4,0,6,5,4,27,5,6,0,4,3,1,3,
1160 6,5,4,0,2,14,1,24,25,6,0,28,7,27,7,27,16,0/
1170 DATA N21 /0,22,22,2,6,9,22,0,2,22,26,29,22,2,0,22,26,29,
1180 2,22,0,6,9,6,25,24,1,0,14,9,29,29,9,12,0/
1190 DATA N12 /0,23,3,23,5,10,23,0,23,3,25,30,3,23,0,2,3,5,10,
1200 2,3,23,0,25,30,5,26,21,4,0,13,10,30,10,30,11,0/
1210 DATA N22 /0,1,6,5,4,27,1,0,5,6,1,28,6,5,0,1,2,14,
1220 8,5,6,1,0,3,13,4,21,26,5,0,27,8,28,28,8,17,0/
1230 DATA D /0,5,4,1,2,14,5,0,1,4,3,13,4,1,0,5,4,27,
1240 1,4,5,0,1,28,2,2,2,2,0,9,1,3,13,1,3,15,0/
1250 DATA NORM /5,2,5,2,1,0,7,4,1,1,4,0,7,4,1,1,7,0,6,3,3,6,1,0/
1260C-----CHECK FOR RECTANGULAR INPUT-----
1270 IF(IF.EQ.1) GO TO 1
1280C-----CONVERT INPUT POLAR TO RECTANGULAR-----
1290 DO 2 I=1,2
1300 DO 2 J=1,2
1310 2 R(I,J)=RECT(R(I,J))
1320C-----CHECK FOR PARAMETER CONVERSION-----
1330 1 IF(IC.EQ.OC) GO TO 3
1340C-----SELECT APPROPRIATE CONVERSION CODES-----
1350 K=(OC*6)-6+IC
1360 N1=N11(K)
1370 N2=N21(K)
1380 N3=N12(K)
1390 N4=N22(K)
1400 DD=D(K)
1410C-----CHECK FOR ANY S-PARAMETERS-----
1420 IF(IC.NE.6.AND.OC.NE.6) GO TO 4
1430C-----SELECT APPROPRIATE NORMALIZATION CODES-----
1440 IF(IC.EQ.6) IK=OC
1450 IF(OC.EQ.6) IK=IC
1460 NM1=NORM(IK)
1470 NM2=NORM(IK+6)
1480 NM3=NORM(IK+12)
1490 NM4=NORM(IK+18)
1500C-----CALCULATE NORMALIZATION TERMS-----
1510 N(1)=1
1520 N(2)=R01
1530 N(3)=R02
1540 N(4)=SQRT(R01*R02)
1550 N(5)=1/R01
1560 N(6)=1/R02
1570 N(7)=1/N(4)
1580C-----CHECK FOR S-PARAMETER OUTPUT-----
1590 IF(OC.NE.6) GO TO 4
1600C-----NORMALIZE INPUTS-----
1610 R(1,1)=R(1,1)*N(NM1)
1620 R(2,1)=R(2,1)*N(NM2)
1630 R(1,2)=R(1,2)*N(NM3)
1640 R(2,2)=R(2,2)*N(NM4)
1650C-----CALCULATE CONVERSION TERMS-----
1660 4 DET=R(1,1)*R(2,2)-R(2,1)*R(1,2)
1670 X(1)=R(1,1)
1680 X(2)=R(2,1)
1690 X(3)=R(1,2)
1700 X(4)=R(2,2)
1710 X(5)=DET
1720 X(6)=(1.,0.)
1730 X(7)=DET*X(1)-X(4)-X(6)
1740 X(8)=DET-X(1)+X(4)-X(6)
1750 X(9)=2*X(2)
1760 X(10)=2*X(3)
1770 X(11)=2*DET
1780 X(12)=2*X(6)
1790 X(13)=DET+X(1)+X(4)+X(6)
1800 X(14)=DET-X(1)-X(4)+X(6)
1810 X(15)=X(1)+X(3)+X(2)+X(4)
1820 X(16)=X(1)+X(3)-X(2)-X(4)
1830 X(17)=-X(1)+X(3)-X(2)+X(4)
1840 X(21)=-X(1)
1850 X(22)=-X(2)
1860 X(23)=-X(3)

```



# For digital printers

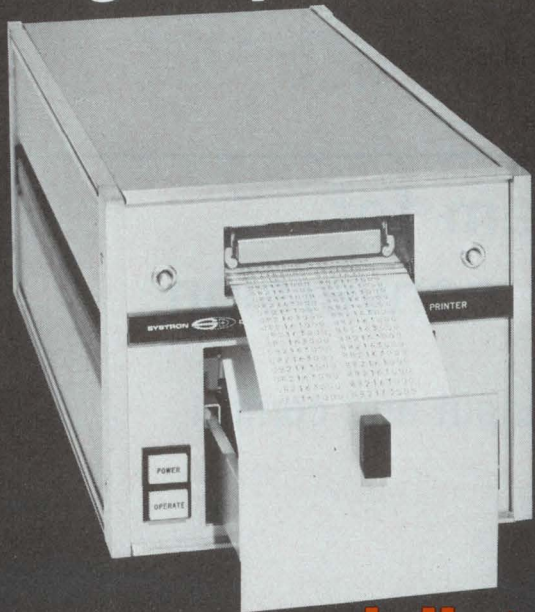

## see a specialist

Systron-Donner can supply you with medium-speed digital printers that precisely match your requirements—for either instrumentation or systems use. Standard features include:

- up to 21 column printout
- 16 characters/column
- any input can print in any column
- programmable zero suppression
- 2 color printing with ink impression paper
- automatic out-of-paper sensor.

In addition to these standard features, S-D's Model 5103 (shown) accepts either positive or negative logic, inputs from 2 data sources, and can be field-expanded with plug-in column boards. Options include different BCD input codes, direct printout of measurement units, floating decimal point, digital clock, third data source input.

S-D's Model 5103B is well-suited for automatic data systems or general lab use. Data storage, IC compatible inputs, grounded or floating input circuits are standard in addition to the features listed above.

Prices? Competitive. For immediate details, contact your Scientific Devices office or Systron-Donner at 1 Systron Drive, Concord, CA 94518. Phone (415) 676-5000.



```

1870 X(24)=-X(4)
1880 X(25)=-X(5)
1890 X(26)=-X(6)
1900 X(27)=-X(7)
1910 X(28)=-X(8)
1920 X(29)=-X(9)
1930 X(30)=-X(10)
1940C-----EXECUTE PARAMETER CONVERSIONS-----
1950 R(1,1)=X(N1)/X(DD)
1960 R(2,1)=X(N2)/X(DD)
1970 R(1,2)=X(N3)/X(DD)
1980 R(2,2)=X(N4)/X(DD)
1990C-----CHECK FOR S-PARAMETER INPUT-----
2000 IF(IC,NE,6) GO TO 3
2010C-----DENORMALIZE OUTPUTS-----
2020 R(1,1)=R(1,1)/N(NM1)
2030 R(2,1)=R(2,1)/N(NM2)
2040 R(1,2)=R(1,2)/N(NM3)
2050 R(2,2)=R(2,2)/N(NM4)
2060C-----CHECK FOR POLAR OUTPUT-----
2070 3 IF(OF,EQ,1) GO TO 999
2080C-----CONVERT OUTPUT RECT. TO POLAR-----
2090 DO 5 I=1,2
2100 DO 5 J=1,2
2110 5 P(I,J)=POLAR(R(I,J))
2120C-----
2130 999 CONTINUE
2140 RETURN
2150 END
2160C*****

```

## Auxiliary subroutines for coordinate conversion

RECT

```

1000C*****
10010 COMPLEX FUNCTION RECT(Z)
10020 COMPLEX J,Z
10030 J=(0.0,1.0)
10040 R=Z
10050 A=AIMAG(Z)
10060 A=FPI(A)/180
10070 RECT=R*(COS(A)+J*SIN(A))
10080 RETURN
10090 END
10100C*****

```

POLAR

```

2000C*****
20010 COMPLEX FUNCTION POLAR(Z)
20020 COMPLEX J,Z
20030 J=(0.0,1.0)
20040 R=CABS(Z)
20050 A=AIMAG(Z)
20060 B=REAL(Z)
20070 C=(0.+0.)
20080 IF(A.EQ.0.AND.B.EQ.0) GO TO 1
20090 C=ATAN2(A,B)
20100 C=C+180/FPI(1.)
20110 ICONTINUE
20120 POLAR=R+J*C
20130 RETURN
20140 END
20150C*****

```

R01 = Input } Impedance-level normaliza-  
R02 = Output } tion/denormalization (re-  
required for S-parameters  
only).

The organization of AZCON is such that very little computation occurs if the user specifies that both input and output are the same two-port parameters (Fig. 2). Otherwise the program performs normalization, computes elements of array X, then performs four computations of the type shown in Eq. 2. The remainder of the calculations involve normalization and polar conversion. The mainline sets the variable OF to a value of two, so the polar-form output is provided. Both rectangular and polar forms of the output are displayed simultaneously. But the user can choose to have the value for OF set to one (rectangular) or two (polar) as needed. ■■



# Wherever you are Staco Switches Make Things Happen

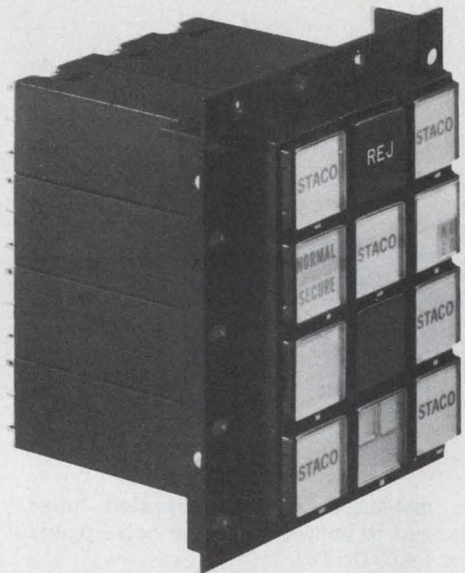
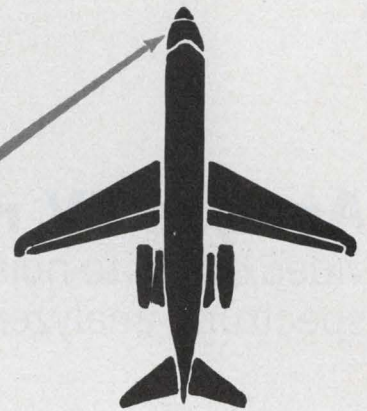

**Flexible**—Jet plane or rapid transit train... Staco switches make things happen when they should. Mount in matrix array or individual switch stations. Four-lamp or single lamp illuminated colorful message panels that really communicate. Choice of circuitry, switch action, and legend style to meet your particular needs.

**Durable**—Design qualifications, premium grade materials, precious metal contact alloys make for reliable, trouble-free operation. Careful workmanship and thorough testing assure highest quality switches every time.

**Available**—Realistic delivery schedules you can depend on will help you to meet your production schedule. Check the total cost... purchase, installation, and maintenance... and you'll find it costs nothing extra to order the very finest.

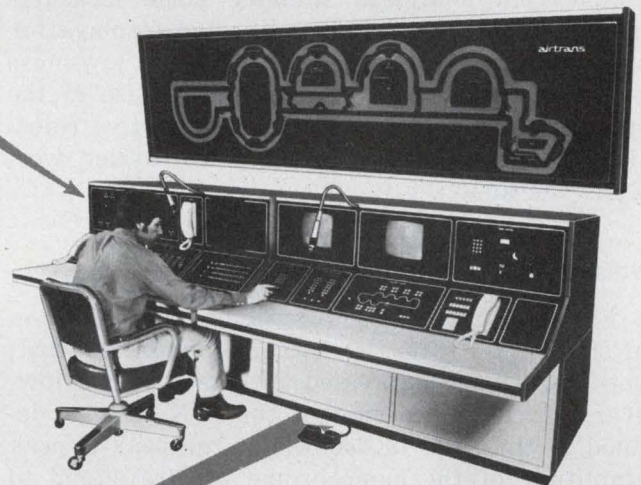

**Get full details**—Write today for free general catalog giving complete specifications along with a handy Product Selection Guide.

When you think switch...  
think STACOSWITCH

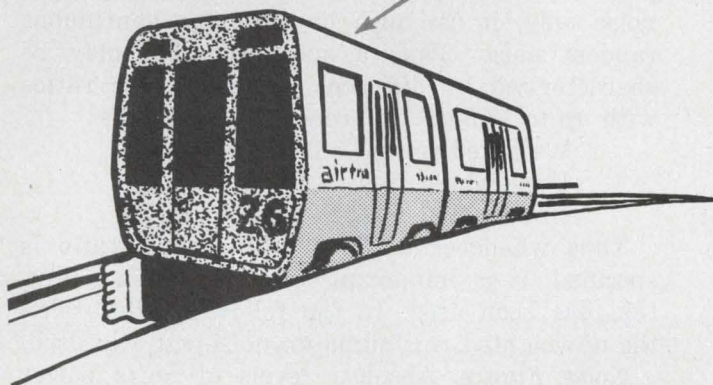

**STACOSWITCH**  
a STACO, INC. company

1139 BAKER STREET, COSTA MESA, CALIF. 92626  
(714) 549-3041 TWX: 910/595-1507

Other STACO Company products: Fixed Ratio Transformers, STACO, INCORPORATED, Richmond, Indiana; Variable Transformers, STACO, INCORPORATED, Dayton, Ohio.



## Analyze TV noise performance by correlating video signal-to-noise ratio with rf noise figure. Then use a spectrum analyzer to perform the measurements.

Noise in TV systems, a source of irritation to the viewer, can be analyzed rapidly by correlation of the signal-to-noise (S/N) ratio in video circuits and the noise figure for rf devices. Rf signal level, modulation degree and detector performance are just a few of the parameters involved in developing the key correlation equation. Calculations using this correlation equation closely match results measured with video noise level meters or spectrum analyzers.

Spectrum analyzers simplify noise measurements, since they include calibrated displays for sync and noise readings. A wideband low-noise preamp is included if the inherent noise of the spectrum analyzer is too high; a selective rejection filter can be added if the video carrier overloads the analyzer.

### Noise terms can be misleading

For most transmission systems, the definition of the S/N ratio is rather straightforward; both terms are expressed in rms values. However, for TV video signals, the S/N ratio is defined as the ratio in decibels of the peak-to-peak amplitude of the monochrome picture signal to the rms amplitude of the noise (within the range of 10 kHz to the nominal upper limit of the video frequency band,  $f_c$ ).

For monochrome TV, the noise band may be shaped by a weighting filter that attenuates the high end of the video band. The theoretical weighting (dB) for "white noise" is 8.5 dB for TV systems B, D, G and H, 6.1 dB for system M and 6.5 dB for system I.<sup>1</sup> TV system M is used in North America, South America and Japan; system I in England, and systems B, D, G and H in continental Europe.

The S/N ratio is a critical factor for modulators, converters and amplifiers designed for monochrome and color TV systems. However, the prescribed weighting filter is not suited for color TV, because the chroma information (being in

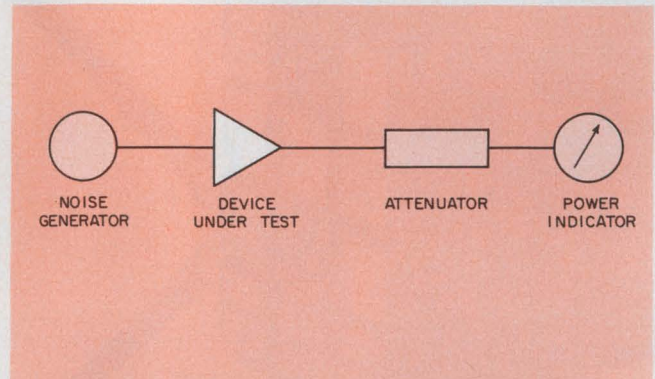

1. Noise figure is measured with a calibrated noise generator (NG), adjusted to deliver the same noise power as the device under test (DUT).

the attenuated region) is also sensitive to noise.

Several solutions to this problem have been proposed, but an international standard has not yet been established. In the meantime it has become practice to use just the unweighted S/N ratio. It is generally conceded that 40-dB rms unweighted S/N produces visible impairment on a TV screen, and that better than 60-dB S/N is required for test measurements.

**Periodic and impulsive noise** is often defined as S/N, except that the noise level is expressed in peak-to-peak value rather than rms. This is called for in CCIR (International Radio Consultative Committee) Rec. 421-2. For example, a single-frequency noise (sine wave) peak-to-peak value is  $2\sqrt{2}$  times ( $\sim 9$  dB) lower than the rms value. Although the CCIR recommendation restricts the peak-to-peak term to periodic and impulsive noise only, it can also be used for continuous random noise. Thus a specific device may be characterized by different signal-to-noise ratios with up to 17.5-dB difference. For example:

Weighted rms = 58.5 dB,

Unweighted rms = 50 dB,

Unweighted peak-to-peak = 41 dB.

Thus whenever a TV signal-to-noise ratio is specified, it is important to state which definition has been used. In the following discussion the unweighted rms signal-to-noise ratio is used.

**Noise Figure.** Absolute levels of noise power

Jens Simonsen, Development Group Leader, Professional TV Equipment, Philips Radio, Copenhagen, Denmark



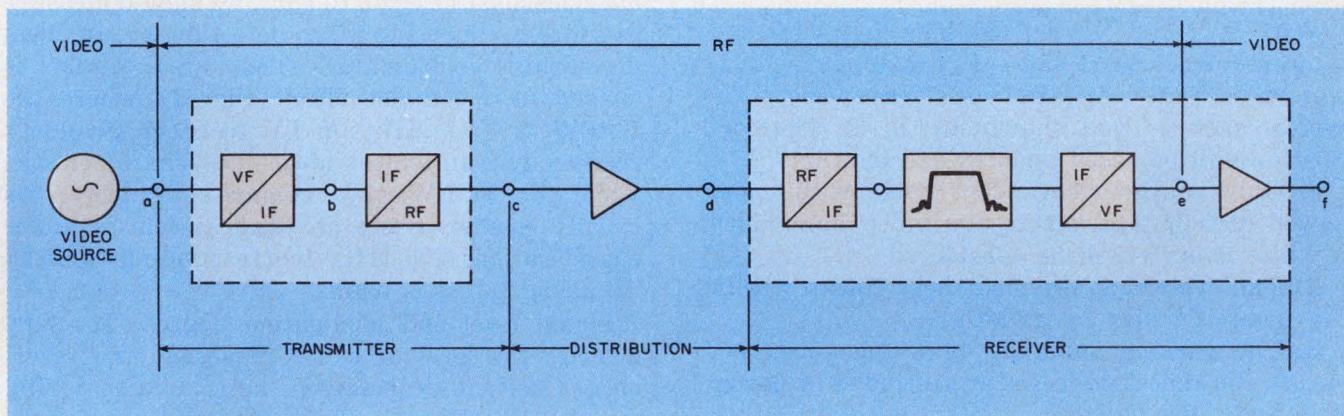

2. In a typical TV system, noise figure is used to characterize performance in the rf section while S/N is used

in the video section. But rf noise figures can be transformed to equivalent video S/N ratios.

are usually specified in terms of thermal noise:

$$P_N = kTB, \quad (1)$$

where  $P_N$  = Noise power in watts,

$k$  = Boltzman's constant ( $1.38 \cdot 10^{-23}$  Joule/K),

$T$  = Temperature in degree Kelvin,

$B$  = Noise power bandwidth (NPBW) in Hz.

Noise Figure (NF) is a figure of merit relating the actual noise power of a device (referenced to its input terminals) to an equivalent ideal device when the input termination is at the standard reference temperature  $T_0$  (290 K). If the noise power available at the output of an amplifier is called  $P_N$  and the power gain  $G$ ,

$$NF = \frac{P_N}{kT_0 B G} \quad (2)$$

and, in dB

$$F = 10 \log NF. \quad (3)$$

Expressed in dBm,  $kT_0$  is equal to  $-174$  dBm/Hz.

When noise is considered in terms of power only and correct matching is assumed, the characteristic impedance is not involved in the equations. However, since TV signals are often given in voltage, dBmV or dB $\mu$ V, it is useful to know that

$$0 \text{ dBm} \cong 47 \text{ dBmV} = 107 \text{ dB}\mu\text{V at } 50 \Omega, \quad (4)$$

$$\text{and } 0 \text{ dBm} = 49 \text{ dBmV} = 109 \text{ dB}\mu\text{V at } 75 \Omega. \quad (5)$$

Calculations become simple if dBm and dB terms

are used exclusively.

Suppose we want to determine the noise output power of an amplifier with

$$F = 14 \text{ dB},$$

$$G = 30 \text{ dB},$$

$$(\text{NPBW}) = 1 \text{ MHz}.$$

NPBW is  $10^6$  times 1 Hz, or  $10 \log 10^6 = 60$  dB. Thus  $P_N = -174 + 14 + 30 + 60 = -70$  dBm.

When two amplifiers are cascaded, the total noise figure is

$$NF_T = NF_1 + \frac{NF_2 - 1}{G_1}. \quad (6)$$

The gain may be greater or less than unity when passive components, lossy cable, attenuators or mixers are included. The noise figure of an attenuator is considered to be equal to its power damping factor. For instance, a 6-dB attenuator has  $G = 0.25$  and  $NF = 4$ .

### Measure noise figure simply and reliably

The noise figure is usually measured with a calibrated noise generator, adjusted to deliver the same noise power as the device under test. At this point, the output noise power is doubled (a 3-dB increase).

First, the relative noise  $P_N$  is noted with the noise generator switched off (Fig. 1). Next, 3-dB attenuation is added, and the generator is



adjusted until the output is at its original level  $P_N$ . Noise figure can now be read directly from the scale of the noise generator. The measurement is simple and reliable.

Note that gain and bandwidth need not be known and that the power meter is used only as a reference indicator. The frequency range of the noise generator and the power indicator must exceed that of the device under test (DUT). The noise figure can also be measured by other instruments, such as a spectrum analyzer.

### Correlating S/N and noise figure

With S/N and NF defined, let's find a method to transform any rf noise figure to an equivalent video S/N ratio, and vice versa, for a TV system such as that shown in Fig. 2. The correlation will be based upon these conditions:

1. Only continuous random noise with equal power distribution within the video bandwidth ("white noise") will be considered.
2. The system is assumed to be linear within the nominal video bandwidth.
3. The various units are impedance-matched, or else the reflection losses are included in power gain and noise figure.

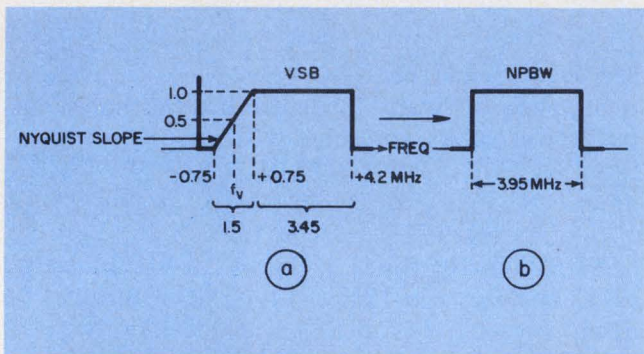

3. The vestigial sideband (VSB) signal (a) is shaped by a Nyquist filter. The equivalent noise-power-bandwidth (NPBW) is shown (b).

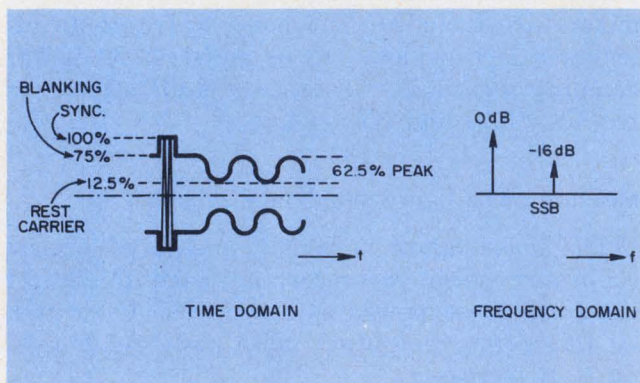

4. The active video information level of a TV rf signal is 62.5% of the total peak-to-peak composite signal, or 16 dB below the carrier.

In practice, these conditions are not critical, since slight deviations will have negligible influence on the result. The derivation is based upon the TV system used in the U.S., system M. Other systems give slightly different figures, as shown in Tables 1 and 2.

Several parameters are involved in the correlation analysis. For example: NPBW due to vestigial sideband (VSB) shaping, rf signal level, modulation degree and detector performance. Let's consider each.

**Noise-power-bandwidth (NPBW) and VSB filter shape.** The signal-to-noise ratio at rf frequencies must be equal to what we should measure at video frequencies after detection by an ideal measuring demodulator. The VSB signal is shaped in a Nyquist filter (Fig. 3) where the NPBW is 3.95 MHz. A TV test (or Nyquist) receiver has an almost ideal filter characteristic, while the NPBW of a commercial receiver is usually smaller. Since an ideal system is under consideration, 3.95 MHz (corresponding to 65.97 dB above 1 Hz) is used.

**Signal level and modulation degree.** To characterize the level of a TV rf signal, the reference is normally considered the rms value during sync peaks (Fig. 4). The active video information is only 62.5% when the rest-carrier and sync are subtracted. This corresponds to a sideband that is 16 dB below the sync level. The noise is measured relative to -16 dB, which represents the video information at maximum modulation. According to the CCIR recommendation, the S/N figure should include an artificial reference that is 9 dB higher, because of the ratio of  $2\sqrt{2}$  between the rms and the peak-to-peak value of the signal information.

**Detector performance.** Although a linear system is assumed, obviously the diode detector produces nonlinear distortion of video signals. However, the noise level is generally small compared with the vision carrier, and thus there is no need for a detector correction factor.

### Deriving the correlation formula

Let's consider the various elements of the video signal and the noise signal. Fig. 5 displays a graphic representation of the noise and signal composition. Signal and noise must be referenced to the same terminals—in the case of a two-port arrangement, either to the input or to the output. S/N and sync peak level are usually referenced to output, whereas noise figure is referenced to input; so to combine them we must use the power gain factor "G." The thermal noise reference ( $1kT_0 = 174$  dBm) and the various system conditional factors can be merged to a common correctional figure "C," and for a two-port arrangement we get:



$$S/N \text{ (dB)} = P_s \text{ (dBm)} - G \text{ (dB)} - F \text{ (dB)} + C \text{ (dB)} \quad (7)$$

For system M (used in the U.S.), "C" is equal to 100.9 dB, and, as shown in Table 1, it is approximately 100 dB for all TV systems. Thus we can use the approximate expression:

$$S/N_{\text{(dB)}} \approx P_{s\text{(dBm)}} - G_{\text{(dB)}} + F_{\text{(dB)}} + 100. \quad (8)$$

This rule of thumb is easy to remember, and the rounding off of the "C" figure is suitable for TV systems B, D, G, H, I and M with a maximum error of 1.1 dB.

The correction factor C is composed of  $k_0$ ,  $k_1$  and  $k_2$ . For TV system M:

$k_0$  = Thermal noise reference at 220 K expressed in dBm,

$$k_0 = 10 \log (1.38 \times 10^{-23} \times 290 \times 10^3) = -173.977 \text{ dBm},$$

$k_1$  = Signal level and modulation degree.

The rms voltage of one sideband relative to rms voltage during sync peak is

$$\frac{V_{sb}}{V_s} = \frac{0.625}{2\sqrt{2}} \frac{1}{\sqrt{2}} = \frac{0.625}{4} = 0.15625,$$

$$20 \log 0.15625 = 16.124 \text{ dB} (\sim 16 \text{ dB}).$$

The reference level of video S/N is  $2\sqrt{2}$  times higher.

Thus:

$$k_1 = 20 \log \left( \frac{0.625}{\sqrt{2}} \right) = 7.093 \text{ dB},$$

$$k_2 = \text{NPBW of Nyquist filter.}$$

$$\text{In general, NPBW} = \frac{1}{2\pi} \int_{\omega=0}^{\omega=\infty} |A(\omega)|^2 d\omega,$$

where  $A(\omega)$  is the amplitude transfer function, (Fig. 3a),

$$\begin{aligned} \text{NPBW} &= \int_0^{1.5 \text{ MHz}} f^2 df + \int_0^{3.45 \text{ MHz}} 1 df \\ &= 1.5 \times \frac{1}{3} + 3.45 = 3.95 \text{ MHz}, \end{aligned}$$

**Table 1. Correction factors for worldwide TV systems**

TV system	White-level† (%)	Blanking-level† (%)	Sideband (%)	(dB)	K1 (dB)	VSB† (MHz)	F(C)† (MHz)	NPBW (MHz)	K2 (dB)	Correction (dB)
B.G	10 (10-12.5)	75 (72.5-77.5)	65.0	-15.783	-6.752	.75	5.0	4.750	66.767	C = 100.4583
D	10 (10-12.5)	75 (72.5-77.5)	65.0	-15.783	-6.752	.75	6.0	5.750	67.597	C = 99.6285
I	20	76	56.0	-17.077	-8.047	1.25	5.5	5.083	67.061	C = 98.8692
I*	20	76	56.0	-17.077	-8.047	1.25	5.0*	4.583	66.612	C = 99.3189
M	12.5 (10-15)	75 (72.5-77.5)	62.5	-16.124	-7.093	.75	4.2	3.950	65.966	C = 100.9186

\* Luminance BW = 5 MHz for S/N measurement for System I acc. to CCIR Rec. 451-1

† Data from CCIR rep. 308-2

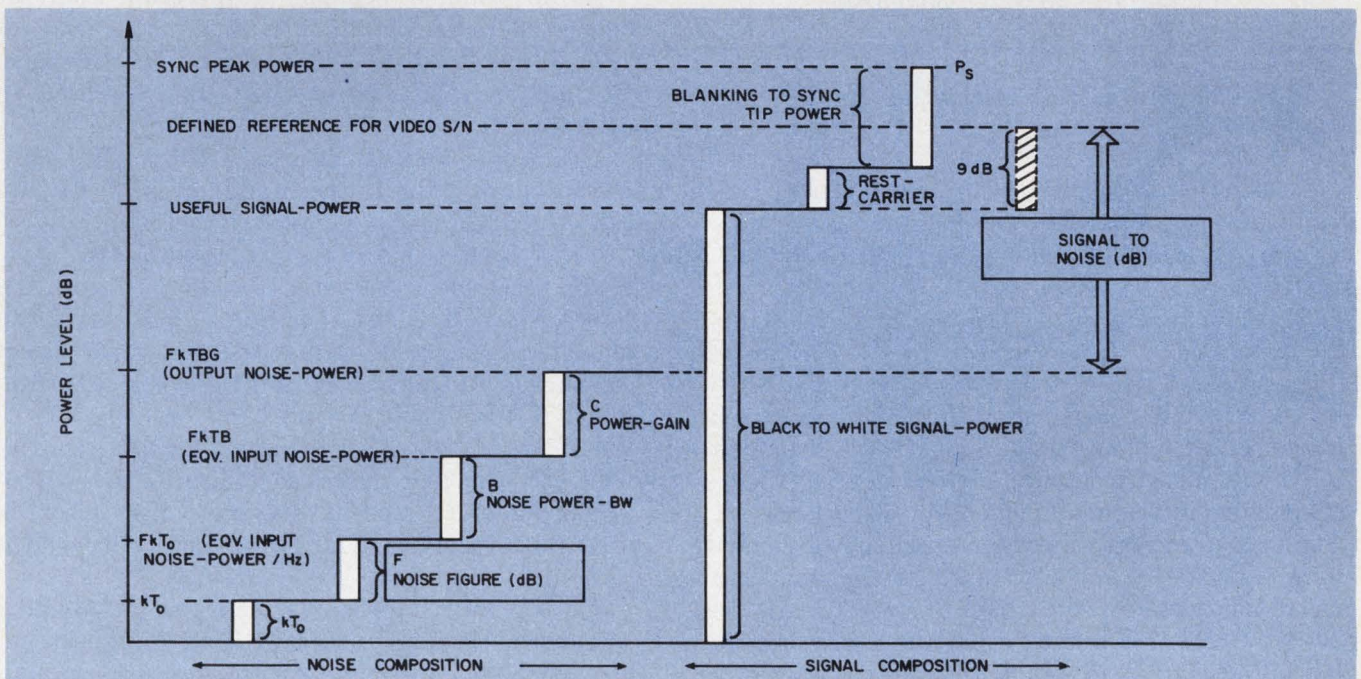

**5. Graphic representation of noise and signal components identifies each element's contribution to the total level.**



$$k_2 = 10 \times \log (3.95 \times 10^6) = 65.966 \text{ dB},$$

$$C = k_1 - k_0 - k_2 = 7.093 + 173.977 - 65.966$$

$$= 100.918 \text{ dB}.$$

Here is an example to illustrate the correlation. A distribution amplifier with 14-dB power gain and 12-dB noise figure has an rms sync peak output of 100 dB $\mu$ V into 75  $\Omega$ . What is the equivalent signal-to-noise ratio?

$$\text{(From Eq. 5)} \quad P_s = 100 - 109 = -9 \text{ dBm}.$$

$$\text{(Using Eq. 8)} \quad S/N \cong -9 - 14 - 12 + 100$$

$$= 65 \text{ dB}.$$

If the  $P_s$  and  $F$  terms are referenced to the same port, "G" in Eq. 7 and 8 must be omitted.

As another example, assume the output signal from a TV converter is 100 mV into 50  $\Omega$  with  $S/N = 60$  dB. The signal is distributed via a lossy coaxial cable to a receiver having an input noise figure of 14 dB (Fig. 6). How much cable attenuation can be tolerated when the signal-to-noise ratio must be 50 dB?

First, calculate noise from the converter:

$$\text{(From Eq. 8)} \quad F_1 = P_1 - S/N_1 + 100 = -7$$

$$-60 + 100 = 33 \text{ dB} \sim 2000 \text{ kT}_0.$$

Next, the noise figure at point a:

$$NF_a = NF_1 + \frac{1}{G}.$$

The system noise figure is found next:

$$\text{(Using Eq. 8)} \quad F_T = -7 - 50 + 100$$

$$= 43 \text{ dB} \sim 20,000 \text{ kT}_0.$$

$$\text{(Using Eq. 6)} \quad NF_T = NF_a + \frac{NF_3 - 1}{G}$$

$$20,000 = 2000 + \frac{1}{G} + \frac{25 - 1}{G}$$

$$G = \frac{25}{20,000 - 2000} = \frac{1}{720} \sim -28.6 \text{ dB}.$$

With 28.6-dB cable loss, the signal level at point b will be:

$$P_b = -7 - 28.6 = -35.6 \text{ dBm},$$

and (using Eq. 4)  $V_b = -35.6 + 47 = 11.4$  dBmV = 3.7 mV.

Proceeding to a trial calculation for S/N:

$$\text{(From Eq. 6)} \quad NF_a = 720 + \frac{25 - 1}{1/720} = 18,000 \text{ kT}_0.$$

$$NF_T = 18,000 + 2000 = 20,000 \text{ kT}_0$$

$$\sim 43 \text{ dB}$$

$$\text{(Eq. 8)} \quad S/N = 35.6 - (-28.6) - 43 + 100$$

$$= 50 \text{ dB}$$

Experiments have verified the validity of Eq. 7. In a system like that of Fig. 2, calibrated "white noise" was added to test points a to f. By means of a noise generator, the noise figure was measured at various points, and, after detection, S/N was measured with a video signal-to-noise measuring instrument (video noise level meter). The measured results were in excellent agreement with calculations made with Eq. 7 for small signal-to-noise ratios (deviation of only 0.5 dB for 30 dB S/N). At higher S/N, the error became larger (up to 2 dB at SN = 60 dB) due to inherent noise in the test setup. After corrections

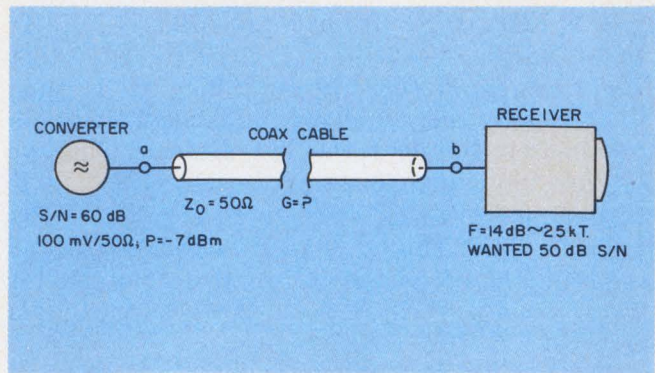

6. The acceptable cable attenuation may be found once the converter and receiver noise are calculated.

(using Eq. 6), it was shown that the correlation formula (Eq. 7) could be used to the sensitivity limit of the measuring instruments. The experiments also indicated that a spectrum analyzer could be used for noise measurement with almost the same accuracy as a standard noise generator and a video noise level meter.

### Spectrum analyzers for S/N tests

Spectrum analyzers (SPA), widely used for measurement of spurious and intermodulation signals, can also be used for noise measurements. Since modern spectrum analyzers are calibrated in dBm, the sync level,  $P_s$ , can be read directly from the screen, and noise power,  $P_N$ , can be found from a simple calculation. The measurement technique has been described<sup>2</sup> with the necessary correction factors for spectrum-analyzer detector performance, logarithmic shaping and NPWB vs i-f, 3 dB BW. For a 3-dB of 10 kHz, these factors are calculated as  $k_3 = 38.3$  dB.

As an example, consider a spectrum analyzer connected to an amplifier with a noise level of -70 dBm measured in a 10-kHz i-f bandwidth. To find the noise power per Hz expressed in dBm:

$$-70 \text{ dBm} - 38.3 \text{ dB} (k_3) = -108.3 \text{ dBm/Hz}.$$

If the power gain of the amplifier is 20 dB, we can calculate the noise figure as before:

$$F = 174 - 108.3 - 20 = 45.7 \text{ dB}.$$

If the spectrum analyzer is always used with the same i-f bandwidth position, the correction figures can easily be included in Eq. 7 for direct calculation of S/N. For 10-kHz i-f bandwidth, the S/N for system M is:

$$S/N_{\text{dB}} = P_{S(\text{dBm})} - P_{N(\text{dBm})} - 34.8 \text{ (dB)} \quad (9)$$

when  $P_N$  is the indicated noise level in 10-kHz bandwidth and a 100-Hz video filter is used for averaging. The figure may be rounded to 35 dB.

The constant in Eq. 9 is derived as follows: The measurement is made with an HP spectrum analyzer. We must add 2.5 dB for log shaping and detector performance. The NPBW is 1.2



## Table 2. Constants for S/N spectrum-analyzer measurements

TV System	K3 (dB)	C2 (dB)	Video NPBW (MHz)	K4 (dB)	V(REF) (V)	K5 (dBm)	C3 (dB)
B-G	-38.3	35.219	5.0	66.990	.700	8.151	20.538
D	-38.3	36.049	6.0	67.782	.700	8.151	21.330
I	-38.3	36.808	5.5	67.404	.700	8.151	20.952
I*	-38.3	36.358	5.0*	66.990	.700	8.151	20.538
M	-38.3	34.759	4.2	66.232	.714	8.323	19.609

\*) Luminance BW = 5 MHz for S/N measurements for System I acc. to CCIR Rec. 451-1

times the 3-dB i-f bandwidth.

$$k_3 = 2.5 \text{ dB} + 10 \log \left( \frac{1 \text{ Hz}}{1.2 \times \text{BW}_{3\text{dB}}} \right).$$

Therefore  $P_N$  measured in 10-kHz i-f bandwidth converted into 1-Hz bandwidth is:

$$k_3 = 2.5 \text{ dB} + 10 \log \left( \frac{1}{10^4 \times 1.2} \right) = -38.3 \text{ dB}$$

$$C_2 = k_2 + k_3 - k_1 \\ = 65.966 - 38.3 + 7.093 = 34.759 \text{ dB.}$$

Now let  $P_s$  be +5 dBm. Then  $\text{SN} = +5 - (-70) - 35 = 40 \text{ dB}$ .

With high S/N ratios, the inherent noise of the spectrum analyzer may be too large, but a wideband low-noise preamplifier can be used to improve the sensitivity. Another problem often met is overloading of the spectrum analyzer input caused by the video carrier. For linear devices, the carrier can simply be switched off during measurement of  $P_N$ . This method is not applicable to nonlinear devices because the noise level may change when the carrier is removed. In this case a rejection filter tuned to the carrier frequency can be used before the spectrum analyzer to prevent overloading (Fig. 7).

If resistive pads are used to match a 75- $\Omega$  system to a 50- $\Omega$  spectrum analyzer, the power damping factor must be included. Power attenuation is different from voltage damping; power damping = 5.7 dB for 75  $\Omega$  to 50  $\Omega$  minimum loss-pad.<sup>3</sup> However, it is generally unneces-

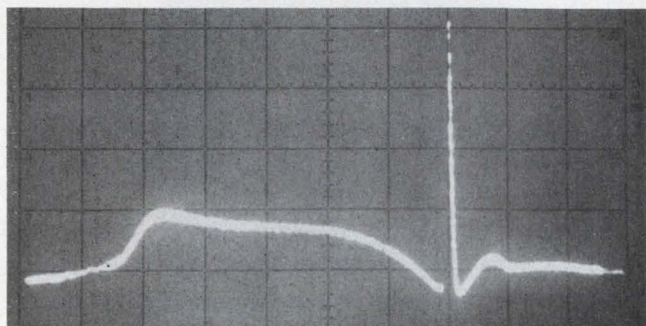

7. A notch filter attenuates the video carrier to avoid spectrum-analyzer overload during noise measurement.

sary to use such matching pads during the measurement of noise level, since a VSWR of 1.5 (50  $\Omega$  to 75  $\Omega$ ) produces only a power reflection loss of 4% (-0.18 dB). The 5.7-dB higher sensitivity in the unmatched case is often preferred and justifies the 0.18-dB error.

It is also interesting to note that the spectrum analyzer can be used for direct S/N measurements of video signals. Here we obtain another correction figure, because the VSB filter and the modulation degree are not involved. In addition the monochrome signal is assumed to be the standard level of 0.714  $V_{pp}$  at 75  $\Omega$ . So the reference level is 0.714 V rms = +8.3 dBm. If we again standardize on 10-kHz i-f bandwidth for the spectrum analyzer during measurement of  $P_N$ , the equation for system M (4.2 MHz NPBW) becomes

$$S/N_{(\text{dB})} = -P_{N(\text{dBm})} - 19.6_{(\text{dB})}. \quad (10)$$

Again, a rounding to -20 dB is appropriate.

The constant for Eq. 10 is derived as follows:

NPBW = 4.2 MHz,

$$k_4 = 10 \times \log (4.2 \times 10^6) \simeq 66.2 \text{ dB,}$$

Video S/N reference = 0.714 V rms in 75,

$$P_r = \frac{.714^2}{75} \times 1000 = 6.797 \text{ mW,}$$

$$k_5 = 10 \log 6.797 = 8.3 \text{ dBm,}$$

$$C_3 = k_3 + k_4 - k_5,$$

$$C_3 = -38.3 + 66.2 - 8.3 = 19.6 \text{ dB.}$$

In Table 2 the correction figures for Eqs. 9 and 10 are shown for other TV systems.

As a final example: From a video amplifier with nominal black/white level = 0.714  $V_{pp}$ , we read  $P_N = -65 \text{ dBm}$  in 10-kHz BW from a spectrum analyzer. What is the rms unweighted S/N?

$$S/N = -(-65) - 20 = 45 \text{ dB.} \quad \blacksquare$$

### References

1. C.C.I.R. 12th Plenary Assembly, New Delhi, 1970, Vol. 5, Part 2. Broadcasting Service (Television) International Telecommunication Union, Geneva, 1970.
2. "Measure Oscillator Spectral Purity with a Spectrum Analyzer," *Microwave Journal*, Vol. 16, No. 4, April, 1973, pp. 53-56.
3. Simonsen J., "How to Make Your Own Matching Pads," T & M News Supplement PTV series, Philips, Test and Measuring Dept., 1973.



# Our family of high the broadest and fas

## Here's proof.

Compare the performance characteristics of these monolithic high slew rate op amps. Device for device, ours offer more. Even the slower slew rates are fast. And nobody tops our fastest. What's more, the slew rates are guaranteed and tested. And where bandwidth limits are critical and you need wide bandwidths at high output levels, these are the op amps for you.

Other advantages are better settling times; space savings because of fewer external components; the best possible DC performance at the highest speeds; and availability in chip form. So, wherever you need high speeds and greater reliability in op amps, look to Harris. For details see your Harris distributor or representative.

comparative diagram

PRECISION  
NON-COMPENSATED  
5V/V GAIN STABLE

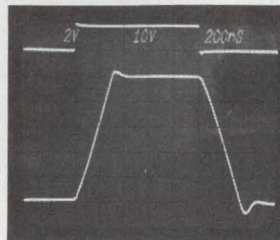

INTERNALLY COMPENSATED  
UNITY GAIN STABLE

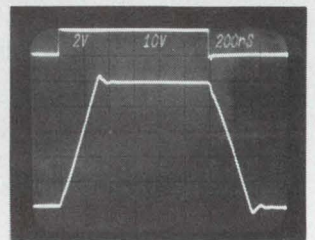

PARAMETERS	LOW SLEW RATE			LOW SLEW RATE		
	HA-2620	HA-2622	HA-2625	HA-2500	HA-2502	HA-2505
Slew Rate	± 25	± 20	± 20	± 25	± 20	± 20
Full Power Bandwidth	400	320	320	350	300	300
Gain Bandwidth Product	100	100	100	12	12	12
Settling Time	1000	1000	1000	330	330	330
Voltage Gain	100k	80k	80k	20k	15k	15k
Bias Current	15	25	25	200	250	250
Offset Current	15	25	25	50	50	100
Offset Voltage	4	5	5	5	8	8
100-999 Units	\$14.95	\$8.95	\$5.95	\$18.50	\$12.95	\$7.50

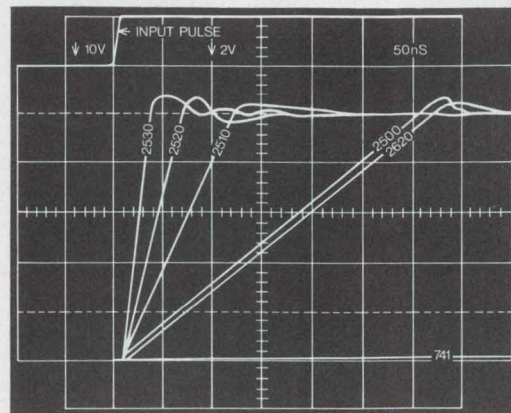



# slew rate op amps is best in the industry.

NON-COMPENSATED  
3V/V GAIN STABLE

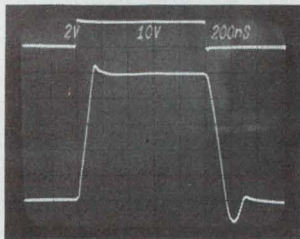

NON-COMPENSATED  
3V/V GAIN STABLE

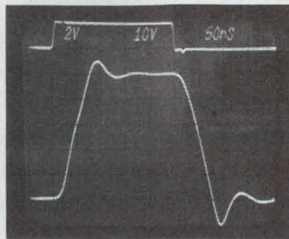

NON-COMPENSATED  
10V/V GAIN STABLE  
INVERTING ONLY

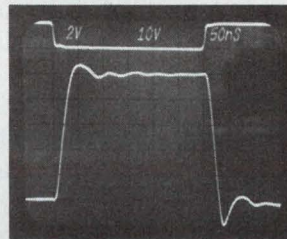

MEDIUM SLEW RATE

HA-2510	HA-2512	HA-2515
---------	---------	---------

HIGH SLEW RATE

HA-2520	HA-2522	HA-2525
---------	---------	---------

VERY HIGH SLEW RATE

HA-2530	HA-2535	UNITS
---------	---------	-------

±50	±40	±40	±100	±80	±80	±280	±250	V/μS (MIN)
750	600	600	1500	1200	1200	4000	4000	kHz (MIN)
12	12	12	20	20	12	70	70	MHz (TYP)
250	250	250	200	200	200	500	500	ns (TYP)
10k	7.5k	7.5k	10k	7.5k	7.5k	100k	100k	V/V (MIN)
200	250	250	200	250	250	100	200	nA (MAX)
50	50	100	25	50	50	20	20	nA (MAX)
8	10	10	8	10	10	3	5	mV (MAX)
\$18.50	\$12.95	\$7.50	\$18.50	\$12.95	\$7.50	\$33.00	\$14.30	



**HARRIS**  
**SEMICONDUCTOR**  
A DIVISION OF HARRIS CORPORATION

P.O. Box 883, Melbourne, Florida 32901 (305) 727-5430

**WHERE TO BUY THEM:** ARIZONA: Phoenix—Hamilton, Liberty, Weatherford; Scottsdale—HAR (602) 946-3556 CALIFORNIA: Anaheim—Weatherford; El Segundo—Liberty; Glendale—Weatherford; Long Beach—HAR (213) 426-7687; Mountain View—Elmar; Palo Alto—Weatherford; HAR (415) 964-6443; Pomona—Weatherford; San Diego—Liberty; Weatherford COLORADO: Commerce City—Elmar; Denver—Hamilton; Englewood—Weatherford CONNECTICUT: Danbury—Schweber, Norwalk—Harvey FLORIDA: Hollywood—Hamilton, Schweber, Melbourne—HAR (305) 727-5430 GEORGIA: Atlanta—Schweber, Norcross—Hamilton ILLINOIS: Elk Grove Village—Schweber, Schaumburg—HAR (312) 894-8824; Schiller Park—Hamilton INDIANA: Indianapolis—Pioneer KANSAS: Lenexa—Hamilton MARYLAND: Baltimore—Hamilton, Rockville—Schweber MASSACHUSETTS: Burlington—Hamilton; Lexington—Harvey; Wellesley—HAR (617) 237-5430 MICHIGAN: Livonia—Hamilton; Troy—Schweber MINNESOTA: Edina—Hamilton, Schweber; Minneapolis—HAR (612) 432-6111 MISSOURI: Hazelwood—Hamilton NEW JERSEY: Cedar Grove—Hamilton, Mt. Laurel—Hamilton, Somerset—Schweber NEW MEXICO: Albuquerque—Hamilton, Weatherford NEW YORK: East Syracuse—Hamilton, Melville—HAR (516) 249-4500; Syracuse—HAR (315) 463-3373; Rochester—Schweber; Westbury—Schweber; Woodbury—Harvey NORTH CAROLINA: Raleigh—Schweber OHIO: Beachwood—Schweber; Cleveland—Pioneer; Dayton—Pioneer; HAR (513) 226-0636 PENNSYLVANIA: Wayne—HAR (215) 687-6680 TEXAS: Dallas—Hamilton, Weatherford; HAR (214) 231-9031; Houston—Hamilton, Weatherford UTAH: Salt Lake City—Hamilton WASHINGTON: Seattle—Liberty, Weatherford WASHINGTON, D.C.: HAR (202) 337-3170 CANADA: Mississauga, Ontario—Hamilton; Montreal, Quebec—Hamilton; Ottawa, Ontario—Hamilton

**LEGEND FOR HARRIS SALES OFFICES & DISTRIBUTORS:** Elmar Electronics (Elmar); Hamilton Avnet Electronics (Hamilton); Harris Semiconductor (HAR); Harvey Electronics (Harvey); Liberty Electronics (Liberty); Pioneer Standard Electronics (Pioneer); Schweber Electronics (Schweber); R. V. Weatherford Co. (Weatherford)

INFORMATION RETRIEVAL NUMBER 52



# ECL 10,000 interconnects economically.

Controlled edge speeds and low-voltage swings allow use of conventional boards for this increasingly popular logic.

The ECL 10,000 high-speed logic family doesn't necessarily need expensive packaging. Surprised? For many applications, inexpensive double-sided PC or wire-wrappable boards can be used in place of costly multilayer boards.

Once priced significantly higher than other logic families, ECL 10-k used to be confined to expensive systems. But prices have fallen as a result of multiple sourcing, plastic packaging and volume manufacturing. As a result, logic designers are turning increasingly to the high-speed ECL family. They're using ECL 10-k to upgrade older systems or as an alternative to TTL for new systems.

Earlier, higher-speed, ECL circuits require multilayer boards and stripline wiring to take advantage of the logic speed. ECL 10-k can use the less-expensive boards because of controlled edge speed, input pull-down resistors and voltage reference sources. Features like these simplify interconnect considerations, which conveniently break down into the following:

- Grounding.
- Coupling and loading.
- Terminations.
- Crosstalk.
- System connections.

The most popular bipolar logic lines are ECL 10-k, Schottky-TTL and standard TTL. Table 1 compares the family characteristics that affect wiring and interconnects.

## Grounding differs with board types

Current transition ( $\Delta I$ ) during a change in logic level is about the same for all three logic families. ECL 10-k, with its lower noise margin, requires a lower inductance ground connection than the TTL families to maintain comparable performance.

For double-sided PC boards, this means maintaining a ground plane over 60 to 70% of one

side of the board and using a 0.1-in. minimum line width for  $V_{EE}$  connections. For wire-wrappable, or solderless, boards or backplanes, the designer can construct a 1-in. ground grid by bussing together ground pins at 1-in. intervals.

In addition to low impedance, a ground plane or grid provides a controlled characteristic impedance for signal lines. At the connector interface to the board, about 10% of the pins should

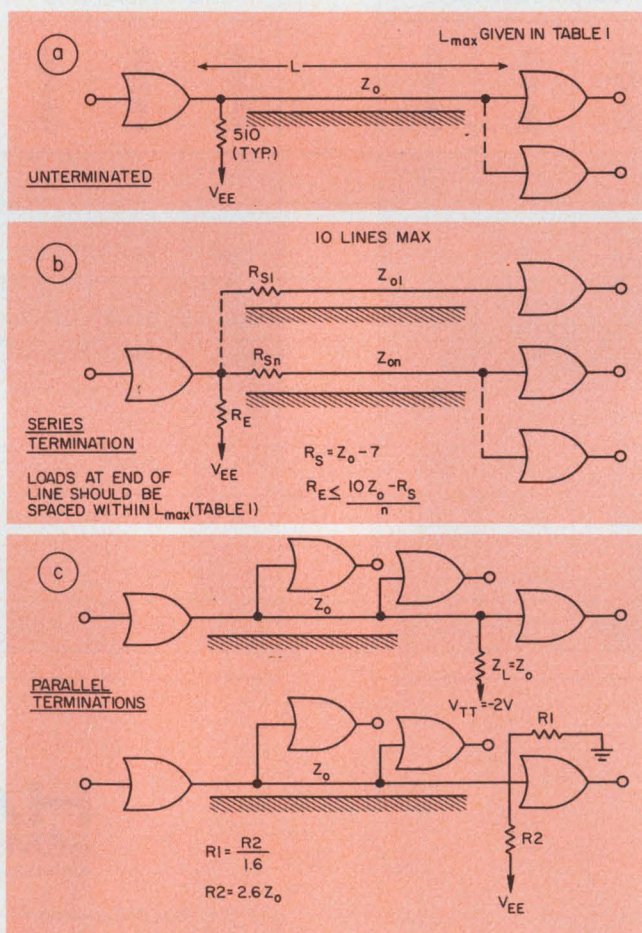

1. Series or parallel terminations on ECL 10-k circuits eliminate noise problems caused by mismatches on unterminated lines (a). In the series configuration (b), each load at the receiving end reduces the noise margin by 0.16 ( $R_S$ ) millivolts. In the parallel configuration (c), up to 16 distributed loads can be accommodated. Each load adds about 100 ps of delay.

Robert Jaeger, Applications Engineer, Signetics Corp., 811 E. Arques Ave., Sunnyvale, Calif. 94086.



be reserved for grounds.

Decoupling requirements can be met by a  $1\text{-}\mu\text{F}$  bypass capacitor on each board at the power-supply inputs. Ground and  $V_{EE}$  inputs should be close to each other to minimize lead inductance in the bypass capacitor. Generally every four or five packages on a board require a  $0.01\text{-to-}0.1\text{-}\mu\text{F}$  rf capacitor. Also, lines connecting  $V_{EE}$  pins on each package to the power supply should be a

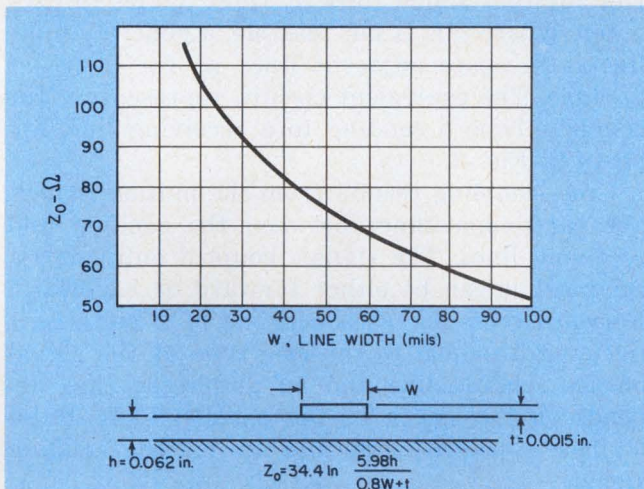

2. A line on a PC board produces a controlled value of characteristic impedance ( $Z_0$ ). The values and expression for  $Z_0$  assume a dielectric constant that is typical of glass-epoxy material.

minimum of 0.1-in. wide.

Inputs to ECL 10-k circuits typically require only  $220\ \mu\text{A}$  at the logic ONE level. Hence dc loading doesn't impose restrictions. Instead loading is constrained solely by ac considerations.

### Lines don't require terminations

Unlike some of the earlier ECL families, ECL 10-k doesn't necessarily require terminated lines (Fig. 1). However, the ability to drive terminated lines allows a reduction of line noise.

Terminations are not required when the two-way delay of the lines is less than the rise time of the signal edge. Each ECL 10-k input has a  $3\text{-pF}$  input capacitance. Since capacitive loading of the line increases the line delay, the maximum allowable line length decreases with increased loading. This capacitive loading has less effect on lines with low characteristic impedance ( $Z_0$ ). Table 2 shows the maximum line length that should be used for unterminated lines with different values of  $Z_0$  and loading.

The value of  $Z_0$  for lines on a wire-wrappable board is about  $120\ \Omega$ . However, this can vary from 100 to 180, depending on distance from the ground plane, proximity of adjacent wires and configuration of the ground grid.

The value of  $Z_0$  for a line on a PC board is much more closely controlled. The impedance de-

**Table 1. Comparison of three logic families**

Parameter	TTL	Schottky TTL	ECL 10,000
Propagation delay—ns	10	3	2
Voltage swing—V	3.5	3.5	0.8
Noise margin—V	0.4	0.3	0.125
%	11	9	15
Rise/fall time—ns	8	2	2
Edge speed ( $\Delta V/\Delta T$ )*—mV/ns	440	1750	400
Edge current ( $\Delta I$ )**—mA	16	20	17

\* affects crosstalk  
 \*\* affects grounding and decoupling



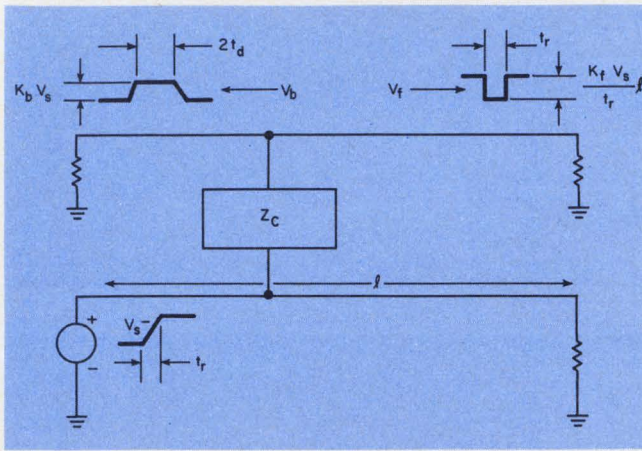

3. Adjacent, parallel lines produce crosstalk noise. Impedance  $Z_c$  represents a combined mutual inductance and capacitance. This impedance is responsible for the coupling of signals from one line to another.

depends on board thickness and line width. Fig. 2 shows a plot of  $Z_0$  vs line width for 0.062-in. boards having a ground plane on one side.

### 'Ringing' can be eliminated

The ability to terminate signal lines with ECL 10-k circuits provides several design benefits. Terminations can be used to eliminate line reflections, or ringing, completely when line lengths exceed the values in Table 2. In addition terminations can reduce crosstalk between parallel signal lines.

Line reflections occur when the impedance of the load at the receiving end of the line ( $Z_L$ ) differs from the characteristic impedance of the line ( $Z_0$ ). The value of the reflected voltage ( $V_r$ ) depends on the impedance mismatch, as follows:

$$V_r = V_{line} \frac{(Z_L - Z_0)}{(Z_L + Z_0)}$$

Table 2. Allowable unterminated line lengths depend on fanout

$Z_0 - \Omega$	Maximum line length— $L_{MAX}$ (inches)			
	fanout = 1	fanout = 2	fanout = 4	fanout = 8
micro-strip:				
50	8.3	7.5	6.7	5.7
68	7.0	6.2	5.0	4.0
75	6.9	5.9	4.6	3.6
90	6.5	5.4	3.9	3.0
100	6.3	5.1	3.6	2.6
back-plane:				
100	6.6	5.4	3.8	2.8
140	5.9	4.3	2.8	1.9
180	5.2	3.6	2.1	1.3

For any value of  $Z_L$  close to  $Z_0$ , the reflection drops to a negligible value; for  $Z_L = Z_0$ ,  $V_r = 0$ . Also, the polarity of the reflection is the same as the driving signal when  $Z_L > Z_0$ , and it is reversed when  $Z_L < Z_0$ .

Both series and parallel terminations can be used in ECL 10-k systems (Fig. 1). In a series termination a resistor is placed in series with the signal line at the driving end. For parallel terminations, a load resistor is used between the line and  $V_{EE}$  (or a  $V_{TT}$  voltage) at the end of the line.

### Crosstalk can be controlled

Crosstalk results from the coupling of a pulse on one signal line to an adjacent line. It can be controlled readily when ECL 10-k is used. The logic family has a linear input impedance, low output impedance and capability for signal-line termination. These features permit crosstalk to be analyzed and minimized—which is why ECL 10-k is called the "quiet" high-speed family.

The simplest way to minimize crosstalk is to run adjacent signal lines at right angles to each other. Where this is not feasible, a general guideline is to space adjacent lines as far apart as possible. The equivalent circuit, representing the coupling from a sending to a receiving line, appears in Fig. 3.

Cross-coupling results from the mutual inductance and capacitance between the sending and receiving lines. The signals coupled onto the receiving line can be either forward or backward. Forward crosstalk ( $V_f$ ) consists of a pulse having a width equal to the rise time of the signal on the sending line and an amplitude that depends on the length of the parallel lines. Pulse  $V_f$  has a polarity opposite to  $V_s$ , the sending signal.

Forward crosstalk isn't usually significant in ECL 10-k systems, because of the small  $\Delta V/\Delta T$  on the signal edge. As indicated in Table 1, the value of  $\Delta V/\Delta T$  in ECL 10-k is about the same as that for TTL and less than a quarter the value for Schottky-TTL.

The backward crosstalk pulse ( $V_b$ ) has a width that is equal to twice the propagation delay of the sending line. The amplitude depends on the line spacing only and is independent of the length of the parallel lines or signal rise time. The rise and fall times of  $V_b$  equal the rise and fall times, respectively, of  $V_s$ . Fig. 4 shows a plot of these times vs line spacing for 0.062-in. boards.

Fig. 5 shows the waveforms of the backward crosstalk signal for a variety of terminations on the receiving line. Since  $V_b$  always travels in a direction opposite to  $V_s$ , a termination at the lefthand side of each diagram completely absorbs

(continued on page 94)



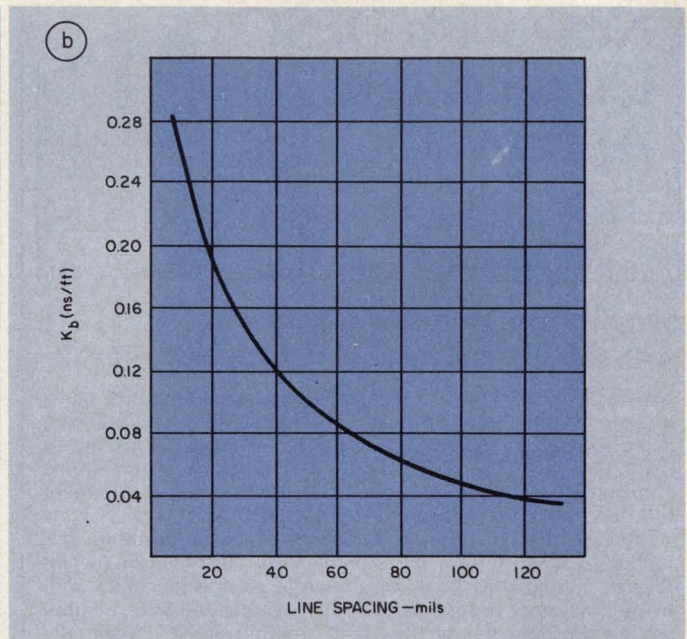
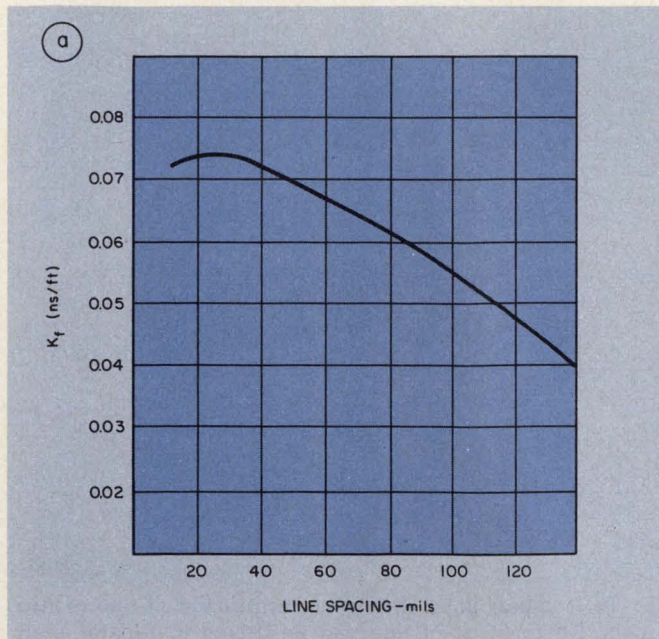

4. Rise and fall times of crosscoupled signals are drawn for the two possible cases: forward crosstalk (a)

and backward (b). The first type has a small  $\Delta V/\Delta T$  on the signal edge, making it less significant.

CONFIGURATION	WAVEFORM AT X=0	WAVEFORM AT X=1

5. Waveforms of backward-crosstalk signals are affected by the terminations used. Regardless of the type of transmission line employed, a termination with an im-

pedance value equal to the line's characteristic impedance completely absorbs any incident reflection. Curves of constants  $K_b$  and  $K_f$  appear in Fig. 4.



# Now with DESC Qualification Approval\*



## Simplify MIL fault signal detection with this manual reset BITE Indicator.

Use our L21603/01 manual reset BITE indicator to monitor faults in systems and components and provide an automatic warning when operation falls outside design parameters. Only a minimum of circuitry is required. Miniature size permits compact grouping, and its rugged construction allows it to meet MIL spec reliability standards—Mil-I-83287C(USAF).

In use, the indicator has a normal all-black appearance. If a fault signal occurs in a monitored circuit, the face of the indicator immediately turns to a sharply contrasting black-and-white cloverleaf design. A built-in magnetic fail-safe memory latches the indicator in the "fault" mode until it is manually reset. As a result, transient as well as permanent fault signals are detected and there is no possibility of the indicator being accidentally reset until servicing is undertaken.

\*Approval letter #EQA 73-756 dated Dec., 11, 1973

**Send for information now!**

A. W. HAYDON CO. PRODUCTS

**NORTH AMERICAN PHILIPS CONTROLS CORP.**

Cheshire, Conn. 06410 • (203) 272-0301

INFORMATION RETRIEVAL NUMBER 53

## Welded switch terminals assure flaw-free connections.

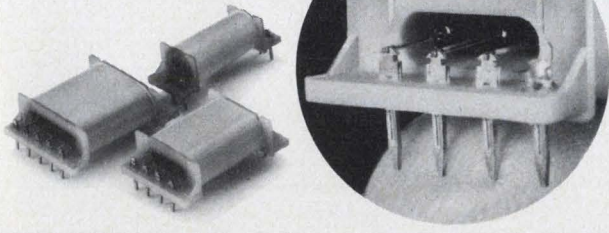

## Series 46 reed relays. Built better to perform better.

Welded switch terminals prevent damage during assembly and handling and prevent softening and failure of connections when Series 46 open type miniature reed relays are soldered to PC boards. As a result, you get better performance and lower reject rates. Both dry and mercury wetted switches are available. Dry reed models employ NV Philips high reliability reed switches which give the extremely stable contact resistance desired in logic circuit applications. Five different coil forms offer many contact combinations in A, B or C forms. Contact ratings range from 2.8 to 50 watts, 3-48 vdc. Terminals are spaced on 1" centers in the popular .150" grid.

**Send for information now!**

**NORTH AMERICAN PHILIPS CONTROLS CORP.**

Frederick, Md. 21701 • (301) 663-5141

INFORMATION RETRIEVAL NUMBER 54

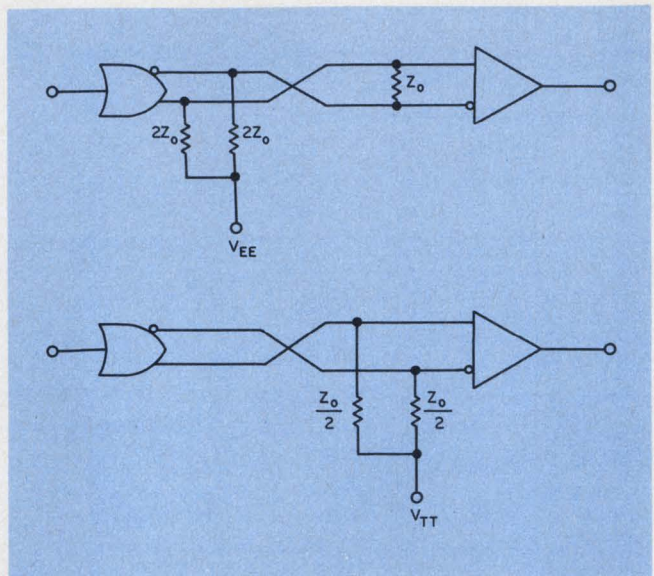

6. Twisted-pair lines should be terminated in one of two ways. Up to 50 ft of line can be driven at greater than 100 MHz.

any coupled  $V_b$ .

Series-terminated lines generate less crosstalk than parallel-terminated ones. The reason is that only half the logic swing is sent down a series-terminated line.

## Coax and twisted-pair to connect boards

Generally coax or twisted-pair are used for ECL interconnections between boards. Coax should have a characteristic impedance in the range of 50 to 100  $\Omega$ , and each end of transmission-line returns should be grounded. Twisted-pair—AWG24 to 28, twisted 30 turns per foot—yields a satisfactory  $Z_0$  of about 110  $\Omega$ .

If ribbon cable is used, select types having low attenuation at the maximum operating frequency. The maximum recommended attenuation for ECL 10-k is 2.5 dB, which may limit the cable length to 15 ft or less. Alternate leads in the ribbon cable should be grounded to maintain the transmission-line effect.

At connectors, use multiple-ground pins, equally spaced, to reduce the connection impedance to negligible amounts.

Very long lines—20 ft or more—can be driven differentially to maintain noise immunity at high frequencies. The complementary outputs of gates can be used for differential drive; and a 10114/15 ECL circuit can be employed as the line receiver.

Fifty feet of twisted pair can be driven differentially at frequencies over 100 MHz. Differentially driven lines should be terminated as shown in Fig. 6, and the fanout should be limited to four. The twisted-pair lines should be shielded when the common-mode noise on the pair exceeds  $\pm 1$  V. ■■



# Ferrite power supplies are more efficient and cost less.

## Inverter-Rated ferrites™ end the guesswork.

Replace metal laminations with ferrite components and get a lot of trade-offs going in your direction. Less weight. Higher efficiency. Smaller size. Better regulation. And lower system cost.

### New applications

High frequency, low loss ferrites from Indiana General have improved the efficiency of inverters and power supplies in everything from computers to portable test equipment.

Whenever you need high efficiency power transfer, our Inverter-Rated components will also give you better regulation and vastly simplify your filter requirements.

### Today's answer

Improved ferrite technology has made it economically feasible to operate inverter systems at 2KHz and beyond.

Inverter-Rated® ferrite components from Indiana General are designed and tested specifically for high frequency operation and feature low power loss to 150°C.

With our full line of components you can select the circuit characteristics you need in meeting your specific application requirements.

### Ferrites for inverters

We specify and guarantee inductance and core loss under maximum and recommended conditions to end guesswork. By giving you circuit performance data instead of routine magnetic parameters, we make your design task easier and more precise.

Inverter-Rated components are tested under square wave drive so the performance you design in—stays in.

### Free design guide

Our new design guide has all the

facts you need; component specifications, temperature characteristics and application data. The design procedure we outline in this guide and an afternoon of your time will tell you if higher frequency operation is the solution to your specific power supply requirements.

Circle the Bingo card for your copy or call (201) 826-5100 and ask us for specific answers to your requirements. Either way, if you're talking high efficiency power supplies, talk to the ferrite experts.

That's us.

Indiana General  
Keasbey, N.J. 08832

National distribution through Permag locations in Atlanta, Boston, Chicago, Dallas, Detroit-Toledo, Los Angeles, New York and San Francisco.

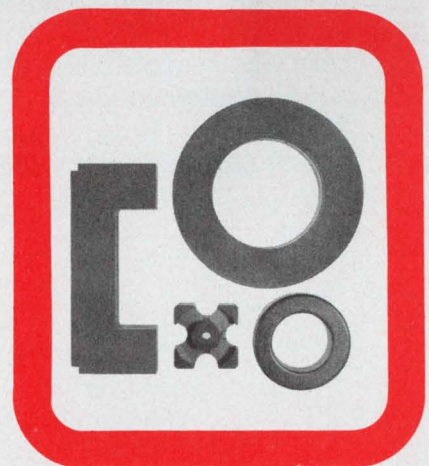
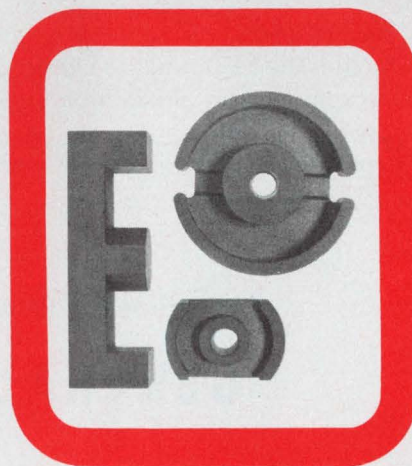
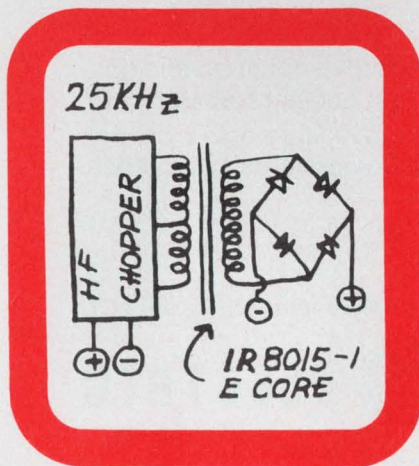

**indiana general**

a division of Electronic Memories & Magnetics Corporation

INFORMATION RETRIEVAL NUMBER 55



# 2 NEW OPTO COUPLERS FROM GENERAL ELECTRIC

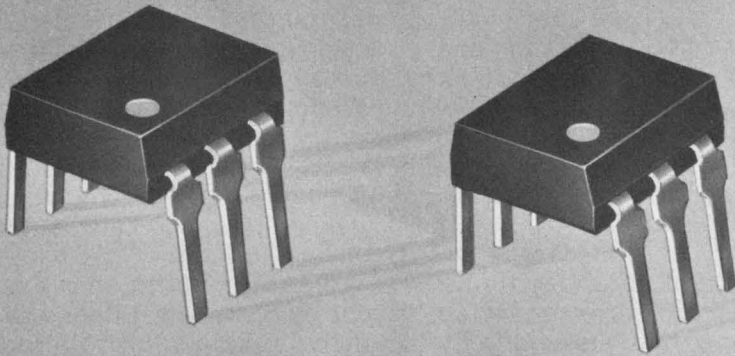

## NEW H11AA AC INPUT

- 2 LEDs reverse connected for bidirectional inputs
- 1500 V isolation, 20% min current transfer ratio
- 10% symmetry
- \$1.65 each, 1000 lot quantities

## NEW H11A10 SWITCH

- Programmable threshold detection triggerable by 2:1 change in  $I_{IN}$
- 1500 V isolation, 10% min current transfer ratio "on" state
- Covered under "UL" file E51868
- \$1.30 each, 1000 lot quantities

Only GE uses "glass isolation" between the LED and the Detector to achieve optimum and controlled photon coupling....the best combination of isolation voltage and current transfer ratio. The Industry's broadest line of opto couplers competitively priced and available now from any authorized GE Semiconductor Distributor or from any GE Electronic Components sales office.

Semiconductor Products Department, Syracuse, N.Y.

GENERAL  ELECTRIC





## Take the gamble out of trimmer buying.

Three of the winners in our extensive cermet trimmer line can give you a sure jackpot, because, right now, they satisfy over 90% of all trimmer requirements and board layouts.

Pick the 3/8" square, single-turn, sealed Model 72. Or the 3/4" rectangular, multiturn, sealed Model 89. Or the 3/8" diameter, covered, single-turn Model 91. Each in 19 standard resistance values from 10 ohms to 2 megohms... and in a variety of pin spacings.

Prices are right, too. Models 72, 89, and 91 are respectively just \$0.53, \$1.01, and \$0.41 in the 500-piece quantity.

And after all that, if exceptional setability

and 100 ppm° C tempco isn't enough, think of this: They're all available for immediate delivery from stock at your local Beckman/Helipot distributor!

Considering the stakes in your own competitive field, you should look into the quality and performance of Beckman cermet trimmers.

If you need immediate technical literature or the phone number of your local Beckman/Helipot representative, call toll-free (800) 437-4677.

**Beckman®**

**HELIPOT DIVISION**



# Reliability is staggered steps and a hunk of DAP.

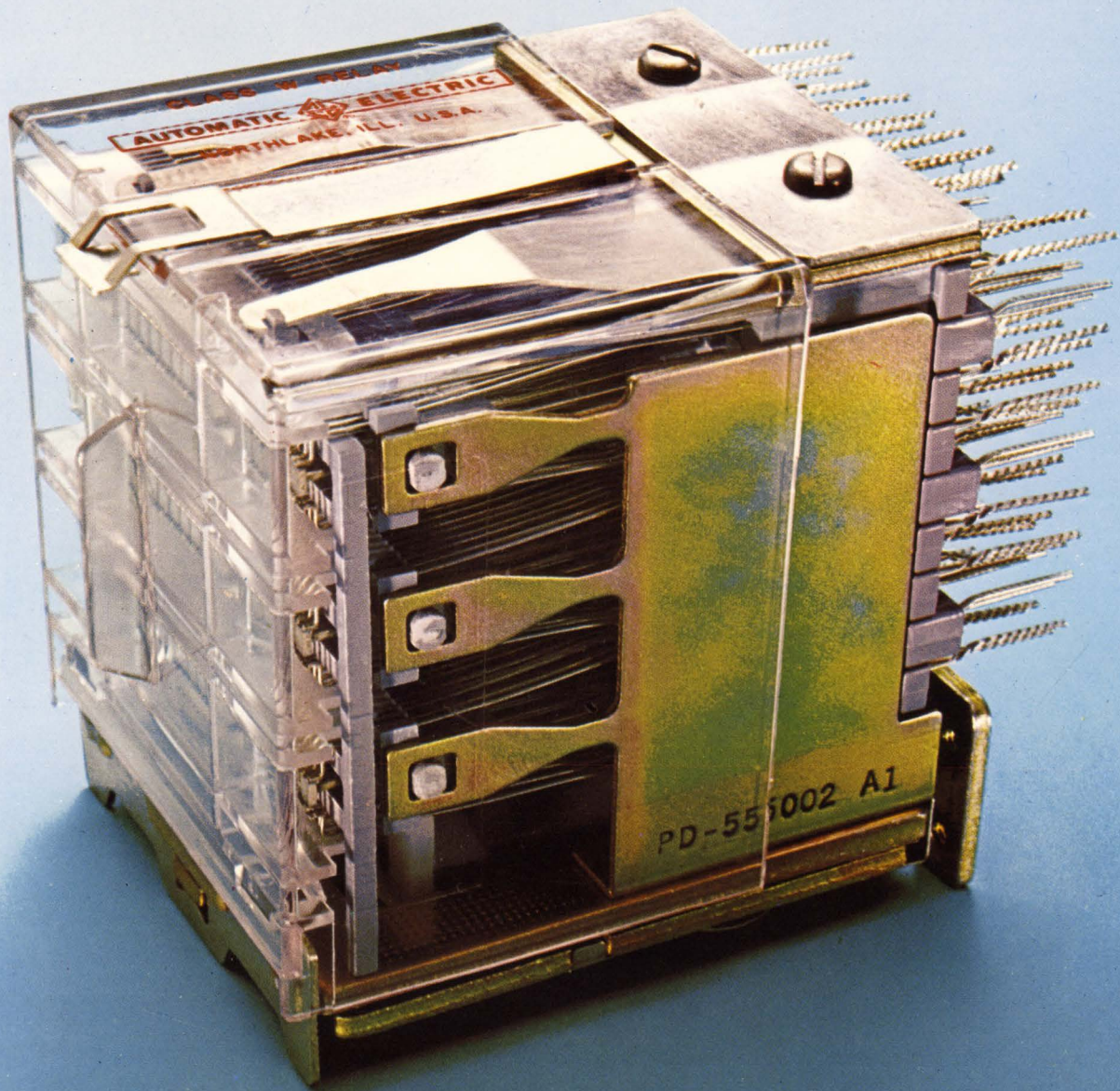



## Expect over a billion operations.

Our Class W wire-spring relay is different. In fact, there's nothing like it in the entire industry. Where else can you find a relay with lots of contacts and a mechanical life of more than a billion operations! That's about two and a half times the life of the best conventional relay around.

Another nice thing about our Class W is that it takes up a lot less space and costs less than using a bunch of other relays. That's because we build our Class W relay with one, two or three levels of contact assemblies, with 17 form C combinations per level. By the way, they're available with gold contacts for low-level switching.

## Making it tough on creepage.

All those staggered steps you see on the side were put in to raise the breakdown voltage between terminals. These molded steps add extra creepage distance between the terminals. This really counts for high voltage testing, or when using our Class W in unfavorable ambient conditions.

These steps, and all the molding compound used for insulating the contact springs, are made from

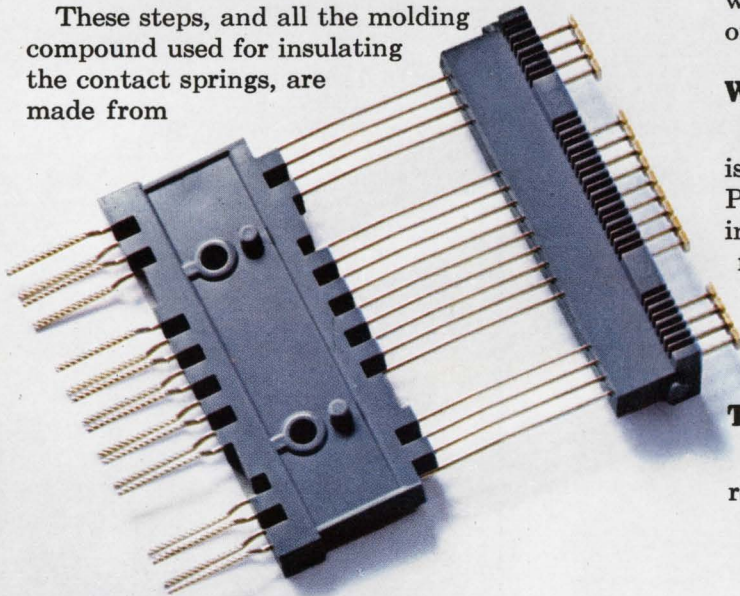

diallyl phthalate. (They call it DAP for short.) It has great insulating properties and it wears like iron. Even if the humidity is high, you have excellent protection.

## Redundancy—two springs are better than one.

Each of our long wire-spring contacts has an independent twin with the same function. One tiny particle of dust could prevent contact on other relays. Not with our Class W. You can be sure one of the twins will function. That's back-up reliability.

The twin contacts are twisted together at the terminal end. Then we give them a spanking (you might call it swedging) to provide solderless wrap.

## We're for independence.

Our springs are longer, because the longer the spring, the more independent they get. And the better contact they make. Don't forget, the wire-spring relay is the most reliable way to get a permissive make or break contact. You can rely on it.

The middle contact springs have to be stationary. To make sure they stay that way forever, we actually mold them between two thick pieces of DAP on both ends. Just try to move one.

## When we say flat, it's flat.

Each frame, banged out by a gigantic machine is extra thick and extra flat. Then they're planished. Planishing is another step we go through in forming the frame to add strength and stability by relieving surface strain.

We've made our spring-loaded pile-up clamp extra thick, too. Once it's tightened down, the whole pile-up is nice and tight, and stays tight.

## There's more.

We could tell you a lot more about our Class W relays. Like how the tough high-temp molded

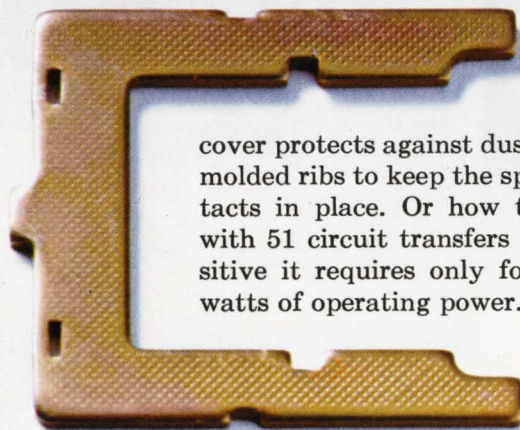

cover protects against dust and has molded ribs to keep the spring contacts in place. Or how this relay with 51 circuit transfers is so sensitive it requires only four to six watts of operating power.

But why don't you let us prove how much reliability we put into our Class W? We'll be waiting to hear from you. GTE Automatic Electric, Industrial Sales Division, Northlake, Ill. 60164.

# GTE AUTOMATIC ELECTRIC



# A GOLD MINE OF INFORMATION & DATA

- **520** CATALOG PAGES ON  
ICs & SEMICONDUCTORS
- **300** CATALOG PAGES ON  
INSTRUMENTS
- **290** CATALOG PAGES ON  
POWER SUPPLIES
- **210** CATALOG PAGES ON WIRE  
& CONNECTOR PRODUCTS
- **150** CATALOG PAGES ON  
SWITCHES
- **2800** CATALOG PAGES ALL  
TOLD IN 52 PRODUCT  
CATEGORIES

Electronic Design's GOLD BOOK puts the entire electronics industry at your fingertips. Use it for product search, selection, specification and purchase. It's the most thorough industry master catalog & directory ever compiled.

When you need information . . .

**Electronic Design's**  
**GOLD BOOK**  
**IS THE PLACE**  
**TO LOOK**

## SEVEN NEW MODULAR POWER SUPPLIES FROM ANALOG DEVICES.

Four new chassis-mount power supplies that let you install the power supply on the chassis of your instrument when you want it there, instead of on the pc board. All input/output connections are made easily through a four post terminal strip.

Model 952  $\pm 15V$  @ 100mA \$58  
Model 955 5V @ 1000mA \$79  
Model 970  $\pm 15V$  @ 200mA \$79  
Model 971  $\pm 12V$  @ 240mA \$79

Two new thermal barrier power supplies that provide higher output power than ever practical in a module because of its thermal isolation feature.

Model 925  $\pm 15V$  @ 350mA \$99  
Model 922 5V @ 2000mA \$89

A new lower profile version of the industry's most popular  $\pm 15V$  modular power supply, Model 902. The new 902-2 is only 0.875" low to save you space. \$51.

Ask about our OEM discounts.

## AND A NEW CATALOG, TOO.

Our latest catalog will give you complete information on power supplies from Analog Devices — the people who fill all your modular power supply needs.

Modular Instrumentation Division. Analog Devices, Inc., Norwood, Massachusetts 02062. East: (617) 329-4700. Midwest: (312) 297-8710. West: (213) 595-1783.



INFORMATION RETRIEVAL NUMBER 248



# Three New REED RELAYS from CLARE

## Perfect blend of economy and reliability in a dry reed relay

Clare's new 951 dry reed relay is a product of Clare's automated manufacturing process that combines economy with reliability. This epoxy molded PCB relay houses the popular Picoreed capsule which gives you from 100 million operations at signal level loads to 5 million operations at 10 volt-amps. It's an excellent, rugged relay for telecommunications, process control and general electronic applications where reliability and long life is critical. Available in 1, 2 and 4 form A configurations.

951



## Longer life than a dry reed; less expensive than mercury wetted contact

The new 851 mercury wetted reed relay gives you as much as a billion bounce-free operations, plus switching capabilities from signal level to 50 volt-amperes. The epoxy molded PCB relay is in performance and price, somewhere between the popular dry reed and the more expensive mercury contact relays. And that makes it ideal for applications in telecommunications, computer peripherals, data acquisition and industrial control. Available now in 1, 2 and 4 form A configurations.

851



## A new kind of self-latching reed relay

Clare's new relay is the 961 self-latching PCB dry reed relay which features a unique switch that provides the magnetic memory function without the external biasing magnets

961



found in conventional latching relays.

It is designed to operate on one millisecond pulse, but the pulse duration is limited only by coil heating. Once pulsed, the relay remains in that state until the opposite mode is selected.

Ideal for complex automatic test equipment or telecommunications systems, they're available in 1 to 6 pole configurations and have 5 volt-ampere contact ratings.

## Availability? Right now!

All three relays are in production and in stock right now. For full technical specifications contact your nearest Clare Distributor. For more comprehensive application information, contact C. P. Clare & Company, 3101 W. Pratt Avenue Chicago, Illinois 60645 or phone (312) 262-7700.

QUALITY, SERVICE, RELIABILITY

**C. P. CLARE & COMPANY** a subsidiary of  
**GENERAL INSTRUMENT CORPORATION**





# Look to asynchronous sequential logic

for best speed-power performance. Then add a self-clocking feature to obviate design constraints.

Before you design your next sequential logic circuit, take a look at a new asynchronous approach. A self-clocked feature makes the design job as simple as the conventional synchronous approach. And you gain a number of advantages:

- Fast response—the circuit does not wait for a clock edge.
- Power conservation—with the popular CMOS, there is no external clock and hence no rapid dissipation of power.
- Low CMOS standby power—when the inputs don't change, all circuitry is quiescent.

With all these features, the designer has all the leeway of synchronous designs—a minimal number of states and arbitrary input signal changes.

An internal clock is generated when input changes occur. The clock pulse then drives edge-clocked flip-flops that change the state. In this sense internal operation is similar to that of synchronous systems. This overcomes the traditional asynchronous bugaboos of races, hazards and the need to assign extra external states to combat them. In addition there needn't be any restrictions against multiple-input changes.

The conventional asynchronous machine is usually represented by combinatorial logic plus a delay section (Fig. 1). The delay block represents internal propagation delays through the combinatorial logic. Any change of input variables results in an immediate change in state variables, outputs or both.

With the restriction on multiple input changes, Table 1 could represent a typical asynchronous machine with four states, A, B, C and D. The circled letters represent stable states; the others transitions to new stable states. To avoid race conditions, a common requirement for asynchronous design is that only one input variable change at any instant of time. Don't-care assignments are used for multiple changes.

A critical race exists for a transition between stable states A to C for input  $x_1 x_2 = 10$ . State

A (00) must change to C (11). In so doing state B (01) might occur and the ultimate state attained is stable state D (10). Extra states can avoid races through the adjacent state transitions they provide.<sup>1</sup> Or use edge-sensitive flip-flops and avoid the need for additional states.

One scheme (Fig. 2) allows arbitrary state assignments within the restriction of single input transitions.<sup>2</sup> An input change produces a  $0 \rightarrow 1$  or  $1 \rightarrow 0$  transition at the output of the block labeled  $f(x)$ . The delay element—triggered by  $f(x)$  on either transition—clocks the flip-flops at a later time,  $T$ . Practical circuit elements include a modulo-2 adder (whose output equals ONE for an odd number of inputs) followed by a one-shot for the delay element.

Delay  $T$  is made long enough to ensure proper setup time for the flip-flops and to allow for propagation delays through the system. Thus the delay block of Fig. 1 now becomes a controlled delay (as in the synchronous case), but the combinatorial logic in Figs. 1 and 2 remains the same.

At first glance, the flip-flop method appears costly. But you can use the minimum number of state variables with comparatively few flip-flops. In the true asynchronous example, an extra state variable is necessary. With many input variables, a race problem might not show up until the entire circuit is constructed.

## Use a more general design

An extension of the clocked flip-flop approach allows for multiple changes.<sup>3</sup> Edge-sensitive flip-flops acquire the state variables, so their number remains minimal. Rather than generate a clock for arbitrary input change, we now produce a trigger only when a change of input warrants a change of internal state. The clock is made a function of the input variables, together with the state variables, to furnish the selective trigger.

The combinatorial logic provides the state variables, as in Fig. 2, but does not provide the output logic (Fig. 3). The state flip-flops perform their original functions; however, the clock input (derived from Block 3) depends on both

---

Michael J. Charland, Development Engineer, Canberra Industries, Inc., 45 Gracey Ave., Meriden, Conn. 06450.



state and input variables. The input to the delay-hold block must be present and stable for a specified time before an output is issued to the flip-flops.

Block 4, along with associated flip-flops, prevents output transients. State variables  $y_j$  do not change instantaneously, as inputs  $x_i$  can. To avoid possible transients, the output flip-flops receive their clock signal at time  $T_0$  after the clock pulse to the state-variable flip-flops. And the outputs are now hazard-free.

**Table 1. Flow table with no multiple input change**

STATE / $y_1 y_2$	INPUTS $x_1 x_2$			
	00	01	11	10
A / 00	(A)	(A)	B	C
B / 01	—	A	(B)	D
C / 11	—	A	B	(C)
D / 10	A	—	B	(D)

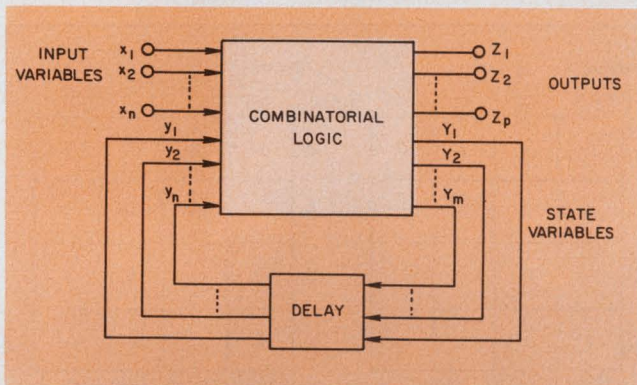

1. Any change of input variables in an asynchronous machine results in an immediate change of state or output variables. The various internal propagation delays are represented by a single delay block.

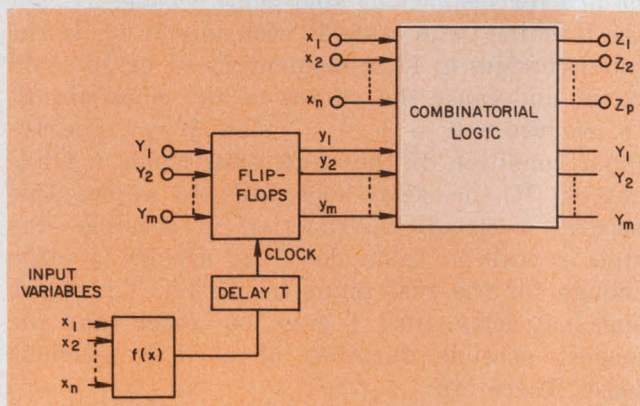

2. Use of edge-triggered flip-flops permits arbitrary state assignments with asynchronous design. Any change of input variable sets off the clock, but also allows time for the original state variables to settle.

A majority element plus a delay circuit produces the delay-hold effect. To react, the circuit requires the presence of an input for a time,  $T$  (Fig. 4).

Table 2 describes a sequential machine with double input changes. A map of the clock circuit provides for a pulse only for transition to a new stable state. To obtain this map, insert 0 for a stable state and a 1 for an unstable state. The ONE output produce a  $0 \rightarrow 1$  transition from the delay-hold circuit. And when the machine reach-

### Conventional asynchronous machine pitfalls

Skewing—the simultaneous change of gate inputs—can lead to an erroneous output transient or glitch (a) because the asynchronous design consists mainly of logic gates whose outputs are fed back to the input. Any erroneous output glitch could be recognized at the input and cause the machine to acquire a wrong state or even step through a number of states. This is a main source of problems in an asynchronous design and, as can be imagined, very difficult to troubleshoot.

Outputs that do not return to the input need no restriction, since they do not control internal sequencing. If, however, the transients due to skewing are harmful to the output they control, then they must be eliminated. Output transients or glitches are called hazards. They can be eliminated by a double cover of the minterms in the output function Karnaugh Map. This type of additional cover is required when adjacent minterms are not completely covered (b). The dotted encirclement adds the top gate and ensures that the output remains high as it should (free of hazards) while the lower gates switch. It is basically for the problems of critical races and hazards that the triggered flip-flop methods have evolved.

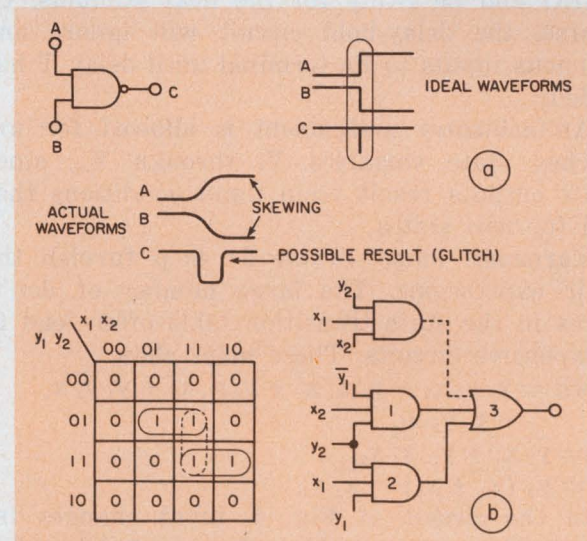



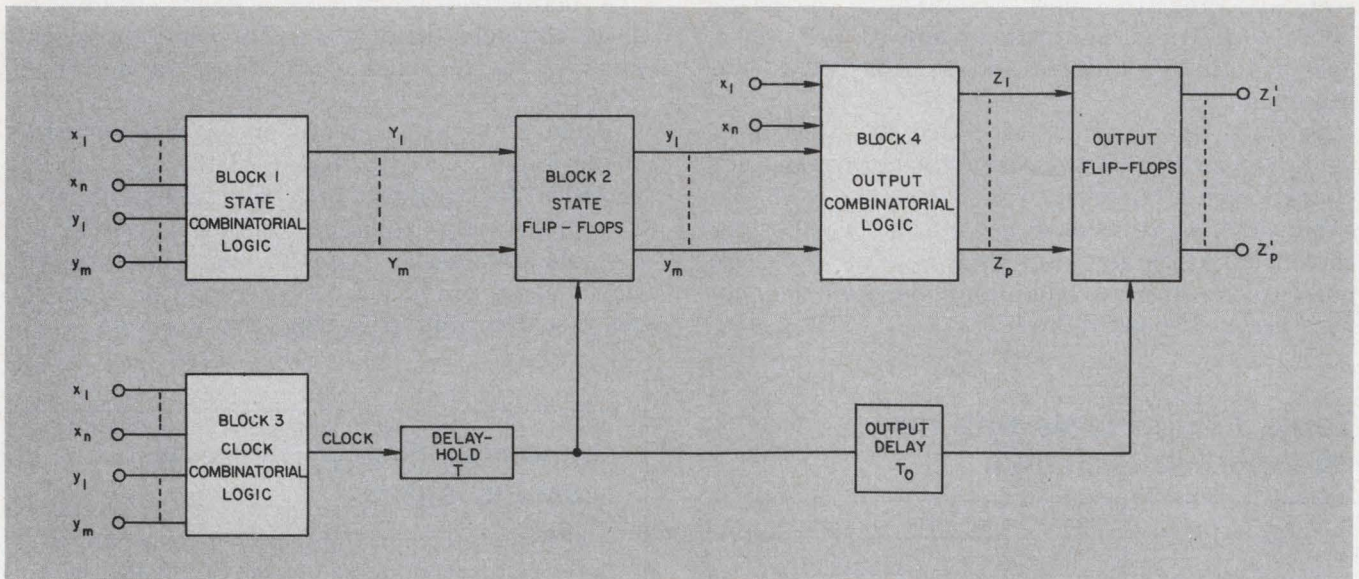

3. Selective timed clocks, triggered by input and output variables, remove single-input change restrictions. Use of

output flip-flops, in conjunction with a controllable delay, prevents logic hazards.

Table 2. Flow table with double input change and decomposition to clock and state tables

STATE / $y_1 y_2$	INPUTS $x_1 x_2$			
	00	01	11	10
A / 00	(A)	B	D	(A)
B / 01	(B)	(B)	(B)	D
C / 11	B	(C)	B	A
D / 10	A	C	(D)	(D)

FLOW TABLE

STATE	INPUT			
	$x_1 x_2$ 00	01	11	10
A	0	1	1	0
B	0	0	0	1
C	1	0	1	1
D	1	1	0	0

CLOCK CIRCUIT TABLE

STATE	INPUT			
	$x_1 x_2$ 00	01	11	10
A	—	B	D	—
B	—	—	—	D
C	B	—	B	A
D	A	C	—	—

STATE TRANSITION TABLE

es a new stable state, the clock will return to ZERO and be ready for the next stimulus. Of course, the delay-hold circuit will ignore any spurious inputs to its terminal until delay T has ended.

An arbitrary assignment is allowed for unclocked state variables  $Y_1$  through  $Y_m$ , since clock outputs result from input conditions that call for new states.

Karnaugh maps (Table 3) help furnish the logic expressions. The large number of don't-cares in the state transition table often lead to inexpensive circuits. These maps show

$$\text{Clock} = y_1 \bar{y}_2 x_2 + y_2 x_1 x_2 + y_1 x_1 x_2 + y_1 \bar{y}_2 x_1 + y_1 y_2 x_1,$$

$$Y_1 = \bar{y}_1 x_1 + y_1 \bar{x}_1 x_2,$$

$$Y_2 = y_2 (x_1 + x_2) + \bar{x}_1 x_2.$$

In the circuit of Fig. 4, input changes influence the state variables after a set delay, following which a clock is applied to the flip-flops.

If the hold delay becomes too short, critical races and hazards loom, particularly with multiple input changes. Consider the possible functional hazard for insufficient hold delay (Table 2). Let the machine be in state B with inputs 00. If the input changes to 11, a momentary 01 or 10 could result and cause the output of the clock circuit to produce a  $0 \rightarrow 1 \rightarrow 0$  pulse. Why? The 10-input condition of the clock map yields a ONE output. If the delay-hold fails to reject this hazard, a circuit malfunction is possible—the state transition table does not specify a state change for the real input transition. To ensure sufficient delay, time T must be larger than the longest possible duration of such a spurious pulse. Therefore

$$T \geq T_1 = t_{1(\max)} - t_{3(\min)} + d, \quad (1)$$

where  $t_{1(\max)}$  is the maximum stray delay in Block 1,  $t_{3(\min)}$  is the minimum stray delay in Block 3 and d is the maximum time difference



**Table 3. Karnaugh maps for states and clock**

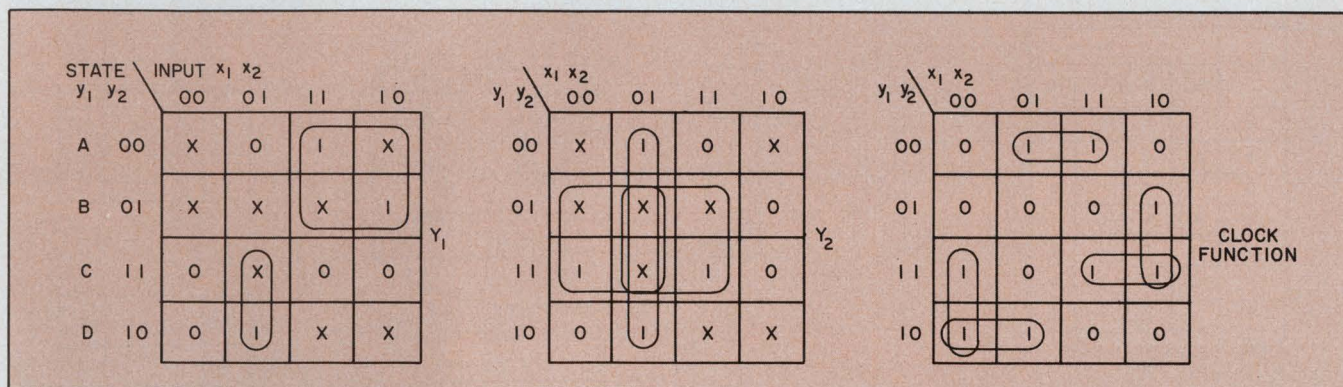

between input changes.

Possible race problems also exist. The flow table (Table 2) indicates a race condition if the hold delay is too short. Consider stable state A with input 10. Allow the input to change to 11, and the clock generates a 0 → 1 transition—which gets through the delay-hold—and then triggers the state variable flip-flops. Now, instead of a clean transition to state D, there is a possible pass through state B because of races. This could cause multiple 0 → 1 → 0 transitions, as seen in the clock map. To avoid this type of malfunction, another requirement for T can be established:

$$T \geq T_2 = (\omega_{\max} + t_{3(\max)}) - (\omega_{\min} + t_{3(\min)}), \quad (2)$$

where  $\omega_{\max}$  = the maximum switching time of the flip-flop,

$\omega_{\min}$  = the minimum switching time of the flip-flop,

$t_{3(\max)}$  = the maximum stray delay in Block 3,

$t_{3(\min)}$  = the maximum stray delay in Block 3.

A further requirement for T is it must allow for the proper setup time of the flip-flop. This must include a deduction for the minimum propagation time of the clock generation.

With these constraints,

$$T \geq T_3 = (t_{1(\max)} + d + \epsilon) - t_{3(\min)}, \quad (3)$$

where  $t_{1(\max)}$ , d,  $t_{3(\min)}$  have the same meaning as before and  $\epsilon$  is the maximum flip-flop setup time.

It is easily seen from Eqs. 1, 2 and 3 that if

$$T \geq \text{MAX}(T_1, T_2, T_3), \quad (4)$$

then the delay-hold not only smooths the transients caused by hazards, but also guarantees that when the trigger pulse arrives at the flip-flop clock inputs, all the data lines are stable.

$T_3$  is obviously greater than  $T_1$ , so that Eq. 4 is equivalent to

$$T \geq \text{MAX}(T_2, T_3). \quad (5)$$

With most TTL J-K flip-flops,  $T_2$  is definitely smaller than  $T_3$  and Eq. 5 further reduces to

$$T \geq T_3 = (t_{1(\max)} + d + \epsilon) - t_{3(\min)}. \quad (6)$$

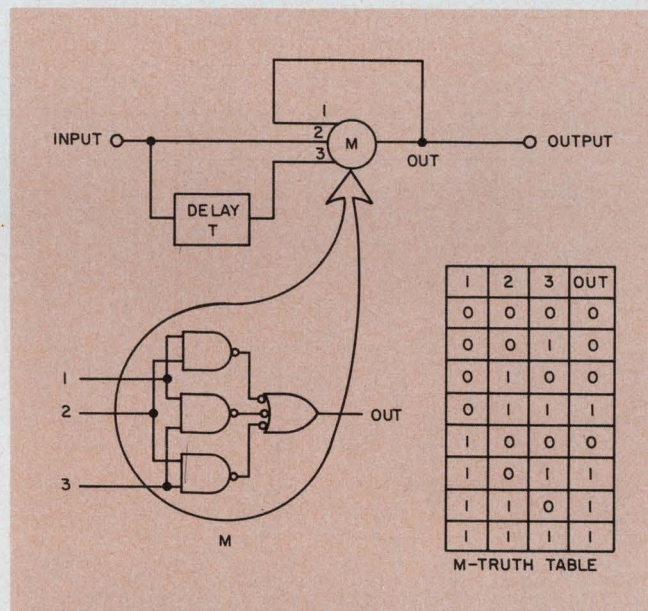

**4. Majority logic plus delay** provides the delay-hold circuit. The purpose: ignore inputs with changes that occur during a predetermined interval T.

Delay  $T_0$  in Fig. 3 is needed to ensure enough time for the state variables to propagate through Block 4 and meet the setup time of the output flip-flops. Thus

$$T_0 \geq \omega_{\max} + \epsilon + t_{4(\max)},$$

where  $\omega_{\max}$  = the maximum switching time of the state-variable flip-flops.

$\epsilon$  = the maximum flip-flop setup time,

$t_{4(\max)}$  = the maximum stray delay in Block 4.

The time for one cycle of operation is the time between any two input stimuli that will cause the circuit to react. If we disregard the output, the cycle time for state change is

$$\Delta' = t_{3(\max)} + T + \omega_{\max}. \quad (7)$$

Including the output function, the total cycle time is

$$\Delta = t_{3(\max)} + T + T_0 - t_{4(\min)}. \quad (8)$$

The addition of  $T_0 - T_{4(\min)}$  to the state cycle time is needed to ensure that the x inputs are



STATE	$x_1 x_2$			
	00	01	11	10
A	-	-	C	B
B	A	-	-	-
C	-	D	-	B
D	A	-	E	-
E	-	F	-	B
F	G	-	B	-
G	-	A	-	B

STATE TRANSITION ASSIGNMENT

(a)

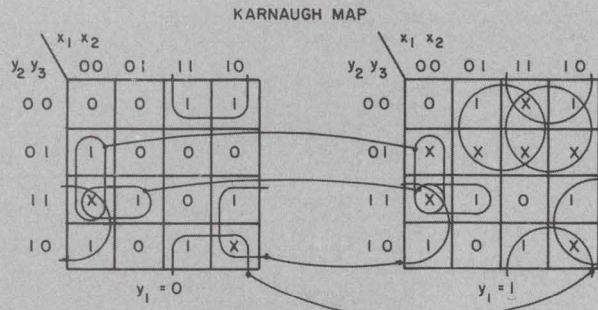

(b)

STATE	$x_1 x_2$			
	00	01	11	10
A	0	0	1	1
B	1	0	0	0
C	-	1	0	1
D	1	0	1	-
E	-	1	0	1
F	1	0	1	-
G	0	1	-	1

CLOCK FUNCTION

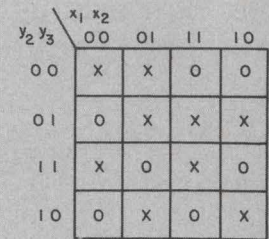

$y_1 = 0$

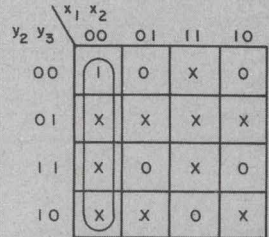

$y_1 = 1$   
OUTPUT

(c)

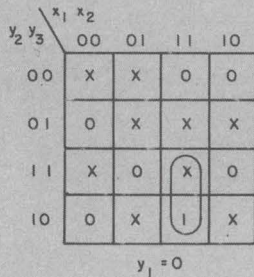

$y_1 = 0$

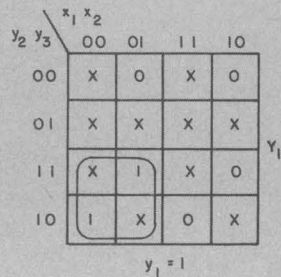

$y_1 = 1$

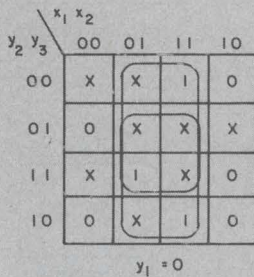

$y_2 = 0$

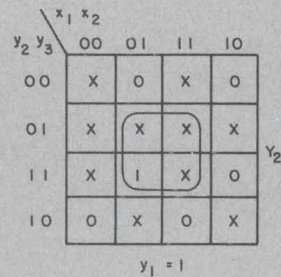

$y_2 = 1$

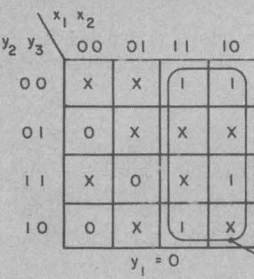

$y_3 = 0$

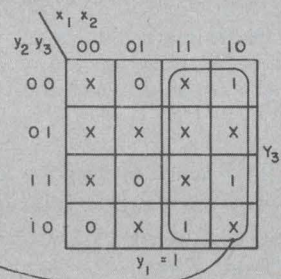

$y_3 = 1$

STATE VARIABLE MAPS

5. Detailed design includes clock function and state-transition assignments (a, b). Choice of state assignment governs clock output equations and state variables. The output map (c) can be filled in with don't-cares for all stable states in the transition table.

7 ns and  $t_{\min} \approx 2.5$  ns.<sup>4</sup>

Thus the total system cycle time is

$$\Delta = 42 \text{ ns} - 10 \text{ ns} + d + 6 \text{ ns} + 6 \text{ ns} = 44 \text{ ns} + d,$$

where  $d$  is the input requirement on the time difference between input changes (for multiple input change systems).

With only one input change at a time,  $\Delta \approx 44$  ns.

The clocked flip-flop technique does not materially increase the number of gates used, as a design example readily shows. The problem to be solved is the design of an asynchronous machine that recognizes an input sequence and produces output  $Z$ . Expressed in another way:

$x_1$  -- 0010100 --  
 $x_2$  -- 0111110 --  
 $Z$  -- 0000001 --

Three state variables suffice, but four ensure race-free operation with the conventional asynchronous design outlined in Fig. 1. The equations for states and outputs are:

State variables:

$$Y_1 = \overline{x_1} + \overline{x_2} + \overline{y_3} + \overline{y_4}$$

$$Y_2 = \overline{x_1} + y_3 x_2 + \overline{y_3} \overline{y_4} + y_3 \overline{y_4}$$

$$Y_3 = \overline{x_2} + x_1 \overline{y_3} + x_1 \overline{y_2} + y_1 \overline{y_3}$$

$$Y_4 = x_1 x_2 + x_1 y_4 + x_2 y_3 y_4$$

Output:

$$Z = \overline{y_2} \overline{y_4} \overline{x_1} \overline{x_2}$$

The triggered flip-flop method will start with

stable and do not cause an output change prior to clocking the output flip-flops.

For instance, with two-level combinatorial logic for all blocks and  $t_{i(\max)} = 2 t_{(\max)}$ ;  $t_{i(\min)} = 2 t_{(\min)}$  ( $i = 1, 3, 4$ ) and where  $t_{\max}$  and  $t_{\min}$  are the corresponding gate delays, then

$$\Delta = 2 t_{\max} + (2 t_{\max} + d + \epsilon - 2 t_{\min}) + (\omega_{\max} + \epsilon + 2 t_{\max}) - 2 t_{\min} = 6 t_{\max} - 4 t_{\min} + d + 2 \epsilon + \omega_{\max}$$

For a Schottky J-K flip-flop,  $\epsilon \approx 3$  ns and  $\omega_{\max} \approx 6$  ns; so for typical gates of the same line,  $t_{\max} \approx$



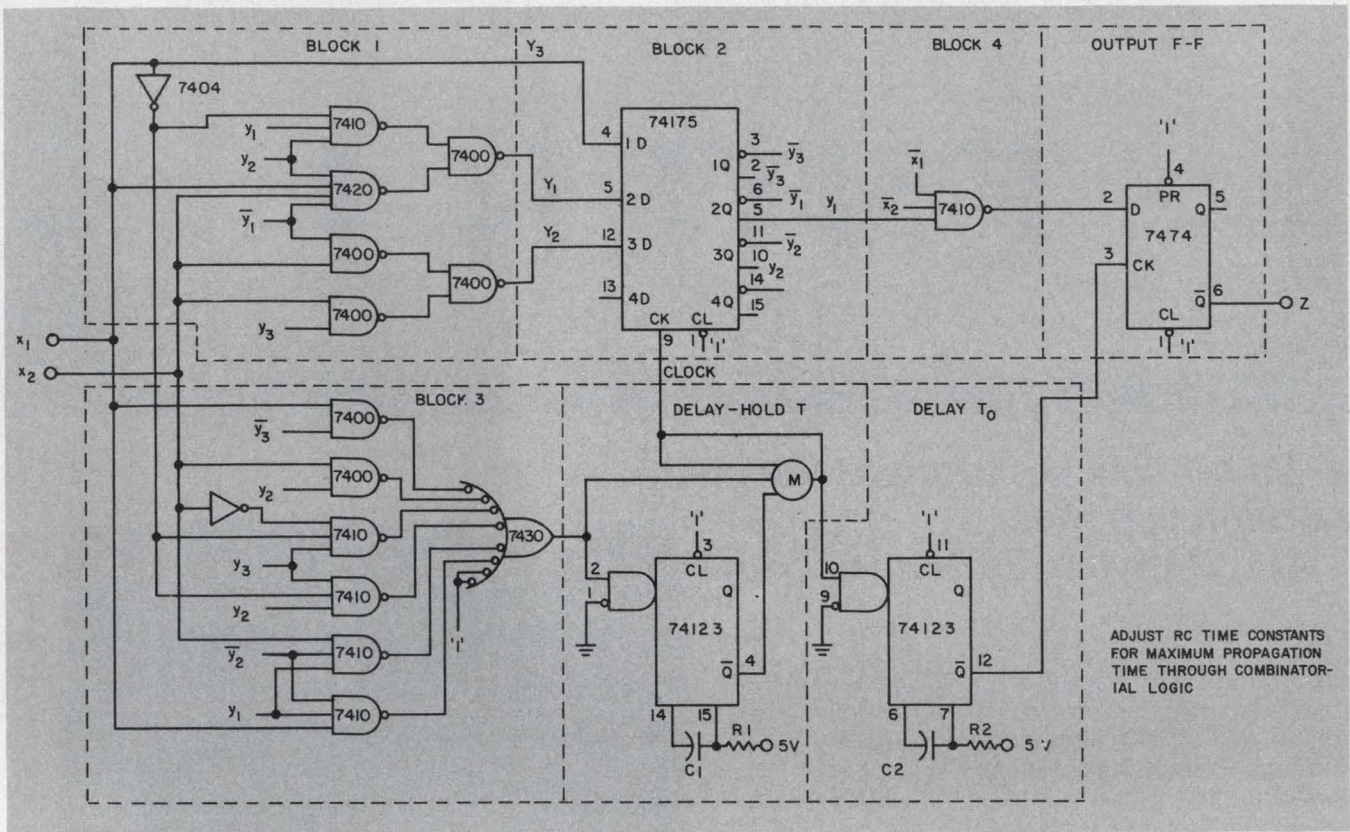

6. Completed circuit shows clearly defined segments related to the block diagram of Fig. 4. Two one-shots

add the necessary delays and permit individual adjustment for hold and output delay times.

the conventional reduced flow table, rewritten as follows:

State	$y_1 y_2 y_3$	$x_1 x_2$				Z
		00	01	11	10	
A	000	(A)	(A)	C	B	0
B	001	A	(B)	(B)	(B)	0
C	011	-	D	(C)	B	0
D	010	A	(D)	E	-	0
E	111	-	F	(E)	B	0
F	110	G	(F)	B	-	0
G	100	(G)	A	-	B	1

Proceed, as before, to draw up maps of the clock and state-transition tables. The clock output need only be ONE for a transition to a new state. Therefore all stable states in the flow table are don't-cares, since there will be no clock output to effect a change. The arbitrary state assignment chosen (Fig. 5a) determines the clock output equations (Fig. 5b) and the state variables. The single output is derived in Fig. 5c. The

output map can also be filled in with don't-cares for all stable states, since there is no clock output for these states.

The following expressions are taken from the maps:

$$Y_1 = y_1 y_2 \bar{x}_1 + \bar{y}_1 y_2 x_1 x_2$$

$$Y_2 = y_3 x_2 + y_1 x_2$$

$$Y_3 = x_1 \bar{x}_2$$

$$Z = y_1 x_1 \bar{x}_2 \bar{y}_2$$

$$C = y_2 x_2 + \bar{y}_3 x_1 + y_1 \bar{y}_2 x_1 + y_1 \bar{y}_2 x_2 + y_3 \bar{x}_1 y_2$$

Compared with normal asynchronous design, there is no need to work with an adjacency diagram and introduce another state variable. A more careful choice of state assignment can realize the clock function with still fewer gates. To complete the design add the delay-hold circuit, the  $T_0$  delay, three state variable flip-flops and one output flip-flop (Fig. 6). ■■

#### References

1. Smith, W.R., "Level Operated Sequential Machines," Course CE 485 handout, University of Bridgeport, Bridgeport, Conn. Spring Semester 1974, pp. 8-6 and 8-7.
2. Bredeson, J.G., and Hulina, P.T., "Generation of a Clock Pulse for Asynchronous Sequential Machines to Eliminate Critical Races," IEEE Trans. Comput., Vol. C-20, February, 1971, pp. 225-226.
3. Chuang, H.Y.H., and Das, S., "Synthesis of Multiple Input Change Asynchronous Machines Using Controlled Excitation and Flip-Flops," Vol. C-22 December, 1973, pp. 1103-1109.
4. *The Integrated Circuits Catalog for Design Engineers*, First Edition, Texas Instruments, Inc., Dallas, Tex., pp. 5-15 to 5-22.



# ENTER ↑

## This is your key to unprecedented calculating power. Only Hewlett-Packard offers it.

In 1928 a Polish mathematician, Dr. Jan Lukasiewicz, invented a parenthesis-free but unambiguous language. As it's evolved over the years it's come to be known as Reverse Polish Notation (RPN), and it's become a standard language of computer science.

Today, it's the one language that allows you to "speak" with total consistency to a pocket-sized calculator.

**ENTER** ↑ is the key to Hewlett-Packard's patented RPN logic system because it enables you to load data into a 4-Register Operational Stack with the following consequences:

1. You can *always* enter data the same way, i.e. from left to right, the natural way to read any expression.
2. You can *always* proceed through your problem the same way. Once you've entered a number you ask: "Can I operate?" If yes, you perform the operation. If no, you press **ENTER** ↑ and key in the next number.
3. You can see *all* intermediate data anytime, so you can check the progress of your calculations *as you go*.
4. You almost never have to re-enter intermediate answers—a real time-saver, especially when your data have eight or nine digits each.
5. You don't have to think your problem all the way through beforehand to determine the best method of approach.
6. You can easily recover from errors since each operation is performed sequentially, immediately after pressing the appropriate key, and all data stored in the calculator can be easily reviewed.
7. You can communicate with your calculator efficiently, consistently and without ambiguity. You always proceed one way, no matter what the problem.

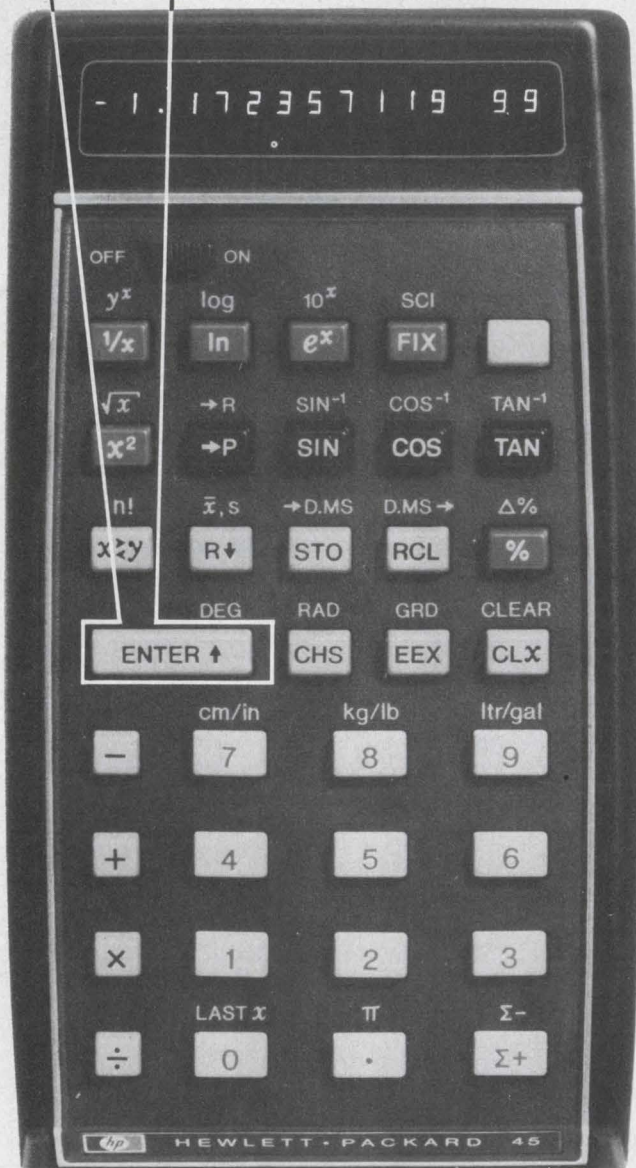





## The HP-45 uses RPN.

That's one reason it's the most powerful pre-programmed pocket-sized scientific calculator. Here are 8 others:

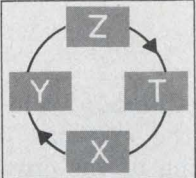
**1.** It's pre-programmed to handle 44 arithmetic, trigonometric and logarithmic functions and data manipulation operations beyond the basic four (+, -, X, ÷).

**2.**  It offers a 4-Register Operational Stack that saves intermediate answers and automatically retrieves them when they are required in the calculation.

**3.**  It lets you store up to nine separate constants in its nine Addressable Memory Registers.

**4.** It gives you a "Last X" Register for error correction or multiple operations on the same number. If you get stuck midway through a problem, you can use the "Last X" Register to unravel what you've done.

**5.**  It displays up to 10 significant digits in either fixed-decimal or scientific notation and automatically positions the decimal point throughout its 200-decade range.

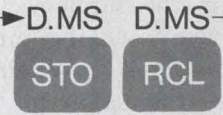
**6.**  It converts angles from decimal degrees, radians or grads to degrees/minutes/seconds and back again.

**7.**  It converts polar coordinates to rectangular coordinates... or vice-versa. In seconds.

**8.**  Its Gold "Shift" Key doubles the functions of 24 keys which increases the HP-45's capability without increasing its size.

## The HP-35 uses RPN too.

If the HP-45 is the world's most powerful pre-programmed pocket-sized scientific calculator, the HP-35 is runner-up. It handles 22 functions, has a 4-Register Stack, one Addressable Memory Register and also displays up to 10 digits in either fixed-decimal or scientific notation.

\*Domestic U.S.A. prices, not including applicable state and local taxes.

## New low prices.



HP-45: \$325\*

HP-35: \$225\*

Now the exceptional value of these exceptional instruments is even more apparent, because we've cut their prices by \$70\*. You can now own the world's most powerful pocket-sized pre-programmed scientific calculator, the HP-45, for only \$325\*. The HP-35 now costs just \$225\*.

### Send for our booklet "ENTER vs. EQUALS."

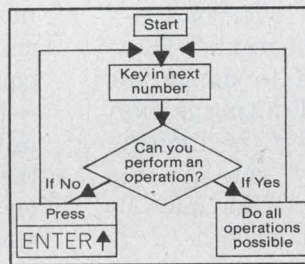

It demonstrates the superiority of Dr. Lukasiewicz' language by comparing it to other calculators' systems on a problem-by-problem basis, and it explains the algorithm shown above which lets you evaluate any expression on a calculator that uses RPN and an Operational Stack. This booklet is

must reading for anyone seriously interested in owning a powerful pocket-sized calculator.

### The coupon gets you detailed specifications of either the HP-45 or the HP-35 plus the booklet.

Just check what you want and send it along. We'll get your information back to you by return mail.

**Hewlett-Packard makes the most advanced pocket-sized computer calculators in the world.**



Sales and service from 172 offices in 65 countries.  
Dept. 232L, 19310 Pruneridge Ave., Cupertino, CA 95014. 614/20

Hewlett-Packard  
Dept. 232L  
19310 Pruneridge Avenue  
Cupertino, CA 95014  
Please send the booklet, "ENTER vs. EQUALS!"  
 Detailed specifications on your HP-35.  
 Detailed specifications on your HP-45.  
 HP-35(s) at \$225\* each plus state and local taxes.  
(Check enclosed.)  
 HP-45(s) at \$325\* each plus state and local taxes.  
(Check enclosed.)

Name \_\_\_\_\_

Company \_\_\_\_\_

Street \_\_\_\_\_

City \_\_\_\_\_ State \_\_\_\_\_ Zip \_\_\_\_\_



## Is a crowbar alone enough? To reduce the risk of power-supply damage or even fires, an overcurrent interrupt element may also be needed.

Even with a crowbar, a low-voltage, series-regulated power supply may still destroy itself, harm your load or—under extreme circumstances—touch off a fire.

This can happen because, in the course of its sole job—to protect a load from overvoltage—the crowbar draws short-circuit currents. These currents, if not limited, can lead to dangerous secondary heating. While current limiting is built into most crowbar supplies, what if the limiting action doesn't work? Don't worry, you say, the fuse is sure to blow—eventually. This may be true. But if “eventually” isn't fast enough . . .

To counteract both possibilities, an overcurrent interrupt element should be tied in to the crowbar. Then if the crowbar trips—and the limiting or the fuse doesn't function—the overcurrent interrupt element will shut down the supply.

### A crowbar alone isn't enough

With both the crowbar and interrupt element in the supply, you can rest easy. After all, your load is now fully protected.

Or is it?

Just as the presence of a crowbar doesn't by itself ensure against all hazards, a crowbar's mere presence doesn't necessarily guarantee adequate overvoltage protection: All crowbars are not alike.

Therefore look for the following characteristics in a well-designed crowbar circuit:

- Comparator-circuit bias—should be independent of the main power and reference circuitry.
- Response speed—can't be too slow—or too fast.
- Fuse selection—must ensure a fuse blow at the right time.
- Crowbar thyristor location—must be selected for optimum protection.

If current limiting doesn't function, and the line fuse doesn't open when the crowbar fires, you can expect rapid overheating of the crowbar thyristor, of any isolation diodes in series with the thyristor, and of a number of resistors within the supply. The latter includes resistors for current monitoring, series-regulator emitter equalizing and for surge limiting.

How much overheating can you expect? If the initial fault, say, is a series-regulator short, then the emitter resistor will be forced to dissipate at least twice its normal amount. This high dissipation may melt the coating of wirewound resistors or—carried to the extreme—reach the flash point of nearby materials.

Overheating in the crowbar thyristor or any of its isolating diodes may result in a strange phenomenon. The components neatly unsolder themselves from the circuit. If this happens, the crowbar can no longer clamp the output, and the voltage at the load rises to that of the supply's unregulated dc level. What happens to the load? Poof!

To ensure a fuse blow, some supplies connect the crowbar thyristor across the input-rectifier filter capacitor and the crowbar sensing circuit across the output terminals (Fig. 1). When the thyristor fires, it discharges the capacitor and clamps the rectifier voltage to a low value. If the current path through the thyristor is of low-enough impedance, the overload will reflect back to the ac line and open the fuse.

### Where's the fuse?

There are several drawbacks to this configuration, however. First, the ac line fuse will probably—and annoyingly—blow more frequently. This means that an abundant supply of fuses must be readily available to avoid needless downtime.

If the power supply is also buried in an all but inaccessible location—forget it. (Don't forget, however, that frequent manual fuse changes pre-empt the advantages of automatic-reset crowbars.)

Another limitation of the “inboard” crowbar

---

Willis C. Pierce, Jr., Project Manager, Hewlett-Packard, New Jersey Division, Green Pond Rd., Rockaway, N.J. 07866.



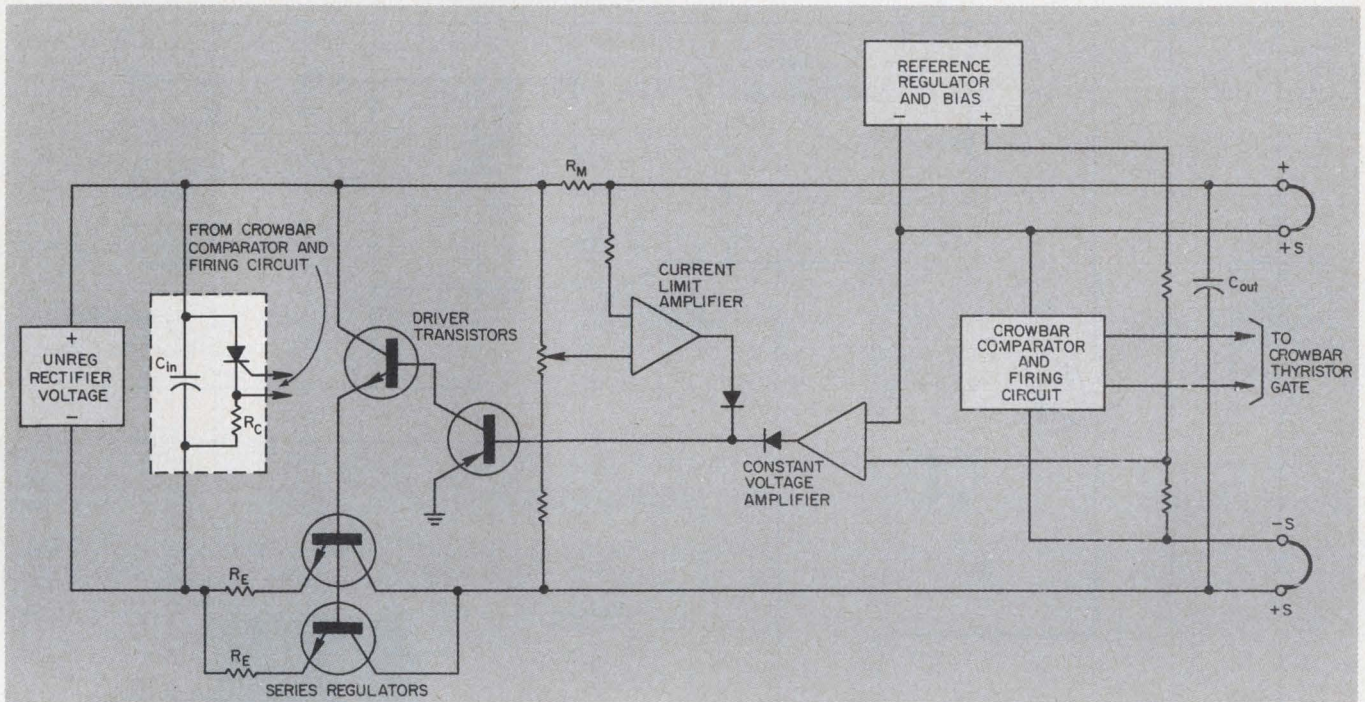

1. To ensure a fuse blow when a fault occurs, some power supplies place the crowbar thyristor across the

input-rectifier filter capacitor. But this may cause the fuse to blow more frequently.

## What is a crowbar?

In a crowbar, when a power supply's output voltage rises above a predetermined, acceptable level, circuitry detects the overvoltage condition and fires a thyristor (SCR or triac) connected across the power-supply output terminals. The thyristor places a virtual short across the terminals and thereby clamps the output voltage to a safe level.

Whether SCR or triac, the significant characteristic of this element is that it must behave as a switch. When the crowbar is in its non-actuated state, the element is a virtual open circuit that draws no current from the power supply. When the crowbar is actuated, the thyristor switches on and begins to absorb the output current while it forces the output voltage down (see figure).

The crowbar thyristor is controlled by a circuit that compares the power-supply output voltage to that of a reference. As long as the output is less than the reference, no firing signal is sent to the thyristor. When the output exceeds the reference, the comparator signals the thyristor, which then switches on.

The supply output voltage is held to the thyristor's saturated forward drop—1 to 1.5 V.

When the supply senses the increase in load current, it goes into the foldback current mode to limit the internal dissipation and that of the thyristor.

The power supply and crowbar remain in a state of equilibrium until input power is removed. The crowbar then resets, and the supply returns to normal operation after input power is reapplied. The sequence of operation from firing to current limit requires only tens of milliseconds before steady state is reached.

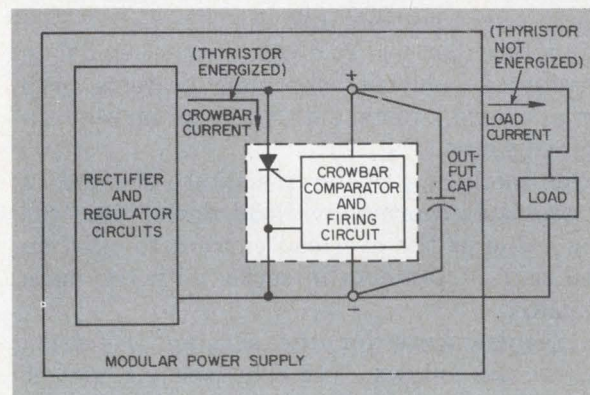



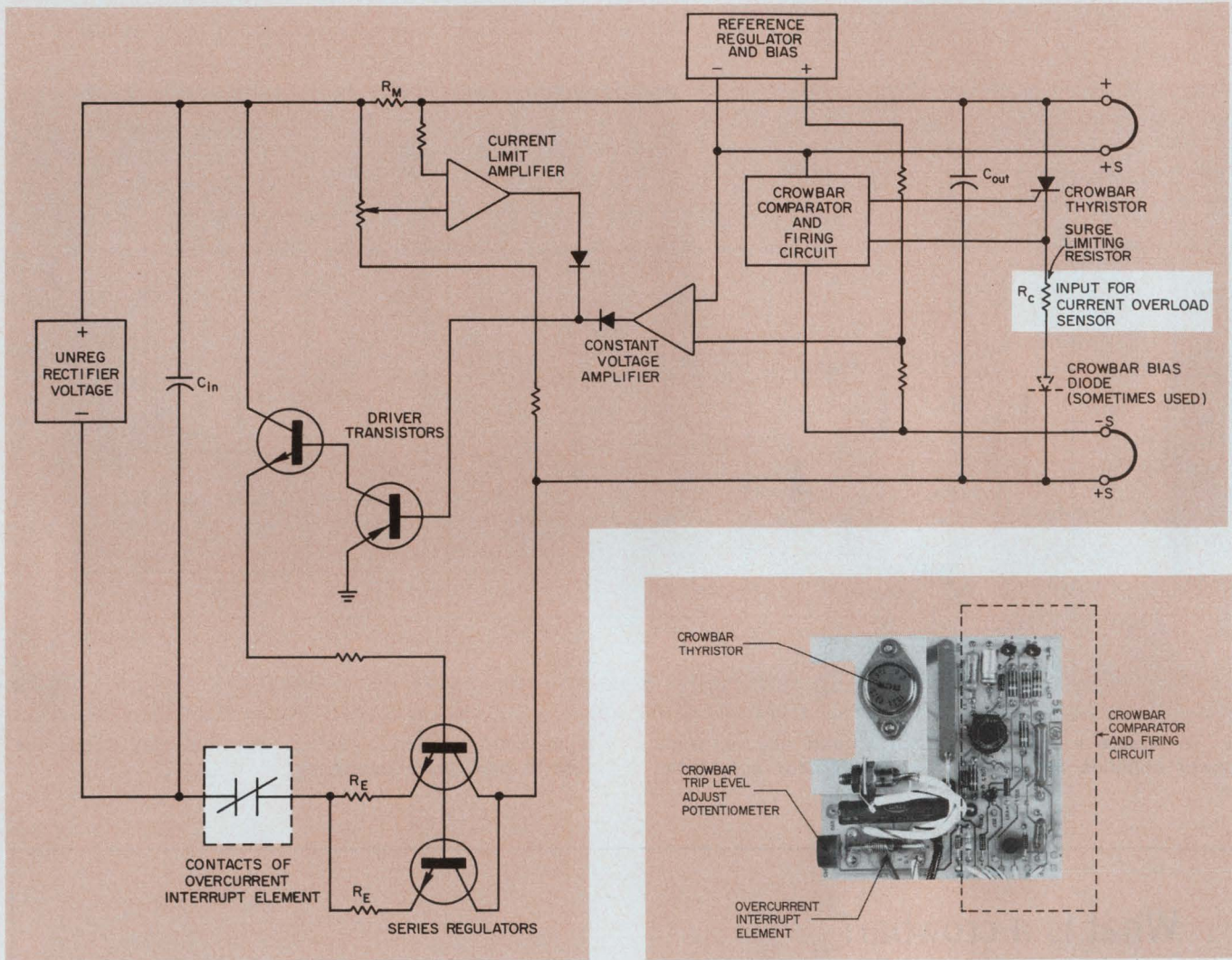

2. To protect against damage if both the fuse and the foldback-current limiting circuit become inoperative, an overcurrent interrupt element is used along with the

crowbar. When a fault occurs, the interrupt element's contacts open the main series power path. With this method, both the supply and load are fully protected.

is the stress placed on the input rectifiers when the crowbar fires. Since the crowbar thyristor places a virtual short across the unregulated dc, the rectifiers must provide the overload current until the ac line fuse opens and interrupts the input power. The repeated overload surges can adversely affect rectifier life.

In supplies that use foldback current limiting, the preferred solution—one that protects both supply and load—rests with the overcurrent interrupt element (Fig. 2).

In this method, a heater resistance element in a nonresettable thermal-overload device uses the heating value of the overload current to open an isolated pair of contacts in series with the main power path.

The requirements for the sensing/protection device are as follows: (1) The sensing circuit must be electrically isolated from the contacts; (2) The interrupt element must have a sufficient-

ly long time constant to prevent false actuation of the protection device. This can happen when the crowbar initially fires and receives a surge from the output-capacitor discharge.

Thus the protection device must be selected so the thermal time constant of the heater element is significantly shorter than that of the other circuit elements. But the time constant must be long enough to prevent tripping of the overload device when the crowbar operates upon an external failure, rather than an internal one.

The non-resettable, or one-shot, characteristic of the interrupt element prevents the power supply from being turned on after a fault has occurred. This stops repeated on-off cycling of the supply, which can result in unnecessary stress on internal components, or of the load.

To replace the actuated overload device presents no particular problem since, presumably, the device opened because of an internal failure



and the power supply must be disassembled any way for repair.

Since the thermal overload actually operates at some fixed value of temperature, and since the device is heated by the current through its resistor, both the ambient temperature and ac line voltage will influence the trip point.

### Select for worst case

Therefore the interrupt element must be selected or biased with additional resistors to ensure satisfactory operation under worse-case conditions of ambient and line voltage. One worse-case condition occurs at low line voltage and low ambient temperature. This condition results in the longest actuating time.

But while the device must actuate fast enough to protect at low line, low ambient, the actuating time must be long enough to prevent false tripping. This can occur under high ambient conditions or when the crowbar actuates but no power-supply failure has occurred.

Though the resistively heated thermal-overload is probably the best way to provide secondary protection, other methods exist. For example, reed relays or Hall-effect sensors can be used to sense the overload current magnetically. But these require auxiliary circuitry at additional cost.

Another method uses an electromechanical thermal device, such as a thermostat. The thermostat, which can be automatically or manually reset, operates as the one-shot thermal overload does, but doesn't respond as fast. Also it is larger and more expensive.

Note that, with normal crowbar action, the element will not actuate. When the crowbar trips—and there has been no power-supply failure—the thyristor clamps the output voltage to a low value. The power-supply current limit then takes over and the supply remains in equilibrium until the ac input power is removed and reapplied.

If, however, the crowbar trips because of an internal failure, and the current limit circuit is not operating, then the interrupt element shuts down the supply before a serious hazard or load damage occurs. Thus the overload-protected crowbar may be considered as one with secondary protection.

To avoid the possibility that a single component failure can disable both the power supply and its crowbar, the crowbar's comparator circuit should be biased separately from the rest of the power supply. The crowbar may derive power from the supply transformer windings and rectifiers, but should have its own reference element, comparator and firing circuitry.

Crowbar circuits are sometimes built as two-terminal devices to be connected across the power-supply output terminals. In these circuits, the crowbar reference and comparator circuits undesirably draw bias and excitation power from the power-supply output.

Also undesirable: And the load may not be adequately protected if remote sensing is used. This is because the crowbar's trip level must set high enough to compensate for both normal drops in the load leads and output transients caused by unloading. The sum of these effects can be enough to permit excessive load voltage before the crowbar senses the fault.

By contrast, a four-terminal crowbar permits the crowbar thyristor leads to be connected at the output terminals, while the crowbar sense leads can be connected to the remote sense terminals. Thus the crowbar senses the actual load voltage and is not affected by the drop across the load leads.

### Critical crowbar specs

Another critical parameter is the crowbar's speed of response to an overload. If the crowbar's response time—the time required to sense and trigger following an overvoltage—is too fast, then spurious noise can cause false tripping. If the response is too slow, then the output can rise high enough to damage the load.

As an example, assume that a 5-V, 16-A power supply fails because of a short in one of its series-regulator transistors. Now with 10-V across a 40,000- $\mu$ F rectifier filter capacitor, an output capacitor of 10,000  $\mu$ F, a load voltage of 5 V and 17 m $\Omega$  of resistance in series between the two capacitors, the voltage across the load rises to 5.5 V in 17.9  $\mu$ s.

Because of the crowbar's trip margin, which may be as much as 1 V above the output-voltage setting, and because of the rapid rate of rise of the output voltage, the crowbar should respond in about 20  $\mu$ s. This will ensure safe limits for TTL and similar loads.

Safety in power supplies frequently depends on the fuse—that thin string of metal whose only function is to burn up and die. In one of the most common power-supply failure modes—that of a shorted series regulator—current limiting becomes inoperative and the burden of protection falls upon the fuse. Unfortunately the fuse may not want to die. Here's why.

### Don't depend on the fuse

When a modular power supply—one with a fixed output voltage—is designed, the output power is usually optimized for the user's load.



# IEE-POLARIS<sup>TM</sup>

## FIELD EFFECT LIQUID CRYSTAL DISPLAYS

- Ideal for high ambient lighting and low power, portable equipment applications



- Individual left hand decimals, overflow  $\pm 1$ , & colon (:) for clock and counter applications

- 200 lines/cm resolution; 25:1 contrast

- Reflective or transmissive, 3½ decade arrays with .43" high, 7-segment characters

- 40-50 msec switching time

- Extremely low power (<1/2  $\mu$ W per segment @ 10-15VAC, 30-1000 Hz)

- Slim profile (.125")

- Long life (20/000 hours @ 12VAC); broad operating range (-10 to +65°C)



For your every man/machine interface requirement, IEE has a solution. From "the Olympus of Displays," the world's most diversified selection of display products, technologies, and design expertise, IEE offers you your choice of:

- Multiple Message Displays — rear projection; status indicator/annunciators; mini-CRT's
- Dynamic Message Displays — 64 & 256 character dot matrix panels
- Numeric & A/N Displays — line filament; neon; transilluminated;

LED's (with integrated electronics); liquid crystals; gas discharge; fibre-optics

- Subminiature Lamps — LED & incandescent
- Low Profile Switches — completely sealed, illuminated, custom arrays
- Peripheral Accessories — universal mounting hardware; bezels; interface circuitry
- Customized Products & Multi-Function Systems. Never has

so much been available to so many from a single source. Hadn't you better write or call today for your copy of IEE's Product Selector?



**the Olympus of displays**

Industrial Electronic Engineers, Inc.  
7740 Lemona Ave., Van Nuys, Calif. 91405  
Phone: (213) 787-0311 TWX 910-495-1707

European Office: 6707 Schifferstadt, Eichendorff-Allee 19, Germany.

**DIAL-A-SOURCE: Call toll-free 800-645-9200**

To do this, the power-supply engineer designs the power transformer and filter capacitor to provide just enough dc voltage to prevent saturation of the series-regulator transistors under worst-case operating conditions. This means that the low-line, full-load rectified input voltage may be only a few volts higher than the regulated output voltage.

When the thyristor fires and clamps the output voltage, it produces a saturated drop of between 1 and 1.5 V across the power-supply output terminals. This voltage subtracts from the available unregulated rectifier voltage. The dc current is then determined by the rectified voltage less the thyristor voltage, divided by the sum of the series circuit resistances. Included in series are the resistors for current monitoring and emitter equalizing, the thyristor surge-limiting resistor, and the resistance of the circuit-board conductors and interconnecting wires.

Though the sum of these series resistances seems to be rather low, the total is not much less than that which the regulator's dc load resistance presents to the input rectifier filter capacitor under normal operation. Thus thyristor current under fault conditions is limited by the power-supply circuitry, and this current may be sufficient to blow the fuse.

Fault current is limited by another factor—the regulation characteristic of the unregulated dc supply (transformer, rectifier, filter capacitor) under fault conditions. When a fault occurs in the dc load circuitry, the output voltage rises, the crowbar fires and drastic changes occur in the operation of the rectifier filter capacitor. In effect, the rectifier input sees a reduction in load resistance, which results in a lower average voltage at the capacitor terminals. Consequently the overload current is limited to a value that can be insufficient to open the ac line fuse.

Typically, the rectifier capacitor sees an apparent load of 1.08  $\Omega$  when the power supply behaves normally, and 0.36  $\Omega$  when one of the series-regulator transistors shorts. The rms line current changes from 1.4 to only 2.4 A under fault conditions even though the load impedance changes by a factor of three to one. If the power supply carries a 2.5-A fuse—probably the minimum value necessary to avoid annoying fuse blowing upon turn on—then it is obvious that the ac line fuse can't adequately protect the supply.

### Fuse selection isn't simple

Therefore to make sure the fuse does its job, it should be selected with these criteria in mind: With a capacitive input filter, the fuse must



handle the steady-state line current, as well as the peak inrush currents that occur on turn on. To do this, it is common practice to select a fuse whose rated current is between 125% and 250% of the supply's rated full-load line current. This usually provides enough overload capability to prevent fuse blowing from aging and fatigue with repeated turn-on overloads.

Next examine the opening time vs overload characteristics of standard commercial fuses such as the commonly used 3AG or 3AB glass type. Known for reliability, low cost and widespread availability, the 3AG or 3AB offer normal, fast or slow-blow characteristics. These characteristics specify the percentage overload vs typical opening time for the first 100 s of overload. Beyond 100 s the characteristic is the same for all three types: Each can sustain a 135% overload for one hour.

Now, recall the example in which the supply's rms line current increased to only 2.4 A under a fault (17% of full rated current). If the ac line fuse for this supply was selected for 175% of rated line current—and it can sustain a 135% specified overload for one hour—the fuse can operate for up to one hour with 236% of full rated current through it. Clearly, this line fuse cannot do its job when a series-regulator transistor or one of the driver transistors shorts.

An obvious solution to this problem is to place a fuse in the dc-load circuit. This appears to be a good solution because a fault gives a greater percentage increase in dc-load current than in the rms primary or secondary load current. But wait!

To move the fuse to the dc side, you've got to find one whose rating just equals the power supply's output-current rating, and that accepts an overload for approximately 100 s before it opens.

Since fuses normally come in specific values only (they increase in about 1-A increments from 3 to 8 A, 2-A increments from 8 to 12 A and 5-A increments above 15 A), it may not be possible to find one that will open in 100 s under all fault conditions. Even if you do, 100 s can be long enough to permit gross overheating of resistors in the dc circuit and severely damage the supply.

Another important point: Because many possible failure modes exist, and because a failure may not present a zero-impedance short, fault currents in the power-supply load circuit and in the crowbar are not accurately predictable. It's conceivable that a failure mode could limit the fault current and keep it at 135% of the fuse rating, or less. If this were to occur, the fuse would tolerate the overload for much longer than 100 s. The potential problems are obvious. ■■

# IEE·MIDAS™

## ILLUMINATED MEMBRANE SWITCHES

- Environmentally sealed, transparent mylar membranes
- Extremely lightweight, "wafer-thin," profile — front & rear of panel
- Long life: 1,000,000 cycle life-rated
- No mechanical linkage, springs or buttons
- Quiet, positive, fingertip pressure (4-9 oz.), single pole/single throw, momentary contact switching
- Lowest cost per switch for high density switch requirements
- Optional matrix design (customized or standard), such as 1x8, 3x4, 2x3, 5x6, 7x8, 10x10, etc.
- Displays any graphic data reproducible on film; optional color

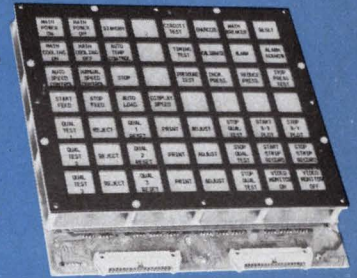

From the very beginnings of information display, IEE has been a leader in the innovative design, successful introduction, reliable manufacture, condensed packaging, and effective application of high quality, display devices and integrated systems for commercial, industrial and military use. Based on two decades of experience, and a dedication to quality, IEE today offers:

- the world's most diversified selection of display products
- the design, human factors, and

systems integration expertise to fulfill your most sophisticated requirements.

- the pricing, product availability, and productive capacity to meet your most demanding schedules
- and the ingenuity and sincere desire to help solve your most complex display problems.

Information Display is OUR business; why not contact the experts for YOUR solutions? Call or write today for information regarding introductory offers on prototype evaluation quantities of many of IEE's display products.



# the Olympus of displays

Industrial Electronic Engineers, Inc.  
7740 Lemona Ave., Van Nuys, Calif. 91405  
Phone: (213) 787-0311 TWX 910-495-1707

European Office: 6707 Schifferstadt, Eichendorff-Allee 19, Germany.

**DIAL-A-SOURCE: Call toll-free 800-645-9200**



Do you face  
a make or buy  
decision on  
power supplies?

# BUY LAMBDA'S 5-YEAR 11 POWER PACKAGES. ALL 1-DAY

## SPECIFICATIONS FOR LX SERIES

### DC Output

#### Regulated Voltage

regulation, line . . . . . 0.1%  
regulation load . . . . . 0.1%  
ripple and noise . . . . . 1.5 mV RMS, 5 mV pk-pk with either  
positive or negative terminal grounded  
temperature  
coefficient . . . . . 0.03%/°C

### AC Input

line . . . . . 105-132 VAC; 47-440 Hz. For 187-242 VAC, add  
suffix "V" to model numbers and add 12% or  
\$30.00 to the price, whichever is greater. For  
operation of LX-D, LXS-E, LX-EE, LXS-7, and  
LXS-8 units at 50 Hz or at 400 Hz, consult fac-  
tory. Ratings apply to 57-63 Hz. For all other mod-  
els delete 40°C rating for 50 Hz operation.

### Ambient operating temperature range

continuous duty from 0° to + 71°C with corresponding load  
current ratings for all modes of operation.

### Storage temperature range

-55°C to +85°C

### Overload protection

#### Thermal

thermostat, automatic reset when over-temp. condition is re-  
moved. (Not applicable to LXD-3); circuit breaker must be reset  
on LX-8 models.

#### Electrical

external overload protection, automatic electronic current limit-  
ing circuit limits the output current to the present value,  
thereby providing protection for load as well as power supply.

### Overshoot

no overshoot on turn-on, turn-off or power failure.

### Input and output connections

through terminal block on chassis; output terminals on LX-7,  
LX-8 models are two heavy duty studs.

### Power hybrid voltage regulator or integrated circuit regulation

some models have Power Hybrid Voltage Regulator providing  
complete regulation system while others have an integrated  
circuit providing regulation system except for input and output  
capacitors, rectifiers and series regulation transistors.

### Controls

#### DC Output Control

simple screwdriver voltage adjustment over entire range.

### Remote sensing

provision is made for remote sensing to eliminate effect of  
power output lead resistance on DC regulation.

### Transformer

MIL-T-27C, Grade 6

### Tracking accuracy (dual models)

2% absolute voltage difference; 0.2% change for all conditions  
of line, load and temperature.

### Fungus proofing

All fungi nutrient components are rendered fungi inert with  
MIL-V-173 varnish—Standard on all LX models and is included  
in price.

## 5 VOLTS ±5% SINGLE OUTPUT

MODEL	MAX. AMPS AT AMBIENT OF:				PRICE
	40°C	50°C	60°C	71°C	
LXS-A-5-OV-R*	4.0	3.4	2.7	2.0	\$ 95.
LXS-B-5-OV-R*	5.8	5.0	4.0	3.0	130.
LXS-4-5-OV-R*	7.4	6.5	5.4	3.9	145.
LXS-C-5-OV-R*	9.0	8.0	6.8	5.3	160.
LXS-CC-5-OV-R*	16.0	14.5	12.7	10.5	220.
LXS-D-5-OV-R*	27.5	24.2	20.5	16.5	260.
LXS-E-5-OV-R*	35.0	30.0	24.0	17.5	320.
LXS-EE-5-OV-R*	45.0	39.0	32.0	25.0	445.
LXS-7-5-OV-R**	65.0	56.0	46.0	35.0	535.
LXS-8-5-OV-R**	85.0	77.0	68.0	56.0	580.

\*Includes fixed overvoltage protection at 6.8V ±10%

## 6 VOLTS ±5% SINGLE OUTPUT

MODEL	MAX. AMPS AT AMBIENT OF:				PRICE
	40°C	50°C	60°C	71°C	
LXS-A-6-R	3.7	3.1	2.5	1.9	\$ 95.
LXS-B-6-R	5.5	4.7	3.8	2.9	130.
LXS-4-6-R	6.6	5.8	4.8	3.5	145.
LXS-C-6-R	8.8	7.8	6.7	5.2	160.
LXS-CC-6-R	15.2	13.8	12.1	10.0	210.
LXS-D-6-R	26.5	23.4	19.8	16.0	260.
LXS-E-6-R	34.0	29.0	23.0	16.5	320.
LXS-EE-6-OV-R†	42.0	36.0	30.0	22.0	445.
LXS-7-6-OV-R**	59.0	50.0	41.0	32.0	535.
LXS-8-6-OV-R**	70.0	70.0	68.0	56.0	580.

†Includes fixed overvoltage protection at 7.4V ±10%

## 12 VOLTS ±5% SINGLE OUTPUT

MODEL	MAX. AMPS AT AMBIENT OF:				PRICE
	40°C	50°C	60°C	71°C	
LXS-A-12-R	2.7	2.2	1.8	1.5	\$ 95.
LXS-B-12-R	3.8	3.6	3.0	2.2	130.
LXS-4-12-R	4.4	3.8	3.1	2.5	145.
LXS-C-12-R	6.5	6.1	5.5	4.6	160.
LXS-CC-12-R	10.5	9.4	8.2	5.0	210.
LXS-D-12-R	16.0	14.0	11.9	8.0	260.
LXS-E-12-R	21.0	18.0	15.0	12.5	320.
LXS-EE-12-R	32.0	27.0	22.0	16.0	420.
LXS-7-12-OV-R**	40.0	36.0	30.0	23.0	535.
LXS-8-12-OV-R**	50.0	45.0	40.0	34.0	580.

## 15 VOLTS ±5% SINGLE OUTPUT

MODEL	MAX. AMPS AT AMBIENT OF:				PRICE
	40°C	50°C	60°C	71°C	
LXS-A-15-R	2.4	2.0	1.6	1.3	\$ 95.
LXS-B-15-R	3.2	2.8	2.5	1.5	130.
LXS-4-15-R	4.0	3.5	2.8	2.3	145.
LXS-C-15-R	6.0	5.6	5.1	4.5	160.
LXS-CC-15-R	9.5	8.6	7.4	4.8	210.
LXS-D-15-R	14.0	12.3	10.4	7.5	260.
LXS-E-15-R	19.0	17.0	14.0	12.0	320.
LXS-EE-15-R	28.0	24.0	19.5	14.0	420.
LXS-7-15-OV-R**	36.0	32.0	26.0	20.0	535.
LXS-8-15-OV-R**	45.0	41.0	36.0	30.0	580.

\*\*Built-in continuously adjustable overvoltage protection crowbars output  
when trip level is exceeded. Included on all LXS-7, LXS-8 models.



# GUARANTEED LX SERIES. DELIVERY.

## 20 VOLTS $\pm 5\%$ SINGLE OUTPUT

MODEL	MAX. AMPS AT AMBIENT OF:				PRICE
	40°C	50°C	60°C	71°C	
LXS-CC-20-R	7.7	7.2	6.5	4.4	\$210.
LXS-D-20-R	11.5	10.2	8.6	6.8	260.
LXS-E-20-R	15.0	13.0	10.5	7.0	320.
LXS-EE-20-R	22.0	18.5	14.5	10.0	420.
LXS-7-20-OV-R**	28.0	25.0	20.5	15.5	535.
LXS-8-20-OV-R**	32.0	29.0	25.0	17.0	580.

## 24 VOLTS $\pm 5\%$ SINGLE OUTPUT

MODEL	MAX. AMPS AT AMBIENT OF:				PRICE
	40°C	50°C	60°C	71°C	
LXS-CC-24-R	6.8	6.4	5.7	4.4	\$210.
LXS-D-24-R	10.0	8.8	7.5	6.0	260.
LXS-E-24-R	13.0	11.0	9.5	6.0	320.
LXS-EE-24-R	19.0	16.5	13.0	9.5	420.
LXS-7-24-OV-R**	25.0	22.0	18.0	14.0	535.
LXS-8-24-OV-R**	30.0	27.0	23.5	17.0	580.

## 28 VOLTS $\pm 5\%$ SINGLE OUTPUT

MODEL	MAX. AMPS AT AMBIENT OF:				PRICE
	40°C	50°C	60°C	71°C	
LXS-CC-28-R	6.0	5.6	5.0	4.3	\$210.
LXS-D-28-R	9.0	8.0	6.8	5.5	260.
LXS-E-28-R	11.0	10.0	8.5	5.5	320.
LXS-EE-28-R	17.0	15.0	12.0	9.0	420.
LXS-7-28-OV-R**	22.0	19.5	16.0	12.5	535.
LXS-8-28-OV-R**	28.0	25.5	22.5	17.0	580.

## $\pm 15$ TO $\pm 12$ VOLTS DUAL OUTPUT <sup>(1)</sup>

MODEL	ADJ. VOLT. RANGE VDC	MAX. AMPS AT AMBIENT OF:				PRICE
		40°C	50°C	60°C	71°C	
LXD-3-152-R	$\pm 15$	0.400	0.370	0.340	0.300	\$ 90.
	to $\pm 12$	0.400	0.370	0.340	0.300	
LXD-A-152-R	$\pm 15$	1.0	1.0	0.9	0.7	130.
	to $\pm 12$	0.8	0.8	0.7	0.6	
LXD-B-152-R	$\pm 15$	1.6	1.4	1.2	0.7	160.
	to $\pm 12$	1.4	1.3	1.1	0.6	
LXD-C-152-R	$\pm 15$	2.5	2.3	1.9	1.5	170.
	to $\pm 12$	2.0	1.8	1.5	1.2	
LXD-CC-152-R	$\pm 15$	4.0	3.7	3.2	2.4	255.
	to $\pm 12$	3.0	2.7	2.3	1.8	
LXD-D-152-R	$\pm 15$	6.2	5.6	4.9	4.0	300.
	to $\pm 12$	4.5	4.1	3.7	3.0	
LXD-EE-152-R	$\pm 15$	12.5	11.0	9.0	7.0	455.
	to $\pm 12$	10.0	9.0	7.8	6.0	

Overvoltage protector accessory available for all models without built-in overvoltage protection.

(1)  $\pm 15$  to  $\pm 12$  and  $\pm 6$  to  $\pm 3$  volts are each dual tracking outputs; dual outputs can be connected in series for 30-24 volts and 12-6 volts, respectively.

## $\pm 6$ TO $\pm 3$ VOLTS DUAL OUTPUT <sup>(1)</sup>

MODEL	ADJ. VOLT. RANGE VDC	MAX. AMPS AT AMBIENT OF:				PRICE
		40°C	50°C	60°C	71°C	
LXD-B-062-R	$\pm 6$	2.7	2.4	1.9	1.4	\$170.
	to $\pm 3$	2.1	2.0	1.6	1.2	
LXD-C-062-R	$\pm 6$	3.5	3.3	2.7	1.7	180.
	to $\pm 3$	2.6	2.4	1.9	1.3	

## 5 VOLTS $\pm 5\%$ , $\pm 15$ TO $\pm 12$ VOLTS TRIPLE OUTPUT

MODEL	ADJ. VOLT. RANGE VDC	MAX. AMPS AT AMBIENT OF:				PRICE
		40°C	50°C	60°C	71°C	
LXT-D-5152-R	5 $\pm 5\%$ *	12.0	11.5	11.0	9.5	\$395.
	$\pm 15$	3.1	2.7	2.2	1.7	
	to $\pm 12$	2.3	2.0	1.7	1.3	

\*5 volt output has fixed overvoltage protection at 6.8V  $\pm 10\%$ .  $\pm 15$  to  $\pm 12$  output is dual tracking output.

## NEW LX-7 DESIGNED TO MEET MIL ENVIRONMENTAL SPECIFICATIONS.

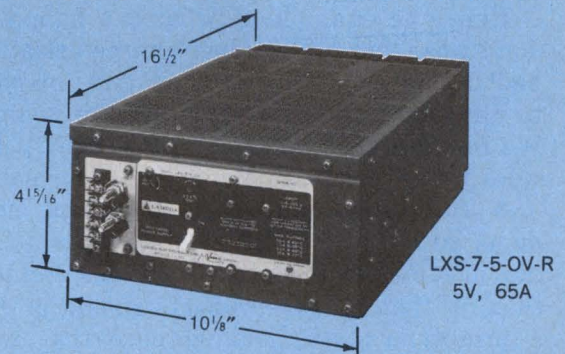

**\$535**  
**5-YEAR GUARANTEE**

Send for free copy of  
1974 Power Supply Catalog and Application Handbook

**LAMBDA**  
ELECTRONICS CORP.

A **Yocco** Company

MELVILLE, NEW YORK 11746 515 Broad Hollow Road Tel. 516-694-4200 ARLINGTON HEIGHTS, ILL. 60005 2420 East Oakton St., Unit Q Tel. 312-593-2550 NORTH HOLLYWOOD, CALIF. 91605 7316 Varna Ave. Tel. 213-875-2744 MONTREAL, QUEBEC 100C Hymus Blvd., Pointe Claire, Quebec 730 Tel. 514-697-6520 HIGH WYCOMBE, BUCKS, ENG. Abbey Barn Road, Wycombe Marsh Tel. High Wycombe 36386/7/8 ORSAY, FRANCE 91 Gometz le Chatel. ACHERN-FAUTENBACH, W. GERMANY Im. Holzbosch 14 Tel. 078-41-5527

INFORMATION RETRIEVAL NUMBER 68



## Servicing a high-technology product

means that engineering must provide a design capability that minimizes later problems with the customer.

As a company whose goal is to do complete servicing for every product we design, we're acutely aware of a problem that nearly all electronics manufacturers face: How to design products that won't give the end user trouble—or, if they do, that can be serviced easily.

Our engineering staff aims to do it by meeting the following challenges:

- Providing full product characterization.
- Using long-life components.
- Realizing that compromise designs are possible.
- Providing complete documentation.

### The push beyond minimum/maximum specs

Any company that is going to service its own product must determine the full characterization of the products. It must find out everything its products can do—not just the minimum and maximum specs, but everything. That will also provide a complete list of applications for potential customers.

Here's an example of what can happen if you don't push for full product characterization: We had developed a fine product and introduced it to the market before most of the competition. We found a good demand for the unit, and there were many questions about its performance.

A full characterization of it had not been done, so we had to do a lot of tests to answer the questions of potential users. We decided from then on that all our products should go through a prototype stage, making sure that we don't skip any steps in the full characterization. It was an expensive process, but in the long run it was a more efficient technique than doing a number of spot tests.

It also saved the potential user the job of doing a lot of the testing himself. Then, too, if you characterize the product, you may find out that there are some parts of the item that

can be improved with only a minor change. That'll cut down on your servicing time later.

### Figuring the component tradeoffs

Another major challenge that always comes up in any major engineering product is the component question. Since the project manager wants to produce a device that will be sold for several years, should he use established components or newer components?

The problem in using older components—transistors vs integrated circuits, say—is that with the older components, the design may be easier and more quickly done but the cost may be higher. It costs more, for example, to use many transistors instead of a few ICs.

The engineer must look into the future and figure which costs will come down; he must equate material costs against the material plus associated labor for the older components.

To solve the component challenge, it's important for the manager to emphasize future use. He has to make sure that engineering personnel are informed daily of presently available components and at the same time make sure that they have a feeling as to what the future projects.

If the engineer designs something that contains a single-sourced component, part of his future projection should consider whether there'll be multiple sources in the future.

### Specs are made to be broken

Any engineer who works for a high-technology company must realize that some specs are written to be compromised. With any particular product design, there's always an initial specification that engineers are designing against. That spec is basically a guide. It's very easy for an engineer to say: "Spec 'A' is what I need, and I'm going to keep butting my head against the wall until I achieve it."

The other, more practical alternative to this is for engineering management to present the philosophy that the specs are a goal and that in

---

Jack Alford, Director of Product Planning, ILC Data Devices Corp., 105 Wilbur Pl., Bohemia, N.Y. 11716



## Jack Alford and DDC

During the 8-1/2 years that Jack Alford has been with ILC Data Device Corp., he has held positions of Product Engineer, Director of Engineering, and Director of Micro-electronics. He is now Director of Product Planning.

Prior to joining ILC DDC, he was with Telemet Company as Product Line Manager for supervisory control instrumentation and sub-systems. Before that he was Product Engineer for Loral Electronics Corp. and for Sperry Gyroscope in countermeasures systems.

ILC DDC is a wholly owned subsidiary of ILC Industries, which is owned by Rapid American. The company has been in business for approximately 10 years and is presently located in a 50,000 sq. ft. building in Bohemia, N.Y. Present employment is over 300 people.

DDC originally manufactured operational amplifiers and subsequently became a major factor in the synchro conversion and video digitizing area. The company also has been growing at a rapid rate in producing thick film hybrid circuits.

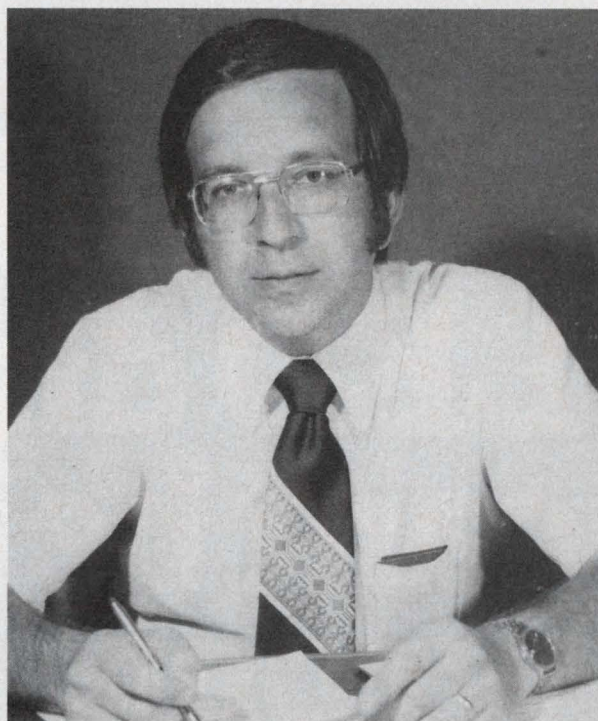

the real world those goals can be compromised. It's important for the engineer to realize at that point that if he runs up against this brick wall, he should find out where he's running against it and come up with a good alternative.

Tradeoffs are always possible. The thing to remember is that this is real life, and real-life people are willing to make compromises.

### **Making sure the product can be produced**

In the initial stages of any company a certain number of products are released before the design is completely debugged and before production has been set up to assure producibility. One management problem is to make sure that appropriate systems are set up to ensure that all necessary documentation and design reviews are complete. This is particularly important when the company services its own products.

After growing from a small company to a larger one, we initiated a unilateral engineering review of all new-product designs. As we progressed, we found that the best method was a joint review of design among management, design and manufacturing personnel. This helped to uncover some more of the difficulties that come up in any normal design, and it eliminated the bulk of them. Engineering must always realize that its job isn't done until manufacturing is capable of producing the design with minimum assistance from engineering.

And two obvious but important points before your company can even begin to meet its servicing goal: The product must be designed on time at a reasonable cost, and it must be a product that will sell. Unless it meets these essentials, the company won't stay in business long.

One of the most important jobs any electronics manufacturer faces is to make maximum use of the engineer's time. Many engineers tend to optimize their designs beyond the point that's necessary. The moment the engineer has met his specs is the moment he should stop designing and determine how much time he has left before the deadline. If he has enough to improve the product, fine. But if he doesn't, he must realize that the timing for introduction of a new product takes precedence over improving the product beyond its specs.

If the engineer keeps stretching the schedule for an additional three to six months, the competition may have enough time to produce an equivalent product. Engineers must interface with marketing enough to know that if there isn't a well-defined time factor for product introduction, the whole product ballgame is lost.

And a company might as well stay away from the ballpark altogether if its engineers are hooked on designing only products that are technological milestones. Engineering managers should make it clear to their staffs that the idea for new products is only as good as the market will accept. ■■



# 20 million LED digits can't be wrong.

Litronix DL-707 0.3" high digit has same superior features as DL-747 below.

Litronix DL-747 has 0.6" high digits 44% larger in area than digits from any other major supplier.

Mitered corners increase eye appeal.

Light pipe spreads illumination evenly.

Mounted on DIP with standard pin spacing.

DL-747 with cap in place over light pipes.

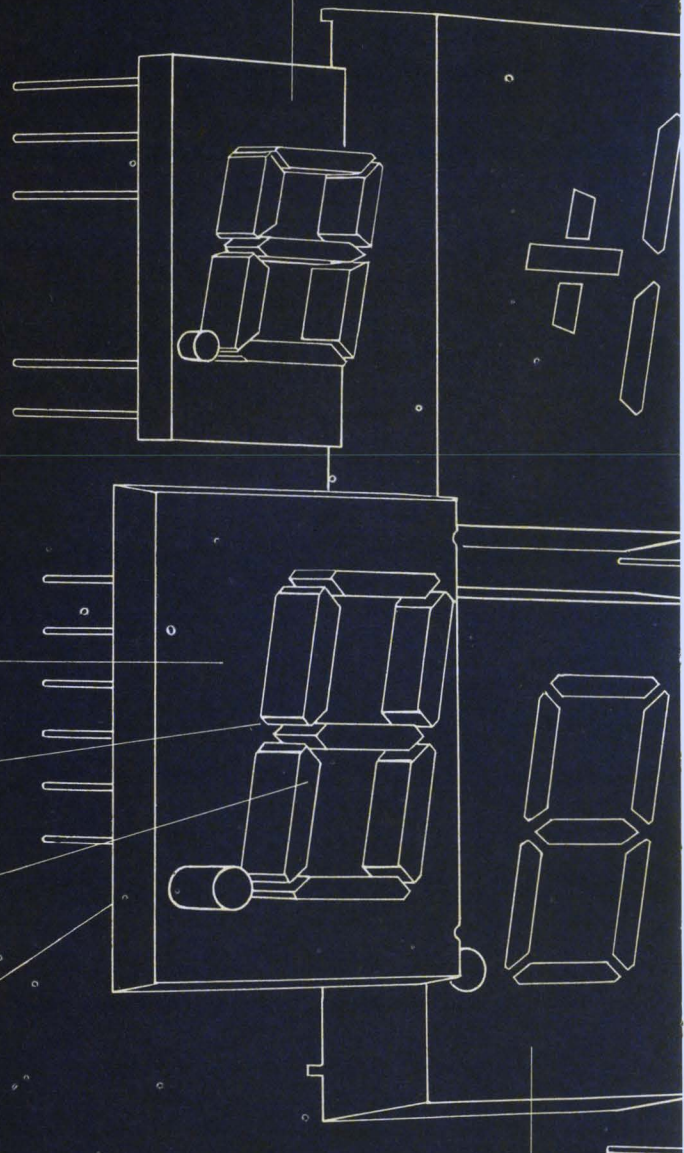



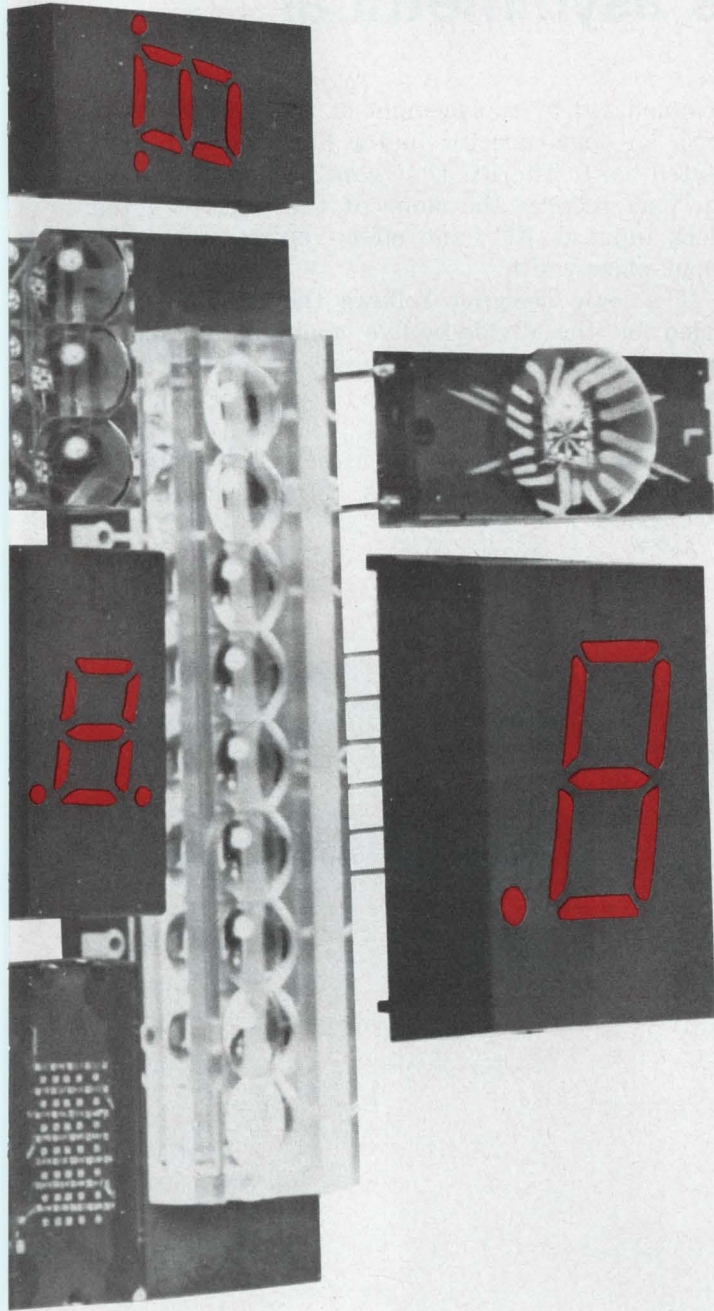

You'll find major advantages in dealing with the world's largest supplier of LEDs—the one that's shipped over 20 million LED digits to date and will deliver many millions more in 1974.

For openers, the Litronix product line is so broad that you can get exactly what you need. Sizes from 0.1" to 0.6". Colors like red and orange today, with yellow and green in volume production soon. Common anode or common cathode. And polarity overflow digits in many sizes.

Perhaps even more important, you're assured of a consistent, reliable product. Litronix doesn't buy any high-technology parts from others. We make everything in-house—starting with the basic GaAsP materials. The result is that we have better overall control: high brightness, proven reliability and assured delivery.

Litronix has two plants in the U.S. and three more overseas to keep the LEDs flowing. Because our volume is large, our prices are very, very competitive.

The drawing at left of our big 0.6"-high DL-747 shows some of the superior characteristics of the popular Litronix 700 Series displays.

Contact us right now for LED displays, LED lamps, opto-isolators, or phototransistors. We know we can meet your needs. Like we say, over 20 million LED digits can't be wrong.

Litronix, Inc., 19000 Homestead Road, Cupertino, CA 95014. Phone (408) 257-7910. TWX 910-338-0022.

**No wonder  
we're No. 1  
in LEDs**

# litronix



## Counter has symmetrical output though the input signal is asymmetrical

The divide-by-five synchronous counter shown in the figure provides a 50%-duty-cycle output with an asynchronous input. This feature is unusual, since most odd pulse-counter circuits require a symmetrical input to obtain a symmetrical output.

The asymmetry that the circuit can handle is limited only by the minimum pulse width that is determined by the propagation delay time of  $FF_3$  and the data setup time required by  $FF_1$ . The manufacturer's maximum specifications of 45 ns and 20 ns, respectively, for these time intervals yield a minimum clock input pulse width,  $t_w$ , of 65 ns for reliable operation.

Pulse widths between 30 and 65 ns can be ac-

commodated by replacement of the 7404 inverter with an open-collector buffer like the 7416 (see dotted box). The RC time constant of the collector load reduces the slope of the positive-going clock input to  $FF_1$ , and effectively stretches the input pulse width.

If a logic designer follows the example provided by the divide-by-five counter, he should easily be able to modify the circuit for different moduli.

*M. Barry Greenberg, Project Engineer, Systems Div., GB Instruments, 2030 Coolidge St., Hollywood, Fla. 33020.*

CIRCLE No. 311

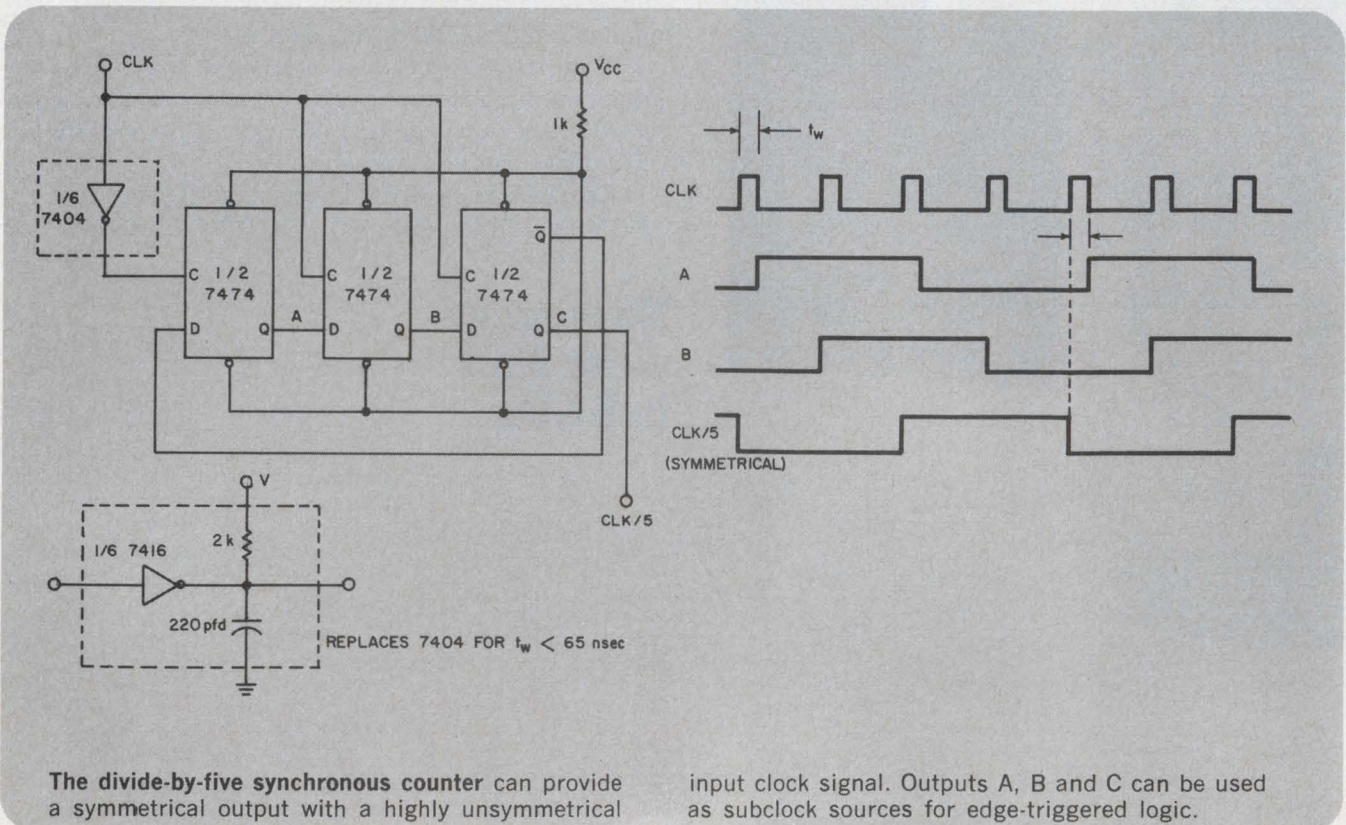



If you need panel instruments with **custom** dials, cases, accuracy, tracking, resistance, response time, or practically any combination of unusual specs...

Buy **Triplett's** designed-for-you Panel Instruments

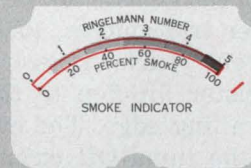
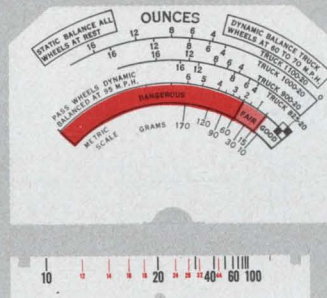
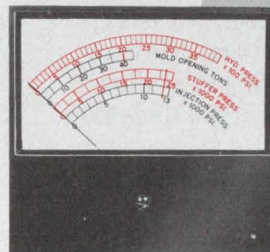
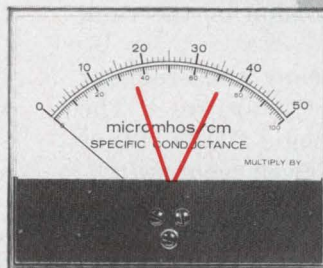
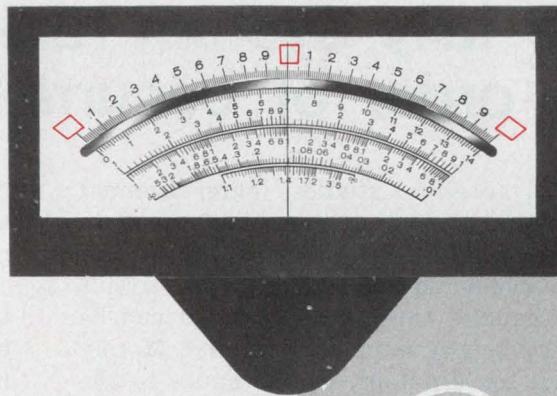

Although we stock some 1369 different styles, sizes and types of standard panel instruments, a very large proportion of our customers buy custom instruments.

Because they need:

**custom dials**

reading in such units as pH, roentgens, mm Hg, rpm, %, inches.

**custom cases**

square, round, rectangular, edge-wise (horizontal and vertical), wide, narrow, shallow.

**custom accuracy**

to within 1/2% with mirror scales and knife-edge pointers.

**custom tracking**

to match the specific needs of existing or new instrument designs.

**custom resistance**

for low circuit loading with tolerances as low as ±1%.

**custom damping**

to meet stringent electrical and vibration requirements.

For instance, one of our customers had us design and manufacture a custom instrument to replace — in every detail of physical and electrical specifications — one which he was using on a delicate piece of medical instrumentation. Rejects from his previous source had risen to over 20%. He rejected only 3 of the first hundred we shipped—with almost negligible rejections from the many hundreds we've shipped since.

What custom panel instrument specifications do you need to make your

product more reliable, more accurate, more rugged and — in the long run — less expensive? For quick, dependable delivery of small quantities of Triplett's "designed-for-you" panel instruments, contact your Triplett Sales/Service/Modification Center. For prototypes or production quantities, contact your Triplett representative. He'll put you in touch with our Instrument Designers/Engineers who'll help you analyze the problem and suggest the optimum cost/result solution.

**TRIPLETT**  
BLUFFTON, OHIO 45817  
Manufacturers of the World's most complete line of V-O-M's

INFORMATION RETRIEVAL NUMBER 63



# Simple tally system ranks events in the order of occurrence

Behavioral-science studies, entertainment games and special logic-design problems need an order-of-occurrence circuit to rank a sequence of events with nanosecond unambiguity. The circuit in the figure handles three events, and it can be expanded to cover any number of events. Merely add event-register flip-flops, extra inputs to the Input-OR circuit and the expansion of the rank shift registers and displays.

To start an event cycle, all rank shift-register stages except the first ( $A_1$ ,  $B_1$ ,  $C_1$ ) are reset. The first-rank flip-flops are set to logic ONEs. Input pulses for each event can be derived from switches or other transducers, such as photocells.

An event pulse triggers its corresponding event-register flip-flop to the ONE state on the pulse's trailing edge. The event pulse also passes through the input-OR circuit. But the delay inherent in several serially connected gates allows the Event-Register flip-flop to block its associated rank register from shifting.

Thus if event A occurs first, the first-rank flip-

flop of A remains in its present ONE-state, but the second-rank flip-flops of the B and C rank registers go to ONE.

The next event pulse, say C, sets event-register C so the C second-rank flip-flop remains high, but the B-rank register shifts a ONE to the third rank. Thus A is ranked first, C second, and B is third.

The rank shift register outputs are  $A_1$  through  $A_3$ ,  $B_1$  through  $B_3$ , etc. Each output connects to a corresponding lamp driver. The figure shows typical lamp drivers for  $A_1$  and  $A_2$ . The bulbs are arranged on a tally scoreboard as shown.

If the display should light only at the "end-of-play," add the section shown within the dotted box. The Q outputs of all the third-rank flip-flops are ORed to enable display of the tally only at the end-of-play.

*Sujit R. Kumar and G. Dutta, Computer Centre, Japavpur University, Calcutta 700032, India.*

CIRCLE No. 312

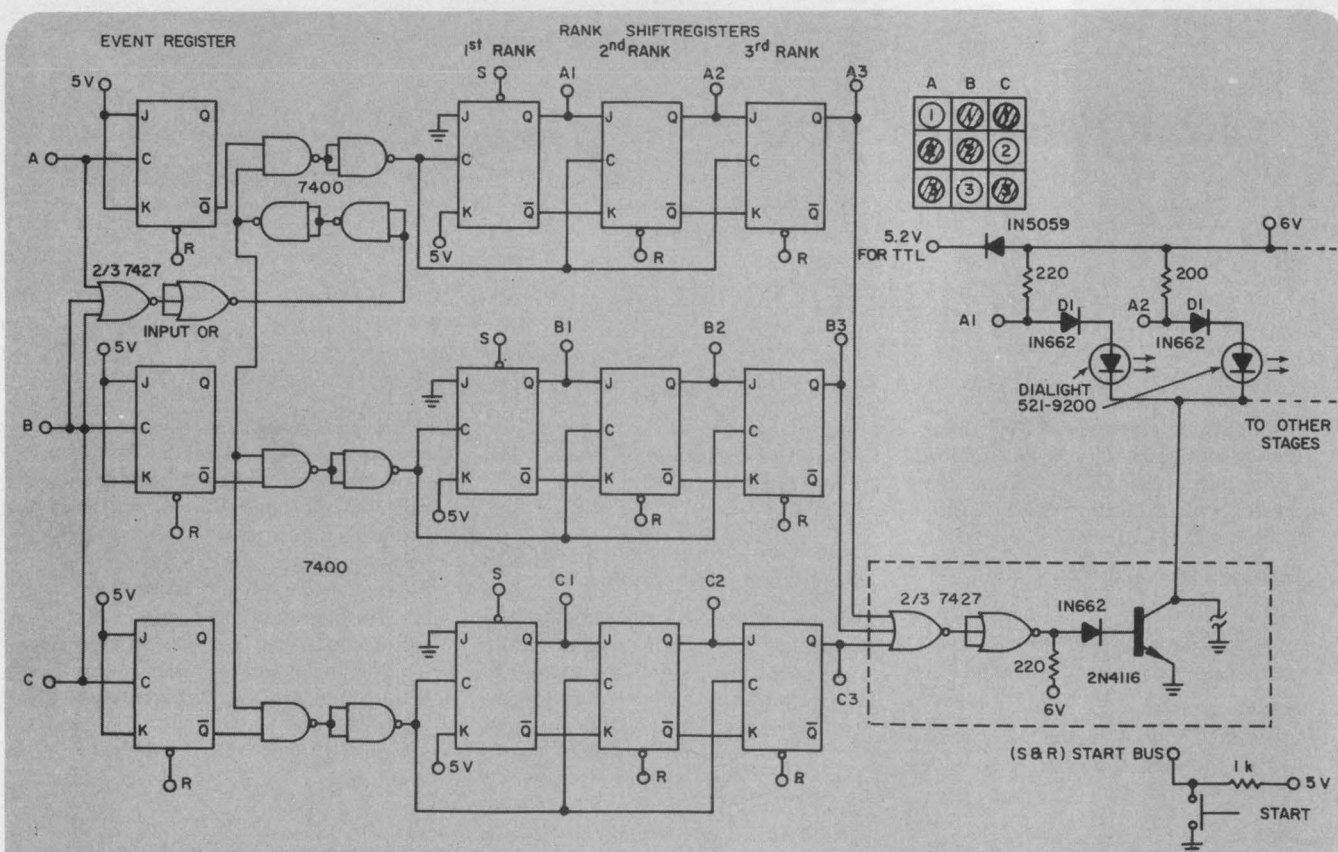

**A tie-breaker circuit ranks the occurrence of event pulses with nanosecond precision. A delay in the input-OR circuit is necessary to avoid a race condition and allow the event pulses to toggle the**

event-register flip-flops before the pulses can clock the rank shift registers. The delay is obtained inexpensively by use of cascaded "left-over" gates.



# POWER MINI'S FOR CHASSIS MOUNTING

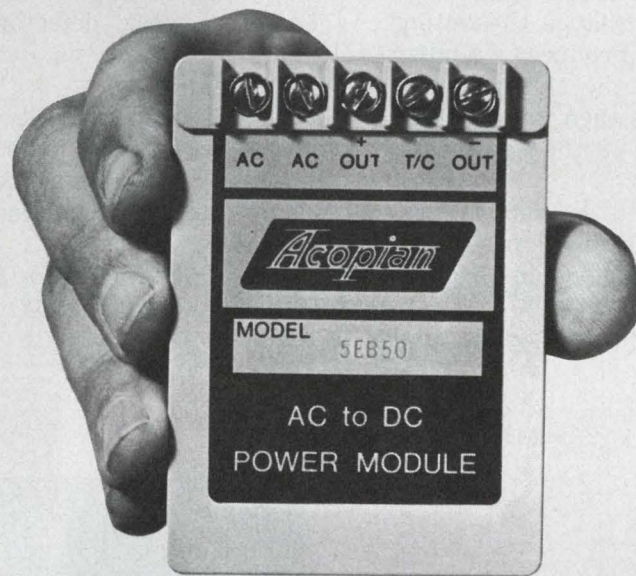

## ALL MODELS U.L. RECOGNIZED

OUTPUT VOLTAGE	OUTPUT CURRENT AMPS.	REGULATION LOAD $\pm\%$	REGULATION LINE $\pm\%$	RIPPLE MV RMS	SIZE INCHES LxWxH	PRICE	MODEL
5	.500	.15	.05	1	3.5x2.5x1.38	\$ 55.00	5EB50
5	1.0	.25	.05	1	3.5x2.5x1.63	75.00	5EB100
5	1.5	.35	.1	1	3.5x2.5x1.63	105.00	5EB150
5	2.0	.25	.05	1	3.5x2.5x2.38	115.00	5EB200
5	2.5	.25	.05	1	3.5x2.5x2.38	130.00	5EB250
$\pm 15$	.100	.05	.05	1	3.5x2.5x1.38	55.00	DB15-10
$\pm 15$	.150	.05	.05	1	3.5x2.5x1.38	65.00	DB15-15
$\pm 15$	.200	.05	.05	1	3.5x2.5x1.38	75.00	DB15-20
$\pm 15$	.300	.05	.05	1	3.5x2.5x1.63	105.00	DB15-30
$\pm 15$	.350	.05	.05	1	3.5x2.5x1.63	110.00	DB15-35
$\pm 15$	.500	.1	.05	1	3.5x2.5x2.38	135.00	DB15-50

Input, 105-125 VAC. Other mini power supplies from 1 to 75 volts. Three day shipment guaranteed. Complete details on these plus a comprehensive line of other power supplies and systems are included in the Acopian 1974-75 catalog. Request a copy.



Corp., Easton, Pa. 18042. Telephone: (215) 258-5441.

INFORMATION RETRIEVAL NUMBER 64



# Inexpensive AM modulator replaces clipping type and gives less distortion

A simple amplitude modulator provides a cleaner output signal than conventional clipping modulators. The improved circuit removes or adds a signal to the middle portion of the carrier sine wave instead of clipping the height of a square wave. Using only three op amps and some passive components, the circuit requires no initial adjustment, is temperature-stable, has a wide modulation-frequency range and needs no filtering—and hence no returning if the carrier frequency changes.

The input to  $A_1$  (Fig. 1) is the sum of the carrier and modulation signals. Amplifier  $A_1$  clips the composite input to produce the output shown in Fig. 2a. Amplifier  $A_2$  produces a similar signal (Fig. 2b), except that the carrier phase is inverted. The output of  $A_2$  is then inverted and summed with the output of  $A_1$  in the output amplifier  $A_3$ .

Diode feedback paths around  $A_1$  and  $A_2$  provide sharp clipping, even with small input amplitudes. However, the clipper output impedances are nonlinear, varying from near zero to approximately 10 k $\Omega$  when a negative-going out-

put is being clipped. This means that Fig. 2b doesn't accurately represent the output of clipper  $A_2$ . The waveform at that point will, because of resistive division and mixing, contain a small portion of the waveform of Fig. 2a. To compensate for the output-impedance variation, resistor  $R_1$  at  $A_3$ 's noninverting input is made 5 k $\Omega$ .

Distortion in the net output signal (Fig. 2c) appears only in the valleys of the modulation envelope. This distortion depends on the modulation percentage and is most objectionable near minimum output. However, the circuit doesn't distort the peaks of the modulated waveform. Therefore peak detectors will respond to the signal of Fig. 2c as if it were a distortionless AM signal.

The circuit was built with Type 709 op amps and performs well with carrier frequencies up to 30 kHz. At higher frequencies the rate-limiting of the op amps restricts the output amplitude.

*Penn Clower, Design Engineer, Charles Stark Draper Laboratory, 68 Albany St., Cambridge, Mass. 02139* CIRCLE No. 313

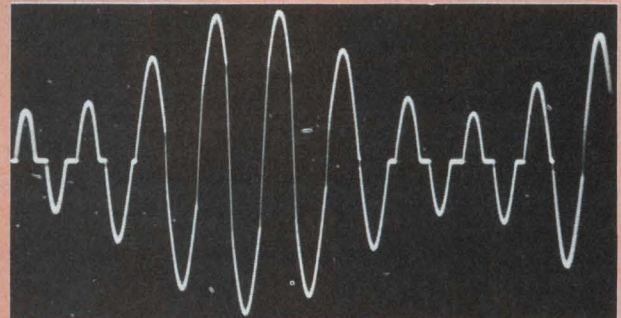
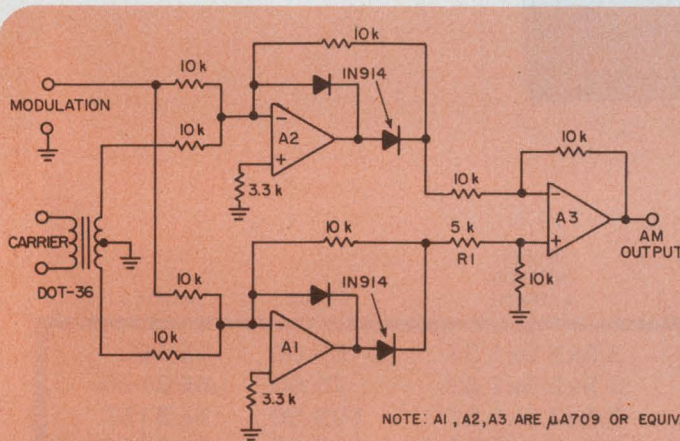

10 KHz CARRIER, 1500 CPS MODULATION, 50% MODULATION, MAX AMPLITUDE 10 V P-P

1. A simple circuit with three op amps provides amplitude modulation without distorting the output peaks.

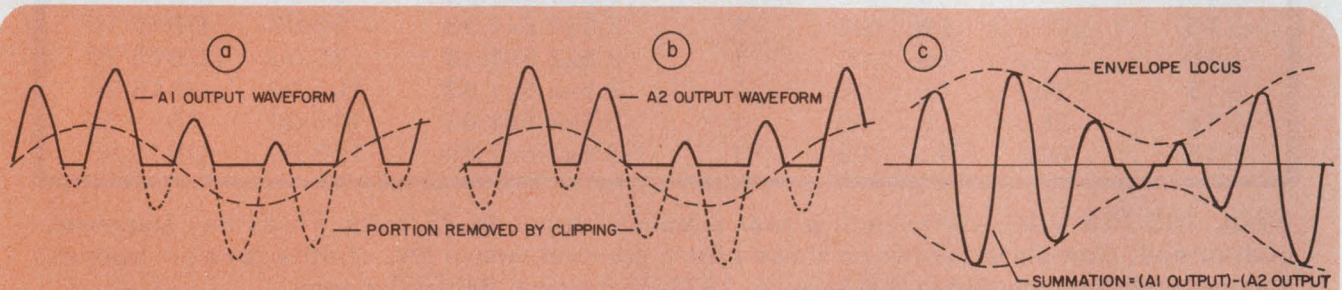

2. Amplifier  $A_1$  clips the negative peaks of the composite input to produce half of the modulated carrier. The output from amplifier  $A_2$  is similar to

that from  $A_1$ , but the carrier is displaced by 180° (b). The summed signal has no distortion at peaks, but has crossover distortion in troughs (c).



# 4 SWITCHED ON ADVANTAGES!

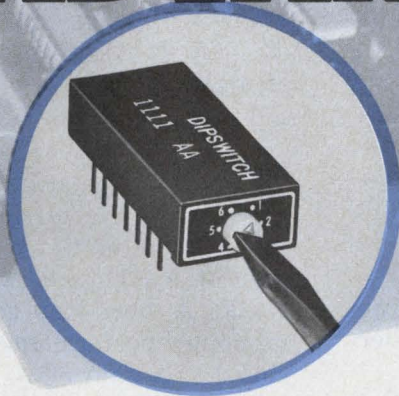

**DIPSWITCH** was the industry's first rotary switch for DIP sockets. It offers the designer the versatility and reliability only experience can bring.

Here are four reasons you should consider **DIPSWITCH** for your switching needs.

- 1** if multilayered boards are part of your design, **DIPSWITCH**'s .230" profile is about half anybody else's. You can stack as close as 1/4".
- 2** if saving board space is important, you can piggyback an IC right onto **DIPSWITCH**.
- 3** if you need additional switch closures, **DIPSWITCH** can be tandem coupled using extended shafts.
- 4** if you need special switch closure programming, **DIPSWITCH**'s six independent cams can be factory assembled to perform your programming.

If you have a switching problem, why not let us help? We have factory consultants ready to help you design your switch program and pick your options.

**DIPSWITCH**® is a Registered Trademark of the McGraw-Edison Company. Pat. No. 3621157



**EDISON ELECTRONICS**  
a McGraw-Edison Company Division

Grenier Field Municipal Airport, Manchester, New Hampshire 03103 (603) 669-0940



# Comparator detects volts in narrow window and accurately nulls to reference level

A very accurate window-comparator circuit can be made by insertion of an integrator into the feedback loop of an op amp. The integrator servos out the effects of offset and drift voltages of both amplifiers.

In the circuit (see figure), this servo action keeps point  $e_s$  within a few hundred microvolts of  $e_A$ , and the value of  $e_R$  can range over  $\pm 10$  V, independent of the window size ( $2\Delta V$ ). The window size is determined by  $V_z$ , which is the maximum voltage output of  $A_2$ . At null within the window region  $e_A \approx e_s$ , the two inputs of  $A_1$  behave as if they were connected to make  $e_R$  sink the current  $i_s$ . Thus:

$$e_R/R_3 = (E_i/R_1) \pm (V_z/R_2).$$

At the edges of the window range,  $V_z$  is approximately  $\pm 13$  V when an LM301 amplifier is used for  $A_2$ .

If we make  $R_1 = R_3$  (though  $R_1$  need not equal  $R_3$ ) for  $E_i = e_R \pm \Delta V$ , then  $0 = (\pm \Delta V/R_1) \pm 13/R_2$ , or  $\Delta V = \pm 13 R_1/R_2 = 1.3$  mV, when  $R_1 = 100 \Omega$  and  $R_2 = 1$  M $\Omega$ .

For a value of  $E_i$  that falls outside  $\Delta V$ , amplifier  $A_1$  saturates, and its plus and minus outputs are converted into a ZERO logic level via  $Q_1$ ,  $Q_2$  and  $Q_3$ . Voltage  $\Delta V$  is entirely a function of  $A_2$ 's maximum output stability. However, the stability of the window is improved considerably if  $A_2$  is bounded with zeners.

The circuits containing  $Q_1$ ,  $Q_2$  and  $Q_3$  convert the output of  $A_1$  to a unipolar function for logic interface.

The long-term stability of this circuit is excellent, since amplifier drift is constantly corrected relative to the reference voltage. Assume the window reference voltage  $e_R$  is at zero. The offset voltage of  $A_1$  is represented as  $e_A$  and the servo voltage as  $e_s$ .

$$\text{Then } A_1 (\text{out}) = -A_1(e_A - e_s),$$

$$A_2 (\text{out}) = -A_2(-A_1)(e_A - e_s),$$

if we neglect  $e_B$

$$e_s = A_1 A_2 e_A - A_1 A_2 e_s,$$

$$\text{and } e_s = \frac{A_1 A_2 e_A}{A_1 A_2 + 1} \approx e_A.$$

Similarly the offset voltage,  $e_B$ , of amplifier  $A_2$  is  $e_s \approx e_B/G_1$ , where  $G_1$  is the closed-loop gain of  $A_2$ . Thus  $e_A$  will equal  $e_s$  within 0.004% for an  $A_2$  open-loop gain of 25,000, which is the minimum performance for a 301A op amp. The closed-loop gain of  $A_2$  equals unity.

The 0.004% unbalance results in less than 1  $\mu\text{V}/^\circ\text{C}$  integrator drift. This compares with a typical drift of 60  $\mu\text{V}/^\circ\text{C}$  in conventional window comparators, which usually contend with the drift of two amplifiers. Obviously an amplifier with high open-loop gain will give better performance, but a gain of 10,000 is generally more than adequate.

Speed is not of prime consideration in many comparator circuits—especially in low-level window detection, where long-term stability and low drift are the main criteria. In the servo-nulled circuit, speed is predominantly a function of the op-amp slew rate for slowly changing input signals. However, the effect of  $C_1$ ,  $C_3$ ,  $R_2$  and  $R_3$

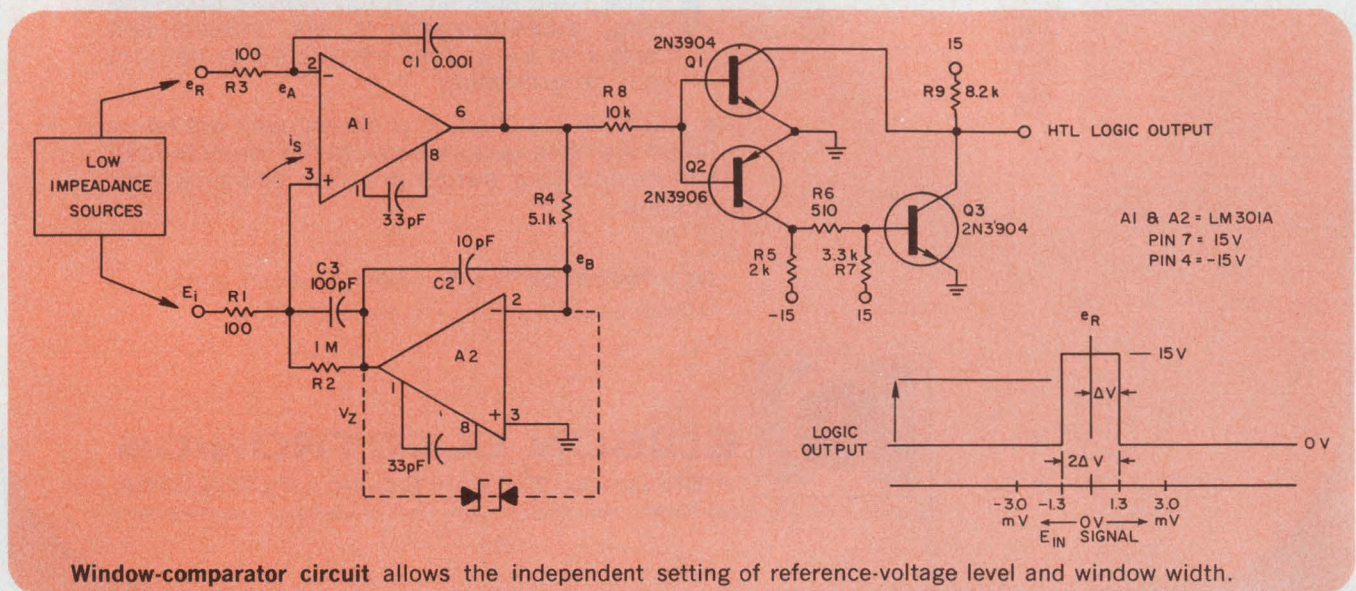

Window-comparator circuit allows the independent setting of reference-voltage level and window width.



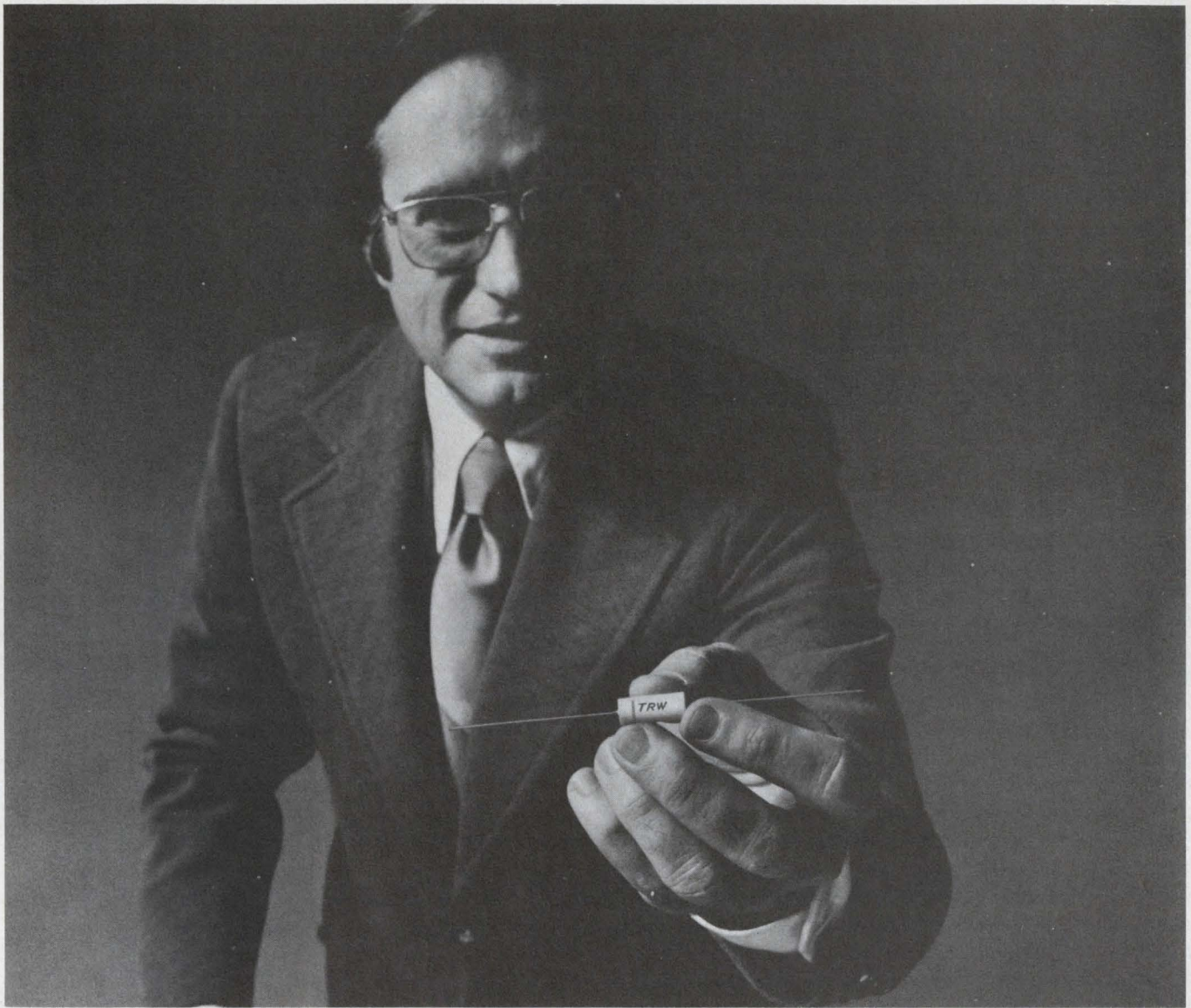

## Tell you what we're not going to do.

Sure, we know *how* to make cheaper capacitors. But not with "TRW" stamped on them. No way. Because we figure you can't make quality capacitors and me-too capacitors under the same roof. Not without one operation eventually goofing the other one up.

So if it's marked "TRW," you *know* you're getting the top technology in wound—both metallized and film foil—and solid tantalum capacitors.

You're also getting a pipeline to some of the best minds in capacitor R&D, design, QC, and application engineering—ready to help you with *any* capacitance problem. From TV to aerospace.

All this will cost you a little more per capacitor. In return, it can help *your* product earn a reputation for "no headaches, no surprises." What better edge in today's marketplace?

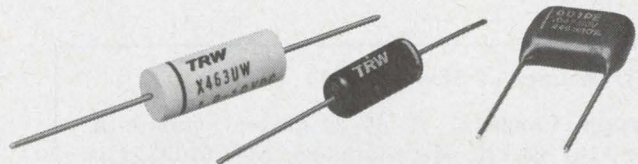

TRW Capacitors, an Electronic Components Division of TRW, Inc., Box 1000, Ogallala, Nebraska 69153.

# TRW<sup>®</sup> CAPACITORS

INFORMATION RETRIEVAL NUMBER 66



## IDEAS FOR DESIGN

become dominant as they increase in value.

Of course, a fast FET amp for  $A_1$  and a fast bipolar for  $A_2$  could improve the response time and allow the use of larger values for  $R_1$  and  $R_2$ . For slowly changing input signals, the response delay at the logic output is about  $5 \mu\text{s}$ . For a fast-step input or a high frequency superimposed

on dc,  $C_3$  acts a momentary short across  $R_2$  to increase the window width temporarily. This short lasts as long as  $500 \mu\text{s}$  for the values shown and it eliminates input voltage transitions in the output during this period—a form of high-frequency and transient-noise filtering.

*K. R. Johnson, Canaleco Inc., 5635 Fisher Lane, Rockville, Md. 20852.* CIRCLE No. 314

# Counter resets itself reliably with one additional flip-flop

One additional set-reset flip-flop allows you to reset reliably a BCD counter that divides a pulse train by a preset number. The maximum count desired is detected with a decoder gate. However, if the output of the decode gate is used directly to reset the counters, race problems can occur.

Without this circuit, as soon as 1 bit of the counter returns to ZERO, the decode condition is lost. A very short reset pulse results, which might not reset all the counter bits properly. The difficulty can be overcome by addition of a flip-flop circuit to the reset path.

As an example, the circuit in the figure uses CMOS 4029 counters to achieve division by 60 with BCD outputs. Both the clock and reset inputs for the 4029 operate on a rising edge. The count of 60 is decoded by a NAND gate to set the flip-flop, which in turn resets the counters. The flip-flop, however, does not reset until the trailing edge of the clock. This results in a square reset-pulse output, half the width of the clock pulse train. The reset pulse, or its complement, is available as a carry-out.

*John Budlong, Design Engineer, Western Research & Development Ltd., Lab #3, 1313-44th Ave. N. E., Calgary, Alberta, Canada T2E-665.*

CIRCLE No. 315

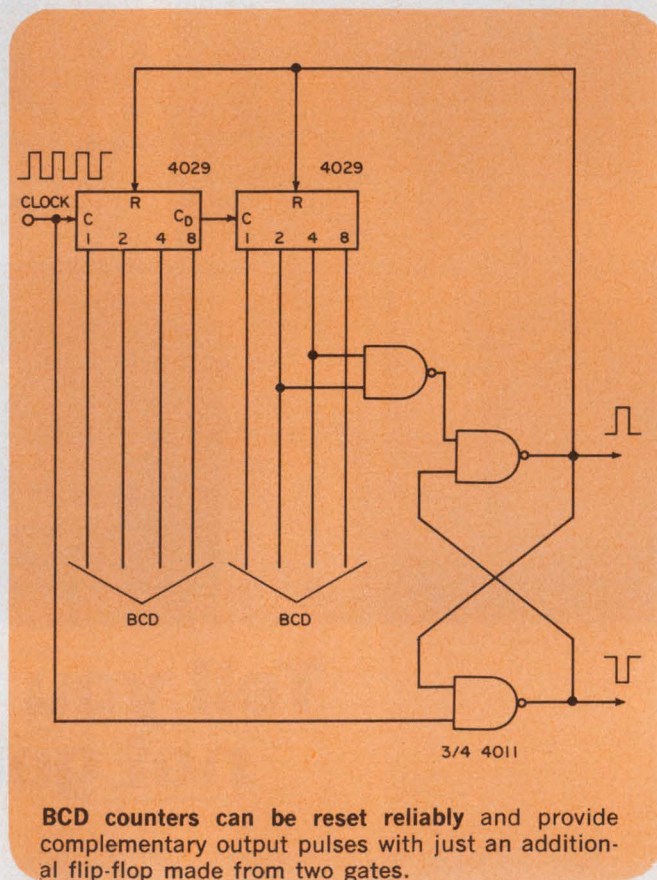

### IFD Winner of May 24, 1974

**Joseph Panzitta**, Chief Engineer, Quindata, Inc., 101 Rt. 22, Mountainside, N.J. 07092. His idea "Versatile Programmable-Counter Chains Are Built from Simple MSI Modules" has been voted the Most Valuable of Issue Award.

**Vote for the best Idea in this issue** by circling the number for your selection on the Information Retrieval Card at the back of this issue.

**SEND US YOUR IDEAS FOR DESIGN.** You may win a grand total of \$1050 (cash)! Here's how. Submit your IFD describing a new or important circuit or design technique, the clever use of a new component or test equipment, packaging tips, cost-saving ideas to our Ideas for Design editor. Ideas can only be considered for publication if they are submitted exclusively to ELECTRONIC DESIGN. You will receive \$20 for each published idea, \$30 more if it is voted best of issue by our readers. The best-of-issue winners become eligible for the Idea of the Year award of \$1000.



# Our dedication to efficiency led us to some of the most advanced peripheral data equipment in the world.

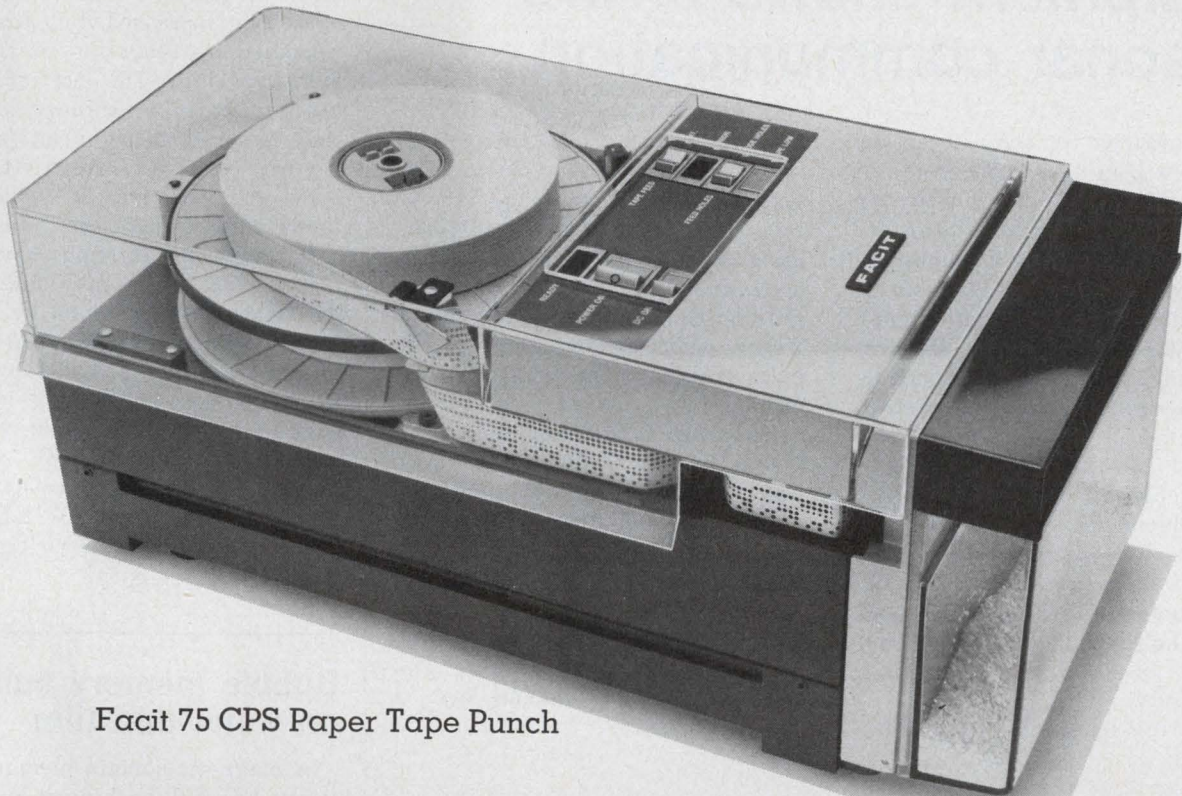

Facit 75 CPS Paper Tape Punch

Our dedication to efficiency led us to a line of peripheral data equipment that can do just about anything you could ask. Complete products or sub-units featuring top performance and long service with a minimum of maintenance requirements.

In fact, we honestly feel that no other OEM manufacturer offers a better performance to price ratio.

Our dedication to efficiency led us to a line of products that are expanding swiftly from alphanumeric page printers, strip printers and 75 CPS and 150 CPS tape punches to punch mechanisms, readers, input/output typewriters and numeric printing units.

Our dedication has also led to components that are compatible with, and adaptable to, just about any system.

Let us express our dedication by sending you more information. Just express

your interest in the coupon below, and send it to us.

Before too long you could have some very dedicated people at Facit, and a very efficient product, working for you.

Facit. A leading manufacturer of peripherals for all types of computers and data recording systems.



## DEDICATED TO EFFICIENCY.

FACIT—O.E.M. Division  
501 Winsor Drive  
Secaucus, New Jersey 07094

ED974

Gentlemen:

I'd like to dedicate myself to efficiency. Please send me all the information you have on Facit Peripheral Data Equipment.

NAME \_\_\_\_\_  
FIRM \_\_\_\_\_  
ADDRESS \_\_\_\_\_  
CITY \_\_\_\_\_ STATE \_\_\_\_\_ ZIP \_\_\_\_\_



## Equipment shows errors in sonar communication

A prototype of error-detection and correction equipment for teleprinter-to-teleprinter underwater sonic communication has been developed by Marconi Communication Systems Ltd., Chelmsford, England. The equipment—Sonar 2010—was designed in collaboration with the Royal Navy Admiralty Underwater Weapons Establishment.

Initial studies at sea investigated techniques for solution of the problems in this type of data transmission. Such problems include fading, multipath distortions, noise bursts and Doppler shifts that are caused by the relative motion between communicating vessels.

During sea trials of the proto-

type equipment, the Marconi underwater telephone Sonar 2008 was used to transmit and receive telegraph signals. The performance target of 98% error-free copy, under a wide range of propagation conditions from shallow water, deep sea and rough sea to calm tropical conditions, was exceeded.

The 2010 system sent traffic at above speech transmission rates. The greatly increased range provided by the 2008 underwater telephone has extended the communications abilities of the submariner. Production, scheduled to start this year, will cover a ship-fitting program of existing and new Royal Navy vessels over a period of years.

---

## Laser method detects IR absorbing gases fast

A laser system for detection of methane and other infrared absorbing gases has a fast response (less than 1 second), high gas-flow rate and a wide range of sensitivities. Unlike flame-based techniques, the laser method measures concentrations of infrared absorbing gases in inert atmospheres and, unlike some solid-state detectors, cannot be affected by the gases.

Developed by International Research & Development Co. Ltd. and A.M.G. Zuurbier Ltd. of Doncaster, England, in collaboration with the Safety in Mines Research Establishment, the system will be used in natural-gas safety surveying, petrochemical safety monitor-

ing or concentration measuring, and high-sensitivity, gas-leakage alarm systems. In its first application, the equipment has been installed in a patrol vehicle for the detection of small quantities of methane; for example, 100 parts in  $10^6$ .

Operation of the system relies on the absorption of  $3.39\text{-}\mu\text{m}$  radiation by the sample gas in a cell located within a laser cavity. Gases and vapors that absorb strongly in the  $3.39\text{-}\mu\text{m}$  band include butane, ethane, propane, hexane, heptane, butadiene, dimethylamine, dimethylether, ethylether, ethyl mercaptan, ethylene, ethylene oxide and propylene.

CIRCLE NO. 319

## Yagi-array size shrunk by dielectric powder

Yagi and resonant-slot antennas can be reduced in size by use of dielectric coatings, according to researchers at the Royal Military College of Science in England.

Experiments on a three-element Yagi array that was coated with barium titanate powder tuned the antenna, and also lowered the radiation resistance. The radiation back lobe increased, but that was remedied by reduction of the element spacing. The use of fired-ceramic coatings—thinner coatings than have formerly been possible—with relative permittivities of 3000 are expected to reduce antenna lengths more than one-third.

Aircraft slot antennas have been tested with titanium-dioxide powder held on the antenna by a thin plastic skin. At 1 GHz, the length of the slot was reduced by 20% at resonance. There is a loss incurred in the dielectric coating material, typically 2 dB at 100 MHz. However, applications are seen in radio and TV wherever small size is more important than power loss.

---

## Bubble memory built on wafer-thin film

A magnetic-domain memory that stores one million binary digits on a wafer the size of a postage stamp could eventually replace disc and tape memories, according to General Telephone & Electronics in Switzerland.

Still in the prototype stage, the new memory consists of thin film of magnetic material deposited on a garnet crystal. The film, no thicker than a human hair, contains minute cylindrical magnetic domains, known as bubbles, that can be moved at high speed within the material. Bubble movements are controlled by "tracks" of magnetic material placed on the garnet chip.

The presence or absence of bubbles provides the zero/one digital information that can be read by a detection device. Since magnetic-bubble devices are small, economical and reliable, their use in large memories has great potential. A model is being evaluated in a telephone-switching system.



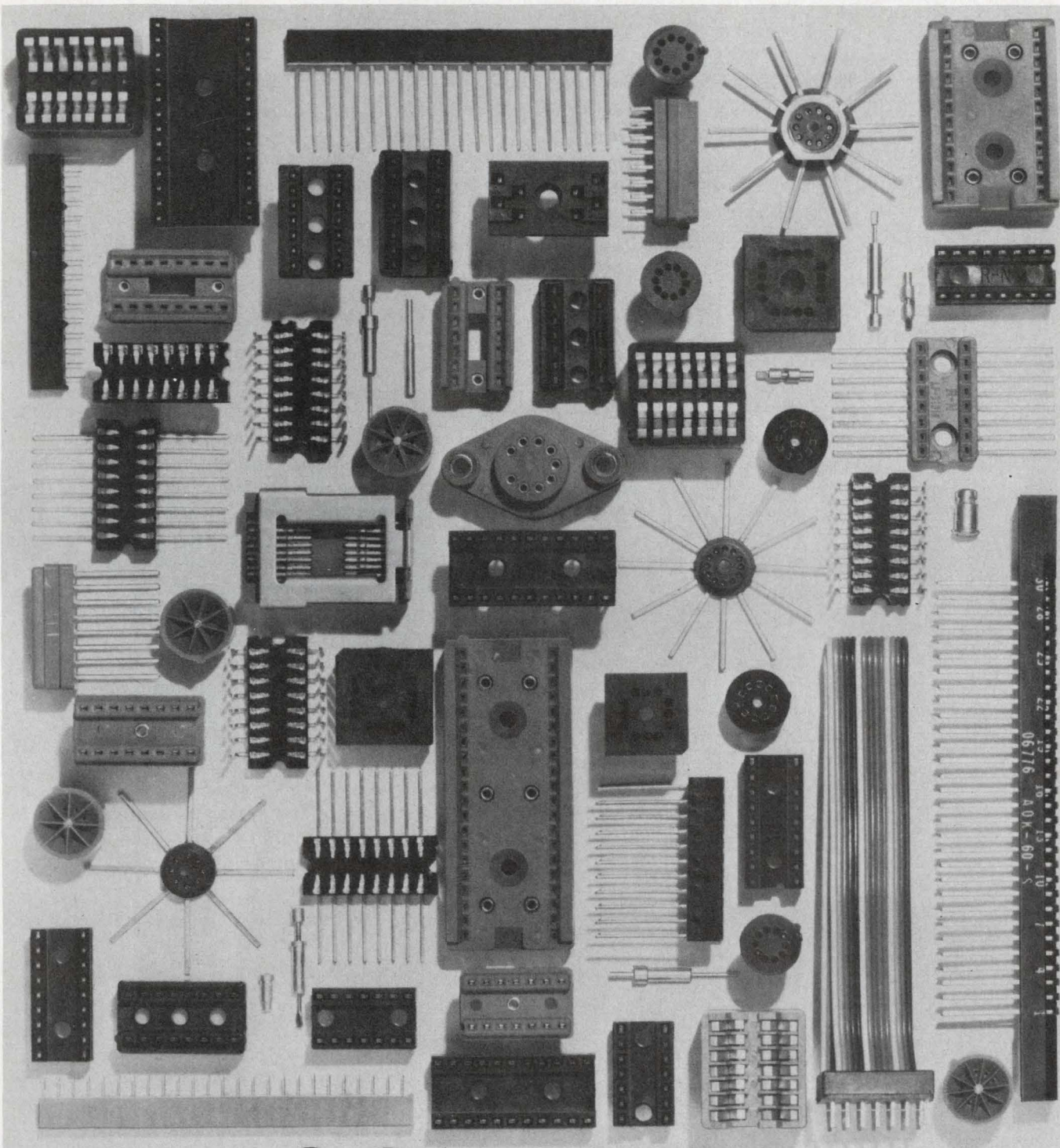

# SOCKETS

The most complete competitive line in the industry.

Literally hundreds of socket products - over 800 standard items. Sockets for 8-pin mini-Dips to 64-pin LSIs. Can styles. Transistor sockets. Pin sockets. Surface mount, solder and wirewrap styles. Adaptors. Plugs. Jumpers. Even complete interconnect systems. You name it, we make it. To meet

RNs exacting standards. At a price that's right. And delivered when and where you need them. Off the shelf. From our plant or one of 20-plus stocking distributors. If you need to know about plug-ins, see... The Socket People.



ROBINSON NUGENT INC.  
800 EAST EIGHTH STREET  
NEW ALBANY, INDIANA 47150  
(812) 945-0211 / TWX 810-540-4082



**GATES** - INS4000, INS4001, INS4002, INS4011, INS4012,  
INS4019, INS4023, INS4025

**BUFFERS** - INS4007, INS4009, INS4010, INS4049, INS4050

**FLIP FLOPS** - INS4013, INS4027

**COUNTERS** - INS4017, INS4018, INS4020, INS4022, INS4024,  
INS4029, INS4040, INS14510, INS14516

**REGISTERS** - INS4035, INS4042

**SWITCHES** - INS4016, INS4051, INS4052, INS4201

**MEMORIES** - INS4061, INS4200

**ARITHMETIC  
FUNCTIONS** - INS4008, INS4030, INS14581, INS14582

**DECODER** - INS4028

# HIGH SPEED CMOS

Our 4000 series SOS/CMOS are pin-for-pin compatible with the CD-4000 series, but ours are different. Different in that our 4000 series offer you the optimum balance between higher speed (three times faster than monolithic CMOS) and lower power dissipation (typically less than 10nW) than any other logic family. Different in eliminating SCR latch-up problems while the noise immunity remains 45% of supply voltage (3 to 15 volts).

Our INS4000 series is available in both military (-55°C to +125°C) and commercial (-40°C to +85°C) grades. Inselek also offers the INS4200

series of proprietary devices, including the INS4200 --- a 256 x 1 SOS/CMOS RAM, and the INS4201 --- a 4 x 4 cross point

switch. Check the devices you want above and then contact one of our authorized sales representatives or distributors below.

Sometimes being different is better!



SALES OFFICES IN:  
CONCORD, MASS. (617) 369-5298  
LOS ANGELES, CALIF. (213) 889-2788  
AUTHORIZED SALES REPRESENTATIVES  
COAST TO COAST

**DISTRIBUTORS:**

CALIFORNIA, Westates Electronics, Chatsworth, (213) 341-4411 ● COLORADO, Electronic Parts Co., Denver, (303) 744-1992 ●  
MASSACHUSETTS, Greene Shaw Co., Newtonville, (617) 969-8900 ● NEW JERSEY, Wilshire Electronics, Cinnaminson, (609) 786-8990  
● NEW YORK, Summit Dist. Inc., Buffalo, (716) 884-3450 ● WASHINGTON, Sterling Electronics, Seattle, (206) 762-9100



## new products

# Analog-function array aids instrument designs

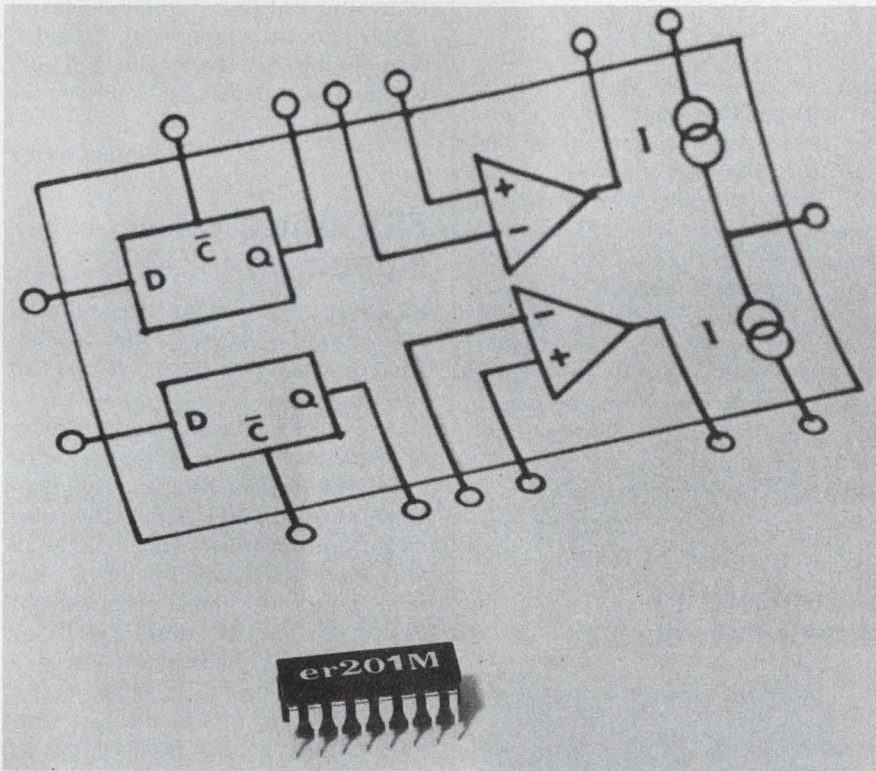

Electronics Research Group, 22 Mill St., Arlington, Mass. 02174. (617) 646-9760. P&A: See below.

With a unique combination of basic analog functions on a single chip, the ER201M IC gives instrument designers a new analog building block.

The new circuit from Electronics Research Group replaces at least two standard ICs and several transistors to simplify analog circuitry in a host of instrumentation applications.

For example, one ER201M can be used as a log converter, capacitance meter or dual chopper. And the IC can operate from a single supply in the range of 5 to 15 V (for dual supplies, the range is  $\pm 2.5$  to  $\pm 8$  V).

The ER201M analog-function array combines two precision comparators and two current sources with a pair of special analog

samplers. All of these sections are externally accessible. Voltages applied to the samplers' inputs form test or reference signals. Analog sampling can be performed at 200-kHz rates, minimum.

When strobed, each sampler corresponds to a high-speed, unity-gain buffer plus JFET output. The sampler has an offset of 30 mV maximum, 10 mV typical, and it requires a bias current of 2  $\mu$ A. Sampler cutoff and recovery are obtained at rates of 10 V/ $\mu$ s and 50 V/ $\mu$ s, respectively. OFF impedance reaches 8 M $\Omega$ .

Each of the chip's comparators has typical offsets of 3 mV (12 mV maximum) and 20 nA. A bias of 200 nA is typical. The comparators use pnp differential inputs, so that comparisons down to  $V^-$  can be performed. And slew rates of +50 V/ $\mu$ s can be achieved by connection of an external resistor.

When used for log conversion, the IC can display a variable voltage over a 50-dB range to an accuracy of  $\pm 0.1$  dB. Besides display and driver/decoder units, a complete log converter requires only one ER201M, two RC networks, a diode and a pull-up resistor.

The ER201M comes in a 16-pin DIP and operates from  $-55$  to 125 C. In hundred quantities, units cost \$15; for 10,000 quantities, the unit price drops to \$5.75. Samples are available.

CIRCLE NO. 251

## 1-k TTL pROMs feature MIL temp range

Fairchild Semiconductor, 464 Ellis St., Mountain View, Calif. 94042. (415) 962-3816. \$39 (100 up); stock.

Two new versions of the company's 256  $\times$  4-bit TTL programmable ROMs operate over the full MIL temperature range of  $-55$  to 125 C. The pROMs are the 93416, with open-collector outputs, and the 93426, which has three-state outputs.

CIRCLE NO. 253

## 64-bit ECL RAM has 6.5-ns access

Signetics, 811 E. Arques Ave., Sunnyvale, Calif. 94086. (408) 739-7700. \$19.40 (100); stock.

The 10142, a 64-bit ECL RAM, features a typical address access time of only 6.5 ns and a chip-select access time of 5.5 ns. This ECL 10-k memory is pin-for-pin and functionally equivalent to the popular 10148 RAM, which has a typical access time of 8.5 ns. Both read and write cycles for the 10142 can be accomplished in 10 ns, allowing data rates up to 100 MHz.

INQUIRE DIRECT



## Divide-by-4 counter operates at 250 MHz

*Plessey Semiconductors, 1674 McGaw Ave., Santa Ana, Calif. 92705. (714) 540-9979. \$7.90 to \$18 (100 up); stock.*

A high-speed divide-by-4 counter series operates with a specified input frequency range of 15 to 250 MHz over the full military temperature range. The series has a low current drain of 23 mA maximum. At 25 C, typical current drain is 16 mA and typical maximum input frequency is 390 MHz. The SP600 employs external bias and it uses capacitive coupling to the signal source. Inputs can be either single, or double driven with two complementary input signals. And load resistors may be taken to any bias voltage up to 12 V more positive than  $V_{EE}$ .

CIRCLE NO. 254

## Character generator interfaces to printer

*Nortec Electronics Corp., 3697 Tahoe Way, Santa Clara, Calif. 95051. (408) 732-2204. \$14.50. (100-999).*

A MOS/LSI ASCII-code character generator, the Model NEC-4881, interfaces directly with Bowmar's TP-3100 Thermal Printer. The 4881 decodes 7-bit ASCII code into the appropriate  $5 \times 5$  matrix format for printing. The IC also has mask options available for  $4 \times 5$  and  $5 \times 7$  matrix outputs.

CIRCLE NO. 255

## 7 ICs expand MIL-temp MECL 10-k

*Motorola, Semiconductor, P.O. Box 20924, Phoenix, Ariz. 85036. (602) 244-3466. \$11.25 to \$29.50 (100-999).*

Seven flat-pack versions of circuits in the MECL 10,000 series are added to the MIL temperature-range lineup. The recent additions consist of a quad latch (MC-10533F), universal decade counter (MC10537F), binary 1-of-8 decoders (MC10561F/62F), dual binary 1-of-4 decoders (MC10571F/72F) and a look-ahead carry block (MC-10579F).

CIRCLE NO. 256

## FET op amps come in single, dual versions

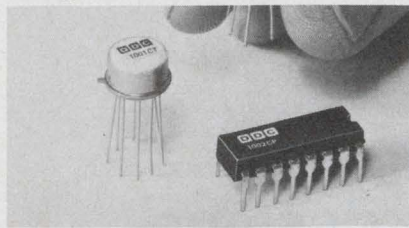

*ILC Data Device Corp., 100 Tec St., Hicksville, N.Y. 11180. (516) 433-5330. \$4 to \$50; stock to 4 wks.*

A line of FET-input op amps, the 1001 and 1002 series, combines an input bias of typically 2 pA with a slew rate of 6 V/ $\mu$ s. The 1001 series is pin compatible with the 741 op amp, while the 1002 series includes two 1001-type amps in a single package. Selected versions are available with a maximum input bias current of 1 pA, and offsets and drifts as low as 1 mV and 5  $\mu$ V/ $^{\circ}$ C, respectively. The 1001 series comes in a TO-99 can, while the 1002 is available in a 16-pin ceramic or plastic DIP. Inputs and outputs are protected against short circuits.

CIRCLE NO. 257

## IC contains i-f part of FM receiver

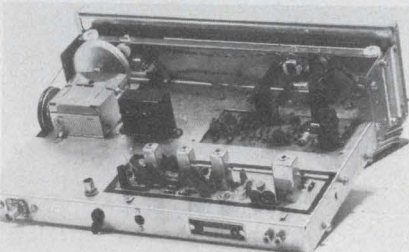

*Signetics, Consumer Products, 811 E. Arques Ave., Sunnyvale, Calif. 94086. (408) 739-7700. \$2.55 (100).*

An advanced phase-locked loop IC, the NE563, can be used to replace many of the components presently needed in the i-f section of FM receivers. Without requiring coils, inductors or variable tuning components, the NE563 performs such functions as agc, afc, drive for a signal-strength meter and variable muting. The IC has 5-mV rms input sensitivity (with 30 dB S/N), 500-mV rms recovered audio (75-kHz deviation) and 0.05% harmonic distortion (75-kHz deviation and 1-kHz modulation).

CIRCLE NO. 258

## TV sound system contained in single IC

*National Semiconductor Corp., 2900 Semiconductor Dr., Santa Clara, Calif. 95051. (408) 732-5000.*

The monolithic LM1808 contains the audio circuitry required by a TV receiver. The unit, a 2-W audio i-f circuit, basically combines the features of two earlier ICs—the LM3065 and the LM380. However, an improved volume-control circuit allows a single nonshielded wire to be run from the LM1808 to the front panel for volume control.

INQUIRE DIRECT

## FET switch driver outputs up to 30 V

*Siliconix Inc., 2201 Laurelwood Rd., Santa Clara, Calif. 95054. (408) 246-8000. \$6.80 to \$20.40 (100); stock.*

A dual FET analog-switch driver comes with complementary outputs for MOS interface applications. Called the D139, the new circuit incorporates bipolar, PMOS and Schottky technology on a common substrate, and each output can drive one or more PMOS or NMOS FETs directly, or drive a junction FET switch with a few additional circuit elements. Output voltage swing is as high as 30 V and switching time is 200 ns max. Supply current is 1.5 mA typical.

CIRCLE NO. 259

## 400-ns 1-k RAM dissipates only 263 mW

*Advanced Micro Devices Inc., 901 Thompson Pl., Sunnyvale, Calif. 94086. (408) 732-2400. \$16.95 to \$32 (100).*

A high-speed, low-power 1024-bit NMOS RAM—the Am9102—offers access times down to 400 ns (suffix B). In addition, the company also has a 500-ns circuit (suffix A) and a 650-ns circuit (basic model). All versions of the 2102-type memory guarantee power dissipation at 263 mW, and they feature a dc standby mode that reduces power requirements by 75%. Fanout is guaranteed at two TTL loads.

CIRCLE NO. 260



# Value Packed Spectrum Analyzers

**Communications:**  
10Hz - 43MHz  
(or 400MHz)

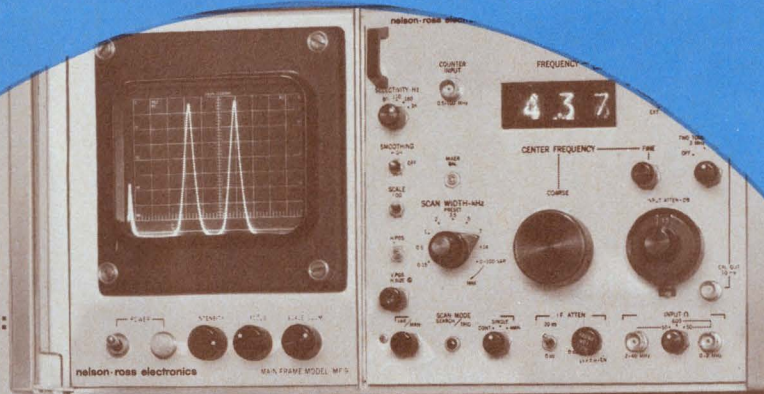

**Broadband:**  
100Hz - 25MHz

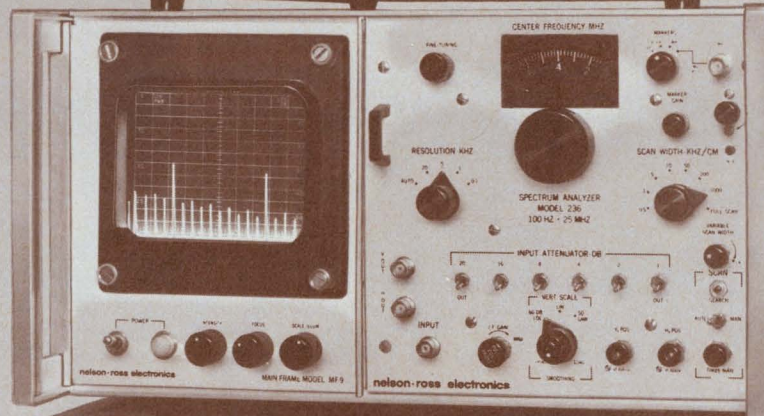

**Microwave:**  
10MHz - 6.5GHz

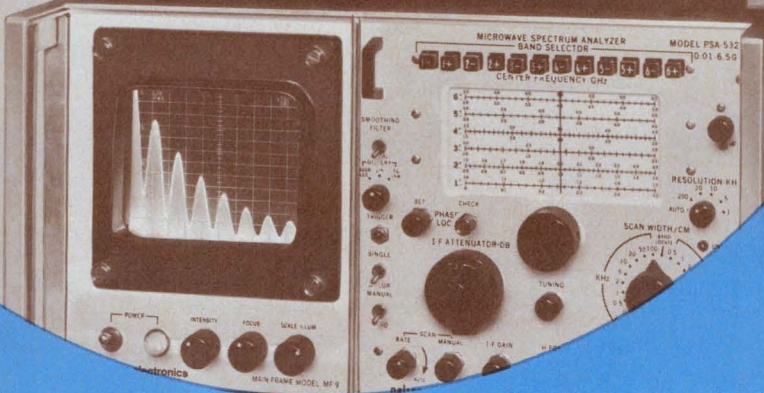

**Sub-Audio thru Microwave 0.5Hz to 6.5GHz**  
**Self-Contained Analyzers or Plug-Ins for hp & Tek Scopes**

Nelson Ross, the "SPECIALIST" in Spectrum Analyzers, offers you the most comprehensive selection of reliable, easy-to-use instruments — and backed by 15 years of spectrum analysis leadership.

Select from more than 30 models: Sub-Audio, Audio, Ultrasonic, Broadband, Telemetry, RF/SSB, RF/UHF, TV, Microwave . . . all at lowest cost.

Ask for your new NR SPECTRUM ANALYZER CATALOG with specifications and prices. Chances are that we have the right Spectrum Analyzer for you.

**nelson • ross electronics**

A Division of Polarad Electronics Corp.

5 Delaware Drive / Lake Success, New York 11040 / 516-328-1100 / TWX 510-223-0414

INFORMATION RETRIEVAL NUMBER 73

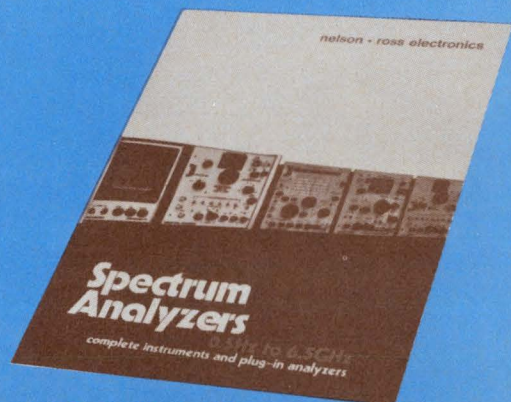



**Domestic or Professional  
YOUR potentiometer is here**

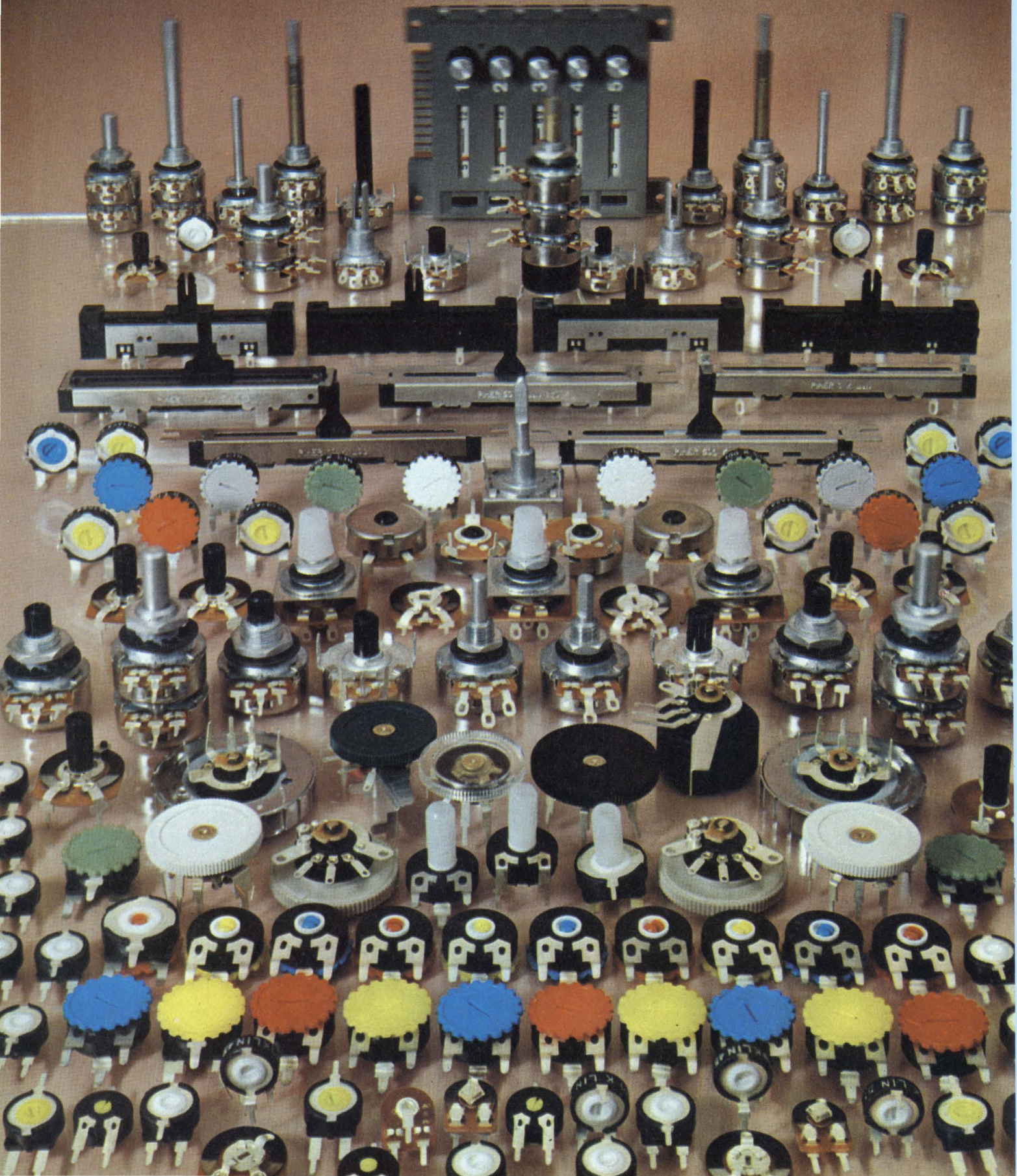



With our range of preset, rotary spindle, slider and rectilinear potentiometers—all designed round the prime requirements of noise-free operation and long life—we have brought new standards of quality and reliability to the potentiometer market for domestic or professional use.

In a technology not normally associated with dramatic breakthroughs we have introduced new ideas to component design and manufacture.

Like our Series PT preset pots which are fully enclosed in flame retardent plastic for protection from environmental factors. And the new PL40 slider pot, with its enclosed track and specially designed wiper movement that eliminates jitter, giving ultra-smooth operation.

Of course we also provide the usual options, like matched pairs for stereo applications, various terminal arrangements, earth screening and mains switches.

There's also the new PL25, a 20-turn rectilinear preset control for radio and tv varicap tuning applications.

In short, in any situation calling for high quality potentiometers, the discerning engineer should turn to PIHER.

Write or ring for full details.

U.K. — PIHER International LTD.,  
Romar House, The Causeway,  
Staines, Middlesex, England.  
Tel: Staines 56157. Telex 934167.

U.S.A. — PIHER International Corp.,  
1239 Rand Road, Des Plaines,  
Illinois 60016, U.S.A.  
Tel: 312 297 1560. Telex 282154.

Germany — PIHER International GmbH.,  
85 Nurnberg, Tuchergartenstrasse 4,  
W. Germany.  
Tel: 0911 533 051. Telex 623354.

France — PIHER International SARL,  
83, Rue Etienne Dolet, 94230,  
Cachan, France.  
Tel: 656 26 07. Telex 27107.

Italy — PIHER International S.P.A.,  
Via Censio 34, 20154 Milan, Italy.  
Tel: 314532/316213.

Head Office — Riera Cañado,  
s/n Apartado de Correos 53,  
Badalona (Barcelona), Spain.  
Tel: 389 03 00. Telex 59521.



## INTEGRATED CIRCUITS

### FET op amps settles in 600 ns to 0.01%

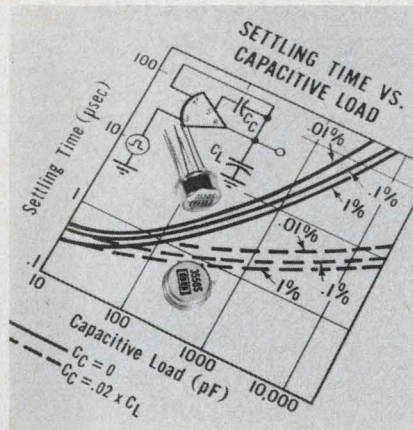

Burr-Brown, International Airport Industrial Park, Tucson, Ariz. 85706. (602) 294-1431. \$15 to \$26 (100); stock to 4 wks.

Not only does the Model 3550K FET-input op amp provide a unity-gain bandwidth of 20 MHz and a guaranteed slew rate of 100 V/µs. The new IC also offers a maximum settling time to 0.01% of just 600 ns. And these specs hold when the internally compensated op amp, which has a full differential input, is operated in a noninverting or inverting mode. Typical dc open-loop gain is 100 dB and input impedance is  $10^{11}\Omega$ . Good settling can also be obtained with large capacitive loads when a small external compensation capacitor is added. Settling with a 10,000-pF load then reduces by over an order of magnitude.

CIRCLE NO. 517

### Dual, quad op amps use single supply

Signetics, 811 E. Arques Ave., Sunnyvale, Calif. 94086. (408) 739-7700. \$1.05 to \$2.50 (100); stock.

Both the NE532 dual op amp and the LM324 quad op amp can operate from a single source of 3 to 30 V. Operation from dual supplies of 1.5 and 15 V is also possible. Internally compensated, differential voltage amplifiers are used in both ICs. Each op amp has a unity-gain bandwidth of 1 MHz and a bias current of 45 nA, both of which are temperature compensated. Input offset voltage is 2 mV.

INQUIRE DIRECT

### 4-k-bit ROM accesses in 330 ns

Siemens, Z1/Presseabteilung Technik, D-8520 Erlangen, Postfach 3240, Germany.

The latest 4096-bit RAM has an access of 330 ns, a read-refresh cycle of 600 ns and a write cycle of 800 ns. Packaged in a 22-pin DIP, the Model S 142 memory dissipates 400 mW in operation and 10 mW when idle. Supplies required for the NMOS RAM are 12, 5 and -5 V. Refresh for the dynamic memory takes 64 cycles, and its operating temperature range extends from 0 to 70 C.

CIRCLE NO. 518

### ICs performs sample and hold function

Intersil, Inc., 10900 N. Tantau Ave., Cupertino, Calif. 95014. (408) 257-5450.

Two sample-and-hold circuits are being offered. The IH5110 is optimized for signals up to 10 V ac pk-pk or  $\pm 10$  V dc, and the IH5111 is optimized for signals up to 20 V ac pk-pk or  $\pm 10$  V dc. Drift rate for both devices—with an external 0.01-µF capacitor—is 10 mV/sec maximum, and less than 2 mV/sec typical. Maximum charge injection is 5 mV pk-pk for the IH5110 and 10 mV pk-pk for the IH5111. Maximum acquisition time for a 10-V step input is 10-µs for the IH5110 and 15 µs for the IH5111. Aperture time for both units is 500 ns.

CIRCLE NO. 519

### MOS terminal IC aids data systems

Motorola Semiconductor, P.O. Box 20924, Phoenix, Ariz. 85036. (602) 244-3466. \$10.75 (100-999); stock.

The MC2260L, an MOS asynchronous/synchronous terminal transmitter, provides a serial communications link in data systems. Character lengths are selectable in 5, 6 or 7 bits. Also, one or two stop bits are externally selectable in asynchronous mode. Data rates are from dc to 10,000 bits per second (BPS) in a divide-by-64 mode, 40,000 BPS in a divide-by-16 mode and 200,000 BPS in the divide-by-1 mode or at the clock frequency.

CIRCLE NO. 520



# MORE POWER MORE BANDWIDTH

Our Model 503L is an ultra-wideband RF power amplifier whose wide range of frequency coverage and power output provides the user with the ultimate in flexibility and versatility in a laboratory instrument. Easily mated with any signal generator, this completely solid state unit amplifies AM, FM, SSB, TV, pulse and other complex modulations with minimum distortion.

Constant forward power is continuously available regardless of the output load impedance match, making the 503L ideal for driving highly reactive loads.

Unconditional stability and instantaneous failsafe provisions in the unit provide absolute protection from damage due to transients and overloads.

This low cost instrument, covers the frequency range of 1.6 to 540 MHz with a linear power output of 3 watts . . . and there's no tuning. Priced at \$995.\*

#### Applications include:

- Laboratory instrumentation
- Communication systems
- Laser modulation
- RFI/EMI testing
- Spectroscopy

\*USA and Canada



For further information or a demonstration contact

ENI, 3000 Winton Road South,  
Rochester, New York, 14623.

Call 716-473-6900.

Or TELEX 97-8283 ENI ROC.

# ENI

The world's leader  
in solid-state power amplifiers.

INFORMATION RETRIEVAL NUMBER 75

## INTEGRATED CIRCUITS

### FET analog switches handle 20-V signals

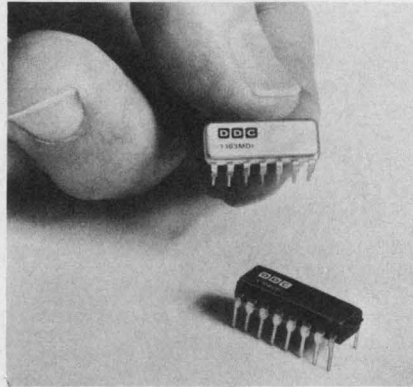

ILC Data Device Corp., 100 Tec St., Hicksville, N.Y. 11801. (516) 433-5330. Less than \$1 per switch; stock to 4 wks.

A complete line of FET analog switches (the 1101 through 1108 series) are available in both industrial and military-temperature ranges. Each package contains up to four channels of analog switches and eliminates the need for an external driver. The 1101 through 1104 devices are driven directly from low-level TTL logic (5 V), and can switch signals in the -10 to +10-V range. The 1105 through 1108 series is driven from TTL open-collector logic (15 V) and can switch 0 to 20-V signals. Each channel of the 1101 through 1108 simulates a SPDT switch, while that of the 1105 through 1108 simulates a SPST switch. The ON resistance for each channel is less than 150  $\Omega$ .

CIRCLE NO. 261

### Static registers guarantee 1.5-MHz rate

Advanced Micro Devices Inc., 901 Thompson Pl., Sunnyvale, Calif. 94086. (408) 732-2400. \$4.80 to \$9.20 (100).

Three static shift-register circuits have speeds guaranteed to 1.5 MHz. The trio of p-channel, silicon-gate MOS units include these: the Am40/5055, a quad 128-bit circuit; the Am40/5056, a dual 256-bit circuit; and the Am40/5057, with 512 bits. These devices are pin compatible with like-numbered circuits originally offered by National Semiconductor.

CIRCLE NO. 262

### ECL counters operate above 100 MHz

Signetics, 811 E. Arques Ave., Sunnyvale, Calif. 94086. (408) 739-7700. \$13.55 (100).

Two ECL counter circuits, the 10136 and the 10137, offer operating speeds in excess of 100 MHz. The 10136 is a 16-state hexadecimal synchronous counter, while the 10137 is a 10-state, or decimal, counter. Both devices have four operating modes—count up, count down, preset and stop—controlled by two function-select inputs. Other features include a carry-in and carry-out for extending the count range, a clock input for synchronous operation, and four data inputs for presetting the counter and variable-modulus count operations.

INQUIRE DIRECT

### Isoplanar RAMs switch to plastic

Fairchild Semiconductor, 464 Ellis St., Mountain View, Calif. 94042. (415) 962-3816. \$12.40 to \$22 (100); stock.

Plastic-packaged versions are offered for three Isoplanar RAMs, including the company's 93415 TTL 1024-bit RAM. The two other RAMs are the 93411 TTL 256  $\times$  1-bit memory (with open-collector output) and the 93421 TTL 256  $\times$  1-bit memory (with three-state output).

CIRCLE NO. 263

### CMOS decoder/driver aims for LCD watch

Nortec Electronics Corp., 3697 Tahoe Way, Santa Clara, Calif. 95051. (408) 732-2204. \$17.50 (100-999).

The NEC-5015 CMOS decoder drives a 3-1/2 digit, seven-segment field-effect LCD directly without external components. The new decoder/driver handles a display of hours and minutes from 23 outputs and a common line with a 32-Hz ac signal. Seconds are displayed with a flashing colon, and two time-setting inputs are provided for hours and minutes. The new 5015 can interface with an oscillator/countdown chip (NEC-5016) to form a complete watch circuit.

CIRCLE NO. 264



# it takes more

than a spark gap to solve surge voltage problems like these ...

## COMM GAPS PROTECT COMMUNICATIONS EQUIPMENT

Voltage surges from lightning and its secondary effects have very fast rise times which are hazardous to equipment and personnel. Signalite COMM GAPS are used in telephone, CATV, telegraph and other communications lines to protect against these hazards.

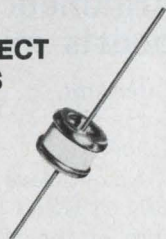

## POWER SUPPLY PROTECTION

Supply transformers are subject to line surges. Signalite COMM GAPS are used across transformer secondaries to prevent these surges from affecting power supply components or load circuits. COMM GAPS protect both laboratory and modular types.



## ELECTRICAL ENERGY TRANSFER

In circuits using capacitors and flash tubes, such as photoflash and strobe applications, it is necessary to dissipate large amounts of energy in a short time period. Low cost, miniature Signalite COMM GAPS provide increased speed of circuit function and improved reliability.



It takes application help from a group of surge protection specialists ...  
...yours for the asking.



**SIGNALITE TRANSIENT VOLTAGE PROTECTION KIT**—includes 28 page illustrated technical manual on the applications of gas discharge devices in transient protection and energy transfer. Also detailed specifications bulletins and an applications engineering worksheet. Available from your Signalite representative or by contacting Signalite, 1933 Heck Ave., Neptune, New Jersey 07753, (201) 775-2490.

**SIGNALITE DIVISION  
GENERAL INSTRUMENT CORP.**





# First floppy disc peripheral made for microcomputers



iCOM, 6741 Variel Ave., Canoga Park, Calif. 91303. (213) 348-1291. See text; 45 days.

In response to the need for peripherals for microcomputers, iCOM has developed the first microperipheral floppy-disc drive with integral controller.

The disc drive, the FD360, can operate under directions received from either the Intel (Santa Clara, Calif.) or the National Semiconductor (Santa Clara, Calif.) microprocessor systems.

The FD360 is available in either a single or dual-disc version, and can be expanded so that four drives can be manipulated by one controller. Two drives fit into the main chassis, and up to two more drives can be put into an expansion chassis.

Hardware interfaces are available for the Intel Intellec-8 and Intellec-8/MOD-80 and National's IMP-16P, 16L and 8P.

The manufacturer uses Pertec's IBM-compatible floppy-disc drives in the system. The floppy discs thus have format compatibility with the IBM 3741, 3742 and 3540 systems.

Features of the FD360 include

the following: motor shutdown to reduce disc hub wear; built-in hardware track seek and seek verification; automatic head unload and load to minimize head and media wear; individual write-protect switch for each drive; operation with either programmed I/O or DMA interfaces; automatic single-command write of deleted data-address mark, and input and output buffering to enable asynchronous programmed I/O.

Input and output buffering (128-byte buffers) on the FD360 allows integration of the microperipheral with other asynchronous data handling devices such as keyboards, communications equipment, paper tape and data-acquisition equipment.

Built-in CRC (cyclic redundancy code) generation and verification hardware works with the data buffers to make write verification unusually easy on the FD360. When data are written onto the disc from the write buffer, the data are recycled into that buffer. The written data are then verified when a "read for CRC verification" command is issued. This function reads, checks and discards the data

being read, thus not destroying the existing contents of the read buffer. If a data error is detected, only a new write command need be issued, since the data are still present in the write buffer.

Interfacing to the FD360 is done through eight input lines and 16 output lines.

The drive and controller are contained in a 10 × 17 × 17-in. desk-top cabinet, and the system uses 115 V ac, 47 to 440 Hz lines and consumes 150 W.

In a single drive configuration, the selling price is \$2350 (unit quantity). With two drives, the price rises to \$3000. Special interfaces cost a few hundred dollars more.

In addition to the microcomputer interfaces, iCOM also offers hardware to interface the system to the Hewlett-Packard 2100 and Data General Nova families of mini-computers.

CIRCLE NO. 252

## Arithmetic logic unit boosts mini throughput

Interdata, 2 Crescent Pl., Oceanport, N.J. 07757. (201) 229-4040. \$4900.

An outboard arithmetic logic unit dubbed HSAU improves performance of the Model 7/16 mini. The unit provides hardware multiply/divide, floating point arithmetic and list processing. The latter assists real-time schedulers by indicating the number of slots in a list and the number used as the lists are processed. The unit also detects privileged instructions—a feature found mainly in large-scale computer operating systems. According to the manufacturer the unit improves standard execution times by 30% or even more.

CIRCLE NO. 265



# Our switches are very sensitive to your needs

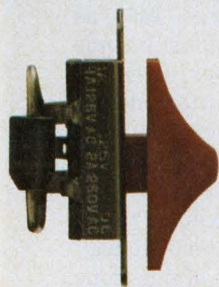
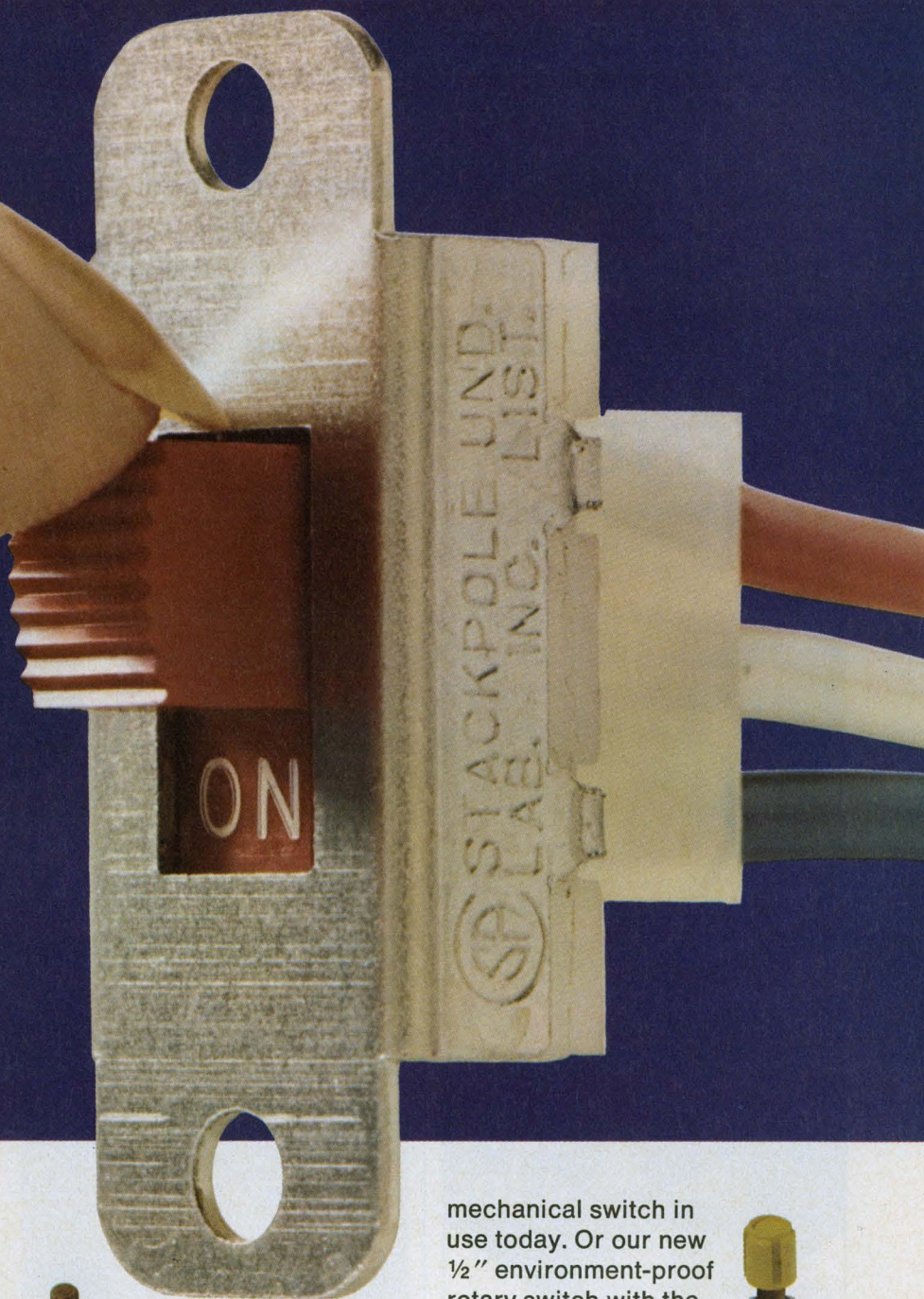

Need a slide switch that demands sixty ounces of force to move it off center? Or one that is so sensitive a wisp of air will turn it on?

Only Stackpole gives you that flexibility.

A massive slug contact in our slide switch provides unique detent adjustment for heavy appliances or delicate instruments. This contact, combined with sturdier terminals, insures longer life under rated load.

It's the finest slide switch design from the world's largest manufacturer.

And coming soon, a new sub-miniature switch with case just  $\frac{3}{8}$ "

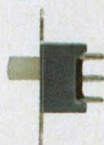

long for the ultimate in space-saving efficiency.

Across the line Stackpole provides special features to uniquely meet your needs. Like the addition of resistors or diodes and wiring

on slides and rotaries to cut handling and assembly costs. Or a unique toggle or rocker knob to set your product apart without upsetting the price. Try our low-priced Lo-Pro™ keyswitch (and choice of keyboards) which develops lower error rates than any



mechanical switch in use today. Or our new  $\frac{1}{2}$ " environment-proof rotary switch with the industry's most attractive price and delivery.



That's Stackpole value . . . and it's working for you in every slide, rocker, rotary, and keyswitch we produce. Have a special switch need? Test our sensitivity. Give us a call.

Stackpole Components Company  
P.O. Box 14466, Raleigh, NC 27610  
Phone: 919-828-6201  
TWX: 510-928-0520

 **STACKPOLE**



# 1%

AMERICAN

MADE

## Tolerance SCHAUER 1-Watt ZENERS

### Immediate Shipment Low Prices

ANY voltage from 2.0 to 16.0

Quantity	Price each
1-99	\$1.07
100-499	.97
500-999	.91
1000-4999	.86
5000 up	.82

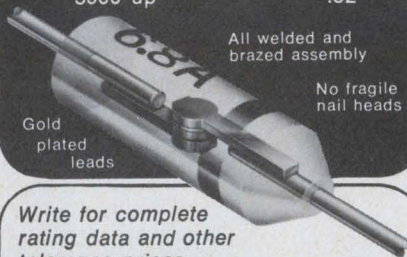

Write for complete rating data and other tolerance prices.

### Buy the kit- Save a lot



Kit contains a 51-piece assortment of SCHAUER 1% tolerance 1-watt zeners covering the voltage range of 2.7 to 16.0. Three diodes of each voltage packaged in reusable poly bags. Stored in a handy file box. Contact your distributor or order direct.

A \$54.57 value for  
ONLY \$24<sup>50</sup>

Semiconductor Division

## SCHAUER

Manufacturing Corp.

4511 Alpine Ave. Cincinnati, Ohio 45242  
Telephone: 513/791-3030

### DATA PROCESSING

#### Credit-card reader is hand operated

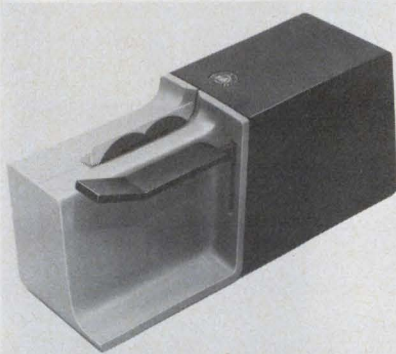

American Magnetics Corp., 2424 Carson St., Torrance, Calif. 90501. (213) 775-8651. Under \$50 (quan).

The Model 10 reader accepts information from magnetic-stripe cards and takes about two seconds to read a card. The unit is hand operated. A spring and a dash pot provide a constant read velocity so stray magnetic fields that accompany the use of an electric motor are eliminated. Double-axis gimbals mount the magnetic read head and supply the necessary compliance to read warped cards.

CIRCLE NO. 266

#### NMOS memories offer 275-ns access times

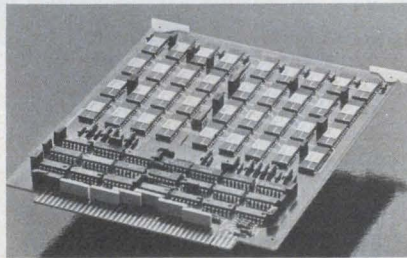

Electronic Memories & Magnetics Corp., 12621 Chadron Ave., Hawthorne, Calif. 90250. (213) 644-9881. \$495 to \$617; 40 days.

Basic systems in the Microram NMOS memory series are organized as 4096, 9-bit words. Board size is 7 x 8.875 in. for the N models and 7 x 10.75-in. for the NV models. The NV models require only 5 V; the N models use 15 V, -5 V and 5 V. The 1200 N and NV units provide 350 ns access and 900 ns cycle times. The 1210 N and NV units have 275 ns and 400 ns access and cycle times. All memories feature TTL compatible operation.

CIRCLE NO. 267

#### Modem for 4800 bit/s is Bell 208B compatible

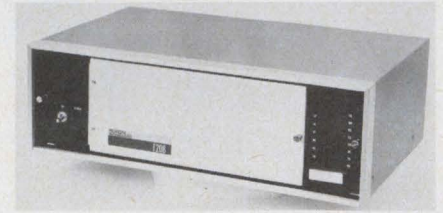

Rixon, 2120 Industrial Parkway, Silver Spring, Md. 20902. (301) 622-2121.

The T208B modem provides 4800 bit/s data rate and is end-to-end compatible with the AT&T 208B unit. The unit operates over two-wire direct-dial facilities in the half-duplex mode and is equipped with automatic equalization. Features include automatic answer, automatic echo suppressor disable and alternate voice/data.

CIRCLE NO. 268

#### Smart controller is fast and programmable

Xerox Corp., 701 S. Aviation Blvd., El Segundo, Calif. 90245. (213) 679-4511. From \$4500.

A microprogrammable controller, dubbed the system control unit (SCU), has a throughput rate of 2.86 M, 16-bit word/s. The device is designed to provide high data throughput and fast response to interrupts. Response to interrupts is 350 ns and the multiplexed interrupt response is as fast as 1.05  $\mu$ s. SCU applications include use as an I/O controller, preprocessor for a host computer, device controller for peripherals, communications system controller, special algorithmic processor, computer emulation system, remote intelligent processor, video display controller, and as a stand-alone processor. A three-bus 16-bit parallel architecture allows up to three concurrent data transfers within a single microinstruction. Data may be intermixed combinations of bytes and 16-bit words. Other features of the SCU include 256 to 4096 words of 32-bit control memory, 4000 to 65,000 words of 16-bit data memory, eight general-purpose registers, and up to 128 I/O addresses. The unit is available with a wide variety of standard peripheral interfaces as well as a general I/O structure.

CIRCLE NO. 269



# Digivue® - a better way to look at it.

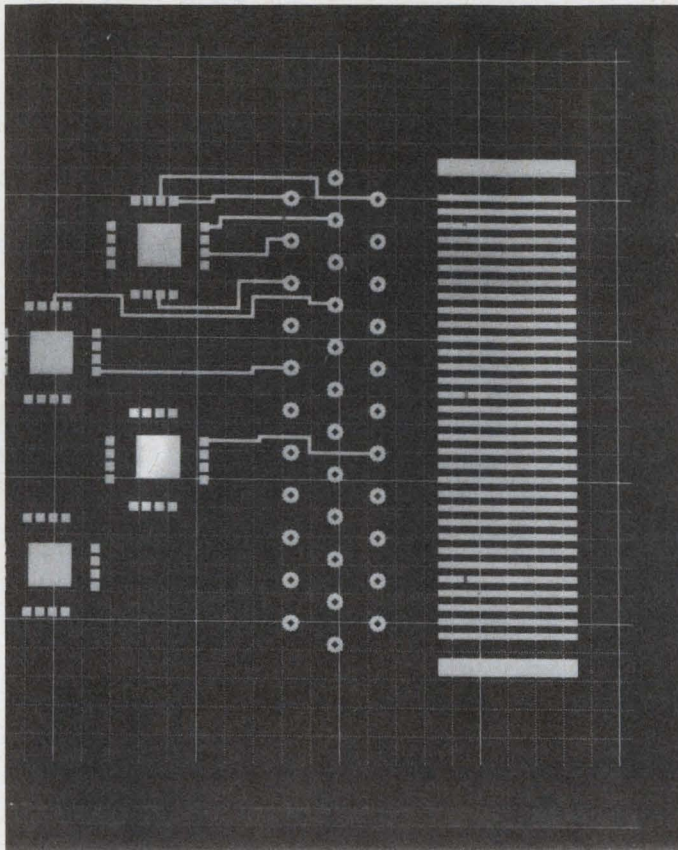

Unretouched time exposure of data displayed on a Digivue unit. Note high contrast picture, precise graphics.

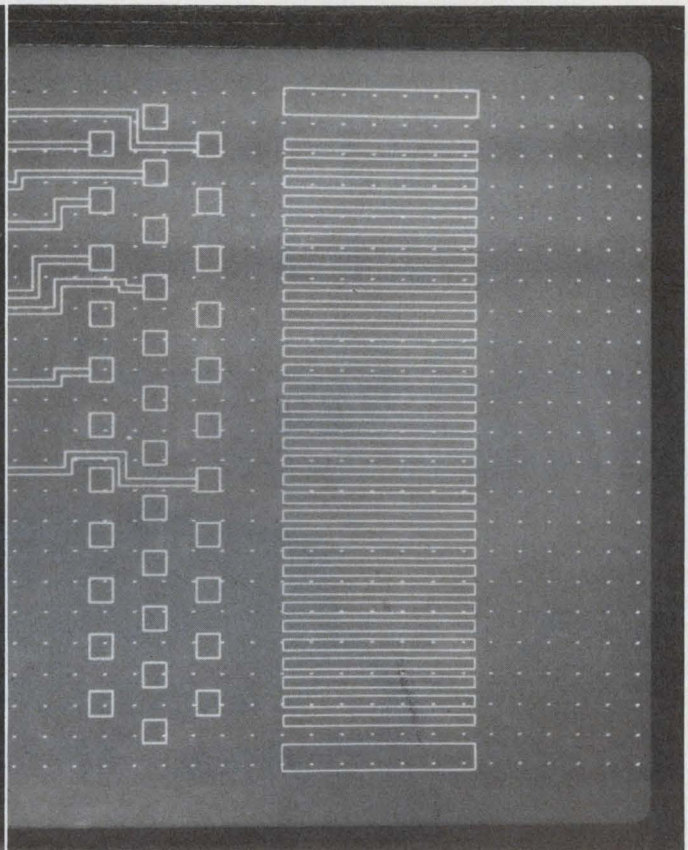

Unretouched time exposure of same data displayed on a CRT. Note lack of contrast in CRT image.

When your customers spend a lot of time looking at data displays and computer terminals, the advantages of Digivue plasma display units over CRT's become clear.

Very simply, Digivue display/memory units are better to look at. Digivue units present a flicker-free high contrast display for more precise readings and reduced chance of eye fatigue.

And Digivue units make it easier to use what's on the screen. Inherent memory is a feature of every unit. Digivue images appear on a thin, flat panel—which allows you to design compact components. The 512-60 models offer hard copy and rear projection capabilities, too. All of which gives you a product with more features to sell.

Sure, Digivue display/memory units currently cost more than CRT's. But they're worth a lot more to your customer, because they do a lot more.

For an informative booklet about Digivue display/memory units call (419) 242-6543, Ext. 66-415, or write Electro/Optical Display Business Operations, Owens-Illinois, Inc., P.O.Box 1035, Toledo, Ohio 43666.

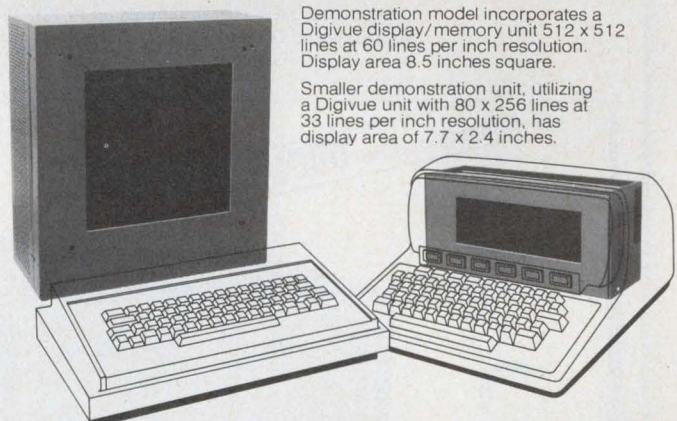

Demonstration model incorporates a Digivue display/memory unit 512 x 512 lines at 60 lines per inch resolution. Display area 8.5 inches square.

Smaller demonstration unit, utilizing a Digivue unit with 80 x 256 lines at 33 lines per inch resolution, has display area of 7.7 x 2.4 inches.

**OWENS-ILLINOIS**  
Toledo, Ohio



# Now New from T.R.I. a engineering and

All four of these new additions to our product line will cause quite a stir. They're totally new and so is a lot of the technology behind their manufacture. Technology developed specifically to meet user needs and innovate user measuring techniques.

There's also something else behind their manufacture in addition to new technology. T.R.I.'s traditional concept of measuring instrument efficiency, reliability, easier use, and increased cost economy.

Find out about the total advantages of all four direct. Phone (408) 733-9080, 9081. Or write us. We'll send complete details to supplement the specs we're introducing here.

Price **\$279.00**

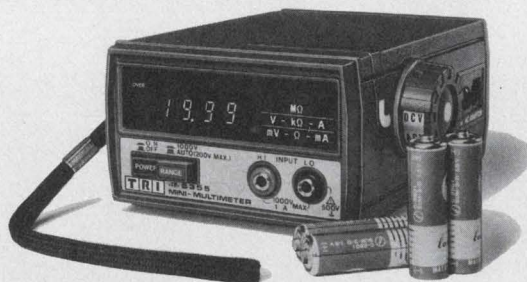

**Model: 6355**  
**Mini-multimeter**

- Five functions. Automatic range selection.
- Drop-proof, portable (4-3/8W, 2-7/8H, 6D in.), Lightweight (1.8 lb)
- High performance—DCV measurements at 10  $\mu$ V resolution. ACV measurements up to 1000Vrms.
- Operates on DC battery and AC power supply.

## 10 $\mu$ V, Fully automatic DMM. \$279

Announcing the fully automatic, 10  $\mu$ V resolution Model 6355 portable DMM standard. And at only \$279. Not only that, but also 5 functions and automatic range selection. Measures AC voltages up to 1000Vrms, can even be operated from a battery. The same performance as a laboratory use DMM. Can be easily hand carried. Weights only 1.8 lb. Moreover, shock resistant design protects it even if it is accidentally dropped. Five auto functions range switching, units display, polarity, overrange indication, and overload protection.

**Display:** 1999 **DC Voltage:** 20mV—1000V (resolution 10  $\mu$ V) **AC Voltage:** 200mVrms—1000Vrms (resolution 100  $\mu$ V) **Resistance:** 200  $\Omega$  ~ 20M  $\Omega$  (resolution 100m  $\Omega$ ) **DC Current:** 20mA ~ 1A (resolution 10  $\mu$ A) **AC Current:** 200mA ~ 1A (resolution 100  $\mu$ A) **Size:** Approx 4-3/8 (W) x 2-7/8 (H) x 6 (D) in. **Weight:** Approx 1.8 lb **Price:** \$279

Repetition rate **500MHz**

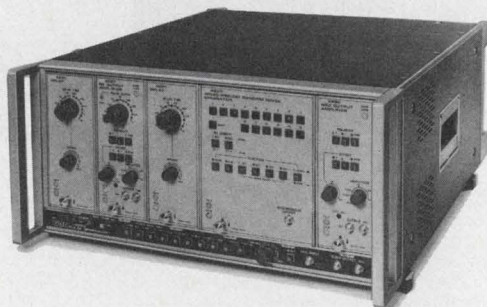

**Model: 4220**  
**Pulse Generator**

## Maximum repetition rate up to 1000MHz make it ideal for PCM communication.

Model 4220 is a high-performance pulse generator with a repetition rate of 500 MHz. It can also generate word patterns. Among the main features of this high performance instrument is generation of a multitude of waveforms through combinations of different modules. Eight modules enable pulse generator tailoring to a specific requirement. Each unit also has a remote control function and such complementing features as delay of 1 or more periods, 50  $\Omega$  output impedance which enables generation of highly accurate pulses, variable rise and fall time, and two outputs.

**Repetition Frequency:** 100 kHz—500 MHz **Modules:** Delay, double pulse gate, word generator, word/pseudo random noise generator, NRZ output amp, RZ output amp, RZ output amp (rise time/fall time variable), bipolar output amp.



# Product Line to Innovate production ideas.

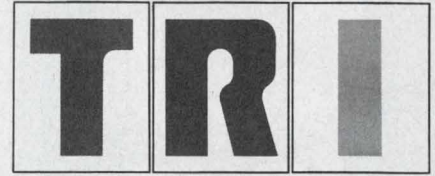

T.R.I. CORPORATION  
505 West Olive Avenue Sunnyvale, CA 94086  
(408) 733-9080

**Programmable**



**Model: 6141**  
**Programmable DC V/I Generator**

- Economy plus programmable functions suitable for a host of OEM applications.
- Easy flip-switch operation.
- Extremely stable. Also has pulse-width modulation system.
- Variable in  $1\mu\text{V}$  steps. All-range continuous-function performance.

Suitable for OEM and production line use.

Model 6141 features a remote control function for OEM use and wide usage on production lines. These unique features have been made possible through the adoption of a new pulse-width generator system. Easy usage has been realized through the adoption of a flip switch to automatically set the output level with one touch instead of the conventional rotary switch. Since automatic carry is performed when this switch is depressed, automatic sweep is also possible.

**DC Voltage:**  $0 \sim \pm 11.999\text{V}$  ( $1\mu\text{V}$  steps) **Stability:**  $\pm 0.015\%$  of setting  $\pm 3\mu\text{V}$  (10 mV range) **DC Current:**  $0 \sim \pm 119.99\text{mA}$  ( $0.1\mu\text{A}$  steps) **Stability:**  $\pm 0.02\%$  of setting  $\pm 0.2\mu\text{A}$  ( $1\mu\text{A}$  range) **Dimensions:** Approx  $11\text{-}3/4$  (W)  $\times$   $3\text{-}5/16$  (H)  $\times$  10 (D) in. **Weight:** Approx 11.023 lb **Price:** \$890

**Resolution 0.00001Hz**

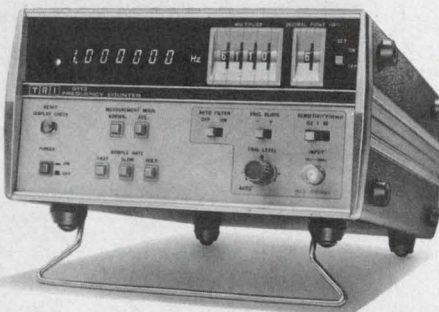

**Model: 5112/13**  
**Milli-Hertz Counter**

High resolution counter which permits direct reading of rotational speed and flow rate.

Model 5112 and 5113 are revolutionary products which permit direct-reading measurement of rotational speed, flow rate, and other comparatively low frequencies (1 Hz ~ 1 MHz) at high accuracy in these respective units. Moreover, measurement accuracy has been increased through the averaging function. The measured result can be directly displayed and a multiplier function is employed to directly read physical quantity.

**Frequency Range:** 1 Hz ~ 1 MHz **Resolution:** 0.1 mHz (Model 5112), 0.01 mHz (Model 5113) **Display:** 199999 (5112), 1999999 (5113) **Size:**  $8\text{-}7/16$  (W)  $\times$   $4\text{-}2/4$  (H)  $\times$   $12\text{-}15/16$  (D) in. **Weight:** Approx 11.02 lb **Price:** \$1300 (5112), \$1400 (5113)

INFORMATION RETRIEVAL NUMBER 81



# TO-5's WE CAN Cool 'em



**5.0¢\***

1134-U Press on  
Typical  $R_{\theta}$ , 59° C/W



**5.1¢\***

2226-U Press-on  
Clears adjacent compo-  
nents  
Typical  $R_{\theta}$ , 59° C/W

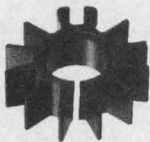

**8.2¢\***

2230-B5, 3/4" Press-on  
gear type, screw mount  
Typical  $R_{\theta}$ , 51° C/W



**8.5¢\***

2257-R 1/2" Press-on  
gear type  
Typical  $R_{\theta}$ , 68° C/W

Popular, easy-to-use economy coolers for PC board components. Thermally offers the most complete line of heat sinks in the industry: over 100 designs for cooling all types of packages including DIP's, plastics, TO-3's, TO-66's, and power transistors.

\*Prices for 5000 quantity  
 $R_{\theta}$  values for natural convection @ 1 W

Free Samples  
and Catalog  
Write Today



**Thermalloy Inc.**  
NUMBER ONE IN SEMICONDUCTOR ACCESSORIES  
P.O. BOX 34829  
2021 W. VALLEY VIEW LANE, DALLAS, TEXAS 75234  
PHONE 214-243-4321/TWX 910-860-5542

## DATA PROCESSING

### On-line storage for minis stores 262-k bytes

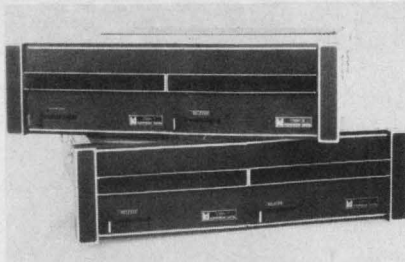

Kennedy Data Systems, 31829 La Tienda Dr., Westlake Village, Calif. 91361. (213) 889-4455. Under \$3300.

The Model KDS 28C floppy-disc memory includes two drives, controller cable and hardware and is designed for use with Computer Automation's Alpha 15, LSI-1, LSI-2 and Naked Mini/LSI processors. The system affords 0.5-s random access to 262 kbytes (131 k for each disc) with a transfer rate of 3.7 kbyte/s. Track-to-track access time is 6 ms. The price includes software drivers. System size is 5.25 × 19 × 22 in.

CIRCLE NO. 270

### Low-cost CRT terminal displays 960 characters

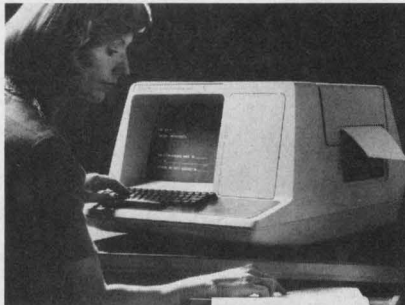

Digital Equipment Corp., Components Group, One Iron Way, Marlborough, Mass. 01752. (617) 481-7400. \$950 (100 quan).

The VT50 terminal displays 12 lines of 80 dot-matrix characters and can operate at rates up to 9600 bit/s. A cursor underscores the selected character and can be moved a line-at-a-time or a character-at-a-time. Transmission code is ASCII with a 20-mA current loop. An EIA interface is optional. A separate electrolytic copier is available to record the screen contents.

CIRCLE NO. 271

### Core memories available with 256-k words

Standard Memories, 2801 E. Oakland Park Blvd., Fort Lauderdale, Fla. 33306. (305) 566-7611. From \$49,000; 60 days.

The ECOM H-Series core memories use a coincident current three-wire 3D technique that provides full cycle times of 750 ns and allows access to data in 325 ns. Maximum capacity is 262-k, 20-bit words. Temperature compensation is provided from zero to 50 C and data save circuits are included. Other models are available with word sizes of 40-bits and capacities to 262-k words.

CIRCLE NO. 272

### Laser system sends data at 9600 bit/sec

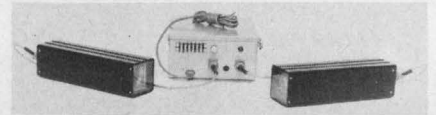

International Laser System, Op Com Div., 2111 W. Central Blvd., Orlando, Fla. 32805. (305) 843-4731. From \$7200; 4 mos.

An injection laser is part of an optical system that provides 9600 bit/s asynchronous transmission for line-of-sight distances up to 3000 ft. Two of the four models in the DL-100 series provide a voice channel that is multiplexed with data on a single carrier. The terminals are compatible with current-loop or RS-232-C interfaces. Warehouses, manufacturing facilities and refineries are places where the system is said to offer advantages over wire lines or rf links.

CIRCLE NO. 273

### Calculator simplifies technical computations

Canon U.S.A., 10 Nevada Dr., Lake Success, N.Y. 11040. (516) 488-6701. \$169.95.

The Palmtronic F-5 calculator performs a variety of scientific calculations that include trigonometric, exponential logarithmic and square root. The calculator also performs the four basic functions and various mixed calculations. Other features include floating point, 8-digit display and memory to retain intermediate calculations.

CIRCLE NO. 274



# GUIDEPOST FOR TDK FIXED INDUCTORS

TDK fixed inductors you may select from the table are all production units supported by comprehensive quality assurance program in various phases including own ferrite, coil winding, expertise core design and manufacturing technique.

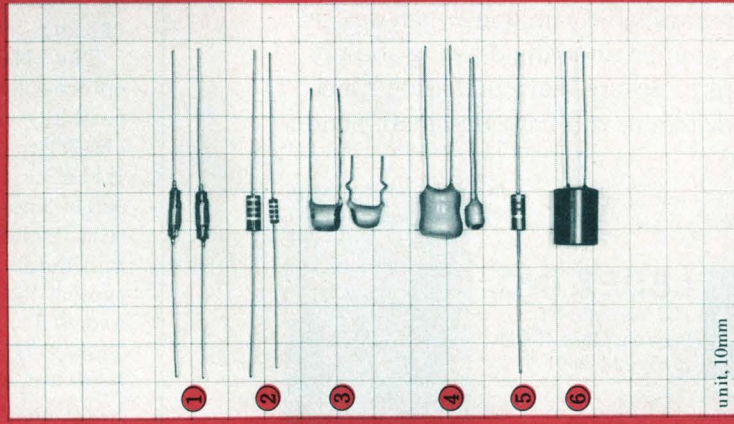

Type & photo No.	Features	Size (mm) $\phi \times L$	Inductance range	Nr. of L-values available	Q (min.) range	Catalog No.
Type SP ① Axial Lead Magnetically Non-shielded Construction	Small size, low dc resistance Inductor's figure of merit sustained well into high frequency range because of low distributed capacitance	4 x 6	0.82 $\mu$ H-1mH	55	30-85	BCE2X-013A
		4 x 8	0.15 $\mu$ H-27 $\mu$ H	25	45-65	
		4 x 10	0.15 $\mu$ H-56 $\mu$ H	31	45-75	
		4 x 12	0.15 $\mu$ H-91 $\mu$ H	36	45-80	
Type TP ② Radial Lead Magnetically Non-shielded Construction	Packaging in transfer molding High reliance design to meet MIL specifications	2 x 6	0.15 $\mu$ H-100 $\mu$ H	35	25-55	BCE39-003B
		4 x 10	0.15 $\mu$ H-1mH	62	33-75	
		5 x 11	270 $\mu$ H-1mH	15	100	
		5 x 14	1.1mH-3.6mH	13	90	
		6 x 19	3.9mH-10mH	11	110	
		8 x 10	0.22 $\mu$ H-1mH	89	30	
Type EL ③ Radial Lead Magnetically Non-shielded Construction	TDK's best effort products for cost effectiveness Epoxy hermetic sealed	10 x 10	1.1mH-2.2mH	8	30	BCE39-012B
		8 x 10	0.22 $\mu$ H-1mH	89	30	BCE39-012B
Type SL ④ Axial Lead Magnetically Shielded Construction	Elements having large inductance value Epoxy hermetic sealed	6 x 9	1 $\mu$ H-100 $\mu$ H	24	45-80	BCE39-016A
		8 x 12	100 $\mu$ H-8.2mH	28	60-150	
		13 x 16	10mH-100mH	16	60-140	
Type TPF ⑤ Axial Lead Magnetically Shielded Construction	Magnetically shielded by TDK ferrite High inductive loading factor Packaging in transfer molding Performance characteristics to meet MIL specifications	4 x 10	0.1 $\mu$ H-100mH	73	18-67	BCE39-011B
		8 x 10	12 $\mu$ H-1mH	41	55-95	BCE39-011B
Type FS ⑥ Radial Lead Magnetically Shielded Construction	Type SL elements in ferrite shielded configuration Best used in circuits critical of electromagnetic induction hazards	10 x 12	1.1mH-5.6mH	18	98-112	
		12 x 15	6.2mH-100mH	29	50-105	



**TDK CORPORATION OF AMERICA**  
 931 South Douglas St., El Segundo, Ca. 90245 Phone: (213) 644-8625  
**CHICAGO BRANCH**  
 2905 West Peterson Av., Chicago, Ill. 60659 Phone: (312) 973-1222  
**NEW YORK BRANCH**  
 755 Eastgate Blvd., Garden City, N.Y. 11530 Phone: (516) 746-0880  
**EL PASO BRANCH**  
 Room 6, 8201 Montano Plaza, El Paso, TX 79925  
**TDK ELECTRONICS CO., LTD.**  
 14-6, 2-chome, Uchizawa-ku, Tokyo 101, Japan



## Power transistors handle 300 to 1400 V, $V_{ce0}$

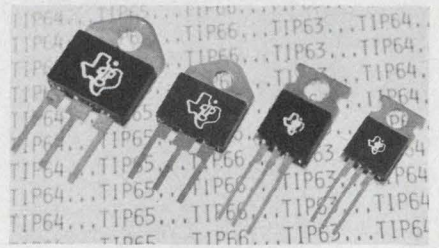

Texas Instruments Inc., Inquiry Answering Service, P.O. Box 5012, M/S 308, Dallas, Tex. 75222. (214) 238-3741. From \$0.55 to \$1.53 (100-up); 8 wk.

The two series of TIP63, TIP64 and TIP65, TIP66 npn power transistors are available in TO-66 and TO-3 plastic packages, respectively. The TIP63 and TIP64 units are high-voltage, medium-power transistors. These devices feature  $V_{ce0}$  breakdown voltages ranging from 300 to 350 V and continuous power dissipation of 20 W at 25-C case temperatures. Other features include a free-air continuous power dissipation of 2 W at 25 C and 0.5-A continuous collector current. The TIP65 and TIP66 units are horizontal TV deflection transistors designed for line-operated CRT deflection circuits. They have 1200 and 1400 V collector-emitter off-state voltage ratings and 1.5-A collector currents. Their switching fall times are 0.7  $\mu$ s at a current of 1 A typically.

CIRCLE NO. 275

## Optocouplers guarantee 2000 V of isolation

National Semiconductor, 2900 Semiconductor Dr., Santa Clara, Calif. 95051. (408) 732-5000. 1000 up lots: NCT 200 (\$1.65); 260 (\$1.20); stock.

The NCT 200 and NCT 260 optocouplers are pin-for-pin compatible with competitive devices (MCT2; MCT26; ISO-LIT 16, H11A2; 4N26; 4N27 and FCD-820). They offer a higher guaranteed isolation voltage of 2000 V minimum. The NCT 200 has a typical 80% current transfer ratio and 0.5 pF isolation capacitance. The NCT 260 has a 6% current transfer ratio, and typical 0.5-pF isolation capacitance.

INQUIRE DIRECT

## SWITCHING...

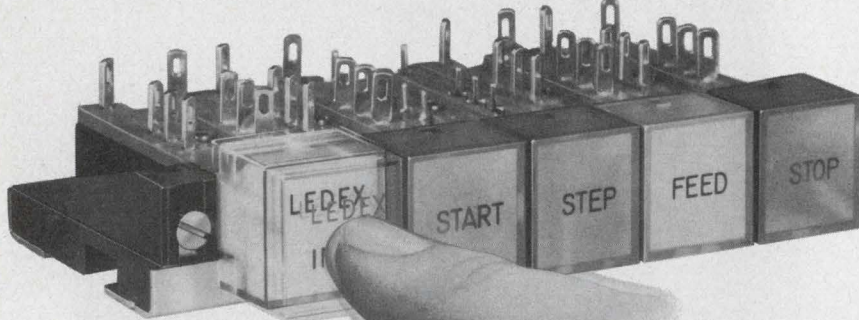

# to Ledex<sup>®</sup> could be the most profitable thing you do this year.

Single illuminated push button switches, or mounted arrays on a single frame, Ledex can supply your switching needs through the dramatically different Series 1400 switches. You can save dollars and assembly time and have all the variations you need... Momentary... Push/Push... Reciprocal Release... Master Release... Interlock... you name it.

It all starts with a basic momentary push button switch and is built to your specifications. Specify 2 to 20 on a single frame, silver or gold plated contacts, 6, 12, or 24 volts illumination, rectangular or square caps, transparent or opaque colors, and on and on. Ledex is also known for dependable, long-life rotary switches, stepping switches, and solenoids.

To help you specify Ledex Series 1400 illuminated push button switches and to make your time more profitable, we have available a unique switch design chart. It serves as your engineering drawing and ties down every detail to ensure that purchasing specifies exactly the switching you have designed. Send for it now.

Toll free number for name of your nearest representative: 800-645-9200



**LEDEX INC.**  
123 Webster St.  
Dayton, Ohio 45401  
(513) 224-9891





## High voltage rectifiers handle up to 10 kV PIV

Sarkes Tarzian, 415 N. College Ave., Bloomington, Ind. 47401. (812) 332-1435. Under \$1 single unit.

The F60-F-100 series of high voltage rectifiers have PIV ratings of up to 10,000 V. Each model is housed in 0.335 in. long by 0.195 in. diameter case. The diodes have a maximum one cycle surge current of 30 A and are available in five values from 6000 to 10,000 V PIV. Maximum current at 60-C oil temperature is 220 mA dc. The oil bath normally used to prevent arcing with this type of device is adequate for all cooling requirements.

CIRCLE NO. 276

## Thermopile detector has 120-junction active area

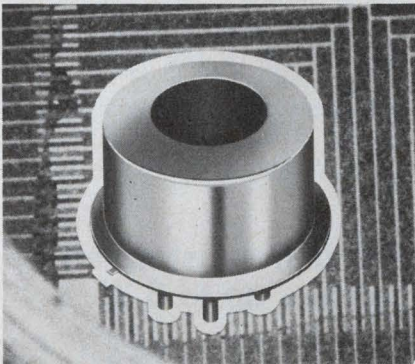

Sensors, Inc., 3908 Varsity Dr., Ann Arbor, Mich. 48104. (313) 973-1400. \$126 (unit qty).

The L66 thermopile detector has a 6-mm thin-film active area with 120 junctions. It has a responsivity of 1 to 2 V/W, making the detector an ideal candidate for laser measurement. The standard L66 is packaged in a TO-8 case, and is back-filled with argon at one atmosphere to yield  $D^*$  (at 500 K, dc) of 0.5 to  $1 \times 10^8$   $\text{cmHz}^{1/2}$  W. Although standard window material is KBr, other materials can be supplied, including:  $\text{CaF}_2$ ,  $\text{BaF}_2$ , Ge, KRS-5, Irtran-2, and  $\text{SiO}_2$ . The L66 can also be supplied without the window material. Additional L66 specifications include: Noise equivalent power =  $10^{-10}$  W/Hz $^{1/2}$ ; response time (1/e) = 60 ms; resistance = 30 to 40 k $\Omega$ ; operating temperature range = 60 to 100 C; and damage threshold = 200 mW/cm $^2$ .

CIRCLE NO. 277

## Varactor tuning diodes have Qs up to 5000

Varian, 611 Hansen Way, Palo Alto, Calif. 94303. (415) 493-4000. From \$75; stock to 2 wk.

A line of improved performance high-Q varactor tuning diodes offers guaranteed minimum values for Q varying from 2400 to 5000, and capacitance ratios up to 6:2. These GaAs device improvements

represent a 10 to 25% increase in capability. Typical applications include wide tuning range vhf and uhf oscillators, broad tuning range filters, high stability oscillators, and tuning of microwave transistor oscillators. Total capacitance values may be specified from 0.5 to 5 pF with  $\pm 10\%$  tolerance. Additional values and tightened tolerances are available on special order.

CIRCLE NO. 278

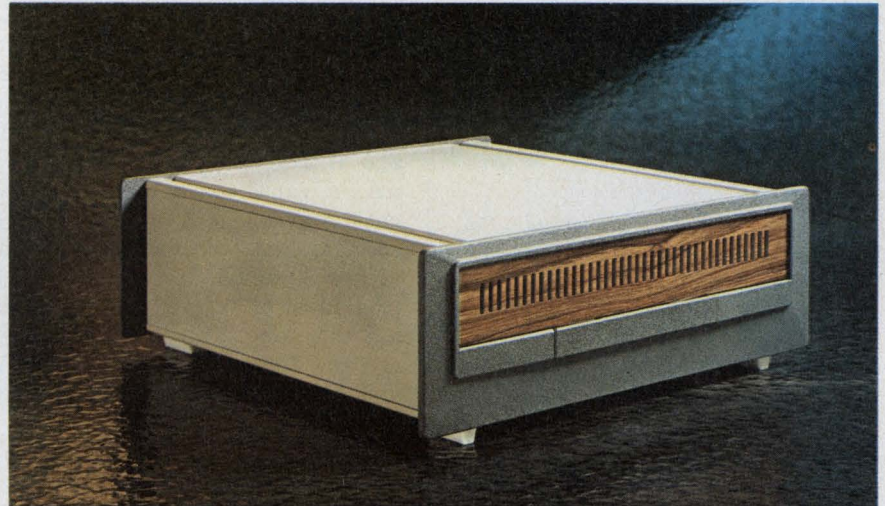

# The Optima Experience

The Optima experience—it's colorful, stylish and now a great new way to package your electronics. We call it OptimaPAK. There is nothing like this case on the market today. Molded sculptured sides with handles neatly designed in... easily removed top and bottom panels and that's not all. The front and rear panels are part of a chassis assembly that slides right out of the front of the case or you may just want to mount it in a rack. We are eager to tell you all about OptimaPAK and share the Optima experience right now.

# OPTIMAPAK

Write Optima Enclosures, a division of Scientific-Atlanta, Inc.  
2166 Mountain Industrial Blvd., Tucker, Georgia 30084 or  
call (404) 939-6340.



## LED includes voltage sensing circuit

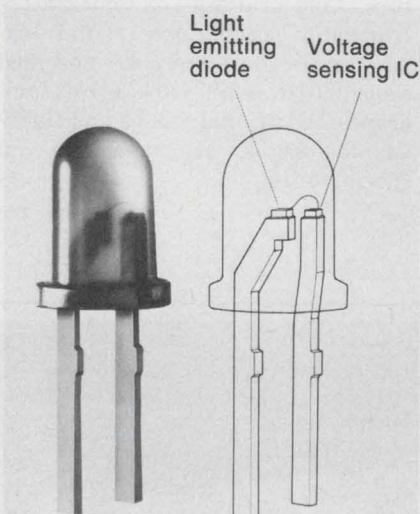

Litronix, 19000 Homestead Rd., Cupertino, Calif. 95014. (408) 257-7910. \$0.60 (1000-up).

The RLC-400 is a tiny LED lamp that acts as a self-contained battery status indicator for portable equipment. The lamp gives users an early warning of imminent battery failure. It is brightly lit at 3 V and completely dark when battery voltage has dropped to 2 V. The LED RLC-400 combines a voltage-sensing integrated circuit and a GaAsP LED in a conventional T-1 size lamp package.

CIRCLE NO. 393

## Power SCR handles 1.6 kA at up to 1.7 kV



National Electronics, Geneva, Ill. 60134. (312) 232-4300.

The NL-F701 is a SCR rated for 1600 A rms. It uses a disc design and is available in voltage ratings of up to 1700 V. Peak one-cycle surge forward current is 18,000 A. Turn-on current rate-of-rise,  $di/dt$ , is 100 A/ $\mu$ s. Peak gate power dissipation,  $P_{gm}$ , is 400 W for a 10  $\mu$ s gate pulse width.

CIRCLE NO. 394

## Yellow and green LEDs come with axial leads

Dialight, 203 Harrison Pl., Brooklyn, N.Y. 11237. (212) 371-8800. \$0.55 (1000-up); stock.

Two miniature LED lamps with axial leads are available in green (521-9206) or yellow (521-9207) and are otherwise identical to the most popular red LEDs. Maximum ratings for these lamps are: power dissipation of 112 mW, derate linearly from 25 C at 1.49 mW/ $^{\circ}$ C; storage and operating temperature of  $-20$  to 100 C; continuous forward current of 40 mA; peak pulse current (1  $\mu$ s pulse, 1% duty cycle) of 1 A; and peak reverse voltage of 5 V. The green LED has a typical forward voltage of 2 V, a reverse current of 1  $\mu$ A, a capacitance of 100 pF, a peak wave length of 560 nm, a spectral line half width of 30 nm and a luminous intensity of 1.5 mcd. Most of the yellow LED specs are the same. The only differences are the forward voltage of 1.9 V and the peak wavelength of 580 nm.

CIRCLE NO. 395

## IR LEDs have peak transmission at 885 nm

International Rectifier Corp., 233 Kansas St., El Segundo, Calif. 90245. (213) 678-6281. From \$1.50 to \$3.20 (100-up).

The L-10 series of infrared LEDs is claimed by the manufacturer to offer an order of magnitude improvement in switching speeds, with the same or better output compared with other units on the market. The units are also more closely matched to the frequency response characteristics of fiber optics cable. Peak emission wavelength for the IR units is 885 nm. The 3-dB bandwidth of the L-10 diodes is 10 MHz. The first line of devices is housed in a TO-46 package. Other series, and a line of couplers, will be introduced later this year. Typical total radiation power output at 25 C and forward current of 100 mA is 1 mW for type LA 10-C; 2 mW for the LA 10-D; and 3 mW for the LA 10-E. Derating is 1.8 mW/ $^{\circ}$ C at  $T_A = 25$  C, and 13 mW/ $^{\circ}$ C at  $T_C = 25$  C. Maximum dc forward current at  $T_C = 25$  C is 500 mA.

CIRCLE NO. 396

## Vhf and uhf transistors deliver up to 50 W

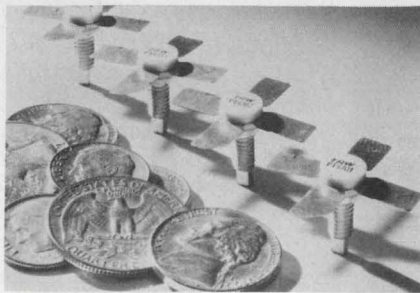

TRW Semiconductors, 14520 Aviation Blvd., Lawndale, Calif. 90260. (213) 679-4561. From \$13.85 (up to 999); stock.

A line of vhf and uhf transistors is rated for up to 50 W of output power. In the vhf range, devices are specified for output power of 4, 8, 15, 25 and 50 W. The PT9731, for example, has power output of 25 W and a gain of 10 dB. The PT9733, has power output of 50 W and a gain of 7 dB. In the uhf range, devices are specified for 4, 10, 20 and 30 W. As an example, the PT9704A is equivalent in performance to 2N-6105A, with rated output power of 30 W and gain of 7.8 dB.

CIRCLE NO. 397

## 3-GHz transistor series delivers up to 6 W

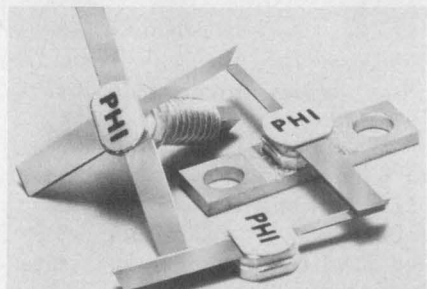

Power Hybrids, Inc., 1742 Crenshaw Blvd., Torrance, Calif. 90501. (213) 320-6160. 1 to 99 prices: 3006, \$95; 3004, \$75; and 3001, \$51; stock.

A family of 3-GHz rf power transistors are all gold metalized and emitter ballasted. Included in this family are 6, 4 and 1 W transistors housed in hermetic ceramic-to-metal, flange, stud or pill packages. At 3 GHz Model PH3006 typically produces 6 W of rf power with 5.2 dB of gain and 33% efficiency at 28 V. at 2.3 GHz and 22 V the PH3006 will typically produce 8 W with 7 dB of gain.

CIRCLE NO. 398



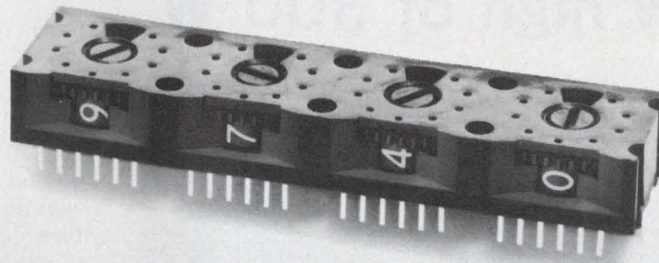

# Introducing the programmable memory with visual readout.

We're talking about our unique Stripswitch,<sup>™</sup> the miniswitch for direct printed circuit board

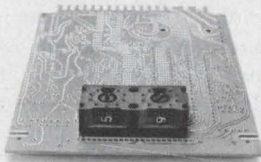

mounting or panel installation. This little marvel is molded of impervious Valox\*, and is guaranteed for two years.

Other facts: it comes in one, two, three, four, five, and six station models (\$1.95 per station, standard); in a variety of codes, including decimal, BCD, Complimentary, Special Binary, and 1, 2, 3, and 4 pole.

On a custom basis we can do lots of other things to your Stripswitch. Like interconnections, markings and legends, color coding, stops, number of switch positions, additional stations, et cetera.

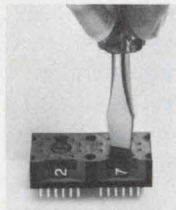

A 10¢ stamp will get you an immediate reply, or your finger on the dial of your telephone will get you instant answers. Call us collect. Or one of our distributors: G.S. Marshall, Hall•Mark, or Schweber.



Your sample awaits.

\*Registered General Electric trademark

## EECO

1441 East Chestnut Avenue  
Santa Ana, California 92701  
Phone 714/835-6000



## 35-MHz linear rf amp outputs new high of 300 W

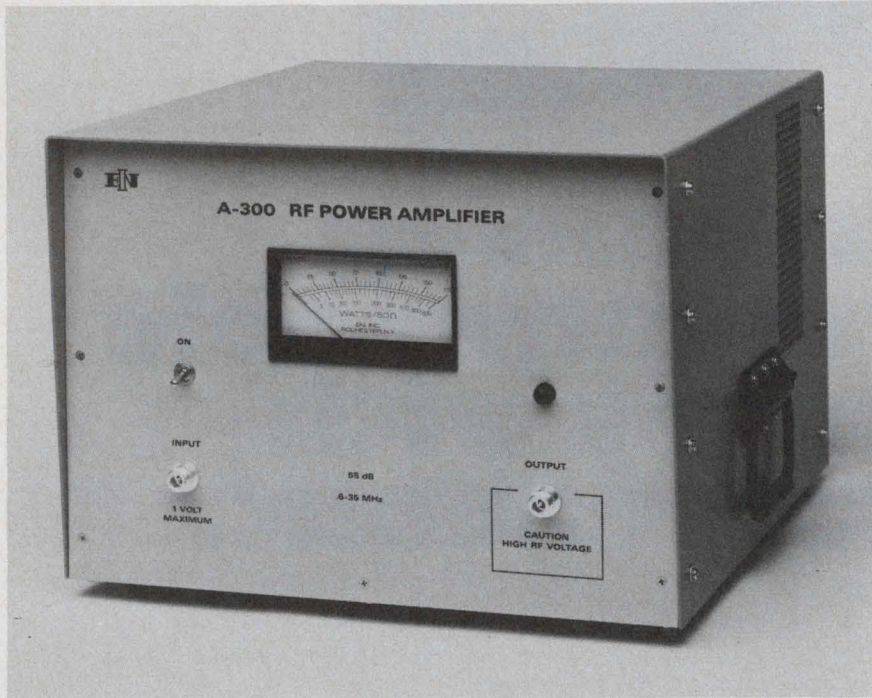

*Electronic Navigation Industries, 3000 Winston Rd. South, Rochester, N.Y. 14623. (716) 473-6900. \$4700; 60 days.*

A new tubeless, class-A rf amplifier boasts the highest power output, 300 W, of any commercial unit in the frequency range of 0.6 to 35 MHz. In a pulsed or cw mode, Electronic Navigation Industries' Model A-300 power amplifier can output 500 W.

The new solid-state unit replaces bulkier, heavier, more costly tube types with far higher dissipation. And you can safely connect any load from short to open circuit.

Moreover the high power ratings don't require special electrical wiring. Any 115-V ac single-phase outlet that supplies 18 A can be used to provide primary power.

Similarly, special drive sources aren't needed. Because the 55-dB gain is flat to within  $\pm 1$  dB, any laboratory signal generator, synthesizer or transmitter can be used to drive the Model A-300.

Distortion is low, too. Second harmonics are at least 35 dB below the fundamental frequency at a

300-W output. Third harmonics are held to at least 25 dB below the fundamental at 250 W. Lower distortion results at reduced output powers.

Maximum transmitted power occurs when loads are  $50 \Omega$ —the impedance of the output as well as the input. However, any load can be connected to the output—or input—without amplifier failure or oscillation resulting. Reflected powers due to load mismatches are absorbed within the amplifier.

The unit can withstand more than 16-dB overdrive (input signal of 1 V rms) for all output load conditions. It has a maximum noise figure of 10 dB and operates over the 0-to-40-C temperature range. The compact unit measures 12-1/4  $\times$  17  $\times$  17 in. and weighs 88 lbs.

The impressive specifications for the Model A-300 result from the following: 16 custom rf-power transistors, a low-loss hybrid matrix network that combines the outputs of the transistors, and a cooling system that maintains the internal heat-sink plate to within 25 C of the outside air.

The rf transistors are said to be the largest devices for the frequency range. Also, the high-power custom chips use nichrome resistors deposited at the emitter sites to minimize hot spots and to even out the current distribution.

The manufacturer reports a full power burn-in of 100 hours for each device, and calculates MTBF (mean time between failure) for the complete amplifier to be more than 15,000 hours.

A special nickel-zinc ferrite material in the hybrid matrix contributes a maximum loss of only 0.1 dB at 35 MHz. Transformer hybrids using the ferrites are connected to form a 16-way summing network. The over-all maximum insertion loss is only 0.5 dB, or 12% of the power generated.

Maximum heat generation, totaling about 2000 W with 1400 W in the rf transistors, occurs under zero-signal conditions. To dissipate the power, amplifier modules are mounted on low-thermal-resistance aluminum plates. A cooling fan and corrugated fins on the heat-bearing plates combine to wash outside air over the modules.

CIRCLE NO. 250

### Transistor array works up to 500 MHz

*RCA Solid State Div., Route 202, Somerville, N.J. 08876. (201) 722-3200. \$2.40 (1000).*

A high-frequency npn transistor array has a frequency range up to 500 MHz. Called the CA3127E, the new array consists of five independent transistors, each with a gain-bandwidth product ( $f_T$ ) in excess of 1 GHz. The unit comes in a 16-lead plastic DIP and operates over the full military temperature range of  $-55$  to  $+125$  C.

CIRCLE NO. 279



# Which of these spring contacts can you get from Instrument Specialties?

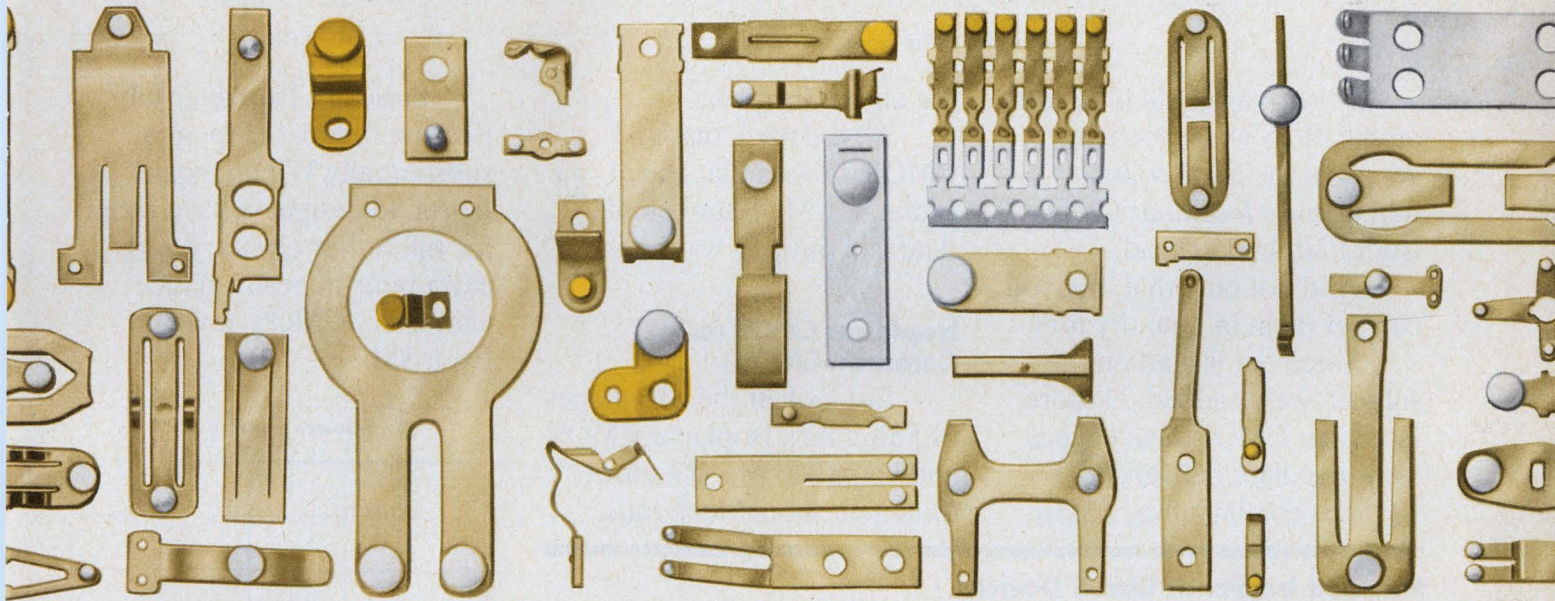

## All of 'em!

The number of different designs and combinations of springs and contacts is as boundless as your imagination. Yet, no matter what your requirements, chances are i/s can meet them. Specialists in the design and manufacture of beryllium copper springs, we can furnish these springs with your choice of many types of gold, silver or other precious metal contacts.

Perhaps you require large welded contacts in which precious metal is bonded to a layer of inexpensive material. Or, small welded contacts in which precious metal is welded directly to the spring. Or, riveted contacts offering close tolerances with either single or double headed contacts. Instrument Specialties has all of them!

One other thought: Sometimes, you may *think* you need welded or riveted contacts. However, our engineers may find that our CONTIP® bonding technique, or our gold selective plating process, can meet your needs at considerably less cost. If so, we'll tell you that, too.

Our latest catalog contains complete information on all types of i/s spring contacts. For your free copy, circle the Reader Service Card or write us at Dept. ED-51.



INSTRUMENT SPECIALTIES CO., INC.  
Little Falls, New Jersey  
Phone 201-256-3500



# Isoplanar CMOS does what common CMOS can't. And now you can even get it in uncommon quantity.

Look, why settle for *common* CMOS when you can get all of the most popular functions in *Isoplanar* CMOS from Fairchild instead?

And not only that, but you can get them in quantity now.

Since our last ad on the subject, we've added 24 more Isoplanar CMOS device types for immediate delivery, with 19 more coming along before

the end of the year.

All together, that's 53 CMOS devices that leave ordinary CMOS far behind. And can put you way ahead.

## Isoplanar CMOS vs. Common CMOS.

Just look at the advantages of Fairchild's Isoplanar CMOS and you'll see why it's something you should look into.

Basically, Isoplanar fabrication reduces chip area substantially. Which means Fairchild designers have room for full buffer circuitry and extra built-in performance with every CMOS device. Even SSI.

### Fairchild Isoplanar CMOS Devices.

<i>Available Now.</i>		
34001	Quad 2-Input NOR Gate	340161 4-Bit Binary Asynchronous Reset Counter
34002	Dual 4-Input NOR Gate	340162 4-Bit Decade Synchronous Reset Counter
34011	Quad 2-Input NAND Gate	340163 4-Bit Binary Synchronous Reset Counter
34012	Dual 4-Input NAND Gate	340194 4-Bit Right/Left Shift Register
34013	Dual D Flip-Flop	340195 4-Bit Shift Register
34015	Dual 4-Stage Shift Register	
34019	Quad 2-Input Multiplexer	<i>Available 4th Quarter.</i>
34020	14-Stage Timer	34014 8-Stage Parallel to Serial Shift Register
34023	Triple 3-Input NAND Gate	34016 Quad Bilateral Switch
34025	Triple 3-Input NOR Gate	34017 Decade Sequencer
34027	Dual JK Flip-Flop	34021 8-Stage Serial to Parallel Shift Register
34028	1-of-10 Decoder	34024 7-Stage Binary Counter
34030	Quad Exclusive OR Gate	34029 4-Bit Binary/BCD Up/Down Counter
34040	12-Stage Timer	34035 4-Bit Parallel In/Out Shift Register
34042	Quad D Latch	34068 8-Input NAND Gate
34049	Hex Inverting Buffer	34099 8-Bit Addressable Latch
34050	Hex Non-Inverting Buffer	34104 TTL-to-High-Level CMOS Converter
34051	8-Input Analog Multiplexer	34518 Dual 4-Bit Decade Counter
34052	Differential 4-Input Analog Multiplexer	34527 BCD Rate Multiplier
		34555 Dual 1-of-4 Decoder
34069	Hex Inverter	34725 16 X 4 Bit RAM
34071	Quad 2-Input AND Gate	340085 4-Bit Magnitude Comparator
34077	Quad Exclusive NOR Gate	340174 Hex D Flip-Flop
34081	Quad 2-Input OR Gate	340175 Quad D Flip-Flop
34085	Dual 2-Input 2-Input AND/OR/Invert Gate	340192 4-Bit Up/Down Synchronous Decade Counter
34086	Expandable 4-Wide 2-Input AND/OR/Invert Gate	340193 4-Bit Up/Down Synchronous Binary Counter
34512	8-Input Multiplexer	
340097	Hex 3-State Non-Inverting Buffer	
340098	Hex 3-State Inverting Buffer	
340160	4-Bit Decade Asynchronous Reset Counter	

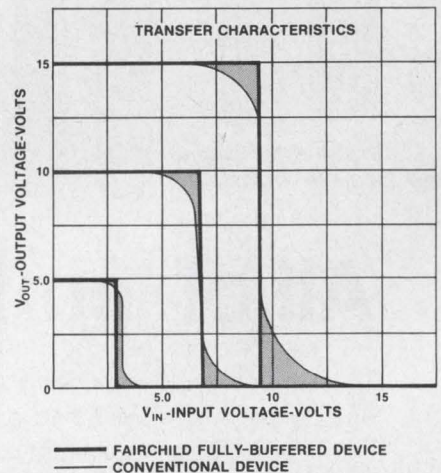

Because Fairchild devices are buffered for superior standardized performance, transfer characteristics are almost ideal.

And if you're a system designer, you'll really appreciate the benefits:

1. Highest guaranteed noise immunity in the industry.
2. Fully-standardized drive outputs for direct interface with low power TTL and low power Schottky TTL.
3. Pick your package: commercial grade plastic and military ceramic DIP is available now, commercial grade ceramic DIP in October.



### 30-40-GHz front end has low noise figure

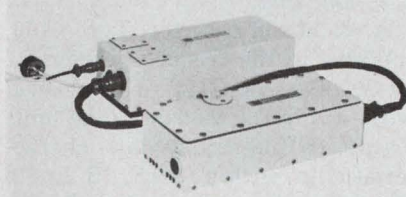

Alpha Industries, Inc., 400 Border St., East Boston, Mass. 02128. (617) 569-2110.

A low-noise radiometric receiver front-end operates in the 30-to-40-GHz range with noise figures of about 2.5 dB. The system consists of a degenerate parametric amplifier first stage followed by a low-noise, broadband mixer-amplifier section. A single Gunn oscillator source provides both pump and local-oscillator signals. The unit operates at 33.6 GHz with an overall gain of 70 dB over a bandwidth of 600 MHz. The system noise figure from input flange to i-f output port is typically 2.5 dB, or 226°K excess noise temperature. The package, which measures 3 × 5 × 12-in., operates over the temperature range of -40 to +140 F.

CIRCLE NO. 280

### Fast laser yields narrow pulses

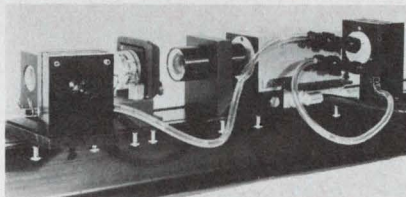

Korad Div. of Hadron, 2520 Colorado Ave., Santa Monica, Calif. 90404. (213) 829-3377.

Equipped with the KQS3 Q-Switch, the company's Model K15-QPTM laser system can achieve narrow pulse widths in the 3-to-5-ns range at high pulse-repetition rates. Pulse peak power is 60 MW minimum at a repetition rate of 60 ppm. The system consists of cabinet, mounting rail, and water-to-water cooling system. The cooler regulates the temperature of the polarizer and mirror mount to assure long-term stability in laser output at 60 ppm.

CIRCLE NO. 281

### Flatbacks hold cascadable amps

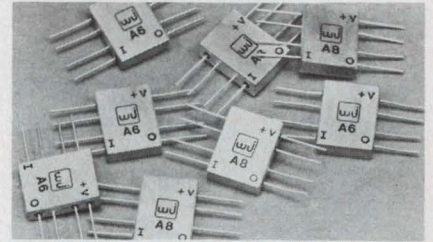

Watkins-Johnson Co., 3333 Hillview Ave., Palo Alto, Calif. 94304 (415) 493-4141. \$99 to \$109 (1-9); stock.

Now in 0.5 × 0.38-in. flatbacks, with a low profile of 0.125-in. maximum, are the company's cascadable amplifiers previously available only in TO-8 packages. The amplifiers have a frequency range of 5 to 500 MHz with typically 14.5 dB of gain over the two-decade bandwidth. Noise figure is typically 4 dB for the WJ-A6 and 5 dB for the WJ-A8. Output power is +9 dBm for the WJ-A6 and +14 dBm for the WJ-A8. All units are specified over the -54 to 71 C operating temperature range.

CIRCLE NO. 282

### Acoustic component line expands

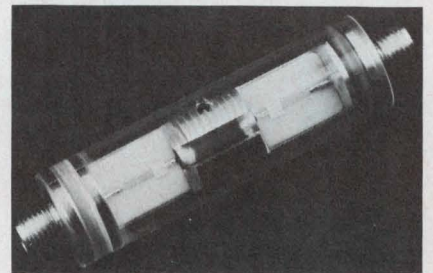

Thomson-CSF, Electron Tube Group, 8 rue Chasseloup-Laubat, 75737 Paris Cedex 15, France.

The company's line of acoustic-wave components expands with bulk-wave delay lines that reach to X-band, tapped SAW delay lines for generating and detecting programmable codes, and a family of Love-wave dispersive delay lines with 80% frequency excursion at up to 500 MHz. The new soldered-transducer X-band models have insertion losses of 10 dB, for 1-μs delay (plus 15 dB per transducer), relative passbands of 20% and time delays of from 0.5 to 2 μs. The Love-wave delay lines possess a very wide passband of 80% and an insertion loss of 40 dB.

CIRCLE NO. 283

4. Propagation delay that is less dependent on loading, for increased system speeds.

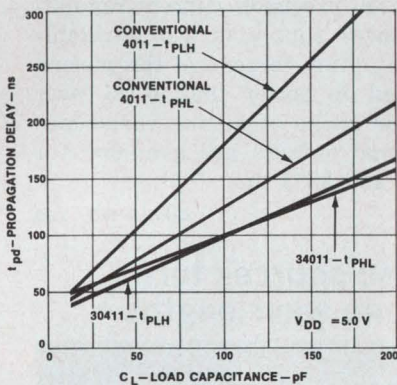

Fairchild's buffered CMOS gate has propagation delays which exhibit balanced  $T_{PLH}$  and  $T_{PHL}$  times and are less sensitive to load capacitance.

And the best part is, Fairchild's Isoplanar CMOS can replace any other 4000 series CMOS pin-for-pin.

So if you need production quantities of CMOS at competitive prices, call your Fairchild Distributor or Representative.

He's got all the facts on the kind of CMOS you need. Now.

**MADE IN FAIRCHILD**

Semiconductor Components Group, Fairchild Camera & Instrument Corp., 464 Ellis St., Mountain View, CA 94040. Telephone (415) 962-5011. TWX: 910-379-6435.



## Barretter mounts span 18-GHz range

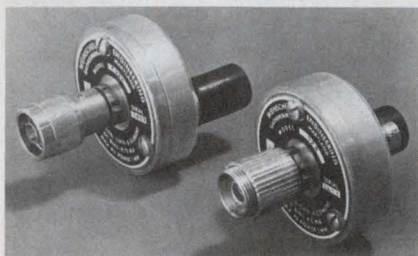

Weinschel Engineering Co., Box 577, Gaithersburg, Md. 20760. (301) 948-3434.

Barretter mounts with internal noise suppressors are available for the following frequency ranges: 50 MHz to 12.4 GHz—Models 926 and 928; and 50 MHz to 18 GHz—Models 927 and 929. These mounts feature a maximum SWR of 1.45 to 11 GHz, 1.75 to 12.4 GHz and 2.0 to 18 GHz. The Models 926 and 927 are furnished with Type N male or female connector, and the Models 928 and 929 are available with 7-mm precision connector.

CIRCLE NO. 284

## S-band TWT delivers 160 kW peak

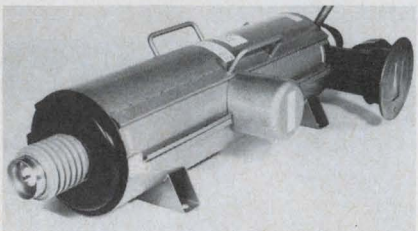

Thomson-CSF, Groupement Tubes Electroniques, 8, rue Chasseloup-Laubat, 75737 Paris Cedex 15, France

Incorporating a novel slow-wave structure, a high-power radar TWT, the TOP 1304, delivers 160 kW of peak output power—2 kW average—with a gain of at least 30 dB, anywhere in its S-band operating range of 2.85 to 3.15 GHz. With collector depression, its typical electrical efficiency—dc to rf—is 35%. To avoid the shortcomings associated with coupled-cavity or conventional ringbar slow-wave structures, a solid copper stub-supported ring structure is used. It enables high peak-power operation with no danger of arcing, while lossy coatings suppress multimodes.

CIRCLE NO. 285

## Wideband detector maintains sensitivity

Marconi Instruments Ltd., Sanders Div., Gunnels Wood Rd., Stevenage, England.

A wideband detector, Type 6160, operates in the frequency range of 10 MHz to 18 GHz. When loaded with a high impedance, the unit maintains its square-law characteristic to within  $\pm 0.5$  dB up to 40 mV output. As a result the sensitivity is at least 400  $\mu$ V output per microwatt input. Also available are factory-matched pairs.

CIRCLE NO. 286

## Rugged SMA termination has small size



Midwest Microwave, 3800 Packard Rd., Ann Arbor, Mich. 48104. (313) 971-1992. \$17.50 (1-9); stock to 15 days.

A broadband SMA termination, covering the frequency range of dc to 18 GHz, is only 0.39-in. long. Moreover, the unit meets environmental specifications of MIL-STD-202. The Model 4444 is fabricated in stainless steel, and it has a maximum VSWR of  $1.05 + 0.008 f$ , where  $f$  is in gigahertz.

CIRCLE NO. 287

## 4-GHz tunable osc outputs 0.5 W

Frequency Sources, Inc., 166 Middlesex St., North Chelmsford, Mass. 01863. (617) 251-8747.

The Model FS-2148-1 cavity-stabilized oscillator can mechanically tune any 100-MHz band from 3 to 4 GHz at power levels to 500 mW. The afc option allows voltage tuning across  $\pm 0.1\%$  of the band at typically 1 MHz/V and tuning rates to 10 MHz. FM noise is  $-90$  dBc/Hz at 100 kHz from the carrier. Thermal frequency drift from 0 to 60 C is  $\pm 0.15\%$ . Operation into all phases of a 1.5:1 mismatch is typically  $\pm 1$ -dB power variation and  $\pm 1$ -MHz frequency pulling. Harmonic rejection is  $-35$  dBc and all nonharmonics are greater than  $-60$  dBc down.

CIRCLE NO. 288

## Laser systems offer choice of powers

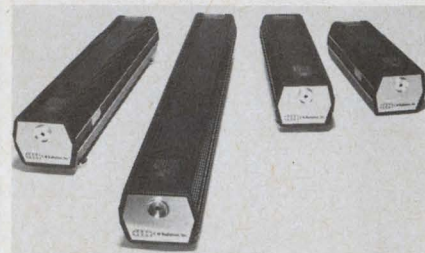

C W Radiation, Inc., 111 Ortega Ave., Mountain View, Calif. 94040. (415) 969-9482. \$190 up.

The LS Series of HeNe laser systems offers a broad selection of output powers: 1 through 5, 7, 10 and 15 mW. All laser systems have a regulated power supply for a  $\pm 10\%$  change in ac-line variations. A precision current-regulated power supply is also available as an option to control the plasma current to better than 0.1% over a wide range of ac-line variations. Optional outputs are available for 1152 and 3391 nm.

CIRCLE NO. 289

## Noise sources turn to mm wavelengths

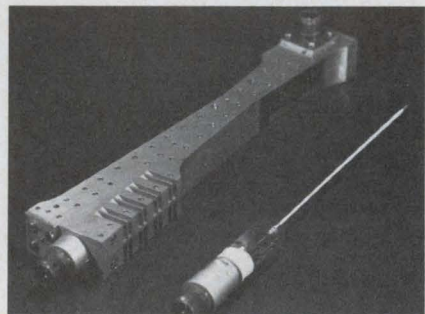

Signalite, Div. of General Instrument Corp., 1933 Heck Ave., Neptune, N.J. 07753. (201) 775-2490. About \$1000.

Noise sources come in nine waveguide sizes covering the frequency range of 18 to 170 GHz. Low VSWR is obtained by use of a 7-degree insertion angle for the alumina ceramic noise tube and by use of a higher than normal pressure of argon gas along with a Kr85 additive. Units are furnished as transition type or with loads. Insertion losses in transition types are approximately 2 dB cold and 15 dB hot. Test data reveal a maximum cold VSWR of 1.30 and a hot VSWR of 1.20. ENR is 15.0 dB at 18 GHz and 13.6 dB at 90 GHz.

CIRCLE NO. 290



# Announcing...

now there are more than  
300 ways to improve your  
harnessing production  
with the **TY-RAP®** system  
*(if you need another way... we'll make it)*

Anytime you have the opportunity to pick and choose exactly what you want, you increase design flexibility... you make a better buy. The TY-RAP line lets you do just that. You buy only what you need... without waste. There is a tie for just about every tying requirement, from 1/16" to 9" dia. Best of all, uniform reliability and most efficient production of your design is assured through the wide selection of tying aids and tools.

A major new benefit of the TY-RAP system is our national network of tool service centers to insure your continued high level of production efficiency.

If you are not a user of TY-RAP products, perhaps our evaluation service for cost reduction techniques will help you. Call us, we'll be pleased to conduct a study of your production operation.

Thomas & Betts Co., Elizabeth, N. J. 07207. (201) 354-4321. In Canada, Thomas & Betts Ltd., P.Q.

Circle 69 on Reader-Service Card

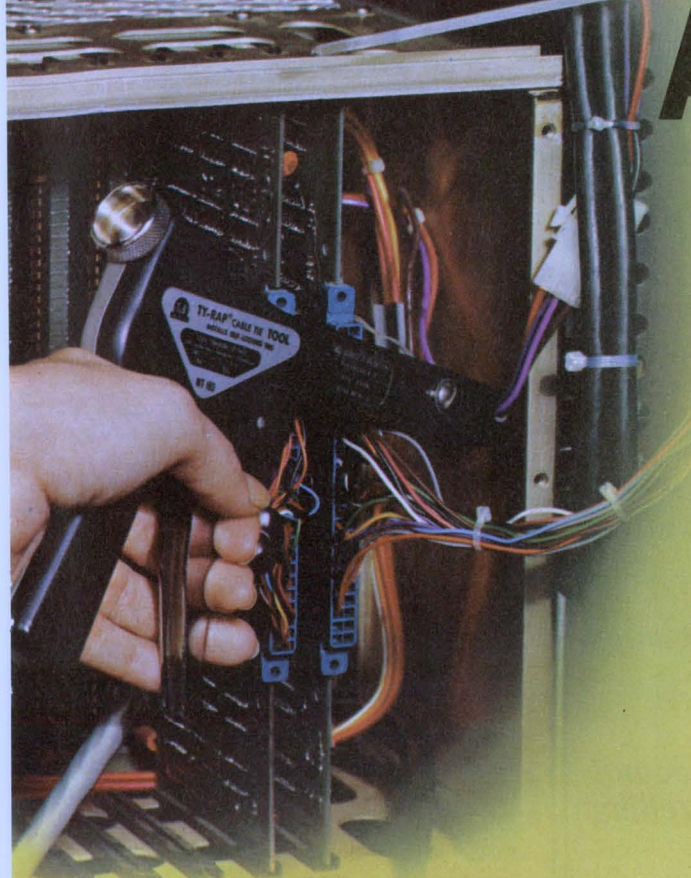

WT-193 mechanical tying tool gets into tight places... great for small volume harnessing or point-to-point tying.

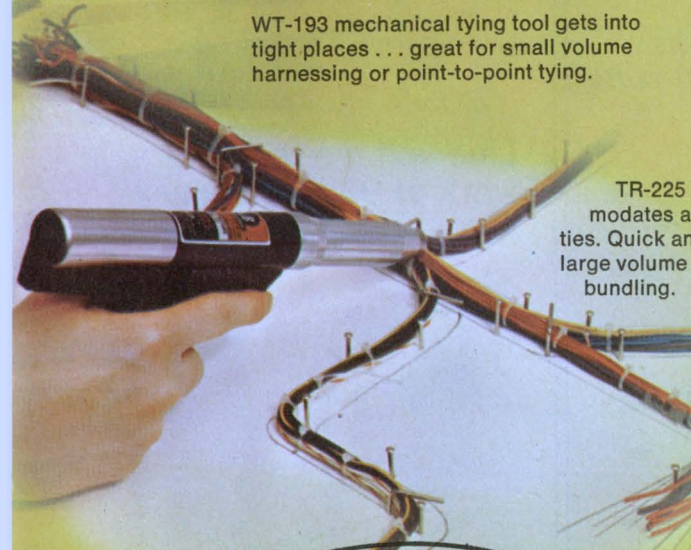

TR-225 pneumatic tool accommodates a full range of TY-RAP ties. Quick and rugged... ideal for large volume harnessing and cable bundling.



New TR-300 automatic tool applies ties in 8/10 of a second. Counterbalance system makes it a "feather-weight".

1/16" to 4"

3/16" to 3 1/2"

3/16" to 3"

1/16" to 1 1/4"

1/16" to 1 3/4"

1/16" to 2"

1/16" to 5/8"

Sold Only Through Authorized T&B Distributors



**THOMAS & BETTS**

Division of Thomas & Betts Corporation



# BUILDING BLOCKS

from GENERAL SEMICONDUCTOR

If your circuits require  
high-speed high-power  
SWITCHING TRANSISTORS  
or "CHIPS" we have  
just the right product  
for you...

- 1 amp to 30 amps
- Nanosecond switching
- 40 volts to 250 volts
- Low saturation voltage
- Low leakage
- Delivery from stock



GENERAL  
SEMICONDUCTOR  
INDUSTRIES, INC.

2001 WEST TENTH PLACE • P.O. BOX 3078 • TEMPE, ARIZONA 85281 • 602-968-3101 • TWX 910-950-1942

## POWER SOURCES

Dc/dc converter outputs  
only 1 mV of noise

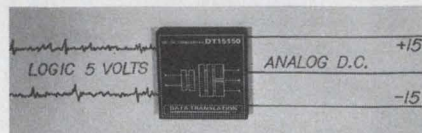

Data Translation, Inc., 109 Concord St., Framingham, Mass. 01701. (617) 879-3595. \$109 ea.; 2 wks.

The DT15150 dc/dc converter is designed to be compatible with the company's recently announced DATAX series of data-acquisition modules. The DT15150 converts 5-V to noise-free  $\pm 15$ -V power, capable of supplying 150 mA from each side of the 15 V. The unit offers multiple input/output isolation of 80-pF effective capacitance, 1000-M $\Omega$  resistance, and a breakdown voltage in excess of 500 V. Efficiency is 65% min. at  $\pm 150$  mA. Output noise voltage is a low 1 mV rms, an equivalent value of of less than 1/2 LSB in a 12-bit data-acquisition system.

CIRCLE NO. 291

Line-voltage regulators  
work at 98% efficiency

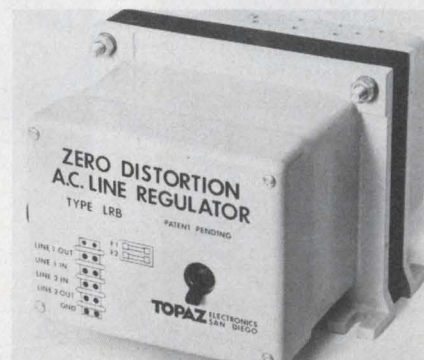

Topaz Electronics, 3855 Ruffin Rd., San Diego, Calif. 92123. (714) 279-0831. Start at \$245.

These ac line regulators are offered in power ratings from 500 VA to 24 kVA, with outputs of 115 to 240 V ac. They operate from 47 to 63 Hz. And they have a minimum efficiency of 98%. Response time is less than 1 cycle. The output adds less than 1% total harmonic distortion. Audible noise is typically 2 dB. These compact units are designed for brownout conditions, when input voltage may drop as much as 30%.

CIRCLE NO. 292



## Modular supplies offered for PC boards



ACDC Electronics, Oceanside Industrial Center, Oceanside, Calif. 92054. (714) 757-1880. Start at \$25; stock.

PCM series of miniature, encapsulated plug-in power supplies is designed for PC board mounting for op amps, d/a and a/d converters and nonlinear circuits. They come with built-in overload and short-circuit protection. For logic circuits, all 5-V models have built-in overvoltage protection. There are 13 models in this new series. Single output models range from 5 V at 500 mA to 24 V at 50 mA. Dual output models are available from  $\pm 12$  V at 120 to 400 mA and  $\pm 15$  V at 65 to 350 mA.

CIRCLE NO. 293

## CRT supply gives more than 50% efficiency



LectroLogic Inc., P.O. Box 3727A, Milwaukee, Wis. 53217. (414) 351-1070. \$750 (1-4); 16 wks.

H Series CRT high-voltage dc/dc power supplies feature output voltages from 1 to 20 kV dc, up to 10-W output, efficiency greater than 50%,  $-55$  to  $+71$  C operating temperature range, and compact size—approximately 19 cu. in. Other features include remote programmability, current limiting and short-circuit protection, remote high-voltage disable in response to logic +5 V dc, and reverse polarity and input surge-voltage protection.

CIRCLE NO. 294

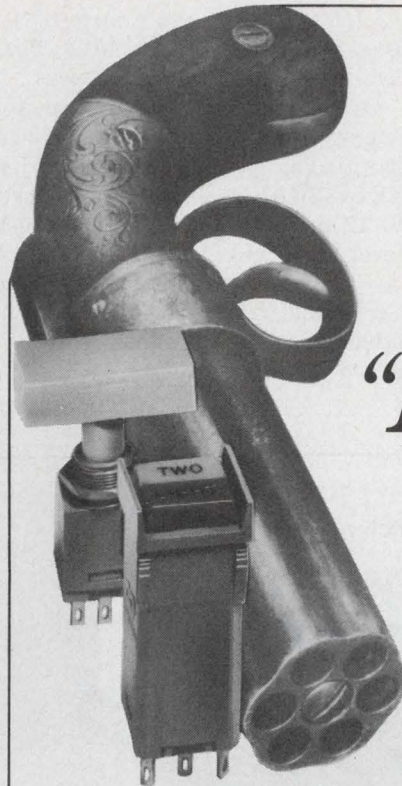

Before you order switchlights, we challenge you to compare our low cost

# "Persuader Line"

feature for feature with other leading brands

We're the kind of firm that believes in more than one gun barrel and plenty of ammunition. So when you add our familiar S410\* series to our new S190\* series, you'll find we have a very convincing line of general purpose switchlights indeed. It's "The Persuader"—the line we invite you to compare for low cost, quality and versatility with that of any other manufacturer. Just check the list below, then get in touch with your local distributor for exact specifications. And we're easy to find . . . located in major cities world wide.

Standard Features	Clare-Pendar "Persuader"	Micro	Dialight	Other
1. Low Cost	YES			
2. Distributor Stock	YES			
3. U.L. Listed	YES			
4. 2 Form C	YES			
5. Wiping Contacts	YES			
6. Snap Action Contacts	YES			
7. 10 amp Rated	YES			
8. 2 amp Rated	YES			
9. 100,000 Cycle Life	YES			
10. 6 Lens Shapes	YES			
11. Split Lens Displays	YES			
12. Solid/Proj. Displays	YES			
13. 5 Adapter Shapes	YES			
14. Barrier Adapters	YES			
15. Snap-In Mount	YES			
16. Rear Panel Mount	YES			
17. Gang Frame Mount	YES			
18. Quick Connect Trmls.	YES			
19. Engraved Legends	YES			
20. Alt. Remain-In	YES			
21. Mom./Alt./Indicator	YES			

\*S190 \$1.62 in quantities of 1000

\*S410 \$2.53 in quantities of 1000

**CLARE-PENDAR**



CLARE-PENDAR  
a GENERAL INSTRUMENT CO.  
Box 785, Post Falls, Idaho 83854  
(208) 773-4541



POWER SOURCES

**Dc/dc converters drive high-voltage displays**

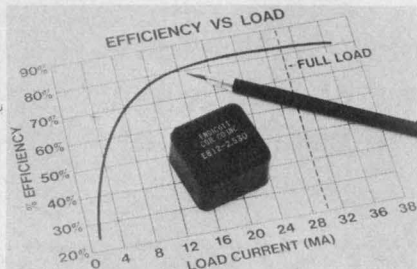

Endicott Coil Co., 24 Charlotte St., Binghamton, N.Y. 13905. (607) 797-1263. \$13.50 (lm); 3-4 wks.

Series 800 is a dc-to-dc power supply for matrix-type readout displays, such as Burroughs' SELF-SCAN®. The series converts 9, 12 or 15 V to a nominal 250-V level at 30 mA. Size is 1.43 × 1.5 × 1.03 in. and weight is 40 g. Series 800 units are fully encapsulated and are designed for PC-board mounting.

CIRCLE NO. 295

**Batteries hold charge for long periods**



Wisco Div., ESB, Inc., 2510 Louisburg Rd., Raleigh, N.C. 27604. (919) 834-8465.

The Willard brand of Charge Retaining (CR) storage batteries holds a charge over long periods and still provides uniform voltage. Pure lead grids hold stand loss to only 15% of capacity per year at 80 F. At current rates that discharge batteries over a period of 90 days or longer, voltage is practically linear throughout 90% of the discharge. The batteries are available in 2 and 6 V, with up to 1200 A-h rated capacity.

CIRCLE NO. 296

When a standard switch won't do...  
**take advantage of P&B's free engineering program**



After you've seen the standard switches and still can't find what you need, call us. P&B offers unique design and manufacturing capabilities in actuator assemblies, push buttons and pneumatic actuated units. From dry circuit to 25 amps. And, there's no charge for reasonable initial engineering services and samples.

Besides the more common actuating assemblies, special P&B designs can include push on/push off, rocker maintain, rocker momentary, bar lever, air cylinders, relays, rotary, and many more. P&B was the first to qualify with U/L TV rated switches.

For help with your switch problem, call your P&B representative or write Potter & Brumfield Division AMF, Princeton, Indiana 47670. 812 385 5251.

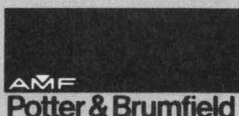

**Open-frame supplies offer 1% stability**

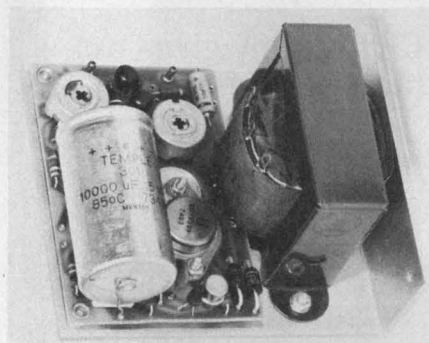

Deltron Inc., Wissahickon Ave., North Wales, Pa. 19454. (215) 699-9261. Start at \$28 (10); stock.

EPS Series of open-frame power supplies incorporates an additional frequency-compensating network for improved transient response and better stability under varying load changes. Line and load regulation is 0.5% with 0.1% available as an option. Stability is typically 1% for 8 h after warmup. Cut-back current limiting protects the supply from overloads. These units are available in 15, 18, and 24-W models. Size is 4 × 4-1/2 × 2-1/2-in. and weight is 2 pounds.

CIRCLE NO. 297



# After your 360/370 massages the information, a Gould Plotmaster can draw you a picture within 3 seconds.

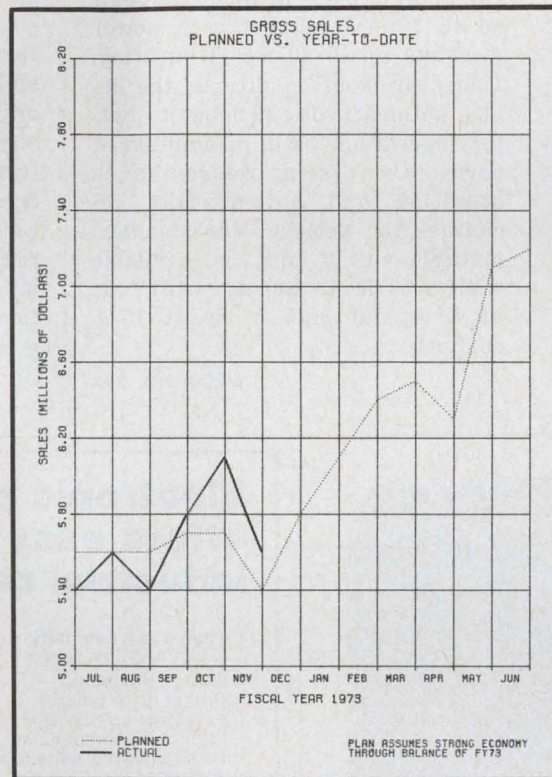

If alphanumeric information is what you want, a Gould Plotmaster can print it for you. At speeds up to 3000 lines per minute. But there are times when alphanumeric listings are just too much. Too much paper to handle, too tough to read, too difficult to digest.

And it's at times like these that a Gould Plotmaster can draw you a picture. A line chart, a bar chart, a pie chart, a graph. A picture that tells your story at a glance.

Employing high-speed electrostatic printer/plotters, Gould Plotmaster Systems give you power and versatility for both on-line and off-line operation. And they're designed to run on any IBM System/360 or 370 operating under DOS or OS, real or virtual.

Easy-to-use software packages help our Plotmaster Systems do the whole job. There's our DISPLAY package that provides even non-programmers with the capability of easily generating line, bar and pie charts. And there's our PLOT package which, due to the speed

and flexibility of our printer/plotters, lets you do background grids, variable line weights, automatic stripping, text annotation, and allows you to erase previously programmed line segments.

All software is written in assembler language to con-

serve internal storage and make efficient use of your main computer — yet each subroutine package is callable from Fortran for ease of operation and efficiency in preparing input.

As for the hardware itself, our Plotmaster Systems can provide on-line/off-line operation, paper widths up to 22 inches, resolution up to 100 dots per inch, output speeds up to 7 inches per second. And, of course, a printing capability, as well.

Get all the facts on Plotmaster Systems from Gould Inc., Instrument Systems Division, 20 Ossipee Road, Newton, Mass. 02164 U.S.A. or Kouterveldstraat 13, B 1920 Diegem, Belgium.

 **GOULD**



POWER SOURCES

**Open-frame supplies give 2-year warranty**

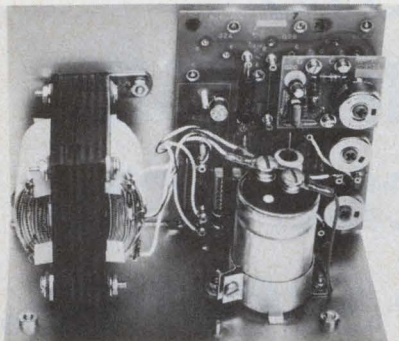

NJE Corp., P.O. Box 50, Culver Rd., Dayton, N.J. 08810. (201) 329-4611. \$85 (5V at 9 A).

These open-frame supplies come with a two-year warranty on labor and material. Other features include computer-grade electrolytic capacitors; plug-in IC regulator; and rack-adaptor capability with various front and rear-panel options. The units come in 12 models from 5 V at 3 A to 5 V at 15 A with 12, 15, and 24-V versions also included.

CIRCLE NO. 298

**800-W computer supply works under blackouts**



Pioneer Magnetics, 1745 Berkeley St., Santa Monica, Calif. 90404. (213) 829-3305. \$897 (100 quan.); 150 days, ARO.

Designated the Model PM 2478, this 800-W uninterruptable, multiple-output computer power supply can operate over an input range of 90 to 130 V ac, and with power dropouts up to 20 ms in duration. Under blackout conditions, the device automatically switches to battery operation. Upon resumption of power, the system returns to ac operation and automatically recharges the battery. The standard multiple-output unit is available with 5 V dc at 100 A, -15 V dc at 5 A and  $\pm 15$  V dc at 15-A channels.

CIRCLE NO. 299

**Ac power source delivers 250 VA**

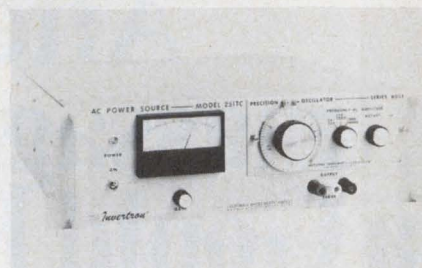

California Instruments, 5150 Conroy St., San Diego, Calif. 92111. (714) 279-8620. \$690; 30 days.

The Model 251TC is a 250 VA, single-phase power source. Full power is obtained from 45 to 5000 Hz, and its two output voltage taps of 0 to 67.5 and 0 to 135 V make it convenient to stack two units to achieve 500 VA of single-phase power. Total harmonic distortion is less than 0.9% over the frequency range with an amplitude stability to  $\pm 0.25\%$ . Load regulation is  $\pm 1\%$  over the frequency range while line regulation is  $\pm 0.25\%$  of full output for a  $\pm 10\%$  line change.

CIRCLE NO. 300

**PORTABLE SPECTRUM ANALYZER 4-1000 MHz**



Texscan's AL-51 spectrum analyzer is a general purpose, high reliability instrument designed for making rapid signal strength measurements in the 4 to 1000 MHz frequency range. The unit is completely portable, can operate off its own internal rechargeable batteries or from an external 12 to 20 volt source, including vehicle 12V battery. Weighing less than 25 pounds, it is provided with a protective cover and a carrying handle for simple field operation in adverse environments.

**Texscan**

A WORLD LEADER IN ELECTRONICS  
"And Coming On Strong"

Texscan Corporation  
2446 North Shadeland Avenue  
Indianapolis, Indiana 46219  
Ph: 317 357-8781  
TWX: 810-341-3184 Telex: 272110

INFORMATION RETRIEVAL NUMBER 97

**Electronic preset controller offers easy interface and industrial reliability.**

- **High noise immunity**  
New CMOS circuitry
- **Design flexibility**  
Preset up to 6 digits  
Presignal up to 6 digits  
With or without display  
Panel mount & table top versions
- **Input versatility**  
Switch closure or electronic all in one
- **Compact package**  
More features per square inch of panel than any other industrial controller.

Write for complete information today.

HECON CORPORATION  
P.O. Box 247  
Eatontown, N.J. 07724  
Phone (201) 542-9200  
HECON OF CANADA, LTD.  
80 Galaxy Blvd.  
Rexdale, Ontario M9W-4Y8  
Phone: (416) 678-2441.

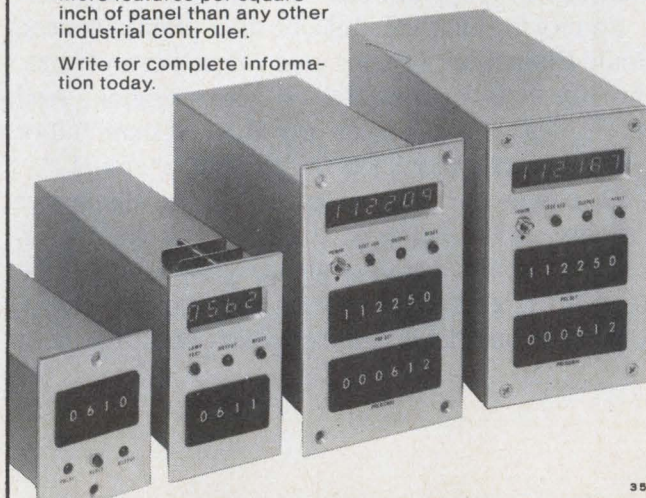

35

INFORMATION RETRIEVAL NUMBER 98

ELECTRONIC DESIGN 20, September 27, 1974



## Submodules offer 1200 supply configurations

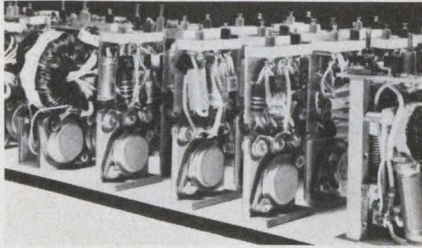

Arnold Magnetics, 11520 W. Jefferson Blvd., Culver City, Calif. 90230. (513) 870-7014. \$62 up; 10 days.

Thin-Mod submodules provide over 1200 possible configurations of high-efficiency ac/dc and dc/dc regulated power converters. Each completed system is provided in a tested and encapsulated miniaturized package. Available inputs include 115 V ac, 50 to 500 Hz and 12, 28, 48 and 115 V dc. Output submodules are offered from 4.2 to 300 V dc, and feature line and load regulation to 0.1%. Up to 120 W per output can be obtained and efficiencies run as high as 85%. All regulator submodules are short-circuit protected.

CIRCLE NO. 301

## Unregulated converters offer 80% efficiency



Semiconductor Circuits, Inc., 306 River St., Haverhill, Mass. 01830. (617) 373-9104. \$25.95 to \$30.95; stock to 8 wks.

Unregulated miniature dc/dc converters come in encapsulated modules and deliver 900 mW. Packaged in a 1-1/8 x 1-1/8 x 1/2-in. module, these devices convert 5, 6, 12, 24 or 28 V to an isolated 5, 12,  $\pm 12$  or  $\pm 15$ -V output at efficiencies of more than 80%. Regulation is  $\pm 3\%$  from 10% load to full load.

CIRCLE NO. 302

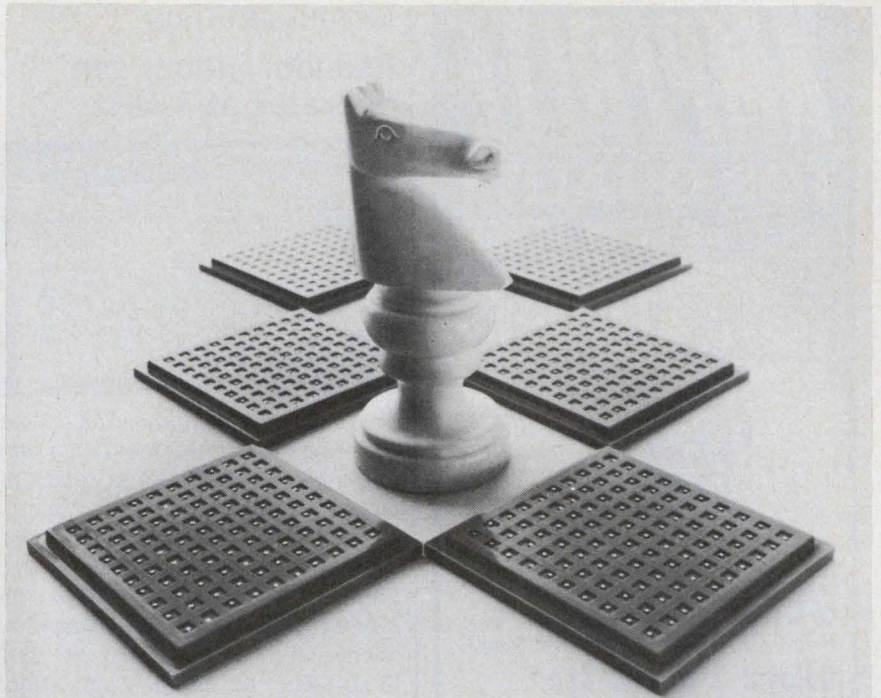

# Our resistor chips: Your move.

30-MIL thin-film-NiCr Resistor-Chips.

RESISTANCE RANGE: 10 $\Omega$  to 510K $\Omega$ .  
TEMPCO: 0 to +50 PPM/ $^{\circ}$ C.  
TRACKING MATCH:  $\pm 1$  PPM/ $^{\circ}$ C.  
POWER DISSIPATION: 250 mW. NOISE: 0.01 $\mu$ V/Vmax.  
RESISTANCE TOLERANCE:  $\pm 1$  and  $\pm 5\%$   
(or tighter, by request).  
TEMPERATURE:  $-55^{\circ}$ C to  $+125^{\circ}$ C.  
MIL-STD-883 A or B. GLASS PASSIVATED.  
CONFIGURATION: chips, wafers,  
multi-chip trays, tube packs.

### For Fast Action, Call:

In USA: (617) 272-1522 (or TWX 710-332-7584)  
In Europe: Hybrid Systems Europa GmbH, 61 Darmstadt,  
Luisenplatz 4, Germany Tel. 6151-291595 TELEX 841-419390

Hybrid Systems Corporation  
Burlington, Massachusetts 01803

**Hybrid Systems**  
CORPORATION

INFORMATION RETRIEVAL NUMBER 99



# AMPERITE

TOP QUALITY  
Still at LOW PRICE!

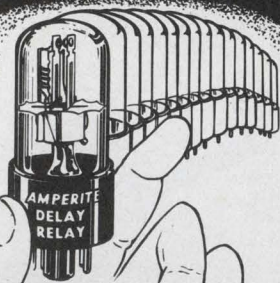

## Thermostatic DELAY RELAYS

Hermetically Sealed for Maximum Stability

Delays: 2 to 180 Sec.\*

Hermetically sealed — not affected by altitude, moisture, or climate changes... SPST only — normally open or normally closed... Compensated for ambient temperature changes from -55° to +80°C... Rugged, explosion-proof, long-lived... Standard radio octal and 9-pin miniatures.

Price, standard or min., under \$4.00 ea.

\*Miniatures delays: 2 to 120 seconds.

PROBLEM? Send for Bulletin No. TR-81.

## New! LONG DELAYS

240 & 300 Sec.

Same rugged construction, hermetic sealing and stability as the shorter Delay Relays described above... For delays beyond 300 seconds, these Relays may be used in series.

Price, under \$6.00 ea.

Write for Bulletin No. LD-73.



## DIFFERENTIAL RELAYS

For automatic overload, over-voltage or under-voltage protection... Made only to specifications for 70V, 80V, 90V and 100V.

Price, under \$6.00 ea.

## AMPERITE BALLAST REGULATORS

Automatically keeps current and voltage at a definite value. For AC or DC... Hermetically sealed, rugged, vibration-resistant, compact, most inexpensive.

Price, under \$3.00 ea.

Write for 4-p. Bulletin No. AB-51.

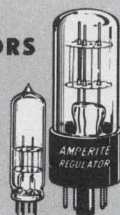

# AMPERITE

600 PALISADE AVE., UNION CITY, N.J. 07087

Telephone: 201 UNION 4-9503

In Canada: Atlas Electronics, Ltd.,  
50 Wingold Ave., Toronto 19

## INSTRUMENTATION

### Pseudorandom gen operates at 1 GHz

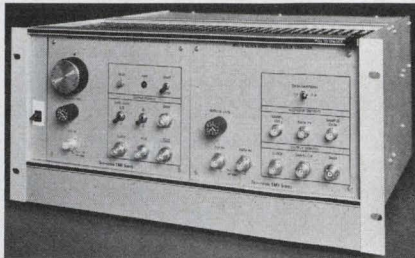

Tau-Tron, 11 Esquire Rd., North Billerica, Mass. 01862. (617) 667-3874. MN-2, starts at \$11,000; 120 days.

The MN-2 Pseudorandom Data Generator and the MX-2 Data Sampler operate at 1 GHz. The MN-2 produces a pseudorandom sequence at bit rates from 200 MHz to 1 GHz. In actual applications, the MN-2 output is used to excite the system under test. Output from the system under test drives the MX-2, which samples the received data. The sampling process lowers the data rate to a 300-MHz maximum rate, but preserves the pseudorandom character of the signal. To measure errors in the sampled signal requires a standard S-1100A PCM Receiver/Counter.

CIRCLE NO. 303

### Dual-trace mini scope brags advanced trigger

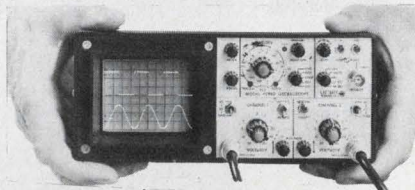

Vu-Data Corp., 7170 Convoy Ct., San Diego, Calif. 92111. (714) 279-6572. \$1095; stock to 30 days.

Model PS940A Mini-Portable oscilloscope offers computerized triggering: a logic circuit eliminates front-panel adjustments to achieve a stable trace display. Once power has been turned on and the input signals are connected, the operator is guaranteed a stable, dual-trace presentation at all times. Furthermore, vertical position adjustments can be made without losing sync. Other specs include a 20-MHz bw, 10 mV/div sensitivity, a built-in delay line and full dual-trace switching.

CIRCLE NO. 304

### 2-MHz pulse gen sells for just \$159



Interdesign, Inc., 1255 Reamwood Ave., Sunnyvale, Calif. 94086. (408) 734-8666. \$159.

In the Model 1101 pulse generator, 85% of all components are contained in a single custom IC. The unit is battery operated, so it can be isolated from ground. The batteries provide 40 h of operating time and are rechargeable in 10 h with the included charger. Frequency range is more than seven decades: 0.1 Hz to 2 MHz. Fall time is 10 ns and rise time is 50 ns. Pulse width is continuously variable from 0 to 100% of the period. Output voltage is adjustable from 0 to 5 V.

CIRCLE NO. 305

### Event recorder captures transients

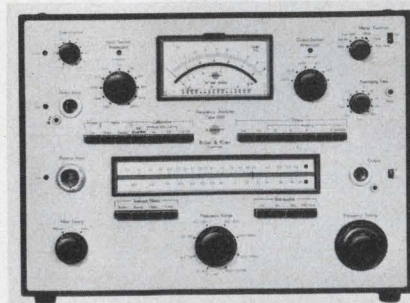

B & K Instruments, 5111 W. 164th St., Cleveland, Ohio 44142 (216) 267-4800. \$8397; 30 days.

Digital Event Recorder, Model 7502, contains an 8-bit a/d converter, an 8-bit shift register with 40-k words and a d/a converter for analog data recovery. The capacity can be increased in 2-k word increments to 10-k words. Variable sampling and playback rates provide speed scaling. A transient trigger provides automatic data capture. Multiple units may be interlocked for synchronous multichannel recordings. Built-in anti-aliasing filters simplify application. Frequency range is dc to 50 kHz.

CIRCLE NO. 306



# Centralab perspectives

FOR USERS OF ELECTRONIC COMPONENTS

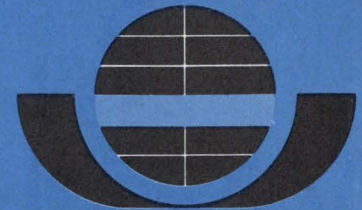

**CENTRALAB**

Electronics Division

GLOBE-UNION INC.

5757 NORTH GREEN BAY AVENUE  
MILWAUKEE, WISCONSIN 53201

## To get the latest generation component, engineers are saying Selectashaft®—before they say rotary switch.

Distributor assembly of this mechanically superior rotary switch gives them instant delivery on over 100,000 custom assemblies and eliminates secondary modification costs.

If you're specifying or buying rotary switches, your Centralab Selectashaft Distributor would like to let you compare this totally new switch with any old style switch. One sample is all you'll need to see how it can meet custom specifications yet save from 3% to 17% on total cost, depending on switch type and quantity.

Selectashaft is the first name for rotary switch. Electrically equivalent to our famous PA-Series switches, it's the latest generation component. Mechanically superior to any old style rotary, it gives you adjustable torque, better feel and longer life. It uses a new dual ball, side-thrust index, and incorporates an adjustable stop ring instead of the old style stop tabs. There are no modification problems—no bare metal to rust or corrode, no scrap, no loss of warranty and no secondary modification cost. You get everything you need—exact shaft length, end detail and shaft flat angle without modification. And, when you consider the cost savings, the reasons to say Selectashaft—before you say rotary switch—are clear. Ask for a sample and see.



THIS CATALOG, available from your Distributor, gives complete specs, dimensional drawings, circuit diagrams and easy ordering instructions. Ask for it. You'll find the answers to your design and delivery problems.

THE SELECTASHAFT SYSTEM consists of preassembled standard rotary switches and a series of individual exact shafts. Factory trained Distributors, using specially designed equipment, assemble these parts to meet custom requirements. You choose from three shaft styles—.250" plain round, .218" and .156" flat. There are 24 shaft lengths, .687" to 2.375" and 24 shaft flat angles in 15° increments. You select from 92 subminiature and miniature switches—1", 1.325" and 1.500" diameters; diallyl phthalate, phenolic or ceramic sections. You have your choice of knobs, dial plates, index assemblies and hardware. You get the design freedom of over 100,000 possible custom switch combinations.

### ASK FOR SELECTASHAFT ROTARY SWITCHES AT THESE CENTRALAB DISTRIBUTORS:

#### CALIFORNIA

Abacus Electronics  
Mountain View 94040  
415/961-1500

Elmar Electronics Inc.  
Mountain View 94041  
415/961-3611

Kieruff Electronics Inc.  
Los Angeles 90022  
213/685-5511

#### COLORADO

Acacia Sales, Inc.  
Lakewood 80215  
303/232-2882

#### FLORIDA

Electronic Equipment Co.  
Miami 33142  
305/871-3500

Hammond Electronics  
Orlando 32802  
305/241-6601

#### INDIANA

Radio Distributing Co., Inc.  
South Bend 46624  
219/287-2911

Ra-Dis-Co, Inc.  
Indianapolis 46202  
317/637-5571

#### KANSAS

Radio Supply Co., Inc.  
Wichita 67211  
316/267-5214

#### MASSACHUSETTS

Wilshire Electronics/N.E.  
Cambridge 02138  
617/491-3300

#### MICHIGAN

RS Electronics  
Detroit 48227  
313/491-1012

#### MINNESOTA

Gopher Electronics Co.  
St. Paul 55113  
612/645-0241

#### NEW YORK

Peerless Radio Corp.  
Lynbrook, L.I. 11563  
516/593-2121

Summit Distributors  
Buffalo 14202  
716/884-3450

#### NORTH CAROLINA

Kirkman Electronics  
Winston-Salem 27108  
919/724-0541

#### OHIO

Esco, Incorporated  
Dayton 45403  
513/226-1133

Pioneer-Standard Electronics  
Cleveland 44105  
216/587-3600

Stotts-Friedman Company  
Dayton 45402  
513/224-1111

#### PENNSYLVANIA

Cameradio Electronics  
Pittsburgh 15222  
412/288-2600

Herbach & Rademan, Inc.  
Philadelphia 19134  
215/426-1700

Philadelphia Electronics Inc.  
Philadelphia 19107  
215/568-7444

#### TEXAS

Harrison Equipment Inc.  
Houston 77004  
713/224-9131

Texas Instruments Supply  
Dallas 75235  
214/238-6811

Southwest Electronics Inc.  
Stafford 77477  
713/494-6021

#### WASHINGTON

Almac/Strom Electronics  
Seattle 98108  
206/763-2300



---

---

# WIN A FREE CARIBBEAN WINDJAMMER CRUISE

PLUS ROUND-TRIP TRANSPORTATION FOR TWO

---

---

(OFFER LIMITED TO *Electronic Design's GOLD BOOK*  
USERS IN U.S. AND EUROPE ONLY)

## WE WANT TO LEARN HOW YOU USE **Electronic Design's GOLD BOOK**

Have you noticed this Diary and Quick Reference (see right)? It's on page 935, Volume 1, of *Electronic Design's GOLD BOOK*.

It's there to make the industry's most useful directory even more useful.

You can jot down frequently called numbers and suppliers' names, or keep a log of the progress of your contacts, negotiations, or purchases.

When you're contacting many suppliers it's often difficult to keep track of whom you've worked with, what you said, what they said. You can jot it down on this Diary or make copies of the Diary and keep one in each project file.

If you'll share your diary with us, we'll return the favor with a \$5.00 certificate toward book purchases plus a chance for a week's Windjammer Cruise in the blue Caribbean.

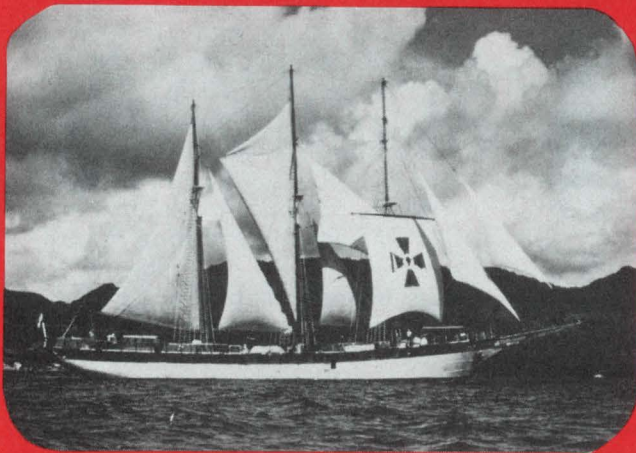

**PRIZE DRAWING  
DEADLINE**

**OCT. 15, 1974**

**SEND US A COPY OF YOUR DIARY & QUICK REFERENCE FORM (OR YOUR OWN LOG OF *Electronic Design's GOLD BOOK* USE) . . . IF YOU HAVEN'T BEEN KEEPING ONE, YOU CAN START NOW. USE THE FORM AT RIGHT**

**\$5<sup>00</sup>**

**A \$5.00 CREDIT CERTIFICATE TOWARD PURCHASE OF HAYDEN TECHNICAL BOOKS FOR EVERY USER'S DIARY WE RECEIVE**

To find out how *you* use *Electronic Design's GOLD BOOK*, we're offering a special incentive. If you'll send us a copy of your Diary (or a copy of your own record of dates, companies contacted, and action taken) we'll send you the \$5.00 book certificate described above. Then to make it even more worthwhile, we'll put all the replies in a hat and give a FREE WINDJAMMER CRUISE for two, plus air trans-

portation for two to the lucky winner. Be sure to indicate your complete name, title, company, and address.

SEND THE COPY OF YOUR DIARY OR PERSONAL LOG TO:

Marion Kerstner  
*Electronic Design's GOLD BOOK*  
50 Essex Street, Rochelle Park, N.J. 07662

### DRAWING RULES

To be eligible, a copy of your Diary & Quick Reference sheet(s) or your own personal record of use of *Electronic Design's GOLD BOOK* must be mailed and post-marked on or before midnight **Oct. 15**. Diaries must cover at least a two-week span. No awards to any individual sending more than one entry (entry may be more than one page). No cash prizes or other substitutes will be made in lieu of any prize. Void where prohibited by law. Liability for any taxes on prizes is sole responsibility of winner. Employees (and their families) of Hayden Publishing Company, Inc., and its subsidiaries ineligible. Air transportation provided by regularly scheduled airlines to and from cruise point of departure. Cruise dates subject to advance booking requirements.







# Four power supplies in one



## Tele-Dynamics T12/15 dual-output dc supply

The first and only  
OEM power supply  
with these four capabilities:

- Two outputs—each independently adjustable from 11.7 to 15.3V @ 750mA
- Can be series-connected for double voltage (23.4 to 30.6V)
- Can be parallel-connected for double current (1.5 A)
- Master-slave tracking for op-amp applications

QUANTITY	PRICE
1-9	\$51.00
10-24	\$48.50
25-49	\$46.00
50-99	\$43.50

AC input: 105-125/210-250 V, 57-63 Hz, single phase. Regulation: line and load each  $\pm 0.1\%$ . Ripple: 0.05% rms. Overload protection: foldback current-limiting.

Off-the-shelf delivery at 110 stocking locations... call toll-free (800) 645-9200\* for the distributor or engineering representative nearest you.

\*N.Y. state, call (516) 294-0990 collect.



**Distributors** • Allied • Arrow-Angus • Cramer • Intermark • Newark • Olive Radio • Philadelphia Electronics • Pioneer Standard • RPS Electronics • Ralph's • Stark • Sterling (Calif.) • Summit • Testco • T. I. Supply • Zack  
Distributed in Europe by Texas Instruments, Ltd. and Tisco

WANLASS POWER SUPPLIES

# TELE-DYNAMICS

DIVISION OF **AMBAC**

525 Virginia Drive, Fort Washington, PA 19034 (215) 643-3900

Career opportunities for power supply engineers—write Mr. W. Booth.  
AN EQUAL OPPORTUNITY EMPLOYER M/F

© TELE-DYNAMICS

5988

## INSTRUMENTATION

### Panel counter-timers display any units

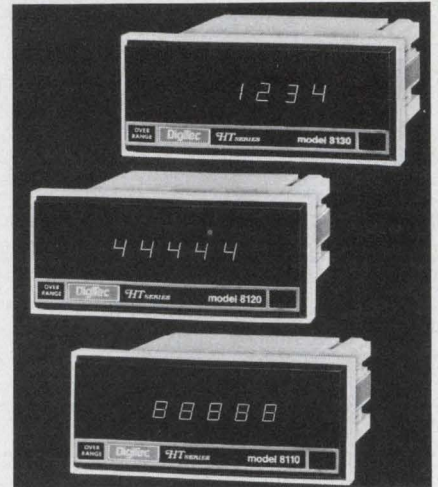

United Systems Corp., 918 Woodley Rd., Dayton, Ohio 45403. (513) 254-6251. \$275; stock.

Consisting of three different models, the 8100 Series of factoring counter-timers count, totalize or time and provide a direct or factored digital readout in the desired units of measure. Error producing and time-consuming calculations, interpolations or look-up tables are no longer required. The series uses an internal crystal clock and each model comes with a 5-digit, Monsanto MAN 72 LED display. The 8110 is a counter; the 8120 a totalizer; and the 8130 a timer.

CIRCLE NO. 307

### pROM programmer checks 256-bit memories

Tycom Corp., 26 Just Rd., Fairfield, N.J. 07006. (201) 227-4141. \$895; 30 days.

A programming system, the PROVER I, is designed to program or verify 256-bit pROM ICs. The system can duplicate one master 82S23 or 8223 pROM and verify another simultaneously. It can also be used to program or verify in a single step, permitting the operator to program, verify, or modify information on a particular address within the circuit. Other characteristics of PROVER I include a duplicate time of 80 s, verify time of 80 s and indefinite data retention time.

CIRCLE NO. 308



**Panel DVM measures only 9/16-in. thick**

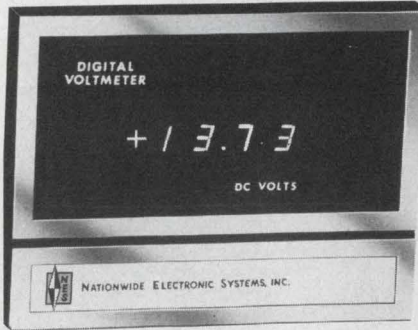

Nationwide Electronic Systems, 1536 Brandy Pkwy., Streamwood, Ill. 60103. (312) 289-8820. \$199 to \$225.

The Slimline digital voltmeter—only 9/16-in. thick—is a bipolar, 3-1/2-digit instrument with LED display and BCD outputs. The unit mounts flat on the front of the panel. Specs include 10 readings per second and an accuracy of better than  $\pm 0.05\%$  of reading  $\pm 1$  count. The unit requires 5-V dc power.

CIRCLE NO. 309

**Transistor tester handles 2.5 kV, 1 mA**

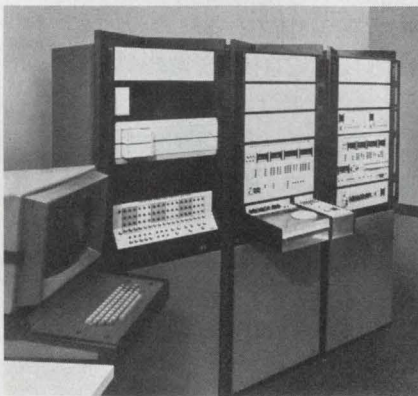

Teradyne, 183 Essex St., Boston, Mass. 02111. (617) 482-2700. \$15,000; 20 wks.

The T397 high-voltage transistor test instrument automatically tests npn transistors at voltages up to 2500 V. The unit can function independently or with the T347 computer-operated transistor test system. The T397 tests breakdown voltage and leakage current at up to 2500 V and 1 mA. Latching voltage and current gain can be tested at up to 1000 V and 100 mA. The internal memory of the instrument has a basic capacity for 32 tests.

CIRCLE NO. 310

**When it comes to one-source savings on solid-state power relays...**



**COME TO CRYDOM...**

**We're first with the most of the best!**

After all, we originated and patented (#3,723,769) what has become the industry standard for solid-state power relays. Of course, we make the broadest line available, 18 models, all in the same field-proven package. What's more, they're UL recognized and CSA certified. And since you can satisfy every application need from one source, you'll simplify procurement, lower expenses.

So, whenever you need to control rugged AC loads from low voltage ICs or AC line voltage signals, you're sure to quickly find the most appropriate and reliable solution with the leader — Crydom.

LINE VOLTAGE (VAC)	FULL-LOAD CURRENT RATING (AMPS)				
	2.5	8	10	25	40
120	D1202 A1202		D1210 A1210	D1225 A1225	D1240 A1240
240	D2402 A2402		D2410 A2410	D2425 A2425	D2440 A2440
480		D4808 A4808			

CONTROL VOLTAGES: D PREFIX — 3-32VDC/A PREFIX — 90-280VAC

Call your local Crydom authorized distributor for off-the-shelf deliveries of any of our 18 models. And, when you need production quantities in a hurry, contact us at the factory for all the facts.

**CRYDOM CONTROLS IOR**

DIVISION OF INTERNATIONAL RECTIFIER

1521 Grand Ave., El Segundo, California 90245 · (213) 322-4987

INFORMATION RETRIEVAL NUMBER 103



# NOW!

## LINISTORS™

sensitive linear  
negative temperature  
coefficient thermistor  
assemblies

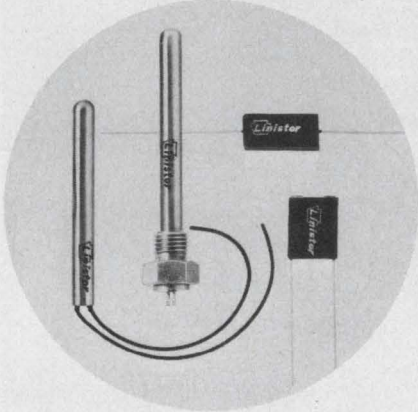

Linistor assemblies will provide you with an accurate straight line resistance/temperature plot from 0°C to 100°C.

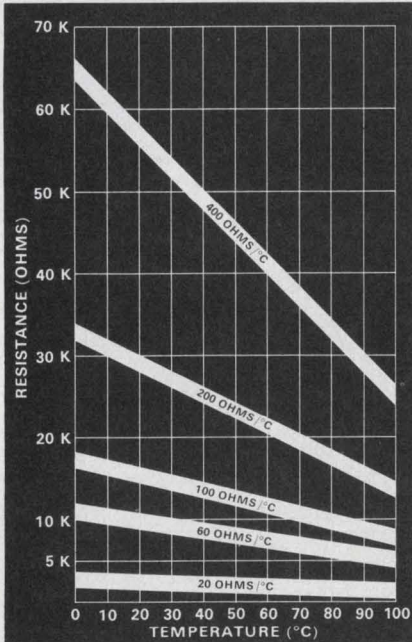

Linistors are ideal for temperature sensing and temperature compensating devices. They are now available in four standard enclosures to satisfy most design applications. Write for Data Bulletin L-601.

**Keystone**  
CARBON COMPANY

Thermistor Division  
St. Marys, Pa. 15857  
Phone 814/781-1591

INFORMATION RETRIEVAL NUMBER 104

### INSTRUMENTATION

#### Unit determines semi parameters



Princeton Applied Research, Box 2565, Princeton, N.J. 08540. (609) 452-2111. \$2000; 90 days.

Model 410 C-V plotter determines semiconductor flat-band voltage, mobile ion concentration, surface-state concentration and can be used for carrier lifetime studies. The unit contains a 1-MHz capacitance meter, a variable dc voltage for bias stressing the sample and a ramp generator/programmer designed specifically for semiconductor applications. Completely integrated systems containing the Model 410 and accessory items such as an X-Y recorder, automatic temperature controller and hot chuck and various probe stations are available.

CIRCLE NO. 320

#### Logic tester fits in a suitcase

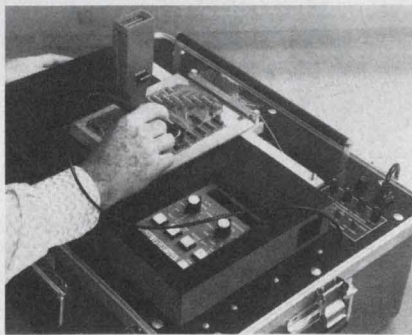

Fluke/Trendar, 500 Clyde Ave., Mountain View, Calif. 94040. (415) 965-0350. \$5975; 30 days.

TRENDAR 1000A is a high-speed, portable tester, self-contained in a suitcase and with the capability of one pass, go/no-go testing. The unit is a successor to the TRENDAR 1000. The 1000A accepts up to 60 output signals from the board to be tested and combines these into one digital bit stream which represents the "signature" of the UUT. The transition counter probe can now be placed on the output test point for a complete go/no-go test of the UUT in one pass.

CIRCLE NO. 321

#### \$245 buys 2-MHz function generator



Krohn-Hite Corp., 580 Massachusetts Ave., Cambridge, Mass. 02139. (617) 491-3211. \$245; stock.

Model 5800 function generator is a rep-stocked unit that provides sine, square and triangle waveforms at low cost. Features include: distortion less than 0.5%; frequency range of 0.2 Hz to 2 MHz; 50-Ω output with 15 V pk-pk and pushbutton operation. In addition, the 1000:1 tuning dial covers the entire audio range in one turn of the dial with no multiplier adjustments.

CIRCLE NO. 322

#### Multifunction counter offers remote control

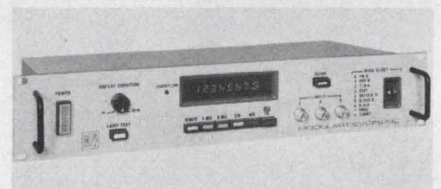

Modular Devices, Inc., 1385 Lakeland Ave., Bohemia, N.Y. 11716. (516) 567-9620. \$725 with 0.0025% time base.

Model 2319FE multi-function counter offers remote control as standard. All functions are remotely or locally controlled by non-critical TTL/DTL signals. Parallel and serial data output is standard. Serial data format is either low or high-order bit first, field selectable. The unit, which mounts in a 19-in. rack, provides time-interval measurements of pulse width, period, B-A (to 100-ns resolution), frequency ratio E/B. Measurement averaging of ten consecutive readings increases time resolution to 10 ns.

CIRCLE NO. 323



### RF Microwattmeters— Analog and Digital— FS Sensitivities from 10 nW to 10 mW



MODEL  
42B/42BD

Boonton rf microwattmeters offer unrivalled sensitivity: 10 nW fs to 10 mW fs; from 200 kHz to 18 GHz, at highest stability ever attained at these sensitivities. Analog (42 B) or digital (42 BD) versions, both with linear DC outputs and logic-level programmability. BCD outputs are standard on digital version, auto-ranging and dB display (0.01 dB resolution) optional. Boonton Electronics, Parsippany, N.J. 07054

INFORMATION RETRIEVAL NUMBER 161

### Wide-Range Programmable Capacitance Meters



MODEL  
72B/72BD

Boonton analog (72B) and digital (72BD) provide rapid, accurate, 3-terminal and differential measurements, at 1 MHz, from 1 pF fs. Measures semiconductor-junction capacitance at low (15 mV) test level, with provision for external DC bias. Phase-sensitive detector measures accurately even at  $Q=1$ . Logic-level range programmability and fast-tracking DC output are ideal for ATE. Model 72BD has standard BCD output and autoranging. Boonton Electronics, Parsippany, N.J. 07054

INFORMATION RETRIEVAL NUMBER 162

### Direct Capacitance Bridge 0.00005 to 1000 pF and 0.01 to 1000 mho

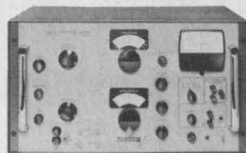

MODEL  
75D

Boonton Model 75D Direct Capacitance Bridge is designed for 1 MHz capacitance and loss measurement. Capacitance range, 0.00005 pF to 1000 pF; basic accuracy, 0.25%. Conductance range: 0.01 mho to 1,000 mho, basic accuracy,  $\pm 5\%$ . Internal bias from -6 V to +150 V. Adjustable test level, 1 mV to 250 mV, at 1 MHz. Two modes of operation allow either conventional capacitance and loss measurements or one-control balance for capacitance only. 3-terminal input configuration. Boonton Electronics, Parsippany, N.J. 07054

INFORMATION RETRIEVAL NUMBER 163

INFORMATION RETRIEVAL NUMBER 164 ►

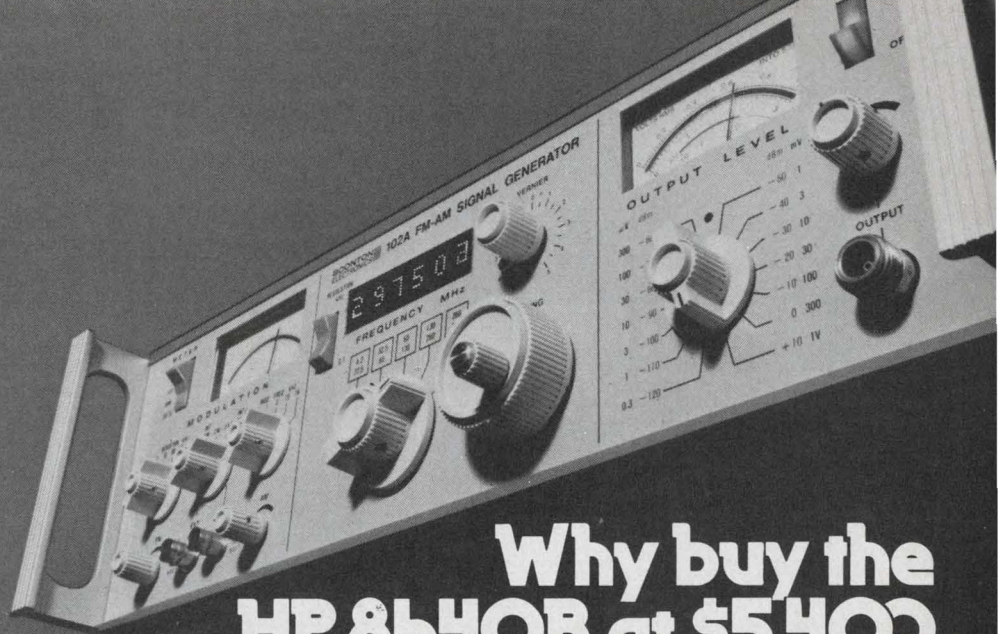

# Why buy the HP 8640B at \$5,400 when \$2,205 less will get you Boonton's competitive 102A signal generator?

Our Model 102A, at \$3,195, has everything you need for just about any AM/FM application — plus seven performance and convenience features you won't get in the HP \$5,400 design.

#### What did we leave out?

Phase-lock synchronization, for one (but our dc-coupled FM channel can be externally locked if you need better stability than our typical 4 ppm); and narrow-pulse modulation (belongs in a different class of generators).

#### What did we add?

Four different signal-generation techniques — for optimum performance in each band, from 4.3 to 520 MHz, without the usual compromises in noise, stability, or residual-distortion characteristics.

The most logical panel layout and convenient control setup you've ever seen. And a unique adjustable "feel" main drive mechanism for narrow-band receiver setting with ease — even without our electrical vernier.

Separate meters for modulation and output — no annoying auto-ranging or out-of-range annunciators . . . we don't need them.

15 minute warmup to typically

meet 10 ppm/10 minute stability — made possible by low internal dissipation (only 30 watts; no fan!)

Wider FM deviation at low carrier frequencies than any other design in this class (how does 2 MHz peak-to-peak grab you?)

A detected-AM-output option, to verify our negligible phase-shift for VHF-omni testing.

Versatile modulation features — like five internal frequencies, 30% and 100% AM scales, and true-peak-responding AM and FM metering.

All these performance pluses are coupled with low spurious and close-in noise, excellent low-frequency phase integrity, really effective leveling, a low and flat VSWR curve, accurate wide-range attenuation, high output power . . . all of it buttoned up tight for low leakage in a lightweight 30 pound package.

. . . and it's all yours for \$3,195. Get the full specs today — before you spend 70% more . . .

For complete data or a demonstration write or call Boonton Electronics Corp., Rt. 287 at Smith Road, Parsippany, N. J. 07054, (201) 887-5110.

# BOONTON



# ALPHA NUMERIC DOT MATRIX THERMAL PRINTHEADS ARE HERE!

DL 1100  
10-DOT CHARACTER  
PRINTER TO 18 c.p.s.

Features:

- Thick film — low cost
- Closely spaced square dots — high legibility

DM 1101  
10 column  
expandable  
page printer  
8 l.p.s.

THIS IS  
AN EXAMPLE OF  
THERMAL PRINTING

also available — PS015 7-segment series

# gulton

Electronic Components Division  
Gulton Industries Inc.  
212 Durham Avenue  
Metuchen, New Jersey 08840  
(201) 548-2800

## MODULES & SUBASSEMBLIES

### Adjust on and off times separately on timer



Metrix Manufacturing, 51 Sheff-  
field St., Toronto, Ontario M6M3-  
E5. (416) 249-9153. \$85.

The Model CT/LR recycle timer has on and off times independently adjustable from 1 to 100 h or longer. It is specifically designed to drive an external relay or contactor. The unit is available for operation from 12 V dc or 115 V ac 50/60 Hz, and has a spst/NO solid state output rated at 1.5 A. Operation from other supply voltages can be provided on request. Each timer is equipped with two controls for independently adjusting the on and off times as a percentage of the maximum time periods. The CT/LR is available in a wide range of maximum on and off times. A LED indicator as to whether the CT/LR is in the on or off cycle is optionally available. The CT/LR can also be supplied with an extra set of output contacts to provide a direct reading of elapsed time on any external 1 mA meter. Repeat accuracy of the CT/LR is  $\pm 1\%$  at 25 C,  $\pm 0.2\%$  typical. Transient protection of the LSI timing circuit is 2 kV for 10 ms or 1.2 kV for 20 ms. Temperature coefficient is  $\pm 0.15\%/^{\circ}\text{C}$  typical for time ranges up to 30 min. Reverse polarity protection is provided on dc models and the entire unit is housed in a plastic case with built-in screw-type terminal connections. The CT/LR is protected against moisture, chemicals and dust, and operates over the temperature range  $-10$  to  $+55$  C.

CIRCLE NO. 324

### Programmable controller made for simple gear

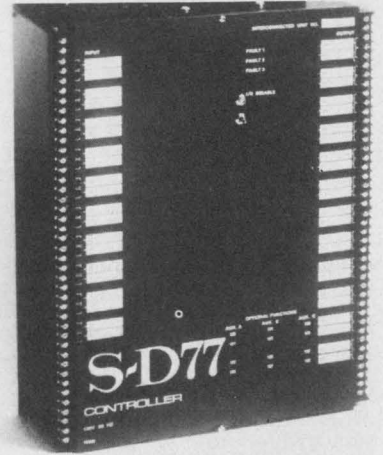

Struthers-Dunn, Inc., Pitman, N.J.  
08071. (609) 589-7500. Under \$800.

The S-D77 programmable logic controller (PLC) is designed for the "low end" of the industrial control market. It offers two design features not found in most other controllers. The multiple-slaving capability enables one PLC to directly communicate with another, thus allowing for distributed control functions on transfer lines, printing presses, etc. The vertical, slim-profile configuration enables the unit to fit in a standard 8-in. deep relay cabinet. The S-D77 is housed in a  $12 \times 16.125 \times 7$  in. package and has 20 inputs, 12 outputs, 32 internal storage (scratch pad) locations and four timers. Included in the standard unit is all necessary hardware to process 120 V ac/dc input signals and deliver output signals in 4 ms. Also included as standard are fault monitoring for bus and scanner, I/O terminals and status lights, isolated inputs and fused outputs and a reprogrammable memory.

CIRCLE NO. 325

### Temperature stabilizer preset for 65 C

Jermyn, 712 Montgomery St., San  
Francisco, Calif. 94111. (415) 362-  
7431. Stock.

The 4ST2-4 temperature stabilizer can control the temperature of TO-5 size devices at 65 C. The stabilizer is suitable for ICs where the lead lengths are restricted to 0.5 in. Power requirements are 24 V ac/dc, 0.6 W (at 25 C ambient). Maximum warm-up time from  $-55$  C is 3 min.

CIRCLE NO. 326





# NEW Simpson 360 Digital VOM

Handy and rugged enough for the field — accurate and versatile enough for the lab. And its simplicity and readability make it perfect for production line testing.



- 3-1/2" digit, non-blinking, auto-polarity 0.33" LED display
- AC line or battery operation
- 29 popular ranges including "low-power" ohms
- Analog indicator for scanning nulls and peaks
- Analog output signal permits interfacing with recorders and other instruments
- Up-down integration analog/digital conversion assures superior stability, accuracy and noise immunity

Supplied with test leads, AC line cord, operator's manual, without batteries ..... \$295



## SIMPSON ELECTRIC COMPANY

853 Dundee Avenue, Elgin, Illinois 60120 • (312) 695-1121  
 CABLE: SIMELCO • Telex: 72-2416  
 IN CANADA: Bach-Simpson, Ltd., London, Ontario  
 IN ENGLAND: Bach-Simpson (U.K.) Ltd., Wadebridge, Cornwall  
 IN INDIA: Ruttonsha-Simpson Private, Ltd., Vikhroli, Bombay

ORDER NOW FROM YOUR LOCAL ELECTRONICS DISTRIBUTOR OR WRITE FOR NEW CATALOG 4200

INFORMATION RETRIEVAL NUMBER 107



custom-pick  
your options  
in this family  
of enclosed  
1/4 amp 1/2 inch  
switches from  
Grayhill

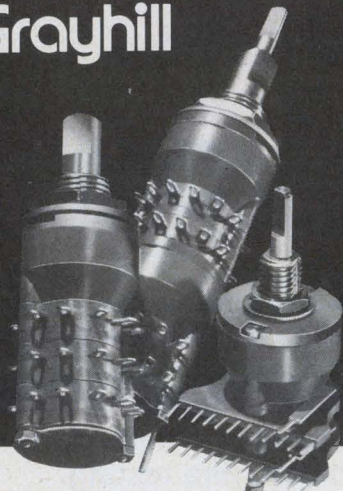

**Value engineered  
to compete in price  
and out-perform  
open wafers**

- 10 or 12 positions, 1 to 6 poles, up to 12 decks.
- Options include concentric shaft, adjustable stop, PC terminals all out one side, and 1/8" or 1/4" shafts
- Ideal for instruments, medical electronics, avionics, mobile communications, and many more applications.

From Grayhill's capability at insert molding technology and value engineering emerges this miniature switch family that provides the performance benefits of enclosed construction at price levels associated with open-wafer. No compromise in materials—even gold plated contacts and diallyl phthalate insulation—in this "best switch for the money" you're likely to find anywhere. For information on these Series 71 switches, consult EEM or write for engineering data.



561 Hillgrove Avenue • LaGrange, Illinois 60525  
(312) 354-1040

## MODULES & SUBASSEMBLIES

### Long period timer wires as repeat cycle or delay

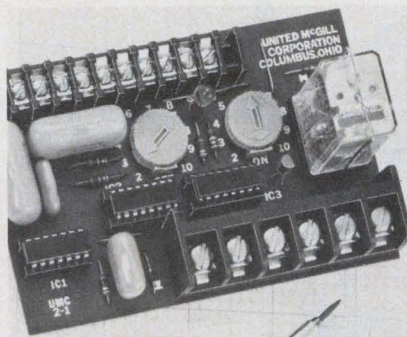

United McGill Corp., P.O. Box 280, 2400 Fairwood Ave., Columbus, Ohio 43216. (614) 443-0192.

The Model UMC-1 Unitimer can be field wired for use either as a time delay relay or as a repeat cycle timer. It can cover time ranges from 0.8 to 40 s or 12 min. to 10 hr. By jumping terminals it is possible to program various timing combinations over a wide range of precisely set on and off intervals (varying from 0.8 s to 10 hr.). Reference dials and a LED are provided for  $\pm 2\%$  time setting and checking. The Unitimer has a 5 A spdt (Form C) output that can handle a 120-V-ac resistive load. The device operates on an input of 12 V dc  $\pm 10\%$ , 70 mA and in temperatures of  $-10$  to  $+60$  C.

CIRCLE NO. 327

### Voltage sensor stability better than 1 mV/°C

Calex, P.O. Box 555, Alamo, Calif. 94507. (415) 932-3911. \$48; 2 to 3 wk.

The Model 725 ac Voltensor is a precision ac voltage monitor, in a  $1.5 \times 1.5 \times 0.7$  in. epoxy potted module. The unit has a single adjustable 0-to-10-V ac pk-pk trip point range and a sensitivity better than 10 mV. Input impedance is greater than 100 k $\Omega$  and trip point stability is better than 1 mV/°C. The dc output is approximately 80% of the power supply voltage at up to 50 mA. A single supply from +12 to +30 V dc with regulation to 5% is required. The unit is also available with the following modifications: reversed output, latching output, or 0 to 100 mV trip point range.

CIRCLE NO. 328

### Hybrid quadrature works from 0.1 to 10 MHz

Merrimac, Inc., 41 Fairfield Pl., West Caldwell, N.J. 07006. (201) 228-3890. \$225; 30 to 45 day.

The Model QH-7-4.9 hybrid quadrature is designed for applications in the 0.1-to-10-MHz frequency range. Its 100:1 bandwidth is particularly attractive for such applications as communications systems, single-sideband modulators, antenna-phasing networks, homing systems, and image reject mixers. The coaxial network has four BNC female connectors. Minimum performance specifications include amplitude balance of  $\pm 0.75$  dB with a pk-pk amplitude balance of 1.5 dB, nominal coupling of  $-3$  dB, maximum insertion loss typically 1 dB, VSWR of 1.3:1 at 50  $\Omega$  impedance, phase quadrature of  $90^\circ \pm 3^\circ$ , minimum isolation of 20 dB, and average power to 100 mW. The unit's dimensions are  $4.25 \times 2.3 \times 1.53$  in.

CIRCLE NO. 329

### Modulated motor control handles 10 to 50 hp

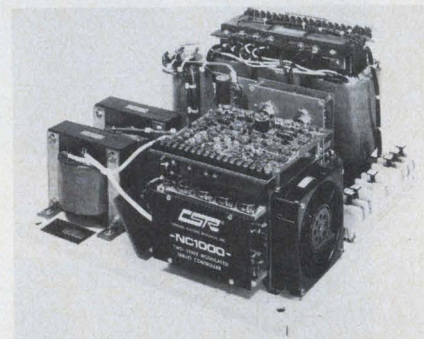

Control Systems Research, 632 Fort Duquesne Blvd., Pittsburgh, Pa. 15222. (412) 566-1200.

The two-state modulated dc servo controller Model NC1000 can control dc motors in the 10 to 50 hp ranges. Both pulse-width and frequency modulation are incorporated in the controllers. The servo controller has a form factor of 1.01 compared with form factors of 1.4 and above for conventional SCR controllers. The low form factor can increase the efficiency of the dc motor by as much as 60%. The bandwidth of 500 Hz represents an increase by a factor of eight over conventional SCR techniques.

CIRCLE NO. 330



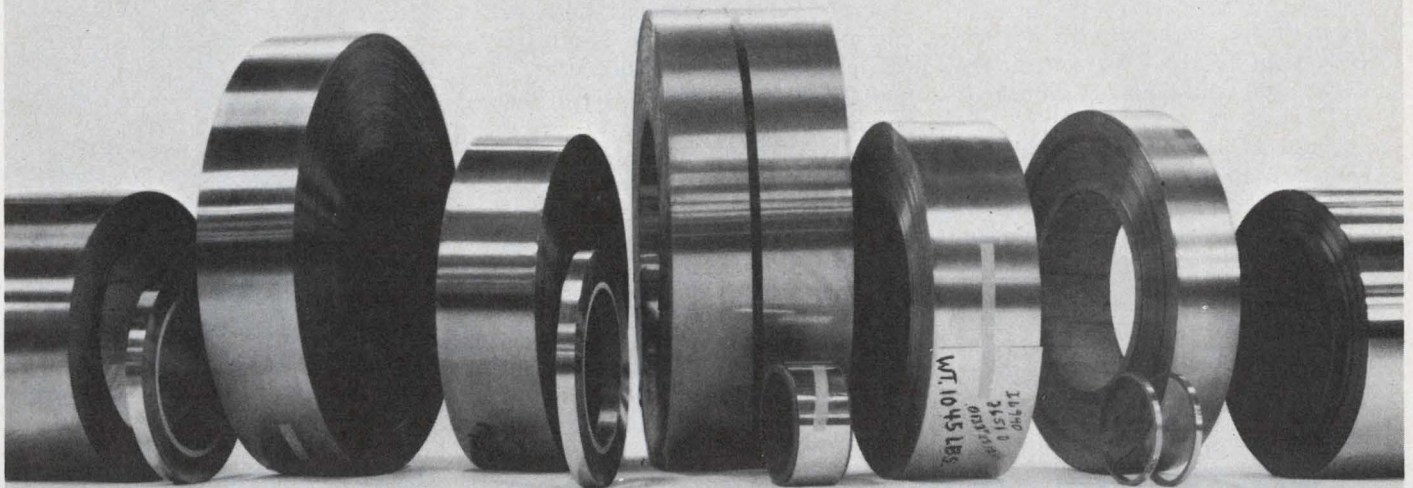

# For quick action on metals too special for the big or little mill, come to the mill that's both.

We take on what the big mills can't handle economically or promptly and the small mills haven't the equipment for.

Our specialties are: magnetic alloys, glass-to-metal sealing alloys, expansion alloys, temperature compensating alloys, shielding alloys and electronic alloys. In strip, foil, cut lengths or rod and wire. From several pounds to several tons.

We're geared to give fast service because we're totally integrated.

We're not slowed down by outside suppliers because we do all our own processing: vacuum and air melting, powder metallurgy production, hot and cold rolling, precision flattening, slitting and annealing.

So when you need specialty alloys, come to the mill whose total in-house capability includes quality control from start to finish. Come to Magnetics. Send for Bulletin MPB-1.



A DIVISION OF SPANG INDUSTRIES INC.

Butler PA 16001.



## MODULES & SUBASSEMBLIES

### D/a converter has gain drift of only 10 ppm/°C

Burr-Brown, International Airport Industrial Park, Tucson, Ariz. 85734. (602) 294-1431. \$169 (10 to 24); stock to 2 wk.

The DAC85LD hybrid 12-bit d/a converter has laser trimmed linearity to  $\pm 1/2$  LSB. It also has an internal reference and output

amplifier. The gain drift is guaranteed at  $\pm 10$  ppm/°C and the offset drift is  $\pm 5$  ppm/°C. The DAC-85LD is available in a voltage or current output version. Both are hermetically sealed in a 24-pin DIP case and offer nonlinearities of  $\pm 0.012\%$  over an extended temperature range of  $-25$  to  $+85$  C. The voltage output model settles to  $\pm 0.01\%$  in  $5 \mu\text{s}$ , and current output model in 300 ns.

CIRCLE NO. 331

### Mini charge amplifier requires only 0.5 in.<sup>3</sup>

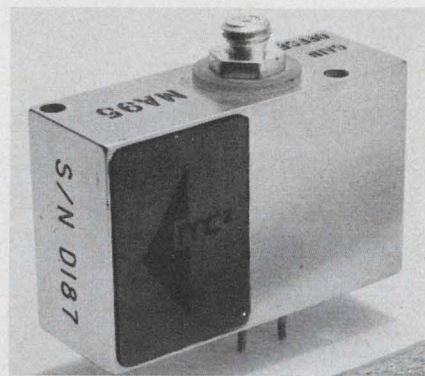

Microcom, 1115 Mearns Rd., Warminster, Pa. 18974. (215) 672-6300.

A thick-film, hybrid, high-g charge amplifier, Model MA-95, is designed to interface between piezoelectric transducers and other components in airborne telemetry systems and it takes up only 0.5 in.<sup>3</sup> of space. The amplifier is able to respond to changes in charge at the input instead of changes in voltage, and thus produce a high level output. The MA-95 offers optional features including gain and dc offset adjusts and a low-pass filter. The amplifier is encapsulated to withstand high shock levels such as those encountered in gun launch applications.

CIRCLE NO. 332

## Test your logic before you test your logic circuit. Logical.

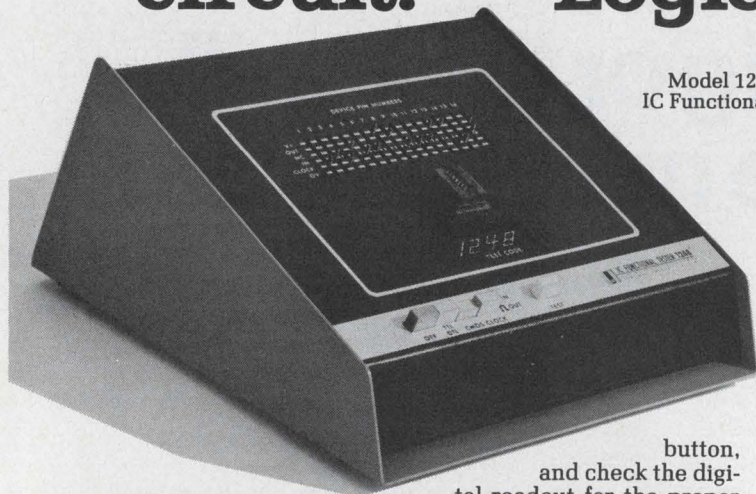

Model 1248  
IC Functional Tester

Doesn't it make great good sense to eliminate your malfunctioning digital ICs—TTL, DTL and CMOS—before you wire them in a circuit?

The Model 1248 does precisely that, evaluating each device in from 1 to 5 seconds, for only \$535. And every time you eliminate a disabled IC with your Model 1248, you save yourself from 30 to 60 minutes of expensive logic circuit troubleshooting trying to find the little bugger.

Simply insert the IC in the tester socket, push the

button, and check the digital readout for the proper test code. No comparison with a "good" IC is necessary, and changeover from one device type to another takes less than a minute.

Write for our free full-color brochure on this entirely logical logic tester.

Electro Scientific Industries  
13900 N. W. Science Park Drive  
Portland, Oregon 97229  
Phone: (503) 646-4141



### Dc-to-synchro converter current limits to 1 A

Singer Kearfott, 1150 McBride Ave., Little Falls, N.J. 07424. (201) 256-4000.

The C70 4798 402 converter accepts dc signal inputs proportional to the sine and cosine of an angle and provides a three-wire, 400 Hz, 11.8-V synchro stator output. The output (protected against overload or short circuit) can drive multiple loads of torque repeaters or control transformers. The current limiting range of 1 A (nominal) can be extended to 3 A by use of four jumper wires at the connector. The converter has a static accuracy of 0.2 degree and will track input variations of  $720^\circ/\text{s}$  within  $3^\circ$ . This unit is packaged as a two-channel unit on a printed circuit card and has dimension of  $9.8 \times 7.25 \times 1.12$  in. maximum. It is also available as a single channel unit on special order.

CIRCLE NO. 333



## Data-acquisition system provides 32 channels

Data Translation, 109 Concord St., Framingham, Mass. 01701. (617) 879-3595. \$795.

The 32-channel data-acquisition system, Model DT1640/16EX, features a 25 kHz throughput rate, full 12-bit resolution, 0.5-LSB linearity and a system accuracy of 0.03% of full scale range. Two identically sized modules,  $3 \times 4.6 \times 0.375$  in., make up of the full 32 channels. A feature of the DT1640/16EX is its immunity to noise when used in close proximity to the minicomputer core memory. Encasement of the modules in steel packaging prevents EMI/RFI noise from causing interference in sensitive analog circuits.

CIRCLE NO. 334

## Synchro-to-dc converters accurate to within 0.1%



Astrosystems, 6 Nevada Dr., Lake Success, N.Y. 11040. (516) 328-1600. Stock.

The M2000S series of synchro-to-dc converters can convert selsyn, resolver or synchro signals to proportional dc for input to computers, data loggers and analog or digital displays. The converters are accurate to 0.1%, are packaged in  $2.5 \times 2.5 \times 0.8$  in. modules and provide a choice of outputs: 0 to 10 V dc for 0 to 360°, or -5 to +5 V dc for -180 to +180°. The converters may be used with an internal or external reference; they are short-circuit proof and have full transformer isolation at the inputs. Standard models include units that are compatible with 60 Hz synchro and selsyn inputs; 400 Hz synchro or resolver inputs.

CIRCLE NO. 335

# Volts My Line?

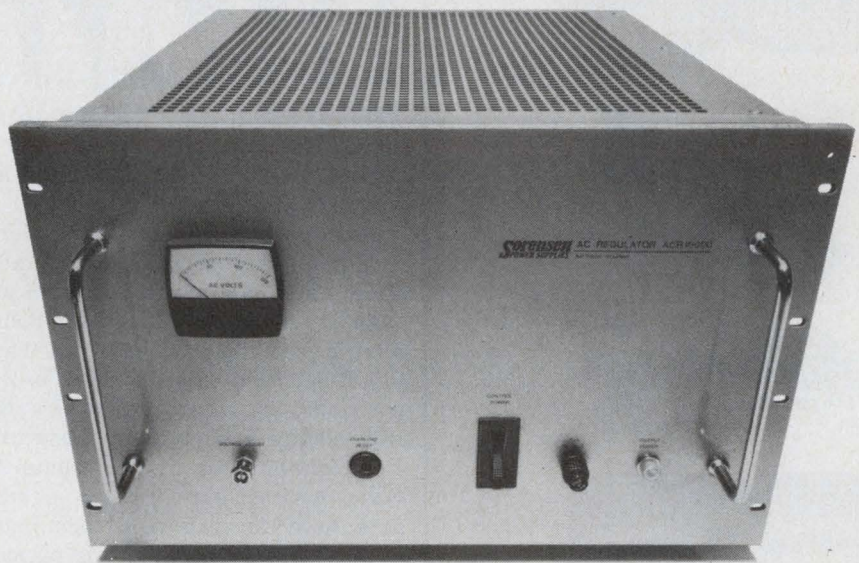

Holding that line-voltage. AC voltage regulation is efficient with the Sorensen ACR Series all solid-state regulators. Problems and damage caused by erratic line voltage are eliminated . . . performance is maximized with ACR features that include MTBF > 25,000 hours . . . remote sensing and remote programming capabilities . . . electronic current limiting . . . adjustable output voltage . . . power outputs to 15kVA—depending on model. Eight models in series. Three-phase systems available. For complete data, contact the Marketing Manager at Sorensen Company, a Unit of Raytheon Company, Manchester, N.H. (603) 668-4500.

### Representative Specifications — ACR

- Input Voltage: 95 to 130 Vac
- Total Regulation: 0.4% to 0.6%
- Efficiency: to 95%
- Price Range: \$395 to \$1825

## Sorensen POWER SUPPLIES

INFORMATION RETRIEVAL NUMBER 111



# Switches-

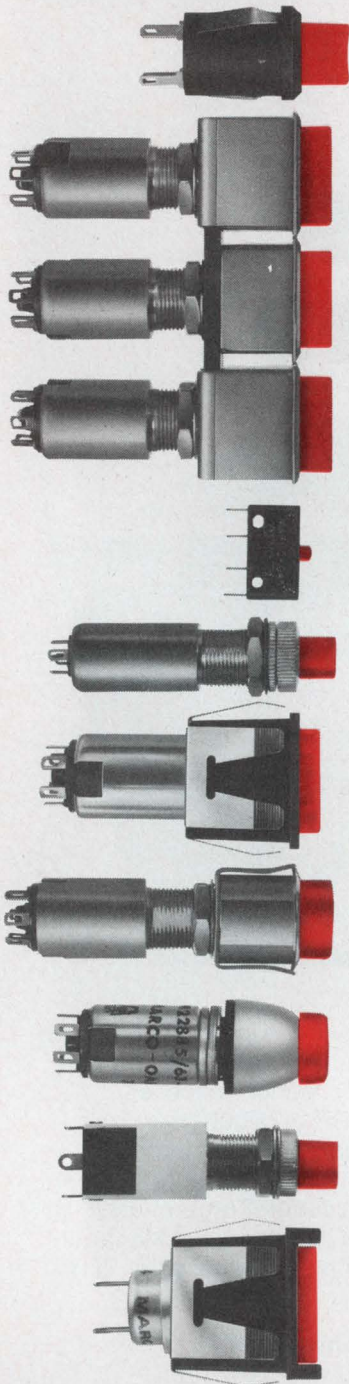

**We've got them all**

Lighten your decisions  
contact...

## ILLUMINATED PRODUCTS INC.

(formerly MARCO-OAK)  
A Subsidiary of OAK Industries Inc.

207 S. Helena St., P.O. Box 4011  
Anaheim, CA 92803  
Tel: (714) 535-6037 TWX 910-591-1185

INFORMATION RETRIEVAL NUMBER 112

## COMPONENTS

### PC barrier terminals mount at right angles

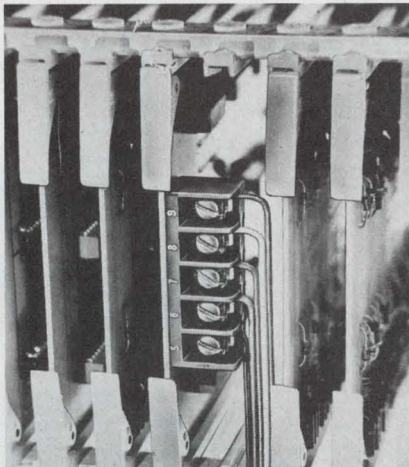

Reed Devices Inc., 21W183 Hill Ave., Glen Ellyn, Ill. 60137. (312) 858-2050. \$1.17: 10 position (100 up); stock to 4 wks.

A right-angle-mounting, barrier, terminal strip for PC boards affords all the structural strength of regular mounting types without auxiliary support brackets. The 6PCR series, available in two to 24 positions, features 6-32 screws with wire-clamps and specially designed PC terminals on 3/8-in. centers. Labor-saving wire clamps eliminate need for crimp-on terminals as the stripped bare wire is placed under the raised clamp and the screw tightened for a full pressure connection. The strips are shipped with the screws raised.

CIRCLE NO. 336

### Bracket converts snap switch to PB assembly

Cherry Electrical Products Corp., 3600 Sunset Ave., Waukegan, Ill. 60085. (312) 689-7600. \$0.26 (2000 up).

A new bracket and plunger assembly makes it an easy matter to add a pushbutton to many Cherry snap-action switches. The new unit features a one-piece molded bracket and ferrule, and a choice of gray or red button. The bracket can be supplied as an addition to the regular Cherry Series E33 and E61 switches, as well as the three-wide E61 subminiature modules. The bracket is indicated by adding a "J" to the regular Cherry switch number.

CIRCLE NO. 337

### Rocker switches are UL recognized

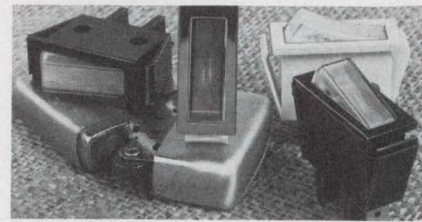

Oak Industries, Inc., Crystal Lake, Ill. 60014. (815) 459-5000. 8 to 10 wks.

A family of UL-recognized rocker switches for the appliance and industrial/commercial market, designated OAK Series 17 rocker switches, are illuminated SPST snap-action switches. All switches have metric dimensions. The switch has a maximum rating of 16 A, 120 V and 8 A, 240 V ac inductive, and it can function in ambient temperatures to 90 C. The body is available in black or white, and the lens in amber, red or clear with other colors on special order. It is available with or without chromium trim.

CIRCLE NO. 338

### Miniature motor moves without cogging

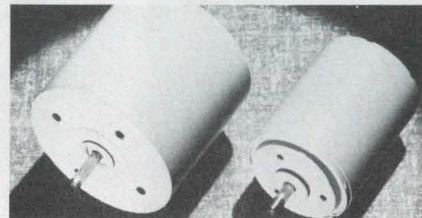

North American Philips Controls Corp., Cheshire Industrial Park, Cheshire, Conn. 06410. (203) 272-0301.

Two miniature, ironless-rotor, reversible, dc motors are ideally suited for reel and capstan drives in digital-cassette recorders, X-Y drives and chart-and-pen drives in chart recorders. They can also be used in magnetic-tape drives and special drives in sophisticated cameras. A 24-V-dc, 3.85-W and a 12-V-dc, 3.7-W model are available. Both offer low cogging, rapid acceleration and low noise levels. Use of the ironless rotor and an oblique-winding design provides a low rotor inertia, high starting torque and a low mechanical time constant. Both motors can achieve efficiencies of over 70%.

CIRCLE NO. 339



# Rotron? In commercial blowers?

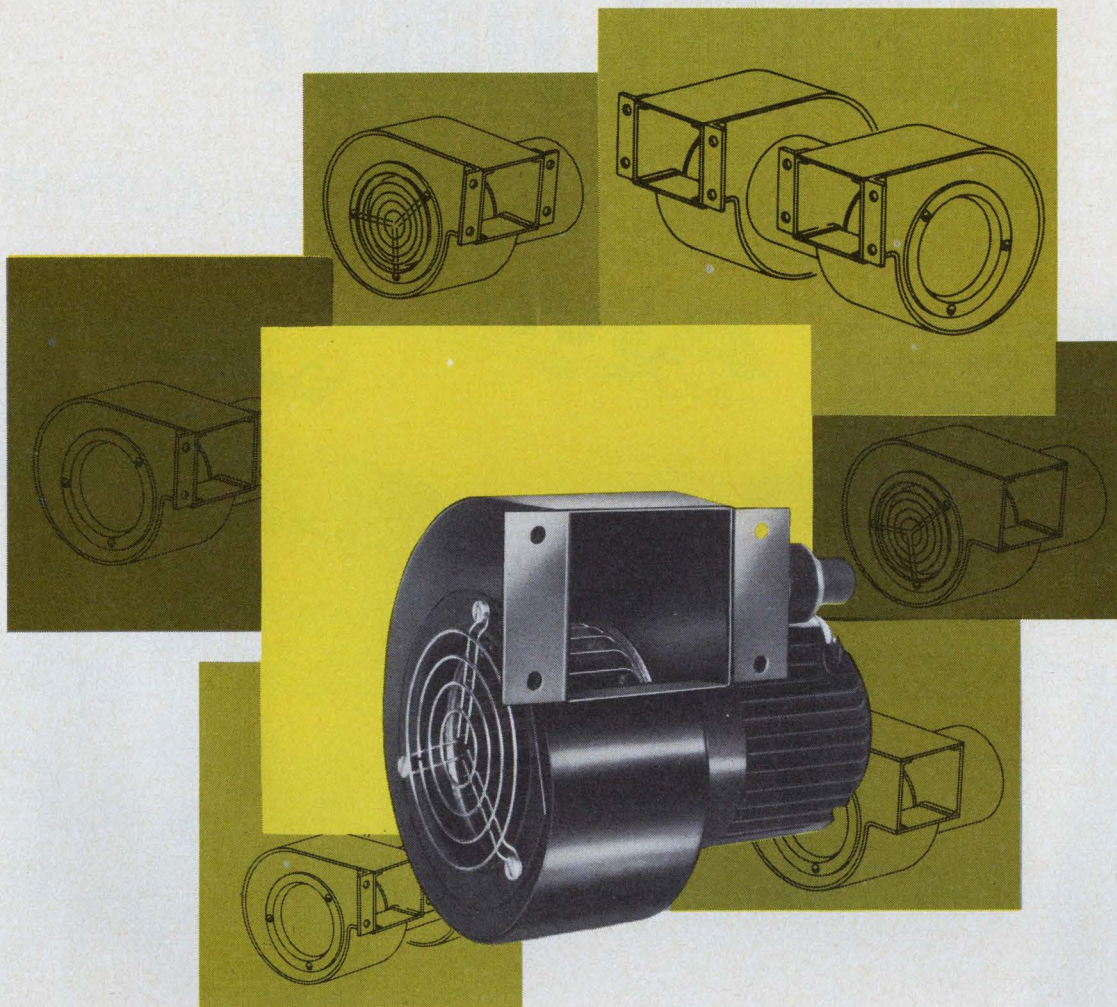

Ask Eastman Kodak. Or Ampex. Or IBM. Or Control Data. Or Digital Equipment. Or Honeywell. Or Univac. Or Mohawk Data Sciences.

These are a few of the dozens of companies that are major customers for Rotron's Vanguard™—the new commercial centrifugal blower that provides a balanced combination of quality and economy. In simplex and duplex models, flows to over 600 cfm, pressures to 2" H<sub>2</sub>O. And that can be quickly and easily customized to meet highly specific customer needs.

Many of these same companies, of course, have long known Rotron for its leadership in fan products. For the completeness of its application engineering and distributor services. And for the fact that these Rotron "extras" cost no more. Now they, and you, know this. Rotron® is fast becoming a name in blowers, too.



**ROTRON INC.**

Woodstock, N. Y. 12498 ☐ 914 • 679-2401 ☐ TWX 510-247-9033  
Pacific Div., Burbank, Cal. 91506, 213 • 849-7871 • Rotron B.V., Breda, Netherlands, Tel.: 79311, Telex: 844-54074

16340

INFORMATION RETRIEVAL NUMBER 113



# LOOKING FOR CONNECTORS?



VIKING INDUSTRIES, INC.  
STANDARD PRODUCTS DIVISION

BUNKER RAMO

AMPHENOL



Electrical Components Division

**AMP**  
INCORPORATED

**SWITCHCRAFT**

Sec 3100: Connector Products & Terminal Boards



ROBINSON NUGENT inc



Jermyn

Scotchflex®

CAMBION®

DALE®



POMONA ELECTRONICS

**AUGAT®**

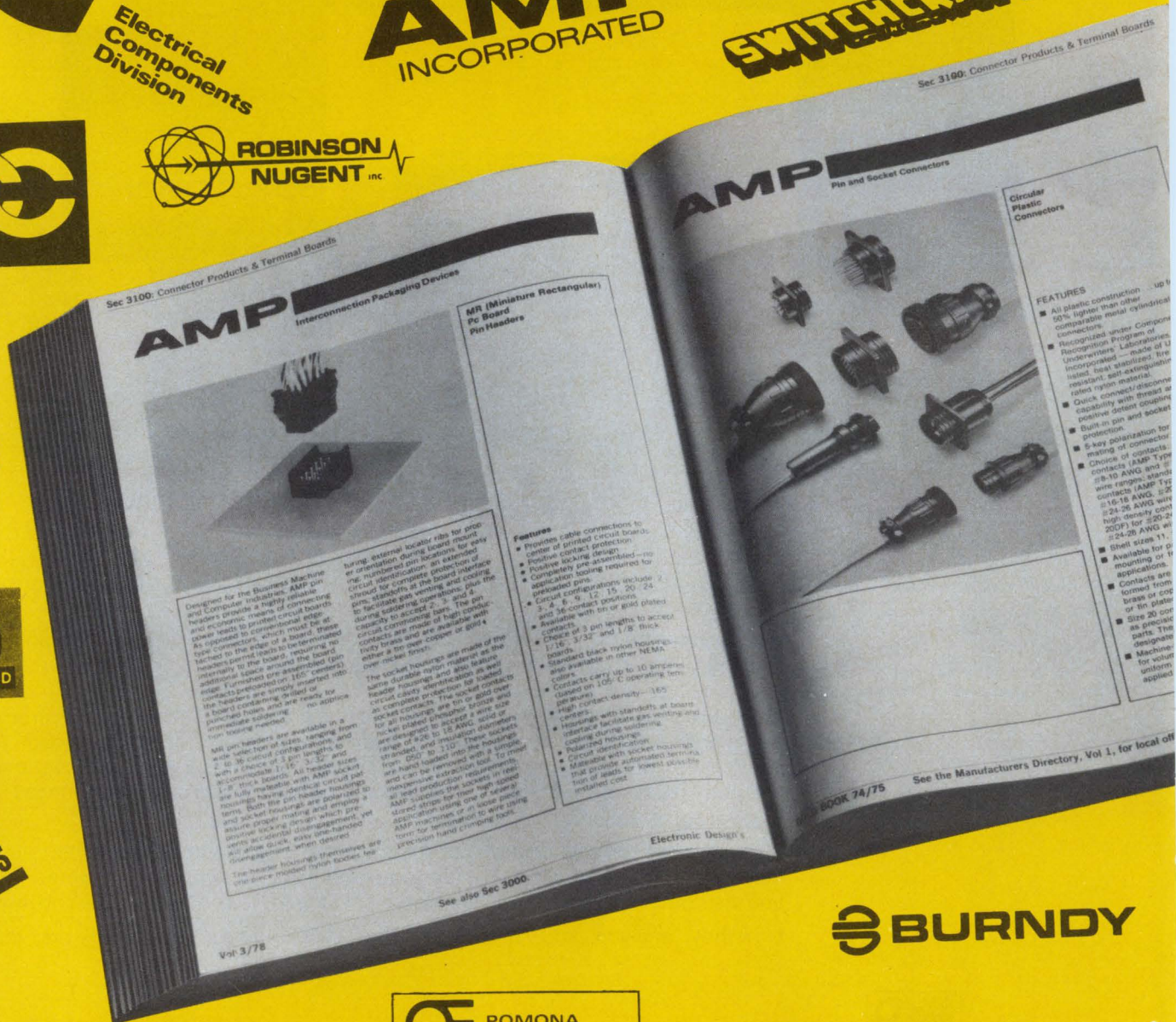

BOOK 74/75

See the Manufacturers Directory, Vol 1, for local office

Electronic Design

Vol 3/78

See also Sec 3000.



# LOOK FIRST IN Electronic Design's GOLD BOOK

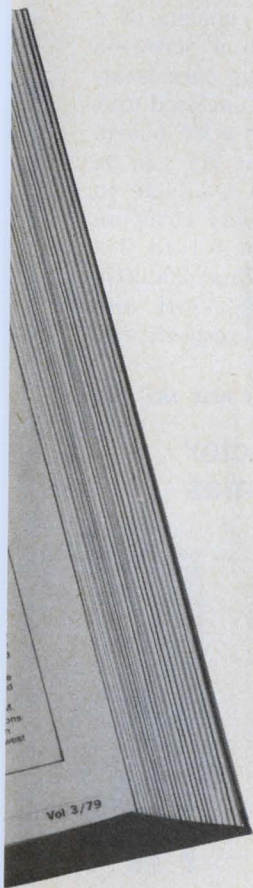

**IT'S ALL THERE** For example for CONNECTOR PRODUCTS you'll find source information listed for the following categories in the PRODUCT DIRECTORY (each listing gives *complete* manufacturer's name, street address, city, state, zip and phone for convenience in contacting suppliers):

CONNECTOR ADAPTERS • CONNECTOR BOXES AND STRIPS • CONNECTOR CAPS • ANTENNA CONNECTORS • AUDIO CONNECTORS • BATTERY CONNECTORS • CIRCULAR CONNECTORS • COAXIAL CABLE CONNECTORS • CORD CONNECTORS • FILTERED CONNECTORS • HIGH VOLTAGE CONNECTORS • INTERLOCK CONNECTORS • PRINTED CIRCUIT CONNECTORS • QUICK DISCONNECT & PUSH-ON CONNECTORS • RACK & PANEL CONNECTORS • RF CONNECTORS • SOLDERLESS CONNECTORS • STRIPLINE CONNECTORS • UMBILICAL CONNECTORS

## YOU'LL FIND 216 CATALOG PAGES ON WIRE & CABLE AND CONNECTOR PRODUCTS

Volume 3 of *Electronic Design's* GOLD BOOK leads off with catalog pages on wire and cable and is followed immediately by connector products and terminal boards. Forty-three manufacturers are represented in these two sections. Amphenol has 24 pages packed with detailed specifications; AMP Incorporated emphasizes its flexible flat cable products, miniature and pin socket connectors; Augat has 10 pages; Robinson Nugent, Inc. offers 8 pages, and so on. Check these pages first before you contact a supplier. You may find the exact item you need—and that goes for each one of the 52 product categories in *Electronic Design's* GOLD BOOK. There are 2,820 catalog pages in all right at your fingertips for immediate reference. And TWICE the number of directory pages available from any other industry source.

**WHEN YOU'RE LOOKING FOR MANUFACTURERS,  
DISTRIBUTORS, OR PRODUCT INFORMATION...  
ELECTRONIC DESIGN'S GOLD BOOK  
IS THE PLACE TO LOOK**



# SURPRISE!

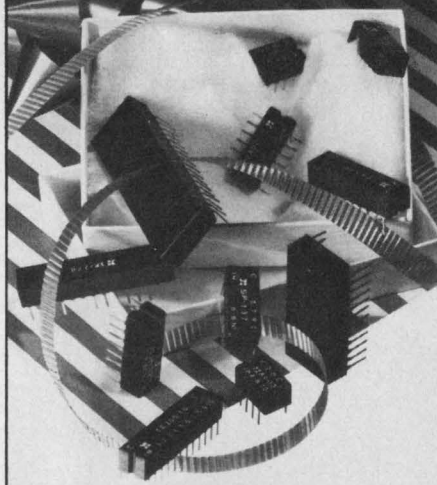

## dip

### DELAY LINES

Stop looking for DIP packaged electromagnetic delay lines . . . you've found 'em! Mini dip's, standard dip's, low profile dip's and double dip's . . . all with unmatched performance.

Leads	Length	Width	Height
8*	.510	.300	.225
14*	.750	.300	.225
16*	.850	.300	.225
20*	1.050	.300	.225
24*	1.250	.300	.225
28*	1.450	.300	.225
14*	.750	.300	.175
16*	.850	.300	.175
24	1.300	.600	.235
34	1.975	.600	.235

\*Also available in flat pack configurations.

#### SPECIFICATION HIGHLIGHTS

- Tap capabilities from 500 ps to 25 ns
- Delays from 5 ns to 1000 ns
- Rise time ratios from 5:1 to 30:1
- Std. impedances of 50, 75, 100 ohms
- Frequency capabilities to 300 MHz
- Temp. -55 to +125°C (TC 70 PPM/°C)
- Manufactured to MIL-D-23859; environmental to MIL-STD-202

Phone, wire or write for more information today!



**RHOMBUS  
INDUSTRIES INC.**

22119 S. Vermont Ave., Torrance, Ca. 90502  
(213) 325-7440 • TWX 910-349-7512

#### COMPONENTS

### Latching relay handles 10 A with 4PDT contacts

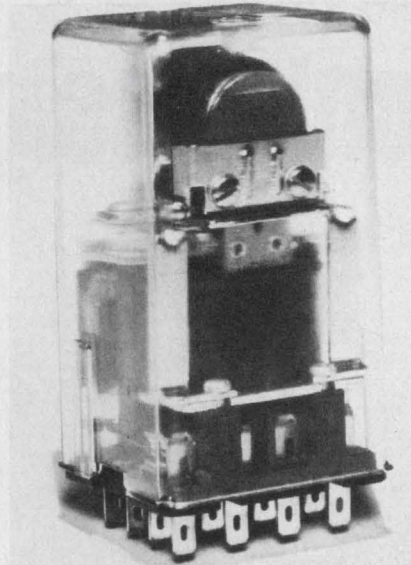

Struthers-Dunn Inc., Lambs Rd., Pitman, N.J. 08071. (609) 589-7500.

Mechanical latching and electrical reset are featured in Model 455 relays for 10-A service. The relay has 4PDT load-handling contacts capable of controlling 1/3-hp motor loads or 10-A resistive loads at 120 V ac. After the operate coil is energized, the contacts remain transferred, even if power fails, until reset. For test or maintenance, optional manual actuators are available for both operate and reset. Voltages for the reset and operate coils are 6 to 240 V ac or 6 to 125 V dc. Contacts have a minimum life expectancy of 300,000 operations at rated loads.

CIRCLE NO. 340

### DIP dry-reed relay handles power voltages

Magnecraft Electric Co., 5575 N. Lynch Ave., Chicago, Ill. 60630. (312) 282-5500.

Magnecraft's new eight or 14-pin Class 171VDIP dry-reed DIP relay can switch 120 V rms or 200 V dc. This allows both triac triggering and compatibility with DTL and TTL combined with total isolation of the integrated circuit. The relay is available in 1-Form A contact arrangement with coil voltages of 5, 6, 12, or 24 V dc. All versions provide for a choice of internal clamping diodes.

CIRCLE NO. 341

### Miniature cores provide Qs to 200 at 200 kHz

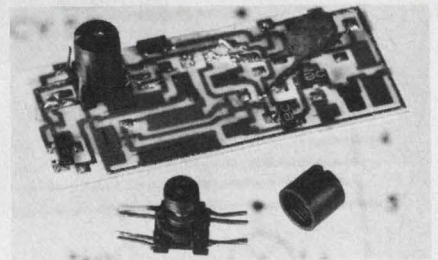

Siemens Corp., 186 Wood Ave. S., Iselin, N.J. 08830. (201) 494-1000. \$0.90 (1000 up).

Conventional discrete inductors are often required for miniature electronic circuits. Siemens' new adjustable miniature core can be used for resonant circuits, chokes and transformers. It consists of a yarn roller core with a screw-on cup core. When the cup core is attached, the completely enclosed unit can be dip soldered on a PC board. Values of Q as high as 200 can be achieved. The core is available in three different materials covering frequency range from 0.1 to 200 MHz. A Q factor of 175 at 200 kHz and 50 MHz with 0.23-mH and 0.15- $\mu$ H inductances, respectively, is typical.

CIRCLE NO. 342

### Ultraviolet detector responds to flames

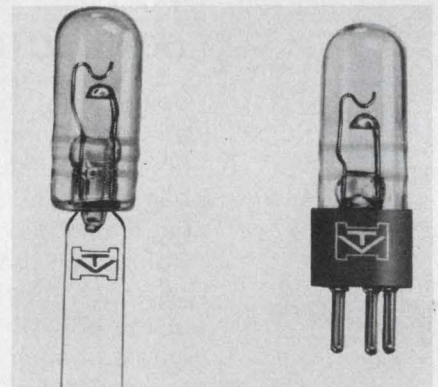

Hamamatsu Corp., 120 Wood Ave., Middlesex, N.J. 08846. (201) 469-6640.

The R334 is a head-on detector that responds only to ultraviolet radiation between 1600 and 2900 Å with maximum sensitivity at 2100 Å. It is ideal for detecting flames in a fire alarm or in a fail-safe, flame-control monitor. The detector can recognize if the pilot flame is out or if the fuel supply is incorrect.

CIRCLE NO. 343



FOR NEW STANDARDS IN SIGNAL GENERATORS, THINK HP



**“A good general purpose signal generator should handle most of your bench needs and be cheap enough to fit every budget. That’s why we designed the HP 8654A.”**

Frequency range: 10-520 MHz  
Calibrated  
output level: +10 to -130 dBm, leveled  
Modulation: AM & FM,  
internal & external  
Stability: 20 ppm/5min  
Price: \$1700. Domestic USA price only.

But you'll want to evaluate the 8654A for yourself. A call to your local HP field engineer will put one in your hands. Or for more information just write.

**HEWLETT  PACKARD**

Sales and service from 172 offices in 65 countries.  
1501 Page Mill Road, Palo Alto, California 94304

04406A

INFORMATION RETRIEVAL NUMBER 115



### Mercury relay sells for less than \$5

Durakool, Inc., 1010 N. Main St., Elkhart, Ind. 46514. (219) 264-1116. See text.

Durakool's 10-A model of its new series of small mercury-to-mercury displacement relays costs less than \$5, and the 15 and 20-A

models cost only slightly more. The new relays offer a range of coil voltages from 24 to 600 V ac or dc. The units are ultra compact. They measure only 1.5 × 1.75 × 2.0 in. The stainless-steel body minimizes overload damage because it permits use of hydrogen under high pressure to reduce arcing. And fully enclosed contacts and hermetic seals ensure against explosions and fires.

CIRCLE NO. 344

### Variable air capacitor mounts on PC board

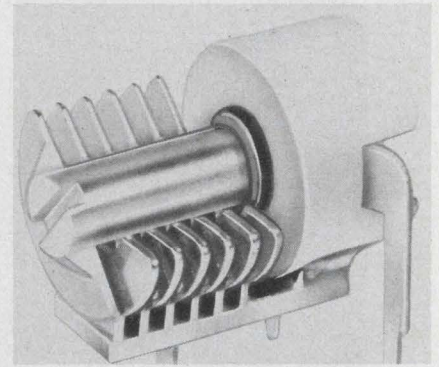

E.F. Johnson Co., Waseca, Minn. 56093. (607) 835-2050.

A subminiature Type T variable air capacitor has a horizontal PC mount that gives the tuning capacitor more stability and strength. The rotors and stators are precision machined from solid-brass extrusions for stability and uniformity. The capacitor is low in cost (not given) and about one-third the volume of a U capacitor. Metal parts are silver plated and iridited for easy soldering. Ceramic is 95% alumina, Grade L-624 or better. Temperature coefficient is +30 ± 15 ppm/°C. High torque holds rotor securely under vibration. Peak voltage is 250 V.

CIRCLE NO. 345

No need to look further for a reliable R-F power source. MCL has one.

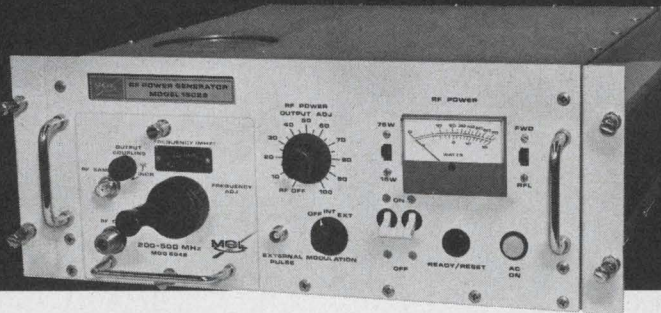

And here's what we built into it:

- solid state circuitry
- short and open circuit protection
- frequency stability ±0.1 db
- external pulse or AM modulation
- internal square wave modulation
- low tube cost/operating hour
- qualified to MIL-STD-461 and 810

It has six different plug-in heads

Model	Freq. (MHz)	Pwr. (MIN)
6047	10-50	65
6048	50-200	65
6049	200-500	65
6050	500-1000	65
6051	1000-2000	40
6052	2000-2500	25

You have now ended your search for a stable, reliable 65 watt oscillator. Just call or write for detailed engineering data. Or ask for a demonstration

MCL, INC.,  
10 North Beach Avenue,  
LaGrange, Illinois, 60525.  
(312) 354-4350



Now on GSA contract GSOOS-27086 See us in EEM—Vol. 1 pp. 284-291

### PB-switch kit allows custom design assembly

Ledex Inc., 123 Webster St., Dayton, Ohio 45401. (513) 224-9891. \$25; stock.

To shorten prototype time, a new pushbutton-switch designer's kit containing 135 parts is offered by Ledex. The user can custom design up to a six-station Series 1400 switch assembly with interrelated switching logic. The designer can build momentary and push-push switches with interlock, reciprocal release, master release or any combination of these functions. The kit includes step-by-step assembly instructions and identification drawings for ten different release functions. Also included are assortments of pushbutton caps, lens, mounting rails, blocks, release rods and six switch modules. The kit can be replenished. An enclosed order form gives a complete description, part number and price for each component in the kit.

CIRCLE NO. 346



## Tall and narrow oven conserves floor space

The Grieve Corp., 510 Hart Rd., Round Lake, Ill. 60073. (312) 546-8225.

The high and narrow type P-402 electric oven can handle long pieces and conserves floor space. The unit's inside dimensions are only 30 x 38 in., but it is 108-in. high. Channels for up to eight shelves are spaced on 13-1/2-in. centers, which permits curing several shelves of smaller parts in addition to long pieces. A maximum temperature of 650 F is achieved from a 30-kW heat input that is circulated upward at 2450 cfm. Controls include an indicating proportioning temperature controller, a manually resettable excess temperature controller, and a 12-h timer for automatically shutting off the oven after a specified period of operation.

CIRCLE NO. 347

## Diamond saw dices clean edged alumina chips

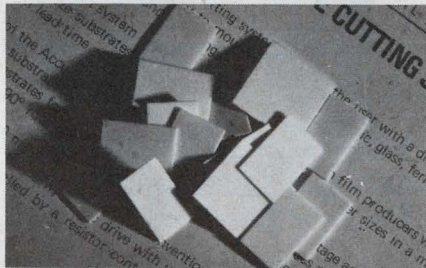

Aremco Products, Inc., P.O. Box 429, Ossining, N.Y. 10562. (914) 762-0685. See text.

A diamond dicing-saw system cuts alumina substrates for use in thick and thin-film circuits and provides an improved edge quality, according to the manufacturer. Because of delays in obtaining alumina substrates to exact size and tolerance, hybrid-circuit makers have been shifting to dicing their own substrates. Thus, the user can stock 2 x 2 or 1 x 1-in. substrates and dice them to size. But laser dicing machines cost about \$40,000 and ordinary diamond mechanical scribing, though inexpensive, produces poor edges. However, Aremco's Accu-Cut 5000 diamond dicing saw system costs less than \$5000.

CIRCLE NO. 348

# GET ON BOARD...

## with TANTALEX<sup>®</sup> Low-Cost Solid Tantalum Capacitors

Sprague Gives You a Choice . . . . . for Flexibility in Your Printed Board Designs.



### DIPPED... SPRAGUE TYPE 196D

Small size economical capacitors that utilize high-quality tantalum pellet construction. Conformal epoxy resin coating is highly resistant to moisture and mechanical damage. This capacitor has found wide usage in consumer and commercial electronic equipment. Operating temperature range, -55 C to +85 C. Available in all popular 10% decade values from 0.1  $\mu$ F to 330  $\mu$ F. Voltage range, 4 to 50 VDC. Standard lead spacing, 0.125" and 0.250". For complete data, write for Engineering Bulletin 3545B.



### MOLDED... SPRAGUE TYPE 198D

Economically priced, molded-case Econoline<sup>™</sup> capacitors. Standard lead spacing, 0.100", 0.200", and 0.250". Tough, flame-retardant, crack resistant case has flatted section and polarity indicator for easy-to-read marking and error-free insertion. Fixed external dimensions allow increased productivity during assembly of PC boards. Designed for severe vibration and shock environment, where lead support alone is not adequate. Operating temperature range, -55 C to +85 C. Capacitance values from 0.1 to 100  $\mu$ F. Voltage range, 4 to 50 VDC. For complete data, write for Engineering Bulletin 3546.

Call your nearest Sprague district office or sales representative, or write for the bulletins mentioned above to Sprague Electric Company, 347 Marshall Street, North Adams, Mass. 01247.

THE BROAD-LINE PRODUCER OF ELECTRONIC PARTS



INFORMATION RETRIEVAL NUMBER 117



## SELF-ILLUMINATING !! KEYBOARD SWITCHES

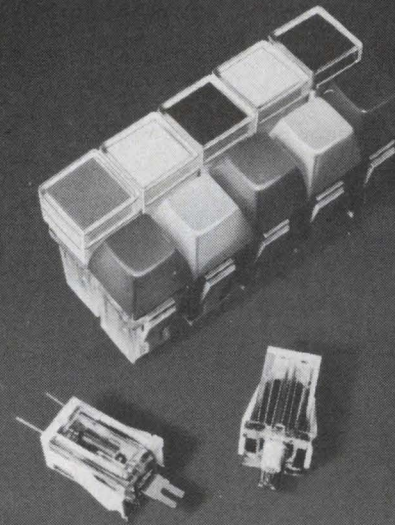

Contributing an extra feature to the automated systems such as computer peripheral equipment, measuring instruments, vending machines, control appliances, etc.

Built-in are a reed switch and a bi-pin lamp. Switching is perfect and the lamp shows automatically whether the circuit is active. Installation can be completed at once by a single push-in action.

### PARTICULARS

Operating force: 70g, full stroke

Stroke: 4mm, full

Colors: Snow white, bright green, yellow, true blue, and fire red

Rated voltage: 5, 12, and 28V

Average service life: 50,000 hrs. or better

•Quality. Our reputation's built on it.

# SMK

**SMK ELECTRONICS  
CORPORATION OF AMERICA**

743W. Gardena Blvd., Gardena,  
Calif, 90247 Phone: (213) 770-8915  
Telex No.: 230691144

Cable Address: SHOWACO GDNA

**SHOWA MUSEN KOGYO CO., LTD.**

No. 5-5, 6-Chome Togoshi Shinagawa-ku,  
Tokyo 142, Japan Phone: 785-1111  
Telex: 2466301 SMK TOK J  
Cable: SHOWA MUSEN TOK

## PACKAGING & MATERIALS

### Lab ware is inert to molten metals, halides



*Union Carbide Corp., 270 Park Ave., New York, N.Y. 10017. (212) 551-5114.*

Semiconductor materials are temperamental when it comes to impurities. They must be processed under extremely sterile conditions. High-purity lab ware is an absolute necessity. Laboratory crucibles, evaporating dishes, tubes and metallizing boats are among the standard items available. Custom shapes can be fabricated to user specifications. They are made from Boralloy pyrolytic boron nitride, which is inert to most molten metals and halide salts. The material has the high thermal-shock resistance needed for repeated cycling to temperatures as high as 2000 C. Vessels made from it can't contaminate critical material that is processed in them, according to Union Carbide.

CIRCLE NO. 349

### Spreader pad converts TO-5 relay to DIP

*Teledyne Relays, 3155 W. El Segundo Blvd., Hawthorne, Calif. 92050. (213) 973-4545.*

Spreader pads for TO-5-cased relays provide a standard DIP pin-out of 0.3-by-0.1-in. spacing. TO-5 relays can be inserted and soldered to standard-grid PC boards or plugged into 14 or 16-pin DIP sockets. Teledyne relay users can order relays with the spreader pads mounted.

CIRCLE NO. 350

### Thick-film kit provides trial quantities

*Cermet Div. of Bala Electronics Corp., 14 Fayette St., Conshohocken, Pa. 19428. (215) 828-4650. \$195; stock.*

Trial-quantity evaluation kits of thick-film pastes for screen-printable electro-optics contain four conductor materials and two dielectric materials. The materials are high and low-temperature-firing nickel conductors, copper and silver conductors, an opaque dielectric and a clear dielectric. These pastes are designed for applications that include the production of LEDs, liquid crystals and plasma displays, channel-multiplexers, fiber optics and ultraviolet transmitting faceplates. The pastes fire in a nitrogen atmosphere and thus eliminate the possibility of explosion associated with hydrogen processing. Each jar contains 1 oz of thick-film material.

CIRCLE NO. 351

### Conductive elastomer provides EMI seals

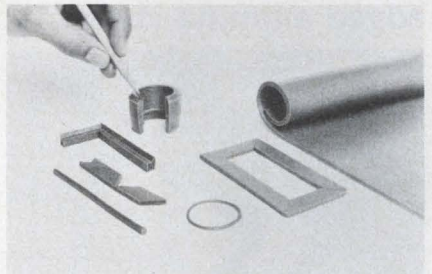

*Technical Wire Products Inc., 129 Dermody St., Cranford, N.J. 07016. (201) 272-5500. \$15 to \$30 per sheet (15 up).*

Conmax, an electrically conductive elastomer, is particularly suited for EMI shielding and environmental sealing applications. It is a high-performance, low-compression-set silicone elastomer (ZZ-R-765, Class III), which contains a uniform dispersion of randomly oriented nickel fibers to impart electrical conductivity. The material is compatible with most metals and alloys. Standard and custom sheets from 0.020 to 0.125-in. thick and die-cut or stamped gaskets in strips or molded form are available. The material has an operating-temperature range of -65 to 450 F. Standard sheets are 12 x 12 x .020 to 0.060-in. thick.

CIRCLE NO. 352



# CDI CREATES THE BETTER LINEAR SWITCH

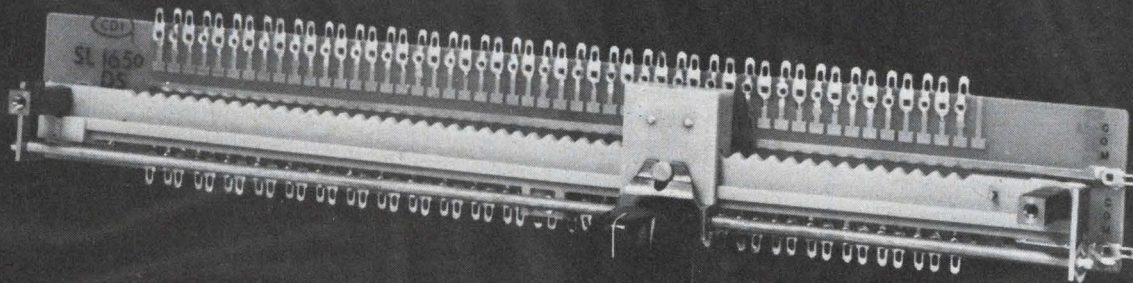

CHOOSE ANY NUMBER OF POSITIONS UP TO 100 (UNIQUE)

Series SL Linear Slide Switch (Patented)

### APPLICATIONS: CONTROL FUNCTIONS REQUIRING RAPID POSITION SELECTING

- CATV channel selecting
- High & Low limit switches
- Process equipment controls
- Computers & peripherals
- NC applications
- Many others

### OTHER REMARKABLE FEATURES:

Mounts EITHER left/right OR up/down (versatile) • Single or multiple position selectors • Solder lugs or dip solder termination for p.c. use • 1 or 2 Poles, or coded outputs available.

### ELECTRICAL CHARACTERISTICS:

200 megohms min. insulation • 1000 volts min. dielectric strength • 2 amps @ 115 VAC current carrying capability • 125 ma @ 115 VAC current breaking capability.

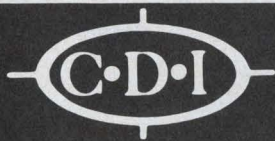

## CHICAGO DYNAMIC INDUSTRIES, INC.

PRECISION PRODUCTS DIVISION

1725 Diversey Blvd., Chicago, Illinois 60614, Phone (312) 935-4600 TELEX 25-4689

INFORMATION RETRIEVAL NUMBER 119

## ATLAS positively guarantees...

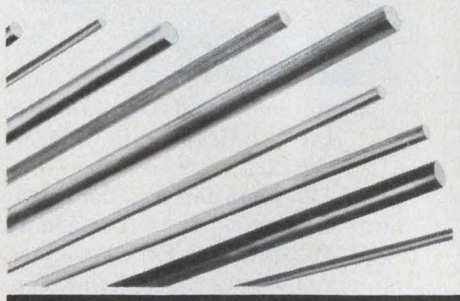

fastest  
delivery  
↓  
unsurpassed  
accuracy  
↓  
lowest  
prices

on Turned and Precision-Ground

## PHENOLIC RODS

EPOXY

BAKELITE

Glass Supported TEFLON

- Stock sizes in any diameter from 3/32" to 1/2"
- Increments of .001 at no extra charge
- Most sizes available for immediate delivery
- Accuracy guaranteed to  $\pm .001$ "

Plus... the largest inventory in the world!

SEND FOR  
COMPLETE  
PRICE LIST

### ATLAS FIBRE COMPANY

6980 N. Central Pk. Ave. Chicago, Ill. 60645  
(312) 465-1234

INFORMATION RETRIEVAL NUMBER 120

ELECTRONIC DESIGN 20, September 27, 1974

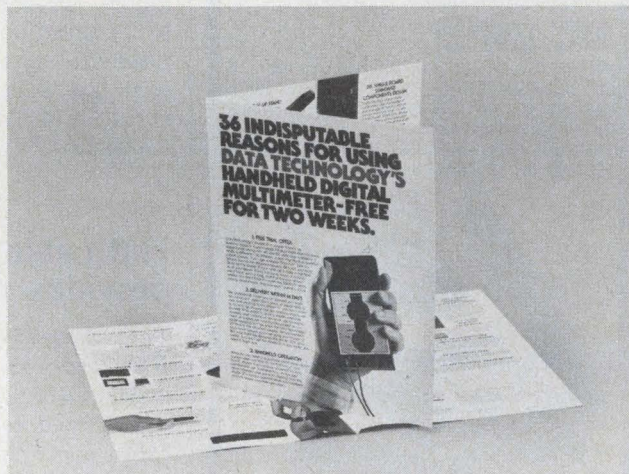

IF YOU MISSED IT LAST ISSUE, GET IT NOW.

If you missed the Data Technology Model 21 insert from the last issue, or if it was ripped out before you got the magazine, just circle the reader service number below, and we'll rush you a copy.

The Model 21: It's worth reading about. A handheld portable digital multimeter that measures AC volts, and DC volts, ohms and capacitance. It's the only handheld DMM that measures capacitance.



**data technology corporation**

2700 South Fairview Rd., Santa Ana, California 92704 • Phone (714) 546-7160

INFORMATION RETRIEVAL NUMBER 121



...in test systems where integrity is essential, specify cunningham

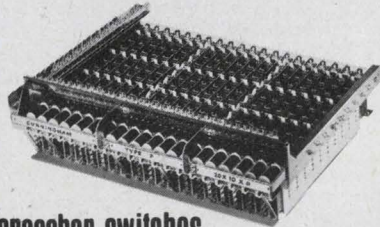

### Crossbar switches

FROM TEN TO THREE HUNDRED 6 WIRE CROSSPOINTS. EXTREMELY LOW PATH RESISTANCE, LOW NOISE AND MINIMAL THERMAL EMF. MINIMUM OF 20 MILLION OPERATIONS/CROSSPOINT LIFE EXPECTANCY. HANDLES LOW LEVEL AND BROADBAND SIGNALS.

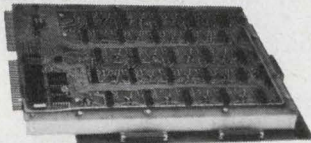

### reed matrix

STANDARD 5X10 (50 CROSSPOINT) MATRIX FOR GROUP TO GROUP SWITCHING. INTERMEDIATE FREQUENCY (IF) HANDLES DC TO 4 MHz SIGNALS. HIGH FREQUENCY (HF) CAPABILITY OF 60 MHz WITH SHIELDED SIGNAL PATHS.

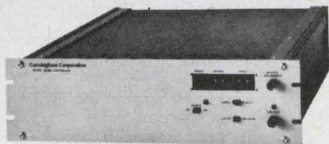

### matrix controller

INTERFACES A SWITCH MATRIX TO ANY 16 BIT ADDRESS DEVICE. FACILITATES A WIDE VARIETY OF SWITCH MATRIX APPLICATIONS BY PROGRAMMABLE REMOTE AND MANUAL CONTROL. ESPECIALLY USEFUL IN AUTOMATIC TESTING OR TELEMETRY SWITCHING.



### scanners

FOR SEQUENTIAL OR RANDOM CONNECTION OF INSTRUMENT LEVEL SIGNALS. REED SCANNERS OFFER HIGH SPEED SWITCHING FOR DATA LEVELS. CROSSBAR SCANNERS BEST FOR LOW THERMAL OR LOW NOISE DATA ACQUISITION SYSTEMS. BOTH FEATURE LOCAL AND REMOTE CONTROL.

### applications assistance

FOR ADDITIONAL DATA OR APPLICATIONS ASSISTANCE, CALL THE CUNNINGHAM CORPORATION, HONEOYE FALLS, NEW YORK: (716) 624-2000.

**Cunningham Corporation**  
SUBSIDIARY OF GLEASON WORKS

## PACKAGING & MATERIALS

### Special tool kit repairs relays

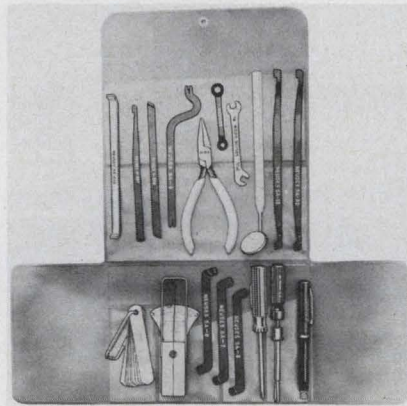

*P. K. Neuses, Inc., Box 100, Arlington Heights, Ill. 60006. (312) 253-6555.*

There has always been a need for a set of tools specifically designed to service relays. The TK-18 kit is not just a lot of makeshift gadgets to help fill up a tool box, but rather a set of tools exactly suited for any job required in the servicing, aligning, checking and maintenance of relays. The kit comes complete with a vinyl case that includes contact burnisher with extra blades, spring tension gauge, wrenches, thickness gauge set, inspection mirror—everything needed to do the job fast. Included with kit is a new eight-page instruction booklet on "How to Service Relays."

CIRCLE NO. 353

### Flat cable zip-on jacket provides rfi shielding

*The Zippertubing Co., 1300 S. Broadway, Los Angeles, Calif. 90061. (213) 321-3901.*

Designed to fit and protect flat cable, a new zip-on, shielded, flexible jacket, ZFT, is especially suited for use in communications and computer data terminals. The lightweight jacket shields ribbon or flat cable against rfi and electrostatic interference. Standard jacket material is vinyl-coated nylon mesh with 3-mil aluminum-foil shielding. Where extra conductivity is desired, a silver coat is available. A tinned-copper braid runs the full length to provide a positive ground with a solderable termination.

CIRCLE NO. 354

### Fabricate conductive rubber items normally

*Mobay Chemical Co., Pittsburgh, Pa. 15205. (412) 923-2700.*

Semiconductive silicone-rubber material, Baysilone HV 8/700, can be used in the manufacture of conductive flexible-rubber items with most common rubber fabrication techniques, such as molding and extruding. Volume resistivity of the rubber is usually kept within 30 to 50  $\Omega$  cm to reduce the effect of mechanical processing on the rubber's resistivity. However, volume resistivity can be increased as high as  $10^{16}$   $\Omega$  cm by blending with other nonconductive Baysilone rubber materials. The rubber has a useful temperature range from -50 to 200 C and is available in catalyzed or uncatalyzed form.

CIRCLE NO. 355

### PC connector line fits commercial applications

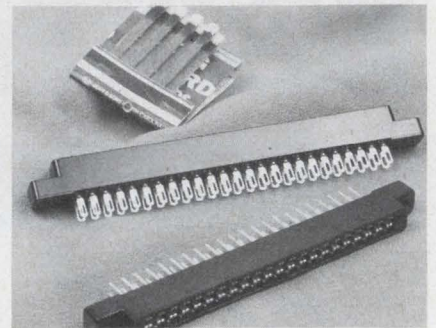

*Amphenol Industrial Div., 1830 S. 54th Ave., Chicago, Ill. 60650. (312) 652-1220.*

The 117-deviation PC connector line is an expansion of Amphenol's family of 225 Series PC connectors. The line includes 10 popular contact positions—from 6 to 43 positions—to suit most commercial applications. Solder terminations provide for flush installation on PC boards 0.054-to-0.071-in. thick. There are four different tail styles. An eyelet solder tail accepts up to three 20 AWG wires and the other tail styles are straight for dip or flow soldering. All dip-solder terminals are designed for 0.043-in. min diameter holes. The connectors have an operating voltage range from 600 at sea level to 150 V ac rms at 70,000 ft. Current rating is 5 A. Contact resistance produces 30 mV at rated current for gold over copper.

CIRCLE NO. 356



# 1/32 of an ounce of prevention for your electronic circuits.

## MICROTEMP SAFETY THERMAL CUTOFFS\*

With a MICROTEMP installed on the winding of your motor or transformer, you'll get positive fail-safe protection without adding

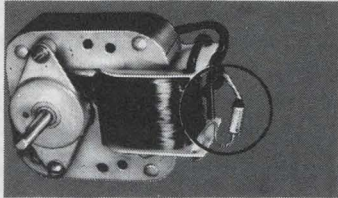

any appreciable weight or size. Facilitating transformer and motor compliance with many UL specifications, especially UL506; UL544, and UL547, MICROTEMP will sense excessive temperature and interrupt the power circuit

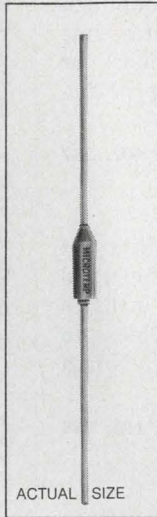

ACTUAL SIZE

should a fault condition develop. An alternate means of protecting the transformer can be provided by a MICROTEMP which has a small heating element fitted to

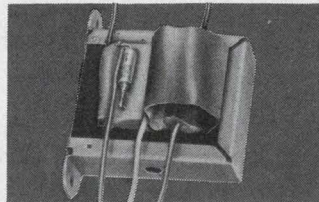

its case. This heating element is connected in series with the secondary coil winding and its load, transferring heat to the MICROTEMP with the flow of current. Should the current flowing through the element exceed normal operating levels, the resulting heat will cause the

MICROTEMP to open, thus also opening the primary or secondary coil winding to which it is connected. Reliable, inexpensive and accurate to  $\pm 3^\circ\text{F}$ , MICROTEMPS are available in ratings to fit your application. Add our little prevention to your product now!

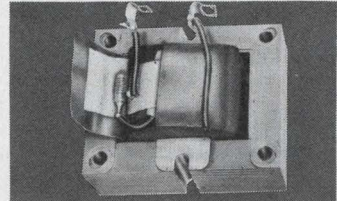

**MICRO DEVICES CORP.**  
1881 Southtown Blvd.  
Dayton, Ohio 45419  
(513) 294-0581

See us at the  
ASEC Show.  
Booth #411

\*UL/CSA Recognized Component  
**MICRO DEVICES CORP.**

INFORMATION RETRIEVAL NUMBER 124

## IT'S YOUR MOVE TO BETTER MATRIX BOARDS

.125 CENTERS	RELIABILITY • ECONOMY AND STANDARDIZATION		UP TO 8 DECK SWITCHING
ISOLATED CONTACT	.250 CENTERS	.100 CENTERS	BUSSED CONTACT
CLOSED ENTRY DESIGN	SPECIAL TENTH INCH MATRICES AT \$.08 PER POINT		DUAL CONTACT STRIPS
SHORTING PINS	TERMINAL OPTIONS	MOUNTING OPTIONS	MIXED CONTACTS
WRITE FOR CATALOG	DIODE PINS	LIGHTED PINS	CODED PANELS
			COLORS PANELS



**CO-ORD SWITCH**

A DIVISION OF LVC INDUSTRIES INC.

135-25 37th AVE., FLUSHING, N.Y. 11354 • 212-939-9777

INFORMATION RETRIEVAL NUMBER 125

ELECTRONIC DESIGN 20, September 27, 1974

If you think there are no other ways to cut your **POWER SUPPLY** costs, get proven performers and realistic delivery... you didn't figure on

**QUAD-MOD**  
Versatile multiple output  
OEM Power Supplies

from **\$135.00**

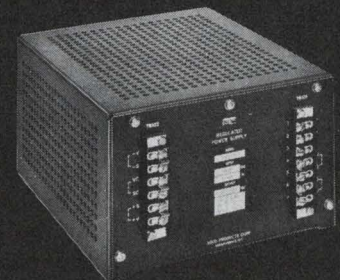

**TODD PRODUCTS CORP.**

123 Milbar Blvd., Farmingdale, N.Y. 11735 • (516) 293-3440

INFORMATION RETRIEVAL NUMBER 126



# Price is the Object.

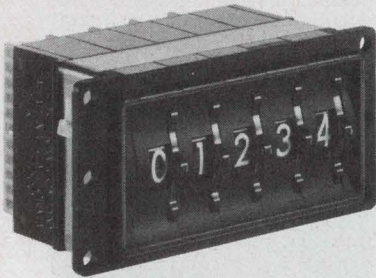

( 25¢ per  
switch function\* )

## SERIES 29000 ECONOMY MINISWITCH

...has many of the qualities of the more expensive switches with the added feature of being dust and moisture sealed.

A unique assembly strap makes it possible to build assemblies consisting of end mounting brackets and switch modules without using tools.

\*List prices start at \$3.00 per switch module or only 25¢ per switch function for a sealed switch with 12 dial positions. That's less than the cost of most toggle, pushbutton, lever, slide, or rotary switches.

YES... "PRICE IS THE OBJECT", but when you buy Series 29000 Economy MINISWITCHES you get performance and quality too. Compare... Evaluate... We think you will agree. Send for details today.

There is a Digitran authorized distributor and a sales engineering group near you. Just dial EEM (800) 645-9200 (toll-free) to find out who they are.

See pages 1148 and 1149, Vol. 2, of the 1973-74 EEM Directory for more DIGITRAN products.

**SERIES 29000 ECONOMY  
MINISWITCH  
ANOTHER SWITCH FROM THE  
DIGITRAN<sup>®</sup>  
COMPANY**

Division of Becton, Dickinson and Company **B-D**  
855 South Arroyo Parkway / Pasadena, Ca. 91105  
Telephone: (213) 449-3110 / TWX 910-588-3794

INFORMATION RETRIEVAL NUMBER 127

## application notes

### Spring pins

"70 Ways to Cut Costs and Simplify Assembly Operations," a 32-page booklet with 70 simplified "how to" drawings, illustrates time and cost-saving applications of spring pins. Amerace Corp., Esna Div., Union, N.J.

CIRCLE NO. 357

### Metal-film resistors

A paper, "The Reliability of Laser-Trimmed Screen-Printed Metal-Film Resistors," includes photos, diagrams and tables to support the text. Sprague, North Adams, Mass.

CIRCLE NO. 358

### Valve-noise booklet

How to calculate valve noise is covered in a booklet. It explains the causes and remedies for excessive noise related to control valve use. Honeywell Process Control, Fort Washington, Pa.

CIRCLE NO. 359

### Limiters

"The Application of Limiters to Communications Equipment" discusses limiters for receiver protection, electrical parameters and design constraints. A comparison of the performance of a communications limiter with that of a typical EW limiter is included. Five graphs provide illustrative support. American Electronics Laboratories, Lansdale, Pa.

CIRCLE NO. 360

### Inductors, transformers

"Transformer and Inductor Design" is a source book for design and core selection information on toroidal and laminated power inductors and transformers. Representative chapters of the 36-page manual include metric system conversion data, powder core selection, wound toroid O.D. calculation, permeability and air gap and specifications with nomographs. A nominal charge of \$1 per copy is requested. Magnetics, P.O. Box 391, Butler, Pa. 16001.

INQUIRE DIRECT

## vendors report

Annual and interim reports can provide much more than financial-position information. They often include the first public disclosure of new products, new techniques and new directions of our vendors and customers. Further, they often contain superb analyses of segments of industry that a company serves.

Selected companies with recent reports are listed here with their main electronic products or services. For a copy, circle the indicated number.

**Solid State Scientific.** Semiconductors, rf transistors, CMOS and electronic digital watch modules.

CIRCLE NO. 361

**P. R. Mallory & Co.** Batteries, electrolytic and ceramic disc capacitors, alumina substrates, hybrid circuitry, piezoelectric devices, metals and materials, controls, timers and motors.

CIRCLE NO. 362

**ACDC Electronics.** Power supplies.

CIRCLE NO. 363

**Cognitronics.** Optical character-recognition equipment and precision machine parts and subassemblies.

CIRCLE NO. 364

**General Radio.** Network analyzers, frequency synthesizers, sound-level meters, logic-circuit analyzers, electronic and medical instrumentation and electronic stroboscopes.

CIRCLE NO. 365

**Cryogenic Technology.** Environmental protection systems, cryogenic systems, cryocoolers and cryogenic vacuum pumps.

CIRCLE NO. 366

**Rapidata.** Remote access computer service.

CIRCLE NO. 367

**Matsushita Electric.** Consumer equipment and components, communication and measuring equipment, lighting equipment, tubes and semiconductors, industrial equipment and batteries.

CIRCLE NO. 368



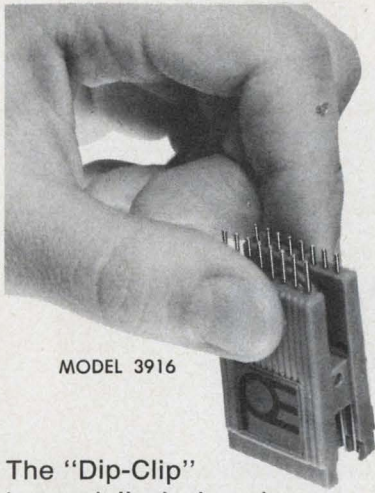

MODEL 3916

The "Dip-Clip" is specially designed to allow the attachment of test probes to 14 or 16 lead DIPs. The unique patented design greatly reduces the possibility of accidental shorting while testing live circuits. Numerous test probes may be quickly connected for hands-free testing.

# dip clip

T.M.

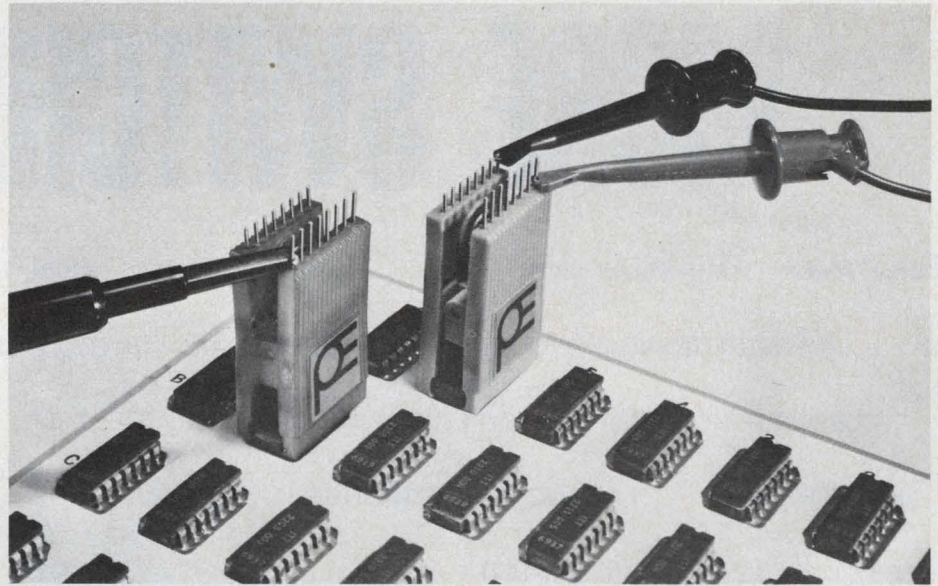

**POMONA ELECTRONICS**  
A Subsidiary of ITT

1500 E. Ninth St., Pomona, Calif. 91766 • Telephone: (714) 623-3463

INFORMATION RETRIEVAL NUMBER 128

## High Quality — Immediate Delivery

**relays....** general purpose, sensitive, miniature and magnetic latching

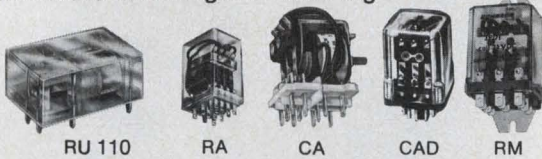

## stepping switches...



**NEW**  
RTM miniature  
— 2 pole,  
10 or 12  
position

RT rotary  
— 1, 2, &  
4 pole

## accessories...

plugs, sockets and dust covers



SEND FOR FREE CATALOGS

**SCHRACK** ELECTRICAL SALES CORP.

1140 Broadway, New York, New York 10001 Tel: (212) 683-0790

INFORMATION RETRIEVAL NUMBER 129

ELECTRONIC DESIGN 20, September 27, 1974

If you think there are no other ways to cut your **POWER SUPPLY** costs, get proven performers and realistic delivery... you didn't figure on

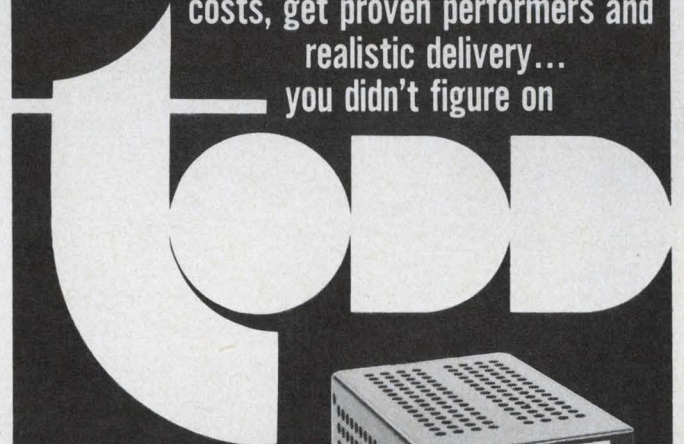

**M SERIES**  
Hi-performance OEM  
systems Power Supplies

from **\$69.00**

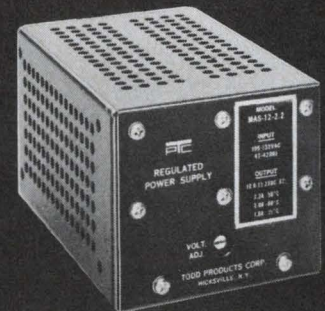

**TODD PRODUCTS CORP.**

123 Milbar Blvd., Farmingdale, N.Y. 11735 • (516) 293-3440

INFORMATION RETRIEVAL NUMBER 130



# LOOKING FOR MORE SWITCHES?

ACCELERATION AIR FLOW ACTUATED AIR PRESSURE HIGH TEMPERATURE HIGH VOLTAGE  
 CAPACITIVE CENTRIFUGAL COAXIAL CROSSBAR INTERLOCK KEYBOARD KEY-LOCK  
 R-F ELECTROCHEMICAL EXPLOSIVE ACTUATED INERTIA KNIFE  
 LOAD FOOT PEDAL FREQUENCY RESPONSE LEVER  
 HALL-EFFECT HERMETICALLY SEALED  
 LIMIT LIQUID LEVEL

ROCKER  
 FEED  
 ROTARY  
 TAP  
 SLIDE  
 WELDED  
 WOGGLE  
 TRIGGER  
 SOLENOID  
 DUMBWHEEL  
 CAP ACTION  
 PUSHBUTTON

Sec 1400: Switches

## CENTRALAB SELECTASHAFT ROTARY SWITCH ORDER FORM

**SHIP TO:** Company, Address, City, State, Zip, P.O. No., Customer No., Quantity, Price Ex., Due Date

**COMPLETE STEPS 1-3 TO SPECIFY DESIRED SWITCH**

- 1 SWITCH**  
Select the desired switch (by index assembly) part number from the catalog and enter number below.  
EXAMPLE: SA-2001
- 2 SHAFT**  
Select the desired shaft part number from the catalog and enter number below.  
EXAMPLE: 2D
- 3 FLAT ANGLE**  
Select the desired shaft flat angle using Diagram 1 and enter the angle position code number below. For plain round shafts enter "XXX", no flat angle.  
EXAMPLE: 060

**COMPLETE SELECTASHAFT SWITCH PART NUMBER**

**HOW TO SPECIFY SHAFT FLAT ANGLE**

SHAFT FLAT ANGLES CAN BE SPECIFIED IN INCREMENTS OF 15° AS SHOWN ON OUTER CIRCLE OF DIAGRAM 1.

- Using the dotted circle, draw an end detail outline of the flat out with flat in the desired position.
- Draw a perpendicular line from the surface of the flat out to the corresponding angle position (degree) code number.

EXAMPLE: 090°, 225°, 180°

Enter the angle position code number above to complete switch part number.  
 NOTE: Angle indicates knob set screw position, not knob pointer position.

CENTRALAB Electronics Division • GLOBE-UNION INC.  
 3757 NORTH GREEN BAY AVENUE • MILWAUKEE, WISCONSIN 53201 • (414) 228-1200

Reference GOLD BOOK page numbers when you call or write.

Vol 2/1016

Sec 1400: Switches

## CHERRY DISCOUNT SCHEDULE FOR ALL SNAP-ACTION SWITCHES

NOTES apply to all products in this product price list:  
 1. Cash Terms — 1/10, 10 days, net 30 days.  
 2. Shipments and Discounts — Are subject to change without notice.  
 3. Net Price can be determined by multiplying list price and multiplying times in discount schedule.  
 4. Multiplicator — Are offered on basis of volume production.  
 5. Discounts — Are offered on each shipment's most costly of 2000 pieces minimum, or complete order if less than 2000 pieces.

Quantity	Discount	Multiplicator
1 to 49	—	1.00
50 to 99	2%	0.98
100 to 499	3%	0.97
500 to 999	4%	0.96
1000 to 9999	5%	0.95

For quantities of 1000 and over, consult factory.

### GENERAL PURPOSE - SINGLE POLE E13 SERIES/E14

E13 SERIES — 15 AMPS., 125-250 VAC, 1/2 H.P., 125 VAC — 1 1/2" x 1 1/2" x 1 1/2"  
 E14 SERIES — 25 AMPS., 125-250 VAC, 1 H.P., 125 VAC — 2 H.P., 250 VAC

SWITCH BODY — 1 1/2" x 1 1/2" x 1 1/2"

Part No.	Quantity	List Price	Part No.	Quantity	List Price
E13-000	100	\$1.00	E13-000	100	\$1.00
E13-001	100	\$1.00	E13-001	100	\$1.00
E13-002	100	\$1.00	E13-002	100	\$1.00
E13-003	100	\$1.00	E13-003	100	\$1.00
E13-004	100	\$1.00	E13-004	100	\$1.00
E13-005	100	\$1.00	E13-005	100	\$1.00
E13-006	100	\$1.00	E13-006	100	\$1.00
E13-007	100	\$1.00	E13-007	100	\$1.00
E13-008	100	\$1.00	E13-008	100	\$1.00
E13-009	100	\$1.00	E13-009	100	\$1.00
E13-010	100	\$1.00	E13-010	100	\$1.00
E13-011	100	\$1.00	E13-011	100	\$1.00
E13-012	100	\$1.00	E13-012	100	\$1.00
E13-013	100	\$1.00	E13-013	100	\$1.00
E13-014	100	\$1.00	E13-014	100	\$1.00
E13-015	100	\$1.00	E13-015	100	\$1.00
E13-016	100	\$1.00	E13-016	100	\$1.00
E13-017	100	\$1.00	E13-017	100	\$1.00
E13-018	100	\$1.00	E13-018	100	\$1.00
E13-019	100	\$1.00	E13-019	100	\$1.00
E13-020	100	\$1.00	E13-020	100	\$1.00
E13-021	100	\$1.00	E13-021	100	\$1.00
E13-022	100	\$1.00	E13-022	100	\$1.00
E13-023	100	\$1.00	E13-023	100	\$1.00
E13-024	100	\$1.00	E13-024	100	\$1.00
E13-025	100	\$1.00	E13-025	100	\$1.00
E13-026	100	\$1.00	E13-026	100	\$1.00
E13-027	100	\$1.00	E13-027	100	\$1.00
E13-028	100	\$1.00	E13-028	100	\$1.00
E13-029	100	\$1.00	E13-029	100	\$1.00
E13-030	100	\$1.00	E13-030	100	\$1.00
E13-031	100	\$1.00	E13-031	100	\$1.00
E13-032	100	\$1.00	E13-032	100	\$1.00
E13-033	100	\$1.00	E13-033	100	\$1.00
E13-034	100	\$1.00	E13-034	100	\$1.00
E13-035	100	\$1.00	E13-035	100	\$1.00
E13-036	100	\$1.00	E13-036	100	\$1.00
E13-037	100	\$1.00	E13-037	100	\$1.00
E13-038	100	\$1.00	E13-038	100	\$1.00
E13-039	100	\$1.00	E13-039	100	\$1.00
E13-040	100	\$1.00	E13-040	100	\$1.00
E13-041	100	\$1.00	E13-041	100	\$1.00
E13-042	100	\$1.00	E13-042	100	\$1.00
E13-043	100	\$1.00	E13-043	100	\$1.00
E13-044	100	\$1.00	E13-044	100	\$1.00
E13-045	100	\$1.00	E13-045	100	\$1.00
E13-046	100	\$1.00	E13-046	100	\$1.00
E13-047	100	\$1.00	E13-047	100	\$1.00
E13-048	100	\$1.00	E13-048	100	\$1.00
E13-049	100	\$1.00	E13-049	100	\$1.00
E13-050	100	\$1.00	E13-050	100	\$1.00

### GENERAL PURPOSE - DOUBLE POLE E19 SERIES/E20

E19 SERIES — 15 AMPS., 125-250 VAC, 1/2 H.P., 125 VAC — 1 1/2" x 1 1/2" x 1 1/2"  
 E20 SERIES — 20 AMPS., 125-250 VAC, 1 H.P., 125 VAC

SWITCH BODY — 1 1/2" x 1 1/2" x 1 1/2"

Part No.	Quantity	List Price	Part No.	Quantity	List Price
E19-000	100	\$1.00	E19-000	100	\$1.00
E19-001	100	\$1.00	E19-001	100	\$1.00
E19-002	100	\$1.00	E19-002	100	\$1.00
E19-003	100	\$1.00	E19-003	100	\$1.00
E19-004	100	\$1.00	E19-004	100	\$1.00
E19-005	100	\$1.00	E19-005	100	\$1.00
E19-006	100	\$1.00	E19-006	100	\$1.00
E19-007	100	\$1.00	E19-007	100	\$1.00
E19-008	100	\$1.00	E19-008	100	\$1.00
E19-009	100	\$1.00	E19-009	100	\$1.00
E19-010	100	\$1.00	E19-010	100	\$1.00
E19-011	100	\$1.00	E19-011	100	\$1.00
E19-012	100	\$1.00	E19-012	100	\$1.00
E19-013	100	\$1.00	E19-013	100	\$1.00
E19-014	100	\$1.00	E19-014	100	\$1.00
E19-015	100	\$1.00	E19-015	100	\$1.00
E19-016	100	\$1.00	E19-016	100	\$1.00
E19-017	100	\$1.00	E19-017	100	\$1.00
E19-018	100	\$1.00	E19-018	100	\$1.00
E19-019	100	\$1.00	E19-019	100	\$1.00
E19-020	100	\$1.00	E19-020	100	\$1.00
E19-021	100	\$1.00	E19-021	100	\$1.00
E19-022	100	\$1.00	E19-022	100	\$1.00
E19-023	100	\$1.00	E19-023	100	\$1.00
E19-024	100	\$1.00	E19-024	100	\$1.00
E19-025	100	\$1.00	E19-025	100	\$1.00
E19-026	100	\$1.00	E19-026	100	\$1.00
E19-027	100	\$1.00	E19-027	100	\$1.00
E19-028	100	\$1.00	E19-028	100	\$1.00
E19-029	100	\$1.00	E19-029	100	\$1.00
E19-030	100	\$1.00	E19-030	100	\$1.00
E19-031	100	\$1.00	E19-031	100	\$1.00
E19-032	100	\$1.00	E19-032	100	\$1.00
E19-033	100	\$1.00	E19-033	100	\$1.00
E19-034	100	\$1.00	E19-034	100	\$1.00
E19-035	100	\$1.00	E19-035	100	\$1.00
E19-036	100	\$1.00	E19-036	100	\$1.00
E19-037	100	\$1.00	E19-037	100	\$1.00
E19-038	100	\$1.00	E19-038	100	\$1.00
E19-039	100	\$1.00	E19-039	100	\$1.00
E19-040	100	\$1.00	E19-040	100	\$1.00

Compact switch with double pole electrical control, large castbar, wide range of actuator, in two electrical configurations and wide range of actuators.

CHERRY ELECTRICAL PRODUCTS CORPORATION  
 3800 SUNSET AVENUE / WAUKESHA, ILLINOIS 60085 / (312) 889-1700 / TWX (810) 235-1570

See the Manufacturers Directory, Vol 1, for local GOLD BOOK 74/75

Electronic Design's  
 DECADE  
 MAGNETICALLY ACTUATED  
 MERCURY MOTOR-DRIVEN POWER  
 MATRIX PLUNGER PRESSURE-ACTUATED PRINTED CIRCUIT  
 TOUCH ACTUATED WAVEGUIDE PHOTOELECTRIC PROXIMITY



# LOOK FIRST IN Electronic Design's GOLD BOOK

More than 52,500 of *Electronic Design's* qualified subscribers recommend or specify switches & relays for purchase. To aid in product search and selection, the PRODUCT DIRECTORY of *Electronic Design's* GOLD BOOK lists manufacturers of switches & relays in 95 sub-categories. For example there are 53 classifications of switches ranging from *Acceleration* through *Waveguide*; 42 classifications of relays from *Capacitance* through *Voltage Band*. To make it easier for you or your secretary to contact many manufacturers about a given item, each supplier's name is followed by complete street address, city, state, zip and phone every time it appears—no need to refer to other directories for missing portions of address.

CATALOG PAGES Volume 2 of *Electronic Design's* GOLD BOOK contains 235 catalog pages on *Switches; Relays & Solenoids*. You'll find most major manufacturers represented; many units contain detailed specs and ordering information, configurations, etc. Check these pages carefully before you specify . . . you may find the exact product you need.



FOR FURTHER INFORMATION  
SEE OUR TECH PAGES

IN *Electronic Design's*  
GOLD BOOK

## PASS THE WORD TO YOUR SALES & MARKETING PEOPLE

*Electronic Design's* GOLD BOOK is the place to look for information about products and suppliers in this industry. Be sure your company takes full advantage of your catalog pages. Ask your advertising people to call attention to your pages at every opportunity, especially in your regular advertising program.



## new literature



Complete with "drop-in" charging stand.

## CORDLESS SOLDERING FREEDOM

Wahl's Iso-Tip® Soldering Iron is cordless, 8" long with tip, weighs 6 oz. and reaches a 700° Soldering temperature in 5 seconds! DC operated to eliminate AC leakage and the need for grounding. Gives up to 150 consecutive joints, depending on wire size, without recharging. Available with five standard tips (from .020" to .187" dia.). Quick Charge model also available.

Write or call today for complete information.

### **WAHL®** Clipper Corporation

2902 Locust Street  
Sterling, Illinois 61081  
(815) 625-6525

"Manufacturing Excellence  
for over 50 Years"

INFORMATION RETRIEVAL NUMBER 131

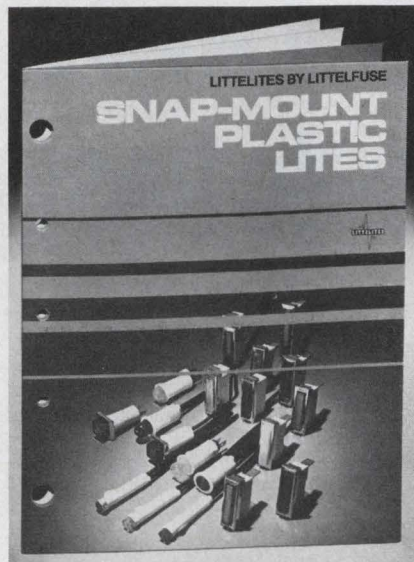

### Snap-mount lights

Three series of snap-mount plastic lights are described in an eight-page catalog. The catalog includes dimensional drawings and illustrations of each of the series. An easy-to-use ordering table facilitates correct designation of features, including termination, lamp, resistor, housing color and lens style and color. Littelfuse, Des Plaines, Ill.

CIRCLE NO. 369

### Discrete semis and ICs

"Semiconductor Survey 1974," a 37-page short-form catalog, describes discrete semiconductors and ICs. The products are listed in application groups and include transistors and diodes (silicon and germanium), optoelectronic devices (emitters and sensors), digital and analog ICs and multi-chip components. Specifications and dimensional drawings are included. AEG-Telefunken, Englewood Cliffs, N.J.

CIRCLE NO. 370

### Micromanipulators

Features of precision micromanipulators including motor-operated fine adjustment motions with micrometer readout to 0.01 mm are given in a five-page brochure. Hacker Instruments, Fairfield, N.J.

CIRCLE NO. 371

### Wire-wound resistors

A revised and updated precision and power wire-wound resistor handbook includes a military style ordering guide and cross-reference chart, information on established reliability wire-wound resistors, a technical guide on resistance temperature characteristics and data on 200 resistor types. RCL Electronics, Irvington, N.J.

CIRCLE NO. 372

### Open frame power supplies

The Omni series of open frame modular power supplies are described in a bulletin. Included are electrical specifications, mechanical dimensions, photos and pricing for single and multiple output models. Deltron, North Wales, Pa.

CIRCLE NO. 373

### Stock and custom tool kits

Tool kits designed for maintenance, assembly and repair in the electronic, electrical, vending, computer, relay, appliance and office machine industries are featured in a 12-page catalog. Electronic Tool, Mount Vernon, N.Y.

CIRCLE NO. 374

### Batteries

Nickel-cadmium cells and batteries are described in two six-page brochures. Gulon Battery, Metuchen, N.J.

CIRCLE NO. 375

### Calculator handbook

To extend the usefulness of the HP-35 pocket-sized scientific calculator, a \$10 handbook gives the most efficient keystroke sequences for solving commonly encountered mathematical problems. The 169-page book has seven major sections dealing in detail with calculator operations, number theory and algebra, geometry and trigonometry, statistics, numerical methods and finance. Hewlett-Packard, 1501 Page Mill Rd., Palo Alto, Calif. 94304.

INQUIRE DIRECT



# 'SNO DRIFT

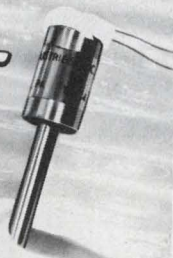

No temperature drift is just one of a pile of features of PSG Solid State Thermostats.

- NO TEMPERATURE DRIFT FROM SET POINT - SSTC series thermostats drift less than 0.05°C over a minimum life of 2 million cycles.
- ACCURACY - ±0.25 to 3°F standard depending on model, other tolerances on request.
- DIFFERENTIAL - 0.25 to 2°F standard depending on model, other ranges on request.
- SHOCK & VIBRATION RESISTANT - Withstand 100 g's shock and 30 g's vibration at 2000 cps.
- LOW COST - Solid state dependability at bimetal prices.

WRITE OR CALL FOR THE SSTC SERIES DATA SHEET.



**PSG Industries, Inc.**  
 MANUFACTURER OF PRECISION THERMO AND ELECTRONIC CONTROLS  
 NINTH & RIDGE AVENUE • PERKASIE, PA. 18944  
 TELEPHONE (215) 257-3621  
 FORMERLY PHILA. SCIENTIFIC GLASS CO.

INFORMATION RETRIEVAL NUMBER 132

## This new 10-watt amplifier is tough -- even in a mismatch!



The Model 10LA is one broadband amplifier you don't have to treat with kid gloves. It will stand up under any mismatched load and provide you with 10 watts of swept power from 1-110 MHz. A directional wattmeter enables you to determine actual power delivered to the load. You can perform antenna and component testing, equipment calibration, NMR research -- any number of tests -- with complete confidence. It takes more than a mismatch to knock out our 10LA. Find out for yourself, write: Amplifier Research, 160 School House Road, Souderton, Pa. 18964. Phone: 215-723-8181



INFORMATION RETRIEVAL NUMBER 134

Millions already in use  
**NEW KIT LETS YOU TRY IT**

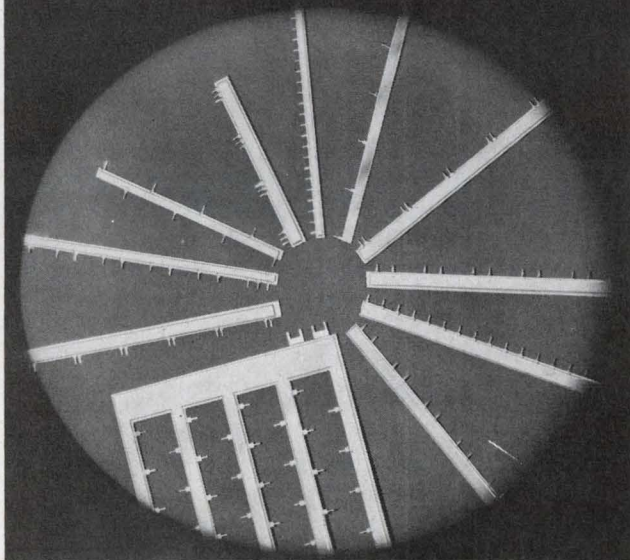

Evaluation kits @ \$25 in stock.  
 Standard parts on 2 weeks delivery, or less!  
 Custom parts 4 to 6 weeks delivery!

**MINI-BUS** The low-cost, noise attenuating, high packaging density, power distribution system for PC boards. Ask for data.



Rogers Corporation / Chandler, Arizona 85224  
 West: (602) 963-4584 East: (203) 774-9605

INFORMATION RETRIEVAL NUMBER 133

ELECTRONIC DESIGN 20, September 27, 1974

**ALCOSWITCH** The World's smallest BI-DIRECTIONAL, CODE PUSHBUTTON switch with large easy-to-read numerals. Available in a variety of coded outputs (includes decimal) and lots of mounting and mating accessories.

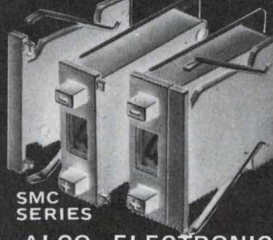

Call (617) 686-0126 today for detailed information and ask us for a "dummy" switch to study and compare on your own panel design.

**ALCO ELECTRONIC PRODUCTS, INC.**  
 1551 Osgood St., No. Andover, Mass. 01845

INFORMATION RETRIEVAL NUMBER 210

**ALCOSWITCH** Our MINI-SLIDE switches spell quality and cost you less . . . Simply because we make 'em by the millions. Improved actuator coiled spring provides a smooth tactile operation and a contact wiping action. Available either for PC or hand wiring with or without mounting tabs.

SLS-220  
 SLS-120



Call (617) 686-0126 for samples, literature and pricing and you will see what we mean!

**ALCO ELECTRONIC PRODUCTS, INC.**  
 1551 Osgood St., No. Andover, Mass. 01845

INFORMATION RETRIEVAL NUMBER 211



# Unimax gives you more.

More Quality—More Reliability—More Choice—More Service

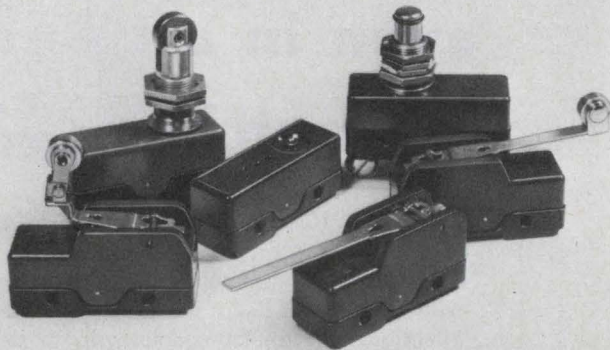

For example: A line of BASIC PRECISION SWITCHES that provide an endless combination of ACTUATOR STYLES—pin, plunger, flexible leaf or rigid lever with and without roller, spring loaded one-way roller, interlock, reset button—TERMINAL CONFIGURATIONS—solder, side or bottom facing screw, quick connect—ELECTRICAL RATINGS—up to 25 amp, 2 HP at 250 VAC—and CIRCUITRIES—SPST, SPDT, DPST, DPDT—to meet your exact requirements.

Unimax gives you the most complete GENERAL PURPOSE line in the industry. BASIC PRECISION switches that are the first choice of the volume OEM users. All styles of MINIATURE, SUBMINIATURE, and MINIATURE SUBMINIATURE switches. Rugged METAL-CASED LIMIT switches. And the broadest variety of ILLUMINATED PUSH-BUTTON CONTROLS you can buy.

Interested in more? Write Unimax Switch Corporation, a Riker-Maxson Subsidiary, Ives Road, Wallingford, Connecticut 06492. Or call (203) 269-8701.

 **Unimax**  
We give you more.

INFORMATION RETRIEVAL NUMBER 136

## SUBMINIATURE LAMP SPECIALISTS

### Complete line of PC board Bi-Pin lamps and sockets

INCANDESCENT—SOLID STATE

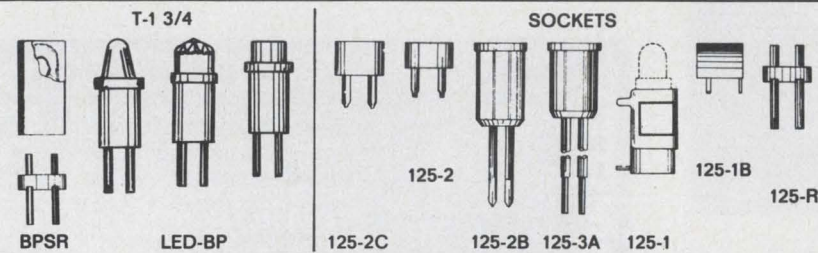
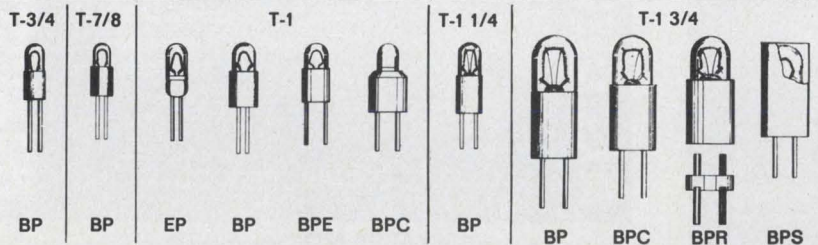

15 sizes, hundreds of electrical specifications.

• Ask informations to:

**WAMCO Technical Sales, Inc.**  
705 W. 16th Street, Costa Mesa, California 92627  
TEL: (714) 642-5100 TELEX: 678459

Mid West 12 states only

**CIMCO International, Inc.**  
201 North Wells St. (Rm. 1920) Chicago, Illinois 60606  
TEL: (312) 782-5621 TELEX: 724426

**OSHINO ELECTRIC LAMP WORKS, LTD.** TOKYO, JAPAN

INFORMATION RETRIEVAL NUMBER 137

## NEW LITERATURE

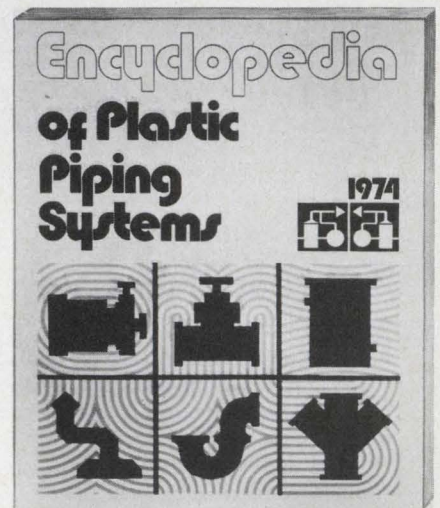

### Plastic piping systems

A 240-page reference book for plastic piping systems contains data to enable users to design, estimate and purchase either partial or complete plastic air or fluid handling systems. Plastic Piping Systems, South Plainfield, N.J.

CIRCLE NO. 376

### MOS LSI circuits

RAMs, ROMs, keyboard encoders, shift registers, standard patterns and calculator circuits are described and illustrated in an 18-page catalog. Electronic Arrays, Mountain View, Calif.

CIRCLE NO. 377

### Optoelectronic components

LED displays, discrete indicators, optoisolators and solid-state relays are itemized in a short-form catalog. Electrical, optical and mechanical data are included. Monsanto, Palo Alto, Calif.

CIRCLE NO. 378

### Cassette recorders

"Handbook on Incremental Digital Tape Cassette Recorders" is aimed at acquainting potential users with the advantages of incremental recording using magnetic tape cassettes as the storage medium. Low power, high-density data logging recorders are described as well as serial, parallel (TTL and CMOS levels) and RS 232C/TTY interfaces in OEM and stand-alone instrument configurations. Memorydyne, Newton Upper Falls, Mass.

CIRCLE NO. 379



## Microwave ovens

A guide to microwave ovens, with tube complement, lists brand name, manufacturer and model number of all of the microwave ovens sold in the U.S. within the last 10 years. With each model number is the tube type number installed by the manufacturer, together with the type of the company's magnetron which is a direct, interchangeable equivalent. Amperex Electronic, Hicksville, N.Y.

CIRCLE NO. 380

## Resistor networks

A 12-page resistor network bulletin covers 16 DIP networks (dual in line packaged) and two flatpack networks that solve resistor requirements for pull-up, pull-down, line termination, LED current limiting, pulse squaring networks and sense amp termination. Over 31 schematics are included. Beckman Instruments, Helipot Div., Fullerton, Calif.

CIRCLE NO. 381

## Power supplies

Power supplies for IC logic and op amps are described in a four-page brochure. Acopian, Easton, Pa.

CIRCLE NO. 382

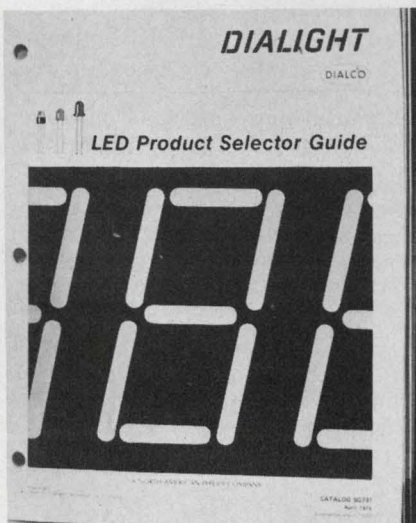

## LEDs

A 72-page "LED Product Selector Guide" details the company's light-emitting diodes, indicators and related readout displays including red, green and yellow LED products. Dialight, Brooklyn, N.Y.

CIRCLE NO. 383

# Unimax gives you more.

More Quality—More Reliability—More Choice—More Service

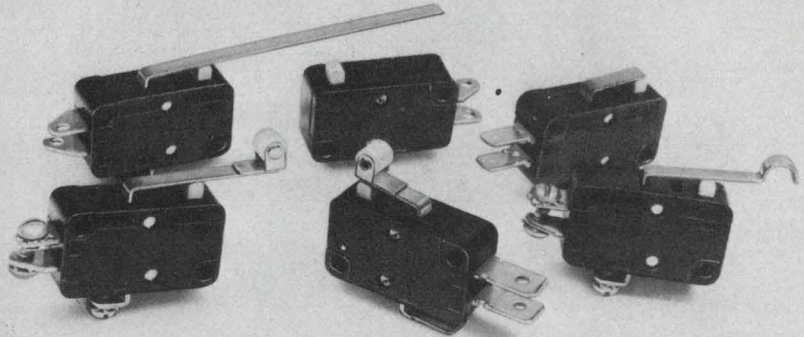

For example: A line of MINIATURE SWITCHES featuring as STANDARDS, low force, extra low force and heavy duty types with pin, rigid lever, lever/roller, simulated roller lever, and interlock actuators—electrical ratings from 1 ma 1.5 VDC up to 15 amp, ½ HP 250 VAC—a choice of four terminal styles. And if one of the standards doesn't fit your application, we'll design a special configuration just for you.

Unimax gives you the most complete GENERAL PURPOSE line in the industry. BASIC PRECISION switches that are the first choice of the volume OEM users. All styles of MINIATURE, SUBMINIATURE, and MINIATURE SUBMINIATURE switches. Rugged METAL-CASED LIMIT switches. And the broadest variety of ILLUMINATED PUSH-BUTTON CONTROLS you can buy.

Interested in more? Write Unimax Switch Corporation, a Riker-Maxson Subsidiary, Ives Road, Wallingford, Connecticut 06492. Or call (203) 269-8701.

**Unimax**  
We give you more.

INFORMATION RETRIEVAL NUMBER 138

# NOBODY WANTS A CLUTTERBUG

We had your end-user in mind when we engineered our compact, self-contained, no fuss, no muss, 50/60 cps, electro-mechanical punches.

With conveniences that show at the installation. Like bi-directional feed. An over-sized chad box that can contain chad from up to 1000 feet of punched tape without emptying. A drawer which holds a standard 8½" tape supply reel. An out of tape/tape tension switch. Side mounted take-up reel Operation "cool" at 100°F. Long life. Extremely low operator intervention.

We had you in mind when we built over 60 models. The 500 Series are paper tape models. The 400 Series include edge card capabilities as well.

Once you sell them (as part of your system installation or terminal) they'll stay sold and require less maintenance than any other punch on the market. In that way, they won't be cluttering up your shelves, either.

You can "bug" any of our field representatives for prices and delivery information.

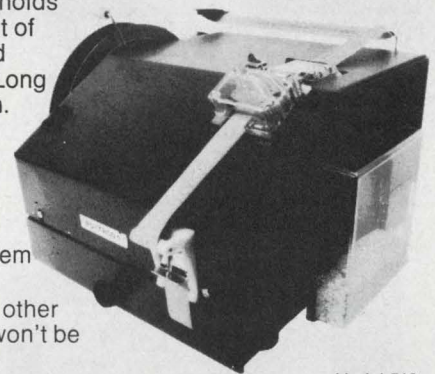

Model 518  
Paper Tape Punch Station



OEM PRODUCTS DIVISION  
**LITTON ABS**

Automated Business Systems

34 Maple Avenue, Pine Brook, N.J. 07058/(201) 575-8100

IN U.K. — LBS, 27 Goswell Road, E.C.1, London

IN FRANCE — LITTON ABS/OEM, 9/15 Avenue Paul Doumer, 92504 Rueil-Malmaison

INFORMATION RETRIEVAL NUMBER 139



# Unimax gives you more.

More Quality—More Reliability—More Choice—More Service

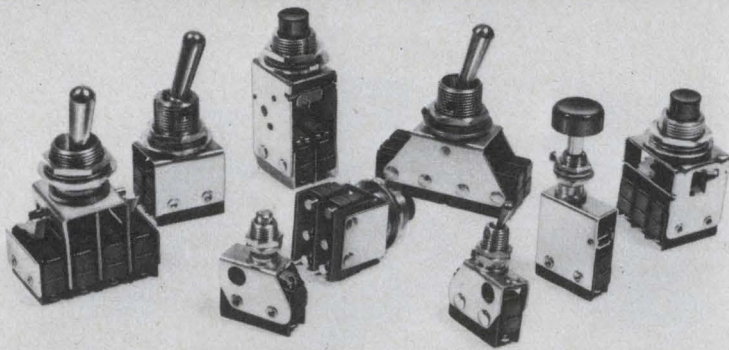

For example: A line of TOGGLE, PUSHBUTTON, and PLUNGER actuated switches combining the high reliability and space saving of our subminiature switches with the convenience of panel-mounted manual actuation, featuring: pushbuttons with HIGH or LOW TRAVEL and HIGH FORCE or FEATHER TOUCH actuation—miniature and standard TOGGLE HANDLES—ELECTRICAL RATINGS from 1 ma 1.5 VDC up to 10 amp 250 VAC and 2.4 amp 28 VDC lampload—SPDT up to 4PDT CIRCUITRY with combinations of momentary and alternate maintained modes—and four terminal styles.

Unimax gives you the most complete GENERAL PURPOSE line in the industry. BASIC PRECISION switches that are the first choice of the volume OEM users. All styles of MINIATURE, SUBMINIATURE, and MINIATURE SUBMINIATURE switches. Rugged METAL-CASED LIMIT switches. And the broadest variety of ILLUMINATED PUSH-BUTTON CONTROLS you can buy.

Interested in more? Write Unimax Switch Corporation, a Riker-Maxson Subsidiary, Ives Road, Wallingford, Connecticut 06492. Or call (203) 269-8701.

 **Unimax**  
We give you more.

INFORMATION RETRIEVAL NUMBER 140

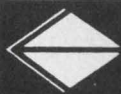

**EFRATOM**  
CALIFORNIA, INC.

Time and Frequency Systems

3303 Harbor Blvd., Suite E, Costa Mesa, Ca. 92626, USA Phone 714/556-1620

## THE WORLD'S SMALLEST RUBIDIUM FREQUENCY STANDARDS Model FRK-L, Model FRK-H, Model FRT

Rb-Atomic Resonance  
Controlled Oscillator  
Excellent Stability  
10 min. Warm up  
5 Year Lamp/Cell Warrantee



Model FRK-L \$3,480.00  
Model FRK-H \$5,100.00  
Model FRT \$6,780.00  
O.E.M. Available

**Model FRT, Atomic Frequency Standard**  
2 x 4 Output Frequencies, 10-5-1-0.1 MHz  
Built-in Battery - Portable or Rackmounted

Replaces PRIMARY FREQUENCY STANDARD, when coupled to Model EFR and synchronized to National Standard Frequency, Absolute Frequency is few parts in  $10^{12}$ .

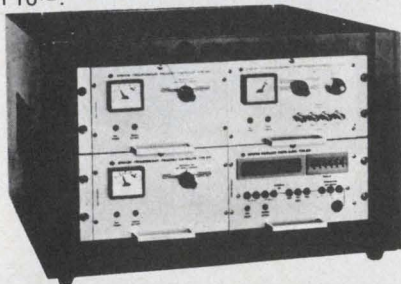

**Model EFR Receiver-Controller**  
VLF/LF Frequency Coverage  
Controls Frequency Standards  
Time Synchronization Output for Clocks  
Price \$1,975.00

**Model EDU Digital Clock**  
BCD - Outputs - Time  
Leap Second Insertion  
Price \$1,790.00

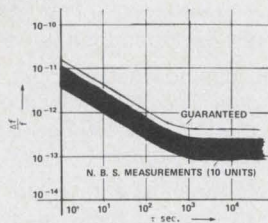

FOR EUROPE: Efratom Elektronik GmbH, 8000 Muenchen 90, Langobardenstr. 7 West Germany, Ph. (089) 647138

INFORMATION RETRIEVAL NUMBER 141

## bulletin board

The Digital Products Div. of Fairchild has introduced a proprietary line of low-power Schottky TTL circuits (series 9LS), which makes it possible to produce 2-mW-per-gate digital systems that operate at twice the speed attained by standard TTL logic.

CIRCLE NO. 384

A family of TTL/MSI function devices built using advanced Schottky technology is now available in production quantities from Advanced Micro Devices. These devices, which include registers, decoders, multiplexers, counters and operators, function at approximately twice the speed of their standard TTL/MSI counterparts. All units that carry the 54S/74S series numbers are pin-compatible with like devices from Texas Instruments.

CIRCLE NO. 385

General Automation has announced a new combination of computer hardware and software, which has been tailored and priced to meet the needs of those users requiring remote job entry to an IBM 360/370 HASP system.

CIRCLE NO. 386

Tektronix' new software package, the PLOT-10/APL GRAPH-II, expands the potential of interactive graphics and APL with the Tektronix 4013 and 4015 computer display terminals.

CIRCLE NO. 387

Siltek International has added 20 new device types to its family of CMOS 4000 Series integrated circuits.

CIRCLE NO. 388

Signetics, 811 E. Arques Ave., Sunnyvale, Calif. 94086 has announced that two high-speed RAMs, formerly available in silicone packages, are now being manufactured in epoxy packages at \$14 (100). The price of the RAMs in silicone was \$28. The silicone RAMs have been superseded by the epoxy versions.

INQUIRE DIRECT



Stewart-Warner Microcircuits has introduced a line of CMOS integrated circuits in the standard 4000 series.

CIRCLE NO. 389

SE Labs (EMI) Ltd.'s low-cost SM272 FRA transfer function analyzer/frequency response analyzer is now offered with a digital readout as an option to standard analog meters.

CIRCLE NO. 390

### Price reductions

A 33% price reduction of semiconductor memories and a 30% reduction of the V-70 series memory management system (memory map) has been announced by Varian Data Machines.

CIRCLE NO. 391

Litronix has announced a 14 to 22% price reduction on 13 optoisolators that use LED emitters and npn phototransistors or photo-Darlington detectors.

CIRCLE NO. 392

**SUBSCRIBER SERVICE** For prompt service include the addressed label when writing about your subscription.

#### CHANGE OF ADDRESS

	NEW ADDRESS
name	_____
company	_____
division/department	_____
company address	_____
city	_____
state	_____
zip	_____

If you're moving, please let us know six weeks before changing your address. If you have a question, place your magazine address label here and clip this form to your letter.

MAIL TO: ELECTRONIC DESIGN Circulation Dept. Hayden Publishing Co., Inc., 50 Essex Street, Rochelle Park, NJ 07662

## Unimax gives you more.

More Quality—More Reliability—More Choice—More Service

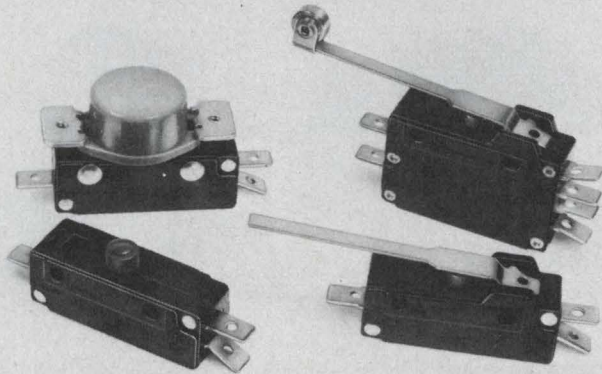

For example: A line of GENERAL PURPOSE switches that combine with their low cost and high performance a selection of features unparalleled in the industry: ACTUATOR STYLES—integral flexible leaf, leaf/roller, hinged rigid lever, lever/roller, plunger, push button, large push button, auxiliary leaf, push-on push-off—CIRCUITRIES—SPST, SPDT, DPST, DPDT—ELECTRICAL RATINGS up to 25 amp, 2 HP 250 VAC—to meet the requirements of your application.

Unimax gives you the most complete GENERAL PURPOSE line in the industry. BASIC PRECISION switches that are the first choice of the volume OEM users. All styles of MINIATURE, SUBMINIATURE, and MINIATURE SUBMINIATURE switches. Rugged METAL-CASED LIMIT switches. And the broadest variety of ILLUMINATED PUSH-BUTTON CONTROLS you can buy.

Interested in more? Write Unimax Switch Corporation, a Riker-Maxson Subsidiary, Ives Road, Wallingford, Connecticut 06492. Or call (203) 269-8701.

**Unimax**  
We give you more.

INFORMATION RETRIEVAL NUMBER 142

## Interference Suppression With Miller Heavy Duty Hash Chokes



Write on your letterhead for full line catalog.

**BELL INDUSTRIES / J. W. Miller Division**  
19070 REYES AVENUE • P.O. BOX 5825 • COMPTON, CALIFORNIA 90224

INFORMATION RETRIEVAL NUMBER 143



# Unimax gives you more.

More Quality—More Reliability—More Choice—More Service



For example: A line of ILLUMINATED PUSHBUTTON PANEL CONTROLS that put total control right at your fingertips. Whether as indicators or switches, the exact control you require may be selected from the many options offered by our EAO Series—three shapes—round, square, rectangular—one, two, and three pole, double break circuits—momentary or maintained action—ratings up to 10 amps 380 VAC—conventional actuation and keylock models—and multicolored lens caps of all descriptions.

Unimax gives you the most complete GENERAL PURPOSE line in the industry. BASIC PRECISION switches that are the first choice of the volume OEM users. All styles of MINIATURE, SUBMINIATURE, and MINIATURE SUBMINIATURE switches. Rugged METAL-CASED LIMIT switches. And the broadest variety of ILLUMINATED PUSHBUTTON CONTROLS you can buy.

**Interested in more?** Write Unimax Switch Corporation, a Riker-Maxson Subsidiary, Ives Road, Wallingford, Connecticut 06492. Or call (203) 269-8701.

**Unimax**  
We give you more.

INFORMATION RETRIEVAL NUMBER 144

## USC GR/RGR HIGH DENSITY WRAP/CRIMP CONNECTORS

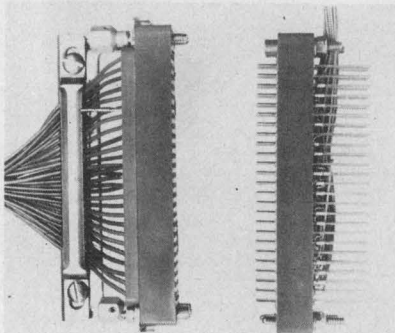

1 of over 20,000 types  
of Connectors. Send today  
for GR/RGR Series Catalog.

**U. S. COMPONENTS, INC.**

Leader in advanced engineering & design

1320 Zerega Avenue, Bronx, N. Y. 10462  
(212) 824-1600 TWX: 710-593-2141  
Telex: 1-2411 Cable: COMPONENTS, N. Y. K.

INFORMATION RETRIEVAL NUMBER 145

## LOOKING FOR A DISTRIBUTOR NEAR YOU?

*Electronic Design's* GOLD BOOK lists 5,700 distributors with access both *alphabetic*, by distributor name, and *geographic* by location.

When you need information . . .

Electronic Design's

**GOLD BOOK  
IS THE PLACE  
TO LOOK**

# Electronic Design

ELECTRONIC DESIGN's function is:

- To aid progress in the electronics manufacturing industry by promoting good design.
- To give the electronic design engineer concepts and ideas that make his job easier and more productive.
- To provide a central source of timely electronics information.
- To promote communication among members of the electronics engineering community.

**Want a subscription?** ELECTRONIC DESIGN is sent free to qualified engineers and engineering managers doing design work, supervising design or setting standards in the United States and Western Europe. For a free subscription, use the application form bound in the magazine. If none is included, write to us direct for an application form.

If you do not qualify, you may take out a paid subscription for \$30 a year in the U.S.A., \$40 a year elsewhere. Single copies are \$1.50 each.

**If you change your address,** send us an old mailing label and your new address; there is generally a postcard for this bound in the magazine. You will have to requalify to continue receiving ELECTRONIC DESIGN free.

**The accuracy policy** of ELECTRONIC DESIGN is:

- To make diligent efforts to ensure the accuracy of editorial matter.
- To publish prompt corrections whenever inaccuracies are brought to our attention. Corrections appear in "Across the Desk."
- To encourage our readers as responsible members of our business community to report to us misleading or fraudulent advertising.
- To refuse any advertisement deemed to be misleading or fraudulent.

Microfilm copies are available of complete volumes of ELECTRONIC DESIGN at \$19 per volume, beginning with Volume 1, 1961 through Volume 20. Reprints of individual articles may be obtained for \$2.00 each, prepaid (\$.50 for each additional copy of the same article) no matter how long the article. For further details and to place orders, contact the Customer Services Department, University Microfilms, 300 North Zeeb Road, Ann Arbor, Michigan 48106 telephone (313) 761-4700.

**Want to contact us?** If you have any comments or wish to submit a manuscript or article outline, address your correspondence to:

Editor  
ELECTRONIC DESIGN  
50 Essex Street  
Rochelle Park, N.J. 07662



# Electronic Design

## Advertising Sales Staff

Tom W. Carr, Sales Director

### Rochelle Park, N.J. 07662

Robert W. Gascoigne  
Daniel J. Rowland

(Recruitment, Quick Ads, Classified)

50 Essex Street  
(201) 843-0550  
TWX: 710-990-5071

### Philadelphia

Thomas P. Barth  
50 Essex Street  
Rochelle Park, N.J. 07662  
(201) 843-0550

### Boston 02178

Gene Pritchard  
P.O. Box 379  
Belmont, Mass. 02178  
(617) 489-2340

### Chicago 60611

Thomas P. Kavooras  
Berry Conner, Jr.  
200 East Ontario  
(312) 337-0588

### Cleveland

Thomas P. Kavooras  
(Chicago)  
(312) 337-0588

### Los Angeles 90303

Stanley I. Ehrenclou  
Burt Underwood  
2930 Imperial Highway  
Inglewood, Calif.  
(213) 757-0183

### San Francisco 94022

Jerry D. Latta  
P.O. Box 1248  
Los Altos, Calif.  
(415) 965-2636

### London, Amsterdam, Tokyo, Seoul

John Ashcraft  
12, Bear St.  
Leicester Square  
London WC2H 7AS England  
Phone: 01-930-0525

W. J. M. Sanders  
John Ashcraft & Co.  
Herengracht 365  
Amsterdam C., Holland  
Phone: 020-24-09-08

Haruki Hirayama  
Electronic Media Service  
5th Floor, Lila Bldg.,  
4-9-8 Roppong  
Minato-ku, Tokyo, Japan  
Phone: 402-4556  
Cable: Electronicmedia, Tokyo

Mr. O-kyn Park, President  
Dongbo International  
Corporation  
1.P. O. Box 4010  
Seoul, Korea  
Phone: 28-1911  
Cable: Dongbo Seoul



# Unimax gives you more.

More Quality—More Reliability—More Choice—More Service

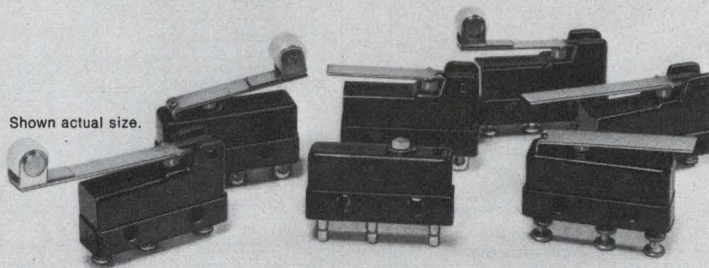

Shown actual size.

For example: A line of SUBMINIATURE switches designed to give you unlimited performance in a limited space. Features like: five basic ACTUATOR STYLES—pin, integral flexible leaf, leaf/roller, integral rigid lever, lever/roller—four TERMINAL STYLES—ELECTRICAL RATINGS from 1 ma 1.5 VDC up to 10 amp 250 VAC and 2.4 amp 28 VDC lampload—allow you to select the exact small switch to do your big job.

Unimax gives you the most complete GENERAL PURPOSE line in the industry. BASIC PRECISION switches that are the first choice of the volume OEM users. All styles of MINIATURE, SUBMINIATURE, and MINIATURE SUBMINIATURE switches. Rugged METAL-CASED LIMIT switches. And the broadest variety of ILLUMINATED PUSH-BUTTON CONTROLS you can buy.

Interested in more? Write Unimax Switch Corporation, a Riker-Maxson Subsidiary, Ives Road, Wallingford, Connecticut 06492. Or call (203) 269-8701.

**Unimax**  
We give you more.

INFORMATION RETRIEVAL NUMBER 146

Sb-Cs, BIALKALI, MULTIALKALI, MULTIALKALI, Ag-O-Cs, Cs+Te, GaAs(Cs), RNOX Sb-Cs, BIALKALI, MULTIALKALI

## QUALITY DETECTORS FOR INSTRUMENTATION

A complete line of side on, end on, photomultipliers and phototubes including the new GaAs and RNOX.

FREE CATALOG call or write

**HAMAMATSU CORP.**

120 Wood Avenue  
Middlesex, New Jersey 08846  
201-469-6640



INFORMATION RETRIEVAL NUMBER 147



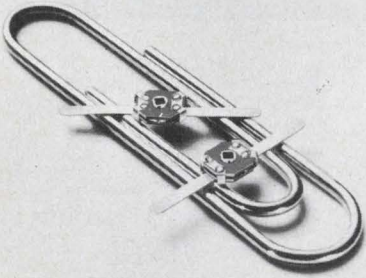

**Thin-Trim variable capacitors** provide a reliable means of adjusting capacitance without abrasive trimming or interchange of fixed capacitors. Series 9401 has high Q's and a range of capacitance values from 0.2-0.6 pf to 3.0-12.0 pf and 250 WVDC working voltage. Johanson Manufacturing Corporation, Boonton, New Jersey (201) 334-2676.

INFORMATION RETRIEVAL NUMBER 181



**VLF receiver - VLF portable receiver** for RF, Acoustic, Sonar Communication and EMI. Low cost, dual IF bandwidth, AGC, and immunity to RFI. Tunes 40 to 200 KHz; Ranges of 6 to 400 KHz available. Compatible antenna, hydrophones, transmitters (acoustic), decoders, and recorders available. - BAYSHORE SYSTEMS - Springfield, Va. (703) 321-9625.

INFORMATION RETRIEVAL NUMBER 184

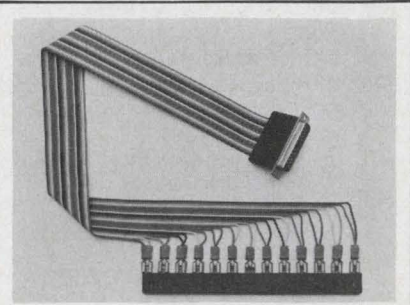

**COMPLETE INTERCONNECTION ASSEMBLIES** to your exact specifications! Low cost - highest quality - produced to MIL specs or with UL approval. Spectra-Strip "Ready to install" interconnection assemblies save you time - save you dollars! Fast delivery! Spectra-Strip, 7100 Lampson Ave., Garden Grove, Ca. 92642, (714) 892-3361.

INFORMATION RETRIEVAL NUMBER 187



**LAB SERIES DC POWER SUPPLIES** from Powertec feature high power outputs in small, low-weight cases. Triple output units available in addition to single and six output models, each specifically designed for precision power requirements at the lowest costs in the industry. From \$295.00. Powertec, Inc., Chatsworth, CA. (213) 882-0004.

INFORMATION RETRIEVAL NUMBER 182

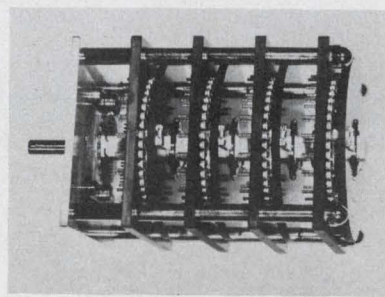

**Instrument quality, Precision Rotary Switches** are offered by Cole Instrument Corp. Up to 24 poles per deck, 100 or more positions per pole are standard. Custom, remote control, and many other options available. We will manufacture to your requirements. Send for new short form catalog. 2034 Placentia Ave Costa Mesa, CA 92627. (714) 642-8080.

INFORMATION RETRIEVAL NUMBER 185

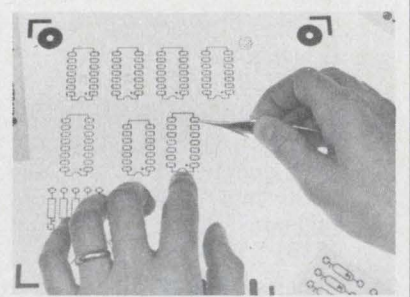

**Cut PC layout time 75% with PUP-PETS™**, Bishop's die-cut, transparent, reusable layout patterns in 2X or 4X scale that represent electronic components. Contain no adhesive yet adhere to any clear, non-matte drafting film. FREE Sample & technical bulletin. Bishop Graphics, Inc., 20450 Plummer Street, Chatsworth, CA 91311 (213) 993-1000.

INFORMATION RETRIEVAL NUMBER 188

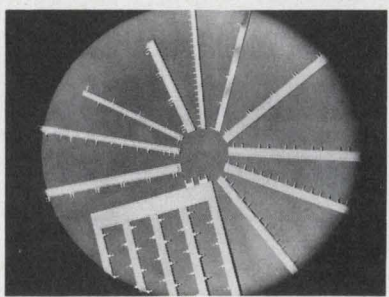

**Mini/Bus® Evaluation Kit, \$25**, in stock. Lets you try Rogers' low-cost, noise attenuating, high packaging density power distribution system for PC boards. Millions in use. Standard parts on 2 weeks delivery, or less! Customer parts 4 to 6 weeks delivery. Rogers Corporation, Chandler, Ariz. 85224. Phone (602) 963-4584

INFORMATION RETRIEVAL NUMBER 183

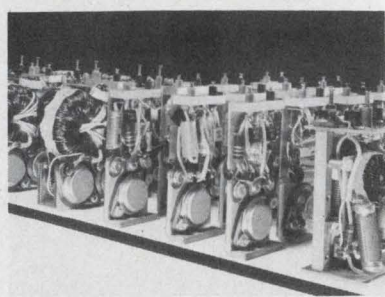

**Custom Power Supplies from off-the-shelf sub-modules.** Over 1200 configurations. No engineering charges! AC (115VAC, 50-500Hz) and DC (12, 28, 48 & 115VDC) inputs. Multiple isolated and regulated (to .1%) DC outputs. 1-500 Watts. Miniaturized. Efficiencies to 85%. Arnold Magnetics, Culver City, Ca. (213) 870-7014.

INFORMATION RETRIEVAL NUMBER 186

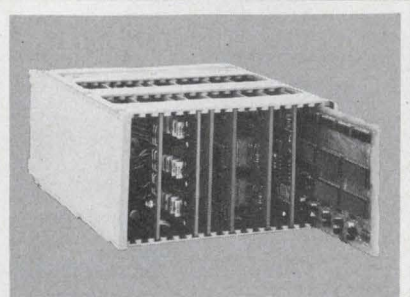

**Solid-State Voice Systems** for audio readout of numbers and words. Whole-words are stored in ROMs with natural sounding voice reproduction. Standard models offer 10 numeric words (0 - 9). Master Specialties, 1640 Monrovia, Costa Mesa, Calif. 92627. (714) 642-2427.

INFORMATION RETRIEVAL NUMBER 189



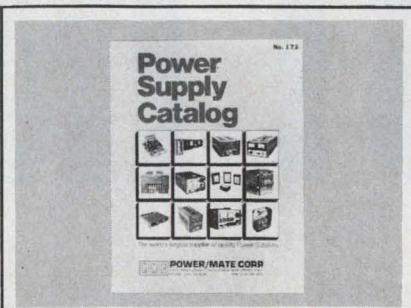

Free catalog of 34,500 power supplies from the worlds largest manufacturer of quality Power Supplies. New '74 catalog covers over 34,500 D.C. Power Supplies for every application. All units are UL approved, and meet most military and commercial specs for industrial and computer uses. Power Mate Corp. (201) 343-6294.

INFORMATION RETRIEVAL NUMBER 190



Cramolin contact cleaner & lubricant dissolves oxide films caused by corrosive atmospheres i.e. sulphur dioxide. Effective on metals & alloys. Reduces contact resistance. Will not harm plastics. Free of acids. Wide operating temperature range. Tech data & test evaluation fluid sample available. Caig Laboratories, Inc., P.O. 788, Westbury, N.Y. 11590.

INFORMATION RETRIEVAL NUMBER 193

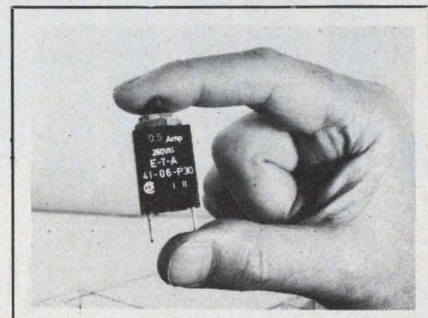

Overcurrent Protector, manual reset eliminates fuse replacement. Convenient panel mounting. 15 fractional ratings from 0.1 to 3 amp. Other models up to 400 amp. Trip-free and fool-proof, UL and CSA approved. High quality, low cost \$1.20 ea. in 1000 lots. E-T-A Products Co. of America, 7400 N. Croname Rd., Chicago, Ill. 60648. Tel: (312) 647-8303. Telex: 253780.

INFORMATION RETRIEVAL NUMBER 196

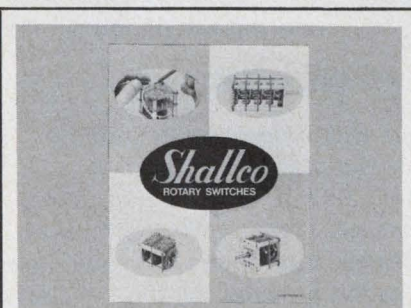

Precision rotary switches for instrumentation and control applications. Many combinations of various electrical and mechanical features offer a wide range of switching functions in three basic sizes. Catalog 201. Shallco, Inc., P.O. Box 1089, Smithfield, NC 27577.

INFORMATION RETRIEVAL NUMBER 191



Model PT55 Trigger Generator \$295. Feature 55kV output, 75ns wide, rise time 2ns, negligible jitter. Will fire most any triggered gap, including hi-capacitive Mid-plane, and Lo-impedance Rail-switches. With 1000:1 output monitor std. Pacific-Atlantic Trading Co. Inc. Electronics Div. P.O. Box 754 El Cerrito, Ca. 94530 (415) 788-5258.

INFORMATION RETRIEVAL NUMBER 194

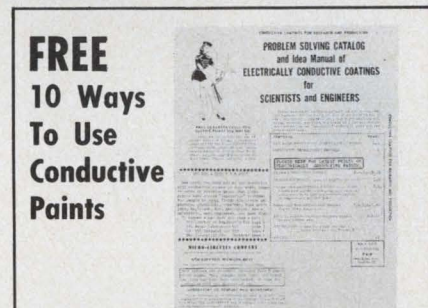

**FREE**  
10 Ways  
To Use  
Conductive  
Paints

Our electrically conductive paints are solving "impossible" lab problems and reducing unit production costs. One customer saves a fortune each year PAINTING on four MILLION pin head 1000 meg resistors. Add that up. Why not request "Ten Ways To Use Conductive Paints"? Micro Circuits Co., New Buffalo, Mich. 49117. (616) 469-2727.

INFORMATION RETRIEVAL NUMBER 197

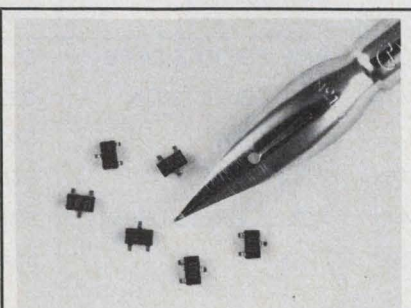

The NEC V734M is a high frequency transistor in a very small package, 1.5 x 2.8 mm. With an  $f_t$  of 2 GHz and a noise figure of 3 db at 500 MHz this inexpensive transistor is suitable for many applications in amplifiers and oscillators. California Eastern Labs, Inc. One Edwards Court, Burlingame, Calif. (415) 342-7744.

INFORMATION RETRIEVAL NUMBER 192

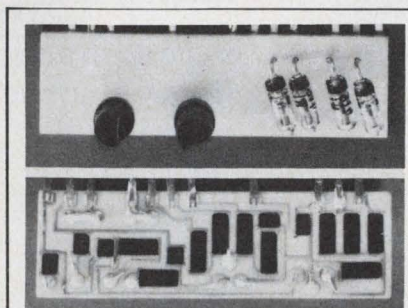

IMS, INC. THICK FILM CIRCUITS offer the advantage of high quality combined with low cost. Products include resistor and resistor-capacitor networks, hybrid packages, special rheostat designs, component outboarding. Short delivery times. IMS, INC., 288 East Main Rd., Middletown, R.I. 02881

INFORMATION RETRIEVAL NUMBER 195

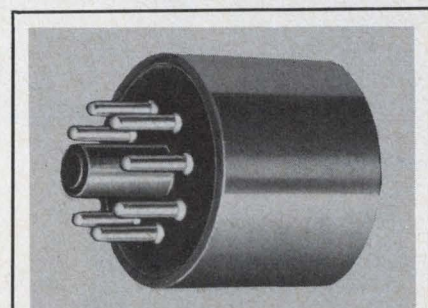

Solid-state full wave ac flasher—Type FS131 handles 1 amp resistive, incandescent, inductive loads at 120 VAC. 90 flashes/min. Low cost. Circuitry totally encapsulated. Complete line of solid state flashers and signal controls for every application. SSAC Precision Products, Inc., P.O. Box 395, Liverpool, N.Y. 13088. (315) 457-9610.

INFORMATION RETRIEVAL NUMBER 198



# LOOK FIRST IN

## FOR POWER SEMICONDUCTORS

### ■ WHO MAKES THEM

You'll find 97 manufacturers of power semiconductors beginning on pages 353, 428 and 457 of *Electronic Design's* GOLD BOOK (Volume 1—Product Directory). For your convenience, each manufacturer is listed with complete street address, city, state, zip and phone number.

### ■ SALES OFFICES—REPS DISTRIBUTORS

To find information about each power semiconductor manufacturer, turn to the *Manufacturers Directory*. Whenever possible it lists names of key officials, sales offices, export offices, foreign offices, U.S. and foreign reps followed by a list of U.S. distributors. In many cases there is additional data, when provided by the company: TWX, TELEX, cable address, facsimile equipment (make and call number), 800 (toll-free numbers) as well as number of engineers, number of employees and financial data.

### ■ CATALOG PAGES

Here's a rundown of the catalog pages you'll find on power transistors in *Electronic Design's* GOLD BOOK.

Manufacturer	Starts in Vol. 2, Page:	Manufacturer	Starts in Vol. 2, Page:
DELCO ELECTRONICS	379	RCA SOLID STATE	511
GENERAL ELECTRIC	414	RSM SENSITRON	537
INTERNATIONAL RECTIFIER	451	SEMTECH	542
MOTOROLA	471	SOLITRON	545
POWER TECH, INC.	507	TEXAS INSTRUMENTS	547
		TRW	554

KEEP *ELECTRONIC DESIGN'S* GOLD BOOK  
HANDY WHEN YOU CALL

Refer to your copy of *Electronic Design's* GOLD BOOK before you dial your next vendor. Referral to specific product pages can shorten your long distance phone calls. LOOK FIRST in *Electronic Design's* GOLD BOOK.

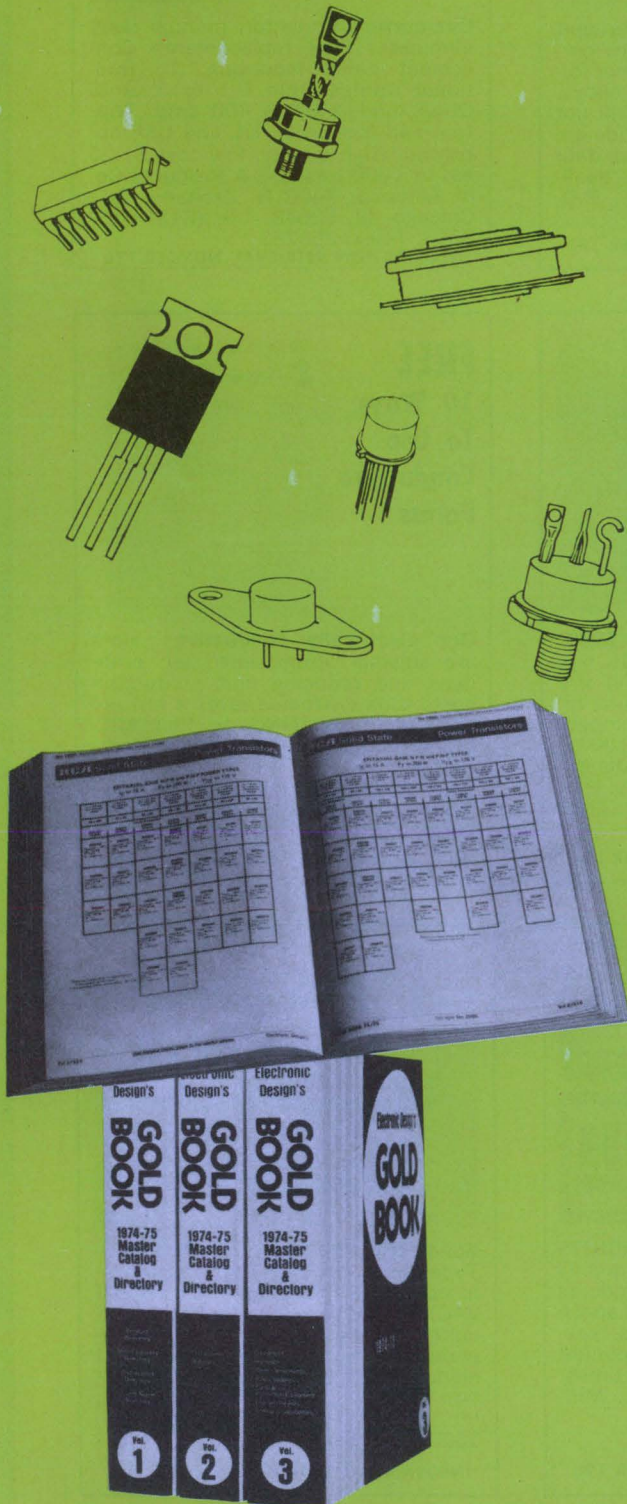



# Electronic Design's

# GOLD BOOK

## FOR COOLING EQUIPMENT

### ■ WHO MAKES IT

You'll find eleven categories of cooling equipment and related products listed in the *Product Directory of Electronic Design's GOLD BOOK*. For blowers and fans 38 manufacturers are listed. For thermoelectric cooling/heating modules, 17; circulating liquid cooling units, 21; heat sinks and dissipators, 50; thermal conductive coatings, 23; insulators and insulating hardware, 52; transistor mounting pads, 23; epoxy potting compounds, 41; silicone greases, 17; and washers, 18. As with power semiconductors, data about each manufacturer, his reps and distributors can be found by referring to the *Manufacturers Directory*.

### ■ HERE'S A RUNDOWN OF THE CATALOG PAGES YOU'LL FIND ON HEAT SINKS AND DISSIPATORS ALONE

Manufacturer	Number of Catalog Pages	Starts On Page:
AHAM	3	Vol. 2, 1286
Hughes Aircraft Co.	4	Vol. 2, 1289 Vol. 3, 1264
Hughes Connecting Devices	2	Vol. 3, 1442
Intl. Elec. Research	4	Vol. 2, 1291
Intl. Rectifier	2	Vol. 2, 458
Jermyn	1	Vol. 2, 1295
Thermalloy Inc.	1	Vol. 2, 1304
Unitrack	1	Vol. 3, 271
Wakefield Engrg. Inc.	42	Vol. 2, 1307

### ■ TAKE WAKEFIELD ENGINEERING, FOR EXAMPLE

Wakefield Engineering's 42 page catalog of semiconductor cooling products begins on page 1307 of Vol. 2. In addition to detailed specs and information about its heat sinks and thermal cooling products (most show curves of natural and forced convection characteristics) the pages include diagrams of 99 heat sink extrusion shapes with dimensions, surface area, and thermal characteristics. Wakefield's unit also provides guides on HOW TO SELECT HEAT SINKS, ENGINEERING DATA, HEAT SINK MOUNTING SPECIFICATIONS, HOLE PATTERNS, U.S. DISTRIBUTORS, EUROPEAN SALES AGENTS, U.S. FIELD SALES ENGINEERS, and lists other available Wakefield catalogs.

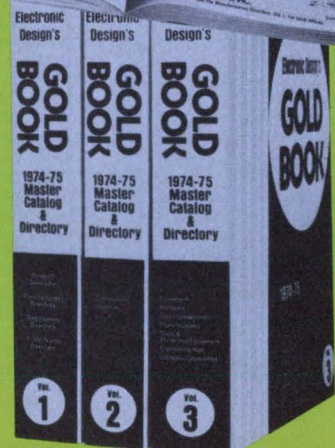
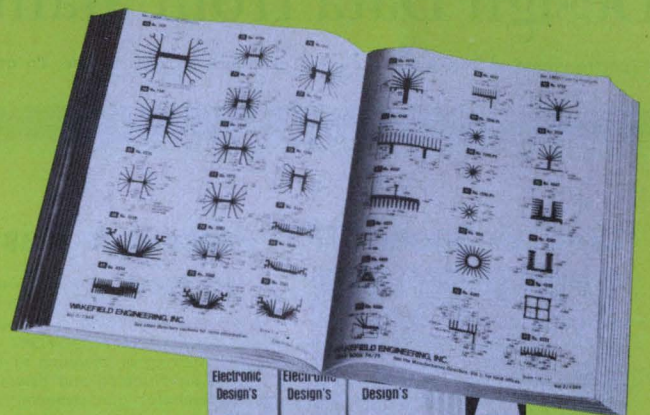
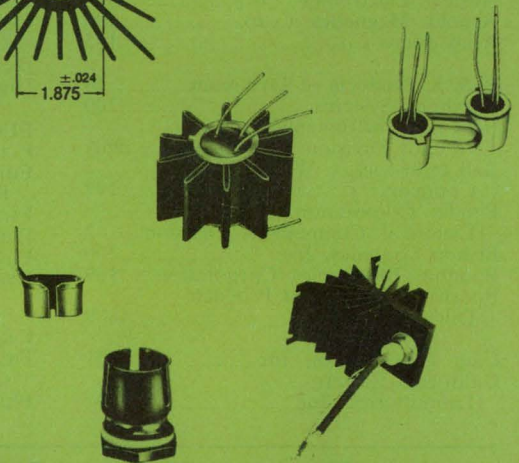
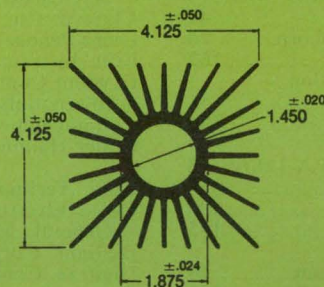



# advertiser's index

Advertiser	Page	Advertiser	Page	Advertiser	Page
AMP, Incorporated	42, 43	Centralab, The Electronics		GTE Automatic Electric	96B, 96C
AVX Ceramics Corporation	17, 19, 21	Division of Globe-Union, Inc.	163	GTE Sylvania, Parts Division	51
Acopian Corp.	121	Cherry Electrical Products Corp.	24	General Electric Company, Semiconductor Products	
Airpax Electronics, Controls		Chicago Dynamics Industries, Inc.	185	Department	96
Division	39	Clairex Electronics, A Division		General Instrument Corporation, Semiconductor Division	37
Alco Electronic Products, Inc.	193	of Clairex Corporation	52	General Semiconductor	
Allen Bradley Co.	47	Clare & Co., C. P.	97	Industries, Inc.	156
Allen Bradley Co.	47	Clare-Pendar	157, 208	Gold Book, The	96D, 160A, 160B, 164, 165, 178, 177, 190, 191, 200, 201
Amerite Co., Inc.	162	Cole Instruments	200	Gould, Inc., Instrument Systems	
Amphenol Connector Division, Bunker-Ramo Corp.	55	Crydom Controls, Division of		Division	159
Amplifier Research Corporation	193	International Rectifier	167	Grayhill, Inc.	172
Analog Devices, Inc.	96D, 96 A-1 thru A-8	Cunningham Corporation	186	Gulton Industries, Inc.	170
Ansley Electronics Corp.	54	Cutler-Hammer	22, 23		
Arnold Magnetics Corp.	200				
Atlas Fibre Co.	185				
B & K Products of Dynascan	46	Data Technology Corporation	185	Hamamatsu Corp.	199
Bayshore Systems	200	Delco Electronics, Division of		Harris Semiconductor, A Division	
Beckman Instruments, Inc.		General Motors Corporation	10, 11	of Harris Intertype Corporation	88, 89
Helipot Division	96A	Dialight Corporation	12	Hecon Corporation	160
Bell Industries, J. W. Miller		Digitran Company, The	188	Heinemann Electric Company	35
Company	197			Hewlett-Packard	4, 5, 104, 105, 181
Bendix Corporation, The				Hybrid Systems Corp.	161
Electrical Components Division	2	EECO	149		
Bishop Graphics, Inc.	200	E-T-A Products Co. of America	201	ITT Semiconductor, A Division	
Boonton Electronics Corporation	169	Edison Electronics, a McGraw- Edison Company Division	123	of International Telephone and Telegraph Corporation	74, 75
Bourns, Inc. Trimpot Products		Efratom California, Inc.	196	Illuminated Products	176
Division	8, 9	Electro Scientific Industries	174	Indiana General	95
		Electronic Navigation Industries	136	Industrial Electronic Engineers, Inc.	110, 111
		Exar Integrated Systems	1	Inselek, Inc.	130
				Instrument Specialties Company, Inc.	151
Caig Laboratories, Inc.	201	Facit-Addo, Inc.	127	Intel Corporation	4, 5
California Eastern		Fairchild Semiconductor		International Manufacturing	
Laboratories, Inc.	201	Components Group	152, 153	Services	201
		Fluke Counter Division	44		

## Design Data from Manufacturers

Advertisements of booklets, brochures, catalogs and data sheets. To order use Reader-Service Card.

(Advertisement)

### Dual Hi-Speed FFT Processor Easy to Operate

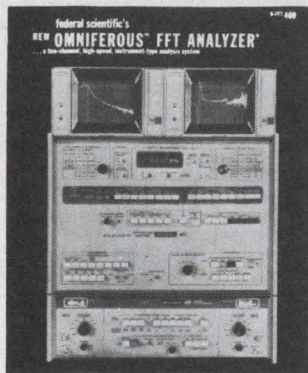

Conceived from the point of view of the operating engineer rather than the computer programmer, the new Omniferous™ FFT Analyzer operates like an instrument, calculates like a computer. This Series OF-400 Analyzer is a universal digital signal analysis system for real-time viewing of changing functions, a complete instrument with all signal conditioning and display calibration built-in. For the first time an operator can observe transfer function, cross-spectra or coherence as the signal is changing without waiting for the analyzer to perform successive laborious calculations.

Features include high speed of 68,000 samples/sec throughput, and high resolution with a 2048 transform size and extra-sharp input anti-aliasing filtering. Calculates FFT, IFFT, power spectra, auto-correlation, cross correlation, and signal enhancement (time averaging), as well as the averaging of any calculated function in sum, peak or exponential mode.

The system excels in high dynamic range, ease of use, display flexibility with two simultaneous display outputs, frequency coverage to 100 kHz, and reasonable cost. Designed by the originators of the famous Ubiquitous® family of real-time spectrum analyzers.

**Nicolet Scientific Corp.** (formerly Federal Scientific Corp.)

245 Livingston St., Northvale, New Jersey 07647  
(201) 767-7100. TWX: 710-991-9619

IMMEDIATE, CIRCLE NO. 170  
ROUTINE, CIRCLE NO. 171

Johanson Manufacturing Corp.	7, 200
Keystone Carbon Company	168
LVC Industries, Inc., Co-ord Switch	187
Lambda Electronics Corp.	112, 113
Ledex, Inc.	146
Licon, Division of Illinois Tool Works, Inc.	48
Litronix, Inc.	116, 117
Litton OEM Products Division	195
MCL, Inc.	182
Magnecraft Electric Company	Cover III
Magnetics, Inc.	173
Master Specialties	200
Micro-Circuits	201
Microswitch, A Division of Honeywell	14, 15
Microwave Devices Corp.	187
Mini-Circuits Laboratory	207
Mostek Corporation	27
Nelson Ross Electronics	133
Nicolet Scientific Corp.	204
North American Philips Controls Corp.	94
Optima, A Division of Scientific Atlanta, Inc.	147
Oshino Electric Lamp Works, Ltd.	194



## recruitment and classified ads

Advertiser	Page
Otto Controls, Division, Otto Engineering, Inc. ....	208
Owens-Illinois, Inc. ....	141
PSG Industries, Inc. ....	193
Pacific-Atlantic Trading .....	201
*Philips Industries, Electronic Components and Materials Division .....	128A
*Philips Industries, Test and Measuring Instruments Dept.....	128B
Pico Electronics, Inc.....	Cover II
Piher International Corp.....	134, 135
Pomona Electronics Co., Inc.....	189
Potter & Brumfield, Division of AMF, Incorporated .....	158
Power/Mate Corp. ....	201
Power Physics Corporation.....	208
Powertec, Inc. ....	13, 200
Princeton Electronic Products, Inc..	67
RCA Solid State .....	Cover IV
RCL Electronics, Inc.....	40
Reader Service .....	208A, 208B
Rhombus Industries, Inc.....	180
Risk Industries, Inc., Geo.....	208
Robinson Nugent, Incorporated .....	129
Rogers Corporation .....	193, 200
Rotron, Inc. ....	177
SSAC Precision Products, Inc.....	201
Scanbe Canoga Industries.....	41
Schauer Manufacturing Corp.....	140
Schrack Electrical Sales Corp.....	189
Shallco .....	201
Showa Musen Kogyo Co., Ltd.....	184
Siemens Corporation .....	18
Signalite, Division of General Instrument Corporation .....	137
Simpson Electric Company.....	171
Solid State Scientific, Inc.....	28, 29
Sorenson Company, A Unit of Raytheon Company .....	175
Spectra-Strip .....	200
Sprague Electric Company.....	183
Stackpole Components Company .....	139
Stacoswitch .....	81
Systron-Donner .....	80
TDK Electronics .....	145
T. R. I. Corporation.....	142, 143
TRW Capacitors, an Electronic Components Division of TRW, Inc. ....	125
Tele-Dynamics/Wanlass Division of Ambac .....	166
Texscan Corporation .....	160
Thermalloy Company .....	144
Thomas & Betts Co., The.....	155
Todd Products Co.....	187, 189
Triplett Corporation .....	119
USCC/Centralab Electronics Division, Globe-Union, Inc.....	33
U. S. Components, Inc.....	198
Unimax Switch Corporation .....	45, 194, 195, 196, 197, 198, 199
Wahl Clipper Corporation.....	192
Watkins-Johnson .....	16
Western Digital Corporation.....	68, 69
Woven Electronics .....	7

\*Advertisers in non-U.S. edition

# ENGINEERS POWER ELECTRONICS

The Industrial Controls Division of Emerson Electric Company has immediate need for Engineers in key positions, capable of handling product design and orders in our power conversion engineering group.

These are challenging positions requiring initiative, creativeness and self-motivation. This is an expanding field and provides unlimited growth opportunity for the successful candidates. Prefer background in product design, project and systems work in large power electronic equipment or related field.

### PROJECT ENGINEER

This is a key position with project responsibility for high power uninterruptible systems from specifications to shipping. Must be well organized and project oriented. Past circuit design experience useful. Will contribute to new product design. Will be involved in customer contacts.

### TRANSFORMER - POWER SUPPLY ENGINEER

Full responsibility for design of all magnetics produced inhouse. Also deals with transformer vendors to coordinate purchases. Wide variety of product design responsibilities of high power DC-power supplies and inverter systems. Requires experience in large transformer and inductor design and a strong interest in electronic power.

### INVERTER DEVELOPMENT ENGINEER

Development of new variable frequency motor control and uninterruptible power supply products from circuit design through packaging. Project responsibility. Requires strong background in high power SCR inverter and related control circuit design.

### DESIGNER

Will layout and package solid state power conversion equipment including PC boards. Experience with wiring diagrams, schematics, sheet metal structures desirable.

Emerson Electric Company, Industrial Controls Division, manufactures uninterruptible power supply and inverter AC motor control systems. The selected individuals will join the leader in a fast growing field.

## EMERSON ELECTRIC COMPANY

Industrial Controls Division  
3300 So. Standard St., Santa Ana, Ca. 92702  
Attn. Mr. Canavan (714) 545-5581  
An equal opportunity employer m/f

**Protect Your Heart  
HAVE REGULAR MEDICAL  
CHECK UPS**



Give Heart Fund



**SAME DAY SHIPMENT  
Minis & Peripherals  
PRINTERS**

**"BRAND NEW"  
DATA PRODUCTS  
2440- 700LPM  
2470-1250LPM  
MDS 4320-300LPM**

**ALSO  
CENTRONICS, POTTER, CDC  
A. B. DICK, IBM, HIS, UNIVAC  
617/261-1100**

*Send for Free Report  
"Maintenance of Computers"*

**AMERICAN USED COMPUTER CORP.**  
P.O. Box 68, Kenmore Sta., Boston MA 02215  
member COMPUTER DEALERS ASSOCIATION



# product index

**Information Retrieval Service.** New Products, Evaluation Samples (ES), Design Aids (DA), Application Notes (AN), and New Literature (NL) in this issue are listed here with page and Information Retrieval numbers. Reader requests will be promptly processed by computer and mailed to the manufacturer within three days.

Category	Page	IRN	Category	Page	IRN	Category	Page	IRN
<b>Components</b>			switches, slide	193	<b>211</b>	counter	168	<b>323</b>
batteries (NL)	192	<b>375</b>	switches, subminiature	199	<b>146</b>	counter-timers	166	<b>307</b>
bracket, PB switch	176	<b>337</b>	switches, subminiature	208	<b>153</b>	DMM	208	<b>156</b>
capacitor, air trim	182	<b>345</b>	switches, toggle	196	<b>140</b>	DMMs	143	<b>81</b>
capacitors	7	<b>6</b>	switchlights	157	<b>94</b>	data generator	162	<b>303</b>
capacitors	17	<b>13</b>	switchlights	208	<b>154</b>	function generator	168	<b>322</b>
capacitors	19	<b>15</b>	terminals, barrier	176	<b>336</b>	HV transistor testing (AN)	254	<b>590</b>
capacitors	125	<b>66</b>	thermal cut-offs	187	<b>124</b>	how to use a voltsensor (AN)	254	<b>589</b>
capacitors	183	<b>117</b>	thermistor assemblies	168	<b>104</b>	IC functional tester	174	<b>110</b>
chips, resistor	161	<b>99</b>	transformers	11	<b>243</b>	logic tester	168	<b>321</b>
chokes	197	<b>143</b>	trimmers	47	<b>36</b>	millivolt, rf	169	<b>166</b>
circuit breakers	35	<b>27</b>	trimmers	96A	<b>57</b>	oscilloscopes	46	<b>35</b>
circuit breakers	39	<b>29</b>	ultraviolet detector	180	<b>343</b>	panel instruments	119	<b>63</b>
contacts and relays (NL)	254	<b>591</b>	valve-noise booklet (AN)	188	<b>359</b>	power amplifier, rf	136	<b>75</b>
cores, miniature	180	<b>342</b>	voltage protectors	137	<b>76</b>	pROM programmer	166	<b>308</b>
delay lines	180	<b>114</b>	wire-wound resistors (NL)	192	<b>372</b>	pulse generator	162	<b>305</b>
detector, thermopile	147	<b>277</b>				scope	162	<b>304</b>
detectors	199	<b>147</b>	<b>Data Processing</b>			semiconductor test equipment	18	<b>14</b>
diodes, varactor	147	<b>278</b>	calculator	105	<b>151</b>	spectrum analyzer	160	<b>97</b>
electromechanical punches	195	<b>139</b>	calculator	144	<b>274</b>	spectrum analyzers	133	<b>73</b>
filters	21	<b>17</b>	cassette recorders (NL)	194	<b>379</b>	transient recorder	162	<b>306</b>
filters, EMI/RFI	33	<b>26</b>	controller	140	<b>269</b>	transistor tester	167	<b>310</b>
inductors	145	<b>83</b>	controllers	160	<b>98</b>	voltmeter	167	<b>309</b>
limiters (NL)	188	<b>360</b>	image storage system	67	<b>46</b>	voltmeter, rms	169	<b>167</b>
matrix boards	187	<b>125</b>	laser comm system	144	<b>273</b>			
metal-film resistors (NL)	188	<b>358</b>	memory, NMOS	140	<b>267</b>	<b>Integrated Circuits</b>		
miniswitch	188	<b>127</b>	memory, core	144	<b>272</b>	analog switches	136	<b>261</b>
motor, miniature	176	<b>339</b>	memory, floppy-disc	144	<b>270</b>	array, analog	131	<b>251</b>
panel controls, push-button	198	<b>144</b>	modem, data	140	<b>268</b>	CMOS	135	<b>74</b>
photoconductive material	52	<b>43</b>	paper tape punch	127	<b>67</b>	CMOS, high-speed	130	<b>72</b>
plasma display units	141	<b>80</b>	peripheral, disc	138	<b>252</b>	CMOS, isoplanar	153	<b>90</b>
relay	180	<b>340</b>	plotters	159	<b>96</b>	character generator	132	<b>255</b>
relay, mercury	182	<b>344</b>	printers, digital	80	<b>50</b>	counter	132	<b>254</b>
relay, reed, DIP	180	<b>341</b>	processor, arithmetic	138	<b>265</b>	decoder/driver, CMOS ICs, linear	136	<b>264</b>
relays	96C	<b>58</b>	reader, credit-card	140	<b>266</b>	ICs, MECL 10,000	132	<b>256</b>
relays	158	<b>95</b>	terminal, CRT	144	<b>271</b>	MOS LSI circuits (NL)	194	<b>377</b>
relays	162	<b>100</b>	thermal printheads	170	<b>106</b>	op amps	89	<b>52</b>
relays	167	<b>103</b>				op amps, FET	132	<b>257</b>
relays	189	<b>129</b>	<b>Discrete Semiconductors</b>			pROMs	131	<b>253</b>
relays, reed	97	<b>59</b>	analog switches (AN)	254	<b>593</b>	RAM	132	<b>260</b>
relays, reed	111	<b>244</b>	detector, thermopile	147	<b>277</b>	RAM, 4-k	69	<b>47</b>
resistor			diodes, high-voltage	147	<b>276</b>	RAMs	136	<b>263</b>
networks (NL)	195	<b>381</b>	diodes, varactor	147	<b>278</b>	RAMs, 4-k	27	<b>24</b>
switch	123	<b>65</b>	discrete semis and ICs (NL)	192	<b>370</b>	receiver	132	<b>258</b>
switch kit, PB	182	<b>346</b>	LEDs	12	<b>9</b>	shift register	136	<b>262</b>
switch, thumbwheel	24	<b>20</b>	LEDs	117	<b>62</b>	switch driver, FET	132	<b>259</b>
switches	15	<b>11</b>	LEDs (NL)	195	<b>383</b>	timers	1	<b>2</b>
switches	23	<b>19</b>	memory, NMOS	140	<b>267</b>			
switches	45	<b>34</b>	optocouplers	16	<b>12</b>	<b>Microwaves &amp; Lasers</b>		
switches	81	<b>51</b>	optoelectronic components (NL)	194	<b>378</b>	acoustic components	153	<b>283</b>
switches	139	<b>78</b>	rectifiers	37	<b>28</b>	amplifier, rf	150	<b>250</b>
switches	146	<b>84</b>	semiconductors	29	<b>25</b>	amps, cascadeable	153	<b>282</b>
switches	172	<b>108</b>	switch driver, FET	132	<b>259</b>	barretter mount	154	<b>284</b>
switches	184	<b>118</b>	transistors, power	146	<b>275</b>	detector	154	<b>286</b>
switches	194	<b>136</b>	ultraviolet detector	180	<b>343</b>	front end	153	<b>280</b>
switches	208	<b>155</b>	zeners	140	<b>79</b>	laser	153	<b>281</b>
switches, g-p	197	<b>142</b>				laser systems	154	<b>289</b>
switches, linear	185	<b>119</b>	<b>Instrumentation</b>			mixers, double-balanced	207	<b>149</b>
switches, miniature	195	<b>138</b>	amplifier, 10-W	193	<b>134</b>	mixers, microwave	96	<b>56</b>
switches, pushbutton	193	<b>210</b>	bite indicator	94	<b>53</b>	noise sources	154	<b>290</b>
switches, rocker	176	<b>338</b>	bridges, admittance	169	<b>165</b>	oscillator	154	<b>288</b>
switches, rotary	40	<b>30</b>	C-V plotter	168	<b>320</b>			
			counter	44	<b>33</b>			



# DOUBLE-BALANCED MIXERS

Great Value at

**\$7<sup>95</sup>**  
500 piece quantities.

\$9.95 in quantities of 1 to 49 pieces

DC-500MHz  
6dB conversion loss  
40dB isolation  
EMI shielded case

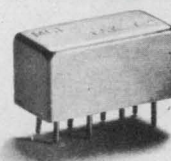

A breakthrough in technology and high production volume enables Mini-Circuits Laboratory to offer these new products at an unprecedented low price.

In today's tough competitive market can you afford not to use these remarkably low priced and high performance units?

Ruggedness and durability are built in the SRA-1. These new units are packaged within an EMI shielded metal enclosure and hermetically sealed header. They use well matched hot-carrier diodes and uniquely designed transmission line transformers.

We invite you to convince yourself. Place your order now and check our delivery, product performance and reliability.

## Mini-Circuits Laboratory

837 Utica Avenue, Brooklyn, N.Y. 11203  
(212) 342-2500

A Division Scientific Components Corp.

\*FRANCE: S.C.I.E., \*31, rue George-Sand, Palaiseau 91, France \*GERMANY, AUSTRIA, SWITZERLAND: Industrial Electronics GMBH, \*Klüberstrasse 14, 6000 Frankfurt/Main, Germany \*UNITS IN STOCK

ENGLAND; Dale Electronics: Dale House, Wharf Road, Frimley Green, Camberley, Surrey, JAPAN; Denisho Kaisha, Ltd.: Eguchi Building, 8-1, 1-Chrome, Hamamatsucho, Minato-Ku, Tokyo.

\*UNIT IN STOCK.

INFORMATION RETRIEVAL NUMBER 149

Category	Page	IRN
TWT, S-band termination	154	285
transistor array	154	287
	150	279

### Modules & Subassemblies

a/d converter (AN)	254	592
amplifier, charge	174	332
analog switches	136	261
array, analog	131	251
controller, motor	172	330
controller, prog.	170	325
converter, d/a	174	331
converter, dc-to-synchro	174	333
converters, synchro	175	335
frequency standards	196	141
modem, data	140	268
processor, arithmetic	138	265
quadrature, hybrid	172	329
sensor, voltage	172	328
stabilizer, temp	170	326
system, data acquisition	175	334
timer, long period	172	327
timer, recycle	170	324

### Packaging & Materials

blowers	177	113
bus	193	133
cable	6	5
card file system	41	31
conductive elastomer	184	352
connector, PC	186	356
connectors	55	45
connectors	198	145
connectors, PC board	2	3
diamond saw, alumina	183	348
enclosures	147	85
heat sinks	144	82
jumpers	54	44
lab ware	184	349
metals	173	109
micromanipulators (NL)	192	371
microwave ovens (NL)	195	380
oven, electric	183	347
pads, TO-5 to DIP	184	350
phenolic rods	185	120
plastic piping systems (NL)	194	376
rubber, conductive	186	355
snap-mount lights (NL)	192	369
sockets	129	71
soldering iron	192	131
spring contacts	151	88
spring pins (AN)	188	357
stock and custom tool kits (NL)	192	374
test clip	189	128
thick-film knit	184	351
tool kit, relay	186	353
tying tools	155	91
zip-on jacket, flat cable	186	354

### Power Sources

batteries	158	296
CRT supply	157	294
computer supply	160	299

Category	Page	IRN
converter, dc/dc	156	291
converter, dc/dc	158	295
converter, dc/dc	161	302
line regulators	156	292
open frame power supplies (NL)	192	373
open-frame supplies	158	297
open-frame supplies	160	298
PC-board supplies	157	293
power source	160	300
power source	182	116
power supplies	13	10
power supplies	20	16
power supplies	113	68
power supplies	120	64
power supplies	166	102
power supplies	187	126
power supplies	189	130
power supplies (NL)	195	382
power supplies, modular	96 E1-E8	248
submodules	161	301
voltage regulator	175	111

### new literature

batteries	192	375
cassette recorders	194	379
LEDs	195	383
MOS LSI circuits	194	377
micromanipulators	192	371
microwave ovens	195	380
open frame power supplies	192	373
optoelectronic components	194	378
plastic piping systems	194	376
power supplies	195	382
resistor networks	195	381
snap-mount lights	192	369
stock and custom tool kits	192	374
switch kit, PB	182	346
wire-wound resistors	192	372

### application notes

contacts and relays	254	591
converter, a/d	254	592
HV transistor testing	254	590
how to use a voltmeter	254	589
limiters	188	360
metal-film resistors	188	358
spring pins	188	357
valve-noise booklet	188	359



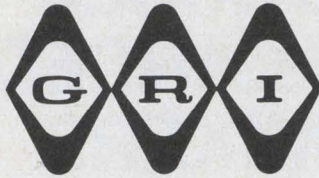

## REED TYPE PUSHBUTTON SWITCHES

- Hermetically sealed contacts
- Life expectancy in the millions
- Low closed contact resistance
- Ideal for dry circuits
- Explosion proof
- Low bounce characteristics.

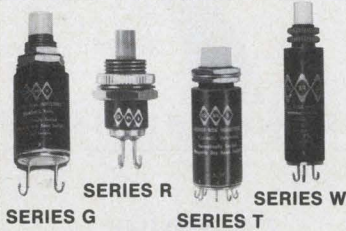

**SERIES G**      **SERIES R**      **SERIES W**      **SERIES T**

Momentary Action  
and Mercury-Wetted Reed

## KEYBOARD SWITCHES



Illuminated  
Non-illuminated

- Low Cost
- Immediate Delivery

## KEYBOARDS

- Standard off-the-shelf
- Custom for O.E.M.'s
- Encoded or non-encoded
- Low cost
- Choice of "N" key rollover, 2 key rollover or 2 key lockout
- Large selection of key caps and space bars
- Any or all keys illuminated
- Fast delivery

Write or call today for delivery dates and quotations.



### GEORGE RISK INDUSTRIES, INC.

G.R.I. Plaza, Kimball, Nebraska 69145  
Phone: 308-235-4645 TWX: 910-620-9040

INFORMATION RETRIEVAL NUMBER 153

# OTTO®

## Sub-subminiature Switches

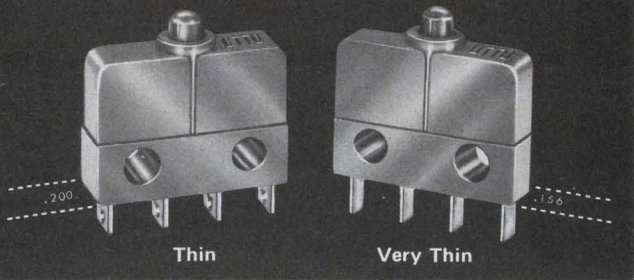

snap-action • precision • 8 A. to dry circuit!

Less than 10 milliohms contact resistance in a ten million cycle switch! That's the OTTO B3 series with patented\* design featuring high contact force and minimal contact bounce. Commercial or military, your options include "thin" and "very thin" sizes, contact arrangements to form Z, terminals, and contact materials. Load ratings to 8 A. resistive. Actuators available, too.

For full details including prices and local distributors, write for Bulletin B3.

\*U.S. Pat. No. 3,612,793

## OTTO CONTROLS

Division, OTTO engineering, inc.  
36 Main Street, Carpentersville, Illinois 60110 • Phone: 312/428-7171  
© OTTO engineering inc.

INFORMATION RETRIEVAL NUMBER 155



## We challenge any leading switchlight manufacturer to match our "Persuader Line"

Make your own comparison from our 21 point check list. See page 157 then call your local distributor or Clare-Pendar, Box 785, Post Falls, Idaho 83854 (208) 773-4541

CLARE-PENDAR



INFORMATION RETRIEVAL NUMBER 154

Call Sandy collect at (201) 542-1902 to get all the information (prices, delivery, specs) on our popular 2N4998 through 2N5005 (2N5006-9 on special request) series. We make them all. High quality 5 Amp NPN-PNP Planar devices for hi-voltage, hi-current and hi-speed applications. Excellent gain stability, power dissipation (50W), switching times and Safe Energy Area specified.

If you need more power (140W, 20A) ask about our 2N5038 & 2N5039 devices. If you're really serious call Sandy now, or, circle the reader service number to obtain a data sheet.

Power Physics —  
Specialists in Power  
Semiconductor  
Technology  
Industrial Way West,  
Eatontown,  
N.J. 07724



INFORMATION RETRIEVAL NUMBER 156

ELECTRONIC DESIGN 20, September 27, 1974



Reed Relays in Stock with Long Life & Versatility

# READY REEDS

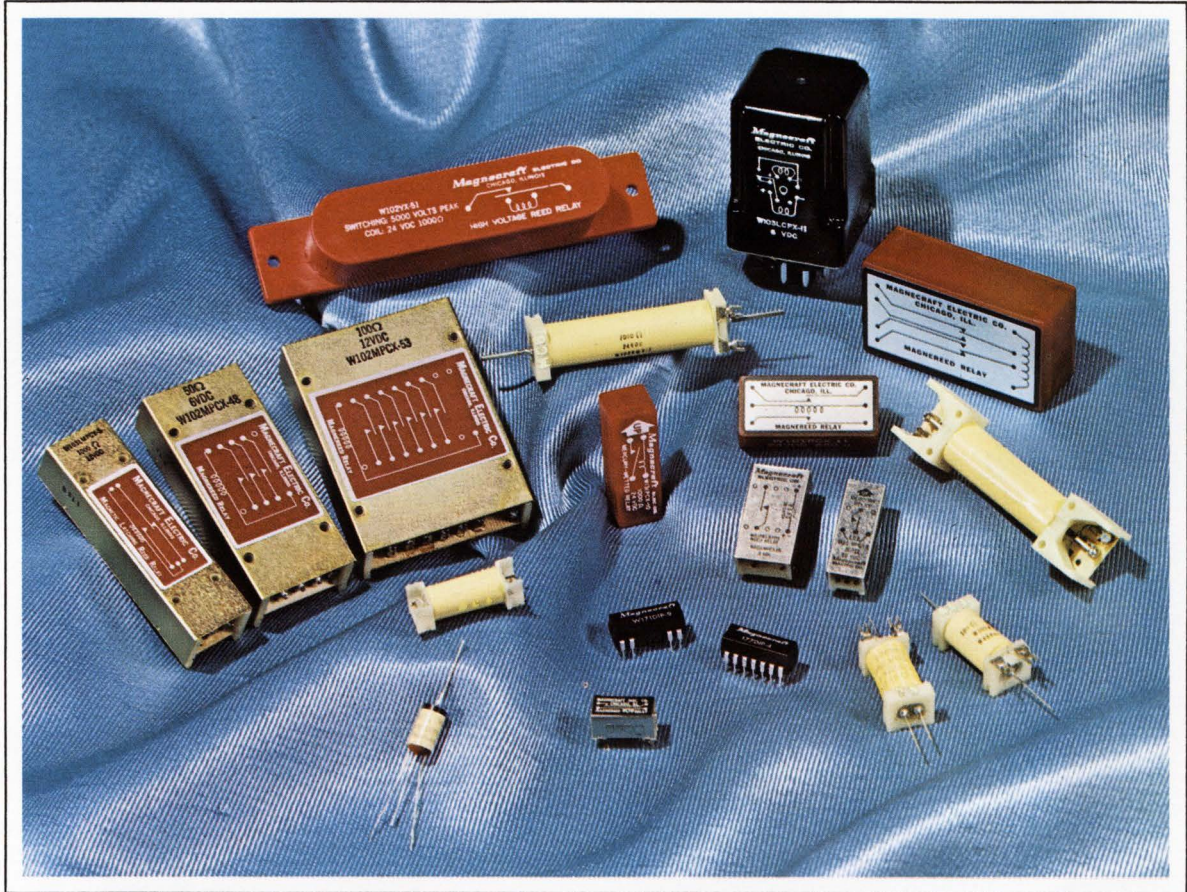

The Ready Reeders are ready for you! Over 290 high quality types of reed relays are in stock for immediate delivery. A wide variety of hermetically sealed contact combinations and packaging techniques are available. Versions offered include; dry, mercury-wetted, sensitive, latching, power, high voltage, time delay, electro-statically shielded, and dual-inline-package DIP's.

Magnecraft's reed relays can provide almost everything that a designer would want in order to accomplish a high speed switching function. The versatility of the relay is so great that it can be custom-fitted to almost any application at a lower cost in dollars and power and in a smaller space than almost any other device, conventional or solid state.

The photo above portrays the reed relay packaging characteristics available: epoxy encapsulated, axial leads, plug-in, eight and fourteen pin dual-inline-package, open styles, and standard, miniature, and micro miniature printed circuit packages.

Our nationwide network of distributors and Chicago plant stand ready to serve your applications. But, if you don't find what you need in stock we will make it for you!



**Free!**  
STOCK CATALOG

To help specify all your relay needs, ask for Magnecraft's new 1974 Stock Catalog with the most diversified line of over 1060 relays. A 68 page Designers Handbook and Catalog of Reed and Mercury Wetted Contact Relays with specific data drawings, and photos on all the various relays will accompany the Stock Catalog.

Find Magnecraft Relays in EEM sec. 4500.

**Magnecraft** ELECTRIC COMPANY

5575 NORTH LYNCH AVENUE • CHICAGO, ILLINOIS 60630 • 312 • 282-5500 • TWX-910 221 5221





## The solid-state janitor. If you want to design one tomorrow, we're ready with your linear IC's today.

Whatever you conjure up, we can help make a reality.

Maybe you're looking ahead to remote control using Digital to Analog Converters, to advanced mobile communications equipment, even to a completely automated factory. However advanced your design, we have a full house capability to help you get from the drawing board to the real world. We can supply the popular standard types, meet your

custom requirements and offer proprietary types.

We can help you with other products, too. We're a commodity supplier of power transistors; a recognized leader in CMOS; developers of liquid crystal displays; technology innovators of RF components; and a major supplier of thyristors.

In addition to comprehensive technical product data, RCA also gives you professional and expe-

rienced field engineering and applications support. As well as a commitment to excellence in everything from research to manufacturing.

So whatever you're into, and whatever you need, check with us first. Chances are one or more of our products anticipate your needs. A good place to start is to check our handy product-line guide. Write RCA Solid State, Section 57127, Box 3200, Somerville, N. J. 08876.

**RCA** Solid State