

Shopping for batteries isn't easy. There are now more than eight battery systems to choose from and more to be announced. The newer batteries offer longer shelf

life, more energy per cubic inch and higher cell voltages. For a look at the latest developments in batteries and tips on how to select them, turn to page 28.



How to cut the cost of special resistors

(even if you don't know what you want)

Project costs don't have to escalate when you find you can't use a standard resistor. There are positive ways you can save money and time—and even come out ahead in the bargain.

You can start cutting project costs by reducing what we call "visualization loss". This is the expensive extra time required to figure out an exact set of electrical, physical, environmental and dimensional parameters for the special part you need. *Don't go too far.* Especially don't wait until you're completely bogged down before you ask Dale for help. In electrical terms, we've long since figured out practical ways to deliver resistance as low as .001 ohm... tolerance as low as .01%... TC as low as ± 5 ppm and power just as high and as stable as you want it to be. And we can put your non-standard electrical parameters in unique packages that are one part sophistication and one part mid-western ingenuity. Every day we're showing companies how they can bend, squeeze,

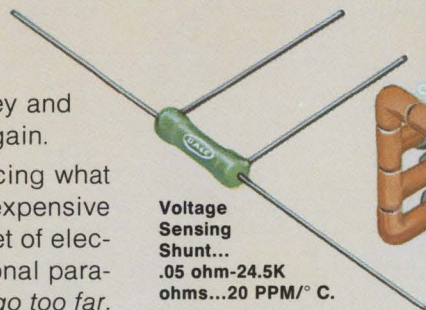

Voltage Sensing Shunt...
.05 ohm-24.5K ohms...20 PPM/° C.

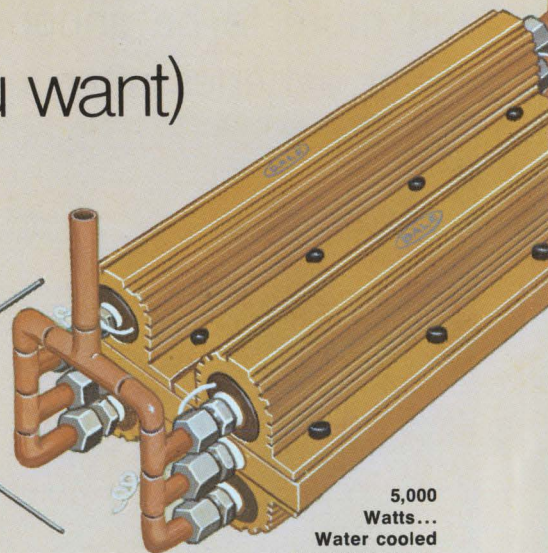

5,000 Watts...
Water cooled
.1 ohm-500K ohms,
0.5%-5% tol.



Space-saving P.C. board module containing 3 non-inductive resistors. (Far left)

Network with 16 quick couple connections containing 12 resistors from .025 ohm 50 watts to .1 ohm 10 watts.

High Pulse Wattage railway safety resistor. Special housing for underground use.

mill, tap, bury and inter-connect resistors for special purposes. We even put in plumbing, when required. Your non-standard resistor may only need a different kind of lead or it may look like a Rube Goldberg nightmare. Either way, you'll find Dale is unique among resistor suppliers in the ability to help you quickly visualize what you need...and to deliver a prototype with a minimum of design lag. We've already designed and built nearly 5,000 special resistors—so it's quite possible we've already blueprinted the design you need.

Call us. You'll be glad to find someone is working to make the basics better.

Send for our free **Functional Guide to Non-Standard Resistors.**

DALE ELECTRONICS, INC.
1300 28th Avenue, Columbus, Nebraska 68601
A subsidiary of The Lionel Corporation
In Canada: Dale Electronics Canada Ltd.
In Europe: Dale Electronics GMBH,
8 Munchen 60, Falkweg 51, West Germany

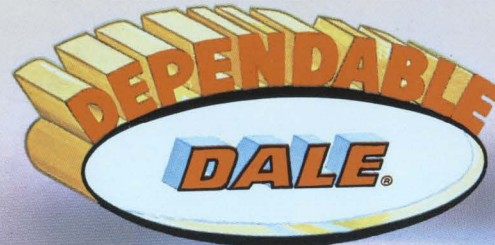
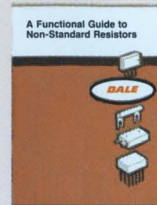

BOURNS NEW LOW-COST DIGITAL DIAL

**COUNT ON IT...
AND SAVE!**



Bourns new Model H-357 KNOBPOT® Dial is the lowest cost digital turns-counting dial we know of. It's designed for use with 1/4-inch shaft (Dia.) precision potentiometers — or other rotating devices. The H-357 is ruggedly made, features exceptional readout accuracy . . . and pairs nicely with Bourns Model 3540 low-cost 10-turn wirewound potentiometer.

Best of all, the H-357 is a BOURNS product . . . and costs only \$5.00 each in production quantities.

FEATURES INCLUDE: Rugged, industrial grade construction • Large, easy-to-read numbers • Protective lens covers readout • Readability of 1 part in 2,000 • Readout accuracy of 0.1% • Size (7/8" Dia.) and appearance compatible with Bourns KNOBPOT potentiometer family • Brake available at no additional cost.

Delivery is off-the-shelf. For complete details, contact your local Bourns field office, representative or the Factory direct.



TRIMPOT PRODUCTS DIVISION • 1200 COLUMBIA AVE., RIVERSIDE, CALIF. 92507

INFORMATION RETRIEVAL NUMBER 2

We shaped up DC

Solid state relay with controlled rise and fall time

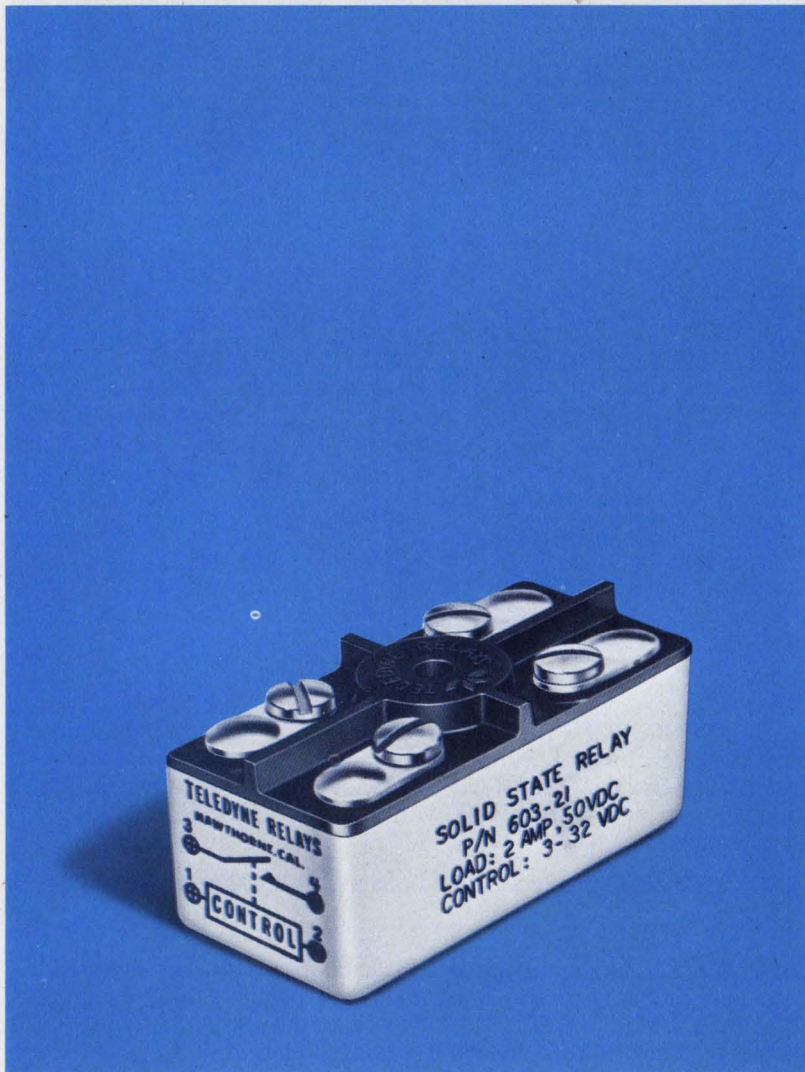

Take a good solid state DC relay — Teledyne's 603, for example — add some shaping circuitry so its response waveshape is carefully altered (rise time, turn-off slope, etc.), and something good happens for designers. In-rush currents for capacitive and lamp loads are limited, and so are turn-off transients for inductive loads. Also, controlled rise and fall time minimize EMI and switching transients.

An excellent choice for applications like process control systems, and machine tool controls, the 603 is optically isolated, with sensitive control input (directly compatible with TTL). It's available for loads up to 5 amps, 50 VDC.

The 603 also features Teledyne's exclusive "adaptive" packaging . . . screw or quick-disconnect terminals for chassis mounting, pins for PC boards.

If your application is less critical about in-rush currents and transients, you can order the 603 without controlled rise and fall time; it's identical, with a fast clean conventional waveshape. If you want to switch even higher level loads, shape up and call Teledyne.

 **TELEDYNE RELAYS**

3155 West El Segundo Boulevard Hawthorne, California 90250
Telephone (213) 973-4545

INFORMATION RETRIEVAL NUMBER 3

NEWS

- 25 **News Scope**
- 28 **In terms of power, longevity and voltage, batteries are reaching new peaks**—an Electronic Design special report.
- 36 **Ion implantation has progressed** from a specialty technique to a standard method for fabricating new integrated circuits.

TECHNOLOGY

- 52 **Six ways to control transients:** Varistor, gas-discharge and RC suppressors protect circuits from destructive surges. Don't be caught short.
- 60 **Use pulse instead of cw signals** to analyze discontinuities in high-frequency circuits. Time-domain reflectometry can pinpoint the problem.
- 70 **Linear systems analysis simplified:** State-space equations, manipulated by a Fortran program, give root-locus, system zeros, Bode-plot and time response.
- 80 **Design a floating-point a/d converter.** The circuit offers improved dynamic range, reduced processor workload and it uses standard ICs.
- 88 **Give the Hall transducer flexibility** by adding a control electrode. It will let you compensate for offset voltage or for a magnetic bias field.
- 94 **Customize your audio filter.** A Fortran program makes it easy to design a low-power active filter for use in spectral signal analysis.
- 100 **Good design is a business challenge,** manager advises engineers. When profitability is the goal, cost, product adaptability and customer commitment are what count.
- 106 **Ideas for Design:** Tester built for less than \$10 gives GO/NO-GO check of timer ICs . . . Versatile programmable-counter chains are built from simple MSI modules . . . Inexpensive low-Q bandpass filters made with tweaked standard chokes.
- 116 **International Technology**

PRODUCTS

- 119 **Integrated Circuits:** Power hybrid ICs improve switching-regulator response.
- 123 Instrumentation
- 134 Microwaves & Lasers
- 142 Modules & Subassemblies
- 150 Data Processing
- 156 Packaging & Materials
- 162 Discrete Semiconductors
- 170 Power Sources
- 172 Components

Departments

- 49 **Editorial:** Fantasies come true
- 7 Across the Desk
- 176 Application Notes
- 176 Design Aids
- 179 New Literature
- 182 Bulletin Board
- 188 Advertisers' Index
- 190 Product Index
- 192 Information Retrieval Card

Cover: Photo by Art Director, Bill Kelly—Batteries courtesy of Eagle-Picher, General Electric, Gould, Mallory, Power Conversion, RCA and Union Carbide.

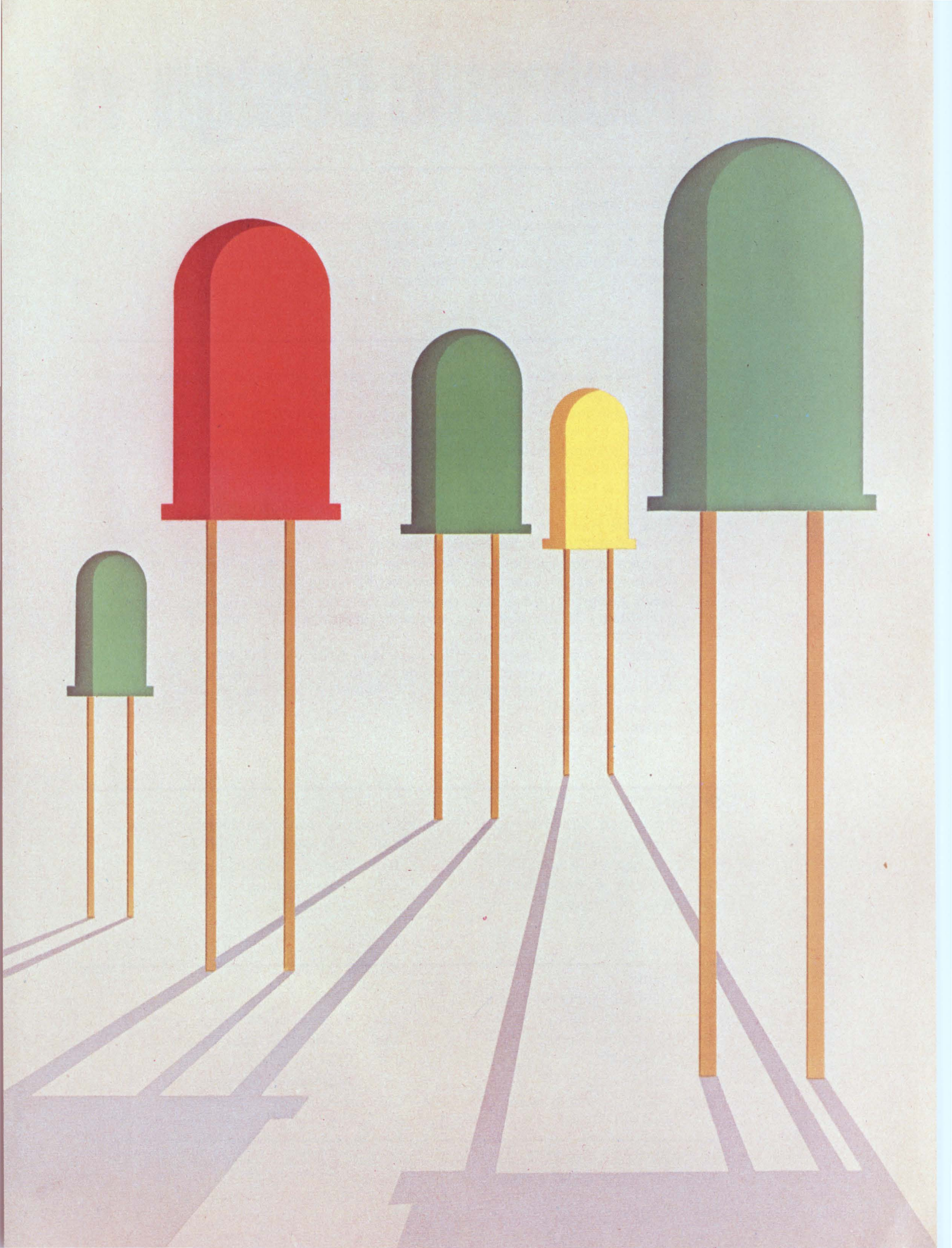

Pass your next design test with flying colors

- Engineer Motorola LEDs and op amps into industrial controls.
- Innovate Motorola LEDs and A/D converters into test instruments.
- Design Motorola LEDs and zener diodes into PC board service aids.
- Use Motorola LEDs and tuning diodes in home entertainment.
- Introduce Motorola LEDs and MOSFets into RF communications.
- Plug Motorola LEDs and MECL into computers.
- Apply Motorola LEDs and McMOS in automotive control panels.
- Install Motorola LEDs and thyristors in home appliances.
- Utilize Motorola LEDs and regulators in fault indicators.
- Originate Motorola LEDs and plastic transistors in cameras.
- Employ Motorola LEDs and counters in telephone instruments.
- Initiate Motorola LEDs and rectifiers into backlighting.
- Go to Motorola LEDs and memories in computers.
- Admit Motorola LEDs and opto couplers into airborne instruments.
- Bring Motorola LEDs and DTL into small appliances.
- Insert Motorola LEDs and DVMs into hand-held instruments.

MOTOROLA LEDs HAVE MORE THAN
20,000 SEMICONDUCTOR DESIGN ADVANTAGES.
SEE A GREAT SELECTION: BOX 20912, PHOENIX.

GET IT ALL TOGETHER NOW...



obvious
From Motorola, the LED producer.

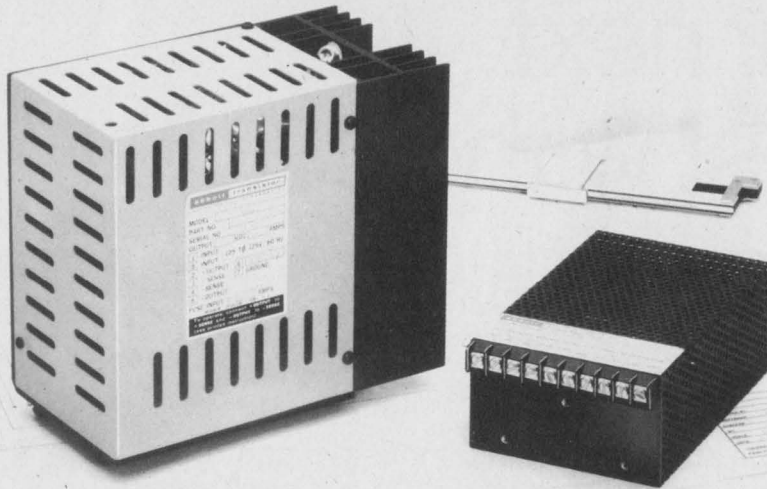

Reduce Your Power Supply Size and Weight By 70% for \$49

A new way has been found to substantially reduce power supply size and weight. Consider the large power supply shown at left in the above photo — it uses an input transformer, into a bridge rectifier, to convert 60 Hz to 5 volts DC at 5 amperes. This unit measures 6½" x 4" x 7½" and weighs 13 pounds. It sells for \$170 in small quantities. For just \$49.00 more, Abbott's new model Z5T10, shown at right, provides the same performance with 70% less weight and volume. It measures only 2¼" x 4" x 6" and weighs just 3 pounds.

This size reduction in the Model Z5T10 is primarily accomplished by eliminating the large input transformer and instead using high voltage, high efficiency, DC to DC conversion circuits. Abbott engineers have been able to control the output ripple to less than 0.02% RMS or 50 millivolts peak-to-peak

maximum. This design approach also allows the unit to operate from 100 to 132 Volts RMS and 47 to 440 Hertz. Close regulation of 0.15% and a typical temperature coefficient of 0.01% per degree Centigrade are some of its many outstanding features. This new Model "Z" series is available in output voltages of 2.7 to 31 VDC in 9 days from receipt of order.

Abbott also manufactures 3,000 other models of power supplies with output voltages from 5 to 740 VDC and with output currents from 2 milliamps to 20 amps. They are all listed with prices in the new Abbott catalog with various inputs:

- 60 A to DC, Regulated
- 400 A to DC, Regulated
- 28 VDC to DC, Regulated
- 28 VDC to 400 A , 1 ϕ
- 24 VDC to 60 A , 1 ϕ

Please see pages 581-593 of your 1973-74 EEM (ELECTRONIC ENGINEERS MASTER Catalog) for complete information on Abbott Modules.

Send for our new 56 page FREE catalog.

abbott transistor

LABORATORIES, INCORPORATED
 general offices eastern office
 5200 W. Jefferson Blvd./Los Angeles 90016 1224 Anderson Ave./Fort Lee, N.J. 07024
 (213) 936-8185 Telex: 69-1398 (201) 224-6900 Telex: 13-5332

INFORMATION RETRIEVAL NUMBER 5

Vice President, Publisher
 Peter Coley

Editors

Editorial Offices
 50 Essex St.
 Rochelle Park, N.J. 07662
 (201) 843-0550
 TWX: 710-990 5071
 Cable: Haydenpubs Rochellepark
Editor-in-Chief George Rostky

Managing Editors:

Ralph Dobriner
 Michael Elphick

Associate Editors:

Dave Bursky
 Jules H. Gilder
 Morris Grossman
 Seymour T. Levine
 John F. Mason
 Stanley Runyon
 Edward A. Torrero
 Richard L. Turmail

Contributing Editors:

Peter N. Budzilovich
 Robert Willins

Editorial Field Offices

East

Jim McDermott, Eastern Editor
 P.O. Box 272
 Easthampton, Mass. 01027
 (413) 527-3632

West

David N. Kaye, Senior Western Editor
 2930 West Imperial Highway
 Inglewood, Calif. 90303
 (213) 757-0183
 Northe K. Osbrink, Western Editor
 112 Coloma St.
 Santa Cruz, Calif. 95060
 (408) 426-3211

Washington

Heather M. David, Bureau Chief
 2506 Eye St., N.W.
 Washington, D.C. 20037

Editorial Production

Marjorie A. Duffy

Art

Art Director, William Kelly
 Richard Luce
 Anthony J. Fischetto

Production

Manager, Dollie S. Vieblg
 Helen De Polo
 Anne Molfetas
 Christopher G. Hill

Circulation

Evan Phoutrides

Information Retrieval

Peggy Long

Promotion

Manager, Jeffrey A. Weiner
 Karen Kerrigan (Reprints)

Phase-margin spec touches off a debate

Your writeup on the Analog Devices AD528 (see "Low-Cost, 10-MHz FET Op Amp Provides Higher Stability," ED No. 1, Jan. 4, 1974, p. 178) says that the phase-margin spec is important. An op amp needs good phase margin to minimize peaking when it handles sines. And for the handling of steps, phase margin is needed to damp out ringing quickly, so the output can settle. Good phase margin is necessary, but it isn't enough to give an op amp good settling time.

Apparently Analog Devices has set up "straw men," not only for its specs but for competitors. The National Semiconductor LH0062, at a higher price, is listed as the "only other competing op amp."

The Teledyne Philbrick 1324 sells for only \$9.85 in quantities of one to nine. And it is guaranteed and tested 100% to settle inside 0.01% of final value in 1 μ s max for a 10-V step. (The AD528 is reported to settle to 0.1% in less than 1 μ s.) The AD528 has smaller I_{bias} , but the 1324 has much lower TC V_{so} . This is usually much more important in fast-settling circuits, where Z_{in} and Z_f are almost always lower than 5 k Ω , so that I_b and TCIB are not important.

We also sell FET-input devices with quick settling—at prices far below \$42.50 or \$28. Also, the 1324 needs two or three external capacitors to achieve its settling. But if you count the necessary power-supply bypass capacitors, we need five and AD needs three. The advantage is not overwhelming.

*Robert A. Pease
Staff Engineer*

Teledyne Philbrick
Allied Drive at Route 128
Dedham, Mass. 02026

The manufacturer replies

Mr. Pease is comparing a bipolar amplifier to our FET amplifier. And he's pretty cavalier about a total input-current spec on the AD528, which is less than the current noise of the Teledyne 1324.

If he has a comparable FET op amp, why doesn't he tell us about it, or at least give us a type number? If he wants to talk bipolar, he should do a comparison with the AD518—one of our fast, internally compensated bipolar amplifiers that sells for as little as \$1.95 in quantities of 100.

In regard to the relevance of the phase-margin spec, I might make similar remarks about Mr. Pease's myopic view of settling time as the only parameter of interest in a fast op amp. As the widely recognized guru of settling-time measurements, he takes a parochial stand that neglects other important factors. While the Teledyne 1324 is faster than a speeding bullet, it is also hotter than a locomotive—so hot that a full-temperature-range device isn't even specified on his data sheet.

Mr. Pease is understandably defensive about all the capacitors required by the Teledyne 1324, and he neglects to mention the resistor that is also part of the compensation network. Many users prefer the simplicity of the completely internally compensated AD528 circuit.

The phase-margin spec on the AD528 indicates ease of use and flexibility. Not everyone using fast op amps needs 0.01% settling time. But everyone using fast op amps worries about oscillations. An ample phase margin gives the designer some relief from tough layout and design problems, which

(continued on page 8)

Electronic Design welcomes the opinions of its readers on the issues raised in the magazine's editorial columns. Address letters to Managing Editor, Electronic Design, 50 Essex St. Rochelle Park, N.J. 07662. Try to keep letters under 200 words. Letters must be signed. Names will be withheld on request.

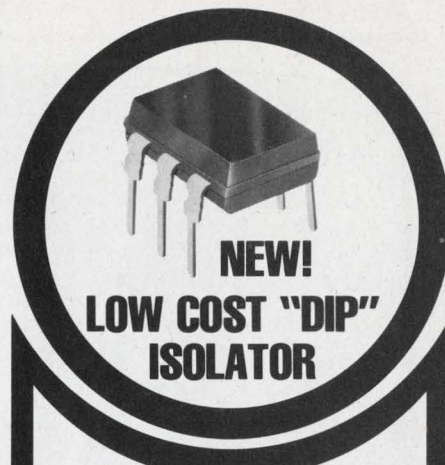

OPTRON OPTICALLY COUPLED ISOLATORS

LOW COST "DIP" SERIES FURTHER EXPANDS ISOLATOR LINE

OPTRON's addition of a new, low cost 6-pin plastic dual in-line isolator series further broadens its line to provide a coupler for every application.

The new "DIP" series includes six models offering complete interchangeability with popular industry types. It offers a wide range of capabilities to allow you to choose a device most suited to your circuit requirements at the best possible price. The "DIP" series has isolation voltages of 1500 or 2500 volts with a current transfer ratio of 2.0 to 50%.



OPI 102

OPTRON's broad selection of "DIP" and other packages with isolation voltages to 50 Kv now provides the versatility required for maximum electrical and mechanical design flexibility.

1.5 Kv isolation with 60% current transfer ratio. Phototransistor base lead available. Hermetic TO-5 package.

OPI 108



1 Kv isolation and 20% current transfer ratio. 5 μ sec switching time in a welded axial lead hermetic package.

Detailed technical information on these and other OPTRON optoelectronic products... chips, discrete components, assemblies, and PC board arrays... is available from your nearest OPTRON sales representative or the factory direct.



OPTRON, INC.

1201 Tappan Circle
Carrollton, Texas 75006
214/242-6571



the first production Serial Analog Memory

RETICON
SAM-64

"SAM™ DID IT."

The SAM™64 is the first of a family of monolithic Serial Analog Memory devices to be introduced by RETICON. It provides 64 independent capacitive memory cells, each of them individually addressable by two independent shift registers. The Read-in register sequentially time samples the analog input signal and stores it in the memory cells. The Read-out register then reconstructs the stored information to its original form. Any desired delay may be achieved by simply delaying the initiation of the Read-out register or by varying clocking rates while maintaining constant relation between the initiation of Read-in and Read-out.

Time base correction (or delay as shown in the photo) to compensate for wow and flutter of recording systems can be easily achieved. Other applications include real time Fourier transforms, digital filtering, drop-out correction, bandwidth/time compression or expansion, analog FIFO, chirp Z transforms and many others.

Several devices may be cascaded to store a complete TV line. Over 10 MHz sampling rates and 50 dB S/N ratio have been achieved.

The SAM-64 comes in a 16 lead ceramic/gold dual-in-line package, available from inventory. Call for more information.

RETICON®

Reticon Corporation • 450 E. Middlefield Rd. • Mt. View, California 94043
(415) 964-6800 HOTLINE (415) 964-3033 TWX 910-379-6552

INFORMATION RETRIEVAL NUMBER 7

ACROSS THE DESK

(continued from page 7)

cause oscillations with marginally stable ICs.

Mr. Pease indicates that in his designs the feedback network usually has very low resistance. What he doesn't say is that this is to prevent input-node capacitance from destabilizing the circuit. In circuits where large feedback resistors are mandatory, the extra phase margin *mitigates* the effect of node capacitance to maximize stabilized bandwidth.

Mr. Pease is comparing apples to oranges (or possibly apples to lemons) and is asking us to concentrate on only the pits and the seeds.

Paul Brokaw
Manager

Advanced Product Development
Analog Devices
Semiconductor Div.
829 Woburn St.
Wilmington, Mass. 01887

Is there a solution to fires in TV sets?

Recently I was doing a home fire-prevention project when I came across some statistics that astonished me. The TV set causes approximately 18% of all home fires, according to the statistics. The set can act like a time bomb, bursting into flames at about 2 or 3 a.m., when the TV is off or unplugged and the family is asleep.

Electricity causes approximately 36% of all home fires, with wall plugs and light switches apparently the biggest culprit. Plugs and switches give off a blue arc at the instant of connection, which has a temperature of about 2000° at 110 V. This is higher than the kindling point of any dust and lint behind the wall plate. If the dust and lint ignite, the flames spread inside the walls before breaking out.

A similar situation happens in the TV set. Dust and lint build up to where they form a connection between the poles of a capacitor or other elements. When ignited, other dust and lint present also burst into flames.

(continued on page 15)

From the voltmeter house...

**The most
important
announcement
you'll see
this year about
digital
voltmeters**

**Introducing
the new Fluke...**

8600A 20,000-count DMM

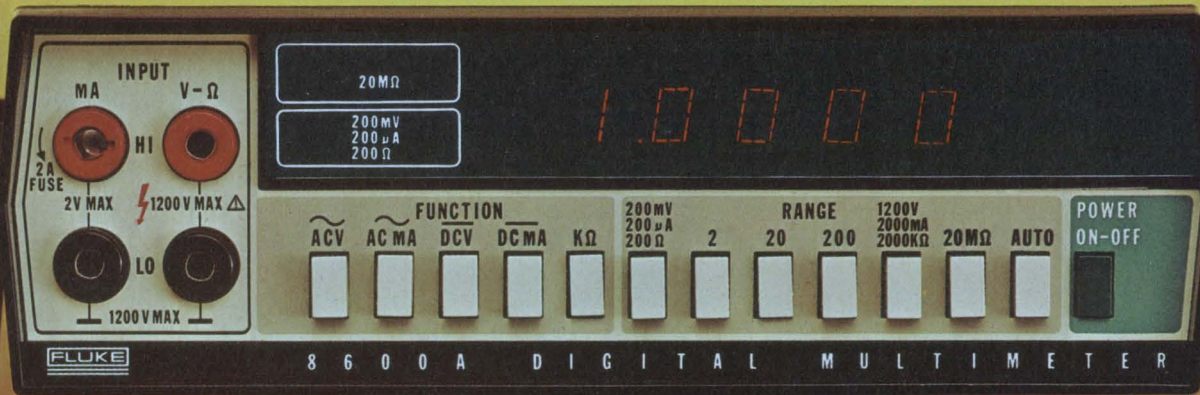

8800A 200,000-count DMM

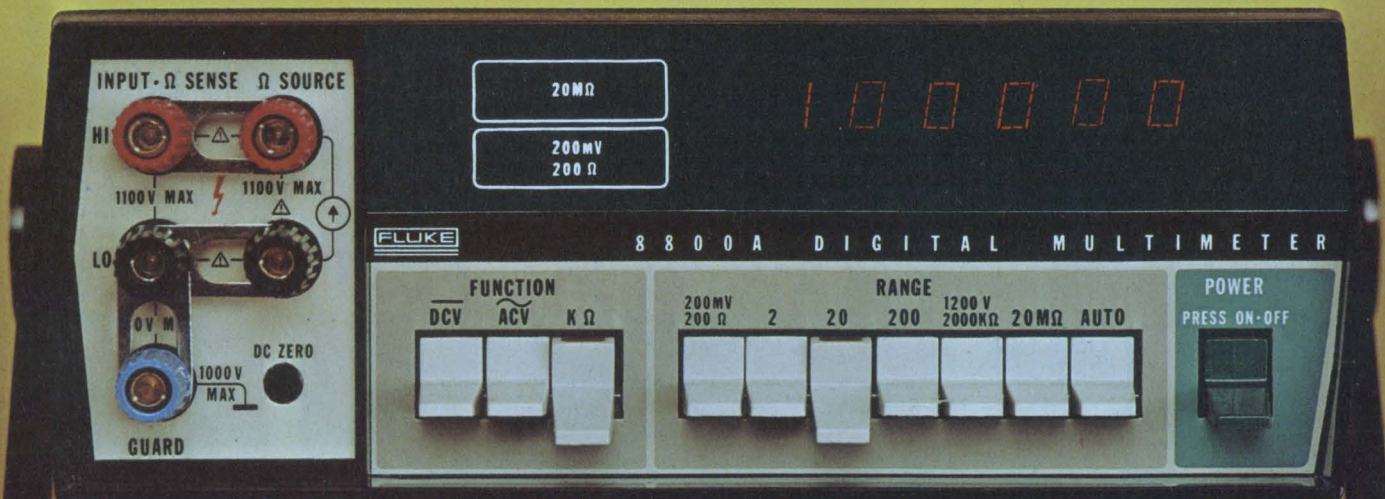

New automatic digital multimeters use advanced Fluke LSI technology. They're accurate and complete—just as they come from the box. Everything you need is built-in. They're small, tough and reliable. Maximize multimeter measure power for little more than half the price you're used to paying.

The 26-range Fluke 8600A, \$599

Here's what you get: a 4½ digit auto-ranging multimeter with five ranges of dc volts, five ranges of ac volts, five ranges of dc current, five ranges of ac current, and six ranges of resistance. Own a digital multimeter with a basic dc accuracy of 0.02% and autozero on all functions. Get up to 1000 megohms input resistance for minimum loading.

All dc ranges from 200 mV through 1200 volts are continuously protected to $\pm 1200V$ dc or 1700 volts peak ac. AC bandwidth to 100 kHz offers 10 μV resolution. From 200 ohms full scale through 20 megohms full scale, the 8600A takes a continuous 250V rms or dc. A front panel fuse protects all ac and dc current ranges from 200 μA full scale to 2 A full scale.

Optionally, a rechargeable battery pack with charger is built right in . . . no bulky snap-on's or external chargers. For true portability, the Fluke 8600A offers 8 hours off-line operation for slightly more money.

Weight, 5 pounds (2.3 kg). Two 8600A's fit neatly in a standard EIA rack. Rack mounting kits are optional. Optional low-cost printer output is fully isolated and TTL/DTL compatible for use in datalogging applications.

Accessories, we've got 'em galore. There's a best buy high voltage probe that measures one kV to 40 kV. There are two RF probes, a 20 kHz to 250 MHz probe and a 1 GHz probe. To measure high currents there's a clamp-on probe that reads 2 to 600 amperes. Other accessories include deluxe test leads, rack kits, dust covers and two different carrying cases.

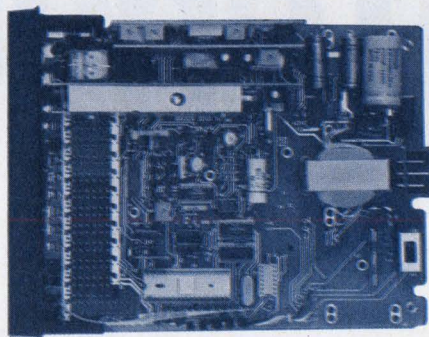

Note the clean functional layout and careful workmanship of the Fluke 8800A.

The .005% Fluke 8800A, \$1099

Here's what you get: a 5½ digit auto-ranging multimeter with full guarding on five ranges of dc volts, four ranges of ac volts, and six ranges of 4-wire ohms. With a basic accuracy of 0.005% and common mode rejection better than 120 dB, it's the top voltmeter for the money.

The 8800A gives you full guarding, 1000 megohm input resistance on the 200 mV, 2V and 20V ranges, excellent ac accuracies over the entire frequency range of 30 Hz to 100 kHz and autoranging on all functions. Completely isolated four-terminal ohms measurement on the 200-ohm full scale through 20-megohm full scale ranges with less than 4 volts open circuit voltage.

For datalogging, add low-cost isolated printer output. Weight is 10 pounds (4.5 kg). Width of 9 inches (23 cm) allows the Fluke 8800A to fit conveniently into a standard EIA rack.

Both instruments feature LED readout with easy-to-read numbers. Both instruments use a proprietary Fluke digital LSI chip for low parts count, high performance and extraordinary reliability. And, remember, Fluke has more LSI experience in instrumentation than anybody else.

These instruments are rated for a minimum 10,000 hour MTBF as a result of exhaustive Fluke environmental testing. They are rugged and will take a lot of abuse and still work well within specs.

Fluke backs you up after the sale

When you buy a new Fluke instrument, you may be gone from the salesman's short term prospect list, but you're not forgotten. We have technical and service centers throughout the United States, Canada, Europe and Japan. The one nearest you will give you super service on both in and out of warranty repair. We also invite you to become a member of our **user's group**, for service notes and seminars on getting the most out of your Fluke instrument.

Maximize measure power now

Fluke invites you to try one or both of these new multimeters on your bench right away. Call your nearest Fluke sales engineer for details or simply dial our hotline.

In the continental U.S., dial our toll-free number 800-426-0361 for the name and address of your nearest local source. Abroad and in Canada, call or write the office nearest you listed below. John Fluke Mfg. Co., Inc., P.O. Box 7428, Seattle, Washington 98133. Phone (206) 774-2211. TWX: 910-449-2850. In Europe, address Fluke Nederland (B.V.), P.O. Box 5053, Tilburg, The Netherlands. Phone 013-67-3973. Telex: 844-52237. In the U.K., address Fluke International Corp., Garnett Close, Watford, WD2 4TT. Phone, Watford, 33066. Telex: 934583. In Canada, address ACA, Ltd., 6427 Northam Drive, Mississauga, Ontario. Phone 416-678-1500. TWX: 610-492-2119.



For data out today, dial our toll-free hotline, 800-426-0361.

**All those little
wires have been
pushed around
long enough.**

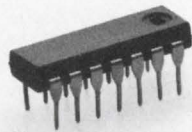

Until now, all those wires have been at the mercy of packaging materials that expand when things get hot.

So we developed new Dow Corning® 480 semiconductor molding compound.

Dow Corning 480 has a low coefficient of thermal expansion.

So it virtually eliminates the hot intermittent open. And moisture penetration.

Which means that an integrated circuit stays integrated. Through all sorts of temperature and atmospheric extremes.

But that's not all that's different about 480 molding compound.

Its resistance to salt spray is excellent.

And it reduces your packaging costs because it saves time. Molding times are short—less than one minute for some components. Post curing is unnecessary.

Of course, Dow Corning 480 molding compound also has the advantages of our other silicones. Consistency. Long shelf life. Less cleaning downtime because there's no buildup. Non-flammability. And, because it doesn't irritate skin, there's no need for special handling.

Dow Corning 480 semiconductor molding compound is the kind of improved product you can expect to keep getting from Dow Corning. Our Technical Service and Development Department has more manpower and greater technical facilities than any other in the industry.

If you want to know more about 480, call us at 517 636-8000, or write Dow Corning Corporation, Dept. A-4334, Midland, Michigan 48640.

DOW CORNING

DOW CORNING

FOR PEOPLE WHO WANT TO READ ALL ABOUT IT!



We have nothing less than a fully illustrated, systematic, easy-to-use survey of the entire field of data management as it exists today. It covers it all, from A to Z, so it's for everybody. The programmer tightening up his files. The analyst working out a workable timesharing program. Top management needing industry-wide perspective on competitive system designs.

It's a rare publication that takes a unique "blueprint approach" to current know-how. Beginning with the single data item as the first building block in total system design. And progressing through specific techniques for data structures, streams, files . . . total hardware and operating system control . . . the latest advances in timesharing and multiprogramming . . . system modeling and simulation . . . complete

designs for various types of commercial accounting and document-oriented storage and retrieval systems. It all adds up to a vast and impressive "top to bottom" view.

And it does it all in fresh, jargon-free language, with scores of illustrations and diagrams for a rapid, visual grasp.

Whether you use it as an on-the-job manual, as a desk-top reference, or as a conference room companion with all the answers, it's an indispensable tool guaranteed to broaden your perspective and practical skill in a field that knows no limits to growth and progress. And generally give you the professional confidence that comes from knowing just about everything that's going on.

#5100-X, 6 x 9, 300 pages, cloth \$14.95

To Order:

Circle the **Information Retrieval Number** to order your 15-day free examination copy of **Data Management for On-Line Systems** by **David Lefkowitz**. At the end of that time please remit payment or return the book with no further obligation.



Hayden Book Company, Inc., 50 Essex Street, Rochelle Park, N. J. 07662

ACROSS THE DESK (continued from page 8)

I wonder if a cooling fan would not eliminate this buildup of dust and lint in the television set. Switches and plugs are another matter. Do your readers have other ideas?

These two situations account for over half of all home fires and resulting deaths.

*Kenneth Willoughby
Senior Research Engineer*

Willoughby Research Co.
R.R. 3, Box 1
Potter, Neb. 69156

Who manufactures this card puller?

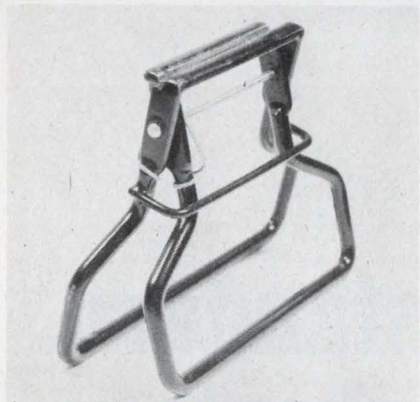

I have been trying to locate and buy a printed-circuit-card extractor (see photo). The extractor does not carry any identification, and though I have gone through many catalogs, I have not been able to locate this particular device.

Can any reader help me find the manufacturer?

*Jeffrey Stellman
Systems Engineer*

ITT
Data Equipment and Systems Div.
E. Union Ave.
East Rutherford, N.J. 07073

A warning for users of FET plug-ins

I would like to bring to the attention of your readers a potential hazard regarding the use of FET replacements for vacuum tubes. Several manufacturers have brought out plug-in replacements.

When the loading of the power transformer is lightened by a lack

(continued on page 22)

There's a world of difference between Dow Corning and the other semiconductor packaging-materials suppliers.

The difference is that only Dow Corning has available worldwide a complete line of silicone molding compounds, an accomplished technical service and development team, the advantage of a completely compatible product line, and the convenience of worldwide delivery and service. If you want to give your packaging operation a competitive advantage, just call or write. One of our representatives is nearby.

NORTH & SOUTH AMERICA

Resins and Chemicals Marketing
DOW CORNING CORPORATION
Midland, MI 48640
Telephone: 517 636-8682

EUROPE

R. Hediger
DOW CORNING INTERNATIONAL LTD.
Chaussée de La Hulpe 177
1170 Brussels, Belgium
Telephone: 73.80.60

B. Sneddon
DOW CORNING LTD.
Reading Bridge House
Reading RG1 8PW
Berkshire, England
Telephone: Reading 57251

R. Jones
DOW CORNING GmbH
1150 Vienna
Mariahilferstrasse 180/4
Austria
Telephone: 83.85.38

S. Haberer
DOW CORNING GmbH
8000 Munchen 50
Pelkovenstrasse 152
West Germany
Telephone: 14.861

J. Guillot
DOW CORNING S.A.R.L.
140, Avenue Paul Doumer
92500 Rueil Malmaison
France
Telephone: 977.00.40

M. Tedone
DOW CORNING SpA
Viale Restelli 3/7
20124 Milan, Italy
Telephone: 688.2458

ASIA

H. Takahashi
DOW CORNING ASIA LTD.
P&O Building, 9th Floor
21 Des Voeux Road, C.
Hong Kong
Telephone: 5-258035

H. Hotta
DOW CORNING ASIA LTD.
Room 803, Cathay Building
Mount Sophia
Singapore - 9
Republic of Singapore
Telephone: 321213-5

AUSTRALASIA

H. Tuynman
DOW CORNING AUSTRALIA PTY. LTD.
36 O'Dea Avenue
Waterloo, N.S.W. 2017
Sydney
Telephone: 699 8055

P. Winter
DOW CORNING AUSTRALIA PTY. LTD.
103 High Street
Prahran, Vic. 3181
Telephone: 51 5450

Dow Corning semiconductor molding compounds...quality and dependability worldwide.

A-4335

DOW CORNING

DOW CORNING

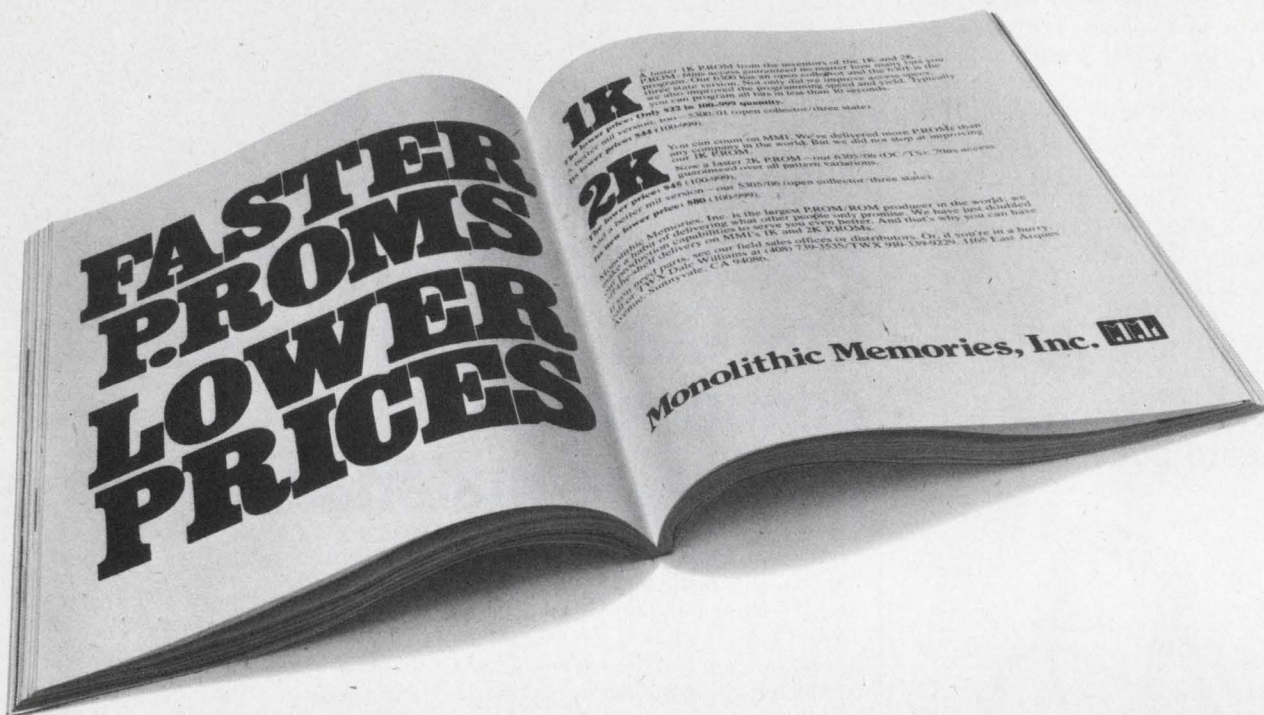

**We created an industry standard.
You created an industry shortage.**

The 2K PROM.

Monolithic Memories, Inc. is the largest PROM/ROM producer in the world; we make a habit of delivering what other people only promise.

With the help of our recently expanded production facilities, we now offer immediate availability on faster 2K PROMs (70ns) that come in open collector and three state versions. Mil versions, too.

Our numbers: MMI 6305J/6306J (OC/TS) commercial.
MMI 5305D/5306D (OC/TS) military.

Your numbers: \$45 (6305J/06J) (100-999).
\$80 (5305D/06D) (100-999).

Come and get 'em.

Monolithic Memories, Inc., 1165 East Arques Avenue, Sunnyvale, CA 94086, (408) 739-3535/TWX 910-339-9229.

Monolithic Memories, Inc. 

EASTERN AREA SALES OFFICE: (617) 653-3158 • NEW ENGLAND REGION: (617) 475-8883 • NEW YORK REGION: (607) 748-3211 • CENTRAL AREA SALES OFFICE: (214) 239-9148 • MINNEAPOLIS REGION: (612) 922-9122 • WESTERN AREA SALES OFFICE: (714) 556-1216

Representing your best buy in memories: ALABAMA, Huntsville (205) 539-1771; ARIZONA, Phoenix (602) 264-7971; CALIFORNIA, Palo Alto (415) 369-4671; COLORADO, Denver (303) 423-1020; CONNECTICUT, North Haven (203) 239-9762; FLORIDA, Orlando (305) 423-7615; ILLINOIS, Chicago (312) 593-0200; INDIANA, Ft. Wayne (219) 432-5591; Indianapolis (317) 359-9283; IOWA, Cedar Rapids (319) 393-8703; KANSAS, Kansas City (913) 236-4646; KENTUCKY, Louisville (502) 893-7303; MARYLAND, Baltimore (301) 825-3330; MASSACHUSETTS, Boston (617) 444-2484; MICHIGAN, Detroit (313) 358-2020; Grand Rapids (616) 451-8901; St. Joseph (616) 983-7337; MINNESOTA, Minneapolis (612) 929-6721; MISSOURI, St. Louis (314) 432-2830; NEW JERSEY, Teaneck (201) 692-0200; NEW YORK, N.Y.C./L.I. (201) 692-0200; NORTH CAROLINA, Raleigh (919) 834-6591; OHIO, Cincinnati (513) 521-2290; Dayton (513) 298-9546; Cleveland (216) 228-7525; PENNSYLVANIA, Willow Grove (215) 674-3850; Pittsburgh (412) 344-7277; TEXAS, Dallas (214) 239-9148; Houston (713) 721-1054; WASHINGTON, Seattle (206) 455-2778; WISCONSIN, Wauwatosa (414) 786-6330.

INFORMATION RETRIEVAL NUMBER 12

IF YOUR COPY OF THE ACDC ELECTRONICS INSERT IS MISSING, CIRCLE 243 ►

The widest selection of analog CMOS switches and multiplexers.

Available now.



Get them all from one source. And get them fast. 4-, 8- and 16-channel multiplexers. Quad and dual SPDT switches.

Some of our designs you've never seen before. They'll give you specs, functions, and package options you can't order anywhere else.

And we've got other designs you'll recognize right away. You probably ordered them from someone else a while ago — and you're still waiting for delivery.

Check them out. They'll give you the design benefits of CMOS — and the lowest power dissipation you can get.

The multiplexers:

AD7501 8-channel
AD7502 differential
4-channel.
AD7503 8-channel.

AD7506 16-channel.
AD7507 differential
8-channel.

The switches:

AD7510/AD7511/AD7519
quads.

AD7512 dual SPDT.

AD7513 dual.

AD7516 quad.

Get it only from us. Again, only from us.

A replacement for HI1818.

Replaces DG506.
Replaces DG507.

You can't get them anywhere else. Another that's ours alone.

Use it instead of DG200.

Instead of CD4016A.

The price is right.

So give us a call — to order or to ask for our new catalog. It'll tell you everything you need to know about our entire line of analog CMOS switches and multiplexers.

Our analog CMOS switches and multiplexers, like our AD7520 CMOS DAC, are more innovative uses of advanced technology — to keep you (and us) a step ahead of everyone else.

Analog Devices, Inc., Norwood, Mass. 02062.





Beckman®

HYBRID MICROCIRCUITS

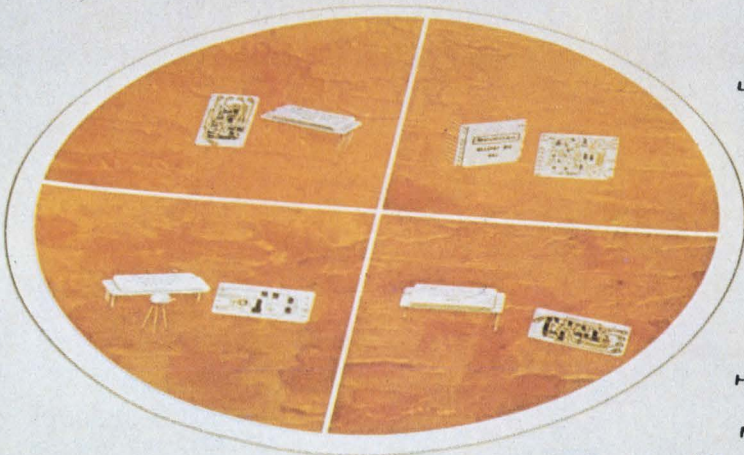

- UNIVERSAL ACTIVE FILTERS
- TELEPHONE TONE FILTERS
- PRECISION LADDER NETWORKS
- DAC/ADC PRODUCTS
- POWER AMPLIFIERS
- VOLTAGE REGULATORS
- INDUSTRIAL CONTROL CIRCUITS
- CUSTOM DISPLAY SUBSTRATES
- HYBRID MEDICAL FUNCTIONS
- MODEM FILTERS
- MIL-PERFORMANCE MICROCIRCUITS

Beckman Electronic Component Distributors

EASTERN REGION

Arrow/Angus
P.O. Box 126
Moorestown, N.J.
(609) 235-1900
(215) 928-1800

Arrow Electronics, Inc.
5207 East Dr.
Baltimore, Md.
(202) 737-1700
(301) 247-5200

Arrow Electronics, Inc.
900 Route 110
Farmingdale, N.Y.
(516) 694-6800

Arrow Electronics, Inc.
295 Treadwell St.
Hamden, Conn.
(203) 248-3801

Arrow Electronics, Inc.
No. 15 A Street
Burlington, Mass.
(617) 273-0100

Arrow Electronics, Inc.
285 Midland Ave.
Saddle Brook, N.J.
(201) 797-5800

Harvey R & D Electronics
44 Hartwell Ave.
Lexington, Mass.
(617) 861-9200

Kierulff Electronics, Inc.
49 Bestpage Rd.
Hicksville, N.Y.
(516) 433-5530

Kierulff Electronics, Inc.
5 Industrial Dr.
Rutherford, N.J.
(201) 935-2120

Lynch-Gentry Associates, Inc.
1932 Drew Street
Clearwater, Fla.
(813) 443-2697

Lynch-Gentry Associates, Inc.
3470 Bowman Dr.
Winter Park, Fla.
(305) 671-7649

Marshall Industries
G. S. Marshall Products Group
88 Needham St.
Newton Highlands, Mass.
(617) 965-5115

Marshall Industries
G. S. Marshall Products Group
230 Sherwood Ave.
Farmingdale, L.I., New York
11735 (516) 293-4141

M & C Sales
1106 Burke St.
Winston-Salem, N.C.
(919) 723-1001

M & C Sales
904 Bob Wallace Ave.
Huntsville, Ala.
(205) 539-8476

Ossmann Component Sales Corp.
395 Cleveland Dr.
Buffalo, N.Y.
(716) 832-4271

Ossmann Component Sales Corp.
411 Washington Ave.
Kingston, N.Y.
(914) 338-5505

Ossmann Component Sales Corp.
280 Metro Park
Rochester, N.Y.
(716) 442-3290

Ossmann Component Sales Corp.
132 Pickard Building
Syracuse, N.Y.
(315) 454-4477

Ossmann Component Sales Corp.
1911 Vestal Parkway East
Vestal, N.Y.
(607) 785-9949

CENTRAL REGION

Magnuson Electronics
2420 Oakton St.
P.O. Box 130
Mount Prospect, Ill.
(312) 956-0700

Magnuson Electronics
1246 West 7th St.
St. Paul, Minn.
(612) 227-8495

Norvell Electronics
10210 Monroe Dr.
Dallas, Tex.
(214) 350-6771

Norvell Electronics
6440 Hillcroft Ave.
Houston, Tex.
(713) 774-2568

Norvell Electronics
3340 S. Memorial Dr.
Tulsa, Okla.
(918) 663-1247

Sheridan Sales Co.
Box 37826
Cincinnati, Ohio
(513) 761-5432

Sheridan Sales Co.
Box 4457
Cleveland, Ohio
(216) 524-8120

Sheridan Sales Co.
Box 423
Dayton, Ohio
(513) 277-8911

Sheridan Sales Co.
Suite 5009
1717 Penn Ave.
Wilkinsburg, Penn.
(412) 244-1640

Sheridan Sales Co.
P.O. Box 677
Florissant, Mo.
(314) 837-5200

WESTERN REGION

Almac/Strom Electronics
8888 S.W. Canyon Rd.
Portland, Ore.
(503) 292-3534

Almac/Strom Electronics
5811 Sixth Ave. South
Seattle, Wash.
(206) 763-2300

Marshall Industries
G. S. Marshall Products Group
5633 Kendall Court
Arvada, Colo. 80002
(303) 423-9670

Marshall Industries
G. S. Marshall Products Group
835 W. 22nd Street
Tempe, Ariz. 85282
(602) 968-6181

Marshall Industries
G. S. Marshall Products Group
9674 Telstar Ave.
El Monte, Ca.
(213) 686-0141

Marshall Industries
G. S. Marshall Products Group
17975 Sky Park Blvd.
Irvine, Ca. 92707
(714) 556-6400

Marshall Industries
G. S. Marshall Products Group
8057 Raytheon Rd.
San Diego, Ca.
(714) 278-6350

Marshall Industries
G. S. Marshall Products Group
788 Palomar Ave.
Sunnyvale, Ca.
(408) 732-1100

Wyle Distribution Group:
Elmar Electronics
6777 East 50th Avenue
Commerce City, Colo.
(303) 287-9611

Elmar Electronics
2288 Charleston Road
Mt. View, Ca.
(415) 961-3611

Liberty Electronics
124 Maryland Street
El Segundo, Ca.
(213) 322-8100

Liberty Electronics
3130 North 27th Avenue
Phoenix, Ariz.
(602) 257-1272

Liberty Electronics
8248 Mercury Court
San Diego, Ca.
(714) 565-9171

Liberty Electronics
5305 Second Avenue South
Seattle, Wash.
(206) 763-8200

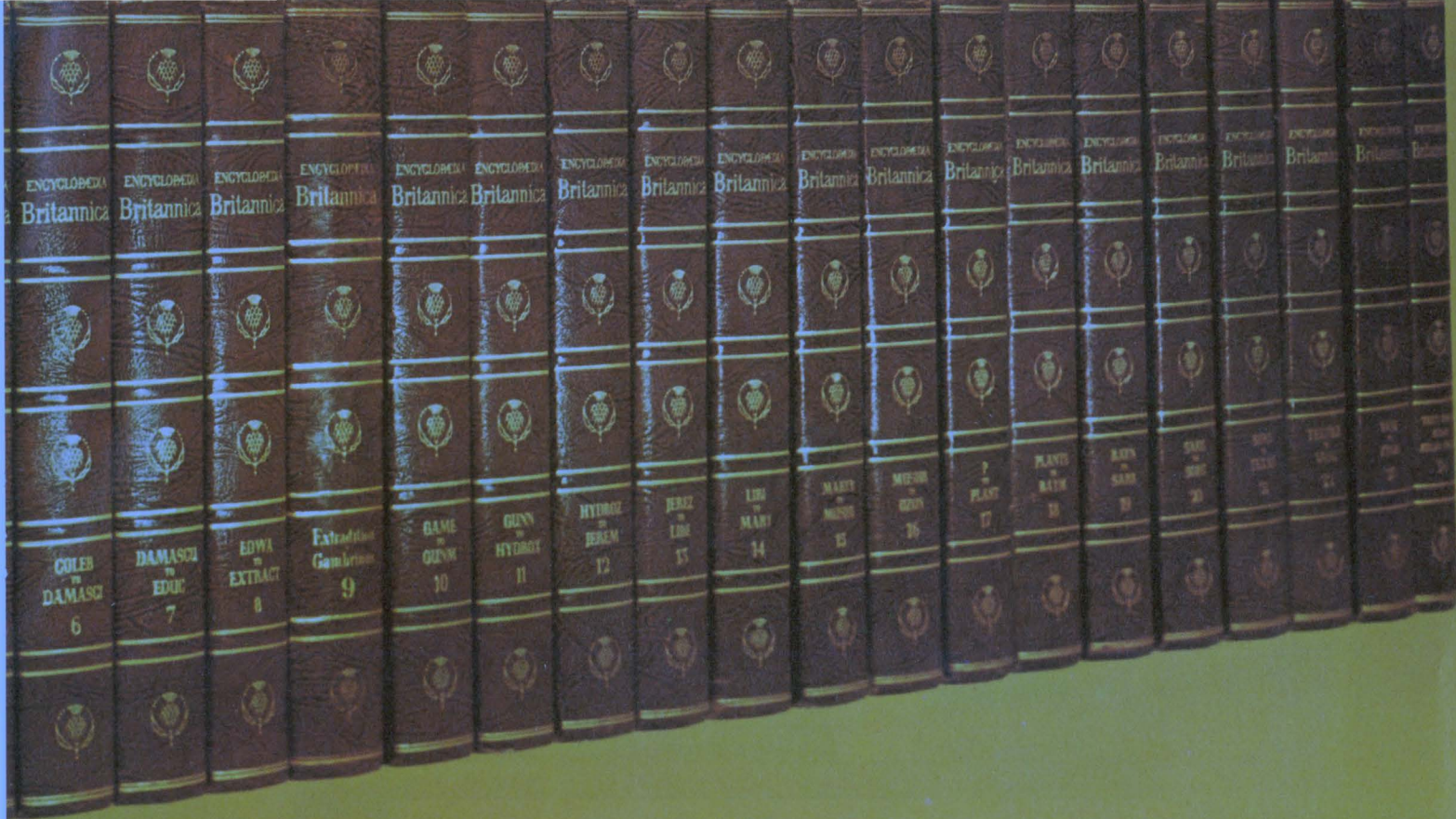

For breadth of line in microcircuits or in information, hit the right books.

Reliable, at-hand sources are some of the good things in life. Like the encyclopedia, for compact information. And, to more and more electronic designers, Beckman for our broad line of high-quality hybrid microcircuits at competitive prices.

Our distributors are a main reason. All around the country, they're stockpiled with the full line of standard hybrids, as well as with our industry-leading DIP resistor networks, trimmers, dials and pots. So they can offer delivery as fast as any in the industry, and usually faster.

Typical Beckman standards include universal active filters, for example. And telephone tone frequency filters. Precision ladder networks. Four-quadrant multiplying DACs. Successive approximation ADCs. High-power, high-slew FET input Op Amps. High-reliability MIL voltage regulators. And dual-tracking voltage regulators.

Our custom hybrid service is also something to turn to. Because we produce custom alterations or new products

in infinite variety. To time schedules few others can meet. We either build to customer design and specs or supply the design help when needed.

Typical custom units are modem and tone frequency filters. Entertainment system hybrid DACs and equalization filters. Custom display substrates (calculators, watches). Medical diagnostic timing and control functions. MIL-performance log amps, regulators, DACs, ADCs, and many others.

The point is, as a hybrid source, the Beckman line and distributor system are front-runners. For high quality and fast delivery. For competitive price and thorough service — including even a toll-free telephone express system to get literature to customers in just days. (Call toll-free 800-437-4677.) It's no wonder thousands of designers think of the Beckman catalog as a "most-valued reference work."

Beckman®

HELIPOT DIVISION

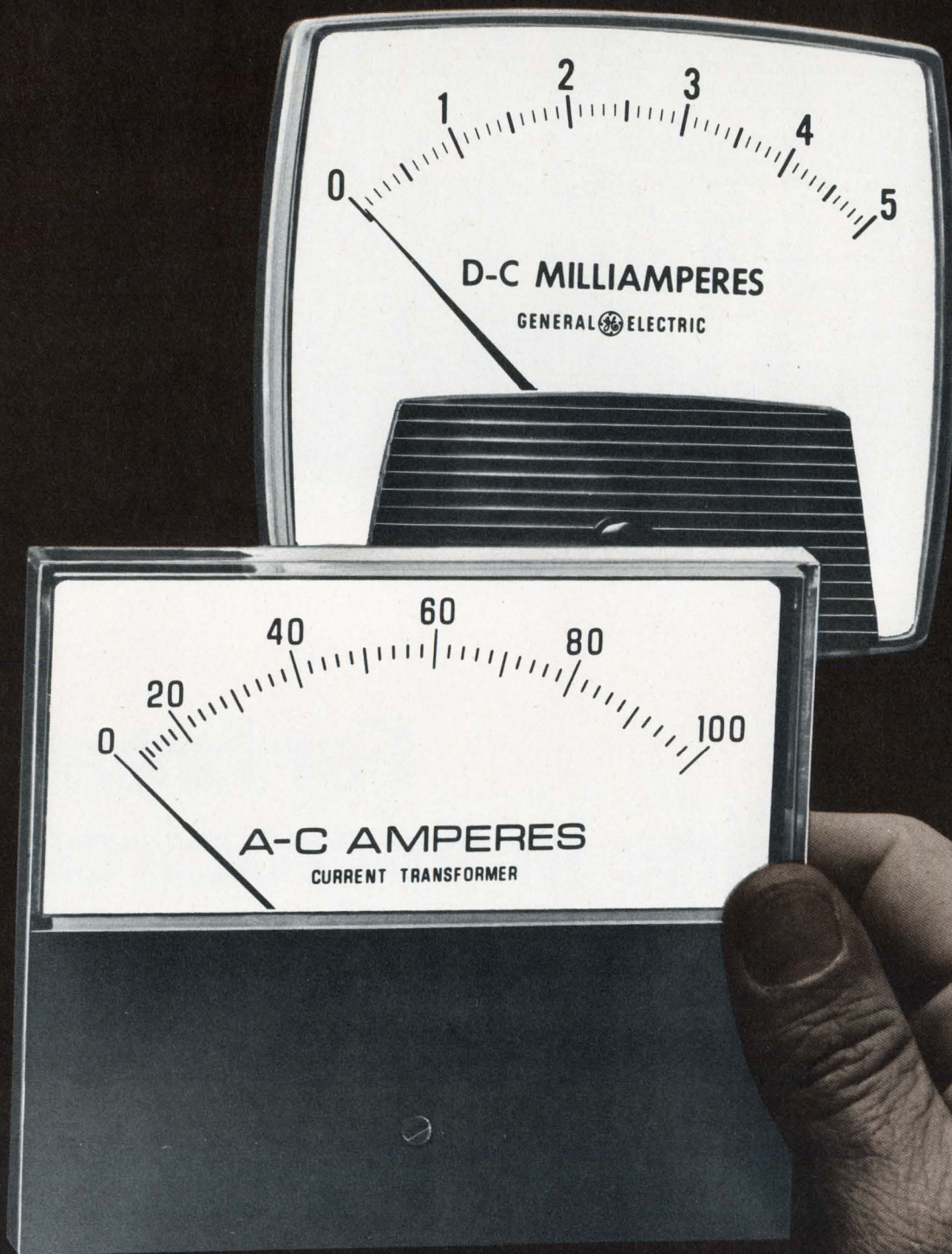

GENERAL  ELECTRIC

All Panel Meters are not created equal.

General Electric puts in more . . .
just for good measure.

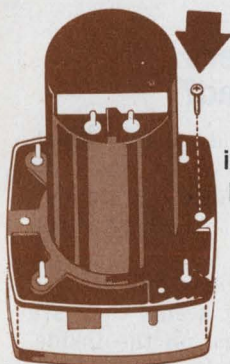

200 BIG LOOK® and HORIZON LINE® panel meters.

For example, if you must remove the cover, it's a lot safer with a GE panel meter. The lucite cover is held in place by a safety screw behind the meter face. Before taking off the cover, you must first remove *the instrument itself* from the panel to reach the screw. This prevents shock hazard and helps you meet national safety requirements. It's standard on our Series

GE solves your replacement-instrument problems.

The mounting studs on GE's new Series 200 panel meters can be ordered to fit existing panel openings. At no extra cost. There's a BIG LOOK or HORIZON LINE instrument in a-c or d-c, from 1½ to 4½ inch, in the range and rating you need. When it's replacement time, think of GE.

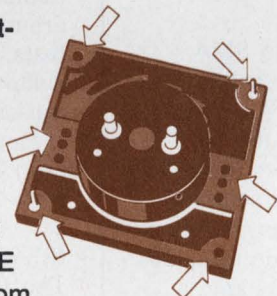

GE panel meters are quick-change artists.

Mount your square-shouldered HORIZON LINE panel meter *either behind the panel . . . or in front. It's your choice.* Just remove the snap-off mask to mount behind-panel. What's more, you don't have to buy a bezel, *and* you'll get a better-looking panel installation.

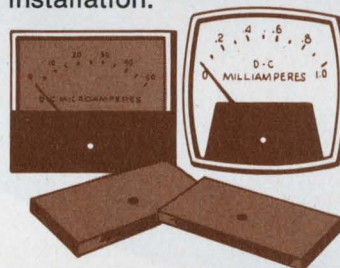

For front-mounting, you can order masks in six available colors. Or choose the wide-eyed BIG LOOK style for unmatched readability and unique impact.

General Electric handles a full line.

GE makes panel meters with taut-band or pivot-and-jewel movements. Slim edgewise meters for vertical, horizontal, or stacked mounting. Motor load indicators. Self-contained frequency meters. Elapsed-time meters. Meter relays and pyrometers. Come to GE to find it . . . and get GE quality and dependability.

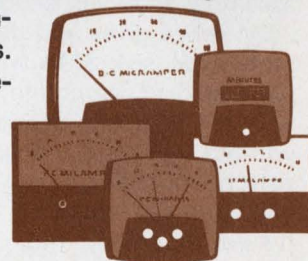

For a complete catalog of competitively priced and readily available GE panel meters, see your nearby authorized GE Distributor, Modification Center, or GE Sales Office.

Or write to General Electric Company,
Section 592-45, One River Road,
Schenectady, N. Y. 12345.

**Specify
General Electric...
just for good measure.**

A year ago we introduced 7 new JCM miniature RF coaxial connectors that "do the job for a fraction of SMA prices."

Here, by popular demand, are 8 more.

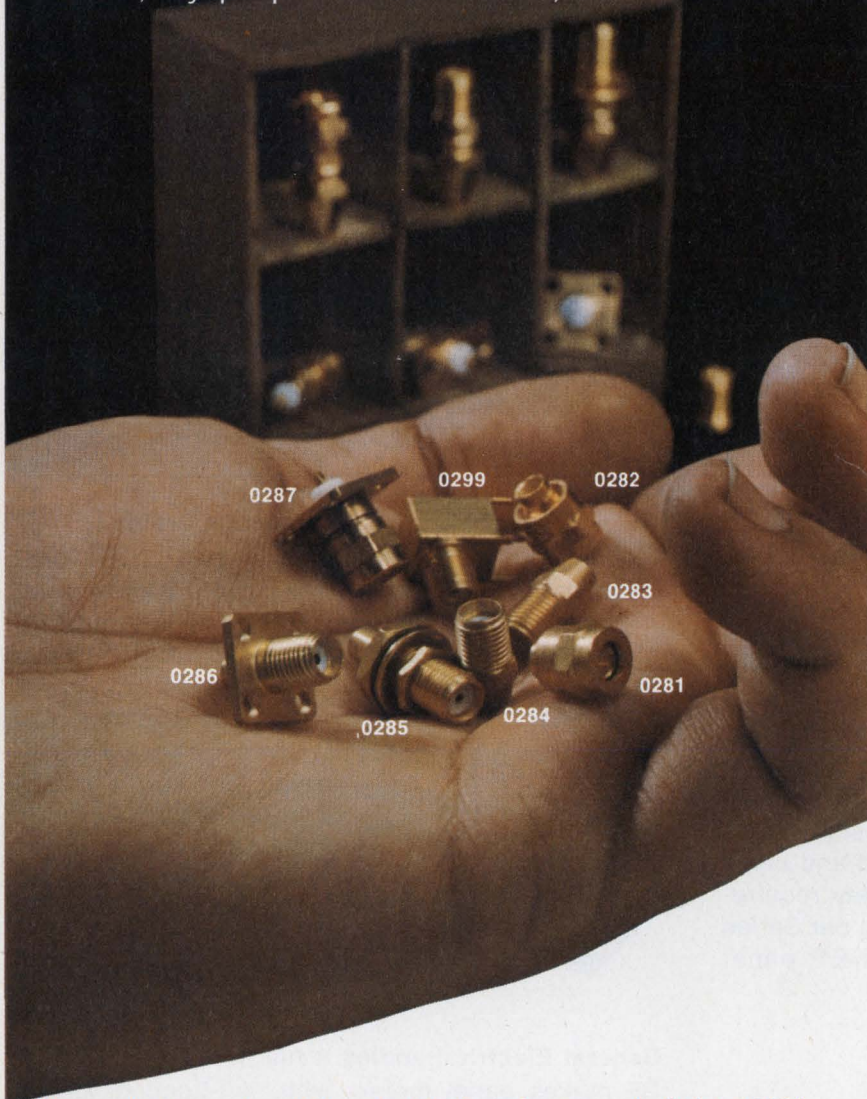

If you don't require all the electrical performance built into SMA type connectors, why pay for it? Up to 3 GHz for flexible cable assembly and even beyond 6 GHz for semi-rigid assembly, our new JCM series gives you the same electrical performance as the far more expensive SMA types. The series includes connectors for both panel and PC mounting. All are interchangeable and intermateable with the standard, expensive SMA connectors. So you can use them without making any changes... and without compromising required performance. There are JCM connectors to accept virtually any miniature size cable, so you don't have to stock a big variety. It's worth looking into, isn't it? All it costs is a stamp.

E. F. JOHNSON COMPANY / Waseca, Minnesota 56093
Please check for technical information or test samples of our new low-cost series 142-0200-001 JCM connectors.

Dept. ED-5

- Please send technical information.
- I desire test samples. Please call me at _____

NAME _____

FIRM _____ TITLE _____

ADDRESS _____

CITY _____ STATE _____ ZIP _____



E. F. JOHNSON COMPANY

INFORMATION RETRIEVAL NUMBER 16

ACROSS THE DESK

(continued from page 15)

of (or fewer) filaments, the B+ voltage will rise, often substantially, since filament power often represents the major drain. The rectifiers, filter capacitors and voltage-regulator devices will be overstressed, and may fail. In unregulated systems, the higher voltage may cause malfunction or failure.

We had the same problem in the early 60s when HV rectifiers became available, and we had to redesign the power transformers for less output ac.

Michael Neidich

19 Osage Court
Coram, N.Y. 11727

Have engineers really changed?

I wish I could share Ralph Dobriner's optimism in the editorial "We've Changed... Haven't We?" (ED No. 8, April 12, 1974, p. 57).

Engineers may look different on the outside, but it seems they are still much the same on the inside. I was quite distressed to find a great many of my classmates being interviewed by such organizations as Naval Underwater Research and the Army Materiel Command. These students were around during the Vietnam protests, but are now following the dollar signs and burying their consciences.

Hopefully the engineers of the late 70s will remember the protests of the late 60s.

Herb Perten

School of Engineering
The City College
New York, N.Y.

A lesson in punography

I'm sure few readers are interested in the arguments as to whether some of your ads are pornographic. Most of us don't even own a pornograph.

James W. Hole

Sandia Laboratories
Box 5800
Kirtland Air Force Base
Albuquerque, N.M. 87115

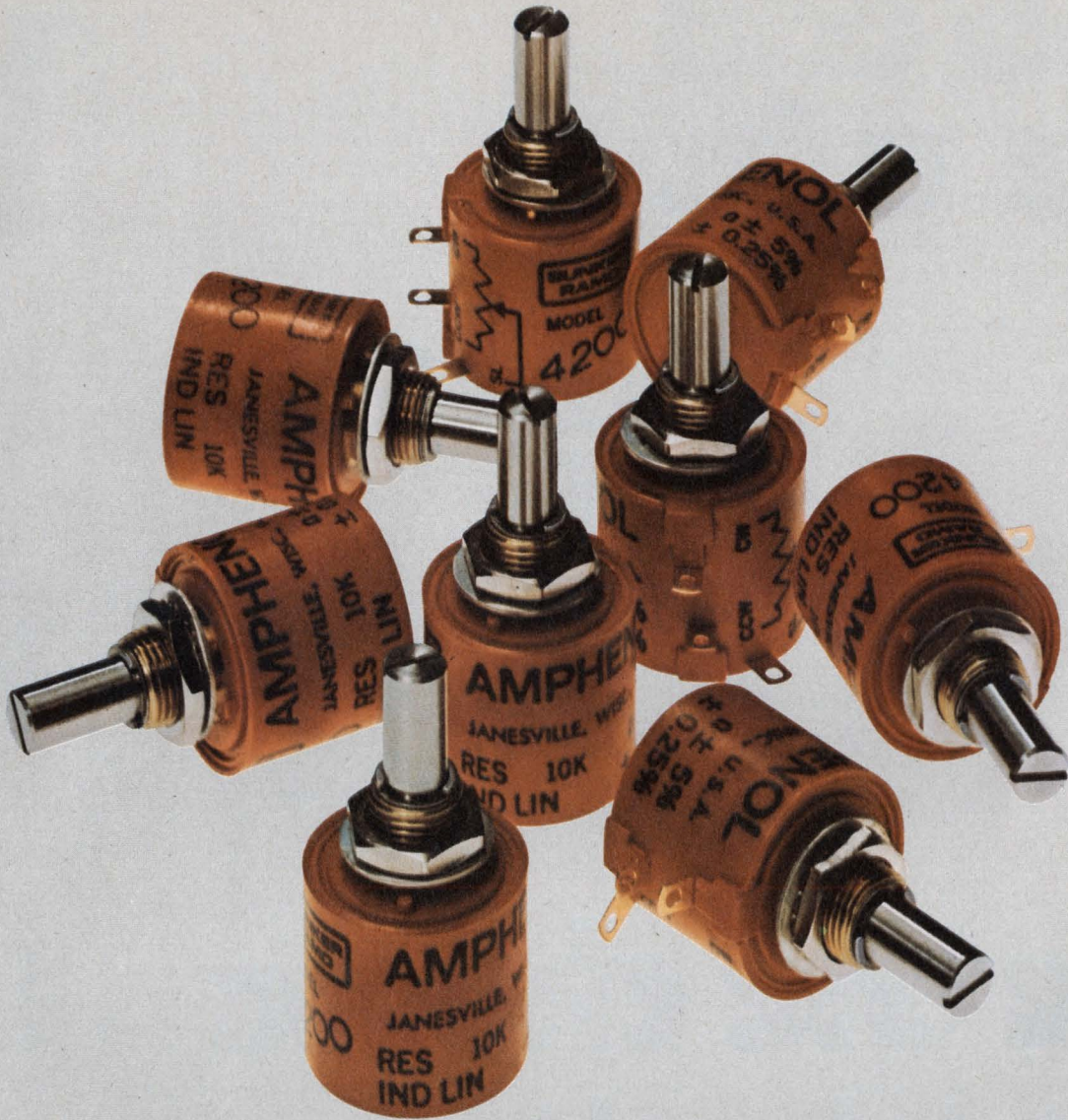

We promised higher performance at a lower price and we're delivering.

Less than a year ago we announced Scot Pot—a 10-turn, wirewound, $\frac{7}{8}$ -inch diameter, $\frac{3}{4}$ -inch short potentiometer to meet high performance specifications. We promised to deliver at an astonishingly low price.

And we've kept our promise.

We are mass-producing Scot Pot and it's now available off your distributor's shelf. Scot Pot has been thoroughly tested by an independent testing laboratory to VRCI standards and meets all the high performance criteria you set. A copy of the test report is available upon request.

Scot Pot guaranteed performance will

exactly replace, form, fit and function, the part you're now using—or having trouble getting. So save yourself some time, cost and a lot of headaches. Scot Pot is here now.

Right now, today, you can get a few hundred Amphenol Scot Pots from one of our distributors. And for large quantity orders we'll deliver in time to satisfy your most demanding schedules. For immediate action call us at 312/261-2000. Or write the Amphenol Scot Pot Department, 2801 S. 25th Avenue, Broadview, Ill. 60153.

ScotPot
■■■■■■■■■■

BUNKER RAMO AMPHENOL

you can see why...

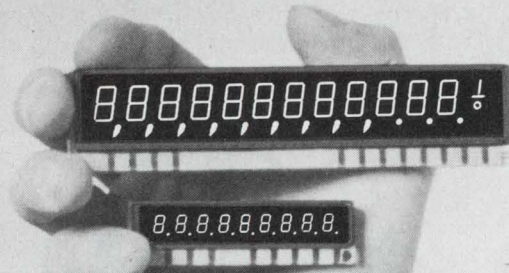

PANAPLEX™

PANEL DISPLAYS

are the choice for total quality

Designers of quality products that display 4 to 16 digits consistently choose PANAPLEX panels. These clear, easy-to-read displays are available in five character sizes (0.2, 0.25, 0.4, 0.5, and 0.7 inch) and provide excellent visibility—even under the harshest lighting conditions.

PANAPLEX displays have MOS compatibility and low power requirements (under 5mW per segment), too —

low enough to enable four AA penlight batteries to operate Berkey-Keystone's competitively-priced pocket calculators, or four D-size batteries to operate Computer Design Corporation's top-of-the-line scientific programmable calculators.

The soft, neon orange color of PANAPLEX panels is easy on the eyes, overcoming the fatigue so often encountered with the LED-red displays. PANAPLEX displays need no magnifiers, so you have a wide viewing angle (150°) with an attractive appearance. Because the display is so important,

you should judge displays on how the display "feels" and "looks".

With only two to four connections per digit and less than ¼-inch thick, PANAPLEX panels are ready for installation in your product with a minimum of effort and a maximum of design flexibility.

For more information about PANAPLEX panels and their applications, write to Burroughs Corporation, Electronic Components Division, P. O. Box 1226, Plainfield, New Jersey 07061, or call (201) 757-3400 or (714) 835-7335.

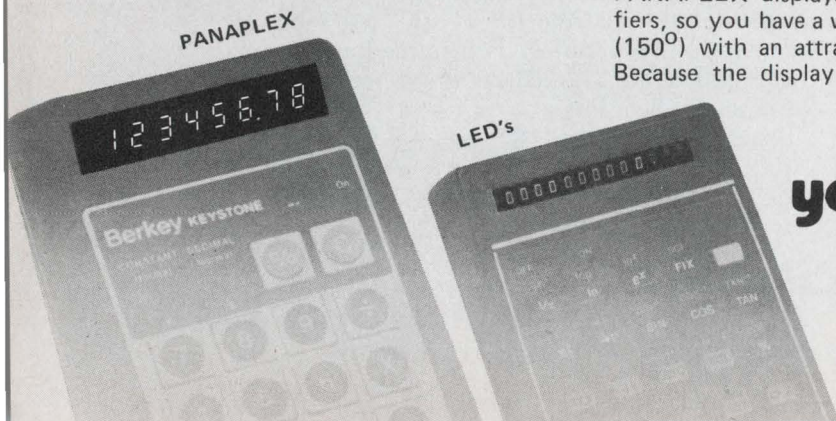

you can **see** the difference

Burroughs



INFORMATION RETRIEVAL NUMBER 18

16-bit microprocessor/mini, a 'first,' uses SOS chips

Using a silicon-on-sapphire technology to increase the speed of MOS circuitry, General Automation of Anaheim, Calif., has developed what it says is the industry's first fully compatible 16-bit microprocessor/minicomputer.

Known as the LSI-16, it replaces the company's discrete-component mini and is software and hardware-compatible with it. This eliminates a major problem for users of microprocessors—the lack of software support.

The LSI-16 is made with two custom SOS chips, fabricated for General Automation by Rockwell International. The chips—an arithmetic logic unit and a control read-only memory—combine with 1 k of random-access memory and associated circuitry to provide the basic machine.

Features include power-failure/automatic-start capability, a real-time clock, direct memory addressing, cold-start capability and an asynchronous memory interface.

An additional PC board for options is also available. Some of these extras are parity and hardware memory protection, a teletypewriter controller, an operator's console and a piggyback read-only memory board that can accommodate up to 4000 16-bit words.

The LSI-16 can handle up to 32 k of random-access memory, with 32 k on a single PC board. General Automation has obtained the high density by mounting eight 1103A memory chips onto a common ceramic substrate and plugging the substrates into vertical connectors on the board. If individual DIPs had been used instead of the substrates, the maximum density on the board would have been only 16-k bits.

The substrate approach also makes it easy to expand the memory, a company spokesman notes.

When 4-k memory chips become widely available, the memory will be expandable to 120-k bits.

While the LSI-16 is slightly slower than the SPC-16, which it replaces—1.8- μ s cycle time vs 1.4- μ s—it is significantly less expensive. The cheapest SPC-16 costs \$3950 in quantities of 200, while the LSI-16 sells for less than \$1000. A full-blown version of the LSI-16, with 32 k of memory, costs \$5700 in quantities of 200.

Other manufacturers said to be developing a 16-bit micro/mini include Digital Equipment Corp., Interdata, Varian, Hewlett-Packard and Computer Automation. So far, however, these companies have declined to comment publicly on their progress in this area.

Bubble data recorder to be tested by NASA

A prototype magnetic-bubble data recorder will undergo NASA tests soon to determine whether such memories can replace tape without undue problems.

The recorder is to be delivered in the next few months to NASA's Langley Research Center by the Electronics Research Div. of Rockwell International, Anaheim, Calif.

The 60,000-bit machine is reported to be a step toward NASA's goal of producing a 100-million-bit, all-solid-state satellite data recorder by the end of the decade. According to Paul Besser, Rockwell's principal investigator on the project, the next step is to develop a 100,000-bit bubble-memory chip.

The chip—which is to be the basic building block of the recorder—will measure about 225 mils on a side and have a data density of 2.5 million bits/sq. in., Besser says. The bubbles are to be 4 μ in diameter.

The high packing density, Besser says, will be achieved with state-of-the-art photolithography to obtain 1- μ lines.

This phase of the recorder-development program will take 18 months, according to Besser, and will include the following:

- Tradeoffs studies of device organization, processing and packaging.
- Design of the 100,000-bit element and masks.
- Fabrication of the device and yield studies.
- Extensive operational and environmental testing.

In explaining NASA's interest in bubble recorders, Besser notes that they are inherently more reliable than the tape units they are to replace. And a bubble recorder could eventually be significantly cheaper, he adds. Early versions, which will be produced in small quantities will cost about \$500 per chip. However, once in production, the 100,000-bit bubble chips would cost only about \$50 each, Besser says.

Honeywell Series 60 eases update process

Honeywell's Series-60 computers make it easy to update computer systems. The new line offers total software compatibility with all Honeywell computers, as well as special "bridges" of hardware and software to provide compatibility with competitive systems.

Stephen F. Keating, president and chief executive officer of Honeywell, notes that the Series 60 consists of seven computer models broken down into four levels of capability. All models have a semiconductor main memory, and 1-k and 2-k RAMs with p-channel MOS technology are used. The higher-level Models 66 and 68 also contain up to 8-k bytes of bipolar cache memory with 100-ns access time.

All processor logic is TTL. Although several IC houses tried to push ECL 10-k logic into these systems, Honeywell kept the more conservative TTL technology.

All Series-60 computers can operate in either remote batch, on-line or time-sharing modes. In the time-sharing mode up to 200 users

can be supported.

New peripherals include disc drives, magnetic tape drives and printers. Honeywell has finally announced a disc drive with IBM-3330 technology that can store up to 157 Mbytes on a 20-surface disc pack. The average seek time is 25 ms.

The page-printing system includes an electrostatic nonimpact printer capable of selectable speeds up to 18,000 lines per minute.

All computers and peripherals are to be available in January, of 1975.

Mobile communications get more megahertz

Makers of land-mobile communication equipment have received a much-needed shot in the arm from a Federal Communications Commission ruling that gives them 70 more megahertz now, with 45 more held in reserve for a later date.

The new allocations of frequencies, the FCC says, should accommodate requirements for private-car telephones and radio-dispatch service through the year 2000. The increased use of such equipment, according to the Government agency, should make land-mobile communications a billion-dollar business within five years.

The FCC gave 40 MHz to wire-line carriers, the largest of which is American Telephone & Telegraph, and 30 MHz to private systems, such as those used by taxis and construction companies. Where the remaining 45 MHz will be allocated has not yet been decided.

The 115-MHz allocation lies in the 806-to-947-MHz region. A 26-MHz portion of this region—902 to 928 MHz—is already used for microwave ovens and other devices.

To ensure competition for private radio service in given areas, the FCC limits each land-mobile-equipment maker to one common user trunk system per city. Each trunk system could accommodate five to 20 companies, with a private line for radio communications.

Silicon carbide studied for microwave devices

The development of silicon-car-

bide, high-frequency devices promises to improve the power output and extend the operating frequency of microwave devices.

Silicon carbide, according to investigations at the Westinghouse Astronuclear Laboratory, Pittsburgh, may overcome a basic problem: the fact that the power output and operating frequencies of silicon and gallium-arsenide devices are limited by the inherent characteristics of these materials.

Dr. Robert B. Campbell, manager of silicon-carbide technology at Westinghouse, points out that measurements on silicon carbide indicate a high probability of success for a microwave diode. The material's superior properties, he says, include these:

- Higher thermal conductivity—better than three times that of silicon and about 10 times that of gallium arsenide at room temperature (30 C), and some 2.5 times better than silicon at 300 C.

- Inherently higher operating temperatures. Silicon-carbide devices have been built that operate successfully at 500 C—considerably greater than the upper temperature limits of competing materials.

- Higher critical field voltage— 3.10^5 V/cm for silicon and from 2 to 4.10^6 V/cm for silicon carbide. This is the maximum voltage that can be applied before avalanche occurs. Higher voltages and power can thus be applied to the silicon-carbide devices before breakdown.

- Higher saturated-carrier velocity— 1.10^7 cm/s for silicon and 1.3 to 2.10^7 cm/s for silicon carbide. A large saturation velocity is desirable, Campbell notes, because it allows a wider depletion width, which in turn leads to higher power operation and improved efficiency, especially at the higher fre-

quencies.

Campbell notes that the saturated-carrier velocity for silicon carbide was measured for the first time by Westinghouse, while the latest phase of the company's research has included the fabrication of Schottky barriers in this material.

The Schottky barriers were made with gold on n-type silicon carbide, Campbell explains, and measurements verify the potential of silicon carbide as a superior material.

2-ton package testing stratosphere pollution

A laser, an opto-acoustic device and a computer have been sent up in a balloon to 92,000 ft to measure pollution in the stratosphere.

The whole package—which looks “decidedly unairworthy,” according to a witness—weighs two tons, is 8 ft long and 4 ft wide and anywhere from 2 to 6 ft high.

The package, developed by Bell Laboratories in Murray Hill, N.J., has been launched from the National Center for Atmospheric Research in Palestine, Tex. The purpose is to gain data on the composition and chemical stability of the stratosphere and to find out what man-made pollutant gases might be doing to its chemical balance.

The concentration of nitric oxide in the stratosphere is important because of the crucial role that it and other oxides of nitrogen play in the chemical cycle of ozone, says C. Kumer N. Patel, director of the Bell Electronic Research Laboratory. Ozone helps to block hazardous amounts of ultraviolet radiation from reaching the earth.

News Briefs

The Soviet Union, according to the Pentagon, has put radar-carrying satellites into orbit to monitor surface-ship traffic on the high seas. The radar's high-energy requirements are believed to be supplied by radio-isotop sources.

Employment in the aerospace industry will return this June almost to the 949,000 level of June

1973, the Aerospace Industries Association predicts. Earlier pessimistic estimates have been revised as a result of the devaluation of the dollar, liberalization of trade with Eastern-bloc countries, the rate of inflation in other industrial countries and the Mideast War and its demands for additional weapons.

Stable Trimmers
Small Duals
Rugged Pots

If you're really
serious about cost,
be serious about quality.

Type FD trimmer. Type GD pot. Ideal variable resistors for CATV attenuators. Or any Bridged-T or L pad application requiring minimum size, stability and long life in severe environments. Exclusive hot-molded composition resistance elements permit peak set-ability. Diameter 1/2

inch (12,70 mm). Immersion-sealed (can be potted). Standard resistance values from 100 ohms to 5 megs and many popular impedance values. Single turn. For complete technical details request Publication 5231 (FD trimmer), Publication 5213 (GD potentiometer), Publication 5221 (FD/

GD attenuators). Allen-Bradley Electronics Division, 1201 South Second Street, Milwaukee, Wisconsin 53204. Export: Bloomfield, New Jersey 07003. Canada: Allen-Bradley Canada Limited, Cambridge, Ontario. United Kingdom: Jarrow, County Durham NE32 3EN.

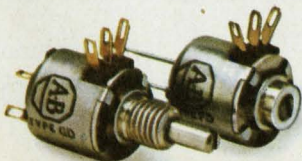

Actual Size



Allen-Bradley
Milwaukee, Wisconsin 53204

In power, longevity and voltage, batteries are reaching new peaks

The carbon-zinc workhorse battery, in use for 125 years, is getting new stable mates as the electronics industry moves increasingly toward portable operation of test equipment and communications gear.

To meet the demands, manufacturers are coming up with new electrochemical systems, as well as redesigns and improved fabrication techniques. Recent advances include these:

- Lithium batteries that offer greater energy density and longer shelf life than other types.

- Special mercury batteries that produce a signal after 70% of the battery life has lapsed, to indicate that it's time to replace the battery.

- Wafer-thin batteries capable of producing short-circuit currents equal to those produced by batteries many times larger.

- Nickel-cadmium units that can be recharged in minutes instead of hours.

- "Dry" lead-acid storage batteries that require no maintenance.

Enthusiasm for lithium

The lithium organic electrolyte battery has been called by some the most significant improvement in battery technology in 25 years. The reason for the enthusiasm is evidence that lithium produces a battery that has an energy density that is four times greater than that of existing types.

The use of lithium as the anode in a battery system has intrigued technologists for years. However, several problems have until recently hindered the development of a



Lithium batteries from Power Conversion have a shelf life in excess of five years. Because of the 3-V cell, one battery can replace two carbon-zinc units. A spring-like adapter takes up the extra space.

commercial device, notes Bruce Jagid, president of Power Conversion, Inc., Mount Vernon, N.Y.

According to Jagid, a main problem that had to be overcome was lithium's tendency to react chemically with even trace amounts of water. This made it necessary, he says, to develop a nonaqueous electrolyte with high conductivity and

the ability to operate over a wide temperature range. Another problem was the need to develop an active cathode that was both compatible with the organic electrolyte and capable of yielding a high electrochemical efficiency when combined with the lithium anode.

All of these problems have now been overcome, he reports, and Power Conversion has commercial lithium batteries available under the Eternacell label. Prices start at \$4.95 for a D cell in single-unit quantities. Once high-volume production is reached, lithium batteries will be price-competitive with mercury units, Jagid predicts.

The Eternacell has a nominal cell voltage of 2.8 V—twice that of carbon-zinc batteries. It has an energy density as high as 150 Whrs/lb, an operating temperature range of from -65 to 165 F and a shelf life of more than five years.

To get an idea of how the lithium battery stacks up against others, Jagid points out that at 70

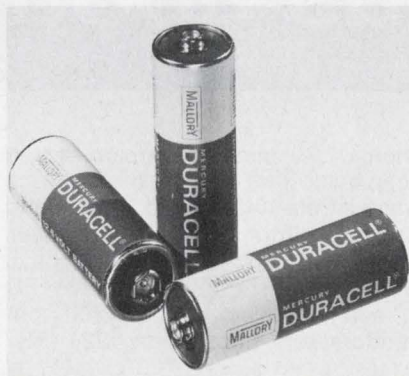

Mercury-cadmium battery from Mallory drops 1.5 V after 70% of its energy is delivered to indicate a replacement is required.

Jules H. Gilder
Associate Editor

Replace Gas Tubes With Solid-State TUBE-PAC!

Reduce Energy Consumption by 80% with NEW TUBE-PAC!

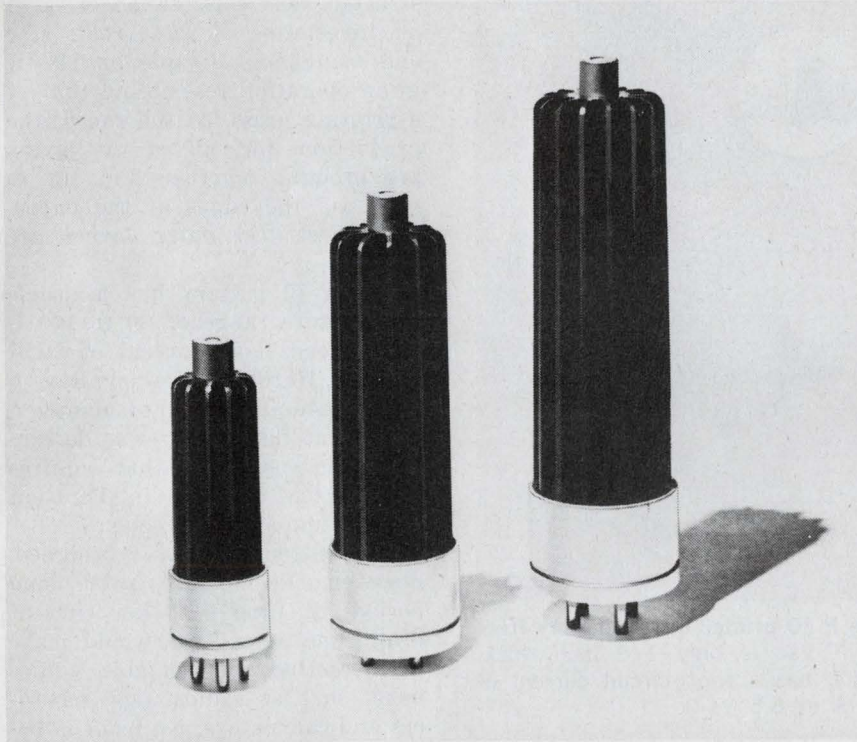

TUBE-PAC is Semtech's new line of silicon tube replacements. A direct plug-in substitute for most popular gas tube type rectifiers, TUBE-PAC requires no special adaptors.

OFF-THE-SHELF GAS TUBE REPLACEMENTS

Type	PIV-KV	Io Amp	Cathode Connection	Type	PIV-KV	Io Amp	Cathode Connection
STR3B25	4.5	0.5	1	STR5720	1.0	2.5	4
STR3B28	10	0.5	1	STR6587	16	0.23	2
STR4B32	10	1.25	1	STR6693	15	5	2
STR249C	10	0.5	1	STR6807	1.5	6.4	2
STR575A	15	2.5	2	STR6808	1.5	6.4	2
STR576A	25	0.5	2	STR6894	20	2.5	2
STR250R	60	0.25	2	STR6895	20	2.5	2
STR253	15	0.35	2	STR7018	2	2.5	1
STR577	25	0.3	2	STR7019	1	6.4	2
STR593	25	0.3	1	STR7454	25	6.5	1
STR615	2	2.5	1	STR7789	15	0.4	2
STR635	1	6.4	3	STR7790	20	1.0	2
STR672A	2.5	3.2	2	STR7792	25	2.0	2
STR816	7.5	.13	2	STR8008	10	1.25	2
STR866A	10	0.5	1	STR8080	25	2.5	2
STR872A	10	1.25	2	STR8253	20	0.25	2
STR5544	1.5	3.2	2	STR8434	20	1.8	2
STR5560	1.5	2.5	4	STR8435	20	1.8	2

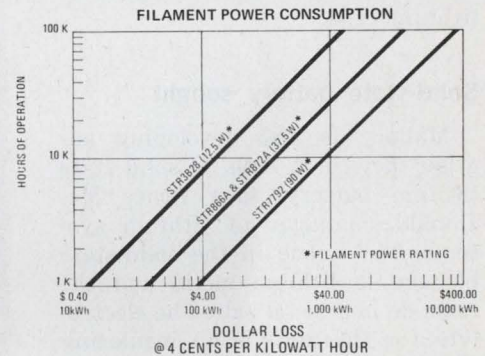

TUBE-PAC is a completely solid-state device. The energy normally used to power the gas tube rectifier filament is eliminated.

Semtech's TUBE-PAC is corona free and dissipates heat more effectively.

TUBE-PAC rectifiers reduce maintenance and last hundreds of hours beyond the normal replacement period for gas or vacuum tubes.

For information on TUBE-PAC gas tube replacements not listed, and TUBE-PAC vacuum tube replacements, contact the factory with your requirements.

"We're number 1 because we try harder"



652 Mitchell Road, Newbury Park, California 91320
(805) 498-2111, (213) 628-5392 / TWX: 910-336-1264

CHICAGO: (312) 352-3227
DALLAS: (214) 253-7644
FLORIDA: (305) 644-5404
NEW JERSEY: (201) 654-4884
SAN FRANCISCO: (415) 328-8025
EUROPEAN SALES: (Switzerland) (042) 323-242

Ask your Semtech Dealer about TUBE-PAC vacuum tube replacements.

F with a 1-A drain current, one D-sized Eternacell is equal to four mercury-zinc D cells, five alkaline-manganese D cells, seven magnesium D cells and 30 carbon-zinc D cells.

Power Conversion is not the only company working on lithium cells. Virtually every other battery manufacturer is looking at them, too. Power Conversion is, however, the only company that has them commercially available as a standard product, although Mallory Battery Co., Tarrytown, N.Y., does have a pilot-production facility that turns out a limited number of lithium cells.

Solid-state battery sought

Mallory is also developing another device it calls a solid-state lithium battery, says Bruce McDonald, manager of lithium systems. The anode in the solid-state battery is lithium metal and the cathode is a metal salt. The electrolyte for this unit is an insulating solid, which also serves as the separator between the cathode and the anode.

Extrapolated data from high-temperature tests indicate that the solid-state battery could last between 10 and 20 years, McDonald says.

Another type of lithium battery has been developed by Matsushita Electric. Unlike the Mallory and Power Conversion devices, this one uses poly-carbonmonofluoride for the positive electrode. The nominal voltage of this cell is similar to the others—2.8 V—but its shelf life of “at least one year” appears to be considerably less than the Mallory and Power Conversion devices.

A big advantage of the Matsushita lithium battery is that since poly-carbonmonofluoride is a solid, leakage is not as critical a problem as it would be for the other cells, which contain sulphur-dioxide gas.

Early-warning battery developed

A major drawback of most batteries is that you can't tell how much life the unit has left. Mallory has overcome part of this problem with a new 12.6-V mercury battery, designated 304116.

Designed for alarm applications, the battery drops sharply by 1.5 V

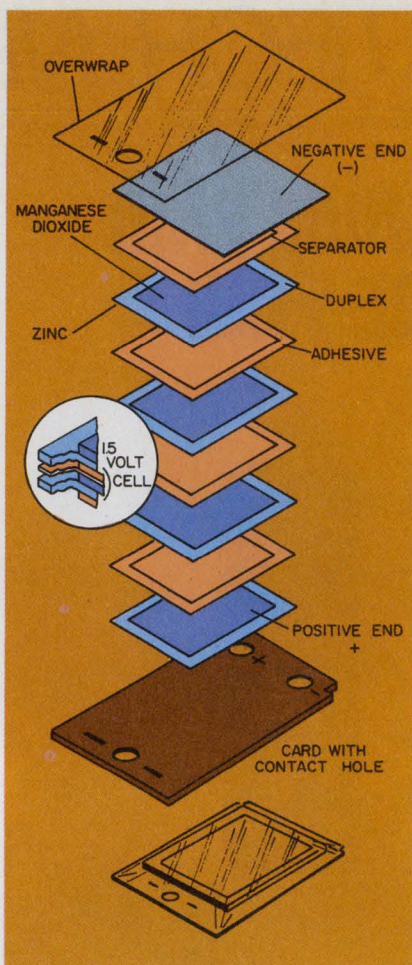

The P-70 printed-circuit battery from Ray-O-Vac is only 1/8 inch thick, but it has a short-circuit current of 30 A at 6.5 V.

after delivering 70% of its rated capacity. This drop in voltage is large enough and sharp enough to trigger an external sensing circuit, which can be used to trigger a light or buzzer indicating it is time to replace the battery. The remaining capacity in the battery, however, is sufficient to operate the equipment until the battery can be replaced.

According to Glenn F. Cruze, manager of application engineering and government sales for Mallory, the early-warning capability of the 304116 battery results from two specially designed cadmium cells that are contained in the unit. These two cells are constructed so that each will drop 0.75 V 30% sooner than the other cells in the battery.

'Printed' battery produced

A novel battery that is used in the film packs of Polaroid's new

SX-70 camera was developed by the Ray-O-Vac Div. of ESB, Inc., Madison, Wis. Known as the P-70 battery the new unit is only 1/8 in. high and contains four 1.5-V cells stacked to produce a 6-V battery.

Although the electrochemistry of the battery is not new—standard carbon-zinc technology is used—the design and packaging format are. The 19 layers of materials from which the battery is constructed pass through a series of machines. One of these coats zinc and manganese dioxide on plastic in an operation resembling that of a printing press. At the end of the production line, all of the layers are brought together and cut to size, and the edges of the paper-thin sheet-steel outer layers are sealed.

The P-70 battery has a usable temperature range of 30 to 160 F and a dead short current of 30 A at 6.5 V. Harold A. Coakley, Ray-O-Vac's national accounts manager, notes that the battery was designed for an application that requires high current drain for intermittent periods and limited cycles.

The battery can be redesigned, however, to operate over long periods of time with low current drains, he says. This would make it attractive for portable equipment, such as radios, tape recorders and calculators. No work is being done on such a battery at present, but Coakley indicates that if there is a sufficient market, that picture could change.

Rechargeable batteries advance

Not all of the new developments in battery technology are taking place in primary batteries. Secondary, or rechargeable types are also improving.

In nickel-cadmium batteries, the most recent development is a unit from General Electric that can be recharged in as little as 15 minutes without damage to the battery or shortening of its life. Previously nickel-cadmium batteries required between four and 16 hours to recharge.

Called the Powerup-15, the new battery contains a special cell design that permits significant overcharging at a fast rate. To ensure that the battery will not be damaged, a special sensing cutoff system automatically terminates the

Dialight sees a need:

(Need: Single source supply for all indicator lights.)

See Dialight.

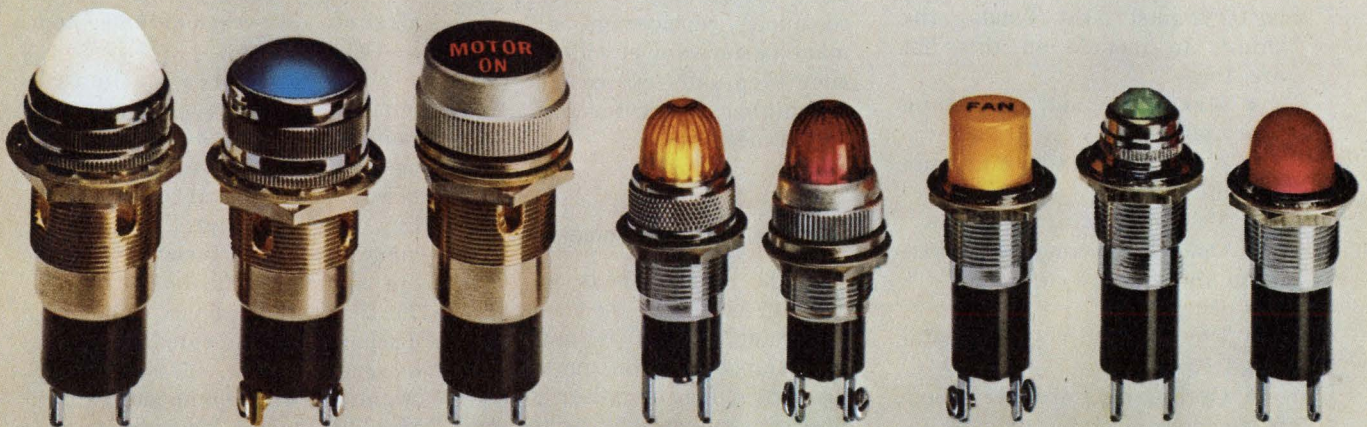

INCANDESCENT OR NEON MINIATURE AND LARGE INDICATORS

Designed to accommodate either incandescent (2-250V) or neon (105-250V) lamps for panel mounting in 11/16" or 1" clearance holes. Units meet or exceed MIL-L-3661 requirements; all are listed in Underwriter's Recognized Components Index. Wide selection of lens shapes, colors,

finishes and terminations. Many lenses may be hot stamped, engraved or offered with film legend discs. Oil-tight units with unique "O" ring construction make them oil, water and dust tight on the face of the panel. Available off the shelf for prompt delivery.

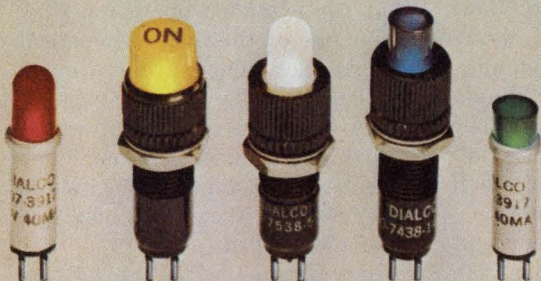

LED, INCANDESCENT OR NEON ULTRA-MINIATURE DATALITES®

Meet or exceed MIL-L-3661. Replaceable plug-in cartridges for 1.35-125V operation. Indicators mount as close as 1/2" centers; available with red, green, amber, blue, white translucent, light yellow or colorless lenses in wide range of lens shapes, legends and finishes. Off-the-shelf.

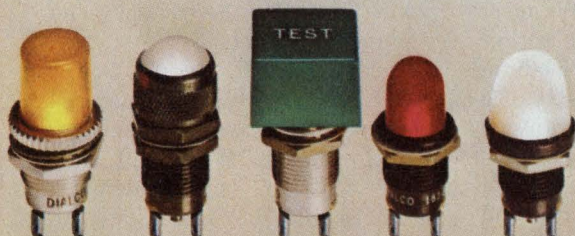

INCANDESCENT OR NEON SUB-MINIATURE INDICATORS

Meet or exceed MIL-L-3661. Mounts in 15/32", 1/2" or 17/32" clearance holes. Incandescent for 1.35-28V; neon has patented built-in current limiting resistor. Choice of cylindrical, faceted, convex, flat, square and round lens shapes, colors, finishes, legends. Off-the-shelf.

DIALIGHT

Dialight, A North American Philips Company
203 Harrison Place, Brooklyn, N. Y. 11237 (212) 497-7600

SEND ME FREE INDICATOR LIGHT PRODUCT SELECTOR GUIDE.



Don't make the battery a last-minute design decision

With the advent of new batteries, designers may find it harder to pick a battery for their application. According to Samuel R. Converse, director of market development for Union Carbide in New York City, the selection can be simplified if the engineer calls in the battery manufacturer at an early stage of the design process.

Prepare a list

Before you call in the manufacturer, however, prepare a list of requirements that the battery must meet. Among the things to include on this list are these:

- Maximum and minimum load voltage.
- Maximum and minimum current drain.
- Total operating time.
- Operating time at maximum and average current.
- Duty cycle.
- Physical and environmental requirements.
- Cycling data (for secondary batteries).

Battery voltage is one of the most important, and sometimes troublesome, specs. All battery systems do not have the same basic cell voltage. Most everyone knows that carbon-zinc cells have a basic voltage of 1.5 V. Thus, for an application requiring 6-V, four cells would be needed. But if the designer leaves space for four cells and decides to pick the actual battery at a later date, he could be in for trouble—particularly if he decides to use nickel-cadmium cells, which have a basic voltage of only 1.2 V. In that case, he would need 5 cells.

Other battery systems have other voltages. For example, lithium batteries have a basic voltage of 2.8 V, and lead-acid cells 2 V. The problem is compounded further by the manufacturers who produce all these cells in the same size package. If a piece of equipment is designed to operate from two D-

sized lithium cells, an unwary customer may try to replace those batteries with two alkaline D cells and then complain that his equipment doesn't work.

When noting current requirements, take into account any current pulses that will occur. These may require the selection of a larger-capacity battery or a different type. A higher-capacity unit is needed for pulsed-current applications to reduce the internal resistance.

If the equipment is to operate for a very long time, rechargeable batteries have a clear advantage. The cost of continual replacement of primary batteries over an extended time eventually exceeds the initial higher outlay for rechargeable types.

Primary battery choices

If the decision is to go with primary batteries, the choice for most applications is narrowed to Leclanche (carbon-zinc), alkaline, mercury or silver oxide. Special applications may require magnesium, lithium, zinc-air or solid-state batteries.

The big advantages of Leclanche batteries, says Union Carbide's Converse, are their low cost and universal availability. They are only good, however, in light-current-drain applications, he points out. The disadvantages of Leclanche batteries include a limited shelf life and a variable output.

For continuous high-current applications, the designer can choose alkaline manganese batteries. They have better shelf life than Leclanche cells and can operate between three and 10 times longer. Although for most applications alkaline cells are superior, it is only at medium and high-current drains that a significant economic advantage is achieved.

For applications requiring a high energy-to-volume ratio and a flat discharge curve, the traditional choice has been mer-

cury batteries. The flat-discharge characteristic has made this cell ideal for miniaturized equipment, as well as for reference-voltage applications.

Like mercury cells, silver-oxide cells provide a flat discharge curve. They have a higher voltage than mercury cells—1.55 V for silver and 1.35 V for mercury—but a lower capacity.

Secondary possibilities

For applications requiring secondary batteries, the choice is between three major types: alkaline, nickel-cadmium and lead-acid.

Where low cost and a limited number of recharging cycles are required, rechargeable alkaline batteries are attractive. When new, alkaline rechargeables have the same characteristics as primary alkaline batteries, and they can be recharged between 20 and 75 times. The device must be discharged to its rated capacity, however, before it will withstand any overcharge. Care should be taken, however, to ensure that the battery does not discharge completely.

Nickel-cadmium batteries have a very high initial cost, but for extended operation they offer one of the most economical approaches. They are low-energy-density cells but very rugged. They have large-current capability and long cycle lives. They are best for applications where they will be frequently charged and discharged.

Problems with nickel-cadmium operation include the possibility of cell reversal, variation of self-discharge rates from cell to cell and hysteresis effect, which degrades the capacity and voltage of the cells.

Lead-acid cells don't suffer from the hysteresis effect or cell reversal. They are cheaper than nickel-cadmium types, but they have a lower energy density. Care should be taken not to overcharge the lead-acid battery.

WANTED

for not impersonating an op amp

Unlike most other comparators, these MC3430-33 high-speed quads don't don the usual op amp spec disguise. We've combined a conglomeration of specs into one helpful parameter that treats the MC3430 series like digital devices rather than op amps. This revealing new spec is called "input sensitivity" (V_{IS}).

Traditional comparator specs are a heritage from the early "op amp" development days of linear. But these parameters don't adequately describe comparators with their notably different applications. Like the MC3430-33 quads. They're at home as sense amps in 1103 type MOS memory systems, other computer interface applications, or even control systems. That's where input sensitivity comes to the rescue.

Input sensitivity blends the effects of voltage gain, input offset voltage and input offset current. This provides you with the comparator's differential input requirements to guarantee a given logic state at the output. In short, input sensitivity gives you your worst-case design at a glance.

And just so there are no unexpected surprises, we've even included some usually ignored influences in conventional specing. Like the effects of $\pm 5\%$ power supply variations, a $\pm 3.0V$ common-mode voltage range and temperature changes from 0° to $70^\circ C$.

It all adds up to a ± 7 mV or ± 12 mV total sensitivity, depending on how stringent your requirements. Both versions are available in either open-collector or three-state TTL compatible configurations. And prices for these 10 fan-out comparators start as low as \$4.00 (100-up) with off-the-shelf delivery.

So just how good is the MC3430-33 series compared with other popular industry standard comparators? The table tells all.

WORST CASE COMPARISONS

Type Number	$T_A = 0$ to $70^\circ C$					
	V_{IO} mV Max	A_{VOL}^* V/V Typ	Differential Input Voltage Required for 3.0 V Output Change	I_{IO} $R_s = 200\Omega$ μA Max	Error Voltage Generated into 200 Ω Source Resistors	Input Sensitivity mV
MC3430, MC3432	—	—	—	—	—	7.0
MC3431, MC3433	—	—	—	—	—	12
MC1711C	5.0	1000	3.0 mV	25	5.0 mV	13
MLM311	10	100 k	0.030 mV	70**	0.014 mV	10.04
MNE521	10	4000	0.75 mV	12	2.4 mV	13.15

*Typical values given, as minimum gain not always specified.
** I_{IO} measured in nA.

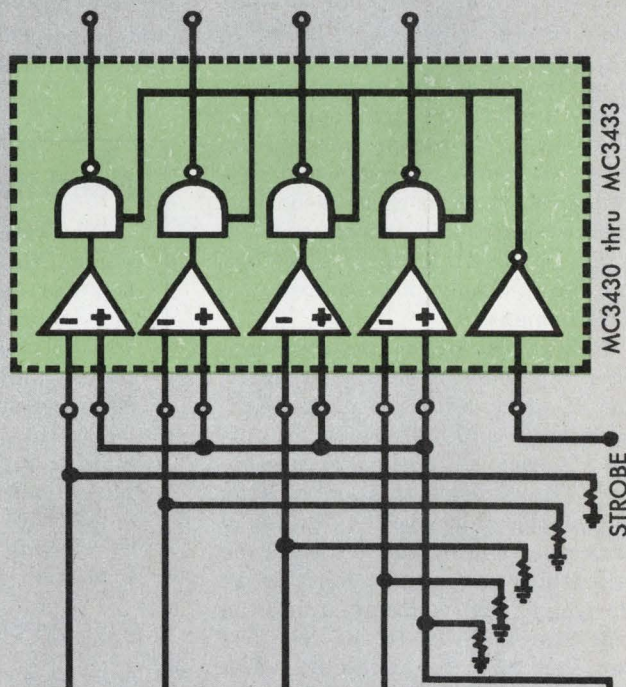

4096 word by 4-bit
memory system with
1103 type MOS memory.

Hopefully, your curiosity is peaked. Satisfy it by capturing the MC3430-33 comparator data sheet which details our unique new parameter. Correspond to P.O. Box 20912, Phoenix, Arizona, 85036, or circle the reader service number below.

Now you've got their complete description. And we've got the MC3430-33 high-speed quad comparators.

Seize them and reap the rewards.



MOTOROLA LINEAR
— practical innovations for systems design!

fast charge current.

This sensing system operates whenever the battery voltage or cell temperature reaches a predetermined set point.

Lead-acid looks good

Developments in lead-acid battery technology in the last decade have made that storage battery system a truly portable device that is both spill-proof and maintenance-free.

Until recently, lead-acid batteries had to be either of the vented type, where water must be added periodically, or of the semi-sealed type, which requires no maintenance. While the semi-sealed, or gelled electrolyte, batteries eliminate the need to add water and they allow the battery to be used in any position, they have some disadvantages. They produce an acid spray and allow water to escape in the form of an explosive hydrogen and oxygen mixture. And there is no way the lost water can be replaced.

This type of battery, therefore, can be used only in a nonexplosive environment.

Robert Doster, marketing manager of Gates Energy Products, Inc., Denver, agrees that the semi-sealed lead-acid battery has a limited life because of the water problem. To overcome this, he reports, Gates has developed a lead-acid "dry cell." Like other dry cells, the unit isn't really dry. It contains an electrolyte that is absorbed into the separator material in the cell. The new cell has the reliability of a nickel-cadmium battery without its associated problems, such as cell reversal.

One of the most important features of the new cell, Doster points out, is its completely sealed operation. This is possible, he explains, because the oxygen that is usually generated during overcharge is recombined.

Doster admits that a slight amount of hydrogen does diffuse through the battery case, but this is less than 1% of the gas lost during overcharging by any other lead system, including gelled-electrolyte, maintenance-free batteries, he says.

According to Huey M. York, marketing manager for Eagle-Picher, Seneca, Mo., the Gates cell is not all it appears to be. The seal in that battery operates at high

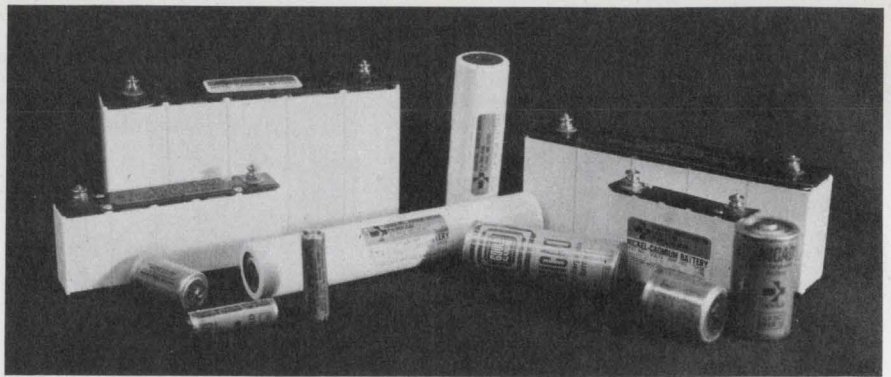

Nickel-cadmium batteries from Gould come in a variety of shapes. They are used where frequent charge and discharge are required.

pressure, thus for mild overcharge it does not vent much hydrogen, he notes. But once the seal does open, it will lose much more hydrogen than other batteries because of the pressure inside. Another disadvan-

tage is that it has a more limited range of operating temperatures. "As far as the acid spray problem is concerned, our batteries have a package that eliminates this problem," he says. ■■

Need more information?

We wish to thank the companies that provided information for this report. The products cited have been selected for their illustrative, or in some cases, unique qualities. However, manufacturers not mentioned in the report may offer similar products. Readers may consult with the manufacturers listed here for further details by circling the appropriate information retrieval number.

- Acme Battery Corp., 700 Canal St., Stamford, Conn. 06904. (203) 324-4125. L. Schub, President. **Circle No. 430**
- Bright Star Industries Inc., 600 Getty, Clifton, N.J. 07015. (201) 772-3200. Marketing Manager. **Circle No. 431**
- C & D Batteries, Div. of Eltra Corp., 3043 Walton Rd., Plymouth Meeting, Pa. 19462. (215) 828-9000. Marketing Manager. **Circle No. 432**
- Century Storage Battery, Alexandria NSW, Birmingham St., Australia. Marketing Manager. **Circle No. 433**
- E S B Inc., P.O. Box 8109, Philadelphia, Pa. 19101. (215) 564-4030. **Circle No. 434**
- Eagle-Picher Industries, Electronics Div., P.O. Box 47, Joplin, Mo. 64801. (417) 623-8000. Marketing Manager. **Circle No. 435**
- Electro Powerpacs Corp., 253 Norfolk St., Cambridge, Mass. 02138. (617) 876-9200. Marketing Manager. **Circle No. 436**
- Electrochimica, 1140 O'Brien Dr., Menlo Park, Calif. 94025. (415) 323-0283. Marketing Manager. **Circle No. 437**
- Electronic Batteries, 14 De Forest, Amityville, N.Y., 11701. (516) 842-5111. Marketing Manager. **Circle No. 438**
- Elpower Corp., 2117 S. Anne St., Santa Ana, Calif. 92701. (714) 540-6155. Marketing Manager. **Circle No. 439**
- Fuji Electric, 1-1-Chm, Chiyodaku, Marunouchi, Tokyo, Japan. Marketing Manager. **Circle No. 440**
- Gates Energy Products Inc., Div. of Gates Rubber Co., 999 S. Broadway, Denver, Colo. 80217. (303) 744-4806.

- R. Doster, Mktg. Mgr. **Circle No. 441**
- General Battery Corp., P.O. Box 1262, Reading, Pa. 19603. (215) 929-0771. Marketing Manager. **Circle No. 442**
- General Electric Co., Electronic Capacitor & Battery Prod. Dept., P.O. Box 114, Gainesville, Fla. 32602. (904) 462-3911. John S. Hodgman, Mktg. Mgr. **Circle No. 443**
- Globe Battery Div., 5757 N. Green Bay Ave., Milwaukee, Wis. 53201. (414) 228-2393. A. Buckmann. **Circle No. 444**
- Gould, Inc., Burgess Div., Box 3140, St. Paul, Minn. 55165. (612) 452-1500. H. P. Barry, Dir. of Mktg. **Circle No. 445**
- Gulton Battery, Inc., Electronic Components Div., 212 Durham, Metuchen, N.J. 08840. (201) 548-2800. Robert Alexander. **Circle No. 446**
- Hitachi Maxell Ltd., 501 Fifth Ave., New York, N.Y. 10017. (212) 986-1844. Marketing Manager. **Circle No. 447**
- Mallory Battery, Div. of P. R. Mallory, S. Broadway, Tarrytown, N.Y. 10591. (914) 591-7000. G. Cruze, Mgr. Appl. Eng. **Circle No. 448**
- Marathon Battery Co., 8301 Imperial Dr., Waco, Tex. 76703. (817) 776-0650. Marketing Manager. **Circle No. 449**
- Matsushita Electric Corp., 200 Park Ave., New York, N.Y. 10017. (212) 973-5700. Marketing Manager. **Circle No. 457**
- Mauratron, Inc., 2741 Satsuma, Dallas, Tex. 75229. (214) 243-3329. J. E. Sykes, President. **Circle No. 450**
- Power Conversion, Inc., 70 MacQuisten Parkway South, Mt. Vernon, N.Y. 10550. (914) 699-7333. Stewart Chodosh, Mktg. Mgr. **Circle No. 458**
- Prestolite Co., Div. of Eltra Corp., Box 931, Toledo, Ohio 43601. (419) 244-2811. Marketing Manager. **Circle No. 451**
- RCA Electronics Components, 415 S. Fifth St., Harrison, N.J. 07029. R. B. Means, Sls. Mgr. **Circle No. 452**
- Ray-O-Vac, Div. of E S B Inc., 212 E. Washington Ave., Madison, Wis. 53703. (608) 255-7201. Marketing Manager. **Circle No. 453**
- Tadiran Israel Elex. Ind., 3 Derech Hashalom Rd., Tel Aviv, Israel. Marketing Manager. **Circle No. 454**
- Union Carbide, Consumers Products, 270 Park Ave., New York, N.Y. 10017. (212) 551-2345. R. J. Price, Mgr. **Circle No. 455**
- Yardney Electric Div., 82 Mechanic St., Pawcatuck, Conn. 02891. (203) 599-1100. Marketing Manager. **Circle No. 456**

DigiTec introduces the first in the **HT** SERIES *(a breakthrough in High Technology)* with five new Digital Recorders.

DigiTec's new HT Series (High Technology) is the culmination of a long term program to produce a complete line of digital instruments of the future for your needs. DigiTec has combined the state of the art with our own patented circuitry to offer truly innovative in-

strumentation. The HT Series, our proudest achievement, delivers instruments with the ultimate in reliability and performance. Reflecting the advanced technology contained within, all units utilize a new designer-styled, diecast enclosure.

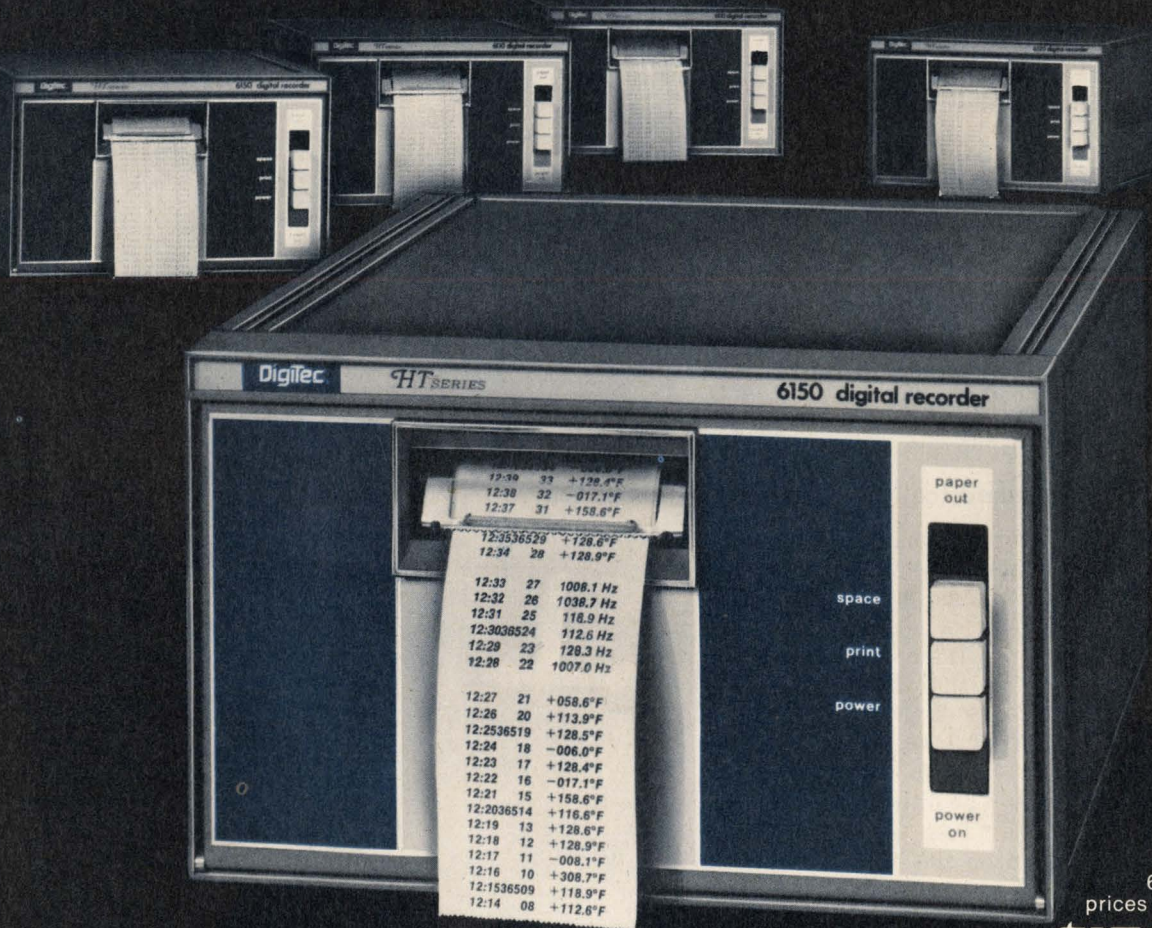

6100 Series
prices range from

\$535.

plus generous OEM discounts

Selected models in the 6100 series Digital Recorders offer combinations of: 10 or 18 column capacity / integral quartz clock, printing real or elapsed time and integral events or day counter.

All models feature: printing rate, 3 lines per second nominal / wide variety of parameter symbols / programmable floating decimal / "paper out" protection / programmable red or black print / TTL compatible, BCD input / programmable single or double spacing / systems output / automatic column blanking / front loading / rack mountable diecast enclosure / compact, half-rack size (5¼" h x 8½" w x 12½" d). Contact your nearest DigiTec representative for an immediate demonstration.

UNITED SYSTEMS CORPORATION
918 Woodley Road, Dayton, Ohio 45403
Ph. (513) 254-6251 Twx. (810) 459-1728
a subsidiary of

Monsanto

INFORMATION RETRIEVAL NUMBER 241

DigiTec®

FOR DEMONSTRATION, CIRCLE 242

Ion implantation: From a specialty to a standard method for new ICs

A recent ad campaign that began with the slogan "You've come a long way baby!" is also applicable to ion-implantation technology.

During the late 1960s, when ion implantation began to be used as a complementary technique to commercial diffusion processes, it was employed primarily to adjust threshold voltages precisely and to form self-aligned gates in MOS circuits.

Today virtually every semiconductor house uses ion implantation in volume production of a growing list of superior standard and custom MOS devices. In addition the technology is making inroads in the fabrication of bipolar ICs, and its reach is extending well into active and nonactive discrete areas (see table on p. 40).

'It's become a standard tool'

As Gene Carter, product marketing manager at National Semiconductor, observes: "We no longer consider it a research or even a limited processing step. It's become a standard tool for the device engineer."

According to Alfred Mac Rae, head of exploratory semiconductor technology at Bell Laboratories, Murray Hill, N.J.: "Just about every new IC design on the drawing boards includes ion implantation. At Bell Labs we have taken some of the cheapest conventional processing steps and replaced them with implant techniques, and we've still reduced fabrication costs."

The more complex ICs are actually being designed around what implantation can do, MacRae says.

But although ion implantation has become an accepted and increasingly important process, it isn't likely to replace diffusion altogether in the foreseeable future. The consensus among device engineers is that it will continue to be

used mainly as a complementary step to standard fabrication techniques.

They emphasize that its most successful application will be when it can improve device performance, and when it can do this more eco-

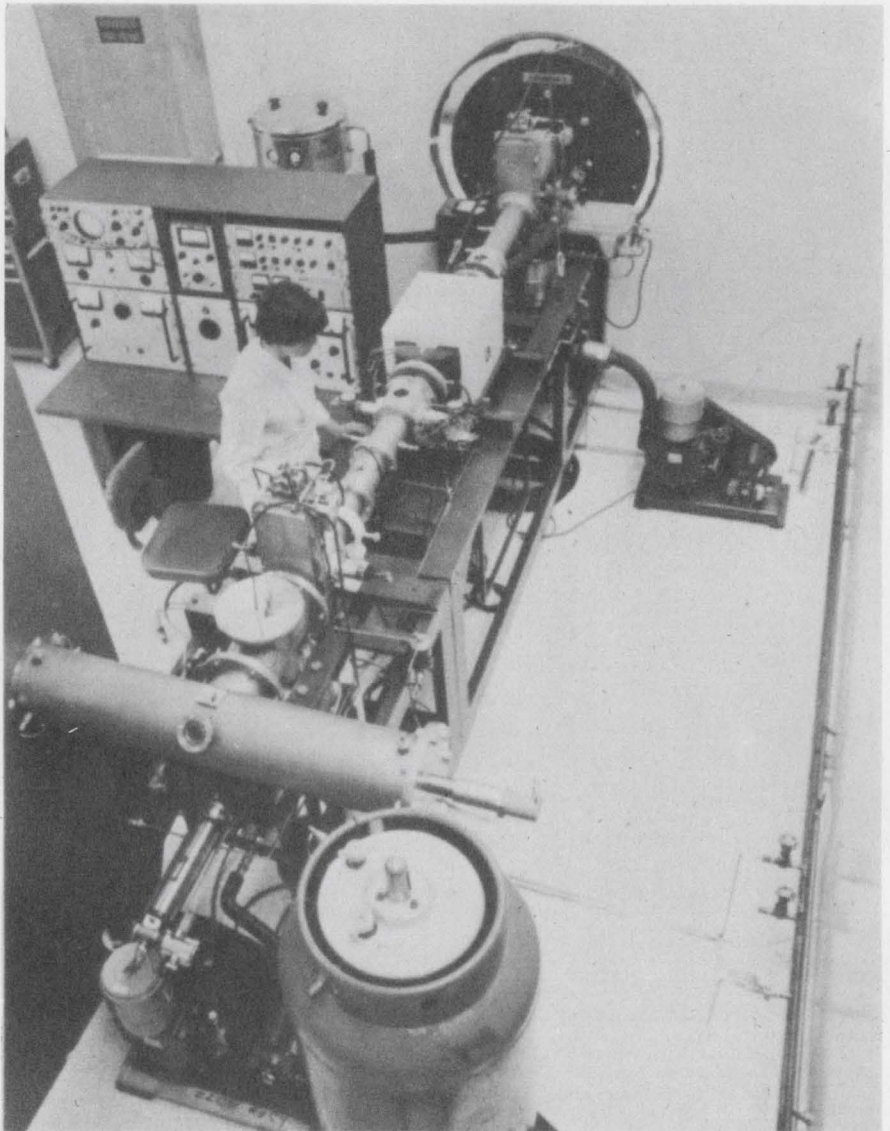

One of the first production versions of an ion-implant machine was installed at Mostek in 1969. The company has implanted 1.5 million wafers to date.

Ralph Dobriner
Managing Editor



The model 33 is so good you'll never believe its price.

Underneath the cover of the model 33 is a data terminal that offers the most in reliability and versatility at a very economical price.

In fact, you can't buy a terminal that offers as much as the model 33 does—for as little as the model 33 costs.

That was true when we introduced the model 33. And it's still true today. Although the terminal we're selling today is hardly the terminal we started with. That's because over the years we've had a crack team of engineers assigned to the model 33. And their only job is to search out ways to improve it.

Some of their improvements have made the model 33 more

reliable and rugged. Others have kept the cost down.

But as improved as the model 33 is, the changes haven't outmoded previous model 33's. So the oldest unit still putting in a hard day's work is compatible with the units coming off our assembly lines right now.

However, there is one small part of the model 33 we're trying to keep as old-fashioned as possible. That's the price. We want to make sure our customers get more than a data terminal. By making sure they also get a bargain.

It takes more than manufacturing facilities to build the terminals Teletype® Corporation offers. It also takes commitment. From people who think service is as important as sales. In terminals for computers and point-to-point communications.



The computercations people.

nominally than conventional fabrication methods. Used in this way, ion implantation may simplify certain present doping steps, improve the performance of existing devices and make possible the creation of new classes of products.

The following is just a sample of the devices that are being fabricated with ion implantation: CMOS circuits, shift registers, semiconductor memories, charge-coupled devices, bubble memories, Impatts, JFET switches, varactors, mixer diodes, p-i-n switching diodes, silicon vidicons, solar cells, resistors and even contacts.

Major impact in MOS

Ion implantation has had and continues to have its biggest impact in the MOS area. The reason is that although diffusion techniques offer accurate and relatively heavily doped regions, they are generally not well suited for forming accurately doped regions of low impurity concentration.

With ion-implant techniques, on the other hand, dopants are introduced into the silicon IC wafer over a greater range of concentrations and with more precise control than is possible with conventional diffusion. This has resulted in significant improvements in MOS device performance. For example:

- Threshold voltage distribution can readily be shifted to any range the circuit designer considers op-

timum. Implanted devices are being manufactured that offer consistently reproducible low-threshold voltages from the standard 2 V down to a TTL-compatible 1.5 V or less.

- Previously unrealizable ICs have been fabricated. Devices such as depletion-mode loads and enhancement drivers on the same chip have provided logic gates with speed-power products that are twice those of circuits with only enhancement loads.

- N-channel IC fabrication has been simplified, permitting the construction of complementary MOS ICs that feature higher speed and lower power dissipation than CMOS built with diffusion.

- Extraneous gate overlap capacitance, which occurs with most MOS processes, can be eliminated. The resulting self-aligned gate structure improves circuit performance considerably. For example, in circuits with minimum interconnect between stages, such as shift registers and linear amplifiers, the frequency response can be increased by a factor of about three over standard metal-gate processes.

A must for CMOS

According to George Marr, manager of advanced memory technology at American Microsystems, "One of the most significant contributions made by ion-implant technology in recent years is in the manufacture of CMOS circuits

that operate from a 1.5-V power supply." Such CMOS clock circuits, he notes, could never have been economically made with standard diffusion techniques.

CMOS circuits employ p and n-channel enhancement mode devices on the same chip. The p-channel devices are formed in the conventional manner on an n-type substrate. The n-channel devices are built in shallow, low-concentration, accurately doped, p-type mesas formed in the n-substrate.

The threshold of the n-channel device is set primarily by the concentration of the p-dopant in this mesa. With conventional diffusion techniques, this concentration is difficult to control and the yield is low. Ion implantation is a more precise method for forming these p-mesas, and it permits accurate and reproducible n-channel threshold voltages. If an additional implant operation is used, the threshold voltages of p-channel devices can also be shifted to match those of the n-channel.

With ion-implantation and conventional fabrication processes, both n and p-channel threshold voltages have been controlled to within ± 0.3 V. Circuits operating with supply voltages as low as 1.0 V and with a power consumption of a few microwatts have been fabricated.

Silicon-gate ion-implanted fabrication has permitted American Microsystems, Santa Clara, Calif., to manufacture a single-chip CMOS circuit for 3-1/2-digit, liquid-crystal-display watches. The S1400 circuit contains display drivers and decoders on the chip, operates off a 1.5-V cell and can replace currently available two-chip systems.

A two-chip set for liquid-crystal displays from Intel, Santa Clara, also uses ion-implanted silicon-gate technology to achieve low power consumption. The two circuits consume less than 15 μ W when used with a 32-kHz crystal. The chips operate from a single 1.35-V battery.

All of Motorola Semiconductor's line of silicon gate and metal-gate CMOS products—the MC14000 McMOS series—use some degree of ion implantation, according to a company spokesman. Motorola currently has six ion-implant machines in operation—one for R & D and the rest for production.

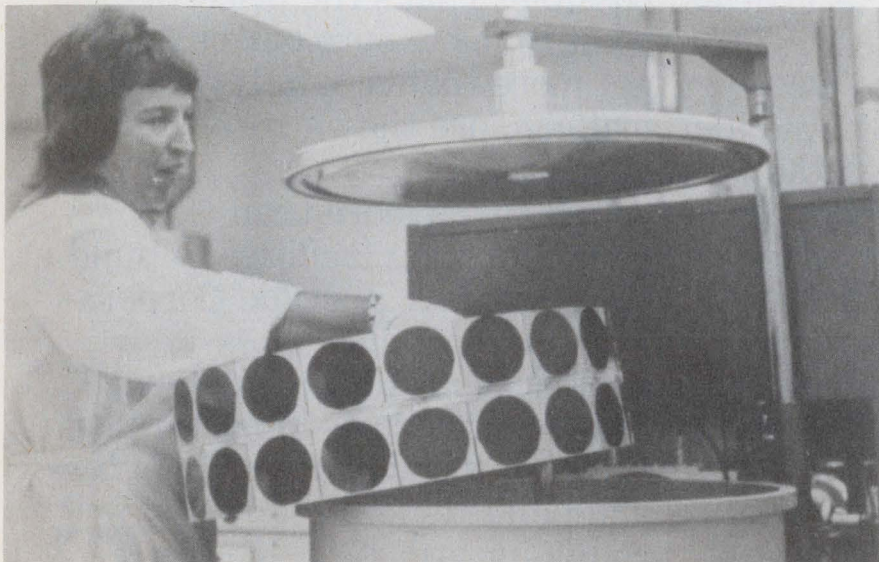

Circular carousel loaded with wafers is being placed into a vacuum chamber in an ion implanter at Mostek. The machine can process 200 3-in. wafers or 200 2-in. wafers an hour.

Hughes Microelectronics Products Div., Newport Beach, Calif., a major supplier of ICs for watches, is using ion-implant techniques to build high-density custom CMOS circuits. The company has a proprietary process that is said to yield 25 to 30% more density than competing ion-implant processes.

According to Peter Coppen of Hughes' MOS wafer manufacturing facility: "Almost every PMOS device we've designed over the past two years uses ion implantation, either to increase circuit speed or for implanting high-value load resistors (10 kΩ per square)."

Within three months the RCA Solid-State Div., Somerville, N.J., plans to announce pilot plant production of CMOS/silicon-on-sapphire devices that employ ion-implant technology. According to Harry Weisberg, director of MOS IC products: "These devices simply could not have been fabricated without the use of ion-implant techniques. We needed it to improve process control."

RCA is also coming out with CMOS circuits that are rated at 18 V. Most standard CMOS ICs have a maximum operating level of 15 V, says Weisberg, "but with a combination of ion implant and silicon gate for threshold voltage control, we can increase the voltage and can even design custom CMOS circuits over 20 V."

Used in calculator chips

Ion-implant techniques are, of course, used in many of the chips in pocket calculators. All of the MOS chips in the Hewlett-Packard line of calculators—the HP-35, 45, 65 and 80, supplied by American Microsystems and Mostek, Carrollton, Tex.—are ion-implanted.

The technology has been used on two MOS chips for Texas Instruments' recently introduced SR-50 slide-rule calculator, to achieve lower power consumption and longer battery life. One of the ICs is an arithmetic chip measuring 233 to 240 mils. The other is one of the largest MOS ROMs around. It measures 200 mils square and contains 13,312 bits of memory storage. Both ICs contain over 25,000 transistors. The total MOS chip power dissipation is about 125 mW.

A pioneer in the application of

Cut package count . . . Simplify board layout . . .
Reduce equipment size . . . with

DIP MULTI-COMP[®] RESISTOR-CAPACITOR NETWORKS

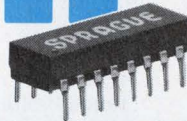

(Metanel[®] Film Resistors, Monolythic[®] Ceramic Capacitors)

STANDARDIZED DESIGNS* FOR BETTER AVAILABILITY, BETTER PRICES

BYPASSED PULL-UP AND R-C COUPLING NETWORKS		R (Ω)		C ₁	
1	14	100	470	2000	100pF
		150	500	2200	330pF
2	13	200	680	3300	0.01μF
		220	1000	4700	C ₂
3	12	330	1500	6800	

BYPASSED PULL-UP AND R-C COUPLING NETWORKS

SPEED-UP NETWORKS		R (Ω)		C	
1	14	100	470	2000	1000pF
		150	500	2200	3300pF
2	13	200	680	3300	0.01μF
		220	1000	4700	C
3	12	330	1500	6800	

SPEED-UP NETWORKS

ACTIVE TERMINATOR NETWORKS		R (Ω)		C (pF)	
1	14	100	470	2000	100
		150	500	2200	
2	13	200	680	3300	330
		220	1000	4700	
3	12	330	1500	6800	

ACTIVE TERMINATOR NETWORKS

*OTHER PACKAGES, CIRCUIT CONFIGURATIONS, AND RATINGS AVAILABLE ON SPECIAL ORDER

Sprague puts more passive component families into dual in-line packages than any other manufacturer:

- TANTALUM CAPACITORS
- CERAMIC CAPACITORS
- TANTALUM-CERAMIC NETWORKS
- RESISTOR-CAPACITOR NETWORKS
- PULSE TRANSFORMERS
- TOROIDAL INDUCTORS
- HYBRID CIRCUITS
- TAPPED DELAY LINES
- SPECIAL COMPONENT COMBINATIONS
- THICK-FILM RESISTOR NETWORKS
- THIN-FILM RESISTOR NETWORKS
- ION-IMPLANTED RESISTOR NETWORKS

For more information on Sprague DIP components, write or call Ed Geissler, Manager, Specialty Components Marketing, Sprague Electric Co., 347 Marshall St., North Adams, Mass. 01247. Tel. 413/664-4411.

THE BROAD-LINE PRODUCER OF ELECTRONIC PARTS



Application of ion implantation to non-MOS technologies

Device	Use of ion implantation	Effect on device performance	Application
Resistor fabrication in ICs	Formation of doped regions of specified sheet resistivity	<ol style="list-style-type: none"> 1. Increased resistor values 2. High frequency capability 3. Low temperature coefficient 4. Accurate resistor value 	Amplifiers, D/A converters, filters
Diodes	Formation of junctions with accurately controlled depth	Higher frequency response	Microwave oscillators
Voltage variable Capacitors	Formation of hyper-abrupt junctions	<ol style="list-style-type: none"> 1. Increased range of capacitance/voltage characteristics 2. Improved distortion characteristics 	Communications equipment
CCD	Formation of fixed charge layers	Improved frequency response	Self-Scan Vidicon High-density shift registers
Magnetic bubbles	Alters magnetic properties of material to eliminate "hard bubbles"	Improved operation and speed	Memories
Injections lasers	Delineate arrays	Greater precision	Optical scanning, communications

ion-implantation technology to commercial products is Mostek. It has made more than 1.5 million implanted wafers since 1969, according to Marlin Shoppell, senior engineer at the company.

Mostek has recently added n-channel silicon-gate processing to its existing MOS ion-implant capabilities. With n-channel processing, Mostek says it can offer products featuring direct TTL compatibility with 5-V operation. The company has combined the three processes—n-channel, silicon-gate and ion-implantation—into its recently introduced MK 4102, a 1024-bit static RAM with "greatly improved operating efficiency, faster access time (450 ns) and lower power requirements."

This combination, according to Shoppell, was an industry first, taking advantage of the self-aligned structure provided by silicon gate and the depletion load advantages of ion implantation.

According to Dr. Bruce Deal, head of IC research and development at Fairchild Semiconductor, Palo Alto, Calif., every new device that the company has under development is using ion implantation.

"In MOS structures we're using it both for field doping and threshold control," he reports. "In bipolars, with very shallow and very

small geometries, we are able to get device performance with implantation that we couldn't get with conventional diffusion techniques."

Deal says Fairchild is also using the technique in compound semiconductors for LEDs as well as in silicon microwave devices and CCDs.

"We're even thinking about devices that would be 100% ion-implanted," Deal says, "although products are not yet imminent."

Bipolar: A last frontier

One of the last frontiers to feel the impact of ion implantation will be bipolar circuitry, according to Jim Marley, manager of solid-state research at Signetics, Sunnyvale, Calif. Many applications in bipolar lend themselves to the technique or shortly will, he says, particularly in the high-speed logic families.

But ion-implantation machines that can handle large bipolar wafer volumes are still not available, Marley notes. Whereas MOS circuits require concentrations of ions over very narrow regions near the surface, bipolar require doping over the whole base width. In addition a higher-energy ion beam is required for bipolar, because the implantation of ions must be to much greater depths than those in

MOS, which are basically surface implants.

Some of the implants required in bipolar devices need 300 keV—a level not yet available in today's machines, most of which operate at around 150 keV.

Marley predicts that machines will be available by the beginning of next year for wafer production that matches volumes now possible with standard diffusion.

Nevertheless bipolar manufacturers are already applying ion-implant technology to some of their product lines—for precise surface deposition rather than for deep implants. It's being used, for example, to implant tight-tolerance resistors—of 4 to 5 k Ω per square—in linear bipolar ICs.

Signetics is using ion implantation in its recently announced 54/74 LS, low-power Schottky logic line, "for area savings, speed improvement and to reduce parasitic capacitances." Dissipation is 2 mW per gate, propagation delay 8 ns (at a 35-MHz toggle rate) and the speed power product 15 picojoules—which is said to be five times faster than the standard 54/74 ICs.

In related research development, all-ion-implanted bipolar transistors operating in the 1-to-8-GHz regions have been fabricated at Bell Laboratories. ■■

SURPRISE!

SURPRISE!

SURPRISE!

SURP



**2½ times
brighter green.**



**6 times
brighter yellow.**

RISE!



**6 times
brighter red.**

HP brings you three new LED's that are many times brighter than our standard T-1 red lamps. All offer a 180° viewing angle, plus high axial luminous intensity and a good on-off contrast ratio. Ideal for front panel applications.

Our new green lamp (5082-4984) uses high efficiency gallium phosphide to generate a typical luminous intensity of 2 mcd at 20 mA.

Our new yellow LED's are really yellow. The 5082-4584 lamp offers 2.5 mcd typical at 10 mA.

And red has been dramatically brightened six times in output using non-saturating gallium arsenide phosphide. With a luminous intensity of 2.5 mcd at 10 mA our 5082-4684 high-efficiency red is unbeatable.

Just \$0.80* in 100 quantities.

Contact Hall-Mark, Schweber or the Wyle Distribution Group for immediate delivery. Or, write us for more details. They're the brightest way to improve your product.

*Domestic USA price only.

01404

HEWLETT  PACKARD

Sales and service from 172 offices in 65 countries.
1501 Page Mill Road, Palo Alto, California 94304

MC14510CP | Now \$3.75 | Down
 MC14536CP | Now \$5.75 | Down
 MC14555CP | Now \$1.50 | Down
 MC14556CP | Now \$1.50 | Down
 MC14581CL | Now \$7.15 | Down

More than meets the eye

In CMOS MC14500 series price cut

Price reductions are rare in these days of spiraling inflation, so cuts as high as 56% across practically the complete MC14500 CMOS series should be welcome. We suspect they are. But there is greater significance to these reductions than meets the eye at first glance.

Looking beyond the obvious, it becomes clear that an entire family of outstanding MSI logic functions is placed for the first time in a price range where its devices can compete successfully with small scale ICs, with the "simple gate" design approach. Thus, for designers who elect to use MC14500 Series MSI functions, the system savings related to space, handling, simplicity and reduced PC board requirements become pure bonus.

Our price cuts shape up this way. Of the 39 MC14500 Series types available in the CP plastic packages, 34 received healthy cuts and none went up. Seventy percent of the CL commercial grade ceramic types were reduced, and a few went up very slightly. All wide temperature range AL ceramic types were significantly reduced.

Here are just a few typical examples using 1,000 to 4,999 quantity prices.

BCD Up/Down Counter,	MC14510CP	Now \$3.75,	Down from \$4.77
Programmable Timer,	MC14536CP	Now \$5.75,	Down from \$9.94
Dual Binary to 1 of 4 Decoder/Demultiplexer, (*inverting)	MC14555CP	Now \$1.50,	Down from \$2.60
	MC14556CP*		
4-Bit ALU,	MC14581CL	Now \$7.15,	Down from \$9.75

We've lost track of the number of times we've heard, "Your McMOS MC14500 Series is an outstanding logic family, but I just can't afford it." Now, with yields taking off, and quantities like a million devices hitting the warehouse shelves in May, we can price them where you can afford them. With that many units available, you shouldn't encounter delivery problems. Motorola sales offices and franchised distributors will be pleased to provide further details when they accept your order.

Refresh your memory on what's available. Ask Motorola Semiconductor Products Inc., P.O. Box 20912, Phoenix, AZ 85036 for an up-to-date McMOS* Selector Guide, or circle the reader service number.



MOTOROLA McMOS

—MOS for contemporary systems

*Trademark of Motorola Inc.

INFORMATION RETRIEVAL NUMBER 27

washington report



Heather M. David
Washington Bureau

New TV receiver safety standard due

The Consumer Product Safety Commission will develop several alternative safety standards for television receivers, as a result of charges that TV sets have caused many home fires. The commission will then select a single standard for industry comment. An Electronics Industries Association consumer electronics spokesman, J. Edward Day, although disputing the Commission's allegation that there have been as many as 10,000 TV-related fires each year, says the EIA will participate in the formulation of a new standard. Two manufacturers have told the commission they will stop making hybrid tube/solid-state sets, and a Zenith representative has said that his company will drop the instant-on feature from its receivers. Both designs have been mentioned as cause for concern.

Air Force to contract for space-based navigation system

The Air Force will award two large contracts this summer for the development of satellite and ground portions of its space-based navigation system. Called the Global Positioning System, the system is to provide navigation for military activities from artillery positioning to worldwide mapping, with accuracies to tens of feet.

Four industry teams are competing for the satellite development contract: Philco-Ford; Rockwell International/ITT; RCA/TRW, and Grumman Aerospace/Hazeltine. The Air Force plans to launch four satellites in 1977, which would make it possible to obtain position data for nine hours each day in the U.S. If this phase is successful, additional satellites are to be added until worldwide, two-dimensional coverage is achieved in 1981. Vertical coverage would be added by the mid-1980s.

Two companies—General Dynamics Electronics and Philco-Ford—are vying to develop the control and user equipment for the system.

Solar power studies backed in House

Concerned over the need for sources of energy that would end U.S. dependence on oil, the House has added \$1.8-million to NASA's budget for an experimental solar satellite power station. The station would be an orbital satellite that would collect solar energy, convert it to microwave energy and transmit it to earth. Authorization for the program, which was not requested by the Administration, is one of several pluses that NASA has received from the House and Senate Space Committees as part of the first round of action on its budget.

The House committee also added \$20-million to the Space Shuttle program to overcome engine problems and the Senate panel added \$16-million

for a third Earth Resources Technology Satellite. The net effect of all of the House unit's actions on the NASA budget has been to add \$12-million to the administration's request for \$3.24-billion, while the Senate actions have added \$20.1-million.

G.A.O. bids Congress study alternatives to B-1 bomber

Congress has been admonished by the General Accounting Office to study the "viable options" that are still available before it commits the costly B-1 bomber design to production. The cost is estimated at \$65.7-million for each aircraft that is built.

While the B-1 design still shows the most advanced capabilities in range, payload, electronic countermeasures and survivability, alternatives could do the job in varying degrees, a special G.A.O. report says. The alternatives would include use of the existing B-52 and FB-111 force, stretched FB-111 aircraft at \$15-million each, and re-engined B-52s at \$7-million to \$12-million apiece. However, the B-1 can carry more electronic countermeasures than the others, and it would also have a reserve capacity for additional avionics to meet changing requirements in the future, the G.A.O. concedes.

NASA to seek bids on Tracking and Data-Relay Satellite

The National Aeronautics and Space Administration will ask industry to bid this summer on its proposed Tracking and Data-Relay Satellite System. The synchronous-orbit system will track spacecraft in low-altitude earth orbit and relay communications from them to a ground terminal in the continental United States. The system will, the space agency says, provide 85 to 100% coverage for all spacecraft at altitudes below 3000 miles, compared with as little as 13% coverage now by existing ground stations.

NASA will ask industry to design and build a two-satellite system that it proposes to use on a lease arrangement. Technology studies, including one to demonstrate the feasibility of a space-erectible antenna, indicate the design is well within the state of the art, industry representatives have told the agency.

Capital Capsules: NASA's Lewis Research Center is undertaking a **laboratory demonstration project aimed at reducing the cost of solar cells** by automating the steps to process a silicon blank to a completed cell. . . . The Air Force's Electronic Systems Div. will issue requests for industry proposals around **June 28 for a contract leading to development of a radio solar telescope network.** . . . The General Accounting Office is expected to issue an interim report soon examining the Defense Dept.'s practice of funding the independent R&D and bid-and-proposal activities of its contractors. Three major organizations—the Aerospace Industries Association, the Electronics Industries Association and the National Security Industrial Association—have issued a report stressing the benefits of these programs. Two Senate committees are considering whether to cut back these activities. . . . Philco-Ford is **developing a new laser-guided, man-portable air defense missile that the Army wants as an alternative to current infrared homing systems,** such as Redeye and the advanced Stinger weapon systems. . . . The Justice Dept. has told Motorola that the **proposed sale of its TV business to Matsushita Electric Industries Co. raises substantial antitrust questions.** Motorola has agreed to delay the sale and is looking for an alternate buyer.

1000 cm/ μ sec stored writing speed, four storage modes, and more.

100 MHz oscilloscope

Tektronix 7633 oscilloscope gives you 100 MHz bandwidth and 1000 cm/ μ sec stored writing speed. So you can retain and view fast rise, low repetition rate, single shot or slow moving waveforms. All with one instrument. This allows you to solve problems in computer sciences, aerospace, ballistics, communications and various other applications.

Multi-mode storage

The 7633 offers four operating modes: Non-store, normal and fast Variable Persistence and Bistable modes are available at the touch of a button. And, an 8 x 10 div. (.45 cm/div.) mode gives the instrument's top writing speed.

Bright, burn-resistant CRT

No special operating safeguards are necessary with the 7633's rugged, burn resistant CRT. This makes it a dependable unit for design bench, hospital laboratory, service facility or classroom. The large 8 x 10 div. CRT is easy to read in both cabinet and rackmount configurations. An alphanumeric readout, exclusive on Tektronix instruments, makes quick on-screen reference and easy interpretation of photographic records. Or, the instrument may be ordered without the readout for \$400 less.

Part of the 7000 Series

Select from thirty different 7000 Series plug-ins. You can custom tailor your instrument to meet your immediate need. And expand its capabilities later as the need arises. A 7633 mainframe costs \$3650. A typical configuration with dual trace vertical amplifier and delaying sweep timebase sells for \$5,550. For rackmount add \$100.

Specifications

Vertical System—Accepts all 7000 Series vertical amplifiers. Bandwidth determined by mainframe plug-in unit up to 100 MHz. Left, Alternate, Add, Chop, Right display

modes. Chopped rate approximately 1 MHz. Horizontal System—Compatible with all 7000 Series plug-ins. Fastest calibrated sweep rate is 5 ns/div. Phase shift between vertical and horizontal is 2°, DC to 35 kHz for X-Y operation.

CRT and Display—Internal 8 x 10 div. (.9 cm/div) graticule with superimposed 8 x 10 div. (.45 cm/div) reduced scan area. Nonstore, variable persistence, and bistable in normal or fast and full or reduced scan storage modes push-button selected. Writing Speed and View Times—From .03 div/ μ sec until erased up to 2222 div/ μ sec at 30 sec view time. View time may be increased more than 30 times by using reduced intensity in the SAVE display mode.

See for yourself

For a "hands-on" demonstration, contact your nearby Tektronix Field Engineer. Or write: Tektronix, Inc., P. O. Box 500, Beaverton, Oregon 97005. In Europe write: Tektronix Ltd., P. O. Box 36, St. Peter Port, Guernsey, C. I., U. K.



TEKTRONIX®
committed to technical excellence

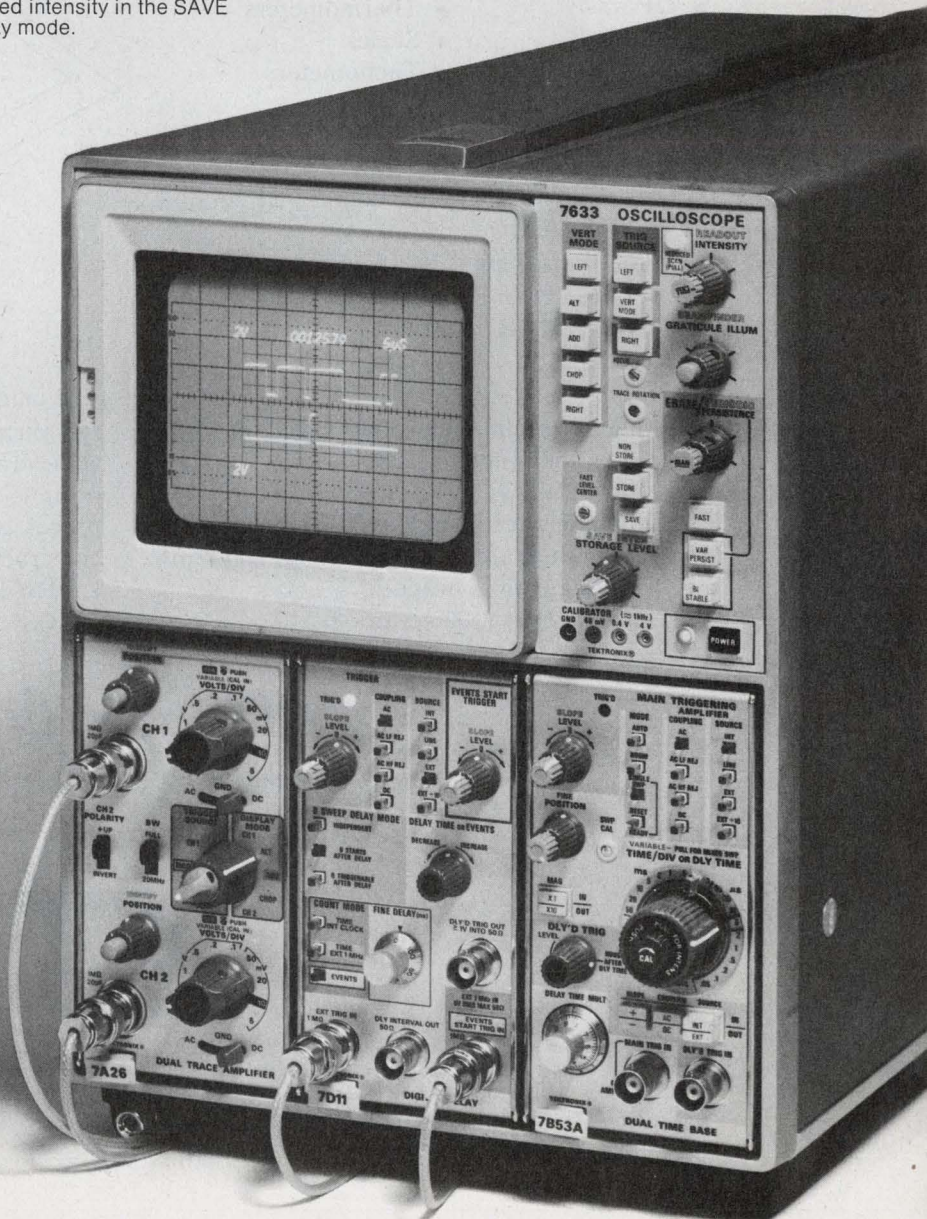

A New Standard For Accuracy!

3 $\frac{1}{2}$ Digit A/D Converter

The LD110/LD111 A/D converter sets the pace for accuracy with a specification of 0.05% of reading, ± 1 digit. The set consists of two ICs, and with the addition of a reference voltage and clock becomes a full 3 $\frac{1}{2}$ -digit analog-to-digital conversion system. LD110/LD111 features and specifications make the converter set an ideal choice for digital display processors in

- DPMs
- Thermometers
- DVMs
- Scales
- Controllers
- Tachometers
- Instrumentation

Specifications

- Accuracy of 0.05% of reading, ± 1 count
- $Z_{IN} > 1000 \text{ M}\Omega$
- 4 pA typical input bias current (25°C)
- 100 μV resolution (200.0 mV range)
- 40 dB NMRR @ 60 Hz

Features

- Auto-zero minimizes effect of offset, drift and temperature
- Auto-polarity
- Sampling rates from $\frac{1}{3}$ to 12 samples/second
- Two voltage ranges: 2.000V and 200.0 mV
- TTL-compatible outputs
- \$28.60 per set (100-set price)

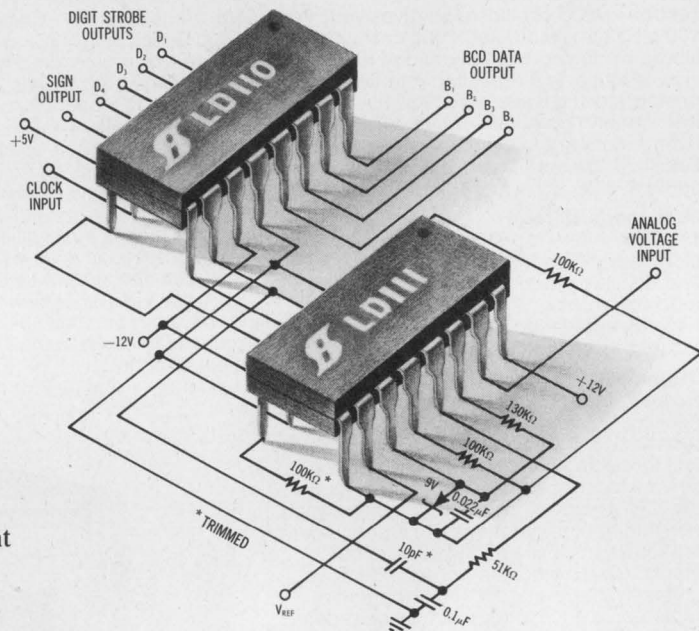

The unique conversion technique uses a single reference and a single full-scale adjustment to achieve a highly-accurate strobed 3 $\frac{1}{2}$ -digit output of up to 3100 counts plus sign. LD111 analog processor employs monolithic PMOS/bipolar construction and interfaces directly with the LD110 digital processor, which has a monolithic PMOS structure. For further information

write for data

IC Applications: (408) 246-8000, Ext. 120



Siliconix incorporated

2201 Laurelwood Road, Santa Clara, California 95054

INFORMATION RETRIEVAL NUMBER 29

Fantasies come true

Since I was a young lad, I've had these wonderful fantasies of being surrounded by lovely ladies, all demanding my attention. Well, it finally happened.

I was involved in a rather massive project, Electronic Design's GOLD BOOK, a comprehensive master directory and catalog, which you will soon receive. This project required battalions of clerical helpers and it had to be executed in a short time span. So I was surrounded by all these women demanding my attention (just as in my fantasies). All day long they beleaguered me with questions like:

"George, what do I do about this company that seems to have three presidents?" "George, what do I do about this company that says, in one place, it was established in 1956 and, in another place, 1943?" "George, do we accept this abbreviation?" "George, can we list electronic acupuncture kits . . . confessional hearing aids . . . electronic chick counters?" Well, that's not quite what I had in mind in my fantasies.

But I suspect I'm not the only one who has ever had fantasies. I suspect that there are many more of us who, like James Thurber's marvelous character, Walter Mitty, have a secret life. If you remember Thurber's wonderful story, you will recall that Mitty, thoroughly henpecked, frequently had reveries in which he was a fearless Navy commander, a brilliant surgeon, the greatest pistol-shot in the world or a daring bomber pilot. Are any of us immune to such dreams?

And yet, many of us have fascinating jobs that might be the envy of fearless Navy commanders, brilliant surgeons and great pistol-shots. I've met hundreds of engineers who love their jobs, who love the challenge and the excitement of finding better solutions to problems. Yet almost every one of them had reservations. "If only this company weren't so stingy." "If only my boss weren't such a jerk." "If only there weren't so much politics around here." If only. If only. If only. That could surely have been the cry of Walter Mitty.

Many of these engineers felt they would have been happier if they were working elsewhere. Or if they had more responsibility. Or if they were in charge of more people. Or if they were running the company. Would they really have been happier?

It might be a good thing if each of us could take the time to make an honest assessment of what we are and what we'd really like to be. Then, if our assessment were really honest, we could courageously decide, "This is the job for me. I'll stick to it and do my best at it from here on in." Or we could decide to do all in our power to change horses and become the fearless Navy commander, the brilliant surgeon, the greatest pistol-shot—or the man surrounded by a bevy of beauties.



George Rostky

GEORGE ROSTKY
Editor-in-Chief

Designers'

Toggle Switches
Bat, lever lock, Designer
Line, sealed. Big, broad
choice.

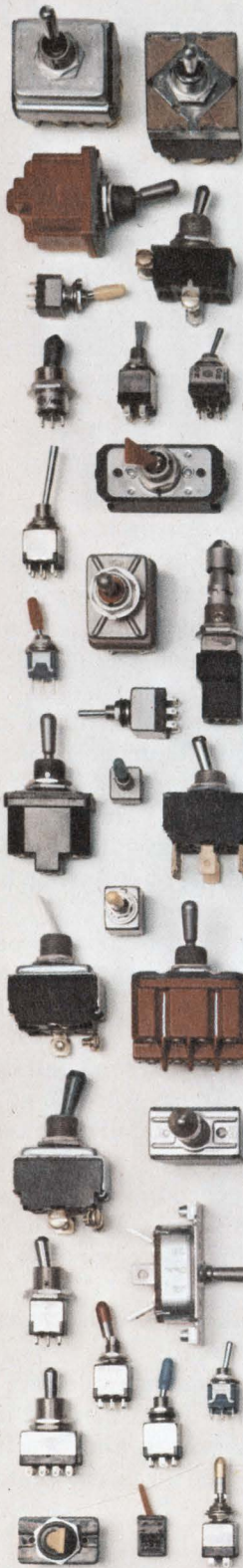

Rocker Switches
Singles and multiples.
Wide, colorful selection
range. Legends, too.

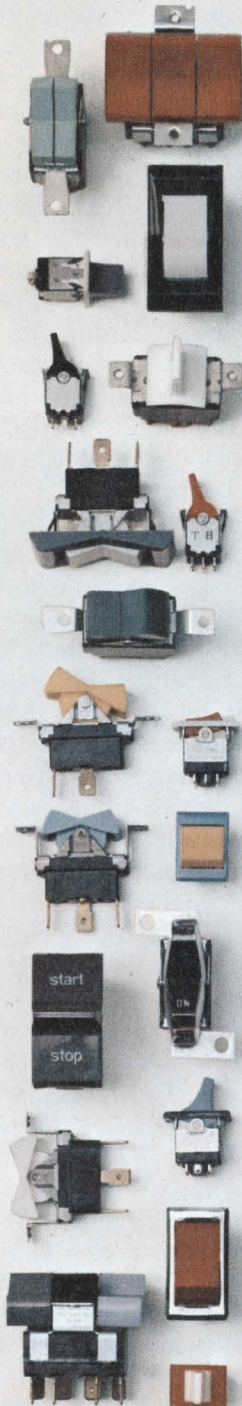

Cutler-Hammer, of course! The broadest
line. Styled to meet today's and tomorrow's
requirements. They're solid quality, look
great, work long and hard. Carried in stock
for local availability by Switch Distributors.
Backed by Cutler-Hammer sales engineers
who can deliver innovative design help for

Pushbutton Switches
Choice of sizes, colors,
circuits, ratings.
to "turn you on".

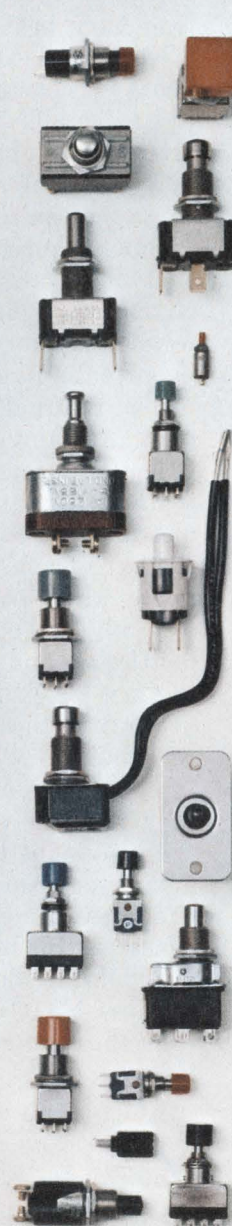

**Tool Handle &
Slide Switches**
Variable speed, reversing.
Double insulated.

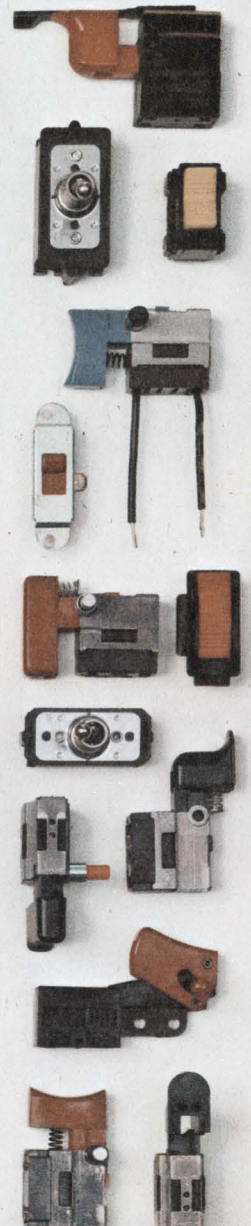

 **Switch to No. 1**

Choice.

the exact switch or relay you need—
when you need it.

It's no wonder so many designers specify
Cutler-Hammer. For quality, reliability,
availability, and style. For commercial,
industrial, and military applications.

We simply offer more—of everything!

Snap Switches

Lever, roller, leaf, and
pushbutton actuators.
Four terminal styles.



Rotary Switches

Precision and general
purpose. Single and
multiple wafer.

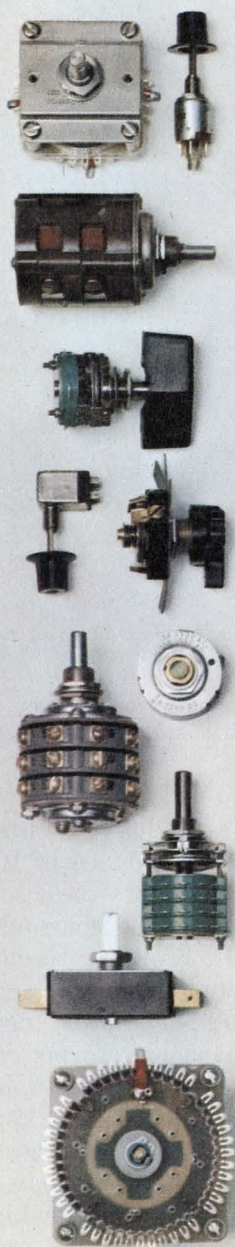

Switch Accessories

Guards. Boots. Seals.
Caps. Decorator
facenuts. And much
more to protect, code
or customize.



Illuminated Switches

Rockers, paddles,
pushbuttons, indicators.
Snap-in and bushing.

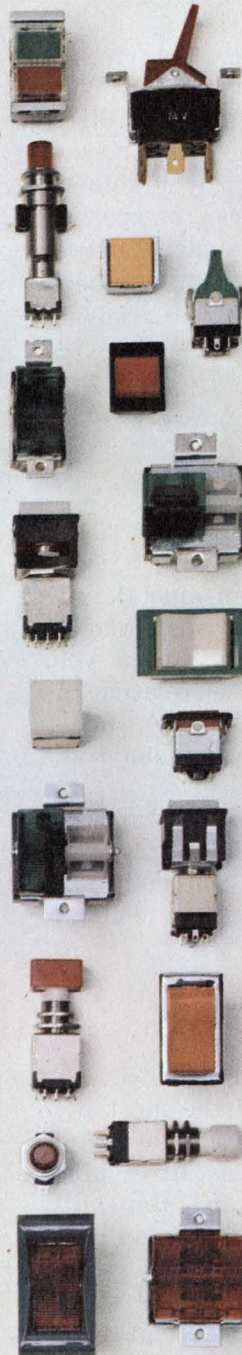

Relays

Hermetics, non-sealed,
potted. Power, latching,
and timing functions.



CUTLER-HAMMER

SPECIALTY PRODUCTS DIVISION, Milwaukee, Wis. 53201

INFORMATION RETRIEVAL NUMBER 30



Six ways to control transients: Varistor, gas-discharge and RC suppressors protect circuits from destructive surges. Don't be caught short.

There are six good ways to protect circuits from the devastating effects of transient currents. Yet, simply because they aren't a direct part of a system's operation, such suppressors are sometimes overlooked by circuit designers.

Without protective suppressors, a circuit's semiconductor devices can be damaged or destroyed, and the radio frequency interference (RFI) generated by the transients can seriously disturb the circuit. To get protection, you can use one of these suppressors:

- Zener diodes.
- Selenium devices.
- Metal-oxide devices.
- Silicon-carbide devices.
- Gas-discharge (spark-gap) devices.
- Resistor-capacitor networks.

Of these, zener-diode, selenium, metal-oxide and silicon-carbide devices are considered to have varistor characteristics, because their volt-ampere characteristics follow the relationship

$$I = KV^\alpha,$$

where α (alpha) is a number greater than 1 and K is a constant.

Gas discharge devices and resistor-capacitor networks each form a special category of suppressors. Varistors are the most commonly used types, especially for low and intermediate clamping voltages.

Transient signals are standardized

For testing purposes, standard transient signals have been proposed. Two of the most popular waveforms are shown in Fig. 1a and b. One, suggested by the IEEE Relaying Committee, is called the Surge Withstand Capability Test. It is a damped sine wave that has an open-circuited, first half-cycle peak of 2500 V, which decays to half value in 6 to 10 μ s. The wave's source impedance is 150 Ω . The second waveform is a unilateral triangular pulse. The peak voltage is 5000 V with a 1000-V/ μ s linear rise

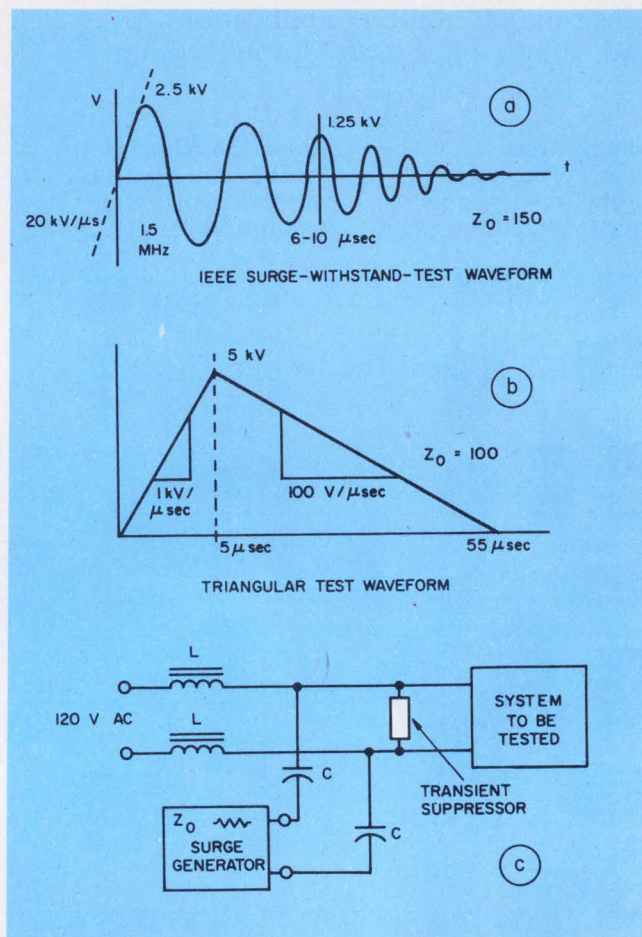

1. Standard wave shapes (a and b) test the response of electrical systems to line transients (c).

rate and 100-V/ μ s linear fall rate. The pulse's source impedance is 100 Ω .

Neither of these standard transient waveforms can be considered as worst-case signals. They merely represent transients that can be expected in normal service.

Surge-generator circuits that develop the standard waveforms can then be applied to test a system and its suppressor method (Fig. 1c). The two chokes, L, confine the surge energy to the system under test. The capacitors, C, decouple the 60-Hz power from the surge generator, but allow the high frequency transient to

Richard W. Fox, Product Engineer, General Electric, Semiconductor Products Dept., Syracuse, N.Y. 13201.

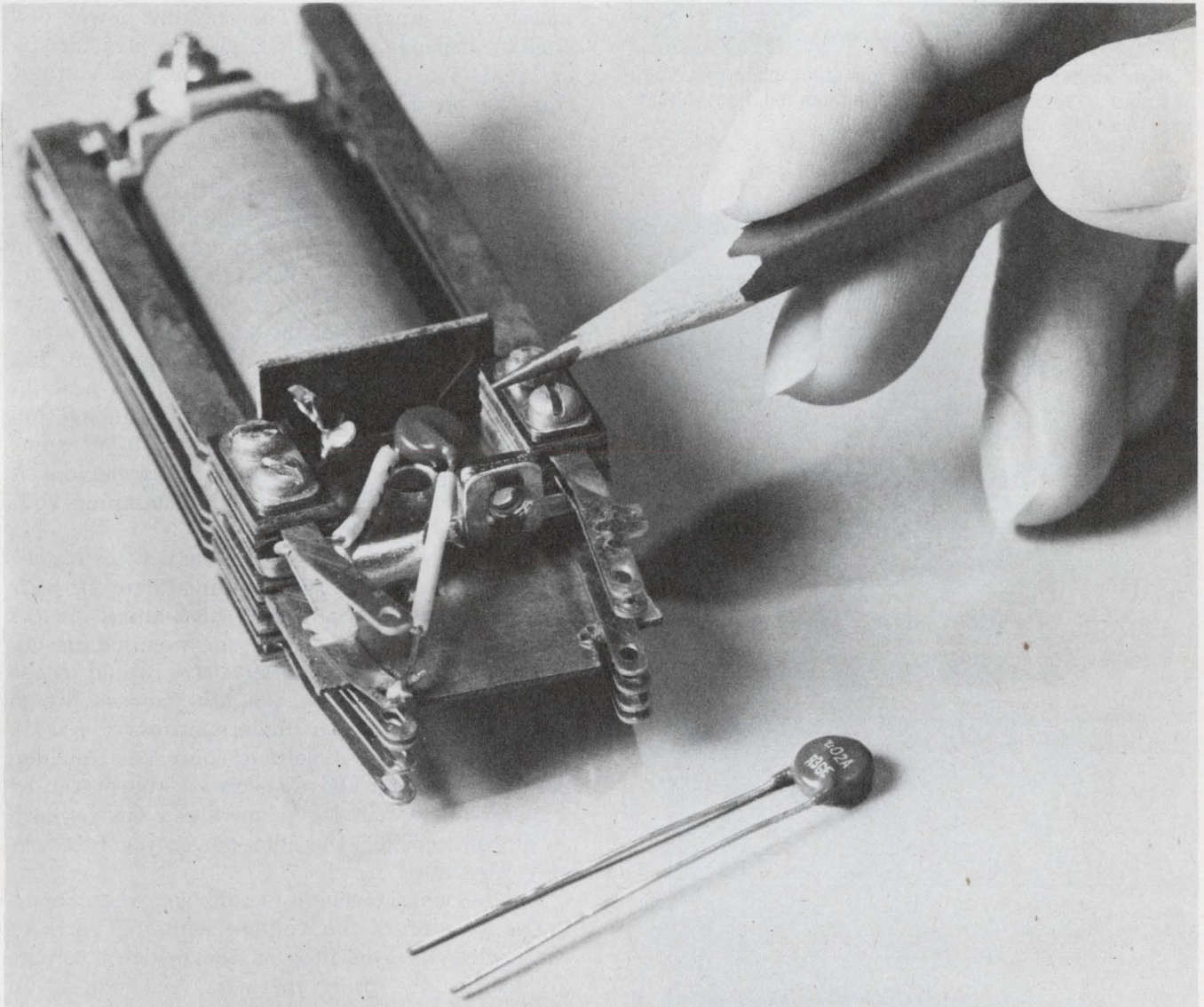

Varistor transient suppressors come in a wide range of sizes. At the low-power end, varistors such as this GE

MOV^R unit provide protection with maximum dc voltage ratings of 53 to 110 V.

pass into the system under test.

Because of their wide diversity of characteristics and nonstandardized manufacturer specs, varistor devices are not easy to compare. A graph (Fig. 2) shows the relative volt-ampere characteristics of the four common varistor devices that are used in 120-V-ac circuits. A curve

for a resistor is included for reference. Alpha for a resistor is unity. It can be seen that as the alpha factor increases, the curve's voltage-current slope becomes less steep and approaches an almost constant voltage. High alphas are desirable for clamping applications that require operation over a wide range of currents.

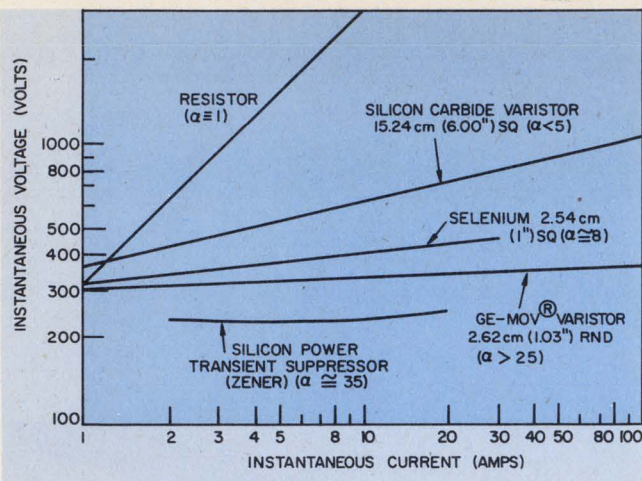

2. High alphas provide nearly constant clamping voltages, but a small increase of the nominal line voltage raises the idle current substantially.

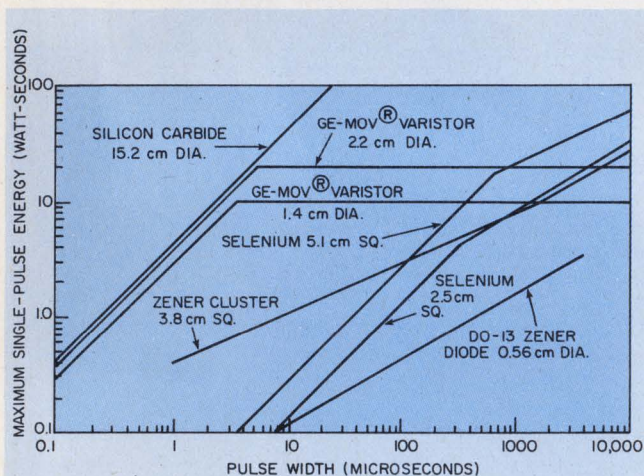

(a)

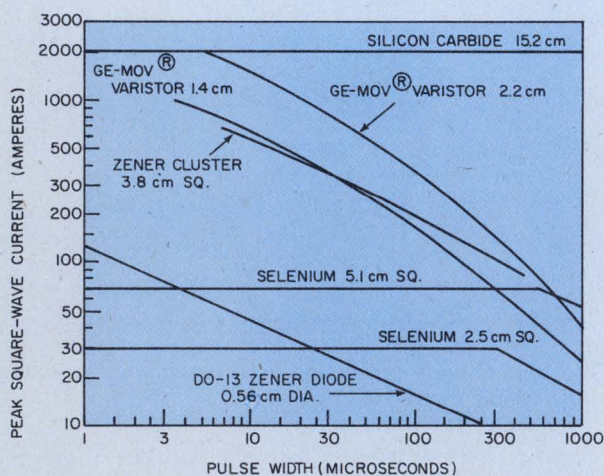

(b)

NOTE: FOR 120 V AC

3. Maximum energy and current at 100- μ s pulse widths are good rule-of-thumb values for the comparison of transient-absorbing capacity of suppressors.

It also is necessary to know the varistors' energy-absorption and peak-current capabilities (Figs. 3a and b) when comparisons are made. Table 1 includes other important parameters, such as peak idle current, clamping capability, size and weight. They are shown along with the 100- μ s points from Figs. 3a and b. Pulse widths of 100 μ s approximate the widest transient pulses that have been encountered in studies.

Standby-power—the power consumed by the suppressor unit at normal line voltage—is an important selection criterion. And peak idle current is one factor that determines the standby power of a suppressor. The standby power dissipation depends also on the alpha characteristic of the device (Fig. 4). For a sinusoidal voltage, this can be calculated as

$$P_{AC} = V_{PK} I_{PK} \frac{P_{AC}}{P_{DC}},$$

where V_{PK} and I_{PK} are the specified peak voltage and currents and P_{AC}/P_{DC} is the ratio from Fig. 4.

As an example, the selenium suppressor in Table 1 has a 12-mA peak idle current and an alpha of 8 (Fig. 2). Therefore it has a standby power dissipation of about 0.5 W on a 120-V-rms line (170-V peak). A zener-diode suppressor has standby power dissipation of less than a milliwatt. And a silicon-carbide varistor, in a 6-in.-dia. disc, has idle power in the 3-to-5-W range. High idle power in the lower alpha devices is necessary to achieve a reasonable clamping voltage at higher currents.

The amount of idle power that your circuit can tolerate may be the deciding factor in your choice of a varistor. Though high-alpha devices consume low idle power at the nominal design voltage, a small line-voltage rise would cause a dramatic increase in the idle power. Fig. 5 shows that for a zener-diode suppressor, a 10% increase above rated voltage increases the idle-power dissipation above its rated idle power by a factor of 30. But for a low-alpha device, such as silicon carbide, the idle power increases by only 2.5 times.

Another characteristic to consider when choosing a varistor is the voltage-clamping ratio of the device. It is defined as the device's voltage divided by the peak operating ac voltage. In Table 1, the operating voltage is 120-V rms, or 170-V peak, and the voltages of the devices—often called let-through voltage—is taken at a nominal current of 10 A. This current was chosen because most of the published specs suggest this—either directly or by extrapolation.

Varistor specs follow few standards. Some manufacturers publish their devices' let-through voltages at only one current. Others provide a complete plot. Some supply peak current as a function of pulse width, or they provide these data for only a long pulse. Others do not pro-

Table 1. Suppressor characteristics at 120 V rms

Suppressor	Peak idle curr. (mA)	Max* curr. (A)	Peak* power (k Watt)	Peak* energy (joules)	Effective clamping ratio at 10 A	Weight (Grams)	Volume (cm ³)	Voltage range for commercial devices
GE-MOV ^R Varistor (26mm dia)	1.0	350	200	20	1.70	05	4.4	57 - 1400
Selenium (25.4mm sq)	12	30	15	1.5	2.3	35	20	35 - 700
2-Zener, 6 Cell clusters (38mm sq)**	.05	180	30	3	1.6	60	50	14 - 180
2-Zener Suppression Diodes (DO-15)**	.005	17	4.2	0.42	1.7	3	1.0	18 - 300
Silicon Carbide (15.2cm) dia.	45	2000	4000	400	3.2	560	175	6 minimum
Spark Gap (8mm OD)	10 ⁻⁶	1700	3.4	0.34	8.2 (1kV/ μ s)	1.5	0.6	90 minimum

* Single square wave pulse, 100 μ s wide from Fig. 4
 ** Zeners in inverse series for use on ac line

Table 2. Let-through voltages for selenium suppressors

Manufacturer	Minimum cell size inches	Part Number	Peak Let-through voltage*	Reference Number
General Electric	2	6RS25SA5D5	410	180.32
	4	6RS16SA5D5	350	
Sarkes-Tarzian Int. Rectifier	3	6KV335A5AS	340	72KV7
	4**	KSP5DAD	299	TD16-435 10/67
	4	KSP4DAL	264	
Westinghouse	4	506C12AC	315	

* For a 50-A peak, triangular pulse—Fig. 1b.
 ** IR's 2-in. cell can handle 50 A, but let-through voltage was not given.

vide any such data.

A survey of selenium suppressors built by four different manufacturers required considerable effort to find a common basis for comparison. The results are shown in Table 2. Here 50 A was chosen as the peak current to establish the let-through voltages. The voltage varies between 264 and 410 V for a triangular-wave surge as in Fig. 1b. The suppressors listed are large units with a minimum cell size of 2-in. dia.

Silicon-carbide varistors can absorb extremely high energy, but they are generally also large. And the clamping voltages rise rapidly with increasing current, because of their low alpha. For example, NL Industries, Inc., 68W60100 is 6-in. dia. and 3/8-in. thick, and it clamps at about 600 V at 10 A, and at 900 V at 50 A (Table 1). A 3-in. unit clamps at about 1000 V at 50 A. Most published data indicate that a

Table 3. GE-MOV^R varistor suppressors

Model number	Peak let-through voltage	
	at 12 Amp	at 50 Amp
V130LA1	480	730
V130LA10	360	440
V130LA20A	350	395
V130LA20B	330	375
V130PA20C	290	330

1-in.-dia. silicon-carbide varistor can handle 50 A, but, by extrapolation from its volt-ampere characteristic curve, the let-through voltage at this current is high—about 1500 V.

The Fig. 2 curves show that zeners and the GE MOV (metal-oxide) suppressors have exceptionally high alphas (Table 3). They are the only bulk varistors with alphas of more than 25. The zeners provide alphas of about 35.

Note that with zener diodes, two diodes must be used in an opposing-series arrangement on ac lines. A pair of 50-W Motorola zener diodes provides peak clamping voltages between 225 and 275 V.

Spark gaps: Voltage rate important

In a gas-discharge suppressor the peak let-through voltage of the gap depends upon the rate of voltage application rather than the current through it. Thus the basis for the gas-discharge clamping ratio is a voltage rate of change in kV/ μ s. Table 1 also lists an 8-mm-OD spark gap for comparative purposes. Note the almost total absence of idle current and the very high maximum current.

The Siemens B1-A230 gas-discharge unit has

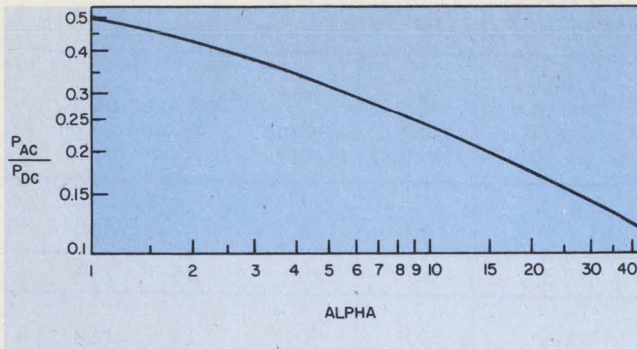

4. Power calculations with nonlinear devices like varistors require a P_{ac}/P_{dc} factor that depends upon the device's alpha.

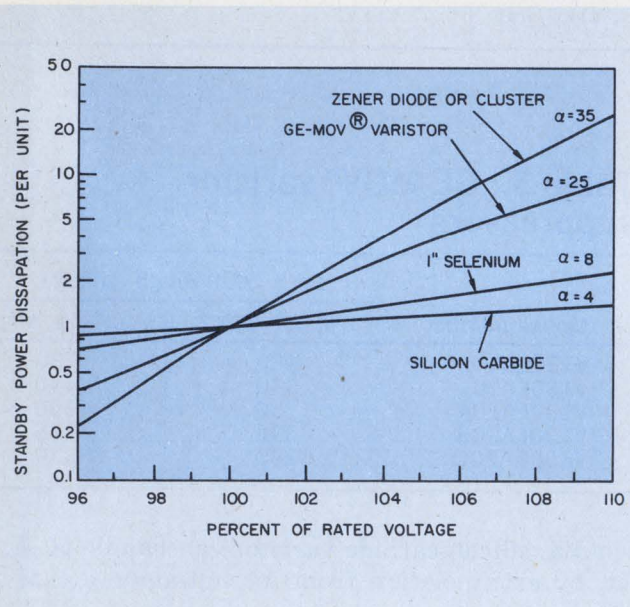

5. Changes in standby power are considerably greater when the suppressor's alpha is high.

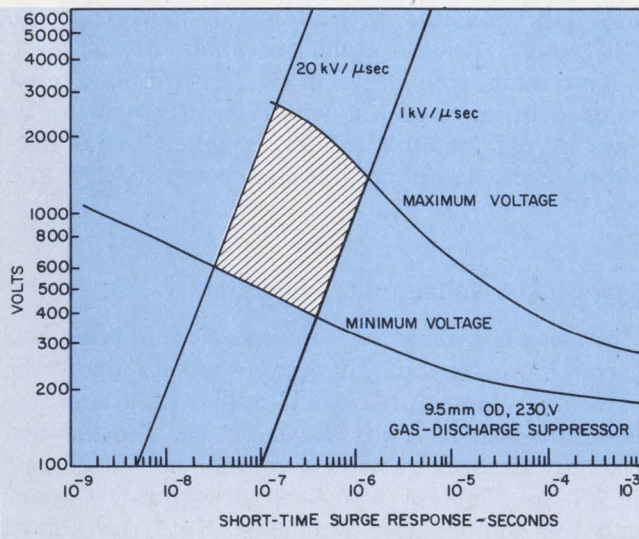

6. The firing point of a gas-discharge device depends upon the rate of voltage rise as well as the absolute voltage level.

Table 4. Relative costs of suppressors for 120 V ac

Method	Relative cost/unit
1. R-C Network	1.0
2. MOV Varistor (low energy)	1.4
3. 1/2" Dia. Selenium	1.6
4. Miniature gas discharge	2.0
5. GE-MOV Varistor	2.3
6. 1" Selenium	3.0
7. MOV Varistor (power types)	3.2
8. (2) DO-13 Zeners	3.6
9. Silicon Carbide	5.0
10. 2" Selenium	5.4
11. (2) 50 Watt Zeners	8.0
12. (2) Zener Clusters	12.0
13. 3" Selenium	16.0
14. 4" Selenium	20.0

a minimum dc striking voltage of $230\text{ V} \pm 15\%$. If this device is placed across a 120-V-ac line, a resistor of $7\ \Omega$ must be placed in series with it to limit the follow-on current after breakdown to 25-A peak. Once a transient turns a gas-discharge unit on, the unit remains on until the end of the half cycle of the applied ac voltage.

The gas-discharge suppressor does not turn on unless the transient pulse interval exceeds the unit's short-time surge striking voltage. Two representative surge rates—1 and $20\text{ kV}/\mu\text{s}$ —are shown in Fig. 6. When a surge voltage is applied, the device turns on at some point within the indicated limits.

For example, with an IEEE surge (Fig. 1a), the first-cycle rise time is approximately $20\text{ kV}/\mu\text{s}$. The discharge unit will ignite between 600 and 2300 V. With a triangular wave (Fig. 1b), the $1\text{ kV}/\mu\text{s}$ will ignite the discharge between 390 and 1200 V. The surge currents of both transients are well within the device's capability.

The RC network: Simplicity

A simple series RC network, placed across the ac line, can also suppress transients. When an IEEE damped-sine wave surge is applied, a capacitance, C , of $0.1\ \mu\text{F}$ has only $1\text{-}\Omega$ reactance. This is practically a short-circuit.

Response to the triangular wave is shown in Fig. 7. As the capacitor increases from a low value of about $0.1\ \mu\text{F}$, the let-through voltage decreases rapidly, and the resistor has only a small effect. When the capacitor is larger than about $2\ \mu\text{F}$, the resistor has greater control.

Of course, when electrical characteristics fail to provide clear-cut criteria for making a selec-

tion, the relative cost of a suppressor may tip the final decision (Table 4).

Transients are common

Why use suppressors? Studies show that many transients on the ordinary 120-V power line have voltages to 5600 V. The average residential circuit receives more than one transient a day in excess of 200 V and can expect at least one a year in excess of 1000 V. Some ordinary home motor loads, such as sump pumps and oil burners, regularly introduce transients of over 1500 V into residential circuits.

Transients also result from lightning that strikes directly, or even close by, power-transmission lines. Though the power-system's protection system limits the transient voltage at the suppressor, reflections and other interactions may permit high-crest voltages at other points in the system. And a power-distribution transformer can couple fast-wavefront transients, not via its step-down turns ratio but by the transformer's often high primary-to-secondary interwinding capacitance. A capacitance transfer ratio of approximately 1:6 is very common.

Thus a 13.8-kV-to-240-V transformer hit by a 50-kV primary transient would put out an 8.3-kV surge on the low voltage side. This is almost 35 times the normal voltage. Most residential wiring will, however, limit the surge to between 2500 and 6000 V, because of insulation, wire spacing and transient suppressors that are included in watt-hour meters. But 2500 to 6000-V transients are high enough to cause damage to insulation and semiconductor devices.

Manufacturers have found that from 50 to 70% of television warranty failures are caused by voltage transients. But the failure of a heart-lung machine is much more consequential than that of a TV set. And an industrial-control failure can stop a production line and cost thousands of dollars in lost production and wages.

Any electrical apparatus that is highly inductive also becomes a powerful source of RFI. An equivalent circuit for RFI purposes (Fig. 8) shows the equipment's inductance L and stray capacitance C_s . Also, the power line has distributed inductance and capacitance, L_d and C_d . When the switch is closed, the system inductances store energy in their magnetic fields.

The abrupt interruption of this current by opening the switch can easily produce 10-kV peak-to-peak transients in typical inductive devices, such as solenoids, but usually the switch breaks down when, say, a 1.5-kV level is reached. The air is ionized, and sparks jump across the open switch contacts. The line and the device resonate in a complex manner. The old spark-gap rf transmitters operated similarly.

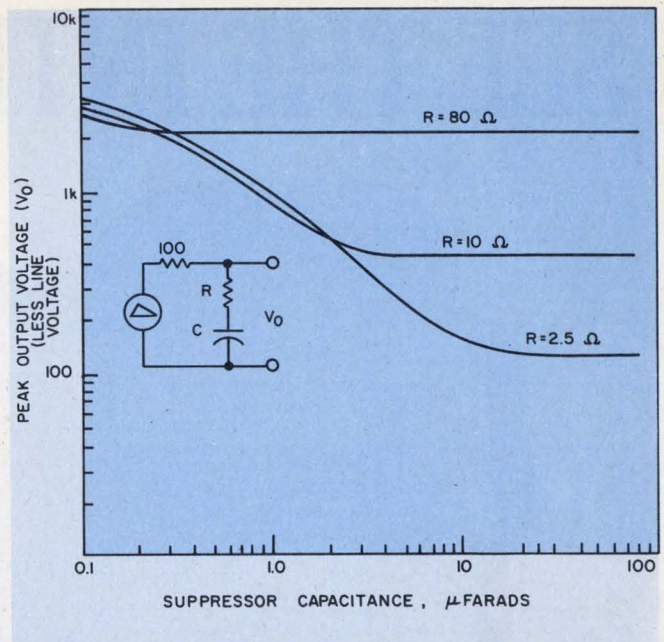

7. A simple series RC circuit can provide good transient suppression at low cost. The curves show the response to a triangular waveform.

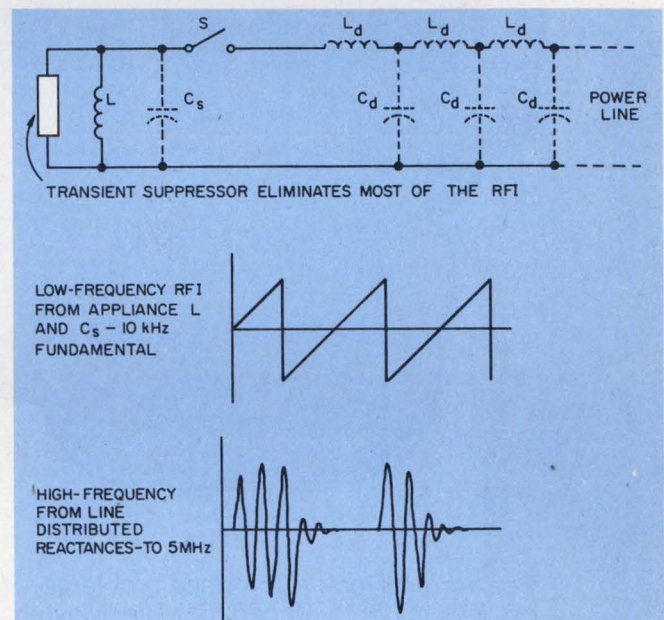

8. Inductive devices are potential sources of line transients and RFI unless suppressed.

Broadband RFI is generated, and the frequencies can extend from 10 kHz to 5 MHz, depending upon the specific inductances and capacitances in the system. The energy at the resonant frequencies can be at 10,000-W levels. Such rf energy is very disruptive to communications and control systems, even at great distances from its source.

However, a transient suppressor placed across inductive devices can reduce substantially the inductively generated RFI, and at the best place—its source. ■■

SEE THE INTERFACE FOREST

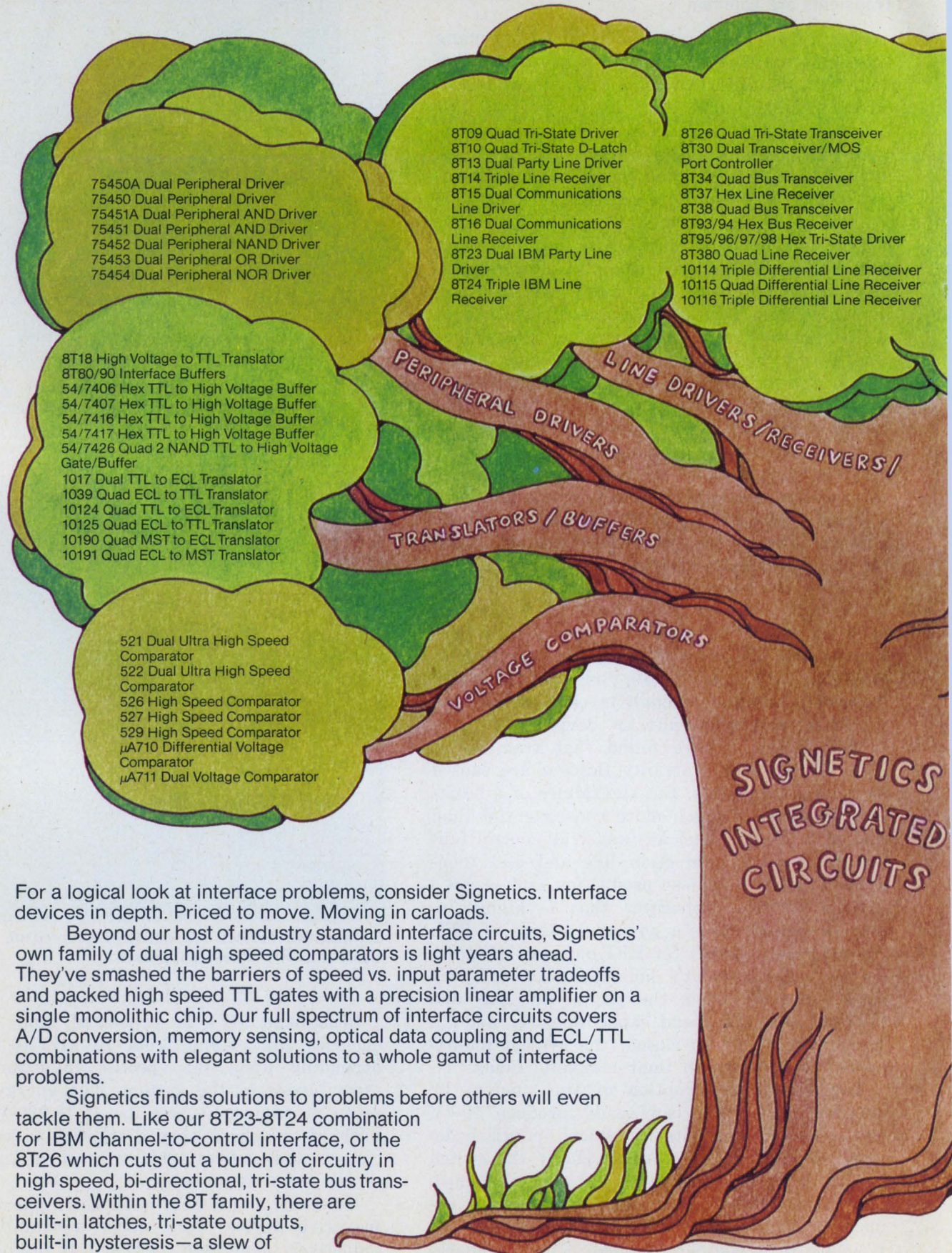

For a logical look at interface problems, consider Signetics. Interface devices in depth. Priced to move. Moving in carloads.

Beyond our host of industry standard interface circuits, Signetics' own family of dual high speed comparators is light years ahead. They've smashed the barriers of speed vs. input parameter tradeoffs and packed high speed TTL gates with a precision linear amplifier on a single monolithic chip. Our full spectrum of interface circuits covers A/D conversion, memory sensing, optical data coupling and ECL/TTL combinations with elegant solutions to a whole gamut of interface problems.

Signetics finds solutions to problems before others will even tackle them. Like our 8T23-8T24 combination for IBM channel-to-control interface, or the 8T26 which cuts out a bunch of circuitry in high speed, bi-directional, tri-state bus transceivers. Within the 8T family, there are built-in latches, tri-state outputs, built-in hysteresis—a slew of

(BECAUSE OF THE TREE).

10129 Quad Bus Receiver (w Latch)
 10192 Bus Driver
 10216 Triple Differential Line Receiver
 54/7438 Quad Bus Driver
 54/7439 Quad Bus Driver
 54/74124 Quad Tri-State Driver
 54/74125 Quad Tri-State Driver
 54/74128 Line Driver
 54/74S40 Dual 4 NAND Buffer/Line Driver
 54/74S140 Dual 4 NAND Buffer/Line Driver
 78/8820 Dual Line Receiver
 78/8830 Dual Line Driver

8T51 5 mA Source LED Decoder Driver
 8T59 50 mA Source LED Decoder Driver
 8T74 20 mA Sink (w Latch) LED Decoder Driver
 8T75 20 mA Source (w Latch) LED Decoder Driver
 54/7445 BCD to Decimal Decoder/Driver
 54/74145 BCD to Decimal Decoder/Driver
 8880 Sperry Display Decoder/Driver

8T25 Dual MOS Sense Amplifier/Latch
 3207A Quad MOS Clock Driver
 3207A-1 Quad MOS Clock Driver

7520 Dual Core Memory Sense Amplifier
 7521 Dual Core Memory Sense Amplifier
 7522 Dual Core Memory Sense Amplifier
 7523 Dual Core Memory Sense Amplifier
 7524 Dual Core Memory Sense Amplifier
 7525 Dual Core Memory Sense Amplifier

501 Video Amplifier
 592 Video Amplifier
 μ A733 Differential Video Amplifier

555 Timer
 556 Dual Timer
 8T20 Bi-Directional One Shot
 8T22A/9601 Retriggerable One Shot
 8T363 Dual Zero-Crossing Detector
 9602 Dual Retriggerable One Shot
 54/7413 Dual Schmidt Trigger
 54/7414 Hex Schmidt Trigger
 54/74121 One Shot
 54/74122 Retriggerable One Shot
 54/74123 Dual Retriggerable One Shot
 54/74132 Quad 2 NAND Schmidt Trigger
 54/74232 Quad 2 NOR Schmidt Trigger

TRANSCEIVERS

DISPLAY DRIVERS

MOS MEMORY SENSE AMPLIFIERS/CLOCK DRIVERS

CORE MEMORY SENSE AMPLIFIERS

VIDEO AMPLIFIERS

TIMING CIRCUITS

dam busting solutions for simpler, more reliable systems. Low current PNP inputs give greater design freedom and you can interface with any data source—TTL, memories and MOS micro-processors. It's all spelled out in our information package.

Whatever you're interfacing, you can count on Signetics. Before you accept a tradeoff in design, or in price or in delivery, give us a call. We're specialists in solving problems and if we haven't hit yours yet, we'd sure like to try.

CLIP THIS COUPON AND ATTACH TO LETTERHEAD FOR FAST ACTION.

Signetics-Interface
 P.O. Box 3004-34
 Menlo Park, California 94025

No more out on a limb for me. Send me your new interface information package.

Name

Title

Mail Stop

Signetics Corporation, a subsidiary of Corning Glass Works, 811 E. Arques Ave., Sunnyvale, Ca. 94086 (408) 739-7700.

signetics

INFORMATION RETRIEVAL NUMBER 31

Use pulse instead of cw signals

to analyze discontinuities in high-frequency circuits.
Time-domain reflectometry can pinpoint the problem.

If you need to isolate individual discontinuities within a high-frequency system, Time-Domain Reflectometry (TDR)—a pulse-reflection measuring technique—can do the job. TDR is a useful companion to cw measuring techniques, which indicate only the composite effect of discontinuities.

TDR is often referred to as a “closed-loop-radar” system. This is because the basic technique propagates a voltage step down a transmission line or system under test (Fig. 1a). If the step encounters any deviation in the impedance of the system, part of the incident step is reflected back to the sending point, where it is compared in time and amplitude to the original step (Fig. 1b).

The comparison reveals the nature of the discontinuity, as well as its location; the observed display is thus an impedance profile of the system.

Resolution depends on over-all rise time

The distance or time resolution of the TDR method directly relates to the system rise time, that is, the combined rise time of the step and the monitoring scope. For example, if a system is interrogated with a step of 2-ns rise time and is monitored with a 100-MHz scope, the resulting system rise time is about 4 ns.

The distance to a discontinuity is given by $d = ct_0/2 \sqrt{\epsilon_r}$, where c is the speed of light, t_0 is the elapsed time between the incident step and the reflected waveform, and ϵ_r is the relative dielectric constant of the dielectric material. For an air dielectric, this simplifies to $d = ct_0/2$.

Thus the distance that separates two discontinuities in an air medium is given by $d = c(t_2 - t_1)/2$. When two discontinuities are separated by a time $(t_2 - t_1)$, of less than half the system rise time, they become indistinguishable. Therefore the minimum distinguishable distance between two discontinuities is given by $d_{\min} =$

Russ Harding, Project Leader, Hewlett-Packard, 1900 Garden of the Gods Rd., Colorado Springs, Colo. 80907.

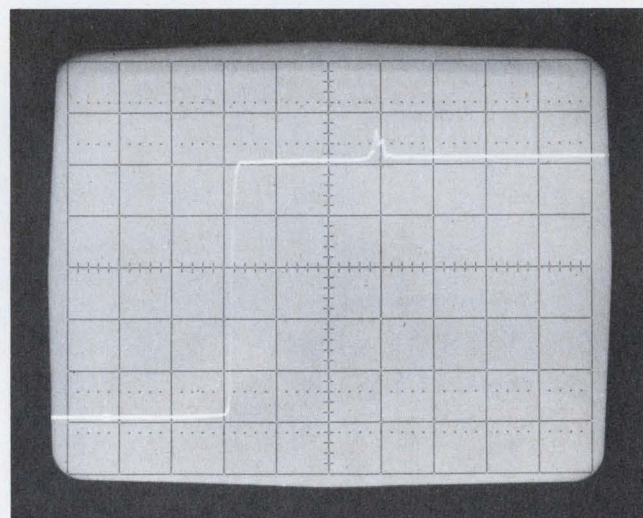
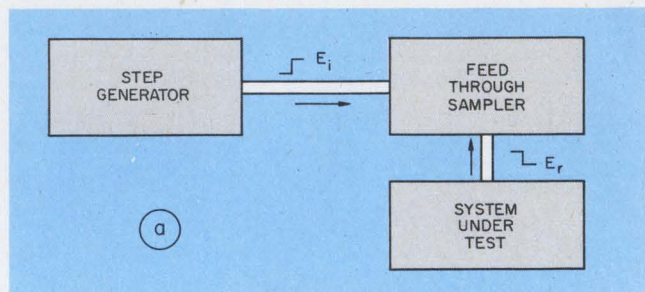

1. In the TDR method, a pulse is propagated down the system under test (a). Any discontinuity in the system shows up on the TDR display (b), where it can be compared to the incident step. The comparison reveals the nature and location of the discontinuity.

$ct_r/4$. For the 4-ns system, a resolution of 0.3 meters is possible—quite useful for long-line measurements.

To achieve higher resolution, it's necessary to use the sampling technique, in which a response up to 18 GHz is possible. Picosecond, solid-state switching devices also help to obtain resolutions in the millimeter range.

For example, a step generator with a 20-ps rise time and an oscilloscope with a 28-ps rise time (equivalent to 12.4 GHz) yield a system resolution of 2.6 mm—the resolution needed to look at connectors, strip lines, terminations and

other high-frequency devices.

In addition to wide bandwidth, the sampling scope has the advantage of both large dynamic amplitude range and fast recovery time.

A large dynamic range allows the user to distinguish a very small pulse, or perturbation, that rides on top of a large pulse, for amplitude ratios as large as 1000:1. And fast recovery is important for viewing transitions.

Transmission-line equations are used

To understand applications for TDR better—and to interpret a TDR display—it's helpful to understand basic transmission-line theory.

From the theory, the fraction of an incident voltage step reflected from a discontinuity is given by

$$\rho = \frac{Z_L - Z_0}{Z_L + Z_0},$$

where Z_L is the load impedance or impedance of the discontinuity, Z_0 is the characteristic impedance of the transmission line and ρ is the voltage-reflection coefficient (ranging from -1 to $+1$).

Consider for now a system in which Z_0 is real (purely resistive) and equal to R_0 . This is a good assumption for short lengths of high-quality commercial cable. The equation for ρ then becomes:

$$\rho = \frac{Z_L - R_0}{Z_L + R_0}.$$

Fig. 2 illustrates five typical scope displays and the corresponding load impedance. These show that the reflected waveform is positive for resistive loads greater than R_0 , and is negative for resistive loads less than R_0 .

Note that, for purely resistive discontinuities, the shape of the reflected waveform is the same as that of the incident waveform. To check the values given in Fig. 2, simply substitute the impedances into the equation for the reflection coefficient.

Of more practical interest than reflections from purely resistive discontinuities are those from complex discontinuities (Fig. 3). The waveforms shown in the figure can be verified first

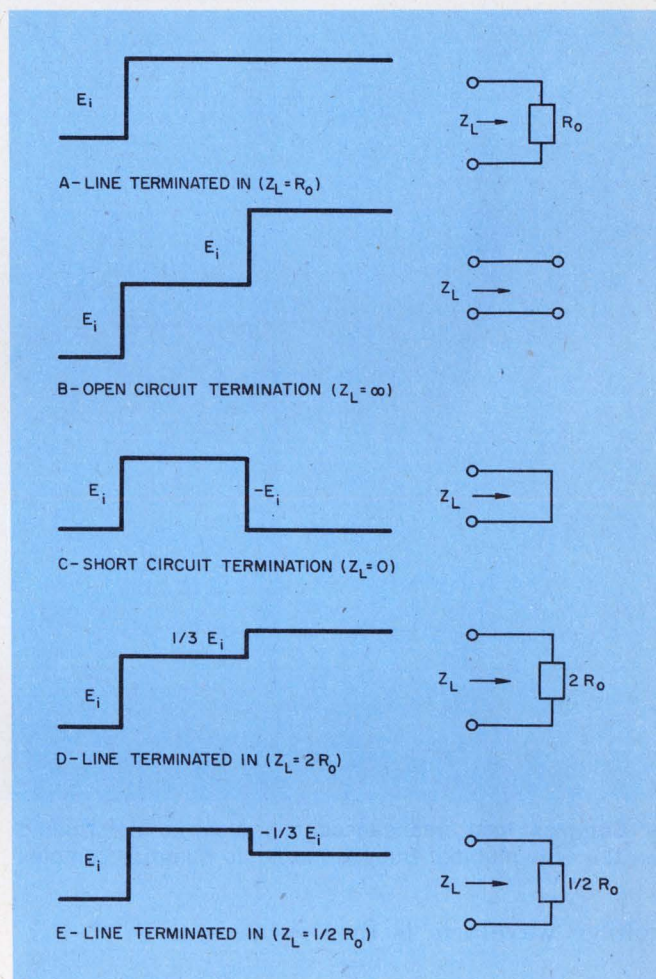

2. Typical TDR displays for various resistances can be used to characterize a load. For example, an open termination results in a double-step staircase (b).

by writing the expression for $\rho(s)$ in terms of the complex load impedance, then multiplying by E_i/s (the transform of a step function of height E_i) and finally transforming back to the time domain to determine the expression for the reflected voltage, $e_r(t)$. The composite waveform shown in Fig. 3 is then the sum of $e_i(t)$ and $e_r(t)$.

In another approach, you can evaluate the voltages at the discontinuity at $t = 0$ and $t = \infty$, and assume an exponential transition between these two values. The expression for the total

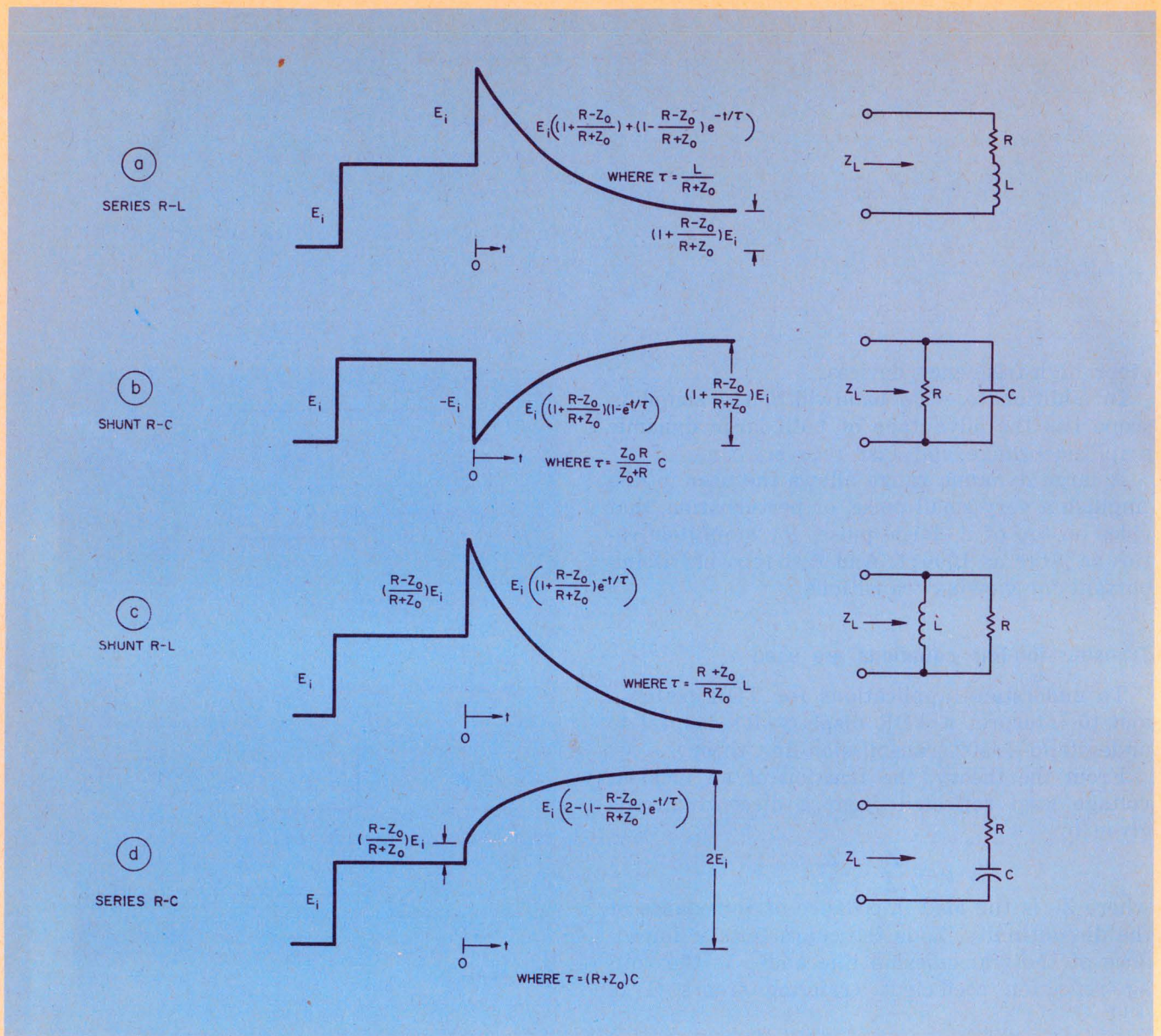

3. **Complex load impedances** can also be determined via the TDR method. But it's harder to quantize complex

loads than pure resistance. Generally, inductance produces a decaying exponential; capacitance a rising one.

voltage waveform is then given by:

$$v(t) = V_r + (V_i - V_r)e^{-\frac{t}{\tau}}$$

where V_r is $v(t)$ at $t = \infty$, V_i is $v(t)$ at $t = 0$ and τ is the time constant.

For the shunt RC example, V_r is equal to $E_i + \rho_r E_i$. In this case, the reflection coefficient is calculated for a purely resistive termination (R), since the capacitor "looks" like an open circuit to the incident step after sufficient time has elapsed for all transients to die out. At $t = \infty$, V_r is then equal to

$$V_r = E_i (1 + \rho_r) = E_i \left[1 + \frac{(R - Z_0)}{(R + Z_0)} \right]$$

At $t = 0$, V_i is equal to $E_i + \rho_i E_i$. Because the capacitor looks like a short circuit to the fast transition of the step, $\rho_i = -1$ and $V_i = 0$.

The time constant, τ , is given by the product of C and its shunt resistance; that is, R in parallel with Z_0 . Thus

$$\tau = C \left(\frac{R Z_0}{R + Z_0} \right)$$

When you substitute into the equation for $v(t)$ the result is

$$v(t) = E_i \left[1 + \frac{R - Z_0}{R + Z_0} \right] - E_i \left[1 + \frac{R - Z_0}{R + Z_0} \right] e^{-\frac{t}{\tau}}$$

$$v(t) = E_i \left[\left(1 + \frac{R - Z_0}{R + Z_0} \right) \left(1 - e^{-\frac{t}{\tau}} \right) \right],$$

as given in Fig. 3.

The remaining expressions can be calculated in the same manner. The waveforms in Fig. 3 illustrate that a TDR display gives a great deal

of information about the nature of a discontinuity. Thus a series inductance causes a positive spike and a shunt capacitance causes a negative spike, independent of the value of R.

TDR display offers clues

Such generalizations can't be made for shunt inductance or series capacitance, since the sign of the reflected voltage at $t = 0$ is determined by the value of R. However, it's generally true that inductive discontinuities—series or shunt—produce a decaying exponential, while capacitive discontinuities produce a rising exponential.

Up to this point we've assumed an ideal transmission line. To account for losses, the classical model of an infinite transmission line can be used (Fig. 4). In the model, both series and shunt losses are taken into account, and the input impedance is given by

$$Z_{in} = \left(\frac{R + j\omega L}{G + j\omega C} \right)^{1/2},$$

where R is the series resistance per unit length, G is the shunt conductance per unit length, L is the inductance per unit length and C is the capacitance per unit length.

In a cable where series loss predominates, G is small with respect to ωC and can be neglected. Z_{in} then becomes

$$Z_{in} = \left(\frac{R + j\omega L}{j\omega C} \right)^{1/2} = \sqrt{\frac{L}{C}} \left(1 + \frac{R}{j\omega L} \right)^{1/2}.$$

Because the leading edge of the incident step is primarily made up of high frequency components, R is small with respect to $j\omega L$ at $t = 0^+$. With $R < \omega L$, $(1 + R/j\omega L)^{1/2}$ can be approximated by $(1 + R/j2\omega L)$:

$$Z_{in} = \sqrt{\frac{L}{C}} \left(1 + \frac{R}{j2\omega L} \right) \text{ for } R < \omega L.$$

Thus the input impedance can be represented by a resistor of value $R' = \sqrt{L/C}$ in series with a capacitor of value $C' = 2\sqrt{LC}/R$. The equivalent circuit at $t = 0^+$ is shown in Fig. 5a.

As shown in Fig. 3d, the impedance profile of a line with series loss consists of a step followed by an exponential rise. (Step = 0 when $\sqrt{L/C}$ equals the impedance of the driving line.)

This shape occurs because, with time, the line looks like an open circuit; that is, as the voltage wave travels down the line, it "accumulates" more resistance through which to force current.

The series resistance of a lossy line is related to the skin depth of the conductor and is therefore not constant with frequency. Consequently it is difficult to relate the initial slope of the exponential to the series loss, R. However, TDR measurements are still useful for comparing cables.

Similarly an analysis can be made for a cable in which shunt losses dominate. In this case, the

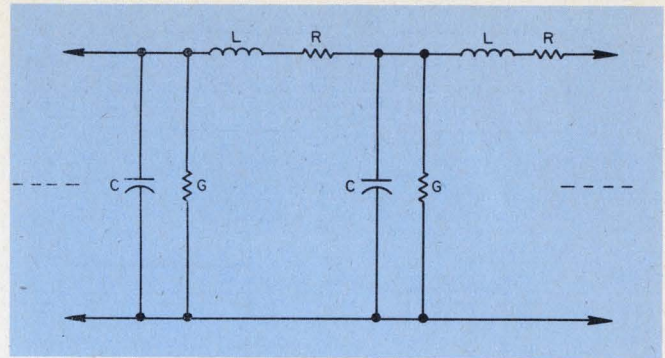

4. Classical model of a transmission line is used to account for losses in cables.

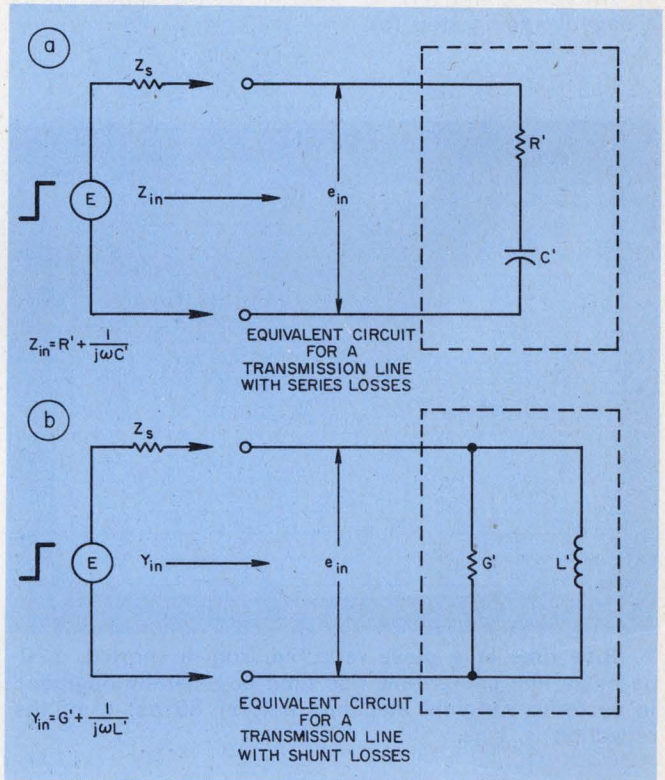

5. Where series loss predominates, the transmission-line model can be simplified for conditions at $t = 0^+$ (a). Similarly, when shunt loss dominates, the model can be changed accordingly (b).

input admittance is given by

$$Y_{in} = \frac{1}{Z_{in}} \sqrt{\frac{G + j\omega C}{R + j\omega L}} = \sqrt{\frac{G + j\omega C}{j\omega L}} \text{ for small } R.$$

If you rewrite, this yields

$$Y_{in} = \sqrt{\frac{C}{L}} \left(1 + \frac{G}{j\omega C} \right)^{1/2}.$$

When you approximate the radical, as before, you get

$$Y_{in} = \sqrt{\frac{C}{L}} \left(1 + \frac{G}{j2\omega C} \right) \text{ for } G < \omega C.$$

The admittance can be thought of as a conductance of value $G' = \sqrt{C/L}$, shunted by an inductance of value $L' = 2\sqrt{LC}/G$. The equivalent circuit at $t = 0^+$ appears in Fig. 5b.

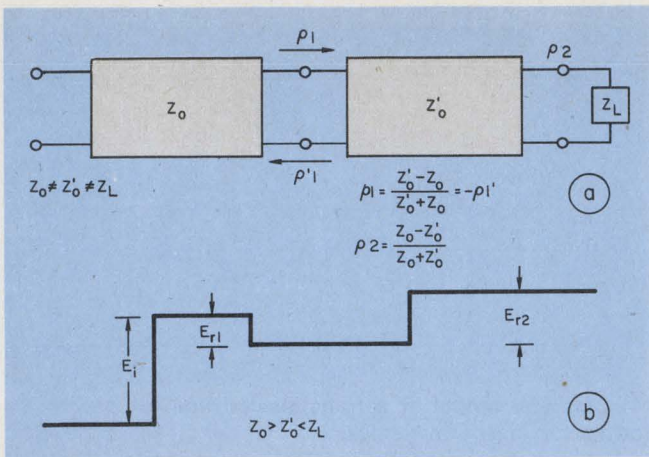

6. Mismatch at the junction of two transmission lines of different characteristic impedances (a) shows up as a negative-going step (b).

In reference to Fig. 3c, the reflected waveform is a step, followed by a decaying exponential. (Again, the step = 0 for $\sqrt{C/L}$ equal to the admittance of the driving line.)

This shape occurs because the line looks more and more like a short circuit as time goes on; that is, the current wave that travels down the line "accumulates" more conductance across which to develop voltage. As with the series-loss case, absolute measurements cannot be made, but comparative ones can.

Mismatches are easily spotted

To see how TDR separates discontinuities, consider the mismatch at the interface between two transmission lines, Z_0 and Z_0' (Fig. 6). At the discontinuity, a reflected wave, E_{r1} , is generated, where

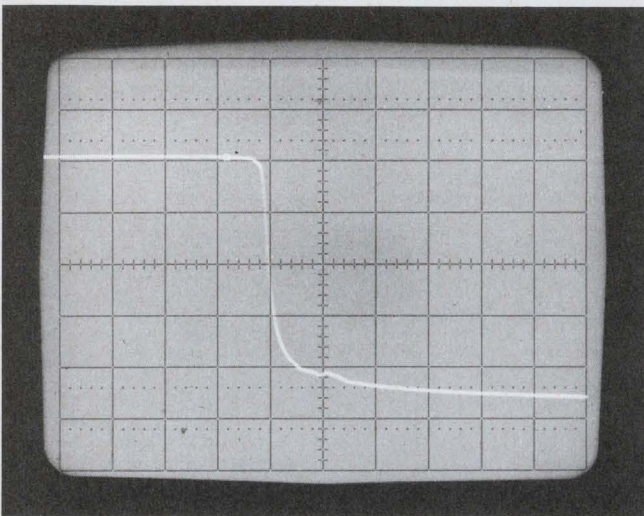

7. Rise time of a pulse reflected from a shorted, 120-ns delay line shows how rise time is generally degraded in systems. Original step had a t_r of 80 ps; t_r of the reflection is 3 ns.

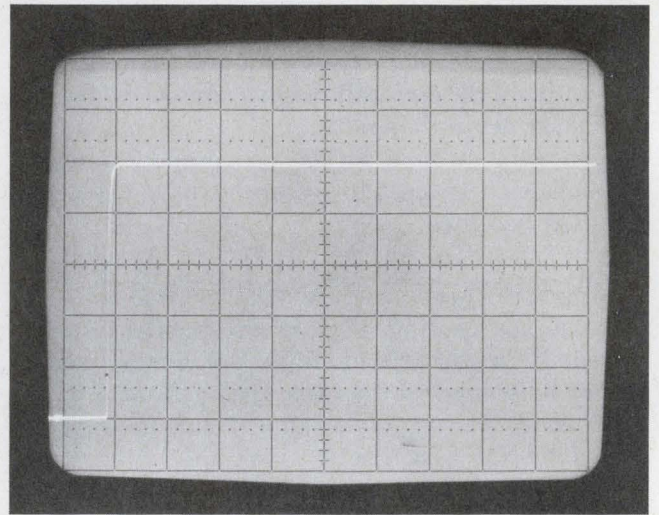

(a)

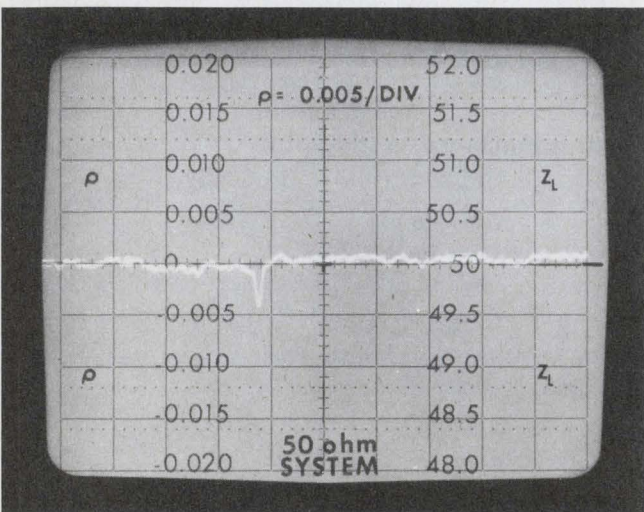

8. Measuring aid helps to determine load impedances: An overlay placed on the TDR screen can be calibrated directly and changed when necessary.

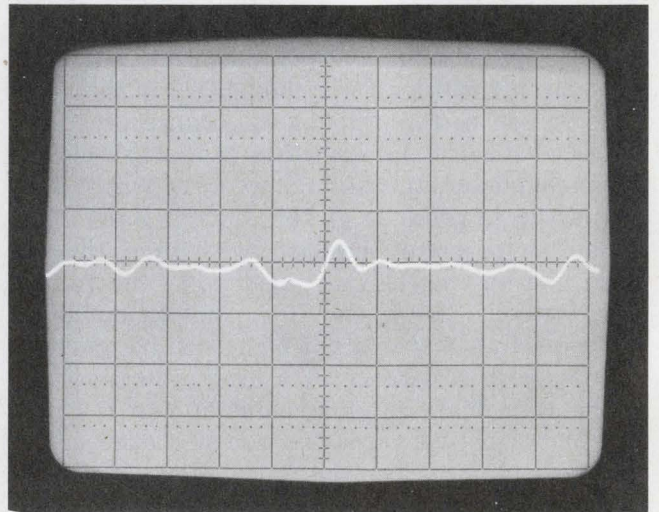

(b)

9. Impedance profile of ideal cable is flat (a), while that of commercial cable shows variations in characteristic impedance along the line (b).

$$E_{r,1} = \rho_1 E_i = E_i \left(\frac{Z_o' - Z_o}{Z_o' + Z_o} \right).$$

The second mismatch, located at the load, generates a reflected wave with an amplitude proportional to the load impedance, Z_L . To calculate the amplitude, first consider the voltage step incident on the load.

The voltage-transmission coefficient is given by $\tau = 1 + \rho$. Therefore the energy incident at the load is $(1 + \rho_1) E_i$ and not E_i . The voltage reflected at the load is thus not $E_{r,2}$, but equals $\rho_2 (1 + \rho_1) E_i$. This is because only part of the reflected voltage is transmitted across the discontinuity at the junction of the two transmission lines.

At this junction, the transmission coefficient is $\tau = (1 + \rho_1')$ and the expression for $E_{r,2}$ becomes

$$E_{r,2} = \rho_2 (1 + \rho_1) (1 + \rho_1') E_i.$$

But since $\rho_1' = -\rho_1$,

$$E_{r,2} = \rho_2 (1 + \rho_1^2) E_i.$$

Since all of the energy isn't transmitted at this junction, another step is transmitted toward the load and is again reflected. These reflections continue until the magnitude of the reflection approaches zero.

Thus we see that TDR is indeed valuable for analysis of discontinuities, but the display must be carefully interpreted. In practical situations, where only small discontinuities and mismatches occur, the effect of multiple discontinuities is small.

To locate and to eliminate discontinuities in such a system, it's best to take them one at a time. And because the first discontinuity is unaffected by the ones that follow, you should start at the end from which the step was transmitted. After the first discontinuity has been eliminated or reduced, the second can be treated in the same fashion.

Enhancing TDR measurements

It may be valuable to consider some techniques that can enhance the value of a TDR measurement. For instance, if impedance measurements are made in the region of 50 Ω , a calibrated air line—with constant impedance over its length—provides an excellent reference when placed immediately before the system under test.

It's also usually worthwhile to separate the TDR and the system under test by two to three feet of air line or high-quality cable. This permits reflections between the sampler and pulse generator to die down before a measurement is made.

In distance measurements, it's important to preserve the fast rise time of the incident step, since distance resolution is directly related to the rise time. Consequently high-quality, low-loss

cable should be used to interconnect the TDR and the system under test.

To illustrate how rise time is degraded, Fig. 7 shows an 80-ps pulse reflected from a short at the end of a 120-ns delay line. The 10-to-90% rise time has been degraded to about 3 ns, which thereby limits the resolution to about 10 inches.

The quantity obtained from a TDR display is the reflection coefficient, ρ . However, the quantity of general interest is the load impedance, Z_L , which can be obtained from the equation for ρ . To make this conversion easier, impedance overlays can be made for 50- Ω systems, with the graticule marks labeled in units of impedance.

Overlays can be provided for each vertical scale of the TDR and the user need only select the overlay for his range to read impedance directly. An overlay is also valuable when photo-

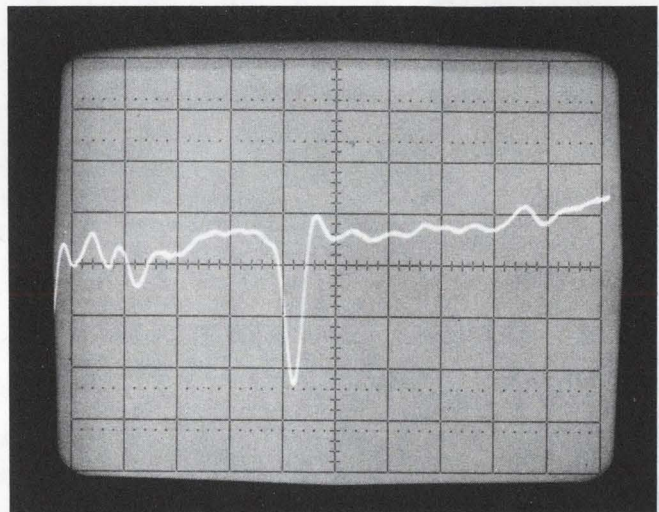

(a)

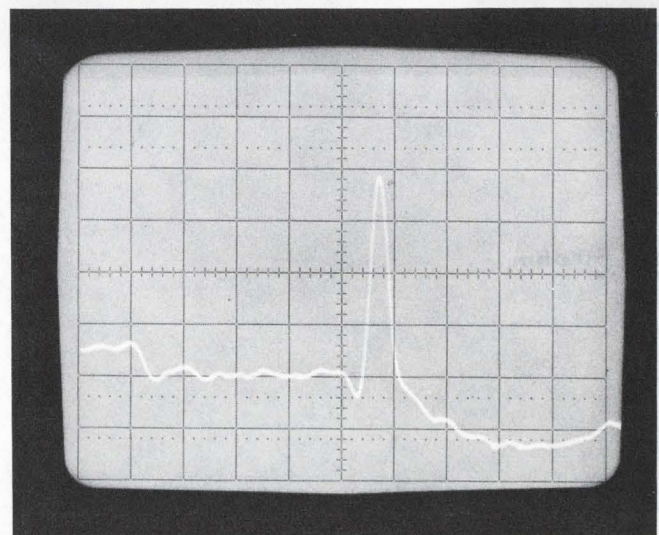

(b)

10. Pinched cable shows drop in impedance at point of compression (a), while cable with missing braid segment exhibits a rise in impedance (b). The anomalies result from changes in capacitance at the point of stress.

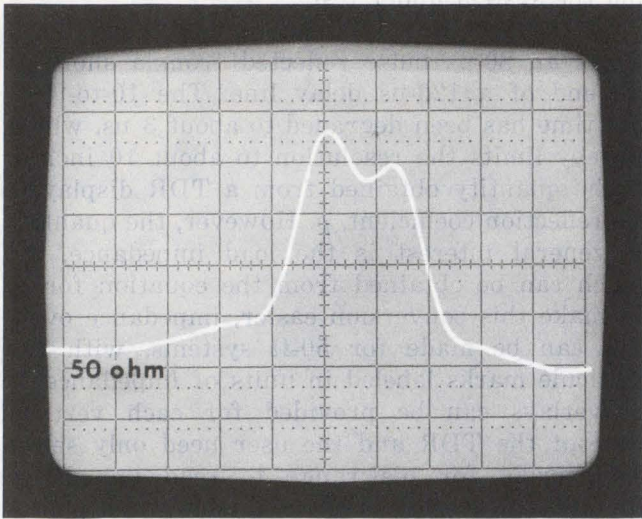

(a)

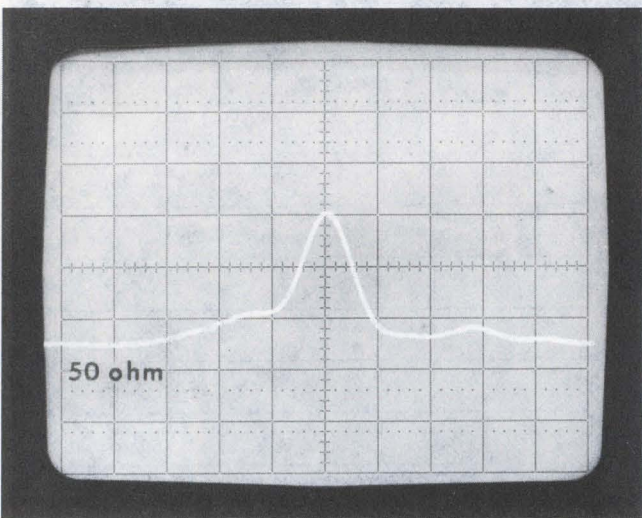

(b)

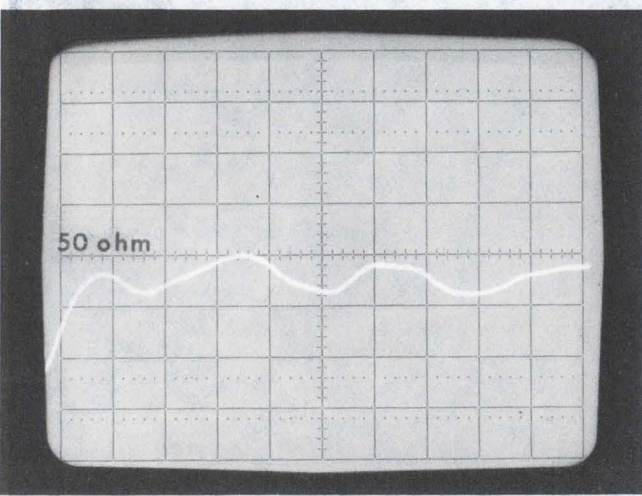

(c)

11. Unique signature, or impedance profile, of a connector is revealed with TDR. Profiles above are for a female-female BNC adapter, which looks inductive (a), a female BNC-to-GR 874 adapter (b) and a male precision "N"-to-APC-7 adapter (c).

graphs are taken, since the scale will appear with the waveform on the photo (Fig. 8).

Now that we've seen what TDR can do, let's look at some more specific applications.

Faulty cables are spotted

Cable manufacturers use TDR to monitor the impedance of cables. An ideal cable should appear as a resistive load with no reflections, except those at the beginning and end of the cable (Fig. 9a).

However, commercial cable usually looks something like the display shown in Fig. 9b. Here changes in the characteristic impedance of the line are indicated. These variations might be caused by nonuniformity in the dielectric material or by nonuniform braid windings.

To illustrate the effect of changes in the dielectric material, the cable in Fig. 10 was pinched with a pair of pliers to compress the dielectric. The display indicates a lowered impedance at the pinched portion of the cable because of the increase in cable capacitance at that point.

An opposite effect can be demonstrated if part of the braid over a small segment is cut off to decrease the capacitance (Fig. 10b).

As another example, it's desirable to eliminate or to reduce discontinuities in connectors to avoid the effects of high VSWR at the discontinuities. These discontinuities can be located with TDR, since every connector has a unique signature, or impedance profile, for a specific TDR system. Fig. 11 illustrates the impedance profile of various connectors.

Fig. 11a shows how a BNC female-female connector looks to a 170-ps TDR system. The horizontal scale is 200 ps/div and the vertical scale is $\rho = 0.01/\text{div}$. The 50- Ω reference is located two divisions up from the bottom. The connector looks primarily inductive, with a maximum impedance of about 55 Ω .

Fig. 11b shows a female-BNC-to-GR-874 adapter; and Fig. 11c illustrates a male precision "N"-to-APC-7 adapter. The discontinuity introduced by the BNC-to-GR-874 is also inductive, while the precision "N"-to-APC-7 exhibits an impedance of slightly less than 50 Ω , with a variation of approximately 1 Ω .

Method handles transmission tests

A TDR system can also be configured for transmission testing if the system under test is placed between the step generator and the feed-through sampler (Fig. 12). This configuration is useful for measurement of one-way rise time of cables, cable attenuation or a system's transmission response.

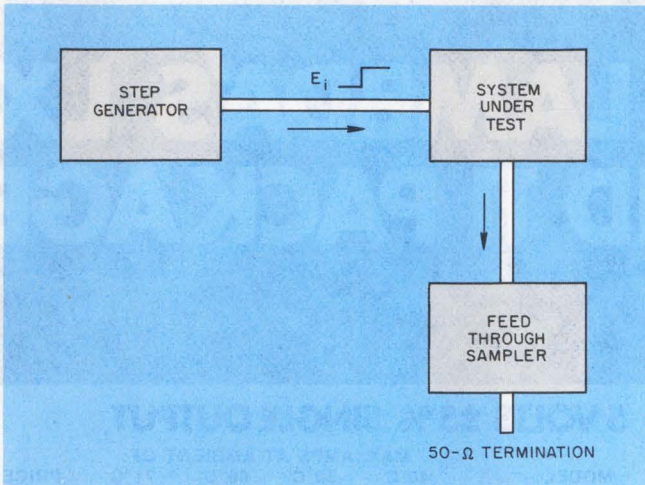

12. In transmission testing, the system under test is placed between the step generator and the feedthrough sampler. Cable rise time can be so measured.

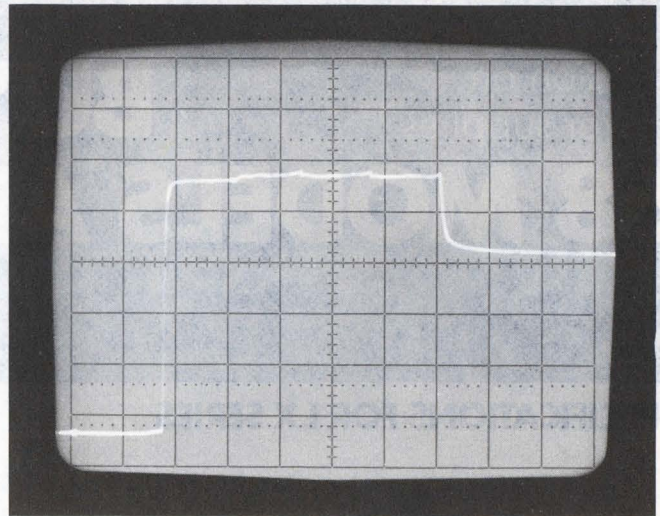

(a)

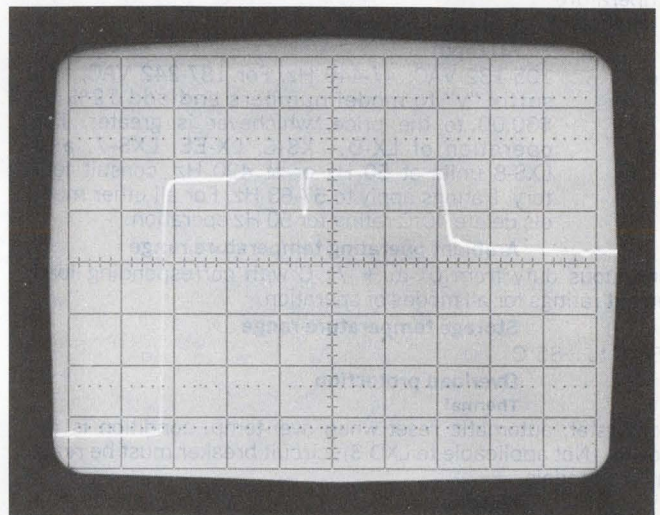

(b)

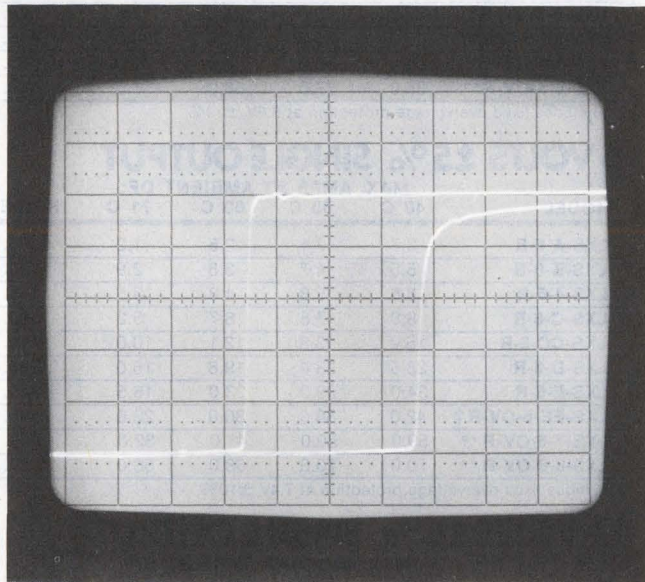

13. Transmission test reveals rise-time degradation and attenuation of a delay line. Double exposure shows both the incident step (left) and the step after transmission down the line.

14. Signature of a good coaxial system (a) reveals three small perturbations caused by connectors within the system. When the center connector goes bad, it's immediately detected by the negative-going pip (b).

In Fig. 13, a double-exposure photograph shows both the incident step and the step at the end of a 120-ns delay line. Because of the high-frequency loss in the delay line, the rise time is degraded to about 400 ps. Note that there is also a slight attenuation in the line.

Here's another application. In signature testing, a technique frequently used to test aircraft and ship-board communication systems, a "good" system is interrogated with a TDR and a hard copy of the characteristic impedance or signature is made with an X-Y recorder. Bounds are placed on the impedance variation and the signature is then used as a comparison standard.

Fig. 14a illustrates the signature of a coaxial system, known to be O.K. The three small perturbations are caused by connectors. In Fig. 14b, the second connector is bad. Thus, the TDR technique allows a technician to locate and to repair a problem connector, or other part, without full knowledge or understanding of the entire system.

Note that point-by-point data can be taken from the X-Y plot for further processing. For instance, the data can be differentiated to obtain the discontinuity impulse response, and then transformed to obtain the frequency spectrum. With the aid of a plotter and a computer, another dimension can be added to TDR testing. ■■

Do you face
a make or buy
decision on
power supplies?

BUY LAMBDA'S LX 68 MODELS AND 11 PACKAGE

SPECIFICATIONS FOR LX SERIES

DC Output Regulated Voltage

regulation, line 0.1%
regulation load 0.1%
ripple and noise 1.5 mV RMS, 5 mV pk-pk with either
positive or negative terminal grounded

temperature
coefficient 0.03%/°C

AC Input

line 105-132 VAC; 47-440 Hz. For 187-242 VAC, add
suffix "V" to model numbers and add 12% or
\$30.00 to the price, whichever is greater. For
operation of LX-D, LX-E, LX-EE, LX-7, and
LX-8 units at 50 Hz or at 400 Hz, consult factory.
Ratings apply to 57-63 Hz. For all other models
delete 40°C rating for 50 Hz operation.

Ambient operating temperature range

continuous duty from 0° to + 71°C with corresponding load
current ratings for all modes of operation.

Storage temperature range

-55°C to +85°C

Overload protection

Thermal

thermostat, automatic reset when over-temp. condition is removed.
(Not applicable to LX-D-3); circuit breaker must be reset
on LX-8 models.

Electrical

external overload protection, automatic electronic current limiting
circuit limits the output current to the present value,
thereby providing protection for load as well as power supply.

Overshoot

no overshoot on turn-on, turn-off or power failure.

Input and output connections

through terminal block on chassis; output terminals on LX-7,
LX-8 models are two heavy duty studs.

Power hybrid voltage regulator or integrated circuit regulation

some models have Power Hybrid Voltage Regulator providing
complete regulation system while others have an integrated
circuit providing regulation system except for input and output
capacitors, rectifiers and series regulation transistors.

Controls

DC Output Control

simple screwdriver voltage adjustment over entire range.

Remote sensing

provision is made for remote sensing to eliminate effect of
power output lead resistance on DC regulation.

Transformer

MIL-T-27C, Grade 6

Tracking accuracy (dual models)

2% absolute voltage difference; 0.2% change for all conditions
of line, load and temperature.

Fungus proofing

All fungi nutrient components are rendered fungi inert with
MIL-V-173 varnish—Standard on all LX models and is included
in price.

5 VOLTS ±5% SINGLE OUTPUT

MODEL	MAX. AMPS AT AMBIENT OF:				PRICE
	40°C	50°C	60°C	71°C	
LXS-A-5-OV-R*	4.0	3.4	2.7	2.0	\$ 95.
LXS-B-5-OV-R*	5.8	5.0	4.0	3.0	130.
LXS-4-5-OV-R*	7.4	6.5	5.4	3.9	145.
LXS-C-5-OV-R*	9.0	8.0	6.8	5.3	160.
LXS-CC-5-OV-R*	16.0	14.5	12.7	10.5	220.
LXS-D-5-OV-R*	27.5	24.2	20.5	16.5	260.
LXS-E-5-OV-R*	35.0	30.0	24.0	17.5	320.
LXS-EE-5-OV-R*	45.0	39.0	32.0	25.0	445.
LXS-7-5-OV-R**	65.0	56.0	46.0	35.0	535.
LXS-8-5-OV-R**	85.0	77.0	68.0	56.0	580.

*Includes fixed overvoltage protection at 6.8V ±10%

6 VOLTS ±5% SINGLE OUTPUT

MODEL	MAX. AMPS AT AMBIENT OF:				PRICE
	40°C	50°C	60°C	71°C	
LXS-A-6-R	3.7	3.1	2.5	1.9	\$ 95.
LXS-B-6-R	5.5	4.7	3.8	2.9	130.
LXS-4-6-R	6.6	5.8	4.8	3.5	145.
LXS-C-6-R	8.8	7.8	6.7	5.2	160.
LXS-CC-6-R	15.2	13.8	12.1	10.0	210.
LXS-D-6-R	26.5	23.4	19.8	16.0	260.
LXS-E-6-R	34.0	29.0	23.0	16.5	320.
LXS-EE-6-OV-R†	42.0	36.0	30.0	22.0	445.
LXS-7-6-OV-R**	59.0	50.0	41.0	32.0	535.
LXS-8-6-OV-R**	70.0	70.0	68.0	56.0	580.

†Includes fixed overvoltage protection at 7.4V ±10%

12 VOLTS ±5% SINGLE OUTPUT

MODEL	MAX. AMPS AT AMBIENT OF:				PRICE
	40°C	50°C	60°C	71°C	
LXS-A-12-R	2.7	2.2	1.8	1.5	\$ 95.
LXS-B-12-R	3.8	3.6	3.0	2.2	130.
LXS-4-12-R	4.4	3.8	3.1	2.5	145.
LXS-C-12-R	6.5	6.1	5.5	4.6	160.
LXS-CC-12-R	10.5	9.4	8.2	5.0	210.
LXS-D-12-R	16.0	14.0	11.9	8.0	260.
LXS-E-12-R	21.0	18.0	15.0	12.5	320.
LXS-EE-12-R	32.0	27.0	22.0	16.0	420.
LXS-7-12-OV-R**	40.0	36.0	30.0	23.0	535.
LXS-8-12-OV-R**	50.0	45.0	40.0	34.0	580.

15 VOLTS ±5% SINGLE OUTPUT

MODEL	MAX. AMPS AT AMBIENT OF:				PRICE
	40°C	50°C	60°C	71°C	
LXS-A-15-R	2.4	2.0	1.6	1.3	\$ 95.
LXS-B-15-R	3.2	2.8	2.5	1.5	130.
LXS-4-15-R	4.0	3.5	2.8	2.3	145.
LXS-C-15-R	6.0	5.6	5.1	4.5	160.
LXS-CC-15-R	9.5	8.6	7.4	4.8	210.
LXS-D-15-R	14.0	12.3	10.4	7.5	260.
LXS-E-15-R	19.0	17.0	14.0	12.0	320.
LXS-EE-15-R	28.0	24.0	19.5	14.0	420.
LXS-7-15-OV-R**	36.0	32.0	26.0	20.0	535.
LXS-8-15-OV-R**	45.0	41.0	36.0	30.0	580.

**Built-in continuously adjustable overvoltage protection crowbars output
when trip level is exceeded. Included on all LX-7, LX-8 models.

SERIES. NOW AVAILABLE IN SIZES.

20 VOLTS $\pm 5\%$ SINGLE OUTPUT

MODEL	MAX. AMPS AT AMBIENT OF:				PRICE
	40°C	50°C	60°C	71°C	
LXS-CC-20-R	7.7	7.2	6.5	4.4	\$210.
LXS-D-20-R	11.5	10.2	8.6	6.8	260.
LXS-E-20-R	15.0	13.0	10.5	7.0	320.
LXS-EE-20-R	22.0	18.5	14.5	10.0	420.
LXS-7-20-OV-R**	28.0	25.0	20.5	15.5	535.
LXS-8-20-OV-R**	32.0	29.0	25.0	17.0	580.

24 VOLTS $\pm 5\%$ SINGLE OUTPUT

MODEL	MAX. AMPS AT AMBIENT OF:				PRICE
	40°C	50°C	60°C	71°C	
LXS-CC-24-R	6.8	6.4	5.7	4.4	\$210.
LXS-D-24-R	10.0	8.8	7.5	6.0	260.
LXS-E-24-R	13.0	11.0	9.5	6.0	320.
LXS-EE-24-R	19.0	16.5	13.0	9.5	420.
LXS-7-24-OV-R**	25.0	22.0	18.0	14.0	535.
LXS-8-24-OV-R**	30.0	27.0	23.5	17.0	580.

28 VOLTS $\pm 5\%$ SINGLE OUTPUT

MODEL	MAX. AMPS AT AMBIENT OF:				PRICE
	40°C	50°C	60°C	71°C	
LXS-CC-28-R	6.0	5.6	5.0	4.3	\$210.
LXS-D-28-R	9.0	8.0	6.8	5.5	260.
LXS-E-28-R	11.0	10.0	8.5	5.5	320.
LXS-EE-28-R	17.0	15.0	12.0	9.0	420.
LXS-7-28-OV-R**	22.0	19.5	16.0	12.5	535.
LXS-8-28-OV-R**	28.0	25.5	22.5	17.0	580.

± 15 TO ± 12 VOLTS DUAL OUTPUT ⁽¹⁾

MODEL	ADJ. VOLT. RANGE VDC	MAX. AMPS AT AMBIENT OF:				PRICE
		40°C	50°C	60°C	71°C	
LXD-3-152-R	± 15	0.400	0.370	0.340	0.300	\$ 90.
	to ± 12	0.400	0.370	0.340	0.300	
LXD-A-152-R	± 15	1.0	1.0	0.9	0.7	130.
	to ± 12	0.8	0.8	0.7	0.6	
LXD-B-152-R	± 15	1.6	1.4	1.2	0.7	160.
	to ± 12	1.4	1.3	1.1	0.6	
LXD-C-152-R	± 15	2.5	2.3	1.9	1.5	170.
	to ± 12	2.0	1.8	1.5	1.2	
LXD-CC-152-R	± 15	4.0	3.7	3.2	2.4	255.
	to ± 12	3.0	2.7	2.3	1.8	
LXD-D-152-R	± 15	6.2	5.6	4.9	4.0	300.
	to ± 12	4.5	4.1	3.7	3.0	
LXD-EE-152-R	± 15	12.5	11.0	9.0	7.0	455.
	to ± 12	10.0	9.0	7.8	6.0	

Overvoltage protector accessory available for all models without built-in overvoltage protection.

(1) ± 15 to ± 12 and ± 6 to ± 3 volts are each dual tracking outputs; dual outputs can be connected in series for 30-24 volts and 12-6 volts, respectively.

± 6 TO ± 3 VOLTS DUAL OUTPUT ⁽¹⁾

MODEL	ADJ. VOLT. RANGE VDC	MAX. AMPS AT AMBIENT OF:				PRICE
		40°C	50°C	60°C	71°C	
LXD-B-062-R	± 6	2.7	2.4	1.9	1.4	\$170.
	to ± 3	2.1	2.0	1.6	1.2	
LXD-C-062-R	± 6	3.5	3.3	2.7	1.7	180.
	to ± 3	2.6	2.4	1.9	1.3	

5 VOLTS $\pm 5\%$, ± 15 TO ± 12 VOLTS TRIPLE OUTPUT

MODEL	ADJ. VOLT. RANGE VDC	MAX. AMPS AT AMBIENT OF:				PRICE
		40°C	50°C	60°C	71°C	
LXT-D-5152-R	5 $\pm 5\%$ *	12.0	11.5	11.0	9.5	\$395.
	± 15	3.1	2.7	2.2	1.7	
	to					
	± 12	2.3	2.0	1.7	1.3	

*5 volt output has fixed overvoltage protection at 6.8V $\pm 10\%$. ± 15 to ± 12 output is dual tracking output.

NEW LX-7 DESIGNED TO MEET MIL ENVIRONMENTAL SPECIFICATIONS.

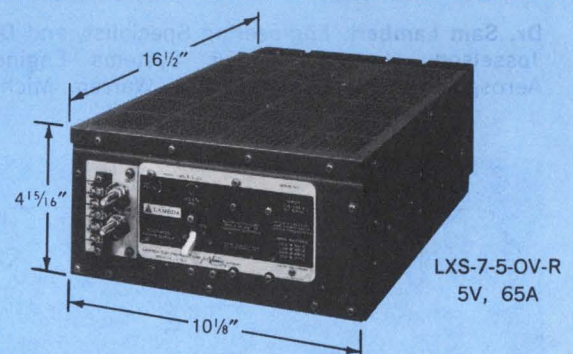

\$535
5-YEAR GUARANTEE

Send for free copy of
1974 Power Supply Catalog and Application Handbook



LAMBDA
ELECTRONICS CORP.

A *Yanaco* Company

MELVILLE, NEW YORK 11746 515 Broad Hollow Road Tel. 516-694-4200 ARLINGTON HEIGHTS, ILL. 60005 2420 East Oakton St., Unit Q Tel. 312-593-2550 NORTH HOLLYWOOD, CALIF. 91605 7316 Varna Ave. Tel. 213-875-2744 MONTREAL, QUEBEC 100C Hymus Blvd., Pointe Claire, Quebec 730 Tel. 514-697-6520 HIGH WYCOMBE, BUCKS, ENG. Abbey Barn Road, Wycombe Marsh Tel. High Wycombe 36386/7/8 ORSAY, FRANCE 91 Gometz le Chatel. ACHERN-FAUTENBACH, W. GERMANY Im. Holzbosch 14 Tel. 078-41-5527

INFORMATION RETRIEVAL NUMBER 32

Linear systems analysis simplified:

State-space equations, manipulated by a Fortran program, give root-locus, system zeros, Bode-plot and time response.

To simplify linear analysis regardless of system complexity, use the state-space approach. A simple computer program, written to manipulate state equations in matrix form, provides the classical analysis tools: root-locus, Bode plots and step and ramp responses.

The rules for obtaining these diagrams are well known; however, the complexity of the system to be analyzed often makes their manual calculation, with conventional transfer-function methods, difficult. The simplicity of the Linear Systems Analysis Program results from the use of a small input subroutine that transmits the elements of the state matrices to the rest of the program.

The program is designed for interactive use on a time-sharing terminal. The interactive feature allows the user to select the type of analysis desired, the magnitude and range of the parameter being analyzed and the output format.

To work with the program, the user must first

Dr. Sam Lambert, Engineering Specialist, and **Dr. Robert Josselson**, Lead Electronics Systems Engineer, LTV Aerospace Corp., P.O. Box 909, Warren, Mich. 48090.

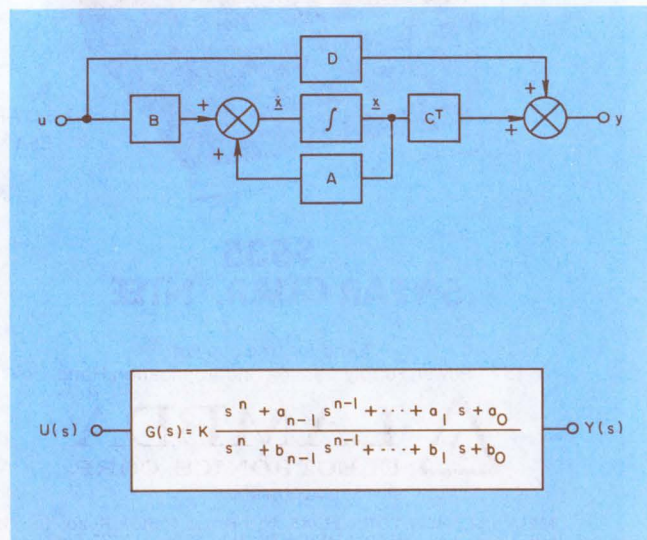

1. Linear systems analysis program uses the state-space equivalent of transfer functions. Elements of the A, B, D and C^T matrices constitute the input.

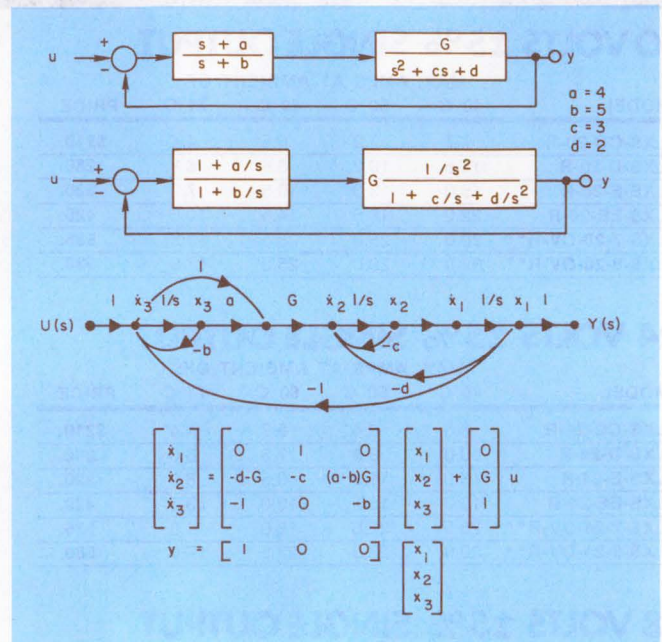

2. Conversion of the system block diagram to a signal-flow graph lets you find the matrix elements by inspection. Numerator and denominator are divided by the highest power in s to give the flow graph. The state-space equations relate the integrator inputs to the forcing function and the integrator outputs.

```

00100 SUBROUTINE SVEQ
00110 DIMENSION A(20,20),B(20,1),CT(1,20),D(1,1)
00120 COMMON A,B,CT,D,DIM,N
00130C SUPPLY VARIABLE TO BE INVESTIGATED HERE
00140 COMMON G
00150 DO 1 I=1,20
00160 B(I,1)=0.
00170 CT(1,I)=0.
00180 DO 1 J=1,20
00190 A(I,J)=0.
00200C SUPPLY PARAMETERS AND STATE MATRIX ELEMENTS HERE
00210 XA=4.
00220 XB=5.
00230 XC=3.
00240 XD=2.
00250 A(1,2)=1.
00260 A(2,1)=-XD-G
00270 A(2,2)=-XC
00280 A(2,3)=(XA-XB)*G
00290 A(3,1)=-1.
00300 A(3,3)=-XB
00310 B(2,1)=G
00320 B(3,1)=1.
00330 CT(1,1)=1.
00340 D(1,1)=0.
00350 N=3
00360 RETURN
00370 END
    
```

3. Program input is through subroutine SVEQ. When called, SVEQ calculates the elements of matrices A, B, C^T and D and provides the data to the main program.

convert the system block diagram, or transfer function, to state equations (see box). The general state-space representation of a linear system (Fig. 1) is

$$\begin{aligned} \dot{\underline{x}} &= \underline{A}\underline{x} + \underline{B}u \\ \underline{y} &= \underline{C}^T \underline{x} + \underline{D}u, \end{aligned} \quad (1)$$

which is equivalent to the classical transfer function¹

$$\frac{Y(s)}{U(s)} = G(s) = \underline{C}^T (s\mathbf{I} - \underline{A})^{-1} \underline{B} + \underline{D}. \quad (2)$$

What are state variables?

State variables and state equations describe linear systems. The values of the variables at any instant, $t = t_0$, describe the history of the system to time t_0 . Knowledge of the initial state, $\underline{x}(t_0)$, together with subsequent values of the input completely specify the system behavior for all $t > t_0$.

With no external inputs, the state of the linear system can be described by a set of first-order linear equations:

$$\begin{aligned} \dot{x}_1 &= a_{11}x_1 + a_{12}x_2 + \dots + a_{1n}x_n \\ \dot{x}_2 &= a_{21}x_1 + a_{22}x_2 + \dots + a_{2n}x_n \\ &\vdots \\ \dot{x}_n &= a_{n1}x_1 + a_{n2}x_2 + \dots + a_{nn}x_n \end{aligned}$$

The variables are the state variables, and the equations are referred to as state equations.

The state equations can be written in matrix notation as

$$\frac{d}{dt} \underline{x} = [\underline{A} \underline{x} + \underline{B} \underline{u}],$$

where the matrix \underline{B} accounts for external inputs or signals u_1, u_2, \dots, u_k . In addition the output y is given by the equation

$$y = \underline{C}^T \underline{x} + \underline{D} u.$$

in which matrices \underline{C}^T and \underline{D} relate the output to the state variables and forcing function, respectively.

If you represent these equations by their signal-flow-graph equivalent, the relation to actual circuits becomes apparent. The output of each integrator represents one state variable. A linear sum of the variables and the forcing function gives the output y .

There is no one-to-one relation between the state variables and a given transfer function; many state equations can represent a single transfer function. However, you can easily find a set of suitable state equations for the general transfer function

$$Y(s) = K \frac{s^n + a_{n-1}s^{n-1} + \dots + a_0}{s^n + b_{n-1}s^{n-1} + \dots + b_0} U(s).$$

Divide numerator and denominator by the largest power of s to get

$$Y(s) = K \frac{1 + \frac{a_{n-1}}{s} + \dots + \frac{a_1}{s^{n-1}} + \frac{a_0}{s^n}}{1 + \frac{b_{n-1}}{s} + \dots + \frac{b_1}{s^{n-1}} + \frac{b_0}{s^n}} U(s).$$

The program calculates the system root locus, or root contour, by repeatedly finding the eigenvalues of the \underline{A} matrix as any parameter is varied. The frequency response is merely the algebraic evaluation for the magnitude and the angle of the expression on the righthand side of Eq. 2. The system transmission zeros are found by solving a generalized eigenvalue problem.² The time response is obtained by the numerical integration of Eq. 1, with use of a fourth-order Runge-Kutta method that includes Gill's coefficients.³

The signal-flow diagram shown represents the equation. The loops correspond to the denominator coefficients; the forward paths correspond to the numerator coefficients.

From the diagram, we also find that the state equations are as follows:

$$\frac{d}{dt} \begin{bmatrix} x_1 \\ x_2 \\ \vdots \\ x_{n-1} \\ x_n \end{bmatrix} = \begin{bmatrix} 0 & 1 & 0 & \dots & 0 & 0 \\ 0 & 0 & 1 & \dots & 0 & 1 \\ \vdots & \vdots & \vdots & \ddots & \vdots & \vdots \\ 0 & 0 & 0 & \dots & 1 & 0 \\ -b_0 & -b_1 & -b_2 & \dots & -b_{n-2} & -b_{n-1} \end{bmatrix} \begin{bmatrix} x_1 \\ x_2 \\ \vdots \\ x_{n-1} \\ x_n \end{bmatrix} + \begin{bmatrix} 0 \\ 0 \\ \vdots \\ 0 \\ K \end{bmatrix} u$$

and

$$y = [(a_0 - b_0)(a_1 - b_1)(a_2 - b_2) \dots (a_{n-1} - b_{n-1})]$$

$$\times \begin{bmatrix} x_1 \\ x_2 \\ \vdots \\ x_{n-1} \\ x_n \end{bmatrix} + K u.$$

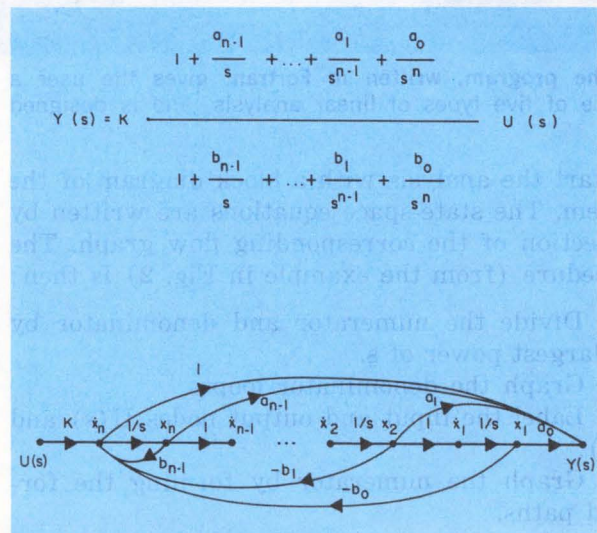

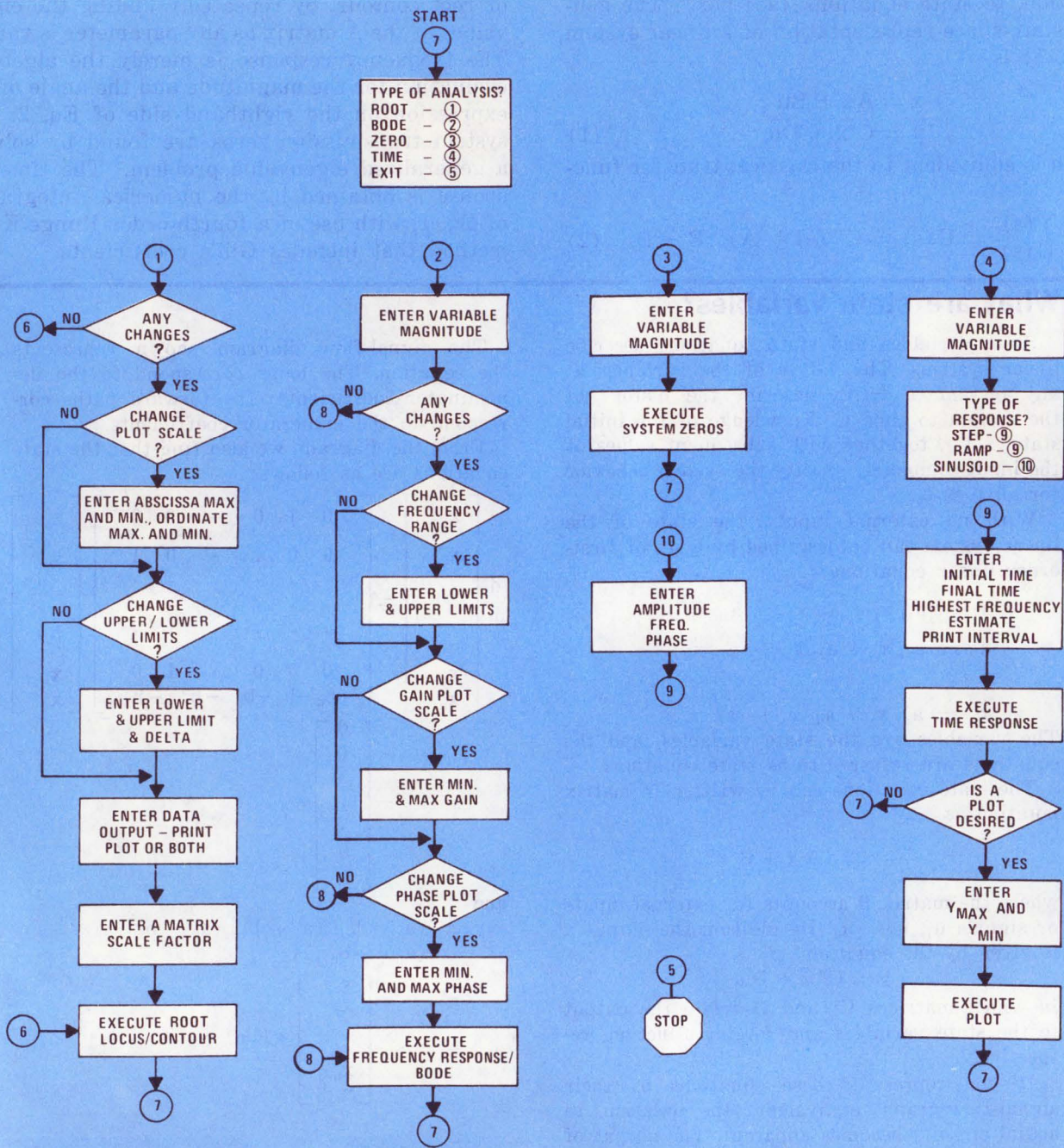

4. The program, written in Fortran, gives the user a choice of five types of linear analysis, and is designed

to be interactive with the user. ROOT, BODE, ZERO and TIME are the principal subroutines.

Start the analysis with a block diagram of the system. The state-space equations are written by inspection of the corresponding flow graph. The procedure (from the example in Fig. 2) is then:

1. Divide the numerator and denominator by the largest power of s .
2. Graph the denominator loops.
3. Label the input and output nodes $U(s)$ and $Y(s)$.
4. Graph the numerator by forming the forward paths.
5. Label the outputs of the integrators as

states x_1 , x_2 and x_3 , etc., and the inputs as \dot{x}_1 , \dot{x}_2 and x_3 , etc.

6. Write the state equations from the graph. The state equations

$$\dot{x}_1 = x_2, \quad (3a)$$

$$\dot{x}_2 = (-d-G)x_1 - cx_2 + (a-b)Gx_3 + Gu, \quad (3b)$$

and

$$\dot{x}_3 = -x_1 - bx_3 \quad (3c)$$

are derived from the signal flow-graph, as is the expression for the output $y = x_1$. (3d)

Modified subroutines for use with program

Original subroutine	Modified version	Function performed by modified version
GMSUB	GCMSBC	Finds a complex matrix that is the difference of two complex matrices.
GMPRD	GCMPAC	Finds a complex matrix that is the result of the product of a complex matrix multiplied by a real matrix.
GMPRD	GCMPBC	Similar to GCMPAC, except that the complex output matrix is the result of the product of a real matrix multiplied by a complex matrix.
SMPY	CSGMP	Finds a complex matrix by multiplying a real matrix by a complex scalar.
SMPY	SGMP	Finds a real matrix that is the product of a scalar and a real matrix.
MINV	CCMINV	Calculates the complex matrix inverse of a complex matrix.
DGELG	DGELG	No modification required. Solves a system of general simultaneous linear equations by Gauss elimination.
GMADD	RMADD	A double precision version of the matrix addition subroutine GMADD
GMTRA	GMTRA	A double precision version of the matrix transpose subroutine GMTRA.
GMPRD	GMPRD	A double precision version of the general matrix product subroutine.
SMPY	GSMPY	A double precision version of the scalar and real-matrix product subroutine SMPY.
HSBG	HSBG	A double-precision version of subroutine HSBG, which reduces a real matrix to almost triangular form.
ATEIG	ATEIG	A double precision version of ATEIG, which finds the eigenvalues of a real, almost triangular matrix.
DRAW	DRAW	No modification required.

Note: The modified subroutines can be derived from the original subroutines (from IBM) or from another source.

There are many terms in the second row of the A matrix because the numerator and denominator of the first subsystem are of the same order. Therefore the derivative of the state variable x_3 is coupled to the output of a unity transmission branch.

From the diagram, we see that

$$\dot{x}_2 = -d x_1 - c x_2 + G (\dot{x}_3 + a x_3) \quad (4)$$

in which the term in the parenthesis represents the input to branch G.

Replacement of \dot{x}_3 in Eq. 4 by the value in Eq. 3c gives

$$\dot{x}_2 = -c x_2 - d x_1 + G (-x_1 - b x_3 + u + a x_3), \quad (5)$$

which in turn is simplified to obtain the final result, Eq. 3b.

These manipulations put the expression for x_2 in state-space form—that is, the righthand

side contains only the state variables and, if needed, the input signal; the lefthand side contains derivatives of the state variables.

Program the inputs

The matrix elements, derived from the signal-flow diagram, must now be placed or calculated in subroutine SVEQ. The systems analysis program calls on SVEQ to obtain matrix elements. SVEQ, in turn, may use either values or expression for the nonzero elements of the state matrices. A typical SVEQ for the system in Fig. 2 is listed in Fig. 3. For the example shown, the problem parameters $a, b, c,$ and d have been replaced by variables XA, XB, XC and XD . These conform to the upper case alphabet of Fortran but do not conflict with the matrix array names A, B, C and D . The variable to be investigated, $G,$

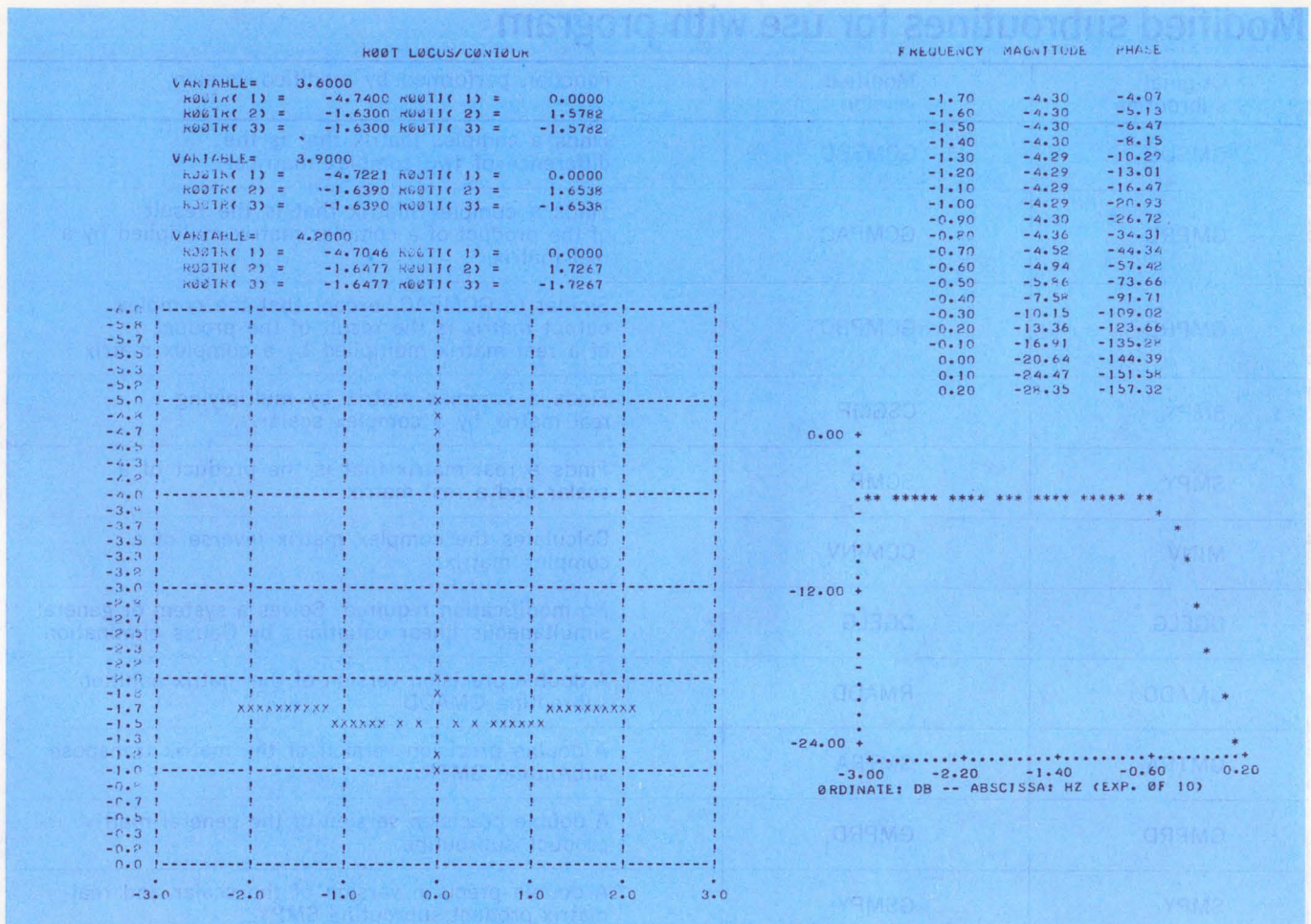

5. Sample outputs from ROOT and BODE attest to the versatility of the program. The root-locus program uses repeated solutions for the eigenvalues of the A-matrix

to plot root-locus or root-contour data. Algebraic evaluation of Eq. 2 for magnitude and phase gives the frequency response.

is placed in common storage. As shown, the system parameters and nonzero elements of the state matrices are used to create the SVEQ subroutine. The program is now ready to run.

Once the program is started, the user can choose from four analyses: root locus, Bode response, system zeros or time-domain response. Based upon the analysis chosen, the program asks for further information, as shown in the flow chart (Fig. 4). After the analysis is completed, the user may repeat it for a different variable range, or he may choose another type of analysis or terminate the program.

The user investigates the effect of a second parameter by removing the first parameter from COMMON, putting in the second parameter and assigning a value to it. For example: To investigate the variable A, change statements 140 and 210 in Fig. 3 to 140 COMMON XA and 210 G = 3.9. G is now set to a nominal value of 3.9.

Sample outputs for the system of Fig. 2 are shown in Fig. 5.

The Linear Systems Analysis Program is written as four major subroutines:

1. ROOT. Performs root locus and root con-

tour analysis and uses the A matrix only.

2. BODE. Analyzes the frequency response. Uses all four matrices to give phase and gain data.

3. ZERO. Calculates the system zeros and constant multiplier based on the theorems in Ref. 1. All four matrices are used.

4. TIMEDM. Provides the time response of the system to step, ramp or sine-wave input.

The program also uses a number of IBM subroutines, several of which must be altered (see table) to use complex arithmetic or to give greater precision. The plotting procedure used with ROOT is part of that subroutine. However, a standard routine, DRAW, produces the output for frequency-response and time-domain data. Any available subroutine can be substituted, so long as the form is

DRAW (X, Y, N, YMAX),

and the parameters are the following:

- X—An array that contains abscissa values and scaling parameters.
- Y—An array that contains ordinate values and scaling parameters.
- N—The number of data points to be plotted.

YMAX—Maximum value to be plotted on Y axis.

X(N+1)—Value of abscissa at lower left-hand corner.

X(N+2)—Abscissa scale factor (units/character position)

Y(N+1)—Value of ordinate at lower left-hand corner.

Y(N+2)—Ordinate scale factor (units/line).

The program execution begins in the mainline portion with a request to the user terminal for the type of analysis desired. The user responds with a key word: ROOT, BODE, ZERO, TIME or

EXIT. This response selects the analysis through a transfer to the appropriate subroutine. Subsequent dialogue allows the user to specify such factors as the type of output and the range or magnitude of the variable to be investigated. ■■

References:

1. Saucedo, R., and Schiring, E., "Introduction to Continuous and Digital Control Systems," The Macmillan Co., New York, N.Y., 1968, pp. 587-591.
2. Kaufman, I., "On Poles and Zeros of Linear Systems," *IEEE Transactions on Circuit Theory*, Vol. CT-20, No. 2, March, 1973, pp. 93-101.
3. Rosko, J., "Digital Simulation of Physical Systems," Addison-Wesley Publishing Co., Reading, Mass., 1972, pp. 190-197.

Fortran program for linear systems analysis

Initialization and startup

```
DATA ND,NW,ZE,EX,II/'R0 ','B0 ','ZE ','EX ','II '
ASSIGN 3 TO NREPLY
CALL REENIR(NREPLY)
TYPE 10
10 FORMAT(IX,'LINEAR SYSTEMS ANALYSIS PROGRAM',/)
TYPE 11
11 FORMAT(IX,'QUESTIONS OR COMMENTS SHOULD BE DIRECTED TO:')
TYPE 12
12 FORMAT(IX,'S. LAMBERT (X7193) OR DR. JUSSELSØN (X7126)')
TYPE 13
13 FORMAT(IX,' NOTE: USE "KEENIEK" TO RE-START AFTER "BREAK"',
//)
3 TYPE 1
1 FORMAT(IX,'TYPE OF ANALYSIS (ROOT,BODE,ZERO,TIME,EXIT)?',/)
ACCEPT 2, NREPLY
2 FORMAT(A2)
IF(NREPLY.EQ.N0) GO TO 5
IF(NREPLY.EQ.N6) GO TO 6
IF(NREPLY.EQ.ZE) GO TO 9
IF(NREPLY.EQ.II) GO TO 14
GO TO 4
5 CALL ROOT
GO TO 3
6 CALL BODE
GO TO 3
9 CALL ZERO
GO TO 3
14 CALL TIME
GO TO 3
4 CONTINUE
STOP
END
```

Input data subroutine (for example shown in Fig. 2)

```
SUBROUTINE SVEC
DIMENSION A(20,20),B(20,1),CT(1,20),DJ0(1,1)
COMMON A,B,CT,DJ0,N
C SUPPLY VARIABLE TO BE INVESTIGATED HERE
COMMON G
DO 1 J=1,20
B(1,J)=0.
CT(1,J)=0.
DO 1 J=1,20
1 A(1,J)=0.
C SUPPLY PARAMETERS AND STATE MATRIX ELEMENTS HERE
XA=4.
XB=5.
XC=3.
XD=2.
A(1,2)=1.
A(2,1)=-XD-G
A(2,2)=-XC
A(2,3)=(XA-XB)*G
A(3,1)=-1.
A(3,3)=-XB
B(2,1)=G
B(3,1)=1.
CT(1,1)=1.
DJ0(1,1)=0.
N=3
RETURN
END
```

Root locus analysis

```
SUBROUTINE ROOT
DOUBLE PRECISION BAUX,N00TR,N00T1
DIMENSION BB(400)
DIMENSION A(20,20),BAUX(400),N00TR(20),N00T1(20),JANA(20)
DIMENSION B(20,1),CT(1,20),DJ0(1,1)
DIMENSION OUL(61),YPR(7)
DIMENSION XYAKRY(37,61)
DIMENSION AI(20,20)
COMMON A,B,CT,DJ0,N,N00D
COMMON VAR
COMMON /CUMSUB/BB,AT
REAL NU
DATA YES,N0/'YE ','N0 '
DATA BLANK,ANG/' ','X '
DATA BAK,DASH/' ','-'
41 FORMAT(///20X,19H ROOT LOCUS/CONTIQUH)
42 FORMAT(1H ,F8.1,1X,61A1)
47 FORMAT(1H ,9X,61H.
*)
4R FORMAT(1H ,1X,7F10.1)
IXSCL=37
XSCL=IXSCL
GRYMIN=0.
GRYMAX=10.
GRXMIN=0.
GRXMAX=10.
XLL=0.
ASCALE=1.
UL=10.
DELTA=.
511 TYPE 512
512 FORMAT(IX,'ANY CHANGES ? (YES,N0)',/)
ACCEPT 501, NREPLY
IF(NREPLY.EQ.N0) GO TO 513
502 TYPE 500
500 FORMAT(IX,'CHANGE PLOI SCALE ? (YES,N0)',/)
ACCEPT 501, NREPLY
501 FORMAT(A2)
IF(NREPLY.EQ.N0) GO TO 505
TYPE 503
503 FORMAT(IX,'ENTER ABSCISSA MAX & MIN; ORDINATE MAX & MIN',/)
ACCEPT 504, GRYMAX, GRYMIN, GRXMAX, GRXMIN
504 FORMAT(E20.7)
505 TYPE 506
506 FORMAT(IX,'CHANGE LOWER OR UPPER LIMIT ? (YES,N0)',/)
ACCEPT 501, NREPLY
IF(NREPLY.EQ.N0) GO TO 507
TYPE 507
507 FORMAT(IX,'ENTER LOWER & UPPER LIMIT AND DELTA',/)
ACCEPT 504, XLL, UL, DELTA
508 TYPE 509
509 FORMAT(IX,'DATA OUTPUT -- PRINT, PLOT, OR BOTH? (1,2,3)',/)
ACCEPT 510, PPH
TYPE 516
516 FORMAT(IX,'ENTER A MATRIX SCALE FACTOR',/)
ACCEPT 504, ASCALE
510 FORMAT(11)
513 CONTINUE
DO 200 ILR7=1,37
DO 200 ILC7=1,61
XYAKRY(ILR7, ILC7)=1.E+25
200 CONTINUE
N00D=0
DO 400 NN=1,20
N00TR(NN)=1.E+30
DO 10 I=1,20
DO 10 J=1,20
10 A(I,J)=0.
TYPE 41
NN=(UL-XLL)/DELTA+1
DO 20 II=1, NN
VAR=XLL
IF(PPH.EQ.2) GO TO 30
TYPE 104, VAR
104 FORMAT(IX,9HVARIABLE=,F10.4)
30 XLL=XLL + DELTA
CALL SVEC(A,B,CT,DJ0,N,N00D)
```



```

D0 1515 I=1,20
D0 1515 J=1,20
1515 A1(J,I)=A(I,J)
CALL ANKAY(2,N0KD,N0KD,20,20,BB,A1)
D0 515 IASS=1,400
515 HALX(IASS)=ASCALE+BB(IASS)
CALL HSBG(N0KD,BALX,N0KD)
CALL ATEIG(N0KD,BALX,N001K,N001I,IANA,N0KD)
D0 401 NN=1,N0KD
R001K(NN)=R001K(NN)/ASCALE
R001I(NN)=R001I(NN)/ASCALE
IF(FPH.EQ.2) G0 T0 50
TYPE 105,NN,R001K(NN),NN,R001I(NN)
105 F0RMA1(2X,'R001K(',I2,') =',F11.4,I3,'R001I(',I2,') =',F11.4)
R001K=R001K(NN)
R001I=R001I(NN)
XLX=(XSCL-1.)/ (GRXMAX-GRXMIN)*(R001A-GRXMIN)+1.50001
YLX=60./ (GRYMAX-GRYMIN)*(R001Y-GRYMIN)+1.50001
LX=XLX
LY=YLX
JF(LX.G1.IXSCL).OR.(LX.LI.1).OR.(LY.G1.6).OR.(LY.LI.1)
& G0 T0 201
XYAKRY(LX,LY)=ANG
201 C0NTINUE
401 C0NTINUE
IF(FPB.EQ.1) G0 T0 20
NKC=NKC+1
JF(NKC.NE.NK) G0 T0 20
N=IXSCL
NLL=TXSCL
15R XB=GRXMIN
L=1
J=1
R5 F=1-1
XPA=XB+F*(GRXMAX-GRXMIN)/(XSCL-1.)
D0 90 95 IX=1,61
95 0UT(IX)=BLANK
JF(M0D(-1,6),NE.0) G0 T0 97
D0 96 IXD=1,61
96 0UT(IXD)=UASH
97 D0 98 IXV=1,7
98 0UT(IXV-9)=BAK
0UT(31)=BAK
D0 202 I1TP=1,61
JF(XYAKRY(I,I1TP).EQ.ANG) G0 T0 203
G0 T0 202
203 0UT(I1TP)=ANG
202 C0NTINUE
TYPE 42,XPR,(0UT(I2),I2=1,61)
120 J=1+1
JF(I-NLL)R5,124,126
124 XPR=GRXMAX
G0 T0 90
126 TYPE 47
YPR(I)=GRYMIN
D0 130 K=1,5
130 YPR(KN1)+YPR(KN)+ (GRYMAX-GRYMIN)/6.
YPR(I)=GRYMAX
TYPE 48,(YPR(IP),IP=1,7)
20 C0NTINUE
RETURN
END

```

Bode plot analysis

```

SUBROUTINE BODE
COMPLEX CS,W1J,SM1,SM1B,GH,CX
COMPLEX DETC
DIMENSION XM1(100),PHI(100),W(100)
DIMENSION A(20,20),C1(1,20),B(20,1),U(400),AW(400),
& ANEG(400),G1W(400),G1J(400),SM1(400),
& SM1B(20,1),GH(1,1),U10(1,1)
COMMON A,B,C1,U10,N
COMMON VAR
COMMON /COMSUB/W,AW
EQUIVALENCE (W1J,SM1)
REAL N0
DATA YES,N0/'YE ','N0
TYPE 69
69 F0RMA1(1X,'ENTER VARIABLE MAGNITUDE:','/)
ACCEPT T0,VAR
70 F0RMA1(E20.7)
CALL SVEU
U10=U10(1,1)
M=N
FL=-2.
FU=3.
NDATA=(FU-FL)/.1+1.000001
JF(NDATA.GE.98) NDATA=98
PHI(NDATA+1)=-270.
PHI(NDATA+2)=9.
PHIMAX=90.
XM1(NDATA+1)=-60.
XM1(NDATA+2)=2.
XMIMAX=40.
25 TYPE 26
26 F0RMA1(1X,'ANY CHANGES ?','/)
ACCEPT 27,REPLY
27 F0RMA1(A2)
JF(REPLY.EQ.N0) G0 T0 37
TYPE 28
28 F0RMA1(1X,'CHANGE FREQUENCY RANGE ?','/)
ACCEPT 27,REPLY
JF(REPLY.EQ.N0) G0 T0 31
TYPE 29

```

```

29 F0RMA1(1X,'ENTER LOWER & UPPER LIMITS AS A POWER OF TEN:','/)
ACCEPT 30,FL,FL
NDATA=(FU-FL)/.1+1.000001
JF(NDATA.GE.98) NDATA=98
PHI(NDATA+1)=-270.
PHI(NDATA+2)=9.
PHIMAX=90.
XM1(NDATA+1)=-60.
XM1(NDATA+2)=2.
XMIMAX=40.
30 F0RMA1(E20.7)
31 TYPE 32
32 F0RMA1(1X,'CHANGE SCALE ON GAIN PLOT ?','/)
ACCEPT 27,REPLY
JF(REPLY.EQ.N0) G0 T0 34
TYPE 33
33 F0RMA1(1X,'ENTER MIN & MAX GAIN IN DB:','/)
ACCEPT 30,XMIMIN,XMIMAX
XMIDEL=(XMIMAX+XMIMIN)/50.
XM1(NDATA+1)=XMIMIN
XM1(NDATA+2)=XMIDEL
34 TYPE 35
35 F0RMA1(1X,'CHANGE SCALE ON PHASE PLOT ?','/)
ACCEPT 27,REPLY
JF(REPLY.EQ.N0) G0 T0 37.
TYPE 36
36 F0RMA1(1X,'ENTER MIN & MAX PHASE IN DEGREES:','/)
ACCEPT 30,PHIMIN,PHIMAX
PHIDEL=(PHIMAX+PHIMIN)/50.
PHI(NDATA+1)=PHIMIN
PHI(NDATA+2)=PHIDEL
37 W(NDATA+1)=FL
W(NDATA+2)=(FL-FL)/50.
D0 20 J=1,400
20 L(I)=0.
N1=N+1
D0 21 J=1,400,N+1
21 U(J)=1.
DET=0.
CS=(0.,1.)
F=FL
D0 2 J=1,NDATA
CALL ANKAY(2,N,N,20,20,AW,A)
D0 1 J=1,400
1 ANEG(I)=AW(I)
W2=.3-1416*10.**F
W2=-W2*W2
F=FL+.1*J
G0 T0 6
7 C0NTINUE
CALL GCMFAC(SM1,B,SM1B,N,N,1)
CALL GCMFBC(C1,SM1B,GH,1,N,1)
CX=GH(1,1)+D10X
XM1(J)=20.*AL0G10(CABS(CX))
PHI(J)=180./3.1416*ATAN2(AIMAG(CX),REAL(CX))
W1(J)=AL0G10(W2./3.1416)
2 C0NTINUE
TYPE 98
98 F0RMA1(1X,'FREQUENCY',' MAGNITUDE',' PHASE:','/)
TYPE 99,(W1(K1),XM1(K1),PHI(K1),K1=1,NDATA)
99 F0RMA1(1X,3F10.2)
CALL DRAW(W1,XM1,NDATA,XMIMAX)
TYPE 38
38 F0RMA1(1X,'ORDINATE: DB -- ABSCTISSA: HZ (EXP. OF 10):','/)
CALL DRAW(W1,PHI,NDATA,PHIMAX)
TYPE 39
39 F0RMA1(1X,'ORDINATE: DEG -- ABSCTISSA: HZ (EXP. OF 10):','/)
G0 T0 9
6 C0NTINUE
CALL SGMP(U,U10,W,N,N)
CALL CSGMP(U10,C1,CS,N,N)
CALL GCMFBC(ANEG,G1J,SM1,N,N)
CALL GCMFAC(SM1,N,N,DETC)
G0 T0 7
9 C0NTINUE
RETURN
END

```

Calculation of system zeros

```

SUBROUTINE ZERO
DIMENSION A(20,20),B(20,1),C1(1,20),A1(400)
DIMENSION IANA(20),R2(20,1),A1J(400),BB(400)
DIMENSION ABRR(20),ABR1(20),BP(20,1),C1(400)
DIMENSION K3(1,20),A1JS(400),AA(400)
DIMENSION AK1(400),AB1(361),U10(1,1)
DIMENSION KJA(20,20),KJB(20,1),KJC1(1,20),KJDU(1,1)
DOUBLE PRECISION ABT,C0NS1
DOUBLE PRECISION ARI,A2B,C1,AT, R2,A1J,ABRR,ABK1
DOUBLE PRECISION BP,C1,K3,A1JS, AA,1,1S1
COMPLEX S,CPR0D,CZEK0(400),DETC
COMMON KJA,KJB,KJC1,KJDU,N0KD
COMMON VAR
EQUIVALENCE (C1(1), A1JS(1)),(AA(1),A1J(1),AB1(1))
TYPE 69
69 F0RMA1(1X,'ENTER VARIABLE MAGNITUDE:','/)
ACCEPT T0,VAR
70 F0RMA1(E20.7)
CALL SVEU
N0KD1=N0KD+1
N0KD2=N0KD+N0KD
CPR0D=1.
S=0.
N1=N0KD2+2*N0RD+1
N0RD3=N0KD2+N0RD
N0RD1=N0RD-1
C0NST=1.D0
TST=1.D-12
EPS=1.E-16

```



```

349 D0 1 J=1,N0RD2
A1(J)=0.
AK1(J)=0.00
IF (M0D(J,N0RD1).NE.1) G0 T0 1
A1(J)=1.00
AR1(J)=1.00
1 C0NTINUE
D0 101 J=1,20
R3(J)=0.
BP(J)=0.
B(J)=0.
CT(1,J)=0.
R2(J)=0.
ABRR(J)=0.
ABR1(J)=0.
D0 101 J=1,20
101 A(1,J)=0.
D0 103 J=1,400
C1(J)=0.
103 AA(J)=0.
D0 171 L=1,20
B(L)=DBLE(RJBL(L,1))
171 CT(1,L)=DBLE(RJCT(1,L))
D10(1,1)=DBLE(KJDI0(1,1))
CALL ARRAY(2,N0RD,N0RD,20,20,BB,KJA)
D0 172 LL=1,N0RD2
172 AA(LL)=DBLE(BB(LL))
IF (D10(1,1).NE.0.) G0 T0 1470
CALL GMPY(A1,-C0NST,CT,N0RD,N0RD)
CALL RMADD(AA,CT,A1,N0RD,N0RD)
CALL DGELG(ART,A1,N0RD,N0RD,EPS,IER)
D0 550 JK=1,N0RD2
IF (DABS(ART(JK))-LE.TST) ART(JK)=0.00
550 C0NTINUE
D0 78 JK=1,N0RD2
78 A1(JK)=ART(JK)
CALL GMPRD(A1,B,R2,N0RD,N0RD,1)
CALL GMPRD(CT,R2,T,1,N0RD,1)
IF (T.NE.0.00) G0 T0 279
C0NST=C0NST+.13754
G0 T0 349
279 CALL GMPRD(CT,A1,R3,1,N0RD,N0RD)
CALL GMPRD(R2,R3,A1J,N0RD,1,N0RD)
T=-1./T
CALL GMPY(A1J,T,A1J,N0RD,N0RD)
D0 630 TK=1,N0RD2
X=A1(TK)
Y=A1J(TK)
Z=X+Y
630 A1JS(TK)=DBLE(Z)
BMAX=DABS(B(1,1))
1SAV=1
D0 3 J=2,N0RD
BSUB=DABS(B(J,1))
IF (BSUB.LE.BMAX) G0 T0 3
BMAX=BSUB
1SAV=J
3 C0NTINUE
BDIV=B(1SAV,1)
BP(1,1)=1.
BP(1SAV,1)=B(1,1)/BDIV
IF (1SAV.NE.1) G0 T0 5
D0 4 J=2,N0RD
4 BP(J,1)=B(J,1)/BDIV
G0 T0 8
5 IF (1SAV.EQ.N0RD) G0 T0 12
1SAVL=1SAV-1
1SAVD=1SAV+1
IF (1SAVL.EQ.1) G0 T0 33
D0 6 J=2,1SAVL
6 BP(J,1)=B(J,1)/BDIV
33 D0 7 J=1SAVL,N0RD
7 BP(J,1)=B(J,1)/BDIV
G0 T0 8
12 IF (N0RD .EQ. 2) G0 T0 8
D0 13 J=2,N0RD
13 BP(J,1)=B(J,1)/BDIV
R LAJ=1-N0RD
LRJ=1SAV-N0RD
D0 140 J=1,N0RD
LAJ=LAJ-N0RD
LRJ=LRJ+N0RD
1=A1JS(LAJ)
A1JS(LAJ)=A1JS(LBJ)
143 A1JS(LBJ)=1
1LA=0
1LB=N0RD*(1SAV-1)
D0 144 J=1,N0RD
1LA=1LA+1
1LB=1LB+1
T=A1JS(1LA)
A1JS(1LA)=A1JS(1LB)
144 A1JS(1LB)=1
N0RDL=N0RD-1
D0 9 I=1,N0RDL
IC=1+1
D0 9 J=1,N0RDL
JC=J+1
L=(JC-1)*N0RD
M=J*(J-1)*N0RDL
9 AHT(M)=A1JS(IC+L)-BP(IC,1)*A1JS(1+L)
CALL HSBG(N0RDL,AB1,N0RDL)
CALL ATEIG(N0RDL,AB1,ABRR,ABR1,IANA,N0RDL)
TYPE 750
750 F0RMAT(//2X,'ZER0S ARE:',27X,'DISREGARD IF 0.0 APPEARS HERE')
D0 20 J=1,N0RDL
DEN0R1=ABRR(J)*ABRR(J)+ABR1(J)*ABR1(J)
IF (ABS(DEN0R1).LE.1.E-10) G0 T0 21
ZER0R=C0NST+(ABRR(J)/DEN0R1)
ZER0I=(ABR1(J)/DEN0R1)
G0 T0 10
21 ZER0R=0.
ZER0I=0.
ABRR(J)=0.
ABR1(J)=0.
10 TYPE 11,ZER0R,ZER0I,ABRR(J),ABR1(J)
11 F0RMAT(2X,4E16.7))
ABRR(J)=ZER0R
ABR1(J)=ZER0I
20 C0NTINUE
G0 T0 1500
1470 I=-1.D0/D10(1,1)
CALL GMPN(LB,CT,A1JS,N0RD,1,N0RD)
CALL GMPY(A1JS,T,AK1,N0RD,N0RD)

```

```

CALL NMAUD(AA,AK1,A1JS,N0RD,N0RD)
CALL HSBG(N0RD,A1JS,N0RD)
CALL ATEIG(N0RD,A1JS,ABRR,ABR1,IANA,N0RD)
TYPE 760
760 F0RMAT(//2X,'ZER0S OF THE SYSTEM ARE:',/)
D0 39 J=1,N0RD
39 TYPE 111,ABRR(J),ABR1(J)
111 F0RMAT(2X,2E1R.7)
1500 D0 601 J=1,N0RD
ZER0(N0RD+J)=CMPLX(RJBF(1,1),0.)
ZER0(N0RD+1+J)=CMPLX(-RJCT(1,1),0.)
D0 601 J=1,N0RD
L=(J-1)*N0RD
M=J*(J-1)*N0RD
CZER0(M)=CMPLX(-RJA(J,1),0.)
IF (J-1.NE.0) G0 T0 601
CZER0(M)=S+CZER0(M)
601 C0NTINUE
CZER0(N1)=CMPLX(RJDI0(1,1),0.)
CALL CCMNV(CZER0,N0RD1,N0RD1,DETC)
DETR=REAL(DETC)
IF (DETR.NE.0.) G0 T0 602
S=S+.13579
G0 T0 1500
602 D0 607 J=1,N0RD
CZER0(J)=CMPLX(ABRR(J,0.)+CMPLX(0.,ABR1(J))
IF (CABS(CZER0(J)).LE.0.0001) G0 T0 607
CPR0D=CPR0D+(S-CZER0(J))
607 C0NTINUE
GAIN=DETR/REAL(CPR0D)
TYPE 112,GAIN
112 F0RMAT(//2X,'GAIN= ',E18.7,/)
RETURN
END

```

Computation of time response

```

SUBROUTINE TIMEDM
REAL K1(20),K2(20),K3(20),K4(20)
DIMENSION X(20),XD(20),XT(20),A(20,20),B(20,1),CT(1,20),DI0(1,1)
DIMENSION GG(102),AG(102)
COMMON A,B,CT,DI0,NINT,VAR
COMMON /XINTDM/ X,XD,U
DATA YES/'YE '/
TYPE 18
18 F0RMAT(1X,'ENTER VALUE OF VARIABLE',/)
ACCEPT 16,VAR
JENT=1
S2=SQRT(2.)
TYPE 20
20 F0RMAT(1X,'TIME DOMAIN RESPONSE: STEP=0,RAMP=1,SINUS0IU=2?',/)
ACCEPT 21,IU
LRAMP=(IU+IU+IU-6*IU+IU+11*IU-6)/(+6)
LRSIN=(IU+IU+IU-5*IU+IU+6*IU)/2
LRSJN=(IU+IU+IU-4*IU+IU+3*IU)/2
LRIPL=(IU+IU+IU-3*IU+IU+2*IU)/6
IF (IU.NE.2) G0 T0 26
TYPE 27
27 F0RMAT(1X,'ENTER AMPLITUDE,FREQUENCY(HZ), AND PHASE(DEG)',/)
ACCEPT 16,AMP,FREQ,PHAZ
21 F0RMAT(J1)
26 TYPE 15
15 F0RMAT(1X,'ENTER INITIAL TIME',/)
ACCEPT 16,T0
16 F0RMAT(E20.7)
HS2=1./S2
TYPE 23
23 F0RMAT(1X,'ENTER FINISH TIME',/)
ACCEPT 16,TF
T=TO
TYPE 17
17 F0RMAT(1X,'ENTER ESTIMATE OF HIGHEST FREQUENCY',/)
ACCEPT 16,F
DI=1./100./F
TYPE 25,D1
25 F0RMAT(1X,'TIME INCREMENT=',F12.6)
N=(TF-T0)/D1
IPL=N/100
TYPE 24
24 F0RMAT(1X,'ENTER PRINT INTERVAL WHICH IS A MULTIPLE OF TIME INC
REMENT',/)
ACCEPT 16,PR
JPRDI=PR/D1+.5
D0 19 J=1,20
X(J)=0.
19 XD(J)=0.
U=1.*LSTEP+LRAMP*T+AMP*SIN(2.*3.1416*FREQ*T+PHAZ*3.1416/180.)*LRSJN
& +LIMPL*I.E+06
CALL SVE0
Y=DI0(1,1)*U
AG(1)=Y
IPL=1
GG(1)=I
TYPE 14
14 F0RMAT(//1X,'THE OUTPUT F0RMAT IS:',/5X,'TIME',/5X,
& 'STATES 1 THROUGH N',/5X,'SYSTEM OUTPUT Y',/)
TYPE 1,T,(X(J),I=1,NINT),Y
IF (NINT.GE.3) TYPE 28
28 F0RMAT(1X,' ')
1 F0RMAT(1X,1P5E15.6)
D0 33 I1=2,102
GG(I1)=1.E+20
33 AG(I1)=1.E+20
D0 2 I=1,N
IF (I.GE.2) LIMPL=0.
D0 3 J=1,NINT
3 XT(J)=X(J)
T=(I-1)*DT+T0
U=1.*LSTEP+LRAMP*T+AMP*SIN(2.*3.1416*FREQ*T+PHAZ*3.1415/180.)*LRSJN
& +LIMPL*I.E+06
CALL SVE0
CALL UPDATE

```



```

D0 4 J=1,NINT
4 K1(J)=DT*XD(J)
T=DT*(J)-.5*D1+T0
U=1.*LSTEP+LRAMP*T+AMP*SIN(2.*3.1416*FREQ*T+PHAZ*3.1416/180.)*LSIN
& +LIMPL*1.E+06
D0 5 J=1,NINT
5 X(J)=X(J)+.5*K1(J)
CALL UPDATE
D0 6 J=1,NINT
6 K2(J)=DT*XD(J)
D0 7 J=1,NINT
7 X(J)=X(J)
D0 8 J=1,NINT
8 X(J)=X(J)+K1(J)*(HS2-.5)+K2(J)*(1.-HS2)
CALL UPDATE
D0 9 J=1,NINT
9 K3(J)=DT*XD(J)
T=DT*(J)+T0
U=1.*LSTEP+LRAMP*T+AMP*SIN(2.*3.1416*FREQ*T+PHAZ*3.1416/180.)*LSIN
& +LIMPL*1.E+06
D0 10 J=1,NINT
10 X(J)=X(J)
D0 11 J=1,NINT
11 X(J)=X(J)-HS2*K2(J)+K3(J)*(1.+HS2)
CALL UPDATE
D0 12 J=1,NINT
12 K4(J)=DT*XD(J)
D0 13 J=1,NINT
13 X(J)=X(J)+K1(J)+(2.-S2)*K2(J)+(2.+S2)*K3(J)+K4(J)/6.
Y=0.
D0 22 J=1,NINT
22 Y=Y+CT(1,J)*X(J)
Y=Y+DIB(1,1)*U
IF(I.EQ.1) GO TO 2
IF(MOD(I),IPRDT).NE.0) GO TO 36
TYPE 1,T,(X(J),J=1,NINT),Y
IF(NINT.GE.3) TYPE 28
36 IF(N.LE.100) GO TO 34
IF(MOD(I),IPLT).NE.0) GO TO 35
34 JPLT=JPLT+1
IF(JPLT.GT.100) GO TO 35
AG(JPLT)=Y
0G(JPLT)=T
35 CONTINUE
2 CONTINUE
TYPE 29
29 FORMAT(IX,'IS A PLOT OF THE OUTPUT DESIRED ?','/)
ACCEPT 30,REPLY
30 FORMAT(A2)
IF(REPLY.NE.YES) GO TO 31
TYPE 32
32 FORMAT(IX,'ENTER THE MINIMUM AND MAXIMUM VALUES OF Y1','/)
ACCEPT 16,AG(101),YMAX
AG(102)=(YMAX-AG(101))/30.
0G(101)=T0
0G(102)=(TF-T0)/60.
CALL DRAW(0G,AG,100,YMAX)

```

```

31 CONTINUE
RETURN
END
SUBROUTINE UPDATE
DIMENSION A(20,20),B(20,1),CT(1,20),DJ(1,1),X(20),XD(20)
COMMON A,B,CT,DJ,NINT,VAR
COMMON /XINTDM/ X,XD,U
D0 4 J=1,NINT
XD(J)=0.
D0 4 J=1,NINT
4 XD(J)=A(J,J)*X(J)+XD(J)
D0 5 J=1,NINT
5 XD(J)=XD(J)+B(J,1)*U
RETURN
END

```

Array conversion, double to single subscript.

```

SUBROUTINE ARRAY(MODE,I,J,N,M,S,L)
DIMENSION S(1),D(1)
N=N-1
IF(MODE-1) 100,100,120
100 IJ=I+J+1
NM=N+J+1
D0 110 K=1,J
NM=NM-K
D0 110 L=1,I
IJ=IJ-1
NM=NM-1
110 D(NM)=S(IJ)
G0 10 140
120 IJ=0
NM=0
D0 130 K=1,J
D0 125 L=1,I
IJ=IJ+1
NM=NM+1
125 S(IJ)=D(NM)
130 NM=NM+1
140 RETURN
END

```

(See table for additional subroutines used.)

Use Deltrol Controls' series D solenoids where **DEPENDABILITY** is a must

Deltrol Series D solenoids are intended for use in quality applications such as business machines, tape recorders and industrial control equipment and are available in the widest range of sizes in the industry. These linear-type units are available in 12 basic sizes with enough variations available to match almost any application. Deltrol "D" - frame solenoids have a high efficiency factor which provides for a maximum starting force and fast plunger operation. Standard units are intended for Class A coil temperature operation, but units may also be ordered with Class B or F coil insulation for extra-high ambient operation. A molded nylon coil, standard on four units, improves heat dissipation while providing greater resistance to moisture, shock and rough handling. Available in a six to 240 volt, AC or DC coil voltage range, these moderately priced units are interchangeable with many competitive units. Options include push-mode units, spring returns, custom mounting frames, power-surge units and special coil treatment.

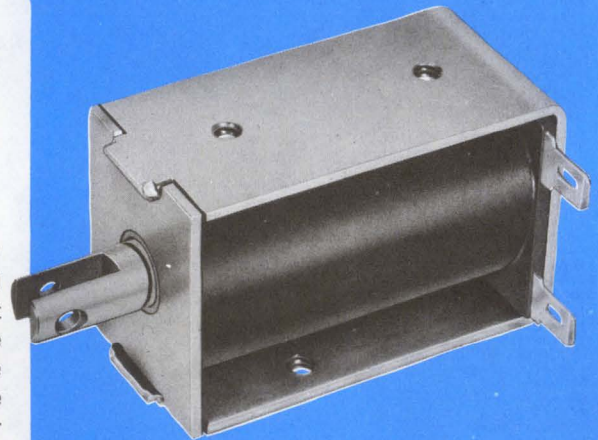

DELTRON
controls

Division Of Deltrol Corp.

2745 South 19th Street, Milwaukee, Wisconsin
53215, Phone (414) 671-6800, Telex 2-6871

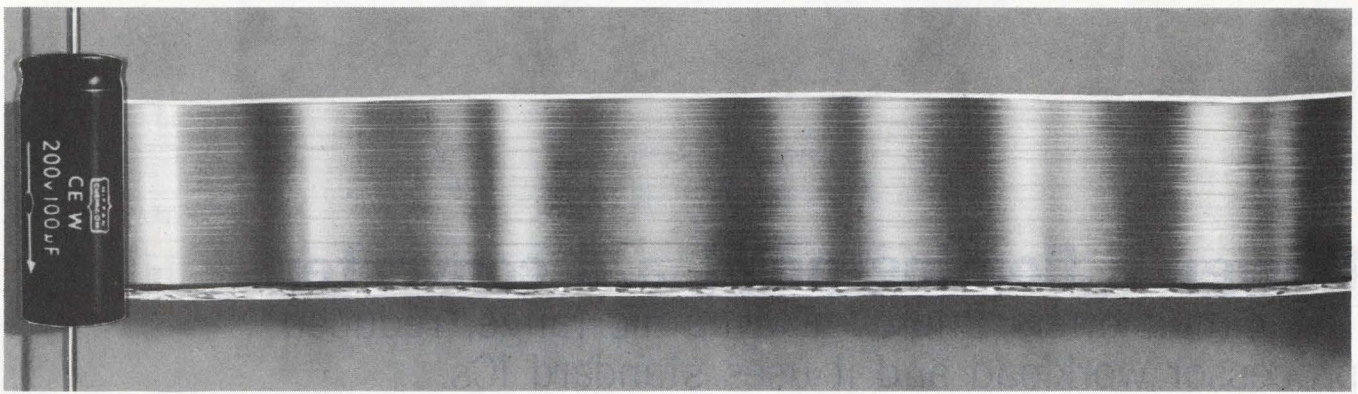

The world's largest manufacturer of miniature aluminum electrolytics wants to show you their etchings.

In the production process of electrolytic capacitors, the etching and forming of the foil is one of the most critical processes. The design of the foil directly affects performance and life.

This is why United Chemicon designs, etches and forms all its own foil and achieves complete quality control of every one of the over 60 million miniatures we sell each month. We know that we must use exactly the right type of foil to meet our customers' specific performance characteristics. That's why we welcome special, tough applications.

Now that you know more about our etchings, you should also know that our special machinery division designs, develops and builds all our machinery. Every capacitor is automatically aged and 100% tested.

This control guarantees an unparalleled degree of product uniformity, predictability and reliability of supply.

Shouldn't you know us?

Write, call 315/474-2954
or wire for full information
and latest technical bulletins.

6.3 to 500 WV, op temps from -40° to +85° C.
We solicit inquiries to your specs, as broader temperature ranges and performance characteristics are available.



United Chemicon.

World's largest manufacturer of miniature aluminum electrolytics. You should know us.

©1974 United Chemicon, Inc. 731 James Street Syracuse, New York 13203 315/474-2954 TELEX 937439

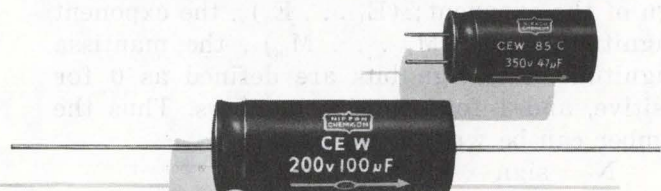

Design a floating-point a/d converter.

The circuit offers improved dynamic range, reduced processor workload and it uses standard ICs.

For today's computer-based systems, a floating-point analog-to-digital (a/d) converter makes processing easier and faster.

The converter is built with standard logic circuits and low-cost op amps. It provides a wider dynamic range, direct input to floating-point computer processors and simple interfacing to other systems that use floating-point arithmetic.

Applications that are well-suited for floating-point computation include the following:

- Digital filtering—in which the a/d converter is the input interface for floating-point digital or range adaptive filters.
- Process control—in which the converter is the input interface for on-line real-time control systems.
- Instrumentation—where the converter is the input sampler for measurement of electronic signals with a large dynamic range and for data logging, formatting, processing and display.
- Automated test stations—in which the converter is the input interface for automatic scaling of test signals. The setup allows on-line testing of devices that operate in different environments.

Defining the binary floating-point number

The single-precision, floating-point number system used by most general-purpose computers can be described by

$$N = (S_M S_E E_1 E_2 \dots E_q M_1 M_2 \dots M_m)_{flt}$$

S_M represents the sign of the number; S_E , the sign of the exponent; $(E_1 \dots E_q)_2$, the exponent magnitude; and $(M_1 \dots M_m)_2$, the mantissa magnitude. The sign bits are defined as 0 for positive, and 1 for negative numbers. Thus the number can be written as follows:

$$N = \text{sign} \times \text{mantissa} \times 2^{\text{sign} \times \text{exponent}}$$

$$= (1 - 2 S_M) \cdot (M_1 \dots M_m)_2 \times 2^{(1 - 2 S_E) (E_1 \dots E_q)_2}$$

James Heath, Adjunct Assistant Professor, and **Troy Nagle**, Associate Professor, Dept. of Electrical Engineering, Auburn University, Auburn, Ala. 36830

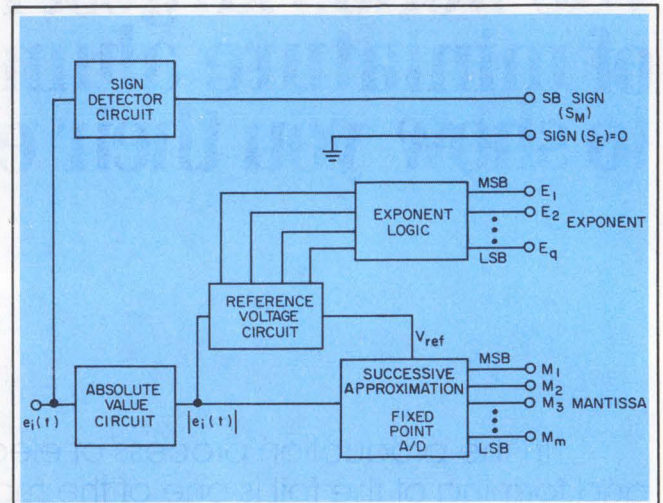

1. A floating-point a/d converter consists of a fixed-point a/d and a lot of auxiliary control circuitry.

Now that the number system is structured, you can define the dynamic range. Take the absolute value of the number with the largest magnitude and divide it by the magnitude of the smallest number. When you calculate dynamic range, assume that the mantissa has m bits and the exponent q bits. The word length of the number system then becomes

$$n = m + q + 2.$$

The dynamic range of the floating-point number system (DR_{flt}) can be expressed by

$$DR_{flt} = |(N)_{max} / (N)_{min}|$$

where

$$(N)_{max} = \frac{2^m - 1}{2^m} \times 2^{(2^q - 1)}$$

and

$$(N)_{min} = \frac{1}{2^m} \times 2^{(0)}.$$

If these two expressions are substituted into the earlier equation,

$$DR_{flt} = 2^{(m + 2^q - 1)}.$$

This can be further restricted in the case of a fixed-point number system of n bits (including one sign bit). For this case, the dynamic range is

$$DR_{fix} = 2^{n-1} - 1.$$

For a typical 16-bit minicomputer, the single-

precision floating-point number has $m = 7$ and $q = 7$. This yields

$$DR_{flt} = 2^{(7+2^7-1)} = 2^{134} = 2.18 \times 10^{40}.$$

For the fixed-point case, the same numbers yield a dynamic range of 3.28×10^4 .

Where's the starting point?

To design a floating-point a/d converter, you must know how to structure it mathematically. The converter is outlined in the block diagram of Fig. 1. The functional components are depicted as a reference source, exponent logic and a successive-approximation, a/d converter.

The reference circuit generates a voltage reference for the converter. However, this reference voltage must be a function of the input voltage magnitude, so the exponent logic can convert the input magnitude range data into floating-point exponent format.

Mathematical analysis of the complete converter circuit can start with the reference voltage. Before that, let's define some symbols used in the expressions. A set of inverted L brackets, $[x]$, means: Take the next positive power of two (2^k) that is greater than x . For example, if x is 33, $[x]$ is 64. A set of noninverted L brackets $\lfloor x \rfloor$ means: Take the greatest integer

less than x . For example if x is 24.7, $\lfloor x \rfloor$ is 24.

Then the reference voltage can be defined as

$$V_{REF} = \left\lceil \frac{|e_i(t)|}{R} \right\rceil R,$$

where R is the smallest allowable value of the reference voltage and is called the scaling factor.

A second definition for the scaling factor is that R represents the value $|e_i(t)|$ that produces

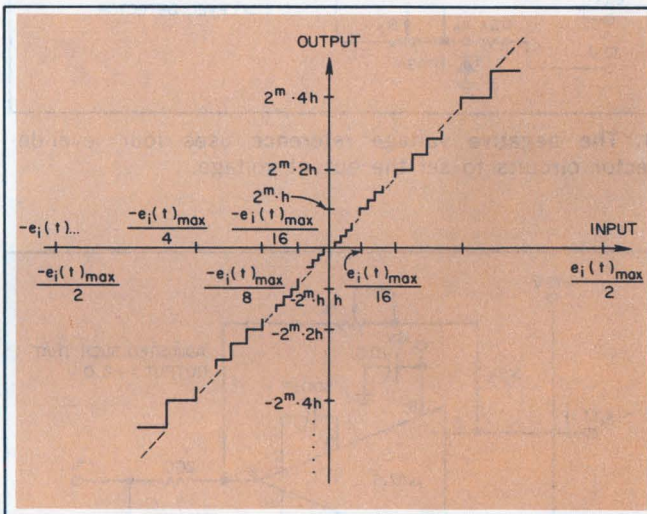

2. Quantization effects of the different values of V_{REF} produce a ramp with five step sizes when plotted.

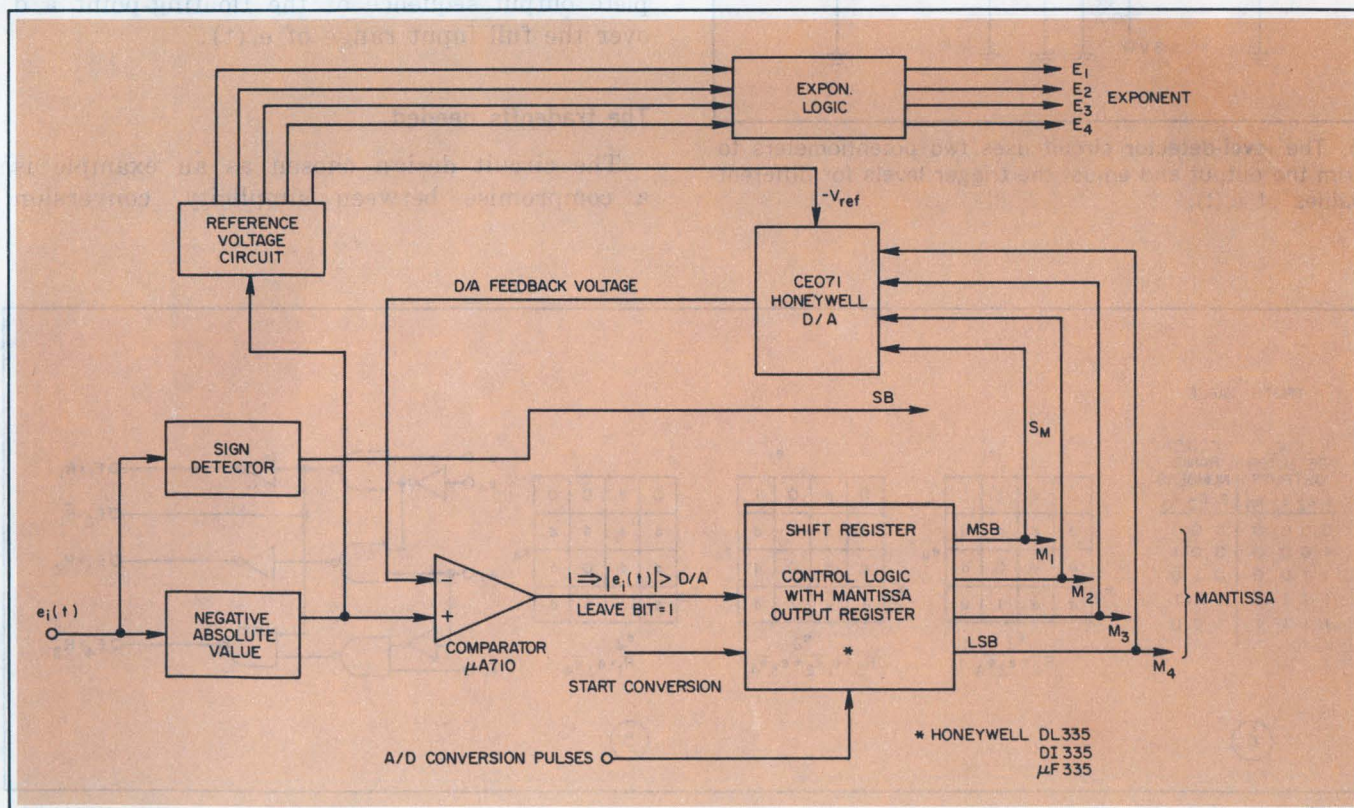

3. A more detailed version of Fig. 1 shows how the floating-point a/d converter handles a signal.

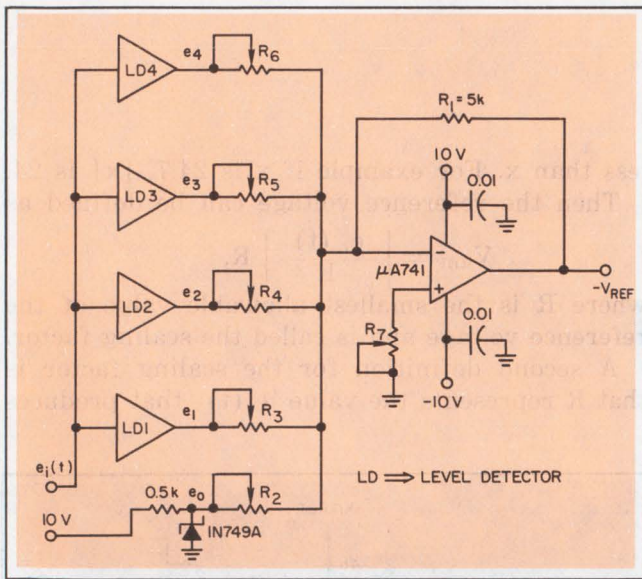

4. The negative voltage reference uses four level-detector circuits to set the output voltage.

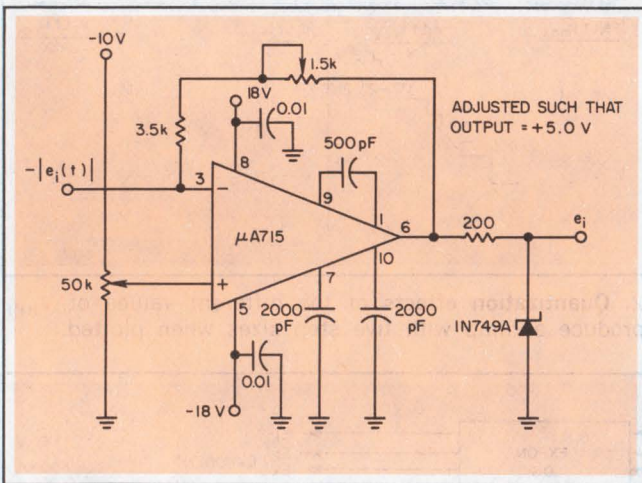

5. The level-detector circuit uses two potentiometers to trim the output and adjust the trigger levels for different values of $e_i(t)$.

a mantissa of value 2^{m-1} and an exponent of $m + 1$. Thus the exponent of the converter output can be expressed as $m + \log_2(V_{REF}/R)$ and the mantissa as $\lfloor 2^m |e_i(t)| / V_{REF} \rfloor 2^{-m}$.

If you're designing a floating-point a/d converter around a commercially available digital-to-analog (d/a) converter, be careful. The d/a converter must work with a wide range of input reference voltages. Most conventional converters operate over a limited reference-voltage range.

Now, as an example, let's design a small-scale, floating-point a/d converter. To start the design, first set up the specifications. Let's assume $|e_i(t)|_{max}$ is 5 V; the mantissa, m , is 4 bits; the exponent, q is 4 bits; and the scale factor, R , is 0.3125 V.

Because of the chosen magnitudes of the input voltage and R , V_{REF} for the fixed-point a/d converter has the following discrete magnitudes:

$$V_{REF} = 0.3125 \text{ for } 0 \leq e_i(t) < 0.3125,$$

$$V_{REF} = 0.625 \text{ for } 0.3125 \leq e_i(t) < 0.625,$$

$$V_{REF} = 1.25 \text{ for } 0.625 \leq e_i(t) < 1.25,$$

$$V_{REF} = 2.50 \text{ for } 1.25 \leq e_i(t) < 2.50,$$

$$V_{REF} = 5.00 \text{ for } 2.50 \leq e_i(t) \leq 5.00.$$

The plotted results of these equations form the a/d quantization characteristics in Fig. 2.

The magnitude of V_{REF} depends upon the range of the input signal. If the smallest range is denoted as range 0 and the next biggest as range 1, etc., you get a convenient method to determine the exponent bits. These bits represent the decimal-range number, coded into a q -bit notation, plus the integer m . The table shows the complete output sequence of the floating-point a/d over the full input range of $e_i(t)$.

The tradeoffs needed

The circuit design chosen as an example is a compromise between simplicity, conversion

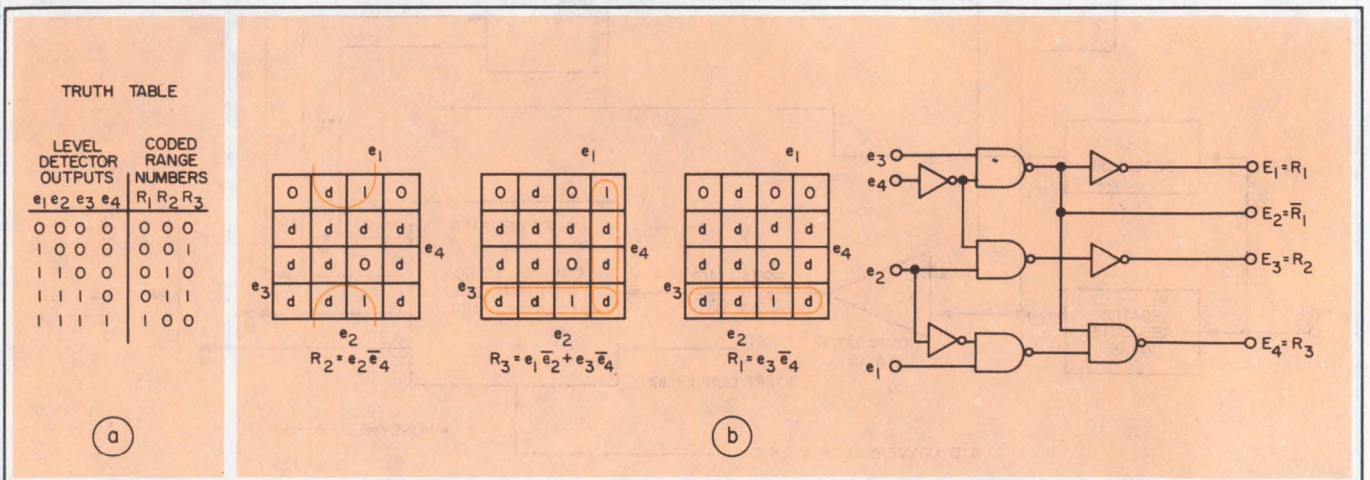

6. The truth table (a) for the exponent logic circuit can be designed using Karnaugh maps (b) to determine the circuit connections needed to set exponent magnitude.

Exponent and mantissa outputs

	EXPONENT				MANTISSA				
	E_1	E_2	E_3	E_4	M_1	M_2	M_3	M_4	
0 V	0	1	0	0	0	0	0	0	RANGE 0
	0	1	0	0	1	1	1	1	
$e_i(t)$	0	1	0	1	1	0	0	0	RANGE 1
	0	1	0	1	1	1	1	1	
5 V	0	1	1	0	1	0	0	0	RANGE 2
	0	1	1	0	1	1	1	1	
	0	1	1	1	1	0	0	0	RANGE 3
	0	1	1	1	1	1	1	1	
	1	0	0	0	1	0	0	0	RANGE 4
	1	0	0	0	1	1	1	1	

speed, conversion accuracy and cost. The 4-bit model can be modified to increase accuracy, speed or any other factor.

Once the specifications are detailed, the design procedure consists of three major steps: selection of the fixed-point a/d, design of the reference circuit and design of the exponent logic.

The a/d converter section used for our feasibility model consists of a Honeywell 4-bit d/a converter that produces a negative analog output voltage; a comparator, shift register, control logic and mantissa output register. All these can be implemented with standard logic circuits.

The multiple-value reference circuit is probably the most complex part of the design. Based upon the specs outlined earlier, the voltage reference must detect the range of the input signal and supply the correct value of reference voltage to the d/a converter.

If the input signal is restricted to 5 V or less, the range-finding level-detector circuits can be built around simple op amps like the $\mu A715$. The five-range circuit in Fig. 4 supplies five discrete reference-voltage levels. The level detector (LD) outputs are at ground potential when they are off, and at about 4 V when they are on.

LD_1 triggers when $|e_i(t)| \geq 0.3125$ V; LD_2 , when $|e_i(t)| \geq 0.625$ V, etc. The final output of the reference circuits is summed by an op amp. We find several problems in the operation of the voltage reference. For instance, when $|e_i(t)| < 0.3125$ V, all level detectors are off. Hence all outputs are at ground level. Now a constant output is needed to maintain $V_{REF} = 0.3125$ V.

To solve this problem, a zener-diode resistive divider is paralleled onto the summing junction of the output amplifier. The zener drops the voltage down to about 4 V, and when R_1 is adjusted, $V_{REF} = -0.3125$ V.

If the input changes to the second range, the LD_1 output is high. Potentiometer R_3 can now be adjusted to force V_{REF} to equal -0.625 V. As $e_i(t)$ is increased one range at a time, the adjustable summing resistors, R_2 through R_6 , can be adjusted to fix V_{REF} at the desired levels.

V_{REF} can be described by the following equation:

$$V_{REF} = - \left[\left(\frac{1}{R_2} \right) e_0 + \left(\frac{1}{R_3} \right) e_1 + \left(\frac{1}{R_4} \right) e_2 + \left(\frac{1}{R_5} \right) e_3 + \left(\frac{1}{R_6} \right) e_4 \right] R_1$$

The voltages e_0, e_1, \dots, e_4 have only two magnitudes—ground and about 4 V. Resistors R_2 through R_6 are trim pots.

What about the rest of the converter?

The single level-detector circuit of Fig. 5 requires several trims. When the voltage at pin 4 is greater than the magnitude of the input voltage (pin 3), the op-amp output is at ground level. As the input voltage increases so that its magnitude equals the voltage at pin 4, the op amp is turned on, and pin 6 goes high. Pin 6 will remain high as long as the magnitude of the voltage at pin 3 exceeds the magnitude at pin 4. The 50-k Ω trimmer sets the triggering level.

To clip the output signal of the op amp, a zener diode is connected through a resistor from pin 6 to ground. This clips the output to a more accurate level. The 1N749A diode used has a breakdown voltage of about 4 V. Since this breakdown level varies from diode to diode, trimming pots must be used for each detector.

The zener diode in the level-detector circuits is one of the most critical components in the converter. Its breakdown voltage varies with temperature, and this temperature sensitivity also determines the diode cost—less sensitive, the higher the cost.

Implementation of the exponent logic is the final step in the converter design. This logic derives the exponent for the a/d output. The design procedure can be done with one truth table and several Karnaugh maps (Fig. 6).

The two additional, noncritical circuits needed are those for absolute-value determination and sign-detection.

How the test circuit performs

The converter's operation can be checked with some simple tests, such as those for linearity, conversion speed and voltage error.

The test for linearity consists of recording the output for a series of input voltages. First, for

each range, adjust the input so that it just triggers the least significant bit, then the next bit, etc. Next, apply the sum of all the input voltages to the a/d to excite all the output bits. For the circuits shown, the average error was only 1.5% over the four ranges.

To determine the conversion speed, start with the time required by the a/d to convert one magnitude bit of the mantissa. Take this time and multiply it by the number of magnitude bits of the mantissa. For the 4-bit converter, this results in a delay of $1.6 \mu\text{s}$ per bit or a total delay of $6.4 \mu\text{s}$. From the total time we can get the implied throughput rate of 157 kHz for the 4-bit circuit.

The tradeoffs for converter speed are fairly simple: to increase the throughput, a faster fixed-point a/d converter can be used. As noted earlier, conversion speed was sacrificed for design simplicity.

Other converter error sources can now be brought out. For instance, the error introduced by the absolute-value circuit can be quite substantial, if not corrected. The circuit has two important sources of error (Fig. 7b). The first is a deadband, or dc input offset error.

Typically the input offset for the 741 amplifier is about 2 mV. Since the two op amps are cascaded, there is a possible deadband of 4 mV. The nulling circuits connected between amplifier pins 1 and 5 can reduce the deadband and thus increase the accuracy.

The other source of error comes from the noise in the power-supply lines. It can cause an increase in the input offset voltage. The amplifiers have a typical power-supply rejection ratio of $30 \mu\text{V}/\text{V}$. Along with good bypassing techniques, this eliminates any high-frequency spikes and small supply variations that can affect operation.

Errors are also introduced from a/d reference. The two major sources of error from the reference are dc offset and ripple.

The offset error stems from the offset drift of the op amp and from the errors in the zener diodes at the output of each level detector. Zener diodes are very temperature-sensitive, which, in turn, cause a very unstable breakdown voltage. The variable summing resistors are also temperature-sensitive, and they introduce a dc-offset error. Finally the 10-V supply, which guarantees that $-V_{\text{REF}} = -0.3125 \text{ V}$ when $e_i(t)$ is in the lowest range, also introduces a dc-offset error in the detector circuit.

The dc-offset error can be reduced by use of nulling networks or low-temperature-coefficient zeners. One substitute is the 1N4000 series of low-TC diodes. And a current source can be substituted for the 10-V voltage source.

Ripple errors caused by noise in the power-

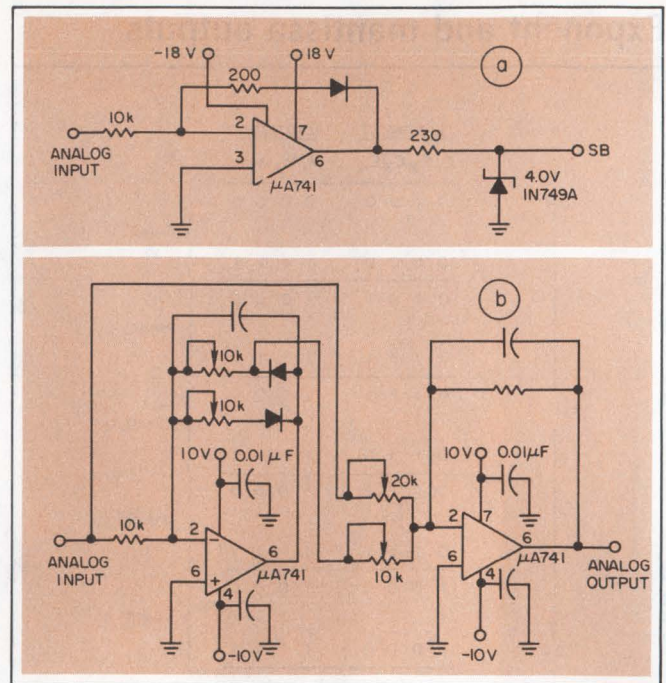

7. Checking the sign of the input signal requires a very simple circuit (a), while conversion of the input to its absolute value is a much more complex job (b).

supply lines can be minimized by use of an op amp with a high power-supply rejection ratio and by use of a current source to replace the 10-V supply.

Increasing the a/d resolution

If the ripple noise in the reference voltage supply is small, the 4-bit converter can be expanded. A measurement for ripple noise in the circuit of Fig. 3 shows it to be less than 2 mV. This small value will not interfere with the determination of the least-significant bit of the converter, since the quantization step for the LSB approaches 20 mV.

With this knowledge, we can find out the maximum number of mantissa bits that the floating-point converter can resolve. We must determine for the lowest input range, the minimum quantization step length allowable for a reference voltage with 2 mV of ripple.

As a rule of thumb, the 2-mV ripple will cause problems if the value of h (step length of the lowest range) has a magnitude less than twice the ripple on the referenced voltage. This implies that for the voltage reference of Fig. 4, a 6-bit mantissa is possible. Of course, the more elaborate the reference, the higher the resolution attainable. ■■

Reference

1. Heath, J. R., "Range Adaptive Digital Filtering," Doctoral Dissertation, Auburn University, Auburn, Ala., June 5, 1973.

Knute had his Four Horsemen. HiNIL has its MSI.

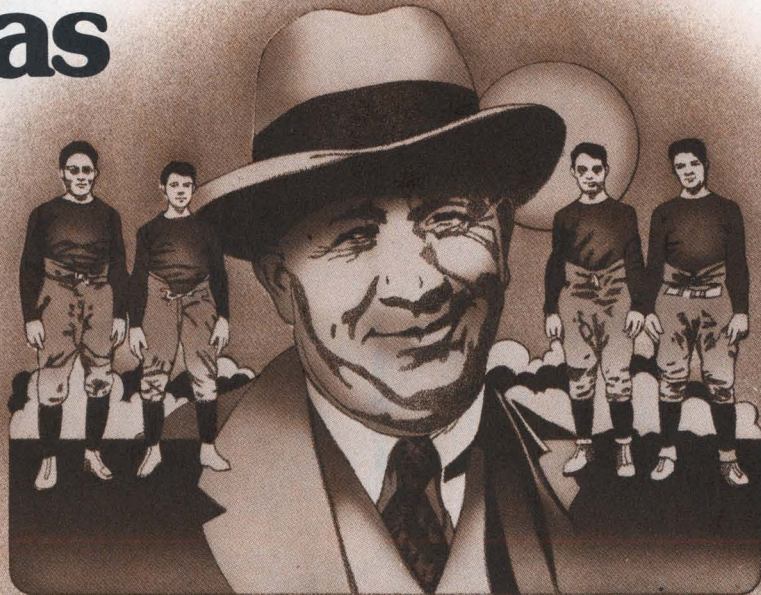

Knute Rockne's Four Horsemen of Notre Dame crushed the opposition every time they ran onto the field. A lot like HiNIL's four new MSI circuits. Our high noise immunity logic circuits will crush the biggest noises and make them just whispers when you use them in industrial control applications. Here's the lineup:

367 Quad Schmitt Trigger—Line Receiver. Deaf as a doornail with a typical D.C. noise margin of 5.5V and 2.5V during switching. The 367 eliminates false counts due to contact bounce on switches, relays, etc. and has a 4.5V dead zone to eliminate noise problems occurring on long lines. The 367 directly interfaces with CMOS and the 368 open collector version with TTL.

375 4-bit Shift Register. A universal shift register and storage element that can be used in serial in, serial out, parallel in and parallel out modes. For increased flexibility, the 375 has both parallel entry enable and master reset pins. For serial entry, we've provided J and K inputs as well as Q and \bar{Q} outputs. Worst case noise margin is 3.5V and typical shift rate is 3MHz.

383 BCD to 7-segment Decoder/Driver. Decodes binary to 7-segment code. Drives LEDs (like the MAN-1) and gas-filled seven segment tubes. Has blanking and lamps test inputs.

347 Dual Retriggerable Monostable Multivibrator (One Shot). Has both inverting and non-inverting trigger inputs and active pull-up complementary outputs. Isn't sensitive to power transients. Output pulse times are determined by an external capacitor making them independent of input-trigger pulse width. Can be used as a free-running one-shot by inhibiting retrigger capability.

So there they are. Like all 40 of our HiNIL devices, guaranteed noise margin is 3.5V without shielding, filter capacitors or spot regulators. They operate at either 12 or 15 volts with regulation to $\pm 1V$. They interface with TTL, DTL, MOS or CMOS. And they come handily packaged in ceramic or molded silicone DIPs attached to a very modest price tag. Available from Teledyne, reps or distributors.

Our HiNIL literature describes the entire team and shows you how to lead the way in industrial controls. And it's free. For your copy just give us a yell.

 **TELEDYNE
SEMICONDUCTOR**

1300 Terra Bella Avenue Mountain View, California 94043
(415) 968-9241 TWX: 910-379-6494 Telex: 34-8416

INFORMATION RETRIEVAL NUMBER 35

ELEC-TROL ON SCHEDULE



MAKING THE BEST DARN RELAYS IN THE COUNTRY

That's no idle boast. Elec-trol didn't grow to be one of the largest dry reed relay manufacturers by accident. Product quality did it. Product quality and product performance in demanding applications. Applications like yours, for instance.

We started with engineering. Everyone does, but with us it was an obsession. We took on problems that no one else could solve, and solved them. Not once, but time and time again. We earned our reputation that way, and we've made it a habit ever since — not only engineering the finest possible product, but the most effective and cost effective solutions to your specific application problems.

But engineering doesn't really solve your problems; products do. Products you can count on; most of them off the shelf. Delivery you can count on to meet your own production schedules. Service you can

count on from select local distributors. It wasn't easy, but we solved those problems, too.

Today we can provide you with reed relays to meet almost any application. We can provide them when you need them at the right price.

Take our Open Line, for instance. They are designed to provide you with high quality at a budget cost, when environment is not a critical consideration.

Our Econo-Line is one step up in environmental protection — but not in performance. There is no step up in performance. They are designed to meet more stringent environmental conditions; the enclosed type for severe industrial and similar environments, and the sealed type to meet military applications.

Then, of course, our DIP line gives you all the good things that come with DIP configurations: parts

density, automatic insertion, board spacing, plug-in capability.

Whatever the application you're designing for — communications, computers, industrial control systems, instrumentation and test equipment, military, automotive, what have you — chances are one of our standard products will meet your need. If not, we have many special products and our engineers are always on the job to solve your problems.

If you'd like specific technical information on any of our products call or write us at the address below, and let us know your requirements.

ELEC-TROL INC.

26477 North Golden Valley Road
Saugus, California 91350
Telephone (805) 252-8330,
(213) 788-7292 TWX 910-336-1556.

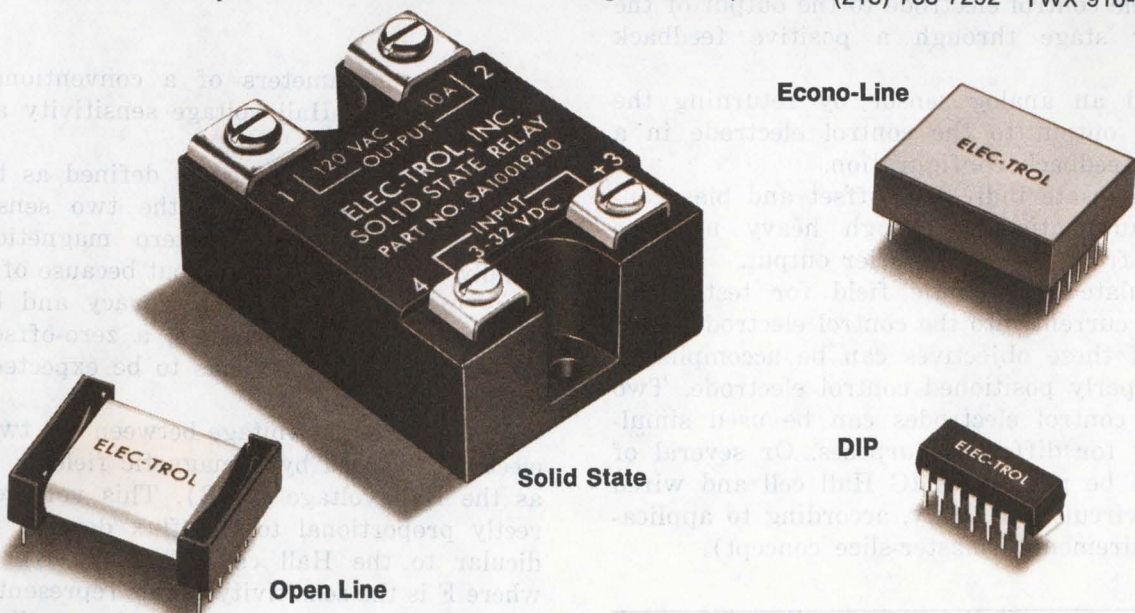

1974-75
eem
VOL. TWO

1974-75
**GOLD
BOOK**

Give the Hall transducer flexibility

by adding a control electrode. It will let you compensate for offset voltage or for a magnetic bias field.

The veteran Hall-effect transducer, now so easy to build with planar IC technology, gains new flexibility with the addition of a control electrode.

With planar technology, a Hall cell and its associated circuitry can be formed directly on a silicon chip to provide a complete transducer/switching function with a logic level output.¹ But Hall cells in their conventional form (Fig. 1) have serious limitations. There is the inevitable zero-offset-voltage tolerance caused by physical inaccuracies and nonuniformities. And once designed, the zero-offset voltage is fixed within its tolerance band; it cannot be changed to compensate for magnetic bias conditions or to introduce a switching threshold.

The addition of the control electrode (Fig. 2) provides the flexibility to overcome the limitations of the basic device: The electrode can be used to compensate for the offset-voltage or for a magnetic bias field. As a result, the new device allows us to perform the following.

- Adjust the switching threshold over a large range.
- Introduce a switching hysteresis by connecting the control electrode to the output of the switching stage through a positive feedback loop.
- Build an analog sensor by returning the amplifier output to the control electrode in a negative feedback configuration.
- Compensate individual offset and bias conditions automatically through heavy negative feedback from the preamplifier output.
- Simulate a magnetic field for testing by injecting current into the control electrode.

Any of these objectives can be accomplished by a properly positioned control electrode. Two or more control electrodes can be used simultaneously for different purposes. Or several of them can be put on an IC Hall cell and wired into the circuit selectively, according to application requirements (master-slice concept).

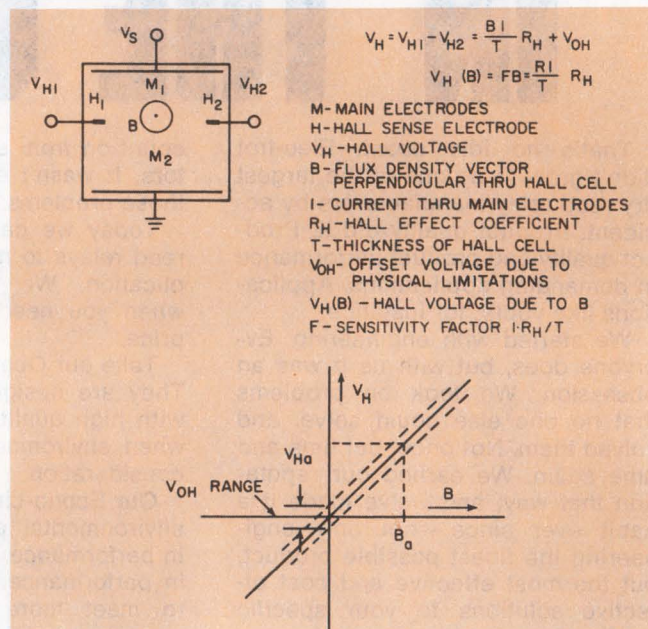

1. A conventional Hall cell doesn't have V_H exactly zero with zero magnetic field, because of physical inaccuracies and nonuniformities. This finite offset voltage is shown as the V_{OH} range in the graph. The total Hall voltage is the sum of the V_{OH} and V_H(B).

The key parameters of a conventional Hall cell include the Hall voltage sensitivity and the zero-offset voltage.^{1,2}

The zero-offset voltage is defined as the differential voltage between the two sense electrodes, H₁ and H₂, for zero magnetic field. Ideally V_{OH} should be zero, but because of limitations in the dimensional accuracy and because of material nonuniformities, a zero-offset voltage of up to ±10 mV has to be expected for a 5-V supply voltage.

The differential voltage between the two sense electrodes caused by a magnetic field is defined as the Hall voltage V_H(B). This voltage is directly proportional to the flux density perpendicular to the Hall cell. Thus V_H(B) = FB, where F is the sensitivity factor representing the Hall voltage sensitivity of a given cell in mV per Gauss for a certain current I through the Hall cell.

Roland J. Braun, Advisory Engineer, IBM Corp., System Products Div., Endicott, N.Y. 13760.

The total Hall voltage measured between the two sense electrodes is therefore the sum of the zero-voltage V_{OH} and of the Hall voltage $V_H(B)$. Or, as indicated in Fig. 1, $V_H = V_H(B) + V_{OH}$.

Now consider the effect of injecting current into control electrode C of the new device (Fig. 2). A constant current causes a proportional Hall voltage, $V_H(I_C)$, which is equivalent to a zero offset voltage. Any reasonable zero offset condition—for, say, switching-point adjustments—can be obtained in this way without changing the physical structure of the Hall cell.

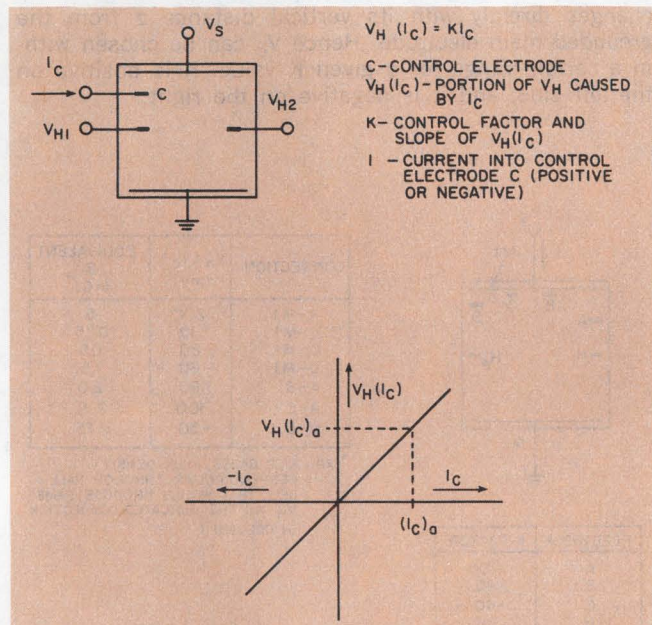

2. Current, I_C , injected into electrode C causes a linear change $V_H(I_C)$ in the Hall voltage. The change—equivalent to that of magnetic flux B of Fig. 1—can be used to compensate for undesirable offsets, to introduce bias or to simulate a magnetic field.

An undesirable offset voltage or magnetic bias condition can be compensated for in one of two ways: either by an initial zero adjustment or by a continuous, automatic compensation via a highly dampened, negative feedback loop.

Moreover voltage V_H varies directly with current I_C , just as it does with flux density, B. Hence control electrode C can be used in place of a magnetic field for testing.

With a control electrode on the Hall cell, the total Hall voltage between the two sense electrodes H_1 and H_2 now becomes

$$V_H = V_H(B) + V_{OH} + V_H(I_C),$$

where $V_H(B)$ is the portion generated by the B vector (perpendicular flux density vector produced by external magnetic field); V_{OH} is the inherent offset voltage caused by physical non-symmetries, and $V_H(I_C)$ is the portion of V_H caused by the control current I_C (Fig. 3).

A current injected into the control electrode

creates the voltage and current distribution shown in Fig. 3 for a zero supply voltage and zero magnetic field. In the case of an operative Hall generator—one with a supply current flowing through the main electrodes and with a magnetic field applied—this secondary field/current pattern superimposes onto the primary field/current distribution. Its influence on the Hall voltage and its $K = V_H(I_C)/I_C$ ratio are largely independent of the supply and field conditions. This means that K is constant for a given electrode, independent of the operating conditions,

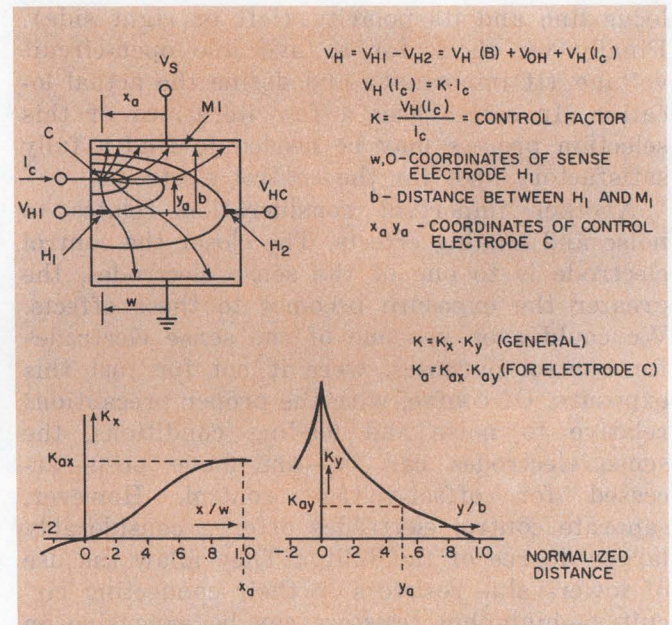

3. Current and voltage pattern introduced by I_C are shown for $V_S = 0$ and $B = 0$. For any other values of V_S and B, this secondary distribution is superimposed on the primary pattern. K depends on the location of the control electrode relative to the sense electrode.

and is determined only by its physical location.

The two graphs of Fig. 3 indicate the location dependency of the control factor, K. Generally the closer the control electrode is placed to one of the sense electrodes, H_1 or H_2 , the stronger its influence—or the larger its K value. A control electrode placed on the vertical center line between the sense electrodes has zero influence, as does an electrode in contact with either main electrode.

Fig. 4 illustrates the K value and its sign relative to the electrode location on the two-dimensional Hall area. The K values are fully symmetrical about the vertical center line, with K positive on the left and negative on the right. The graph of Fig. 4 shows the open-circuit voltage of a control electrode as a function of its vertical distance, z, from the grounded main electrode. Note the following three degrees of freedom:

1. Considerable freedom exists to locate a control electrode having a certain K value.

2. The vertical symmetry line splits the Hall cell into two equivalent halves, with opposite signs for K.

3. The open-circuit voltage of a control electrode depends only on its vertical position and on the total voltage between the main electrodes.

These relationships provide great flexibility. For example, for a certain value or range of V_H (I_C) = $K I_C$, we first determine the available range of I_C and its polarity (current to be injected or taken out). Then we determine a suitable value for K and determine its location or locus line and its polarity (left or right side). Finally we check for a favorable open-circuit voltage (if important) and define the actual location. In some cases a few iterations of this selection process may be needed to find a fully satisfactory spot for the control electrode.

Another important consideration relates to noise and loading effects. The closer the control electrode is to one of the sense electrodes, the greater the exposure becomes to these effects. We could even use one of the sense electrodes for control purposes, were it not for just this exposure. Of course, with the proper precautions relative to noise and loading conditions, the sense electrodes can be—and have been—accessed for offset-voltage control. However, separate control electrodes offer a considerably larger degree of flexibility: They allow the use of lower-value resistors in their connecting circuitry—high-ohm resistors can be expensive on IC chips—and they can be brought out for external adjustment with much less exposure to noise problems.

The noise influence of a control electrode on the sense electrode (the sensor input to the amplifier) depends mainly on its K factor and on the impedance of the sense electrode, R_s . The sensitivity factor $K = V_H / (I_C)$, a transimpedance, equals R_s in the case of the sense electrode. This means that an R_s of 1000 Ω results in a K of the same number when the sense electrode is used for control. For an application requiring a control electrode with a 10-mV/100- μ A influence, the K value becomes 100, or 1/10 that of the sense electrode, and the noise feedthrough reduces by the same ratio.

For a complete noise evaluation, the control-electrode impedance, R_C , also has to be considered. However, R_C is usually dominated by a resistor in series with the control electrode. Hence the total impedance can be largely tailored to the application.

The loading effect of a control electrode on the sense electrodes diminishes much faster with distance than the K factor. The exact relationship is rather complex, but as long as the distance of the control electrode from the sense

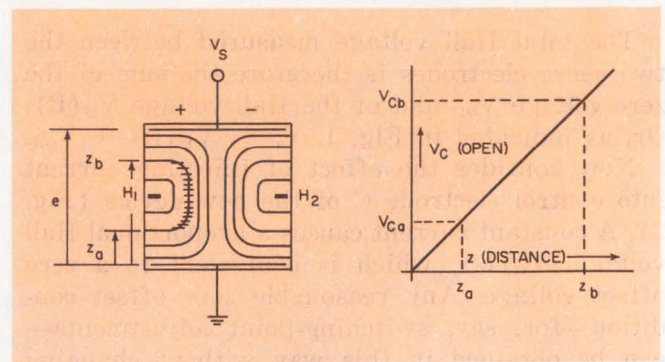

4. A control electrode positioned at any point along a given locus line produces the same relative influence on the Hall voltage. But the open-circuit voltage of V_C changes directly with its vertical distance z from the grounded main electrode. Hence V_C can be chosen within a certain range for a given K value. K is positive on the left side, and it is negative on the right.

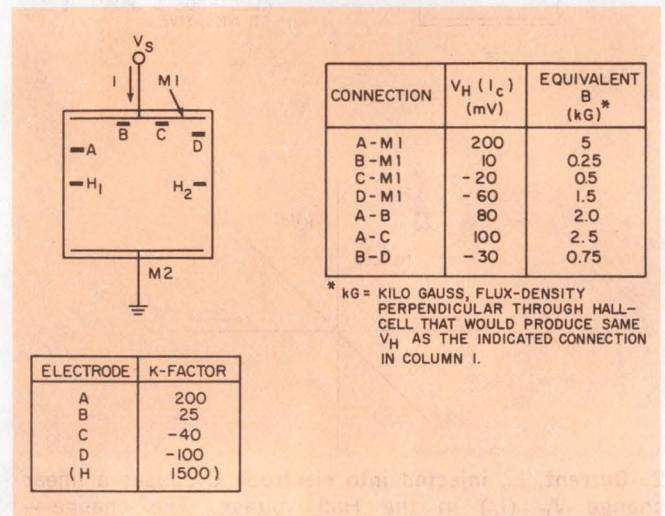

5. A connection of one or more control electrodes, A through D, to main electrode M_1 or cross-connections between them produces various Hall voltages. Representative K factors and V_H values assume a conversion ratio of 40 mV/kg sensitivity for a fixed supply.

electrode is equal to or more than its distance from the main electrode, the loading can usually be neglected.

How do you use the new device?

A control electrode can be connected directly or via a resistor to a suitable reference point on the IC chip. Or the electrode can be connected to a terminal pad, with the control current, I_C , externally adjustable. In the second case, the control current can usually be chosen arbitrarily, so that we can place the control electrode at a safe distance from the sense electrode to eliminate noise pickup. If the same device has to serve different applications, with the capability for large bias adjustments on one hand and for offset-voltage compensation on the other, two separate electrodes with different spacings (K

values) may be appropriate.

When the Hall cell and its associated circuitry are integrated on a chip, a fixed bias offset or some functional feedback control can also be provided on the chip. Also, use of more than one electrode permits the simultaneous performance of different functions or allows for selective wiring to different electrode(s) on a master-slice basis.

Fig. 5 shows a Hall cell with four control electrodes. The accompanying list presents possible offset bias conditions in millivolts and equivalent kilogauss values for direct connections of any electrode to the main electrode, M_1 , and for three cross connections. While it is certainly preferable to design for direct connections, a connection via a resistor provides greater flexibility since the resistance can be freely chosen. A resistor in a hybrid configuration could even be actively trimmed to a precise offset voltage.

Actual production runs of 10×10 -mil conventional Hall cells on silicon wafers, using extremes in epi-layer thickness and resistivity, show offset voltages of up to ± 12 mV at a 5-V supply voltage. This offset translates into an equivalent ± 300 Gauss value, which is unacceptable for many applications. Exact compensation can be achieved via any of the control electrodes of Fig. 5. However, the least sensitive—lowest K value—electrodes are best suited for small offset-voltage compensation. For example, by simply shorting electrode B to M_1 —which produces a +10-mV offset—all cells with initial offsets from -6 to -14 mV can be brought to within ± 5 mV.

Fig. 6 shows three circuits that provide different types of automatic feedback control via a control electrode. The control electrodes may be at different locations for the three applications, or the same electrode may be used for all of them. Again, on a master-slice basis, any one of the circuits can be fabricated by use of different metallization masks to connect the same components and circuit parts in different ways.

In the hysteresis configuration (Fig. 6a), the switching stage output is fed back in-phase with the driving signal, increasing the Hall voltage by a preset amount as the switching transition is initiated. The hysteresis value depends mainly on the feedback resistor, R, the voltage swing at the switching-stage output and the C-electrode's K factor. Typically hysteresis ranges from about 4 to 8 mV—equivalent to 100 to 200 Gauss—but it may be increased to provide a full latching function with external pulse-reset.

In the linear amplifier (Fig. 6b), negative feedback through the C electrode ensures good linearity that varies directly with the ratio of open-loop to closed-loop gain. The closed-loop voltage gain can be adjusted with feedback resistor R. The gain also depends, of course, on the K

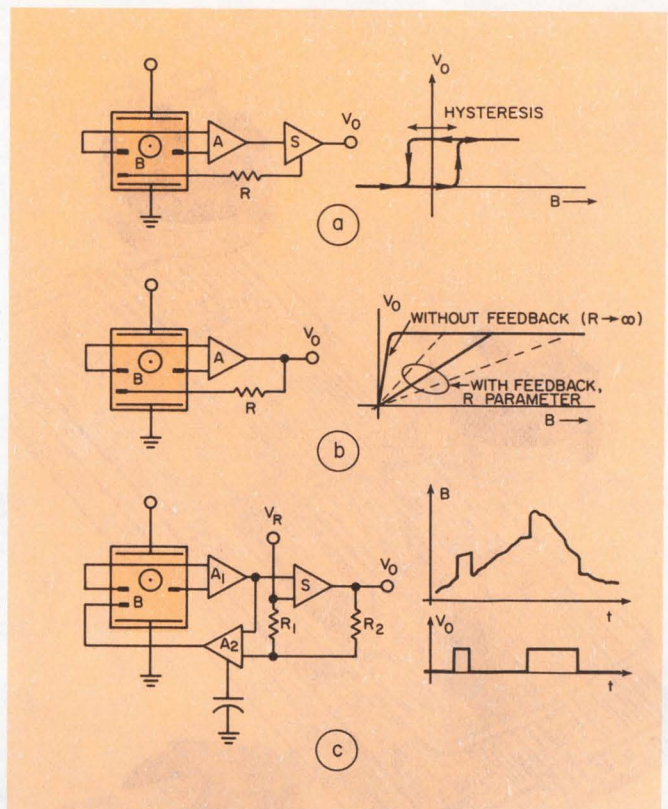

6. Three examples use a control electrode on Hall cell for feedback control. Positive feedback (a) from switching stage to control electrode provides switching hysteresis. Negative feedback produces a linear amplifier (b) and automatic bias compensator (c).

factor of the control electrode. An output signal slope anywhere between 1 V/100 G and 1 V/2000 G can be obtained easily.

The final circuit in Fig. 6 automatically compensates for initial offset and for bias conditions. And it continuously adjusts for slowly occurring environmental changes and drifts. Signals with a fast rise time can cause switching. Resistors R_1 and R_2 determine the switching thresholds for positive and negative signal excursions. To cover a large bias range, a control electrode with a high K value is needed. The circuit also requires a high-gain amplifier, A_2 , and a large off-chip damping capacitor, C.

Use the new device for chip testing

Apart from these functional applications, the most important and widest use of control electrodes promises to be in Hall IC-chip testing. In the case of a conventional integrated Hall transducer, a relatively strong, well-defined and adjustable magnetic field is required for a full functional test. Such a magnetic field source is very difficult to incorporate in a high-speed wafer or chip tester.

A control electrode eliminates the need for a magnetic field, at least at the chip level testing. It allows full functional testing of the Hall cell and its associated circuitry to almost the same



When you Build a Better Thermostat...

... leading design engineers know it. World-wide manufacturers of precision computer/data/communication equipment, as well as commercial appliances, are specifying Elmwood snap-acting thermostats. A choice of wide or narrow differentials reduce cost. UL, CSA and European listings are available for world-trade applications. All are factory preset, tamperproof and 100% temperature and mechanically tested, for high limit or control functions at -65° to $+550^{\circ}$ F exposure. Phone, TWX or write for prototypes, specs and prices. Elmwood Sensors, Inc., 1675 Elmwood Avenue, Cranston, R. I. 02907, U. S. A. Phone (401) 781-6500. TWX 710-381-6413.

ELMWOOD SENSORS

INFORMATION RETRIEVAL NUMBER 37

degree as a precisely adjustable magnetic field source. All that is required, in addition to the control electrode with its own chip pad, is a current source, adjustable up to ± 1 mA. Since a direct and linear relationship exists between the control current and an equivalent magnetic field (determined by the electrode's K factor) tests and measurements can be directly performed in Gauss. This relationship is very uniform between chips made with the same masks and can easily be measured with a calibrated field source.

Oscillations are a serious problem encountered with circuits of the type shown in Fig. 6 when they are built with separate Hall cells and discrete amplifiers. Filter capacitors across the Hall electrodes are needed whenever separate, high-speed amplifiers are used. However, fully integrated devices (Hall cell and circuitry on same IC chip) show no oscillation problems, except when instrument connections are made to the Hall electrodes or, in some cases, to a control electrode.

Other problems, well known to anyone working with Hall devices, are stress and temperature influences. While control electrodes are of no direct help against these problems, they can be used in certain cases to compensate for their effects—for example, with the feedback scheme shown in Fig. 6c or by individual offset compensation.

Another concern is the effect the control electrodes might have on the basic Hall-cell sensitivity (mV/G) due to the loss in active area and due to the loading effect on the sense electrodes. If we consider the small size of the electrodes—typically 0.2×0.4 mils vs a 10×10 -mil Hall-cell area—the direct area loss is negligible and can be compensated for by increasing the cell size. The same is true for a change in cell resistance. No decrease in sensitivity can be detected experimentally.

However, a certain loading effect is measurable, in terms of a change in the resistance between the two sense electrodes, when a control electrode is directly connected to one of the main electrodes. This influence is related to the K factor of a particular electrode—its location relative to the sense electrodes. It amounts to $< K/200\%$, or at most to 1% change, with the most sensitive electrode of Fig. 5 (electrode A) directly shorted to electrode M_1 . Again, this influence is negligible for all practical purposes, as long as the control electrodes remain at least a quarter of the Hall-cell length away from either sense electrode. ■■

References:

1. Urban, F. K., and Frank, J. G., "Hall Effect Devices, Part 1: The Hall Effect Comes Into Its Own," *Electronic Products*, Sept. 18, 1972, p. 59.
2. Putley, E. H., "The Hall Effect and Related Phenomena," (Butterworth & Co., Ltd., London), 1960.

Reliable low-energy switching is not new at MICRO SWITCH.

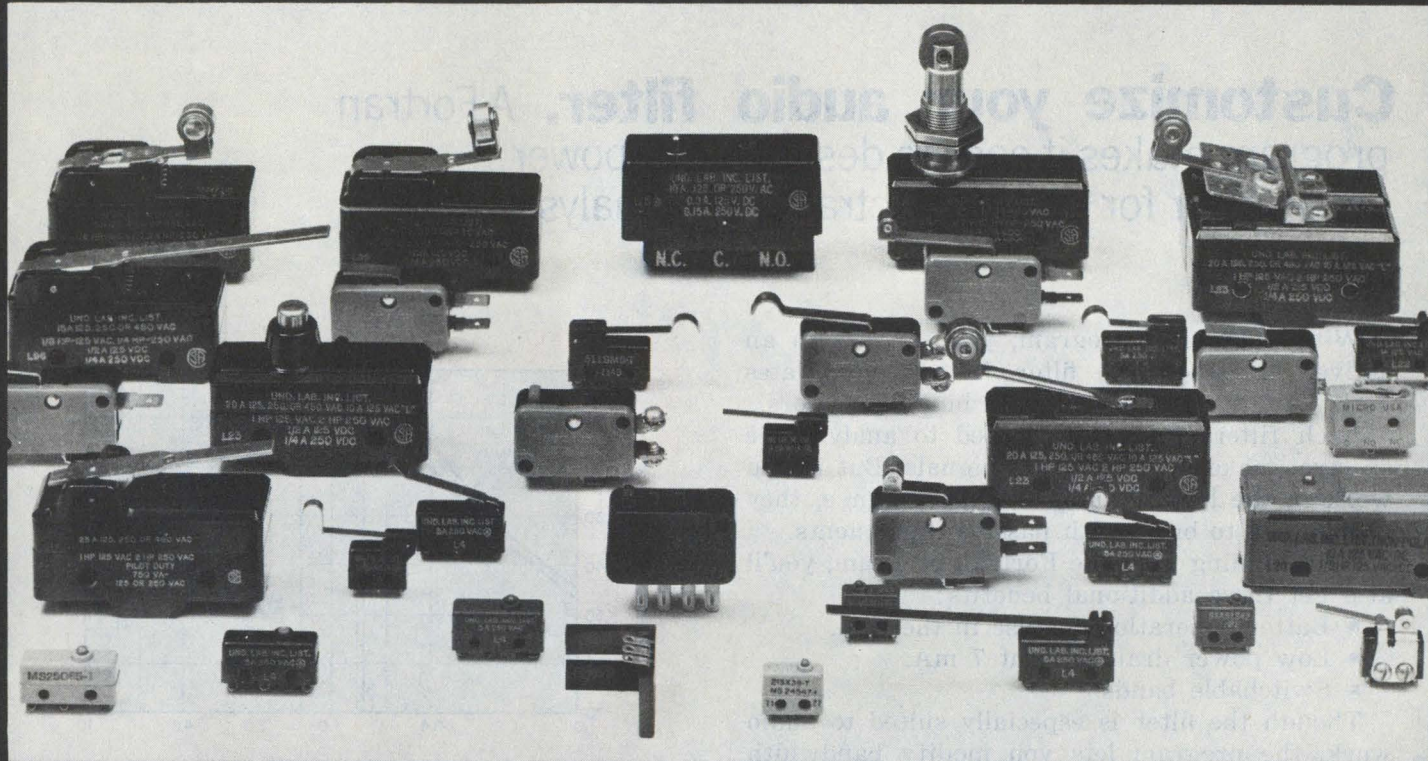

We developed our first high fidelity gold contact switch in 1953. This was only the beginning. Advances include bifurcated and cross-point contacts. Today we offer an entire low-energy basic switch line. From subminiature types less than $\frac{1}{2}$ " wide to versatile thumb-size basics.

With important features: A spring design that contributes to millions of operations. Choice of integral or auxiliary actuators. Terminal types such as solder screw, quick-connect and PC mount.

If your switching energy needs are in the milliamp range, MICRO SWITCH has a complete line of Hall-effect, magnetically operated, solid-state switches. They directly interface with logic circuits. Output options include sinking or sourcing, digital or analog.

We also offer precision switches for power functions to 25 amps. Again, choice of actuators and terminals.

Low energy, solid-state, power—for a comprehensive catalog of available switches for all energy levels, contact MICRO SWITCH.

For the address and telephone number of your nearest MICRO SWITCH Branch Office or Authorized Distributor, call toll-free 800/645-9200 (in N. Y., 516/294-0990, collect).

MICRO SWITCH

FREEMONT, ILLINOIS 61032

A DIVISION OF HONEYWELL

Customize your audio filter.

A Fortran program makes it easy to design a low-power active filter for use in spectral signal analysis.

With a Fortran program, you can design an active, low-frequency filter that demonstrates high stability and doesn't need bulky inductors.

Such filters are often needed to analyze the spectral makeup of electrical signals. But if you work in the low or audio-frequency range, they aren't easy to build with passive components.

By designing with the Fortran program, you'll also get these additional benefits:

- Battery operation for use in the field.
- Low power drain—about 7 mA.
- Switchable bands.

Though the filter is especially suited to audio work, the program lets you modify bandwidth and center frequency to match your application. With the op amps used, bandwidth can narrow to at least 1/3 octave and the center frequency can go to about 25 kHz. With wider bandwidth op amps, this can be easily extended into the hundreds-of-kilohertz region.

Analyze noise pollution

One application for such a filter is in noise-pollution control, where spectral analysis of noise sources is frequently performed. But the filter, when modified, can be put to good use to analyze acoustical vibrations or high-fidelity signals.

An octave-band filter is generally required in noise analysis, and the bandpass characteristics usually conform to those specified by the American National Standards Institute (ANSI) or some other organization.

A three-stage, six-pole Butterworth design can meet the characteristics shown in Fig. 1. The response is flat in the passband to within ± 1 dB, and the 3-dB attenuation points locate at $0.707 f_0$ and $1.414 f_0$ —where f_0 is the center frequency of the selected octave band.

At one decade above or below f_0 , the attenuation exceeds 45 dB. Thus if the filter were set on the 1000-Hz octave band, the signal would be

Dr. Robert Mauro, Assistant Professor of Electrical Engineering, Manhattan College, Manhattan College Parkway, Bronx, N.Y. 10471.

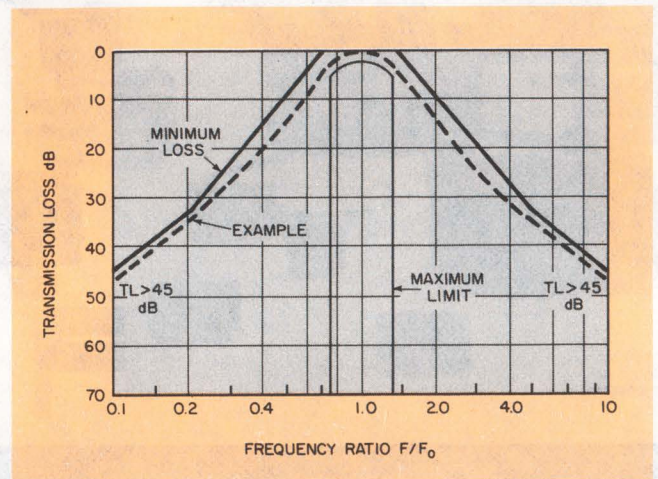

1. Normalized passband characteristic of active, six-pole Butterworth filter conforms to ANSI specifications for octave-band filters.

attenuated by 3 dB at 0.707 and 1.414 kHz, and by more than 45 dB at 100 and 10,000 Hz.

In accordance with ANSI recommendations, the filter has switchable bands with center frequencies at 31.5, 63.0, 125, 250, 500, 1000, 2000, 4000 and 8000 Hz.

Each of the three active-filter stages is of the multiple-feedback, bandpass variety, and each exhibits exceptionally high stability compared with similar active-filter configurations (Fig. 2). Because of the low output impedance of the op amps (less than 10Ω), the over-all filter response is simply the product of the transfer functions of the individual stages.

To vary the octave bands, resistive switching is preferred over capacitive. Capacitors cost significantly more, and nonstandard capacitor values would be required for each band. Further, series-parallel combinations would be needed to achieve the desired center frequencies with standard capacitor values. Thus, though fewer capacitors than resistors are used in the general design of Fig. 2, the advantage is lost when you band-switch the capacitance.

Moreover if you recognize that individual values of R_1 and R_2 are required only to form an

input-signal voltage divider, you can significantly decrease the resistor component count. Just replace this portion of the circuit with a single, fixed-voltage divider that has the correct resistance values for the 8-kHz band.

Then the R_1/R_2 combinations needed for the lower frequencies can be formed by connection of the fixed divider in series with a single resistor. In this way the total resistance is brought up to the appropriate value for a specific frequency. This modification reduces the number of 1% resistors needed from 81 to 57.

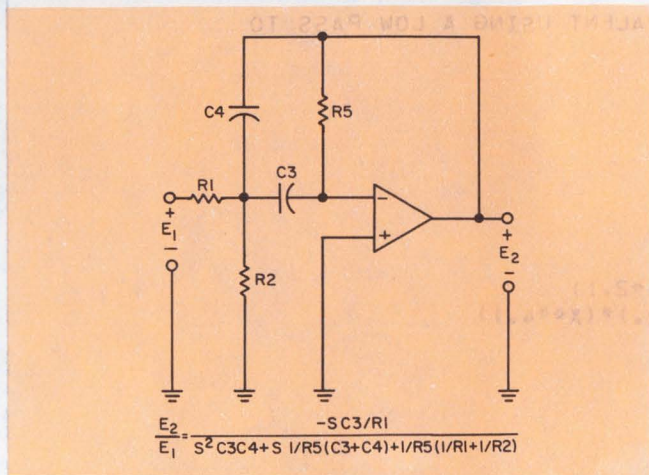

2. Each stage of the three-stage filter takes on the general form of a multiple-feedback, bandpass design. The transfer function of each stage is shown.

Because the filter is active, the maximum input signal is limited to 5 V peak. Higher signals produce clipping, and possibly erroneous outputs.

The situation is particularly serious when a large input signal is present at a frequency outside the filter's set octave band. Here harmonics of the input signal can pass through the filter and be read as actual signals within the pass-band.

To circumvent this problem, an overload circuit can be added easily to indicate the presence of excessively large signals at frequencies outside the set octave band (Fig. 3).

Minimum input signals, on the other hand, are set by the filter's internal noise levels in each octave band. Typical noise values increase linearly from about 40 mV rms in the 8-kHz octave band to about 250 mV in the 31.5-Hz octave band.

To get the passband accuracy indicated in Fig. 1 and to minimize temperature effects, 1% carbon-film resistors and 1% polystyrene capacitors should be used for the frequency-determining elements.

Battery-aging effects on filter performance are minimized by zener diodes CR205 and CR206, which fix the supply voltages at ± 5.6 V. Current consumption from the three standard 9-V batteries is typically only about 7 mA. Thus the battery lifetime is about 90 hours. The complete filter schematic is shown in Fig. 3, and the Fortran design program in Fig. 4 (next page).

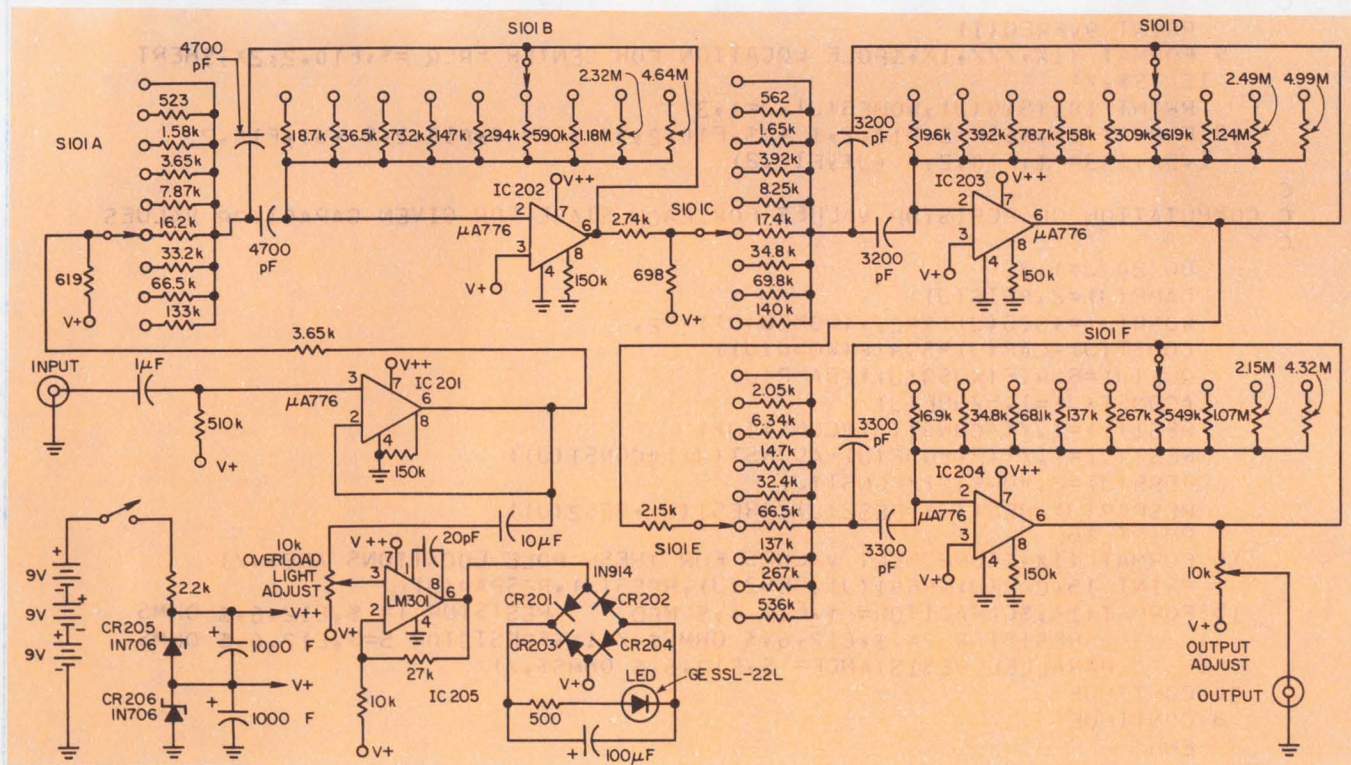

3. The complete filter uses only five op amps—three for the active filter (IC202, 3, 4), one as a pre-amp/buffer

(IC201), and one in an overload indicator (IC205) that "watches" for large, out-of-band signals.

```

C   DESIGN OF A THREE STAGE BUTTERWORTH OCTAVE BAND FILTER SET
C
C   DIMENSION FREQ(10),CAP(3),DAMP(3),WOSQ(3),SIG(3),WOMEG(3)
C   DIMENSION CONST(3),QUE(3),ACONST(3),RES1(3),RES2(3),RES5(3)
C   DIMENSION RESPAR(3)
C   READ 1,(FREQ(I),I=1,10)
1   FORMAT(5F10.2)
C   READ 2,CAP
2   FORMAT(3E10.4)
C
C   PI=3.141593
C
C   LOCATION OF THE POLES FOR UNITY GAIN LOW PASS WITH THREE DB AT W=1 ARE
C   S1=-1, S2=-.5+J.866, S3=-.5-J.866
C
C   FINDING THE UNITY GAIN BAND PASS EQUIVALENT USING A LOW PASS TO
C   BAND PASS TRANSFORMATION
C
C   X= BANDWIDTH/CENTER FREQUENCY
C   X=0.707107
C
C   SIGA=0.5
C   WOA=0.866
C   DO 8 I=1,10
C   WR=PI*FREQ(I)*2.
C   RA=.5*(4.-(SIGA**2.)*X*X+X*X*(WOA**2.))
C   RB=SQRTF(RA**2.+(SIGA**2.)*(WOA**2.)*(X**4.))
C   U=SQRTF(RA+RB)
C   V=X*X*SIGA*WOA/U
C
C   DO 7 J=1,2
C   SIG(J)=.5*(SIGA*X+(3-2*J)*V)*WR
C   WOMEG(J)=.5*(WOA*X+(3-2*J)*U)*WR
7   CONTINUE
C   SIG(3)=.5*X*WR
C   WOMEG(3)=.5*WR*SQRTF(4.-X*X)
C
C   LOCATION OF THE TRANSFORMED POLES
C
C   PRINT 9,FREQ(I)
9   FORMAT(1X,///,1X,$POLE LOCATION FOR CENTER FREQ =$,F10.2,2X,$HERT
C   1Z IS$,/)
C   PRINT 10,(SIG(J),WOMEG(J),J=1,3)
10  FORMAT(1X,$S1= $,F10.2,$ +J$,F10.2,5X,$S2= $,F10.2,$ +J$,F10.2
C   1,5X,$S3= $,F10.2,$ +J$,F10.2)
C
C   COMPUTATION OF RESISTOR VALUES FOR EACH STAGE FOR GIVEN CAPACITOR VALUES
C
C   DO 20 J=1,3
C   DAMP(J)=2.*SIG(J)
C   WOSQ(J)=(SIG(J)**2.+(WOMEG(J))**2.)
C   CONST(J)=CAP(J)*SQRTF(WOSQ(J))
C   QUE(J)=SQRTF(WOSQ(J))/DAMP(J)
C   ACONST(J)=1.5/QUE(J)
C   RES1(J)=1./(ACONST(J)*CONST(J))
C   RES2(J)=1./((2.*QUE(J)-ACONST(J))*CONST(J))
C   RES5(J)=2.*QUE(J)/CONST(J)
C   RESPAR(J)=RES1(J)*RES2(J)/(RES1(J)+RES2(J))
C   PRINT 16
16  FORMAT(1X,$COMPONENT VALUES FOR THESE POLE LOCATIONS ARE$,/)
C   PRINT 15,CAP(J),RES1(J),RES2(J),RES5(J),RESPAR(J)
15  FORMAT(1X,$CAPACITOR= $,E10.4,$ MFD RESISTOR 1= $,E12.6,$ OHMS
C   1 RESISTOR 2= $,E12.6,$ OHMS$,/,1X,$RESISTOR 5=$,E12.6,$ OHMS
C   2 PARALLEL RESISTANCE= $,E12.6,$ OHMS$,/)
20  CONTINUE
C   8 CONTINUE
C   END

```

4. Fortran program designs the Butterworth octave-band filter with less than 8 k of memory. Bandwidths and

center frequencies are easily changed to accommodate applications in other frequency regions.

AMPEREX HAS WHAT IT TAKES TO BE NUMBER ONE IN RF POWER SEMICONDUCTORS...

THE LINE - THE BOOK - THE BOARDS.



Amperex is going all out to support its state-of-the-art line of RF power semiconductors with a state-of-the-art program of applications engineering assistance.

The line is a broad one with an RF power semiconductor to fill virtually any RF amplification need in fixed and mobile transmitting equipment—from 30 MHz single sideband through 960 MHz UHF FM.

At the heart of the program is a 640-page applications manual containing 24 detailed engineering reports. This manual, available to communications design engineers, will cut RF power amplifier design time and cost to a fraction of that normally required between the drawing board and the production line.

The engineering assistance doesn't end with the applications manual—it only starts there. You won't even have to build the prototypes to get these circuits into production! We will supply sample boards, built for you, here in the Amperex applications laboratory.

Use them to test, to evaluate, to demonstrate your system. Typical of the sample boards now being made available to Amperex customers, is a 25 watt, 225 MHz Class E Citizens Band Amplifier (illustrated at left) with 50 mV input power and 12.5 V operation.

For more information... on the line, the book, the boards; for data, write to Marty Burden, Group Product Mgr., Amperex Electronic Corporation, Hicksville Division, Hicksville, N.Y. 11802. Telephone: (516) 931-6200.

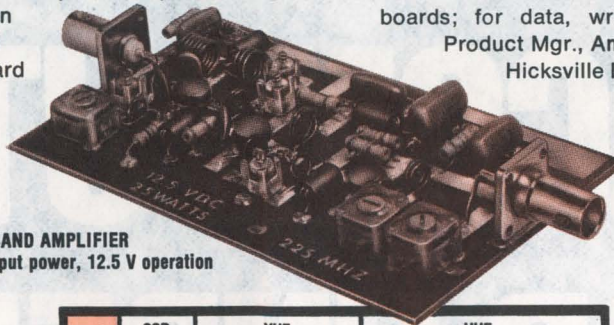

CLASS E, CITIZENS BAND AMPLIFIER
25 W output, 225 MHz, 50 mV input power, 12.5 V operation

P out (watts)	SSB		VHF		UHF	
	30 MHz		175 MHz FM		470 MHz FM	
	28 V	13.5 V	28 V	13.5 V	28 V	28 V
2.0				BLX65		
2.5				2N3553	BLX66	
3.0		2N3924		BLX67		BLX92
4.0		BFS22A	BFS23A		BGY22	
6.0			2N3375			
7.0		2N3926		BLX68	BGY23	BLX93
8.0	BLX13	BLY87A	BLY91A			
12.0		2N3927				
13.0			2N3632			
15.0		BLY88A	BLY92A		BGY24	
20.0				BLX69		BLX94
25.0		BLY89A	BLY93A			
40.0						BLX95
50.0	BLX14	BLY90	BLY94			
150.0	BLX15					

Amperex®

TOMORROW'S THINKING IN TODAY'S PRODUCTS

Sold through
North American Philips Electronic Component Corporation

INFORMATION RETRIEVAL NUMBER 39

**INTERDATA
ANNOUNCES
THE INDUSTRY'S
FIRST 32-BIT
MINICOMPUTER
FOR UNDER
\$10,000.**

WITH UP TO A MILLION BYTES OF DIRECTLY ADDRESSABLE MEMORY.

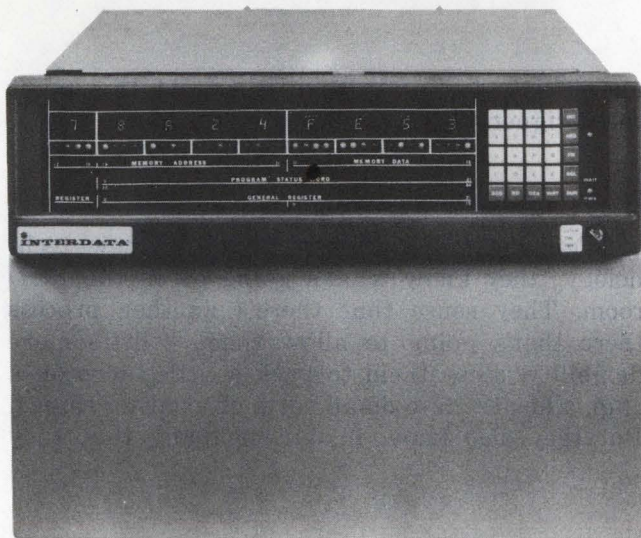

Minicomputer myths you can live without:

1. There's no such thing as a 32-bit minicomputer.
2. Minicomputers have an absolute 64K addressing limit.
3. The only way to even access more is to resort to some sort of hardware kluge with a hairy software scheme that'll cost you an arm and a leg.

All wrong.

Because now there's the Interdata 7/32 — a powerful new 32-bit minicomputer with main memory expandable up to a million bytes and direct addressing up to 16 million bytes.

Big it is. But hairy it isn't.

Because it's simple, straightforward and efficient. And it's the industry's first uncomplicated extended-memory software environment.

Backed up by a lot of hardware muscle like thirty two, 32-bit registers, 1024 I/O interrupts with automatic vectoring, 239 instructions. And a lot more. All of which would lead you to expect to pay a lot more money, right? Well, that's also a myth.

Performance	7/32	Nova 840	PDP-11/40
Word length	32	16	16
Memory speed (nanoseconds)	750	800	900
Maximum memory capacity (bytes)	1,048,576	262,144	262,144
Addressing range (bytes)			
Direct	1,048,576	512	65,536
Relative	±16,384	±256	±32,768
Indexed	1,048,576	65,536	65,536
Double indexed	1,048,576	No	No
General-purpose registers	32 32-bit	4 16-bit	8 16-bit
Index registers	30 32-bit	2 16-bit	8 16-bit
Vectored interrupt levels	Yes	No	Yes
Minimum interrupt overhead time (usec)	6.5	47.5	46.5

Price	7/32	Nova 840	PDP-11/40
32 KB processor	\$ 9,950	\$12,930	\$15,345
64 KB processor	14,450	19,330	26,925
128 KB processor	23,450	35,630	44,725
256 KB processor	41,450	61,230	80,825
1 Megabyte processor	171,650	Not available	Not available

Source: Data General Price List, 5/15/73. DEC PDP-11/40 Price List, 6/73. DEC OEM & Product Services Catalog, 1972. Auerbach Minicomputer Characteristic Digest, June, 1973. "How to use Nova Computers", 1973.

The software muscle is all there, too. A new FORTRAN V compiler. An optimizing assembler called CAL. And the first extended operating system that's both powerful and simple — OS/32. Plus all the other field-proven Interdata software — it's all compatible.

The new Interdata 7/32.

We put our muscle where their myth is.

INTERDATA®

2 Crescent Place, Oceanport, New Jersey 07757 (201) 229-4040.
 Boston — (617) 890-0557. Washington — (703) 525-4806. Philadelphia — (215) 436-5579.
 Orlando — (305) 851-6962. Chicago — (312) 437-5120. Detroit — (313) 356-5515.
 Dayton — (513) 434-4193. Kansas City — (913) 384-1606. Houston — (713) 783-3060.
 Dallas — (214) 238-9656. Denver — (303) 758-0474. Los Angeles — (213) 640-0451.
 Phoenix — (602) 968-2477. San Diego — (714) 565-0602. San Francisco — (415) 969-1180.
 Seattle — (206) 455-0680. Toronto — (416) 677-8990. Tokyo — (270) 7711.
 Sydney — 439-8400. London — Uxbridge 52441. Munich — 0811-8543887.

Good design is a business challenge, manager advises engineers. When profitability is the goal, cost, product adaptability and customer commitment are what count.

If you want to be a successful designer in the electronics industry, think as a businessman first and then as an engineer.

Our success as a semiconductor company has been based on this approach. And, in the process, we have given our engineers greater freedom than they might ordinarily receive in a corporation. As a manager, I delegate authority to my designers, because I know they're the people who are going to make things happen, not me.

But before they take on a design, our engineers must find answers to these three questions:

1. What will be the ultimate price of the device and what will it cost to develop?
2. Does the device have any further impact on our business—that is, can it be adapted to another market? If it can be, can it be designed with the technology that we have in our factory today?
3. Is the customer really committed to the program, or is he using us for his own R&D?

Assessing the business challenge

There's no doubt that the electronics industry offers engineers exciting design opportunities. But, as an engineering manager, my challenge is to find the opportunities that will offer a reasonable return on engineering investment.

Since we're committed to making a lot of custom designs, I tell our engineers to work with our customers at all levels of the product program. Usually we send out two men to confer with a customer, a marketing engineer and a design engineer. This team has been trained to think of the opportunity as a business challenge, not as a technical innovation.

Usually the marketing engineer determines whether or not there's an opportunity. If he thinks there is, our design engineer then assesses the difficulty of the task and whether or not it's

appropriate for us to take it on. At this point the designer's business sense is put to the test.

Working technologies only

Engineers are always tempted by new technology; they know what's going on in the R&D room. They sense that there's another process there that's going to allow them a little more flexibility, allow them to pack a little more on a chip, allow them to do all sorts of exciting things. But they also know in our company that they

Dick Pinto and ITT Semiconductor

When Dick Pinto was traveling the management circuit with RCA's Solid State Division first at Somerville, N.J., and then at Mountaintop, Pa., in the late fifties, little did he know that the division he would one day manage had not yet come into existence.

Not until 1964 did ITT enter into development and production of integrated circuits in a newly constructed plant in West Palm Beach, Florida. The nucleus for the new operation was National Transistor Company, Lawrence, Mass., acquired by ITT in 1962, engaged primarily in the production of gold bonded diodes, with sales of \$5 million and about 650 employees.

Also in 1964 ITT acquired Clevite Transistor, a manufacturer of germanium power transistors, germanium diodes, small signal transistors, rf power transistors and four-layer diodes, with plants in Palo Alto, Calif., Waltham, Mass., and Freiburg, Germany. Product lines were transferred from Waltham to West Palm Beach and Lawrence, and several years later, the transistor lines at Palo Alto were transferred to West Palm Beach.

A worldwide concept of semiconductor manu-

Richard Pinto, General Manager, ITT Semiconductors, West Palm Beach, Fla. 33407.

can't use the process for custom applications until it's in the factory, because if they did, their program would take three years to finish instead of nine months, and the investment would probably cost more than the return.

So our first prerequisite for taking on a design is that we don't accept a custom job that requires development of a new process. When we develop a custom integrated circuit for a customer, we don't discuss or use any technology that isn't already working in the factory. Not that we don't do technological work—we do, but there's a

certain distinction.

Generally, our new technology programs are independent of specific customers; they are tied to a new generation of products. We don't tell customers about them until we've defined the process, characterized it and put it into production. We may generate commodity products from it, like memory or MSI devices, but when we talk custom design with doctors about medical equipment, or with a stop watch manufacturer about a timing circuit, we insist that the design be done with technology that's installed and running

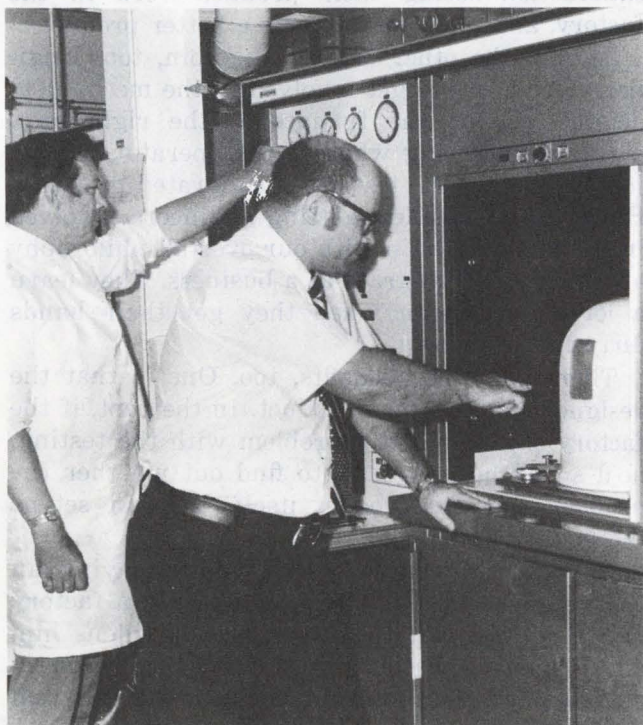

facturing was developed in 1966 which included the U.S. plants in Massachusetts and Florida, Intermetall in Germany, STC Semiconductors in England, and a new assembly facility in Portugal. ITT Semiconductor Worldwide sales in 1973 were in excess of \$100 million.

Before Pinto became Vice President and General Manager of the West Palm Beach division of ITT Semiconductors in 1972, he served RCA as production engineering manager; Minuteman program manager; manufacturing manager—power transistors and later ICs; and a product line manager—digital bipolar ICs and later thyristors and rectifiers. Now at ITT he is responsible for the development, production and sales of bipolar ICs—both digital and linear—for the U.S. market.

At one time Pinto taught freshman mathematics at Newark College of Engineering where he had earned a BSEE. He also has an MS in physics from Stevens Institute of Technology. Now living in Tequesta, Florida, with his wife, Ruth, and two sons, Bill and Mark, Pinto tries to find time for his hobbies—hiking, canoeing, reading and music.

in our factory and that requires no process innovations.

That's a good policy for us, because it guarantees a high success rate. We'll be able to accommodate the customer in the shortest possible time; the design will go into the factory without any major tooling problems, without any major crises, and it's likely to be the most cost-effective design that the customer can get.

Capitalizing on spinoffs

Our second prerequisite for design acceptance is anticipated synergism. We tell our engineers that since there are more opportunities in the marketplace than we could ever hope to service, they should stick to opportunities that will give the company some fallout benefits. In other words, pick a program that will allow the company to move quickly from one market area to another.

That doesn't mean that we make a chip for one customer and then sell it to another. It means that we are able to modify a design concept slightly or repackage it for use in some other application. We look for applications that are very broad, so that what we do for one customer we'll be able to make in some other form for several other customers.

We don't play games with the customer's proprietary rights. But if we fail to capitalize on the unique applications that will have a high payoff, then the ratio of engineering investment to our return is usually not good enough for us to remain profitable.

The importance of being committed

Customer commitment is the third prerequisite. Is the customer just sampling the waters, checking the temperature? Or is he really serious? And this is the toughest question to answer, because some customers offer our engineers an exciting design opportunity but can't afford the engineering bill. Here's where the product marketing engineer has to acquire a gut feeling about where, when and how he extracts from the customer some kind of commitment that proves he's in the program for real and not just using our company for R&D of his own.

There are several techniques the product marketing engineer can use to determine this. He can get a purchase order from the customer that says: "If you get X number of acceptable samples by such and such a date, you've got to order a million devices for the next two years at this price."

Another way to guarantee that the engineer gets a healthy percentage of his customer's requirement is to ask the customer to put up front-end money. That's fair. We often put up \$10,000

to \$40,000 to create a design. We take a chance, because it's the customer's design, and when it's done we can't sell it to anyone else if he doesn't want it. The engineer has to tie the customer down so he knows he's as committed as we are.

We don't ask for one-way contracts that tie down the customer but not ourselves; we put our neck on the line, too. Our samples have to be acceptable; they have to meet the specs, and they have to be ready on time. Otherwise the whole contract is renegotiable. We're willing to live that way as long as we can get a commitment from our customers.

We've taken a chance on one or two programs. We've taken one in the medical electronics business. It's not that our medical customer doesn't give us a purchase commitment, but there are some products that require government approvals, acceptance by doctors and special testing. And if the product doesn't qualify at one of these junctures, our effort goes down the drain. So I can't say we don't take chances; we do. But when we take a chance, we like to know we're taking one; we don't want to be completely surprised if the product is a flop.

Blooming of the businessman-engineer

Once a design job has been accepted, our designers stay with it until it comes off the production line. They used to turn over their designs to the product engineers and start on something else. But staying with the product gives us a two-edged sword—designers get a tremendous satisfaction seeing their product work in the factory, and the company gets a better product.

There's the other side of the coin, too. Engineers don't like to get involved in the mechanical details—getting the furnace at the right temperature, worrying whether the operator did his job or whether the test set is calibrated properly. However, on balance, getting engineers involved in the factory ties in with our over-all philosophy of running the program as a business. They learn a lot about design when they get their hands dirty in the factory.

There are other benefits, too. One is that the designer tests his own product. In the past, if the factory engineer had a problem with the testing, he'd spend hours trying to find out whether the problem was the product itself, the test set or the specification.

The one drawback is that you're paying an R&D engineer a high salary to work in a factory half the time. But the experience broadens him and is part of the blooming of the businessman-engineer. It puts him in touch with the real world of manufacturing.

Our management system isn't designed to punish the R&D engineer if he doesn't succeed.

It's designed to reward the engineer who's a business entrepreneur. We're not a research community; we're in manufacturing, and the name of the game is profitability. We help our engineers understand how they can help us profit.

I liken an organization to an electrical circuit. In such a circuit there are active gain blocks like transistors and integrated circuits that provide gain. Also, there are resistors, capacitors, and inductors—all passive elements that consume energy and don't generate gain.

In a business, people are the gain blocks. I believe a good manager is able to take those active gain blocks and put them in the right place so he gets maximum gain out of his system. If he puts people in the wrong places, he's going to get more noise than gain. Even positive people in the wrong places are going to oscillate and not work.

System is self-perpetuating

This management system is exciting and fruitful; I'm not always in the position of trying to assess marketing, engineering and manufacturing inputs in a vacuum, because my marketing and engineering teams fill me in. And from a new-product development and manufacturing point of view my job is a lot easier than before, because now I know that my people aren't committing themselves to products that would require something we haven't got in the factory.

The development of engineers who are business-conscious and profit-conscious has enabled us to undertake programs that would have been impossible for us to consider previously. We've improved our own resources, and we've strengthened our R&D. This management system is dynamic—its effect multiplies. Now our engineers understand why it's important not to invent a new technology in custom circuitry, but why it's important to stay with the product through manufacturing. It's not something we force them to do. They understand it, and they want to do it.

Now when one of our engineers meets a customer with a unique requirement that looks exciting and profitable, the engineer is the first one to come back all smiles, and say: "Hey, look, this is a great opportunity, and here's what else we could do with it."

And we can already measure our success. In the past 18 months or so we've completed between 50 and 70 custom design programs. In the middle of 1972 we weren't making LED drivers, and in the beginning of 1974 we've developed four generations of LED driver circuits. Also, we've yet to have a program that hasn't had a fallout effect for the company.

So far we haven't taken on a custom program that has failed. ■■

THE MOST RELIABLE STANDBY POWER SYSTEMS HAVE



A HEART OF GOLD.

**GENERAL ELECTRIC GOLDTOP® BATTERIES
... THE MAINTENANCE-FREE POWER SOURCE
FOR LONG LIFE DEPENDABILITY IN YOUR
STANDBY POWER APPLICATION**

In addition to maintenance-free dependability and long life, Goldtop rechargeable nickel-cadmium batteries offer you:

- Convenient small size for mounting anywhere in any position. Ideal for those hard-to-get-to applications.
- High temperature capability for hot ambient locations.
- High current discharge capability. This small battery does a big job.
- A sealed battery to eliminate venting of corrosive gases.
- Simple constant current charging. No voltage cutoff circuitry required.

These are just a few reasons why you should put a heart of gold into your next standby power system. For more information circle the reader service card, or write General Electric Company, Section 452-05, Schenectady, N. Y. 12345

GENERAL  ELECTRIC

INFORMATION RETRIEVAL NUMBER 42

NEW VALUES HIGH ENERGY

TYPE	$I_C(\text{max.})$	V_{CE0}	V_{CEV}	$V_{CE0}(\text{sus.})$	$V_{CE}(\text{sat.})$ @ I_C, I_B	Power Dissipation (max.)	h_{FE} min./max. @ I_C, V_{CE}
DTS-701	1.0 A	800V	—	600V	—	50W	20/— @ 150mA, 5V
DTS-708	3.0 A	900V	900V	600V	2.0V max. @ 1.0A, 250mA	50W	—
DTS-709	3.0 A	900V	900V	600V	1.0V max. @ 2.0A, 800mA	50W	—
DTS-710	3.0 A	900V	—	600V	—	50W	10/50 @ 150mA, 5V
DTS-712	3.0 A	900V	1200V	700V	—	50W	2.5/— @ 2.0A, 5V
DTS-714	3.0 A	900V	1400V	700V	—	50W	2.5/— @ 2.0A, 5V
DTS-723	3.0 A	1000V	1200V	750V	0.8V max. @ 1.0A, 250mA	50W	10/— @ 500mA, 5V
DTS-801	2.0 A	800V	—	700V	—	100W	20/— @ 200mA, 5V
DTS-812	5.0 A	900V	1200V	700V	—	100W	2.2/— @ 3.5A, 5V
DTS-814	5.0 A	900V	1400V	700V	—	100W	2.2/— @ 3.5A, 5V

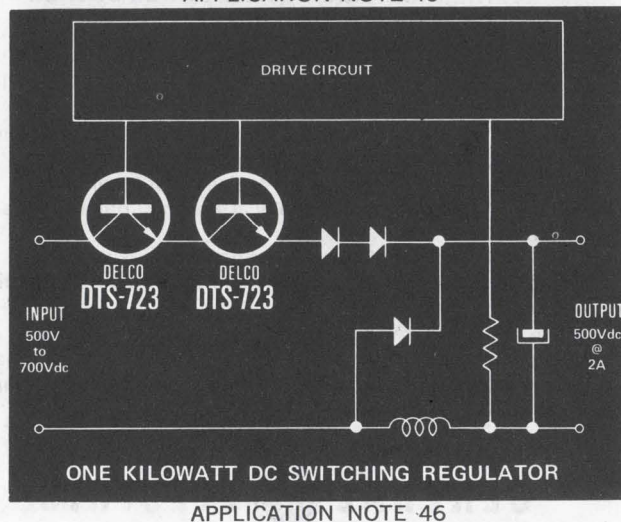
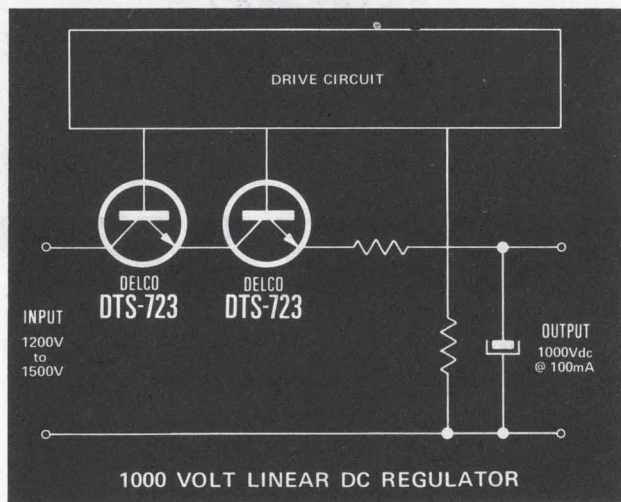

Delco Electronics has made it possible for your Delco distributor to offer you better values than ever on these ten silicon high-power transistors. What's more, he has them in stock now and there's a healthy factory inventory to back him up.

These high quality, high voltage devices are all NPN, triple diffused, and packaged in Delco's solid-copper TO-204MA (TO-3) case.

Some are specifically designed for use in high voltage switching circuits where inductive loads or fault conditions pose problems. Some are ideal for linear regulators and power amplifiers.

In fact, all the devices share Delco's reputation for being ideal where circuit conditions and high energy requirements are a concern. And because they're 100 percent pulse energy tested, you know they're rugged.

The circuit diagrams in this ad will give you a quick reading of how these ten transistors can meet your needs.

Applications literature and complete device data are available from your Delco distributor.

Give him a call for the information you need and the delivery promises and prices you'll like.

**NOW AVAILABLE FROM THESE DISTRIBUTORS
IN PRODUCTION QUANTITIES.**

ALABAMA, Birmingham
Forbes Distributing Co., Inc.
(205) 251-4104

ALABAMA, Huntsville
Powell Electronics
(205) 539-2731

ON DELCO'S TRANSISTORS.

ideas for design

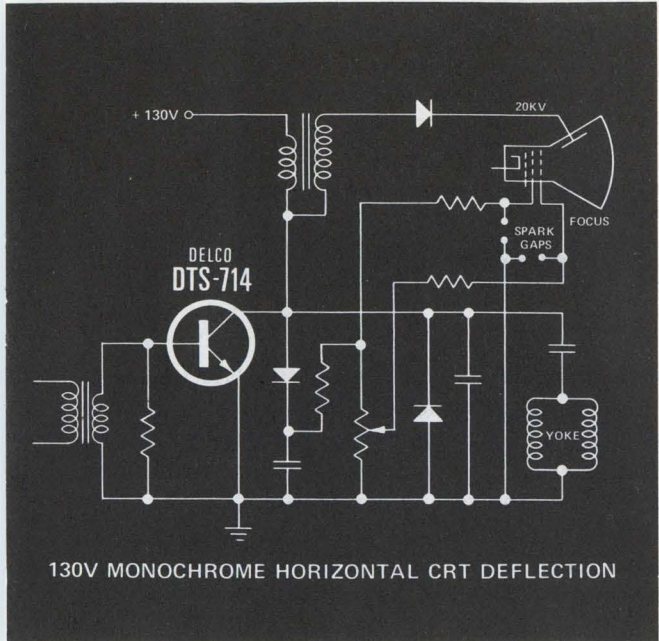

130V MONOCHROME HORIZONTAL CRT DEFLECTION

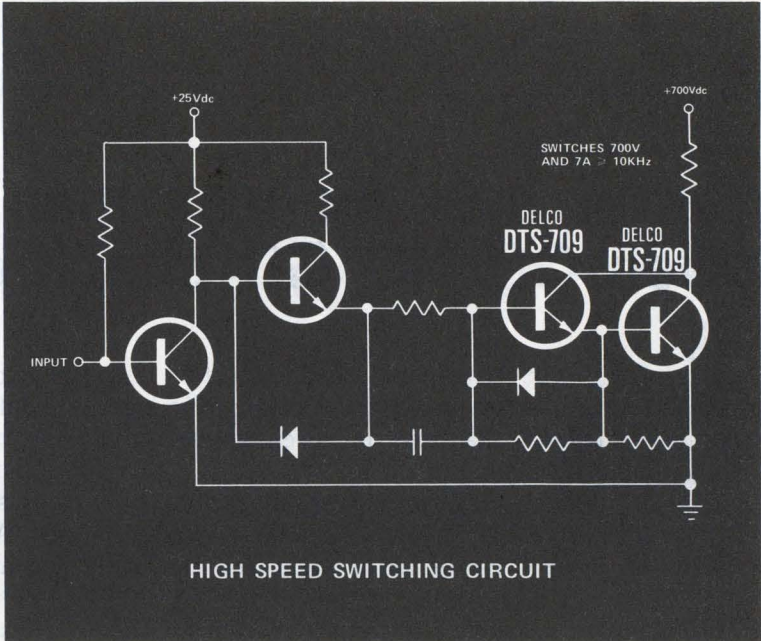

HIGH SPEED SWITCHING CIRCUIT

APPLICATION NOTE 54

ARIZONA, Phoenix
Sterling Electronics, Inc.
(602) 258-4531

CALIFORNIA, Goleta
R.P.S. Electronics, Inc.
(805) 964-6823

CALIFORNIA, Los Angeles
Kierulff Electronics, Inc.
(213) 685-5511

CALIFORNIA, Los Angeles
R.P.S. Electronics, Inc.
(213) 748-1271

CALIFORNIA, Palo Alto
Kierulff Electronics, Inc.
(415) 968-6292

CALIFORNIA, San Diego
Kierulff Electronics, Inc.
(714) 278-2112

CALIFORNIA, San Diego
R.P.S. Electronics, Inc.
(714) 292-5611

COLORADO, Denver
Kierulff Electronics, Inc.
(303) 371-6500

CONNECTICUT, Norwalk
Harvey Electronics
(203) 853-1515

FLORIDA, Miami Springs
Powell Electronics/Florida
(305) 592-3260

FLORIDA, Orlando
Powell Electronics/Florida
(305) 859-1450

ILLINOIS, Rosemont
Kierulff Electronics, Inc.
(312) 678-8560

ILLINOIS, Skokie
Bell Industries
Electronics Distributors Div.
(312) 282-5400

INDIANA, Indianapolis
Graham Electronics Supply, Inc.
(317) 634-8202

INDIANA, Indianapolis
Harvey-Indiana
(317) 297-4910

MARYLAND, Baltimore
Radio Electric Service Co.
(301) 823-0070

MASSACHUSETTS, Needham Heights
Kierulff Electronics, Inc.
(617) 449-3600

MASSACHUSETTS, Newton
The Greene-Shaw Co., Inc.
(617) 969-8900

MICHIGAN, Farmington
Harvey-Michigan
(313) 477-1650

MINNESOTA, Minneapolis
Stark Electronics Supply Co.
(612) 332-1325

MISSOURI, Kansas City
Walters Radio Supply, Inc.
(816) 531-7015

MISSOURI, North Kansas City
LCOMP-Kansas City
(816) 221-2400

MISSOURI, St. Louis
LCOMP-St. Louis
(314) 647-5505

NEW JERSEY, Clifton
Wilshire Electronics/New Jersey
(201) 365-2600 (212) 244-8930

NEW YORK, Binghamton
Harvey Electronics
(607) 748-8211

NEW YORK, Buffalo
Summit Distributors, Inc.
(716) 884-3450

NEW YORK, Farmingdale
Wilshire Electronics/Long Island
(516) 293-5775

NEW YORK, Woodbury
Harvey Electronics
(516) 921-8700 (212) 895-9260

OHIO, Cincinnati
United Radio, Inc.
(513) 761-4030

OHIO, Cleveland
Pattison Supply Co.
Industrial Electronics Division
(216) 441-3000

PENNSYLVANIA, Philadelphia
Almo Electronics
(215) 676-6000

PENNSYLVANIA, Pittsburgh
RPC Electronics
(412) 782-3770

SOUTH CAROLINA, Columbia
Dixie Radio Supply Co., Inc.
(803) 253-5333

TEXAS, Dallas
Adleta Electronics Company
(214) 741-3151

TEXAS, Fort Worth
Adleta Electronics Company
(817) 336-7446

TEXAS, Garland
Kierulff Electronics, Inc.
(214) 271-2471

TEXAS, Houston
Harrison Equipment Co., Inc.
(713) 224-9131

WASHINGTON, Seattle
Kierulff Electronics, Inc.
(206) 763-1550

IN CANADA
ONTARIO, Scarborough
Lake Engineering Co., Ltd.
(416) 751-5980

ALL OVERSEAS INQUIRIES:
General Motors Overseas Operations
Power and Industrial Products Dept.,
767 Fifth Avenue, New York, N.Y.
10022. Phone: (212)-486-3723.

Delco Electronics
Regional Sales Offices
Union, New Jersey 07083
Box 1018 Chestnut Station
(201) 687-3770
Van Nuys, California 91404
Box 2968
(213) 988-7550
General Sales Office
700 E. Firmin, Kokomo, Ind. 46901
(317) 459-2175
Operator (317) 457-8461



Delco Electronics, Division of General Motors.

ideas for design

Tester built for less than \$10 gives GO/NO GO check of timer ICs

A circuit built with two timer ICs for less than \$10 permits incoming inspection of timer modules without the use of oscilloscopes or elapsed-time instruments.

Two IC timers determine the allowable accuracy for the unit under test. Potentiometers R_1 and R_2 permit ready adjustment for the desired range.

With power applied, all timers switch to the high state and begin their cycles. The output of IC₁ inhibits the flip-flop for the first T_1 sec. After T_2 sec, the output of IC₂ goes low and inhibits any signal from the timer under test. The period between T_1 and T_2 is the time allotted for IC₃ to

complete its cycle, as signified by a ZERO output. Only during this time can the ONE-to-ZERO transition of IC₃ trigger the flip-flop so LED₁ illuminates. LED₂, of course, always illuminates to signify that the test is complete.

Although there can be a few milliseconds of contact bounce when S₁ is first turned on, thereby causing a delay in capacitor charging, the delay appears across all the ICs. But the ratio of delay times among all three timers is the same, and the effect on test accuracy is nil.

John Predescu, Assistant Research Engineer, Buchler Instruments, 1327 16th St., Fort Lee, N.J. 07024.

CIRCLE No. 311

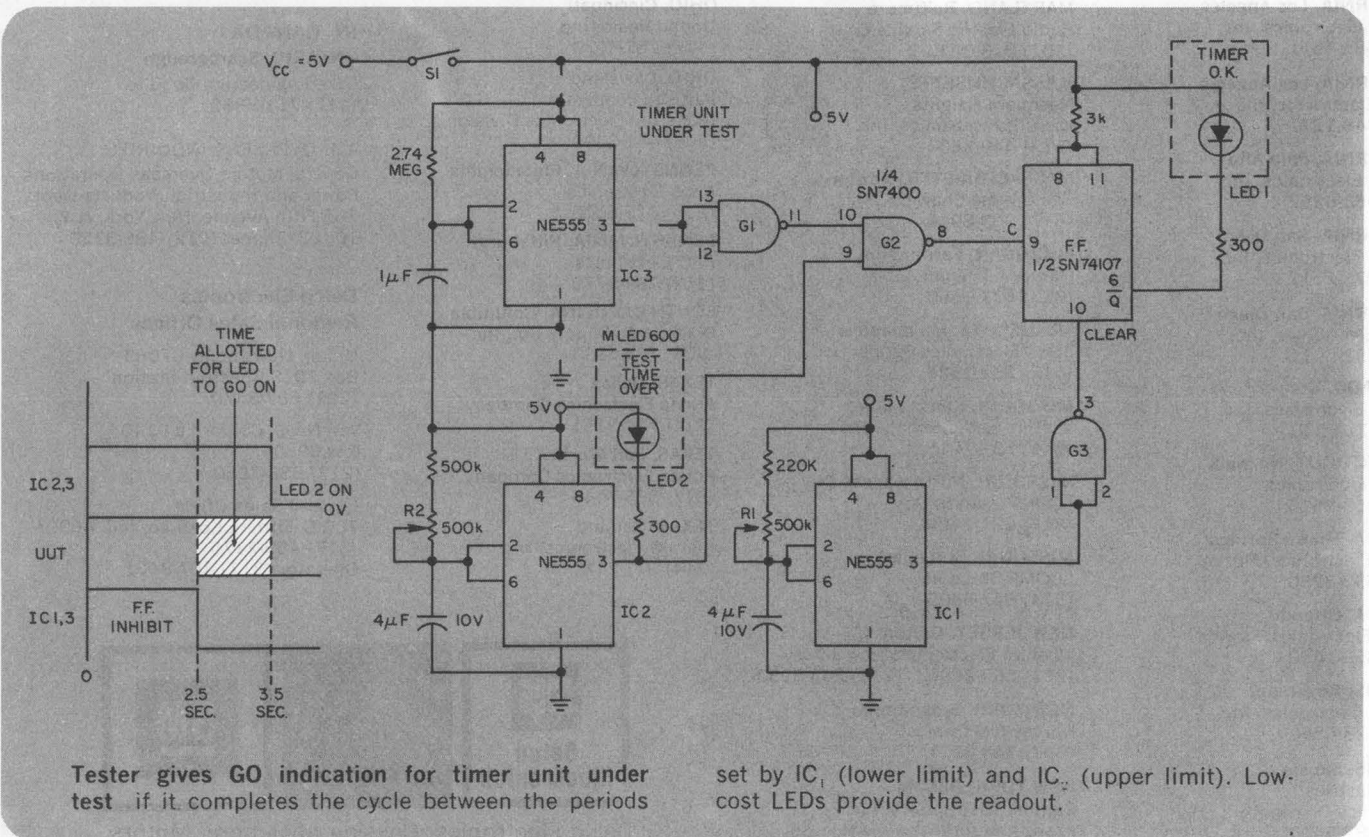

±15 VOLT POWER MINI'S FOR OP AMPS

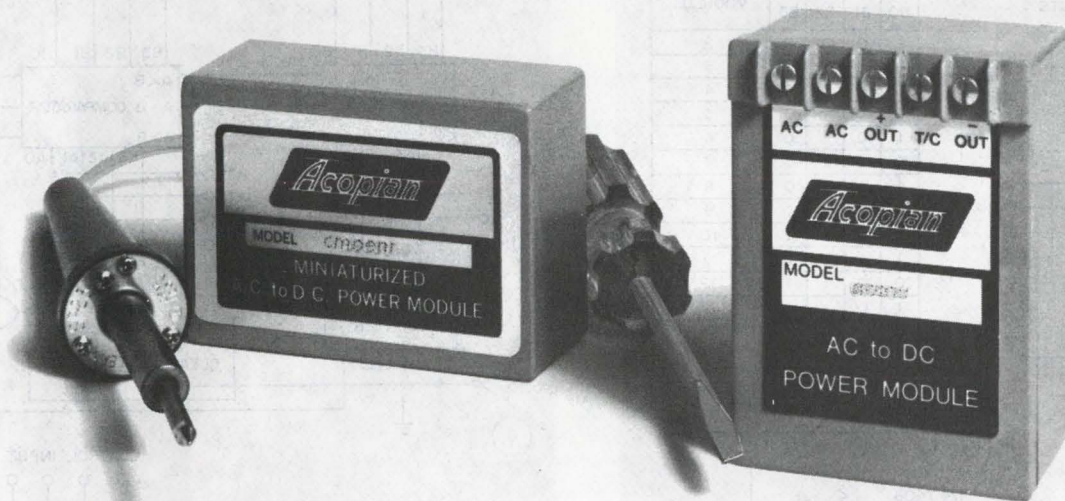

PC-BOARD MOUNTING

OUTPUT CURRENT MA	SIZE INCHES	PRICE	MODEL
25	2.3 x 1.8 x 1.00	\$24	D15-03
50	2.3 x 1.8 x 1.00	39	D15-05
100	3.5 x 2.5 x 1.00	49	D15-10A
200	3.5 x 2.5 x 1.00	69	D15-20
300	3.5 x 2.5 x 1.25	105	D15-30
500	3.5 x 2.5 x 2.00	130	D15-50

CHASSIS MOUNTING

OUTPUT CURRENT MA	SIZE INCHES	PRICE	MODEL
100	3.5 x 2.5 x 1.38	\$55	DB15-10
150	3.5 x 2.5 x 1.38	65	DB15-15
200	3.5 x 2.5 x 1.38	75	DB15-20
300	3.5 x 2.5 x 1.63	105	DB15-30
350	3.5 x 2.5 x 1.63	110	DB15-35
500	3.5 x 2.5 x 2.38	135	DB15-50

Line/load regulation, $\pm 0.1\%$ or better; ripple, 1 mv; input, 105-125 VAC. Other single and multiple output models from 1 to 75 volts, to 2.5 amps. Liberal quantity discounts. Three-day shipment guaranteed.

Complete details on these plus a comprehensive line of other power supplies and systems are included in the Acopian 74-75 catalog. Request a copy.



Corp., Easton, Pa. 18042. Telephone (215) 258-5441.

INFORMATION RETRIEVAL NUMBER 44

Versatile programmable-counter chains are built from simple MSI modules

Two basic MSI circuits—a 4-bit comparator and a 4-bit synchronous counter—let you design flexible programmable counters.

The two ICs form a variable modulus counter (Fig. 1a). A pulse applied to the reset input clears the counter to zero. The event clock causes the counter value to reach the number (N + 1) programmed for the comparator (Fig. 1b). The comparator output then initiates the necessary clear operation. Inverter I₁ and gate G₁ provide the additional clock pulse to clear the synchronous counter.

For larger moduli—up to 256—cascade the

comparators and AND the carry-out with the clock of the previous stage (Fig. 2a).

Each stage represents a digit, with the connections shown in Fig. 2b. The control input determines the type of digit—binary, octal BCD or hexadecimal. The carry signal from one digit to the next is generated by A = B output of the previous stage's comparator.

The programmable counter module is versatile enough so that a single circuit can perform a variety of different functions in a system.

Joseph Panzitta, Chief Engineer, Quindata, Inc., 101 Rt. 22, Mountainside, N.J. 07092.

CIRCLE No. 312

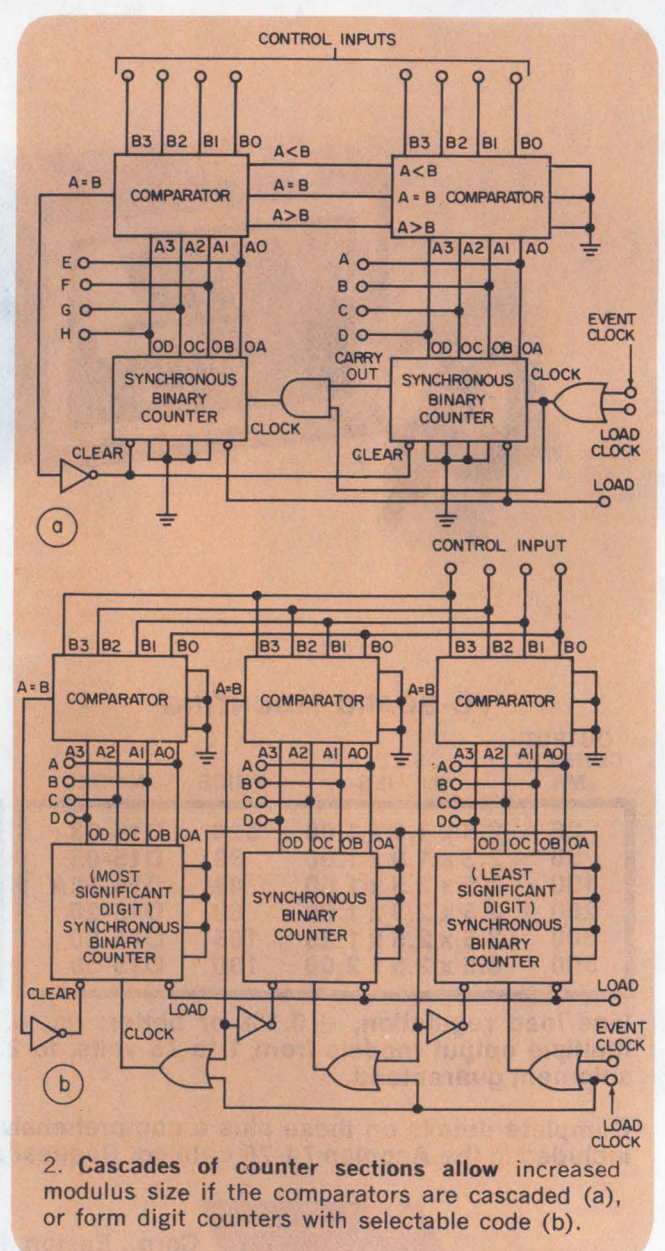
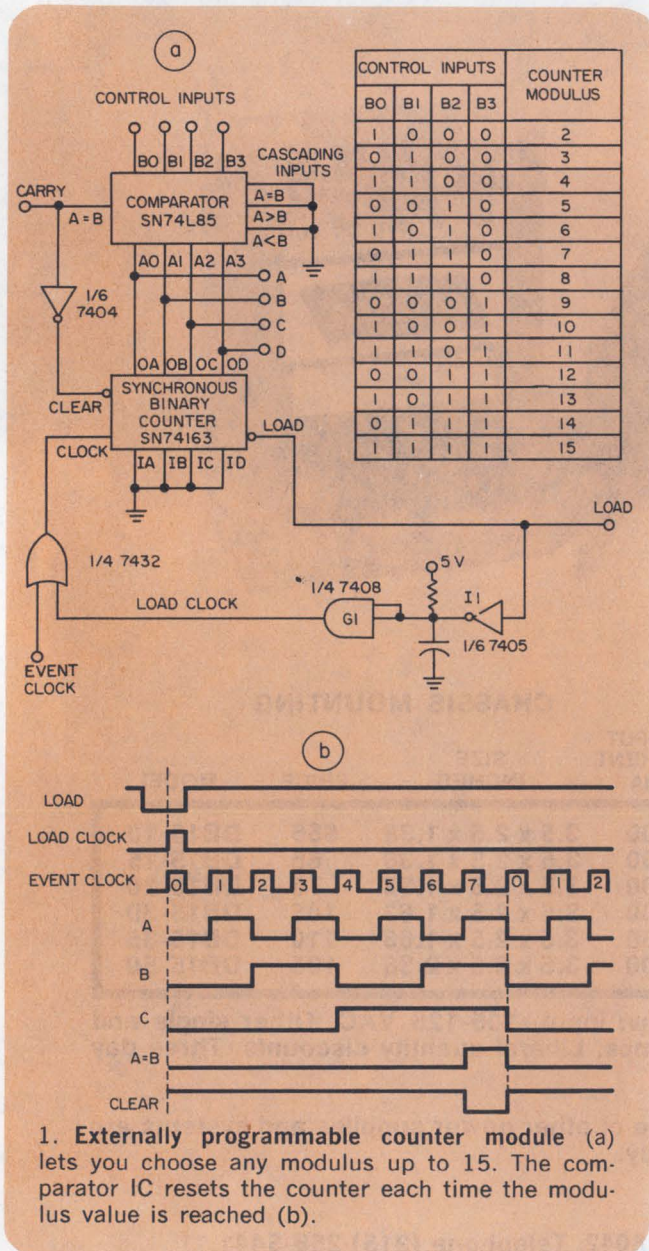

Micaply® Substrates and Circuits

For Thick/Thin Film Applications

Thick/thin film resistor-conductor circuits utilizing Micaply Ohmega™ Resistor-Conductor Laminates

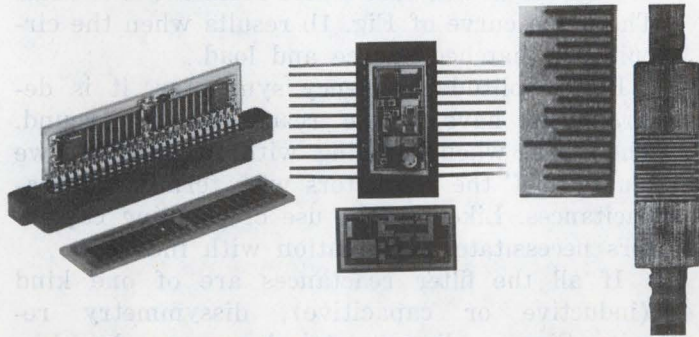

Circuits of Micaply Ohmega™ offer designers a proven epoxy glass substrate with both the resistor and conductor layers completely covering the substrate on one or both sides. **Selective etching produces conductors complete with integral thin film type resistors as shown at the right.** The circuits shown above are examples of its use to replace more expensive thick/thin film resistor circuits and discrete resistor circuits.

Complete design assistance and circuit production are available. Contact us for an evaluation of your requirement and comprehensive technical literature. Find out how Micaply Ohmega™ can reduce your circuitry cost.

- Much lower cost than conventional materials and processing.
- 25 or 100 ohms-per-square sheet resistivity.
- Line widths consistent with thin film microelectronic techniques.
- Subtractive etching process — no screening, firing, or vacuum equipment required.
- 10" x 36" sheets for processing economy.
- Can be easily drilled and cut.
- Can be multilayered for higher density.
- Resistors can be laser trimmed.

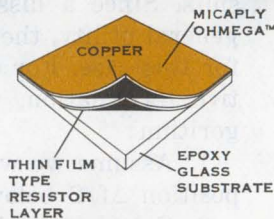

Before Etching

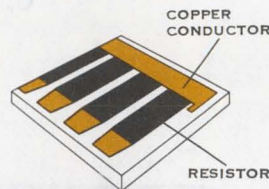

After Etching

Hybrid microcircuits utilizing Micro-Thin Copper Clad Laminates (a low cost ceramic substrate alternative)

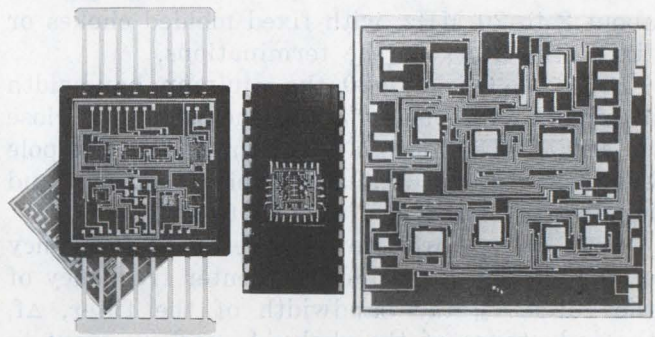

Micaply® Micro-Thin Copper Clad Laminates make possible lower cost hybrid microcircuits. Epoxy glass microcircuits like the ones shown above eliminate the cost and costly processing of ceramic in many applications. Micro-Thin is an epoxy glass laminate completely clad on one or both sides with 100 microinches of copper. Using conventional etching techniques conductors with line widths as fine as two mils can be produced.

Complete design assistance and prototype service is available. Contact us for an evaluation of your requirement and for comprehensive technical literature. Find out how Micaply® Micro-Thin can reduce your microcircuit costs.

- Much lower cost than metal coated ceramic substrates.
- 100 microinch copper clad epoxy glass.
- Can be easily drilled and cut.
- 10" x 12" sheets for processing economy.
- Etched line widths as fine as two mils.
- Can be multilayered for higher density.
- Active and passive chips are easily bonded.
- No screening, firing, or vacuum equipment required.



Request complete literature on Micaply Ohmega™ and Micro-thin Copper Clad Laminate materials and production services.

See us at
NEPCON '74 EAST
Booth 4546

The Mica Corporation

10900 Washington Boulevard, Culver City, California 90230, (213) 839-5282, TWX: 910-340-6365, Telex: 674999

Micaply International, Ltd. Silloth, Cumberland, England, Silloth 571, Telex: 64120, Cable: Micaply Silloth

INFORMATION RETRIEVAL NUMBER 45

Inexpensive low-Q bandpass filters made with tweaked standard chokes

A new type of choke that displays a series-resonant response at self-resonance, instead of the usual anti-resonance, can be used to make medium to wide bandwidth filters. These chokes are made at three standard resonant frequencies: 3.58, 4.5 and 10.7 MHz. Filters using these chokes can be made at center frequencies ranging from about 2 to 20 MHz, with fixed molded chokes or fixed capacitors at the terminations.

Since the Q is only 20, the minimum bandwidth attainable is about 10% and the maximum close to 100%. The design algorithms for two-pole bandpass filters with acceptable frequency and bandwidth ranges are easy to follow.

Let's assume we know the resonant frequency of the chokes, f_r , the desired center frequency of the filter, f_o , the bandwidth of the filter, Δf , the inductance of the choke, L, and we want to use inductive coupling. Then one possible algorithm follows:

1. Assume we want to shift the resonator to a position $\Delta f/2$ above f_o .

2. Calculate the total loop capacity,

$$C_T = \frac{1}{4 \pi^2 \left(f_o + \frac{\Delta f}{2} \right)^2 L}$$

3. Calculate the choke series capacitance,

$$C_r = \frac{1}{4 \pi^2 f_r^2 L}$$

4. Calculate intermediate capacitance,

$$C_L = \frac{C_r C_T}{C_r - C_T}$$

5. Calculate intermediate load,

$$R_L = \pi L \Delta f$$

6. Calculate

$$Q = \frac{1}{\omega_o C_L R_L}$$

7. Calculate the parallel load capacitance

$$C_p = \frac{C_L}{1 + \frac{1}{Q^2}}$$

8. Calculate the parallel load resistance,

$$R_p = R_L (1 + Q^2)$$

9. Calculate coupling inductance,

$$L_c = \frac{f_o L}{\Delta f}$$

This step-by-step procedure leads to the circuit of Fig. 1a. In this case a 3.58-MHz choke is used. The notch curve of Fig. 1b results when the circuit has matched source and load.

For amplitude-frequency symmetry, it is desirable to have unlike reactances to ground. Therefore, when coupling with inductances, we must "pull" the resonators with terminating capacitances. Likewise the use of coupling capacitors necessitates termination with inductors.

If all the filter reactances are of one kind (inductive or capacitive), dissymmetry results. Since a dissymmetrical response has less general utility, the design formulas are not given for this case. For capacitive coupling and inductive termination, we can use the following algorithm:

1. Assume we want to shift the resonator to a position $\Delta f/2$ below f_o .

2. Calculate series choke capacity

$$C_r = \frac{1}{4 \pi^2 f_r^2 L}$$

Series resonant choke characteristics

Dale Electronics Model	Frequency (MHz)	Toler.	Z at resonance	L (μ H)	C (pF)
IRT-1088-3M58	3.58	$\pm 5\%$	$20 \Omega \pm 20\%$	12	167
IRT-1088-4M50	4.5	$\pm 5\%$	$19 \Omega \pm 20\%$	8.4	150
IRT-1088-10M7	10.7	$\pm 5\%$	$12 \Omega \pm 20\%$	2.90	77

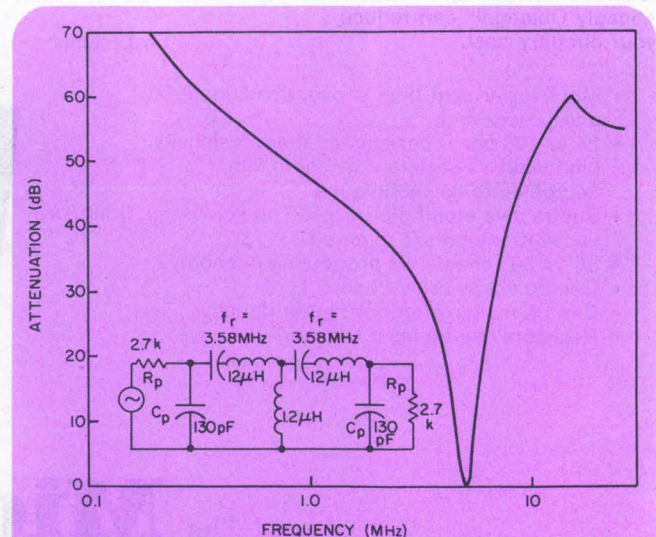

1. A 5-MHz filter (a) can be built with 3.58-MHz chokes. The response of the two-pole filter (b) is plotted for a 2.7 k Ω source and load.

The world's biggest little black box is on the road

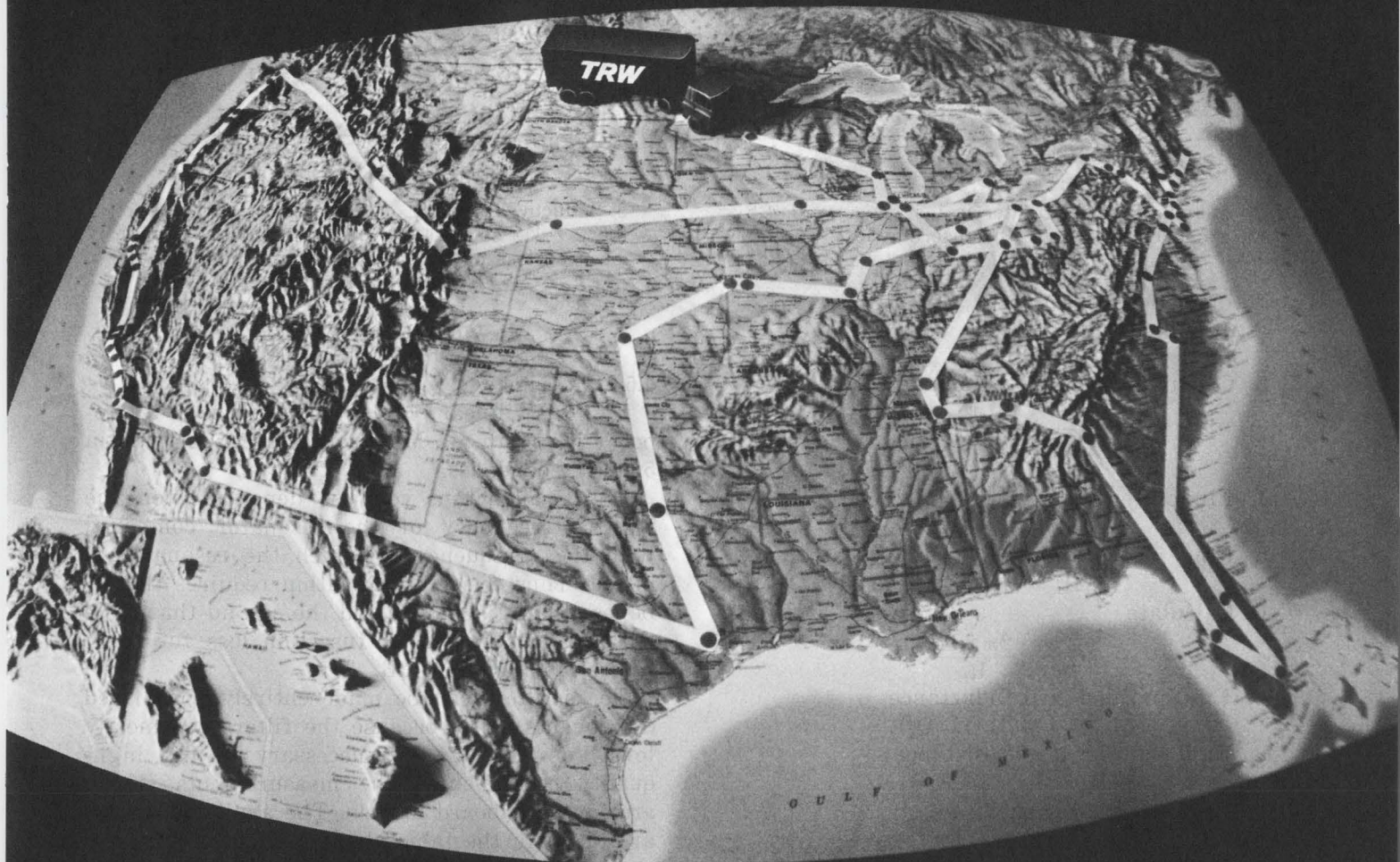

It's a unique display of TRW Electronic Components' newest products, circuit applications and ideas—coming right to you.

Picture a typical electronics chassis, grown to mammoth proportions. In fact, to the size of a 40-foot tractor-trailer; far and away the world's *biggest* "little black box." Inside, you'll find components which look like nothing you've ever seen before—because the scale is *giant*. Five feet high for some.

Our technical experts will be on hand to answer your questions on more than 1000 different products from the 14 separate divisions that form TRW Electronic Components.

And the show is on the road right now. We're zig-zagging our way across country, stopping at 155 plants in 27 states. Watch for announcements when we'll be in your area. TRW's little black box is where electronics is, and we're bringing it where you are. Because we *are* TRW.

TRW® **ELECTRONIC COMPONENTS**

Connectors • Resistors • Semiconductors • Capacitors • Motors • PC Boards • Potentiometers • Transformers • Coils and Inductors • Wire and Cable

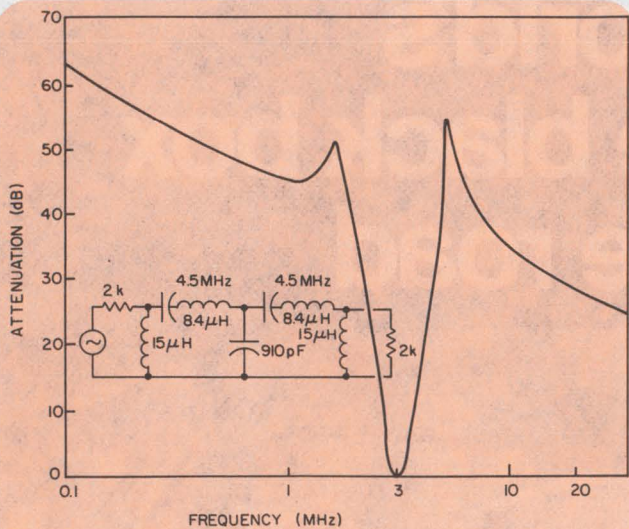

2. Building a 3 MHz filter is just as easy if 4.5 MHz chokes are used. The insertion loss for this filter runs about 2 dB when load matches source.

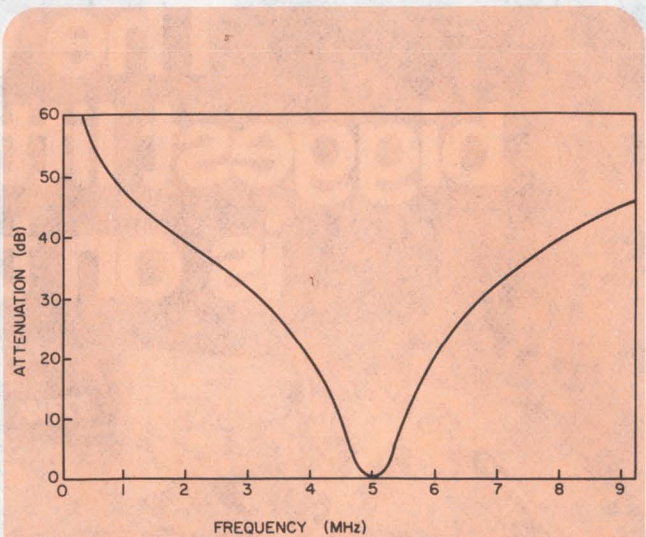

3. Inductive coupling of the chokes and use of the 2.7 kΩ source and load impedances give an insertion loss of 4 dB for a two-pole filter.

3. Calculate total loop inductance

$$L_T = \frac{1}{4\pi^2 \left(f_o - \frac{\Delta f}{2} \right)^2 C_r}$$

4. Find intermediate inductance

$$L_L = L_T - L$$

5. Find intermediate load resistance

$$R_L = \pi L_T \Delta f$$

6. Calculate

$$Q = \frac{2\pi f_o L_L}{R_L}$$

7. Find parallel load inductance

$$L_p = L_L (1 + 1/Q^2)$$

8. Find parallel load resistance

$$R_p = R_L (1 + Q^2)$$

9. Find coupling capacitance

$$C_c = \frac{f_o}{\Delta f} C_r$$

This algorithm very closely follows the earlier one. The resulting circuit and response curve are shown in Fig. 2 for a design that uses the

4.5-MHz choke.

Fig. 3 is a linear plot of the response of a two-pole filter with a 5-MHz center frequency and a 500-kHz bandpass.

Which algorithm you use depends upon the relative frequency of the resonator compared with the frequency to which the resonator is pulled. Thus the first algorithm requires that f_r be less than $f_o + \Delta f/2$, and the second that f_r be greater than $f_o - \Delta f/2$. Insertion loss for these filters runs about 4 dB.

These filters can be made entirely with fixed components. Also, because the filters are mostly low-Q devices, it's not necessary to use high-quality components. The measurements shown are for breadboard models. The available chokes are listed in the table along with some of their characteristics.

Christopher Vale, Senior Engineer, Westinghouse Electric Corp., Systems Development Div., Baltimore, Md. 21203. CIRCLE NO. 313

IFD Winner of January 18, 1974

Akavia Kaniel, Design Engineer, Digital Equipment Corp., 146 Main St., Maynard, Mass. 01754. His idea "Digital Delay Circuit For One-Shot Controls Timing Interval in Programmable Integer Steps" has been voted the Most Valuable of Issue Award.

Vote for the best Idea in this issue by circling the number for your selection on the Information Retrieval Card at the back of this issue.

SEND US YOUR IDEAS FOR DESIGN. You may win a grand total of \$1050 (cash)! Here's how. Submit your IFD describing a new or important circuit or design technique, the clever use of a new component or test equipment, packaging tips, cost-saving ideas to our Ideas for Design editor. Ideas can only be considered for publication if they are submitted exclusively to ELECTRONIC DESIGN. You will receive \$20 for each published idea, \$30 more if it is voted best of issue by our readers. The best-of-issue winners become eligible for the Idea of the Year award of \$1000.

Hughes heat pipes. Order 'em hot off the shelf.

Now you can order heat pipes just like you order nuts and bolts. Because now Hughes stocks heat pipes in a variety of standard, off-the-shelf sizes and thermal capacities. (If you have a heat transfer problem that calls for a custom solution, we solve those, too.)

1333H STAINLESS STEEL AND AMMONIA

Thermal transport capacity: 50 watts with evaporator 90° below condenser, 15 watts horizontal operation, 7 watts with evaporator 90° above condenser. Recommended operating range: -80° to +90°C. Weight: 8 grams. Active Length: 5.69 inches. Diameter: 3/16". \$37.00.

1370H COPPER AND WATER

Available in diameters of 1/4", 1/2", and 1" at \$37.00, \$40.00 and \$50.00, respectively, with thermal transport capacities of 345, 750, and 6000 watts with the evaporator 90° below condenser; 115, 250 and 2000 watts horizontal operation; 38, 60, and 500 watts with evaporator 90° above condenser. Recommended operating range: +50° to +150°C. Weight: 21, 70, 550 grams. Standard Active Length: 6, 6, 12 inches.

1350H STAINLESS STEEL AND METHANOL

Available in diameters of 3/16" and 1/4" at \$37.00 each and 1/2" at \$40.00. Thermal transport capacities are 55, 75, and 180 watts with evaporator 90° below condenser, 17, 25, and 60 watts horizontal operation, and 6, 10, and 20 watts with evaporator 90° above condenser. Recommended operating range: -40° to +120°C. Weight: 8, 11, and 38 grams. Standard Active Length: 6 inches.

1361H FLEXIBLE STAINLESS STEEL AND METHANOL

Available in active lengths of 7" and 8" at \$75.00 each, with thermal transport capacities of 20 watts with the evaporator 90° below condenser, 7.5 watts horizontal operation, 2.5 watts with evaporator 90° above condenser. Recommended operating range: -40° to +120°C. Weight: 20 grams. Diameter: 1/4".

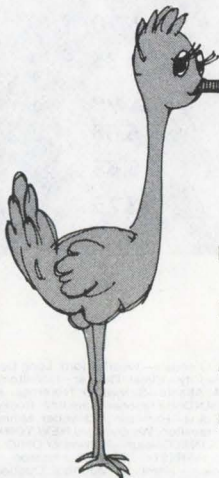
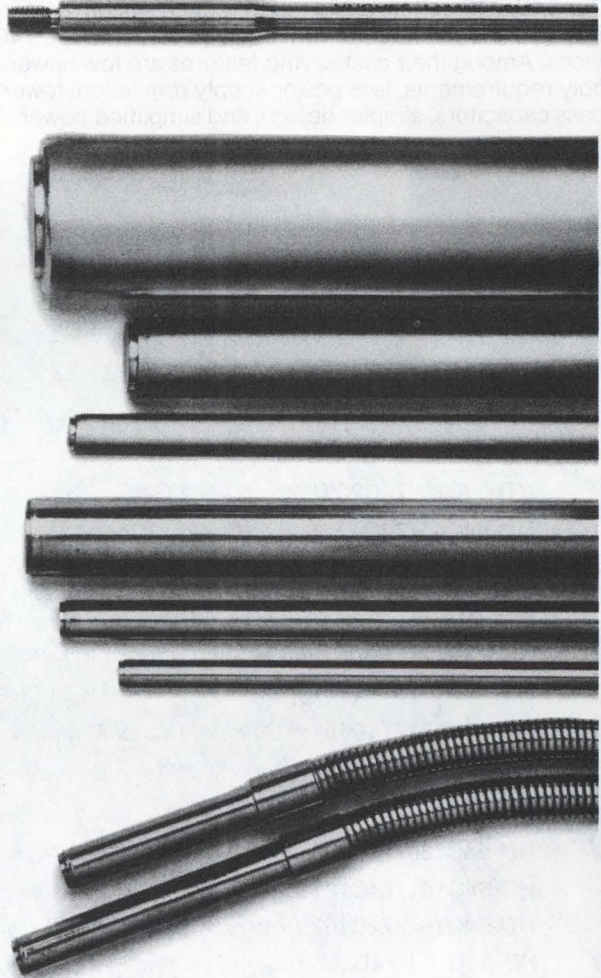

For detailed information, or if you have a hot requirement and want one now, just fill out and send in the coupon. Hughes Electron Dynamics Division, 3100 W. Lomita Blvd., Mail Station 2124, Torrance, California. (213) 534-2121.

PLEASE PRINT

SEND INFORMATION.

SEND QUICK ORDER FORM.

NAME _____ COMPANY _____

ADDRESS _____ CITY _____

STATE _____ ZIP _____ TELEPHONE _____

All prices shown are effective in U. S. A. and Canada

ED-5

INFORMATION RETRIEVAL NUMBER 47

Not just a second source. But a

Introducing Harris'

Here they are—22 device types offering true alternate-source availability for 54C/74C CMOS. Combined with our existing 4000 series and custom LSI capability, addition of these new units makes Harris one of the few suppliers with total CMOS capability. So, choose from our 54C/74C series—44 devices with more on the way.

Our **54C/74C series**, designed to reduce system costs, is pin-for-pin and function-for-function equivalent to T²L 7400 devices. Among their cost-saving features are low power supply requirements, less power supply regulation, fewer bypass capacitors, simpler design, and simplified power

distribution. The units also offer high noise immunity—typically 45% of supply voltage, and they have a guaranteed 1V noise margin. This means that 1V of noise at the input will not cause the output to rise beyond T²L levels. As a result, logic errors are less likely.

Applications are easy, too, with industry standardized input and output characteristics. Experience acquired with the 7400 series can also be applied directly to use of the 54C/74C's. For details, see your Harris distributor or representative.

	100-999 UNITS	
	-55°C to +125°C	0°C to +70°C
HD-54C00/74C00 Quad 2 NAND Gate _____	2.98	.69
HD-54C02/74C02 Quad 2 NOR Gate _____	2.98	.69
HD-54C04/74C04 Hex Inverter _____	3.30	1.04
HD-54C10/74C10 Triple 3 NAND Gate _____	2.98	.69
HD-54C20/74C20 Dual 4 NAND Gate _____	2.98	.69
HD-54C42/74C42 BCD to Decimal Decoder _____	7.15	3.30
HD-54C73/74C73 Dual J-K Flip Flop with Clear _____	4.75	2.26
HD-54C74/74C74 Dual D Flip Flop _____	4.20	1.45
HD-54C76/74C76 Dual J-K Flip Flop with Clear and Preset _____	4.75	2.26
HD-54C107/74C107 Dual J-K Flip Flop with Clear _____	4.75	2.26
HD-54C151/74C151 8 Channel Digital Multiplexer _____	6.40	3.95
HD-54C154/74C154 4-Line to 16-Line Decoder/Demultiplexer _____	16.20	5.40
HD-54C157/74C157 Quad 2 Multiplexer _____	5.10	2.88
HD-54C160/74C160 Decade Counter with Asynchronous Clear _____	10.40	5.70
HD-54C161/74C161 Binary Counter with Asynchronous Clear _____	10.40	5.70
HD-54C162/74C162 Decade Counter with Synchronous Clear _____	10.40	5.70
HD-54C163/74C163 Binary Counter with Synchronous Clear _____	10.40	5.70
HD-54C164/74C164 8-Bit Parallel Out Serial Shift Register _____	11.00	4.35
HD-54C173/74C173 Three State Quad/D Flip Flop _____	9.15	3.80
HD-54C192/74C192 Synchronous 4-Bit Up/Down Decade Counter _____	10.30	5.65
HD-54C193/74C193 Synchronous 4-Bit Up/Down Binary Counter _____	10.30	5.65
HD-54C195/74C195 4-Bit Register _____	5.70	3.75

WHERE TO BUY THEM: ARIZONA: Phoenix—Hamilton, Liberty, Weatherford; Scottsdale—HAR (602) 946-3556 CALIFORNIA: Anaheim—Weatherford; El Segundo—Liberty; Glendale—Weatherford; Long Beach—HAR (213) 426-7687; Mountain View—Elmar; Palo Alto—Weatherford, HAR (415) 964-6443; Pomona—Weatherford; San Diego—Liberty, Weatherford COLORADO: Commerce City—Elmar; Denver—Hamilton; Englewood—Weatherford CONNECTICUT: Danbury—Schweber; Norwalk—Harvey FLORIDA: Hollywood—Hamilton, Schweber; Melbourne—HAR (305) 727-5430 GEORGIA: Atlanta—Schweber; Norcross—Hamilton ILLINOIS: Elk Grove Village—Schweber; Schaumburg—HAR (312) 894-8924; Schiller Park—Hamilton INDIANA: Indianapolis—Pioneer KANSAS: Lenexa—Hamilton MARYLAND: Baltimore—Hamilton; Rockville—Schweber MASSACHUSETTS: Burlington—Hamilton; Lexington—Harvey; Wellesley—HAR (617) 237-5430 MICHIGAN: Livonia—Hamilton; Troy—Schweber MINNESOTA: Edina—Hamilton; Schweber; Minneapolis—HAR (612) 432-6111 MISSOURI: Hazelwood—Hamilton NEW JERSEY: Cedar Grove—Hamilton; Mt. Laurel—Hamilton; Somerset—Schweber NEW MEXICO: Albuquerque—Hamilton; Weatherford NEW YORK: East Syracuse—Hamilton; Melville—HAR (516) 249-4500; Syracuse—HAR (315) 463-3373; Rochester—Schweber; Westbury—Schweber; Woodbury—Harvey NORTH CAROLINA: Raleigh—Schweber OHIO: Beachwood—Schweber; Cleveland—Pioneer; Dayton—Pioneer HAR (513) 226-0636 PENNSYLVANIA: Wayne—HAR (215) 687-6680 TEXAS: Dallas—Hamilton; Weatherford, HAR (214) 231-9031; Houston—Hamilton; Weatherford UTAH: Salt Lake City—Hamilton WASHINGTON: Seattle—Liberty, Weatherford WASHINGTON, D.C.: HAR (202) 337-3170 CANADA: Mississauga, Ontario—Hamilton; Montreal, Quebec—Hamilton; Ottawa, Ontario—Hamilton.

LEGEND FOR HARRIS SALES OFFICES & DISTRIBUTORS: Elmar Electronics (Elmar); Hamilton Avnet Electronics (Hamilton); Harris Semiconductor (HAR); Harvey Electronics (Harvey); Liberty Electronics (Liberty); Pioneer Standard Electronics (Pioneer); Schweber Electronics (Schweber); R. V. Weatherford Co. (Weatherford).

source with total CMOS capability.

New 54C/74C Series

Our 4000 (S) series offers you the fastest, low-power logic devices available today. With 10-volt power supplies, speeds are typically twice that of comparable IC's. Power supply range is 3 to 15VDC, while noise immunity is typically 45% of supply voltage. Other advantages are low power dissipation and elimination of SCR latch-up problems. All units are pin-for-pin compatible with the CD-4000A series. And you have a choice of high-speed or direct CD-4000A replacement characteristics. To order a high-speed unit just add the suffix "S" to the HD-4000 part number (HD-4000S). For a direct CD-4000A replacement add an "A" to the number (HD-4000A).

In addition to the HD-4000 series, we offer the HD-4800 group of Harris proprietary devices. Among these devices are six units which together comprise the first family of three-state CMOS interface circuits available. By providing the ability to regulate the state of hard wired outputs, these interface circuits permit an extremely high level of flexibility in buss oriented systems design. These units also have buffered outputs for driving high capacitive lines and T²L directly. When four circuits are utilized, they permit the user to perform logic translation (i.e. MOS to T²L) directly at the buss line. For complete details on our 4000 and 4800 series, see your Harris distributor or representative.

	100-999 UNITS			
	-40°C to +85°C	-55°C to +125°C		
	A	S	A	S
HD-4000 Dual 3 NOR Gate plus Inverter, 14 pin DIP	.78	1.86	1.17	3.10
HD-4001 Quad 2 NOR Gate, 14 pin DIP	.78	1.98	1.17	3.30
HD-4002 Dual 4 NOR Gate, 14 pin DIP	.78	2.04	1.17	3.40
HD-4007 Dual Complementary Pair plus Inverter, 14 pin DIP	.78	1.59	1.17	2.65
HD-4009 Hex Inverter/Buffer, 16 pin DIP	1.69	3.15	2.54	5.25
HD-4010 Hex Buffer, 16 pin DIP	1.69	3.15	2.54	5.25
HD-4011 Quad 2 NAND Gate, 14 pin DIP	.78	1.98	1.17	3.30
HD-4012 Dual 4 NAND Gate, 14 pin DIP	.78	2.07	1.17	3.45
HD-4013 Dual D Flip Flop, 14 pin DIP	1.62	2.85	2.43	4.75
HD-4019 Quad AND/OR Select Gate, 14 pin DIP	1.91	3.03	2.87	5.05
HD-4023 Triple 3 NAND Gate, 14 pin DIP	.78	2.06	1.17	3.44
HD-4025 Triple 3 NOR Gate, 14 pin DIP	.78	2.06	1.17	3.44
HD-4030 Quad Exclusive OR Gate, 14 pin DIP	1.63	2.27	2.45	3.79
HD-4804 Three State Hex Buffer with Level Translator, 16 pin DIP	-	6.15	-	7.67
HD-4805 Three State Hex Buffer Inverter with Level Translator, 16 pin DIP	-	6.15	-	7.67
HD-4806 Three State Triple True/Complement Buffer with Disable, Independent Level Translator, 16 pin DIP	-	6.15	-	7.67
HD-4807 Hex Buffer with Disable, 16 pin DIP	-	6.15	-	7.67
HD-4808 Three State Hex Buffer with Disable, 16 pin DIP	-	6.15	-	7.67
HD-4809 Triple True/Complement Buffer, 16 pin DIP	1.69	3.15	2.54	5.25
HD-4810 Three State Triple True/Complement Buffer with Disable, Common Level Translator, 14 pin DIP	-	6.15	-	7.67
HD-4811 Quad Exclusive NOR Gate, 16 pin DIP	1.63	2.27	2.45	3.79
HD-4814 Hex Inverter, 16 pin DIP	.97	2.27	1.45	3.80



P.O. Box 883, Melbourne, Florida 32901
(305) 727-5430

Coax-to-open-wire feed gives best performance

To obtain a wideband match between a coaxial line and an open-wire feed, a long, even taper of the outer coaxial conductor used to be needed.

A coax-to-open-wire matching design that achieves optimal Chebyshev performance has been developed at the University of Essex in Colchester, England. A stepped version includes corrections for the junction capacitances caused by the steps in the outer conductor.

The outer conductor is cut away progressively in a series of steps of one-quarter wavelength. Only the last stage of this progressive reduction is a taper. Thus the transition is made from a coax to an open, two-wire balanced line.

The advantages claimed for the new design are: (1) The length of the balun is considerably reduced, and (2) Machining is substantially simpler than for a gradual taper.

A test transformer built on this principle was used to connect a 50- Ω coaxial line and a 140- Ω two-wire feed to a log-periodic antenna. At the center of the 2-to-4 GHz band, the VSWR was only 1.1. A VSWR of less than 1.2 was obtained over the full bandwidth.

Three sections were required to achieve a Chebyshev response in the passband in this transformer. In a fourth, tapered, section of the transformer, the outer conductor became circular, so that it could run parallel to the inner conductor to form a balanced two-wire output.

The junction-discontinuity effects at the steps in the outer conductor are significant. And the transformer design uses slotted-line theory to calculate the angle of each cutaway of the outer conductor. In practice, it is estimated that the error in this process is within $\pm 3\%$ of the ideal.

Video map generator enhances radar display

EMI Electronics of Hayes, Middlesex, England, has introduced a video map generator designed for use with air-traffic-control radars, harbor-surveillance radars and radar simulators. The equipment, 498 \times 225 \times 437 mm, permits static information to be drawn on a slide. The slide is then scanned and the analog information amplified and added to the video-signal input on the radar display. Semiconductors and ICs are used throughout, and servicing is made easy by modular construction.

Simple math model aids antenna calculations

The study of multiple-beam antennas has been aided by the development of a simple mathematical model for the vector radiation fields from offset parabolic-reflector antennas. The antenna calculations, developed by researchers at Birmingham University in England, agree with measured results on a 30-GHz antenna system.

The model is useful for communication systems that use dual-polarized beams for simultaneous communications on the same frequency. In addition the use of an

offset portion of a parabolic reflecting surface—in conjunction with a single or multi-element primary feed—provides a compact design in which aperture-blocking effects, due to the primary-feed hardware, are reduced to a minimum.

The mathematical expressions for the modeling of an offset-reflector, offset-feed antenna use a Romberg integration technique. A computer program, developed for use in a design-optimization mode, is fast and requires limited memory. Very accurate predictions of co-polar and cross-polar radiation from offset-reflector antennas can be obtained.

Solid-state contactor ignores power variations

A 50-to-400-Hz solid-state contactor that is said to operate reliably in spite of varying power factors—and without need for additional circuits—has been developed at Britain's Royal Aircraft Establishment in London. Electrical isolation between the control circuit and the power supply is provided by an optically coupled isolator. Switching transients are minimized.

Switching is provided by a pair of thyristors connected back to back or by a single triac. Either combination is triggered by control circuitry that includes the isolator and an auxiliary supply. The current and voltage that can be handled are limited only by the maximum ratings of the thyristors used.

The control signal ranges from 5 to 20 mA. The thyristors or triac become fully conducting at the first voltage zero after applying the control signal. Switchoff occurs at the first current zero after the control signal is removed.

The contactor has been developed as a single-phase, single-pole unit, three of which can be used with a common signal for three-phase, three-pole operation.

Licensing information is available from the National Research Development Corp.

The most complete line anywhere.

Intersil's line of analog switches includes more functions, more technologies and a wider range of prices than that of any other semiconductor manufacturer. Delivery is off-the-shelf for most devices, available in commercial, industrial and military versions. We make all three basic types:

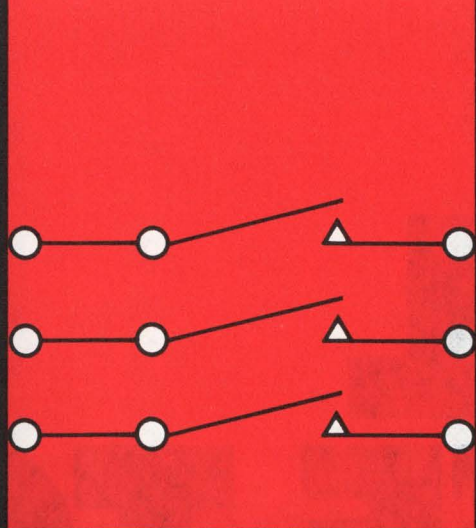

We make the analog gate you need.

1. Low cost J-FET analog gates.

At less than \$1 per channel, the IH5009-thru-5038 series replaces reed relays in multiplexing, gain-ranging and similar applications. Gates are available in "virtual-ground" versions, with effective R_{ON} from 5 to 50 ohms, and positive-signal versions. Configurations range from SPST and SPDT through 4PST.

2. Floating-body monolithic CMOS analog gates.

Low power IH5040 series CMOS gates are free from latch-up and channel-to-channel shorting. They come in commercial and military temperature ranges, with configurations from SPST and SPDT through 4PST.

3. DG-type switches, D-type drivers and G-type gates.

For years, Intersil has been making these devices, and is currently shipping the complete line of these driver-switch combinations you can't get anywhere else. DG111 through DG164 analog gates are available in all popular package types, as well as in high-reliability versions.

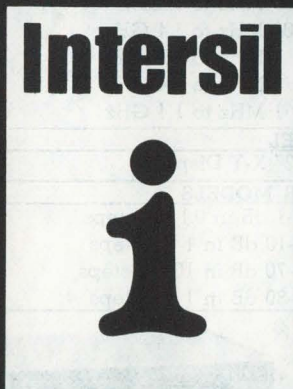

We make the

analog gate you need.

Ask for our new product catalog.

All product data sheets, designer's guides, cross references and a complete listing of detailed application notes are in our new 1974 Products Catalog. From Intersil, 10900 North Tantau Ave., Cupertino, CA 95014.

Get 'em here.

Intersil stocking distributors.

Elmar/Liberty Electronics.
Schweber Electronics.
Semiconductor Specialists.
Weatherford.

Intersil area sales offices.

Boston (617) 861-7380.
Chicago (312) 371-1440.
Los Angeles (213) 532-3544.
Minneapolis (612) 925-1844.
New York (201) 567-5585.
San Diego (714) 278-6053.
San Francisco Bay Area (home office) (408) 257-5450.
Upstate New York (315) 463-3368.

Representatives in all major cities.

FEEL FREE TO USE OUR NAME . . .

(when specifying sweepers).

Wavetek has a sweeper for just about every use imaginable—with frequency coverage from 0.5 to 1400 MHz. All are all-solid-state with excellent linearity characteristics. Crystal-controlled markers and pin-diode leveling are standard. So is the remote programming capability. And to complement our line of sweepers, we've introduced a new X-Y display scope that sells for just \$475. It has a 12" diagonal CRT and four ranges of sensitivity to 1 mV/division. Attenuators and detectors to complete your test set-up are also available. To get more information, be sure to use our complete name: Wavetek Indiana, Inc., P.O. Box 190, Beech Grove, Indiana 46107.
Tel: (317) 783-3221 TWX 810-341-3226

SWEEPER MODELS		
1001A	0.5 MHz to 300 MHz	\$ 995
1002	1 MHz to 500 MHz	1095
1004	500 MHz to 1 GHz	995
1005	700 MHz to 1.4 GHz	995
1801A	1 MHz to 950 MHz	1445
2000	1 MHz to 1.4 GHz	1375
2001	1 MHz to 1.4 GHz	1695
SCOPE MODEL		
1901A	12" X-Y Display	\$475
ATTENUATOR MODELS		
5001	0-1 dB in 0.1 dB steps	\$80
5010	0-10 dB in 1 dB steps	80
5070	0-70 dB in 10 dB steps	80
5080	0-80 dB in 1 dB steps	185

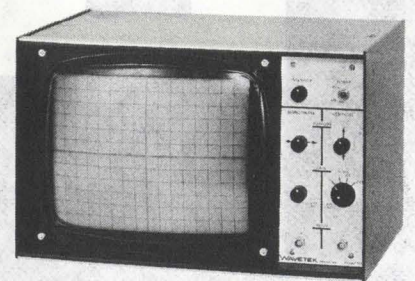
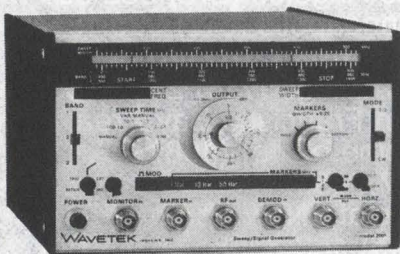

WAVETEK®
INDIANA INCORPORATED
INFORMATION RETRIEVAL NUMBER 50

new products

Power hybrid ICs improve switching-regulator response

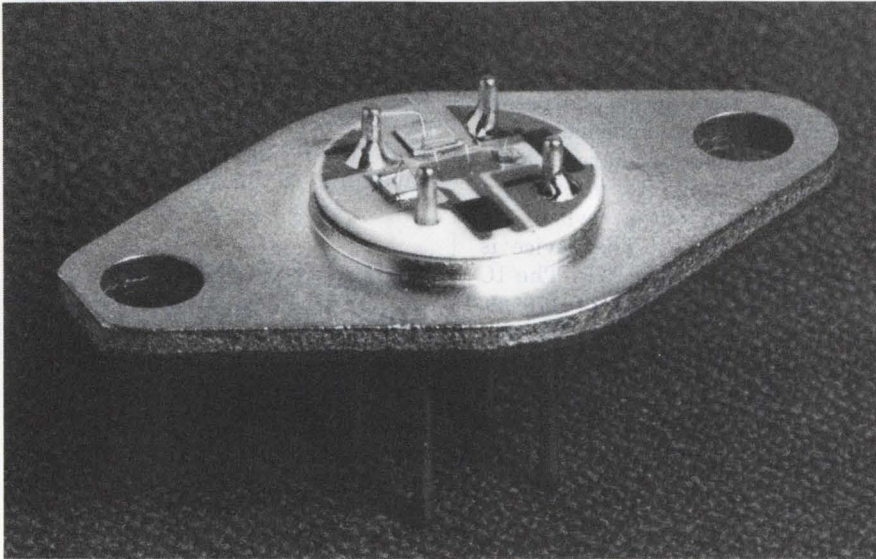

Unitrode, 580 Pleasant St., Watertown, Mass. 02172. (617) 926-0404. P & A: See text.

Switching-regulator response can be speeded and switching noise reduced with TO-66 cased power-output stages. The PIC-600 series of hybrid integrated circuits made by Unitrode can operate at switching frequencies up to 100 kHz.

The power hybrid circuits are available in eight voltage and current ratings. The PIC-600/601 and the PIC 610/611 are rated for 5 A of output current, but at 60, 80, -60 and -80 V of input voltage, respectively. The four other units—the 625/626/635/636—have the same voltage ratings but are rated for 15 A of output current.

To characterize the 5-A hybrid circuits, Unitrode uses a V_{in} of 25 V, a V_{out} of 5 V, an I_{out} of 2 A and a drive current of -20 mA. Depending upon the polarity of the unit used, the applied voltages may have to be reversed. With these voltages and currents, efficiency can approach 85% or better (output power divided by input power).

The higher-current hybrid circuits can be characterized in a similar fashion, but with I_{out} increased to 7 A and the drive cur-

rent increased to -30 mA.

All circuits are specified for operation over the full military temperature range of -55 to 125 C. The four-pin, TO-66 hermetically sealed package has a thermal resistance, Θ_{jc} , for the power switch of 4 C/W and a Θ_{jc} for the commutating diode of 4 C/W. The case-to-ambient thermal resistance is 60 C/W.

The power hybrid circuit, built on a beryllia substrate, consists of a Darlington-connected transistor pair, a commutating diode and two thick-film resistors. Well-matched transistors, and a commutating diode that has a low reverse current of 10 μ A at 25 C and a forward voltage drop of about 1 V, eliminates the reverse or forward recovery spike normally generated during switching by the commutating diode. This, in turn, results in greater efficiency and reliability, since the power-switch transistor doesn't have to handle any currents larger than the load current.

The PIC-600, 601, 610, 611, 625, 626, 635 and 636 cost \$3.55, \$4.05, \$3.35, \$3.82, \$7.10, \$8.10, \$6.71 and \$7.65, respectively, for 1000-up lots. Delivery of these units is from stock.

CIRCLE NO. 250

2-wire Xmtr IC eases sensing designs

National Semiconductor, 2900 Semiconductor Dr., Santa Clara, Calif. 95051. (408) 732-5000. LH0045C: \$18.50 (TO-8), \$21.50 (TO-3), 100 up; stock.

A two-wire transmitter IC, the LH0045, converts a voltage signal from a sensor into a current and transmits the current down a simple twisted pair to a receiver. The LH0045 interfaces with thermocouples, strain gauges and thermistors. The output current scale can be set to match industry standards of 4 to 20 mA, or 10 to 50 mA, full scale.

INQUIRE DIRECT

256-bit CMOS RAM dissipates 0.5 μ W/bit

Intersil, 10900 N. Tantau Ave., Cupertino, Calif. 95014. (408) 257-5450. Commercial: \$25.60; military: \$46.00 (1-99); stock.

A 256-bit CMOS RAM, the IM-6523, requires less than 1/2 μ W/bit standby power and uses a single power supply. Nominal supply voltage is 5 V, but the silicon-gate RAM can operate from any supply from 3 to 7 V. The memory provides static, totally asynchronous operation and it is fully decoded and buffered. Typical access time is 350 ns.

CIRCLE NO. 251

ICs control SCRs or triacs

SGS-ATES Semiconductor, 435 Newtonville Ave., Newtonville, Mass. 02160. (617) 969-1610. \$4 (100-999); stock.

Either the L120 or L121 monolithic IC can be used as a control system for SCRs or triacs. The L120 can vary firing angle continuously and linearly between 0 and 180 degrees. Output pulses maintain the polarity of the source. For burst-type control, the L121 determines the number of half cycles of output power to be transferred to the load in an interval; duty cycle can be varied from 0 to 100% continuously. The ICs come in 16-pin DIPs and operate over the 0-to-70-C temperature range.

CIRCLE NO. 252

High Voltage Diffused Silicon Rectifiers

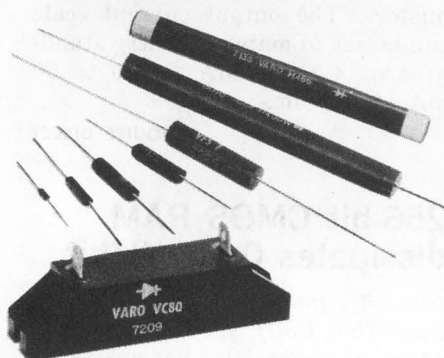

Six series in a wide range of minimum size packages with low leakage currents for commercial and industrial applications requiring high reliability at economical cost.

These devices feature 1kV to 40kV V_{RRM} with 5mA to 2A, I_o. All series available in fast recovery versions.

Typical applications: CRT power supplies, RF transmitters, microwave ovens, electrostatic copiers and precipitators and TV receivers.

Series VG; 20kV V_{RRM} **\$1.49** (1000).

Rectifiers for medical and industrial X-Ray equipment and high voltage multipliers also available from Varo.

Write for free catalog.



Design us in —
We'll stay there

VARO

VARO SEMICONDUCTOR, INC.

P.O. BOX 676, 1000 NORTH SHILOH,
GARLAND, TEXAS 75040
(214) 272-4551 TWX 910-860-5178

Distributed by:

ALLIED ELECTRONICS, Chicago, Ill. 312/421-2400.
THE ALTAIR CO., Houston, Tex. 731/781-5300; Richardson, Tex. 214/231-5166. BELL INDUSTRIES, Menlo Park, Cal. 415/323-9431; Skokie, Ill. 312/965-7500; Bellevue, Wash. 206/747-1515. BRIDGEFIELD SUPPLY, Chesterland, Ohio 216/729-9451. CRAMER ELECTRONICS, Nationwide; Newton, Mass. 617/969-7700; 303/266-3755. MILGRAY ELECTRONICS, Freeport, N.Y. 516/546-6000; Hyattsville, Md. 301/864-1111; Cherry Hill, N. J. 609/424-1300. WESTATES ELECTRONICS, Chatsworth, Calif. 213/341-4411.

In Canada:

ELECTRO SONIC, Toronto, Ont. 416/924-9301. R.A.E. IND. ELECTRONICS, Vancouver, B. C. 604/687-2621.

INFORMATION RETRIEVAL NUMBER 51

INTEGRATED CIRCUITS

CMOS IC translates low voltages to high

Solitron Devices, P.O. Box 23157, San Diego, Calif. 92123. (714) 278-8780. \$3.45 (100-999); 6-8 wk.

The CM4104A CMOS quad level translator permits low to high voltage conversions. The circuit consists of four level translators each with a true/complement output. Each translator shares a common-enable input to provide a high-impedance output when the enable input is low. The device is contained in a 16-pin DIP. The IC has a low-to-high delay of 170 ns, power dissipation of 100 μ W and output impedance of 700 Ω .

CIRCLE NO. 253

Drivers perform NAND/OR functions

Signetics, 811 E. Arques Ave., Sunnyvale, Calif. 94086. (408) 739-7700. 96¢ (100).

Two alternate-source 7400-series dual peripheral drivers, the 75452 NAND and the 75453 OR drivers, convert TTL and DTL logic levels to high-current-drive capability. Each circuit has a typical propagation delay time from low to high of 50 ns, and from high to low of 35 ns. The devices have a maximum output-current capability of 100 μ A and operate from 5-V supplies.

INQUIRE DIRECT

Linear COS/MOS IC contains array of 3

RCA Solid State, Route 202, Somerville, N.J. 08876. (201) 722-3200. \$1.55 (100-999).

The COS/MOS IC transistor array, called the CA3600E, consists of three n-channel and three p-channel, enhancement-type MOS transistors. It is reportedly specified and tested for linear-circuit operation. The transistors operate from supply voltages in the 3-to-15-V range and at frequencies up to 5 MHz (untuned). Each transistor in the device can conduct currents up to 10 mA.

CIRCLE NO. 254

IC contains FM stereo demodulator

National Semiconductor, 2900 Semiconductor Dr., Santa Clara, Calif. 95051. \$2.10 (100); stock.

A phase-locked loop FM stereo demodulator, called the LM1800, features automatic stereo/monaural switching and a built-in stereo-indicator-lamp driver. An on-chip voltage regulator helps provide a supply rejection of typically 45 dB. Other characteristics include an operating supply range of 10 to 24 V, channel separation of typically 45 dB and a lamp drive capability of up to 100 mA.

INQUIRE DIRECT

Calculator chip set aims for desk tops

Electronic Arrays, 550 E. Middlefield Rd., Mountain View, Calif. 94043. (415) 964-4321. \$21 (100); stock.

A two-chip 12-digit calculator set computes square root, reciprocal and percent add-on or discount—as well as the usual four functions. Intended for compact desk-top calculators, the S-142 set has a memory, and drives popular gas-discharge displays directly with a few external passive components. The ICs come in 40-pin and 24-pin silicone-molded packages.

CIRCLE NO. 255

One-shot pulse-width change held to 1%

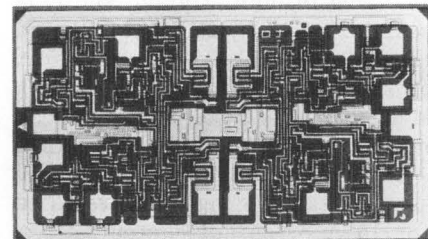

Advanced Micro Devices, 901 Thompson Place, Sunnyvale, Calif. 94086. (408) 732-2400. \$1.45 up (100).

A dual one shot with a guaranteed pulse-width change of less than 1% offers the same pinout as the SN 54/74123, which performs the same function. The new one-shot, called Am 26123, also features a built-in output latch and an output pulse-width range of 50 ns to infinity.

CIRCLE NO. 256

Dramatic new product opportunities ... yours with new 3C8 ferrites

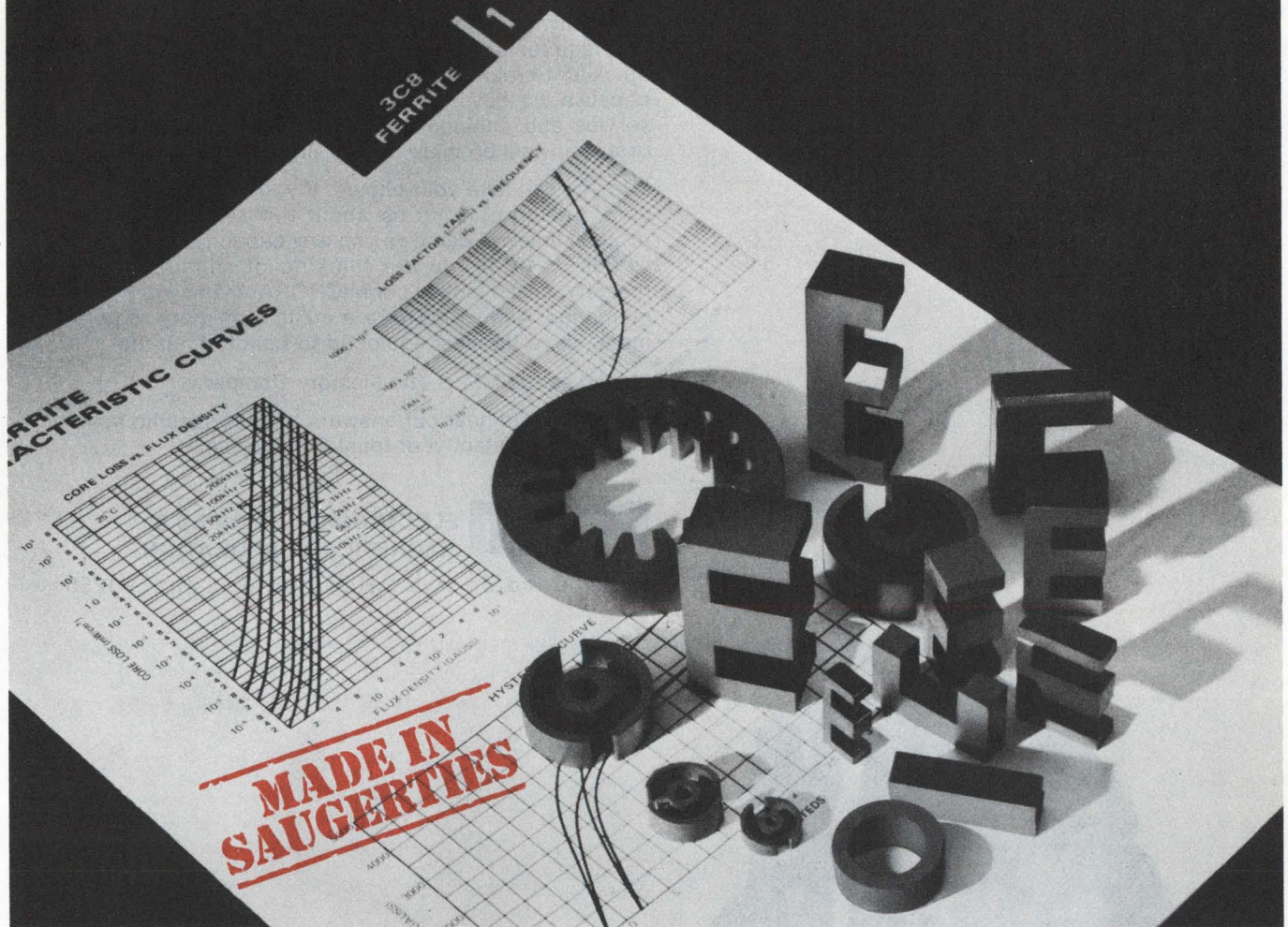

The market is ripe for product breakthroughs. Just look, for example, at the growth of such items as the hand-held calculator, small camera flashguns, ultra-mini portable radios and recorders. The key to these tremendous sales successes is high frequency power conversion circuits.

And the key to still *more* efficient, high-frequency power conversion is Ferroxcube's new 3C8!

This important new ferrite material gives significantly higher flux densities at higher temperatures, and lower losses at high excitation levels than any other magnetic core material. It is available in practical size cores for use up to kilowatt power levels.

3C8 is already being used with great success in: inverters, battery chargers, fluorescent lamp ballasts,

strobe light devices for highway markers and harbor buoys, power oscillators, power amplifiers, ultrasonic generators.

In all of these circuits Ferroxcube's 3C8 material has led to greater efficiency, lower cost, less weight, and smaller sized units. In one power supply, for example, the size of the core was reduced from 13 lbs. at 60Hz to 4 lbs. at 20,000 Hz and the volume from 35 to 9 cu. inches—savings of 70 to 75%!

Can 3C8 improve your present products or suggest new products and markets for your company? If you've got the imagination, we've got the core! Call 914•246-2811, TWX 510-247-5410 or write today.

Ferroxcube linear ferrites—made in Saugerties, N.Y. and stocked in seven U. S. locations.



FERROXCUBE CORPORATION, SAUGERTIES, N. Y. 12477
A NORTH AMERICAN PHILIPS COMPANY 914-246-2811

Distributed through North American Philips Electronic Components Corporation with warehouses in Boston, 617•899-7100; New York, 516•2300; Saugerties, 914•246-5861; Philadelphia, 215•836-1616; Chicago, 312•593-8220; San Diego, 714•453-5440

INFORMATION RETRIEVAL NUMBER 52

WHY BUY EMM
MEMORY?

JUST ASK OUR SALES MANAGER

"**Reliability**, for one thing," says Don Miller. "We started in the military memory business where reliability is the name of the game. And we still have 80% of that market because we put reliability first... first in military, first in commercial, first in all our products."

"**Versatility** is important, too. We make everything from cores and chips to complete memory systems. Commercial, industrial, or military. If you have a requirement for memory, you can get it from us."

"**Standardization** is another key idea. While our custom capability is second to none, we can usually meet custom requirements with standard products. That means quick turn-around and delivery—anywhere in the world, because we have worldwide facilities. That goes for service and engineering support, too. If you have a problem, we'll be there. It's as simple as that."

"So you can take your choice. If you want commercial core memory, talk to us about our MICROMEMORY product line. We can give you any capacity from 1K x 8 to 256K x 40. If you are thinking of semiconductor memory, take a look at our MICRORAM family of NMOS memories. And if you have a military memory requirement, we're the best equipped to handle that, too."

"Like I said, EMM is **The Memory Company.**"

If you'd like to hear our answers to your specific memory needs, contact your local EMM office.

EMM ELECTRONIC MEMORIES &
MAGNETICS CORPORATION

12621 Chadron Ave., Hawthorne, Calif. 90250



Pulse generator has a built-in 5 V dc supply

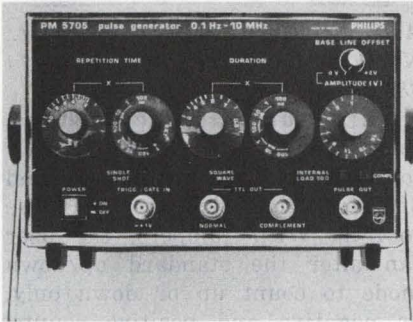

Philips Industries, P.O. Box 42099, S-126 12 Stockholm, Sweden.

The TTL driver-power supply, PM 5704, provides pulses up to 10 MHz and +5 V dc power for the circuits. It has two TTL outputs—normal and complement. Both outputs have a fan out of > 30 gates and can be loaded simultaneously. The internal 5 V supply is short and open circuit safe and the crowbar circuit prevents damaging output voltages. The generator goes down to 0.1 Hz on the low end but it also has single shot, external triggering and gating to further extend the range.

CIRCLE NO. 257

18-MHz counter comes in kit form



Heath Co., Benton Harbor, Mich. 49022. (616) 983-3961. \$379.95.

IB-1103 8-1/2-digit Frequency Counter reads to 180 MHz. Push-button selection permits multiplication by 1 (direct), 10, 100 or 1000. An input frequency of up to 10 kHz can be measured down to 0.001 Hz. A temperature-compensated crystal oscillator generates the time base, and three pushbuttons provide 1 ms, 100 ms and 1 s gate times. Input sensitivity is 50 mV to 120 MHz and 100 mV to 180 MHz.

CIRCLE NO. 258

System troubleshoots PC boards in circuit



Zehntel, Inc., 2440 Stanwell Dr., Concord, Calif. 94520. (415) 676-4200. \$14,435; 90-120 days.

Troubleshooter II isolates defects in complete PC boards to the exact location or component in seconds. The unit, which implements in-circuit component testing, can be operated as a subsystem with the company's Testpac II or III series, or as a peripheral to larger, computerized test systems. In the Testpac system, programming is supplied directly by the master unit's memory. With a computer originating test commands, Troubleshooter II can be programmed with standard ASCII characters. Test results are represented by a computer compatible word.

CIRCLE NO. 259

Unit converts DPM to limit device

LFE, Process Control Div., 1601 Trapelo Rd., Waltham, Mass. 02154. (617) 890-2000. \$95 to \$150.

Model 4355 Dual Control Comparator adds limit-set GO/NO-GO, or ON/OFF control capability to any measuring device with TTL-compatible BCD output: DPMs, DVMs, up-down counters, scalars, digital temperature indicators and other process digitizers. Though the unit has been designed to complement the LFE 4350 series DPMs, it will work equally well with all types of meters with the same standard BCD output capability.

CIRCLE NO. 260

There's an EMM office near you.

WESTERN REGION

Regional Office

SAN FRANCISCO
(408) 247-9711

LOS ANGELES AREA
(213) 644-9881

ORANGE COUNTY AREA
(714) 639-5811

MINNEAPOLIS AREA
(612) 941-2404

PHOENIX AREA
(602) 968-2492

DALLAS AREA
(214) 231-7207

EASTERN REGION

Regional Office

BOSTON
(617) 861-9650

CHICAGO AREA
(312) 297-7090

WASHINGTON, D.C. AREA
(703) 941-2100

NEW YORK AREA
(516) 423-5800

CLEVELAND AREA
(216) 842-8920

International OFFICES

European Headquarters

BELGIUM
(03) 76.69.75

UNITED KINGDOM
(01) 751-1213

WEST GERMANY
(0811) 74.30.40

Far East Headquarters

JAPAN
(03) 404-8520

EMM ELECTRONIC MEMORIES & MAGNETICS CORPORATION.

12621 Chadron Avenue
Hawthorne, Calif. 90250
(213) 644-9881

Keystone

VERSATILE THERMISTOR PROBES



Get quick response for sensing temperatures of gases, liquids and surfaces with 23 thermistor probe styles and configurations. Probes with stainless steel tips can be ordered in lengths from 1" to 4", giving you an extra dimension to customize certain standard probes. Other features include:

Sensitivity . . . highly sensitive to minute temperature changes . . . fast response.

Temperature range . . . can withstand temperatures from -50°C to 260°C .

Resistance values . . . from 1K to 1 meg at 25°C . . . also miniature discs and rods of 100 ohms to 1 meg at 25°C are available.

Tolerance on resistance . . . $\pm 20\%$ at 25°C is standard; $\pm 10\%$ and $\pm 5\%$ or tighter tolerances if desired.

Low-cost series . . . three inexpensive probes to answer many requirements.

Catalog TP-739

. . . gives details on 23 probe styles and ordering information. Circle reader service card.

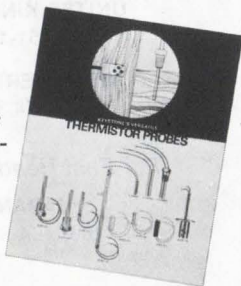

Keystone

CARBON COMPANY
Thermistor Division
St. Marys, PA 15857
814/781-1591 • Telex 91-4517

INFORMATION RETRIEVAL NUMBER 55

INSTRUMENTATION

Digital thermometer fits in pocket



Kane-May Ltd., Swallowfields, Welwyn Garden City, Herts, England. \$200; Sept.

The Digitherm is claimed to be the world's first pocket-sized, battery-operated, digital electronic thermometer. The unit measures $4 \times 2\text{-}1/2 \times 1\text{-}1/2$ in. and weighs 7-3/4 oz. Measurement range extends from -50 to 999°C with a single probe, and design accuracy is $\pm 1\%$. Power is provided by four standard 1-1/2-V batteries. A built-in battery check is provided and a stabilization circuit ensures that accuracy is unaffected by voltage decline until the output is reduced by 20%. Three basic probe types are available.

CIRCLE NO. 261

500-MHz power amp needs no tuning

R. F. Power Labs, 11013-118th Pl. N.E., Kirkland, Wash. 98033. (206) 822-1251. \$615.

Model M502 rf power amplifier is claimed to be the only instrument available with a flat bandwidth from 0.5 to 500 MHz at a linear power output over 2 W without any tuning. The unit is capable of linear amplification of any AM, FM, CW, SSB or complex pulse and waveform. It can be driven from a standard signal or sweep generator to full output of 2 W into 50Ω . The instrument is capable of driving any load impedance and is fully protected against mismatch and overdrive.

CIRCLE NO. 262

Up/down counter takes many pulse sources



Artronics Corp., 530 Turnpike St., North Andover, Mass. 01845. (617) 685-4336. About \$35/digit.

This multipurpose up/down counter/display is delivered ready to be plugged into a system and operates from a variety of pulse sources. With jumpers, the user can alter the standard up/down mode to count up or down only, or negative and positive counts. Simple jumpers also allow the user to count from separate UP/DOWN lines or from one count line with UP/DOWN enable. All units may be used as master accumulators or as decoder/driver slave-cascaded displays with parallel BCD entry. Any width TTL pulse may be used as a count input.

CIRCLE NO. 263

100-kHz analyzer plugs into scope

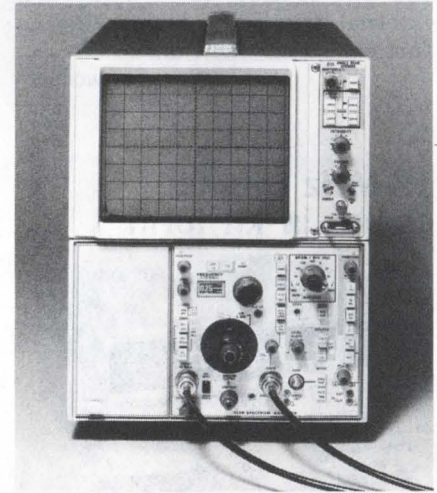

Tektronix, Inc., P. O. Box 500, Beaverton, Ore. 97005. (503) 644-0161. \$1950; June, 1974.

Model 5L4N is a 0-to-100-kHz spectrum analyzer that offers pushbutton selection of 50Ω , 600Ω or $1\text{-M}\Omega$ input impedance, with calibration appropriate to the selected impedance. Dynamic range is 80 dB with intermod more than 70-dB down from two full-screen signals. A built-in tracking generator is standard. The unit operates with any 5000-Series System, and uses two of the three compartments.

CIRCLE NO. 264

Frankly, you asked for it. New low-load 7800 Series Voltage Regulators in TO-92. About 50¢.

You always wanted a low-cost voltage regulator to handle loads up to 100mA. Now you've got it.

Why pay for power capacity you don't need?

The 78L Series is the newest member of our growing family of 7800 positive 3-terminal voltage regulators.

And because it has lower power capacity, it has a lower price. About 50¢ in 100-up quantities.

Low price, plus lower installation cost, elimination of outboard resistors and transistors, and reduced board space, component count and system design time—all make the 78L extra economical.

Superior performance. With self-protection, too.

With the 78L, you also get output voltages of 2.6, 5.0, 6.2, 12 and 15. And two grades of product with output voltage tolerance of 5% and 10% over the full temperature range, including effects of line and

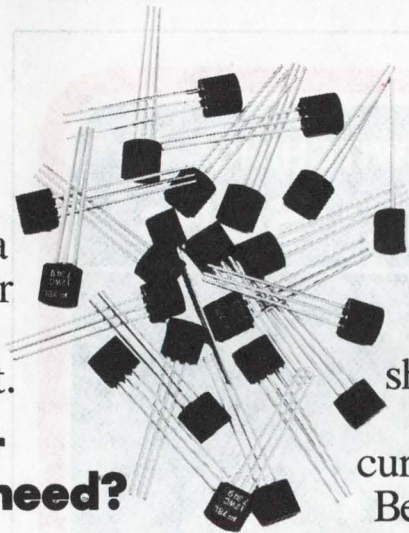

load regulation.

What's more, internal current limiting and thermal shut-down protects the device and the load circuit from current and power fluctuations.

Because it's complete and self-contained, it's extra simple to use, too. No calculations or design time required. Just add normal line de-coupling capacitor.

And you can use the versatile 78L where you want. Power source. Remote chassis. PC cards. Almost anywhere.

The versatile 78L Series—both in TO-92 and TO-39—is now in stock at your friendly Fairchild Distributor. Contact him or your Fairchild Sales Office for complete data.

**MADE IN
FAIRCHILD**

Semiconductor Components Group, Fairchild Camera & Instrument Corp.,
464 Ellis St., Mountain View, CA 94040. Telephone (415) 962-5011. TWX: 910-379-6435.

Unit aids scope trigger on digital inputs

Tektronix, P. O. Box 500, Beaverton, Ore. 97005. (503) 644-0161. \$200.

Model 821 four-bit TTL word recognizer helps solve scope triggering problems on digital signals.

The unit is essentially a four-input AND gate. Four front-panel word selector switches determine the level—TRUE, FALSE or don't care—on each input that is required to satisfy the AND condition. Each input cable is color coded and comes with an interchangeable probe tip. Power for the 821 is obtained from a scope's probe power connector or any other 5-V supply.

CIRCLE NO. 265

Compact s/d converter offers 0.01° accuracy

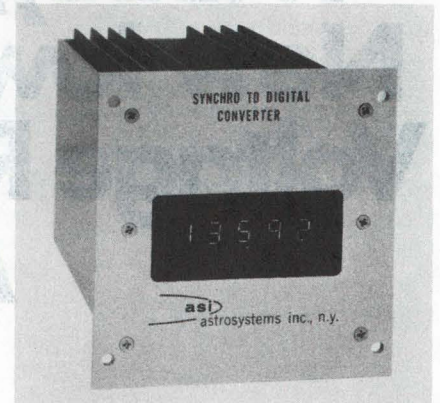

AstroSystems, Inc., 6 Nevada Dr., Lake Success, N.Y. 11040. (516) 328-1600. Approx. \$3000 (depending on options).

This dual-speed synchro-to-digital converter contains all the electronics and power supplies necessary to convert synchro data to BCD outputs and display the composite angle. The units accept all standard 60 and 400-Hz synchro inputs at 1 and 36 speed and provide outputs and displays accurate to 0.01° over a full 360° range. Display is 0.4-in. high and size is 4-5/8 × 4-1/2 × 9-in.

CIRCLE NO. 266

Mini scopes fit on palm or around neck



Philips, P.O. Box 523, Eindhoven, the Netherlands.

Two new mini oscilloscopes can be placed on the palm of the hand, but are normally used hung around the neck. Both instruments have a 5-MHz bw, dimensions of 86 × 135 × 190 mm and weigh only 1.8 kg, including the optional, rechargeable battery pack. Sensitivity of the single-trace model, designated the PM 3000, is 10 mV, while that of the dual-trace PM 3010 is 30 mV. The display is on a 4 × 6 division screen (one division equalling 4.5 mm) which can be magnified approximately 1.3 times using a removable lens.

CIRCLE NO. 267

8 CASES FOR SWITCHING TO NATIONAL® SCRs

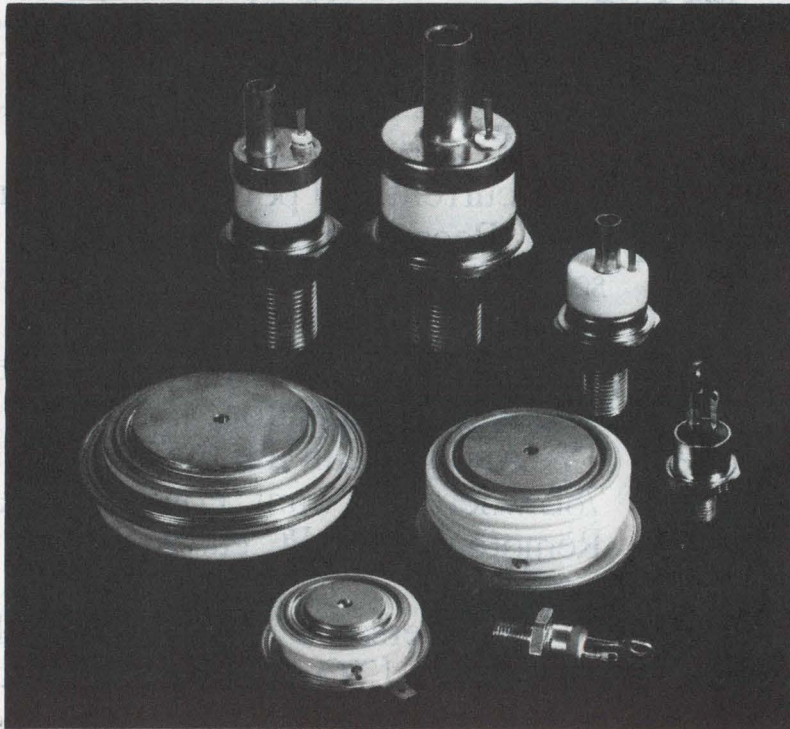

16-1600 Amperes rms
25-1700 Volts
Power and Inverter SCRs
Patented Regenerative Gate

Call or write for full details



NATIONAL ELECTRONICS

a varian division

geneva, illinois (312) 232-4300

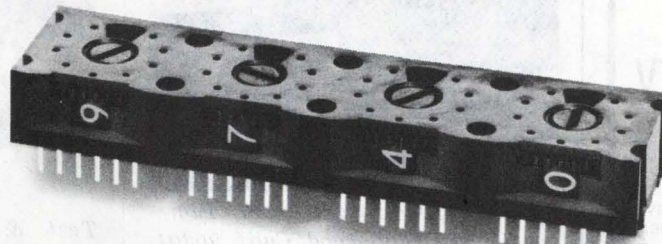

Introducing the programmable memory with visual readout.

We're talking about our unique Stripswitch,[™] the miniswitch for direct printed circuit board mounting or panel installation. This little marvel is molded of impervious Valox*, and is guaranteed for two years.

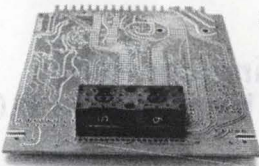

Other facts: it comes in one, two, three, four, five, and six station models (\$1.95 per station, standard); in a variety of codes, including decimal, BCD, Complimentary, Special Binary, and 1, 2, 3, and 4 pole.

On a custom basis we can do lots of other things to your Stripswitch. Like interconnections, markings and legends, color coding, stops, number of switch positions, additional stations, et cetera.

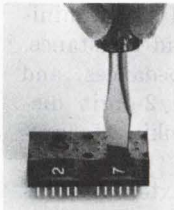

A 10¢ stamp will get you an immediate reply, or your finger on the dial of your telephone will get you instant answers. Call us collect. Or one of our distributors: G.S. Marshall, Hall•Mark, or Schweber.

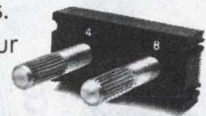

Your sample awaits.

*Registered General Electric trademark

EECO

1441 East Chestnut Avenue
Santa Ana, California 92701
Phone 714/835-6000

Special Offer...

lithium primary battery Designer's Kit

The purpose of this offer is to have you check out the remarkable performance of the revolutionary lithium primary battery:

- 2.8 volts-per-cell nominal operating voltage (with adapter, single cell replaces 2 ordinary cells).
- highest energy per unit weight and volume.
- 5-year shelf life.
- outstanding low-temperature performance — down to -65°F .

We're offering, for a limited time, our special **Designer's Kit** of two "C" and two "D" cells (plus adapters) for \$12.

Test these super-performance batteries in your equipment; subject them to rugged conditions in your lab; prove to yourself that the lithium primary battery is as good as we say it is. Order your **Designer's Kit** today.



PCI lithium batteries are also available in five other standard cell sizes and in configurations for special portable-power applications.



Power Conversion, Inc.
70 MacQuesten Parkway South
Mt. Vernon, N.Y. 10550
Telephone: 914-699-7333

Enclosed is check or money order for \$12 postpaid for my lithium primary battery **Designer's Kit** (includes two "C" and two "D" cells, plus adapters).

NAME _____

TITLE _____

COMPANY _____

ADDRESS _____

CITY _____

STATE _____

ZIP _____

INFORMATION RETRIEVAL NUMBER 59

INSTRUMENTATION

Two miniscopes weigh in at 11 and 15 lb

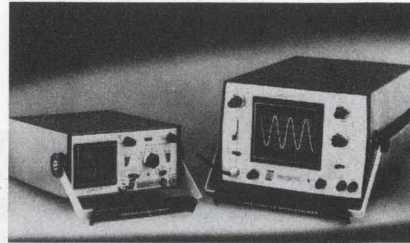

Systems Electronics, 9727 Inglewood Ave., Inglewood, Calif. 90301. (213) 671-8231. 37: \$165; 27: \$280.

Systems 37 "Mini Scope" weighs only 11 lb, has a 3-in. CRT and operates over a bandwidth from 5 Hz to 2.5 MHz. The unit comes in either 110-120 V or 220-240 V models, for either 50 or 60 Hz. The Systems 27 scope features solid-state circuitry, a 5-in. CRT, bandwidth from dc to 2.5 MHz, and weighs only 15 lb.

CIRCLE NO. 268

Meter automatically measures impedance

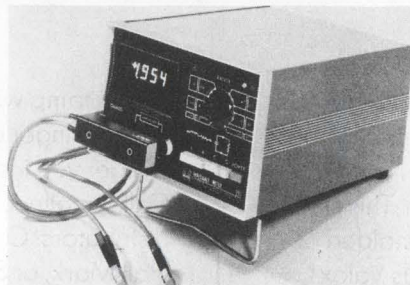

Electro Scientific Industries, 13900 N.W. Science Park Dr., Portland, Ore. 97229. (503) 646-4141. \$990; stock to 90 days.

Model 251 digital impedance meter, with 0.25% basic accuracy, makes automatic, split-second measurements of L, R, C and G. Four-terminal shielded connections and an external guard signal minimize the effects of lead resistance, leakage or shunt impedances, and stray fields. The 3-1/2-digit display has overload blanking to prevent false readings. Other features include an external bias input for polarizing electrolytic capacitors or measuring diode capacitance, and low test voltages and currents to protect delicate components and minimize temperature effects.

CIRCLE NO. 269

120-MHz, portable scope stresses human factors

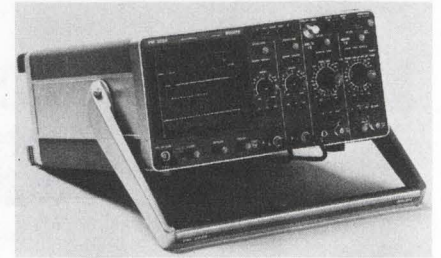

Test & Measuring Instruments, 224 Duffy Ave., Hicksville, N.Y. 11802. (516) 433-8800. \$1850; stock.

Panel layout based on user criteria is one of the major features of this compact, portable oscilloscope, the PM3260. The unit uses remote dc switching for all functions. At 19.8 lb., the 120-MHz PM3260 is said to be the lightest in its class. The power-supply design eliminates the need for a cooling fan and air filter. An additional feature is the ability of the unit to operate over a line variation of 90 to 250 V and 46 to 440 Hz. Power consumption is 45 W. A full 8×10 -cm screen is provided, with a 20-kV accelerating voltage. Basic specs include 5 mV/division sensitivity and 5 ns/division maximum sweep rate.

CIRCLE NO. 270

Timing controller can be preset to 0.05%

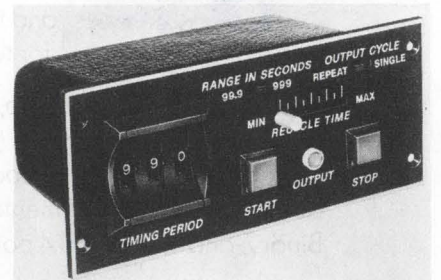

Artisan Electronics, 5 Eastmans Rd., Parsippany, N.J. 07054. (201) 887-7100. About \$190; 2-3 wk.

Model 4900 solid-state timing device offers presettable accuracy of better than 0.05%, with repeatability to match. Output is a solid-state ac switch, which uses zero-voltage switching. Timing range is 00.1 to 99.9 s in 0.1-s increments and 001 to 999 in 1-s increments.

CIRCLE NO. 271

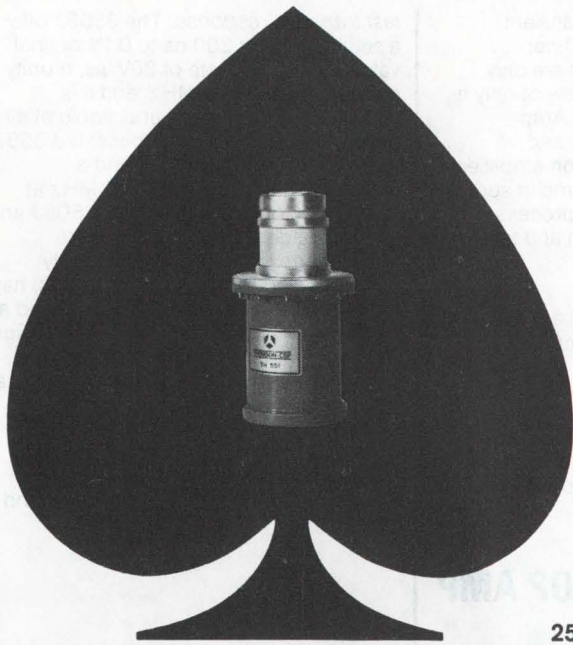

25 kW 100 kW



250 kW 1000 kW

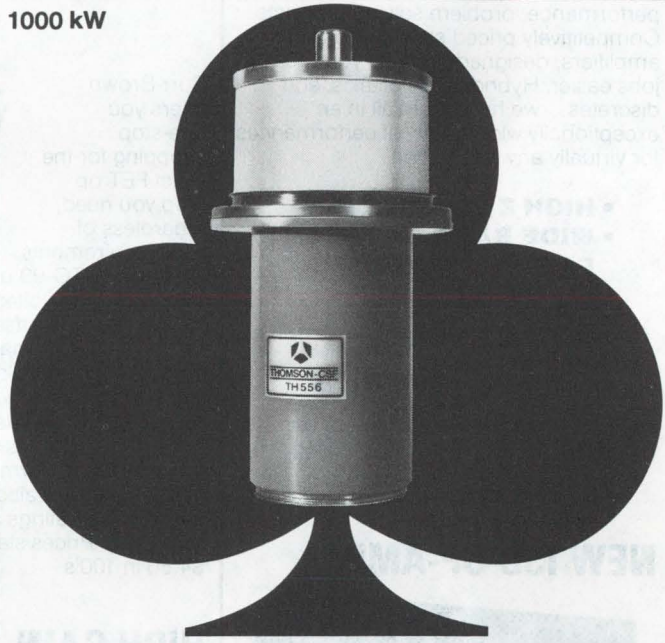

From 25 kW up to one megawatt...

... four RF-heating aces, every one a winner!

Announcing a whole new deal for RF-heating - a new generation of rugged metal/ceramic triodes, especially designed for this application. Incorporating both the latest progress in vapor - phase anode cooling-hypervapotron - and our revolutionary advance in grid technology - **Pyrobloc***, these four tubes represent today's state-of-the-art in power grid triodes. In various standard single - tube or multitube installations, they deliver anywhere from 20 kW up to 2 MW of CW RF power for industrial thermal treatment. These four new tubes are the latest addition to our full line of triodes, for economical and reliable induction or dielectric-loss heating. For more details on them or any of our other tubes, contact us directly or just circle the appropriate number on the Readers' Service Card.

*Registered trade mark.



THOMSON-CSF

THOMSON-CSF ELECTRON TUBES, INC. / 50 ROCKEFELLER PLAZA / NEW YORK, N.Y. 10020 / TEL. (212) 489.0400

France - THOMSON-CSF Groupement Tubes Electroniques / 8, rue Chasseloup-Laubat / 75737 PARIS CEDEX 15 / Tél. 566 70.04

Germany - THOMSON-CSF Elektronenröhren GmbH / Am Leonhardsbrunn 10 / 6 FRANKFURT/MAIN / Tél. 70 20.99

Italy - THOMSON-CSF Tubi Elettronici SRL / Viale degli Ammiragli 71 / ROMA / Tél. 638 14.58

Japan - THOMSON-CSF Japan K.K. / Kyosho Building / 1-9-3 Hirakawa-cho / Chiyoda-ku / TOKYO / 〒 102 / Tel. (03) 264.6341

Sweden - THOMSON-CSF Elektronrör AB / Box 27080 / S 10251 STOCKHOLM 27 / Tél. (08) 22 58.15

United Kingdom - THOMSON-CSF Electronic Tubes Ltd / Bilton House, Uxbridge Road, Ealing / LONDON W 5 2TT / Tel. (01) 579 55.11 / Telex : 25 659

INFORMATION RETRIEVAL NUMBER 60

And, Burr-Brown makes OP Amps, too!!!

With all of our product lines, you may have forgotten that Burr-Brown still makes a complete line of operational amplifiers. In fact, we've been making them since 1956. That's almost two decades of high quality, high performance, problem solving products. Competitively priced state-of-the-art amplifiers, designed to make your design jobs easier. Hybrids, monolithics, and discretives... we have them all in an exceptionally wide variety of performances for virtually any application.

- HIGH Z IN, LOW BIAS
- WIDE BAND, FAST SETTLING
- HIGH CURRENT, HIGH VOLTAGE
- LOW DRIFT
- GENERAL PURPOSE

Here are just a few samples from our "just-off-the-press" Op Amp Catalog

NEW ISO-OP-AMP™



Burr-Brown's new Iso-Op-Amp provides all the advantages of a true differential input op amp, AND offers up to 500 volts

of continuous (2000 volts transient) input/output isolation, too. Other amplifiers offer isolation, but are only unity gain isolators, or capable of only a few fixed gains. The Iso-Op-Amp provides better gain linearity and stability than ordinary isolation amplifiers, and can be used as an op amp in such demanding applications as process control, and instrumentation and test equipment design.

The 3450 is optimized for use with low-level signals from low impedance sources. Voltage drift is less than $\pm 1\mu\text{V}/^\circ\text{C}$ and gain linearity is $\pm 0.01\%$. The FET input 3451 is designed for use with higher level voltage sources or low level current sources. Input impedance is 10^{11} ohms and bias current is a low -25pA . Prices start at \$105.00, 1-9.

COMPLETE FET OP AMP FAMILY

Burr-Brown offers you one-stop shopping for the exact FET op amp you need, regardless of your requirements.

We have 20 TO-99 units to choose from with maximum voltage drifts as low as $\pm 1\mu\text{V}/^\circ\text{C}$, initial offset voltages at 25°C as low as $250\mu\text{V}$, maximum bias currents of -0.1pA , noise as low as 0.003pA p-p , and CMR's of 90 dB. Active laser trimming of proprietary Burr-Brown high stability, thin-film resistors contribute to outstanding performance at reasonable prices. Units are also available with MIL temperature ratings and MIL-883 screening. Prices start as low as \$4.50 in 100's.

HIGH GAIN, WIDEBAND IC's



Another of Burr-Brown's exceptional offerings is a group of low cost, high gain, differential input wideband IC's. Models 3505J and 3507J are designed for circuits requiring

fast transient response. The 3505J offers a settling time of 300 ns to 0.1% of final value, has a slew rate of $30\text{V}/\mu\text{s}$, a unity gain bandwidth of 6 MHz, and it is internally compensated and stable at all gains. The externally compensated 3507J has a slew rate of $120\text{V}/\mu\text{s}$ and a gain-bandwidth product of 20 MHz at $\text{ACL}=10$. Companion Models 3506J and 3508J are designed for wideband applications. The 3506J is internally compensated for stability at all gains, has a unity gain bandwidth of 12 MHz, and a slew rate of $7\text{V}/\mu\text{s}$. The 3508J has a high gain-bandwidth product of 100 MHz at $\text{ACL}=100$, a slew rate of $35\text{V}/\mu\text{s}$, and can be externally compensated to allow the user to select the proper frequency response for his individual circuit. The 100's price for the 3505J and 3507J is \$7.50, and just \$5.95 for the 3506J and 3508J.

NEW FAST SETTLING WIDEBAND FET IC OP AMP

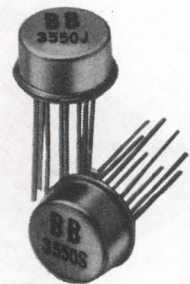

The 3550 family is so special we have to talk about it all by itself. Just think of all the things that you've always wanted a wideband FET IC Op Amp to be and you have the characteristics of the 3550. Where just wideband and fast slewing are not enough, this device fills the bill. In addition to having a respectable unity gain bandwidth of 20MHz and a guaranteed slew rate of $100\text{V}/\mu\text{sec}$, the 3550K is guaranteed to settle to within 0.01% of final value in just $0.6\mu\text{sec}$. max. It has a fully differential input, too. While some amplifiers operate non-inverting only and others operate inverting only, the 3550 gives you the same slew rate and settling time in either the inverting or non-inverting mode. And, it has low output impedance internally compensated for a stable 6 dB/octave gain rolloff. That means no oscillations and no complicated compensation networks. Prices start at just \$15.00 in 100's.

amplifiers / DAC-ADC / multipliers-dividers
analog functions/modular power supplies
active filters/data conversion products

ULTRA LOW BIAS CURRENT FET IC OP AMP

Model 3523L, the latest edition to Burr-Brown's family of problem solving FET amplifiers, offers premium performance at "ordinary" prices.

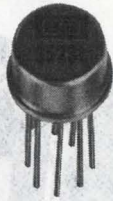

It is especially designed for those sticky design problems where bias current can be the primary source of error — measurement of low level currents or small voltages from high impedance sources.

The 3523L key specifications include:

- 0.1 pA max. bias current
- 0.003 pA rms noise current
- 500 μ V max. offset voltage
- 25 μ V/ $^{\circ}$ C max. voltage drift

These outstanding specifications make the 3523L your best choice for demanding applications such as electrometer amplifiers, current measurements from photo transducers, and voltage measurements from pH transducers. Price for the 3523L is \$21.50 in 100's.

GET THE ENTIRE PICTURE

OPERATIONAL AMPLIFIERS

BB
Burr-Brown
operational amplifiers
deliver what they promise

BRAND NEW FOR 1974. ORDER YOURS TODAY!!

You'll need a copy of our new Operational Amplifier catalog to really get the entire picture. For your copy, use this publications reader service card, or contact your Burr-Brown Representative or our nearest office.



BURR-BROWN RESEARCH CORPORATION

International Airport Industrial Park • Tucson, Arizona 85734
Telephone: (602) 294-1431 • TWX: 910-952-1111 • CABLE: BBRCORP
Chicago Office: (312) 832-6520
United Kingdom Office: Watford WD1 8BT Phone: 33837
French Office: Le Chesnay Phone: 954.35.58

INSTRUMENTATION

Function generator weighs just 4 lb



Exact Electronics, Box 160, Hillsboro, Ore. 97123. (503) 648-6661. \$350; stock.

Model 191 is said to be the first truly portable function generator. The unit operates on ac, its own rechargeable batteries or from any 12-V source, including an automobile cigarette lighter. Weight is only 4 lb including battery pack and charger and size is 7-3/8 × 2-7/8 × 8-1/2 in. Model 191 generates sine, square, triangle, pulse and ramp waveforms at frequencies from 0.1 Hz to 1 MHz.

CIRCLE NO. 272

RCL bridge offers automatic controls



Philips Test & Measuring Instruments, Inc., 400 Crossways Park Dr., Woodbury, N.Y. 11797. (516) 921-8880. \$495; stock.

A search mode that permits quick selection of the correct measuring range, and automatic adjustment of output sensitivity are two features of the RCL Bridge. Designated the PM6302, the bridge provides nine ranges covering 0.1 Ω to 100 M Ω on resistance, 1 pF to 1000 μ F on capacitance and 1 μ H to 1000 H on inductance. Measurement accuracy is better than 2%; on loss-factor measurements, the accuracy is better than 5%. Additional features include polarization of electrolytic capacitors and connection of an external driving source (up to 20 Hz).

CIRCLE NO. 273

35-MHz pulse generator offered for \$695



Tau-Tron, 11 Esquire Rd., North Billerica, Mass. 01862. (617) 667-3874. \$695; 1-2 wk.

The DG-7 is a 35-MHz Pulse Generator which provides outputs of 15 ns to 10 ms width; 0 to +5 V into 50 Ω amplitude; \pm 2-V offset, and 5-ns edges. Both logical true and complement are simultaneously provided. The unit also has a programmable width and delay channel that provides toggle-switch programming of width and delay, with resolution from 15 ns to 1 s. Asymmetrical or periodic patterns can also be digitally created.

CIRCLE NO. 274

\$189 buys 3-1/2-digit, five-function DMM

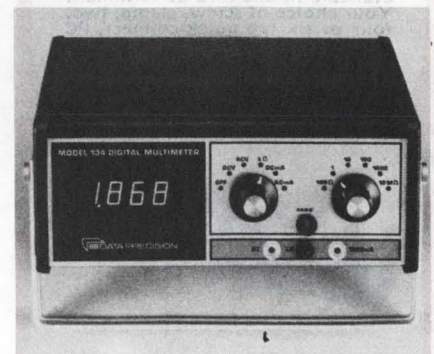

Data Precision, Audubon Rd., Wakefield, Mass. 01880. (617) 246-1600. \$189.

Model 134 DMM is a 3-1/2-digit, 5-function unit with a 1/2-inch, 7-segment planar gaseous display. Features include 1999-count display and automatic decimal-point positioning. The instrument displays three full digits plus over-range "one" for all functions with minus sign displayed and plus sign implied. Model 134 reads dc and ac volts, dc and ac mA, and ohms. Weight is 4-1/4 lb.

CIRCLE NO. 275

Terminate connection problems with Curtis terminal blocks

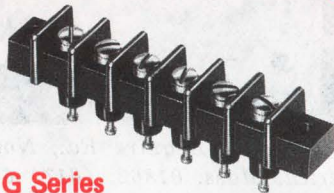

G Series

Our popular 7/16" center barrier-type blocks are ideal for jobs demanding a variety of terminations at low cost. Tab, screw, clamp, PC pin, solder or taper pin terminals are available. Surface-connect and full feed-thru insulation models are also offered. Available in one thru 26 terminals. G Series feature precision-machined brass inserts, molded in place, for a full mechanical thread system. Rated 20 amps/300 volts.

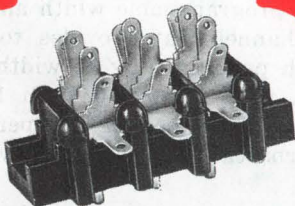

E Series

Designed primarily for electronic control and low power circuit application, these 3/8" center in-expensive barrier-type blocks are available in one thru 22 terminals. Your choice of screw, clamp, two, four or six tab quick-connect, PC pin or solder terminals. Surface-connect and feed-thru models are offered. Rated up to 15 amps/300 volts.

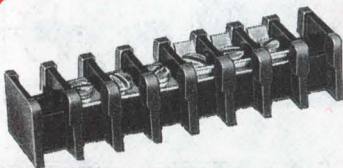

SE Series

Several terminal variations coupled with miniature size make these 1/4" center blocks ideal for use in tight spaces where versatility must not be sacrificed. These barrier-type blocks are available in screw, clamp, two, four or six tab terminals. Surface-connect and full feed-thru insulation models are also offered. Available in one thru 26 terminals. Rated 5 amps/300 volts.

Send for free engineering catalog No. 1273.



CURTIS INDUSTRIES, INC.
formerly Curtis Development & Mfg. Co.

3266 North 33rd Street, Milwaukee, Wisconsin 53216, Call (414) 445-1817 for the name of a representative or distributor near you.
In Canada: A.C. Simmonds & Sons, Ltd., Willowdale, Ontario.

1680

INFORMATION RETRIEVAL NUMBER 63

INSTRUMENTATION

Memory testers handle all semiconductors

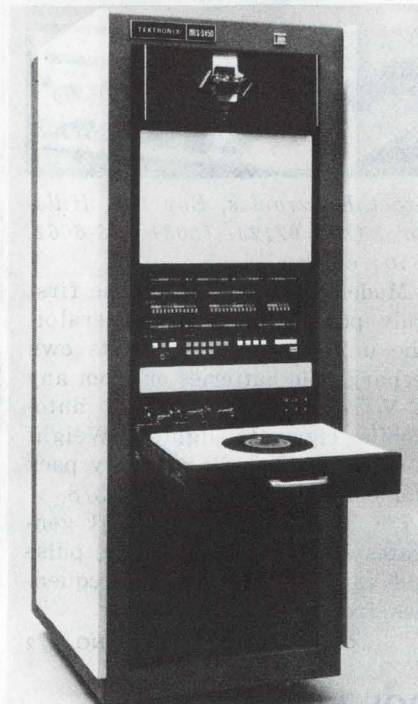

Tektronix, P. O. Box 500, Beaverton, Ore. 97005. (503) 644-0161. \$40,000 to \$80,000; 90 days.

These semiconductor-memory testers, the S-3400 series, are modularly constructed, fully programmable and perform dc parametric and functional tests on all semiconductor memories. With the available interfaces for wafer probers and automatic device handlers, a total package can be configured to solve almost any memory test problem.

CIRCLE NO. 276

5-in. servo recorder is coupled to integrator

Linear Instruments Corp., 17282 Eastman Ave., Irvine, Calif. 92705. (715) 546-6776. \$595; stock.

Model 152 Porta Grator combines a completely new integrator with a standard 5-inch, 1-mV servo recorder. Overranging capability of the integrator provides an effective chart width of 15 inches. Specifications include completely electronic integration with selectable count rates up to 6000 counts per minute, and 400% overranging capability. 1-mV through 25-mV sensitivity and $\pm 0.5\%$ over-all accuracy are also standard.

CIRCLE NO. 277

Digital VOM also gives analog display



Simpson Electric Co., 853 Dundee Ave., Elgin, Ill. 60120. (312) 695-1121. \$375 less batteries.

The 460-2 VOM combines both digital and analog displays in a portable instrument. The unit operates either from the ac line or from automatically recharging internal batteries. The primary readout is 0.33-in. 3-1/2-digit LED display, with automatic blanking of non-significant zeros. The analog readout is a dual-scale rotating drum meter. Twenty-six ranges are provided: five each for ac and dc V and I, six for resistance measurements. Accuracy on dc ranges is $\pm 0.1\%$ of reading ± 1 digit for voltage.

CIRCLE NO. 278

Panel meter joins high-technology series



United Systems, 918 Woodley Rd., Dayton, Ohio 45403. (513) 254-6251. \$219; stock.

Part of the HT Series (high technology), the Model 2780 bipolar 4-1/2-digit DPM is available in four voltage ranges, measuring 1.9999 V dc through 1000.0 V dc fs. Accuracy for all ranges is $\pm 0.01\%$ of reading, $+0.005\%$ fs. Current models come in five ranges, measuring 199.99 μ A through 1.9999 A. Accuracy for all current ranges is $\pm 0.05\%$ of reading $\pm 0.005\%$ fs. The unit samples automatically, at a rate of four per second, nominal. Power can be 115, 230 V ac or 5 V dc.

CIRCLE NO. 279

TRAK RAPID RESPONSE LINE (813) 884-1411

100 WATT PULSED AMPLIFIER MODEL 8108-1101

A new 150 watt (100 watt minimum) pulsed L-Band solid state amplifier with 15 nanoseconds rise and fall times. Features advanced microstrip, thin-film hybrid, miniature ferrite technology, and the latest in transistors available today.

Center Frequency: 1300 MHz.

1 db Bandwidth: 110 MHz.

Gain Flatness: ± 0.5 db maximum in any 30 MHz segment.

Saturated Output Power (matched load): 100 watts peak minimum.

Input Power for Constant Rated Output Power: 0 to +6 dbm peak.

Load VSWR: Open and short circuit protected by isolator.

Duty Cycle: 10% maximum.

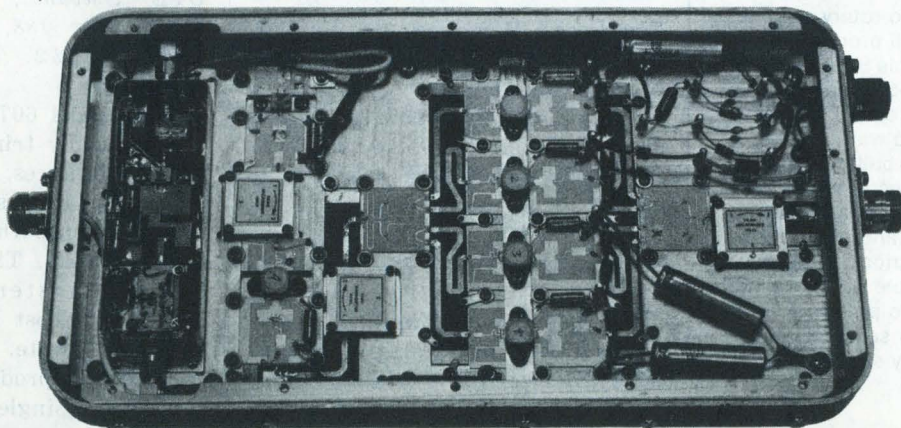

TRAK MICROWAVE CORPORATION, 4726 EISENHOWER BOULEVARD, TAMPA, FLORIDA 33614.

CALL TODAY FOR ADDITIONAL SPECIFICATIONS, PRICES, DELIVERY, QUOTATIONS, LITERATURE, APPLICATION ASSISTANCE, INFORMATION ON CIRCULATORS, ISOLATORS, SOLID STATE SOURCES, HYBRID THIN FILM OSCILLATORS AND IF AMPLIFIERS, CUSTOM SUBSYSTEMS AND SYSTEMS.

immediate prototype delivery on Grayhill rotary switches

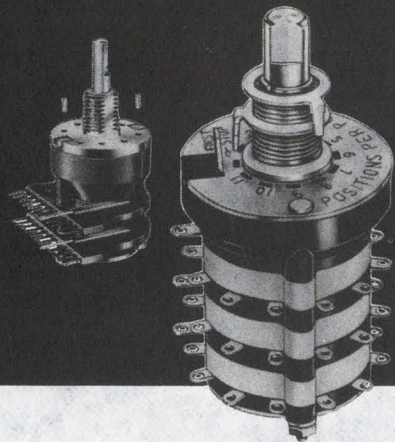

Adjustable stop switches off-the-shelf with the form-fit-function characteristics you need

- Simple pin adjustment provides the right number of positions per pole
- Over 100,000 possible combinations
- Available now from your local Grayhill distributor

Here's the fast route to rotary switches for prototypes or small production runs. Grayhill Adjustable Stop switches, available from your local Grayhill distributor, cut procurement lead time. You no longer need to wait for even small quantities to be built to order. The Adjustable Stop feature is available in one-inch and half-inch diameter, single deck and multi-deck versions. Your distributor can supply 1- and 2-deck Adjustable Stop switches from stock (one or two poles per deck) and can quickly secure other variations from factory stock. Write for complete literature.



561 Hillgrove Avenue • LaGrange, Illinois 60525
(312) 354-1040

INFORMATION RETRIEVAL NUMBER 65

MICROWAVES & LASERS

Log i-f amplifier has 70-dB dynamic range

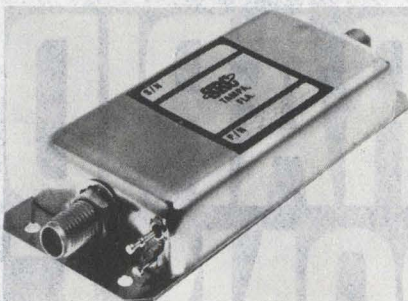

Trak Microwave, 4726 Eisenhower Blvd., Tampa, Fla. 33614. (813) 884-1411; 90-120 days.

The Model 8306-1001 log i-f amplifier, with a center frequency of 30 MHz, can handle input signals over a 70-dB dynamic range with a ± 2 -dB log-tracking accuracy. The dual-mode unit operates at 20 V dc and 100 mA maximum. The unit's compact package measures $3.2 \times 1.4 \times 0.5$ inches.

CIRCLE NO. 280

Filter/duplexer aims for TACAN designs

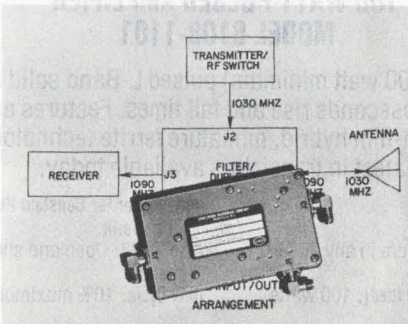

Engelmann Microwave Co., Skyline Dr., Montville, N.J. 07045. (201) 334-5700.

The Model SB-A100 solid-state filter/duplexer, for the TACAN frequency range, specs a transmitter and receiver frequency of 1030 and 1090 MHz, respectively, ± 0.2 MHz. Maximum insertion loss is 0.75 dB (receiver) and 1.00 dB (transmitter). The unit has a power rating of 15 dBW average, with a $0.5\text{-}\mu\text{s}$ pulse width. Transmitter-to-antenna isolation is at least 40 dB from dc to 500 MHz; it is 60 dB for harmonics, including the fourth, of the transmitter frequency. The unit measures $5.1 \times 4.2 \times 0.6$ in.

CIRCLE NO. 281

TO-5 cans contain 2-GHz DB mixers



Watkins-Johnson Co., 3333 Hillview Ave., Palo Alto, Calif. 94304. (415) 493-4141. \$50 to \$70 (1-4); stock.

A series of miniature double-balanced mixers, for operation at frequencies up to 2 GHz, comes in four-pin TO-5 packages having a height of only 0.275 in. With a 7-dBm drive the series features a noise figure of 5.5 to 6.5 dB, isolation of 25 to 50 dB and an output frequency range of dc up to 1 GHz. The series consists of three models: the M6V, for the 0.4-to-500-MHz range; the M6R, for the 10-to-1200-MHz range; and the M6G, for the 0.6-to-2-GHz range.

CIRCLE NO. 282

Resistor-trim laser cuts operation costs

GTE Sylvania, Laser Products Dept., Box 188, Mountain View, Calif. 94042. (415) 966-2312. \$5500 up.

The Model 607 laser, which can automatically trim resistors to desired tolerances, operates from a standard 115-V supply for reportedly one-tenth the cost of conventional models. The laser uses air-cooled, tungsten-halogen pump lamps that cost less than 10¢ per hour to operate. The Neodymium:YAG device produces 1-1/4-W output power (single transverse mode) at 5-kHz repetition rate when Q-switched. Continuous-wave output is 1-1/2 W (TEM₀₀ mode) and 10 W (multimode). The 607 measures $20 \times 6\text{-}1/4 \times 6\text{-}1/4$ inches.

CIRCLE NO. 283

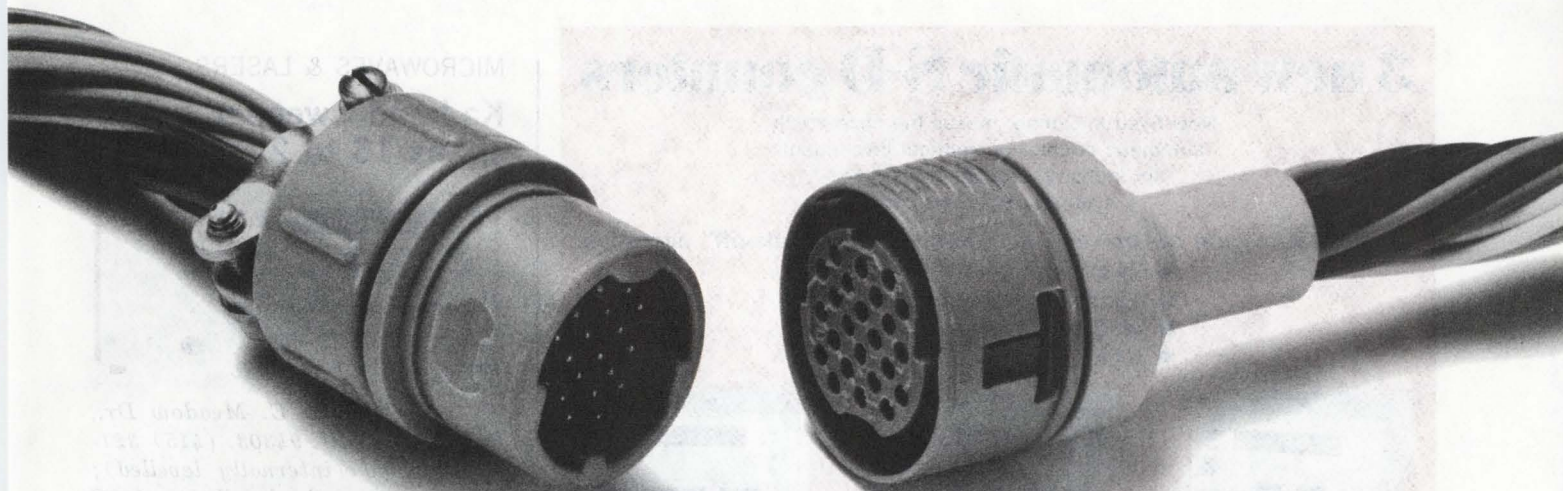

You may remember these when they were made out of metal, and only a cost-plus contract could afford them.

Our miniature, Thorkom connectors are almost identical to the expensive, can't-possibly-fail version we developed and produced for critical, aerospace needs.

They have positive, vibration-proof locking with squeeze release (we also have a new variable friction release version for special needs). Contacts are gold plated and available in screw machined or die formed versions, and with crimp or solder pot types. Mounting to panels is quick and easy. And tolerances

throughout are just as close and exacting as before.

But there are two major changes:

1. Insulator, coupling ring and connector housing are molded into a single unit from high impact, UL approved polycarbonate, able to withstand 50 G's shock.

2. And the R&D costs are well behind us, so the cost to you is down where you want it.

Send for details. Or, if you're in a hurry, call Customer Service. (213) 341-4330.

Ok. Send me: Details on low-cost Thorkom circular connectors.

My possible application: _____

Name _____ Title _____

Company _____ M/S _____

Address _____

City _____ State _____ Zip _____

 **Viking**
CONNECTORS

Viking Industries, Inc./21001 Nordhoff St./Chatsworth, Calif. 91311

3 new automatic S-D counters

Now Systron-Donner makes the once-costly automatic counter a practical investment for industry, education, field and systems use. Features:

- automatic gain control and autoranging for "hands-off" operation
- 25 mV input sensitivity
- optional battery operation
- leading zero suppression
- 5 high stability options



200 kHz Model 6202 Frequency Counter. \$295. The first automatic counter-totalizer at this price. 5 digits standard, 2 optional. Price includes BCD serial output and a full complement of connectors rear panel for systems interface.



2 MHz Model 6220 Frequency Multiplier/Counter. \$450. Replaces the expensive recipromatic counter for direct-reading measurements of audio and low frequencies. Resolves 0.001 Hz in 1 second. 6 digits standard, 2 optional.



50 MHz Model 6250 Counter/Timer. \$670. This versatile, automatic instrument offers 5 measurement functions: frequency, TIM, period, ratio and totalize. The 8-digit readout and BCD serial output are standard.

Contact your Scientific Devices office or Systron-Donner at 10 Systron Drive, Concord, CA 94518. For immediate details, call our Quick Reaction line (415) 682-6471 collect.

SYSTRON  DONNER

INFORMATION RETRIEVAL NUMBER 67

new SWITCHING VOLTAGE REGULATORS

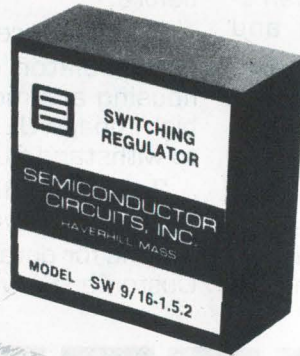

HIGH PERFORMANCE

High Efficiency . . . to 90%
MTBF > 100,000 hrs
Low Case Temperature Rise . . .
< 10°C above ambient
Load Regulation . . . 0.1%

SMALL SIZE

2" x 2" x 7/8" Encapsulated Module

LOW COST **From \$30⁹⁵** (1-9)

FOR USE IN

Point of Load Regulation
High Efficiency Power Supply Designs
Battery Powered Applications

1 or 2 Amp Models from 5 to 28 Vdc

Also Available: High Efficiency Power Supplies and Power Supply Kits

Our NEW 32 page catalog describes our full line of component module, PC card, open-frame, cased, and laboratory power supplies, DC/DC converters, DC/AC inverters, DC/DC isolators, switching regulators, and power kits.



SEMICONDUCTOR CIRCUITS, INC.

306 RIVER STREET ■ HAVERHILL, MASSACHUSETTS 01830
(617) 373-9104

INFORMATION RETRIEVAL NUMBER 68

MICROWAVES & LASERS

Ka-band sweeper spans 18 to 22 GHz

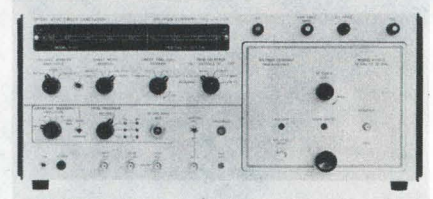

Wiltron Co., 930 E. Meadow Dr., Palo Alto, Calif. 94303. (415) 321-7428. \$3800 (internally levelled); \$3300 (externally levelled); 610C mainframe: \$1325; 6 wk.

The Model 6132C sweeper provides a 5-mW test signal over the 18-to-22-GHz frequency range. The sweeper has a flatness of ± 0.5 dB and it maintains harmonics 30 dB below the carrier. Spurious signals are 60 dB below the carrier. The sweeper uses a YIG-tuned Gunn-diode oscillator.

CIRCLE NO. 284

Laser xmtr/rcvr works over 15-mile range

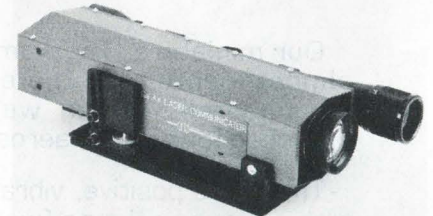

American Laser Systems, Inc., 106 James Fowler Rd., Santa Barbara Airport, Goleta, Calif. 93017. (805) 967-0423. xmtr, rcvr: \$1500 each.

The 736 laser communicator consists of a separate transmitter and receiver, each housed in identical 4 x 4 x 13-inch weather-resistant aluminum housings. The communicator can operate over distances in excess of 15 miles. The GaAs laser transmitter has a peak pulse power of 10 W and a maximum repetition rate of 10 kHz. Temperature compensation circuitry maintains constant laser output from -18 to 65 C. The receiver uses a silicon avalanche photodiode, biased for optimum sensitivity over the -40 to 60 C temperature range. The receiver has a 5-MHz bandwidth, in which an optical signal of only 0.58 mW can be detected.

CIRCLE NO. 285

We bridged the forward surge gap. For extra protection.

Our bridge rectifier ratings for DC output and forward surge capacities are substantially greater than those of competitive devices. Even though our physical dimensions are the same.

So, our single phase and three phase bridge rectifiers provide important added safety at normal operating levels.

You no longer have to take the chance of using a marginally rated bridge rectifier and running the chance of expensive down time and replacement costs.

Wagner single and three phase bridge rectifiers as well as center tap rectifiers come in standard size packages. Only our current ratings and forward surge ratings are higher.

B-10 Series. DC rating-30A@75°C Case. Forward Surge rating-400A@ rated load. B-10 Series replaces look-

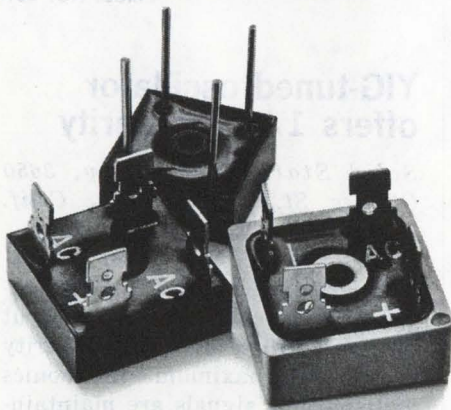

alike bridges rated up to 25A and from 50 to 1,000 PRV per leg.

B-40 Series. DC rating-15A@75°C Case. Forward surge rating-300A@ rated load.

B-50 Series. DC rating-10A@75°C Case. Forward surge rating-300A@ rated load.

For additional information on Tung-Sol® bridge rectifiers, write to: Tung-Sol Division, Wagner Electric

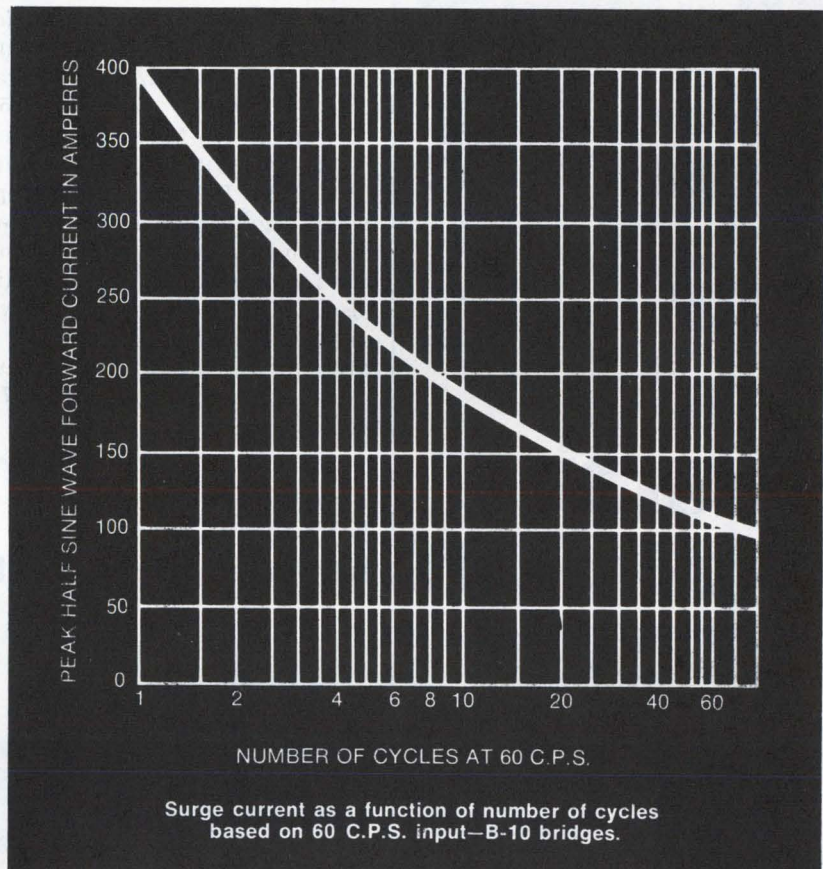

Corporation, 630 West Mt. Pleasant Avenue, Livingston, New Jersey 07039.

Wagner makes other quality products in volume for the electronics industry, including vacuum fluorescent readouts, power supplies and subsystems, silicon rectifiers, resistors, miniature lamps and status indicators. And Wagner offers contract manufacturing.

WAGNER®

We've got a lot more riding for you.

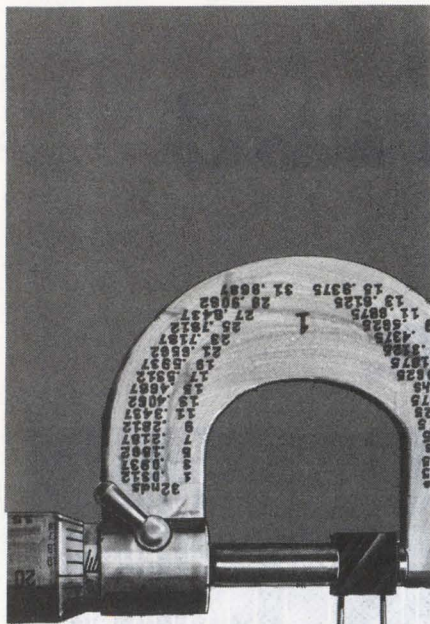

Our 2 mfd ceramic capacitors measure up.

Now AVX offers the CKR08 with 2 mfd capacitance in just 40% more space than a 1 mfd capacitor. It's a 2 mfd standard with all the advantages of ceramic dielectric.

The advanced design of the AVX CKR08 helps make your conceptual circuitry a reality faster. AVX provides you with the ceramic capacitors needed for tomorrow's designs today.

When you need ceramic capacitors, AVX delivers the quantities you need up to spec, on time and within budget.

For complete information, write AVX Ceramics, P.O. Box 867, Myrtle Beach, S.C. 29577. Telephone: (803) 448-3191. TWX: (810) 661-2252.



THE CERAMIC CAPACITOR MANUFACTURER

INFORMATION RETRIEVAL NUMBER 70

MICROWAVES & LASERS

225 to 400 MHz amp delivers 500 W

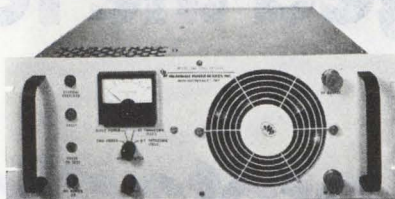

Microwave Power Devices, Inc., Adams Court, Plainview, L.I., N.Y. 11803. (516) 433-1400. 90-120 days.

This 500-W solid-state amplifier, Model EW2240-52/1506, operates in the frequency range of 225 to 400 MHz, 175-MHz instantaneous bandwidth, with a power output of 500 W cw. It is electronically protected against open or short-circuits in the output load. The amplifier features power output leveling, load VSWR protection, forward and reverse power monitoring, 40-dB power output control, automatic fault indication and 57-dB rf gain.

CIRCLE NO. 286

500-MHz DB mixer handles 23-dBm input

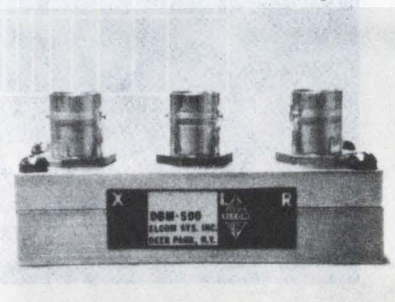

Elcom Systems, Inc., 127F Brook Ave., Deer Park, N.Y. 11729. (516) 667-5800. \$39.50; stock to 30 days.

A ruggedized double-balanced mixer covers the 2-to-500-MHz frequency range. The mixer has a 50- Ω input impedance and an i-f output port which operates from dc to 500 MHz. Typically the mixer exhibits 15 to 50 dB of isolation between ports and a conversion loss of 5 to 10 dB (SSB NF), with a +7-dBm LO input-signal level. The use of Schottky-barrier diodes permits a total power input of +23 dBm over the temperature range of -54 to +71 C. The mixer comes in a machined aluminum case measuring 1.00 x 0.63 x 2.50 in.

CIRCLE NO. 287

CATV transistor lists 3-dB noise figure

RCA, Solid State Div., Route 202, Somerville, N.J. 08876. (201) 772-3200. \$2.16 (100); stock.

A silicon npn overlay transistor, the 41039, is offered for CATV/MATV applications. In a narrow-band amplifier circuit operating at a frequency of 200 MHz and a current of 30 mA, the device has a maximum noise figure of 3 dB and a gain of 15 dB minimum. The 41039 comes in the JEDEC TO-39 hermetic package.

CIRCLE NO. 288

Antenna pair comes on printed circuit

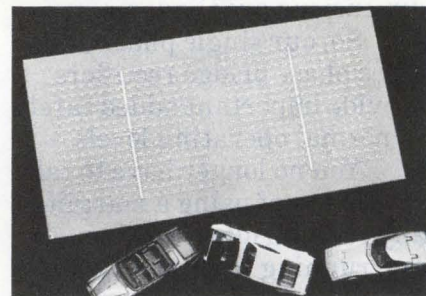

EMI-Varian Ltd., 248, Blyth Road, Hayes, Middlesex UB31HR England.

A transmit/receive antenna pair is offered on a printed circuit. Intended for automobile radars, the antennas have a bandwidth of 34.5 to 35.0 GHz, a minimum gain of 25 dB and a 3-dB nominal bandwidth of 5°. Cross-coupling between antennas is -40 dB and sidelobes are typically at least 9 dB below the main lobe.

CIRCLE NO. 289

YIG-tuned oscillator offers 1/4% linearity

Solid State Technology, 3650 Charles St., Santa Clara, Calif. 95050. (408) 247-8620. 60 days.

A series of YIG-tuned oscillators covers the 1-to-2 and 2-to-4-GHz frequency range with output powers of 10 to 20 mW. Linearity is $\pm 1/4\%$ maximum. Harmonics and spurious signals are maintained, respectively, 25 dB and 60 dB below the carrier. Frequency stability is 0.5% over the -30 to +60 C temperature range.

CIRCLE NO. 290



PACKAGED POWER

Computer Products' PM Series regulated DC power supplies provide high performance, warranted reliability, and convenience. Encapsulation offers compact ruggedness, simplicity and modest cost. We call it packaged power. Packaged so you can put it to work quickly and easily. Packaged for fast delivery, virtually off-the-shelf. Packaged power that wraps up brand-name components with intensive testing and consistently precise assembly and production techniques.

At Computer Products, every power module is triple-tested during production. That's why we can offer a full, TWO-year warranty on all PM Series modules with complete confidence. That's why we supply most of the encapsulated power supply market. During our final testing phase we find very few faulty modules. You won't find any.

*Write today for our
1974 Packaged Power Catalog.
You can order directly from it.*

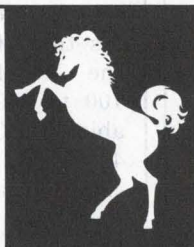

Computer Products, inc.

1400 NW 70 Street, Fort Lauderdale, Florida 33309 (305) 974-5500 • TWX (510) 956-9895

INFORMATION RETRIEVAL NUMBER 71

Price is the Object.

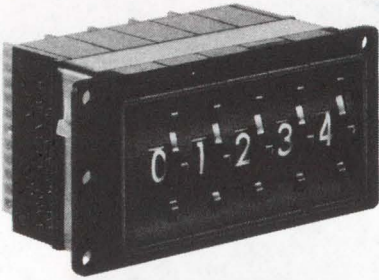

**25¢ per
(switch function*)**

SERIES 29000 ECONOMY MINISWITCH

...has many of the qualities of the more expensive switches with the added feature of being dust and moisture sealed.

A unique assembly strap makes it possible to build assemblies consisting of end mounting brackets and switch modules without using tools.

*List prices start at \$3.00 per switch module or only 25¢ per switch function for a sealed switch with 12 dial positions. That's less than the cost of most toggle, pushbutton, lever, slide, or rotary switches.

YES... "PRICE IS THE OBJECT", but when you buy Series 29000 Economy MINISWITCHES you get performance and quality too. Compare... Evaluate... We think you will agree. Send for details today.

There is a Digitran authorized distributor and a sales engineering group near you. Just dial EEM (800) 645-9200 (toll-free) to find out who they are.

See pages 1148 and 1149, Vol. 2, of the 1973-74 EEM Directory for more DIGITRAN products.

**SERIES 29000 ECONOMY
MINISWITCH
ANOTHER SWITCH FROM THE
DIGITRAN®
COMPANY**

Division of Becton, Dickinson and Company **BD**
855 South Arroyo Parkway / Pasadena, Ca. 91105
Telephone: (213) 449-3110 / TWX 910-588-3794

INFORMATION RETRIEVAL NUMBER 72

MICROWAVES & LASERS

Linear i-f amp offers 80-dB gain

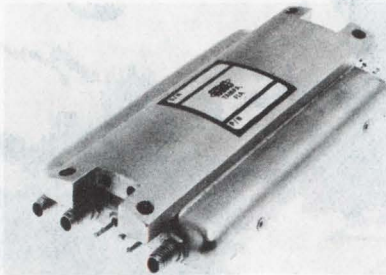

Trak Microwave Corp., 4726 Eisenhower Blvd., Tampa, Fla. 33614. (813) 884-1411. \$2000; 90 days.

An 80-dB gain linear i-f amplifier, with an internal limiter-discriminator and AM detector-video amplifier, comes in a compact 3.5 × 2.25 × 0.6-in. package. Called the Model 8401-1002, the new unit permits closed-loop agc operation with an 80 dB to 2 dB compression ratio and allows submicrosecond external agc preset. Center frequency may be specified from 100 to 150 MHz and a maximum noise figure of 3 dB is guaranteed.

CIRCLE NO. 291

Vary attenuation electronically



Lorch Electronics Corp., 105 Cedar Lane, Englewood, N.J. 07631. (201) 569-8282.

A line of electronically variable attenuators covers the frequency range of 2 to 350 MHz in two models. Model VA-417A/418A covers the 2-to-150-MHz range, while the Model VA-419B/420B spans 100 to 350 MHz. Units are available in PC board (VA-417A, VA-419B) and connector (V-418A, VA-420B) versions. The attenuators have a minimum insertion loss as low as 1.5 dB, and provide smooth variable attenuation of over 50 dB as a function of dc control current.

CIRCLE NO. 292

2-GHz linear amp outputs 1 W



Hughes Electron Dynamics Div., 3100 W. Lomita Blvd., Torrance, Calif. 90509. (213) 534-2121. \$2795; stock to 45 days.

A 1.7-to-2.4-GHz solid-state linear power amplifier, the Model 1405H, provides a minimum gain of 28 dB and 1-W minimum power output over its entire frequency range. The amplifier features hybrid microstrip circuitry and includes an integral ac-to-dc regulated power supply. The unit weighs approximately 12 lbs and measures 10.1 × 14.5 × 3.9 inches.

CIRCLE NO. 293

Dual TO-5 mixers match phase and amplitude

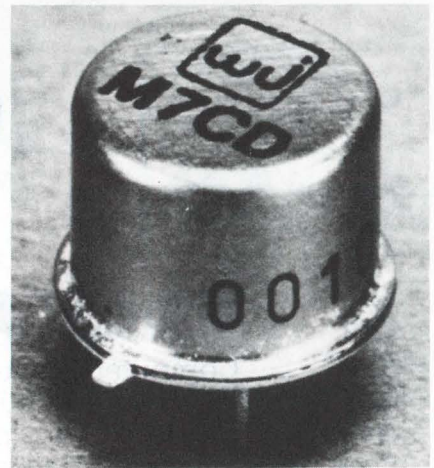

Watkins-Johnson Co., 3333 Hillview Ave., Palo Alto, Calif. 94304. (415) 493-4141. \$50 (1-4); stock.

The WJ-M7CD dual mixer, featuring a frequency range of 10 to 500 MHz with i-f's from dc to 500 MHz, provides phase and amplitude match from -55 to 100 C. At 25 C, the phase match is typically ±1° referred to 180° and the amplitude match is typically ±0.1 dB. L-port VSWR is typically less than 1.5:1. R and I port VSWRs are typically 2.0:1. The unit contains two single-balanced mixers, requiring a single local oscillator, and it comes in a hermetically sealed TO-5 package.

CIRCLE NO. 294

The case for Liquid Crystal Displays

Liquid crystal displays; light emitting diodes; incandescent and fluorescent displays and "Nixie" tubes are popping up frequently in circuit designs as the trend to digital readout continues. Each has a purpose and the design engineer should become familiar with all types. We make liquid crystal displays.

The display of the future?

Our display is a sandwich of two plates, joined and hermetically sealed at the perimeters. A space of about .0005" separates the plates, and this is filled with a nematic liquid crystal solution.

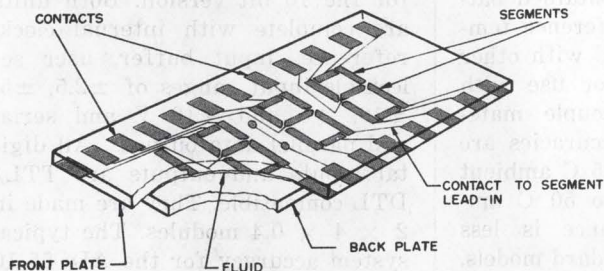

When the liquid is not electrically excited, its long, cigar-shaped molecules are parallel to one another in a position perpendicular to the plates. Thus, the liquid appears transparent. Applying an electric current creates ion activity which leads to turbulence and causes the liquid to scatter incident light. The visual effect is that of a frosted glass. LCD's can be made completely transmissive for back-lighting, reflective for ambient light or semi-reflective for dual mode operation.

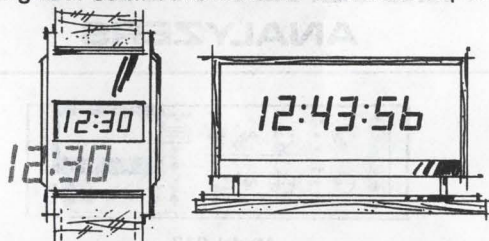

Producing an image — digital or other — simply requires a conductive surface the shape of the desired image on the glass plate toward the viewer. Current flowing from the conductive image on the front plate through the crystal liquid to the common-ground back plate causes the liquid to change from clear to a frosted appearance in the current-carrying area.

These images are almost always in the form of seven segments that make up the numerals 1 through 0. Energizing the proper segments produces the desired numerals. Lead-ins connect the segments to external contacts on the sandwich (display).

Consider the advantages.

Liquid crystal displays have a number of distinct advantages. Simplicity is the reason for several of these. The elements are few and passive — very little can go wrong with an LCD and this means reliability and long life.

Simplicity means low cost, too — lower than that of most comparable displays. Packaging costs are low because LCD's can be driven directly by MOS and C/MOS circuits. In our dynamic scattering displays very narrow character widths are possible and still provide a good viewing angle — 60 degrees in many cases.

Low power consumption makes the LCD a logical choice where power limitations rule out other display types. Watch type LCD's use only 30 μ W, for example, with all segments energized at 15 volts.

LCD's offer the greatest flexibility of any display type. Several standard displays are immediately available from Hamlin's stock. Special displays with virtually any type of image can be produced with surprisingly low preparation or "tooling" cost. Because of the LCD's simplicity, lead time on specials is only a matter of weeks.

A few limitations.

LCD's have limitations, too. Operating temperature range is one. Liquid crystals slow down and may even cease to function at temperatures below 0°C. Above 50-60°C, crystals go into solution and will not function normally.

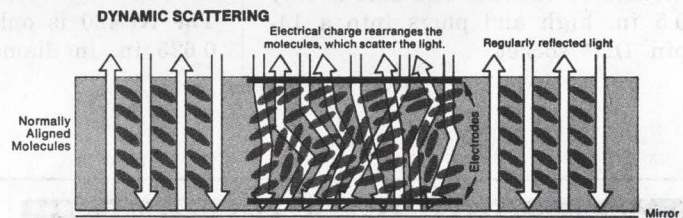

Extremes do not damage LCD's. Once the temperature returns to normal, operation is automatically resumed.

LCD's do not generate light, and they are somewhat difficult to read under low ambient light conditions. (Side or back lighting can remedy this.) Visibility under medium to high ambient light conditions is excellent.

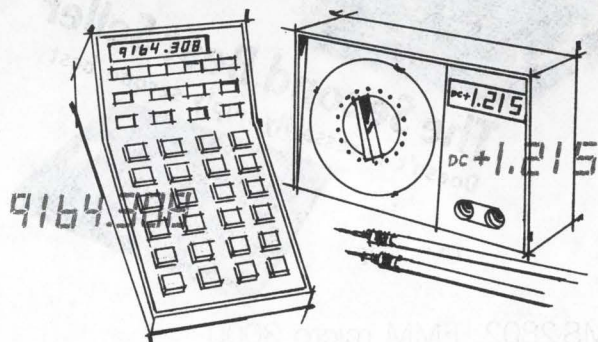

In the majority of display applications, MOS and C/MOS compatibility, reliability, flexibility and low power requirement are important considerations. No other display type can match the liquid crystal display on these jobs. They could become the display of the future. And that's the case for the LCD. For specification and application data, write Hamlin, Inc., Lake Mills, Wisconsin 53551. Or call, 414/648-2361. (Evaluation samples are available at moderate cost.)

HAMLIN
INCORPORATED

INFORMATION RETRIEVAL NUMBER 73

MODULES & SUBASSEMBLIES Adjustable timing unit has 5 operating modes

Krohn, Box 543, Easton, Pa. 18042.
(215) 252-0968.

The Versamod timing module can operate in the following modes: as a latching time delay with both normally on and normally off outputs; as a nonlatching timer with both normally on and normally off outputs; as a sequencer when cascaded in two or more sections; as a missing event detector and as a pulser. The timing is adjustable to 120 s using a screwdriver adjustable 15-turn potentiometer built in. Timing can be extended to hours with an externally connected capacitor. The Versamod may be triggered or reset on falling waveforms and can source or sink 200 mA at 25 C. The operating voltage is normally 4.5 to 15 V dc and the timing is not affected by supply voltage variations. The unit is only 0.5 in. high and plugs into a 14-pin DIP socket.

CIRCLE NO. 295

Reference junction has built-in battery

Hades Manufacturing, 151A Verdi St., Farmingdale, N.Y. 11735.
(516) 249-4244. \$69; stock to 4 wk.

Model NC420 self-powered thermocouple reference junction compensator has an internal battery. It can be energized by connecting the external switch leads. The unit is completely encapsulated and can replace ice baths and ovens. Up to 5000 hr of life with continuous use or up to three years of life with intermittent use can be obtained from its self-contained battery. The standard reference temperature setting is 0 C with other references available for use with all types of thermocouple materials. Compensation accuracies are typically ± 0.25 C at 25 C ambient to ± 0.75 C from 0 to 50 C ambient. Output impedance is less than 250 Ω on the standard models. The NC420 is only 3 in. long and 0.625 in. in diameter.

CIRCLE NO. 296

A/d converters speed along at 1 μ s/bit

Burr-Brown, International Airport Industrial Park, Tucson, Ariz. 85734. (602) 294-1431. \$260 (10-bit), \$305 (12-bit); 2 to 4 wk.

Models ADC55-10 and ADC55-12 are 10 and 12-bit successive approximation a/d converters. They are designed for applications where conversion speeds of 0.8 to 1 μ s/bit are required. They offer $\pm 1/2$ LSB maximum nonlinearity and no missing codes at 25 C. Typical gain drift for the 12 bit models is ± 10 ppm/ $^{\circ}$ C, and ± 15 ppm/ $^{\circ}$ C for the 10 bit version. Both units are complete with internal clock, reference, input buffer, user selectable input ranges of ± 2.5 , ± 5 , ± 10 , $+5$ and $+10$ V and serial and parallel data outputs. All digital inputs and outputs are TTL/DTL compatible. They are made in $2 \times 4 \times 0.4$ modules. The typical system accuracy for the ADC55-10 is $\pm 0.05\%$ and $\pm 0.012\%$ for the ADC55-12.

CIRCLE NO. 297



16K BYTES MEMORY CARD

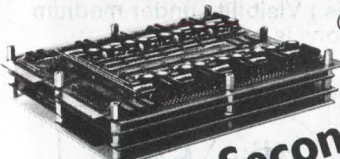

CMS2803



CMS2802

The Second Best Seller

Doesn't necessarily imply second best

CMS2802: EMM micro 3000
CMS2803: AMPEX 1800 series

Plug-to-plug compatible.
A clear system using our own hybrid circuit ICs.

	Access time	Cycle time	Temp. range	Power supply voltage
CMS2802	300 ns.	650 ns.	0 $^{\circ}$ ~+50 $^{\circ}$ C	+5V $\pm 3\%$, 4.0A max. +15V $\pm 3\%$, 4.0A max. -15V $\pm 3\%$, 0.9A max.
CMS2803	340 ns.	850 ns.	0 $^{\circ}$ ~+55 $^{\circ}$ C	+5V $\pm 5\%$, 3.5A max. -15V $\pm 3\%$, 4.5A max.

FUJI ELECTROCHEMICAL CO., LTD.

Head Office: Hamagomu Bldg., 5-36-11, Shinbashi, Minato-ku, Tokyo, Japan. TEL: 434-1271
Overseas Office:
New York, TEL: (212) 532-5630/Los Angeles, TEL: (213) 620-1640/Düsseldorf, TEL: (211) 89031

FREQUENCY RESPONSE ANALYZERS

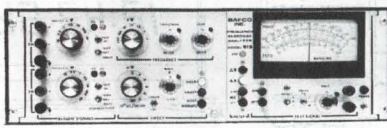

Model 913

Two Channel-Sweep-Directly plots Amplitude Ratio (db) and Phase Shift vs. Log Frequency. Open loop results from close loop tests. 0.005 - 10 KHz.

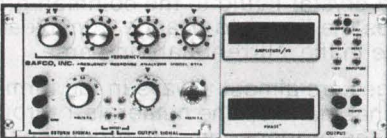

Model 911-A2D

Universal single channel .01-10 KHz with dual digital readout of Amplitude Ratio (db) and Phase Shift. Simple to operate, fast, and low in cost.

All units field portable and for rack mounting.
SEND FOR COMPLETE CATALOG OF ALL MODELS

BAFCO, INC.

717 MEARNS ROAD
WARMINSTER, PENNSYLVANIA 18974
TEL: (215) 674-1700 • TWX No. 510-665-6860

New! A 600-watt, 5V, 100 amps switching regulated power supply that has four outputs, measures just 3.9" x 7.5" x 16.12", weighs only 14 lbs., is 75% efficient and costs only \$493.*

And LH has 84 other equally exciting models to choose from — all of them smaller, lighter, more efficient and priced lower than competitive switchers.

250 to 1500 watts

LH offers 7 standard wattage ratings — 250, 300, 500, 600, 1000, 1200 and 1500** watts. This is the most comprehensive line of high-efficiency switchers available anywhere.

4 outputs

Standard LH switchers are available with single, dual, triple or quad DC outputs.

Low DC voltage, high power outputs

Primary voltages are at 5 VDC; 50, 100, 200 and 300** amps. 2nd and 3rd voltages are standard ± 12 , ± 15 and ± 18 V at 8 amps each; 4th voltage is 24V at 2 amps. Other voltages available.

Input voltages externally selectable

110/220 VAC, 47 to 440 Hz, can be selected by simply changing a jumper on the front terminal strip. DC input, 24 to 300 VDC, also available.

6 case configurations

All LH switchers use one basic *proven* design and package it in six

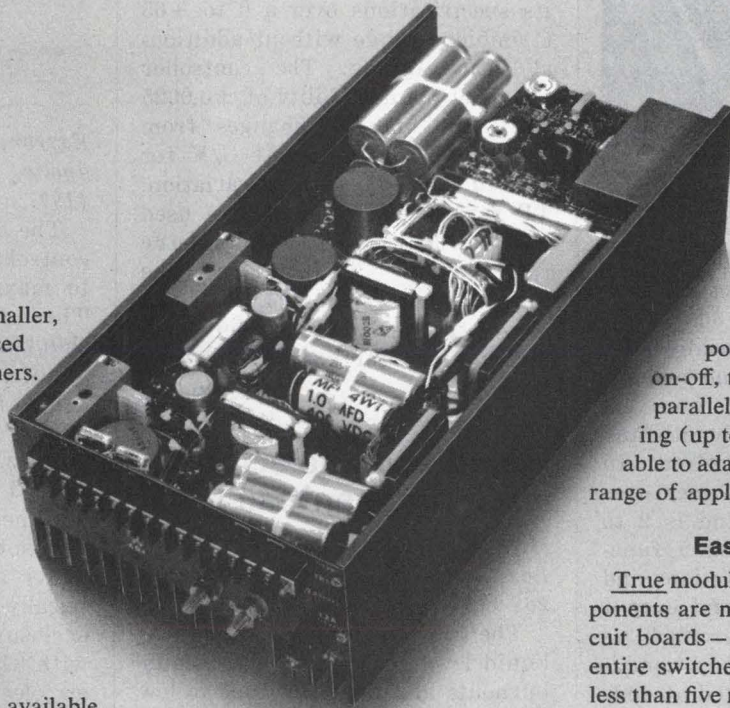

A number of options

Over-voltage protection, power fail detection, remote on-off, thermal cutoff, DC input, paralleling, master-slave paralleling (up to 10 units) — all are available to adapt LH switchers to a wide range of applications.

Easy maintenance

True modular construction — all components are mounted on just three circuit boards — make servicing easy. The entire switcher can be disassembled in less than five minutes.

different case shapes — wide and short or narrow and long — for customer convenience. With a nominal power density of 1.37 watt/cu. in., LH switchers pack more power into a smaller package than any other switchers you can buy.

80% efficient

On single output models, over 80% of the primary input power is delivered to the output terminal. On models with dual, triple and quad outputs, efficiency averages 75%.

Lighter weights

For example, LH's 250-watt single output model weighs only 7 lbs.; the 1200-watt, quad output unit, just 30 lbs.

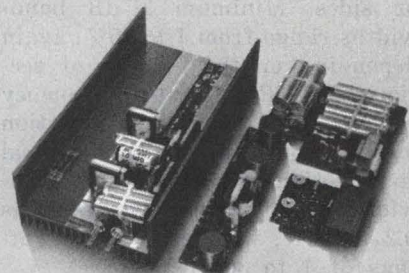

Priced as low as 63¢/watt

Watt-for-watt, LH units are the lowest priced switching regulated power supplies you can buy. In 1 to 24 quantity, a 250-watt single output model sells for \$360; a 1200-watt quad goes for \$1245.

Ask for full-line folder

The LH rep in your area has a new six-page folder that fully describes the 85 standard LH switchers, and discusses possible options and modifications to meet specific requirements.

Ask him for a copy today.

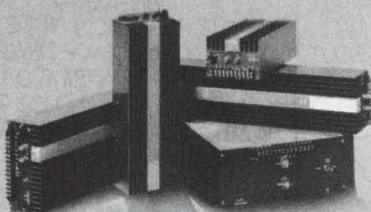

*1000 pc. qty.

**Available Sept. '74

LH RESEARCH, INC., 2052 South Grand Avenue, Santa Ana, CA 92705 • (714) 546-5279

Subminiature filter handles 30 W peak pwr

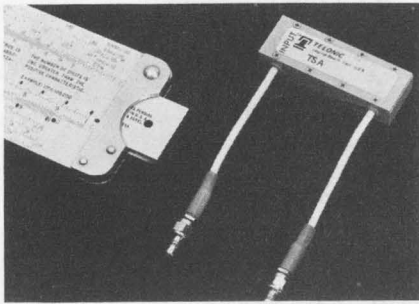

Telonic Ind., 21282 Laguna Canyon Rd., Box 277, Laguna Beach, Calif. 92652. (714) 494-9401. From \$150.

The Model TSA subminiature Chebyshev filters have center frequencies from 200 to 600 MHz. The filter is a magnetically coupled resonator design, and may be specified with two to eight sections depending on bandwidth and other characteristics desired. In cross-section, the filter measures only 3/8 x 11/16 in. and is 2 to 3.5 in. long, length being a function of the number of sections and pass bandwidth. Input and output connectors may be specified as Sealectro or OSM, or any combination, and may be located at ends or sides. Minimum 3 dB bandwidths range from 1 to 15%, again depending on the number of sections. VSWR at center frequency is less than 1.5:1, and insertion loss is about 2.45 dB for a typical four-section unit with a 10% bandwidth. The average power input is 0.2 to 5 W, with peak power ratings of 1 to 30 W.

CIRCLE NO. 298

Proportional controller handles up to 200 W

Oven Industries, P.O. Box 229, Mechanicsburg, Pa. 17055. (717) 766-0721.

Model 3C4-200 is a 200-W fully proportional dc temperature controller for precise control of resistive heaters. The unit will meet its specifications over a 0 to +65 C ambient range without additional heat sinking. The controller has a set point stability of ± 0.0025 C/ $^{\circ}$ C for ambient changes from 0 to +65 C and ± 0.001 C/V for a $\pm 10\%$ input voltage variation. TP series sensor probes are used for control over temperature ranges from -20 to +25 C. The total package size is 4.75 x 5.5 x 4.5 in. and has barrier strip terminations for easy installation.

CIRCLE NO. 299

Liquid level detector lets equipment fail-safe

HBS Equipment, 3543 E. 16 St., Los Angeles, Calif. 90023. (213) 262-1151.

The HBS, solid state "fail safe" liquid level sensor, prevents heater burnouts and tank fires due to low liquid levels. The standard unit is equipped with two 6-in. removable titanium probes which maintain conductivity only while immersed in solution. The "fail safe" control is totally enclosed in a gasketed PVC box 4 x 4 x 2 in. and mounts on the tank rim. Alternate probes and probe lengths are available.

CIRCLE NO. 300

Dc motor controls span 1/4 to 5 hp motors

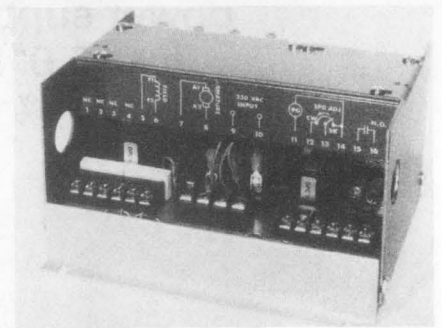

Extron, 5735 Lindsay St., Minneapolis, Minn. 55422. (612) 544-4197.

The Snap-Pac series of dc motor controls is designed to provide zero to maximum motor speed control. The units are for use with dc shunt-wound or permanent-magnet motors. Models cover a range from 1/4 to 5 hp with input voltages of 120 or 230 V ac, single phase, 50/60 Hz. The basic Snap-Pac is housed in a NEMA 1 enclosure designed for use in a clean, dry atmosphere. The power diodes and SCRs are contained in one electrically isolated package within the enclosure. Other features offered with the Snap-Pac series include an electrically isolated heat sink, full-wave rectification, high and low speed adjust, IR compensation, current limit and a test plug for checkout. Options available include a run-brake, automatic reversing, a self-contained speed pot, pulse tach feedback, a feeder control, an isolated instrument follower, a self-contained circuit breaker and manual reversing dynamic braking.

CIRCLE NO. 301

ANA&LOG
QUICK ANA COVER YOUR EYES. HERE COMES A STREAMER.

SO FAST YOU CAN BARELY SEE HIM.

UH HUH. JUST ABOUT MY SPEED.

GET THE BARE FACTS ON THE A-843 VOLTAGE TO FREQUENCY CONVERTER. STREAKS YOUR SYSTEM AT 0.1MHZ IN A STRAIGHT LINE $\pm 0.01\%$. NEAT LITTLE 1x1 1/2x3 PACKAGE. RUN OUT AND GET ONE.

intech INCORPORATED
(408) 244-0500
1220 COLEMAN, SANTA CLARA CA 95050

INFORMATION RETRIEVAL NUMBER 77

Active transformer runs from dc to 360 kHz



Burwen Labs, 209 Middlesex Tpk., Burlington, Mass. 01803. (617) 273-1488. \$200; 4 to 6 wk.

The Model AT200 active transformer handles signals from dc up to 360 kHz. AT200 characteristics include a small-signal 3-dB bandwidth at unity gain of dc-to-350 kHz (150 kHz at 30 dB gain); a 20 kHz minimum full power response; a ± 10 V output for a 10 k Ω load; an output of ± 9 V into 600 Ω ; gain adjustable from unity to 30 dB using a single external resistor; 85 dB minimum common-mode rejection from dc through 1 kHz for ± 10 V common-mode input; 0.03% harmonic distortion at 30 dB gain, 0.01% at unity gain; and 3.5 μ V rms of input noise. Offset and drift data include ± 1 mV maximum initial offset, externally trimmable to zero; 20 μ V/ $^{\circ}$ C voltage drift; ± 7 nA bias current; ± 0.7 nA/ $^{\circ}$ C bias current drift, all valid for the 0 to 70 $^{\circ}$ C temperature range. The AT200 transformers operate from ± 15 -V-dc supplies, measure 1.5 in. square by 0.62 in. high, and fit conventional AC1010 mating sockets.

CIRCLE NO. 302

Tone decoder modules span 250 to 1600 Hz

Alpha Electronic Services, 8431 Monroe Ave., Stanton, Calif. 90680. (714) 821-4400.

The TT-88 two-tone sequential decoder is fully tunable over 250 to 1600 Hz. It has low current drain of 9 mA standby. Frequency stability is $\pm 0.05\%$ over the temperature range of -30 to $+100$ $^{\circ}$ C. Supply voltage is 11 to 15 V dc and size is 1 \times 2 \times 3/8 in.

CIRCLE NO. 303

30-MIL-center-tapped thin-film-NiCr resistor-chips.
10 Ω to 510K Ω .
24-hour turnaround.

Our chips, your game.

From Hybrid Systems, naturally.

resistor-chips

To be precise...

RESISTANCE RANGE: 10 Ω to 510K Ω .

TEMPCO: 0 to +50 PPM/ $^{\circ}$ C.

TRACKING MATCH: ± 1 PPM/ $^{\circ}$ C.

POWER DISSIPATION: 250 mW.

NOISE: 0.01 μ V/Vmax.

RESISTANCE TOLERANCE: ± 1 and $\pm 5\%$ (or tighter, by request).

TEMPERATURE: -55° C to $+125^{\circ}$ C.

MIL-STD-883 A or B.

GLASS PASSIVATED

CONFIGURATION: chips, wafers, multi-chip trays, tube packs.

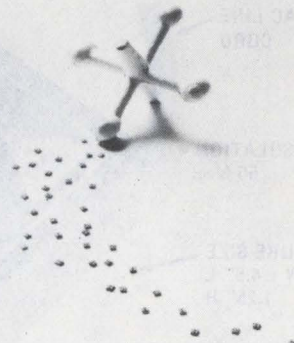

For Fast Action, Call:

In USA: (617) 272-1522 (or TWX 710-332-7584)

In Europe: Hybrid Systems Europa GmbH, 61 Darmstadt, Luisenplatz 4, Germany Tel. 6151-291595

Hybrid Systems Corporation
Burlington, Massachusetts 01803

Hybrid Systems
CORPORATION

When PRD makes frequency synthesizers, the performance is high...

not the price.

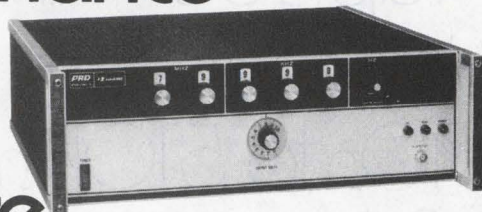

Our 7828 Frequency Synthesizer is offered with 1 kHz phase-locked steps from 1 kHz to 80 MHz. An optional vernier provides 1 Hz resolution. It's fully programmable with contact closures, RTL, DTL, or TTL logic; 1 part in 10⁶/mo stability; up to 1.0 volt output into 50 ohms.

Our 7808 Signal Generator/Frequency Synthesizer-Sweeper has digital synthesizer performance, yet retains the manual and vernier tuning and low spurious output of conventional signal generators. Its frequency range is 0.05 to 80 MHz. Key functions are programmable.

Best of all, these synthesizers cost little more than half the price of comparable instruments. For literature, write:



PRD Electronics, Inc.
A subsidiary of Harris-Intertype Corporation
1200 Prospect Avenue
Westbury, N.Y. 11590 Tel: (516) 334-7810

INFORMATION RETRIEVAL NUMBER 79

NEW POCKET-SIZE LAB POWER SUPPLIES

PRECISE, PRESET VOLTAGE SOURCES START AT
LAB AND MODULAR TYPES

\$39.00
(1-9)

SOLVE YOUR POWER SOURCE PROBLEMS NOW

3-WIRE AC LINE CORD

INPUT ISOLATION • 50 Meg

MINIATURE SIZE
2.5" W x 4.5" L
1.25" H

SHORT CIRCUIT & OVER VOLTAGE Protected Indefinitely

ON-OFF TOGGLE SWITCH
6-Amp Cap.

• REGULATION
Line: 0.01%
Load: 0.05%

• RIPPLE & NOISE
1mV rms

• TEMP. COEF.
0.015% / °C

6-WAY BINDING POSTS
Silver Plated Shank

SINGLE OUTPUT				DUAL OUTPUT			
MODEL	VOLTAGE	CURRENT	PRICE	MODEL	VOLTAGE	CURRENT	PRICE
M55	5.0	500 mA	\$ 49	D15.5	± 15.0	50mA	\$ 39
M510	5.0	1000 mA	\$ 69	D151	± 15.0	100mA	\$ 49
				D152	± 15.0	200mA	\$ 69



Instant Instruments Inc.

306 RIVER STREET ■ HAVERHILL, MASSACHUSETTS 01830
TEL: (617) 373-9260

INFORMATION RETRIEVAL NUMBER 80

MODULES & SUBASSEMBLIES

Modulatable Xtal osc goes up to 300 MHz

Damon, 80 Wilson Way, Westwood, Mass. 02090. (617) 449-0800.

A series of crystal-controlled sources is available with modulation capabilities. Types of modulation available with these sources include FM, PM, AM, DSB and SSB. Other specifications include: a carrier frequency range of 1 to 300 MHz, a frequency stability of $\pm 0.001\%$ over 0 to +50 C, modulation rates up to 100 kHz, flat to ± 0.5 dB and a linearity of 1% of peak modulation. Peak modulation for FM is +0.25% of center frequency, for PM is $\pm 180^\circ$ and for AM is 100%. The output power is 100 mW into 50 Ω . Units are typically 6 x 2 x 1 in.

CIRCLE NO. 304

Oscillator/amp systems reduce testing problems

Ancom Ltd., Denmark House, Devonshire St., Cheltenham, Glos, GL50 3LT, England.

Models 15PO and 15PSA are paired modules of a power oscillator and a phase sensitive amplifier. Available frequencies for the oscillator modules are 3, 5 and 10 kHz. The output of the oscillator module is 5 V rms into a 50- Ω minimum load—adjustable approximately $\pm 10\%$. Output stability is $\pm 0.5\%$ over a temperature range of 10 to 50 C at constant load, and distortion ranges from 1 to 5%, depending upon load. Input requirements are ± 15 V at 10 mA plus load. The synchronizing output is a square wave, ± 15 V with a 33 k Ω source impedance. The 15PO oscillator module measures 2 x 1 x 0.75 in. The amplifier module has an input impedance of 30 k Ω at 3 kHz and requires a synchronizing input of 5 V pk-pk, square or sine wave with a 40 k Ω input impedance. Gain is 500 to 100,000, adjustable by fixed resistors. The amp output is ± 10 V at 5 mA and the unit has a power requirement of ± 15 V at 10 mA. Size is 2.375 x 1.5 x 0.75 in.

CIRCLE NO. 305

Watch Out.

The volts are out to ruin your computer, maybe your entire system!

Nobody needs to remind you that the erratic demand on electric power these days has created a potential "brownout" condition in just about every major industrial area.

Protecting your computer or system from the crazy dips and surges in voltage is critical.

A slight dip can cause a computer to drop a few digits, lose parity, distort information, or lose its memory entirely. A surge damages delicate components and ruins printed circuits.

Sola Electric's "brownout insurance" comes in the form of highly reliable constant voltage transformers and Solatron® Voltage Regulators

—in a wide range of specifications. Most are standard units and immediately available for off-the-shelf shipment. And our applications engineering people are ready to help right now —whether you're designing voltage regulation into your equipment or adding protection to an existing system.

Protect yourself. Contact your local Industrial Distributor or the AC Products Group at Sola Electric. Call (312) 439-2800 or write Sola Electric, 1717 Busse Rd., Elk Grove Village, Illinois 60007.

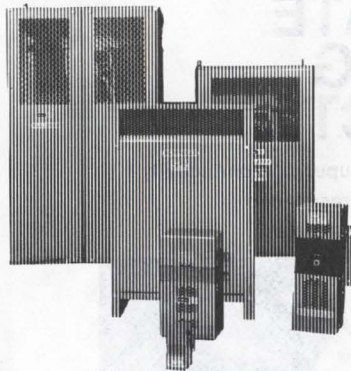

Get brownout "insurance" from SOLA

SOLA BASIC 

SOLA

SOLA BASIC DIVISIONS: ANCHOR ELECTRIC • BISHOP ELECTRIC • DIELECTRIC COMMUNICATIONS • DOWZER ELECTRIC • GUTH LIGHTING
HEVI-DUTY ELECTRIC • LINDBERG • NELSON ELECTRIC • SIERRA ELECTRIC • SOLA ELECTRIC • TEMPRESS
WARREN G-V COMMUNICATIONS

INFORMATION RETRIEVAL NUMBER 81

JACKS, PINS & TERMINALS

SHIPMENTS FROM STOCK

TEFLON/MICRO MINI/SUB MINI/STANDARD/
PRINTED CIRCUIT/BRASS SOLDER

Hundreds of configurations in stock

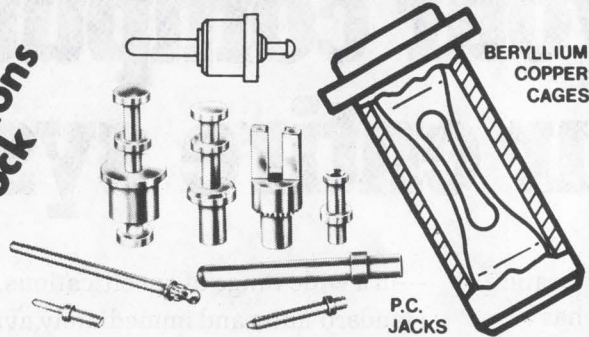

WE PRECISION-MANUFACTURE AND PLATE TO MIL SPEC IN GOLD, SILVER, TIN, SOLDER, AND OTHERS TO ORDER. FREE CATALOG AVAILABLE.

CONCORD ELECTRONICS CORPORATION

37 GREAT JONES STREET, NEW YORK, N. Y. 10012
(212) 777-6571 TWX 710-581-4930

INFORMATION RETRIEVAL NUMBER 82

INTRICATE SPRING CONTACTS

- Any shape, size, purpose • Superior conductivity, thermal, corrosion and abrasion resistance
- Make your products more dependable

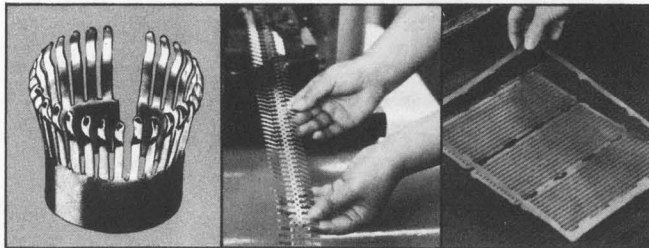

Let us quote on your contact strips, springs, washers, clips, stamped or precision etched parts, or complete assemblies. High quality, good service. Complete fabrication facilities. Welded contacts of precious metals on your specified contact arm which may be beryllium, copper, brass or nickel, etc. Send for our 20-page catalog.

braun company inc.

4200 31st Street North St. Petersburg, Florida 33714
813/526-9104

INFORMATION RETRIEVAL NUMBER 83

MODULES & SUBASSEMBLIES

SCR gate drivers have 200 ns pulse rise times

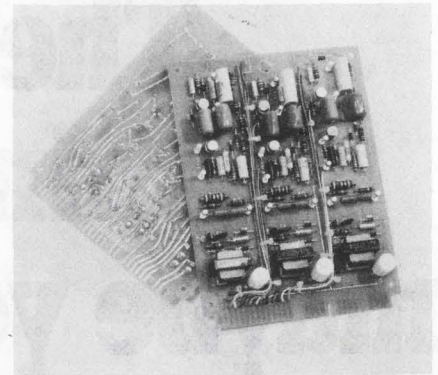

Vectrol, 1010 Westmore Ave., Rockville, Md. 20850. (301) 424-6900.

The VPH 4158 is a three-phase, half-wave SCR gate drive. Rise time of each pulse is typically 200 ns. Nominal phase shift capability ranges from 0 to 150° of conduction angle. Each phase is adjusted to provide 3° tracking of the gate pulse outputs throughout the conduction angle range. Phase rotation is not critical, allowing three-phase connections to be made in any rotation. Gate outputs, dc input and ac line circuits are completely isolated. Factory flash tests are performed on all units at 2000 V rms.

CIRCLE NO. 306

Telephone tone encoder includes all switches

Frequency Devices, 25 Locust St., Haverhill, Mass. 01830. (617) 372-6930. \$85 (1 to 9); stock.

The Model 510 tone encoder is a completely self-contained, digitally programmable unit, designed to provide tone frequencies, either individually or in pairs as selected by digital logic inputs. The internal oscillators settle to their new frequency within a half cycle after they are switched and the amplitude transient time constant is 10 ms. The gating controls do not introduce transients in the oscillator outputs. When the output gates are off, the output is attenuated by > 60 dB. Distortion in the output is 1%. Frequencies are normally set to better than 0.2% and are specified to be within 1% over temperature.

CIRCLE NO. 307

We take your reputation seriously.



That's why we build and test our Standard Power Modules so carefully.

The fact is, the basic power supply can put an expensive business machine out of business. And, while the shutdown may only be temporary—the possible loss of reputation and customer confidence may be permanent. This is why many O.E.M.'s are taking another look at their power supply "economies". When they do, North Electric looks better and better.

This is because our line of Standard Power Modules offers the highest levels of engineering skill, production line care and quality control in the industry—the same standards that have made North Electric the leading custom power source for more than 40 years. The point is—when North delivers power, you can bet your reputation on it.

Send for a complete product catalog today, or call your North Standard Power Product Manager at 419/468-8874.



Listed here are the more popular models—many other voltages are available.

MODEL	11000	12000	13000	14000	15000	16000	17000	18000
VDC								
AMPERES								
5.0	3.9	5.3	11.3	13.0	20.0	32.5	49.0	82.0
12.0	2.8	4.2	8.0	10.5	15.0	23.0	36.0	58.0
15.0	2.4	3.7	7.5	9.5	14.0	20.5	27.0	47.0
18.0	2.1	3.3	6.0	8.0	13.0	18.0	26.0	40.0
24.0	1.5	2.8	4.2	7.0	11.0	15.0	21.0	33.0
28.0	1.4	2.4	4.0	6.3	9.0	14.0	20.0	29.0
36.0	1.2	2.2	3.1	5.6	8.0	11.0	14.0	23.0
48.0	.95	1.8	2.6	4.2	6.0	8.0	10.0	18.0

MODEL	10000
VDC	
AMPS	
0-7.5	2.10
0-16	1.25
0-25	0.85
0-33	0.68

DUAL OUTPUT SUPPLIES	
MODEL	N03052
VDC	AMPS
±15-12	400MA
MODEL	N60052
VDC	AMPS
±15-12	1.0A

NORTH 
ELECTRIC COMPANY

Low-cost calculator does percentages

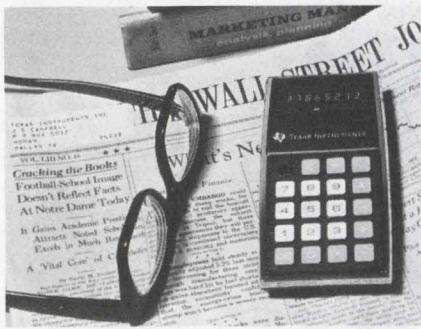

Texas Instruments, P. O. Box 5012, Dallas, Tex. 75222. (214) 238-3741. \$69.95; stock.

A miniature calculator, the TI-1500, performs basic addition, subtraction, multiplication and division and has a percent key. Features include repeat addition or subtraction, full floating decimal, and an 8-digit diode LED display. The keyboard consists of 10 digit keys, a decimal key, and eight function keys.

CIRCLE NO. 308

Color CRT terminal is also intelligent

Intelligent Systems Corp., 2405 Pine Forrest Dr., Norcross, Ga. 30071. (404) 449-5961.

A 22 x 17.5 x 16-in. package contains CPU, refresh memory and color CRT for an intelligent terminal designated the Intercolor 8000. The unit displays up to 2000 characters in an 80-character by 25-line format and offers 64 standard ASCII characters in a 5 x 7 dot matrix. Options include 32 programmable graphic symbols in a 6 x 8 dot matrix and a plot mode. The standard I/O is an asynchronous transmitter/receiver with a 20-mA TTY current loop interface. Baud rates may vary from 110 to 4800 to accommodate any speed requirements. In addition to the serial I/O, four additional 8-bit input ports and four 8-bit latching output ports are available as options for printer, tape cassettes or other peripheral requirements. Custom functions are available.

CIRCLE NO. 309

Microcomputer designed for process control

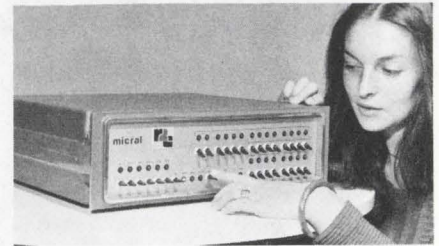

R2E, Paris, France. In U.S.: International Marketing Services, 38 Garden Rd., Wellesley, Mass. 02181. (617) 235-3130. \$2000.

An 8-bit microcomputer, called MICRAL, has one, two or three-byte instructions. The unit handles up to seven asynchronous data channels. A single bus joins memory, I/O and data channels and has eight priority interrupt levels. The CPU can address up to 64 k bytes, but provides relatively slow execution speeds—12 to 44 μs. However, for industrial applications I/O speed is said to be more important, and each of the channels handles 1-Mbit/s.

CIRCLE NO. 310



Data Communication Users!

SONEX, INC.

The company that brought the world Marketline* offers a broad range of Data Handling Equipment including Modems, Terminals and Multiplexers.

* Marketline is the first computer console developed for the general public and the only portable stock quotation system available. It is operational 24 hours a day, 7 days a week, keeping tabs on over 7000 stocks including all of NASDAQ and full CBOE coverage.

Sonex Inc. also offers a full line of standard Bell Compatible Modems (103, 403 and 202 equivalents) as well as special Modems and Terminals for high noise environments. Send for your information today.

SONEX, INC.
2337 Philmont Ave., Huntingdon Valley, Pa. 19006
Phone (215) 947-6670

Please send Data Communications Literature
 Please send Marketline information

Name _____ Company _____
Street _____ Phone _____
City _____ State _____ Zip _____

Key territories open for qualified representatives

ED

Up front with Tenney



NEW

30 cu. ft. workspace. Another "Tenney Series" breakthrough!

Economical TenneyThirty temperature and humidity test chambers offer 30 cu. ft. inside capacity yet are only 45" wide and 63" deep. All instruments and controls on front panel. 4 models with or without humidity.

Model T30RS
— 30°F to + 350°F with humidity

Model T30RC
— 100°F to + 350°F with humidity

Model T30S
— 30°F to + 350°F

Model T30C
— 100°F to + 350°F

Control tolerance ± ¼°F or better

Write or call for details.



Tenney

ENGINEERING, INC.

1090 Springfield Road, Union, N.J. 07083
(201) 686-7870 • (212) 962-0332

712

Dual processors share work via disc memory



Data General, Southboro, Mass. 01722. (617) 485-9100. See text.

The Dual Nova is said to be the first dual processor/shared disc system available as a standard item from a minicomputer manufacturer. It can be built around three standard Data General computers, one of three standard fixed-head and moving head discs, and the Real-Time Disc Operating System—all from Data General. The dual configuration enables joint access to disc data and programs between the computers for the purpose of sharing the work load or taking over in the event that one of the CPUs fails. A Dual Nova system includes 65,536 bytes of memory in each computer, an interprocessor bus for communication between computers, a disc, and a full complement of software. Prices for Dual Nova systems range from \$44,930 for a system built around two Nova 2 computers and a 524-kbyte fixed-head disc to \$83,172 for two Nova 840's sharing a 24,944-Mbyte disc pack drive.

CIRCLE NO. 320

Mobile data terminal operates on voice link

Sunrise Electro-Service Corp., 45 Willow Park Center, Farmingdale, N.Y. 11735. (516) 293-5757.

The MOSCAN is a small mobile communications terminal. The unit accepts a 256-character message in less than 0.75 s over a voice link. The protocol used is said to afford error-free results. Options include an alphanumeric keyboard, a 10-line memory and hard copy printer.

CIRCLE NO. 321

NEWS FROM AIRPAX

about Magnetic and Digital PICK-UPS

Airpax manufactures "passive" analog and "active" digital transducers (pick-ups) to provide the most effective and accurate means of converting mechanical motion into usable voltage control signals...without mechanical linkage. These magnetic pick-ups operate by accurately detecting moving ferrous discontinuities. Want to know more about pick-ups?... How is the selection made? How does the gear or discontinuity affect the pick-up output?

These questions are answered

in the new 20 page AIRPAX Text #8510

"MAGNETIC PICK-UPS AT WORK."

Send for it today!

AIRPAX
Controls Division
P.O. Box 8488
Fort Lauderdale, Florida 33310

Phone 305 587-1100

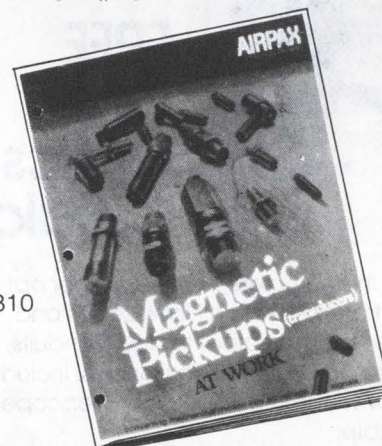

AIRPAX™

INFORMATION RETRIEVAL NUMBER 87

Remote-batch terminal has a dual personality



Control Data Corp., 8100 34th Ave. S., Minneapolis, Minn. 55440. (612) 853-4636. See text; stock.

Best described as a batch data processing terminal with a flexible configuration, the unit features dual protocol options to support Control Data CYBER 70, 6000 and 3000 series systems, in addition to emulating the IBM 2780 batch terminal. The terminal, designated as either the CDC 734 or the CDC 27801 depending on op-
(continued next column)

tional protocol, extends the resources of a central computer complex to remote locations. The CDC 734 interfaces with all Control Data computer systems that have communications hardware and software to support the Model 200 user terminals. The basic configuration includes a 734-1 modular terminal controller with 16 k, 8-bit bytes of memory, adapter logic for the card reader/printer, a synchronous communication line adapter, operator panel, keyboard/display, and the 200-User Terminal emulation controlware. The user has a choice of two card readers (300 or 600 CPM, 80-column), and two line printers (300 or 600 LPM, 136-column). Card reader and line printer speeds need not be the same. Cost is about \$27,000. The 734-11 option includes the CDC 2780 Emulator which allows the terminal to emulate IBM 27801 terminals. A typical configuration of the 27801 terminal that includes low-speed card reader and printer costs about \$25,900.

CIRCLE NO. 322

CRT terminal offers versatile display



Delta Data Systems Corp., Woodhaven Industrial Park, Cornwall Heights, Pa. 19020. (215) 639-9400. \$3000; 90 days.

The Delta 5500 CRT terminal displays up to 27 lines of 80 characters each. Characters are formed on the screen by a 7 x 9 dot matrix, and are said to be easy to read. A paging feature permits display of all the characters in memory (optionally up to 3072)—regardless of line width. Other features include a 2048-character buffered memory.

CIRCLE NO. 323

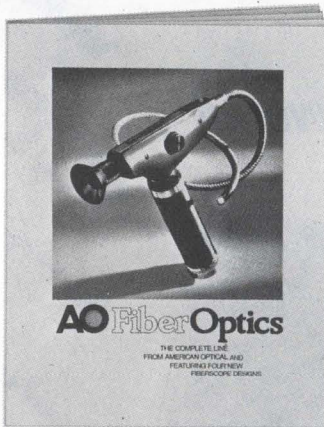

FREE Fiber Optics Catalog

Features the complete AO line of fiber optics products—from Inspection Fiberscopes and Light Guides to Illuminators, Image Conduits, Faceplates and Custom Components. Includes the four newest remote inspection fiberscopes now available.

Describes the principle, technology and techniques used to make flexible light and image transmissions a proven, practical fact. Write today for your FREE copy of the AO Fiber Optics catalog to American Optical Corporation, Fiber Optics Division, Southbridge, Mass. 01550.

AO
American
Optical

INFORMATION RETRIEVAL NUMBER 88

Look to Ballantine for TRUE RMS Voltmeters

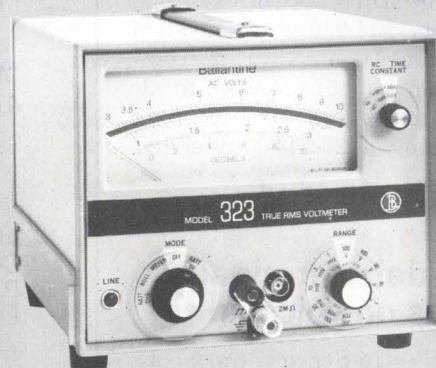

- True RMS • Battery Option
- 100 μ V to 300 V
- 2 Hz to 20 MHz (Usable to 50 MHz)
- 1% Mid-Range Accuracy
- Fast Response
- Fully Overload Protected

From \$615



Ballantine Laboratories, Inc.
P.O. Box 97, Boonton, New Jersey 07005
201-335-0900, TWX 710-987-8380

INFORMATION RETRIEVAL NUMBER 89

Fujitsu Quality on Sale in Reed Switches

Fujitsu reed switches combine ultra-small size with reliability and superior performance.

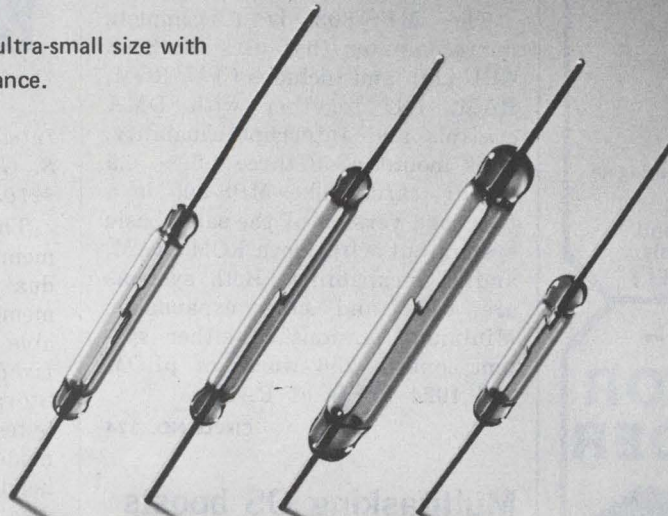

Select the most suitable reed switch for your requirements from the following:

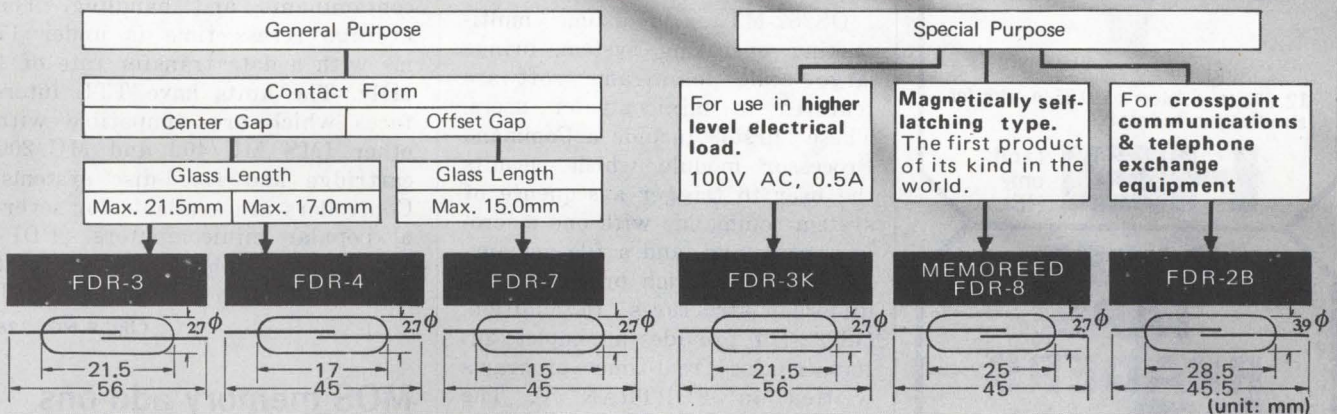

Reed Switch	Contact Form	Contact Rating	Pull-in Ampere-turns	Drop-out Ampere-turns	Operate Time	Release Time	Initial Contact Resistance	Dielectric Withstanding Voltage
FDR-3	A(make) Center Gap	10VA DC (0.5A DC max.) (100V DC max.)	20 ~ 60	8 min.	800µs max. (including contact bounce)	50µs max.	150mΩ max.	250/500V DC (1min.)
FDR-4	A(make) Center Gap							250/350V DC (1min.)
FDR-7	A(make) Offset Gap							250/500V DC (1min.)
FDR-3K	A(make) Center Gap	30VA DC (1A max.) 50VA AC(0.5A max.)	20 ~ 60	8 min.	1.5mS max. (including contact bounce)	0.1mS max.	100mΩ max.	600VDC (1min.)
FDR-8	A Self-latching Type B Type	5VA DC (0.5A max.)	85 ± 10	-28 ± 6				800V DC (1min.)
			110 ± 15	-24 ± 10				
FDR-2B	A(make) Center Gap	10VA DC (0.5A max.)	40 ~ 60	15 ~ 25	800V DC (1min.)			

FUJITSU LIMITED
Communications and Electronics
Marunouchi, Tokyo, Japan

For further information, please contact:
Head Office: 6-1, Marunouchi 2-chome, Chiyoda-ku, Tokyo 100, Japan Telex: J22833
New York Office: 680 Fifth Avenue, New York, N.Y. 10019, U.S.A. Phone: (212) 265-5360
Fujitsu California Inc.: 1135 East Janis Street, Carson, California 90746, U.S.A. Phone: (213) 636-0858, (213) 537-8930

MAIN PRODUCTS Telephone Exchange Equipment Carrier Transmission Equipment Radio Communication Equipment Space Electronics Systems Electronic Computers & Peripheral Equipment (FACOM) Telegraph & Data Communication Equipment Remote Control & Telemetering Equipment Electronic Components

OPTICAL SWITCH

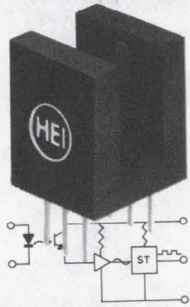

Photoelectric contactless switch using an LED & a phototransistor.

HEI (and only HEI.)

PHOTO-TRANSISTOR CARD READER

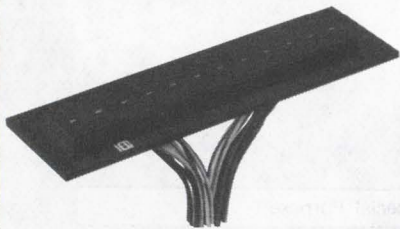

12 Phototransistors on 0.25-in. ctrs for standard punched cards.

HEI (and only HEI.)

PAPER TAPE READERS

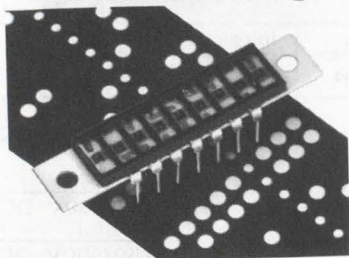

1 — 12 channel arrays. Phototransistors aligned to $\pm 0.002"$.

HEI (and only HEI.)

Call Pete Spaulding Now... (612)448-3510

HEI inc.

Jonathan Industrial Center
Chaska, Minn. 55318

DATA PROCESSING

Microcomputers come in small PC cards

Pro-Log Corp., 852 Airport Rd., Monterey, Calif. 93940. (408) 372-4593. \$920 (MPS-803); 2 wks.

The MPS-803 is a complete microcomputer that uses the 8008 CPU chip and includes CPU, ROM, RAM, I/O together with DMA controls and Interrupt capability. It is mounted on three 4.5 × 6.5 in. PC cards. The MPS-805 is a five card version of the same basic system but with more ROM, RAM, and I/O capability. Both systems are card and chip expandable. Minimum versions of either system contain 256 words of pROM and 1024 words of RAM.

CIRCLE NO. 324

Multitasking OS boosts 32-bit mini's utility

Interdata, Inc., 2 Crescent Pl., Oceanport, N.J. 07757. (201) 229-4040.

OS/32-MT, a real-time multitasking operating system, brings large scale mainframe software features to minicomputer users. These "firsts" include a Command Processor module which permits the user to trigger a sequence of system commands with one macro-level command, and a file management system which provides three different structures. In addition, OS/32-MT provides a complete interface for real-time programs written in FORTRAN V. The Command Processor module permits the user to store sequences of these commands tailored to his own needs, then call up the entire sequence with one macro-level command of his own choosing. The three file-management structures are: (1) A chained structure, which is open-ended and provides for automatic expansion, does processing of logic records which are automatically blocked and de-blocked by the OS; (2) An indexed structure is provided for those applications where fast random access files are required; (3) A contiguous file structure for physical input/output of variable length records.

CIRCLE NO. 325

Floppy-disc memory also uses fixed-head method

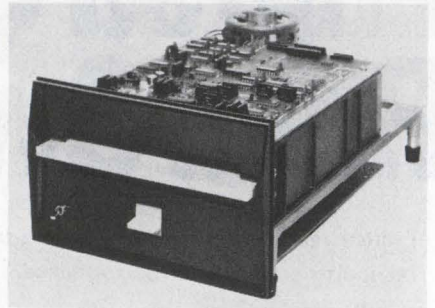

Intelligent Memory Systems, 2165 S. Grand Ave., Santa Ana, Calif. 92705. (714) 556-4200.

The MU/300 Series of mini-memory systems offers a unique dual capability for floppy disc memories—a front-loading, removable cartridge, combined with a fixed disc—all in a single package. Storage capacities range from 16-k bytes to 100-k bytes over the six-model series. Four or eight data heads are used on the cartridge disc, eight or 16 heads on the fixed disc. Both cartridge and fixed disc use Mylar floppy discs. The removable cartridge is self-sealing to protect against dust, contaminants and handling. The average access time is under 17 ms with a data transfer rate of 1 MHz. The units have TTL interfaces which are compatible with other IMS MU/400 and MU/200 cartridge and fixed-disc systems. Controllers are available for several popular minicomputers (PDP-11, Nova, Alpha 16, Datapoint 2200) with other models scheduled.

CIRCLE NO. 326

MOS memory add-ons fit PDP-11 series

Interactive Information Systems, P.O. Box 37403, Cincinnati, Ohio 45272. (513) 761-0132.

The Model IIS-75 is a MOS add-on memory for the PDP-11/45 series computers. These memories offer 450-ns cycle time and 350-ns access time and can be expanded to 32 k with increments of 8 k on each chassis. Although the memory operates off the Unibus, the processor cycle time of the PDP-11/45 allows full use of the memory speed. A PDP-11/40 or below may use the IIS-85 which offers 675-ns cycle time and 450-ns access time.

CIRCLE NO. 327

Thyristors, Rectifiers and Capacitors for Inverters



6 new high speed Thyristors

C609 SWITCHES 1400A pk @ 5KHz
C509 SWITCHES 1000A pk @ 5KHz

New involute interdigitated pellet configuration allows more than double the frequency-current capability of comparable competitive types.

C364, 275A RMS, up to 600V, 10 μ sec tq
C365, 275A RMS, up to 600V, 20 μ sec tq

For high speed, low-loss power switching in 1-10 KHz range.

C149, 63A RMS, up to 600V, 10 and 20 μ sec tq
C148, 55A RMS, up to 1200V, 30 and 40 μ sec tq

15° C cooler operation than competitive types at same case temperature; 1/4"-28 stud mount package.



New fast recovery Rectifiers

A396, 400A Ave, 1200V, up to 10KHz
A596, 750A Ave, 1400V, up to 5KHz

Companions to GE inverter SCR types C398, C509, C609. Better ratings and characterization than comparable competitive types.

Commutating and Snubber Capacitors

Metal-encased paper, metalized paper and poly-carbonate film dielectric capacitors are available in a variety of case styles and several lead terminations. Ratings from 0.1 to 150 μ f and up to 2,000V DC.

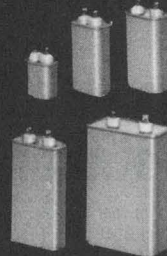

For more information contact
General Electric Semiconductor, Electronics Park 7-49
Syracuse, N.Y. 13201

GENERAL  ELECTRIC

Soldering-iron cleaner uses no abrasives

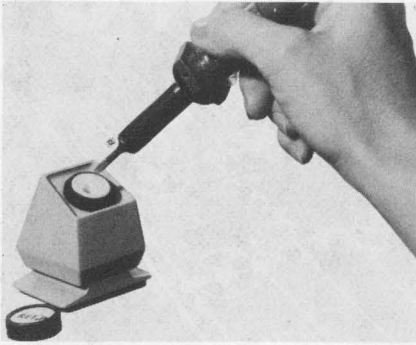

Solder Removal Co., 1077 E. Edna Pl., P.O. Box 1678, Covina, Calif. 91724. (213) 331-0955.

Re-Tip cleans soldering iron tips when you simply insert and withdraw the hot tip. No wiping or rubbing is required and no sponges need be kept wet. The cleaning unit allows the iron to stay hot, since it absorbs little heat. It works almost instantaneously and it does not use abrasives of any kind. The unit will clean any tip shape up to 1/4-in. diameter.

CIRCLE NO. 328

Heat sinks hold two 14 or 16-pin DIPs

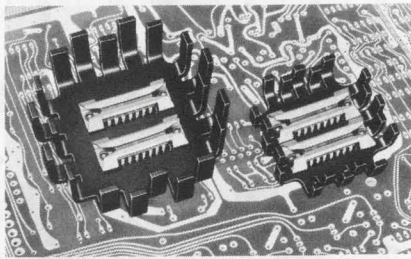

International Electronics Research Corp., 135 W. Magnolia Blvd., Burbank, Calif. 91502. (213) 849-2481.

High-power heat dissipators for DIP packages feature staggered fingers. Two dissipators, the Series HP1 and the smaller Series UP, are each configured for two 14 or 16-pin DIP packages. The HP1-348-CB is capable of dissipating almost 8 W in a closed cabinet with natural convection. The UP-348-CB, which uses half the board area of the HP1, permits operating two DIPs at 2-1/2 times the power possible with bare devices, IERC says. Greater dissipation can be achieved with forced air.

CIRCLE NO. 329

Hand power tool aids repair of PC boards

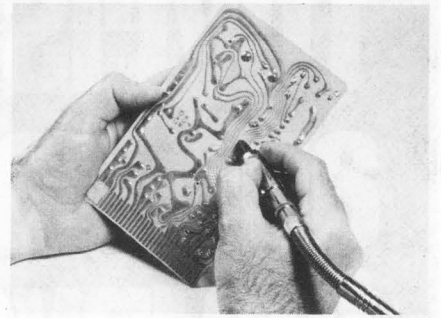

Foredom Electric Co., Route 6, Bethel, Conn. 06801. (203) 748-3521.

Repair and rework of PC boards are simplified with Foredom's miniature power tools. They may be fitted with a variety of hand-pieces and dozens of different burrs, brushes, sanding discs, abrasive wheels, ball cutters, drills and saws. Power is supplied by a 1/10-hp electric motor through a flexible shaft at speeds from very slow to 14,000 rpm. A foot control varies the motor speed smoothly and frees both hands for manipulating tool and board.

CIRCLE NO. 330

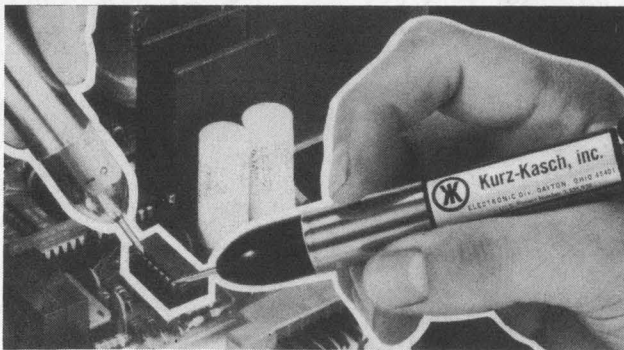

now...two-probe digital logic testing does it all...from Kurz-Kasch

The newest digital logic test system available today is the famous Kurz-Kasch LP-520 logic probe in combination with the HL-582 Hi-Lo pulser. The HL-582 is an in-circuit stimulator used to exercise IC's and cards pulling a Lo state to Hi or a Hi state Lo. Any change in logic is indicated on the LP-520. You now can control the logic input and monitor the output.

SPECIAL OFFER For only \$149.95 you can purchase both the LP-520 (regular price \$69.95) and the HL-582 (regular price \$89.00) and get a handsome belt clip type carrying case that accommodates both units. Act now. For a 15 day free trial, contact Tom Barth, General Manager.



Kurz-Kasch, Inc.
ELECTRONICS DIVISION
Dayton, Ohio 45429
Telephone 513/296-0330

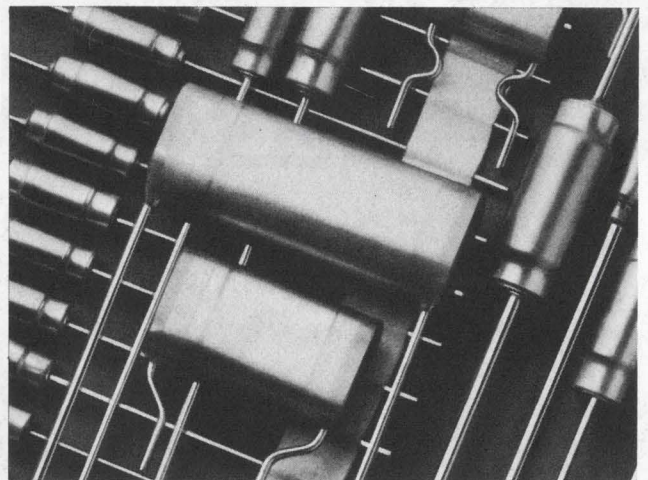

Two remarkable film capacitor types. Only from Paktron.

Axial lead polyester and polypropylene Micromatic® capacitors. Self-encased—wound on their own leads. Radial lead Filmatic® capacitors with Rippleweld® lead attach process. Modern plants in Vienna and Lynchburg, Virginia. For free catalog, write:

PAKTRON, Division Illinois Tool Works Inc.,
900 Follin Lane, S. E., Vienna, Virginia 22180.
Phone (703) 281-2810. TWX 710-833-0682.



PAKTRON
innovators in film capacitors
The Innovative Electronic Group of ITW...
PAKTRON ■ LICON ■ EMCON © ILLINOIS TOOL WORKS INC. 1974

The best ultra-precision resistor value

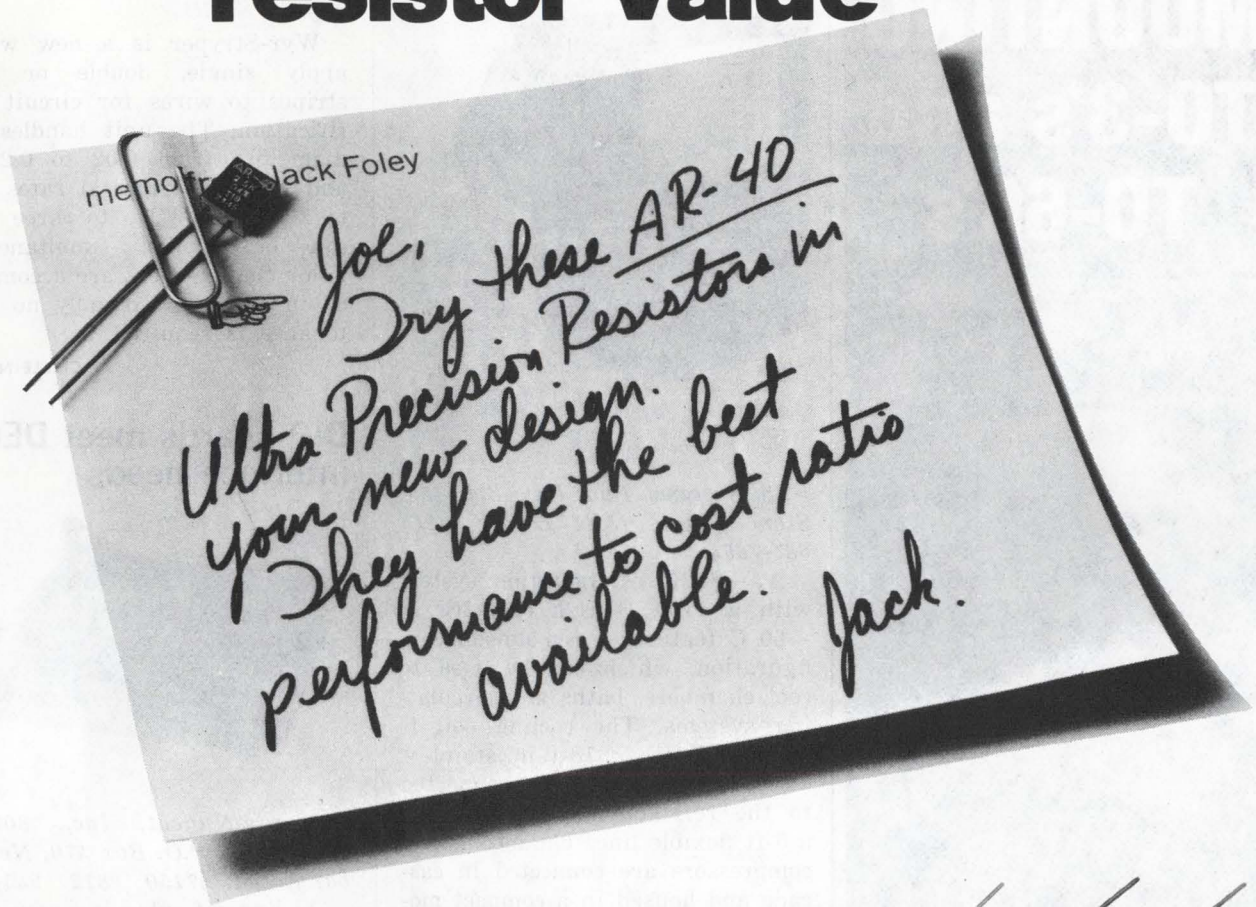

Hung up on resistor performance vs cost? Then check the AR40 metal film resistor—sophisticated, ultra-precision resistors from TRW's precision resistor technology.

With the AR40, you get ultra-precision, exceptional stability, and documented reliability. Temperature coefficient to ± 2 PPM/ $^{\circ}$ C and tolerances to .01% are standard. High frequency characteristics are outstanding and noise levels are not even measurable on commercially available equipment.

Additional value is provided by the AR40's rugged construction which withstands normal production handling. The AR40 is available now to solve your ultra-precision resistor problems at a cost you can afford.

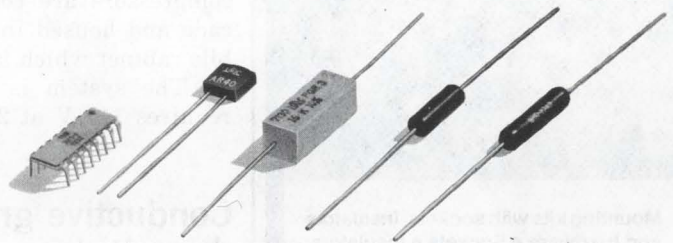

Complete resistor choice. TRW offers you a total resistor capability—carbon comp., thin-film, Metal Glaze™, wirewound, networks. For specs and application data on the AR40, contact your local TRW sales representative. Or write TRW/IRC Resistors, an Electronic Components Division of TRW, Inc., 2850 Mt. Pleasant St., Burlington, Iowa 52601. (319) 754-8491.

Performance and dimensions

TCR CLASS	STANDARD TEMP. COEFF. ($^{\circ}$ C)	RESISTANCE RANGE* (Ohms)	STANDARD TOLERANCE RANGE (\pm %)	WATTAGE 85 $^{\circ}$ C	DIMENSIONS IN INCHES	
					Height	Length
T-18	2 ppm 0 to 60 $^{\circ}$ C 5 ppm -55 to 125 $^{\circ}$ C	20 to 100K	.01 to 1.00	.3 watts	Width	.320 \pm .020
T-16	5 ppm 0 to 60 $^{\circ}$ C 10 ppm -55 to 125 $^{\circ}$ C				Length	.295 \pm .010
					Lead spacing	.150 \pm .010
					Lead gage # 22	.0253**

*Wider ranges available, contact factory. **Lead length 1.00 minimum.

TRW[®] IRC RESISTORS

INFORMATION RETRIEVAL NUMBER 95

Everything you need
for
**MOUNTING
TO-3's and
TO-66's**



Mounting kits with sockets, insulators and hardware ■ Sockets ■ Insulators: Thermalfilm I and II, BeO, and hard-anodized ■ TO-3 covers. All available now at your Thermalloy distributor.

Mounting kits include hardware and insulator; simplify inventories; reduce assembly time; and are available with or without sockets. They may be marked with your own assembly code if desired.

Whatever you need in semiconductor accessories from cooling to insulators, call your local Thermalloy distributor today.

**Write for
FREE
SAMPLES**



Thermalloy Inc.

NUMBER ONE IN SEMICONDUCTOR ACCESSORIES
P.O. BOX 34829
2021 W. VALLEY VIEW LANE, DALLAS, TEXAS 75234
PHONE 214 243 4321 / TWX 910 860 5542

PACKAGING & MATERIALS

**Refrigeration unit
features remote coil**



FTS Systems Inc., P.O. Box 158, Stone Ridge, N.Y. 12484. (914) 687-7664.

A -84 C refrigeration system with a 1700 BTU/h capacity at -60 C features a remote-coil configuration, which can be used to cool chambers, baths and circulating systems. The cooling coil is made of 7-OD \times 18-L-in. stainless steel tubing and it is connected to the refrigeration system with a 5-ft flexible line. The mechanical compressors are connected in cascade and housed in a compact mobile cabinet which is 17 \times 17 \times 28 in. The system is air cooled and requires 115 V at 20 A to operate.

CIRCLE NO. 331

**Conductive grease
doesn't drip**

Technical Wire Products Inc., 129 Dermody St., Cranford, N.J. 07016. (201) 272-5500.

A thermally and electrically conductive grease compound made with a silver/silicone base contains no graphite or carbon fillers. It is a one-part, nonsetting material with high moisture resistance and operates between -65 and 450 F . This conductive grease is a viscous paste that can be applied to vertical or overhead surfaces without dripping or running at elevated operating temperatures. No special dispensing equipment is needed. After it is applied to the surfaces, the grease can be wiped smooth with the fingers to achieve a thin, even coating.

CIRCLE NO. 332

**Color code your wire
with spiral stripes**

ETC, Div. of ITT, 29000 Aurora Rd., Solon, Ohio. 44139. (216) 248-8800.

Wyr-Stryper is a new way to apply single, double or triple stripes to wires for circuit identification. The unit handles wire diameters from 0.02 to 0.25 in., and spirally stripes at rates of 10 to 200 ft/min. Up to three colors can be applied simultaneously. Color change-overs are accomplished in seconds. Virtually no maintenance is required.

CIRCLE NO. 333

**DIP boards meet DEC
interface needs**

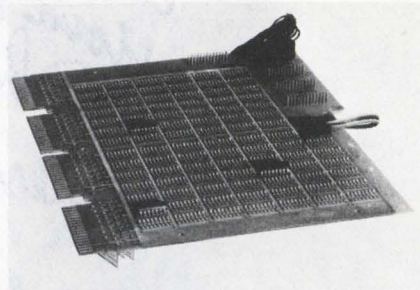

Robinson-Nugent, Inc., 800 E. Eighth St., P.O. Box 470, New Albany, Ind. 47150. (812) 945-0211.

A line of plug-in, wire-wrapable logic boards interfaces Digital Equipment Corporation PDP minicomputers with custom systems, peripheral equipment and specific applications. The contact/terminals in the A-OK, one-piece configuration have an above-board profile of only 0.025-in. They wipe on the broad, smooth surface of IC leads rather than the rough edges to provide lead-contact mating on approximately 60% of the lead surface. The boards are compatible with DEC's W-Series extended-module board dimensions and features. Three rows of 54 contacts, each on 0.300-in. row spacing provide a universal pattern for either 0.3 or 0.6-in. devices. Eighty-five, 16-contact patterns are provided for mounting 14 or 16-lead DIPS. Input/output provisions include four, 36-contact, PC tabs for DEC #H807 connectors, on the head end of the board, and five clusters of 26 feed-through pins for RN #PL-261 I/O plugs at the rear of the board.

CIRCLE NO. 334

Strip turns black at preset temperature

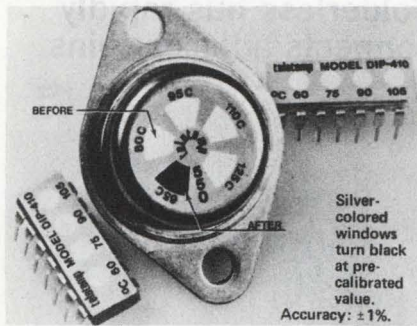

Telatemp Corp., P.O. Box 5160, Fullerton, Calif. 92635. (714) 879-2901. \$1.00 (15-99); stock to 1 wk.

Telatemp component temperature "recorders" are adhesive backed and easily applied to the top surface of many standard packages. Each recorder contains a series of temperature sensitive increments, which is precalibrated in degrees Centigrade. As the temperature of the component rises above these values, the increments turn black. Model 550, for use with TO-3, TO-66 and 42-lead LSI flatpacks, contains five temperature increments covering 65 to 125 C. Model DIP-410, for dual-in-line packages, contains four increments that cover 60 to 105 C.

CIRCLE NO. 335

Glass-epoxy for PC board reduces tool wear

Synthane-Taylor, Valley Forge, Pa. 19482. (215) 666-0300. \$1.80/ft²: 1/16-in. copper on two sides; 8 wks.

A new commercial-grade, glass-epoxy, copper-clad laminate, Taylorclad Fireban 670P, is specially formulated to reduce tool wear in punching and stack-drilling operations. The material is similar to NEMA FR-4 types, but it has a mat core to minimize abrasiveness and tool wear. Since it is punchable at ambient temperatures, 670P offers users significant savings in processing time. In addition, it eliminates haloing around punched or drilled holes that is common in conventional glass-fabric laminates, according to Synthane-Taylor. The laminate is available in thicknesses of 1/32 to 1/2 in. and in sheets measuring 36 × 42 or 36 × 48 in. Standard colors are green or tan.

CIRCLE NO. 336

Volts My Line?

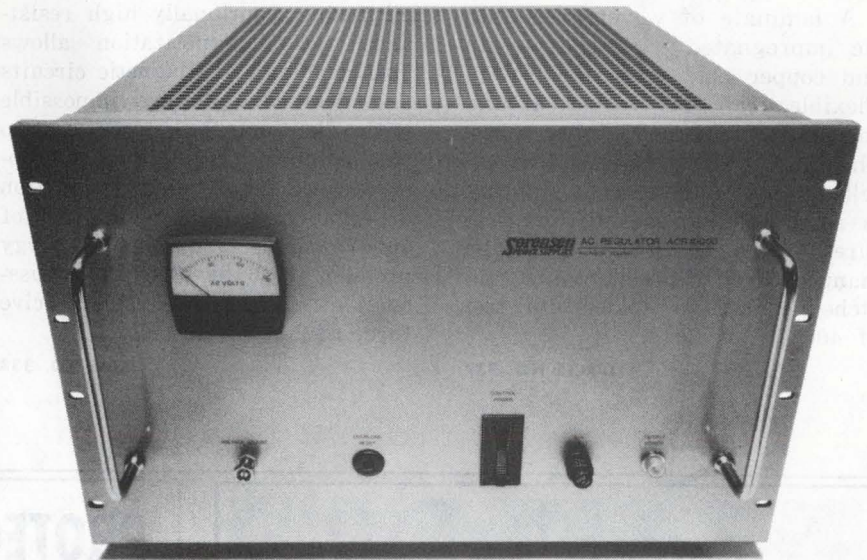

Holding that line-voltage. AC voltage regulation is efficient with the Sorensen ACR Series all solid-state regulators. Problems and damage caused by erratic line voltage are eliminated . . . performance is maximized with ACR features that include MTBF > 25,000 hours . . . remote sensing and remote programming capabilities . . . electronic current limiting . . . adjustable output voltage . . . power outputs to 15kVA—depending on model. Eight models in series. Three-phase systems available. For complete data, contact the Marketing Manager at Sorensen Company, a Unit of Raytheon Company, Manchester, N.H. (603) 668-4500.

Representative Specifications—ACR

- Input Voltage: 95 to 130 Vac
- Total Regulation: 0.4% to 0.6%
- Efficiency: to 95%
- Price Range: \$380 to \$1775

Sorensen POWER SUPPLIES

Flexible PC material operates at 300 F

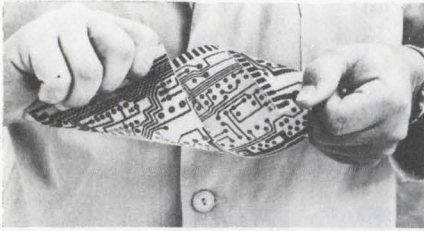

Universal Oil Products Co., 1300 Norplex Dr., La Crosse, Wis. 54601. (312) 391-2443.

A laminate of woven-glass fabric impregnated with epoxy-resin and copper clad, designated G-10 Flexible, can be folded around corners or shaped into tubes. Shear and tear qualities are excellent and dimensional stability is retained at operating temperatures of 300 F, according to the manufacturer. This laminate, unetched, passes a solder dip test of 400 F for 20 s.

CIRCLE NO. 337

PM material has twice Alnico's energy product

Electron Energy Corp., 329 Main St., Landisville, Pa. 17538. (717) 898-2994.

A new magnet material called Remco 16 is a rare-earth cobalt alloy that yields an energy product more than twice that of the best commercially available Alnico magnets and four times that of the best ferrite magnets. The high energy product in combination with an exceptionally high resistance to demagnetization allows size reduction of magnetic circuits and designs that are impossible with other materials, according to the manufacturer. Typical properties include: a residual induction of 8200 gauss, coercive force of 7000 oersteds, a maximum energy product of $16 \text{ to } 18 \times 10^6$ gauss-oersteds and an intrinsic coercive force of 20,000 oersteds.

CIRCLE NO. 338

Solderless bus rapidly connects adjacent pins

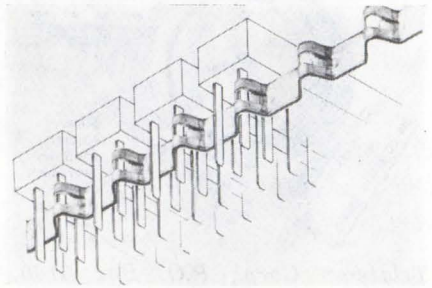

Lear Siegler, Inc., 714 N. Brookhurst St., Anaheim, Calif. 92803. (714) 774-1010.

Model 1062 pin-bars provide solderless, gas-tight terminations for 0.031×0.062 -in. connector pins with any spacing. Adjacent pins can be discretely bussed with separate pin-bars. Manual or semi-automatic application techniques can apply thousands of connections per hour, according to the manufacturer.

CIRCLE NO. 339

An autoranging DMM for only \$299?

Yes. And it's a KEITHLEY—no less. The new Model 168 is a full-function DMM. It measures ac/dc volts, ac/dc amps and ohms too. Autoranging, optional battery operation, two-terminal input, push-button operation and lighted function indicators are only a few of its added features. Send for full details now.



KEITHLEY INSTRUMENTS
 U.S.A.: 28775 AURORA ROAD, CLEVELAND, OHIO 44139
 EUROPE: 14, AVENUE VILLARDIN, 1009 PULLY, SUISSE

INFORMATION RETRIEVAL NUMBER 99

PROTECT YOUR BUSINESS AGAINST POWER PROBLEMS

with an
ACDCo UPS System
 (Uninterruptible Power Supply)
 Sizes from 125VA to 5KVA

ACDCo also manufactures Static Inverters, Frequency Changers, Static & Hybrid Switches, Battery Floating/Charging Systems, etc.

Call or write Mr. St. John for FREE engineering guidance.

If we can help you, we will. If we can't, we'll try to refer you to someone who can.

ADVANCE CONVERSION DEVICES COMPANY **ACDCo**
 109 EIGHTH STREET, PASSAIC, NEW JERSEY 07055 Phone (201) 778-0707

INFORMATION RETRIEVAL NUMBER 100

ELECTRONIC DESIGN 11, MAY 24, 1974

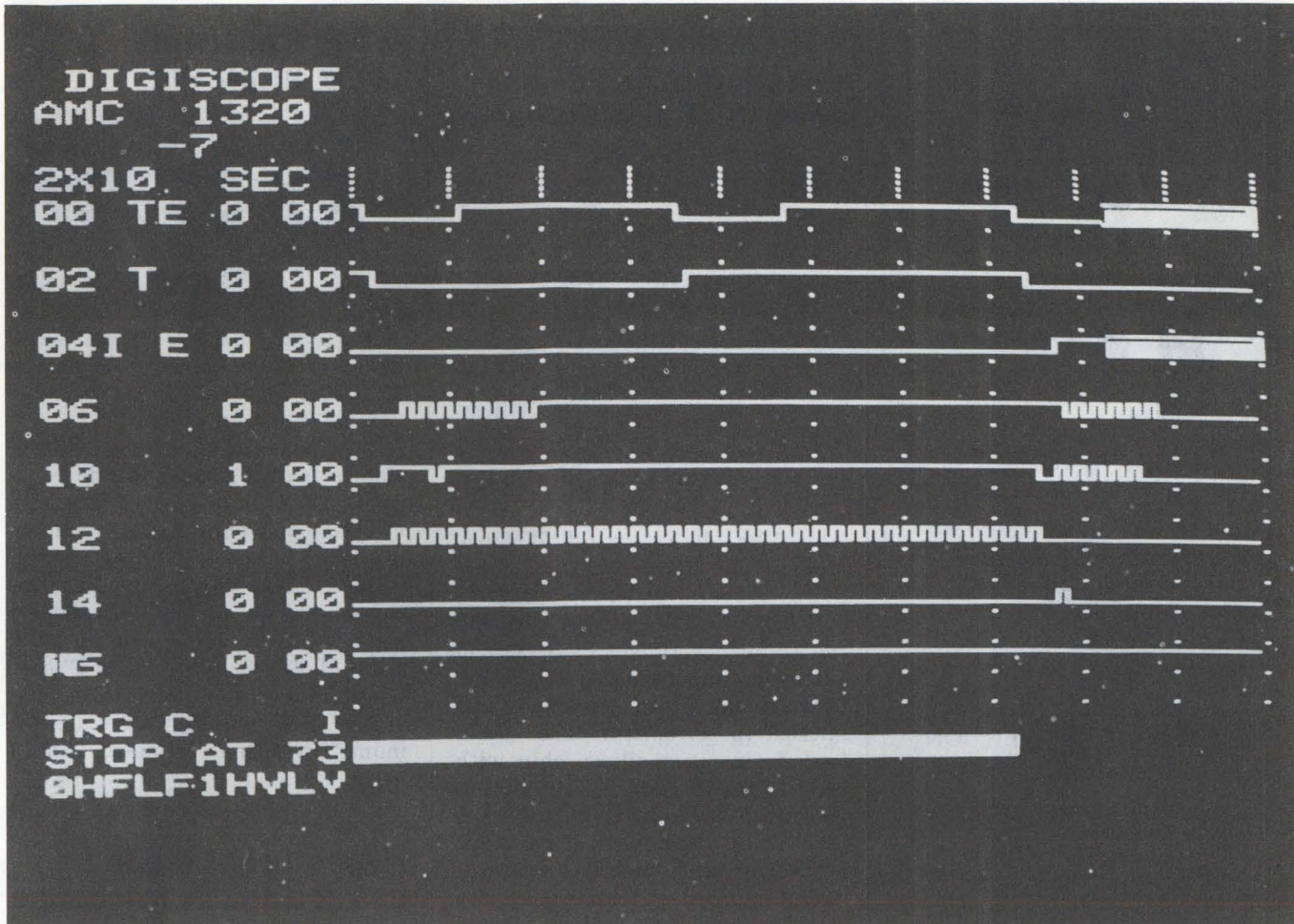

Digital timing, analog problems—only the Digiscope shows you both

"A radically new logic state analyzer from E-H Research gives you the equivalent of an 8 or 16 gun, 50 MHz, real time scope display of logic timing. It lets you see such analog parameters as glitches, ringing, rise and fall times, and voltage levels."

— Jerome Lyman,
ELECTRONIC PRODUCTS
Magazine, 1/19/74

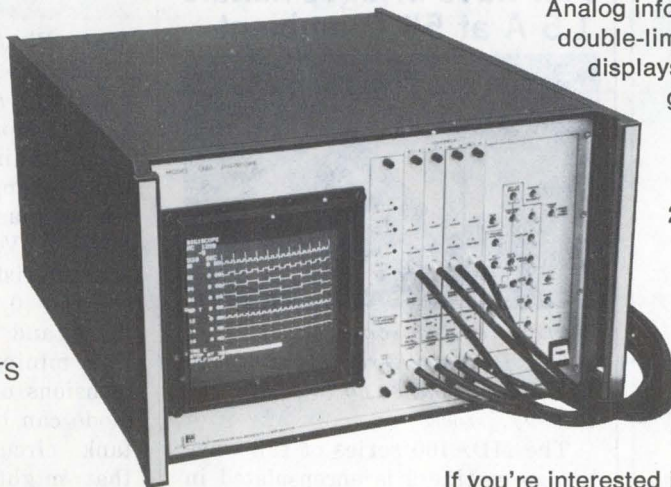

The Digiscope gives you eight channels of digital data simultaneously acquired at 50 MHz, up to 100 bits of pre-trigger lookback, and single shot measurements without sacrificing critical analog information in the signals.

Now Digiscope lets you see such anomalies as glitches (Channel 14), slow rise times (Channel 6), low "one" levels (Channel 12), high "zero" levels and ringing (Channel 10) that are often the cause of mysterious system failures.

Analog information is preserved with unique, double-limit threshold comparators. Screen displays all instrument settings for photographic recording.

You can trigger on any logical combination of the eight inputs. Probe impedance is greater than 20 megohms, shunted by less than 8pF, so you don't have to worry about a probe loading the circuit. We think when you see it, you'll agree: Digiscope is the most efficient, error-free test instrument ever made for designing, debugging, and maintaining digital electronic equipment.

If you're interested in the whole story about this radically new logic state analyzer, let us know. We'll send you the AMC 1320 Digiscope brochure immediately.



**E-H Research
Laboratories, Inc.**

515-11th Street, Box 1289
Oakland, California 94604
(415) 834-3030

European Subsidiary: P. O. Box 1018, Eindhoven, The Netherlands, (040) 433704

INFORMATION RETRIEVAL NUMBER 101



**PRICES CUT
37% to 66%**

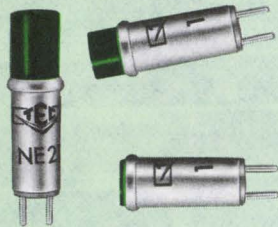

**REPLACEABLE
CARTRIDGE LITES**

Now only **40¢ to 86¢***

**IMMEDIATE DELIVERY ON
MANY LENS COLORS & LAMPS**

Low-cost RCL Series Cartridge Lites are offered in 3 lens styles, 10 lens colors, a full range of voltages and incandescent or neon lamps. Clear anodized aluminum body is also available in other colors and finishes—including iridite—on special order.

Devices mount in panel with spring steel clip, lead wire connectors or solderless cartridge holders shown below. Lens may be imprinted with up to two symbols. Stainless steel terminals are offset to provide neon lamp polarity and to align legends in holders.

*Each in 100-499 quantities.



**PRICES ALSO REDUCED ON
CARTRIDGE LITE HOLDERS**

Save 33% to 67%... RCLH Series Holders now priced from 25¢ to 70¢. Available in front- and rear-mounted versions, solder cup and turret lug terminals and printed circuit board mounting.



9800 N. ORACLE ROAD
TUCSON, AZ. 85704
(602) 297-1111
TWX 910-952-1377

INFORMATION RETRIEVAL NUMBER 102

DISCRETE SEMICONDUCTORS

**Schottky mixer diodes
cover S, X and Ku bands**

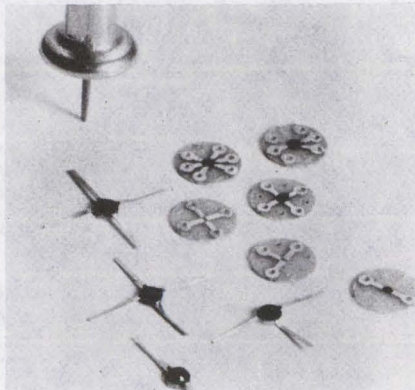

Alpha Ind., 20 Sylvan Rd., Woburn, Mass. 01801. (617) 935-5150. From \$5.95 (1 to 9); stock to 30 day.

Schottky mixer diodes, covering the frequency ranges of S, X, and Ku bands, are designed as the hybrid elements in stripline and microstrip circuitry. The beam lead device is a silicon chip with leads "grown" by electroplating gold onto the silicon during slice processing. Beam-lead diodes have low series resistance along with a narrow spread of capacitance for close impedance control. These diodes can be provided, on request, in LID package or in chip form for MIC use.

CIRCLE NO. 340

**Full wave bridges handle
1.5 A at 55 C ambient**

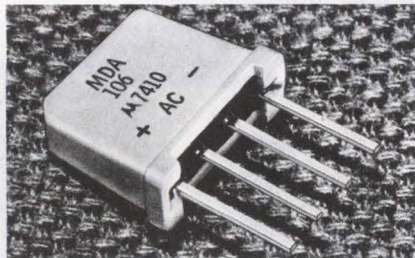

Motorola Semiconductor, Box 20924, Phoenix, Ariz. 85036. (602) 244-3466. From \$0.60 to \$1.57 (100 to 999); stock.

The MDA100 series of full wave bridge rectifiers is encapsulated in miniature plastic cases. The cases help provide high dielectric strength, vibration and shock resistance and low cost. These rectifiers use the same chips as the popular 1N4000 rectifier series. Rated at 55 C ambient for full output of 1.5 A, they are available in voltages up to 1 kV.

CIRCLE NO. 341

**0.5-A transistors
come in plastic**

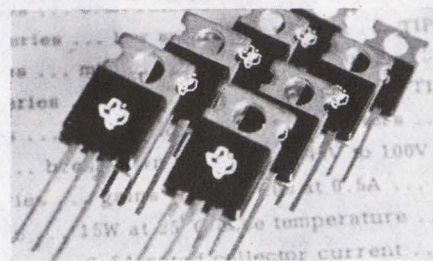

Texas Instruments, P.O. Box 5012, M/S 308, Dallas, Tex. 75222. (214) 238-3741. 40¢ up (100).

Two series of silicon power transistors feature TO-66 plastic packaging. The new devices are npn (TIP61) and pnp (TIP62) complementary types, providing a collector current of 0.5 A. Other features include a V_{CEO} -breakdown range of 40 to 100 V, and a 0.5-A gain of 15 to 100. At 25-C case temperature, the transistors dissipate 15 W, and they have a minimum transition frequency of 3 MHz.

CIRCLE NO. 342

**Hyperabrupt diode
has fourfold cap change**

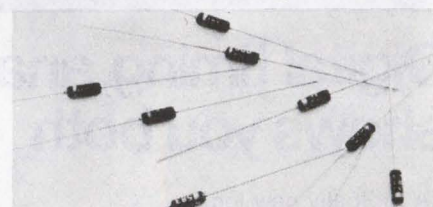

MSI Electronics, 34-32 57 St., Woodside, N.Y. 11377. (212) 672-6500. \$12 (100 up); 2 wk.

The Model HA1217A hyperabrupt tuning diode has a capacitance change from 5.5 to 1.5 pF for a bias voltage change from 3 to 8 V. The low capacitance characteristic is further enhanced by the 0.15-pF package capacitance and the 2.5-nH inductance. The minipackage is half the dimensions of the DO-7 so that the diode can be soldered directly into tank circuits, minimizing losses that might otherwise occur. The Q for this hyperabrupt tuning diode is 400, measured at 50 MHz and 4 V bias. The nominal capacitance at 4 V is 4 pF and the voltage breakdown rating is 20 V; the HA1217A is also available in matched pairs and quads for pre-selector, synthesizer and electronic tuning applications.

CIRCLE NO. 343

A Major Tooling Breakthrough in Production Wire Tying

Until 1958, when the Thomas & Betts Co. introduced TY-RAP® cable ties and tools, the harnessing of wires was accomplished by either taping, lacing with string or spot tying. Today the TY-RAP system of harnessing has become the accepted way of handling wires — even in high volume production. The new T&B TR-300 automatic tying tool, the most recent addition to our tooling technology, has made harnessing a cost controlled proposition with measurable savings. With proper harness board preparation, the TR-300 tool can offer 4 to 5 times quicker installation than hand tying.

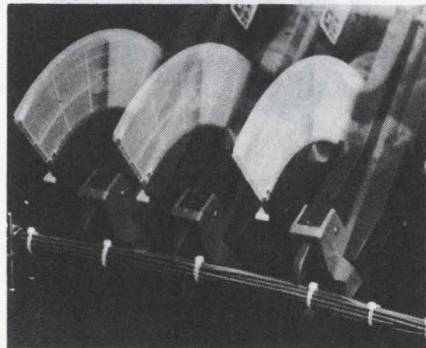

How Do You Determine Your Tooling Needs?

The selection of the best TY-RAP tying system for your operation means evaluating:

- Volume of tying vs. costs
- Present harnessing methods
- Number of people involved
- Bundle diameters & breakouts

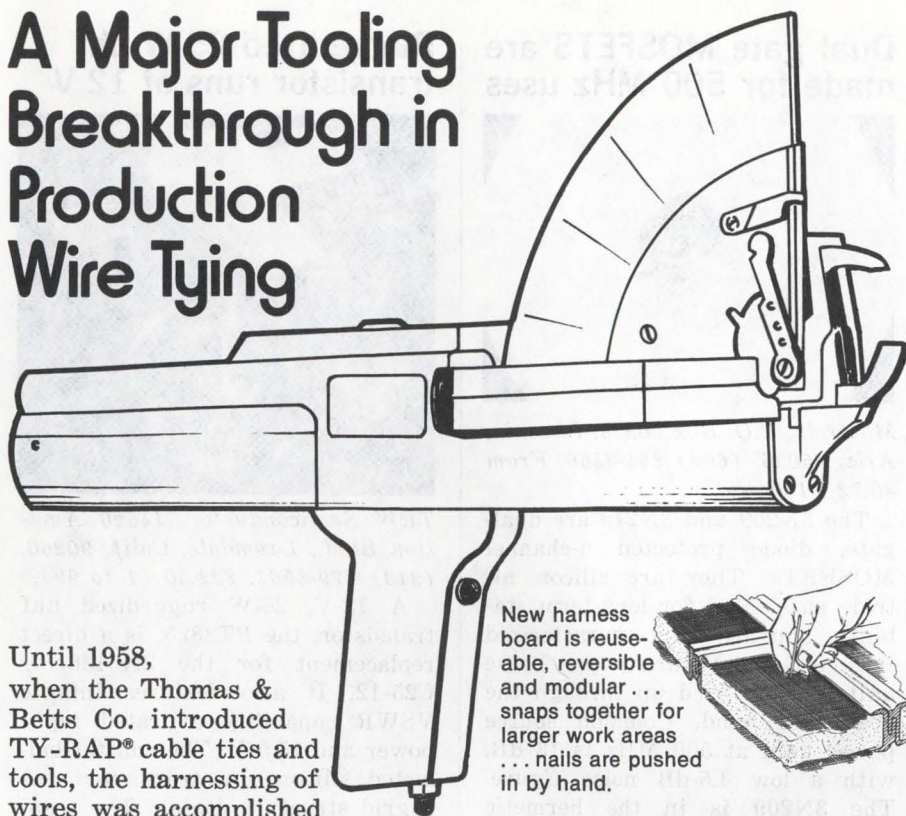

New harness board is reusable, reversible and modular... snaps together for larger work areas... nails are pushed in by hand.

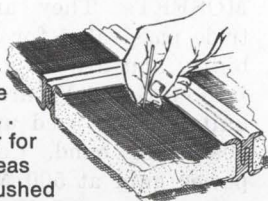

These and other considerations can be reviewed by your local T&B harnessing specialists. Your production rates, system flow and total installed costs are all of major concern to us. For example, we might recommend the New TR-225 pneumatic tool, a

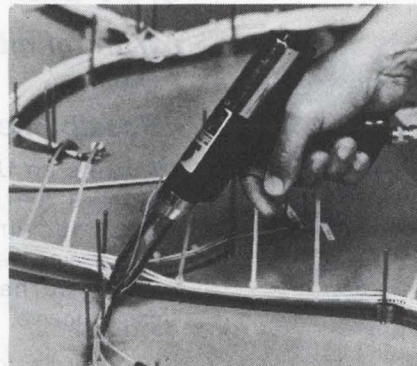

rugged design yet light weight and human engineered for both men and women operators. It was built to provide reliable performance day after day in a production environment... (has been test cycled 1,000,000 times per month without a failure). The tool accommodates most TY-RAP tie sizes... 16 in all... ranging from 1/16" to 4" bundle diameters. A further convenience is the long narrow nose that works easily at breakouts or in tight areas. If your production volume is such that it does not require the exclusive use of the TR-225, per-

haps the new WT-193 hand tool would supplement your operation.

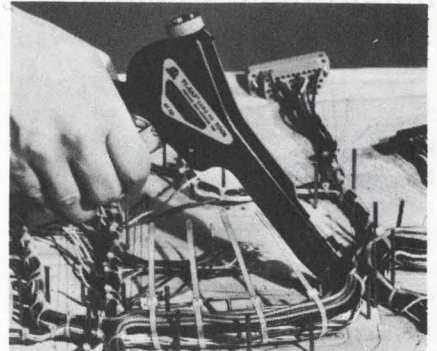

The WT-193 tool accommodates the same bundle range as the TR-225. With a similar narrow nose and long barrel, it is also well suited for tough-to-reach places. This particular design gives the operator the convenience of a long tying stroke with one squeeze of the trigger... the tie is cinched to a preset tension and trimmed flush with the head. The speed of tying is good for smaller volume tying as compared to the pneumatic TR-225.

Harnessing aids are available for your existing operation. The bundle shaper/retainer is effective in reducing the cost of routing wires. It shapes the bundles

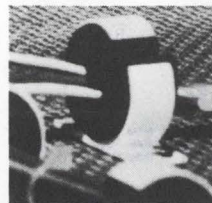

and holds them firmly above the surface of the board facilitating the ease of tying.

In our evaluations of harness fabricating techniques used across the country, operator performance, fatigue factors and process convenience appeared as major considerations in the cost structure of harnessing. Our harnessing specialists are equipped to study these costs as well as all pertinent factors involved in your wiring and harnessing operations. Write or call us today.

The Thomas & Betts Co., Elizabeth, New Jersey 07207, (201) 354-4321. In Canada, Thomas & Betts Ltd., P.Q.



THOMAS & BETTS

Division of Thomas & Betts Corporation

DISCRETE SEMICONDUCTORS

Impatt diodes deliver 1.5 W at 5.5 GHz

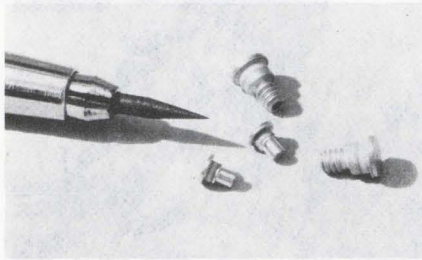

Hewlett Packard, 1501 Page Mill Rd., Palo Alto, Calif. 94304. (415) 493-1501. \$95 (1 to 9), \$75 (10 to 99); stock.

Rated at 1.5 W minimum power output at 5.5 GHz, the 5082-0423 silicon Impatt diode provides output power over the 4 to 6.4 GHz band. The AM noise spec for the 5082-0423 is typically -140 dB in a 100 Hz bandwidth, 1 kHz from the carrier; FM noise is typically less than 4 Hz (rms) in a 100 Hz bandwidth, 100 Hz from carrier. Efficiency of the 5082-0423 is typically greater than 5.5%. Thermal resistance is rated at 5.5 C/W.

CIRCLE NO. 344

Dual gate MOSFETS are made for 500 MHz uses

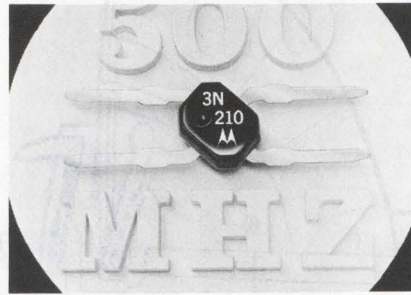

Motorola, P.O. Box 20924, Phoenix, Ariz. 85036. (602) 244-3466. From \$0.72 (100 up).

The 3N209 and 3N210 are dual-gate, diode protected n-channel MOSFETs. They are silicon nitride passivated for long-term stability, and are fully characterized in both S and Y parameters. These units can be used up through the 500 MHz band. Common source power gain at 500 MHz is 13 dB, with a low 4.5-dB noise figure. The 3N209 is in the hermetic metal TO-72 package, and the 3N210 plastic version is in a Micro-H package.

CIRCLE NO. 345

Ruggedized 25 W uhf transistor runs at 12 V

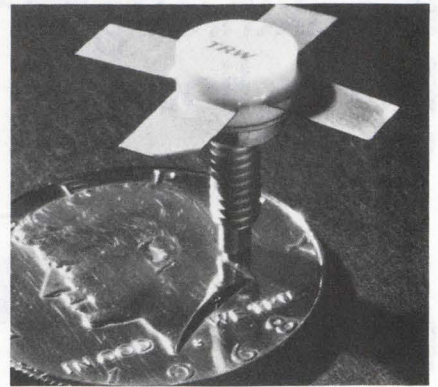

TRW Semiconductor, 14520 Aviation Blvd., Lawndale, Calif. 90260. (213) 679-4561. \$22.50 (1 to 99).

A 12-V, 25-W ruggedized uhf transistor, the PT8825, is a direct replacement for the 2N6136 or C25-12. It also features infinite VSWR capability at rated input power and 15.5 V. The emitter-balanced silicon npn transistor uses a grid structure design. The transistor is intended for applications up to 512 MHz. Units are offered in standard 380 SOE packages.

CIRCLE NO. 346

NO SHORTAGES HERE!

**ECCOSIL®
RTV
SILICONES**

- the most complete line . . .
- from the most respected supplier . . .
- of plastics for electronics . . .



Encapsulants, sealants, adhesives, mold-makers, coatings, lightweight foams. Immediate delivery. Competitive prices. Send for complete technical data and price list.



Emerson & Cuming, Inc.
CANTON, MASS.
GARDENA, CALIF. • NORTHBROOK, ILL.
Sales Offices in Principal Cities

EMERSON & CUMING EUROPE N.V., Oevel, Belgium

INFORMATION RETRIEVAL NUMBER 104

QUICK-CONNECT BLOCKS

*With Infinite
Design
Possibilities*

There's an Underwriters Terminal Block for virtually any design requirement you have or can conceive.

No other line offers a wider selection of blocks and variations of in-block circuitry. Any number of terminations. Wide choice of configurations. Most are UL recognized and CSA certified. Blocks in kit form, too. Also special designs and hot-stamped coded blocks.

Request bulletin.

**Underwriters
Safety Device Company**

7300 W. Wilson Ave., Chicago, Ill., 60656 • 312-867-4600

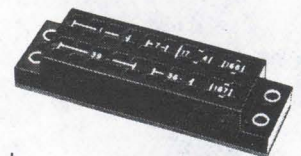
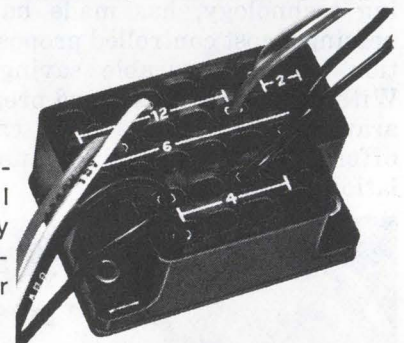

**PERSONNEL
RECRUITMENT
ADVERTISING
IN
Electronic Design
REACHES THE
RIGHT PEOPLE
AT A LOWER COST
PER THOUSAND**

*Call the
HOTLINE
today
for complete
information:
(201) 843-0550
extension 203*



**Light-Reflecting Electromagnetic
Display Components**

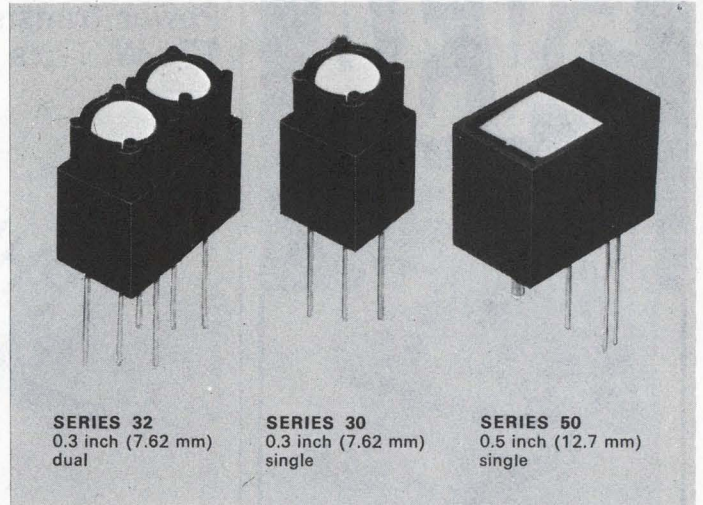

SERIES 32
0.3 inch (7.62 mm)
dual

SERIES 30
0.3 inch (7.62 mm)
single

SERIES 50
0.5 inch (12.7 mm)
single

STATUS INDICATORS

MEMORY — inherent remanent magnetism maintains the display state.

LOW POWER — one milli-watt second set/reset energy. Zero power to retain state. Drive voltages from 3-48 volts.

VISIBILITY — rotating fluorescent discs and flags provide excellent visibility over a wide range of ambient light conditions and wide viewing angles.

RELIABILITY — only one moving part rated for over 20 million operations. No lights or mechanical linkages to wear out. Virtually maintenance free.

FERRANTI-PACKARD STATUS INDICATORS

Ideal for

- Transient Recorders
- Industrial Process Displays
- Contact Status Indicators
- High Density Matrix Displays
- Portable Field Equipment.

Fluorescent discs and flags available in a range of colors.

The electromagnetic operation requires zero energy to maintain status.

Unique memory retention eliminates the need for memory circuits and reduces power supply and circuitry costs. Indicators are fully operational over a wide range of environmental conditions.

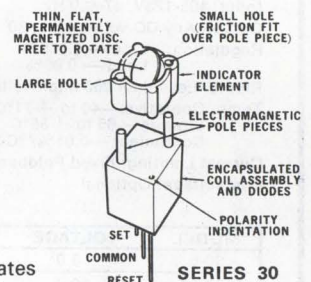

Ferranti-Packard's status indicators are light weight (Series 30, 0.17 oz (5 grams)) and are ideal for mounting on printed circuit boards and high density matrices.

For full information and specifications, contact the Display Components Department,

**FERRANTI-PACKARD
LIMITED**

ELECTRONICS DIVISION
121 Industry Street,
Toronto, Ontario, M6M 4M3, Canada.
Telephone: (416) 762-3661.
Telex: 06-22007.

7304



DIRECT FROM STOCK

5V3A

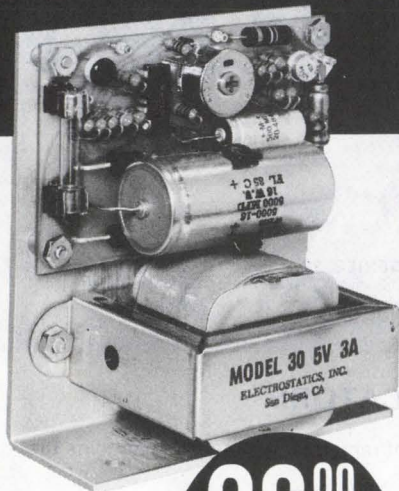

26⁰⁰
(1-9)

\$19.90 - 100 pcs.

Excellent regulation and ripple.

SPECIFICATIONS

Size: 4 x 4.5 x 2.75 overall
 Input: 105-125V, 47-420 Hz
 Output: Any DC voltage 3 to 30
 Regulation: Line — 0.005%
 Load — 0.05%
 Ripple: Less than 250 Microvolts
 Temp: Operative —40 to +71°C
 Storage —65 to +85°C
 Coefficient —0.01%/°C Max.
 Current Limiting: Fixed Foldback Type
 Overvoltage: Optional

MODEL	VOLTAGE	AMPS
30-5	5.0	3.0
30-12	12.0	1.5
30-15	15.0	1.2
30-24	24.0	1.0
30-28	28.0	1.0

ORDERING INFORMATION

QUANTITY	PRICE	WITH O.V.
1-9	\$26.00	\$31.00
10-24	24.20	28.70
25-49	22.60	26.90
50-99	21.20	25.10
100-	19.90	23.70

CALL (714) 279-1414 FOR DELIVERY

Electrostatics, Inc.
 7718 CLAIREMONT MESA BLVD. • SAN DIEGO, CA 92111

DISCRETE SEMICONDUCTORS

Power transistor gives 175-W, 1- μ s pulses



Power Hybrid Inc., 1742 Crenshaw Blvd., Torrance, Calif. 90501. (213) 320-6160. \$2.50 (1 to 24); stock to 3 wk.

The PH1175 is a hermetically sealed transistor that delivers 175 W peak pulse power. At 1090 MHz the PH1175 will produce a 175 W, 1 μ s pulse at a 10% duty factor with 8 dB of gain and a V_{cc} of 50 V. Up to 225 W can be attained with higher V_{cc} . The PH1175 has a gold metalized multicellular fishbone geometry and emitter ballasting. The transistor is internally matched for broadband DME/TACAN applications with input and output impedances of $4+j7.5$ and $3-j4$, respectively, at 1090 MHz.

CIRCLE NO. 347

Orange LEDs have T-1, 1-1/4 and 1-3/4 cases

Xciton Corp., Shaker Park, 5 Hemlock St., Latham, N.Y. 12110. (518) 783-7726.

Orange light-emitting diode lamps are available in plastic lens packages. The packages come in the popular 0.125, 0.16 and 0.2-in. diameter sizes corresponding to T-1, T-1-1/4 and T-1-3/4 lamps. Both panel mounting "snap-in" and printed-circuit board styles are included. All orange lamps are rated for luminous intensity at the low forward current of 10 mA. Luminous intensity values range from 0.14 millicandela, typical, to 6 mcd, minimum.

CIRCLE NO. 348

Silicon optical sensor has blue-violet range

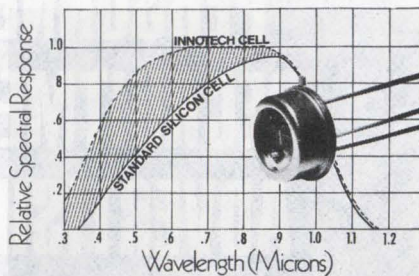

Innotech, 181 Main St., Norwalk, Conn. 06851. (203) 846-2041. \$5 (100 to 499).

The PVD090F photovoltaic detectors have high short-circuit current and higher blue-violet sensitivity than existing silicon devices. The PVD090F detector has a sensitive area of 0.09×0.09 in. The typical short circuit current is 165 μ A with a 500 foot-candle 2854 K tungsten source. The open circuit voltage is 200 mV minimum. The minimum sensitivity of the device at a 7500 Å wavelength is 13 μ A/mW/cm², which is up to 70% higher than standard silicon units. At a 5000 Å wavelength the device sensitivity is 8 μ A/mW/cm². The PDV090F is packaged in a TO-5 low profile, flat glass windowed case.

CIRCLE NO. 349

Opto-isolator has 1500 V of isolation capability

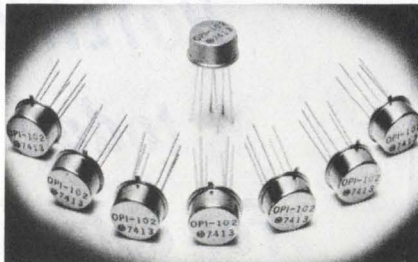

Optron, Inc., 1201 Tappan Circle, Carrollton, Tex. 75006. (214) 242-6571. \$3.25 (100-up); stock.

The OPI 102 has an isolation voltage of 1500 V. This is claimed to be the highest available in a TO-5 package. The isolator uses a high efficiency gallium-arsenide infrared-emitter coupled with a silicon phototransistor. It has a current transfer ratio of 60% with an input of 10 mA. Input-output off resistance and capacitance are typically $10^{12} \Omega$ and 2.5 pF, respectively.

CIRCLE NO. 350

Plastic cased power transistors handle 80 W

Motorola Semiconductor, P.O. Box 20912, Phoenix, Ariz. 85036. (602) 244-3466. From \$1.55 to \$2.75 (100 to 999); stock.

The 2N6497, 2N6498 and 2N6499 silicon npn power transistors have dissipation ratings of 80 W. These devices are rated at 5 A dc continuous collector current, 10 A peak, and have a gain-bandwidth product of 5 MHz. The transistors are housed in type 199 plastic packages. The 2N6497, 2N6498 and 2N6499 are rated at 250, 300, and 350 V dc V_{CE0} , respectively.

CIRCLE NO. 351

Npn driver transistors have 100 V BV_{CE0} ratings

Kertron Inc., 7516 Central Industrial Dr., Riviera Beach, Fla. 33404. (305) 848-9606. 100-up prices \$0.60 (2N5189), \$0.95 (KP-3540); stock to 6 wk.

The 2N5189 power transistor handles 1 A in a TO-39 package. The transistor is a double diffused epitaxial npn device with interdigitated geometry. It can be used in any application requiring collector currents of 1 A with total switching speeds less than 100 ns. The transistor can be supplied with BV_{CE0} ratings as high as 100 V (Model KP3540) with a moderate increase in price over the 2N5189 which is rated at 35 V.

CIRCLE NO. 352

Rf overlay transistor delivers 15-dB gain

RCA, Box 3200, Somerville, N.J. 08876. (201) 722-3200. \$2.16 (100 up); stock.

A silicon npn overlay transistor, type 41039, is intended for small-signal applications where both large dynamic range and high gain are required. In a narrowband amplifier circuit operating at a frequency of 200 MHz and a current of 30 mA, the device has a maximum noise figure of 3 dB and a gain of 15 dB min. This low noise figure and a high dynamic range in the vhf band make the 41039 especially suitable for use in CATV and MATV circuits. The unit is supplied in the JEDEC TO-39 hermetic package.

CIRCLE NO. 353

TEKELEC, INC. TA



Call Crystal

Toll Free at (800) 423-5163* for your FREE 15-day trial of TEKELEC'S sensational new MULTEX.



MULTEX TA 357 DIGITAL MULTIMETER
\$179.00 Complete

7 Functions
27 Ranges

- AC VOLTS
- DC VOLTS
- AC CURRENT
- DC CURRENT
- RESISTANCE
- CONDUCTANCE
- LEAKAGE

Extra Long Life Field Effect Liquid Crystal Display
 10^{-12} MHO Sensitivity (10^{12} Ohms!)
 10 pA Sensitivity • Built-in Bias Supply
 AC Line Measurement Switch
 20,000 Volts Measurement Capability
 .05% F.S. + .1% R Accuracy
 Automatic Decimal and Function Display
 .1Ω/Digit
 "Touch 'N Hold" Probe Optional

31829 W. LA TIENDA DR., WESTLAKE VILLAGE, CALIFORNIA 91361

*In California, Call Collect: (213) 889-2834

TWX: 910-494-1910

Electronic Design's

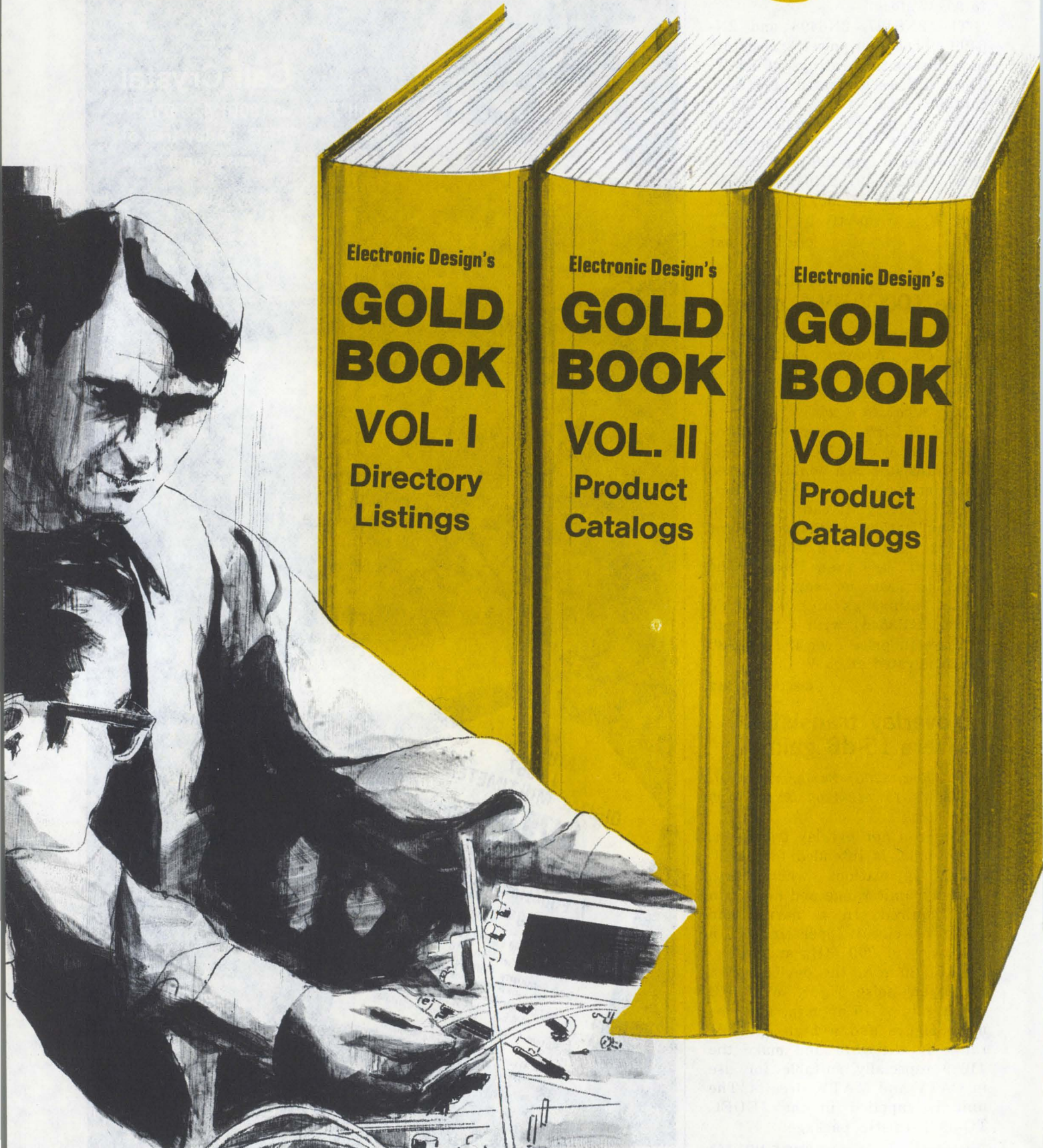

Electronic Design's
**GOLD
BOOK**
VOL. I
Directory
Listings

Electronic Design's
**GOLD
BOOK**
VOL. II
Product
Catalogs

Electronic Design's
**GOLD
BOOK**
VOL. III
Product
Catalogs

GOLD BOOK

IS TAKING SHAPE

**INDUSTRY RESPONSE HAS
PUSHED THE SIZE UP TO
3 VOLUMES!**

We promised that *Electronic Design's* GOLD BOOK would make all other directories seem obsolete. Response from electronics manufacturers has been so enthusiastic that three volumes are required for the first edition!

Volume I contains directory listings — who makes what and where to find it. Volume II and III contain product information — catalog-type material, application data, product specs, technical details. When you see and use *Electronic Design's* GOLD BOOK you'll wonder how you ever got along without it. It's the one-step reference and purchasing tool that will save you many hours as you search for the exact products to meet your needs.

COMING YOUR WAY

JULY 1974

ANOTHER SERVICE FOR READERS FROM

Electronic Design

IMC FAN FACTS

Our standard Boxer Fan is rugged and reliable

Here's a compact* whose whirlwind delivers 70 to 115 cubic feet of air per minute. The Boxer can convert to a variety of uses — has long life and saves time and money. Literature on request! For immediate service please call Fred Taylor, Sales Manager — 603/332-5300 or write:



*4-11/16" square by 1-1/2" deep.



IMC MAGNETICS CORP.
NEW HAMPSHIRE DIVISION

ROUTE 16B, ROCHESTER, NEW HAMPSHIRE 03867

INFORMATION RETRIEVAL NUMBER 110

POWER SOURCES

NiCd battery offered for emergency use



NIFE Inc., 21 Dixon Ave., Copiague, N.Y. 11726. (516) 842-5240.

This 6-V monoblock NiCd storage battery is designed for emergency lighting, communications, and general standby-power applications. The battery is housed in a translucent plastic container, 10-1/4 × 3-1/2 × 9 in. Capacity is 24 A-h. Integral leads are furnished. Instead of individual vent caps, a single vent-cap strip streamlines the dead-top.

CIRCLE NO. 354

Solar panel outputs 0.1 A

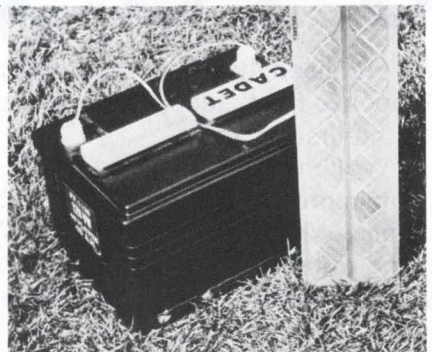

Edmund Scientific Co., 380 Edscopec Bldg., Barrington, N.J. 08007. \$89.95; stock.

This solar panel is comprised of 30 0.5-V silicon solar cells in series with a diode. Fully weather-proof, the plastic-coated panels can be used anywhere a trickle charge is needed. Yield is in excess of 12 V dc, no load. Current is 0.1 A in full sun and capacity is approx. 30 W-h per week. Size is 3.5 × 12.5 × 2-in.

CIRCLE NO. 355

Before you buy

COMPARE MODULATION METERS

We invite you to use Radiometer's Type AFM2 or AFM3 in your laboratory on a 10 day trial. Check features, specifications and especially performance in your own precise measurements of FM deviation and AM modulation on carriers from 5 MHz to over 1 GHz. Determine distortion levels of signal generators or transmitters and make sensitive measurements of incidental AM or incremental FM on carriers.

You can check all these and more.

For details contact us at
811 Sharon Drive,
Cleveland, Ohio 44145
Phone 216/871-8900

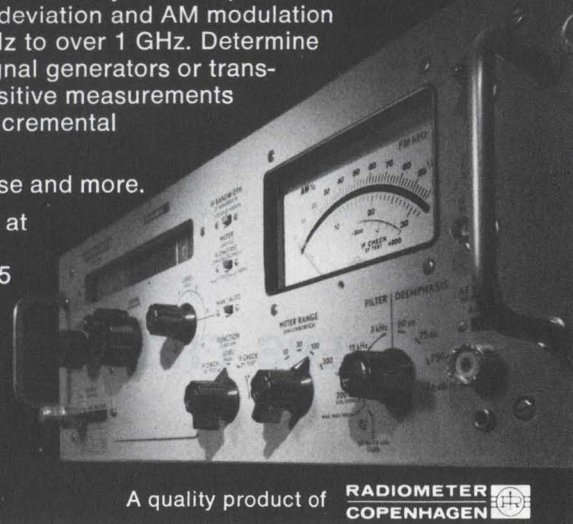

A quality product of **RADIOMETER COPENHAGEN**

INFORMATION RETRIEVAL NUMBER 111

300-W switchers yield triple outputs

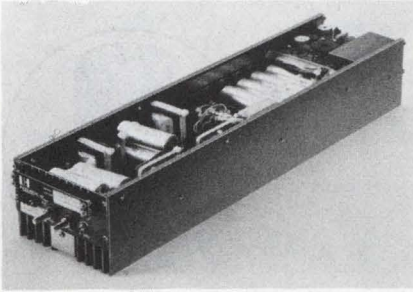

LH Research, Inc., 2052 S. Grand Ave., Santa Ana, Calif. 92705. (714) 546-5279. \$460.

Designated the LH300T Series, these 300-W switching-regulated power supplies feature three dc outputs. They measure 5.05 × 3.65 × 16.12 in. and provide 5-V at 50-A primary output and ±12 or ±15 or ±18 V semi-regulated at 8 A each for the remaining two outputs. Average efficiency of all three outputs is 75%. Overvoltage protection is provided on the 5-V channel and, in the event of ac-input power failure, dropout of output voltages is delayed 20 ms. Weight is 9.5 lb.

CIRCLE NO. 356

Battery power supply cuts instrument weight

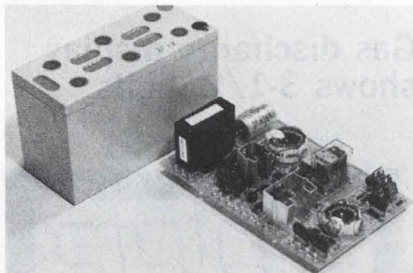

Cellmate Div. of Seven Sciences, Inc., 933 Kifer Rd., Sunnyvale, Calif. 94086. (408) 735-0200. \$59; 30 days.

Claimed to be the first battery power supply developed for portable instruments, the Cell-Mate 1000 series features nondissipative dc/dc converters and switching regulators to conserve battery energy. The models are for use with gelled lead-acid batteries, and function as both power supply and charger. The power supply provides regulated, isolated outputs. Quad outputs are available, including +5 and ±12 V. Power ratings range from 1-1/2 to 20 W.

CIRCLE NO. 357



Having a little pull in the right places is what **Ledex® Solenoids** are all about

Get that extra pull or push right when you need it with a compact Ledex solenoid.

We have catalogued over six dozen standard models for immediate delivery. But, our specialty is providing the exact solenoid to fit your requirements . . . strokes, forces, speeds, mountings, etc.

Quality to you means long term dependability. Ledex tubular solenoids provide that because of exacting construction features that include a heavy duty plunger stop that keeps the pole faces from taking a beating at the end of the power stroke. The shaft is electroless nickel plated for smoother operation and longer bearing life. When you are making professional decisions, specifying Ledex push/pull solenoids, rotary solenoids, stepping switches, rotary switches, and push button switches can make a dramatic difference in your end product.

Send now for this complete reference book of application fundamentals, specifications, types and sizes of both Ledex straight pull and push/pull solenoids.

Toll free number for name of your nearest representative: 800-645-9200.



LEDEX INC.
123 Webster Street
Dayton, Ohio 45401
(513) 224-9891

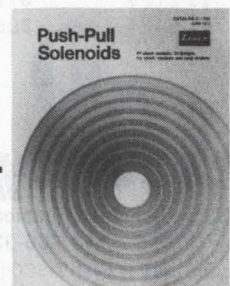

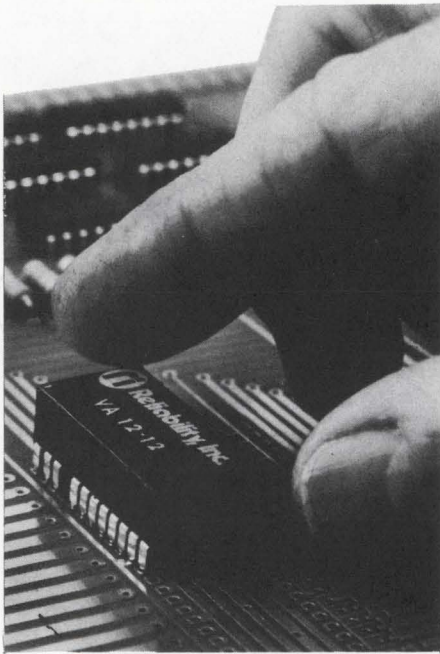

POWER

- FOR YOUR
- OP AMPS
- LINE RECEIVERS
- COMPARATORS

Convenient, money saving, practical — V-PAC* power sources give you needed voltages for linear ICs from standard +5v source. Operate as many as 25 linear devices from a single V-PAC power source!

Standard DIP pin configuration, and less than a third cubic inch volume, lets you use V-PAC sources right on the PC card, with minimum length interconnections.

TYPE:	VA 12-12	VA 15-15	VA 12-6
VOLTAGES:	+12 -12	+15 -15	+12 -6

Write or call for full specifications.

WEST:	EAST:
213-843-5200	513-761-5432
214-231-6181	201-992-2505
505-265-6794	803-288-4450
312-654-8645	416-743-9130
415-593-2189	617-272-7655
206-747-9424	305-941-5544



Reliability, Inc.

5325 Glenmont, Houston, Texas
77036 • 713-666-3261

Europe and the Far East: TISCO (TI Supply Co.)

TWX: 910-881-1739 *TM, Reliability, Inc.

INFORMATION RETRIEVAL NUMBER 113

COMPONENTS

Optical fibers transmit data over 25 meters

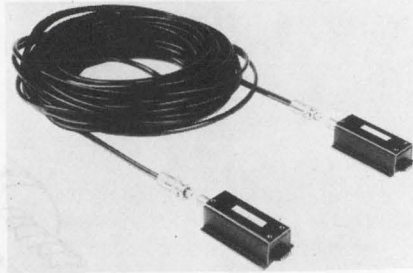

North-American Cifal Export Corp., 25 Broadway, New York, N.Y. 10004. (212) 943-3280. Model 2G with 10-m cable: \$306.

Optical data transmission replaces the electron with the photon as the carrier of the data. The photon, or light, is insensitive to electrical interference. The Fort Company's (of Massy, France) optical transmission system provides complete galvanic isolation. It uses glass fiber that has the advantage of handling like ordinary cable. This eliminates the problems of direct-vision transmission, such as the influence of the atmosphere, interference from luminous sources and need for precision alignment. The system consists of a light transmitter and a light receiver that are coupled by a glass-fiber light conductor. One type of light conductor, designated 2G, has double sheathing. The inner sheath is polyethylene and the outer sheath is PVC. Maximum length for efficient transmission is 25 meters. Dielectric strength is 50 kV/m. Operating temperature is -30 to 90 C. The LX light conductor has a dielectric strength of 110 kV/m and operating temperature of -40 to 90 C. A light cable with a dielectric strength of 300 kV/m can also be supplied. Both transmitter and receiver are enclosed in a metal housing to protect the circuitry against electromagnetic disturbances. The transmitter power requirement is 5 V at 250 mA and the receiver power is 5 V at 70 mA and 15 V at 10 mA. Both receiver and transmitter are TTL compatible and they have an operating temperature of 0 to 55 C.

CIRCLE NO. 358

Subminiature rotary switch plugs into board

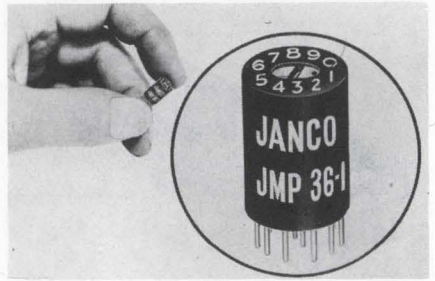

Janco Corp., 3111 Winona Ave., Burbank, Calif. 91504. (213) 845-7473.

The Series JMP rotary switch plugs directly into a PC board. The pin terminals fit a standard TO-100 grid pattern. The switch measures less than 0.3-in. diameter and less than 0.4-in. long and it weighs only 1-1/2 g. It has a 36 degree angle of throw for 10 positions, 1 or 2 poles and bridging functions. A screwdriver, slotted shaft actuates the unit and a detent mechanism prevents accidental switch settings. Voltage breakdown is 500-V-ac minimum. Electrical rating is 2-A continuous, and life testing exceeds 25,000 double cycles. It is available in both low-level and medium-level switching configurations.

CIRCLE NO. 359

Gas discharge display shows 3-1/2 digits

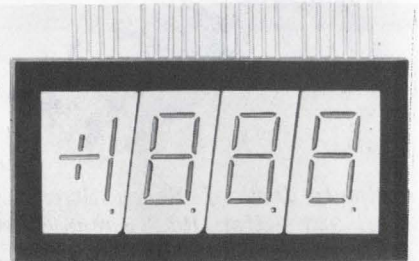

Diacon, 4812 Kearny Mesa Rd., San Diego, Calif. 92111. (714) 279-6992. \$15 (1-99); 4-8 wks.

Type D-03035 DiaDigit display is a 3-1/2 digit, single-envelope, planar package with a character height of 0.3 in. The planar package eliminates alignment problems usually found with single-digit displays. Assembly is similar to techniques used to mount standard DIP packages. The display may be operated in a dc or multiplex mode.

CIRCLE NO. 360

THE BETTER BATTERY

Replace NiCd batteries at about half the cost per watt-hr.

The Gates Sealed Rechargeable Energy Cell gives you Nickel-Cadmium reliability and performance with no memory or cell reversal problems.

Available in 1.8AH, 2.5AH and 5AH sizes; 2V, 6V and 12V, or any multiple of 2V by special order.

For a free 50-page Application Manual, write on your letterhead to Bob Doster, Gates Energy Products, Inc., 1050 S. Broadway, Denver, Colo. 80217. Or call (303) 744-4806.

Gates Energy Products, Inc.

A subsidiary of The Gates Rubber Company



INFORMATION RETRIEVAL NUMBER 114

SET POINT CONTROL with DECITRAK[®] OPTICAL ENCODERS



Designed for long life, these Decitrak industrial-grade set point controls operate in even the most adverse environments. Applications include rolling mills, machine tools, nuclear reactor controls, and materials handling. Features include:

- Closed-loop set point control
- Absolute or incremental control
- Metric and English units
- Plug-in modular design
- Drives AC, DC, and stepper motors

Call or write today for more details and your copy of our applications brochure.

Theta **INSTRUMENT CORP.**

Specialists in Digital Automation
Fairfield, New Jersey 07006
Phone: 201 - 227-1700

INFORMATION RETRIEVAL NUMBER 115

ELECTRONIC DESIGN 11, May 24, 1974

"Off-the-shelf deliverability" of triple-output DC power supplies!

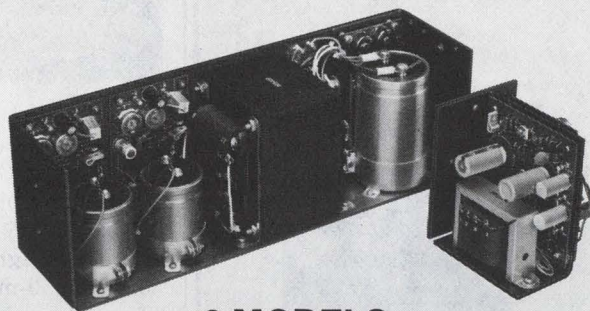

**8 MODELS
AT LOW OEM PRICES NOW
by Standard Power Incorporated!**

"Deliverability" means deliverable **now** off-the-shelf of 55 leading distributor locations nationwide... **AND** delivering top performance for years, backed by a guarantee!

Check the low single-unit prices on these 8 models now in stock: **SPS 30TA-5/12/15**, @ 2, 0.25, 0.25 Amps (\$69); **SPS 50T-5/12/15**, @ 3, 0.7, 0.7 Amps (\$75); **SPS 60T-5/12/15**, @ 5, 0.7, 0.7 Amps (\$79); **SPS 70T-5/12/15**, @ 3, 1.5, 1.5 Amps (\$82); **SPS 80T-5/12/15**, @ 5, 1.8, 1.8 Amps (\$86); **SPS 90T-5/12/15**, @ 7, 1.8, 1.8 Amps (\$86); **SPS 120T-5/12/15**, @ 7, 3.5, 3.5 Amps (\$135); and **SPS 250T-5/12/15**, @ 12, 3.5, 3.5 Amps (\$149).

And, OEM quantity discounts are available, of course! Compare these specs to your needs:

Input: 115/230 VAC, $\pm 10\%$; 47 to 440 Hz

Output: Simultaneous 5 VDC and from ± 12 to ± 15 VDC, isolated

Line & Load Regulation: $\pm 0.1\%$

Ripple: 0.1% typically 0.5 to 2 mV rms

Find out more. Ask our nearest stocking distributor for our Cross-Reference Guide. To find him, call toll-free "Dial-A-Source": (800) 645-9200. (In N.Y. State, call collect: (516) 294-0990.) Or call direct to: Apollo, Arneson & Co., Arrow/Arrow-Angus, Cameradio, Electronic Supply, ESCO, Ft. Wayne Electr., Graham, Hammond, J&M, Lafayette, Lykes, LCOMP, Muncie Supply, Mytronic, Radio Inc., RS Electr., Rose, Scott, Taylor, Treeko, Weatherford, or Van Sickle. Export: **Constantex, Inc., P.O. Box 64574, L.A., Calif. 90064.**

**STANDARD
POWER
INCORPORATED**

1400 South Village Way
Santa Ana, California 92705
Telephone: (714) 558-8512
Eastern Sales Office:
Telephone: (516) 420-0944

**STANDARD
POWER
SUPPLIES**

See our Ad in EEM, Vol. 1, page 874.

INFORMATION RETRIEVAL NUMBER 116

THE BIG POWER SUPPLY FOR LITTLE SPACES

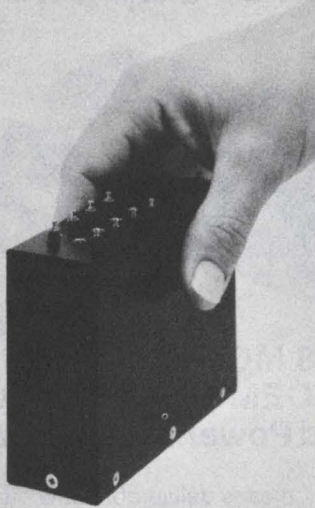

Miniaturized High Efficiency AC-DC Regulated Power Converters

INPUTS: 115 VAC, 50-500 Hz.

OUTPUTS:

- 1 to 6 isolated and regulated DC outputs.
- 120 watts per output.
- Short circuit and transient protected.

POWER DENSITY: 3.9 watts delivered per cubic inch.

MODULAR CONSTRUCTION lets you Design-As-You-Order. Choose from "off the shelf" input and output modules. More than 1200 possible configurations.

Easy to use Design-As-You-Order Forms provided.

No engineering charges.

Immediate deliveries.

Call us collect . . . ask for Mark Warren. We'll have a Specification Form and our 14 page Catalog in the mail to you today!



ARNOLD MAGNETICS CORPORATION

11520 W. Jefferson Blvd.
Culver City, Ca. 90230 • (213) 870-7014

COMPONENTS

Grain-oriented magnet raises motor efficiency

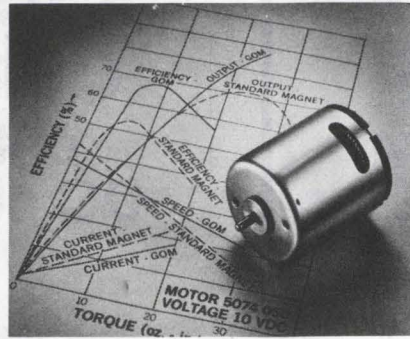

International Components Corp., 9950 W. Lawrence Ave., Schiller Park, Ill. 60176. (312) 678-8832.

Motor output efficiency has been increased 15% or more with grain-oriented magnets in ICC's 22, 27, 35, and 50-mm diameter motors. The motors develop from 1/500 to 1/5 hp when battery-operated. Aligned grains in the magnets' ferromagnetic material increase the flux density and thus the motor output torque and efficiency also are increased. For example, a 50-mm, grain-oriented magnet motor provides 10 oz-in. of torque at a maximum efficiency of 69% compared to only 7 oz-in. at an efficiency of 54% for a conventional anisotropic-magnet.

CIRCLE NO. 361

Miniature reed-relays handle 10 W

North American Philips Control Corp., Frederick, Md. 21701. (301) 663-5141.

Series 49 reed relays provide 1-Form-A contact rated at 10 W. Originally designed to trigger a triac, the 49-0011 relay has two coils that provide AND-OR logic. One coil with 4 V dc applied and 0.45 A in the second coil actuates the relay. The contacts remain in a closed position with only 3 V dc on the second coil, but the relay will not pull-in even with 6.5 V dc applied to one coil. The 49-0012 relay features an extremely close differential between pull-in and drop-out, according to the manufacturer. It pulls-in when 5.5 to 8 V dc is applied and drops-out when the applied voltage is lowered to 3 V dc.

CIRCLE NO. 362

DESIGN AND APPLICATION OF ACTIVE FILTERS

**A FIVE-DAY SHORT COURSE
AUGUST 12-16, 1974
MIRAMAR HOTEL BY THE SEA
SANTA BARBARA, CALIFORNIA**

A five-day short course on the subject of the design and application of active filters will be held during the week of August 12-16, 1974 at the Miramar Hotel in Santa Barbara, California. The course is being organized and coordinated by Prof. Phillip Allen of the Department of Electrical Engineering, University of California, Santa Barbara. Besides Prof. Allen, instructors include Prof. Larry Huelsman from the Department of Electrical Engineering, University of Arizona and Dr. James Means from the Naval Missile Center, Pt. Mugu, California.

The course will cover active filter fundamentals, active elements and networks, finite and infinite gain realizations, synthetic inductance and impedance converters. Special emphasis will be placed on practical applications and improving active filter performance. Universal building blocks and tunable filters will also be included.

The course is organized in a manner which makes it attractive for combining with a personal vacation. The 30 hours of instruction will be arranged so that either the afternoon/evening of each day will be free. A workshop will be held during three evening sessions where each attendee will have the opportunity to design, build and measure various types of active filters.

The fee for this short course is \$250 and includes a comprehensive, 300 page set of notes. The pre-requisite for the course is an engineering degree or equivalent experience. For more information or to enroll, write or phone:

Prof. Phillip Allen
Department of Electrical Engineering
University of California
Santa Barbara, Calif. 93106

(805) 961-3509 or 961-3409

INFORMATION RETRIEVAL NUMBER 118

TALK TO THE CHRISTIE

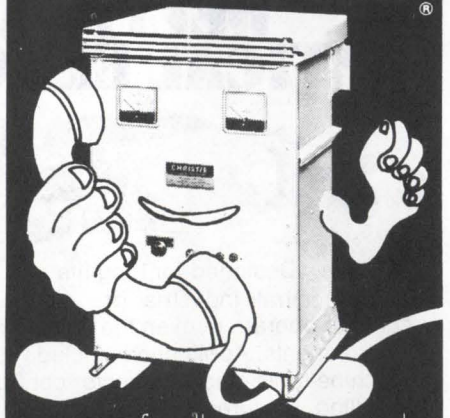

for all you ever wanted
to know about **high current
DC POWER SUPPLIES**
BATTERY CHARGERS
Call HERM RUDMAN toll-free
(800) 421-2058

SINCE 1929
CHRISTIE
ELECTRIC CORP.
3412-A W 67TH ST • BOX 60020
LOS ANGELES, CALIFORNIA • 90060
(213) 750-1151 • TWX 910-321-3867

INFORMATION RETRIEVAL NUMBER 119
ELECTRONIC DESIGN 11, MAY 24, 1974

INFORMATION RETRIEVAL NUMBER 117

Neon lamp protects against line transients

Glow-Lite Corp., Pauls Valley, Okla. 73075. (405) 238-5541.

The NE4018 neon lamp is designed to protect semiconductors from inductive transients. Bilateral in characteristic, the NE-4018 is placed across the 115 V ac line. The lamp's maintaining voltage of 180 V dc min. will not interfere with normal line voltage when fired by light to medium-powered transients. However, if the transient is heavy enough, the device will go into an arc condition and drop to approximately 19 V. The NE4018 also can be connected to blow a fuse or open a circuit breaker when the condition persists for a period of time. If the transient is a one-time occurrence, the lamp will extinguish when the line goes through zero. The lamp is constructed with diodes that have a peak inverse rating of 600 V and is available in lengths up to 1 in.

CIRCLE NO. 363

Low-cost counters pulse at 350-400 counts/min

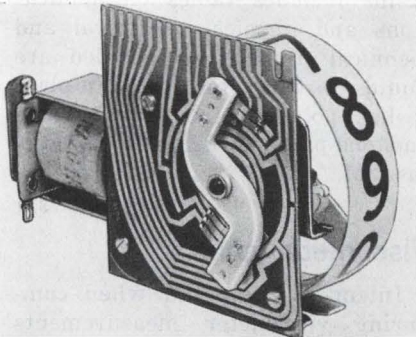

Chicago Dynamic Industries Inc., 1725 Diversey Blvd., Chicago, Ill. 60614. (312) 935-4600. \$9.75 (1000 up); 2-3 wks.

Series 503-2500 pulse operated counters are designed for remote applications where large, highly-visible, black-on-white numbers are desired. They measure 3-1/2 H x 5-1/4 x 1-1/2 in. W. Pulses can be fed by a cam or via a remote switch. Electrical decimal readout is available from a PC edge connector. Coded BCD can be customer provided with a diode matrix. Solenoid operating voltages are 12 to 115 V ac/dc (pulsing operations only). Mounting frames for one to four units are available.

CIRCLE NO. 364

RFI/EMI filters. Made a better way to give you more.

Two big families of low-pass feedthrough types. The "55 Series" of standard suppression filters—the "25 Series" of miniatures and subminiatures. Each in a variety of configurations—solder flange, sleeve/conductor, sleeve/eyelet, bolt-in.

They're the direct result of our up-to-date, proven technology.



Featuring rugged one-piece sleeve construction that distributes inductance, capacitance and resistance over the filter. A truly integrated assembly—no lumped elements to cause internal resonance—made possible by a unique ferrite-titanite composition. High-temperature solder to eliminate risk of solder reflow and pin dropout.

No beads, no low-temperature solder—for consistency of electrical specifications within each series.

For data, contact:
AMP Capatron Division,
Elizabethtown, Pa. 17022.
(717) 367-1105.

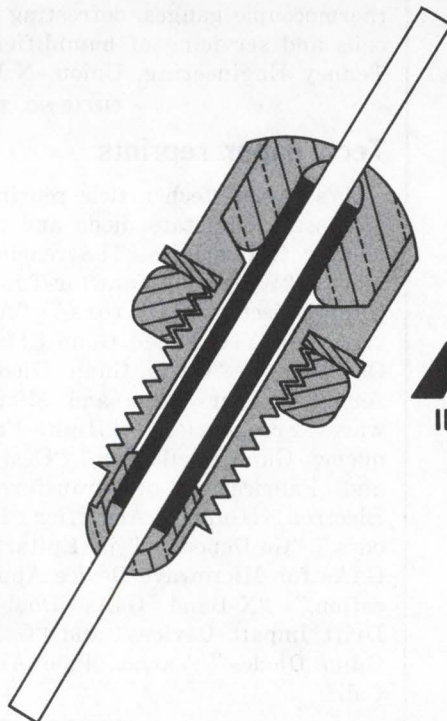

AMP INCORPORATED

NCR WICHITA



IF THINGS ARE A LITTLE SLOW ON YOUR LADDER... GRAB ONE OF OUR RUNGS

NCR's new Accounting Computer Division in Wichita has immediate openings for seasoned engineers in several disciplines. Genuine ground-floor opportunities for engineers who are tired of the status quo.

Advancement opportunities for professionals who want personal growth, technical development, responsibility and diversity. Here is one of our requirements:
SEMICONDUCTOR COMPONENT ENGINEER

Responsibilities will be to evaluate, characterize, qualify and perform failure analysis of semi-conductor devices including LSI, MSI, SSI, discretes and opto-electronics. You will participate in design reviews, make application recommendations, and specify semi-conductor devices. Requires BSEE and one year related experience.

We also have related Component Engineer (BSEE) and Electronics Technologist (Associate Degree) positions available.

Start up the ladder by getting all the details about NCR in Wichita today. Send complete resume including salary history and requirements to Ron Clarke, Professional Placement
P.O. Box 1297, CR
Wichita, Kansas 67201.

An Equal Opportunity
Employer

application notes

Problem-solving ideas

"Magnitude-Plus-Sign ADC Using a V-to-F Converter" is the first of a series of monthly application notes to acquaint readers with a variety of problem-solving ideas. Teledyne Philbrick, Dedham, Mass.

CIRCLE NO. 365

Film resistors

A bulletin describes how Bulk Metal film trimming potentiometers are used to stabilize operation of constant-current power supplies. Typical examples include circuits for sorting semiconductors and for measuring contact resistance of relays and switches. Vishay Resistor Products, Malvern, Pa.

CIRCLE NO. 366

Environmental testing

"Get the Most From Your Environmental Test Equipment" includes suggestions for mode selections, instrument settings and switch positions. There are sections on heat and refrigeration selection, humidification and dehumidification modes. The book discusses chamber leaks, diffusion pumps, thermocouple gauges, defrosting of coils and servicing of humidifiers. Tenney Engineering, Union, N.J.

CIRCLE NO. 367

Tech paper reprints

A series of tech article reprints discusses solid-state diode and oscillator technologies. The reprints include "Wideband Varactor-Tuned Gunn-Effect Oscillators," "Advances in YIG-Tuned Gunn-Effect Oscillators," "GaAs Gunn Diodes for Millimeter Wave and Microwave Frequencies," "High Frequency Gunn Oscillators," "Design and Fabrication of Transferred Electron (Gunn) Amplifier Diodes," "Ge-Doped p-Type Epitaxial GaAs for Microwave Device Application," "X-Band GaAs Double-Drift Impatt Devices" and "GaAs Gunn Diodes." Varian, Palo Alto, Calif.

CIRCLE NO. 368

design aids

Rotary switches

A quick guide specifies rotary switches that adhere to different sections of MIL-S-3786. Information on the switches' construction, angle of throw, temperature life characteristics, vibration grade, shock type, insulation and altitude rating is provided. Oak Switch Div.

CIRCLE NO. 369

Silicon rectifiers

A product locator for 86 models of silicon rectifiers lists specific current ratings, surge current ratings, voltage range, case style and data sheet number. Each series part number is followed by a brief explanation. International Rectifier, Semiconductor Div.

CIRCLE NO. 370

Insulating resins

A guide to electrical insulating resins includes tables on applications and physical, electrical and technical properties. Included are liquid epoxy resins, foam-in-place resins, polyurethane liquid resins and one-part powdered epoxy resins. 3M.

CIRCLE NO. 371

Viscometer chart

Intended as an aid when comparing viscometer measurements of Newtonian fluids, this chart compares viscosity units obtained from different measuring systems. Brookfield Engineering Laboratories.

CIRCLE NO. 372

IR detector

A tell-tale IR detector helps when checking, installing or aligning infrared SSLs (LEDs) and detector systems. The 1-in.-sq. phosphor screen on a 4 x 6 in. card converts invisible IR energy into a visible image and permits viewing the lamp's beam pattern. Send \$1.75 check or money order for the detector to GE, Nela Park, #4454-K, Cleveland, Ohio 44112.

INQUIRE DIRECT

Your load impedances can't upset
our 1 kW broadband amplifier

Model 1000L will drive
any load impedance

10 KHZ - 220 MHZ

Versatile and reliable -- that's the best way to describe Amplifier Research's Model 1000L. This powerful 1000-watt unit features unique protective circuitry to permit operation into any load impedance without shutdown or damage. And it's simple to operate -- all you need is a standard sweep or signal generator. Convenient front panel controls permit you to select the desired operating mode -- 100 or 1000-watt CW output or 4-kilowatt pulse output. Model 1000L is ideally suited for antenna and component testing, equipment calibration, EMI susceptibility testing, biological research, and a variety of other applications. For complete information, write or call Amplifier Research, 160 School House Road, Souderton, Pa. 18964 Phone 215-723-8181



INFORMATION RETRIEVAL NUMBER 121

DRIVE I.C.'s, REED RELAYS, WITH

SNAPTRACK™
D.C. POWER SUPPLIES

FAST,
CONVENIENT
MOUNTING
IN SNAPTRACK
PVC CHANNEL

- 1% Regulation
- Overload protected
- Short circuit protected
- Compact: 3x3 inches
- Input: 105-135 VAC
- Output: Choice of 5, 6, 10, 12, 15 or 24 VAC. 1.5 Watts.

In stock at RDI Distributors. Write for
Bulletin 301.

RDI/Reed Devices Inc.

21W183 Hill Ave. • Glen Ellyn, IL 60137
Tel: 312/858-2050 Telex: 72-1527

In Canada: Renfrew Electric, Toronto • Tel. 416/461-3511

INFORMATION RETRIEVAL NUMBER 122

ELECTRONIC DESIGN 11, May 24, 1974

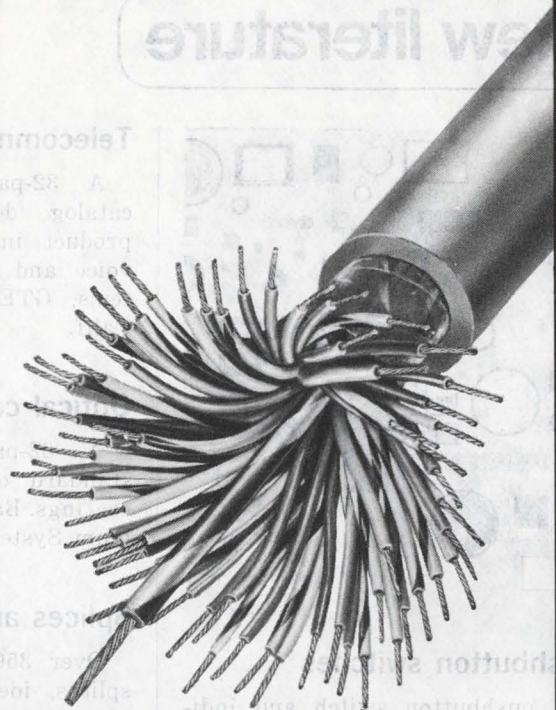

What do you
need in
Multi-Conductor
Cable?

Victor
will make it.

Get exactly what you need in multi-conductor cable. We'll design and produce multi-conductor cable to meet just about any individual requirement.

We have the plant, the equipment, the personnel and the know-how to solve your particular problem.

Victor
Electric Wire & Cable Corp.
WEST WARWICK, RHODE ISLAND

INFORMATION RETRIEVAL NUMBER 123

new literature

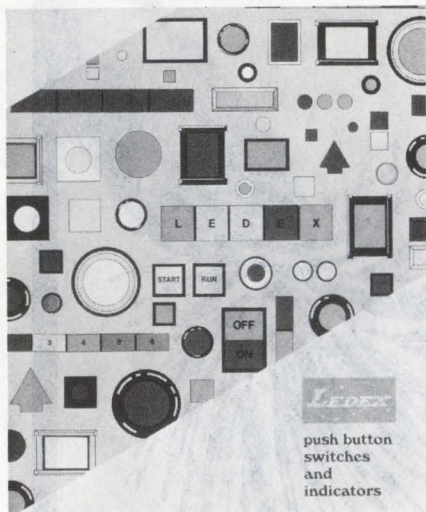

push button switches and indicators

Pushbutton switches

A pushbutton switch and indicator catalog comes in binder form and is arranged in five sections: single station lighted switches, single station unlighted switches, control switches, multistation switches and indicators, lamps and sockets. Each section is supported by illustrations, diagrams, descriptive data and application information. Ledex, Dayton, Ohio.

CIRCLE NO. 373

16-bit word computer

A 20-page brochure features a family of 16-bit word and 32-bit word computers. The company's software is described and a chart shows more than 30 systems and packages. Modular Computer Systems, Fort Lauderdale, Fla.

CIRCLE NO. 374

Mercury relay spin-out

The cause and effect of mercury rotation and its control in mercury displacement load relays is given in a booklet. Adams & Westlake, Elkhart, Ind.

CIRCLE NO. 375

Fasteners

A 52-page catalog covers fastening and related devices. The catalog provides descriptions, illustrations, dimensional diagrams and parts numbers for clamps, clips, wire ties, wire saddles, spacers, bushing and circuit-board hardware. Richco Plastic, Chicago, Ill.

CIRCLE NO. 376

Telecommunications

A 32-page telecommunications catalog describes every major product in the company's video, voice and data transmission systems. GTE Lenkurt, San Carlos, Calif.

CIRCLE NO. 377

Optical components

A 62-page catalog describes standard optical components and coatings. Barnes Engineering, Spectrum Systems, Stamford, Conn.

CIRCLE NO. 378

Splices and contacts

Over 350 open barrel contacts, splices, identification bands, bobbin terminals, strain reliefs, shielded wire ferrules, welding tabs and special items designed for machine application are described in a 28-page catalog. AMP, Harrisburg, Pa.

CIRCLE NO. 379

Microwave radio relays

A 12-page brochure describes and illustrates the FM 1800-TV6000 microwave radio relay system. Descriptions of features, application notes, sections on each of the instruments making up the system, system layout information, electrical data and weights and dimensions are included. Siemens, Iselin, N.J.

CIRCLE NO. 380

Error rate test sets

Specifications for the 271 series error rate test sets are given in a four-page data sheet. Bowmar, Acton, Mass.

CIRCLE NO. 381

Analyzer

An all-digital Fourier transform analyzer (SAI-470) used with the company's correlators is described in an eight-page brochure. Operational principles are described with representative scope displays illustrating interpolation, Hamming weighting, spectrum flatness, phase and Nyquist plots. Signal Analysis Operation, TID, Honeywell, Hauppauge, N.Y.

CIRCLE NO. 382

Line thermal relay

A thermal-overload relay for the protection of high and medium-voltage overhead lines from deterioration caused by excessive temperature rise is described in a six-page catalog. Weston Industries, Power Protection Group, Sarasota, Fla.

CIRCLE NO. 383

Cardiopulmonary products

An eight-page bulletin describes and illustrates products for measuring and monitoring medical and respiratory gases. A full-page chart of performance specifications, including leakage current, summarizes the details of each product. Beckman Instruments, Fullerton, Calif.

CIRCLE NO. 384

Panel meters

A six-page brochure describes miniature and subminiature panel meters. About two dozen different styles are illustrated, ranging in size from less than 1 in. to 4.75 in. wide. Mura Corp., Jericho, N.Y.

CIRCLE NO. 385

Semi device accessories

Heat sinks, mounting pads, insulators, mounting kits and mounting compounds are among the items listed in a short-form catalog. Thermalloy, Dallas, Tex.

CIRCLE NO. 386

Components

A 44-page catalog details the company's mixer, switch, hybrid and transformer lines. Each component type is discussed by description, operational factors, environmental characteristics, guaranteed specifications and typical performance. Included are spurious charts showing the relative amplitude of intermodulation products and a two-tone graph of third order products. Watkins-Johnson, Palo Alto, Calif.

CIRCLE NO. 387

High megohm meters

High megohm resistors and a high megohm meter are described in an eight-page brochure. Standard values and specifications are given. Eltec Instruments, Daytona Beach, Fla.

CIRCLE NO. 388

Transistor tester

The T317 automatic transistor and diode test instrument used primarily for incoming inspection and classification of small-signal transistors, diodes, zeners, SCRs, FETs and other semiconductor devices is described in an 18-page brochure. Teradyne, Boston, Mass.

CIRCLE NO. 389

Signal conditioners

Electrical specifications are listed in a two-page brochure for four signal conditioners that can be plugged into any of the company's two, four, six or eight-channel portable or oscillographic recorders. Gulon, East Greenwich, R.I.

CIRCLE NO. 390

Interchangeable thermistors

Precision interchangeable thermistors designed for high-volume, low-cost applications where maximum temperature does not exceed 150 C are described in a catalog. Fenwall Electronics, Framingham, Mass.

CIRCLE NO. 391

Modems, multipliers

Stand-alone modems, frequency division multiplexers and diagnostic testers are described in a 12-page catalog. The catalog explains how multiplexing can be used in a variety of point-to-point or multi-point systems. DataStat, Sunnyvale, Calif.

CIRCLE NO. 392

Ceramic capacitors

Characteristics of ceramic capacitors and performance curves for BX, NPO and Z5U dielectrics are shown in a catalog. Union Carbide, Greenville, S.C.

CIRCLE NO. 393

Terminal strips

A 12-page quick-reference catalog describes modular terminal blocks, terminal strips and specialty items. The catalog includes drawings, photos, features and design of these products. Applications, material specifications, ratings, accommodating wire sizes, mounting and physical dimensions are included. Electrovert, Mount Vernon, N.Y.

CIRCLE NO. 394

they
all
have
one
thing
in

common... a →

DYNAMIC

WALL PLUG-IN CHARGER/CONVERTER

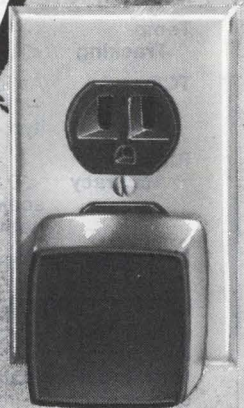

For all your power conversion and charging requirements, consult the leader in wall plug-in power equipment.

DYNAMIC battery chargers, converters, charger/converters and power supplies are widely used in a variety of industries. Feel free to consult our engineering staff with your requirements. Literature on request.

516 234-2900



DYNAMIC INSTRUMENT CORP.

MANUFACTURERS OF POWER CONVERSION AND BATTERY CHARGING SYSTEMS TO THE ORIGINAL EQUIPMENT MANUFACTURER

933 MOTOR PKWY. • HAUPPAUGE, N.Y. 11787

Thin-Film Resistor LADDER NETWORKS for D/A Converters

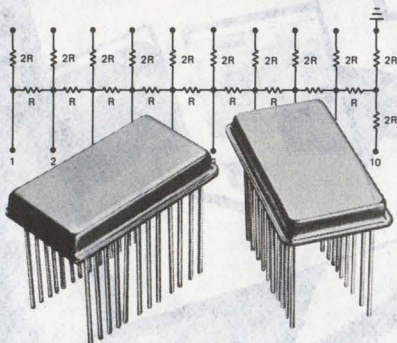

HIGH PRECISION, HIGH STABILITY ladder networks compatible with a variety of quad current switches are being supplied by LRC in both chip networks and 24-pin ceramic DIPs.

Bits	4-12
Resistor Values	Customer Specified
Accuracy	$\pm 1/2$ LSB (typ.)
Temp. Tracking	<1 ppm (typ.)
TCR	As low as -15 ppm, typ. -50 ppm
Ratio Accuracy	<0.012% full scale (for 12-bit network)

Mil-Std-883 Screening Available

LASER TRIMMING facilities permit rapid delivery of standard and custom networks in volume with excellent reliability. Single chip ceramic substrate design minimizes parasitic capacitance and results in fast settling speed. LRC can also provide custom feedback resistors plus compensation for switching resistance.

Give us your
CUSTOM REQUIREMENTS
today.



11 Hazelwood Road
Hudson, N.H. 03051
(603) 883-8001
(603) 883-9351
TWX 710 228-1377

NEW LITERATURE

Resistor system

Data on a carbon resistor system and thick-film hybrid capabilities can be found in a 12-page catalog. Centralab, Milwaukee, Wis.

CIRCLE NO. 395

Solid-state keyboards

Series 555 solid-state keyboards are described in an easy-to-read 20-page catalog. The basic key switch, electronics, options are all there. Licon, Chicago, Ill.

CIRCLE NO. 396

Ac-dc wattmeters

Prices, specifications and data on ac-dc wattmeters and volt-amp-wattmeters are contained in an eight-page catalog. Electrical Instrument Service, Mount Vernon, N.Y.

CIRCLE NO. 397

HV power supplies

Forty-five standard models of high-voltage dc power supplies are covered in an eight-page brochure. Typical units for each type of power supply, insulation tester and power pack are illustrated. Specifications, standard and safety features are given as well as options. Hipotronics, Brewster, N.Y.

CIRCLE NO. 398

10-bit d/a converter

Eight and 10-bit IC d/a converters, series aimDAC100, are described in an eight-page brochure. Test procedures and definition of specifications are included. Precision Monolithics, Santa Clara, Calif.

CIRCLE NO. 399

Rectifiers

A 36-page catalog features lead-mounted Glass Amp and plastic rectifiers such as high-voltage and fast-recovery types. Also included are bridges, center-tap and doubler units, power-hybrid custom assemblies and a full listing of MOS-FETs and CMOS. A glossary of MOSFET terms and symbols, an index of rectifiers by current and voltage, a cross-reference bridge guide and case drawings are given. General Instrument, Hicksville, N.Y.

CIRCLE NO. 400

Different hopes for different folks.



People want different things from a college education.

But they all agree on one thing. It takes more than brains to get a diploma.

Why not make the burden a little easier? Start buying U.S. Savings Bonds now.

Bonds are a dependable way to build a college fund for your children. And an easy way to start saving them is by joining the Payroll Savings Plan.

Start a college fund now with U.S. Savings Bonds. They just might let your kids spend more time studying and less time working to stay in school—whatever they hope to be.



Take stock in America.

Buy U.S. Savings Bonds

Now E Bonds pay 5 1/4% interest when held to maturity of 5 years, 10 months (4% the first year). Bonds are replaced if lost, stolen, or destroyed. When needed they can be cashed at your bank. Interest is not subject to state or local income taxes, and federal tax may be deferred until redemption.



The U.S. Government does not pay for this advertisement. It is presented as a public service in cooperation with The Department of the Treasury and The Advertising Council.

D/a modules

A two-page brochure describes the DAC-HR series of high resolution, high-performance digital-to-analog converter modules. The brochure contains a description, application data, specifications, mechanical dimensions, I/O connections and ordering information. Datel Systems, Canton, Mass.

CIRCLE NO. 401

Color video tape

Features and specifications of the 170 color video tape for 1-in. helical scan recorders are given in a six-page brochure. Ampex, Redwood City, Calif.

CIRCLE NO. 402

Low-profile keyboards

Low-profile, flip-chip solid-state keyboards are illustrated in a 12-page catalog. The catalog provides information on a switching module, operating characteristics, switch mounting and termination, stock listings, encoding, button variations and manufacturing capabilities. Micro Switch, Freeport, Ill.

CIRCLE NO. 403

Testing systems

Techniques for simplifying the testing of complex digital logic modules in a production environment are described in a brochure. The 12-page brochure lists features of the company's minicomputer-driven CAPABLE tester system and gives the advantages of Guided Fault Isolation (GFI) software. Computer Automation, Irvine, Calif.

CIRCLE NO. 404

Metric conversion

A concise primer on going metric explains the when, where, why and how of the change. Metric's, Golden Valley, Minn.

CIRCLE NO. 405

Process instruments

A quick-reference digest covers process analyzers, air-quality instrumentation, vehicle-emissions analyzers, water-quality instrumentation, power-plant water management systems and occupational safety instrumentation. Beckman Instruments, Fullerton, Calif.

CIRCLE NO. 406

Standard bandpass, low pass, tubulars, cavity types, interdigital, and combline—now they all have a **5-year warranty**.

Which means we will guarantee our filters for 1,826 working days—five times longer than the competition—probably five times longer than the equipment incorporating the filters. But, now we can offer you a component that promises reliability in the order of solid state devices. Telonic filters are a strong link in the network dependability chain.

You can have this kind of security over the industry's widest range of filter types and frequencies. From 20 MHz to 12 GHz. And for special phase-related requirements, we can now provide matched filters in these same types and frequencies.

Your local Telonic representative or our Marketing Dept. will be glad to provide you with specs, prices, quotes, or our textbook catalog on filters. Call or write, Telonic Altair, 21282 Laguna Canyon Road, Laguna Beach, California 92652, Tel: 714 494-9401, TWX: 910-596-1320



Telonic filters arrive with a 5-year security blanket.



INFORMATION RETRIEVAL NUMBER 129

apc

For Fast Delivery

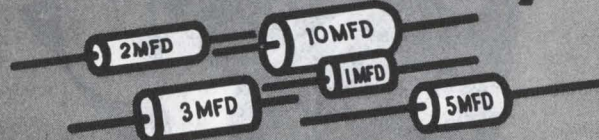

MICRO-MINIATURE

Metallized Film Capacitors

- ★ POLYCARBONATE ★ POLYSTYRENE
- ★ POLYPROPYLENE ★ MYLAR*
- ★ SPECIAL SIZES

MADE IN THE U.S.A. in large quantities and competitively priced.

Contact Larry Crane for fast quote at 516-433-5311.

ACTIVE & PASSIVE COMPONENTS, INC.

121-18 DuPont St., Plainview, N.Y. 11803 • 516-433-5311

*DuPont Reg. TM

bulletin board

3M has extended the warranty for its thermoelectric power system from one to five years.

CIRCLE NO. 407

Electro-Science Laboratories has announced a series of thick-film conductive compositions. The palladium-silver coatings offer low cost, good solder bond strength retention when operated at elevated temperatures and solder leach resistance. Adhesion is greater than 1.25 kg/sq. mm in peel.

CIRCLE NO. 408

Fairchild Camera & Instrument Corp. has announced an agreement with Mostek to serve as an alternate source for Mostek's MK4096-P, a 4096-bit dynamic MOS RAM.

CIRCLE NO. 409

Two synchronous tape transports from Kennedy Co. provide threshold scanning to automatically compensate for drop-outs and drop-ins. An extension of the 9000 series, the transports—Models 9000-2 and 9000-3—offer a choice of NRZI, PE or NRZI/PE formats.

CIRCLE NO. 410

The GE Silicone Products Dept. has announced an adhesive for bonding KAPTON and other films to copper and aluminum. The material, SR-574, features cure time of less than two minutes, bond strengths of up to 8 lb. of peel on rolled annealed copper (180° peel) and uniform adhesion to difficult-to-bond substrates.

CIRCLE NO. 411

Bourns has introduced a line of dual-inline and single-inline packaged passive networks. The first networks are a group of six resistor types commonly used in IC logic circuits for pull-up, pull-down, line terminating, current limiting and impedance balancing applications.

CIRCLE NO. 412

The IM5604, a 2048-bit bipolar programmable ROM, is available from Intersil. The new pROM is fully decoded and organized as 512 words \times 4 bits. Typical access time is 50 ns, and it requires less than 275- μ W of power per bit. It has DTL and TTL-compatible inputs and outputs and will drive an output load of 16 mA at 0.45 V.

CIRCLE NO. 413

Micro Switch has announced a price increase of 5-1/2% on most basic and enclosed switch lines, manual products, photoelectric devices and mercury switches.

CIRCLE NO. 414

An expanded line of converter/chargers from Dormeyer Industries is UL listed. The converter/chargers can be used as ac-dc power converters, ac-dc power converter/chargers, ac-dc filtered converters, ac-ac low-voltage transformers or nickel-cadmium chargers.

CIRCLE NO. 415

PLUG UGLY.™

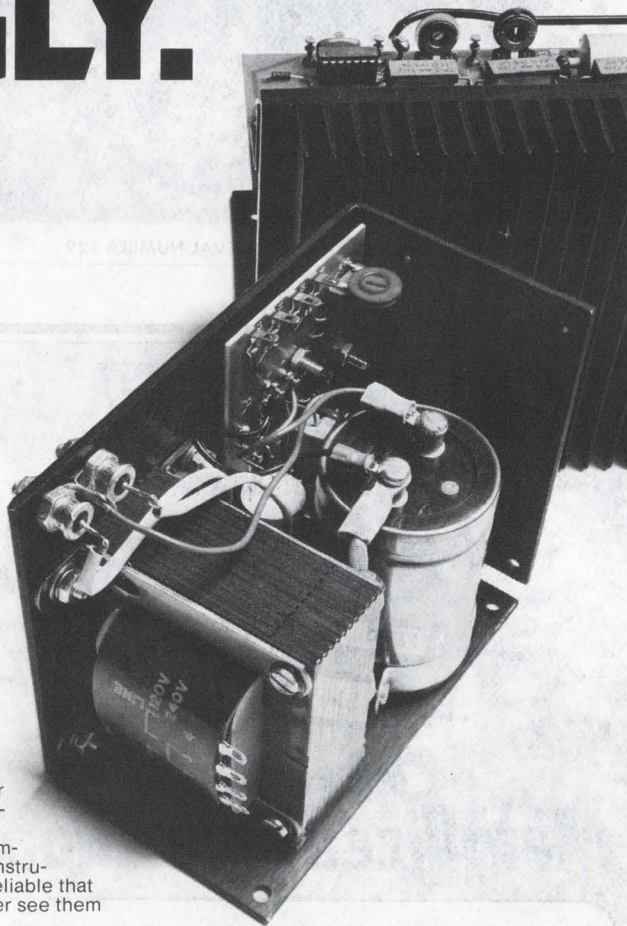

\$44 (1-9)
5V, 6A

They're not much to look at.

Because instead of fancy front panels, we designed our standard open-frame dc power supplies to cover 90% of your OEM applications. And once you plug them into your computers, peripherals or instrumentation, they're so reliable that chances are you'll never see them again.

They're designed and built conservatively, so you get full rated power all the way up to +55°C. Regulation, ripple and noise are specified by the book. And with no expensive options, you can now get your dc power for as little as 68¢/W (1-9 qty).

If you've looked at the competition, we know that has to be a sight for sore eyes.

For more info, use the bingo card or call 714/979-4440. Or call your local Cramer or Newark distributor and get Ugly today.

OPEN-FRAME OLV SERIES: 4-28 Vdc, 15-250 W

STANDARD FEATURES: Choice of 16 voltages, adjustable \pm 5%.
Currents to 50A, no derating to +55°C. \pm 0.1% IC regulation,
 \pm 0.1% ripple and noise. Remote sensing/programming
Spike suppression. Foldback current limiting. 120/240 Vac,
50/60 Hz inputs.

OPTIONS: OVP crowbar. PRICES: \$24.95 to \$179 (1-9)

Elxon Power Systems

©Copyright 1974 Elpac, Inc. ELPAC

INFORMATION RETRIEVAL NUMBER 131

RCA Solid State Div. has adopted a uniform, coded system for designating thyristor and rectifier types. JEDEC designations for 1N and 2N-series devices and SK types are not affected. RCA has published charts and matrices to explain the new numbering system and to cross-reference related old and new type and family numbers.

CIRCLE NO. 416

ADT is offering specialized door control hardware developed and manufactured by Alarm Lock Corp.

CIRCLE NO. 417

Bausch & Lomb's newest safety lenses are made of a tough, clear polycarbonate, which weighs only half as much as glass. They have a clear, scratch and solvent resistant coating.

CIRCLE NO. 418

Two grades of fluorocarbon resin produced by the Plastics Div. of Allied Chemical have been granted UL approval for use as appliance wire insulation at temperatures up to 125 C.

CIRCLE NO. 419

Varian Data Machines has introduced the V70 Remote Processing System (RPS). In this system, the 70 Series computers serve distributed processing functions, while concurrently communicating with IBM 360/370 computers in a network environment.

CIRCLE NO. 420

The Product Assurance Div. of American Electronic Laboratories has expanded the capabilities of its semiconductor screening laboratory through the integration of an automatic data logging and reporting system.

CIRCLE NO. 421

Gould Data Systems has announced that it has increased the speed of its Model 5000 electrostatic printer/plotters by up to 33%. The 5000 operates at 1600 lpm when using a 64-ASCII-character, 7 x 9 dot matrix font to produce alphanumeric data.

CIRCLE NO. 422

Omnitec has announced a full one-year warranty on parts and labor of all its acoustic couplers and modems.

CIRCLE NO. 423

Remote video display systems for the Datapoint 2200 minicomputers are available from RDA. Four models provide 24 lines of 80 upper-case characters each. All monitors are solid state. With the exception of one model they are available in rack or console versions. The displays come with a 2200 interface, refresh memory, power supplies, cables and utility software.

CIRCLE NO. 424

Price reductions

Price reductions of up to 24% on synchro converter modules have been announced by ILC Data Devices.

CIRCLE NO. 425

An average 25% across-the-board price reduction on vhf, uhf and microwave transistors has been announced by TRW Semiconductors.

CIRCLE NO. 426

MEAN AND UGLY.™

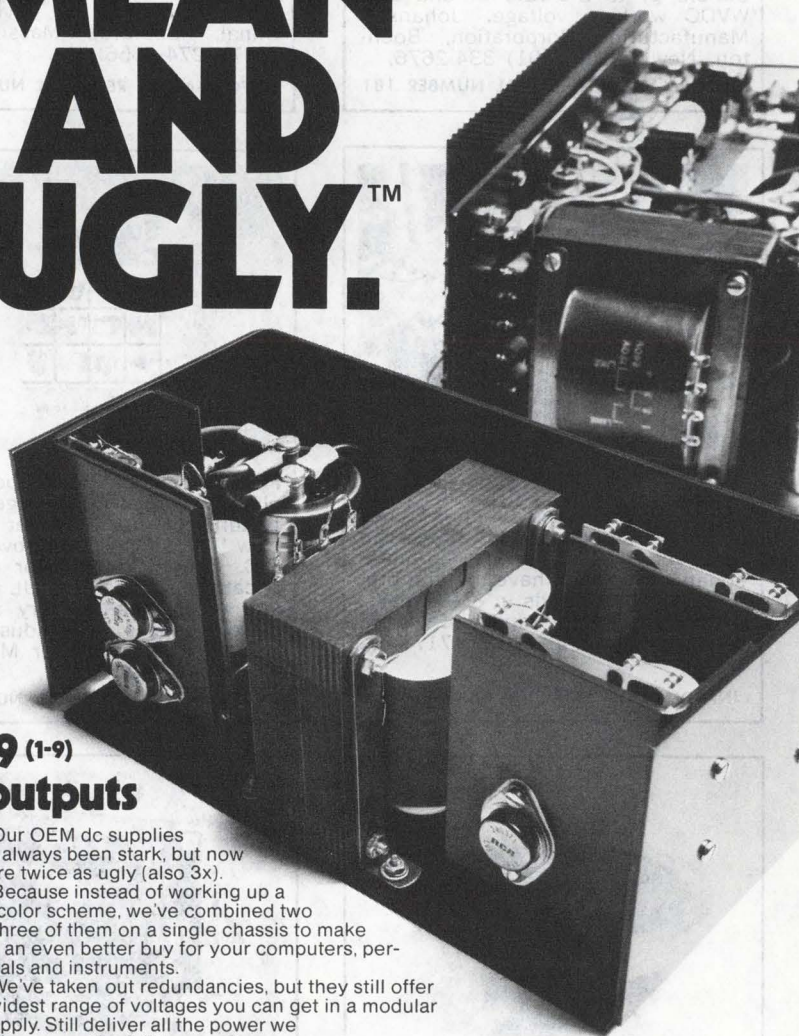

\$79 (1-9)
3 outputs

Our OEM dc supplies have always been stark, but now they're twice as ugly (also 3x).

Because instead of working up a new color scheme, we've combined two and three of them on a single chassis to make them an even better buy for your computers, peripherals and instruments.

We've taken out redundancies, but they still offer the widest range of voltages you can get in a modular dc supply. Still deliver all the power we promise across the full temperature range (even with 50 Hz inputs). And still include all the features you need as standards, not expensive options.

So that now if you check us out against the competition, they're liable to tell you that we're not just ugly.

We're downright mean.

For more info, use the bingo card or call 714/979-4440. Or call your local Cramer or Newark distributor and get Ugly today.

MULTIPLE OUTPUT DLV/TLV SERIES: 1st output: 5 V at 3-15 A, OVP standard. 2nd and/or 3rd outputs: each 4-28 V, 6-15 W, OVP optional. All outputs isolated, may be used as positive or negative supplies.

STANDARD FEATURES: Choice of 16 voltages, adjustable $\pm 5\%$. Currents to 15 A, no derating to $+55^\circ\text{C}$. $\pm 0.1\%$ regulation, $\pm 0.1\%$ ripple and noise. Remote sensing/programming. Spike suppression. Foldback current limiting. 120/240 Vac, 50/60 Hz inputs.

OPTIONS: Enclosure. PRICES: \$29 to \$151 (1-9)

Elexon Power Systems

© Copyright 1974 Elpac, Inc. ELPAC

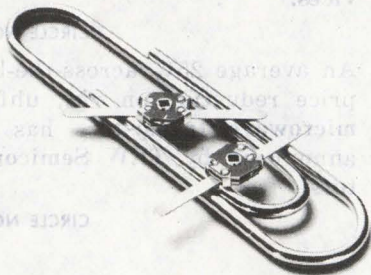

Thin-Trim variable capacitors provide a reliable means of adjusting capacitance without abrasive trimming or interchange of fixed capacitors. Series 9401 has high Q's and a range of capacitance values from 0.2-0.6 pf to 3.0-12.0 pf and 250 WVDC working voltage. Johanson Manufacturing Corporation, Boonton, New Jersey (201) 334-2676.

INFORMATION RETRIEVAL NUMBER 181

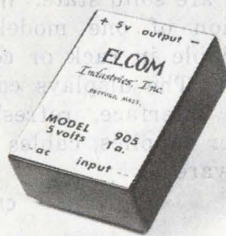

Modular Power Supplies 900-Series supplies are pin compatible with industry standard. 905 5 volt-1 amp 2% reg. direct replacement for many manufacturers. \$39.00 in units. Send for complete info on line of inexpensive supplies. ELCOM Industries, Inc., Civil Air Terminal, Bedford, Mass. 01730. (617) 274-6656.

INFORMATION RETRIEVAL NUMBER 184

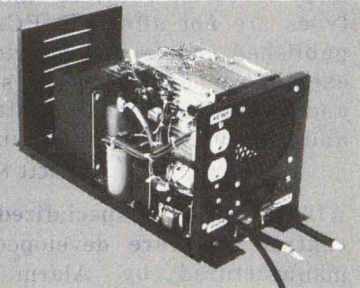

New DC to AC inverters with surge capacity of 5 times continuous rating. Frequency regulation of $\pm .2\text{Hz}$. Modular design offers wide variety of DC input voltages, 50 or 60Hz, simulated SINE wave or pure SINE wave with regulation of ± 2 volts. Models from 1KW to 10KW. Delatron Systems Corp., 20370 Rand Rd., Palatine, IL. 60067, 312-438-9225.

INFORMATION RETRIEVAL NUMBER 187

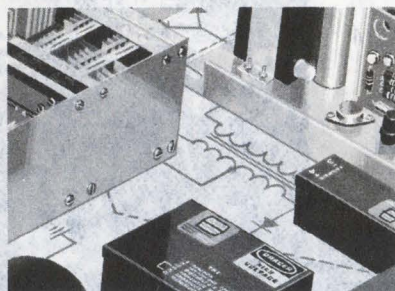

AMP Capatron specializes in power supplies. With over 1000 performance-proven designs. When it comes to custom-made models, we can meet your available space—at a reasonable price. And have the first prototype in your hands in 8-10 weeks. AMP Incorporated, Capatron Division, Elizabethtown, Pa. 17022. 717-367-1105.

INFORMATION RETRIEVAL NUMBER 182

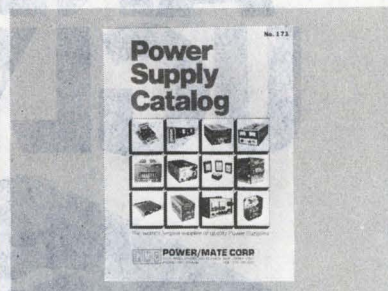

Free catalog of 34,500 power supplies from the worlds largest manufacturer of quality Power Supplies. New '74 catalog covers over 34,500 D.C. Power Supplies for every application. All units are UL approved, and meet most military and commercial specs for industrial and computer uses. Power Mate Corp. (201) 343-6294.

INFORMATION RETRIEVAL NUMBER 185

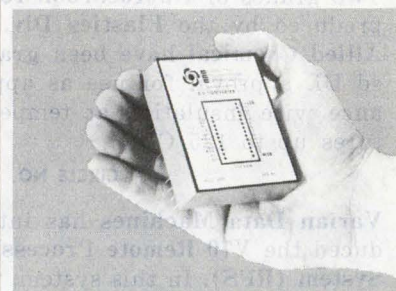

"Synchro to digital converters - 10, 12, or 14 bit output, errorless tracking up to 4 r.p.s., accuracy ± 4 min. of arc $\pm .9\text{LSB}$, resolution - 1.3 minutes, 60 or 400 Hz input, Module 2.6 x 3.1 x .82" H, Price From \$350 in qty. Computer Conversions Corp., East Northport, N.Y. 11731 (516) 261-3300."

INFORMATION RETRIEVAL NUMBER 188

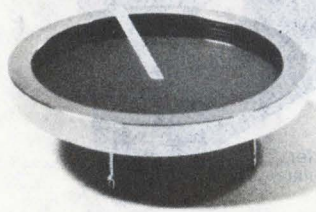

Silicon photodiodes for high resolution position sensing. UDT offers a wide variety of single and dual axis silicon photodiodes for light spot position sensing. Continuous lengths to 9" and areas to 1.4" in diameter with precision resolution to better than 10^{-5} inches. United Detector Technology, 1732 21st St., Santa Monica, Ca. 90404. (213) 829-3357.

INFORMATION RETRIEVAL NUMBER 183

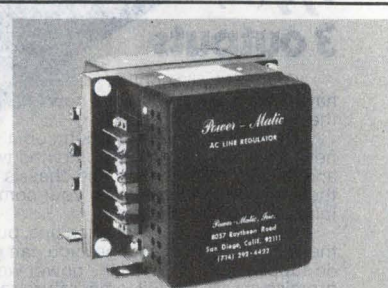

Ultra high efficient AC regulators for BROWN-OUT and POWER ECOLOGY. Features: 99% efficiency, $\frac{1}{2}$ cycle step response, small size and low cost. Write or call for literature. Units from 250VA to 30KVA single phase, 45-70Hz. POWER-MATIC, INC., 8057 Raytheon Rd., San Diego, Ca. 92111. Phone (714) 292-4422.

INFORMATION RETRIEVAL NUMBER 186



VLF receiver - VLF portable receiver for RF, Acoustic, Sonar Communication and EMI. Low cost, dual IF bandwidth, AGC, and immunity to RFI. Tunes 40 to 200 KHz; Ranges of 6 to 400 KHz available. Compatible antenna, hydrophones, transmitters (acoustic), decoders, and recorders available. - BAYSHORE SYSTEMS - Springfield, Va.

INFORMATION RETRIEVAL NUMBER 189

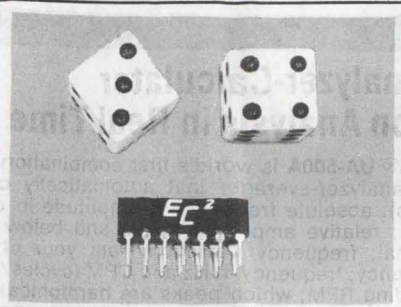

Win with EC²'s "DIP Series" lumped constant delay lines. Packaged in a low silhouette epoxy encapsulated 14-pin dual in-line configuration, EC² offers over 200 variations of either fixed or tapped delays, from 4 to 150 nanoseconds. Engineered Components Company, 3580 Sacramento Drive, San Luis Obispo, Ca. 93401. (805) 544-3800

INFORMATION RETRIEVAL NUMBER 190

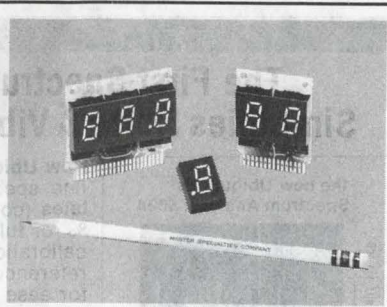

Plug-in LED Display Assemblies with decoder/driver circuits already assembled, ready to plug-in and read-out. Accepts 4-line BCD input. Operates from 5 VDC. Utilizes 0.6" high red numeric LED display. Master Specialties, 1640 Monrovia, Costa Mesa, Calif. 92627. (714) 642-2427.

INFORMATION RETRIEVAL NUMBER 193

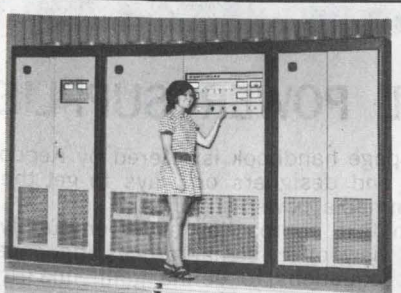

Lorain UPS Systems provide maximum power protection against Brownouts, Blackouts and voltage spikes. Ideal for computer applications such as: charge card billing; airline, hotel-motel reservation; process control; critical instrumentation; hospital. Lorain Products Corporation, 1122 F St., Lorain, Ohio 44052. A subsidiary of Reliance Electric Co.

INFORMATION RETRIEVAL NUMBER 191

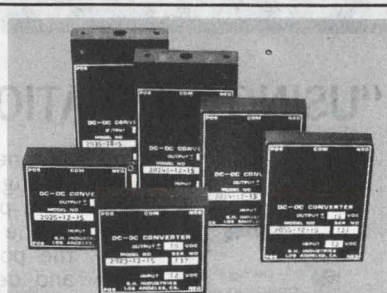

Modular DC/DC Converters. 1.5 W to 30 W. Miniature easy to use P.C.B. mntg. Hundreds of standard variations are available. All have low-noise filtered inputs and outputs. Inputs are reverse voltage protected. Regulated units have current limited outputs. (1 to 9) qty from \$37.25 B. H. INDUSTRIES, Los Angeles, Ca. (213) 479-8278.

INFORMATION RETRIEVAL NUMBER 194



A collector's item . . . 20th anniversary issue of Electronic Design (11/23/72) salutes 25th anniversary of the transistor, features milestones in design over past quarter century. Rare nostalgic view of industry. Fascinating reading. \$2 per copy pre-paid. Checks, money orders: Electronic Design, Promotion Mgr., 50 Essex St., Rochelle Park, N.J. 07662.

INFORMATION RETRIEVAL NUMBER 192

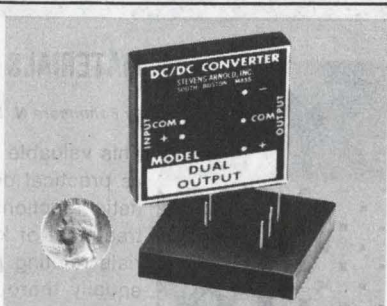

DC/DC converter power supply. 4.5 watts of isolated, regulated $\pm 15VDC$, $\pm 150mA$ from a 5, 12, 24, 28 or 48 VDC input. Low noise, multiple transformer shielding and 6 sided case shield. No derating required; $-25^{\circ}C$ to $71^{\circ}C$. Ultra-miniature $2" \times 2" \times 0.375"$ module. \$79 (1 - 9). Stevens-Arnold Inc., South Boston, Mass. (617) 268-1170.

INFORMATION RETRIEVAL NUMBER 195

Advertisers wishing to reserve Quick Ad units should note the following mechanical requirements: Specs—Supply glossy photo of product and approximately 40 words which will set no more than 10 lines of 34 characters each. AFTER SUBMISSION NO COPY CHANGES CAN BE ACCEPTED. Quick Ads cost only \$300 per insertion, less for frequency advertisers.

RATES:

1x
\$300

7x
\$280

13x
\$255

19x
\$250

26x
\$245

39x
\$240

52x
\$235

104x
\$230

ELECTRONIC DESIGN's function is:

- To aid progress in the electronics manufacturing industry by promoting good design.
- To give the electronic design engineer concepts and ideas that make his job easier and more productive.
- To provide a central source of timely electronics information.
- To promote communication among members of the electronics engineering community.

Want a subscription? ELECTRONIC DESIGN is sent free to qualified engineers and engineering managers doing design work, supervising design or setting standards in the United States and Western Europe. For a free subscription, use the application form bound in the magazine. If none is included, write to us direct for an application form.

If you do not qualify, you may take out a paid subscription for \$30 a year in the U.S.A., \$40 a year elsewhere. Single copies are \$1.50 each.

If you change your address, send us an old mailing label and your new address; there is generally a postcard for this bound in the magazine. You will have to requalify to continue receiving ELECTRONIC DESIGN free.

The accuracy policy of ELECTRONIC DESIGN is:

- To make diligent efforts to ensure the accuracy of editorial matter.
- To publish prompt corrections whenever inaccuracies are brought to our attention. Corrections appear in "Across the Desk."
- To encourage our readers as responsible members of our business community to report to us misleading or fraudulent advertising.
- To refuse any advertisement deemed to be misleading or fraudulent.

Microfilm copies are available of complete volumes of ELECTRONIC DESIGN at \$19 per volume, beginning with Volume 1, 1961 through Volume 20. Reprints of individual articles may be obtained for \$2.00 each, prepaid (\$.50 for each additional copy of the same article) no matter how long the article. For further details and to place orders, contact the Customer Services Department, University Microfilms, 300 North Zeeb Road, Ann Arbor, Michigan 48106 telephone (313) 761-4700.

Want to contact us? If you have any comments or wish to submit a manuscript or article outline, address your correspondence to:

Editor
ELECTRONIC DESIGN
50 Essex Street
Rochelle Park, N.J. 07662

The First Spectrum Analyzer-Calculator Simplifies Noise & Vibration Analysis in Real Time

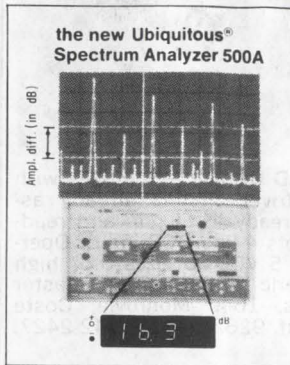

New Ubiquitous® UA-500A is world's first combination 500-line spectrum analyzer-averager that automatically **calculates** (computes): absolute frequency & amplitude in dB or % of full scale; relative amplitude above and below your calibration signal; frequency deviation from your chosen reference frequency; frequency in Hz and CPM (cycles/min.) for ease in reading RPM; which peaks are harmonically related by isolating them from others with harmonic markers or eliminating all else from the CRT display. Applications simplified include: machine diagnosis, rotating machine analysis, noise source identification, mechanical signatures, underwater acoustics, and noise reduction. Built-in dual memory averager allows comparison of past & present data. Small, portable, only 8¾" high. Highest speed: real-time 100% analysis to 10kHz. Thirteen ranges from 0-10Hz to 0-100kHz providing analysis bandwidths of .02Hz to 200Hz (also 0-5mHz direct input). Simplest to use.

CIRCLE NO. 171

Federal Scientific Corporation An Affiliate of Nicolet Instrument
615 West 131st St., New York, N.Y. 10027 (212) 286-4400 TWX: 710 581 4059

"USING OPERATIONAL POWER SUPPLIES"



A new 32-page handbook is offered by Kepco, Inc., to engineers and designers on ways to get the most from programmable power supplies.

The Kepco text approaches a power supply from the point of view of its signal processing capability, and develops equations to define gain, linearity, offset, speed, bandwidth, accuracy, etc.

Using Operational Power Supplies also devotes considerable space to the problems of digital interface, reviewing the hardware by which Kepco Bipolar and Unipolar Operational Power Supplies can be controlled by digital logic. Send for your free copy.

CIRCLE NO. 172

Kepco, Inc.
131-38 Sanford Avenue, Flushing, New York 11352
Phone: 212-461-7000, Ext. 742

MATERIALS FOR MAGNETIC FUNCTIONS

by Fennimore N. Bradley

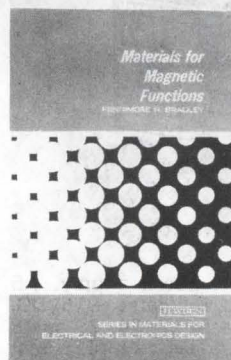

This valuable reference provides a thorough background as well as practical design techniques for the materials needed for magnetic functions. Included in its exhaustive coverage is detailed treatment of key parameters of about 30 classes of ferrite materials relating processing to costs and design trade-offs . . . and equally thorough coverage of about 40 classes of both conventional and exotic magnetic metals and processes. The book focuses on design problems encountered in a wide range of permanent-magnet applications . . . pinpoints design problems in nearly 30 categories of electromagnetic devices . . . and concludes with coverage of environmental influences such as corrosion, magnetic field, temperature, stress, etc. 360 pp., 6 x 9, illus., cloth, \$14.95. **Circle the reader-service number to order a 15-day examination copy.**

CIRCLE NO. 173



HAYDEN BOOK COMPANY, INC., 50 Essex St., Rochelle Park, N.J. 07662

Manufacturers

Advertisements of booklets, brochures, catalogs and data sheets. To order use Reader-Service Card (Advertisement)

FAST FOURIER TRANSFORM PROCESSOR FOR \$6,000

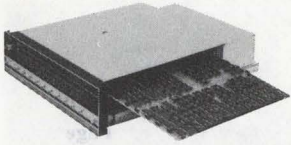

The 306/MFFT Fast Fourier Transform Processor is delivered with all control programs and plugs directly into any Data General Nova computer. It offers a complete Fourier Transform capability including Forward and Inverse FFT, Spectral magnitude, Hanning Weighting, and Complex Multiplication. Arrays from 16 to 16,384 real samples can be processed. An array of 1024 real samples is transformed in only 139 ms.

Time domain signal processing functions, such as correlation and convolution, can be calculated utilizing the high speed array operations X , $+$, $-$, \sqrt and Σ .

Call or write today for brochures on 306/MFFT or Elsytec's complete line of Fourier Spectrum Analyzers and Higher Speed Hardware Fast Fourier Transform Processors.

ELSYTEC INC.

212 Michael Drive, Syosset, New York 11791 (516) 364-0560

CIRCLE NO. 174

PRACTICAL RELAY CIRCUITS

By Frank J. Oliver

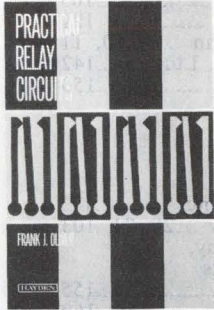

Uniquely groups various relay circuits according to the functions they perform, enabling the systems designer to quickly select the best circuit for his specific purposes. Includes arc and RFI suppression systems; time delay function; audio tone control and resonant-reed relays; sequential relays; protective functions of relays against overload overvoltage, and overcurrent, pulse generation and detection; logic circuits; and more. Particularly important is coverage of pulse-operated relay systems now extensively used with automated control systems. Illustrated with many circuit diagrams using the latest American National Standard graphical symbols. 363 pp., 6 x 9 1/4, illus., cloth, \$14.95. Circle the reader-service number to order a 15-day examination copy.

CIRCLE NO. 175



HAYDEN BOOK COMPANY, INC., 50 Essex St., Rochelle Park, N.J. 07662



Power Supply Catalog Fall • 1974 FREE

Modular D.C. Power Supplies are described in this new 20 page brochure. It gives applications, specifications and features on a complete line of P.C. board mounting D.C. Power Supplies for both digital and linear integrated circuits.

Included is a selection guide which categorizes D.C. Power Supplies according to output (volts and current), regulation data, price information, and complete mechanical specifications.

D DATAL
SYSTEMS, INC.

1020 Turnpike St., Canton, Mass. 02021

CIRCLE NO. 176

Electronic Design

Advertising Sales Staff

Tom W. Carr
Vice President &
Sales Manager

Rochelle Park, N.J. 07662

Robert W. Gascoigne
Daniel J. Rowland
(Recruitment, Quick Ads, Classified)
50 Essex Street
(201) 843-0550
TWX: 710-990-5071

Philadelphia

Thomas P. Barth
50 Essex Street
Rochelle Park, N.J. 07662
(201) 843-0550

Boston 02178

Gene Pritchard
P.O. Box 379
Belmont, Mass. 02178
(617) 489-2340

Chicago 60611

Thomas P. Kavooras
Berry Conner, Jr.
200 East Ontario
(312) 337-0588

Cleveland

Thomas P. Kavooras
(Chicago)
(312) 337-0588
(call collect)

Los Angeles 90303

Stanley I. Ehrenclou
Burt Underwood
2930 Imperial Highway
Inglewood, Calif.
(213) 757-0183

San Francisco 94022

Jerry D. Latta
P.O. Box 1248
Los Altos, Calif.
(415) 965-2636

London

For United Kingdom and Europe
John Ashcraft
John Ashcraft & Co.
12, Bear St.
Leicester Square
London WC2H 7AS England
Phone: 01-930-0525
W. J. M. Sanders
John Ashcraft & Co.
Herengracht 365
Amsterdam C., Holland
Phone: 020-24-09-08

Tokyo

Haruki Hirayama
Electronic Media Service
5th Floor, Lila Bldg.
4-9-8 Roppong
Minato-ku
Phone: 402-4556
Cable: Electronicmedia, Tokyo



Defeat 1/f noise and power line pickup in your PHOTOMETRIC experiment!



With our new Model 181 Current Sensitive Preamplifier and a lock-in amplifier, you can modulate your light beam at any frequency up to one hundred kilohertz—more than enough to beat low frequency interference and flicker noise. You won't have to give up sensitivity either—in fact, with an internal noise current of only 4 fA/Hz^{1/2}, the Model 181/lock-in combination can resolve currents typically less than 1 fA(10⁻¹⁵ A). And, you don't have to worry about the photodetector's quiescent current or stray light, because the Model 181 can handle dc inputs up to 10 times its current-to-voltage conversion setting without overload.

Find out how our Model 181 Preamplifier can simplify your photometric measurements. Write or call Princeton Applied Research Corporation, Post Office Box 2565, Princeton, New Jersey 08540. Telephone [609] 452-2111. In Europe contact Princeton Applied Research GmbH, D8034 Unterpaffenhofen, Waldstrasse 2, West Germany.



243

INFORMATION RETRIEVAL NUMBER 127

IC POWER SUPPLY 5 volts at 1 amp

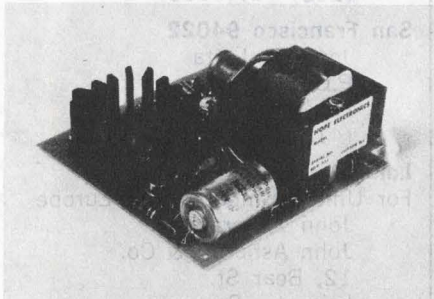

DELIVERY FROM STOCK

1-9 QUANTITY **\$3300**

- Input 117 V ±10% — 60 to 400 CPS
- Output Adjustable ±10% at 1 amp
- Line Regulation 0.1%
- Load Regulation 0.5%
- Ripple and Noise <1 MV peak to peak
- Short Circuit Proof
- Over Voltage Protection

HOPE ELECTRONICS

Box 773, Clifton, New Jersey 07013
Phone (201) 777-3522

Contact us for Your Custom Requirements

Oscillators • Amplifiers • Modulators
Attenuators • Sweep Generators • Filters

INFORMATION RETRIEVAL NUMBER 128

Advertiser's index

Advertiser	Page	Advertiser	Page
ACDC Electronics, Inc.	16A—F	Elec-Trol, Inc.	86, 87
AMP, Incorporated	184	Electronic Memories, Commercial Memory Products	122, 123
AMP, Incorporated, Captron Division	175	Electrostatics, Inc.	166
AVX Ceramics Corporation	138	Elxon Power Systems	182, 183
Abbott Transistor Laboratories, Inc.	6	Elmwood Sensors, Inc.	92
Acopian Corp.	107	Elsytec, Inc.	187
Active & Passive Components, Inc.	181	Electronic Design	185
Advance Conversion Devices Company	160	Emerson & Cuming, Inc.	164
Airpax Controls Division	151	Engineered Components Company	185
Allen Bradley Co.	27		
American Optical Corporation	152	Fairchild Semiconductor, A Division of Fairchild Camera and Instrument Corporation	125
Amperex Electronics Corporation	97	Federal Scientific Corporation	186
Amphenol, Bunker-Ramo Corp.	23	Ferranti-Packard	165
Amplifier Research Corporation	177	Ferroxcube Corporation	121
Analog Devices, Inc.	17	Fluke Mfg. Co., Inc., John	9, 10, 11
Arnold Magnetics Corporation	174	Fuji Electrochemical Co., Ltd.	142
		Fujitsu Limited	153
B & H Industries	185		
Bafco, Inc.	142	Gates Energy Products, Inc.	173
Ballantine Laboratories, Inc.	152	General Electric Company	20, 21, 103
Bayshore Systems	184	General Electric Company, Semiconductor Products Department	155
Beckman Instruments, Inc., Helipot Division	18, 19	Gold Book, The	168, 169
Bourns, Inc., Trimpot Products Division	1	Grayhill, Inc.	134
Braun Company, Inc.	148		
Burr-Brown Research Corporation	130, 131	HEI, Inc.	154
Burroughs Corporation	24	Hamlin, Inc.	141
		Harris Semiconductor, A Division of Harris Intertype Corporation	114, 115
Christie Electric Corp.	174	Hayden Book Company, Inc.	14, 186, 187
Circuit Stik, Inc.	190	Hewlett-Packard	41, 42, 43
Computer Conversions	184	Hope Electronics	188
Computer Products, Inc.	139	Hughes Aircraft Company, Electron Dynamics Division	113
Concord Electronics Corporation	148	Hybrid Systems Corp.	145
Curtis Industries, Inc.	132		
Cutler-Hammer	50, 51	IMC Magnetics Corporation	170
		Instant Instruments, Inc.	146
Dale Electronics, Inc.	Cover II	Intech, Incorporated	144
Datel Systems, Inc.	187	Interdata	98, 99
Delatron Systems Corp.	184	Intersil	117
Delco Electronics, Division of General Motors Corporation	104, 105		
Deltrol Controls	78	Johanson Manufacturing Corp.	184
Dialight, A North American Philips Company	31	Johnson Company, E. F.	22
Digitran Company, The	140		
Dow Corning Corporation	12, 13, 15		
Dynamic Instrument Corp.	179		
EECO	127		
E-H Research Laboratories, Inc.	161		
Elcom Industries, Inc.	184		

recruitment
and
classified ads

SAME DAY SHIPMENT
Minis & Peripherals
PDP SPECIALISTS
8, 8I, 8L & 11
NEW 300 LPM
PRINTERS
PDI CARD READERS
BRPE PUNCHES

\$750 Minis

TELETYPE 35 & 37
DEC & HONEYWELL Modules
617/261-1100

Send for Free Report "Maintenance
of Computers"

AMERICAN USED COMPUTER CORP.
P.O. Box 68, Kenmore Sta.
Boston, MA 02215
Members Computer Dealers Association

CIRCLE NO. 209

ENGINEERS

Over 15 years of Engineering and Professional placement coast to coast. Entry level to Management with openings cutting the spectrum of the engineering disciplines. All fees paid.
E. B. HENDRICK ASSOCIATES, INC.
"The Village Mall", Vine Street
Liverpool, NY 13088
Phone: 315-451-0121

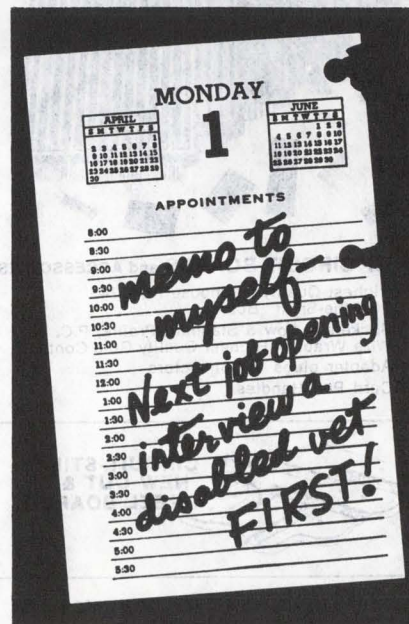

The President's Committee
on Employment of the Handicapped
Washington, D.C. 20210

Advertiser	Page
Keithley Instruments, Inc.	160
Kepco, Inc.	186
Keystone Carbon Company	124
Kurz-Kasch, Inc.	156
L H Research, Inc.	143
LRC, Inc.	180
Lambda Electronics Corp.	68, 69
Ledex, Inc.	171
London Company, The	170
Lorain Products Corporation	185
Master Specialties	185
Mica Corporation, The	109
Microswitch, A Division of Honeywell	93
Mini-Circuits Laboratory	191
Monolithic Memories, Inc.	127
Motorola Semiconductor Products, Inc.	4, 5, 33, 44
NCR Wichita	176
National Electronics, A Varian Division	126
North Electric Company	149
Optima Enclosures	Cover III
Optron, Inc.	7
PRD Electronics, Inc.	146
Paktron, Division Illinois Tool Works, Inc.	156
*Philips Industries, Electronic Components and Materials Division	14, 18
*Philips Industries, Test and Measuring Instruments	18
Power Conversion, Inc.	128
Power/Mate Corp.	184
Powermatic	184
Princeton Applied Research Corp.	188
RCA Solid State	Cover IV
Reed Devices, Inc.	177
Reliability, Inc.	172
Reticon	8

Advertiser	Page
Semiconductor Circuits, Inc.	136
Semtech Corporation	29
Signetics Corporation	58, 59
Siliconix, Incorporated	48
Sola Electric, Division of Sola Basic Industries	147
Sonex, Inc.	150
Sorensen Company, A Unit of Raytheon Company	139
Sprague Electric Company	39
Standard Power, Inc.	173
Stevens-Arnold	185
Systron-Donner	136
TEC, Incorporated	162
TRW Electronic Components	111
TRW/IRC Resistors, An Electronic Component Division of TRW, Inc.	157
Tekelec, Inc.	167
Tektronix, Inc.	47
Teledyne Semiconductor	85
Teledyne Relays, A Teledyne Company	2
Teletype Corporation	37
Telonic Altair	181
Tenney Engineering, Inc.	150
Thermalloy Company	158
Theta Instrument Corp.	173
Thomas & Betts Co., The	163
Thomson-CSF	129
Trak Microwave Corporation	133
Underwriters' Safety Device Company	164
United Chemi-Con	79
United Detector Technology, Inc.	184
United Systems Corporation	35
University of California	174
Varo Semiconductor, Inc.	120
Victor Electric Wire & Cable Corp.	177
Viking Industries, Inc.	135
Wagner Electric Corporation	137
Wavetek Indiana Incorporated	118
Zeltex, Inc.	192

*Advertisers in non-U.S. edition.

**FROM
BREADBOARD
TO FINAL
PACKAGING
HARDWARE...**

**ALL AVAILABLE
FROM ONE SOURCE**

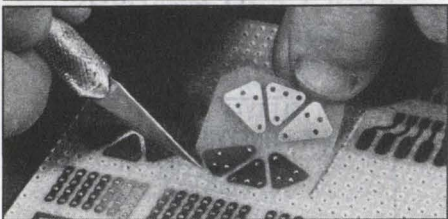

★ **ADHESIVE BACKED
CIRCUIT SUB-ELEMENTS**
(Over 200 Pre-Drilled component mounting
patterns available "off-the-shelf.")

★ **EPOXY GLASS BOARD
MATERIALS**

- 76 Standard "Off-the-Shelf" Boards.
- Including Unclad, Copper Clad, Cut & Peel
Copper Clad, Pre-etched "X-Y" Pattern and
Plated thru Hole Copper Clad.
- .100" Grid Hole Pattern or Undrilled.

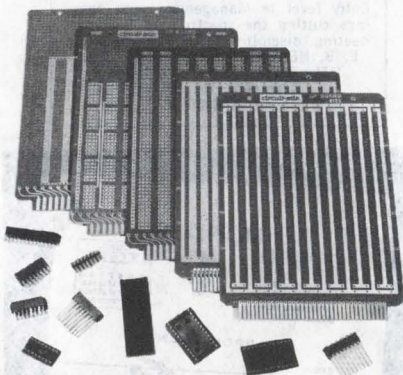

★ **GP CIRCUIT BOARDS and ACCESSORIES**

- Highest Quality — Choose from 74
"Off-the-Shelf" Boards.
- Sockets — Low & Standard Profile, P.C. and
Wire Wrap. • Highest Quality Gold Contacts.
- Adapter plugs • Connectors
- Card Pull Handles.

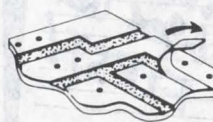

**CIRCUIT-STIK'S
NEW CUT &
PEEL BOARDS**

SEND FOR OUR NEW CATALOGS #502 & #801

circuIt-stik®

P.O. BOX 3396 • Torrance, California 90510
Phone (213) 530-5530

product index

Information Retrieval Service. New Products, Evaluation Samples (ES), Design Aids (DA), Application Notes (AN), and New Literature (NL) in this issue are listed here with page and Information Retrieval numbers. Reader requests will be promptly processed by computer and mailed to the manufacturer within three days.

Category	Page	IRN	Category	Page	IRN
Components			microcomputer	154	324
capacitors, ceramic	138	70	minicomputer, 32-bit	99	40
capacitors, film	156	94	operating system	154	325
capacitors, metalized			recorder, digital	35	241
film	181	130	terminal, CRT	150	309
counter, electromech	175	364	terminal, CRT	152	323
dial, digital	1	2	terminal, data	151	321
display, gas discharge	172	360	terminal, remote	152	322
displays, liquid-crystal	141	73			
encoders, optical	173	115	Discrete Semiconductors		
fans	170	110	coupler, optical	166	350
ferrites	121	52	diodes, hyperabrupt	162	343
fiber optic system	172	358	diodes, IMPATT	164	344
indicators, light	31	21	diodes, Schottky	162	340
lights, cartridge	162	102	isolators, optically coupled	7	6
magnetic and digital pick-ups	151	87	LEDs	5	4
miniswitch	140	72	LEDs, orange	166	348
motors, dc	174	361	MOSFETs, dual-gate	164	345
panel displays	24	18	rectifiers, bridge	137	69
potentiometers	23	17	rectifiers, bridge	162	341
readout	16	12	rectifiers, silicon	120	51
rectifiers, capacitors			SCRs	126	57
inverters	155	92	sensor, light	166	349
relay, reed	174	362	transistor, hf power	164	346
relays, solid-state	2	3	transistor, uhf power	166	347
resistor-capacitor net- work	39	25	transistors	105	43
resistor chips	145	78	transistors	162	342
resistor network	180	126	transistors, driver	167	352
resistors	III	246	transistors, power	167	351
resistors	157	95			
rotary swi, PC board	172	359	Instrumentation		
silicon tube	29	20	analyzers, freq.	142	75
solenoids	78	33	comparator	123	260
solenoids	171	112	counter	123	258
switch, optical	154	91	counter	124	263
switches	93	38	counters	136	67
switches, reed	153	90	DMM	131	275
switches, rotary	134	65	DMM	160	99
thermostats	92	37	DPM	132	279
transformers, rf	191	134	digiscope	161	101
transient protector	175	363	digital VOM	132	278
trimmers and potentiom- eters	27	19	digital thermometer	124	261
triodes, metal/ceramic	129	60	digital word recognizer	126	265
voltage transformers	147	81	frequency synthesizer	146	79
			function generator	131	272
Data Processing			generator, pulse	123	257
calculator	150	308	impedance meter	128	269
data handling equip- ment	150	85	integrating recorder	132	277
data terminal	37	24	logic test system	156	93
dual CPU system	151	320	memory tester	132	276
memories	123	53	meters, modulation	170	111
memory, MOS	154	327	oscilloscope	47	28
memory card, 16 k	142	74	oscilloscopes	126	267
memory, floppy disc	154	326	PC board tester	123	259
microcomputer	150	310	pulse generator	131	274
			RCL bridge	131	273
			rf amplifier	124	262
			S/d converter	126	266

Category	Page	IRN
scopes	128	268
spectrum analyzer	124	264
sweeper	118	50
thermistor probes	124	55
timer/controller	128	271
voltmeters	152	89
Integrated Circuits		
analog gates	117	49
analog memory system	8	7
calculator chip set	120	255
IC, linear COS/MOS	120	254
IC, one shot	120	256
IC, power hybrid	119	250
IC, thyristor control	119	252
ICs, linear	IV	248
pROMs	127	58
RAM, CMOS	119	251
switches and multi-plexers, CMOS	17	13
voltage regulator	125	56
Microwaves & Lasers		
amplifier, i-f	134	280
amplifier, linear i-f	140	291
amplifier, pulsed	133	64
amplifier, 2-GHz linear	140	293
amplifier, 225-400 MHz	138	286
antenna pair	138	289
attenuator	140	292
filter/duplexer	134	281
laser communicator	136	285
laser, resistor trim	132	283
mixer, double balanced	138	287
mixers, dual TO-5	140	294
optics	152	88
oscillator, YIG-tuned	138	290
rf power amplifier	97	39
sweeper, Ku-band	136	284
transistors, CATV	138	288
Modules & Subassemblies		
amp, phase-sensitive	146	305
amplifier, broadband	177	121
control, dc motor	144	301
controller, temp	144	299
converter, a/d	48	29
converter, a/d	192	135
converters, a/d	142	297
decoder, tone	145	303
encoder, tone	148	307
filter, Chebyshev	144	298
filters	181	129
filters, RFI/EMI	175	120
gate drive, SCR	148	306
hybrid microcircuits	19	14
junction, reference	142	296
module, timing	142	295
op amps	33	22
op amps	131	61
oscillators, modular	146	304
preamplifier	188	127
sensor, liquid level	144	300
transformer, active	145	302
Packaging & Materials		
active filter seminar	174	118
automatic tying tool	163	103
boards, DEC interface	158	334
circuit boards, gp	190	133
cleaner, solder-iron	156	328
color striper	158	333
conductive grease	158	332
connectors	22	16
connectors	135	66
contacts, spring	148	83
cooling unit	158	331

Category	Page	IRN
enclosures	III	247
heat pipes	113	47
heat sinks, DIP	156	329
jacks, pins, terminals	148	82
molding compound, semi	13	9
mounting kits	158	96
multiconductors	177	123
PC material, flexible	160	337
PM material	160	338
silicones	164	104
substrates and circuits	109	45
temperature strips	159	335
terminal blocks	132	63
terminal blocks	164	105
test chambers	150	86
tool, manual power	156	330
Power Sources		
batteries	103	42
batteries	128	59
batteries	173	114
charger/converter	179	125
NiCd battery	170	351
power modules	149	84
power sources	172	113
power supplies	69	32
power supplies	136	68
power supplies	146	80
power supplies	173	116
power supplies	174	117
power supplies	183	132
power supplies	182	131
power supplies, dc	165	106
power supplies, dc	174	119
power supplies, dc	177	122
power supply	6	5
power supply	143	76
power supply	166	108
power supply, IC	188	128
power supply, uninter-ruptible	160	100
regulators, solid-state	159	97
solar panel	170	355

new literature

analyzer	179	382
cardiopulmonary products	179	384
ceramic capacitors	180	393
color video tape	182	402
components	179	387
d/a modules	182	401
error rate test sets	179	381
fasteners	179	376
HV power supplies	181	398
interchangeable thermis-tors	180	391
low-profile keyboards	182	403
mercury relay spin-out	179	375
microwave radio relays	179	380
optical components	179	378
panel meters	179	385
process instruments	182	406
pushbutton switches	179	373
rectifiers	181	400
resistor systems	181	395
signal conditioners	180	390
solid-state keyboards	181	396
splices and contacts	179	379
telecommunications	179	377
terminal strips	180	394

WIDE BAND RF TRANSFORMERS

Great Value at

\$2⁹⁵
10 piece quantities

Some Models \$3.45

0.1 - 500 MHz
50 Ohm impedance
1:1 to 16:1
impedance ratio
micro-miniature case

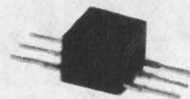

A breakthrough in technology and high production volume enables Mini-Circuits Laboratory to offer these new products at an unprecedented low price.

Ruggedness and durability are built in the T-series transformers. These new units are packaged within a 1/3 D.I.P. package. They use uniquely designed transmission line transformers for extra wide bandwidth.

Impedance ratios of standard models are 1:1, 2:1, 4:1, 9:1 and 16:1. MCL kit TK-1 includes 2 units of each type and sells for \$32.

We invite you to convince yourself. Place your order now and check our delivery, product performance and reliability.

Mini-Circuits Laboratory

2913 Quentin Rd., Brooklyn, N.Y. 11229
(212) 252-5252, Int'l Telex 620156
A Division Scientific Components Corp.

*FRANCE: S.C.I.E., *31, rue, George-Sand, Palaiseau 91, France. *GERMANY, AUSTRIA, SWITZERLAND: Industrial Electronics GMBH, *Klüberstrasse 14, 6000 Frankfurt/Main, Germany. ENGLAND: Dale Electronics, Dale House, Wharf Road, Frimley Green, Camberley, Surrey. JAPAN: Densho Kaisha Ltd. Eguchi Building, 8-1 1-Chrome, Hamamatsucho, Minato-Ku, Tokyo.

*UNIT IN STOCK

INFORMATION RETRIEVAL NUMBER 134

ZELTEX' 12 bit, 10 μ sec ADC is just one of our strong, fast, silent types.

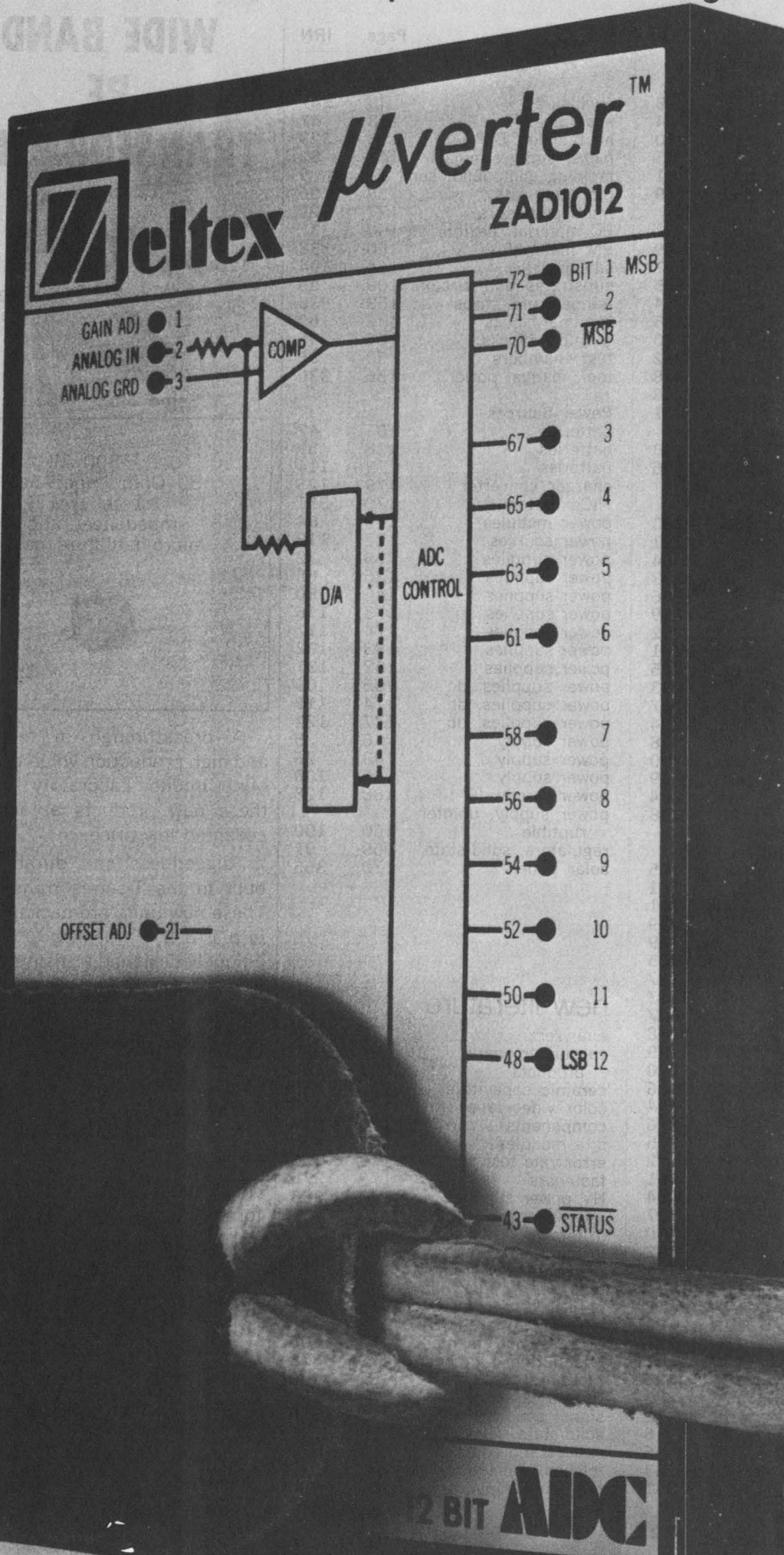

And, aside from performance like 8 bits at 3 μ seconds up to 12 bits at 10 or 20 μ seconds, you get:

- Lowest noise/repeatability error of any ADCs on the market
 - Zeltex' unique thick film small size packaging
 - Fully monotonic over their full specified temperature range
 - All fully specified to $\pm 1/2$ LSB linearity
 - Models pin interchangeable for upgrading specs.
- Plus they truly meet their specifications so you are getting a lot of converter for your money.

The new ZAD 1000 Series is a result of Zeltex' unique product design and manufacturing technologies which have produced a comprehensive line of D/A and A/D converter problem solvers.

So phone (415) 686-6660 to find out how you can put Zeltex' great Micro Giants to work solving your systems design problems.

ZELTEX, INC.
 940 Detroit, Concord California 94518
 (415) 686-6660
 TWX 910-481-9477



The Micro Giants.
 CIRCLE NO. 135

12 BIT ADC

When the questions are about enclosures, Optima has beautiful answers.

Whether packaging small, digital multimeters or a huge, communications center, you need enclosures with structural integrity, access, and versatility. Doing their job and doing it well.

How do you get them? Consider the alternatives... job shop?... in-house construction?... a manufacturer? To decide, it is important to ask the right questions and get the right answers.



Sales Appeal

The first ten seconds of display for an electronics unit focus simply on its style, color and finish. They won't break a sale—the equipment inside does that. But they can sure help make one.

- Is an industrial designer with packaging skills involved?
- Can you get the superior vinyl finishes so much in demand today? Or woodgrains? Or special textures?
- Is a total range of designer colors on hand?

Versatility

An important sales tool is the ability to adapt to the changing needs of a client.



- Does a source offer hundreds of configurations to choose from? If, for instance, your client is thinking vertical rack, but wants the operator seated, can you offer a console-desk?

- Does a client need a ventilating grille? a blower? stabilizers? Wouldn't drawer slides help his operations? What about writing surfaces, storage areas, drawers, casters? Are they in production, on line and ready to go?

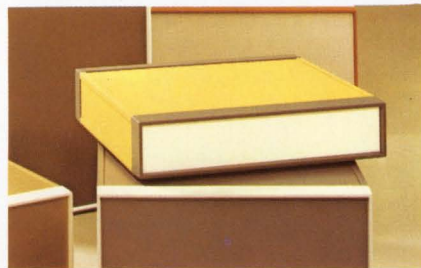

Customer Service

Are your own needs being served?

- Can you get personal service from engineers, designers, and production people?
- Can you get special applications assistance?
- Does your source have a knowledgeable customer-service representative?

The Optima Line

Our line of enclosures for electronics is the product of finding good answers to tough questions. Whether your question is component access, cooling, special applications or new product development and even safe shipping—we're ready!

Ready with Small Cases in 24 sizes from 133.6 to 1445.4 cubic inches; Instrument Cases and Racks in 124 sizes for 19- and 24-inch panels; Desk Consoles which are adaptable systems of instrument housing, counter and storage space; and the unique combination of chassis and case—Optima 17.

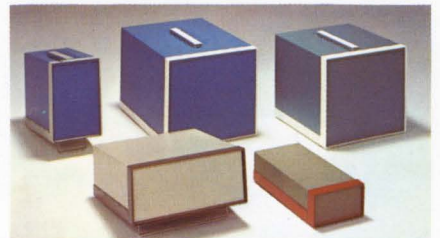

Computer scheduled manufacturing assures you of top quality control. We finish each unit inside and out with rugged vinyl and assemble them for final inspection—including most options and accessories—right at the plant.

Optima is the best answer. No question about that.

Write Optima Enclosures, 2166 Mountain Industrial Blvd., Tucker, Ga. 30084 or call (404) 939-6340.

OPTIMA



The flat-as-a-pancake TV. If you want to design one tomorrow, we're ready with your linear IC's today.

Whatever the idea you put on paper, we can probably help bring it to life.

Whether you want to design the world's flattest TV or the world's most advanced oscilloscope, chances are we've got the devices for the circuit functions you need to achieve your goals. Ready now to help your product perform the way you design it. And supply your needs in numbers from one to one million and beyond.

We're a full house in linear IC's offering standard as well as custom and proprietary types; a commodity supplier of power transistors; a recognized leader in CMOS building blocks; developers of liquid crystal displays; technology innovators of RF power components; and a major supplier of thyristors.

In addition to comprehensive technical product data, RCA gives you professional and experienced field engineering and applications

support. As well as a commitment to excellence in everything from research to manufacturing.

So whatever you're into, and whatever you need, we're here when you need us. With products that can anticipate your needs. And service that can meet your demands. A good place to start is to check our handy product line guide. Write RCA Solid State, Section 57E24, Box 3200, Somerville, N. J. 08876.

RCA Solid State