

Electronic Design 17

VOL. 20 NO.

FOR ENGINEERS AND ENGINEERING MANAGERS

AUG. 17, 1972

LSI testers come in all shapes and sizes and in a wide range of prices. They've advanced in the last few years, with more speed, improved software and

systems dedicated to memory testing. Yet many engineers still build their own test equipment. For a close look at some tough decisions, start on Page 60.

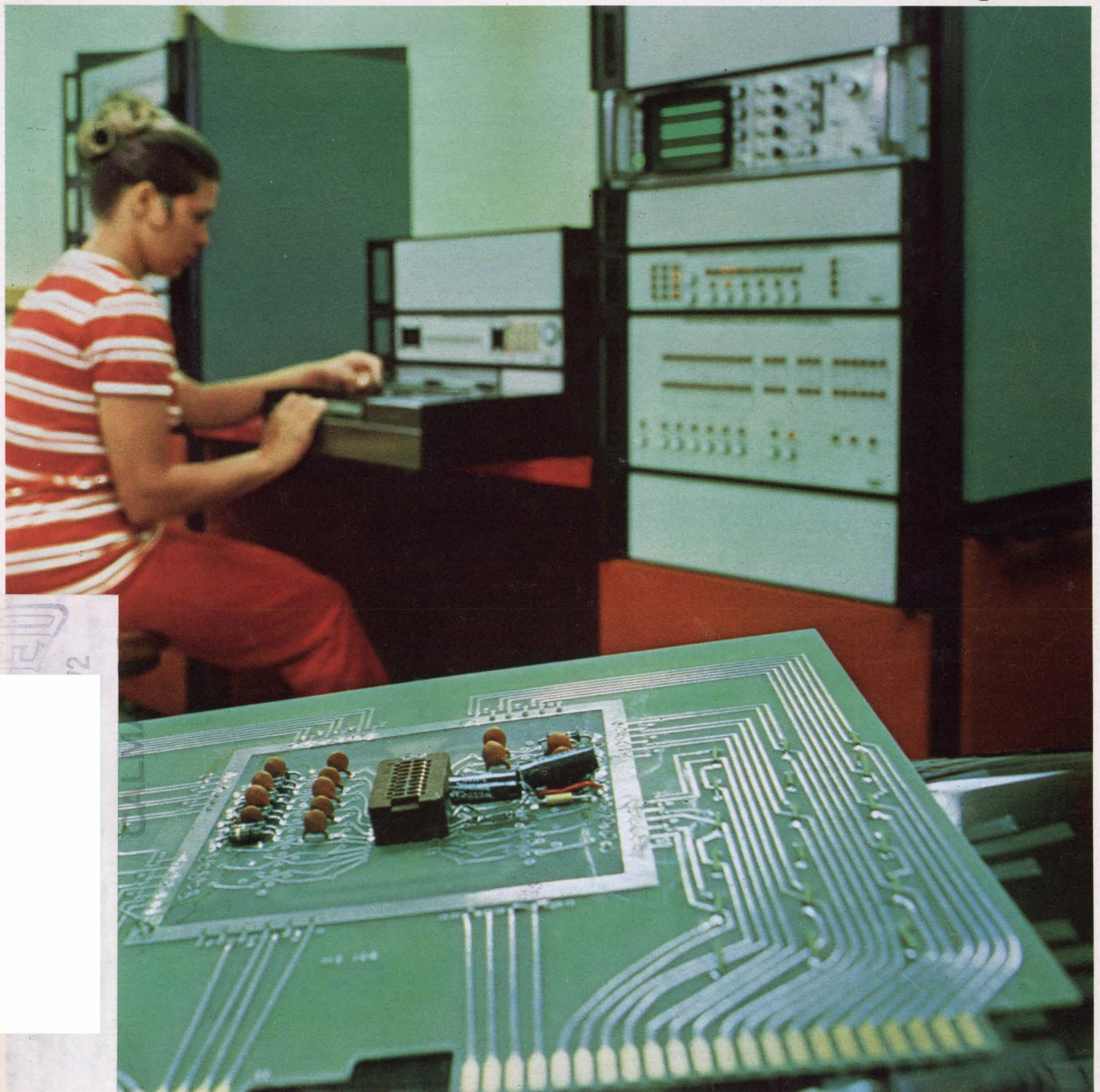

DEPENDABLE

DALE

has an edge for you in '72.

Depend on Dale for new ideas that will help you cut costs, save space and improve quality. Here's just a sample. For the complete story, send our special reply form below or contact your Dale Representative or Distributor.

new networks

We're ready now to handle your "odd jobs". Complete thick film facilities for design and production of DIP, SIP in volume. Chips. Hybrids. LED metallization a specialty.

exceptional wirewounds

Still the greatest resistor for your high power, tight tolerance needs. Models to 5000 watts—even higher in water-cooled versions. Nation's best source for non-standard resistors...send for brochure on "specials".

slimmer trimmers

Low profile DIP styles handle a full watt in .25" H x .165" W x .75" L. Cermet and wirewound models. Priced as low as 60¢. Available off-the-shelf.

powerful film

Send for free comprehensive resistor reference guide, listing industry's widest range of film styles and functions.

competitive connectors

Our price per contact in a .156" edgeboard best in the industry. Excellent prices and fast delivery on many models... including .050". NEW styles for liquid crystal applications.

capable coils

Check our new line of trigger transformers. Printed circuit and bobbin type styles for low-cost trigger source isolation in full and half wave SCR power control circuits.

special fast reply form

Clip and Mail for fast reply

Send information on:

- Thick Film Networks
- High Power Wirewounds
- Non-Standard Resistors
- Low Profile Trimmers
- Edgeboard Connectors
- Connectors for Liquid Crystal applications
- Film Resistor Reference Guide
- Trigger Transformers

NAME _____

COMPANY _____

ADDRESS _____

CITY _____ STATE _____ ZIP _____

DALE ELECTRONICS, INC.
1300 28th Ave., Columbus, Nebr. 68601
In Canada: Dale Electronics Canada, Ltd.
A subsidiary of The Lionel Corporation

N
pdp11/05

RT DEP

PANEL LOCK

POWER

OFF

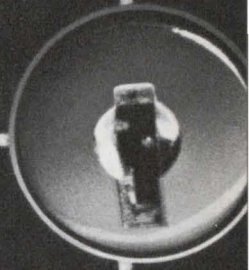

The smallest PDP-11 just got bigger.

Bigger in performance. Not in price. Or size. It's a power package that's designed to shake up the competition.

We've given the 11/05 a real time clock.

We've replaced the standard 1.2 usec memory with one that's 0.9 usec fast.

And added our PDP-11 multi-level automatic priority interrupt.

So now you can spend less time writing programs and more time out selling

your systems.

Now the 11/05 will do your job, any job, better, more efficiently than ever before.

You can even use it for disc-based systems.

But the 11/05 still goes for the same, easy-to-take \$4,795 per. Including 4K core.

Or \$3,070 in quantities of 100.

For which you still get the same UNIBUS™ architecture, direct memory access, hardware stacking, vectored interrupts, automatic power fail protection and all the other

features that have made the PDP-11 the best-selling 16-bit computer on the market.

We've already sold a lot of 11/05's.

And we're going to sell a lot more.

Because now the 11/05 is an even bigger bargain.

Digital Equipment Corporation, Maynard, Mass. 01754. (617) 897-5111. European headquarters: 81, route de l'Aire, 1211 Geneva 26. Tel.: 42 79 50.

digital

MAN-MADE DURABILITY

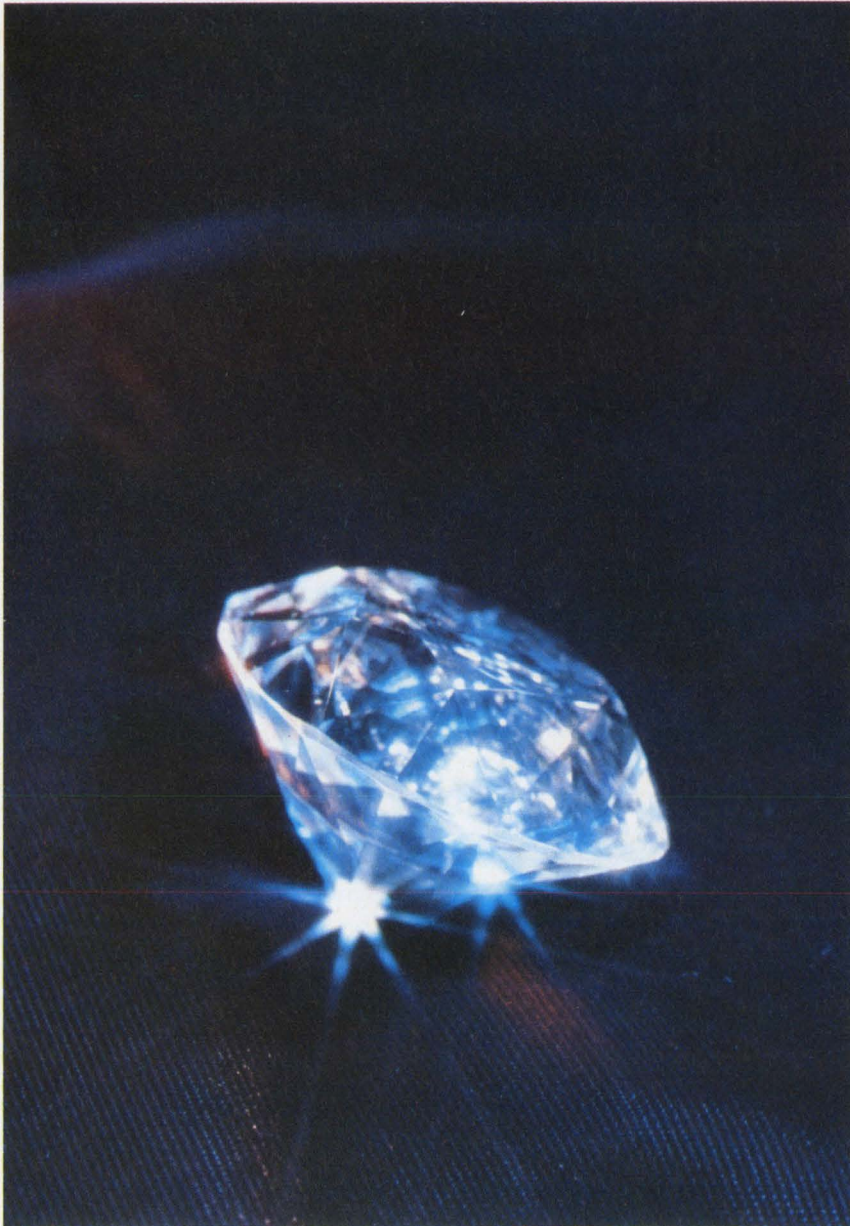

The diamond is one of the most durable of earth's elements. Man can make it into a jewel or use it as an industrial tool. It remains durable to the end. The "diamond" of the electro-mechanical relay world is the Teledyne TO-5. This accolade has been earned. The family of tiny Teledyne TO-5 general purpose Relays continues to withstand the critical requirements of long life, phenomenal reliability, and all-around hard use. These relays remain the standard for industrial, scientific, and aerospace applications throughout the world. Durability and dependability are hallmarks of Teledyne Relays and its products. You can be assured of this same high quality from our newly developed family of advanced Solid State relays. Teledyne products are constructed to last. Send us your requirements.

3155 West El Segundo Boulevard
Hawthorne, California 90250
Telephone (213) 679-2205



**TELEDYNE
RELAYS**

NEWS

- 27 **News Scope**
- 30 **Space shuttle** will largely employ off-the-shelf electronics but will also feature unique tailoring of new technologies.
- 34 **Capacitive strain gage** operates at 1750 F.
- 36 **Electronic systems to pace** the 1972 Summer Olympics. A real-time computer system will permit many innovations.
- 40 **Anyone for armchair tennis?** Try it soon on your TV screen.
- 52 **Technology Abroad**
- 55 **Washington Report**

TECHNOLOGY

- 60 **Focus on MSI/LSI Testers:** A special report on the effect that high-density microcircuitry is exerting on the design of IC test equipment.
- 72 **Use ECL 10,000 layout rules** to help solve PC-board interconnect problems. You may find you don't need large ground planes or complete transmission lines.
- 80 **Ring map minimizes logic circuit.** The technique, a modification of the Karnaugh map, detects EXCLUSIVE-OR functions or their complements at a glance.
- 84 **Try building a pulse generator** if you need one for testing logic circuits. Its performance is adequate for routine tests. The parts cost? About \$30.
- 88 **To design products that others build** engineers must anticipate the builder's problems. But the bonus is often a better product.
- 94 **Ideas for Design**
- 100 **Design Decisions**

PRODUCTS

- 103 **ICs & Semiconductors:** 8, 12-bit registers advance a/d converter designs.
- 104 **ICs & Semiconductors:** Hybrid ladder switch cuts cost for precision designs.
- 110 **Data Processing:** Static tab-card reader handles hole misalignment with brush contacts.
- 116 Components
- 119 Instrumentation
- 124 Modules & Subassemblies
- 126 Packaging & Materials
- 128 Microwaves & Lasers

Departments

- 59 **Editorial:** Manage your own career before it's too late
- 7 Across the Desk
- 130 Evaluation Samples
- 130 Design Aids
- 131 Application Notes
- 132 New Literature
- 137 Bulletin Board
- 140 Advertisers' Index
- 142 Product Index
- 142 Information Retrieval Card

Cover: Photo by Horst Osterwinter, Courtesy of Teradyne Inc.

The new P&B
solid state time delay
is more than
just a pretty face.



Our PT times with accurate solid state circuitry...switches with rugged relays. It's the best of both worlds. And it's available now from authorized P&B distributors.

A pretty face? Yes, indeed. But you get more, much more in our new PT Series panel mount time delay. For example:

- Solid state precision plus hard-contact electrical isolation.
- 10-ampere switching capacity.
- Eight dial-adjustable timing ranges...from 0.1 to 300 seconds.
- Choice of three timing modes: delay on operate, delay on release, delay on operate with both timed and instantaneous contacts.

- The accuracy, dependability and longevity associated only with solid state circuitry.

Standard models, stocked by leading electronic parts distributors, are available for 24 and 120 volts AC or 12, 24, 48, and 110 volts DC operation. They have a 3-inch diameter Lexan housing designed to be interchangeable with most mechanical timers.

Timing function lights on the face of the PT are available options. A red light indicates timing is being performed and a white light shows tim-

ing has been completed. These lights are available on 110 VDC and 120 VAC models.

The dial is calibrated in seconds and is accurate to within 10% of the full scale. Repeatability is $\pm 1\%$. Typical release time is 45 milliseconds. DC models have polarity protection and AC models withstand transients up to 1000 volts.

Modern in appearance and concept, the panel-mount PT adjustable time delay can add new precision and reliability to your equipment economically.

For full information, call your local P&B representative or write Potter & Brumfield Division of AMF Incorporated, Princeton, Indiana 47670. Telephone 812 385-5251. In Europe, AMF International Limited, Oxford, Oxon, England or S.p.A. Milan, Italy.

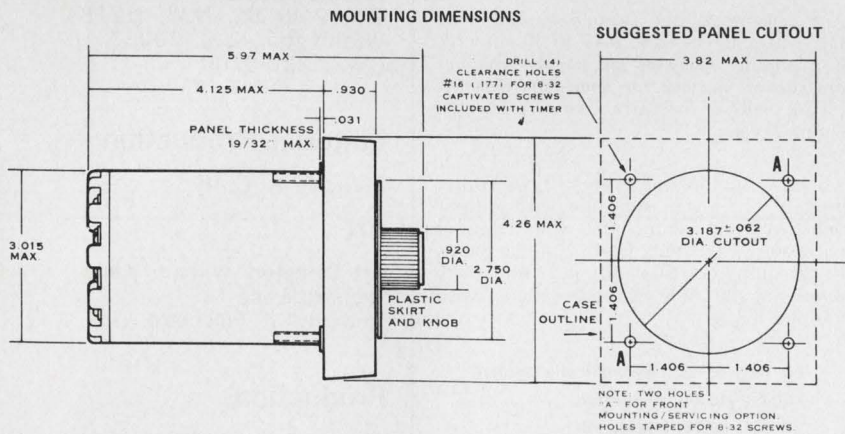

P&B makes more of more kinds of time delay relays than anybody in the business.

Anybody.

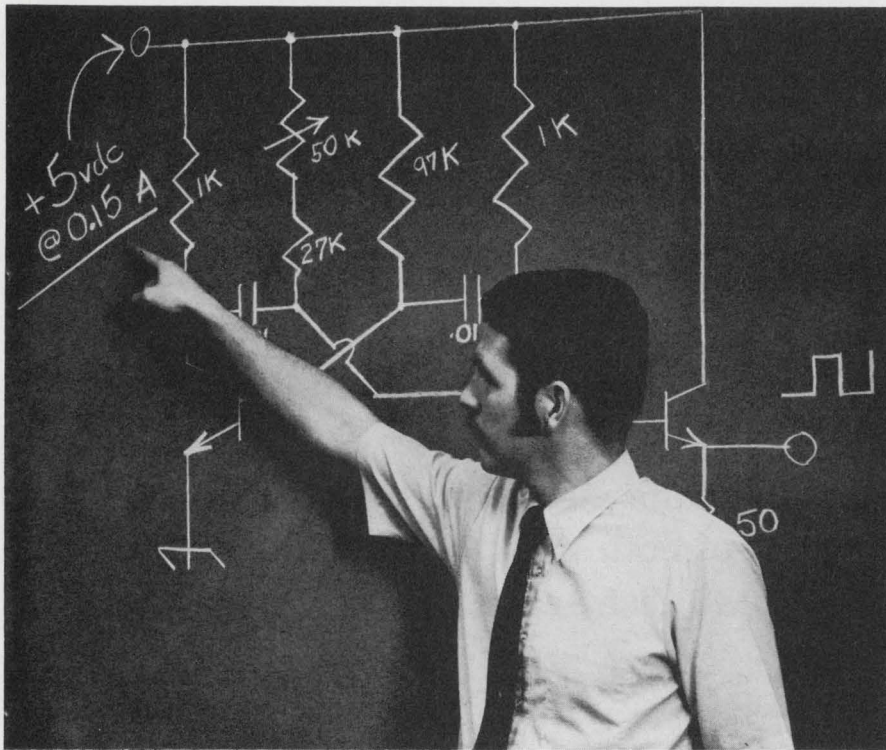

How to Design Your Power Supply for \$83

You get the **complete schematic diagram, and parts list** with operating and installation instructions when you spend \$83 for an Abbott Model "R" power supply. Two years in development, this model represents the latest state of the art in power module design. It features close regulation ($\pm 0.05\%$), low ripple (0.02%), automatic short circuit and complimentary overvoltage protection and continuous operation in a 160°F ambient.

Abbott Engineers followed specific design criteria in engineering these modules. First, the electrical design was carefully engineered to insure that all components operate well within their limits, under "worst case" operating conditions. Second, the thermal design, including case construction, was carefully made to insure that the maximum temperature limits of all components are never exceeded. Then the size and weight of these modules were controlled to a minimum, without sacrificing reliability. Finally these units were thoroughly tested to make certain that all design and performance specifications were met.

So, you can build your own power supply using our schematic diagram if you want to—but we think we can build it more

reliably and for less cost, simply because we have been doing it for ten years. Put our power supply in your system first and try it. Examine its performance. We think you will be pleasantly surprised at the quality, adherence to specifications, and the reliability you find in the Abbott Model "R".

Any output voltage from 5 to 100 volts DC with current from 0.15 to 20 amperes is available. **Many of the popular voltages are carried in stock for immediate delivery.** Please call us for attractive O.E.M. discount prices.

Abbott also manufactures 3,000 other models of power supplies with output voltages from 5.0 to 3,650 volts DC and with output currents from 2 milliamperes to 20 amperes. They are all listed **with prices** in the new Abbott catalog with various inputs:

- 60 Δ to DC, Hermetically Sealed
- 400 Δ to DC, Regulated
- 28 VDC to DC, Regulated
- 28 VDC to 400 Δ , 1 ϕ or 3 ϕ
- 24 VDC to 60 Δ , 1 ϕ

Please see pages 618 to 632 of your 1971-72 EEM (ELECTRONIC ENGINEERS MASTER Catalog) for complete information on Abbott modules.

Send for our new 56 page FREE catalog.

abbott transistor

LABORATORIES, INCORPORATED

5200 W. Jefferson Blvd./Los Angeles 90016
(213) 936-8185

1224 Anderson Ave./Fort Lee, N.J. 07024
(201) 224-6900

INFORMATION RETRIEVAL NUMBER 5

Publisher

Peter Coley

Editors

Editorial Offices
50 Essex St.
Rochelle Park, N.J. 07662
(201) 843-0550
TWX: 710-990 5071
Cable: Haydenpubs Rochellepark

Editor: George Rostky

Managing Editors:

Ralph Dobriner
Michael Elphick

Associate Editors:

Jules H. Gilder
Richard Lee Goldberg
Morris Grossman
John F. Mason
Stanley Runyon
Edward A. Torrero
Richard L. Turmail

Contributing Editor:

Peter N. Budzilovich

Editorial Field Offices

East

Jim McDermott, Eastern Editor
P.O. Box 272
Easthampton, Mass. 01027
(413) 527-3632

West

David N. Kaye Senior Western Editor
2930 West Imperial Highway
Inglewood, Calif. 90303
(213) 757-0183

Washington

Michael Blake
922 24th St., N.W. #718
Washington, D.C. 20037
(202) 338-0700

Editorial Production

Marjorie A. Duffy

Art

Art Director, William Kelly
Richard Luce
Anthony J. Fischetto

Production

Manager, Dollie S. Viebig
Helen De Polo
Maxine Correal
Anne Molfetas

Circulation

Manager, Nancy L. Merritt
Ron Deramo

Information Retrieval

Peggy Long

across the desk

Reader critiques us: 2 passes, 1 failure

In the past few years ELECTRONIC DESIGN has become one of my primary sources of new products and techniques in electrical engineering. The articles published have been, on the whole, very good because they allow one to understand a new concept or to use an old idea in a better way. It is my opinion that an article that describes a design technique should be written so that the reader can duplicate the work described and, if necessary, be referred to additional sources of information. Most of the articles you publish are well-designed, self-contained units that attain this goal. The May 25, 1972 issue contains three major articles on technology. Two of them are complete units; the third article is, to me, an irritation.

Ralph D. Taylor, in his article on CAD ("Speed Computer-Aided Design," p. 54) spends three pages on generalities, and when he finally talks about an application of his method, there is only one-half page on it. From his explanation, it was impossible to figure out how he had obtained his results. First, there was no real statement of the problem, except in generalities; the active filter specifications were omitted, when they are of prime importance in showing how the method works. Second, none of the necessary equations—again, except as generalities—was shown. Third, a flow chart and an idea of a method for picking the variables was not given. A FORTRAN program was printed; however, it is not complete enough to run, nor is it either self-explanatory or complete enough to give any idea where the results come from.

In some articles, related to CAD there has been a tendency to omit a complete example in the use of the method. By this I mean starting with the specifications for the circuit and ending with the completed design. When a program is printed, but its complete use is not given, the entire article is devalued. If it is not possible to print a more complete explanation, would it be possible to make one available to interested engineers?

Kittredge D. Seely
Materials Research Laboratory
Pennsylvania State University
University Park, Pa. 16802

Ed. note: Any reader is free to get in touch with the authors of articles in this magazine. For that reason we try to give complete mailing addresses with the authors' names.

A foolproof method to convert temperature

If you can never remember whether to add 32 or subtract 32 (and whether to do it before or after multiplying) when converting from degrees centigrade to degrees Fahrenheit or vice versa, try this technique: Add 40, multiply, subtract 40. This procedure works in both directions as follows:

$$F = (C \times 9/5) + 32$$

$$F + 40 = (C \times 9/5) + 32 + 40$$

$$F + 40 = (C \times 9/5) + 72$$

$$\text{But } 9/5 (40) = 72$$

$$\therefore F + 40 = (C + 40) 9/5$$

or

$$F = (C + 40) 9/5 - 40$$

and, conversely

$$C = (F + 40) 5/9 - 40$$

Thus, whichever conversion is desired, the same number is added

(continued on p. 10)

giga-trim capacitors for microcircuit designers

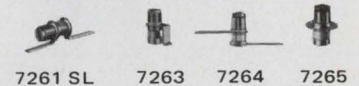
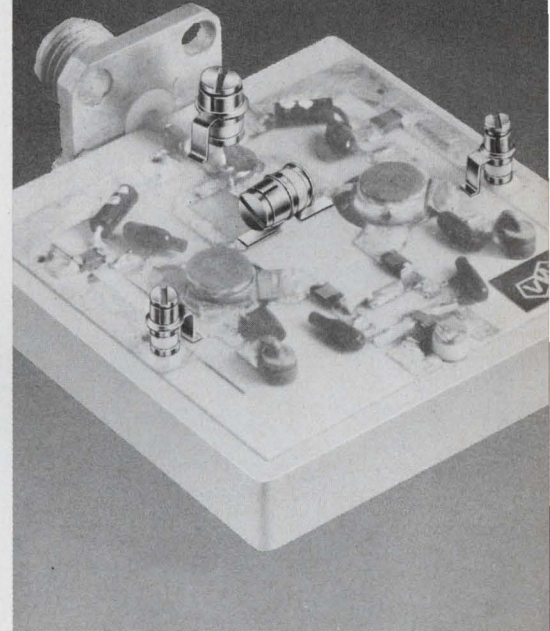

Giga-Trim® (gigahertz-trimmers) are tiny variable capacitors which provide a beautifully straight forward technique to fine tune RF hybrid circuits and MIC's into proper behavior. They replace time consuming cut-and-try adjustment techniques and trimming by interchange of fixed capacitors.

Applications include impedance matching of GHz transistor circuits, series or shunt "gap-trimming" of microstrips, external tweaking of cavities, and fine tuning of crystal oscillators.

Johanson

MANUFACTURING CORPORATION

BOONTON, NEW JERSEY 07005
201 / 334-2676

Electronic Design welcomes the opinions of its readers on the issues raised in the magazine's editorial columns. Address letters to Managing Editor, Electronic Design, 50 Essex St. Rochelle Park, N. J. 07662. Try to keep letters under 200 words. Letters must be signed. Names will be withheld on request.

INFORMATION RETRIEVAL NUMBER 6 ▶

As components become more sophisticated, the versatility of silicones is more evident.

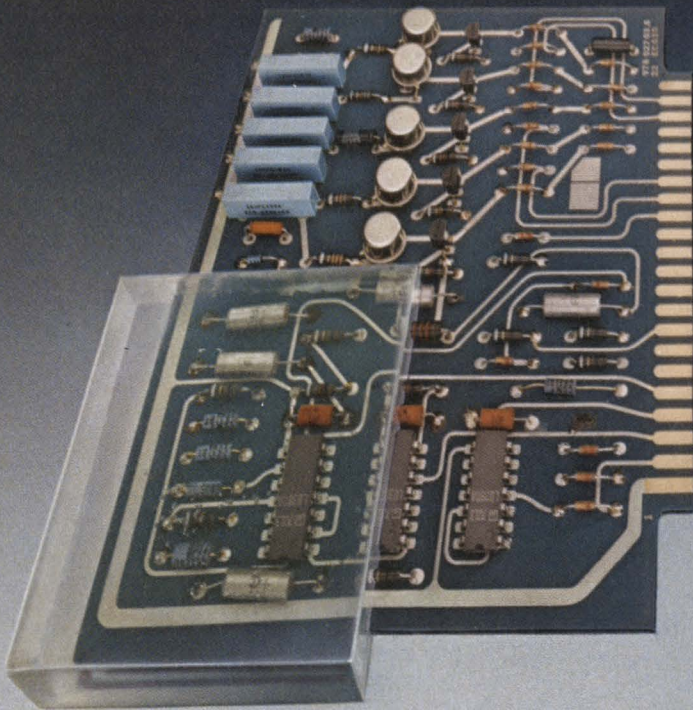

For see-through protection, encapsulate with this clear, resilient silicone resin. Self-extinguishing, it guards against humidity, heat, cold, radiation, thermal shock and vibration. Information retrieval number 221.

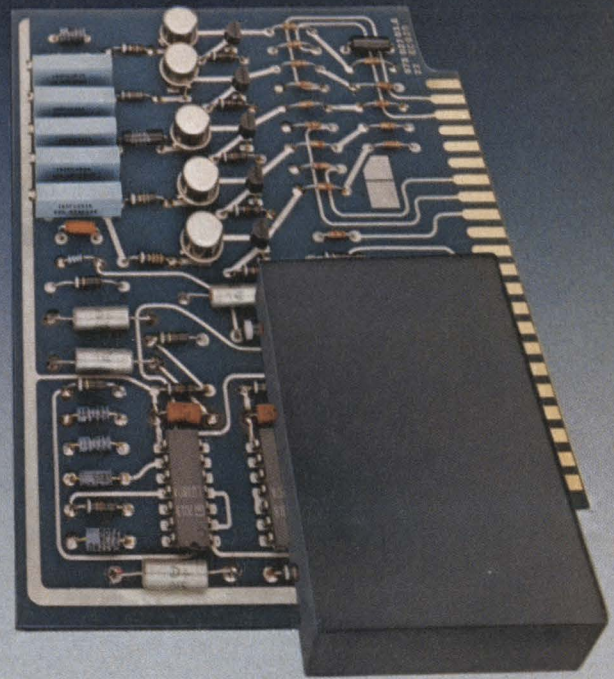

For added safety, specify this flame-retardant, pourable silicone elastomer. Uses for this low-cost packaging material include coating, potting and encapsulating. Information retrieval number 222.

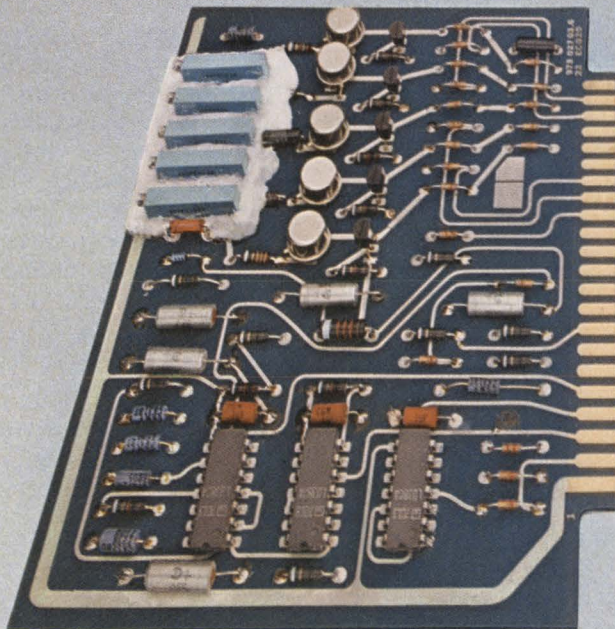

For excellent adhesion to corrosion-prone metals such as copper, use this new noncorrosive, one-part Dow Corning sealant. Cure mechanism produces no exothermic heat or acetic acid. Information retrieval number 223.

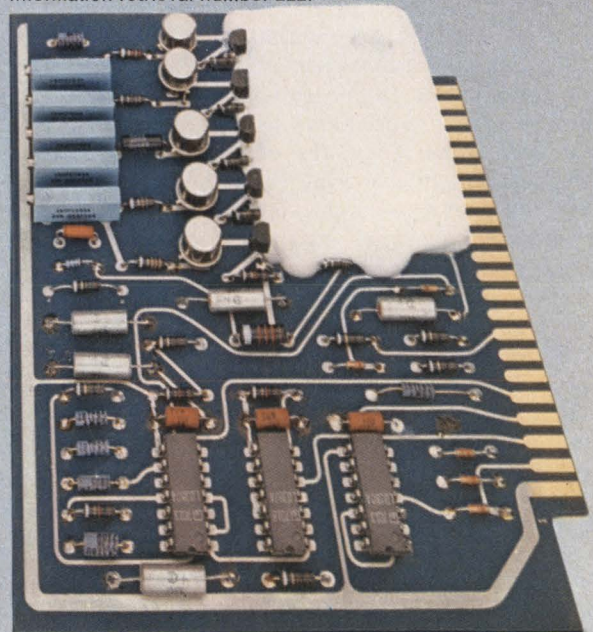

For protection against moisture, dirt, ozone, radiation and many solvents and chemicals, select this conformal coating. It flows on easily and cures at room temperature to a tough silicone rubber with excellent dielectric properties. Information retrieval number 224.

Silicones are unusual in the number of ways they protect. They resist change in hostile environments where other materials are unstable. They have excellent dielectric properties. With the electronic industry's concentration on higher performance and smaller components, the application areas where only silicone materials

can ensure design integrity have increased dramatically. Here are some of the newest examples. Many others are described in our Silicone Electronic Materials brochure available from your Dow Corning distributor. His name appears on the following page. Or write Dept. A-2202, Midland, Michigan 48640.

Electrical/electronic materials from

DOW CORNING

DOW CORNING

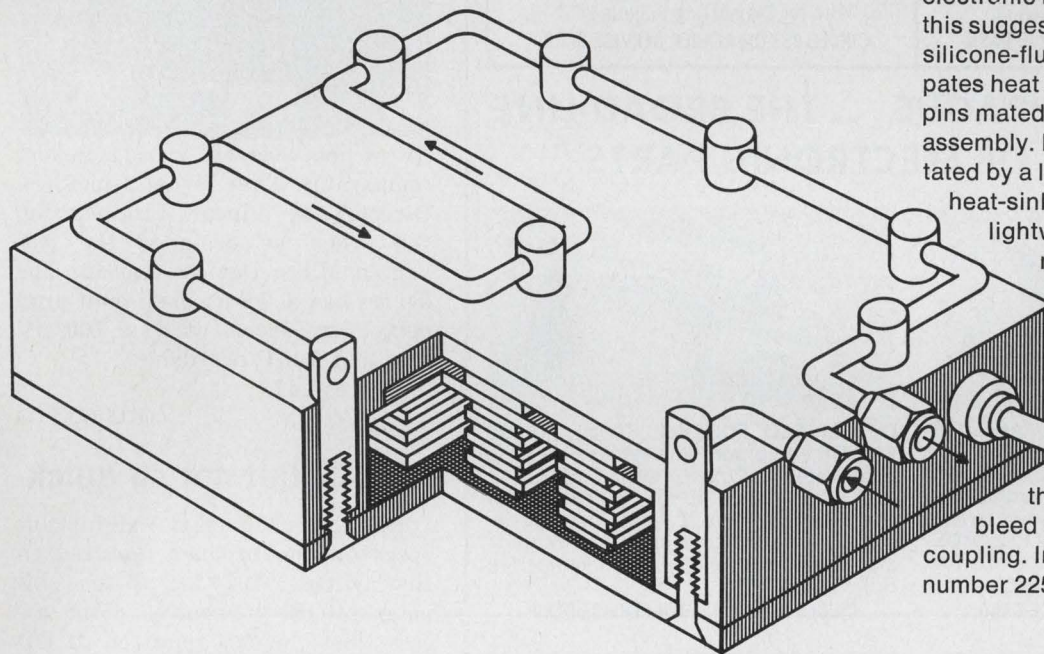

Silicones for cooling high-density modules. More efficient cooling of electronic modules is possible with this suggested assembly design. A silicone-fluid-filled coolant tube dissipates heat transferred to it from dowel pins mated to holes in the module assembly. Further conduction is facilitated by a layer of Dow Corning® heat-sink compound between a lightweight cold plate and module base. Silicone fluids have excellent heat-transfer properties and maintain constant viscosity over a wide temperature range. The heat-sink compound has high thermal conductivity and low bleed properties for long-term coupling. Information retrieval number 225.

Silicones add durability to Ominimite* transducer. This magnetostrictive device converts electrical energy into sound for ultrasonic cleaning systems. It is insulated with Dow Corning silicones. Bendix Instruments and Life Support Division uses coil forms fabricated from a Dow Corning silicone resin bonded glass laminate. Finished coils are dipped in Dow Corning® 997 varnish and baked. Silicones help add the physical and electrical stability required for long-term performance. Information retrieval number 226.

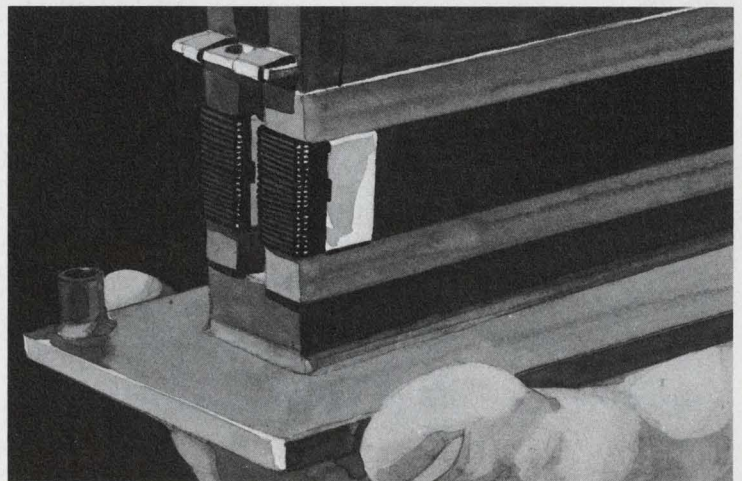

*TM, Bendix Corporation

RANGE CHANGE

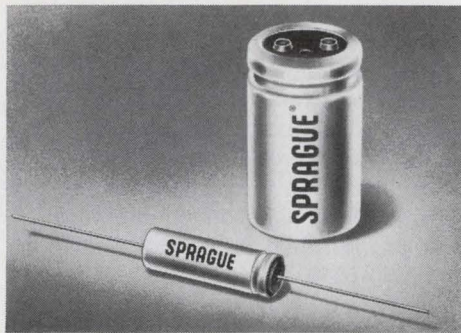

Extralytic® Aluminum 'lytic Capacitors give you extended temperature range without sacrifice in life or leakage current.

Type 601D Tubular Case	Type 602D Cylindrical Case
-55C to +105C	-55C to +85C
Superior performance over entire temperature range, unlike conventional 'lytics that do not operate satisfactorily at low temperatures. High volumetric efficiency, long shelf life, low leakage current. Withstand high ripple current. Write for Engineering Bulletin 3456A or; CIRCLE 882 ON READER SERVICE CARD.	Power supply filter capacitors specifically designed for maximum efficiency. Offer the power supply design engineer the lowest ESR and the highest ripple current capability per case size available today for long, trouble-free life. Write for Engineering Bulletin 3457 or; CIRCLE 883 ON READER SERVICE CARD.

MORE FROM SPRAGUE ... THE BROAD-LINE PRODUCER OF ELECTRONIC PARTS

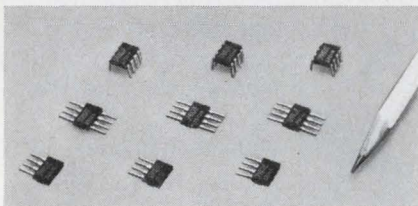

HALL EFFECT SWITCH ICs. Actuated magnetically, not mechanically or optically. Hall generator trigger circuit and signal amplification circuit on single silicon chip. Reliable (no moving parts). Easy interfacing with DTL/TTL/MOS logic. High speed. Low cost. Write for Engineering Bulletin 27,402A or; **CIRCLE 884 ON READER SERVICE CARD.**



U.L. LISTED FILTERS. Series JX5000 for EDP equipment and general-purpose use. Rated 125/250 VAC, 0-60 Hz, 1 thru 50 amps. 60 db @ 150 kHz, 80 db from .5 MHz thru 1 GHz. Special designs and rectangular multi-circuit units also available. Write for Engineering Bulletin 8210 or; **CIRCLE 885 ON READER SERVICE CARD.**

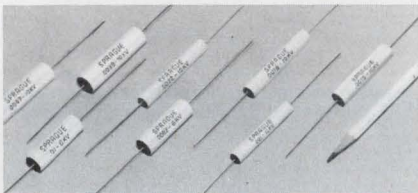

TYPE 430P METFILM® 'E' CAPACITORS. High-Voltage metallized polyester-film capacitors designed for voltage multiplier circuits used in electrostatic copiers, TV power supplies, etc. Working voltages from 4,000 to 15,000 V. Capacitance is stable with time, temperature, voltage. Write for Engineering Bulletin 2445.1 or; **CIRCLE 886 ON READER SERVICE CARD.**

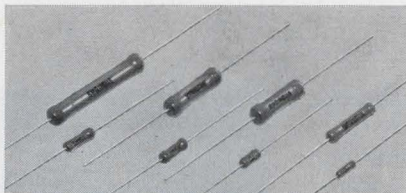

BLUE JACKET® RESISTORS. Vitreous-enamel power wirewound. Unique all-welded end-cap construction eliminates moisture paths along leads, anchors leads securely to resistor body. Expansion coefficients of vitreous enamel, ceramic body, and end caps are closely matched. Write for Engineering Bulletin 7410E or; **CIRCLE 887 ON READER SERVICE CARD.**



TECHNICAL LITERATURE SERVICE, SPRAGUE ELECTRIC CO., 347 MARSHALL ST., NORTH ADAMS, MASS. 01247

ACROSS THE DESK

(continued from p. 7)

and subtracted in both cases. If you remember that positive Fahrenheit numbers are bigger than the corresponding centigrade number—for example, water boils at 212 F or 100 C—then you can remember to multiply centigrade by the large fraction (9/5) to get Fahrenheit and multiply Fahrenheit by the small fraction (5/9) to get centigrade.

James M. Wrenn

Hewlett Packard
Automatic Measurement Div.
395 Page Mill Rd.
Palo Alto, Calif. 94306

You'd smile, too

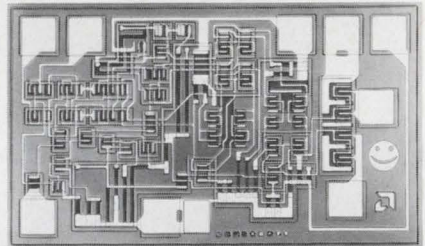

... if you were the world's fastest comparator. That's what Jim Giles, Director of Linear Engineering, felt when he designed the Advanced Micro Devices Am685. The device has a 7.5-ns maximum prop delay (measured with a 100-mV step and 5-mV overdrive).

Interested?

CIRCLE NO. 315

Less \$, but not so quick

Intel has changed two significant specs on the product featured in the article, "1024-bit Si-fuse bipolar pROM guarantees 45-ns access time," which appeared in ED 12, June 8, 1972, p. 90. The 100-up price has been lowered from \$55 to \$39, allowing Intel to beat Harris and Monolithic Memories at \$55 and Intersil at \$45. But the maximum access time has gone from 45 ns to 70 ns.

That's still quicker than Intersil's 80 ns, but it's slower than Monolithic Memories' 60 ns. It can't properly be compared with Harris' 50 ns, which is a typical—not maximum—figure.

For more information from:

Intel	CIRCLE NO. 316
Intersil	CIRCLE NO. 317
Harris	CIRCLE NO. 318
Monolithic Memories	CIRCLE NO. 319

Economical on-board programming. Quite a switch.

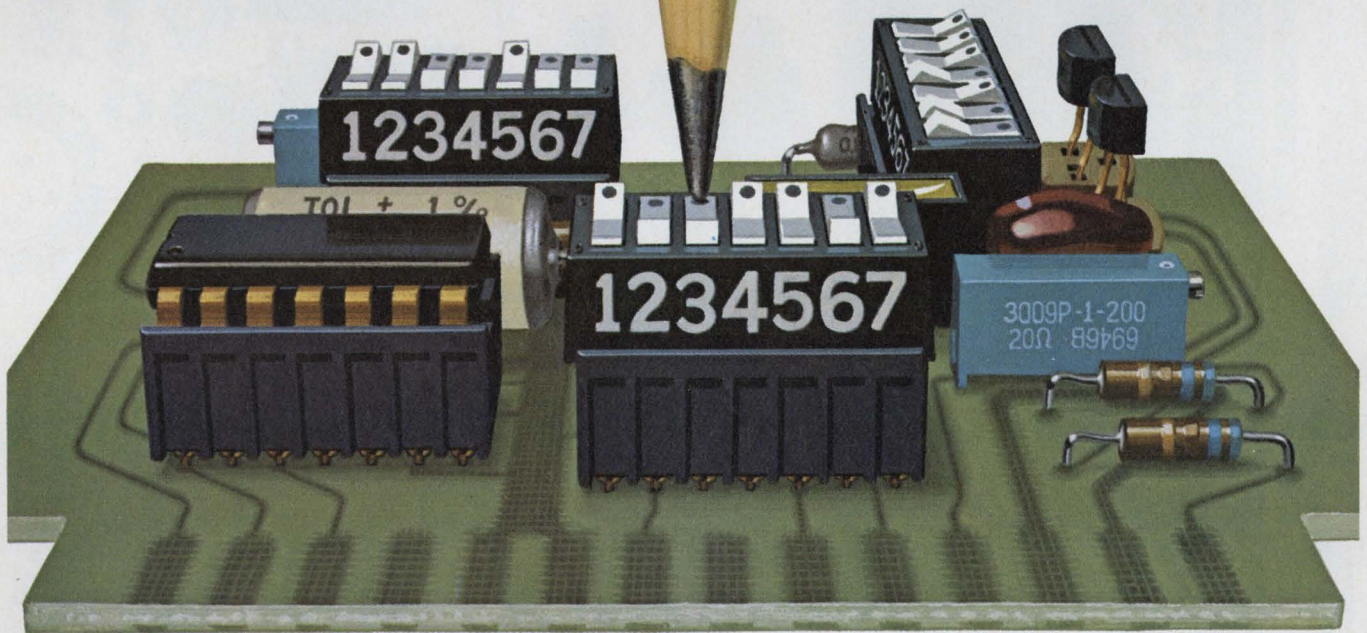

Our DIP switch, in fact. A brand-new device that lets you program your IC's right on their boards. Without the labor costs, nuisance and excessive space required by jumper wires or bracket-mounted toggle switches.

Now all you need for fast, reliable programming is a pencil and a logic diagram. Rocker buttons operate positively but easily with the touch of a pencil. And they're legibly marked to show "on" and "off" positions.

New, low-profile DIP switches take up no more room on the board than a standard DIP. And can be reflowed into plated through-holes or plugged into our

DIP headers. Gold-over-nickel plating on phosphor-bronze contacts assures reliable operation in the milliamp "dry-circuit" range.

These DIP switches are available with any number of poles you want, from 4 to 10. Most popular to date are the 7-pole and 8-pole versions which correspond, respectively, to 14-lead and 16-lead standard DIP's.

For more information on really economical on-board programming with DIP switches, write to: **AMP Incorporated, Industrial Division, Harrisburg, Pa. 17105.**

AMP INCORPORATED

Manufacturing and direct sales facilities worldwide: Barcelona, Brussels, Buenos Aires, Frankfurt, London, Mexico City, Paris, Puerto Rico, Sao Paulo, s'Hertogenbosch (Holland), Sydney, Stockholm, Tokyo, Toronto, Turin, Vienna.

191 PLEASE SEND LITERATURE—IMMEDIATE INTEREST.

192 PLEASE SEND LITERATURE—POSSIBLE FUTURE INTEREST.

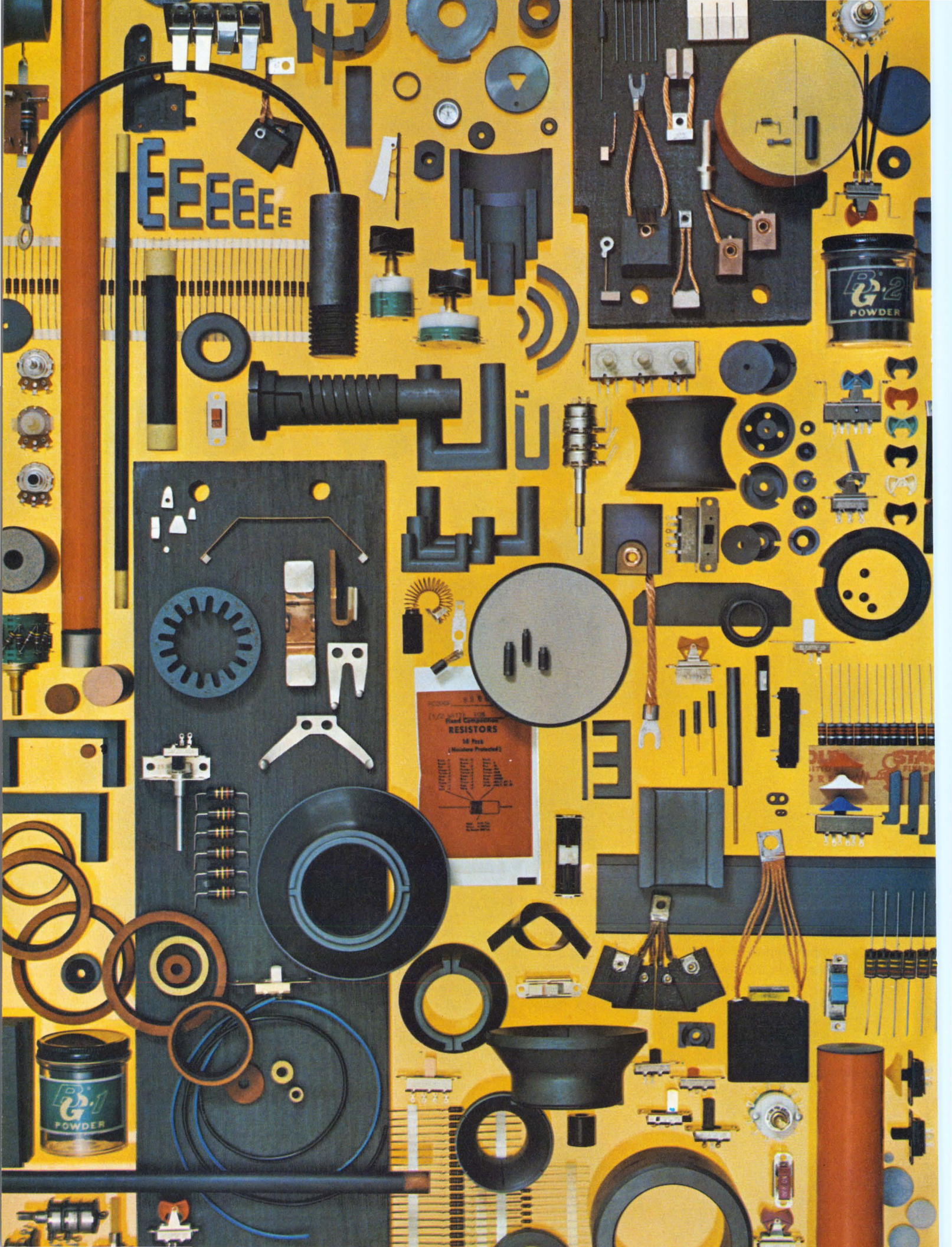

Our part in your product is value

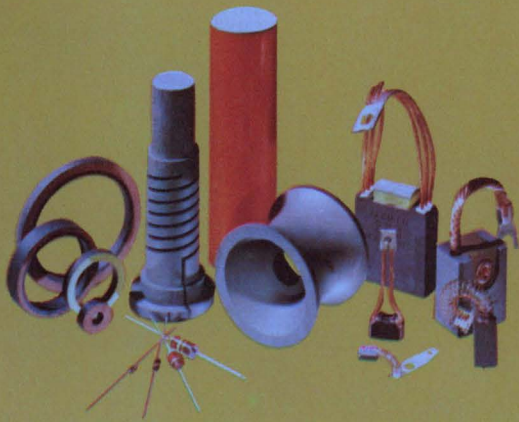

**Carbon and
Graphite
Products**

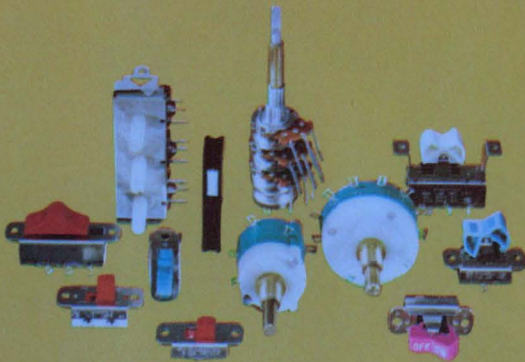

**Electro-
Mechanical
Components**



**Hard and Soft
Ferrites**

*The items shown are produced by Stackpole's
Carbon Division, Electronic Components Division,
Magnet Division and Stackpole Components Company.*

We make a lot of things at Stackpole. Components by the millions. Materials by the ton. But what really makes us different is our philosophy.

Stackpole believes in producing the best possible product, for the lowest practical price, delivered on time and backed by service. Simple? Sure. Perhaps even old-fashioned. But true. And certainly no small task.

Ours is a manufacturing technology. A capability to produce. In volume. To your specific needs.

For sixty-five years, Stackpole has served virtually every industry. To many, we are the known, respected leader. Others in emerging technologies are coming to know the special skills, imagination, experience and quality uniquely Stackpole.

Value. It's determined in performance. For products and companies alike. Let us be a part of your production team.

Stackpole Carbon Company,
St. Marys, Pennsylvania 15857.



STACKPOLE

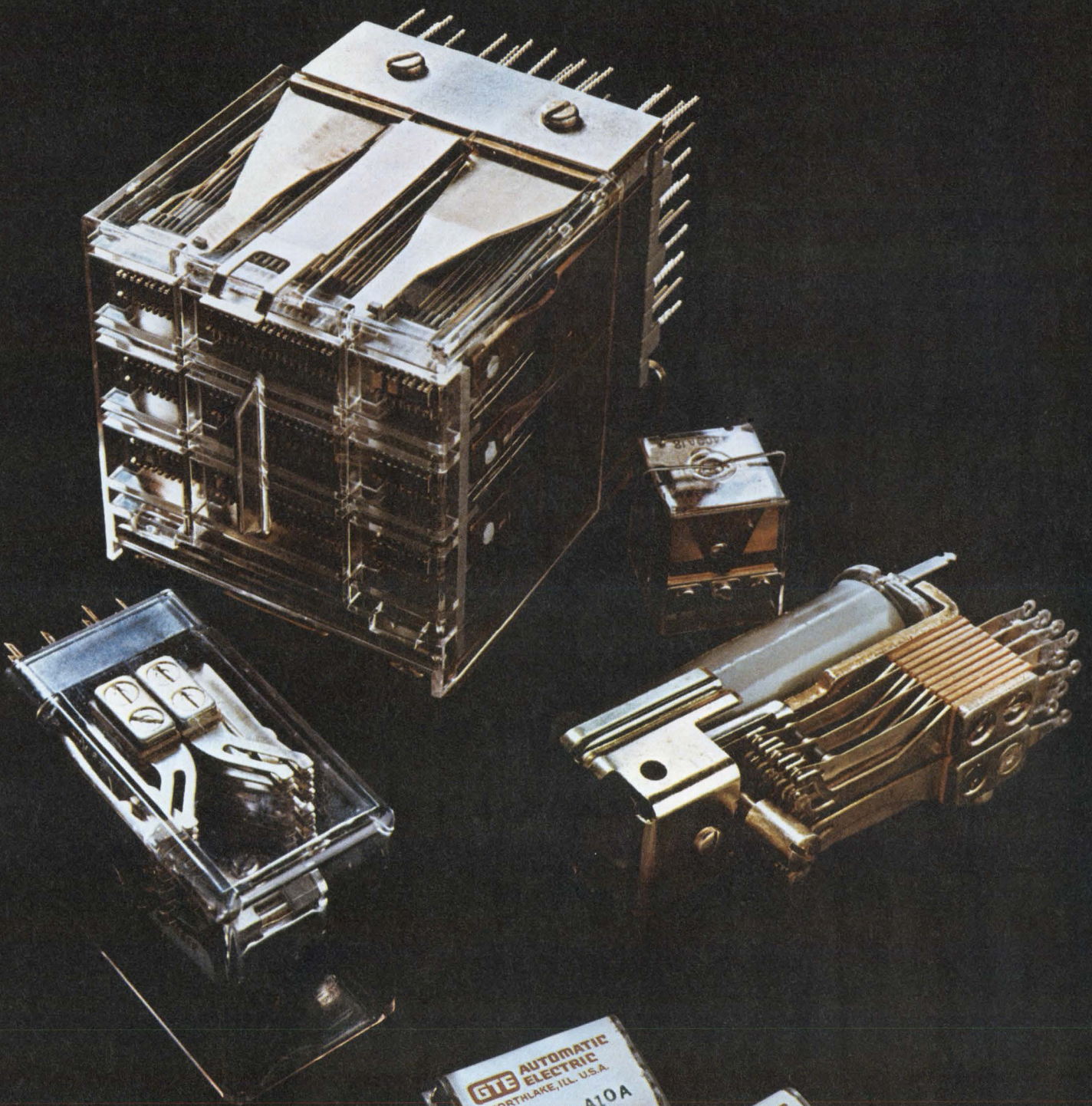

GTE AUTOMATIC
ELECTRIC
NORTHLAKE, ILL. U.S.A.
PD1311 A10A
1930 OHMS

GTE AUTOMATIC
ELECTRIC
NORTHLAKE, ILL. U.S.A.
PD1308 A11A
2600 OHMS

Announcing the rediscovery of the relay.

In an age when most people think solid state is the only way to go, some designers have rediscovered the good old electro-mechanical relay. They found relays still can't be beat when it comes to certain jobs. And when they're dealing with tight fisted cost control committees. Maybe you can save some effort and expense by rediscovering the relay whenever you need these things:

1. Simple logic:

Relays let you combine both power switching and logic functions economically. Memory can usually be retained, even after a power loss. And you don't need special power supplies or noise suppression techniques.

2. Easy troubleshooting:

Most relay failures (and they do occur occasionally) can be identified visually. You can see what's wrong. And fix it easily.

3. Heat resistance:

A relay shrugs off a short dose of overheating. Give a solid state device the same treatment while it's functioning near capacity and it's ruined forever. The amount of heat a solid state device can take is usually dependent on the heat sink used. It can take up all the room you expected to save with solid state in the first place. And finding the right heat sink design can become very involved.

4. Electrical isolation:

Relays have a natural isolation between input

circuits, between output circuits, and between output and input control circuits. You can't get that with junction type semiconductors.

5. High insulation resistance:

Open relay contacts have an insignificant amount of leakage (10^{10} ohms or more). Semiconductors can't match this. And, their leakage rates vary greatly with temperature changes.

6. Wide operating power range:

Relays work with operating power anywhere from milliwatts to watts. And they usually don't require regulated power. Semiconductors do.

7. Transient voltage immunity:

Transient voltage doesn't bother a relay. But high voltage, short duration transients can be sure death to semiconductors.

8. Forgiveness:

Relays give you a little margin of safety should you want to change your mind. Maybe you find you need more contacts, or uncover a timing problem, or discover a need for absolute input-output isolation. You can change your circuit design a lot easier with relays.

If your project or product needs any of these things, just ask our salesman to help you rediscover relays. GTE Automatic Electric, Industrial Sales Division, Northlake, Illinois 60164.

GTE AUTOMATIC ELECTRIC

(continued from p. 10)

Let George do it? How about the others?

I notice that your solicitation for letters states that the opinion of readers should be restricted to the issues raised in the editorial columns, so that you can easily decide to not print this on a legal basis. The reference is to the section on your editor, George Rostky (ED 10, May 11, 1972).

The whole write-up comes off as though George is the only man on the staff worthy of mention. Can you find any other editor's name mentioned? The only place I could find one was in a well-buried caption. I assume that George approved the section, and if this is true, is he the tyrant that is portrayed? Is he really a self-appointed combination of Ralph Nader and UL? Does he stop all articles that are "interesting"?

It would have been OK to send the write-up to your advertisers, but I think you made a mistake to print it for your readers.

*Burt Bernhold
Project Engineer*

Bell & Howell
Consumer Products Group
7100 McCormick Rd.
Chicago, Ill. 60645

Ed Note: The "George Rostky" write-up in the May 11 issue used the man simply as an embodiment of the magazine. It pointed out that an editorial team—not one man—is responsible for ELECTRONIC DESIGN. It has always been that way and always will be. We're genuinely sorry if we didn't convey that message adequately.

Readers find morals in morality advice

A number of Grummanites were glad to see Stanley Runyon's editorial "If you Want to be a Pro, Try Morality and Guts" (ED 11, May 25, 1972, p. 47). Had we not given every single relay used in

each of the lunar modules a 100% incoming X-ray "videocon" inspection, there is little doubt that Grumman's record for moon landings would have suffered. We have found all manner of crud, solder balls, unwelded brackets, loose extra seal plugs, etc., in relays submitted by manufacturers as "highly reliable" Mil Spec types.

We are also glad to see George Rostky's editorials and articles on specmanship from time to time. Keep it up.

Naturally we take a dim view of counterfeit relays that end up in flight-safety circuits, or of manufacturers who permit relays to be used on 115-V circuits when they know full well those relays can fail catastrophically once their relay cases are grounded, as they should be to protect personnel from electrical shock.

Another area of concern is the program manager who wants to meet calendar dates, whether design and parts are satisfactory or not.

E.U. Thomas

Grumman Aerospace Corp.
Dept. 482
Plant 35
Bethpage, N.Y. 11714

I find bitterly amusing the sentence in your editorial, "If engineers want to earn the much-deserved respect of management, they'll stop worrying about their jobs. . . ." And now I apparently have not earned the respect of management, because I am out of a job.

I previously worked in engineering evaluation for a large, scientific mail-order house. The quality, reliability or value of an item was seldom the answer. What was desired were descriptive words to sell the item—without complete dishonesty—and an assurance that the item would not result in too many returns. Or that it would get through the mail to the customer in one piece. And if at first you couldn't succeed in this, try again.

"Out-of-spec" devices? How about the thousands of items being sold that have no specs. And no morality even enters into the selling of them!

Ed Schempp

Barrington, N.J.

New too!

The new F.E.T. HA-2000 combines with the Harris HA-2520 and HA-2620 high performance op amps to provide two additional new F.E.T. Input devices:

HA-2050/2055 High Slew Rate F.E.T. Input Op Amp

High slew rate 120/ μ s
Fast settling time 400 ns
Wide power bandwidth 20 MHz
High input impedance 10^{12} Ohms
Ultra-low bias current 1 pA

Operates inverting or non-inverting
Supplied TO-99 pkgs.

	Input offset voltage	100-999 units
HA-2050 -55°C to +125°C	15mV	\$19.25
HA-2050A -55°C to +125°C	7mV	\$24.00
HA-2055 0°C to +75°C	30mV	\$11.75
HA-2055A 0°C to +75°C	7mV	\$13.40

HA-2060/2065 Wideband F.E.T. Input Op Amp

Widepower bandwidth 600 KHz
Gain bandwidth product 100 MHz
High input impedance 10^{12} Ohms
Low bias current 1 pA
High slew rate 35 V/ μ s

Operates inverting or non-inverting
Supplied TO-99 pkgs.

	Input offset voltage	100-999 units
HA-2060 -55°C to +125°C	15mV	\$15.40
HA-2060A -55°C to +125°C	7mV	\$19.90
HA-2065 0°C to +75°C	15mV	\$10.20
HA-2065A 0°C to +75°C	7mV	\$11.85



HARRIS
SEMICONDUCTOR
A DIVISION OF HARRIS-INTERTYPE CORPORATION

P.O. Box 883, Melbourne, Florida 32901
(305) 727-5430

INFORMATION RETRIEVAL NUMBER 91

Unique.

Our new F.E.T. input preamp offers more design features and application possibilities than any alternative device.

The HA-2000 is universal. A monolithic unity gain differential amplifier stage with junction F.E.T. inputs and bipolar transistor outputs, it can be combined with any op amp, comparator, and most linear circuit functions without compromising the features of these devices.

As a result, the HA-2000 offers almost limitless possibilities for

low-input current, high source impedance applications such as buffers for op amps and comparators. In addition, because of its compatibility with so many other components, the device permits the user great flexibility in systems design at optimum prices. Find out about our new "universal" F.E.T. preamp. See your Harris distributor or representative.

Features:

Converts any op amp or comparator to F.E.T. input

Input bias current 1 pA

Input resistance 10^{12} Ohms

Slew rate 100 Volts/ μ Sec.

Bandwidth flat to 10 MHz and -10db at 100 MHz

Supplied TO-99 pkgs.

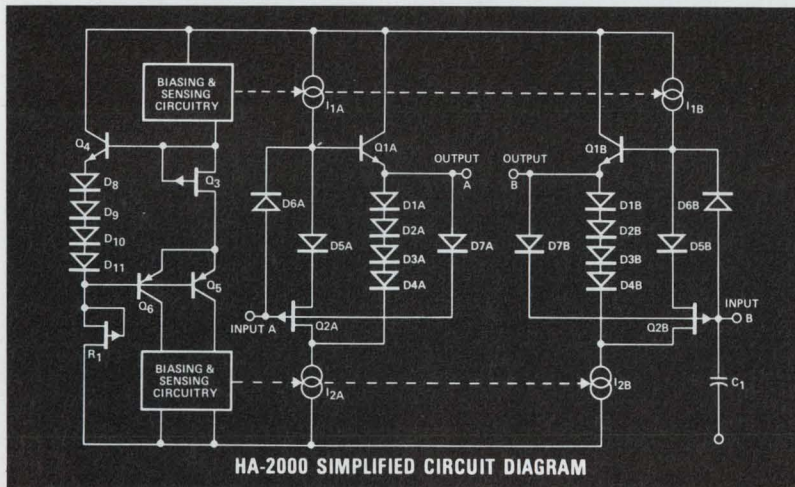

	Input offset voltage	100-999 units
HA-2000 -55°C to +125°C	12mV	\$ 6.50
HA-2000A -55°C to +125°C	5mV	\$10.95
HA-2005 0°C to +75°C	25mV	\$ 4.35
HA-2005A 0°C to +75°C	5mV	\$ 5.95

For information on other new F.E.T. Op Amps incorporating the HA-2000, see the adjacent column.

Harris



HARRIS
SEMICONDUCTOR
A DIVISION OF HARRIS-INTERTYPE CORPORATION

P.O. Box 883, Melbourne, Florida 32901
(305) 727-5430

WHERE TO BUY THEM: ARIZONA: Phoenix—Liberty, Weatherford; Scottsdale—HAR (802) 946-3556 CALIFORNIA: Anaheim—Weatherford; El Segundo—Liberty; Glendale—Weatherford; Long Beach—HAR (213) 426-7687; Mountain View—Elmar; Palo Alto—Weatherford, HAR (415) 321-2280; Pomona—Weatherford; San Diego—Weatherford, Western COLORADO: Denver—Elmar, Weatherford WASHINGTON, D.C.: HAR (202) 337-4914 FLORIDA: Hollywood—Schweber; Melbourne—HAR (305) 727-5430 ILLINOIS: Chicago—Semi-Specs, Schweber; Palos Heights—HAR (312) 597-7510 INDIANA: Indianapolis—Semi-Specs MARYLAND: Rockville—Schweber MASSACHUSETTS: Lexington—R&D; Waltham—Schweber; Wellesley—HAR (617) 237-5430 MICHIGAN: Detroit—Semi-Specs MINNESOTA: Minneapolis—Semi-Specs MISSOURI: Kansas City—Semi-Specs; St. Louis—Semi-Specs NEW MEXICO: Albuquerque—Weatherford NEW YORK: Melville—HAR (516) 249-4500; Syracuse—HAR (315) 463-3373; Rochester—Schweber; Westbury—Schweber OHIO: Beachwood—Schweber; Dayton—Semi-Specs PENNSYLVANIA: Pittsburgh—Semi-Specs; Wayne—HAR (215) 687-6680 TEXAS: Dallas—Weatherford, Semi-Specs, HAR (214) 231-9031 WASHINGTON: Seattle—Liberty, Weatherford.

LEGEND FOR HARRIS SALES OFFICES & DISTRIBUTORS: Harris Semiconductor (HAR); Elmar Electronics (Elmar); Harvey/R&D Electronics (R&D); Liberty Electronics (Liberty); Schweber Electronics (Schweber); Semiconductor Specialists, Inc. (Semi-Specs); R. V. Weatherford Co. (Weatherford); Western Radio (Western).

INFORMATION RETRIEVAL NUMBER 10

Line drivers and

MOTOROLA LINE DRIVERS

TYPE	MC75109	MC75110	MC75113
BLOCK DIAGRAM			
OPERATING FREQ.	< 10 MHz	< 10 MHz	< 10 MHz
LENGTH OF LINE	< 5000'	< 10,000'	< 20,000'
INPUT	TTL	TTL	TTL
TYPICAL LOAD CURRENT	6 mA	12 mA	± 20 mA
PARTY LINE OPERATION	YES	YES	YES
STROBE	YES	YES	NO
POWER SUPPLIES	± 5 V	± 5 V	± 5 V
FEATURES	INSENSITIVE TO SUPPLY VARIATIONS OVER ENTIRE OPERATING RANGE INHIBITOR AVAILABLE FOR DRIVER SELECTION		CAPABLE OF SOURCING CURRENT WITH ONE OUTPUT AND SINKING CURRENT WITH THE OTHER

TYPE	MC1488	MC1580	MC1582	MC75450	MC75451
BLOCK DIAGRAM					
OPERATING FREQ.	< 2.5 MHz	< 10 MHz	< 10 MHz	1 MHz	1 MHz
LENGTH OF LINE	< 50'	< 5000'	< 5000'	< 500'	< 500'
INPUT	TTL	MECL	TTL	TTL	TTL
TYPICAL LOAD CURRENT	10 mA	8 mA	8 mA	—	—
PARTY LINE OPERATION	NO	YES	YES	YES	YES
STROBE	NO	NO	NO	NO	NO
POWER SUPPLIES	± 9 V	± 5 V	± 5 V	± 5 V	± 5 V
FEATURES	SATISFIES EIA STANDARD RS-232 SIMPLE SLEW-RATE CONTROL	COMMON-MODE INPUT RANGE ± 3.5 V COMMON-MODE OUTPUT RANGE -3 V/+9 V		TWO STANDARD TTL GATES TWO UNCOMMITTED HIGH VOLTAGE NPN TRANSISTORS	POSITIVE "AND" DRIVER OUTPUT TRANSISTORS INTERNALLY CONNECTED

MOTOROLA LINE RECEIVERS

TYPE	MC75107	MC75108	MC1581	MC1583	MC1584	MC1489/89A
BLOCK DIAGRAM						
INPUT SENSITIVITY	25MV MAX	25MV MAX	50MV MAX	50 MV MAX	60MV MAX	ADJUSTABLE FROM -3 V TO +3 V
PROPAGATION DELAY NSEC	25 MAX	25 MAX	20 MAX	30 MAX	37 NSEC	50 MAX
STROBE CAPABILITY	YES	YES	NO	NO	NO	THRESHOLD ADJUST AND RESPONSE CONTROL
OUTPUT	TTL ACTIVE PULL-UP	TTL OPEN COLLECTOR	MECL	TTL OPEN - COLLECTOR	TTL - ACTIVE PULL-UP	RESISTIVE PULL-UP
POWER SUPPLIES	± 5 V	± 5 V	+5 V, -5.2 V	± 5 V	± 5 V	+5 V
FEATURES	DIODE PROTECTED INPUT STAGE HIGH COMMON-MODE REJECTION RATIO HIGH DC NOISE MARGINS		± 3.5 V COMMON-MODE INPUT RANGE HIGH INPUT IMPEDANCE			SATISFIES EIA STANDARD, RS-232 BUILT-IN HYSTERESIS



- Supply variation immunity
- Diode protected inputs
- New design

receivers step ahead.

Line driver and receiver design advances don't come along every day. Now, in three simultaneous strides, two Motorola twisted-pair line drivers offer more than the types they replace, so do two receivers, and a brand new driver is introduced to serve a previously unmet need.

Output sink current is independent of positive and negative supply fluctuations, allowing immunity to supply variations over their entire operating range. Thus the MC55/75109 and 110 are superior to the line drivers they replace. Step one.

MC55/75107 and 108 are superior to the receiver types they replace because diode protection on all input stages preserves data transmitted during power down periods of a particular receiver in

party line applications. Step two.

Step three. The MC75113. A brand new push pull driver designed for high speed data transmission systems using balanced terminated lines. The first one specifically created for party line operation. Output sink current (typ) is 20 mA. Output common-mode voltage range is ± 3 V.

FOR PRICE WATCHERS

Circuit	100-999 \$ Price	Circuit	100-999 \$ Price
MC55107L	4.80	MC55109L	5.15
MC75107L	3.20	MC75109L	3.35
MC75107P	2.65	MC75109P	2.80
MC55108L	-4.80	MC55110L	5.15
MC75108L	3.20	MC75110L	3.35
MC75108P	2.65	MC75110P	2.80
MC75113L	3.10		

In late 1969 we introduced the industry's first twisted pair line driver and receiver family, the MC1580 series. Hundreds of thousands of Motorola line drivers and receivers have been delivered since we introduced the industry's first

EIA RS232C drivers and receivers, the MC1488 and MC1489. And our new developments are only the latest steps in Motorola's continuing effort to meet the expanding needs of a dynamic industry.

These new devices are among the many in Motorola's broad line of linear interface circuits available now from Motorola distributors and sales offices. Since you probably want more information before you buy than the selection guide on the opposite page provides, circle the reader service number or write to Motorola Semiconductor Products Inc., Box 20912, Phoenix, AZ. 85036. We'll also send a copy of our handy new Linear IC Pocket Cross Reference as long as the supply lasts.

MOTOROLA LINEAR
— Serving a greater range of analog designs

EA1500 N-CHANNEL Si GATE TAKES ON BIPOLAR.

There's a lot of noise these days about RAMs and new super, bipolar processes. Well, we'd like to challenge all those bipolar claims. In fact, you can too. All one needs to do is pick up the data sheets and compare.

You may have heard or read that MOS is slower than bipolar. The fact is that the EA1500 N-channel silicon gate 1K RAM has an access time of 85nsec—worst case, including voltage variation, over the 0° to 70°C temperature range. Our "fair" competition also specs their 1K bipolar RAM at 85nsec—but at a nominal voltage and a junction temperature of 25°C!

OK, let's just assume it's a standoff in speed. In power dissipation, the EA1500 with a maximum, worst case, guaranteed .220mW/bit wins right out. The 93415 draws .684mW/bit at 75°C case temperature. That would take a whole bunch of air conditioning if you're going to use more than one.

Then, of course, there's price. The EA1500 sells for about one-third less than the 93415. That's 2.4¢/bit vs. 6.8¢ per bit in 100 up quantities. Just add up your bits and add up your savings. Finally, when you come to EA, you can get it. Because we don't tout it until we got it.



electronic
arrays,
inc.

501 ELLIS STREET
MOUNTAIN VIEW, CALIFORNIA 94040
(415) 964-4321 TWX: 910-379-6985



THE GREAT RAM CHALLENGE: N-CHANNEL VS. BIPOLAR.



APPROVED MIL-C-39010

Nytronics' history of technical leadership in inductors has a new chapter. The first company to extend the standard line concept to variable inductors has remained ahead in every subsequent step of refinement and miniaturization.

Today, there's a new place for a familiar group of inductors under highest reliability military specifications—MIL-C-39010

With sizes ranging from the world's smallest shielded inductor to the most complex variable inductor...shielded, unshielded, chip and variable, in hundreds of off-the-shelf values...it makes good sense to check first with Nytronics or your local distributor.

Now tested and approved to highest reliability military specifications.

Nytronics Standard Inductor Part Number	Standard Military Series	New High Reliability Qualification
SWD	MS90537	MIL-C-39010/01-0001 thru /03-0185
SWD	MS75037	MIL-C-39010/01-0001 thru /01-0046
SWD	MS75088	MIL-C-39010/02-0001 thru /02-0053
SWD	MS75089	MIL-C-39010/03-0001 thru /03-0185
RFC-SS	MS18130	MIL-C-39010/06-0001 thru /06-0061 /07-0001 thru /07-0037
RFC-S	MS75008	MIL-C-39010/04-0001 thru /04-0049 /05-0001 thru /05-0045



Nytronics, Inc.

ORANGE STREET, DARLINGTON, S. C. 29532
(803) 393-5421 • TWX 810-665-2182

New bi-polar power-dac* solves five major system problems in automatic test equipment TM

A new programmable power source from the John Fluke Company solves several big system problems. Appropriately called a Power-DAC, the Models 4250A and 4265A provide up to ± 65 volts at 1 amp, with a 100 micro-second settling time to 0.01% accuracy. A full complement of options provide needed flexibility in both price and performance.

1. Parallel or series operation — just like batteries

Have you ever needed just a little more current or voltage to test a new device? (Probably this slight extra capability is only needed for a very few tests.) With the 4200 Series Power-DAC, you can double, triple or quadruple your current or voltage capability by a simple parallel or series connection with external relays. No special hardware or software protection features are required. With several Power-DACs in your system you have both single unit control and unlimited power configuration at the discretion of the programmer.

2. AC or DC outputs provide versatility

In addition to the standard internal dc reference, an external reference option allows any external ac or dc signal to be used as the reference for the bi-polar D-to-A ladder network. The Power-DAC can perform many different functions within the test system. Operate it as a programmable amplifier, attenuator or multiplying DAC for either ac or dc signals up to 30 kHz. Amplitude of fixed level function generators and special purpose signal sources can be precisely controlled from microvolt levels up to 50v rms at 0.7 amp rms. By accurately controlling the level of the external reference, programming resolution can be varied from 1 millivolt to several microvolts. Either the internal or external reference is selected by a 1-bit control line. The 100 μ sec settling time includes polarity change, range change and selecting either the internal or external reference.

3. Fast programmable current limiting protects circuits under test

Standard models provide a gross 1.2 amp current limit as an overload protection feature. One option provides a programmable current limit in two ranges, 100 ma and 1 amp. Each range is programmable in 10 percent steps, yielding 10 ma or 100 ma resolution. When the overload occurs, transition from the constant voltage mode to the current mode requires less

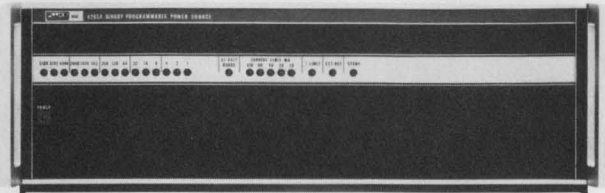

Model 4265A

than 20 microseconds, the crossover time being a function of the load. The larger the overload, the faster the transition. This fast crossover capability minimizes the energy transients to the circuits under test.

4. Programming glitch reduction

A unique track-and-hold technique during the programming interval reduces the peak glitch and transient excursions to less than 50 mv in the 16 volt range, and less than 100 mv in the 65 volt range. Transitions from computer generated waveforms or incremental slewing operations take place smoothly.

5. Isolation and guarding reduces noise and ground loops

Digital and analog portions of the 4200s are separated by a metal guard to eliminate both ground loops and digital noise which severely affect the system performance of conventional power supplies and D-to-A converters. With the isolated control logic option, impedance between the digital control logic and the analog circuits is 10^9 ohms in parallel with 3 picofarads. This isolation provides significant rejection of system noise on the analog output. Up to 1000 volts of common mode voltage can be applied between chassis ground and the guard terminal without harming the instrument, or causing severe common mode errors.

Prices and options

For \$1295, the basic 4250A and 4265A are equipped with direct coupled control logic and blank front panel.

The isolated control logic option which also contains a memory register for storing the program command is \$300. The external reference, programmable current limit and front panel digital display options are priced at \$200 each. Delivery is 30 days. For complete specifications on all 4200 Series Power-DACs, write Fluke, P. O. Box 7428, Seattle, WA 98133.

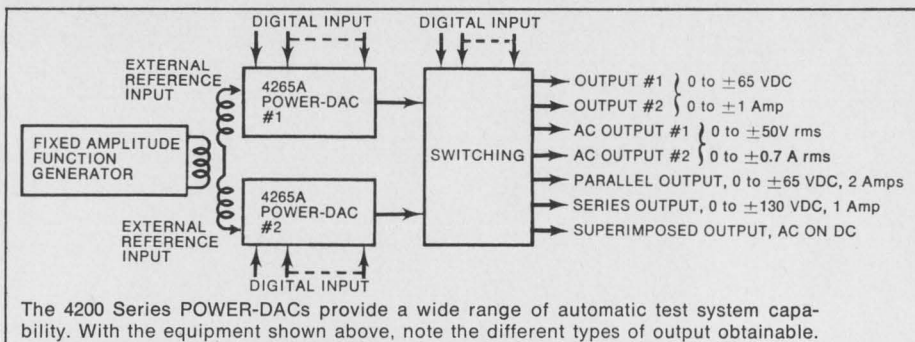

Someday other switches may have it.

*But until then, only Licon can build and sell patented double-break Butterfly® switching.
(Type 16 switch Butterfly mechanism shown twice its actual size.)*

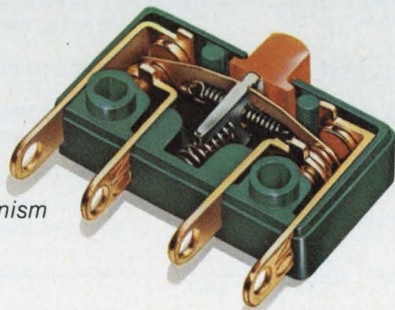

Why are Licon patented double-break Butterfly® switches better? Because they give a degree of reliability you simply can't get in single-break switches. It's inherent in the design. There are other advantages, too. A higher current rating than comparably-sized single-break switches. Two-circuit control with one switch. High shock and vibration resistance. And Licon's exclusive Butterfly wiping action which resists contact welding ... minimizes mechanical bounce to increase electrical life. And there's a

versatile variety of low-cost Butterfly switches available immediately. In sub-miniature switches, our Type 16 SPDT series offers a wide choice of terminal styles. With our Type 26 DPDT series you can control up to four isolated circuits. Type 36 3PDT series controls multipole circuits. Or try our sub-subminiature Type 18 SPDT series which packs super reliability into super small volume. All these switches are snap action. All meet MIL specs. And all offer choice of contact arrangements, case and contact

materials. Check them out with your Licon distributor or representative. Or call or write for a Licon Switch Catalog. **Licon, Division Illinois Tool Works Inc., 6615 W. Irving Park Road, Chicago, Illinois 60634. Phone (312) 282-4040. TWX 910-221-0275.**



i t w LICON

The Innovating Electronic Group of ITW... LICON ■ ELECTRO MATERIALS ■ PAKTRON

INTRODUCING 54C/74C. CMOS, SIMPLIFIED.

If you've been designing with 54/74 series TTL (standard or low-power) and would now like to design with CMOS, we've greatly eased the procedure.

Our new MM54C and MM74C devices are functionally equivalent to and pin-and-power-supply-compatible with standard and low-power 54/74. Noise immunity is typically *45% of supply voltage* (which can be anywhere from 3 to 15 volts). And power dissipation is typically *10 nanowatts per gate*. All this with the kind of functions you've come to know and love with 54/74 TTL.

In addition to our new full temperature range MM54C/74C series and our intermediate temperature range MM64C series, we are also second-sourcing many of the other popular CMOS devices on the market.

For full particulars on CMOS, National style, simply call us at (408) 732-5000.

Or drop us a line. National Semiconductor Corporation, 2900 Semiconductor Drive, Santa Clara, California 95051.

CMOS, NATIONAL STYLE

Part Number	Function	Availability
MM74C00/MM64C00/MM54C00	Quad 2-input NAND Gate	Now
MM74C02/MM64C02/MM54C02	Quad 2-input NOR Gate	Now
MM74C04/MM64C04/MM54C04	Hex Inverter	November
MM74C10/MM64C10/MM54C10	Triple 3-input NAND Gate	Now
MM74C20/MM64C20/MM54C20	Dual 4-input NAND Gate	Now
MM74C74/MM64C74/MM54C74	Dual "D" Flip-Flop	Now
MM74C73/MM64C73/MM54C73	Dual J-K Master-Slave Flip-Flop	October
MM74C76/MM64C76/MM54C76	Dual J-K Master-Slave Flip-Flop	October
MM74C107/MM64C107/MM54C107	Dual J-K Master-Slave Flip-Flop	October
MM74C95/MM64C95/MM54C95	4-Bit Parallel-In/Parallel-Out Shift Register	December
MM74C160/MM64C160/MM54C160	Synchronous Decade Counter	November
MM74C161/MM64C161/MM54C161	Synchronous 4-Bit Binary Counter	November
MM74C162/MM64C162/MM54C162	Fully Synchronous Decade Counter	November
MM74C163/MM64C163/MM54C163	Fully Synchronous 4-Bit Binary Counter	November
MM74C195/MM64C195/MM54C195	4-Bit Parallel-Access Shift Registers	November
MM74C173/MM64C173/MM54C173	Quad Latch	December
MM74C151/MM64C151/MM54C151	8-Bit Data Selections/MUX with Strobe	December
MM74C157/MM64C157/MM54C157	Quad 2 Line to 1 Line MUX	February
MM74C42/MM64C42/MM54C42	BCD-to-Decimal Decoder	December
MM74C154/MM64C154/MM54C154	4 to 16 Line Decoder Demultiplexer	January
MM74C192/MM64C192/MM54C192	Synchronous Up/Down Decade Counter	February
MM74C193/MM64C193/MM54C193	Synchronous Up/Down 4-Bit Binary Counter	February
MM74C164/MM64C164/MM54C164	8-Bit Parallel-Out Shift Register	January
MM74C165/MM64C165/MM54C165	Parallel-Load 8-Bit Shift Register	February
MM74C123/MM64C123/MM54C123	Retriggerable Monostable Multivibrator	January
MM74C200/MM64C200/MM54C200	256 Bit RAM	2nd Qtr 1973
MM4601A/MM5601A	Quad 2-input NOR Gate	Now
MM4602A/MM5602A	Dual 4-input NOR Gate	Now
MM4609A/MM5609A	Hex Inverter Buffer	Now
MM4610A/MM5610A	Hex Non-inverter Buffer	Now
MM4611A/MM5611A	Quad 2-input NAND Gate	Now
MM4612A/MM5612A	Dual 4-input NAND Gate	Now
MM4613A/MM5613A	Dual "D" Flip-Flop	Now
MM4623A/MM5623A	Triple 3-input NAND Gate	Now

NATIONAL

INFORMATION RETRIEVAL NUMBER 16

5 new capacitor ideas.

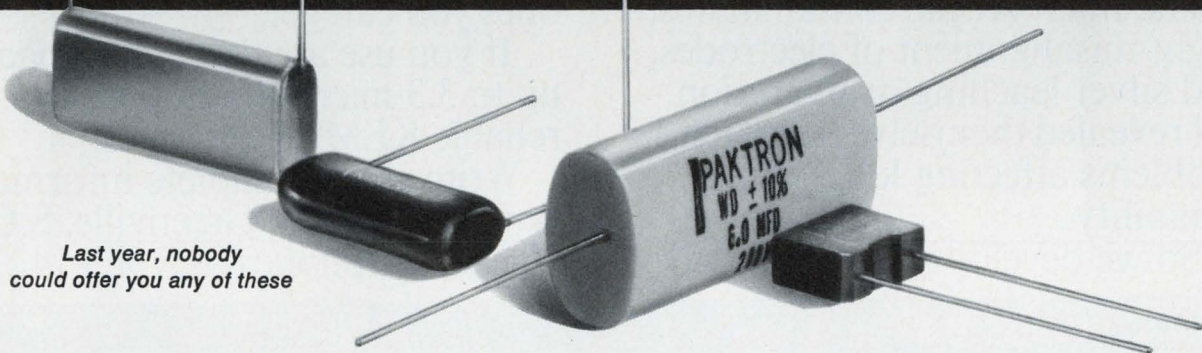

Last year, nobody
could offer you any of these

From Paktron, the one U.S. company that keeps making news in film capacitor development and manufacturing automation advances. *Metalized Film Capacitors* for use in voltage multiplier circuits to replace and outperform more expensive ceramic disc capacitors. New *Paktron® Metalized Polypropylene Capacitors* for high voltage/high current application — up to 1200 volts. *Molded Polyester Capacitors*

designed for PC board use in the widest possible capacitance range and popular voltage ratings. *Micromatic® Type PP Polypropylene Capacitors* for specialized applications in the instrumentation and telecommunications industries. *Wrap and Fill Capacitors* that combine polycarbonate type performance with metalized type stability and miniaturization. For details on any of these — plus a long

line of standardized film capacitors — write to the domestic leader in film capacitors: **Paktron, Division Illinois Tool Works Inc., 1321 Leslie Ave., Alexandria, Va. 22301. Phone (703) 548-4400. TWX 710-832-9811.**

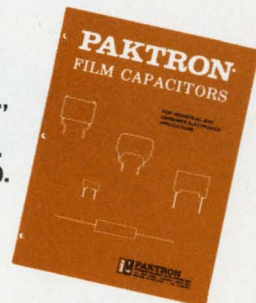

itw PAKTRON

The Innovating Electronic Group of ITW... PAKTRON ■ LICON ■ ELECTRO MATERIALS

No ceramic capacitor should be permitted to enter this world with a birth defect.

Because Union Carbide now has a way to manufacture reliability into KEMET® ceramics, rather than just test it in.

This all started when we examined ceramic capacitors that had failed at the tender age of 10 or 20 thousand hours. Even after they'd passed the burn-in, temperature cycling, and testing requirements of Mil-C-39014.

We found that the failures were not wear-out mechanisms, but were process irregularities common to popular manufacturing techniques. Such as minute dielectric faults, microscopic contaminates, slight misalignment of electrodes, and silver leaching or migration. All revealed themselves as potential problems affecting long-term reliability.

So we developed a high-speed

manufacturing process that gives predictable, uniform results. With new formulation techniques that provide the smallest possible particle size and eliminate contamination. With a continuous-belt casting system for controlled density and quality. With automated equipment for electrode printing and lamination to insure precision assembly. With the exclusive KEMET "Solder-Guard" process to prevent end-metallizing problems.

With all that, KEMET ceramic capacitors are now the most reliable ones you can get.

If you use any ceramic capacitor up to 3.3 microfarads, specify reliable KEMET ceramics.

Write us for complete information at Box 5928, Greenville, S.C. 29606. Telephone (803) 963-7421.

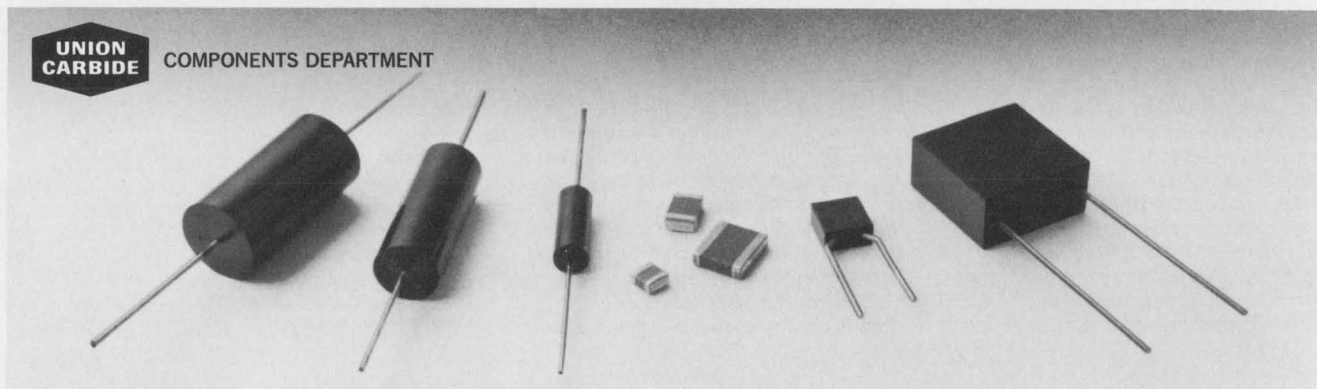

SUPPORT HEALTHY CAPACITORS. WITH A CHECK.

Available through your KEMET distributor.

INFORMATION RETRIEVAL NUMBER 18

Nuclear communications proposed as competitive

An unusual communications system that promises to be competitive with present microwave and satellite links has been developed by Dr. Richard C. Arnold of the Atomic Energy Commission.

Dr. Arnold, a researcher at the Argonne National Laboratory in Illinois, says that the system uses atomic particles known as muons to transmit information. Because they have a large mass and lack strong nuclear interactions, muons—unlike electromagnetic waves—can penetrate solid objects, such as steel or other dense substances.

A beam of muons is produced by a particle accelerator. The beam is modulated by control of the rf power to the accelerator. On the receiving end, the beam is detected by at least two scintillation counters. Multiple counters are used to reduce background interference. The received signal is then processed and read out on some display device. In Dr. Arnold's work, a strip chart recorder was used.

The muon communication system, he says, has a maximum range of about 500 miles. While operation is generally line-of-sight, Arnold points out that it is possible to use the magnetic field of the earth to bend the muon beam.

The bandwidth of such a system has a practical upper limit of about 1 GHz, although this is only possible in cases where the radiation emitted by the beam will not affect the environment.

According to the AEC researcher, the cost of a muon communication system would be competitive with microwave and satellite systems. He estimates that a 500-mile muon system would cost between \$10-million and \$20-million. A system of microwave relay towers covering the same distance would cost about \$10-million, while a satellite system, including ground stations,

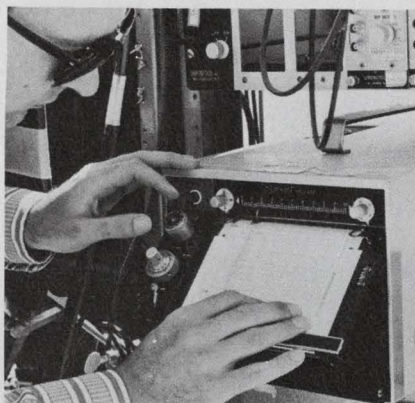

Pulse pattern transmitted by muon communication system is displayed on a chart recorder.

would cost about \$18-million, Dr. Arnold says.

He sees the muon system as the first step toward an even more sophisticated system—a neutrino system. Using neutrinos, he explains, there would be no radiation problems. In addition neutrinos are capable of penetrating the earth, so that point-to-point communications between any two sites on earth would be possible. A neutrino communication system, however, is still a long way off, Dr. Arnold admits.

Computer makers opt for one show a year

When the doors close Dec. 7 on the Fall Joint Computer Conference in Anaheim, Calif., it will mark the end of twice-a-year computer conferences sponsored by the American Federation of Information Processing Societies. Beginning in 1973, there will be a single meeting called the National Computer Conference and Exposition.

"We're moving to one conference a year instead of two for a number of reasons," Caroline Enos, public relations for AFIPS, told ELEC-

TRONIC DESIGN. "Our exhibitors feel that one national conference a year serves their marketing needs better. The meetings were too regional, and it was too expensive for the engineer to attend two meetings a year."

The first of the annual meetings will open next June 4 in New York City's Coliseum. The association hopes it will halt declines in attendance and exhibitors.

Solar-cell wristwatch planned for sale in '73

By combining solar energy with quartz-crystal accuracy, Uranus Electronics, Inc., is developing a LED wristwatch that it says will surmount the power-supply problems associated with LED displays. The solar watch is to be introduced by the New Rochelle, N.Y., company in early 1973. It will use a solar cell to recharge and thus prolong battery life.

To be called the LED- ϕ , the solar watch will have the same electronics, except for the solar cell, as a watch Uranus has just put on the market. The latter consists of a quartz crystal that oscillates at 30,720 kHz and drives a CMOS LSI circuit that was developed for Uranus by Hughes Aircraft. The chip is fabricated by ion implantation and has outputs for the hour, minute, second, date and a.m. or p.m. Two 1.5-V batteries, each rated at 200 mA-hours, supply enough power to turn on the LED display 25 times a day for a year. The batteries are made by Union Carbide, RCA, Mallory, Gould and Rayovac and can be easily replaced. Because of the absence of moving parts, accuracy under normal usage is guaranteed to a 1 minute a year.

The watch available now is being marketed by Elgin, Croton, Zales and various department stores and discount houses.

Growth of 8% a year forecast for electronics

Sales in the electronics industry should grow on the average about 8% a year over the next eight years, while employment increases at about 2% a year, according to

a report just released by the Institute of Electrical and Electronics Engineers.

Entitled "Economic Conditions in the U.S. Electrical, Electronics and Related Industries—An Assessment," the forecast contains the results of a study conducted by a committee of top industrialists. It includes information on engineering employment, growth in the industry, Government expenditures and international and financial considerations.

Areas where the committee expects rapid growth through 1980 include nonmilitary transportation electronics and process and industrial controls, both with a 12% annual increase; computers, peripherals and memories, up 11% a year, and test, measuring, scientific and medical instruments, also with an 11% annual increase. Semiconductors and communications equipment, except for radio and TV, are expected to grow by 9% a year.

The report, published in two parts, is available from the IEEE, 345 East 47th Street, New York City, at \$6 for members and \$12 for nonmembers.

U.S. investigates perils in medical equipment

Increasing concern over hazards associated with medical equipment has prompted the Federal Food and Drug Administration to commission a study of the situation.

The study is being conducted by the Emergency Care and Research Institute of Philadelphia. According to Dr. Joel J. Nobel, director of the institute, typical hazards that are being investigated include death due to electric shock from patient-monitoring equipment, inhibition of pacemakers by radiation from microwave ovens and operational problems with heart defibrillators. The data are to be analyzed to see if any patterns emerge.

New opportunities seen for antisub engineers

Prospects for design engineers with experience in antisubmarine warfare work look good. Accord-

ing to Frost & Sullivan, a market-research consultant based in New York, the ASW market should rise from its current \$2.5-billion a year to \$4.5-billion by 1975.

The sharpest increase in requirements will be for big fixed surveillance equipment for the Navy, such as that used in the Caesar program—an array of hydrophones planted on the floor of the Atlantic Ocean to listen for intruder submarines and ships. The market for these devices should grow steadily to "several billions of dollars by the early 1980s," the report states.

Spending for ASW aircraft, missiles and tactical equipment, which amounted to \$283-million in 1971, should hit \$1,003,000,000 by 1975, according to Frost & Sullivan, and shipbuilding and conversion, which totaled \$1,143,000,000 in 1971, will require \$2.1-billion in 1975.

The 1973 budget also sets aside \$628-million for 42 carrier-based ASW S-3 aircraft.

Nova minis to be shown at Peking trade fair

Data General Corp. of Southboro, Mass., has announced that its Nova minicomputer series will be the only computers on display at a Canadia "solo fair" in Peking Aug. 21 to Sept. 2. These Novas were built by Datagen of Canada, Ltd., Data General's Canadian subsidiary.

The company also reports that it has delivered its 3000th mini, a Nova 1200, to Action Communica-

tions Systems of Dallas. The computer will control communications in the Detroit headquarters of the Fruehauf Corp., a manufacturer of freight trailers. The Nova 1200 is part of a message switching/store-and-forward system that handles the flow of data and messages throughout Fruehauf's 167 sales offices, regional headquarters and plant sites.

Virtual storage added to IBM's 370 computer

International Business Machines Corp. is offering virtual storage capability for the first time in any standard data-processing machine.

IBM has offered virtual storage before in a special-purpose computer, and RCA planned to provide it in a system before the company got out of the commercial computer business.

IBM's new machines are models 158 and 168 of the 370 series. Virtual storage means extending the capacity of a core memory by adding a disc. Information then flows from the disc to the core, giving the operator the impression that he is dealing only with a core. The disc, in a sense, becomes part of the core memory.

IBM's new models use advanced semiconductor components that provide it with a main memory that is eight times denser than any previously announced by IBM. The company is also offering four new programming systems one of which is available for shipment.

News Briefs

The Federal Aviation Administration has awarded a contract to the Norden Div. of United Aircraft, Norwalk, Conn., to develop a **prototype color display for air-traffic control systems**. Replacing present black-and-white displays with color equipment, it is felt, would simplify a controller's task in sorting and tracking aircraft.

America's \$5.5-billion electronic components manufacturing industry has rebounded strongly after a year-long decline, according to statistics from the U.S. Dept. of Commerce. Estimated shipments of selected components rose near-

ly 6% in the fourth quarter of 1971, and preliminary figures indicate an even greater upswing in the first and second quarters of 1972.

Interested in industrial robots? Complete data on some 140 of the robots manufactured in Japan, Europe and the U.S. are contained in a 176-page report published by International Fluidics Services Ltd., Felmersham, Bedford, England. (Price: \$35.) An industrial robot is defined as an automatically controlled handling device that can be reprogrammed for different work cycles.

If you buy transistors, find out what you're buying. Data doesn't cost that much anymore.

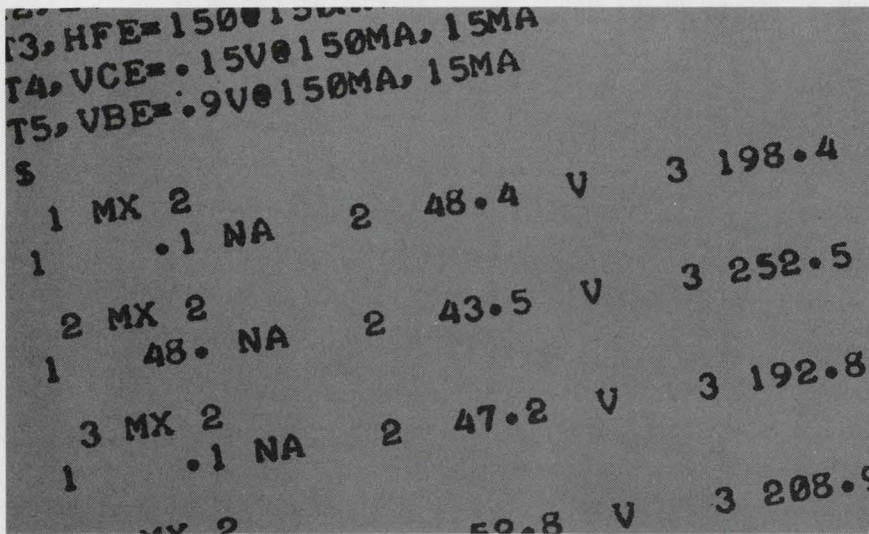

at different stations, simultaneously.

The system that gives you all this is our T241, the most widely accepted, thoroughly field-proven system of its kind. More than 150 T241s are at work the world over, most of

them on production lines. Maybe the basic go/no-go type of transistor tester is all you really need. Fine. We can sell you the best there is, for as little as \$12,500.

Now we have packaged an incoming-inspection version of the T241, complete with special software. Program writing couldn't be easier. In T241 talk, I_{CBO} is ICBO. H_{FE} is HFE.

Like all Teradyne test equipment, the T241 carries a 10-year warranty and is built to work without worry at least that long.

And it costs only \$29,000. Learn more.

Write Teradyne, 183 Essex St., Boston, Mass. 02111.

In Europe:
Teradyne Europe S.A., 11 bis, rue Roquépine, 75 Paris 8^e, France. Tel. 265 72 62.



TERADYNE

Down-to-earth avionics planned for a versatile space shuttle

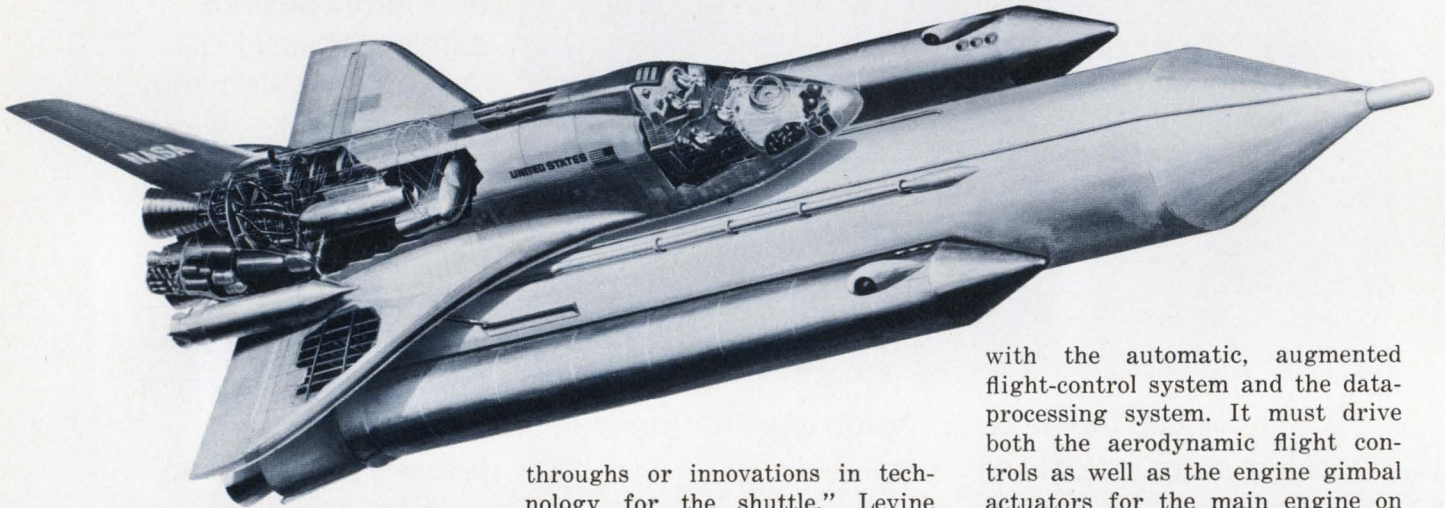

The thousands of design engineers who will work on the space shuttle over the next few years face a number of conflicting avionics requirements. The nation's fourth-generation spacecraft will be a hybrid—part spacecraft, part aircraft—but NASA is demanding guaranteed performance with the use mainly of off-the-shelf hardware.

Among the tough design requirements are these:

- The costs must be low and the reliability higher than that for the Apollo spacecraft.

- Today's technology must be used, yet 40% of the shuttle's functions have never been required before.

- The shuttle must perform reliably with a minimum of aid from the ground for up to 500 flights, and it must be able to accommodate the evolution of new avionics.

How this all will be done was outlined to *ELECTRONIC DESIGN* by David Levine, assistant chief engineer of North American Rockwell in Downey, Calif., prime contractor for the shuttle.

"We're not looking for break-

throughs or innovations in technology for the shuttle," Levine said, "but because of the unique tasks the vehicle must perform, 40% of the avionics must be tailor-made.

"But we're going to use today's technology. We want components that we can count on without large duty-cycle reliability tests or mission-life tests. The shuttle can't afford the costs for these."

Wanted: Mature components only

"We'll use more ICs than we did in Apollo, because we're 10 years farther along. And today ICs are proven; they're mature, known quantities, which is what we want throughout the system.

"Our computers will use MSI and to some extent LSI. We're not going to develop new LSI components, but we are certainly going to take advantage of those that are available."

Unique problems for the shuttle include tasks that must be performed by the flight-control system, some of the antennas and their interfaces with subsystems, and the input-output devices for the computers.

"The guidance and control computer," Levine said, "must interface not only with the radio navigation aids, with Tacan and ILS, but also

with the automatic, augmented flight-control system and the data-processing system. It must drive both the aerodynamic flight controls as well as the engine gimbal actuators for the main engine on the orbiter. And it must drive the orbit-maneuvering-system engine as well."

Combining a spacecraft with an aircraft calls for using as many proven systems for each as possible. North American studied equipment in commercial and military aircraft and in spacecraft and decided to use a mixture of the most reliable. This eliminated the need to design new equipment. But would there be a need for repackaging? Some of the equipment was built to operate in a vacuum and was cooled by cold-plate techniques. Electronics used in aircraft, or spacecraft crew quarters, was designed to operate in atmosphere and was cooled by air. North American's solution was to provide each system with the kind of cooling it originally used, regardless of the fact that in the shuttle all would be housed in atmosphere.

"We're going to have air blowers working at all times under pressure in isolated avionics bays for equipment that depends on air cooling," Levine explained. "The rest will get cold plates."

The space shuttle's reliability will not depend on the most expensive components—although they won't necessarily be cheap. It will depend on redundancy.

John F. Mason
Associate Editor

Getting together in the computer industry costs less than you'd expect.

Something new in connectors gives you something new in economy for interconnections between peripherals and to mainframes. It's our new AMPLIMATE* connector, which uses gold-plated, phosphor bronze, crimp-type hermaphroditic contacts, with three-point contact to assure high performance.

You save on material because of the AMPLIMATE connector's economical price. You save on labor costs, too.

Because you can use our high-speed automated terminated machines instead of manual methods. And you have fewer parts to put together because of our one-piece connector housing construction. No need for heat-shrink sleeves; egg-crated cavities in the housing give you the insulation you need.

And lest we forget, the AMPLIMATE connector not only mates with itself, but also with a 48-position hermaphroditic connector widely used in the computer industry.

Get the facts on getting together, by writing:
AMP Incorporated,
Industrial Division, Harrisburg, Pa. 17105.

AMP
INCORPORATED

Manufacturing and direct sales facilities worldwide: Barcelona, Brussels, Buenos Aires, Frankfurt, London, Mexico City, Paris, Puerto Rico, Sao Paulo, s'Hertogenbosch (Holland), Sydney, Stockholm, Tokyo, Toronto, Turin, Vienna.

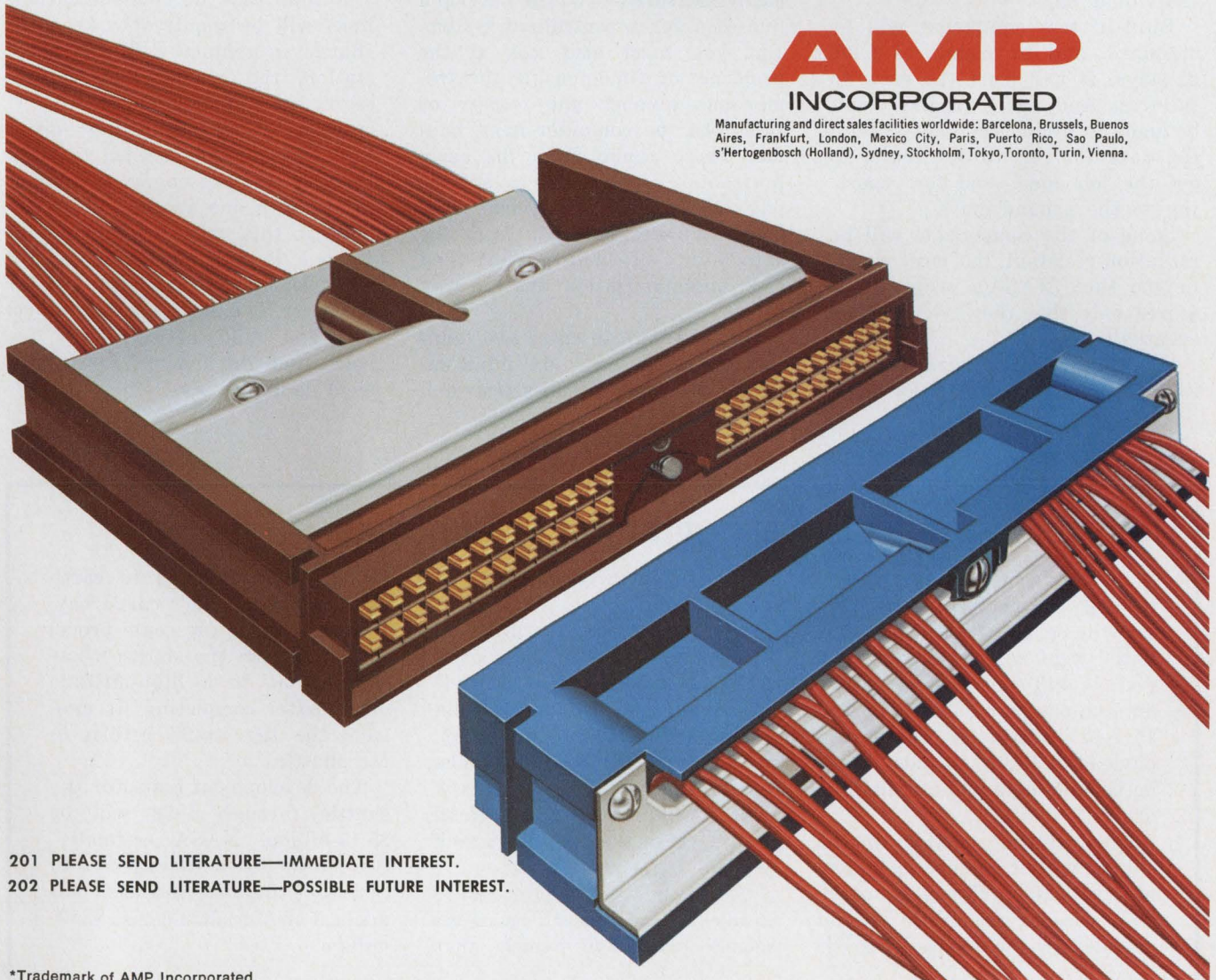

201 PLEASE SEND LITERATURE—IMMEDIATE INTEREST.
202 PLEASE SEND LITERATURE—POSSIBLE FUTURE INTEREST.

*Trademark of AMP Incorporated.

The main consideration in choosing components, Levine said, is that they be "mature" rather than developmental; that they have no fundamental problems; and that "we know that a component is on the plateau of its MTBF and not on the wrong end of the bathtub curve." The ideal component won't be too new, nor will it be nearing its replacement stage.

The safety and mission success of the shuttle will depend on triple redundancy.

"In some cases Apollo would have to be aborted if one component failed," noted Levine, who worked on Apollo before going to the shuttle program. "Generally, with the shuttle, we're thinking of three ways to get there. If one component fails, we can still carry out the mission. If a second fails, we can get home. The chances of the third failing are astronomical."

Redundancy even extends to separating the electronics into three individual bays.

Built-in test equipment will be standard, and by means of CRT displays, it will alert the crew to failures. And while repairs won't be made in flight, the crew will use the data for rerouting circuits to get the job done. And for reporting to the ground crew.

Some of the components will be radiation-resistant, but most won't, Levine said. NASA's proposal requires only that they be hardened eventually.

"A few might be hardened initially," the North American engi-

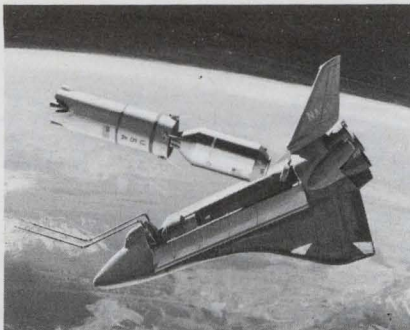

Space Tug, controlled by radio, pulls a satellite payload out of the space shuttle's cargo bay.

neer said, "in inaccessible places, so that later on the whole subsystem won't have to be redesigned. And we would probably choose equipment—such as the computers—in which provisions were already made for making such a change without trouble.

"When you look at weight and power requirements for a big central computer—things that are easily measured—you can develop a fine case for a centralized system. But you must also look at the problems of time-phasing the tremendous number and variety of functions the computer must handle. These range from the early horizontal flight tests to specific payload-oriented operational missions. We decided that from the standpoint of management and risk, decentralization was the way to go."

North American chose two families of computers: six minicomputers dedicated to subsystems and

three larger computers. The big ones, which are triple redundant, will handle guidance and control tasks. The minis will handle such jobs as high traffic interfaces between crew members' CRTs and the big computers, "much like the system used in Apollo." They will also take care of the payload-handling functions and the checkout and continual status of equipment—"which will provide more autonomy than we had with Apollo," Levine noted.

By using a mass memory, each minicomputer will be able to handle more than one function, as well as provide some redundancy in data processing.

While Apollo's primary guidance was from the ground, with its on-board systems considered secondary, the shuttle's set-up will be the opposite. An on-board optical-inertial system will be its principle means of guidance from blast-off to orbit to return.

A multitude of communications links will be required to keep the shuttle in contact with the space station, the ground and the research and application modules it launches after achieving orbit. Links will also be needed to allow the crew and passengers to communicate with one another.

What this calls for, Levine indicated, is S band for voice, TV and telemetry, C band for a radar altimeter, L band for a Tacan system and ATC network, vhf for voice, and uhf and vhf for instrument landings. ■■

The space shuttle: Big enough for 4 to 10 people

Looking somewhat like a DC-9 jetliner, the manned space shuttle will be about 120 feet long, with swept wings measuring 80 feet. It will contain a cargo bay approximately 60 feet long and 15 feet in diameter. Carrying a payload of 65,000 pounds, it will be capable of a 115-statute-mile orbit.

The orbiting portion of the shuttle will be manned by a crew of two and equipped to carry two passengers. With special modules in the payload bay, it

will be able to carry six more passengers.

The manned craft will lift up from earth on the back of a 175-foot booster. At an altitude of 25 miles, the booster's solid rockets will fall into the ocean, to be recovered for reuse. The orbiter and its propellant tank will continue into a low earth orbit, where the propellant tank will be jettisoned.

An auxiliary vehicle under study is the Space Tug, a reusable propulsive vehicle that

would be transported to earth orbit in the shuttle's cargo bay. From there the tug could propel satellites from the shuttle's low earth orbit to a high-altitude orbit. After completing its mission, the tug would return to the shuttle.

The development costs for the shuttle through 1978 will be \$5.15-billion, NASA estimates. Ground facilities are expected to cost \$300-million. And each additional orbiter should cost \$250-million.

“Scotchflex” Flat Cable Connector System makes 50 connections at a time.



“SCOTCHFLEX” IS A REGISTERED TRADEMARK OF 3M CO.

Build assembly cost savings into your electronics package with “Scotchflex” flat cable and connectors. These fast, simple systems make simultaneous multiple connections in seconds without stripping or soldering. Equipment investment is minimal; there’s no need for special training. The inexpensive assembly press, shown above, crimps connections tightly, operates easily and assures error free wiring.

Reliability is built in, too, with “Scotchflex” interconnects. Inside of connector bodies, unique U-contacts strip through flat cable insulation, grip each conductor for dependable gas-tight connections.

“Scotchflex” offers you design freedom, with a wide choice of cable and connectors. From off-the-shelf stock you can choose: 14 to 50-conductor cables. Connectors to interface with standard DIP sockets, wrap posts on standard grid patterns, printed circuit boards. Headers for de-pluggable connection between cable jumpers and PCB. Custom assemblies are also available on request.

For more information, write Dept. EAH-1, 3M Center, St. Paul, Minn. 55101.



“Scotchflex”.
Your systems approach
to circuitry.

INFORMATION RETRIEVAL NUMBER 20

Capacitive strain gage operates at 1750F

Most strain gages are unuseable above 1200 F and, in fact, begin to deteriorate at about 850 F.

Larry Gillette, senior staff engineer at Hughes Aircraft Co.'s Space Systems Div., El Segundo, Calif., has developed a capacitive strain gage that operates at 1750 F and, he says, may be useful at temperatures as high as 2000 F.

The gage consists of a square TD nickel-chrome frame, 0.354 inch on

a side, containing four Inconel capacitor plates separated by 0.005-inch-thick Mica dielectric slabs. The capacitor sits in a state of mild compression.

A strain across either diagonal axis of the gage causes the capacitor plates to either separate or compress, depending upon whether the strain is an expansion or a contraction. The gage length is 0.5 in. measured along the diagonal axis.

The gage has a mass of 1.0 gram and a nominal capacitance of about 10 pF.

Gage factors of greater than 25 are possible. Gage factor is defined as the ratio of the percent change in capacitance to the percent change in gage length.

Maximum strain that can be measured at 1750 F is 1500 $\mu\text{in/in}$. Maximum drift at 1750 F is less than 250 $\mu\text{in/in/hour}$.

Research on the strain gage was funded by the Air Force Flight Dynamics Laboratory at Wright-Patterson Air Force Base in Ohio. It was originally designed for the Phoenix missile program but was never used. It is now intended for such applications as space vehicle stress analysis, atomic reactor monitoring and turbine engine monitoring.

Gillette notes that major problems in developing the gage included finding materials that would not deteriorate at 1750 F and getting a cable that could be used to get electrical signals to and from the Inconel leads attached to the gage.

Maser Rex Hi Temp Wire Co. of Monrovia, Calif., supplied the cable. It has a 0.020-in stainless steel center conductor insulated with quartz fiber and shielded with braided 304 stainless steel. ■■

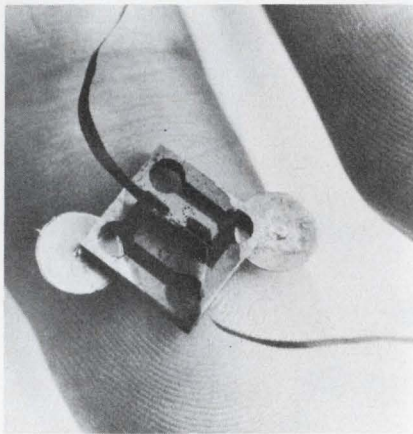

As positive or negative strain is applied across the strain axis of the gage, the capacitor plates either expand apart or contract together. Although the plates are initially in a state of mild compression, they can still compress further together due to the crushability of the Mica.

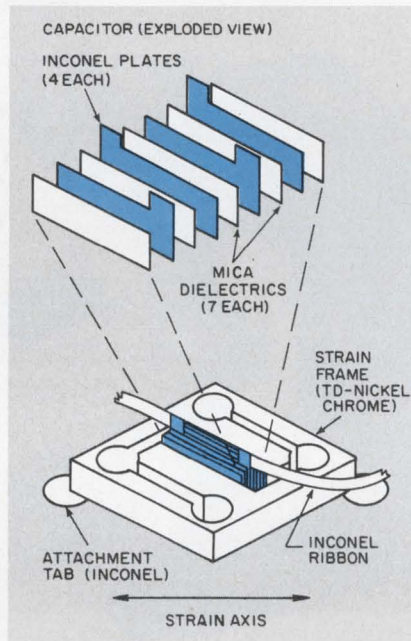

Air abrasion cuts ICs with a soft touch

A process that uses the cutting action of an air abrasive to separate beam-lead integrated circuits on a silicon slice has been developed by Bell-Northern Research in Ottawa, Canada.

The experimental technique is said to provide strong chips without breaking any of the delicate interleaved beam-lead connections.

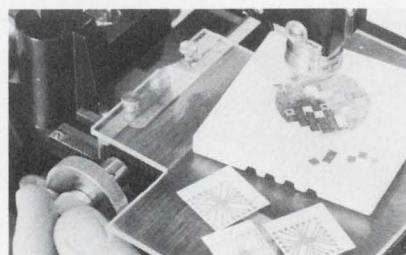

IC wafers cut with new technique

The standard technique of beam-lead IC separation involves "lapping," or trimming the slice prior to etching through the back to separate the circuits. The new method coats the back of the slice with a soft metal, defines the separation pattern and then air-abrades channels close to the surface before the final separation etching. ■■

**Other computers
have the capability
of our new 8-bit
NAKED MINI.™**

But they use 16 bits.

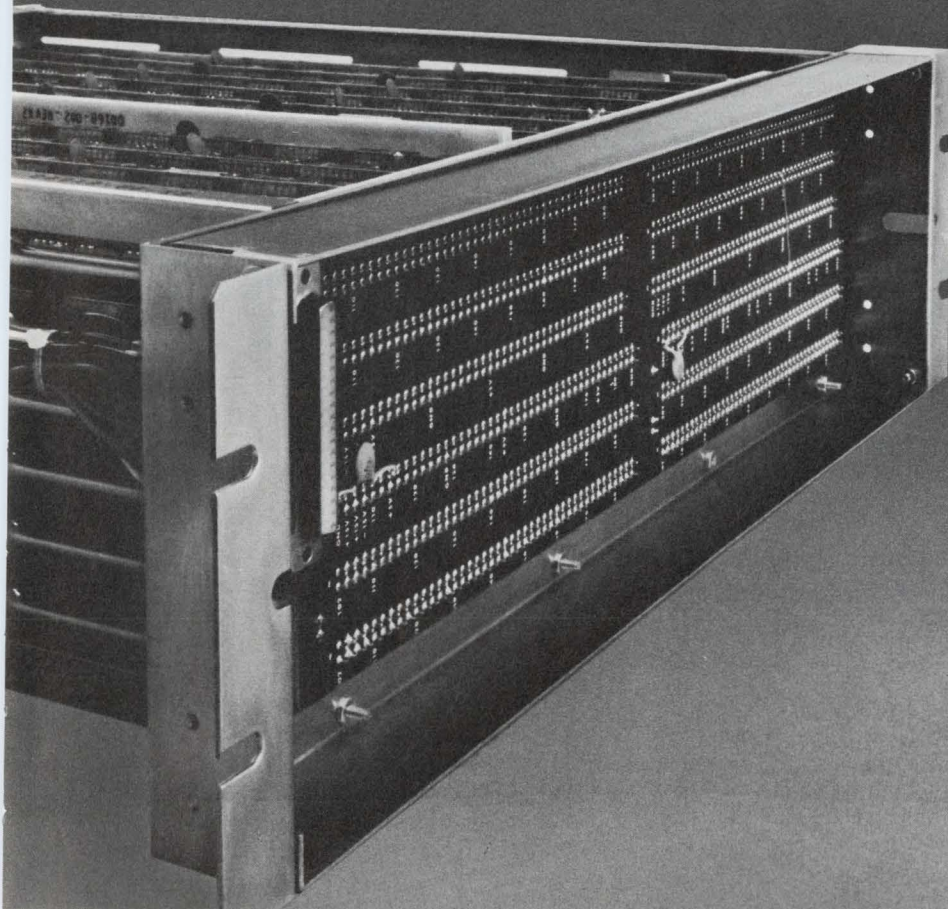

Every systems designer who's looking for a powerful, versatile computer for the lowest possible price should take a closer look at our byte-sized NAKED MINI 8.

Start by comparing its capability. It does everything a 16-bit machine can do except fast arithmetic (or inflate the price of your product). In byte-oriented applications like intelligent batch terminals, source data entry and data communications, the NAKED MINI 8 provides a potent capability that is unmatched by other 8, 12, and most 16-bit machines.

Priced at \$1,450, in 200 OEM quantities, the NAKED MINI 8 represents the industry's lowest cost high-performance minicomputer.

So think about it. Capability and price. They're two good reasons you should ask about the computer that's also a component. Write 18651 Von Karman, Irvine, Calif. 92664 TWX 910-595-1767 (714) 833-8830



COMPUTER AUTOMATION, INC.
the NAKED MINI company

Electronic systems to pace the 1972 Summer Olympics

New records will be set at the 20th Summer Olympic Games in Germany, not only by the contestants but also by the electronics industry.

For the first time in Olympics competition, a computer system will record the results of events in real time as they take place from Aug. 26 through Sept. 10 at 31 sites in Germany. In addition the games will be covered by the largest television linkup ever attempted anywhere.

A big advantage of the computer setup is that it will provide a final statistical summary of all events on the closing day of the Olympic Games. Previously several months have been needed to assemble a final summary from handwritten judges' scores.

Planned and coordinated by Siemens of Munich, West Germany, the electronics for the games will include the following:

- A computer center in the Olympic Stadium in Munich, where most of the events will be held.
- The largest disc memory of sporting-event statistics in the world.
- Computer-controlled, animated scoreboards that will use megawatts of power for operation.
- A television center in Munich that will permit the transmission of up to 13 different programs and 60 commentaries in as many as 45 languages.

Simultaneous coverage planned

The real-time computer system was designed by Siemens to ensure that 4000 journalists, thousands of visitors and millions of TV viewers receive up-to-the minute news of



Two giant, computer-controlled displays, designed by Conrac Corp., have been installed in the Olympic Stadium in Munich, the principal site of the Summer Olympic Games. These boards use up to 1.26 MW for operation.

events as they unfold at the 31 Olympic sites between Munich and Kiel. As many as 15 sports events will be under way simultaneously.

In the service for the last year, the computer center has three Siemens 4004/45 computers, each with a core storage of 256 kilobytes. Additional storage is provided by four magnetic drums, 12 magnetic tape units and 15 disc stores.

One computer will handle message switching and two-way communication over data networks during the Olympic Games. The networks will have input/output devices at the 31 competition sites.

The data received from the Olympic sites will be processed by the second computer, which has access to more than 6000 results of former sporting events, including

every Olympic event since 1896. The 1972 Summer Olympic results, and any comparison with former records that might be desired, will be flashed on scoreboards for spectators and relayed directly to news and television reporters over their closed-circuit network.

The third 4004/45 computer will be on stand-by status.

For events taking place in Olympic Stadium in Munich, a Siemens 301 satellite computer will receive inputs from data keyboards placed by the various judges' positions on the field. Contest results will be sent to the computer the moment the judges make their decisions. In some cases—as in swimming events, where the swimmer's hand closes a switch at the finish line—the data will be entered automati-

Jim McDermott
Eastern Editor

Press here to save on lighted pushbutton switches.



**buys all
the switch
you need.**

Oak's Series 300 gives you good looks and a small price-tag in lighted pushbutton switches. Plenty of switching performance for most jobs, without paying a premium. Even the Series 300 Split-Legend/4 Lamp Switch is less than \$1.60 (normal latch, 2P2T, glass alkyd insulation, no engraving, less lamps.)

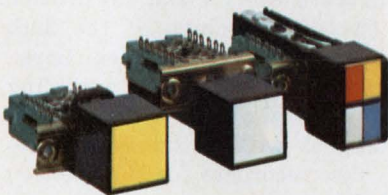

Three versions with switching up to 4P2T.

Choose from single, dual, or four lamp display as well as non-lighted type. One to twelve station, momentary, interlock, alternate action, or any combination available on the same switch bank. Lockout feature available for all types. Power Module 3A125VAC. Lighted indicators are identical in size and appearance, but without switching.

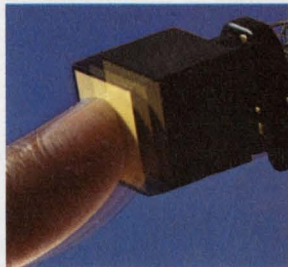

Built to take it.

Series 300 is built for reliable performance and long life. Applications galore — bank terminals, calculators, and copy equipment.

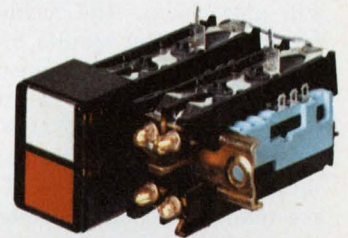

Modular design.

Single-legend/single-lamp, split-legend/4-lamp, and single-legend/redundant lamp switches have snap-on lamp holders. Plus replaceable legend plates, lens caps, and button assemblies. Front-panel relamping, too, without special tools on all types.

Gang them up by the dozen.

Order up to 12 switching stations on a single channel, any switching mix, with convenient panel-mounting studs. Color selection: white, lunar white, yellow, amber, orange, red, green, blue. Choose silk-screened, hot-stamped, or engraved-and-filled legends. Split-legend switches can be specified with any two, three, or four colors on insertable legend plates.

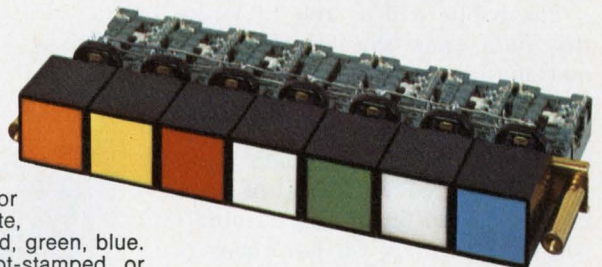

Write for our Series 300 Brochure

OAK Industries Inc.

SWITCH DIVISION / CRYSTAL LAKE, ILLINOIS 60014
TELEPHONE: 815 • 459 • 5000 ■ TWX: 910 • 634-3353 ■ TELEX: 72 • 2447

INFORMATION RETRIEVAL NUMBER 22



Sporting-event results from 31 Olympic competition sites will be transmitted by wire to a computer center in Munich's Olympic Stadium. The computers will sort the data and distribute and display them.

cally in the computer.

The computer center will send out the results simultaneously to the 31 Olympic sites for viewing on scoreboards and TV screens.

In addition the main computers will also update the memory containing the 6000 results of former sports events. This random-access memory has a list type of organization. An advantage of this organization is that only simple search equations need be used. The data are maintained on multiple-spindle discs with two standby magnetic-card memories. Altogether the memory contains about 150,000 data words, enough to fill over four million punched cards. It has information on 15,000 athletes, officials, trainers and team officials, as well as on all the rules of the 196 events for this year's Olympics.

The public will be able to access this data bank through 72 information stations placed at strategic points. Each station will have a data terminal to display the answers to queries. The data bank will be queried by a hostess at a keyboard, and 50 of the terminals will have printers for hard copy.

Spectators at Olympic Stadium will be able to follow the progress of events by watching the first fully computer-controlled scoreboards to be used both in Olympic competition and in Europe. Two of these 90-by-30 foot, computer-driven displays have been installed, one at each end of the stadium.

Each main scoreboard in the Olympic Stadium has a display area of 24,000 25-W light bulbs. Alongside it is a smaller, auxiliary board with 1160 lamps.

Fabricated by Elektron GmbH, a West German subsidiary of the Conrac Corp., New York City, these displays use technology developed by Conrac for installations in the U.S., including the Oakland Stadium in California and the recently completed Texas Stadium in Dallas.

The display area of the large board is 100 lamps high by 240 lamps long. Each lamp is individually controlled by a computer, so that characters of various size, as well as symbols and animated pictures can be shown (see photo).

The smaller board, which will be used as a digital clock for event



TV signals from the Olympic Games will be beamed around the world from this new earth-station antenna.

timing, has 1160 bulbs.

For Olympic sites other than the stadium—such as at the rowing area in Feldmoching and the canoe races in Augsburg—Conrac will supply a third display that is trailer mounted.

Smaller scoreboards will be placed at other areas. Most of these scoreboards, as well as the two big boards at Olympic Stadium, will receive their information from the computer center in the stadium.

Data for the major scoreboards will be received at two control rooms in tape form and in a special format of 34-character lines. After each item of information has been checked by control-room personnel, it will be fed by way of a 200-character-per-second tape readed to a minicomputer that controls the individual scoreboard lamps.

TV center to serve a billion

Over a billion television viewers throughout the world are expected to see some portion of the 1972 Summer Olympics. The production center to accommodate them was developed by Siemens and representatives of Deutsches Olympiazentrum Radio Television, a combine of German TV and radio broadcasters.

The center has a master control room and a switching center with 90 TV monitors. Pictures from 130 field cameras and reports by 380 commentators will be fed to the switching room.

A total of 84 videotape units will record every event, to provide an electronic archive of the 20th Summer Olympics. Ampex Corp., Redwood City, Calif., is providing the majority of the videotape recorders as well as six instant replay disc recorders for slow-motion and stop-action coverage.

In addition the American Broadcasting Company of the U.S., NHK of Japan, the British Broadcasting Co. and the Canadian Broadcasting Co. will have their own studios for recording and editing.

Deutsches Olympiazentrum Radio Television estimates that 1200 hours of action will be recorded—about 85% on TV tape and the balance on film. More than 1000 reels of magnetic video tape (nearly 1000 miles long) will be required, according to Ampex. ■■

BOURNS LOW COST FAMILY

OF INDUSTRIAL *TRIMPOT*[®]
POTENTIOMETERS

49^{*}¢

OFF THE SHELF AS LOW AS

POWER: ½ WATT (or better) AT 70°C.

TEMPCO: AS LOW AS 100PPM/°C OVER TEMPERATURE RANGE
OF -55° TO +125°C AND -55° TO +150°C.

Bourns **LOW-COST FAMILY** was designed specifically to fill the requirements of cost-conscious industrial users — *so were the prices!* Imagine how they reduce on large production-run quantities. As a bonus, you get Bourns TRIMPOT potentiometer quality, reliability and performance.

AVAILABILITY

All models shown are stocked in depth **RIGHT NOW**, so delivery is off-the-shelf from the factory or your local Bourns distributor.

Complete data on all models of the **LOW-COST FAMILY** is available upon request. Just write, or call, your local Bourns Sales office, representative, or distributor.

*1000-piece price Model 3389, U.S. dollars, F.O.B., U.S.A.

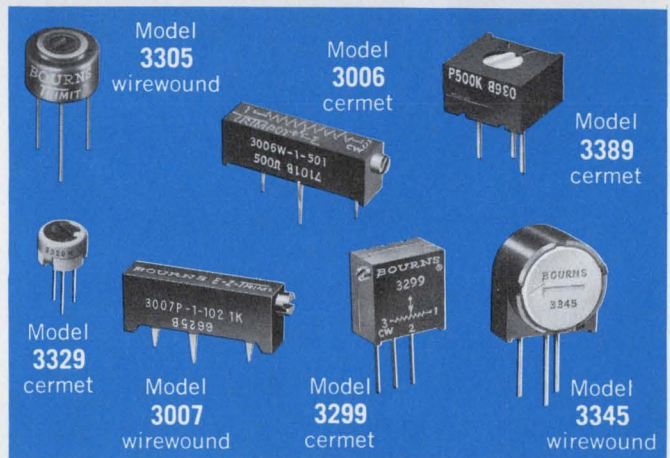

BOURNS, INC., TRIMPOT PRODUCTS DIVISION • 1200 COLUMBIA AVE., RIVERSIDE, CALIF. 92507

INFORMATION RETRIEVAL NUMBER 23

Anyone for armchair tennis? Try it soon on your TV screen

When television programs get boring, viewers will be able to generate their own excitement, starting this fall, by converting the TV screen into an electronic game board. They'll be able to play simulated tennis, roulette, and 10 other games.

A game simulator that connects to the vhf antenna terminals of the TV set is being placed on the market by the Magnavox Co., Fort Wayne, Ind. Called Odyssey, it is comprised of three basic units: a master control, which contains most of the electronics, and two player

control boxes, with which the contestants move lighted squares or other symbols around on the TV screen.

Odyssey will come with a set of 12 printed-circuit game program cards. To play a game, the contestants insert the appropriate game card into a slot in the master control unit. They then choose a corresponding transparent overlay that is taped to the TV screen. Suitable for screens 18 inches and larger, the overlay turns the screen into a game board or playing field, depending on which particular

game is chosen.

For example, when the "tennis" card is inserted, a fixed vertical bar, or "net," appears on the screen, dividing it into two equal parts, as shown in the photo. At the same time, two squares of light appear, one on each side of the net. These represent the "players."

The players can be moved up, down, or sideways by rotating a large knob on the side of the operator's unit.

The "ball"—a third, smaller square of light—appears from a player's square when a button on top of the control boxes is pushed.

The ball is bounced back and forth between two players as the contestants manipulate their control boxes. When a player intercepts the ball, it is returned automatically to the other side of the net. If the player fails to intercept the ball, it continues on off the screen, and must be served again.

To provide a curved trajectory, or "english," on the ball, a second, smaller knob is included on the side of the control box.

The speed with which the ball bounces back and forth is controlled by a knob on the master control unit.

According to John Silvey, director of consumer product engineering at Magnavox, the master control unit electronics produces the TV rf carrier for either channel 3 or 4, to which the set must be tuned. In addition, horizontal and vertical sync signals are generated in this same unit.

From these sync signals, video pulses are produced that can be advanced or restarted, with respect to the raster sweep, by the controls on the operator's unit. This has the effect of moving the images around on the screen. ■■



An electronic game simulator that connects to the TV set antenna, by the Magnavox Co., permits TV viewers to play a dozen games of skill or chance. Figures on the screen are manipulated by the contestants.

hp MEASUREMENT NEWS

innovations from Hewlett-Packard

AUGUST edition



in this issue

Now, automate your calibration lab

New fast-writing storage scopes

Precision power supplies? Exactly!



New multimeters with multi-innovations

A new multimeter that tests itself and a new low-cost "clam-shell" DMM that can be several meters in one have joined HP's growing line of solid-state LED instruments.

The 3490A multimeter performs its own diagnostics and troubleshooting. Automatic self-testing checks the meter's readiness, reduces your calibration time, reduces the required verification standards, and lets you quickly isolate possible troubles from the front panel.

The 3470A digital measuring system is really five compact modules that snap together. In seconds, a digital voltmeter converts to a multimeter, to a battery-operated field instrument, or to a digitizer with BCD output.

(For both stories, please turn to page 3.)

Compact OEM peripherals for mass storage



The 7900 disc drive (top) and 7970 tape transport (underneath) are compact, flexible peripheral memories.

Besides data products and computer systems, HP has developed high-quality disc, tape and card peripherals for original equipment manufacturers. Now, OEMs can select the storage capacity, speed and I/O hardware that they need to complement their own systems.

The 7900A disc drive is an ultra-fast, random-access, moving-head dual-disc memory. The compact design is ideal for small and medium-sized computers. Average seek time

is less than 30 ms; and the data capacity is five million bytes on-line (with unlimited shelf storage). A new single-cartridge version, 7901A, is now available for low-cost, random-access data base applications. Both disc drives are fully compatible.

For a versatile, compact tape drive, consider the 7970 family. There are over 200 configurations—from 9-track PE and 7/9-track NRZI to a single unit that reads multiple-density 7- and 9-track NRZI as well as 9-track PE tapes.

For card input, the 2761A-07 optical mark reader handles punched and marked cards at the rate of 200-250/min. Reading time is 190 ms/card.

For more information on these OEM products, check T on the HP Reply Card.



The 2761A-07 optical mark reader

All you ever wanted to know about dc power supplies

How can ground loops in multiple loops be avoided? What's the difference between a constant voltage/constant current and a constant voltage/current limit power supply? How do you measure power supply performance? Questions like these are answered in the 138-page *DC Power Supply Handbook* (AN-90A).

Choosing the right power supply for your application is easier, too, with HP's *DC Power Supply Selection Guide*. Both general and special-purpose power supplies are listed by voltage and current in tabular form. This 40-page booklet also contains performance data,

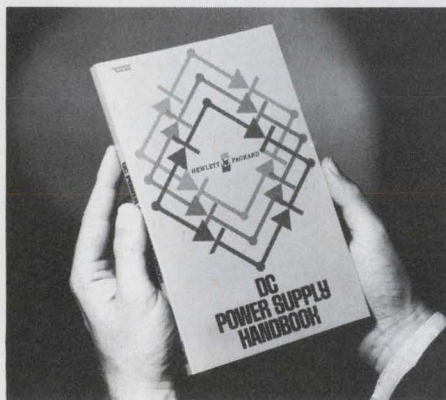

operating features, and outline drawings with dimensions. If you would like copies, check O and P on the HP Reply Card.

New microwave test set for production, lab, field



In a typical production test application, the 8755L large screen display shows forward- and return-loss response of components.

Our new 8755 series frequency response test set gives you accurate swept displays of characteristics from 100 MHz to 18 GHz. Use it for those basic insertion gain/loss and return loss (VSWR) measurements. The 8755 features high sensitivity (-50 dBm), high resolution (better than 0.05 dB), and a full 60 dB dynamic range with only 10 mW of RF drive, which means it's compatible with your solid-state microwave sweeper (e.g., HP 8620 series).

Production testing and incoming inspections are accurate and easy with the 8755 test set. Fewer controls mean simpler operation. Outstanding stability means less recalibration and greater confidence in results. This broadband test set is ideal for testing active and passive circuits, coax and waveguide. It's also immensely useful in the lab.

Because the solid-state system is rugged and compact, it's a natural for field tests of antennas and cables. The detectors can be placed as far as 200 feet away from the test set.

A typical system consists of analyzer, detectors, modulator, and HP 180 series scope display and costs approximately \$3200.

For details, check M on the HP Reply Card.

New HP self-testing DMM improves reliability

Now, HP introduces a new concept in digital multimeters: self-testing. The 3490A multimeter provides 5 ranges of dc measurement (0.1 V to 1000 V), 4 ranges of ac measurement (1.0 V to 1000 V, 20 Hz to 250 kHz), 6 ohms ranges (100 Ω to 10 megohms), and the exclusive self-test function. For readability and reliability, the five-digit display uses HP light-emitting diodes.

Measurement capability is unsurpassed. The 3490A uses a dual slope integrating technique and is fully guarded, providing excellent noise immunity at 5 readings/sec. on all dc ranges. It detects average ac



With self-testing, the 3490 is calibrated and ready for any measuring task.

and displays rms at the rate of 1 reading/sec. All six resistance ranges provide true 4-wire ohms measuring. Maximum current through the unknown is 1 ma, and there is built-in over-voltage protection in case you inadvertently apply a high voltage to the ohms terminals.

There are 16 front-panel tests, each of which interrogates an

internal parameter and displays the results. You merely compare the readout with the proper values on an instruction card. Logic tests, ratio amplifier offset, reference voltage—the multimeter checks them faster than you can.

Price: \$1650

For more information, check E on the HP Reply Card.

Diverse uses for compact strip-chart recorder

Smoke stack monitoring, soil analysis for mineral content, oceanographic research, and automobile exhaust emission tests—they all use a 680 strip-chart recorder to graph final output. Since 1961, this compact recorder has proven itself highly accurate in specialized industrial applications as well as in general laboratory use.

With a 5-inch (12 cm) writing width, the recorder has multi-range input, multi-speed chart transport, full-range zero set, electric pen lift, and full-tilting chart magazine. You can choose standard (English) or metric scaling, and electric writing is optional.

This popular recorder also has a popular price: only \$900.

For details, check H on the HP Reply Card.

The "tried and true" 680 recorder weighs only 11 lbs. (5 kg) and fits into a rack mounting space 7 inches (178 mm) high.

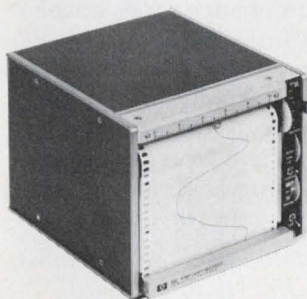

New 'clam-shell' DMM can be several meters

More than just a multimeter or a dc voltmeter, the new 3470 measuring system features versatile snap-together modules that you can configure in minutes. The same system can be a bench instrument in the lab and, five minutes later, a test device in the field. And it couldn't be easier:

- Start with the four-digit solid-state display.
- Snap it on top of the multimeter module and it's a digital multimeter with 4 full digits plus 100% overranging. It has 4 ac and dc ranges from 1 V to 1000 V full scale and 6 ohms ranges from 100 Ω to 10 megohms.
- Or, snap the display and dc section together for a dc voltmeter from 1 V to 1000 V full scale. Dc accuracy is $\pm 0.03\%$ of reading $+0.01\%$ of range on all four ranges.
- For portability, merely add a battery module between the display and the bottom section. Immediately, your system converts to 6 hours of continuous measuring on rechargeable batteries.
- Need BCD output? Simply take out the battery and insert the BCD module for the center section. Nonisolated BCD output can be used

to drive printers and other devices. It's as economical as it is easy. Modules start at \$150.

For prices and full details, check D on the HP Reply Card.

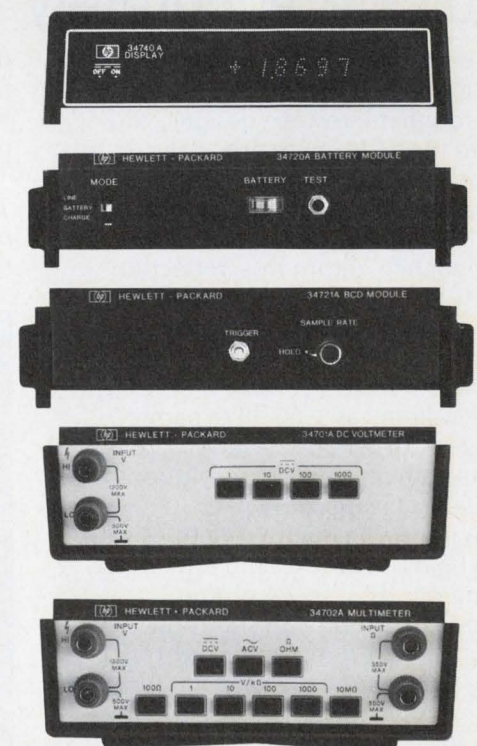

More precision and power in four new dc supplies



A 6115A precision power supply is used to calibrate the dc voltmeter section of an HP multimeter.

If you need a low-cost calibrator, a systems reference supply, or a high-performance lab supply, consider one of HP's four new precision power supplies.

These new 40-watt supplies feature output voltage accuracy of 0.025% plus 1 mV, with 5-minute cold-start warmup. Two supplies (6114A and 6115A) use four-digit pushbutton switches for fast and accurate voltage setting, with a fifth-digit vernier

providing 200 μ V resolution. The other two supplies (6104A and 6105A) are designed for applications where the supply is programmed remotely.

Models 6104A and 6114A provide 0-20 V at 0-2 A and 20-40 V at 0-1 A. Models 6105A and 6115A provide 0-50 V at 0-0.8 A and 50-100 V at 0-0.4 A. These supplies also feature constant voltage/constant current operation, front-panel mode indicator, built-in overvoltage protection, high speed, and remote programming capability. In addition, there are full voltage and current metering and auto-tracking, series, or parallel operation.

Prices: 6104A, \$440; 6105A, \$455; 6114A, \$525; and 6115A, \$540. For power supply specifications, check I on the HP Reply Card.

Get microwave design data quickly, accurately

To save hours of work while producing more accurate and thorough microwave designs, you need the 8410S network analyzer. In minutes, this complete system measures key network parameters, such as: phase, gain, attenuation, impedance, return loss, reflection coefficient, and s-parameters. You can quickly characterize active and passive components—even stripline devices—from 110 MHz to 40 GHz. The system has >60 dB dynamic range with 0.1 dB resolution and 360° phase range with 0.1° resolution.

Even a taxing chore like characterizing microwave transistors can be done quickly and effectively, using our precise yet simple transistor fixtures, pushbutton-controlled test sets, and bright CRT

With this stripline test fixture, merely drop in a stripline microwave device or transistor and let the 8410S do the work.

display of results. Many system functions are readily programmable to further speed the measurement process.

Full systems start at \$11,745. To learn more about solving tough microwave measurements, check K on the HP Reply Card.

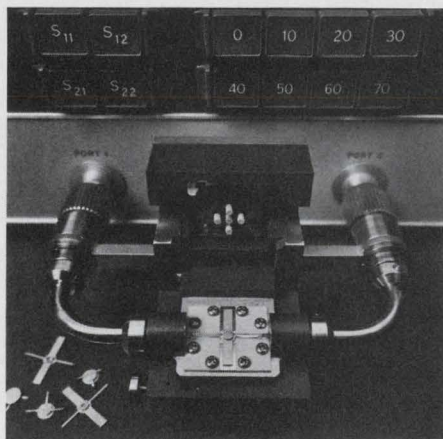

HP videotapes make inexpensive, individual, on-the-job service training a reality.

HP videotapes: a better way to learn

When planning a training program—for beginners or for experienced staffers—consider HP's library of quality videotapes. This new medium offers:

- More information in less time.
- Higher retention, even higher than with live lectures.
- Convenience. Your "instructor" is available anytime, anywhere.
- Flexibility. You can organize seminars for 100 people or view the tape alone for refresher purposes.
- Economy. For just the initial cost, you use a videotape over and over. Executives and engineers don't have to interrupt projects to teach a seminar.

The HP library covers three categories: tutorial, "how to use," and service/maintenance tapes. Our most popular tutorial series is *Practical Transistors*, a 15-program course for electronic service technicians. The "how to" topics range from *How to Use HP Instruments* to *BASIC Programming*. Service/maintenance tapes cover many areas from adjusting oscilloscopes to servicing computers. Tape format is usually EIAJ half-inch, but other formats are available including cassette. You can also order Sony cameras, video recorders and monitors from HP.

For a complete index and price list, check U on the HP Reply Card.

New instrument calibration system reduces costly overhead

A scope for all seasons
(or any environment)

Calibrating a sweep-time plug-in for a scope, the operator reads the CRT instructions, changes ranges with one hand and answers "done" with the keyboard in the right hand.

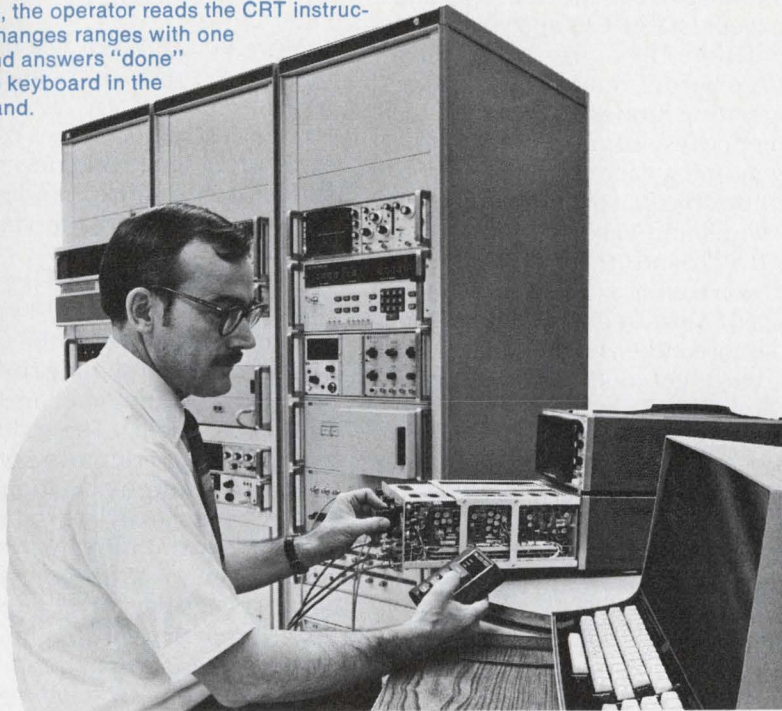

Now, there is a way to calibrate today's proliferation of complex instruments, to beat spiraling labor costs, to reduce training costs, and yet to increase efficiency—all without raising the operating budget. How? With an HP 9550A automatic instrument calibration system.

Whether you calibrate HP instruments or others, this automated system covers oscilloscopes, plug-ins, voltmeters, multimeters, test oscillators, amplifiers, DVMs, and low-frequency generators. The system calibrates to manufacturer's recommendations and for the instrument's intended use.

HP has developed almost 50 application programs for calibration. You can adapt or convert these to other workloads by modifying the program. Should you need to write a special program from scratch, the system language is ATS-BASIC, a conversational language that any skilled technician can easily learn.

The calibration system uses a 16K core and a mass memory disc for flexible information storage and fast access. This combination makes it easier to convert programs and parameters, as well as being more

economical. (Saving two minutes on each calibration by having fast access is worth about \$10,000 each year.)

HP quality instruments and reliable hardware provide a precise calibration-quality stimulus, dc to 1300 MHz.

The 9550A system optimizes man-machine capabilities. An HP 2100 computer handles programming and switching the stimulus, pacing test sequences, measuring and data keeping. The operator makes connections, adjustments, and control checks and decides whether anomalies are within tolerance or if he should rerun a certain test sequence. For the past year and a half, we've used the 9550A instrument calibration system on our own instruments at the HP Customer Service Center.

Because the 9550A is a modular system, you can also add digital test units or programmable scopes to handle other lab applications. Instrument calibration systems range from \$125,000 to \$175,000.

To learn more, check N on the HP Reply Card.

You probably won't use your oscilloscope under water, but it's reassuring to know that an HP portable scope (1700B, Option 300) operates in virtually any environment. This 35-MHz scope is dustproof, weatherproof, shockproof, and with slight modifications, waterproof. You get laboratory quality and accuracy even when external conditions are less than perfect.

Take the rugged case; fill it with a weight equivalent to the scope; raise it 30 inches off the ground, then drop it onto concrete 14 times—it's still watertight. Use the scope on shipboard without concern about corrosive salt spray. Send it up in an airplane; the scope operates between -40° and $+55^{\circ}\text{C}$ at altitudes up to 10,000 feet. The 1700B, Option 300 is reliable in a chemical plant, refinery or dusty environment; contaminants won't get inside the instrument. The key to environment-resistance is low power consumption and low heat buildup which eliminates the need for vent holes in the case.

An optional internal battery pack enables the scope to operate anywhere without ac or dc power lines. Yet you get laboratory qualities such as 10 ns risetime, 10 ns/div sweep speed, and 10 mV/div minimum deflection factor.

Price: \$2600

Interested? Just check B on the HP Reply Card.

Should you accidentally drop your scope overboard, don't worry. It floats.



Solid-value, solid-state microwave sweepers

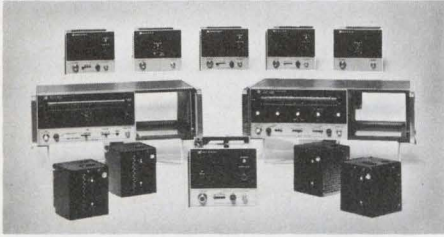

Choose from our family of mainframes, RF plug-ins and modules . . .

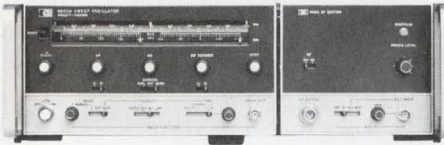

. . . for a high-value solid-state sweeper only 5 inches (12 cm) high.

High performance and attractive pricing are two features of the HP 3620 series solid-state sweepers. And there's a wide selection so you can choose the configuration that best suits your needs.

Two new x-y recorders designed for the lab

Two new general-purpose x-y recorders will withstand all sorts of abuse and rough handling and still give you laboratory quality, speed and accuracy. Both the 7044A and 7045A are contained by a rugged aluminum mainframe which eliminates the need for critical

Both the 7044A (pictured here) and 7045A boast an accuracy of $\pm 0.1\%$ of full scale.

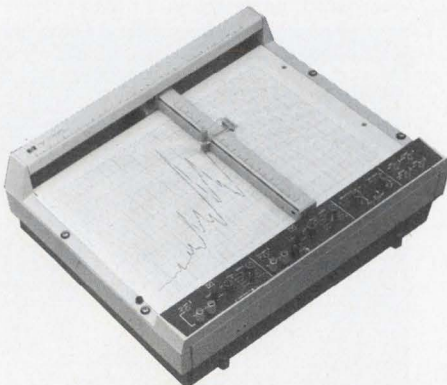

Start with the mainframe. The economical 8620B has start-stop and ΔF sweeps, stable CW and versatile modulation. The more sophisticated 8620A provides remarkable latitude in operating modes, exceptional frequency resolution, plus remote programming capability.

For flexible RF coverage, there are new wideband VHF/UHF plug-ins (3-350 MHz and 10-1300 MHz) plus microwave units extending to 18 GHz. For most frequency ranges, you can choose either single-band plug-ins or get multiband operation by combining RF modules in a single drawer (e.g., 0.1-6.5 GHz or 5.9-12.4 GHz).

All versions give you high sweep linearity, accurate frequency calibration, low residual FM, low spurious content—and a low price. The 8620A mainframe costs \$1,450; the 8620B, \$975; and RF units range from \$1,375 to \$2,950.

For details, check L on the HP Reply Card.

mechanical adjustments, yet provides desired durability.

The 7044A operates at medium speed with a slewing speed of 20 inches/sec. The faster 7045A has a slewing speed of 30 in./sec. and acceleration of 3000 in./sec² on the y axis and 2000 in./sec² on the x axis. Input ranges for both instruments are from 0.5 mV/in. to 10 V/in.; input resistance is one megohm on all ranges.

Both recorders use a servo-actuated ink pen. The writing area is 10 by 15 in. (25 by 38 cm) which means you simply use 11 by 17 in. or standard European A3 size paper. Metric calibration is available with either recorder at no extra charge.

Prices: \$1350 for the 7044A; \$1675 for the 7045A.

For more on these new x-y recorders, just check J on the HP Reply Card.

New storage scopes show nanosecond transients

Now, you can view fast rise, low rep-rate or single-shot signals without having to photograph them. The HP 184 A/B oscilloscopes combine fast writing speed and new storage surface processing to produce a bright display of hard-to-capture signals.

Storage writing speed is greater than 400 cm/ μ s. The FAST mode automatically switches the CRT display to a high-writing speed, reduced scan and maintains a fully calibrated display. The reduced graticule is superimposed on the center of the normal graticule. This lets you see signals such as a 16-bit computer word directly, without using a camera. With storage, you can retain the display for 5 minutes from FAST mode or over 30 minutes from the standard mode.

In variable persistence mode, match persistence to the signal speed. Thus, a slowly-moving dot becomes a complete trace and meaningful waveform for study.

Several plug-ins complement these new scopes and let you tailor sweep, bandwidth and sensitivity to specialized applications. The cabinet style 184A costs \$2200; rack style 184B, \$2275.

For more on these new storage scopes, check A on the HP Reply Card.

A single-shot TTL digital word with a 10 ns noise pulse shows up readily on the 184 display.



Microwave measurements—quickly and reliably

For the most accurate, reliable frequency measurements of CW signals in the shortest time, the heterodyne converter is unsurpassed. For equal resolution, counter gate time is up to 500 times shorter than with a transfer oscillator. Now, there are four easy-to-use plug-in converters (up to 18 GHz) for HP 5245, 5246 and 5248 counters.

Tuning is easy. Just dial upwards in frequency until the level meter needle indicates "tuned," then add

the dial and counter readings for your answer. Constant bandwidth cavities ensure that tuning is consistent over the entire range. HP converters give the most reliable answers—there are no spurious responses.

Converter prices are as follows: (50–512 MHz) \$675; (0.15–3 GHz) \$925; (3–12.4 GHz) \$2,200; and (8–18 GHz) \$2,300.

For more information, check Q on the HP Reply Card.



The heterodyne converter provides rapid, reliable resolution of CW and heavily-modulated signals.

hp COMPONENT NEWS

New Schottky ring quad double-balanced mixer

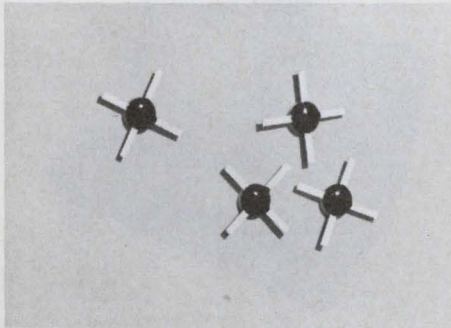

Its small size makes the ring quad ideal for microstrip applications.

This monolithic array of Schottky diodes features wideband operation to 2 GHz, tight diode match and temperature tracking, low conversion loss, and a compact mechanical package. Typical characteristics are: 4 dB conversion loss at 1 GHz and V_f of 0.4 V at $I_f=1$ mA.

Designed for high-volume low-cost applications, these devices provide diode circuit functions in double-balanced mixers, AM modulators, pulse modulators, phase detectors and low-power limiters requiring wideband operation and small size. The 5082-2830 ring quads are available from stock.

Price: \$3.90 each in 1K quantity.

For details, check G on the HP Reply Card.

Low-cost PIN diodes for industrial electronics

HP's expanded series of PIN diodes cover the frequency spectrum from RF to above 1 GHz. Types 5082-3080 and 5082-3081 are ideally suited for constant impedance EGC circuits in bi-directional CATV trunk and line extender amplifiers, where operation with extremely low distortion down to frequencies of 5 GHz is required.

The 1N5767 is a general-purpose PIN diode for low-cost switching, attenuating, and modulating. A minimum effective carrier lifetime of $1 \mu\text{s}$ extends the useful frequency range below 10 MHz. The 5082-3077, with minimum effective carrier lifetime of 100 ns, has similar applications in the UHF frequency band.

Prices in quantities of 1000: 5082-3077, \$1.80 each; 5082-3080, \$1.65 each; 5082-3081, \$1.80 each; and 1N5767, \$1.95 each.

For data sheets and Application Note 936, check S on the HP Reply Card.

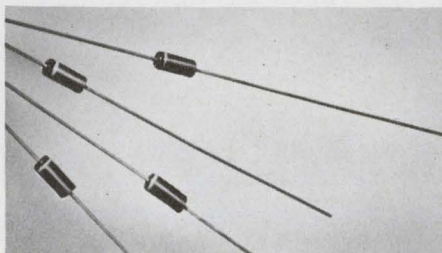

Two component kits for engineers, designers

Two popular kits are available so that you can try HP components in your design or development project. The 5082-0050 Schottky diode kit features 24 diodes (8 each of 3 different types) together with supporting literature. Price: \$8.40.

The 5082-0051 communications kit contains a transistor and several PIN and Schottky diodes for amplifiers, AGC and mixer/detector applications. It's a \$34 value for \$19.40.

To find out how to get your kit, check F on the HP Reply Card.

Diode fits military specifications

Now, Schottky diode type 1N5711 qualifies to military specification MIL-S-19500/444. This specification applies to both JAN and JAN TX devices. Stock to four weeks delivery. Prices:

	JAN 1N5711	JAN TX 1N5711
1-99	\$1.95	\$6.95
100-999	1.45	5.95

To learn more, check C on the HP Reply Card.

New logic probe and logic pulser aid IC troubleshooting

Together the pulser and probe form an IC logic stimulus-response test set that's only the size of two pens.

At last, you can inject logic pulses between TTL and DTL gates without unsoldering or trace cutting. Simply touch the new 10526T logic pulser to any in-circuit node, press the pulse button, and a 300-nanosecond pulse is "stuffed" into inputs and outputs. If the node is high, it is pulsed low instantaneously; if low, it goes high—all automatically. The ability to source or sink up to 1 amp, typically, ensures a pulse into even the hardest loads.

Another addition to the IC troubleshooting line is the new three-state 10525T logic probe. Besides detecting TTL highs and lows, the new probe detects bad levels and open circuits. Single pulses as narrow as 10 ns and pulse trains to 50 MHz rep rate are also indicated. (No wonder so many engineers and technicians reach first for their logic probe when digital troubleshooting.)

Combine the unique stimulation capabilities of the logic pulser with the response monitors—the logic probe and the 10528A logic clip. The pulser injects pulses into logic gates; the probe monitors the output. Shorts to ground or Vcc are detectable with the pulser and probe. (Opens are detected by the probe itself.) Attach

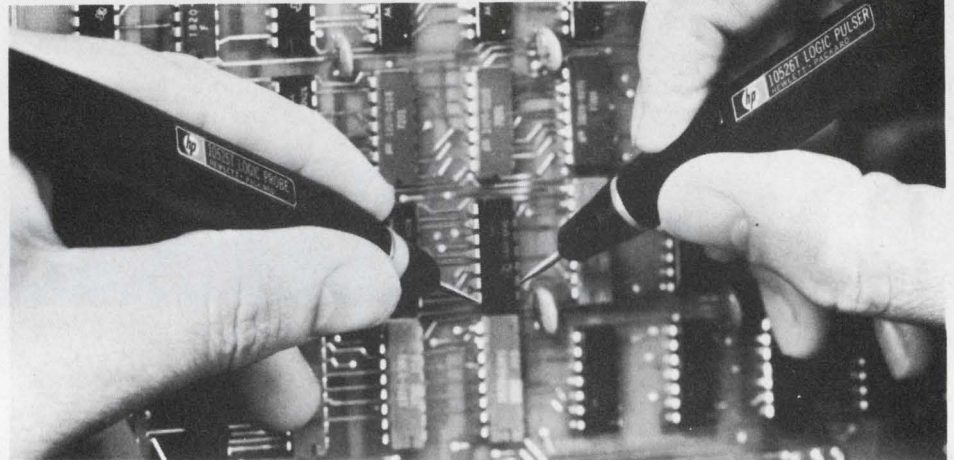

the logic clip to flip-flops, counters, decoders, shift registers, and other MSI chips; then monitor exact operation 14 or 16 pins at a time with the pulser providing clock, reset, clear or transfer pulses.

You can buy these three troubleshooters separately or all together in a convenient low-cost kit. The 10525T logic probe and 10526T pulser cost \$95 each; the 10528A logic clip, \$125. The 5015T troubleshooting kit contains all three for only \$285.

For more information, check R on the HP Reply Card.



The 5015T logic troubleshooting kit packs complete stimulus/response capability into a single package . . . at a 10% discount.

HEWLETT  **PACKARD**

Measurement, Analysis, Computation

East—W 120 Century Road, Paramus, N.J. 07652, Ph. (201) 265-5000.
South—P.O. Box 2834, Atlanta, Ga. 30328, Ph. (404) 436-6181.
Midwest—5500 Howard Street, Skokie, Ill. 60076, Ph. (312) 677-0400.
West—3939 Lankershim Boulevard, North Hollywood, Calif. 91604, Ph. (213) 877-1282.
Europe—Post Office Box 85, CH-1217 Meyrin 2, Geneva, Switzerland, Ph. (022) 41 54 00.
Canada—275 Hymus Boulevard, Pointe Claire, Quebec, Canada, Ph. (518) 561-6520.
Japan—Ohashi Building, 59-1, Yoyogi 1-chrome, Shibuya-ku, Tokyo 151, Japan, Ph. 03-370-2281/92.

Announcing a wave of power.

Our newest miniature basic is a snap-action switch capable of handling power loads.

This addition to the SV line uses the same "Rolling Wave" spring principle as our low-energy SV. So it provides maximum assurance for a reliable switching function.

There's a 3 amp version (25 grams max. operating force) and a 5 amp version (40 grams max. operating force). Both UL and CSA listed for 125/250 VAC. Both offering benefits needed to meet today's demanding applications.

Like *high overtravel*. This allows more latitude in interfacing with other components.

And *small size*. Since the switches are a mere 0.25" wide, more can fit in a small space and are ideal for gang mounting.

And *easy installation*. Combination quick-connect/solder terminals exit at the bottom to simplify wiring.

And *design freedom*. Among other things, there's a choice of end or center plungers and optional integral levers. Also, lower operating force versions are available for your special applications.

Call your MICRO SWITCH Branch Office or Authorized Distributor (Yellow Pages, "Switches, Electric"). Or write. Whichever you decide, more power to you.

MICRO SWITCH makes your ideas work.

MICRO SWITCH

FREEPORT, ILLINOIS 61032

A DIVISION OF HONEYWELL

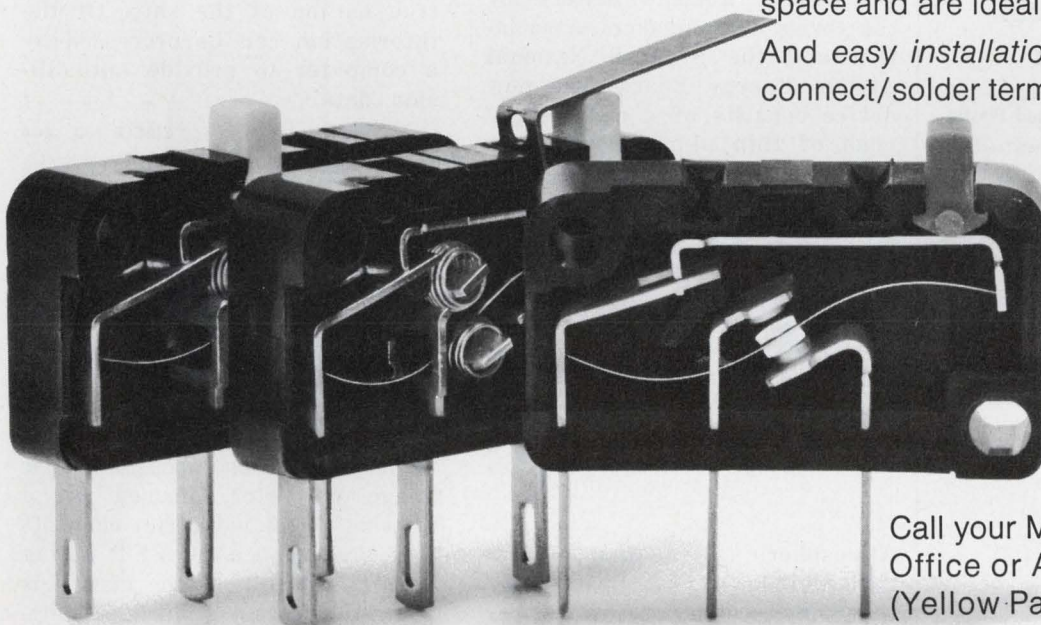

Low-energy versions.

Power version.

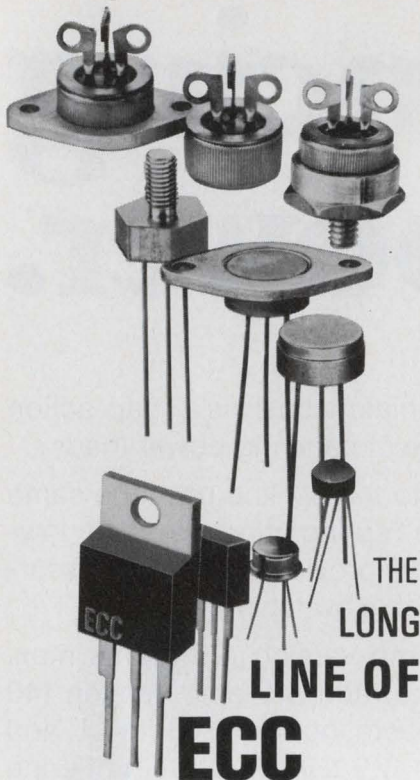

THE
LONG
LINE OF

ECC LOW AND HIGH CURRENT TRIACS

World's leading
Triac producer offers
fast delivery,
electrical isolation and
a variety of packages.

LOW CURRENT TRIACS

THERMOTAB® and THERMOPAK*; Swedge and TO-3; 5/8" Hex Stud, and TO-5 Metal and Plastic Packages

*trademark of ECC

$I_{T(RMS)}$ 0.8 - 16 amps

I_{gt} I, III 3, 10, 25, 50 ma max;
with or w/o internal trigger

I_{TSM} 20 - 150 amps

V_{DROM} 200 - 800 volts

For more information, circle No. 238

HIGH CURRENT TRIACS

3/4" Press-Fit, Stud and TO-3 Packages

$I_{T(RMS)}$ 25 - 40 amps

I_{gt} I, III 50 - 100 ma max

I_{TSM} 230 - 300 amps

V_{DROM} 200 - 800 volts min

For more information, circle No. 239

All packages are electrically isolated except TO-5 Metal Can. ECC triacs feature heavily glass passivated junctions for high reliability.

Contact your nearest ECC Sales Representative or Authorized Distributor for pricing and technical information.

ECC
CORPORATION

P.O. Box 669 • Euless, Texas 76039
817/267-2601

technology abroad

Crowded terrestrial commercial television relays may be supplemented with a geostationary satellite relay system in Germany by late 1978. The project—under investigation jointly by Dornier, AEG-Telefunken and Erno Raumfahrttechnik—would add three to five channels to the present three-channel system. The new channels would be transmitted at 400 W from the satellite. Power would be supplied by solar cells with an area of 75 m². Home receivers would be fitted with Schottky-barrier diode mixers in a new frequency converter. Paraboloid-receiving antennas of 80-cm diameter would also be required.

CIRCLE NO. 441

Electrolytic capacitor manufacturing techniques have been adapted in the production of a watch-sized nuclear battery by the Swiss Watchmakers Association and the Swedish National Atomic Energy Board. The new device consists of a metal sandwich of thin aluminum foil, an aluminum oxide dielectric and either titanium tritide or lithium tritide. The tritium decays radioactively, giving off beta particles that migrate to the aluminum foil as electrons and produce a voltage. The battery is a few cubic millimeters in volume. The device typically produces 10⁻⁹ W/cm² at about 10 V.

CIRCLE NO. 442

Atmospheric attenuation of less than 8 dB/km for a CO₂, 5-W laser telephony system operating over 5.4 km is claimed by Siemens of West Germany. The system—still in prototype form in Munich—incorporates Cassegrainian telescopes at the receiving and transmitting ends to collect and collimate the 10.5- μ m beam. The primary concave mirror is 35 cm in diameter, while the convex

secondary is 3.2 cm across. The laser beam is modulated by transmission through a GaAs crystal. At the receiver the beam is converted to electrical signals by a germanium photodetector.

CIRCLE NO. 443

Doppler sonars for docking oil tankers and large freighters will be installed on ships of the French merchant marine in the next few months. The sonars, developed by Thomson CSF of France, measure a ship's speed to an accuracy of 0.01 knot and can sense speeds as low as 0.05 knot. The sonic measuring system is based on the transmission of ultrasonic waves from the forward and aft parts of the ship's hull and the reflection of waves from either the sea bed or stable layers of the ocean. The doppler system can transmit signals to a radar display, thus indicating the true motion of the ship. Or the information can be processed by a computer to provide anticollision data.

CIRCLE NO. 444

A solid-state converter that displays CRT images from acoustic transducer outputs is being constructed by researchers at Britain's Portsmouth Polytechnic. Objects to be viewed are immersed in water before being illuminated with 1-MHz sonic waves. The diffracted waves are then focused onto an acousto-electric image converter, formed by a matrix of piezoelectric elements that are scanned by FET gating circuits. At present the matrix is 10-by-10 elements, but a 100-by-100 element unit is under development. The matrix element may be manufactured with integrated-circuit technology. Pictures produced with this system compare favorably with those produced with more complex electron-beam scanned converters.

CIRCLE NO. 445

Centralab Trimmer Resistors... in line with your design requirements

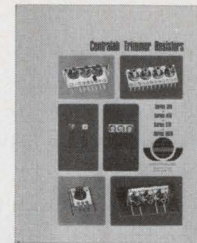

Write
Centralab
for
Bulletin
No. 1284PR3

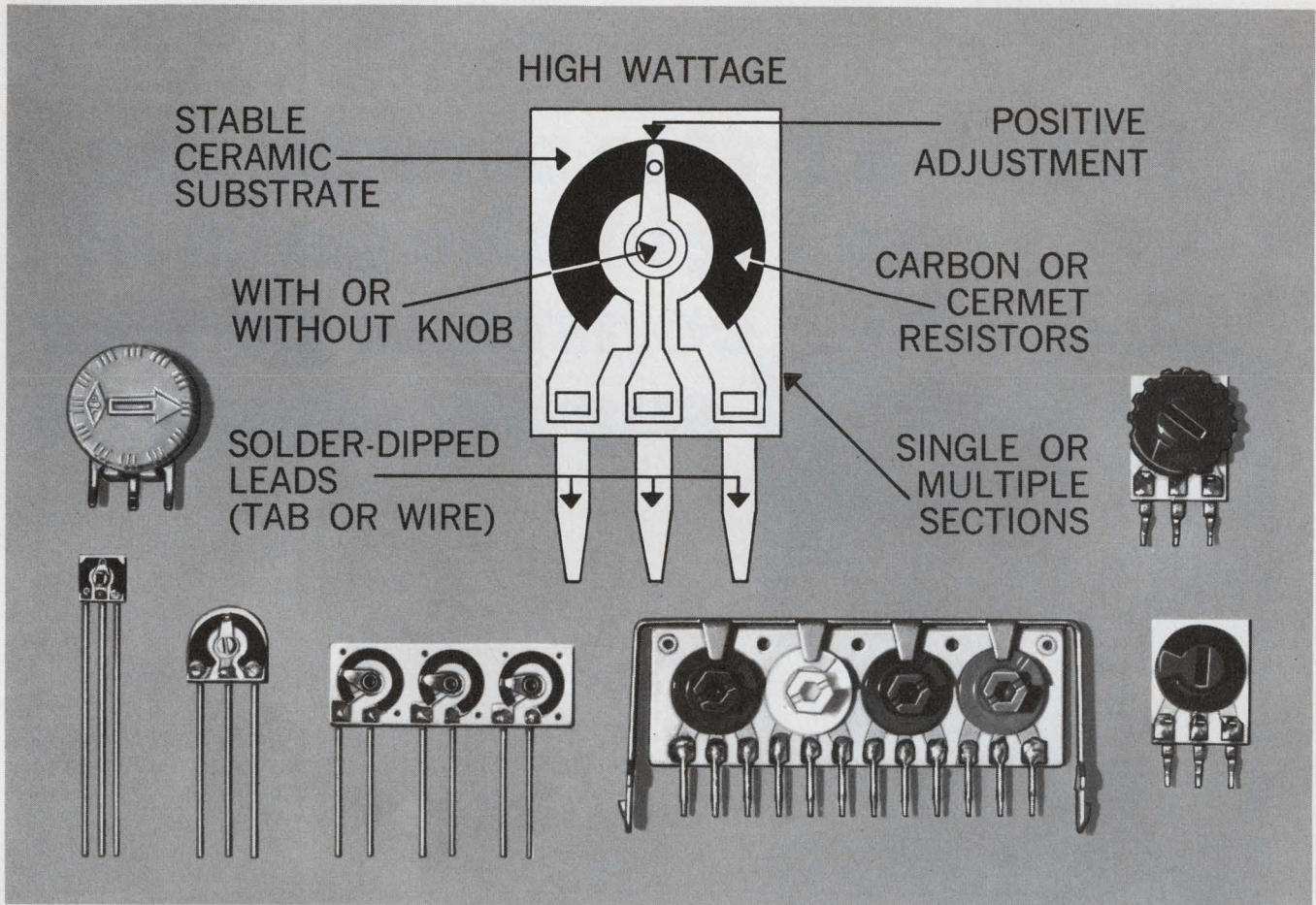

Ceramic—just one reason they're better!

The ceramic substrates of Centralab trimmer resistors—in both carbon and cermet—give them performance unmatched by phenolics. They're conservatively rated at double the wattage capability! You get higher wattage in a smaller space. They'll withstand higher operating temperatures. At 70° C they accept a full wattage load and derate to zero at temperatures of 105° C for carbon and 125° C for cermet.

Ceramic bases give you dimensional stability you can depend on—they won't shrink. They eliminate the problem of flux migration during flow soldering, too, so you can forget catastrophic failures often encountered with conventional trimmers. And—whether

you specify wire leads or one of three tab styles, all are solder-dipped for ease of installation.

Another reason for selecting Centralab trimmer resistors is their smooth, positive adjustment. Their design eliminates the erratic, "slip-stick" effect in setting.

The seven series of Centralab trimmer resistors come in sizes from 1/4" to 3/4", single or multiple sections, in ratings from 1/20 to 3/4 watt, TC as low as 150 PPM, competitively priced with phenolics. They give you more of what you're looking for in a trimmer. If you need more reasons or specifications see EEM, 1972-73 Edition, or write Centralab Electromechanical Sales.

GET CENTRALAB THE "IN" LINE FOR YOUR DESIGN

Hybrid Microcircuits
Pushbutton & Rotary Switches
Capacitors
Potentiometers
Technical Ceramics
Ceramic Packages
Semiconductor Devices
Trimmer Resistors



CENTRALAB

Electronics Division
GLOBE-UNION INC.
5757 NORTH GREEN BAY AVENUE
MILWAUKEE, WISCONSIN 53201

Now there's an easy way to make major revisions in power supplies. It's no big deal. Powercube's new Cirkitblock™ modules make even major changes easy and you know the cost before you make the change.

You can use off-the-shelf Cirkitblock modules to put together instrumentation power supplies covering most required voltage and current ratings, with substantial reductions in size and weight.

Cirkitblock modules provide high efficiency conversion and low thermal rise. They are ruggedly constructed, completely self-contained, simple to install. Each basic type — pre-regulator, power generator, or output module — is packaged in a 1" x 1" x 2" building block.

Send for your Cirkitblock power supply design chart. It can bring even your biggest power supply problem down to size.

here's a little something to fight the pain of constant power supply changes

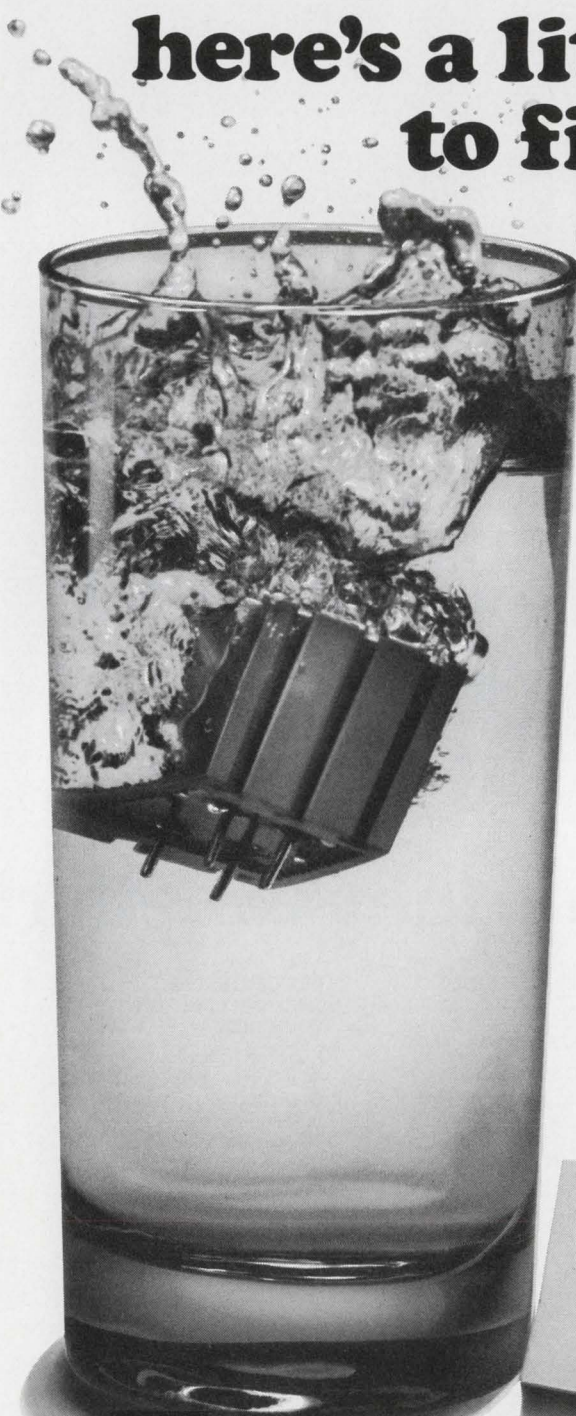

**take one or two
or three...**

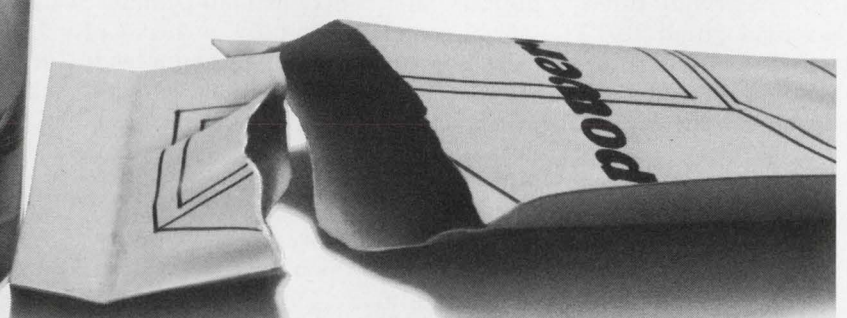

POWERCUBE CORPORATION

214 CALVARY STREET, WALTHAM, MASS. 02154 (617) 924-1758
SUBSIDIARY OF UNITRODE CORPORATION

INFORMATION RETRIEVAL NUMBER 26

washington report



Michael H. Blake, Jr.
Washington Bureau

Employment a big factor in shuttle decision

North American Rockwell's \$2.6-billion contract to build the nation's first space shuttle will create job openings for approximately 8800 employees over the next three years at the company's Space Div. in Downey, Calif. Nearly 3000 of the jobs will go to engineers. The contract will boost the Space Div.'s present employment rolls of 6200 to 15,000 during the program's peak in 1975.

Employment elsewhere will be increased by North American's plan to award as many as 10,000 subcontracts to companies employing a total of 160,000 people. NASA officials estimate that the entire space-shuttle program, including two remaining major contracts still to be awarded, will create about 24,000 new jobs, approximately half of them in California.

Although denied officially by NASA and the Administration, the choice of North American Rockwell was heavily influenced by the White House, sources in the capital report. About a month before the final decision, they say, the Administration asked each of the four aerospace-company candidates to provide a state-by-state breakdown of how the shuttle jobs would be allocated. The aim apparently was to favor areas with pockets of high unemployment.

Raytheon silent on charges it was bailed out

Raytheon Corp. has declined to answer publicly allegations by Rep. Jack Brooks (D-Tex.) that the Federal Aviation Administration "bailed out" the company at the expense of the taxpayer by buying "unacceptable" air-traffic-control display equipment. Brooks is chairman of the House Government Activities Subcommittee, which over the years has investigated alleged mismanagement in Government purchases.

Brooks charges that the FAA paid Raytheon \$1.5-million for ATC display units that failed to meet Government specifications. In January, 1967, the Texas Democrat contends, Raytheon received a \$44-million fixed-price contract for production of the display unit of an ATC system, and it has yet to provide a completely acceptable production model.

In Lexington, Mass., John Severence, spokesman for Raytheon in the Corporate Public Relations Dept., told ELECTRONIC DESIGN: "We're not being charged with anything. FAA is. So we really have no comment."

An FAA spokesman admitted that there had been problems with the Raytheon equipment but said that changing air-traffic-control regulations in the past four years had forced the agency to request design modifications. He said that three of the displays had been delivered with one undergoing tests on a "conditional acceptance" basis at the Los Angeles

air-traffic-control center, a second under test at the FAA National Aviation Facilities Experimental Center, Atlantic City, N.J., and the third in use for air-traffic-controller training at the FAA Academy in Oklahoma City.

Trade imbalance worries U.S. and Japan

In moves to head off what could turn out to be a trade war, U.S. and Japanese officials are pressing their negotiations to reduce both the heavy imbalance in U.S.-Japanese import-export trade and the accompanying pressures for import barriers being demanded by U.S. manufacturers. Japan last year exported \$3.2-billion more in goods to this country than it imported from the U.S., and estimates are that the figure could reach \$4-billion this year.

Both countries are deeply concerned. Prime Minister Kakuei Tanaka has announced that Japan will attempt to close the trade imbalance by at least \$1-billion.

In a related development the U.S. Export-Import Bank has authorized two direct loans, totaling approximately \$110.9-million, to the Tokyo Electric Power Co. and the Japan Atomic Power Co. This will help them buy U.S. equipment, materials and services for two new 1100-MW nuclear power plants. The total purchase comes to \$246-million. General Electric will be the major equipment supplier for both projects, and the GE Technical Services Co. will supply the technical services for one of the plants.

AT&T, Comsat assail FCC domestic-satellite decision

American Telephone and Telegraph and the Communications Satellite Corp. have urged the Federal Communications Commission to reconsider its recent decision restricting their activities with domestic communications satellites. The decision ruled that all qualified applicants could provide domestic-satellite services so long as they demonstrated financial and technical qualifications and showed that their service was in the public interest. AT&T and Comsat, however, were saddled with limitations. AT&T, under the ruling, can use satellites initially only for telephone and Defense Dept. Autovon (Automatic Voice Network) operations within the continental U.S. In addition a joint Comsat/AT&T proposal under which Comsat would provide services solely for AT&T was rejected.

AT&T says that although it is in "substantial agreement" with many of the FCC's conclusions, the limitations placed on its domestic operations will create a "protective umbrella" under which domestic-satellite applicants seeking to provide "specialized services" will be sheltered from competition. The phone company also urged, as did Comsat, reconsideration of the joint AT&T/Comsat project.

Capital Capsules: The Senate has approved two Navy programs whose futures were in doubt. It authorized \$299-million for a nuclear-powered carrier and \$926-million for the Trident missile-launching submarine. . . . **U.S. exports of industrial process instruments** exceeded \$160-million in 1971, up 1.5% from the 1970 figure.



THE TEKTRONIX S-3260 AUTOMATED TEST SYSTEM

...the result of years of systems experience...

THE S-3260 WILL TEST:

- **MOS and Bipolar Shift Registers**
- **Random Access Memories**
- **Read-Only Memories**
- **MOS and Bipolar Random Logic Arrays**
- **Circuit Boards**
- **Modules**
- **Subsystems**

S-3260 FEATURES:

- **Advanced Test Fixturing**—Nanosecond Response Characteristics
- **128 Active Pins**—64 Input, 64 Output
- **Functional Tests**—20-MHz Data Rate; Force, Compare, Mask and Store @ 20 MHz; Individual Drive and Compare Levels at Each Pin; Programmable Loads.
- **Parametric (DC) Tests**—Functional Preconditioning, Differential Voltage Measurements; Kelvin Connections; Force V, Measure I; Force I, Measure V.
- **Dynamic (Timing) Tests**—One Shot Time Measurements; Functional Preconditioning; Dual, Strobed Comparators; Active or Passive Loads.
- **Go-No-Go or Analytical Tests**
- **Interactive Program Writing**
- **Device-Oriented Source Language**
- **Graphical Test Result Displays**
- **Data Logging and Data Reduction with Computer Graphics Displays**
- **Optional Hard Copy Output**
- **Modify Tests and Data Logging Options at Run Time**

Your TEKTRONIX Field Engineer can arrange a discussion with a Systems Specialist. Call him or write Tektronix, Inc., P. O. Box 500-A, Beaverton, Oregon 97005.



INFORMATION RETRIEVAL NUMBER 27
FOR DEMONSTRATION, CIRCLE 123

to build a better VHF/UHF FET mixer:

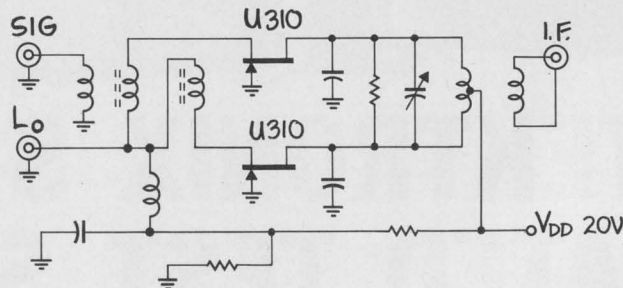

Try our U310 junction FET in this balanced mixer and make your own performance comparison. Our results are below. The inherent square-law transfer characteristic of the FET ensures high intermodulation intercept and signal desensitization. The grounded-gate connection is most stable, while source injection of both the signal and local oscillator make easy impedance matching into the FETs. Also, the balanced configuration reduces l.o. radiation from the signal port and suppresses the generation of even harmonics (which helps reduce intermodulation).

How do you select an optimum JFET for a mixer? Low gate capacitance is needed for wide bandwidth — the Siliconix U310 typically has $C_{gs} = 4.5$ pF and $C_{gd} = 1.9$ pF. Useful conversion gain comes from high transconductance. Our U310 has typical $g_{fs} = 14,000$ μ mhos. Dynamic range is bracketed by the lowest drain current for an acceptable noise figure and the maximum drain current — typically $I_{DSS} = 40$ mA for the U310. For an optimum balance, matched pairs are available.

50-250 MHz Mixer Performance Comparison

Characteristic	JFET	Schottky	Bipolar
Intermodulation Intercept Point	+ 32 dBm	+ 28 dBm	+ 12 dBm [†]
Dynamic Range	100 dB	100 dB	80 dB [†]
Desensitization Level (the level for an unwanted signal when the desired signal first experiences compression)	+ 8.5 dBm	+ 3 dBm	+ 1 dBm [†]
Conversion Gain	+ 3 dB*	- 6 dB	+ 18 dB
Single-sideband Noise Figure	6.5 dB	6.5 dB	6.0 dB

[†] Estimated * Conservative minimum

There's a lot more to this, so

write for data

and get the complete story on VHF/UHF mixing and the Siliconix U310.

Applications Engineering: (408) 246-8905



Siliconix incorporated

2201 Laurelwood Road, Santa Clara, California 95054

Manage your own career before it's too late

The business recession of the past couple of years has taught us all an important lesson: Good engineers can lose their jobs along with the others—if they happen to be working for the wrong company at the wrong time. A lay-off is no longer something that happens to the other guy.

During the boom years we got careless. We concentrated on doing a good engineering job and stopped worrying about the big picture. We assumed that while we were taking care of the engineering, others were taking care of the marketing, finance, management and everything else that's needed to run a successful corporation. But somebody dropped the ball, and many of us lost our jobs.

In a sense, therefore, all of us have to become managers. Of course, it's not likely that many of us will be invited to manage the corporations we work for. But one thing we can all do is to manage our own careers. By this, I mean we should work where we want to work and not where others want us to work.

We should evaluate the companies we intend to work for, just as they evaluate the people they intend to hire. Probably none of us would buy stock in a company that we knew to be poorly managed, or that concentrated its efforts in a declining market, or that was dependent on a single, unreliable customer. Yet too many of us, out of sheer inertia, continue to work for such companies long after the warning signals start flashing.

If you don't like your job, the time to look for a better one is now—while business is expanding and while you have a job. As we found out during the recession, it's difficult to land any sort of job when you're out of work and business is contracting.

But, conversely, if you enjoy your present job and believe in the company's future, then stay with it. Why switch jobs just because some other company is offering a few bucks more? Career planning is one thing, job hopping is something else.

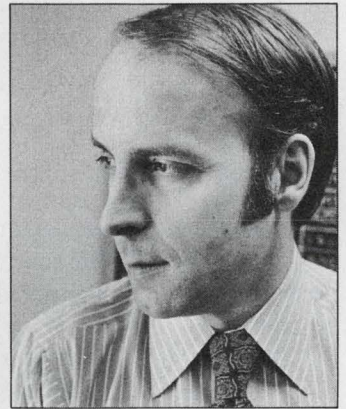

A handwritten signature in dark ink that reads "Michael Elphick". The signature is fluid and cursive, with a horizontal line under the name.

MICHAEL ELPHICK
Managing Editor

FOCUS

on
MSI/LSI
testers

MSI/LSI circuitry is changing the approach to IC testing. And changing with it is the test equipment to check, analyze and characterize MSI/LSI devices and systems.

The changes are taking account of the fact that LSI is becoming increasingly synonymous with MOS technology, which has its own set of test requirements. MOS memories are particularly involved; last year they accounted for about 10% of the estimated \$103-million LSI market.

LSI is also becoming associated with digital subsystems—d/a and a/d converters, calculators, counters and other devices—on one or two chips. These are mostly custom devices, and they require test concepts that differ from those for SSI and MSI.

Moreover the explosion of IC processes, device types and configurations complicates the problem for both tester makers and tester users. Questions like these are stirring controversy: Exactly what is a pure MSI/LSI tester? Should it handle all device technologies? Should it be a dedicated or universal machine? Should it be computer-controlled or pattern-generator-controlled? For that matter, what is LSI itself?

Wading through the specifications of available testers requires the mind of a Bobby Fischer. Direct comparisons are almost impossible to make. Mistakes, however, are easy to make when you consider not only the voluminous specifications that the prospective buyer faces but also the proliferation of manufacturers, each offering many types of equipment.

Fred Van Veen, who has written extensively about testers and is now director of corporate relations for Teradyne, says: "The biggest mistake an engineer can make in reading test-system specs is to take them on faith. This is especially



Semiconductor Test Systems' Venture II, a dedicated semiconductor-memory tester, has a microprogrammed controller and an English-language entry console.

true in MOS clock-rate testing, where specs are often too hard to verify."

However, faith is what many manufacturers pitch to sell their product. "Too many tester manufacturers," asserts Clyde J. Davis, president of Datatron, "have based their whole sales strategy on creating a mystique around their tester and then playing the role of a messiah who will pull them through if only they will have faith."

The baffling speed race

The road to tester selection is bugged with traps for the unsuspecting. And nowhere is this

Stanley Runyon
Associate Editor

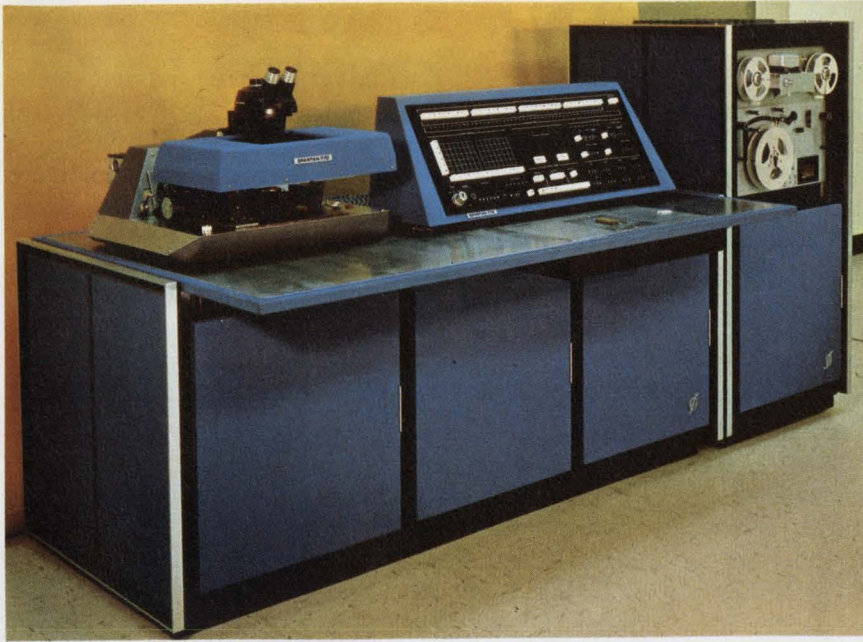

An example of the newer machines is Western Digital's Spartan 770 MOS/LSI tester. It uses a bipolar, microprogrammable RAM instead of the ubiquitous minicomputer of other systems.



Representative of the production-oriented large-scale test systems is the J277 computerized MOS system, manufactured by Teradyne. Its features include multiplexed

test stations, datalogging of dc and time-related parameters, generation of distribution curves, on-line editing, a 10-MHz clock rate and 0.1-ns timing resolution.

more true than in the related areas of speed, throughput and dynamic testing.

Speed, more than any other machine parameter, is the spec that is most discussed—and the hardest to pin down and define in solid terms. Thus you have clock rates, data rates, real-time rates, time per test, four-phase clock rates and other time-related parameters, all of which may mean different things to different people.

Performing truth-table tests at a 20-MHz data rate sounds fabulous at first—until you notice the pauses in the data stream that occur when data are stripped from the computer and serialized to achieve this rate.

And 24-MHz clock rates are breathtaking—until you take a closer look and find out that this rate is specified on a pulse-to-pulse basis with multiphase clocks.

Another term that pinpoints the need to separate fact from fantasy is device data rate. This is used to specify real-time address generation when dummy, or blank, cycles are inserted in a test program to make up for hardware deficiencies.

More speed is desired, of course, to increase throughput, and throughput is the key to profits. But throughput is another evasive parameter, resisting attempts at quantification because of its

dependence on such factors as the types and order of tests, the use of multiplexing and the characteristics of the handling equipment. In fact, the complexity of determining throughput has led one company, Fairchild Systems Technology, to use a computer simulation to evaluate this parameter.

But more speed does not necessarily buy greater throughput and lower testing cost. David E. McGreenery, applications manager of Macrodata, says: "The complexity of the device means that the rules to determine speed/performance vs cost have changed considerably."

In LSI testing the speed discussion takes on new, and more subtle, arguments. While it seems that greater speeds are needed to test the thousands of elements on a single LSI chip within a reasonable time (usually 1 to 3 seconds), a closer look reveals that it is impossible in many cases to check all possible pin combinations functionally.

For example, 2^{40} tests are needed to check all combinations of a 40-pin device. Even at a million tests per second, over 300 hours would be required to run all the tests. If you have a 64-pin device, better cancel your appointments for the next 500,000 years.

The solution? Worst-case and other critical tests. Or, as recommended by James Fischer, national sales manager of Computest, "Prayer is

very helpful." This may be good advice, since there is little agreement among device makers, tester makers and users as to worst-case patterns. To compound the problem, worst-case can vary from process to process, geometry to geometry and manufacturer to manufacturer.

The relatively long time needed to check even a limited number of pins also tarnishes the argument for high-speed handlers that operate with multiplexed stations. This configuration arose in the days when the device test time for standard DTL and TTL was short compared with handling time.

Of course, the spec sheets don't tell you what tradeoffs you have to make to get the maximum advertised speeds. Questions that should be asked are: Do I get the maximum accuracy at the fastest speed? What patterns and what tests can be run at this speed? What happens when I add handlers or time-shared stations to the basic system? Must I switch the device to different sockets for different tests? And do I have to change tapes in the middle of a test to vary my programming?

Down time, the anathema of test engineers, is another item that is rarely mentioned. Computer-controlled testers that use sophisticated software are particularly subject to down time, since complicated programs need debugging, and debugging may mean temporary loss of the system. Also, on a time-shared system, when the computer goes down, all stations go along. Further, some testers need periodic calibration; to a user, calibration is synonymous with down time.

While superspeeds hold the limelight, it's easy to forget that the slowest test frequency may also be important. For dynamic MOS, clock-rate testing also refers to the minimum rep rate (keep-alive time), which can be as low as a few hertz in some cases.

Other tradeoffs that must be made include functional vs parametric vs dynamic capabilities. Often these are tied in with the level of testing—that is, with the device, PC board or system level.

In the functional testing of a digital IC, you check the truth table of a device by applying a pattern of ONEs and ZEROs to the input and comparing the outputs with those expected from the truth table. MOS circuits are usually checked functionally at their maximum and minimum repetition rates, referred to as clock-rate testing. Since functional testing of LSI involves an enormous number of tests, the highest machine speed is used—but at the expense of accuracy.

Parametric testing refers to the measurement of voltages, currents or time-related characteristics of an IC. In dc parametric testing the inputs are held constant until the outputs stabilize.



Macrodata's answer to obsolescence is the MD-150, a tester that features independent modules that can be replaced as necessary to update the system.

In ac, pulse or dynamic parametric testing, such properties as propagation delay, rise time and fall time are measured.

Dynamic testing—do you really need it?

Dynamic testing—in which a device's time-related characteristics are checked either by comparison or measuring and recording—is another area in which the issues are not clear-cut. Controversy probably occurs here because dynamic tests are the most difficult and expensive to perform. If you really need them, be prepared to pay; the price of a tester skyrockets when dynamic capability is added.

According to PRD Electronics, manufacturer of the Cast 950 digital test system, the increased complexity in design required to support dynamic testing places the tester out of reach of most customers in today's market. Dynamic testing, PRD believes, is a must only when the device must be exercised at rated speed to evaluate performance.

Adar Associates agrees. Dynamic testing is essential, the company says, if it is defined as testing the device under maximum expected operating conditions, including access time, but not if it is defined as measuring rise and fall times.

However, other manufacturers disagree. Computest, for example, states that dynamic testing is a necessity but not a cure-all. As complexity increases, the need for dynamic testing goes up twice as fast. A semiconductor device with 5000 to 6000 interconnected devices may have only 20 or so that communicate with the outside world. Dynamic functional verification is the only sure-fire way of locating bad parts.

To avoid the complexity and expense of dynamic tests, many engineers check a device at dc and then attempt to project the ac performance from the results. This, too, is controversial. Here are some pros and cons:

From the Alma Corp: Dynamic testing of such pulse parameters as propagation delays, rise and fall times, data rates and cycle times is very costly. There was much talk of 100% dynamic testing of bipolars a few years ago, but in the face of a 15-cent gate price and an increase in device speeds to 50 MHz, who would spend the money trying to measure TTL propagation delays in a 100% production test?

The quality of the product, Alma continues, is maintained by 100% testing of the dc parameters needed to guarantee noise margin and fan-out. Of course, with MSI and LSI, thorough functional testing is a must. Pulse parameters can always be inexpensively sampled in a setup that uses pulse generators and scopes.



Computer Automation's Capable II uses the company's own 16-bit minicomputer. The system isolates faults in logic cards and IC devices.

Not so, says E-H Research Laboratories. It explains: In the past the traditional users of semiconductors in large quantities or the manufacturers of semiconductors would satisfy themselves that ac specs could correlate with dc specs to an "adequate" level. E-H, however, has been preaching ac testing for years. The extra 0.5 to 12% of bad devices that are not found without it can cause serious manufacturing problems.

E-H says its has learned that at the board level, ac testing makes the difference between a yield of 0 and 50%. The company points out that one major computer supplier has been 100% ac-testing for 10 years, and another for at least five years.

The level of testing and the device complexity may be keys to the dynamic-test controversy. As complexity grows and as more devices are placed on a PC board, new problems develop. Races and propagation delays, for example, may not occur at the device level. But even here we find disagreement.

Computer Automation, for one, says that dynamic testing is not necessary at the PC level if device testing is performed. But Teradyne counters with this remark: "In board testing, one is generally interested in ensuring proper functional operation, but you need ac parametric data to simplify troubleshooting. Board testing is a specialized task, requiring specialized equipment."

Tektronix adds this: "Dynamic testing appears to be most important for those complex logic circuits that depend on time relationships for proper operation—like a multi-input/output logic

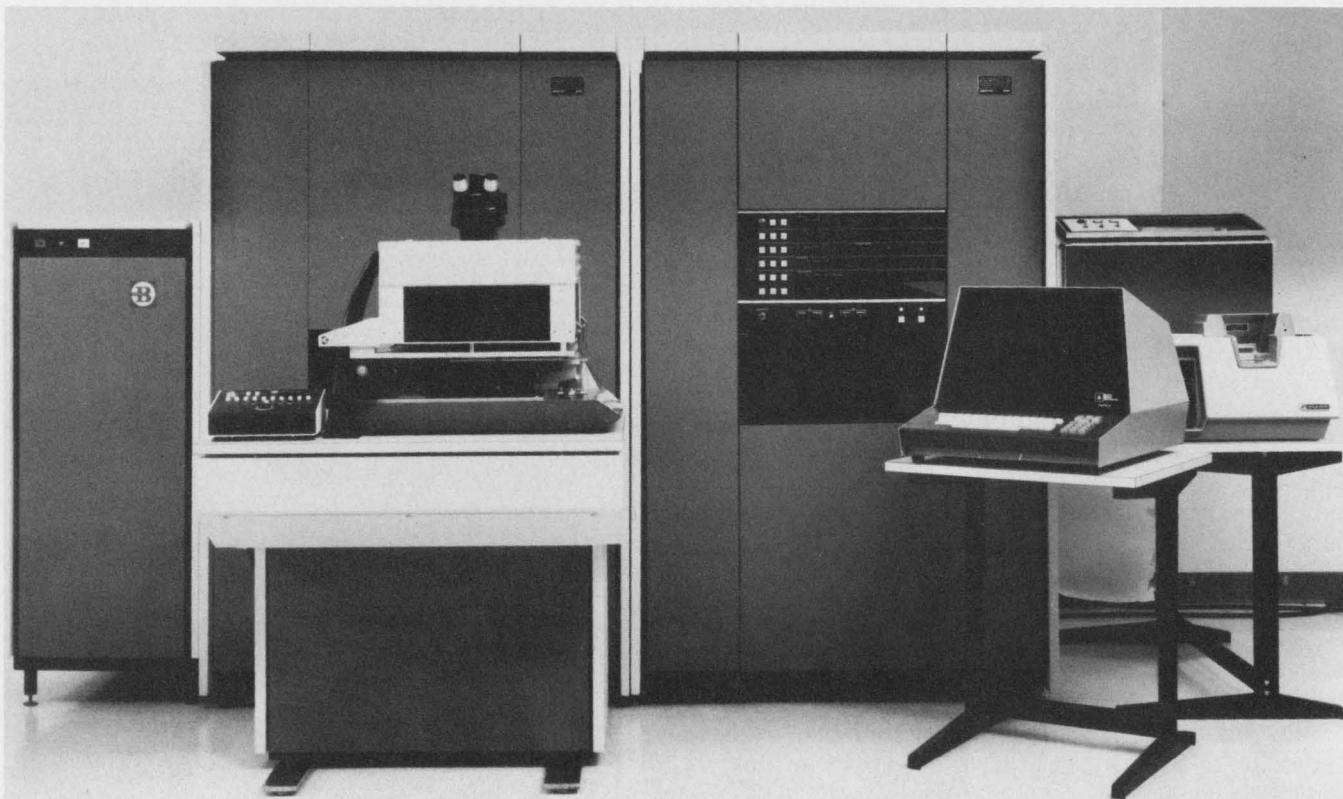

Fairchild's big gun is the Sentry 600, with architecture organized around a main CPU and a test-station group.

gate on a PC board that has different time paths for the input signals. The exact propagation delay for each intermediate gate becomes important in these circumstances."

Is it best to test at device level?

As for the level of testing, tester makers feel that it's best to test at the most basic levels—wafer and device—as well as at the PC board and system level. (For LSI, the device and system levels may be the same.)

The semiconductor manufacturer must test at the component level to characterize and check his device. His credibility depends on that. But the user must justify device testing economically, and this depends upon his device volume and the number of devices per PC board as well as his testing approach.

For example, Teradyne points out that if a computer manufacturer mounts 200 untested incoming devices per board and 2% of the devices are defective, over 95% of the boards will be defective. The cost of isolating and repairing these boards would be disastrous.

If the manufacturer can reduce the defective devices to 0.1% at incoming inspection, he'll reduce his bad boards to about 18%. Thus economics may dictate that the high-volume user test at both device and board level.

By contrast, take the case of a manufacturer

of high-volume consumer products who mounts only 10 devices per board. If 2% of the incoming devices are defective, 18% of his boards will be bad. Incoming inspection could reduce this to less than 1% and thus reduce his costs. However, this manufacturer may find it more cost effective to throw away the defective board rather than spend time repairing it.

Still other tester specs that must be carefully watched are those dealing with waveform integrity. High machine speed means that the pulses arriving at the device pins have nanosecond rise times, and transitions this fast can deteriorate just as fast if the capacitance of the cables and of other devices along the pulse path is too high.

Low capacitance is nice, but don't forget to ask where it's specified: at the end of cables, where it's really needed? Or somewhere way up the line? And what happens to capacitance when you tack on a multiplexer? Does the fantastic, advertised slew rate hold for full swing or is it extrapolated from the linear portion, which may be a small part of the total voltage change?

The best bet here is to roll up a fast scope and check the waveshapes right at the device pins. But don't forget that while voltage transitions should be fast enough to represent actual conditions in use, they shouldn't cause ringing and overshoots that can result in false triggering. Of course, transitions that are too slow can cause

multiple changes in logic states.

One feature to watch for is test-head pin electronics. This locates drivers and receivers right at the device and, if properly designed, should guarantee waveform integrity at the device pins. At least one company, Macrodata, offers interchangeable pin electronics in its MD150. By changing the driver/receivers, you can set up to test either MOS or bipolar devices.

Fairchild's Sentry 600 provides each device pin with its own dedicated electronics. This includes device bias, input drive and clock pulses, detect output pulses and access to the dc-measurement unit.

Other systems that provide I/O head electronics include Teradyne's J277, Adar's Doctor 64, E-H's 4600, Western Digital's Spartan 770 and Tek's 3260.

Timing requirements for MOS call for nanosecond resolutions that put even the best testers to the test. Resolutions of 1 and even 0.1 ns are great. But what are the jitter and stability of the pulse at these resolutions? And what warmup time is required? Further, does the full resolution apply at all test frequencies or does the resolution fall off at the lower ranges? Don't forget that memories may exhibit failure patterns that are a function of the timing and that variations of a few nanoseconds may be critical. In fact, although they have been upstaged by machine speed and waveform integrity, timing resolution and control may be just as important for today's LSI devices.

Software—the biggest headache

While wading through the multitude of tester specs can result in sweaty brows, be prepared for a complete soaking when swimming through the software flood.

Everyone wants programming that's easy to use and flexible. The problem is determining whether the software package is easy to use and what tradeoffs must be made to get it—for example, is real-time operation sacrificed for programming ease?

Evaluating software by just reading or comparing specs is difficult, even for a programming specialist. And that's exactly what you've got to be to get a handle on the software situation.

With some of the newer machines offering hard-wired instead of software-controlled pattern generation, a new question arises: Do I need software at all? Indeed, considerable overhead and down-time savings can result from eliminating debugging time. But proponents of pattern generation by software contend that hardware methods are not suitable for complex logic or ROMs. All of which leaves the prospective buyer up the proverbial creek.

Again, the first question that should be asked

is: What do I really need? Most large machines offer a number of software packages, including an Executive, or Master, program and Compiler, Translator, Editor, Datalogging, Binning and Diagnostic programs. The cost of these is easily the second largest expense of purchasing a test system.

If you do need a good portion, or all, of the available software, it's advisable to find out what configuration it comes in. Is one program on paper tape and another on magnetic tape or disc? Do you have to shut down to reload? Is the core storage adequate for all the programs? How much does the disc memory, if needed, slow you down? And can you make program changes without disturbing the actual testing?

The question of easy programming relates to the number of different device types you have to test. If you've got large quantities of one or two types to test, speed is essential, and programming, even if awkward, takes a secondary role. But if you're checking or characterizing small quantities of many different device types, as in quality control or engineering evaluation, then you'll be looking for software that's easy to use.

What does it really cost?

The initial cost of a test system can be readily ascertained. But, like everything else connected with LSI testers, determining real costs requires more than a cursory examination. It helps if you've got an accounting degree.

To initial price must be added the difficult-to-determine costs of programming and debugging; training; installation; service contracts and other maintenance; operator expenses; and a slew of accounting-sheet costs, such as floor-space utilization, interest on capital investment, depreciation and down time.

By combining these with such factors as the numbers and types of devices to be tested, the speed and duration of tests, failure rates and



The Model 4400, which Datatron says was the first system to use force/monitor circuitry at each device pin.

fault-isolation and repair times, an expert can calculate true cost or savings over manual testing, based on one of the standard accounting methods, such as pay-back period, discounted rate of return, or net present value.

Many of these expenses are not fixed, though they appear to be or are glossed over by the manufacturer. Programming may be a continued expense as new devices are added to the testing list. And don't think that your warranty frees you from maintenance or troubleshooting. Most manufacturers will replace a bad PC board or other part, but only after the user has located it. Further, in spite of claims about no calibration requirements, the equipment will have to be put on a calibration schedule if you're doing Government work. And that means down time.

McGreenery of Macrodata sums up the cost problem this way: "Engineers can determine real cost by taking into consideration all of the items involved in using a system. By far, the most overlooked cost is programming. Two applications engineers will cost more than the system and its maintenance over the life of the tester. Down time—caused by waiting for programming of new devices—as well as actual failures, must be considered. Speed vs performance vs cost figures are changing with LSI devices, since each device is a system in itself. Thus the engineer must take into account a whole new set of values to determine the real cost to test MSI/LSI devices."

With the problem of spending an unknown sum added to that of digging out the true performance of an LSI tester, the question arises: Can a large-scale system be truly evaluated before it's purchased? Perhaps the best advice that can be given is this: Take your device to a tester manufacturer and say, "Check it—now." If it takes four days to program the machine—well, at least you've learned something. Then check with other owners of the system to determine the manufacturer's track records.

A good question to ask another user is: Would you buy the tester again? Find out if the manufacturer has actually delivered his system and if the software, peripherals and other add-ons are available now—or in a year. Finally, the stability of tester manufacturers demands an additional investigation: What is his financial status? Will he stay in business?

Buy or make—an old choice

For bipolar testing at least, some common grounds have been reached by both the tester maker and the prospective user. But for MOS and other fast-moving technologies, unresolved conflicts as to test requirements still lead to the age-old question: Buy or make?

A company's decision to build its own tester

usually stems from one of two reasons: The system that fits the need exactly is not available commercially or the universal, large-scale commercial systems are too expensive.

In recent years manufacturers have made testers specifically intended for MOS/LSI and other new devices. While the performance of these testers has approached the needs of semiconductor makers, the prices have remained in the \$50,000-and-up region, where the sales resistance is stiffest. It is the smaller, dedicated and less expensive machine that seems to command most interest at present.

Only two years ago Wally Raisanen, a staff member of the New Venture Development program at Motorola Semiconductor, told *ELECTRONIC DESIGN* in an interview: "There's no motivation for us to spend the money on the outside when we're able to design and build machines for one-fifth to one-tenth the cost of commercial machines."

When queried recently as to the present validity of his statement, Raisanen had this to say: "Well, our costs have risen, and other people's prices have come down, so the ratio is smaller now, but it's still generally true. However, the tactical situation is different. Before, we couldn't get the software, but we had the resources to develop it ourselves. Now we can get the software, and we don't have the resources. So the motivation to buy the machine is a lot higher than it was two years ago."

Raisanen adds: "Small companies can't afford to hire and train the kind of talent that's required to design the hardware and software that go into making a large-scale test system. The smaller people are more or less forced to buy what's commercially available."

Tester manufacturers, of course, contend that the home-built equipment is at a distinct disadvantage, with the possible exception of the dedicated tester with a narrowly defined purpose. This is the viewpoint of Sidney Freshour, president of Alma, which claims that its Model 480B is the "only true LSI/MSI benchtop tester."

"It makes no more sense to build your own IC tester than to build your own oscilloscope or DVM," Freshour says. "The economics are very poor."

Most of the arguments against home-built, large-scale testers run along economic lines. Initial estimates of development costs are usually over-optimistic, critics say, and in the end the costs snowball, giving rise to many compromises that result in an inferior system. Also, the argument continues, in-house test groups, to lower costs, usually maintain a minimum of documentation, and it tends to get lost in a few years. As a result, the in-house system may become an orphan, still carrying the burden of depreciation

while leaving management with the problem of sorting out an electronic jigsaw puzzle. The development costs for a purchased system, however, are shared by a large customer base.

Van Veen of Teradyne, one of the largest tester makers, adds this argument to the build-or-buy cauldron: "Good test-system design today requires the very highest level of technical skills, and it is not surprising that these skills gravitate toward companies whose principal business is test equipment."

Unlike the semiconductor manufacturers, who must test their devices, the device user is not as pressured by the build-or-buy decision. Many users simply elect a third option—don't test the device.

Hewlett-Packard, a large user of LSI devices, weeds out bad 1103 memories at incoming inspection by plugging them into a desk calculator. The ones that get away are spotted at production during system test of the calculator.

A similar procedure is followed for the custom LSI chips used in the HP Model 35 electronic slide rule. HP has worked with its two chip suppliers to assure adequate device testing by the suppliers. The chips are then checked in a breadboard on a sample basis at incoming inspection, and they are 100% functionally tested at the system level. A computer-controlled logic board built by HP is used for this purpose.

Interestingly, one of HP's two chip suppliers—American Microsystems—uses a commercial tester, the Redcor PAFT—while the other—Mos-tek—uses its own special testers.

Know what you really need

Once a company decides to buy a system, it must take a hard look at the device or devices it wants to test. Perhaps the best way to end up spending \$200,000 when a \$50,000 machine will do is to fail to understand fully the test requirements of the device. This also results in over-testing or undertesting, either of which can be damaging to company profits.

The device user must ask: What is adequate testing? What do I really need? These lead to a multitude of more specific questions: Do I need dynamic testing, functional testing or both? Are parametric tests necessary? What speeds and accuracies are important? Shall I test at device or board level, some higher level or at some combination? Can I get by with a small, special-purpose machine or do I need a large, automatic test system? And if the latter, should it be computer-controlled or have a pattern generator? Also, which machine won't be obsolete within two years?

The answers are not always clear-cut. A purchase in the \$100,000-and-up range may take

from six months to a year to complete, but in general the purchasing decision depends on the following:

- The particular device application.
- The number of different device types.
- The quantities to be tested.
- The end market: either consumer, military or industrial.
- The test function: production, incoming inspection, quality control, engineering evaluation, or a combination of these.

Selection is wide and tough

Even if your test requirements are well-known, selection can be really tough. The first question that must be answered is: What is an MSI/LSI tester? This is not as strange as it may seem, since there are many large, automatic test sys-



Tektronix's entry into the big-system market is the S-3260, which includes a graphic terminal among its standard features.

tems that manufacturers say will test almost everything from diodes to whole communication systems. An example is the Avmots System, manufactured by the Avco Corp. It is said to be capable of testing anything electrical or electronic by synthesizing all known measurement devices.

Even if such systems are eliminated from consideration, there still remains a wide choice of machines designed specifically to test LSI devices. These may be roughly sorted into three categories, based on size, area of operation and types of tests to be performed.

In the first category there are universal, large-scale machines, usually (but not always) computer-controlled; machines dedicated to one, specialized task (memory testers, for example); small, bench-type lab testers, and a host of sys-

tems of intermediate size.

The second category—area of operation—includes equipment intended primarily for production use; equipment for use in quality-control and engineering evaluation; incoming-inspection equipment; machines for device characterization, and equipment that is touted to perform all of these tasks.

Finally, some test systems perform functional tests; others perform functional and parametric tests; and still others “do everything.”

Despite the profusion of equipment, some consensus seems to be taking shape. “It is gratifying to note,” says Francis J. Bigda, marketing manager for Adar Associates, “that users are beginning to believe that there is no perfect tester which will perform all tests on all devices.”

Motorola's Raisanen agrees. He says: “At one time we felt that we could build a machine that would do everything—test memories, test shift registers, test custom products. It turns out that that's not really true.”

Selecting a test system, though, seems to have been made easier by the recent economic recession. A number of IC test-equipment manufacturers have either thrown in the towel or are struggling to survive.

However, despite business failures and reorganizations, optimism is alive among newer arrivals on the tester scene. Semiconductor Test Systems, a subsidiary of the Computest Corp., has recently entered the LSI tester market with its Venture II, a dedicated system designed to test RAMs, ROMs and shift-register memories functionally at a 10-MHz rate. And Xincom, a two-year-old function-module house, appears to be backing into the market with a line of do-it-yourself modules, with which you can build a small, dedicated tester.

Still other companies are retreating from an image of being strictly LSI tester manufacturers, ostensibly to broaden the market for their equipment. But another explanation for the retreat may be that the pure LSI/MSI test system is not only becoming increasingly specialized but has been caught up in a race for greater and greater test speeds. And many of the computer-controlled universal systems originally recommended for LSI testing can't supply the complex patterns and the 10-MHz, 20-MHz and even higher rates that are now needed to test some MOS devices.

The new breed—dedicated testers

The millions of patterns and speeds required of testers simply to walk ONEs and ZEROs through MOS memories have led to the development of dedicated machines—that is, machines that test memories only. These testers use micro-programmed pattern generators instead of com-

puters to produce the long test patterns and high test rates required to check RAMs, ROMs and shift-register memories. Elimination of the computer also eliminates the need for extensive software. As a result, these memory testers are generally less expensive, falling in the range of \$15,000 to \$50,000. Included are Macrodata's MD-100, Pacific Western's Model 20, Semiconductor Test Systems' Venture II and Western-Digital's Spartan 770 (which can also be configured for other devices).

However, some large-scale machines, such as Teradyne's J277 MOS-circuit test system and Fairchild's Sentry 600, include both a local pattern and address generator and a computer controller. The address generator in the J277 can exercise memories of up to 4096 words without use of the computer, while the Sentry 600's local, or special-purpose, controller can handle up to 60 device pins to a depth of up to 1024 bits per pin. Some of these machines offer expansion capabilities, so modules can be added to perform tests on other LSI devices.

The large-scale machine is usually used for de-

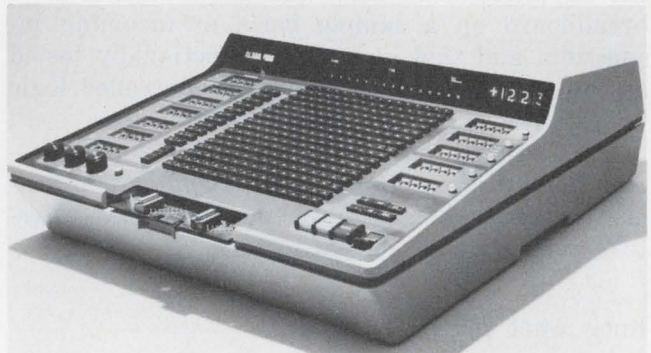

A small, bench-top tester, the Alma 480B, is programmed from the front panel by a pushbutton array and thumbwheel switches. Most other bench-top testers use personality cards to match the tester to the device.

vice characterization or for production, where the large quantities of devices to be tested and the high throughput justify the \$50,000 to \$250,000 price tag. For use in incoming inspection, engineering analysis or quality control, however, the mix of devices to be tested may span many technologies from ECL to CMOS and a complexity spectrum ranging from SSI to LSI. In this case, where small quantities of many device types are measured or checked, the high-priced installations are probably out of the question, and the smaller, lower-priced testers enter the picture.

Representative of the latter are Microdyne's 721A (\$4850), Alma Corp.'s 480B (\$8750) and Teradyne's J133 (\$4850). Except for the 480B, these bench-top testers are programmed by the insertion of plug-in printed-circuit cards—or

"personality" cards, as they are called in the industry. One card is required for each different IC device. The 480B, designed specifically to test MSI/LSI, is programmed from the front panel via a 16-by-16 pushbutton array and a series of thumbwheel switches. Other companies, such as Comaltest, make bench-top equipment to analyze chips and devices that are rejected in production.

Big machines, big price

Representative of the larger machines are Teradyne's J277 and J283, the Fairchild System's Technology Sentry 500 and 600, Macrodata's MD-150 and MD-200, the Adar Associates Doctor 64, E-H Research Laboratories' 4500 and 4600 and Tektronix's new S-3260 system.

The J277 is a MOS clock-rate test system with a 10-MHz clock rate, 0.1-ns timing resolution, multiplexed test stations, datalogging of dc and time-related parameters, generation of distribution curves or summary sheets, on-line editing and many other features. The older J283 is a bipolar and static MOS test system.

In contrast, Fairchild's Sentry 600 can test both bipolar and MOS, discrete devices and digital modules. It can perform dc parametric tests at the rate of 1000 per second, functional tests at a 10-MHz data rate (and 20-MHz, four-phase clock rate) and go/no-go limit comparisons at the rate of 2000 per second. And it has 10-ns timing resolution, multiplexed test stations, datalogging and data analysis.

Tek's recently introduced S-3260 performs functional, dynamic and dc parametric tests on bipolar and MOS devices with up to 64 pins, and it can handle complex logic arrays and PC boards. The computer-controlled system features 20-MHz data rates for the functional, or truth-table, tests; four-phase clock pulses plus three strobe pulses, all programmable to 1 ns; a 250-Hz parametric test frequency; functional go/no-go tests; analytical tests; dynamic Δt measurements by timing between level crossings; datalogging and data reduction with graphic display; time sharing and interactive software.

In an effort to solve the obsolescence problem, Macrodata has come up with the MD-150, a tester that offers stand-alone, modular construction. It is a cascaded, computer system in which one module, a 5-MHz processor, functionally exercises the device on its own. Another module—called a sequencer, or control computer—handles the data shuffling between the modules.

Modularity, Macrodata says, means that a buyer need replace only one module (at about \$20,000) to update his system.

Macrodata was not the first, or only, tester manufacturer to offer the modular approach. Fairchild's Sentry series, culminating in the 600,

emphasizes the concept by using a central processor that operates with a series of specialized test stations and a test-station controller.

Western Digital, a two-year-old MOS house, markets the Spartan 770, a MOS/LSI tester whose basic architecture features a modular configuration. And both Teradyne and E-H offer modular systems, Teradyne with the J277 and E-H with its 4500 series.

The 4500, E-H reports, is totally modular—both in hardware and software—down to the fixture system, which can be expanded from the basic 20-pin structure to an 80-pin, dc functional system.

The 4540 exemplifies the kind of system that can be put together from the various packages. It makes ac switching-time, dc parametric and clock-rate tests on any MOS or bipolar device at superfast speeds. E-H says it has delivered one 4540 system geared for real-time functional testing of ECL memories at an incredible 100-MHz rate. ■■

Need more information?

The information on products in this report touches only on the highlights. For complete product details, get in touch with these manufacturers:

- Adar Associates, Inc., 85 Bolton St., Cambridge, Mass 02140, (617) 492-7110. (Francis J. Bigda, Marketing Manager) **CIRCLE 400**
- Alma Corp., 1061 Terra Bella Ave., Mountain View, Calif. 94040. (415) 961-9833. (Sidney G. Freshour, President) **CIRCLE 401**
- Comaltest, Inc., Commerce Dr., Danbury, Conn. 06810. (203) 792-3777. (John Cocking, President) **CIRCLE 402**
- Computer Automation, Inc., 895 W. Sixteenth St., Newport Beach, Calif. 92660. (714) 642-9630. (David Methvin, President) **CIRCLE 403**
- Datatron, Inc., 1562 Reynolds Ave., Santa Ana, Calif. 92711. (714) 540-9330. (Clyde J. Davis Jr., President) **CIRCLE 404**
- Digital General Corp., 11000 Cedar Ave., Cleveland, Ohio. 444106. (216) 721-0440. **CIRCLE 405**
- E-H Research Laboratories, Inc., 515 11th St., Oakland, Calif. 94604. (415) 834-3030. (William F. Boggs, Systems Marketing Manager) **CIRCLE 406**
- Fairchild Systems Technology, 974 E. Arques Ave., Sunnyvale, Calif. 94086. (408) 735-5011. (Gordon R. Dagg, Manager, Marketing Services) **CIRCLE 407**
- General Radio, 300 Baker Ave., Concord, Mass. 01742. (617) 369-4400. **CIRCLE 408**
- Instrumentation Engineering, 769 Susquehanna Ave., Franklin Lakes, N.J. 07417. (201) 891-9300. **CIRCLE 409**
- Macrodata Co., 20440 Corisco St., Chatsworth, Calif. 91311. (213) 882-8880. (William Mow, President) **CIRCLE 410**
- Optimized Devices, Inc., 220 Marble Ave., Pleasantville, N.Y. 10570. (914) 769-6100. (Al Rosenthal, Chief Engineer) **CIRCLE 411**
- Pacific Western Systems, Inc., 855 Maude Ave., Mountain View, Calif. 94040. (415) 961-8855. (Donald Snow, Director, Research and Development) **CIRCLE 412**
- PRD Electronics, Inc., 1200 Prospect Ave., Westbury, N.Y. 11590. (516) 334-7810. **CIRCLE 413**
- Semiconductor Test Systems Div., Computest Corp. (also markets the Microdyne line of testers), 3 Computer Dr., Cherry Hill, N.J. 08034. (609) 424-2400. (James E. Fischer, Marketing Manager) **CIRCLE 414**
- Sitek Corp., 1078 W. Evelyn, Sunnyvale, Calif. 94086. (408) 735-9800. (Bob Prescott, Marketing Manager) **CIRCLE 415**
- Tektronix, Inc., P.O. Box 500, Beaverton, Ore. 97005. (503) 644-0161. **CIRCLE 416**
- Teradyne, Inc., 183 Essex St., Boston, Mass. 02111. (617) 482-2700. **CIRCLE 417**
- Western Digital Corp., 19242 Red Hill Ave., Newport Beach, Calif. 92663. (714) 557-3550. (Ron Griffin, Manager, Test Systems Sales) **CIRCLE 418**

Mil spec synchro/digital converters:

We've got 'em in cards. Or cased. For off-the-shelf delivery.

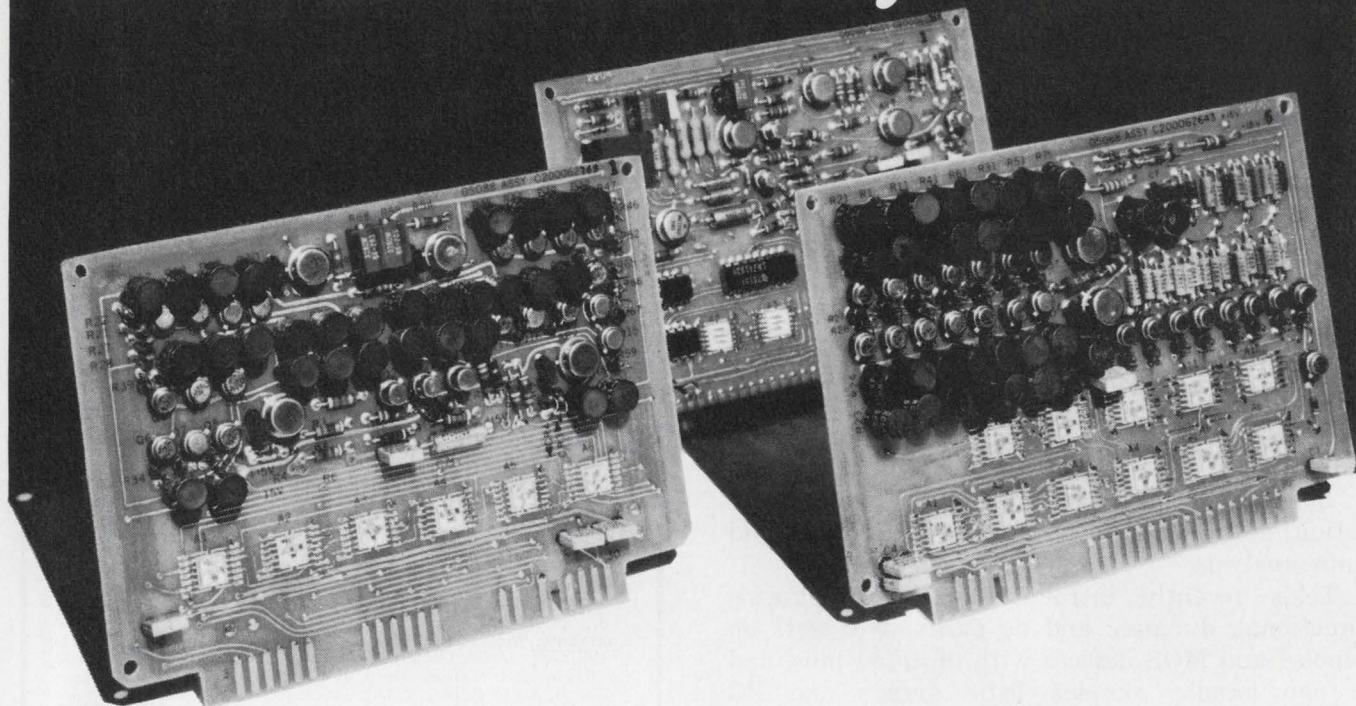

Kearfott can solve your synchro-to-digital and digital-to-synchro conversion problems with three production model solid state converters. All three meet MIL-E-5400.*

TRIGAC I—A low cost synchro to digital converter, accurate to 12 minutes.

TRIGAC III—Synchro to digital tracking converter dynamically similar to an electro mechanical follow-up servo.

TRIGAC IV—Digital to synchro converter, accurate to four minutes.

Typical Characteristics

		TRIGAC I		TRIGAC III	TRIGAC IV
Model Number	C70 4773 017	C70 4773 011	C70 4773 019	C70 4773 022	C70 4773 020
Package	2 P C cards	metal enclosure	2 P C cards	3 P C cards	3 P C cards
Input Signal	4 wire resolver	3 wire synchro	4 wire resolver 4 channels	4 wire resolver	12 bit parallel
Output	13 bit BCD			14 bit natural parallel	3 wire 11.8V 400Hz
Resolution	6 minutes of arc				
Accuracy	12 minutes of arc			4 minutes of arc	
Logic Levels	Logic "1" = $\pm 5V \pm 10\%$, Logic "0" = 0-0.5V				

*Commercial version available

We can supply any of the cards shown in corrosion-resistant metal enclosures. Write today for new catalog. The Singer Company, Kearfott Division, 1150 McBride Avenue, Little Falls, New Jersey 07424.

SINGER
AEROSPACE & MARINE SYSTEMS

They said no one could build and sell a computer-controlled LSI/IC test system for under \$100K...

then along came Macrodata!

"Once upon a time test equipment manufacturers convinced each other that \$250K wasn't too much to pay for a computer-controlled DC/IC test system. In fact, they even convinced their customers.

"Then along came Macrodata. First off, for only \$200K, they built and delivered the first high-speed LSI test system, the MD-200. Then they set their sights on a system that could sell for about one-third of that price.

"No sooner said than done—they called it the MD-150. And within the first two months, many systems were purchased by leading IC manufacturers—installed and at work testing devices.

"The MD-150 is a cascaded, computer-controlled system designed to test all types of LSI/IC devices at functional speeds up to 5 MHz. It tests RAM's, ROM's, shift registers, and semiconductor memories, as well as random logic. It lets you test both MOS and bipolar devices optimally because of its unique interchangeable pin electronics and Macrodata's 'firmware' packages, and testing can be done at the wafer level and/or in the final package.

"When you buy the system, here's what you get: (1) an MD-50 Sequencer, which includes a computer and tape cassette that control the execution of a variety of test programs;

(2) an MD-100 Tester, which performs functional testing and supplies control information to the device under test at 5 MHz; (3) an MD-83 Automatic Parameter Tester, which is capable of running a full complement of DC functional/parametric tests for single-pin or multiple-pin testing; (4) an MD-73 Programmable Clock, which consists of up to six, one-nanosecond, programmable 'clocks,' with rep rates of 11 MHz; (5) an MD-44 Programmable Power Supply, with up to nine, precision, programmable units; (6) Pin Electronics, with up to 42 channels, which can be configured for LSI.

"In plain talk, the MD-150 is here today, ready to work for you now. It is packed with many third-generation design features, and provides 5 MHz performance at half the price of other so-called competitive units, for as little as \$60K. It requires no special software or add-on boxes, so you can launch right into a 'zero overhead testing' program immediately."

So much for Chapter II of the Macrodata Story. Look for the next exciting chapter soon.

Meanwhile, for a free copy of the MD-150 brochure, use the reader service card; and if you can't wait, just call us directly.



Chapter Two. The Macrodata Story.



Macrodata Company, 20440 Corisco Street, Chatsworth, California 91311, Phone: (213) 882-8880, Telex: 65-1345

Sales Offices: Los Angeles Area Tel. (213) 245-9404 · San Diego Area Tel. (714) 232-2017 · Northern California Area Tel. (408) 244-1505 · Philadelphia Area Tel. (609) 228-1325 · New England Tel. (617) 862-5700 · Southeast Area Tel. (205) 883-0140 · **Foreign:** Munich, West Germany Tel. 34 56 00 Telex: 841-521-5969 · Milan, Italy Tel. 871-988 - 899-248 Telex: (843) 34314 · Tokyo, Japan Tel. 03 985 5266 Telex: (781) 272-2171

Use ECL 10,000 layout rules to help solve PC-board interconnect problems. You may find you don't need large ground planes or complete transmission lines.

First of two articles

Designing with ECL 10,000—a high-speed, emitter-coupled logic family—requires special attention to layouts. The family has a typical gate propagation delay of 2 ns, while an ECL 10,000 system can achieve clock rates in excess of 100 MHz. To get the higher speeds, printed-circuit-board interconnects must be designed carefully.

The layouts range from simple, single-layer PC boards with wired interconnects to elaborate multilayer boards with complete transmission line systems. A good layout will not only give higher speeds but will also help to minimize packaging complexity and to reduce costs.

A basic element in the layout is a ground plane. Its use permits optimum performance by an ECL 10,000 system, since it allows for a constant characteristic impedance (Z_0) to signal interconnections and also provides a low inductance path for ground currents on the V_{CC} positive voltage supply. The following guidelines apply when using ground planes:

1. Up to 30 to 40% of the V_{CC} ground surface can be removed for signal interconnections and V_{EE} routing, as shown in Fig. 1. When using edge connectors, pin the ground plane out to about every seventh connector pin.

2. Bus the V_{EE} (negative voltage) supply to pin 8 of each 16-pin DIP package. The bus line width at any point should be a minimum of 0.1 inch. Extend the V_{EE} supply to a plane under the etched signal lines of a two-sided circuit board. The signal lines then exhibit a constant characteristic impedance. (This technique is also shown in Fig. 1.)

3. Provide a low inductance 0.01- μ F bypass capacitor every two to six packages, depending on the extent of the ground plane. If it covers less than 50% of the board area, bypass every two packages. On two-sided systems or multilayer systems with 100% ground-plane coverage,

only one capacitor is needed for every four to six packages.

4. Use only a pull down resistor (Normally 510 Ω to V_{EE}) when board interconnects are six inches or less and fanouts are less than four. In this case the rise and fall times of ECL 10,000—typically 3.5 ns—allow these lines to be treated as unterminated transmission lines requiring only the pull down resistor.

5. Use terminated transmission lines or twisted-pair lines for high fanouts and high-speed clock distributions.

Layouts without ground planes

In small systems, where the number of interconnects and the package density are high, it's difficult to reserve a large ground plane area without the use of a multilayer board—a costly approach. However, ECL 10,000 can still be used if the following guidelines are followed:

1. Bus V_{CC} directly to the V_{CC} pins of each package. The bus lines should be as wide as possible, with a minimum of 0.1 inch per row of packages. If an edge connector is used, pin V_{CC} out to several connector pins.

2. Bus V_{EE} to pin 8 of each 16-pin DIP package (or pin 12 of the 24-pin package). When V_{EE} is brought onto the board via an edge connector, lay out the V_{EE} line in close proximity to a V_{CC} pin for easy bypassing.

3. Bypass each device between the V_{CC} and the V_{EE} pins with a low inductance 0.01- μ F capacitor.

4. Keep logic interconnecting lines to minimum length. A maximum line length of six inches is suggested. For longer lengths, ringing becomes too severe and series damping resistors are necessary.

5. Use twisted pair lines, coaxial cable or series termination for high fanouts (eight or more) and high-speed clock distributions.

A double-sized PC board in which these rules have been applied is shown in Fig. 2. Several MECL 10,000 devices (Motorola's designation for this ECL family) are used with MTTL (Motorola's transistor-transistor logic circuits) in a high-speed counter. The MECL and MTTL ICs

Tom Balph, Applications Engineering, Motorola Semiconductor Products, 5005 E. McDowell Rd., Phoenix, Ariz. 85008

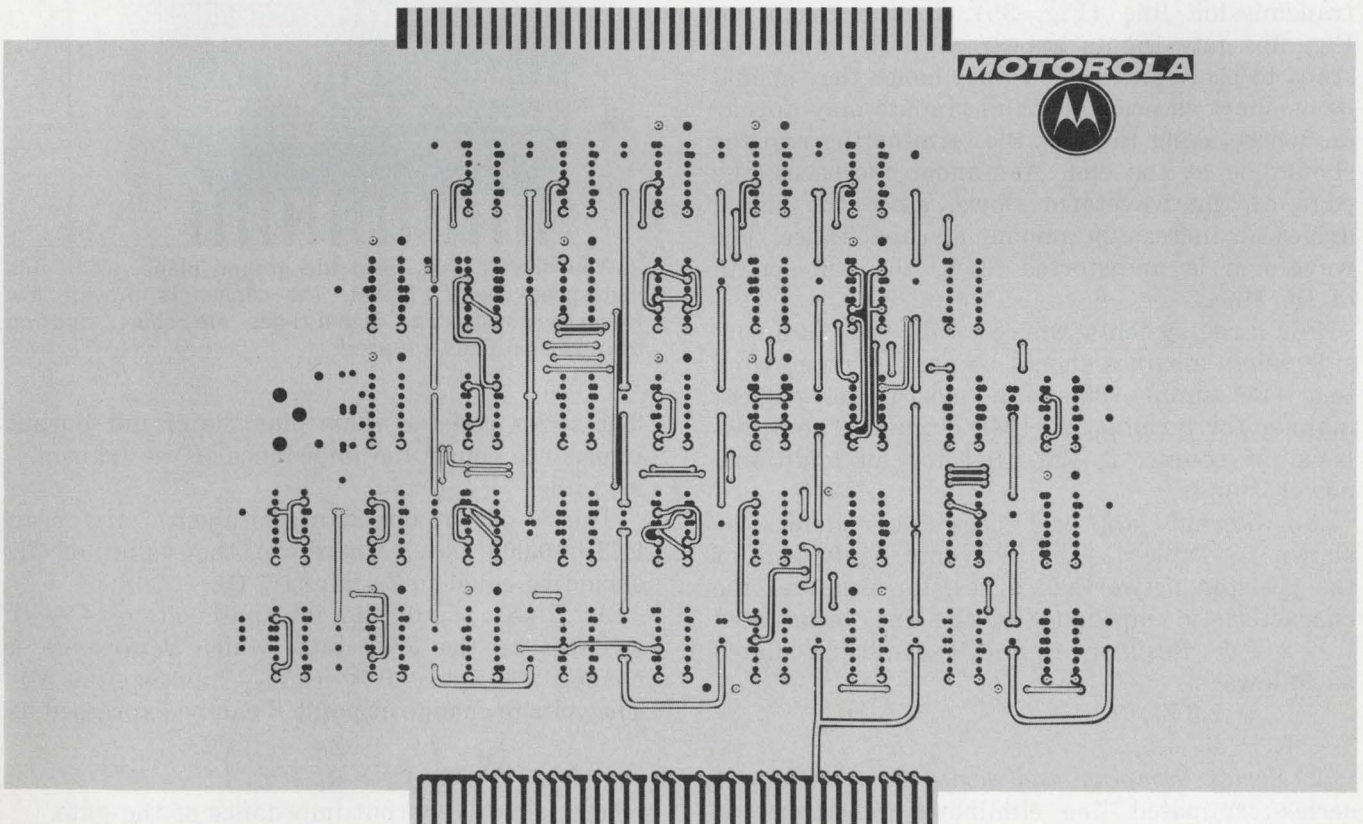
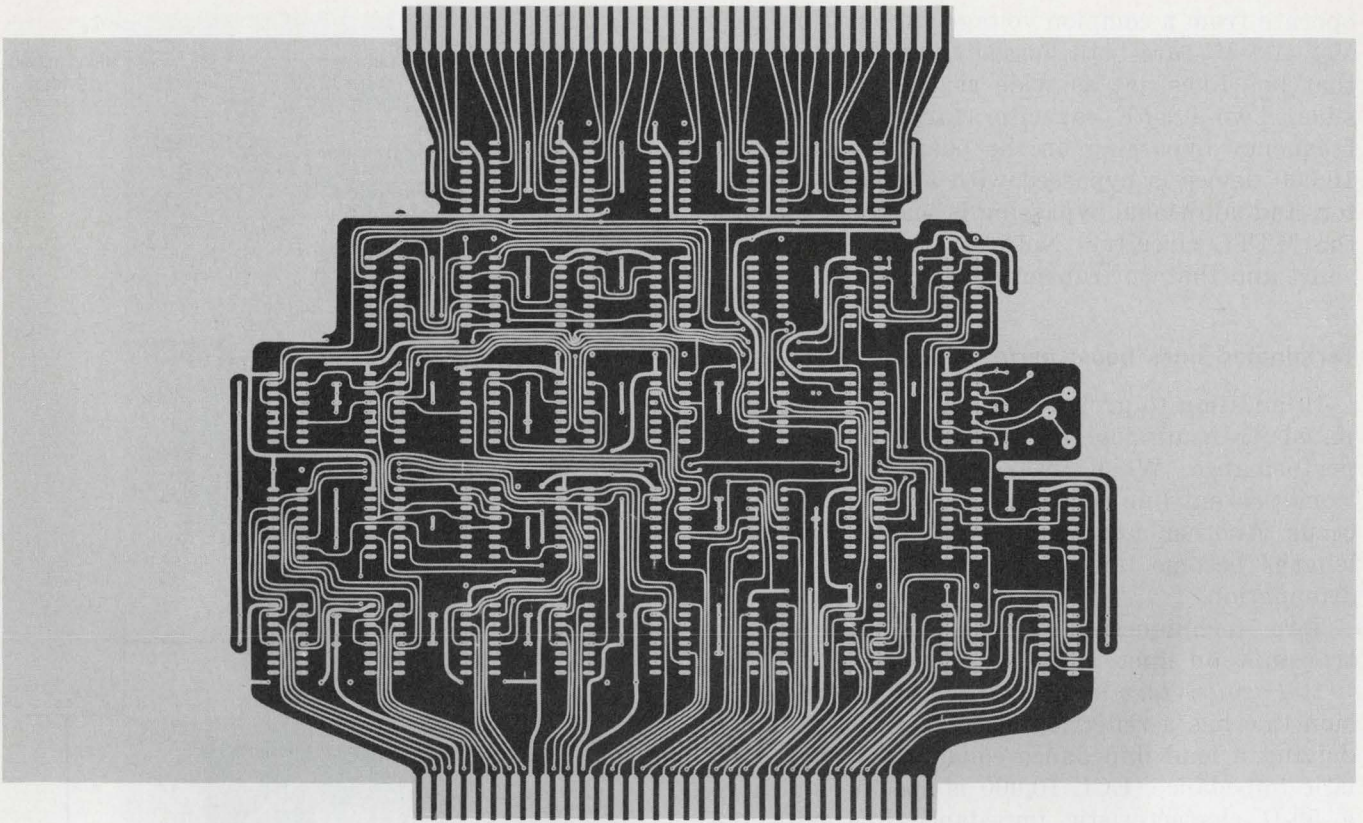

1. A MECL 10,000 PC board with a ground plane. The board provides a constant characteristic impedance and low inductance path for ground currents. The ground

plane also serves to maintain a noise-free voltage plane for the V_{CC} supply. About 30 to 40% of the ground plane is removed for signal interconnections.

operate from a common voltage supply. Note that V_{EE} and V_{CC} are both bussed to the package and that bus lines are as wide as conveniently possible. Two $0.1\text{-}\mu\text{F}$ capacitors are used for low-frequency bypassing on the board. Each MECL 10,000 device is bypassed with a $0.01\text{-}\mu\text{F}$ capacitor, and additional bypassing is scattered through the MTTL circuitry. Note that signal lines are short and that no transmission lines are used.

Terminated lines boost performance

In addition to ground planes, the use of terminated transmission lines can improve circuit performance. When properly applied, terminations prevent line reflections, so ringing does not occur. Another advantage is that interconnection lengths become limited only by bandwidth and attenuation.

Two techniques can be used to terminate transmission line:

1. *Parallel termination* (Fig. 3). A transmission line has a reflection coefficient of zero when driving a load impedance equal to its characteristic impedance. ECL 10,000 is specified to drive a $50\text{-}\Omega$ characteristic impedance line with the line terminated by $50\ \Omega$ to $-2\ \text{V}$. The termination voltage ($V_{TT} = -2\ \text{V}$) is necessary because $50\ \Omega$ loaded to V_{EE} would use excessive current.

Gate inputs can either be lumped at the end of the line (Fig. 3a) or distributed along the transmission line (Fig. 3b). In the circuit of Fig. 3b, gate inputs appear as high impedance stubs to the transmission line; hence they should be as short as possible. While inputs may appear anywhere along the line, the terminating resistor should be at the end. As fanout increases, the edge of the waveform slows, since the signal drives an increasing amount of capacitance. The waveform is undistorted along the full length of the line.

For large systems, where total power is a consideration, all lines should be parallel-terminated to a -2-V supply. This is the most power-efficient manner for terminating ECL circuits. The drawback, of course, is the need for an additional power supply.

An alternate approach uses two resistors, as shown in Table 1. The Thevenin equivalent of the resistor network is a resistor equal to the characteristic impedance of the line, terminated to $-2\ \text{V}$ dc. Resistors R_1 and R_2 can be calculated as follows:

$$R_2 = 2.6 Z_0,$$

$$R_1 = R_2/1.6.$$

2. *Series damping and series termination.* A series-terminated line eliminates reflections at the sending end of the line. Series termination is accomplished by inserting a resistor in series with the output of the gate, as shown in Fig. 4.

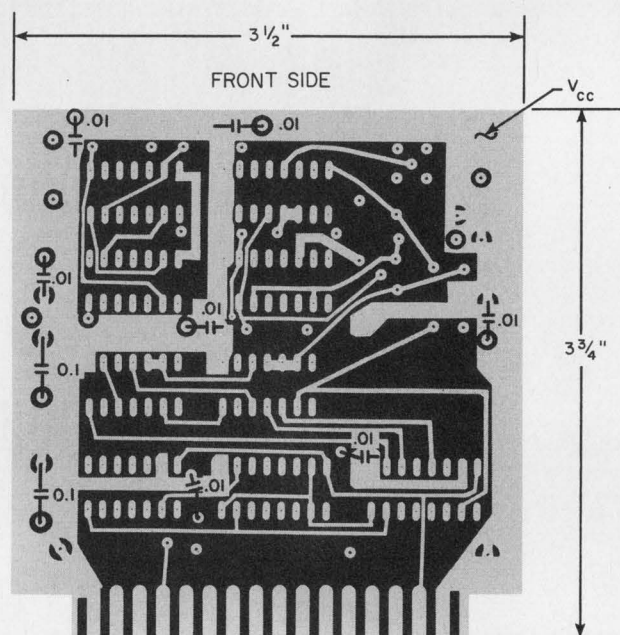
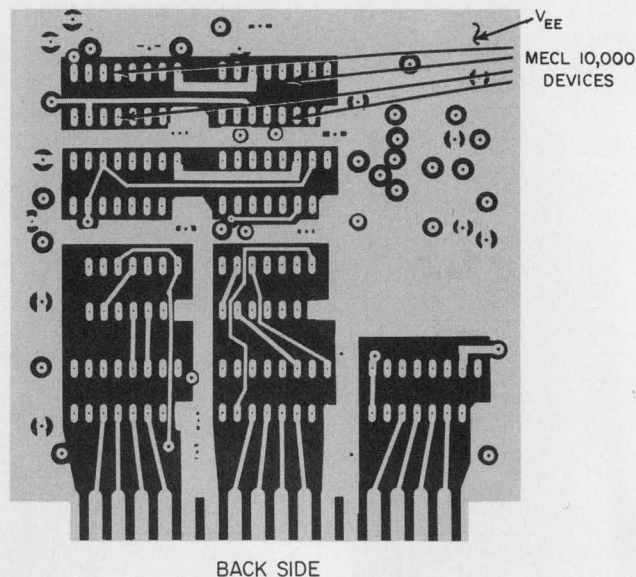

2. You don't always need the ground plane, as in this high-speed counter layout. The capacitors provide low frequency bypassing. Signal lines are short, and no transmission lines are used.

The series resistor value plus the circuit output impedance equals the impedance of the transmission line.

The dc output impedance is about $7\ \Omega$ for an ECL 10,000 gate. Therefore the value of R_s should be equal to Z_0 minus $7\ \Omega$.

At time $t = 0$, the internal voltage (V_{INT}) switches to the low state, which represents a change of 0.8 to $0.9\ \text{V}$ ($\Delta V_{INT} = 0.8\text{-to-}0.9\ \text{V}$). The voltage change at point B can be expressed as

$$\Delta V_B = \Delta V_{INT} \left(\frac{Z_0}{R_s + R_o + Z_0} \right),$$

where R_o is the output impedance of the gate.

Since $R_s + R_o$ is made equal to Z_0 , the voltage change at B is one-half the voltage ΔV_{INT} . It takes the propagation delay time of the transmission

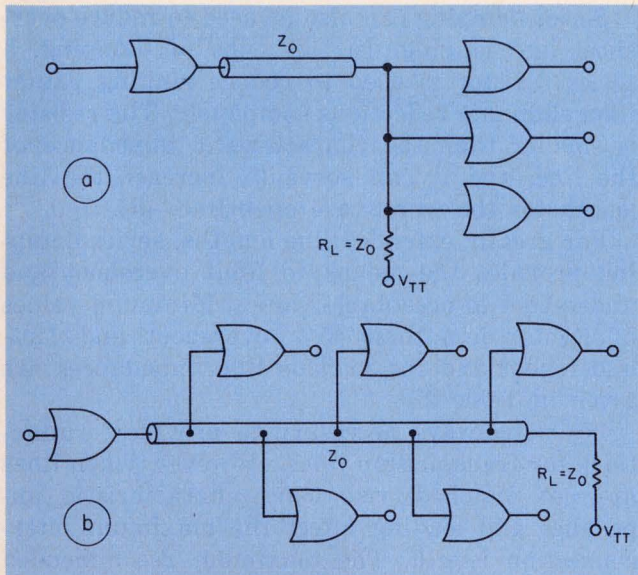

3. **Parallel-terminated lines** can have lumped (a) or distributed (b) fanouts. A termination voltage, V_{TT} , is required to prevent excessive termination-resistor power.

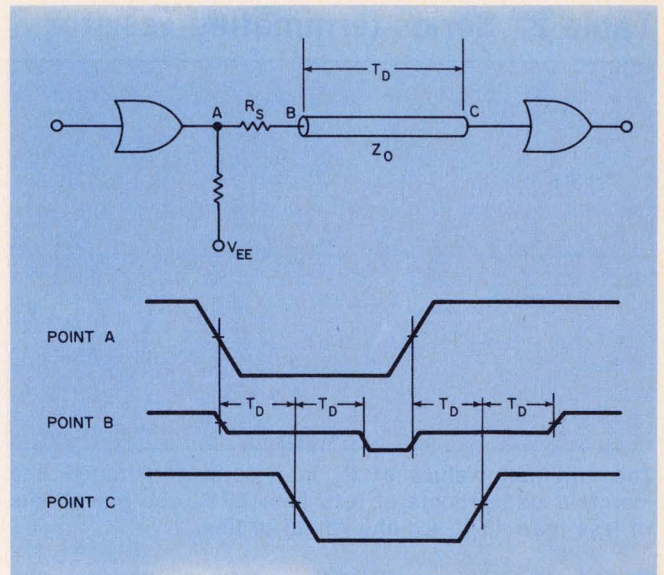

4. **Series-terminated lines** don't need the extra power supply. But you can't have distributed fanouts because of the half-voltage waveform on the line (waveform B).

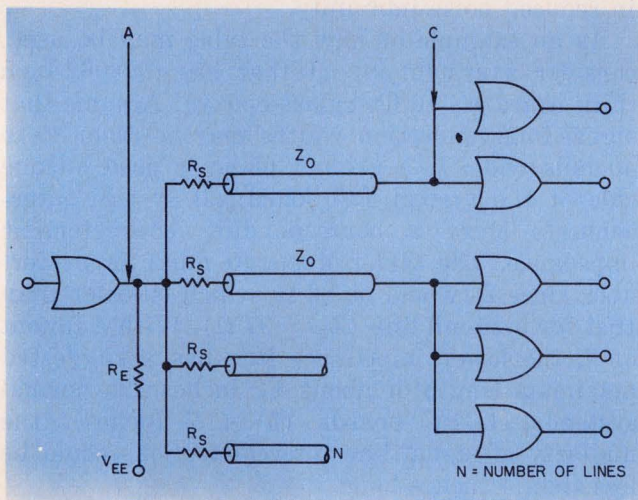

5. With N lines, N loads are obtained on a series-terminated line. Resistor R_E must be less than a maximum value fixed by the number of lines and Z_0 to prevent the output transistor from turning off during switching.

line, T_D , for the waveform to reach point C, where the voltage doubles because of the unity reflection coefficient at the end of the line. The reflected voltage, which is equal to the sending voltage, arrives back at point B at time $2 T_D$. No more reflections occur if $R_S + R_0$ is equal to Z_0 . Similar waveforms occur when the driving gate switches to the high state.

One power supply does the job

An advantage of using series-terminated lines is that only one power supply is required. The Thevenin equivalent-parallel-termination technique also uses only one supply, but requires more over-all power. A disadvantage of series termina-

Table 1. Termination resistor selection

Z_0 (OHMS)	R_1 (OHMS)	R_2 (OHMS)
50	81	130
70	113	182
75	121	195
80	130	208
90	146	234
100	162	260
120	194	312
150	243	390

On the basis of a Thevenin equivalent-resistor network, termination resistors R_1 and R_2 are given for various characteristic impedances. This approach avoids the use of termination-supply voltage, V_{TT} .

tions is that distributed loading along the line cannot be used because of the half-voltage waveform traveling down this line (Fig. 4 waveform B). Several lumped loads can be placed at the end of the terminated line without causing problems. A full initial signal transition occurs at this point, and all subsequent reflections are absorbed at the source.

The disadvantage of using only lumped loading at the end of a series-terminated line and not distributed loading can be eliminated by adding more lines (Fig. 5). There are N transmission lines for parallel fanout. The recommended value of R_S is unchanged: $Z_0 - 7 \Omega$.

The value of R_E , the emitter pull down resistor, is determined by the number of lines in the fol-

Table 2. Series-terminating resistor

Z_0 (OHMS)	50	65	75	82	90	100	120	140	160
MIN R_s (OHMS)	19	25	28	31	34	38	46	55	64

The minimum values of R_s in a series-terminated line maintain undershoots of less than 12% and overshoots of less than 45% for any length of line.

Table 3. Unterminated line lengths

TYPE TRANSMISSION LINE	Z_0 (OHMS)	MAXIMUM LINE LENGTH (INCHES)			
		FANOUT = 1 (2.9 pF)	FANOUT = 2 (5.8 pF)	FANOUT = 4 (11.6 pF)	FANOUT = 8 (23.2 pF)
MICROSTRIP (PROPAGATION DELAY 0.148 ns/inch)	50	8.3	7.5	6.7	5.7
	68	7.0	6.2	5.0	4.0
	75	6.9	5.9	4.6	3.6
	82	6.6	5.7	4.2	3.3
	90	6.5	5.4	3.9	3.0
	100	6.3	5.1	3.6	2.6
BACKPLANE (PROPAGATION DELAY 0.140 ns/inch)	100	6.6	5.4	3.8	2.8
	140	5.9	4.3	2.8	1.9
	180	5.2	3.6	2.1	1.3

For microstrip and backplane transmission lines, the table gives maximum line lengths to maintain less than 12% undershoot.

lowing way: Resistor R_E must be small enough to supply each transmission line with the proper voltage level. If R_E is too large, the output transistor will turn OFF when switching from the high to the low voltage state, causing "steps" in the output waveform. The maximum value is

$$R_{E(max)} = \frac{10 Z_0 - R_s}{N}$$

The fanout at the end of a series-terminated line is limited by the value of the series resistor, R_s . In the high state the voltage drop across R_s is given as

$$V_s = \text{fanout} \times (\text{input current}) \times R_s$$

The input current to an ECL 10,000 gate is typically about 160 μ A. With a fanout of 4 and $R_s = 43 \Omega$ (for a 50- Ω line), V_s equals about 28 mV. The noise margin usually is cut by that amount. As fanout or the value of R_s increases, V_s increases and results in lower noise margins.

Series damping can also be used to reduce overshoot and ringing. In this type of damping, a series resistor is used to reduce ringing rather than eliminate reflections completely. The resistor is smaller than the characteristic impedance of the line, and it can serve to increase the line length for the worst-case open line— $R_s = 0$.

For greatly extended line lengths, series damping provides the means to limit overshoot and undershoot to acceptable values. Minimum values of R_s for less than 45% overshoot and 12% undershoot and for various line impedances are given in Table 2.

It's not always necessary to provide terminations for transmission lines. However, when lines are not matched, rise time, characteristic impedance and loading affect the maximum interconnection length. The maximum recommended open line lengths are shown in Table 3.

The calculated values limit overshoot to 35% of the logic swing or undershoot to 12%—which ever is the limiting factor. Severe overshoot can slow clock rates, and severe undershoot can result in reduced noise immunity.

As an example of how the table may be used, consider a system layout that has a 0.062-inch thick board (G-10 fiberglass-epoxy). Assume that signal interconnection widths may be from 25 to 40 mils wide. If a ground plane is used on one side of the system PC board, all system interconnects show a corresponding characteristic impedance. The wider line (40 mils) is preferable, since Z_0 would be 82 Ω , which is lower than that for a 25-mil line ($Z_0 = 97 \Omega$). With a fanout of 4, the lower impedance line has a suggested maximum length of about 4.2 inches. On normal system-sized PC boards (5 \times 7 inches), the majority of signal line interconnections could be less than 4 inches long.

An interconnection with the pull down resistor at the sending end of the line is the worst-case situation for an unterminated line. If unterminated interconnection lengths are extended beyond the suggested limits, overshoot and undershoot are increased. The lengths given are calculated so that undershoot never exceeds the guaranteed noise margins.

Overshoot and undershoot can also be reduced by placing the pull down resistor at the receiving end of the line. This decreases the reflection coefficient, which in turn reduces ringing. ■■

Bibliography:

- Balch, T., *Interconnection Techniques for Motorola's MECL 10,000 Series Emitter Coupled Logic*, Application Note 556, Motorola, Inc., 1972.
- MECL System Design Handbook*, Motorola, Inc., 1971.

The concluding article on ECL 10,000 interconnection techniques will cover board-to-board interconnects and Wire-Wrap techniques.

NEW



GOT THE MESSAGE?

Our DigiTec engineers got the message. We told them to take a good multimeter and make it better. We didn't put any restrictions on them, just gave them a free hand. Now instead of an improved meter, we have a new meter, from the inside out!

They started with a new A to D board which gave the meter improved basic accuracy (.05%), greater stability, and a four digit LED display.

Next they tackled the metal case; building it

stronger, more rugged to house and protect. Controls were simplified and redesigned to provide the best possible human engineering factors.

They might have stopped there and been satisfied with an almost-totally new meter, but they had steam up and went on. A new, 8 hour battery pack was incorporated as standard instead of an option at no increase in price. That's right... all these improvements plus the battery pack and still only \$375.

Our model 262C Multimeter carries its own message and DigiTec Representatives carry a model 262C. **HAVE YOU GOT OUR MESSAGE?**

DigiTec by United Systems Corporation 918 Woodley Rd., Dayton, Ohio 45403 (513) 254-6251 Representatives throughout the world. For complete specifications, request new catalog.



DigiTec: precision measurements to count on.

**1103 RAMS
IN 4 SPEEDS
WITHOUT
CRITICAL
TIMING**

Our 3534 1024x1 OPTIMOS RAM is now available in 4 speeds: 150ns, 180ns, 220ns and 300ns access time. At lowest prices in the industry.

Our new dynamic silicon gate RAM is a vastly simplified, *pin for pin replacement* for the 1103. Not only have timing margin problems been eliminated and stand-by power dissipation been reduced 97%, but now there are four standard versions: each with its own standard specs, each with its own speed, each at lowest industry prices. All available off-the-shelf in production quantities.

We've optimized the design of 3534 in five important areas. Important to those who would use it as a plug-in replacement for the 1103 in an existing system. Equally important to those who would design our device into new systems. Important to both because these innovations solve the major problems of the existing 1103.

No Precharge and Chip Enable overlap requirement. Result: Better and less critical timing margin on control of Chip Enable-Precharge overlap. Less drift problem. Less adjusting. Less maintenance. No critical window to stew about. Greater design margins (other 1103's have no margin, worst case).

Data Out referenced to the leading edge of the Chip Enable. Unlike other 1103's, which have as many as five critical times affecting access, ours has only two; the 3534 array access time is dependent on the timing of only one critical edge relative to Precharge and only one delay relative to Chip Enable. No timing margin problems to create system malfunctions,

Fairchild 3534/1103 (300ns version)

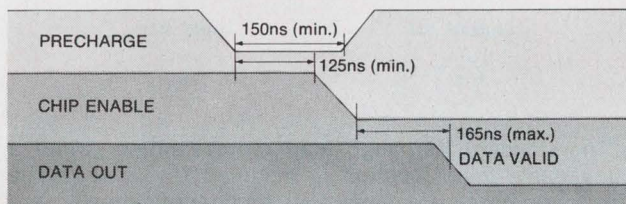

No Precharge and Chip Enable overlap requirements. The 3534 requires only that the Precharge pulse stays low for a minimum of 150ns and that at least 125ns delay occur from the start of Precharge to the start of Chip Enable. The Data Out is valid 165ns after the Chip Enable goes low but is independent of Precharge.

There are no other restrictions on the Precharge pulse. It can go high immediately or it can stay low throughout the entire cycle. Or it can remain low for successive cycles.

board rework, acceptance tests, downtime, and other virulent forms of field aggravation.

Maximum standby power dissipation reduced 97%. From 70mW for the other 1103's to 2mW for our 3534. Result: significantly lower power supply costs.

Equal Read and Write cycle time.

The system can now operate at a higher data rate. You don't need to Read before Writing. By a simple pre-selection the 3534 can go either way. The system can operate at a higher data rate without additional timing and control circuitry.

Read/Write specified as a voltage level rather than a pulse. Since the Read/Write input may remain low indefinitely (assuming continuous Write cycles), Read/Write timing is no longer critical. And system Read and Write cycle times are sharply reduced.

The 3534 is another example of Fairchild OPTIMOS: *practical* MOS devices that optimize your system. Easy to use. Simple to produce. At less cost / function.

The 3534/1103 is available now – in ceramic DIP – from your friendly Fairchild distributor.

PART #	GUARANTEED MAX. ACCESS TIME	PRICES	
		100-999	1000-4999
35342 DC (1103)	300ns	\$8.00	\$5.00
35343 DC (1103S146)	220ns	\$9.60	\$6.00
35344 DC (1103-1)	180ns	\$12.80	\$8.00
35345 DC (1103-1)	150ns	\$18.40	\$11.50

24-page applications guide free. Detailed, comprehensive applications guide (and composite data sheet on each of the 4 versions of 3534) are available on request.

Other Standard 1103's

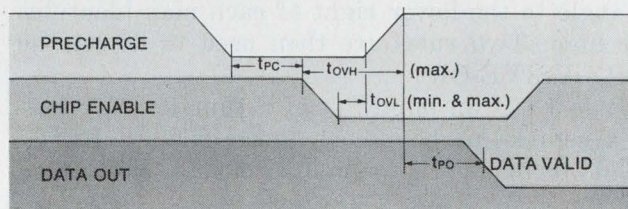

With other 1103's, the Precharge pulse not only must stay low for a precise Precharge interval but its transition from low to high must occur within a time interval which has a *minimum* as well as a *maximum* limit. As a result, the designer must stay within very tight boundaries of these maximum and minimum values. All control circuitry must be extraordinarily precise, and system costs rise sharply.



Ring map minimizes logic circuit.

The technique, a modification of the Karnaugh map, detects EXCLUSIVE-OR functions or their complements at a glance.

If you are working with logic circuits that include the EXCLUSIVE-OR function—for example, edge-sensitive flip-flops, decoders and parity circuits—a new technique called a Ring map can help you minimize circuit complexity.

The technique, a simple modification of the popular Karnaugh map, allows the user to detect the presence of the EXCLUSIVE-OR (also known as the RING-SUM) immediately, and consequently to reduce the number of required logic gates. The technique is applicable to cases with any number of logic variables.

The Ring map differs from the Karnaugh map in structure only. The row and column unit-distance arrangement of the Karnaugh map—00, 01, 11, 10—is replaced by the sequence 00, 01, 10, 11 (Fig. 1). The designer then partitions the map by drawing heavy or colored lines between column 01 and 10 and between rows 01 and 10. Similarly heavy or colored lines are drawn between columns 11 and 00 and between rows 11 and 00 (these lines represent the outside perimeter of the map). In the illustrations a small triangle to the lower right of each map identifies the map. Two rules are then used to detect the EXCLUSIVE-OR:

Rule 1: If an implicant of a function, f , crosses a center-line boundary, there exists a RING-SUM term in the sum-of-products expression for f .

Rule 2: If an implicant of a function, f , crosses a perimeter-line boundary, there exists a RING-SUM COMPLEMENT in the sum-of-products expression for f .

To illustrate the use of the map, let's derive a function, f_1 , in the minimum-sum-of-products form from both the Ring and Karnaugh maps (Fig. 2). As can be seen, the Ring map easily detects the Ring (or Ring complement) form of the function, while it is difficult to detect this form from the Karnaugh map.

The Ring map of Fig. 1 can be sectioned into four quadrants: (0, 1, 4, 5); (2, 3, 6, 7); (8, 9, 12, 13); and (10, 11, 14, 15). Since implicants within each quadrant are a unit distance apart,

they can be combined with standard Karnaugh-map procedures. Thus functions that contain both EXCLUSIVE-ORs and other terms are easily handled. Fig. 3 depicts the mapping of such a function.

Three maps are necessary

Note that EXCLUSIVE-OR combinations may exist between row and column variables A and C or B and D. These EXCLUSIVE-ORs would not be detected in the single map of Fig. 3a. This is because the implicants fail to cross boundary lines, as shown in the example of Fig. 4.

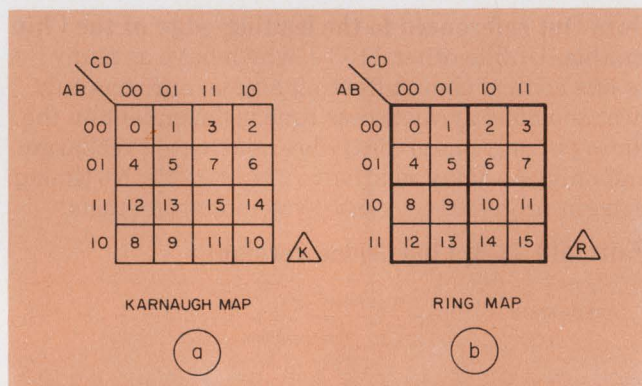

1. The standard Karnaugh map representation (a) of a four-variable logic function is modified (b) to form the Ring map. Boxes are numbered for identification.

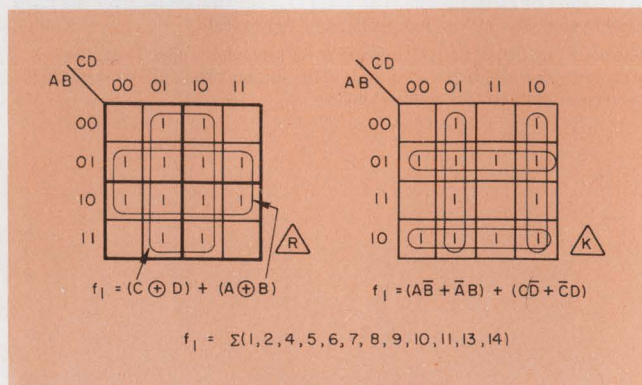

2. EXCLUSIVE-OR functions contained in f_1 are spotted immediately on the Ring map, but the Boolean equation for f_1 that is derived from the Karnaugh map must be manipulated to minimize the function.

Donald K. Fronek, University of Idaho, Moscow, Idaho 83843.

To cover all possible cases for four variables, two additional Ring maps are required (Fig. 5). These maps are drawn with the row and column variables interchanged. The logic designer then selects the map that provides the minimum implicant combination. For example, from Fig. 4 and Fig. 5 three different Boolean equations can be written for the mapped function. They are:

From Fig. 4: $f = \bar{A}\bar{C} + AC$

From Fig. 5a: $f = A \oplus C$

From Fig. 5b: $f = \bar{A}\bar{B}\bar{C} + \bar{A}\bar{B}C + A\bar{B}\bar{C} + A\bar{B}C$

In this case the equation derived from Fig. 5a would be selected as the one that gave the minimum logic.

The function plotted in Figs. 6 and 7 demonstrates the advantage of the Ring map over the Karnaugh map. In Fig. 6, a Karnaugh reduction of the function results in a circuit that requires four dual four-input gates plus one additional gate to perform the OR function. The Ring-map realization (Fig. 7), however, requires only two two-input quad gates. The circuit can be implemented with wired-AND gates, as shown, or with AND-OR-INVERT gates. ■■

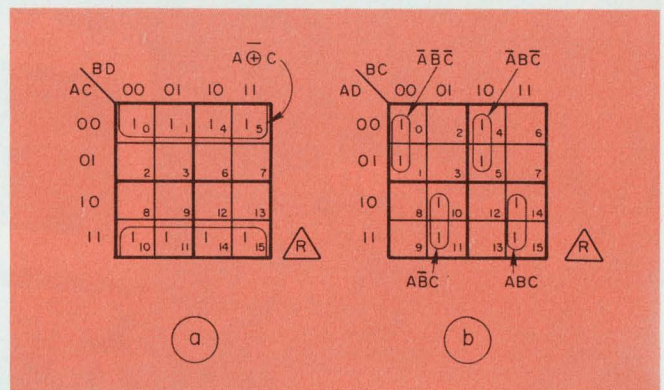

5. To detect EXCLUSIVE-ORs that don't cross boundaries, the map of Fig. 4 is redrawn by combining row and column variables. A is combined with C in "a" and with D in "b."

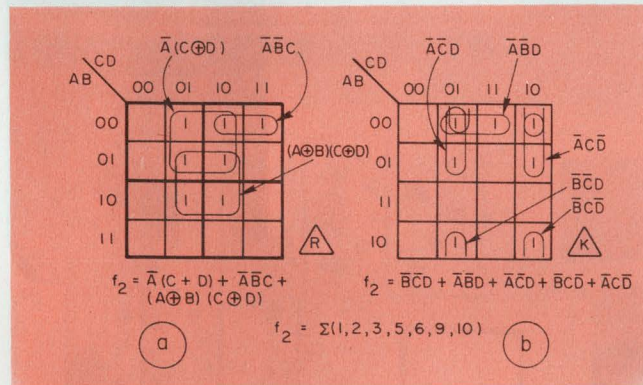

3. Functions containing mixed terms are easily handled by the Ring map (a). The standard Karnaugh procedure is shown in (b).

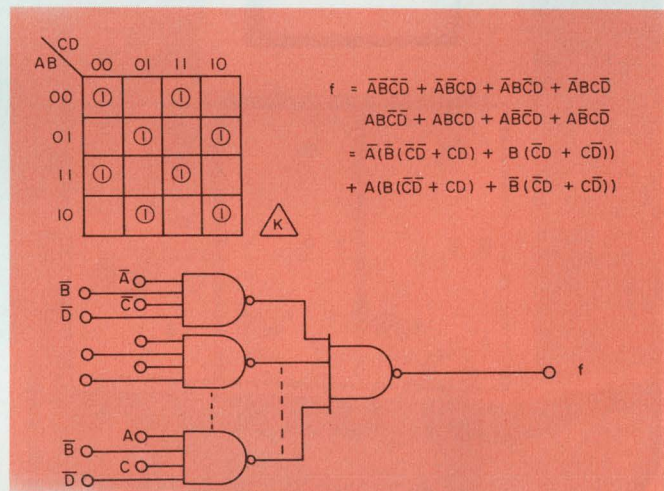

6. Karnaugh reduction in this example results in a circuit that requires five DIPs and 32 inputs. Contrast this with the Ring-map reduction in Fig. 7.

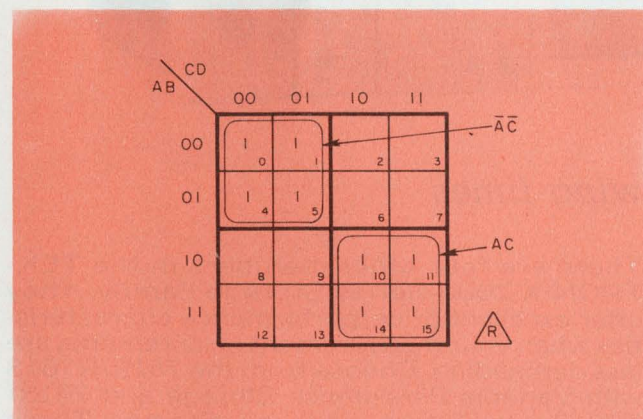

4. EXCLUSIVE-ORs formed from row and column variables are not readily detected, since the implicants do not cross Ring-map boundaries.

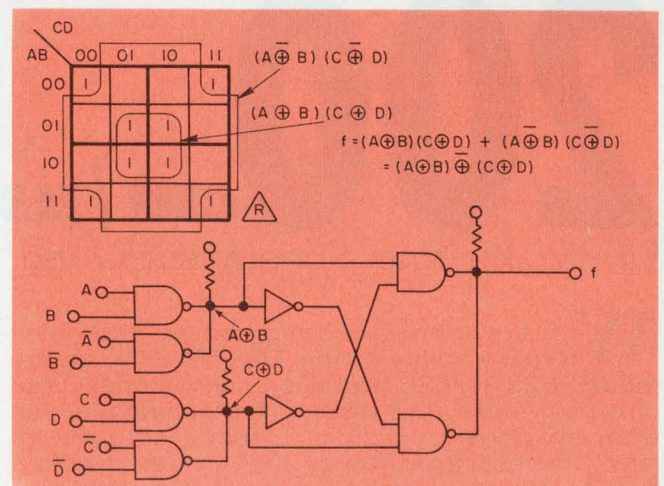

7. Resulting Ring-map circuit needs only two DIPs with eight inputs. A considerable cost savings is realized with the Ring map.



TEKTRONIX®

**7000 SERIES
STORAGE
FAMILY**

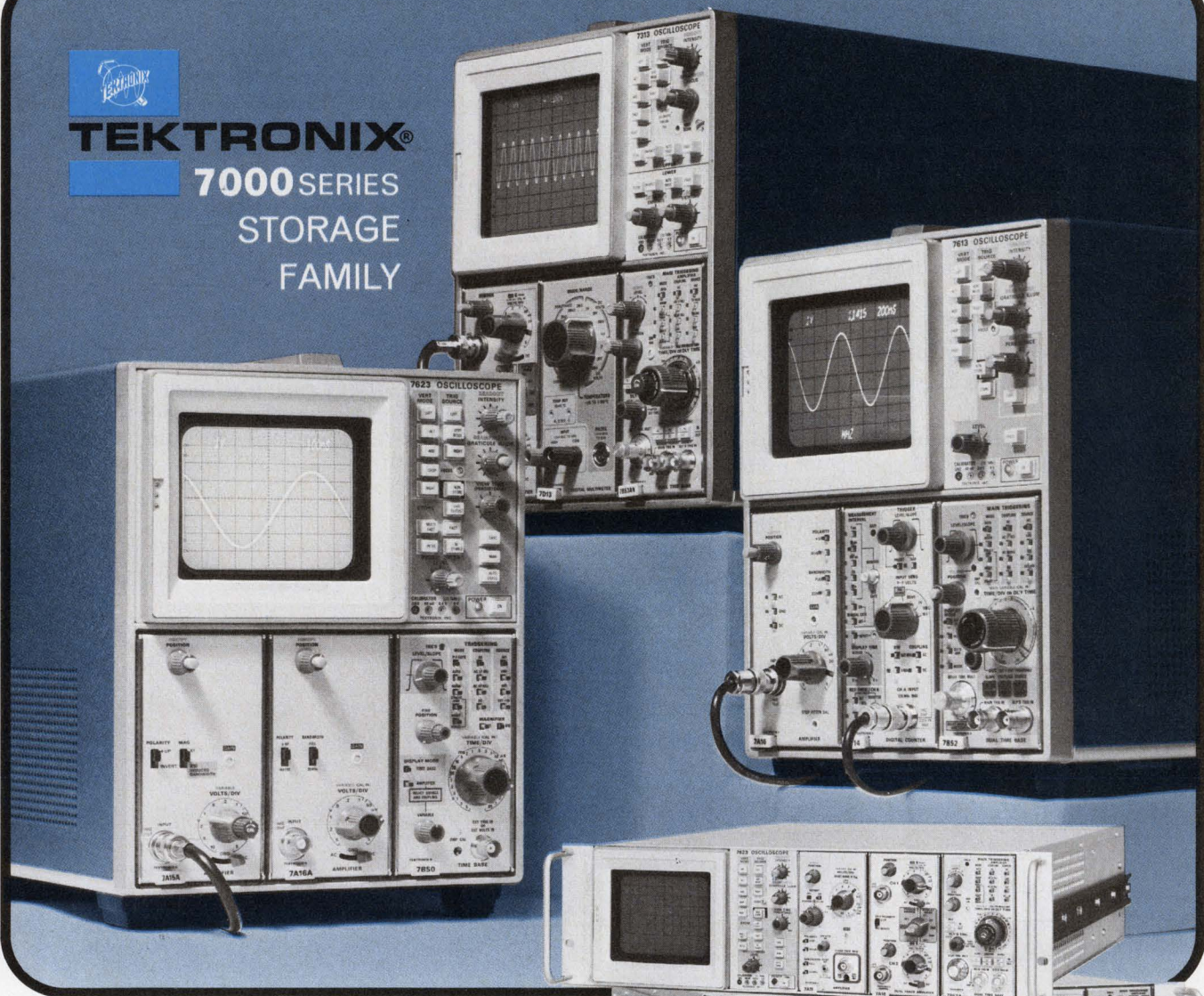

200 *cm / μ s*

Stored Writing Speeds, with long viewing times.

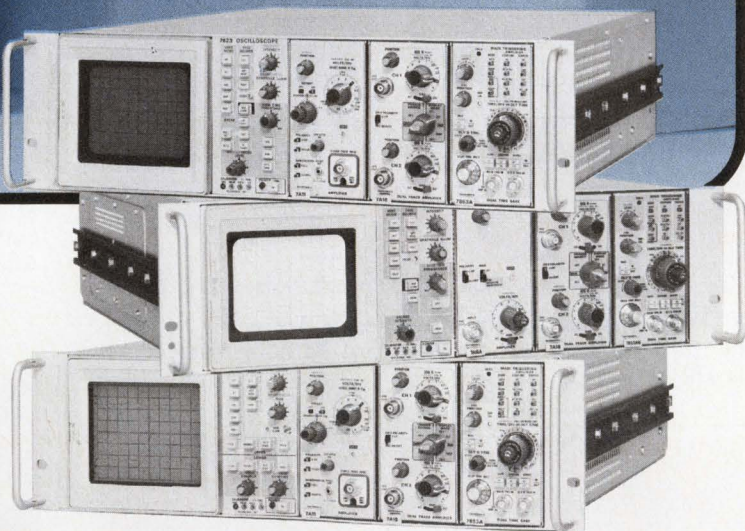

With the unmatched high speed trace retention ability of the TEKTRONIX multimode 7623/R7623 Storage Oscilloscopes, you can now store and display faster waveforms than previously possible. Directly coupled to this fast storage ability are longer display times, 10's of hours, even days, if necessary. And high speed storage is just one mode of the multimode 7623/R7623, you may choose either Variable persistence, Bistable storage or Nonstorage operation at the push of a button.

There are four other members in the TEKTRONIX 7000-Series Storage Family. They offer excellent price/performance characteristics when your measurement requirements are less demanding. Choose from the 7613/R7613 with Variable Persistence Storage and 7313/R7313 with Bistable Phosphor Storage. These models have stored writing speeds of 5 div/ μ s (0.9 cm/div) and 5 cm/ μ s respectively. They have two modes; storage and nonstore (conventional).

Select from *three* types of Storage

MULTIMODE STORAGE (7623/R7623) 4 modes of operation

FAST—stores up to 200 cm/ μ s with the FAST CRT option and up to 100 div/ μ s (0.9 div/cm) in the standard model. VARIABLE PERSISTENCE—for those bright, high contrast or half tone displays. BISTABLE—for the slower writing speed requirements (30 div/ms). NONSTORE—for the conventional oscilloscope applications.

VARIABLE PERSISTENCE STORAGE (7613/R7613) 2 modes of operation

VARIABLE PERSISTENCE—gives bright, high contrast display of fast-risetime low rep-rate signals. Stores up to 5 div/ μ s (0.9 div/cm). NONSTORE—for the conventional oscilloscope applications.

BISTABLE PHOSPHOR STORAGE (7313/R7313) 2 modes of operation

STORE—retains fast waveforms moving up to 5 cm/ μ s. Features split screen operation for real-time and stored waveform comparisons. NONSTORE—for the conventional oscilloscope applications.

All CRT'S are extremely burn resistant

... they require no special operating precautions.

All oscilloscopes with CRT READOUT

You gain overall efficiency in operator speed and accuracy and simplify your measurements by using CRT READOUT. It puts the measurement parameters, right on the CRT, adjacent to the waveform you are viewing, measuring or photographing.

With CRT READOUT you can use the complete line of Digital plug-ins available in the 7000-Series. 27 plug-ins offer widest range of measurement solutions available. The very simple to extremely complex measurement problems of many disciplines are solvable with 7000-Series plug-ins. Here are the choices; Amplifiers, Time bases, Curve Tracers, digital multimeter, digital counter, Rapid Scan Spectrometer, Sampling and Spectrum Analyzer plug-ins ... and there are more coming.

AN INTEGRATED TEST SYSTEM

An oscilloscope mainframe equipped from a selection of over 27 plug-ins plus an entire line of probes, cameras, SCOPEMOBILE[™] carts and other accessories can become an INTEGRATED TEST SYSTEM for solving virtually any measurement requirement.

Tektronix, Inc. ... the pioneering pacesetter in storage display technology, offering sales, after sales support and service ... world wide.

For a "hands-on" demonstration of the only total storage capability, contact your nearby TEKTRONIX Field Engineer or write: Tektronix, Inc., P.O. Box 500, Beaverton, Oregon 97005.

PRICES without plug-ins:

Mainframe	w/o CRT READOUT	STANDARD
7623	\$2450	\$2850
R7623	\$2550	\$2950
for FAST WRITING CRT add \$500		
7613	\$2100	\$2500
R7613	\$2200	\$2600
7313	\$1600	\$2000
R7313	\$1700	\$2100

INFORMATION RETRIEVAL NUMBER 33
FOR DEMONSTRATION, CIRCLE 98

Try building a pulse generator if you need one for testing logic circuits. Its performance should be adequate for routine tests. The parts cost? About \$30.

At some stage in the design of integrated and discrete logic circuits, engineers use a pulse generator to test the circuits. Commercial units are available with impressive pulse-width and repetition ranges and equally impressive price tags. But in most cases all that's needed is a generator that can give a pulse of constant width and repetition rate with a reasonably clean shape. You can build one yourself with about \$30 worth of parts. It offers pulse widths ranging from 50 ns to 20 ms and repetition rates from 10 Hz to 8 MHz.

The amplitude of the output pulses in this generator may be varied up to 10 V with an optional power-output stage, thereby matching the output to what various types of logic require.

One-shots provide minimum delay

Obviously, an adjustable, free-running pulse generator may be thought of as a single-shot pulse generator, with a variable width control, triggered by a repetition-rate generator. To achieve high repetition rates, the rate generator must have minimum delay in its oscillator loop. The more elements that are in the loop, the longer the delay. If two high-speed monostable multivibrators (one-shots) are connected in a loop, propagation delays will be kept small and pulse widths can be made as narrow as 20 ns.

The one-shots will fire alternately if each is connected so that triggering occurs on the negative-going edge and the positive pulse outputs are used.

The useful frequency range of this configuration depends on several factors. The upper frequency is limited not only by one-shot delay, but also by the width of the one-shot's output pulses. If t_1 and t_2 are the propagation times of one-shots MM_1 and MM_2 respectively, and T_1 and T_2 are the corresponding widths of their output pulses, then the maximum frequency of oscillation (neglecting wiring delays) is given by the expression

$$f_{\max} \approx \frac{1}{t_1 + t_2 + T_1 + T_2}$$

The lower frequency limit depends only on the maximum RC network that the one-shots can handle. If $(R_1)_{\max}$ and $(C_1)_{\max}$ are the maximum component values for MM_1 and $(R_2)_{\max}$ and $(C_2)_{\max}$ are those for MM_2 , the minimum oscillation frequency, for SN74121 type one-shots, is given by

$$f_{\min} \approx \frac{1.4}{[(R_1)_{\max} \cdot (C_1)_{\max} + (R_2)_{\max} \cdot (C_2)_{\max}]}$$

When two SN7412N one-shots are used, the circuit yields a maximum oscillation frequency of over 8 MHz. The minimum oscillation frequency, using a value for R_{\max} of 40 k Ω and for C_{\max} of 10 μ F—which the manufacturer of the SN-74121Ns recommends—is less than 2 Hz.

The MM_1 and MM_2 one-shots form a nonself-starting frequency source. Power-on transients may start the oscillator, but to guarantee starting upon application of power, an additional circuit is required.

When power is initially applied, transistors Q_3 and Q_4 in the starting circuit are both off. The output thus rises with the supply. Transistor Q_5 will be off until C_5 charges to about 1.2 V. Since the time constant of R_5 and C_5 is much less than that of R_4 and C_4 , Q_3 and Q_4 will not turn on until some time after Q_5 has conducted. When capacitor C_4 charges to about 1.2 V, transistors Q_3 and Q_4 conduct, turning off Q_5 and causing the output to rise. If this positive voltage is applied to the B input of MM_1 , some time after supply power has stabilized, it will fire. This firing is all that is necessary to initiate oscillation.

Retriggerable one-shot determines width

A third one-shot, MM_3 , provides a means of pulse-width control. An SN74122N retriggerable one shot is used here, since it allows duty cycles up to 100%. Pulse width, of course, is varied by changing the RC time constant of MM_3 . A buffer stage consisting of SN7437N gates G_2 , G_3 , and G_4 increases the load driving capability. The output of G_2 provides a synchronization signal source.

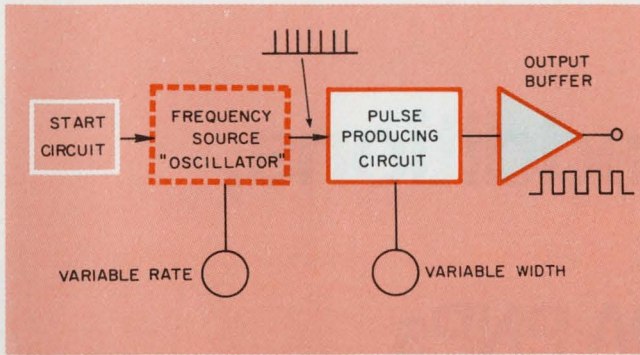

1. Pulses are initially generated by a variable frequency oscillator. These pulses then trigger a monostable multivibrator with adjustable time constant which determines the output pulse width. Output buffer provides additional amplification.

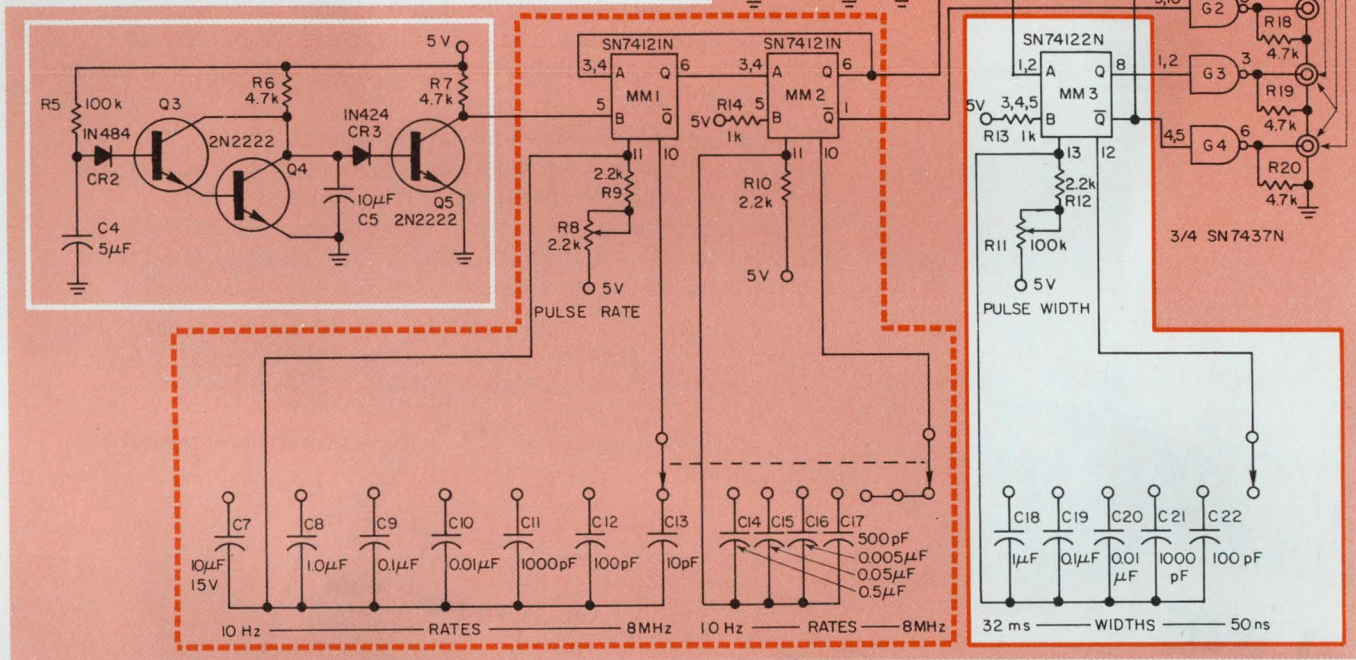
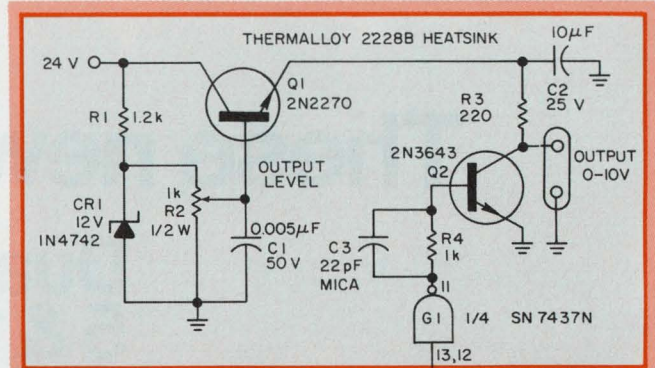

2. One-shots MM_1 and MM_2 act as a variable rate generator, and retriggerable one-shot MM_3 produces variable

width pulses in the above schematic. A manual output is provided with switches S_1 and S_2 .

The range capacitors C_{14} and C_{17} on MM_2 are necessary on the lower rate ranges to prevent multiple output pulses at narrow widths. The latter occurs because the timing capacitor on MM_1 is so large. If the time constant of MM_2 is not sufficient, as MM_1 's output drops, MM_2 may trigger at several different points. If MM_2 has a short time constant, it recovers early enough to be triggered again by MM_1 .

When the time constant of MM_2 is increased, the recovery time also increases, thus preventing multiple triggering. Since MM_1 and MM_2 are not retriggerable, no further triggering occurs until the one-shot has recovered.

A variable pulse-amplitude stage allows various types of logic to be driven by the pulse generator. Transistor Q_1 , diode CR_1 and resistors R_1 and R_2 act as a variable power supply for the load and

for Q_2 and R_3 . If the resistance of R_2 is varied, the supply voltage to Q_2 changes. The relatively low value of R_3 allows transistor Q_2 to turn off rapidly. The load capability is determined by the current gain of transistor Q_2 and the value of R_3 . For components shown, the supply current is approximately 20 mA for 5 V output. The sink current is greater than 50 nA. The amplitude of the output pulses can be varied up to 10 V, since the supply voltage to Q_1 is greater than 10 V.

To generate a manually controlled single pulse, disconnect the oscillator and connect the A input of MM_3 to the collector of transistor Q_6 using S_2 . When manual switch S_1 is pressed, capacitor C_6 discharges through R_{16} . The resulting voltage at the base-to-emitter junction of Q_6 causes Q_6 to conduct briefly. The negative output pulse of Q_6 triggers MM_3 . ■■

These new additions,

Duals 5 & 10A PNPs 20A NPNs...

New Dual 10A NPN Power Darlingtons give you twice as much in a single package. And double the space efficiency. They're ideal for full wave bridge applications such as stepper motor drivers and converters and desirable as print hammer, servo, relay and lamp drivers, and linear amplifiers. They provide inherently higher reliability through the use of monolithic planar Darlington chips.

The completely new PNP line beginning with 5A and 10A devices and the 20A NPN additions provide design advantages through unsurpassed performance in saturation voltage, current gain, compact packaging and voltage ratings. It adds up. We'll continue to give you more in Darlingtons because our capabilities are still growing.

For complete specifications and prices, call Sales Engineering collect at (617) 926-0404 Unitrode Corporation, Dept. 7 X, 580 Pleasant Street, Watertown, Mass. 02172

INFORMATION RETRIEVAL NUMBER 34

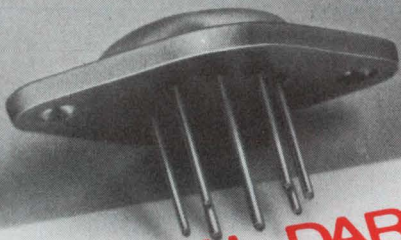

C-LINE DUAL DARLINGTONS

Type	P _D W	V _{CEO} V	h _{FE}	V _{CE (sat)} V	t _{on} μS	t _{off} μS	Package	Price (100- 999)
PIC500	30	100	2000	1.5	0.55	2.0	TO-3 (8-pin)	\$10.00
PIC501	20	100	1000	2.0	0.65	3.6		6.50
PIC502	20	80	750	2.0	0.65	3.6		4.90

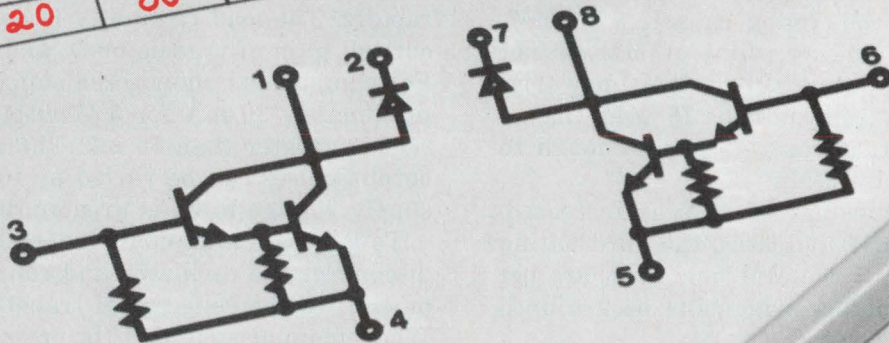

C-LINE

POWER DARLINGTONS

add to our unequalled
Darlington capability.

C-LINE POWER DARLINGTONS

Peak I _c A	Type	Package	V _{CE} V	h _{FE}	V _{CE (sat)} V	t _{on} ns	Price (100- 999)	
5	U2T301	TO-33	60	1000 @ 2A	1.5 @ 2A	300	\$1.25	
	U2T401	TO-66					1.50	
	U2T305	TO-33	150	1000 @ 2A	2.5 @ 2A	400	1.80	
	U2T405	TO-66					2.10	
	U2T101	TO-33	80	2000 @ 5A	1.5 @ 5A	400	2.25	
	U2T201	TO-66					2.55	
	10	U2T105	TO-33	150	1000 @ 5A	2.5 @ 5A	500	2.85
		U2T205	TO-66					3.15
		U2T501	TO-66	80	2000 @ 10A	1.5 @ 10A	400	4.30
		U2T601	TO-3					4.30
		U2T505	TO-66	150	1000 @ 10A	2.5 @ 10A	500	5.40
		U2T605	TO-3					5.40
20	U2T351	TO-33	60	1000 @ 2A	2.0 @ 2A	250	1.50	
	U2T451	TO-66					1.80	
	U2T355	TO-33	120	1000 @ 2A	2.5 @ 2A	300	2.16	
	U2T455	TO-66					2.52	
	U2T151	TO-33	80	2000 @ 5A	2.5 @ 5A	300	2.70	
	U2T251	TO-66					3.06	
5	U2T155	TO-33	80	2000 @ 5A	3.0 @ 5A	400	3.44	
	U2T255	TO-66					3.78	
	U2T155	TO-33	120	1000 @ 5A	3.0 @ 5A	400		
U2T255	TO-66							

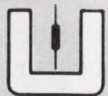
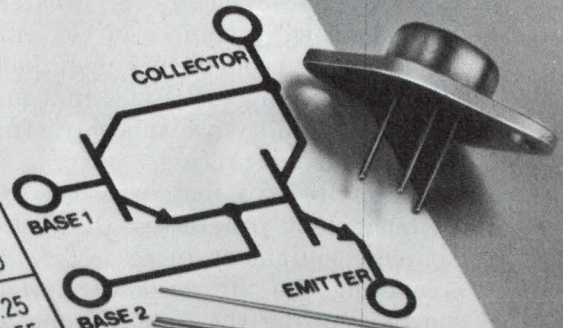

UNITRODE quality takes the worry out of paying less.

To design products that others build

engineers must anticipate the builder's problems. But the bonus, this director says, is often a better product.

Howard Bogert, Engineering Vice President, Unicom, Cupertino, Calif. 95014

Have you ever designed a product that a subcontractor is going to build? That's what I'm doing now, and it's my most difficult assignment as a manager. It means that my staff and I have to solve all the design problems before we send the drawings to the manufacturer. And that means that my engineers have to perform functions they never dreamed of performing before.

The need for engineers to know about designing for subcontractors is greater today than ever. A growing number of electronic companies are letting subcontractors manufacture their design. Even many companies that maintain a production capability are subcontracting part of the manufacturing process.

There are two main reasons for this trend: As technology progresses, the cost of tooling up complex equipment increases. And obsolescence is making the life cycle of electronic products shorter, cutting the time a manufacturer has to recapture his tooling cost.

In-house and out—the differences

When we started our company, we didn't have time to set up a manufacturing facility. So we decided to look at subcontracting as an opportunity, since working with a big manufacturer could give us better purchasing power than we would have had otherwise.

There are two ways a company can subcontract: either give the manufacturer the material and let him charge you so much an hour for his labor, or engage him to supply both material and labor.

With our entire manufacturing operation out of house, we have to anticipate the builder's problems and questions before we send him the design. It means that my engineers have to learn to be interdisciplinarians. They're responsible for a number of functions that would have been handled by a variety of departments in an in-house operation.

Here's a rundown on what those interdisciplinary duties are, how they compare to an in-house

operation and how we handle them. The five general areas of responsibility include design, procurement, liaison with the manufacturer, product reliability and staffing and attitude. Let's examine them.

1. *Design*: We design with multisource components in mind, to preserve the broadest selection of potential manufacturers. For example, we design our printed-circuit boards to accommodate as many different methods of inserting components as possible. We design trace-to-trace separations for either hand or for flow soldering. Sometimes we have to use standard key buttons on our calculators. All of this creates extra burdens on our industrial designers, who have to make a handsome product without too much flexibility of design.

We have to anticipate alternative design methods, too. The way we set up the drawings structure depends on how the material flows through the manufacturing area. For instance, a harness may or may not be part of an assembly, depending on whether or not the maker wants to put all of his harnesses on at the end of the run or put a harness on each module and then plug all the parts together. We may have to change our design to make his work flow easier.

One design we did for a manufacturer called for welded nuts on a U.S. made sheet metal chassis. We changed the design to specify loose nuts, because the manufacturer planned to assemble this portion of the product in Mexico. Mexican labor could hand assemble nuts cheaper than U.S. labor could automatically weld them. The change represented a saving of .25% of the manufacturing cost of the item—50 cents on a \$200 product. In mass production, the saving was sizable.

In-house, the designer works out the drawing tree in liaison with the manufacturer. We have to work out the drawing tree ourselves, send it to several manufacturers for price quotes and then select the best manufacturer.

Most companies build a number of units prior to the production run to wring out the bugs in the engineering drawings. We want our manufacturer to make the run, because the shakedown

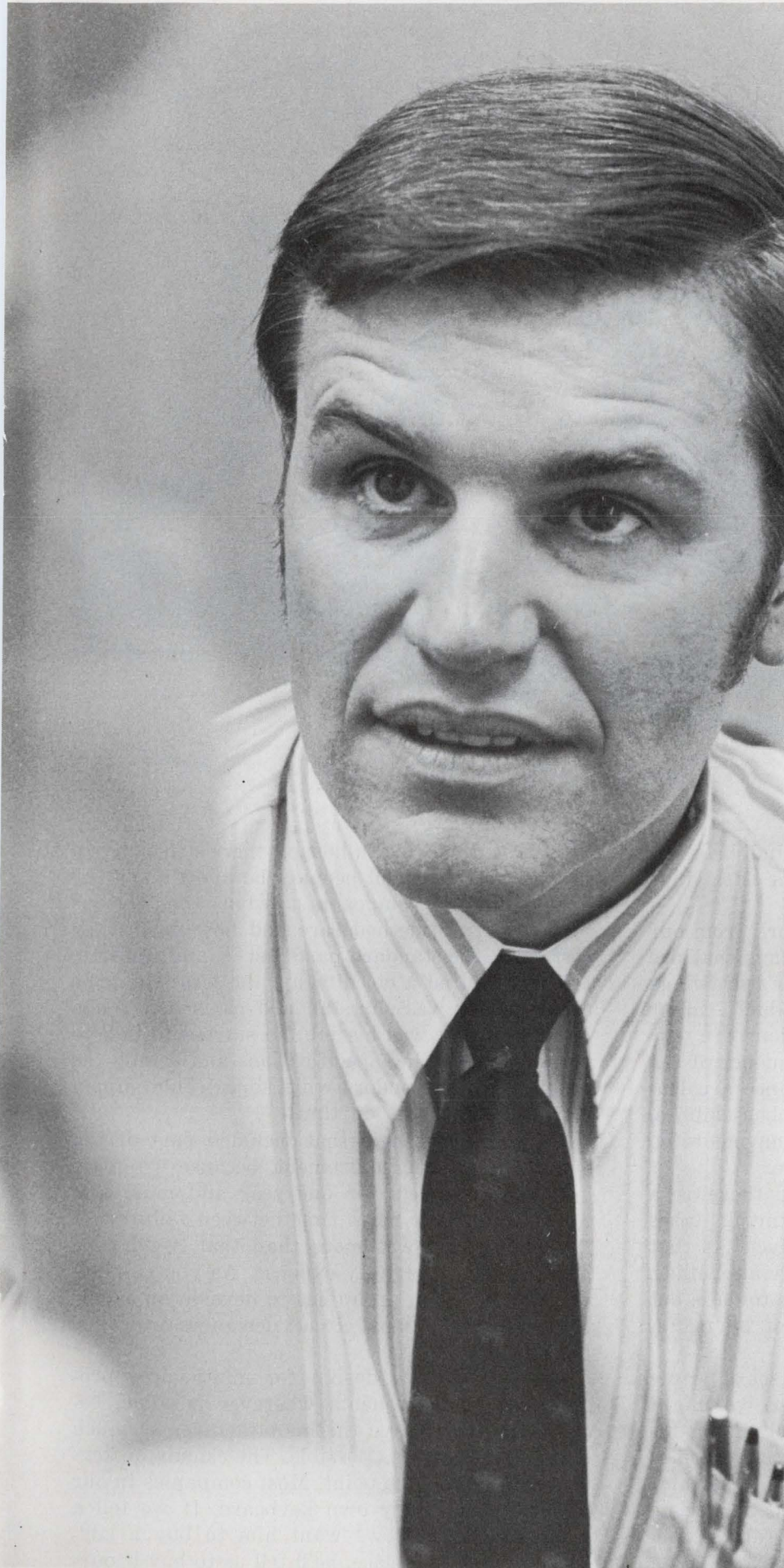

Howard Z. Bogert

Education: B.S., electrical engineering, Stanford U.; M.S., electrical engineering, U. of Maryland; MBA Program, U. of Santa Clara. Also postgraduate courses in management, digital computers and space technology.

Experience: Seven years as an electronics designer, eight years in management. Began work on the first MOS-LSI chip at Philco-Microelectronics as manager of systems engineering. Ran own company for a year developing integrated circuits for the first LSI calculator to sell under \$200.

Professional affiliations: IEEE

Patent Applications: Memory Device, Application No. 498026; Circuit Employing a Transistor as a Load Resistor, August, 1965; Zero Suppressor for Electronic Calculator, August, 1965; Two Speed Arithmetic Calculator, October, 1966; A Periodic Electronic Calculator, October, 1966.

Publications: An Integrated DC Differential Amplifier, *Electronic Design*, 1963; Applications of the Surface Potential Controlled Transistor Tetrodes, International Solid State Circuits Conference, 1962; Metal Oxide Silicon Integrated Circuits, *Semiconductor Products*, March, 1966.

Personal: Married, three children; ages 13, 11, and 10; hobbies include: sailing, bicycling, and back packing.

Employer: Founded in 1971 by a group of executives from major calculator companies, Unicom designs and markets calculators, but does not manufacture them. The company's product line ranges from pocket-sized mini-calculators to multi-memory printers.



will uncover engineering mistakes and help the manufacturer understand what the drawings mean.

The manufacturer is willing to work from our prints because we try to send drawings that are clear and concise. Usually a designer's drawings will not show how to make the product; rather they show how the product functions. In our drawings we reflect the assembly sequence of the product instead of how it works. Since a calculator is made up of a number of subassemblies, our drawings emphasize how the components go together and what parts to purchase.

In-house, it's generally true that there is a point of transfer where manufacturing takes complete responsibility for the product. At that point engineering is out of the picture altogether. Someone has to keep the drawings up-to-date, but sometimes even this is taken care of by manufacturing.

In our case we have to maintain a set of prints for the life of the product, because we might find that the manufacturer isn't really doing his thing right. We want him to know that we're in a position to switch manufacturers, if necessary. Controlling the design puts an added burden on our document people. It's an administrative problem most in-house engineers don't have.

2. Procurement: In-house, there's usually a group of procurement people who know about the availability of components, what the various manufacturing methods are and how much they cost, what the standard parts list is, and so forth.

When I hired a circuit guy, the first thing he asked me for was our standard parts list. When I told him that was his job, he started to talk to vendors, generating specifications and asking the people who use vendors which ones could supply reliable components on time.

We generated specs that included part of the quality-assurance requirement, because we guarantee our products for one year and must aim for a 40,000 hour mean time between failures. If the failure rate was more than that, we'd have a tremendous warranty expense. As you can see, our circuit-design group has to develop an expertise beyond what most circuit designers are called upon to develop.

Also, we had to design for multisource procurement of components wherever possible, because we had to give the manufacturer as much bargaining power as possible. The calculator keyboard illustrates the point. Most companies in our business make their own keyboard. If we tell a manufacturer that we want him to buy a keyboard at only one place, he'll tell us to buy it our-

selves, because you've taken away his bargaining power. So we have to provide him with a design that incorporates parts that are generally available. Of course, if it's a sole-source item, we have to buy it.

Figuring the cost tradeoffs

3. *Liaison with the manufacturer:* In-house, the manufacturing department observes the design function, lays out its production cycles and estimates the labor needed to build the product. Then it feeds back data to the designer, so he can design the item for easier production.

In an out-of-house operation we must have some criteria from which to choose a manufacturer. We often try to make a selection that's determined by cost. But to get a price quote from a manufacturer we have to freeze the design and give the manufacturer a complete breakdown of materials that are needed to build the product. This list must be accurate and complete, because manufacturers are very competitive; they need a good materials list to bargain with.

This can create problems. For example: How do you choose connectors before you know if the manufacturer will have automatic insertion equipment? How do you figure the cost tradeoffs before you know if the product will be made in or out of the country?

To do the job, we hire engineers who are generalists, who know what manufacturing techniques are available. They also know how to include these techniques in their designs, which gives our prospective manufacturer freedom in his choice of vendors.

On the one hand we ask the manufacturer for a fixed-price quote, and on the other we anticipate the fact that he may discover ways of reducing costs after we release the contract to him. We provide ways in the contract to give him incentive to make these cost reductions. We've come up with a contract stipulating that any savings on the manufacture of the product are shared by both the manufacturer and the designer. That way we get a less expensive product, and the manufacturer gets more profit. We have the incentive to spend the money to change the design, and he has the incentive to spend the money to change the product through his shop.

4. *Product reliability:* Most companies test the product in liaison with engineering as it's being manufactured. If the item proves to be unreliable, the boss tells the manufacturing manager and the engineering manager to fix it.

We can't generate all testing procedures until the manufacturer has been selected, because each manufacturer has a different way of doing things. So we have to define our separate responsibili-

ties. We have to decide in a precise way what kind of product failures the manufacturer has to back up and what kind we have to back up. The manufacturer may say, "How do we know that you designed the product for reliability?" We counter: "How do we know you procured the parts from a reliable vendor?"

So we recommend that the manufacturer "burn in" the product before he ships it. The product is placed in a hot room for a couple of days and then retested.

We agree to generate testing procedures for the manufacturer because we don't want him to spend money duplicating our engineering. We supply him with a test specification or method that holds us responsible for establishing the criteria for a good product. He'll decide, however, at what points to test the subassemblies. If a product dies in the field, the manufacturer has the responsibility of supplying it with free spare parts; later on he'll probably ask his vendors why their parts failed.

5. *Staffing and attitude:* We look for experience in our employees more than anything else. High-technology companies tend to go for the younger engineer because he may be somewhat more up-to-date. Our fellows are not so much technical as they are attitudinal. By that I mean I look for people who have mature attitudes, who have had experience getting products through manufacturing, who aren't parochial, who are motivated to help the company and who admit mistakes.

In recruiting for one job I had each applicant critique OEM gear (the least expensive machine on the market at the time) on how he would make it more manufacturable. One of the applicants explained how we could take out three connectors and save \$1.50 worth of parts. I hired him on the spot.

Forced to design a better product

Normally there's a large amount of tension between engineers and manufacturers—finger pointing, trying to blame each other for problems, etc. I try to convince our engineers that our manufacturers have to be successful, because if they aren't, neither are we. Our manufacturers have to make a profit on our designs. Our attitude toward a manufacturer must be better than in an in-house situation. If it isn't, the manufacturer is going to be uneasy about not making money on the product. We try to make him understand that we know we need a manufacturer. If we're successful in this interface, then I think we can be more successful than if we had been an in-house group. Why? Because we're forced to design a better product than they are before manufacturing ever sees it. ■■

NOW, 400V & 600V DARLINGTONS FROM



Delco Electronics

DIVISION OF GENERAL MOTORS CORPORATION, KOKOMO, INDIANA

Delco's new DTS-4000 series Darlington transistors with V_{CE0} 's of 400V and 600V are triple diffused mesa units built for rugged duty. They come to you with a practical 15 Ampere rating that you can depend on all the way up to the high voltage requirements of ac motor speed controls, for instance—or the 1.5 kW switching regulator in the illustration.

And they offer new possibilities

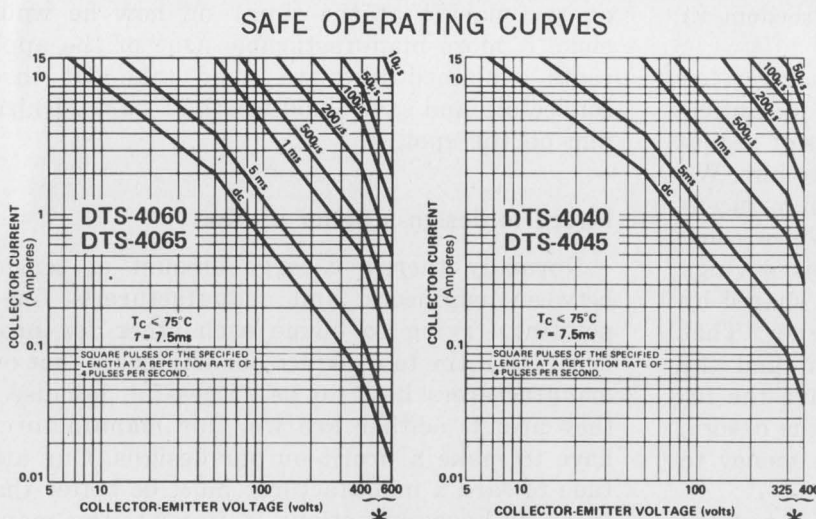

*Reverse Bias Required

TYPE	V_{CE0}	I_C (Cont.)	V_{EBO} (Max.)	V_{CE0} (sus)	h_{FE} @ I_C	t_f (com. base)	P_D (max.)
DTS-4040	400V	15A	20V	325V	250/3A	0.25 μ s	100W
DTS-4045	400V	15A	20V	325V	500/3A	0.25 μ s	100W
DTS-4060	600V	15A	20V	400V	250/3A	0.25 μ s	100W
DTS-4065	600V	15A	20V	400V	500/3A	0.25 μ s	100W

NPN—Triple diffused Darlington transistors packaged in solid copper TO-204MA (TO-3) cases.

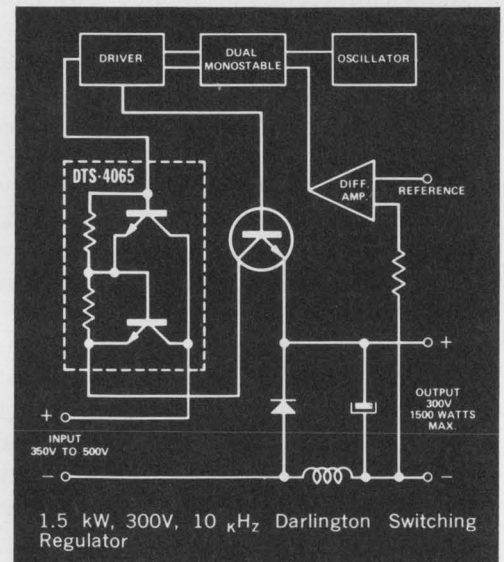

in circuit design where dc drive conditions may have created awkward problems when using SCR's.

Our new Darlington transistors can save you space and give you more design flexibility. The high energy capability of the DTS-4000 series is

HIGH ENERGY THE KOKOMOANS.

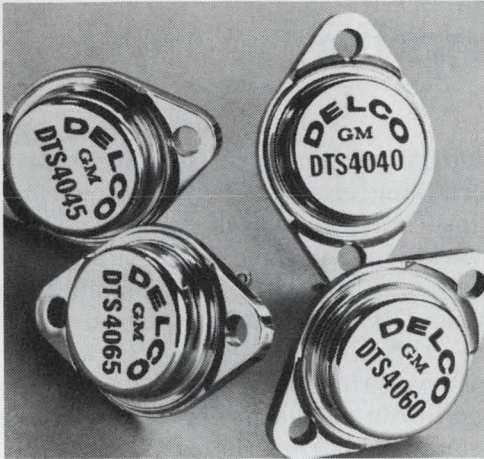

backed by safe operating curves up to 600 volts, as shown at left. And to further aid your circuit design h_{FE} is plotted continuously from 15mA to the maximum collector current rating of 15A.

As you expected, the new DTS-4000's are in stock and ready for delivery. Contact us or your nearest Delco distributor for complete details. Ask for Application Note 52 on the switching regulator.

Now available from these distributors in production quantities:

ALA., BIRMINGHAM • Forbes Distributing Co., Inc. (205)-251-4104
 ARIZ., PHOENIX • Sterling Electronics (602)-258-4531
 CAL., LOS ANGELES • Kierulff Electronics, Inc. (213)-685-5511 • Radio Products Sales, Inc. (213)-748-1271
 CAL., PALO ALTO • Kierulff Electronics, Inc. (415)-968-6292
 CAL., REDWOOD CITY • Cramer/San Francisco, (415)-365-4000
 CAL., SAN DIEGO • Radio Products Sales, Inc. (714)-292-5611
 CAL., SAN DIEGO • Kierulff Electronics, Inc. (714)-278-2112
 COLO., DENVER • Cramer/Denver (303)-758-2100 • Denver Walker Electronics (303)-935-2401
 CONN., NORWALK • Harvey/Connecticut (203)-853-1515
 FLA., MIAMI SPRINGS • Powell/Gulf Electronics (305)-885-8761
 ILL., ROSEMONT (Chicago) • Kierulff Electronics (312)-678-8560

ILL., SKOKIE (Chicago) • Merquip Electronics (312)-282-5400
 IND., INDIANAPOLIS • Graham Electronics Supply, Inc. (317)-634-8202
 MD., BALTIMORE • Radio Electric Service Co. (301)-823-0070
 MASS., NEEDHAM HEIGHTS • Kierulff Electronics, Inc. (617)-449-3600
 MASS., NEWTON • The Greene-Shaw Co., Inc. (617)-969-8900
 MICH., ROMULUS • Harvey-Michigan (313)-729-5500
 MINN., MINNEAPOLIS • Stark Electronics Supply Co. (612)-332-1325
 MO., KANSAS CITY • Walters Radio Supply, Inc. (816)-531-7015
 MO., NO. KANSAS CITY • LCOMP-Kansas City, Inc. (816)-221-2400
 MO., ST. LOUIS • LCOMP-St. Louis, Inc. (314)-647-5505
 N.J., CLIFTON • Eastern Radio Corporation (201)-365-2600, (212)-244-8930
 N.Y., BINGHAMTON • Harvey/Federal (607)-748-8211
 N.Y., EAST SYRACUSE • Cramer/Eastern (315)-437-6671
 N.Y., ROCHESTER • Cramer/Rochester (716)-275-0300
 N.Y., WOODBURY • Harvey/New York (516)-921-8700, (212)-582-2590
 OHIO, CINCINNATI • United Radio, Inc. (513)-761-4030
 OHIO, CLEVELAND • Pattison Supply (216)-441-3000
 OHIO, DAYTON • Kierulff Electronics (513)-278-9411
 OKLA., TULSA • Radio, Inc. (918)-587-9123
 PENN., PHILADELPHIA • Almo Electronics (215)-676-6000
 PENN., PITTSBURGH • RPC Electronics (412)-782-3770
 S.C., COLUMBIA • Dixie Radio Supply Co., Inc. (803)-253-5333
 TEXAS, DALLAS • Adleta Electronics Co. (214)-741-3151
 TEXAS, FORT WORTH • Adleta Electronics Co. (817)-336-7446
 TEXAS, GARLAND • Kierulff Electronics, Inc. (214)-271-2471
 TEXAS, HOUSTON • Harrison Equipment Co., Inc. (713)-224-9131
 UTAH, SALT LAKE CITY • Cramer/Utah (801)-487-3681
 VA., RICHMOND • Meridian Electronics, Inc., a Sterling Electronics Company (703)-353-6648
 WASH., SEATTLE • Kierulff Electronics, Inc. (206)-763-1550
 WASH., TACOMA • C & G Electronics Co. (206)-272-3181
 CANADA, ONT., SCARBOROUGH • Lake Engineering Co., Ltd. (416)-751-5980
 ALL OVERSEAS INQUIRIES:
 General Motors Overseas Operations
 Power and Industrial Products Dept.,
 767 Fifth Avenue, New York, N.Y.
 10022. Phone: (212)-486-3723.
Kokomoans' Regional Headquarters.
 Union, New Jersey 07083, Box 1018, Chestnut Station, (201) 687-3770.
 El Segundo, Calif. 90245, 354 Coral Circle, (213) 640-0443.
 Kokomo, Ind. 46901, 700 E. Firmin, (317) 459-2175 (Home Office)



Build a long-period one-shot with separate set and reset inputs

One CMOS quad, two-input logic gate acts as a one-shot with a 1-s period and separate set and reset inputs. The one-shot ignores trigger pulses at the set input after the first pulse is received, but the period can be truncated at any time by a pulse at the reset input. The CMOS input impedance of $10^9 \Omega$ allows long one-shot periods with small-valued capacitors.

The circuit of Fig. 1 can be considered as an oscillator (G_3 and G_4) followed by a divide-by-two flip-flop (G_1 and G_2) that turns off the oscillator after one period. A ZERO (Fig. 2) sets the flip-flop and starts the oscillator. The ZERO must last longer than three inverter transition periods plus the R_1C_1 time constant (about $4.7 \mu\text{s}$ for the values shown). After the ZERO starts the oscillator, signals at the set input will have no effect on the one-shot output.

At the end of one complete oscillator cycle, the flip-flop resets. It may also be reset at any time by a ZERO on the reset line.

Input and output lines are isolated from the period-determining circuit. The output period is relatively insensitive to power-supply and logic-threshold variations. The period of the one-shot increases only 0.1% for a 1% increase in supply voltage. When Mylar capacitors are used, the temperature coefficient is $-0.1\%/^{\circ}\text{C}$.

The logic-level threshold may vary from a third to two-thirds of the power-supply voltage, depending on the characteristics of the CMOS ICs. This variation can be minimized in the oscillator if the total period equals the RC rise time plus the RC fall time. The threshold change will make one of these long and the other short, but the sum will be constant. Period variation caused by temperature or power-supply variations, is eliminated.

Pete Lefferson, Milton Roy Co., 5000 Park St. No., St. Petersburg, Fla. 33733.

CIRCLE No. 311

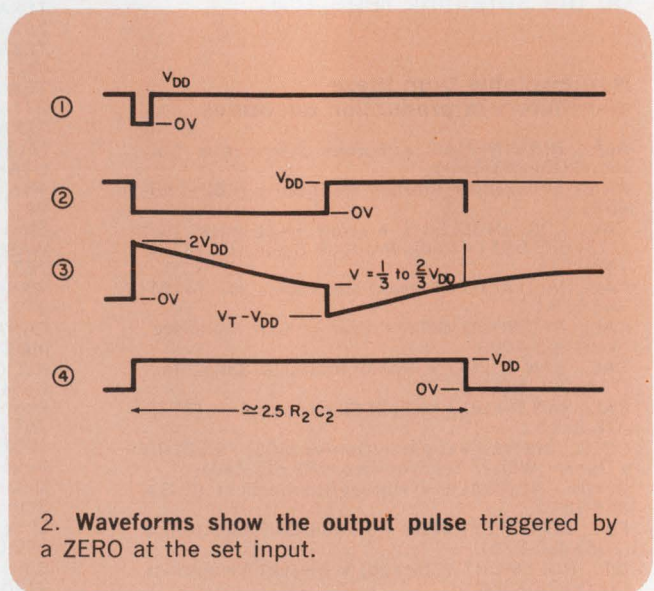
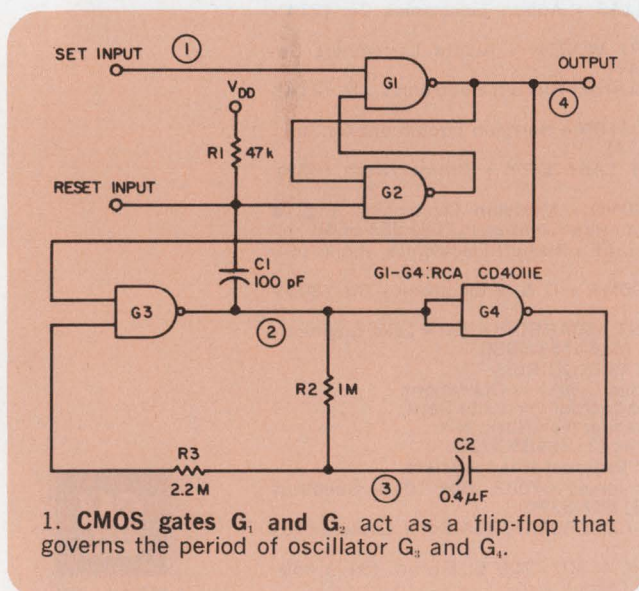

New from Helipot: the lowest trimmer profile in the business.

SHOWN ACTUAL SIZE

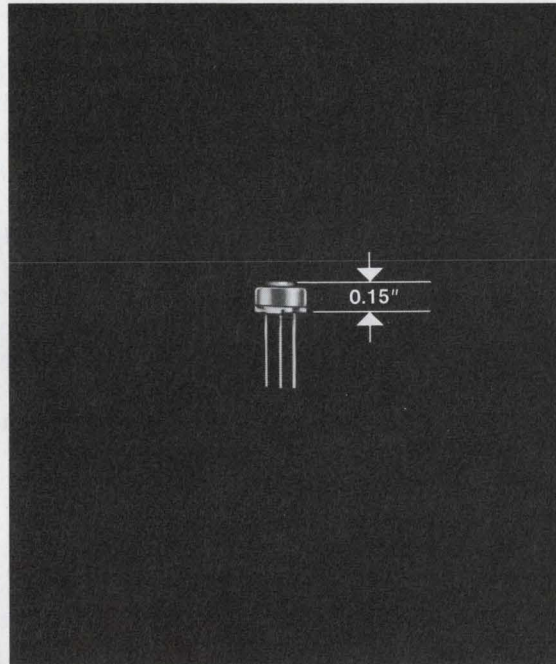

You can't do better than our Series 82 Trimmers for small size and low cost . . . and, of course, Helipot dependability. These 1/4," single-turn, general-purpose cermet models have the lowest profile in the industry with a proven cermet resistance element that can be set to any voltage ratio within 0.05% of full scale. Sealed metal housings, solid stops, and essentially infinite resolution. They'll save you space—they'll save you money. (Our prices start at \$1.40 list.) Two good reasons to write for specs and prices today.

Beckman® INSTRUMENTS, INC.

HELIPOT DIVISION

2500 Harbor Blvd., Fullerton, Calif. 92634

HELPING SCIENCE AND INDUSTRY IMPROVE THE QUALITY OF LIFE

INFORMATION RETRIEVAL NUMBER 36

To decode counter state, use a NOR gate instead of an AND

To identify a desired state in a four-bit binary counter, either a NOR or an AND gate configuration will work (Fig. 1). The NOR gate configuration, however, does not cause glitches at the output (Fig. 2). Such decoding is found in IC synchronous counters, where the maximum count is used to enable the next significant package, as required for synchronous operation with multiple packages. In a decade counter the maximum count is $9_{10} = 1001_2$ and in a four-bit binary counter it is $15_{10} = 1111_2$.

Glitches occur in the AND implementation because the TTL flip-flops, in addition to the registers and counters, have a nonsymmetrical propagation delay from the clock to the output. The delay of a rising output is one gate delay less than for a falling output. A TTL counter advances from clock pulse 7 to 8 (Fig. 2) in two steps: from 7 to 15 and from 15 to 8. The intermediate state, 15, causes the maximum count to glitch for the duration of one gate. An intermediate state also occurs for transitions from clock pulses 11 to 12 and from 13 to 14.

The glitches may rise above the 1.5-V threshold of the master-slave flip-flops. A glitch occurs when all the inputs to the AND gate are logical ones. In the transition 0111 (7 in decimal) to 1000 (8), the ONEs change to ZEROs and the ZERO changes to a ONE. Since a ZERO-to-ONE transition occurs first, an intermediate state 1111 pro-

duces a ONE at the output of the AND gate. A short time later when the other gate in the slave portion of the ONE flip-flop turns on, the AND gate returns to ZERO. However, by this time a glitch has occurred.

The unique state of the NOR gate is when all the inputs are low. Since low inputs occur always after high inputs, the unique state does not occur during the transitions and no glitches result. The logic to the NOR gate must be in the complemented form used in the AND implementation.

With ECL this problem does not exist, since the outputs have symmetrical propagation delays. However, since a NOR is much easier to implement than the AND/NAND, here, too, the NOR is the preferred form of logic to decode counters.

Ury Priel, National Semiconductor Corp., 2900 Semiconductor Dr., Santa Clara, Calif. 95050

CIRCLE NO. 312

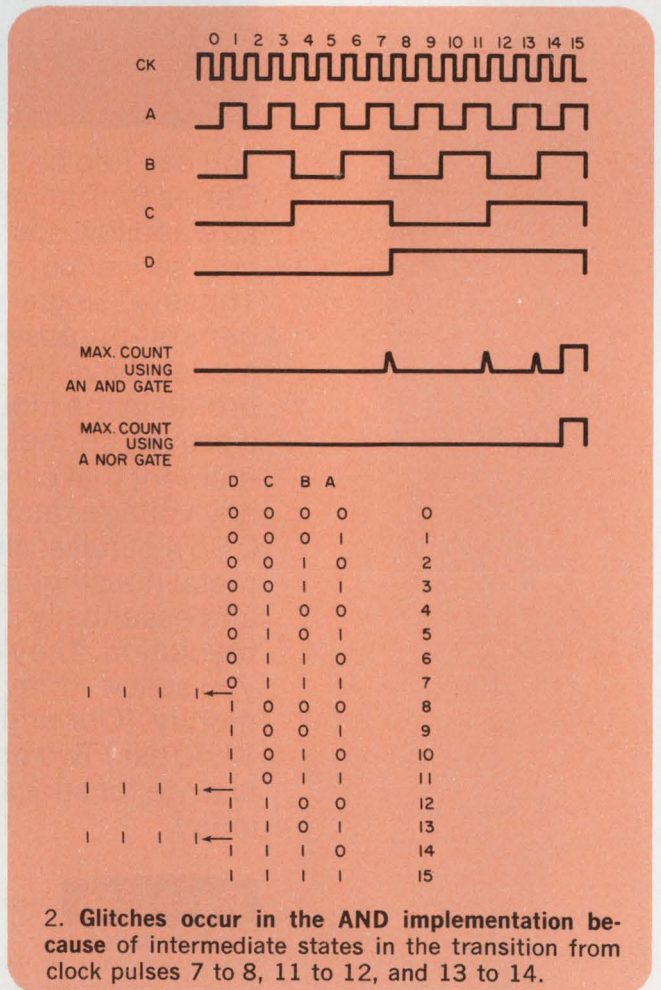
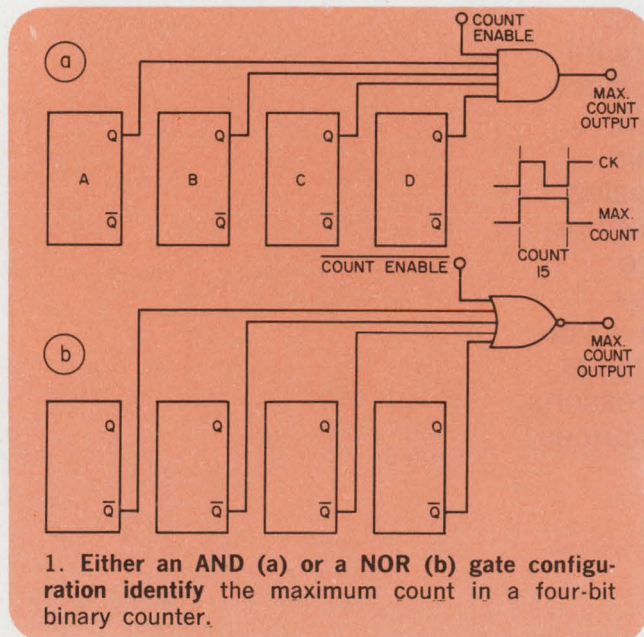



TRY 'EM...YOU'LL LIKE 'EM

Instant relief for design congestion: Cherry Subminiature snap-action switches.

When your design is afflicted with circuit congestion brought on by acute lack of space, here's the prescribed cure: Cherry 5 and 10 amp subminiature switches! Compact, easy-to-take size . . . refreshingly dependable coil spring action . . . plus long overtravel to combat assembly line headaches. You get Speedy snap-action relief in the dosage you prescribe: Either individual switches or space-saving multiple switch modules. Consultation available if design distress persists . . . Cherry diagnoses proven in over 160 million cases.

Try 'em: Send for free sample switch.
You'll like it.



E61-00A
Standard Force Basic 10 amp.
Circle Reader Service No. 232

E63-00A
"Goldie" Low Energy 0.1 amp.
Circle Reader Service No. 231



E62-50K
Roller Actuator 10 amp.
Circle Reader Service No. 233



CHERRY



TWX 910-235-1572 . . . or PHONE (312) 689-7600 . . . or WRITE:

CHERRY ELECTRICAL PRODUCTS CORP.
3609 Sunset Avenue, Waukegan, Illinois 60085

Makers of patented Leverwheel/Thumbwheel Switches, Matrix Selector Switches, Snap-Action Switches and Keyboards.

Add current limiting to your lab power supply with simple circuit

Many laboratory power supplies have overvoltage and overcurrent cut-off controls. A simple modification enables these supplies to be current limited as well.

The circuit below the dashed line in the diagrams can be added to a Sorensen 230-3/12P R&D supply, but any high-voltage supply would work as well. The current-limiting circuit is particularly useful where output interruptions (such as occur with standard overcurrent cut outs) interrupt a test. Test-sample failure or abnormal operation can be detected or studied continuously, whereas a current cut out would simply stop the test. At the same time the normal voltage and current cutout circuits will still work independently.

In operation, transformer T_1 serves as a saturable reactor, limiting the voltage applied to T_2 . Transformer T_1 's impedance is varied by the transistor/diode-bridge combination in response to the output of A_1 .

When transistor Q_1 turns on, T_1 's secondary is shorted, and this low impedance is reflected into the primary winding. The low impedance in T_1 's primary allows nearly full line voltage to be applied to T_2 , resulting in maximum output voltage from the power supply. Conversely, when Q_1 is off, high impedance in T_1 limits the voltage applied to T_2 to less than half the line voltage.

The op-amp configuration is a common current-to-voltage converter, arranged so that the high-voltage load current passes through either the adjustable resistance network or the op-amp summing junction. Diodes CR_1 and CR_2 protect A_1 's input from the line voltage. With no high-voltage load current flowing, A_1 's output is held positive by the R_3/R_4 network. As load current increases beyond that absorbed by the resistor

network, current passes through the summing junction and produces a less positive dc output from op amp A_1 . This output turns Q_1 off just enough to limit the ac voltage applied to T_2 , thereby limiting output current of the supply.

If the 10-K Ω potentiometer, R_4 , is set to minimum resistance, maximum high voltage output current results. The output current limits will be between 600 μ A and 1.5 mA for the component values shown for R_3 and R_4 .

Ralph Tenny, Equipment Technician Master, Texas Instruments Inc., M.S. 126, P.O. Box 5936, Dallas, Tex. 75222.

CIRCLE No. 313

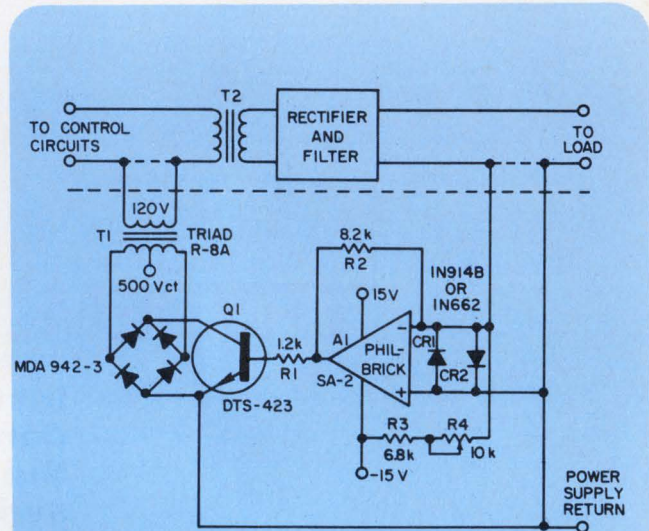

Output current above 1.5 mA causes op amp A_1 to turn transistor Q_1 off, creating a high impedance at transformer T_1 's secondary. This high impedance is reflected into T_1 's primary, limiting further increases in load current.

IFD Winner of April 13, 1972

A. Vaisnys Jet Propulsion Laboratory, M.S. 161-228, 4800 Oak Grove Dr., Pasadena, Calif. 91103. His idea, "LED-phototransistor couplers isolate analog signals," has been voted the Most Valuable of Issue award.

Vote for the Best Idea in this issue

SEND US YOUR IDEAS FOR DESIGN. You may win a grand total of \$1050 (cash)! Here's how. Submit your IFD describing a new or important circuit or design technique, the clever use of a new component or test equipment, packaging tips, cost-saving ideas to our Ideas for Design editor. Ideas can only be considered for publication if they are submitted exclusively to ELECTRONIC DESIGN. You will receive \$20 for each published idea, \$30 more if it is voted best of issue by our readers. The best-of-issue winners become eligible for the Idea of the Year award of \$1000.

UP-FRONT SIMPLICITY: LEVER-LITE III

Rugged modular construction gives you a reliable lighted lever switch that provides front-of-panel convenience on the assembly line or in the field.

Our new "Lever-Lite" III switches were designed to simplify installation and servicing of lighted lever switches on computers, telecommunications systems, industrial control equipment, intercoms, broadcast consoles and scientific or test instruments of all kinds.

SIMPLE to mount and terminate. "Lever-Lite" III switches are installed from the front. In a single hole. The lever assembly (lever-actuator, lamp and socket, and color filters) simply

slips into its housing. An escutcheon that "snaps-in" place secures the lever assembly and "trims" the mounted switch. Switching and lamp terminals are solder lug type but also accept standard quick connect-disconnect receptacles.

SIMPLE to relamp. Front-of-panel relamping or changing of color filters can be done easily by removing the escutcheon and lever assembly with your fingertips.

SIMPLE to find what you need. "Lever-Lite" III switches are available in 2- and 3-position types. With locking, non-locking and talk-listen functions. You can order multi-color (different colors in each position), mono-color (one color in all positions) or non-illuminated "Lever-Lite" III switches. And they can be specified with SPST to 8PDT switching.

SIMPLE to get. Contact your local Switchcraft distributor, sales representative, or write us direct. Switchcraft, Inc., 5539 N. Elston Avenue, Chicago, Illinois 60630.

SWITCHCRAFT
INC.

INFORMATION RETRIEVAL NUMBER 38

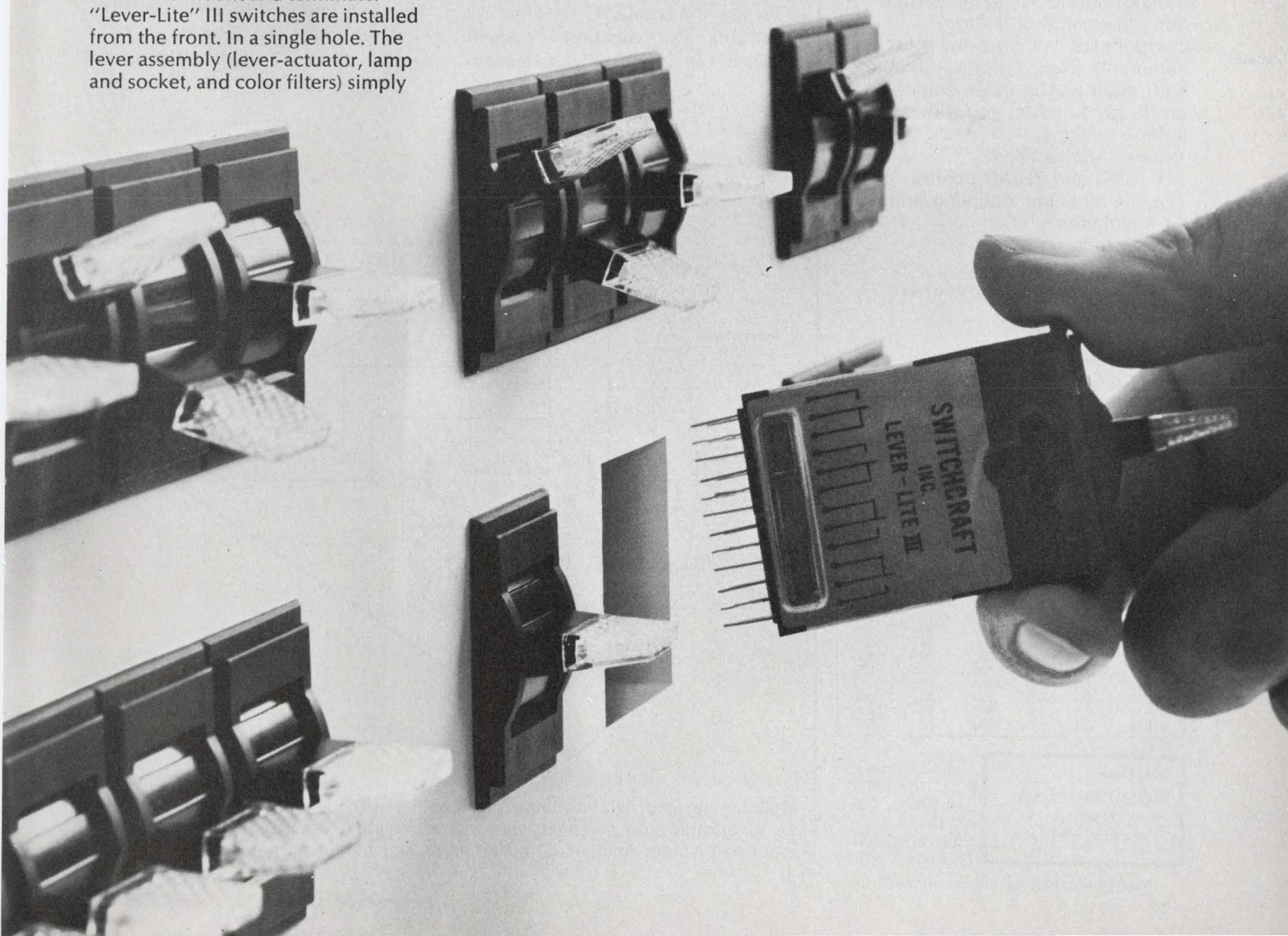

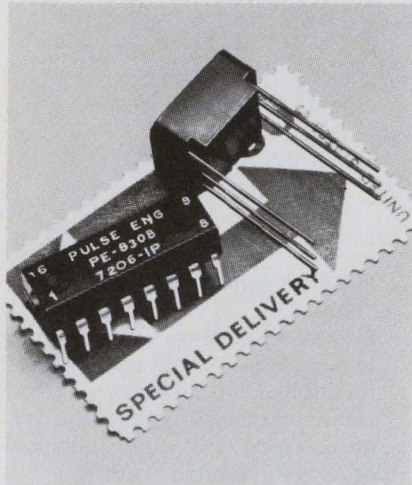

Immediately available Pulse Transformers Delay Lines

Now you can save time and money by specifying standard Pulse transformers or delay lines from our wide range of in-stock components. We have the most commonly used designs—complete and reliable. And Pulse engineers are ready to assist you with unique designs.

Typical Applications

1. SCR and TRIAC control
2. Small signal coupling and isolation
3. Baluns
4. Floating switches
5. Line drivers and receivers
6. DC isolation
7. Timing delays

For the broadest selection of in-stock components, available for immediate delivery in any quantity, call our catalog sales department.

SCR & TRIAC CONTROL TRANSFORMERS

(not shown)

Catalog Number	Turns Ratio ±10%	OCL mh MIN	ET V-μS MIN	Cw/w pf MAX	LL (μh) MAX
61000	1:1	0.2	180	24	3.2
61001	1:1	1.0	360	30	15.0
61002	1:1	5.0	866	36	64.0
61003	2:1	0.2	180	24	5.0
61004	2:1	1.0	360	30	13.0
61005	2:1	5.0	866	36	65.0
61013	1:1	0.2	290	30	6.2
61014	1:1	1.0	700	36	26.0
61015	1:1	5.0	1500	42	130.0
61016	2:1	0.2	290	30	8.9
61017	2:1	1.0	700	36	24.0
61018	2:1	5.0	1500	42	125.0

Pulse Engineering Inc.

A Varian Subsidiary
P. O. Box 12235
San Diego, Calif.
92112
(714) 279-5900
TWX 910335-1527

INFORMATION RETRIEVAL NUMBER 39

Two IC op amps make one stable modular one

An IC op amp's time and temperature offset stability is limited by the collector-current balance of the input-stage. Even with a perfect V_{BE} match, the input offset drift depends on the current sources used in the collectors. So to make a stable, low-drift op amp without resorting to chopper-stabilized techniques, the designers at Function Modules, Inc., Irvine, Calif., used a second op amp as a precise, stable current source, then added matched, wire-wound resistors in the input stage. The result is the Model 370.

In the diagram, IC op amp A2 maintains a constant current through the input pair, independ-

ent of variations in the common-mode input voltage. The matched, wire-wound resistors split the current equally into the collectors. A monolithic input pair is selected for low noise and good stability of V_{BE} . Finally, an IC op amp with very low bias current forms the output stage.

The offset current drift multiplied by the difference between R_{C1} and R_{C2} will appear as voltage drift, so this drift must be kept very low. The input offset drift is approximately $dV_{os}/dt = 200 \log R_{C2}/R_{C1} (V/^\circ C)$. With the collector resistors matched to within $\pm 0.1\%$, drift is less than $\pm 0.086 \mu V/^\circ C$.

CIRCLE NO. 314

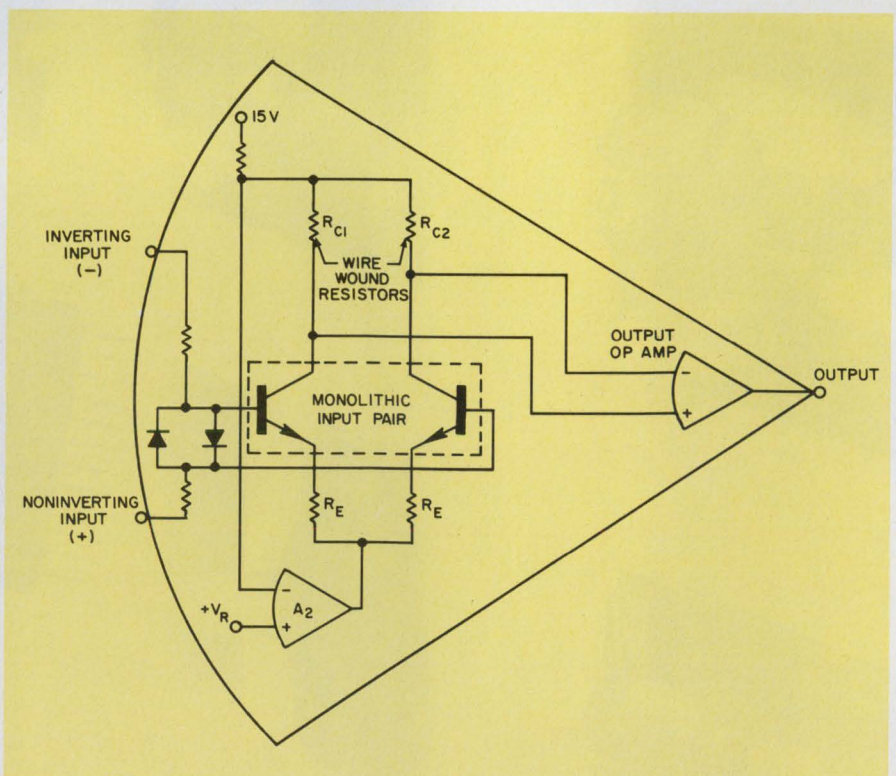

Modular op amp exhibits improved stability with time and temperature when an IC op amp and matched, wire-wound resistors are used in the monolithic input-pair stage. Another IC op amp is used in the output stage.

All cats look the same in the dark.

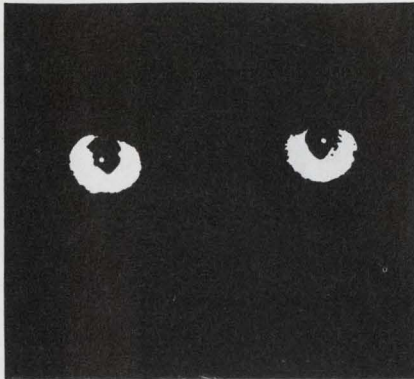

Heaven help the man who has to choose one, when the "cats" are computer automated test systems. Nailing down the most efficient, least costly system to suit the

plant's requirements has been expensive and tough—if not impossible.

Equipment capabilities, system speed, hardware/software flexibility all come into the picture. But the boardroom wants to take a hard-nosed, profit-oriented look at capital outlay, payback periods, overhead, and the impact of cost savings over current test methods.

At last one test system manufacturer, Fairchild Systems, has taken the guesswork out of the selection process. By developing an illuminating computer-based tool that helps you determine the economic feasibility—and the financial justification—of the pre-use testing of semiconductor devices. And matches the results to the level of our equipment you will find most advantageous for all concerned.

We call it SAVE.

System Analysis of Value Economics. A fancy name for a simplified mathematical procedure that simulates your particular plant operations over a wide range of testing situations—incom-

ing inspection, QA, PCB, wafer and final production testing.

SAVE consists of easy-to-fill-in forms, which take you step by step through all your applications, configurations, number of stations, even the number of daily work shifts. Types and quantities of devices used are considered, with your average rate of untested defectives balanced in.

Your completed forms are fed through Fairchild Systems' SAVE-programmed computer. To deliver hard data on total comparative costs for test equipment replacement, system costs, operating expenses, including payback period and actual net savings realized.

The SAVE read-out is also useful for evaluating alternative system configurations as they relate to the customer's operation, to provide cost-effective solutions. And because SAVE offers in-depth simulation of system test operations, a plant designer can also use this capability to maximize his software/hardware utilization, his operating policies, and to "fine tune" his system for optimum performance.

And finally, the computerized analysis helps you establish the most economical, most productive level of test equipment from our optimized Sentry series—the large-scale Fairchild Systems with unmatched speed, sophistication and flexibility. From MOS to bipolar, from IC's to discretes, or LSI—with software compatible to all, and the lowest throughput costs in the field—the Sentry family offers you total semiconductor testing capability with enormous expansion and adaptability options. And SAVE shows you how to make the most of it.

	Fairchild Systems 3500 Deer Creek Road Palo Alto, California 94302
<input type="checkbox"/>	Please send us your SAVE Economic Analysis Kit for semiconductor test systems.
<input type="checkbox"/>	with details on your modular testers.
<input type="checkbox"/>	with details on your Sentry Systems.
<input type="checkbox"/>	Call us immediately for individual application assistance.
Name _____	
Title _____	
Company _____	
Street _____	
City _____ State _____	
Zip _____ Telephone _____	ED

Fairchild Systems

Fairchild Systems Technology, a division of Fairchild Camera & Instrument Corporation.

INFORMATION RETRIEVAL NUMBER 40

Now awaiting orders

It can go into service for you fast. Because it's already designed, tested, and operative. Order it packed with capacities from 1/2 to 7 megabits and assign it to the toughest applications—the L107MA can handle the duty.

How rugged and reliable is it? A major aerospace company put it through survival school: three clobbering, 40G drop tests, one for each axis. The L107MA emerged undamaged and operating unimpaired. And it

came out with flying colors in passing critical EMI tests of MIL-STD-461A/462.

Only 8" by 12" in its hermetically sealed housing, it can operate in any position. And in just about any application. The low-cost L107MA is about to have a big brother, too. Scheduled for production in early 1973, the L107MB will pack capacities up to 18 megabits in an 11" by 17" package.

For more about these little shock-troopers, call (213) 245-8711. Or write to Librascope Division of The Singer Company, 833 Sonora Avenue, Glendale, California 91201.

SINGER
AEROSPACE & MARINE SYSTEMS



Librascope's militarized L107MA disc memory

8, 12-bit registers advance a/d converter designs

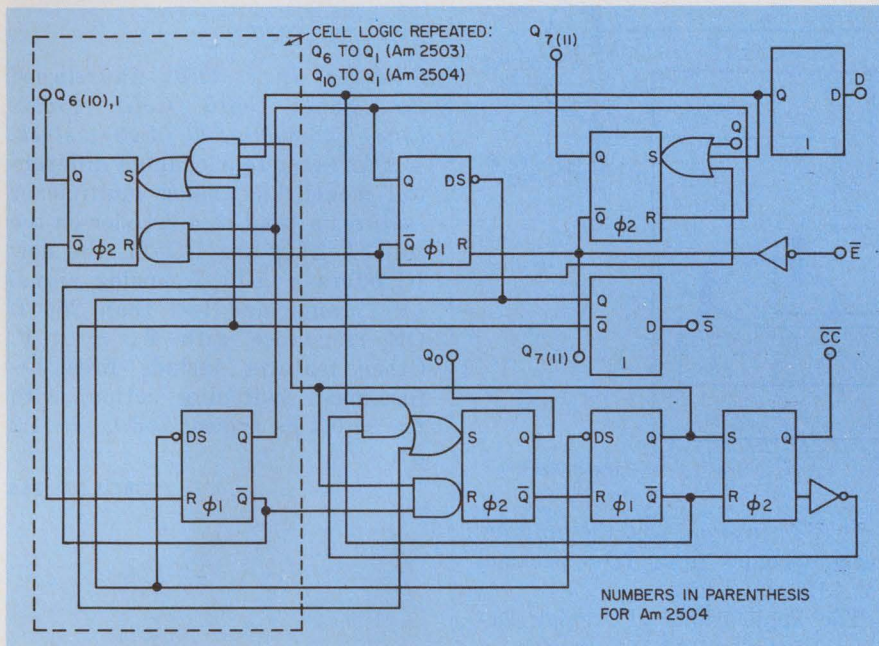

Advanced Micro Devices, Inc., 901 Thompson Pl., Sunnyvale, Calif. 94086. (408) 732-2400. Am 2503: \$7.10 (100 up).

With all the digital control and storage required for successive approximation a/d conversion, Advanced Micro Devices' 8-bit Am 2503 and 12-bit Am 2504 TTL monolithic registers speed conversions while simplifying converters. The Am 2503/2504 ICs are faster with additional component-saving features, when compared to the only other registers of this type—Harris Semiconductor's 8-bit HI-0180 (military version) and HI-0185 (commercial version) circuits. The use of either the Harris or AMD circuits in a/d converters eliminate several MSI devices.

In addition to the higher resolution of the new ICs (8-bits for the HI 0180/0185 vs 12-bits for the Am 2504), they feature faster conversions and clock frequencies. The HI 0180/0185 registers require two clock periods for 1-bit conversions. The Am 2503/2504 accomplish the same conversion in

one clock period. And typical clock frequencies are 20 MHz for the Am 2503/2504 vs 4 MHz for the HI 0180/0185 circuits.

Other features of the new AMD ICs include synchronous starts, direct cascading for register extensions and complementary output of the most significant bit. The Harris circuits don't have these features.

The AMD registers include master latches that act as control elements (see diagram). These change state when the input clock is LOW. A set of slave latches hold register data and change state on the input clock LOW-to-HIGH transition.

Externally the device acts as a special purpose serial-to-parallel converter that accepts data at the D input. The input data can change state at any time except during the set-up prior to the clock transition.

To allow complementary conversion, the complementary output of the most significant register bit is made available.

For Am 2503/2504 **CIRCLE NO. 252**
 For HI 0180/0185 **CIRCLE NO. 253**

TV deflection transistors offered

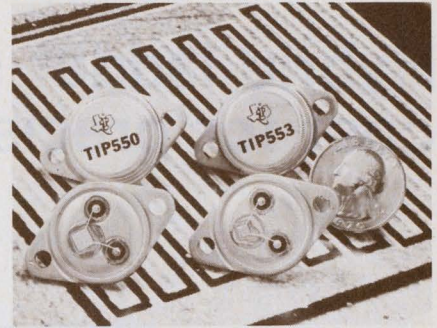

Texas Instruments Inc., P.O. Box 5012, MS/308, Dallas, Tex. 75222. (214) 238-3741. TIP-550: \$2.10; TIP-551: \$2.50; TIP-552: \$4.05; TIP-553: \$4.55 (100-up); 3 wks.

A series of high-voltage power transistors provide a solid-state alternative for deflection circuits of TVs. The TIP550 and 551 are intended for monochromatic TV circuits and high-voltage inverters, while the TIP552 and 553 are designed for high-voltage inductive switching in addition to high-voltage CRT deflection for color TVs.

CIRCLE NO. 254

75¢ timer offers delays from 1 μs to 1 hr

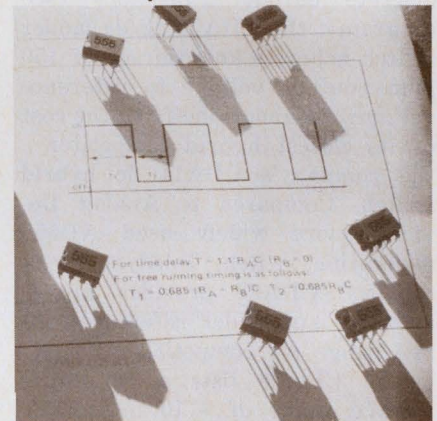

Signetics, 811 Arques Ave., Sunnyvale, Calif. 94086. (408) 739-7700. P&A: See below.

The Model 555, an IC timer, can produce fully controllable time-delays between 1 μs and 1 hr. If the timer is allowed to run free, it can be set to oscillate at any frequency between 1 MHz and 1 pulse per hour (or 3.6 MHz). All that are required are an external resistor and a capacitor. The price of the plastic version, which has an accuracy of 5%, is 75¢ (100 up).

CIRCLE NO. 255

Hybrid ladder switch cuts cost for precision designs

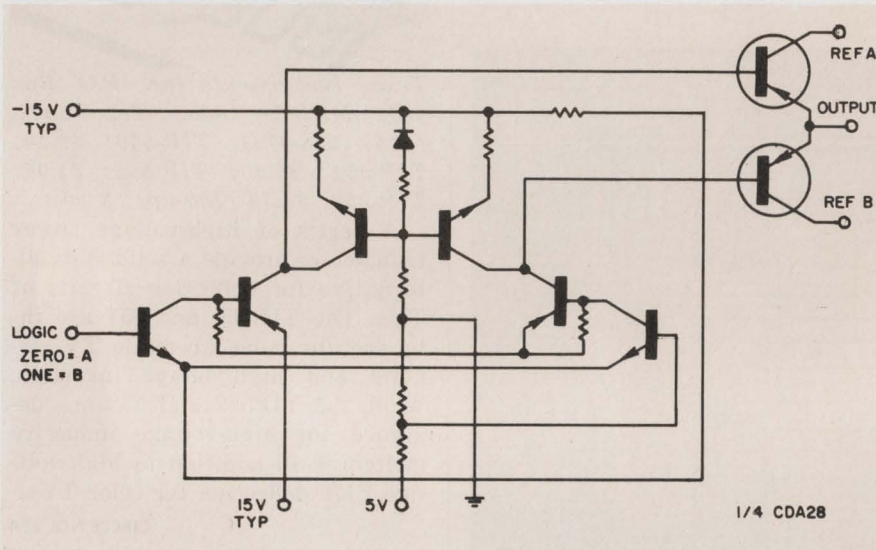

Teledyne Crystalonics, 147 Sherman St., Cambridge, Mass. 02140. (617) 491-1670. P&A: See below.

With a monolithic driver and discrete output transistors (see diagram), the CDA28 ac/dc ladder switch achieves an accuracy of 150 ppm (output voltage to reference voltage) at about one-fifth the cost of its closest hybrid competitor—the company's CDA11 dc hybrid switch. Compared to Analog Devices' more widely used AD555 monolithic switch, Teledyne Crystalonics' CDA28 provides higher accuracy and wider reference-voltage range for competitive prices.

The CDA28 lists a reference-voltage range of -10 to $+10$ V (ac or dc), offset voltage of 1.5 mV max, ON resistance of 10Ω max (5Ω typical) and settling time of $3 \mu\text{s}$ max. The military version (suffix A) is available in a TO-116 DIP for \$23.90 (100 up). A commercial version (suffix B), with a 0 to 70 C range, sells for \$16.90 in the same package and quantity.

By comparison, Teledyne's CDA-11, which has far more components than the CDA28, has about the same accuracy, offset voltage, ON resistance and settling time. But its reference-voltage range is only

-10 V to ground. And the military version comes in a TO-8 package for \$120 (100 up).

The applications of Analog Devices' popular AD555 switch—a monolithic current-summing device—can also be filled by Teledyne's CDA28 switch—a hybrid voltage-summing circuit. However, some of the key specs of the AD555 fall short of the CDA28's.

The AD555's reference-voltage range is -3 to $+3$ V (vs -10 to $+10$ V for the CDA28); its maximum offset voltage spec is 2 to 10 mV (vs 1.5 mV), and its maximum ON resistance listing is 25 to 100Ω (vs 10Ω). In addition, the AD555 has a settling time of $5 \mu\text{s}$ (vs $3 \mu\text{s}$ for the CDA28) and an accuracy of 670 ppm (vs 150 ppm). The cost of the AD555 ranges from \$22 to \$34 in quantities of 100.

The CDA28 consists of four switches per package. Positive and negative supply voltages for each switch can range from 12 to 18 V. Switching action is break-before-make. The CDA28 can be used for converters with up to 12-bit resolution.

For Analog Devices' AD555

CIRCLE NO. 250

For Teledyne's CDA28, CDA11

CIRCLE NO. 251

PMOS multiplexer has 1-out-of-4 decoder

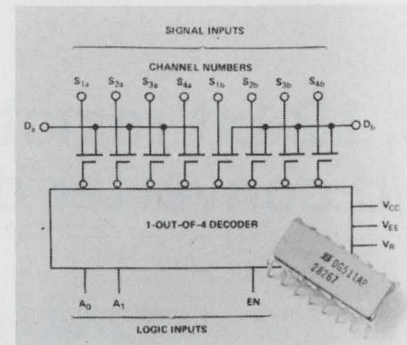

Siliconix Inc., 2201 Laurelwood Rd., Santa Clara, Calif. 95054. (408) 246-8000. \$20 (1.29); stock.

A low-cost four-channel differential monolithic analog multiplexer features a 1-out-of-4 decoder on the chip. Termed the DG511, the new IC offers a ± 10 V analog signal (V_A) range and less than 250Ω ON resistance with $V_A = 0$ V. Other features include break-before-make switching action, with $t_{\text{off}} = 0.4 \mu\text{s}$ typical and $t_{\text{on}} = 1.2 \mu\text{s}$.

CIRCLE NO. 256

N-channel quad switch has 20- Ω ON resistance

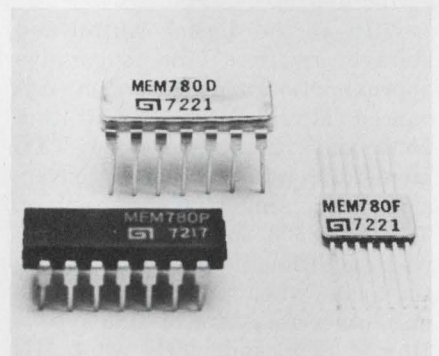

General Instrument Corp., 600 W. John St., Hicksville, Long Island, N.Y. 11802. (516) 733-3535. P&A: See below.

A high-speed, N-channel quad switch, the MEM 780, features nanosecond switching time with a matched ON resistance of 20Ω . Applications include high speed multiplexing, video switching, memory gating and high speed choppers. The MEM 780 sells for \$5.15 in 100-999 piece quantity.

CIRCLE NO. 257

When RFI problems get sticky, try **stickn fingers**®

Attaches faster, shields better than anything else!

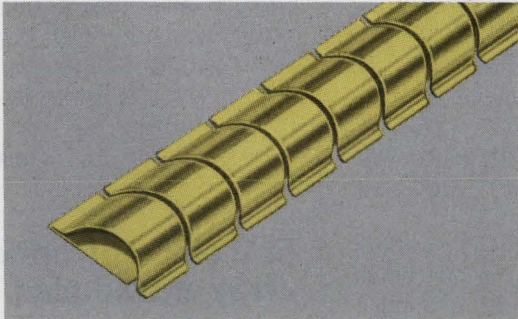

SERIES 97-500 The original Sticky Fingers with superior shielding effectiveness.

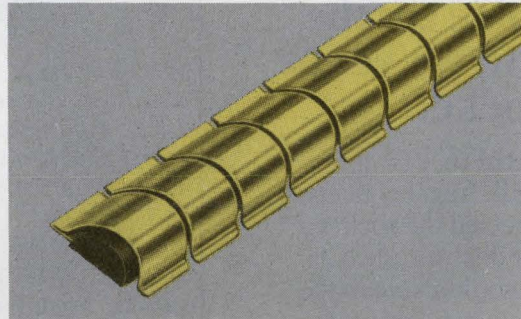

SERIES 97-510 Provides even better magnetic shielding with Magnefil® insert strips.

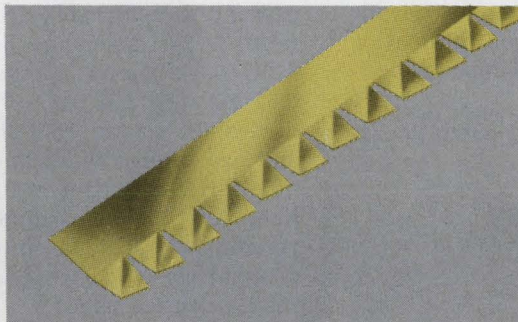

SERIES 97-555 New Single-Twist Series for use when space is at a premium. Measures a scant $\frac{3}{8}$ " wide.

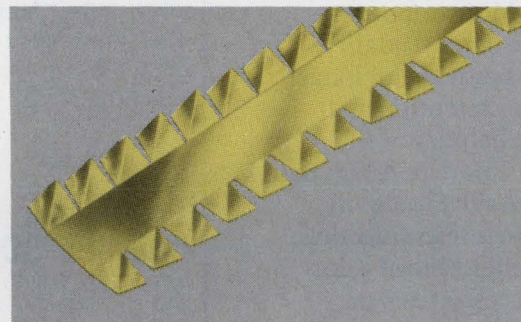

SERIES 97-560 New $\frac{1}{2}$ " wide Double-Twist Series, ideal for panel divider bar cabinets.

Now you can specify the exact type beryllium copper gasket that solves just about every RFI/EMI problem. Perfect for quick, simple installation; ideal for retro-fitting. Self-adhesive eliminates need for special tools or fasteners. Write for free samples and catalog.

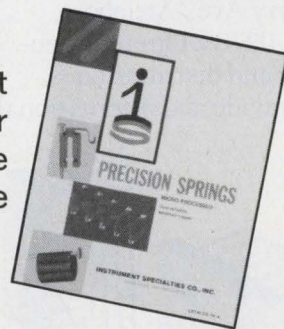

INSTRUMENT SPECIALTIES COMPANY, Dept. ED-65

Little Falls, N.J. 07424

Phone—201-256-3500 • TWX—710-988-5732

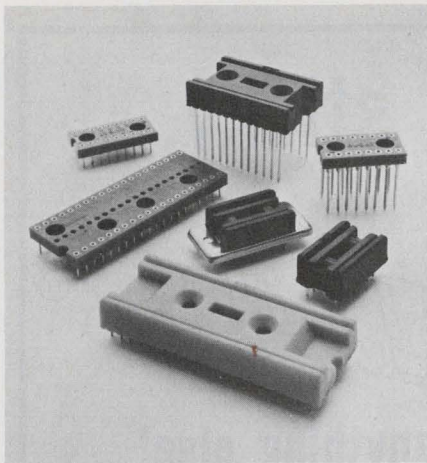

If you've got the circuit, we've got the socket.

We ought to.

After all, Augat conceived and pioneered the socket panel for dual-in-line IC's. So why wouldn't we make other sockets for printed circuit boards as well?

We do. Low profile types, ultra-low profile types, MSI and LSI types, even LED sockets. More important, Augat design and quality standards provide for longer life, better retention and greater reliability.

There's more to Augat than sockets. As the leader in electronic interconnection, we also offer a broad selection of accessories. For quick information on price and delivery, call us at (617) 222-2202. Or write for our catalog. Augat Inc., 33 Perry Ave., Attleboro, Mass. 02703. Our representation and distribution is nationwide and international.

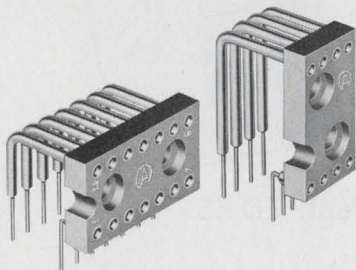

Plug into Augat®

See Augat's new Dead or Alive at the WESCON Show, Booths 3410-3411.

INFORMATION RETRIEVAL NUMBER 43

ICs & SEMICONDUCTORS

CMOS up-counters operate at 6-MHz rates

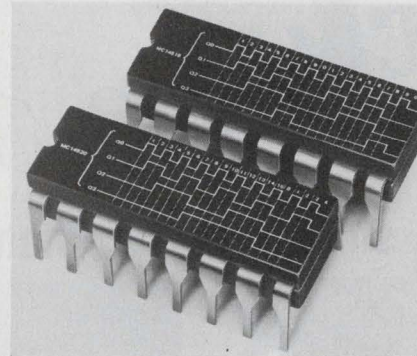

Motorola Semiconductor Products Inc., P.O. Box 20912, Phoenix, Ariz. 85036. (602) 273-3465. MC-14518: \$7.20-\$12.90; MC14520: \$7.00-\$12.60.

Two CMOS logic up-counters, the MC14518 and the MC14520, can be used for counting applications at rates up to 6 MHz. The MC14518 provides a dual, BCD up-counting function while the MC14520 offers a dual, binary up-counting capability. These counters offer noise immunity of typically 45%, quiescent power dissipation of 1 μ W typical and input capacitance of 5 pF.

CIRCLE NO. 258

Transistor array handles 300 A

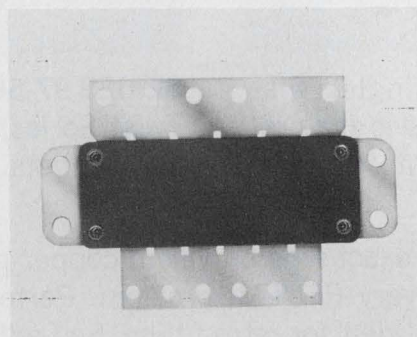

RCA Solid State Div., Route 202, Somerville, N.J. 08876. (201) 722-3200. \$99 (1-99); stock.

With the six transistors of the Type TA8624 array connected in parallel, the new device features a switching capability of 300 A and a dissipation of 1000 W. Each transistor is a 50-A npn device mounted in a compact plastic package with a common collector connection to the mounting flange.

CIRCLE NO. 259

2048-bit MOS RAM offers 360-ns access

Advanced Memory Systems, Inc., 1276 Hammerwood Ave., Sunnyvale, Calif. 94086. (408) 734-4330. \$20.48 (250).

The first commercially available 2048-bit MOS dynamic RAM, the AMS 6003, offers 360 ns maximum access time and 595 ns maximum cycle time; maximum power dissipation is listed at 160 mW (operating) and 40 mW (standby). The memory features TTL-compatible inputs, and incorporates address registers, chip-select registers and data output latches on the chip. The operating temperature range is 0 to 70 C.

CIRCLE NO. 260

512-element optical array introduced

Reticon Corp., 365 Middlefield Rd., Mountain View, Calif. 94040. (415) 964-6800.

The RL-512, the first 512-element self-scanning optical array, operates at sample rates from 1 kHz to 10 MHz (depending on external TTL clocks) with a sensitivity of 0.67 pA per μ W/cm². The photodiodes are spaced on 1 mil centers and are internally scanned to provide serial output on a single video line. Applications include pattern recognition, OCR, facsimile and industrial control. Two RL-512s can read an entire page.

CIRCLE NO. 261

1024-bit isoplanar TTL RAM introduced

Fairchild Semiconductor Components Group, 464 Ellis St., Mountain View, Calif. 94040. (415) 962-3816. P&A: See below.

A 1024-bit TTL random-access memory, termed the 93415, is the industry's first such memory fabricated with the Isoplanar process, according to the company. The new device features a 60-ns access time. The 93415 is packaged in standard 16-pin ceramic DIPs, and has a power dissipation of 0.5 mW per bit. The price is \$87.50 (1 to 24) and \$70 (100 to 999). Evaluation quantities are available.

CIRCLE NO. 262

If you need
a tester
with **special**
scales, ranges,
accessories
or any
combination...

Buy a
Triplett tester
custom-designed
for you

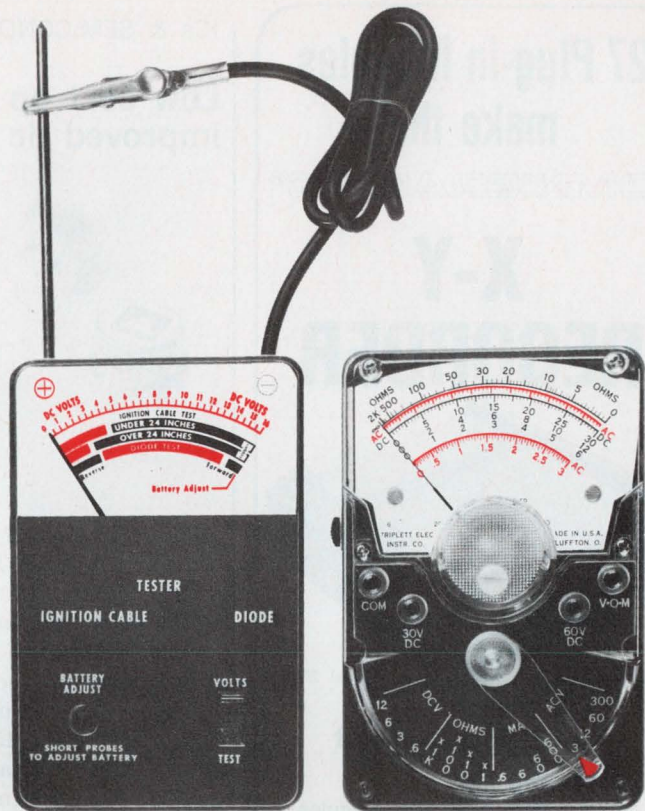

A

B

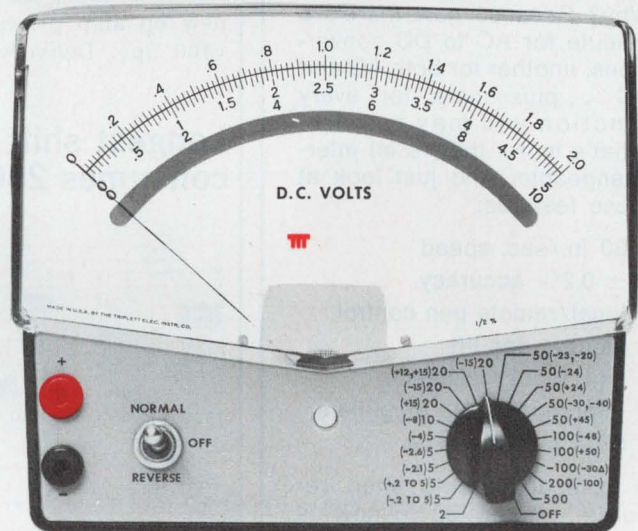

C

Triplett, manufacturer of the World's most complete line of V-O-M's, is ready, willing and able to design and manufacture special testers of virtually any size, style or type to meet your specifications.

Tester A (above) was designed to give auto mechanics a simple, rugged tester for "go/no go" tests that would otherwise be measured in electrical units unfamiliar to them.

Tester B is a modification of a

standard Triplett tester incorporating only the specific ranges needed by the field service engineers for whom it was designed.

Tester C has special ranges and special input connectors and cables to permit a single-point connection for trouble-shooting and servicing all the circuits of a complex business machine.

Several other buyers of standard Triplett test equipment request their company name on the dial to personalize their testers.

If you think a custom tester may solve some problems for you, contact your Triplett representative. He'll put you in touch with the Tester Designers and Engineers at Triplett who'll help you analyze the problem and suggest the optimum cost/result solution. Triplett Corporation, Bluffton, Ohio 45817

TRIPLETT
BLUFFTON, OHIO 45817
Manufacturers of the World's
most complete line of V-O-M's

INFORMATION RETRIEVAL NUMBER 44

27 Plug-in Modules make the

OMNIGRAPHIC®

X-Y RECORDER

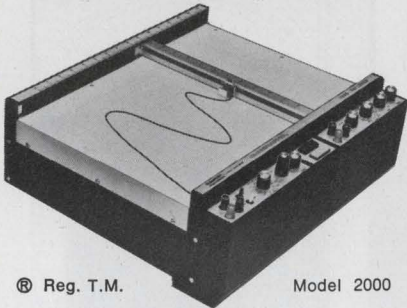

® Reg. T.M.

Model 2000

a terrific value at

\$795 plus modules

Why? Because now there's a module for AC to DC conversions, another for both AC and DC... plus more for every function you may require. What's more, they're all interchangeable. And just look at these features:

- 30 in./sec. speed
- $\pm 0.2\%$ accuracy
- local/remote pen control
- electric pen lift
- high input resistance
- interchangeable amplifiers
- \$795 plus modules

A companion strip chart recorder, model 3000, now is available with a full span automatic integrator for gas chromatography and with modules for point plotting.

Write for brochures today.



houston instrument | DIVISION OF BAUSCH & LOMB

4950 Terminal Avenue, Bellaire, Texas 77401
(713) 667-7403 Cable Hoinco

houston instrument | European Office

Johanneskirchner Strasse 17, 8043 Unterföhring
München, W. Germany (0811) 97-1673

INFORMATION RETRIEVAL NUMBER 45

ICs & SEMICONDUCTORS

Low cost op amp offers improved dc specs

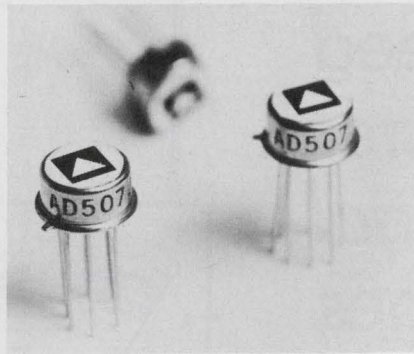

Analog Devices, Inc., Route 1 Industrial Park, P.O. Box 280, Norwood, Mass. 02062. (617) 329-4700. P&A: see below.

The AD507 op amp, a low cost alternative to "economy" general purpose types, combines maximum bias current of 15 nA and maximum offset voltage drift of 15 $\mu\text{V}/^\circ\text{C}$ with minimum slew rate of 25 V/ μs and typical gain-bandwidth product of 100 MHz. The new op amp prices start at \$6.95 (100 up). Delivery is from stock.

CIRCLE NO. 263

Longest shift register consumes 250 $\mu\text{W}/\text{bit}$

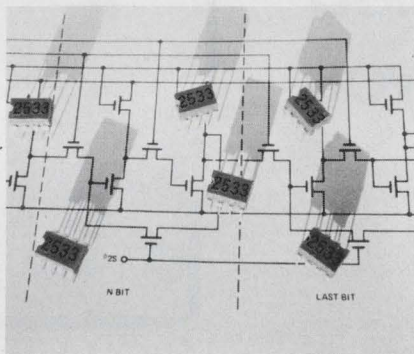

Signetics, 811 E. Arques Ave., Sunnyvale, Calif. 94086. (408) 739-7700. \$15.30 (100).

A 1024-bit MOS static shift register, believed the longest, has a power drain of only 250 $\mu\text{W}/\text{bit}$. Termed the 2533, the new IC is guaranteed over a frequency range of dc to 2 MHz and over a temperature range of 0 to 70 C. All inputs, including the single-phase clock, can be driven directly by standard bipolar circuits. The output operates between 0 and 5 V and provides 1.6 mA sink current for one standard TTL load.

CIRCLE NO. 264

FET dynamic range reaches 135 dB

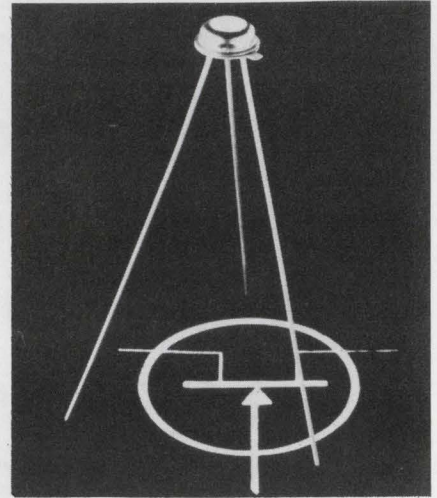

Teledyne Crystalonics, 147 Sherman St., Cambridge, Mass. 02140. (617) 491-1670. \$4 (500-999); stock.

The CP643 FET features a dynamic range of 135 dB, as compared with normal ranges of 110 dB for other FETs and 90 dB for bipolar transistors, according to the company. Transconductance is typically 25,000 micromhos at a drain current of 25 mA. This compares with about 7500 for the average small signal FET at 5 mA. Input impedance is about 65 Ω .

CIRCLE NO. 265

Monolithic MODEM for FSK signal

Exar Integrated Systems, 733 N. Pastoria Ave., Sunnyvale, Calif. 94086. (408) 736-7970. \$6.50 (100 up); stock.

A monolithic MODEM that modulates and demodulates frequency-shift-keyed (FSK) signals can handle both low speed and medium speed data rates up to 1800 bits per second. Termed the XR-210, it is directly compatible with Bell Telephone 103 or 202 type "Data Sets." This MODEM is believed to be the only IC capable of providing this function without additional ICs for logic compatibility. The XR-210 can operate with either single or split power supply voltages ranging from 5-to-26 V and has a frequency range from 0.5 Hz to 20 MHz.

CIRCLE NO. 266

high power linear amplifiers from MCL

Reliability in linear amplifiers begins with cavity amplifier design. MCL combines today's most advanced cavity designs with regulated power supplies, metering and cabinetry for total system dependability.

For example, MCL Model 10581 linear amplifier system covers a frequency range of 200 to 400 MHz for dependable command communications. Bandwidth at 3 db is 4 MHz and gain is 13 db. Servo controlled automatic tuning is available as an option. And MCL can provide this amplifier in the exact power and frequency configuration you require.

A wide range of high-reliability amplifier systems in addition to Model 10581 are available from MCL. For complete specifications on the amplifier that meets your high power microwave requirements, call (312) 354-4350, or write: MCL, Inc., 10 North Beach Avenue, La Grange, Illinois 60525.

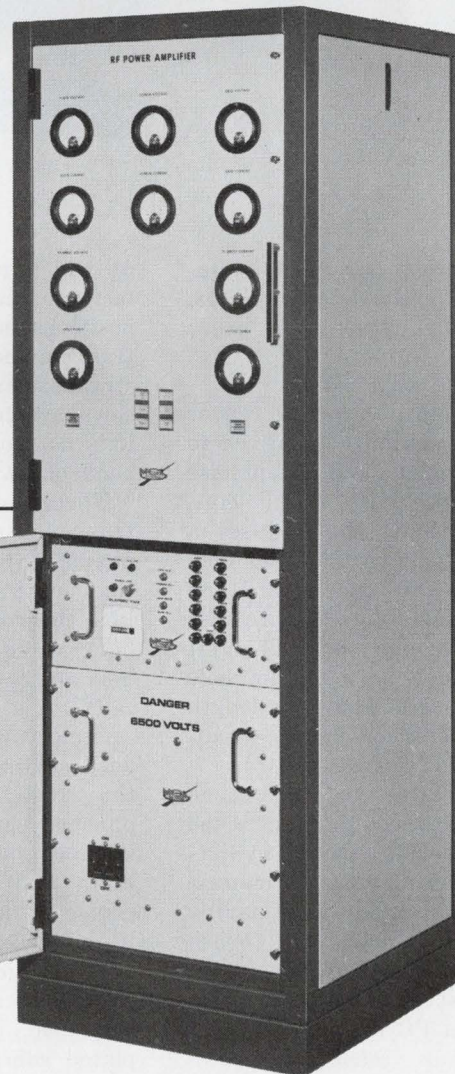

MCL
INC

Opportunities developing now for RF engineers at MCL, Inc.—an equal opportunity employer.

INFORMATION RETRIEVAL NUMBER 46

Static tab-card reader handles hole misalignment with brush contacts

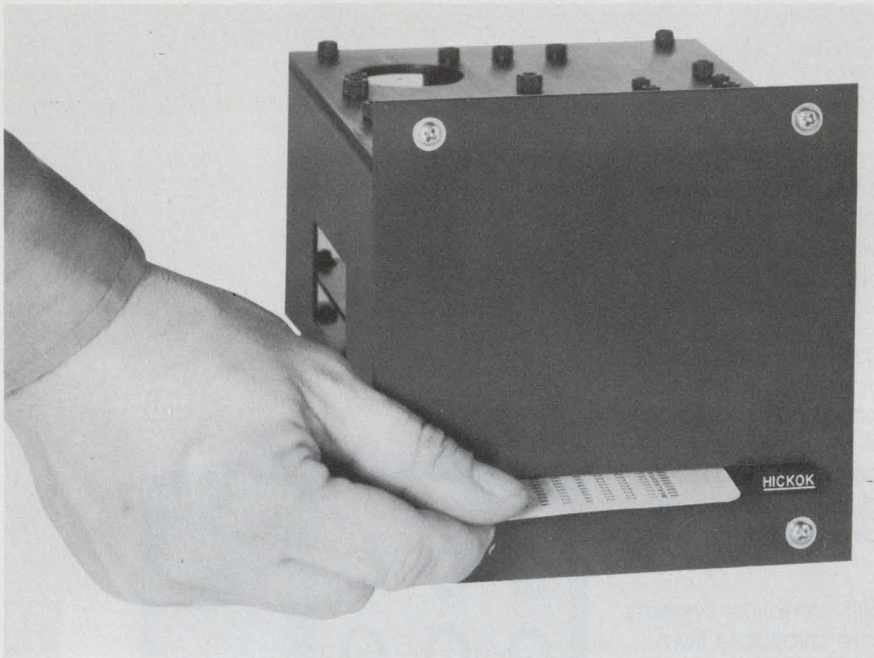

Hickok Controls Div., 10514 Dupont Ave., Cleveland, Ohio 44108. (216) 541-8060. \$495 (unit qty); 90 days.

Hickok's static tab-card reader promises to maximize tolerance to card misalignment and non-precise hole punching. In its Model 960A, 80-column reader, Hickok uses a brush-contact array. This not only reduces need for critical card and hole positioning but also provides multiple contacts per hole. The unit allows as much as 0.023 in. hole displacement error along the length of the card. This is 0.009 in. greater than EIA standards call for.

Typically three to five brush strands pass through a punched hole. This provides increased likelihood of making a good connection, compared with units having single-point contacts. The brush strands are said to provide a double wipe against gold contact pads plated onto a PC board.

The Hickok reader competes most directly with AMP's Model 2981 and Sealectro's SCR-1280 both

of which use 960 individual contacts to match the 80 × 12 hole positions in the tab cards. By contrast, in the Hickok unit, all brush strands, arranged in horizontal rows, are connected together. Thus it is not possible to have 960 independent switches.

Therefore the AMP and Sealectro units provide greater circuit flexibility. However, Hickok says that, with single-point hole sensing, the contact is more likely to hang-up on the edge of misaligned hole or fail to make contact because of a speck of dirt.

Sealectro, however, senses holes with spring loaded pins, and does the switching away from the punched card to reduce contact-resistance problems due to lint or dirt. And also, the user has a choice of normally-open or normally-closed contacts.

AMP, on the other hand, makes electrical contact directly through the hole using individual gold-plated contact springs which provide a double-acting wiping motion, to alleviate dirt problems.

In many applications—like those that require reading only one hole at a time, or one character code per column—it's very convenient to use a bussing arrangement. This permits the reader to use a minimum number of interconnecting wires. Hickok's unit can provide diode-matrix bussing for 256, 128, 64 or 40-Hollerith character sets, and for special codes that require a full diode matrix. In applications, however, that require simultaneous random access to every hole in the card, only the full 960-point readers are suitable.

To partially alleviate the restrictions of contact bussing, Hickok offers its Model 80, TTL-compatible scanner to interface with the 960A. The scanner has two modes: random addressable and sequential. In the random mode any column location may be addressed at random and the column information is then presented on 12 data lines with binary indication of the column address. In the sequential mode, an external advance pulse steps the scanner to the next column in sequence.

A corner-sensing feature, in the Hickok unit, verifies that a card has been correctly inserted. The card is then held until a command is given to eject it and to reset the unit. Remote eject and reset is a standard feature of the 960A.

Hickok says the mechanical simplicity of the 960A enables the company to offer the unit at from 30 to 60% less than the cost of competing units. Sealectro's reader is priced at about \$1500 and AMP offers its basic unit at about \$730, in unit quantities. All three companies can supply other card readers for different card sizes and styles. Also, the AMP and Sealectro units are available in a variety of bussed arrangements.

Hickok	CIRCLE NO. 267
Sealectro	CIRCLE NO. 268
AMP	CIRCLE NO. 269



Still paying for oscillator stability you don't need?

Plug in our K1065A instead. Medium stability and price. 1 to 5 MHz range: 3×10^{-8} stability for -20° to $+55^{\circ}\text{C}$; less than 5×10^{-9} aging per day. Prototype quantities available for immediate delivery in 1.0 MHz and 5.0 MHz. Details available from Motorola Component Products Dept., 4545 W. Augusta Blvd., Chicago, Ill. 60651.  **MOTOROLA**

**New
from
General
Electric**



Goldtop Rechargeable
Nickel-cadmium
Batteries
for elevated
temperature
applications



Here's the rechargeable battery for your tough, high-temperature design applications. General Electric's new Goldtop nickel-cadmium batteries have a maximum sustained temperature capability of 65°C — permitting their use in spots previously too hot for nickel-cadmium batteries. And, at 65°C cell temperature, Goldtop batteries have a longer life expectancy than conventional units at 50°C cell temperature. Goldtop batteries are also available in a quick-charge version that can be recharged in 3½ to 4 hours using a standard charger. These cylindrical cell batteries are available in a wide variety of sizes and ratings.

For more information, write Section 452-02, General Electric Co., Schenectady, New York 12345, or circle reader service card.

452-02

GENERAL ELECTRIC

INFORMATION RETRIEVAL NUMBER 48

DATA PROCESSING

**Error corrector claims
99.999% corrections**

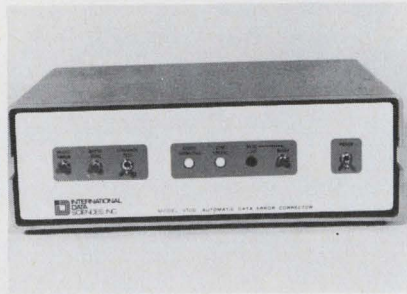

International Data Sciences, Inc., 100 Nashua St., Providence, R.I. 02904. (401) 274-5100. \$1 per day (lease).

Validata-9100 is claimed to be a revolutionary automatic data-error corrector. The unit is said to detect and correct 99.999% of all data errors on four-wire, full-duplex, synchronous, data-transmission channels at operating speeds up to 9600 b/s. Errors due to noise, line drop out, and temporary loss of modem sync are corrected in both directions, simultaneously. A Validata unit between the terminal and modem at each end of the channel adds a code to the data to detect and correct the errors.

CIRCLE NO. 270

**Acoustic coupler offered
at reduced cost**

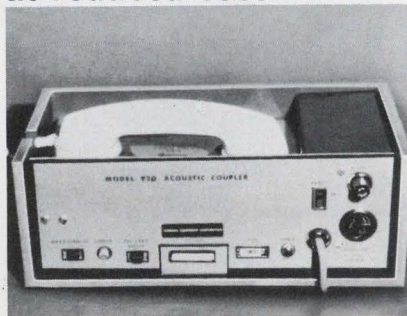

Tycom Systems, Terminal Equipment Corp., 750 Hamburg Tpke., Pompton Lakes, N.J. 07442. (201) 839-3000. \$99.50; stock to 30 days.

The Model 920, originate-only acoustic coupler comes with a power supply and operates to 300 baud. It automatically switches between data and acoustic operation. The coupler can be used at full or half-duplex with any terminal having an EIA RS-232 connector. A carrier-detect light and direct-line access (DAA) interface is standard on all units.

CIRCLE NO. 271

**Portable calculator said
to rival larger units**



Computer Design Corp., 12401 W. Olympic Blvd., Los Angeles, Calif. 90064. (213) 829-3501. See text.

Offering a range of key functions comparable to larger and more costly calculators, the Models 320-Scientist (\$595) and 340-Statistician (\$795) have multiple storage registers. They calculate with 13-digit accuracy, and display 10 digits with sign and two-digit exponent. The small computers measure 5 × 9 × 2 in. and weigh less than three pounds. They are powered by rechargeable batteries. Programmable versions of these calculators, designated 322 (\$795) and 342 (\$995), are also available.

CIRCLE NO. 272

**Modem/dialer replaces
Bell units at lower cost**

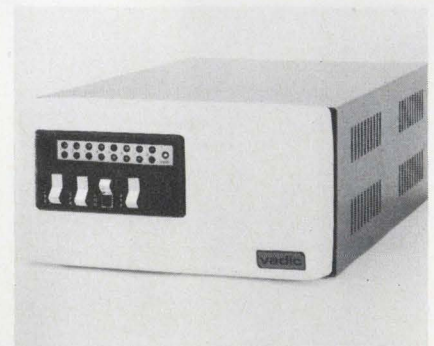

Vadie Corp., 916 Commercial St., Palo Alto, Calif. 94303. (415) 321-6201. See text; 60 days.

Composed of standard Vadie plug-in modules, the modem/dialer is compatible with Bell's 103A (300 baud) or 202C (1200 baud) modems and 810A (pulse) or 801C (touch-tone) automatic calling units. Where a Bell 103A and 801A combination rents for about \$70 per month, Vadie's equivalent single unit sells for \$700, singly, or \$23 per month on a three-year lease.

CIRCLE NO. 273

What's new about the new Wescon?

New prime time

WESCON is September 19-22. Vacations are over, and everybody has his mind on the job ahead.

Perfect timing to see everything in electronics that's new and significant.

New prime place

The new Los Angeles Convention Center just may be the best show and convention facility anywhere.

Located centrally, fully air-conditioned, acres of parking, and spacious.

Seeing is believing.

New product preview

The new instruments, components, devices, and production equipment you need to see will all be there in one place and demonstrated *live* by over 300 companies.

You can see more in four hours than you could see individually in eight weeks.

Smart new program

This program concentrates on current and useful material, tied closely to where electronics is now and where it is going.

The proof is in the session titles below.*

New visitor benefits

Computerized registration: fast, smooth, efficient (Down with red tape!)

Remote registration centers and fast bus service from Orange County and L.A. International.

Full preprints of almost every session, available at the show.

And everything is under one beautiful roof!

(If you're travelling from the East or Midwest, write now for a WESCON/American Airlines reduced-rate flight plan.)

Come to WESCON and take home some new ideas!

WESCON SCHEDULE

SEPT. 19	Show hours: 9:30am to 5pm Sessions: 10am and 2pm
SEPT. 20	Show hours: 9:30am to 9pm Sessions: 10am and 2pm
SEPT. 21	Show hours: 9:30am to 5pm Sessions: 10am and 2pm
SEPT. 22	Show hours: 9:30am to 4pm Sessions: 10am



WESCON in los angeles

at the Convention Center / September 19-22, 1972



Wescon Professional Sessions:

1. Impact of Parallel Processing Systems
2. IC's in Consumer Products
3. New Career Opportunities for Engineers
4. Alterable Nonvolatile Semiconductor Memories
5. Technology Transfer: A Growing National Interest
6. Aggressive Marketing in a Climate of Change
7. Computer Networks
8. Magnetic Bubbles
9. Automotive Electronics
10. Digital Readouts: Trends and Applications
11. The Dwindling Technology Gap and What It Means
12. Needs and Trends in Medical Electronics: 1972
13. Programmable Calculators as System Components
14. Trends in Data Communication Test Equipment
15. The Solid State Quality-Cost Equation
16. Biomedical Engineering: A New Horizon
17. Graphic Displays for Minicomputers
18. Venture Capital — After the Fall
19. Trends in Materials, Devices, and Circuits
20. Electronics and Microwaves in Autos and Highway Systems
21. Automating Software Verification
22. Marketing Methods for the '70's
23. Patents, Trademarks, and Proprietary Information
24. Producibility: The Critical Engineering/Manufacturing Interface
25. Advances in Electronic Tuned and Wideband Solid State Microwave Sources
26. Design and Application of Micro Computer Sets
27. Applications of Digital Processors To Flight Control
28. PCM and Digital Transmission: Wave of the Future?

Western Electronic Show and Convention, 3600 Wilshire, Los Angeles, Ca. 90010 (213)381-2871

Sponsors: Region 6, IEEE and WEMA

Minicomputers can talk with this speech maker

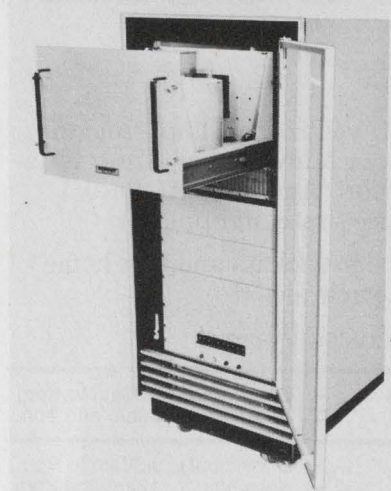

Cognitronics Corp., 25 Crescent St., Stamford, Conn. 06906. (203) 327-5305.

The new Mini-Speechmaker, an automatic-speech generation system designed for compatibility with most minicomputers, has a word vocabulary from 31 to 378 0.5-second words or up to 126, 1.5-second phrases. Separate audio outputs are provided for each of its 256 channels in a multiplexed system. The outputs are compatible with standard telephone-line impedances and levels.

CIRCLE NO. 274

Digitizer uses a free cursor and 4-k mini

Computer Equipment Corp., 14616 Southlawn Lane, Rockville, Md. 20850. (301) 424-4790.

COMP-U-GRID is provided with a 20 × 20 in. (expandable to 42 × 60 in.) electronic-grid, digitizing work surface and its free-cursor operation is unencumbered by mechanical linkages. It can digitize any graphic pattern with an operating accuracy and resolution of 0.01 in. Incorporating a 4-k minicomputer, the system can process I/O formats, error corrections, tilt and scale factors, shifts, rotation, interpolation and supplemental coordinates. When connected to an ASR-33 unit, it can be used as a remote entry device to a central computer.

CIRCLE NO. 275

Tone-decoder offers high immunity to noise

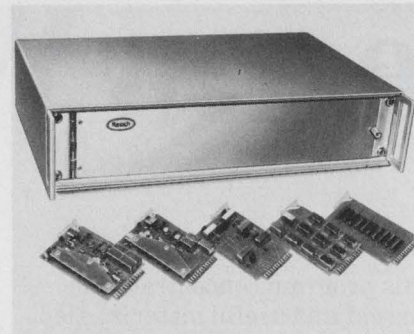

Reach Electronics, Inc., P.O. Box 308, Lexington, Neb. 68850. (308) 324-4608. 60 days.

Featuring modular construction, the Model 22FD3 touch-tone control terminal is designed to achieve a wide variety of circuit configurations. For example, it can be expanded from a basic 10-digit to a 12-digit sequence with many different tone codes by simply adding circuit cards. It is said to operate dependably with more imbalance between tones than do other currently available decoders and will not activate from "white" noise, regardless of signal level.

CIRCLE NO. 276

Line conditioner uses no inductors

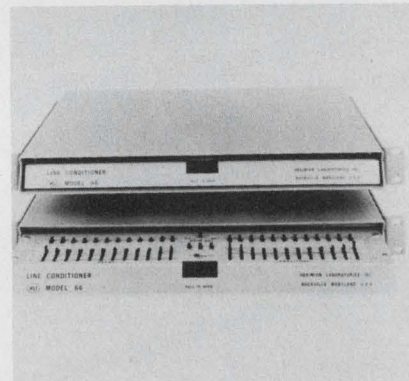

Hekimian Laboratories, Inc., 322 N. Stonestreet Ave., Rockville, Md. 20850. (301) 424-3160. \$550 (unit); 45 days.

The Model 66 line conditioner corrects the amplitude response and envelope delay of voice frequency telephone circuits for data transmission. It is said to combine the latest active-network design theory with integrated circuit technology. Occupying only 1-3/4 in. of vertical rack space, the conditioner does not use conventional inductors.

CIRCLE NO. 277

Data acquisition system records on cassette tape

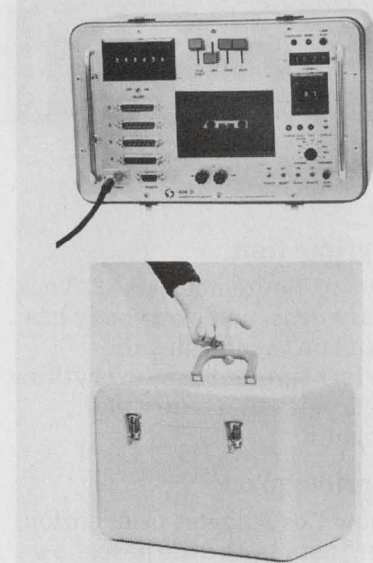

Sander Instruments, Div. of Sander Geophysics Ltd., 1035 Richmond Road, Ottawa, Ont., Canada K2B 7Y2. (613) 829-1433.

The ADR II data-acquisition system is a programmable, eight-channel (expandable to 64), analog-to-digital converter and recording system for portable applications. It accepts ±1 V analog-voltage signals from transducers with impedances of less than 50 kΩ, and provides a resolution of 0.1% of full scale. Data is recorded in digital format on a standard cassette tape.

CIRCLE NO. 278

Tone system provides multi-channel data link

Bramco Controls Div., Ledex Inc., College and South St., Piqua, Ohio. 45356. (513) 773-8271. \$230 per channel (ten channel system); 4-6 wks.

Bramco's 40/20 AM tone system is a completely packaged data link. The units require only a screw driver to install. Up to five standard voice-frequency tone transmitters or receivers can be housed in a single NEMA-3 enclosure. The system can provide twenty independent channels over telephone, microwave or radio links. An important feature is the availability of constant-percentage channel-spacing in the receivers. This permits the system to tolerate errors caused by tape-speed variations.

CIRCLE NO. 279

OUR ANGLE: Modular D/S and S/D Converters

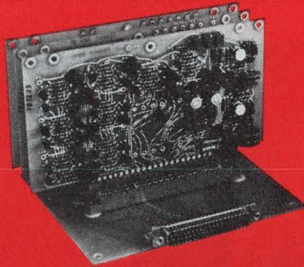

NT

A

Do Low Cost Repairable Circuit Cards Make Sense from Your Angle?

North Atlantic's new 701 D/S and 711 S/D Converters offer unmatched advantages for the digital/analog interface at low-low cost . . . typically \$1000. Open-card construction is easily and economically maintained. Adaptable to systems needs, interchangeable converter cards are compatible with your automatic test, simulation or digital control systems.

Compared to 19" panel designs, these units provide a choice of accuracy, frequency, resolution, and systems customization without the extra bulk and expense of unnecessary power supplies and other panel controls. They are ideal for multi-channel applications where a converter is assigned to a specific function.

These new converters are available to meet a wide range of systems needs. The 701 D/S has selectable accuracies of 9 or 12 bits with resolution of 8 through 14 bits, transformer output isolation and short circuit protection, operation at 60 Hz or 400 Hz with 1VA or 10VA output. The 711 S/D has 0.05° accuracy, 13 bit resolution with input transformer isolation, and continuously tracks 400 Hz synchro data to 1000°/second.

Don't these converters make sense from any angle? Talk it over with your North Atlantic sales engineering representative today.

NORTH ATLANTIC
industries, inc.

200 TERMINAL DRIVE, PLAINVIEW, NEW YORK 11803
cable: noatlantic / twx: 510-221-1879 / phone: (516) 681-8600

INFORMATION RETRIEVAL NUMBER 50

Custom networks in DIP reduce assembly cost

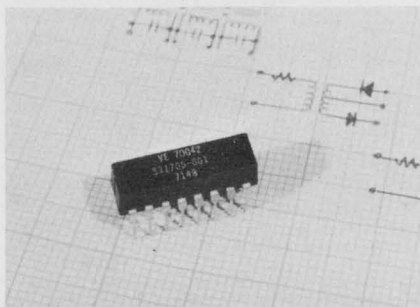

Vanguard Electronics, 930 W. Hyde Park Blvd., Ingelwood, Calif. 90302. (213) 678-7161. From \$1 (OEM quantities).

Vanguard claims that customers can save up to 40% of production costs compared with discrete components by using its 14 or 16-pin DIP networks which eliminate handling and soldering. Even though each network is custom made, fast turn-around time is promised, limited only by component availability.

CIRCLE NO. 300

Ion-implant diode offers nanosec. performance

Solid State Devices, Inc., 12741 Los Nietos Rd., Santa Fe Springs, Calif. 90670. (213) 698-3711. From \$0.75 (1000 up); 2-3 wks.

A new 1-A, glass-body hermetically-sealed rectifier features ultra-fast recovery, a forward-voltage drop of less than 0.5 V, reverse recovery of 9 ns max and forward recovery of 1 ns max. The new series, designated HSR-OA, is manufactured by an improved ion-implantation process. The diodes are in D029-size packages and have a PIV of 10, 25, 50, 75 or 100 V. The max reverse current at 0.5 PIV, for all types, is 10 μ A.

CIRCLE NO. 301

Diodes generate broad spectrum of white noise

Codi Semiconductor, Div. of Computer Diode Corp., Pollitt Drive S., Fair Lawn, N.J. 07410. (201) 797-3900. Stock to 3 wks.

The white noise generator diodes, CND 1000 to 4000 and 6000 series, are sealed-silicon diodes that operate in the avalanche mode to produce high levels of noise. Bandwidth of the units ranges from 10 Hz to 500 MHz with avalanche-mode voltages of 8 and 14 V. Noise output ranges from 0.15 μ V/ $\sqrt{\text{Hz}}$ to 1.0 μ V/ $\sqrt{\text{Hz}}$, with a maximum variation of ± 2 dB across the frequency spectrum.

CIRCLE NO. 302

Object detector uses LED in single package

Monsanto Commercial Products Co., 10131 Bubb Rd., Cupertino, Calif. 95014. (408) 257-2140. \$4.80 (1-9); stock.

A new solid-state device senses objects by detecting reflected-LED light. Designated the MCA7 reflective-object sensor, it incorporates an LED-infrared emitter and a photo-darlington detector in a single package. The LED and the detector are mounted in the same plane. In the absence of an object, the photo-darlington remains in an "off" state.

CIRCLE NO. 303

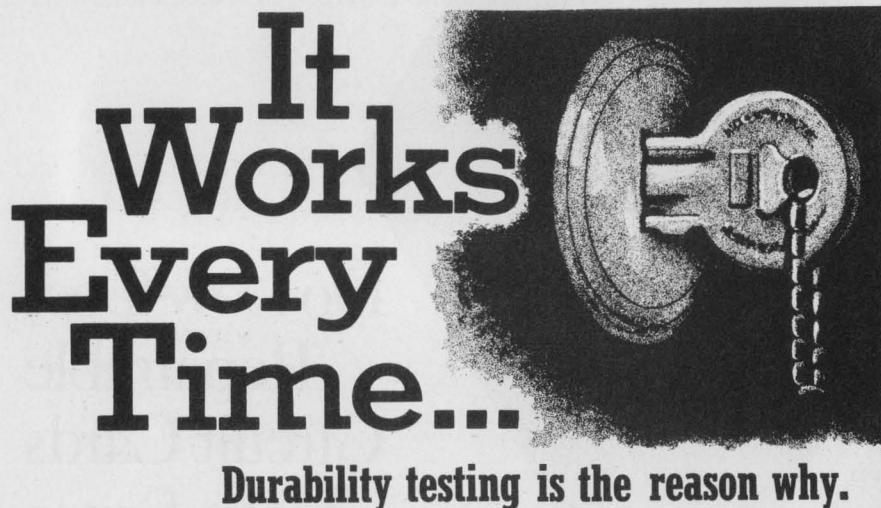

Durability testing is the reason why.

Stringent "in-process" quality control durability testing by Controls Company of America, a Division of the Singer Company, insures highest MTBF for their automobile electric switches.

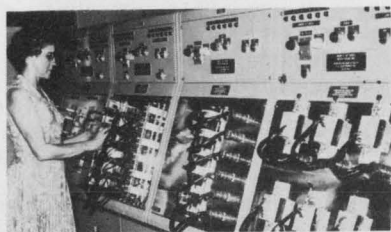

CCA's durability testing stands, manufactured by K. & L. Electronics, Inc., were designed to accept and test switches of several sizes, randomly selected from "in-process" production runs.

K. & L. Electronics required a compact, well-constructed, readily available, well-regulated power supply with low ripple. Electronic Measurements' SCR Power Supplies met these requirements.

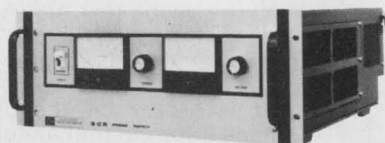

IF YOU DEMAND RELIABILITY AND NEED A LOW WEIGHT/SMALL SIZE, LOW RIPPLE, WELL-REGULATED POWER SUPPLY AT 2.5, 5 OR 10 KW . . . CALL TOLL FREE 800 - 631-4298, OR WRITE FOR OUR LATEST CATALOG.



ELECTRONIC MEASUREMENTS INC.

405 ESSEX ROAD, NEPTUNE, NEW JERSEY 07753

INFORMATION RETRIEVAL NUMBER 51

We made it as a snap-in replacement for your analog meter. And it is.

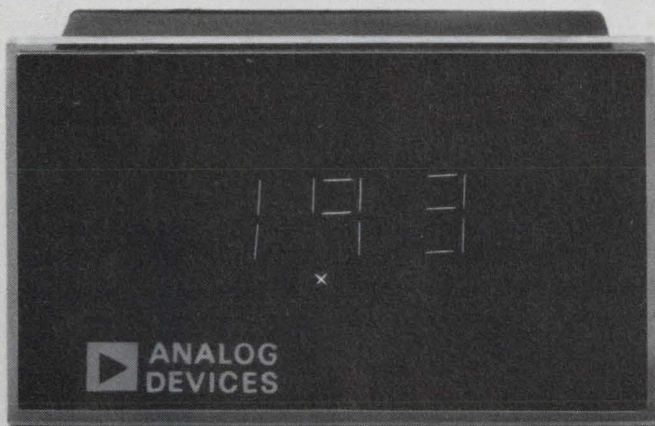

Our AD2002 2½-digit DPM. Only \$50.00.

Our panel meter gives you everything.

Right off, it's the smallest high performance 2½-digit DPM you can buy right now. Only eight cubic inches that measures 1.8" H x 3" W x 1.5" D.

Think of it as a component.

It easily snaps into your panel from the front. And has a green filter because we found that green is easier to look at.

For options, you can have our AD2002 with red, blue, or amber colored filters to color-code your readouts.

Plus BCD outputs to provide data processing interfacing capability with a variable reading rate to

let you hold and read on command.

All it lacks is ambiguity.

It's an improvement over any analog meter because it improves the reading of critical signals.

In medical, scientific and industrial instrumentation. And measurement, control and data acquisition systems.

It's accurate to $0.5\% \pm 1$ digit with 10mV resolution. Accepts unipolar, single ended input signals over a full scale range of 1.99V.

It has automatic overload indication. RCA Numitron tubes. Is 5VDC powered. And even has a seven segment filament test.

To assure reliability, we burn-in each meter for 7 days before shipping.

Like our first digital panel meter, if we couldn't have made it better, we wouldn't have made it.

Or any of the 3½, 4½, and other DPM's we've got on the way.

We can send you an evaluation sample of our AD2002 right now. Along with our 1972 Product Guide which shows all the other things we make to solve more of your problems better than anyone else.

Analog Devices, Inc., Norwood, Mass. 02062.
(617) 329-4700.



COMPONENTS

Tiny shielded inductor mounts on PC board

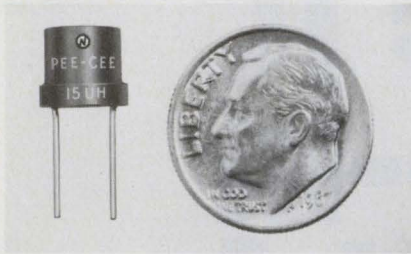

Nytronics, Inc., Darlington Div., Orange St., Darlington, S.C. 29532. (803) 393-5421. \$1.55 to \$2.10; 4 wks.

Nytronics' subminiature, shielded radial-lead inductor has been designated the Pee-Cee Ductor. Designed with 0.2 in. grid spacing for PC applications, it is epoxy-molded and comes in 73 values ranging from 0.1 to 100,000 μ H. The standard inductance tolerance is $\pm 10\%$.

CIRCLE NO. 304

Bat-handle lever switch features a new look

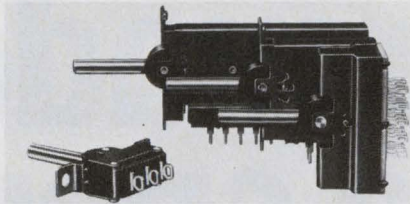

ALCO Electronic Products, Inc., 1551 Osgood St., N. Andover, Mass. 01845. (617) 685-4371. \$1.45 (single-pole power version in unit qty).

This make-before-break lever-switch series offers multiple-circuit switching. The switches are available with from 2 to 8 poles and with either two or three active positions. The baton lever provides a good feel and sense of position. The switches are available with solder lugs or PC terminals. A break-before-make, 10-A power switch matches the appearance of other switches in the series.

CIRCLE NO. 305

Capacitors have high microfarads, small size



S&EI Manufacturing, 18800 Parthenia St., Northridge, Calif. 91324.

Capacitors in the new Mini-Miniature 22 series are produced in a variety of styles and leads in 50 and 100 V dc space-saving sizes. Ranges are from .001 μ F through 50 μ F with tolerances to $\pm 1\%$. A typical size of a 10- μ F, 50-V dc unit is 0.58 OD \times 1.16-in. length. A 1- μ F size is 0.40 \times 0.67 in. Operating temperature is from -55 to $+105$ C.

CIRCLE NO. 306

FREE YOKE SELECTION KIT
Information you need to know about selecting and specifying a precision yoke for your CRT display. Indicates the interaction between circuitry, CRT and yoke. Includes an application checklist to simplify your work. Send for your kit.

SYNTRONIC INSTRUMENTS, INC.
100 Industrial Road Addison, Ill. 60101 (312) 543-6444

syntronic

INFORMATION RETRIEVAL NUMBER 53

BITE SIZE INDICATORS

ACTUAL SIZE

MINELCO® Bite Indicators are extensively utilized in Military Avionic equipment (Per Mil-I-83287 and Mil-E 5400) and in a wide range of Industrial and Commercial applications. Write for our full line catalog including MINELCO® Indicators, Switches and Trimmer Potentiometers. **Built-In Test Equipment*

MINELCO
DIVISION
GENERAL TIME
A Tally Industries Company

135 SOUTH MAIN STREET • THOMASTON, CONN. 06787
PHONE: 203/283-8261 • TWX: 710/475-1091

INFORMATION RETRIEVAL NUMBER 54

ELECTRONIC DESIGN 17, August 17, 1972

Six-digit counter-timer autoranges time and freq



Ballantine Laboratories, PO Box 97, Boonton, N.J. 07005. (201) 335-0900. \$650 (6 digits); 2 weeks ARO.

The Autometronic 5500A counter-timer autoranges time interval as well as frequency. The autoranging circuit uses a ROM, enabling time and frequency measurements to be made with the desired resolution without operator adjustments. The unit automatically computes the dimensions of the measurement and the position of the decimal point and immediately displays the result on the numeric readout. Resolution is selectable in 4, 5, 6 or 7 digits. The Model 5500A has ten operating modes and a check or test mode. The display uses gas discharge display. Operating temperature is 0 to 50 C.

CIRCLE NO. 307

FET multitester covers 150 nA to 150 A ac/dc

Conway Electronic Enterprises Ltd., 88 Arrow Rd., Weston, Ontario, Canada. (416) 742-6631. \$182 (Canadian).

The Model 639 FET multitester measures both ac and dc voltage and current. It spans a nine-decade range for current—150 nA to 150 A—and six decades for voltage—1.5 mV to 1500 V. Input resistance on most voltage ranges is 100 MΩ and accuracy on all ranges is 1.5%. Resistances can be measured up to 10,000 MΩ. Other features include battery or line operation, floating input, overload protection and 90-dB CMR.

CIRCLE NO. 308

NOW!
from **RMC**

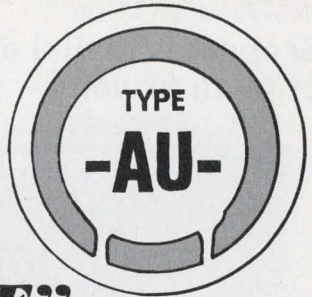

**“ACROSS-THE-LINE”
U.L. LISTED DISCAPS**

EIA Class				
	Class II	330 470 680	820 .001 .0015 .0022 .0027	.0033 .0039 .0047 .005
Class I	NPO 3.9 - 20 N750 15 - 35 N1500 15 - 67	21 - 31 36 - 61 68 - 119	32 - 47 62 - 82 120 - 180	

THICKNESS: .225 Max.

RMC now offers a complete line of -AU- ceramic disc capacitors fully approved by Underwriters Laboratories for the NEW “Across-The-Line” capacitor requirements. This approval is required of all capacitors utilized directly or indirectly across the power supply line.

This application is significantly different from the “Antenna Coupling and Line By Pass” capacitor requirements of Underwriters Laboratories Subject 492, and the original RMC -U- capacitor type continues to be approved for those applications.

SPECIFICATIONS

CAPACITANCE: Within tolerance: Class I @ 1M and 25°C Class II @ 1K and 25°C	TEMPERATURE COEFFICIENT: Class I NPO N750 N1500 Class II Z5U
CAPACITANCE TOLERANCES: Class I ±5%, ±10% or ±20% Class II ±20%, +80 -20% or GMV at 25°C.	FLASH TEST: 2800 VDC for 1 second and per U.L. Sub. 492
WORKING VOLTAGE: 150 VRMS @ 60 cycles (210 volts peak AC plus DC)	LIFE TEST: Per U.L. Sub. 492
POWER FACTOR: Class I .1% max. at 1 MC .2% max. less than 30 pf Class II 1.5% max. at 1K	INSULATION RESISTANCE AFTER HUMIDITY: Greater than 1000 Megohms @ 500 VDC
INSULATION RESISTANCE: Greater than 7500 Megohms @ 500 VDC	BODY INSULATION: Durez phenolic - vacuum wax impregnated. Standard coating on leads 3/16" max. measured from tangent
	LEAD STYLES AVAILABLE: Long lead - #20 AWG tinned copper

DISCAP
CERAMIC
CAPACITORS



RADIO MATERIALS COMPANY

A DIVISION OF P. R. MALLORY & CO., INC.
GENERAL OFFICE: 4242 W. Bryn Mawr Ave., Chicago 46, Ill.
Two RMC Plants Devoted Exclusively to Ceramic Capacitors
FACTORIES AT CHICAGO, ILL. AND ATTICA, IND.

INSTRUMENTATION

Scope has digital display of pk to pk volts



Dynascan Corp., 1801 W. Belle Plaine Ave., Chicago, Ill. 60613. (312) 327-7270. \$299.95.

The Model 1440 (Cali-Brain) scope features a digital display of amplitude on the scope screen. The unit has dc to 10 MHz bandwidth, TV-H and TV-V positions on the sweep selector and Vectorscope capability on the front panel. Sweep is recurrent, with time base ranges of 5-50 Hz, 50-500 Hz, 500 Hz-5 kHz, 50-500 kHz. Between ranges, there's continuous vernier control.

CIRCLE NO. 320

Transient recorder offers dual channels

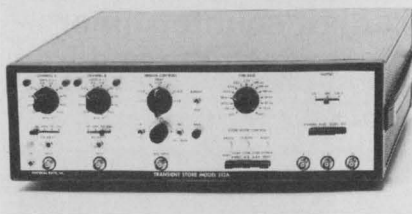

Physical Data, Inc., 1561 S.W. Market St., Portland, Ore. 97201. (503) 283-5116. \$2475.

Physical Data's 512A transient store recorder accepts and stores single-shot transients or recurring analog signals in single or dual channels for playback in digital or analog form. The 512A has been specifically designed for low-frequency data acquisition (dc to 50 kHz). The unit's microcircuit memory offers 2048 samples in a single channel or 1024 samples in dual channels with 0.1% amplitude resolution.

CIRCLE NO. 321

Why spend time looking through our catalogs?

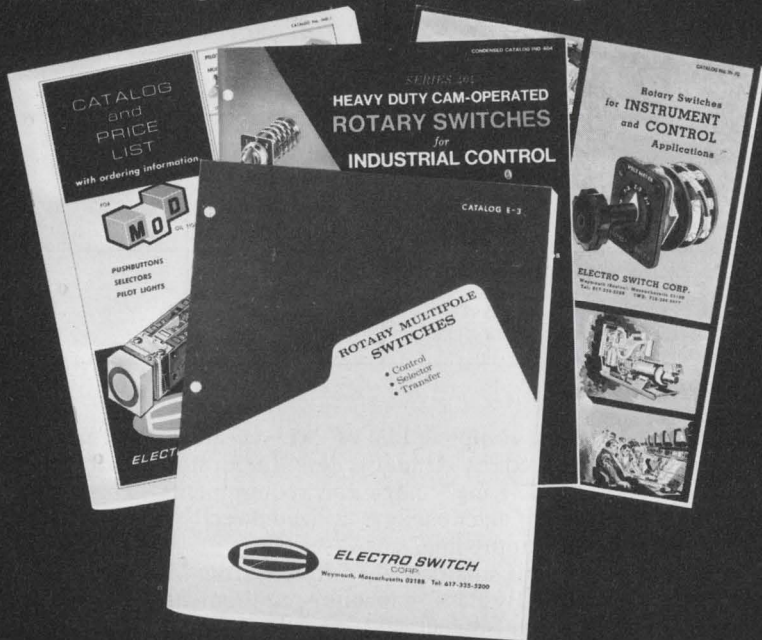

To save time (and money) designing a custom switch!

The overwhelming chances are that you'll find the *exact* power switch you need in one of our catalogs. Here's why: You'll find literally *hundreds* of types *in stock*. Or you can combine your own special configuration from *millions* of components off-the-shelf! Choose from Rotary, Cam, Detent & Snap-action, Pushbutton and other types. Standard specs range from 1/2 up to 200 Amps...from one to 75 poles per switch...plus combinations (tandem, gear train, etc.). And if you don't find your specific need, we'll find it (or build it) for you...usually at *standard* switch prices!

Send for Bulletin C-1 (our "Catalog of available catalogs") or tell us your specific interests for detailed information.



ELECTRO SWITCH
CORP.

Weymouth, Massachusetts 02188

Telephone: 617/335/5200 TWX: 710/388/0377
INFORMATION RETRIEVAL NUMBER 56

Electrostatic voltmeters withstand 100 g's



Beckman Instruments Inc., 89 Commerce Rd., Cedar Grove, N.J. 07009. (201) 239-6200. 30 days.

These new dc to rf electrostatic voltmeters feature automatic overload protection and a rugged "Unifilar" suspension system capable of withstanding shock to more than 100 g. The two instruments, Models LVE and KVE, offer input impedances up to 3×10^{15} ohms, accuracies to 0.25% FS, repeatability of better than 0.05% FS and true rms response regardless of waveform or level. The 6.5-inch scales are linearized for good resolution at the low end. The Model LVE is available with ranges of 200 V FS to 6 kV FS; and the Model KVE, with ranges from 3 kV FS to 140 kV FS.

CIRCLE NO. 322

Digital counter
is only 1/2-inch thick

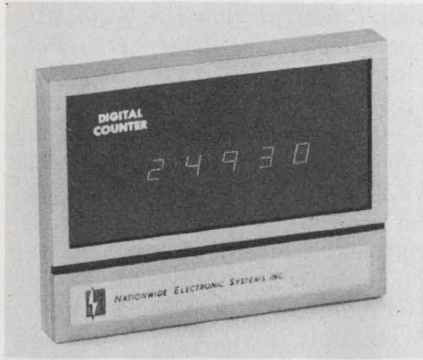

Nationwide Electronic Systems, Inc., 7N662 Route 53, Itasca, Ill. 60143. (312) 773-0370. \$150 (3 digits); stock.

The CT1420 series of digital counters can be used as accumulators, event recorders, and totalizers. The units are 4-1/2 x 3-1/2 x 1/2-inch. No behind-the-panel space is required. All controls are hidden behind the name-plate panel at the bottom. Also, the unit has an LED readout, BCD outputs, touch-activated switches, and MSI and LSI circuitry. The counter information can be fed directly into computers, process controllers, and other electronic equipment. The CT1420 is available from 3 to 6 digits.

CIRCLE NO. 323

High-voltage DVM offers 4 digits, 0.05% accuracy

AMP Inc., Capiton Div., Elizabethtown, Pa. 17022. (717) 367-1105.

Useful up to 30 kV dc (50 kV dc with a range extender), the Model HVM 30-1 can be used as a direct-reading, four-digit DVM, or as a precision (0.1% accuracy) voltage divider. As a DVM this instrument has an accuracy of $\pm 0.05\%$ FS (± 2 digits). Maximum source current drain is 25 or 100 μ A, depending on model. As a voltage divider, the instrument has a division ratio of 10,000:1 with an accuracy of $\pm 0.1\%$. The unit is calibrated for 10^{-6} M Ω , but deviation tables are provided for use with other external impedances. Model HVM 30-1 also provides analog and BCD outputs for use with recording devices.

CIRCLE NO. 324

Compare Mini-Mox to whatever film resistor you're using now.

Our Miniature Metal Oxide Resistors Can Give You up to 10,000 Megs and 5000 Volts in 1/10th the Space.

Compared to metal film resistors our tiny Mini-Mox can give you greater power handling capability and substantially better resistance to size or voltage to size ratios. Mini-Mox reliability is unmatched under high voltage conditions.

Mini-Mox outstrips conventional carbon film in every category: 100 ppm TCR; voltage to size ratio; stability; power handling capability; initial tolerance and reliability, particularly under extreme environmental conditions.

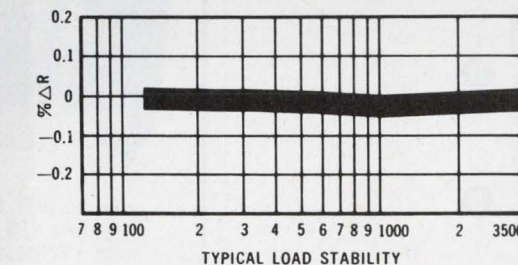
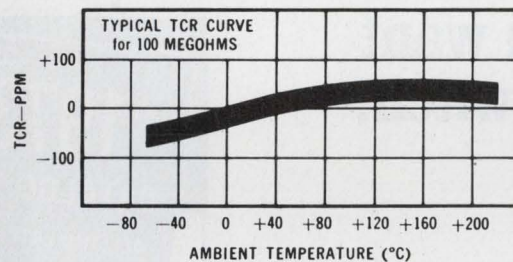

Mini-Mox resistors offer a new degree of design freedom in stable and dependable high voltage circuitry. They are available in a range of sizes and we stock them for prompt delivery.

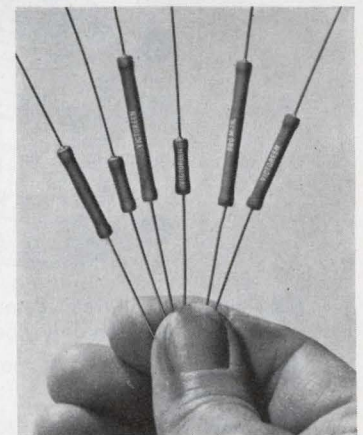

Model	Resistance	Rating @ 70°C	*Max. Oper. Volts	Length Inches	Diameter Inches
MOX-400	to 2500 megs	.25W	1000V	.420	.130
MOX-750	to 5000 megs	.50W	2000V	.790	.130
MOX-1125	to 10,000 megs	1.00W	5000V	1.175	.130



For detailed specifications on Mini-Mox send for this technical bulletin. Victoreen Instrument Div. of VLN Corp., 10101 Woodland Avenue, Cleveland, Ohio 44104. Telephone: 216/795-8200

DMA 683



Expertise in high voltage.

Monochrome monitors have 15/20-inch screen

Tektronix Inc., P.O. Box 50, Beaverton, Ore. 97005. (503) 644-0161. 631: \$735; 632: \$750; 633: \$800.

Three monochrome monitors complement the Tek 650-Series color monitors. The 631 and 632 units are 10-1/2 x 19 inches. Both use a 15-inch diagonal kinescope featuring D6500° K phosphor (WD300° K is optional). The 632 is more measurement oriented, since it has display shift, calibrated brightness and contrast and A-B input mode. The 633 is larger (14 x 19 inches), with a 20-inch diagonal kinescope and has the same phosphors and performance characteristics of the 631 and 632. All units can be switched from 525/60 to 625/50. The 632 automatically performs this function; the 631 and 633 require an internal strap change.

CIRCLE NO. 325

512-MHz counter-timer costs \$1095

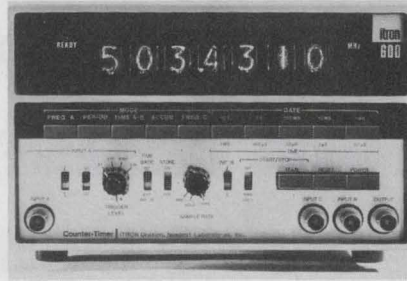

Newport Laboratories, 630 E. Young St., Santa Ana, Calif. 92705. (714) 540-4914. 600: \$750; 600H: \$1025.

Models 600 and 600H are self-contained, universal counter-timers capable of measuring from dc to 512 MHz. Measuring modes include period, time interval, frequency ratio, totalizing and stopwatch. High sensitivity and stable input-triggering are combined for reliable, low-level signal measurements. An input-triggering feature synchronizes the internally-controlled gate with the signal frequency.

CIRCLE NO. 326

Signal generator boasts 1 ppm/24 hrs stability

Singer Instrumentation, Palo Alto Operation, 3176 Porter Dr., Palo Alto, Calif. 94304. (415) 493-3231. \$4250; 60 days.

Singer has gone one-up on its own SG-1000 (ED, May 25, 1972) with this new digital-readout signal generator, the Model 6202. The unit uses a digital, automatic frequency-locking circuit to provide a stability of 1 ppm for 24 hours. A six-digit, LED readout displays the output frequency which covers the range of 7.75 to 512 MHz and can go as low as 61 kHz with the optional 6201 plug-in. Other features and specs include: AM, FM, and pulse modulation with meter readout of both percent AM and frequency deviation; a residual FM of 0.25 ppm peak; a frequency accuracy of ±1 digit plus time-base accuracy (or about 0.001%) tempo of 0.5 ppm/°C, max; and a leveled output of 0.01 μV to 2.2 V into 50 ohms.

CIRCLE NO. 327

What do you want in a rotary switch?

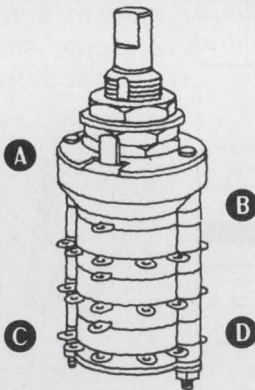

- A** Positive "stall-free" detents with: spring return, isolated position or keylock option.
- B** Circuit versatility 1-12 poles/deck, 2-24 positions/pole.
- C** Solder lug or PC mount terminals.
- D** Molded-in terminals.

These are just a few of the thousand-plus standard design options with Grayhill Rotary Switches.

For our latest Engineering Catalog write or phone: Grayhill, Inc., 565 Hillgrove Ave., La Grange, Illinois 60525. (312) 354-1040.



INFORMATION RETRIEVAL NUMBER 58

FREE

The World's Largest
Consumer
Electronics Catalog

• Stereo/Hi-Fi Components • Musical Instruments and Amplifiers • CB & Ham Equipment • Tools and Test Equipment • Police and Fire Monitor Receivers • Public Address Systems • Photography Equipment • Semiconductors, Books, Parts • Plus Much More!

Send For Your Free Lafayette Catalog Today!
Lafayette Radio Electronics, Dept. 45082
P.O. Box 10, Syosset, L.I., N.Y. 11791

Send Me the Free Lafayette Catalog 45082

Name

Address

City

State Zip

(Please include your zip code)

INFORMATION RETRIEVAL NUMBER 59

DPMs suppress transients to 400 V

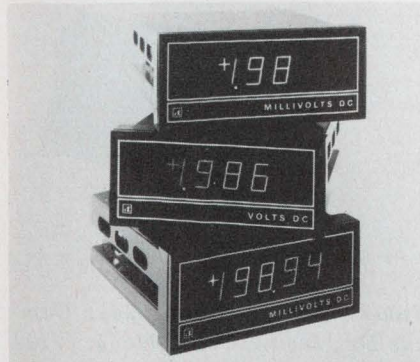

Data Technology Corp., 2700 S. Fairview Rd., Santa Ana, Calif. 92704. (714) 546-7160. \$95 (3-digits); 30 days ARO.

Special line transient suppression circuits and a transformer power supply combine to make these new DPMs insensitive to line pulses as high as 400 V peak-to-peak. The units use single-plane displays to make readings easy from any angle. Input bias current is below 100 pA to assure accuracy and stability, even when operating temperatures change rapidly. Three models are available, with 2-1/2, 3-1/2, and 4-1/2-digit displays. Each model is available in unipolar and bipolar versions in any of 11 different ranges from 200 mV dc to 1000 V dc, and from 20 μ A dc to 200 mA dc.

CIRCLE NO. 328

Instrumentation amp boasts 0.01% accuracy

Preston Scientific, Inc., 805 E. Cerritos Ave., Anaheim, Calif. 92805. (714) 776-6400. \$645; 30 days.

The Model 8300XWB-A instrumentation amplifier offers 0.01% gain accuracy, 0.005% gain linearity, variable gain to 2500X and bandwidth selection between 10 Hz and 100 kHz. Slewing rate is greater than 3 V/ μ s; the output settles within 30 μ s to $\pm 0.01\%$ of final value. TC is less than 0.1 μ V/C (referred to input). Long-term (6 months) zero drift is $\pm 5 \mu$ V (referred to input), and ± 1 mV (referred to output). Common mode rejection is a minimum of 150 dB at dc, 130 dB at 60 Hz, and 60 dB at 100 kHz.

CIRCLE NO. 329

NEW AUTORANGING DIGITAL MULTIMETER... IN-PROBE DISPLAY, HIGH-SPEED READOUT, BATTERY OPERATION...

\$325.

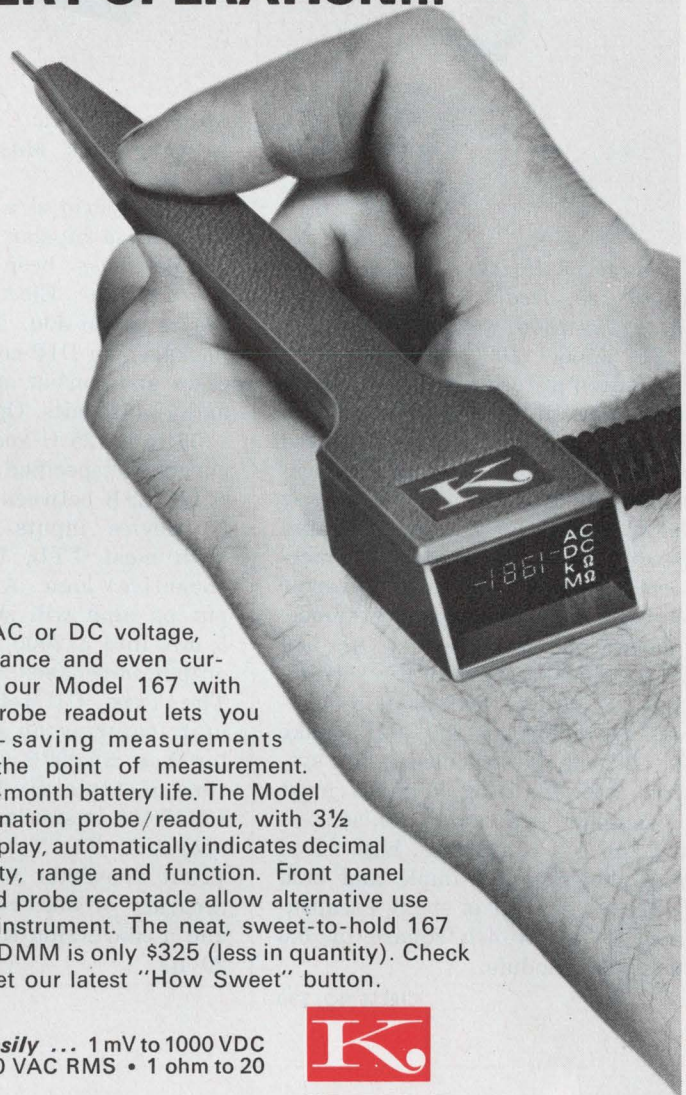

For AC or DC voltage, resistance and even current, our Model 167 with unique in-probe readout lets you make time-saving measurements directly at the point of measurement. With up to 3-month battery life. The Model 167's combination probe/readout, with 3 1/2 digit LED display, automatically indicates decimal point, polarity, range and function. Front panel terminals and probe receptacle allow alternative use as a bench instrument. The neat, sweet-to-hold 167 Auto-Probe DMM is only \$325 (less in quantity). Check it out and get our latest "How Sweet" button.

Measures easily ... 1 mV to 1000 VDC
• 1 mV to 500 VAC RMS • 1 ohm to 20 megohms
with the convenience of ... 55 megohms input resistance • 2-sec. reading time to rated accuracy • 1200 volts overload protection • Complete choice of accessories.



KEITHLEY INSTRUMENTS
U.S.A.: 28775 AURORA ROAD, CLEVELAND, OHIO 44139
EUROPE: 14, AVENUE VILLARDIN, 1009 PULLY, SUISSE



The Model 167... another how-sweet-it-is Keithley Multimeter
Buy now using BankAmericard or Master Charge

INFORMATION RETRIEVAL NUMBER 60

Op amp works fast as inverter or non-inverter

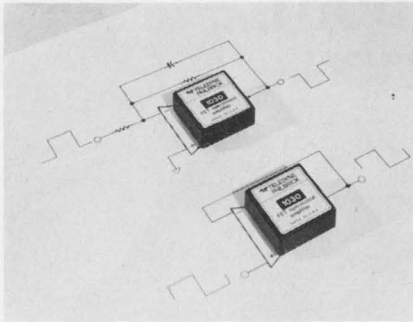

Teledyne Philbrick, Allied Drive at Route 128, Dedham, Mass. 02026. (617) 329-1600. \$62 (hundreds).

The Model 1030 op amp offers high-speed differential performance coupled with low current drain. Low current drains are achieved by elimination of internal stray capacitance that would otherwise draw high current during rapid slewing. And the Model 1030 performs at top speed as an inverter or in the non-inverting mode. Guaranteed specifications of 500 V/ μ s slew rate, 500-ns settling time to 0.01% and a gain-bandwidth product of 100 MHz make the 1030 a natural choice for systems where analog voltages must be sampled at a rapid rate, such as a/d and d/a converters, high speed multiplexers and sample and hold buffers. The unit is epoxy encapsulated in a 1.5-inch square by 0.6 inch high module.

CIRCLE NO. 330

Hybrid d/a converters use bipolar or ac ref

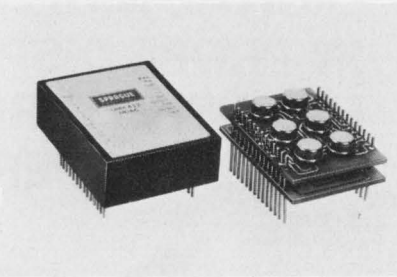

Sprague Electric Co., Marshall St., North Adams, Mass. 01247. (413) 664-4411.

New hybrid d/a converters for use with a bipolar or ac reference voltage have been introduced by the Sprague Electric Co. as the Series UHM-400. The devices are packaged in DIP-compatible plastic cases and consist of complete 8, 10 and 12-bit units. Operation is from -55 to $+125$ C and conversion accuracy is specified as better than $\pm 1/2$ LSB between -25 and $+100$ C. Device inputs are compatible with most TTL, DTL, and MOS (negative) logic. A monolithic-output op amp will supply, typically, 5 mA into a 2000 Ω load, with an output impedance of less than 1 Ω . The Type UHM-408 is an 8-bit unit featuring an accuracy of better than $\pm 0.097\%$ and a conversion time of, typically, 15 μ s. The Type UHM-409 is similar, but has 10-bit operation. The Type UHM-412 is a 12-bit converter with an absolute accuracy of better than $\pm 0.0244\%$ and a conversion time of, typically, 20 μ s.

CIRCLE NO. 331

12-bit a/d converter has no missing codes

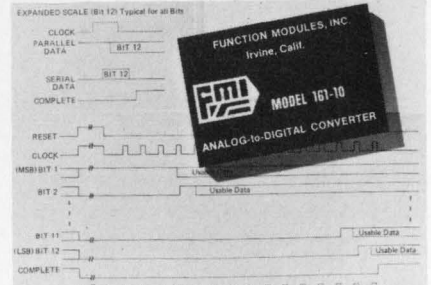

Function Modules Inc., 2441 Campus Dr., Irvine, Calif. 92664. (714) 833-8314. 160 (10-bit): \$85 (25-99); 161 (10-bit): \$99 (25-99).

Models 160/161 modular a/d converters achieve better than $\pm 1/2$ LSB linearity over a temperature range of 25 C ± 15 C. The 160 is guaranteed to have no missing codes over this temperature range. Two conversion speeds are offered. Model 160-12 converts in 100 μ s and the 161-12 converts in 30 μ s. The 10-bit versions are faster: Model 160-10 converts in 75 μ s and the 161-10 takes only 20 μ s. Both parallel and serial outputs are provided. By varying pin connections, you can make the 160 convert analog inputs with ranges of 0 to -10 V, 0 to -20 V, ± 5 V, or ± 10 V. External pin connections also determine the output coding—straight binary, offset binary, or 2s complement binary. The converters are packaged in a $2 \times 4 \times 0.4$ -inch module, and the pin connections are compatible with DIP circuit boards and sockets. Power requirements are ± 15 V and ± 5 V.

CIRCLE NO. 332



ANALOGY
 INTECH'S A-132 AND A-134 ARE THE FASTEST FET-INPUT DIFFERENTIAL OP AMPS AROUND. WE GUARANTEE A SLEW RATE OF 1,000 V/ μ S, 0.01% SETTling TIME OF 200NS, AND LESS THAN 5% UNDERSHOOT OR OVERSHOOT. TYPICALS ARE 1,500 V/ μ S AND 100 NS SETTling TIME. THE A-132 DRIVES HIGH-SPEED LOGIC AND OTHER LOADS TO 1,000 PF WITH ITS 10 MA OUTPUT, WHILE THE A-134 DRIVES VIDEO CABLES AND OTHER HEAVIER LOADS WITH ITS 100 MA OUTPUT.

intech INCORPORATED
 (408) 244-0500
 1220 COLEMAN, SANTA CLARA CA 95050

Linear amplifier module covers 5 kHz to 600 MHz



RF Communications Inc., 1680 University Ave., Rochester, N.Y. 14610. (716) 244-5830.

A low-noise wideband amplifier, the RF-807-56, covers a range of 10 kHz to 500 MHz with ± 20 -dBm output and flatness of ± 1 dB. The 3-dB points are typically 5 kHz and 600 MHz, with usable amplification available over even wider limits. Gain of the unit is 30 dB, minimum, and noise figure is typically 6 dB. AM, FM, pulse, SSB and video signals can be amplified by the RF-807-56 amplifier. This linear amplifier is suitable for MIL-E-16400 and MIL-E-5400 applications. Power leads are filtered per MIL-I-6181.

CIRCLE NO. 333

Dc/dc converter gives ± 15 V at 200 mA

Analogic Corp., Audubon Rd., Wakefield, Mass. 01880. (617) 246-0300. \$69.00; 2 wks. ARO.

A compact dc to dc converter designed for digital systems in which 5 V power is available, but ± 15 V is not, was announced today by Analogic Corp. The unit, called the MP3015, is just $2 \times 2 \times 0.39$ -inches in size. It operates from a 5-V source, supplying regulated ± 15 V at currents up to 200 mA. The MP 3015 has an output impedance of less than 0.10Ω . The MP 3015 provides the user with the option of either local or remote voltage sensing, depending upon the dc resistance of his lines and the degree of load regulation desired. The load regulation of the unit, even with local sensing, is $\pm 0.1\%$ maximum change for a 100% change in load. With remote sensing, load regulation will be improved to approximately 0.01%.

CIRCLE NO. 334

A lot of module for your money.

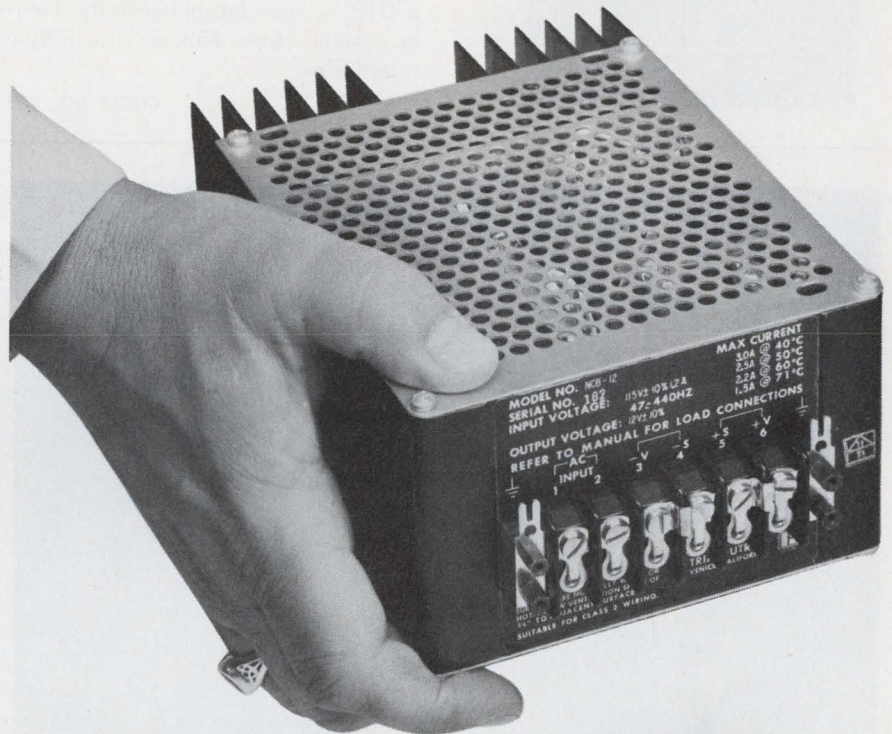

TRIAD'S slot power supplies in B package for OEM systems.

Designed for computers, peripheral equipment and similar applications, Triad's NCB Series in 5 voltage ranges delivers from 25 to 45 precisely regulated watts of DC power at extremely low ripple. They feature built-in overvoltage protection, automatic fold back current limitation, 10-year life computer grade capacitors, and reverse polarity protection. Lower in cost, the NCB's retrofit many models on the market today. In stock and available now from Triad distributors.

Wide range, adjustable 40-watt regulated power supplies.

The low cost WR Series features open top construction, integral heat sink housing, 10-year life computer grade capacitors, all silicon semiconductors, FR glass epoxy pc boards, and electrostatically shielded transformers. In stock and available now from Triad distributors.



TRIAD-UTRAD DISTRIBUTOR

305 North Briant Street, Huntington, Indiana 46750

INFORMATION RETRIEVAL NUMBER 62

Dip-a-DIP, Pul-a-DIP, or Pic-a-DIP

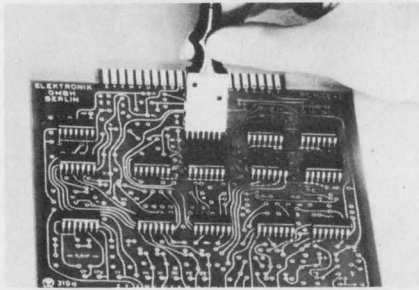

Micro Electronic Systems Inc., 30 Lawson Lane, Ridgefield, Conn. 06877. (203) 438-2554. \$8.50; stock.

Tools for inserting, extracting or feeding 14 or 16-lead DIP ICs cut the time needed for manual insertion by at least one third. Dip-a-DIP (photo) has an adjustable screw for various pin lengths. Pic-a-DIP, a ten-channel gravity feeder, sells for \$59.95 in single quantities.

CIRCLE NO. 335

Plug-in IC cards reduce subsystem wiring

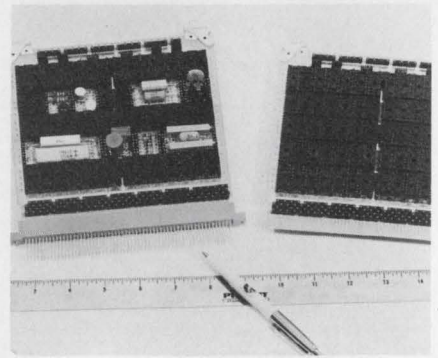

Electronic Engineering Co. of Calif., 1441 E. Chestnut Ave., Santa Ana, Calif. 92701. (714) 547-5651.

Two unique advantages are claimed for the 3-D IC-plug-in cards. The design has been based on a quantitative survey of current logic design averages to determine the most efficient size and IC density for minimum subsystem wiring. The second advantage is easy inclusion of any type of discrete component within the wrap-wire pin pattern and the ability to connect any desired circuit points to test points that are accessible when cards are in a file or drawer and the system is operating. EECO 3-D cards are 5.82-in. high, 5.25-in. wide and can hold up to 70 ICs per card.

CIRCLE NO. 336

**RF Coils
Chokes
Transformers**

**In Stock for
Immediate Delivery**

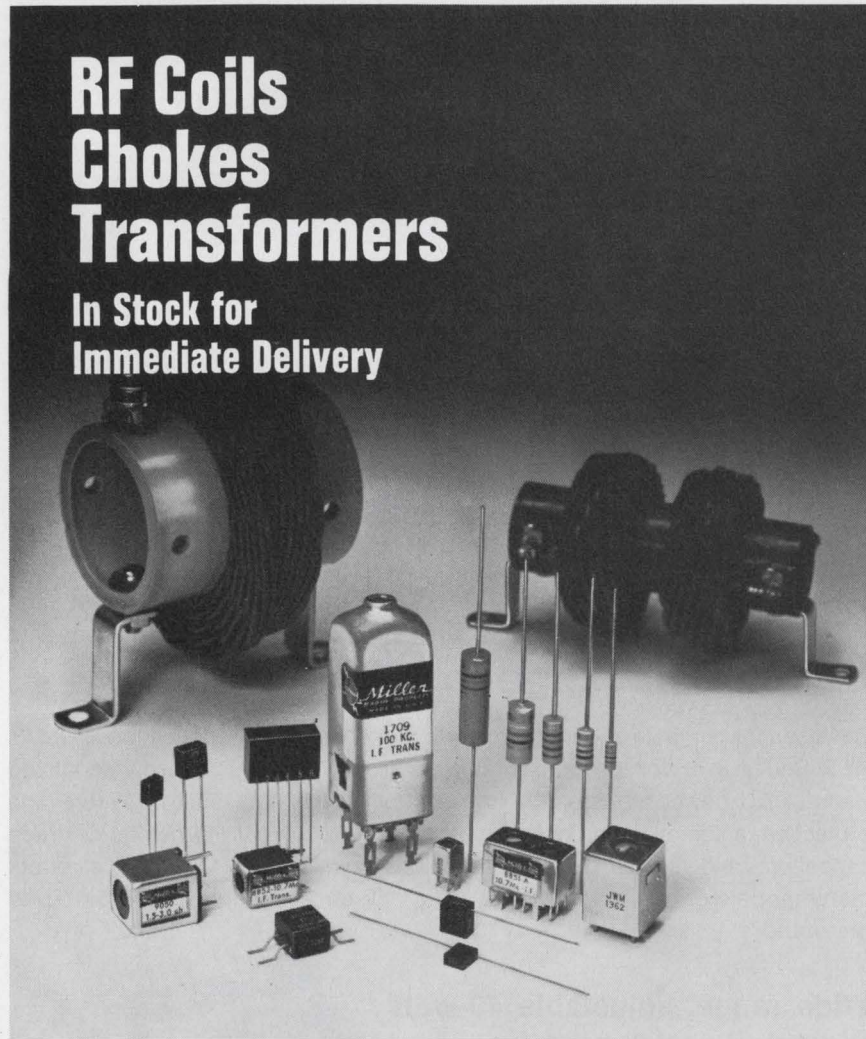

Write for your copy of the 80-page full line Catalog 72.

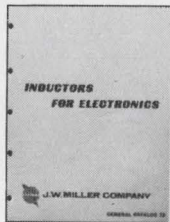

- Custom Winding
- MIL SPEC Testing
- Samples — 10 days
- Shipments start within 3 weeks after sample approval



J.W. MILLER COMPANY

19070 REYES AVE. ■ P.O. BOX 5825 ■ COMPTON, CALIF. 90224

Semiconductor package dissipates 450 W

International Electronic Research Corp., 135 W. Magnolia Blvd., Burbank, Calif. 91502. (213) 849-2481. Price: see text.

A forced-air semiconductor heat dissipator provides power dissipation at what is claimed to be the highest efficiency-to-cost ratio ever offered to the industry. The Series FAHP4 measures 3-3/4 × 5-3/16 × 4-11/16 in. (less fan) and weighs only 14 ounces, yet dissipates 450 W in a 25 C ambient with a semiconductor case temperature rise of less than 95 C. The cost is \$6.50 (plus fan) in 1000-unit orders, and \$9.95 in 10-unit quantities. The new unit will operate with any standard fan that produces 100 to 115 cfm of air, and which has mounting holes on 4-1/8 in. centers.

CIRCLE NO. 337

Hybrid substrate method cuts costs in half

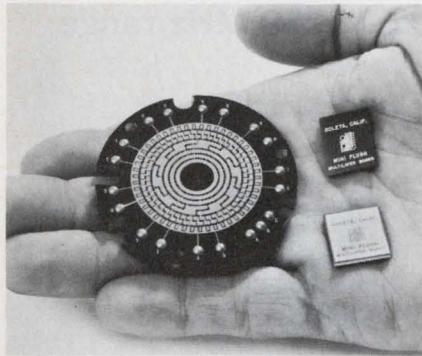

Photronics, Inc., 26 Coromar Dr., Goleta, Calif. 93017. (805) 968-3541.

A unique method of producing high-density hybrid substrates can cut costs by 50% or more over ceramic substrates. Using solid-post multilayer printed circuits and precision flush circuits, the technique yields low-cost, reliable circuits for mounting beam-lead, flip-chip and other miniature components. Components are mounted on conductive pads that are flush with the PC board surface to within 1 micron. Line widths of 2 mils on 10 mil centers are readily achieved in the surface conductors and pads.

CIRCLE NO. 338

Shielding tape eliminates need for plating

3M Co., Dielectric Materials and Systems Div., Box 33686, St. Paul, Minn. 55101. (612) 733-4033.

Scotch brand shielding tapes Nos. X-1245 and X-1267 for EMI and RFI energy control are designed to restrict radiating energy. They provide long-term effectiveness for such applications as: shielding for enclosures, electronic test equipment shielding; static charge draining and trouble shooting. Scotch tape No. X-1245 has an embossed copper backing which permits solder connections; tape No. X-1267 is an embossed aluminum foil-backed tape. Both have pressure sensitive adhesive backing for fast, clean application. The tapes offer cost savings by eliminating the need for painting, spraying or plating. Application can be made in the field and repairs to the shielding made on the spot.

CIRCLE NO. 339

Diffused and epitaxial wafers custom prepared

Monsanto Commercial Products Co., P.O. Box 8, St. Peters, Mo. 63376. (314) 272-7676.

An advanced line of silicon material for the semiconductor industry includes sub-diffused (buried island), deep diffused and epitaxial wafers. The silicon products are made from Monsanto-grown, dislocation-free substrates that have damage-free and extremely clean surfaces. The diffusion and epitaxial processes are performed before the wafers can be exposed to possible contaminants.

CIRCLE NO. 340

Pd/Ag pastes combine adhesion, solderability

Plessey Inc., Materials Div., 320 Long Island Expwy. South, Melville, N.Y. 11746. (516) 694-7910.

Six Pd/Ag conductor compositions have distinctive adhesion, conductivity and solderability characteristics. The materials were developed to meet unusual production requirements for adhesion, conductivity and solderability. Adhesion numbers vary from 8-14 to 15-20, and resistance from 0.01 to 0.06 ohm/sq.

CIRCLE NO. 341

Conformal coating boasts adhesion

Applied Plastics Co., Inc., 612 E. Franklin Ave., El Segundo, Calif. 90245. (213) 322-8050.

Apco 1266 is specifically directed to solving the problems encountered with conformal coatings in obtaining good adhesion to ceramic and gold surfaces, while retaining excellent properties. It is a two component urethane that can be cured at either room or elevated temperatures. The coating is characterized by excellent toughness and flexibility; resistance to moisture, salt spray, environmental temperature extremes ranging from -100 C to 130 C; and aging.

CIRCLE NO. 342

The Obliging Ticket Printer.

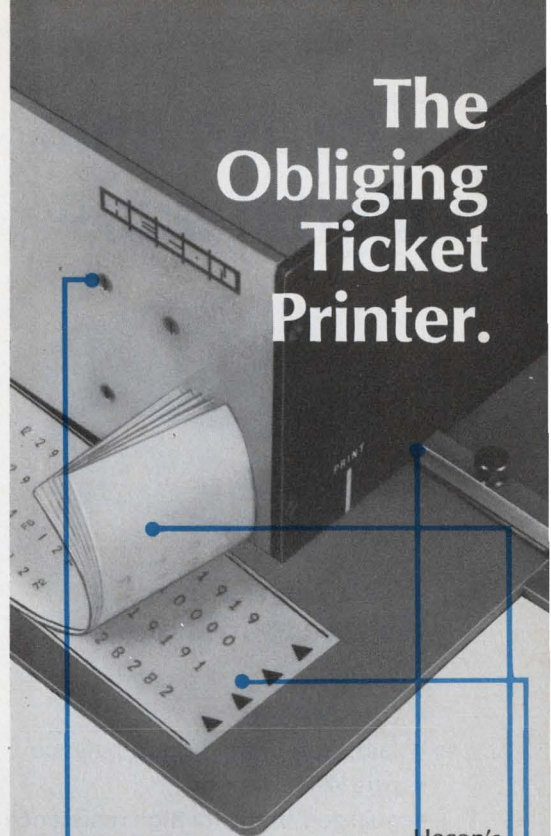

Hecon's TP-900 Series Ticket Printer could be the most versatile printer

you'll ever put to work. It offers from 4 to 18 columns of information. Our unique T-stops and guides enable you to imprint information anywhere on the ticket you select. The printer will accept almost any size or shape ticket, from 2" x 4" up to 8½" x 11". Modular construction allows rapid repositioning of print modules.

A unique ribbonless inking and imprint system assures you of smudge-free imprints...up to 7 legible copies per ticket.

Additional facts you should know are:

- Input: Pulse, BCD (10 or 12 line, TTL compatible) or both.
- Print wheels: Large library of alpha, numeric, and special characters available.
- Clock: Time and date, 8 columns (4 for each).

The Hecon Ticket Printer is precision made and field proven for maximum reliability and ruggedness. You can have a complete 12 column Ticket Printer for less than \$900.

Hecon Corporation
P.O. Box 247, Eatontown, N. J. 07724
Tel: (201) 542-9200
In Canada: Hecon of Canada Ltd.
80 Galaxy Blvd., Rexdale, Ontario
Tel: (416) 678-2441

HECON

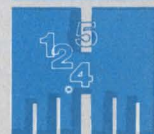

The dynamic digital duo -



\$690 buys a lot of resistance measurement:

- 1 milliohm to 1 gigaohm
- 3½ digits, 0.1% accuracy
- fast, automatic bridge balance
- true 4-wire input
- guarded input for high resistance



\$690 also buys a lot of capacitance measurement:

- 1 picofarad to 10 millifarads
- 3½ digits, 0.1% accuracy
- use of NBS-recommended charge transfer technique
- no polarizing voltage needed
- low voltage to device under test

And for \$995, you can have both. Hickok's plug-in design lets you pay for only what you need

DP170 Resistance Plug-in \$305
 DP200 Capacitance Plug-in \$305
 3202 Main Frame \$385
 3202P Main Frame with buffered display and printer output \$475

HICKOK

the value innovator

INSTRUMENTATION & CONTROLS DIVISION
 THE HICKOK ELECTRICAL INSTRUMENT CO.
 10514 Dupont Avenue • Cleveland, OH 44108
 (216) 541-8060 • TWX: 810-421-8286

INFORMATION RETRIEVAL NUMBER 65

MICROWAVES & LASERS

Pulse or cw-mode traveling-wave tube

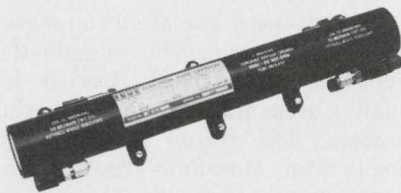

ITT Electron Tube Div., Box 100, Easton, Pa. 18042. (215) 252-7331. Under \$4000.

A traveling-wave tube, the Type-2119, capable of operating in either pulse or continuous-wave modes, covers the 1.7-to-4.0-GHz frequency range. It provides a minimum of 1 kW peak pulse output at 5% duty factor, or produces 100 W of continuous-wave power. The 2119 operates at a fixed beam voltage, with mode changes achieved through modification of the gating-electrode voltage.

CIRCLE NO. 343

Gallium-arsenide varactors reach 550-GHz

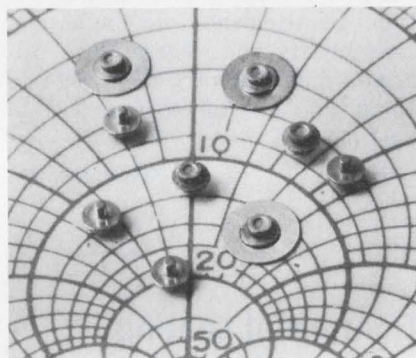

Control Data Corp., Boston Microwave Products Div., 400 Border St., E. Boston, Mass. 02128. (617) 569-2110. \$92 (small quantities); stock.

A line of gallium-arsenide varactors boast cutoff frequencies to 550 GHz at zero volts. These varactors, which can be used from 7 GHz to 42 GHz, have a voltage breakdown range from 10-to-20 V and a capacitance range from 0.25-to-0.50 pF. The new line includes the TRG series C-200 and C-300 parametric amplifier varactors, the TRG series C-210 and C-310 multiplier varactors and the C-220 and C-320 phase-shift diodes.

CIRCLE NO. 344

Diplexers cover 25-to-250 MHz range

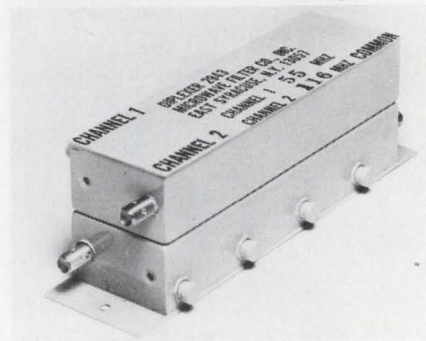

Microwave Filter Co., Inc., 135 W. Manlius St., E. Syracuse, N.Y. 13057. (315) 437-4529. P&A: see below.

The Model 2943 diplexer is available with two customer-specified channels in the 25-to-250 MHz range. Depending on channel-frequency separation, isolation reaches 30-to-70 dB. With SMA connectors, diplexer measurements are 1-1/2 x 2 x 5 inches. The 2943 is priced at \$145; delivery is 2 weeks.

CIRCLE NO. 345

Schottky diodes good for Doppler radars

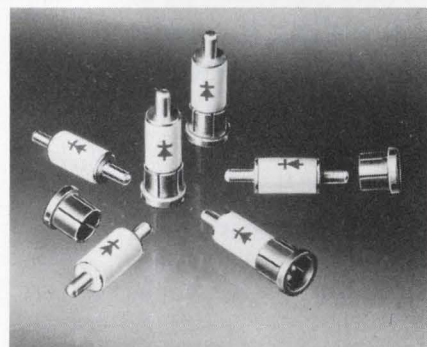

N.V. Philips, Electronic Components and Materials Div., P.O. Box 523, Eindhoven, The Netherlands.

The BAV46 Schottky-barrier diode has low flicker noise at frequencies near the carrier frequency and high conversion efficiency when driven by low level LO signals—required features for Doppler radar systems. The diode has an over-all noise figure of 10 dB at 1 kHz from the carrier frequency. Forward current is typically 30 μ A and the rf level is 1 μ W at 9.375 GHz. Its conversion frequency is about 1 μ A/ μ W.

CIRCLE NO. 346

High-power cavity oscillators offered

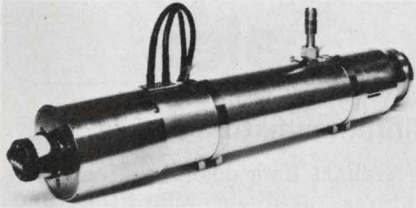

Epsco Inc., 411 Providence Hwy., Westwood, Mass. 02090. (617) 329-1500.

Cavity oscillators covering selected frequency bands from 150 to 1290 MHz have a guaranteed minimum peak power of 40 kW. Pulse width is 10 μ s with 0.003 duty cycle. Each oscillator consists of a triode tube mounted in a precision-machined triaxial cavity. The cavities are operated in the 3/4-wave-length mode, which makes tube replacement less critical.

CIRCLE NO. 347

Spiral antennas cover 2 to 18 GHz range

Frequency Engineering Laboratories, P.O. Box 527, Farmingdale, N.J. 07727. (201) 938-9221.

Three cavity-backed broadband spiral antennas offer a power rating of 10 W average and 100 W peak, and nominal beamwidth at half power of 70 degrees. The Model SMK-2012 operates from 2 GHz to 12 GHz with a 7.0 dB nominal gain; the Model SMK-2018 covers 2 GHz to 18 GHz at a nominal gain of 6.0 dB and the Model SMK-4011-010 operates from 4 GHz to 10.5 GHz, with a nominal 3 dB gain that can be matched to within ± 1.0 dB of the characteristics gain curve.

CIRCLE NO. 348

Traveling-wave amps have 12-dB noise figure

Watkins-Johnson Co., 3333 Hillview Ave., Stanford Industrial Park, Palo Alto, Calif. 94304. (415) 326-8830.

A line of traveling-wave amplifiers offer 12-dB maximum noise figure and 37-dB minimum gain in the 7-to-11 GHz frequency range. Termed the WJ-3041 series, the amplifiers meet or exceed the respective requirements of MIL-E-16400F, Class 2, according to the company.

CIRCLE NO. 349

Spur-free filters handle up to 15 kW

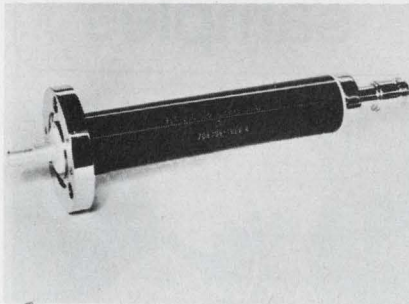

CIR-Q-TEL, 10504 Wheatley St., Kensington, Md. 20795. (301) 946-1800.

A family of high power band-pass and low-pass filters, with cut-off frequencies from 100 to 2500 MHz, are free of spurious responses. Designated Series FLT/20 (low-pass) and FBT/20 (band-pass), the filters have power ratings as high as 15 kW. Other features include low VSWR (1.3:1) and low insertion loss (0.3 dB).

CIRCLE NO. 350

The latest word in readers: reliability

Phototransistors provide maximum noise immunity and *no* read errors.

Rugged light emitting diodes (LED's) provide an indefinitely long-lived light source.

Self-cleaning heads read all tapes with *no* adjustments, *no* errors.

Fully-proportional reel servos provide gentle tape handling at any speed.

Stop-on-character at all speeds with *no* overshoot.

Step motor drive has only a single moving part and an MTBF of over 10,000 hours.

Free demo: We've got the most reliable, most convenient line of OEM punched tape readers going. And we're ready to prove it. Just tell us what you need and we'll lend it to you for 30 days, free. Choose any model from our \$500 Mini-Reader to our 750 ch/sec Series 8000 and put it through its paces. If it doesn't do your job more reliably than any competitive reader, simply return it. But it's only fair to warn you: we don't get many back.

EECO OEM readers and spoolers

EECO, 1441 E. Chestnut Avenue, Santa Ana, California 92705 • Tel: (714) 547-5651

INFORMATION RETRIEVAL NUMBER 66

Now you need
only ONE reader
for 150/300/600 CPS



DECITEK'S NEW UNIVERSAL READER

**cuts inventory costs
saves on spare parts
speeds servicing
simplifies your designs
reduces documentation,
software and training**

Think of the money, time and trouble you can save by standardizing on *one*, proven-reliable punched-tape reader for *all* your applications. Decitek's evolutionary new "Universal Reader" reads to 300 CPS step-at-a-time truly asynchronously . . . to 600 CPS stop-on-character.

Combines refined electromechanical design and improved electronics with all original Decitek advantages that avoid edge guides, capstans, pinch rolls, brakes, lenses . . . stepping motor/dual sprocket bi-directional drive . . . interchangeable reading of 5, 6, 7 or 8-level paper, metallized polyester or paper-polyester tapes having up to 70% transmissivity. Basic reader with or without electronics, fanfold or spooler. Call or write DECITEK, 16 Sagamore Rd., Worcester, Mass. 01605. Tel. (617) 757-4577.

DECITEK
A DIVISION OF JAMESBURY CORP.

INFORMATION RETRIEVAL NUMBER 67

evaluation samples

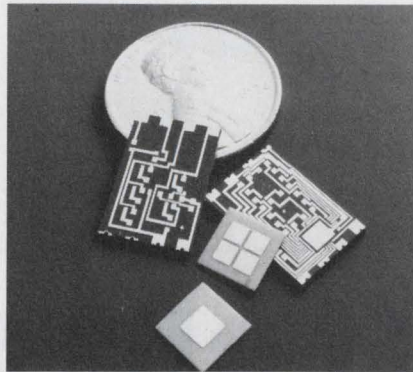

Ceramic substrates

An improved technique yields highly precise metalized and plated ceramic substrates in squares (or multiples of squares) from 1 mil to 3 inches, and in carefully controlled thicknesses from 10 mils to 50 mils. The technique combines earlier developments in fine-line photoetching and precision gold-plating used in manufacturing multilayer DIP packages for MOS/LSI and black-ceramic packages for LEDs, with a new laser technology for fast, precise substrate dimensioning. Using this new combined technique, metalization patterns with a standard of 3-mil line/3-mil space can be centered on a part within a standard tolerance of $\pm .005$ inches. Metalized Ceramics Corp.

CIRCLE NO. 351

Wire tie mounts

A pressure-sensitive adhesive wire tie mount and three sizes of marker plates are designed for use with wire ties. To secure wiring harnesses with wire ties made of nylon for use in wide temperature variations, the new wire tie mount is also designed with three counter-sunk holes for screw fastening in heavy-duty applications or to offset the effects of vibration. The handy marker plates are available in sizes from 3/4 in. \times 1-1/4 in., 3/4 in. \times 1-1/2 in. and 3/4 in. \times 2 in. and can be installed lengthwise on the wire harness or around the wire bundle. Lorain Tool & Manufacturing Co.

CIRCLE NO. 352

design aids

Vibration fixture design

A chart lists design criteria for fixtures used in vibration and shock testing. Instead of "motherhood" statements, the new chart presents numerical limits for lowest resonant frequencies, for allowable lateral motion and for allowable differences between vibration intensities at test item attachment points. These limits are less restrictive for large and heavy test items. Tustin Institute of Technology, Inc.

CIRCLE NO. 353

Resistor mil spec digest

A Fixed Resistor Mil Spec Digest offers a handy and easy explanation of the Mil Spec numbering system for seven major fixed resistor specifications. It is complete with charts to interpret all digits of the Mil Spec numbering systems. TRW Inc.

CIRCLE NO. 354

Thermocouple calibrator

A slide rule to aid in comparing thermocouple alloy combinations provides a fast and convenient means of comparing emf output of Chromel-Alumel, iron-constantan, Chromel-constantan and copper-constantan thermocouples at temperatures from -300 F to 2500 F. All data is based on the recently adopted International Practical Temperature Scale of 1968. Hoskins Manufacturing Co.

CIRCLE NO. 355

Pushbutton switches

A full color 12-page catalog with an accompanying color coordinating kit describe a complete line of colored micro-miniature pushbutton rotary switches. The color coordinating kit contains actual size reproductions of Janco's colored pushbutton switches. Designed with self-adhesive backing, they permit the user to place and replace the various colored switches until he finds the color combination that best suits his panel design. Janco Corp.

CIRCLE NO. 356

WESCON PREVIEW

Los Angeles Convention Center

September 19-22, 1972

Wescon in Los Angeles: September Show-Down For New Electronics



New prime time and place / page 2
Professional program review / page 3
Special Wescon Week features / page 4-5
Who's exhibiting? / page 7

Wescon 'Show-Down' of Products, Technology Will Attract 25,000

Wescon opens new doors to the electronics world on September 19 in Los Angeles.

The 21st annual presentation of the West's prime technical and product forum is "new" in many ways. For the first time, the four-day program is in September, after the summer vacation season. And it's in the sparkling, new Los Angeles Convention Center—a \$41 million building covering eight city blocks in the downtown area.

Virtually all Wescon activities—exhibition, technical, social, and special—will be conducted in the Center.

Credentials for more than 25,000

visitors will be produced by a new, computer-aided system that provides each person with his own plastic "credit-card badge," both for admission and for requesting additional technical information.

Twenty-eight regular and two "special" professional sessions will be conducted in carpeted and air-conditioned meeting rooms on the Center mezzanine, all concurrent with exhibit hours.

Product and system demonstrations by more than 300 companies will be carried out in a single, great hall on the main floor. New com-

ponents, devices, and systems are divided into seven appropriate categories of interest and presented in adjacent "departments" on the show floor. Exhibits open every morning (Tuesday through Friday) at 9:30 a.m. Concurrent professional sessions are presented each morning at 10 and each afternoon at 2.

An added attraction on the show floor will be a model processing line demonstrating steps in the fabrication of MOS Nitride P-Channel Integrated Circuits. About 20 organizations are participating.

Wescon's traditional Distributor-Manufacturer-Representative Conference, an all-day marketing meeting involving companies who sell through distributors (or who wish to do so), their sales representatives, and distributor-companies, will also be held in the Convention Center. D-M-R, too, has a new time—it will be presented on Thursday, September 21, rather than on Monday.

Two major opening day events, the Wescon Luncheon and the all-industry reception, are also scheduled for the spacious Center. Robert Anderson, president of North American Rockwell Corporation will be the featured luncheon speaker, and a variety of leadership and technological awards will be presented.

The Science Film Theater, typically a standing-room-only Wescon feature, will screen about 25 films daily in its mezzanine "cinema."



Tuesday, September 19 / 10 am

1/Parallel Processing Systems

 Organizer: Tse-yun Feng, Syracuse University

The session will evaluate the impact of parallel processing systems on the computer society. Five panellists will cover the rationale of hardware and software design, current state of development, intended applications and performance.

2/Problems and Potentials of ICs in Consumer Electronics

 Organizer: Jim Mc Dermott, Electronic Design

Design and selection of presently available ICs and development of new circuits for new mass markets will be explored, with emphasis on ICs for home entertainment systems, for automotive applications, and for such products as mini-calculators, and wristwatches.

3/New Career Opportunities for Engineers

 Organizer: Bruce S. Angwin, Technology Utilization Project, NSPE.

Session reviews recent and current projects in assisting career changes for defense/aerospace engineers, describes the "skills technique" of man-vs.-job comparisons, reports on new areas of job opportunity, and suggests effective courses of individual action.

4/Electrically Alterable Nonvolatile Semiconductor Memories

 Organizer: Andrew C. Tickle, Nitron Corp.

Reviews recently evolved technology, describes current and upcoming modes of operation, and discusses applications and advantages in computer systems.

Keying the sessions by technology interest

Wescon technical sessions are keyed by the following symbols defining the area of technical/professional interest.

-  Components and Micro-electronics
-  Instruments and Instrumentation
-  Solid State Fabrication
-  Communications and Science Systems
-  Microwave Technology
-  Management, Education and Marketing
-  Computers and Data Processing

NAR's Anderson Keynotes Week



Robert Anderson, president of North American Rockwell Corporation, will deliver the Wescon Luncheon keynote address on Tuesday, September 19. About 500 industry and engineering leaders will attend the luncheon in the Los Angeles Convention Center.

Mr. Anderson, president of North American Rockwell since early in 1970, joined the company after a long career as an executive of Chrysler Corporation.

Other features of the Wescon Luncheon will include presentation of the IEEE Mervin J. Kelly award to Dr. Harold A. Rosen (Hughes Aircraft), for his pioneering inventions and leadership in the development of stationary communications satellites, and the Achievement Award for Region 6, IEEE.

28-Session Program Aims at 'Real-World' Problems, Solutions

Twenty-eight professional sessions will make up Wescon's program, all to be presented in the Los Angeles Convention Center, September 19-22.

The sessions, organized under direction of a 10-man volunteer program committee of senior engineers and managers, are scheduled each morning and afternoon on Tuesday, Wednesday, and Thursday, and on Friday morning. Four sessions will be held concurrently in each time period.

In addition, two special sessions will be offered—one a management-level panel on new directions of the electronics industry, and the second an historical look at the electronics and electric power technologies, presented by IEEE's Life Members.

As listed on this and following pages, the sessions present a wide variety of subject material—including sessions dealing with technical marketing challenges and techniques, new career opportunities for engineers, the application of electronic systems to medicine, transportation, and manufacturing, and surveys of new and emerging sub-technologies.

Each Wescon session is made up of authors and papers invited by the organizer to cover a specific area within the session topic. The result is the

Wescon 'session unit' program format, in which all presentations within a session are complementary to one another.

Convention Center conference rooms are all on the mezzanine level of the building, accessible by escalator from the lobby. All rooms are carpeted, air-conditioned, and equipped with individual audio systems.

Preprints of most Wescon papers are to be made available during the convention, bound by individual session, and priced at \$2 per session.

Program co-chairmen are Dr. Eldred Nelson (TRW Systems) and Dr. Walter Leverton (Aerospace Corp.).



One of Wescon's most popular features, the Science Film Theater, will be brought back for a return engagement in Los Angeles.

The program features daily screenings of about 25 films, chosen in competition from among outstanding technical and scientific motion pictures nominated from throughout the nation.

The program is repeated daily on a scheduled basis, and is free to all Wescon registrants.

Tuesday, September 19/2 pm

5/Technology Transfer—A Growing National Interest

 Organizer: Robert T. Diehl, Jet Propulsion Laboratory

Official and public interest in the direct transfer of federally funded science projects to activities in the public sector has grown rapidly. This session will describe in-progress technology-transfer projects, and discuss programs now being proposed.

6/Aggressive Marketing in a Climate of Change

 Organizer: Raymond D. Speer, Speer Marketing Services Corp.

This session combines formal presentations and a panel discussion of the changing media and technology of marketing. The electronics industry has had to learn how to present and sell its product on the open market in a very short period of time.

7/Computer Networks

 Organizer: G. D. Cole, System Development Corp.

The program concerns itself with an up-to-date report on existing networks, their promise of much greater value in the period ahead, and some observations on how networks can bring about resource-sharing and help to meet the challenge to build on prior results.

8/Magnetic Bubbles

 Organizer: Stephen L. Johnston, U.S. Army Missile Command, Redstone Arsenal.

An overview of magnetic bubble technology, a report on pioneer research on the subject, present state of the art, and future applications are included in this session plan.

Wednesday, September 20/10 am

9/Electronics for Automotive Safety and Control

 Organizer: R. R. Hoge, The Bendix Corp.

Non-entertainment electronic systems for automobiles are forecast as the fastest growing segment in the industry in the next five years. This session describes some environmental problems, and discusses current and future thinking as to specific systems needed.

10/Digital Readouts: Trends and Applications

 Organizer: Stephen A. Thompson, The Electronic Engineer Magazine

Gas Discharge, LED, and liquid crystal display will be covered in three detailed papers, and a fourth will deal with criteria for choosing the right display mode for particular applications. Total acquisition cost will be emphasized.

All-Industry Event Salutes World Scope of 'New Electronics'

Phileas T. Fogg's globe-girding gambit in 80 days will be condensed into a space-age time-span at Wescon's all-industry reception on Tuesday evening (September 19) at the Convention Center.

"Around the World in 80 Minutes" will set the theme for the party, planned for the elegant grand entry to the Center. Festivities will last from 5:30 to 7:30 p.m.—120 minutes, rather than 80. ("Around the world in 120 minutes" didn't seem to make much sense.)

The party theme includes a salute to electronics around the world—the growing interchange of technology, products, and systems. Hostesses will be attired in native costumes from many lands, while industry hosts will squeeze into

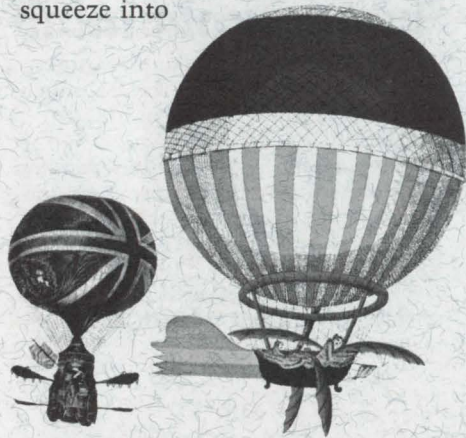

Contemporary equipment and techniques for processing MOS Nitride P-Channel Integrated Circuits will be demonstrated "live" on the Wescon convention floor. The demonstration line will occupy a special 4800-square foot display area, and will illustrate (subject to safety restraints) most of the processing steps. About 20 suppliers of equipment are cooperating in the model line, and will man the stations.

Fogg's famous formal suits.

About 1000 persons will join the cocktail reception 30 minutes after show-closing on Tuesday to meet with friends and colleagues, and talk over the week's activities. Wives and feminine guests are invited.

The 16,000-square-foot grand lobby is carpeted, has a vaulted luminous ceiling, and two-story walls of bronzed mirror. There is a giant modern chandelier, designed for the Center and crafted in Venetian glass, and exotic greenery in architectural ceramic bases. An area of the lobby will be reserved for IEEE Life Members and their wives.

Price of "Around the World in 80 Minutes" is \$6.50, which includes hors d'oeuvres and three cocktails.

Computer Keys 'Credit Card' Badge System

An electronic system has finally taken over the procedures of visitor registration in an electronics convention.

The system consists of CRT entry of registration card information, then activation of high-speed embossers that produce plastic "inquiry badges." The badges serve both for visual identification and as "credit cards" with which to request technical literature at exhibit booths.

As the information entry is made for badge production, the same and additional data is recorded on magnetic tape, for use in post-show exhibitor billings and as the basis for an attendance audit.

Wednesday, September 20/2 pm

11/The Dwindling Technology Gap

Organizer: Geoffrey C. Ziman, Zi-Tech Company.

The long-time U.S. technological advantage in electronics over other countries of the world is being eroded by many economic and policy factors. American "know-how" is finding a counterpart in "savoir faire"—along with new European and Japanese mastery of marketing techniques.

12/Needs and Trends in Medical Electronics 1972

Organizer: Morton D. Schwartz, California State University, Long Beach.

By 1975 the nation's health care bill will be more than \$100 billion—and the industry will employ 6 million doctors and hospital workers. To provide high levels of health care at the lowest cost, new instrumentation and systems must be developed.

13/Programmable Calculators: System Components

Organizer: David N. Kaye, Electronic Design Magazine.

Three speakers will first provide a guideline to considerations in designing calculator-based systems, then sit as a panel to discuss actual problems with the audience.

14/Trends in Modern Data Communication Test Equipment

Organizer: Renato D'Antonio, International Data Sciences Inc.

Digital data communication is expanding exponentially—by 1980, there will be an incredible 10 million modems in operation. The session provides expert opinion on the criteria for modern test sets, and requirements for different classes of data communications systems.

15/The Solid State Quality Cost Equation: Impact on Buyer, Supplier

Organizer: Dan Del Frate, RCA Solid State Division.

Four points of view are included in this discussion of the special logistics of the solid-state manufacturer, the specifier, and the buyer. Seller-purchaser and seller-specifier interfaces will be explored.

16/Biomedical Engineering: Educating the Engineers for Careers in Health Care Delivery

Organizer: F. M. Long, University of Wyoming.

This session organized with the cooperation of the Biomedical Committee of the American Society for Engineering Education. Present programs in re-training engineers to undertake active roles in health care delivery will be described.

Women-at-Wescon Plan 'City and Sea' Social Program

Women at Wescon will take a week-long view of "The City and the Sea," while their husbands are measuring microwaves and letting the chips fall in technical sessions.

The ladies will have their own hospitality suite at the Los Angeles Hilton Hotel, headquarters for morning coffee, tour and shopping directions, and as a meeting-place.

Wescon's first day, Tuesday, is open for getting acquainted and for forays into the city and to make ready for the all-industry reception that evening. On Wednesday afternoon, the Hilton's terraced Patio Room will be the locale of a welcoming afternoon tea and program. Speaker will be Marianne Alireza, now a resident of monogamous Pasadena, but for 20 years a member of a middle eastern harem. As a Mid-East feminist, she



Thursday, September 21 / 10 am

17/Graphic Displays for the Minicomputer

Organizer: Rudolf Panholzer, Naval Postgraduate School.

This session is designed as a "micro-course" in graphic displays for minicomputers. Lectures will be short, providing time for open discussion and for a 45-minute laboratory, during which equipment will be demonstrated.

18/Venture Capital After the Fall

Organizer: Thomas A. Skornia, Skornia, Rosenblum & Geyman.

Five spokesmen representing different participation roles in the funding of a new technological enterprise discuss the current "ground rules" and trends in formulating the venture capital "package."

'Three Marketeers' Get it Together in DMR Conference

About 500 manufacturers, distributors, and sales representatives will participate in Wescon's traditional D-M-R Conference in Los Angeles—but the "time and station" are both new.

Thanks to the spaciousness of the new Convention Center, D-M-R will be conducted there, rather than in a downtown hotel. And for 1972, it moves to Thursday—in all previous years, it had been a pre-show event on Monday. The move is a major convenience to participants who also have exhibit booth responsibilities, and who can now move easily from

was active in the successful program that resulted in "The Drop of the Veil," which also happens to be the title of her recently published book. Program chairpersons Louise Ross and Ina Welmers have issued a veiled invitation to male electronicers to attend the Wednesday tea.

On Thursday (September 21), Wescon women board air-conditioned buses for a day at nearby Marina Del Rey. Attractions include a 30-minute cruise aboard the Marina Belle paddle-wheeler, shopping in the new Fishermans Village of import and boutiques, and luncheon and a fashion show at the Pieces of Eight.



the conference in Petree Hall to the show floor and back again.

The D-M-R Conference, in its 18th annual presentation, is made up of 20 individual conference periods during the day. Factory sales executives and their regional reps meet, by appointment, with distributors during each of these conference periods. Time is also provided in the master schedule for more informal talks between distributors and companies exploring possibilities of selling through distributors.

The day starts with a continental breakfast rap session at 8:30. Conference periods start at 9 a.m. At noon, there's a no-speech luncheon, followed by 10 afternoon conference periods. D-M-R registrations are \$10, and include the breakfast and luncheon, the conference, and admission to Wescon.

Thursday, September 21 / 2 pm

21/Automating Software Verification

Organizer: A. C. Arterbery, TRW Systems.

Four engineer-managers with differing points of view as to "tool selection" and application, but who agree test cost, efficiency, and control can be improved through automated software application, will present their own experiences in planning, concepts for control, and procedures.

22/Marketing for the Dynamic 70's

Organizer: Jerry Wasserman, Arthur D. Little Inc.

Companies, as do products, have a "life cycle." Expert spokesmen describe the stages in which their companies find themselves, and how each designs the programs to meet the needs of their markets. A final paper offers management guidelines for allocating marketing resources.

19/Advances in Processing and Packaging of Materials, Devices, and Circuits

Organizer: Samuel L. Marshall, Solid State Technology Magazine.

The technological and applications advances in solid state materials, packaging, circuits, and devices are explored — with specific discussions of wafers, ceramic packages, ion implantation, and isoplanar devices.

20/Electronics and Microwaves in Automobile/Highway Systems

Organizer: Harold Staras, RCA Laboratories.

Devices and systems for automotive danger signalling, emergency communications, urban traffic control, and automatic longitudinal control will be discussed.

Freeway Flyers Serve Wescon Commuters

Express commuter bus service between two key Southern California electronics centers and the Los Angeles Convention Center will be operated throughout Wescon week.

The air-conditioned Wescon Specials will serve Orange County (Anaheim) and the Los Angeles International Airport area, starting at 8:30 a.m. daily and continuing through show hours.

The Orange County round-trip (nearly 40 miles each way) will cost \$3, and the round-trip from the airport to the Center and return will be \$2.

Visitors from either of the two areas can park free, receive their Wescon programs, and plan their personal show schedules during the ride.

A free shuttlebus will operate on a continuous basis from the Biltmore and Los Angeles Hilton Hotels to the Center throughout the show and convention.

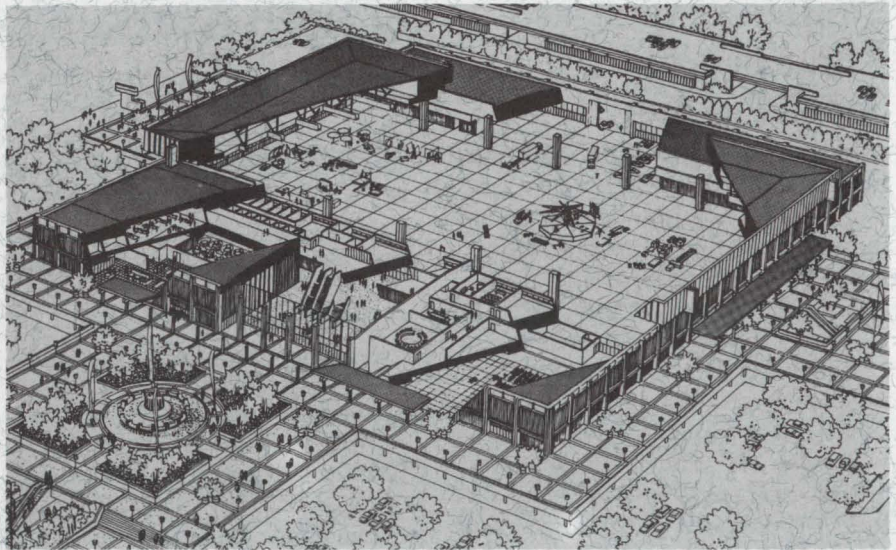
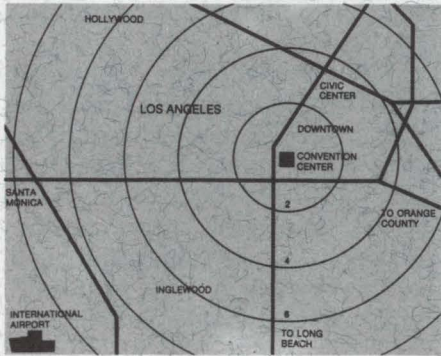

All Wescon exhibits and programs will be in \$41-million Los Angeles Convention Center. New Center occupies eight city blocks just south of downtown and adjacent to freeway complex. Mezzanine level has 25 meeting rooms, the largest with capacity of 2000 persons. All are air-conditioned and carpeted. There's parking for 4000 autos on the property.

Two Programs Cover 'Yesterday' and 'Tomorrow'

Two special-interest sessions will supplement the Wescon professional program, both on Wednesday, September 20.

At 10 a.m., IEEE Life Members will present a two-speaker program as part of their Wescon week activities: Dr. Fred Terman will review early developments in the western radio and electronic industries, and Charles T. Malloy, retired executive of Southern California Edison, will look back on

development of the power industry in the West.

At 2 p.m. the same day, five speakers will assess "New Goals for the Electronics Industry," in a program organized by C. V. Kovac, North American Rockwell Microelectronics. Speakers include John J. Guarrera, IEEE Region 6 Director; Robert L. Boniface, Hewlett-Packard; J. E. Smith, Victor Comptometer; Dan McMillan, Electronics; and Erich Bloch, IBM.

23/The Value of Patents and Trade Secrets

Organizer: Thomas E. Schatzel, Schatzel and Hamrick.

A corporate patent attorney, private attorney, venture capital executive, and spokesmen from a large and a small corporation will provide a panel discussion involving patents, trademarks, copyright, trade secrets, and the employer-employee relationship in such matters.

24/Productibility

Organizer: Alfred Levy, RCA Electromagnetic and Aviation Systems. Engineering-management liaison during the translation of design drawings to manufacturing specs can provide important stories from the engineering and manufacturing management points-of-view.

25/Tunable Solid State Microwave Sources

Organizer: James F. Caldwell, Varian Solid State West.

Four speakers examine the current interest in electronic tunable solid state components in three areas: communication, instrumentation, and countermeasures.

26/Micro Computer Sets

Organizer: Thomas F. Prosser, PD Labs.

LSI packages, each of which contains one functional block of a large computer (a memory bank or a central processing unit, as examples) are described as Micro Computer Sets. This session describes some current applications, potential uses, and limitations of these new component blocks.

27/Digital Processors in Flight Control

Organizer: T. A. Fuhrman, TRW

Low-cost, highly reliable computation capability can be a major factor in dealing with increasingly complex problems of aircraft and spacecraft flight control. The session deals with the cost, schedule, and other advantages of digital systems. flight control.

28/Universal Digital Transmission

Organizer: Harold A. Norby, Litton Data Systems Division.

The session is designed for relatively short formal presentations, followed by free-form discussion of some of the potentials of digital transmission and some of the possible "mirages."

Look for new electronics from these fine companies at Wescon

Accel Industrial Heat Sink Corp.
Accelerators Inc.
Adar Associates
Addmaster Corp.
ALLTECH, Cutler-Hammer
Air Products & Chemicals, Inc.
Alco Electronic Products, Inc.
Algo Div., Hamilton Electronic Corp.
Allen Avionics, Inc.
American Telephone & Telegraph Co.
American Zettler
Americon Corp.
Aqua Media
Arco Electric (U.K.)
Arrowhead Puritas Water
Astrosystems, Inc.
Augat, Inc.
Avco Corp./Systems Div.
Bead Electronics
Beede Electrical Instrument Co., Inc.
Belden Corp.
Benwill Publishing Corp.
Berlin Electronic Association
Berliner Transformatoren und
Gerätebau (Berlin)
Biomation
Blue Electric Co.
Boeing Electronic Products
Wolfgang Bogen (Berlin)
Boonton Electronics Corp.
Brown, Boveri Corp.
Buckeye Stamping Co.
Burroughs Corp.
California Electronic Mfg. Co., Inc.
California Electronic Marketing, Inc.
Cambridge Thermionic Corp.
The Capitol Machine & Switch Co.
Celco-Pacific Div.
Cherry Electrical Products Corp.
Chicago Switch, Inc.
Circon Microtechnology
Circuit Assembly Corp.
Circuit-Stik, Inc.
C & K Components, Inc.
Cleveland Institute of Electronics
Coates & Welter Instrument Corp.
Coil Winding Equipment Co., Inc.
Component Manufacturing
Services, Inc.
Computer Automation Inc.
Computer Design Corp.
Computer Design Publishing Corp.
Cornell-Dubilier Electronics,
Div. of F.P.E.
Cossor Ltd. (U.K.)
Coutant Electronics (U.K.)
Cummings & Associates
Data I/O
Data Precision Co.
Datel Systems, Inc.
Daymarc Corp.
DeAngelo, Rothman & Co.
Dennison Manufacturing Co.
Digilin Inc.
Digital Equipment Corp.
Digitec-United Systems Corp.
Disc Instruments, Inc.
Douglas Electronics, Inc.
Du Pont Co.
Dynage, Inc.
Dynamic Gear Company, Inc.
Dynasales Co.
Eagle Signal, Div. of Gulf & Western
Eastern Marking Machine Corp.
EDN, Cahners Publishing Co.
E-H Research Laboratories, Inc.
Electric Motor Engineering
Electro Scientific Industries
Electronic Buyers News
Electronic Concepts, Inc.
Electronic Enclosures, Division of
Wyle Laboratories
Electronic Engineering Assoc. (U.K.)
Electronic Engineering Co. of Calif.
Electronic News, Fairchild
Publications
Electronic Representatives Assoc.
Electrotech (U.K.)
Electrotube (U.K.)
Electrovert Inc.
Elektronik (Berlin)
Elmwood Sensors, Inc.
Emerson & Cuming, Inc.
EMI Gencom Div.

Emitronics Inc.
Englehard Industries
Equipment Reporter
Feedback (U.K.)
Fieldtech (U.K.)
Fisher & Porter Co.
John Fluke Manufacturing Co., Inc.
General Electric Co.,
Miniature Lamp Dept.
General Electric Co.,
Lamp Glass Dept.
General Electric Co.,
Semiconductor Division
General Measuring Instruments
General Radio Co.
Genisco Corp.
Globe Union, Inc.
Gordon-Elliott, Inc.
Gorman Machine Co.
Gould Inc., Instrument Systems Div.
Grayhill, Inc.
GTE Automatic Electric Inc.
Guardian Electric Mfg. Co.
Halax, Inc.
Harada Electric Co.
Hayden Publishing Co., Inc.
HEI Inc.
Hewlett-Packard Co.
Hickok Electrical Instrument Co.
Houston Instrument
Hudson Tool & Die Co.
Hughes Aircraft Co.
Electron Dynamics Div.
Hughes Aircraft Co.
Industrial Products Div.
Hughes Aircraft Co.
Products Equipment Group
Hybrid Systems Corp.
Hysol Div., The Dexter Corp.
IEEE
Illumination Industries, Inc.
Industrial Electronic Engineers, Inc.
Insaco, Inc.
Instrument Specialists
Intech Inc.
International Data Sciences, Inc.
Interstate Electronics Corp.
Interswitch Div. Wm. J. Purdy Co.
IPT Corporation
ISE Electronics Corp.
Isophon-Werke (Berlin)
ITT Howard W. Sams & Co., Inc.
Richard Jahre (Berlin)
Jay-El Products, Inc.
J-B-T Instruments, Inc.
Jermyn Industries (U.K.)
Jewett Co.
Jonathan Manufacturing Co.
Juno Tool & Plastic Corp.
Kay Elemetrics Corp.
Keithley Instruments, Inc.
Kistler Instrument Co.
H. Koch & Sons
Krone (Berlin)
Kulka Electric Corp.
Lear Siegler, Inc.
Leeds & Northrup Co.
Liberty Mirror Div., Libby-Owens
Liquid Carbonic Corp.
Litton, Electron Tube Division
Littrell Western Sales, Inc.
Lorlin Industries, Inc.
Luscombe Engineering Co.
Macrodata Co.
Magic Dot, Inc.
Magnecraft Electric Co.
Magnuson Engineers, Inc.
Marconi Instruments (U.K.)
Matheson Gas Products,
Division of Will Ross Inc.
Matsuo Electric Co., Ltd.
McFadden Electronics Co.
McLean Engineering Laboratories
Metals Research Ltd. (U.K.)
MFE Corporation
The Mica Corp.
Micro Networks Corp.
Microtran Co., Inc.
Midtex/Aemco Division
J. W. Miller Div. of Bell Industries
C. H. Mitchell Co.
MM Electronic Enclosures, Inc.
Monroe, The Calculator Co.
Motorola, Inc.

Mouser Corp. dba Wescom
International
Moxson Electronics
Mycalex, Div. of Spaulding
Fibre Co. Inc.
Mystic Tape, Div. Borden Chemical
Nagra Magnetic Recorders, Inc.
The Narda Microwave Corp.
Natel Engineering Co.
National Bureau of Standards,
U.S. Dept. of Commerce
Neff Instrument Corp.
The J. M. Ney Co.
NIKON/PTP, Div. of EPOI
NL Industries, Electronics Dept.
North American Rockwell Corp.
North Atlantic Industries, Inc.
Nuclear Specialties, Inc.
O'Donnell Associates
O'Halloran Associates
Olympus Corp. of America
Omega Engineering, Inc.
Omni Spectra, Inc.
Optimation Inc., Subsidiary of
MCA Technology Inc.
Opto-Metric Tools
Pacific Western Systems, Inc.
Pamotor Div. of Wm. J. Purdy Co.
Panduit Corp.
Permacel Div. of Johnson & Johnson
Pie Design Corp.
Plasmetex Ind. Inc.
Plastic Capacitors, Inc.
Plessey Semiconductors (U.K.)
Pomona Electronics Co., Inc.
The Potter Co.
Potter & Brumfield Div., AMF Inc.
Power Designs, Inc.
Powertec Inc.
Premier Metal Products Co.
Princeton Case Company, Inc.
Commonwealth of Puerto Rico
Wm. J. Purdy Co.
Raytheon/Sorenson
RCA Electronic Components
RDX Corporation
Recortec, Inc.
Renco Corporation
Rental Electronics, Inc.
REP Associates
Republic Electronics Corp.
RF Communications, Inc.
RFL Industries, Inc.
Rockland Systems Inc.
Rogan Brothers, Inc.
Rustrak Instrument Div.
San Fernando Electric Mfg. Co.
Sargent-Welch Scientific Co.
Sealectro Corp.
SECS, Inc.
Seiko Business Machines
SDC Electronics Sales (U.K.)
Sigma Instruments Inc.

Simpson Electric Co.
Sitek, Inc.
S-K-S Die Casting Div. Whittaker Corp.
Sloan Technology Corp.
Herman H. Smith, Inc.
Sola Electric, Div. of Sola Basic Ind.
Solid State Devices, Inc.
Southco, Inc.
S. P. Marketing
Spectra-Strip Corp.
Sprague Electric Co.
Standard Logie Inc.
Standard Power Inc.
M. A. Stolaroff Co.
The Superior Electric Co.
Switchcraft, Inc.
Systron-Donner Corp.
Tapeswitch Corp. of America
TEAC Corporation of America
Techmar Corp.
Technik Spezial Karl Fritz Reich
(Berlin)
Techni-Rite Electronics, Inc.
Tektronix, Inc.
Teledyne Hastings-Raydist
Tempil Div.,
Big Three Industries, Inc.
Teradyne, Inc.
Teratron Corp.
Time Electronics (U.K.)
Time-Life Libraries, Inc.
Trendar Automation Corp.
Triplett Corp.
Trompeter Electronics, Inc.
UID Electronics Corp.
Ungar Div. of Eldon Industries
United Aircraft Corp., Norden Div.
U. S. Dept. of Commerce
United Detector Technology
Vaco Products Co.
Vector Electronic Co., Inc.
Vernitron Beau Products Div.
Versatec Inc.
Vickers (U.K.)
Virginia Panel Corp.
Waber Electronics
Wagner Computer
Wang Laboratories, Inc.
Watkins-Johnson
Waytek
Wayne Kerr Co. Ltd. (U.K.)
Weckesser Co., Inc.
Weightman & Associates
Weinschel Engineering Co., Inc.
Welch Allyn, Inc.
West Kensington Engineering
Wild Heerbrugg Instruments, Inc.
Wiltron Co.
Wright Engineering
Xcelite Inc.
Yellow Springs Instrument Co.
Zero Manufacturing Co.
The Zippertubing Co.

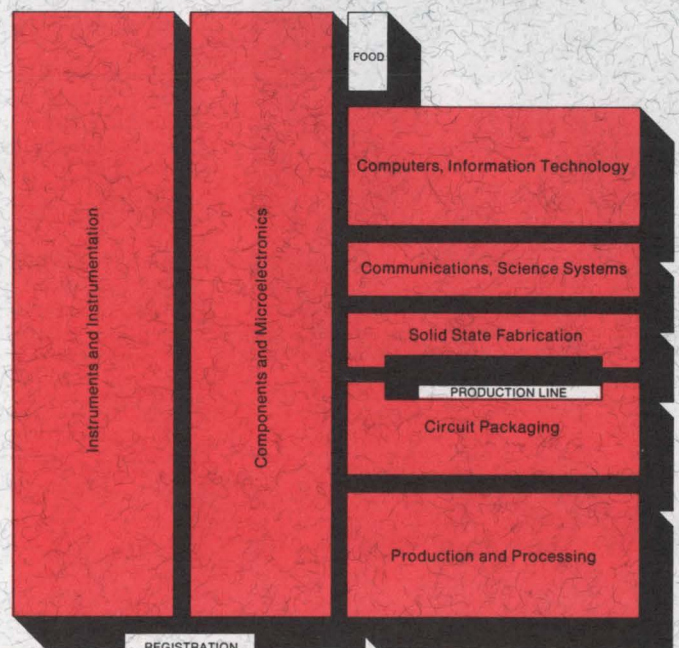

Wescon Vital Statistics at a Glance

Where: Los Angeles Convention Center

When: Tuesday, September 19 through Friday, September 22.

Registration fee:

Except for exhibitor personnel, all Wescon registration is at the door. Advance registration is not available. \$5 registration includes credentials for all professional sessions, Science Film Theater, and all exhibits for all four days.

Proceedings:

Manuscript preprints of most papers are available at the convention, bound by sessions, at \$2 per session.

Exhibit hours:

Tuesday, September 19/9:30 am-5 pm
 Wednesday, Sept, 20/9:30 am-9 pm
 Thursday, September 21/9:30 am-5 pm
 Friday, September 22/9:30 am-4 pm

Professional Sessions:

10am and 2 pm, Tuesday, Wednesday and Thursday; 10am Friday

Special Events Ticket Order Form

Mail to: WESCON Ticket Bureau, 3600 Wilshire Blvd., Los Angeles, Ca. 90010
 Sirs: Please fill the following ticket order and mail to me as indicated below:

- WESCON Luncheon, Convention Center, September 19 _____ at \$6.50, total _____
- "Around the World in 80 Minutes" All-Industry Reception, Convention Center, September 19 _____ at \$6.50, total _____
- Women's Marina tour and luncheon, September 21 _____ at \$5.00, total _____

Name _____
 Company _____
 Address _____
 City _____ State _____ Zip _____

Check in the amount of \$ _____ enclosed.
 (Mail orders filled until September 10. After that date, they will be held in Will-Call at Convention Center.)

Hotel/Motel Reservation Form

Mail to: Wescon Housing Bureau, Box 3696, Los Angeles, Ca. 90054

Please make the following hotel reservation:

Hotel: (First choice) _____ (Second choice) _____

Arrival Date: _____ Time _____ Single Double

Departure Date: _____ Time _____

Room occupants _____

Mail confirma- Name _____
 tion to: Company _____

Reservations will be confirmed directly by hotel. Address _____
 City _____ State _____ Zip _____

Hotels	Address	Single	Double
Airport-Marina	8601 Lincoln Blvd.	18.00-23.00	22.00-27.00
Alexandria	Spring at Fifth St.	11.00 Up	14.00 Up
Ambassador	3400 Wilshire Blvd.	18.00-28.00	24.00-34.00
Biltmore	515 S. Olive St.	16.00-28.00	21.00-31.00
Century Plaza	2025 Ave. of the Stars	30.00-40.00	38.00-48.00
City Center Motel	1135 W. 7th St.	12.00-14.00	14.00-16.00
DeVille Motel	1123 W. 7th St.	9.00-12.00	10.00-14.00
Downtown Motel	944 Georgia St.	10.00	12.00
Figueroa	939 S. Figueroa St.	8.00-10.00	12.00-14.00
Holiday Inn—Downtown	750 Garland St.	14.00	20.00
International	6211 W. Century Blvd.	18.00-24.00	22.00-28.00
Kent Inn Motel	920 S. Figueroa St.	12.00-15.00	15.00-17.00
Los Angeles Hilton	930 Wilshire Blvd.	16.00-27.00	22.00-33.00
Mayfair	1256 W. 7th St.	10.00-14.00	12.00-16.00
Mayflower	535 S. Grand Ave.	13.50-20.00	18.00-24.00
Nutel Motel	1906 W. 3rd St.	9.00-11.00	12.00-14.00
Olympian	1903 W. Olympic Blvd.	13.00-16.00	16.00-20.00
Royal Host Olympic	901 W. Olympic Blvd.	10.00-12.00	12.00-14.00
Sheraton West	2961 Wilshire Blvd.	21.00-30.00	27.00-36.00
Vagabond Motor Hotel	1904 W. Olympic Blvd.	10.00-16.00	14.00-18.00
Wilshire Hyatt House	3515 Wilshire Blvd.	20.00-24.00	25.00-30.00



application notes

Insulation materials

The second edition of the "Electrical Insulation Materials Guidebook" has been considerably expanded to include sleeving, heat-shrinkable tubing, and insulated wire, relevant data on phenolics, tapes and adhesives. Commercial Plastics & Supply Corp., Cornwells Heights, Pa.

CIRCLE NO. 357

Magnetic shielding

A 12-page booklet entitled "Magnetic Shielding, Electrical Materials," contains data on classes of shielding materials, selection of materials, annealing and handling procedures, design considerations, evaluation of effectiveness of shielding, and other similar subjects. Allegheny Ludlum Steel Corp., Pittsburgh, Pa.

CIRCLE NO. 358

Spectrum analysis

A discussion of spectrum analyzers and how they can serve cable television systems is included in a 24-page, three-part booklet. The booklet discusses how a spectrum analyzer can verify good engineering standards and make measurements, presents a summary of the FCC requirements that can be verified with a portable battery-operated spectrum analyzer, and gives a brief tutorial on spectrum analyzers. Tektronix, Inc., Beaverton, Ore.

CIRCLE NO. 359

Optical glasses

Properties of four types of high-temperature, low-expansion optical glasses are reported in a series of technical bulletins. The illustrated publications describe Vycor infrared transmitting glass (Corning Code 7906); Vycor optical glass (Corning Code 7913); fused silica (Corning Code 7940); and ULE titanium silicate (Corning Code 7971). Corning Glass Works, Corning, N.Y.

CIRCLE NO. 360

Metal deposition

An eight-page brochure contains technical information on the Hone-Forming process. Using a question and answer format, the brochure discusses Hone-Forming's ability to simultaneously deposit metal onto a base material surface and abrade the new surface to a required dimension and finish. The brochure covers deposition rates, hardness factors, type of base materials and plating metals, and typical Hone-Forming applications. In addition, the Hone-Forming brochure features the machine's ecology system and illustrations of the machine. XLO Micromatic, Excell-O Corp., Holland, Mich.

CIRCLE NO. 361

FET-input op amps

A six-page application bulletin on the 8007 6V/microsecond slewing FET-input amp lists a number of important applications, with circuit diagrams, including log and antilog amplifiers, photocell amplifier, peak detector and sample-and-hold circuits. It also includes an introduction discussing the design impact of the 8007's \$5 price, plus a summary of characteristics, detailed circuit description, and short paragraphs on the device's 0.5 to 3.0 pA input current, input offset voltage drift, and wideband noise performance. Intersil Inc., Cupertino, Calif.

CIRCLE NO. 362

Coupling transformers

A telephone coupling transformer application bulletin aids in the specification of telephone system interconnect coupling transformers. The six-page bulletin is intended to familiarize the design engineer with information regarding the telephone system, its capabilities, requirements, and terminology. The bulletin presents typical capabilities of voice grade dial-up as well as dedicated telephone lines for audio and data transmission. Also presented are interconnect requirements such as return loss, frequency response, distortion, and longitudinal balance. Microtran Co., Inc., Valley Stream, L.I., N.Y.

CIRCLE NO. 363

Low cost CRT Power Supplies

YOU ASKED FOR HIGH VOLTAGE AT LOW COST ... SO WE BUILT THE "L" SERIES JUST FOR YOU.



MODEL LR-15 (Regulated)

- Input: +21 to 32VDC
- Output: +10 to 15KV @ 300 μ A
- Auxiliary outputs:
 - G₁: 0 to -150VDC @ 1mA
 - G₂: +650VDC @ 1mA
- Ripple: .05% P-P @ 250 μ A
- Excellent dynamic regulation, 10V/100 μ A load
- .03%, 0 to F.L. static regulation

MODEL LU-15 (Output \propto input)

- Input: +3 to 15VDC
- Output: +3 to 15KV @ 300 μ A
- Auxiliary outputs:
 - G₁: 0 to -150VDC @ 1mA
 - G₂: +650VDC @ 1mA
- Ripple: .25% P-P @ 150 μ A
- Regulation: 2%, 1/2 to F.L.
- 15" anode lead w/connector
- High voltage monitoring T.P.

The new Venus "L" Series provides variable outputs to 15KV with ultra-reliability—MTBF is 52,000 hours (0 to 60°C). Other features include plug or wire-in capability, short circuit and reverse polarity protection... and *this* big feature: low price. "L" Series supplies are available off-the-shelf, and are priced in the \$66/\$100 range for production quantities. Write for full data before you specify another miniature CRT power supply.

Venus Scientific Inc.

399 SMITH STREET
FARMINGDALE, N.Y. 11735
Telephone (516) 293-4100
TWX: 510-224-6492

new literature

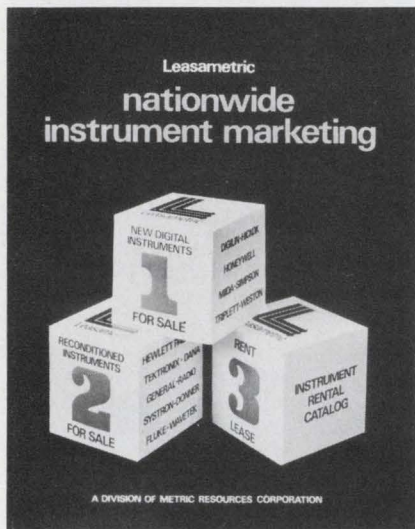

Digital instruments

A 64-page Instrumentation Marketing Catalog covers three sections. The first section contains detailed spec sheets of 12 DVMs by seven prominent manufacturers that may be purchased new. The second section covers used Hewlett Packard and Tektronix equipment that is refurbished and guaranteed. It also serves as a "blue-book" of used prices. The last section contains rental rates and information on instruments. Leasametric, Burlingame, Calif.

CIRCLE NO. 364

Industrial relays

Dimensional, and electrical data on electronic, electromechanical and reed relays are contained in a four-page short-form catalog. Included are latching, industrial, general purpose and military types. North American Philips Controls Corp., Cheshire, Conn.

CIRCLE NO. 365

Test instrumentation

The J133 analogical circuit test instrument is described in a 55-page price list and catalog. Over 3800 digital ICs that can be tested on the J133 are listed by manufacturers' part numbers, with the stock numbers and prices of the J133 programming board for each IC. Teradyne, Inc., Boston, Mass.

CIRCLE NO. 366

Modular oscillators

A 12-page, two-color catalog describes a complete modular oscillator line. Detailed specifications including frequency ranges, output waveforms, dimensional and mounting drawings and terminal layouts are shown. Related accessories such as modular power supplies and frequency dividers, along with a line of precise frequency power inverters, are also included. Fork Standards, Inc., Chicago, Ill.

CIRCLE NO. 367

Power supplies

Specifications, descriptions and features of power supplies are described in a series of bulletins. Power/Mate Corp., Hackensack, N.J.

CIRCLE NO. 368

Instrumentation amp

A data sheet on model 310 instrumentation amplifier describes the use of this low-drift module as a bridge amplifier. Techniques for grounding and shielding are discussed. Function Modules, Inc. Irvine, Calif.

CIRCLE NO. 369

Portable recorder

A new data sheet provides complete specifications on Model TR-444 four-channel portable recorder. Full details are provided on five types of interchangeable signal conditioners. Useful options and accessories are listed. Gulton Techni-Rite Electronics, Inc., Greenwich, R.I.

CIRCLE NO. 370

PC board testing

A six-page brochure describes the Model DC-IV computerized circuit board test system. The brochure describes system operation; capabilities, control system and display and available options of this versatile and expandable diagnostic test equipment. Digital General Corp., Cleveland, Ohio.

CIRCLE NO. 371

LSI design systems

A 12-page, two-color brochure describes the MD-170 FEDIS LSI design system. The brochure discusses the need for a modern LSI design system and the "make-or-buy" alternatives. Complete with photos and charts, it describes the operation in detail. Also, four pages are devoted to the CADIS software programs that, together with FEDIS, provide the designer with a unique and virtually error-free system for checking his LSI designs. Macrodata Co., Chatsworth, Calif.

CIRCLE NO. 372

Oscilloscope accessories

A two-color catalog of accessories available for the company's line of oscilloscopes includes detailed applications information as well as illustrations and descriptions. The inside back cover of the catalog is devoted to a computer-generated chart for multiple square-law addition of pulse rise times. Test & Measuring Instruments, Inc., Hicksville, N.Y.

CIRCLE NO. 373

Data General price list

A price-list catalog contains pricing information on all of the company's minicomputer and peripheral equipment along with space requirements and prerequisite equipment necessary for each hardware item. Service and warranty extension contract prices for each product are also available. Data General Corp., Southboro, Mass.

CIRCLE NO. 374

Ac line conditioners

A broad line of ac line conditioners, ac regulators, converters, inverters and switching dc power supplies are described in a 28-page catalog. Text in the catalog gives technical explanation of the principal of passive power conversion which provides regulation combined with bilateral filtering of ac. The catalog then gives specifications and prices of ac line conditioners. Ambac Industries, Tele-Dynamics/Wanlass Div., Fort Washington, Pa.

CIRCLE NO. 375

'D' SERIES CASES



Part of a Complete Packaging Capability

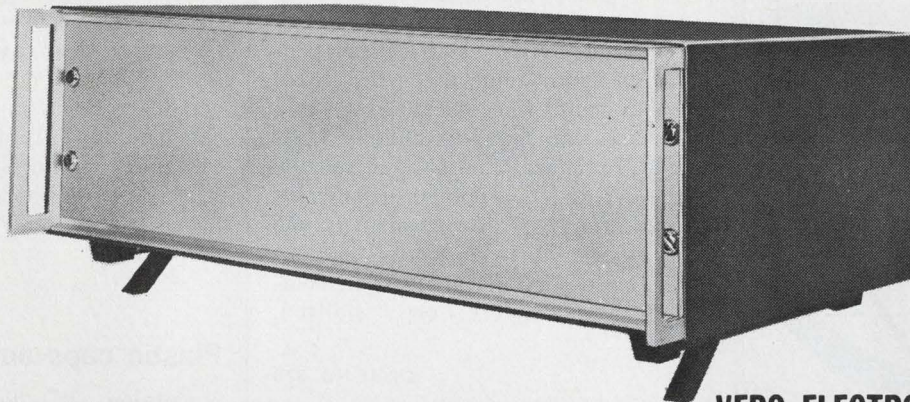

Vero slim-line 'D' cases add style to any instrument.

Features include:

- Integral front trim with or without handles
- Retractable tilt feet
- Removable bottom and rear panels incorporating ventilation slots

- Wide range in common styling
- 8½", 12½" or 17½" deep
- 10½" or 19" wide
- 1U to 6U heights
- Side handles - standard on 17½" deep version, extra on other sizes
- Chassis runners and front panels also available

VERO ELECTRONICS INC.

171 BRIDGE ROAD
HAUPPAUGE, N.Y. 11787
TEL: 516 234-0400
TWX: 510 227-8890

**INQUIRE ABOUT OUR
NEW DESIGN SERVICE**

INFORMATION RETRIEVAL NUMBER 69

FREE! NEW INSERTION HANDBOOK

FOR AXIALS, DIP'S, TRANSISTORS

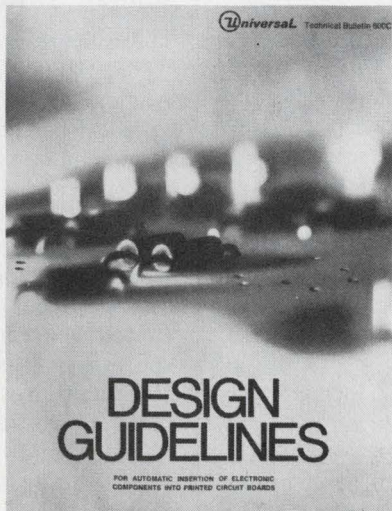

New, comprehensive, 16 page technical bulletin covering today's industry standards and design parameters for automatic insertion of electronic components into PC boards. Over 30 detailed schematics. Send for it now. Dept. ED-72

Universal INSTRUMENTS CORPORATION
East Frederick St., Binghamton, N.Y. 13902
(607) 772-1710/TWX 510-252-1990

INFORMATION RETRIEVAL NUMBER 70

ELECTRONIC DESIGN 17, August 17, 1972

SECURITY with ALCOSWITCH



Long-life switch & Alnico-5 magnet assemblies actuate within distances of 1". Use as interlock, counters, alarms & other applications. 0.5A break, 1.0A carry. N.O. \$2.85, N.C. \$3.15.

ALCO

ELECTRONIC PRODUCTS, INC., NO. ANDOVER, MASS. 01845



Attractive Keylock Switch with convenient one-hole mounting. Key is removable in either on/off position. Has double-bitted keys. 5A @ 125 VAC rating. Supplied with two keys @ \$4.95.

INFORMATION RETRIEVAL NUMBER 101

PUSH BUTTON SWITCH - RELAY WITH MEMORY

Another Alco First. . . By combining a push on/off switch and a relay, we've created a very unusual safety switch. If power is accidentally interrupted it automatically cuts off the load. Specify, 117 VAC, 6VAC or 12VDC. Rating 5A.

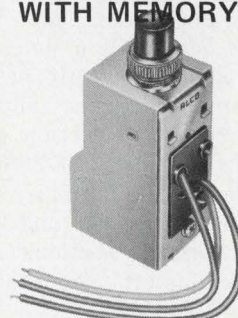

ALCOSWITCH[®]
ALCO ELECTRONIC PROD.,

NO. ANDOVER, MASS. 01845.

INFORMATION RETRIEVAL NUMBER 102

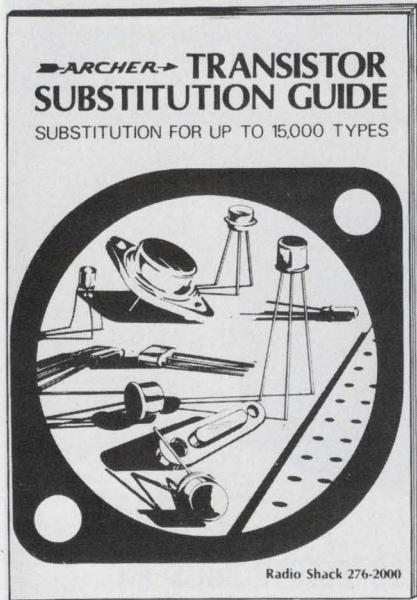

Transistor substitutes

The Archer Transistor Substitution Guide lists 15,000 commercial transistor types which, in most cases, may be directly replaced or substituted for with one of the company's 29 transistors. Detailed specifications and electrical characteristics are given in the 96-page booklet. The booklet also contains useful information on the care and handling of transistors, details on testing transistors and important suggestions on the use and replacement of transistors and is priced at \$1. Radio Shack, Dept. EP-1, 2617 W. Seventh St., Fort Worth, Tex. 76107.

JFETs

Junction field effect transistors (JFETs) are covered in a 160-page manual entitled, "JFET Specifications and Applications." Included in the manual are the following sections: tabular data, specifications, parameters and operating curves; application notes covering basic theory, circuit design, performance analysis and critical measurements; selection guides for finding the best JFET for a given circuit use; definitions, equations, glossary of terms and dozens of other useful sections. Teledyne Semiconductor, Mountain View, Calif.

CIRCLE NO. 377

Test equipment

An illustrated 16-page all-line test equipment catalog features digital VOMs, hand-size portable and general multipurpose VOMs, FET VOMs with micropower, low power ohms and auto polarity features, laboratory accuracy 1-1/2 to 3% VOMs, special industrial maintenance analyzer kit, portable panel instrument kits, electrical compensation type temperature tester, an assortment of accessories, sales and service data plus a unique VOM selector chart. The 58-T catalog is three-ring, hole punched and indexed for easy reference use. Single unit prices for each test instrument and accessory are printed in bold-face red. Triplet Corp., Bluffton, Ohio.

CIRCLE NO. 378

Function generators

A complete catalog covers a line of function, sweep and digital function generators plus waveform synthesizers. The catalog contains specifications, prices, options and rackmounting information along with ordering and warranty information. Exact Electronics, Inc., Hillsboro, Ore.

CIRCLE NO. 379

Peak detector

A new bulletin, DP-550, describes a digital peak detector that accurately measures dynamic peaks. Koehring, Pegasus Div., Troy, Mich.

CIRCLE NO. 380

Instrument enclosures

A color brochure provides an overview of cases, racks and consoles that are represented in a large variety of configurations and colors. Scientific-Atlanta, Inc., Optima Enclosures, Tucker, Ga.

CIRCLE NO. 381

Digital joystick

Features and a description of the direct digital joystick are given in a two-page data sheet, A9 724 AF. Also listed are typical applications and general specifications. The Singer Co., Librascope Div., Glendale, Calif.

CIRCLE NO. 382

Computer graphics

An amusing 12-page booklet tells the story of man's attempts to communicate using graphics. Starting with the cave man, this new booklet traces man's requirements for increasing sophistication of graphic displays. Actually, this publication details specifications of the Model 7200A graphic plotter. In easy-to-read cartoon style, "The Story of Computer Graphics" demonstrates advantages of graphical computer output and gives many examples in the fields of business, statistics, mathematics and engineering. Hewlett-Packard Co., Palo Alto, Calif.

CIRCLE NO. 383

Plastic caps and plugs

Catalog PD-200 illustrates a complete line of plastic caps and plugs and includes prices and dimensions. Robroy Industries, Plastics Div., Morrisville, Pa.

CIRCLE NO. 384

Strip-chart recorders

Catalog sheet, REC-1002, describes the company's full line of strip-chart recorders. Also listed and described as ac and dc ammeters and voltmeters, ac volt/ammeters, thermometers, pyrometers, event recorders and time-sharing recorders. SOS Consolidated, Inc., Amprobe Instrument Div., Lynbrook, N.Y.

CIRCLE NO. 385

Analog switches

Application Bulletin No. A004, "The IH5009 Series of Low-Cost Analog Switches," includes a detailed description of circuit operation and applications of the analog switches. Other sections in the eight-page bulletin include a discussion of interfacing the switches with 5 V logic, or with 15 V open-collector logic; maximum switch current; and switching speed and crosstalk. A comprehensive table presents details of input logic drive, actual and effective $R_{DS(ON)}$, and product description for all 32 switch variations in the family. Also shown are circuit diagrams. Intersil Inc., Cupertino, Calif.

CIRCLE NO. 386

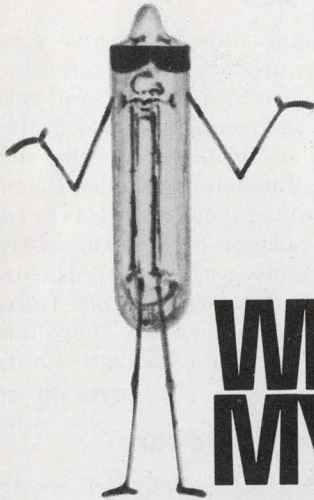

WHAT'S MY LINE?

Making things happen! . . . as arc suppressors, multivibrators, oscillators, photochoppers, voltage regulators, relays, SCR controllers, wave generators and lots of other things. I'm low-cost and long-lasting with close tolerance and reliability . . . I'm an Inner-Vator from Glowlite. Take the blindfold off. Write for my catalog # ELD-172.

Glowlite

CORPORATION

Subsidiary of El-Tronics, Inc.
Pauls Valley, Okla. 73075 • (405) 238-5541
INFORMATION RETRIEVAL NUMBER 72

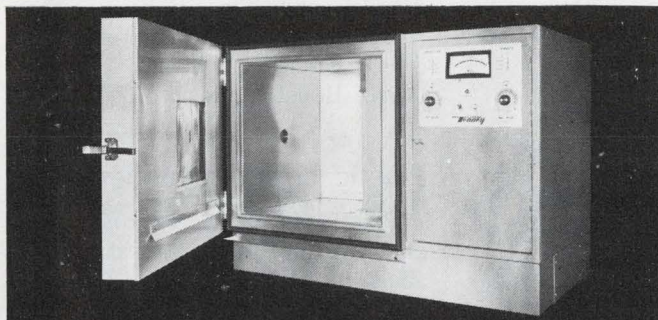

NEW BENCHMASTER... 5 CUBIC FEET OF BENCH-TOP TEST SPACE!

Economical, portable, and compact, this all-new front-opening temperature and humidity test chamber is only 4 feet wide!

It's extremely versatile, too. Benchmaster offers medium or extreme temperature ranges—with or without humidity. Benchmaster is available in 4 performance variations:

- Model BTH: 0°F to 200°F with humidity
- Model BTRS: -40°F to 350°F with humidity
- Model BTR: -100°F to 350°F with humidity
- Model BTC: -100°F to 350°F without humidity

Write for complete information.

TNY
Tenney
ENGINEERING, INC.

1090 Springfield Rd., Union, N. J. 07083 (201) 686-7870 • (212) 962-0332
Western Division: 15721 Texaco St., Paramount, Calif. 90723.

INFORMATION RETRIEVAL NUMBER 73

ELECTRONIC DESIGN 17, August 17, 1972

Your old counter and

\$365*

gets you to

600 MHz



The new Heath/Schlumberger SM-114A Scaler extends the useful range of any counter with more than 100 kHz capability. Three pushbutton-selected ranges allow division of input frequency by 1, 10 and 100. The $\div 1$ range provides for direct transmission of frequencies from 10 MHz to 100 MHz with a gain of 17 dB; $\div 10$ and $\div 100$ ranges will scale frequencies between 40 MHz and 600 MHz.

Output voltage and impedance matches all counters. The new SM-114A features a 50 ohm output impedance with 50 mV rms sensitivity and an output of 1 V P-P into a 50 ohm load. The input is protected to 5 V rms and has a VSWR of 2:1 up to 2 V rms. The 1 V P-P output will drive virtually every counter on the market, and with only 50 mV required from the signal source.

Simple to use. Unlike many other frequency scalars, the Heath/Schlumberger SM-114A has no sensitivity adjustment or input attenuator. Just connect the input and output signals with standard BNC-type cables and select the dividing range. Scale frequency into the UHF region at low cost.

Order the SM-114A now.

Assembled SM-114A, 8 lbs. \$365.00*

SM-114A SPECIFICATIONS — INPUT — Frequency Range: $\div 1$ — Sine or square wave: 10 MHz to 100 MHz. $\div 10$ — Sine wave: 40 MHz to 600 MHz (typical 15 MHz to 600 MHz). Square wave: 10 MHz — 600 MHz. $\div 100$ — Sine wave: 40 MHz to 600 MHz (typical 15 MHz to 600 MHz). Square wave: 10 MHz — 600 MHz. **Amplitude:** Minimum — 50 mV RMS. Maximum — 2.0 V RMS (to maintain 2:1 VSWR) protected to 5 V RMS. **Impedance:** 50 Ω with less than 2:1 VSWR from 10 MHz to 600 MHz and less than 2 V RMS input voltage, AC coupled. **OUTPUT — Amplitude:** 1 V P-P. Impedance: 50 Ω , AC coupled. **POWER REQUIREMENTS —** 120 V, 50/60 Hz, 7 watts. May be changed to 240 V with internal switch and change of fuse. **DIMENSIONS —** 9 $\frac{1}{4}$ " deep, 6 $\frac{3}{4}$ " wide, 2 $\frac{1}{4}$ " high.

Count Frequency
To 80 MHz For
As Little As \$350.*



For counting capability into the high frequency region at modest cost, check out the Heath/Schlumberger 80 MHz frequency counters:

Our SM-105A provides 10 Hz to over 80 MHz range, 5-digit LED readout, 100 mV rms input sensitivity and time base stability of ± 10 ppm... for just \$350.*

Our SM-104A counter provides the same range and readout as the SM-105A, but has a research-grade TCXO time base guaranteed stable to 1 part in 10⁶ per year and 5 digits of TTL-compatible BCD output... for only \$500.*

HEATH/SCHLUMBERGER SCIENTIFIC INSTRUMENTS

Dept. 531-263
Benton Harbor, Michigan 49022

- Please send additional information on the SM-114A Scaler.
- Please send latest Scientific Instruments catalog, which includes SM-104A & SM-105A information.

Name _____
Title _____
Company/Institution _____
City _____ State _____ Zip _____

*Mail order prices; F.O.B. Benton Harbor, Michigan
Prices and specifications subject to change without notice. EK-338

INFORMATION RETRIEVAL NUMBER 74

The Elegant Molded Parts

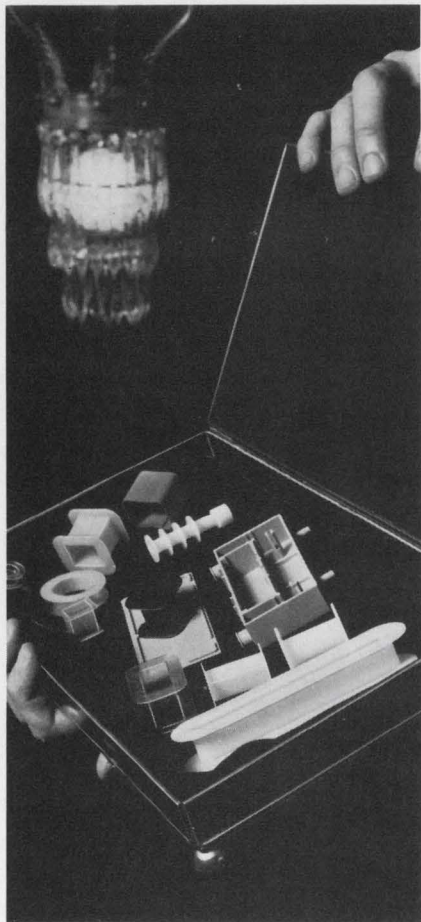

For elegant applications. Custom-made or standard, EPC parts come with thin walls down to 5 mils, tolerances to $\pm .05\%$ — even threaded bushings. In six different materials: fluorocarbon, nylon, glass-reinforced nylon, DAP, polyester and epoxy. For temperature ranges that go up to 200°C.

It's just the sort of selection and craftsmanship that you expect from EPC as an EAI component company. Look to EPC also for transformer kits. Or to EAI for thick-film audio amps. Capacitors. Custom coils. Solenoids. Active filters. Analog / digital converters and other special function modules. Plus a growing list of other elegantly crafted etceteras.

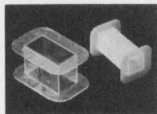

EPC

Electrical Plastics Corporation
500 Long Branch Avenue
Long Branch, New Jersey 07740
Tel. (201) 870-9500

A Subsidiary of Electronic Associates, Inc.

INFORMATION RETRIEVAL NUMBER 75

NEW LITERATURE

Microwave instruments

Catalog No. H-72 gives complete descriptions, specifications, photographs and prices of a line of microwave instruments and components. Also contained is descriptive material on the computerized automatic systems tester system. Typical applications of many products are described and a list of domestic and foreign sales offices is provided. A postpaid catalog registry card is included to permit the recipient to request continuous updating of the catalog. PRD Electronics, Inc., Div. of Harris-Inter-type Corp., Westbury, N.Y.

CIRCLE NO. 387

Digital correlators

A 16-page, two-color brochure on real-time digital correlators shows how these universal time-domain processing instruments are used for real-time auto-correlation, cross-correlation, signal enhancement, probability density and cumulative probability distribution. Federal Scientific Corp., New York, N.Y.

CIRCLE NO. 388

Servo controller

A servo controller designed to drive a linear or rotary hydraulic actuator in a closed-loop load or position servo system is described in bulletin, SC-503. Koehring, Pegasus Div., Troy, Mich.

CIRCLE NO. 389

Solid-state relays

Solid-state relays for applications ranging from motors, solenoids, load banks and heaters to machine tool control, computer load interface, lamp drivers and traffic signal control are described in a general catalog. Design characteristics are cited. The catalog contains standard mounting recommendations and thermal characteristic charts. Charts indicate thermal characteristics vs. current and show heat sink effect on ac relays. A schematic drawing shows resistance values. Genisco Technology Corp., Components Div., Compton, Calif.

CIRCLE NO. 390

Slide rules

All-metal slide rules and other precision products are covered in a 40-page catalog. The full-color catalog has complete and definitive sections on linear and circular slide rules (all-metal, plastic and bamboo), templates and lettering guides, calculators, drafting instruments and accessories, drawing boards and tables. Pickett Industries, a subsidiary of The Times Mirror Co., Santa Barbara, Calif.

CIRCLE NO. 391

Electronic hardware

A 250-page catalog features the company's full range of products, electrical/electronic hardware, spring clips, washers and military standards specially indexed for ready reference. Engineering tables, materials, finish specifications, and a list of local sales representatives are also included. Seastrom Manufacturing Co., Glendale, Calif.

CIRCLE NO. 392

Transducers and load cells

Seven product data sheets contain complete specifications on force washers, position and position/velocity transducers and load cells. Houston Scientific, HSI Corp., Houston, Tex.

CIRCLE NO. 393

Plastic circular connectors

Plastic circular connectors, available in 7, 12 and 24-contact versions in both plug and receptacle body styles for panel mounting, cable-to-cable or cable-to-panel applications, are described in an eight-page brochure. Viking Industries, Inc., Chatsworth, Calif.

CIRCLE NO. 394

Diode bridges

The six most frequently used circuits in the PACE/pak series are described in a data sheet. The bulletin provides complete specifications, characteristics and ratings of the six circuits, as well as circuit diagrams for the different configurations. A dimensioned outline drawing, two graphs and a photograph of the device are included. International Rectifier Corp., Semiconductor Div., El Segundo, Calif.

CIRCLE NO. 395

bulletin board

RCA has introduced a line of **communications and navigation equipment for general aviation aircraft** that offers double the frequency operating channels of earlier systems. The new systems are called the AVC-110A and 111A VHF communications transceivers and the AVN-220A and 221A integrated navigation system. The communications unit is an all solid-state, 720-channel transceiver with 25-kHz spacing. Previous RCA systems offered 360 channels with 50-kHz spacing. The AVC-110A and 111A have a frequency range from 118 to 135.975 MHz. The AVN-220A is an all solid-state navigation system featuring a glide-slope with 40 channels—twice that of previous RCA systems—that can be selected automatically.

CIRCLE NO. 419

A **conversational assembler** that also provides extensive on-line editing and updating capabilities is being offered to users of **Computer Automation, Inc.**, 16-bit Naked Mini and Alpha 16 mini-computers, without charge. Called OMEGA, the software package enables paper tape users to perform both editing and program assembly functions in core memory, eliminating the treadmill chore of re-punching tapes to eliminate all errors prior to final program assembly.

CIRCLE NO. 420

Price reductions

Tyco Saphikon Div., Waltham, Mass., has revealed a dramatic 50% reduction from present market prices for **polished, single crystal sapphire substrates**. A typical 2-inch diameter, polished sapphire substrate with 1102 crystal orientation for SOS use is priced at less than \$18 in quantity, claimed by the company to be around 50% of any price on the market today for high quality sapphire substrates.

CIRCLE NO. 421

Micro Switch has reduced prices 7 to 13% on **solid state keyboards** scheduled for delivery after Jan. 1, 1973. The new prices would depend on quantity, array and electronic configuration. The current price reduction is the fourth occasion on which Micro Switch keyboard prices have been reduced since the division introduced the Hall-effect solid state keyboard in 1968. This is credited to continuing cost reduction and increasing demand.

CIRCLE NO. 422

Intel Corp.'s Type 3601 bipolar 1024 bit silicon gate pROM (see ED 12, June 8, 1972, p. 90) has been reduced in price from \$55 to \$39 in 100-up quantities. At the same time, the access time has been increased from 45 to 70 ns.

CIRCLE NO. 423

Monsanto Commercial Products Co. has announced a price reduction for its **dual-channel optoisolator**, the MCT6, formerly MCT2D. Former pricing was \$9.80 (1-9), \$7.75 (10-99), \$6.60 (100-999), and \$5.95 (1000). The new pricing is listed at \$6.95, \$5.65, \$4.65, and \$4.20, respectively. The reduction was made possible because of improved production yields and improved product efficiency.

CIRCLE NO. 424

Prices have been reduced on **Varian Associates' Gunn-effect fundamental oscillator diodes** amounting to 50%-85%. Large quantity prices for C, X and K-band diodes now begin at \$21.90. The new price schedule applies to diodes operating between 4 and 26 GHz with output powers between 10 and 200 mW.

CIRCLE NO. 425

Intech has cut prices 23% on its **chopper stabilized amp, models A-240 and A-241**. The A-240 now sells for \$63 vs. \$82 in quantities of 10 to 99. For lower quantities the new price is \$70 compared to \$91. Model A-241 now sells for \$67.50 vs. \$88 in lots of 10 to 99 and for \$75 compared to \$97 in quantities less than 10.

CIRCLE NO. 426

Your best choice in enclosures

- oil and dust tight
- EMI/RFI shielded
- rigid one-piece construction
- available from stock

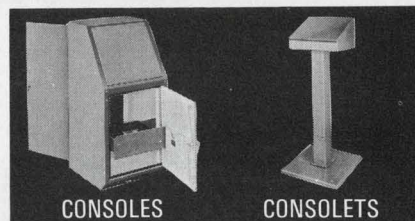

CONSOLES

CONSOLES

Consoles in versatile stock design, 50" x 24" x 23", with gasketed front and rear doors. Options include rack angles, swing-out and stationary subpanels and writing desk. **Consoles** are offered in eleven stock sizes for desktop mounting of remote controls. Floorstand optional.

All units are heavy gauge steel with all-welded seams, easily shielded.

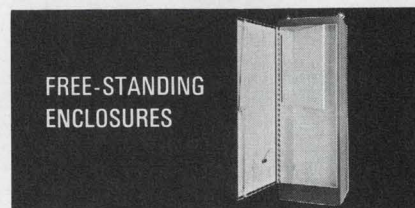

FREE-STANDING ENCLOSURES

NEMA 12 units in stock sizes up to 90" x 36" x 24". Rigid 12 gauge steel with all-welded seams, gasketed doors front and/or rear. Oil and dust tight. Options include several interior panel arrangements, rack angles and shielding.

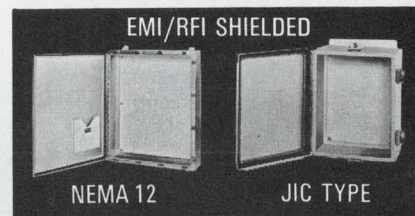

EMI/RFI SHIELDED

NEMA 12

JIC TYPE

Heavy gauge steel boxes with hinged doors, all cadmium plated. Oil and dust tight, fully shielded. Interior mounting panels and terminal block kits optional. Shipment from stock, all sizes.

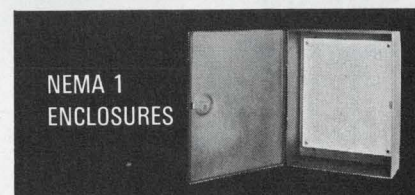

NEMA 1 ENCLOSURES

For mounting controls where oil, dust and water are not a problem. One-piece heavy gauge steel construction, finished in gray prime. Flush latches. Interior panels for mounting components. Wide size range in stock.

Hoffman

HOFFMAN ENGINEERING COMPANY
Division of Federal Cartridge Corporation
Anoka, Minnesota, Dept ED-4310

ELECTRICAL ENCLOSURES

INFORMATION RETRIEVAL NUMBER 76

Now get a firm grip on your lead-mounted semi's and heat problems, too

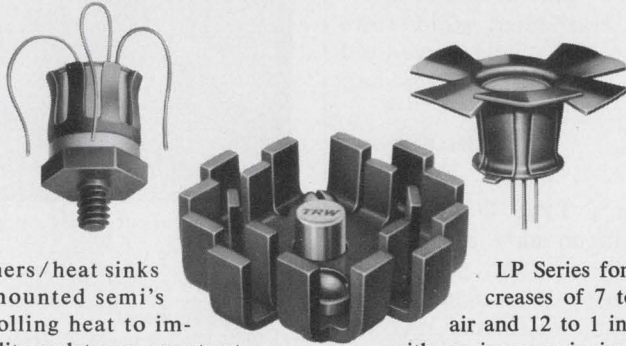

IERC retainers/heat sinks hold lead-mounted semi's while controlling heat to improve reliability or let you operate at higher power levels. Our TXB's for Mil-spec environments are excellent retainers on p-c boards or serve as efficient thermal links between case and heat sink. BeO washers are available for electrically-hot-case applications. Use our staggered-finger

LP Series for power increases of 7 to 1 in still air and 12 to 1 in forced air with no increase in junction temperature. And, if your semi's are already mounted, slip on a Fan Top and get higher wattages for just pennies. Send for catalog. IERC, 135 W. Magnolia Blvd., Burbank, Calif. 91502, a Corporate Division of Dynamics Corporation of America.

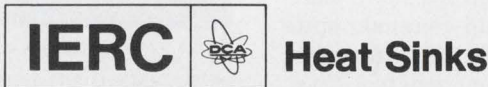

INFORMATION RETRIEVAL NUMBER 77



Synchron.®

The motor with 10,000 lives.

Our A-C timing motors are quietly at work in thousands of applications, all over the world. Each fitted to specific requirements, with our confidential help.

Choose from five major styles. Speeds from one revolution per week to 900 revolutions per

minute. Torque from 8 to 98 oz.-in. at 1 rpm. Hundreds of output options. All competitively priced.

Write now for specs of the motor with 10,000 applications. Including yours. Or contact one of our representatives below.



hansen manufacturing company, inc.
Princeton, Indiana 47670

Hansen Representatives: CAREY & ASSOCIATES, Houston and Dallas, Texas; R. S. HOPKINS CO., Sherman Oaks, Calif.; MELCHIOR ASSOCIATES, INC., San Carlos, Calif.; THE FROMM CO., River Forest, Ill.; JOHN ORR ASSOCIATES, Grand Rapids, Mich.; H. C. JOHNSON AGENCY, INC., Rochester, N.Y.; WINSLOW ELECTRIC CO., Essex, Conn.; KILEY ELECTRIC CO., Villanova, Pa.; and HERBERT RUDE ASSOCIATES, INC., Teaneck, N.J.



INFORMATION RETRIEVAL NUMBER 78

Electronic Design

ELECTRONIC DESIGN's function is:

- To aid progress in the electronics manufacturing industry by promoting good design.
- To give the electronic design engineer concepts and ideas that make his job easier and more productive.
- To provide a central source of timely electronics information.
- To promote communication among members of the electronics engineering community.

Want a subscription? ELECTRONIC DESIGN is sent free to qualified engineers and engineering managers doing design work, supervising design or setting standards in the United States and Western Europe. For a free subscription, use the application form bound in the magazine. If none is included, write to us direct for an application form.

If you do not qualify, you may take out a paid subscription for \$25 a year in the U.S.A., \$35 a year elsewhere. Single copies are \$1.50 each.

If you change your address, send us an old mailing label and your new address; there is generally a postcard for this bound in the magazine. You will have to requalify to continue receiving ELECTRONIC DESIGN free.

The accuracy policy of ELECTRONIC DESIGN is:

- To make diligent efforts to ensure the accuracy of editorial matter.
- To publish prompt corrections whenever inaccuracies are brought to our attention. Corrections appear in "Across the Desk."
- To encourage our readers as responsible members of our business community to report to us misleading or fraudulent advertising.
- To refuse any advertisement deemed to be misleading or fraudulent.

Microfilm copies are available of complete volumes of ELECTRONIC DESIGN at \$19.00 per volume, beginning with Volume 9, 1961. Work is now in process to complete the microfilm edition of Volumes 1-8. Reprints of individual articles may be obtained for \$2.00 each, prepaid (\$.50 for each additional copy of the same article) no matter how long the article. For further details and to place orders, contact the Customer Services Department, University Microfilms, 300 North Zeeb Road, Ann Arbor, Michigan 48106 telephone (313) 761-4700.

Want to contact us? If you have any comments or wish to submit a manuscript or article outline, address your correspondence to:

Editor
ELECTRONIC DESIGN
50 Essex Street
Rochelle Park, N.J. 07662

Electronic Design

Advertising Sales Staff

Bryce Gray
Sales Manager

Rochelle Park, N.J. 07662

Robert W. Gascoigne
Daniel J. Rowland
50 Essex Street
(201) 843-0550
TWX: 710-990-5071

Philadelphia

Thomas P. Barth
50 Essex Street
Rochelle Park, N. J. 07662
(201) 843-0550

Boston 02116

Richard L. Green
20 Columbus Avenue
Boston, Mass.
(617) 482-7989

Chicago 60611

Thomas P. Kavooras
Berry Conner, Jr.
200 East Ontario
(312) 337-0588

Cleveland

Thomas P. Kavooras
(Chicago)
(312) 337-0588
(call collect)

Los Angeles 90303

Stanley I. Ehrenclou
Burt Underwood
2930 Imperial Highway
Inglewood, Calif
(213) 757-0183

San Francisco 94022

Jerry D. Latta
P.O. Box 1248
Los Altos, Calif.
(415) 965-2636

London W. 1

For United Kingdom and Holland
Brayton C. Nichols

For Eastern Europe
Peter Kehr

The American Magazine Group

27 Maddox Street
London, W. 1, England
Phone: 499-0180

Cable: Ammagnic, London

Verviers, Belgium

For Continental Europe

Andre Jamar
1, Ru Mallar, 1
(087) 253.83 Telex 41563

Tokyo

Haruki Hirayama
Electronic Media Service
5th Floor, Lila Bldg.,
4-9-8 Roppongi
Minato-ku
Phone: 402-4556
Cable: Electronicmedia, Tokyo



our international interpreter

(it reads and writes any language)

ASCII
BCDIC
EBCDIC
HOLLERITH

OEM 64, programmable card terminal, can read and write anything you can mark, punch or edge notch. In any code. Or many codes on the same card. You can change its internally stored program. In 5-10 seconds. Edit data before entry. And, it is designed for easy interface. Talk to us about OEM 64 in any language.

日本
volare
parlez vous
buenas días

We also have a full line of readers, punches and printers.

For more information
call Frank Mistlewicz
OEM Products
(201) 935-2200



LITTON ABS

Automated Business Systems
600 Washington Avenue, Carlstadt, N. J. 07072

INFORMATION RETRIEVAL NUMBER 79

ELECTRONIC ENGINEERS:

CAREER OPPORTUNITIES WITH A FLORIDA COMPANY SPECIALIZING IN ADVANCED COMMUNICATIONS SYSTEMS AND HIGH TECHNOLOGY UHF RADIO EQUIPMENT

Electronic Communications, Inc., a subsidiary of NCR, has openings at all levels for electronic engineers experienced in the design and development of communication systems, RF, digital and audio equipment. You will be working with major UHF command and control systems, satellite relay and telemetry systems, and a variety of other challenging long-term programs. At ECI, you (like all of our pros) will function with a minimum of supervision and a maximum of opportunity for advancement. ECI is small enough to give your accomplishments high visibility, yet big enough to provide the facilities and benefits of the largest companies. ECI is on Florida's West Coast — the BEST COAST — in comfortable, sunny cosmopolitan St. Petersburg.

If you are tops in your field, and if you are interested in a career opportunity on long-term programs in an intriguing location, write in confidence today to Paul D. Jordan, Supervisor of Professional Placement, Electronic Communications, Inc., Box 12248, St. Petersburg, Fla. 33733.



A Subsidiary of NCR
An Equal Opportunity Employer

INFORMATION RETRIEVAL NUMBER 900

advertiser's index

Advertiser	Page	Advertiser	Page	Advertiser	Page
AMP, Incorporated	11, 31	Electronic Engineering Co. of California	129	Dynamics Corporation of America	138
Abbott Transistor Laboratories Incorporated	6	Electronic Measurements, Inc.	116	Instrument Specialties Company	105
Alco Electronic Products, Inc.	133	Electrostatics, Inc.	148	Intech, Incorporated	124
Alden Electronic & Impulse Recording Equipment Co., Inc.	142	Fairchild Semiconductor, A Division Fairchild Camera and Instrument Corporation	78, 79	Johanson Manufacturing Corp.	7
Analog Devices, Inc.	117	Fairchild Systems Technology, A Division of Fairchild Camera and Instrument Corp.	101	Keithley Instruments, Inc.	123
Augat, Inc.	106	Federal Scientific Corporation	140	Lafayette Radio Electronics	122
Beckman Instruments, Inc., Helipot Division	95	Fluke Mfg. Co., Inc., John	22	Lambda Electronics Corp.	Cover III
Bourns, Inc., Trimpot Products Division	39	GTE Automatic Electric	14, 15	Librascope Division of The Singer Company	102
Burroughs Corporation	Cover IV	General Electric Company	112	Licon Division, Illinois Tool Works, Inc.	23
Centralab, the Electronics Division of Globe-Union, Inc.	53	Glowlite Corporation	135	Litton Automated Business Systems	139
Cherry Electrical Products Corp.	97	Grayhill, Inc.	122	Litton Industries, Triad Distributor Division	125
Com Cir Tek, Inc.	141	Halex, Inc.	141	3M Company	33
Computer Automation, Inc.	35	Hansen Manufacturing Co., Inc.	138	MCL Inc.	109
Dale Electronics, Inc.	Cover II	Harris Semiconductor	16, 17	Macrodata Company	71
Data Precision Corp.	141	Heath/Schlumberger Scientific Instruments	135	MicroSwitch, A Division of Honeywell	51
Decitek, Division of Jamesbury Corp.	130	Hecon Corporation	127	Miller Company, J. W.	126
Delco Electronics, Division of General Motors Corporation	92, 93	Hewlett-Packard	41, 42, 43, 44, 45, 46, 47, 48, 49, 50	Minelco Division, General Time	118
Digital Equipment Corporation	1	Hickok Instrumentation and Controls Division	128	Motorola Component Products Dept.	111
Dow Corning Corporation	8, 9	Hoffman Engineering Company	137	Motorola Semiconductor Products, Inc.	18, 19
ECC Corporation	52	Houston Instrument, A Division of Bausch & Lomb	108	National Semiconductor Corporation	24
Electrical Plastics Corporation	136	IERC, A Corporate Division of		North Atlantic Industries, Inc.	115
Electro Switch Corp.	120			Nytronics, Inc.	21
Electronic Arrays, Inc.	20			Oak Industries, Inc.	37
Electronic Communications, Inc.	139			Paktron Division, Illinois Tool Works, Inc.	25

Design Data from Manufacturers

Advertisements of booklets, brochures, catalogs and data sheets. To order use Reader-Service Card.
(Advertisement)

Free Wallchart Of Waveform Comparisons

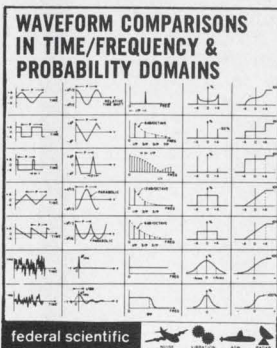

For analyzing random data such as noise, vibration, shock, underwater acoustic signals, and radar, this unique new engineering tool is a convenient picture-reminder of how 10 different basic waveforms look in terms of 5 different processing domains. The waveforms consist of 5 examples of repetitive waveshapes & 5 different random signals. The typical functions shown are: time, auto-correlation, averaged frequency spectrum (PSD), probability density, & cumulative distribution. Printed on heavy glossy stock, the 10" x 12" wallchart is free by writing directly to Federal Scientific, originators of the Ubiquitous® brand of real-time spectrum analysis equipment.

FEDERAL SCIENTIFIC CORP.
615 West 131st Street, New York, N.Y. 10027

CIRCLE NO. 171

Potter & Brumfield Division of AMF, Incorporated	4, 5
Powercube Corporation	54
Pulse Engineering, Inc.	100
Radio Materials Company	119
Siliconix Incorporated	58
Singer Company, The, Kearfott Division	70
Sprague Electric Company	10
Stackpole Carbon Company	12, 13
Switchcraft, Inc.	99
Syntronic Instruments, Inc.	118
Tektronix, Inc.	57, 82, 83
Teledyne Relays, A Teledyne Company	2
Tenney Engineering, Inc.	135
Teradyne	29
Triplett Corporation	107
Union Carbide, Components Department	26
United Systems Corporation	77
Unitrode Corporation	86, 87
Universal Instrument Corp.	133
Vero Electronics, Inc.	133
Venus Scientific, Inc.	131
Victoreen Instrument, Div. of VLN Corp.	121
Wescon	113, 130A—H

FAST, ACCURATE

computer plotted printed circuit conversion

computer
aided
layout design

digitizing

computer
controlled
plotter

film
processing

prototype
fabrication

production

Com-Cir-Tek system converts basic electric logic into highly accurate artwork, prototypes and production run circuit boards in a matter of days. Minimizes time and expense. Accuracies to ± 0.0005 are routine. Laborious manual designs, changes and corrections are eliminated. Flexible Com-Cir-Tek capability easily adapts to your requirements. Free bulletin gives full details. Write:

COM CIR TEK Inc.

210 FRENCH ROAD, GARDENVILLE, NEW YORK 14227
PHONE 716 675-3800

INFORMATION RETRIEVAL NUMBER 80

The PC power supply that delivers years of service and costs

\$27 in single units

SPECIFICATIONS:

Size: 4.5 x 4.5 x 1.5

Input: 105-125V, 47-420 Hz

Output: Any DC voltage 3 to 30

Regulation: Line 0.005%
Load 0.05%

Ripple: Less than 250 microvolts

Recovery Time: 25 microseconds
Temperature:
Operating -20 to $+71^\circ\text{C}$
Storage -65 to $+85^\circ\text{C}$
Coefficient 0.01%/°C Max
Current Limiting:
Fixed-foldback type
Overvoltage: Optional

MODEL	VOLTAGE	AMPS	MODEL	VOLTAGE	AMPS
10-5	4.5 to 5.5	1.2	10-28	26 to 30	0.35
10-12	11 to 13	0.8	10-1212	± 11 to 13	0.35
10-15	14 to 16	0.6	10-1515	± 14 to 16	0.35
10-24	23 to 25	0.4	10-1818	± 17 to 19	0.35

For Overvoltage Models, add -0 to Model number

QUANTITY	PRICE	WITH OVERVOLTAGE	DUAL SUPPLIES
1-9	\$27	\$32	\$35
10-24	\$24	\$28	\$32

DIRECT FROM STOCK
FREE - POWER SUPPLY CATALOG

Electrostatics, inc.

7718 CLAIREMONT MESA BLVD. • SAN DIEGO, CA 92111 • (714) 279-1414

INFORMATION RETRIEVAL NUMBER 143

ELECTRONIC DESIGN 17, August 17, 1972

2 for 1

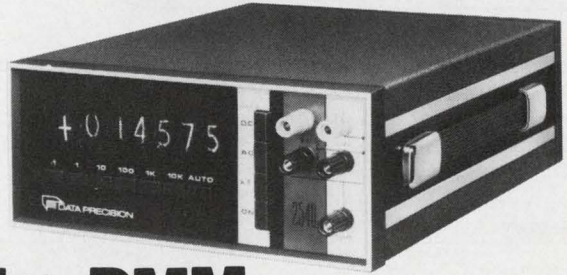

5 1/2 DMM

BASIC ACCURACY IS $\pm 0.001\%$ f.s. $\pm 0.007\%$ rdg. ± 1 DIGIT GUARANTEED FOR 6 MONTHS.

"Two for the price of one." This is the way many of our customers have reacted to our Tri-Phasic 5 1/2 DMM. At a cost of 50% less, they purchase two of ours for the same price or less than one of the closest comparable DMM's.

It's The Best Buy in the DMM field.

This precision 5 1/2 digit Model 2540 gives you DC Volts, AC Volts, Resistance, Voltage Ratio, Auto-Ranging, Auto-Polarity, Isolated BCD Outputs, Remote Triggering and Remote Ranging. Documented by full test data and Certificate of Conformance. **All for \$1195.**

Choose from eight 4 1/2 digit and 5 1/2 digit models from \$580. Call or write Bob Scheinfein (617) 246-1600, Data Precision Corp., Audubon Rd., Wakefield, Ma 01880.

VISIT US AT WESCON

DATA PRECISION
...years ahead

INFORMATION RETRIEVAL NUMBER 81

Need 0033 Voltage Follower pin-for-pin replacement?

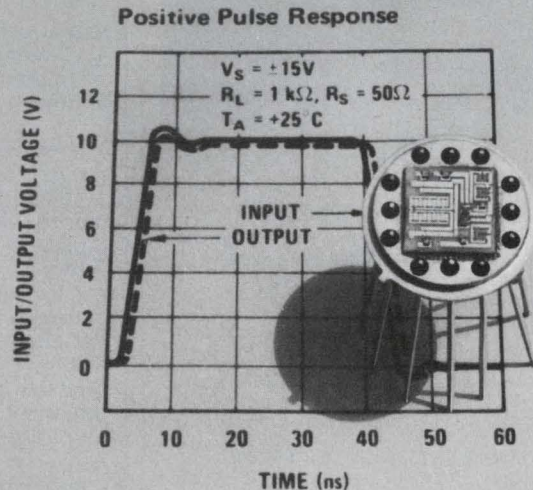

The Halex Model HX 0033 Voltage Follower is a high impedance, unity gain buffer used for ultra high-speed interface requirements. Slew rates are typically 1500 V/usec. Pin-for-pin replacement, \$30. each, in 100-piece lots, off-the-shelf delivery.

For more information on this product, custom hybrids and precision thin-film resistor networks, or Halex facilities and capabilities, circle No. 170 or write

HALEX INC.

Box 2940

Torrance, California 90509

141

product index

Information Retrieval Service. New Products, Evaluation Samples (ES), Design Aids (DA), Application Notes (AN), and New Literature (NL) in this issue are listed here with page and Information Retrieval numbers. Reader requests will be promptly processed by computer and mailed to the manufacturer within three days.

Category	Page	IRN	Category	Page	IRN	Category	Page	IRN
Components			modem/dialer			new literature		
capacitors	118	306	speech generator	114	274	computer graphics	134	383
diode bridges (NL)	136	395	tone decoder	114	276	connectors, plastic	136	394
diodes, ion-implant	116	301	ICs & Semiconductors			data sets	132	375
diodes, noise generator	116	302	FET	104	251	digital correlators	136	388
inductors, PC	118	304	ladder switch	108	265	digital joystick	134	382
networks, DIP	116	300	modem	108	266	diode bridges	136	395
object detector, LED	116	303	multiplexer	104	256	electronic hardware	136	392
switch, bat-lever	118	305	op amp	108	263	function generators	134	379
Data Processing			optical array	106	261	instrument enclosure	134	381
acoustic coupler	112	271	RAM, 1024-bit	106	262	instrumentation amps	132	369
calculator, portable	112	272	RAM, 2048-bit	106	260	instruments, digital	132	364
card reader, static	110	267	registers, a/d	103	252	JFETs	134	377
computer graphics (NL)	134	383	shift register	108	264	LSI design system	132	372
data acquisition	114	278	switch, quad	104	257	microwave instruments	136	387
data link, AM tone	114	279	switches, analog (NL)	134	386	minicomputer prices	132	374
digitizer, board	114	275	timer	103	255	modular oscillators	132	367
error corrector	112	270	transistor array	106	259	oscilloscope accessories	132	373
line conditioner	114	277	transistors, power	103	254	PC board testing	132	371
			up-counters	106	258	peak detector	134	380
			Instrumentation			plastic caps	134	384
			amplifier	123	329	portable recorder	132	370
			counter, digital	121	323	power supplies	132	368
			counter-timer	119	307	recorder	134	385
			counter-timer	122	326	relays, industrial	132	365
			DPMs	123	328	relays, solid state	136	390
			multitester	119	308	servo controller	136	389
			oscilloscope	120	320	slide rules	136	391
			PC board testing (NL)	132	371	switches, analog	134	386
			recorder, transient	120	321	test equipment	134	378
			signal generators	122	327	test instrumentation	132	366
			T.V. monitor	122	325	transducers, load cells	136	393
			voltmeter, digital	121	324			
			voltmeter, electrostatic	120	322			
			Microwaves & Lasers			application notes		
			amps, traveling-wave	129	349	glass, optical	131	360
			antenna, spiral	129	348	insulation materials	131	357
			diodes, Schottky	128	346	magnetic shielding	131	358
			diplexers	128	345	metal deposition	131	361
			filters	129	350	op amp	131	362
			oscillators, cavity	129	347	spectrum analysis	131	359
			paramp	128	344	transformers	131	363
			traveling-wave tube	128	343			
			Modules & Subassemblies			design aids		
			amplifier, operational	124	330	resistor mil specs	130	354
			amplifier, wideband	125	333	switches, pushbutton	130	356
			converter, a/d	124	332	thermocouple calibrator	130	355
			converters, d/a	124	331	vibration fixtures	130	353
			converter, dc/dc	125	334			
			Packaging & Materials			evaluation samples		
			cards, IC	126	336	mounts, tie	130	352
			coating, conformal	127	342	substrates, ceramic	130	351
			connectors (NL)	136	394			
			DIP tools	126	335			
			material, silicon	127	340			
			package, cooling	126	337			
			pastes, PdAg	127	341			
			substrates, hybrid	127	338			
			tape, shielding	127	339			

**PICTURE, PATTERN,
OR PLOT**



Alden recorder reproducing scanning electron microscope image of a 1 mil wire bond to an IC

Get sharp recordings displaying three dimensions and yielding greater detail and informational content than your present display with ALDEN COMPONENT FACSIMILE RECORDERS.

- Synchronizes easily with your scanning sensor or transducer
- Available in print-out widths from 2" to 48"
- Speeds range from 8 RPM to 3600 RPM
- Presentations, linear or non-linear . . . simply
- Used with a broad variety of systems such as ultrasonic/infrared flaw detectors, spectrum analyzers, computers, television, medical instrumentation and scanning radiometers, etc.

Call or write for free descriptive catalog.

ALDEN

ELECTRONIC & IMPULSE RECORDING EQUIPMENT CO., INC.

Westboro, Mass. 01581 Tel.: (617) 366-8851

Do you face
a make or buy decision
on power supplies?

How to use power hybrid voltage regulators to build your own power supplies.

There's another choice now in power-supply design. You're no longer restricted to a supply designed by others, nor to one you have to design from scratch. You can buy the heart of the supply—the voltage regulator—in a hybrid form that offers much more power output than monolithic regulators. Then you can design the rest of the supply and the heat sink, if necessary, using a straightforward procedure.

Hybrid regulators are now available in many models with outputs to 28 V dc and to 5 A. Dissipation at 25°C can reach 85 W—a far cry from the watt or so available in monolithic regulators.

Though there are differences in circuitry, specifications and packaging among regulators available from companies like Lambda, Melville, N. Y.; Micropac, Garland, Texas; and Tecnetics, Boulder, Colo., you can design with them around your own needs.

A typical unit

This article in Lambda's new hybrid regulator brochure tells you how to use these devices to build your own power supplies. . . . Send for your free copy.

**Announcing:
NEW POWER HYBRID
VOLTAGE REGULATORS**

62W 5V 3A

\$25 ea.
(in quantity
of 1)

\$14 ea.
(in quantity
of 100)

\$11 ea.
(in quantity
of 1000)

**NEW
LOW PRICES ON
85W 5V 5A**

\$30 ea.
(in quantity
of 1)

\$18 ea.
(in quantity
of 100)

\$15 ea.
(in quantity
of 1000)

**100,000 hours MTBF
demonstrated**

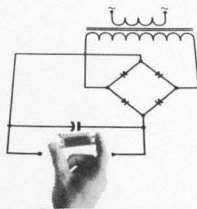

**WHETHER
YOU MAKE
OR BUY...**

LAMBDA
ELECTRONICS CORP.
A  Company

MELVILLE, NEW YORK 11746 515 Broad Hollow Road Tel. 516-694-4200 ARLINGTON HEIGHTS, (CHICAGO) ILL. 60005 2420 East Oakton St., Unit Q Tel. 312-593-2550
NORTH HOLLYWOOD, CALIF. 91605 7316 Varna Ave. Tel. 213-875-2744 MONTREAL, QUEBEC 100C Hymus Blvd., Pointe-Claire, Quebec-730 Tel. 514-697-6520

INFORMATION RETRIEVAL NUMBER 243

SELLS ON SIGHT

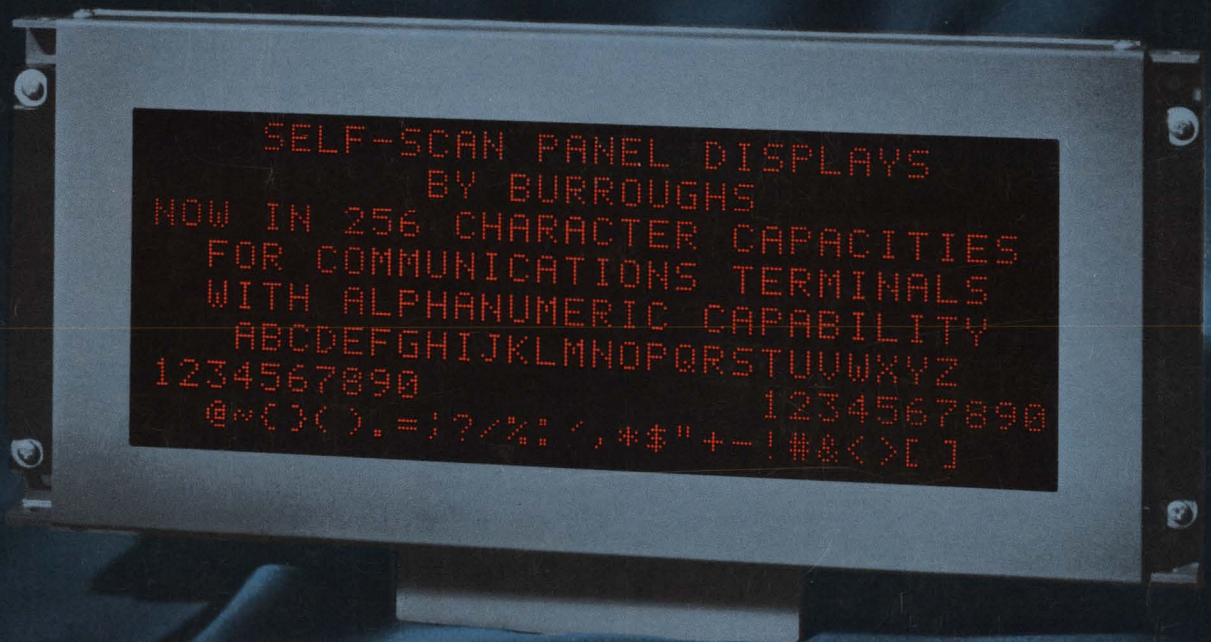

superior readability that competitors can't match

One look at an operating SELF-SCAN[®] panel display and you will know why you should be featuring one in your system. SELF-SCAN displays are a new solution to the operator machine interface that provides advantages to the system builder, to the system user, and to the system operator.

You can offer your customer the advantage of a custom-stylized unit that his operators can use efficiently. SELF-SCAN panels are measurably superior to CRT for operator accuracy while significantly reducing fatigue level in day in-day out high volume production applications.

The 0.2" high characters are in the popular 5x7 dot matrix format and are made up of dots on .040" centers. The unit is ASCII compatible and displays a modified 64-character ASCII character set.

256-character display subsystems are available from stock for immediate delivery. Call or write Burroughs Corporation, Electronic Components Division, Box 1226, Plainfield, New Jersey 07061, Phone: (201) 757-3400. Ask to have a Burroughs sales engineer stop by your office and show you his 256-character SELF-SCAN panel, keyboard, and power supplies packaged in a standard Samsonite[®] briefcase.

Burroughs

