

Electronic Design

FOR ENGINEERS AND ENGINEERING MANAGERS

VOL. 20 NO.

1

JAN. 6, 1972

RECEIVED
JAN 04 1972

Digital panel meters are gaining on two fronts -- size and cost. Some have shrunk to 7 cubic inches and many have cracked the \$100 barrier. A wide choice is available but engineers must beware of "specsmanship." Data sheets are often unclear and may be downright misleading. For a special report see P. 48.



TOP TEN CONTEST!
Important You Enter
See Page 160

DEPENDABLE DALE®

has an edge for you in '72.

As you make your plans for '72, depend on Dale to deliver the "edge" you need to cut costs, save space and improve quality. Here are just a few of the reasons you'll want to keep in close touch with your Dale Representatives and Distributors this year.

new networks

Your thick film design or ours goes from substrate to state of the art as fast as our laser can trim. DIP, SIP, Chips. It's a great year to get acquainted. Circle 221.

exceptional wirewounds

Still the greatest resistor for your high power, tight tolerance needs. Even better since we've broadened values and shrunk sizes on important styles. Need a DIP network, a fuse function or *anything* special... we still have the edge. Circle 222.

slimmer trimmers

Low profile DIP styles for automatic insertion. Wirewound and film element models available soon as part of our "Fastpack" Series. Circle 223.

competitive connectors

Including a good line of .050" and .156" edge boards. Check us out. You'll find we're inclined to be very helpful and sharp-pencilled. For background, Circle 224.

powerful film

The widest range of resistive functions in the industry will be even wider in '72. Watch for important announcement.

capable coils

Pulse and trigger transformers are among the standard lines we're adding and broadening this year. What else is ready in volume? Circle 225 to find out.

free steaks

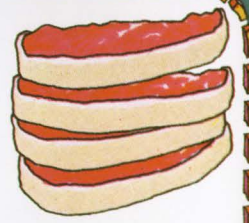

Help us celebrate our 21st Anniversary...

We'll send a box of 4 of Nebraska's best prime sirloins to 25 of you who complete and send us your opinion on what we do well and on what we should do better. Answer frankly. Use additional space if you wish. Steaks will be sent to first 25 names picked randomly at a notarized drawing. No obligation. No one will call. Mail before February 28, 1972.

My job is:

- Design
- Development
- Testing
- Procurement

The Dale product most important to my job is:

_____ None

The thing about Dale that impresses me most favorably is:

Dale can improve or expand its role as a supplier to my kind of company by: _____

NAME _____

COMPANY _____

ADDRESS _____ CITY _____ STATE _____ ZIP _____

DALE ELECTRONICS, INC.
1300 28th Ave., Columbus, Nebr. 68601
In Canada: Dale Electronics Canada, Ltd.
A subsidiary of The Lionel Corporation

Return to: N. Roeder, Notary Public, 1222 P St., Lincoln, Nebr. 68508

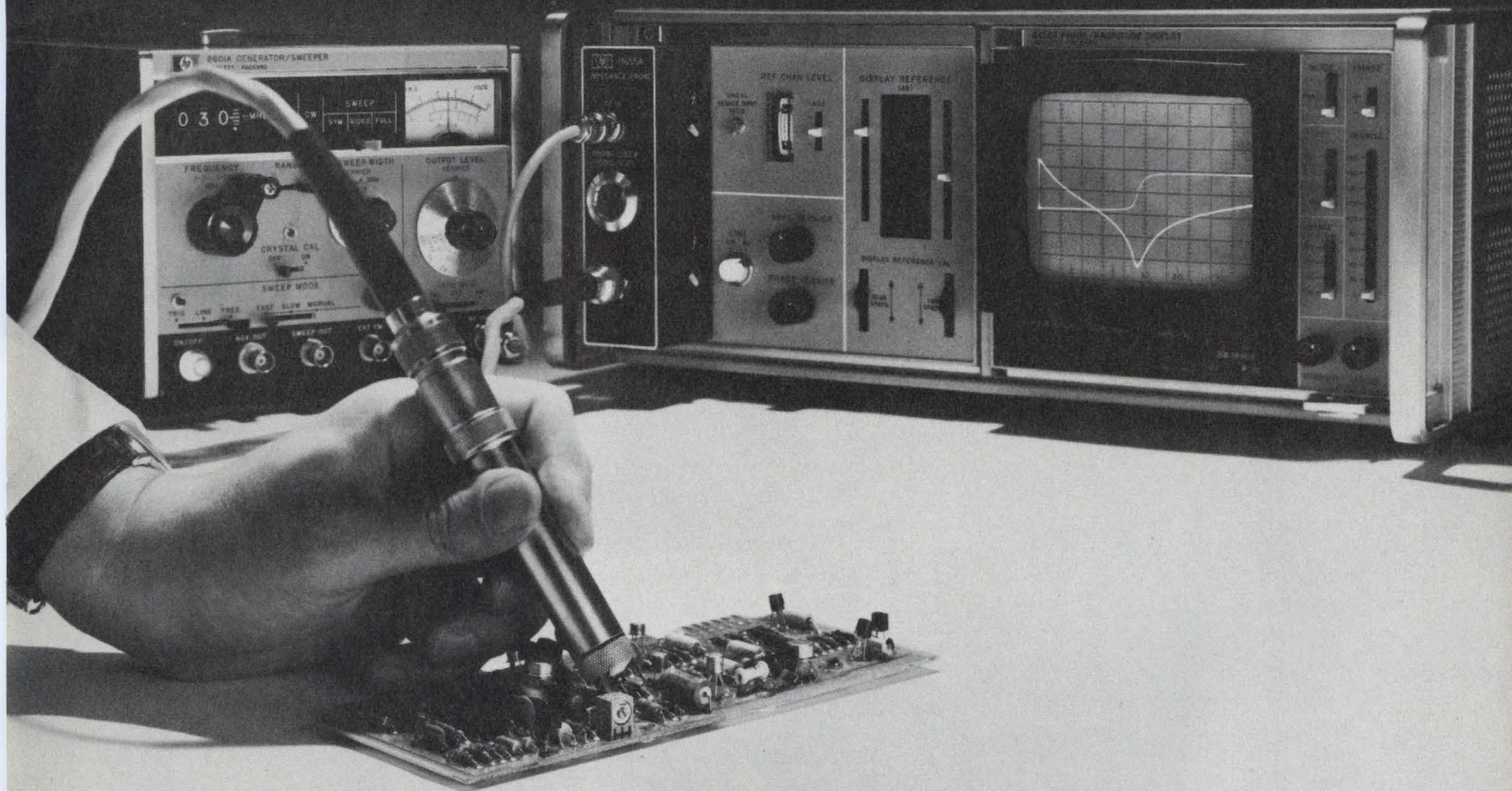

Introducing "touch & see" swept impedance measurement. Now the "do-everything" RF test system does even more.

Just add our new impedance probe to the HP 8407A Network Analyzer, and you can measure complex impedance of circuits, coax systems, discrete components. View impedance excursions over the wide range from 0.1Ω to $10K\Omega$ as you sweep between 500 kHz and 110 MHz.

The HP 8407A Network Analyzer itself makes comprehensive swept RF measurements quickly, and with high accuracy. You see important characteristics like gain/loss, phase shift, voltage and current transfer functions, group delay, impedance, return loss and S-parameters. Dynamic range is greater than 100 dB, yet you can resolve 0.05 dB. It has 360° phase range with 0.2° resolution.

The 8407A Network Analyzer with the 8412A Phase-Magnitude Display costs \$4525. The new impedance probe (Model 11655A) costs \$750. Other accessory kits for circuit probing and for general measurements in coaxial systems are also available, priced from \$325 to \$500.

To learn more about how our "do-everything" network analyzer can help you in design and production test applications, call your field engineer or write Hewlett-Packard, Palo Alto, California 94304; Europe: 1217 Meyrin-Geneva, Switzerland.

HEWLETT  PACKARD
NETWORK ANALYZERS

04112



COMPUTER
HANDLE
WITH CARE



COMPUTER

UP
↑

Some small computers aren't delivered.

They're abandoned.

We believe that when you buy a small computer, you should get more than just a box of hardware. You should get the same service and support capabilities offered with the big systems.

That's the kind of support that goes along with all our small computers. We have documented training programs, including courses in preventive maintenance. And if you should need help, our parts and service are never more than a couple of hours away.

There's a good reason why we can offer this type of back-up. We're the world's largest manufacturer of test instruments. So naturally we understand the needs of engineers and scientists. In fact, we've built our reputation on understanding these needs and filling them. And we're not about to blow it.

You probably won't need much help. Our small

computers have an enviable reputation for reliability and performance in over 2500 successful installations.

And now we've taken another big step forward. Our new HP 2100 combines all three of our earlier minis in one. And its submicrosecond memory makes it almost twice as fast as any of them. It's also much smaller and you can expand from 4K to 32K in the same convenient mainframe. Using the latest in MSI/LSI technology, it also offers control Read Only Memory (ROM) plus a lot of other features usually found only in bigger systems. And it won't put a big crimp in your budget.

So if you want a good small computer, with good "big computer" support, call your local HP computer specialist. Or write: Hewlett-Packard, Palo Alto, Calif. 94304; Europe: 1217 Meyrin-Geneva, Switzerland.

22115

HEWLETT  PACKARD
DIGITAL COMPUTERS

Siemens

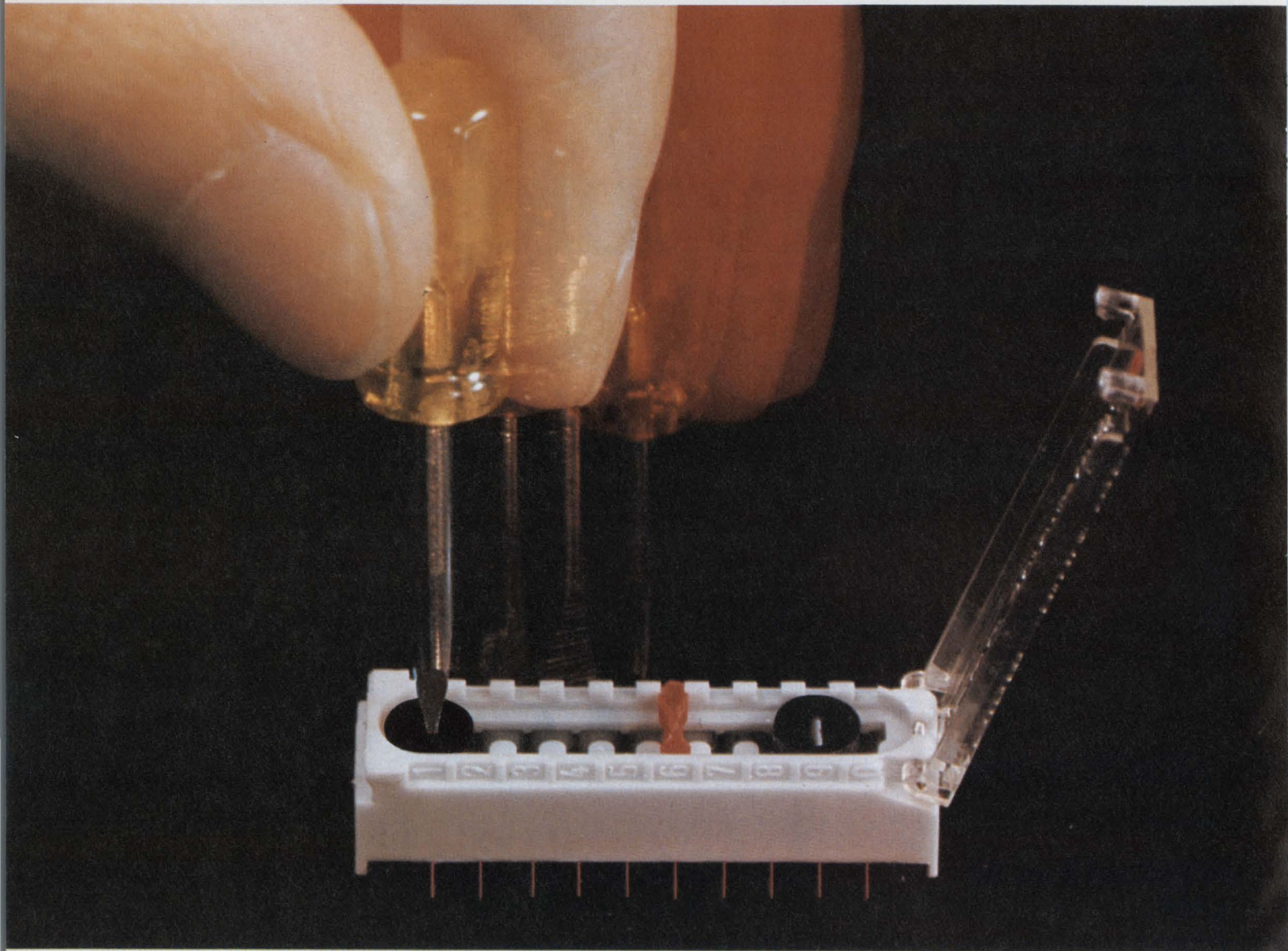

**Introducing the rotary slide switch for PC boards.
Ten positions. Multi-circuit switching. Low profile package.**

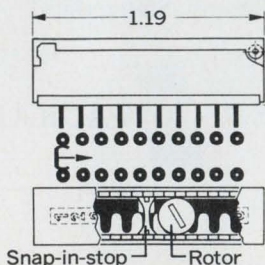

Siemens is introducing a completely new kind of programming switch for closely racked PC boards and for other tight-space applications.

To set the switch just snap open its transparent dust cover and twist the rotor with a screwdriver. This moves the switching element linearly from one of the detented positions to another.

The compact switch has ten pairs of gold-plated contacts and is available with additional rotors for independent switching of up to three circuits. Easy-to-insert snap-in stops separate circuits. Siemens Corporation, 186 Wood Ave. So., Iselin, N.J. 08830. Call 201-494-1000. **SIEMENS**



Electronic Design

FOR ENGINEERS AND ENGINEERING MANAGERS

VOL. 20 NO.

1

JAN. 6, 1972

NEWS

- 23 **News Scope**
- 26 **Industry forecast for 1972:** Electronics taking off strongly after a year of stop and go.
- 32 **Wireless voltage sensor** holds promise for commercial applications. Built for nuclear weapons, it will also find use in laboratories.
- 34 **Test system at MIT controls temperature to microdegrees.**
- 36 **EIA testing a reference signal for precision color television**
- 38 **Technology Abroad**
- 43 **Washington Report**

TECHNOLOGY

- 48 **FOCUS on Digital Panel Meters:** A special report on pitfalls in DPM selection and on the state of the art.
- 60 **Anxiety in Japan:** In spite of the recent business uncertainty, some impressive new products are being announced in Japan.
- 66 **Try a piecewise-linear approach** to the design of wide-range amplifiers and get more accurate transfer characteristics and faster response.
- 72 **Use a single-ended switching regulator** to convert dc to dc with simpler circuitry. You get isolated or multiple outputs and overload protection.
- 78 **Generate stable high-frequency signals** with D flip-flops as digital mixers and all-IC, low-frequency phase-locked loops.
- 84 **'Cleaning up' is the key to promotion,** says this designer. He tells why, as a good manager, he must also be a sounding board, information spreader and buffer.
- 90 **Ideas for Design**

PRODUCTS

- 101 **Instrumentation:** Liquid-crystal DPM sets price/performance standards
- 104 **Instrumentation:** 20-MHz mini-portable scope weighs only 5-1/2 pounds
- 108 Modules & Subassemblies
- 116 Packaging & Materials
- 124 Data Processing
- 128 ICs & Semiconductors
- 138 Components
- 142 Microwaves & Lasers

Departments

- 47 **Editorial: Unhappy New Year**
- 11 Letters
- 146 Application Notes
- 148 New Literature
- 154 Bulletin Board
- 158 Advertisers' Index
- 160 Information Retrieval Card

Cover: Designed by Art Director Bill Kelly.
Photo courtesy of Datascan, Inc., Clifton, N.J.

ELECTRONIC DESIGN is published biweekly by Hayden Publishing Company, Inc., 50 Essex St., Rochelle Park, N.J. 07662. James S. Mulholland, Jr., President. Printed at Brown Printing Co., Inc., Waseca, Minn. Controlled circulation postage paid at Waseca Minn., and New York, N. Y., postage pending Rochelle Park, N. J. Copyright © 1972, Hayden Publishing Company, Inc. 82501 copies this issue.

Third In A Series

DIRECTIONS MOS

Reflections on Custom LSI

Mutual Self-Interest Dictates Close User-Vendor Interaction

Practical, proven, implemented, and growing fast? Yes. Custom MOS-LSI can also be a gamble.

Many features have been forwarded as potential advantages of custom LSI over standard products. Smaller size and weight, very low power consumption, greater reliability, improved performance, are some of these and they are important considerations for some equipments. So is the marketing advantage achieved through proprietary designs. But the overriding impetus for MOS/LSI is cost — lower cost — and if the LSI design does not result in lower cost than an equivalent system of less complex components, chances are it will lose out in the final analysis.

Decisions To Make

MOS/LSI is not necessarily a panacea. Lower costs are not automatically obtained. Achievement of desirable results from custom LSI is predicated on the following choices:

Choose the right volume level product — If the end equipment is manufactured in very small quantities so that the total number of LSI circuits is small, custom design could turn out to be indigestibly expensive.

Choose a competent supplier with

Design know-how — The cost-effectiveness of the LSI part depends critically on the ability of the semiconductor supplier to advise the potential user on how to achieve the most performance per dollar.

Technology know-how — If the system concept clearly points to a particular technology, it is important that the semiconductor supplier be well-versed in this manufacturing technique.

Adequate manufacturing capacity — Product introduction dates are usually critical, development time is usually short, and rapid high volume manufacturing buildup may spell the difference between hitting or missing the peak of the market for the new equipment.

Under many circumstances, custom MOS/LSI makes a great deal of sense. With a hundred or more gate-circuit equivalents on a small chip of silicon (in some state-of-the-art circuits over 6000 devices are being fabricated on a single chip) system manufacturing costs are substantially decreased. Fewer circuits per system means lower packaging cost, smaller board assembly labor costs and reduced inventories.

Mutual Risks and Joint Rewards

It is clear that the advent of MOS/LSI has perturbed the customary relationships between IC user and IC maker. First and foremost, the user may have to relin-

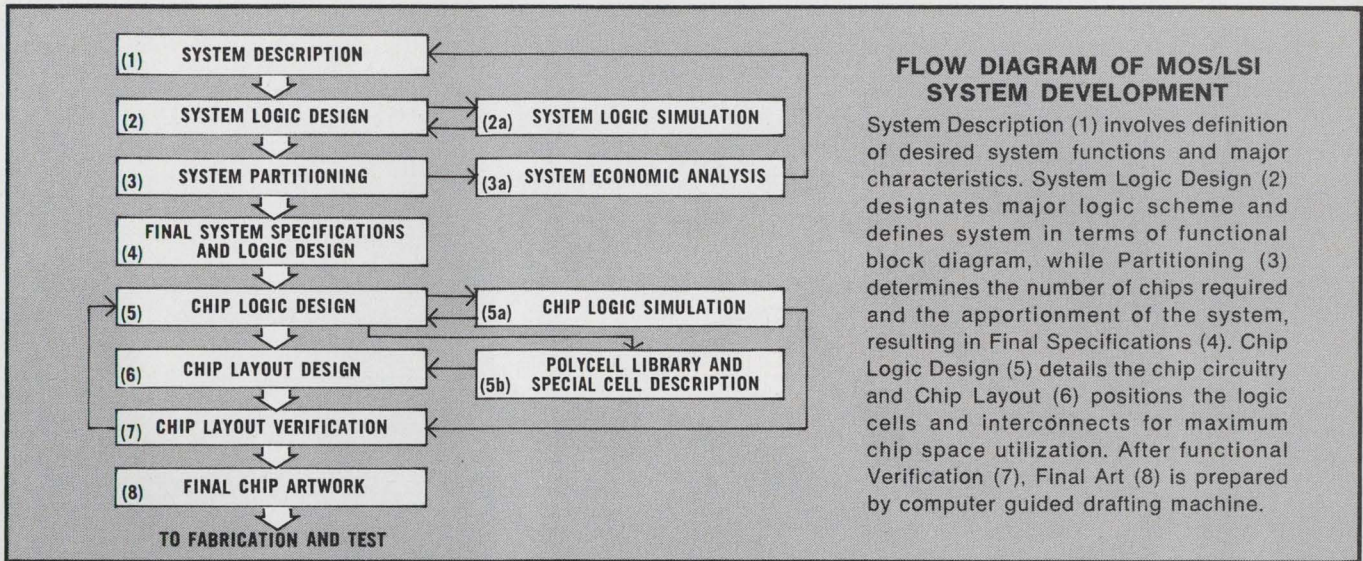

System Description (1) involves definition of desired system functions and major characteristics. System Logic Design (2) designates major logic scheme and defines system in terms of functional block diagram, while Partitioning (3) determines the number of chips required and the apportionment of the system, resulting in Final Specifications (4). Chip Logic Design (5) details the chip circuitry and Chip Layout (6) positions the logic cells and interconnects for maximum chip space utilization. After functional Verification (7), Final Art (8) is prepared by computer guided drafting machine.

quish his prerogative to sole and exclusive control over his equipment design. Frequently he finds the LSI supplier deeply involved in his system definition and design problems, and if his own MOS experience is limited he may find himself largely dependent on the semiconductor manufacturer for development of a new LSI logic system. Strange as this position may be, it is a natural accompaniment of a technology where processing know-how, circuit design, and system design are so intimately and critically entwined in the success of the project.

For his part, the LSI supplier may find that he has committed large portions of his engineering talent to the design of a set of custom chips for a single customer. Since the components manufacturer's profit comes almost exclusively from the sale of the semiconductor parts, failure to go into production, for whatever the cause, results in an irretrievable loss of engineering effort. Even if the parts work fine, but the customer has misjudged the market for his new equipment, the results are equally damaging to the IC maker. For this reason the LSI maker has a strong motivation to do everything he can to help the customer develop the most cost effective LSI system that can be produced.

With the success of the project spurred by such strong self interests on the part of both parties, the design responsibilities must be accepted jointly. At the start, the definition of the system — its intended functions, features and capabilities — are for the equipment manufacturer to determine. At the end, the processing of the LSI chips should be left to the supplier.

Creating A Design

The process begins with the generation of a system description by the equipment manufacturer and ends with the fabrication of the prototype circuit by the supplier. The intermediate steps, the system design phase, usually involve a joint effort, requiring close communications between the user and his supplier.

Two major milestones mark the path of system design. The first is the determination of the specifications and logic of the final system. The second is the

generation of the final artwork from which the circuits are fabricated. Numerous feedback loops among the various design blocks are necessary to accommodate the complexity of design procedures.

Experience has shown that valuable interactive dialogue can take place as early as the System Description stage. At the very least, the components manufacturers should be called upon for an economic analysis, since cost is so strongly dependent on chip size, on manufacturing processes, and on yield.

Other Considerations

Behind the optimism generated by skyrocketing LSI sales figures is the sobering realization that LSI, so far, has been the tool of a few sophisticated manufacturers. These companies have paid the tuition. The systems in use so far are early milestones toward a 1976 MOS/LSI market in the \$300 to \$600 million range that will be generated by many companies. Most of this growth will be in new applications which are not economically feasible with present discrete or bipolar IC designs. Much of the new MOS/LSI will replace electromechanical or magnetic types of equipment. Fortunately for today's newcomers to the field, they no longer need to climb the learning curve from the bottom rung. Enough design and manufacturing experience has been accumulated by semiconductor manufacturers so that many of the false starts and other pitfalls can be circumvented.

This is the third in a series designed to present a realistic, objective analysis of MOS technology in a dynamic, competitive industry. For a more complete view of the fundamental concepts evolved from Motorola's experience in major custom MOS/LSI projects, and of the broad scope of Motorola's total MOS involvement, circle the reader service number or write to Motorola Semiconductor Products Inc., P. O. Box 20912, Phoenix, AZ 85036.



Coming Next: "PUTTING MOS TO WORK"
 INFORMATION RETRIEVAL NUMBER 5

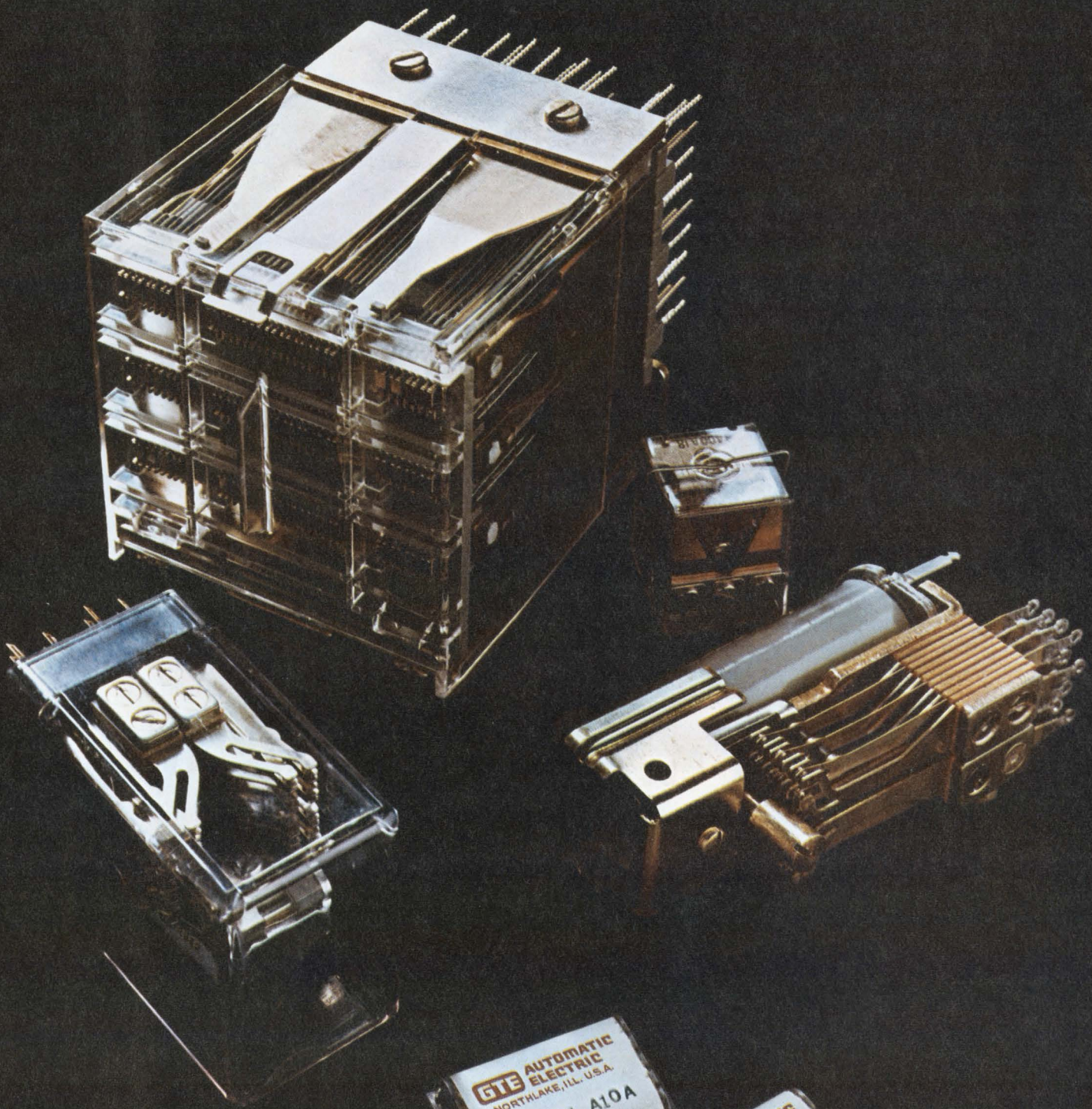

GTE AUTOMATIC
ELECTRIC
NORTHLAKE, ILL. U.S.A.

PD1311 A10A
1930 OHMS

GTE AUTOMATIC
ELECTRIC
NORTHLAKE, ILL. U.S.A.

PD1308 A11A
2600 OHMS

Announcing the rediscovery of the relay.

In an age when most people think solid state is the only way to go, some designers have rediscovered the good old electro-mechanical relay. They found relays still can't be beat when it comes to certain jobs. And when they're dealing with tight fisted cost control committees. Maybe you can save some effort and expense by rediscovering the relay whenever you need these things:

1. Simple logic:

Relays let you combine both power switching and logic functions economically. Memory can usually be retained, even after a power loss. And you don't need special power supplies or noise suppression techniques.

2. Easy troubleshooting:

Most relay failures (and they do occur occasionally) can be identified visually. You can see what's wrong. And fix it easily.

3. Heat resistance:

A relay shrugs off a short dose of overheating. Give a solid state device the same treatment while it's functioning near capacity and it's ruined forever. The amount of heat a solid state device can take is usually dependent on the heat sink used. It can take up all the room you expected to save with solid state in the first place. And finding the right heat sink design can become very involved.

4. Electrical isolation:

Relays have a natural isolation between input

circuits, between output circuits, and between output and input control circuits. You can't get that with junction type semiconductors.

5. High insulation resistance:

Open relay contacts have an insignificant amount of leakage (10^{10} ohms or more). Semiconductors can't match this. And, their leakage rates vary greatly with temperature changes.

6. Wide operating power range:

Relays work with operating power anywhere from milliwatts to watts. And they usually don't require regulated power. Semiconductors do.

7. Transient voltage immunity:

Transient voltage doesn't bother a relay. But high voltage, short duration transients can be sure death to semiconductors.

8. Forgiveness:

Relays give you a little margin of safety should you want to change your mind. Maybe you find you need more contacts, or uncover a timing problem, or discover a need for absolute input-output isolation. You can change your circuit design a lot easier with relays.

If your project or product needs any of these things, just ask our salesman to help you rediscover relays. GTE Automatic Electric, Industrial Sales Division, Northlake, Illinois 60164.

GTE AUTOMATIC ELECTRIC

BOURNS

BOLD NEW

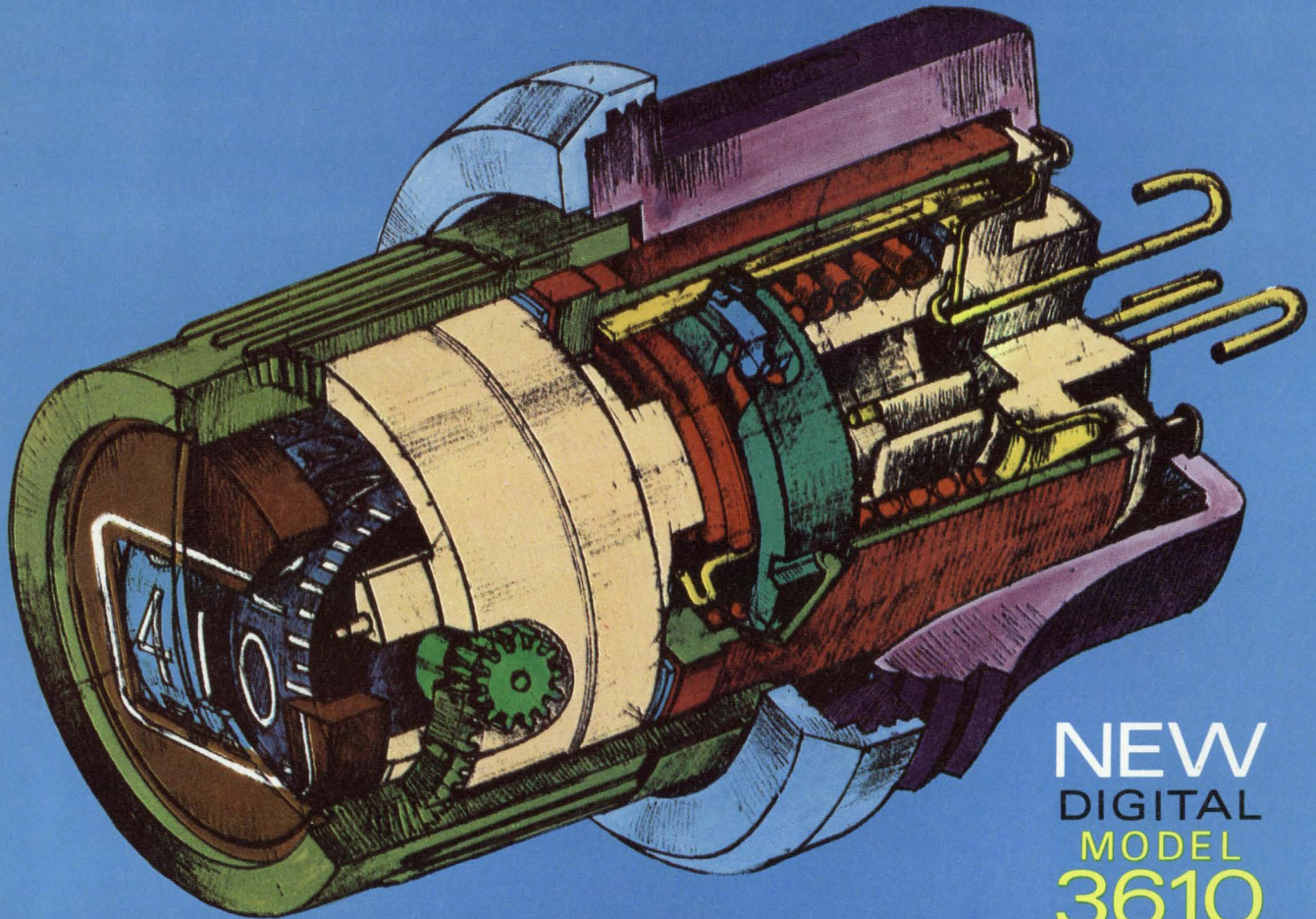

NEW
DIGITAL
MODEL
3610

KNORPOT[®]
POTENTIOMETER

FACTORY - PHASED TO $\pm 0.5\%$ ACCURACY ...

**... AT LESS COST* THAN MOST SEPARATE
DIAL / POTENTIOMETER COMBINATIONS**

*SAVES HIDDEN COSTS OF PHASING AND INSTALLATION TIME NOT REFLECTED IN COMPETITIVE PRICES.

CONCEPT!

A DIAL AND POTENTIOMETER
IN A SINGLE INTEGRAL UNIT —

... AT NEW REDUCED PRICES!

NO DIALS TO ASSEMBLE!

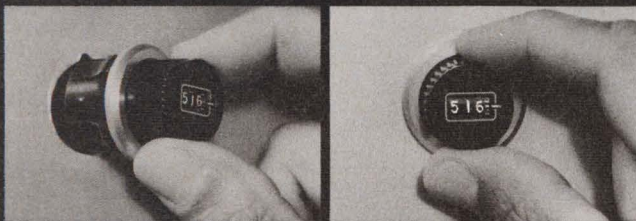

Unlike SEPARATE Digital dial and potentiometer combinations . . . the dial and pot are INTEGRAL IN ONE, 7/8" DIAMETER UNIT. No screws, nuts, or bushing to mess with . . . JUST SNAP UNIT INTO PANEL AND CONNECT TERMINALS.

NO PHASING REQUIRED

Model 3610 is prephased at the factory to a GUARANTEED ACCURACY OF $\pm 0.5\%$ BETWEEN ELECTRICAL OUTPUT AND DIAL (This is equivalent to BETTER THAN 0.5% terminal base linearity).



IF YOU PREFER A CLOCKFACE READOUT . . .

. . . ask about the Model 3600;
clockface brother of the Model 3610.

Also an INTEGRAL DIAL/POTENTIOMETER,
it's only 3/4 inches in diameter and PRICED EVEN
LOWER THAN MOST SEPARATE DIAL/POTEN-
TIOMETER COMBINATIONS.

COMPARE PRICES . . .

With the labor-savings factored-in, Models 3610 and 3600 cost less than separate dial and potentiometer combinations.

Model 3610

\$15.30*

Model 3600

\$14.42*



*in 500-999 quantities.

7/8" DIAMETER

3/4" DIAMETER

TEN-TURN

NOW CHECK THE SPECS!

ACCURACY: $\pm 0.5\%$ (Maximum error between electrical output and dial reading.)

REPEATABILITY: 0.1%

POWER RATING: 1.5 watts

RESISTANCE RANGE: 100 to 250,000 ohms

RESISTANCE TOLERANCE: $\pm 5\%$

TEMPERATURE COEFFICIENT OF RESISTANCE WIRE:
20ppm/ $^{\circ}\text{C}$

TEMPERATURE RANGE

Model 3610
-25 to +85 $^{\circ}\text{C}$

Model 3600
-65 to +85 $^{\circ}\text{C}$

For details, contact your local Bourns Distributor,
Representative, or Bourns Sales Office.





SAMPLE RATE

RESET

10.0000

M Hz

OFF

HOLD

HEWLETT · PACKARD
5300A MEASURING SYSTEM

HEWLETT · PACKARD

SENSITIVITY

TIME BASE

FUNCTION

SENSITIVITY

PERIOD / T.I.

FREQ

PERIOD B

1µs

10µs

1ms

10ms

AUTO

A

B

CHECK

PERIOD B

AT A TO B

AVG B

OPEN / CLOSE B

HEWLETT · PACKARD
5302A 50 MHz UNIVERSAL COUNTER

HEWLETT · PACKARD

Introducing the little counter that can.

It can become four different systems.

It can go anywhere you do.

It can protect you against obsolescence.

It can make buying and maintaining a counter less expensive than ever before.

Meet the Hewlett-Packard 5300, the snap-together counter that's not much bigger than the palm of your hand. It has six digit accuracy, solid state display and autoranging. It'll make period, frequency, time interval and ratio measurements, operate on its own snap-on battery pack and drive a printer. Prices start at only \$520.

If everything sounds too good to be true, we'll tell you how we did it: snap-together construction that lets you choose the module that makes the counter you want and also avoid obsolescence. Plus the most advanced LSI circuitry ever used in a counter. That means you get a compact instrument with high reliability, performance and versatility at a cost lower than ever before.

To make the counter you need, take the \$395 mainframe and add any of the following 4 modules (more are on the way). They lock right onto the mainframe in an instant.

- 10 MHz frequency module. Direct frequency counting to greater than 10 MHz. Model 5301A, just \$125.

- 50 MHz all-purpose module with period average, time interval,

and ratio functions. Model 5302A, \$250.

- 500 MHz frequency module, both 50 Ω and 1 M Ω impedances. DC to 500 MHz. Model 5303A, only \$750!

- Time interval module with features you'd expect to pay twice as much for: 100 ns resolution; attenuators and slope and trigger level controls on both channels; counting to better than 10 MHz; period averaging. A unique "time interval holdoff" feature lets you ignore electrical pulses between the events you want to measure. Model 5304A, \$300.

You ought to be able to take a counter as small and useful as the 5300 anywhere. And you can. All you have to do is snap on the battery pack (Model 5310A, \$175) for 4 to 8 hours worth of cord-free operation. The pack fits between the mainframe and any module. The system's rugged dust-proof aluminum case resists almost any of the bumps it might get in the field.

The 5300 is one system you have to use to appreciate; there is simply no other way. To get you started we'd like to send you more information on this amazing instrument. Just call your nearby HP field representative or write to Hewlett-Packard, Palo Alto, California 94304; Europe: 1217 Meyrin-Geneva, Switzerland.

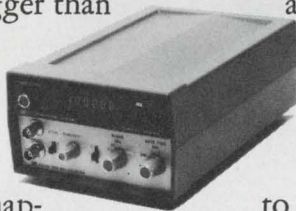

HEWLETT  PACKARD

ELECTRONIC COUNTERS

INFORMATION RETRIEVAL NUMBER 8

02104

Your Guardian Angel presents a..



GUARDIAN[®]

GUARDIAN ELECTRIC MANUFACTURING COMPANY
1572 West Carroll Avenue, Chicago, Illinois 60607

In a hurry? Call your Guardian Distributor.

.LIBRARY full of MIRACLES

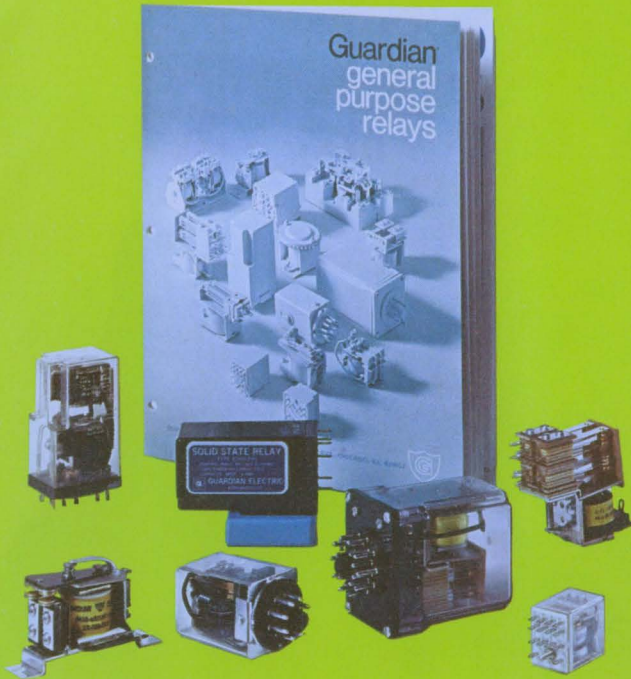

RELAYS 24 PAGE FACT BOOK full of dimensional drawings, specifications and application data on the comprehensive line of Guardian relays... including general purpose, special purpose, power, solid state and interlock.

INFORMATION RETRIEVAL NUMBER 211

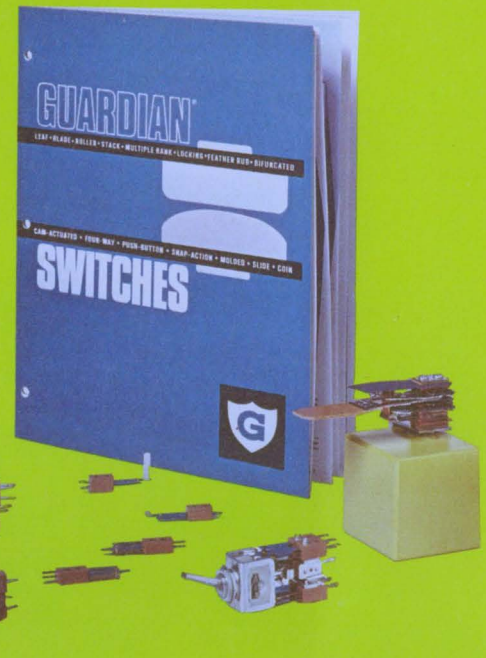

SWITCHES A PORTFOLIO OF TECHNICAL DATA describing the complete line of Guardian switches: Molded, stacked and the miraculous lever switch with snap-in cam inserts so you change actuator functions instantly!

INFORMATION RETRIEVAL NUMBER 213

SOLENOIDS 44 PAGE MANUAL reveals everything you need to know to spec a Guardian solenoid. Includes specs, pull/stroke graphs and dimensional drawings on frame, laminated and tubular types—dozens of basic solenoids with more than 61,000 variations!

INFORMATION RETRIEVAL NUMBER 212

STEPPERS STEPPING RELAY FACT BOOK with 32 pages of catalog and application data on stepper types ranging from counting, sequence selecting and automatic resetting to pulse multiplying, slave and master, and *more*.

INFORMATION RETRIEVAL NUMBER 214

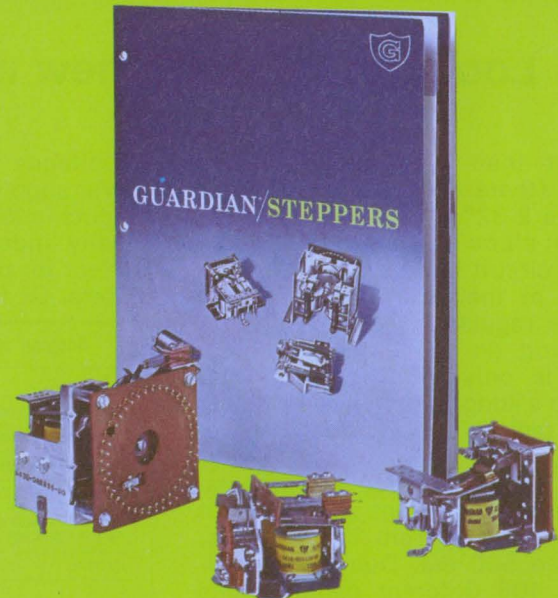
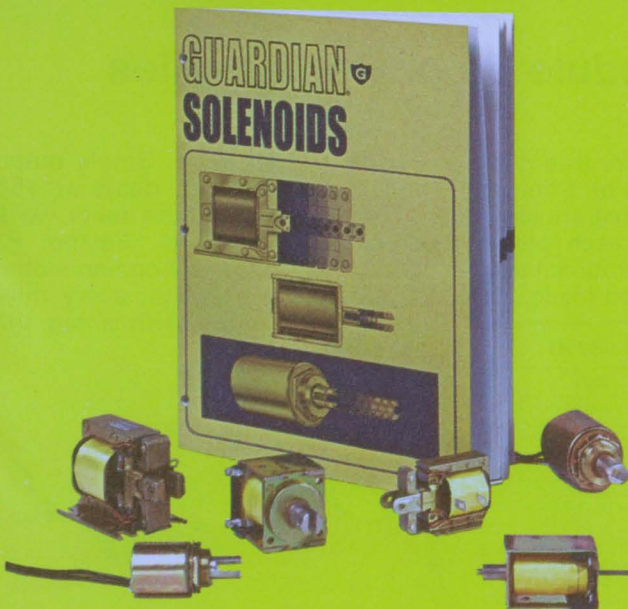



Look at Acopian's new mini-module dc power supplies

Look at their size. Single output models (there are duals, too) are as small as 2.32" x 1.82" x 1.00". And they can all be soldered directly into printed circuit boards.

Look at their performance. Load and line regulation is 0.02 to 0.1% depending on the model selected. Ripple is only 0.5 mv RMS. And Acopian's long experience in power supply technology assures high reliability.

Look at the choice of outputs. There are 58 different single output modules ranging from 1 to 28 volts, 40 ma to 500 ma. Duals are available in 406 different combinations

of voltages. And these are true dual power supplies, with like or different outputs in each section that are electrically independent of each other. Perfect for powering operational amplifiers. Or for unbalanced loads.

Acopian mini-module power supplies

	Singles	Duals
Output Voltages (vdc):	1 to 28	1 to 28
Output Currents (ma):	40 to 500	40 to 250
Line and Load Regulation:	.02 to 0.1% depending on model	
Ripple:	0.5 mv RMS	
Ambient Temperature (without derating)	0 to 55°C	
Polarity:	outputs floating and isolated	

Look at their price. Single output models start at \$39, duals at \$58.

For a look at all the facts, write or call Acopian Corp., Easton, Pa. 18042. And just like Acopian's other 82,000 power supplies, every mini-module is shipped with a tag that looks like this . . .



Weston offers the toughest VOM, the handiest DMM, and a Frequency Counter you can't match at the price.

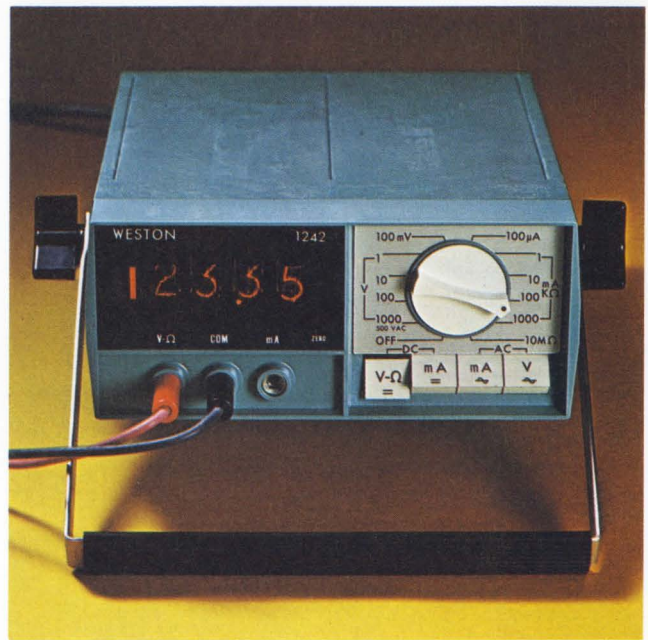
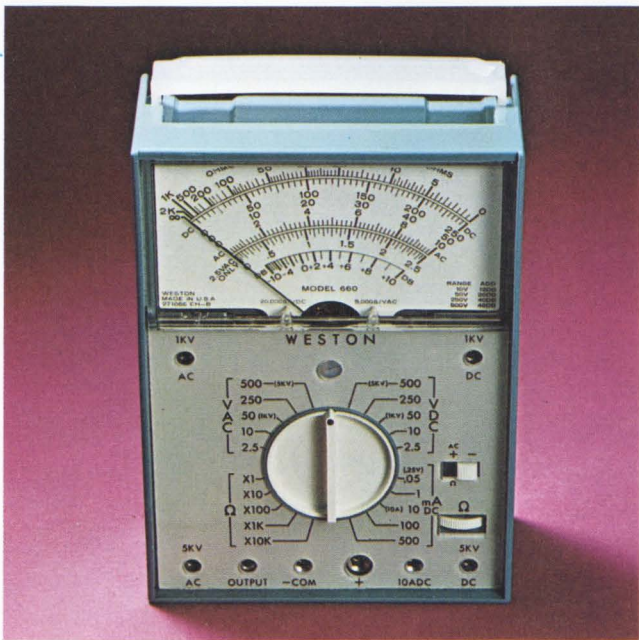

The first drop-proofed VOM.
The new indestructibles. We warrant it in writing: the Weston 660 series VOM will withstand a five-foot drop. Five models pack everything you expect in precision multitesters, plus bonus Weston features. Weston distributors have them. Drop in and try one. Circle No. 201.

The 4½ digit DMM that travels.
The new Weston 1242 measures a
(continued)

First Class
Permit No. 392
Newark, N. J.

Business Reply Mail

Postage will be paid by addressee

Weston Instruments

614 Frelinghuysen Ave.

Newark, New Jersey 07114



handy 3" x 7" x 7.9". And weighs less than 4 lbs. Yet few bench meters match its features and performance. A full 25 ranges, including a 100-mv range for AC and DC with 100% over-range. A response speed of 1/2 second with input filtering, externally replaceable fuses, gold-on-gold contacts. What you'd look for in a \$700 meter. Except it's priced at only \$595 complete. Circle No. 202.



The 5Hz-32MHz bargain.

The new low-cost Weston Model 1250 Frequency Counter covers the full

5Hz-32MHz spectrum with automatic decimal positioning. Solid-state LEDS give non-blinking 5-digit readings. Compact 7" x 3" x 7.9" unit converts to panel mounting, can be used with external time standard. And it has other features you can't match in a Frequency Counter of its size, at its new low price. Ask your Weston distributor. Circle No. 203.

The more you know about precision measurement, the more performance you can build into an instrument at a moderate price. Weston knows precision measurement. Get to know more about Weston instruments. See your Weston distributor, or return the card below for more information. Weston Instruments, Inc., Newark, New Jersey 07114.

We're either first or best. Or both.
WESTON INSTRUMENTS

Send me detailed data on these new Weston products.

- No. 201. Series 660 VOMs.
- No. 202. Model 1242 DMM.
- No. 203. Model 1250 Frequency Counter.
- Have salesman call. Phone _____.

Name _____

Company _____

Address _____

City _____ State _____ Zip _____

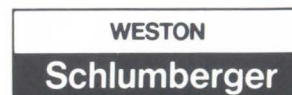

Kurz-Kasch Digital Logic Instruments*



... complete logic systems analysis through the logic-probe concept

Rugged, all solid-state, Kurz-Kasch logic probes are designed for fast, accurate testing of logic levels in all types of integrated circuit systems. A simple readout system indicates "true", "zero", or "pulse" readings precisely through color-coded visual electronic readouts in the probe tip. Absence of logic levels is indicated by all readouts remaining OFF.

Applications Logic levels can be accurately tested in virtually any (DTL, TTL, RTL) IC system including desk calculators, business machines, N/C devices, computers or telephone systems. Power is derived from the unit under test allowing use in the field or in the lab.

Specifications	High input impedance prevents loading of circuit under test.
Readout Light Red=Logic "1"	Size $\frac{5}{16}$ " dia., 6" long, 26 $\frac{3}{4}$ " leads with pin terminals
Readout Light White=Logic "0"	
No Readout Light="infinity"	

A pulse detection feature is available on most models of logic probe. A third readout is provided to display high speed pulse trains or a single cycle pulse of less than 50 nanoseconds on the standard Model LP-520. Overload protection to +50, -20 volts DC is also available.

Standard Probes Logic probes are presently available in five standard models. MODEL LP-500 for use in testing 4.75-5.0 V DC logic systems. MODEL LP-510 for testing 4.75-5.0 V DC systems . . . includes overload protection to +50, -20 V DC. MODEL LP-520 . . . for 4.75-5.0 V DC logic systems . . . includes overload protection and pulse detection features. MODEL LP-530 for testing of 12-15 V DC logic systems . . . includes overload protection to +50, -20 V DC. MODEL LP-540 . . . for 12-15 V DC systems . . . includes overload protection and pulse detection features.

Add these options: **G-S-M: Gating Feature (-G)**— 3 Channel input for timing. Pulse indicator displays only when probe tip and gate/gates are in coincidence. **Memory & Stretch (-M)**— Push-pull switch for selecting stretch or latch mode. Stretch mode detects high speed pulse and displays blue "P" lamp for 200 mS. Latch mode captures high speed pulse/trains and latches blue "P" on until reset. **5 Nano-second capability (-S)**— Allows detection of pulses up to 10 x faster than standard probes. Each option \$10.00.

Special Probes As a routine service, Kurz-Kasch will custom design logic probes to user specifications. Custom designs can include: both positive and negative logic levels from 50 to 30 volts . . . special pulse detection characteristics . . . floating or grounded cases . . . custom power supply requirements . . . power lead reversal protection . . . and your choice of logic crossover parameters.

Kurz-Kasch logic probes provide all the information you need to quickly and accurately evaluate all logic systems . . . and they are the most economical logic testing instruments available. Standard Models range in price from \$39.95 to \$69.95. Write today for complete details on all standard and special logic probes.

*Patent #3,525,939 applies, others pending.



Kurz-Kasch, Inc.

Electronics Division
1421 S. Broadway
Dayton, Ohio 45401
Telephone (513) 223-8161

A Smart Way to Beat Your Power Supply Size Problem

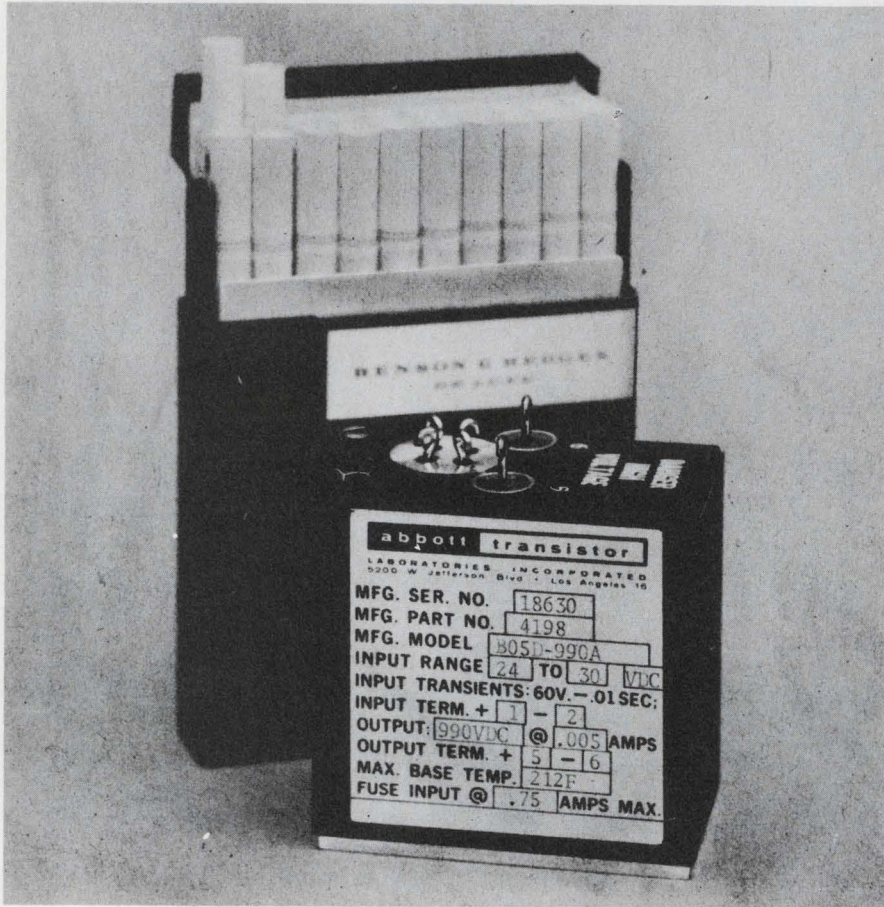

1½" thin, 2¾" narrow, 2¾" short

yet this converter produces 1000 volts DC, regulated, from a battery input of 28 VDC! It weighs less than 15 ounces. This is only one of our wide variety of many small light weight converters, inverters and power supplies — there are over 3000 models listed in our newest catalog, including size, weight and prices. If you have a size problem, why not send for an Abbott catalog?

MIL SPEC ENVIRONMENT — All of the power modules listed in our new catalog have been designed to meet the severe environmental conditions required by modern aerospace systems, including MIL-E-5272C and MIL-E-5400K. They are hermetically sealed and encapsulated in heavy steel containers. New all silicon units will operate at 100°C.

Please see pages 930 to 949 of your 1970-71 EEM (ELECTRONIC ENGINEERS MASTER Catalog) for complete information on Abbott modules.

Send for our new 68 page FREE catalog.

RELIABLE — Highest quality components are used in Abbott power modules to yield the high MTBF (mean time between failure) as calculated in the MIL-HDBK-217 handbook. Typical power modules have over 100,000 hours MTBF — proving that the quality was built in from the beginning.

WIDE RANGE OF OUTPUTS — Any voltage from 5 volts DC to 3,650 VDC is available by selecting the correct model you need from our catalog with any of a variety of inputs including:

- 60 ϕ to DC, Regulated
- 400 ϕ to DC, Regulated
- 28 VDC to DC, Regulated
- 28 VDC to 400 ϕ , 1 ϕ or 3 ϕ
- 24 VDC to 60 ϕ , 1 ϕ

abbott

t r a n s i s t o r

LABORATORIES, INCORPORATED

5200 W. Jefferson Blvd./Los Angeles 90016
(213) 936-8185

1224 Anderson Ave./Fort Lee, N.J. 07024
Cable ABTLABS (201) 224-6900

INFORMATION RETRIEVAL NUMBER 12

Publisher

Peter Coley

Editors

Editorial Offices
50 Essex St.
Rochelle Park, N.J. 07662
(201) 843-0550
TWX: 710-990 5071
Cable: Haydenpubs Rochellepark

Editor: George Rostky
Managing Editor: Ralph Dobriner
Managing Editor: Michael Elphick

Associate Editors:

Roger Allan
Jules H. Gilder
Richard Lee Goldberg
John F. Mason
Nathan Sussman
Edward A. Torrero
Richard L. Turmail
Contributing Editor:
Peter N. Budzilovich

Field Offices

Massachusetts

Jim McDermott
P.O. Box 272
Easthampton, Mass. 01027
(413) 527-3632

West Coast

David Kaye
2930 Imperial Highway
Inglewood, Calif. 90303
(213) 757-0183

Washington

Don Byrne
1111 S. Army Navy Drive
Arlington, Va. 22202
(202) 296-8982

Editorial Production

Dollie S. Viebig

Art

Art Director, William Kelly
Richard Luce
Anthony J. Fischetto

Production

Manager, Thomas V. Sedita
Helen De Polo
Maxine Correal
Anne Molfetas

Circulation

Manager, Nancy L. Merritt
Joan Licari

Information Retrieval

Peggy Long

across the desk

University adds degree in medical electronics

The article on "Defects in Medical Electronics Draw Heavy Fire From Hospitals" in the Oct. 28, 1971, issue is timely. The lack of communications between physicians and engineers is a real and ever-present problem today. It is to the solution of that and other related problems that Texas A&M University has addressed itself in the creation of a new undergraduate degree program in Biomedical Engineering. Like several other similar programs across the nation, we are training engineers who are competent and versed in both the physical and life sciences, and who are able to speak the language of physicians and engineers with equal facility.

The problems of reliability, accurate specifications and standardization are just a few of those with which biomedical engineers will be competent to work. This specialized training will enable engineers to reduce costs and improve reliability in the medical field, as they have in other fields.

Arthur M. Sherwood, Ph.D.
Assistant Professor

Texas A&M University
Bioengineering Program
College Station, Tex. 77843

Some added facts for 'Focus' article

I would like to point out some important features of National Semiconductor's LM112 and LM216A amplifiers not mentioned in "Focus on Linear ICs" (ED 21, Oct. 14, 1971, pp. 52-64).

The LM112 was designed as an internally compensated LM108. With the feature of internal compensation, we were able to offer

easy offset balancing with a single 100-K potentiometer. No other operational amplifier with the input specifications of the LM112 offers easy offset voltage adjustment.

The LM216A amplifier should be best compared with FET input amplifiers. It was designed to offer ultra-low bias currents. The worst-case bias current of 100 pA and offset current of 30 pA is well within the range obtained only with FET amplifiers. Further, because we use super-gain transistors to obtain these low bias currents, we are able to offer much lower offset voltages (6 mV over temperature) than FET devices.

Of course, National makes an LM108A device, which offers maximum 1-mV offset voltage and 400-pA offset current over temperature.

Robert C. Dobkin
Director

Advanced Circuit Development
National Semiconductor Corp.
Santa Clara, Calif. 95051

When "it can't be done" it sometimes takes effort

I am happy to learn through Fred A. Kahl's letter in the Sept. 30 issue ("Subway Power Plan Is a Nice Plan, but—") that the City of London could not solve the problem of air leaking past shaft seals and so dropped an evacuated flywheel energy-storage system for its buses. This knowledge might serve to assure me that "it can't be done" and that further efforts to use a flywheel to store energy are doomed to failure. Unfortunately, many otherwise fruitful ideas have succumbed to such firm knowledge.

However, I am confident that some unknowing engineer will be stupid enough to ignore this factual data and consider enclosing the flywheel and motor-generator

Electronic Design welcomes the opinions of its readers on the issues raised in the magazine's editorial columns. Address letters to Managing Editor, Electronic Design, 50 Essex St., Rochelle Park, N. J. 07662. Try to keep letters under 200 words. Letters must be signed. Names will be withheld on request.

HIGH POWER VOLTAGE REGULATORS

2 1/2" X 1 5/8" X 3/4"

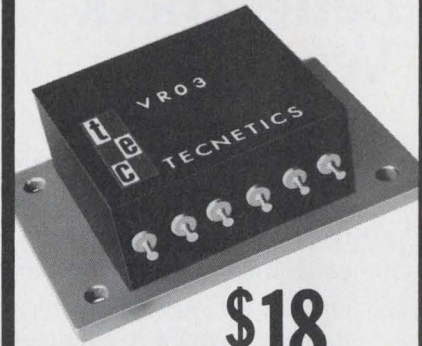

\$18
EACH

Now, there's a second source for high power voltage regulators. Tecnetics offers the new VR03 Series. High powered, low cost, little packages. \$18 each in quantities of 100.

The VR03 Series offers:

- Short circuit and overload protection
- Increased current output when used as a driver for series regulating transistors
- Increased power handling capability with external regulation transistor
- Dual connection and negative regulator connection with transformer isolation
- Positive regulator
- Remote programming
- Up to 5 Amperes D.C. output
- Up to 28 Volts D.C. output
- Up to 70 Watts dissipation
- 0.2% Regulation, line or load
- 0.007%/°C temperature coefficient
- Remote sensing
- Electrically isolated case

Manufactured to your specifications

tecnetics inc.

P.O. Box 910, Boulder Industrial
Park, Boulder, Colorado 80302
(303) 442-3837 TWX 910-940-3246

INFORMATION RETRIEVAL NUMBER 13

So you're looking for bandpass filters...

better check Vernitron... (the ceramic filters people)

Miniature, lightweight, stable, fixed-tuned—that's ceramic filters for you. And Vernitron, innovator in piezoelectric technology, has varieties for almost any kind of communications equipment—consumer, commercial, military. If you're looking for size-reduction, cost-reduction—and high performance where it counts—it will pay you to check with Vernitron. A few examples:



FM-4
10.7 MHz monolithic miniature for quality FM's. Only 0.016 cu. in.—replaces four tuned circuits 20 times its size. Bandwidth: 235 kHz @ 3 dB; 825 kHz @ 40 dB. Less than 1/2% distortion. The filter for the best in home entertainment, auto, or commercial FM's. **Data sheet 94033.**



11-DISC LADDER FILTER
Rugged little 455 kHz lump-filter for MIL or commercial. Rejection above 60 dB in less than 0.1 cu. in. Six standard models, 6 to 40 kHz @ 6 dB. Great for handhelds, mobile or airborne. **Data sheet 94029.**



17-DISC LADDER FILTER
455 kHz. Ultimate in selectivity, stability and ruggedness for MIL-quality AM's or FM's. Ten standard models, shape factors 2.5:1 to 1.4:1. Rejection to above 80 dB. Highest shock and vibration resistance. **Data Sheet 94017.**



TCF SERIES
Low-cost 455 kHz filter with fixed-tuned LC input, for 2-way, landmobile, aircraft, navigation or CB. Choice of standard bandwidths—6, 12, 18, 30 and 35 kHz. Highest selectivity at lowest cost. **Data sheet 94026.**



LOW FREQUENCY (LF) SERIES
9 to 50 kHz. High-performance miniature for LF communications or Omega systems, selective calling, U/W sound, command-destruct. Rejection to 40 dB. Can be cascaded for higher rejections. Cascaded assemblies available; also shock/vibration units to MIL specs. **Data Sheet 94030.**

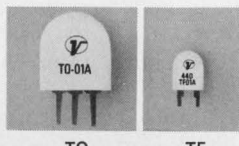

TRANSFILTERS®
Low-cost replacements for inductive or capacitive elements in IF stages or discriminators. TF's contain single resonator, 2 terminals; TO's are complete filters with 3 terminals. Excellent interstage couplers for transistor circuitry. **Data Sheets 94018-20.**

NEED DESIGN HELP? Computer-design facilities give us an edge in designing specials for special needs. If it's bandpass filters you're looking for, get in touch.

Vernitron Piezoelectric Division
232 Forbes Road / Bedford, Ohio 44146 / (216) 232-8600

INFORMATION RETRIEVAL NUMBER 14

ACROSS THE DESK

in the same enclosed housing and thereby avoid the problem of shaft seals. This engineer might even compromise on a level of vacuum and settle for a very "poor" vacuum, and thus even avoid the outgassing problem inherent in evacuating some organic materials.

Too bad Wilbur and Orville were stupid, and Edison, and Eli Whitney, and Marconi, and . . .

Robert W. Bradspies,
President

Design Technology, Inc.
P. O. Box 2700
Pasadena, Calif. 91105

Reader assails laser editorial

I just read "Safety First—Where It Doesn't Matter" (ED 24, Nov. 25, 1971, p. 49). I consider it one of the most irresponsible editorials I've ever read. You remind me of the people who try to play down the Vietnam war because more people get killed every year in auto accidents. The logic is specious. People are not drafted to drive automobiles. And they are well aware of its dangers.

Most people, including most engineers, know nothing about lasers. And employment is not as important as eye damage. You say, "Let's horse around with laser safety after we've taken care of automobile safety." You must be out of your mind!

George Daberstein

Strom Engineering
Hopkins, Minn.

I have to disagree with your view of the proposed safety standard for lasers. First, the level does seem a little low, but it is better to err on the side of safety than to be sorry years later after much damage has been done. One need only look at the mess in Colorado and the sticky problems the Atomic Energy Commission now faces with uranium tailings to see the results of liberal safety standards. Second, perhaps research in low power level lasers will be increased by this standard and thus create more jobs and markets for the industry.

(Continued on p. 16A)

Make the simple move

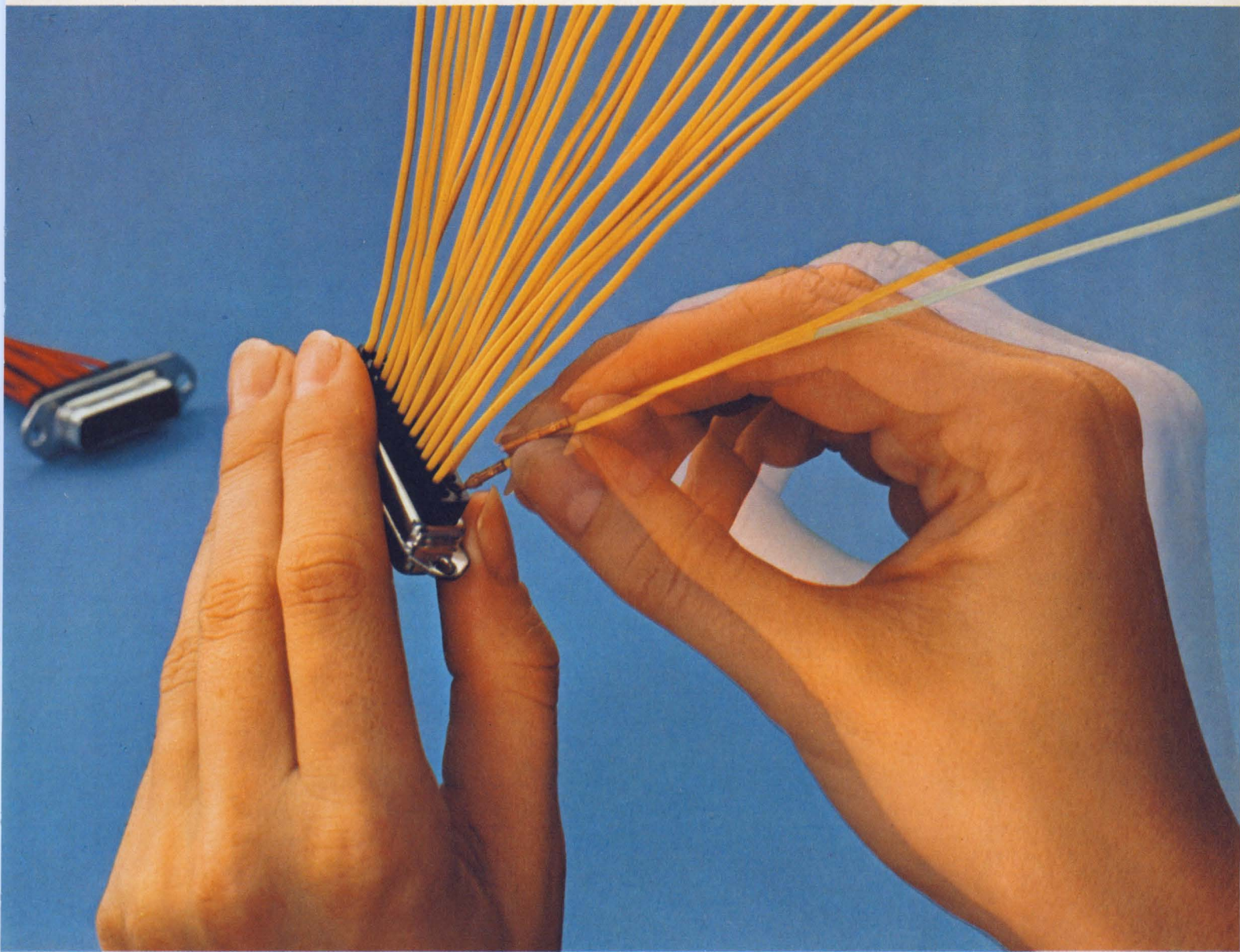

to less assembly time.

Do it the easy way with Amphenol's 17 Series miniature rear-release connectors.

A gentle push from the back of the connector and the contact snaps securely in place. No tools or broken fingernails, just easy fingertip assembly. And to remove the contact for fast-field servicing, insert a simple plastic tool in the back of the connector and out pops the contact.

You can have a choice of screw-machine contacts in bulk packaging, or stamped and formed contacts on a carrier strip. Semi-automatic crimping or hand tools available for either type of contact.

The Min-Rac® 17 Series connectors are available in 9, 15, 25, 37, and 50 contact configurations. All meet EIA Standard RS-232C for data communications input-output connectors. And all are intermountable and intermateable with other Min-Rac 17 Series connectors as well as competitive "D" type connectors.

Find out how simple it really is. Just write Dick Colt asking for the whole story on our Min-Rac 17 Series rear-release connectors. Amphenol Industrial Division, Bunker Ramo Corporation, 1830 South 54th Avenue, Chicago, Illinois 60650.

**BUNKER
RAMO**

AMPHENOL

Dow Corning silicones seal, bond, insulate, cool, encapsulate...

and how's this for repairability?

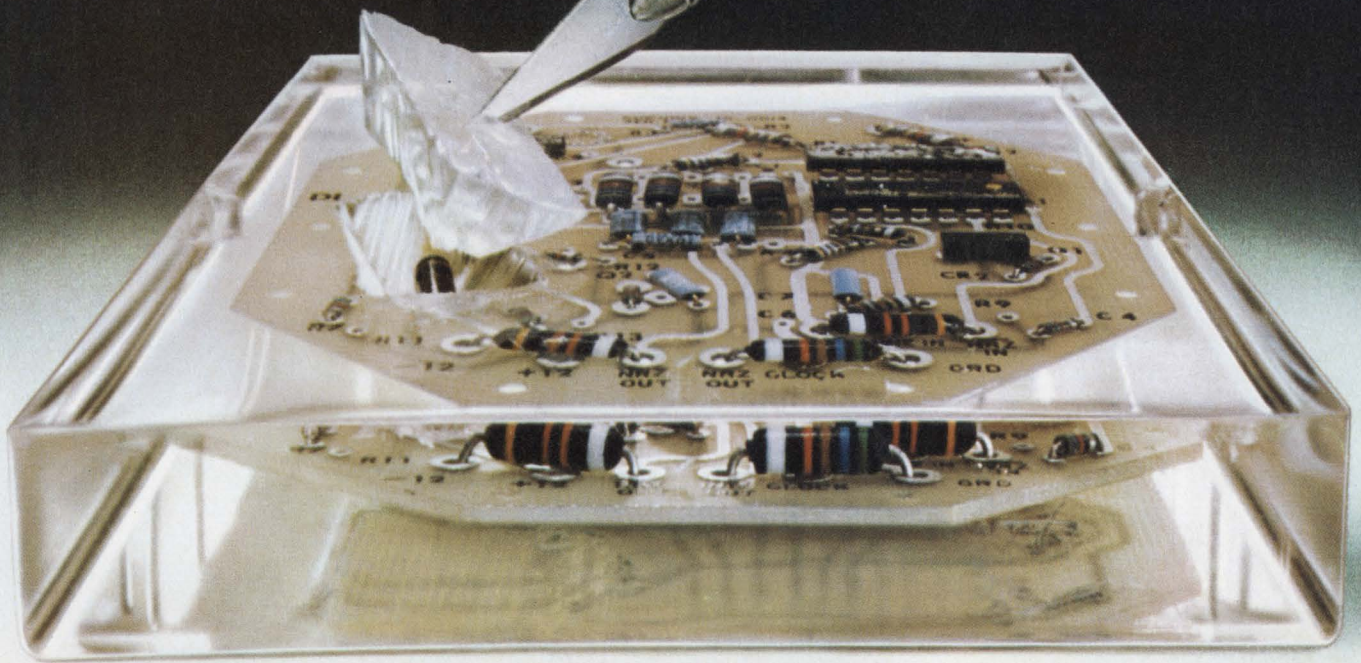

See-through silicone package speeds repair. Encapsulation of microcircuits with a clear resilient Sylgard® brand resin pays off with more than just protection. When circuits are under development, the encapsulant can be cut away to expose components for testing and modification. And, if fast field repair is a factor, defective components are more quickly located and replaced. Voids are merely filled with the silicone resin and protection is again intact. Sylgard resins also eliminate cure shrinkage associated with other encapsulants. They easily meet the most exacting shock, vibration, temperature and moisture resistant requirements. Circle Information Retrieval Number 821.

Silicone materials are unusually versatile. But whether they are used to seal, bond, insulate, impregnate, encapsulate or cool—their one basic function is to protect. And they protect better because of inherent silicone resistance to change—regardless of environment. When electronic equipment must function reliably in hostile atmospheres, look

to silicones from Dow Corning to shut out trouble. Described here are a few ways our materials can ensure the integrity of your designs. Many others are described in our Silicone Electronic Materials brochure available from your Dow Corning distributor. His name appears on the following page. Or write Dept. A-1220, Midland, Michigan 48640.

Electrical / electronic materials from

DOW CORNING

DOW CORNING

Noncorrosive silicone sealants.

For critical electronic insulating requirements on corrosion-sensitive materials. Four noncorrosive, acid-free curing silicone sealants are available from Dow Corning—two are pourable, self-leveling liquids for conformal coatings; the other two are nonslump materials for sealing, mounting and bonding. All are ready to use, cure at room temperature and are serviceable over a wide temperature range. Circle Information Retrieval Number 822.

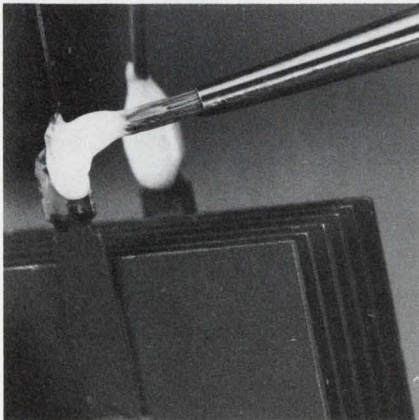

Dissipate heat fast with silicones.

You can use silicone materials to protect from heat, or to get rid of it. A Dow Corning® brand heat sink compound helps cool components such as transistors, diodes and rectifiers by transferring operating heat to heat sink or chassis. Thermal conductivity is effective as high as 200 C with this noncorrosive, metal-oxide filled silicone material. Ask about silicone fluid coolants also. Circle Information Retrieval Number 823.

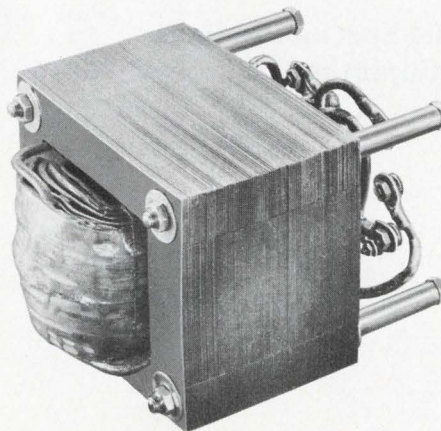

Silicone varnish aids miniaturization.

When operating temperatures of new spacesaving power supplies such as transformers hit the 200 C mark, protection with Dow Corning® brand silicone impregnating varnishes ensures performance. These materials are the most reliable insulating resins available. And they are easy to apply. Stators, chokes, coils, solenoids and other electronic equipment are protected by simply dipping, brushing, flooding or impregnating. Circle Information Retrieval Number 824.

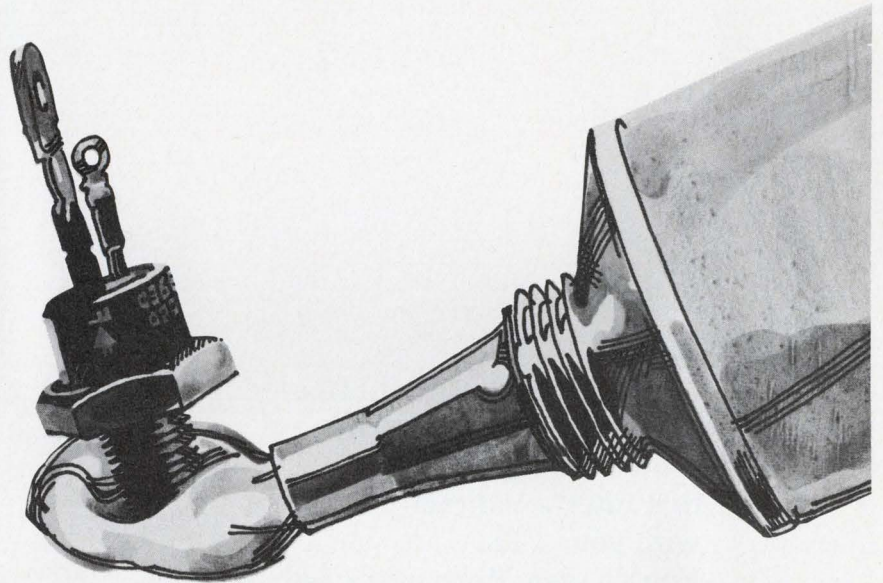

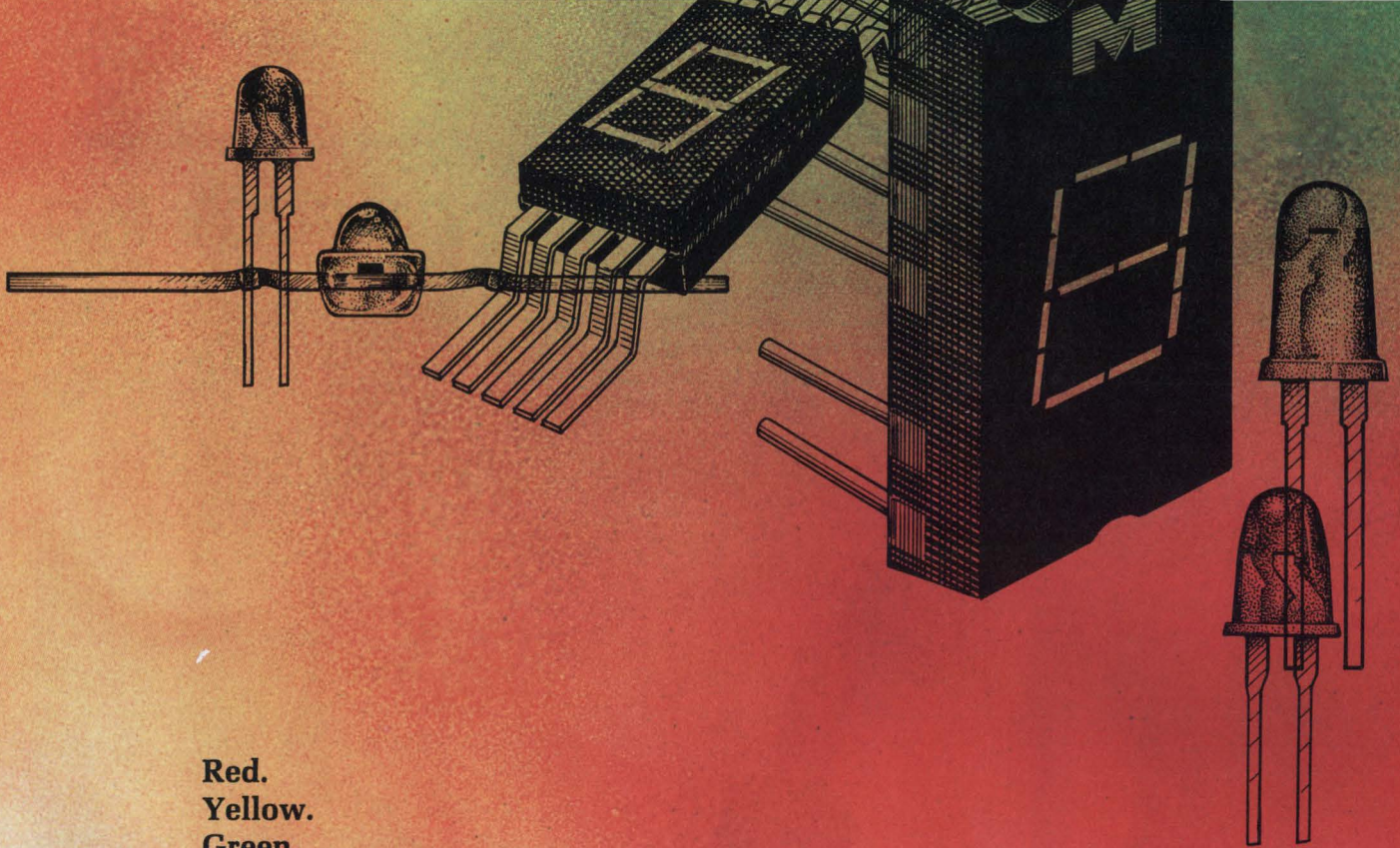

Red.
Yellow.
Green.

And they're all GaAsLITEs,
never-burn-out surge-free
solid state light bulbs
that interface directly
with your TTL.

You've seen Monsanto's red discretes
and displays. Now see what we've
done in bright golden yellow and high
visibility green. Discretes and displays.
Rock-solid GaAsLITEs that take the
worst mechanical punishment
you can dish out.

Up 'til now, GaAsLITE colors could only
say STOP. Or WATCH OUT.

Now they can say WAIT and GO.

Get the whole multi-colored GaAsLITE
story. Drop us a note and we'll send
you our new catalog. And a price
list full of surprisingly small numbers.

Monsanto Electronic Special Products
10131 Bubb Road, Cupertino, California 95014.

Monsanto

ACROSS THE DESK

(continued from p. 12)

Although there are relatively few lasers now in use, they are beginning to be used in industry as standard production tools. This often means that people with little technical training will either be using them or have access to the laser work area.

Michael T. Reischel

Box 3038
University Station
Laramie, Wis. 82070

Right on! I hope copies of the book containing the laser editorial will find their way into the corridors of power in Washington.

Ricardo J. Alfaro 2d

Kelmtner Advertising Inc.
680 Beach Street
San Francisco, Calif. 94109

More memories to remember

I enjoyed reading your "Focus on Semiconductor Memories" in the Sept. 16th issue and would like to bring you up to date on some recent significant Cogar achievements not covered in your report.

We are in volume production of an n-channel, 1024-bit, fully decoded RAM chip. The storage cell is based on a stored-charge principle, with four devices per cell. The chip is designed so that all cells are refreshed simultaneously within one memory cell.

Two chips are packaged on a 0.6-inch-square ceramic module as 2048 words by one bit. The access time is 80 ns with read or write cycle of 100 ns. The modules are packaged on a card with timing and logic circuits, drivers, sense amplifiers and data-out registers. On a card measuring 7.9 × 8.8 inches, we can package 8192 words by 18 bits, with internal timing-control circuits for simplified I/O interface. Access time is less than 150 ns worst case, with a cycle time of 275 ns. Voltages required are +5 V and -6 V. Power dissipation is less than 0.3 mW/bit.

On the system level, we have begun shipment to ICL of 32,768-words-by-25-bit memory systems on six cards for the 1904S com-

(continued on p. 16D)

DOW CORNING SILICONE PROTECTORS

A full line of silicone encapsulating, insulating, sealing, coating and dielectric materials is available from Dow Corning Distributors at the following warehouse locations:

ARIZONA	
Phoenix	Essex International Inc.—I.W.I. Div. 602-278-8568
CALIFORNIA	
Berkeley	C. D. LaMoree 415-841-0601
Culver City	E. V. Roberts & Associates, Inc. 213-870-9561
Los Angeles	Essex International Inc.—I.W.I. Div. 213-264-7000 C. D. LaMoree 213-225-5666
Mountain View	K. R. Anderson Company, Inc. 415-961-6007
San Diego	A. E. Yale Enterprises 714-296-6148
San Francisco	Essex International Inc.—I.W.I. Div. 415-626-5351
COLORADO	
Denver	Waco Electronics, Inc. 303-322-7708
FLORIDA	
Fort Lauderdale	Cramer/Florida Inc. 305-947-6517
Orlando	Brownell, Inc. 305-424-5634 Electrical Insulation Suppliers, Inc. 305-855-7100
GEORGIA	
Atlanta	Electrical Insulation Suppliers, Inc. 404-355-1651
Hapeville	Brownell, Inc. 404-767-9301
ILLINOIS	
Chicago	Prehler Electrical Insulation 312-384-6100
Mt. Prospect	Magnuson Electronics, Inc. 312-956-0700
Niles	Essex International Inc.* 312-647-0044
INDIANA	
Fort Wayne	Essex International Inc.—I.W.I. Div. 219-742-7441
Hammond	Electric Supply Corp. 219-932-8840
IOWA	
Marion	Ensco Distributing Corporation 319-377-6313
KENTUCKY	
Louisville	E & H Electric Supply 502-587-0991
LOUISIANA	
New Orleans	Williamson Distributing Corp. 504-486-5584
Shreveport	Williamson Distributing Corp. 318-424-6638
MARYLAND	
Baltimore	Essex International Inc.—I.W.I. Div. 301-644-0140 Pytronic Industries, Inc. 301-539-6525
MASSACHUSETTS	
Cambridge	Brownell, Inc. 617-864-7500
Newton	Cramer Electronic, Inc. 617-969-7700
Peabody	Essex International Inc.—I.W.I. Div. 617-531-7100
MICHIGAN	
Detroit	Essex International Inc.* 313-921-6000
Madison Heights	McNaughton-McKay Electric 313-399-7500
MINNESOTA	
St. Paul	Magnuson Electronics, Inc. 612-227-8495
MISSOURI	
Kansas City	Essex International Inc.—I.W.I. Div. 816-842-1613
St. Louis	Ensco Distributing Corp. 314-542-3935 Essex International Inc.—I.W.I. Div. 314-371-2616
NEW JERSEY	
Livingston	Robert McKeown Co., Inc. 210-992-0700 or 212-267-9264 (NYC)
Moonachie	Essex International Inc.—I.W.I. Div. 201-641-4400 or 212-695-7495 (NYC)
North Bergen	Electrical Insulation Sales 201-864-2376 or 212-564-6273 (NYC)
NEW MEXICO	
Albuquerque	Waco Electronics, Inc. 505-268-2409
NEW YORK	
Buffalo	Summit Distributors, Inc. 716-884-3450
New York City	Brownell, Inc. 212-691-7900 or 212-924-6000
NORTH CAROLINA	
Charlotte	Brownell, Inc. 704-399-9791 Electrical Insulation Suppliers, Inc. 704-392-2306 Essex International Inc.—I.W.I. Div. 704-394-1315
OHIO	
Cincinnati	Cramer/Tri States, Inc. 513-771-6441 Electrical Insulation Suppliers, Inc. 513-771-4073 Sheridan Sales Co. 513-761-5432 Essex International Inc.* 513-771-6500
Cleveland	Essex International Inc.* 216-781-2310 Prehler Electrical Insulation 216-267-2650
Columbus	McGraw-Edison Co. National Electric Coil Division 614-488-1151
OKLAHOMA	
Oklahoma City	Essex International Inc.—I.W.I. Div. 405-236-5411
OREGON	
Portland	Essex International Inc.—I.W.I. Div. 503-665-0138 C. E. Riggs, Inc. 503-226-3286
PENNSYLVANIA	
Harrisburg	Pytronic Industries, Inc. 717-233-6591
Montgomeryville	Pytronic Industries, Inc. 215-643-2850
Philadelphia	Brownell, Inc. 215-632-3030 Essex International Inc.—I.W.I. Div. 215-236-7100 Prehler Electrical Insulation 215-725-5914
Pittsburgh	Essex International Inc.* 412-244-1145
TENNESSEE	
Memphis	Brownell, Inc. 901-323-7693 Electrical Insulation Suppliers, Inc. 901-947-4176
TEXAS	
Dallas	Essex International Inc.—I.W.I. Div. 214-339-8346 Specialized Products Company 214-358-4663 Williamson Distributing Corp. 214-741-5831
Houston	Essex International Inc.—I.W.I. Div. 713-227-6358 Williamson Distributing Corp. 713-672-1715
WASHINGTON	
Seattle	Atlas Packing & Rubber Co. 206-623-4697 Essex International Inc.—I.W.I. Div. 206-763-8650 C. E. Riggs, Inc. 206-623-5707
WISCONSIN	
Milwaukee	Essex International Inc.* 414-342-3927 *IMC/I.W.I. Div.

Electrical/electronic materials
from

DOW CORNING

DOW CORNING



Think Twice:

How will you choose your next portable scope ...on faith, or on fact?

Forget everything you ever knew about portable scopes; today's portables are something else entirely. In the last year, both major scope manufacturers have brought out completely new lines. So, choosing a new portable on "blind faith" in your old make is about as sensible as marrying a girl you've never met, just because her second cousin was Miss America in 1967.

The only rational way to choose a new portable today is to make a head-on comparison between our scopes and our competitor's. And this means more than just a quick look at price tags and specs. It means a thorough investigation of total acquisition cost. Be sure you check these specific points:

Initial purchase price. Are you getting the best price available? HP's Portables are priced as much as \$200 below the competition, with special purchase agreements available.

Ease of Use. Are the controls simple and logical? Or are they a jungle of tightly packed knobs. Ten minutes a day, spent in needless tinkering, can add up to hundreds of

dollars a year in wasted man-hours.

Fieldworthiness. Some scopes have such high power requirements that battery operation is impossible. HP feels that a portable scope should have "go-anywhere" capabilities, so our Portables all use low-power-requirement designs which permit battery operation. Low power requirements also mean lower heat, which prolongs component life. As a result, only HP's Portables eliminate the need for fans, or dust-admitting vent holes.

Calibration and Service. Have you considered how much your scope will cost you *after* you've purchased it? For example, HP Portables are quickly calibrated — requiring approximately half the time required to calibrate our competitor's portable scope. This could save you hundreds of dollars over the life of your scope. And are you going to have to deal with one manufacturer for scope service, and another for your voltmeters, signal sources, etc.? Or can you save time and money by limiting your dealings to one company? And don't forget training aids; HP offers live

demonstrations, video tapes and literature to simplify conversion problems.

Look into all these points, and we think you'll find that you'll save a lot of time, effort, and money — and avoid a lot of frustration — by choosing HP's Portables. But don't take our word for it; make the comparisons yourself.

For a revealing package of information on HP's new Portables, send for a free copy of our "No-Nonsense Guide to Oscilloscope Selection." Or contact your local HP field engineer for a demonstration. Check before you choose. Hewlett-Packard, Palo Alto, California 94304. In Europe: 1217 Meyrin-Geneva, Switzerland.

**Scopes Are Changing;
Think Twice.**

082/2

HEWLETT  PACKARD

O S C I L L O S C O P E S

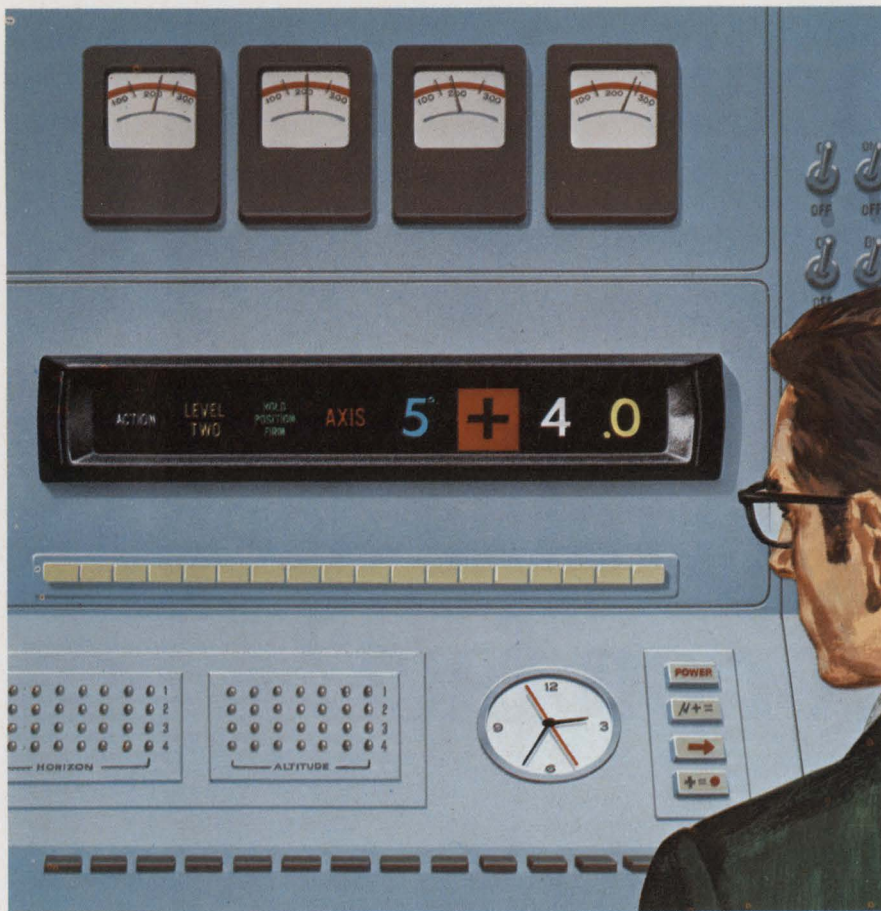

There's more to us than meets the eye!

and it comes in one package, ready to plug in.

Providing the most versatile, eye appealing displays is our main endeavor—but our concern doesn't end there... not by a long shot. We look beyond to the point of application and how we can save you hours of engineering design time and multi-vendor selection procedures. For instance, we can deliver the complete display package (readouts, drive electronics, switches, bezels, mounting hardware, etc.) ready to

plug in at a price that lets you forget about the preliminaries. Typical, are complete assemblies, from low cost commercial equipment, all the way up to complex RFI/safe military systems. It's a total package concept that makes sense in many ways. Give us a call. IEE, "the plug-in people." Industrial Electronic Engineers, Inc., 7740 Lemona Avenue, Van Nuys, Calif. 91405. Telephone: (213) 787-0311 • TWX 910-495-1707.

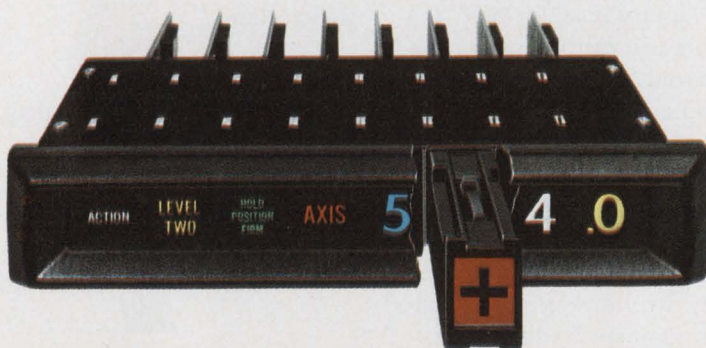

INFORMATION RETRIEVAL NUMBER 17

ACROSS THE DESK

(continued from p. 16A)

puters. The system access time is 175 ns with a 275-ns cycle time. We believe this is the first use of an MOS main memory for a major computer line.

Thomas Kwei

Manager, Systems Applications
Cogar Corp.
Technology Div.
All Angels Hill Rd.
Wappingers Falls, N. Y. 12590

Why can't vendors tell us their prices?

Help! Why are some manufacturers cozy about prices? Few things are more frustrating than to find no price information in an otherwise impressive set of specifications.

I've heard some of the inane excuses that the sales managers offer—"prices change a lot" or "we like to get you to talk to us." While this may please the sales manager, it simply makes me angry. So I try to deal only with those vendors who make at least approximate pricing available with their technical data. In fact, I round-file material that does not include prices, and when I write to a vendor for data I state: "... include prices or forget it!"

Are there many others who suffer from this acute annoyance? If so, let's create a movement. With ELECTRONIC DESIGN coordinating, we could break the price info bottleneck.

L. D. Dillard
Senior Physicist

American Optical Corp.
Framingham Laboratory
P.O. Box 187
Framingham Centre, Mass. 01701

Accuracy is our policy

In the Idea for Design "Nano-second Pulser Gives a 4-A Output" (ED 23, Nov. 11, 1971, p. 64), the collector resistor of transistor Q1 was mistakenly labeled 108 k in the diagram. The correct value should be 180 k.

**\$10.24 is the price of our
1024 bit silicon gate RAM
if you buy 1-999 pcs.**

more is less.

The 1024 bit RAM RA-9-1103, the pin-for-pin replacement for the 1103, is immediately available from authorized General Instrument distributors. Also available are the pin-for-pin replacements for the 1101A and 1101A1, General Instrument's RA-9-1101A and RA-9-1101A1, priced at \$7.50 and \$8.50 respectively, in quantities of 1-999 pcs.

For complete information call 516-733-3138 or write: Marketing Services Manager, General Instrument Corporation, 600 West John Street, Hicksville, N.Y. 11802, or call, in New York: 516-733-3333; in Chicago: 312-774-7800; in Los Angeles: 213-641-7411. In Canada, call or write: General Instrument Canada, Ltd., 61 Industry Street, Toronto 337, Ontario, Canada, Tel: 416-763-4133. In Europe, write: General Instrument Europe S.P.A., Piazza Amendola 9, 20149 Milano, Italy. In the U.K., write General Instrument Microelectronics Ltd., Stonefield Way, Victoria Rd., South Ruislip, Middlesex, England. In the Far East, write General Instrument of Taiwan Ltd., P.O. Box 22226, Taipei, Taiwan.

THE WORLD'S MOS EXPERIENCED COMPANY



GENERAL INSTRUMENT CORPORATION • 600 WEST JOHN STREET, HICKSVILLE, L. I., NEW YORK

INFORMATION RETRIEVAL NUMBER 18

IC panels: by the piece... or

AMP gives you two ways to go for building the IC panels you want, economically.

Make them yourself.

We'll supply all the mounting components you need. Miniature spring sockets, IC receptacles, DIP headers and strip receptacles. And high-speed machines to apply them in your plant.

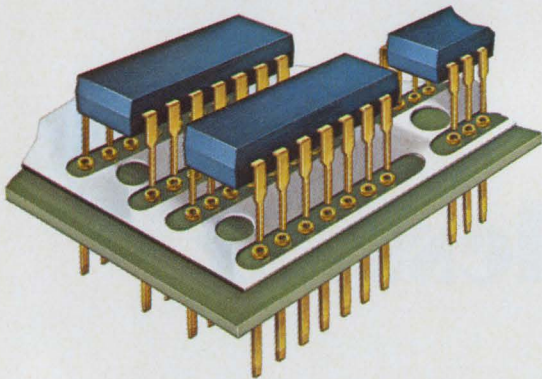

Miniature spring socket • inner spring exerts constant pressure on lead end for maximum retention and conductivity • wide bell-mouth for easy entry • low profile • flare lip for stop • accepts DIP leads and round leads .010" to .040" diameter • available with wrap-type or TERMI-POINT* clip-type posts, also solder version.

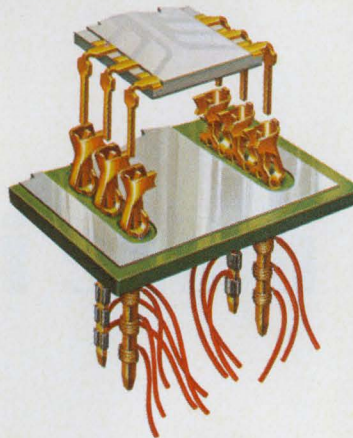

IC receptacles • accepts .022" round leads and .022" x .040" rectangular leads • has wide contact lead-in—unique anti-overstress feature assures good contact • available with wrap-type or TERMI-POINT clip-type posts • solder version available.

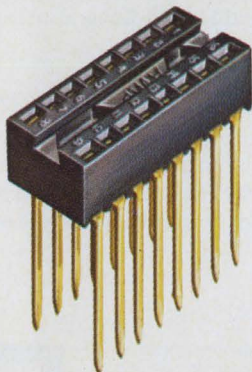

DIP headers • ideal for low-cost, high density packaging • built-in overstress design • bell-mouthed entry for easy insertion of IC's • 14 and 16 leads • available with wrap-type or TERMI-POINT clip-type posts • solder version available.

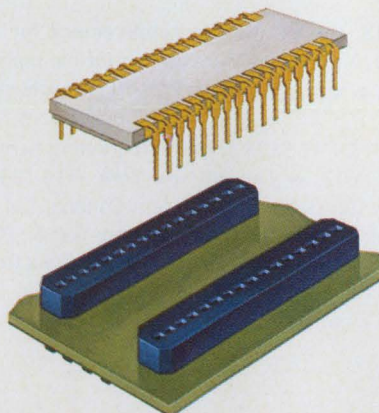

Low profile DIP header and DIP strip receptacles • only .150" high • housings are self-containing for solder operation • header accepts standard 14 and 16 pin DIP's • strip receptacle available in 4 position through 22 position DIP patterns.

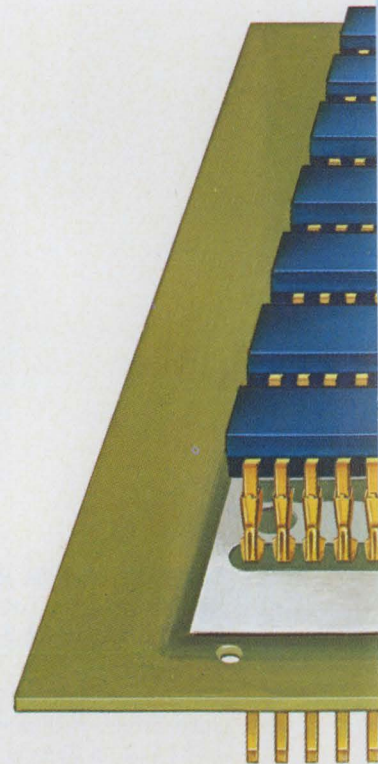

*Trademark of AMP Incorporated.

by the boardful.

Have us make them for you.

Finished IC panels made to your specifications and ready for you to insert IC packages.

Fact is, we can take your IC panels to the final step and supply them pre-wired with wrap-type point-to-point wiring, or our own TERMI-POINT clips.

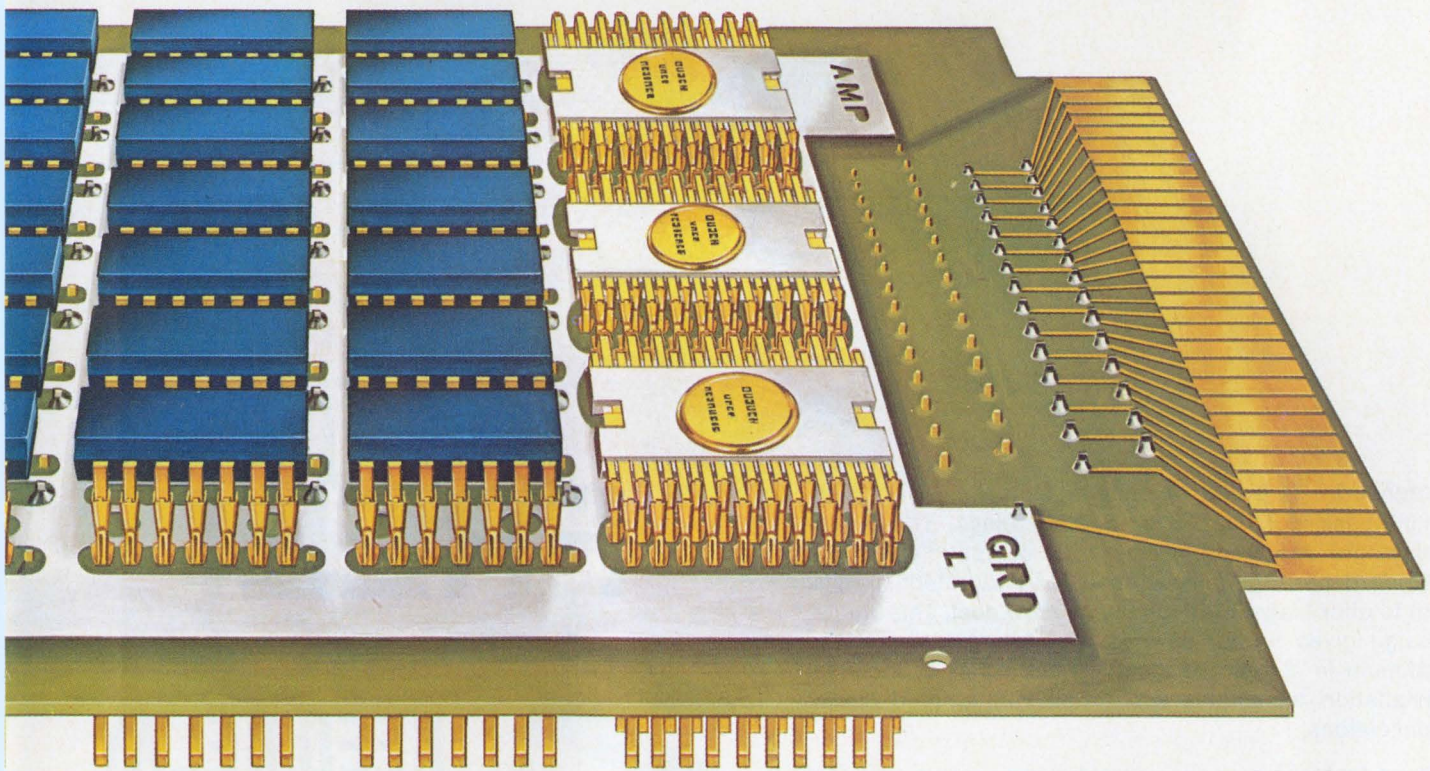

Either way you get all the reliability you need plus the benefits of AMPECONOMATION . . . high-speed AMP automated application machinery that gives you the greatest number of reliable connections at the lowest installed cost.

For details that can help you make a choice write:
AMP Incorporated, Harrisburg, Pa. 17105

AMP
INCORPORATED

Manufacturing and Direct Sales Facilities in: Australia, Canada, France, Great Britain, Holland, Italy, Japan, Mexico, Puerto Rico, Spain, Sweden, United States and West Germany.

INFORMATION RETRIEVAL NUMBER 19

DIP

DUAL-INLINE-PACKAGED REED RELAYS

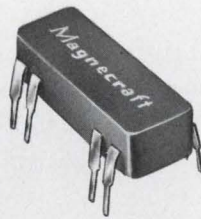

Magnecraft is proud to announce its new DIP (dual-inline-package) line of 8-pin reed relays. These new relays are designed not only to be compatible with the standard packaging developed for integrated circuits, but to offer Magnecraft quality at a low cost. This unique design gives further savings by offering the user the optimum in automated insertion and other economical installation techniques associated with printed circuit applications.

These fantastic new epoxy molded reed relays are ideal for use in circuits where high density packaging is essential. The 5VDC IC compatible versions of these relays will operate directly from TTL or DTL circuits.

Other standard coil voltages are available from stock in 6, 12, and 24VDC as well as contact configurations in 1 form A, 2 form A, 1 form B, and 1 form C. Most versions are also offered with a choice of an internal clamping diode.

Magnecraft[®] ELECTRIC COMPANY

5575 NORTH LYNCH AVENUE • CHICAGO, ILLINOIS 60630 • 312 • 282 5500 • TWX 910 221 5221

FREE!



REED RELAY HANDBOOK

The purpose of this 120-page handbook is to assist the design engineer in specifying the proper reed relay for a given application. The book contains a glossary of terms, principles of operation, applications and design requirements as well as specifying and testing data. New products include the complete line of DIP Reed Relays.

INFORMATION RETRIEVAL NUMBER 20

HEWLETT  PACKARD
POWER SUPPLIES

*take a
close look
when you
specify a
power
supply...*

There's a lot to consider when you specify a power supply, and HP gives you a lot. Take selection for example. HP offers well over 100 models ranging from 10uV to 4000V, from 1uA to 2000A . . . plus a selection of options that satisfy most applications. Performance is another major consideration. At HP, we don't practice "specsmanship". We present specifications conservatively and completely, so you get the performance you expect. And, every model is backed by a comprehensive operating and service manual detailing every aspect of the supply from operation to maintenance. But it doesn't end there . . . if you need assistance, we have an international network of 220 offices to serve you. And it's all based on a concept of quality and reliability — your assurance that you are getting the best value. Hewlett-Packard, New Jersey Division, 100 Locust Avenue, Berkeley Height, New Jersey 07922, Telephone (201) 464-1234.

DC POWER SUPPLY SELECTION GUIDE—this 36-page guide is factual and informative . . . clearly lists all the specs, features, options, prices, etc. on every HP power supply . . . makes it easy to find the right model for any application. Write for your copy.



INFORMATION RETRIEVAL NUMBER 21

21103



6259B DC POWER SUPPLY
HEWLETT - PACKARD 0-10V 0-50A

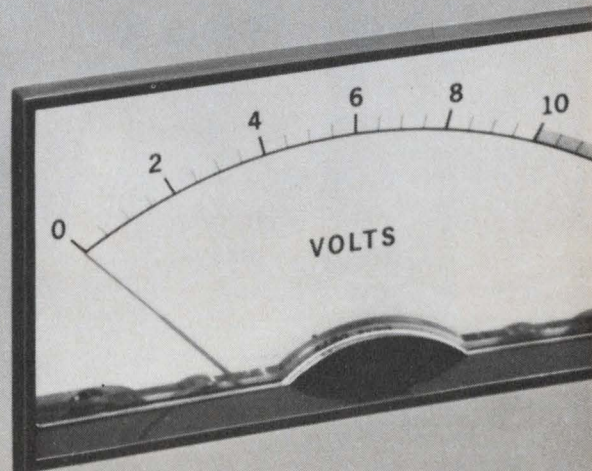

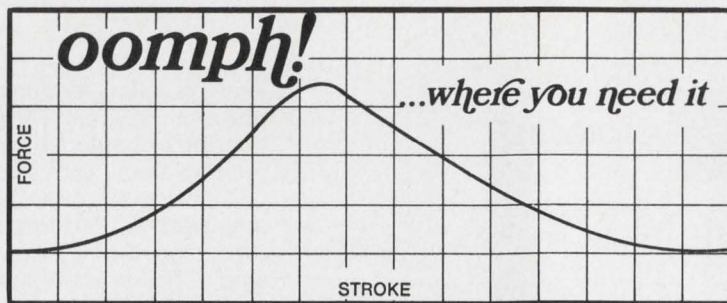

At Ledex we shape solenoids to give you the exact force and stroke you need.

All about oomph . . . and where to get it

The engineer needed a 2" stroke. Little force at the start, then a 40 lb. wallop in the middle. To reduce impact at the end, he wanted the force to tail off.

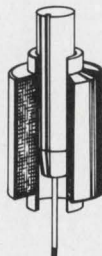

We call our answer the solenoid with the oomph in the middle. Just as the curve shows, it's designed so the maximum output comes out near the center of the stroke.

For other actuating applications, there are over 300 Ledex shelf model solutions to choose from. Here are just three examples:

short fast stroke

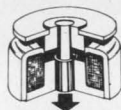

Move a short stroke load in 5 to 10 milliseconds with a Ledex flat-face pancake shape solenoid.

long linear haul

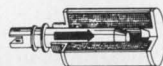

You can move big loads far with Ledex tapered plunger cylindrical solenoids.

swift rotary action

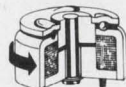

For action in an arc or uniform linear movement, or both, consider a Ledex rotary solenoid.

To get the exact force, stroke and speed you need, just describe your application to our actuating technology people. If your exact answer isn't already on our shelf, we'll design one for you.

LEDEX *the total technology people*

LEDEX INC.
123 Webster Street
Dayton, Ohio 45401
(513) 224-9891



For the latest in actuating technology, here are two catalogs you should have on hand. We'll be glad to send them if you'll write or call.

C-1000



C-1100

*new things
keep
happening
at Ledex*



... a 24 gram solenoid,
Size 50

Only one inch long, 1/2" diameter. What can it do?

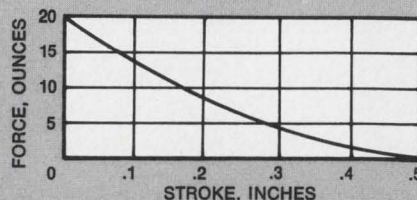

Small, light and powerful, it's built for durability. A heavy duty plunger stop and resilient impact cushion are built in, so the pole faces never clobber each other. For smooth travel, the plunger is electroless nickel plated. Price: about \$2 in lots of 500.



Coil Cords

for products that move

There's more to coil cord design than snapping back in place. Lots more. Like human, electronic, and environmental requirements. Color matching. Reliability. And cost.

Belden has the experience. Hundreds of retractile cord designs that are solving problems in communications, power and control applications. Coil cords in a wide variety of strain and stress relief configurations, special connectors, custom wire assemblies . . .

We've got a new booklet covering coil cord design parameters. It will help you determine important trade-offs between shielding, tensile strength, environmental protection, elasticity, and cost. We'll show you how Beldfoil® can eliminate noise problems that can originate in the shield itself. The advantages of thermoplastic and thermosetting jacket materials. And how to get the right elasticity for your equipment application. Just contact Electronic Sales Service Dept., Belden Corporation, Richmond, Indiana 47374. Phone (317) 966-6681.

Electronic Sales Service Dept.
Belden Corporation
Richmond, Indiana 47374
Phone (317) 966-6681



- I have an immediate coil cord design problem; please contact me.
- Please send me the new Retractable Cord Design Guide.



Name _____
 Company _____
 Title _____
 Address _____
 City _____ State _____ Zip _____
 Application _____

What do you get when you put 2 banks of resistor knowledge together? Superior Technology

MEPCO / ELECTRA CERMET TRIMMER POTENTIOMETERS

**MIL-R-22097 -
CHARACTERISTIC "F" ± 100 PPM
PERFORMANCE FOR
MILITARY/INDUSTRIAL
APPLICATIONS**

The key to superior performance in Cermet Trimmer Potentiometers is the quality of the cermet used. MEPCO/ELECTRA, pioneers in cermet technology, offer proprietary formulations that outperform all others. Resistance values from 10μ thru $5\text{ Meg}\mu$ can be supplied with a standard tolerance of $\pm 10\%$ ($\pm 5\%$ on request).

We're qualified to MIL-R-22097, characteristic "F" in styles RJ 12, 24, 26 and 50. For Industrial users... All the popular sizes and configurations including a $\frac{3}{4}$ " rectangular.

Want to know more about MEPCO/ELECTRA Cermet Trimmers? Call or write MEPCO/ELECTRA, 3347 Industrial Court, San Diego, Calif. 92121 (714) 453-0353.

Watch for an announcement of the opening of our new, expanded facility.

Other plants: Mineral Wells, Texas and Morristown, N. J.



MEPCO/ELECTRA, INC.
A NORTH AMERICAN PHILIPS COMPANY

Sold through NAP Electronic Components

MEPCO / ELECTRA THE ONLY NICHROME BASE FILM RESISTORS QUALIFIED TO MIL-R-39017

**PRECISION PERFORMANCE AND STABILITY
AT SEMI-PRECISION PRICES**

Up to now, it's been impossible to get the stability and performance characteristics of Nichrome in MIL-R-39017 resistors. The advanced production techniques of MEPCO/ELECTRA now make possible nichrome resistors with their superior characteristics, at prices competitive with tin oxide and metal glaze.

These devices exhibit superior noise characteristics and high frequency performance with much tighter tolerances and T.C.'s.

MEPCO/ELECTRA "Precision" RLR's include:

- Qualified to MIL-R-39017 styles RLR 07, RLR 20, with testing completed on RLR 32.
- Failure Rate P.
- T.C.'s to ± 100 PPM
- Tolerances: 2% and 5%
- Extended resistance ranges: RLR 07 to $300\text{ k}\Omega$

And what's more, they're in-stock, in-depth at our Mineral Wells, Texas plant.

Want to learn more about our RLR resistors? Write or call MEPCO/ELECTRA, INC., P.O. Box 760, Mineral Wells, Texas 76067.

Other Plants: San Diego, California and Morristown, New Jersey

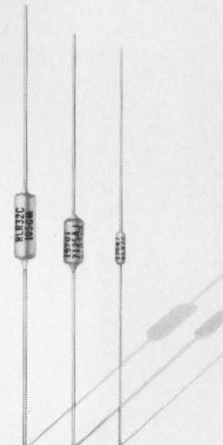

MEPCO/ELECTRA, INC.
A NORTH AMERICAN PHILIPS COMPANY

Sold through NAP Electronic Components

FACTORY LOCATIONS

COLUMBIA ROAD, MORRISTOWN, NEW JERSEY 07960 (201) 539-2000

P.O. BOX 760, MINERAL WELLS, TEXAS 76067 (817) 325-7871

3347 INDUSTRIAL COURT, SAN DIEGO, CALIFORNIA 92121 (714) 453-0353

AN OUTSTANDING SINGLE SOURCE OF RELIABILITY AND EXPERIENCE

Sold through NAP Electronic Components

INFORMATION RETRIEVAL NUMBER 24

The toughest lighted switches.

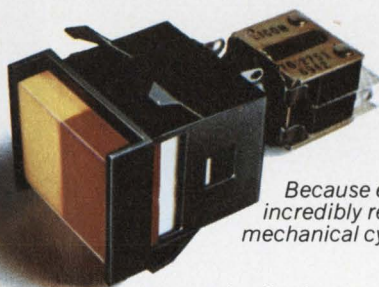
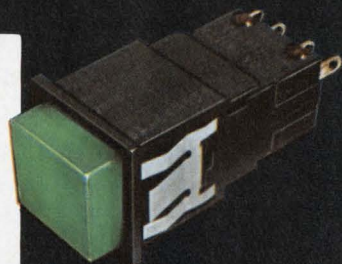
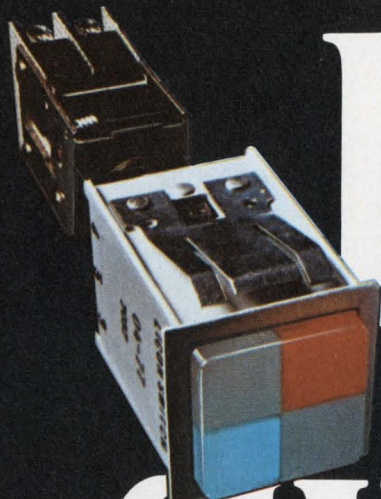

*Because every one is based on Licon's
incredibly reliable (up to 20 million
mechanical cycle) Butterfly switch.*

From the tiny inexpensive Type 01-700 to the four-lamp Type 04, every Licon® lighted switch incorporates one or more Licon Butterfly® switches. Thus the ultimate in double-break switches becomes the basis for one of the broadest lines of lighted switches available. Choose the indicating function required... one; two or four lamps... lens cap configuration... screen color and engraved legend. Name your switching

action... momentary, maintained, solenoid-held, indicator light only, or multi-circuit control. Select your mounting style... flange, barrier, bezel, bezel-barrier, horizontal or vertical, single-switch or multiple in matrix. Meet Mil Specs. In every choice, installation and servicing is fast and easy. Because ultra-reliable switching is our business. Test light the line yourself. Call your local Licon distributor or representative for a

lighted demo in your office. Or call or write for a Licon Switch Catalog. **Licon, Division Illinois Tool Works Inc., 6615 W. Irving Park Road, Chicago, Illinois 60634. Phone (312) 282-4040. TWX 910-221-0275.**



itw LICON

Right for the times!

Here's why these new counters—offered in four frequency ranges of **50, 200, 512 MHz** and **3 GHz**—are right for today's requirements:

New 6150 series expandable universal counter-timers.

S-D developed this line to handle almost every counter/timer requirement—bench and systems. Four basic models cover frequency ranges of 50, 200, 512 MHz, and fully automatic 3 GHz. Buy for current requirements and upgrade frequency range at any time. These instruments were designed from scratch for **programmability**: single line or binary, total control including attenuators, and analog or digital trigger level control.

6150 options and features: Choice of 100 nsec or 10 nsec TIM resolution—choice of five oscillators—four types of BCD output—up to 9-digit readout—versatile remote programming—3½" height in full rack width—10mV rms resolution to 0.1 Hz.

Expandability. The expandable counter concept satisfies many needs, present and future. Why? Because it's so simple and economical to **upgrade** the frequency range of your counter and add options. BCD output, additional readout digits, and a 200 MHz frequency range (in place of 50) are added by inserting new plug-in PC cards right inside your lab in minutes. Go to 512 MHz or 3 GHz, higher stability oscillators, 10 nsec TIM resolution (on 6150 universal series), and remote programming—all are offered as expandable option kits installed by your local S-D service center.

	50 MHz	200 MHz	512 MHz	3 GHz
--	-----------	------------	------------	----------

Universal Model:	6150	6151	6152	6153
Counters	Price: \$1195	\$1495	\$1795	\$2995

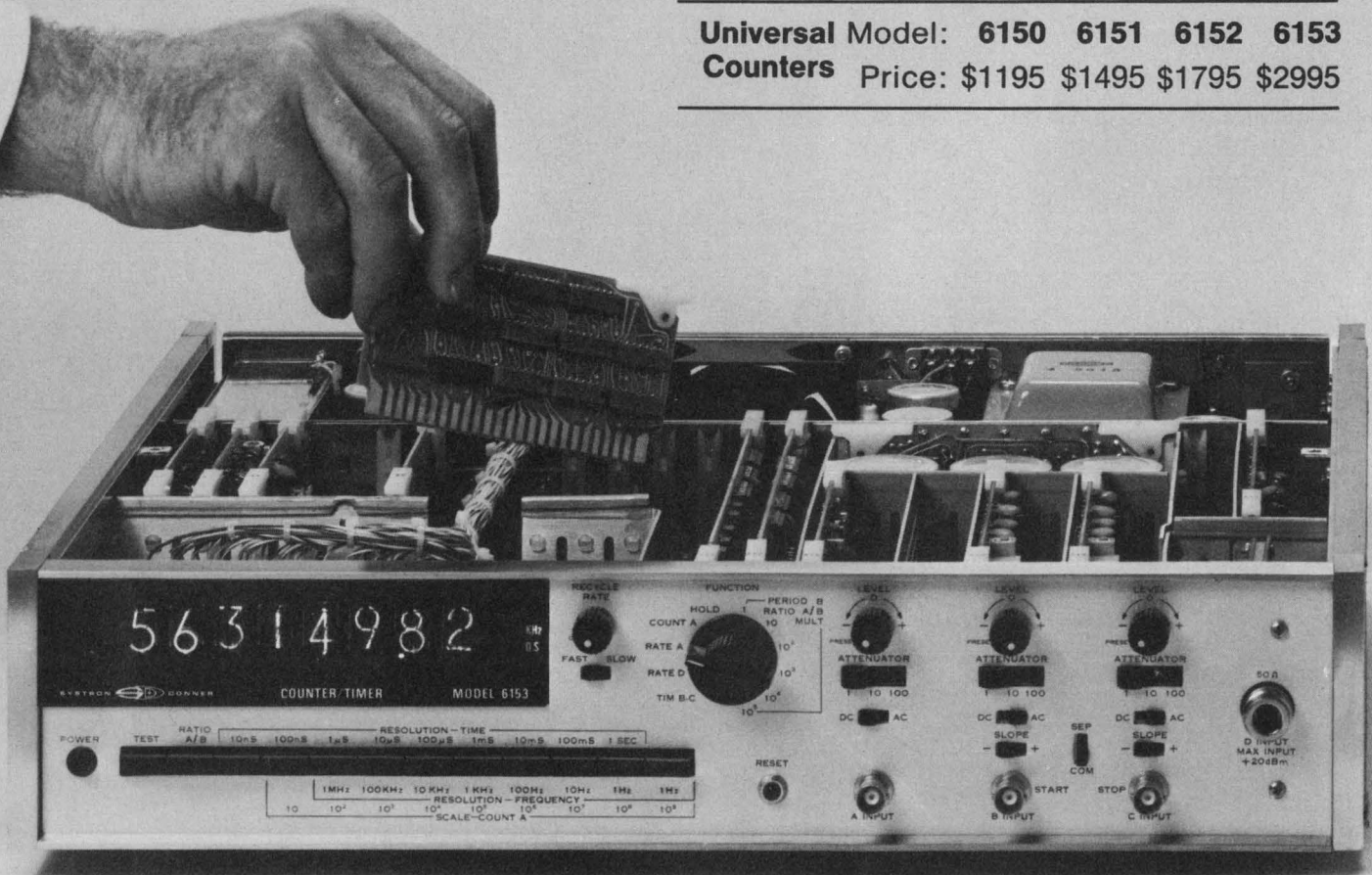

SYSTRON  **DONNER**

Concord Instruments Division, 888 Galindo Street, Concord, CA 94520. Phone: (415) 682-6161

Electrical multiplexer to control B-1 bomber

Electrical multiplexing systems on the Air Force's B-1 bomber, now under development, will be the first such aircraft system to handle power distribution, according to the B-1's prime contractor, North American Rockwell in Los Angeles.

Commercial airliners, such as the Boeing 747, use a simplified multiplexer only for entertainment control at each passenger seat.

The B-1's system, being developed by Radiation Systems Div. of Harris Intertype Corporation, in its Miami and Melbourne, Fla. plants, will control the landing gear, flaps, hydraulic pumps, lights, heaters, engine control and flight instrumentation.

The system could set a trend in the design of other complicated systems such as spacecraft, submarines, ships and even buildings, says Radiation's vice president, Henry Lesser.

The B-1 system will eliminate 33 miles of wire, reduce aircraft weight by 2000 lbs and permit easy interface with new equipment.

Using both time division multiplexing (TDM) and frequency division multiplexing (FDM), the system provides controls, processing and routing for more than 13,000 digital signals, it has a special purpose solid-state 210,000-bit Prom (programmable read-only memory) processor. The multiplexing system is contained in 42 nuclear-hardened boxes, weighs less than 400 lbs, and is right and left redundant.

The transmission system consists of a single, twisted pair of Manchester coded data base bands. Using this kind of base eliminates the need for 2 separate lines—one for the clock and one for the data, or for a system that transmits on

one line and receives on the other.

The multiplexer handles two-way transmission on the same line at 1 Mb/s. It is a "lossless" transmission system terminated in its characteristic impedance at both ends.

The memory is unique, Radiation says, in that it is the first time anyone has assembled a 210,000-bit solid-state programmable read-only memory. It has a built-in work-around program that allows the operator to alter the basic program by deleting selected functions and writing new instructions in a spare memory area. The Prom memory also offers the advantage of hard wiring. It is almost immune to electro-magnetic interference, Radiation says, and hybrid construction of the input-output interface protects the memory against the destructive electro-magnetic pulse created by nuclear explosions.

'Shock wave' technique checks printed circuits

A new means of assessing the reliability of printed circuits has been invented by Sandia Laboratories scientists. It is based on an improved method of measuring how well thin films adhere to their substrates.

A laser or electron beam bombards the thin film and its substrate with short pulses or radiation. The radiation pulse generates a shock wave that imparts a tensile force of known value to the interface between the thin film and the substrate.

When progressive testing stresses the bond to the point of failure the value of the applied force is precisely known.

Previous attempts to make these quantitative measurements have

been frustrated by the fact that no way has yet been devised to grip the thin, nonmagnetic film firmly without damage.

In the new technique, the short pulse of energy is directed at the substrate side of the bond. The pulse sets up a compressive wave that is transmitted through the substrate and into the thin film. This distorts the film and translates the compressive wave into a tensile wave that is propagated back into the substrate and tends to pull the film away from it.

The force exerted on the adhesive or film-substrate interface is determined prior to the test using a transducer clamped to the film surface. This permits calibration in terms of the laser or electron beam energy density needed to impart a given stress value to the test specimen.

Where this is impractical, the force can be calculated mathematically.

New varistors extend transient protection

Protection against high-power transients is reported significantly extended with the introduction of a line of metal-oxide varistors. Termed GE-MOV varistors, the protective devices have a maximum energy rating of 16 joules, or watt-seconds. The maximum current and voltage ratings are, respectively, 1,250 A and 1000 V rms.

General Electric of Syracuse, N.Y., producer of the new varistors, notes that power zener diodes have been used for maximum transient protection in the U.S. The alpha figure—the log/log slope of the volt-amp characteristics—of a power zener-diode is typically about 35, GE says. The GE-MOV varistors are said to reach an alpha figure of around 70.

The market for these varistors "is projected to grow from virtually nothing today to \$20-million to \$30-million in five years," according to Dr. Thomas A. Vanderslice, vice president and general manager of GE's Electronics Components Business Div.

Only about a third of the anticipated sales will come from the replacement of existing protective devices, GE says. The bulk of the

market is expected to emerge from the need to protect, at low cost, such semiconductor devices as SCRs, triacs and rectifiers.

Prices for the GE-MOVs are \$1.08 to \$18 in thousand-lot quantities. Delivery is from stock.

The varistor device is a polycrystalline ceramic sandwiched between metal leads. The ceramic consists of zinc-oxide with a honeycombed structure of bismuth oxide. The device—typically a half-inch wafer—acts as millions of tiny thin-film switches and load resistors.

Eastern Europe buying more than ever from U.S.

At the Systems 71 trade show, held in Munich last month, 112 American companies sold 1.2-million dollars worth of electronic data processing equipment right off the floor. In addition, exhibitors took orders and developed sales leads for another 68-million dollars worth of equipment to be sold during the next 12 months.

Sponsored by the Commerce Department's Bureau of International Commerce, it was the first time that the bureau had made a full-scale effort to attract business delegations from Eastern European nations.

Exhibitors at the show found an eager market waiting for them, says James P. Sutter, president of Typagraph Corp., San Diego, Calif.

This view is also shared by Tom Kendall, vice president of Graphic Sciences Inc., Danbury, Conn. According to Kendall, his firm has agreed to sell \$40,000 worth of equipment to Yugoslavia.

What the show proved to American exhibitors was that the Eastern bloc is indeed interested in buying equipment from the United States, and that the U.S. Board of Export Control is loosening up some of its trade restrictions in order to make this possible.

Condition of pacemakers determined via telephone

Help for heart patients in preventing a pacemaker battery failure or other malfunction is now no further away than the nearest tele-

phone.

A new, portable data terminal, developed by Cardiac Datacorp., Inc., Philadelphia, transmits the condition of the pacemaker and the heartbeat over a special, nationwide toll-free line. The system is currently in use by over 500 subscribers.

The data is received in a central monitoring station located in Philadelphia, with trained attendants on hand 24 hours a day.

Developed by Ted Stern, vice president of Cardiac Datacorp.,—a pacemaker wearer himself—the data terminal is the size of a cigar box. It has two hand-held electrodes.

To check pacemaker condition (over 85% failure is due to battery run-down) the wearer places the phone call in regular fashion, then puts the handset on the data transmitter. He then holds on to both of the electrodes.

The terminal converts the pacemaker's heart-driving voltage spike into what Stern calls a "click" while the pulse beat is converted into a "beep." At the receiving end, a differentiator changes the pacemaker spike to a straight line and the beep to a rounded pulse.

These waveforms are then fed to a computer and to a recorder where a trained attendant interprets the trace.

After installation of a pacemaker, a patient initially makes a phone check every two months.

OCR costs slashed with use of a laser

A system design for an optical character-recognition (OCR) unit has resulted in a machine that is one of the lowest-priced on the market. The developer, Optical Business Machines of Melbourne, Fla., has come up with a price of \$26,000 to \$34,000 depending on options, by using the following:

- A laser that permits the use of low-cost optics.
- Custom-built shift registers that eliminate the need for an external minicomputer.
- Software that is automatically generated from a conditioning sheet prepared by a typist.

The fixed frequency of the 5-mW laser allows the use of low-cost

optics that do not require chromatic compensation of the lenses.

External hardware is excluded by custom-built circuitry. No additional computer equipment or peripherals are needed.

Special circuitry automatically generates the software, omitting expensive programming or a costly computer memory.

The result is System One, a page and document reader that accepts paper from 0.003-inch onion skin to 0.012-inch card stock in sizes from 2.9 by 3.25 inches to 8.5 by 14 inches. Machine-printed OCR-A font and handwritten numerics are read at five lines a second, up to 80 characters on each line. Output can be fed on-line into a computer or converted onto nine-channel magnetic tape at 800 bpi with the tape drive that is included.

An error-correction entry is provided with a keyboard. The keyboard can be used after the rejected character is illuminated on a fiber optics display. A known code can also be substituted for rejected characters, or the machine can reject the document.

Lamp prices halved from 29 to 30 cents

The price of T-1 incandescent lamps will be cut in half with the entering of Ragen Precision Industries, Inc., North Arlington, N.J., into the micro-miniature lamp business, says Richard Jay Glassberg, Ragen's communications manager. "Half" in this case, apparently means a price that's only about one cent higher than quoted by two leading vendors.

Ragen's new lamps are quoted at 30 cents each in quantities of 1000. In contrast, General Electric in Cleveland has been selling T-1 lamps at 29.4 cents, while Chicago quotes 29.1 cents each in quantities of 1000.

The "50% price slash" is the result of Ragen's development of "the only automatic filament mounting machine in existence." However, machines of this type have been available for some time from Kahle Engineering, Union City, N.J. In fact, Kahle's equipment can process lamps at three to four times the 1000-per-hour rate of Ragen's machine.



A-B photo resistors; performance. packaging. price.

A unique electroding process gives Allen-Bradley photodetectors response as fast as 10 milliseconds at 10 Ft-C. And they are available in three spectral sensitivities. New plastic pack PHOTOCHIPS (intermediate between pill and hermetic) are color coded to match the spectral response of each material. Leaded PHOTOCHIPS

are also available in hermetically sealed TO-18 cans. Uncased styles include single cell PHOTOCHIPS, multi-cell PHOTOCHIP ARRAYS, single-channel PHOTOBAR detectors. We're also equipped to handle your special orders for large area custom styles promptly. And you'll find that our prices are competitive. Performance.

Packaging. Price. Plus famous Allen-Bradley quality and service. What more could you ask in photoresistors? Write for Publication 5910A. Allen-Bradley Electronics Division, 1201 South Second Street, Milwaukee, Wisconsin 53204. Export: Bloomfield, New Jersey 07003. Canada: Galt, Ontario. United Kingdom: Bletchley, Bucks.



ALLEN-BRADLEY
QUALITY ELECTRONIC COMPONENTS



INFORMATION RETRIEVAL NUMBER 27

INDUSTRY FORECAST FOR 1972

Electronics taking off strongly after a year of stop and go

Forget the defense and space market temporarily, and the prospects for the electronics industry in 1972 are definitely bright. A firm thrust upward from last year's wobbly economic state is programmed. Even defense and space spending should at least hold steady. Here is a fast look at what's expected this year:

- **Consumer market:** Color TV sales are likely to reach a new high of 6.5 million sets. Servicing of some sets will be accomplished with low-cost, throw-away modules.

- **Defense and aerospace:** Spending will remain relatively stable, with inflation chewing up the slight increase that is expected. Problems to be solved for the space program include redundancy management and higher-resolution sensors.

- **Computers:** Minicomputer sales should increase about 30%. Core memories will maintain their first-place position, with semiconductor memories running a close second.

- **Components:** Silicon-gate technology should emerge as the preferred technique for MOS devices. 4-k-bit RAMs and shift registers, as well as 16-k-to-32-k-bit ROMs, will become a reality. Bicolor LEDs may become available.

Strong consumer trend becoming even stronger

The consumer electronics industry, led by color television, bounced back strongly in 1971 and expects

The following editors contributed to this report: Jules H. Gilder, John F. Mason and Jim McDermott.

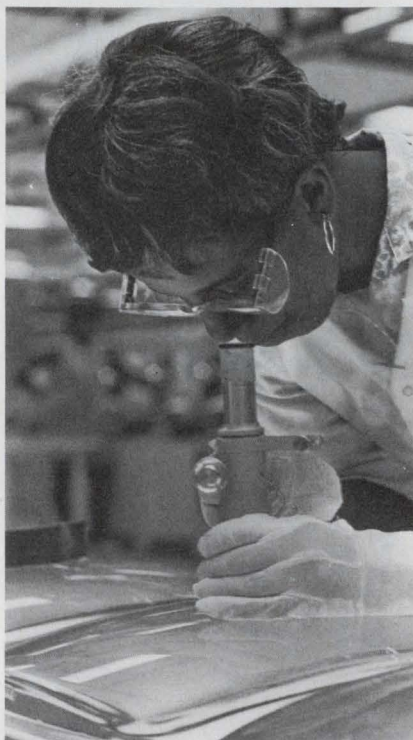

Improvements in picture tubes continue. Here, a Philco employee inspects new tubes that have a recently doubled life expectancy.

to set even higher marks this year.

Edward P. Reavy Jr., vice president and general manager of the Motorola Consumer Products Div., Franklin Park, Ill., says that industry sales of color TV sets in 1971 will top 6.2 million units, an increase of some 26% over 1970's 4.9 million. He predicts a continued upswing in 1972, to a new sales record of 6.5 million color TV sets.

Donald F. Johnstone, general manager of the General Electric Television Receiver Products Dept., Portsmouth, Va., says that consumer demand this year will grow

for small-screen black-and-white receivers as well as for color. But the real growth market, he says, will be in color TV replacement. He estimates that over 44 million replacement sets will be sold over the next five years.

Television receiver designs for 1972 and the next five years will be influenced by the following, among other considerations:

- **Housing trends.**

- The emphasis on consumerism, with its demands for higher reliability and easier maintenance.

- New UHF tuner requirements by the Federal Communications Commission, leading to the adoption of 72-discrete-channel UHF tuners by July of 1974.

Changes in housing are expected to produce demands for smaller, more compact TV sets that will at the same time retain reasonable picture-tube sizes. GE's Johnstone notes that with steep rises in construction costs, the living area per household is getting smaller, placing a premium on available space.

In an effort to satisfy consumer demands for higher reliability and reduced maintenance time and costs, the industry is converting hybrid tube-and-solid-state TV sets to all-solid-state models. Johnstone predicts that the number of all-solid-state receivers sold will reach and exceed that of the hybrids in 1972.

A debate goes on in the industry as to the best design approach to rapid, low-cost TV servicing. One side favors the growing trend of modular construction, with replaceable, factory-repairable modules. The other side chooses throw-away, low-cost modules and components.

W. Dan Schuster, chief engineer at Sylvania's plant in Batavia, N.Y. says that, based on consumer research, the company feels that conventional servicing techniques, together with throw-away modules and such components as ICs and transistors, are popular with the set owners.

A new FCC ruling requires at least six discrete tuning positions on present TV sets for UHF stations. By July, 1974, a 70-position, nonmemory detent system will be required with numbers for at least every other channel.

Johnstone sees a future proliferation of electronic tuning systems, along with a substantial increase in automatic control systems. Schuster predicts that Sylvania's 11-channel, pushbutton varactor tuning system, introduced in 1971, will probably set the trend for ultimate tuner designs in the next few years.

A spectacular newcomer to the consumer electronics front is the counter-top microwave oven. The first one, introduced by Amana in the fall of 1967, opened a market that has risen from 5000 units sold in 1968 to over 75,000 in 1971.

Defense and aerospace should hold their own

Defense spending is not expected to improve in 1972, short of an attack on the United States, and as for space projects, the public seems disenchanted with manned flight for the present.

In terms of dollars, defense expenditures will probably rise a bit, the Electronic Industries Association indicates, but not enough to offset the effects of inflation.

NASA is still fighting for a reusable space shuttle, but it may get a nonusable, cheaper shuttle instead. Meanwhile it is working in-house on fundamental technology for a shuttle concept.

The shuttle problems under study include understanding how to minimize generic software problems in the guidance and navigation systems, and establishing redundancy levels plus techniques for redundancy management. What, for example, should be repaired in flight by the crew and what should be taken care of automatically by redundancy.

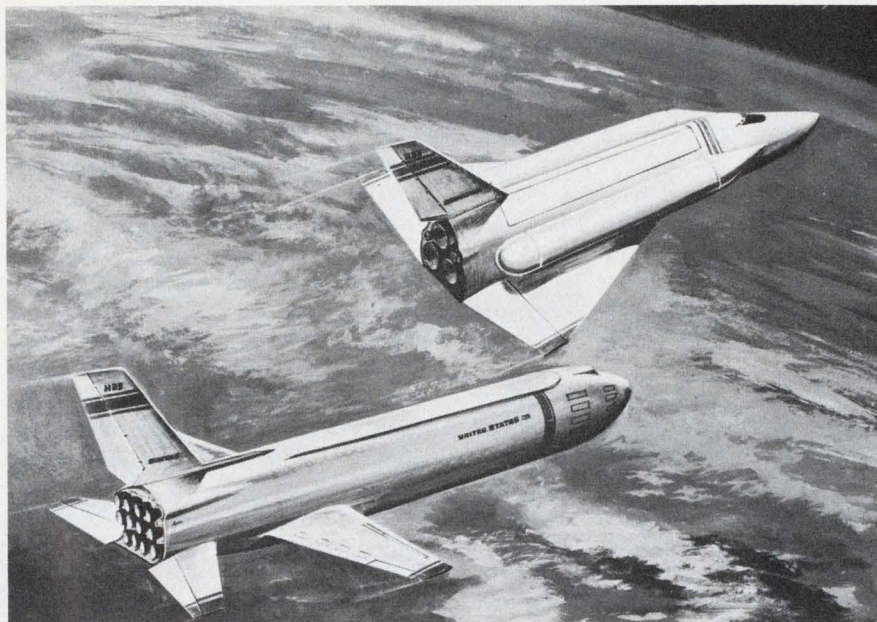

The space shuttle, though still in-house, could be NASA's biggest program.

The biggest technological challenge for the unmanned satellite program is to develop sensors and scanners with higher resolution, says Daniel G. Mazur, director of Space Applications and Technology at NASA's Goddard Spacecraft Center, Greenbelt, Md.

More resolution is needed for better definition in the Earth Resources Satellites, and also, Mazur adds, for satellites to be built for higher orbit. While many satellites operate now at an altitude of 600 miles, they will eventually go out to 22,000 miles, where they will be "stationary" over one place on earth.

For the planetary probes, better sensors and photographic and television systems will be needed. And for the really far-out missions, such as the planned "grand tour" of the outer planets, the electronics industry must come up with self-test and repair systems. With a six-hour communications lag each way between earth and the outer planets, it will not be feasible for word of an impending malfunction to be sent back to earth and then to wait while repair instructions are radioed back to the spacecraft.

The Viking craft, which is to orbit Mars and then put a lander on its surface in 1975, when the planet is on the far side of the sun, will require a 40-minute round-trip for radio signals. Redundancy and automatic checkout of electronic equipment with a

digital computer will be used.

One of the big problems with Viking, says W. F. Cuddihy, electronics manager for the Mars program at NASA's Langley Research Center, Va., is building components that will withstand the required sterilization. Everything on the lander must be heated three times to 125 C for 120 hours. A tape recorder using metal tape was finally developed that would meet this test.

The Defense Dept.'s major new acquisition programs will be Ulms (undersea long-range missile system), Awacs (airborne warning and control system), the Navy's F-14 fighter, the Air Force's F-15x fighter and B-1 bomber, and the Navy's program to build the DD 963 destroyers.

Growth areas in Defense, according to Quantum Sciences Corp., a market forecasting service in New York, include airborne navigation systems; advanced fuzes; strategic communications, which includes satellites; laser systems for communications, ranging and missile guidance; training and simulation equipment; surveillance, which includes infrared and ultraviolet sensors, light-enhancement devices and low-light-level television; and electronic warfare devices, including jammers and deceivers.

A number of technological advances are being sought from industry by the Naval Material Com-

mand, according to the deputy director of program management, Dr. Sam Rothman. These include:

- Super-conducting materials that operate at very low temperatures.

- Terminal guidance for cruise missiles that use active radar, infrared or radiation-seeking techniques.

- Improved reliability of electronic materials in all environments.

- Charge couple devices, which replace the electron gun and thus reduce the size of the receiver.

- Low-light-level techniques for a variety of applications.

- Electroptical devices.

- Functional modularization to permit a system to be rearranged simply for different missions.

Industrial equipment: An area of promise

Industrial electronics sales in 1972 are promising for two major reasons: (1) Capital spending has been slashed heavily in the U.S. in the last year, because of the recession, and much equipment is believed to be overdue for replacement; and (2) Under recent legislation, the Federal Government is giving manufacturers a better break on depreciation of equipment and reinvestment of capital.

Demand should be good in the following areas of industrial electronics:

- Process control.
- Machine control.
- Test instruments.
- Dispensing and measuring equipment.

The largest area of demand this year will be process control, according to Quantum Science Corp., in New York, a forecasting service that covers technological markets. In 1972, process control is expected to gain 8.9% over its \$359-million in gross sales in 1971.

Process-control systems for an increasing variety of plants will undergo configuration change to direct computer-controlled systems, according to Quantum's director of Maptek marketing, Robert G. Simko. This change, he says, will increase the requirement for digital displays at operator stations and will change the profile on displays in master control equipment.

Pollution control will be a big market from now on, calling for a variety of sensors—lasers, infrared and chemical reagents with electronic monitors.

Machine-control equipment will be the fastest growth area, Quantum says, with projections showing gains of 16%—from \$221-million in 1971 to over \$256-million in 1972.

Numerical control (NC) machine sales were slow last year, because of the economic slump, and computerized, or direct numerical control (DNC) units, did even worse.

"DNC was set back by programmable controllers," says L. R. Sedgeley, manager of electrical engineering in GE's Automation Equipment Operation, Schenectady,

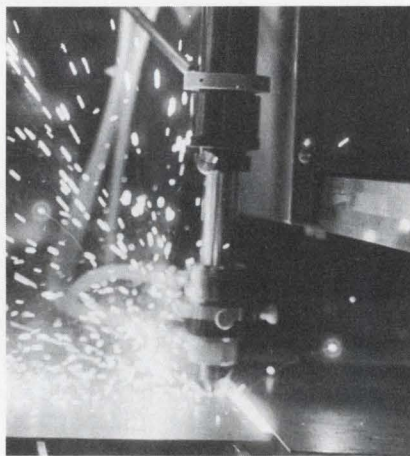

Cw gas laser slices through a 0.39-inch-thick titanium sheet at 100 inches per minute. Called the Laser-Matic, the unit is made by the Liquid Carbonic Corp.

N.Y. "Programmable controllers don't have the full flexibility that DNC does, but it's in between computer control and hardwire logic."

GE hopes to move more heavily into plane-cutting and welding equipment—anywhere that fabricated structures or designs are used.

Lasers will be used more than ever this year for a variety of cutting and welding jobs, Quantum's Simko predicts. And there is also a big future, Gilbert says, in material handling—moving production pieces from one operation to the next.

With increased use of MSI and LSI circuits, encoder and position sensors will require smaller and

lower-power displays, says Simko.

Master control equipment, he predicts, will shift from large display panels to computer consoles, changing the display system from Nixie incandescent segments and incandescent rear projection to smaller neon and incandescent segments and later to LEDs and liquid-crystal displays.

As for industrial test instrument sales, Simko sees sales growing 10%—from \$300-million in 1971 to \$330-million this year. Technologically, he says, the trend will continue toward lower costs and remote programmable instruments, spurred by cost reductions in ICs and the user's desire to connect his instrument to a computer.

The market for dispensing and measuring equipment, such as gasoline pumps and weighing stations, should increase from \$134-million last year to \$138-million in 1972, Simko reports. Gas-discharge displays, he says, will lose some of their predominance as liquid-crystal displays gain users because of cost and size advantages.

Looking beyond 1972, Simko says that liquid-crystal displays will begin to be used in gasoline pumps by 1973 and will become dominant in that area by 1975.

A maxi rise for minis due in computer market

The minicomputer market will be up strongly this year, virtually all experts in the industry say. Stanford Research Institute is predicting sales of 14,000 units. Richard Jennings, marketing manager of TI's Minicomputer Div. is more conservative: He looks for 10,000 minicomputers to be sold in 1972.

Jennings attributes the expected increase in sales to lower costs and increased capability for the mini. He feels that with the many peripherals available and the constantly increasing speed of the machine, buyers are beginning to realize in many instances that they can get a better price/performance ratio with minicomputers than with some of the larger, medium-scale computers.

This view is shared by David Armstrong, director of marketing services for Computer Automation, Newport Beach, Calif. According

ANALOG SWITCH PITCH.

We'll get right to the point.

We're in the analog switch business. (In addition to our very own designs, we're also second sourcing all of the best switches in the industry. Including the entire DG 126 thru 164 series.)

More importantly, we're also in the op amp business.

And the sample-and-hold circuit business.

And the high speed voltage follower business.

And the comparator business.

And so on and so forth.

In short, if you have any kind of analog

switch application, we'll be glad to sell you the switches. And everything else you'll need in the same application. (Which means you'll only have to make one phone call, write one letter, TWX once or send a single cable.)

National Semiconductor Corporation,
2900 Semiconductor Drive, Santa Clara,
California 95051. Phone (408) 732-5000.
TWX: (910) 339-9240. Cable NATSEMICON.

National

to Armstrong, the CDC 1700, the IBM 1800 and even some small IBM 360s are being replaced by minicomputers, because the minis pack tremendous power per dollar. He feels that the industry is approaching the point where individual consumers, as opposed to companies, will buy minicomputers, especially if the price drops.

Julius Marcus, Digital Equipment Corp.'s product line manager for the end user and communications products, believes that although semiconductor memories are making tremendous strides, core memories will remain competitive. He sees the mini market growing by about 30% and bipolar ICs growing in density.

In mainframes, spokesmen for IBM say that there will be a rapid shift to semiconductor memory in processors. With this shift will come lower power requirements, new reliability and much more capacity in a given space.

The mainframe market appears to be losing some ground to the minicomputer. One area is in numerical control. According to spokesmen for Univac, the use of mainframes has not been popular here because the user needs only 3 to 5% of the total computing capability. Knowing this, potential users have switched to minis, which offer a better price/performance ratio.

Component sector sees substantial expansion

Component sales are expected to increase this year, with the thrust provided by rising computer sales and increasing use of electronics in consumer products.

Because of the expected computer growth, MOS will be the dominant component technology in 1972, according to Robert G. Simko, director of Maptek marketing for the Quantum Science Corp. N-channel MOS will become a reality, he continues, while silicon-gate technology will rapidly become the industry standard.

In passive components, Simko says, the highest growth rate for the next five years will occur in the capacitor markets. Despite the trend toward integrated circuits, he foresees an increase in the use of discrete electronic capacitors.

Profound technological changes will restructure the capacitor industry over the next five years, according to Simko. New developments—such as laquered or solvent-deposited stack capacitors, currently being investigated—could replace discrete foil and film types.

The components industry will see a number of advances in 1972. Daniel Baudouin, Texas Instrument's new products marketing manager for MOS products, says that by the third quarter 4-k-bit RAMs and shift registers, as well as 16-k or even 32-k-bit ROMs, will be available. The trend in electronic design for '72, Baudouin says, will be increasingly toward the use of entire subsystems to reduce size and costs.

Growing use of subsystems is also expected by Ian McCrae, marketing manager of TI's Optoelectronics Div. He cites card and tape readers and notes that TI is suddenly being called upon to design entire read-head assemblies, including sensors, emitters, and the necessary logic to provide a TTL-compatible output.

Looking at this year's markets, McCrae says that the biggest single product for optoelectronics will probably be point-of-sale registers. He predicts TI's 1972 optoelectronics sales will be up 30% over last year's, with a fairly substantial chunk of that business already on the books.

Asked about possible new developments this year, McCrae suggests bicolor LEDs—diodes that would produce different colors, depending on the amount of current applied. In addition he says that TI will soon introduce hexadecimal displays with built-in logic.

Instrument makers look for long-awaited revival

For instrument manufacturers, 1972 looks like the year of the comeback. Some are expecting new highs in business after two years of recession.

Despite a dip in the first half of 1971, the year-end finish was strong, with obvious signs that the downward trend was reversing.

William Walker, vice president of engineering for Tektronix, Beaverton, Ore., gives these reasons for the instrumentation comeback: The

industry has accepted the fact that large Government-sponsored business—by the Defense Dept., NASA and other R&D sources—will probably continue to be missing. But there are new and expanding markets in the automotive and home-appliance fields, as well as in medical equipment and environmental monitoring.

"Most places I look, I see a trend upwards," Walker says. "I think that in 1972 we'll move above the top levels that were reached before the recession."

John Fluke, president of the John Fluke Manufacturing Co. in Seattle, agrees. But he says business in the coming years will also be more competitive. And new technology, with continually improving components and instruments, will play a part in making present instrumentation obsolete.

A major factor affecting future instrument design, Fluke notes, is the fact that the new customers—particularly in the highly competitive, profit-conscious industrial and consumer fields—are not as greatly impressed with high accuracy as the military customer was.

Alfred Oliverio, domestic marketing manager for Hewlett-Packard, Palo Alto, Calif., agrees.

"In the heyday of aerospace business," he says, "you could sell that last 0.01% of accuracy, whether the buyer needed it or not. But today the engineer is looking only at what he really needs to get the job done."

Fluke says that the new breed of customers is impressed most by "cost of ownership"—low initial cost and minimum maintenance.

To achieve good performance at minimum price, Fluke sees larger large-scale integrated circuits being used in instruments. But this, he predicts, will produce a new philosophy and method of instrument maintenance.

"We'll be approaching partial or complete throw-away instruments," Fluke says, simply because LSI chips aren't repairable. As one alternative, he notes, the instrument may be designed to save the read-out section and discard the main circuit board, which would be replaced with a new one.

The next four or five years, says Walker of Tektronix, will see meter instruments with needles giving way to digital presentations. ■■

And it doesn't look like a circuit breaker.

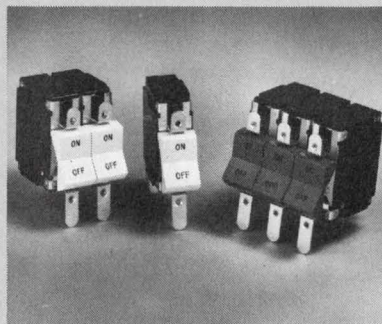
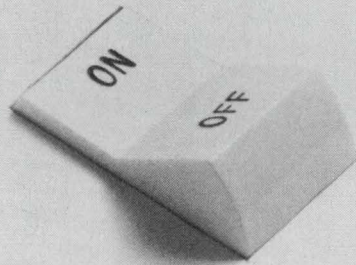

Therein lies its beauty.

When you use the JC rocker-handle circuit breaker as a front-panel on-off switch you get overload protection, too. Without the expense of using a switch and a breaker.

Behind that handsome rocker handle is the engineering and construction you know Heinemann for. Hydraulic-magnetic protec-

tion. Which means precise ratings from 0.020 to 30 amp. 32, 50, and 65V DC; 125 and 250V at 60 Hz and 400 Hz. Job-matched time delays or non-time-delay response. Temperature-stable trip points. Optional special-function internal circuits. One, two, or three-pole

models. And a five-year warranty.

Oh, yes. The rocker handle comes in white or gray.

A pretty attractive package. All around.

Write us for Bulletin 3381. Heinemann Electric Company, 2616 Brunswick Pike, Trenton, N.J. 08602. Or Heinemann Electric (Europe) GmbH, 4 Düsseldorf, Jägerhofstrasse 29, Germany.



HEINEMANN

4933

Wireless voltage sensor holds promise for commercial use

It is the morning after a big wind storm, and a power company jeep is rolling along a residential street, its two-man crew looking for likely points of damage to the overhead power lines. One man in the vehicle is looking up at the lines which are attached to tall metal supports.

Suddenly he raises a hand for the driver to stop, then points a hand-held laser toward a sensor on the wire above and flips a switch. With the aid of a mirror alongside the laser, he gets a quick return that tells him with an accuracy of 2% the voltage in the line. And he's never left the jeep, let alone had to climb a pole.

Such a commercial application could evolve from a new wireless optical voltage sensor recently developed for use with nuclear weapons at Sandia Laboratories' Solid-State Research Div. in Albuquerque, N.M.

Labs will benefit first

More immediately the device will probably find its way into laboratories to measure voltages in inaccessible places, such as experiments being carried out in a vacuum or in high magnetic fields.

Developed from a ferroelectric ceramic, the sensing element is an optical voltmeter that can be designed with full-scale voltage ranges from 50 V to 5 kV dc, with essentially an infinite input resistance, says Sandia's P. D. Thacher, who developed it.

The device is basically a thin electroded wafer of transparent lanthanum-enriched lead zirconate-lead (PLZT) ceramic, sandwiched

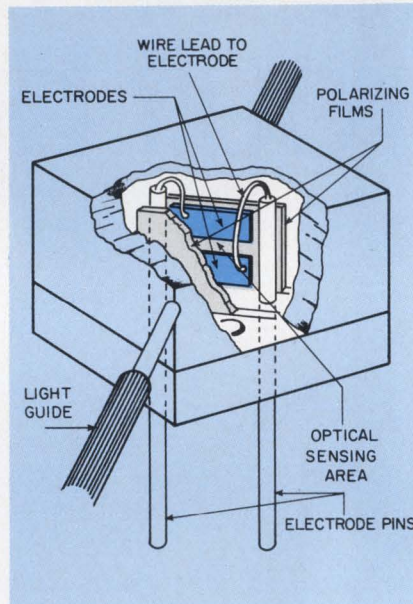

Wireless optical voltage sensor is actuated when light passes through bipolarizing material. The intensity of one of the two resultant beams changes in relation to the applied voltage, which in turn is read by a silicon photocell.

between crossed polarizers. Metal electrodes with a separation proportional to the full-scale design voltage are deposited on both major surfaces of the ceramic wafer. The electrodes are connected to the potential to be measured by wire leads. The entire package has a volume of approximately one cubic centimeter.

Light guided by fiber optics

In the design model, the visible light needed to activate the sensing area is guided to and from the sensor by flexible optical fibers. To eliminate this physical connection, as in the theoretical power-line example, a laser could be used.

During fabrication of the volt-

meter, the ceramic is permanently polarized by exposure to a large electric field. This causes internal changes (alignment of ferroelectric domains), which make the material permanently birefringent (double refractive)—unless it is thermally depolarized by elevation of its temperature above the Curie point (130 C).

Making the material birefringent, a process called pre-poling ensures that the subsequent application of relatively small electric fields will cause easily detectable, linear and nonpermanent changes in the birefringence.

The sensor is activated when light hits and passes through the birefringent material, which alters its polarization—or, in other words, rotates the vibration directions of its waves. Then a ceramic wafer, placed between crossed polarizing filters (which normally will not transmit any light), "twists" the polarization of the incoming beam so that at least part of it is transmitted.

Light intensity reveals voltage

As voltage is applied to the ceramic, its birefringence increases or decreases, depending on whether the voltage is positive or negative, and the intensity of the light transmitted by the second polarizer increases or decreases in proportion to the applied voltage.

The changes in the light intensity transmitted by the optical voltmeter are sensed by a silicon photocell at the terminal end of the "collector" light guide. This sensor converts the light into an electrical signal that is directly proportional to the voltage "seen" by the PLZT detector. ■■

John F. Mason
Associate Editor

DANA

AC Ω
BCD
PROGRAMMING
100% OVERRANGING
AUTORANGING
±DC

only \$985.00

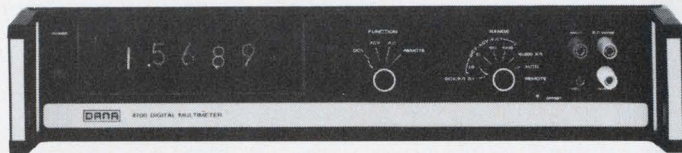

We put it all together in a 4-digit multimeter... our 4700. It's loaded with capability... 5-DC, 4-AC, 6 ohm ranges; 10 μ V resolution; 100% overranging; full autoranging (10 μ V through 1000V); isolated programming and BCD; auto polarity; plus Dana's trademark of quality. We did it all without options or accessories and made it to sell for only \$985.00... At that price you won't find a better instrument to buy... The 4700 really has it.

You have the budget and the decision... Dana has the DIGITAL VOLTMETERS.

DANA
DIGITAL VOLTMETERS

Dana Laboratories, Inc.
2401 Campus Drive, Irvine
California 92664 (714) 833-1234

When Test and Measurement Count

Test system at MIT controls temperature to microdegrees

Temperature control to within a few millionths of a degree has been demonstrated in a four-inch spherical oven at the Massachusetts Institute of Technology's Education Research Center, Cambridge, Mass.

The experimental system has maintained the oven interior to

Jim McDermott
East Coast Editor

within 20 to 25 microdegrees of a stable temperature (close to 50 C) for half-hour periods, and within 100 microdegrees of this value for days at a time.

Microdegree temperature stabilization could open up new achievements in areas now limited by present stabilities, says James M. Williams, the MIT staff member who developed the experimental system. The areas include crystal

growing, biomedical electronics and other precision temperature-controlled processes.

The stability of quartz crystal ovens used for frequency control may be substantially improved over today's standards, Williams says. Applying techniques used in designing the micro-stable oven, Williams is confident that crystal ovens could be made with a stability of 0.01 C over the military range of -40 to +70 C.

The new oven system is comprised of two concentric, temperature-controlled spheres. An inner four-inch globe is suspended in the center by means of an 11.5-inch sphere by means of plastic foam insulation (see photo).

The large sphere is, in turn, covered with aluminum foil and placed inside a pressure-sealed Dewar vessel. The Dewar minimizes heat-loss variations caused by changes in atmospheric pressure.

Special temperature-control subsystems are used in each sphere, with each subsystem independent of the other. The subsystems are linear rather than the conventional on-off type.

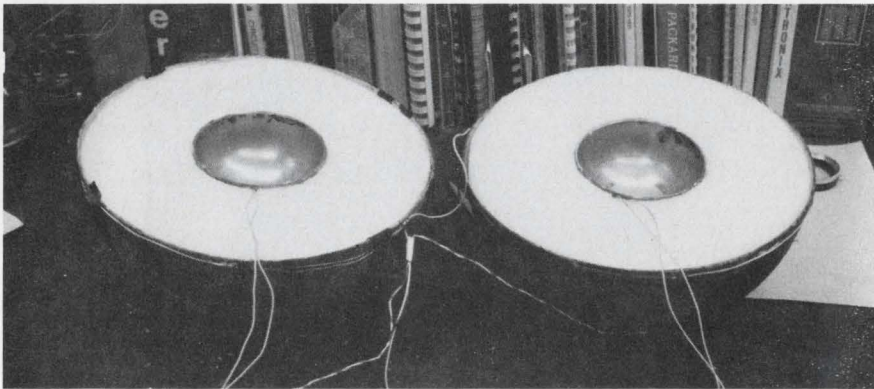

The core oven of MIT's microdegree temperature control system is a four-inch sphere fabricated as two hemispheres. Each half is set in the insulating foam that fills the outer 11.5-inch hemispheres.

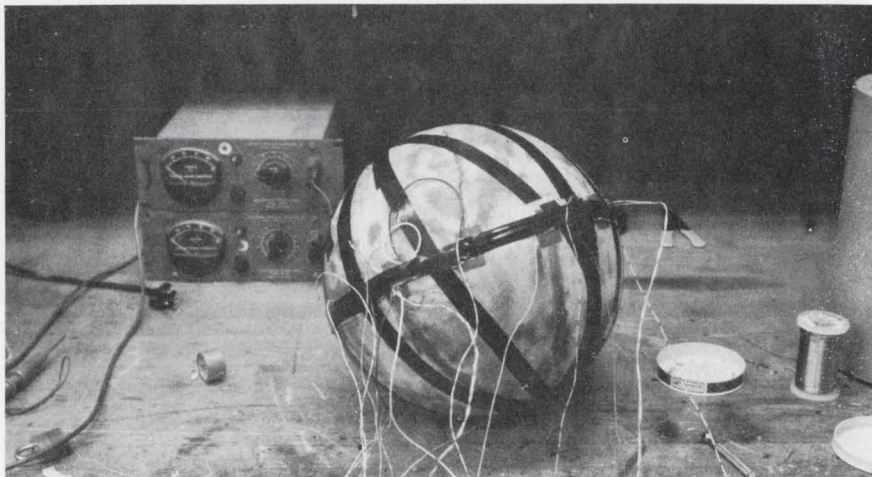

Both temperature-control and data-readout thermal sensors are inserted in the insulating foam inside both the 4-inch and the 11.5-inch ovens. Connections to the sensors and oven heaters are brought out.

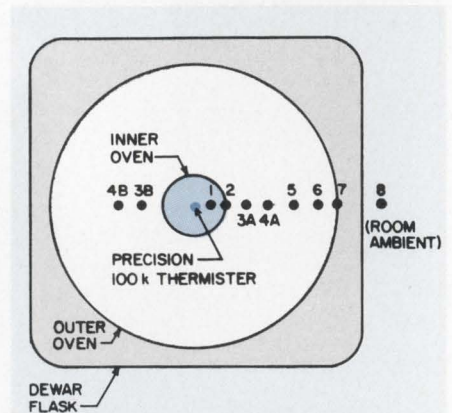

The data-gathering sensors for the experimental microdegree oven are in these positions.

GOODBYE SOLID STATE.



Hello better switching alternatives.

Until now, you considered solid state the only approach to multiplexing low-level, sensor-based analog information or to matrixing both analog and digital stimuli/response signals. High common mode or handling signal and power levels with the same switching device still causes you problems. But no more! Clare developed two mercury-wetted relays that do a better job. We call them the HGJ and the HGQ. And only Clare has anything like them. The "J" and the "Q" give you a direct, reliable and economical solution to switching problems in process control, data logging/acquisition, and automatic component/system testing.

A PROVEN APPROACH

Clare is already supplying these new relays in quantity to manufacturers of computer control systems and automated test equipment. Names like IBM, Teradyne, Westinghouse,

SEL, G.E., and Honeywell. If our new mercury-wetted relays are used in their advanced systems, they can work for you, too.

ECONOMICAL

Why? "J" two-pole versions are designed specifically for capacitor-transfer switching applications and the "Q" is designed for direct three-wire multiplexing. You don't need *any* other components for timing-sequencing or to protect solid-state devices from CMV.

RELIABLE

Like all Clare mercury-wetted relays, the heart of the "J" and the "Q" is a hermetically sealed glass capsule. Contact switching is mercury-to-mercury. So there's *no* contact wear, *no* contact bounce, constant ON and OFF impedances—*every* operation. Clare "J" and "Q" mercury-wetted relays are rated for *billions* of operations.

GREATER VERSATILITY

Clare "J" and "Q" mercury-wetted relays can switch wide ranges of signals simultaneously . . . from microvolt to 500 volt levels, from nanoamperes to 2 amps, from dc to megahertz frequencies, and handle common mode to 1500 vac. The "J" can be driven to 250 Hz, the "Q" to 400 Hz. And they both mount on 0.5" PCB centers.

For enough information on C. P. Clare & Company, and all mercury-wetted relays (including the new "J" and "Q") to fill a coffee break, circle our reader service number or write to us. C. P. Clare & Co., 3101 Pratt Avenue, Chicago, Ill. 60645.



a GENERAL INSTRUMENT company

NEW! Adjustable Automatic Reset Timing Without Relays



SERIES 600

...reduces system cost, increases reliability.

- Deltrol Controls' NEW Series 600 Adjustable Automatic Reset Timer remains in the timed-out position without the use of an external (or internal) relay or without stalling the timer motor. At end of time cycle, motor is turned off while clutch holds switch position.
- Standard adjustable time cycles of 5, 10, 15, 20, 30, 60 seconds; 5, 10, 15, 20, 30, 60 minutes. Other time cycles on request.
- Reset time is 25 milliseconds maximum. Reset time is not a function of the total time cycle.
- Clutch control is independent of time motor and may be operated on either AC or DC voltage while timer motor is operated on AC.
- May be wired for interval or delay timing.
- Surface or panel mount.
- Recognized under the Components Program of Underwriters Laboratories Inc. (File No. E19033).
- Costs less . . . interchangeable with all clutch motor interval timers.

Write for complete specifications and prices

1488

DELTROL CONTROLS

2745 So. 19th St. Milwaukee, Wis. 53215
Phone (414) 671-6800 Telex 2-6871

With the outer sphere inside the Dewar unit (which integrates fast transient room-temperature changes into long ramps) and with the outer sphere temperature-controlled, Williams has determined that the inner-core sphere is in an environment with a temperature stability of 0.005 C. Inside the inner sphere, temperature is controlled to within a few millionths of a degree.

Both the outer and inner ovens are divided into hemispheres that

have heater wires evenly and densely distributed about their surfaces and secured in place with a Fiberglas coating.

The sensors for both ovens are thermistors imbedded snugly alongside the heater wires.

The principal sensor that controls the internal oven to within microdegrees is a 100-k-ohm thermistor that produces a 5-k-ohm change for a 1° temperature change. This means that for a 1 microdegree change, a change of

EIA testing a reference signal for precision color television

If Electronic Industries Association tests of a color-television reference signal are successful, designers of TV equipment will have, for the first time, an exact means of insuring that colors on the home receiver are the same as those televised by the studio camera.

The color-reference signal, inserted on line 20 of the vertical blanking interval, would provide an electronic standard that could be converted through circuitry to monitor and control the hues and saturation levels of signals at the transmitter. The reference signal could also be applied at the receiver for automatic correction there.

The tests are being conducted at major cities in the U.S. by the EIA's Broadcast Television Systems Committee. Eric N. Leyton, a member of the corporate staff of RCA Laboratories, Princeton, N.J., is chairman of the subcommittee that is running the field tests.

Ordinarily the color on present TV transmitters and receivers does not remain within acceptable limits for the same or different programs on the same channel, and differences are particularly noticeable when the set is switched to different channels. Factors contributing to the color differences include lighting variations at the camera, incorrect chrominance

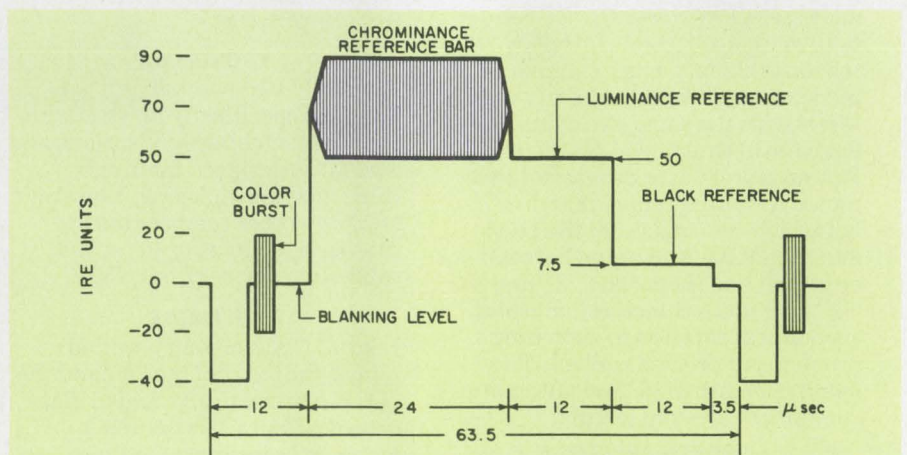

The EIA color reference signal gives designers a way to adjust TV transmitter outputs automatically to compensate for color signal errors either in the transmitter, studio or receiver equipment.

5 milliohms out of 100 k ohms must be measured.

To do this, a special, high-gain measurement system was designed, with a thermistor in a precision bridge circuit.

Additional sensors were included in the ovens for data analysis (see figure). The output of these sensors is fed to a computer as well as an oscilloscope.

Thermal disturbances of 5 pW have been observed in the inner sphere. ■■

level, incorrect phase relation between the color burst and picture information, and variations in the position and duration of the color burst.

Objectionable color saturation changes may also arise from any distortion of the amplitude-vs-frequency response of a TV system. While TV receiver manufacturers have attempted to minimize this by incorporating an automatic chrominance control that uses the amplitude of the color burst as a reference, present Federal Communication Commission tolerances permit as much as a 10-dB error in the amplitude of this signal in the receiver.

The new color reference signal provides a standard for luminance amplitude, black level, chrominance amplitude and chrominance phase of the picture signal in transmitter, studio and receiver equipment.

Three months of EIA tests in New York City on telecasts by the three big networks have verified that insertion of the reference signal on line 20 of both fields of a frame does not adversely affect TV receiver operation.

Subjective tests over five stations in Portland, Ore., have given substantial evidence that the viewer sees an improved picture. The color-reference signal was used as a control by transmitter operating personnel in Portland.

The EIA plans further evaluation of the reference signal. ■■



Teflon* gives you capacity to save a lot of money!

1.1 to 3.5 is a fairly narrow capacity range. But many applications fall within it.

And within that range, our new Teflon dielectric trimmer capacitors are every bit as reliable as capacitors costing a lot more money. So it makes sense to design with them in mind.

We make them for both stripline and PC mounting. And we make them miniature—just 0.250" diameter. With Q typically 2500 at 1MHz and temperature characteristics like these:

Max. % Capacitance Change from value at 25°C.

-55°C		+85°C		+125°C		 Actual Size
Max.	Min.	Max.	Min.	Max.	Min.	
+3.0	-0.5	+1.0	-3.0	0	-5.0	

Worth looking into? All it costs is a stamp.

*Registered trademark of DuPont.

E. F. JOHNSON COMPANY / 3009 Tenth Ave. S.W. / Waseca, Minn. 56093
Please send technical information and test samples of your new low-cost Teflon dielectric trimmer capacitors.

NAME _____

FIRM _____

TITLE _____

ADDRESS _____

CITY _____

STATE _____

ZIP _____



® E. F. JOHNSON COMPANY

INFORMATION RETRIEVAL NUMBER 33

Now your #1 source for digital is also your #1 source of reference.



The "can-do" champions in digital capability put it in writing. With the most complete "how-to" library available off-the-shelf. Check the coupon below, or call your local Signetics salesman or rep.

signetics

Signetics-Digital
811 E. Arques Avenue
Sunnyvale, California 94086

Please rush your digital manuals, containing comprehensive logic diagrams, schematics, pin configurations, operating characteristics and application information on Signetics #1 Digital Line.

Check or money order, payable to Signetics-Digital, enclosed to cover nominal postage and handling costs. \$1.00 for entire set, 50¢ each for individual handbook.

- Complete Digital Package (6 books). \$1.00
- 54/7400 TTL Handbook, 256 pages. 50¢
- Utilogic II/600 TTL/DTL Handbook, 64 pages. 50¢
- 8000 Series TTL/MSI and Memory Handbook, 208 pages. 50¢
- DCL SSI 84/8800 TTL/DTL Handbook, 112 pages. 50¢
- MOS Silicon Gate 2500 Series Handbook, 176 pages. 50¢
- 8000/5400 Chip Catalog, 72 pages. 50¢

Name

Title

Company

Address

City

State

Zip

Telephone ()

SIGNETICS CORPORATION — A SUBSIDIARY OF CORNING GLASS WORKS

SALES OFFICES

CALIFORNIA

Del Mar: (714) 453-7570
Irvine: (714) 833-8980 (213) 437-6718
Sunnyvale: (408) 739-7700

FLORIDA

Boca Raton: (305) 391-8318
Clearwater: (813) 726-3469

ILLINOIS

Rolling Meadows: (312) 259-8300

MARYLAND

Silver Springs: (301) 946-6030

MASSACHUSETTS

Lexington: (617) 861-0840

NEW JERSEY

Fort Lee: (201) 947-9870

PENNSYLVANIA AND SOUTHERN NEW JERSEY

Medford: (609) 665-5071

VIRGINIA

Reston: (301) 946-6030

REPRESENTATIVES

ALABAMA

Huntsville
Compar Corp. (205) 539-8476

ARIZONA

Scottsdale
Compar Corp. (602) 947-4336

CALIFORNIA

San Diego
Celtex Company (714) 279-7961

CANADA

Montreal, Quebec
Corning Glass Works of Canada
Toronto, Ontario
Corning Glass Works of Canada (416) 421-1500

COLORADO

Denver
Elcom (303) 771-6200

CONNECTICUT

Hamden
Compar Corp. (203) 288-9276

FLORIDA

Altamonte Springs
WMM Associates, Inc.
(305) 831-4645
Clearwater
WMM Associates, Inc.
(813) 446-0075
Pompano Beach
WMM Associates, Inc.
(305) 943-3091

INDIANA

Indianapolis
R. H. Newsom Associates
(317) 849-4442

MARYLAND

Silver Springs
Mechtronic Sales, Inc.
(301) 622-2420

MASSACHUSETTS

Newton Highlands
Compar Corp. (617) 969-7140

MICHIGAN

Grosse Pointe Park
Greiner Associates, Inc.
(313) 449-0188 (313) 449-0189

MINNESOTA

Minneapolis
Compar Corp. (612) 922-7011

MISSOURI

St. Louis
Compar Corp. (314) 567-3399

NEW MEXICO

Albuquerque
Compar Corp. (505) 242-3633

METROPOLITAN NEW YORK

Manhasset, Long Island
Win-Cor Electronics Sales Corp.
(516) 627-9474

UPSTATE NEW YORK

TriTech Electronics, Inc.
(315) 446-2881

NORTH CAROLINA

Winston-Salem
Compar Corp. (919) 723-1002

OHIO

Dayton
Compar Corp. (513) 890-9260
Fairview Park
Compar Corp. (216) 333-4120

SOUTHERN NEW JERSEY AND PENNSYLVANIA

Haddonfield, N.J.
Compar Corp. (609) 429-1526

TEXAS

Richardson
Semiconductor Sales Associates
(214) 231-6181

UTAH

Salt Lake City
Elcom (801) 846-2317

WASHINGTON

Bellevue
Western Technical Sales
(206) 454-3906

technology abroad

A variable-frequency motor controller that uses power transistors instead of thyristors has been developed by Scragg Power Drives of Cheshire, England. It was designed by scientists at the University of Manchester Institute of Science and Technology, working under contract to Scragg. The major objective was to develop an advanced method of controlling high-speed textile machinery drives by adjusting the speed of small motors or groups of motors through a variation in motor supply frequency. The controller produces a voltage that is adjustable between 50 and 1500 Hz.

CIRCLE NO. 441

A unique electro-optical system has been devised for the automatic focusing of movie projectors by a British inventor, David Fenner. His system fits the open sections of the shutter with an infrared filter. Two infrared-sensitive photocells are placed at equal distances behind and in front of the screen. As each frame edge passes over the screen, the photocells respond to the change in light transmission. The greater the change, or contrast, the better the focus. Out-of-focus frames produce unequal signals from the photocells, which actuate a servo that brings the image back in focus. This point is achieved when the photocell outputs become equal.

CIRCLE NO. 442

A new, rapid-changeover device for insuring the continuity of power supplies to station auxiliaries and industrial plants has been introduced by Switzerland's Brown Boveri. In operation, a solid-state, thyristor-driven comparator continually monitors the phase and frequency differences between the power feed network

and the standby supply. When the phases coincide, the system automatically shuts down one supply and switches in a second. Power interruption varies from zero to 60 ms, depending upon the operating time of the circuit breakers. The thyristor comparator operates at 110/220 V, with a peak reverse voltage of 500. The maximum forward current is 4 A for 10 minutes.

CIRCLE NO. 443

The flow velocities of gases and liquids are measured with a Doppler laser system, the 55L anemometer, developed by DISA of Denmark. The beam of a 5-Mw Spectra Physics laser is split by a prism into two paths, both directed at the point of measurement in the flow. Natural or artificial tracer particles scatter the laser beam, and the frequency of this scattered light is Doppler-shifted in direct ratio to flow velocity. A special photomultiplier tube picks up the Doppler signal and amplifies it for conversion to a linearly related electrical analog signal. DISA claims high accuracy for the system, which requires no calibration and is insensitive to temperature changes in the flow medium.

CIRCLE NO. 444

A new, low-light-level tube capable of handling illumination of 10^{-4} lumens/m² is now in initial production at Thomson-CSF in France. An optical system forms the image on the tube's high-gain photocathode. Electrons ejected from the cathode are collected on a flat, dielectric target of high insulation value. An image can thus be built up by charge integration over several hours before a readout gun is energized and the image is viewed. The tube can also be fitted with a fiber-optics front plate for coupling to an image-intensifier first stage.

CIRCLE NO. 445

We've turned the world of displays upside down

NEW PANAPLEX lowest cost... MOS compatible



**PANEL
DISPLAY**

lowest power ility

- Lowest power—average power less than 5 milliwatts per segment
- Lowest cost—\$1.00 per digit*
- MOS compatibility—cathodes and anodes can be driven from MOS circuits

There is a lot of talk about displays—new technologies, new innovations, a lot of good new things just “over the horizon.” But the fact is that the PANAPLEX II panel display, representing a technology that grew from the NIXIE® tube, is the best numeric display available now.

Only PANAPLEX II panels switch on voltage and current low enough for direct MOS compatibility . . . Cut power requirements to milliwatts . . . And cut costs down to \$1.00 per digit.* Characters are bright and readable and can be custom-tailored for numerous applications . . . including annunciators requiring special fonts. We packed 8 to 16 digits into a 0.2”-thick (not including tubulation) in-plane display panel for calculators, cash registers, special instruments, you name it.

PANAPLEX II PANEL DISPLAY — More than another new readout, a whole new way of looking at numeric displays.

For additional information write: Burroughs Corporation, Electronic Components Division, P.O. Box 1226, Plainfield, N.J. 07061; or call our special applications assistance number, (201) 757-3400.

*50,000 tube quantity.

Leader in the World of Displays **Burroughs**





lighting
bug
collection

Your logic level display problems are over with this new, Compatible Lighting Bug Collection of LED's and subminiature incandescent lamps. Now you can opt for either, or both types in your circuit design because they're practically equal in life, color, brightness and operating power. Only Chicago Miniature offers you the design freedom of interchangeable LED's and incandescents.

For example, CM4-50 solid state lamps operate from 1.65 to 2.0 volts at .040 amps maximum and the T 3/4 through T 1 - 3/4 incandescents operate from 1.0 to 5.0 volts at .008 to .022 amps. These low current incandescents permit highly extended lamp life to balance with the inherent long life of the LED's. Color displays

are red or amber for the LED's and red, blue, blue/white, green or yellow for the incandescents. Each incandescent lamp is carefully controlled to produce .002 - .022 MSCP for brightness compatibility with the LED's.

Chicago Miniature's balanced line includes a full selection of discrete LED or incandescent lamps, indicators, seven-segment alpha-numeric readouts and special assemblies all designed for integration into a single system. A full variety of mounting styles, package types and pin configurations are available, such as tinned wire leads, TO-18 headers, epoxy molded snap-in packages, cartridges, etc.

Just circle the reader service number

to receive complete information on our balanced line of LED's and incandescent lamps or write on your company letterhead to receive product samples.

Call Chicago Miniature Sales Representatives as they are specialists in optoelectronics and you'll find their application assistance very helpful. For off the shelf delivery, contact Chicago Miniature for the name of your local authorized Electronic Distributor.



CHICAGO MINIATURE
LAMP WORKS
4433 N. Ravenswood Ave.
Chicago, Illinois 60640
(312) 784-1020

a GENERAL INSTRUMENT company

THE LIGHTING BUGS

LED'S/Incandescent
lamps, our
compatible bugs.

washington report



Don Byrne
Washington Bureau

Aeronautical satellite plan running into serious snags

The plan by the Federal Aviation Administration to launch an over-ocean airline communications and surveillance satellite program is running into heavy weather. The chairman of the Senate Commerce Committee, Senator Warren G. Magnuson (D-Wash.), has asked the Dept. of Transportation, the parent agency of the FAA, to hold up any action, pending hearings before Commerce Committee at a yet unannounced date this year. It is not likely that the department will go against the wishes of the Senator, whose committee oversees the department and who also sits on the panel handling its appropriations. In addition, as reported previously, the White House Office of Telecommunications Policy is not overly enthused about the project, nor are Comsat or the nation's airlines.

Microwave common-carrier competition appealed

The Federal Communication Commission's final order in the specialized microwave common-carrier case, in which it opened the field to competition, has been appealed in the District of Columbia and Ninth Circuit Court of Appeals. The Washington State Utilities and Transportation Commission said in its appeal that by authorizing competition, the FCC was deregulating a portion of interstate common-carrier communications without Congressional approval. A similar action was filed in the District of Columbia Circuit Court by the National Association of Regulatory Utility Commissioners.

Air Force creates new ideas hopper

The Air Force has set up a new initiatives office to serve as a focal point for new ideas, systems and techniques in research and development. The new organization is expected to be a model for similar offices in the other services as the Pentagon tries to make it easier for people with ideas to get them to the right place in the confusing maze of defense agencies.

The Air Force says all ideas offered by private citizens, institutions and industry will be reviewed and that promising approaches will be sent to the Air Force Systems Command for further evaluation. "Creation of the new office will not change established procedures for submitting unsolicited proposals through AFSC, nor is it a substitute for the normal request for proposals procedure," the Air Force said. "It will, however, provide a place where new ideas can be introduced to the interested air

staff agency and should give industry representatives a better understanding of the Air Force areas of interest in research and engineering.”

The new office will be headed by Lt. Col. William A. Murphy in Room 4C348 in the Pentagon.

Arinc orders study on two segments of microwave network

The board of directors of Aeronautical Radio, Inc., (Arinc), the airlines' communications company, has authorized field studies and a frequency plan for two microwave segments as the start of a possible \$257-million private microwave airlines communications network. The data from the study would be needed to file applications with the Federal Communications Commission.

Advanced Loran selection date pushed back

The Air Force has put off until next month the selection of a contract winner in the advanced Loran competition. The announcement originally was expected last June, and then the Air Force received its plans and said it would pick the winner before the end of 1971. The program, expected to outfit more than 3000 tactical aircraft at a cost of more than \$100-million, is aimed at providing “building block” navigational equipment for tactical craft of all services. The reason for the delay, the Air Force says enigmatically, is that the “evaluation of the proposals is taking longer than expected.”

Capital Capsules: Texas Instruments has received a \$640,000 contract to build the **terrain-avoidance radar for three prototypes of the B-1 bomber**. The contract will be lucrative if the B-1 ever goes into production. The Air Force wants 250 of the craft to replace the B-52. . . . You can expect the Defense Dept. to present its annual posture statement to Congress about the second week in March. . . . The FCC's long-awaited decision on how, and by whom, a domestic communications satellite will be operated is expected very shortly. **The agency is expected to hew to the line of open competition already established in the specialized microwave common carrier case** and in policy statements by the Office of Telecommunications Policy. The systems are expected to cost up to \$200-million apiece. . . . **A last-minute appeal to keep Telpak sharing alive died** as the year ended when the U.S. Court of Appeals in New York rejected a stay from the American Trucking Association and the National Association of Motor Bus Operators. Under Telpak sharing, regulated utilities were allowed to buy the bulk offering of circuits and divide them among themselves. The courts and the FCC have ruled it illegal and discriminatory against other users. . . . **AT&T has asked for approval for plans to build a sixth cable across the Atlantic Ocean**. To be called TAT-6, it would accommodate 4000 voice-grade channels. . . . The first trans-Atlantic picture telephone call has been placed between the U.S. and Sweden. The event marked the opening of a new Comsat earth station at Tanum, Sweden. . . . **The general counsel of the Federal Communications Commission Richard E. Wiley, has been nominated as an FCC commissioner** to fill the unexpired term of Robert Wells, who resigned. Wiley will serve under an interim appointment until he can be approved when the Senate reconvenes.

a pocketful of solutions for your measurement problems



Now there's a 3-pound scope that can be carried in your tool kit, suitcase, briefcase, coat pocket, glove compartment . . . almost anywhere.

It's the **211**, our first laboratory-quality mini-scope. Size is only 3 x 5¼ x 9 inches. Bandwidth is 500 kHz. A lot of scope in a small package.

The **211** is easy to use. You spend your time solving measurement problems, not studying scope operation. Deflection factors from 1 mV/div and sweep rates from 5 μ s/div are read out from controls easily related directly to the CRT. One rotary control does all the triggering.

Ever wanted to float a scope? Here's one that floats to 500 volts RMS when operated from its internal batteries.

How many times have you misplaced a probe or power cord? There's no chance of that with the **211**. The probe and cord are attached and stored in a convenient, recessed area of the case. When you arrive on the job, both are right there, where you can find them.

And the **211** is built to take rugged trips. The double insulated high-impact plastic case takes tool kit knocks and bangs. Knobs are recessed for added protection. It's packaged in a real survival kit.

Need battery operation? The **211** operates from internal rechargeable batteries for up to 5 hours, and from AC.

Price? It's lower than many other 500-kHz scopes. Only \$545, FOB Beaverton, Oregon.

For a demo, just contact your local TEKTRONIX Field Engineer. He probably has a **211** in his briefcase. Ask him for complete information or write Tektronix, Inc., P.O. Box 500, Beaverton, Oregon 97005.

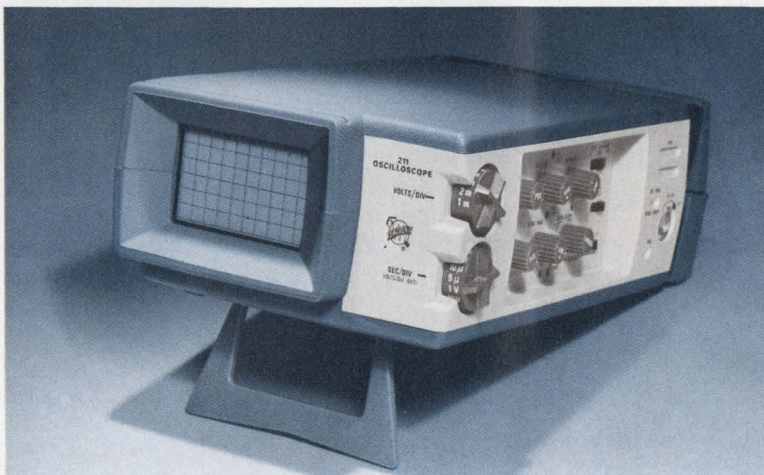

TEKTRONIX®



We invented an rf signal generator for people who always dreamed of owning a synthesizer

It's frequency stability is ± 10 Hz over its 50 kHz to 80 MHz range

Until now, you couldn't get this kind of frequency stability — ± 10 Hz — until you bought a synthesizer.

But now the patented Signallock™ circuit provides synthesizer-like stability and accuracy. In addition there's a six-digit built-in counter to directly display your generator frequency.

The counter has variable resolution to 100 Hz and can be used independently to measure external frequencies to 80 MHz.

The Model 925 Signal Generator produces a signal output which is continuously adjustable from 0.1 microvolt (-127 dBm) to 3 volts RMS ($+23$ dBm) and is leveled to within ± 0.5 dB throughout the frequency range. Harmonics are at least 30 decibels below the carrier. Noise and AM hum are 70 dB below the carrier, while residual FM is less than 1 ppm plus 10 Hz.

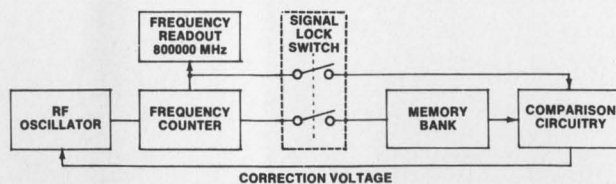

"Signallock" is a patented circuit which enables the output of the built-in rf oscillator to be locked into the crystal time base of the built-in counter. When the Signallock mode is switched in, the digital readout is stored in a memory, and then continuously compared to the generator's output frequency. If an error exists between the output frequency and the memory frequency, a correction voltage is fed back to the oscillator, causing frequency to return to the original setting.

LogiMetrics INC. A Subsidiary of Slant/Fin Corp., 100 Forest Drive, Greenvale, N.Y. 11548 • Phone: (516) 484-2222 • Telex: 96-1371

INFORMATION RETRIEVAL NUMBER 39

Unhappy New Year

This year marks the twentieth anniversary of ELECTRONIC DESIGN and we've resolved to make it an unhappy one. That won't be easy because there's a natural tendency for editors of a very successful magazine to sit back and relax. It's awfully tempting to look back at a bunch of editorial awards and popularity polls you've won, then assume you're doing everything right. That's the easiest way to slip.

We don't want to slip; so we can't relax. We're working harder than ever to help you do your job better. That's our job. Because our intuition and experience may be inadequate guides, we're depending more heavily on what you tell us you need. We've made it easier for you to tell us.

We recently eliminated the "Editorgram" card, replacing it with a newly designed Information Retrieval Card, expanded to include space for your comments and advice. That's a small change, but it saves you the trouble of filling out a separate card. So it has already yielded a twentyfold increase in feedback from you to us.

That feedback is priceless. Your comments under "Articles I liked, disliked" serve as a report card, letting us know how well we've served you and where we've missed. Even more important, your comments under "Articles I would like" help us keep on course and alert us to needs we might not have discovered early enough to help you fully.

In other ways, too, we're refusing to be happy with past achievements. We start with the assumption that our previous issue was OK, but the next one must be much better. We're in a dynamic industry that doesn't stand still. Your work keeps changing; ours does, too. No matter how well we do, none of us can afford to sit back and be happy. To forge ahead, we must cultivate that powerful motivator—unhappiness.

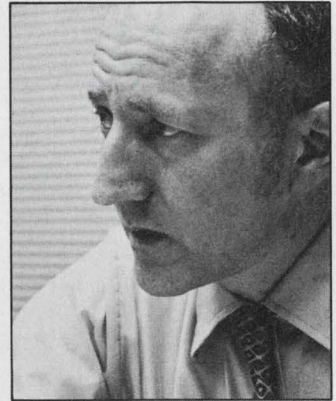

A handwritten signature in cursive script that reads "George Rostky". The signature is written in dark ink and is positioned above the printed name.

GEORGE ROSTKY
Editor

FOCUS

on
Digital
panel
meters

Digital-panel-meter vendors keep popping up from all directions, and some who couldn't take the competition have dropped out. But the field is still growing. Weston started it at the 1967 Wescon show. Today there are 24 domestic vendors (last count as we go to press) offering a wide selection of smaller, cheaper and fancier models. As the competition heats up, prices keep falling and have now cracked the \$100 barrier. One might think an engineer should have an easy time choosing a meter for his application. Not always.

Roger S. Allan, Technical Editor

"Specsmanship"—the art of concealing a product's shortcomings and highlighting its virtues—is rife among DPM vendors. They don't specify their meters in a uniform way, and most data sheets have incomplete specs; so it's difficult to make comparisons. Further, there is no standard definition for such key specs as accuracy and stability, and vendors take advantage of this by inadequate specification of key parameters. As a result, engineers cannot compare products on an equal basis without having some standardization of specifications.

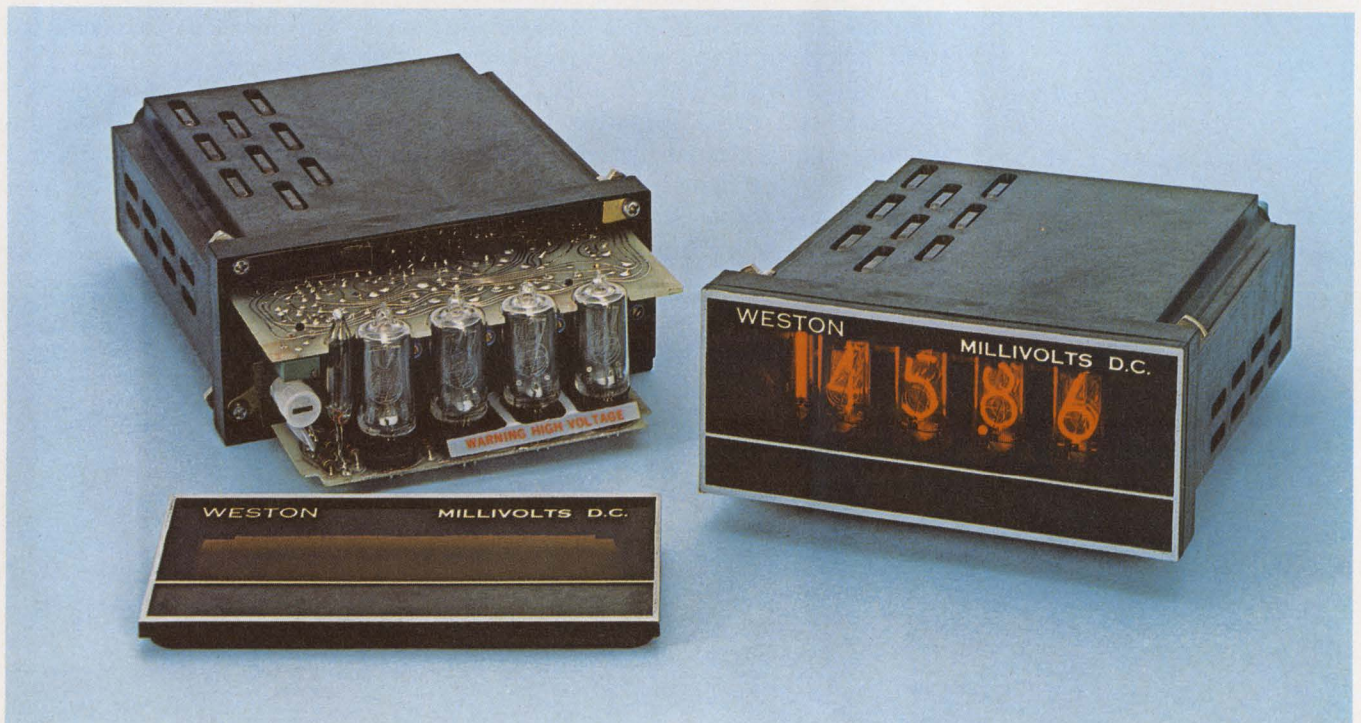

Sensitivity of $10 \mu\text{V}$ is available in Weston's model 1294 bipolar 4-1/2-digit DPM. It dissipates 6 W and has

ranges from 100 mV to 1000 V (plus 100% overrange). Two PC boards slide out for simplified servicing.

To make life a little harder, a prospective purchaser has to understand his application thoroughly or wind up paying \$200 or more for a DPM when a \$100 meter might perform just as flawlessly in his circuit. Unlike analog meters, today's digital panel meter is a sophisticated little instrument. It's crammed with circuitry that's sensitive to temperature, voltage and external-circuit conditions. And there is very little application engineering available to assist a DPM user in integrating his meter into a system.

Why a DPM in the first place?

To be sure, DPMs offer many advantages over analog meters. They're at least 10 times more accurate. They can make faster measurements. And most have recording capability with BCD outputs. Further, they provide readings that are absolutely unambiguous. Unfortunately some users fall into the trap of assuming that freedom from ambiguity equals freedom from error. And that's not so.

Flexibility is another advantage of DPMs. Many options are available, especially for systems applications. For example, many DPMs can drive printers. Some are available with remote readout. Some can be used to linearize nonlinear parameters, like the outputs of thermocouples and other transducers.

One example appears in Digilin's 3-1/2-digit (1999-count) Model 2330. It's available with circuitry to compensate for the nonlinearity of almost any thermocouple. In OEM quantities, the meter, with BCD output, costs about \$185.

There are a few disadvantages to DPMs. Unlike analog types, they require power to operate—about 4 to 5 W. They also occupy more behind-the-panel volume. And they cannot show trends—a feature that is important in many applications, such as peaking and nulling.

There is one DPM that does show trends. Faratron (which took over the Time Systems line) has a DPM that has, in addition to the digital readout, an analog scale that uses a series of 20 neon lamps to indicate the reading. The lamps light or go out in succession, showing increasing or decreasing input signals.

DPMs also cost more. While their prices have declined sharply, a low-cost 2-1/2-digit (or 199-count) DPM still costs about \$100 in single quantities, while a high-quality pointer meter with almost comparable resolution costs about \$50.

Which DPM for you?

Before you decide on a DPM, carefully evaluate your application. If all you need is a signal monitor with about 2% (of full-scale) accuracy



1-in.-high characters are featured on Electro-Numerics' model 3350 3-1/2-digit DPM. The meter's seven-segment display is illuminated by neon bulbs.



Faratron (successor to the Time Systems line) has a DPM that can display trends. Its model 710 uses an analog scale with lamps that light or go out in order.



Simple behind-the-panel mounting is offered with the series 35 3-1/2-digit meters from Gralex Industries. Features include 5/8-in.-high display characters and a rear-panel control that permits the scaling factor to be linearly varied for matching to transducer inputs.

—and you don't need an electrical output and the readings will be taken by people who know how to read an analog meter—then stick with the pointer meter.

If you need more accuracy and resolution and you're concerned with the time needed to train unskilled people in meter reading, consider one of the low-cost DPMs. Datascan, for example, has a 2-1/2-digit unit for \$95, and Analogic has a similar one for \$110. BCD is available in each as an extra-cost option. Both operate from 115 V ac and dc and do not include a case and bezel.

Analogic also offers a 2-1/2-digit, cased DPM for only \$69 in single quantities. This one, however, operates from 5 V dc and includes BCD as standard. Several manufacturers offer 2-1/2-digit meters for well under \$100 in 100 quantities or more.

DPMs with 3-1/2 digits (1999-count) are also available at about \$130 in single quantities. In quantities of 100 and up, the two lowest-priced 3-1/2-digit units, both cased, are being offered by Analogic (\$78) and Analog Devices (\$89). Both operate from 5 V dc. Weston, Datascan and Data Technology offer 3-1/2-digit units that operate from 115 V ac for less than \$100 in 100 quantities.

If you have a systems application, you may need a more sophisticated DPM with features like automatic polarity selection, local or remote command capabilities, differential input, high noise rejection and buffered BCD output. These can boost the cost to the \$300 to \$400 level.

Probably the best way to select a DPM, according to Jack Stegenga, Weston's product manager, is to try it before you buy it. "There are many industrial applications," he points out, "where noise from machinery plays havoc with the reading of reduced-performance DPMs. The spec sheets are not going to tell you that."

Bernard Grand, Gralex's chief engineer, concurs. "Specifications can only be used as a guideline by the prospective user," he says. "How well a unit performs can only be verified by a thorough evaluation of a typical production unit."

There are many nonstandard applications where requirements are very critical. One example is in a hospital operating room, where a DPM may be used to monitor a patient's temperature or blood pressure. Erroneous readings of a few tenths of a percent can be tolerated. But grossly inaccurate readings, which can result from radiated interference from nearby equipment, may prove fatal. Further, the bright lights that are common in operating rooms can wash out the readouts on most DPMs, unless circularly polarized filters are used to improve the contrast.

Some applications, like those in steel mills and other industrial environments, require high-tem-

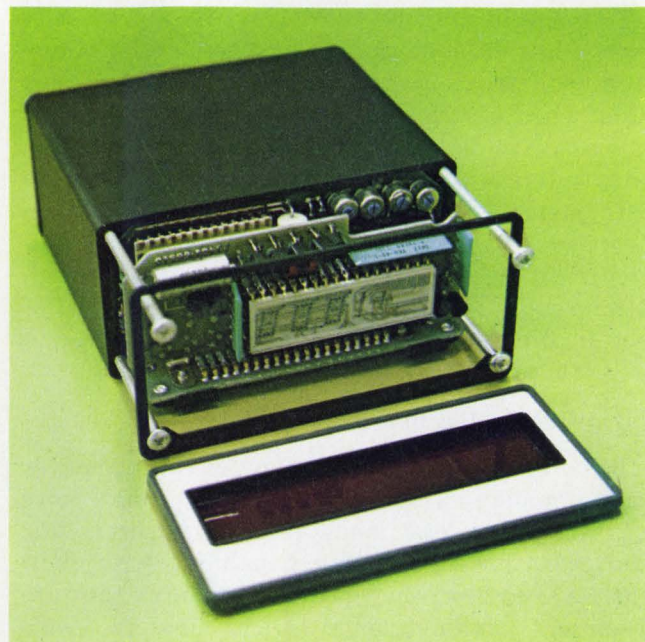

Hewlett-Packard's 3431 LED-display DPM has only nine components for increased reliability.

perature operation—up to 60 C or higher. Several manufacturers—Electro-Numerics, Newport Laboratories, Analog Devices, Analogic, Beede, Datascan, Hewlett-Packard and Computer Products—rate their meters for operation to 60 C. Instrument Displays offers operation to 70 C.

In almost all cases, there's a sacrifice of accuracy at higher temperatures. Rated accuracy may apply only at about 25 C, and a temperature coefficient may have to be applied to determine the accuracy at other temperatures. In some cases accuracy is given over a band of temperatures—typically 15 to 35 C—a range that's quite adequate for most applications.

Some critical applications can't be satisfied with a standard DPM. To meet these needs, some vendors—like Intercontinental Electronics—specialize in custom designs. Intercontinental's director of engineering, Charles Reynolds, explains: "We fit the DPM circuitry to the customer's electrical, mechanical and display criteria."

To clear away some of the confusion caused by specsmanship, let's take a closer look at some of those key DPM specs and see how manufacturers may mislead—sometimes unwittingly—through their data sheets.

Accuracy—it can add up

Accuracy—or rather inaccuracy, as it should properly be called—is probably the most important parameter, the one most bandied about and the least understood. The typical accuracy spec is taken after the instrument has been warmed up, calibrated and placed in a closely controlled laboratory whose temperature is usually 23 C \pm 1 C—a rather limiting condition

for most DPM applications.

It's a rare data sheet that lists ALL specs that contribute to reading inaccuracy. And there are many: operating temperature range, temperature coefficient, warm-up time, settling time, line-voltage changes, input bias current effects, common-mode voltage interference and normal-mode noise. Any one of these can have an important effect on over-all DPM accuracy. No accuracy spec is complete without them.

The most realistic way to interpret a vendor's accuracy spec is to add up all specified errors, including errors caused by the DPM's operating temperature range and input loading effects. Don't be surprised to find the total error to be many times the advertised accuracy spec.

For example, one manufacturer has a 3-1/2-digit DPM (999 full scale with 100% overrange) with an advertised accuracy of $\pm 0.1\%$ of reading. Assume a reading of 10.0 V. Taking the basic accuracy of $\pm 0.1\%$ of reading, you get a possible error of ± 10 mV. The temperature coefficient is specified as $\pm 0.01\%$ of full scale (100 V) per C. Assuming an operating range of 15 to 35 C, you get an additional error of $\pm 0.1\%$ of full scale, or ± 100 mV. So now the total error is ± 110 mV or $\pm 1.1\%$ of the 10-V reading. That's 11 times the advertised accuracy. And that's not including error effects of line-voltage variation and long-term stability, which are not specified in many cases.

A five-digit DPM may have 10 times the resolution of a four-digit instrument, but not necessarily 10 times as much accuracy. Five-digit DPMs encounter more sources of error as they approach noise levels than four-digit meters do. So don't get carried away with a large number of digits. A well-designed four-digit DPM can have more accuracy than a poorly designed five-digit meter, in spite of the fact that the latter has 10 times more resolution.

Bias current can upset accuracy

When making low-level measurements, input bias current can have a degrading effect on accuracy. A DPM bias current of 1 nA will cause a 0.1% measurement error when 1 mV is measured from a 1-k Ω source impedance. While some data sheets fail to list any bias-current spec, consider others showing bias currents of 300 nA. With the same source impedance of 1 k Ω , the 1-mV measurement would have an error of 30%. For higher source impedances, the effect of bias current can be even more devastating.

The bias-current error is in addition to any input loading errors. Most DPMs have input impedances of 10 to 100 M Ω —sufficiently high for making measurements from source impedances of 1 k Ω or less—without seriously degrading the

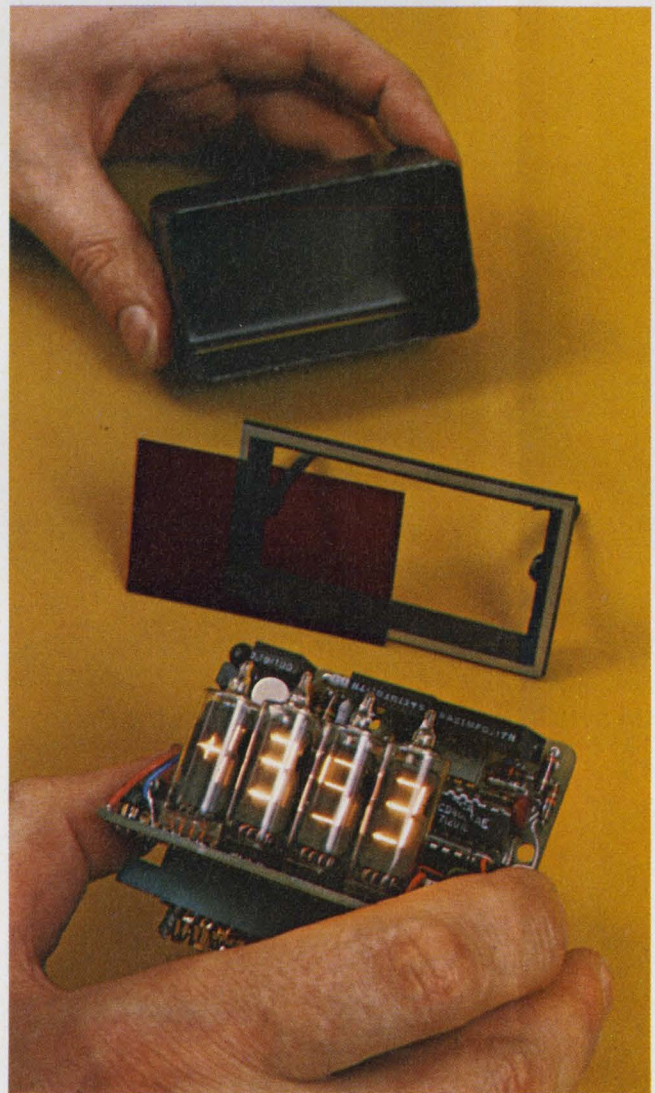
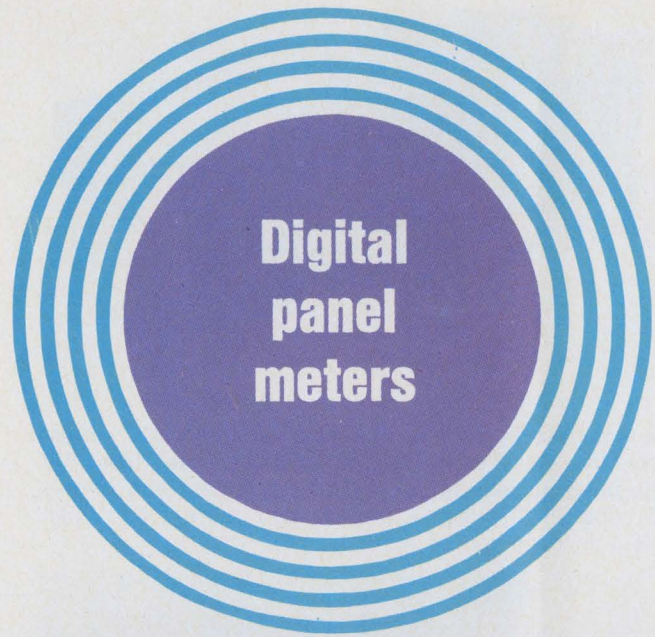

Analog Devices has entered the DPM field with its model AD2001. The 3-1/2-digit instrument is just 8 cubic in. in volume and costs only \$89 in 100-quantity lots. The meter operates from 5 V dc.



The smallest in volume and cost is Analogic's newest entry, the 3-1/2-digit AN2535 which operates from 5-V logic lines. It sells for \$78 (100 quantities) and is only 6.6 cubic in. in volume, measuring a mere 1.4-in. high by 1.4-in. deep by 3.4-in. wide.



The first DPM with a liquid-crystal readout is this new 3-1/2-digit model 4352 from Digilin. It dissipates only 0.5 W while operating in the reflective mode.



A 3-4-digit concept is obtained with Triplet's model 4228-N. The 3/4 digit is made up of a 100% overrange 1/2 digit and a least-significant 1/4 digit.

rated accuracy.

There are, however, many applications where measurements are taken from source impedances of 100 k Ω or more. Under these circumstances, a DPM with a 10-M Ω input can have a loading error of 1%. That's 10 μ V of error for a 1-mV measurement on a 3-1/2-digit instrument.

The point here is that a high-input-impedance DPM does not automatically give freedom from loading errors. It can still load down relatively high-impedance sources. So watch out for loading errors.

One spec that is never found on data sheets is "kickback" current. DPMs with automatic-zeroing techniques kick back current into the source, which can cause significant errors in the measurement of capacitive sources. The source capacitance stores up this kickback current and introduces a voltage offset.

Watch those noise specs!

Electrical noise and ground-loop signals riding in on input dc signals can cause large measurement inaccuracies, particularly with the line-voltage-operated DPMs. This would not occur if the unknown dc voltage to be measured had no ac noise component and the input-signal's low side corresponded to the DPM's power-supply low side. Battery-operated DPM's generally avoid noise problems of this type.

Two types of noise signals can cause inaccurate measurements with a DPM: common-mode and normal-mode noise. The former is the noise signal that is common to both the high and low sides of the DPM's input. The latter consists of noise in series with the signal source.

Some manufacturers will give a common-mode spec, or a normal-mode spec, but not both. Still others give neither. Many specify normal-mode rejection at 60 Hz only. But this parameter is a function of frequency. What happens at frequencies other than 60 Hz?

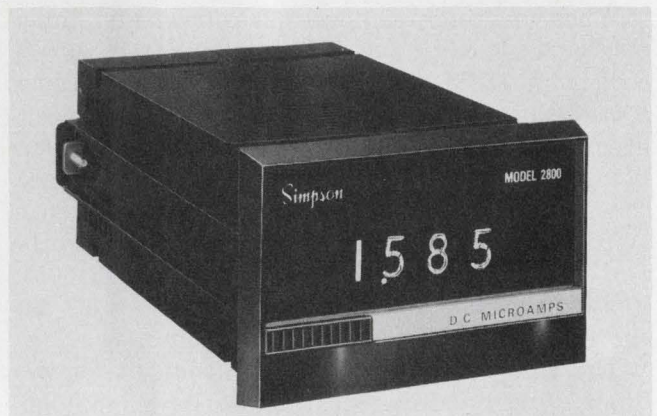

Accuracy for Simpson's model 2800 is rated over a 15 to 35 C span. The 3-1/2-digit instrument operates from either 115 V ac 60/400 Hz, or from dc power.

Look carefully at the common-mode voltage spec, which isn't always supplied. Only a few millivolts of this noise signal can cause large errors when low-level measurements are made or when BCD output is used.

Find out if the spec given for normal-mode rejection is taken with input filtering present in the DPM. Some vendors will give a normal-mode spec with an input filter in the meter and a response time spec with the filter taken out. While the filter may make the normal mode-rejection spec look good, it also slows the DPM's response time, which can be important in a systems application.

Both common-mode and normal-mode rejection specs vary widely from one DPM to another. Don't assume adequate noise rejection for every DPM. Listen to what Electro-Numeric's president, Russell Walton, has to say about this: "Specifying the amount and type of noise coming in on the ac power line that a DPM can tolerate is extremely difficult, even for the manufacturer. If there is any chance that you're going to have a noisy power line, try a meter in your application first."

BCD: What kind and how fast?

BCD output is available on nearly all DPMs, but only a few manufacturers offer it as standard; most make it an option. Some data sheets, however, don't spell out what kind of BCD is being offered. Is it serial or parallel? Isolated or nonisolated? How much drive capability does it contain? Isolated, or buffered, BCD output is necessary to keep the digital system noise out of the meter and to avoid measurement errors.

There isn't much point in buying nonisolated BCD output when logic system noise will cause all sorts of errors and the BCD can't drive a printer because of insufficient current. This does not mean, however, that nonisolated BCD is useless for all applications.

Speed in a DPM is widely misunderstood, and it's no wonder. Look at any data sheet and you will find some manufacturers call it conversion rate, some prefer reading rate, while still others specify settling time. Each of these speed parameters has a different meaning.

Conversion rate is the time needed to complete the a/d process. It varies according to the process used and is generally a few milliseconds. Reading rate can be nearly as fast as the conversion rate. It is limited by the internal logic required to provide automatic-polarity indication.

Speed is nearly always determined by the settling time, which includes the input buffer amplifier's full-scale slew rate and is usually specified to include a full-scale step-function change in input signal. It also depends on the input filter,

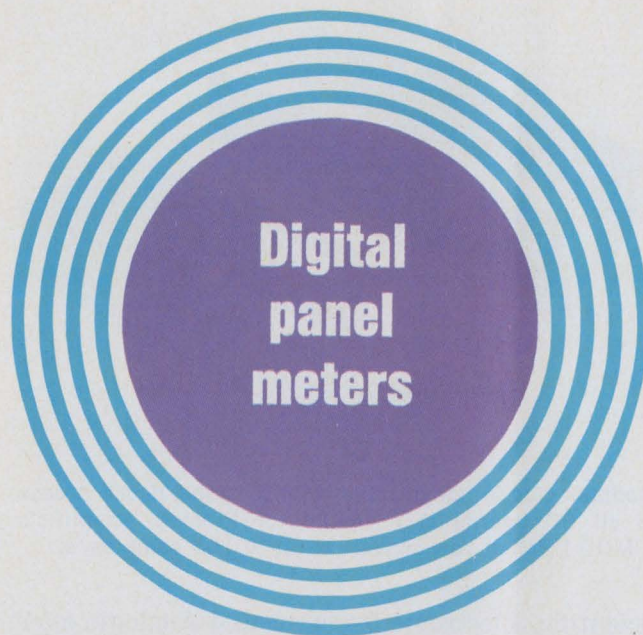

which increases normal-mode rejection. With a normal-mode rejection of 20 to 30 dB, the settling time for a 3-digit DPM is about 150 to 200 ms. This can be reduced by cutting the value of the input filter, but accuracy may suffer because of excessive normal-mode noise.

You may ask: Of what value is a high reading rate of 60 or more readings per second when the settling time of 150 to 200 ms controls the speed? The value occurs for small input changes. The input filter responds to small incremental changes in the input signal and provides fast and accurate readings.

Don't be too concerned with speed if you're using the DPM as a monitor. Anywhere from 3 to 6 readings per second will do. Where speed comes in handy is for system applications. If you're driving a printer or providing data for a computer, tying up this equipment while waiting for the DPM to provide data can be expensive. High-speed readings are needed here. Preston

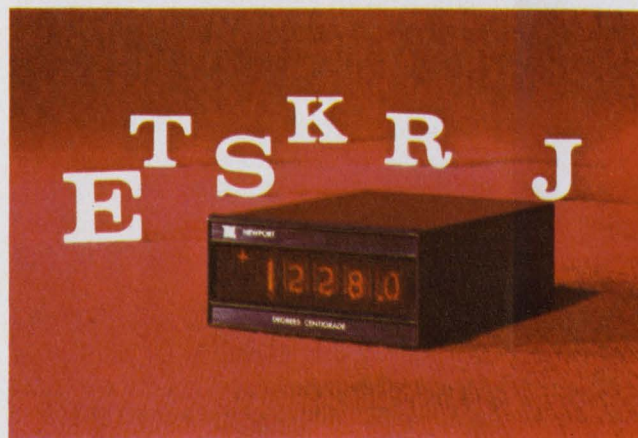

An entire range of thermocouple types are covered with Newport Laboratories' series 2600 DPM. The instrument has an integral reference junction that is removable.

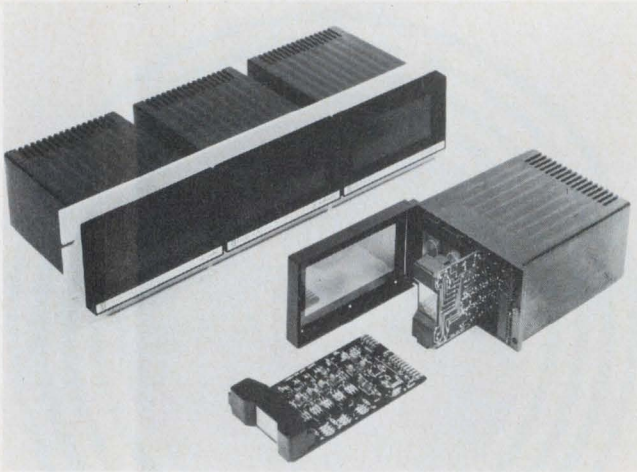

Modular plug-in construction with a "panel-door" access to all PC boards is a feature of Preston Scientific's X-MOD DPM. It can convert at up to 100 samples/s.



The first to use an LED display was Digilin's model 3330 which requires only 3.5 square in. of panel space. The meter operates from 5 V dc.

Scientific, Electronic Research and Analogic offer meters that are capable of 100 readings per second. Many manufacturers have meters with 60-readings-per-second capability.

Some DPMs offer externally programmable reading rates, a useful systems feature. Of equal importance is the method of programming used, which unfortunately is not always spelled out. Is it by contact closure? External resistance? Or some other method?

Digit claims are confusing

Confusion reigns supreme when it comes to specifying the number of digits that a DPM has. Not all DPM's with the same resolution are referred to the same way. One manufacturer's 3-digit instrument is another's 4-digit machine.

Most DPMs offer 100% overranging—typically a neon "1" lights up as the most significant digit. So a 3-digit (999-count) instrument reads 1999 with 100% overranging.

But there is also a growing tendency for meters with 20%, 30%, 200%, 300% and in some cases 400% overrange. And to compound the situation further, we have the 3/4 digit—made up of an overrange "1" and a 1/2-count least-significant digit.

The problem here is that accuracy specs are given in many cases as a percentage of reading plus a percentage of full scale. But what is full scale? Is it 999 or 1999 on a 3-1/2-digit meter? A spec of 0.1% of 999, is 1, but it is 2 if full scale is 1999.

Obviously the best way to clear some of the confusion over how many digits a DPM has is to give the meter's maximum reading. So a 3-1/2-digit instrument should be identified as a 1999-count instrument, and a 4-1/2-digit unit with 20% overrange as a 12000-count meter.

Worth noting is the method of out-of-range, or

overvoltage, indication employed. Some meters blink when the maximum reading is exceeded. Others simply blank out. Still others have special annunciators that light up. Some start all over from zero. If unskilled people are going to be making the readings, it pays to find out what method is used.

Several manufacturers offer multiple ranges for each DPM model. However, it isn't always spelled out what the cost is for a specific range. In some cases the charge for an additional range is a nominal few dollars, but other vendors will charge over \$100, particularly for low-voltage ranges. This is a point to keep in mind, especially when buying low-cost DPMs. You may wind up paying as much or more to change the instrument's range than the instrument's initial cost for the meter.

This brings us to another point. How is range changing accomplished? Is it by changing one or two resistors in the DPM? Can it be done by the user or at an authorized service center? Or must the instrument be shipped back to the factory? Some users find out that they must employ external circuitry to the DPM to change ranges. So when you see the phrase "many ranges are available," find out how.

Some DPMs make range changing very simple. Typical is Newport Laboratories' multi-range and multi-function Model 400 U meter. A hardware kit supplied with the instrument contains everything needed to change ranges, function and panel-mounting method.

It's a good idea to find out if the vendor provides scaling or readout in engineering units—for example, rpm, pH, psi. It may only involve minor component changes, but don't assume that every vendor provides that service. With some, scaling is provided by changing the decimal point with a jumper wire or by grounding a terminal on the meter's back panel.

Remember, most lower-voltage ranges are generally worse off when it comes to accuracy. The accuracy spec most always seen on a data sheet is for the higher-voltage ranges. While some manufacturers give the lower-accuracy spec, some do not.

The elusive matter of reliability

Reliability is one feature that will not be found on any data sheet. Electro-Numeric's Walton puts it this way: "Probably more can be told about the reliability of a DPM and the integrity of the supplier by taking the meter out of its case than by any other method. An engineer should ask himself: Is this the type of product I would design and that my company would manufacture?"

Data Technology's chief engineer, Phillip Wasserman, offers these pointed remarks: "High DPM failure rates are usually traceable to one or more of four causes: design, component quality, assembly workmanship and quality control. There are many meters which meet published specifications but fail to perform as expected. This can be very damaging to the meter user's confidence."

It pays to examine the DPM you buy carefully. Does it disassemble easily? Is wiring kept to a minimum? Is it easy to service? Of what quality are the meter's components? And are they standard parts?

Many manufacturers boast about plug-in readout tubes for ease of replacement. But in reality the ICs that drive the readout tubes fail more often. Are they plugged into sockets instead of soldered?

An important point is the matter of adjustments. DPMs usually have two adjustments, one for zero (except for automatic-zeroing types) and one for full scale. Since no instrument is completely free of drift, frequent zero and full-scale calibration adjustments may be required. This is simple enough if the controls are on the front panel. Some meters, however, have back-panel controls. Even on meters with front-panel controls, bezel removal may be necessary.

The size derby—beware!

Next to price, size is the most hotly sought prize. The competition is fierce among many meter makers to build the smallest DPM.

Here we face a problem in semantics. Many "smallest" sizes are claimed. The smallest 3-1/2-digit (width by length only) meter is one claim. Another is the smallest without a power supply. Or how about the smallest without a case?

The best way to talk about size is to include all three dimensions (length, width and height) and to include those items that a user would

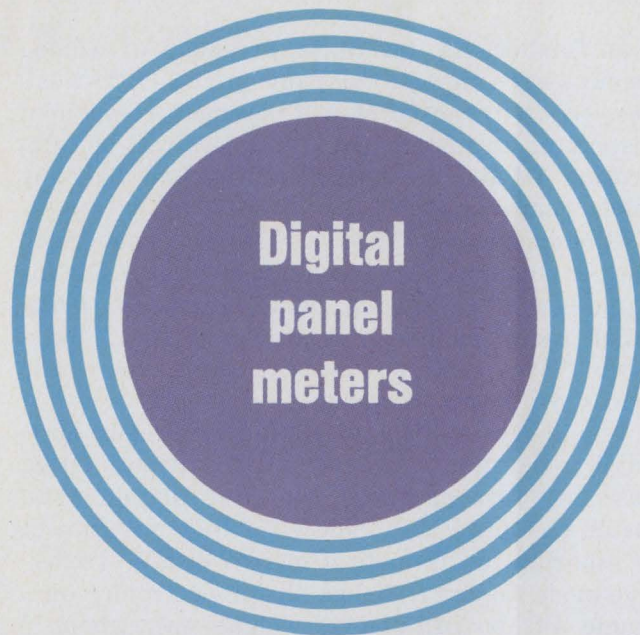

normally buy with the instrument, such as power supply (where used) and case.

Until very recently, Digilin held the crown in smallest volume with its 3-1/2-digit, LED-readout Model 3330. It has a volume of 18 cubic inches. However, Analog Devices introduced its AD2001 3-1/2-digit meter at just under 8 cubic inches, only to be surpassed one day later by Analogic's 3-1/2-digit AN2535 at 6.6 cubic inches—the smallest volume yet. Analogic's meter, however, is a bit wider—3.4 inches vs 3 inches for the Analog Devices model. Neither uses power supplies—both operate from 5 V.

Dimensions vary from one meter to another. Don't get too hung up on the smallest size, unless space is critical. The smallest width or depth or height can be more important, depending on application.

For some applications, front-panel mounting is desired, while for others back-of-panel installation is needed. Be careful how vendors specify dimensions, particularly depth. Many dimension specs do not take into consideration a front bezel, which can be comparatively large.

For users looking for large-size displays, three vendors are in the lead for display-character height. Electro-Numerics has a meter with 1-inch-high, planar 7-segment readouts. Both API and Preston Scientific offer meters with 7/8-inch-high readouts. API uses planar 7-segment displays, while Preston has neon edge-lighted tubes.

Looking ahead: cheaper, smaller DPMs

Demand for lower-cost and smaller-size DPMs, so buyers can justify their choice over analog types, is certain to drive down prices and sizes

even further. As Ray Stata, president of Analog Devices—the newest company in the DPM business—sees it, the DPM will become a component instead of an instrument. Designers will be integrating DPMs into their circuits, just like any other components.

“Complementary-MOS (CMOS) conversion and driver circuitry, combined with LED or liquid-crystal readouts, will ultimately bring DPM prices below \$20, in large quantities,” Stata says. “Even within the next three years \$35 prices will begin to appear.”

Liquid-crystal-display DPMs are already here. Digilin, the first to produce a LED-display DPM, has also just produced the first liquid-crystal meter (see page 101). The 3-1/2-digit instrument is reported to dissipate a mere 750 mW (reflective-mode display). It has all its electronics on a single PC board, and it weighs only about 8 ounces.

Digilin's vice president, Thomas Tremble, says the industry may eventually see the “flat-screen” approach, where the user simply “glues” a flat plate to his panel, connecting only the input signal and perhaps a small power voltage to the meter.

Many in the industry believe that there are too many suppliers at present for the DPM market's demand. Lower prices appear likely to weed out many companies and to consolidate the market to four or five leaders in the next few years.

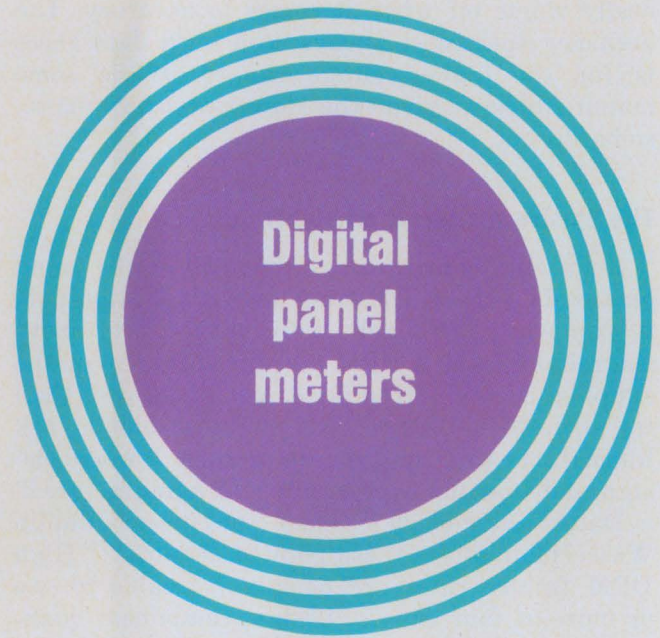

Some standardization will no doubt evolve, too. The National Electronics Manufacturers Association has a subcommittee working on DPM standardization—the Digital Panel Instrument Group Subcommittee of the Electrical Indicating Instrument Section. It hopes to come up with standards for specs, mounting dimensions and test procedures. ■■

Need more information?

DPMs mentioned in this report have, of necessity, received only cursory coverage. Readers may wish to consult the manufacturers listed below for further details. Circle the bold face numbers for fast response.

- Analog Devices, Inc., Route 1 Industrial Park, Norwood, Mass., 02062. Phone: (617) 329-4700. (Ray Stata, President; Fred Molinari, Marketing Manager). **401**
- Analogic, Audubon Rd., Wakefield, Mass., 01880. Phone: (617) 246-0300. (Bernard Gordon, Technical Director; Bernard Friedman, Vice President of Marketing). **402**
- API Instruments Co., subs. of LFE Corp., 1601 Trapelo Rd., Waltham, Mass., 02154. Phone: (617) 894-6600. (Roland Gubisch, Product Manager). **403**
- Beede Electrical Instrument Co., Inc., Penacook, N.H., 03301. Phone: (603) 753-6362. (Lou Issel, Sales Manager; Joel Friedman, Marketing Manager). **404**
- California Instruments Co., 5150 Convoy St., San Diego, Calif., 92111. Phone: (714) 279-8620. (Bill Barker, Marketing Manager). **405**
- Computer Products, 1400 N.W. 70th St., Fort Lauderdale, Fla., 33307. Phone: (305) 974-5500. (Daniel Wiper, Director of Marketing). **406**
- Datascan, Inc., 1111 Paulison Ave., Clifton, N.J., 07013. Phone: (201) 478-2800. (Arnold Cohen, Product Engineering Manager). **407**
- Data Technology Corp., 2700 S. Fairview St., Santa Ana, Calif., 92704. Phone: (714) 546-7160. (John Dunn, Product Line Manager; Phillip Wasserman, Chief Engineer). **408**
- Digilin, Inc., 1007 Air Way, Glendale, Calif., 91201. Phone: (213) 240-1200. (Stan Ericsson, Sales Manager; Thomas Tremble, Vice President). **409**
- Dixon, Inc., Grand Junction, Colo., 81501. Phone: (303) 242-8863. (W. E. Boulton, Division Manager). **410**
- Electronic Research Co., 10,000 W. 75th St., Overland Park,

- Kan., 66202. Phone: (913) 631-6700. (Robert Rush, Marketing Manager; Karl Keck, Sales Engineer). **411**
- Electro-Numerics Corp., 2961 Corvin Dr., Santa Clara, Calif., 95051. Phone: (408) 738-1840. (Russell Walton, President). **412**
- Faratron Corp., 290 Lodi St., Hackensack, N.J., 07601. Phone: (201) 488-1440. (Henry Aufiero, President). **413**
- Gralex Industries, Div. of General Microwave Corp., 155 Marine St., Farmingdale, N.Y., 11735. Phone: (516) 694-3600. (Bernard Grand, Chief Engineer). **414**
- Hewlett-Packard, Loveland Instrument Div., Loveland, Colo., 80537. Phone: (303) 667-5000. (Bill Beierwaltes, Product Manager; PenDell Pittman, Marketing Manager). **415**
- Instrument Displays, Inc., 225 Crescent St., Waltham, Mass., 02154. Phone: (617) 894-1577. (Ted Chadurjian, Marketing Manager). **416**
- Intercontinental Electronics Corp., 260 Macedon Center Rd., Fairport, N.Y., 14450. Phone: (716) 377-5991. (Charles Reynolds, Director of Engineering). **417**
- Newport Laboratories Inc., 630 E. Young St., Santa Ana, Calif., 92705. Phone: (714) 540-4914. (Martin Culverhouse, Sales Manager; Lyell Kinney, Applications Engineer). **418**
- Non-Linear Systems, Inc., Del Mar, Calif., 92014. Phone: (714) 755-1134. (Robert Rockwell, Systems Sales Manager; Charles Marsh, Vice President of Marketing). **419**
- Preston Scientific, Inc., 805 E. Cerritos Ave., Anaheim, Calif., 92805. Phone: (714) 776-6400. (Bernard Spear, Vice President of Marketing). **420**
- Simpson Electric Co., 5200 W. Kinzie St., Chicago, Ill., 60644. Phone: (312) 379-1121. (Hal Moore, Product Manager; Mel Buehring, Sales Manager). **421**
- Takeda Riken Industry Co., Ltd., c/o Marubeni-lida (America), Inc., 200 Park Ave., New York, N.Y., 10017. Phone: (212) 973-6500. (Andrew Babiak). **422**
- Triplett Corp., Bluffton, Ohio, 45817. Phone: (419) 358-5015. (William Triplett, President; Walter Cerveny, Manager of Engineering). **423**
- United Systems Corp., 918 Woodley Rd., Dayton, Ohio, 45403. Phone: (513) 254-6251. (Fred Pummill, Technical Sales & Marketing Manager). **424**
- Weston Instruments, Inc., 614 Frelinghuysen Ave., Newark, N.J., 07114. Phone: (201) 243-4700. (Thomas Kelly, Chief Engineer; Jack Stegenga, Manager of New Products). **425**

Ring up a savings on keyboard switches.

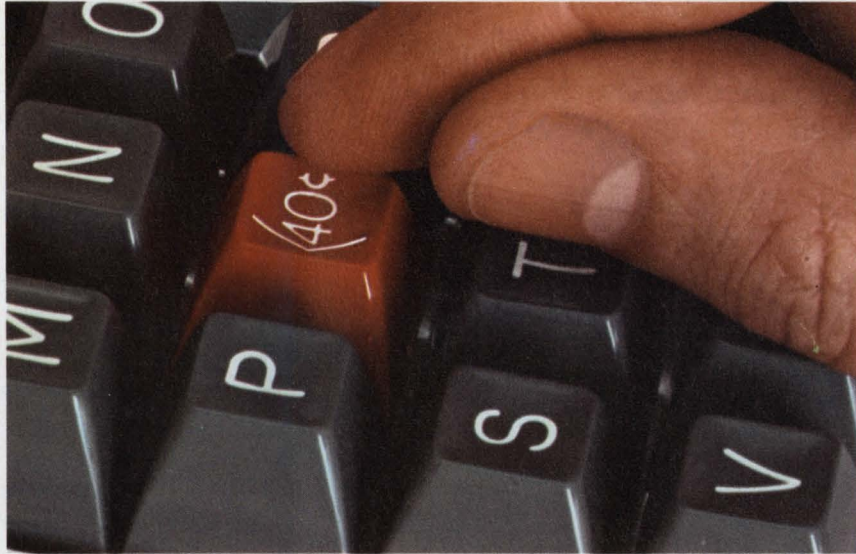

As much as **40%**
[savings per key]

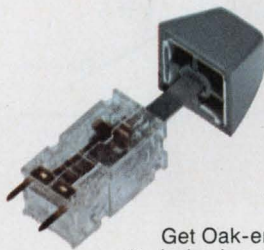

The new Oak Series 400.

Get Oak-engineered quality in keyboard switches with the inherent reliability of electro-mechanical operation. Ideal for peripheral data-processing equipment. Contact bounce is less than 3 milliseconds. Long life, up to 20 million operations per key. Designed with self-cleaning crossbar-wiping contacts.



Under 40¢ each.

For SPST/NO in production quantities. Other versions comparably priced. Keytop button and snap-in mounting extra.



A feather touch.

We kept the operator in mind. Standard operating force is approximately 85 grams (3 oz.).

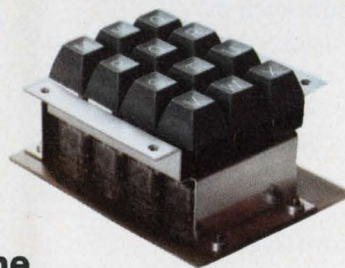

The configurations you want.

The Series 400 is available in limitless arrangements, including standard 10, 12, and 16-button keyboards. And you can specify any of six different contact circuits. Choose snap-in or plug-in P.C. mounting. Compact—only 1/2" x 1/2" x 1".

Write today for our Series 400 brochure.

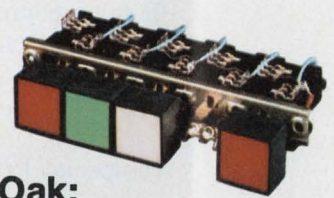

Also from Oak: Series 300 Lighted Pushbutton Switches.

Featuring Oak's exclusive twin-lamp lighting. If one lamp goes out, the other stays on. Double-wiping contact clips. Short stroke. Smooth, quiet operation. Unlimited combinations. Request our Series 300 brochure.

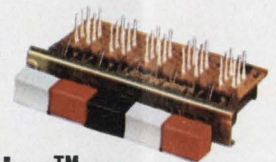

And our Series 800 Econo-Line™ Pushbutton Switches.

Compact—more buttons and more contacts in less space: 1 PST to 8 PDT per button. Your choice of mechanical actuation. Colored buttons, legend engraving to your specifications. Request our Series 800 brochure.

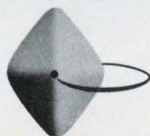

OAK MANUFACTURING CO.

CRYSTAL LAKE, ILLINOIS 60014 • A DIVISION OF OAK ELECTRO/NETICS CORP

Telephone: 815-459-5000

TWX: 910-634-3353

TELEX: 722-447

INFORMATION RETRIEVAL NUMBER 40

Some straight talk about **MECL 10,000**...

Perhaps you have already evaluated MECL 10,000 and discovered the many ways your system performance can be improved. Or, you may have questions concerning its application and you are considering various logic options. Here are a few answers to questions commonly asked. And if you don't know the answers, don't worry, we'll show you how to become a MECL 10,000 expert.

Q. How fast is MECL 10,000 and can it be adapted to very high speed systems?

A. MECL 10,000 offers 2 ns gate delays combined with low power dissipation (25 mW/gate). Where necessary, MECL 10,000 is compatible with MECL III to "shift up" for the high data rates required in critical timing chains.

Q. Are special PC boards required?

A. No. Although toggle rates are as high as 150 MHz, switching rise and fall times are slow enough (edge speed 3.0 ns) so that conventional system layouts such as two sided PC boards can be used. Also, the slow edge speeds allow the added flexibility of driving open wire, wire over a ground plane, wirewrap, or coax.

Q. How can MECL 10,000 improve system performance and cut costs?

A. MECL 10,000 provides design flexibility in many ways. For instance, the open emitter outputs and high impedance inputs allow wire-"OR"ing of several levels of gating, with a marked savings in gate and package count. Open emitter outputs allow data "bussing" and two-way data transfer. Also, the open emitter outputs allow complete flexibility in the choice of terminating schemes and logic interconnects.

Complementary (OR/NOR) outputs provide simultaneous "true" and "complement" functions, minimizing gate and package count in a system. And the complementary outputs provide excellent twisted pair (differential) line drivers at standard gate prices.

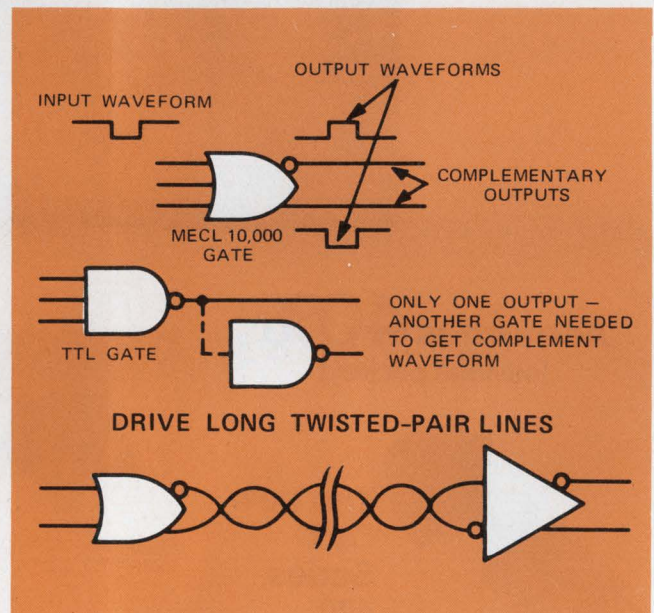

Q. How many functions are available in MECL 10,000?

A. Motorola has introduced 16 devices to date and now two more are available; the MC10116 Triple Line Receiver and the MC10160 Twelve-Bit Parity Generator/Checker.

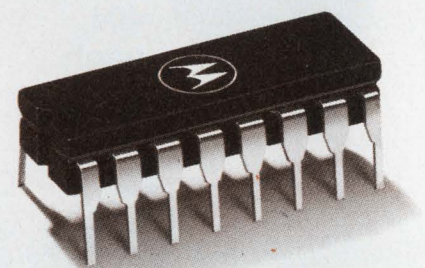

to help you eliminate the alternatives

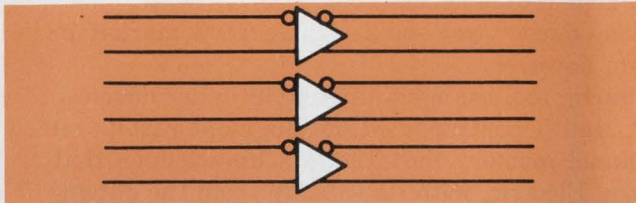

MC10116 Triple Line Receiver — A triple differential line amplifier for sensing differential signals over long lines. Also useful as a Schmitt trigger, or in applications where a stable reference voltage is necessary.

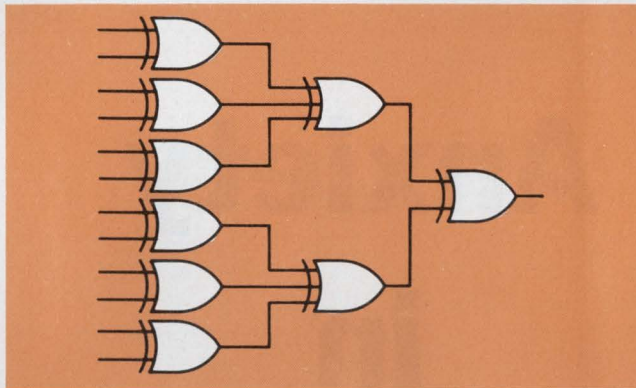

MC10160 12-Bit Parity Generator/Checker. Useful for high speed detection or generation of parity on long data words with minimum package count. One package offers nine EXCLUSIVE-OR gates internally connected to provide odd parity checking or generation.

Additional devices will shortly be introduced including:

- Multiplexers (Dual 4-to-1, Quad 2-to-1)
- Universal Counters (Binary and Decade)
- Universal Shift Registers
- Flip-Flops (100 MHz, 200 MHz, 500 MHz)
- MECL-to-MOS Interface (for memory systems)
- Buss Drivers/Receivers
- 16 x 4 Fast RAM, plus other memory configurations

MECL 10,000 eliminates the alternatives. Evaluate and compare!

MECL and MECL 10,000 are trademarks of Motorola Inc.



MOTOROLA MECL
... for faster computers & systems

Q. Is MECL 10,000 a single source logic family?

A. Definitely not. MECL 10,000 will be second-sourced by Signetics and several others will be announced shortly.

Q. Are special regulated power supplies necessary?

A. Not at all. MECL 10,000 operates over a wide range of supply voltages and there is a minimum change in operating characteristics within a $\pm 10\%$ supply voltage. Also, constant noise immunity is guaranteed over the new wide temperature range of -30°C to $+85^{\circ}\text{C}$.

Q. What special cooling requirements are required?

A. No special cooling is required. MECL 10,000 low power gates eliminate cooling and power distribution problems and insure long term reliability. Operate in still air or forced air.

You still have questions? We now have a new MECL 10,000 book covering MECL 10,000 specifications, design rules and applications. Be a MECL 10,000 expert, write to Motorola Semiconductor Products Inc., P.O. Box 20912, Phoenix, Arizona 85036 and ask for "MECL 10,000 Facts." And for immediate evaluation devices call your local Motorola distributor.

Some impressive new products are being announced in Japan, in spite of the recent business uncertainty in that country. Japanese companies are technically strong, and growing more so every day.

Typical of their accomplishments are these:

- Two-chip calculator LSI circuits, with microprogramming.
- 1.5-ns, 6-mW ECL ICs.
- 2048-bit, n-channel RAMs with cycle times of 400 ns.
- A 4900-bit, fusible-link ROM with 50-ns access time.
- Minicomputers with 32-kilobyte memory and 4.5-ns machine-cycle time, finding wide use in Japan as communications computers.
- New low-cost line printers for use with minicomputers.
- Prototype liquid-crystal displays nearing commercial use, with Japanese developers eyeing the wristwatch and calculator markets.
- An LSI tester capable of 10-MHz operation, featuring one-socket dynamic and dc functional and parametric tests.

Semiconductors: Fast and complex

One of Japan's most advanced semiconductor manufacturers, Nippon Electric Co., Ltd., has developed—in addition to extensive results in high-frequency diodes, transistors and ICs—low-power, high-speed modified ECL circuits in a joint project with the Electrical Communication Laboratory of Nippon Telegraph and Telephone.

The chips, used in the CPU control logic of the DIPS-1 computer system, have gold beam leads and a complexity of 20 to 50 gates. They're used in multichip assemblies of 15 to 20 chips, with a multi-layer substrate that has gold metalization.

"We also make n-channel RAM chips with gold beam leads," says Dr. Hiroe Osafune, general manager of Nippon Electric's Semiconductor Div. in Kawasaki, "with up to 2048-bit capacities and full decoding on the chip." Access time for the 144-bit chip is 50 to 60 ns, and the rest, 250 to 300 ns. Cycle times are 300 to 400 ns.

Nippon Electric also offers both ROMs and pROMs. The ROMs are available in sizes up to 4096 bits per chip, both n-channel and p-channel. Access times are as low as 40 to 50 ns for the n-channel type, with polarity compatible with TTL, and threshold voltage can be controlled to be TTL-compatible also. The pROMs are metal-alumina-semiconductor, and can be erased and rewritten.

The company also boasts a complete set of ICs and transistors for color TVs, including a deflection-drive power amplifier, LEDs, silicon-vidicon tubes and a new CRT color display.

Hitachi, also very active in semiconductors, is now supplying a two-chip MOS, eight-digit microprogrammable calculator circuit to Casio and several other Japanese users, and Hitachi engineers are at work on a one-chip version.

"The target for Japanese companies now," says Dr. Toshio Inoue, deputy general manager of the engineering staff of Hitachi's Electronic Devices Group in Tokyo, "is to produce the 1103 RAM and improve on it." The 1103, with 300-ns access and 600-to-700-ns machine cycle times, is fairly slow, he noted, but the next generation will probably have 100-ns access.

Inoue doesn't yet see a sizable 1103 market in Japan, however.

Hitachi, too, has n-channel MOS under development, and it has reported development results on n-channel memory, but Inoue acknowledges that Nippon Electric, with its subsidy from the Japanese Government to develop n-channel MOS, is strongest in this area.

No Japanese manufacturers have yet announced a commercially available CMOS product,

Anxiety in JAPAN

Inoue says, but there is a high degree of interest on the part of watch manufacturers. Research in this area is being pushed by all of the major semiconductor houses—Hitachi, Toshiba, Nippon Electric, Mitsubishi.

Hitachi is making ultra-high-speed ECL, too. Typical is an arithmetic control unit with 60-mW dissipation and 1.5-ns delay per gate, used in Japan's national computer project and also in Hitachi's Hitac 8700 and 8800 computers.

Hitachi also has a 256-bit bipolar RAM—called FCI memory—with a power consumption only 1/10th that of conventional RAMs.

Hitachi engineers are working on liquid crystals but have no product to show yet. Their work

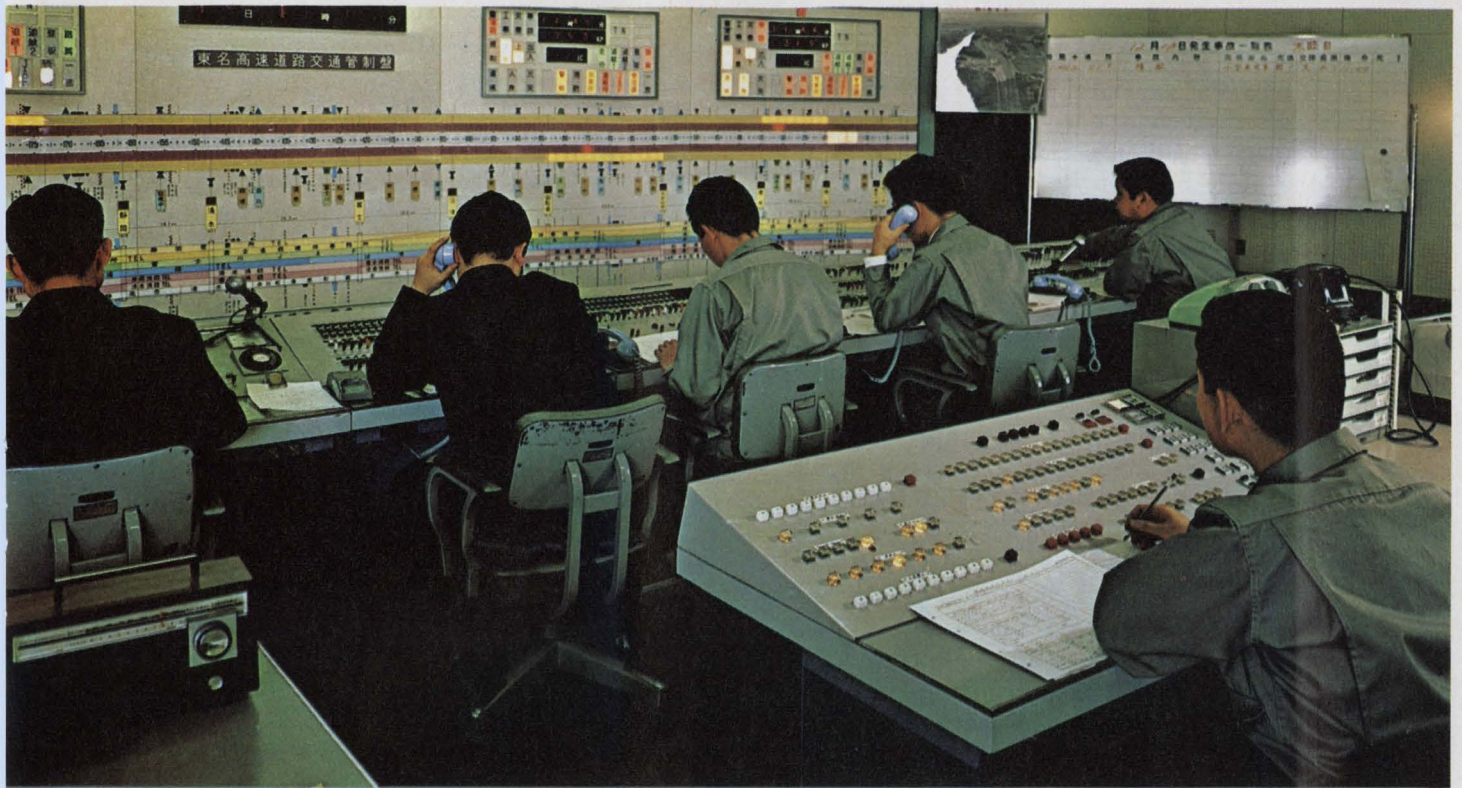

Part 2

Impressive new products in spite of the slump.

Raymond Daniel Speer
Managing Editor

shows promise, Inoue says, but they need improved seeding techniques, better glass and better driving circuits. Lifetime guarantee is still difficult, and making rise and fall time equal is taking most of their research time at the moment, but they feel that threshold voltage problems are well on the way to being solved. Right now, rise time is roughly 10 ms and fall time 100 ms.

The target applications, of course, are the desk-top calculator and the wristwatch.

The Mitsubishi Electric Corp., in Tokyo, also in the semiconductor game, is making Gunn diodes, already being used by the Japanese National Railway in doppler radars to measure freight car

speed in switching yards. Chikashi Kazuaki, manager of the Mitsubishi Electronic Materials and Devices Dept., says that this is the first such application approved by the Japanese Signal Allocation Agency, and he points to a zero failure rate so far.

Mitsubishi is also developing K-band Gunn diodes. The company has achieved 300-mW outputs at S band and expects 150 mW at K band with 3% efficiency. In pulse operation, the output peak power can reach 5 W for 20- μ s pulse widths at 1 kHz repetition rates.

Mitsubishi researchers are growing their own gallium arsenide crystals, and they maximize cooling of their Gunn diodes by making the n+ layer, which contacts the heat sink, very thin—about 1 micron.

In wide—20-microsecond—pulse operation at 10 GHz, frequency drift can be 100 MHz or more, depending on circuit Q and diode operating conditions, but Mitsubishi engineers say they have cut this drift to 5 MHz by shaping the input pulses or by using a varactor shunt.

Susumu Industrial Co. Ltd., a specialist in thin-film components, is making a 4900-bit, fusible-link, thin-film ROM, with a nominal access time of 50 ns. It expects it to find wide use in computer peripherals. The ROM is built on a glass substrate with nichrome metalization, and it involves use of a plasma reaction technology that Susumu developed.

The Kyoto company uses an organic thin-film

layer for insulation—a polymerization technology—to get dielectric breakdown up to 400 V. Isao Wada, SSM's chief engineer, says Susumu is emphasizing speed in this product, probably at higher cost; the price has not yet been set.

Susumu also builds capacitors, using the preliminary technology and samples are now available.

Sanken in Tokyo, a manufacturer of power transistors, diodes and hybrids, has announced a hybrid 50-W audio amplifier for consumer use, and a monolithic audio amplifier with 4-W output into a 4-ohm load, 13.2 V_{cc} supply, 40-dB voltage gain, 45 k Ω input and a total harmonic distortion at 1-W output of 0.5%. Bandwidth is 30 Hz to 30 kHz.

Sanken also makes flip-chip transistors at ratings up to 750 mW for hybrid manufacturers. "Hughes used to make these," says Dr. Sei-ichi Denda, manager of Sanken's Microelectronic Research and Development Center, "and we don't understand why they stopped." Sanken is competing with RCA in this area, he says.

Questions about memory

Japanese companies are making wire memories as well as semiconductor units, but they are largely uncertain about how each type of memory will be applied in the years to come.

Tokyo Shibaura Electric Co., Ltd. (Toshiba), a manufacturer of billing machines, and scientific, industrial and business minicomputers, is studying both wire and semiconductor memories, although Aritoki Murakami, manager of computer sales for the company, feels that the trend toward IC memories is very clear.

"The cost/performance ratio is best with ICs," the Toshiba manager says, "and it will get better. Every year the price of IC memory comes down, and IC memory will soon be cheaper than wire.

"Of course," he adds, "special considerations, such as volatility, may swing you to wire memories, depending on the application." Toshiba's computers so far use core memory.

Murakami is not sure yet whether Toshiba will make or buy the IC memory components it will need, or whether they'll be Japanese or U.S.-made if bought.

Everybody's building minicomputers

There are no computer companies in Japan that are not thinking about building a new minicomputer, according to Masateru Takagi, manager of the Systems Components Dept. in Nippon Electric's Industrial Automation Div. All of the companies, he says, are looking at IC and wire memory and at microprogramming. There's a high de-

gree of interest, he notes, in both high-speed and low-power possibilities.

The way to sell the minicomputer is to aim at the end-user market, Takagi feels, and Nippon Electric will sell its new NEAC M4 for use in automated service stations and automatic-data-concentration and air-pollution-monitoring systems, hopefully throughout Japan.

The NEAC M4 and the NEAC 3200 Model 30 both use core memory. "We'll probably use wire memory as writeable ROM in our next mini for program storage, and core memory for data store to avoid a commitment to a hard-wired program," Takagi says. He believes it will take one to two years for semiconductor memory to find use in Nippon Electric minis; they don't need the speed yet.

A modified NEAC M4 with writeable read-only memory will soon be in wide use, Takagi says, as a communication computer for data concentration, message switching and data terminals. Total memory capacity will be about 32,000 eight-bit words, including core store and a writeable ROM program memory. Roughly 10 kilowords are in writeable ROM, 22 kilowords in core. Memory access time for the M4 is 0.5 μ s, cycle time 1.5 μ s, and machine cycle time 4.5 μ s per instruction.

The NEAC 3200 Model 30 has a machine cycle time, including add and subtract, of 3.2 μ s, a multiplication time of 8.8 μ s and division time of 17.6 μ s. The basic memory module size is 4096 words, with a maximum of 16 kilowords.

Hitachi, Nippon Electric, Fujitsu and Electrical Communication Laboratories, in a joint Japanese Government contract to develop the DIPS-1 computer, have completed the hardware; the software is being generated now at Electrical Communication Laboratories. The computer will be used by Nippon Telegraph and Telephone to upgrade its data communications and time-sharing services.

The CPU used in DIPS-1 has a scratch-pad semiconductor memory with 100-ns cycle time and a million-byte core memory with 2- μ s cycle time.

A main feature of the DIPS hardware is its special multi-processor configuration: Up to 4 CPUs can be hooked up to the system to increase processing power and capacity and the reliability of the system through redundancy.

Nippon Telegraph and Telephone in Tokyo already offers three kinds of time-sharing for public use—DEMOS for scientific and engineering calculation, DRESS for sales and inventory control and DIALS, a push-button telephone calculator service with audio readout. DIPS-1 will be used for this whole area of computer services.

The scratch-pad memory approach is used because DIPS-1—since it is designed to serve a

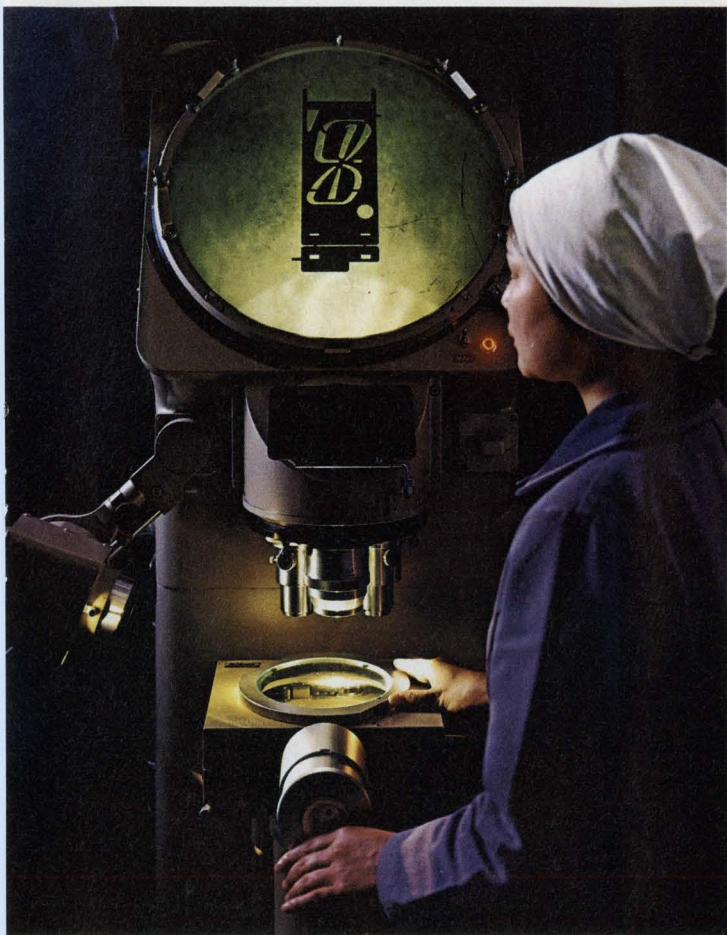

large number of subscribers—needs large capacity and high speed and this is an expensive combination. So Nippon Telegraph and Telephone uses large, slow core bulk storage and 8 or 16 kilobytes of local semiconductor memory in each CPU. The selection of size depends on the service; CPU speeds are 630 ns per instruction.

In a DEMOS application, DIPS-1 will serve about 600 simultaneous users in a time-sharing mode, using only three CPUs. The average response time, between instruction entry and answer from the system will be less than two seconds, the company says.

Calculators and peripherals

Casio's new AS8—an eight-digit calculator with a floating decimal, that adds, subtracts, multiplies, divides and allows the setting of a numerator constant—has been announced at the lowest price yet: 38,000 yen (about \$125) retail in Japan.

Casio engineers in Tokyo expect the price of calculators in Japan to come down quickly to 30,000 yen, with at least one manufacturer introducing a cheaper calculator this year.

Casio has also developed an ink jet printer, with a 5-cc-capacity cartridge system, good for about 800,000 characters per refill. The company engineers say they have solved the traditional nozzle-clogging problem with a special ink that Casio makes and an improved emitter that has new accelerating and deflection plates. The printer uses an MOS/LSI character generator and prints a 64-by-32-dot matrix.

"A.B. Dick has a similar system," say Hiroaki Usami, Casio's development division manager, "but they use ultrasonic vibration to break the ink up into tiny droplets. The advantage of the Dick process is high speed; they can get 4000 characters per minute. But the Casio advantage is a compact low-cost emitter that doesn't need ultrasonic vibration—and a smaller pump. It is capable of smaller, intricate characters—such as Japanese characters—because line width can be held to 100 microns or less."

The character generator used by Casio is a one-chip device, with control and timing on the chip. The system can handle 128 characters, and the Japanese retail price will be 450,000 yen (about \$1250). Prototype quantities are available now and production quantities will be offered next spring.

A subsidiary of Tokyo Electron Laboratories, MEC Engineering, has come up with a unique concept for a medium-speed line printer. MEC's engineers found an engineering bottleneck in the hammer-drive circuits of conventional printers. Hammer drives typically require high voltage and high power; they must use high-power transistors, protective circuits, fuses, etc., and as a result they're costly.

In MEC's new printers mechanical energy is used to activate the hammer. Springs are kept cocked until current to a trigger mechanism is cut allowing the hammer to strike the drum.

"From 6 to 8 V at 60 A for 2 ms or so is a typical conventional drive current for each hammer," says Kunio Arimori, director of export operations for Tokyo Electron Laboratories, "but we supply only 6 V at 6 mA to each hammer trigger, and the hammers are reset after each line by the drive motor—and hammer trigger pulses are only 0.5 milliseconds. We can print one line in one revolution of the drum, no matter what characters are printed."

The new printer is primarily intended for the OEM market, with a price below \$3000 FOB Japan, including electronics for the drive and buffer. Availability will be 10 to 20 units per month starting next month.

A new LSI tester from Takeda Riken Industry Co., Ltd., the 320/10, features a high test rate—up to 10 MHz—and dynamic functional testing. It can check dynamic MOS exercise memory and



LSI components—all at designed operating speeds.

“With highly complex LSI available, and the computer on a slice being discussed,” says Dr. Ikuo Takeda, president of the Saitama Company, “there is a need for dynamic testing involving highly complex data on both input and output, and the 320/10 tester provides for this. Typically, 20% of the cost of LSI manufacture is testing cost.”

The new tester is a one-socket system. All tests—dynamic functional, dc parametric and dynamic parametric tests of t_r , t_f , t_{td} are performed with the device in the same socket on one insertion.

The Takeda tester is a software-oriented system that uses compiler-level language, a CRT display for a data-pattern monitor and program debugging, a marked-card reader for data-pattern information loading and an operator terminal. The system is modular; it can grow with the user's needs. It's expandable, for instance, in the number of leads it will accommodate and in its pattern memory size, and because it's software oriented, it can even accommodate additional strobe pulses.

“Four things make high-speed dynamic func-

tional testing possible,” says Takeda.

First, the drivers are hybrid circuits, using Nippon Electric chips. Second, the comparators use switching technology and FET differential input amplifiers.

Third, a special test fixture is used, in which one driver is used as a data driver, a clock driver and a current load driver, and one comparator is used as the output data comparator and the discriminator. This markedly reduces the number of relay contacts necessary and lowers stray capacitance.

And fourth, a buffer memory is used—a 10-MHz memory using Nippon Electric—n-Channel MOS—instead of the usual core memory. With core memory, you can achieve only 20 to 50 kHz.

The Nippon Electric n-channel MOS memory was developed as a result of the national DIPS project. The system uses a Hitac minicomputer, but the Nippon Electric system will use the Nippon minicomputer.

Takeda Riken also makes a digital multimeter that can be used as a high-speed dc-to-32-MHz universal counter. Called the TR6656, it offers 1 μ V dc voltage resolution, 100 $\mu\Omega$ to M Ω resistance measurement, dc current reading with 1 Ω or less input impedance and BCD output for automatic recording. The push-button unit sells for 480,000 yen in Japan, available in 45 days.

At Nichicon Capacitor Ltd., N. Murakami, the company's vice president believes that U.S. companies are still far more advanced than Japanese in thick and thin-film hybrid work, and he says that because of this gap, it's very hard to export hybrid circuits to the U.S.

Murakami sees hybrids greatly reducing assembly cost in a myriad of products, by modularizing display drivers for desk-top calculators, TV processing circuitry, communications transceivers, etc. Examples of Nichicon products include these: a synchronous signal generator, an 18-chip MSI assembly, a liquid-crystal driver with 12 MOS ICs and 80 plated-through holes, and an rf amplifier, local oscillator, mixer i-f amplifier and detector module.

And Matsushita, long an innovator in consumer ICs, has a new, hermetically sealed 25,000-V TV flyback transformer and rectifier with silicon oil cooling to eliminate fire danger. Another innovation is a piezoelectric high-voltage generator, used in black-and-white TVs.

Matsushita has in production a monochrome TV set that uses an LSI circuit, a bipolar IC horizontal oscillator and MOS count circuits that divide 31.5 kHz down to 60 Hz—17 ICs in all. The horizontal oscillator and the count circuit eliminate horizontal and vertical adjustment, and no knob is provided. The only tube used in the set is the picture tube. ■■



Sperry displays are available in 3 digit, 2 digit, and 1½ (7 segment character and a 1 with + and -) digit models in both ½" and ¼" sizes.

Compare panel meter displays

If you think that Nixie® tubes or LED displays are the only one's you can logically use in your panel meters, you had better take a close comparison look at Sperry. The facts speak for themselves.

COMPARE READABILITY . . . a must requirement. Sperry displays† can be read in direct sunlight with no loss of legibility. And, continuous, "no-gap" Sperry characters make your panel meters a lot more attractive to your customers. Try the others.



COMPARE POWER . . . a very important factor. Under DC operation, LED's require over 500 mW — Nixie® tubes require over 400 mW as compared to Sperry ½" with 200 mW and ¼" with 370 mW. Sperry can go down even further — to 85 mW under pulsed operation using a Sperry decoder/driver, without affecting readability. What about voltage? A simple, inexpensive DC/DC converter takes the battery voltage up to the 170 volts required to operate Sperry displays.

COMPARE RELIABILITY . . . simplicity is the key. Sperry displays have no wirebonds. They are so ruggedly built and reliable that they are used aboard the Boeing 747. Need we say more.



COMPARE SIZE . . . it's the housing to character size ratio that counts. Which display do you want in your equipment?



Sperry ½"



Sperry ⅓"



LED ¼"



Nixie® ½"

Add these Sperry advantages to greater clarity and brightness, wider viewing angle and a low cost of \$2.30** per digit for either the ½" and ¼" device and you can end the comparison and specify Sperry — the right displays for your panel meters. Get the whole story on Sperry displays by requesting complete technical information using this publication's reader service card or phone or write: Sperry Information Displays Division, Post Office 3579, Scottsdale, Arizona 85257, Telephone (602) 947-8371

SPERRY
INFORMATION DISPLAYS

It's a whole new ball game in display devices!

Try a piecewise-linear approach

to the design of wide-range log amplifiers and get more accurate transfer characteristics and faster response.

The conventional approach to the design of log amplifiers—a compensated diode and an op amp—is fine for most applications. But what if the designer is faced with requirements for accurate, wide-range logging together with extremely fast pulse response? It's better to use a piecewise-linear approach to design.

With the conventional approach, diode current dips into the low microampere range to achieve the wide dynamic range. At such low currents, the circuit can't charge diode and circuit capacitance rapidly, and response time is slower than desired.

A second problem with the conventional design is difficulty in realizing correct transfer characteristics. Good log response can be achieved, but it is hard to compensate for the saturation effects that occur in actual wide-band circuits.

Why go piecewise-linear?

The piecewise-linear approach offers several advantages in the design of accurate, wide-range log amplifiers. It produces a faster pulse response time, more accurate transfer characteristics and operation over a wider range.

The method requires that the desired transfer curve be divided into a number of linear segments, or pieces. The accuracy of the approach improves with the number of segments used.

Log video amp illustrates technique

The design of a logarithmic video amplifier that functions as part of a pulse receiver can demonstrate the use of the piecewise-linear technique.

Assume the receiver system imposes the following design requirements:

- An amplifier gain transfer curve that is neither linear nor logarithmic (Fig. 1). This is required primarily to compensate for nonlinearities of detectors used in the receiver.

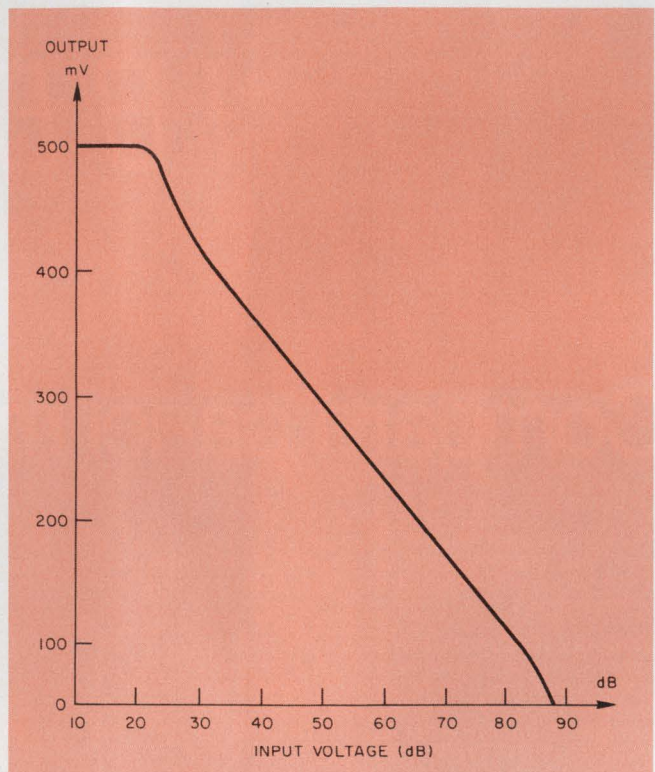

1. This log amplifier gain-transfer characteristic compensates for detector nonlinearities in the over-all receiver system. The usual compensated diode log amp design cannot match these characteristics.

- The transfer curve of Fig. 1 must be accurate and linear within $\pm 1\%$ of full scale at 25 C.

- The transfer curve of Fig. 1 must not vary more than $\pm 3\%$ of full scale over the military temperature range of -55 C to 125 C.

- Pulse-settling time to within $\pm 1\%$ of full scale must be within 75 ns.

- Overshoot, ringing or other aberrations are not allowed.

- Both input and output must block dc.

Figure 2 shows the piecewise-linear approach in block-diagram form. The basic plan of attack is to begin with the required maximum gain for low-level inputs and decrease amplifier gain at regular intervals as a function of signal level to fit the curve of Fig. 1.

The way to decrease gain at regular intervals

George Smith 3d, R&D Manager, Microcircuits Operation Helipot Div., Beckman Instruments, Inc., Fullerton, Calif. 92634.

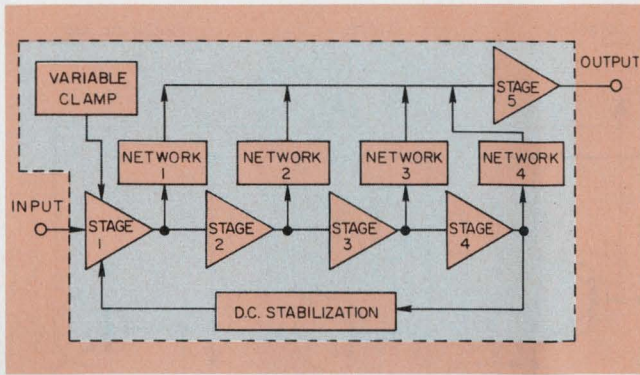

2. Five gain stages and five clamping networks produce a 10-segment log amplifier. Greater accuracy can be achieved by using more segments.

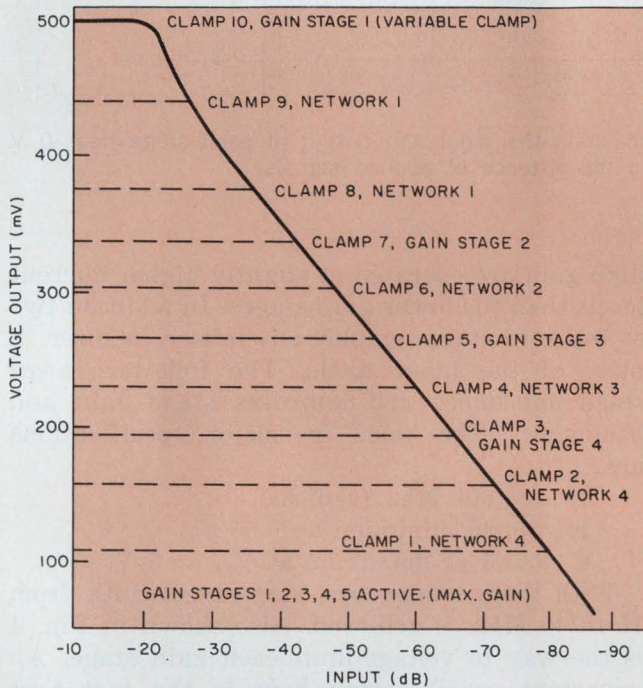

3. The location of the 10 break points shows how the transfer curve is shaped from a series of straight line approximations. The piecewise linear segments approximate the actual curve to better than 1%.

is to clamp the output of the various amplifier stages in these two ways:

1. Network attenuation changes as a function of signal level. Networks 1 through 4 are resistor diode networks.

2. Amplifier stages 1 through 4 are gain-limited (clamped) as a function of signal level.

As the input signal level rises, the networks and gain stages are successively clamped, beginning with the output end (network 4) and working back toward the input end (stage 1). The log amplifier is finally saturated when gain-stage 1 is clamped off.

For the accuracy required in this design, 10 segments were used. The resulting error is about ± 1.5 mV, which is about one-fourth of the total allowed error. The 10 segments are generated

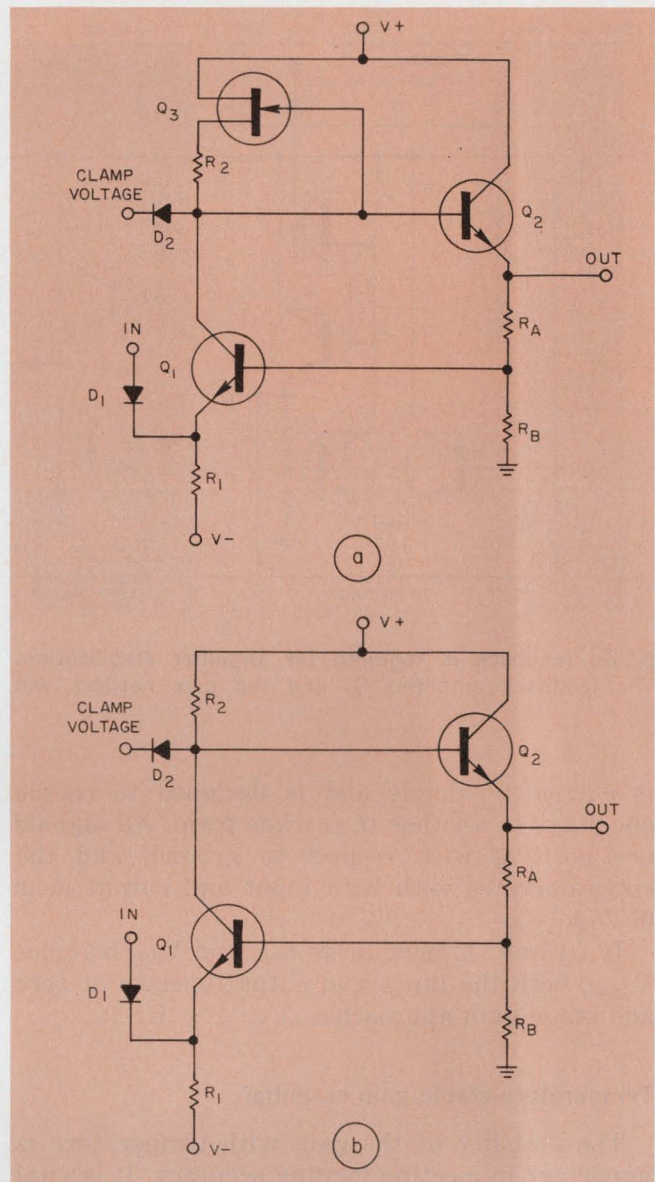

4. The only difference between the basic gain stage used for high gains (a) and the one for low gains (b) is the use of an active collector load to increase transistor gain for the higher-gain requirements.

with the four gain stages and four resistor diode networks. Figure 3 shows how segments and clamps are employed to shape the curve.

Beginning with the basic over-all gain requirements and working backward, the gains required for the five gain stages of Fig. 2 can be calculated:

Stage 1.....	39.20
Stage 2.....	6.15
Stage 3.....	4.00
Stage 4.....	7.50
Stage 5.....	10.00

Stages 1, 4 and 5 are implemented with the circuit of Fig. 4a, and stages 2 and 3 use circuit 4b. The only difference between these two gain stages is the use of an active collector load for the higher gain requirements. Basically the stage

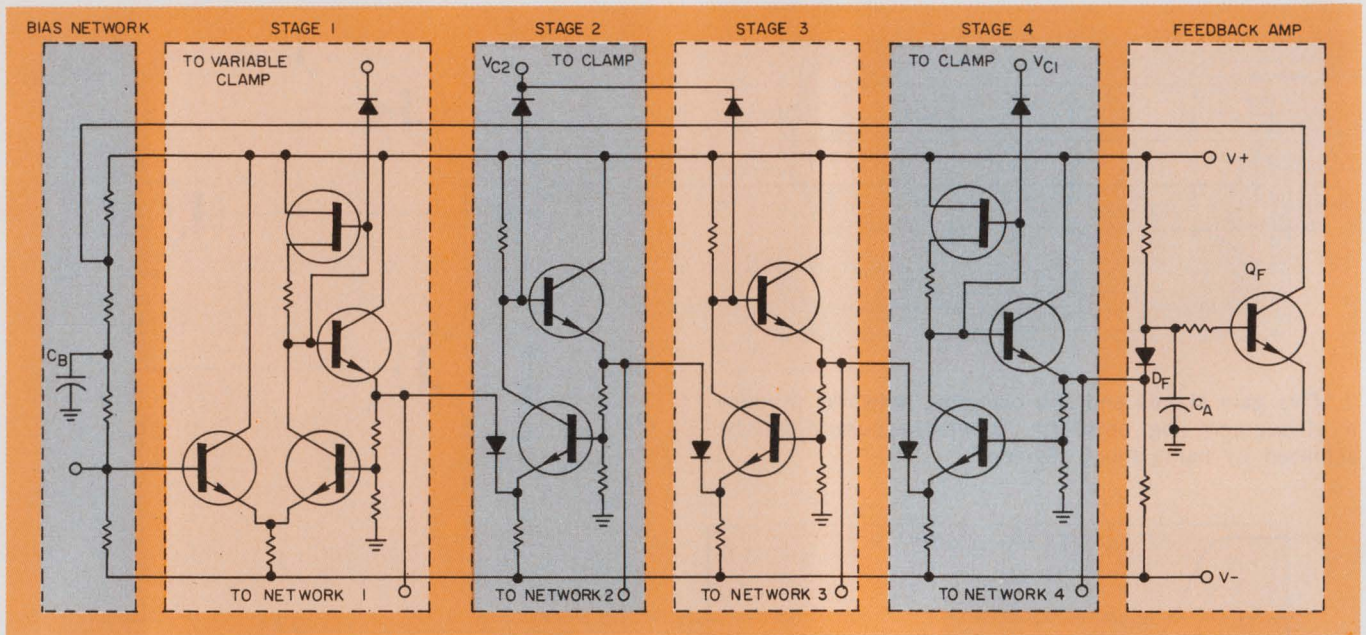

5. Dc feedback is required for amplifier stabilization. The feedback amplifier Q_7 and the bias network will

maintain the input and output of each stage near 0 V in the absence of applied signals.

is extremely simple and is designed to couple one stage to another in cascade form. All signals are positive with respect to ground, and the stage operates with both input and output near 0 V dc.

If Q_1 and Q_2 have large h_{FE} , and V_{FD1} matches V_{BEQ1} , both the input and output operate at zero and stage gain approaches $A = 1 + R_A/R_B$.

Temperature-stable gain essential

The stability of the gain with temperature is important in meeting logging accuracy. It is vital that stage gain depend primarily upon the resistor ratio, since the ratio may be controlled accurately. To ensure this, forward-loop stage gains from 150 to 500 are employed in the various gain stages.

The transistors used in the gain stage present difficult requirements. They must be fast, have low C_{ob} , and high h_{FE} at currents from 1 to 10 mA.

The compromise between transistor speed and h_{FE} is a problem. From the speed standpoint, the ideal case would be to burn up sufficient power to keep circuit resistances down near the 50-to-100-ohm level. At such low circuit impedances, however, circuit loading requires transistors with large h_{FE} to maintain enough loop gain to ensure gain linearity.

Get speed while conserving power

For an airborne application, where power is limited, each gain-stage operating point is tailored for its specific job. The gain stages requiring

high gain are operated at slightly higher current levels than the lower gain stages. In addition two of the gain stages employ an emitter follower in place of the input diode. The follower raises stage impedance and improves stage gain and bandwidth. The basic transistor specifications are:

- $f_t = 600$ Mhz (typical)
- $h_{fe} = 40$ minimum at -55 C
- $C_{ob} = 3$ pf maximum at $V_{CE} = 5$ V.

With these transistors, stage bandwidth from 15 to 40 MHz is achieved. Also shown in Fig. 4 is the way to voltage-limit each gain stage. An important consideration here is the fact that the clamped voltage level out of each stage must remain constant with temperature. If the clamp voltage input is temperature-compensated and V_{FD2} tracks V_{BEQ2} , the desired effect is achieved. In practice, tracking is excellent, since both semiconductors are on the same substrate. The voltage clamps for the four gain stages create the 66-dB, 54-dB, 42-dB and 20-dB break points shown in Fig. 3.

Figure 5 shows the four basic gain stages connected together, with an over-all dc feedback scheme for stabilization. As noted earlier, the input and output of each gain stage must operate near zero volts when no input signal is applied. To ensure this, feedback is required.

The over-all dc gain through the amplifier from the input to the output of stage 4 is approximately 72,440. The output of stage 4 is sensed by the feedback amplifier (Q_F) and compared with ground. The output of the feedback amplifier is then applied to the input bias network to establish the correct operating point for

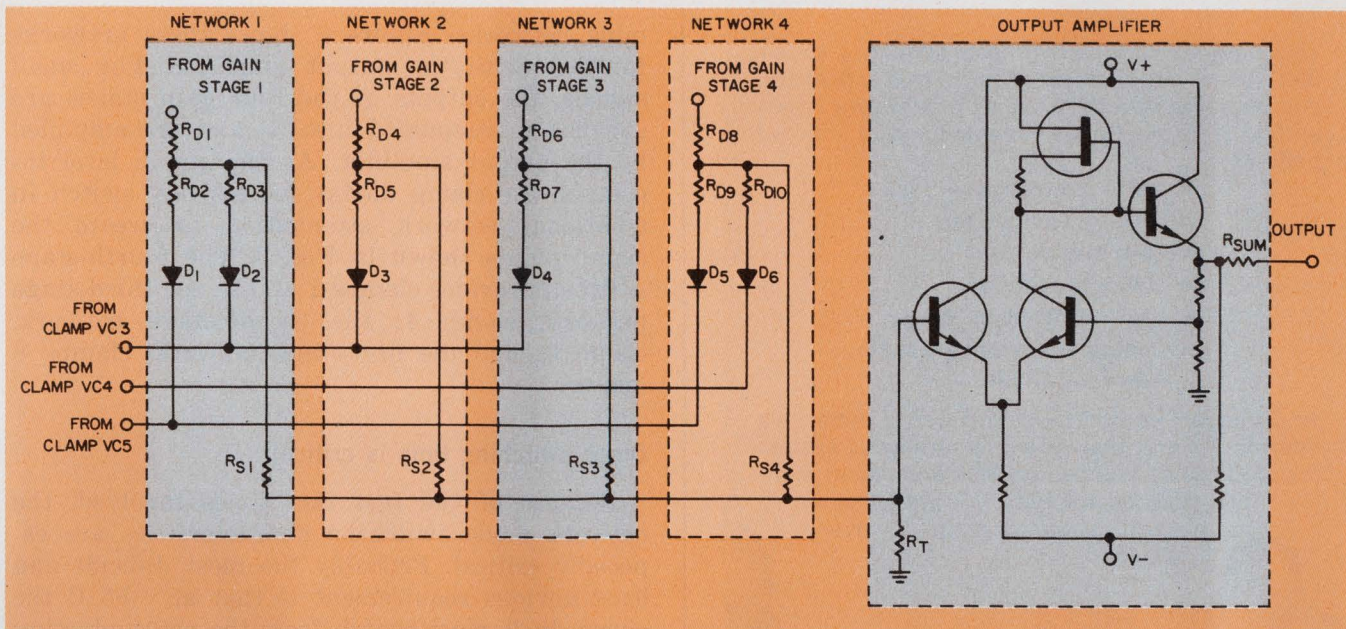

6. Resistor-diode clamping networks are summed in the output amplifier to form the final output. As input level

increases, diodes switch in attenuation to shape the curve.

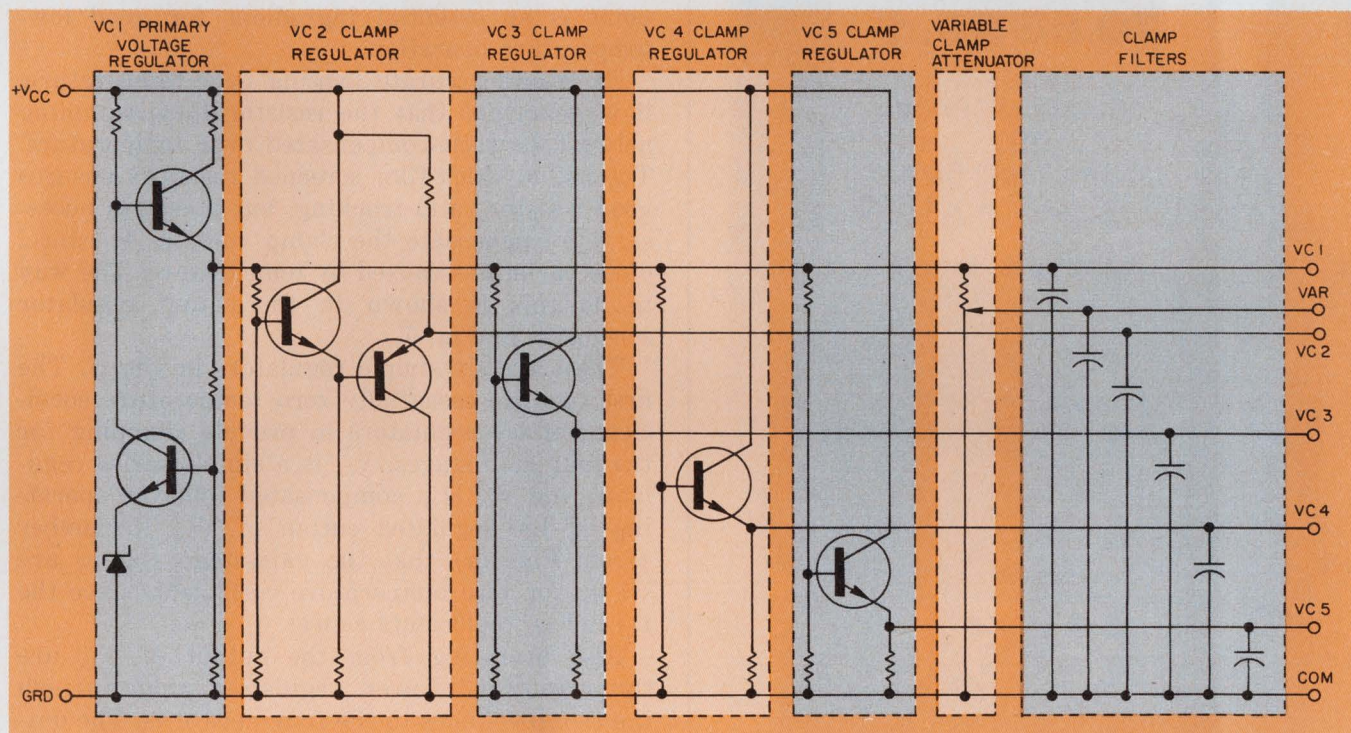

7. Simple regulators provide temperature compensated clamp voltages to the resistor-diode networks and the

gain stages. All clamps operate from the primary voltage regulator to maintain stability.

over-all amplifier operation. The feedback ensures that all stages quiescently operate within a few millivolts of zero volts.

The feedback system in Fig. 5 indicates two poles generated by capacitors C_A and C_B and their associated Thevenin equivalent resistor networks. The ratio between these poles is approximately 10:1, so that system response is essentially that due to a single dominant pole. The diode D_F in the feedback amplifier base circuit tem-

perature compensates the base-emitter diode of the feedback amplifier. In addition to providing temperature compensation, the diode provides the additional feature of disconnecting the forward and feedback loops during input pulse time. During pulse time C_A is large enough to hold the feedback voltage from moving significantly, thus ensuring good baseline recovery.

Figure 5 also shows the outputs of each of the four gain stages directed toward the four sum-

This new 3½ digit panel meter combines excellent specs., an aesthetic design, quick delivery, compact size and OEM prices of \$95 (Uni Polar) and \$101 (Auto Polar). Check these additional benefits:

- 100% overrange — 1999
- 0.1% ±1d accuracy
- Zero bias current
- 100uV sensitivity
- 0 to +60°C temp. range
- Complete line of 2½, 3, 3½, 4 and 4½ Digits

At Datascan we don't just ship you a meter, we interface it and help you optimize your system (or product) so you can provide something extra to your customers . . . we've been helping people go digital for over a decade.

**NOW WE'RE
"SMALLEST"
ENOUGH
TO BE NO. 1**

"Smallest" Price
\$95

"Smallest" Size
2.6" W. x 3.2" H. x 4.6" D.

Call or write to our
Vice-President Jim Maloy, he would
like to help you with your OEM needs.

Datascan
/ digital products group

Datascan Inc., 1111 Paulison Avenue • Clifton, N. J. 07013
(201) 478-2800

ming networks. Figure 6 shows these networks together with the output amplifier. For small signals, the outputs of the four gain stages are summed unattenuated into R_T and are amplified by the output amplifier. As the signal level increases, the clamp diodes successively switch in additional network attenuation to create the clamp points shown in Fig. 3. The fourth-stage network provides clamps 1 and 2; the third-stage network, clamp 4; the second-stage network, clamp 6; and the first-stage network, clamps 8 and 9.

Diode switching time is critical

Because of the fast rise times involved, the network diode switching characteristics are especially critical. Probably the most difficult and least obvious requirement is that at -55°C the clamp diode must switch from the nonconducting state in less than 30 ns. At the low temperatures, diodes tend to be sluggish, producing aberrations and overshoot on the output leading edge. The selection of the correct diode and its operating point is an essential ingredient for good low-temperature operation.

To ensure accurate logging over temperature, it is important that the resistor-diode summing network be ratio-compensated over temperature. The use of thick-film screened resistors ensures good resistor ratio tracking, but it is also necessary to compensate the clamp voltages to cancel diode variations caused by temperature. The way to do this is shown in the clamp regulator schematic in Fig. 7.

There are six simple regulators in Fig. 7. The first two are essentially zero temperature coefficient voltage regulators to provide clamping for the four gain stages. V_{C1} is a simple series regulator, and V_{C2} is a compensated follower operating off the regulated output of V_{C1} . Remember (from Fig. 4a) that the gain-stage clamps are set up for zero temperature coefficient, since the D_2 and Q_2 coefficients cancel.

Also operating from the output of V_{C1} are three emitter-follower regulators that furnish the clamp voltages to the four networks. The output voltage from each of these regulators is essentially the voltage obtained from the divider minus the V_{BE} of the follower (follower betas are in the range of 400). The V_{BE} from these followers gives first-order cancellation of the diodes D_1 through D_6 of the network diodes. The result of this scheme is that all of the clamps, gain stages and networks are temperature-compensated on at least a first-order basis and are slaved to the primary regulator shown in Fig. 7. The variable clamp attenuator operating from V_{C1} , the primary regulator adjusts the flat portion of the transfer curve (Fig. 3). ■■

NEW DIFFUSING LENS.

Makes the MLED55 appear as a large area light source emitting from the entire lens surface. The emitter appears much larger than the actual chip size and is more easily seen from a distance.

NEW 140° FIELD OF VIEW.

The presence or absence of light is easily detected through a full, 140° viewing angle . . . on/off condition can readily be determined from an "off-axis" viewing angle.

NEW LONG LEADS.

Nearly 7/16"-long leads and a visible difference between anode and cathode make the MLED55 easy to work with and easy to install . . . without polarity error.

HIGH LUMINOUS INTENSITY.

The MLED55 shines at 0.6 millicandellas at a drive current of only 20 mA. Applicable to both diffusing lens and point source light emitting devices, axial luminous intensity in millicandellas is a more explicit and translatable LED visibility measurement.

TURN ON THE REDS

VOLUME AVAILABILITY.

High-speed, low-cost stripline fabrication techniques originally pioneered by Motorola for the plastic transistor have been adapted to MLED55 production. There's immediate availability from your Motorola distributor . . . in our factory warehouse . . . for your prototype/production needs.

LOW FORWARD VOLTAGE.

Low V_f in the "on" condition means the MLED55 is compatible with typical IC voltage and current outputs. No separate power supply is needed.

RELIABILITY.

No filaments to burn out, no parts to shake loose. Operated under forward voltage conditions only so current-steering circuit conditions are realized, the MLED55 has a life expectancy in excess of 100,000 hours.

LOW COST.

Just 57¢ for 100-up quantities of the MLED55 puts solid-state LEDs in reach of designers of circuit/status indicators, fault indicators in systems requiring frequent trouble-shooting, on-off indicators for small, hand-held instruments and linear or large matrix displays.

LIGHT EMITTING DIODES	PLASTIC		HERMETICALLY SEALED					
	ACTUAL SIZE	ACTUAL SIZE	ACTUAL SIZE	ACTUAL SIZE	ACTUAL SIZE	ACTUAL SIZE		
Visible Red 660 nM	LED	Axial Luminous Intensity	LED	Brightness	LED	Brightness	LED	Brightness
	MLED50	1.0 mcd @ 20 mA	MLED600	1100 fl @ 50 mA	MLED610	1100 fl @ 50 mA	MLED630	1100 fl @ 50 mA
	MLED55	0.6 mcd @ 20 mA						
Infra Red 900 nM	LED	Power Output	LED	Power Output	LED	Power Output	LED	Power Output
	MLED60	550 μ W @ 50 mA	MLED900	550 μ W @ 50 mA	MLED910	150 μ W @ 50 mA	MLED930	650 μ W @ 100 mA
	MLED90	350 μ W @ 50 mA						

**A LED for every application!
Volume-availability on every LED!**

. . . an unbeatable combination to fill today's exploding application needs for red and infrared light-emitting diode in instruments, computers, peripherals, industrial controls, optical communications and entertainment equipment.

And a variety of packaging techniques makes it easy to choose a just-right LED for your design, too: tiny, hermetically-sealed "pill" packages, — large, bright REDHEADS* in the industry-standard, TO-18 — economical, plastic Mini-T* cases.

Motorola has a full complement of photodiodes, phototransistors, photo Darlingtons and PIN diodes to match its capability in LEDs. All available for your needs from distributor or factory.

Write on your company letterhead for a copy of our new, updated Let There Be Light brochure . . . full of specs and applications to turn you on to the world of optoelectronics. Send for it: Box 20912, Phoenix, AZ 85036!

TRADEMARK MOTOROLA INC.



Use a single-ended switching regulator

to convert dc to dc with simpler circuitry. You get isolated or multiple outputs and overload protection.

Conventional dc-to-dc converters are generally of two types: One has a push-pull transistor pair controlling a primary of a transformer; the other uses a step-up or step-down switching regulator. Each has disadvantages that a single-ended regulator can overcome.

The push-pull converter requires matched transistors and an accurately wound transformer, and it has no regulation unless additional controls are provided. The switching regulator provides good regulation at high efficiencies, but it can't provide isolated (or multiple) outputs; moreover it is limited by its input voltage.

The single-ended switching regulator (Fig. 1a), relieves the designer of these concerns. Its major characteristics include:

- Use of a single switching transistor.
- Isolated, nonisolated or multiple outputs.
- A simple control circuit that uses off-the-shelf ICs.
- Well-regulated output voltage.

How does the single-ended switching regulator work? Referring to Fig. 1a, we see that when transistor Q_1 is turned on, current I_1 builds up in the primary of the transformer, T_1 , as is shown in Fig. 1b. Note that the secondary winding of T_1 is phased so that diode D_1 blocks the current flow. Also note that T_1 is not a transformer in the normal sense, but a choke. It stores the energy during the ON time of Q_1 in the primary winding of T_1 . This energy is released by the secondary winding after Q_1 is turned OFF and the choke windings reverse polarity, thereby permitting the secondary current I_2 , to flow through diode D_1 into the filter capacitor, C_1 , and the load.

Develop design equations

Four basic design equations are required to build the control circuit. One is the energy expression, the second the input current, the third the input power and the fourth the number of

William P. Steele, Senior Staff Engineer, Sperry Rand Corp., Space Support Div., 716 Arcadia Circle, Huntsville, Ala. 35801.

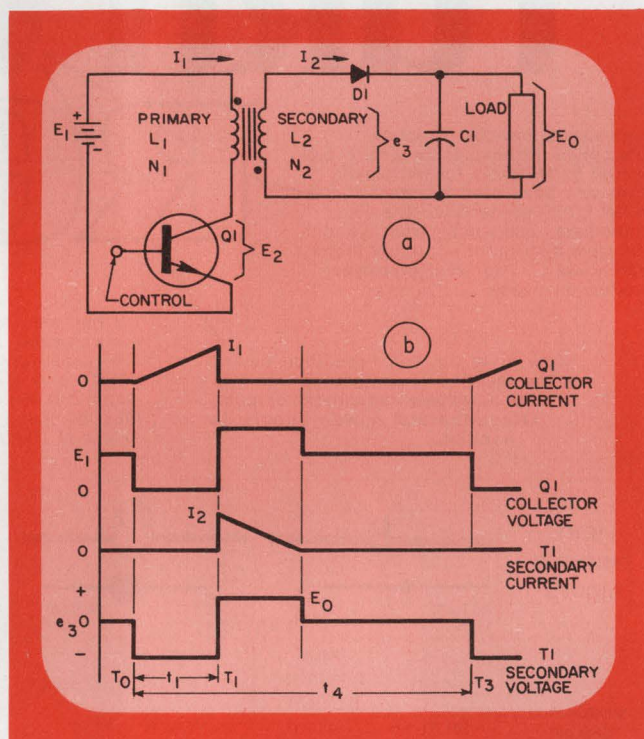

1. A single-ended switching regulator replaces push-pull dc-to-dc converters (a). T_1 dumps its energy into the output circuit during the OFF time of Q_1 , (b).

turns on the secondary winding of the transformer.

Referring to Fig. 1b, we see that current I_1 builds up linearly to some value as long as the core of the choke does not saturate during the ON time of Q_1 .

Thus the expression for the choke's energy is

$$W = (1/2) L_1 I_1^2, \quad (1)$$

where W is in joules, L_1 is in henries, and I_1 is in amperes.

To derive the expression for the input current, I_1 , we can first write

$$E_1 = L_1 (di_1/dt), \quad (2)$$

so that

$$\begin{aligned} I_1 &= (E_1/L_1) \int_{T_0}^{T_1} dt \\ &= (E_1/L_1) (T_1 - T_0), \end{aligned}$$

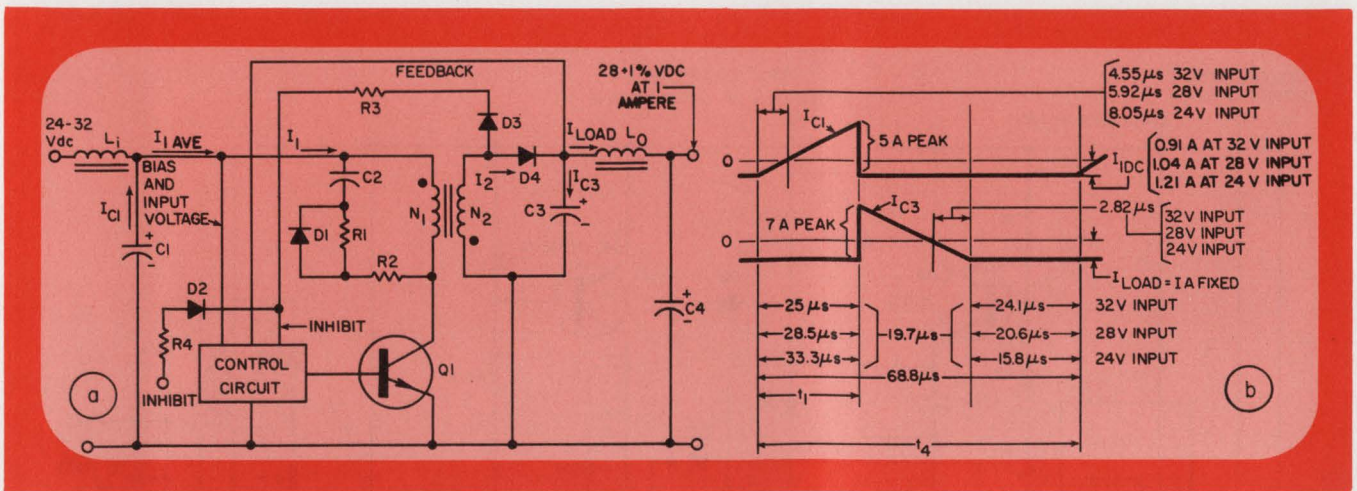

3. A simple step-by-step design procedure results in this power supply (a). The values of C_1 and C_3 are determined by specifying allowable ripple and examining their currents and voltages as functions of time (b).

since the constant, k , for a given core is the same for both windings.

The desired expression for the number of turns on the windings thus becomes

$$N_2 = N_1 \sqrt{(L_2/L_1)}. \quad (7)$$

Control circuit uses ICs

The main function of the control circuit is to turn the transistor Q_1 ON and OFF for predetermined intervals of time. The length of Q_1 ON time (for a given E_1 and L_1 , see Eq. 3) determines the value of core charging current, I_1 , which in turn determines the amount of energy stored in the core (see Eq. 1). Thus the output of a switching regulator is controlled by controlling the number of times per second that the core dumps its energy expressed by Eq. 4.

In operation (Fig. 2) op amp A_2 works as a free-running oscillator. R_8 and C_6 control the timing of one of A_2 's states, while R_9 and C_6 control the timing for the other state. The bias voltage for these two states is provided by the voltage divider, R_9 and R_{10} .

To maintain I_1 constant, the input voltage, E_1 , is connected to R_8 . If this voltage varies, the Q_1 ON-time interval, t_1 , varies inversely with E_1 , since the length of t_1 is determined by the $R_8 C_6$ time constant.

To vary t_4 , the error amplifier, A_1 , provides a voltage that charges C_6 through R_6 . This voltage is directly proportional to the regulator output, since the A_1 input is connected to the output of the regulator.

The fixed-bias voltage for A_2 is provided by Q_2 . The output of A_2 drives Q_5 via a buffer, Q_4 . When Q_5 is saturated, the control circuit turns on Q_1 .

The control circuit can be inhibited by transistors Q_3 and Q_6 . This can be used to provide overload and short-circuit protection, time-delay applications or intermittent operation. In fact,

terminated by specifying allowable ripple and examining their currents and voltages as functions of time (b).

this circuit can be used to turn the power supply ON and OFF wherever a remote, low-power control is desirable.

Here's a design example

Suppose a power supply is to be designed with these functional specifications:

Input voltage	24 to 32 Vdc
Output voltage	28 Vdc, $\pm 1\%$
Load current	1 A maximum
Efficiency	80% minimum

A schematic of such a power supply is shown in Fig. 3a. The first step in determining its component values is to compute the output power:

$$P_o = E_o I_o = (28)(1) = 28 \text{ W.}$$

If 1 W is allowed for diode D_4 dissipation, the input power, P_{in} , becomes 29 W.

The input current, I_1 , is determined from Eq. 4. The values for t_1 and t_4 in Eq. 4 occur at full load and minimum input voltage, $E_1 = 24$ Vdc. From experience, we can assume that $t_4 = 2t_1$. Then

$$P_{in} = 29 = (E_1 I_1 / 2) (t_1 / t_4) \\ = (24 I_1 / 2) (1/2),$$

so that

$$I_1 = 4.83 \text{ A, or about 5 A.}$$

The value of the inductance of primary winding, L_1 , can be now calculated with Eq. 3. A minimum value of t_1 is used in this equation. From experience, we know that this minimum value will be 20 μ s and that it depends on the type of power-switching transistor Q_1 , diode D_4 and capacitors C_1 and C_3 that are used. Thus a reasonable value for t_1 is 25 μ s. Therefore

$$L_1 = E_1 t_1 / I_1 \\ = 32(25 \times 10^{-6}) / 5 \\ = 160 \mu\text{H.}$$

The value of 32 Vdc for E_1 is used because the minimum t_1 occurs at maximum input voltage.

Experimentally it has been determined that

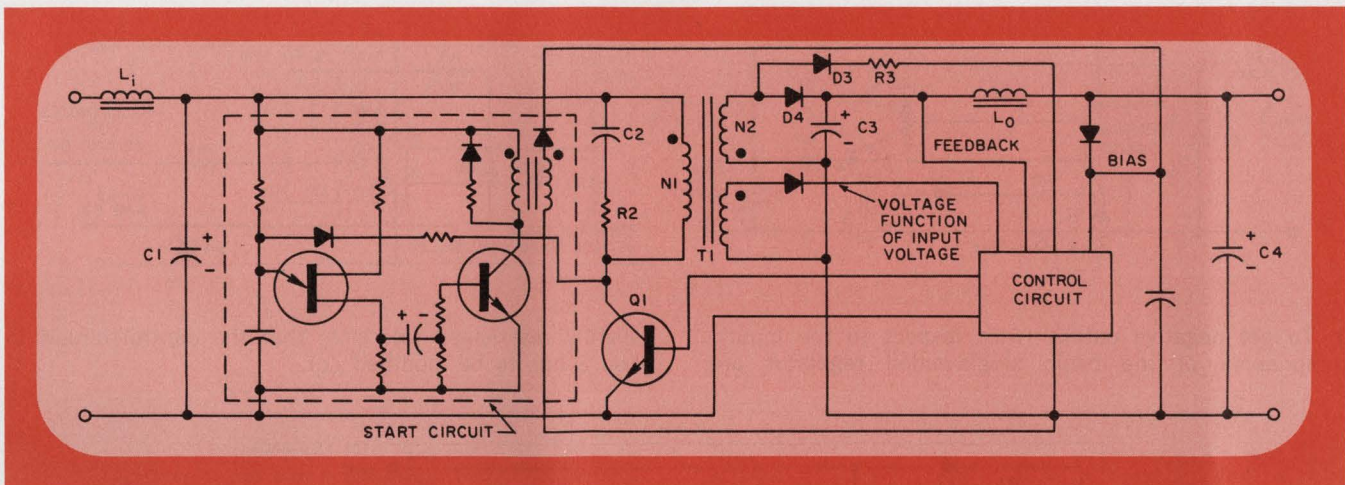

4. If isolation is required, a starting circuit is added to the basic single-ended switching regulator. Also note

that the control circuit is now connected to the output side requiring more output power.

power permalloy cores with a permeability of 60 have stable characteristics when used at 100 oersteds or more. When cores of higher permeability are used, the saturation limits should not be exceeded.

Core data in many catalogs are given in terms of the number of turns and inductance they produce. Thus a core for this application with one thousand turns would produce an inductance of 75 mH. Since the required inductance, L_i , is only 160 μ H, the required number of turns, N_1 , can be determined as follows (using Eq. 7) :

$$\begin{aligned} N_r &= N_c \sqrt{L_r/L_c} \\ &= 1000 \sqrt{0.16/75} \\ &= 46 \text{ turns.} \end{aligned}$$

Subscripts "r" and "c" in this equation stand for "required" and "catalog data," respectively. Thus the number of turns on the primary of T_1 in Fig. 3 is $N_1 = 46$ turns.

To determine the number of turns on the secondary winding of T_1 , the collector-to-emitter voltage rating, BV_{ce} , of Q_1 must be taken into account—that is, the maximum voltage appearing across the primary winding, N_1 , must be less than the difference between the input voltage, E_1 , and BV_{ce} . If a 2N2814 is used as Q_1 , the maximum voltage that can be safely developed across the secondary is

$$\begin{aligned} BV_{ce} - E_1 &= 80 - 32 \\ &= 48 \text{ V.} \end{aligned}$$

With about 20% for a safety margin, $E_2 = 40$ V is acceptable. Then

$$N_1/N_2 = 40/29,$$

so that

$$N_2 = 33 \text{ turns.}$$

Diode D_4 is determined from the value of peak output current, I_2 , as follows:

$$I_1/I_2 = N_2/N_1,$$

so that

$$I_2 = 6.97 \text{ A, or about 7 A.}$$

With both currents known, the wire size for

the windings of T_1 is selected to be AWG 18.

Next, the values of C_1 and C_3 are determined. The criterion is the amount of ripple that is acceptable. Assuming that 1-V ripple is acceptable and using the general relation between voltage and current in a capacitor, we get

$$e = 1 = (1/C_1) \int_0^T idt.$$

From the waveshapes of Fig. 3b, we obtain

$$\begin{aligned} C_1 &= \int_0^{25.3 \times 10^{-6}} [3.79(t) dt] / (25.3 \times 10^{-6}) \\ &= 48 \mu\text{F (theoretical)}. \end{aligned}$$

All the values for this calculation are for $E_1 = 24$ Vdc, the minimum input voltage (Fig. 3b). Furthermore $i = It/T$, with $I = 3.79$ A and $T = 25.3 \times 10^{-6}$ seconds used (Fig. 3b).

In a similar fashion,

$$\begin{aligned} C_3 &= \int_0^{16.9 \times 10^{-6}} [6(t) dt] / (16.9 \times 10^{-6}) \\ &= 50 \mu\text{F (theoretical)}. \end{aligned}$$

In general, these capacitors should have a low dissipation factor (DF). For instance, it can be shown that if 50- μ F capacitors are used as C_1 and C_3 , and if their DF is 2%, C_1 will dissipate approximately 1.3 W, while C_3 will dissipate about 1.8.

To prevent oscillations during the OFF time of Q_1 , a damping network made up of C_2 , D_1 and R_2 is used. Generally C_2 can be 0.001 to 0.1 μ F, and R_2 can be 100 to 1000 ohms.

L_i can be 50 to 200 μ H, and it must be present to decouple the supply from the source.

If isolation were required for the supply just designed, the circuit in Fig. 4 could have been used. Note that more output power is required

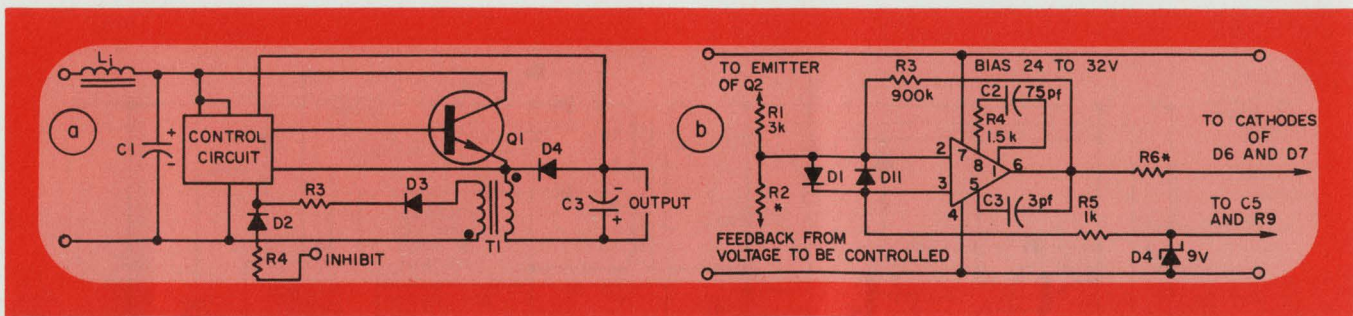

5. To get negative output (with respect to the input), components of the basic single-ended regulator are

slightly rearranged (a). Note that the control circuit in Fig. 2 has to be modified (b).

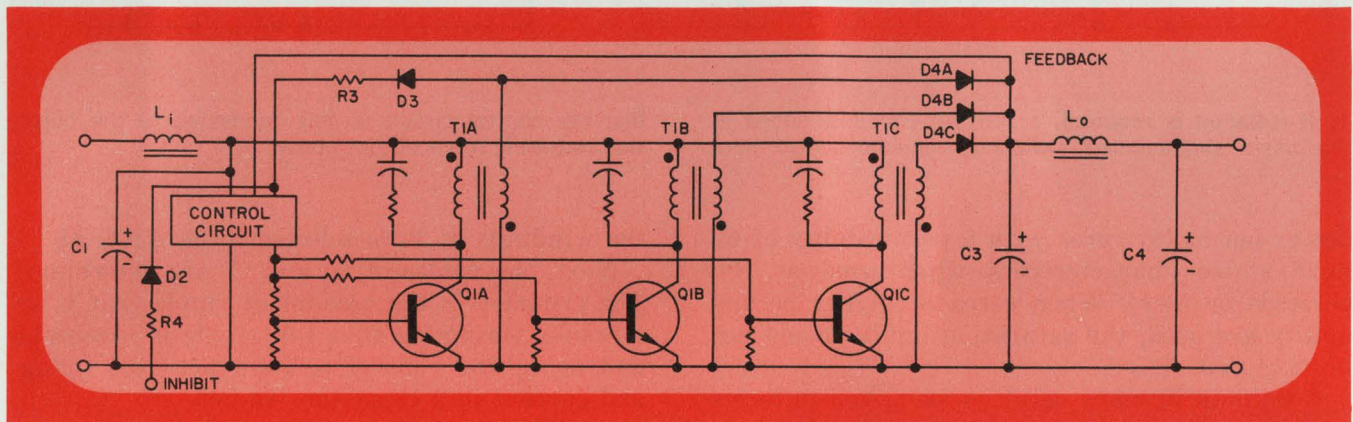

6. A wide range of power outputs can be obtained by building several power-conversion units with different pow-

er ratings and then combining them in parallel. Suggested building blocks are 20-W, 50-W and 100-W modules.

in this circuit, since the control is now connected to the output side of the power conversion unit. Also note that an additional winding is provided on the Transformer, T_1 , to develop a signal proportional to the input voltage for the control circuit. Also, a starting circuit is added (decoupled from the output filter capacitor because of its large value). If inhibiting is required, it must be connected via an isolating network if it is not referred to the output side.

If a negative output with respect to input is desired, the circuit of Fig. 5a can be used. The feedback to the error amplifier A_1 in Fig. 2 is brought in, as shown in Fig. 5b.

With 28 Vdc as the input voltage, a 20-W module can be built with a 2N2880 transistor; a 50-W module with a 2N2814, and a 100-W module with a 2N3599. By paralleling these modules, various power outputs can be obtained (Fig. 6). Once again, the power ratings of C_1 and C_3 are critical.

And finally, if a high output voltage is required, the circuit of Fig. 7 can be used. Note that each winding is continuous, rather than a segmented transformer secondary. To keep the primary-to-secondary coupling uniform, the primary should be wound after approximately half of the secondary has been wound. Then the remaining secondary turns are wound. If isolation is required, the technique in Fig. 4 can be applied. ■■

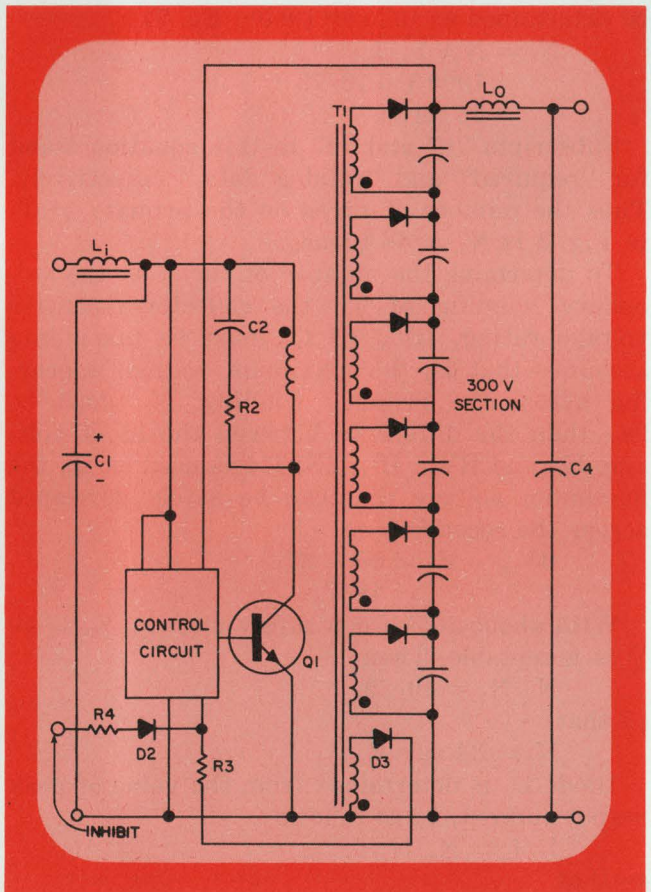

7. High output voltages are obtained by stacking the required number of separate windings serially.

**"ESP rectifiers.
They're new from Unitrode.**

"Typical recovery time is 15 nano-seconds in any circuit. And that's the fastest available in a power rectifier. Forward voltage drop is as low as .8V at 20A. That's efficiency. And, as you can see, they're in extremely compact packages having continuous ratings of 2.5A to 20A in 50V, 75V, 100V and 125V types. And with many thousands of hours of life tests behind them, you can be sure of a state-of-the-art product with demonstrated reliability. Unitrode has the statistical test data to prove it.

"With ESP rectifiers, you can design high current, high frequency power supplies to 500 KHz with very low diode losses and at very low cost.

They're available off-the-shelf in three series. UES 101 - 4 series for 2.5A, UES 201 - 4 series for 6A, and UES 301 - 4 series for 20A applications. Now you know what ESP stands for."

"You mean Efficiency, Speed and Power."

"That's very perceptive of you."

For fast action, call Sales Engineering collect at (617) 926-0404, Unitrode Corporation, Dept. 1BB, 580 Pleasant Street, Watertown, Mass. 02172.



UNITRODE

INFORMATION RETRIEVAL NUMBER 45

Generate stable high-frequency signals

with D flip-flops as digital mixers and all-IC, low-frequency phase-locked loops.

High-frequency digital, or square-wave, synthesizers are finding increasing applications in communications, control systems and electronic data handling, where stable frequency outputs are demanded of the synthesizers. A good way to ensure that the signals are always stable is to use the phase-locked-loop technique. It will do the job automatically.

Since a phase-locked loop generally requires the output frequency to be some integral multiple of the reference frequency, let's consider generating a 152-MHz signal with a 6-MHz crystal. In a direct synthesis approach the 6-MHz signal is divided by 3 and then multiplied in a loop by 76 (Fig. 1).

This division in frequency lowers the loop gain by a factor of 76 and requires several stages of counting elements (8 flip-flops). The chain of counters can be replaced by a single D flip-flop acting as a digital harmonic mixer with no loss in loop gain (Fig. 2).

Use D flip-flop as a digital mixer

A functional diagram of a 152-MHz generator is shown in Fig. 2. Briefly the 6-MHz output of a crystal-controlled IC oscillator is divided by three to produce a 2-MHz signal as one phase-detector input. The 25th harmonic of the 6-MHz signal, or a 150-MHz signal, is mixed within the D flip-flop with the 152 MHz produced by the VCO. The resulting output of the flip-flop (2 MHz) is used as the feedback to lock with the reference frequency (also 2 MHz).

The D flip-flop used as a mixer must be either a positive or negative *edge-triggered* flip-flop (Fig. 3)—that is, if the input is a logic ONE when the clock makes its transition, the output goes to and remains a ONE for a full clock period. If it is a ONE from the previous time, it remains a ONE. The inverse holds true for logic ZERO inputs.

If the D flip-flop is considered as a binary

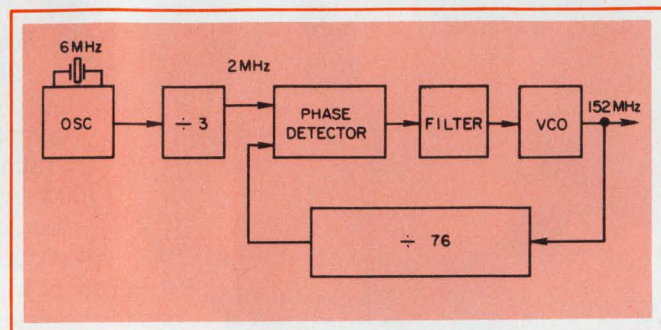

1. A phase-locked, 152-MHz digital output is obtained by dividing in frequency a 6-MHz signal by 3. Then, the frequency is multiplied by 76.

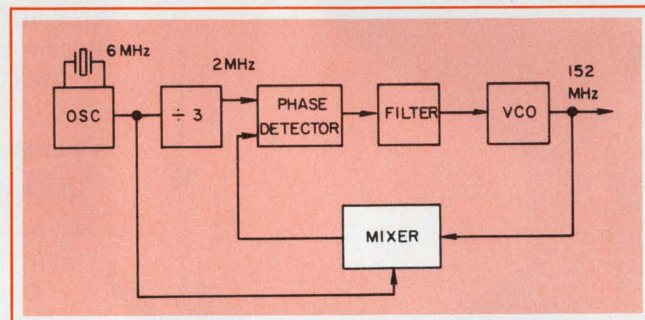

2. A single D flip-flop, as a digital mixer, is used to replace several stages of counting elements in Fig. 1. There is no loss in loop gain here.

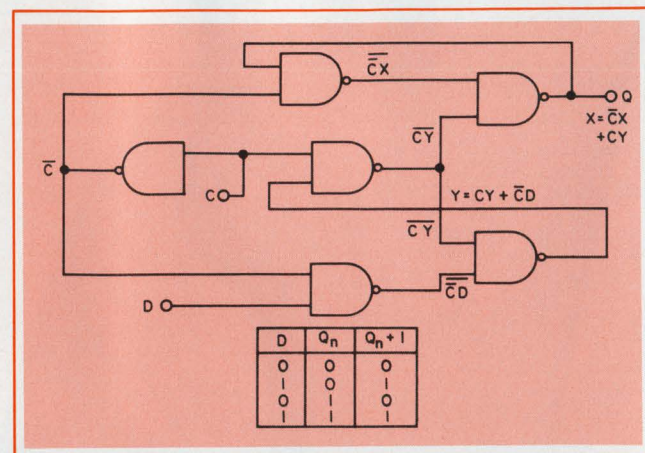

3. Digital mixing is accomplished within an edge-triggered D flip-flop. In the truth table, Q_n denotes the output logic level before clocking, while $Q_n + 1$ denotes the output logic level after clocking.

R. Treadway and L. J. Reed, Design Engineers, Semiconductor Products Div., Motorola Inc., Mesa, Ariz.

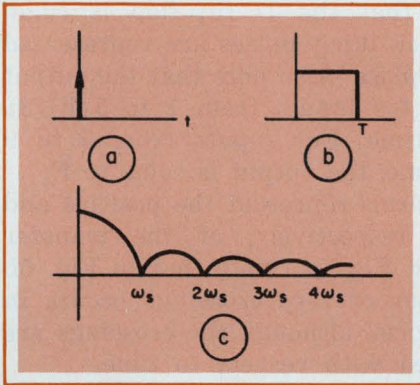

4. A D flip-flop works as a binary zero-order hold filter—that is, if a unit impulse is applied to its input (a), the resulting output will be as shown in (b). The gain characteristics of a zero-order hold filter (c) displays nulls occurring at integer multiples of the sampling frequency.

5. The mixer transfer function (a) can be derived graphically (b). By examining the response of the D flip-flop to input frequencies higher than the clock frequency (c), we see that a D flip-flop is a harmonic mixer.

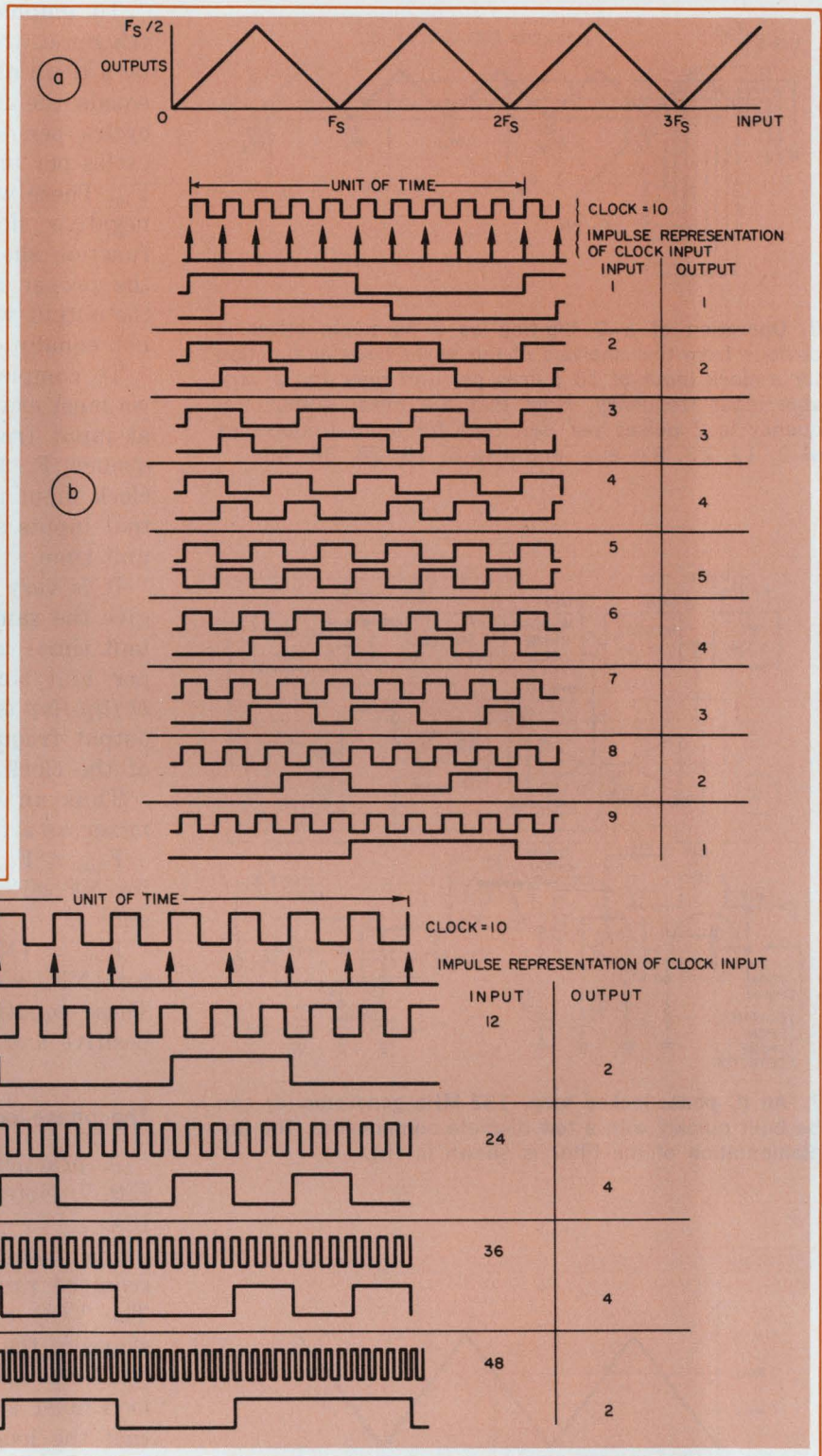

ZERO-order hold filter, its operation as a harmonic filter element can be understood by examination of its response to a unit impulse (Figs. 4a, 4b and 4c). The significance of the response characteristic is that the output frequency of the D flip-flop cannot exceed one-half the sampling frequency. Nulls in the output response (Fig 4c) occur at integral multiples of the sampling frequency. Thus, if we consider a flip-flop as the

sampling element, we see that the maximum output cannot exceed half the clock input frequency, since this is the condition in which the output changes once for every clock input.

The transfer function for the D flip-flop is shown in Fig. 5a. It can be derived graphically (Fig. 5b) by considering the flip-flop operation for a range of values of data input, F_{in} , with a fixed value of the clock input, F_s .

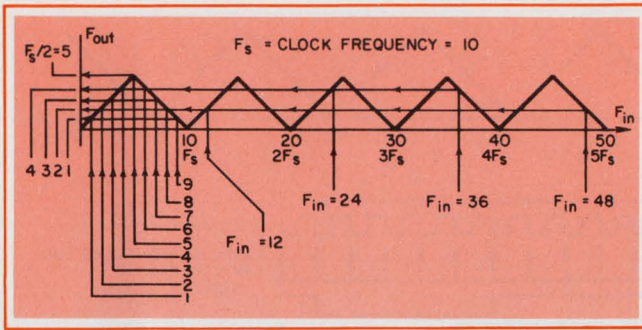

6. Operation of a D flip-flop as a harmonic mixer is obvious from this analysis of the mixer transfer function for a clock input of 10 pulses per unit time and a variable input frequency. Note that the mixer output frequency is 2 pulses per unit time for input frequencies of 2, 12, 22, 32, etc., and also 8, 18, 28, 38, 48.

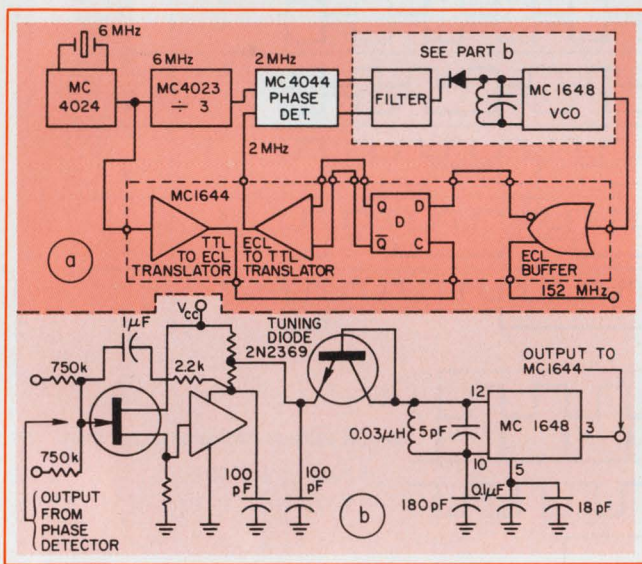

7. An IC phase-locked loop, 152-MHz generator (a) can be built quickly with a few discrete components. The implementation of the filter is shown in (b).

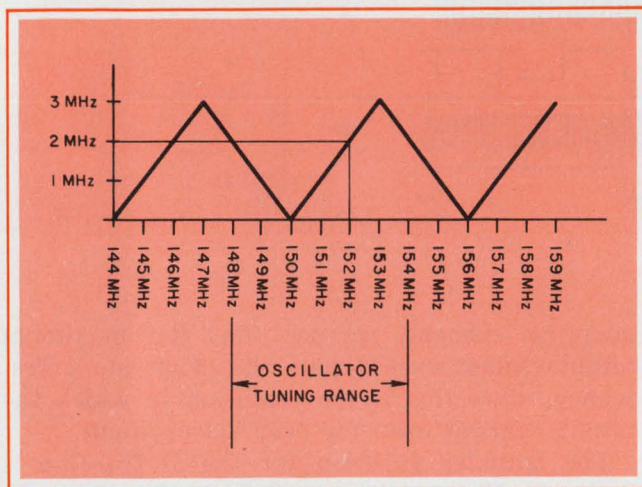

8. Erratic frequency outputs are prevented by use of a tuning diode with a range that makes sure the output frequency lies on the positive slope of the mixer transfer function. The diode is part of the filter.

To emphasize that the D flip-flop is edge-triggered, the clock input pulses are represented by a train of impulses. Also note that the output equals the input for inputs from 1 to 5 ($F_s/2$) cycles per unit time. For inputs from 5 to 9 cycles per unit time, the output is equal to $F_s - F_{in}$. These waveforms represent the positive and negative slopes, respectively, of the transfer function shown in Fig. 5a. Note that in Fig. 5b the proper number of zero crossings occurs in the output waveform, although the crossings are not equally spaced with respect to time.

To complete the transfer function of Fig. 5a, we must examine the operation of the D flip-flop at input frequencies higher than the clock frequency, F_s . Referring to Fig. 5c, we see that the clock input is again 10 pulses per unit time but that inputs are now 12, 24, 36 and 48 cycles per unit time.

It is very important to note that these inputs give the same outputs (2, 4, 4 and 2 cycles per unit time) as the inputs of 2, 4, 6 and 8 cycles per unit time (Fig. 5b). In other words, the D flip-flop is a harmonic mixer, with nulls in the output frequency occurring at integer multiples of the clock frequency (Fig. 5).

Thus an equation stating the output of the mixer as a function of its input is written as

$$F_{out} = F_{in} - NF_s$$

for $NF_s < F_{in} < [NF_s + (F_s/2)]$
and

$$F_{out} = (N + 1)F_s - F_{in}$$

for $[NF_s + (F_s/2)] < F_{in} < (N + 1)F_s$.

These equations correspond, respectively, to the positive and negative slopes in Fig. 5a.

The phase-locked frequency generator

A practical 152-MHz generator is shown in Fig. 7. Note that it is built almost entirely with ICs.

The transfer function for this unit, with the required range of frequency, appears in Fig. 8. The VCO could lock onto any of the positive slopes of the transfer function. To avoid this, the oscillator must be tuned to a range where the loop must lock onto the desired frequency. Note that the loop cannot lock on either 148 or 154 MHz, since the slope is in the wrong direction (negative). To prevent it from locking on either 146 or 158 MHz, a tunable tank with the range shown in Fig. 8 is used. The complete circuit for this purpose is shown in Fig. 7b.

Get different output frequencies with ease

The digital mixing technique, combined with the phase-locked loop, can be extended to obtain a wide range of output frequencies. From the transfer function of the mixer, we see that if the

input to the phase detector is changed, the output will follow linearly. This will be true so long as the reference-frequency changes are small enough to keep the reference frequency on the positive slope of the transfer function—that is, the reference frequency must not exceed $F_s/2$.

If a wider output frequency range is required, the mixing frequency, F_s , must be increased. Thus if the mixing frequency is changed to 50 MHz (third harmonic of 150 MHz), the output variation can approach 25 MHz, or $F_s/2$.

Mix frequencies from different sources

In the systems we've described, the mixing and reference frequencies have been derived from the same crystal oscillator, and consequently, they have been *phase coherent*. It has been shown experimentally, however, that phase coherency is not required to produce adequate mixing.

The functional diagram of the system used in the experiment is shown in Fig. 9. A tunable

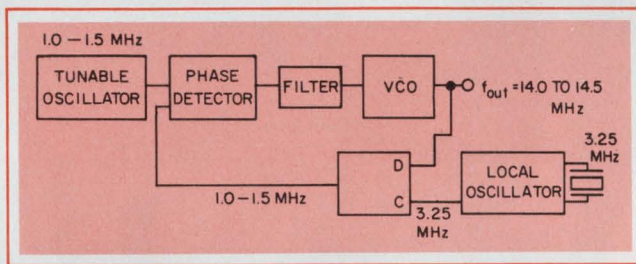

9. Good results are obtained even when the mixing signals are derived from different sources.

oscillator from 1 to 1.5 MHz was used as the reference input to the loop, with the tuning range restricted to frequencies between 12 and 14.75 MHz. The local oscillator frequency was 3.25 MHz, so that the apparent mixing frequency was 13 MHz (4 times 3.25). Since the input oscillator was tunable, there was no guarantee of phase coherency between it and the crystal-controlled oscillator for the mixing frequency.

As the reference frequency was tuned from 1 to 1.5 MHz, no evidence of sporadic operation could be observed. While the reference was swept, a frequency-ratio counter connected at the inputs of the phase-detector always read 1.000000.

This experiment showed that proper mixing could be achieved with phase noncoherent signals and that the gain of the mixer was +1 when operated on the positive slope of the transfer function. A similar experiment operating on the negative slope of the transfer function would show a gain of -1. ■■

OSCILLATORS

1 Hz to 250 MHz



ACCUTRONICS IS NOW COMPATIBLE WITH ULTRA-HIGH SPEED LOGIC MECL III, SCHOTTKY

SURE, ANYONE CAN BUILD . . . their own oscillator between 1 MHz and 50 MHz and maybe even two, BUT TRY TO BUILD one at 250 MHz compatible with high-speed saturated logic, non-saturating Schottky or emitter coupled logic, then come to Accutronics and we'll save you on your prototype or production runs. Accutronics was the first to advertise oscillators compatible with RTL, DTL and TTL logic (Electronic Design October 1965), and we have continued our engineering capabilities to keep up with the latest IC logic.

NEED HELP? Call Wayne Benson (area) 312-232-2600, and he will be glad to fill you in on the details and send you our new catalog.



Series 110

FREQUENCY: 50 MHz to 250 MHz
 FREQ. TOLERANCE: $\pm 0.001\%$
 TEMPERATURE RANGE: 0°C to 60°C
 SUPPLY VOLTAGE: + or -5Vdc or -5.2VDC
 OUTPUT VOLTAGE: Compatible with the newest logic
 SIZE: 38.1 MM x 38.1 MM x 15.8 MM
 1.5" x 1.5" x 0.62" compliments
 70th edition Machinery's Handbook
 MOUNTING: PC board mount

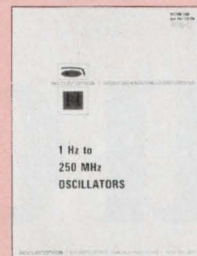

FREE:

NEW 1972 CATALOG

Our new catalog covers various types of oscillators: VCXO, LCVCO, RCVCO, high stability, computer clocks, high output power, Navy standard hardware modules and low current drain oscillators from 1 Hz to 250 MHz. We'll even send you three neat conversion charts (3) to hang on your wall and impress your friends.

accutronics

A HAMMOND CORPORATION COMPANY

628 NORTH STREET • GENEVA, ILLINOIS 60134

INFORMATION RETRIEVAL NUMBER 46

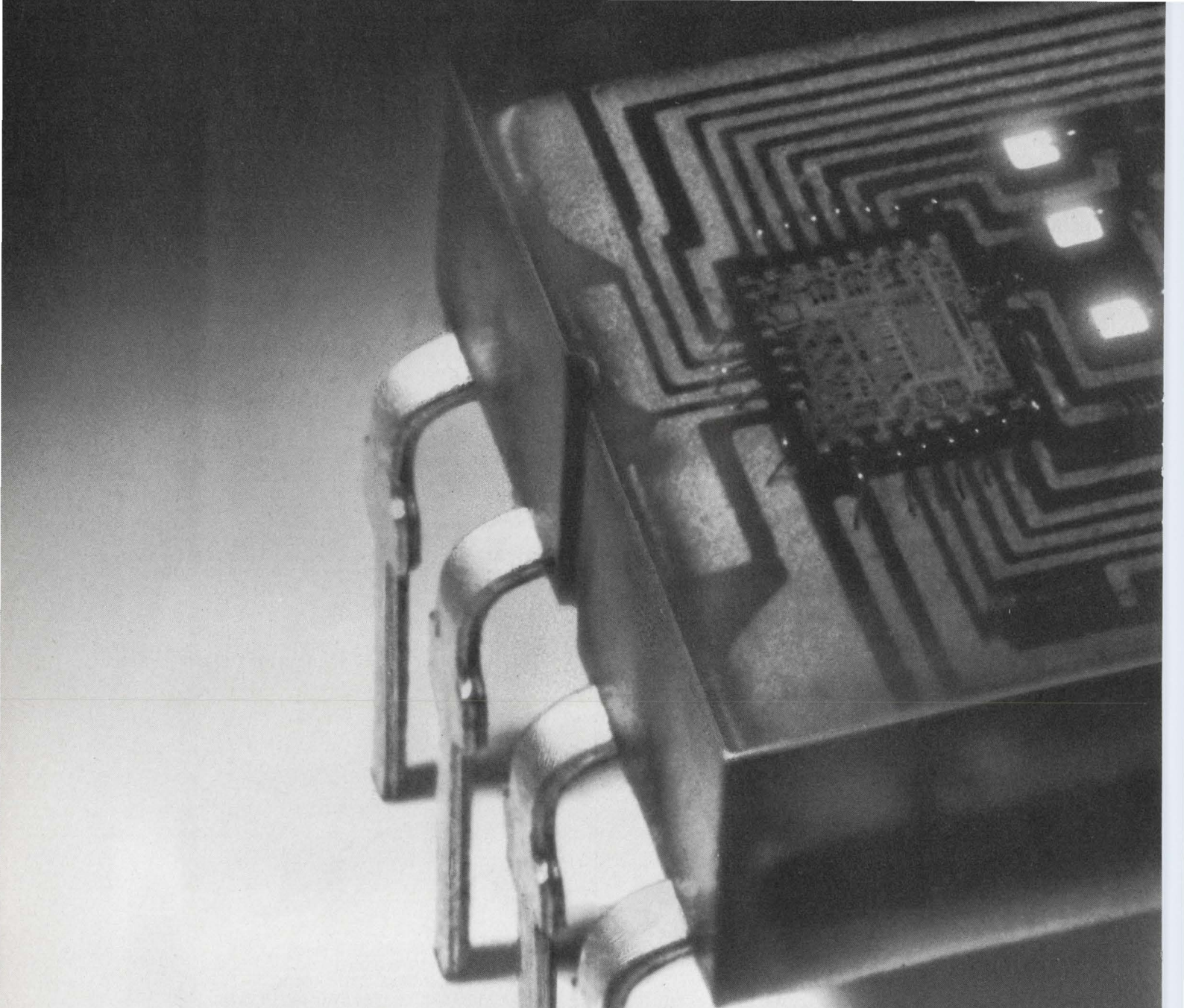

We built in the so you don't have

Not only the decoder/driver but the memory too!
Now available for *immediate* delivery is the
HP 5082-7300 series solid state display.

It's completely TTL compatible. All you do is
address it directly with four-line BCD input. The

on-board IC allows for either the storage of input
data or real-time display. You save design time,
space, and money, and get a completely reliable
integrated display system.

A bright .290 inch high, shaped character gives

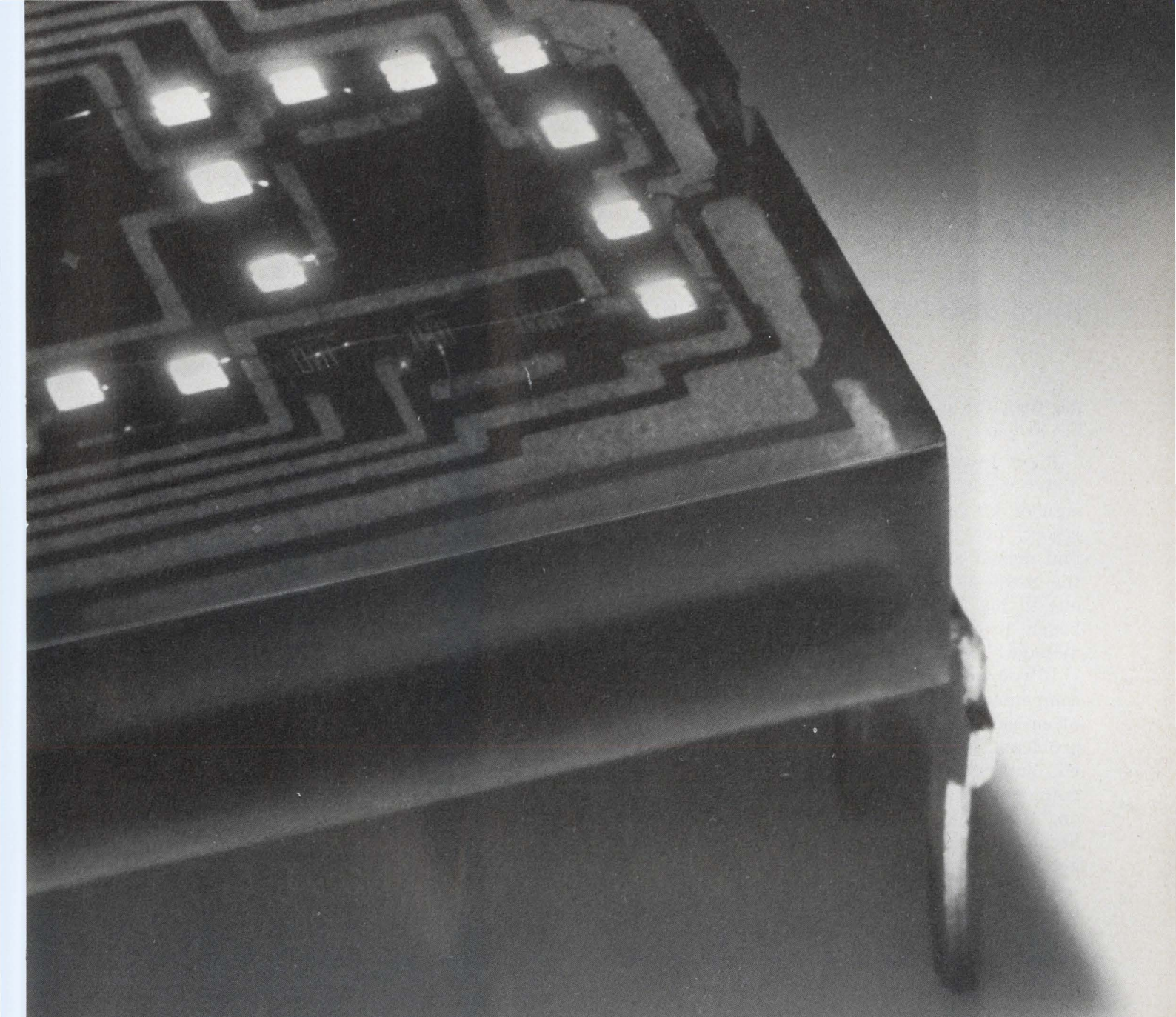

decoder/driver to.

excellent readability over a wide viewing angle in a compact .600 inch by .400 inch package.

Best of all is the price: \$10.00 each in 1K quantities. So why wait? Order now! For *immediate* delivery on the HP 5082-7300 call your local HP

sales office, or Hewlett-Packard, Palo Alto, Calif. 94304. In Europe: 1217 Meyrin-Geneva, Switzerland.

01104

HEWLETT  PACKARD

COMPONENTS

'Cleaning up' is the key to promotion, says this designer. He tells why, as a good manager, he must also be a sounding board, information spreader and buffer.

Ray Gerr, Group Leader, Ballantine Laboratories, Boonton, N.J.

First I was a "clean-up man." If a product didn't work, I cleaned it up by refining the design or by repositioning a resistor or, as a last resort, by revising the specs. I mean I didn't find myself an engineer one day and a manager the next—it just didn't happen that way. No one in his right mind pulls an engineer off his bench, props him up in an office and says, "OK, manage!"

If you have a reasonable amount of technical competency, as I have, the other engineers will often ask you to help them solve their design problems. And then one day, as happened to me, the supervisor will walk up and say, "You're going to be responsible for this design from now on," and walk away. So—I guess I was promoted because I was a clean-up man with a history of getting things done.

Frankly, I didn't have a lot of interest in becoming a manager. I was happy being an engineer. But sometimes your managers test you without your knowing it. They'll take notice of an engineer who innovates technically, and when they need a manager, they'll try him out. If the engineer doesn't work out, they can always send him back to the bench. In my case, management kept giving me bigger and bigger jobs with more and more engineers to keep busy. I was so occupied getting the job done that I didn't realize I was becoming a manager. I didn't realize it, that is, until I had to start judging the people who worked under me.

One of my hardest problems is judging people for raises, and for competency on the job. I find the task distasteful because I know what I say can change people's lives. And I can't always be sure my judgments are right.

I've taken some managerial training courses to help me to be right most of the time, but I've found that most of them don't really apply to engineering management. The courses are aimed at the office manager of an insurance company, for example, who's in charge of from 10 to 20 people who handle paperwork. The course tells

him how to manage these people, how to schedule them and how to know if they're doing what they're supposed to be doing. In engineering that part of managing is self-evident. An engineering job sort of lays itself out in logical sequence: the project tells you what you're doing; the deadlines are built in. I don't have to attend a special training course to learn that.

Then, too, I find that I don't have to motivate my people as much as the managers of other fields do. Engineers are motivated to begin with—they generally like what they're doing. The main problem is keeping them on the track so they don't go into left field with their design ideas. I go around and talk to them. I look in their notebooks and find out what's going on—literally talk over the schematics with them. If one guy on my team has to make a change, then all the other guys have to be told; because they'll have to make a change, too. I'm really an "information spreader."

I'm also a "sounding board." Engineers have come into my office and talked out their problems with me for a half hour and then thanked me for helping them, when all I did was listen while they talked it out for themselves. I have a great amount of self-confidence as a manager. I've also learned that some people are going to know more than I do, and I'm going to have to accept that. I can't know everything about everything.

A manager is often forced to do what he was told never to do as an engineer—make a decision without having all the information to support it.

If I have a philosophy about managing people, I guess it's trying to get a group of engineers to work together as a team without their being in competition with one another. It's important to the success of my projects for me to establish an atmosphere of trust and confidence. I make it known to all my project team members that if they don't know how to do something they can ask the project leader or any other member of the team for help. And they can do it without feeling that they're going to be called down for

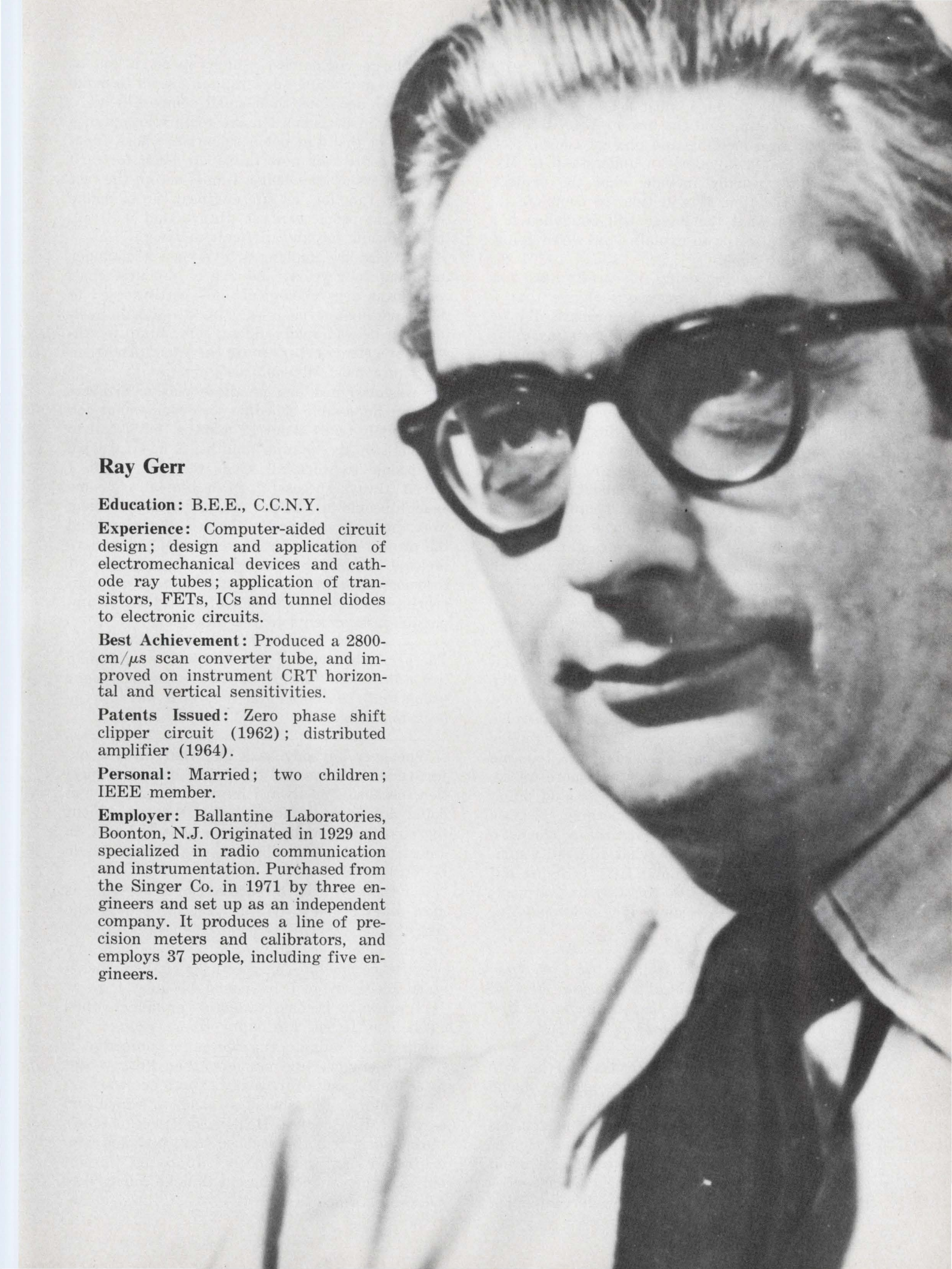

Ray Gerr

Education: B.E.E., C.C.N.Y.

Experience: Computer-aided circuit design; design and application of electromechanical devices and cathode ray tubes; application of transistors, FETs, ICs and tunnel diodes to electronic circuits.

Best Achievement: Produced a 2800-cm/ μ s scan converter tube, and improved on instrument CRT horizontal and vertical sensitivities.

Patents Issued: Zero phase shift clipper circuit (1962); distributed amplifier (1964).

Personal: Married; two children; IEEE member.

Employer: Ballantine Laboratories, Boonton, N.J. Originated in 1929 and specialized in radio communication and instrumentation. Purchased from the Singer Co. in 1971 by three engineers and set up as an independent company. It produces a line of precision meters and calibrators, and employs 37 people, including five engineers.

not knowing the answer themselves.

Another problem I have as an engineering manager is that often I must act as a "buffer" between marketing and the buyer. A good buffer can get up at a meeting and present the project so clearly that a layman can understand it. My presentations usually include what the project looks like, the time it will take to complete it, the cost and what the buyer will get when it's completed. I also try to explain how we're going to get the job done.

If I know what I'm doing, it's pretty hard for my audience to spring questions on me that I haven't thought about. I try to prepare. I'd be better off if I could think faster on my feet. Unfortunately I can't seem to think fast enough when it comes to the following:

- Being diplomatic: When a guy in the audience asks a question that's obviously out of the ballpark, I have difficulty telling him how far out he is without hurting his feelings.

- Eating humble pie: When a guy who's obviously more knowledgeable about a subject than I am asks a question that I can't answer, I don't have the ability to maneuver around him verbally, like a lot of managers can. I have to tell him either that I don't know the answer or that I'll have to think about it and give him an answer later.

- Making snap decisions: Like most engineering managers, I dread being forced into making a decision without having enough background information to make it properly. Sometimes I've been pushed into a corner at a meeting and told that something's got to be decided, because there's a deadline to meet. Even though a supplier who promised me a part yesterday now tells me that he can't get it for me for three more weeks, and maybe not at all, I can't sit around doing nothing. I've got to decide something, because there are customers waiting for the product. So what do I do? I summarize what I know; I summarize what I think I know; I try to figure out what would happen if I go this way or that way; and then I make a decision. If I'm wrong, I've had it!

To be or not to be—that is the project question. In small companies, especially, knowing when to kill the project is an art that the manager and the marketer must develop together.

One of the most difficult decisions I have to make is deciding whether or not a project should be continued. I share this responsibility with the marketing department. My decision depends on whether or not I think the product can be produced inexpensively enough to make a profit for the company. Knowing when to cut off a project is an art, especially in small companies.

Even large companies, which spend a lot of money on marketing surveys, don't seem to make any better decisions than small companies do.

The cutoff decisions I make require acceptance of the fact that I'm not a scientist, whose function is to discover new things or push forward the frontiers of knowledge. I must accept the fact that my function as an engineer is to make things that people can use, things that will sell. It's a routine job and difficult to accept.

But there are challenges. I've been a manager for about four years, and one of my first challenges was a psychological one—getting used to the managing approach—getting used to the feeling that I was really doing something worthwhile by getting others to do the work. And then I got my most difficult assignment.

I was assigned one of those classic projects with an impossible schedule—a development job that usually takes about 18 months that I had to complete in six to nine months. I had to drive my people to work all kinds of wild hours. I wasn't always successful. Management gave me enough people for the project, but not all of them were the right caliber for the job. We completed the project on time, but it never went anywhere because the concept was wrong. I guess one of the most important decisions I have as an engineering manager is whether or not to accept impossible assignments in the first place.

The graduate engineer has carried on a life-long love affair with "things." If he wants to manage people with the same feeling, he'll have to go back to school.

Whenever anybody asks me what my job objective is, I always feel that it's a nonsense question, because I'm always happy doing what I'm doing. I suppose I shouldn't feel that way about the question, though. I suppose that if I had an objective and knew where I was going, I'd do better.

But then my idea of success isn't the same as most other people's. I think that the people who feel that they have to be a big shot to be a success have false standards. I never had any plans to become an engineering manager when I started out—it just happened because I grew. If I grow to become company president, then I'll be one. If not, I'm happy where I am.

But if a graduate engineer's job objective is to be an engineering manager, then I'd say that after he has had a few years' experience working as an engineer, he should go back to school and earn an MBA degree. He'll need it, because he's "thing"-oriented. He needs to store up some non-engineering information to help round himself out into the complete person that he must be to succeed as a manager. ■■

RCL MINIATURE ROTARY SWITCHES

MINI MIDI MAXI



1/2" OD
Up to 12 positions
Up to 6 poles/deck
PC or solder terminals



3/4" OD
Up to 12 positions
Up to 6 poles/deck
Multi-deck models available

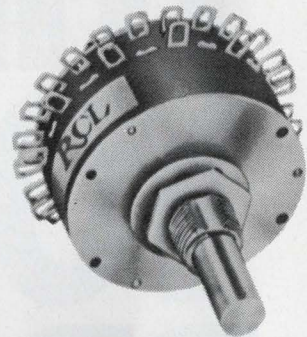

1 3/8" OD
Up to 24 positions
Up to 12 poles/deck
Multi-deck models available

- Totally enclosed. Low contact resistance. Long life — up to 200,000 mechanical operations. Intermix of shorting and non-shorting action available on same deck.
- Explosion and contamination proof. Rugged terminals integrally molded into switch body.
- Priced comparable to open deck wafer-type switches.

Completely automated facilities enable RCL to offer low cost commercial versions at competitive prices for use in commercial applications.

(1,000 piece quantities cost just \$1.96 each)

DELIVERY FROM STOCK

Write for complete technical information

RCL

ELECTRONICS, INC.
700 South 21st Street, Irvington, New Jersey 07111.

REG. U.S. PAT. OFF. #3352979

NOW: THE OP AMP YOU CAN PROGRAM



Our new $\mu A776$: Closest thing to a universal op amp yet devised.

We call the $\mu A776$ our "do-everything" op amp. It probably is the next industry standard: one high quality device that, with the addition of a simple external resistor, can be tailored for optimum performance over an enormous span of applications. From the world's linear leader.

$\mu A776$ Typical Performance

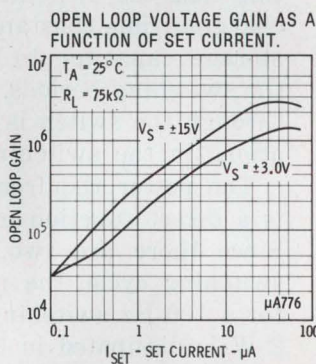
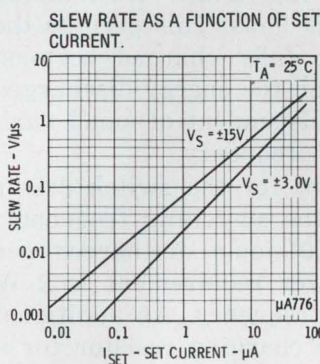
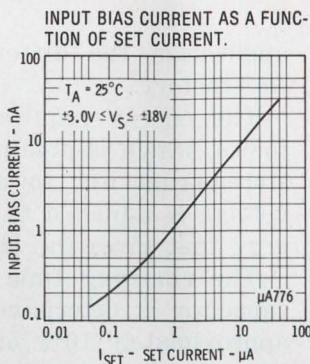
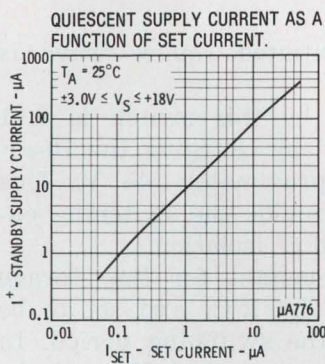

The wide range of available characteristics makes it extremely versatile. And useful. It is adjustable for either standard or micropower application. It can be biased to have any of a number of fixed characteristics; or biased so that the characteristics of the amplifier can be

varied in response to an input signal. And it can be turned on or off externally.

The $\mu A776$ offers superior operation at levels similar to standard general purpose op amps. In fact, when biased with a $15\mu A$ set current, it has approximately the same gain, slew rate and bandwidth as a $\mu A741$. But with an *order of magnitude improvement* in input bias current, input offset current, noise current and power dissipation.

Or you can operate it from a supply voltage of only $\pm 1.2V$. This means the device can be run off of two battery cells and with the proper set resistor the total power drain of the op amp will be lower than the battery leakage.

The broad versatility of the $\mu A776$ means it is ideal for micropower applications, battery powered systems, medical electronics, long-time integrators, high-accuracy sample and hold, frequency processors and active filters. For many uses, it becomes the only op amp you need specify on your standard parts list.

Available with complete data package, from your friendly Fairchild distributor.

New LIC Data Book

The $\mu A776$ is the newest of 17 general and specific purpose op amps. All fully described in our new LIC Data Book: 320 pages covering 84 quality LIC devices.

Available now by writing to the address below.



**MADE IN
FAIRCHILD**

SCRs drive pulse-latched ferrite switch

Pulse-latched ferrite switches require short, high-current pulses to change state. Because of the low coil impedance, a capacitor-discharge circuit to generate the high peak currents is often more efficient than using power transistors. SCRs are turned on alternately to discharge the storage capacitor through the opposite halves of the coil.

The trigger for the SCRs is a differentiated square wave, and phase opposition is obtained by use of a center-tapped transformer. The RC time constant of the differentiator must be short enough so the gate drive voltage falls below the threshold before the storage capacitor is completely discharged. The inductance of the coil is sufficient to cause a voltage reversal to turn the SCR OFF. If the trigger pulse is too long, the SCR can latch up, because a dc voltage is present at the SCR through the charging resistor. The square-wave drive voltage, therefore, must have a fairly fast rise time—on the order of 10 μ s or less.

If the rise time is too long, the resulting trigger for the SCRs is broad and can result in latch-up of the SCRs. More sophisticated triggering arrangements, such as Schmitt triggers or astable multivibrators, could be used, but for this

application the differentiated square wave is satisfactory.

The energy required by this switch is 0.01 joules, which is obtained by charging the 10- μ F storage-capacitor to approximately 45 V. This voltage is adjusted to provide the switching energy that gives the best rf isolation.

The charging time constant for the storage capacitor is determined by R_3C_3 and set to be approximately 10% of the switching period. In this case the switching rate is 100 Hz and the charging time constant is 1 ms. This permits the storage capacitor to be fully charged between the switching periods, and the energy discharged through the switch is independent of small variations in the switching frequency.

The power requirement for the switch driver is a direct function of the switching frequency. Since there are two 0.01-joule discharges per switching cycle, the power requirement is 2 W for a 100-Hz switching frequency. An additional 2 W is dissipated in the charging resistor for a total power requirement of 4 W. The power supply is 45 V, and the average current is 190 mA.

Theodore V. Seling, Research Engineer, Radio Astronomy Observatory, University of Michigan, Ann Arbor, Mich. 48104.

CIRCLE NO. 311

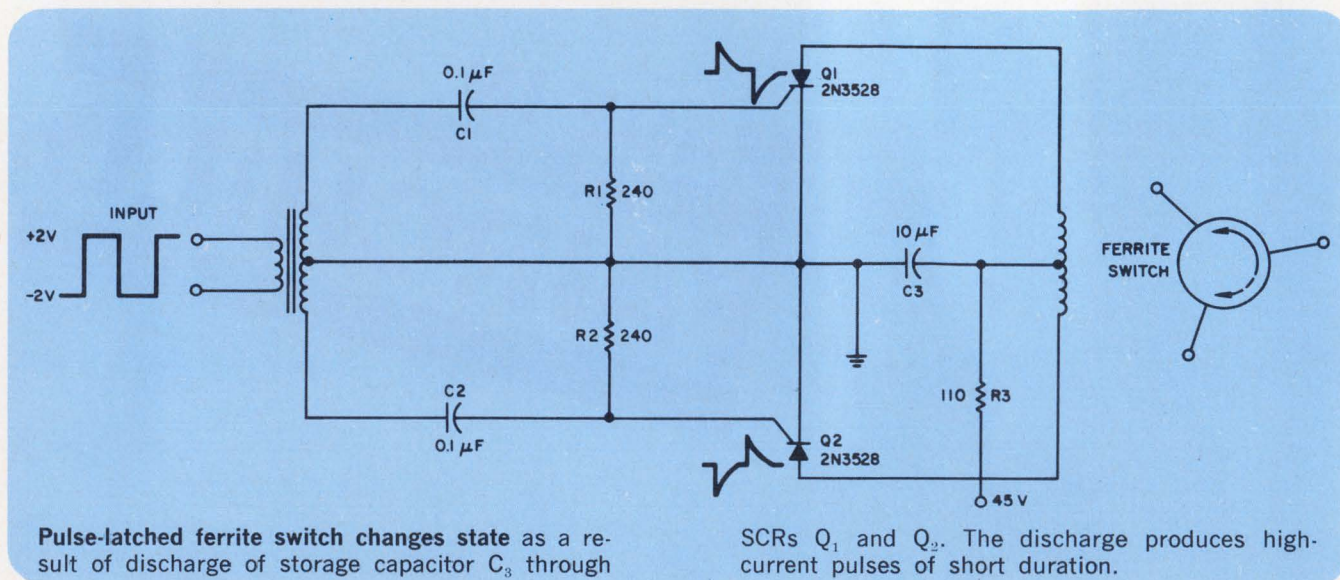

13 STANDARD RESISTORS

13 STANDARD RESISTORS

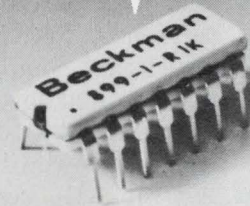
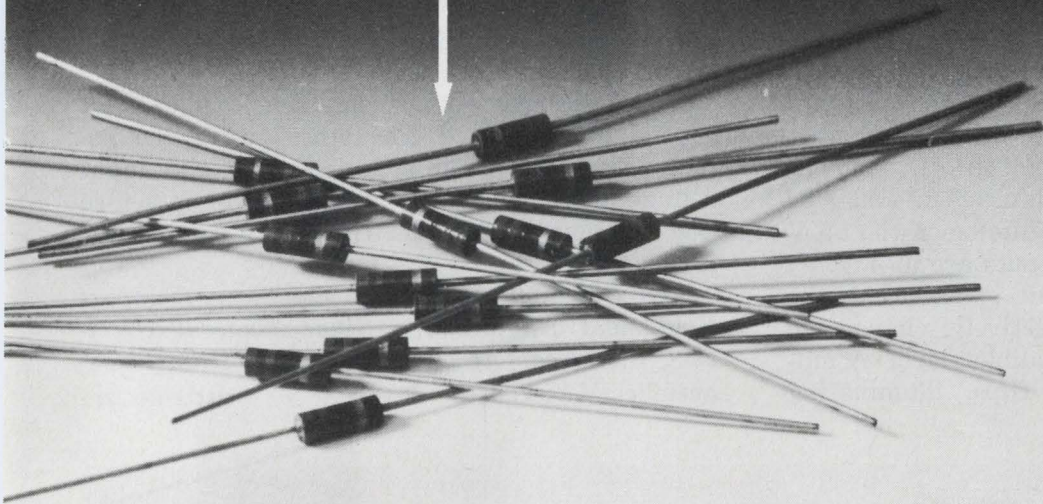

Helipot's one-piece money saver saves time and space, too.

To keep working with discrete standard resistors just isn't logical. Not when there are ceramic DIPs available that do the same jobs in less space — quicker, easier and cheaper. Whether inserted automatically or by hand.

Stocked locally for immediate delivery, too. At "on the board" cost-saving prices, in small or large quantities.

(Check the specs.) No wasted time while they're "made to order," unless you want custom modifications, which we can do fast.

And remember, ceramic. Ceramic reliability at plastic prices.

Why wait? Call your local Helipot Representative now for applications assistance or more information.

Beckman
INSTRUMENTS, INC.
HELIPOT DIVISION
Fullerton, California

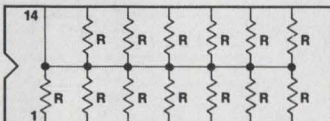

MODEL SERIES 899-1

Resistance Values (ohms): 100, 150, 220, 330, 470, 680, 1K, 1.5K, 2K, 2.2K, 3.3K, 4.7K, 6K, 6.8K, 10K, 15K, 22K.

Common Applications: Digital pulse squaring; MOS/ROM pull-up/ pull-down; "wired OR" pull-up; power driver pull-up; open collector pull-up; TTL input pull-down; TTL unused gate pull-up; high-speed parallel pull-up.

Standard Tolerance: $\pm 2.0\%$

Pricing:	1-99	\$1.45
	100-499	1.12
	500-999	0.97



MODEL SERIES 899-2

Resistance Value (ohms): 10K

Common Applications: Inverting operational gain; potentiometric gain; differential gain; noninverting gain; gain adjustment.

Standard Tolerance: $\pm 2\%$

Pricing:	1-99	\$2.75
	100-499	2.15
	500-999	1.86

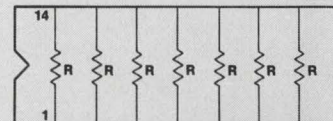

MODEL SERIES 899-3

Resistance Values (ohms): 68, 100, 110, 150, 220, 330, 470, 680, 1K, 1.5K, 2.2K, 3.3K, 4.7K, 6.8K, 10K, 15K, 22K.

Common Applications: Line termination; long-line impedance balancing; power gate pull-up; ECL output pull-down resistors; LED current limiting; power driver pull-up; "wired OR" pull-up; TTL input pull-down.

Standard Tolerance: $\pm 2\%$

Pricing:	1-99	\$1.25
	100-499	0.99
	500-999	0.86

Monitor power supplies continuously

It's often necessary to operate power supplies over a long time to measure reliability. When the period extends over several days, an automatic monitoring system becomes mandatory.

Here's a circuit that can monitor 6 power supplies, each having 5 outputs, for several days (a). If the voltage tolerance is exceeded even momentarily, a fault indicator lights and an alarm sounds. Input power to the supply is then turned OFF to prevent possible further destruction.

Let's examine the 15-V output of the power-supply unit under test (UUT)—a typical channel operation. This output is balanced against a -15-V reference. Potentiometers R_1 and R_2 are adjusted, so that comparators AR_1 and AR_2 bracket the upper and lower limits of the 15-V output. The AR_1 and AR_2 outputs are at 4 V.

If the upper or lower limit is exceeded, the output of AR_1 or AR_2 , respectively, changes to logic ZERO, activating the audible alarm. A millisecond later, latch U_1 - U_3 flips, illuminating

fault lamp DS_1 , and inhibiting all latches from subsequent triggering.

A few milliseconds later K_1 is de-energized, opening S_6 and removing the 28-V input from the UUT (b). When this occurs, all UUT output voltages fall to zero, unbalancing all the affected comparator inputs. Since the latches have already been inhibited, only the initial fault lamp is illuminated.

The LED reset momentary switch can be depressed to recheck the fault. This resets all the latches and also closes S_6 .

In the comparator circuit, one input is at ground for reference. The other—after the potentiometer has been adjusted with the input voltage at an upper (or lower) limit—is set so that the comparator just flips. The comparator is now calibrated.

Alfred W. Zinn, Senior Engineer, Support Equipment Engineering, Singer-General Precision, Inc., Kearfott Div., 63 Bedford Rd., Pleasantville, N.Y. 10570

CIRCLE NO. 312

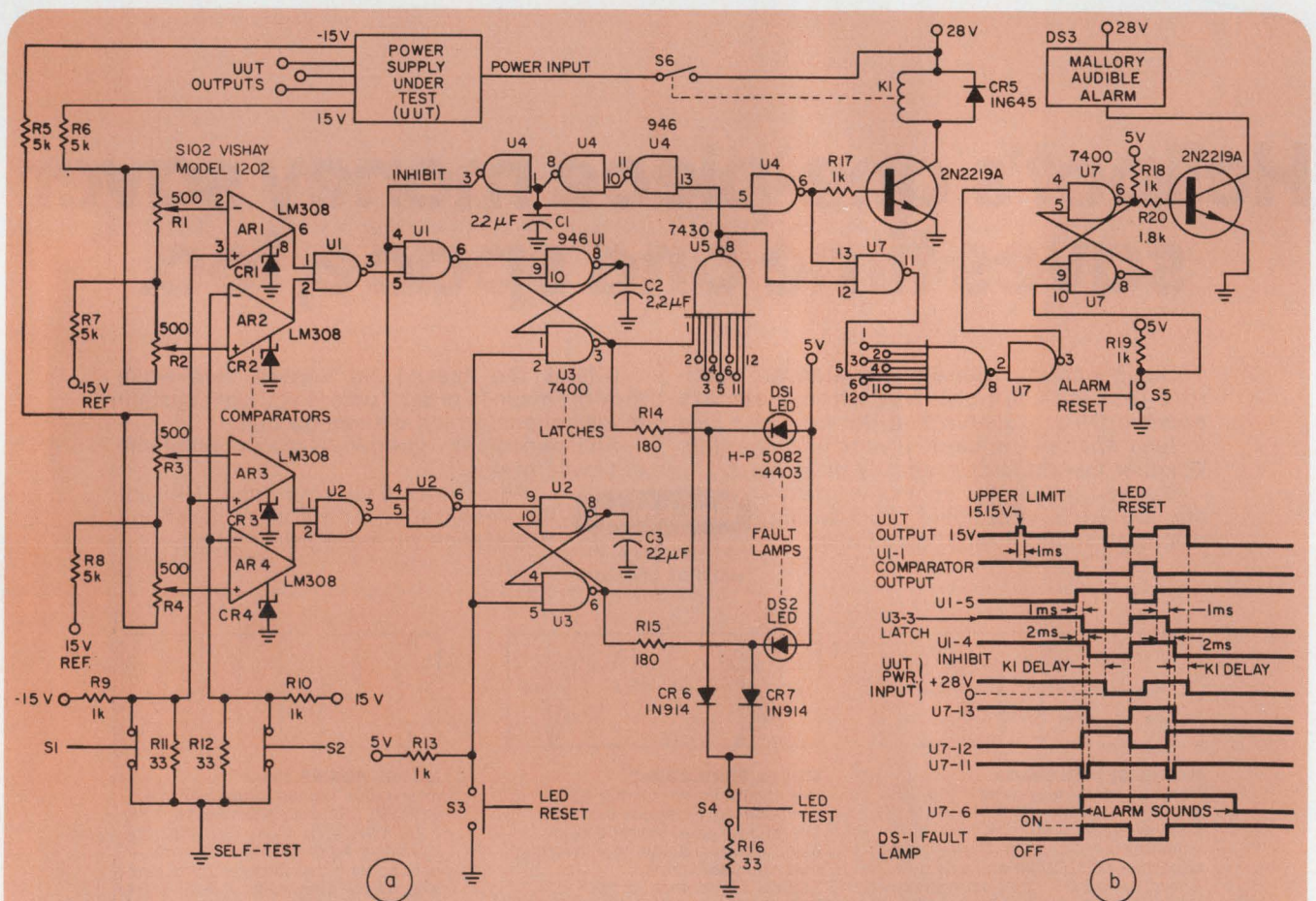

Up to eight supplies can be monitored over several days with this system by use of the leads of U_5 and U_6 (a). Thus 64 channels can be checked—

more if the OR function of U_6 is expanded. Waveforms illustrate the circuit operation (b). The alarm can be reset while an earlier fault exists.

If you need cool, accurate, reliable DPMs ... Buy Triplett

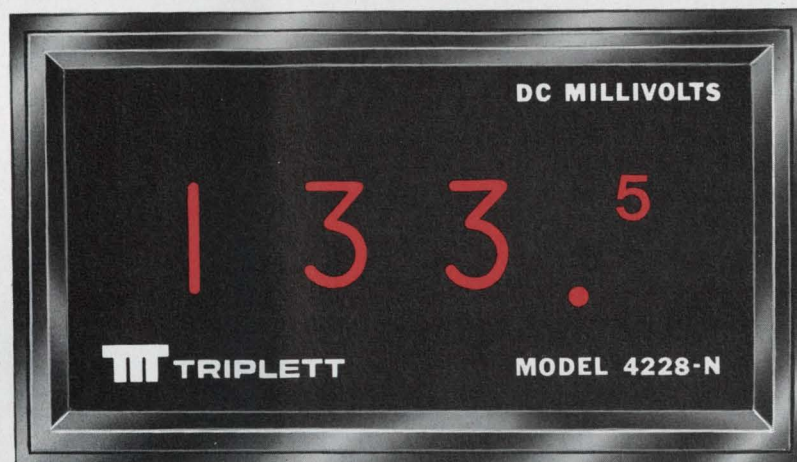

Model 4228-N

actual size

\$140

1. 2 $\frac{3}{4}$ digits — Provides double the accuracy (0.25% of reading \pm 1/2 digit) and double the resolution at lower cost.
2. Instantaneous Response — 16-millisecond display rate with 60 times per second sampling rate.
3. Fool-proof Numeral display blurs beyond over-range and with negative polarity.

Designed for OEM applications as well as R&D, production, quality control, maintenance and education use, Triplett's line of digital panel meters combine compactness, convenience and capability with characteristic Triplett accuracy and quality.

To 2 Watts power consumption (for reduced heat and increased reliability) and positive over-range and reverse polarity indications, Triplett's Model 4228-N adds a unique (patent pending) 2 $\frac{3}{4}$ -digit display that effectively doubles the accuracy and resolution of 2 $\frac{1}{2}$ -digit instruments . . . at the cost of 2 $\frac{1}{2}$ -digits. Accuracy is \pm 0.25% of reading \pm 1 digit.

Model

4235-F \$240

1. 3 $\frac{1}{2}$ digits with auto-polarity.
2. Low Power Drain — provides low operating temperature and long-lived reliability.
3. Single-plane, Seven-bar Readout — for accurate, wide-angle readability.

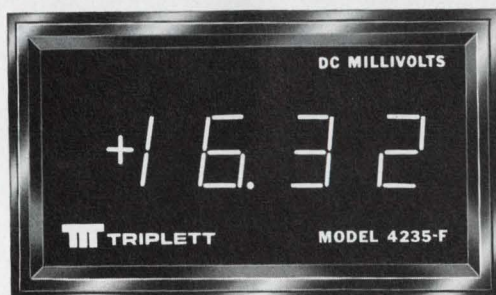

The Model 4228-N is a real value at \$140, so call your local Triplett Sales/Service/Modification Center or Triplett sales representative right now. Either will also be pleased to demonstrate two companion products: Triplett's Model 4225-N at \$125 which merely omits the neon lamp "1" (thus reading to 995) and offers \pm 0.50% \pm 1 digit accuracy; and the Model 4220-N at \$110 — a 2-digit instrument (reading to 99) with \pm 1% \pm 1 digit accuracy.

Mounted in the same size case and boasting the same low power consumption and positive over-range indication, Triplett's 3 $\frac{1}{2}$ -digit Model 4235-F adds auto-polarity

(with polarity indication) display hold capability, high input resistance (from 10 to 1,000 megohms depending on range) and a 3 $\frac{1}{2}$ -digit single-plane seven-bar fluorescent display. For many users, the wide-angle viewing capability — enhanced by a green, circularly-polarized viewing window that eliminates confusing internal reflections — will make the 4235-F the obvious choice.

Boasting a voltage accuracy of \pm 0.10% (current \pm 0.15%) of reading \pm 1 digit, Triplett's Model 4235-F sells for \$240. Its companion, the 3-digit Model 4230-F, is \$220. More information, or a free demonstration of both models, is available from your Triplett Sales / Service / Modification Center or your Triplett sales representative. Triplett Corporation, Bluffton, Ohio 45817.

TRIPLETT

Manufacturers of the World's most complete line of V-O-Ms.

INFORMATION RETRIEVAL NUMBER 51

NEW ...

A complete family of low cost, high performance packaged AC-DC regulated power supplies

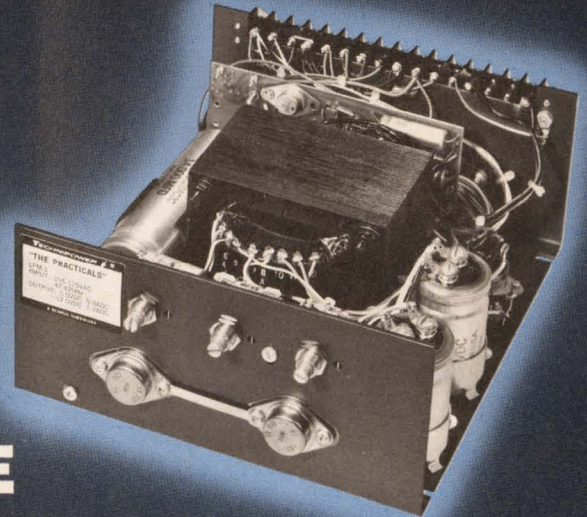

"THE PRACTICALS"™

...they make systems engineers cost-efficiency experts!

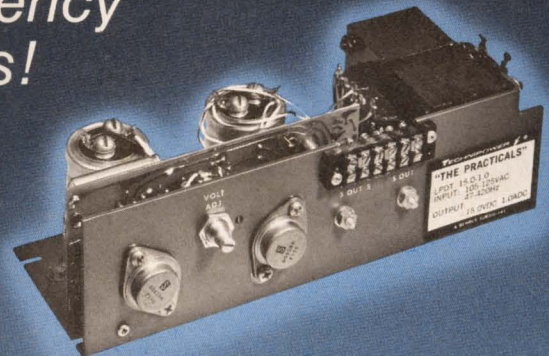
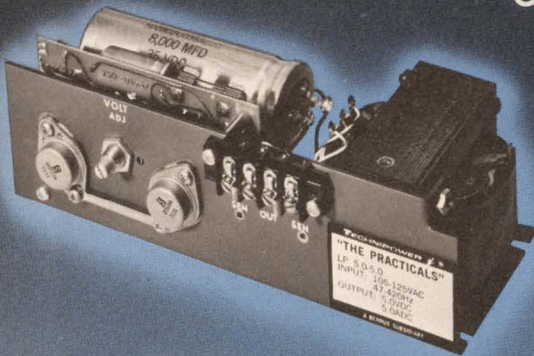

In today's tough competitive OEM business world, an engineer must assume many responsibilities beyond the pure optimum design of systems.

He must realistically specify the components and sub-systems; buy the required performance specifications at competitive prices; package the system in its most compact form.

In short, he must achieve the greatest cost-efficiency and reliability per dollar invested. That's what Technipower's Practicals are all about.

Just compare the basic specifications and prices of the "The Practicals" with other open construction power supplies. Then consider Technipower's reputation for rigid high-quality standards. And, we give "The Practicals" the identical 5-Year Warranty as our premium spec units.

Standard output voltages and power availabilities are tailored to satisfy the most popular circuits. Custom specifications can easily be adapted to order.

"The Practicals" are today's OEM Engineer's most realistic answer to any power supply need. Call, wire, or write today for immediate delivery.

U.L. APPROVED. BACKED BY TECHNIPOWER 5-YEAR WARRANTY



TECHNIPOWER, INC.



A **BENRUS** SUBSIDIARY

Benrus Center, Ridgefield, Ct. 06877 203-438-0333 TWX: 710-467-0666

TECHNIPOWER "PRACTICALS" STANDARD SPECIFICATIONS

Single, Dual, Triple, and Quadruple Output Models

Input voltage range: 105-125 volts
Input frequency range: 47-420 Hz
Regulation-Line and Load Combined: $\pm 0.5\%$
Ripple (RMS): (with either positive or negative terminal grounded): 10mv.
Temperature Coefficient: (TYP.) 0.05%/°C or 5 mv/°C whichever is greater.
Polarity: May be used positive or negative.
Output voltage and current: See model listing.
Short circuit protection: Automatic circuit protects the power supply if the output is shorted continuously. Automatic return upon removal of short circuit.
Remote sensing: Provisions are made for remote sensing to eliminate effects of lead resistance on dc regulation.
Ambient Operating Temperature: 0°C to +55°C for current ratings specified in model listings.
Storage temperature: -20°C to +85°C.
Recovery time: (TYP.) Less than 50 usec, 1/2 L to FL.
Fixed output voltage: Can be pre-set at the factory with a setting accuracy of $\pm 2\%$ of nominal output for any or all of the outputs at slight additional cost.
OEM quantity and less than 10 unit prices quoted upon request.
Custom specifications easily adapted to order.

Single Output Series designed for logic, op-amp, signal and other commercial applications

Adjustable Output Voltage	Output Current Amperes	Standard Model No.
5.0 $\pm 5\%$	5.0	LP5.0-5.0
6.0 $\pm 5\%$	4.5	LP6.0-4.5
12.0 $\pm 5\%$	2.5	LP12.0-2.5
15.0 $\pm 5\%$	2.0	LP15.0-2.0
24.0 $\pm 5\%$	1.5	LP24.0-1.5
28.0 $\pm 5\%$	1.2	LP28.0-1.2

\$39⁷⁵

ALL MODELS
10 or more
combined units

Overvoltage protection available on all models, add \$5.00.

Dual Output Tracking Series designed for op-amp and other commercial applications

Adjustable Output Voltage	Output Current Amperes	Standard Model No.
$\pm 12.0 \pm 5\%$	1.2	LPDT-12.0-1.2
$\pm 15.0 \pm 5\%$	1.0	LPDT-15.0-1.0

\$74⁷⁵

ALL MODELS
10 or more
combined units

Overvoltage Protection available on all models, add \$10.00.
 Independent output adjustment (non-tracking) provided at slight additional cost.
 Modification of standard output voltages can be provided over the range of ± 5 to ± 28 volts at slight additional cost. Voltages below ± 7 volts not available in Tracking models.

Triple Output Series combines single and dual output functions

Adjustable Output Voltage	Output Current Amperes	Standard Model No.
+5.0 $\pm 5\%$	5.0	LPM-1
+12.0 $\pm 5\%$	1.2	
-12.0 $\pm 5\%$	1.2	
+5.0 $\pm 5\%$	5.0	LPM-2
+15.0 $\pm 5\%$	1.0	
-15.0 $\pm 5\%$	1.0	

\$142⁷⁵

ALL MODELS
10 or more
combined units

Overvoltage Protection is standard on 5 Volt Output at no additional cost.
 Available on the ± 12 or ± 15 volt output, add \$10.00.
 Modification of standard output voltages can be provided at slight additional cost.

Quadruple Output Series combines triple output functions plus output for indicator or drive voltage

Adjustable Output Voltage	Output Current Amperes	Standard Model No.
+5.0 $\pm 5\%$	10.0	LPQ-1
+15.0 $\pm 5\%$	2.0	
-15.0 $\pm 5\%$	2.0	
+28.0 $\pm 5\%$	1.0	
+5.0 $\pm 5\%$	7.5	LPQ-2
+15.0 $\pm 5\%$	4.0	
-15.0 $\pm 5\%$	4.0	
+28.0 $\pm 5\%$	1.0	LPQ-3
+5.0 $\pm 5\%$	5.0	
+15.0 $\pm 5\%$	6.0	
-15.0 $\pm 5\%$	6.0	
+28.0 $\pm 5\%$	1.0	

FROM
\$229⁷⁵

ALL MODELS
10 or more
combined units

Overvoltage Protection is standard on 5 Volt Output at no additional cost.
Overvoltage Protection is available on the ± 12 or ± 15 volt output, add \$10.00.
 Modification of standard output voltages can be provided at slight additional cost.

See TechniPower products in Volume 1 of the 1971/72 EFM. Pages 905-928.

IDEAS FOR DESIGN

Discharge capacitors with a MOSFET

The discharge of floating capacitors—when one terminal is not at a ground reference—can present design troubles. When you use a bipolar device across the capacitor, the base current interacts with the charging circuit. And if a unijunction is connected across the element, the capacitor does not always discharge completely.

The solution to this problem, for a capacitor in an op amp integrator circuit, is an enhancement mode MOSFET across the capacitor (see diagram). Since insulated gate devices do not draw gate current, the capacitor is completely isolated from the reset voltage. And because the substrate is connected to +V instead of the source, as it normally is, the FET operates bilaterally.

Glen Coers, Electronics Devices Div., Texas Instruments, Inc., P.O. Box 5012, Mail Station 84, Dallas, Tex. 75222

CIRCLE NO. 313

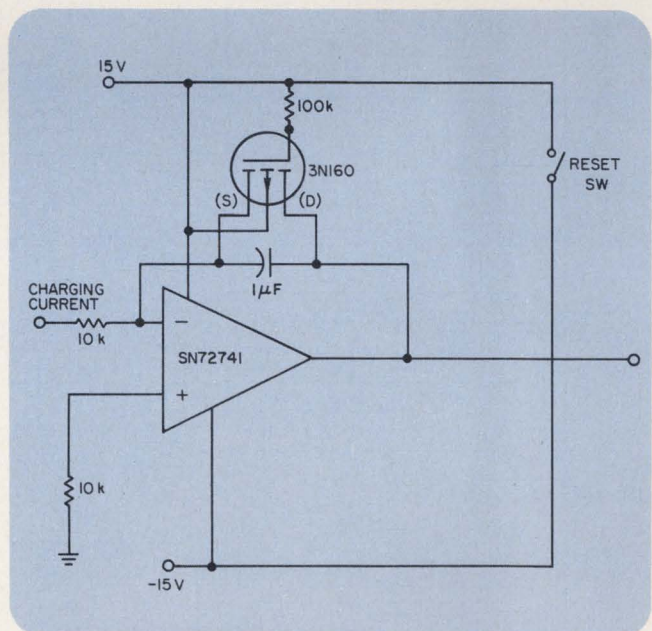

Base-current interaction and incomplete discharge are eliminated when a MOSFET is used to discharge the capacitor in this integrator circuit. The reset function can be performed by an op amp or discrete device.

◀ INFORMATION RETRIEVAL NUMBER 52

Test one-shots for min, max widths

If you have to screen one shots for pulse-width specs on a production basis, a simple tester can be built with available ICs (a). It can screen models SW 9600-9602, 54121-54123, 728, 951, 751, 941 and their equivalents.

The circuit has an indicator light whenever the pulse width of the device under test (DUT) is either more than a preselected minimum value or less than a preselected maximum value.

In the diagram, an SW 9601 is tested for a minimum and maximum pulse width of $3.08 \mu\text{s}$ and $3.76 \mu\text{s}$, respectively (b). A dual one-shot provides a 100-kHz clock to A with an 80-ns width. Each falling edge of the clock triggers the DUT. This provides an output pulse to B, with duration and accuracy depending on the external timing components.

The rising edge of the clock triggers the first one-shot of each of the four 9602s. These dual one-shots provide delayed pulses to C, D, E and F. The output of the DUT is compared with V_{CC} and ground by use of SW 5486 Exclusive-OR gates.

If there is a failure, the output of the 946 is pulled to ground, turning off the indicator light. A reset pulse at G of $1 \mu\text{s}$ is generated to reset the indicator light for every 100 clock pulses. Two SW 938 decade counters and one SW 728 one-shot are used.

Rama M. Reddy, Senior Applications Engineer, Stewart Warner Microcircuits, 730 E. Evelyn Ave., Sunnyvale, Calif. 94086

CIRCLE NO. 314

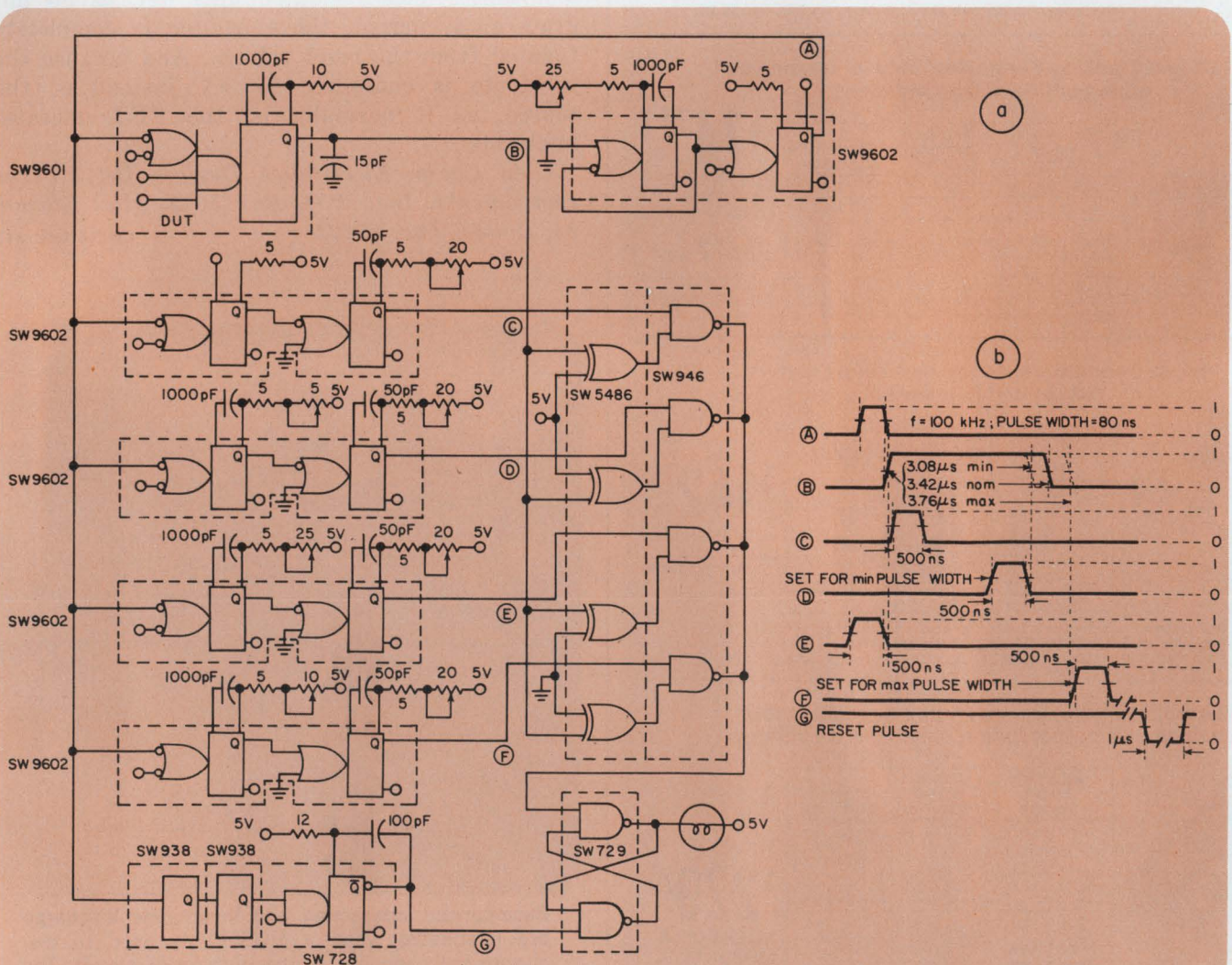

An indicator lights when a one-shot under test passes its pulse-width specs. The tester (a) con-

sists of one-shots and decade counters. Waveforms (b) illustrate the testing of an SW 9601.

NEW! 1024 PROM/ROM.

For greater flexibility in obtaining economical bipolar read-only memory devices from design through volume production.

We invented the PROM concept, established its reliability, and delivered in volume. Now we're adding to the most complete line offered in the industry and have used the knowledge obtained over a year's experience to bring you an even more dependable product. The application flexibility of our new PROM/ROM is achieved because both are electrically identical and pin-for-pin interchangeable with each other and other 1024 bit devices. The PROM is available with two outputs—open collector or tri-state. The ROM is mask programmable and available in standard ASCII to EBCDIC code converter patterns. Custom programming is also available. The reliability of both PROM devices is documented by 260,000,000 fuse hours of life test data. For further details see your Harris representative or distributor.

Features:

256 words/ 4 bits per word

Fully decoded

DTL/ TTL compatible

50 ns access time

Expandable—"Wired-OR" outputs with chip select input

Available in military and commercial temperature ranges

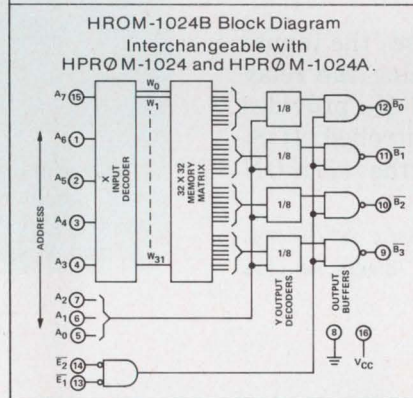
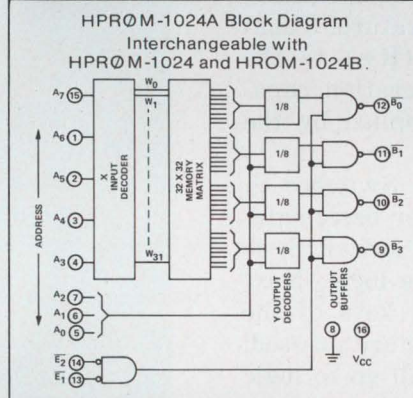
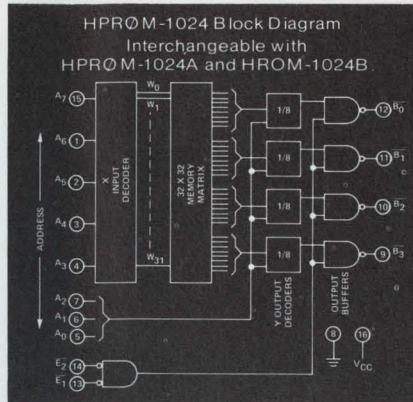

1024's are also available in the innovative Diacon package.

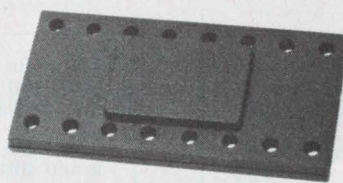

New too!

HROM-2561M Character Generator

One of the highest speed devices of its kind, with guaranteed A.C. performance over the full military temperature range.

Features:

1.5 MHz over full military temperature range

512 x 5 organization

ASCII to 5 x 7 dot matrix, p-MOS

	100-999 units	100-999 units
	0°C to +75°C	-55°C to +125°C
HPR0M-8256 Bipolar	\$12.00	\$24.50
32 x 8 TA= 40ns		
HPR0M-1256 Bipolar	\$14.75	\$24.50
256 x 1 TA= 35ns		
HPR0M-0512 Bipolar	\$27.50	\$43.00
64 x 8 TA= 55ns		
†HPR0M-1024 Bipolar	\$55.00	\$71.50
256 x 4 TA= 60ns		
†HPR0M-1024A Bipolar	\$55.00	\$71.50
256 x 4 TA= 60ns		
†HROM-1024B Bipolar	\$15.00*	\$18.75*
256 x 4 TA= 60ns		
†HROM-2561M p-MOS	\$19.25	\$28.60
512 x 5 f0= 1.5MHz		
† New		* 500-999 units



HARRIS SEMICONDUCTOR
A DIVISION OF HARRIS-INTERTYPE CORPORATION

P.O. Box 883, Melbourne, Florida 32901
(305) 727-5430

DISTRIBUTORS: **Schweber Electronics**: Westbury, New York (516) 334-7474; Rockville, Maryland (301) 881-2970; Hollywood, Florida (305) 927-0511 / **Harvey R & D Electronics**: Lexington, Massachusetts (617) 861-9200 / **Semiconductor Specialists, Inc.**: Chicago (312) 279-1000; Detroit (313) 255-0300; Minneapolis (612) 884-8132; Kansas City (816) 452-3900; St. Louis (314) 428-6100; Dallas (214) 358-5211; Indianapolis (317) 243-8271; Pittsburgh (412) 781-8120; Dayton (513) 278-9455 / **R.V. Weatherford Co.**: Albuquerque (505) 265-5671; Anaheim (714) 547-0891; Austin (512) Enterprise 1443; Dallas (214) 231-6051; Denver (303) 427-3736; Glendale (213) 849-3451; Houston (713) Enterprise 1443; Palo Alto (415) 321-5373; Phoenix (602) 272-7144; Pomona (714) 623-1261; San Diego (714) 278-7400; Seattle (206) 762-4200. **HARRIS SALES OFFICES**: Wellesley, Massachusetts (617) 237-5430; Wayne, Pennsylvania (215) 687-6680; Palos Heights, Illinois (312) 597-7510; Melbourne, Florida (305) 727-5430; Palo Alto, California (415) 321-2280; Norwalk, Connecticut (203) 853-3646; Washington, D.C. (202) 337-4914; Dallas, Texas (214) 231-9031; Scottsdale, Arizona (602) 946-3556; Long Beach, California (213) 426-7687

INFORMATION RETRIEVAL NUMBER 53

Insure safety in control logic

It's often necessary to build safety features in control logic for dangerous systems. In a high-pressure controlled system, for example, it may be essential that the pressure and environmental temperature be within acceptable levels before the system is operated. And it's important to provide an alterable combination code to operate the system, thus preventing unauthorized use. A circuit for this kind of safety logic is shown in the diagram.

Switches S_1 and S_2 provide series contact closure to meet the basic safety requirements, such as proper pressure and temperature. Turn-ON switch S_3 provides dc power ($B+$) to the logic. Patch panel PP_1 provides alteration capability for the combination code supplied by the operator via the keyboard.

The circuit performs as follows: Switches S_1 and S_2 are closed, because the proper basic safety requirements are met. Turn-ON switch S_3 is closed by the operator to power the logic. Next the operator presses simultaneously keys of the combination code. If the proper keys are pressed, the inputs to the relay driver RD_1 all go to logic ONE, and relay K_1 is activated.

The output from K_1 contact A causes the inputs to RD_1 to remain high, thus sustaining the relay in the activated state. Output B of K_1 provides the operate signal to the system controlled. If S_3 is opened, K_1 is deactivated and the turn-ON sequence must be repeated.

A. H. Marsh, 111 Horse Pond Rd., Sudbury, Mass. 01776

CIRCLE NO. 315

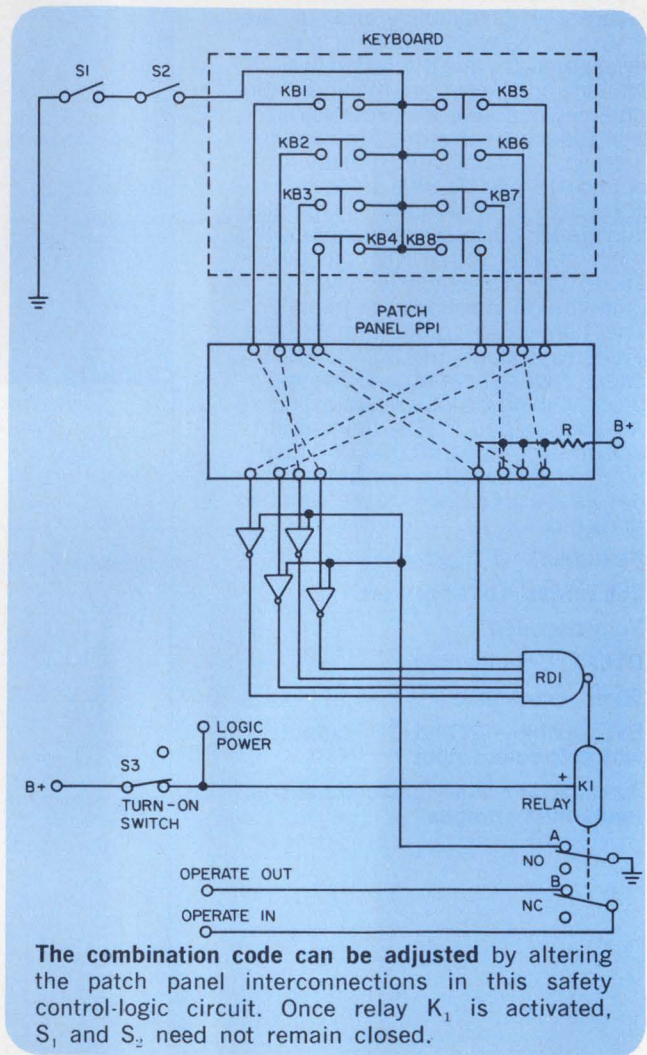

IFD Winner for August 16, 1971

L. E. Davies, Terminal Systems Dept., International Computers Ltd., Kidsgrove, Stoke-on-Trent, ST7 1TL, England. His idea "Home tape recorder stores binary data" has been voted the Most Valuable of Issue award.

Vote for the Best Idea in this Issue.

VOTE! Go through all Idea-for-Design entries, select the best, and circle the appropriate number on the Reader-Service-Card.

SEND US YOUR IDEAS FOR DESIGN. You may win a grand total of \$1050 (cash)! Here's how. Submit your IFD describing a new or important circuit or design technique, the clever use of a new component or test equipment, packaging tips, cost-saving ideas to our Ideas-for-Design editor. You will receive \$20 for each accepted idea, \$30 more if it is voted best-of-issue by our readers. The best-of-issue winners become eligible for the Idea Of the Year award of \$1000.

THE CROWD DISAPPEARS AT 20MHz

Now we're alone with the world's first 20 megahertz function generator, which starting at 0.0001 Hz, makes it twice the frequency range of other wide-range function generators. The model 7230 thus opens up new signal generator applications in the testing of MOS devices and IC's where frequencies are well over 10 MHz and will be going higher. It also will find application in pulse generation with its 30V P-P outputs and 10 nanosecond rise/fall times (equivalent slew rate of 2400 V/microsecond). Another new field for the 7230 will be intermediate frequency applications in FM receivers and telemetry. For only \$795 you get a precision source of sine, square, triangle, ramp, pulse and sync waveforms, plus these other features: VCF input control; several choices of DC offset; sync input for locking the generator to an external clock, and 80 db of step attenuation. And if 11 MHz is still all you need, you should check out EXACT's other three fine instruments in this series: the Model 7030, which has the same operating features of the 7230 above but saves you \$200; the Model 7050, same as the 7030 but with the additional capability to trigger and gate (with variable start/stop levels on the triggered and gated waveforms) for \$745; and the Model 7060, which at \$845 adds a second generator (again at 11 MHz) for ramp, pulse and sweep, 1000 seconds to 100 nanoseconds. Call on us to rise above the crowd with your next function generator.



EXACT
electronics, inc.

Box 160
Hillsboro, Oregon 97123

(503) 648-6661
TWX 910-460-8811

a subsidiary of
Vector
Management
Corp.

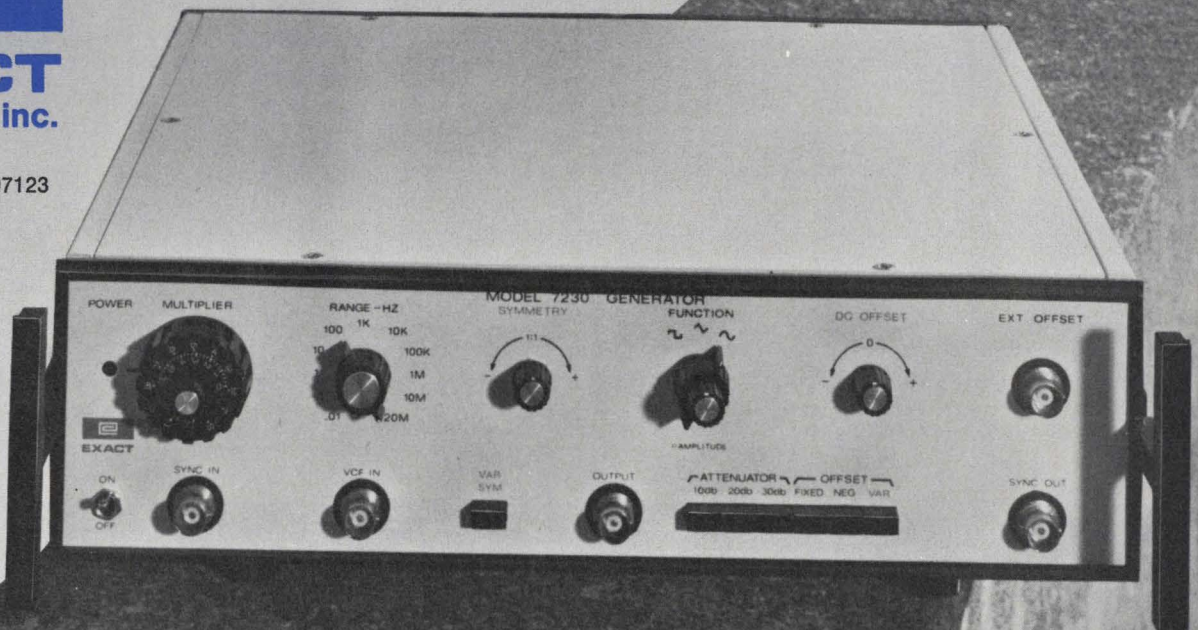

TRANSZORBS[®] STOP ALL TRANSIENTS WITH SUB-NANOSECOND RESPONSE
(NEED WE SAY MORE?)

TransZorb[®] is a registered trademark of GENERAL SEMICONDUCTOR INDUSTRIES, INC.
230 W. Fifth St., Tempe, Arizona 85281 (602) 966-7263 TWX 910-950-1942 Mailing Address: P. O. Box 3078

new products

Liquid-crystal DPM sets price/performance standards



Digilin, Inc., 1007 Airway, Glendale, Calif. Phone: (213) 240-1200. P&A: see text; March, 1972.

The industry's first liquid-crystal-readout DPM is a bipolar 3-1/2-digit unit from Digilin, the company that produced the first LED-display DPM. The new instrument uses 0.65-in.-high seven-segment readouts and is expected to retail for well under \$100. It dissipates milliwatts of power and offers an increase in reliability over present meters.

The model 4352 is available in two versions: a standard version that uses display backlighting (transmissive-mode display) with a built-in fluorescent tube and operates from 115 V ac, 50 to 400 Hz. It dissipates about 2-1/4 W. A dc version that operates from ± 15 V dc and dissipates a mere 500 mW is available with a reflective-mode readout. This version can be viewed even in direct sunlight.

According to Digilin, the standard version will initially cost about \$75 in 100 quantities. In single quantities, the price will be about \$120 to \$125.

Except for the fluorescent backlighting tube and a few allied com-

ponents, the DPM includes all its electronics on one PC board. These include MOS counter, decoder and driver chips. The use of fewer components is expected to increase the meter's reliability.

Specifications include an accuracy rating of $\pm 0.05\%$ of reading $+0.05\%$ of full scale at $25\text{ C} \pm 5\text{ C}$, typical bias current and 2 nA and input impedance of over 10 M Ω . Temperature stability is about 0.01% of full scale per C.

The meter is rated to operate over a temperature range of 10 to 50 C. Unlike all Digilin's other DPMs, it does not contain automatic-zeroing circuitry. The meter has capability for optional BCD output.

Except for the performance characteristics mentioned above, the model 4352 is identical to Digilin's 3-1/2-digit model 2330.

The 4352's size is rather small—it's 3.5-in. deep and approximately 2.1-in. high. These dimensions do not include the bezel which is 2.16-in. high by 4.5-in. wide. The instrument's case is made of plastic and is very light—total DPM weight is approximately 8 oz.

CIRCLE NO. 250

Strip chart recorder has 23 different speeds

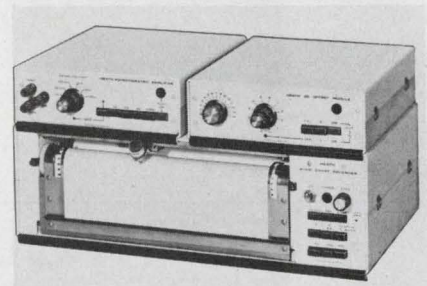

Heath/Schlumberger Scientific Instruments, Benton Harbor, Mich. Phone: (616) 983-3961. Price: \$675.

A new solid-state strip chart recorder, model EU-205B, features front panel pushbutton selection of 23 different chart speeds, from 30 in./min to 0.2 in./h, with all speeds accurately derived from a digital drive stepper motor. Eighteen calibrated spans are also switch-selectable, from 1 mV to 500 V full scale, in a 1-2-5 sequence. The EU-205B is fully programmable.

CIRCLE NO. 251

Lock-in amp has auto reference tracking



Princeton Research Corp., P.O. Box 565, Princeton, N.J. Phone: (609) 452-2111. P&A: \$1195; 90 days.

The PAR model 128 offers a unique tracking reference channel which automatically locks onto the reference signal regardless of its symmetry and completely without adjustment. The signal channel offers a flat frequency response from 0.5 Hz to 100 kHz and the amp features 1- μ V sensitivity combined with a common-mode rejection of better than 80 dB.

CIRCLE NO. 252

Pocket logic checker tests 14-/16-pin DIP ICs

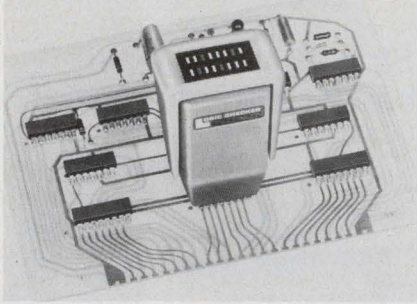

Alco Electronic Products, Alcolite Div., P.O. Box 1348, Lawrence, Mass. Phone: (617) 686-3887. Price: \$89.95.

Model 101 logic checker tests the logic state of most TTL and DTL bipolar circuits except expandable gates or circuits using non-standard voltage levels. The 1.7 by 2.65 by 1.35-in. instrument is actually 16 binary voltmeters, each one indicating the logic state at one of the terminals. No batteries or power cord are required.

CIRCLE NO. 253

Medical chart recorders feature inkless styluses

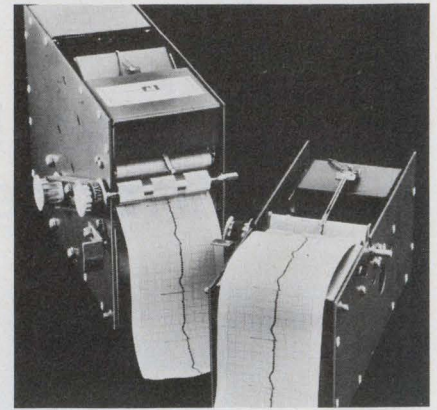

Asto-Med Div. of Atlan-Tol Industries, Inc., Atlan-Tol Industrial Park, W. Warwick, R.I. Phone: (401) 828-7010.

A line of new medical, industrial, and scientific electronic chart recorders, designed particularly for OEM use, features a newly developed heated inkless stylus that can be replaced, when necessary, in less than 10 seconds by untrained personnel. The main body of the stylus, mounted permanently on the galvanometer and pre-adjusted at the factory, never requires maintenance or charging. Chart speeds are 25 and 50 mm/s, with slower speeds available as options.

CIRCLE NO. 254

FOR YOUR PRECISE REGULATION CONSTANT CURRENT/VOLTAGE REQUIREMENTS

To age aluminum electrolytic capacitors, General Electric in their Irmo, South Carolina, plant required a 5 KW power supply with precise, constant current/voltage regulation.

By using these constant current/constant voltage power supplies, the power and, hence, the process can be closely controlled. Previously, power supplies in these ratings would take up several times the space without affording the same degree of regulation.

IF YOU NEED PRECISE CONTROL, SMALL SIZE, WELL-REGULATED KILOWATT CONSTANT CURRENT AND VOLTAGE POWER SUPPLIES... CALL TOLL FREE 800-631-4298, OR WRITE FOR OUR LATEST CATALOG.

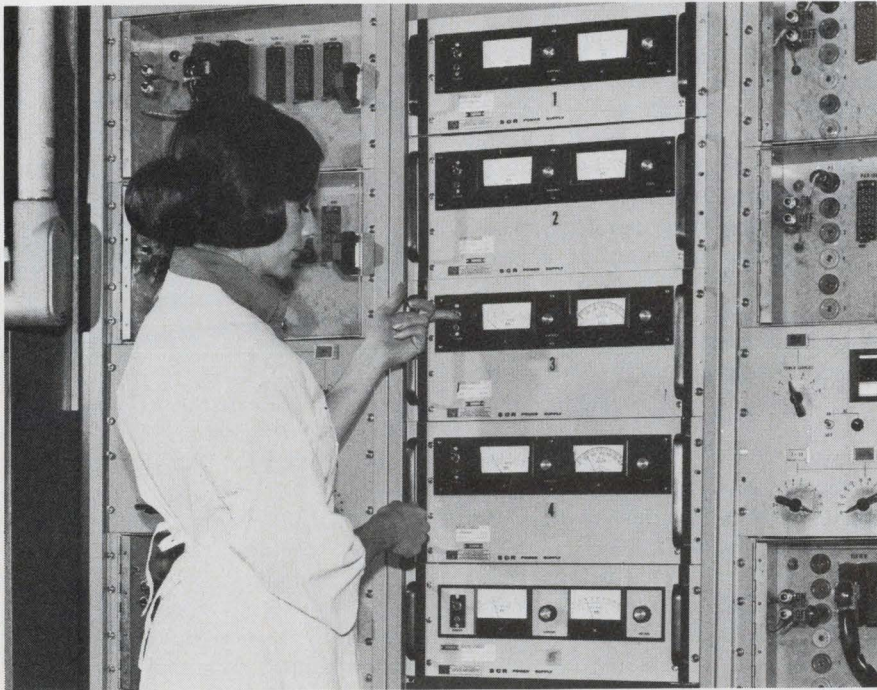

Five of E/M's 5 KW SCR Power Supplies are used in General Electric's electrolytic capacitor aging system.

Sweep oscillators span 100 kHz to 18 GHz

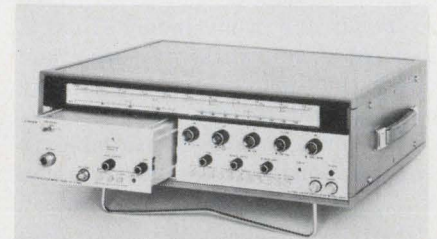

Singer Co., 3176 Porter Dr., Palo Alto, Calif. Phone: (415) 493-3231. P&A: \$1450/mainframe, \$790 to \$2900/plug-in; 120 days.

The Alfred model 6600 provides stable cw and swept-frequency coverage from 100 kHz to 18 GHz with a series of 19 plug-in units. All units feature high output power—100 mW up to 500 MHz; 30 mW at 2 to 4 GHz—stable cw with exceptionally low residual FM, and closed-loop leveling with external or internal p-i-n diode leveling above 1 GHz.

CIRCLE NO. 255



ELECTRONIC MEASUREMENTS INC.
405 Essex Road, Neptune, New Jersey 07753

BABCOCK DRY REED RELAYS...

New Versatility in Selection, Packaging, Performance

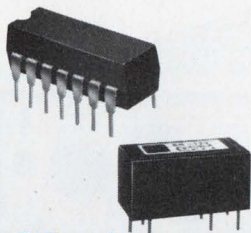

DIP and Subminiature Relays

Dual-inline, 8 and 14-pin packages are offered in Forms A, B and C and 2 Form A, with ratings 3 to 10 watts, for switching 3, 5, 10, 12, 24 and 28 VDC. They interface directly with TTL, RTL, DTL and HTL logic.

The new sub-miniature Series R is a heavy duty, SPDT, PC board, glassless polar reed relay. Rated to 20 watts at 1 amp., latching and non-latching, open coil and encapsulated versions will switch 1.5, 3, 6, 12, 24, 28, 35, 42 and 60 VDC.

For more information, circle No. 231.

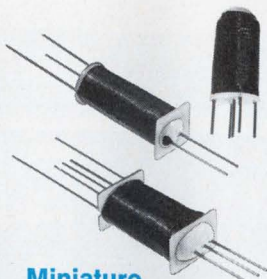

Miniature, Open Frame Relays

Low cost, faster switching speeds, high-density packaging, rugged reliability and long life (to 100,000,000 cycles) are features of these axial-lead and plug-in units. Offered in Forms A, B and C — and combinations — they are rated at 3 to 10 watts, for switching 5, 6, 12 and 24 VDC. Axial-lead relays may be ordered with from 1 to 6 contacts.

For more information, circle No. 232.

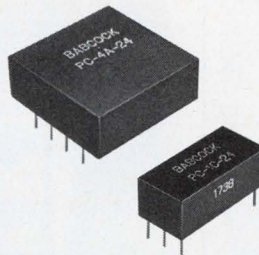

Miniature, PC Board Relays

From 1 to 12 reeds, selectable in combinations from a large assortment of options, may be specified in Series PC relays. Rated at 4 and 10 watts, for switching 28 to 250 VDC, these encapsulated units will operate over 100,000,000 cycles at low levels.

For more information, circle No. 233.

Detail technical data on the complete line of Babcock relays is available by writing or calling Babcock Control Products, Babcock Electronics Corp., Subs. of Esterline Corp., 3501 No. Harbor Blvd., Costa Mesa, Calif. 92626; Tel: (714) 540-1234

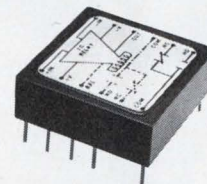

Sensitive Hybrid Relay

This extremely sensitive relay will operate on as little as 1.0 mv . . . ideal for many transducer and thermocouple applications. It is available in any 1 or 2 reed combinations, rated at 3 to 10 watts DC. This unit comprises an IC op-amp precisely matched to a reed relay; an integral programmable hysteresis option eliminates problems due to input signal variations or noise.

For more information, circle No. 234.

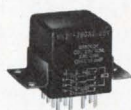

MIL-R-6106



MIL-R-5757



Timers/Sensors



Mercury Wetted



2A Industrial



20A Industrial



ESTERLINE



all shapes
and
sizes

Standard
CONDENSER

**specialized
capacitors**

to your specifications
at stock prices

Standard Condenser has designed and produced thousands of specialized capacitors for industry. In fact, what you think of as "special" may be among the many designs already available from stock at Standard. However, if you require capacitors of unusual shape, size, value and material, our engineering department will help you design and produce them to your exact specifications at stock prices. For immediate action, send us a sketch and complete details.

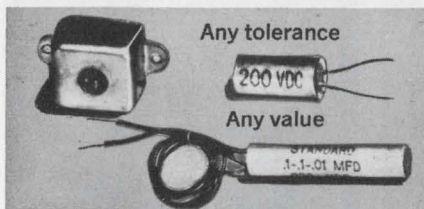

Any tolerance

Any value

Send for Catalog and complete details.

Standard

CONDENSER CORPORATION

Dept. ED-1

1065 West Addison Street
Chicago, Illinois 60613 • (312) 327-5440

INFORMATION RETRIEVAL NUMBER 57

INSTRUMENTS

20-MHz mini-portable scope weighs only 5-1/2 pounds

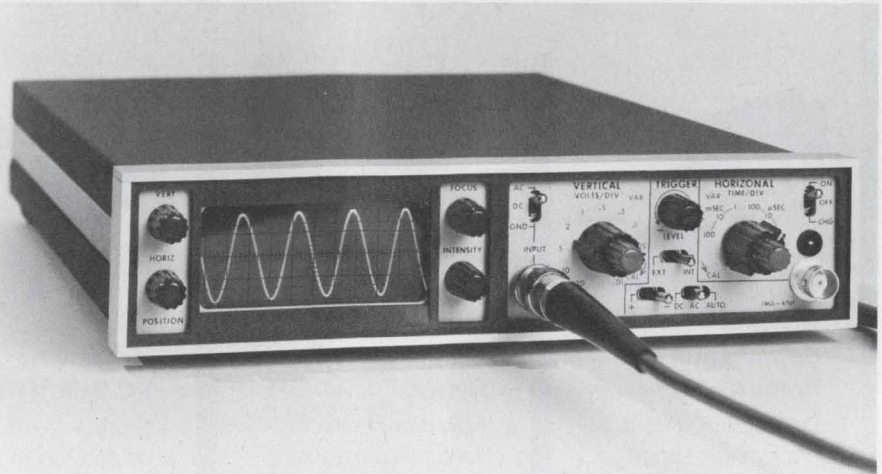

VU-DATA Corp., 7595 Convoy Court, San Diego, Calif. Phone: (714) 279-6572. P&A: \$595; stock to 30 days.

The first mini-portable oscilloscope bringing laboratory quality "on-site"—that's Vu-Data's claim for its 20-MHz 5-1/2-lb series PS900.

"Flat-Pack" model PS910A is 1-3/4-in. high by 8-1/2-in. wide by 12-in. deep. Controls are alongside the CRT. "Stack Pack" model PS920A with the same volume and weight is reshaped to 3-1/2-in. high by 4-1/4-in. wide by 12-in. deep.

The scopes operate up to five hours on internal batteries but alternately plug into a 115-V power line, 50 to 400 Hz.

Field engineers servicing computers and communication systems and other wideband equipment trouble-shooters should find themselves carrying a lighter scope load.

The 3-dB bandwidth is dc to 20 MHz and the rise time 18 ns. Input impedance is $1\text{ M}\Omega \pm 2\%$ paralleled with approximately 47 pF. Deflection factor ranges from 10 mV/div. to 20 V/div. in 11 ranges calibrated to $\pm 3\%$. A vernier extends maximum deflection to 50 V/div. A 3-foot X1 alligator clip probe is provided, but standard probes can also be used.

Display area is 4 by 10 divisions, at a 1/4 in. per division. The cali-

brated time-base ranges from 1 $\mu\text{s}/\text{div.}$ to 100 ms/div. Trigger modes are internal or external, automatic or manual level and slope selection.

Batteries are furnished as optional equipment. Eight C-size rechargeable Ni-Cd or alkaline cells are required; internal recharging circuitry is provided. Standard flashlight cells can be substituted in an emergency.

Since expensive Ni-Cd batteries can be ruined by a short-circuit, the battery circuit is fused at the rear panel. Batteries operate in parallel with the ac line, serve as an added filter capacitor, and provide scope power if the line drops.

Servicing this new scope is easy. All circuits are located on two single-sided PC boards. Standard off-the-shelf linear ICs and discrete components are used. A square-wave output jack for self-test and probe compensation is on the rear panel.

With Series PS900, Vu-Data tosses its hat into the mini-scope ring. Tektronix recently announced model 211 (see "Palm-size 3-lb scope works to 0.5 MHz." ED 25, December 9, 1971, p. 78). Model 211 measures a small 5-1/4 by 9 inches. Bandwidth is less (0.5 MHz) but deflection is a sensitive 1 mV/div. Model 211 price is somewhat lower at \$545.

CIRCLE NO. 256



TRY 'EM...YOU'LL LIKE 'EM

**Instant relief for design
congestion: Cherry
Subminiature snap-action
switches.**

When your design is afflicted with circuit congestion brought on by acute lack of space, here's the prescribed cure: Cherry 5 and 10 amp subminiature switches! Compact, easy-to-take size . . . refreshingly dependable coil spring action . . . plus long overtravel to combat assembly line headaches. You get Speedy snap-action relief in the dosage you prescribe: Either individual switches or space-saving multiple switch modules. Consultation available if design distress persists . . . Cherry diagnoses proven in over 160 million cases.

Try 'em: Send for free sample switch.
You'll like it.

CHERRY



TWX 910-235-1572... or PHONE (312) 689-7600... or WRITE:

CHERRY ELECTRICAL PRODUCTS CORP.
3600 Sunset Avenue, Waukegan, Illinois 60085

Makers of patented Leverwheel/Thumbwheel Switches, Matrix Selector Switches, Snap-Action Switches and Keyboards.

Designed to assist you in the translation and comprehension of specialized Russian texts—

**RUSSIAN-ENGLISH
DICTIONARY OF
ELECTROTECHNOLOGY
AND ALLIED SCIENCES**

Compiled by PAUL MACURA,
University of Nevada

Containing approximately 60,000 entries, this dictionary constitutes the most extensive listing of vocabulary in the fields of radar, radio, television, electronics, electrotechnology, and related areas. In addition to the technical vocabulary, the dictionary also includes transliterated names of foreign scientists, English equivalents of compound words, participles, synonyms, and abbreviations.

1971 707 pages \$32.50

Industry's first book devoted entirely to the new field of Large-Scale Integration—

**INTRODUCTION TO
LARGE-SCALE
INTEGRATION**

By ADI J. KHAMBATA,
Sperry Rand Corporation

This book, written in an easily readable style and oriented from the user's point of view, is specifically intended for people who are new to this field. Initially, the author discusses the device and technology aspects of LSI. He then points out not only the advantages and shortcomings of this new approach to systems designing, but also how it will affect computer systems architecture in the future.

1969 196 pages \$9.95

Offering the reader a basic understanding of operational amplifiers—

**OPERATIONAL
AMPLIFIERS**

By ARPAD BARNA, University of Hawaii

Operational Amplifiers presents the fundamental principles underlying the use of these important circuits, and provides many applications emphasizing their use in system design. Four tables summarizing the results obtained in the text and listing operational amplifier characteristics are presented in the appendix.

1971 148 pages 75 illus. \$9.95

Available from your bookstore
or from Dept. 093—



WILEY-INTERSCIENCE

a division of JOHN WILEY & SONS, Inc.
605 Third Avenue, New York, N.Y. 10016
In Canada:
22 Worcester Road, Rexdale, Ontario

INSTRUMENTS

Comm test sets weigh under four pounds



Data Products Corp., Telecommunications Div., 6219 Desoto Ave., Woodland Hills, Calif. Phone: (213) 887-8246. Price: \$500.

The 404 pattern generator and data analyzer are both fully adjustable between 37.5 and 300 bits/s, factory set to the user's requirements and capable of field change. Both units come with rechargeable dc Ni-Cd batteries and feature true start-stop distortion measurement, simultaneous peak and bias/end distortion readouts, 5, 7, or 8-level "fox" messages and four pushbutton-selectable distortion levels.

CIRCLE NO. 257

Function generator has symmetry control



Krohn-Hite Corp., 580 Massachusetts Ave., Cambridge, Mass. Phone: (617) 491-3211.

The Model 5400A incorporates a new symmetry control to allow pulse repetition rate to be set independently of pulse width and also provides an independently adjustable triangle slope. Sine, square, triangle, ramp, pulse and sawtooth waveforms as well as an auxiliary 5 V pk-pk square wave are produced over the frequency range of 0.002 Hz to 5 MHz. Output is controlled by a 70-dB push-button attenuator.

CIRCLE NO. 258

Multi-point recorder accepts thermocouples

Leeds & Northrup Co., Sumneytown Pike, N. Wales, Pa. Phone: (215) 643-2000. Price: \$890.

The Speedomax M Mark II offers six-point or four-point recording and can be used with a wide variety of transmitters having compatible current or voltage outputs—with spans from 0 to 200 μ A up to 0 to 50 mA, or from 1 to 200 V. Equipped with a low-level preamplifier, the recorder will accept thermocouple or direct millivolt inputs, with spans from 0.9 to 120 mV.

CIRCLE NO. 259

Pulse generator has 10-ns pulses

Marconi Instruments, Ltd., St. Albans, Hertfordshire, England.

The TF2025, a general-purpose pulse generator, is capable of delivering positive or negative double-pulse waveforms, either delayed or undelayed, at any repetition frequency from 0.2 Hz up to 25 MHz. The pulse width is variable from 10 ns to 1 sec and the rise time is 5 ns. Pulse duration is continuously variable and the output amplitude is adjustable between zero and 10 V.

CIRCLE NO. 260

500-line analyzer acts like 650 lines

Federal Scientific Corp., 615 W. 131 St., New York, N.Y. Phone: (212) 286-4400.

A revised version of the MINI-UBIQ real-time low-frequency spectrum analyzer incorporates a sharper computer-designed filter which provides increased selectivity. Additional ranges to 50 kHz and complete computer control of input attenuation, range, and input filtering are also featured. The analyzer, originally introduced for field test and production, provides on-line analysis of machinery noise and vibration and underwater acoustic signals.

CIRCLE NO. 261

REQUESTED DATA DELIVERY SERVICE is here—see card inside front cover.

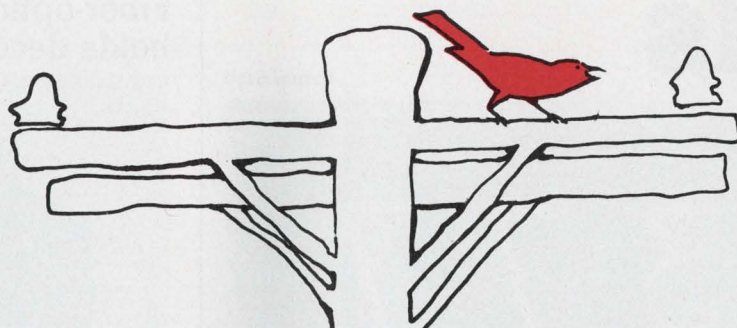

Measure ohms,
volts and amps
anywhere with
the 8120A.

It's the new multimeter
system with full Fluke
dependability and
service.

- five ranges, five modes, 4½ digits, \$795
- voltage from 100 millivolts to 1000 volts
- current from 100 microamps to 1 amp
- resistance from 1000 ohms to 10 megohms
- published overload and environmental specs
- fully guarded circuits
- guaranteed range, accuracy and resolution specs
- field installable options
- push button convenience
- single mainframe option structure



Introducing the Fluke 8120A, the first low cost complete universal multimeter measurement system. Ask your local Flukeman for a demo today. Call him now or write us directly for literature.



Fluke, Box 7428, Seattle, Washington 98133. Phone: (206) 774-2211. TWX: 910-449-2850 / In Europe, address Fluke Nederland (N.V.), P.O. Box 5053, Tilburg, Holland. Phone: (04250) 70130. Telex: 884-52237 / In the U.K., address Fluke International Corp., Garnett Close, Watford, WD2, 4TT. Phone: Watford, 33066. Telex: 934583.

INFORMATION RETRIEVAL NUMBER 60

DPMs

Actual Size



**In 2¹/₂, 3¹/₂ or 4¹/₂-digit models.
We've got them all.
Just ask us.**

GRALEX
INDUSTRIES

DIV. OF GENERAL MICROWAVE CORP. • 155 MARINE ST., FARMINGDALE, N. Y. • 516-694-3600

INFORMATION RETRIEVAL NUMBER 61

DON'T KID YOURSELF!



This won't ward off heart disease. But a gift to the Heart Fund will help protect your heart and the hearts you love.



GIVE...
so more will live
**HEART
FUND**

Contributed by the Publisher

MODULES & SUBASSEMBLIES

Fiber-optic readout holds decoder/drivers

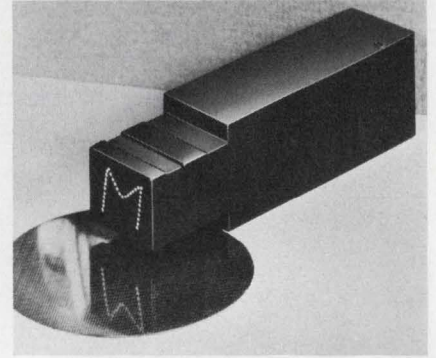

Master Specialties Co., 1640 Monrovia, Costa Mesa, Calif. Phone: (714) 642-2427. Availability: 3 to 4 wks.

With the inclusion of built-in decoder/driver ICs, model 902 16-segment alphanumeric fiber-optic readout makes space savings possible—it measures 3.5-in.-long by 0.62-in. high by 0.75-in. wide. The readout operates from 5 V dc $\pm 5\%$. It employs 0.42-by 0.42-in. characters in a 16-segment dot pattern to form the complete alphabet, numerals 1 to 9 and a number of symbols.

CIRCLE NO. 321

Kit-form 100-MHz amp delivers 2.5 W cw

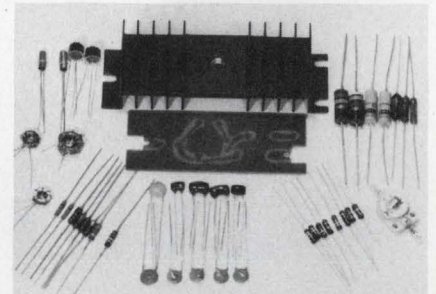

Larkton Scientific, Box 302, Monroeville, Pa. Phone: (412) 731-6829. P&A: \$249; stock to 3 wks.

A new kit-form (MP-100) power amplifier covers 0.5 to 100 MHz with 2.5 W of cw output. It accepts inputs of AM, ssb, pulse and other complex modulation. Full power is delivered when a drive of 0.15 V is applied over the entire frequency range without tuning adjustments. The unit withstands a +15-dB overdrive including short and open-circuit loads. Assembly time is 3 h.

CIRCLE NO. 322

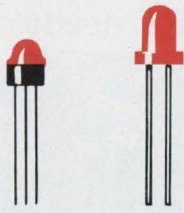

DIODE-LITEs

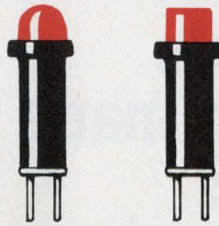

Cartridges

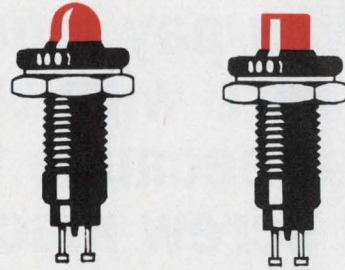

Indicator lights

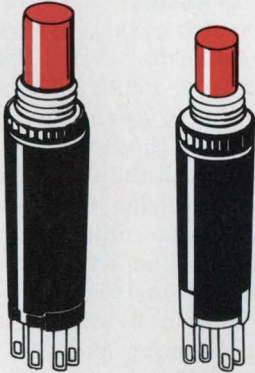

Lighted push button switches

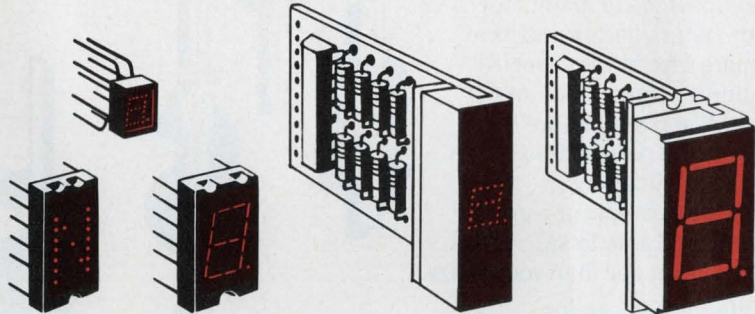

Readout modules and packages

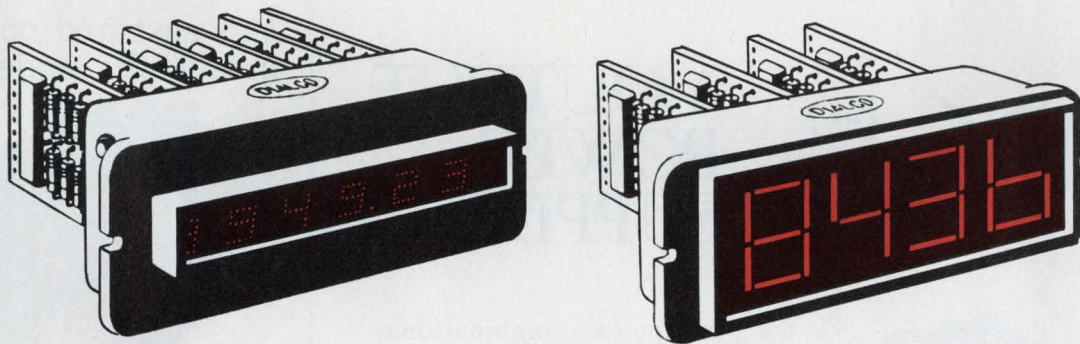

Readout assemblies

LED displays?

**Talk to the specialists at Dialight first.
You won't have to talk to anyone else.**

Whether you're looking for LEDs as light sources for build-your-own displays or for a variety of products that utilize LEDs, bring your requirements to us. Dialight is a major supplier of both LEDs (we call ours DIODE-LITE™) and of indicator lights, readouts and lighted push button switches that incorporate

DIODE-LITEs. We can even give you a contactless solid state switch that uses a DIODE-LITE in the circuit to provide cleaner, faster switching than any mechanical switch. Dialight can help you do more with LEDs than anyone else because we've done more with them. Write for LED Data File.



DIALIGHT CORPORATION, A NORTH AMERICAN PHILIPS COMPANY • 60 STEWART AVENUE, BROOKLYN, N. Y. 11237 • (212) 497-7600

INFORMATION RETRIEVAL NUMBER 62

Why pay more for square wire terminals just because they're made on screw machines?

Screw machined parts are expensive. If you're using a square wire terminal (or even round wire parts) made on screw machines, we can save you money. Our equipment can upset, head, point, cut radii, knurl, flatten and form square wire to your specifications . . . and at far less cost. If you require, we'll supply the parts plated to suit your specifications. Send us a sample or a print. We may be able to save you a lot more money than you realize. Write for free catalog.

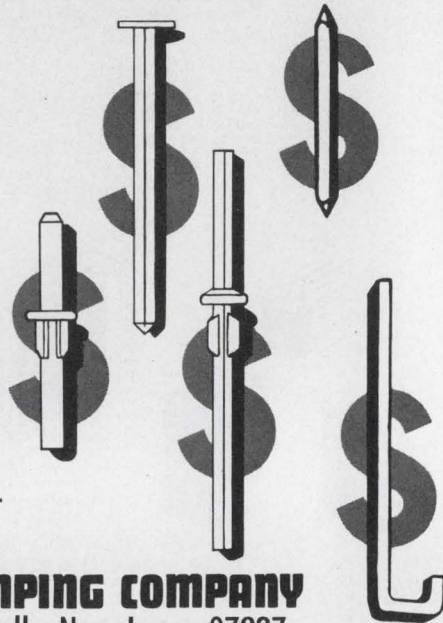

ART WIRE & STAMPING COMPANY

116 Wing Drive, Cedar Knolls, New Jersey 07927

INFORMATION RETRIEVAL NUMBER 63

\$136.¹⁻⁹ QTY 3-OUTPUT POWER SUPPLY

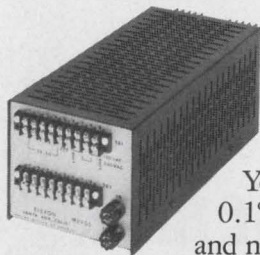

5 V, 5 A plus any two combinations from 3 V, 3 A to 28 V, 0.5 A. The Elexon MLV-55 Series gives you your choice of 256 output voltage/current combinations in a single low-cost package. You get the three voltages you need with 0.1% line and load regulation, 0.1% ripple and noise, 120/240 VAC $\pm 10\%$ input, built-in

foldback current limiting, remote sensing and electrostatically-shielded transformers standard for all outputs, with a crowbar option available. Whatever your system needs, the MLV-55 Series will save you design time, space, money and maybe some grief. For all the details, just use the bingo card or call us today: (714) 833-2950.

ELEXON POWER SYSTEMS

18651 Von Karman, Irvine, Calif. 92664

A Division of Pacific and Southwestern Industries, an Elpac Company.

INFORMATION RETRIEVAL NUMBER 64

MODULES & SUBASSEMBLIES

HV power supplies fulfill CRT needs

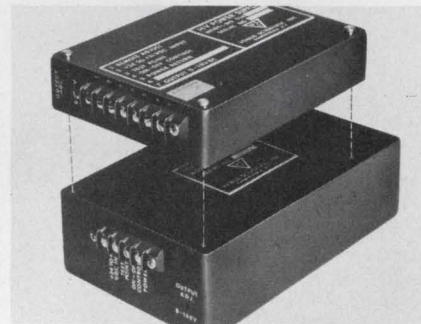

Venus Scientific, Inc., 399 Smith St., Farmingdale, N.Y. Phone: (516) 293-4100. P&A: \$620, \$280, \$310; stock to 6 wks.

A trio of new high-voltage power supplies fulfill the requirements of 95% of precision CRT display applications. The units are: the D-16 which has an adjustable anode supply of 8 to 16-kV at 1 mA; the E-10 with a 0 to 1-kV focus supply at 10 mA; and the E-30 with 0 to 3-kV focus supply at 5 mA. The supplies are tightly regulated dc-to-dc converters (0.003% for +24 to +31-V-dc inputs and 0.05% for full-load).

CIRCLE NO. 262

Low-cost a/d converters include 30 models



Graylex Industries Div. of General Microwave Corp., 155 Marine St., Farmingdale, N.Y. Phone: (516) 694-3600. Price: see text.

Series 51 a/d converters are offered in a choice of 30 models that range from a 2-digit BCD unit at \$59 to a 0.01%-accurate 12-bit binary unit at \$86. Series 51 converters feature an accuracy of $\pm 1/2$ LSB (equivalent to 0.01% of full scale in the 12-bit binary converter). Available input voltage ranges are 0.1, 1.0 and 10 V, unipolar or bipolar.

CIRCLE NO. 263

The Heavy-Duty DMM

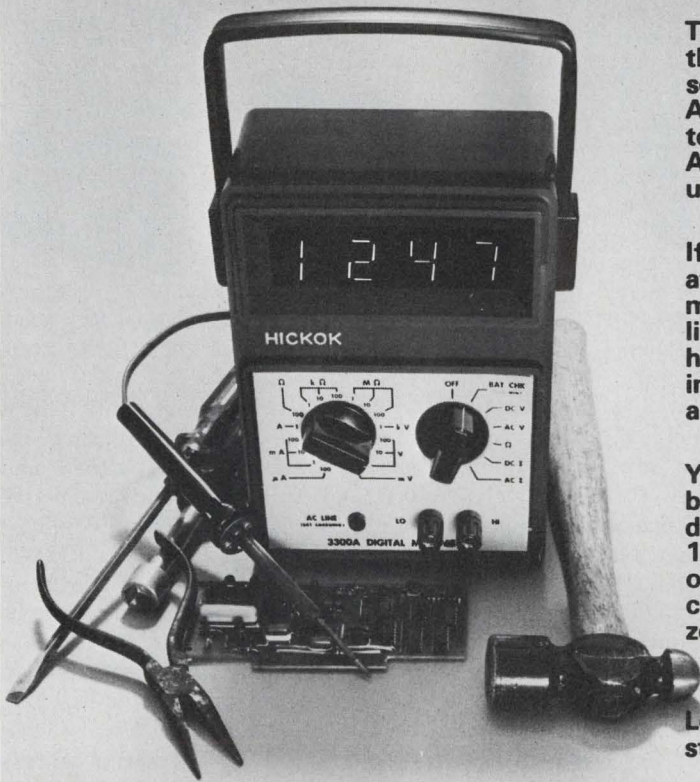

This versatility is standard; you get it all in the \$435 price. If you add options and accessories, then the 3300A goes to 30 kilovolts AC/DC. It has a clamp-on current probe good to 100 amperes, DC as well as AC. With an Adapter, the Multimeter becomes a counter up to 20 MHz.

If you want a sweet multimeter, take a look at the Hickok 3301. It has the same measurement capabilities as the portable 3300A in a line-operated bench-top configuration. And it has a sweet price—\$385. Options for the 3301 include a BCD output or an internal rechargeable battery.

You'll like the other features standard with both Hickok models: automatic polarity and decimal point position, out-of-range indication, 1500 volts off ground operation, outstanding overload protection, easy operation with color-coded front panels, and continuous automatic zeroing.

Look for yourself. Call Hickok for a demonstration or complete specifications.

Take a look at the digital multimeter you can really knock around—and still get 0.1% accuracy for a year. The Hickok 3300A in its tough Cycalac case and with its shock-mounted circuits has enough built-in versatility to take the place of a stack of instruments.

The 3300A measures:

- DC/AC voltage from 100 microvolts to 1.5 kilovolts;
- DC/AC current from 100 nanoamperes to 2 amperes;
- resistance from 100 milliohms to 200 megohms.

To add to your value, the rugged 3300A is truly portable at no extra cost. It operates continuously for 24 hours off its internal rechargeable battery—no other DMM can hold a candle to that performance. You can make measurements while recharging the battery. And the battery's good for 1000 recharges.



HICKOK

the value innovator

Instrumentation and Controls Division
10514 Dupont Avenue • Cleveland, Ohio 44108
(216) 541-8060

HICKOK



unwanted

noise or signals
effectively reduced
or eliminated
with



Rtron

Cylindrical Style Interference Filters

that reduce or eliminate unwanted noise or signals. Small size, light weight, maximum attenuation. Voltage current or insertion loss characteristics required, determine physical size. Maximum isolation of terminals and high frequency performance are assured by threaded neck design for bulkhead mounting. Feed-thru capacitor circuitry conservatively rated for both military and commercial applications.

Send us your specifications.
Ask for catalog and complete details.
Dept. ED-1

Rtron corporation
P.O. Box 743 Skokie, Illinois 60076
Phone 312 • 327-4020

INFORMATION RETRIEVAL NUMBER 67

MODULES & SUBASSEMBLIES

Low-cost FET amplifiers offer 1- μ V/C drift



Zeltex, Inc., 1000 Chalomar Rd., Concord, Calif. Phone: (415) 686-6660. P&A: \$35, \$45; stock.

Two new low-cost FET-input amplifiers, models ZA903M2 and ZA903M1, offer low drift of 1 μ V/C and 3 μ V/C, respectively, over a 0 to 60 C operating temperature range. They feature 4-MHz frequency response, 100-kHz full-power output, 25,000:1 common-mode rejection and output of ± 10 V at 7 mA. Each is packaged in a 1-in.² by 0.4-in.-high case that may be soldered directly to a PC board.

CIRCLE NO. 264

12-bit d/s converters provide 400-Hz outputs

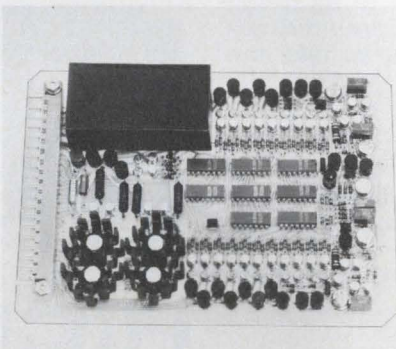

Northern Precision Laboratories, Inc., 202 Fairfield Rd., Fairfield, N.J. Phone: (201) 227-4800.

A new line of d/s converters will accept up to 12-bit binary words and translate them into three or four-wire 400-Hz synchro or resolver outputs. Depending upon the input reference voltage, the synchro equivalent can be produced to yield 11.8, 26 or 90-V outputs at 3 VA maximum. Accuracy of the new units is ± 1 bit or 5 minutes 16 seconds. Required input power is +5 V dc at 250 mA and ± 15 V dc at 200 mA.

CIRCLE NO. 265

Low-cost multipliers have high accuracies

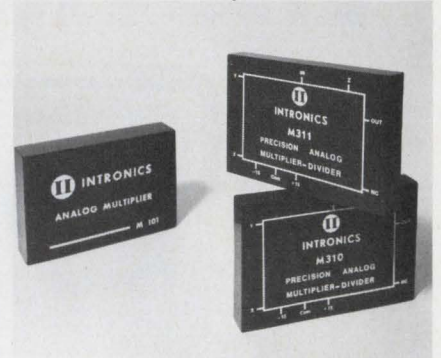

Intronics, Inc., 57 Chapel St., Newton, Mass. Phone: (617) 332-7350. Price: see text.

Two new analog multipliers, models 310 and 311, feature respective accuracies of 0.15% and 0.1% of full scale, and respective stabilities of 0.01%/C and 0.005%/C, yet cost only \$115 and \$145. They use a pulse height-width input technique to control the amplitude and duty cycle of a pulse train. The train is averaged by a multi-pole low-pass filter to give an output product voltage.

CIRCLE NO. 266

Tiny power converter delivers 5 V at 12 A

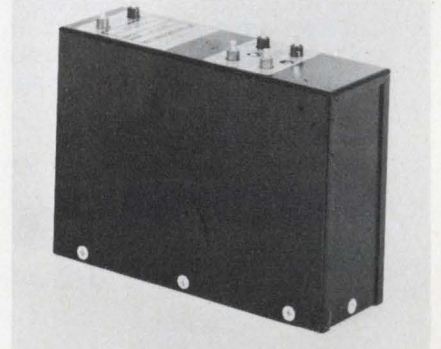

Arnold Magnetics Corp., 11520 W. Jefferson Blvd., Culver City, Calif. Phone: (213) 870-7014. P&A: \$295 (10 quantities); 1 to 3 wks.

Model PIC-5-M tiny power converter delivers 5 V dc at 12 A from 115-V rms, 50 to 500-Hz inputs. Small size of 1-5/8 by 3-5/8 by 7-in. and high efficiency with reliability are achieved using a high-frequency inverter and magnetic amplifier. Emi/rfi is contained to negligible levels by a balanced filter design. Over-voltage and current protection are also included.

CIRCLE NO. 267

VACTEC PHOTOCELLS *in the rocks*

The finest imported gin, ice and vermouth mixture can't penetrate Vactec's positive hermetic seals. Even the plastic passivated types are exceptionally stable. Other environmental extremes are just as routinely endured by Vactec Photocells. Capable of storage from -55°C to 85°C . Continuing to operate at liquid nitrogen cold (-196°C), and up to boiling water (100°C).

You simply can't buy a better photocell *anywhere*, and Vactec is competitive with import prices because of automated processing, assembling, and testing. Take advantage of Vactec engineering, research, and manufacturing in the heart of America. Because Vactec has 249 different types of cells in stock, we can ship before your order reaches an overseas supplier. Included is a complete line of visible detectors: photoconductors (CdS and CdSe); photovoltaic cells (Se and Si); couplers of LED's or lamps and photoconductors called Vactrols. Vactec also has a photometer which measures from .0002 to 10,000 fc, for as little as \$300.00.

You needn't compromise. Vactec has it all. Quality, economy, and service.

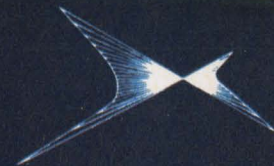

VACTEC, INC.

2423 Northline Industrial Blvd.
Maryland Heights, Mo. 63043
Phone (314) 872-8300

THE P741 SERIES

SCI's Newest, Smallest Power Supply Building Blocks

**DUAL REGULATED PLUG-IN POWER SUPPLIES
FOR IC OP AMP APPLICATIONS**

for as low as \$25 (1 to 9)

30mA: ±12, ±15, ±18,
and ±22 VDC

50mA: ±18 and ±22 VDC

60mA: ±12 and ±15 VDC

100mA: ±12 and ±15 VDC

500mA: 5 VDC

REGULATION: 0.02%, line & load
RIPPLE & NOISE: 1 mV RMS
NO DERATING
SHORT CIRCUIT PROTECTED



DIMENSIONS: 2.25" x 2.50" x 1.25"

SEMICONDUCTOR CIRCUITS, INC.
306 RIVER STREET ■ HAVERHILL, MASSACHUSETTS 01830
(617) 373-9104
INFORMATION RETRIEVAL NUMBER 69

MURA/HIOKI PANEL METERS

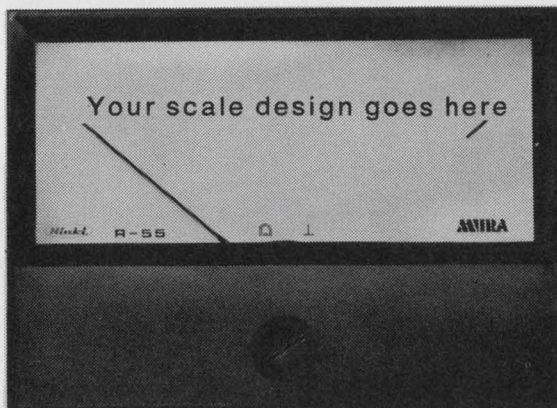

TOP QUALITY AND FULLY GUARANTEED

Made by Hioki, Japan's leading manufacturer of quality panel meters, these fine instruments can be used wherever precision measurement is an absolute requirement. They come in various sizes from 2" x 2½" to 6" x 4½" with either d'Arsonval or taut-band movements. Resistances and scale designs can be tailored to your special needs. Distributed in the United States only by Mura Corp., they are attractively priced and fully guaranteed. Sold only in O.E.M. quantities of 300 and up.

Write for detailed information on your letterhead.

MURA 50 SOUTH SERVICE ROAD, JERICHO, N.Y. 11753
Telephone: (516) 334-2700 Telex: 967-879

Mura is the world's largest supplier of miniature panel meters.

INFORMATION RETRIEVAL NUMBER 70

MODULES & SUBASSEMBLIES

Phone-line system dials numbers automatically

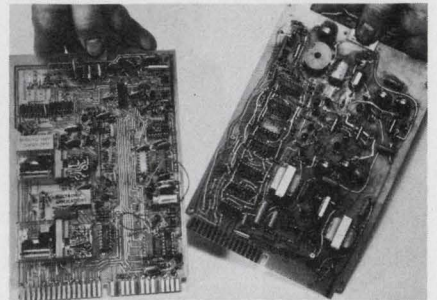

G-V Controls Div. of Sola Basic Industries, 101 Okner Pkwy., Livingston, N.J. Phone: (201) 992-6200. P&A: \$1000; 8 to 10 wks.

A new automatic telephone line-connect system offers automatic dialing of any regular directory number upon command. Designated ATLC907002 for pulse and ATLC907006 for tone, it consists of both central and remote units. The remote unit detects ringing, provides off-hook supervision, passes hand-shake tones back to the central control unit and transfers the line to the customer's equipment after verification.

CIRCLE NO. 268

Bipolar power regulator has precision reference

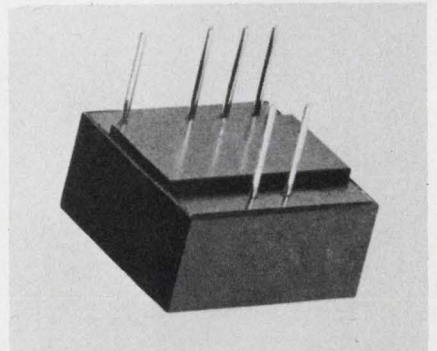

Optical Electronics, Inc., Box 11140, Tucson, Ariz. Phone: (602) 624-8358. P&A: \$160; stock.

Model 8900 bipolar power regulator provides +5 and +10 V at up to 100 mA, plus a bipolar reference adjustable from 0 to ±10 V for analog system references. The 8900 is packaged in a 9-pin standard module. It features a ±0.1% maximum 10-V reference error, a dc to 3-kHz reference bandwidth and operates from ±13 to ±20-V supplies.

CIRCLE NO. 269

We took everything they could throw at us

and came back for more.



MAGNETIC SHIELD DIV.
**CO-NETIC
NETIC**
PERFECTION MICA CO.

We've written enough of the "book" on shielding to know there's no substitute for experience when solving tough EMI problems. That's why it took us practically twenty years to build our comprehensive line of shielding products... one solution at a time.

Perfection Mica offers bulk shielding materials for high or low density fields that are stress annealed for ease in punching, forming, spinning or drawing. These same quality materials are used in our line of portable or cabinet style mag-

netic tape preservers that prevent the degradation of vital taped information.

On the specialty side, there's our multi-cellular magnetic shield that permits sensitive instruments to operate in extreme magnetic field environments, or unique inter-8 weave cable for applications where either radiation or magnetic interference is a problem. We can furnish rooms that have lower spectrum magnetic shielding capability.

The tougher the shielding problem, the better we like it. Throw it at Perfection Mica.



PERFECTION MICA COMPANY / Magnetic Shield Division

740 Thomas Drive □ Bensenville, Illinois 60106 □ (312) 766-7800 □ TWX (910) 341-7277

Hermetic DIP packages increase reliability

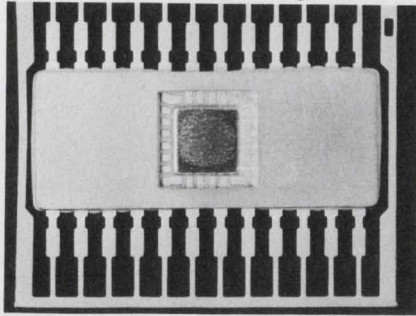

Glasseal Products, Inc., 725 Commerce Rd., Linden, N.J. Phone: (201) 486-2067.

The 1100 series of hermetic dual-in-line packages features a ceramic combination of glass and nickel-iron-cobalt alloy resulting in higher reliability at greater economy. All packages are plated with 50 μ -in. of gold per MIL-G-45204B. Packages available employ 14 through 40 leads in both metal and glass back designs. For hybrid applications, 14 and 16-lead versions are offered.

CIRCLE NO. 270

PC-board cards come with single/double sides

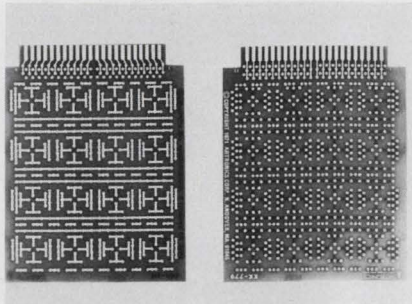

Atronics Corp., 530 Turnpike St., N. Andover, Mass. Phone: (617) 685-4336. P&A: \$6.25, \$8; stock.

Two new kluge cards are available as single or double-sided PC boards. Each board has specific transistor locations, a power and ground bus and convenient pad locations for a total of 779 0.35-in.-dia holes. The single-sided KK-779S accommodates 16 TO-5/TO-18 transistors and associated circuitry. It also accepts solderless wrap terminals. Double-sided KK-779D has 44 contact fingers, 22 on each side.

CIRCLE NO. 271

New insulating method improves on terminals

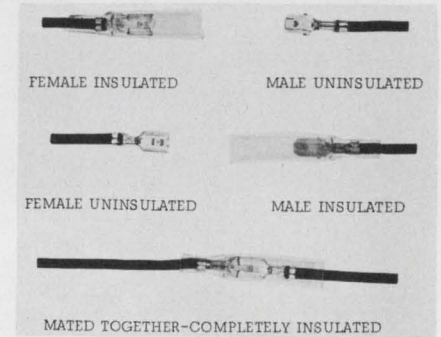

Varied Industrial Products, Inc., 445 5th Ave., Paterson, N.J. Phone: (201) 279-2334.

The Gromeeck technique, perfected at Varied Industrial Products, introduces a simplified, more reliable visual method of mating and insulating male-female terminal junctions. Compared to cold crimp, molded boots and rigid molded pods, the new technique offers smaller, more economical, reliable and flexible positive-positioning for mating terminals requiring insulation.

CIRCLE NO. 272

NOW! FLAT TOGGLES

New style flat toggles are now available on any of our standard line of miniature toggle switches. If you have other ideas, let us know. Possibly we can personalize a toggle just for you.



ALCOSWITCH®

DIV. OF ALCO ELECTRONIC PRODUCTS, INC., LAWRENCE, MASS.

INFORMATION RETRIEVAL NUMBER 72

TOGGLE SWITCH MINIATURES

Higher ratings, longer life 250,000 operations. Metal construction, high impact insulation allows use under wide range of environmental conditions. U/L approved. SPDT, DPDT, 1/4" or 1/32" bushings.

10A @ 125 VAC



ALCOSWITCH®

CYLINDRICAL CASE

DIV. OF ALCO ELECTRONIC PRODUCTS, INC., LAWRENCE, MASS.

INFORMATION RETRIEVAL NUMBER 73

.000000"

(The surface finish variation in the new Meller Sapphire Substrates)

The new Meller high quality sapphire substrates with the superior surface finish are ideal for silicon-on-sapphire deposition and hybrid microcircuitry.

- Scratch-free finish (up to 70X magnification) obtained by using a special surface polishing method that removes work damage
- High and uniform resistivity
- Excellent reliability on a piece-to-piece basis
- X-ray oriented or random
- In-stock in a wide variety of sizes

For full information, contact Adolf Meller Co., P.O. Box 6001, Providence, Rhode Island 02904. Telephone: 401-331-3717.



INFORMATION RETRIEVAL NUMBER 74

ELECTRONIC DESIGN 1, January 6, 1972

For built-in reliability, design with "Scotchflex" Flat Cable/Connector Systems.

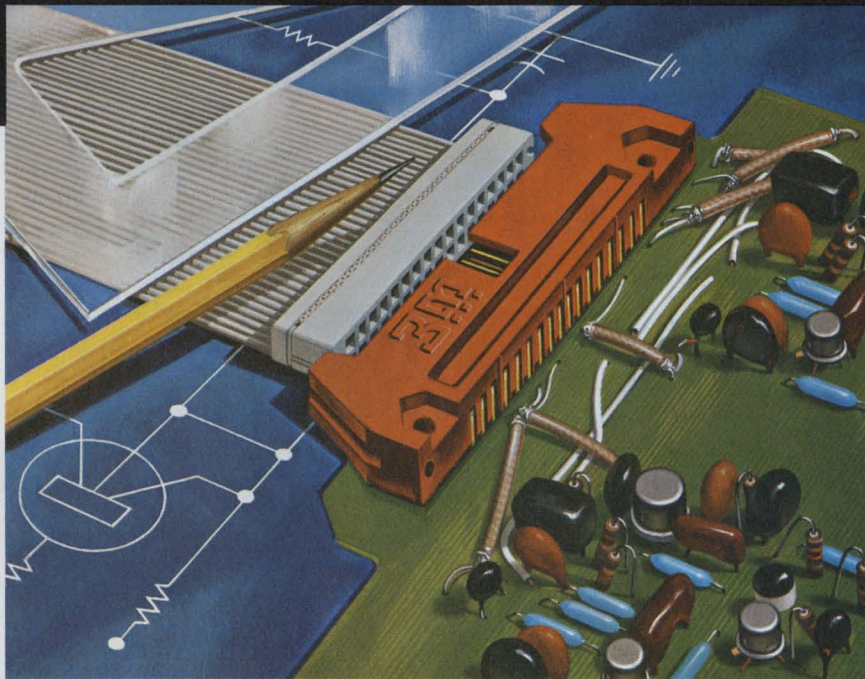

"SCOTCHFLEX" IS A REGISTERED TRADEMARK OF 3M CO.

"Scotchflex" Flat Cable and Connectors can offer you trouble-free packaging for your next generation equipment.

There's built-in reliability for your circuit inter-connects. Our flat, flexible PVC Cable has up to 50 precisely spaced conductors. The gold plated U-contacts are set into a plastic body to provide positive alignment. They strip through the insulation, capture the conductor, and provide a gas-tight pressure connection.

Assembly cost reductions are built-in, too. "Scotchflex" Connectors make up to 50 simultaneous connections without stripping or soldering. No special training or

costly assembly equipment is needed.

Off-the-shelf stock offers you flat cable in a choice of lengths and number of conductors from 14 to 50. Connector models interface with standard DIP sockets, wrap posts on .100 x .100 in. grid, or printed circuit boards. Headers are available to provide a de-pluggable inter-connection between cable jumpers and printed circuit boards (as shown). Custom assemblies are also available on request.

For full information on the "Scotchflex" systems approach to circuitry, write to Dept. EAH-1, 3M Center, St. Paul, Minn. 55101.

3M
COMPANY

All 10,000 gain indicators are not alike... INSIDE OR OUT

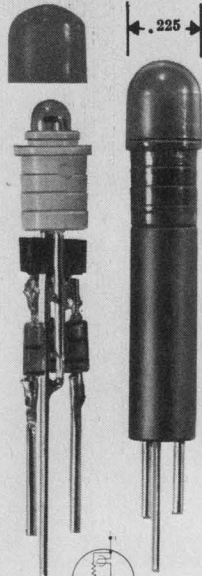

TE201E
TRANS-EYE

Inside a Shelly TRANS-EYE, you can pick one of 16 transistor/diode/resistor combinations and turn on 0.008A to 0.115A indicators with logic levels low as 250 μ A. Here is more inside data.

TE201 & TE202 — Transistor driven lamp — requires ext. base current limiting resistor.

TE201A & TE202A — Internal base current limiting resistor. Requires 1.6mA max. base drive. Any value resistor can be specified.

TE201B & TE202B — Internal pull up resistor. Requires a -1.6mA sink. Use with external open collector transistor.

TE201C & TE202C — Internal pull up and limiting resistors. Use with circuitry that both sinks and sources current or circuitry that cannot supply adequate "on" current.

TE201D & TE202D — Internal diode in series with base. Increases noise immunity and defines turn-on threshold voltage.

TE201E — Compatible with most TTL, DTL and current sinking logic families.

TE202E — Compatible with positive inverted logic.

TE201F & TE202F — General purpose with provision for biasing external circuitry.

TE201G & TE202G — Same as TE201E except with lower logic "1" threshold -1.3V min.

Bases are either black or white and there are 70 lens cap colors and styles to fit your exact need.

For the complete story, inside-out, contact your local rep. or the factory.



SHELLY ASSOCIATES, INC.

A Datatron Company
1562 Reynolds Ave., Santa Ana, Calif. 92711
Phone: (714) 557-3942, TWX: 910-595-1589

INFORMATION RETRIEVAL NUMBER 76



Sapphire substrates. More for less.

Polished, single crystal sapphire substrates cut from sapphire ribbon stock. Standard lengths from 1/4 to 4 inches. Standard widths in 1/4, 1/2, 3/4 and 1 inch sizes. For thin film and epitaxial requirements. Available with 1102 orientation for SOS work. Free of microvoids. Low in cost. Check 'em out. Call Frank Reed, Marketing Manager, for price and delivery.

LYCO saphikon division 16 Hickory Drive • Waltham, Mass. 02154 • (617) 890-2400

INFORMATION RETRIEVAL NUMBER 77

40-pin SHP connector is fully repairable

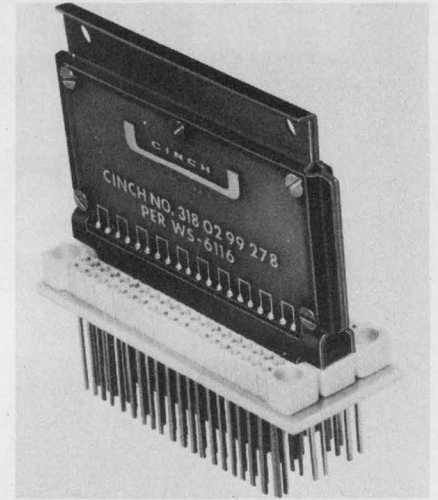

TRW Cinch Div., 1501 Morse Ave., Elk Grove Village, Ill. Phone: (312) 921-6151.

A miniature 40-pin SHP module connector assembly can be quickly and easily disassembled and reassembled for wave-solder installation of PC boards for field service and retrofit. The device features a unitized metal frame with integral extractor fin pin shields and guide ribs for bin installation.

CIRCLE NO. 273

Printed-circuit boards simplify prototyping

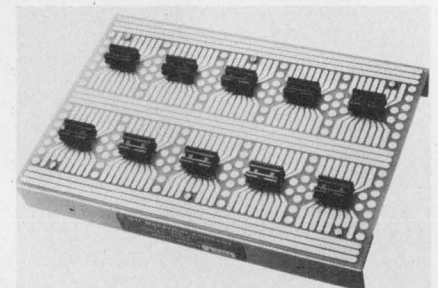

Martron Co., Box 777, Dallas, Tex. Phone: (214) 691-2500. Price: \$9.95/board (without sockets).

A new line of electrical-circuit prototyping boards are specifically designed for transistor and IC applications. Patterns are available for 4-lead transistors (model 131), 16-lead DIPs (model 141), 8-lead TO-5 ICs (model 151) and 10-lead TO-5 ICs (model 152). They are also available in dot patterns for prototype discrete components (model 121, 122).

CIRCLE NO. 274

These new IC op amps have the lowest drift yet!

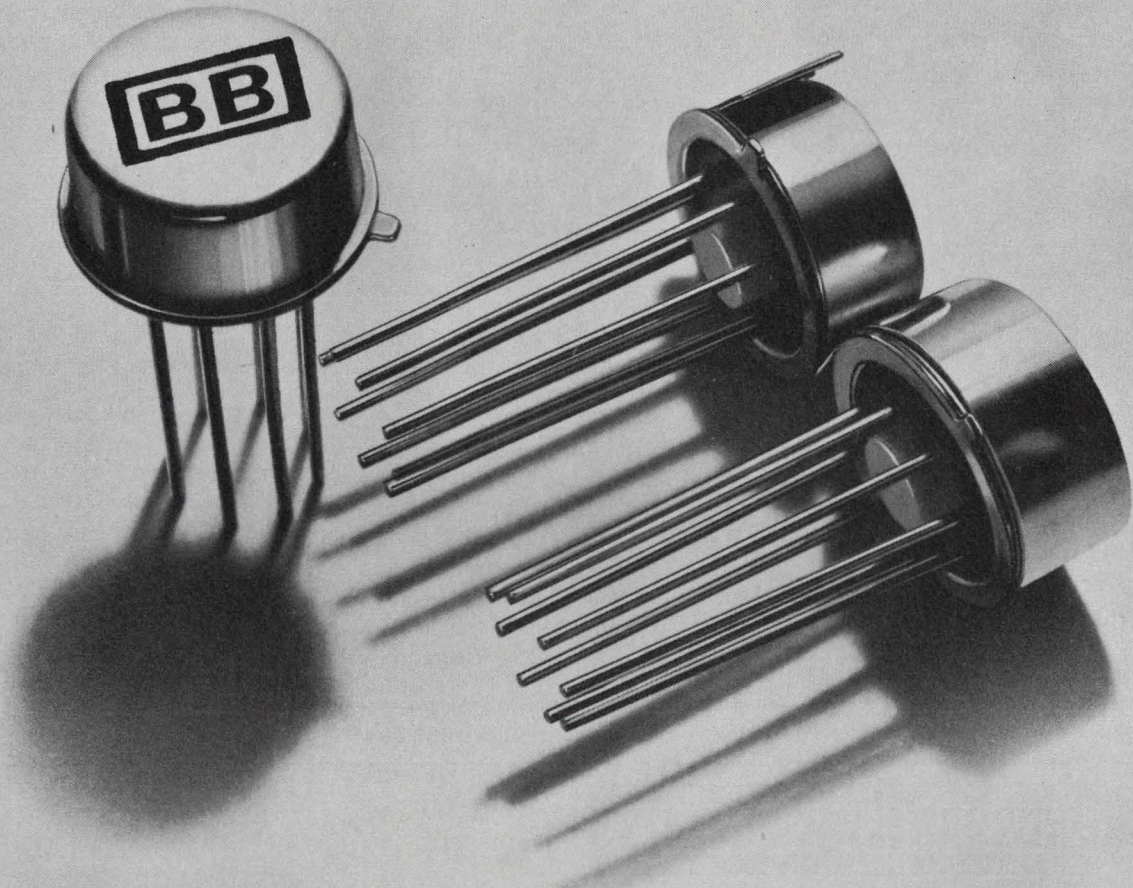

1 μ V/ $^{\circ}$ C, in solo or duet!

Now you have a monolithic op amp that has a maximum voltage drift of just 1 μ V/ $^{\circ}$ C **with no external compensation**. What's more, this performance is also available in drift-matched pairs, computer-matched to obtain 1 μ V/ $^{\circ}$ C tracking.

As good as it is, low voltage drift isn't the only outstanding feature of these Burr-Brown units. Offset voltage is just 500 μ V, maximum (200 μ V for matched pair), without external trimming. In addition, they have extremely low noise, low bias current over temperature and common mode voltage ranges, high input impedance, and are internally current limited to provide short circuit protection.

Designed for low input current while maintaining a respectable slew rate (1.0V/ μ sec) and bandwidth (1.5MHz), the 3500E (single) and 3500MP (matched pair) are ideal for a wide variety of applications. Burr-Brown quality is assured

since all units are 100% tested to all min/max specifications including voltage and current drift vs. temperature.

HIGHLIGHT SPECIFICATIONS

	3500E	3500MP (matched pair)
Voltage Drift	1.0 μ V/ $^{\circ}$ C, max.	1.0 μ V/ $^{\circ}$ C, max. (Tracking) 5.0 μ V/ $^{\circ}$ C, max. (Each unit)
Input Offset Voltage	\pm 500 μ V, max.	\pm 200 μ V, max. (Match)
Open Loop Gain	100dB, min.	100dB, min.
Input Bias Current	\pm 50nA, max.	\pm 50nA, max.
Slew Rate	1.0V/ μ sec, min.	1.0V/ μ sec, min.
Price, 1-24	\$30.00 each	\$25.00 per pair

For complete technical information and applications suggestions, use this publication's reader service card or contact your Burr-Brown Representative.

NEW BURR-BROWN BOOK

"Operational Amplifiers — Design and Applications", over 470 pages, 300 illustrations. Written by Burr-Brown application-engineering staff, published by McGraw-Hill. U.S. price, 15.00 dollars. Order from Burr-Brown.



BURR-BROWN
RESEARCH CORPORATION
International Airport Industrial Park • Tucson, Arizona 85706
TEL: 602-294-1431 • TWX: 910-952-1111 • CABLE: BBRCORP

Hermetic circuit modules cut device parasitics

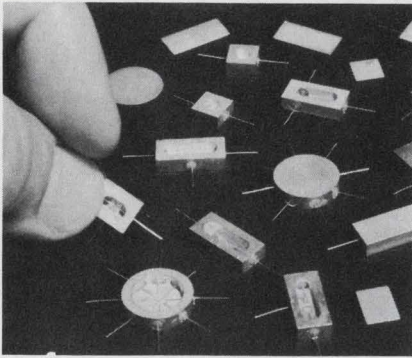

Tek-wave, Inc., Box 994, Somerville, N.J. Phone: (201) 526-1150. P&A: \$2 to \$2.50 (5000 quantities); 2 to 6 wks.

A line of miniature hermetic circuit modules is available for integrating semiconductor devices into stripline, microstrip and/or coax circuits. Tekmodule circuit modules are hermetically sealable, permitting placement of unpackaged semiconductor devices inside, thus reducing or eliminating package parasitics and enhancing performance.

CIRCLE NO. 275

Card-edge connector mates 0.025-in. posts

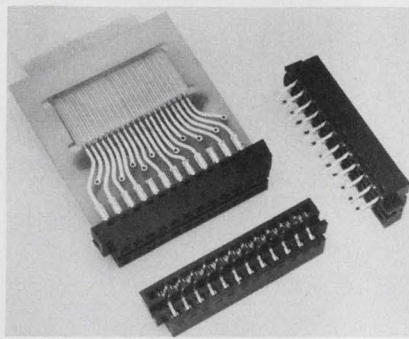

Berg Electronics, Inc., Route 83, New Cumberland, Pa. Phone: (717) 938-6711.

A new card-edge connector has two rows of 12 contacts spaced on 0.125-in. centers. Row-to-row contact spacing is 0.25 in. The contacts will accept 0.025-in. square Wire-Wrapping posts or 0.028-in. round pins. The connector has a keyed housing which mates to IBM 360/370 computer backpanels.

CIRCLE NO. 276

A FREE new Hayden Service for you—see card inside front cover.

Flat cable comes with mixed conductor sizes

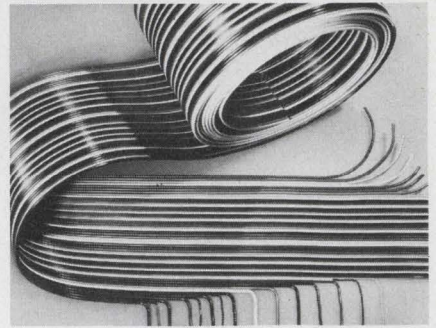

Bi-Tronics, Inc., 76 Main St., Tuckahoe, N.Y. Phone: (914) 961-4700.

A new flat, bonded, round conductor ribbon cable can be supplied with mixed conductor sizes ranging from 14 to 30 AWG in any mix required and with as many separate conductors as necessary. This new cable also provides a constant, repeatable and predictable impedance over a given length. Color coding is visible for the entire cable run, thus facilitating tracing and trouble-shooting procedures.

CIRCLE NO. 277



SCIENCE · OPTICS · ELECTRONICS
ONOSUAL & HARD TO FIND BARGAINS
NEW PRODUCTS · NEW MATERIALS · NEW METHODS

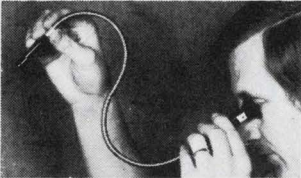

FLEXIBLE IMAGE TRANSMITTER
Hi-resolution image-transmitter lets you see into remote, inaccessible illuminated areas; through pipes, tubes or any 3/8" + opening no matter how intricate. Provides clear, wide sighting 7X magnifying eyepiece focuses from less than 1/2" from subject to infinity. Ideal for monitoring hazardous processes, surveillance instrument, demonstrate fiber optics. Over 4,000 coherent glass fibers (.002"), 3/8" dia. semi-rigid gooseneck sheathing.
Stock No. 60,857DA\$40.00 Ppd.

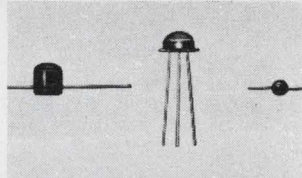

NEW LIGHT EMITTING DIODE KIT
Bargain kit ideal for economical experimenting with amazing L.E.D.s, the tiny solid state monochromatic lamps that use low voltage DC, last up to 1MM hrs. Used in card-tape readers, character recognition, hi-speed detectors, all kinds of electro-optical applications. Kit incl. 3 L.E.D.s: gallium arsenide (MLED 600, MV 50, MLED 930); 2 visible red emitting (6600 A°); 1 infra-red emitting (8000 A°); 6 resistors; 1 20mm plastic fibre optic light pipe; instrs.
Stock No. 41,597DA\$5.95 Ppd.

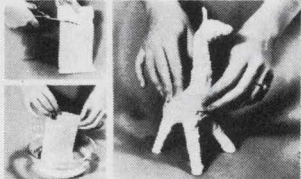

PARISCRAFT® HELPS YOU CREATE!
Combining high-strength fabric and plaster of Paris, Pariscraft's ideal for creating models, prototypes, molds, sculpture with amazing simplicity and speed. Scissors and water are all you need. Then just cut, wet, model, let dry (no oven, baking or firing!) and paint. Great for ornaments, textured paintings, sculptured casts, scenery. 20 lb. package includes 50-60 3-1/2" rolls, from 3 to 6" wide. Instructions.
Stock No. 71,553DA\$15.95 Ppd.
5 ROLLS (3" wide)\$3.50 Ppd.
No. 71,553DA\$3.50 Ppd.



GIANT FREE CATALOG
Completely new 1972 edition — 148 pages. Bargains galore! New categories, items, illustrations, 1,000's of buys for industry—Optics, Ecological and Physical Sciences, Electronics, On-the-Job helps, quality control aids, Optics for research labs, design engineers, experimenters. Instruments for checking, measuring; improve quality, cut costs. Hard-to-get surplus bargains. Write for catalog "DA".

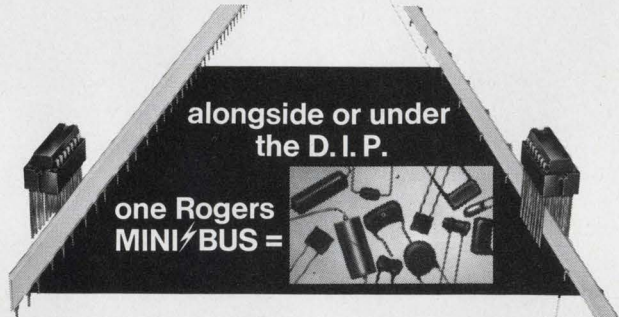

alongside or under the D.I.P.
one Rogers MINI/BUS =

The evidence is accumulating. You may eliminate all discrete bypass capacitors — and get a lower-noise printed circuit board at frequencies where it counts — with a single Rogers Mini/Bus.

DELIVERY: Standard configurations are available on short notice.
Telephone EAST: (203) 774-9605; WEST: (602) 963-4584 to know where we stand today on your requirements. Ask for our Mini/Bus brochure, showing standard parts.

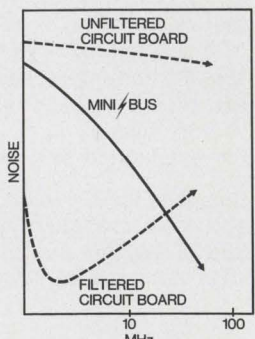

R
Rogers Corporation Rogers, Conn. 06263 (203) 774-9605

EDMUND SCIENTIFIC CO. 300 EDSCORP BLDG. BARRINGTON, NEW JERSEY 08007
ORDER BY STOCK NUMBER · OPEN ACCOUNT TO RATED FIRMS · MONEY-BACK GUARANTEE

If you've been looking for a miniature crystal-controlled clock oscillator in a 14 pin DIP package to fit standard PC board sockets, stop looking and start writing for the K1091A spec. sheet from Motorola Component Products Dept. 4545 W. Augusta Blvd. Chicago, Ill. 60651.  *MOTOROLA*

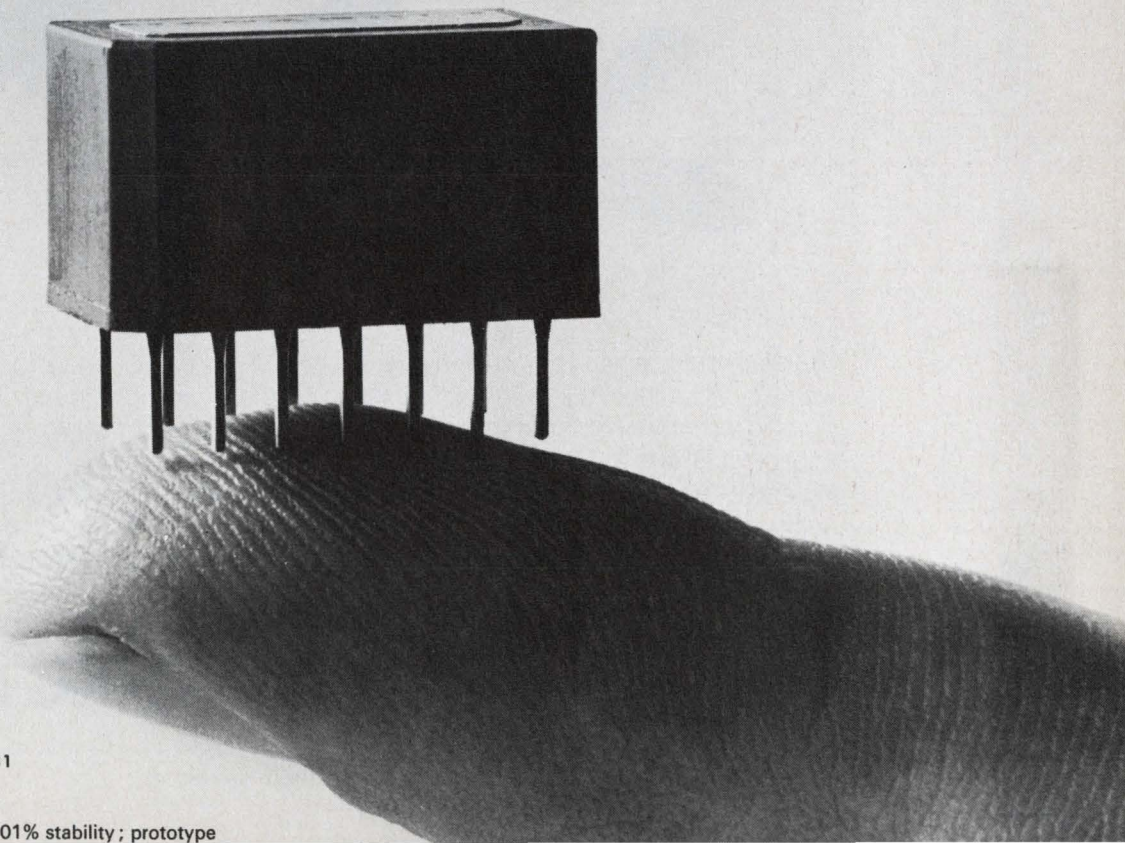

INFORMATION RETRIEVAL NUMBER 81

Specifications: 4 to 20 MHz range; 0.01% stability; prototype

Connector Problem? Call Our Fly Guy.

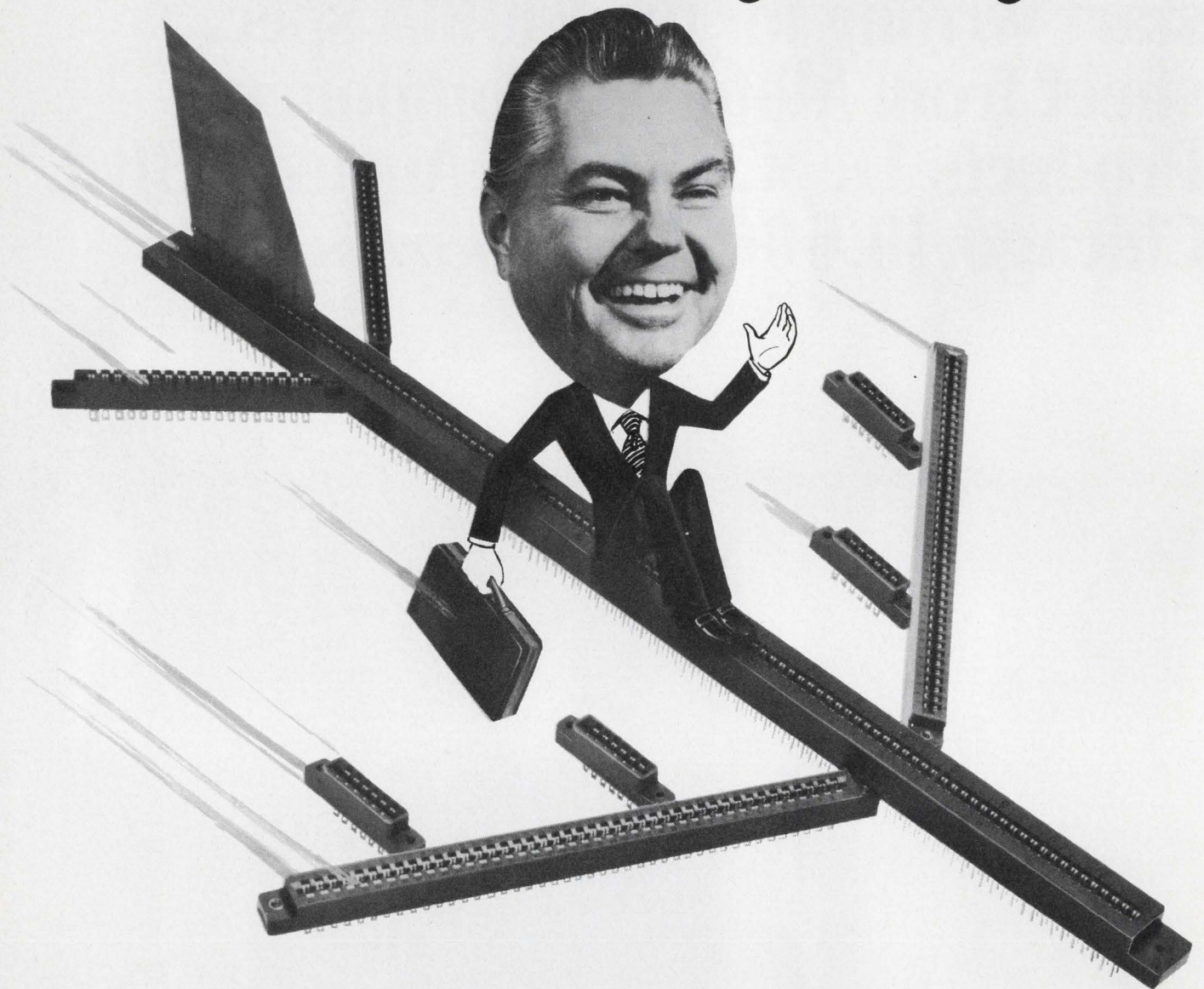

Guy Palmquist. When you need any special help or advice on connectors, get in touch with Guy. He's flown hundreds of thousands of miles working with people just like you to solve their connector problems. At a real competitive price. In back of Guy is a Continental team of design, manufacturing and molding specialists who can give you exactly the connector you require. So next time a connector bugs you — call our Mr. Palmquist. He's your kind of guy.



See EEM and VSMF Directories for Distributor or Sales Representative Nearest You.

CONTINENTAL CONNECTORS

Continental Connector Corporation / Woodside, New York 11377 / 212-899-4422

INFORMATION RETRIEVAL NUMBER 82

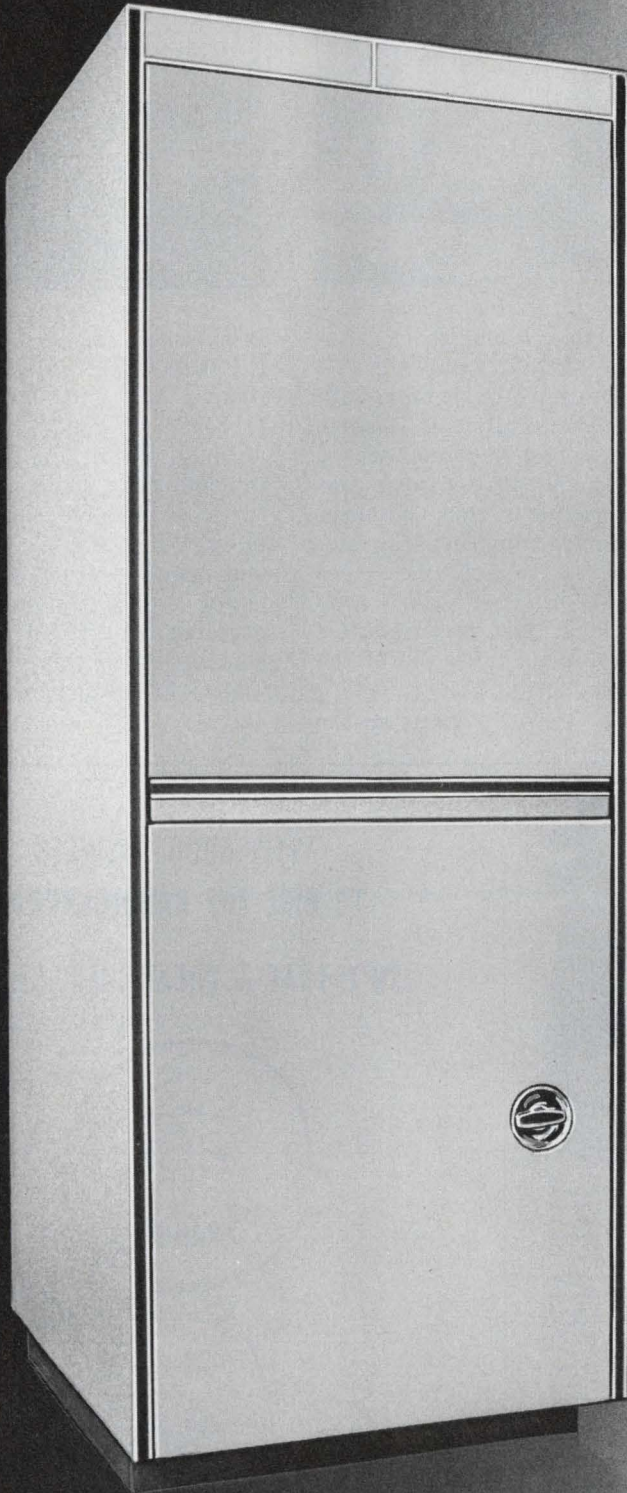

*To a world filled
with Compromise,
We make no
Contribution!*

MODU-MOUNT[®]
CABINETS
from
Honeywell

HONEYWELL INC.
200 BOND STREET • WABASH, INDIANA 46992

Tape heads eliminate need for flux gates

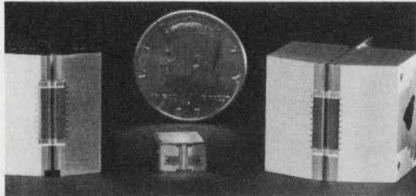

Ampex Corp., 13031 W. Jefferson, Marina del Rey, Calif. Phone: (213) 821-8933. P&A: \$500 (open reel), \$50 (cassette); 60 days.

In heads for open reel drives, high data-transfer rates at speeds ranging from 45 to 200 in./s are possible without flux gates. Other 1/2-in. heads using flux gates are available in the 5 to 45 in./s range. Ampex heads have 5% crossfeed through read amplifiers. The heads for cassette drives allow only 5% crossfeed at 6 in./s and record in phase-encoded formats at 3 to 12 in./s.

CIRCLE NO. 278

Announcing REQUESTED DATA DELIVERY, it's free—see card inside front cover.

Hard-copy machine multiplexes 4 terminals



Tektronix Inc., P.O. Box 500, Beaverton, Ore. Phone: (503) 644-0161. P&A: \$3550; Jan. 1972.

The 4610 hard-copy unit with multiplexing circuitry is capable of producing copies from one to four Tektronix 4010-1 computer-display terminals, thus reducing the initial hard copy costs for multi-terminal uses to 6 to 8 cents per 8-1/2 by 11-in. copy. Hard copy is available in just seconds after manual or remote initiation of the copy command.

CIRCLE NO. 279

Bipolar 8-k bit RAM achieves 100-ns speeds

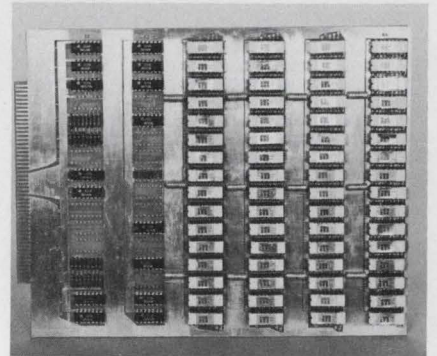

Integrated Memories, Inc., 260 Fordham Rd., Wilmington, Mass. Phone: (617) 658-5073. Price: 18 to 20¢/bit.

Series 2000I bipolar read/write random-access memory system features expandable capacity of 512 to 8k words of 8 to 36-bit lengths, and operates from a single +5 V power supply. Single-rail TTL addressing is provided. The new random-access memory system is TTL/DTL compatible.

CIRCLE NO. 280

BUCKEYE

Buckeye Instrument Knobs are made in matching series to give your instruments quality and continuity in design. Available in six basic sizes and six styles with colors and variations to match specifications. The ideas, cooperation and reliable service of our knob craftsmen to supplement the quality of fine knobs demanded by leading instrument manufacturers — is at your "beck and call." Write today for free selector guide and tell us of your knob requirements.

the BUCKEYE stamping co.

555 Marion Rd., Columbus, Ohio 43207

"QUALITY PRODUCTS SINCE 1902"

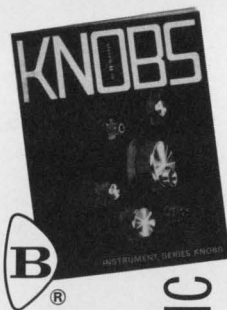

KNOBS

INFORMATION RETRIEVAL NUMBER 84

"IT'S GOOD BUSINESS TO HIRE THE HANDICAPPED."

ISN'T THAT A GREAT IDEA, SNOOPY?



THE PRESIDENT'S COMMITTEE ON EMPLOYMENT OF THE HANDICAPPED, WASHINGTON, D. C.

"I MUST HAVE DRAWN THIS THING 100 TIMES!"

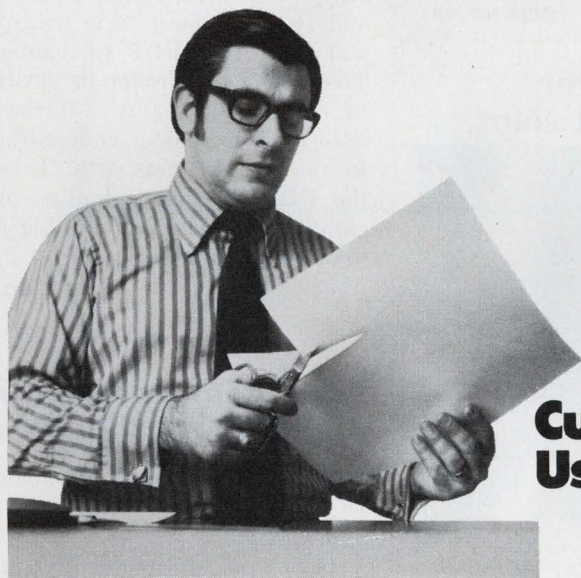

**Cut the detail.
Use KODAGRAPH Films.**

Drawing the same detail over and over is more than tedious—it's a waste of valuable time and money. A far better way is to let Kodagraph film get the job done for you.

That way you draw the detail just once. Make as many photoreproductions as you need. Cut them out, paste them down, then make a Kodagraph film print of the paste-up. And there you have it, a second original for subsequent printmaking.

For a complete rundown on the many shortcuts made possible by using Kodagraph films and papers, just fill out the coupon and send it our way.

Please send me complete details on Kodagraph films and papers and how they can save valuable drafting time.

Name _____

Position _____

Company _____

Address _____

City _____ State _____ Zip _____

Eastman Kodak Company
Business Systems Markets Division
Dept. DP 000, Rochester, N.Y. 14650

ENGINEERING DATA SYSTEMS



LED 3 DIGIT LED

PANEL VOLT METER



- L•E•D DISPLAY
- HI SPEED OPERATION — 100 CONVERSIONS/SEC.
- DIGITAL SAMPLING A/D CONVERTER
- BUFFERED BCD OUTPUT — STANDARD
- COMPLETE SYSTEM CONTROL PROVISIONS

New! 3 Digit Panel Volt Meter for high speed use with computer controlled systems. Digital sampling technique provides high reliability and improved performance specs in both accuracy and stability; .05% accuracy at room temperature, .1% from 0° C to 50° C operating ambient.

Rugged all aluminum case, polarized lens and L•E•D display... a premium instrument at a moderate price . . . \$180

Design compatibility with all ERC Digital instruments—Counter—Clock—Stop Watch—Calendar Clock—Preset—Remote Display—Comparator—Frequency Meter.

call or write Bob Rush
for technical data
Phone 913, 631-6700



electronic research co.

Box 913 • Shawnee Mission, Kansas 66202

DATA PROCESSING

Video terminal transmits 4800 baud



Centronics Data Computer Corp., 1 Wall St., Hudson, N.H. Phone: (603) 883-6505. Price: \$1495.

The model 401 video terminal displays 4 lines of 0.12 by 0.18-in. characters with 33 characters per line for a total display of 132 characters. The data transfer rate is up to 4800 baud serial, 75,000 characters per second parallel. The USASCII input can contain 63 characters. The terminal operates from 115 V ac, 50/60 Hz and uses 4 A.

CIRCLE NO. 281

Pocket calculator uses LEDs, LSI chips

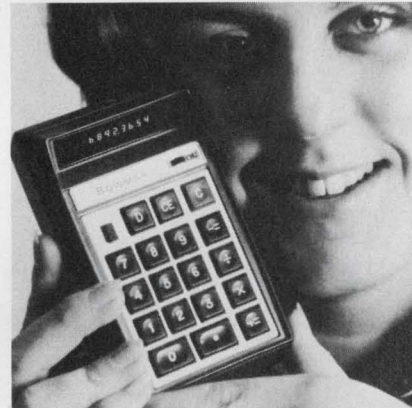

Bowmar/Ali Inc., 531 Main St., Acton, Mass. Phone: (617) 263-7711.

A minicalculator made entirely in the U.S. is a small 3 by 5 by 1-in. device that will perform addition, subtraction, multiplication and division, including chain or mixed multiplication and division using a stored constant. The instrument has 8 digits for entry and readout with full-floating decimal point and + or - sign capability. A self-contained rechargeable Ni-Cd battery powers the unit.

CIRCLE NO. 282

PDP-11 and Nova 1200 get add-on memories

Plessey Memories, Inc., Santa Ana, Calif. Phone: (714) 540-9945.

The PM-1100 is a replacement for the MM11-E or MM11-F memories for the DEC PDP-11. It offers four times the packaging density and 2-1/2 times the storage capacity of each DEC memory. Four 8 k by 16 modules may be combined with a resulting cycle time of 1.2 μ s. The PM-1200 replacement for the Nova 1200 memory 8103 features up to 128 k by 16 capacity with 950-ns cycle time.

CIRCLE NO. 283

Tape-deck controller interfaces to PDP-8E

Digitronics Corp., Albertson, N. Y. Phone: (516) 484-1000. P&A: \$2500; 30 days.

A new magnetic tape-deck controller offers plug-to-plug compatibility with Digitronics 1610, 1620 and 1630 magnetic tape transports and the DEC PDP-8E computer. The 1608E controller is designed to operate up to two formatters with each formatter controlling up to four tape transports. It gives the PDP-8E the capability of an eight-station IBM-compatible magnetic tape system.

CIRCLE NO. 284

Core memory expansion doubles 360/22 capacity

Data Recall Corp., 142 Oregon St., El Segundo, Calif. Phone: (213) 322-9024.

The first independently manufactured core memory expansion unit for IBM 360/22 computers represents a 100% greater capacity, to 64 kbytes, than offered by IBM. Data Recall previously expanded IBM 360/30 and 360/40 computer models to capacities of 128 kbytes and 384 bytes, respectively.

CIRCLE NO. 285

REQUESTED DATA DELIVERY SERVICE is here—see card inside front cover.

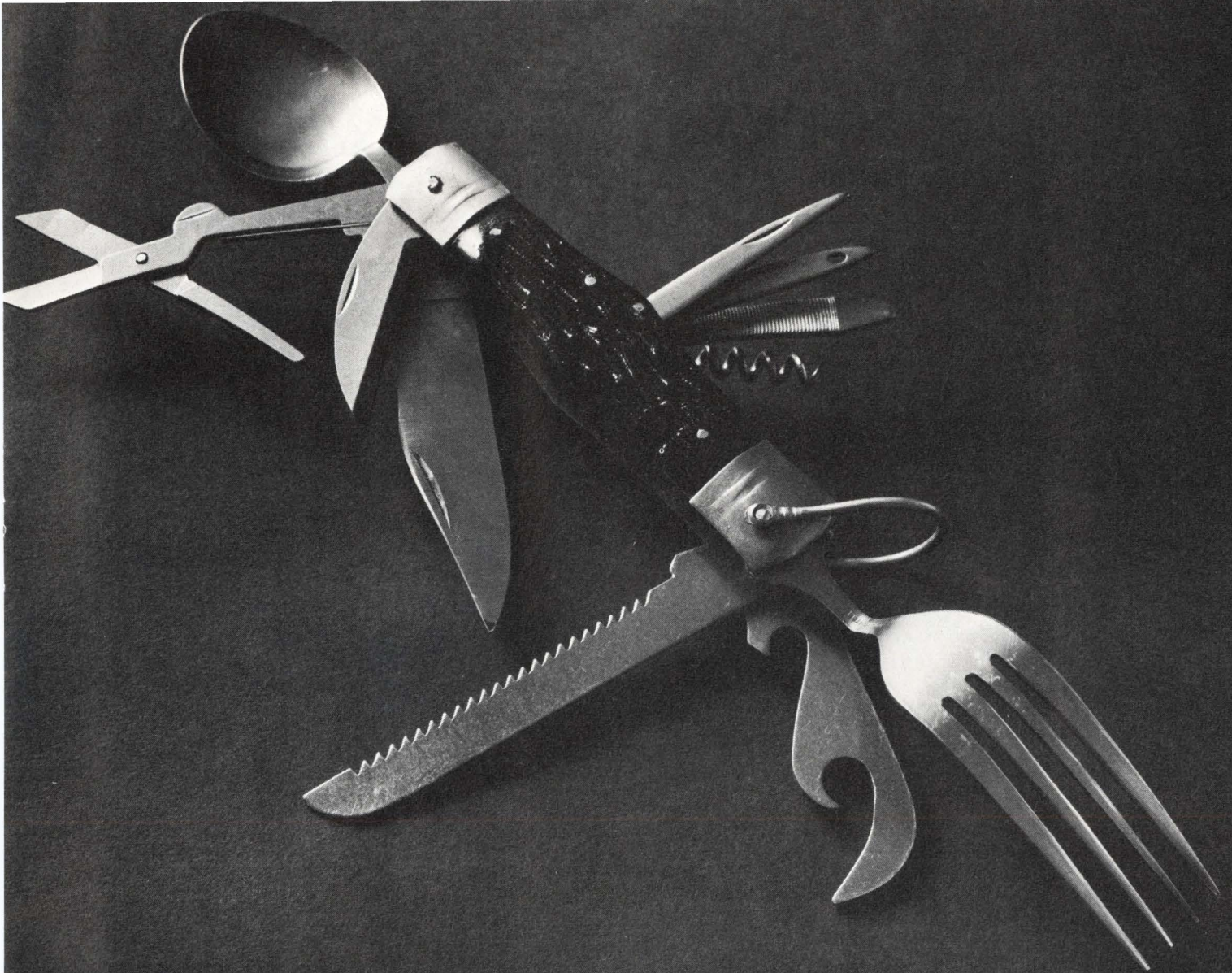

It's as versatile as a PDP-8.

As far as we can tell, there's a PDP-8 computer doing every job that's ever been done by a mini-computer.

We have them in steel mills. Nuclear reactors. Automotive plants. Hospitals. Laboratories. Newspapers. Businesses. All over the place. All over the world.

So it should come as no surprise to learn that the PDP-8 is the most

popular minicomputer ever made. In fact, more PDP-8's are installed every month than all the other minis put together.

Of course, it takes more than versatility to make the PDP-8 so popular. Having more than sixty peripherals to pick and choose from helps, too. As does PDP-8's library of software. It's the biggest collection of mini-computer software in the world.

And all the big computer company backup we offer doesn't hurt either. Over fourteen hundred sales/service engineers, for example.

But a lot of it must go back to what you learned as a kid: That there's nothing like something that'll do almost anything.

Digital Equipment Corporation,
Maynard, Massachusetts 01754.
(617) 897-5111.

digital

MOS shift registers for EDP systems

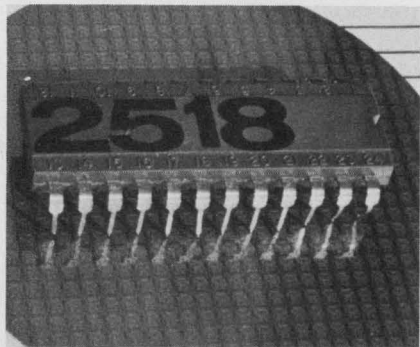

Signetics, 811 E. Arques Ave., Sunnyvale, Calif. Phone: (408) 739-7700. P&A: \$6 (250 to 999); stock.

Two silicon gate MOS static shift registers—the 2518B, a hex-32 bit device, and the 2519B, a hex-40 bit unit—can be used in electronic processing equipment. Typical clock and data rate is 3 MHz, and power supply current is 16 mA during continuous operation. The units operate from sources of +5 V and -12 V.

CIRCLE NO. 286

Calculator chip with 10-digit capacity

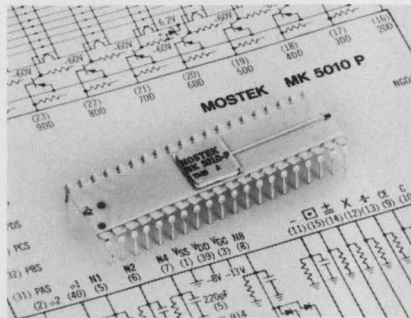

Mostek Corp., 1400 Upfield Dr., Carrollton, Tex. Phone: (214) 242-1494. Price: \$75.

A 10-digit calculator-on-a-chip, the MK 5010P, provides for the display of a numeric entry or the resultant calculation on a multiplexed basis. The circuit has 1 of 10 outputs for selecting the appropriate digit to be displayed. The 5010 is hermetically sealed in a DIP package. Displays that can be used include LEDs and fluorescent anode tubes.

CIRCLE NO. 287

Zero-voltage switch prevents EMI

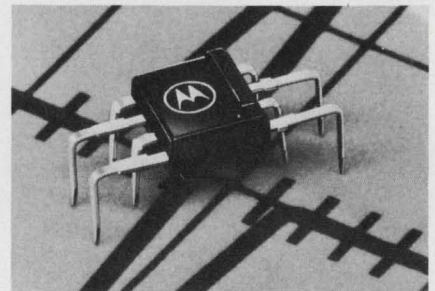

Motorola Semiconductor Products Div., P.O. Box 20912, Phoenix, Ariz. Phone: (602) 273-3466. P&A: \$2.55; stock.

Designed for use in zero-voltage gating of triacs, the MFC8070 provides its own input short or open-circuit protection. Peak output current is at least 50 mA, into a 40-Ω load. Rated power dissipation is 1 W at 25 C, and operating temperature is -10 to +75 C. The MFC-8070 has a built-in voltage regulator that permits operation directly from an ac line.

CIRCLE NO. 288



FREE

LAFAYETTE 1972 Catalog

Our 51st Year



468 PAGES

Your 1st Guide To Everything in Electronics

- Stereo/Hi-Fi Components
- Musical Instruments and Amplifiers
- Photography Equipment
- Ham and CB Gear
- Public Address Systems
- Tools and Test Equipment
- Educational and Optical Equipment
- Black and White/Color Televisions
- Police and Fire Monitor Receivers
- Books and Parts
- Plus Thousands of Additional Items

Lafayette Radio Electronics, Dept. 45012
P.O. Box 10, Syosset, L.I., N.Y. 11791

Send me the FREE 1972 LAFAYETTE Catalog 45012

Name

Address

City State

Zip

(please include your Zip Code No.)

INFORMATION RETRIEVAL NUMBER 89

SURGE AND HIGH FREQUENCY CURRENT MEASUREMENTS

T&M Current

Viewing Resistors simplify all of these difficult measurements.

CVR's are offered in a wide range of models covering all high frequency and/or high current applications.

CVR's are coaxial, broad band-pass, 4-terminal shunts specially designed to provide an inductance-free output voltage directly proportional to circuit current.

Presently utilized in applications ranging from large capacitor banks to solid state circuitry, CVR's might also be the answer to your problems. Probes and inductors for di/dt measurements, voltage dividers for voltage measurements, and special components to complement the CVR line are available. For complete information write:

CAPACITOR DISCHARGE

Megamp Amplitudes



PULSE CIRCUITS

Nanosecond Risetimes



STEADY STATE

High Power



T&M RESEARCH PRODUCTS, Inc.

129 Rhode Island NE • Albuquerque, N. Mex. 87108

INFORMATION RETRIEVAL NUMBER 90



Norden Encoders perform for you!

Look at these new 1971 additions to Norden's line. More are on the way.

	Total Count	Revolutions for Full Count	Diameter"	Model Number
NEW! Optical Absolute	10,000	50	2.25	OADC-23/4/BCDQ-200L
NEW! Optical Absolute	1,000	1	2.25	OADC-23/3/BCD-1000L
NEW! Optical Incremental: Series now available with shaft seal—permits drenched operation.				
NEW! Contact Size 11	8,192	32 or 64	1.06	ADC-11/13/BNRY-256L
NEW! Contact Size 11 Altitude Reporting Encoder	1,280	16	1.06	ADC-11-ALT-1280
NEW! Contact Size 11	10,000	100	1.06	ADC-11/4/BCDX-100
NEW! Contact Size 11	3,600	36	1.06	ADC-11/4-36/BCDX-100
NEW! Rugged Industrial Grade Optical Incremental Encoders				
All available with quadrature and internal squaring circuit options	2,000 Pulses	1	3.500	OADC-35/2000/INC
	1,500 Pulses	1	3.500	OADC-35/1500/INC
	1,250 Pulses	1	3.500	OADC-35/1250/INC
	1,000 Pulses	1	3.500	OADC-35/1000/INC
	600 Pulses	1	3.500	OADC-35/600/INC
	500 Pulses	1	3.500	OADC-35/500/INC
	300 Pulses	1	3.500	OADC-35/300/INC
	200 Pulses	1	3.500	OADC-35/200/INC
	100 Pulses	1	3.500	OADC-35/100/INC
Optical Incremental Encoders				
All available with index marker, quadrature outputs and internal squaring circuit options. Other counts on special order	100 Pulses	1	2.250	OADC-23/100/INC
	250 Pulses	1	2.250	OADC-23/250/INC
	256 Pulses	1	2.250	OADC-23/256/INC
	336 Pulses	1	2.250	OADC-23/336/INC
	500 Pulses	1	2.250	OADC-23/500/INC
	512 Pulses	1	2.250	OADC-23/512/INC
	1,000 Pulses	1	2.250	OADC-23/1,000/INC
	1,024 Pulses	1	2.250	OADC-23/1,024/INC
IC-Compatible Encoders. For direct interface with TTL & DTL circuits				
Binary	128	1	1.750	ADC-ST7-BNRY-E/L
	8,192	64	1.750	ADC-13-BNRY-E/L
	524,288	4,096	1.750	ADC-19-BNRY-E/L

Binary-Decimal Code	100	1	2.250	ADC-ST2-BCD/L
	1,000	10	2.250	ADC-3-BCD/L
	10,000	100	2.250	ADC-4-BCD/L
	100,000	1,000	2.250	ADC-5-BCD/L
	1,000,000	10,000	2.250	ADC-6-BCD/L
	360	1	2.250	ADC-3-36BCD-E-360L
	3,600	10	2.250	ADC-4-36BCD-E-360L
	36,000	100	2.250	ADC-5-36BCD-E-360L
	360	1	3.250	ADC-ST3-36-BCD/L
	3,600	36	2.250	ADC-4-36-BCD/L
	36,000	360	2.250	ADC-5-36-BCD/L
	360,000	3,600	2.250	ADC-6-36-BCD/L
External Logic V-Scan Binary Encoders				
	128 or 256	1	1.750	ADC-7/8-BNRY-XB
	8,192 or 16,384	64	1.750	ADC-13/14-BNRY-XB
	524,288 or 1,048,576	4,096	1.750	ADC-19/20-BNRY-XB
Single Turn Gray Code Encoders				
Available with various levels of RFI suppression	256	1	1.066	ADC/11/8/GRAY
	256	1	1.750	ADC-ST8-GRAY
	512	1	2.250	ADC-ST9-GRAY
	1,024	1	3.062	ADC-ST10-GRAY

Multiturn Gray Code Encoders				
Available with various levels of RFI suppression	1,024	4	1.062	ADC-11/10GRAY256
	1,024	16	1.062	ADC-11/10GRAY 64
Low Cost Magnetic Noncontacting Encoders				
Incremental	128	1	1.750	MADC-18/128/INC
Binary	128(V scan)	1	1.750	MADC-18/7/BV
Binary	8,192(V scan)	64	1.750	MADC-18/13/BV
Binary	524,288(V scan)	4,096	1.750	MADC-18/19/BV

For more information and detailed specs, write Norden, Att: Components Dept., Helen Street, Norwalk, Conn. 06856. Phone (203) 838-4471. TWX: 710-468-0788.

Norden DIVISION OF UNITED AIRCRAFT CORPORATION

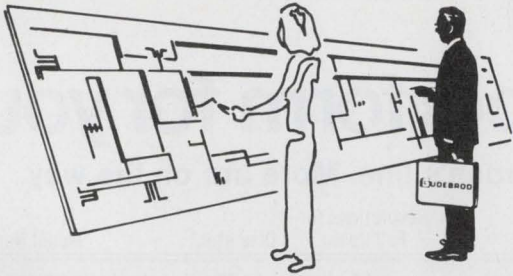
Talk to Gudebrod about your tying operation this month...

And about Lacing Tapes, harness rooms and systems. About temperature and vibration . . . speed and rejects! About Nylon, Dacron, Teflon, Nomex, Glass tapes and cords—treated and untreated . . . that meet or exceed military and industrial specifications, about cost comparisons with other methods . . . and all backed up with one hundred years of manufacturing knowledge.

Dacron, Teflon, Nomex—Du Pont Registered Trade Marks

Talk to Gudebrod this month!

Write to this address for prompt return of our
Product Data Catalog.

Electronics Division
Dept. 431

Gudebrod Bros. Silk Co., Inc. 12 South 12th Street, Philadelphia, Pa. 19107

INFORMATION RETRIEVAL NUMBER 92

Optima 17 The Total Package

Style and Function are masterfully combined in this concept
Body + Chassis + Dress Panel + Rear Panel + Liffoff Cover +
4 Models + 4 Heights + Rack Adaptable + Vinyl Finish.

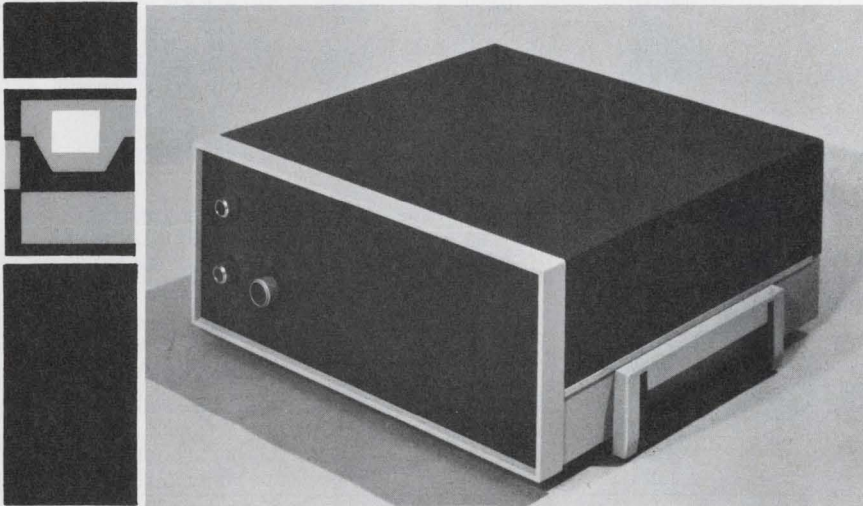

Write or call for a free catalog

optima enclosures
a division of Scientific-Atlanta, Inc.

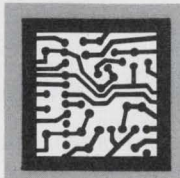

2166 Mountain Industrial Blvd. Tucker, Georgia 30084 Telephone 404-939-6340

INFORMATION RETRIEVAL NUMBER 93

ICs & SEMICONDUCTORS

IC regulator works in bipolarity supplies

Signetics, 811 E. Arques Ave.
Sunnyvale, Calif. Phone: (408)
739-7700. P&A: \$2; stock.

A monolithic precision voltage regulator is available for operation in positive or negative supplies for series, shunt, switching or floating applications. A pin-for-pin replacement for the Fairchild μ A723, the new 5723 provides access for remote shutdown and has line and load regulation of 0.01%. The output voltage is adjustable from 2 to 37 V. The regulator can furnish 150 mA of output current without an external pass transistor.

CIRCLE NO. 289

Shift register encased in mini-dips

National Semiconductor Corp., 2900
Semiconductor Dr., Santa Clara,
Calif. Phone: (408) 732-5000.
Price: \$10.60 (MM4013) to \$16
(MM5013) (100 quantities).

The MM4013/MM5013 LSI/MOS 1024-bit register/accumulator is packaged in 8-pin mini-DIPs and TO-100 cans. The MM4013 is specified for -55 to +125 C, the MM-5013, for -25 to +70 C. Each operates over a frequency range of 400 Hz to 2.5 MHz and on standard 5-V and 12-V supplies.

CIRCLE NO. 290

Seven-stage frequency divider on single chip

Societa Generale Semiconduttori
20041-Agrate Br., Milan, Italy.

Five separate groups of 7 flip-flops (2+2+1+1+1) are diffused in the model SAJ210 silicon chip. The divider features a 7.6-V output swing and frequency range from dc to 150 kHz. The input and the output of each flip-flop are externally accessible. Features also include high noise immunity of 1.4 V and crosstalk of 70 dB. The SAJ210 has output short-circuit protection.

CIRCLE NO. 291

There's plenty more where these

came from.

Literally, thousands more.

Actually, the odds are in your favor that we have the unlighted pushbuttons you need, right-off-the-shelf.

Our secret is interchangeable parts. Pushbutton modules. Switch modules (including hermetically sealed units and high/low temperature versions). Facenuts.

Even a selection of colored buttons.

We also give you a choice of momentary or alternate action. Or a combination of both. And finally, a pick of one, two, three or four pole circuitry.

Which gives you the opportunity to customize your panel — front and back. To make it the way you want it. And to do it economically.

For more information, call your MICRO SWITCH Branch Office or Authorized Distributor (Yellow Pages under "Switches, Electric").

Or write for Catalog 51.

MICRO SWITCH

FREEPORT, ILLINOIS 61032

A DIVISION OF HONEYWELL

MICRO SWITCH products are available worldwide through Honeywell International.

INFORMATION RETRIEVAL NUMBER 94

That's our goal. We are building our reputation on reliable cathode ray tubes and high quality phosphor screens that meet precise application requirements. Specialists in the design, development and production of crt's, our sales and engineering staffs stand ready to recommend an existing design, or develop a new tube from conception to production.

Write or phone today for our "Specification Guide & Short Form Catalog", further sales or technical information and the name of your local representative.



THOMAS ELECTRONICS, INC.

100 RIVERVIEW DRIVE, WAYNE, N. J. 07470 / Telephone: 201 - 696-5200 / TWX: 710-988-5836 / Cable: TOMTRONICS

INFORMATION RETRIEVAL NUMBER 95

a new space unit from Electronic Design

**A NEW 1/9 PAGE SIZE FOR ONLY \$300
INCLUDING PRODUCTION CHARGES!**

Quick Ads will be placed in their own special section, attractively laid out to insure maximum attention. Each will have its own Information Retrieval Number, assuring many inquiries, many sales leads. You simply provide an 8 x 10" glossy photograph, plus approximately 40 words of copy. We do the rest at no cost to you.

For full information, including even lower frequency rates, mail the form at right to Peter D. Coley, Publisher, Electronic Design, 50 Essex Street, Rochelle Park, N.J. 07662

Quick Ads

PLEASE RUSH ME FULL DETAILS ON QUICK ADS IN ELECTRONIC DESIGN

NAME _____

FIRM _____

STREET _____

CITY _____

STATE _____

TITLE _____

ZIP _____

Heath/Schlumberger?

That's right... Heath/Schlumberger. A new name in design-quality, factory assembled and calibrated instruments.

The "Heath" part of our name comes from being a division of that well known manufacturer of kits. But we don't make kits. In fact, Heath/Schlumberger is an entirely separate operation.

The "Schlumberger" (pronounced Shlum-bear-zhay) part of our name comes from being a member of that world-wide corporation devoted to measurements of many kinds. Schlumberger is one of the leading European manufacturers of electronic instrumentation.

With that background, you can see why we're producing state-of-the-art, ready-to-use, instrumentation... comparable to some of the best in performance... but with better performance/price ratios.

So when you're ready to buy electronic instruments, remember us. We're the group to watch.



HEATH/SCHLUMBERGER
SCIENTIFIC INSTRUMENTS
BENTON HARBOR,
MICHIGAN 49022

To order or receive additional information, write Dept. 520-26.

- A. SM-104A 80 MHz counter. BCD output. 1 MHz TCXO with 1 ppm/yr. stability. \$500.
- B. EU-205B solid-state strip chart recorder. 23 speeds, 30 in/min. to 0.2 in/hr.; 18 calibrated ranges, 1 mV to 500 V full scale. 0.5 sec. pen response. 0.1% tracking accuracy and linearity. Completely programmable. \$675.
- C. EU-70A solid-state dual trace scope. DC-15 MHz. Complete dual trace capability. Triggered sweep. 18 calibrated time bases. X-Y capability. \$595.
- D. SM-105A 80 MHz counter. Same as SM-104A above but without BCD output and uses a 1 MHz crystal with ± 10 ppm/yr. stability. \$350.
- E. EU-81A function generator. Sine, square and triangle wave output. 0.1 Hz to 1 MHz. Linear dial. External voltage control. \$245.

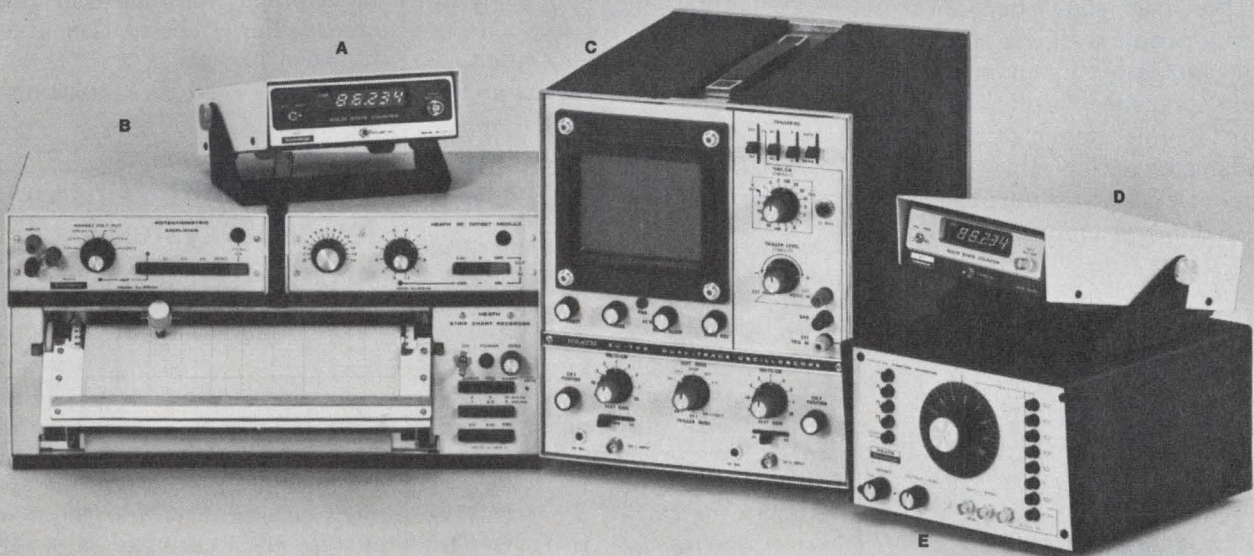

EK-317

Low Frequency MECHANICAL FILTERS

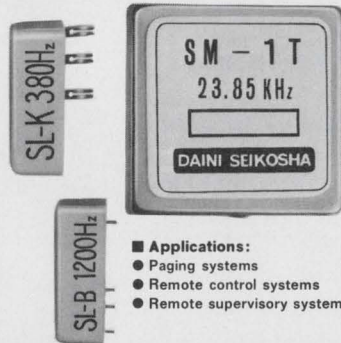

- Applications:
- Paging systems
 - Remote control systems
 - Remote supervisory systems

Mechanical filters distributed by Seiko Instruments Inc. are derivatives of world renowned SEIKO precision, the outcome of exacting processes and production technology. With almost a decade of experience in the manufacturer of mechanical filters, DAINI SEIKOSHA is able to offer miniature types exhibiting truly high performance. Reliability?

Not questionable if you're talking about one of our products.

Many types are available. On special order, we can satisfy a wide range of specifications.

● Sole distributor in the United States:
SEIKO INSTRUMENTS, INC.
14333, South Figueroa Street, Gardena,
Calif. 90247 Phone: 213-770-0152
Telex: No. 673686

INFORMATION RETRIEVAL NUMBER 97

A mouse has already been saved from leukemia. Help us save a man.

For years, you've been giving people with leukemia your sympathy. But sympathy can't cure leukemia. Money can. Give us enough of that, and maybe we'll be able to do for a man what has already been done for a mouse.

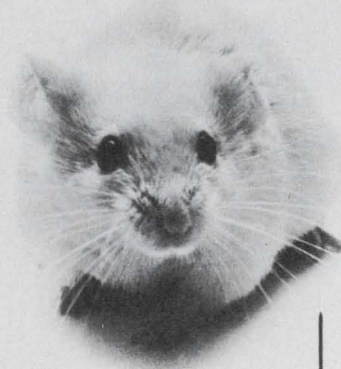

American Cancer Society

ICs & SEMICONDUCTORS

Monolithic digital IC works as a multiplier

Advanced Micro Devices, Inc., 901 Thompson Pl., Sunnyvale, Calif. Phone: (408) 732-2400. P&A: from \$26 (100 quantities); stock.

The Am2505 monolithic digital multiplier has the ability to multiply a 4-bit number by a 2-bit number and add a 4-bit number to the product. All functions are performed in 2's complement representation and result in a 2's complement double-length product. For multiplication over longer word lengths several circuits can be connected in an array. Multiplication of two 8-bit numbers can be done in only 135 ns.

CIRCLE NO. 292

16-bit register file reads/writes at once

Texas Instruments, Inc., 13500 N. Central Expwy., Dallas, Tex. Phone: (214) 238-2011. P&A: \$9.80 (100 quantities); 6 to 8 wks.

A new TTL 16-bit quadriport register file designated SN74172 features simultaneous read/write capability. Ideal for use in high-speed buffer and cache memories, it is functionally equivalent to 196 gates and is available in a 24-pin DIP. The SN74172 is a 16-bit memory which is organized 8 words by 2 bits. It accesses any pair of two-bit words for read or write operations while accessing a third word for the opposite operation.

CIRCLE NO. 293

Silicon diode turns on at low 340 mV and 1 mA

Hewlett Packard, 1501 Page Mill Rd., Palo Alto, Calif. Phone: (415) 493-1501. P&A: 60¢ to 90¢ (over 1000); stock.

At a forward current of 1 mA and junction voltage of 340 mV, the 5082-2535 silicon diode is turned ON. For conventional silicon pn-junction diodes the figure is 700 mV, and for earlier HP Schottky-barrier diodes, it's 410 mV. The new diode has an operating temperature range of -55 to +125 C, and a recovery time of less than 100 ps.

CIRCLE NO. 294

Switching transistors can handle 175 W

RCA Solid State Div., Rt. 202, Somerville, N.J. Phone: (201) 722-3200. Price: \$5-2N6249, \$5.55-2N6250, \$5.95-2N6251 in 1000 quantities.

Three silicon npn switching transistors are rated for 175-W power dissipation and 30-A peak collector current. The transistors feature a maximum V_{CB0} of 300 to 450 V. Type 2N6249 provides high gain and high-energy capability. Types 2N6250 and 2N6251 feature high breakdown and low saturation voltages, and fast-switching times.

CIRCLE NO. 295

MOS/LSI digital filter in 4-array blocks

Collins Radio Co., Newport Beach, Calif. Phone: (714) 833-0600. Price in lots of 10: multiplier \$36.75; I/O \$43.80; storage \$37.10; timing \$38.55.

By combining the basic arrays of the MOS/LSI digital filter, many digital filter forms—including low-pass, high-pass, bandpass, and notch filters—can be configured over the frequency range of 0 to 3500 Hz. Stopband attenuations exceeding 45 dB and comparably narrow bandwidths can also be achieved. The 4 blocks are the multiplier, input/output, storage and timing arrays. Power dissipation of each is under 150 mW.

CIRCLE NO. 296

100-bit shift register for MOS systems

Signetics, 811 E. Arques Ave., Sunnyvale, Calif. Phone: (408) 739-7700. Price: \$3.70 (100 quantities).

A dual 100-bit MOS dynamic shift register is designed to interface with other MOS circuitry. Designated the 2517, the shift register uses two clock phases with a typical clock rate of 4 MHz. Power dissipation at 1 MHz is 400 mW per bit. For normal operation, the 2517 is guaranteed over a temperature range of 0 to 70 C.

CIRCLE NO. 297

Complete Trimmer Satisfaction

One design...9 pin styles

Still the industry's best trimmer value
... Less than **50¢** each in production quantities

Settability of $\pm .03\%$ and environmental performance requirements of characteristic C of Mil-R-22097

- 1.5% average ENR noise resistance
- 0.5% average CRV
- 1/2 watt @ 70°C

You can choose from an expanded line of compact trimmers. .150" — .125" — .100" in-line terminal spacing and TO-5 pin spacing all available in top and side adjust. Plus .200" delta (.100 grid) in top adjust. All available from your CTS Distributor. **Still the best value in the industry.** CTS of Berne, Inc., Berne, Indiana 46711. Phone: (219) 589-3111.

CTS CORPORATION
Elkhart, Indiana



A world leader in cermet and variable resistor technology

*Come
Aboard The
Ad-Venture
of the Year!*



We'll send you on the vacation cruise of a lifetime if you can choose the ten ads in this issue that you think will get highest reader recall "seen" scores in the same ranking as selected by readers. It only takes a little time and some marketing smarts to enter. And it's fun to see if you can outsmart the experts! It may be your ticket to winning these nifty prizes.

1st PRIZE—10 unforgettable days for 2, cruising the storied Caribbean aboard the coveted Windjammer schooners. Sunshine and blue water unlimited...enough out-of-the-way beaches and tropical lagoons to last a lifetime of memories. AND round-trip luxury flights for 2.



2nd PRIZE—Heathkit 25-inch Solid State Color TV. World's most unique color TV, ultra rectangular, largest picture in the industry.

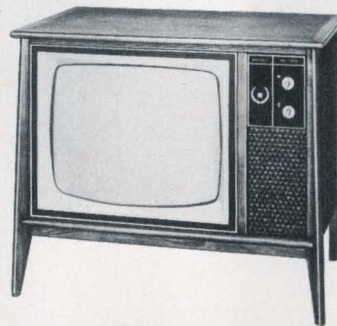

3rd PRIZE—Brother miniaturized Desk-Top Digital Calculator—and 100 other prizes.

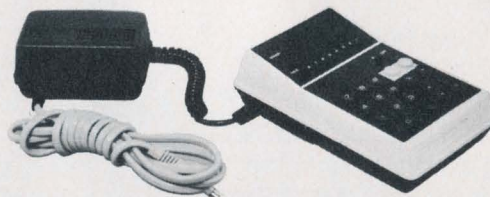

Nothing to write, no gimmicks—all you need do is check the ads carefully and pick the 10 you think have the most memorable information and data and will be noticed best by your colleagues in engineering and management. It's the one contest that tests your marketing sense. It proves, once more, that computers can't do everything.

Electronic Design

1972 TOP TEN CONTEST

*More Prizes, More Excitement,
More Fun Than Ever Before!
It's ALL In This Contest Issue.*

FOLLOW THESE EASY STEPS...IT
COULD BE YOUR FIRST STEP TOWARD
A CARIBBEAN CRUISE!

1. Read this issue with extra care.
2. Pick the 10 ads that you think will be the best "seen" as defined in the contest rules in the next column.
3. List your selections on the specially provided "Top Ten" entry blank available adjacent to the inside back cover.
4. Mail to Electronic Design before midnight, March 15, 1972.

This year the Top Ten ads will again be selected on the basis of "Recall Seen" scores. This means that attractive, well-designed ads in smart form will be *on a par* with strong marketing ads... messages that offer dramatic news, give complete product data and features in compelling copy terms... ads that produce purchasing action for advertisers.

The judges will select winning entries based on the "seen" category of Reader Recall—Electronic Design's method of measuring readership in the contest issue. Remember, in selecting your Top Ten list of ads, be sure to watch for both the graphic form and appealing words that you think would stimulate a strong sales reaction from our 74,000 engineer subscribers.

READ THE RULES CAREFULLY, EXAMINE THE ADS, MAIL IN YOUR ENTRY BEFORE MARCH 15, 1972, AND THIS YEAR YOU MAY BE THE WINNER OF THE WINDJAMMER CRUISE OF A LIFETIME!

ENTRY FORMS IN THE JANUARY 6TH ISSUE

1972 TOP TEN READER CONTEST RULES

1. Enter your Top Ten selections on the entry blank provided, or on any reasonable facsimile. Be sure to indicate the names of the advertiser and page number for each of your choices. These choices should be placed in the order you think readers will rank them. (Ads placed by Hayden Publishing Company in Electronic Design should not be considered in this contest.)
2. No more than one entry may be submitted by any one individual. Entry blank must be filled in completely, or it will not be considered. The box on the entry blank marked "Reader Contest" must be checked. Electronic Design will pay postage for official entry blanks only.
3. To enter, readers must be engaged in electronic design engineering work, either by carrying out or supervising design engineering or by setting standards for design components and materials.
4. No cash payments, or other substitutes, will be made in lieu of any prize.
5. Contest void where prohibited or taxed by law. Liability for any taxes on prizes is the sole responsibility of the winners.
6. Entries will be compared with the "Recall Seen Most" category of Reader Recall (Electronic Design's method of measuring readership). That entry which in the opinion of the judges most closely matches the "Recall Seen Most" rank will be declared the winner.
7. In case of a tie, the earliest postmark will determine the winner. Decisions of Top Ten contest judges will be final.

THERE IS A SEPARATE CONTEST— SEPARATE PRIZES FOR ADVERTISERS

Each advertisement ranking in the Top Ten will receive a free rerun. In addition there is a separate contest, separate prizes for advertisers. The 3 winners can also receive free ad reruns. SEE THE LAST PAGE OF THIS ISSUE FOR RULES, PRIZE INFORMATION AND OFFICIAL ENTRY BLANK.

Numeric display has 0.8-in.-high characters

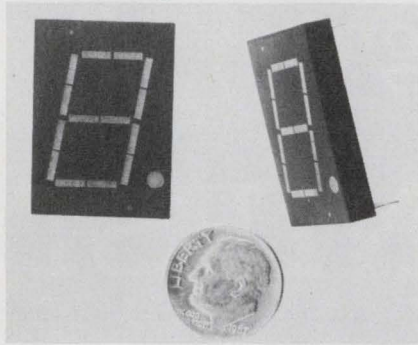

Opeoa, Inc., 330 Talmadge Rd., Edison, N.J. Phone: (201) 287-0355. Availability: stock.

The largest solid-state display presently offered is a seven-segment numeric unit with a decimal point with tightly spaced segments to avoid a "gappy" appearance and completely compatible with standard 74 series decoder/driver ICs. Solid-Lite type SLA-3 display uses two electroluminescent GaP diodes in each segment. The display is readable at a distance of 40 feet. Operating voltage is 4.4 V at 20 mA or 4.7 V at 30 mA. **CIRCLE NO. 298**

Active filter allows simultaneous outputs

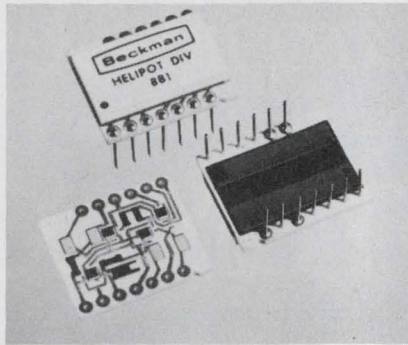

Beckman Instruments, Helipot Div., 2500 Harbor Blvd., Fullerton, Calif. Phone: (714) 871-4848.

The Model 881 active filter, the hybrid version of an active filter design commonly known as a dual-integrator, state-variable and/or a universal active filter permits buffered bandpass, low-pass, and high-pass output to be simultaneously available. The resonant frequency is determined by the value of two external resistors and is adjustable over a frequency range from 1 Hz to 10 kHz. **CIRCLE NO. 299**

Miniature delay line is continuously variable

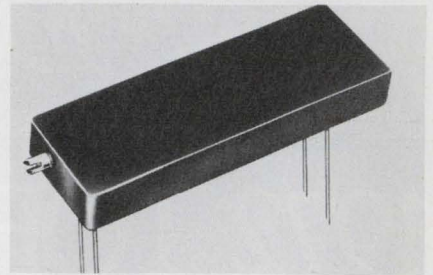

ESC Electronics Corp., 534 Bergen Blvd., Palisades Park, N.J. Phone: (201) 947-0400.

Delay ranges from 5 to 50 ns, with a maximum rise time from 2.5 to 15 ns covering bandwidths up to 150 MHz are possible with the 900 series miniature continuously variable delay line. All units are protected from damage by an override clutch, and are compatible with dual-in-line packaging. The impedance tolerance is $\pm 10\%$, and maximum attenuation is 0.5 dB. **CIRCLE NO. 300**

Announcing REQUESTED DATA DELIVERY, it's free—see card inside front cover.

tach
on to
this
one



Servo-Tek DC TACHOMETER GENERATORS are great for precision speed sensing and velocity feedback. Convert speed to an analog voltage signal with low driving torque; just right for rate damping in all types of servos.

- High Linear Speed/Voltage Relationship
- Highly Stable
- Minimum Ripple
- Low Driving Torque
- Outputs from 2.6 to 45v dc/1000 rpm

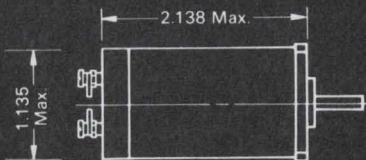

Ask for a copy of our NEW catalog.

SERVO-TEK®
PRODUCTS COMPANY

1086 Goffle Road, Hawthorne, N. J. 07506 • 201 — 427-3100

Servo-Tek of California, Inc.
8155 Van Nuys Blvd., Van Nuys, California 91402 • 213 — 786-0690

INFORMATION RETRIEVAL NUMBER 100

Attention Advertisers:

Could you use copies of your ad exactly as it appeared in **ELECTRONIC DESIGN**? Then order your reprints directly from us; the minimum unit order is 500 copies.

Please specify if you would like the reprint line omitted on your copies and mail your/written order to:

**Production Dept.
ELECTRONIC DESIGN
50 Essex St.
Rochelle Park, N.J. 07662**

	500	1,000	Add'l M
8x10 or smaller			
1 color, 1 side	\$74.70	82.95	18.15
2 color, 1 side	95.47	108.00	25.28
4 color, 1 side	311.03	342.00	44.33
Spreads			
1 color	113.66	126.65	25.98
2 color	191.19	205.98	29.58
4 color	354.17	380.76	53.19

Prices FOB Waseca, Minn.

**50 watt
signal generator**

**10 to 2,500 MHz
with six heads**

**solid state for
high reliability**

**frequency stability
 $\pm 0.003\%/10$ minutes***

**power stability
 ± 0.2 db/hour**

Model 15022 is the first state-of-the-art Signal Source in ten years. Provides highest reliable power currently available. The instrument is solid state except for Planar Triode Oscillator. The System provides direct frequency adjustment from 10 to 2500 MHz.

The 15022 is designed for standard 19" rack mounting, only 7" high, complete with power supply, cooling, and protective circuitry. Plug-in Cavity Oscillator is protected against output load mismatch.

FEATURES:

50 watts CW 10 to 1000 MHz.
35 watts CW 1000 to 2000 MHz.
15 watts CW 2000 to 2500 MHz.
Forward/reflected panel power meter.
RF Sample output.
Meets MIL-STD-462 RFI.
Meets MIL-STD 810B Environmental.
Residual FM < 0.005% CW operation.
Residual AM < 2.0% CW operation.
Power output adjustable .05 to 50 watts.
Automatic protection against high load VSWR.
Internal Modulation 1 KHz \pm 1% square wave.
External Pulse Modulation capability.
Spurious output > 30 db down.

For complete specifications on the newest RF power source today, call (312) 354-4350 or write: Microwave Cavity Laboratories, 10 North Beach Avenue, La Grange, Illinois 60525.



MCL

**MICROWAVE
CAVITY LABORATORIES**



INFORMATION RETRIEVAL NUMBER 102

TOROIDAL TRANSFORMERS

Perkin-Elmer guarantees

a response
within

1

week

That's right! Send us your specs for any one of these transformer types -

- Scott T
 - reference
 - isolation
 - resolver isolation
 - tapped autotransformer
- and we'll respond *within one week!* That's a promise - from Perkin-Elmer.

PERKIN-ELMER TRANSFORMERS

INFORMATION RETRIEVAL NUMBER 103

COMPONENTS

Eight-bar indicator is microminiature

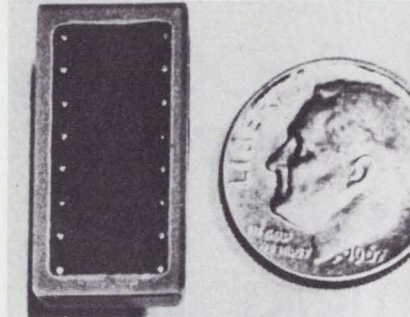

Readouts, Inc., P.O. Box 149, Del Mar, Calif. Phone: (714) 755-2641. P&A: \$2.70 (1000 quantities); stock.

Composed of eight incandescent light bars which are mounted on 0.1-in. centers and packaged on one unit behind a glass face plate, the number 5-3 light-bar indicator mounts in commercial 16-pin DIP sockets or solders directly to PC boards. Its over-all size is 0.88 by 0.46 by 0.24 in. Required power is 8 mA per bar at 5 V with life of 250,000 hours or 10 mA per bar at 4 V with life of 100,000 hours.

CIRCLE NO. 301

Narrowband filters are mechanical flatpacks

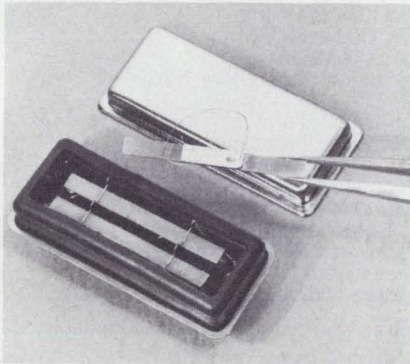

Collins Radio Co., Newport Beach, Calif. Phone: (714) 833-0600.

Mechanical filter flatpacks of 3 to 30 kHz are designed for bandwidths in the 0.2 to 2.0% bandwidth/center-frequency range. The filters utilize flexure-mode resonators composed of iron-nickel bars and piezoelectric-ceramic transducers and are less than 1/3 cubic inch in size. Configurations are available in 1, 2 and 4-resonator models. The last two can be designed with linear-phase characteristics.

CIRCLE NO. 302

TOROIDAL TRANSFORMERS

Perkin-Elmer guarantees

a prototype
within

3

weeks

after receipt of order

That's a guarantee from one of the most experienced and respected names in electronics, a company that has been designing and building highly accurate toroidal transformers since 1954.

After you receive our quote, give us the go-ahead and we'll deliver a finished prototype within three weeks!

PERKIN-ELMER TRANSFORMERS

INFORMATION RETRIEVAL NUMBER 104
ELECTRONIC DESIGN 1, January 6, 1972

Electrolytic capacitors plug into PC boards

Sprague Electric Co., 347 Marshall St., N. Adams, Mass. Phone: (413) 664-4411.

Type 72D aluminum electrolytic capacitor is a single-ended design for vertical mounting on printed wiring boards. It is available in working voltages from 6 through 150 V dc in three different case sizes. The tubular Compu-lytic capacitor employs a new end-seal designed to lengthen capacitor life through a reduction in the loss of volatile components in the electrolyte.

CIRCLE NO. 303

Photocells are designed for hybrid circuits

Allen-Bradley Co., 1201 S. Second St., Milwaukee, Wis. Phone: (414) 671-2000. P&A: 43¢ (1000 quantities); 3 to 4 wks.

PC Photochips, one of a new line of CdS and cadmium sulfoselenide photodetectors, are the first photocells designed specifically for hybrid circuits. Three basic materials are offered, with peak spectral responses at 625, 575 and 515 nm. "On" resistances are 500, 1500 and 3000 Ω , respectively, when measured at 10 foot-candles. "Dark" resistance values are 10 M Ω . Power dissipation is 75 mW.

CIRCLE NO. 304

Dual optical isolator has 20-ns rise time

Quadri Corp., 2950 W. Fairmont, Phoenix, Ariz. Phone: (602) 263-9555.

Quadri's model 814 dual optical isolator, featuring 20 to 30-ns rise times, is ideally suited to high-speed data-link applications. A complete two-channel system is contained in a compact, 24-pin dual-in-line package and is TTL compatible on both input and output. Each of the two channels consists of a GaAs emitter, a p-i-n diode, a high-gain amplifier and an output driver stage.

CIRCLE NO. 305

TOROIDAL TRANSFORMERS

Perkin-Elmer guarantees

a prototype at least

10%

more accurate

size for size, than any other prototype you have received from any other company.

If it's not, you pay *nothing*.

There's our offer: a response within *one* week, a prototype within *three* weeks. And a prototype that's *10%* more accurate or *it's free*.

If you're working on a project right now, and want to take immediate advantage of this offer, phone Larry Kovarovic at (203) 762-4786. Or send us your specifications directly.

If you want more information, including technical data on Perkin-Elmer transformers, circle the reader inquiry number. Electronic Products Dept., Perkin-Elmer Corp., 131 Danbury Road, Wilton, Conn. 06897.

PERKIN-ELMER TRANSFORMERS

PC trimmer capacitors feature low profile

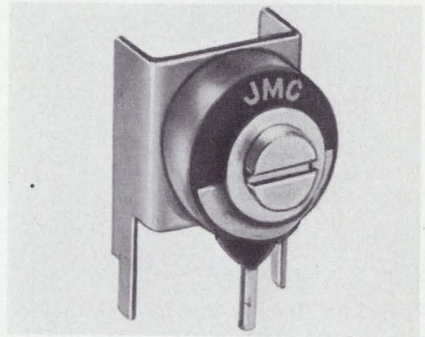

Johanson Manufacturing Corp., 400 Rock Valley Rd., Boonton, N.J. Phone: (201) 334-2676. P&A: 20¢ to \$1.35; stock.

The 9330 series horizontal-mounted miniature rotary ceramic trimmer capacitors feature a low profile with a 0.3-in. above-board height and are designed to provide easy "in-rack" adjustments. The series is available in capacitance ranges of 1.7 to 50 pF with working voltages of 250 V dc and a test voltage of 500 V dc.

CIRCLE NO. 306

Shielded inductors span 0.1 μ H to 0.1 H

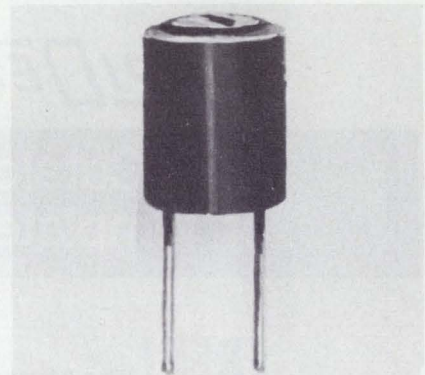

Nytronics, Inc., Orange Street, Darlington, S.C. Phone: (803) 393-5421. Availability: stock.

A new shielded adjustable inductor standardized in 73 stock values from 0.1 to 100,000 μ H known as the Wee V-L combines exceptional stability and high Q in a subminiature (0.4 by 0.3 in.) package. Shield construction allows maximum density packaging, and printed board mounting is facilitated by 0.2-in. grid spacing. Working voltage is 300 V dc.

CIRCLE NO. 307

A FREE new Hayden Service for you—see card inside front cover.

Gunn oscillator series spans 8 to 12.4 GHz

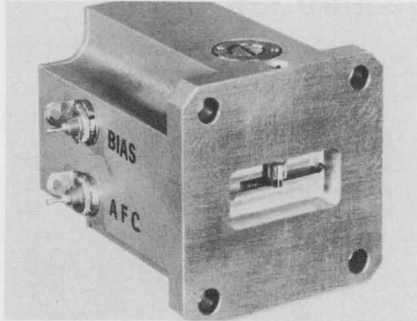

Fairchild Microwave and Optoelectronics Div., 3500 Deer Creek Rd., Palo Alto, Calif. Phone: (415) 493-3100. Availability: 30 to 45 days.

A family of microwave oscillators designed to meet military specifications MIL-E-5400 and MIL-E-16400 is ideal for use in airborne, space, missile or ship-board applications. The GOV(X)-1400 and GOV(X)1500 oscillators incorporate voltage-tuning characteristics which can be tailored to specific design applications and feature electronic tuning to 500 MHz.

CIRCLE NO. 340

Pyroelectric infrared detector handles 100 W



Barnes Engineering Co., 44 Commerce Rd., Stamford, Conn. Phone: (203) 348-5381. P&A: \$95; 14 days.

The series T-301 pyroelectric detectors is designed to measure the power output from high-energy lasers. Responsivity of the T-301 is 1.5 μA per watt, rise time in the current mode is 150 ns, and power handling capability is dissipation of one watt of average power—either cw or pulse—with a peak power capability of up to 100 watts.

CIRCLE NO. 341

Doppler radar module beams 1.5 V into 1-k

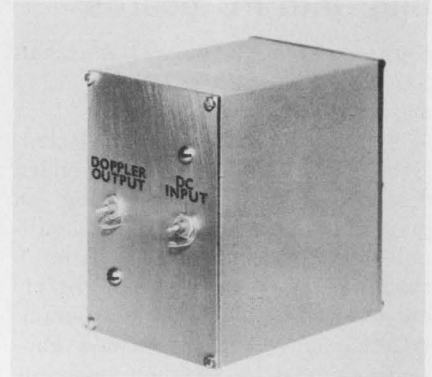

Fairchild Microwave & Optoelectronics Div., 3500 Deer Creek Rd., Palo Alto, Calif. Phone: (415) 493-3100. P&A: \$13; stock.

The DM(X)100 features low-cost single-input voltage, a built-in voltage limitation to prevent amplifier saturation and a field replaceable Gunn flange. The module can be operated from a 12-V dc battery, is usable with a wide range of antennas, and cannot be burned out by reflecting rf output power from an oscillator back into the antenna.

CIRCLE NO. 342

RAPIDDESIGN®

BEROL

1972 Catalog of Templates

FREE! This 24-page catalog precisely describes and illustrates nearly 200 professional drafting templates, including several new templates offered for the first time. RapiDesign continues to provide the world's largest selection of high-quality professional drafting templates. Keep current with all the new templates available in your field. Write today for your free copy of RapiDesign's 1972 Catalog.

RAPIDESIGN, INC., P.O. BOX 6039, BURBANK, CALIF. 91505
A SUBSIDIARY OF BEROL CORPORATION

BEROL

INFORMATION RETRIEVAL NUMBER 106

Now! MATSUSHITA offers New Low Impedance Electrolytic Capacitors "L-series".

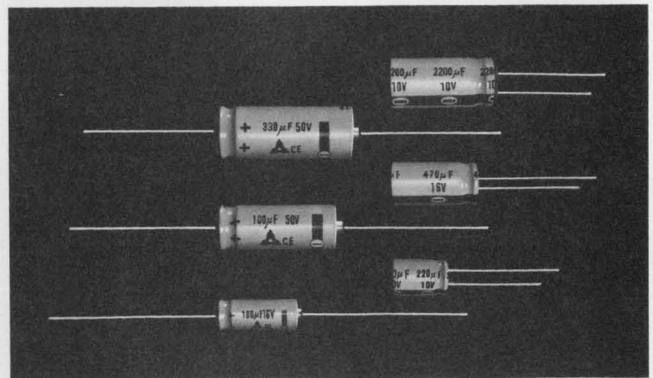

- Wide operating temperature: -40°C to $+85^{\circ}\text{C}$
- Extremely low $\text{Tan}\delta$: 0.13 at 50 WV.DC
- Long operating life: 1,000 hours at $+85^{\circ}\text{C}$
- Capacitance range: 0.47 to 2,200 μF
- Voltage range: 6.3 to 100 WV.DC
- Uniform quality and attractive price
- Application engineering available

MATSUSHITA ELECTRIC CORPORATION OF AMERICA

Pan-Am Building, 200 Park Ave., New York, N.Y. 10017, U.S.A.
TWX: 710-581-4158
Tel: 973-5710 Area Code 212

INFORMATION RETRIEVAL NUMBER 107

ELECTRONIC DESIGN 1, January 6, 1972

A mercury switch that's tough as nails

and operates in any mounting position.

We've used this demonstration to prove a point: new Logcell® II mercury-film switches are almost indestructible. They eliminate the dangers of mercury leakage, the handling problems of glass switches, the need for protective encapsulation, and switch failures caused by rugged environments. Yet these advantages, and more, come to you at costs lower than most mercury capsules, and about the same as many dry reed switches.

Logcell II switches are magnetically actuated. They operate in any mounting position without contact bounce. And they provide up to a billion operations.

Because of their size, ruggedness, reliability and performance, Logcell II switches lend themselves to a whole world of imaginative packaging ideas. Use them in relays, in switching matrices, in pushbuttons for truly low-profile keyboards (switch shafts may be shortened), in stepping, rotary, limit and proximity switches. And who knows what else.

For detailed specifications on Logcell II, plus some applications ideas to get you started, write Fifth Dimension Inc., Box 483, Princeton, New Jersey 08540. Or call (609) 924-5990.

Logcell II mercury-film switches offer:

- Low cost
- Reliability, long life
- 50g shock rating
- No contact bounce—self healing contacts
- Operation in any mounting position
- High temperature capability to 125° C
- Freedom from mercury leakage
- Hundreds of new applications where cost, ruggedness, performance or reliability prohibited the use of fragile mercury capsules or dry reed switches

This is Logcell II

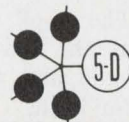

FIFTH DIMENSION INC.

16 Plug-in Modules make the

OMNIGRAPHIC®

X-Y RECORDER

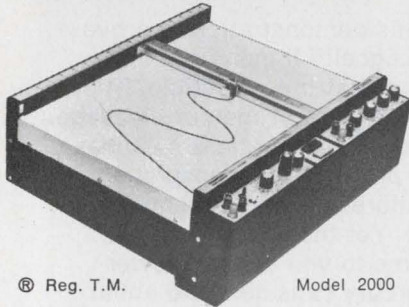

© Reg. T.M.

Model 2000

a terrific value at

\$795 plus modules

Why? Because now there's a module for AC to DC conversions, another for both AC and DC... plus more for every function you may require. What's more, they're all interchangeable. And just look at these features:

- 30 in./sec. speed
- $\pm 0.2\%$ accuracy
- local/remote pen control
- electric pen lift
- high input resistance
- interchangeable amplifiers
- \$795 plus modules

A companion strip chart recorder, model 3000, now is available with a full span automatic integrator for gas chromatography and with modules for point plotting.

Write for brochures today.



houston instrument | DIVISION OF BAUSCH & LOMB

4950 Terminal Avenue, Bellaire, Texas 77401
(713) 667-7403 Cable Hoinco

houston instrument | European Office

Johanneskirchner Strasse 17, 8043 Unterfohring
München, W. Germany (0811) 97-1673

INFORMATION RETRIEVAL NUMBER 110

MICROWAVES & LASERS

Mixer preamp series spans 1 to 12.4 GHz

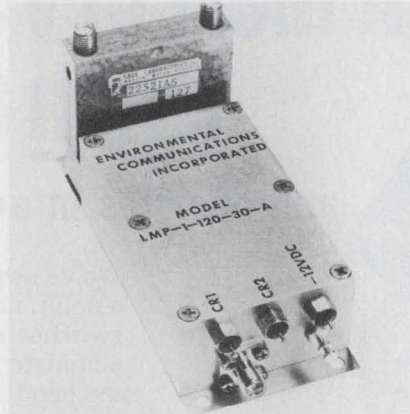

Environmental Communications Inc., 2718 S. Grand Ave., Santa Ana, Calif. Phone: (714) 557-7800. P&A: \$625; 4 wks.

Model LMP-1 series of mixer preamps has a minimum i-f bandwidth of 30 MHz for i-f frequencies of 10 to 500 MHz. For the LMP-1-120-30-A with a 120-MHz i-f, the rf to i-f gain is 20 dB with noise of 9 dB. A supply of -12 V dc, 30 mA is required. The maximum input signal level is -30 dBm.

CIRCLE NO. 343

Rf switches isolate switching signal

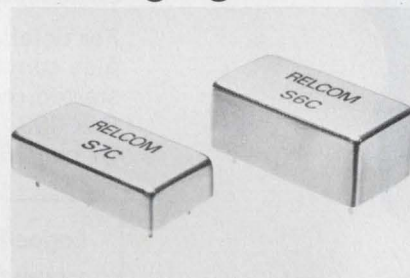

Relcom, 3333 Hillview Ave., Palo Alto, Calif. Phone: (415) 961-6265. P&A: \$65, \$40; stock.

Two spst switches, the model S6C with switching speed of 2 ns and the model S7C with a speed of 25 ns have a temperature range of -54 to $+100$ C. The model S6C has a frequency range from 0.5 to 200 MHz and the model S7C from 0.3 to 200 MHz. Typically, at mid-band, the insertion loss for the S6C is 2 dB and 1 dB for the S7C. The on-off ratio is typically 100 dB at the low end of the frequency band and 48 dB at the high end, for both.

CIRCLE NO. 344

Avalanche photodiode for spectrophotometers

EMI Electronics Ltd., Electron Tube Div., Hayes, Middlesex, England.

The EMI S30500 is a high-speed multiplying device for use in applications including fibre-line communications systems and laser-based range finding equipment. The diode's features include a spectral response extending from the visible region to wavelengths beyond 1.1 microns, a useful active area of 0.5 mm diameter, a wide 90° field of view and a rise time of a fraction of a nanosecond.

CIRCLE NO. 345

Varactor diode has cutoff above 250 GHz

Hughes Aircraft Co., Electron Dynamics Div., P.O. Box 90515, Los Angeles, Calif. Phone: (213) 670-1515. P&A: \$450; 45 days.

The GaAs millimeter wave varactor diode model V5001U-H features a zero-voltage cutoff frequency of greater than 250 GHz. Junction capacitance at 0-V bias is 0.1 to 0.2 pF, and package capacitance is 0.03 pF typical. Self-resonant frequency is between 45 and 55 GHz. Other self-resonant frequencies can be tailored for specific applications.

CIRCLE NO. 346

Rf overlay transistor spans 229 to 400 MHz

RCA Solid State Div., Box 3200, Somerville, N.J. Phone: (201) 722-3200. P&A: \$33 (1000 quantities); stock.

A 30-W, 400-MHz broadband silicon npn rf overlay transistor, the 2N6105 (formerly RCA Dev. No. TA7706), features emitterballasting and high-temperature metalization. At 400 MHz the device provides 5 dB gain with 30 W output when operated from a 28-V supply. It has a low-inductance ceramic-metal hermetic package (JEDEC TO-216) with radial leads for mounting in microstripline circuits.

CIRCLE NO. 347

there is a difference
between

MTBF

AND

MTTR

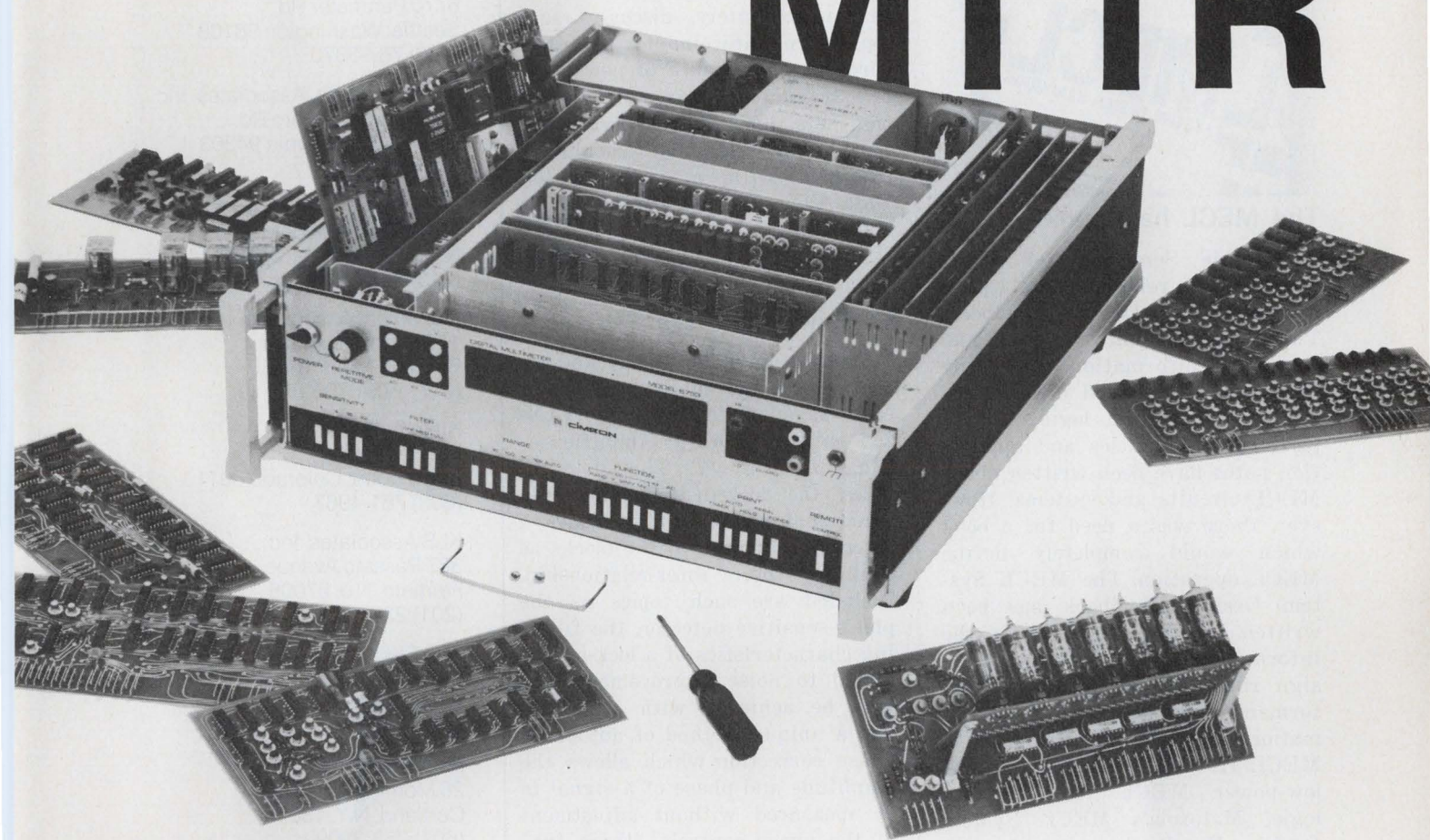

... and the difference is Cimron.

What we're talking about, of course, is the difference between "meantime before failure" and "meantime to repair." All four Cimron DMM'S are designed for the fastest possible service. All functions are on plug-in circuit boards... even the readout. You can replace all cards, button-up, and make an accurate measurement in less than two minutes.

What happens when you have a failure in an instrument that has a majority of its components anchored to the master board? You have the choice of replacement or logging downtime during lengthy and costly repair. "MTTR" now becomes more important than "MTBF."

A word about specsmanship—when looking at accuracy, remember that one least significant digit means 0.01% of range on a 4 digit DVM, and 0.001% of range on a 5 digit DVM; also, a 24 hour spec means calibrating every 24 hours. Cimron's short-term spec is 90 days.

We're proud to show the inside of our DMM—and you will be too.

Remember CIMRON when you need a high quality AC Power Source, Line Regulator, Pulse Generator, Two Phase Clock (MOS Driver), Data Acquisition System, and Digital Multimeter. Local Warranty service is now available. Write or call Lear Siegler, Inc./Cimron Instruments, 714 N. Brookhurst St., Anaheim, California 92803. Telephone 714-774-1010.

LEAR SIEGLER, INC.



CIMRON INSTRUMENTS

Booth #2101

application notes



The MECL handbook

Motorola Semiconductor Products Div. has released the 211-page MECL System Design Handbook. The book presents current and complete information for easy design of high-speed digital systems using MECL logic. In the past, several articles and application notes have been written about MECL circuits and systems. However, there was a need for a book which would completely define MECL operation. The MECL System Design Handbook has been written to give the designer the information needed to establish design rules for his own high-performance systems. Detailed information is given for designing with MECL II, MECL III and the new low-power MECL 10,000 Series logic. Motorola's MECL System Design Handbook may be purchased for \$2 per copy. Motorola Inc., Phoenix, Ariz.

Dc voltage standard

A six-page application note describes 31 ways to use the AN3100 dc secondary voltage standard. Emphasis has been placed upon those applications where the AN-3100 features are pay-off values, such as in calibration or voltage dividers and resistance ratios, measurement of dc amplifier gain and linearity, calibration of d/a converters, and measurement of thermal EMF. Analogic Corp., Wakefield, Mass.

CIRCLE No. 348

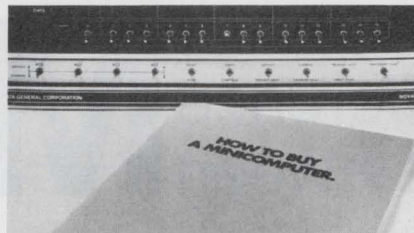

How to buy a minicomputer

A 32-page pamphlet, "How to Buy a Minicomputer," which answers the 17 most commonly asked questions about what to look for in minicomputers, discusses such topics as minicomputer architecture, the importance of new memory techniques, types of instruction sets, and what software and peripheral equipment should be available with a minicomputer. Data General Corporation, Southboro, Mass.

CIRCLE NO. 349

Lock-in amplifiers

Lock-in amplifier theory and operation are the subjects of a new eight-page application note (IAN-21) entitled "Lock-in Amplifiers—What Are They?" This note divides the lock-in amplifier into functional blocks, and provides a discussion of each of the blocks as well as their inter-relationship. Included are such topics as the phase-sensitive detector, the filtering characteristics of a lock-in, the signal to noise improvement that may be achieved with a lock-in, and a unique method of automatic phase correction which allows the amplitude and phase of a signal to be measured without adjustment of the phase controls. Ithaco Inc., Ithaca, N.Y.

CIRCLE NO. 350

Digital frequency synthesis

A two-page application note entitled, "The Advantages of Direct Digital Frequency Synthesis," compares the various approaches and describes the advantages of direct digital frequency synthesis over direct and indirect analog techniques. These advantages include no switching transients, excellent short term stability and precise phase control. Block diagrams of all three techniques are also included. Rockland Systems Corp., Blauvelt, N. Y.

CIRCLE NO. 351

Look for your nearest Raytheon Oscilloscope Representative:

Avionics Liaison, Inc.
6770 Perimeter Rd.
Seattle, Washington 98108
(206) 767-3870

Coherent Mktg. Associates, Inc.
1890 Embarcadero Rd.
Palo Alto, California 94303
(415) 327-2217

FLW, Inc.
10760 Burbank Blvd.
N. Hollywood, Ca. 90601
(213) 877-5518

Instrument Associates, Inc.
175 Middlesex Tpke.
Bedford, Mass. 01730
(617) 275-0700

Klein Aerospace
PO Box 1056
Englewood, Colorado 80110
(303) 781-4967

KLS Associates, Inc.
387 Passaic Avenue
Fairfield, N.J. 07006
(201) 227-2900

K-G Electronics, Inc.
11151 Veirs Mill Rd.
Wheaton, Md. 20902
(301) 946-4055

RJC Associates
26 Morningside Drive
Cortland, N.Y. 13045
(607) 753-3909

Scientific Devices-Midwest
3300 S. Dixie Drive, Suite 212
Dayton, Ohio 45439
(513) 298-9904

Scientific Devices-Philadelphia
PO Box 201
Plymouth Meeting, Pa. 19462
(215) 825-2841

Scientific Devices-Southeast
707 E. Colonial Dr. Suite 6
Orlando, Florida 32803
(405) 424-6792

Scientific Sales Company
777 S. Central Expressway
Richardson, Texas 75080
(214) 231-6541

RAYTHEON

Why buy the Star of India? When you really need a little gem.

Overbuying can be princely fun. If you're the Aga Khan.

But now, with the current budget squeeze, common sense has entered the picture. So has Raytheon's CDU-150 scope.

A top quality, general-purpose oscilloscope with price/performance second to none. DC to 35MHz at 5 mV/cm. Dual channel. Big, bright 8x10 cm display. Stable triggering over the full bandwidth.

Time-base delay.

Plus light weight for honest portability. Ruggedness that can easily take hundreds of miles in the trunk of your car without a flutter. At a price of only \$1495.

Think about it. The uncompromising quality of the CDU-150. And the money you save by not buying more than you need. Send us the coupon. Or contact the nearest sales reps on the opposite page.

Raytheon Company
Instruments Operation
175 Middlesex Turnpike
Bedford, Mass. 01730

Gentlemen: Send information on the CDU-150.

Name _____

Company _____

Address _____

City _____

State _____ Zip _____

RAYTHEON

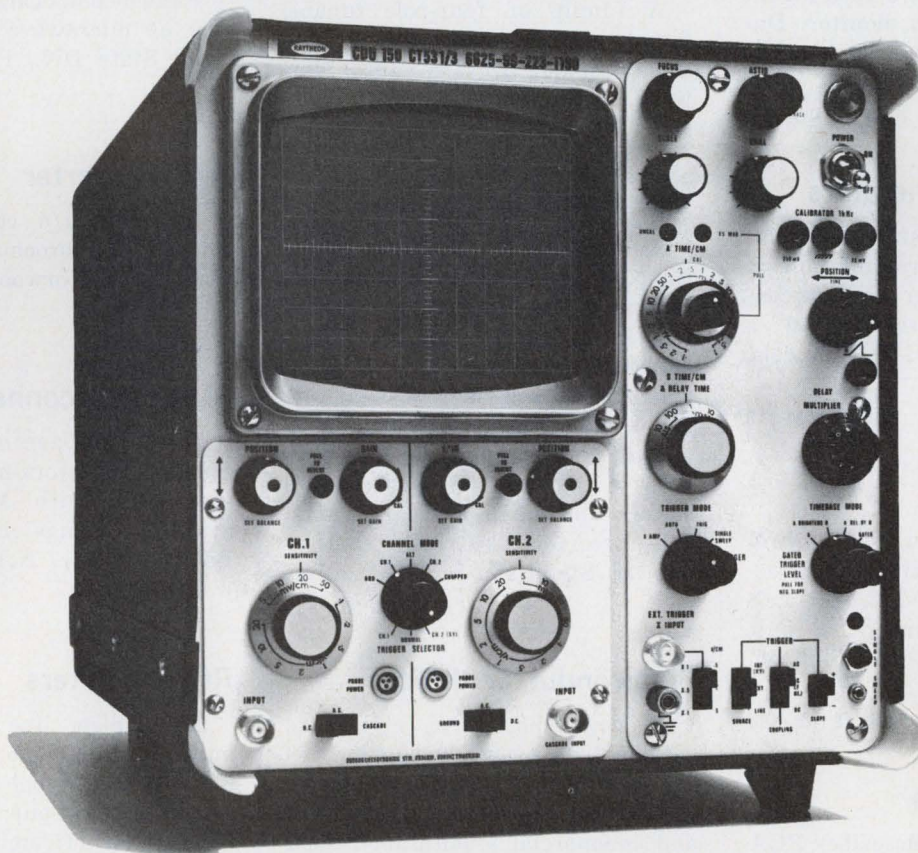

(Our little jewel.)

INFORMATION RETRIEVAL NUMBER 112

new literature

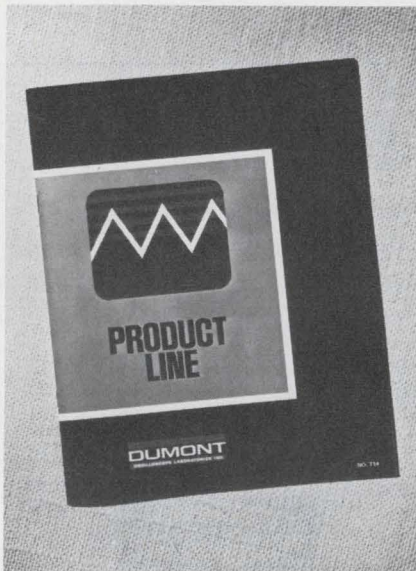

Oscilloscopes

A new 32-page catalog contains information on Dumont's line of general-purpose oscilloscopes, cameras, cars and accessories. New models include a 60-MHz dual-channel portable, and a rack-mount version of an X-Y-Z monitor. Dumont Oscilloscope Laboratories, Inc., Caldwell, N.J.

CIRCLE NO. 352

Plug-in pulse generators

Two plug-in solid-state dial pulse generators—both available in a choice of either 24 or 48-V-dc configurations—are described in a product bulletin. G-V Controls, Livingston, N.J.

CIRCLE NO. 353

DPMs

A comprehensive eight-page brochure contains a specification selection guide for 2, 2-1/2, 2-3/4, 3 and 3-1/2-digit dc and 3-1/2-digit ac DPMs. Triplet Corp., Bluffton, Ohio.

CIRCLE NO. 354

Power transistors

A revised catalog describes RCA silicon power transistors. RCA Solid State Div., Somerville, N.J.

CIRCLE NO. 355

Readout assemblies

Bulletin R05021 details series 749 solid-state readout assembly for applications like electronic thermometers, data-entry keyboards, speedometers, frequency meters, clocks, test equipment, and counters. The readout assembly contains groups of Diode-lite readouts, decoder drivers and a stylish black bezel assembly that is easy to install in a panel. Dialight Corp., Brooklyn, N.Y.

CIRCLE NO. 356

Digital indicator

Complete information on the Howell Instruments H600 digital panel-mounting indicator is contained in a brochure. Howell Instruments, Inc., Fort Worth, Tex.

CIRCLE NO. 357

Active filters

A family of four-pole tunable filters are described in a data sheet. Analog Devices, Inc., Norwood, Mass.

CIRCLE NO. 358

Vibrating reed meters

An eight-page illustrated Bulletin No. 806-B which describes the company's line of vibrating reed frequency meters contains information on 2-1/2-in. and 3-1/2-in. panel mounting meters, 3-1/2-in. panel mounting combination frequency and running time meters, 4 by 4 in. telephone switchboard meters and small and large portable precision instruments. Herman H. Sticht Co. Inc., N.Y., N.Y.

CIRCLE NO. 359

Semiconductor devices

A new short-form eight-page catalog lists over 300 popular off-the-shelf silicon semiconductors to meet a wide variety of military and commercial applications. Solid State Devices, Inc., Sante Fe Springs, Calif.

CIRCLE NO. 360

Transmission measurement

A 12-page illustrated brochure describes a universal transmission measuring system—a centralized digital system for installation in telecommunications test facilities. The modular system can be equipped to measure transmission level, frequency and noise. Telecommunications Technology, Inc., Palo Alto, Calif.

CIRCLE NO. 361

Traveling-wave tubes

A 28-page traveling-wave tube catalog describes lines of low, medium and high-power cw tubes, TWT amplifiers, pulse TWTs and low-noise TWT amplifiers. Varian, TWT Div., Palo Alto, Calif.

CIRCLE NO. 362

Microwave diodes

A two-color catalog features a line of microwave diodes. Varian Solid State Div., Palo Alto, Calif.

CIRCLE NO. 363

A/d converter

An 8-bit a/d converter is described in a brochure. Analog Devices, Inc., Norwood, Mass.

CIRCLE NO. 364

SMA coax connectors

A new 24-page catalog on SMA coaxial connectors manufactured in accordance with MIL-C-39012 is available. Kings Electronics Co., Inc., Tuckahoe, N.Y.

CIRCLE NO. 365

Rfi/emi filters

A complete line of single and multiple-circuit power-lines, communications/signal and telephone-circuit, general-purpose tubular and rectangular rfi/emi filters are described in a brochure. All-Tronics, Inc., Westbury, N.Y.

CIRCLE NO. 366

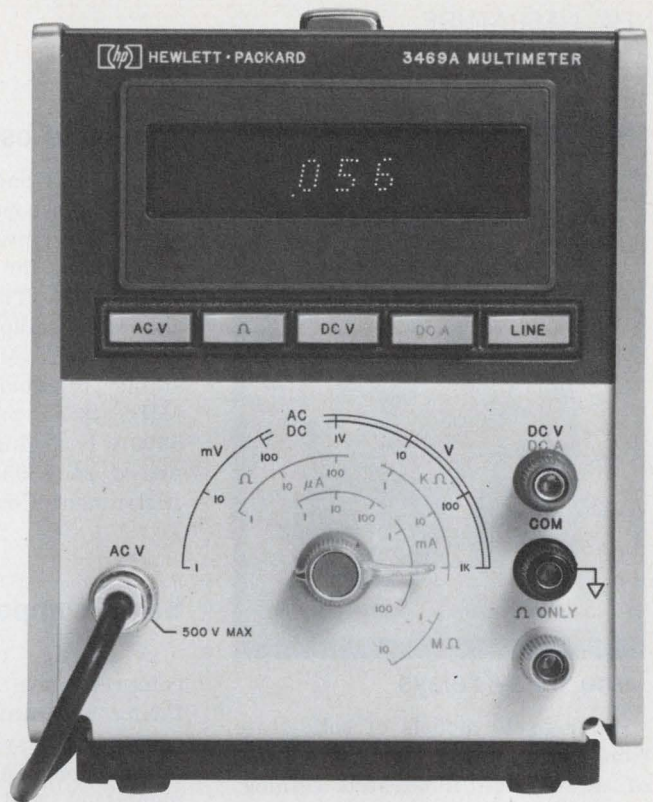
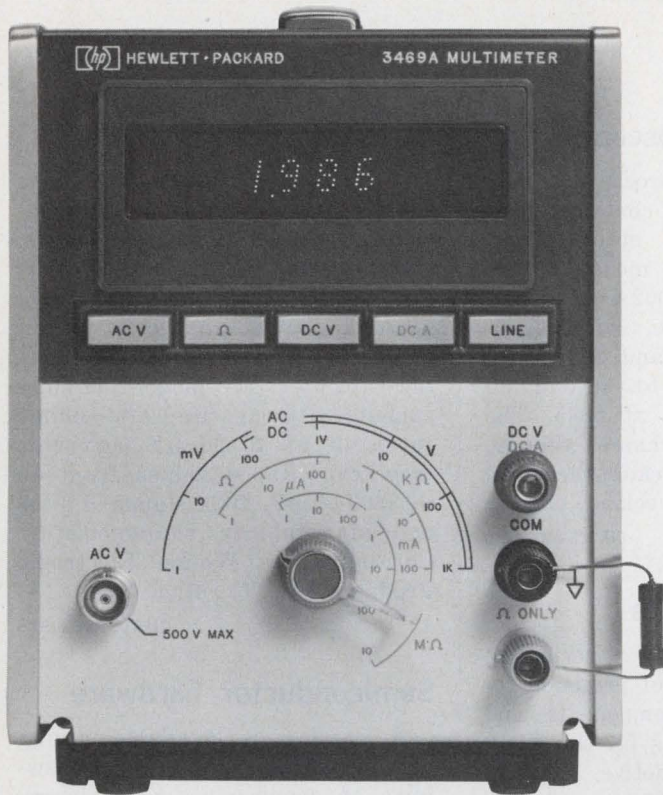

A full-function digital multimeter + A lab-quality digital AC voltmeter
... both for \$595

HP's new 3469A gives you a general-purpose digital multimeter *plus* a lab-quality digital AC voltmeter—for the price of the AC voltmeter alone. Now, you don't have to buy two (or more) instruments to get the capabilities you need—or compromise on quality to stay within your budget.

As a general-purpose multimeter, the 3469A gives you exceptional capabilities. Its 1 Ω range lets you measure low-resistance components and even contact resistances of a few milliohms, with an accuracy of $\pm 0.25\%$ reading $\pm 0.5\%$ range. To make the low range easily useable, a unique offset adjustment lets you compensate for lead resistance. In

the higher ranges (100 Ω to 10 M Ω), accuracy is $\pm 0.3\%$ reading $\pm 0.2\%$ range. The 3469A also gives you five DC voltage ranges (100 mV to 1000 V) and six DC ampere ranges (1 μ A to 100 mA), with accuracy of $\pm 0.2\%$ reading $\pm 0.2\%$ range or better, depending on range.

As an AC voltmeter, the 3469A is unmatched at any price. You get seven voltage scales, ranging from 1000 V full-scale down to 1 mV full-scale—100 times the sensitivity of other digital meters. You also get a 10 MHz bandwidth capability—100 times greater than other digital multimeters—with a basic accuracy of $\pm 0.3\%$ reading $\pm 0.3\%$ range. And

you get a bright, ultra-reliable, shaped-character GaAsP display, that's easier to read than tubes or bar-segment numerals.

Compare the 3469A's specs with any other meter's — and you'll agree that there's no better value, at any price. For further information on the 3469A, contact your local HP field engineer, or write Hewlett-Packard, Palo Alto, California 94304. In Europe: 1217 Meyrin-Geneva, Switzerland.

091/16

HEWLETT  PACKARD
DIGITAL VOLTMETERS

INFORMATION RETRIEVAL NUMBER 113



Time delay relays

Four basic models of solid-state time delay relays are the subject of a six-page illustrated catalog, Bulletin 200. Photographs, cross-section connection drawings, specifications, description, operation details and suggested applications are included for each of the models: the "ON DELAY" TR4, "REPEAT CYCLE" TR7, "INTERVAL" TRS, and "OFF" TR6. Durakool, Inc., Elkhart, Ind.

CIRCLE NO. 323

Transistors/diodes

A complete listing of rf and power switching transistors, zener diodes, rectifiers and microelectronic products is included in a 20-page short-form catalog. TRW Electronic Components, Semiconductors Div., Lawndale, Calif.

CIRCLE NO. 367

Binary switch

Detailed data on a new binary thumbwheel switch is contained in a data sheet. The Digitran Co., Pasadena, Calif.

CIRCLE NO. 368

Timing/control devices

A 28-page catalog describes a line of standard and custom-built miniature timing and control devices. The A. W. Haydon Co., Waterbury, Conn.

CIRCLE NO. 369

Wideband oscilloscopes

The four-page brochure, "Hickok oscilloscopes," contains complete descriptions, specifications and prices for the models 5000A and 5002A. The 5002A is a dual channel oscilloscope, with bandwidth to 25 MHz and simplified, stable triggering to beyond 50 MHz. It is priced at \$845. The 5000A is a single channel version, priced at \$595. Hickok Electrical Instrument Co., Cleveland, Ohio.

CIRCLE NO. 370

Servo components

A 24-page catalog describes a comprehensive line of precision rotating and static components, and custom-built systems for the EDP, automation, automotive, instrumentation and electronics industries. Servo-Tek Products Co., Hawthorne, N.J.

CIRCLE NO. 371

Trimming pots

A four-page publication details 1/2-in.-diameter dual trimming potentiometers. It covers operating and mechanical characteristics with charts, tables and dimensional drawings, Allen-Bradley Co., Milwaukee, Wis.

CIRCLE NO. 372

Voltage tunable active filters

A four-page report provides the systems engineer with an understanding of voltage-tunable active filters, including methods of optimizing usage and many applications. Chebychev, Butterworth and Bessel filters (0.1-20,000 Hz) having simultaneous low, high, and bandpass outputs are described. Frequency Devices, Inc., Haverhill, Mass.

CIRCLE NO. 373

Photodiodes

Data sheets are available describing a series of photodiodes. Wagner Electric Corp., Tung-Sol Div., Livingston, N.J.

CIRCLE NO. 374

Glass-ceramic capacitors

A two-page illustrated data sheet (CAD-CCC) presents dimensions, performance characteristics, stability characteristics and ordering information for miniature Corning glass-ceramic chip capacitors. The sheet notes that the Corning capacitors are monolithic components with capacitance-to-volume ratios of up to 90 μ F per cubic inch, capacitance values from 10 to 330,000 pF, four standard sizes and six stability characteristics. Corning Glass Works, Electronic Products Div., Corning, N.Y.

CIRCLE NO. 375

Semiconductor hardware

A catalog is available giving photographs and dimensional drawings of semiconductor hardware. The catalog is divided into six sections and includes full information on multi-lead and DIP sockets, test clips and pin headers/plugs. It also shows transistor and IC mounting pads, insulating bushes and covers and heat-transfer washers and sink adaptors. Jermyn Industries, Mfg. Div., Vestry Estate, Kent, England.

CIRCLE NO. 376

Controls

A new catalog contains a broad-base line of more than 400 standardized electronic and electromechanical controls. The controls include thermostats, air flow sensors and controls, voltage and frequency sensors, flashers and time-delay relays. G-V Controls, Livingston, N.J.

CIRCLE NO. 377

IC d/a converters

A six-page data sheet describes the monoDAC-01 series, the only complete 6-bit digital-to-analog converter on a single chip. The literature provides detailed information on usage in low-cost a/d converters, expansion of resolution to 7 bits, driving capacitive loads and more. Precision Monolithics, Inc., Santa Clara, Calif.

CIRCLE NO. 378

Greater RFI/EMI shielding in new, narrow-width contact strips from Instrument Specialties

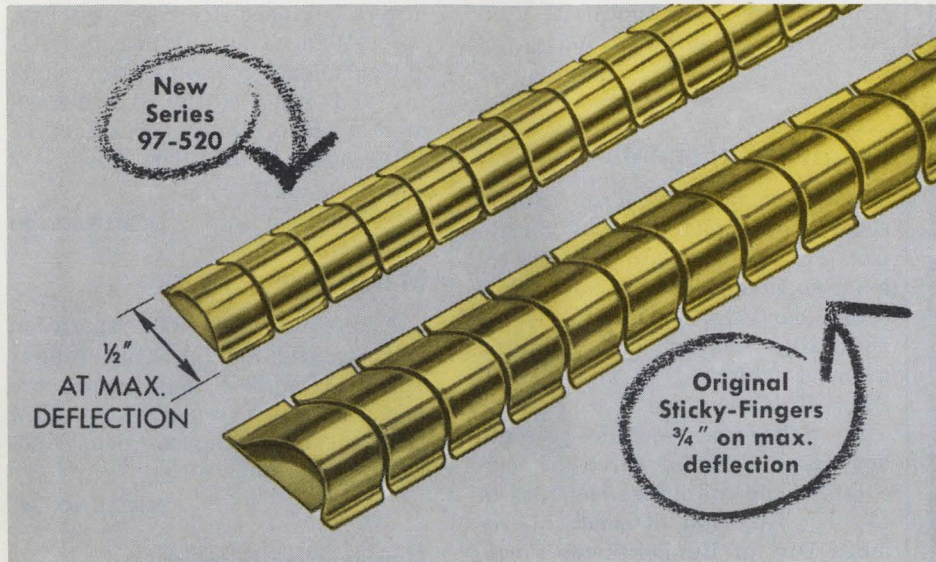

Latest addition to **stickn fingers**® line!

Instrument Specialties now offers Sticky-Fingers self-adhesive, beryllium copper contact strips in three variations to solve your most critical RFI/EMI problems.

Comparable to the shielding effectiveness of the original Sticky-Fingers, our newest series 97-520* offers shielding effectiveness of 92 dB at 10 GHz plane wave or greater than 92 dB at 1 MHz magnetic, and has a dynamic range of 0.10". Yet, it measures a scant 3/8" wide, and 1/2" at maximum deflection.

Supplied in standard 16" lengths, series 97-520 is ideal for metal cabinets and electronic enclosures where variations exist in the space to be shielded, and where high shielding effectiveness must be maintained in narrow spaces, even with frequent opening and closing of the cabinet.

Select the exact series that fits your application best. Write today for a complete catalog, list of finishes available, and our latest Independent Shielding Evaluation Report. Address: Dept. ED-68

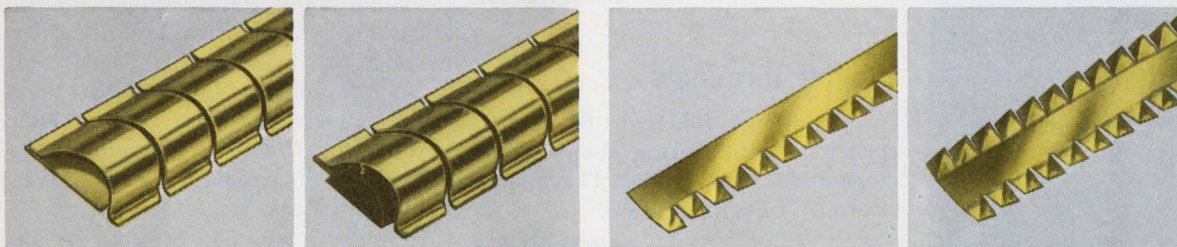

Series 97-500*—the original 3/4" wide Sticky-Fingers. Specify when you require greatest possible shielding and where space permits. Also, supplied as 97-510 with Magnifil® for optimum magnetic shielding.

For those all-purpose applications where economy and space are both factors, specify the 3/8" wide single-twist series 97-555, or 1/2" wide double-twist series 97-560 Sticky-Fingers.

Specialists in beryllium copper springs since 1938

*Patented



Newer, Higher Quality

NDK Products

CRYSTAL FILTERS

10.7MHz or 21.4MHz MCF
(Monolithic Crystal Filters)

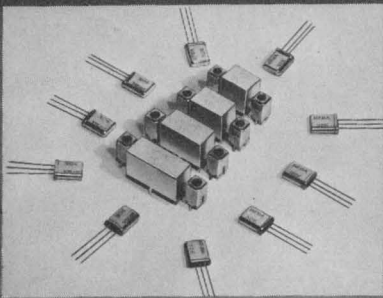

For FM Receivers
(10.7MHz-Series)



EF10.7BK

For SSB Transceivers



YF9000E

World's Leading
Manufacturer of:

- Synthetic Quartz Crystals
- Water Soluble Crystals (LH, ADP, KDP)
- Quartz Crystal Units
- Crystal Oscillators
- Crystal Filters
- Delay Lines
- Ultrasonic Instruments



**NIHON DEMPA
KOGYO CO., LTD.**

Since 1948

1-21-2, Nishihara Shibuya-ku, Tokyo, Japan
Tel: (03) 460-2111
Cable: CRYSTALUNITS TOKYO TLX: 242-2291

NEW LITERATURE

Incremental encoder

Four-page bulletin 818 details electrical and physical specifications for an incremental shaft-angle encoder specifically designed for English-metric measuring systems. Trump-Ross Industrial Controls, Inc., N. Billerica, Mass.

CIRCLE NO. 379

Ferrite components

A six-page short-form catalog covers a complete line of ferrite isolators and circulators. In the coaxial section are specifications for octave-band devices as well as for 10%, 20% and common-band units, most of which are available with SMA, TNC or Type N connectors. The waveguide section presents key parameters for three-port circulators and miniature isolators in C-, X-, Ku, and K-band. Micro-mega Div. of Bunker Ramo Corp., Los Angeles, Calif.

CIRCLE NO. 380

7-resistor DIP

The Beckman series 899-3 resistor package featuring seven thick-film resistors of equal value is described in a new catalog sheet. Helipot Div., of Beckman Instruments, Inc., Fullerton, Calif.

CIRCLE NO. 381

Display/memory unit

A new illustrated brochure describes Owens-Illinois' line of Digivue display/memory units. Owens-Illinois, Inc., Toledo, Ohio.

CIRCLE NO. 382

Solder terminals

A six-page folder is filled with practical information about solder terminals. Cambridge Thermionic Corp., Cambridge, Mass.

CIRCLE NO. 383

Card processors

A data sheet describes a new line of peripheral equipment for processing 96-column cards. Potter Instrument Co., Inc., Melville, N.Y.

CIRCLE NO. 384

Circuit-board patterns

A four-color brochure illustrates the step-by-step use of Circuit Zaps—copper component patterns, pads and conductor paths—to enable the laboratory technician or design engineer to create prototype or customized circuit boards without chemicals, photo-printing, etching and other costly steps associated with prototype construction. International Rectifier Corp., El Segundo, Calif.

CIRCLE NO. 385

Mainframe core

A brochure describes operation and specifications of the Ampex Model ARM-2365 mainframe core memory which replaces the IBM 2365 memory. Ampex Corp., Redwood City, Calif.

CIRCLE NO. 386

Power supply guide

A specifier's guide to power supplies is available. The four page brochure describes power supplies manufactured by Armour Electronics, Worcester, Mass.

CIRCLE NO. 387

Epoxies

Electrically conductive, quick-cure epoxies (five minutes or less), and materials for potting, encapsulating, bonding, casting and sealing are listed in a catalog. Kenics Corp., Danvers, Mass.

CIRCLE NO. 388

Metric hardware

A new metric version of Cambridge Thermionic's latest general catalog 747 is available. Dimensions of Cambion's terminals, boards, inductors, capacitors and connectors are given in metric units in the new version. Cambridge Thermionic Corp., Cambridge, Mass.

CIRCLE NO. 389

Annunciators/alarms

A 16-page catalog describes a wide range of annunciators and alarms systems. AMF Electrical Products Development Div., Alexandria, Va.

CIRCLE NO. 390

It took us years to perfect the transient recorder

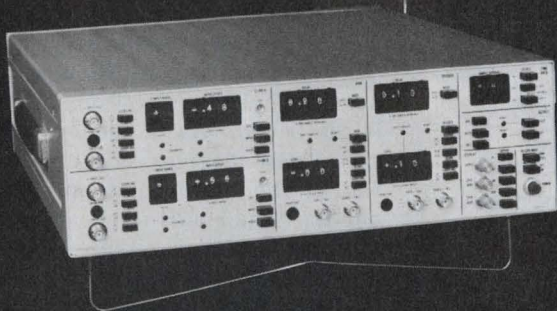

Now give us 40 seconds to prove you need it.

You be the judge. Think how the following talents can benefit your particular application.

Our transient recorders let you capture any single event analog signal in real time. You can digitize it at rates up to 100 MHz. Store it in memory. Then, transmit it in analog or digital form without erasing it from memory. You can even record the data preceding your trigger signal — an exclusive feature called "pre-trigger" recording.

Output controls let you observe the stored waveshape on a scope, make permanent records on a strip chart or recorder, or feed the digital data directly to your computer for analysis.

This kind of data acquisition is priceless in many applications. You can measure explosion shock waves, shock tube studies; T-Jump, stop-flow and other reaction kinetic chemistry; plasma physics; fluorescent decay studies; automatic test systems for component testing; Lidar and other optics systems; pulsed NMR work, biomedical signal analysis, many more.

Model	A/D Rate	A/D Resolution	Memory Length	Price
610B	10 MHz	6 bit	256 word	\$1850
802	2 MHz	8 bit	1024 word	\$2950
8100	100 MHz	8 bit	2000 word	\$9500

In less than 40 seconds you can help us tell you the complete story. Write or call Biomation, 1070 East Meadow Circle, Palo Alto, California 94303. (415) 321-9710.

biomation

INFORMATION RETRIEVAL NUMBER 116

ELECTRONIC DESIGN 1, January 6, 1972

SAVE MONEY AND SPACE WHILE ELIMINATING ALL THESE OPERATIONS

- Multi-component receiving inspection
- Sorting for TC or Ratio match
- Pre-packaging or binning
- Multi-insertions: With only **ONE INSERTION** you can assemble up to 4 resistors on a PC board, and in 1/8 the space!

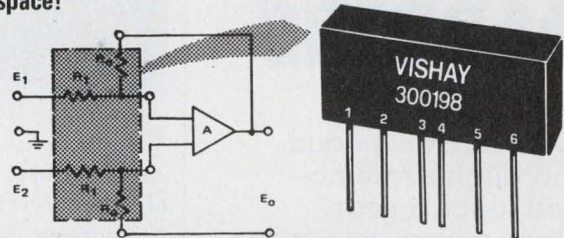

Typical op-amp feedback resistors showing how one VISHAY (actual size) pre-packaged 4 resistor assembly can be used to replace precision wirewounds.

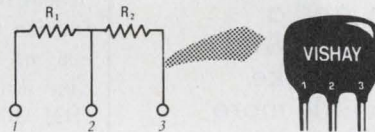

VISHAY (actual size) pre-packaged 2 resistor voltage divider. Other configurations available with up to 4 discreet resistors.

VISHAY UNITIZED RESISTOR CIRCUITS

SPECIFICATIONS	TYPICAL PRICES (QTY. 100)
HIGH ACCURACY RATIO MATCH <ul style="list-style-type: none"> ■ Each Resistor: 100Ω to 75K ■ Absolute Tol. each R: To .005% ■ Absolute TC each R: ±5 ppm/°C (-55°/125°C) ■ Tol. Match: To .005% ■ TC Match: Within 3 ppm/°C (-55°/125°C) 	<p>\$9.52 each (0.01% match; tracking within 3 ppm/°C)</p>
MEDIUM ACCURACY RATIO MATCH <ul style="list-style-type: none"> ■ Each Resistor: Up to 50K ■ Absolute Tol. each R: To .05% ■ Absolute TC each R: ±10 ppm/°C (-55°/125°C) ■ Tol. Match: To .1% ■ TC Match: Within 5 ppm/°C (0°/60°C) 	<p>\$1.56 each (1% match; tracking within 5 ppm/°C)</p>

For details on other Unitized Resistor Circuits for use as bridges, rectifiers, attenuators, ladders, etc., contact:



VISHAY RESISTOR PRODUCTS

A DIVISION OF VISHAY INTERTECHNOLOGY, INC.

63 LINCOLN HIGHWAY ■ MALVERN, PENNA. 19355
TELEPHONE: (215) 644-1300 ■ TWX: 510-668-8944

PRECISION RESISTORS • NETWORKS • DECADE BOXES • TRIMMERS

INFORMATION RETRIEVAL NUMBER 117

153

A MESSAGE FOR DADDIES

Get yourself a good, thorough examination once a year. Once a year, let your doctor really look you over. It'll take a little time, and a little patience. And maybe he'll poke around a little more than you'd really like. And so he should.

The whole idea is to keep you healthy. If nothing's wrong (and more than likely, there isn't) hooray! Come back next year. But if anything's suspicious, then you've gained the most important thing of all: time.

We can save 1 out of 2 persons when cancer is caught in time, caught early. That's a good thing to know. All Daddies should know how to take care of themselves so that they can have the fun of taking care of their kids. Don't be afraid. It's what you don't know that can hurt you.

AMERICAN CANCER SOCIETY

bulletin board

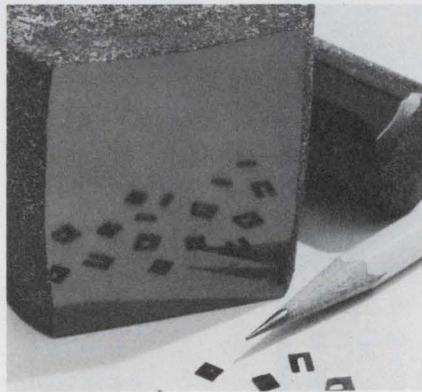

Ampex Corp. has begun delivery of a new ferrite material designed to increase production yields for manufacturers of magnetic disc recording heads. The new PS-135 pressure sintered (hot-pressed) ferrite is being marketed to makers of flying heads for digital disc drives of the types used with IBM 360 and 370 computers. The Ampex ferrite is used in building the core assembly which forms the magnetic gap—that part of the head which makes possible the recording and reproduction (writing and reading) of magnetic impulses. Use of the Ampex pressure sintered ferrite in manufacturing glass-bonded core assemblies has produced more precisely defined gaps than have been achieved by using conventional materials, and the electrical and mechanical gap lengths are in closer agreement. The result is higher production yields, leading to lower manufacturing costs.

CIRCLE NO. 391

TRW has developed a process for new LSI circuitry which makes higher arithmetic speeds (100 ns add time) economically practical in small and medium-sized computers. The new circuitry will allow logic designers to use clock rates of 30 to 50 megabits/s in special and general-purpose processors. The process, called triple-diffused bipolar LSI reportedly will produce a simple LSI with speeds now achieved only by very complex bipolar LSI—and faster than the new silicon gate CMOS.

CIRCLE NO. 392

Advanced Micro Devices has introduced the industry's largest low-power MSI family—developed for systems where power consumption is critical. Eleven MSI circuits with fan-out and speed characteristics permitting designers to replace standard devices to take advantage of reduced power requirements have been added to the company's seven previously introduced circuits. This optimum speed/power trade-off of the low-power series meets a wide variety of military, avionic, and instrumentation system needs where power consumption is essential. As a general rule these new devices consume one-fourth the power and operate at one-half the speed of the standard MSI devices they replace. Outputs of most of the Advanced Micro Devices' MSI family will drive three standard TTL loads virtually eliminating any problem in mixing standard and low-power devices within the same system.

CIRCLE NO. 393

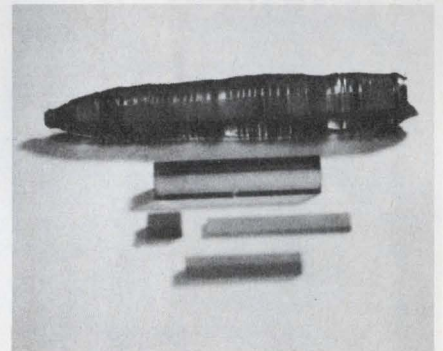

Krystallos Inc. has achieved a major breakthrough in volume production of Bismuth Germanium Oxide (BGO). Using proprietary manufacturing techniques, Krystallos is now able to reduce the cost of producing pure crystallized BGO by over one-half. By combining lowered manufacturing costs with volume discounts, Krystallos has made feasible a substantial number of BGO applications which were previously closed due to high-costs. As an example, BGO has been recognized as a superior time delay generation material for microwave delay circuits, voice-grade transmission and radar, but the large volumes of BGO crystals required were simply too expensive to permit the material's use.

CIRCLE NO. 394

NEW! THE LOVE/HATE SWITCH

Our Customers Love Its
1,000,000 Detents
(for high quality)
And Low Cost
(for savings!)
Our Competitors Hate It . . . for the same reasons!

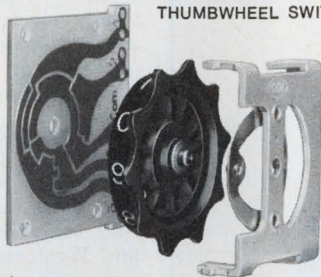

MINIATURE PRECISION THUMBWHEEL SWITCH

9 Top Quality Features

1. .05 ohms max. contact resistance.
2. 200 megohms min. insulation.
3. 1,000 volts min. dielectric strength.
4. 2 amps @ 115VAC current carrying capability.
5. 125 ma @ 115VAC current breaking capability.
6. Mounts on 1/2" centers only 1 1/2" behind panel.
7. Glass laminate with precious metals contacts & plating.
8. Multi-applications—you name it.
9. Over 1,000,000 detents.

IMMEDIATE DELIVERY. ASK THE PRICE—BE PLEASANTLY SURPRISED.

CHICAGO DYNAMIC INDUSTRIES, INC.



PRECISION PRODUCTS DIVISION

1725 Diversey Blvd., Chicago, Ill. 60614. Phone 312. WE 5-4600

INFORMATION RETRIEVAL NUMBER 119

24 HOUR* DELIVERY

DC POWER SUPPLIES

DIRECT FROM STOCK

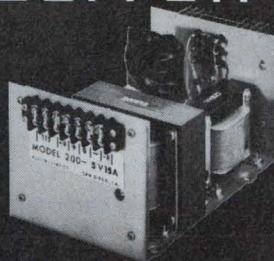

Electrostatics has the lowest priced **Quality** DC Power Supply available today. Compare the specs with supplies that cost twice as much . . . low ripple, excellent regulation, quick transient response, and wide temperature range.

FREE—Send for a copy of our power supply catalog.

Model	Volts	Amps	Size	Price
50A	3 to 30V	5 to 2A	3x4x6.75	\$69 (\$79 w/ov†)
50	3 to 50V	5 to 1A	4.13x5x7.00	\$59 (\$69 w/ov†)
200	3 to 50V	15 to 4A	5x5.5x10.75	\$99 (\$114 w/ov†)
503	±5 to 6V +12 to 20V -12 to 20V	5A 0.5A 0.5A	4.0x8.0x8.0	\$125 (\$150 w/ov†) († with overvoltage)

80 Models available covering ranges shown above.

Abbreviated Specifications: **Line Reg.:** 0.005% (Model 50A) 0.01% (Model 50, 200, 503) **Load Reg.:** 0.05% (Model 50A) 0.1% (Model 50, 200, 503) **Ripple:** 250 Microvolts RMS max. **Foldback current limiting.**

*On all standard models

Phone (714) 279-1414, or circle the number below for our latest data sheet.

Electrostatics, inc.

7718 CLAIREMONT MESA BLVD./SAN DIEGO, CALIFORNIA 92111

INFORMATION RETRIEVAL NUMBER 120

25,000 chips per hour...mean

**LARGEST INVENTORY
FASTEST DELIVERY
LOWEST COST
FINEST QUALITY**

...from USCC/Centralab

Yes, it's true! Because demand for ceramic chip capacitors in hybrid microelectronics will more than double within the next two years, USCC's production capability on popular sizes will increase to 25,000 per hour by mid-1972. That's over 50 million annually, with a demonstrated failure rate level of only .001%/1000 hours.

New automation techniques and materials cost reduction mean to you as a customer: fastest delivery and lowest prices on the finest quality ceramic chip capacitor on the market.



For your free copy of our Ceramic Capacitor Catalog and Applications Manual on how to use chip capacitors more advantageously, write: USCC/Centralab, 2151 N. Lincoln Street, Burbank, California 91504 or circle the information retrieval number below.

USCC

U. S. CAPACITOR CORPORATION



CENTRALAB
Electronics Division • GLOBE-UNION INC.

INFORMATION RETRIEVAL NUMBER 121

**Happiness is
employees
who show up
every day.**

Hire the Handicapped



Electronic Design

ELECTRONIC DESIGN's function is:

- To aid progress in the electronics manufacturing industry by promoting good design.
- To give the electronic design engineer concepts and ideas that make his job easier and more productive.
- To provide a central source of timely electronics information.
- To promote communication among members of the electronics engineering community.

Want a subscription? ELECTRONIC DESIGN is sent free to qualified engineers and engineering managers doing design work, supervising design or setting standards in the United States and Western Europe. For a free subscription, use the application form bound in the magazine. If none is included, write to us direct for an application form.

If you do not qualify, you may take out a paid subscription for \$25 a year in the U.S.A., \$35 a year elsewhere. Single copies are \$1.50 each.

If you change your address, send us an old mailing label and your new address; there is generally a postcard for this bound in the magazine. You will have to requalify to continue receiving ELECTRONIC DESIGN free.

The accuracy policy of ELECTRONIC DESIGN is:

- To make diligent efforts to ensure the accuracy of editorial matter.
- To publish prompt corrections whenever inaccuracies are brought to our attention. Corrections appear in "Across the Desk."
- To encourage our readers as responsible members of our business community to report to us misleading or fraudulent advertising.
- To refuse any advertisement deemed to be misleading or fraudulent.

Microfilm copies are available of complete volumes of ELECTRONIC DESIGN at \$19.00 per volume, beginning with Volume 9, 1961. Work is now in process to complete the microfilm edition of Volumes 1-8. Reprints of individual articles may be obtained for \$2.00 each, prepaid (\$.50 for each additional copy of the same article) no matter how long the article. For further details and to place orders, contact the Customer Services Department, University Microfilms, 300 North Zeeb Road, Ann Arbor, Michigan 48106 telephone (313) 761-4700.

Want to contact us? If you have any comments or wish to submit a manuscript or article outline, address your correspondence to:

Editor
ELECTRONIC DESIGN
50 Essex Street
Rochelle Park, N.J. 07662

Advertising Sales Staff

Bryce Gray
Sales Manager

Rochelle Park, N.J. 07662

Robert W. Gascoigne
Daniel J. Rowland
50 Essex Street
(201) 843-0550
TWX: 710-990-5071

Philadelphia

Thomas P. Barth
50 Essex Street
Rochelle Park, N. J. 07662
(201) 843-0550

Boston 02154

Joseph F. Palmer
1268 Main Street
Waltham, Mass.
(617) 894-2700

Chicago 60611

Thomas P. Kavooras
Berry Conner, Jr.
200 East Ontario
(312) 337-0588

Cleveland

Thomas P. Kavooras
(Chicago)
(312) 337-0588
(call collect)

Los Angeles 90303

Stanley I. Ehrenclou
Burt Underwood
2930 Imperial Highway
Inglewood, Calif
(213) 757-0183

San Francisco 94022

Jerry D. Latta
95 Main Street
Los Altos, Calif.
(415) 941-3084

London W. 1

For United Kingdom and Holland
Brayton C. Nichols

For Eastern Europe
Peter Kehr

The American Magazine Group

27 Maddox Street
London, W. 1, England
Phone: 499-0180
Cable: Ammagnic, London

Verviers, Belgium

For Continental Europe
Andre Jamar
1, Ru Mallar, 1
(087) 253.83 Telex 41563

Tokyo

Haruki Hirayama
Electronic Media Service
5th Floor, Lila Bldg.,
4-9-8 Roppongi
Minato-ku
Phone: 402-4556
Cable: Electronicmedia, Tokyo



Design Data from Manufacturers

Advertisements of booklets, brochures, catalogs and data sheets. To order use Reader-Service Card.
(Advertisement)

3 NEW MINIATURE REAL-TIME SPECTRUM ANALYZERS

THREE NEW MINI-UBIQ®
PORTABLE REAL-TIME
SPECTRUM ANALYZERS

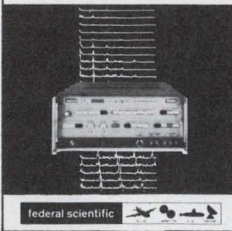

New features highlight Federal's 3 new Mini-Ubiq™ portable analyzers:

- Widest choice of ranges - 12 ranges from 10Hz to 50kHz
- Improved selectivity with 24dB/bandwidth-octave analysis filter
- Highest frequency and amplitude accuracy
- Computer control of input amplitude range, analysis range, and presampling filter
- Operation with weighting function on or off
- Sweep termination adjustable for high sweep rates
- Earphone monitor of filtered input

Write for FSC-L-522/100.

CIRCLE NO. 175

Federal Scientific Corp.

a subsidiary of Elgin National Industries, Inc.
615 West 131st Street, New York, N. Y. 10027

Time Calibration and Synchronization

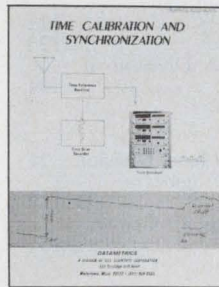

Datametrics is pleased to offer our new valuable handbook that presents a complete technical dissertation on the theory of time measurements and the techniques for precision calibration against primary and secondary time standards. An excellent guide for the instrumentation engineer engaged in real time data indexing, real time data processing, range timing, synchronized communication, aircraft flight testing, voice logging, etc.

Direct request for technical bulletin TCS to:
Mr. Philip Micciche.

CIRCLE NO. 172

Datametrics

127 Coolidge Hill Road
Watertown, Mass. 02172 Tel: 617-924-8505

New Low Voltage Wall Plug-In Literature



Dynamic Instrument Corp. has developed, designed and patented a complete range of filtered, low voltage, solid-state regulated, power supplies and chargers. These compact units are available in either wall plug-in or desk-top enclosures and lend themselves to a wide variety of uses including highly sophisticated electronic equipments.

Their compact size, light weight, heat isolation and adherence to U/L and CSA approved requirements has greatly assisted in product design miniaturization.

The advanced state-of-the-art to which Dynamic has developed these units has presented an ever wider market for their use, including such sophisticated instruments as mini-computers, calculators, keyboard logic circuits and similar such equipment, much of which is detailed in the illustrated literature available on request. Call our Engineering Dept. for specific problem assistance or contact Dept. ED-P/1 for descriptive catalog and product literature.

CIRCLE NO. 173

Power Conversion Products Division of: Dynamic Instrument Corp.

115 E. Bethpage Road, Plainview, N.Y. 11803

advertiser's index

Advertiser	Page	Advertiser	Page	Advertiser	Page
AMP, Incorporated	16F, 16G	General Semiconductor Industries, Inc.	100	Norden Division of United Aircraft Corporation	129
Abbott Transistor Laboratories Incorporated	10	Gralex Industries	108		
Accutronics, Inc.	81	Gudebrod Bros. Silk Co., Inc.	130	Oak Manufacturing Co.	57
Acopian Corporation	8H	Guardian Electric Manufacturing Company	8F, 8G	Optima, A Division of Scientific Atlanta, Inc.	130
Alco Electronic Products, Inc.	116				
Allen-Bradley Co.	25	Harris Semiconductor, A Division of Harris Intertype Corporation	97	Perfection Mica Company, Magnetic Shield Division	115
Amphenol Components Group	13	Hayden Book Company, Inc.	4, 8H, 128D, 159	Perkin-Elmer Corp.	140, 141
Art Wire & Stamping Co.	110	Heath/Schlumberg	133	Philips Electronic Components and Materials	128 A-B-C
		Heinemann Electric Company	31		
Babcock Relays, Division of Babcock Electronics Corporation	103	Hewlett-Packard	1, 2, 3, 8D, 8E, 16B, 16C, 82, 83, 149	RCL Electronics, Inc.	87
Beckman Instruments, Inc., Helipot Division	91	Hewlett Packard, New Jersey	17	Rapidesign, Inc.	142
Belden Corporation	19	Hickok Instrumentation and Controls Division	111	Raytheon Company, Instruments Operation	146, 147
Biomation, Inc.	153	Honeywell Inc.	123	Rectifier Components	159
Blulyne Electronics Corporation	159	Houston Instrument, A Division of Bausch & Lomb	144	Requested Data Delivery Service	Cover II A-B
Bourns, Inc., Trimpot Products Division	8B, 8C			Rtron Corporation	112
Buckeye Stamping Co., The	124	Illinois Tool Works, Licon Division	21	Rogers Corporation	120
Burr-Brown Research Corporation	119	Industrial Electronic Engineers, Inc.	16D, 159		
Burroughs Corporation	40, 41, Cover IV	Instrument Specialities Company, Inc.	151	Seiko Instruments, Inc.	134
				Semiconductor Circuits, Inc.	114
CTS Corporation	135	Johnson Company, E. F.	37	Servo-Tek Products Company	138
Cherry Electrical Products Corp.	105	Kurz-Kasch, Inc.	9	Shelley Associates, Inc.	118
Chicago Dynamics Industries, Inc.	155			Siemens Corporation	4
Chicago Miniature Lamp Works	42	L-H Research	159	Signetics Corporation	38, 39
Clare & Co., C. P.	35	Lafayette Radio Electronics Corporation	128	Sperry Information Displays	65
Conner-Winfield	159	Lambda Electronics Corp.	Cover III	Standard Condenser Corporation	104
Continental Connector Corporation	122	Lear Siegler, Inc., Cimron Division	145	Systron-Donner Corporation	22
		Ledex, Inc.	18		
Dale Electronics, Inc.	Cover II	LogiMetrics, Inc.	46	T & M Research Products, Inc.	128
Dana Laboratories, Inc.	33			Tecnetics, Inc.	11
Datametrics	157	3M Company	113	Technipower, Inc.	94, 95
Datascan, Inc.	70	Magnecraft Electric Company	16H	Tektronix, Inc.	45
Deltrol Controls	36	Matsushita Electric Corporation of America	142	Thomas Electronics, Inc.	132
Dialight Corporation	109	Meller Co., Adolf	116	Triplett Corporation	93
Diametrics Corp.	159	Mepco/Electra, Inc.	20	Tyco Saphikon Division	118
Digital Equipment Corporation	127	MicroSwitch, A Division of Honeywell	131		
Dow Corning Corporation	14, 15, 16A	Microwave Cavity Laboratories, Inc.	139	U. S. Capacitor Corporation	155
Dynamic Instrument Corp.	156	Monsanto Company	16	Unitrode Corporation	77
		Motorola Component Products Dept.	121		
Eastman Kodak Company	125	Motorola Semiconductor Products, Inc.	6, 7, 58, 59, 71	Vactec, Inc.	113
Edmund Scientific Company	120	Mura Corp.	114	Vernitron Piezoelectric Division	12
Electronic Design	136, 137, 160			Vishay Resistor Products, A Division of Vishay Intertechnology, Inc.	153
Electronic Measurements, Inc.	102	National Semiconductor Corporation	29		
Electronic Research Associates, Inc.	126	Newport Laboratories, Inc.	56 A-B-C-D	Weston Instruments, Inc.	9 A-B
Electrostatics, Inc.	155	Nihon Dempa Kogyo Co. Ltd.	152	Wiley Interscience	106
Elexon Power Systems	110				
Exact Electronics, Inc.	99				
Fairchild Semiconductor, A Division Fairchild Camera and Instrument Corporation	88, 89				
Federal Scientific Corporation	156				
Fifth Dimension, Inc.	145				
Fluke Mfg. Co., Inc., John	107				
Fork Standards, Inc.	159				
GTE Automatic Electric	8A				
General Instrument Corporation	16E				

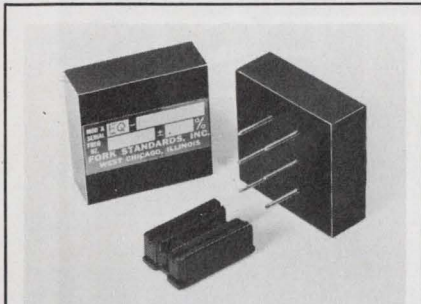

DIP-compatible model EQ oscillator combines crystal-controlled accuracy and stability with physical and electrical IC compatibility. Frequency range 1 Hz to 20 MHz at .002% accuracy. TTL compatible square wave output. Priced from \$50 singly. Fork Standards, Inc., 217 Main St., West Chicago, IL 60185. (312) 231-3511

INFORMATION RETRIEVAL NUMBER 181



Lower cost reliable power supplies feature 5V at 3 Amp. Regulation is 1% and the ripple less than 1 mV. Price is 22.50 in unit quantities. Other LOW COST supplies include potted and higher current modules to 12 Amps at similar LOW PRICES. To order call collect 802-442-8515 Blulyne Electronics Corp., 160 Ben Mont Ave. Bennington, Vt. 05201

INFORMATION RETRIEVAL NUMBER 182

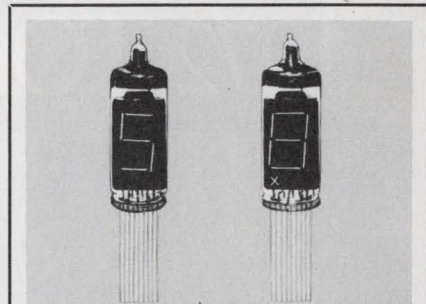

Seven segment filament readouts. 5 volts - 20mA/segment. 6,000 FtL brightness. 100,000 hours life. 1/2" diameter envelope. Character 0.472". Plug-in or P.C. mounting. 1,000 pieces \$1.95 each, \$2.05 with decimal point. Diametrics Corp., 1311 Post Ave., Torrance, Cal. 90501 (213) 328-2080

INFORMATION RETRIEVAL NUMBER 183

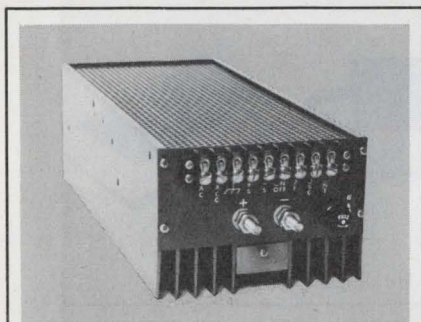

5V-50Amp power supply, model LH-550—3 1/2 x 5 x 11. Features .05% reg., 25 MS energy storage, 80% eff., 90 - 140 V input swing, remote sensing, OVP, current limit, power fail detection, remote on/off control. \$360. 1-9 quantity. L-H Research, 2052 So. Grand, Santa Ana, Calif. 92705 (714) 546-5279.

INFORMATION RETRIEVAL NUMBER 184

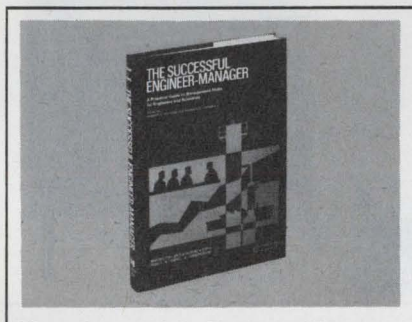

The Successful Engineer-Manager, Edited By R. C. Haavind and R. L. Turmail. Depth discussion and insights of the experts isolate the fine points of management: career, decisions, people, projects, finances, communications. Hayden Book Co., Inc., New York, N. Y. 10011.

INFORMATION RETRIEVAL NUMBER 185

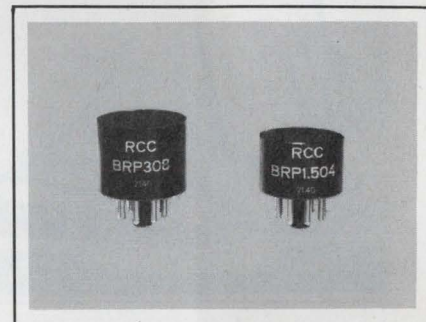

BRP1.500 and BRP300 series single phase bridge rectifiers — ratings: 1.5 and 3.0 resp., max. single cycle surge: 50 amps. pk. Voltage types: 50 to 800v., JEDEC 8 pin octal bases. Glassivated diode elements, welded diode to diode interconnections. 1-99 quant. \$1.00 to \$4.30. Rectifier Components Corp., Freeport, N. Y. 516-868-0470

INFORMATION RETRIEVAL NUMBER 186

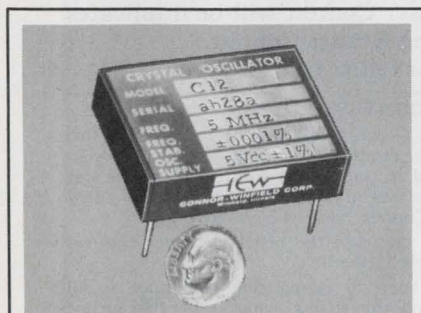

Small TCXO drives 10 TTL or COS/MOS freq. tol. = ±.0001%, 0° C to +50°C, at freqs. from 300 kHz to 10 MHz, ±30 ppm freq. adj.; Supply 5 to 15Vdc ±1%, Sq. wave 2.4V into 200Ω at Vdd = 5V, 9.5V into 10KΩ at Vdd = 10V; 1.75" sq. x 0.4"; Availability, stock to 2 weeks; Connor-Winfield Corp., Winfield, Ill. 60190, Tel. 312-231-5270.

INFORMATION RETRIEVAL NUMBER 187

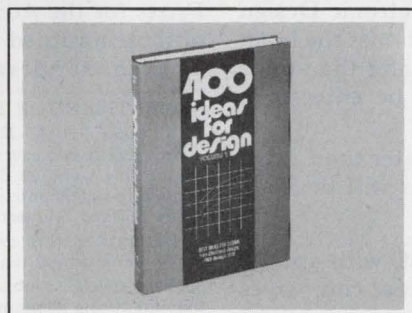

400 Ideas for Design, Vol. 2, Edited by Frank Egan. Ready to borrow, modify, or adapt, the top recent contributions to Electronic Design's popular "Ideas for Design" column. Hayden Book Co., Inc., New York, N. Y. 10011.

INFORMATION RETRIEVAL NUMBER 188

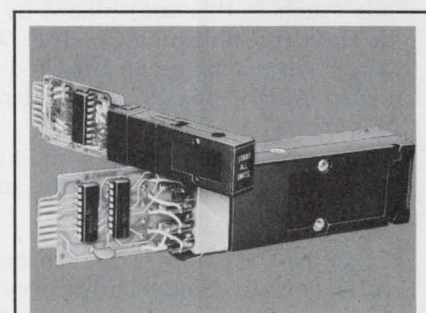

Drive and decode IEE displays with our new hybrid and monolithic Series 7610 and 7800. Priced to "buy not build" as low as \$9.60 in quantity. DTL/TTL, up to 300 ma, memory, non-memory. IEE, Van Nuys, CA (213) 787-0311

INFORMATION RETRIEVAL NUMBER 189

Electronic Design

1972 TOP TEN CONTEST

Entry Card (At Right)

Readers—Advertisers—Your chance to win a millionaire's vacation for 2...round trip air passage and 10 days of Windjamming the Caribbean; a 25-inch Heathkit Solid State Color TV; a Brother Miniaturized Desk-top Digital Calculator, or one of a hundred runner-up prizes. TOP TEN, the one contest of the year that tests your advertising smarts.

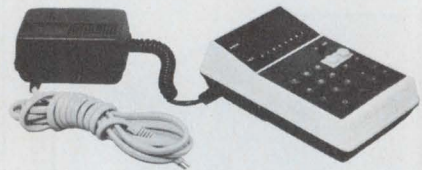
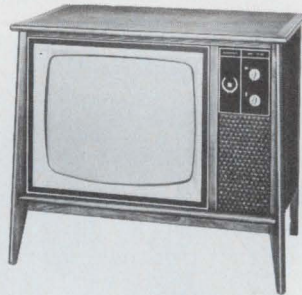
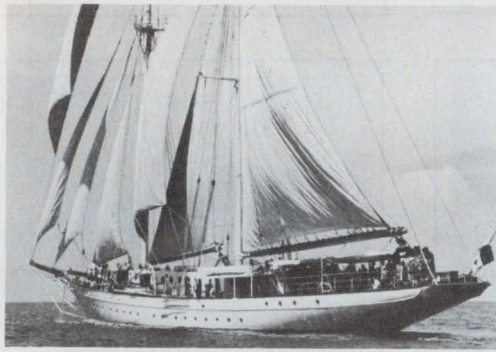

READER CONTEST

After you've read all of the rules in the special Top Ten Contest ad located earlier in this issue, pick the ten advertisements that you estimate will be *best seen* by readers as defined by "Reader Recall" *seen most* which is Electronic Design's method of measuring readership. Rank your selections in the order you think your fellow reader engineer's own choices will follow.

In making your selections do not include "house" ads (such as this one) placed by Electronic Design or Hayden Publishing Co., Inc. *Don't miss the boat.* Your entry must be postmarked no later than midnight, March 15, 1972 in order to be entered in this contest.

Winners will be notified by mail no later than April 15, 1972. The decisions of the judges will be final.

ADVERTISER'S CONTEST

There is a separate Top Ten contest, with special rules, open to all advertising personnel at companies and agencies. You *do not* have to be an advertiser

in Electronic Design to enter. Use the entry blank included on the *Information Retrieval Card*. It's bound in this issue, at right. But, be sure to check the box marked "Advertiser Contest."

All ads that place in the *Top Ten* will be given free reruns. In addition, the three winners in the Advertiser Contest will also be given a free rerun of a like ad of their choice with the proviso that they have an ad in this, the January 6th issue. See rules at right regarding winning ads that are inserts.

Prizes for the Advertiser Contest will be duplicates of those awarded in the Reader Contest.

The contest rules are as follows:

ADVERTISER TOP TEN CONTEST RULES

1. All rules for the *Reader Contest* will similarly apply for this contest, with two exceptions: readers engaged in electronic design engineering work, as defined in the *Reader Contest* rules, are *not* eligible to participate in this special contest. The box on the entry blank marked "Advertiser Contest" must be checked.
2. Entrants in this contest may use the official *Reader Contest* entry blank or any reasonable facsimile.
3. This special contest is open to advertising personnel at all manufacturing companies and advertising agencies whether or not their companies or agencies have an advertisement in the January 6, 1972 issue of Electronic Design. However, only those companies (or divisions thereof), advertising in the January 6 issue, and the advertising agencies placing such advertisements, are eligible for a free rerun of their advertisement should a member of their organization win.
4. Free reruns of any advertisement will be made only from existing plates or negatives. If the advertisement qualifying for a free rerun is an insert, Electronic Design will bind and run the insert, but furnishing the inserts is again the responsibility of the winner. The winner may run a two-page spread in place of the insert.
5. Hayden Publishing Company, Inc., reserves the right to schedule reruns at its discretion.

*Rules & Prize
Information Appear on
Pages 136-137
of This Issue*

Do you face a make or buy decision on power supplies?

BUY LAMBDA LX SERIES

Choose from 7 packages, 36 models
All 1-day delivery. All guaranteed 5 years

"3" PACKAGE

DUAL OUTPUT
12 TO 15 VOLTS 0.4 AMPS...\$85

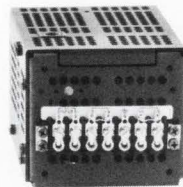
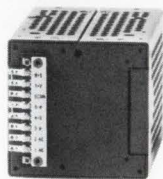

"A" PACKAGE

SINGLE OUTPUT
5 VOLTS 4 AMPS...\$85
DUAL OUTPUT
12 TO 15 VOLTS 1 AMP...\$125

"B" PACKAGE

SINGLE OUTPUT
5 VOLTS 5.8 AMPS...\$125
DUAL OUTPUT
12 TO 15 VOLTS 1.6 AMPS...\$150

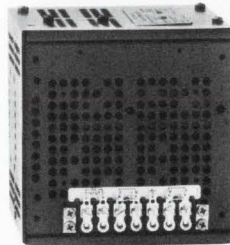
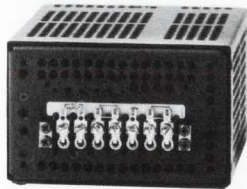

"4" PACKAGE

SINGLE OUTPUT
5 VOLTS 7.4 AMPS...\$135

"C" PACKAGE

SINGLE OUTPUT
5 VOLTS 9 AMPS...\$150
DUAL OUTPUT
12 TO 15 VOLTS 2.5 AMPS...\$160

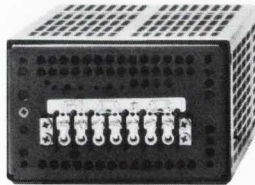

"CC" PACKAGE

SINGLE OUTPUT
5 VOLTS 16 AMPS...\$200

"D" PACKAGE

SINGLE OUTPUT
5 VOLTS 27.5 AMPS...\$235

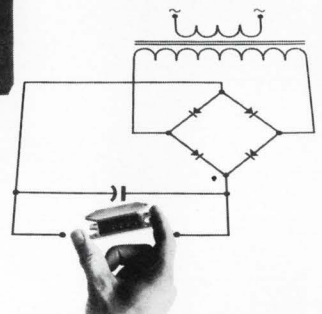
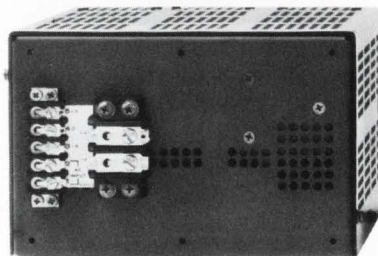

**WHETHER
YOU MAKE
OR BUY...**

LAMBDA
ELECTRONICS CORP.

A **Veco** Company

- Line regulation 0.1% Load regulation 0.1%
- Ripple and noise 1.5 mV RMS, 5 mV P-P with either positive or negative terminal grounded
- AC input 105-132 VAC; 47-440 Hz
- All 5-volt models include built-in overvoltage protection.
- For information on other models up to 28 VDC, send for catalog.

PANEL DISPLAY IT

now it's possible

We've done the hard work— by making the first commercially available panel display subsystem for use in your application. Burroughs new SELF-SCAN panel display subsystem provides 256-character alphanumeric panel display capabilities and all necessary electronics — *drivers, memory, timing and character generation* — in a compact module.

And because SELF-SCAN panel display technology reduces electronics by 90% and cuts display thickness to less than 1½ inch, you get unprecedented flexibility and cost advantages for display applications.

The easily-read characters used in this unit are formed of dots on .040" centers, with eight 32-character rows in a 5 x 7 dot matrix format.

Application versatility is designed-in with options including visual cursor, tab controls and expanded memory capability. The 256-character unit shown is available for off-the-shelf delivery; 64- and 128-character subsystems available soon. Units with only display and driver electronics are also available. Write or call for additional information:

Burroughs Corporation, Electronic Components Division, Box 1226, Plainfield, N. J. 07061 (201) 757-3400.

INFORMATION RETRIEVAL NUMBER 244



(Size 5.5 x 11 x 1.4)

256-Character **SELF-SCAN™** Panel Display Subsystems

