

Electronic Design 23

FOR ENGINEERS AND ENGINEERING MANAGERS

NOV 13 1970

VOL. 18 NO. 11
NOV. 8, 1970

CALMA CO.

Computer peripherals are moving out of the shadow of mainframes. More and more they are becoming systems that operate off-line and far from the central processor.

Complex plotters are typical of this trend to high-performance machines. Lower cost is another objective. For a roundup on the state of peripherals see p.C1.

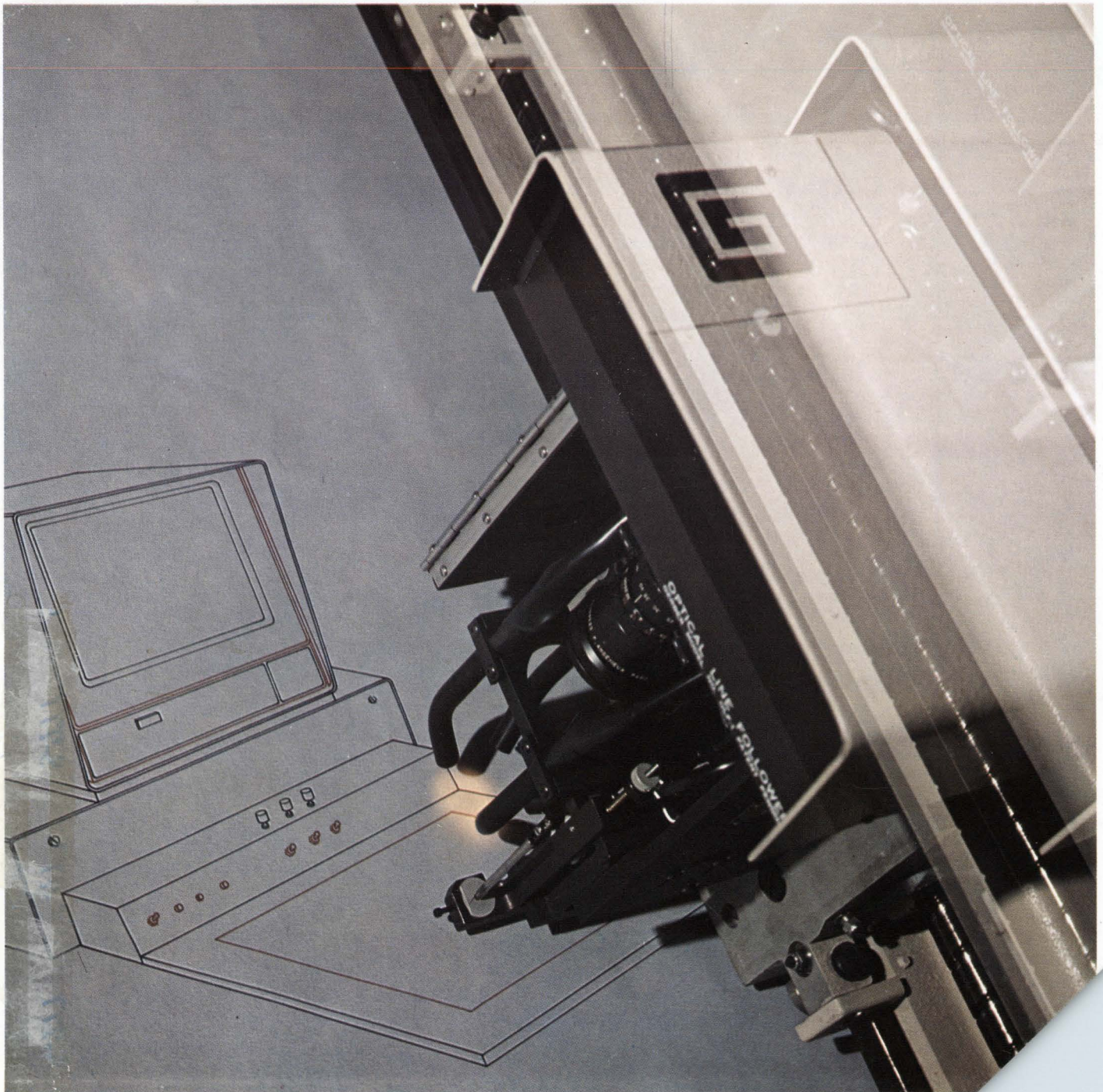

Dale RH and RS resistors are used in Burroughs' popular TC 500 on-line terminal computer.



The
everywhere
resistors
...and why.

DALE WIREWOUNDS:
Found wherever power must be precisely dissipated. Why? Because of these unequalled advantages:

SELECTION—Dale's new resistor catalog gives you the industry's widest choice of standard precision power models—most of them ready to ship from your nearby distributor.

VERSATILITY—Your requirements for variations in configuration and function can be quickly matched from a design bank of more than 4000 pre-engineered specials.

DELIVERY—2-3 weeks on 1 watt MIL-R-26E models. Comparable fast times on all other popular styles.

If you think there's no difference in wirewounds—you haven't dealt with Dale. PHONE 402-564-3131 or write for our new expanded Resistor Catalog.

DALE[®]

DALE ELECTRONICS, INC., 1300 28th Ave., Columbus, Nebr. 68601
In Canada: Dale Electronics Canada, Ltd. • A subsidiary of The Lionel Corporation

INFORMATION RETRIEVAL NUMBER 181

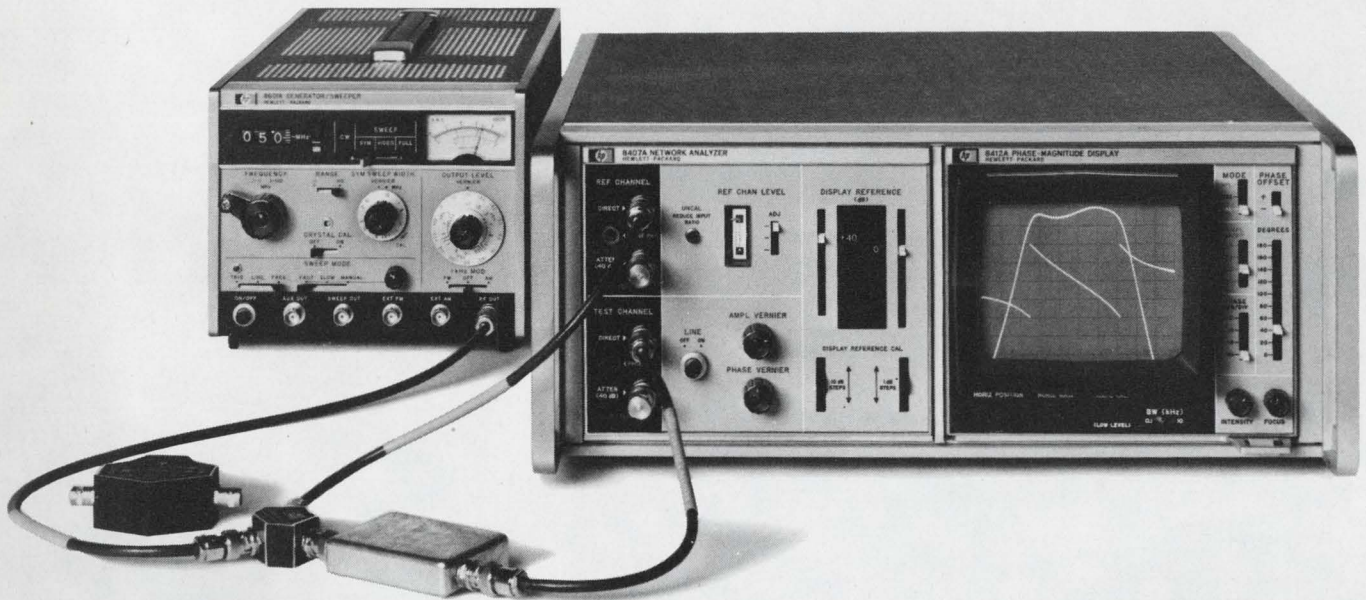

For swept RF measurements of both magnitude and phase, try this test lab.

HP's 8407A Network Analyzer makes quick RF measurements, 100 kHz to 110 MHz with ease, accuracy and thoroughness. Inadequacies of alternate techniques have been eliminated and swept measurements over a wide dynamic range are now possible.

We're talking about full characterization — both magnitude and phase — of filters, amplifiers, attenuators, transistors, antennas, and any other RF component, device or network you can name. And you can check them at any stage of design, development or production.

The system consists of:

- 8601A Generator/Sweeper, a precision swept source, 0.1 to 110 MHz, with flat output, highly linear sweep and low residual FM.
- 8407A Network Analyzer mainframe with 8412A Phase-Magnitude Display unit for CRT presentation of test results.
- Accessory coax devices and probes to monitor the unknown's responses to the swept test signal.

For coaxial work: 11652A Reflection-Transmission Kit with all the accessories you'll need: precision power

splitter, high directivity flat coupler, termination and matched cables. Just hook up — make high accuracy swept measurements of complex transmission and reflection coefficients simply and quickly. For circuit work: 11654A Passive Probe Kit with high impedance voltage probes and dividers plus current probes. You can measure circuit and device performance without disturbing their behavior. And you can see phase response at the same time with 360° phase range. The system also provides 0.05 dB magnitude and 0.2° phase resolution.

Dynamic measurement range is greater than 100 dB, and you can see 80 dB in one viewing of the 8412's CRT. And you can see phase response at the same time with 360° phase range. The system also provides 0.05 dB magnitude and 0.2° phase resolution.

The 8407A is a narrow-band detector that tracks the sweeping test signal; tracking provides these unique benefits:

1. Wide dynamic range *and* high sensitivity — make high-gain/high-loss measurements on sensitive networks and devices.
2. Accurate measurements — free from errors encountered in broadband detec-

tion methods resulting from harmonics and other spurious signals.

The 8407A RF mainframe costs \$2950; 8412A Display, \$1575; 11652A Reflection-Transmission kit (for coax), \$325; 11654A Passive Probe kit, \$325; 8601A Generator/Sweeper (general purpose precision swept source, useful for many applications), \$2250.

You can get the full story by phoning your local HP engineer and asking for a demonstration. He'll also be glad to give you Application Note 121-1, a comprehensive description of what this system can do for you; plus Application Note 121-2 which describes how to make wide dynamic range impedance measurements on a swept-frequency basis. Or write to Hewlett-Packard, Palo Alto, California 94304; Europe: 1217 Meyrin-Geneva, Switzerland.

04016R

HEWLETT  PACKARD
NETWORK ANALYZERS

INFORMATION RETRIEVAL NUMBER 2



When you're adding a new "twist" to tornado tracking...

Symbolic representation of global weather as plotted by Burroughs ILLIAC IV computer.

bring ERIE in early.

Cyclone off Ceylon. 17-inch snow at Salem. Tropical storm in Trinidad. World-wide weather reports? No, forecasts! Made four days in advance... with the same accuracy as present one-day predictions. That's just one of the superscale jobs possible with the incredible new ILLIAC IV computer designed by the University of Illinois and built by Burroughs Corporation. Unlike conventional computers that process serially, ILLIAC IV utilizes parallel processing... crunching numbers on many matrix problems or differential equations simultaneously, and at super speeds. From the start, ERIE engineers have worked closely with Burroughs to develop the highly-sophisticated resistor/capacitor and resistor modules at the heart of ILLIAC IV. Proof, once again, that it pays to bring ERIE in early.

ERIE TECHNOLOGICAL PRODUCTS, INC.
 644 West 12th Street, Erie, Pennsylvania 16512
 (814) 453-5611

NEWS

- 39 **News Scope**
- 43 **Report from International Microwave Symposium:**
- 43 **Satellites would supply world's power needs**
- 44 **The applicator problem in microwave heating**
- 48 **Every home could be a communications center**—with a country-wide two-way broadband network that would cost \$35.5-billion, EIA is told
- 50 **Automatic rain-making with help of computer?** Experiment in
- 54 **Technology Abroad**
- 57 **Washington Report**

TECHNOLOGY

- C1 **A special section: The Fall Joint Computer Conference**
- C4 **Peripherals—Cinderellas of the computer industry**
- C21 **Product Source Directory: Keyboards**
- C27 **New products at the FJCC**
- 68 **What truth tables don't tell you** about using flip-flops. Learn what the problems are and how edge clocking eliminates them.
- 74 **Designing sampling phaselock loops** is easy when you use this approximate stability criterion.
- 78 **Find insertion loss at a glance** for maximally flat (Butterworth) bandpass filters. These curves cover 1 to 10-resonator circuits.
- 82 **Give your patentable ideas a fair trial.** Learn how you can protect your invention by producing a notebook that is legally effective.
- 86 **Ideas for Design**

PRODUCTS

- 95 **ICs & Semiconductors:** MOS static read-only memories hold 5120 bits.
- 100 **Modules & Subassemblies:** Op amps exhibit 0.15 pA bias currents.
- 107 **Components:** Trimmer and five fixed resistors occupy one DIP case.
- 98 **Microwaves & Lasers** 113 **Packaging & Materials**
- 104 **Instrumentation** 113 **Tools & Engineering Aids**
- 110 **Data Processing** 126 **Product Index**

Departments

- 65 **Editorial:** Reflections on the weather . . . and the storm over spending
- 13 **Designer's Calendar** 116 **Annual Reports**
- 62 **Sidelights** 118 **New Literature**
- 114 **Evaluation Samples** 121 **Bulletin Board**
- 114 **Design Aids** 124 **Advertisers' Index**
- 115 **Application Notes**

Information Retrieval Service Card inside back cover.

Cover: Drafting machine traces a CRT terminal. Photo by Franz Kraus, courtesy of Gerber Scientific Instrument Co., Hartford, Conn.

For those of you who don't know FETs from filaments...

... a fresh, A-to-Z, solid-state primer that spells "FET" from unipolar to application.

Leading off with a ground-zero introduction: "What Is a Field Effect Transistor," the manual accelerates to explain FET theory, history, operation, types, advantages and disadvantages, and compares FETs to vacuum tubes and conventional

bipolar transistors in terms of characteristics.

Classes of FETs are clarified: enhancement, depletion (Types A & B) and how they fit into switching, chopper, amplifier, voltage-variable resistor, current/limiter/source and microwatt logic designs.

Specific FET applications are also treated, such as: FETs in Chopper

and Analog Switching, Low Frequency FET Applications, The FET In Digital Designs and A Unified Approach to Optimum FET Mixers are 4 of the many.

Your personal request on your company letterhead will bring you a copy of this valuable instruction — Box 20912, Phoenix, Arizona 85036. Find out what you need to know about FETs . . . write now!



UNDERSTANDING and DESIGNING with FETs

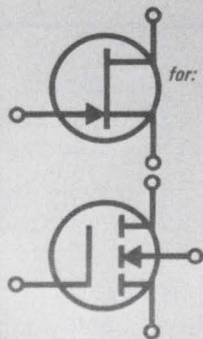

for: CONSUMER · INDUSTRIAL · COMPUTER
COMMUNICATIONS · FEDERAL EQUIPMENT

For those of you who do...

... a FET design kit oriented to your exact market-application need. — Free from your Motorola distributor!

Pick out your "market" — fill in the coupon — (one to a customer, please) return it to your local Motorola distributor. He'll see to it that you receive your devices plus complete data sheets outlining the outstanding performance of these industry favorites.

Motorola now offers nearly 200 individual FET types for virtually any application need — from consumer to military. Junction FETs, silicon-nitride MOSFETs, N or P-channel, for operation from dc to UHF in switching and amplifying applications. You can select from: 20 RF mixers and amplifiers to 400 MHz frequencies . . . 45 JFET choppers with drain-source resistance low as 10 ohms . . . 80 general-purpose

amplifiers offering forward transadmittance high as 12,000 μmhos . . . 23 general-purpose switches furnishing drain-source resistance low as 150 ohms . . . 6 matched pairs with TC's to 10 microvolts/ $^{\circ}\text{C}$ and sub-miniature Micro-T* capability for high density RF designs.

The purpose behind it all is to acquaint you with the broadest FET capability in the industry. What you can do with it is totally up to you!

*Trademark MOTOROLA INC.

MOTOROLA FET

—where the priceless ingredient is care!

COUPON NO. 1:

Return this coupon to your Motorola Distributor for a FREE **ConsumerFET Design Kit #1**

N & P Channel Plastic JFETs for Your Audio Amplifiers

2N5462 **2N5718**

- 40 V Gate-Source V_{GS}
- 2.5 dB max. NF @ 100 Hz
- 2.0 pF max. C_{rss}
- Interchangeable Drain/Source
- High dc input resistance
- 5.0 pF max. C_{iss} @ 15 V
- 1.5 pF max. C_{rss} @ 15 V
- 0.8 — 4.0 mA I_{DSS} @ 15 V

Name _____ Title _____
 Company _____
 Address _____
 City _____ State _____ Zip _____

COUPON NO. 4:

Return this coupon to your Motorola Distributor for a FREE **ComputerFET Design Kit #4**

MOS & Junction Chopper FETs For Multiplexing Applications

MFE3002 **2N5638**

- 100 Ω $r_{ds(on)}$
- 1.0 pF max. C_{rss} @ 1 MHz
- 100 pA max. I_{GSS} @ 10 V
- 10 nA max. I_{DSS} @ 10 V
- 4.0 pF max. C_{rss} @ 1 MHz
- 5 ns max. t_r @ 12 mA
- 30 $r_{ds(on)}$
- 10 pF max. C_{iss} @ 1 MHz

Name _____ Title _____
 Company _____
 Address _____
 City _____ State _____ Zip _____

COUPON NO. 2:

Return this coupon to your Motorola Distributor for a FREE **ConsumerFET Design Kit #2**

Plastic JFET & Dual Gate MOSFET for Your Tuner/IF Applications

2N5669 **MPF121**

- Low Cross/Inter-Mod Distortion
- Drain/Source Interchangeable
- 2.5 dB max. NF @ 100 MHz
- 1.0 pF C_{rss} , 4.7 pF C_{iss} (typ.)
- 17 dB min. G_{ps} @ 200 MHz
- Diode-Protected Dual Gates
- Silicon-Nitride Passivated
- 1% typ. Cross-Mod

Name _____ Title _____
 Company _____
 Address _____
 City _____ Zip _____ State _____

COUPON NO. 5:

Return this coupon to your Motorola Distributor for a FREE **CommunicationFET Design Kit #5**

Plastic JFET & Dual-Gate MOSFET For Front Ends and IF Strips

2N5485 **MPF121**

- 18 dB min. G_{ps} @ 100 MHz
- 2.0 dB max. NF @ 100 MHz
- 5.0 pF max. C_{iss} , 2.0 pF max. C_{oss}
- 3,500/7,000 μmhos max. yfs.
- 5-30 mA I_{DSS} @ 15 V
- 17 dB min. G_{ps} @ 200 MHz
- Diode-Protected Dual Gates
- Silicon-Nitride Passivated

Name _____ Title _____
 Company _____
 Address _____
 City _____ State _____ Zip _____

COUPON NO. 3:

Return this coupon to your Motorola Distributor for a FREE **IndustrialFET Design Kit #3**

Complementary MOSFET Switches and General Purpose JFET

2N4351, 52 **2N5457**

- Enhancement Mode (Normally Off)
- 300 Ω Drain-Source Resistance
- 1.3 pF max. C_{rss}
- Guaranteed Switching Limits
- 1.0 — 6.0 V $V_{GS(off)}$ @ 15 V
- 1.0 — 5.0 mA I_{DSS} @ 15 V
- 2.5 V V_{GS} @ 15 V
- Drain & Source Interchangeable

Name _____ Title _____
 Company _____
 Address _____
 City _____ State _____ Zip _____

COUPON NO. 6:

Return this coupon to your Motorola Distributor for a FREE **FederalFET Design Kit #6**

Hi-Rel Metal JFETs for Audio/Chopper/Switching Designs for JAN Availability

2N3821 **2N4220**

- 6 pF max. C_{iss} @ 1 MHz
- 3 pF max. C_{rss} @ 1 MHz
- 0.1 nA max. I_{GSS} @ 30 V
- Low Cross/Inter-Mod Distortion
- 2.0 pF max. C_{rss} @ 1 MHz
- 6.0 pF max. C_{iss} @ 1 MHz
- 100 pA max. I_{GSS} @ 15 V
- 2.5 V max. V_{GS} @ 50 μA

Name _____ Title _____
 Company _____
 Address _____
 City _____ State _____ Zip _____

Fight noise pollution

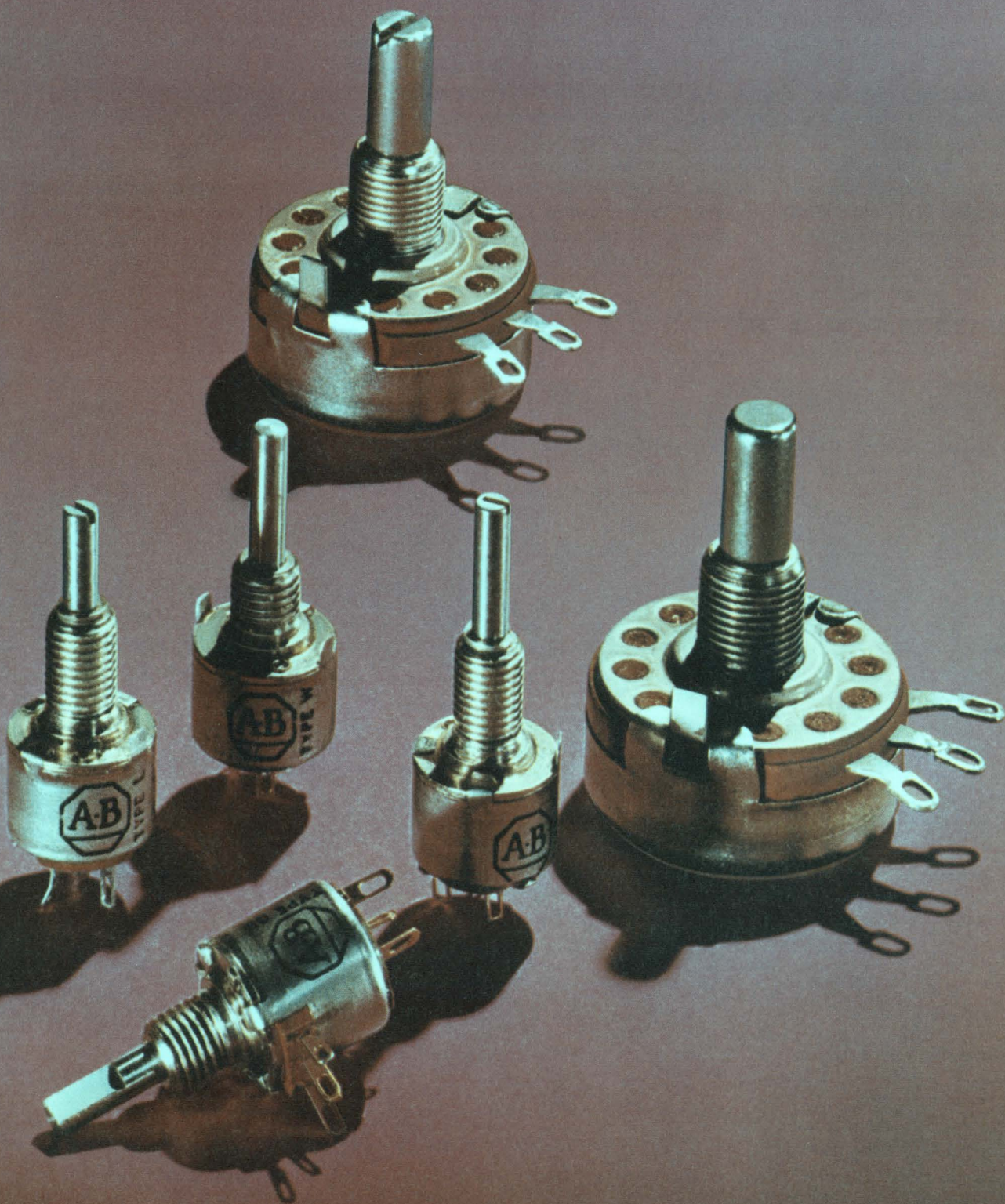

with this quiet family.

Hot Molding with Allen-Bradley's exclusive technique, gives these composition variable resistors an unusually low noise level. And importantly, this low noise level actually decreases in use. Under tremendous heat and pressure the resistance track is molded into place. A solid element with a large cross-section is produced.

This important Allen-Bradley difference means better short-time overload capacity and a long operating life. Control is smooth, resolution almost infinite. These variable resistors are ideal for high frequency circuits. Why should you trust the performance of

your designs or your reputation to anything less than Allen-Bradley quality? Use the most thoroughly "field tested" (over 20 years) variable resistors available today. Quantity stocks of popular types J, G, W and GD available for immediate delivery from your appointed A-B industrial electronics distributor.

For information write: Marketing Department, Electronics Division, Allen-Bradley Co., 1201 South Second Street, Milwaukee, Wisconsin 53204. Export office: 1293 Broad Street, Bloomfield, N. J. 07003, U.S.A. In Canada: Allen-Bradley, Canada Ltd., 135 Dundas Street, Galt, Ontario.

SPECIFICATIONS

| | TYPE J— STYLE RV4 | TYPE K | TYPE G— STYLE RV6 | TYPE L | TYPE W | TYPE GD |
|--|--|--|---|----------------------------------|--|---|
| CASE DIMENSIONS | 5/8" deep x 1-5/32" dia. (single section) | 5/8" deep x 1-5/32" dia. (single section) | 15/32" deep x 1/2" dia. | 15/32" deep x 1/2" dia. | 15/32" deep x 1/2" dia. | 35/64" deep x 1/2" dia. |
| POWER at + 70°C | 2.25 W | 3 W | 0.5 W | 0.8 W | 0.5 W | 0.5 W |
| TEMPERATURE RANGE | -55°C to +120°C | -55°C to +150°C | -55°C to +120°C | -55°C to +150°C | -55°C to +120°C | -55°C to +120°C |
| RESISTANCE RANGE (Tolerances: ±10 and 20%) | 50 ohms to 5.0 megs | 50 ohms to 5.0 megs | 100 ohms to 5.0 megs | 100 ohms to 5.0 megs | 100 ohms to 5.0 megs | 100 ohms to 5.0 megs |
| TAPERS | Linear (U), Modified Linear (S), Clockwise Modified Log (A), Counter-Clockwise Modified Log (B), Clockwise Exact Log (DB). (Special tapers available from factory) | | | | | |
| FEATURES (Many electrical and mechanical options available from factory) | Single, dual, and triple versions available. Long rotational life. Ideal for attenuator applications. Snap switches can be attached to single and dual. | Single, dual, and triple versions available. Long rotational life. | Miniature size. Immersion-proof. SPST switch can be attached. | Miniature size. Immersion-proof. | Commercial version of type G. Immersion-proof. | DUAL section version of type G. Ideal for attenuator applications. Immersion-proof. |

ALLEN-BRADLEY

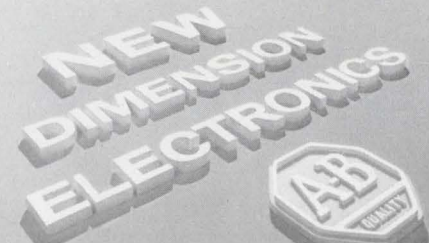
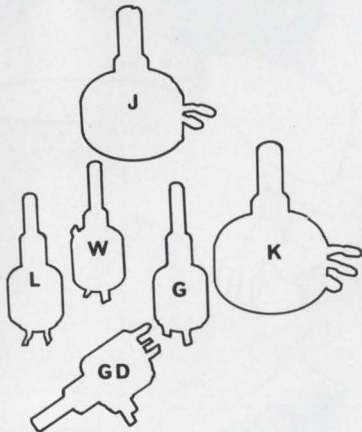

INFORMATION RETRIEVAL NUMBER 5

Good old Stackpole and the new electronic technologies.

Who?

Stackpole. Producers of electrical/electronic componentry for over sixty years. First to the automotive industry. Then to the radio, home entertainment, appliance, railroad, chemical and, most recently, the aerospace industries. Five million quality components daily.

Electronics is fast becoming an important part of every industry. Automated production. Medical electronics. Computers. Education and communications. The needs are diverse. The qualifications demanding. Stackpole has the needed components. Rotary switches. Controls. Precise ferro-magnetic materials. Resistors and contacts. But more importantly, it has the capability to develop still more. Ours is a value approach. Quality products, reasonably priced, delivered on time and backed by service and experience.

If you are part of the emerging industrial electronics technology, then you need reputable, reliable sources. Experienced and capable people. Discover Stackpole. Our components are just about everywhere. Unseen usually, but working. A lot of companies have built their reputations on it.

Stackpole Carbon Company, St. Marys, Pa. 15857.

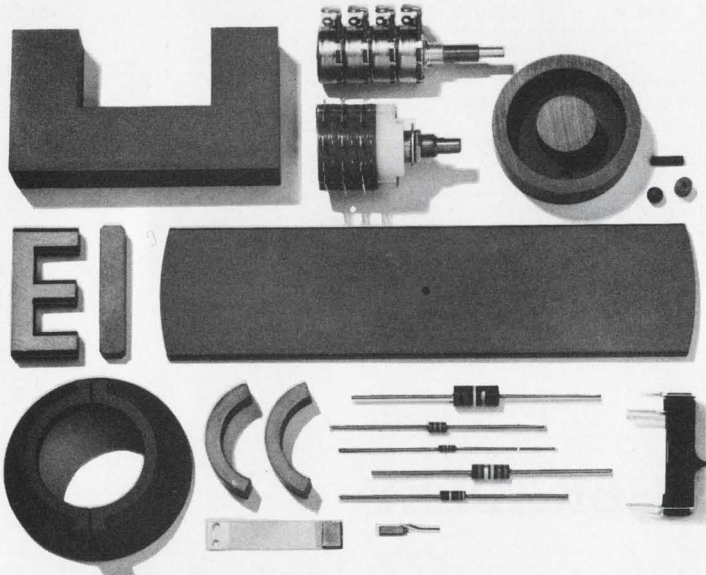

 **STACKPOLE**

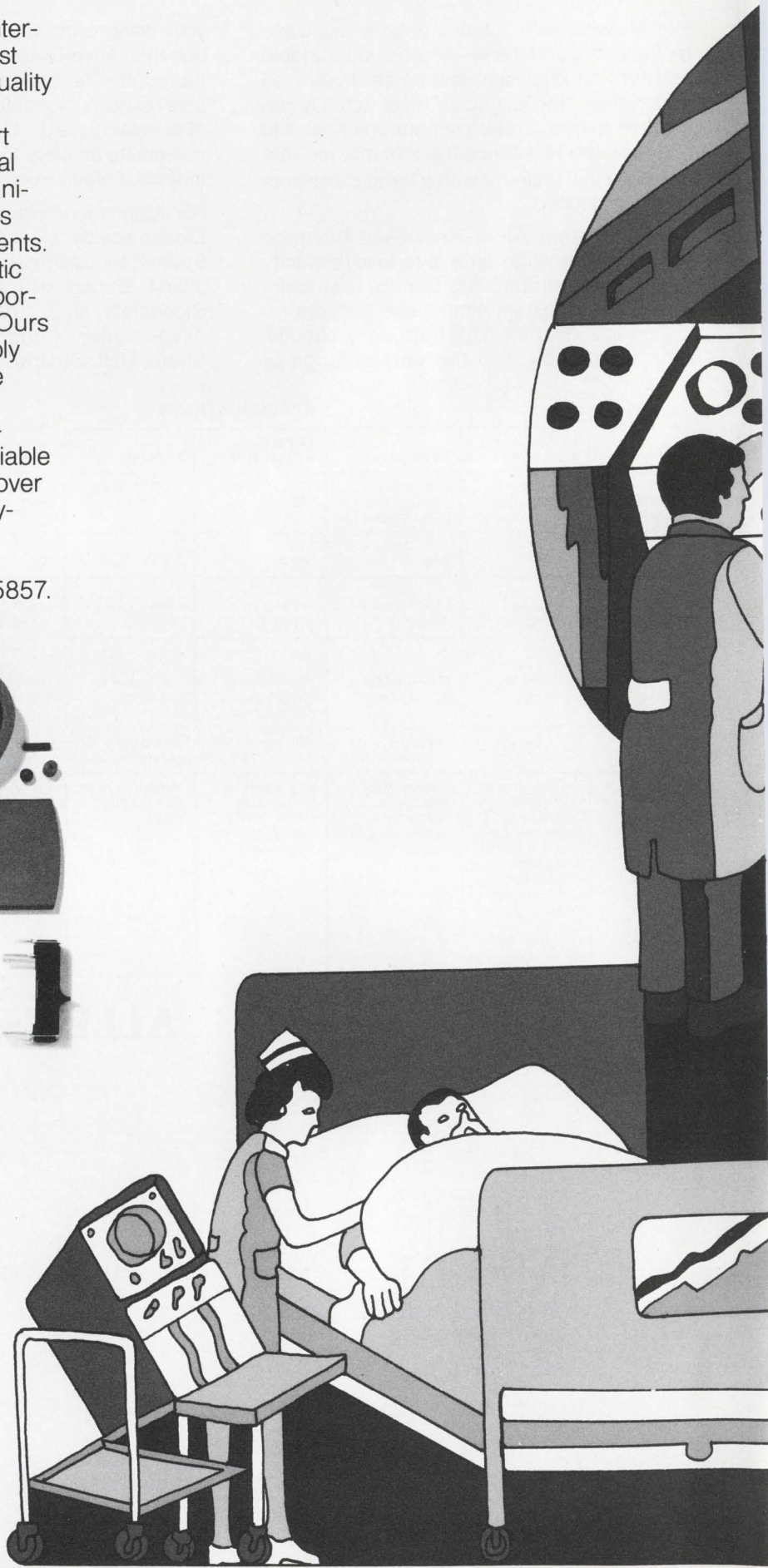

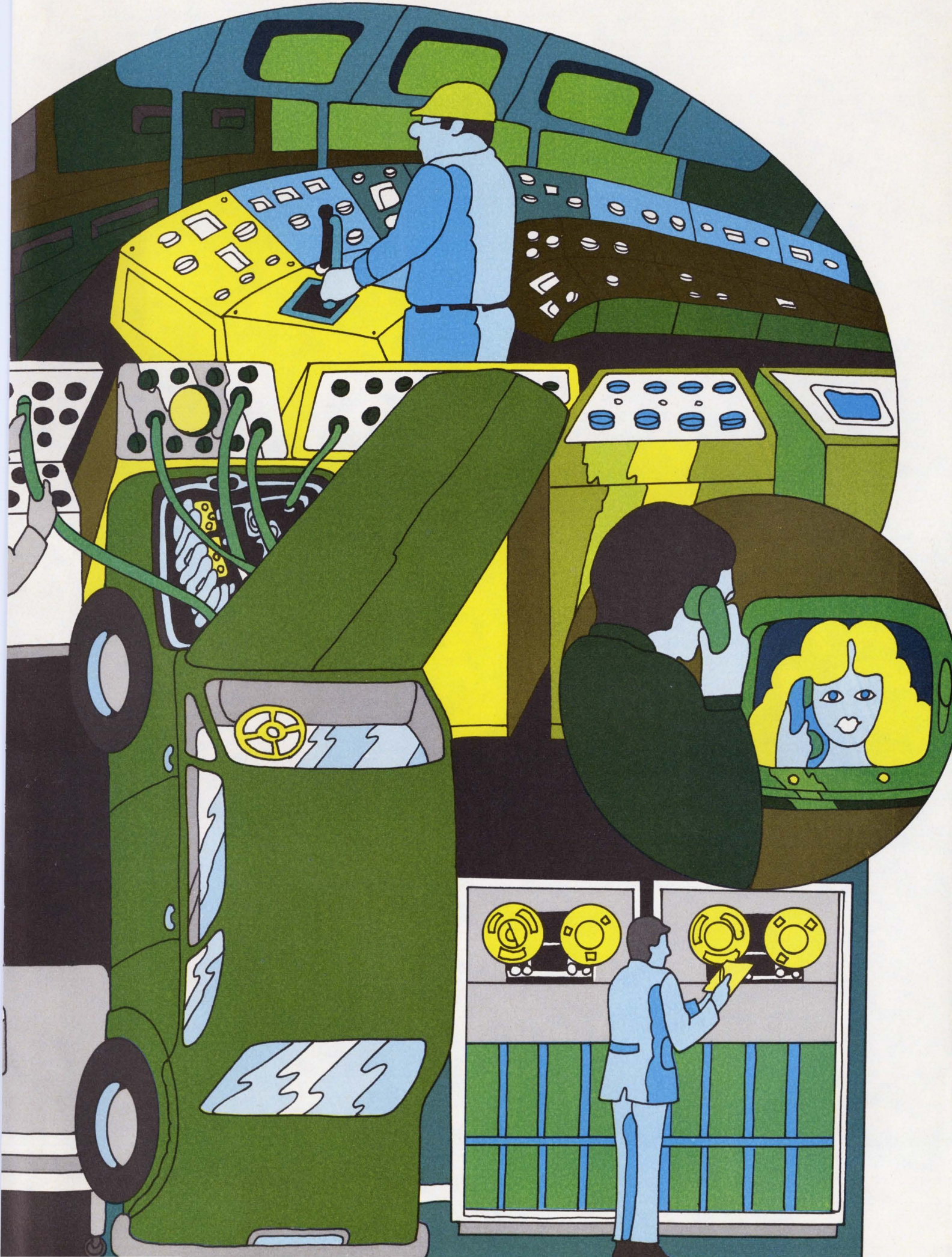

**Reliability is six things we do
that nobody else does.**

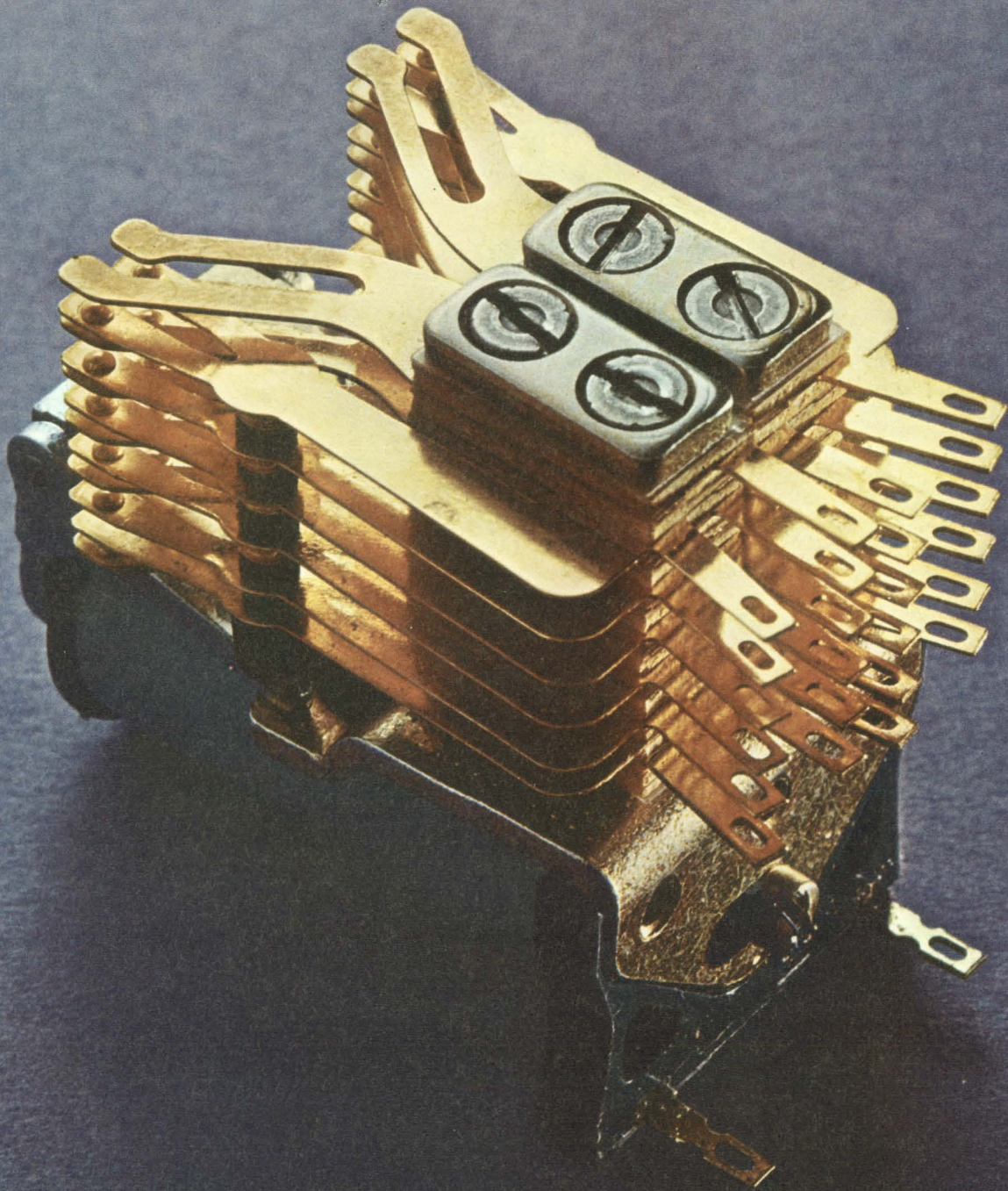

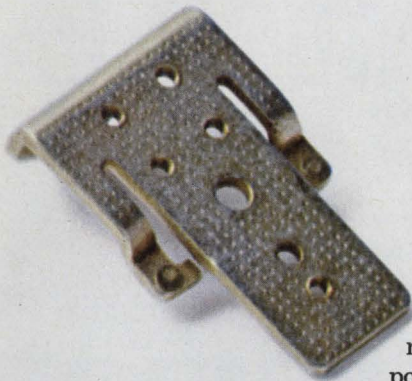

We're fanatics.

We build our relays stronger than we have to. That way, they last lots longer than they ever have to. Our Class E relay (shown on the opposite page) is a good example of our way of thinking.

The industry's strongest heelpiece.

We make the strongest heelpiece in the industry. A gigantic machine bangs them out extra fat and extra flat.

Extra fat to carry a maximum of flux. To handle big loads. Extra flat so that once an AE relay is adjusted, it stays adjusted.

Since our backstop is part of the heelpiece, it's just as thick and flat. But, tough as it is, the slightest wear here would throw the entire contact assembly out of whack. So, to be safe, we weld two tiny, non-magnetic pads where the armature arms meet the backstop. You might say we created the no-stop backstop.

Three parts that'll wear like crazy.

When you build a relay like a small tank, you have to think of everything. We try. Right down to the tiniest part. For example, we make our armature arms and bearing yoke extra thick.



Thicker than years of testing and use say they have to be. Then, to make sure they don't cause wear problems, we insert a hardened shim between the hinge pin and the frame. The pin rides on the shim, instead of wearing into the heelpiece. (You can forget the bearing, it's permanently lubricated.)

Buffers with lots of muscle.

We make our buffers of a special tough phenolic material that lasts. And lasts. And lasts. All without wear or distortion. Another reason why our relays stay in whack.

To make sure our buffers stay in place, we weld the buffer cups to the armature arms. We weld, instead of using rivets, because our lab found that rivets have a habit of falling out.

For the very same reason, we weld buffer cups to the contact springs. And also use the same special tough phenolic buffers.



No, we didn't forget the contact springs.

We have some strong feelings as to what makes a contact spring reliable. Our sentiment is that two contacts are better than one. So, we bifurcate all the springs, not just the make and break. This slotting and the addition of another contact to each spring means you get a completed circuit every time.

We make each set of contact points self-cleaning. The bad stuff doesn't have a chance to build up.

Now, what's different about our bobbin?

Our bobbin is one piece—molded of glass-filled nylon. This provides the maximum in insulation resistance.

Because our bobbin is nylon, we don't have to impregnate with varnish. Moisture and humidity have no effect on the stubborn nylon material. No effect means no malfunctions for you to worry about.



What all this means to you.

What this all adds up to is reliability. The kind of toughness no one else can give you. It means an AE relay works when it's supposed to, longer than it has to.

Isn't this the kind of reliability you really need? Automatic Electric Company, Northlake, Ill. 60164.

AUTOMATIC ELECTRIC

SUBSIDIARY OF GENERAL TELEPHONE & ELECTRONICS

CELANESE NYLON. THE HEAD START MATERIAL.

Give your products a head start on top product design, performance and economics. With Celanese Nylon.

General Electric does. In GE hair dryers, for example, the resilience of Celanese Nylon gives coil bobbins the kind of snap-fit that holds parts together snugly. So assembly is simple, less expensive.

But of course there are lots of other reasons for choosing Celanese Nylon. Like the fact that it has U/L rating on electrical properties of 105° C. Or its great mechanical strength and toughness. Or its high dielectric properties,



so you can design more compact units with thinner walls. Or the fact that Celanese Nylon is made in a totally continuous process. So it's whiter in the pellet. Whiter in your product. Whiter through successive regrinds. And more consistent from lot to lot.

Maybe that's why retainer rings in GE hair dryers are also molded in Celanese Nylon. And why GE uses Celanese Nylon for gears and bushings and bobbins in their broad line of oscillating fans and heaters.

Give your products a good head start by writing for a copy of our brochure on electrical applications of Celanese Nylon. And a U/L Yellow Card. Celanese Plastics Company, Dept. N-502, 550 Broad St., Newark, N.J. 07102.



Celanese Plastics Company is a division of Celanese Corporation. Canadian Affiliate: Chemcell Resources, Ltd. Export: Amcel Co., Inc., and Pan Amcel Co., Inc., 522 Fifth Avenue, New York 10036.



Designer's Calendar

| DECEMBER 1970 | | | | | | |
|---------------|----|----|----|----|----|----|
| S | M | T | W | T | F | S |
| | | 1 | 2 | 3 | 4 | 5 |
| 6 | 7 | 8 | 9 | 10 | 11 | 12 |
| 13 | 14 | 15 | 16 | 17 | 18 | 19 |
| 20 | 21 | 22 | 23 | 24 | 25 | 26 |
| 27 | 28 | 29 | 30 | 31 | | |

For further information on meetings, use Information Retrieval Card.

Dec. 2-3

Conference on Display Devices (New York City). Sponsor: IEEE. Thomas Henion, Palisades Institute, 201 Varick St., New York, N. Y. 10014.

CIRCLE NO. 401

Dec. 2-4

International Wire and Cable Symposium (Atlantic City, N.J.) Sponsor: USAEC. Jack Spergel, U. S. Army Electronics Command Attn: AMSEL-KL-EE, Fort Monmouth, N.J. 07703.

CIRCLE NO. 402

Dec. 2-4

Vehicular Technology Conference (Washington, D.C.) Sponsor: IEEE. P. M. Kelly, Kelly Scientific Corp., 3900 Wisconsin Ave. N. W., Washington, D.C. 20016.

CIRCLE NO. 403

Dec. 6-9

National Electronics Conference (Chicago, Ill.) Sponsor: IEEE, et al. National Electronics Conference, Oak Brook Exec. Plaza #2, 1121 W. 22 St., Oak Brook, Ill. 60521.

CIRCLE NO. 404

Dec. 14-16

International Symposium on Circuit Theory (Atlanta, Ga.) Sponsor: IEEE. Ivan Frisch, Network Analysis Corp., Beechwood, Old Tappan Rd., Glen Cove, N. Y. 11542.

CIRCLE NO. 405

When You Buy a Power Supply, Why Not Get the Best?

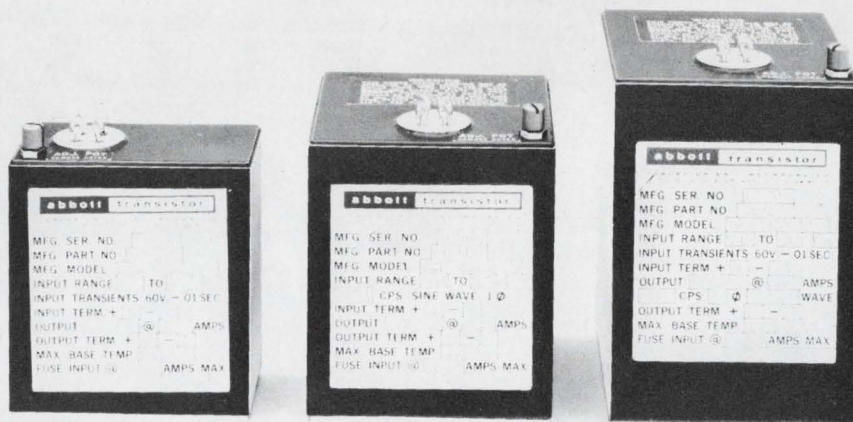

BL1D-27.6A
(109,890 Hrs.)

U2DS-22A
(73,585 Hrs.)

S3D-115A-400
(61,387 Hrs.)

Abbott's New Family of 100°C Units—

are designed to operate in the stringent environment required by military and aerospace systems — (per MIL-E-5400 or MIL-E-5272C) from -54°C to $+100^{\circ}\text{C}$.

RELIABILITY — MTBF (mean time between failures) as calculated in the MIL-HDBK-217 handbook can be expected in excess of 50,000 hours at 100°C for many of our power modules. The hours listed under the photos above are the MTBF figures for each of the models shown. Additional information on typical MTBF's for our other models can be obtained by phoning or writing to us at the address below.

QUALITY CONTROL — High reliability can only be obtained through high quality control. Only the highest quality components are used in the construction of the Abbott power module. Each unit is tested no less than 41 times as it passes through our factory during fabrication — tests which include the scrutinizing of the power module and all of its

component parts by our experienced inspectors.

NEW CATALOG — Useful data is contained in the new Abbott Catalog. It includes a discussion of thermal considerations using heat sinks and air convection, a description of optional features such as short circuit protection and remote output adjustment as well as operating hints for power supplies and a listing of environmental testing costs.

WIDE RANGE OF OUTPUTS — The Abbott line of power modules includes output voltages from 5.0 volts DC to 10,000 volts DC with output currents from 2 milliamperes to 20 amperes. Over 3000 models are listed with prices in the new Abbott Catalog with various inputs:

60 A to DC, Regulated
400 A to DC, Regulated
28 VDC to DC, Regulated
28 VDC to 400 A , 1 ϕ or 3 ϕ
60 A to 400 A , 1 ϕ or 3 ϕ

TO: Abbott Transistor Labs., Inc., Dept. 67
5200 West Jefferson Blvd.
Los Angeles, California 90016

Sir:
Please send me your latest catalog on power supply modules:

NAME _____ DEPT. _____
COMPANY _____
ADDRESS _____
CITY & STATE _____

abbott transistor

LABORATORIES, INCORPORATED
5200 W. Jefferson Blvd./ Los Angeles 90016
(213) WEBster 6-8185 Cable ABTLABS

INFORMATION RETRIEVAL NUMBER 9

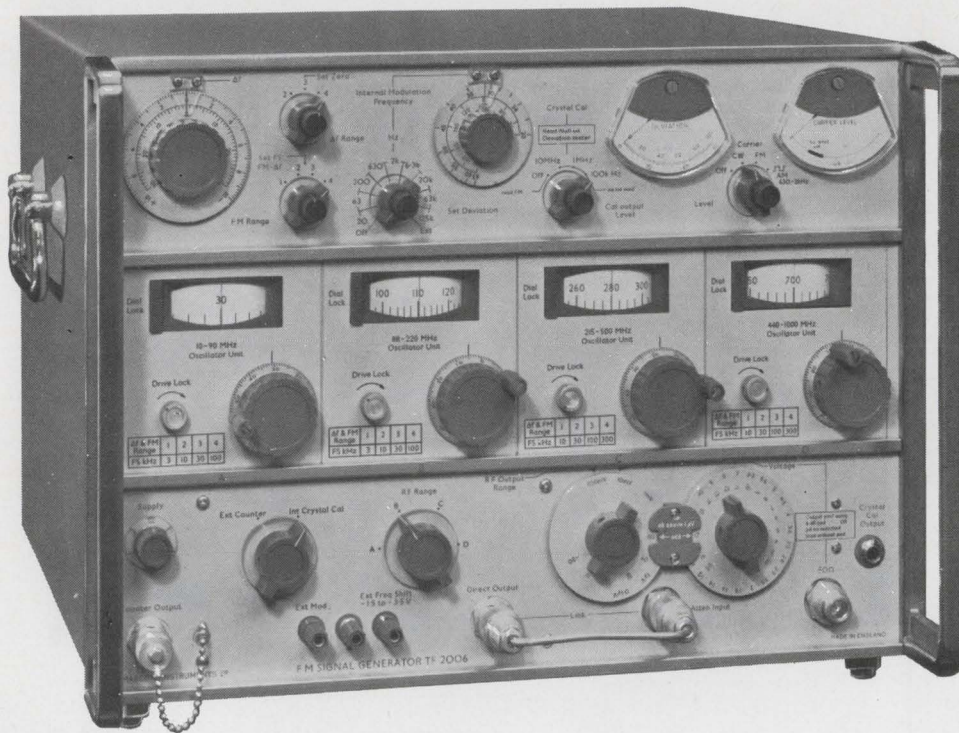

- **Wide Range:**
4-1000 MHz
- **Stability:**
Better than
15 PPM/15 minutes
- **Non-Microphonic**
- **No Range Change
Drift**
- **Fully Solid State**

the clean FM Signal Generator

F.M. Signal Generator TF 2006 is another "first" in the field of wide-range solid-state signal generators. Based on separate high Q resonant-line transistor oscillators, this instrument provides wide deviation f.m. on highly stable carriers up to 1 GHz. Rigid mechanical construction ensures that the precision oscillators have very low drift and microphony. Automatic levelling maintains constant r.f. output over the entire carrier frequency range, which extends down to 4 MHz, and accurate step attenuators offer a dynamic range of 120 db. Electrical fine tuning and f.m. may be simultaneously applied by the drive circuitry. As a result of their electrical relationship within the instrument f.m. as well as the fine tuning may be adjusted to a higher accuracy against the comprehensive crystal calibrator. This oven-controlled calibrator indicates carrier frequencies by meter nulls at 10, 1 or 0.1 MHz intervals and therefore provides almost 10,000 check points of the carrier frequency.

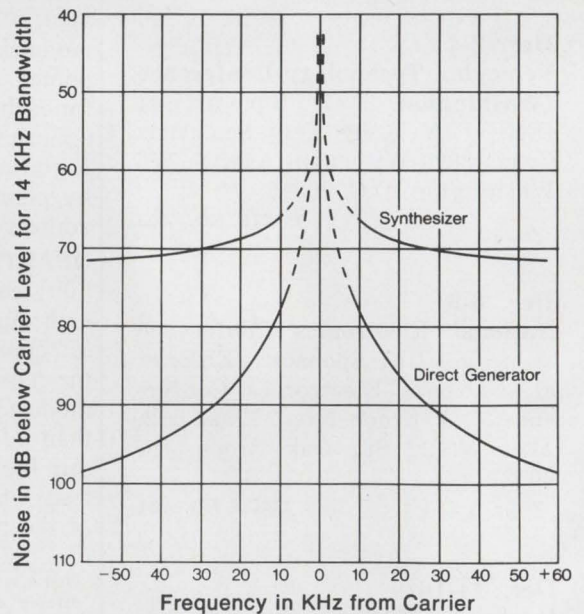

Comparison of Synthesized and Direct Frequency Signal Generator U.H.F. Spectra.

AVAILABLE UPON REQUEST . . .
Detailed specification brochure including operating principles, mechanical, electrical and environmental specifications.

mi MARCONI
INSTRUMENTS
DIVISION OF ENGLISH ELECTRIC CORPORATION

111 CEDAR LANE □ ENGLEWOOD, NEW JERSEY 07631
TELEPHONE: (201) 567-0607

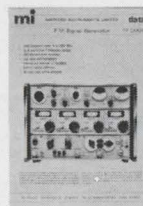



**Scott presents
the flexible urethane foam
that can catch flames
without catching fire.**

PYRELL™ Foam.

A new foam from Scott that's both flame retardant and flexible. Makes it safer for you, your products, and your customers.

When flame is applied, PYRELL intumesces. Its surface swells and chars, forming a protective carbon shield between the flame and the remaining foam. There's no melting and no dripping. Maintains its flame retardant effectiveness, even after aging.

And PYRELL passes the stringent UL-94 flame-retardant specifications.

If you must try to burn it to believe it, we'll send you a sample and complete information.

Just write Foam Division, Scott Paper Company, 1500 East Second Street, Chester, Pa. 19013.

SCOTT

Specialists in urethane foam technology.



Better packaging; one more reason our distributors are faster on delivery.

Your business is too important for procurement delays. That's why we asked your local Allen-Bradley distributor what would help him serve you better. The result; better fixed resistor packaging. Color coded boxes to eliminate errors. Bold identification of all the vital statistics. New clarity that will help your receiving and stockroom people, too.

Inside the carton there are more improvements. Each strip of 25 or 50 resistors is sealed in plastic. Leads are protected, resistors can't fall out. Yet the perforated end zips in a hurry. And every plastic wrapper is clearly marked with wattage, resistance, tolerance, military and commercial part numbers.

Better packaging and IRIS (Instant Response Information System); key elements in our distributors' better service program. It's a whole new dimension in electronics distribution.

Baltimore
Cramer/Baltimore
(301) 354-0100

Boston
Cramer Electronics, Inc.
(617) 969-7700

Chicago
Newark Electronics Corp.
(312) 638-4411

Cleveland
Schweber Electronics Corp.
(216) 464-2970

Denver
Cramer/Denver, Inc.
(303) 758-2100

Detroit
Newark-Detroit Electronics, Inc.
(313) 548-0250

Los Angeles
Kierulff Electronics, Inc.
(213) 685-5511

New York
Schweber Electronics Corp.
(516) 334-7474

Philadelphia
Almo Electronics Corp.
(215) 676-6000

Phoenix
Kierulff Electronics Corp.
(602) 273-7331

San Diego
Kierulff Electronics
(714) 278-2112

San Francisco
Elmar Electronics, Inc.
(415) 961-3611

Seattle
Kierulff Electronics, Inc.
(206) 763-1550

Washington, D.C.
Cramer/Washington
(301) 424-2700

...and in Canada:

Montreal
Cesco Electronics Ltd.
(514) 735-5511

Ottawa
Cesco Electronics Ltd.
(613) 729-5118

Quebec
Cesco Electronics Ltd.
(418) 524-4641

Toronto
Cesco Electronics Ltd.
(416) 638-5250

NEW DIMENSION ELECTRONICS

ALLEN-BRADLEY

Milwaukee, Wisconsin 53204



Highlighting

THE ISSUE

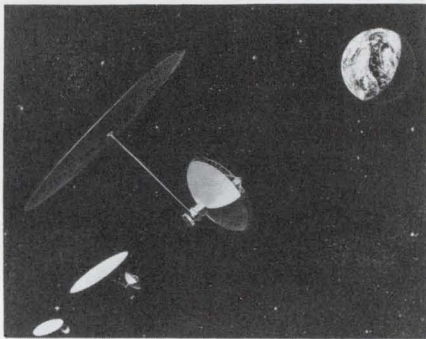

Diminishing fossil-fuel reserves, doubts about the practicality of nuclear power and the problems of air, water and thermal pollution have led Dr. Peter E. Glaser of Arthur D. Little, Inc., Cambridge, Mass., to develop a plan for synchronous satellites to supply electric power to the earth.

The satellites would collect their input power from the sun, using large arrays of solar cells, and then convert the resulting dc into microwave energy for transmission to the earth. On earth, large "rectennas" (rectifier-antennas) would receive the microwave energy and convert it to dc for distribution, possibly through superconducting cables.

Page 43



For years, peripherals were treated as a stepchild of the computer industry. The equipment was largely makeshift and appallingly slow, yet little attempt was made to develop new approaches; engineers concentrated on the more glamorous and profitable work of mainframe design.

But in the last year and a half there has been an upsurge of interest—and also promising results—in developing new peripherals. The equipment coming into use, at long last, is being designed to match the speed of the mainframe. Today's electronic designer, no matter what his field of interest, has a greater choice of peripherals, whether he uses a computer himself or designs it into a system.

Page C4



The new models of FET-input high-performance operational amplifiers with a price range of \$36 to \$84 feature ultra-low bias current of 0.15 pA and a wideband of 1 MHz.

This high-performance pair bridges the gap between conventional low-cost FET-input op amps and more expensive and exotic high-performance varactor-bridge electrometers—giving more performance at no increase in price.

Besides approaching a varactor-bridge amplifier's range of bias current, the new models solve a major varactor-bridge amplifier limitation: the inherent problem of very modest bandwidths.

Page 100

Solid state, for 1000x reliability.

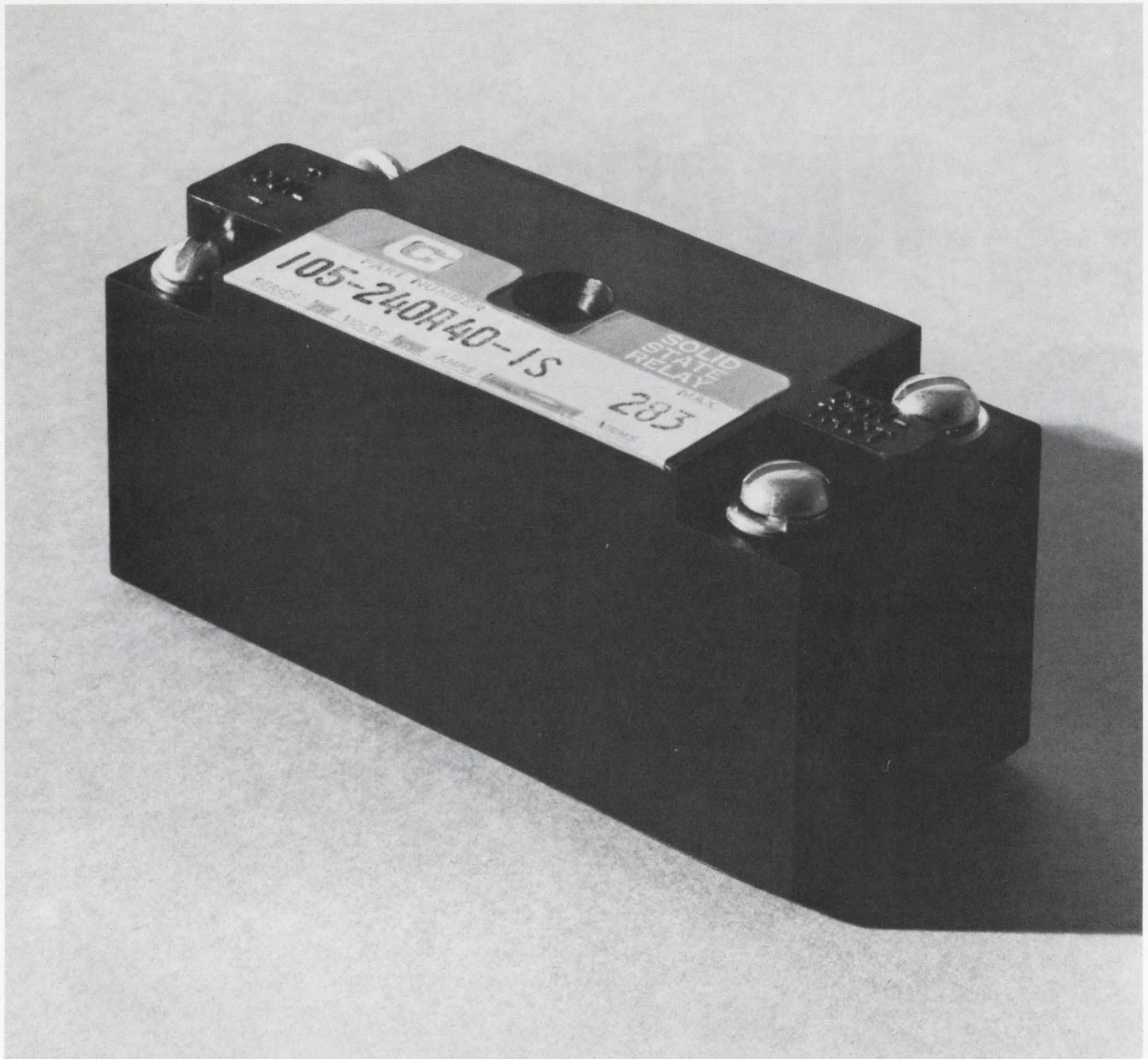

Genistron, for high-amp ratings.

Get it all. The whopping improvement in cycle life that solid state relays switch on: 100-million operations vs. 100,000 from horse-and-buggy EM. Plus the fullest range going in high-amp solid state. All the way to 40 amps—twenty more than the nearest competition.

Up through 240 Volts AC, 40 VDC, Genistron isolated SSR's are fully encapsulated for ruggedness. With barrier-strip screw-type terminals for easy connections. And our AC Syncroswitch Relay has zero-axis switching to eliminate RFI. (Just what you'd expect from the same people who bring you Genistron EMI filters.)

Catalog and specs, yours for the asking. Call or write Genistron Solid State Relays, Genisco Technology Corporation, 18435 Susana Road, Compton, California 90221. (213) 774-1850.

GENISTRON SOLID STATE RELAYS

INFORMATION RETRIEVAL NUMBER 15

A rising market foreseen for U.S. computer exports

WASHINGTON, D. C.—Exports of U. S.-manufactured computer hardware should total \$1-billion this year and reach \$2-billion in four years, according to a survey conducted in 25 non-Communist nations by the Bureau of International Commerce of the U. S. Commerce Dept.

In 1969 computer hardware exports totaled \$657-million. In the first half of 1969, the figure was \$336-million, against \$544-million in the first half of this year.

An extensive market analysis of the 25 countries surveyed showed that 80% of the 34,000 computers installed or on order in those countries were produced by American manufacturers and that most of the remaining 20% were produced abroad under U. S. licenses. The figures, the Commerce Dept. says, indicates "very favorable prospects" abroad for U. S. peripherals and software.

The total non-Communist world market for computers, according to the report, was approximately \$3-billion in 1969, and this is expected to increase at a rate of approximately 20% annually, reaching \$6-billion by 1973. The Commerce Dept. sees International Computers Ltd. of Britain, Siemens of West Germany, Philips of The Netherlands and Hitachi of Japan as the leading competition for U. S. firms overseas.

In the top five foreign markets for computer hardware, the Commerce Dept. expects Japan's \$805-million in purchases to reach \$2.2-billion by 1974; Germany to go from \$568-million to \$1.1-billion in the same time; France from \$418-million to \$896-million; Britain from \$405-million to \$970-million; and Canada from \$175-million to \$360-million.

The report concludes that foreign markets for electronic data

processing are growing at twice the rate of those in the U. S. and that the American computer industry enjoys a commanding lead in manufacturing technology.

Copies of the report can be obtained from the U. S. Dept. of Commerce, Bureau of International Commerce, Washington, D. C. 20230.

... Meanwhile in Japan: A new computer line

Fujitsu, Ltd., of Tokyo has announced a line of computers that it says is comparable to IBM's 360-370 class but at half the price. A New York-based computer service company, Automation Sciences, Inc., has been chosen to market this first challenge by Japan to the U. S. computer industry.

Harold Rosenberg, president of Automation Sciences, says Fujitsu is offering five models: The Facom 230-15, 230-25, 230-35 and 230-75.

Besides lower cost, Automation Sciences is tossing in as standard features virtual memory, multi-programming and communications—extras that usually raise the cost.

The Facom computer will be offered complete with software. Customers switching to the Japanese system are guaranteed that they will be able to use their old software without a conversion fee.

... And in the U. S., drop in EDP growth is seen

The domestic data-processing industry, which grew 20% a year in the 1960s, will slow to an annual rate of 12% to 15% for the decade ahead, according to Henry S. Forrest, vice president, Control Data Corp.

Addressing the 12th annual Business Equipment Exposition in New York City, Forrest forecast a 5% reduction to \$4-billion in the value of EDP equipment shipments in this country in 1970, largely because of the downturn in the economy.

Forrest noted that whereas the 1960s were a period of dramatic growth for computer systems, industry leaders look for a more mature approach to the acquisition of systems in the 70s.

NASA publications start using metric system

The National Aeronautics and Space Administration becomes the first federal agency to require the use of the metric system in certain of its publications.

All of NASA's "Technical Reports," "Technical Notes," "Technical Memoranda," "Contractor Reports" and "Special Publications" must comply by Nov. 14. Waivers will be granted only in cases where it may already be too late or too expensive to make the changes in some publications.

NASA has not yet decided to require the use of metric units in the design of hardware. Such things as metric screw threads must await the results of the U. S. Bureau of Standards study to determine the impact on the nation of the increasing use of the metric system.

MCI petitions for use of intracity links

Microwave Communications, Inc., has petitioned the Federal Communications Commission for use of the now unoccupied 38.6-to-40-GHz millimeter waveband for business and data communications within cities. MCI was granted permission by the FCC to operate as a private-line carrier between cities on Aug. 14, 1969. (See "Plan National Private-Line Microwave net," ED 22, Oct. 15, 1969, p. 32.)

According to John D. Goeken, president, MCI's intracity system would include a variety of links in addition to the microwave transceivers. For example, he says, infrared optical links are cheaper

than 40-GHz microwave equipment and could be used for short distances where visibility is not a problem. Coaxial cable could be used between buildings and wherever tunnels already exist.

He believes the 40-GHz frequencies are well suited for intracity communications because they allow the use of antennas with very narrow bandwidth—about 100 feet at two miles—and this makes it possible to locate multiple paths without interference.

Although existing military equipment for these frequencies is costly, Goeken is confident that the promise of a multimillion-dollar market will spur microwave component manufacturers to design lower-cost equipment. For example, he believes a transceiver could be built profitably for \$3,000.

At this price it would be feasible for MCI to put up a system for a single large customer—such as a newspaper that wants to transmit copy to a suburban printer—and add to it as new customers are attracted.

GE cuts costs 30% for control systems

Two new electronic process-control systems, made of prefabricated, pretested modules, are reported to offer 30% cost reductions over conventional electronic systems.

The savings, says the manufacturer, General Electric of West Lynn, Mass., makes the systems competitive with pneumatic-control devices, which until now had enjoyed a 30% price advantage over electronic units.

According to General Electric, the new GEFAC 1000 and 100 controllers also spare the user the additional costs formerly incurred by having the equipment constructed and tested on his site. The new systems are shipped in modules and are simply plugged in for instant operation.

Each process-control complex consists of a minicomputer, a processor, all the necessary interface devices and related sensors and control elements.

GE says the systems are designed primarily for the petroleum and chemical industries but can be used in many others, too.

Infrared beacon guides copters with precision

A new infrared homing beacon for helicopters enables a pilot to position his craft within 3 inches of his target at an altitude of 50 feet. The signal can be picked up from a distance of 300 feet.

The system, designed by the Aircraft Equipment Div. of General Electric, Utica, N. Y., is for both military and civilian use. Its applications include heavy construction work, search and rescue operations and delivering supplies and evacuating personnel from ships.

Accurate positioning is critical when a helicopter picks up heavy loads. If the copter is not directly over the load when it leaves the ground, a pendulum effect can capsize it.

The three-part homing system consists of a ground emitter—a GaAs light-emitting diode with an intrinsic wavelength on the order of 0.9 micron—a silicon-diode infrared detector mounted on a gimbal on the aircraft, and an indicator in the cockpit—either a conventional ILS type or a more sophisticated CRT display.

For rescue work, another version of the system is offered that provides a range of more than a mile. Either version sells for approximately \$10,000.

A simple hovering unit using a fixed detector, without a gimbal, and providing an accuracy of one foot, sells for \$7000.

100-billion-watt laser aids Battelle research

What is reported to be the world's largest commercially available laser system—capable of providing a 1-ns pulse with a power of 100-billion watts—has been installed at the new Laser Applica-

tions Center of the Battelle Memorial Institute, Columbus, Ohio.

Using neodymium-doped glass rods, the laser is 50 feet long and has six separate stages, according to Dr. Leonard Solon, vice president and technical director of Hadron, Inc., Westbury, N.Y., suppliers of the device.

The first stage is the oscillator, in which the laser discharge is initiated, and this is followed by five amplifier stages that build the power to a 1-ns pulse of 100 joules at a wavelength of 1.06-microns. The output is being used for research in laser-generated plasmas and controlled thermonuclear reactions.

NASA aims to increase solar-cell energy 100%

The National Aeronautics and Space Administration is trying to increase the efficiency of silicon solar cells, the prime energy source for most spacecraft power systems, from 12% to over 24% and thereby reduce by half the number of cells needed in a spacecraft. Savings of millions of dollars would result.

A study of the subject is under way at the University of Pennsylvania's Institute for Direct Energy Conversion, Philadelphia. Martin Wolf, senior research investigator at the university, is seeking to improve the collection efficiency and open circuit voltage of present silicon cells by upgrading the quality of raw materials with which the cells are manufactured.

Westinghouse joins mini market, with high hopes

Westinghouse Electric Corp., a latecomer to minicomputers, says it is going to try to capture the major part of the market in the next 10 years. The company is opening a plant in Orlando, Fla., to build its first small, general-purpose computer, the 2500.

The Westinghouse mini, to be available in June, 1971, will have a word length of 16 bits, memory speed of 850 nanoseconds and internal core memory of 4096 words. It will sell for \$9950.

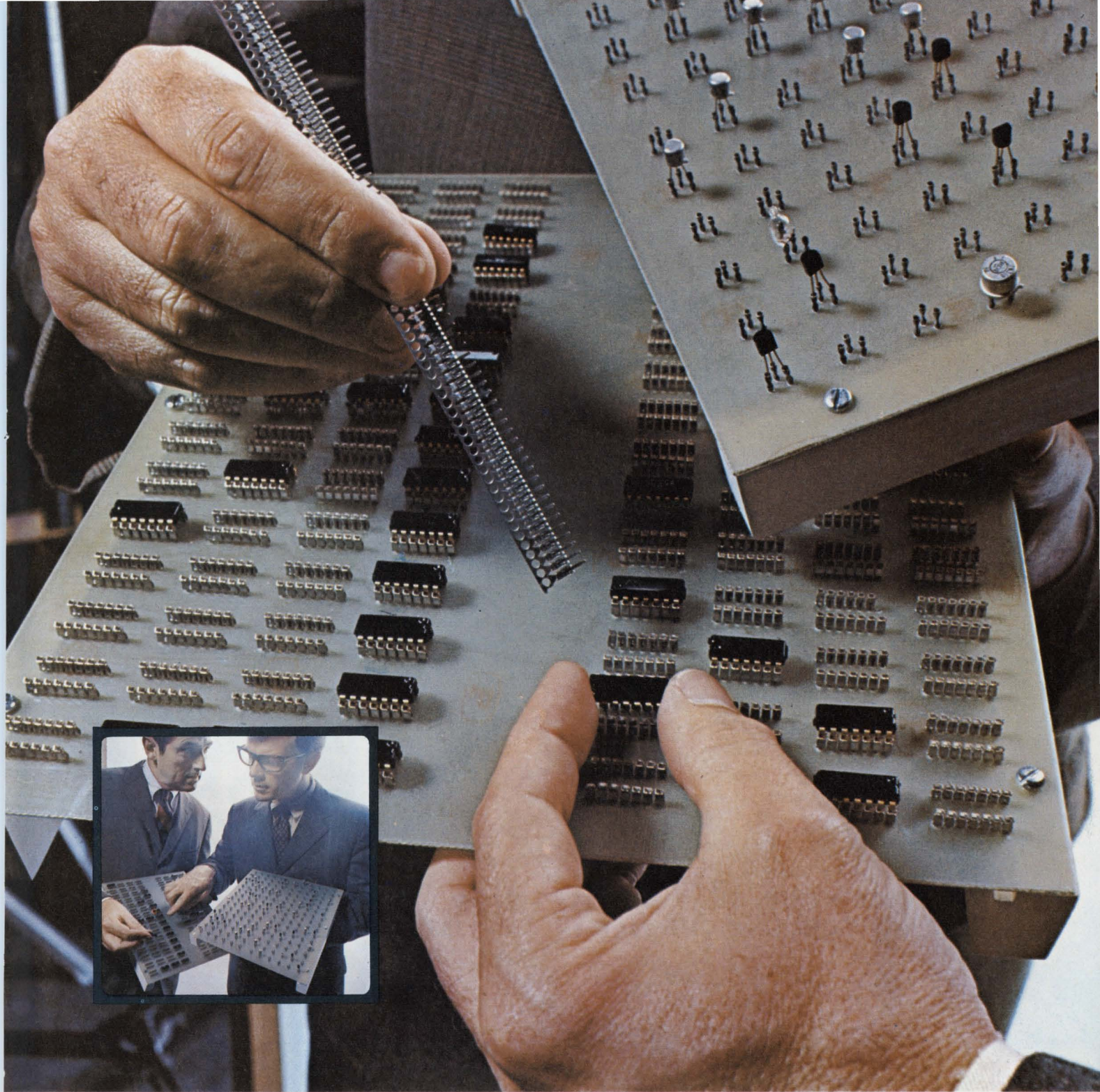

HERE'S A NEW AND BETTER WAY: To make printed circuit board connections. Reliably. At low, low cost. They're Molex Soldercon[®] terminals. Integrated circuit and transistor terminals. Offering the convenience of plug-in I.C.'s and transistors *without* the cost of insulators. They fit directly on the board. And there is equipment available to do the job *automatically*. Fast! Soldercon terminals save time. Money. Speed installation. Make

testing easier, too. And simplify service problems. It's another example of Molex ingenuity . . . in creating components that simplify circuitry. Molex has the know-how and facilities to provide the interconnecting system you need. You can make connections by calling (312) 969-4550. Or write . . . Molex Incorporated, Downers Grove, Illinois 60515.

*... creating components that
simplify circuitry*



Change your mind at the snap of a cam.



NEW FROM YOUR GUARDIAN ANGEL: LEVER SWITCHES WITH SNAP-IN CAM INSERTS

This latest miracle from your Guardian Angel lets you change switch actuator positions instantly . . . at any time. Any combination of **off**, **momentary** or **locked** actuator positions is as easy as inserting a pair of "programmed" molded plastic cam inserts. A snappy little chore that takes maybe 20 seconds.

The new Guardian Lever Switches offer more than versatility. They are available in non-illuminated or illuminated with color coding. Up to 4 pole, double throw per station with switches arranged in any desired form to provide needed circuitry. (Now do you believe there's a Guardian Angel watching over Engineers?)

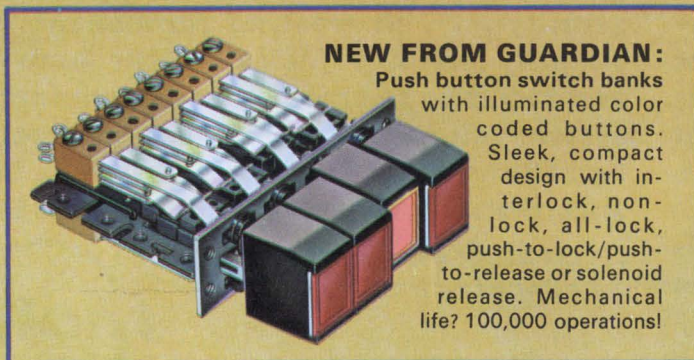

NEW FROM GUARDIAN:

Push button switch banks with illuminated color coded buttons. Sleek, compact design with interlock, non-lock, all-lock, push-to-lock/push-to-release or solenoid release. Mechanical life? 100,000 operations!

WRITE FOR BULLETIN NO. E-2



GUARDIAN ELECTRIC®

MANUFACTURING COMPANY
1550 W. Carroll Ave., Chicago, Illinois 60607

REPORT FROM INTERNATIONAL MICROWAVE SYMPOSIUM

Satellites would supply world's power needs

Michael J. Riezenman
Microwaves Editor

SCHEVENINGEN, The Netherlands—Diminishing fossil-fuel reserves, serious doubts about the practicality of nuclear power and the problems of air, water and thermal pollution have led Dr. Peter E. Glaser of Arthur D. Little, Inc., Cambridge, Mass., to develop a detailed plan for a system of synchronous satellites to supply electric power to the earth.

The proposal isn't as wild as it might sound.

The satellites would collect their input from the sun, using large arrays of solar cells, and then convert the resulting dc into microwave energy for transmission to the earth (see figure). On earth, large "rectennas" (rectifier-antennas) would receive the microwave energy and convert it to dc for distribution, possibly through superconducting cables.

10-year goal feasible

Such a satellite solar power system, Dr. Glaser said, could be operational within 10 years if a crash program similar to the nation's moon-landing program were initiated. Otherwise, he feels, 20 years is a more reasonable estimate.

In describing his scheme here at the Fifth International Symposium of the International Microwave Power Institute, Glaser, who is head of engineering sciences for Arthur D. Little, cited four major advantages that it holds over other approaches for meeting the power needs of the earth in the future:

- It uses no fossil fuel.
- It produces no chemical pollution and less thermal pollution than any competitive approach.
- It "beats the Carnot cycle" on earth—that is, the terrestrial portion of the system will probably operate with an efficiency on the order of 85%.
- It is economical.

In explaining his satellite solar

power plan, Glaser noted that many people, including engineers, imagine when they first hear it described that the microwave beam aimed at the earth will be a virtual "death ray" that could cause great damage if it ever accidentally drifted away from the receiving array.

Actually, in a sample system calculation for a 10^7 -kilowatt station, Glaser showed that the power density in the beam would be only 10 mW/cm² in the vicinity of the earth. The beam would cover an area six miles square and would require a transmitting antenna 1.5 miles in diameter to form it at the proposed operating frequency of 3.0 GHz.

The 3.0-GHz frequency was chosen to minimize atmospheric attenuation. As Dr. G. Goubau of the U. S. Army Electronics Command, Fort Monmouth, N. J., explained it, higher frequencies would begin to feel the adverse affects of attenuation in the troposphere, while lower frequencies would suffer from iono-

spheric attenuation.

The proposed design of the rectenna, described by William C. Brown of the Raytheon Co., Waltham, Mass., is a large array of half-wave dipoles, each with its own four-diode rectifier bridge. Since the individual dipoles (dipole-diode combinations) all act independently, the over-all beam pattern is essentially nondirectional, despite the large aperture of the rectenna. This nondirectional property is a great advantage, because it eliminates the necessity for precise aiming of the rectenna at the satellite.

Another advantage of this design is that it is easy to cool. The diodes are all small and thus can be easily heat-sinked.

To illustrate the performance that can be achieved with rectennas today, Brown cited a 20-W array he has in his laboratory that is 1-foot square and weighs 20 grams. The efficiency is between 69 and 75% per element, he reported.

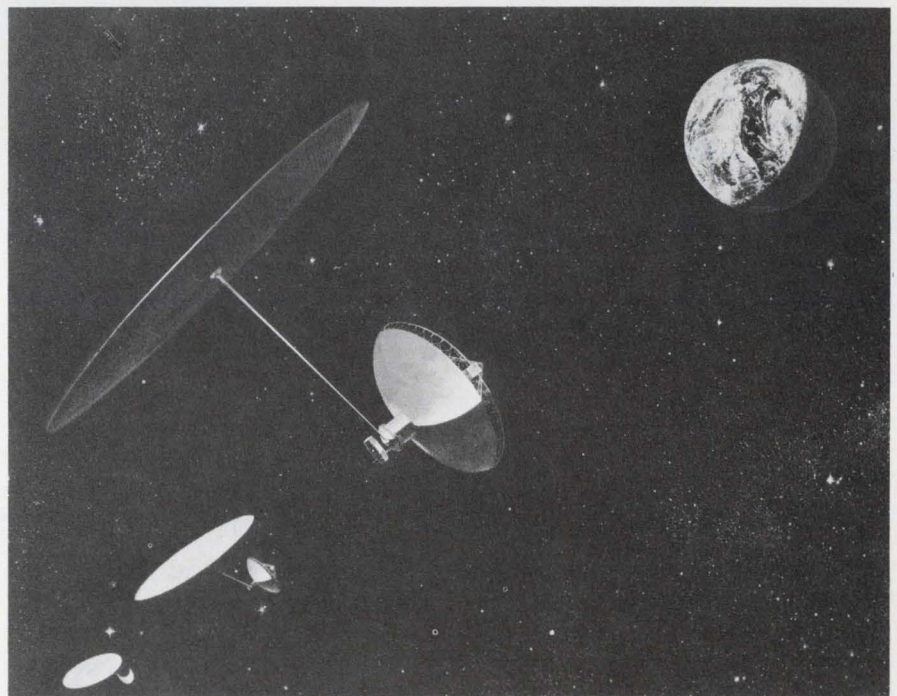

How solar power stations would look in space. In a 10^7 -kW system, the solar-cell array would be about five miles across and the transmitting antenna about 1.5 miles in diameter. The superconducting cable connecting the cells with the rest of the satellite would be two miles long.

The cost of power in the year 2000

Chart prepared by Arthur D. Little, Inc., shows the possible costs of power generation for a variety of methods in the year 2000. The solar power-generation scheme appears to have the edge in large-scale production.

| | Fossil-fuel power | | | | Nuclear power | | | | Solar power | |
|--|-------------------|------|--------|------|---------------|------|----------|------|-------------|------|
| | Current | | MHD | | Current | | Improved | | Volume | |
| | Volume | | Volume | | Volume | | Volume | | Low | High |
| | Low | High | Low | High | Low | High | Low | High | | |
| Initial generation investment (\$/kW) | 140 | 280 | 140 | 240 | 200 | 400 | 180 | 300 | 500 | 360 |
| Average transmission investment (\$/kW) | 50 | 180 | 50 | 100 | 50 | 200 | 45 | 170 | 70 | 40 |
| Capital cost (mills/kWh) | 3.13 | 7.58 | 3.13 | 5.60 | 4.11 | 9.95 | 3.74 | 7.80 | 9.40 | 6.50 |
| Fuel cost (mills/kWh) | 2.95 | 6.47 | 1.45 | 3.70 | 0.25 | 0.46 | 0.05 | 0.10 | — | — |
| Maintenance (mills/kWh) | 0.67 | 1.63 | 0.67 | 1.20 | 0.88 | 2.14 | 0.80 | 1.50 | 3.58 | 1.48 |
| Manpower (mills/kWh) | 0.25 | 0.32 | 0.25 | 0.50 | 0.26 | 0.45 | 0.42 | 0.50 | 0.02 | 0.02 |
| Total cost: generation plus transmission (mills/kWh) | 7.0 | 16 | 5.5 | 11 | 5.5 | 13 | 5.0 | 10 | 13 | 8.0 |

Economic bases

1. Investments and operating cost expressed in 1970 dollars without regard for inflation.
2. Capital charge based on 14% Return on Investment.
3. Base load operating efficiency of 97% for all power-generation methods.

4. Transmission investment cost related to distance between central station and major energy consumption point. Transmission cost is exclusive of local power distribution.

5. Maintenance costs are estimated at 3% of total investment for central station plus transmission.

6. Manpower costs cover central station plus transmission-system operations; they include supervision.

In the satellite plan, the rectenna would be the only portion of the system on the earth. Its projected over-all efficiency of 85% is higher than that of any other power-generating scheme. According to Brown, "There is no thermodynamic process known to man that can match the conversion efficiency of the rectenna."

Cooling is a major problem when working with high power levels in space. Since one way to attack the cooling problem is to cut the amount of heat that is wasted, high efficiency is as important in the microwave generator as it is in the receiver.

Because of the importance of efficiency, it is likely that the satel-

lite system would employ crossed-field devices to generate the microwave energy. In fact, Dr. Glaser's 10⁷-kilowatt sample system would employ 10,000 amplitrons, each with an output of 1000 kW. (An amplitron is a crossed-field amplifier quite similar to a magnetron, except that it is not re-entrant and hence doesn't oscillate.) ■■

The applicator problem in microwave heating

SHEVENINGEN, The Netherlands—The biggest technical factor impeding the wide acceptance of microwave heating by industry, according to Dr. Per O. G. Hedvall of the Microwave Institute Foundation, Stockholm, is the lack of flexibility of the power applicators—the devices that couple energy

from the microwave sources to the material being heated.

Typically, Hedvall pointed out at the Fifth International Symposium of the International Microwave Power Institute, each new industrial use of microwave heating requires the design of a new applicator. This is time-consuming and

expensive.

To solve the problem, Hedvall proposed a "universal applicator" built around a surface waveguide. Another speaker at the symposium, Prof. Michael A. K. Hamid of the University of Manitoba, Winnipeg, Canada, suggested the design of waveguides and cavi-

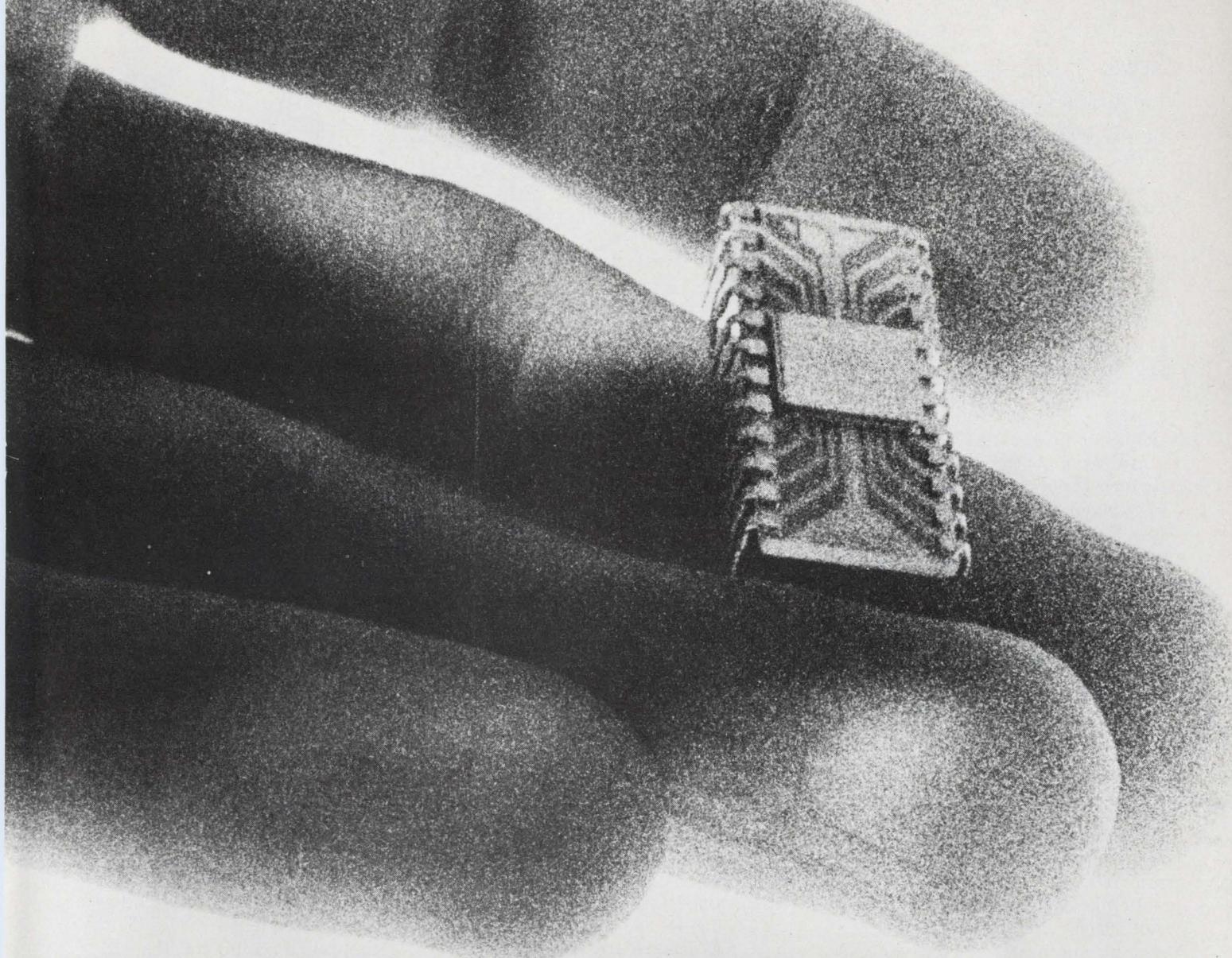

MOS. Ours today. Yours tomorrow.

We're there. Just like you. Up to our oxides in MOS technology. In active production, meeting demand with give-a-damn delivery.

Example: our MOS Read Only Memories, built for extraordinary flexibility in design. Ready for logic-programming to your specs, right on the chip. Just slap a truth table onto a deck of IBM cards and turn us on.

Our 24-pin ROMs don't settle for dinky single-line chip-select either. You can control 1 to 8 devices through our three chip-select terminals—a three-line binary coded function strictly exclusive with us. Access time, 550ns. Power dissipation, 150mW.

Optional output programming too: either bare drain or MOS pull-up resistor. Turn-around time from receipt of deck to delivery, competitive, of course.

Example: a salt-of-the-earth dynamic Random Access Memory. Completely characterized, in high volume MOS production longer than any similar device. Anywhere.

A remarkable RAM. With five chip-select inputs, permitting expansion to 8K—a capability ours alone. And unique 2.5 milliamp outputs for fast, inexpensive sensing. Fully decoded. Cycle time, 650ns. Access time, 400ns.

| | | |
|-------------|-------------------------|--------------------|
| 2410 Series | 256x4 Static ROM | 16-pin Ceramic DIP |
| 2420 Series | 128x8, 256x4 Static ROM | 24-pin Ceramic DIP |
| 2430 Series | 256x8, 512x4 Static ROM | 24-pin Ceramic DIP |
| N2301 | 256-bit Dynamic RAM | 24-pin Ceramic DIP |

In-depth applications info available. In person. Just call George Rigg (408) 739-7700, and let's discuss it man to man. Data sheets and price lists for the whole MOS batch, ready too. Along with our ROM Selection Chart, listing ten option combinations. Call and let George do it too, or write Signetics Corporation, 811 E. Arques Avenue, Sunnyvale, California 94086. A subsidiary of Corning Glass Works.



Signetics

(applicators, *continued*)

ties that operate at higher-order modes.

In describing his surface-waveguide universal applicator approach (see drawing), Hedvall noted that it didn't look too promising at first glance because of the rapid variation of the energy density with distance from the waveguide (a). However, he continued, when a load is placed near the waveguide, it perturbs the field and produces a reasonably uniform energy distribution inside itself (b).

An even better energy-density pattern is obtained, Hedvall said, if a symmetrical structure is used (c). Surface waves are established on two parallel waveguides and the load is placed between them so it can pick up energy from both.

Materials are no problem

A major advantage of Hedvall's scheme is that the applicator is not particularly sensitive to the detailed characteristics of the material being treated. A wide variety of materials can be placed in the applicator and will produce patterns quite similar to those in the drawing.

In his experimental work, Hedvall used surface waveguides 1 meter long by 0.5 meter wide. A power level of 5 kW was employed at an operating frequency of 2.45 GHz. In the symmetrical applicator configuration, the spacing between the two waveguides could be varied between 10 and 15 cm.

Hedvall mentioned two approaches to the design of surface waveguides: the use of dielectric sheets

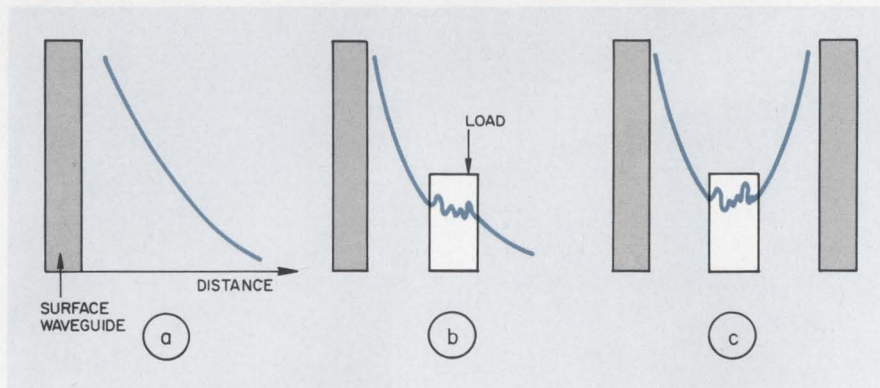

A "universal applicator" can be made from a surface waveguide, despite its rapid variation of field strength with distance (a), because the load evens out the pattern (b). The symmetrical structure (c) is particularly good.

and the use of periodic structures. He used periodic structures in this experimental work he described.

Higher-order modes studied

Hamid and a group he is leading at the University of Manitoba explained their research efforts on the design of waveguides and cavities this way: Higher-order mode operation makes it possible to concentrate the valuable microwave energy at the place where it's really needed, and thus can lead to much more economical applicators. In addition, since the energy is concentrated inside the device, leakage problems are greatly reduced. As Hamid told *ELECTRONIC DESIGN*, it is much better to design microwave ovens so their doors are placed at points where the electric field goes to zero than to rely on metal gaskets to keep the radiation from leaking out.

A prolate spheroidal cavity resonator (see photo) that embodies

Hamid's ideas was described at the symposium by Dr. S. S. Stuchly, a post-doctoral fellow at the University of Manitoba. When this cavity is excited in the TM_{e11m} mode, energy is concentrated at two spots in the oven (not necessarily the geometrical foci), and the electric field vanishes in the plane at which the two halves of the cavity are joined.

The TM_{e11m} notation indicates an even transverse magnetic mode that is degenerate in the ϕ -direction in prolate spheroidal coordinates and has a single half-period in each of the two other coordinate directions.

With proper scaling of the size of the cavity and its frequency of operation, Hamid told *ELECTRONIC DESIGN*, it should be possible to increase the size of the area in which the energy is concentrated, so that high-intensity, fairly uniform power densities would be available to treat fairly large pieces of material. ■■

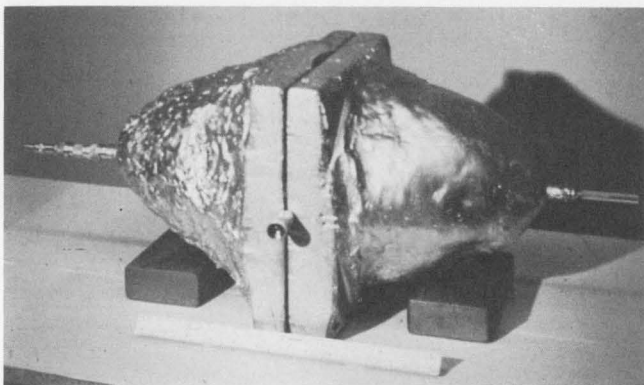

This experimental prolate spheroid resonator is symmetrically excited by the magnetic coupling loop. The

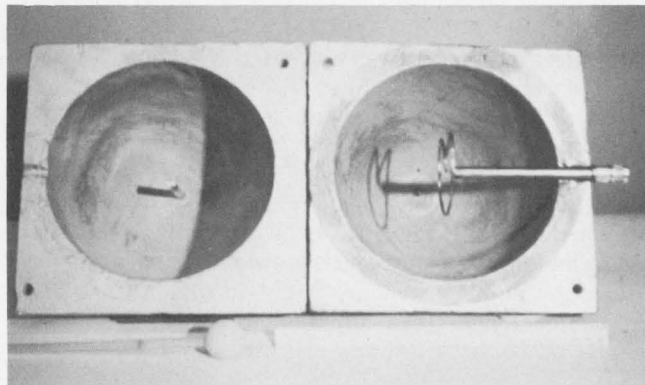

loop's feeder lies in the plane where the E-field is zero, and hence it doesn't distort the field pattern.

Φ-LINE POWER DARLINGTONS

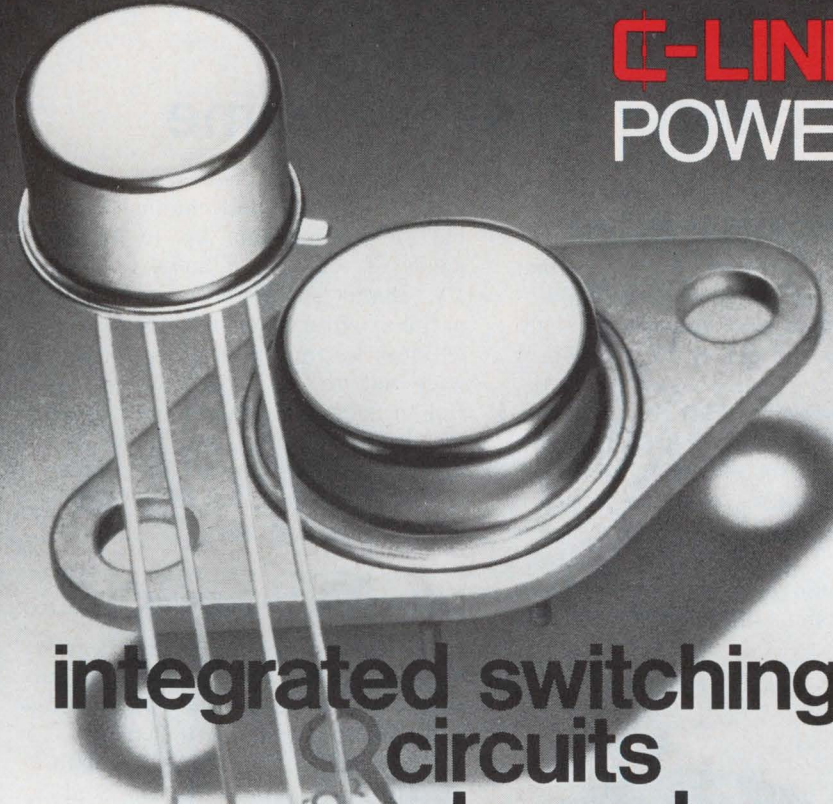

**integrated switching
circuits
cost you less...**

and make your work a lot easier.

Unitrode's new industrial 10 Amp silicon planar NPN Darlington transistors offer you the advantages of a monolithic two transistor circuit for less than the price of comparable discrete devices. They're ideal for high gain switching applications such as print hammer drivers, solenoid, servo and lamp drivers and for amplifying applications such as motor controls and linear amplifiers. They're available in two hermetically sealed metal packages — a lead-mounted TO-33 (U2T101) and a chassis-mounted TO-66 (U2T201). Both utilize overlay (multiple emitter) techniques on driver and output transistors. Saturation voltage is 1.5V max. @ 5A and current gain is 2000 min @ 5A. Collector-Emitter voltage ratings are available up to 150 volts. U2T201 has a power dissipation rating of 25W @ a case temperature of 100°C. For whatever Darlington application you have, Unitrode Φ-Line Darlington are more efficient and less expensive than any other method of performing the function. Why not make us prove it? (U2T101 is \$2.75 ea. in lots of 100.)

For fast action, call sales engineering collect at (617) 926-0404
Unitrode Corporation,
Dept. 11B, 580 Pleasant St., Watertown, Mass. 02172

Free samples on request.

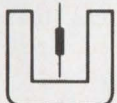

UNITRODE quality takes the worry out of paying less.

A communications center in every home

Two-way broadband network covering U. S. could be built for \$35.5-billion, EIA symposium is told

Elizabeth de Atley
West Coast Editor

The year is 1980, and . . .

- You can work at home and communicate with your office via cable TV.

- You can send and receive letters over your home cable TV terminal.

- Your wife can instantaneously order clothing and other merchandise displayed on the TV screen.

- You can even take a course at the local university without leaving your home.

These and other glimpses of the bright future of broadband communications were given at the Electronic Industries Association Symposium on the Future of Broadband Communications and Satellites, held in San Francisco. Speakers at an all-day session outlined the systems needed to provide such services for the nation, and they described telecommunication services available right now.

System would blanket the U. S.

Dr. William A. Gross, manager of advanced programs for the General Electric Co., Missile & Space Div., Philadelphia, estimated that a system that would provide two-way broadband communications to 80 million subscribers in the entire U. S. could be built for \$35.5-billion. This figure would include two satellites, 200 regional stations and 14,800 local stations with cable connections to and from individual subscribers. He estimated that subscribers' terminals would range in cost from \$100 to \$5000, depending on the services desired. For example, if the subscriber wanted only TV reception plus the ability to order merchandise, he would need just a few buttons attached to his TV set, but if he wanted to do computer-aided design, he would need sophisticated computer interaction capability. An

average price for each terminal would be about \$300, Gross said.

He noted that there were only 200 great centers of information in the country—such as the Library of Congress, NASA centers, etc. The input to these centers is usually in the form of a simple request for information, but the response may be volumes. Thus Gross envisioned that the 14,800 local stations would need only narrowband transmission to the 200 regional

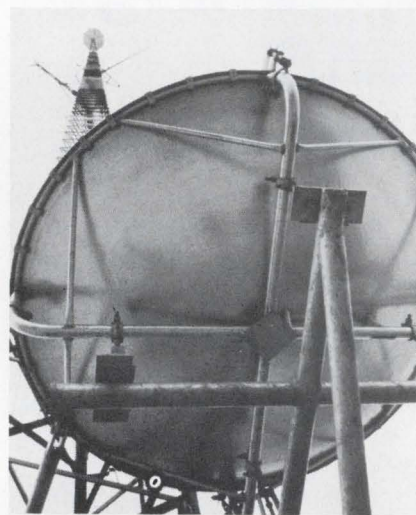

Many microwave towers like this one would be needed to provide nationwide broadband communications.

centers but would require the capability to receive broadband communications from them. The local stations would provide broadband communications to and from the individual subscribers, permitting the latter to interact with a central computer, receive instruction from a nearby university, etc.

A cable system is the most economical way to provide such a two-way capability, Gross said (see "Cable TV: Slumbering Electronic Giant—A Multibillion Industry?," ED 8, April 12, 1970, p. 62). A single cable could provide the subscriber with one full-time, narrow-

band channel for requesting information, a broadband channel capable of sending him up to 14,000 pages of text in an hour, plus 31 TV channels for both local and national entertainment programs.

Gross estimated that a nationwide network offering this potential to 80 million subscribers could be leased to the individual for \$8.75 a month—\$5 for the entertainment channels and \$3.75 for the information services.

California in the forefront

But the computer terminal in the home is admittedly a few years away. What about the status of broadband communications now?

Dr. Charles P. Smith, director of management systems for the State of California, with headquarters in Sacramento, pointed out that at present California operated a statewide microwave system with more than 200 transceivers and multiplexers. It maintains a private statewide telephone network, including Centrex switching systems, in seven cities that have the capability of switching from voice-grade operation during the day to broadband at night. In addition the state uses a number of dedicated lines, leased from the Bell System, that provide for the transmission of data up to 4800 bits per second. Some of the services made possible by these systems include:

- Message switching between Los Angeles, San Francisco and Sacramento to and from data files on motor vehicles, stolen property, gun registrations, drivers' licenses and wanted-persons lists.

- An aqueduct control system for California water supplies, with computers in Sacramento connected on line to 108 minicomputers in the field as well as to hundreds of measuring and control devices.

- A Department of Motor Vehicles system that allows on-line inquiry from field offices to the motor-vehicle and driver-registration files in Sacramento.

In addition, Smith said, the Cali-

fornia Dept. of Human Resources Development, in conjunction with the Federal Government, is developing a system for matching unemployed persons with available jobs throughout the state.

Medical applications lacking

One group that is *not* using broadband communications to meet its needs is the medical community. Dr. Ruth Davis, a computer scientist and director of the Lister Hill National Center, National Library of Medicine, Bethesda, Md., pointed out that broadband communication systems that would meet medical needs were too expensive at present—the “technology just isn’t here yet.” For example, she pointed out, to link the 101 medical schools in the country in a system that would allow teachers at one school to offer interactive instruction to students at other schools would cost each school \$60,000 a month, even using the existing educational television network. An economical system is sorely needed, Dr. Davis said, because it simply isn’t possible to have top teachers in every branch of medicine at all the schools.

Furthermore, she pointed out, cable TV cannot be used in its present form to transmit electrocardiograms and X-rays within the same city because doctors must address individuals rather than an entire network.

“This means message switching,” Dr. Davis said, “not circuit switching. It means computers on the line, and it means two-way communications, which involve two channels or putting in directional amplifiers and a number of other things that just aren’t here yet.”

Dr. Davis said her group at the Lister Hill National Center had tried to solve the problem by encoding TV transmissions but had found this too expensive.

In response, Irving B. Kahn, chairman and president of the TelePrompTer Corp., the nation’s largest cable TV operator, pointed out that TelePrompTer Corp. is already testing two-way broadband communications in a cable-TV system. Furthermore, he said, two-way subscriber terminals exist in breadboard form and TelePrompTer expects to have working test models in the system by 1971. ■■

NOW HIGH-PERFORMANCE SCRs TO MEET THE CRITICAL NEEDS OF...

- Power Inverters
- A.C. Motor Variable Speed Drives
- Induction Heaters
- Pulse Width Modulators



NATIONAL® DISC PACKAGED REGENERATIVE GATE* SCRs provide these plus factors...

- + Voltages to 1000 V
- + dv/dt to 500 V/ μ sec.
- + Turn-off time to 15 μ sec.
- + di/dt to 800 A/ μ sec.
- + Low power gate drive
- + Operation to 20 KHz, with low switching losses
- + 175 and 380 amperes RMS
- + Also available in stud packages to 470 amperes RMS

* A NATIONAL® exclusive.
Patent No. 3,486,088

We welcome requests for detailed data and application assistance. Contact...

NATIONAL ELECTRONICS, INC.

a varian subsidiary

Geneva, Ill. 60134, phone 312-232-4300

Automatic rain-making with computer aid?

U.S. experiment in Rockies will seek to increase water for Southwest by economical cloud seeding

Elizabeth de Atley
West Coast Editor

Not too long ago inhabitants of the Los Angeles region were reconciled to the fact that they lived in a basin with relatively scarce supplies of water. But meteorologists have demonstrated that the water in rivers supplying such parched areas can be increased 20% by dropping silver-iodide crystals into the clouds over the mountains where these rivers originate. The seeding increases rainfall.

With such conventional equipment as teletypewriters and missile-tracking radars, scientists have made great strides in modifying weather in the last few years. Still, to be cost-effective on a steady, operational scale, water-making projects need to be automated. This is because enormous amounts of data must be processed in real time to decide when and where to seed the clouds with silver iodide, and because of the large areas that must be covered.

This winter will see the beginning of the most highly automated water-making project to date. A six-year project sponsored by the Div. of Atmospheric Water Resources Management in the U.S. Bureau of Reclamation, Golden, Colo., will use a computer to control 30 seeding generators scattered over a 1500-square-mile area in the southern Colorado Rockies around Durango. The computer will:

- Monitor the flow of silver iodide crystals from the generators into the atmosphere.

- Receive and process telemetered data from several remote recording stations.

- Command the release of radio sondes (weather-data balloons) from ground-based sonde stations.

- Process the upper-air data these sondes telemeter back.

- Control a radar that will track the movements of the clouds.

In addition there will be remote geophones, capable of picking up vibrations from ice formations that may signify incipient avalanches. The geophones will send out warning signals.

The project is intended to prove the economics of cloud seeding: Can it augment the water supply to the Colorado River—and thus to the entire Southwest, including Los Angeles—more economically than, say, desalination of sea water? At the conclusion of the project in 1976, meteorologists hope to be able to answer questions like these:

How many acre feet of extra water can be provided this way?

Is it certain that the extra water would not have been produced without cloud seeding?

What is the cost per acre foot of the extra water produced?

Will the extra snow in the Rockies harm plant or animal life?

Will it increase the incidence of avalanches?

In the initial phases of the project, there will be no sophisticated displays at the headquarters in Durango—only a teletype for input to and output from the computer and a facsimile for receiving both conventional weather maps and ESSA satellite maps, the latter by telephone from Hughes Aircraft Co., El Segundo, Calif., where the satellite data is collected by a 30-foot dish antenna.

Scientists at Durango will analyze the information from the remote sensors, the weather maps and other sources and attempt to form a picture of such rapidly changing variables as cloud moisture, number of ice crystals in the clouds, wind velocity and temperature, to decide when and where to seed. Because this analysis must be done quickly, the need for a sophisticated 3D display is acute, and Dr. Archie M. Kahan, chief of the Div. of Atmospheric Water Resources Management, says that as water-making projects prove their cost effectiveness, such displays will become commonplace.

One 3D display system has already been designed and is expected to be tried out in mid-1972 in a hail research experiment conducted by the National Center for Atmospheric Research, Boulder, Colo. In this system, information from sensors carried around and into hail clouds by aircraft and dropped through them by sondes will be telemetered to headquarters. This data, together with information from several specially designed radars, will be inserted into two computers. One computer will generate a permanent record of the raw data on magnetic tape. The other will process the data and display it as a three-dimensional picture of the storm. Other displays will show information such as reflectivity contours from selected cross-sections of the storm and alphanumerics. ■■



Clouds show up as shadowy images on the screen of a radar that will be used in the country's first large-scale operational water-making project, starting this winter in southern Colorado under the auspices of the Bureau of Reclamation, Boulder, Colo.

We packed even more circuitry into CTS cermet resistor networks.

*New 8 and 18-lead styles added to 14 & 16-lead
Series 760 Dual In-Line Packages.*

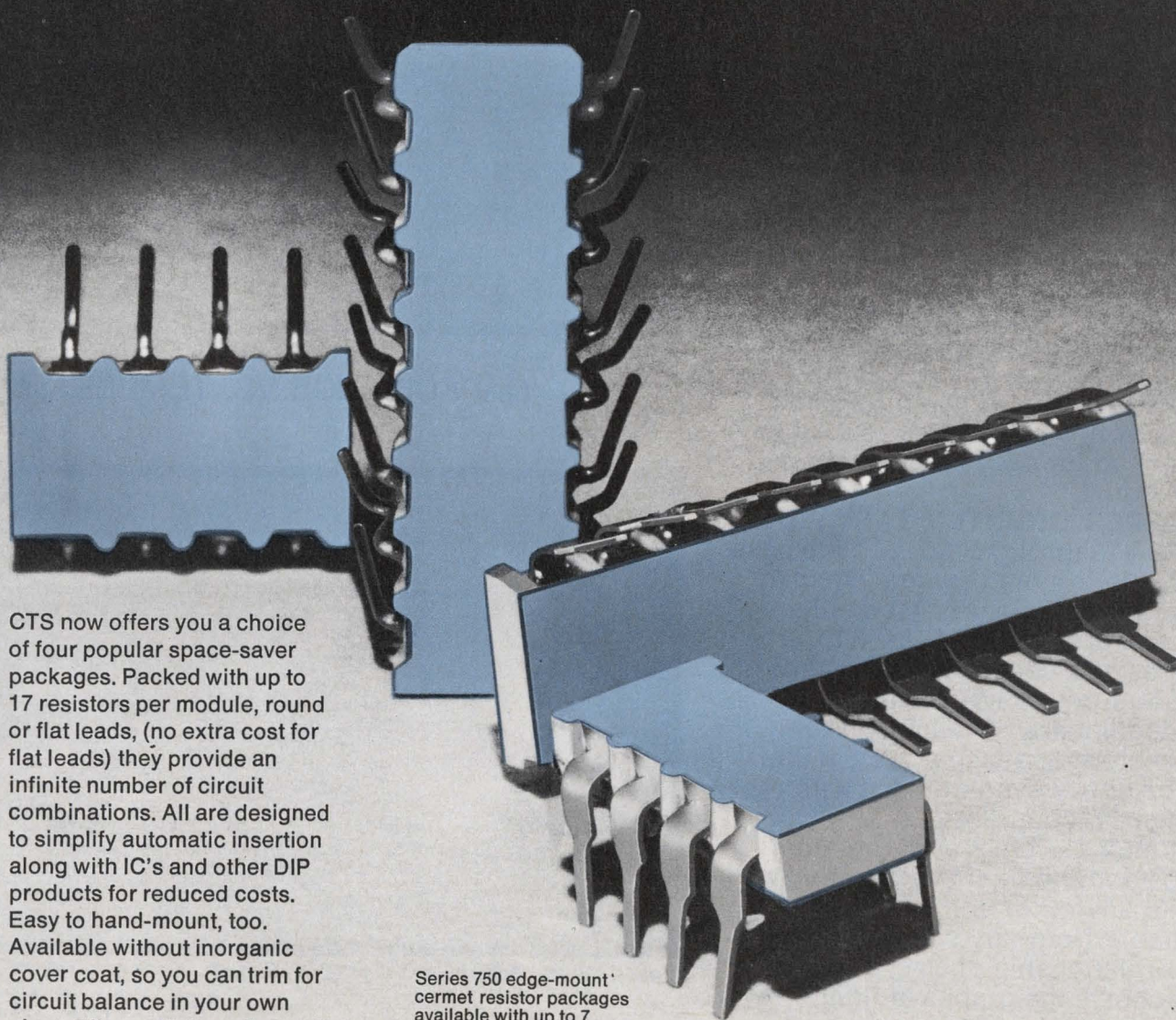

CTS now offers you a choice of four popular space-saver packages. Packed with up to 17 resistors per module, round or flat leads, (no extra cost for flat leads) they provide an infinite number of circuit combinations. All are designed to simplify automatic insertion along with IC's and other DIP products for reduced costs. Easy to hand-mount, too. Available without inorganic cover coat, so you can trim for circuit balance in your own plant. 5 lbs. pull strength on all leads; .100" lead spacing; rated up to 2 watts on 18 lead style.

CTS of Berne, Inc., Berne,
Indiana 46711. (219) 589-3111.

Series 750 edge-mount
cermet resistor packages
available with up to 7
resistors per module in
9 package configurations.

CTS CORPORATION
Elkhart, Indiana



YOUR CTS ANSWER
MAN will be glad to
work with you to pack
maximum circuitry
into your compact
design with this
expanded line of dual
in-line packages.

KEMET®

CHIP CAPACITORS

From 10pF through 100 μ F, the combination of **KEMET** Ceramic Chips, and **KEMET** Solid Tantalum Chips provides you with a single solution to your hybrid circuit capacitor needs.

Both chips feature **HIGH TEMPERATURE CAPABILITY** achieved through the use of a unique copper barrier layer that permits them to withstand the severe temperature conditions of solder reflow assembly with no degradation of performance and electrical characteristics.

SOLDER GUARD CERAMIC CHIPS—10 through 330,000pF. Six standard sizes in both BX and N.P.O. dielectrics. Will withstand 260°C exposure for 20 minutes—supplied pre-tinned for easy application in your circuit.

COPPER COUNTER TANTALUM CHIPS—10 through 100 μ F. Nine case sizes offering the very maximum in volumetric efficiency. Assembly temperatures to 300°C for 3 minutes and continuous operating temperatures to 175°C when derated linearly. Available in an automated dispensing system that can be easily synchronized with your production line.

KEMET Ceramic and Tantalum Chips complement one another unlike any other combination available from any source. Check their relationship of size, stability and cost in the graphs at right.

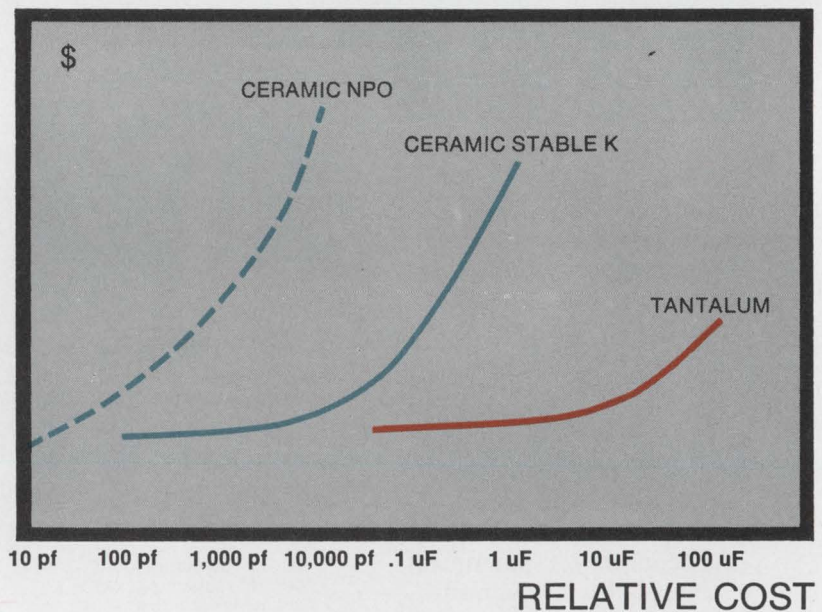
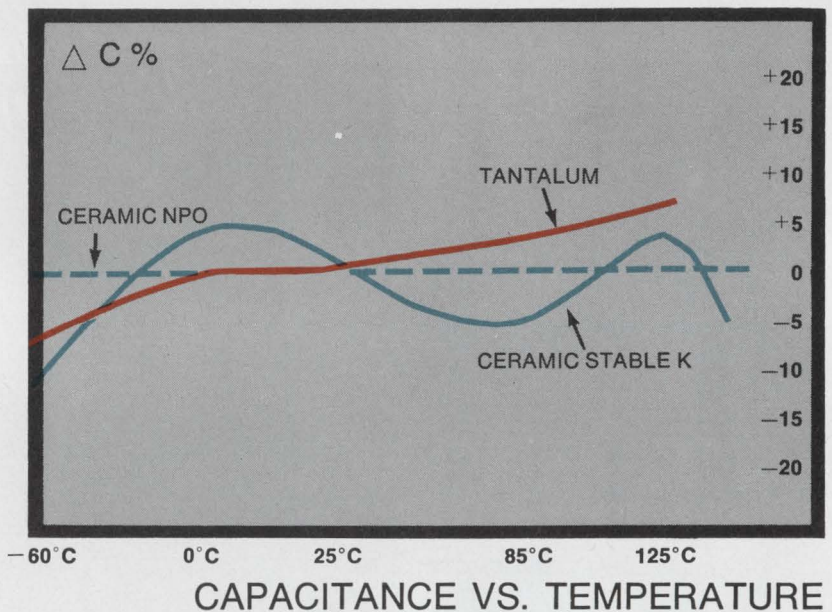

Ask for **FREE** engineering samples and technical literature, today. Call your nearest **KEMET** Sales Representative or write us direct. Union Carbide Corporation, P. O. Box 5928, Greenville, South Carolina 29606; Telephone 803-963-7421; TWX 810-287-2536.

Covers Hybrids

FROM

Puff's
(PICO FARADS)



TO

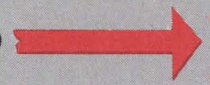

Muff's
(MICRO FARADS)

↑
INCREASING VOLUMETRIC EFFICIENCY

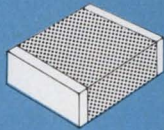

KEMET SOLDER GUARD CERAMIC CHIPS



KEMET COPPER COUNTER ELECTRODE TANTALUM CHIPS

10 pf

1000 pf

100,000 pf

1 uF

10 uF

100 uF

PICO FARADS

MICRO FARADS

COMPONENTS DEPARTMENT

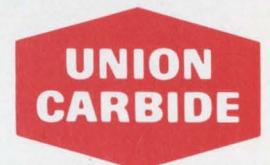

THE DISCOVERY COMPANY

Avantek chip transistors now available for thin film circuitry!

Avantek, leading producer of thin film microwave amplifiers and microwave transistors, now offers a complete line of small-signal, VHF, UHF, L and S Band silicon chip transistors.

Ideal for companies desiring to build their own integrated circuits, Avantek chip transistors feature:

- 1) Low noise figure...VHF through S Band.
- 2) Gold metallization.
- 3) Wide selection of performance options.
- 4) Availability from stock to 30 days ARO.

Representative models include:

| Freq. Band | Chip Type | Generic Avantek Model |
|------------|-----------|-----------------------|
| VHF | CT-25 | AT-25 |
| | CT-25A | AT-25A, AT-25B |
| UHF | CT-51 | AT-51, AT-52 |
| | CT-50A | AT-50, AT-50A |
| | CT-55 | AT-55 |
| L BAND | CT-24 | AT-241, AT-242 |
| | CT-24A | AT-240, AT-240A |
| S BAND | CT-20A | AT-201, AT-201A |
| | CT-20B | AT-201B |
| | CT-30 | AT-301, AT-301A |
| | CT-22 | AT-220 |
| | CT-32 | AT-320 |

In addition, every packet of Avantek chip transistors is guaranteed to be traceable to the same wafer.

For the finest in MIC designs and circuitry, specify Avantek chip transistors.

Avantek

Avantek, Inc. 2981 Copper Rd.,
Santa Clara, Ca. 95051
Phone: (408) 739-6170
Cable: AVANTEK

Advanced engineering opportunities are now available. Avantek is an equal opportunity employer.

Technology Abroad

Russian scientists are using laser energy as an alternative to neutron activation in the analysis of mineral samples. A Soviet-designed instrument produces a spectrum of the test material on a photographic plate in 1 ms. The beam of a ruby laser is focused through a microscope-like lens system upon the sample material. The spectrum of the vaporized material is then recorded photographically. This technique was developed by scientists at the Moscow Institute of Mineral Raw Materials.

A single-mode, fiber-optic waveguide with hairlike dimensions, that is said to be ideal for very wideband communications, has been fabricated by Standard Telecommunication Laboratories (STL) of Harlow, England. Each fiber has been successfully processed through a plastic extruder to form a plastic-coated, wirelike element suitable for assembly into a complete cable. Fiber losses as low as 20 dB/km have been reported. These developments—combined with recent work in room-temperature laser light sources—could mean that practical optical fiber communication systems will be produced within five years, STL researchers believe. These optical systems would be competitive with coax PCM systems since they would boast bit rates in each pair of fibers from 100 to 500 Mbits per second or higher. It is believed that system capacity could be increased to one to two Gbits per second.

The first cargo ship in the world to navigate with the aid of satellites, the M. S. Margaret Johnson of Sweden's Johnson Line, began operations last month. The new navigation system was used on a voyage from Los Angeles to Gothenburg. Satellite navigation, accurate to within 0.1 nautical mile, permits vessels to follow the most direct course, saving time and fuel. The navigation equipment on the Johnson liner consists of a 2-1/2-meter whip an-

tenna mounted atop the mast, plus special receivers and a computer. This equipment operates in conjunction with the U. S. Navy Navigation Satellite System—a series of satellites in polar orbit at about 1000 km, plus a number of master shore stations. The special satellite receiving equipment was developed by ITT Aerospace Corp. of America and installed in cooperation with the Swedish ITT subsidiary, Standard Radio and Telefon AB.

A 15-month study contract on development of new integration techniques for general-purpose, fast, bipolar semiconductor memories has been accepted by Britain's Ministry of Technology from the Electronics Department of Ferranti Ltd., Manchester, England. The work is concentrated on memories of up to 10,000 bits and at speeds of 150 ns. Emphasis is placed on development of an alternative to the existing random access fast-core memory for the lower-cost segment of the computer control and automation market. The study will also attempt to learn the best way of partitioning the memory store into individual chips and components, and assembly methods, for hybrid microcircuits and other multichip circuitry.

To deal with the ever-increasing number of parcels it handles each year, the British Post Office is investigating a digital parcel-sorting machine designed and manufactured by Thorn Automation Ltd (Thorn Group) of Rugeley, Staffordshire. The sorting machine consists of a tilted band conveyor 150 feet long with 27 exit doors. The postal worker looks at the address on each parcel and presses a code button corresponding to the destination. This sets a 6-bit binary address into a memory in the logic system. The parcel is then placed at the beginning of the conveyor and is carried forward, passing through a photoelectric beam. Interruption of this beam transfers the 6-bit code from the temporary memory into a delay-line memory that steers it to the correct exit door. It also resets the coding station to allow the next parcel to be coded with its own address. ■■

Neither heat,
nor cold,
nor any other adversity
can keep our new RAM
from meeting Milspec 883.



It's the first MOS RAM of its size and type that will hold its electrical characteristics from -55C to $+125\text{C}$. And it's designed to meet all the other requirements of Milspec 883, too. The UC6550/7550 comes in a 64 word by 4 bit configuration. Four chip-select lines let you expand up to a 1024 word by n bit memory without external decoders. It's bipolar compatible too.

Typical access time is 600ns. Single phase clocked operation lowers average power dissipation. Total input lockout simplifies timing

requirements. No maximum rise time requirements. No possibility of address racing. Memory elements are self-sustaining flip flops; no "refresh address" is needed. The read/write cycle is non-destructive.

We're already shipping parts for military and commercial applications. Contact us for full specs and prices.

Solitron Devices, Inc., P.O. Box 1416

San Diego, California 92112

Telephone 714/278-8780

TWX 910-335-1221



For custom designs or standards, contact Solitron, leader in semiconductors:

SAN DIEGO, CAL.
8808 Balboa Avenue
FET & Dual FET Transistors
MOS/FET Devices
MOS Memory Arrays
Shift Registers
Monolithic IC's

RIVIERA BEACH, FLA.
1177 Blue Heron Blvd.
Hi Rel Power Transistors
Si & Ge Power Transistors
RF & small Signal Transistors
PNP-NPN Industrial Transistors
PORT SALERNO, FLA.
Cove Road
Microwave Connectors

LONG ISLAND CITY, N.Y.
37-11 47th Ave.
Microwave Components
Bolometer Elements
Ferrite & Ferrite Devices
Microwave Semicond.
Plaxial (R) Cable
Precision RF Coax.

TAPPAN, N.Y.
256 Oak Tree Road
Diodes & Rectifiers
Zeners
High Voltage Assemblies
Power Rectifiers
Thick Film Hybrid Circuits

KENT, ENGLAND
Tubs Hill House
London Road, Sevenoaks
Solidev, Ltd.
Full line of
Solitron devices

BEN BAROQ, ISRAEL
51 Hayarkon Street
AEL Israel, Ltd.
Full line of
Solitron devices

TOKYO 105, JAPAN
NO 5, 3-Chome
Shibahamamatsu-cho
Minato-ku
Matsushita Electric Trading
Full line of
Solitron devices

INFORMATION RETRIEVAL NUMBER 24

Today, fast, low-cost pulses with variable rise and fall —tomorrow, a system!

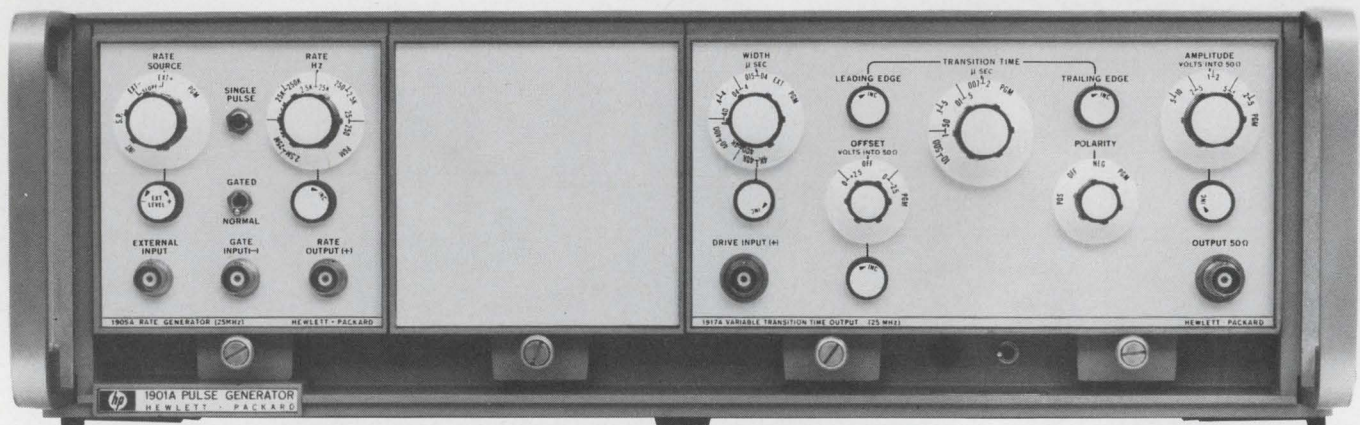

HP's new, all-solid-state 1900 Pulse System gives you the best of two worlds. For only \$1195, you can get a 7 ns variable rise and fall generator, right away. Then, as your needs and/or funds increase, plug-in capability allows you to get additional features, without having to buy a whole new generator.

Our basic package consists of a rate generator, a pulse shaping output, and a mainframe.

The 1917A pulse shaping output provides 10 V pulses with variable rise and fall times as short as 7 ns, reversible polarity, and dc offset. It takes up only half of a mainframe, and can handle rep rates of up to 25 MHz. A unique external-width function allows the 1917A to be used as a pulse amplifier, also, maintaining

width and spacing of externally-supplied pulse trains.

The 1905A Rate Generator ("clock") is a quarter-size plug-in. It provides output triggers at repetition rates from 25 Hz to 25 MHz in six decade ranges. Rep rate can be determined internally, by external triggering, or by single-pulse push-button.

Gating feature allows pulse bursts.

The 1901A Mainframe is a standard rack size unit, and contains power supplies that can be used to power other 1900-series plug-ins. Built-in EMI and RFI shielding are standard.

Price of this three-part package (including a blank plug-in) is only \$1195. As your needs change, available plug-ins include a 350 ps output, a 16-bit (RZ, NRZ) word generator, variable delay generators, fan-in and

fan-out generators, and optional analog programming — plus a high power pulse-shaping output (1 A, 50Ω) and mainframe.

Call your local HP field office for ordering. For further information on the HP 1900 Pulse System, see pp. 254-261 in your 1970 HP catalog, or send for our new free brochure on pulse generators. Hewlett-Packard, Palo Alto, California 94304. In Europe: 1217 Meyrin-Geneva, Switzerland.

080/10

HEWLETT  PACKARD
SIGNAL SOURCES

INFORMATION RETRIEVAL NUMBER 25

Washington Report

DON BYRNE, WASHINGTON BUREAU

Congressional committees to welcome Navy sub request

The Navy plans to ask Congress for \$130-million in January to move its proposed Underwater Long-Range Missile System (ULMS) into high gear. The system would eventually replace the 41 Polaris and Poseidon-equipped submarines now in service. The program is expected to cost between \$10-billion and \$12-billion over the next decade.

Growing concern over the expanding Soviet ballistic-missile fleet within both the DOD and Congress has given the ULMS project new impetus, and sources from both House and Senate Armed Services Committees told ELECTRONIC DESIGN they would welcome the Navy request for additional funding. The budget this year carried \$40-million for R&D work on the project.

Although the design is not yet fixed, the new sub is reported to be one and a half times as large as existing Polaris and Poseidon submarines. Each ship would carry 24 missiles. (Polaris subs carry 16.)

The missiles would reportedly have a range between 4500 and 6000 nautical miles, compared with the 2800-mile range of the Poseidon. The ships themselves would be able to operate much deeper and farther off shore than existing vessels and will carry highly sophisticated electronic countermeasures equipment.

Sink or swim for specialized communications carriers

Specialized microwave communications carriers will face a harsher, colder world than the big telephone companies do, according to a recent opinion filed by the antitrust division of the Department of Justice with the Federal Communications Commission.

While the Communications Act of 1934 charges the FCC with assuring the public adequate telephone service by keeping telephone companies healthy with rates that guarantee a return, microwave companies are not included. Specialized companies are common carriers, Justice agrees, but not to the public-serving extent of the telephone companies. In a word, Justice says, microwave communications is a competitive field, and companies entering it will sink or swim on their own.

Satellite network proposal could hit antitrust snag

The AT&T-Comsat proposal to create the nation's first domestic telephone communications satellite network could face serious problems within the FCC because of antitrust aspects where two or more suppliers of communications join forces to provide satellite services, according to Dr. Clay T. Whitehead, director of the newly established Office of Telecommunications Policy.

The problem could be avoided, he said, if AT&T used the circuits for a public message system rather than a private one. In any case the Department of Justice is expected to file a position paper with the FCC

on the case.

At the same time other companies and teams were awaiting FCC approval to put up their own communications satellites. They include Western Union, which was the first to announce its plans to enter the domestic communications satellite field, Teleprompter, Hughes Aircraft, General Telephone and Electronics Corp., affiliates of Microwave Communications, Inc. and the broadcast networks.

Back for seconds is Comsat, which will soon file a petition on its own for at least two communications satellites, unrelated to its agreement with AT&T. For weeks now, Comsat officials have been meeting with potential—unnamed—users to discuss terms.

Meanwhile, Data Transmission Co. (Datran) has notified the FCC that due to a pessimistic market survey on the economic viability of a communications satellite system, it is withdrawing from the race. It left the door open, however, for a future filing and is also designing into its proposed terrestrial digital network an interface for a satellite system.

Airborne command posts may get new aircraft

The Air Force is considering the purchase of six to eight aircraft to replace planes now flying its Airborne Communications Command Posts. The aircraft now being used is Boeing's C-135—a militarized 707. The reason for moving to a new plane is not the C-135's age but its size. More room is needed for the growing communications equipment the flying command posts require. Lockheed is hoping its C-5A will be chosen, while Boeing is pushing to get its 747 airline plane inducted into the military market.

Defense Communications Agency rapped by GAO

The General Accounting Office, the watchdog of Congress, took a long hard look at the Defense Communications Agency and found a number of things it didn't like.

After 10 years, the critical report stated, little progress has been made with the Defense Department toward achieving an integrated communications system.

The main reason, it claimed, was fragmented management. The director should be a civilian instead of a military man, and he should report directly to the Assistant Secretary of Defense for Communications instead of to the Joint Chiefs of Staff.

A number of examples of "costly inefficiency" were cited, including a program begun in 1965 to procure data subscriber terminal equipment that came to a halt because of inadequate coordination and design deficiencies (ED 22, Oct. 25, 1970 p. 44, "Capital Capsules"). During its lifetime more than 1000 specification changes were required at a cost of \$29-million.

The report also singled out Project Advent, a communications satellite program that, because of its many divisions of management, cost \$170-million and wound up canceled. Despite this, GAO says, plans are now under way for satellite programs similar to Advent.

Although "total costs of DOD's complex communications cannot be determined from the present DOD accounting structure," the GAO report stated that estimated costs in 1969 were \$3.2-billion.

NEW

3 - PLUG - IN OSCILLOSCOPE

- 60-MHz Bandwidth
- Dual-Trace, 5 mV/div
- 5 ns/div Sweep Rate
- 2% Accuracy
- 8 x 10 cm Display
- Solid State

\$2325 COMPLETE WITH PLUG-INS

The TEKTRONIX 7503 THREE-PLUG-IN OSCILLOSCOPE offers *more* measurement capability per dollar than any other quality oscilloscope.

Easier to use. An exclusive peak-to-peak auto-triggering mode provides a triggered sweep throughout the 360° range of the level/slope control. The front panel is uncluttered, lighted push-button switches are extensively used to conserve space. Controls are conveniently related to function through the use of a color-keyed front panel.

Seventeen plug-ins covering a wide performance spectrum are available to solve virtually all of your measurement problems. Some of the features offered are: dual-trace, differential comparator, 10- μ V differential, sampling, current amplifier, a New Digital Multimeter and a New Digital Counter. Plug-ins can be chosen to give the 7503 delaying sweep and 90-MHz bandwidth.

Faster measurements. Auto Scale-Factor Readout is exclusive to Tektronix! It labels the CRT with time and frequency; volts, ohms, temperature (C), and amps; invert and uncal symbols; and automatically corrects for 10X probes and magnifiers. Readout is required when using the 7D13 Digital Multimeter and the 7D14 Digital Counter plug-ins. It can be ordered initially or as a conversion kit, which is easily installed. Either case, the cost is only an additional \$400.



TEKTRONIX®

committed to
technical excellence

For a demonstration of the New Tektronix 7503 Oscilloscope, contact your local Tektronix Field Engineer or write: Tektronix, Inc., P.O. Box 500, Beaverton, Oregon 97005.

| | |
|---|--------|
| 7503 Oscilloscope without readout, Option 1 | \$1375 |
| 7A15 Single-Trace Amplifier | \$ 250 |
| 7B50 Time Base | \$ 450 |
| 7503 Oscilloscope with readout | \$1775 |

U.S. Sales Prices FOB Beaverton, Oregon
Available in U.S. through the Tektronix lease plan

**Open up
closed-circuit
markets...**

**...with this new
one-inch-diameter
Plumbicon***

*Registered trade-mark of
N.V. Philips'Gloeilampenfabrieken
Eindhoven, the Netherlands

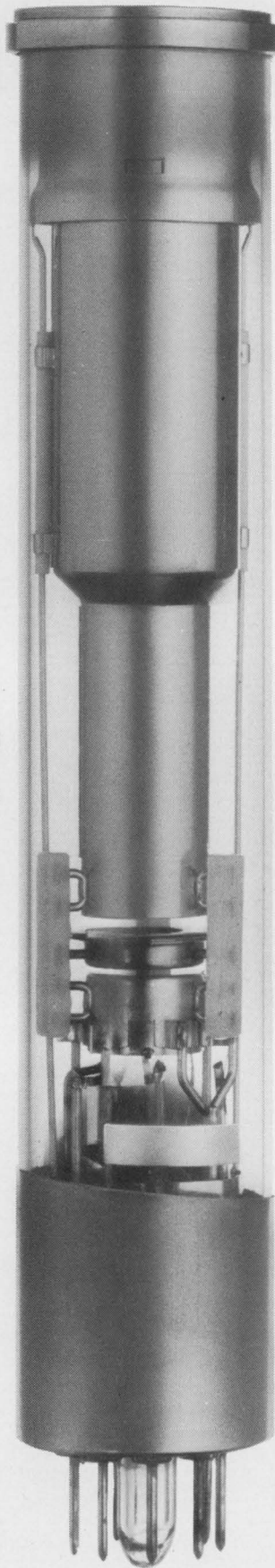

What a boost the entire CCTV industry would enjoy if existing cameras could operate well at significantly lower light levels and higher response speeds. That's exactly what this new Philips **Plumbicon** camera tube has to offer. Its one-inch-diameter makes it **retrofitable into existing cameras now using vidicons**. Developed originally to meet the exacting needs of live broadcast television, the **Plumbicon** won the industry's "Emmy" in 1967, as the year's most significant technological advance. Since then it has dominated its field - today it's in 9 out of 10 colour cameras in use throughout the world. When used in CCTV applications - in medicine, industry, education or commerce - this superb tube makes practical many applications hitherto only theoretical. The very high sensitivity, low dark current and fast response mean greatly improved picture quality - even when the subject is poorly illuminated or moving rapidly. All of which means the **Plumbicon** can make existing CCTV equipment work better, can make **CCTV colour** a practical proposition... can open up vast new markets, not only for cameras, but for related equipment as well! Let's help you open up new opportunities!

**Philips Electronic Components
and Materials Division,
Eindhoven, the Netherlands.**

Manufactured, distributed and sold
in the U.S. by
Amperex Electronic Corporation,
Electro-Optical Devices Division,
Slatersville R.I.

PHILIPS

INFORMATION RETRIEVAL NUMBER 27

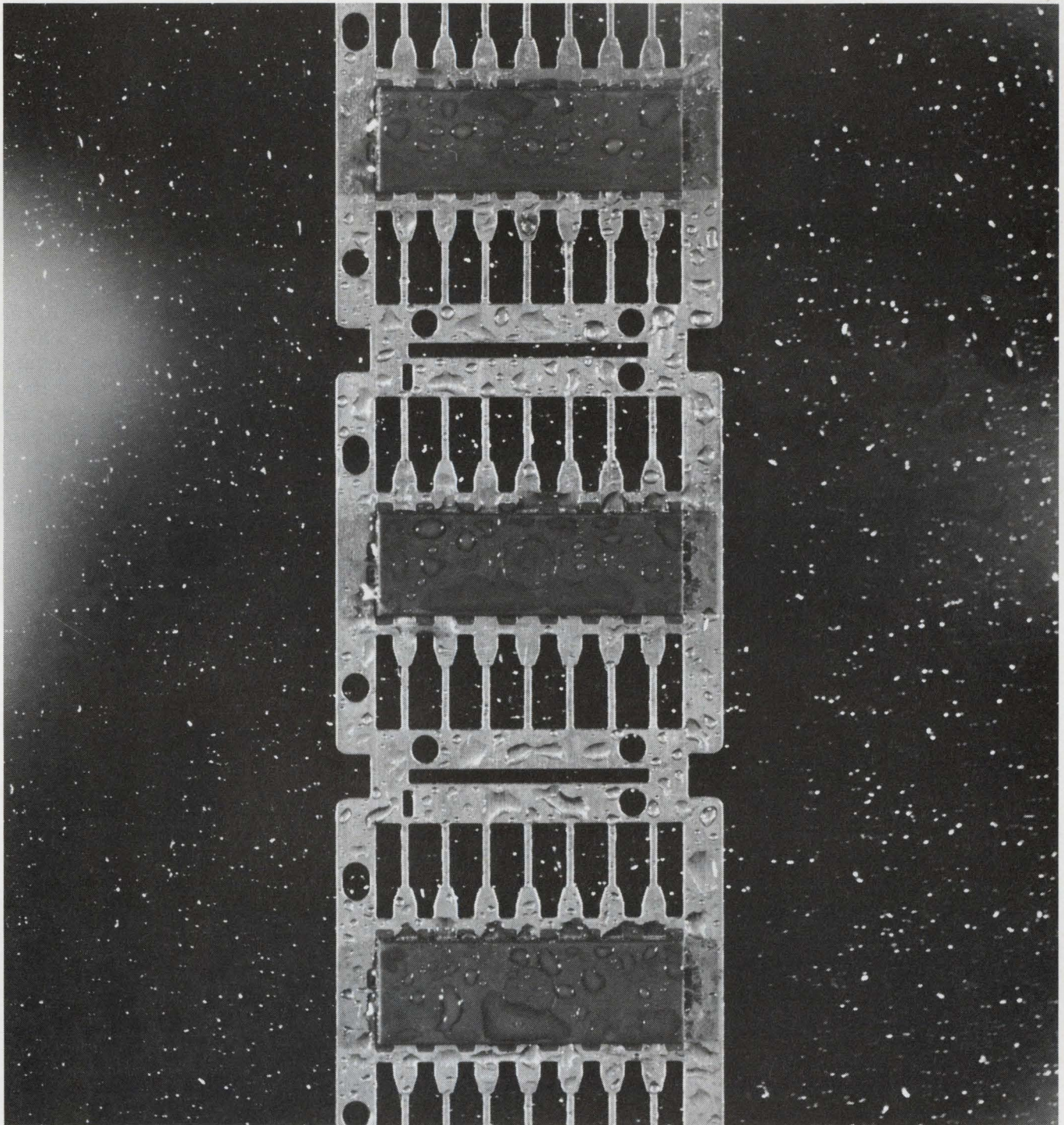

Keep your power dry

Dow Corning® silicone molding compounds and four organic plastics were tested under identical conditions—93% relative humidity at 70C for 5000 hours. The organic plastics absorbed nearly five times as much moisture as the silicones. Moral: silicones protect your power devices from galvanic corrosion. Other advantages of silicones include

superior resistance to thermal shock, cracking and burning. No derating is necessary, the initial cost is low, and you get faster production because of good mold release and minimum flash. Dow Corning silicone molding compounds are a genuine bargain that can improve your product and save you money. Our new booklet gives complete details on Dow Corning silicone

molding compounds. For your copy, write Dow Corning Corporation, Dept. A-9343, Midland, Michigan 48640.

Electrical / Electronic materials from

DOW CORNING

DOW CORNING

INFORMATION RETRIEVAL NUMBER 28

ANNOUNCING:

Cool power

Model CP-5-5
Price: \$145.00

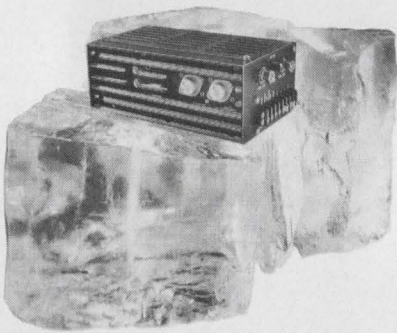

for IC logic

These new power modules from ERA provide *cool performance, total protection* for specialized use in IC, computer, telemetry, strain gauge and transistor applications.

The Transpac CP series is equipped with unique heat sinking for cool (71°C, free air) operation at high currents, protects itself and your equipment through built-in short circuit protection with instant recovery, adjustable current limiting and overvoltage protection.

A special burn-in test program at the factory assures reliability while compact silicon design saves space.

Send for catalog. Write today — before you design.

STANDARD MODELS

| Output Voltage VDC | Current @ | | | Model | Price |
|--------------------|-----------|------|------|------------|----------|
| | 50°C | 60°C | 71°C | | |
| 3.6 | 3.2 | 2.8 | 2.5 | CP-3P6-2P5 | \$125.00 |
| 5 | 3.2 | 2.8 | 2.5 | CP-5-2P5 | \$125.00 |
| 3.6 | 6.5 | 5.7 | 5.0 | CP-3P6-5 | \$145.00 |
| 5 | 6.5 | 5.7 | 5.0 | CP-5-5 | \$145.00 |
| 3.6 | 13.0 | 11.4 | 10.0 | CP-3P6-10 | \$185.00 |
| 5 | 13.0 | 11.4 | 10.0 | CP-5-10 | \$185.00 |
| 3.6 | 22.0 | 19.5 | 17.0 | CP-3P6-17 | \$230.00 |
| 5 | 22.0 | 19.5 | 17.0 | CP-5-17 | \$230.00 |
| 3.6 | 32.0 | 28.5 | 25.0 | CP-3P6-25 | \$310.00 |
| 5 | 32.0 | 28.5 | 25.0 | CP-5-25 | \$310.00 |



ERA TRANSPAC CORPORATION

A Subsidiary of
Electronic Research Associates, Inc.
67 Sand Park Road, Cedar Grove, N.J. 07009
(201) 239-3000

INFORMATION RETRIEVAL NUMBER 29

SIDELIGHTS

Getting a story on peripherals

Casting votes by means of a keyboard in a computer-controlled beauty contest and viewing a chess tournament between computers were just two of the experiences—over a period of several months—that helped to shape Milt Lowenstein's report on computer peripherals (p. C4).

The beauty contest was held at the Spring Joint Computer Conference last May in Atlantic City. All the contestants were booth attendants, and while the contest wasn't exactly fixed the winner did have an advantage over the other girls: she gave out souvenirs—miniature Frisbee discs—and the price of extras was a vote for her on the "machine downstairs." Of course she was also very attractive. A minicomputer with an interactive keyboard-CRT for data input was used. A total vote of less than 10,000 ballots obviously did not overload the core memory.

The chess tournament was featured by the "Unconventional Convention" of the Association for Computing Machinery held in New York City in September. Six computers, representing different companies and universities, were used, and each had a team of programmers at the show. Five of the computers were remotely located and were accessed by telephone lines using teletypewriters. The sixth "contestant" was a minicomputer—and its whole setup was at the show. The mini used an interactive CRT display for access. It had one advantage over the other five: it didn't have to use telephone lines, and bad line service was a problem with the remote computers.

"The computers were lousy chess players," Lowenstein reported. "I could have beaten any of them, and I haven't touched a chess board in 10 years."



A chess tournament between computers was witnessed by Milt Lowenstein while getting material for his report on peripherals. "The computers were lousy chess players," Milt says.

microcircuit reliable, these new opto-hybrids

offer nominal light sensitivity thresholds of 7.0 ("A" version 1.5) mW/cm² • maximum channel matching ratios of 2.0 or 1.2 to 1 • minimum high output of 4.5 Vdc and maximum low output of 0.4 Vdc; inverted logic also available • speed of response 1 microsecond or less.

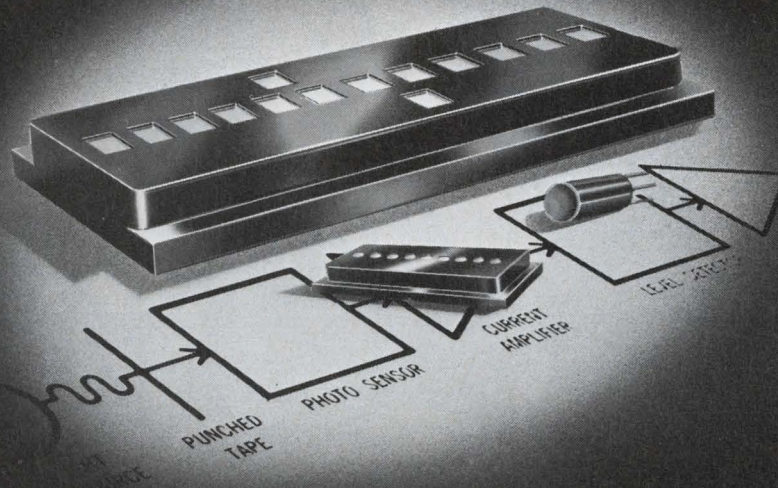

actual size

ready for market opto-hybrid™ readers

These standard Centralab Semiconductor products, complete subsystems with "built-in" light sensors, amplifier/digitizer, provide DTL/TTL-compatible output without the noise problems associated with low signal levels. About 1/10th the size of discrete component layouts and cost competitive with discretes, these "opto's" are now available in 1, 9 and 12-channel configurations for position sensing and for reading punched cards and tape. Let us show you how to fit a Centralab Semiconductor opto-hybrid to your particular application. Write for all the facts about this newest Centralab Semiconductor family. Copies of our brochure "Hybrids... Practical answers to circuit improvement" are also available upon request. Write Centralab Semiconductor, Dept. H, 4501 N. Arden Dr., El Monte, Calif. 91734.



**CENTRALAB
SEMICONDUCTOR**

Division • GLOBE-UNION INC.
4501 NORTH ARDEN DRIVE
EL MONTE, CALIFORNIA 91734

zeners, temp.-compensated devices, tunnel diodes, rectifiers, scr's, semiconductor chips, hi-rel hybrids and photovoltaic products

INFORMATION RETRIEVAL NUMBER 30

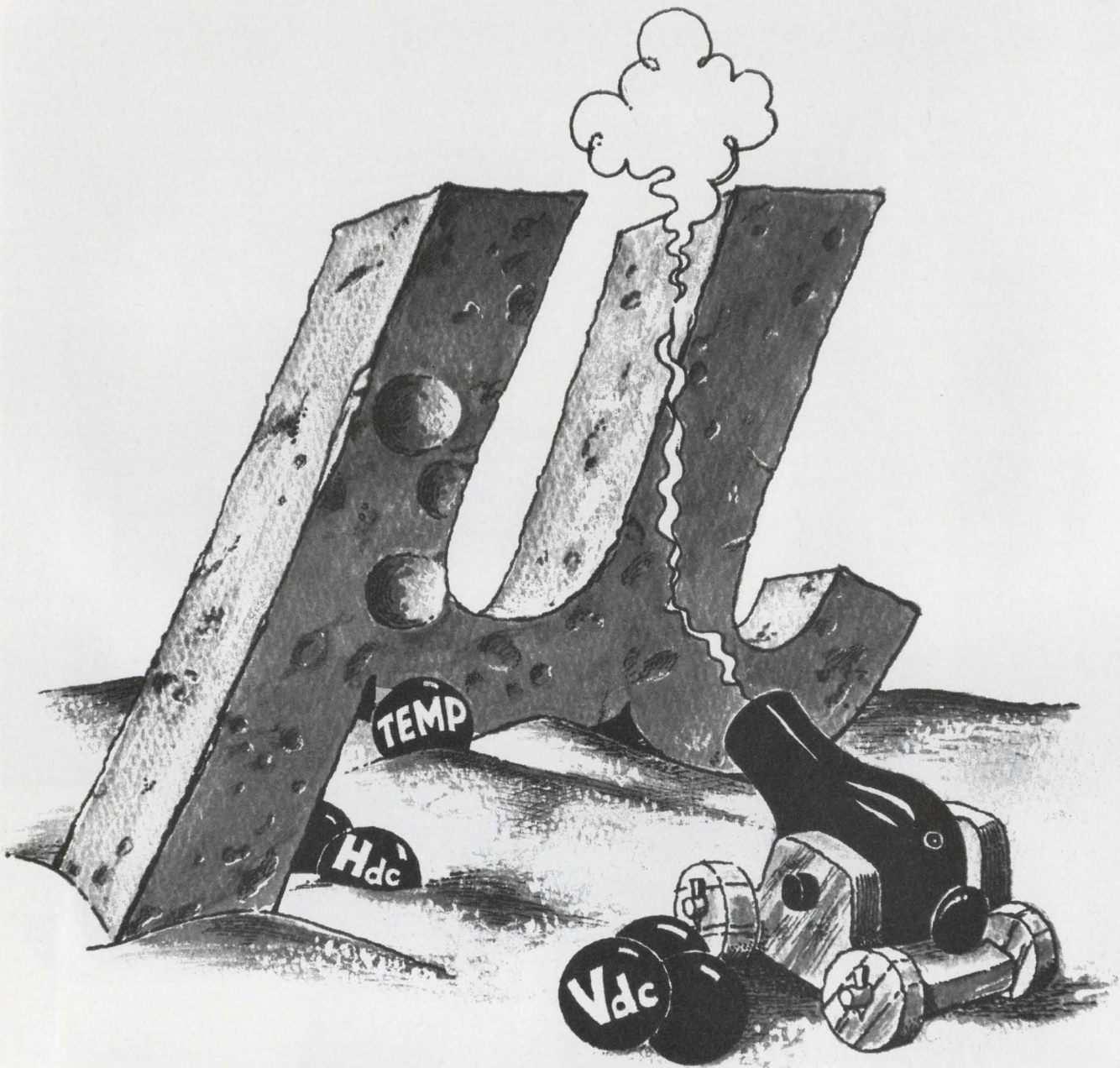

Stability.

Arnold MPP toroidal cores-high stability plus high Q.

No matter what sort of operating conditions our Molybdenum Permalloy Powder cores come up against, their permeabilities stay consistently stable. Through variations in temperature, DC magnetizing force, voltage, frequency, moisture. And our MPP cores also have high Q and high resistivity plus low hysteresis and eddy-current loss.

We produce MPP cores in O.D.'s from 0.140 in. to 5.2 in. With permeabilities from 14μ to 350μ . Think of what that means if you're working with telephone-loading coils, band-pass and band-reject filters, noise-suppression filters, decade inductors, transformers, and the like. You should have a copy of our new MPP Core catalog. Call or write.



The Arnold Engineering Co., Dept. C-1, Marengo, Illinois 60152 • Member Company of Allegheny Ludlum Industries • Branch Offices and Representatives in Principal Cities

INFORMATION RETRIEVAL NUMBER 85

Publisher

Hugh R. Roome

Editors

New York Office
580 Third Ave.
New York, N.Y., 10022
(212) 751-5530

Editor: Frank Egan

Managing Editor: Ralph Dobriner

Managing Editor: Raymond D. Speer

Microelectronics, Steven A. Erenburg

Computers, Milton J. Lowenstein

Microwaves, Michael J. Riezenman

Management, Richard L. Turmail

News, John N. Kessler

Military-Aerospace, John F. Mason

New Products, Roger Allan

New Products, Lucinda Mattera

Copy, Marion Allen

Field Offices

Massachusetts

Jim McDermott
P.O. Box 272
Easthampton, Mass. 01027
(413) 527-3632

San Francisco

Elizabeth de Atley
Suite 6, 95 Main St.
Los Gatos, Calif. 94022
(415) 941-3087

Los Angeles

David Kaye
2930 Imperial Highway
Inglewood, Calif. 90303
(213) 757-0183

Washington

Don Byrne
1425 N St. NW
Washington, D.C. 20005
(202) 667-6568

Editorial Production

Dollie S. Viebig
Richard D. Grissom

Art

Art Director, Clifford M. Gardiner

Assistant, William Kelly

Rita Jendrzejewski

Production

Manager, Thomas V. Sedita

Helen De Polo

Kathleen McConkey

Leslie Stein

Circulation

Manager, Nancy L. Merritt

Information Retrieval

Peggy Long

EDITORIAL



Reflections on the weather . . . and the storm over spending

The cliché that “everyone talks about the weather but no one does anything about it” is heard less and less these days—especially among scientists, engineers and today’s sophisticated weather watchers.

Earlier this year the Environmental Science Services Administration of the U. S. Dept. of Commerce observed the 10th anniversary of a new era in meteorology—the launching of the world’s first weather satellite, TIROS 1. Since April 1, 1960, 24 meteorological satellites—10 TIROS, four nimbus, nine ESSA and one ITOS—have been placed in orbit, returning more than a million pictures of the earth’s cloud cover and other data for weather forecasting and research.

In a decade of spectacular progress, weather satellite technology has advanced from spacecraft that viewed only 20 per cent of the earth each day to vehicles that continuously photograph nearly half the globe and instruments that take soundings down through the atmosphere.

Not only have scientists made great strides in observing weather, but, as pointed out in Elizabeth de Atley’s article on p. 50, they are learning much about modifying weather. This winter will see the beginning of the most highly automated rain-making project to date.

Nearly everyone is pleased with results like these. But not too many voices recall loudly that it all has been made possible by investments in basic R&D and satellite technology. Those satellite weather maps displayed on TV screens on the 11 P.M. newscast are taken for granted by the viewing public. But the millions spent for R&D and space programs cause outcries today: “Let’s spend the money to solve problems on earth instead of in space” is a common public reaction.

Yet, who can separate the two goals at times? Do not advances in space bring corresponding advances on earth—often unexpected advances?

What price can be put on the lives and property saved because we now have hours more of advance warning of approaching storms? On accurate wind and pressure data available to pilots on intercontinental flights? On urgent harvesting information for farmers?

The message is clear, especially now when there is public reluctance to spend for research and space exploration: The connection between esoteric concepts and practical applications isn’t always apparent in science and engineering, but history supports the view that as man increases his knowledge of the universe, he inevitably reaps benefits for himself.

RALPH DOBRINER

Have you sent us your subscription renewal card?

Up-to-date and thorough PE Examination Guides

These two volumes offer the most convenient and economical coverage of the subject matter that must be mastered to successfully pass the preliminary examination (Engineer-in-Training) and the final examination for the professional license in electrical engineering.

Each concise, carefully organized volume presents problems from recent state examinations together with complete step-by-step solutions. Providing rapid access

to important topics, vital for "open book" examinations, each also includes numerous pertinent illustrations and lists of references for further study.

Prepared by practicing engineers, the books have been written on the premise that the reader is versed in engineering, and that he is approaching the time when his State Board of Examiners will consider him qualified for taking the examinations.

BASIC ENGINEERING SCIENCES AND STRUCTURAL ENGINEERING FOR ENGINEER-IN-TRAINING EXAMINATIONS

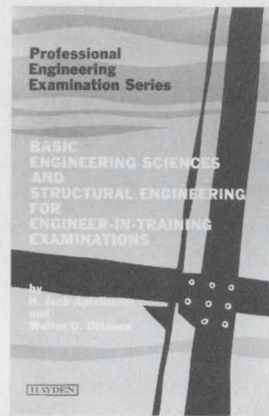

ELECTRICAL ENGINEERING AND ECONOMICS AND ETHICS FOR PROFESSIONAL ENGINEERING EXAMINATIONS

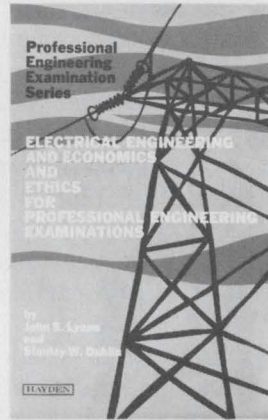

H. JACK APFELBAUM, P.E., Department of Mechanical Engineering, Lowell Technological Institute; and WALTER O. OTTESEN, P.E., Patent Counsel

Comprehensive and well balanced in its coverage of the concepts and techniques fundamental to all areas of engineering practice, this volume presents nearly two-hundred problems carefully chosen from recent examinations given by the individual states. Typical of the material the reader is likely to encounter in Engineer-in-Training Examinations, these are conveniently arranged by subject, and cover three broad areas: background material in mathematics, physics, and chemistry; the basic engineering sciences: statics, dynamics, fluid mechanics, thermodynamics, electricity, and engineering economy; and seven chapters detailing topics in structural engineering. Introductory sections precede each subject area and its fully worked-out problems, providing background in the specific concepts, principles, and terminology. More than three-hundred detailed illustrations insure a complete grasp of problem-solving techniques. #5712, 408 pages, illustrated, \$13.95

JOHN S. LYONS, P.E.; and STANLEY W. DUBLIN, Institute of Environmental Medicine, New York University Medical Center

Presenting a wide range of problems in electrical engineering, this book concentrates on the subjects and topics that form the basis for an ever-changing technology. The portion of the book devoted to economics and legal and ethical considerations is equally complete, providing in-depth understanding that will prove valuable in future engineering assignments.

Almost one-hundred problems in electrical engineering range from basic circuitry to the uncategorizable "bonus" problems frequently encountered in examinations. More than one-hundred-seventy illustrations illustrate the text. The section on economics features an unusual approach to such topics as interest, costs, valuation, and the like — the summarized use of formulas in solving nearly fifty typical problems. #5715, 320 pages, illustrated, \$12.95.

Hayden Professional Engineering Examination Series, LAWRENCE J. HOLLANDER, P.E., Editor-in-Chief. Subsequent volumes will focus on mechanical and civil engineering.

Send no money — clip or duplicate this coupon today!

15-DAY FREE EXAMINATION

Please send the book(s) checked below on a 15-day free examination basis. At the end of that time, I will remit payment, plus postage, or return the book(s) without further obligation.

- #5712, Basic Engineering Sciences and Structural Engineering for Engineer-in-Training Examinations, \$13.95
- 5715, Electrical Engineering and Economics and Ethics for Professional Engineering Examinations, \$12.95
- Further information on the Hayden Professional Engineering Examinations Series



HAYDEN BOOK COMPANY, INC.
116 W. 14 St., New York, N.Y. 10011

Name _____

Firm/Institution _____

Address _____

City/State _____

71-34 1

Payment enclosed (Hayden pays postage). Same return guarantee. On all overseas orders payment in U.S. dollars must be enclosed.

An Electronic Design Special Report

Fall Joint Computer Conference 1970



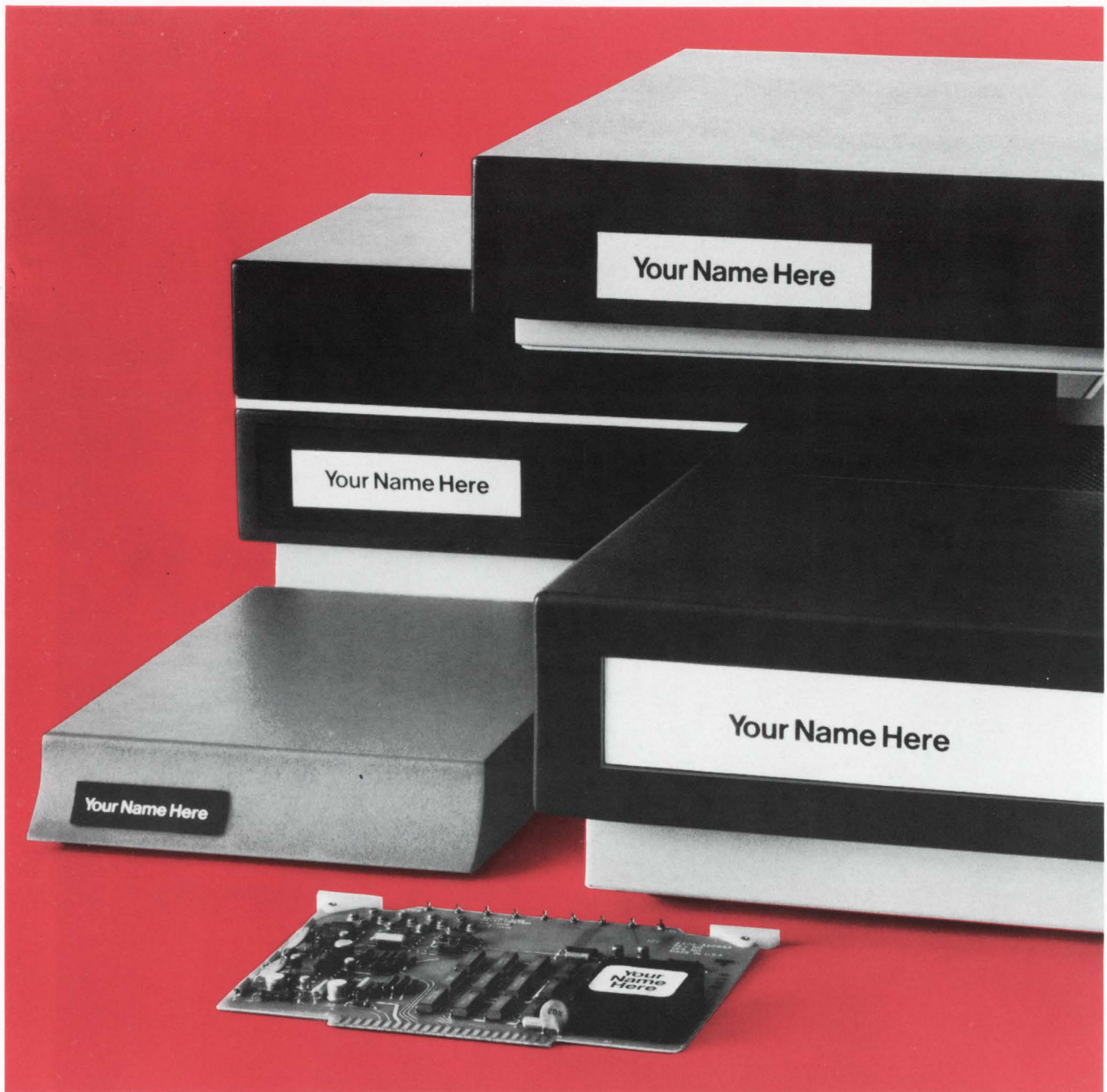

Modems you can trust with your name.

If the equipment you build works with modems, why not supply the modems, too? The data set monopoly is over, and customers are willing to install modems that offer special advantages.

ICC modems have field-proven advantages in economy and operating efficiency.

They can be a part of your product line, or built right into your equipment. Either way, you'll be delivering the most reliable modems in the industry.

Modems from ICC give you a competitive edge, and your customers get double assurance. **Our reputation, and yours.**

For full information, contact Jack Gerber, Director of Marketing.

Booth 1003,
Fall Joint Computer Conference



International Communications Corporation

7620 N.W. 36th Avenue, Miami, Florida 33147
Telephone 305 + 691-1220

a milgo company

In Europe —



Reading, Berks, England

1970 Fall Joint Computer Conference

special report

Peripherals—Cinderella of the computer industry because they have progressed from stepchild to star—now offer the user many new options with more to come in the near future C4

product source directory

Keyboards are important components in many peripheral products. Here is a listing of the ones that can be incorporated into terminal equipment C21

products

Three new 16-bit minicomputers include a high-speed model with a cycle time of 300 ns C27

Modular multiplexer interfaces high and low-speed data equipment into a single link C28

Remote batch terminal can transmit data at speeds from 2000 to 9600 bits per second C30

Cover illustration is a detail from "In Wildness," computer-generated art programmed by Lloyd Sumner, Charlottesville, Va.

Peripherals: Cinderella of the Computer Industry

written by
Milton J. Lowenstein
Computer Editor

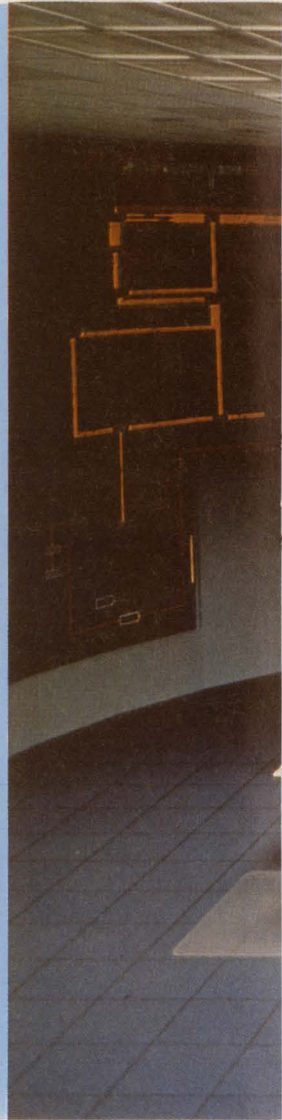

For years, peripherals were treated as a stepchild of the computer industry. The equipment was largely makeshift and appallingly slow, yet little attempt was made to develop new approaches; engineers concentrated on the more glamorous and profitable work of mainframe design.

But in the last year and a half there has been an upsurge of interest—and also promising results—in developing new peripherals. The equipment coming into use, at long last, is being designed to match the speed of the mainframe. Today's electronic designer, no matter what his field of interest, has a greater choice of peripherals, whether he uses a computer himself or designs it into a system.

The impetus for this advance has come from three economically related needs. The first was for peripherals to match the capability—both speed and capacity—of large computers. Users were finding their mainframes standing idle because of deficiencies in peripherals.

The second need was for peripherals for mini-

computers at prices comparable to those of the minicomputer mainframe. Putting a \$50,000 disc memory on a \$10,000 minicomputer was an economic inconsistency.

And the third need was for off-line peripheral systems that could perform their tasks without direct involvement with a computer.

Some examples of the new breed of peripherals include these:

- For large computers: High-speed line printers; large, fast-access disc files, and multiple CRT displays.

- For minicomputers: High-speed character printers; cassette and cartridge tape storers, and head-per-track discs.

- For off-line operations: key-to-tape systems; computer output microfilm systems, and optical character recognition systems.

Each innovation has been backed by a new group of manufacturers and an expansion of the market. However, markets and manufacturing are not the only aspects of peripherals that are

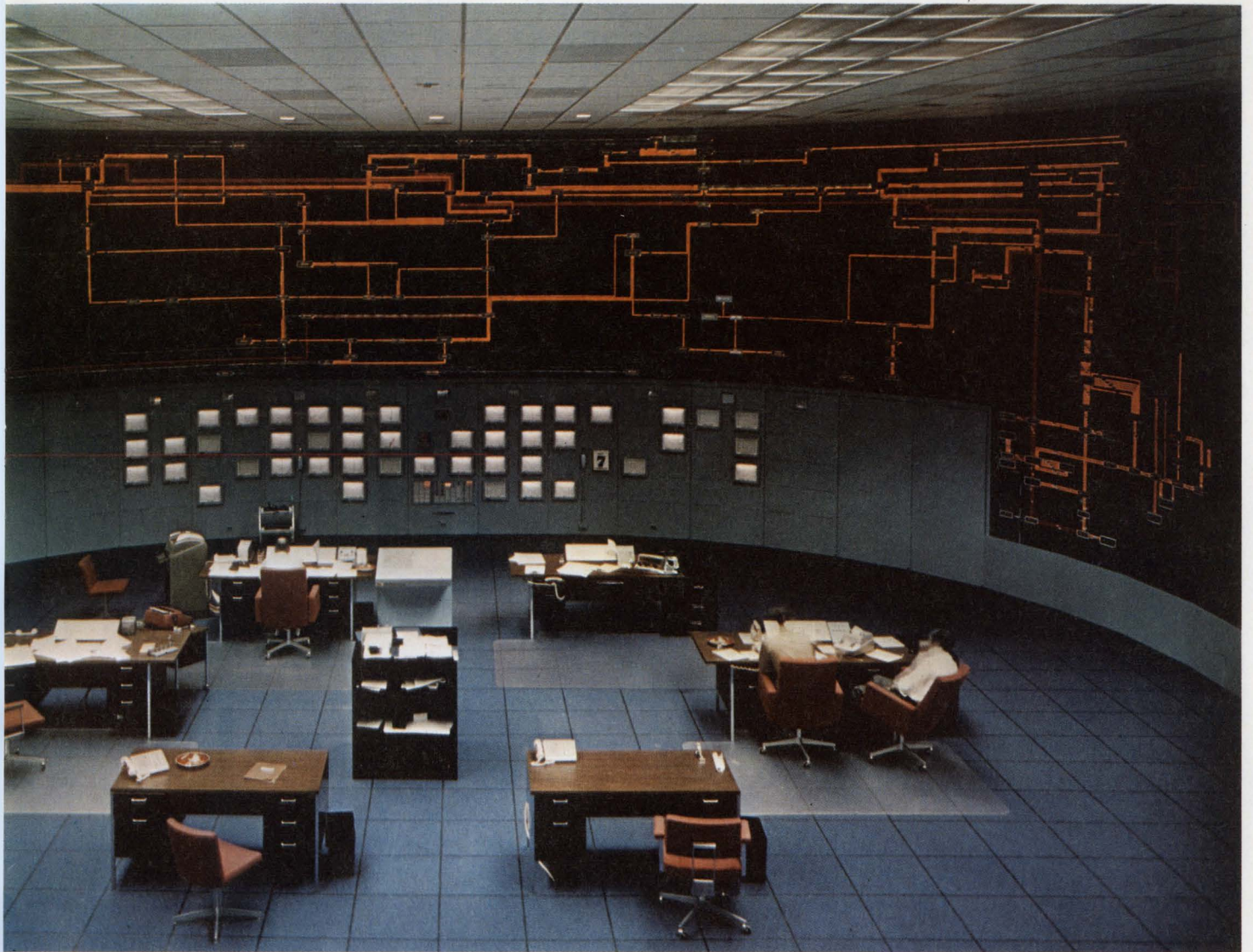

Computer display systems are becoming more elaborate. This is the control room of the N. Y. State power pool.

expanding; the term was restricted to input/output devices, such as card punches, line printers and teletypewriters. Auxiliary memories, both disc and drum, were accorded their own niche. Now, these memories as well as other equipment—like a/d and d/a converters, communications concentrators, acoustic couplers and modems—are coming under the blanket term of peripheral equipment. Peripheral equipment has become the new glamour field in the world of computers.

At the moment, the field is catching its breath while consolidating recent gains. Soon it is expected to reassert its claim as the most innovative branch of the computer industry as it strives to reach the plateau already attained by mainframes.

Printing terminals improved

The problems of man-to-machine communication are primarily those of human engineering—manual input rates are so low that both mechani-

cal and electronic equipment can easily be designed. It is when the machine must communicate with man that problems of speed, quality or storage must be considered.

Improved printing terminals, producing hard copy that can be stored, include character printers, line printers and the newest entry—computer output microfilm. The character printers resemble electric typewriters and print one character at a time. The line printers print one line at a time. The character printers are the slowest and cheapest; the microfilm is the fastest, but its output is not directly readable.

Character printers now available include new kinds of printing heads that permit the typing by impact of 30 to 40 characters per second, or over 200 characters per second if the ink is sprayed on the paper. Terminals of this kind cannot come close to matching computer data rates, but they can be coupled to such higher-speed auxiliary equipment as cassette tape recorders, which can match computer rates. However, char-

acter printers that are coupled with telephone lines have restricted data rates.

The line printers are the high-speed workhorses of the industry. Using rolls of paper or the familiar Z-fold, they can impact-print up to 2500 lines of type each minute. Another version, using electrostatic printing, can produce 5000 lines per minute. The high-speed line printer can come close to matching the data rate of a computer output, but it overwhelms the man who must read its reams of copy. In fact, except for business forms, it is doubtful if even a small fraction of the output of one of these printers is ever read: one hour of continuous operation produces the equivalent of more than three volumes of an encyclopedia.

For the most part, these records are perused and particular sections scrutinized, and then they are stored for possible future reference. Eventually they are discarded, and, if necessary, the pertinent contents can be stored on magnetic tape or some other high-density storage medium.

One such high-density medium is microfilm. A microfilm recorder can photograph up to 30,000 lines per minute in page format from the face of a character-forming cathode-ray tube. The equivalent of a page of Z-fold record can be accommodated on one frame $9/16$ ths by $33/64$ th of an inch. This density allows over 17,000 pages to be stored on one 1000-foot reel of 16-mm microfilm.

Computer-output microfilm is an example of a peripheral system. Whereas an electric typewriter or a line printer can produce copy of immediate use to a user, the microfilm method requires the addition of a reader or printer. The process of producing the microfilm also makes use of several technologies; the cathode-ray tube and its electronics, optics and film processing.

A frequent additional feature of a terminal is an internal buffer memory. The buffer stores data when it is being received at a rate faster than the printer can handle it; the buffer delivers it to the printer at a slower speed. Since buffers are limited in capacity, they are useful for handling data that arrives in bursts; otherwise there is the possibility of having the buffer overflow. Buffers can be semiconductor or core memories, or delay lines.

The trade-offs among these various printing terminals are complex. In terms of initial investment, character-by-character printers cost the least, line printers come next and microfilm, with auxiliaries, are the most expensive.

Some of the other factors to be considered by users are throughput, cost of materials, ease of storing, permanence and accessibility of the records, reliability (or down time) of the equipment, and the size and investment in the computer that produces the data in the first place.

Other considerations have no relation to the performance of the computer but are desirable for the comfort of personnel. Impact terminals, for example, are noisy; electrostatic, ink spray or microfilm terminals are silent.

Some terminals punch

Because one man cannot feed data at a rate fast enough to keep even a minicomputer occupied, several schemes have been devised to allow several operators to feed a computer at one time. Some of these, such as time-sharing, are built

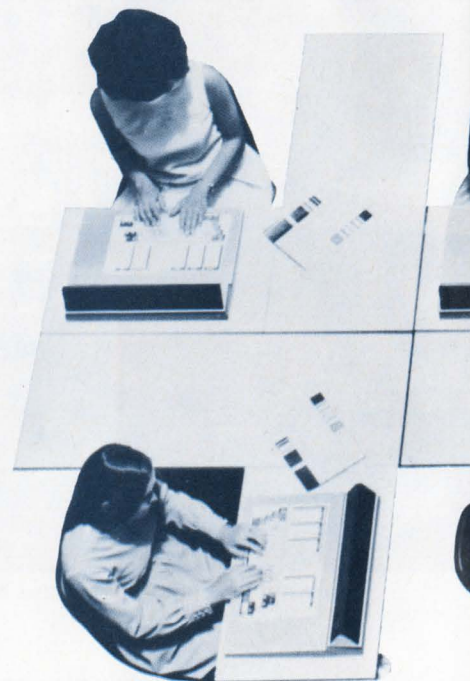

into the system. Others, such as punched cards, require human handling.

The punched card has many features that make it attractive. The efforts of many key-punch operators can be pooled to provide data input to a computer. The materials are cheap, and the operation is easy to learn, thus assuring a labor supply. Once punched, the cards can be read by eye, although with some difficulty. The technology is stable and the equipment has been proved through many years of use. However, the bloom is fast fading from the punched-card approach, and new technologies are pushing to replace it.

The major objections to the punched-card method is that it is bulky and slow. The amount of data stored per cubic inch on cards is very low in comparison with the capability of magnetic tape. The speed at which cards can be read

A key-to-tape system such as this one from Honeywell's Data Products Div. makes use of many different peripheral components. In this photograph, keyboards, a teletypewriter, a disc storage unit and a tape drive can be clearly seen. Not visible is the mini-computer that stores uncompleted records temporarily and controls the entire recording operation. Key-to-tape is one of the more complex of the peripheral systems.



is limited by their size and mass. Tape is much faster.

This has led to one of the most complex of the peripheral systems—key-to-tape. Key-to-tape may make use of keyboard stations, disc memories, minicomputers, line and character printers, and cathode-ray terminals. The operation of a key-to-tape system is off-line—as it is with a key punch. The output is a reel of tape that can be read into the computer at any convenient time.

The operation of a key-to-tape system is as follows: Many typists, typically between 10 and 100, key data into the minicomputer from source documents. The data arrives simultaneously from several keyboard stations at the minicomputer. The core memory of the mini is used to store incomplete records, adding to each as data is received from the appropriate keyboards. When the

records are completed, they are transferred from core onto a disc, thus freeing the core for additional incomplete records. Periodically the contents of the disc are dumped onto the tape.

Sometimes the tape is the final output, and its contents can be transferred to hard copy by a line printer or a computer-output microfilm unit. Most key-to-tape systems also provide a character printer or a cathode-ray-tube display, so a supervisor can verify the data being keyed in. Obviously only spot checks are possible. However, error-correction techniques are included in the coding of the data.

A variant of key-to-tape is direct key input, in which the tape unit is bypassed and the data on the disc is fed directly to a computer. This on-line operation allows for processing of the data prior to recording it on tape.

In spite of the advantages of key-to-tape or

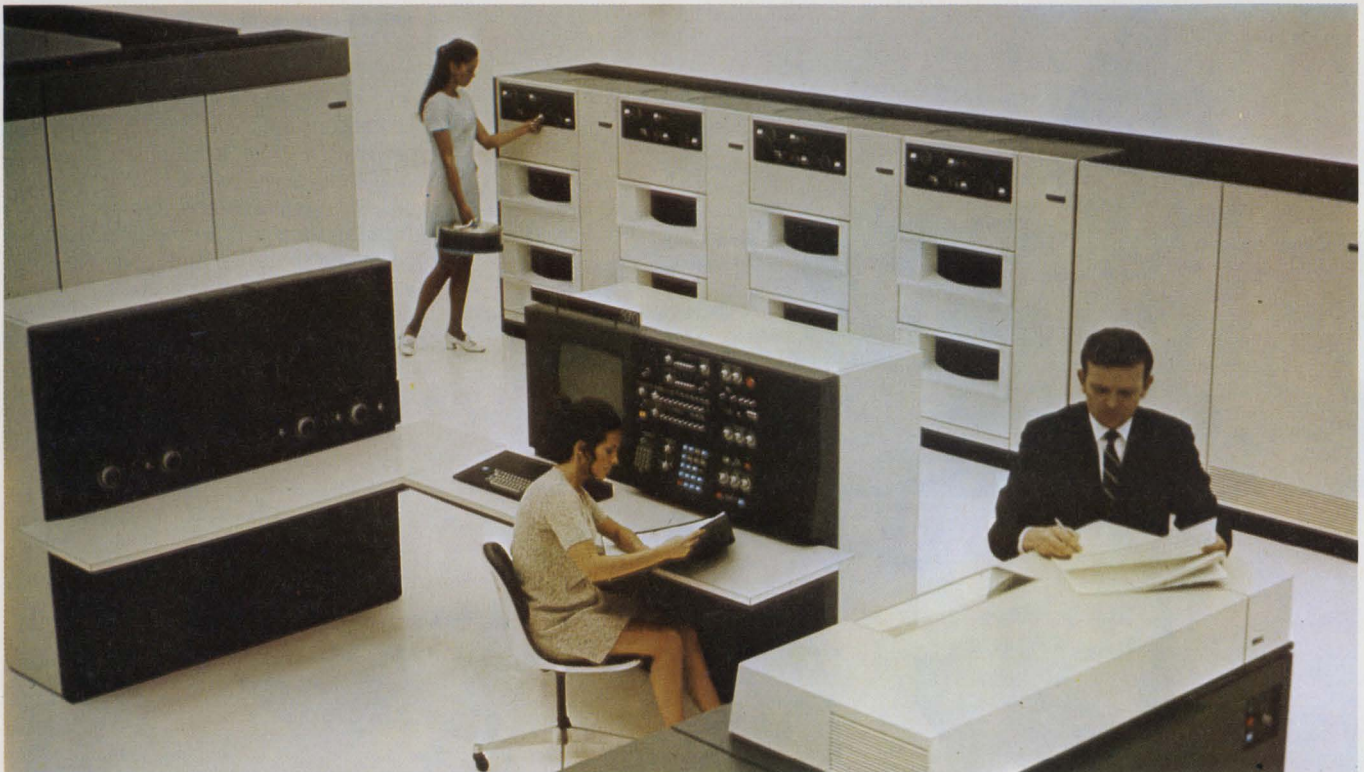

Significant advances are being made in the design of disc memories. More tracks and higher bit density per track enable discs to store more data and reduce access time

to a random bit. IBM's model 3330 disc file (shown above behind the console) was the most important new design of the system 370 computer line.

similar systems over punched cards, the key punch and card are not yet obsolete. For one thing, there are over 500,000 key punches in existence, and these will be replaced only gradually. For another, they will fill a need for the foreseeable future in cases where speed and storage are not a problem and flexibility is. Cards are also a multi-use medium and perform as checks, sales slips or other functions in addition to data processing. New developments, such as IBM's smaller, higher-data-density System 3 card will extend the life of card systems. However, the trend is away from cards, and the replacement market for all those key punches is a very tempting market for manufacturers of more sophisticated equipment.

Terminals that display

The display terminal comes in many shapes and forms. The simplest is the alphanumeric cathode-ray tube without a keyboard. Examples of these are on view in airport waiting rooms, where they display arrival and departure information. The next step-up involves the addition of a keyboard that allows the terminal to transmit as well as receive data. Then there are diagram drawing or vector displays, and interactive displays that accept inputs from a light pen.

However, not all display terminals use CRTs. Arrays of light-emitting diodes or other light sources, and graphic display panels like those

found in power plants and in the chemical and petroleum industries, are a different concept in presenting computer outputs.

One feature of remote display terminals is their ease of access to centrally stored data. Many times all the user wants is the current status of some changing quantity—the price of a share of stock, for example. He has no need for hard copy. As a result, such fixtures as the stock broker's ticker tape are destined to be replaced by CRTs, which do not clutter the office with paper and which can provide the latest price on any stock without need to wait for the next trading transaction.

A CRT terminal with a keyboard is a data entry device as well as a display. If a buffer memory or magnetic tape cassette is added, limited off-line operation is possible. With an electric typewriter or a small line printer attached, the terminal becomes capable of providing hard copy, and a small peripheral information system is the result. A relatively small investment gives the user data-handing power undreamed of a few years ago.

However, a dream of some years back has yet to materialize. Interactive graphic terminals, where commands are given by a light pen, were once thought to be the wave of the future in engineering design. Up to now, this has failed to come about for several reasons, not the least of which is the high cost of the terminal. Other limitations are the difficulty of writing support-

ing software and the limited need for graphics in many forms of engineering design. A circuit designer can work at least as efficiently with coded inputs via a keyboard and a sketch on a piece of paper as he can with an interactive graphic terminal. So, although the dream of interactive graphics isn't yet dead, it is fading.

A different CRT display terminal allows an operator to view radar signals that have been converted by a computer into data giving the position, range, velocity, elevation and identification of a target. The first two quantities are displayed graphically on a PPI scope, while the last three are contained in an alphanumeric packet attached to the target. The operator can obtain the distance between targets and their relative velocities by working front panel controls. Currently in use by the military services, this device, or a modification of it, is expected to find wide application in civilian air-traffic control. (See "Display Converts for Radar or Computer Use," ED 13, June 21, 1970, p. 28.)

Terminals that plot

The familiar electric typewriter is the simplest of the plotting terminals. Operating in a print/plot mode, it draws curves by printing an "x" or an asterisk at its standard spacing. The curves so drawn can be used for engineering estimates, but little else. Print/plot operation is most commonly found on a time-shared terminal.

If continuous line drawings are needed, a plotter or drafting machine is necessary. The major difference between a plotter and a drafting machine is in the continuity of line. The plotter presumably exhibits incremental motions that are visible as straight-line segments, while the drafting machine draws a continuous smooth curve. In fact, both versions move incrementally; it is the size of the increments that determine whether the line is "continuous."

Most flat-bed plotting terminals obtain two-dimensional motion by moving a bridge in the X-direction while the pen carrier moves along the bridge in the Y-direction. At least one design carries its pen on the "rotor" of a linear induction motor that is capable of two-dimensional motion. The reduction of mass in the moving part of this design permits lines to be drawn at a rate in excess of 10 times that of conventional designs. The disadvantages are larger increments and loss of reference to the edges of the table. Another type, the drum plotter, has pen motion along one axis and paper motion along the other.

Two distinct applications are common. The first, in which accuracy is not too great a consideration, includes the drawing of curves and graphs from the output of a computer. This application complements and sometimes replaces the

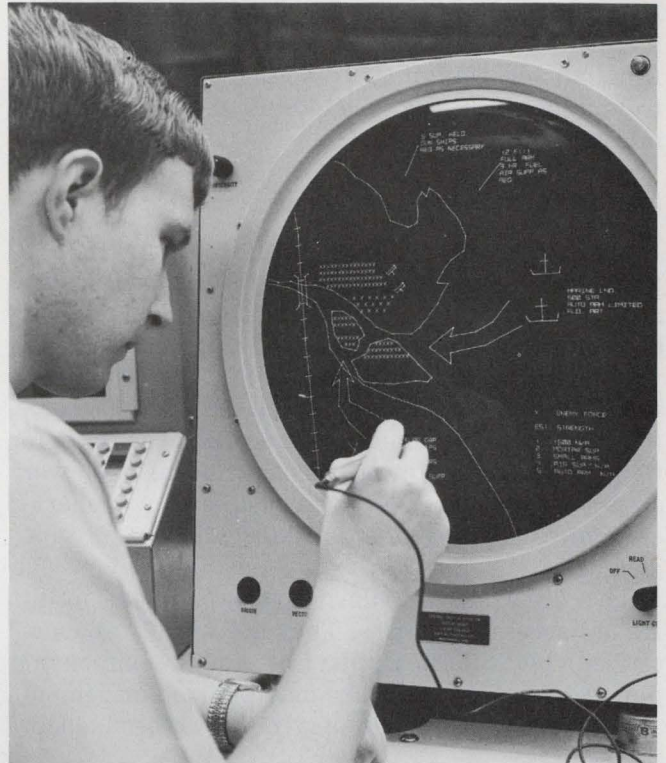

A radar monitor scope with interactive graphic capabilities has properties useful in military or civilian applications. The display is computer generated.

tabulation of the results of a computer run. The second is more demanding. It includes the high-accuracy drafting jobs of laying out printed-circuit cards, integrated circuits and cartography. It is this latter application that is reducing the demand by industries for detail draftsmen.

The drafting machines incorporate minicomputers to control the operation. Suitable programming must be done to provide the input for making a drawing. If the amount of detail in the drawing can be accommodated by the mini's relatively small core, all is well. For some jobs, however, the memory is not adequate. Laying out an LSI mask, for instance, requires too much data—storage capacity for current machines, and so it is done manually. This kind of job is the exception, and progress in drafting machines can be expected to catch up even to LSI technology. It may be the use of LSI in the drafting machine computer that will give it the additional capability to handle these tasks.

Sometimes a simple, inexpensive solution exists for a problem that otherwise might require an involved one. Such is the case in plotters for presenting the output of a minicomputer in graphical form. Instead of a plotter, a recording voltmeter, used with a digital-to-analog converter, can often produce acceptable results.

A development in the field of plotting terminals is the use of light to make drawings directly on film. Since the drawings made by a drafting machine are frequently photographed to

reduce their size, either for storage or for use as integrated circuit masks, direct production of film masters eliminates at least one step. This technique is closely related to computer-output microfilm.

Memories: New types emerging

Memories, the repositories of the data that is processed by a computer, are also involved in the new growth in the peripheral field. Some types, core and semiconductor, are intimately associated with the central processing unit of the computer, and though they are not usually classed as peripherals, they are sometimes used as such. Others that act as mass storage devices and have slower access times are generally considered peripheral equipment. In this group are disc, drum and tape memories.

The discs are the most widely used of milli-second access memories. They are usually characterized by the flexibility of their component parts: Discs or disc packs may be fixed or removable; read/write heads may move or be fixed in place.

The most familiar disc memory combines the removable disc pack and the floating head. Heads move radially across both surfaces of each disc in the pack for reading or writing and can be retracted for the changing of disc packs. The access time to a bit of data is made up of the time required for the disc to rotate to the head position and the time for the head to move to the proper track. Typical access times range from 10 to 100 ms. The principal advantage of this configuration is its ability to store large volumes of data on one disc pack and to maintain a data bank on additional interchangeable packs. IBM's recently announced Model 3330, for example, can store 200 million 8-bit bytes on 12 discs, with an average access time of 30 ms to a random bit.

Similar, but less flexible, are the combined fixed disc and floating head memories, which reflect an earlier technology. A more recent design is the head-per-track memory. Each head is fixed over its respective track. To increase the number of narrow tracks with fairly wide heads, there may be several staggered, radial rows of heads. Since the heads are fixed in position, it is difficult to arrange for removable disc packs with this design. Therefore fixed heads imply either a fixed stack of discs or a single fixed or removable disc.

Head-per-track memories are capable of faster access times because there is no head motion. The elimination of mechanical drives for the heads simplifies the mechanical design and the electronics required to find the proper track. This simplification increases reliability and reduces capital cost. The penalty paid by the user for these benefits is in the reduced volume of data stored and in lesser flexibility.



Low cost peripherals designed for use with minicomputers are recent arrivals on the scene. The cassette tape recorder shown accompanying some of the mini-computers it operates with, is one of this new breed.

The matter of cost requires further study. Memory cost is usually stated in terms of cents per bit. This approach tends to favor large memories, which offer the most bits. IBM's 3330, for example, spreads its high purchase price over 1.6×10^9 bits. The cents-per-bit criterion is not realistic for a minicomputer user, who needs a low-cost memory. Some single disc, head-per-track memories can be purchased for as little as \$4000.

Mechanical design, data density and speed characteristics are only a few of the options in choosing a disc memory. Control electronics and software specifications for interfacing to other computer elements must also be considered. Since the cost of these features are not always included in the first price quoted, it is up to the purchaser to be wary.

As for the drum memory, it is slowly fading. At one time it filled the slot now occupied by disc memories, but it is being displaced because of the superior mechanical properties of discs. In effect, a head-per-track, single disc and a drum are identical in concept.

Some large computers still rely heavily on drum memories, but whatever future drums have

probably rests on small, low-cost designs for use with minicomputers.

Tape memories are burgeoning

The greatest ferment in peripheral memories is now centered on tape. Just as in the audio field, the tape-memory user has a choice of reel-to-reel, cartridge, the Philips cassette and other cassettes.

The big expansion has been in cassette tapes. The first computer cassette tape recorders were displayed at the 1969 Fall Joint Computer Conference in Las Vegas. At that time four fledgling manufacturers showed their wares; now there are over 20. The reason for this growth is easy to see. The cassette recorder has the same attractions for the small computer user as it does for the audiophile: small size, ease of handling, self-protection and low cost.

Tape cassettes, reel-to-reel devices enclosed in their own plastic boxes, are capable of bidirectional motion. The familiar Philips design places the two reels side-by-side, but at least one other design mounts the two reels on the same shaft, thus simplifying the mechanical drive.

By contrast, the tape cartridge is a one-reel device with an endless loop of tape taken from the center of the reel and fed onto the outside of the reel. Because of its geometry, the cartridge tape is only capable of unidirectional motion.

The narrow tape of the Philips design is restricted to two or four tracks of data. Some other cartridges use a wider tape that permits recording of more data per unit of length.

Access time to a random bit is not usually a significant parameter of a tape memory. It depends on tape length as well as speed; longer tapes have longer access times. In general, this quantity is measured in seconds.

The conventional tape drive, with its two large reels behind a transparent cover, is the major mass storage device of the computer industry. Large-scale data banks rely on tape storage to keep their physical size down to manageable limits. With the advent of key-to-tape systems, the demand for computer tape and tape drives will, of necessity, increase.

Some memories stand still

The static memories—ferrite core, semiconductor and plated wire—are usually associated with computer mainframes rather than peripherals. They are, however, used in peripherals as buffers or as internal storage units in such devices as vector displays or interactive graphic terminals. Blocks of memory can also be purchased separately from the mainframe and so can be considered a peripheral.

If LSI semiconductor memories ever fulfill the

many promises of low cost and high volume, there will be a revolution in the field of peripheral memory. (See "Semiconductor Memories Are In," ED 15, July 19, 1970, p. 70) Right now there are other less-familiar forms of random-access static memories that are attempting to compete with disc files. One such is the magnetic domain memory that is too slow (typically 1.0 ms) to compete with core, but much faster than disc.

The advantages of the static memory over the ones that move are obvious. Reliability is increased and maintenance is reduced. They are less susceptible to unfavorable environments. At this time, they cost too much, but, perhaps by the 1980s, they will probably be dominant.

The read-only memories, or ROMs, are a useful group of devices that store microprograms (see "Minicomputer: The Machine with an Endless Future," ED 9, April 26, 1970, p. C5). They are also used in noncomputer applications as function generators (see "Generate Functions from Discrete Data," ED 20, Sept. 27, 1970, p. 42).

While the name "read-only" implies that these memories once set up cannot be changed, they can, in fact, be modified with varying degrees of difficulty, depending on their design. A diode matrix ROM can be rewired, while some plated-wire types can be rewritten electrically (see "Electronically Alterable Read-Only Memories," ED 5, March 1, 1970, p. 95). Because the write cycle time is much longer than the read time, this memory is considered to be a ROM.

The major advantage of the ROM over the static read-write memories is in initial cost. As the more versatile MOS/LSI memory becomes available, the attraction of ROM will decline. However, the locked-in nature of microprograms offers a security feature that probably will keep ROMs popular for some applications.

A very strong trend in computer use is remote processing data. Time-sharing and remote batch techniques require long-distance communications, usually over leased or rented links. Most on-line, real-time systems rely on remote data entry.

The communication peripherals range from such relatively simple devices as a/d and d/a converters and acoustic couplers to communication concentrators, which can be complete computers. Others are modems and optical character recognition equipment. ■■

Free copies available

A limited number of copies of this report are available free. To obtain yours, circle No. 410.

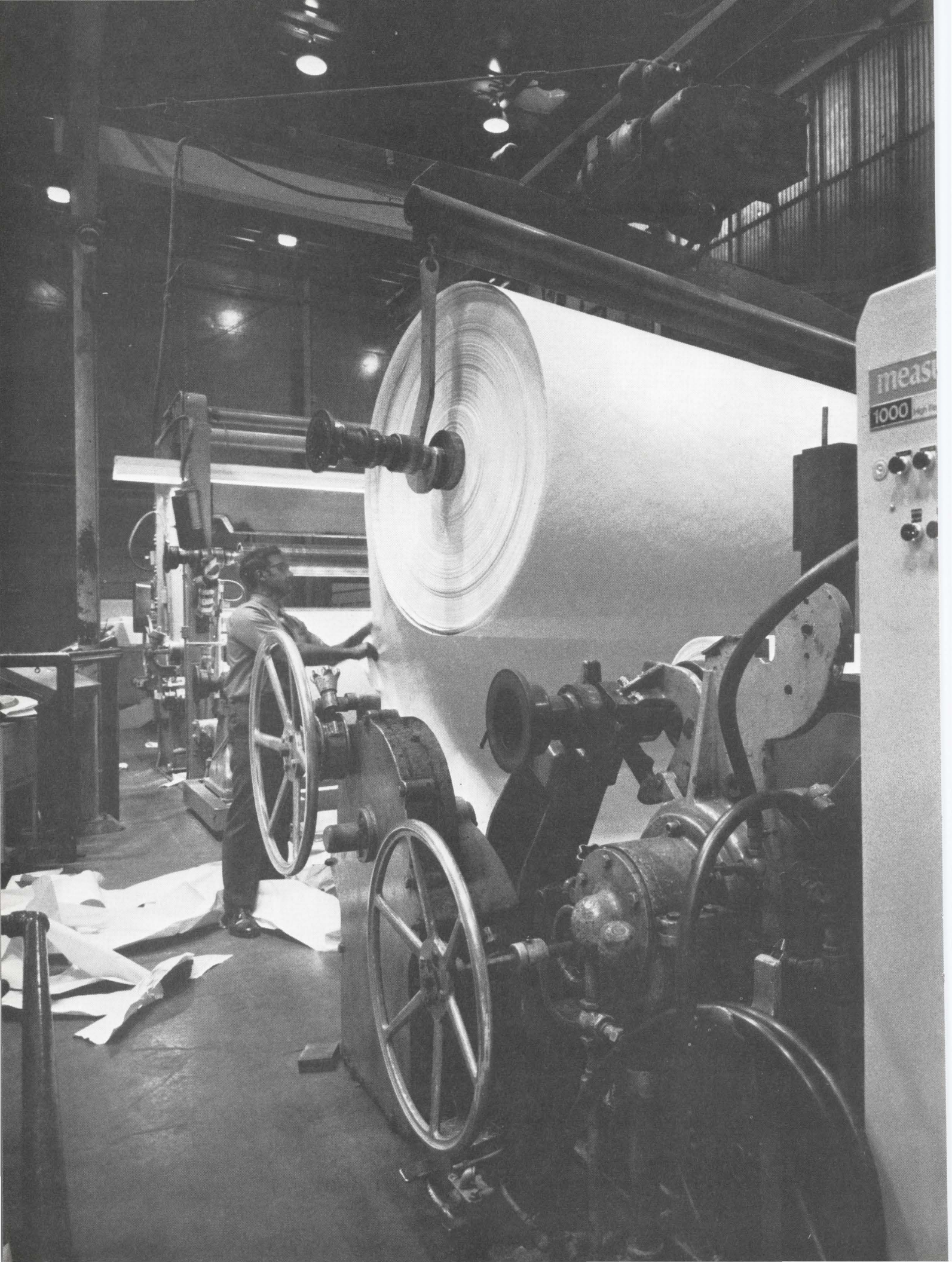

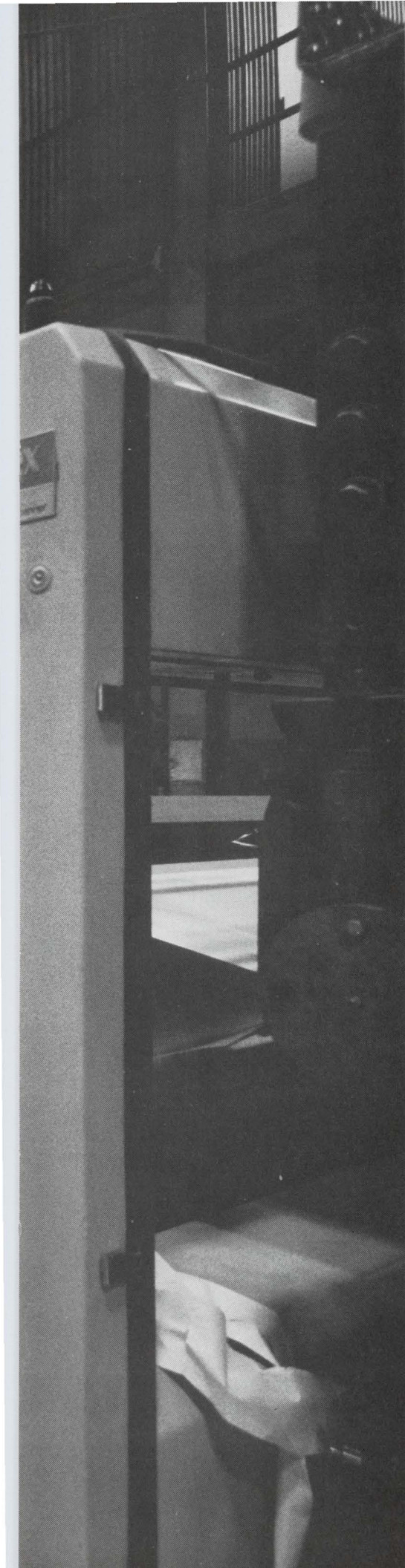

A minicomputer here? Sure! And ours is helping boost profits up to \$20,000 a month.

Paper mills can be pretty rough on electronic equipment. So any computer system put there had better be able to take it—especially if it's guaranteed to increase profits. And Measurex of Santa Clara, California does just that. They guarantee profit increases from \$4,000 to \$20,000 a month.

That's one big reason why they chose our 2116 computer as the heart of their paper mill process control system. They knew it would keep on working in spite of heat, humidity, vibration and corrosive fumes—acting as an on-the-spot control center in Measurex's unique system for regulating the moisture and fiber content of paper speeding along at hundreds of feet per second.

It's a job that affects profitability in a big way. Misjudging fiber or water content, even slightly, can be costly. But improved reliability and accuracy can pay off to the tune of half a million dollars a year in added profit. With so much at stake, it's not surprising that Measurex chose our computer.

There are other things to like about our small computers: good specs, comprehensive software and simple interfacing with all system components. Constant updating without obsoleting your present system. Plus our complete line of input/output devices, available off-the-shelf.

Another benefit: our minicomputers don't put the squeeze on an OEM like Measurex—or any other purchaser. For instance, you can buy our powerful 2116, with 8K of core memory for \$24,000. And it can be expanded in 8K increments up to 32K. If you don't need that kind of power, our 4K version of the 2114 costs just \$8500.

Get the full story on computers you can depend on. Call your nearest HP sales office or write to Hewlett-Packard, Palo Alto, California 94304; Europe: 1217 Meyrin-Geneva, Switzerland.

22010

HEWLETT  PACKARD

DIGITAL COMPUTERS

INFORMATION RETRIEVAL NUMBER 122

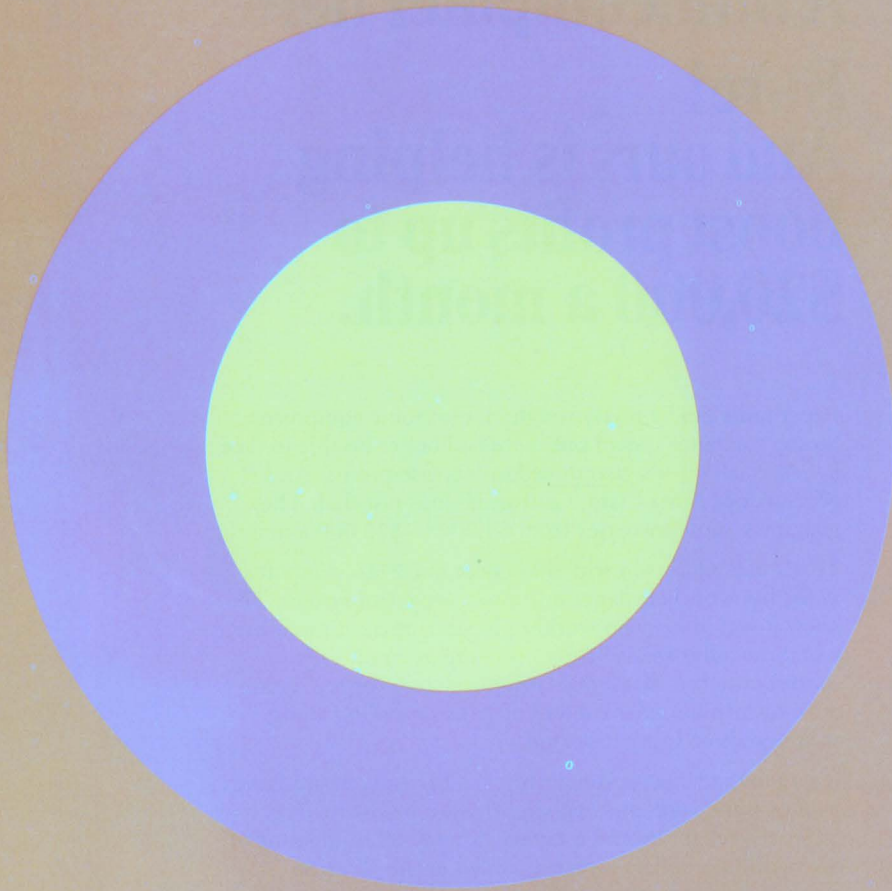

wall-to-wall COLOR increases production

John F. Mason
News Editor

What has pop art got to do with making better printed circuits? Especially when it costs \$5000—half of the amount for the extra paint and half for the artist who did the design.

It can increase production, says Jerome A. Harbin, manager of Sperry Rand Corp.'s Univac Printed Circuit Manufacturing plant in Salt Lake City.

The facility, which consists of 24,000 square feet of floor space, is broken into assembly-line rooms, clean rooms, inspection centers and corridors. The walls have been painted in bold reds, oranges, blues, greens and yellows. Strong horizontal flows of color carry the eye down what might have been a dismal assembly line, to a satisfying bull's eye—concentric circles or a spiral in reds, oranges and blues.

Long narrow hallways are made to look shorter by the use of color and pop-art design. And eyesores, such as heat conduction tubes and fire extinguishers, are covered or at least played down by the paint.

"We did it for a specific reason," Harbin told ELECTRONIC DESIGN, "Our people here perform close tolerance work, they have to make microscopic inspection of printed circuits and very small components. This is hard on the eyes. So, we've created an environment that gives them relief. It eliminates eyestrain and aids the eye's recuperative powers.

"The results have already paid off," Harbin says. "Our output is up and job performance improved."

Responsible for what may be the most far-out walls in the electronics industry is John A. Peterson, chief designer of Environmental Planning Consultants in Tempe, Ariz., whom Univac hired to design the walls.

"We based some of our work on the American Medical Association's study on emotional response to color," Peterson says. "Blues

are an emotional sedative, the report says. Certain shades of yellow are believed capable of producing a sensation of sunlight and warmth. And muscular responses are faster than usual under a red light, while green light retards reactions.

"Besides utilizing design and color to create the best emotional responses and to improve architecturally poor areas, we also wanted to give the employee a sense of identity and perspective in what he's doing.

"For example, the figures and colors vary from room to room in keeping with the particular manufacturing process taking place. Long lines will lead the eye through the normal sequence of production in that particular room, from area to area. The abrupt halts by bull's eyes and other arresting symbols provide a kind of unity and completeness to the whole operation. The technician who is doing one thing over and over again can feel how he fits into the complete operation.

"I also want him to feel the joy of being in a colorful, well designed place."

"We learned a lot of new, helpful things," Peterson says. "You don't have to paint a photography room black. It can be white, if a red light is used, thereby eliminating that claustrophobic effect caused by black walls.

"In an inspection room where intense light is needed, we painted the walls white, but killed the blinding effect by using restful greens and blues. Earth colors—yellow, orange, reds and browns—would have diminished visibility and cut down on the effectiveness of the room's purpose—to inspect printed circuits.

"For a noisy, dirty place, we painted the walls a clean white, softening this with warm sunlight yellows and reds. It's still noisy, but it's brighter, more cheerful and we hope easier to work in." ■■

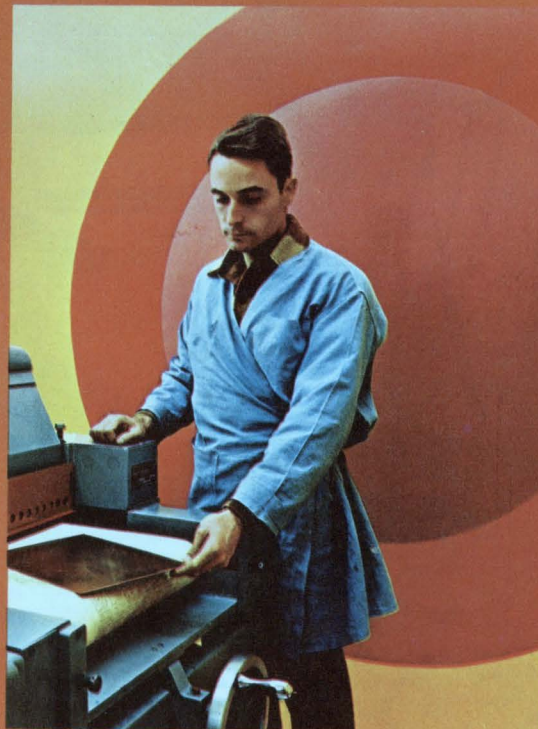

A warm wall surrounds the window to the brightly lighted inspection room where printed circuits are examined. Because intense light is needed inside, greens and blues are used to rest the eye instead of warm, earth colors that would degrade visibility. (above)

To brighten a noisy, dusty room where a sander is used for precision surfacing of raw laminents, three walls were painted a clean white, while the other is warm and lively. (left)



A restful red light is helpful to the operator who must look into green light on this Dainippon 59 reduction camera.

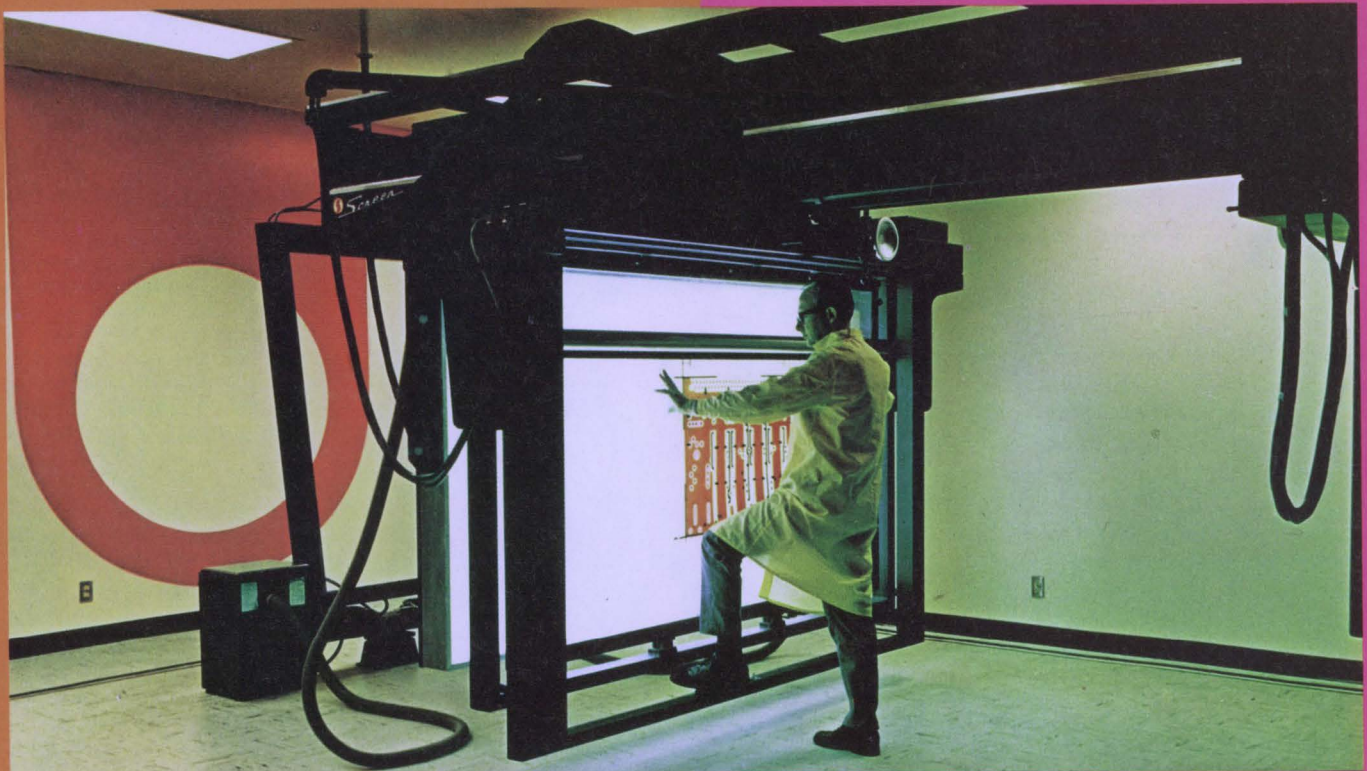

Walls were painted white in the camera room instead of the usual dungeon black. The uninspiring green light

emitted by the Dainippon 59 camera is softened by the yellow and red wall behind the camera.



Graphic artwork specialists prepare high-precision multilayer printed circuit card artwork. White "A" on blue wall stands for "artwork." The red line ending in a bull's eye leads the eye into the room from the supervisor's office.



Monotony of the plating-chemical cleaning room is broken by painting normally gray machine tops orange.

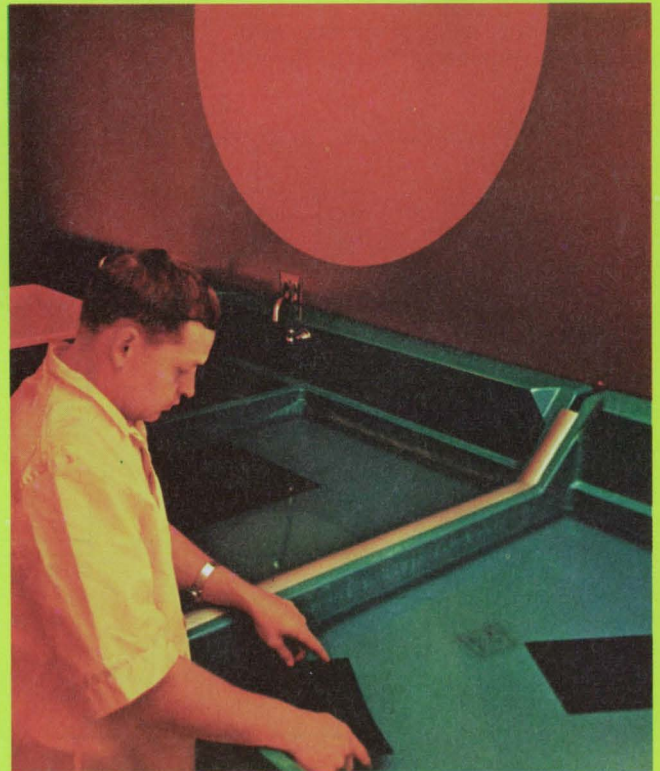

Darkroom walls don't have to be black to protect film. These walls bring cheer into the work area.



...try a Teletype® 37
...and look
into mag tape!

We don't have a crystal ball. And rarely resort to mystic means in recommending what terminal should be used for a particular data communications application.

Some of the things, we at Teletype look at, that make the job a little easier are these:

| | |
|--------------------|----------|
| Distribution | Volume |
| Urgency of message | Language |
| Frequency of use | Accuracy |

The diagram below demonstrates how you can fit a number of Teletype terminals

into a system based on function and usage requirements. Magnetic tape makes the speed and language of various terminals compatible. In this hypothetical case we use one computer program, one major line control procedure, one computer port, one type of data set per link. And deliver greater data through-put per on-line dollar. Using terminals that offer the best capabilities within each station's communication situation.

Using Teletype magnetic tape data terminals, combined with various Teletype keyboard send-receive sets, you obtain

some unique system flexibility. And the on-line time saving aspects of operation are really dramatic. Magnetic tape data terminals can keep data flowing on-line at up to 2400 wpm.

In the example shown, the manufacturer has linked sales, engineering, accounting and inventory control departments to a central office computer. As well as manufacturing plants, warehouse and regional offices. He's covered all critical data points with a common medium speed link, using a variety of terminals. Magnetic tape data terminals make it possible.

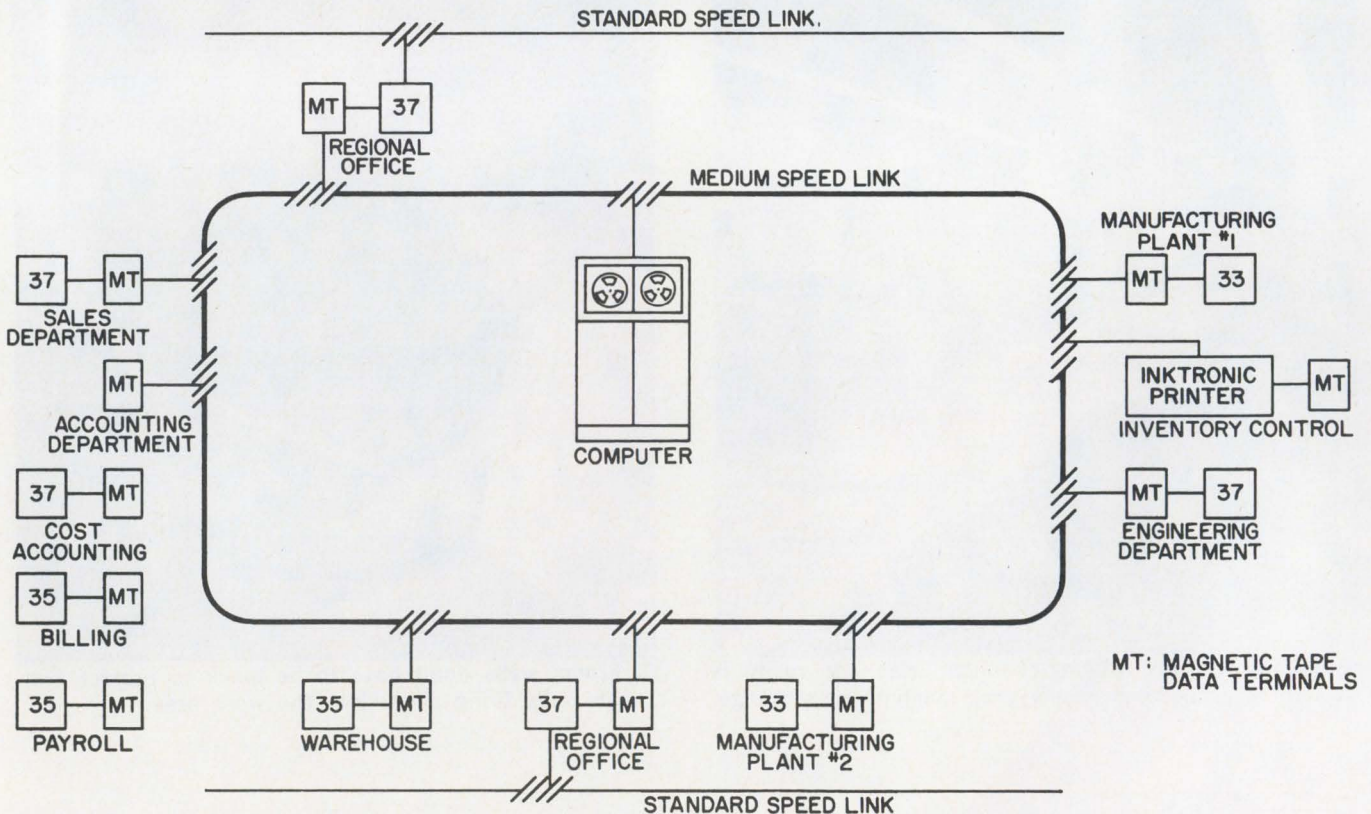

DATA COMMUNICATIONS

equipment for on-line, real-time processing

Routine aspects of the system are maintained in standard speed links. Branch offices are tied into the regional office terminals on standard speed networks. Regional offices batch routine branch office data on one magnetic tape. Transmit the data to the central office processor at one time. Saving a number of additional computer port requirements.

Since data generated at manufacturing plants is urgently needed, but volume is low, low-cost model 33 terminals are used here. The warehouse data volume is higher, but not complex, so a heavy-duty model 35 is working here.

Volume requirements are heaviest in the accounting department. Cost accounting, payroll, billing and invoice payment functions generate data all day long. Here magnetic tape is prepared off-line at various terminals. And an on-line stand-alone magnetic tape terminal is used to transmit data to and receive data from the central processor.

Sales and engineering departments are equipped with Teletype 37 terminals. But for different reasons.

This terminal offers engineering people some unique format flexibility. Half-line and full-line forward and reverse line feed can be used to communicate complex equations and engineering formulae to the processor. It is possible to add special graphic engineering symbols to the normal compliment of letters, numbers and punctuation marks found in the typebox (up to 32).

The sales department uses the model 37 for order processing. It has on-line vertical and horizontal tab set control, and form feed platen (optional) which makes data transmission and reception on multiple copy business forms easy and economical.

At the inventory control point, this manufacturer has an urgent need to obtain printed page copy of large volumes of inventory items. Magnetic tape is used to feed data to the processor and a Teletype Inktronic® KSR set receives data and prints page copy on-line up to 1200 words per minute.

As you can see, Teletype's modular terminal design allows you to use vari-

ous units as building blocks to meet the most demanding system needs. Teletype also has the station and error control accessories necessary for more efficient and economical data communications operations. Since cost is a very important part of the mix, Teletype offers greater terminal capabilities on a price/performance basis than any other manufacturer.

If you're involved in designing a teleprocessing, time-sharing, remote batch or computer switched system; looking into a multi-point private line, point-to-point private line or switched data communications network; talk to Teletype about terminals. For ideas, equipment and understanding, you'll find no better source. Anywhere.

Teletype data communications equipment is available in send-receive capabilities of up to 2400 words per minute. If you would like specific information about any of the equipment described here, write: Teletype Corporation, Dept. 89-16, 5555 Touhy Ave., Skokie, Ill. 60076.

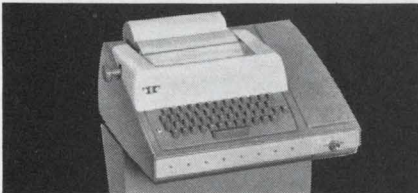

model 33 series: An extremely low-cost 100 wpm terminal line. Uses ASCII. The most widely used terminal in time-sharing systems today.



model 35 series: A rugged, heavy-duty line of 100 wpm terminals. Uses ASCII.



model 37 series: One of the most versatile heavy-duty terminal lines going. Generates all 128 characters of ASCII. Operates at 150 wpm. Prints in upper and lower case.

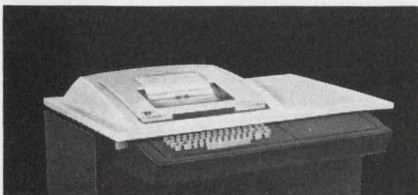

Inktronic® data terminals: A unique electronic, solid state terminal. Prints up to 1200 wpm. Forms characters through electrostatic deflection (no typebox). ASCII compatible.



magnetic tape data terminals: Use compact reusable tape cartridges. Operate on-line at up to 2400 wpm, and connect "locally" to lower speed Teletype terminals using ASCII.

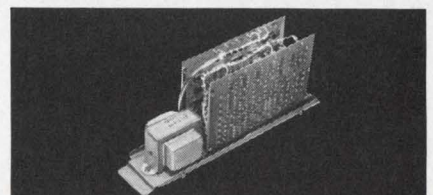

Stuntronic™ accessories: Electronic solid state terminal logic devices offering many control options. Such as, automatic station control, error detection and correction capabilities.

Teletype is a trademark registered in the U.S. Pat. Office

machines that make data move



INFORMATION RETRIEVAL NUMBER 123



MOS keyboards NOW!

Start your own protest about keyboard vendor promises. Clare-Pendar *delivers* MOS Keyboards, not just promises. Production quantity MOS Keyboards NOW, not next year.

MOS Keyboards in stock, too: Teletype Model 37 format, or Model 33/35 format. Or we'll build to your layout—keypunch, CRT display, interactive, portable—you name it.

Choose from the industry's broadest selection of keyboard ROMs. And if we don't have the code you need, a simple mask change can produce any code

you want—bit or non-bit compatible, up to 9 bits/word.

Reliability? Consider this: A fully encoded trimode ASCII Keyboard with 3 major components—an LSI/MOS circuit, reed keyboard switches, and a printed circuit board. How can a keyboard be more simple? And how can a keyboard be more reliable?

You can learn more about super smooth space bars, lighted keytops, 12 and 16 station small keyboards from your nearby Clare Sales Engineer. Call him for a demonstration or call us in

Post Falls for MOS Keyboard action. Clare-Pendar Co., Post Falls, Idaho 83854. Phone 208-773-4541

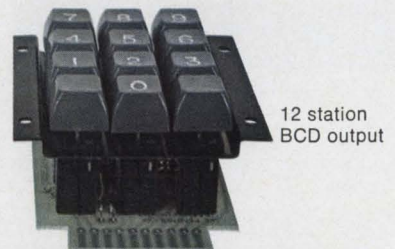

12 station BCD output

CLARE-PENDAR™
The Other Keyboard Company!

See us at the FJCC, Houston, Nov. 17-19, Booth No. 3712

Product Source Directory

Keyboards

The keyboards covered in this Product Source Directory are arranged in ascending order according to the maximum number of keys available. They are subsequently alphabetized according to manufacturer.

Prices, which as given at per-key figures, are only approximations. Manufacturers should be

consulted for a more accurate cost estimation.

Manufacturers are identified by the abbreviations shown in the Master Cross Index below. The following abbreviations are used in the tables:

ina—information not available

req—price on request

| Abbrev. | Company | Information Retrieval No. |
|-----------------|--|---------------------------|
| Alcoswitch | Alcoswitch Alco Electronic Products, Inc. 8 Marblehead St. North Andover, Mass. 01845 (617) 686-3887 | 449 |
| CRC | Controls Research Corp. Sub. of Midtex, Inc. 2100 S. Fairview Santa Ana, Calif. 92704 (714) 557-7161 | 450 |
| CTC | Connecticut Technical Corp. 3000 Main St. Hartford, Conn. 06120 (203) 522-6167 | 451 |
| Cherry | Cherry Electrical Products Corp. 1650 Old Deerfield Rd. Highland Park, Ill. 60035 (312) 831-2100 | 452 |
| Chomerics | Chomerics, Inc. 77 Dragon Ct. Woburn, Mass. 01801 (617) 935-4850 | 453 |
| Clare-Pendar | Clare-Pendar Co. P.O. Box 785 Post Falls, Idaho 83854 (208) 773-4541 | 454 |
| Computronics | Computronics Engineering 4949 Hollywood Blvd. Los Angeles, Calif. 90027 (213) 876-1944 | 455 |
| Control Devices | Control Devices, Inc. 204 New Boston St. Woburn, Mass. 01801 (617) 935-1105 | 456 |
| Datanetics | Datanetics Corp. 2828 Spreckels Lane Redondo Beach, Calif. 90278 (213) 542-4355 | 457 |
| Digitronics | Digitronics Corp. 1 Albertson Ave. Albertson, N.Y. 11507 (516) 484-1000 | 458 |
| Elec-Trol | Elec-Trol, Inc. 21018 Soledad Canyon Rd. Saugus, Calif. 91350 (213) 788-7292 | 459 |
| Flex Key | Flex Key Corp. 1277 Main St. Waltham, Mass. 02154 (617) 891-1320 | 460 |
| IDM Corp. | IDM Corp. P.O. Box 954 Hanover, N.H. 03755 (603) 643-2840 | 461 |

| Abbrev. | Company | Information Retrieval No. |
|--------------|--|---------------------------|
| ITT | ITT Telecommunications P.O. Box 831 Corinth, Miss. 38834 (601) 286-6921 | 462 |
| Ikor | Ikor, Inc. Northwest Industrial Park Burlington, Mass. 01803 (617) 272-4400 | 463 |
| Licon | Licon Div. Illinois Tool Works Inc. 6615 W. Irving Park Rd. Chicago, Ill. 60634 (312) 282-4040 | 464 |
| Litton ABS | Litton ABS OEM Products Div. 600 Washington Ave. Carlstadt, N.J. 07072 (201) 935-2200 | 465 |
| Mercutron | Mercutron Div. Mechanical Enterprises Inc. 5249 Duke St. Alexandria, Va. 22304 (703) 751-3030 | 466 |
| Micro Switch | Micro Switch Div. Honeywell Inc. 11 W. Spring St. Freeport, Ill. 60132 (815) 232-1122 | 467 |
| Milli-Switch | Milli-Switch Corp. P.O. Box 67 Gladwyne, Pa. 19035 (215) 642-9222 | 468 |
| Nucleonic | Nucleonic Products Co. 6660 Variel Ave. Canoga Park, Calif. 91303 (213) 887-1010 | 469 |
| Raven | Raven Electronics Corp. P.O. Box 5337 Reno, Nev. 89503 (702) 786-1965 | 470 |
| Raytheon | Raytheon Co. Industrial Components Operation 465 Center St. Quincy, Mass. 02169 (617) 479-5300 | 471 |
| Risk | George Risk Industries, Inc. 802 S. Elm St. Kimball, Neb. 69145 (308) 235-4645 | 472 |
| TEC | TEC, Inc. 6700 S. Washington Ave. Eden Prairie, Minn. 55343 (612) 941-1100 | 473 |
| Teletype | Teletype Corp. 5555 Touhy Ave. Skokie, Ill. 60076 (312) 982-3111 | 474 |

| Manufacturer | Series | Keys (Min-Max) | Type of Switching | Code Format | Output Level (V, mA) | Keys Available | Approx. Price (\$/key) | Notes |
|--------------|-----------|----------------|------------------------------------|---------------------|----------------------|-----------------|------------------------|-------|
| Alcoswitch | MSPM | 1 | reed | (15) | 50, 100 | a | 3.90 | |
| Alcoswitch | RSM | 1 | reed | (15) | 50, 500 | (5) | 1.95 | a |
| Micro Switch | 4NW3-1 | 4 max | mechanical | (15) | 6, 10 | (5) (6) | 1.23 | t |
| Micro Switch | 4NW7-1 | 4 max | mechanical | (15) | 6, 10 | (5) (6) | 1.32 | t |
| Elec-Trol | KB1001 | 10 | reed | (15) | ina | (4) (6) (8) | 1.80 | |
| Alcoswitch | SB | 1-12 | reed | (15) | 48, 100 | a | 1.95 | |
| Alcoswitch | SBL | 1-12 | reed | (15) | 48, 100 | a | 2.06 | |
| Alcoswitch | SBLR | 1-12 | reed | (15) | 48, 100 | a | 2.25 | |
| Alcoswitch | SB-030 | 10-12 | reed | (15) | 48, 100 | (5) | 2.38 | a |
| Cherry | B65 | 10-12 | reed | (14) (15) | b | (5) | 1.52 | |
| Clare-Pendar | K012 | 10-12 | reed | (15) | ina | (4) | 1.50 | |
| Clare-Pendar | K112-B | 10-12 | reed | (14) | b | (4) | 2.00 | k |
| Flex Key | DK | 10-12 | elastomeric membrane | (15) | ina | g | 0.55 | t |
| CRC | 12C | 12 max | reed | (15) | 10 VA | g | 1.00 | |
| Micro Switch | 12NW1-1 | 12 max | mechanical | (15) | 6, 10 | (5) (6) | 0.64 | t |
| Micro Switch | 12NW3-1 | 12 max | mechanical | (15) | 6, 10 | (5) (6) | 0.97 | t, w |
| Micro Switch | 12NW43-3 | 12 max | mechanical | (14) | b, q | (5) (6) | 3.00 | t |
| Micro Switch | 12SW1-1 | 12 max | Hall effect | (14) | 2.8, 10 | (5) (6) | 2.75 | |
| Elec-Trol | KB1003 | 12 | reed | (15) | ina | (4) (6) (8) | 1.75 | |
| ITT | 32 | 12 | magnetic core | (19) | 20 mA | (4) | 1.66 | |
| Raven | 203-A | 12 | capacitance | (15) | 3-30 V, 50 mA | (4) (6) (7) (8) | 5.00 | |
| Raven | 342 | 12 | capacitance | (14) | 3-30 V, 50 mA | (4) (6) (7) | 12.20 | |
| Raven | 350 | 12 | capacitance | (19) | ina | (4) (6) (7) | 12.00 | |
| Datanetics | DC-400 | 10-16 | elastic diaphragm | (14) (15) | 5, 15 | (4) (6) | 0.45-1.00 | h, t |
| Clare-Pendar | K016 | 14-16 | reed | (15) | ina | (4) | 1.50 | |
| Clare-Pendar | K116-B | 14-16 | reed | (14) | b | (4) | 2.00 | k |
| Clare-Pendar | K116-H | 14-16 | reed | (20) | b | (4) | 2.00 | k |
| CRC | 16C | 16 max | reed | (15) | 10 VA | g | 1.00 | |
| Micro Switch | 16NW1-1 | 16 max | mechanical | (15) | 6, 10 | (5) (6) | 0.48 | t |
| Micro Switch | 16NW3-1 | 16 max | mechanical | (15) | 6, 10 | (5) (6) | 0.93 | t |
| Micro Switch | 16NW43-1 | 16 max | mechanical | (14) | b, q | (5) (6) | 3.12 | t |
| Micro Switch | 16NW7-1 | 16 max | mechanical | (15) | 6, 10 | (5) (6) | 1.04 | t |
| Micro Switch | 16SW3-1 | 16 max | Hall effect | (14) | 2.8, 10 | (5) (6) | 2.54 | |
| CRC | 16B | 16 | reed | (14) | 5, 200 | (4) | 1.80 | |
| Elec-Trol | KB1005 | 16 | reed | (15) | ina | (4) (6) (8) | 1.70 | |
| IDM Corp. | ANK | 16 | reed | (12) | ina | (5) (6) | 24.70 | x |
| ITT | 40 | 16 | magnetic core | (19) | 20 mA | (4) | 3.13 | |
| Raven | 203-B | 16 | capacitance | (15) | 3-30 V, 50 mA | (4) (6) (7) (8) | 5.00 | |
| Raven | 343 | 16 | capacitance | (14) | 3-30 V, 50 mA | (4) (6) (7) (8) | 7.10 | |
| Raven | 351 | 16 | capacitance | (19) | ina | (4) (6) (7) | 7.00 | |
| CRC | 16A | 12-20 | reed | (14) | 5, 200 | (5) (6) (9) | 1.80 | |
| Chomerics | EF | 4-24 | elastomeric contacts | f | 30, 40 | g | 0.20 | h |
| CTC | KBP-N | 14-24 | mechanical (leaf) | (16) | 5 V | (5) (11) | req | m |
| CRC | 20C | 24 max | reed | (15) | 10 VA | g | 1.30 | |
| CRC | 49B | 49 | reed | (13) | 5, 200 | (4) (6) | 1.60 | |
| Datanetics | DC-131 | 49 | elastic diaphragm | (13) | b, q | (4) (6) | 2.00 | |
| Computronics | H600 | 45-50 | mechanical (brushes) | m | 100 mA | g | 3.00 | k |
| Teletype | UK-801 | 1-51 | electromechanical (reset solenoid) | (12) (17) | ina | (4) (6) | 3.66 | |
| CRC | 51C | 51 max | reed | (15) | 10 VA | g | 1.30 | |
| Elec-Trol | KB1006 | 51 | reed | (12) | 5 V | (4) (6) (8) | 2.50 | |
| CRC | 52A | 52 | reed | (13) | 5, 200 | (4) (6) | 1.80 | |
| CTC | KBP-200 | 44-53 | mechanical (leaf) | m | 5 V | (4) | req | |
| Cherry | B70 | 48-53 | reed | (12) | b | (4) (6) | 2.16 | c |
| Micro Switch | 53SW1-1 | 53 max | Hall effect | (12) | b, q | (4) (6) | 4.92 | |
| Clare-Pendar | K353 | 53 | reed | (12) | b | (4) (6) (10) | 2.00 | |
| Clare-Pendar | K453 | 53 | reed | (12) | b | (4) (6) (10) | 2.00 | |
| Elec-Trol | KB1009 | 53 | reed | (12) | 5 V | (4) (6) (8) | 2.50 | |
| Flex Key | TT | 53 | elastomeric membrane | (15) | ina | (4) | 0.50 | t |
| Micro Switch | 51RW1-3 | 54 max | reed | (15) | 8 W max | (4) | 2.19 | t |
| Micro Switch | 51RW2-1 | 54 max | reed | (12) | b, q | (4) | 5.68 | t |
| CRC | 56A | 56 max | reed | (12) | 5, 200 | (4) (6) (9) | 1.80 | |
| TEC | 4915 | 48-58 | mechanical | (14) | 5, 50 | (4) (6) | 5.00 | |
| Micro Switch | 51SW5-2 | 58 max | Hall effect | (13) | b, q, u | (4) (6) | 4.42 | |
| Datanetics | DC-132 | 59 | elastic diaphragm | m | b, q | (4) (6) (9) | 1.85 | |
| Clare-Pendar | K363 | 63 | reed | (12) | b | (4) (6) (10) | 2.00 | |
| Elec-Trol | KB1007 | 63 | reed | (12) | 5 V | (4) (6) (8) | 2.50 | |
| CTC | 700 GA | 46-64 | mechanical (leaf) | (21) | 5 V | (4) (6) | req | m |
| Datanetics | DC-151 | 64 | elastic diaphragm | (12) | b, q | (4) (6) | 1.85 | |
| TEC | EKA O/E | 47-65 | optoelectronic | m | b, q | (4) (6) (9) | 2.00 | |
| Cherry | Special | 48-65 | reed | (13) (14) (17) (18) | b | (4) (6) | req | e |
| Cherry | Wire-Wrap | 48-65 | reed | (12) | b | (4) (6) | 5.78 | c, d |
| Cherry | B80 | 60-65 | reed | (12) | b | (4) (6) | 2.03 | c |
| CRC | 66A | 66 max | reed | (12) | 5, 200 | (4) (6) | 1.90 | |
| Clare-Pendar | K369 | 69 | reed | (12) | b | (4) (6) (10) | 2.00 | |
| CTC | KB-200 | 45-70 | mechanical (leaf) | m | 110 V max | (4) (9) | 10.00 | |
| Datanetics | DC-152 | 70 | elastic diaphragm | (12) | b, q | (4) (6) (9) | 1.90 | |
| Micro Switch | 63SW5-2 | 71 max | Hall effect | (12) | b, q, u | (4) (6) | 4.22 | |
| Micro Switch | 63SW5-1 | 71 max | Hall effect | (12) | b, q, u | (4) (6) | 4.12 | |
| CRC | 71A | 71 | reed | (12) | 5, 200 | (4) (6) | 1.80 | |
| Datanetics | DC-153 | 71 | elastic diaphragm | (12) | b, q | (4) (6) (9) | 1.90 | |



Bodine helps data devices tell it like it is...

Bodine fractional horsepower drives. Small. Quiet. A complete line designed to power information-handling devices precisely, accurately, dependably. Motors built with all the integrity you've designed into your product—that deliver as specified with fewer callbacks and service problems. If this is the kind of power you're looking for, you'll find no better source.

Over 3,500 standard specifications to choose from. Bodine also builds custom fhp motors to meet design requirements. Our engineers will be happy to help you pinpoint the right one for your particular application need. Computers, business machines, instrumentation, copiers—whatever your product, specify Bodine fhp drives. We've been the power behind the leading products for some 63 years. Write for bulletin. Bodine Electric Company, 2500 W. Bradley Place, Chicago, Illinois 60618.

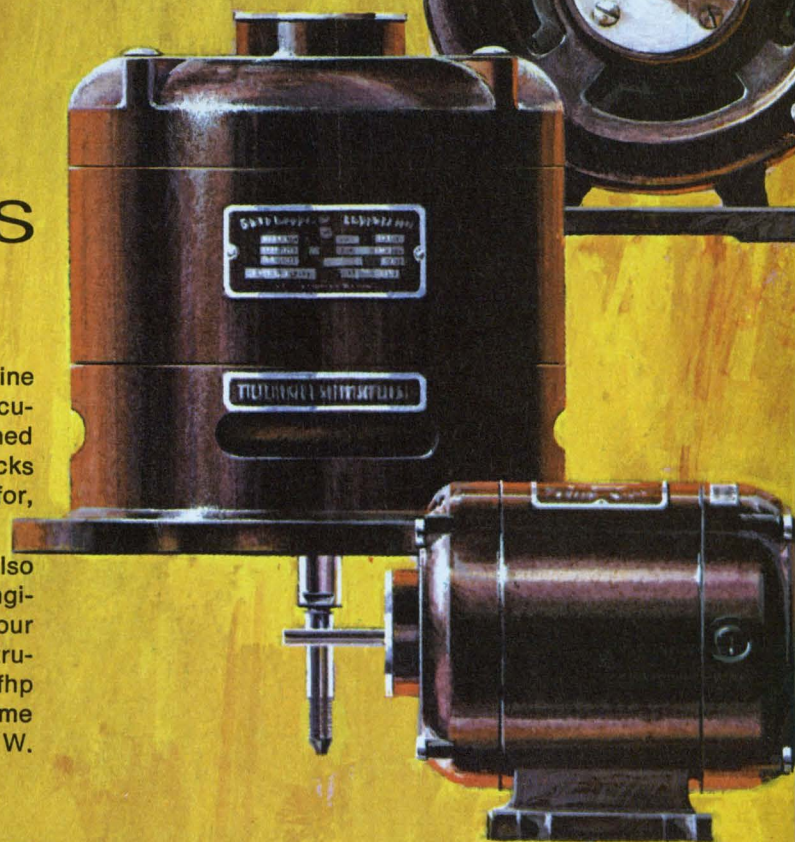

Bodine Motors Wear Out—It Just Takes Longer



BODINE MOTORS/CONTROLS

Ask about Bodine SCR motor speed controls

| Manufacturer | Series | Keys (Min-Max) | Type of Switching | Code Format | Output Level (V, mA) | Keys Available | Approx. Price (\$/key) | Notes |
|-----------------|----------------------|----------------|----------------------|----------------|----------------------|----------------|------------------------|------------|
| Litton ABS | 11 | 73 | photo electric | (14) | -12 V | (4) | 6.30 | (3) |
| Micro Switch | 67SW1-2 | 74 max | Hall effect | (12) | b, q | (4) (6) | 4.81 | |
| Micro Switch | 69SW1-1 | 74 max | Hall effect | v | b, q | (4) | 4.25 | |
| Micro Switch | 64SW1-7 | 75 max | Hall effect | (12) | b, q | (4) | 4.65 | |
| Litton ABS | 30 | 75 | ina | (14) | -12 V | (4) | 6.12 | |
| Milli-Switch | KSB | 4-80 | reed | (12) (13) (14) | b, q, y | (4) (6) (7) | 1.00-2.00 | |
| Raytheon | Custom | 10-80 | mechanical or reed | (12) | 5, 100 | (4) | 2.00-3.00 | |
| Micro Switch | 78SW1-7 | 84 max | Hall effect | (12) | b, q | (4) (6) | 4.70 | |
| Micro Switch | 78SW1-8 | 84 max | Hall effect | (12) | b, q | (4) (6) | 4.70 | |
| Micro Switch | 78SW1-9 | 84 max | Hall effect | (12) | b, q | (4) (6) | 4.08 | |
| Micro Switch | 78SW1-10 | 84 max | Hall effect | (12) | b, q | (4) (6) | 4.08 | |
| Micro Switch | 78SW1-11 | 84 max | Hall effect | (12) | b, q | (4) (6) | 3.92 | |
| Micro Switch | 78SW1-12 | 84 max | Hall effect | (12) | b, q | (4) (6) | 3.92 | |
| Clare-Pendar | K453 | 53-88 | reed | m | b, q, u | (4) (6) (9) | req | h (1) (22) |
| Clare-Pendar | K353 | 53-88 | reed | m | b, q, u | (4) (6) (9) | 4.85 | h (1) (22) |
| Clare-Pendar | K363 | 63-88 | reed | m | b, q, u | (4) (6) (9) | 5.60 | h (1) (22) |
| Clare-Pendar | K369 | 69-88 | reed | m | b, q, u | (4) (6) (9) | req | h (1) (22) |
| Digitronics | PK-200 | 48-90 | photoelectric | r | 5-12 V | g | 4.00 | s |
| Chomerics | ES | 4-96 | elastomeric contacts | i | 30, 40 | g | 0.25 | j |
| CTC | K-301 | 10-100 | reed | m | 5 V | (4) (6) | 2.50 | n |
| CTC | Hyper-Perf 70 | 67-100 | reed | m | 5 V | (4) (6) (9) | req | |
| CRC | 50X | 10-110 | reed | m | 5, 200 | g | 1.90 | |
| Nucleonic | Raycon (contactless) | 1-625 | transistor | m | 5-24 V, 40 mA | (4) (6) (7) | 3.50 | (1) (2) |
| Control Devices | CDK | p | solid state | m | b, q | g | req | h |
| Ikor | 6350 | p | magnetic core | m | b, q | g | 1.50 | |
| Licon | 550 | p | magnetic core | m | 5, 0.5 or 0.4, 16 | g | req | |
| Mercutron | Mercutron | p | mercury tube | m | 3 V | g | 1.20 | |
| Nucleonic | CT | p | mechanical | (15) | 2-20 V, 1-50 mA | z | 0.96 | (1) |
| Raven | 202 | p | capacitance | (15) | 3-30 V, 50 mA | (4) (6) (7) | 7.50 | |
| Risk | 500 | p | reed | m | 5, 300 | (4) | 0.70 | |

- a. Special keys available on request
- b. Output compatible with TTL circuits
- c. Parity bit available
- d. Keys can be encoded to any desired code via wire-wrap or Termi-Point contacts
- e. Up to 16-bit mixed output codes available
- f. Four-bit internal code formats

- g. Any key output function available
- h. Low-profile keyboards
- i. Up to 16-bit output code formats available
- j. Strobe and roll-over features available with eight-bit codes
- k. Bounce-free contact operation
- m. Any code format available

- n. Uncoded keyboards available
- p. Any number of keys available
- q. Output compatible with DTL circuits
- r. Any nine-bit code format available
- s. All keys mechanically interlocked
- t. Form A switch output
- u. Output compatible with MOS circuits

- v. Six-bit code format
- w. Two keyboard sizes available
- x. Auxiliary keyboard for teletypewriter and other ASCII terminals
- y. Output compatible with RTL circuits
- z. One or two normally closed or normally open outputs available

- (1) Modular PC-board design
- (2) Magneto-resistor used to control transistor switch
- (3) Mechanically latching keys
- (4) Alphanumeric key output functions available
- (5) Numeric key output functions available
- (6) Control key output functions available

- (7) Logic key output available
- (8) Arithmetic key output functions available
- (9) Special key output functions available
- (10) Graphic key output functions available
- (11) Partial alpha key output functions available

- (12) ASCII (American Standard Code for Information Interchange)
- (13) EBCDIC (Extended Binary Coded Decimal Interchange Code)
- (14) BCD (Binary Coded Decimal)
- (15) None, done externally
- (16) EIA (Electronic Industries Association) machine tool control code

- (17) Baudot code format
- (18) Hollerith code format
- (19) DTMF (Dual Trace Multiple Frequency)
- (20) Hexadecimal code format
- (21) TTS* (Teletype Setter)
- (22) All encoding performed by one LSI MOS chip

*Registered trademark of Fairchild Camera & Instrument Co.

This issue has your renewal card, inside front cover. Mail it today.

Programming: 128 steps
for linear or conditional
branching operations.

Automatic special functions:
 a^x , \log_{10}/\log_e , SIN/COS,
 $\text{SIN}^{-1}/\text{COS}^{-1}$, $\times!$, $\frac{1}{x}$,
radians to degrees,
single key Σx , Σx^2 , N,
rectangular to polar conversion.
Automatic entry
of values for e and π .

Ten independent, directly
addressable storage registers.

Special punch card system
allows programming without
tying up the calculator.

Dynamic range of 10^{-99} to 10^{+99} .
Decimals displayed in either
Autopoint or scientific notation.



Model 1655 shown.
All MOS/LSI circuitry.
Weight: 12 pounds
Size: 13" x 13½" x 6½"
Available
with or without
programming.

The latest
MOS/LSI technical
calculators. As close
to you as your telephone
in over 350 cities. For
the location nearest
you call collect
800 243-6000*

Accessory card reader for
automatic entry of program
data, special functions
and decision-making
capability not shown
on keyboard.

*In Connecticut: 800 942-0655

**Monroe. The
Calculator
Company**



Buckbee-Mears makes a reflector so perfect one bulb can light a football field

*What a
performer!*



Chicago Aerial Industries didn't ask us to invent a better way to illuminate football games. What they wanted was a three-dimensional, electroformed reflector head formed to incredibly precise specifications for a military contract. They decided we were the only people with the capabilities to produce what they needed.

They were right. No one can match Buckbee-Mears in the field of two or three dimensional precision electroforming. Our mesh screens, for example, go down to four million holes per square inch with perfect accuracy. Line width tolerances of $\pm .0001$ are common.

A few of our standard products include evaporation masks, pin hole apertures, micro-mesh sieves, elec-

tron microscope grids, optical wedges, zone plates and a variety of micro-miniature parts.

We're equally adept at electroforming gold, silver, copper and nickel. Any shape you want. Besides the reflector, we produce seamless tubing to a thickness of .005 inches for housing intricate electronic packages used in space vehicles. We make the carefully angled exhaust pipes for aircraft jet engines.

If it requires an intricate two or three dimensional shape with precision tolerances, just ask us. Call Bill Amundson, our Industrial Sales Manager, and tell him what you need.

If we can help one bulb light a football field, just think what we might be able to do for you!

PRECISION METAL AND GLASS ETCHING • ELECTRO FORMING • AUTOMATED DESIGN



BUCKBEE-MEARS COMPANY

SAINT PAUL, MINNESOTA 55101

INFORMATION RETRIEVAL NUMBER 127

16-bit minicomputer line with LSI emphasizes high densities and speeds

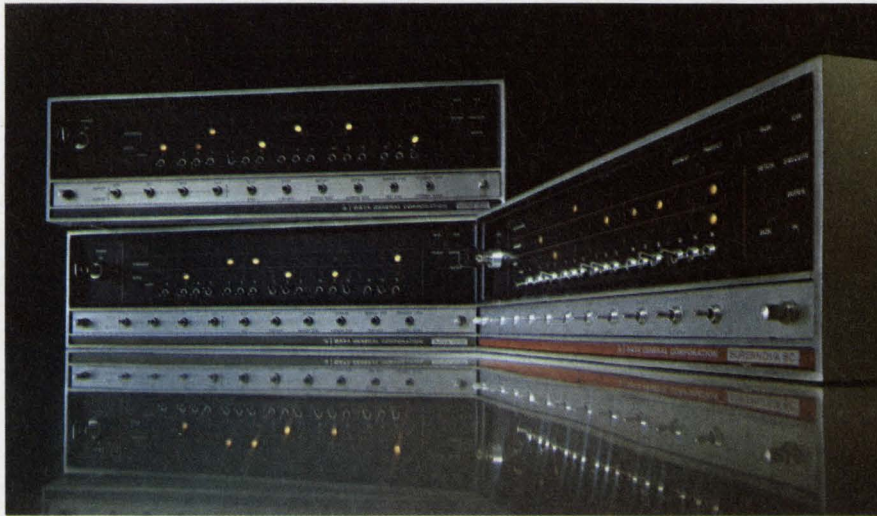

Data General Corp., Southboro, Mass. Phone: (617) 485-9100. P&A: \$5450, \$6950, \$11,900; February, April, June, 1971.

A line of three new 16-bit minicomputers features breakthroughs in memory density and speed with one model using LSI and MSI in its central processor and another with an ultra-fast 300-ns memory.

The Nova 1200 uses 64-bit LSI chips with address decoding in its central processor unit to store 16-bit accumulators. In addition, it uses a high level of MSI circuits.

The use of LSI and MSI has made it possible to build the entire Nova 1200 central processor with 115 ICs mounted on a single PC board. The entire minicomputer, including its processor, a 4k core memory, basic interface and control panel, is made up of only 230 IC packages.

It is a quasi-serial unit operating on 4-bit data nibbles with a basic memory cycle time of 1.2 μ s.

This speed is achieved with a technique known as pipelining. A constant flow of 4-bit data nibbles is maintained as a flowing pipeline through the various data paths in the central processor. All the data paths can be operating on different 4-bit data nibbles simultaneously.

There is a 150-ns time lag from the time the data enters the adder

loop to the time it leaves the loop. This is the time needed for the data pipeline to be filled.

Arithmetic and logical instruction plus JMP and JSR instructions can all be performed in 1350 ns. This includes the time needed to fill up and empty the data pipeline and to execute instructions.

To take advantage of the memory's 1200-ns cycle time, a direct I/O port is available to the memory, bypassing the central processor.

The Nova 1200's core memory system uses 14-pin ICs to replace conventional drive circuits. This, in addition to the use of an 18-mil core, has made it possible to use mother-daughter PC-board configurations for construction of the 1200.

Another mechanical innovation is the elimination of twisted pair wires used to carry high currents. The Nova 1200 uses etched runs overlaid with a laminated copper shield. The performance characteristics of the twisted pair are maintained, but a great deal of hand work is eliminated.

A standard Nova 1200 includes a 4096-word by 16-bit core memory, Teletype interface and a data channel for a cost of \$5450 (single-unit quantities).

The second new minicomputer is

the Nova 800. This minicomputer uses the same package as the Nova 1200 except it is faster with a basic cycle time of 800 ns, and has a fully parallel 16-bit processor.

Some of its attractive features include a variable-speed I/O system, and built-in standard and high-speed data channels.

The variable-speed feature means that the length of time required for an I/O operation depends on the nature of the particular operation. Thus, I/O operations that do not move data use less time than those that do. At the same time, the user can set the machine's basic I/O timing faster or slower, depending on the speed and proximity of the I/O devices involved.

Options include built-in hardware multiply and divide characteristics, power-fail monitor and automatic restarting.

The Nova 800 will cost \$6950 for single-unit quantities. This includes Teletype interface and data channel.

The third model is MOS-memory Supernova SC which is the fastest minicomputer available today with a cycle time of 300 ns. Furthermore, it can execute arithmetic and logical instructions in a single memory cycle.

Since it is designed to overlap instructions, it can, for example, add two numbers in only 300 ns. This is as a result of the central processor executing an instruction during the read cycle of the next instruction.

Data is first read from a core memory with one cycle and immediately re-written with a second cycle. Since semiconductor memories are nondestructive, the re-write cycle is not needed, and consequently the Supernova SC can execute instructions during the read cycle only.

Basic price for the Supernova SC is \$11,900 which includes a 4096-memory, a mapping feature, an automatic program load, data channel and Teletype interface.

Booth No. 2001 Circle No. 287

Modular distribution system multiplexes dc to 2 megabits



Computer Transmission Corp., 1508 Cotner Ave., Los Angeles, Calif. Phone: (213) 477-5020. Availability: 60 days.

Spanning the multiplexing range of dc to 2 megabits/second, Multitrans distribution systems eliminate the need for large numbers of low-speed data sets by multiplexing a wide variety of low and high-speed equipment into a common trunking facility with the simplicity of turnkey operation.

The main building block of these systems is a computer-like device which interfaces the telephone company's 300 series data sets which operate at 19.2, 40.8, 50 or 230.4 kbits/second.

Multitrans systems can intermix a wide variety of low and high-speed terminal equipment such as Teletypewriters with 110, 134.5, 150, 300, and 600 bits/second; CRTs with 2400, 4800 and 9600 bits/second; remote job-entry terminals with 2400 to 50,000 bits/second and transmission units with up to 250,000 bits/second. Even small computers can be multiplexed and put on-line with the main central processor unit.

The present requirements of two data sets and one line for every terminal are no longer needed with Multitrans systems. By multiplex-

ing together several terminals and putting them on a single communication link, the number of data sets and lines is cut down drastically.

The new multiplexing systems can also be used with standard low and medium-speed communication links of 2400, 3600, 4800, 7200 and 9600 bits/second operating via 200 series data sets.

Implementation of a Multitrans distribution system can be through telephone lines, twisted-pair facilities, microwave links or IR communication devices such as the recently introduced Optran by Computer Transmission Corp.

The new distribution systems can be easily reconfigured to accommodate changes in equipment usage and increases in terminal speeds. They are compatible with all standard EIA RS232-C, MIL-STD 188B and other high-speed interfaces.

They operate in transparent full-duplex modes with dedicated channels. Half-duplex or simplex modes with required timing control signals are available as options.

Asynchronous terminal rates for the new distribution systems are 75, 110, 135, 150, 300, 600, 1200, and 1800 bits/second. Other rates are available optionally.

Booth No. 1018 Circle No. 286

CRT-display terminal shows 2000 characters

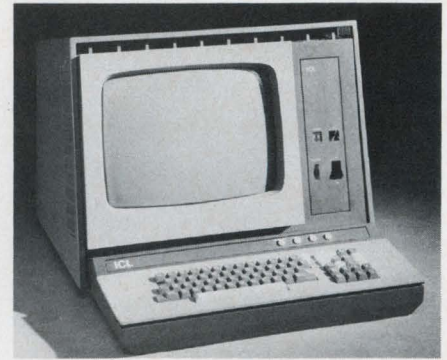

International Computers Ltd., 839 Steward Ave., Garden City, N. Y. Phone: (516) 248-5656. P&A: \$4500; 1st quarter, 1971.

The new model 7181 display terminal can project up to 2000 characters on its screen. It has upper and lower-case 96-character sets. Character generation from an MOS read-only memory provides a subset of ISO 7-bit code. Additional symbols are used for start of message, cursor, start of fixed field, end of field and end of fixed field.

Booth No. 1011 Circle No. 295

\$2000 cassette recorder stores over 2 megabits

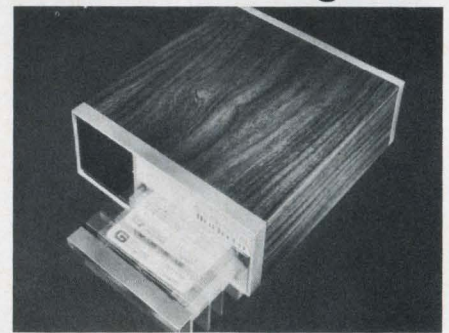

Genisco Technology Corp., 18435 Susana Rd., Compton, Calif. Phone: (213) 774-1850. Price: under \$2000.

The ST-2 Minicorder is a low-cost cassette tape recorder that can store over 2 megabits on a double-width data track organized into 2047 blocks, each containing 1024 bits, for a cost of less than \$2000. A separate double-width address track permits location of data under computer control. Software is included for coupling to most major minicomputers.

Booth No. 3539 Circle No. 274

If Diehl can't solve your high response motor problem...

You've got a problem.

Whether your specs call for a stepper motor or a moving coil motor, you'll find that, we either have or can produce exactly what you need. Our stepper motors are ideal for applications in business equipment, office machines and small peripheral devices for positioning, counting, tape readers, small line printers, etc. Our new moving coil motors are high response D.C. servo motors, ideal for use in high-speed printers, capstan motors and wherever high speed response is needed.



BVE 20 Stepper Motor

- 15° stepping angles compatible with all 24 tooth sprockets
- Bi-directional
- Low inertia
- Permanently lubricated ball bearings
- Stainless steel shaft
- Dampers available. The exact amount of damping required for your specific load and stepping time rate is determined by the Diehl computer program.



Hi-Accel Motor Model HD5520-10-1

- Acceleration better than 140,000 rad/sec² for a 200W motor.
- High efficiency.
- Low armature inertia . . . much lower than normal DC motors.
- Less force cooling required, due to superior motor design.
- Very low inductance.
- Straight line speed-torque characteristics.
- High pulse acceleration torques.
- High overcurrent pulse capability . . . over 10X rated current with no harm to commutator or loss of field flux.
- Output torque, smooth and cogging free.

*High response motor problem? Call your Diehl representative today.
Or call us.*

SINGER
DIEHL DIVISION

Finderne Avenue, Somerville, N.J. 08876 / (201) 725-2200 • TWX 710-480-9325

INFORMATION RETRIEVAL NUMBER 128

Programmable terminal is a multi-speed system



Noller Control Systems, 150 E. Standard Ave., Richmond, Calif. Phone: (415) 233-8220. P&A: \$26,500 or \$690/month; 60 days.

Designed and built to give instant access to any large computer system no matter how far away, the DTS-100 programmable remote data-processing communications terminal can synchronously transmit data at rates ranging over 2000 to 9600 bits/second.

It can operate over switched dial-up facilities, over private or leased voice channels and over broadband facilities in half or full duplex modes and is compatible with EIA standard RS-232B.

The basic DTS-100 terminal is a modular package that houses its own minicomputer to program text formats and to compress data, an I/O processor for communications-line and peripheral control, a printer-keyboard and a card reader. The last two items mount separately on an operator's desk.

The minicomputer contains a basic 4096-bit core memory with a capacity for 12-bit words. The memory is organized into 32 pages of 128 words each. An extra 4096 words of core memory may be added on to the system.

The plug-in I/O processor unit interfaces the basic terminal with a broad range of peripherals. It interfaces and controls up to 7 peripherals including data sets.

A unique software-controlled modem interface is standard on the DTS-100A. It allows hardware compatibility with any central processor or communications terminal utilizing a 6, 7, 8 or 9-bit transmission code.

Available peripherals include card readers with speeds of 400 or 600 cards/minute, line printers with printing speeds of 300 or 1000 lines/minute and IBM-compatible 7-track or 9-track magnetic-tape transports.

Booth No. 1233 Circle No. 309

Impact line printers deliver 150 lines/min

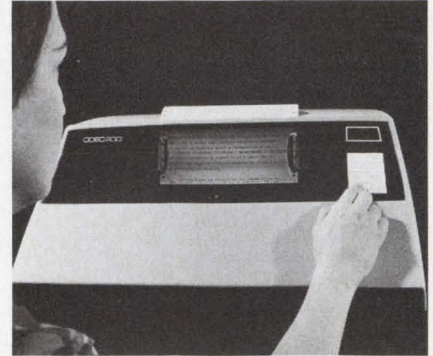

Odec Computer Systems, Inc., 871 Waterman Ave., E. Providence, R. I. Phone: (401) 438-0220. P&A: \$6500, \$7900; December, 1970.

Two new desk-top line printers are models 801 and 1321 with speeds of 150 and 110 lines/minute, respectively. Model 801 is an 80-column unit designed for use with mini-computers, time-sharing systems and a variety of office business systems. Model 1321 is a 132-column unit with a full range of 96 characters including upper and lower case.

Booth No. 2711 Circle No. 285

Time-sharing plotter has many sub-routines

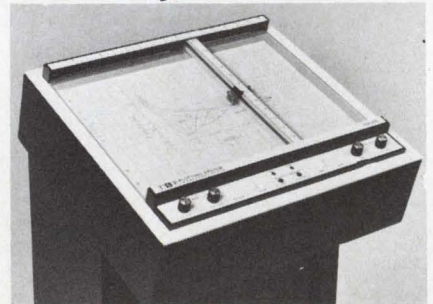

Time Share Peripherals Corp., Box 361, Wilton, Conn. Phone: (203) 762-3348. Price: \$33000 (includes sub-routines).

The TSP-212 high-speed low-cost time-sharing plotting system has sub-routines in FORTRAN, BASIC, APL, and PLI languages that include curve-smoothing, alphanumeric and symbols. The system reduces initial and operating costs and draws conclusions in minutes from columns of digital data. It interfaces with IBM 2741 and most Teletype terminals.

Booth No. 3817 Circle No. 267

New

HARD COPY UNIT



4601 HARD COPY UNIT with T4002 GCT

Permanent copies from the Tektronix T4002

Graphic Computer Terminal and . . .

This New Hard Copy Unit produces copies *directly* from Tektronix Storage CRT's. Operation is easy. At the push of a button or upon programmed command, your computer outputs are permanently recorded on reproducible copies. In just 18 seconds a high resolution copy of even complex displays is ready for use.

Now, information from your computer is quickly copied for distribution to management and office personnel. These copies are ideal for portfolios and permanent records—and serve as a quick, inexpensive method to keep business clients and associates informed with current information.

COPY COST is less than 8 cents per 8.5 x 11-inch copy, depending upon usage.

When people who have a need to know can't come to see the computer display, send them a copy. With the 4601 Hard Copy Unit you'll have a quick, easy, low-cost way to record and send information when and where it's needed.

For additional information, contact your Tektronix Field Engineer or Application Engineer: or write to Tektronix, Inc., P. O. Box 500, Beaverton, Oregon 97005.

4601 HARD COPY UNIT \$3750

Available in U.S. through the Tektronix lease plan
U.S. Sales Price FOB Beaverton, Oregon



. . T4005 GRAPHIC DISPLAY

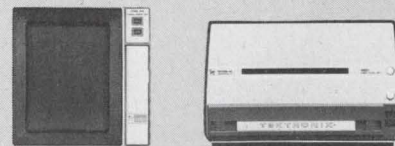

. . 611 STORAGE DISPLAY UNIT



TEKTRONIX®

committed to
technical excellence

See The Tektronix Display At FJCC

INFORMATION RETRIEVAL NUMBER 129

Enroll now in the Magnetics Technology Center

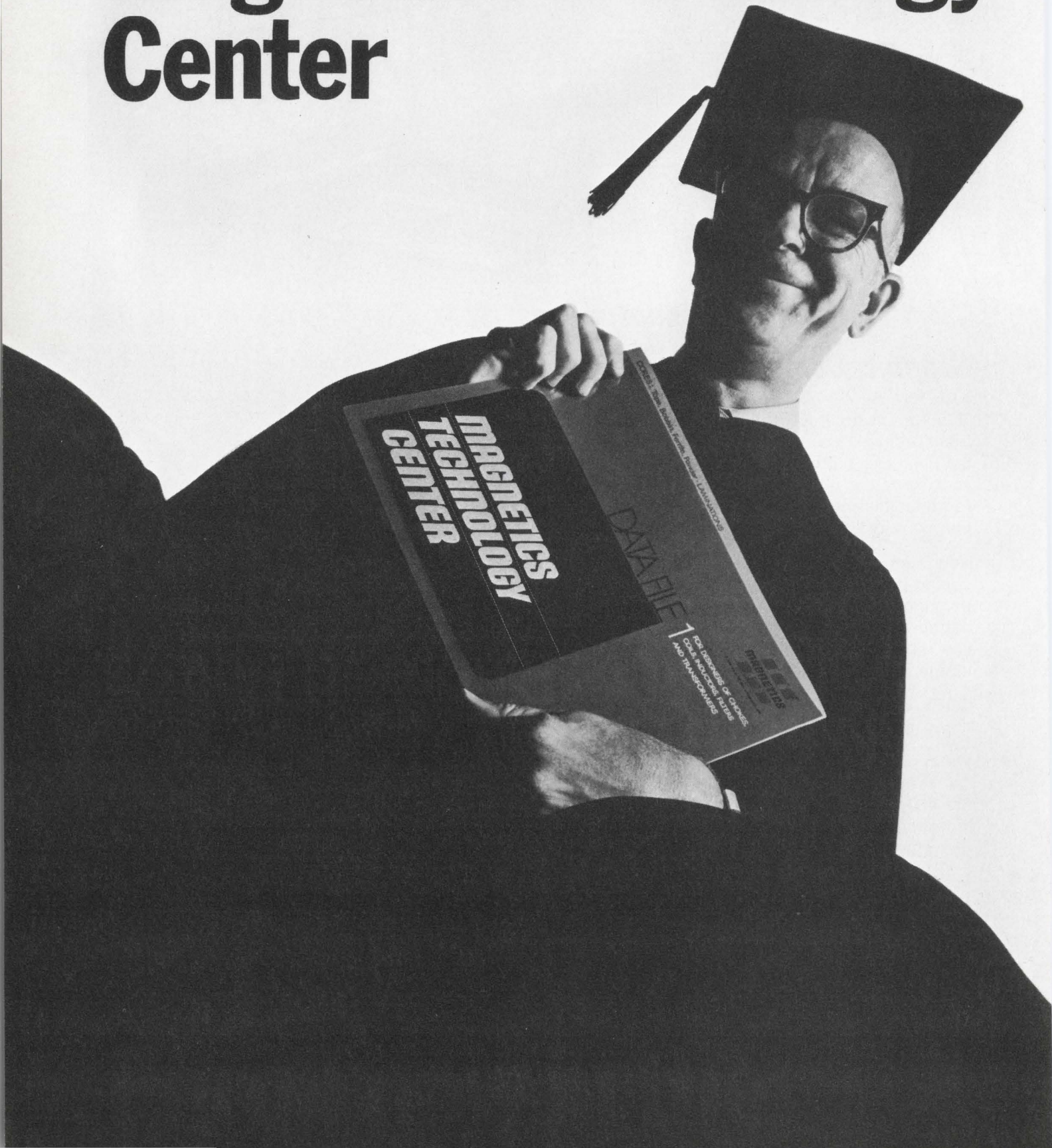

Magnetics introduces a post-grad center that keeps you up to date on the state of the art in magnetic materials. No campus; no fee; texts free. You learn on your own time.

We don't pretend to be scholars behind ivy-covered walls. We are a group of inquisitive specialists with interests in electronics, electrical engineering, physics, metallurgy and related fields. We work with low and high permeability magnetics, ferrites and photo-chemically machined metals. Some of us have spent over 20 years here at Magnetics developing theories and putting them to practical use.

Now we'd like to share with you what we've learned—through a curriculum that no undergraduate school to our knowledge now offers. (Sure, we have another purpose. We believe that as people learn what our products can do, the more these products will be used in future commercial applications. If today we give you the kind of information that will help you do a better job, it seems reasonable to assume you may give us an order someday.)

So we invite you to enroll now in our newly created Magnetics Technology Center. It exists as a repository of what is known about magnetic materials. It intends to spread this knowledge freely—and broadly. It seeks engineers interested in learning more about this field. It welcomes both recent graduates and those who have been involved in design and application for some time. We intend to gear

our programs to your needs.

As an enrollee in the Magnetics Technology Center you will receive without obligation a continuing flow of printed material. You may have received some of this in previous years, but the bulk will be new material developed especially for our Center. Among the items:

1) Magnetics Technology Center Study Courses on such subjects as:

- Ferrites versus magnetic materials
- Photo-chemically machined parts
- Reducing magnetic circuit size and response time
- Ferrites in transformer design
- Proper selection of cores for saturating transformers

2) Magnetics Technology Center Data Bank Files for designers of chokes, coils, inductors, filters, magnetic amplifiers, converter-inverter transformers and electronic transformers

3) Magnetics Technology Center news, at regular intervals, on advances in magnetic materials, applications, etc.

4) Magnetics Technology Center Annual Bibliography of important papers and articles on magnetic science technology

Enroll now. No tuition. No tests.

No campus. Merely fill out and mail the coupon.

MAGNETICS, Magnetics Technology Center, Dept. ED-106, Box 391, Butler, Pennsylvania 16001

How do we qualify to institute this Center?

- We developed the 550 Mu Flake Core, an industry first, that allows miniaturization without excessive circuit losses
- We tightened up industry inductance tolerances for powder cores. Twelve years ago the accepted tolerance was as high as $\pm 22\%$. We went to $\pm 8\%$ and others followed
- We established ourselves as the only approved source of bobbin cores for the Apollo program
- We patented a one-piece powder core die to increase production and help make a more uniform product
- We developed linear inductance-temperature characteristics in powder cores
- We stabilized miniature cores for inductance changes with temperature
- We developed a guaranteed voltage breakdown finish for tape and bobbin cores, eliminating the need for taping
- We developed our own powder metallurgy techniques and producing facilities to gain stricter control of magnetic core properties
- We tightened limits or standards on tape wound cores and set limits on other cores where no industrial standards were in place

To enroll, clip this and mail today.

MAGNETICS, Magnetics Technology Center, Dept. ED-106, Box 391, Butler, Pennsylvania 16001

Please enroll me in the Magnetics Technology Center and forward all curriculum materials, free of charge, to:

Name _____

Title or Function _____

Field of Interest and/or Product Now Working On _____

Specific Subjects You Would Like Us to Include in the Curriculum _____

Degree _____ School _____ Year _____

Firm Name _____

Address _____

City _____ State _____ Zip _____

Your associates may wish to enroll also. Have them furnish the above information on their company letterhead and send it to us. We need this data to assist us in selecting your curriculum.



A DIVISION OF SPANG INDUSTRIES INC.

INFORMATION RETRIEVAL NUMBER 130

Uncommonly good sense

from our Tachometer Generators. They're temperature-compensated, miniaturized, and perfect for precision indicators and velocity servos requiring a highly linear speed/voltage relationship with minimum ripple. Linearity from 0 to 12,000 rpm is better than 1/10 of 1% of voltage output at 3600 rpm. The ripple value will not exceed 3% rms of the D-C value at any speed in excess of 100 rpm. The low-driving torque makes them excellent as damping or rate signals in all types of servos. Brushes and commutators are guaranteed for 100,000 hours of operation — more than ten years — at 3600 rpm. Various models are available with outputs as high as 45v/1000 rpm and can be supplied with an indicator as a complete Speed Indicating System.

SERVO-TEK PRODUCTS COMPANY
1086 Goffle Road, Hawthorne, New Jersey 07506.

SERVO-TEK
PRODUCTS COMPANY

For full technical details write for Catalog 1163 with Test Report and show good sense.



FJCC PRODUCTS

Automated drafter digitizes drawings



Bendix Corp., Computer Graphics, 23850 Freeway Park Dr., Farmington, Mich. Phone: (313) 477-3700. P&A: \$19,500; 60 days.

A new drafting system, known as the Automated Design System, allows anyone to enter digitized coordinate information into a computer while using conventional drafting procedures and drawings. It can calculate areas, lengths, radii and angles two-dimensionally and volumes and clearances from two or three-view drawings three-dimensionally.

Booth No. 3608 Circle No. 307

Disc file systems store three ways



Ampex Corp., 9937 W. Jefferson Blvd., Culver City, Calif. Phone: (213) 836-5000.

The new model DM-312 disc drive unit and the model DC-314 disc-storage control unit offer three IBM-plug-interchangeable storage methods: magnetic tape drives, extended core memories and disc files. They are compatible with IBM 360/370 systems. Minimum, average and maximum access times of the disc drive unit are 8, 32 and 58 ms, respectively.

Booth No. 3013 Circle No. 319

Microfiche reader scans all directions

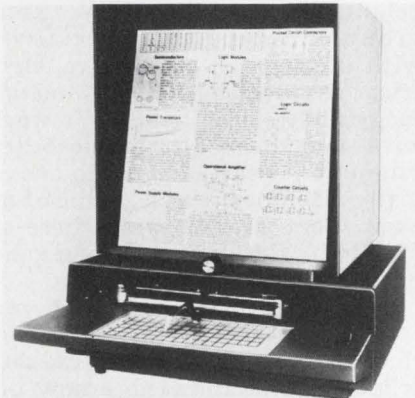

National Cash Register Co., Industrial Products Div., 3131 S. Dixie Highway, Dayton, Ohio. Phone: (513) 449-3970.

The 456-400 series microfiche reader features instant page location, a co-ordinate indexing system and a pointer arm that moves freely in vertical, horizontal and diagonal directions. It accepts fiche sizes of 3 by 5 and 4 by 6 in., and has magnifications of 18X and 24X. Fiche sizes of 6 by 7-3/8 in. and 21X magnification are available on special order.

Booth No. 3012 Circle No. 276

Programmed terminal has many configurations



Data 100 Corp., 7450 France Ave., Minneapolis, Minn. Phone: (612) 920-8800. P&A: \$44,050; December, 1970.

The 78 series programmed terminal, a low-cost remote communications unit, can be configured and programmed to meet unique customer requirements. It may include card readers and punches, line printers, IBM/360-compatible magnetic tapes, paper-tape readers and punches, CRTs, TTYs and synchronous line disciplines such as IBM 360/20.

Booth No. 1519 Circle No. 300



The trio that performs like an orchestra.



Andante. Start with the Trim Trio, a versatile concept that lets you use submini coax, machined or strip formed contacts intermixed in the same connector block.

Allegro. Use the *same contacts, same tooling* for rectangular MS Hyfen® connectors, or Bantam™ miniature round connectors. You get the convenience and savings of common contacts used

in a broad selection of connectors and hardware accessories. Countless design variations are possible for applications in computers, communications equipment, medical electronics, numerical controls and avionics equipment.

Fortissimo. Burndy installation tooling harmonizes with Trim Trio connectors for built-in quality control, whether you crimp one at a time with a hand tool, or

3000 per hour with a Hyfematic™.

Crescendo. For more details send for our catalog. See what beautiful music you can make—from breadboard to production—with the Trim Trio.

Encore! Encore!

 **BURNDY**
Bantam Products/Norwalk, Connecticut

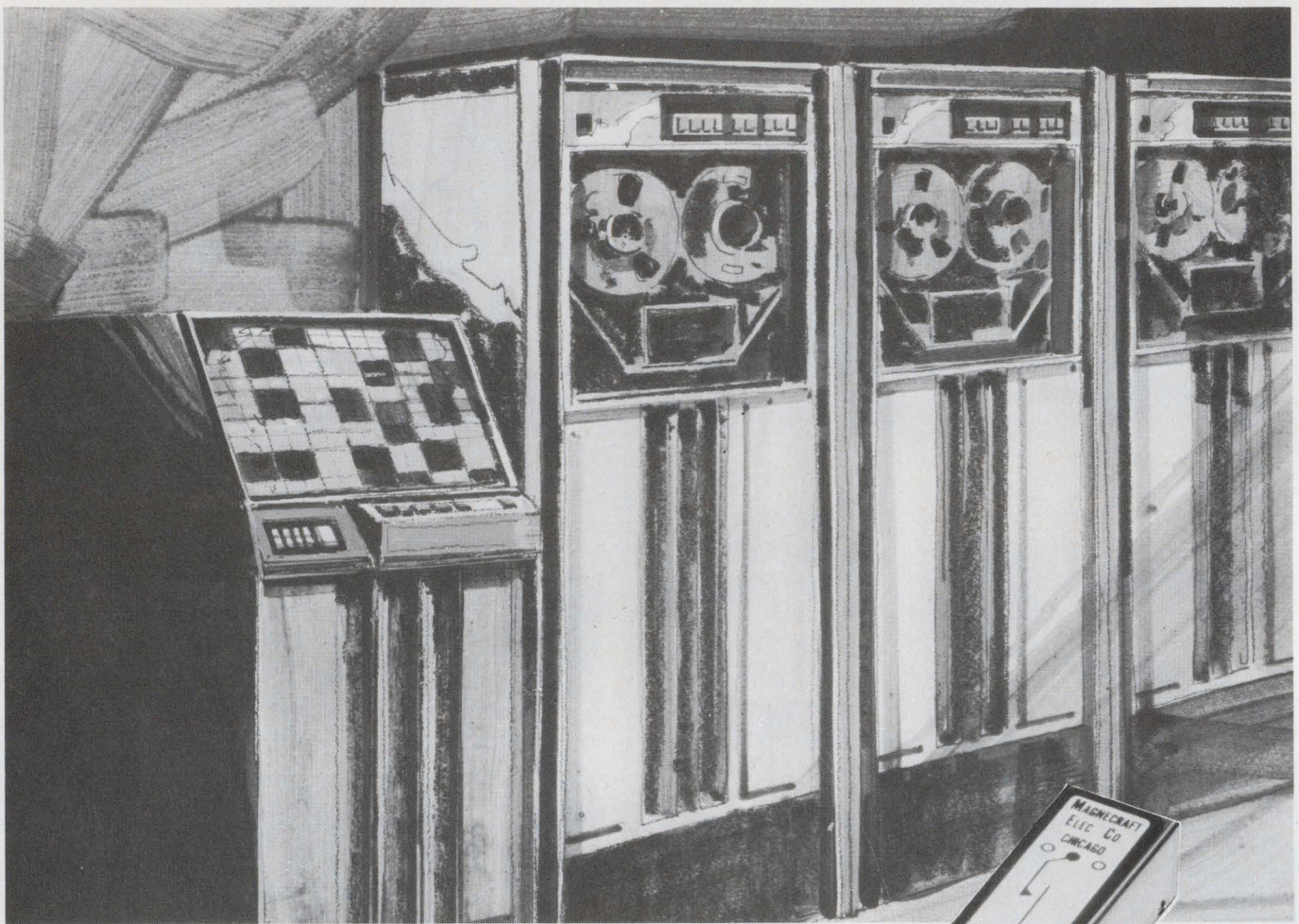

NEW! IC COMPATIBLE REED RELAYS

*Let Magnecraft relays work, while
your integrated circuits think...*

Our new IC compatible reed relays offer total isolation of the integrated circuit. These relays are capable of switching higher voltages, for example a neon lamp readout, while operating at the low input voltage of the IC, 2.5 volts or 5.0 volts.

Best of all, Magnecraft stocks the IC compatible reed relays for immediate delivery. They're priced right, too—as low as \$1.54 in 1000 quantities and even lower for larger quantities.

Contacts are rated 10 VA at 0.5 amp max. or 100 VDC max. resistive load with a configuration of SPST-NO (1 form A), and 3 VA at 0.25 amp or 28 VDC max. resistive load with a configuration of SPDT (1 form C). Two package designs for mounting are available: in-line axial leads; and low profile printed circuit type.

For all the facts on the new IC relays and Magnecraft's 512 other in-stock relays, send for our new Stock Catalog No. 271.

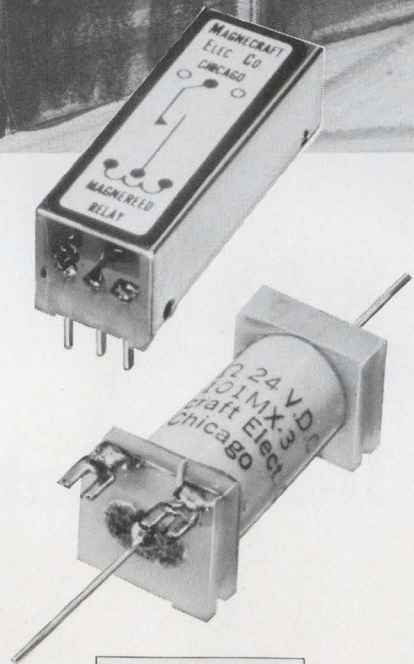

See our product data in EEM

Magnecraft[®] ELECTRIC CO.

5575 NORTH LYNCH AVENUE • CHICAGO, ILLINOIS 60630 • 312 282-5500

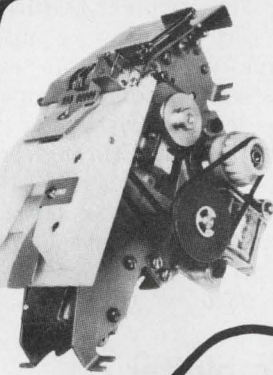
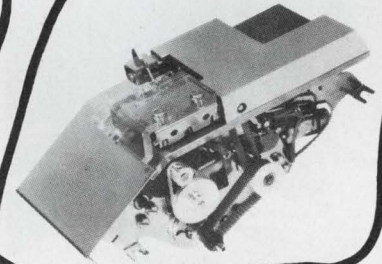
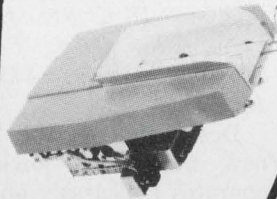
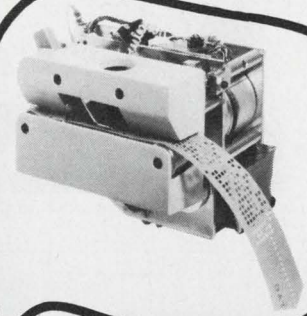
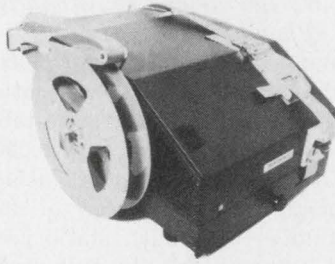
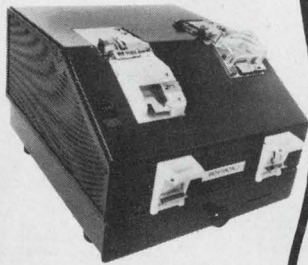

if it reads punched paper tape, punched cards, edge punched cards, pin sensing, cards, badges, optical, reflective, key sort, mark sensing, brush and magnetic stripe cards, we have it!

in more models . . . to fulfill more OEM applications . . . to sell faster and more profitably . . . and stay "on-board" longer with less maintenance than any other readers in the industry.

If you think that's something, you should see our punch line.

FJCC — BOOTH 1401

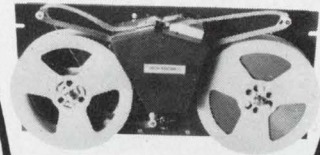
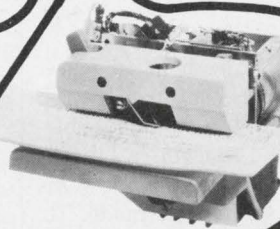
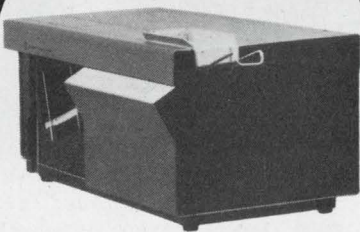
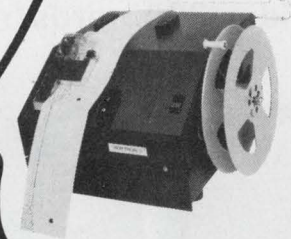

For more information
call Frank Misiewicz
OEM Products
(201) 935-2200

LITTON ABS
automated business systems



600 WASHINGTON AVENUE, CARLSTADT, NEW JERSEY 07072

INFORMATION RETRIEVAL NUMBER 134

Flatbed plotter varies 0.0002 in.

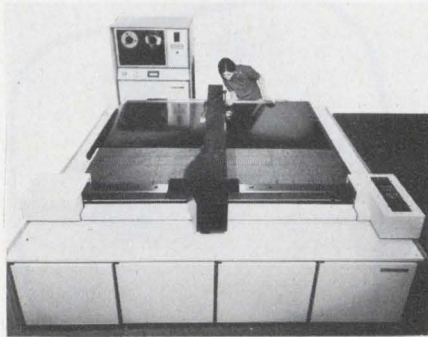

California Computer Products, Inc., 2411 W. LaPalma Ave., Anaheim, Calif. Phone: (714) 831-2541.

Having a resolution of 0.0001 in., the model 745 flatbed plotter features a 4-by-5-foot granite table whose flatness varies only 0.0002 in. Other characteristics include maximum drafting speed of 225 in./minute (diagonal), static positional accuracy for the full drafting area of ± 0.001 in. and repeatability of ± 0.0004 in. Positioning is by ball screws and dc servo.

Booth No. 3014 Circle No. 254

Economy quiet printer produces 5k lines/min



Varian Assoc., Graphics & Data Systems Div., 611 Hansen Way, Palo Alto, Calif. Phone: (415) 326-4000. P&A: \$15,300; early 1971.

Designated as the Statos 21, a new high-speed low-cost printer operates noiselessly on-line at 5000 lines/minute. It uses 640 writing heads across an 8-1/2-in. wide page rather than rotating belts or drums of type. On-line, it can also produce such graphics as maps and charts at the same high speed.

Booth No. 3302 Circle No. 308

Thermal page printer provides 300 words/min



National Cash Register Co., Industrial Products Div., 3131 S. Dixie Highway, Dayton, Ohio. Phone: (513) 449-3970.

The new thermal page printer converts electrical signals directly into characters or symbols and features speeds up to 300 words/minute. It utilizes alphanumeric printing in 5-by-7 dot matrix form with upper and simulated lower case. Other features include an 80-column print line, 96 characters, low rfi and no print deterioration.

Booth No. 3012 Circle No. 277

Bi-direction transport accesses at 120 in./s

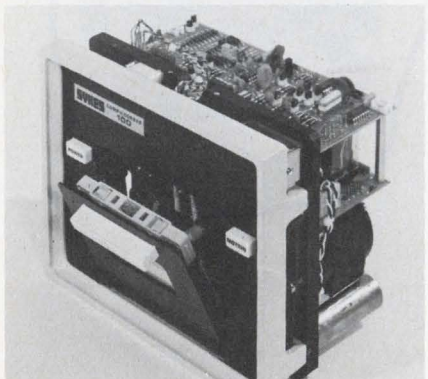

Sykes Datatronics, Inc., 375 Orchard St., Rochester, N. Y. Phone: (716) 458-8000. Price: under \$1000.

Model T/T100 high-speed cassette-loaded magnetic-tape transport can read and write data bi-directionally at 120 in./s in a direct-access mode or at 5 in./s in a conventional sequential mode. It consists of a single tape-deck mechanism, a three-motor drive and motor-control system, a high-precision digital read/write head and associated read/write electronics.

Booth No. 1709 Circle No. 262

CRT-display terminal contains a computer

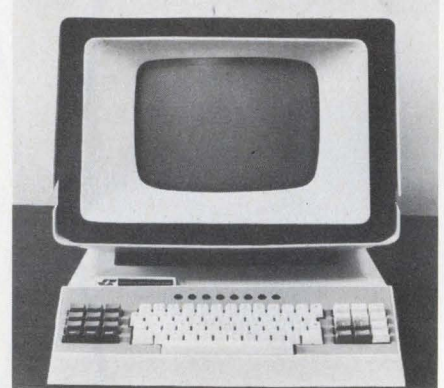

Incoterm Corp., Hayes Memorial Dr., Marlborough, Mass. Phone: (617) 481-2000. P&A: under \$5000; 60 days.

The SPD10/20 is a CRT terminal that contains a stored program computer. The terminal features a magnetic core memory of up to 2048 words with a 1.6- μ s cycle time. The self-contained computer allows the characteristics of the terminal to be defined through software or programming. With a minimum of effort, the terminal can be made to meet an operator's requirement.

Booth No. 2820 Circle No. 299

Graphic plotter draws vectors/points



Hewlett-Packard, 1501 Page Mill Rd., Palo Alto, Calif. Phone: (415) 326-7000. P&A: \$3300; 8 months.

The new 7201A graphic plotter accepts IBM-coded digits which define each point as a 4-digit X and a 4-digit Y coordinate and plots vectors or points. Coded data at 14.8 characters/s is accepted. Input can be data or mathematical functions in source language on time-share systems to produce charts or graphs. Each point is plotted independent of the accuracy of its preceding point.

Booth No. 3002 Circle No. 266

The white "Mini⚡Bus"
on this board
cuts cost and noise
like you wouldn't believe!

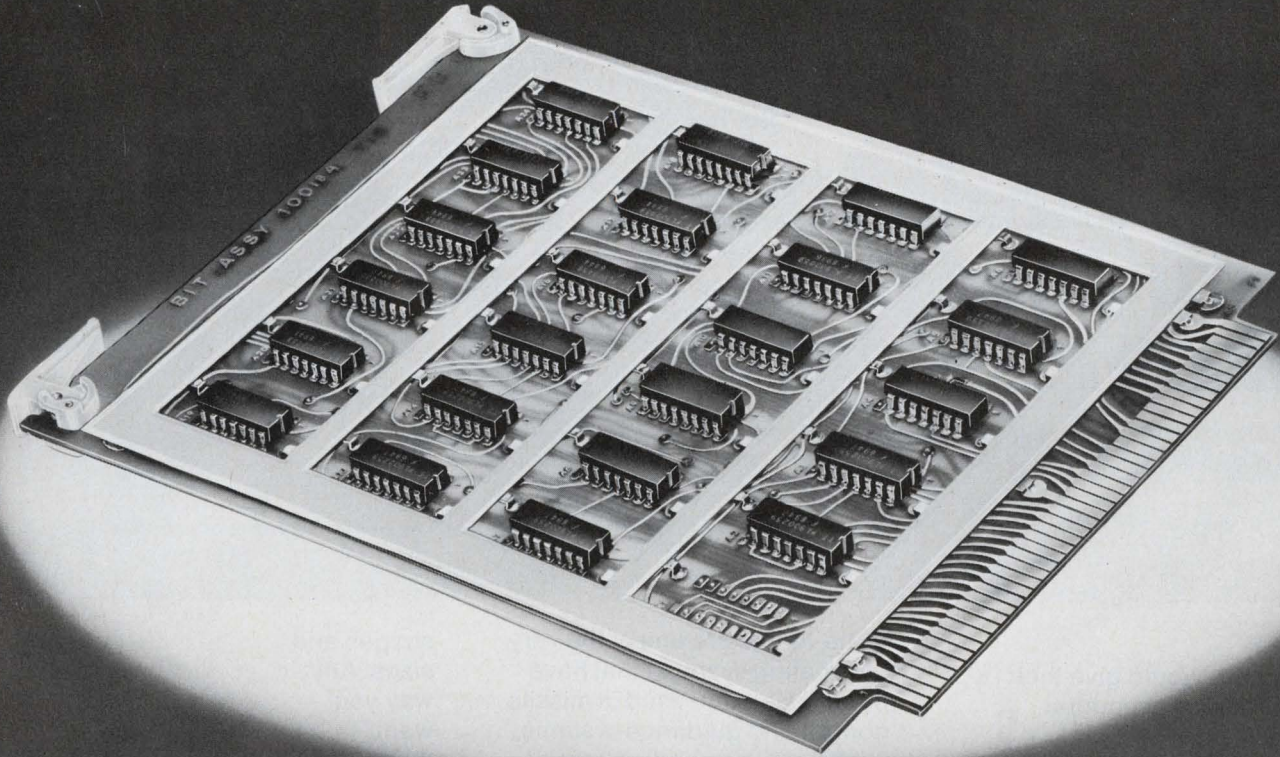

Here's why.

The Mektron® Mini/Bus is a small, voltage-distributing busbar. With V_{cc} and ground return in the bus, not the board, high-density packaging is accomplished without multilayer board construction. *There's cost-cutting!*

And that little bus has so much more capacitance than you could ever get in the board itself, ICs can't be clobbered by surges in line voltage. Also, the capacitance bonus keeps your logic circuitry from being faked out by system transients. Noise-cutting like that means better, more reliable equipment.

Want more details? Design help? Mini/Bus prices?
Ask the people who pioneered laminar bus. Us.

Rogers Corporation / Rogers, Connecticut 06263

Rogers' Mektron products are available from: Mektron Division, Rogers, Connecticut;
Circuit Systems Division, Chandler, Arizona; Mektron N.V., Ghent, Belgium.





We've just eliminated your biggest mating hang-up.

Reliability.

Some guys would give their slide-rule to find a modular mating system they could really depend on. Sure, flexibility and design configurations are important, but more engineers and designers get hung-up on reliability than any other single factor.

If that's your hang-up, we won't let you down.

Malco didn't exactly invent reliable mating. We just perfected it. Perfected it with a little something we call PLATE-MATES. An ultra-high reliability self-locking connector system.

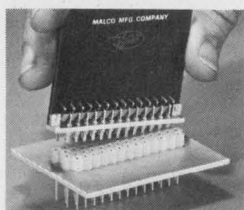
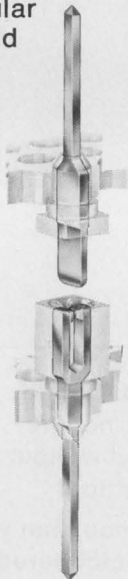

Maybe we're spoil sports, but we designed Plate-Mates to completely eliminate the will-she-won't-she challenge of conventional mating.

Plate-Mates are one of the very few mating systems that have been tested and used in missile control and guidance systems, space vehicles and other systems where design flexibility and total reliability are mandatory. And recently, Plate-Mates have received smiling praise as the best method to package computer logic.

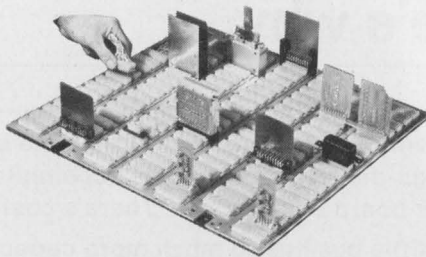

The Wrapost Aluminum Systems Panel (WASP connector to you purchasing agents) is the most famous connector in the Plate-Mate lineup. It utilizes heavy duty blade and fork combinations within custom fabricated metal panels, all arranged to your specifications. So the panels can be produced with cut-outs, mounting holes, datum holes and in countless

shapes and sizes. Any way you want them.

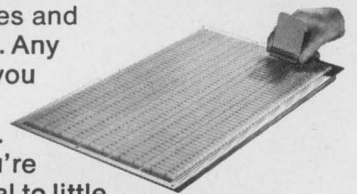

If you're partial to little mates, Malco Mini-Wasps can do the same job for you . . . in one-fourth the space. And like their big sister, Mini-Wasps can also be used for printed circuit headers, wire wrap headers, backpanel arrays and Input-Output connections. Among other things.

The next time you're hung-up for something better, try a Malco Plate-Mate. You'll get what you're after.

We solve your mating problems.



MALCO

MALCO MFG COMPANY INC
5150 WEST ROOSEVELT ROAD
CHICAGO, ILLINOIS 60650
(312) 287-6700

For a complete run-down of our exciting Plate-Mates, write for your free copy of Malco's book:

**Plate-Mate Confidential.
A Guide To The Mate Market.**

FREE

The 28 page Manual which tells you all about Linear Motion Slides.

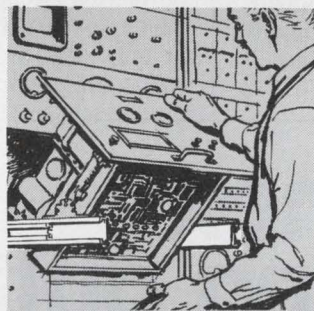

This booklet explains the functions of Linear Motion Slides — the product which manufacturers specify in order to build-in operating convenience and reliability.

It has been carefully written and illustrated, to describe to you, step by step, "why, when and where" to use slides.

The manual has been a long time coming. But then hardly anything of value comes quickly or easily. We'll be happy to send you your free copy.

GRANT[®]
WE KEEP THINGS MOVING

SLIDES:
WHAT THEY ARE,
WHEN THEY ARE USED,
WHERE THEY ARE USED.

GRANT PULLEY & HARDWARE CO., div. of Instrument Systems Corp.,
21 High Street, West Nyack, New York 10994/City of Industry, Calif.

INFORMATION RETRIEVAL NUMBER 137

Highspeed card readers handle 1000 cards/min



Bridge Data Products, Inc., 738 S. 42nd St., Philadelphia, Pa. Phone: (215) EV2-8700. Price: \$2500, \$2000, \$2250.

Three new card readers range in speeds from 650 to 1000 cards/minute. Model 8800 handles 80 and 96-column cards at 650 and 1000 cards/minute, respectively. Model 8060 reads 80-column cards at 650 cards/minute. Model 8600 reads 96-column cards at 1000 cards/minute. Each model comes with hoppers, transport, stackers, read heads, electronics, skins and interface.
Booth No. 3211 Circle No. 253

Versatile transport is 3 separate modules

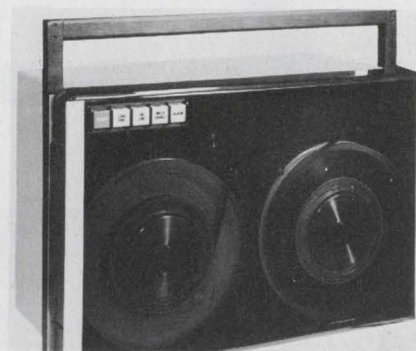

Anderson Jacobson, Inc., 1065 Morse Ave., Sunnyvale, Calif. Phone: (408) 734-4030.

The model 707 magnetic-tape transport is a versatile IBM-compatible device designed around 3 functional modules: a tape deck, an electronic card cage and a power supply. Each is completely unitized, and can be tested, serviced and purchased separately. The transport's speed range is 4 to 25 in./s at 200, 556, or 800 bits/in.
Booth No. 2306 Circle No. 272

Wide-format terminal takes 15-in. printouts



Teletype Corp., 5555 Touhy Ave., Skokie, Ill. Phone: (312) 982-3111.

Wide-format reports can be received at remote locations with a new model 37 terminal which has a wide platen to accommodate 15-in. sprocket-fed computer print-outs. Reports can be transmitted on the model 37 at speeds of 15 characters/second. It accepts all ASCII code combinations and commands and will be available as a receive only, a keyboard send-receive and as an automatic send-receive set.
Booth No. 1207 Circle No. 282

Remex is coming out of its shell.



With an economy photo-electric punch tape reader.
See pages C51 & C53.



INFORMATION RETRIEVAL NUMBER 138

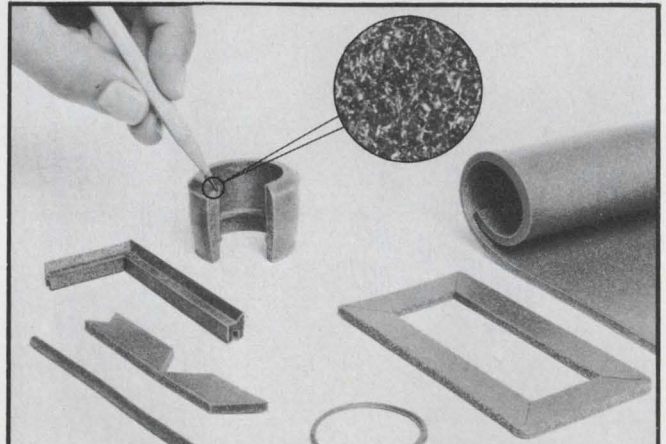

EMI/RFI SHIELDING ELASTOMER CONDUCTIVE NICKEL/SILICONE

CONMAX ● Highly conductive nickel/silicone elastomer ● Uniformly dispersed nickel fiber ● Excellent Total Shielding Effectiveness ● Environmental seal ● Operating temperature: -65°F. to +450°F. ● Good compression-deflection characteristics ● No loose particles ● Highly reliable homogenous composition ● Free of unstable copper ● Low density — Light weight ● As low as 6¢ per square inch ● Available in sheets, strips, die cut, molded and extruded parts ● Write for data #830.

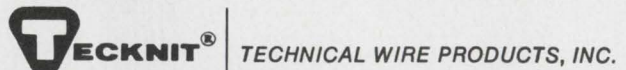

East Division • 129 Dermody St., Cranford, N.J. 07016 (201) 272-5500
West Division • 427 Olive St., Santa Barbara, Calif. 93101 (805) 963-1867

INFORMATION RETRIEVAL NUMBER 139

ELECTRONIC DESIGN 23, November 8, 1970

ROTRON
has the
right angle

for your
critical cooling
problems...

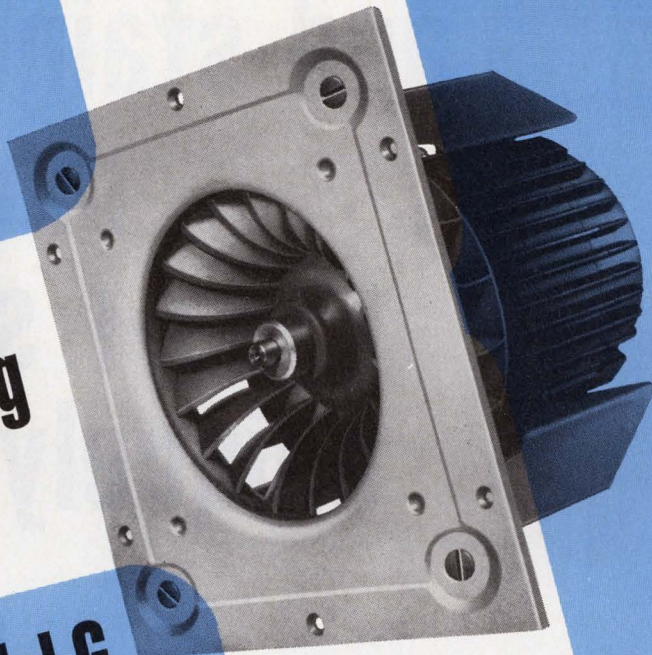

It's our Model G Centraxial Blower

Discharge of air at right angles around the complete periphery of the blower wheel is Rotron's unique solution to difficult applications in which the high pressure of a centrifugal blower is desired, but the concentrated discharge blast is objectionable. These new Centraxial Blowers will supply uniform cooling air in the most out-of-the-way places without the necessity of complicated and costly ductwork. Air flows available from 100 to 400 cfm in a simply installed and extremely compact unit. Available in 50/60 Hz or 400 Hz for single or three phase operation. Other sizes and ranges also available. Send in coupon today for full details or call Rotron, Inc., Woodstock, New York 12498.

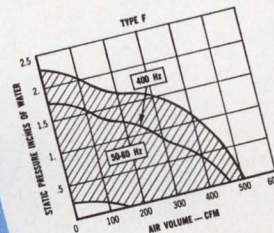

ROTRON, INC. Woodstock, N.Y. 12498
Tell me about the Model G Blower . . .

Name

Title

Company

City

State

Zip

ROTARY SWITCHES

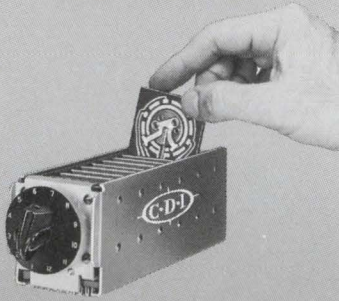

Virtually eliminate down-time—5 second snap-in, snap-out wafer replacement—No disassembly, no wire removal

PUSHBUTTON SWITCHES

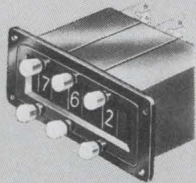

Push one button to add, other to subtract. Retro-fits most thumbwheel panel switch openings. Mount on 1/2 inch centers.

THUMBWHEEL SWITCHES

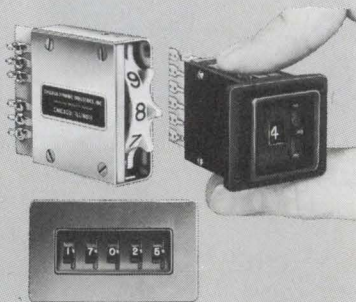

Combine binary and digital wafers. Up to 16 decks operate on one wheel.

precious metals; aluminum; and stainless-steel make C·D·I switches uniquely reliable

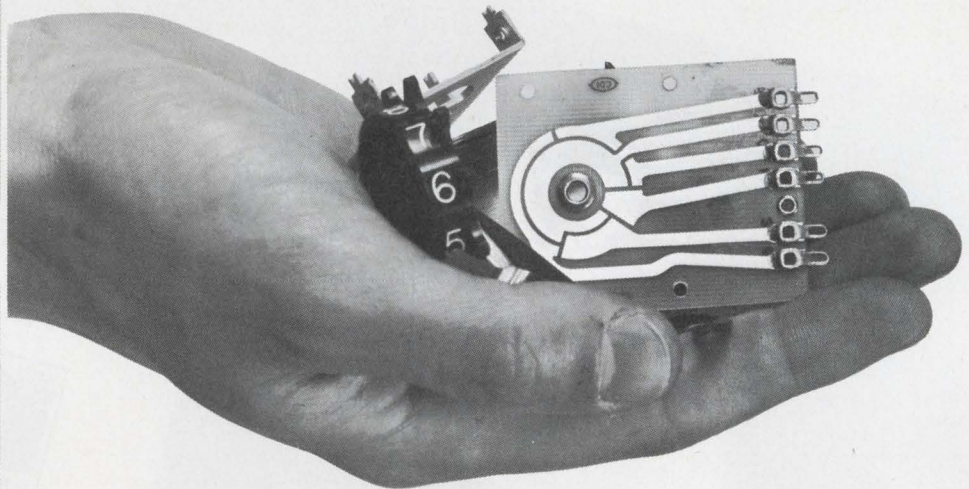

Rhodium-gold printed circuits and precious metal contacts assure high reliability and low contact resistance. Aluminum frames and cases for many applications. Stainless-steel ball and circular spring for a more positive detent. Engraved alpha numerical characters don't rub out—read easier

Mfd. under Tabet U.S. Patents 2,841,660, 2,971,066, 3,015,000, 2,956,131, 2,988,607



CHICAGO DYNAMIC INDUSTRIES, INC.

PRECISION PRODUCTS DIVISION 1725 Diversey Blvd., Chicago, Illinois 60614. Phone 312, 935-4600

Only from Clare... Ultraminiature Picoreed[®] Relays.

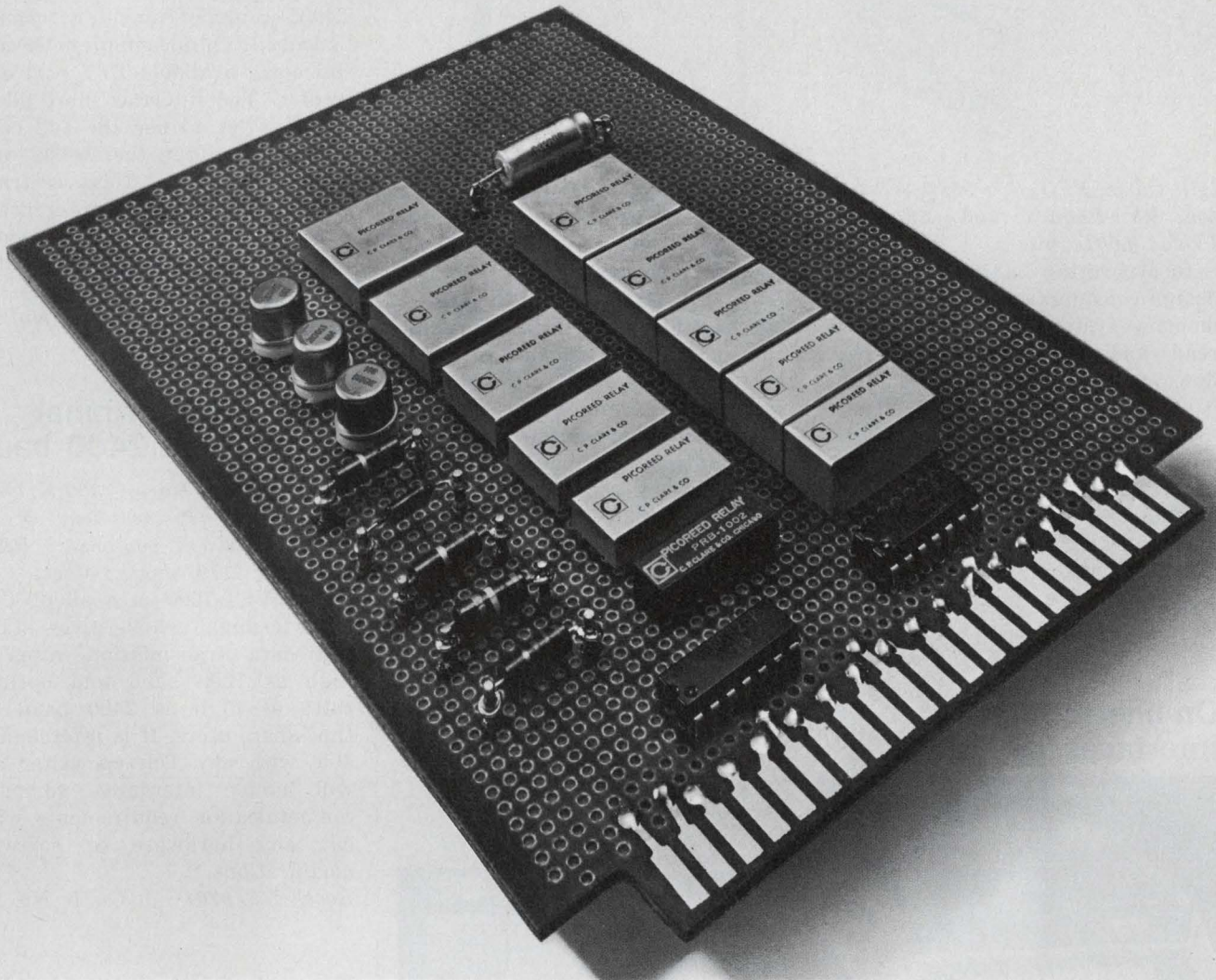

Widest choice of contact configurations. High density packaging. Low profile metal covers. High sensitivity.

Ultraminiature Picoreed relays in a wide range of contact configurations. If you want a 6 form A relay you get just that from Clare—not six 1 form A relays from somebody else.

Need a low profile Picoreed relay? Choose from 1 to 6 form A in our

Type PRB line. They allow 0.375" pc board mounting centers. Need a high sensitivity Picoreed relay? Choose from 1 to 5 form A in our Type PRBH line. They allow 0.500" pc board mounting centers.

Now, observe the performance. Up to 100 million operations at signal levels (5V, 10mA) and 5 million operations at tough 28 Vdc, 125mA loads. Power requirements as low as 50 mW nominal. Fast operate times as low as 500 microseconds including bounce.

One last point: You can order Clare Picoreed relays with electrostatic

shielding. For full information, circle the Reader Service number now. Also available at your nearest Clare distributor. Take your pick.

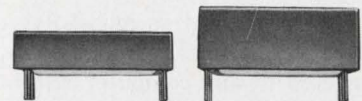

PRB Low Profile: 0.225" high
PRBH High Sensitivity: 0.350" high

And we're delivering now!



C. P. Clare & Co.
Chicago 60645 and worldwide.
A General Instrument company.

Drum-memory system costs only 0.001¢/bit

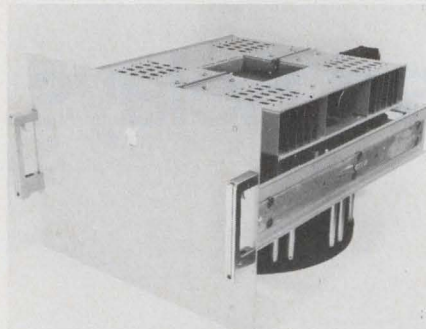

IER Corp., P. O. Box 5537, Arlington, Va. Phone: (703) 527-3400. Price: 0.001¢/bit.

Incorporating unique fail-safe design considerations, a new drum-memory system with high-density read and write features drives down memory costs to as low as 0.001¢/bit. The Series B drum-memory system is available in memory capacities of up to approximately 20 million bits. It is modularized in construction and varies in cost depending on the degree of memory expansion.

Booth No. 1216 Circle No. 260

On-line terminal interfaces IBM 2741



Anderson Jacobson, Inc., 1065 Morse Ave., Sunnyvale, Calif. Phone: (408) 734-4030.

The fourth-generation model 841 on-line conversational terminal can be connected to any computer with IBM 2741 Selectric software. It provides the 2741 keyboard roll-over and space-bar features. Up to 17 characters/s can be handled by the 841 terminal. Off-line, it can perform as a general office typewriter. A telephone-data modem is built-in.

Booth No. 2306 Circle No. 270

Intelligent terminal raises throughput 50%



M&M Computer Industries, Inc., 770 N. Main St., Orange, Calif. Phone: (714) 639-1134. P&A: \$20,900; 30 days.

A 50% increase in throughput can be achieved by the implementation of multileaving hardware and software in a new intelligent remote batch terminal. This development allows simultaneous operation of multiple peripheral devices. Speeds range from 2000 bits/s over dial-up lines to 50 kbits/s broadband with any mixture of device speeds.

Booth No. 1212 Circle No. 305

Remote batch terminal handles magnetic tape



Data Computer Systems, Inc., 17131 Daimler St., Santa Ana, Calif. Phone: (714) 546-7610. Price: \$1295/month.

System CP-4-II-MT is a remote batch communication terminal that offers magnetic-tape capability. It is compatible with both USACII and IBM-2400 formats, and in an off-line mode has a tape-search capability. It can position tape past the tape mark, in either forward or reverse directions, or at the end of or the beginning of the tape.

Booth No. 1301 Circle No. 283

Teletype port unit adapts minicomputers

Tektronix, Inc., P. O. Box 500, Beaverton, Ore. Phone: (503) 644-0161. P&A: from \$750; stock.

A new high-speed Teletype-interface unit interfaces the Tektronix T4002 graphic computer terminal to dedicated minicomputers through commonly available TTY port electronics. The interface unit allows the operator to use the full capabilities of either the T4002 or a Teletype machine. Data is transferred serially by the interface in a full duplex mode at adjustable rates up to 125 kilobaud and it is compatible with USACII code.

Booth No. 2211 Circle No. 256

Silent data terminal transmits at 2400 baud

Video Systems Corp., 7300 N. Crescent Blvd., Pennsauken, N. J. Phone: (609) 665-6688. P&A: \$4990, or \$179/month; stock.

The VST-7000 is a silent CRT data terminal which gives standard data transmission rates as high as 1200 baud and optional rates as high as 2400 baud for time-share users. It is interchangeable with any Teletypewriter and will handle interactive computer communication requirements without any hardware or software modifications.

Booth No. 3701 Circle No. 291

Remote data terminal works on/off-line

Digital Information Systems Corp., P. O. Box 88580, Seattle, Wash. Phone: (206) 228-2526. Price: from \$3000.

A new remote data terminal features complete editing capability: on-line to a computer and off-line for data preparation. It contains a CRT, a keyboard, a controller unit, an MOS TTL memory, a tape and printer ports and a modem. Other features include hard-copy, large local storage with cassette units, and off-line data retrieval using a magnetic tape search feature.

Booth No. 2313 Circle No. 280

How much space can I save by using the new "tini-telephone" jack panels and accessories?

You can figure on a fifty-percent reduction in space by using the Switchcraft "tini-telephone" patching system. And, we do mean system!

These aren't just scaled-down versions of standard-size patching components. The "tini-telephone" jack panels and accessories (see Fig. 1.) were designed from scratch to offer quality and convenience features never before available. (Just circle the reader service number to receive complete information.)

Sounds good, but how about the accessories? I don't want any compatibility problems in matching components from different vendors.

Let's take the accessories one-by-one and you'll see what we mean by "tini-telephone" system:

PATCH CORDS —

Circuit-wise, you can have two or three conductor single plug patch

cords or three or five conductor twin plug patch cords in a variety of cable lengths. The cable is high quality stranded plastic-jacketed type with shielding rated at 70-80%. All connections are soldered, and improved strain relief is accomplished by crimping a long tubular metal sleeve 360° around the cable jacket and plug sleeve.

Flexible, molded PVC handles minimize cable breakage and absorb any tolerance variations between twin plugs and mating panel jacks. Terminating, dummy and looping plugs are also available.

SWITCHES —

A gusseted extra-strength frame is provided on "tini-telephone" switches. Plenty of throw is provided to assure contact wipe and required pressure for low contact resistance. The switches are rated 2 amps 200 watts max., A.C. non-inductive load with circuit configurations up to 2C (or 3A) and momentary or push-pull actuation may be specified.

LAMP JAX —

"tini-telephone" lamp jax accept standard bi-pin lamps and offer convenient front panel relamping. Special heat sink fins dissipate heat and a unique jewel and sleeve

assembly eliminates the need for special insertion or withdrawal tools when relamping. (See Fig. 2.)

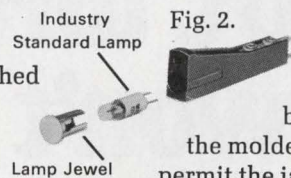

The jack panel, itself, has an extra wide flange for better rigidity and the molded panel inserts permit the jack bushings to

protrude slightly from the panel face for more positive electrical continuity in the sleeve circuit with the mating jack. Then there's the snap-on designation strips and reusable marking strips for fast, frustrationless nomenclature changes. Additional accessories such as, blank panel inserts, opaque-black hole plugs, plus designation strip kits gives you the most versatile, compact patching system ever designed.

Looks like you've thought of everything. I'll need complete specifications for my engineering group.

Just request our "FORUM FACTS" catalog on "tini-telephone" jack panels & accessories on your company letterhead.



5529 North Elston Avenue
Chicago, Illinois 60630

SWITCHCRAFT FORUM

Introducing the new "tini-telephone" patching system

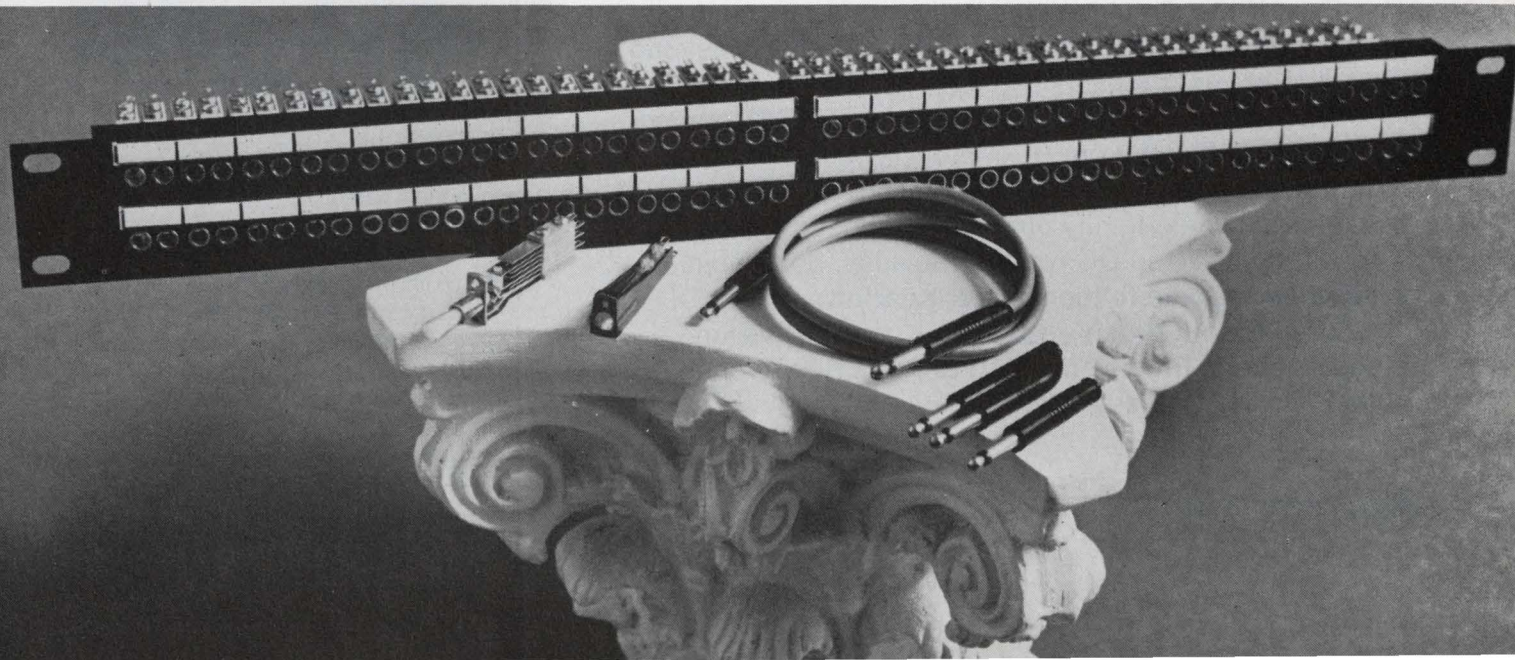

If you overpower our DC torquers you won't overwhelm them.

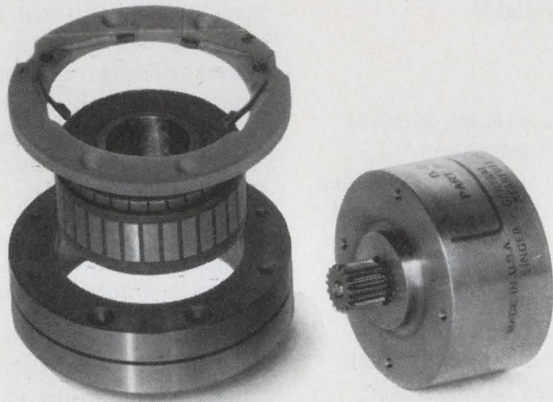

We have a new family of DC torquers—cased and uncased—which can be supplied with almost any feedback elements you might choose. Like potentiometers. Synchros. Tachometers. And more.

For their torque-to-size ratio, these units are as small as you'll find anywhere. But they can take it real big.

Even if you should accidentally give them momentary over voltages of 150%, you won't degrade them beyond their already tight specifications.

We also produce a large range of other DC rotating devices. Size 8 and 9 pm DC motors. Limited rotation DC torquers. Inside out DC torquers. Many types of feedback elements. A whole family of electromagnetic indicators.

When you need DC rotating devices, don't spin your wheels. Come to the source. Kearfott.

Write for our brochures today. Kearfott Division, Singer-General Precision, Inc., 1150 McBride Avenue, Little Falls, New Jersey 07424.

SINGER
KEARFOTT DIVISION

INFORMATION RETRIEVAL NUMBER 144

FJCC PRODUCTS

High-speed data modem works at 2000 bits/s

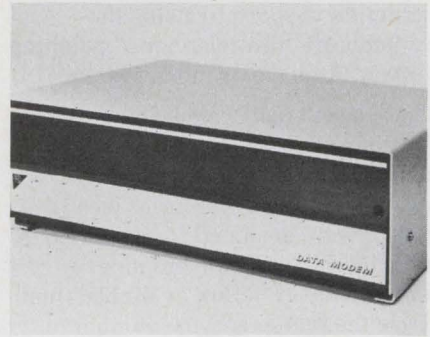

RFL Industries, Inc., Powerville Rd., Boonton, N. J. Phone: (201) 334-3100. P&A: \$2100; 30 to 60 days.

Transmitting and receiving serial binary data over voice bandwidth synchronously, the model 4604 data modem operates at a rate of 2000 bits/second. It is compatible with Western Electric 201A data sets and EIA RS232 specifications. The high-speed is achieved by the use of four-phase differentially coherent modulation. Models include desktop and 19-in. rack-mount versions.

Booth No. 2537 Circle No. 250

Digital recorders boost performances



Mobark Instruments, Inc., 1038 W. Evelyn Ave., Sunnyvale, Calif. Phone: (408) 736-8540. Price: under \$1000 (model 205).

Three new digital recorders feature error-free recordings for high-density applications. The 400T incremental unit offers interchangeable baud rates of 110, 150, and 300. The 205 synchronous unit stores 2 megabits at 500 or 800 bits/in. The 425 incremental block unit block-records 16, 24 or 32 parallel lines at 120 blocks/second, *Booth No. 2131 Circle No. 301*



KEPCO TALKS POWER SUPPLY TECHNOLOGY:

HOW TO TEACH AN ANALOG VOLTAGE, DIGITAL TRICKS

The output of a power supply is an infinite continuum of possible settings limited only by the resolution of the control and your steadiness of hand. To subject such an analog continuum to digital control requires that we divide it into digits of information which can be machine-processed (as opposed to your personal tweaking of a control). The digits must be timed and sequenced correctly—stored if necessary—and then used to select command levels for a programmable power supply.

The device to do all this may take one of several forms. It may be a low level D/A employing semiconductor switching with some sort of capacitive or transformer signal isolation—or it might be a high level D/A, operating at the output voltage level, using mechanical means to switch fixed control resistors.

The first method obtains speed at the expense of resolution and stability. The best semiconductor switches exhibit relatively large "on" resistances and a distinctly noninfinite "off" resistance. Moreover, at low levels, noise limits the resolution. Typically, this type of D/A produces a small (under 10V) analog output that must be amplified in a linear manner by the power supply that it controls, noise and all.

Kepeco has chosen the second method. Cycle times don't break any speed records but are in line with the speed of the fastest programmable power supplies. We use reed relays arranged in decades of four each, controlling precision, wirewound, low TC resistors scaled 8-4-2-1.

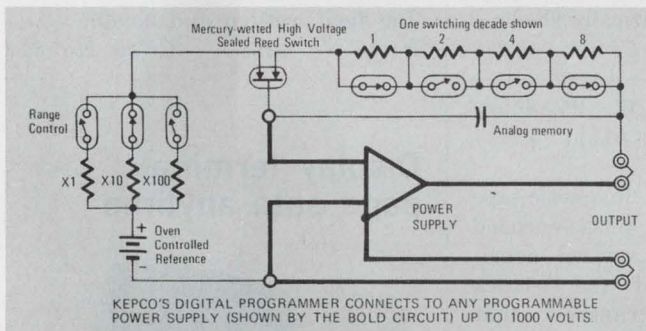

Because the D/A is working right at the output level, controlling voltage 1:1, you can divide voltage into some mighty small pieces. A three-position movable decimal point helps. Model DPD-3, for instance, will control 0-1000.00, 0-100.000 and 10.0000 volts! And, because the reeds firmly connect precision-fixed resistors—with a low "on" resistance—directly to the power supply's control loop, you can leave the setting indefinitely, confident that it will stay right on the nose.

Transients are avoided by a two-stage switching system. A command change is initiated by first opening the mercury-wetted relay to throw the power supply onto an analog memory "hold" capacitor, while the individual decade reed switches open and close in a dry circuit, establishing a new precision command level. The mercury-wetted relay then cycles closed, permitting the supply to slew to its newly established voltage level.

There are seven different D/A's available with separate 3, 4 and 5 digit storage registers, plus a handy keyboard for manual entry. These will teach digital tricks to any of some 102 different programmable power supplies ranging up to 1000 volts.

KEPCO®

For complete specifications
and applications notes,
write Dept. DB-05

KEPCO, INC. • 131-38 SANFORD AVENUE • FLUSHING, N.Y. 11352
(212) 461-7000 • TWX # 710-582-2631

INFORMATION RETRIEVAL NUMBER 145

ELECTRONIC DESIGN 23, November 8, 1970

You say you want a

low-profile snap-in-mounting push button switch or matching indicator that is interchangeable with most 4-lamp displays... available in a full range of cap colors... with a choice of bezels with or without barriers in black, gray, dark gray or white.

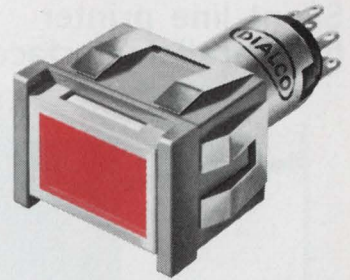

and a

legend presentation that's positive (like this one) or negative (like the one below) or just plain (like the one above)... one that's white when "off" and red, green, yellow (amber), blue or light yellow when "on"... or colored both "on" and "off."

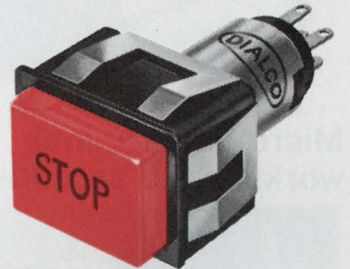

and a

highly reliable switch proven in thousands of installations... available in momentary or alternate action... N.O., N.C. or two circuit (one N.O., one N.C.)... that accommodates a T-1 3/4 bulb with midget flanged base, incandescent, in a range of voltages from 6-28V.

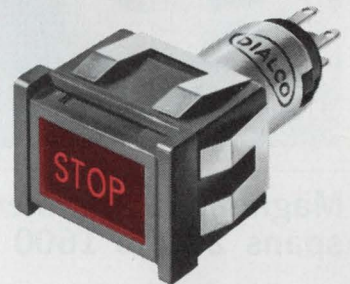

*etc.
etc.
etc.*

Now, for the first time Dialight gives you custom panel designing with a standard line of push-button switches and matching indicators

Dialight offers a broader range of switch and indicator possibilities than you'll find anywhere in a standard single-lamp line. Sizes: 3/4" x 1", 5/8" and 3/4" square and round. Send today for our new catalog.

DIALIGHT

Dialight Corporation, 60 Stewart Ave., Brooklyn, N.Y. 11237

INFORMATION RETRIEVAL NUMBER 146

DT-125

C49

Silent line printer has parallel interface

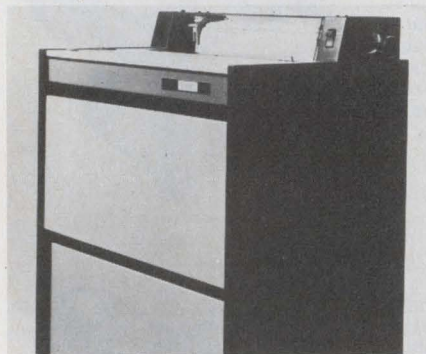

A. B. Dick Co., 5700 W. Touhy Ave., Chicago, Ill. Phone: (312) 763-1900. P&A: \$6990; 30 days.

The new Videojet 9600 printer includes the 9620 parallel interface option for direct compatibility with USASCII data source terminals and minicomputers. The interface uses the set-flag reset-flag concept. When the printer is ready to accept a character, a flag is set. The data source then presents the character to the printer. The printer then resets the flag.

Booth No. 2012 Circle No. 310

Microfilm terminal works in 2.5 seconds



Morgan Information Systems, Inc., 3197 Park Blvd., Palo Alto, Calif. Phone: (415) 327-3991. P&A: \$3750 to \$7000; January, 1971.

Model 200 microfilm retrieval terminal with 45,000 pages of computer print-out on a 100-foot roll of 105-mm microfiche and a coded update roll of 16-mm microfilm locates and displays any image requested in 2.5 seconds. Updated information is automatically shown.

Booth No. 2410 Circle No. 298

Magnetic-tape system spans 200 to 1600 cpi

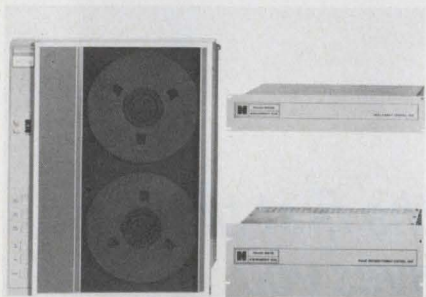

Kennedy Co., 540 W. Woodbury Rd., Altadena, Calif. Phone: (213) 798-0953.

System 8000 is a magnetic-tape system providing phase-encoded tape formats with several densities. It consists of the 7-track model 8107 tape transport that operates at 200/556 or 556/800 characters/in., model 8109 800/1600-characters/in. NRZI phase-encoded 9-track tape transport, model 8208 800-characters/in. NRZI format-control unit and model 8216 format-control unit.

Booth No. 3510 Circle No. 273

Portable CRT terminal interfaces Teletypes



Computer Communications, Inc., 701 W. Manchester Blvd., Inglewood, Calif. Phone: (213) 674-5300.

The Totelcom CC-335 is a self-contained portable CRT-display terminal designed to be completely interchangeable with Teletype models 33 and 35 without using hardware or software. It displays 960 characters and offers format editing, character and line-insertion and deletion capabilities. Transmission rates are 110, 150, 300, 600, or 1200 bits/second.

Booth No. 3108 Circle No. 318

\$995 CRT terminal displays 132 characters



Centronics Data Computer Corp., One Wall St., Hudson, N. H. Phone: (603) 889-6128. Price: \$995.

The model 301 CRT terminal keyboard is a low-cost computer-input device which displays 132 characters and costs only \$995. The displayed characters are formatted in four lines of 33 characters each. Characters are formed by a 5-by-7 dot matrix using a 63-character ASCII code set. Special functions on the terminal include line feed, return and delete.

Booth No. 1308 Circle No. 312

Display terminals page data anytime



Delta Data Systems Corp., Woodhaven Industrial Park, Cornwells Heights, Pa. Phone: (215) 639-9400.

The TelTerm 1 and TelTerm 2 displays feature format, blink and editing capabilities plus a paging feature that allows the user to have any number of lines of data stored at the terminal, and to display at random any 27 lines at a time. This means that as data is rolled up the screen, it is not lost and can be retrieved and viewed at anytime. Options are a cassette recorder and hard copy.

Booth No. 1511 Circle No. 265

**Remex is coming out
of its shell.**



With an economy photoelectric punch tape reader. With a line of tape punches. A magnetic tape cassette series. And this is just the beginning. All the quality that made ours the Grade A name in punch tape reader products--now in a whole line of peripheral equipment.

Welcome to the coming out party!

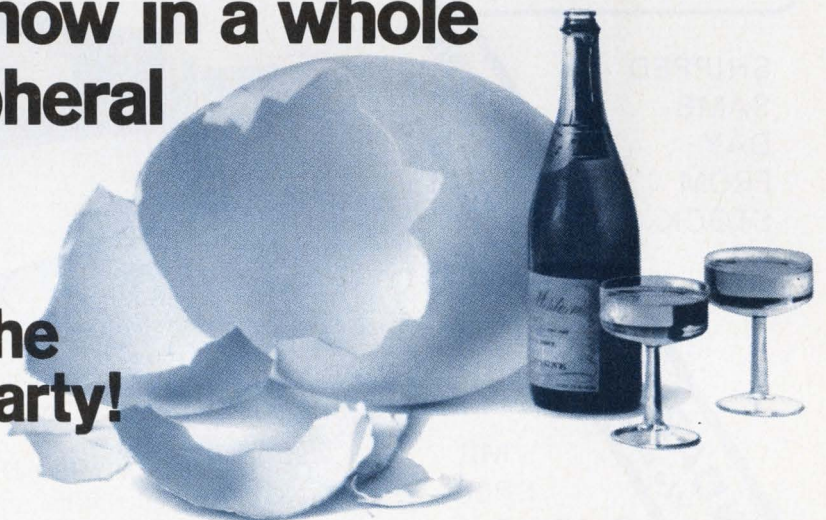

REMEX 5250 W. El Segundo Blvd., Hawthorne, California 90250/See us at the FJCC Booth #2505.



EX-CELL-O CORPORATION

INFORMATION RETRIEVAL NUMBER 147

New Micro-Miniature Form C Reed Relays

Only
.290 OD!

- The First FORM C Micro-Min. Relay Available!
- Measures .435 x .290 OD, only 0.03 cu. in.!
- Min. Overall Length with Bent Leads .600
- High Speed 100 microsec. Operate Time (ex. Bounce)
- Stock Voltages 3, 6, 12 and 24
- Leads or Pins. Also Available with Form A.

Special voltages, resistances, electrostatic and/or magnetic shields available. Write for new Bulletin MR-9.2.



COTO-COIL COMPANY, INC.
59 Pavilion Avenue, Providence, R. I. 02905
Tel: (401) 941-3355

INFORMATION RETRIEVAL NUMBER 148

SPACERS STANDOFFS

SHIPPED
SAME
DAY
FROM
STOCK

STANDARDIZED & CUSTOM
We cross Ref. most MFRS.

MIL
SPEC
PLATING &
MATERIALS

CONCORD
ELECTRONICS CORPORATION

37 GREAT JONES ST. • NEW YORK, N.Y. 10012
(212) 777-6571 TWX 710-581-4930

INFORMATION RETRIEVAL NUMBER 149

C52

FJCC PRODUCTS

Time-sharing system batch-processes too



*Tracor Data Systems, 4201 Ed
Bluestein Blvd., Austin, Tex.
Phone: (512) 926-7770.*

The TDS-1225 time-sharing system operates concurrently in both time-sharing and batch-processing modes. Using a virtual memory concept, FORTRAN programs of 262k words can be executed without segmentation. The memory has 131k words for generated code and 31k words for arrays. A time-sharing EXECUTIVE system simultaneously operates one to 16 local or remote terminals.

Booth No. 2003 Circle No. 268

Graphics plotters print out on microfilm

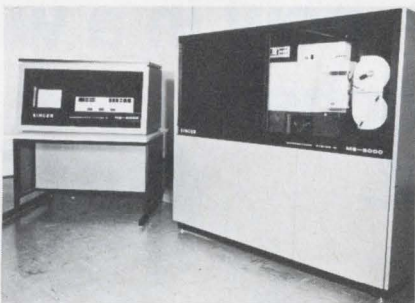

*Singer Micrographic Systems, 1077
E. Arques Ave., Sunnyvale, Calif.
Phone: (408) 732-3800. P&A:
\$135,000 to \$200,000; November,
1970, March, 1971.*

The MS5000 and MS6000 computer-output microfilm printer-plotters are primarily graphics plotters with page-printing capabilities. They convert computer-generated data into alphanumeric characters or graphical plots, display them on a CRT and record them on microfilm. Input data can be from a tape transport or from a computer.

Booth No. 1435 Circle No. 258

Digital cassette system records parallel data



*International Computer Products,
Inc., P.O. Box 34484, Dallas, Tex.
Phone: (214) 239-5381. P&A:
\$1790 to \$2690; 30 days.*

The Keycette is a digital recording system utilizing a parallel buffer memory with incremental characteristics to record up to 700 101-character blocks on a single tape cassette. In the record mode, data from the input device is coupled to the Keycette via interface boards. Two forms of editing are provided: by character and line editing.

Booth No. 1512 Circle No. 263

Remote-entry system rents for \$854/month



*Compat Corp., 177 Cantiague Rock
Rd., Westbury, N. Y. Phone: (516)
822-1320. Price \$854/month.*

A complete new remote-entry system is now available at a monthly rental (including maintenance) of only \$854. Elements of the system are the Comfile 88-23 computing terminal, the Comfile 88-130 card reader, the Comfile 88-120 line printer and a proprietary software that allows the Comfile 88-23 to emulate an IBM 2780. The Comfile 88-23 has a random-access-storage 4k x 16-bit computer.

Booth No. 3702 Circle No. 259

Check the price of our sophisticated new 1150 photoelectric punch tape reader. Cheep. Cheep.

Here's a photoelectric reader and reader/spooler series for the price of the low-cost high-speed mechanical units now on the market. It's the Remex 1150. For applications that need the accuracy of photoelectric reading.

This new series reads 150 characters per second with a hybridized read station. Illumination is by an extra long life prestressed filament lamp. The low inertial stepping motor/sprocket wheel drive responds rapidly for bidirectional reading. A fully proportional servo con-

trols up to 8½-inch reels, which handle up to 1000 feet of 3.4-mill tape. The unit's integrated circuits are TTL, DTL, and RTL compatible.

And it's quiet.

You knew Remex when all we did was make the best punch tape reader products in the business: our high-speed 3000/4001 series.

We're not changing that.

But now we're leaving our shell to put that kind of quality into a whole new line of peripheral data processing equipment

you'll be hearing more and more about.

What better breakthrough than this economy reader/spooler with Remex quality.

We think technical sophistication for the price of a mechanical unit makes the 1150 more than a good buy. It's cheap.

Buy more than one.

They're even cheaper by the dozen. 5250 W. El Segundo Blvd., Hawthorne, Calif. 90250. In Europe and the U.K., contact S.p.A. Microtecnica, Torino, Italy.

REMEX IS COMING OUT OF ITS SHELL.

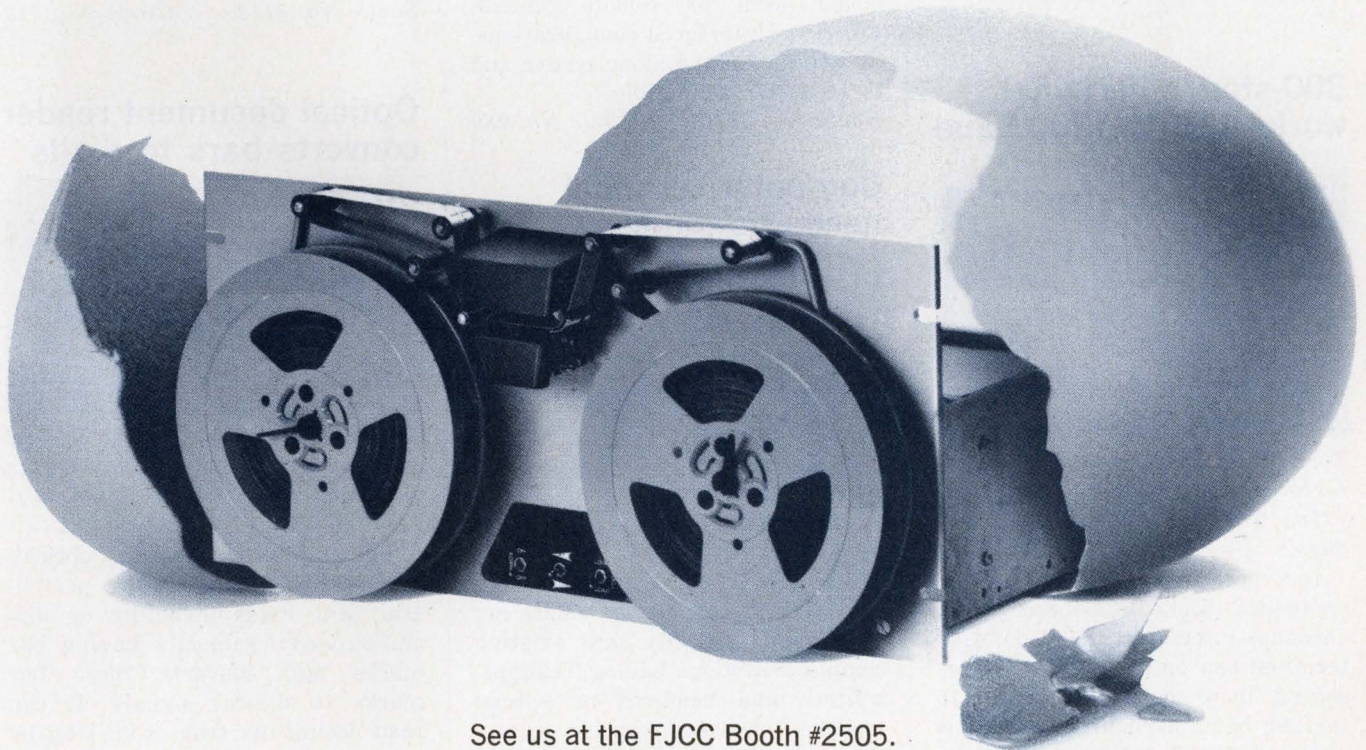

See us at the FJCC Booth #2505.

A UNIT OF



EX-CELL-O CORPORATION

INFORMATION RETRIEVAL NUMBER 150

4-kbit memory modules access in just 15 ns

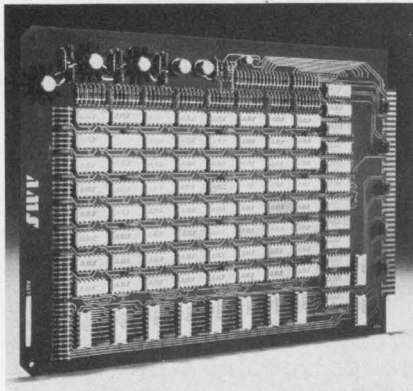

Advanced Memory Systems, Inc., 1276 Hammerwood Ave., Sunnyvale, Calif. Phone: (408) 734-4330. P&A: \$4900; 4 to 6 wks.

Two new modular read/write memories on PC cards, organized as 4k words by 1 bit and 512 words by 8 bits, respectively, feature an access time of 15 ns. Both cards are ECL-compatible and dissipate only 9 mW of power. Heart of the new memory modules are the 0641 64-bit 7-ns memory devices and a storage support circuit.

Booth No. 2812 Circle No. 314

300-step/s terminal works 110 to 1200 baud



Technical Concepts, Inc., 580 Jefferson, St., Rochester, N. Y. Phone: (716) 271-7953. P&A: \$1650; 30 days.

Incorporating both low-speed incremental and high-speed asynchronous interfaces, the model 4100 terminal can operate at 300 steps/second, incrementally, or from 110 to 1200 baud, asynchronously. It is compatible with RS-232B and Teletype equipment and can function as stand-alone batch-processing unit, as a store-and-forward unit and as a minicomputer memory.

Booth No. 1715 Circle No. 252

Voice-response system has 2k word vocabulary



Periphonics Corp., Route 25A, Rocky Point, N. Y. Phone: (516) 744-8578. P&A: \$27,000 or \$927/month; January, 1971.

Using words stored in analog form on a high-speed random-access dish, the Voicepac 2000 audio-response system allows the user to program up to 2000 words into the system and change its vocabulary at any time. It is designed for either local or remote central-processor interfaced configurations, as well as a stand-alone system and is IBM-360 compatible.

Booth No. 3310 Circle No. 289

Computer terminal needs no modems



Electronic Arrays, Inc., Systems Div., 9060 Winnetka Ave., Northridge, Calif. Phone: (213) 882-9610.

The new CT-100 computer terminal is a low-cost device which can be plugged directly into existing computer systems having Teletype-writers and requires no special modems or voice-response equipment. Fixed and variable alphanumeric information can be entered into it and printed out of it simultaneously. It can communicate in ASCII code.

Booth No. 1427 Circle No. 292

Speedy tape transports span 75 to 130 in./s

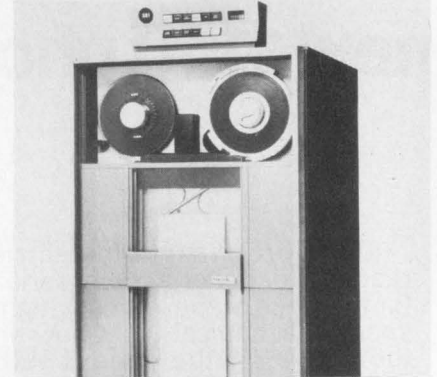

Bucode, Inc., 175 Engineers Rd., Hauppauge, N. Y. Phone: (516) 273-2100. P&A: \$9000 to \$13,000; 60 days.

Two new magnetic-tape transports, models 20291 and 20292, are automatic-loading high-speed drives that operate at speeds of 75 to 120 in./s and 120 to 200 in./s, respectively. Available with read/write electronics for 800-bits/in. NRZI, 1600-bits/in. phase-encoded and dual-density recordings, they transfer data to 180 kHz and 320 kHz, respectively.

Booth No. 2113 Circle No. 313

Optical document reader converts bars to digits

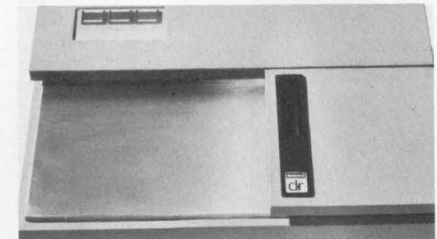

Digital Resources Corp., Hybrid Systems Div., 4301 Dacoma Rd., Houston, Tex. Phone: (713) 681-3581.

The Dataterm-3 is an optical-mark-reading data-capture peripheral that reads manually or machine-coded documents having bar marks and converts these bar marks to digital signals. It can read documents from 8-in. long by 6-in. wide to 18-in. long by 12-in. wide at preselected speeds between 1 and 20 in./s. Manual or automatic (optional) document feeding is available.

Booth No. 1107 Circle No. 264

There are 379 different uses for resealable Zip-lip[®] bags.

Recloseable. Reuseable.

So your customer is reminded of you
over and over and over again. Every
time he reuses his Zip-lip bag.

And a Zip-lip bag is so easy to use.

Simply run your fingers across
the grooves on the top. We know
of 379 uses for our groovy
little bag. With just a little
thought, you might think of use
number 380. Something to do with
electronics, maybe?

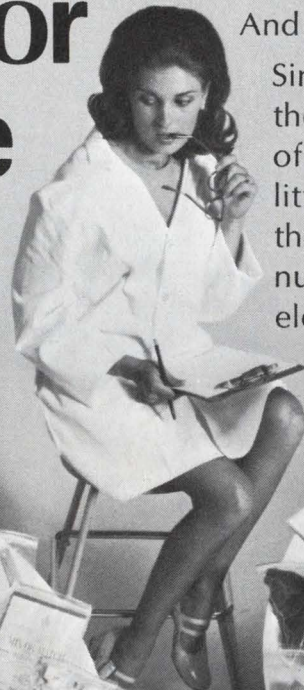

K C L

CORPORATION

5011 PROSPECT AVENUE
SHELBYVILLE, INDIANA

INFORMATION RETRIEVAL NUMBER 151

ON THE MOST WANTED LIST

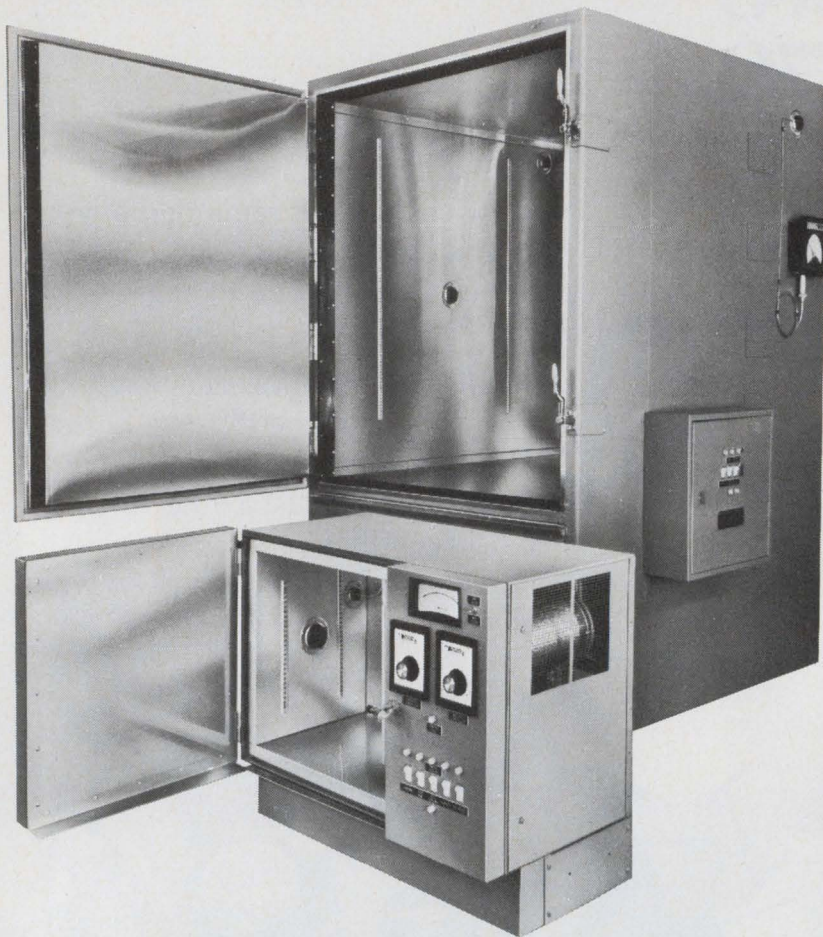

ALIAS MINI & MAXI

Real names: **TH-Jr. and TH-65**. Smallest and largest members of the "Tenney Gang" of reach-in, temperature-humidity chambers. Easily identified by the Tenney Vapor-Flo® humidity generation system and the fully hermetic, all-welded Hermeticool® refrigeration system.

Known to cover a temperature range of 0°F to 200°F and a humidity range of 20% to 95% RH. Noted for responsive performance. Praised for ease of operation and high reliability.

Can be found serving in evaluation or manufacturing of products sensitive to temperature and humidity environments. For details on Mini, Maxi and all the Gang in-between, call or write today:

Tenney
ENGINEERING, INC.

1090 Springfield Rd., Union, New Jersey 07083 • (201) 686-7870
Western Division: 15721 Texaco St., Paramount, Calif. 90723



FJCC PRODUCTS

On-line disc drive handles 58 megabytes

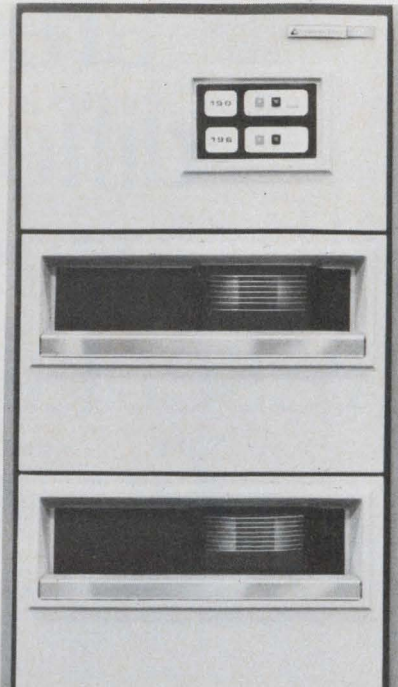

California Computer Products, Inc., 2411 W. La Palma Ave., Anaheim, Calif. Phone: (714) 821-2541.

The CD-22 disc drive, an alternative replacement of the IBM 2314, can handle random-access storage of up to 58 million bytes. Along with the CD-14 controller, it can replace the entire IBM 2314 and is ready to go on-line as soon as it is plugged into the system. It is made up to two CD-12 disc drives in separate drawers, each being functionally independent.

Booth No. 3014 Circle No. 278

Magnetic-tape unit does many functions

Tennecomp Systems, Inc., 795 Oak Ridge Turnpike, Oak Ridge, Tenn. Phone: (615) 482-3491. P&A: \$3590; November, 1970.

Developed for mini and mid-computers, the TP-1372 DoubleDek cartridge-loaded magnetic-tape unit performs timing, byte assembly and motion delays by means of self-contained logic circuits. The transport mechanism is retained, and, in addition, automatic track-select, dual-transport capability and phase-encoding are standard features.

Booth No. 3640 Circle No. 296

Thermostats in any shape.



H. A. Wilson thormostatic bi-metals are being used in literally thousands of different configurations.

The many varieties of thermometal available, coupled with Engelhard's engineering expertise and experience in customer applications makes the uses of these metals almost limitless.

These metals change shape with temperature and, when constrained, build up force with temperature change. They can be rolled to any thickness, formed into almost any shape, plated, brazed or welded.

Our engineering know-how and manufacturing facilities surpass those of anyone in the field. For information and/or technical assistance call or write the H. A. Wilson Technical Service Department (201) 686-6600.

ENGELHARD

ENGELHARD INDUSTRIES DIVISION
ENGELHARD MINERALS & CHEMICALS CORPORATION
2655 U. S. ROUTE 22, UNION, NEW JERSEY 07083

An Equal Opportunity Employer

191

INFORMATION RETRIEVAL NUMBER 153

COMPLETE PACKAGING CAPABILITY

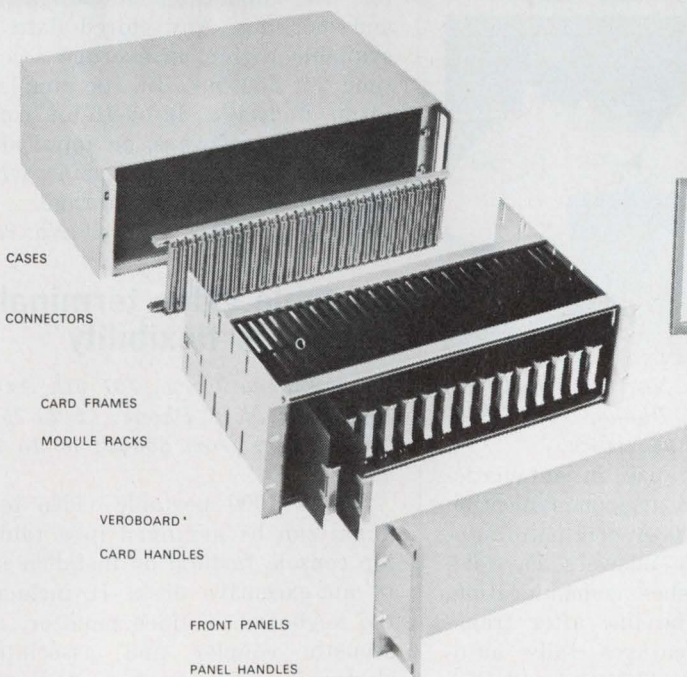

CASES

CONNECTORS

CARD FRAMES

MODULE RACKS

VEROBOARD*

CARD HANDLES

FRONT PANELS

PANEL HANDLES

D SERIES VEROCASE

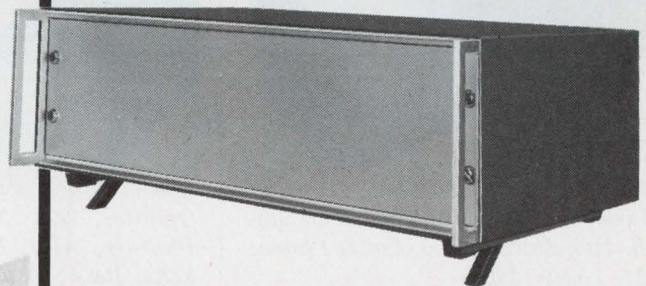

NEW modern, low profile instrument cases in ALL STANDARD PANEL HEIGHTS from 1 $\frac{3}{4}$ " to 10 $\frac{1}{2}$ ". Cases are 12 $\frac{1}{2}$ " deep and only $\frac{3}{4}$ " higher than standard panels. They feature removable louvered bottom and rear panels, tilt-up feet and have a textured vinyl finish. All models are available FROM STOCK with or without handles.

vero

VERO ELECTRONICS INC. TWX 510-224-6425
176 CENTRAL AVE., FARMINGDALE, N. Y. 11735 TEL: 516 MY 4-6550

INFORMATION RETRIEVAL NUMBER 154

High-speed microfilmer prints-on alphanumerics



Peripheral Technology Inc., 757 N. Pastoria Ave., Sunnyvale, Calif. Phone: (408) 732-4940. Price: \$46,950 (on-line), \$59,750 (off-line).

With the use of an integral tape drive, a CRT and a camera, the PTI-2600 computer-output microfilmer takes computer-compatible magnetic print tapes and prints alphanumeric information onto microfilm at a rate of 26,000 lines/minute. Its integral tape drive accepts 9 and 7-track tape at densities of 556, 800 and 1600 bits/in. *Booth No. 2137 Circle No. 311*

Disc storage system accesses in 30 ns

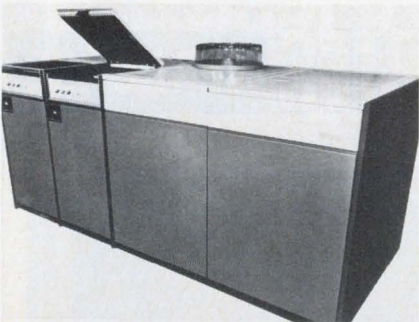

Marshall Data Systems, Div. of Marshall Industries, 2065 Huntington Dr., San Marino, Calif. Phone: (213) 684-1530.

The M2800 disc storage system, a plug-for-plug replacement of the IBM 2314, features average and maximum access times of 30 and 60 ns, respectively. Stop and up times are 12 seconds each. Options include a dual mode controller for simultaneous operation of the M2500 disc drives and M2700 disc-drive modules. Record overflow and file scan features are standard. *Booth No. 3222 Circle No. 275*

Disc memory line stores 1.5 megabits

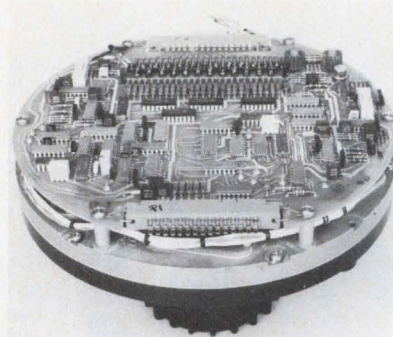

Singer Co., Librascope Div., 1100 Francis Court, Glendale, Calif. Phone: (213) 245-8591. P&A: \$2750, \$3150, \$3530, \$4350; 90 days.

The L107 disc memory line features four storage capacities of: 0.5, 0.75, 1 and 1.5 Megabits, each in the same 9 by 9 by 6-in. size. All memories have identical electronic and mechanical interfaces. The electronics are on a single PC board and include read, write, head-select and clock electronics. Interface signals are TTL NRZ. *Booth No. 2216 Circle No. 279.*

Communications coupler works automatically



Omnitec, 903 North Second St., Phoenix, Ariz. Phone: (602) 258-8264. P&A: \$495; stock.

Suitable for use in automatic-polling or message-communication systems, the 703A originate/auto-answer coupler answers the telephone, establishes communication, and releases the line after transmission. It features fully automatic operation, Teletype and EIA standard RS232 terminal interfacing and half and full duplex modes of operation. *Booth No. 1603 Circle No. 316*

9216-bit serial memory accesses in 0.3 ms

Electronic Arrays, Inc., Systems Div., 9060 Winnetka Ave., Northridge, Calif. Phone: (213) 882-9610.

Called the Mostor 100, a new serial memory for highly sequential memory applications is configured as 1024 by 8 or 9 bits and has a sequential access time of 0.3 ms. It can also be used as a non-synchronous random-access read-write memory in system applications where a relatively slow access time is acceptable. Packaged on a single PC board, it uses a 512-bit dynamic MOS shift register as the basic storage element and is DTL and TTL compatible. *Booth No. 1427 Circle No. 288*

Computer terminal ups capabilities

Compat Corp., 177 Cantiague Rock Rd., Westbury, N. Y. Phone: (516) 822-1320. P&A: \$17,200 or \$500/month; 90 days.

Comfile 88-33 is a multi-capability disc-type computer-terminal system with four independent files of 72,000 characters each available for file updating, interrogating and merging. Any stored data is available within an average access time of 350 ms. In its simplest form, it has a 4k-by-16-bit computer with software, an input station and one tape magazine with 64,000 characters of storage. *Booth No. 3702 Circle No. 257*

Portable video terminal enhances flexibility

Community Corp., 767 5th Ave., New York, N. Y. Phone: (212) 758-4230. P&A: from \$3350; 60 to 75 days.

Series 1000 portable video terminal can be arranged in a table-top console fashion or installed into an executive desk. It includes the keyboard, a video monitor, an acoustic coupler and associated electronics. The entire terminal (less monitor) can also be carried anywhere like an attache case, for use with a home TV and telephone. *Booth No. 1333 Circle No. 251*

If you have problems to solve, these days you need all the help you can get. That's where we come in. We make tools that extend your capabilities. And once you have our tools we give you all the support you need to use them efficiently.

We make three different calculating systems and a time-sharing mini-computer. The one thing they all share is versatility. For instance any calculator we make is capable of doing very sophisticated scientific work but it will also work for a business man, to accommodate the merger of science and business. A lot of things come up during the technical man's day that have to do with dollars and cents.

Every system we make has the added versatility that it can be programmed and will keep records in numeric or graphic

form. The important thing is you can have as little or as much as you want. When you want it.

We had to think of everything. Because you never know what you'll be thinking of.

For information on any Wang system, call Mr. Courtney collect (617) 851-7211. Wang Laboratories, Inc., Dept. ED-11, 836 North Street, Tewksbury, Massachusetts 01876.

Thinking tools.



WANG

164-kbit wire memory accesses in 200 ns

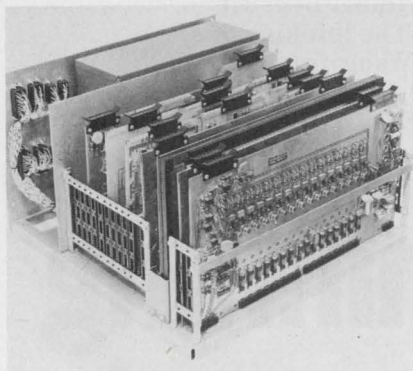

Nemomic Data Systems, Inc., 1301 W. Third Ave., Denver, Colo. Phone: (303) 892-7012. Price: from 3.7¢ to 11¢/bit.

Using a storage element of magnetic thin film plated on 0.005-in.-dia wire, the NM-1000 series random-access, read/write non-destructive-readout memory has an access time of 200 ns, read time of 300 ns, and write time of 500 ns. Maximum memory capacity is 163,840 bits. Because of its modularity it can be configured into 4k to 16k words by 8 to 40 bits/word.

Booth No. 2225 Circle No. 304

Mainframe wire memory reads/writes in 300 ns

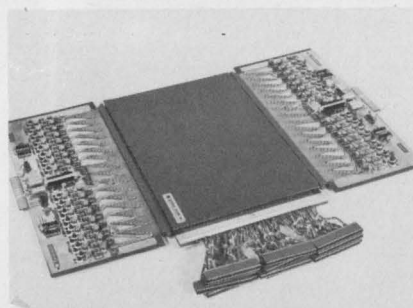

Memory Systems, Inc., 3341 W. El Segundo Blvd., Hawthorne, Calif. Phone: (213) 772-4220. P&A: 3-1/2¢ per bit; January, 1971.

A new mainframe plated-wire memory of 4 k × 72 bits, factorable as 8 k × 36, 16 k × 18 and 32 k × 9 bits, features 300-ns non-destructive-read and write cycles and accesses in 150 ns. The complete system, which includes all drivers, sense amplifiers, timing and control and interface circuits costs 3-1/2¢ per bit. Power consumption is only 0.3 mW/bit.

Booth No. 1234 Circle No. 271

Fast drum line printer raps out 1800 lines/min

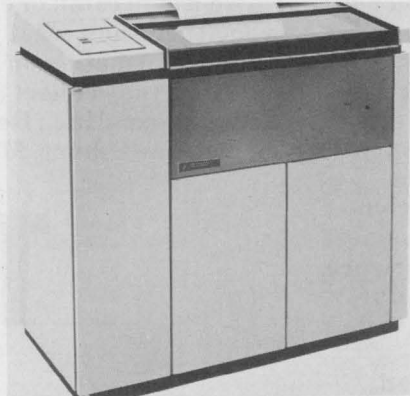

Data Products Corp., 6219 DeSoto Ave., Woodland Hills, Calif. Phone: (213) 887-8246. P&A: \$13,000; 1st quarter, 1971.

The 2470 is a high-speed drum line printer that can print a standard 132 columns at 1800 lines/minute with a 36-character set. It utilizes a patented hammer mechanism and has integrated circuitry throughout. The new printer can also be easily programmed to perform optical character recognition printing at reduced speeds.

Booth No. 1014 Circle No. 297

Optical mark reader scans 3600 copies/h

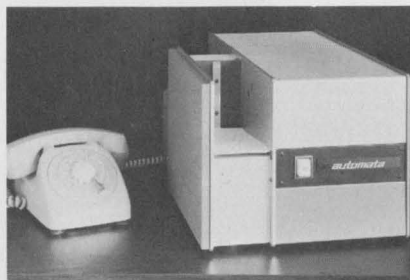

Automata Corp., 1305 Mansfield Ave., Richland, Wash. Phone: (509) 946-5195. P&A: \$1000; 60 days.

A new optical mark reader reads pencil-marked, preprinted, or key-punched source documents at a controlled rate of 3600 documents/h. The 3600 presents data at an output jack in TTL/DTL compatible forms, formatted to customer request. It features unique variable-length card feed, optical compensating electronics, remote feed inhibit, and consists of only 3 moving parts.

Booth No. 2212 Circle No. 294

High-capacity terminal gives 1600 characters



Computer Terminal Corp., 9725 Datapoint Dr., San Antonio, Tex. Phone: (512) 696-4520. P&A: \$103/month; 30 to 60 days.

Designed for information-retrieval and display service, the Datapoint 3360 terminal, can accommodate up to 80 lines of data at 20 characters/line for a display capacity of 1600 characters. It interfaces directly with IBM 360 systems and is fully compatible with standard OS and DOS configurations. The 3360 is equipped with a buffering unit.

Booth No. 1001 Circle No. 293

16-kbit core memory cycles in 1 μs

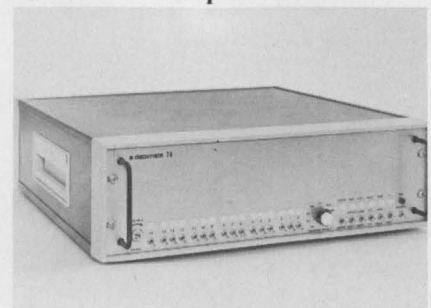

Datamate Computer Systems, Inc., P. O. Box 310, Big Spring, Texas. Phone: (915) 267-6353.

Neatly packaged with its power supply into a box occupying 5-1/4-in. of 19-in. rack space, series 70 16-kbit core memory has a 1-μs cycle time. Its features include multi-register architecture with four 16-bit accumulators, two of which are available as index registers, 800-ns processor cycle time, priority interrupt, direct memory-access channel and power fail-safe standard.

Booth No. 3708 Circle No. 315

Your competitor may be among them.

That's where we're first showing the new CIP/4000 in action.

A computer that *almost* won't let you make a mistake.

A computer that has 30% of its programming done at the factory.

A computer that checks itself and you all the time.

A computer that keeps on

working under the worst possible industrial conditions.

And a computer that was designed from the beginning as a real-time controller.

Come and see how it works.

Or write Cincinnati Milacron, Dept. R-54, Lebanon, Ohio 45036.

For immediate action, call (513) 494-5444.

The CIP/4000 at Booth 2710 FJCC.

Some people won't let anything stop them from getting to Booth 2710 at the FJCC.

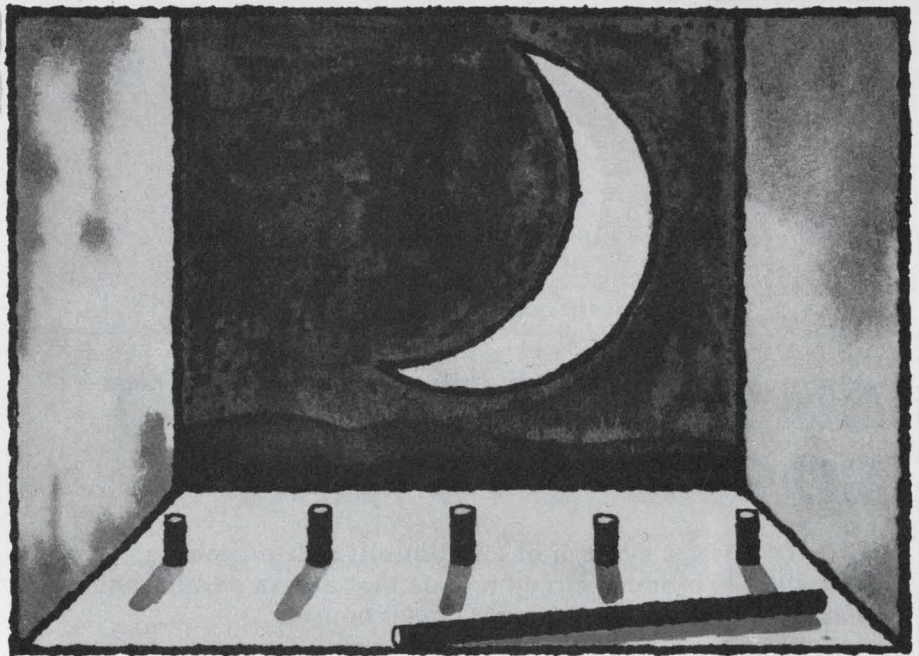

**CINCINNATI
MILACRON**

Machine Tools
Process Controls
Chemicals
Plastics
Plastics Processing Machinery
Abrasives

INFORMATION RETRIEVAL NUMBER 156

Ferrite Shielded Air Core Yoke C5380. Designed for high speed precision character displays (nanosecond writing speeds). Undesirable magnetic coupling and stray fields eliminated by unique shield design.



DESIGN DEVELOPMENT FROM *syntronic* THE YOKE SPECIALISTS

Syntronic engineers and manufactures the most extensive line of deflection yokes available . . . and continually develops new designs to satisfy the ever increasing requirements of the display industry. For large production or custom applications get the engineering control and production experience that only SYNTRONIC, the yoke specialists, can provide.



syntronic INSTRUMENTS, INC.
100 Industrial Rd., Addison, Ill. 60101
phone 312-543-6444

INFORMATION RETRIEVAL NUMBER 157

AN INSTANT CIRCUIT BOARD^(TM) SYSTEM!

CIRCUIT-STIK'S system of component sub-elements and materials produce circuit boards that are as durable and reliable as conventional printed circuit boards.

CIRCUIT-STIK ELIMINATES: design • drilling • art work • photo work • etching

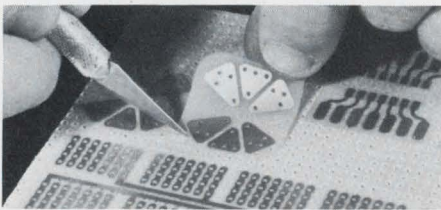

CIRCUIT-STIK sub-elements are pressure sensitive and offer exceptionally good adhesion strength, withstands soldering temperatures and yet may be removed for easy circuit design modifications.

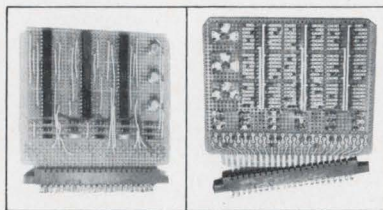

All types of circuit-element configurations may be mixed and combined on the same board.
SEND FOR YOUR FREE CATALOG AND SAMPLES.

CIRCUIT-STIK'S EVALUATION KIT FOR LARGE SYSTEMS APPLICATIONS
PART #8951-N, \$110.00 VALUE FOR \$89.50 (Plus \$1.00 shipping per kit).

circuit-stik^{INC.} PATENT PENDING

1518 W. 132nd ST., GARDENA, CALIFORNIA 90249

INFORMATION RETRIEVAL NUMBER 158

Advertisers' Index

| Advertiser | Page |
|--|----------|
| Automatic Business Systems..... | C37 |
| Bodine Electric Company | C23 |
| Buckbee Mears Company | C26 |
| Burndy Corporation | C35 |
| Chicago Dynamics Industries, Inc..... | C44 |
| Cincinnati Milacron, Inc. | C61 |
| Circuit Stik, Inc. | C62 |
| Clare & Co., C. P. | C45 |
| Clare-Pendar | C20 |
| Concord Electronics Corporation | C52 |
| Coto Coil Company, Inc. | C52 |
| Dialight Corporation | C49 |
| Engelhard Industries Division | C57 |
| Grant Pulley & Hardware Corporation | C41 |
| Hewlett-Packard | C12, C13 |
| International Communications Corporation | C2 |
| KCL Corporation | C55 |
| Kepeco, Inc. | C49 |
| Magnecraft Electric Company | C36 |
| Magnetics, A Division of Spang Industries, Inc. | C32, C33 |
| Malco Mfg. Company, Inc. | C40 |
| Monroe, The Calculator Company.... | C25 |
| Remex Electronics Division of Ex-Cello Corporation...C42, C51, C53 | |
| Ripley Company, Inc. | C63 |
| Rogers Corporation | C39 |
| Rotron, Incorporated | C43 |
| Servo Tek Products Company | C34 |
| Singer Company, The, Diehl Division | C29 |
| Singer-General Precision, Inc. Kearfott Division | C48 |
| Switchcraft, Inc. | C47 |
| Syntronic Instruments, Inc. | C62 |
| Technical Wire Products, Inc. | C42 |
| Tektronix, Inc. | C31 |
| Teletype Corporation | C18, C19 |
| Tenney Engineering, Inc. | C56 |
| Trio Laboratories, Inc. | C64 |
| Vero Electronics, Inc. | C57 |
| Wang Laboratories, Inc. | C59 |

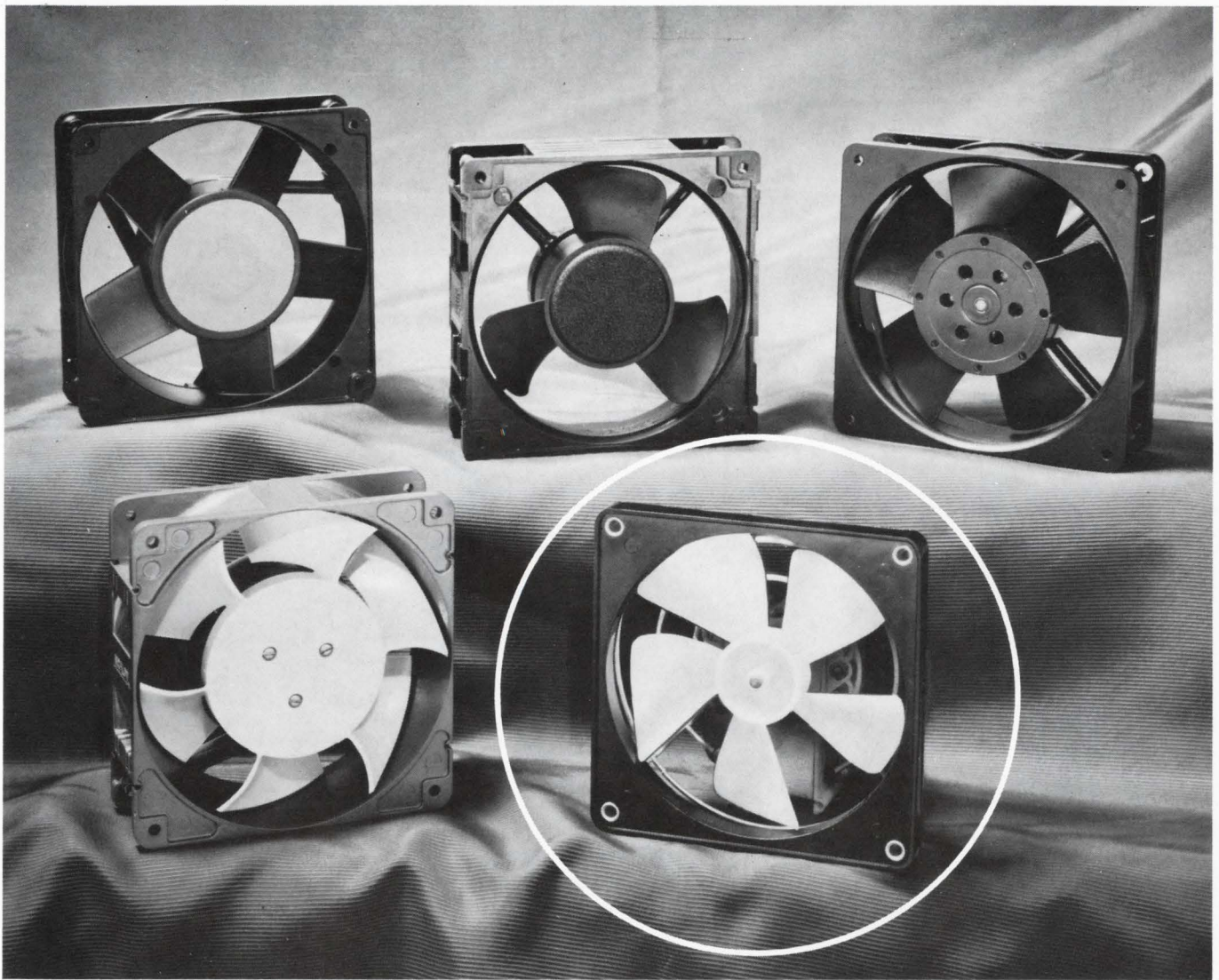

Why buy the \$8⁹⁰ Fan when a \$5⁹⁸ Fan will do—

...and move as much air in the bargain!

Check this comparison: The Ripley SK-4251 axial fan provides 115 cfm air delivery vs. the same with Brand X. The Ripley model has a rugged 4 $\frac{1}{16}$ " square frame just like Brand X, however, our depth is 3 $\frac{1}{16}$ "—now, if this little extra measure doesn't interfere with your application plans you're in for real savings—Because, what's really nice about the Ripley SK-4251 is the price. About \$5.98* vs. \$8.90*—a saving of more than 30% with as much air delivery to boot!

Then, too, there's the 5-year guarantee on every unit backed by a company with over 25 years of experience and ability to design reliability into a product without letting costs run wild.

If you're interested in saving money—send for the facts.

* Prices based on quantities of 250 or more.



RIPLEY COMPANY, INC./MIDDLETOWN, CONN. 06457

INFORMATION RETRIEVAL NUMBER 159

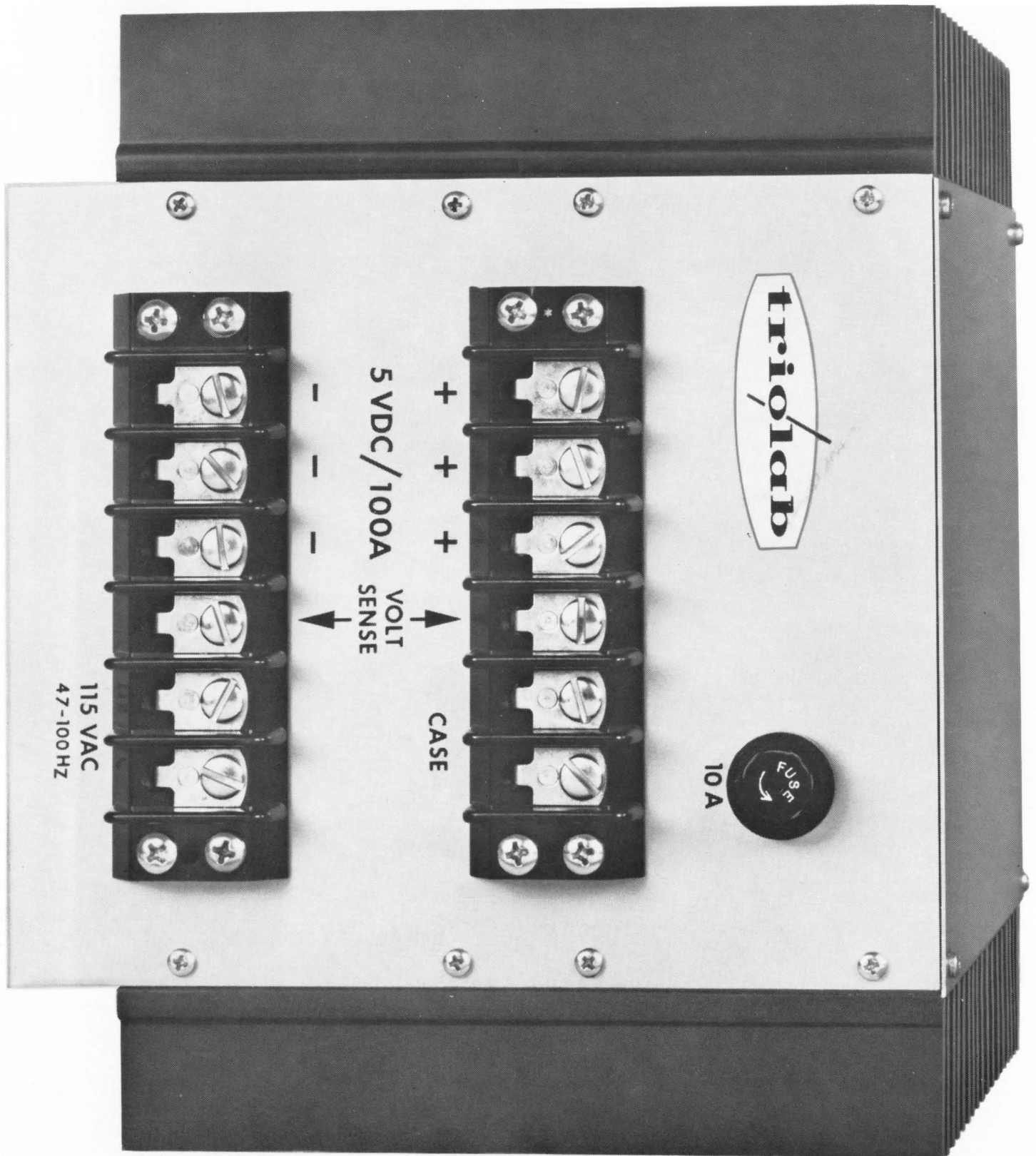

Shown actual size. 5VDC/100A power supply. Off-the-shelf.

The world's smallest 5VDC / 100AMP supply gives you:

- Volume under 500 cubic inches!
8½" x 6¾" x 8½"
- Lightweight. Less than 20 pounds.
- High Efficiency. 65% for all load conditions.
- Cool Operation. No forced air or external cooling for full rated output to 55°C.
- Low Cost. Priced lower than the large brute force supplies.

If our 500 watt supply overpowers your requirement,

let us talk with you about our complete line of off-the-shelf 100 watt supplies, which offer you the same advantages as above: small size, lightweight, high efficiency, cool operation, low cost.

They come in single, dual, and triple outputs with voltages from 5VDC to 30VDC. Commercial, Military, and European models available.

Contact: **Trio Laboratories, Inc.**

80 Dupont Street, Plainview, L. I., N. Y. 11803
Tel: (516) 681-0400 TWX: (510) 221-1861

Visit our FJCC Booth 3717

Practical design tools in the Hayden Series in Materials for Electrical and Electronics Design

MATERIALS FOR STRUCTURAL AND MECHANICAL FUNCTIONS

GABOR KOVES, Manager, Mechanical Technology
International Business Machines General Systems Division

A significant breakthrough in technical literature, this volume offers definitive guidance for those who design hardware for electrical and electronic equipment. First providing an overview of materials structure, properties, fabrication, and test methods, the book then focuses on functional applications.

Tables of essential data, screened for reliability, highlight discussion and guide the design engineer in the practical selection of materials to perform a specific function. Further technological advances are anticipated by discussions of materials and processes soon to be utilized for optimum results. The book includes over 200 pertinent tables and illustrations, plus complete end-of-chapter bibliographies. **368 pages, 6 x 9, illustrated, clothbound, #5637, \$13.95**

MATERIALS FOR CONDUCTIVE AND RESISTIVE FUNCTIONS

G. W. A. DUMMER, Formerly Superintendent Applied Physics,
Royal Radar Establishment, British Ministry of Technology

Written by an internationally recognized authority, this volume satisfies the need for a comprehensive, applications-oriented reference on conductive, superconductive, contacting, and resistive functions. It is exceptionally broad and detailed in coverage, setting forth the basic phenomena for each specific function, describing how the materials for each are used in component parts, and providing the reader with sufficient basic data to deal with problems of specific applications.

In cases involving combined materials, such as cables and wires, brief data is given of dielectrics to insure reasonably complete coverage. More than 140 charts, tables, and diagrams provide rapid access to materials for a specific requirement. Extensive references are also included. **326 pages, 6 x 9, illustrated, clothbound, #5636, \$13.95**

**Subscribe at 15% savings, or examine individual
volumes FREE on 15-day approval . . . clip or
duplicate this coupon today!**

Subscription terms: Please enter my subscription to the Hayden Series in Materials for Electrical and Electronics Design. Each volume will be automatically shipped as published, and billed at 15% discount. This subscription may be cancelled at any time.

15-day free examination: Please ship and bill as published those volumes whose order numbers are circled below. At the end of 15 days I will remit payment, plus postage, or return the book(s) without further obligation.

5636 5634 5638 5640 5637 5635 5639

Payment enclosed. (Hayden pays postage with same return guarantee) On all overseas orders payment in U.S. dollars must be enclosed.

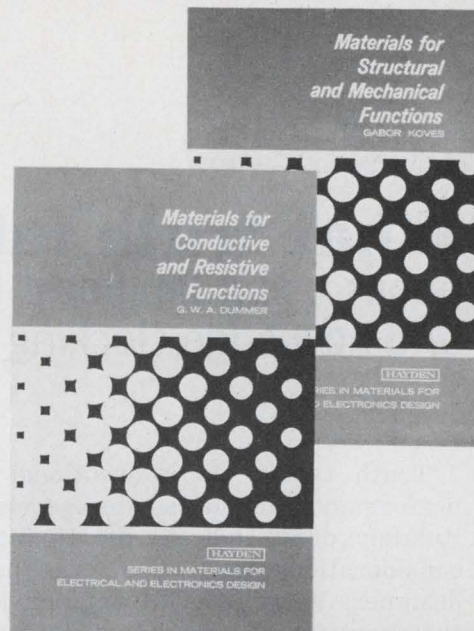

Hayden Series in Materials for Electrical and Electronics Design

Alex. E. Javitz, Editor-in-Chief

This series of practical, integrated engineering books is designed to meet the needs of all who design components, devices, equipment, and systems. Offering a unified approach which treats materials according to functional classes, the books provide essential background in fundamental principles, combined with immediately workable data and techniques for both conventional and advanced applications. Each volume also discusses the relationship between the fundamental nature of materials (microscopic properties) and their functional performance (macroscopic properties).

Forthcoming volumes:

Materials for Semiconductor Functions, #5638,
E. G. Bylander

Materials for Magnetic Functions, #5635,
F. N. Bradley

**Materials for Electrical Insulating and Dielectric
Functions, #5634,** H. L. Saums and W. W. Pendleton

Materials for Combined Functions, #5639, E. Scala
An interdisciplinary volume in the series, **Materials
Science and Technology for Design Engineers, #5640,**
edited by Alex. E. Javitz, provides an advanced expo-
sition of the basic structure and molecular behavior
of all relevant materials. Approximate price of each
forthcoming volume, \$18.00

Alex. E. Javitz, Editor-in-Chief of this series, is currently a technical consultant to industry. Formerly an editor of electrical and electronics magazines, Mr. Javitz is widely known in materials and related fields.

**Add these valuable references to
your library automatically —
enter your subscription today!**

Name _____

Firm _____

Address _____

City _____ State _____ Zip _____

MW71-11-1



HAYDEN BOOK COMPANY, INC.
116 W. 14 St., N.Y., N.Y. 10011

What truth tables don't tell you

about using flip-flops! Learn what the problems are and how edge clocking eliminates them.

Truth tables, the conventional guide to the performance of clocked-storage elements, unfortunately don't indicate the timing and loading considerations that plague the unwary system designer. Very little information is available on the operation of actual flip-flop circuits. Yet the implementation of various counters and registers depends to a large extent on the operation of the selected storage elements.

Past experience has made most system designers more aware of the circuitry inside the IC package. For these designers, conventional black-box specifications are not acceptable. And other designers, who have bought on the basis of incomplete specifications, are presently trying to de-debug their systems.

Let's examine some IC flip-flops and find out what problems they cause in a system. We will then offer a set of design criteria that can overcome these problems.

What are the problems?

Basically, the flip-flop or clocked-storage element is a far more complex circuit than a simple gate. Many integrated-circuit flip-flops are merely monolithic adaptations of discrete transistor or even tube-type multivibrator circuits. In the early days of solid-state circuitry, it was reasonable to sacrifice ease of use to obtain a simpler, lower-cost circuit. Charge-storage designs, for instance, whether using discrete capacitors or semiconductor junction capacitors, require fewer circuit elements than all-logic designs. But with today's high speed requirements and general design sophistication this cost differential virtually disappears.

An analysis of existing IC flip-flops clearly shows some of the problems faced by the systems designer. For example, the circuit shown in Fig. 1 (an early IC design), has almost nothing in common with the gates in its family (RTL). Because of the series capacitors on the set, reset

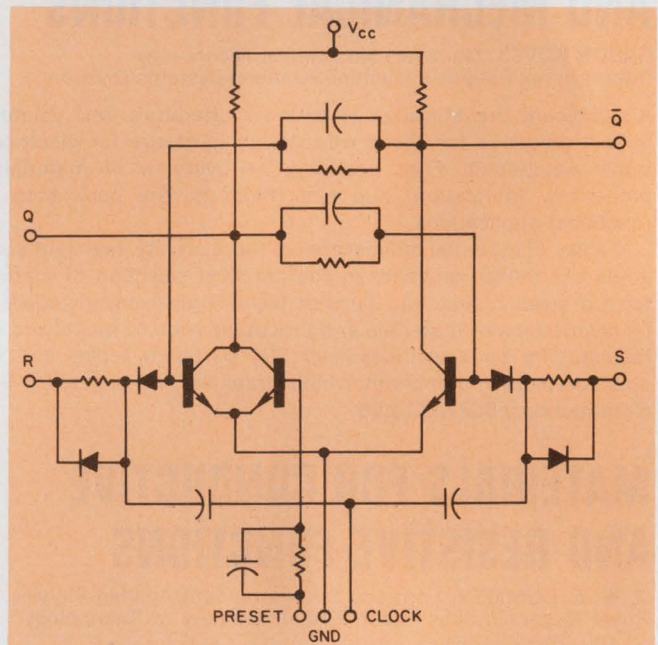

1. Input and output impedances can be a problem in standard flip-flop circuits. The structure of the RTL flip-flop shown differs from that of a simple RTL gate. Resulting impedance mismatches cause transient problems.

and clock lines, the only input to the flip-flop, whose input impedance is consistent with the general family characteristics, is the preset. The clock load is essentially reactive, and the set and reset inputs are combinations of resistance, capacitance and diode drops that do not have the same characteristics that standard gates have. The clock and gates driving these inputs to the flip-flops are obliged to handle large transient currents.

In Fig. 1, not only does the circuit present complex loading problems, but the flip-flop triggers because of a change in input level. The switching threshold is determined by the level of the logic and clock inputs. Since all flip-flops in a register will not have the same clocking threshold, a race condition may occur. To avoid this, a special clock driver is usually required.

An additional problem is the need to keep a minimum ratio between the output-load capacitance and the clock-steering capacitance. Should

Ron Treadway, Development Engineer, Motorola Semiconductor Products, Inc., 5005 E. McDowell Rd., Phoenix, Ariz., 85008.

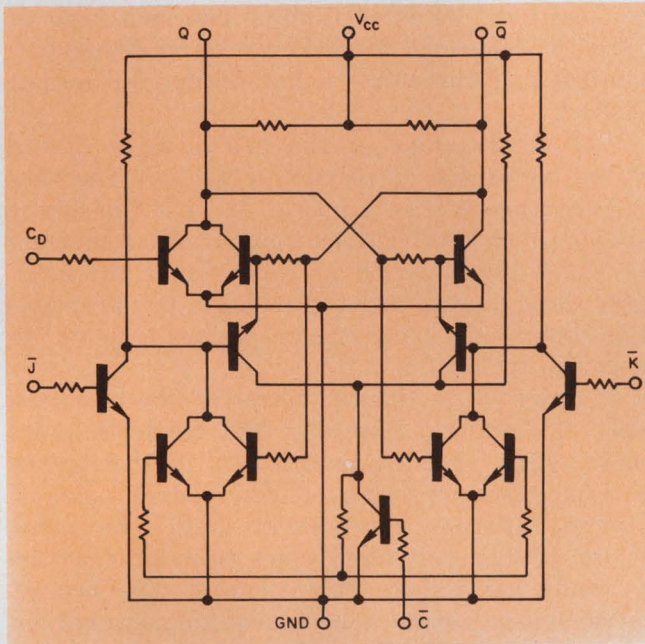

2. The logic inputs to this flip-flop appear as standard RTL gates. This circuit, however, poses timing problems because the input voltages must be held for some time after the transition of the clock.

the load capacitance slow the bistable sections beyond the length of time the clock signals can flow through the input capacitors, the flip-flop will not operate.

A much improved design for the same logic family is shown in Fig. 2. All of the logic inputs now "look" like RTL gates, but timing restrictions must still be solved. Specifically, the logic inputs must be held for some length of time after the transition of the clock.

A more modern version of a stored-charge flip-flop is shown in Fig. 3. This circuit makes use of charge storage in a reverse-biased diode and a saturated transistor. A logical ONE is set into the flip-flop by charging the reverse-biased diode through an emitter follower. The diode is discharged through a transistor coupled to the clock line.

The clock line also gates off the input emitter followers. The setup of a logical ONE through the emitter follower is fast, while the setup of

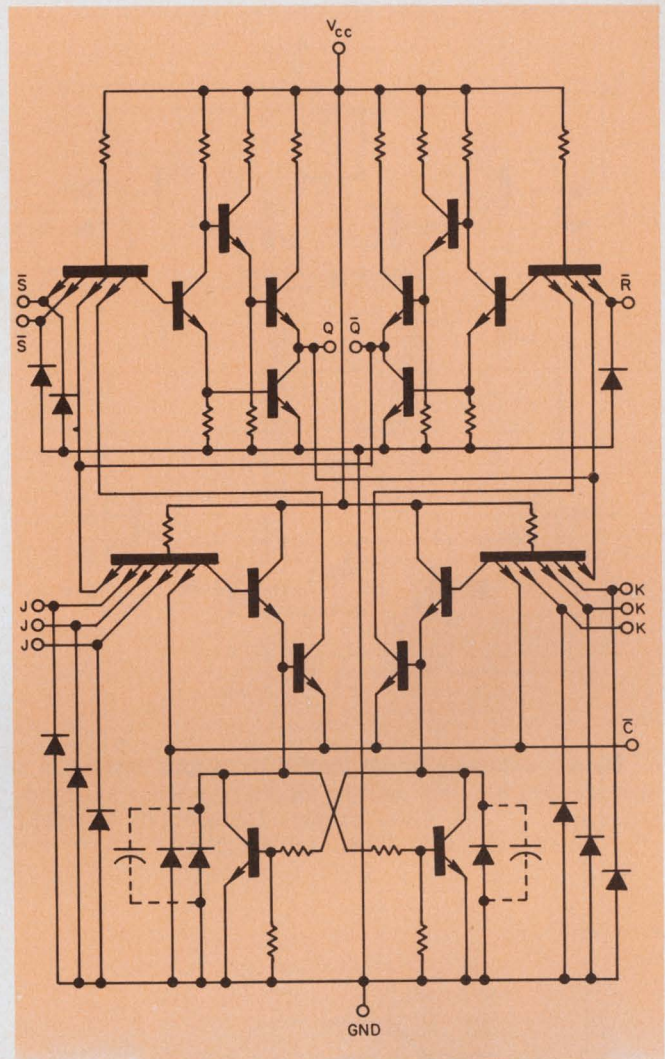

3. This circuit uses a reverse-biased diode and a saturated transistor for charge storage. Special shaping of the clock is required for applications other than toggle operation or direct connection in registers.

a logical ZERO is quite slow since the discharge path of the storage diode is through a large resistance.

To use the flip-flop to greatest advantage, the clock must be shaped so that the input is stable before the clock goes through its positive transition. This places a burden on the systems designer to control both transitions of the clock, although for toggle operation and direct connection in registers the charge-control flip-flop may be quite satisfactory.

Even in these applications, however, a significant disadvantage of this element is the magnitude of the load current that the clock driver must sustain. The driver must be capable of sinking one dc fan-in current, plus the transient current from the diode, the current due to the switching of the bistable section, and the switching transient from the other input for each flip-flop driven. This cannot be represented as a multiple of several gate loads, but must be con-

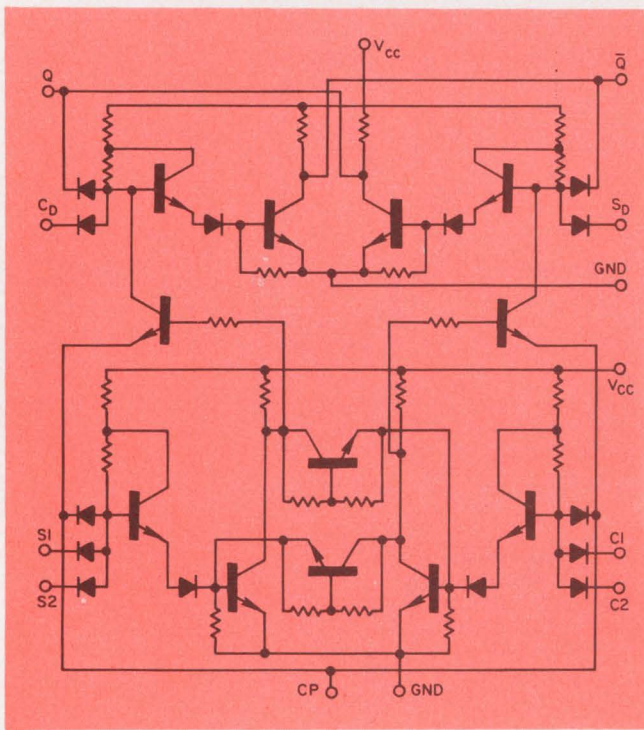

4. Output switching is not limited by output loading in a master-slave flip-flop, and the inputs all appear as standard gates of the same family. Undesirable transient effects and loading problems are avoided.

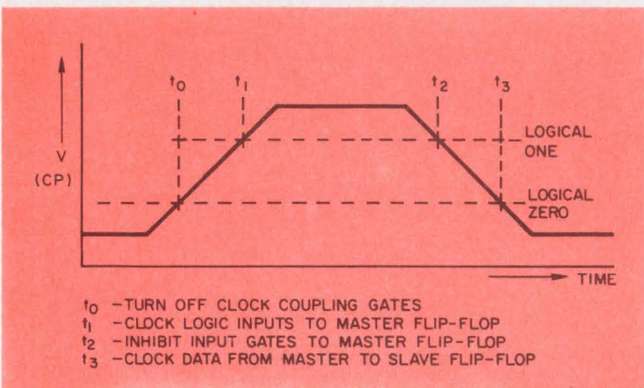

5. A restricted timing sequence is a main disadvantage of the master-slave flip-flop. Information must be stable before positive transition of the clock, but propagation occurs during the negative transition.

sidered as a special transient problem because of the different time constants involved.

A characteristic of many clocked-storage elements is the failure of the direct inputs—the set and reset—to override the clock inputs. In many applications, this characteristic is certainly less than desirable, since it may necessitate additional logic circuits on the clock and logic inputs.

A popular approach to the design of a clocked-storage element is the master-slave or dual flip-flop. A master-slave arrangement (Fig. 4) has very desirable input characteristics. The logic inputs can be made to look exactly like an input to a gate in the same family. The switching of the output does not depend on reactive temporary storage and therefore is not limited by output loading.

The disadvantage of the master-slave design is the imposition of restrictive timing. The timing sequence is shown in Fig. 5. This flop-flop is subject to the restrictions that information must be stable for a period of time before the clock goes through its positive transition, but propagation occurs only when the clock goes through its negative transition.

In order for the master-slave flip-flop to obtain maximum speed, a carefully controlled minimum pulse width must be maintained. This requires careful synchronization of the leading edge of several different clock lines. Also, the pulse width of the individual clock signals must be carefully controlled. This requires the use of more sophisticated monostables than would be needed if edge clocking were used.

Build a better flip-flop

The inputs of the master-slave combined with edge clocking yields a flip-flop with fewer problems by far. Propagation or information transfer is initiated as the clock pulse passes through the transition region. This region is the minimum swing on the clock input that allows sustained toggle operation of the flip-flop. This swing should be centered about the nominal threshold of a compatible gate. The narrower the transition width, the greater the rejection of race conditions achieved.

A definition of the timing sequence is given below and is based on positive-edge triggering; it may be inverted for negative-edge triggering. The relationships between clock and outputs are shown in Fig. 6. The techniques of measurement of these parameters vary with the design of the flip-flop.

If the flip-flop is to be operated at its maximum repetition rate in a shift register, the period of the clock, T_{c1} , must not be less than the setup time, T_s , plus the propagation time, T_p . At maximum frequencies, the propagation time is

defined by the relations

$$T_u + T_d = T_f$$

and

$$T_u = T_L + T_{x1},$$

$$T_d = T_r + T_{x2} + T_s,$$

$$T_p \leq T_L + T_{x1} + T_r + T_{x2}.$$

T_{x1} and T_{x2} are added so that tolerances can be placed on the minimum up and down times. T_r is the recovery time of the flip-flop that is necessary before any new information may be set up.

It is possible that, in a given design, the hold time could be equal to or greater than the propagation time. It is also possible that the sum of latch time and recovery time could be equal or longer than the propagation time. In these cases, the maximum frequency of operation is not simply the reciprocal of $T_p + T_s$. For $T_h > T_p$ direct-coupled shift-register operation with the same clock is not possible, as will be shown later. For $T_p < T_L + T_r$,

$$T_f = T_L + T_r + T_s + T_{x1} + T_{x2}.$$

Analyze the system timing parameters

Two of the greatest concerns of the users of logic blocks are the propagation times of the elements and the skew of system. Skew is the relative time displacement between clock pulses that should occur at the same time. The skew allowance that is available in a direct-coupled shift register is a function of the propagation time, hold time, transition width, and clock waveform.

As an example, consider two clocked R-S flip-flops connected as in Fig. 7. In this example, $T_f = T_s + T_p$. Also, the second flip-flop must be clocked at or before $T_p - T_h$ after clock number 1.

This is not the worst case, however. Since the flip-flops have a discrete transition width and the clock driver has a finite rise time, a more complete treatment is necessary.

If the first flip-flop has a low threshold and the second flip-flop a high threshold, then the system skew allowance will be degraded as a function of the rise time of the clock line driver. An expression for the skew allowance measured at the nominal threshold value is $T_{skew} = T_p - T_h - (\text{transition width/clock rise times})$, assuming the rise times of both clock pulses to be equal. This can be modified to account for rise-time differences so that $T_{skew} = T_p - 1/2 \times [\text{transition width/rise time (1)} + \text{transition width/rise time (2)}] - T_h$. The worst-case rise time that can be applied to the flip-flop input and still be compatible with the family can also be determined. In this case the ramp rate is worse than the worst-case allowable in a system since it gives no allowance for skew. $T_{ramp} = [\text{upper threshold-lower threshold}/(T_p - T_h)]$.

To eliminate as many system design problems

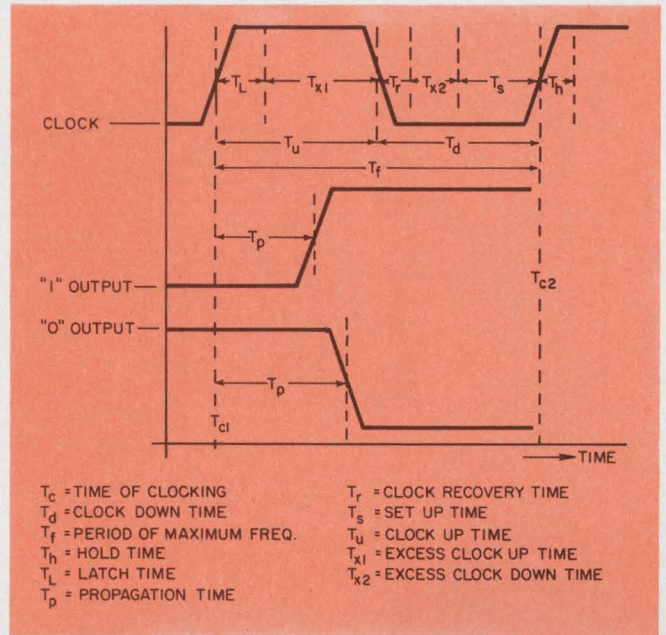

6. The relationship between the clock and the outputs occur as shown for positive-edge trigger timing. For maximum speed, the clock period, T_c , must be greater than the setup time, T_s , plus the propagation time, T_p .

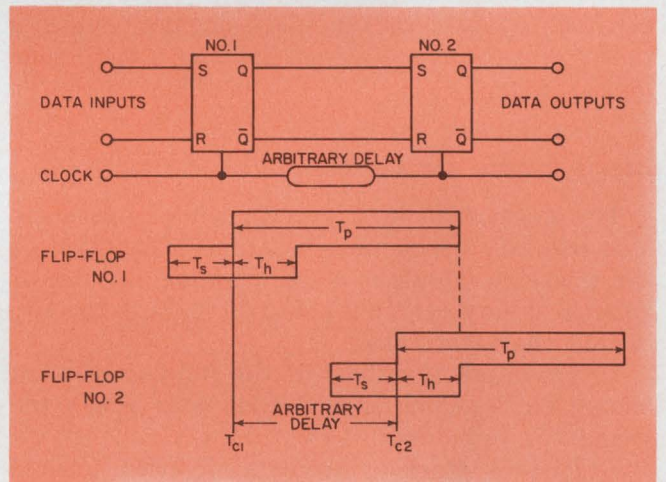

7. Allowance for skew, the relative time displacement between edges of the clock pulse, in a direct-coupled shift register is a function of the propagation time, hold time, transition time and clock waveform.

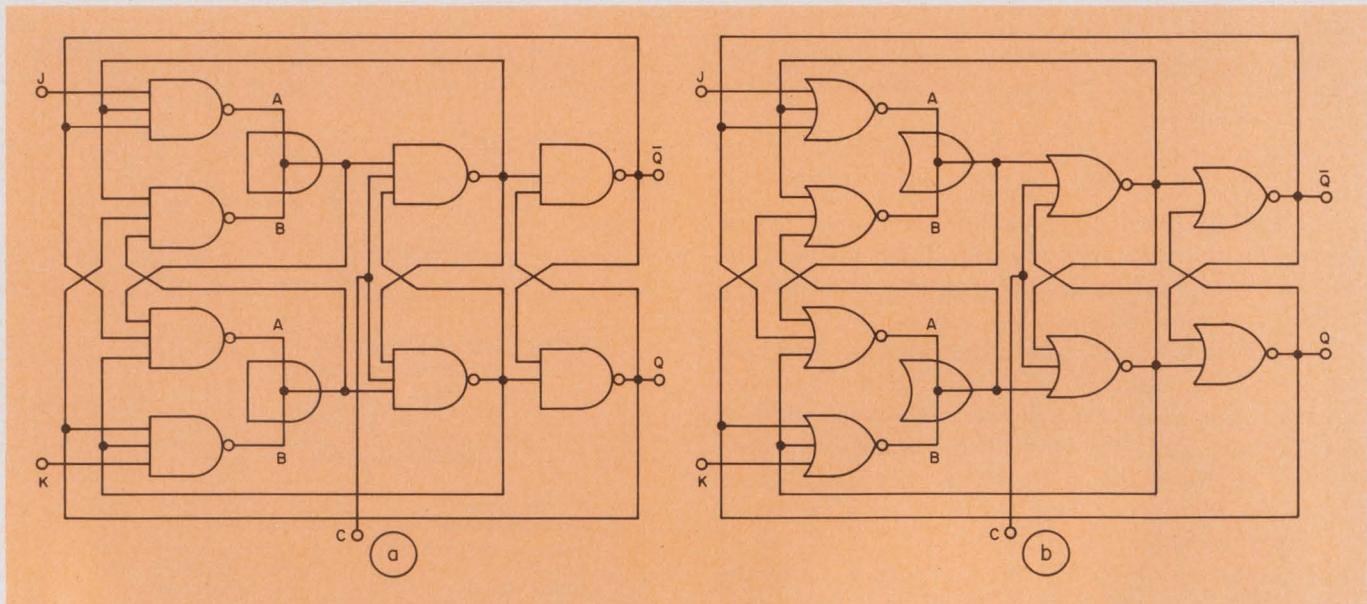

8. No special clock shaping is required for proper operation of the NAND (a) and NOR (b) circuits of the J-K edge-clocked flip-flops. Any of the standard logic families

can be used to form the desired results. The gates controlled by the clock cause an inhibiting signal to be applied so that the input bistable section is locked.

as possible—such as skew allowance, preset override, and waveform dependency—design criteria can be established for clock-storage elements that will be compatible with gates of a particular logic family.

Design criteria can be set

The generation of a specific set of operating characteristics will, in general, be a function of the particular system being designed. A list of general design requirements will include the following characteristics:

1. The input threshold of the flip-flop element should be the same as the gates with which the element is to be used.
2. Passive storage elements, if used, should be isolated from the input terminals.
3. The output must look as much as possible like the output of the gate with which it is to be compatible.
4. Loading of one output should not affect the delay time or waveshape of the other output.
5. The set and reset inputs (direct set and reset) should have similar response times to the transient or clocked inputs.
6. The set and reset inputs should control (override the state of the element), regardless of the transient inputs or state of the clock.
7. The setup time for logical ONE and ZERO values should be as short as possible. Two gate delays should be a maximum value.
8. The hold time should be as small as possible.
9. Propagation time as long as two to three gate delays might not be objectionable. There should be at least one gate-delay difference between the minimum propagation delay and the

maximum hold time.

10. Clock up and down times should be as short as possible.

11. Maximum clock ramp that will permit correct operation should be greater than worst-case rise and fall times that will be encountered with a clock driver of the same family.

The major logic families being produced include DTL, ECL, RTL, and TTL. The interconnection of logic blocks that will yield the desired result for J-K operation is shown for both NAND and NOR families in Fig. 8.

In the edge-clocked flip-flop the input information forms its own complement at the input gates. This complementary information is applied to the set and reset inputs of the input bistable section. When clocking is initiated, the information in the input bistable section is locked and transferred to the output bistable section. The clock gate that reacts upon application of the clock depends on the state of the input gates. This causes an inhibiting level to be applied to the correct pairs of gates so that no new information is allowed to have any effect.

With systems generally requiring faster switching speeds, the all-logic type of storage element is easier to control than a charge-storage type. ■

Bibliography

- Caldwell, S. H., *Switching Circuits and Logic Designs*, John Wiley & Sons, New York, N. Y., 1958.
- Maley, C. A., and Earle, J., *The Logic Design of Transistor Digital Circuits*, Prentice-Hall, Inc., Englewood Cliffs, N. J., 1963.
- Marcus, M. P., *Switching Circuits for Engineers*, Prentice-Hall, Inc., Englewood Cliffs, N. J., 1962.
- Phister, M., Jr., *Logical Design of Digital Computers*, John Wiley and Sons, New York, N. Y., 1958.

SOLID TANTALUM CAPACITORS



BOARDABLE & AFFORDABLE

RIGHT ON THE MONEY
FOR PRINTED WIRING BOARDS
IN INDUSTRIAL, COMMERCIAL,
AND ENTERTAINMENT
ELECTRONICS

Sprague Type 196D Dipped Solid-Electrolyte Tantalex® Capacitors cool the performance/budget argument. Newly broadened line—now available in all popular 10% decade values between 0.1 μF and 330 μF . Voltage range: 4 to 50 vdc. Hard insulating resin coating is highly resistant to moisture and mechanical damage. Straight or crimped, long or short leads. Operate to 125C with only $\frac{1}{3}$ voltage derating. Write for Engineering Bulletin 3545A.

Technical Literature Service
Sprague Electric Company
347 Marshall Street
North Adams, Mass. 01247

SPRAGUE
THE MARK OF RELIABILITY

THE BROAD-LINE PRODUCER OF ELECTRONIC PARTS

INFORMATION RETRIEVAL NUMBER 32

Designing sampling phaselock loops

is easy when you use this approximate stability criterion. It's valid over a wide range of disturbance frequencies.

Sampling phaselock loops are becoming increasingly popular in high-frequency oscillator designs because of two major advantages they have over conventional phaselock loops:

- They make it very easy to lock the voltage-controlled oscillator (VCO) to a high-order harmonic of the reference signal.

- They produce very little spurious output because, in theory at least, they produce no correction voltage at all when the VCO's output has the proper frequency and phase.

Unfortunately, the theory of the stability of the sampling phaselock loop is quite complicated. This makes it difficult to design sampling phaselock loops in many practical situations.

Highly usable results, however, can be obtained by using an approximate solution derived under the assumption that the disturbance frequency is very much less than the sampling rate. This is apparently a severe restriction of the usefulness of the formula. However, it turns out that the result may also be used to calculate the stability when the disturbance frequency is exactly one-half of the sampling rate, and this is often the frequency at which stability problems occur. Thus, it seems, the approximate solution may be valuable in practical engineering.

What is a sampling phaselock loop?

A sampling phaselock loop (Fig. 1a) differs from a conventional PLL (Fig. 1b) in that it uses a sample-and-hold circuit instead of a phase comparator. Instead of locking its output to a sinusoidal reference frequency, it locks it to a harmonic of the repetition rate of the sampling pulse train, f_s .

The sampler is essentially a switch that periodically closes for the very short duration of the sampling pulse. While it is closed, the holding capacitor in the hold circuit is charged to the instantaneous voltage of the VCO. This voltage, V_c , can be shown to be proportional to

the sine of the phase angle, Φ , between the VCO and the harmonic of the sampling pulse to which the oscillator is locked,

$$V_c = V_{\max} \sin \Phi(t). \quad (1)$$

Voltage V_{\max} is equal to the peak value of the VCO if we assume 100% sampling efficiency.

To derive a stability criterion for the sampling PLL, consider that a sinusoidal disturbance signal of frequency f is injected into the loop. According to the Nyquist sampling theorem, the output waveform of the sampler will resemble the disturbance signal as long as the highest frequency in the input waveform is smaller than one-half of the sampling rate, f_s . Thus, for $f < f_s/2$, the sampler may be treated as an ordinary phase detector with an additional time delay.

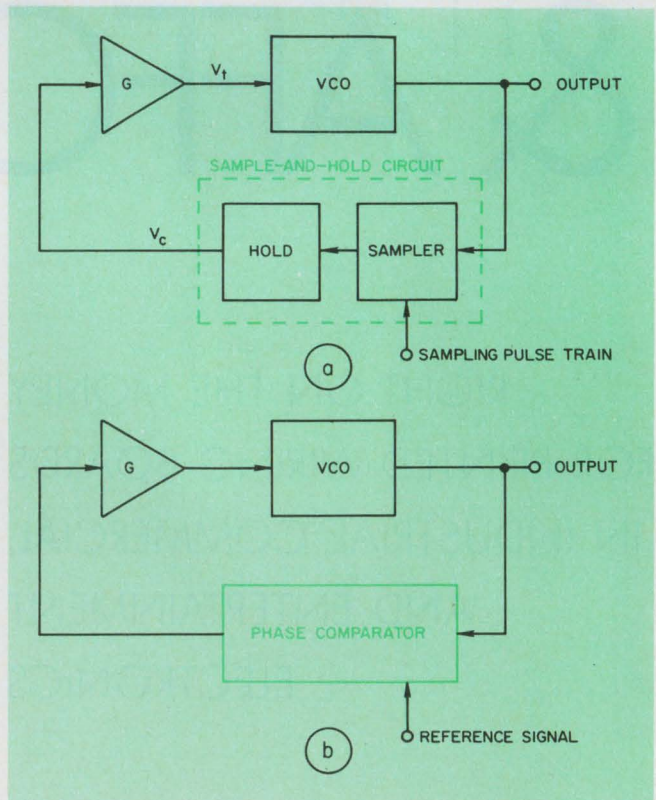

1. The sampling phaselock loop (a) differs from the conventional loop (b) in that it uses a sample-and-hold circuit instead of a continuous phase comparator. The amplifiers, G, in both loops include low-pass filtering.

Dieter R. Lohrmann, Electronic Engineer, U. S. Army Electronics Command, AMSEL-NL-R6 Fort Monmouth, N. J. 07703

By examining a plot of $\sin \Phi(t)$ and $V_c(t)$ (Fig. 2) one can easily see that, for the fundamental component of the disturbance staircase signal, V_c , the delay is $T_s/2$, where T_s is the interval between samples ($T_s = 1/f_s$). This can be proven analytically by developing the staircase function into a Fourier series.

Since only the fundamental need be considered in determining the open-loop stability condition when $f \ll f_s/2$, the sample-and-hold circuit's transfer function can be expressed as

$$\bar{A}(\omega) = \Phi \exp(-j\omega T_s/2) \quad (2)$$

when $|\Phi| \ll \pi/2$.

By requiring that $|\Phi| \ll \pi/2$, we have been able to replace the sine function of Eq. 1 by its argument. This is permissible if we choose the amplitude of the disturbance signal sufficiently small. The exponential factor in Eq. 2 represents the delay caused by the sample-and-hold circuit.

The loop amplifier, G in Fig. 1a, contains the loop's low-pass filter. Its transfer function is

$$\bar{G}(\omega) = \bar{V}_t/\bar{V}_c = |G(\omega)| \exp [j\Psi(\omega)]. \quad (3)$$

Now the total open-loop gain can be expressed as

$$\bar{G}_L = -[2\pi S V_{\max}/j\omega] [\exp(-j\omega T_s/2)] G(\omega) \quad (4)$$

provided that $f \ll f_s/2$ and $f \ll f_{osc}/Q_L$ and the sampling efficiency is close to 100%. In Eq. 4, S is the tuning sensitivity of the VCO ($S = df_{osc}/dV_t$); f_{osc} is the frequency of the VCO; ω is the disturbance frequency in radians per second ($\omega = 2\pi f$); and Q_L is the loaded Q of the oscillator tank. The first factor in Eq. 4 is the transfer function of a conventional phase detector.

Once the open-loop gain equation (Eq. 4) has been derived, either the Nyquist diagram or the Bode plot can be used to find the stability conditions in the usual manner.¹

However, the derivation of Eq. 4 involved the assumption $f \ll f_s/2$. In practice there is a marked tendency for loop oscillations to occur at exactly half the sampling frequency if the low-pass filter is made as broad as possible. Since Eq. 4 is not valid for that case, it must be treated separately.

Finding the stability at $f = f_s/2$

Instead of deriving an expression for the open-loop gain at $f = f_s/2$, the stability condition for that frequency will be calculated directly. The procedure, which is carried out in detail in the accompanying box, assumes that the loop starts oscillating at exactly $f_s/2$. This implies that V_c is a rectangular voltage with a rising amplitude (Fig. 3). If it is assumed that the amplitude of V_c changes only by small increments from sample to sample, then steady-state methods can be used to calculate the output voltage, V_t , behind the filter-amplifier combination. All that must be

done is to develop the rectangular voltage into its harmonic components, multiply each of these by the transfer function of the amplifier, $G(\omega)$, add the results and integrate over the frequency change of the VCO. This gives the phase change at the moment of taking the next sample.

The resulting expression for the stability of the loop will then be found to be:

$$(8/\pi) V_{\max} S T_s [|G(\omega_s/2)| \cos \Psi(\omega_s/2) + (1/9) |G(3\omega_s/2)| \cos \Psi(3\omega_s/2) + (1/25) \dots] < 1. \quad (5)$$

A particularly interesting fact pointed out by this formula is that instabilities at $f_s/2$ can exist even when $|G(\omega)|$ is made very small at $\omega = \omega_s/2$ if it comes back up on $3\omega_s/2$, $5\omega_s/2$, or above.

In most applications, the low-pass filter, $G(\omega)$, will attenuate any frequencies above $\omega_s/2$. In this case, the formula reduces to its first term. As can easily be shown, this first term is just the negative real part of the open-loop gain given by Eq. 4. Hence, an alternative way of expressing the stability condition for a loop, at exactly 1/2 the sampling frequency, with a low-pass cutoff frequency below $3f_s/2$ is

$$(4/\pi) \text{Re} \{G_L(\omega_s/2)\} < 1. \quad (6)$$

The simplified case of the broadband loop

If the loop amplifier is extremely broadband, a different simplification results. The portion of formula 5 in the brackets becomes

$$G(1 + (1/9) + (1/25) + (1/49) + \dots) = (\pi^2/8)G \quad (7)$$

so that the stability condition for a broadband circuit, at the half-sampling frequency, is:

$$\pi V_{\max} S T_s G < 1 \quad (8)$$

where the gain of the amplifier, G , is assumed

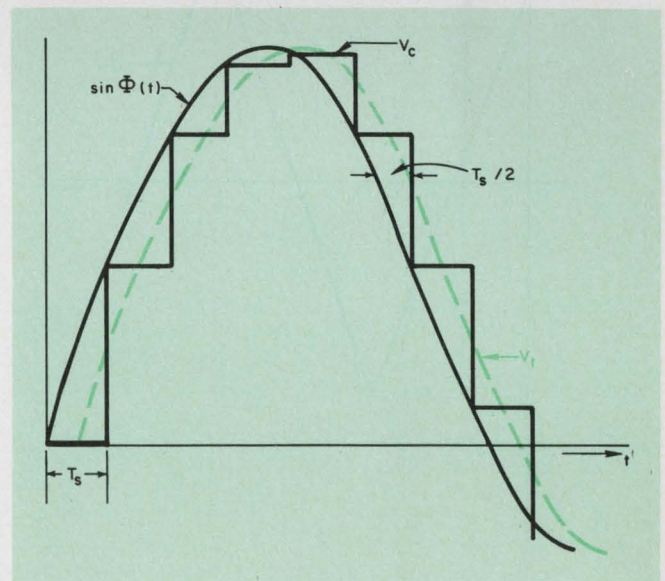

2. A time delay of $T_s/2$ is introduced by the sample-and-hold circuitry, if $\Phi(t)$ is a sinusoid with $f \ll f_s/2$. V_c is the staircase output of the sample-and-hold circuit; it becomes V_t after low-pass filtering.

Details of the derivation

Referring to Figs. 1a and 3, we begin at $t=0$ with an arbitrary phase angle Φ_0 and a voltage step, ΔV_c . During the interval $(0, T_s)$, Φ decreases with a slope proportional to ΔV_c . At $t=T_s$ the error in Φ is measured and the voltage changes from ΔV_c to ΔV_{c1} to correct it. As the process continues, the amplitudes of oscillation of both V_c and Φ must decrease for the system to be stable.

To apply this reasoning analytically, we first express the rectangular voltage waveform (assuming a constant amplitude, ΔV_c) as:

$$V_c = (4/\pi)\Delta V_c [\sin \omega t + (1/3) \sin 3\omega t + (1/5) \dots] \quad (a)$$

where we are using $\omega = \omega_s/2$ for convenience.

The output voltage of the amplifier, V_t , is given by

$$V_t = (4/\pi) \text{Im} \{ \Delta V_c \exp(j\omega t) \bar{G}(\omega) + (1/3)\Delta V_c \exp(3j\omega t) \bar{G}(3\omega) + (1/5) \dots \} \quad (b)$$

where we have taken the imaginary part of the complex voltage because V_c uses the sine.

The complex quantity $G(\omega)$ can be written as:

$$\bar{G}(\omega) = |\bar{G}(\omega)| [\cos \psi(\omega) + j \sin \psi(\omega)]. \quad (c)$$

For convenience, let $|\bar{G}(\omega)| = G_1$, $|\bar{G}(3\omega)| = G_3$, etc. And, let $\psi(\omega) = \psi_1$, $\psi(3\omega) = \psi_3$, etc.

Then Eq. b becomes:

$$V_t = (4/\pi)\Delta V_c [G_1 (\sin \omega t \cos \psi_1 + \cos \omega t \sin \psi_1) + (1/3) G_3 (\sin 3\omega t \cos \psi_3 + \cos 3\omega t \sin \psi_3)]$$

$$+ (1/5) G_5 (\dots)] \quad (d)$$

This is the voltage that is applied to the tuning terminal of the VCO. At the end of the time interval $(0, T_s)$ the total phase change at the output of the oscillator is

$$\Phi_1 = -2\pi \int_0^{T_s} S V_t(t) dt \quad (e)$$

where S is the tuning sensitivity of the VCO. The minus sign is used because every phase detector has a positive and a negative-slope region and, in this case, the negative slope is the critical one.

By plugging Eq. d into Eq. e, we get

$$\Phi_1 = -8S\Delta V_c [(2G_1 \cos \psi_1/\omega) + (2G_3 \cos \psi_3/9\omega) + (2G_5 \cos \psi_5/25\omega) + \dots] \quad (f)$$

where we have made use of the fact that

$$\omega = (\omega_s/2) = \pi/T_s.$$

The voltage V_{c1} on the holding capacitor after taking the next sample is then

$$\Delta V_{c1} \cong (1/2) V_{\max} \Phi_1 \quad (g)$$

where the factor 1/2 comes in because the phase curve is symmetrical about the time axis.

Stability requires that $-\Delta V_{c1} < \Delta V_c$. Inserting Eqs. f and g into this condition yields

$$(-V_{\max}) (-8S\Delta V_c/\omega) [G_1 + G_3/9 + (G_5/25) + \dots] < \Delta V_c \quad (h)$$

or, substituting $\omega = \pi/T_s$, Eq. 5 results.

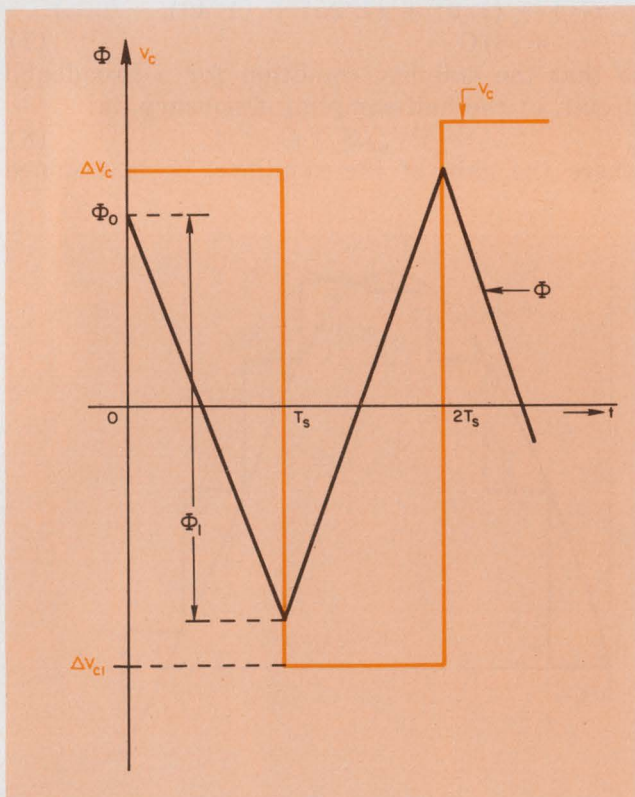

3. Increasing amplitude means instability. For the loop to be stable, we must have $-\Delta V_{c1} < \Delta V_c$. The filter transfer function $|G(\omega)|$ must also be small at $\omega_s/2$ and at the odd harmonics of $\omega_s/2$ for stability.

to be independent of frequency until f is many times larger than $f_s/2$.

A useful fact that is clearly expressed in formula 5 is that the stability at the half-sampling frequency can be improved by designing the filter characteristic so that $\cos \Psi(\omega_s/2) = 0$ or $\Psi(\omega_s/2) = \pm \pi/2$. This fact can be exploited to stabilize a broadband loop without substantially reducing its bandwidth.

For example, consider a loop in which the VCO has a tuning sensitivity of $S = 500$ kHz/V and the amplifier has a broadband gain of 8×10^{-2} . If the voltage delivered from the VCO to the sampler is 200 mV rms, or 283 mV peak, and the sampler has close to 100% sampling efficiency, then we may assume $V_{\max} = 280$ mV. For a sampling rate of 25 kHz, $T_s = 4 \times 10^{-5}$ s.

Under these conditions, $\pi S G V_{\max} T_s = 1.41 > 1$, and the system is unstable at $f_s/2$; it will oscillate at 12.5 kHz. The VCO will still be locked, but it will produce strong sidebands at ± 12.5 kHz from f_{osc} and at multiples of 12.5 kHz.

The condition can be remedied without sacrificing bandwidth by giving the amplifier a phase angle of $\Psi = 90^\circ$ centered at 12.5 kHz. Then $\cos \Psi = 0$, and the loop will be stable. ■

Reference

1. Melsa and Schulz, *Linear Control Systems*, McGraw-Hill Book Co., New York, 1969.

R.M.S. VOLTS -- the scale says -- but what about the circuits behind that scale?

All of us have been making rms readings of ac voltages for years. We know we have, it says so right on the front of the meter.

If someone were to ask what we mean by rms voltage, we could quickly explain the concept of "root mean square." In the interest of accuracy we might add that the rms voltage indication on most meters is true only for a sinusoidal wave. Unfortunately, most measurements are not made on true sinusoidal waves. However, for many applications, average responding meters are adequate.

But it would seem logical, where accuracy is important, to use a meter that measures true rms voltage no matter what the wave shape—a true rms voltmeter.

Why isn't this done more often? Well, until recently, most true rms voltmeters were expensive, limited

in capability and rather slow responding.

Now Hewlett-Packard has adapted the thermocouple concept used in standard laboratories; added protective amplifiers to insure overload protection (800 V p-p); and reduced final-value step function response to less than 5 seconds.

When you combine these features with a low price of \$575, it adds up to the HP 3400A—the first practical true rms voltmeter for general use in the 10 Hz to 10 MHz range. And, a high crest factor (ratio of peak to rms) allows you to measure noise and other non-sinusoidal wave forms at a ratio of 10:1 full scale or 100:1 at 10% of full scale. You get accurate noise and pulse measurements — without having to make non-standard corrections.

The 3400 isn't just a fine true rms

voltmeter—although that's plenty in itself. It can also be used as an ac/dc converter and a current meter. Typical dc output accuracy is 0.75% of full scale from 50 Hz to 1 MHz. Use the HP 456A AC Current Probe (\$250) and you get quick dependable current measurements. The 456A probe has a 1 mA to 1 mV conversion allowing direct readings up to 1 amp rms.

So, if all your measurements aren't made on true sinusoidal wave shapes and if you like direct accurate rms voltage indication no matter what you're measuring, it's time to check into the HP 3400A true rms voltmeter. For more information, contact your local HP field engineer. Or, write to Hewlett-Packard, Palo Alto, California 94304. Europe: 1217 Meyrin-Geneva, Switzerland.

099/19A

HEWLETT  PACKARD

ANALOG VOLTMETERS

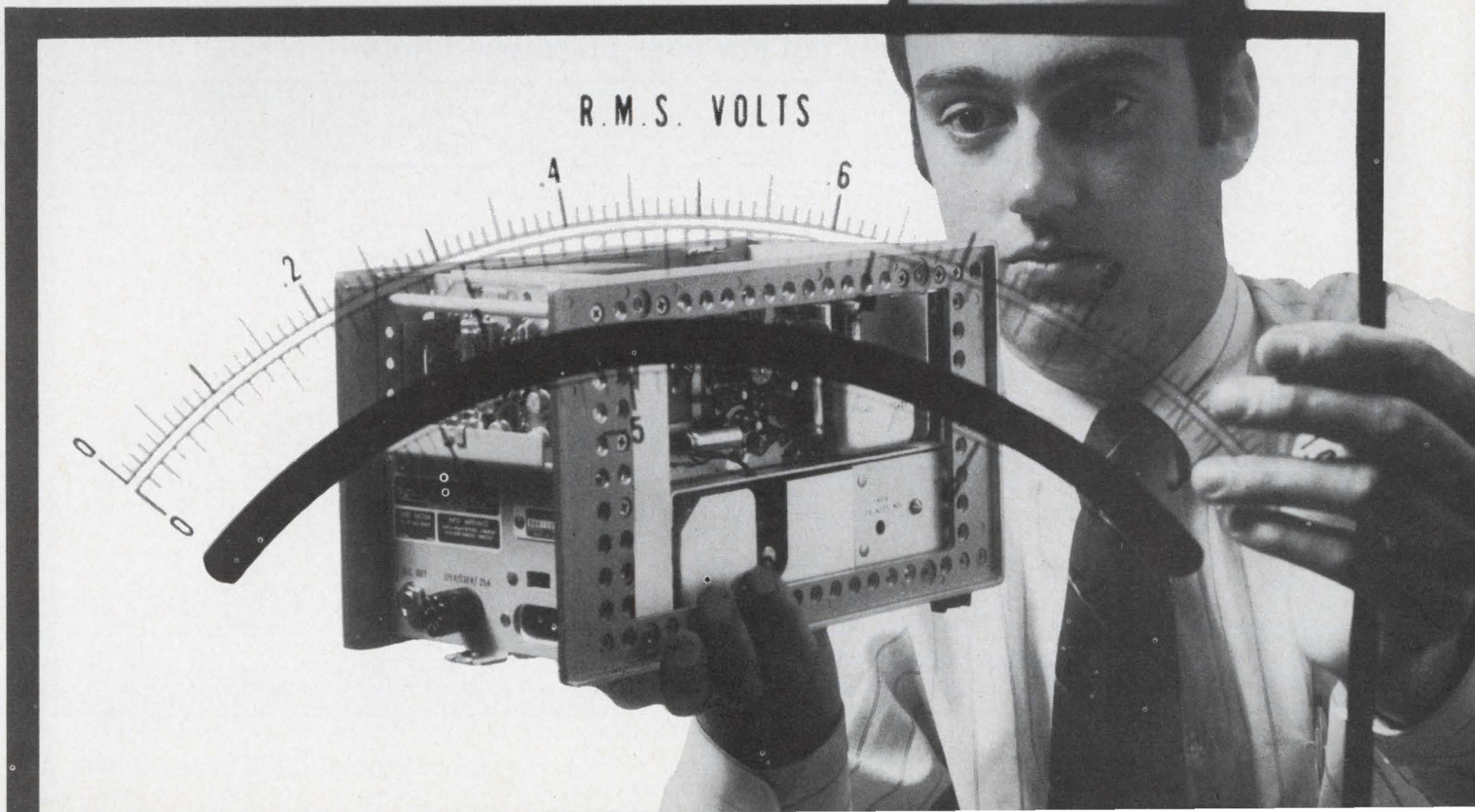

Find insertion loss at a glance

for maximally flat (Butterworth) bandpass filters.
This set of curves covers 1 to 10-resonator circuits.

Communication-system designers often need a quick indication of the midband insertion loss that can be expected from a maximally flat (Butterworth) bandpass filter. The set of curves shown in the drawing provides this information for filters from the first through the tenth orders.

In constructing the curves, it was assumed that all of the resonators in the filter had the same unloaded Q; hence, the curves are not exact. The results they provide, however, have been found to be within 0.5 dB of measured values, indicating that the approximation is a good one.

The curves are a plot of the formula¹

$$L = 4.34(Q_L/Q_u) \sum_{i=1}^n g_i \quad (1)$$

for values of n from 1 to 10. L is the midband

Frank J. Calandra, Circuit-Design Engineer and **Howard Hausman**, Circuit-Design Engineer. ALL Div., Cutler-Hammer, 3900 Program Management Dept., Walt Whitman Rd., Melville, N. Y. 11746.

insertion loss in dB, Q_L is the loaded Q of the filter (the center frequency divided by the 3-dB bandwidth), Q_u is the unloaded Q of each of the resonators, n is the number of resonators and the g_i are the element values of the equivalent low-pass prototype from which the coupled-resonator filter was designed (see Table).

The curves are very easy to apply as is evident if we use them to calculate the midband insertion loss of the following Butterworth bandpass filter:

Center frequency (f_o) = 10.7 MHz

Coil unloaded Q = 80

3-dB bandwidth (BW) = 200 kHz

Number of resonators (n) = 2.

We can assume that the unloaded Q of the resonator capacitor is much greater than 80. Therefore, the unloaded Q of each resonator is that of the resonator coil, or $Q_u = 80$.

The loaded Q of the filter is given by

$$Q_L = f_o/BW = 10.7 \text{ MHz}/200 \text{ kHz} = 53.5. \quad (2)$$

The ratio of loaded Q to unloaded Q is thus 0.67.

Table. Values of g_i for maximally flat low-pass prototype filters

| Value of n | g_1 | g_2 | g_3 | g_4 | g_5 | g_6 | g_7 | g_8 | g_9 | g_{10} |
|------------|--------|--------|-------|--------|--------|--------|--------|--------|--------|----------|
| 1 | 2.000 | | | | | | | | | |
| 2 | 1.414 | 1.414 | | | | | | | | |
| 3 | 1.000 | 2.000 | 1.000 | | | | | | | |
| 4 | 0.7654 | 1.848 | 1.848 | 0.7654 | | | | | | |
| 5 | 0.6180 | 1.618 | 2.000 | 1.618 | 0.6180 | | | | | |
| 6 | 0.5176 | 1.414 | 1.932 | 1.932 | 1.414 | 0.5176 | | | | |
| 7 | 0.4450 | 1.247 | 1.802 | 2.000 | 1.802 | 1.247 | 0.4450 | | | |
| 8 | 0.3902 | 1.111 | 1.663 | 1.962 | 1.962 | 1.663 | 1.111 | 0.3902 | | |
| 9 | 0.3473 | 1.000 | 1.532 | 1.879 | 2.000 | 1.879 | 1.532 | 1.000 | 0.3473 | |
| 10 | 0.3129 | 0.9080 | 1.414 | 1.782 | 1.975 | 1.975 | 1.782 | 1.414 | 0.9080 | 0.3129 |

Using the $n=2$ curve of the drawing, the insertion loss is found to be 8.2 dB.

If greater accuracy is needed than the curves can provide, the data from which they were drawn can be computer-generated. Alternatively, the g_i values of the Table can be used to solve Eq. 1 directly. ■■

Acknowledgment

The authors wish to express their appreciation to D. S. Levinson and N. Worontzoff of the Applied Electronics Department of AIL for introducing computer-aided filter designs and design literature, and to M. LaBella for suggesting the idea of detailed curves for extrapolating insertion-loss information. We express our particular ap-

preciation to R. L. Sleven for reviewing the manuscript and offering constructive criticism.

Reference

1. S. B. Cohn, "Dissipation Loss in Multiple-Coupled Resonator Filters," *Proc. IRE*, Vol. 47, August, 1959, pp. 1342-1348.

Bibliography

R. L. Sleven, "Pseudo/exact Band-Pass Filter Design Saves Time," eight-part article reprinted from *Micro-waves*. (Available from AIL.)

L. Weinberg, "Additional Tables for Design of Optimum Ladder Networks," Part I, *Journal of the Franklin Institute*, Vol. 264, pp. 7-15, July, 1967.

E. G. Fubini and E. A. Guilleman, "Minimum Insertion Loss Filters," *Proc. IRE*, Vol. 47, pp. 37-41, January, 1959.

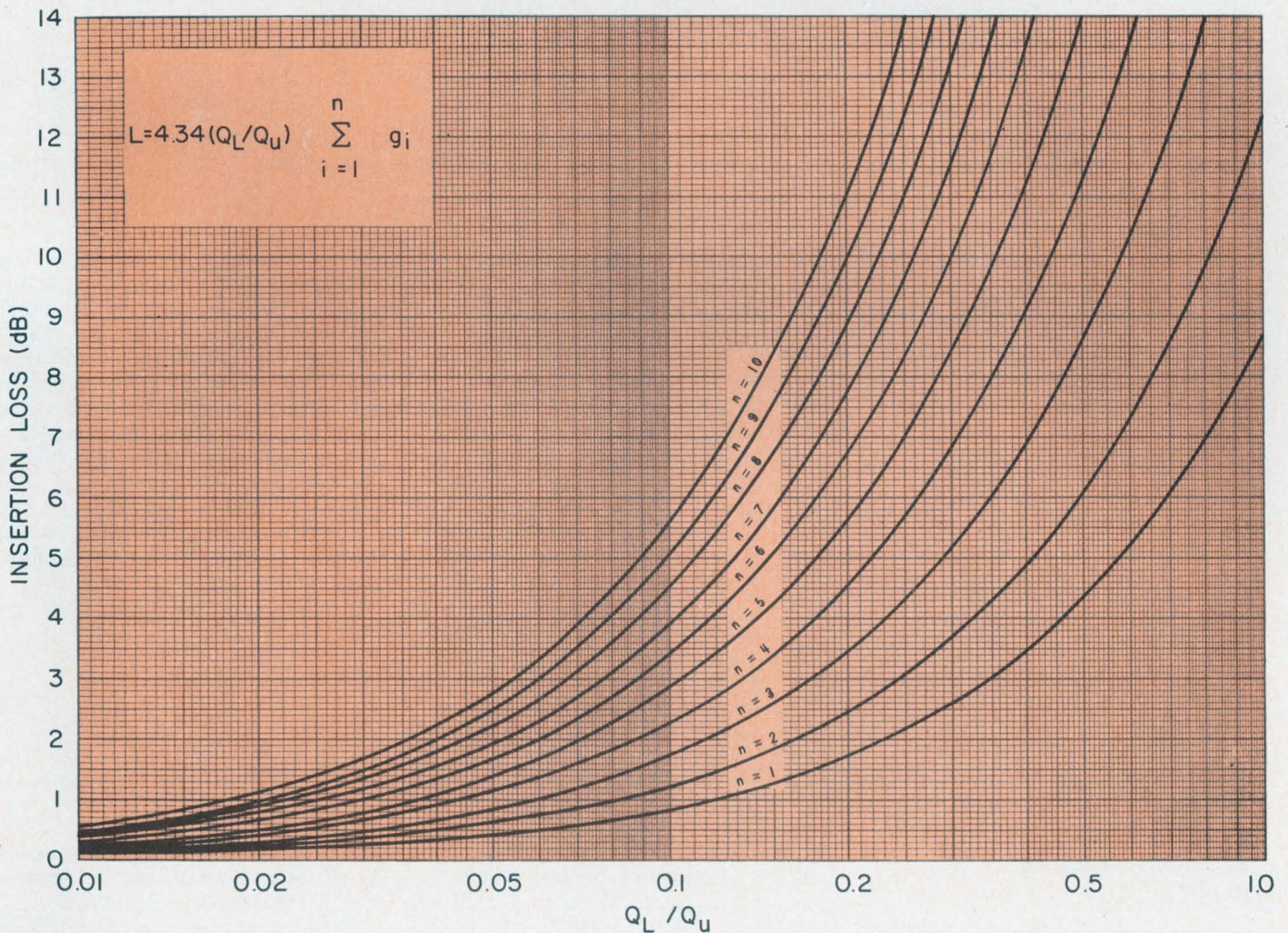

Midband insertion loss is plotted here as a function of Q_L/Q_U for 1 to 10-resonator Butterworth bandpass filters.

The unloaded Q of every resonator is assumed to be equal to Q_U . Q_L is the loaded Q of the filter.

RCA Solid-State Data for Designers

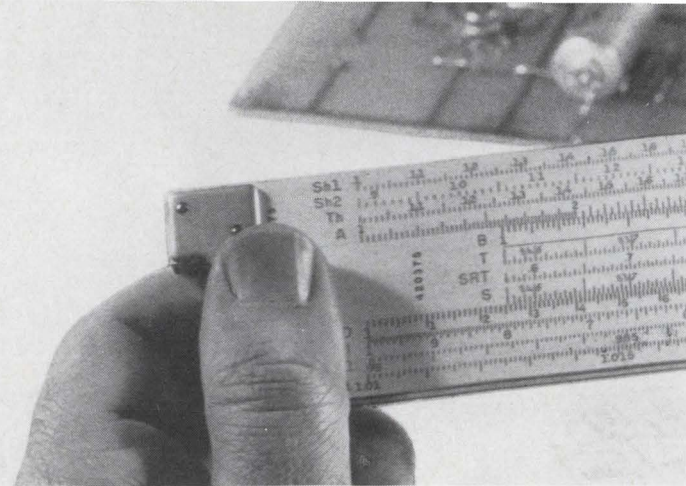

Profit makers: RCA's power transistor families

Here are two established families of RCA low-power transistors—the 2N5320 and its companion type, the 2N5322—that can help you increase profit margins from your equipment sales.

These extremely reliable devices are suitable for a myriad of general-purpose industrial applications. To name just a few: industrial controls, test instrumentation and control equipment, and power amplifier drivers.

The n-p-n 2N5320 and its p-n-p complement, the 2N5322, are double-diffused epitaxial planar tran-

sistors in hermetic TO-5 cases that feature 1 A current capability. They are big brothers to RCA's 2N2102 (n-p-n) and 2N4036 (p-n-p) transistors that have 0.5 A current capa-

bility. Examine their performance curves. You'll find they have the characteristics you need for your circuit application.

Circle Reader Service No. 101.

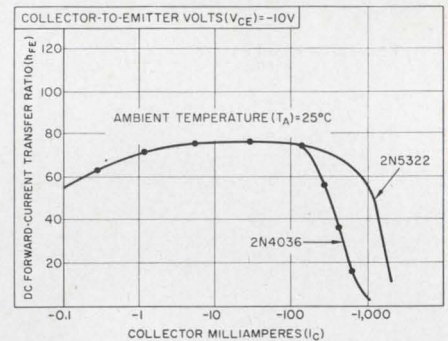
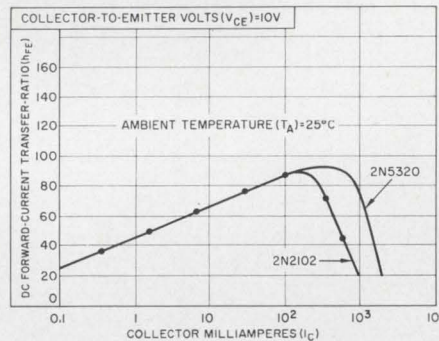

TYPICAL STATIC BETA CHARACTERISTICS FOR TYPES 2N5320, 2N2102, 2N5322, AND 2N4036.

| Application | MOD. or CW | Room Temperature Devices | | | |
|--|--------------|--------------------------|---|-------------------|-----------------|
| | | Emitter | Laser Diode | Laser Diode Stack | Laser Array |
| Paper Tape Reader | CW | 40736R | | | |
| Card Reader | CW | 40736R | | | |
| Shaft Encoder | CW | 40736R | | | |
| Keyboard | CW or CODED | 40736R | | | |
| Circuit Isolator Coupler- "DC Transformer" | MOD | 40736R | | | |
| Data Transmission | MOD | 40736R TA7762R | | | |
| Line Finder/ Edge Sensor | CW or PULSE | 40736R | TA7606, 7, 8, 9, 10, TA7699, TA7925 | | |
| Intrusion Alarm | MOD or PULSE | 40736R TA7762R | TA7606, 7, 8, 9, 10, TA7699, TA7925, TA7763, TA7864 | TA7764 TA7765 | |
| Remote Control Signalling | MOD | 40736R TA7762R | TA7606, 7, 8, 9, 10, TA7699, TA7925, TA7763, TA7864 | TA7764 TA7765 | |
| Voice Communications | PULSE | | TA7606, 7, 8, 9, 10, TA7699, TA7925, TA7763, TA7864 | | |
| Ranging | PULSE | | TA7699, TA7925, TA7763, TA7864, TA7705, TA7787 | TA7764 TA7765 | TA7687-92 incl. |
| Night Vision Applications | PULSE | | All types above plus TA7867* | | TA7924† |

*GaAs — wavelengths from 800 to 880 nm

†77°K

Looking for GaAs lasers and IR emitters? RCA has the devices to meet your requirements

Gallium-arsenide lasers and/or IR emitters are now being designed into a wide range of signaling and illumination equipment. For such applications, RCA offers a broad line of lasers and emitters—well-suited to meet these requirements.

RCA injection lasers feature high peak powers, low drive currents and proven reliability. Because of their simplicity, ease of drive, and covert wavelength, they are naturals for in-

trusion alarms, ranging, data-link communications and secure illumination. RCA IR emitters feature small size and high efficiency. Their pre-focused, high brightness beam pattern allows optimum performance in card readers, shaft encoders, short range intrusion alarms and data-link communications. Finally, RCA lasers and emitters are compatible with most photodetector systems.

Try RCA's superior GaAs lasers and IR emitters in *your* system. You'll beam!

Circle Reader Service No. 102.

RCA Thyristors expands its triac line to 600 volts

RCA announces a new line of 600 V triacs available now for industrial control manufacturers. These new triacs have a 600-V peak repetitive rating at a maximum rated junction temperature of 100° C.

In difficult industrial applications where ac power sources demand

| 600 VOLT TRIACS | | | | |
|-----------------|-------|-------|-------|--------|
| Package | 10 A | 15 A | 30 A | 40 A |
| Press-Fit | 40795 | 40797 | 40671 | 2N5443 |
| Stud | 40796 | 40798 | 40672 | 2N5446 |
| Isolated Stud | 40801 | 40804 | 40807 | 40690 |

added safety margin, this group of RCA triacs can be used to assure reliable equipment operation.

These new triacs (as the chart illustrates) range from 10 amperes, with availability in press-fit, stud and isolated stud packages.

Circle Reader Service No. 103.

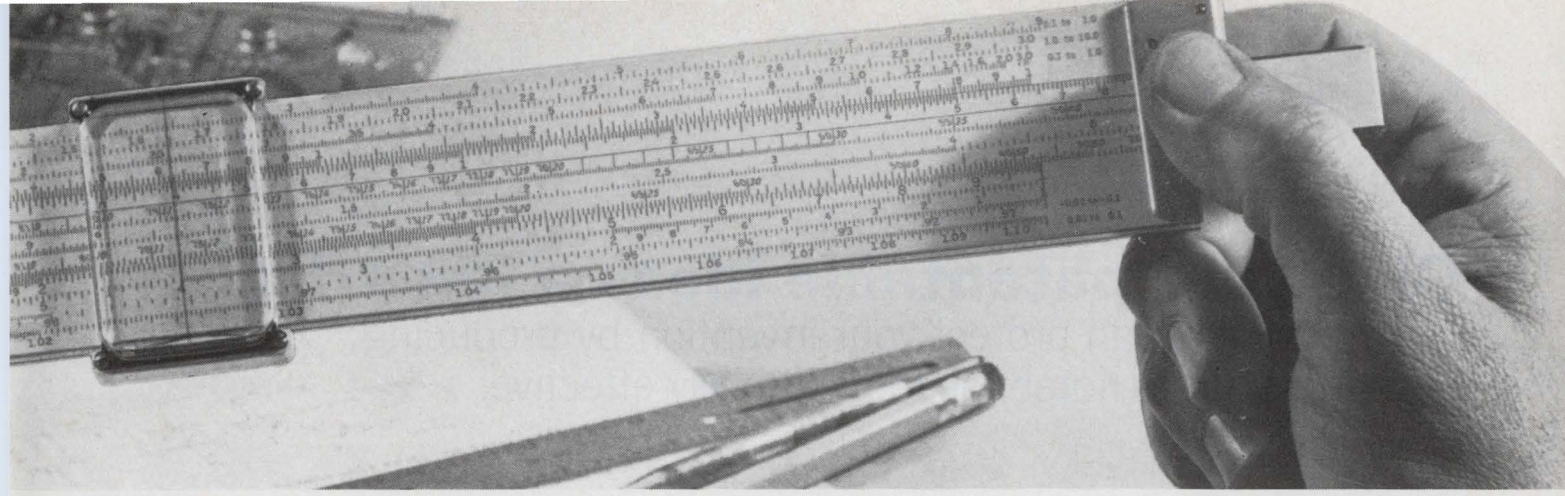

TA7625A: a new high power op amp

RCA's new TA7625A plastic power hybrid amplifier is capable of handling 7 amperes peak current. It is a modification of RCA's well known TA7625 linear amplifier, and thereby

terminal 3 and 4) can be varied to minimize distortion at low frequencies.

What does this mean to the designer? It means that he is better able to use the hybrid as a current source. It also means that the TA7625A has greater capability and

is constant within 1 dB over the full -55°C to $+125^{\circ}\text{C}$ temperature range. With slide rule and breadboard you can custom-tailor this circuit to your own specifications.

RCA's CA3018 and its companion type, the CA3018A, are well suited to a variety of applications in low power systems in the dc through VHF range. The CA3018 provides a V_{BE} match of $\pm 5\text{ mV}$. In the CA3018A, V_{BE} is matched within 2mV and performance characteristics are controlled from 10 μA to 10 mA. You can purchase the CA3018 for just 98¢, the CA3018A for \$1.35 (at 1000-unit levels).

The circuit shown here may also be built with the five-transistor CA3045 in a DIC package or the CA3046 in a DIP package.

For Application Note ST-3895, "Design Ideas for RCA Linear Arrays," circle Reader Service No. 105.

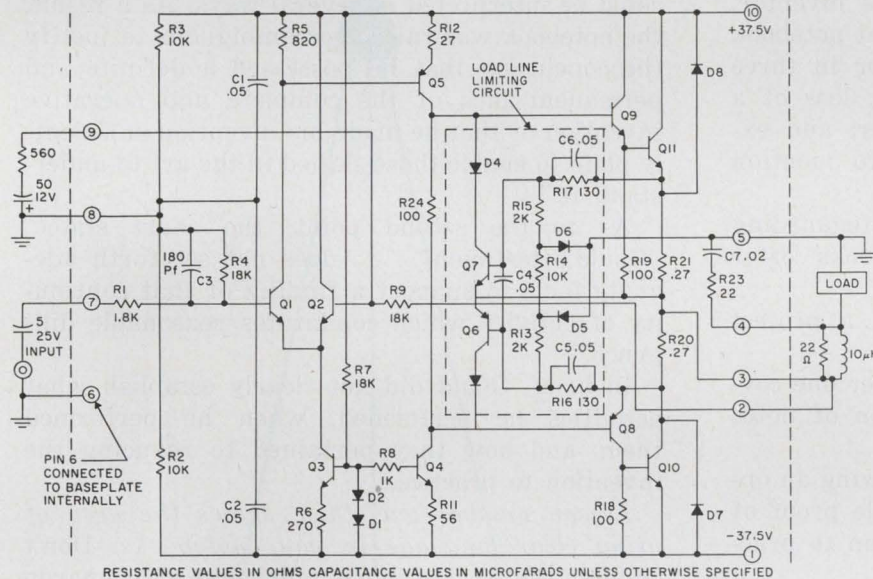

SCHEMATIC OF TA7625A HYBRID POWER MODULE.

provides added versatility. With minor circuit changes, the TA7625A can replace the TA7625.

The TA7625A has both short-circuit protection and reactive load-fault protection. Its inverting terminals are external. Thus the feedback resistor (22 ohms across

versatility in servo-amplifier applications, in voltage-regulator circuits, inverters, and in deflection-amplifier circuits ($V_s = \pm 37.5\text{ V max.}$).

Contact your local RCA Representative for planned price reductions. Circle Reader Service No. 104.

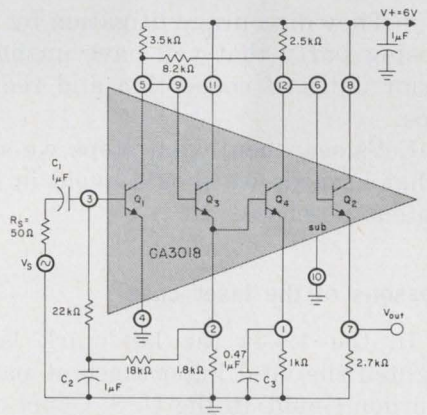

SCHEMATIC OF WIDEBAND VIDEO AMPLIFIER USING THE CA3018.

Custom design your own 30 MHz broadband amplifier with IC's transistor array

RCA's CA3018—monolithic, four-transistor array—offers the circuit designer a best-of-both-worlds approach. Here you have the economy, compactness, and device matching and temperature tracking you expect of IC's, combined with accessibility and design freedom that

normally require discrete transistors. In the CA3018, two independent transistors and two Darlington-connected transistors are housed in a 12-lead TO-5 style package.

The wideband video amplifier shown here (in the schematic at right) utilizes the CA3018 to provide a 30-MHz bandwidth and a gain of 49 dB—with two feedback loops for excellent stability across the full frequency range. Gain of the amplifier

For price and availability information on all solid-state devices, see your local RCA Representative or your RCA Distributor. For specific technical data, write RCA, Commercial Engineering, Section 57K-8/UM6, Harrison, N. J. 07029. International: RCA, 2-4 rue du Lièvre, 1227 Geneva, Switzerland, or P.O. Box 112, Hong Kong.

RCA Solid State Division

Give your patentable ideas a fair trial.

Learn how you can protect your invention by producing a clear, accurate notebook that is legally effective.

It has been said that a good idea usually comes to more than one person at a time. With up to 100,000 patent applications being filed in the U. S. every year, there's always the possibility that an idea has been duplicated. Therefore, equal in importance with what is done with an invention is how it's protected.

Keeping a good patent notebook is the best protection there is.

If you're an inventor or a would-be inventor, you should know that a slipshod patent notebook can hurt both you and your employer in three tangible ways: loss of patent rights; loss of a royalty income based on those rights; and expenditure of heavy legal fees—not to mention churned-up emotions.

Besides their major function of safeguarding your patent rights, well-kept notebooks offer these advantages:

- They can serve as the basis of a project report.
- They're a file of information under one cover, rather than a haphazard collection of notes that can be easily mislaid.
- They discourage litigation by showing an opposing party that you have unshakable proof of prior dates of conception and reduction to practice.

Let's see, then, what steps we should take and what hazards we should avoid in keeping a good patent notebook.

Lessons of the laser case

In the 1960s the landmark laser case spotlighted the vital importance of patent notebooks. Gordon Gould, in the U. S. Court of Customs and Patent Appeals, challenged the validity of U. S. Patent 2,929,922, the basic laser patent held jointly by Nobel Laureate Charles H. Townes and his brother-in-law, Dr. Arthur L. Schawlow. Since Gould filed his application later (April 6, 1959) than Townes (July 30, 1958), he was required by patent law to prove:

- Conception of the invention before July 30, 1958.

- Reasonable diligence in reducing the invention to practice (constructing the device) from a time just before July 30, 1958, to his own filing date.

To prove his earlier conception of the laser, Gould relied on data in a bound notebook. In the court's opinion, the information in his notebook could be interpreted in several ways. As a result, the notebook was ruled "too ambiguous to justify the conclusion that he possessed a definite and permanent idea of the complete and operative invention or that he made his invention sufficiently plain to enable those skilled in the art to understand it."¹

As to the second point, the court stated, "Gould's testimony . . . does not set forth adequate facts to support a finding of that continuity of activity which constitutes reasonable diligence."

In brief, Gould did not clearly establish what activities he performed, when he performed them, and how they pertained to reducing the invention to practice.¹

Lesson number one, then, shows the need of using clear language in your notebooks. Don't emulate the world-famous notebooks of Leonardo Da Vinci. His style was often clumsy and puzzling. He omitted much punctuation, occasionally combined two or three words into one, and wrote (with his left hand) from right to left in reversed characters. As a result, his notebooks can be read only with the aid of a mirror so that deciphering them has been a titanic task for scholars.²

Lesson number two defines the basic requirements of an invention: the conception of the idea and its reduction to practice. Conception by itself is not invention. An invention exists only when conception is reduced to practice, either by filing a patent application or by building an operational device embodying the idea.

Because conception is a mental act, you, as inventor, must describe it in maximum detail in the notebook. You and at least two competent witnesses *who understand the description* must

By **Harold K. Mintz**, Lecturer in Business Communications, Northeastern University, Boston, Mass.

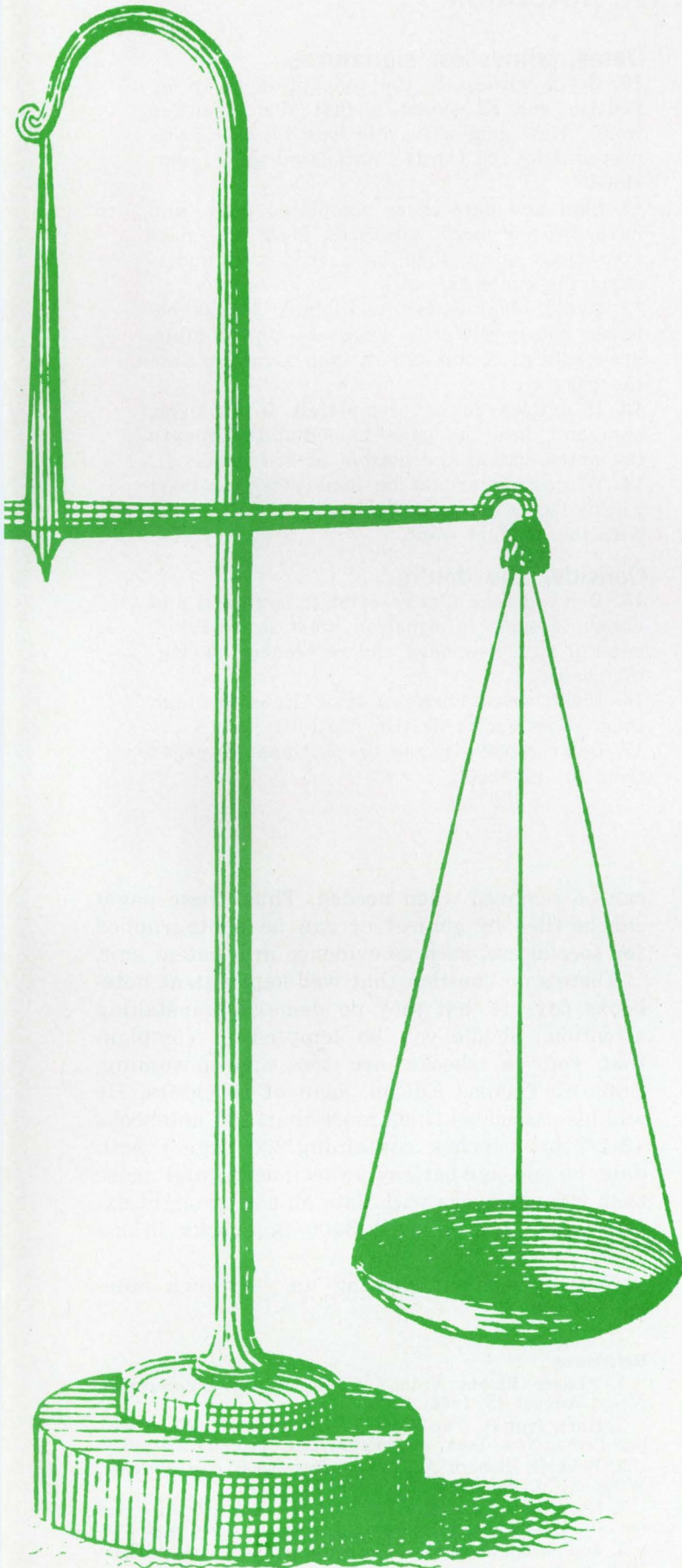

date and sign all pages involved. Only then is the conception legally corroborated.

Once the device is reduced to practice, you should demonstrate its operation and explain it to two or more witnesses. Again, you and the witnesses must date and sign the relevant pages.

Lesson number three emphasizes diligence. Assume that you are the first to conceive an idea, but not the first to reduce it to practice. You can still be judged the first inventor if you can prove to the Patent Office that you were diligent in trying to physically build a working sample of your idea, or in filing a patent application.

To prove priority of your invention, you must have started your efforts before a competitor entered the field, and you must have continued them until you have reduced your invention to practice. Here, corroborated notebook pages are worth more than their weight in gold; they can prove both continuity of effort and reduction to practice.

In determining priority, the Patent Office sets a high value on diligence exerted during this critical period. Lapses of diligence must be explained and justified. In the laser case, the Patent Office ruled that Gould's notebook failed to justify his lapses.¹

Witnesses to your work

Aside from being literate, practical, and diligent, you must prove that your notes are valid. Under patent law, to be valid, your words must be corroborated by two or more qualified witnesses.

A qualified witness meets the following criteria:

- He must understand the invention, its construction and operation, and all written and drawn material. This requirement eliminates most secretaries and wives—and most likely any notary public, unless he is technically competent.
- He must read, understand, date, and sign all pertinent pages in the notebook.
- He cannot be a co-inventor or potential co-inventor, and he must not have any financial interest in the patent sought.

The reason for having two or more witnesses is to increase the probability of finding one, if you need him years later. The practice of having witnesses sign and date all relevant notebook pages makes it possible to introduce into evidence a photocopy of any required page (or pages). Thus you need not show the opposing party any more of your secret pages than necessary.³

Critical dates in notebooks

Court decisions in patent infringement suits usually hinge on your ability to prove that cer-

17 guidelines for a legally effective notebook

General data

1. Use numbered, bound notebooks with printed page numbers and notebook numbers.
2. Before each project, detail what you expect to learn. At project's end state what work was done, when it was started and finished, and what the results and conclusions were.
3. Make all entries in ink (black, preferably, since blue reproduces poorly) or indelible pencil directly in the notebook. Don't use memo sheets, for neat copying later: memo sheets may be lost.
4. Keep all entries current and in chronological order; avoid retroactive entries.
5. Have a patent attorney periodically evaluate notebook procedures and search for patentable ideas that may have been overlooked.
6. Include references to any articles or books used as sources of information.

Procedures, equipment, instruments

7. Describe the procedures, equipment and instruments used.
8. Identify all trademarks and code names to avoid ambiguity.
9. Insert photos (by stapling or gluing) of instrument setups and readings. Sign and date all photos. Extra-large drawings should be photo-reduced and the reductions inserted in the notebook and dated.

Dates, witnesses, signatures

10. Get a witness to the conception of an invention and as evidence that the invention works. Have him write and date his signature, preceded by the words "Witnessed and Understood."
11. Sign and date every completed page, and have two or more witnesses sign and date every page after they have read and understood the contents.
12. Avoid blank pages and blank spaces between notes, but if a space is unavoidable, draw a large X through it, then sign and date the page.
13. If entries do not completely fill a page, sign and date the page immediately beneath the notes, not at the bottom of the page.
14. Witnessing should be done often, at least weekly, so that it may be nearly simultaneous with the original work.

Consider the don'ts

15. Don't change a page after it is signed and dated. If some information must be updated, enter it on a new page and reference the original page.
16. Don't erase entries; draw lines through them so as not to destroy legibility.
17. Don't remove pages or portions of pages from the notebook.

tain events happened on certain dates. When more than one applicant files for a patent on the same invention, the decision often swings solely on dates. The following dates are critical:

- Conception of the invention.
- First disclosure to witnesses, together with their signatures and the inventor's.
- Reduction of the invention to practice (construction of the device).
- Significant events (such as the first sketches, first written description, and first successful operating test) in the evolution of the invention.

On numerous occasions, more than one applicant has filed for the same invention. The most noteworthy cases concern invention of the triode (Lee De Forest vs General Electric) and the telephone (Alexander Graham Bell vs Elisha Gray). In both cases the decisions depended on dates.

As for the notebook itself, a hard-cover, permanently bound notebook with numbered, stitched-in pages is a necessity since, in a court action, there can be no question of pages ever being added or deleted. Some notebooks offer an important convenience—detachable duplicate pages that

can be removed when needed. Thus, these pages can be filed by subject or can be photographed for special use, such as evidence in a patent suit.

There's no question that well-kept patent notebooks pay off, but they do demand painstaking attention. Should you be tempted to complain that your notebooks are too time-consuming, think of Thomas Edison, dean of inventors. He and his associates filled more than 150 notebooks (8-1/2 by 6 inches, containing 200 pages) with data on storage-battery experiments⁴ and more than 200 notebooks with data on electric-light experiments.⁴ Edison used 3400 notebooks in his career.⁵

Now, how about shaping up your own notebooks? ■■

References

1. "Laser Patent Valid," *Chemical and Engineering News*, August 15, 1966, p. 20.
2. Hart, Ivor B., *The World of Leonardo Da Vinci*, Viking Press, New York, copyright 1961, pp. 202, 192, 347.
3. Buckles, Robert A., *Ideas, Inventions and Patents*, Wiley & Co., copyright 1957, pp. 68 and 69.
4. Dyer, F. L., and Martin, T. C., *Edison, His Life and Inventions*, Volume II, copyright 1929, pp. 616 and 208.
5. Josephson, Mathew, *Edison*, McGraw-Hill, copyright 1959, p. 11.

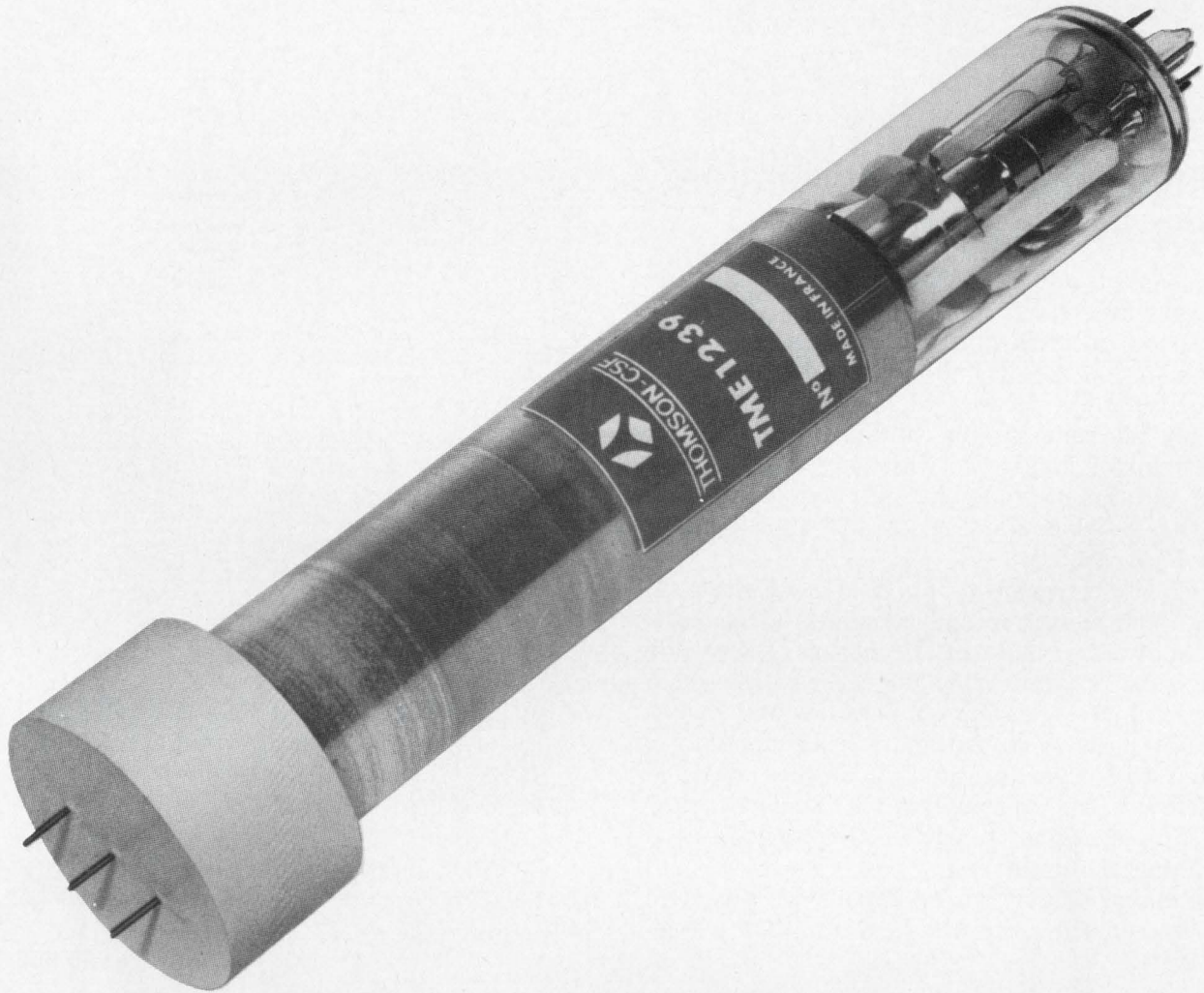

The only miniature storage tube that can hold an image for 1 month...and erase it in one TV frame.

Actually our TME 1239 acts as an electronic buffer memory. It can store a full TV gray-scale image for 15 minutes with constant refreshing, and a black and white image for half an hour. If the power is turned off, storage capability is at least one month.

A unique feature of the TME 1239 is its fast erasing capability: thanks to a specially developed gun*, one TV frame is enough to erase a complete image down to the residual noise level of a good amplifier. Because the display function is separated from the storage system, the user can selectively edit the stored image or, if he is interested in blow-up, zoom-in on any portion of the image.

The 1.5"-diameter structured silicon target of the TME 1239 permits a resolution of 1200 TV lines at a 50% modulation. It also permits operation with standard vidicon hardware, at a voltage level of 750 volts. The resulting flexibility and low cost of associated electronics make the TME 1239 ideal for a number of applications such as TV image storage, bandwidth compression or expansion, scan conversion, peripheral buffer memory, etc.

Also available is the TME 1238: its 1" target permits a resolution of 800 TV lines at 50% modulation.

For specific information, please circle the appropriate number on the Reader Service Card or contact us directly.

*Thomson-CSF patent.



THOMSON-CSF

Thomson-CSF Electron Tubes, Inc./50 Rockefeller Plaza/New York, N.Y. 10020/(212) 489-0400

INFORMATION RETRIEVAL NUMBER 35

Ideas For Design

A simple astable multivibrator uses only two inverters

A reliable astable multivibrator can be made with very few parts as shown in the diagram. The period of oscillation is approximately $3RC$ and varies only 2% for a power-supply range of 4.5 to 5.5 V. The duty cycle varies from 45% to 55% for the same supply voltage variation.

The resistor biases the first gate in the active region and this provides the high loop gain necessary for reliable starting. A 220-ohm resistor biases Y at +1.2 V.

A negative transition at Z is coupled to X through the capacitor and causes Y to be positive. A positive value of Y charges X positive through the resistor. When X reaches a threshold of approximately +1.5 V, Y goes low and Z goes high. The positive transition at Z is coupled to X through the capacitor, and X is then charged negative by the resistor. When X goes below +1.5 V, a negative transition again occurs at Z completing the cycle.

The multivibrator can be gated with a control input by replacing the first inverter with a two-input gate.

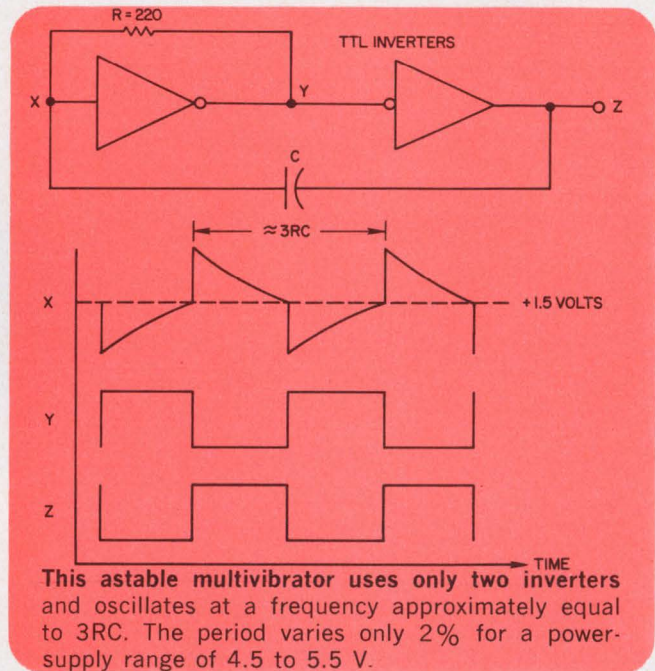

James E. Blecksmith, Senior Engineer, Electronic Engineering Co. of California, 1441 E. Chestnut Ave., Santa Ana, Calif.

VOTE FOR 335

Simple control for sign of op-amp gain

In analog instrumentation it is often necessary to operate an op amp either in the inverting or the noninverting mode, depending upon the value of an external control signal. The circuit shown provides this sign change and by proper choice of resistor values the gain is also a function of sign.

Q_1 is a transistor with a very low $V_{CE(SAT)}$. When the control signal E_c is low, Q_1 is cut off and the op amp works in the noninverting mode, with gain $A^+ = 1 + R_2/R_3$. When E_c is high, Q_1 saturates and the op amp inverts with gain $A^- = -R_2/R_1$. R_3 is not used for unity gain. The divider network (R_6 and R_7) for the base drive of Q_1 is set to comply with the particular type of logic providing E_c .

Accuracy is improved if Q_1 is used as a chopper by simply interchanging the roles of the emitter

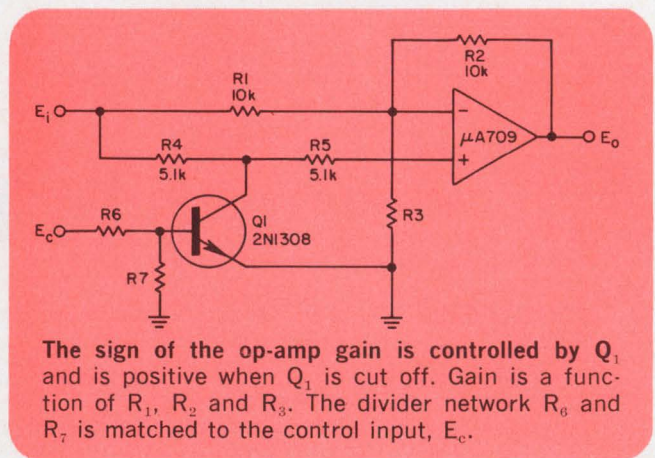

and collector.

Sergio Franco, Department of Computer Science, University of Toronto, 1103 McLennan Lab, Toronto, Ontario 181, Canada.

VOTE FOR 336

When we say High Resolution We mean 10Hz in 40MHz

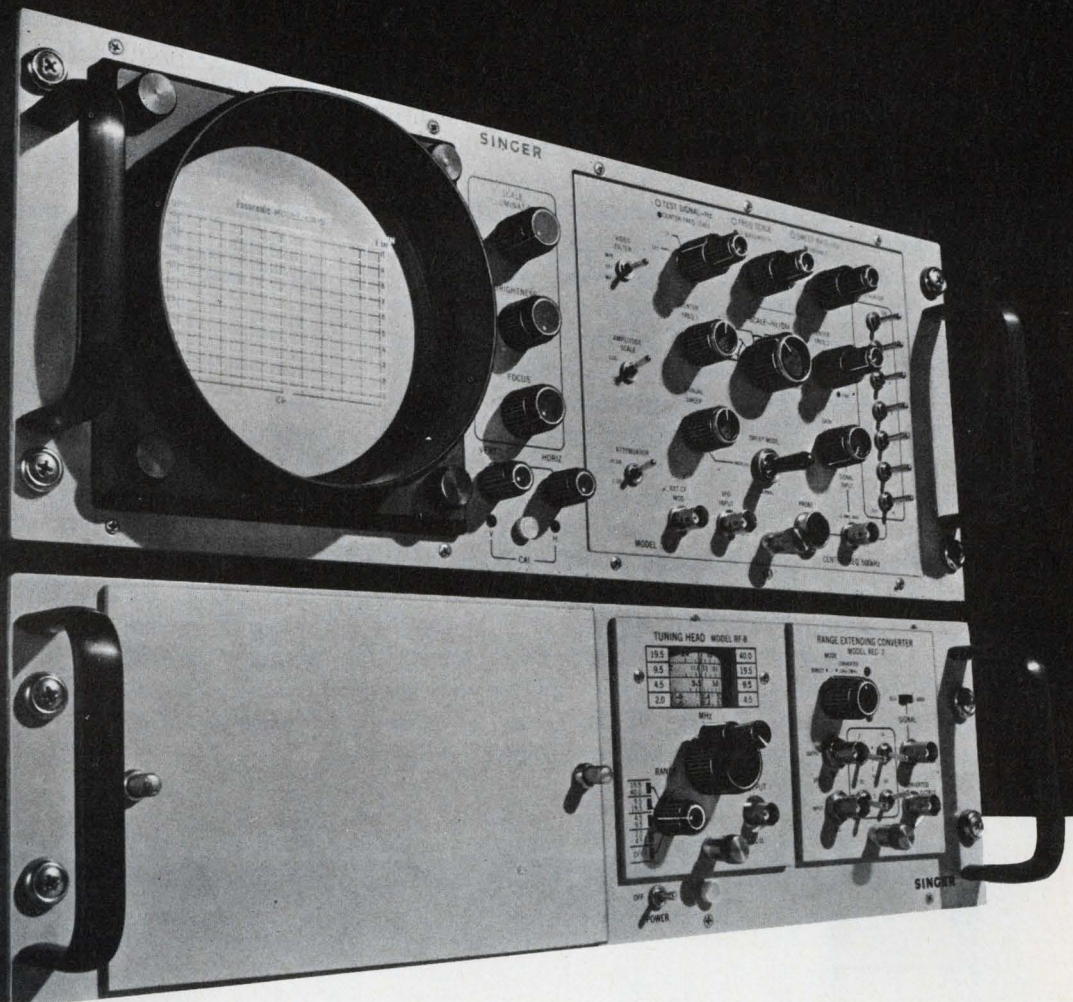

The Singer SA-51B Spectrum Analyzer offers the unbeatable combination of high resolution with 70 dB dynamic range from 10Hz to 40MHz

Signals as closely spaced as 10 Hz are clearly visible from 10 Hz to 40 MHz (and even out to 200 MHz with slightly reduced sensitivity).

■ Now you can measure in-band distortion products down to 70 dB below peak levels . . . exceptionally wide dynamic range with uniform 5 microvolt sensitivity from 2 to 40 MHz; usable to beyond 200 MHz.

■ This measuring system's high stability permits 10 Hz resolution, with steep skirt selectivity, over the full frequency range.

■ An image and spurious free up-converter extends the frequency range to 10 Hz and provides unambiguous displays of audio, base-band or IF signals.

■ A low distortion two-tone audio signal generator supplies modulating signals to equipment under test. (optionally available)

■ The highly linear response of the completely solid-state Model SA-51B High Resolution Spectrum Analyzer makes it ideal for monitoring and "dynamically" analyzing odd- or

even-order AF/RF components of narrow-band SSB, AM, FM and multiplexed FSK signals.

Basic instrument price, \$6060

The Singer Company,
Electronic Products Division,
915 Pembroke Street, Bridgeport,
Conn. 06608. In Europe contact:
Singer Sewing Machine Company,
Electronic Products Division,
P.O. Box 301, 8034 Zurich, Switzerland,
Telephone: (051) 47 25 10.

SINGER
INSTRUMENTATION

Temperature-controlled voltage regulator covers 0°C to 50°C

This thermistor-controlled voltage regulator provides an output level that changes with ambient temperature. If the output is used to drive a motor, continuous adjustment of physical parameters such as liquid level or flow rate is possible. Monitoring the output with a voltmeter provides a simple remotely operated thermometer.

As shown in the drawing, the circuit contains a reference voltage generator, thermistor, amplifier, voltage divider (R_1 and R_2) and a driver. The thermistor is located at the point where temperature variations are sensed—remote from the reference voltage source. A change in temperature causes a shift in reference voltage V_r , which is then amplified and fed to a driver circuit.

Important to good circuit performance are fast response time, low power dissipation and a linear temperature vs output-voltage characteristic. The type 25TD1 thermistor has been selected for its low thermal time constant. The I_o level is set at 2.3 mA so that the maximum power dissipation in the thermistor is less than 1.5 mW.

The design shown provides a 48-V output at a nominal ambient temperature of $T_o = 25^\circ\text{C}$. The circuit has a temperature coefficient $\alpha = 0.00575$ per $^\circ\text{C}$. (α was restricted to $0.006 \pm 5\%$ per $^\circ\text{C}$ before the component values were calculated.) To change the output voltage at 25°C to a value other than 48 V, it is merely necessary to use

different values for the voltage divider (R_1 and R_2).

With E_o set to 48 V at 25°C , typical performance values at the temperature extremes are 41.1 V at 50°C and 54.9 V at 0°C .

Here's how to calculate the component values once the circuit performance has been defined:

Step 1. Calculate R_1 from $R_1 = 0.8 r_o$ where r_o is the resistance of the thermistor at ambient temperature. This empirical relationship provides a parallel resistance that varies linearly with temperature. It is valid for thermistors of curve-D type over the temperature range 0 to 50°C .

Step 2. Find R_3 to satisfy temperature coefficient requirements from the relationship:

$$\alpha = \frac{0.01772}{1 + (2.25 R_3 / r_o) + (2.25 V_{be2} / I_o r_o)}$$

where V_{be2} is the base-emitter drop across Q_2 .

Step 3. Find the reference voltage, V_{ro}' , at ambient temperature T_o ,

$$V_{ro}' = I_o (R_3 + 0.444 r_o) + V_{be2}$$

Step 4. Choose R_1 and R_2 so that

$$(R_2 + R_1) / R_2 = E_o / V_{ro}'$$

where E_o is the output voltage desired at ambient temperature T_o .

R. K. Yee, RCA Information Systems Division, Needham, Mass.

VOTE FOR 337

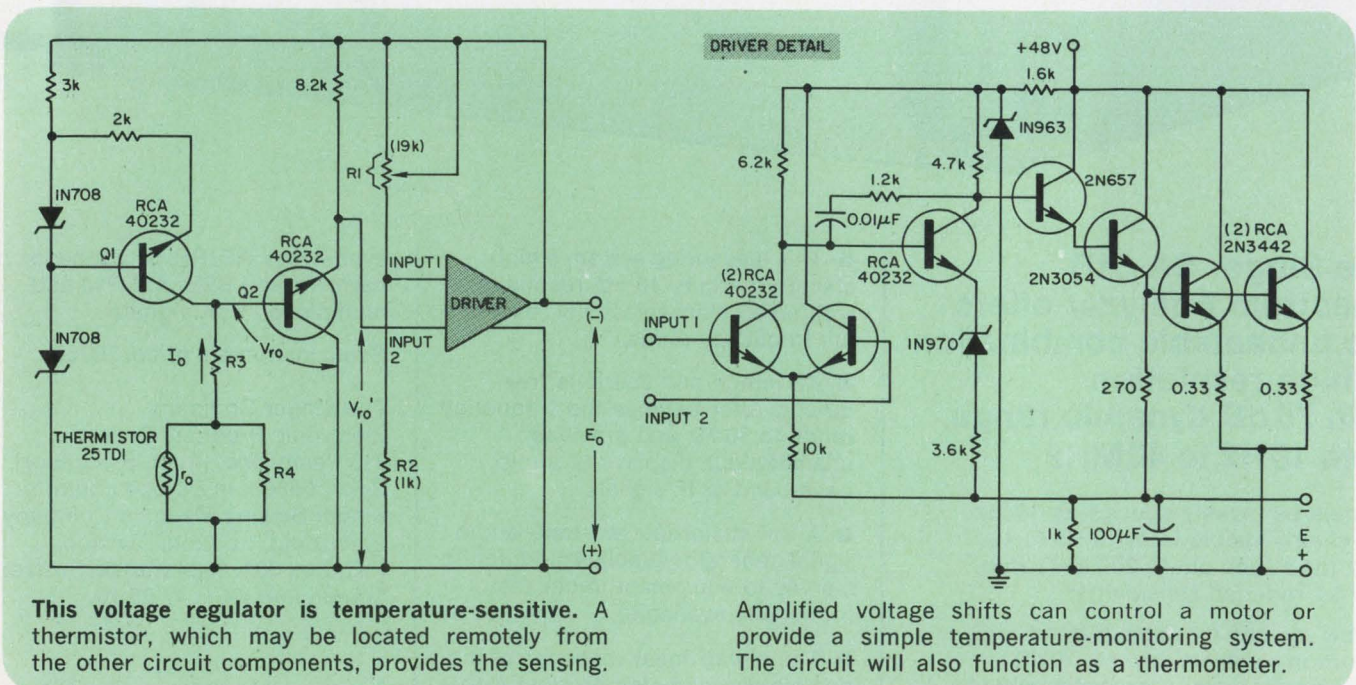

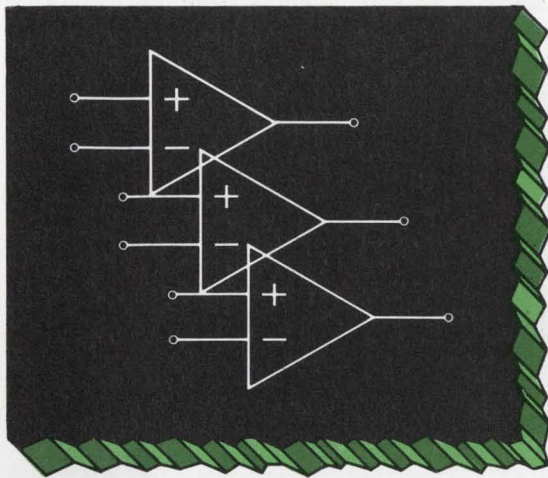

TRIPLE LOW POWER OP AMPS

□ Need low power drain □ High packing density □ Op amps by the dozen? The L143 monolithic triple low power op amp fits. Applications include active filters (shown), complex instrumentation circuits and battery powered equipment.

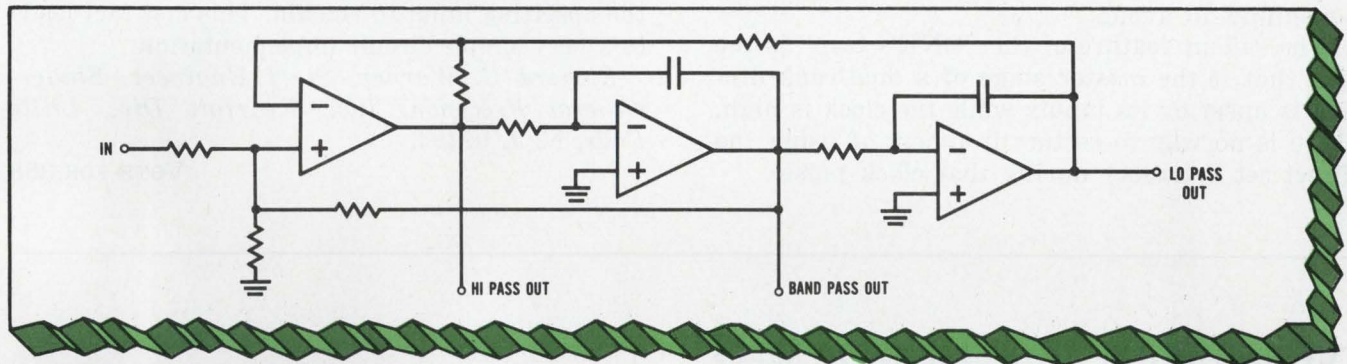

The L143 operates from $\pm 3V$ to $\pm 15V$ supplies, drives an 0.5 mA load, idles at 80 μA (externally adjustable, 20–100 μA). Typical gain is 85 dB with unity gain BW=2 MHz. MIL grade and industrial version in TO-86 flatpac or TO-116 DIP, priced as low as \$16.10/triple in 100 pc. lots. Call any of the offices below for more information.

New York: Sy Levine (516) 796-4680
New England: Al La Croix (617) 762-8114
St. Louis: Jim Spicer (314) 291-3616
Minneapolis: Ed Koelgen (612) 920-4483
Southern California: Dave Ferran (213) 420-1307
Northern California: Chuck Brush (408) 246-8000

 **Siliconix incorporated**

2201 Laurelwood Road • Santa Clara • California 95054
 Telephone (408) 246-8000 Extension 201 • TWX: 910-338-0227
Great Britain: Siliconix Limited, Saunders Way, Sketty, Swansea
West Germany: Siliconix GmbH, 7024 Bernhausen, Postfach 1340
France: Siliconix, 9 Avenue d' Arromanches, 94-Saint-Maur

INFORMATION RETRIEVAL NUMBER 37

Synchronize event detector to sampling time

It is occasionally desirable to determine whether or not an event has occurred during some discrete interval of time and subsequently to synchronize the report of the event with the end of the sampling period. This task can be accomplished using only one-half of a dual J-K flip-flop similar to the 5473, without the aid of other circuitry.

The timing diagram in the drawing shows the relationship between the desired interval of sampling (clock input); the event (the J input in a flip-flop that is being arbitrarily started in the ZERO state); the master stage of the flip-flop; and the slave stage of the flip-flop. Note that the report of the event, as represented by the transition of the slave stage, is delayed until the end of the desired interval. The circuit is prepared for the next desired interval through the use of the direct reset pulse.

The J-K flip-flop which is a master-slave or dual-rank device, makes use of its "ONE's trap" characteristic, which is normally considered something to avoid.

The salient feature of the "ONE's trap" is the fact that if the master stage of a dual-rank flip-flop is upset by its inputs while the clock is high, there is no way to restore it (short of using the direct set or reset) during that clock pulse.

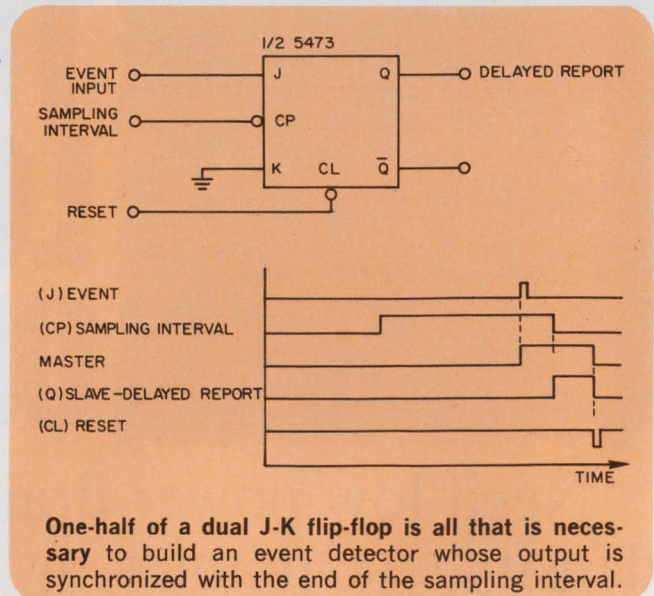

In addition, only one of the inputs, either the J or the K, is involved, depending upon the current state of the slave. If the slave is in the ZERO state, then only the J input can affect the state of the master. If the slave is in the ONE state, then only the K input to the master is effective. Since the master cannot be restored during a given clock pulse, there is no need for the upsetting input to remain. This last fact leads to a very simple circuit implementation.

Richard C. Warner, Staff Engineer, Singer-General Precision, Inc., Kearfott Div., Little Falls, N. J. 07424.

VOTE FOR 338

Differentiator operates to 20 MHz without using discretes

By taking advantage of the inherent delay in TTL ICs, it is possible to construct a differentiator without discrete components.

Referring to the figure it can be seen that if the input to the differentiator is quiescently at a logical ZERO, the outputs of 1A1 and 3A1 will be logical ONE, which makes the output of 2A1 a logical ONE. When the input to 1A1 goes positive the output goes to a logical ZERO, forcing the output of 2A1 to a logical ONE. With both inputs to 3A1 at ONE, the output becomes a ZERO, forcing the output of 1A1 back to ONE.

The width of the output pulse of 1A1 is equal to the delay through three gates and is approximately equal to 30 ns. If a positive output pulse is required or if an output pulse is required on the negative edge of the input, the output or input can be inverted by using the remaining gate

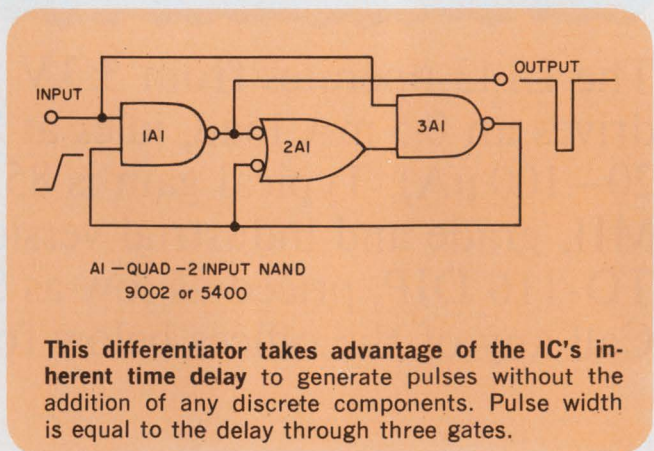

in the quad two-input NAND. Either 9002 or 5400 TTL ICs can be used.

Charles H. Doeller III and Aaron Mall, Design Engineers, Bendix Corp., Communications Div., E. Joppa Road, Baltimore, Md. 21204.

VOTE FOR 339

New Space-Saving 1/16" Wire Wrap Panels ...

WITH *Nurl-Loc*® LOW-PROFILE TERMINALS

Standard or Custom!

Save space, and plug into present PC connectors of any make! Brand new high-density packaging panels from EMC utilize 1/16" non-warping glass epoxy boards, and low profile Nurl-Loc terminals. Typical board shown is 60-position mix pattern, for 40 14-Pin (voltage and ground committed) and 20 16-Pin (uncommitted) dual-in-line I.C.'s. Standard test jacks are accessible from front. Eight decoupling networks are positioned for a cleaner voltage. EMC engineers can custom-design panels to include choice of board size and thickness (1/16", 1/32" or 1/8"), 30 to 352 positions, edgeboard finger patterns, power and ground planes, etc. All panel boards are fabricated to MIL-P-55110 and have UL approval.

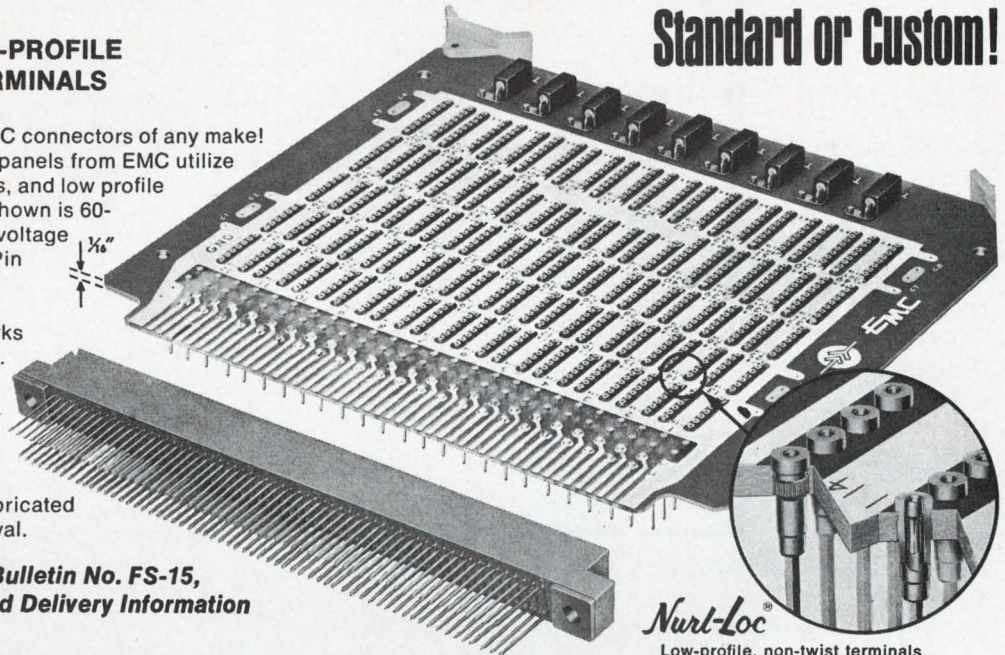

Write or Phone Today for Bulletin No. FS-15,
Price and Delivery Information

Nurl-Loc®
Low-profile, non-twist terminals
with highest push-out resistance.
PATENT NO. 199,930 and 3,292,132



ELECTRONIC MOLDING CORPORATION
98 Mill Street, Woonsocket, Rhode Island 02860 • (401) 726-2100

INFORMATION RETRIEVAL NUMBER 38

CRT Circuitry Breakthrough!

One Victoreen Corotron Acts As
100-Zener Equivalent Regulator

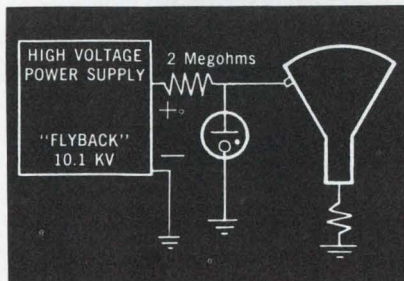

In this circuit example, a Corotron M42D-9.7 (9,700 volts) regulates a high voltage power supply for a computer data display system cathode ray tube. The Corotron provides reliable line and load regulation, and clarity of the CRT display.

Specifying one Victoreen Corotron is like gaining the equivalent regulating performance of hundreds of zener diodes. Ideal "failsafe" reference voltage in 400 to 25,000 volt range. Enables circuitry to hold constant high voltage. Operating range: -65°C to 200°C. Shock resistant to 2000G. Easy to design into circuits. Important size, weight, and cost savings. Send for Design Manual or call.



Free Design Manual
40-page manual contains specs and design data for circuit engineers. Request Corotron Manual.

VICTOREEN INSTRUMENT DIV. of VLN
10101 WOODLAND AVE. • CLEVELAND, OHIO 44104 • TEL. 216/795-8200
EUROPE: ARNDLE HOUSE THE PRECINCT, EGHAM, SURREY, ENGLAND • TEL. EGHAM 4887
DMA 554



INFORMATION RETRIEVAL NUMBER 39

ELECTRONIC DESIGN 23, November 8, 1970

JANCO OFFERS A "TOTAL APPROACH" TO YOUR SWITCHING PROBLEM!

Standard rotary selector switches, miniature, micro-miniature, power, push-button, solenoid operated, keylock, momentary, etc. . . . Janco has the total line for your every need! You'll find this same "total approach" in Janco's quality of design and materials. And if Janco's basic switches do not completely fill your needs . . . Janco engineers will design one!

JANCO CORPORATION
3111 Winona Ave., Burbank, California 91504
Phone 213-845-7473 • TWX 910-498-2701

INFORMATION RETRIEVAL NUMBER 40

NAND gate resets computer flip-flops

The power-clear generator shown can be used to reset the counters, registers and other flip-flops of a computer after a power interruption. This generator will ground the computer reset bus for 150 ms after power is reapplied and then return the bus to its normal high condition.

The circuit operates as follows. Starting with the power off: (t_0), C_1 is discharged. When power is applied (t_1) e_0 is at ground because e_1 is still below the turn-on threshold of gate 1 due to the discharged condition of C_1 . C_1 begins to charge through D_1 and R_2 and the input resistance of gate 1. At t_2 the capacitor voltage e_1 reaches the turn-on threshold of gate 1 (about 1.5 V) and e_0 goes high.

At the instant of a power failure (t_3), C_1 discharges through D_2 and R_1 and is again ready to provide its delay function when power is reapplied. D_2 should be a germanium diode to insure that C_1 is rapidly discharged below the turn-on threshold of gate 1.

Charles A. Herbst, Intelsat Earth Station, Broummana, Lebanon.

VOTE FOR 340

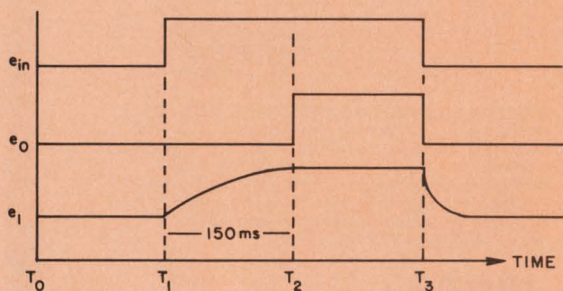
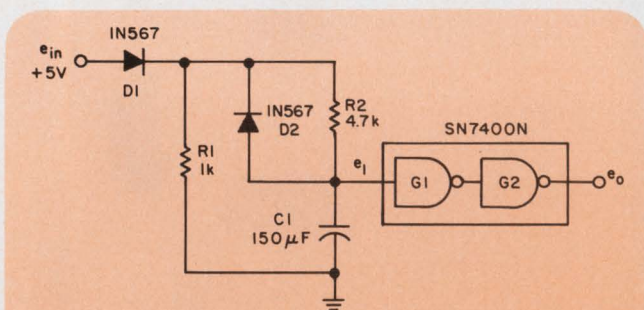

Computer flip-flop can be reset after a power interruption with this power-clear generator. After power is reapplied, the reset bus will be grounded for 150 ms, allowing sufficient time for the computer system power supplies to settle.

IFD Winner for June 21, 1970

Ron Treadway, Design Engineer, Motorola Semiconductor Products, 5005 East McDowell Road, Phoenix, Ariz. 85008. His idea "Exclusive-OR Gate Doubles VCM Output Frequency" has been voted the Most Valuable of Issue award.

Vote for the Best Idea in this Issue.

IFD Winner for July 5, 1970

W. L. Brown, Design Consultant, 8686 Dubonnet St., San Diego, Calif. 92123. His idea "Improved IC Fires SCRs Used In Auto Ignition" has been voted the Most Valuable of Issue award.

Vote for the Best Idea in this Issue.

IFD Winner for July 19, 1970

Ray Kauffman, President, Electronics Engineering Group, 9500 Underwood St., Seabrook, Md. 20801. His idea "Transformerless Converter Yields Plus/Minus Voltages" has been voted the Most Valuable of Issue award.

Vote for the Best Idea in this Issue.

IFD Winner for August 2, 1970

C. J. Ulrick, D. A. Kaplan, Design Engineers, Collins Radio Co., 5200 C. St., Cedar Rapids, Iowa 52406. His idea "SCR Improves UJT Oscillator Circuit" has been voted the Most Valuable of Issue award.

Vote for the Best Idea in this Issue.

VOTE! Go through all Idea-for-Design entries, select the best, and circle the appropriate number on the Reader-Service-Card.

SEND US YOUR IDEAS FOR DESIGN. You may win a grand total of \$1050 (cash)! Here's how. Submit your IFD describing a new or important circuit or design technique, the clever use of a new component or test equipment, packaging tips, cost-saving ideas to our Ideas-for-Design editor. You will receive \$20 for each accepted idea, \$30 more if it is voted best-of-issue by our readers. The best-of-issue winners become eligible for the Idea Of the Year award of \$1000.

This issue has your renewal card, inside front cover. Mail it today.

The power supply
you plan to build
is built!



\$99 each

OTHER MODELS 3 to 50 V available

It's on the shelf, ready for immediate delivery from Electrostatics. With specs proven in service. Low cost. Brief specs on our Model 200:

- 5V 15A DC Power Supply
- Input 105-125V, 47-420 Hz
- Regulation: Line 0.01%
Load 0.1%
- Ripple: 500 μ V max.
- Temp: -20 to +71°C
- Foldback current limiting
- Size: 5.5" W x 5" H x 10.8" L

(\$114 with overvoltage protection)

For full information call Robert McCartney, Manager of Application Engineering, (714) 279-1414. Or circle the number below for our latest data sheet.

Electrostatics, inc.

7718 Clairemont Mesa Blvd., San Diego, California 92111

DEPT. 112

INFORMATION RETRIEVAL NUMBER 41

PANEL & GANG SWITCH SEALS

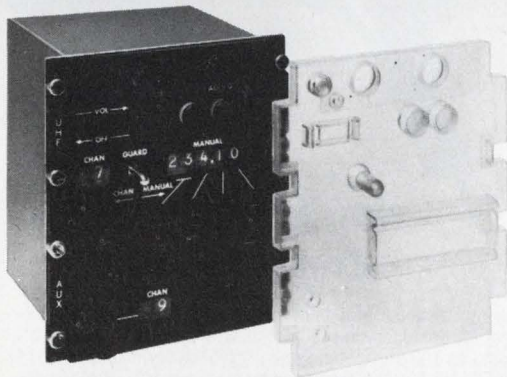

Custom molded to your panel or ganged-switch dimensions, APM-Hexseal silicone protective seals allow complete visibility while keeping out dust and moisture. Gasketing keeps edges tight while flexible molded portions allow easy operation of knobs, toggles, pushbuttons and circuit breakers. Also available are individual sealing boots for standard switches and breakers, with RFI shielding if desired.

All applicable military specifications met. For more data, prices, samples, write:



APM-HEXSEAL

44 Honeck Street, Englewood, New Jersey 07631

(201) 569-5700

INFORMATION RETRIEVAL NUMBER 42

ELECTRONIC DESIGN 23, November 8, 1970

New generation of magnetic shielding.

The name of the shielding material is Westinghouse Hipernom[®] alloy, and the idea is: less does more. Shielding effectiveness is greater, especially at high frequencies, than the older shielding alloys. You can use Hipernom in thinner sections and save weight. Or use it as straight replacement and get more effective shielding.

Among the people who need Hipernom . . .

- Astronauts carrying rock cores back from the moon in Hipernom cans to preserve lunar magnetic characteristics.
- Circuit designers who, having mastered the art of shielding in milliamp circuits, are starting to move to the microamp range.
- Tape-head designers.
- Image or display tube and oscilloscope manufacturers.
- Computer designers; especially for miniaturized computer components.
- Anyone developing electronic medical equipment.
- Anyone concerned with meeting electromagnetic pulse requirements.
- Anyone at all using the same magnetic shielding material he was using five years ago.

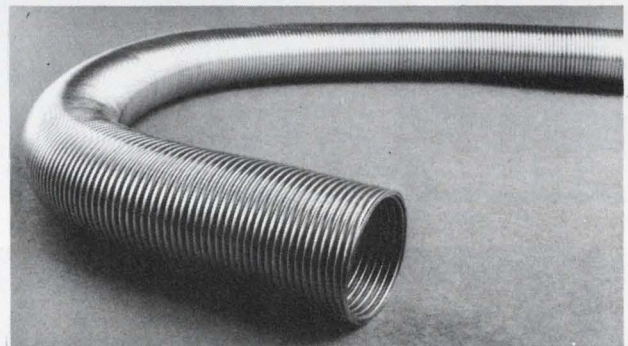

Hipernom as formed by one of its many users into flexible tube. Very time-saving, often very cost-saving. Hipernom is available from Westinghouse in strip, sheet, plates and bar. Total metals capability to serve the electronics and aerospace industries. 1-5-70

Westinghouse Specialty Metals Division

Box 45, Blairsville, Pa. 15717

(412) 459-9400

You can be sure . . . if it's Westinghouse



INFORMATION RETRIEVAL NUMBER 43

A FULL LINE OF MULTI-OUTPUT POWER SUPPLIES NOW FROM ASTRO-SPACE LABS

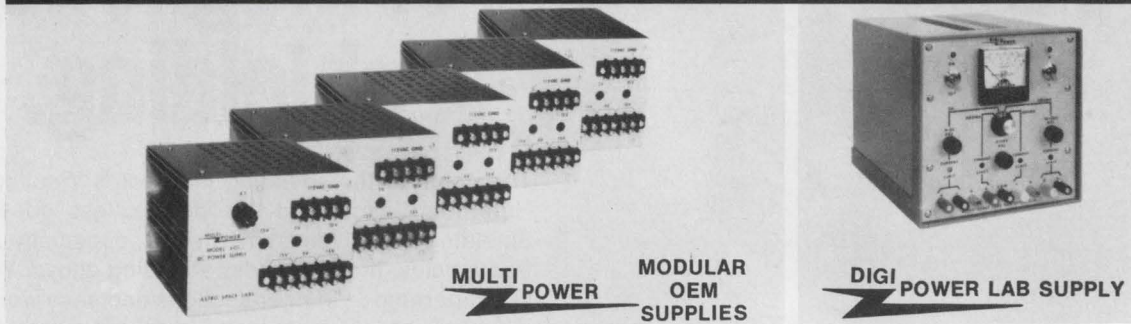

Low Cost, Compact, Reliable Sources of DC
Specifically Designed For

- Digital And Linear Integrated Circuits
- MOS Circuitry
- Relays, Solenoids, Sequencing, Switching Devices

Found In . . . Data Processing Terminals

- Communications Terminals
- Laboratories
- Computers

3 - 4 or 5 Outputs

Inputs: 115VAC/220VAC/240VAC ··· 50/60 HZ
Outputs: 3VDC to 28VDC. Fixed or Adjustable

Astro-Space Laboratories, Inc.



Research Park, Huntsville, Alabama 35806
Phone 205/837-5830 or TWX 810-726-2111

INFORMATION RETRIEVAL NUMBER 44

ALCO LITE OFFERS MORE

Large 3/8" dia. plastic lens removes for easy lamp replacement from front. MC-75 accepts T-1 based lamp. MC-100 accepts T-1 3/4 based lamp. Choice of 5 lens colors. Supplied less lamp.

FLANGED LAMP HOLDER T-1 T-1 3/4

MC-75 USES
T-1 LAMP

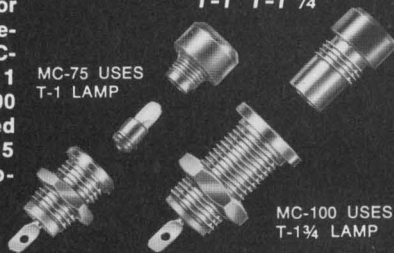

MC-100 USES
T-1 3/4 LAMP

ALCO ELECTRONIC PRODUCTS, LAWRENCE, MASS.

INFORMATION RETRIEVAL NUMBER 53

ALCO LITE OFFERS MORE

Ideal for space limitations. BNE's lens appears slightly above panel. BNF lens is higher for greater illumination. BND square lens projects from panel for max. light intensity. With and without internal resistor.

MODERN NEON PILOTS

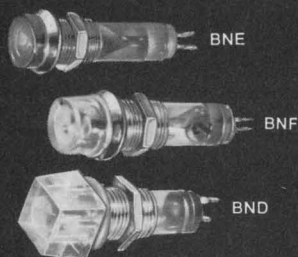

ALCO ELECTRONIC PRODUCTS, LAWRENCE, MASS.

INFORMATION RETRIEVAL NUMBER 45



we're plugging our patching potential

For instance, our brand-new .040" pin patch cord kit is perfect for breadboarding, IC patching or test point work. It contains 100 straight-pin and piggyback style cords in 2-, 4-, 6-, and 8-inch lengths. Packaged by size in neatly labeled poly bags, the cords are red, blue and black to simplify coding. Other colors and lengths are available in the piggyback style, .040" pin. Write or call us today for details.

Cambridge Thermionic Corporation, 445 Concord Avenue, Cambridge, Mass. 02138. Phone: (617) 491-5400. In Los Angeles, 8703 La Tijera Boulevard 90045. Phone: (213) 776-0472.

Standardize on

CAMBION

The Guaranteed Electronic Components

INFORMATION RETRIEVAL NUMBER 46

ELECTRONIC DESIGN 23, November 8, 1970

New Products

High-density 5120-bit ROMs include on-chip decoding

Electronic Arrays, Inc., 501 Ellis St., Mountain View, Calif. Phone: (415) 964-4321. P&A: \$40 (100 quantities); stock.

Featuring an access time as low as 500 ns, the new EA 4000 family of high-capacity high-speed bipolar-compatible static read-only memories packs in 5120 bits, including complete decoding, on a single chip.

Each read-only memory is organized as 512 words at 10 bits/word. The on-chip decoding is through an address-holding register that allows sampling and timing control of the input data.

The first standard-pattern read-only memory unit is the EA 4001. It is programmed to provide all 64 standard ASCII-encoded alphanumeric characters in a 7-by-9 vertical-scan font.

Where a standard 5-by-7 font is acceptable, an EA 4004 memory unit can provide the complete 96-character ASCII-encoded alphanumeric set with upper and lower-case characters and 32 pictorial

representations of the control codes, in the same package.

Other special graphic symbols and foreign-language characters can also be contained on the EA 4000 memories. For example, the Japanese technical phonetic alphabet Katakana can be contained in a single package.

The family of EA 4000 memories also features low power dissipation of only 0.6 mW/bit. Since they are static devices, no clocks are required. This does not, however, limit the access time of each device which depends on the output configuration used. Maximum cycle time is 600 ns.

The new devices achieve bipolar compatibility with a single external resistor on the output. They operate from ± 12 -V supplies and are TTL-compatible.

Custom patterns utilizing the basic EA 4000 read-only memory chip are available. Forms for defining specialized memory contents are also available from the memory's manufacturer.

CIRCLE NO. 320

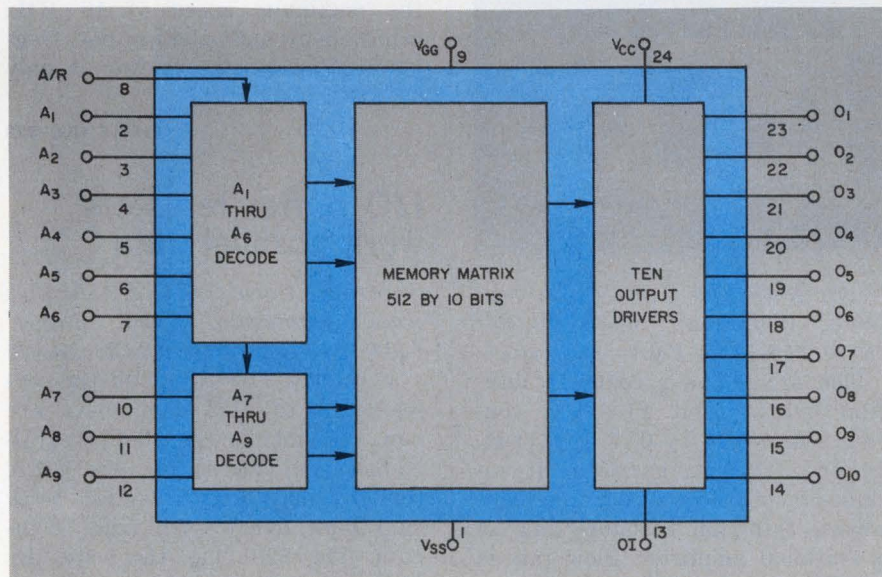

Block diagram of the EA 4000 static read-only memory chip shows the high-density memory configuration of

512 words by 10 bits per word. Also shown on the same chip are input decoding and output stages.

This issue has your renewal card, inside front cover. Mail it today.

Monolithic MOS switch selects dual frequencies

Consumer Electronics Ltd., 142/146 Old St., London, England.

A dual-frequency MOS selective switch amplifies and frequency-categorizes input signals and operates integral switches when the frequencies reach preset values. Type FX-201 Z-Trip consists of two separate band-accept switches, each responding only when a signal within a predetermined frequency range is applied to the common input terminal. It adjusts frequencies, bandwidths and degree of separation from 10 Hz to 50 kHz with a factor of 1000.

CIRCLE NO. 321

2560-bit memory has 500-ns access

Texas Instruments, Inc., 13500 N. Central Expressway, Dallas, Tex. Phone: (214) 238-2011. P&A: \$22.25; stock.

Organized as 256 by 10 bits, a new dynamic MOS/LSI read-only memory accesses in only 500 ns. Designated the TMS2300JC, it can be custom-programmed to meet specific memory requirements at little or no extra cost. Direct input and output with TTL circuits is possible without adding any external components. Only one clock with a 5-V swing is required.

CIRCLE NO. 322

Darlington transistors deliver gains of 2500

Motorola Semiconductor Products, Inc., Box 20924, Phoenix, Ariz. Phone: (602) 273-6900. P&A: \$8.50, \$6.70, \$3.45, \$3.85, \$3.20; stock.

Five new series of complementary silicon power Darlington transistors provide typical gains of up to 2500 with current ratings from 4 to 16 A. The new devices are supplied in 60 or 80-V collector-emitter breakdown-voltage ratings. They incorporate both driver and output transistors plus resistors in one monolithic structure.

CIRCLE NO. 323

Silicon rectifier accepts 15 kV PIV

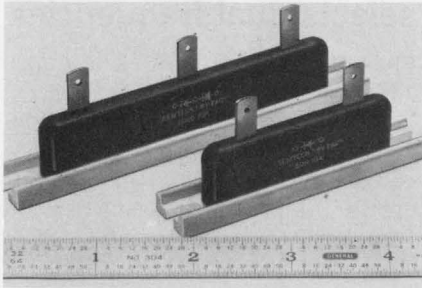

Semtech Corp., Newbury Park, Calif. Phone: (805) 498-2111.

A new high-voltage silicon rectifier device called KV-PAC features average rectified currents of 0.4 A at PIV ratings up to 15 kV. It includes a reverse current of 10 μ A at PIV ratings. KV-PAC units are corona-free and include mounting slots. Universal three-way electrical connections accommodate wirewrap or solder connections. Each KV-PAC rectifier measures 1.32 by 0.63 by 6.09 in.

CIRCLE NO. 324

Four multi-chip ICs form a synthesizer

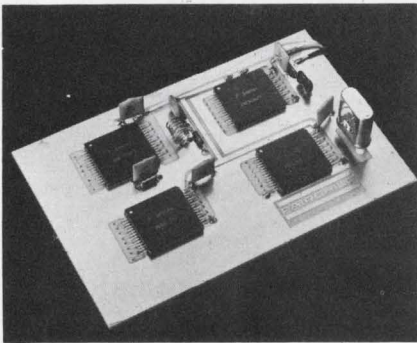

Fairchild Semiconductor, 313 Fairchild Dr., Mountain View, Calif. Phone: (415) 962-3563. Price: \$60, \$50, \$75, \$43.

Four multi-chip ICs together form a general-purpose hybrid frequency synthesizer on a PC board. The synthesizer consists of 1-by-1-in. flatpacks operating up to 200 MHz. They are the SH8095 ECL prescaler, the SH8096 programmable divider, the SH8097 voltage-controlled tuner and oscillator, and the SH8098 programmable reference divider and oscillator.

CIRCLE NO. 325

Power zener diode dissipates 300 W

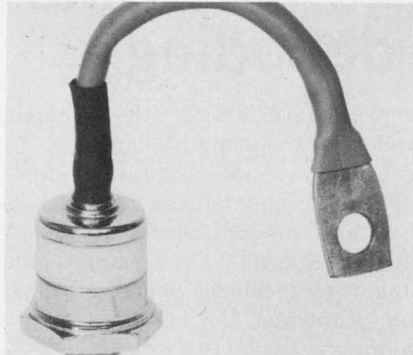

Mullard, Inc., 100 Finn Court, Farmingdale, N. Y. Phone: (516) 694-8989.

Primarily intended for high transient-suppression applications, a new high-power zener diode can dissipate up to 300 W of continuous power at a heat-sink temperature of 65°C. The new zener diode can also suppress repetitive power surges up to 3 kW for a duration of 50 ms. Applications include industrial power-control equipment and heavy-duty power supplies.

CIRCLE NO. 326

Tiny 8-bit converter is a 14-pin DIP

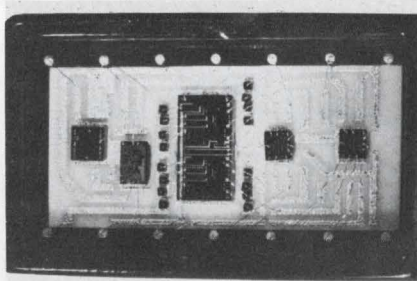

Micro Networks Corp., 5 Barbara Lane, Worcester, Mass. Phone: (617) 756-4635. P&A: \$79; stock.

The MN303 is a complete thin-film hybrid 8-bit BCD d/a converter in a 0.45 by 0.75 by 0.14-in. 14-pin DIP configuration. It includes monolithic switching networks, thin-film resistors and an operational amplifier. Slew rate is 0.5 V/ μ s, temperature coefficient is ± 10 ppm/°C and power consumption is only 400 mW. Operating temperature range is 0° to +70°C.

CIRCLE NO. 327

Complementary MOS ICs dissipate only 10 nW

Motorola Semiconductor Products, Inc., Box 20912, Phoenix, Ariz. Phone: (602) 273-6900. Price: \$5.70, \$5.40, \$9.60.

Three new complementary MOS ICs, two gates and a flip-flop, feature extremely low quiescent power dissipations of 10 nW for the gates and 50 nW for the flip-flop. The MC2501L is a quad 2-input NOR gate and the MC2502L is a dual 4-input NOR gate. The MC2503L is a dual flip-flop. Another outstanding quality of these devices is a high noise immunity.

CIRCLE NO. 328

1024-bit MOS register shifts to 10 MHz

Texas Instruments, Inc., 13500 N. Central Expressway, Dallas, Tex. Phone: (214) 238-2011. P&A: \$14.30; stock to 4 wks.

A four-phase MOS dynamic shift register/accumulator with a capacity of 1024 bits operates up to 10 MHz. The TMS3309JC has two independent 512-bit registers, each with separate input, output and clock lines operating at a different frequency. Each register operates from 10 kHz to 5 MHz with the maximum speed of 10 MHz achieved by multiplexing both registers. Power consumption is only 90 μ W/bit.

CIRCLE NO. 329

I/O buffer registers work parallel data

Signetics Corp., 811 E. Arques Ave., Sunnyvale, Calif. Phone: (408) 739-7700. P&A: \$8.39; stock.

Four new I/O 10-bit buffer register ICs of MSI complexity are now available for parallel-in parallel-out applications. In the 8200, the flip-flops are arranged as a dual 5-bit array with true D inputs. The 8201 has the same arrangement with complementing D inputs. The 8202 buffer is a single 10-bit array with true D inputs. The 8203 has the same complementing D inputs.

CIRCLE NO. 330

four interface problems:

1. Eliminate interface maintenance between a telegraph line and TTL logic for \$3.55.

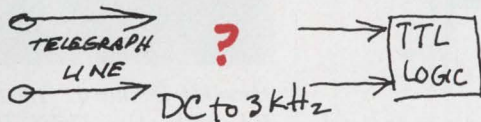

3. Eliminate ground loop spikes between computer and remote terminal for \$3.95.

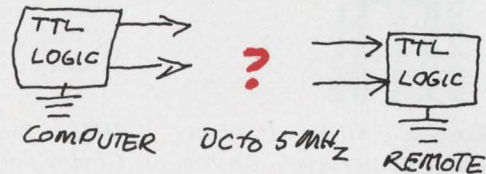

2. Trigger a remote SCR from TTL logic for \$4.50.

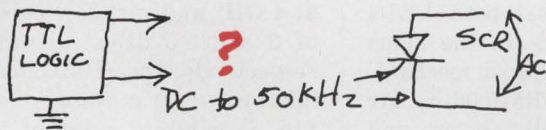

4. Couple TTL logic to 1.5 kV CRT blanking grid for \$3.95.

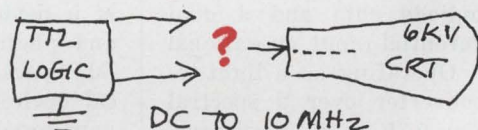

four opto-isolator solutions:

1. GaAs infrared LED
 $t_r = 40 \text{ ns @ } R_s = 50 \Omega$
 $I_F < 100 \text{ mA cont.}$
 $V_F = 1.3 \text{ V}$
 $V_{BR} = 3 \text{ V}$
 $\lambda = 9000 \text{ \AA}$
 This emitter makes solutions 2, 3, and 4 possible.

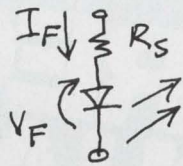

3. Silicon phototransistor MCT 2
 $t_r = 2 \mu\text{s @ } R_L = 100 \Omega$
 $f_{1/2} = 200 \text{ kHz @ } R_L = 100 \Omega$
 $V_{BRCEO} > 30 \text{ V}$
 $I_C/I_F = 35\% \text{ typ.}$
 $I_{C \text{ sat}}/I_F = 5\% \text{ typ.}$
 Solves 1 above.

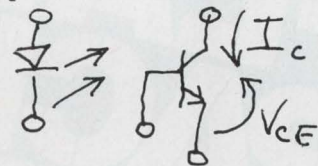

2. Silicon photodiode MCD 2
 $t_r = 110 \text{ ns @ } R_L = 100 \Omega$
 $V_R = 20 \text{ V}$
 $f_{1/2} = 5.5 \text{ MHz @ } R_L = 100 \Omega$
 $V_{BR} > 75 \text{ V}$
 $I_L/I_F = 0.2\% \text{ typ.}$
 Solves 3 and 4 above.

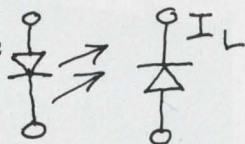

4. Silicon photoSCR MCS 2
 $t_{on} = 5 \mu\text{s @ } I_F = 20 \text{ mA}$
 $I_A < .15 \text{ A cont.}$
 $V_A = 200 \text{ V max.}$
 $I_{F \text{ turnon}} < 10 \text{ mA}$
 Solves 2 above.

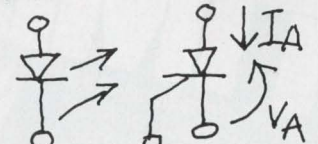

...and an answer kit: \$9.95.

The opto-isolator solves tough design problems. To let you work with these new devices, we've put together an *Opto-isolator Answer Kit*. Contains an MCT 2, MCD 2, MCS 2 in our six-lead Iso-DIP package at about half the price of the discrete parts — plus a new volume of GaAsLITE Tips that shows how to design opto-isolators into your problem circuits. Order from your Monsanto distributor or write Monsanto Electronic Special Products, 10131 Bubb Road, Cupertino, CA 95014. (408) 257-2140. All part prices are suggested resale price in 1,000 quantities

Monsanto

Distributors: In US—Schweber, Semiconductor Specialists, K-Tronics, and Kierulff. UK, Semiconductor Specialists; Semi Comps. France, RTF. West Germany, A.Neyen-Enatechnik. Denmark, Scansupply. Belgium, Techmaton. Norway, Arthur F. Ulrichsen A/S. Switzerland, Omni Ray A.G. Italy, Silverstar Ltd. Sweden, GP-Ingenjoersfirman. Japan, New Metals and Chemicals Ltd. Corp. Australia, Hawker Siddeley. Israel, Monsel. Canada, Schweber; Canadian Dynamics. The Netherlands, Techmaton n.v.

TO-5 photodiode includes op amp

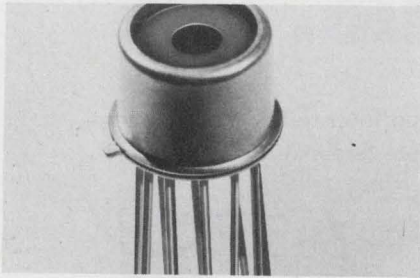

EG&G, Inc., Electronic Products Div., 170 Brookline Ave., Boston, Mass. Phone: (617) 267-9700.

The HAD-1000 incorporates in a TO-5 package the SGD-100A silicon photodiode chip and a dual FET differential-input operational amplifier. Operating as a light-to-voltage converter over a spectral range from 0.35 to 1.15 microns, it features inverting and non-inverting inputs, internal frequency compensation and off-set compensation control.

CIRCLE NO 331

DIP optical switch has LEDs and sensors

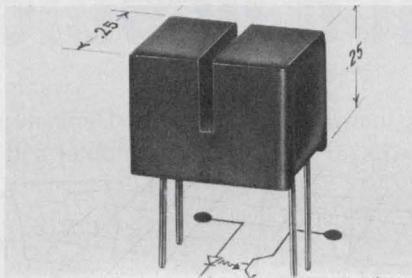

HEI, Inc., Jonathan Industrial Center, Chaska, Minn. Phone: (612) 448-3510. P&A: \$8.05; stock to 4 wks.

The model OS100 optical switch is a device that uses both LEDs and phototransistors in the same DIP package. Passing a mechanical device through its 0.06-in. air gap breaks the light beam and opens the circuit. This unit also doubles as an optically coupled isolator. Used to replace mechanical switches, it will last indefinitely.

CIRCLE NO. 332

12-GHz transistor carries \$15 price tag

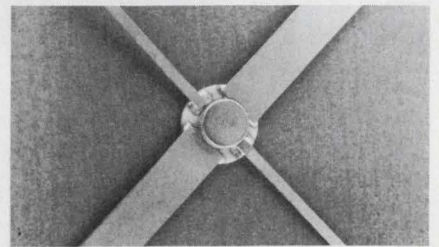

Hewlett-Packard, 1501 Page Mill Rd., Palo Alto, Calif. Phone: (415) 326-7000. P&A: \$15 (chip), \$19 (stripline); under 30 days.

With a unity-gain frequency of 12 GHz, output power of 100 mW at 4 GHz and very low noise figures of 3 and 5.5 dB at 1 and 3 GHz, respectively, the HP21 small-signal microwave transistor costs only \$15. It exhibits gains of 20 and 3 dB at 0.5 and 9 GHz, respectively, and has fast risetimes of 1.5 ps in chip form and 4 ps in stripline form.

CIRCLE NO. 333

FLAT PACK TIMERS

Solid state time delay relays, ideal for high density PC boards. Compatible with dual in-line packaging. Fixed time delays to 500 sec., accuracy $\pm 10\%$. Delay-on-pull-in timing action. Positive or ground output closure. Meet or surpass all applicable MIL requirements. For complete specs, request Tempo Tech Data Publication 103.

TEMPO INSTRUMENT DIVISION
Allen Electric and Equipment Company
PLAINVIEW, N. Y. 11803 • 516-694-4400

FREQ PHASE SENSORS

For under and/or over frequency detection and phase sequence sensing. Trip points from 50 to 500 Hz, accuracy $\pm 2\frac{1}{2}\%$. Relay or solid state output arrangements. Built-in chatter protection. Hermetically sealed. Meet or surpass applicable MIL requirements. For complete specs, request Tempo Tech Data Publication 301.

TEMPO INSTRUMENT DIVISION
Allen Electric and Equipment Company
PLAINVIEW, N. Y. 11803 • 516-694-4400

3-mW He-Ne laser is only \$425

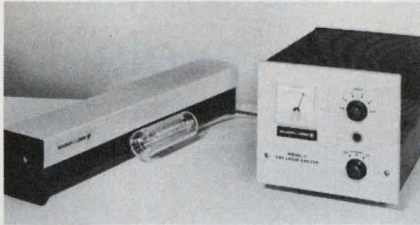

Bausch & Lomb Scientific Instrument Div., 635 St. Paul St., Rochester, N. Y. Phone: (716) 232-6000. Price: \$425.

Producing a 3-mW output, the low-cost model II He-Ne gas laser for interferometry and holography costs a mere \$425. It produces a highly collimated beam at 6328 Å. Beam divergence is 0.7 milliradians with a coherent path length of approximately 9 in. The tube is guaranteed to perform for 1000 hours or one year, whichever comes first.

CIRCLE NO. 334

60-V pill varactors work to 100 GHz

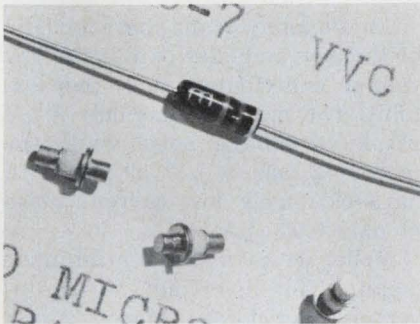

Eastron Corp., 25 Locust St., Haverhill, Mass. Phone: (617) 373-3829. P&A: \$7.80 to \$25; stock to 4 wks.

The new E700 series of high-frequency silicon varactors in ceramic pill packages operate in excess of 100 GHz. They feature working voltages of 60 V and are made with capacitances of 1 to 22 pF to provide full-octave tuning capability. Applications include FM modulation and frequency multiplication for microwave frequencies through S band.

CIRCLE NO. 341

This issue has your renewal card, inside front cover. Mail it today.

Now choose either

PLASTIC

or

GLASS

FIBER OPTICS

from

WELCH ALLYN

For minimum cost (as in disposable products) or for maximum bundle flexibility, check the advantages of fiber optics assemblies or systems made with Welch Allyn's newly developed *plastic* fibers.

For high precision work, where infra-red light transmission is important, or where fiber optics are exposed to high heat, our *glass* fibers are normally still preferable.

COORDINATED FIBER OPTICS/LAMP SYSTEMS

Glass or plastic, your fiber optics system will have maximum optical performance with custom-built, precision Welch Allyn miniature lamps.

Ask us about your glass or plastic fiber optics assemblies or lamp/fiber optics systems.



Welch Allyn, Inc., Skaneateles Falls, N. Y. 13153 Tel (315) 685-5788
INFORMATION RETRIEVAL NUMBER 50

EUTECTIC PREFORMS

for semiconductor assembly



**with quality service to
match quality products**

CRM makes perfect preforms of eutectic alloys of Gold-Tin, Gold-Silicon, and Gold-Germanium.

CRM preforms can help you to produce perfect ICs, hybrids, transistors, and diodes. Quality is controlled from the ingot on, including not only standard tests, but also checks of foil surface finish and flow characteristics. The extensive die inventory at CRM makes most preforms available without delay and without a tooling charge.

CRM will meet your strictest specifications.

CRM delivers what it promises. CRM delivers on TIME.

Call or write CRM for a quotation on your preforms or the CRM catalog with a list of over 300 stock dies.

**CONSOLIDATED
CRM REACTIVE
METALS, INC.**
a Division of CONSOLIDATED REFINING CO., Inc.
114 Hoyt Avenue, Mamaroneck, N.Y. 10543
Tel: (914) 698-2300 □ TWX 710-566-1112

INFORMATION RETRIEVAL NUMBER 51

Thrifty 1-MHz FET op amps unfold 0.15-pA bias levels



Analog Devices, Inc., 221 Fifth St., Cambridge, Mass. Phone: (617) 492-6000. P&A: \$66, \$84, \$36, \$46; stock.

The new models 41 and 42 FET-input high-performance operational amplifiers with a price range of \$36 to \$84 feature ultra-low bias current of just 0.15 pA and a wide-band of 1 MHz.

This high-performance pair bridges the gap between conventional low-cost FET-input operational amplifiers and more expensive and exotic high-performance varactor bridge electrometers at no increase in price due to the increase in performance.

Besides approaching a varactor bridge amplifier's range of bias current, the models 41 and 42 amplifiers solve a major varactor bridge amplifier limitation: the inherent problem of very modest bandwidths.

The 1-MHz small-signal bandwidths of the new amplifiers easily out-compared small-signal bandwidths of varactor bridge amplifiers of the same cost, which are typically in the 2 kHz region.

Another important characteristic of the new amplifier pair is the low voltage and current noise they exhibit. The model 41 has only 8 μV pk-pk of voltage noise while the model 42 has 6 μV pk-pk. Both have extremely low current noise of only 0.005 pA.

Model 41 is a differential-input amplifier for inverting and non-inverting applications. Model 42 is a less costly unit for inverting applications.

There are two versions of both models 41 and 42, each version having a different grade of voltage drift and different maximum bias current.

Model 41J has a maximum voltage drift of 25 $\mu\text{V}/^\circ\text{C}$ and the 41K has a maximum drift of 10 $\mu\text{V}/^\circ\text{C}$. The 42J drifts a maximum of 75 $\mu\text{V}/^\circ\text{C}$ and the 42K has a maximum drift of 25 $\mu\text{V}/^\circ\text{C}$.

CIRCLE NO. 342

Don't miss an issue of Electronic Design; return your renewal card today.

Ten-bit d/a converter is a DIP or flatpack

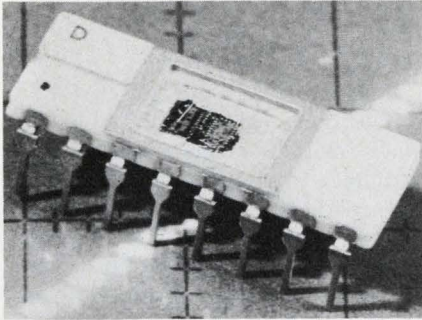

Precision Monolithics Inc., 1500 Space Park Dr., Santa Clara, Calif. Phone: (408) 246-9222. P&A: \$42 to \$200; 30 days.

A new complete 10-bit d/a converter is now available in a dual-in-line or flatpack case. The AIM DAC-100 settles in 350 ns to $\pm 0.1\%$, zero-drifts 2 ppm/ $^{\circ}\text{C}$ and has a temperature coefficient range of 12 to 150 ppm/ $^{\circ}\text{C}$. It operates over -55 to $+125^{\circ}\text{C}$ and is provided with output-voltage ranges of 0 to +5, 0 to +10, 0 to ± 2.5 and 0 to $\pm 5\text{V}$.

CIRCLE NO. 343

Neon indicator light includes a flasher

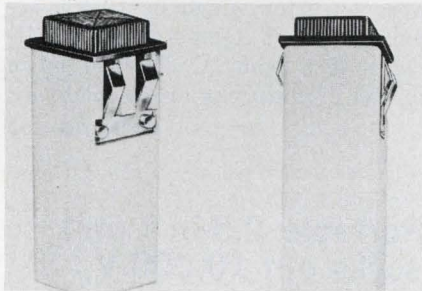

Dialight Corp., 60 Stewart Ave., Brooklyn, N. Y. Phone: (212) 497-7600.

Designed for snap-in panel mounting, a new neon indicator light is now available with a self-contained flasher. Entirely self contained, the components for the flasher are soldered to a PC board which extends through the back of the enclosure and terminates in eyelets for soldering connections. A nominal rate of 130 flashes/minute was selected in designing the indicator.

CIRCLE NO. 344

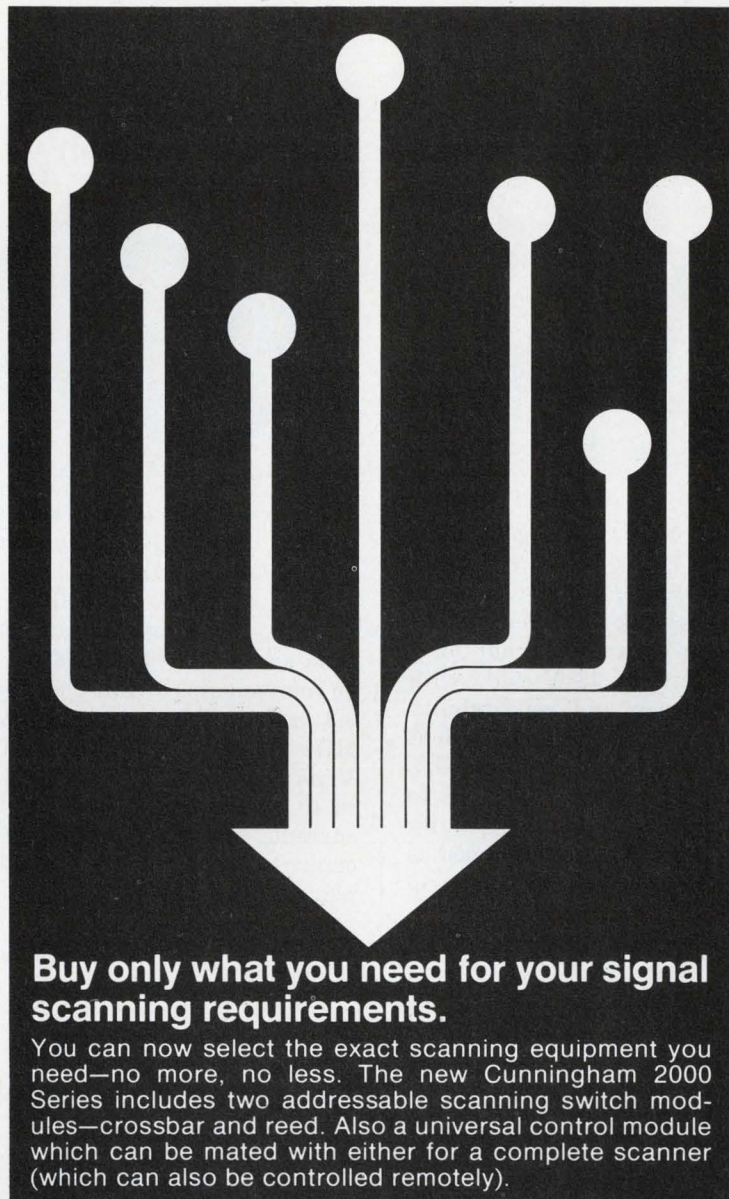

Buy only what you need for your signal scanning requirements.

You can now select the exact scanning equipment you need—no more, no less. The new Cunningham 2000 Series includes two addressable scanning switch modules—crossbar and reed. Also a universal control module which can be mated with either for a complete scanner (which can also be controlled remotely).

Buy these units complete, or their switch and control modules separately



Model 2400 Crossbar Scanner. Includes:
1. Crossbar Module (Model 2100) with capacity from 100 six-wire to 600 single-wire channels. Scans up to 60 channels/sec.
2. Control Module (Model 2300) can control more than one Crossbar Module.

Model 2500 Guarded Reed Scanner.

Includes: 1. Reed Switch Module (Model 2200) with 10 to 100 three-wire channels. Scans up to 250 channels/sec.
2. Control Module (Model 2300) can control up to 10 Reed Switch Modules (1000 channels).

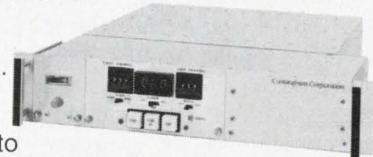

Both scanners and their switches are especially ideal for low-level and low thermal switching, accept BCD address (other optional), and are modular, expandable and 19" rack-mountable. Read the details on Model 2400 (Bulletin 324) and Model 2500 (Bulletin

325). Write Cunningham Corporation, 10 Carriage Street, Honeoye Falls, New York 14472.

Cunningham Corporation

SUBSIDIARY OF GLEASON WORKS

INFORMATION RETRIEVAL NUMBER 52

Dual set-point module senses 1-mV excursions

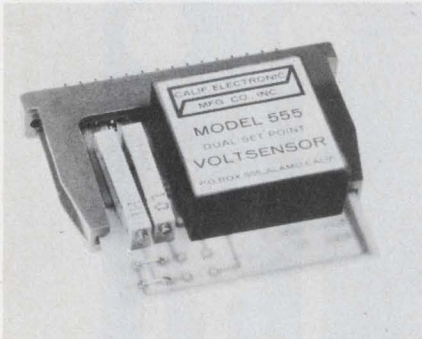

California Electronics Mfg. Co., P.O. Box 555, Alamo, Calif. Phone: (415) 932-3911. P&A: \$68; stock.

The model 555 VoltSensor can sense a 1-mV excursion out of a window 5 mV to 48 V wide with 0.01% accuracy and repeatability up to 10 times/s. Two independent set points are adjustable for 95% of the supply voltages (± 25 V to ± 15 V) without any discontinuity through zero. Input impedance is 5 k Ω , hysteresis is 4 mV and trip point stability is 1 mV/ $^{\circ}$ C.

CIRCLE NO. 345

\$145 rms converter has $\pm 0.05\%$ accuracy

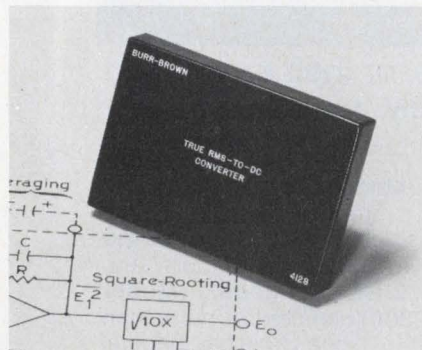

Burr-Brown Research Corp., International Airport Industrial Park, Tucson, Ariz. Phone: (602) 294-1431. P&A: \$145; stock.

The 4128 low-cost true-rms-to-dc converter achieves an accuracy of $\pm 0.5\%$ of full scale $\pm 0.5\%$ of reading with no external trimming at a small-quantity cost of only \$145. With external trimming, accuracy can be improved to $\pm 0.1\%$ of full scale $\pm 0.1\%$ of reading. It will accept most waveforms.

CIRCLE NO. 346

Monolithic op amps boast 10^7 dc gain



Electronic Associates, Inc., Components Dept., W. Long Branch, N. J. Phone: (201) 229-1100.

Two high-gain monolithic differential-input operational amplifiers are the 6.830 and 6.830-1 with dc voltage gains of 10^7 . They require 0.3 μ A of bias current, have 5-MHz full-signal bandwidths, a 300-V/ μ s slewing rate, settle to 0.01% in 10 μ s and have 50-mA of output current. The 6.830 employs 6-dB/octave roll-off and the 6.830-1 employs 1 decade of 12-dB/octave roll-off.

CIRCLE NO. 347

Regulated dual supply is 0.01% stable

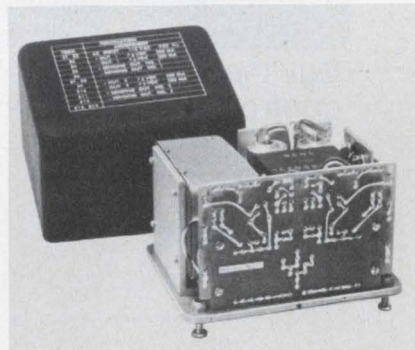

Glentronics, Inc., 748 E. Alosta Ave., Glendora, Calif. Phone: (213) 963-1676.

The model 23077 is a dual adjustable reference-type power supply with line, load and temperature stability of 0.01% for 30 days. Regulation is $\pm 0.002\%$ no load to full load and ripple is 1 mV pk-pk. The model 23077 also features remote sensing, automatic-overload and short-circuit protection. Outputs are 75 V and 250 mA, each.

CIRCLE NO. 348

Edgewise panel meter has taut-band style

Jewell Electrical Instruments, Inc., Grenier Field, Manchester, N. H. Phone: (603) 669-6400.

Measuring a mere 0.5 by 1.75 in., a new miniature edgewise panel meter, model MCE1T, is available in taut-band styles. It features horizontal or vertical positioning, separate bezel and hardware, clear Plexiglas front covers and self-shielded core-magnet construction. The model MCE1T is available in a wide variety of current and voltage ranges. Accuracy for all dc meters is $\pm 2\%$ of full scale. Accuracy for ac rectifier type meters is $\pm 3\%$ of full scale.

CIRCLE NO. 349

D/a 8-bit converter costs as low as \$65

Analog Devices, Inc., 221 5th St., Cambridge, Mass. Phone: (617) 492-6000. P&A: \$65; stock.

The crucial elements of the μ DAC 8-bit d/a converter, two AD550 quad switches and one AD-852 thin-film resistor network, can now be bought for only \$65. With this minimum number of components, one can wire up an 8-bit d/a converter which has 0.4% accuracy and a temperature coefficient of 5 ppm/ $^{\circ}$ C. TO-116 DIPs or TO-87 flatpacks are available.

CIRCLE NO. 350

Portable 2.5-in.³ unit socks out 10,000 V

Elliott Automation Radar Systems Ltd., Neutron Div., Borehamwood, Herts, England.

A new power-supply unit producing up to 10,000 V from a battery-powered package measures only 1-1/2 by 3-1/2 by 4-3/4 in. Called the CMS series, the supply weighing 1-1/2 lb produces 6000 V from a 20-V battery at 2-W of power dissipation. Voltages from 1000 to 10,000 V can be factory set. Nominal current is 30 μ A, and operating temperature range is -40 to $+70^{\circ}$ C.

CIRCLE NO. 351

INSTRUMENTATION

0.5-MHz pulse generator retails for \$175

Houston Magnetics, 6214 Royalton St., Houston, Tex. Phone: (713) 666-3201. Price: \$175.

Containing a 1-MHz crystal oscillator as the basic clock, the model 3200 pulse generator with selectable pulse rates from 1 to 500,000 pulses/second lists for less than \$175. Pulse widths are selectable from 1 μ s to 20 ms through a 12-position switch. Pulse repetition rates are also selected through a 10-position switch. Simultaneous positive and negative-going output pulses have fixed 5-V amplitudes.

CIRCLE NO. 352

Audio-band analyzer operates down to 10 Hz

Systron-Donner Corp., Microwave Div., 14844 Oxnard St., Van Nuys, Calif. Phone: (213) 786-1760. Price: \$3250.

The new model 710/801 is basically a swept-frequency spectrum analyzer operating from as low as 10 Hz up to 50 kHz with 10-Hz resolution. The local oscillator, which is tracked by an available 1-V signal, and the sweep generator can be swept either in a linear mode for display upon a 7-by-10-cm CRT or in a logarithmic frequency display for expanded lower-frequency analysis.

CIRCLE NO. 353

Strip-chart recorders work with linear motors

Hewlett-Packard Co., 1601 Page Mill Rd., Palo Alto, Calif. Phone: (415) 326-7000. P&A: \$750, \$695; 60 days.

Two new 3-1/2-in.-high strip-chart recorders use a unique linear servo motor pen drive to achieve high reliability. Model 7123A/B uses chart paper with a 10-in.-wide grid while the model 7143A/B takes chart paper with a 5-in.-wide grid. Adapting a linear motor results in a drive system with only one moving part: the motor/slider/pen assembly.

CIRCLE NO. 354

Digital voltmeter is a 10-MHz counter



California Instruments Corp., 3511 Midway Dr., San Diego, Calif. Phone: (714) 224-3241. Price: \$695.

In addition to measuring dc and ac voltages and resistances, the model 8420 4-1/2-digit voltmeter allows full-scale frequency measurements of 10, 100 and 1000 kHz and 10 MHz. Basic accuracy is 0.01% for dc voltages, 0.1% for ac voltages and 0.02% for resistance and frequency measurements.

CIRCLE NO. 355

**Can you use
1Kx8
core memory
systems for
\$470⁰⁰?
(Available now)**

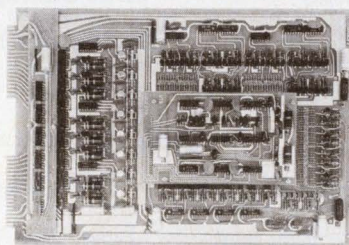

For full information on all the different size UTE Memories at equally attractive prices, write:

UTE UNITED TELECONTROL ELECTRONICS

3500 Sunset Ave., Asbury Park, N.J. 07712

New! Zenith's colorful two gun CRT

Where precise, high resolution color displays are essential, Zenith Dual Neck, Flat-Face Two Color CRTs offer the best answer. Independent operation of two guns allows different scan formats and rates without the need of complex switching circuits . . . assuring excellent color purity from edge to edge. Details are easily separated by variations of vivid color. For specifications, write for Zenith's new Dual Neck product file.

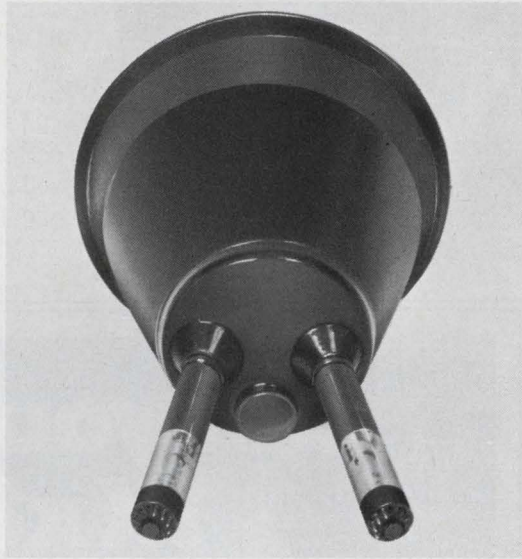

ZENITH RADIO CORPORATION
THE RAULAND DIVISION
5616 W. JARVIS AVE. • CHICAGO, ILL. 60648 • 312-647-8000

INFORMATION RETRIEVAL NUMBER 56

INSTRUMENTATION

Handy logic probes readout in colors

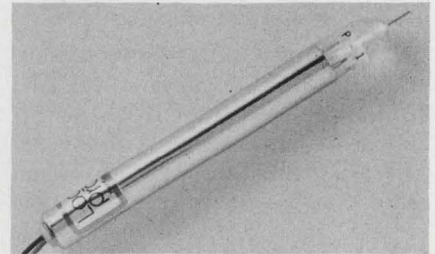

Kurz-Kasch, Inc., 1421 S. Broadway, Dayton, Ohio. Phone: (513) 223-8161. Price: \$44.95, \$69.95, \$44.95, \$79.95.

Using color-coded readout displays to indicate the proper logic state, a new family of four shirt-pocket-size logic probes with input impedances greater than 150 kΩ facilitate the instant and accurate testing of TTL, DTL, RTL and similar logic families.

The color-coded readouts are located on the tips of the chrome-finished-steel probes. They light up as white for OFF states, red for ON states and no readout for open circuits or unconnected wires.

The new logic probe family features high input overload protection up to +50 V dc and down to -20 V dc. They are also protected against damage due to lead reversal and derive power from the equipment being tested.

Model LP-510 works from 4.75 to 5.5 V dc at logic-level voltages ranging from 4.75 up to the collector-supply voltage.

Model LP-520 has the same characteristics as the LP-510, and in addition, can detect positive and negative pulse trains of less than 50 ns in width. Model LP-530 is designed for testing logic levels in the 12-to-15-V-dc level.

The model LG-580 is a square-wave-generator probe for troubleshooting digital circuitry. Simply rotating an integral end switch selects fast-rise-time testing signals of 10, 100, 1000 and 10,000 Hz. A single pulse can also be generated with a pushbutton located on the probe's side.

The LG-580 is powered from 4.5 to 6.5 V dc and includes a built-in power regulator. It can test all logic-voltage levels from 4.75 V dc to the collector-supply voltage.

CIRCLE NO. 356

This announcement is under no circumstances to be construed as an offer to sell or as a solicitation of an offer to buy any of these securities. The offering is made only by the Prospectus.

NEW ISSUE

September 30, 1970

\$150,000,000

Western Electric Company, Incorporated

8³/₈% Sinking Fund Debentures, due October 1, 1995

Price 99³/₄%

(Plus accrued interest from October 1, 1970 to the date of delivery)

Copies of the Prospectus may be obtained in any State in which this announcement is circulated from only such of the undersigned or other dealers or brokers as may lawfully offer these securities in such State.

Merrill Lynch, Pierce, Fenner & Smith
Incorporated

Salomon Brothers

Dillon, Read & Co. Inc. The First Boston Corporation Goldman, Sachs & Co. Kuhn, Loeb & Co.

Blyth & Co., Inc. Drexel Harriman Ripley duPont Glore Forgan
Incorporated Incorporated

Eastman Dillon, Union Securities & Co. Halsey, Stuart & Co. Inc.

Hornblower & Weeks-Hemphill, Noyes Kidder, Peabody & Co. Lazard Frères & Co.
Incorporated

Lehman Brothers Loeb, Rhoades & Co. Paine, Webber, Jackson & Curtis

Smith, Barney & Co. Stone & Webster Securities Corporation Wertheim & Co.
Incorporated

White, Weld & Co. Dean Witter & Co. Bache & Co. Paribas Corporation
Incorporated Incorporated

INFORMATION RETRIEVAL NUMBER 57

Dynamic curve tracer tests in/out of circuit



Jud Williams, Box 335, Long Valley, N. J. Phone: (201) 876-4376. P&A: \$120; stock.

The model A curve tracer dynamically tests transistors both in and out of any type of circuit regardless of its impedance. It is used with a monitor oscilloscope to display its patterns. Two signals are produced: a 120-Hz pulsating dc signal that is voltage variable from 0 to 80 V and a current signal in six steps from 10 μ A/step to 1 mA/step.

CIRCLE NO. 357

25-V 1-A supply is regulated for \$48

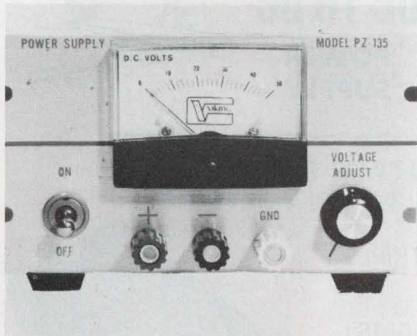

Viking Electronics, Inc., 721 St. Croix, Hudson, Wis. Phone: (715) 386-5188. P&A: \$48; stock.

For a price of only \$48, the model PZ-135-A laboratory power supply contains adjustable output of 0 to 25 V at currents to 1 A, line and load regulation of ± 10 mV and ± 50 mV, respectively and less than 1 mV of ripple. Additional features include current limiting, remote sensing, floating output, a 1-year warranty and a ten-turn voltage control.

CIRCLE NO. 358

This
Sweet
**MICROVOLT
MULTIMETER** is
SENSITIVE to 1 μ V,
STABLE within 2 μ V/day
and easy on the budget at
\$545

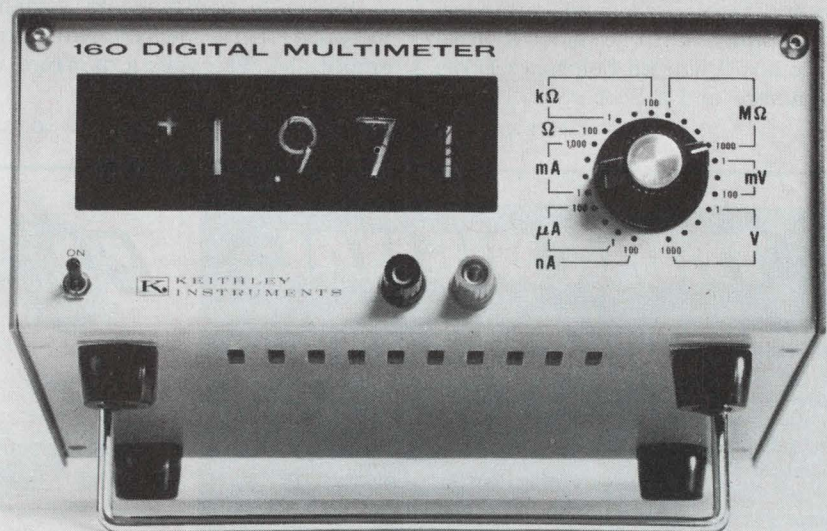

Users call it "the-how-sweet-it-is-meter".
But it's really the Model 160 that . . .

- MEASURES WITH DIGITAL ACCURACY
 - Voltage** — 1 μ V to 1000V
 - Current** — 0.1 nA to 2A
 - Resistance** — 0.1 Ω to 2000 M Ω
- 100% OVERRANGING
- ANALOG and OPTIONAL BCD OUTPUT
- MANY MORE SWEET PERFORMANCE FEATURES

SEND FOR FULL DETAILS AND YOUR FREE "HOW SWEET IT IS" BUTTON



**KEITHLEY
INSTRUMENTS**

U. S. A.: 28775 Aurora Road, Cleveland, Ohio 44139
Europe: 14, Ave. Villardin, 1009 Pully, Suisse

Scope camera set costs only \$89.50



Integrated Controls, Inc., P. O. Box 17296, San Diego, Calif. Phone: (714) 453-5800. P&A: \$89.50; 2 wks.

A new low-cost hand-held oscilloscope camera set which fits virtually all oscilloscopes costs only \$89.50. Scope-Mate model SC01 fits either 3, 4, or 5-in.-round or rectangular oscilloscope faces, can capture and record one-shot or recurring-trace data and provides photography in 15 seconds. It uses a standard Polaroid Colorpack II or III camera and a Scope-Mate hood.

CIRCLE NO. 359

25-MHz pulse generator sells for only \$395

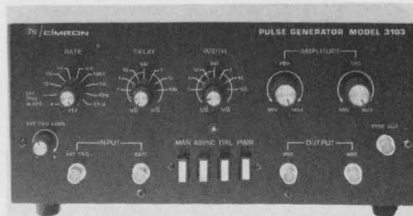

Lear Siegler, Inc., Cimron Div., 1152 Morena Blvd., San Diego, Calif. Phone: (714) 276-3200. P&A: \$395; stock.

Featuring rise and fall times of just 3 ns, the model 3103 economy pulse generator spans the pulse-repetition rate of 1 Hz to 25 MHz for a cost of only \$395. It can also generate double-pulse trains to 40 MHz and covers the pulse-width range of 20 ns to 100 ms. The 3130 is manually continuously variable in pulse rate, delay, width and amplitude. Triggering is from dc to 25 MHz.

CIRCLE NO. 360

Four IC test clips fit 24 to 40-pin DIPs

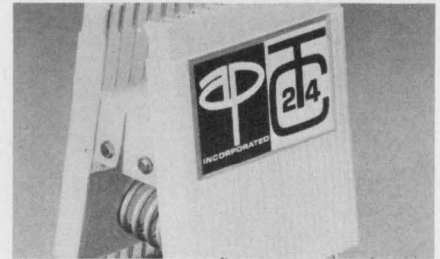

AP Inc., 72 Corwin Dr., Painesville, Ohio. Phone: (216) 357-5597. P&A: \$21; stock to 3 wks.

Four new test clips accommodate DIP packages with up to 40 pins. Model 923724 straddles 24-pin DIPs. 28, 36, and 40-pin IC test clips are available on special order. All four clips accommodate DIPs with 0.5 and 0.6-in. pin spacing. Spring-controlled gripping assures positive contact. All pins are gold-plated phophor bronze and clip bodies are of molded acetal copolymer.

CIRCLE NO. 361

THINK DIGITAL

7-Segment display uses T-1 lamps having the long life of neons. Figure size is .340" x .614". One-piece metal case has built-in filter. Bezel and mount assemblies available. Model MS-4000BR.

7-SEGMENT INCANDESCENT

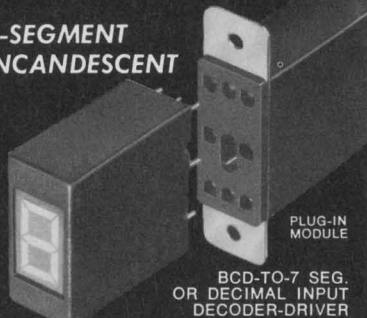

PLUG-IN MODULE

BCD-TO-7 SEG. OR DECIMAL INPUT DECODER-DRIVER

ALCO ELECTRONIC PRODUCTS, LAWRENCE, MASS.

INFORMATION RETRIEVAL NUMBER 59

THINK DIGITAL

BCD-to-7 output decoder/power drivers with counters & memories for Alco & other segmented displays. Hybrid design allows either high voltage or high current output. 1000 lot prices as low as 8.76 each.

HYBRID DECODER DRIVERS

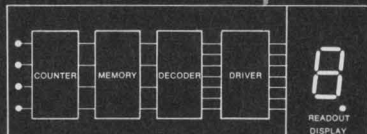
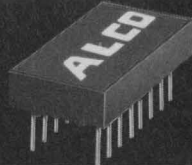

ALCO FOR INCANDESCENT OR NEON DISPLAYS ELECTRONIC PRODUCTS, LAWRENCE, MASS.

INFORMATION RETRIEVAL NUMBER 60

GOING MOBILE

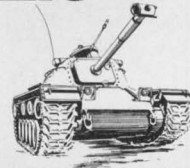

DC TO DC POWER SUPPLY



ONE INPUT VOLTAGE RANGE FROM 11 VOLTS TO 32 VOLTS DC

SINGLE, DUAL, OR TRIPLE OUTPUTS FROM 5 VOLTS TO 2,000 VOLTS

HIGH EFFICIENCY SWITCHING REGULATOR

FOR MORE INFORMATION ASK FOR PRODUCT DATA BULLETIN #16



GOING MOBILE GO MIL

MIL ELECTRONICS INC.

HUDSON, N. H. 03051
TEL. (603)889-6671

INFORMATION RETRIEVAL NUMBER 61

ELECTRONIC DESIGN 23, November 8, 1970

PC dual-in-line trimmer contains 5 fixed resistors

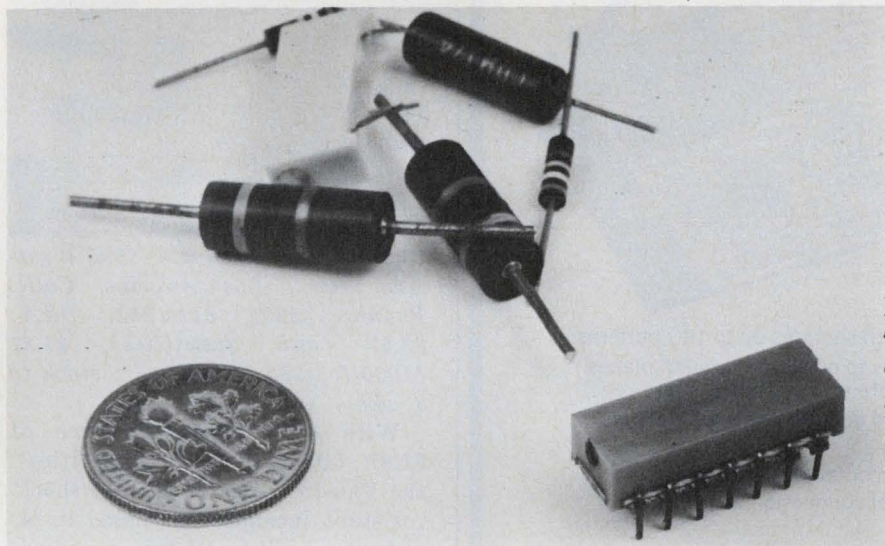

Amphenol Controls Div., The Bunker-Ramo Corp., 120 S. Main St., Janesville, Wis. Phone: (608) 754-2211. P&A: \$1 to \$3; 2 to 4 wks.

A new concept in printed-circuit resistive trimmers is the TRN (trimmed resistor network) which consists of a trimmer and five fixed resistors housed in a single 14-pin dual-in-line package.

The new TRN series 3765 network will sell for approximately \$2 (moderate production quantities) and for as low as \$1 (100,000 quantities or more).

It cuts down on printed-circuit board space and reduces the time needed to assemble individual resistors by taking advantage of automatic insertion techniques. Resultant cost savings can be significant.

Another important advantage of the TRN networks is the benefit of better performance due to matched resistor temperature coefficients. This is because all resistors are on the same substrate and drift together due to temperature changes.

This matched temperature characteristic makes TRNs ideal for use in temperature-critical networks.

Specifically, TRN resistive elements, which are prepared from a newly introduced cermet paste, exhibit a nominal temperature coef-

ficient of 50 ppm/°C over an average temperature range of -40 to +85°C.

All the resistor elements are screened at once and from the same cermet paste. This results in extremely close matching of temperature coefficients and very small amounts of drift.

Each resistor is connected to its own set of terminals, enabling the user to interconnect the terminals in series, in parallel or in series-parallel combinations. The resistors can also be used with the trimmer or without it.

Typical specifications for the TRN series 3765 include a resistance range of 10 Ω to 1 MΩ at a standard tolerance of ±10% with ±1% tolerances available on special order. The operating temperature range is -25 to +85°C for standard units and -55 to +125°C for special units.

Power rating is 0.75 W at 40°C. Temperature tracking is 10 ppm/°C for standard units and is available in special units down to 2 ppm/°C. Resolution is infinite and insulation resistance is a minimum of 100 MΩ.

The new TRN series 3765 will contain five standard resistor values, which can be specified by the user. Future TRNs will be made using thin-film techniques.

CIRCLE NO. 362

Costs less than 60¢ in volume...

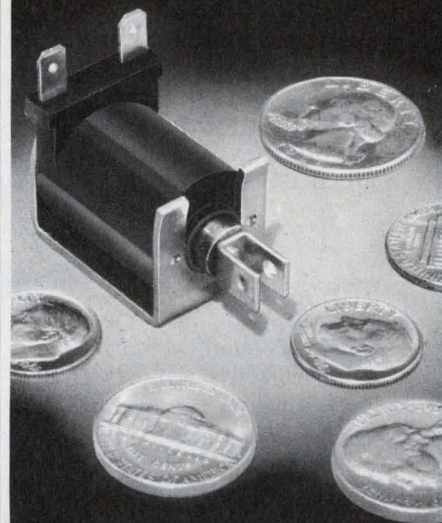

and what a SOLENOID for the money!

■ NEW MODEL C-6

■ More Force - @ .100" stroke force is:

AC CONT. - 7 ounces
AC INT. - 11 ounces

■ Molded nylon coil for fungus and moisture resistance.

■ Terminals molded into coil for extra strength, virtually eliminating open coils.

■ Ideal for applications where cost and performance are important (are there any others?), such as appliances, vending machines, automobiles and trucks.

■ Push and pull types. Plungers suited to your application.

■ Available with optional buzz trimmer that eliminates AC hum - a patented exclusive (Patent No. 3,117,257).

1433

DELTROL CONTROLS

2745 So. 19th St. Milwaukee, Wis. 53215
Phone (414) 671-6800 Telex 2-6871

INFORMATION RETRIEVAL NUMBER 62

HIGH DENSITY IC PACKAGING PANEL

Modular Type

INCREASES FLEXIBILITY
IN PROTOTYPING,
PRODUCTION AND
FIELD SERVICE.

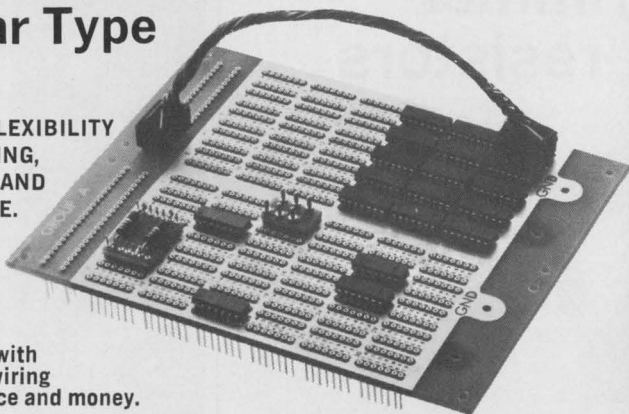

**P Series Panel with
Point to Point wiring
saves time, space and money.**

- Available in multiples of 30 IC pattern sections up to 180 patterns.
- Two pins of each pattern tied directly to power and ground planes. Different numbers available for different pin assignments.
- IC pattern also accepts I.O. plugs and adaptor plugs for discrete components.
- Excellent contact retention and low contact resistance.
- Wire Wrap terminations with Tri-level connection length.

Request Complete IC Folder

AUGAT INC.

Tel: 617-222-2202
31 Perry Ave., Attleboro, Mass. 02703

INFORMATION RETRIEVAL NUMBER 63

COMPONENTS

**\$1.87 lamp with driver
is rated for 18 years**

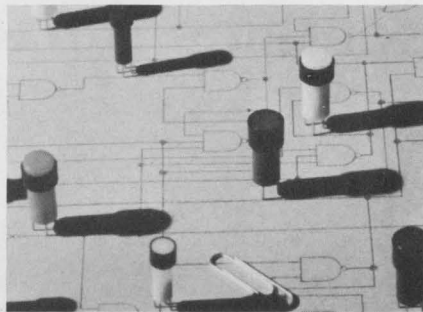

Data Display Products, 8036 Westlawn Ave., Los Angeles, Calif. Phone: (213) 641-1232. P&A: \$2.97 (unit quantities), \$1.87 (1000 to 4999 quantities); stock to 3 wks.

With an irresistible price of \$1.87 (1000 to 4999 quantities), the Fan-In series of rugged shock-resistant incandescent panel lights include a built-in IC driver and are designed for an astounding minimum life of 18 years.

The unusual life length of this series of lights is due to a long-life lamp, a built-in lamp bias for preheating the lamp's filament to increase the lamp and driver life and shock-resistant lamp mounting.

The built-in driver is available to accommodate both positive and negative logic and its input represents 1/2 of a standard TTL load (0.8 mA).

Another feature of the Fan-In series is the availability of standard 0.025-in.-gold-plated square terminal pins for wirewrap installation applications to permit fast mountings.

Standard diameters of 3/8-in. (F60) and 1/4-in. (F40) are available with reducing rings for adaptation to other-size panel holes.

Behind-the-panel depth for a standard 1/8-in.-thick panel is only 0.85 in. A push-on retaining ring is used to easily mount the lights from the front of the panel.

The lights are available in all standard lens colors and can be ordered in special colors. The lateral illumination of the light is defined by a collar which is available in several styles and colors to match the design of any panel.

As an option, a built-in lamp-test facility is also available.

PRICE BREAKTHROUGH!

**BOURNS®
CERMET
POTENTIOMETERS**

for as low as...

35¢

Now you can buy Bourns quality at the lowest prices ever offered on cermet potentiometers.



SPECIFICATIONS

size (top adjust)
power
res. values
res. tol.
temp. coeff.

MODEL 3359

3/8" dia. x .228" high
1/2W at 70°C
100Ω to 1 meg.
±20% Std.; 10% avail.
to 1K, 0 to +300 ppm/°C
1K and up, 0 to +200 ppm/°C

MODEL 3389

.395" x .360" x .240" high
1/2W at 70°C
50Ω to 1 meg.
±20% Std.; 10% avail.
±150 ppm/°C

sealed

no

yes

Price (50,000 quantity)

35¢

50¢

Send for catalog sheets on these two new single-turn adjustment potentiometers. Or call your nearest Bourns sales office for details.



BOURNS, INC., TRIMPOT PRODUCTS DIVISION • 1200 COLUMBIA AVE., RIVERSIDE, CALIF. 92507

INFORMATION RETRIEVAL NUMBER 64

CIRCLE NO. 363

Plug-in reed relay is repairable at once

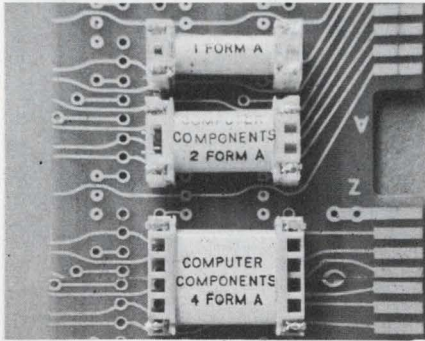

Computer Components, Inc., 88-06 Van Wyck Expressway, Jamaica, N. Y. Phone: (212) 291-3500.

A new reed relay which can be plugged into PC boards, facilitates the removal and replacement of faulty reeds without the need for soldering irons or tools. Should a relay failure occur, the relay can be easily removed from the PC board, its end pushed out, the faulty reed removed and replaced, and the entire reed assembly then replugged into the PC board.

CIRCLE NO. 364

Tiny 1-A reed relay is a bargain at 39¢

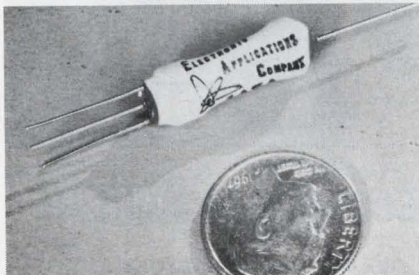

Electronic Applications Co., 2213 Edgewood Ave., S. El Monte, Calif. Phone: (213) 442-3212. Price: 39¢.

A new subminiature reed relay contact-rated up to 1 A at 20 W costs just 39¢. It measures only 0.275 in. in dia by 0.95 in. long and is available for coil voltages of 1, 3, 5, 6, 12, and 24 V. Contacts have a breakdown voltage of 750 V dc. The relays are also available with spdt and mercury contacts. Rated life is over 100 million operations.

CIRCLE NO. 365

Have you sent us your subscription renewal card?

How to put GE SSL's to work.

At General Electric, we make a dozen solid state lamp products (previously called light emitting diodes). All of them tiny. All super-tough. All withstand shock and vibration far better than any incandescent lamp. So they last far longer. And practically eliminate your maintenance problems.

But probably one of the nicest things about them from your point of view is that there are so many ways you can profitably use them.

Indication: If you want to be *positive* that your system is working, use GE's red SSL-22 indicator light. Now in use as on-off indicators, on maintenance panels and for information displays. Or use GE's green SSL-3 as an indicator, or for film marking.

Isolation: For electrical isolation and high-speed switching, we have delivery-ready stocks of two photon couplers. The PC4-73 has the highest transfer ratio (125%) of any coupler on the market. Both PC4-73 and PC15-26 will isolate up to 2,500 volts.

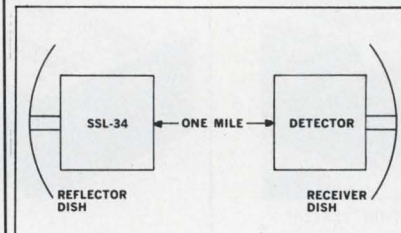
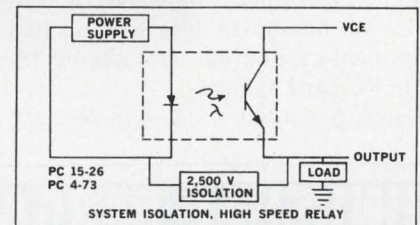

Communication: GE's SSL-34 has successfully transmitted (FM modulation, 10.7 MHz subcarrier, 2W transmitter) infrared signals *over a mile* through fog, rain and snow. Several of GE's infrared SSL's, operative in D.C. or pulsed modes, can be used in data transmission, communication links and remote telemetry applications.

Detection: Eight different GE SSL lamps are already designed into detection systems, such as level indicators, indexing tables, intrusion alarms, choppers, smoke detectors, size monitors, card and tape readers and for edge tracking.

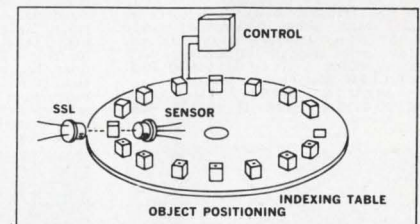

We'll be happy to send you free technical information on all of our SSL products. Or, for \$2.00, we'll send you the most complete SSL manual available. Covers theory, characteristics and applications, with 108 pages of diagrams and circuits.

General Electric Company, Miniature Lamp Department, M-ED, Nela Park, Cleveland, Ohio 44112.

GENERAL ELECTRIC

INFORMATION RETRIEVAL NUMBER 65

64k-by-18-bit memory cycles fully in 950 ns

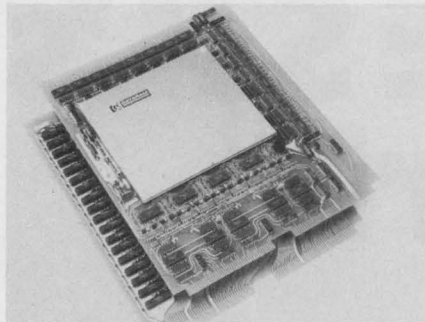

Dataram Corp., Route 206, Princeton, N. J. Phone: (609) 924-3331.

The PDM-950 random-access core memory system consisting of two PC cards with a basic 4k-by-18-bit memory, expandable up to 32 kbits in 4-bit increments, features a total cycle time of 950 ns. The memory's expansion is achieved by adding a PC card for every 4-kbit increment required. A full size of 64k-by-18 bits can be had by field-expanding two 32k-by-18-bit PC-card systems.

Booth No. 1320 Circle No. 317

Remote batch terminal interfaces phone lines

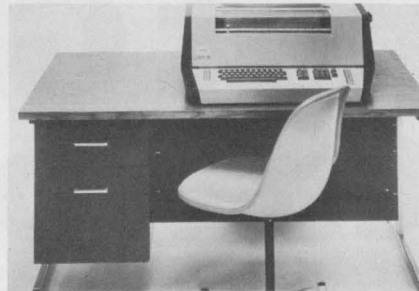

Daedalus Computer Products, Inc., P. O. Box 248, N. Syracuse, N. Y. Phone: (315) 699-2631. P&A: \$12,500, from \$1000 to \$7200; 80 days.

The model 711 is a remote batch intelligent terminal with a 1200-baud modem and a universal I/O printer, that interfaces to a variety of communications and telephone equipment when used with the model 115 adaptor. A built-in 4-kbit core memory is expandable to 32 kbits. The terminal contains a dual cassette-tape transport.

Booth No. 2438 Circle No. 281

Modem test set records on hard copy

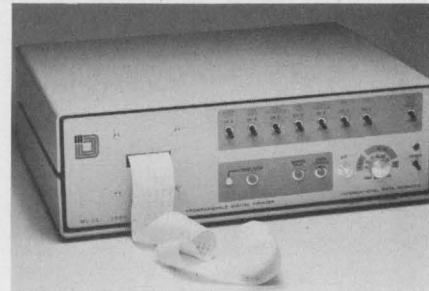

International Data Sciences, Inc., 100 Nashua St., Providence, R. I. Phone: (401) 274-5100. P&A: \$1750; 30 days.

The model 2000 digital printer is an optional device that plugs into the Range Rider series of pseudo-noise transmission test sets to provide hard copy during performance testing of digital transmission equipment. Printouts include time from start of test, a code to indicate what event occurred to cause each print, and a data sample.

CIRCLE NO. 366

UNUSUAL BARGAINS

... MANY U. S. GOV'T SURPLUS

FREE!
GIANT
CATALOG



QUICK OCR "GO...NO-GO" TEST!
Detect problems before they occur. Two 27mm reticles with handy, pocket-sized 6X Comparator for checking ANSI size I & IV character set. Etched transp. red ink. Quickly, easily check character size, shape, skew & spacing; stroke width, voids, smudges, peaks, valleys, extra marks. English & metric scales.
No. 41,350DA \$34.50 Ppd.
RETICLES ONLY:
No. 30,642DA SIZE I \$11.00 Ppd.
No. 30,643DA SIZE II \$10.75 Ppd.

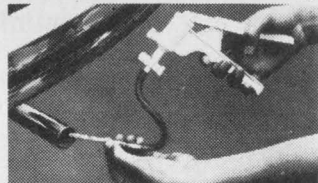

\$16.50 AIR POLLUTION TESTER!
1st low-cost survey-type instrument. Quickly provides quantitative results in threshold limit ranges set by Amer. Conf. of Gov't. Industrial Hygienists. Sensitive, accurate, wide measuring range. Includes 2 ampoules each to test CO₂, CO, H₂S, NO₂, and SO₂. Sufficient for 2 to 4 tests depending on concentration. Lightweight Kit includes sturdy vacuum pump, coupling tubes, complete instructions with scales to determine results. Sets (4) of replacement ampoules available separately for \$4.75. Stock No. 71,349DA \$16.50 Ppd.



4 1/4" ASTRONOMICAL TELESCOPE
See craters on moon, rings of Saturn, double stars. Up to 270x. New vibration-free equatorial mount, f/10 mirror corrected to better than 1/4 wave length. Gives theoretical limited resolution. Rack and pinion focusing. Aluminum tube. 6x finder telescope. 2 standard eyepieces and Barlow lens gives power up to 270x. Star Chart, Handbook & Instrs. Incl. Shpg. wt. 42 lbs.
Stock No. 85,105DA \$84.50 F.O.B.



GIANT FREE CATALOG
Completely new 1970 edition—148 pages. Bargains galore! New categories, items, illustrations. 1,000's of buys for industry — Optics, Science, Math, On-the-job helps, quality control aids, Optics for research labs, design engineers experimenters. Instruments for checking, measuring... to speed work, improve quality, cut costs. Huge selection of telescopes, microscopes, and other hard-to-get war surplus bargains. Write for Catalog DA.

EDMUND SCIENTIFIC CO. 300 EDSCORP BLDG. BARRINGTON, NEW JERSEY 08007
ORDER BY STOCK NUMBER · OPEN ACCOUNT TO RATED FIRMS · MONEY-BACK GUARANTEE

CHRONOLOGICS
MODEL MK-1

TIMING

SOLID STATE

MODULES

From Milliseconds to Hours

Ranges are changeable by the mere addition of external resistors and capacitors. Completely encapsulated, the TM series may be operated in delay or interval modes with pulse, continuous or complementary outputs. Timing is fixed or adjustable. If our standard line isn't just right for YOU, we will design and build for your particular application.

SEND FOR LITERATURE ON OUR COMPLETE LINE OF TIMING DEVICES.

CHRONOLOGICS, Inc.

24 Martin Street / Webster, N.Y. 14580 / (716) 872-1470

Tape degausser erases 90 dB



Bell & Howell, Electronics Instruments Group, 360 Sierra Madre Villa, Pasadena, Calif. Phone: (213) 796-9381.

An automatic tape degausser that is easy to operate provides 90-dB erasure of magnetic tape. The TD-2903-4B degausser erases magnetic recording tape on reels up to 16 in. in diameter and up to 2 in. wide. It is available in a 115-V/230-V 60-Hz model with a 45-second erasure cycle and a 115-V/230-V 50-Hz model with a 55-second erasure cycle.

CIRCLE NO. 367

Digital-data decoders give 4×10^{12} formats



Datotek, Inc., P. O. Box 12374, Dallas, Tex. Phone: (214) 363-4495.

Two new electronic security systems for the encoding and decoding of digital data provide users with total selectivity and control over four trillion possible code formats. They render coded digital data useless to anyone not having access to the proper code sequence. The DC-108 is designed for off-line transmission of 8-level paper tape. The DC-110 is designed for on-line time-sharing applications.

CIRCLE NO. 368

Expandable memory cycles fully in 750 ns

Standard Memories, Inc., 15130 Ventura Blvd., Sherman Oaks, Calif. Phone: (213) 788-3010. Price: 2.46¢/bit.

The new ECOM F is a low-cost high-speed magnetic core memory system with a 750-ns full cycle time and built-in expansion features. It is a complete system with a capacity of 294,912 bits or 16,384 by 18 bits/word, has full and split cycles and an access time of 325 ns. It features address and data register and byte control. The integral MC65 memory control cards permit the expansion of the system to 65 kbits.

CIRCLE NO. 369

EIA RS-232B coupler interfaces Teletypes

Media Technology, Inc., P. O. Box 942, Greensboro, Pa. Phone: (412) 836-0184. Price: \$32.50.

A new EIA interface unit is now available for interfacing Teletype equipment. It provides interface coupling for transmitted and received data only and conforms to specifications of EIA standard RS-232B. When installing the new interface unit, no mechanical modifications to Teletype equipment are required. Cables are provided for a complete installation.

CIRCLE NO. 370

1/2-in. recording head works at 200 in./s

Nortronics Co., Inc., 8101 Tenth Ave. North, Minneapolis, Minn. Phone: (612) 545-0401. P&A: \$750; 10 to 12 weeks.

Faster writing of and access to digital data can now be obtained through the use of a new high-speed 200-in./s IBM-compatible recording head. Available in either 7 or 9-track configurations, this read-after-write unit has a unique construction method that eliminates the need for flux gates and other external shielding, thus facilitating automatic or semi-automatic tape threading.

CIRCLE NO. 371

Sigmund Cohn Corp.
Offers Fine Sizes
in High Quality

Aluminum alloy bonding wire

In producing Aluminum Alloy Bonding Wires our staff carefully checks every step to assure you of sound, reliable, uniform bonds . . .

- The wire must have the maximum homogeneity
 - It is drawn through the best available diamond dies
 - After complete diameter-reduction the wire is thoroughly cleaned.
 - Final annealing (if required) is fully temperature-controlled for uniform physical characteristics.
- Write for latest engineering data.

Good bonding characteristics

Excellent reproducibility

Maximum homogeneity

SIGMUND COHN CORP.

121 So. Columbus Ave.
Mt. Vernon, N.Y. 10553
914-664-5300

Since 1901

INFORMATION RETRIEVAL NUMBER 68

For the circuit designer who wants optimum crystal filters at minimum cost...

Here's the answer!

Table of Contents includes materials on Filter Theory; Parametric Interdependence; Practical Considerations of Packaging vs Performance; Specifying for Optimum Design and Design Trade-offs for Maximum Performance/Minimum Cost.



An Engineering 'Answer' Manual from Bulova

A product of over a thousand engineering man-hours — prepared by network designers who have pioneered the evolution of the modern crystal filter, this Bulova Answer Manual contains all you need to know to Select, Specify and Optimize Modern Crystal Filters. Details the procedures to follow to get . . . • best performance per dollar • best performance per unit/weight • lowest cost for given requirement • highest quality, regardless of design. The manual is FREE upon letterhead-request to anyone involved in the application, specification or purchasing of crystal filters. Send for your copy today.



BULOVA FREQUENCY CONTROL PRODUCTS
Electronic Division of Bulova Watch Company, Inc.
61-20 Woodside Avenue Woodside, N. Y. 11377
INFORMATION RETRIEVAL NUMBER 69

DATA PROCESSING

Systems processor accesses in 35 ns

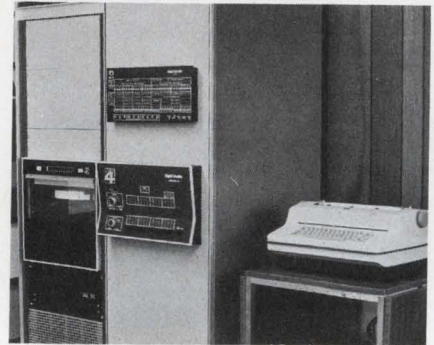

Digital Scientific Corp., 11455 Sorrento Valley Rd., San Diego, Calif.
Phone: (714) 453-6050. P&A: \$15,650; 90 days.

The META 4 read-only memory with a 35-ns access time is the heart of the custom-configurable META 4 processor. The processor's command structure is easily alterable to a specific architecture and application. Its cycle time is 90 ns. The META 4 emulates the IBM/1130/1800 at speeds sufficient to perform all computer operations.
Booth No. 1527 Circle No. 303

DON'T KID YOURSELF!



This won't ward off heart disease. But a gift to the Heart Fund will help protect your heart and the hearts you love.

GIVE...
so more will live
**HEART
FUND**



Communication system calls selectively



Racal Communications, Inc., 8440 Second Ave., Silver Spring, Md.
Phone: (301) 587-8515.

The LA7911 network control unit can selectively call up to 38 LA-7912 remote station units over a variety of networks including AM, FM, SSB and telephone lines. The base station operator can call any individual remote station or, alternatively, any remote station can call the base station and be connected to a telephone line or any other remote station.

CIRCLE NO. 372

This issue has your renewal card, inside front cover. Mail it today.

Contributed by the Publisher

Component insulators mount parts vertically

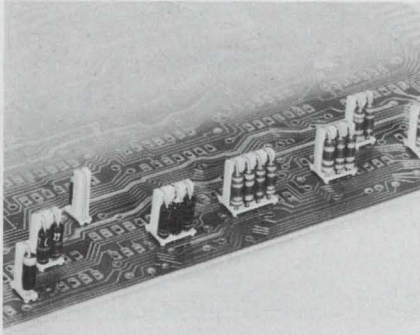

Robison Electronics, Inc., 2134 West Rosecrans Ave., Gardena, Calif. Phone: (213) 327-5661. Availability: stock.

A new series of insulators for axial-lead components permits vertical mounting of D07 diodes and 1/4-W resistors on PC boards. Verti-Mount insulators permit 0.1-in. side-to-side spacing of components with 0.15-in. center-to-center spacings between component leads, at a maximum height of 0.45 in. They are molded from acetal.

CIRCLE NO. 373

Pin sockets for ICs hold modules firmly



Texas Electronic Instruments, Inc., 5619 Etheridge, Houston, Tex. Phone: (713) 645-4821.

A new 0.15-in.-long pin socket for IC modules, type J-150, will accept round leads 0.016 to 0.019-in. in dia or flat leads 0.015 to 0.023-in. wide. Once an IC is plugged in, a force of over 50 grams per pin is required for removal, yet minimum insertion resistance is met. Pins may be plugged in a dozen or more times without loss of gripping.

CIRCLE NO. 374

Thermal wire stripper insulates neatly

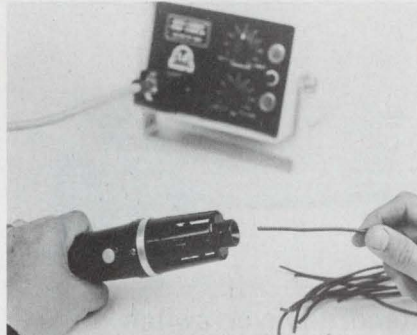

Thomas & Betts Co., 36 Butler St., Elizabeth, N. J. Phone: (201) 354-4321. Availability: stock.

A new thermal wire stripper removes thermoplastic and thermo-setting insulations, such as Kynar, Kapton and Teflon, neatly and quickly with no damage to the conductor. Featuring a high-speed rotating heating element, the RT-1000 Roto-Therm thermal wire stripper accurately controls the stripping depth regardless of thickness of the insulation without risking conductor damage.

CIRCLE NO. 375

I/O connector system interfaces wire types

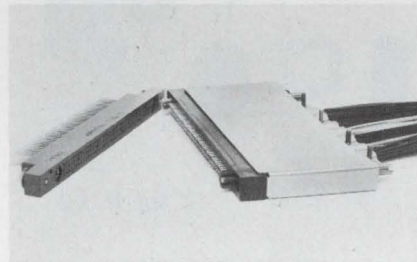

Viking Industries, Inc., 21001 Nordhoff St., Chatsworth, Calif. Phone: (213) 341-4330.

For reliable I/O interfacing, a new connector system for wire-wrap applications allows the transition from stranded to solid wire. The basic connector contains 120 contacts on a 0.1-in. grid. Pin contacts in the stranded wire or on the plug side of the connector are crimp-removable. Dimensions are 5.285 by 0.49 in. for the plug and they are 5.75 by 0.43 in. for the receptacle.

CIRCLE NO. 376

Introducing
the high-low
POWER SUPPLY

(high
performance—
low profile)

Acopian's new low profile power supply offers outstanding performance. Line and load regulation is .005% or 2 mv. Ripple is 250 microvolts. Prolonged short circuits or overloads won't damage it. And built-in over-voltage protection is available as an option.

Yet, it's the thinnest, flattest, most "placeable" 4.0 amp series regulated power supply ever offered . . . just 1.68" low. This low profile makes it perfect for mounting on a 1 3/4" high panel, or vertically in a narrow space.

Standard models include both wide and narrow voltage ranges. Outputs from 0 to 48 volts. Current ratings from 1 to 4 amp. Prices are low, too, starting at \$80.

For the full low-down on the new low-down power supply, write or call Acopian Corp., Easton, Pa. 18042. Telephone: 215-258-5441. And remember, Acopian offers 82,000 other power supplies, each shipped with this tag . . .



It makes good sense to sense power line failures

voltage sensor +
frequency sensor +
phase sensor =
power monitor

How else will you know when a power line failure occurs that could result in permanent system damage or faulty operation? Should voltage, frequency or phase characteristics depart from pre-determined limits, our devices will sense these changes individually or collectively and remove power from your system after a pre-set time-delay. Automatically resets itself when power line returns and remains within normal limits for a pre-set time-delay.

Available as individual voltage, frequency or phase sensor. Or, as a power monitor that combines all three units into a single device.

Designed for single or 3-phase, 60 or 400 Hz power lines with sensing accuracy of ± 1 percent over a temperature range of -55°C to $+125^{\circ}\text{C}$. Full MIL quality.

Write for free catalog

LOGITEK, INC.



42 Central Dr.
Farmingdale, N.Y.
516/694-3080

Evaluation Samples

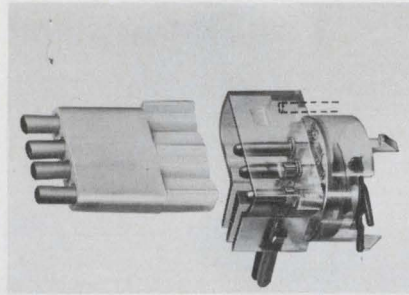

Record-player switch

A free sample of a new two-piece record-player switch is available. The model 1590 switch replaces several individual parts presently used in record players. It has staked-pin terminals which double as external power leads and as internal switch leads. The terminals are crimp-type versions that snap-lock into a receptacle. In addition, the nylon connector portion has positive polarity, total terminal insulation and a ground connection to the die-cast housing. Molex, Inc.

CIRCLE NO. 377

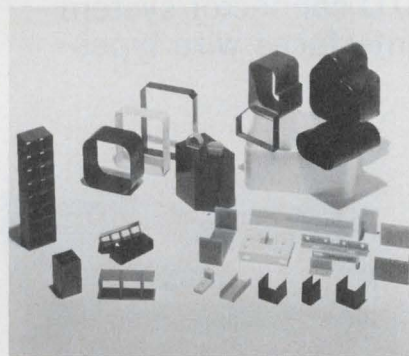

Fiberglass tubing

A line of fiberglass laminated epoxy angles, channels and special shapes allows freedom of prototype design for electronic encapsulating forms, display devices, chassis mounts, structural members and coil forms. Many sizes and shapes are available without additional tooling costs. Shapes are available in paper phenolic (105°C), glass epoxy (155°C), and glass silicone (180°C). Samples and literature are available. Stevens Tubing Corp.

CIRCLE NO. 378

Design Aids

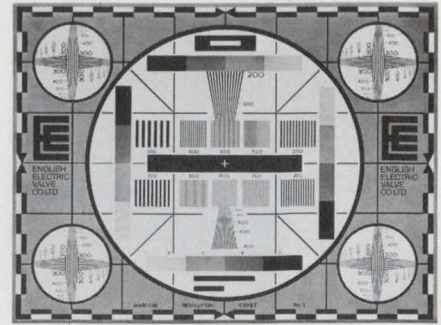

CCTV test chart

Copies of a new camera-tube test chart developed specifically for closed-circuit television (CCTV) systems is available free to anyone using CCTV cameras in return for information about the types of cameras that person is using. The test chart is available along with a brochure that contains instructions on how to use it. The use of the chart enables a TV camera to be adjusted for optimum performance. It is generally intended for CCTV systems using vidicon camera tubes. English Electric Valve Co., Ltd.

CIRCLE NO. 379

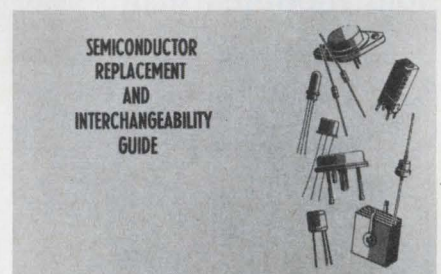

Semiconductor guide

A handy new semiconductor guide containing revised and expanded interchangeability listings for transistors, diodes and other semiconductors is available. Over 100 basic types of semiconductors are listed as substitutes for 12,000 other types. Separate sections list replacements for EIA types, other manufacturer's types and foreign-made semiconductors. There are also separate sections on silicon rectifiers, germanium and silicon diodes, silicon-controlled rectifiers and zener diodes. Semitronics Corp.

CIRCLE NO. 380

Application Notes

S/d converters

A four-page application note explains two different fundamental methods for digitizing shaft angle information produced by synchro shaft transducers. The conversion principles discussed are sampling and tracking. The note commences with a discussion of the principles of resolver and synchro shaft transducers to acquaint the reader with some of the problems designers of such devices face, and to distinguish resolver/synchro-to-digital conversion from simpler voltage-to-digital conversion. North Atlantic Industries, Inc.

CIRCLE NO. 381

Transducers

How to establish pressure-transducer specifications, testing pressure transducers, preferred circuits, practical considerations and precautions, and many other subjects are discussed in detail in a 32-page designers guide. A catalog portion of the guide contains a line of pressure transducers and related instrumentation. Computer Instruments Corp.

CIRCLE NO. 382

Guarded measurements

How to use and how to make the proper guarded connections when making electrical measurements is the subject of an informative technical article. The 17-page article tells where common-mode voltages originate and how common-mode problems are solved using the guarded-measurement technique. The article starts with floating measurements and what they are, discusses the floating voltmeter, then the guarded voltmeter, then goes on to give a thorough discussion on connection and measurement techniques. Each discussion is fortified with schematic and block-diagram outlines. The relationship between true and effective common-mode rejections is shown in three graphs. Hewlett-Packard.

CIRCLE NO. 383

spark & noise eaters

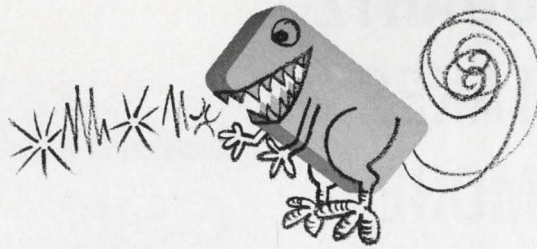

Electro Cube RC networks can chew and swallow at least 200,000,000 tough, jagged edge arcs, sparks and noise transients (when operated according to specifications). Standard molded units have 125 to 500 VAC, 200 to 2,000 VDC

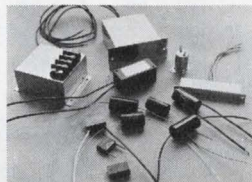

ratings. Custom metal or molded units, single or multicircuit, designed to your electrical, packaging and mounting requirements. Brochure on request. Call or write for engineering assistance. (213) 283-0511. 1710 South Del Mar Ave., San Gabriel, Calif. 91776.



electro cube, inc.
Capacitors, RFI Filters, RC Networks

INFORMATION RETRIEVAL NUMBER 72

the **NEW** mighty-mini

Schrack's NEW MINIATURE STEPPING SWITCH, Type RTM, is the smallest stepping switch available on the market today. Only 1/4 the size of comparable steppers, it combines high performance with economy of space and cost.

The RTM is equipped with 2 x 10 or 2 x 12 gold-plated contacts and mates with our socket which meets standard printed circuit spacings. Unique hold-down spring enables mounting in any position.

Write for free catalog today. Schrack also manufactures all types of relays, stepping switches and accessories. Catalogs upon request.

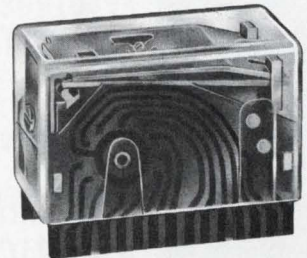

1 41/64" L x 13/16" W x 15/16" H



Selected territories available for representation.

SCHRACK ELECTRICAL SALES CORP.

1140 Broadway, New York, New York 10001
tel: (212) 683-0790

INFORMATION RETRIEVAL NUMBER 73

VITREOSIL®

PURE FUSED
QUARTZ
TAKES
MORE
SHOCK,
HEAT
AND
ACID

THAN GLASS
 OR PORCELAIN —
 RESISTS
 TEMPERATURES TO
 1050°C —
 HANDLES
 MOST HOT ACIDS
 WITHOUT ETCHING —
 WITHSTANDS
 CONSTANT THERMAL
 SHOCK —
 EXCELLENT
 ELECTRICAL AND
 OPTICAL
 PROPERTIES —
 LABORATORY AND
 INDUSTRIAL WARE —
 SPECIAL
 FABRICATION —

SPECTROSIL®
FOR PURITY

ASK FOR
 FREE CATALOG —

THERMAL
AMERICAN
FUSED QUARTZ CO.
 RT. 202 AND
 CHANGE BRIDGE RD.
 MONTVILLE, N. J.
 07045

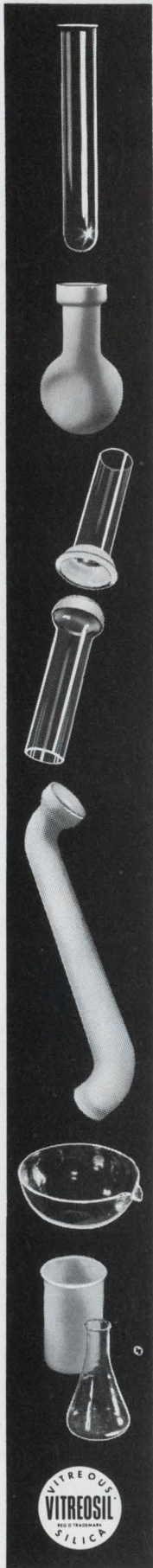

Annual Reports

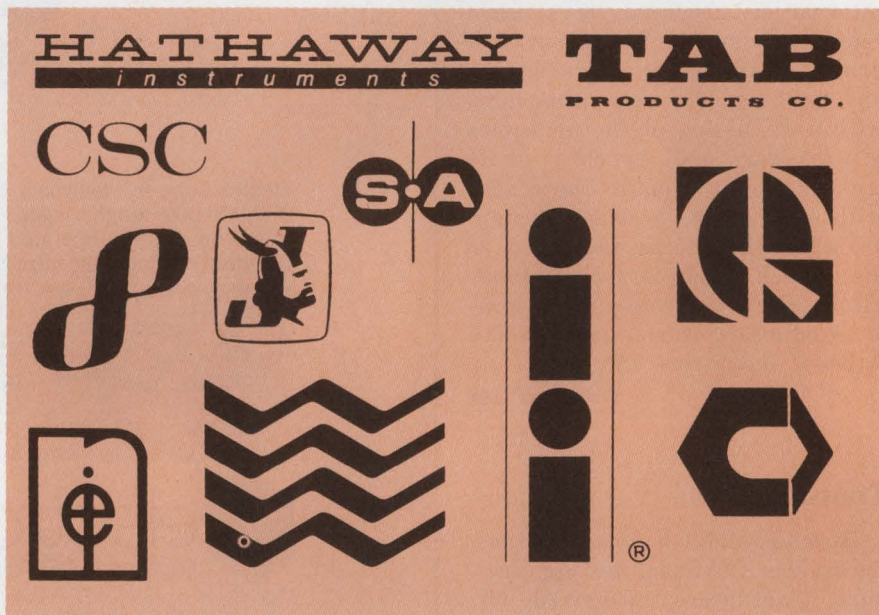

Computer Sciences Corp., Century City, Los Angeles, Calif.

Computer software, time-sharing services, engineering and management consultation services.

1969: revenues, \$79,975,000; net earnings, \$7,190,000.

1970: revenues, \$108,869,000; net earnings, \$5,309,000.

CIRCLE NO. 384

Computest Corp., 409 Route 70 East, Cherry Hill, N.J.

Electronic test systems for the production of core, plated-wire and semiconductor memories.

1969: sales, \$7,743,824; net earnings, \$493,210.

1970: sales, \$11,660,324; net earnings, \$859,148.

CIRCLE NO. 385

Data Products Corp., 6219 De Soto Ave., Woodland Hills, Calif.

Memory cores, modems, printers, card readers and embossers, disc and core stores, terminals.

1969: net sales, \$36,397,000; net income, \$11,998,000.

1970: net sales, \$45,372,000; net income, \$1,822,000.

CIRCLE NO. 386

Dataram Corp., Route 206, Princeton, N.J.

Memory cores, planes and stacks and related test equipment.

1969: operating revenues, \$749,167; net earnings (loss), (\$299,386).

1970: operating revenues, \$2,123,581; net earnings, \$84,214.

CIRCLE NO. 387

Hathaway Instruments, Inc., 5250 E. Evans Ave., Denver, Colo.

Event recorders, annunciators, frequency relays, time code generators, pushbutton switches.

1969: net sales, \$4,997,949; net income, \$347,412.

1970: net sales, \$4,707,223; net income, \$217,141.

CIRCLE NO. 388

Informatics, Inc., 21050 Vanowen St., Canoga Park, Calif.

Software products, data-handling systems, management information systems, display terminals.

1969: revenues, \$11,548,000; net income, \$561,000.

1970: revenues, \$19,070,000; net income (loss), (\$4,243,000).

CIRCLE NO. 389

E. F. Johnson Co., 299 10th Ave. Southwest, Waseca, Minn.

Capacitors, Citizen's-band and two-way radios and transceivers.

1968: net sales, \$13,920,714; net income, \$872,921.

1969: net sales, \$18,629,355; net income, \$1,067,294.

CIRCLE NO. 390

Norel Electronic Industries, Inc., 206 Babylon Tpke., Roosevelt, N.Y.

Electronic components, hardware and plastics.

1969: net sales, \$803,000; net income, \$32,373.

1970: net sales, \$1,389,822; net income, \$25,330.

CIRCLE NO. 391

Scientific-Atlanta, Inc., P.O. Box 13654, Atlanta, Georgia.

Telemetry and commercial communications systems, instruments, metal enclosures.

1969: net sales, \$14,940,962; net earnings, \$144,158.

1970: net sales, \$18,145,117; net earnings, \$226,156.

CIRCLE NO. 392

Tab Products Co., 2690 Hanover St., Palo Alto, Calif.

Card punch-verifiers, minicomputers, PC-board testers, computer accessories, filing systems.

1969: sales, \$17,756,000; net earnings, \$385,000.

1970: sales, \$18,557,000; net earnings, \$446,000.

CIRCLE NO. 393

Waters Instruments, Inc., P.O. Box 6117, Rochester, Minn.

Medical instrumentation, flow-soldered circuit cards, cable assemblies.

1969: net sales, \$3,655,756; net earnings, \$84,537.

1970: net sales, \$3,864,974; net earnings, \$164,694.

CIRCLE NO. 394



The things we do to stay in front!



Because we're No. 1 in control knobs . . .



and because we're Rogan

Our reputation means a lot to us. So much in fact that the knobs we make are quality knobs . . . knobs that are "out in front" with "real design appeal" —yet priced right to fit your budget. Write today for free New color catalog

Rogan
BROTHERS, INC.
8031 N. MONTICELLO AVE.
SKOKIE, ILLINOIS 60076
(312)6751234

INFORMATION RETRIEVAL NUMBER 75

Order your Silicon Rectifiers from the specialty house

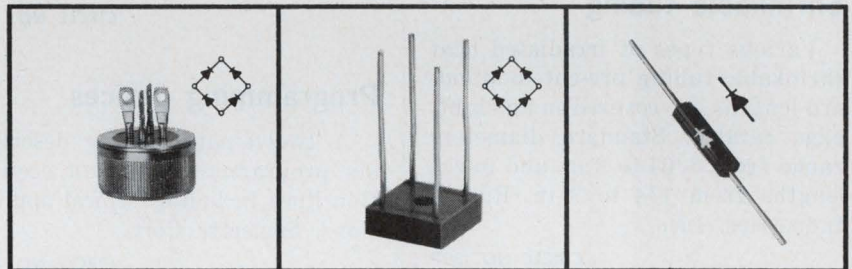

IBR (Integrated Bridge Rectifiers)

Diffused Silicon 200V, 400V, 600V, 10-amp, 25-amp. 10-amp fast recovery. Hermetically sealed. Three mounting options: Press fit. Single stud. TO3 out-line flange.

EBR (Epoxy Bridge Rectifiers)

Diffused Silicon 200V, 400V, 600V, 1-amp, 2-amp, 6-amp, single phase. High reliability for lower current applications. Available with a fast recovery option.

Diffused High Voltage Silicon Rectifiers

1000V to 50,000V. From 5/32 to 5 inches long. Available with 300 nanosecond recovery time (optional) and in custom designed assemblies.



WE CATALOG IN EEM

SEMICONDUCTOR DIVISION, 1000 N. SHILOH ROAD, GARLAND, TEXAS 75040 (214) 272-4551

INFORMATION RETRIEVAL NUMBER 76

New Literature

Instruments

A new 64-page book describes in detail over 45 measuring instruments and auxiliary equipment which are based on fourth-generation integrated-circuit design techniques. The instruments include digital counters and counter/timers, frequency synthesizers, sine, square-wave and pulse generators. Auxiliary equipment includes digital programmers, comparators, calculators and clocks, d/a converters, data scanners, digital printers, multiplexers, prescalers and strip chart recorders. Monsanto Electronic Instruments.

CIRCLE NO. 395

Closed-circuit TV

An expanded, six-page technical data sheet on the 6000 Series closed-circuit television system is available. It includes 11 photographs and a block diagram plus specifications. Cohu Electronics, Inc.

CIRCLE NO. 396

Shrinkable tubing

Various types of irradiated heat shrinkable tubing pre-cut to standard lengths are covered in an eight-page catalog. Standard diameters range from 3/64 to 2 in. and in cut lengths from 1/4 to 2 in. Russell Industries, Inc.

CIRCLE NO. 397

Illuminated switches

A full line of illuminated push-button switches and matching indicator lights is described in a 28-page catalog. Dialight Corp.

CIRCLE NO. 398

Calculators

A line of scientific and engineering calculators is illustrated in a new brochure. Wang Laboratories, Inc.

CIRCLE NO. 399



Transformers

A broad new product line of transformers, inductors and toroids is given in a 32-page catalog. Microtran Co., Inc.

CIRCLE NO. 406

Metal plate connectors

Revised and expanded, a 40-page handbook contains complete design information for backpanel connector arrays. A typical plate blueprint is included as a design aid. Elco.

CIRCLE NO. 407

Programming devices

A twelve-page catalog describes six programming or data acquisition lines including typical applications. Sealectro Corp.

CIRCLE NO. 408

Spectroscopy analysis

How to optimize and simplify atomic spectroscopy analysis is discussed in a 16-page booklet. Performance data, calibration curves and exploded views of a versatile atomic line source are included along with a comprehensive bibliography and price sheet. Barnes Engineering Co.

CIRCLE NO. 409

Don't miss an issue of Electronic Design; return your renewal card today.

Peripherals report

The entire special section for the Fall Joint Computer Conference in this issue is available. It includes the special report on peripherals, the keyboard directory and the conference's complete product highlights and features. Hayden Publishing Co., Inc.

CIRCLE NO. 410

Function modules

A new 24-page catalog gives a complete listing of operational and logarithmic amplifiers, current boosters, voltage followers, function modules, memories, transducers, multipliers and interface circuits. Optical Electronics, Inc.

CIRCLE NO. 411

Reed switches

The selection and application of reed switches are illustrated in a guide which lists 200 switch models and their ratings. Hamlin, Inc.

CIRCLE NO. 412

Rf coaxial connectors

A voluminous, 148-page, catalog/handbook contains mounting installations, general characteristics, cable assembly, physical dimensions, numerical index, and applications data for all commonly used rf connector series. ITT Greomar.

CIRCLE NO. 413

Power supplies

Modular dc power supplies and precision voltage references are listed in a new catalog. CEA, a division of Berkleonics, Inc.

CIRCLE NO. 414

Rotary switches

A comprehensive line of rotary tap switches is described in a 12-page catalog. Ohmite Manufacturing Co.

CIRCLE NO. 415

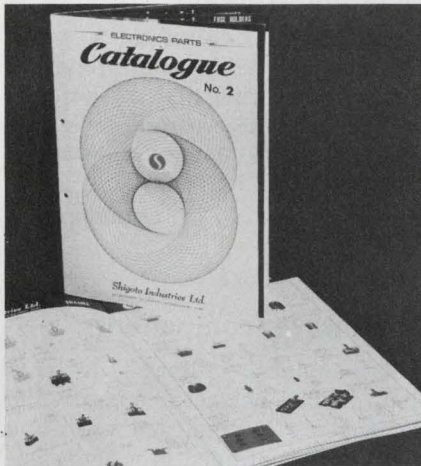

Components

A 32-page illustrated catalog lists extensive lines of switches, terminals, sockets, connectors, cable assemblies, plugs, jacks and knobs. Other components included are adaptors, fuse holders, lamp brackets and bases and battery holders. Shigoto Industries Ltd.

CIRCLE NO. 416

Instruments

A new eight-page catalog describes a complete line of sweep and marker generators, CATV test instruments, noise generators, automatic noise figure meters and pulse generators. Also included are wide-band and logarithmic amplifiers, sweep synthesizers, telemetry FM signal generators, programmable attenuators and audio-spectrum analyzers. Kay Elemetrics Corp.

CIRCLE NO. 417

Lafayette catalog

Lafayette Radio catalog 711 with the latest in electronic components and stereo-fidelity devices is now available. Lafayette Radio Electronics Corp.

CIRCLE NO. 418

Potentiometers

Potentiometers and variable resistors are listed and illustrated in a new 32-page catalog. Samarius, Inc.

CIRCLE NO. 419

VACTEC

"PLASTIC" PHOTOCELLS

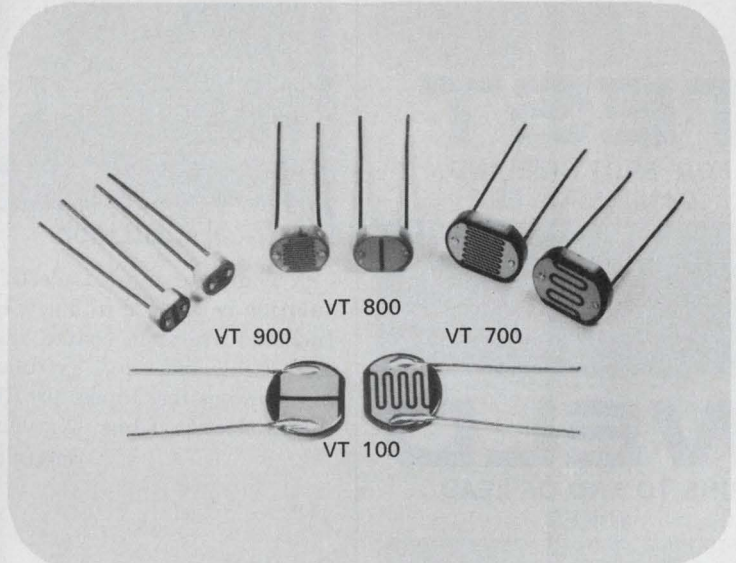

Actual size, priced as low as .25 each ($\pm 33\%$ tolerance) in 10,000 quantities.

EVEN LOWER FOR $\pm 50\%$ TOLERANCE

Low Cost Way to Meet Most Photocell Requirements

Here is a complete line made with the same quality characteristics and precise tolerances by the originator of the first **stable** plastic coated cell. Six different thin-film materials of CdS and CdSe deposited on ceramic substrates. A VACTEC development with almost 10 years of production experience. When others said it couldn't be done — we were doing it! NOW improved passivation processes make them better than ever. Why experiment — buy where the experience is. The proof — they have been used in **millions** of cameras all over the world!

Costing less than $\frac{1}{2}$ of hermetically sealed cells, they have excellent resistance to humidity, eliminating need for hermetic cells in **most** applications. VACTEC "plastic" photocells are conveniently controlled by ambient light or from closely coupled low voltage lamps. Industrial and commercial applications, like controlling relays in line voltage circuits; switching SCR's on or off; phase control and proportional circuits; audio controls; and feedback elements for motor speed controls in consumer appliances.

| Series Type | Substitutes for hermetic type |
|-------------|-------------------------------|
| VT 100 | TO-8 |
| VT 700 | TO-8 |
| VT 800 | TO-5 |
| VT 900 | TO-18 |

Write for Bulletin PCD-5, PCD-41, 57, 58, and 59

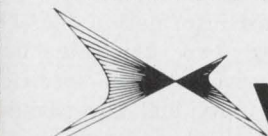

VACTEC, INC.

2423 Northline Ind. Blvd. • Maryland Heights, Missouri 63043
(314) 872-8300

Specializing in standard Cds, Cdse, and Se cells. Custom engineering for every photocell need. Listed in EBG under "Semi-Conductors" and EEM Sec. 3700.

START

WITH A LENS-END LAMP

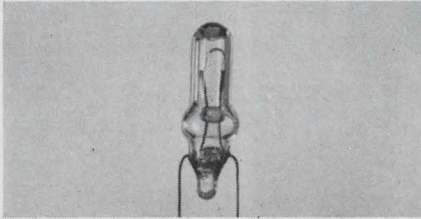

TEST

FOR SPOT SIZE AND
CANDLEPOWER

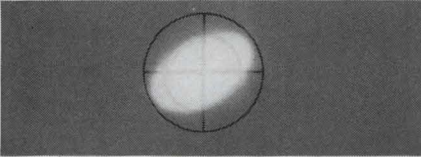

WELD

PINS TO END OF LEAD
WIRES

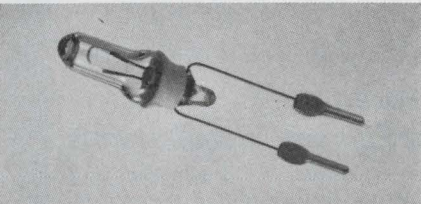

MOLD

TO MAKE A PLUG-IN LIGHT
MODULE THAT WILL ACTIVATE
PHOTO ELECTRIC SENSOR IN
A HIGH SPEED CHECK SORTER

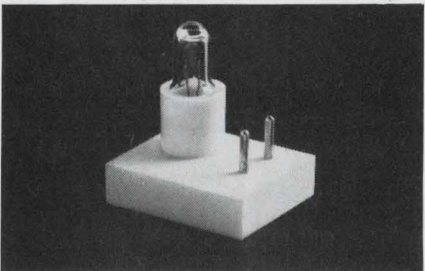

We specialize in finding practical solutions to small applications where cataloged items won't do. Write, describing your requirement. Tung-Sol Division, Wagner Electric Corporation, 630 W. Mt. Pleasant Avenue, Livingston, N.J. 07039. TWX: 710-994-4865. Phone: (201) 992-1100.

TUNG-SOL®

WHERE BIG THINGS ARE
DONE WITH SMALL LAMPS

© Reg. T.M. Wagner Electric Corporation

INFORMATION RETRIEVAL NUMBER 78

NEW LITERATURE

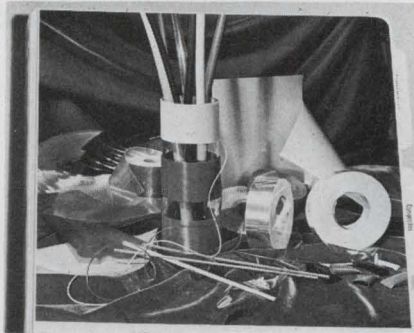

Electrical insulation

A complete line of electrical insulation is covered in a new catalog. Included are such coated materials as flexible sleeving, extruded tubing as flexible sleeving, extruded tubing as flexible sleeving, tapes, profiles and thin-dielectric films. Natvar Corp.

CIRCLE NO. 420

Connectors

A new connector series engineered for rack-and-panel, in-line cable and I/O wirewrap applications is shown in a catalog. Elco Corp.

CIRCLE NO. 421

Heat-sink components

A line of parts for thermally conductive electronic assembly applications such as heat sinks, semiconductor bases, discs, washers, and transistor retainer and mounting clips are included in a new brochure. National Beryllia Corp.

CIRCLE NO. 422

Keyboards

Everything you need to know for specifying or ordering data-entry keyboards is included in a new keyboard information file. The file includes two separate bulletins which give detailed specifications on the individual key modules and complete keyboard arrays. A third bulletin, the keyboard designers' specification sheet, includes worksheets for custom designing keyboards. Cherry Electrical Products Corp.

CIRCLE NO. 423

Antenna systems

Illustrations, descriptions, specifications and performance data are given for a full line of antenna systems and accessories in a new catalog. Phelps Dodge Communications Co.

CIRCLE NO. 424

Microwave components

Attenuators, filters, switches and double balanced mixers and component design curves and charts are contained in a new catalog. RCL Electronics, Inc.

CIRCLE NO. 425

Servo amplifiers

Servo amplifiers for 400-Hz commercial, industrial and military applications are illustrated in a brochure. Bulova Watch Co., Inc., Electronics Div.

CIRCLE NO. 426

FET chips

A new catalog describes 34 standard FET chips for use as single and dual amplifiers, analog switches and current limiters. Both junction and MOSFET chips are shown in either wafer or chip form. Siliconix Inc.

CIRCLE NO. 427

Components

Resistors, capacitors, relays, switches, transformers, chokes, coils and many other electronic components are shown in a new catalog. Hazelton Scientific Co.

CIRCLE NO. 428

Don't forget to mail your renewal card to continue receiving Electronic Design.

Bulletin board

of product news
and developments

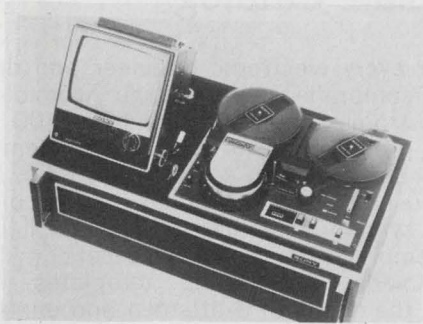

Sony Corp. of America has introduced the TAV-3610 compact Videocorder video tape recorder with a built-in monitor/receiver. It provides an hour of monochrome recording and playback on 1/2-in. tapes.

CIRCLE NO. 429

A program for renting the J133C analogical circuit test instrument for incoming inspection of ICs has been announced by Teradyne, Inc. The J133C, which costs \$4850, can now be rented at only \$300 per month, with the minimum monthly rental period being only one month.

CIRCLE NO. 430

Computer Microtechnology, Inc., will be announcing a 256-bit bipolar read/write random-access memory with full decoding on the chip and three chip-selects at 10¢/bit. The new memory will have a typical access time of 70 ns.

CIRCLE NO. 431

Silicon General is adding a new line of hot-specification operational amplifiers to its list of linear integrated circuits. The new souped-up amplifiers, SG741, SG747 and SG748, offer large-scale improvements in bias and offset currents and offset voltages at reasonable prices.

CIRCLE NO. 432

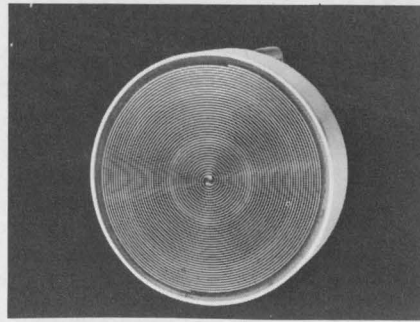

A compact planar spiral antenna for the 2-to-12-GHz frequency band has been developed by HRB-Singer, Inc. The model PSA-212 cavity-backed antenna has a half-power bandwidth of 78 degrees, 3-dB gain and a VSWR of 2:1.

CIRCLE NO. 433

Price changes

Fourteen a/d converter models of DDC's MADC & HADC series have been reduced in price. Examples are the MADC-11-3 11-bit converter which was reduced in price from \$700 to \$275, and the HADC-11 11-bit converter, formerly costing \$750, now costs \$375.

CIRCLE NO. 434

Fairchild Semiconductor has slashed prices on its MSI 9300 line of ICs by as much as 54%. In addition, eight other MOS ICs (series 3300, 3500 and 3700) have been reduced in prices by as much as 80%.

CIRCLE NO. 435

Beckman Instruments Helipot Div. has cut the price of 16 models of its 12-bit binary ladder networks by as much as 42%. Eight models are from the series 811 networks and eight others are from the series 812 units.

CIRCLE NO. 436

There is a difference in Heath Dynamics' Quartz Crystal Filters!

Heath Dynamics specializes in the design and manufacture of the highest quality Quartz Crystal Filters and Discriminators for the Communications Industry.

Our facility is completely new, inside and out, fully staffed and equipped with the most modern mechanical and electronic test measuring devices.

We employ the assistance of one of the largest time sharing computers available.

Heath Dynamics' area of specialization includes the manufacture of miniature and sub-miniature filters in the range of 10 thru 32 Mhz. Bandwidths may be from .025% thru .35% in the smallest packages and may range up to 2.0% in the larger ones.

We manufacture direct replacement filters for all the current monolithic designs using our half lattice configuration which yield lower insertion loss, lower ripple and greater ultimate rejection. Yet our filters cost less and faster delivery is guaranteed!

All Heath Dynamics crystal filters designed and manufactured to your particular specifications meet Mil F. 18327.

In short, we want your business and we'll act like it. Do us both a favor and send us your print or specification for a quote. If you have any questions just write or call us...we're here to serve you.

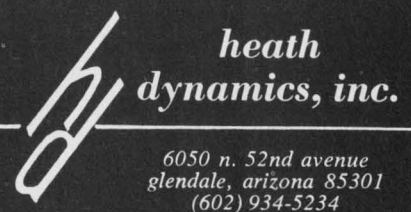

6050 n. 52nd avenue
glendale, arizona 85301
(602) 934-5234

subsidiary of
Heath International, Inc., Richmond, Mich.

INFORMATION RETRIEVAL NUMBER 79

ELECTRONIC DESIGN'S function is:

- To aid progress in the electronics manufacturing industry by promoting good design.
- To give the electronic design engineer concepts and ideas that make his job easier and more productive.
- To provide a central source of timely electronics information.
- To promote two-way communication between manufacturer and engineer.

Want a subscription? ELECTRONIC DESIGN is sent free to qualified engineers and engineering managers doing design work, supervising design or setting standards in the United States and Western Europe. For a free subscription, use the postfree application form inside the back cover. If none is included, write to us direct for an application form.

If you do not qualify, you may take out a paid subscription for \$25 a year in the U.S.A., \$35 a year elsewhere. Single copies are \$1.50 each.

If you change your address, send us an old mailing label and your new address; there is generally a prepaid postcard for this inside the back cover. You will have to requalify to continue receiving ELECTRONIC DESIGN free.

The accuracy policy of ELECTRONIC DESIGN is:

- To make reasonable efforts to ensure the accuracy of editorial matter.
- To publish prompt corrections whenever inaccuracies are brought to our attention. Corrections appear at the end of the Letters column.
- To refuse any advertisement deemed to be misleading or fraudulent.

Microfilm copies are available of complete volumes of ELECTRONIC DESIGN at \$19.00 per volume, beginning with Volume 9, 1961. Work is now in process to complete the microfilm edition of Volumes 1-8. Reprints of individual articles may be obtained for \$2.00 each, prepaid (\$.50 for each additional copy of the same article) no matter how long the article. For further details and to place orders, contact the Customer Services Department, University Microfilms, 300 North Zeeb Road, Ann Arbor, Michigan 48106; telephone (313) 761-4700.

Want to contact us? If you have any comments or wish to submit a manuscript or article outline, address your correspondence to:

Editor
ELECTRONIC DESIGN,
850 Third Avenue,
New York, N.Y. 10022.

Design Data from

Free — New Alvin Template Catalog

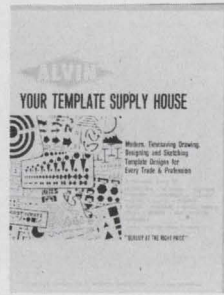

A must for every electronic engineer and draftsman! The comprehensive 36 page Alvin catalog clearly illustrates and describes over 400 templates for practically every use. This template catalog is categorized in sections and shows the templates used for each field, ie, electrical and electronic symbol templates, mechanical engineering templates and many others. Alvin's precision made, time-saving templates cover completely the needs of draftsmen and engineers in all categories. Send for free catalog now.

ALVIN & CO., INC.
611 Palisado Avenue
Windsor, Connecticut 06095

CIRCLE NO. 171

New Monograph on Real-Time Data Processing Techniques

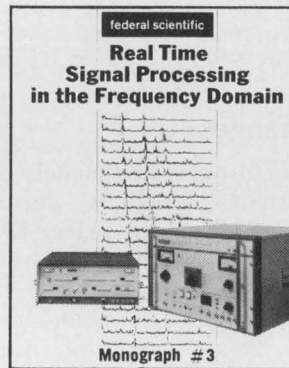

A new publication by Federal Scientific, originators of the Ubiquitous® Spectrum Analyzer, covers general and specific signal processing techniques and theoretical constraints.

- Random data processing and statistical certainty of Power Spectral Density Estimates
- Constraints in frequency analysis due to bandwidth, sampling and signal length
- Time domain weighting, with charts of theoretical performance using different weighting functions
- Theory of operation of time-compression analyzers
- Cross-property analysis and application in determining transmission and transfer functions by correlation and cross-power spectral density
- Processing of Transient data

CIRCLE NO. 172

Federal Scientific Corporation
a subsidiary of Elgin National Industries, Inc.
615 West 131st Street, New York, N. Y. 10027

NEW MATERIALS TECHNOLOGY

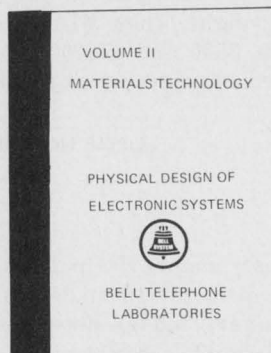

Here's a complete working knowledge of the materials used in the design techniques of the above volume. Shows how to take advantage of the physical structure of crystals & the mechanical behavior of metals in the design process — apply new fabrication techniques using polymers, ceramics & glasses — use principles of electrochemistry & adhesives in improving the appearance & durability of components & systems you design. Pub. Oct. 1970, 544 pp., illus., 7 x 9 1/4", \$19.95. Circle the reader-service number below for a 15-day examination copy.

CIRCLE NO. 173

Prentice-Hall, Inc.
Englewood Cliffs, N. J. 07632

Manufacturers

Advertisements of booklets, brochures, catalogs and data sheets. To order use Reader-ServiceCard.
(Advertisement)

NEW PHYSICAL DESIGN TECHNIQUES

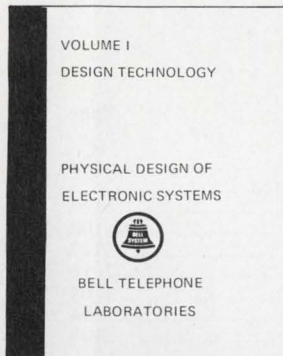

From the technical staff of Bell Telephone Laboratories, here's a new guide for designing structures to control device temperatures — better withstand static loads, shock & vibration environments — transmit signals with minimum delay & distortion — avoid mutual interference between signal paths. Pub. May 1970, 626 pp., 343 illus., 7 x 9 1/4", \$19.95. Circle the reader-service number below for a 15-day examination copy.

CIRCLE NO. 174

Prentice-Hall, Inc.
Englewood Cliffs, N. J. 07632

Clamp or Tie Wire Bundles In Seconds!

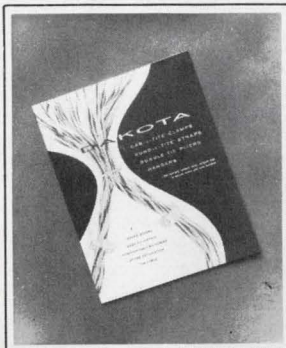

Six-page catalog contains complete ordering information for CAB-L-TITE® clamps and BUND-L-TITE® straps, devices which provide a fast and reliable means of securing wires and wire bundles. Units withstand loadings greater than 50 G's, are removable in seconds for re-routing wires, and are self-locking—no tying, no knots, no hitches to come loose. Lightweight Du Pont Zytel meets MIL-P-17091 and MIL-P-20693. Proved in aircraft and missiles. Photos, dimensional drawings, tables, physical properties, specifications, price list. Request catalog A.

CIRCLE NO. 175

Dakota Engineering, Inc.
4315 Sepulveda Blvd.
Culver City, California 90230

New PC Drafting Aids Catalog

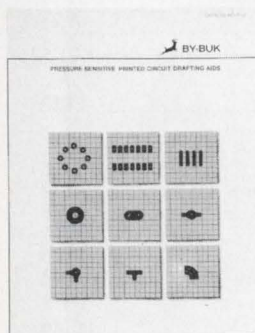

The By-Buk 1970-71 catalog of pressure sensitive printed circuit drafting aids is now available. With thousands of ideas to promote accuracy and efficiency in printed circuit master artwork layouts. Featured are new artwork patterns for: TO cans, multi-pads, dual in-lines and flat packs. Also the most comprehensive listings of conductor line tapes, pads, donuts, connector strips, elbows, corners, etc. Available in opaque black, transparent red and transparent blue materials. Send for your free catalog and samples.

CIRCLE NO. 176

By-Buk Company
4326 W. Pico Blvd.
Los Angeles, California 90019
(213) 937-3511

Electronic Design

Advertising Sales Staff
Keith Aldrich
Sales Manager

New York 10022
Robert W. Gascoigne
Samuel M. Deitch
Daniel J. Rowland
850 Third Avenue
(212) Plaza 1-5530
TWX: 867-7866

Philadelphia 19025
Mort Sullivan
P.O. Box 126
Dresher, Pa.
(215) 884-6880

Boston 02154
Joseph F. Palmer
1268 Main Street
Waltham, Mass.
(617) 894-2700

Chicago 60611
Thomas P. Kavooras
Berry Conner, Jr.
200 East Ontario
(312) 337-0588

Cleveland
Thomas P. Kavooras
(Chicago)
(312) 337-0588
(call collect)

Los Angeles 90303
Stanley I. Ehrenclou
Jerry D. Latta
2930 Imperial Highway
Inglewood, Calif.
(213) 757-0183

San Francisco 94022
Arthur R. Shields, Jr.
95 Main Street
Los Altos, Calif.
(415) 941-3084

London W. 1
For United Kingdom and Holland
Brayton C. Nichols
44 Conduit Street
Tel: REGent 4714

Verviers, Belgium
For Continental Europe
Andre Jamar
1, Rue Mallar, 1
(087) 253.83 Telex 41563

Tokyo
Haruki Hirayama
Electronic Media Service
5th Floor, Lila Bldg.,
4-9-8 Roppongi
Minato-ku
Phone: 402-4556
Cable: Electronicmedia, Tokyo



AMERICAN BUSINESS PRESS, INC.

POWERTEC

THE POWER HOUSE

OEM SERIES POWER SUPPLIES

ADJUSTABLE

\$24⁹⁵

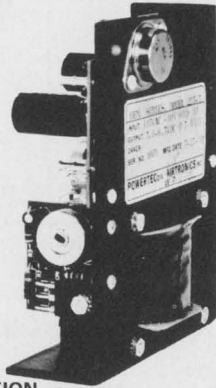

TO 12 AMPS

4 TO 26 VDC 3 TO 12 AMPS
 RIPPLE: 1 MVRMS
 SHORT CIRCUIT PROTECTED
 FOLD BACK CURRENT LIMITING
 OPTIONAL OVER VOLTAGE PROTECTION
 REGULATION: LINE $\pm 0.25\%$ LOAD $\pm 0.25\%$

| MODEL | PRICE | | DIMENSIONS |
|---------------|---------|---------|-----------------------|
| | 1-9 | 100 | |
| 2B5 - 3 AMPS | \$24.95 | \$19.50 | 4.8 W X 4 L X 1.8 D |
| 2C5 - 6 AMPS | \$44.00 | \$36.00 | 4.8 W X 5.7 L X 2.8 D |
| 2C5 - 12 AMPS | \$75.00 | \$60.00 | 4.8 W X 9 L X 3 D |

OEM CONTRACTS AVAILABLE

POWERTEC AIRTRONICS INC.

A DIVISION OF
 9168 DESOTO AVENUE
 CHATSWORTH, CALIFORNIA 91311
 (213) 882-0004 TWX 910-494-2092

INFORMATION RETRIEVAL NUMBER 80

Unlike beer, tires,
 and Italian actresses,
 C&K's Flatted Toggle
 Switch is appealing
 because it's flat.

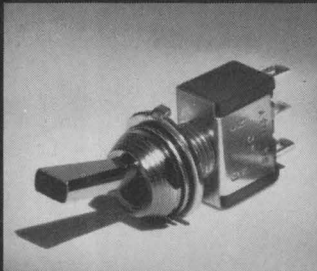

It's also competitively priced, made in America for rugged high-quality performance, and available in SPDT, DPDT, 3PDT and 4PDT models. A sleek, modern-looking visual design element that's as flat as Twiggy.

For more information, contact:
 C&K Components, Inc.,
 103 Morse St., Watertown, MA 02172
 (617) 926-0800.

INFORMATION RETRIEVAL NUMBER 81

Advertisers' Index

| Advertiser | Page |
|--|---------------------|
| APM-Hexseal | 93 |
| Abbott Transistor Laboratories Incorporated | 13 |
| Acopian Corporation | 113 |
| Alco Electronic Products, Inc. | 94, 106 |
| Alvin & Co., Inc. | 122 |
| Allen-Bradley Co. | 6, 7, 16 |
| Arnold Engineering Company, The | 64 |
| Astro Communication Laboratory, Inc. | 94 |
| Augat, Inc. | 108 |
| Automated Business Systems, Division of Litton Industries | C37 |
| Automatic Electric Company | 10, 11 |
| Avantek, Inc. | 54 |
| Bodine Electric Company | C23 |
| Bourns, Inc. | 108 |
| Buckbee Mears Company | C26 |
| Bulova Frequency Control Products | 112 |
| Burndy Corporation | C35 |
| By-Buk Company | 123 |
| C & K Components, Inc. | 124 |
| CTS Corporation | 51 |
| Cambridge Thermionic Corporation | 94 |
| Celanese Plastics Company | 12 |
| Centralab Semiconductor Division, Globe-Union, Inc. | 63 |
| Chicago Dynamics Industries, Inc. | C44 |
| Chronologies, Inc. | 110 |
| Cincinnati Milacron, Inc. | C61 |
| Circuit Stik, Inc. | C62 |
| Clare & Co., C. P. | C45 |
| Clare-Pendar | C20 |
| Cohn Corp., Sigmund | 111 |
| Concord Electronics Corporation | C52 |
| Consolidated Reactive Metals, Inc. | 100 |
| Coto Coil Company, Ltd. | C52 |
| Cunningham Corporation | 101 |
| Dakota Engineering, Inc. | 123 |
| Dale Electronics, Inc. | Cover II |
| Deltrol Controls | 107 |
| Dialight Corporation | C49 |
| Dow Corning Corporation | 61 |
| ERA Transpac Corporation | 62 |
| Edmund Scientific Company | 110 |
| Electro Cube, Inc. | 115 |
| Electronic Molding Corp. | 91 |
| Electrostatics, Inc. | 93 |
| Engelhard Industries Division | C57 |
| Erie Technological Products, Inc. | 2 |
| Federal Scientific Corporation | 122 |
| General Electric Company, Lamp Metals & Components Dept. | 125 |
| General Electric Company, Miniature Lamp Dept. | 109 |
| Genisco Technology Corporation | 38 |
| Grant Pulley & Hardware Corporation | C41 |
| Grayhill, Inc. | 125 |
| Guardian Electric Manufacturing Company | 42 |
| Hayden Book Company, Inc. | 66, 67 |
| Heath Dynamics, Inc. | 121 |
| Hewlett-Packard | 1, 56, C12, C13, 77 |
| International Communications Corporation | C2 |
| Janco Corporation | 91 |

| Advertiser | Page |
|---|------------------|
| KCL Corporation | C55 |
| Keithley Instruments, Inc. | 105 |
| Kepeco, Inc. | C49 |
| Logitek, Inc. | 114 |
| Magnecraft Electric Company | C36 |
| Magnetics, A Division of Spang Industries, Inc. | C32, C33 |
| Malco Mfg. Company, Inc. | C40 |
| Marconi Instruments Division of English Electric Corporation | 14 |
| Merrill, Lynch, Pierce, Fenner & Smith, Inc. | 104 |
| Mil Electronics, Inc. | 106 |
| Molex, Incorporated | 41 |
| Monroe, The Calculator Company | C25 |
| Monsanto Company | 97, Cover III |
| Motorola Semiconductor Products, Inc. | 4, 5, 35 |
| National Electronics, Inc. | 49 |
| Philips Electronic Components and Materials Division | 60 |
| Power-Tec, Airtronics, Inc. | 124 |
| Prentice-Hall, Inc. | 122, 123 |
| RCA Electronic Components and Devices..... | 80, 81, Cover IV |
| Remex Electronics Division of Ex-Cello Corporation | C42, C51, C53 |
| Ripley Company, Inc. | C63 |
| Rogan Brothers, Inc. | 117 |
| Rogers Corporation | C39 |
| Rohde & Schwarz | 94A |
| Rotron Corporation | C43 |
| Schrack Electrical Sales Corp. | 117 |
| Scott Paper Company, Foam Division | 15 |
| Sercel | 94B |
| Servo Tek Products Company | C34 |
| Signetics Corporation | 45 |
| Siliconix Incorporated | 89 |
| Singer Company, The, Diehl Division | C29 |
| Singer Company, The Instrumentation Division | 87 |
| Singer-General Precision, Inc. Kearfott Division | C48 |
| Solitron Devices, Inc. | 55 |
| Sprague Electric Company | 36, 73 |
| Stackpole Carbon Company | 8, 9 |
| Switchcraft, Inc. | C47 |
| Syntronic Instruments, Inc. | C62 |
| Technical Wire Products, Inc. | C42 |
| Tektronix, Inc. | 59, C31 |
| Teletype Corporation | C18, C19 |
| Tempo Instruments Division | 98 |
| Tenney Engineering, Inc. | C56 |
| Thermal American Fused Quartz Co. | 116 |
| Thomson-CSF Electron Tubes | 85 |
| Trio Laboratories, Inc. | C64 |
| Triplett Corporation | 17 thru 34 |
| Tung Sol Division, Wagner Electric Corporation | 120 |
| Union Carbide Corporation | 52, 53 |
| United Telecontrol Electronics, Inc. | 103 |
| Unitrode Corporation | 47 |
| Vactec Inc. | 119 |
| Varo Semiconductor Division | 115 |
| Vero Electronics, Inc. | C57 |
| Victoreen Instrument Division | 91 |
| Wang Laboratories, Inc. | C59 |
| Welch-Allyn, Inc. | 99 |
| Westinghouse Specialty Metals Division | 93 |
| Zenith Radio Corporation | 104 |

FOR EXCELLENCE IN PUSH BUTTON SWITCHES SPECIFY GRAYHILL

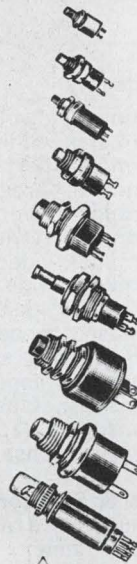

A WIDE SELECTION TO CHOOSE FROM...

- Ratings To 10 Amp.
- SPST, SPDT, DPST, DPDT
- Diameters From 1/4" To 7/8"
- Behind Panel Dimension As Small As .32"
- Momentary - Push-Pull - Lighted - Alternate Action (Push-On, Push-Off)
- Wiping, Snap Action And Butt Contacts
- Solder Lug, "Faston" Or Printed Circuit Terminals
- Life Expectancy Up To 1,000,000 Operations

For your
Grayhill Engineering
Catalog offering complete
technical data—contact



565 Hillgrove Avenue
LaGrange, Illinois 60525
Area Code 312, Phone 354-1040

... the Difference Between Excellent and Adequate

INFORMATION RETRIEVAL NUMBER 82

All the Plastic Platform Headers

you need! ... to do the job in semiconductors ... relays ... photocells ... fuses and many other applications. General Electric designs and produces plastic platform headers to demanding specifications for high volume production. The insulation available includes a wide range of engineered thermosets and thermoplastics ... and lead wires of practically any commercial material and finish can be supplied. If you need production quantities of 1 million headers or more, let's get together. Write for design criteria regarding: ■ Plastic platform geometry and size variations ■ Lead wire lengths, diameters, and spacing ranges ■ Material options. *General Electric Company, Lamp Metals & Components Department, 21800 Tungsten Road, Cleveland, Ohio 44117. Tel: (216) 266-2451.*

GENERAL  ELECTRIC

INFORMATION RETRIEVAL NUMBER 83

Product Index

Information Retrieval Service. New Products, Evaluation Samples (ES), Design Aids (DA), Application Notes (AN), and New Literature (NL) in this issue are listed here with page and Information Retrieval numbers. Reader requests will be promptly processed by computer and mailed to the manufacturer within three days.

| Category | Page | IRN | Category | Page | IRN |
|------------------------|------|-----|-------------------------------------|------|-----|
| Components | | | | | |
| components (NL) | 119 | 416 | terminal, display | C60 | 293 |
| lamp, display | 108 | 363 | terminal, on-line | C46 | 270 |
| relay, reed | 109 | 364 | terminal, portable | C50 | 318 |
| relay, reed | 109 | 365 | terminal, programmed | C34 | 300 |
| switches (NL) | 118 | 398 | terminal, remote | C46 | 280 |
| switches, reed (NL) | 118 | 412 | terminal, retrieval | C50 | 298 |
| transformers (NL) | 118 | 406 | terminal, video | C58 | 251 |
| trimmer, PC | 107 | 362 | terminal, wide-format | C42 | 282 |
| | | | terminals, display | C50 | 265 |
| Data processing | | | test set, modem | 110 | 366 |
| coupler, telephone | C58 | 316 | time-sharing system | C52 | 268 |
| decoders, data | 111 | 368 | transport, tape | C38 | 262 |
| degausser, tape | 111 | 367 | transport, tape | C42 | 272 |
| drafting system | C34 | 307 | transports, tape | C54 | 313 |
| drive, disc | C56 | 278 | voice-response system | C54 | 289 |
| file systems, disc | C34 | 319 | | | |
| interface, Teletype | C46 | 256 | ICs & Semiconductors | | |
| interface, Teletype | 111 | 370 | converter, d/a | 96 | 327 |
| memories, disc | C58 | 279 | diode, zener | 96 | 326 |
| memories, read/write | C54 | 314 | ICs, MOS | 96 | 328 |
| memory, core | C60 | 315 | ICs, multi-chip | 96 | 325 |
| memory, core | 110 | 317 | memories, read-only | 95 | 320 |
| memory, core | 111 | 369 | memory, read-only | 95 | 322 |
| memory, drum | C46 | 260 | rectifiers, silicon | 96 | 324 |
| memory, plated-wire | C60 | 271 | register, shift | 96 | 329 |
| memory, plated-wire | C60 | 304 | registers, buffer | 96 | 330 |
| memory, serial | C58 | 288 | switch, frequency | 95 | 321 |
| microfilmer | C58 | 311 | transistors, Darlington | 95 | 323 |
| minicomputers, 16-bit | C27 | 287 | | | |
| modem, data | C48 | 250 | Instrumentation | | |
| multiplexers | C28 | 286 | analyzer, spectrum | 103 | 353 |
| plotter, flatbed | C38 | 254 | camera, oscilloscope | 106 | 359 |
| plotter, graphic | C38 | 266 | curve tracer | 105 | 357 |
| plotter, time-sharing | C30 | 267 | generator, pulse | 103 | 352 |
| printer, hard-copy | C38 | 308 | generator, pulse | 106 | 360 |
| printer, line | C50 | 310 | instruments (NL) | 118 | 395 |
| printer, line | C60 | 297 | meter, 4-1/2-digit | 103 | 355 |
| printer, page | C38 | 277 | power supply | 105 | 358 |
| printers, line | C30 | 285 | probes, logic | 104 | 356 |
| printers/plotters | C52 | 258 | recorders, chart | 103 | 354 |
| processor systems | 112 | 303 | test clips, IC | 106 | 361 |
| reader, document | C54 | 264 | | | |
| reader, microfiche | C34 | 276 | Microwaves & Lasers | | |
| reader, optical | C60 | 294 | laser, He-Ne | 99 | 334 |
| readers, card | C42 | 253 | photodiode/op amp | 98 | 331 |
| recorder, digital | C28 | 274 | switch, optical | 98 | 332 |
| recorder, digital | C52 | 263 | transistor, 12-GHz | 98 | 333 |
| recorders, digital | C48 | 301 | varactors, silicon | 99 | 341 |
| station, calling | 112 | 372 | | | |
| storage system, disc | C58 | 275 | Modules & Subassemblies | | |
| system, entry | C52 | 259 | amplifiers, operational | 100 | 342 |
| system, magnetic-tape | C50 | 273 | converter, d/a | 102 | 350 |
| system, magnetic-tape | C56 | 296 | converter, rns-to-dc | 102 | 346 |
| tape head | 111 | 371 | converter, 10-bit d/a | 101 | 343 |
| terminal, batch | C46 | 283 | lamp, flashing | 101 | 344 |
| terminal, batch | C46 | 305 | meter, edgewise | 102 | 349 |
| terminal, batch | 110 | 281 | op amps, monolithic | 102 | 347 |
| terminal, computer | C54 | 292 | sensor, voltage | 102 | 345 |
| terminal, computer | C58 | 257 | supply, dual | 102 | 348 |
| terminal, CRT | C38 | 299 | supply, power | 102 | 351 |
| terminal, CRT | C50 | 312 | | | |
| terminal, data | C30 | 309 | Packaging & Materials | | |
| terminal, data | C46 | 291 | connectors (NL) | 120 | 421 |
| terminal, data | C54 | 252 | connectors, rf (NL) | 118 | 413 |
| terminal, display | C28 | 295 | insulation (NL) | 120 | 420 |
| | | | insulators, component | 113 | 373 |
| | | | sockets, pin | 113 | 374 |
| | | | tubing, shrink (NL) | 118 | 397 |
| | | | Tools & Engineering Aids | | |
| | | | connector, I/O | 113 | 376 |
| | | | peripherals report (NL) | 118 | 410 |
| | | | stripper, wire | 113 | 375 |
| | | | test chart, CCTV (DA) | 114 | 379 |
| | | | | | |
| | | | New Literature | | |
| | | | amplifiers, servo | 120 | 426 |
| | | | antenna systems | 120 | 424 |
| | | | calculators | 118 | 399 |
| | | | CCTV | 118 | 396 |
| | | | chips, FET | 120 | 427 |
| | | | components | 119 | 416 |
| | | | components | 120 | 428 |
| | | | components, microwave | 120 | 425 |
| | | | connectors | 118 | 407 |
| | | | connectors | 118 | 413 |
| | | | connectors | 120 | 421 |
| | | | heat-sink components | 120 | 422 |
| | | | instruments | 118 | 395 |
| | | | instruments | 119 | 417 |
| | | | insulation, electrical | 120 | 420 |
| | | | keyboards | 120 | 423 |
| | | | Lafayette catalog | 119 | 418 |
| | | | modules, function | 118 | 411 |
| | | | peripherals report | 118 | 410 |
| | | | potentiometers | 119 | 419 |
| | | | power supplies | 118 | 414 |
| | | | programming devices | 118 | 408 |
| | | | spectroscopy analysis | 118 | 409 |
| | | | switches | 118 | 398 |
| | | | switches | 118 | 415 |
| | | | switches, reed | 118 | 412 |
| | | | transformers | 118 | 406 |
| | | | | | |
| | | | Application Notes | | |
| | | | converters, s/d | 115 | 381 |
| | | | measurements, guarded | 115 | 383 |
| | | | transducers | 115 | 382 |
| | | | | | |
| | | | Design Aids | | |
| | | | guide, semiconductor | 114 | 380 |
| | | | test chart, CCTV | 114 | 379 |
| | | | | | |
| | | | Evaluation Samples | | |
| | | | switch, record-player | 114 | 377 |
| | | | tubing, fiberglass | 114 | 378 |



MSI construction; 50 MHz counting range; BCD output (TTL compatible); Full complement of counter/timer functions (including true time interval and multiple period average). These are some of the advantages that make this latest "Small Wonder" the most wonderful of all.

Will ^{small} wonders never cease?

In the beginning was the Model 100A . . . the original "Small Wonder." Others quickly followed to make the Monsanto 100 Series the most popular line of counters in the industry.

And now there is a new breed, led by the Model 101B. It features wider performance ranges through ex-



tensive use of MSI and other design innovations that enhance its performance, reliability and serviceability. In addition to the advantages highlighted above, the Model 101B also offers dual inputs with individual trigger controls, adjustable display time with storage, crystal controlled clock, plus built-in

interfacing with the rest of Monsanto's line of compact, half-rack instruments.

And—Wonder of Wonders—Model 101B prices begin at \$695. Others of the new breed begin at \$420. Get complete details from your Monsanto Field Engineering Representative or from Monsanto Electronic Instruments, West Caldwell, New Jersey 07006.

Take a look at these typical Complementary Symmetry MOS IC dissipation: gates—10 nW/pkg; counters, registers, decoders—10 μ W ($V_{DD} = 10$ V). You'll see why RCA COS/MOS saves design dollars by cutting system size. It does so by eliminating the need for forced cooling systems; using smaller, less expensive power supplies and enabling higher packing densities.

RCA's broad line of COS/MOS ICs — gates, flip-flops, hex buffer/logic-level converters, multiplexers, static-shift reg-

isters, counters, adders and memories — offers many more unique performance features for logic systems.

Immediately available in production quantities are:

- CD4000 and CD4000D Series — 28 ceramic-packaged devices at new low prices

- CD4000E Series — 19 new economy-priced plastic-packaged ICs

RCA will also custom tailor COS/MOS ICs for your special digital-circuit applications. Ask your RCA Representa-

tive about this service.

For price, delivery or technical information on COS/MOS ICs, see your local RCA Representative or RCA Distributor. And, for more information on COS/MOS performance features, request bulletin ST-4001, "COS/MOS ICs," from RCA, Commercial Engineering, Section 57K-8/CD50, Harrison, N.J. 07029. International: RCA, 2-4 rue du Lièvre, 1227 Geneva, Switzerland, or P.O. Box 112, Hong Kong.

RCA COS/MOS ICs: microwatt power consumption significantly reduces system size...and cost.

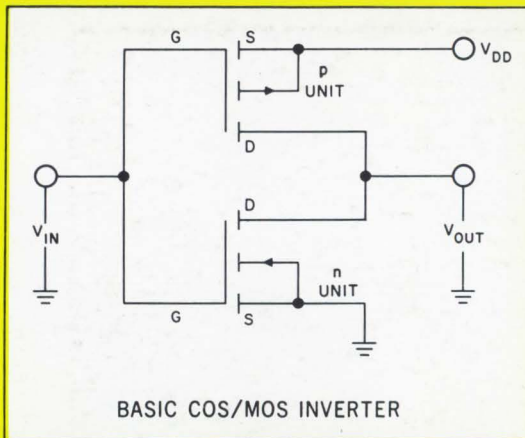

The unique design of the basic inverter circuit in RCA COS/MOS ICs limits the quiescent power consumption to nanowatts.

In most logic systems, the majority of the circuitry changes logic state at only a portion of the clocking rate. Therefore, the quiescent power consumption between switching periods is the major factor in determining total power consumption. Dynamic power consumption is a function of switching frequency.

In either logic state, one transistor of the basic COS/MOS inverter circuit is ON and the other is OFF. A very high OFF-impedance between the supply voltage line and ground limits the quiescent current of the OFF transistor to a very low value (0.3 nA typ at $V_{DD} = 10$ V).

RCA

Integrated Circuits

INFORMATION RETRIEVAL NUMBER 183