

Electronic Design

FOR ENGINEERS AND ENGINEERING MANAGERS

VOL. 18 NO.

7

APRIL 1, 1970

Now TTL can be wire-OR'd. A third, high-impedance output state isolates flip-flops from their output busses in a new quad-D circuit. The flip-flops, addressed

using output enable lines, offer simpler computer organizations through hard-wired logic and full compatibility with 54/74 TTL. For the full story, see page 101.

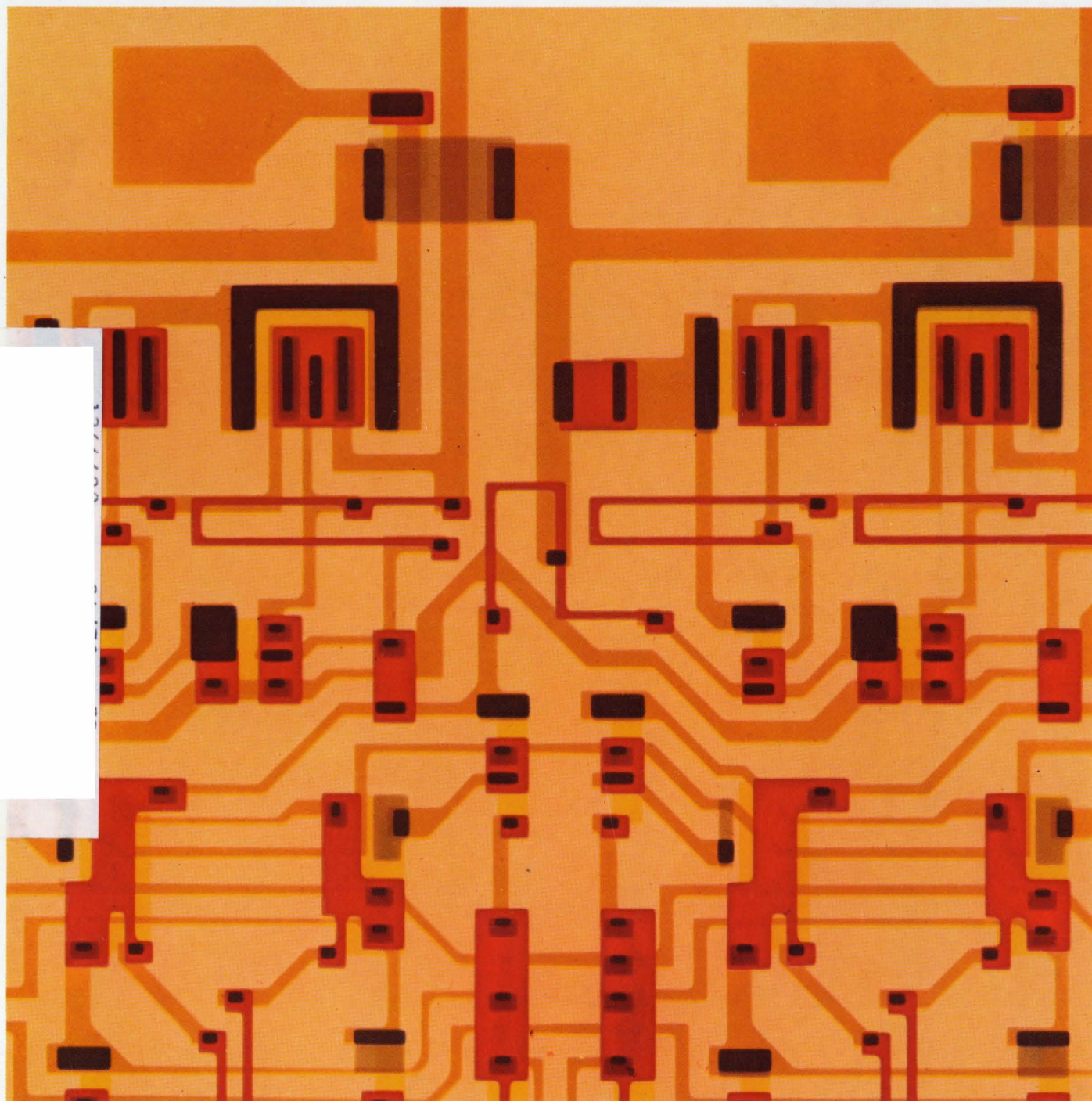



DALE[®]

**COIL
COUNTRY**

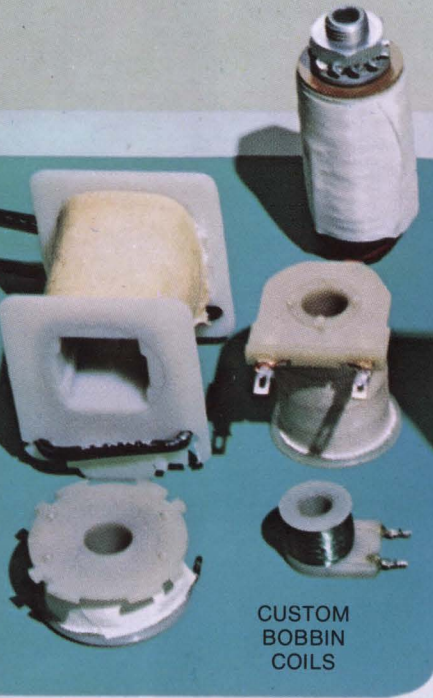

CUSTOM
BOBBIN
COILS



CUSTOM
TOROIDS



RF
TRANSFORMERS
AND
INDUCTORS

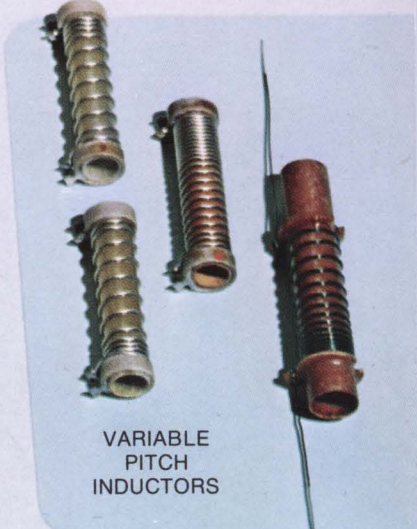

VARIABLE
PITCH
INDUCTORS

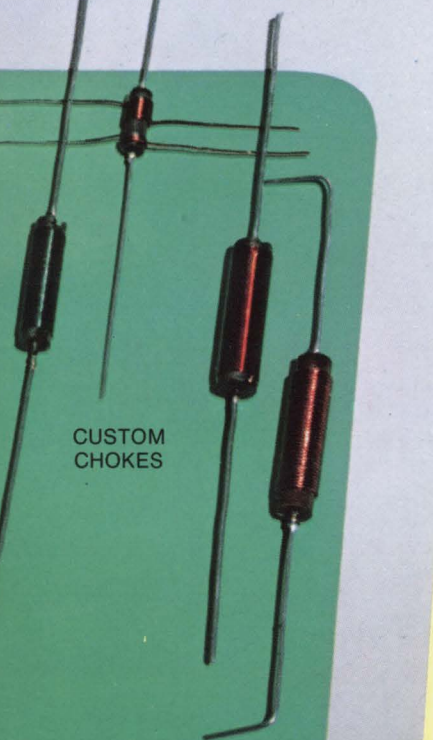

CUSTOM
CHOKES

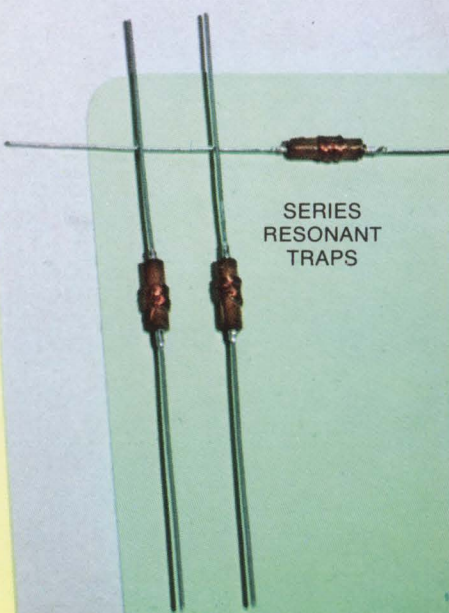

SERIES
RESONANT
TRAPS

New Roll Coated Choke

Now Dale can deliver standard epoxy roll-coated chokes that give you molded quality at lacquer-coated prices. This new Dale line includes 10 standard models designed to meet MIL-C-15305D (Grade 1, Class B). Inductance: $.10\mu\text{h}$ to $1.00\mu\text{h}$; Self-Resonant Frequency: 680-240 Mhz. All are designed for use on automatic insertion equipment and are available *now* in quantity. Standard or special — there's plenty of time and money to be saved in Coil Country.

CALL TODAY:
605—665-9301

DALE ELECTRONICS, INC.

Box 180, Yankton, South Dakota 57078

A subsidiary of The Lionel Corporation

INFORMATION RETRIEVAL NUMBER 246

The best gets better.

The HP 5248 General-Purpose Counter can now measure to 3 GHz with a single plug-in — without any gaps. This is made possible by our new 150 MHz to 3 GHz Heterodyne Converter, Model 5254C, and by extending the direct counting range of the 5248 counter mainframe to 150 MHz.

There's another benefit unique to these instruments that's not immediately apparent. Converter and counter ranges actually overlap so you derive the final answer by merely adding the converter dial reading and counter reading. There's no need to remember to subtract readings over any part of the frequency range.

Even before the latest improvements, no other counter could match the

usefulness and flexibility of the 5245 Series. We now offer fourteen different plug-ins to help you make all the measurements you need. These include six frequency converters; transfer oscillator to 18 GHz; two time interval units; two prescalers; video amplifier; DVM; and preset unit.

And you can't beat the 5245 line for reliability either. Its remarkable dependability has made it extremely popular, particularly with rental firms — some of our best customers. When their clients rent an HP counter, rental firms know they won't lose rental fees because of downtime.

The price of the new 5254C Heterodyne Converter is \$825. The

5248L counter is \$2900. You won't find a more economical single-package solution to your dc to 3 GHz counter needs. Your local HP field office has all the details. Give them a call. Or write to Hewlett-Packard, Palo Alto, California 94304; Europe: 1217 Meyrin-Geneva, Switzerland.



HEWLETT  PACKARD
ELECTRONIC COUNTERS

02918

INFORMATION RETRIEVAL NUMBER 2

**There's a
new reason why
this continues to be
the world's most popular
counter line.**



You're looking at 35 new digital printers!

\$995.



You only see one? That's because you don't see all the plug-in options and features packed into S-D's new printer . . . **including** features found only in \$3,000 printers!

The basic Model 5103 is a 5-column, asynchronous, 3-line/sec. printer, so quiet-running you can hardly hear it. It expands to a 21 column printer with 16 characters/column simply by adding economical 5-column plug-in boards. Just slide them in yourself at any time.

Interface problems just don't exist. For example, Model 5103 handles any 4-line BCD code with a simple IC socket change. No disassembly or rewiring ever. For only \$995, you get a printer that offers **dual source operation**, handles positive or negative logic, and features input channels that can be programmed to print in any column on the print drum. You get a printer with zero suppression, measurement units printout and two-color printing so you can use it directly with limit comparators.

Unique options for every situation. You have your choice of such useful options as plug-in boards for ± 200 V levels, 1 msec transfer time, digital clock, buffer storage, floating decimal point and more.

For complete details, write Data Products Division, 888 Galindo Street, Concord, California 94520. Phone: (415) 682-6161.

SYSTRON  DONNER

Another S-D instrument first! Electronic counters/Digital voltmeters/Pulse generators/Data generators/Time code generators / Sweep generators / Spectrum analyzers / Digital panel meters / Digital clocks / Signal generators / Oscillators Laboratory magnets / Precision Power Supplies/ Analog & analog—hybrid computers / Data acquisition systems.

INFORMATION RETRIEVAL NUMBER 3

NEWS

- 21 **News Scope**
- 25 **Time marches on—but electronically now**
More and more, mechanical wristwatches are giving way to timepieces that are controlled by microcircuitry.
- 30 **Curing engine failures BEFORE they occur**
Ampex R&D system uncovers worn parts by displaying the audio frequencies of vibrations in equipment.
- 32 **Antenna design aid rises in the desert**
Radiation patterns for airborne and vehicular radio antennas can now be measured with precision on the ground.
- 34 **Electronics tunes in on muscle fatigue**
- 39 **Washington Report**

TECHNOLOGY

- 50 **Synchro-to-digital converters:** Part II examines the first of several designs using octant selection circuits.
- 60 **System design means trade-offs,** as shown by one designer's approach to a state-of-the-art airborne computer.
- 66 **Check flip-flops automatically.** Measure preset times and thresholds accurately with this new closed-loop system.
- 70 **Management is being transformed,** says this research director, as a knowledgeable generation replaces experience-based administration.
- 75 **Ideas for Design**
- 83 **Product Source Directory:** Multitestors
- 89 **'Top Ten'** prize-winning advertisements

PRODUCTS

- 101 **ICs & Semiconductors:** TTL quad flip-flops feature three logic states.
- 106 **Instrumentation:** Measuring system interfaces programmable instruments.
- 110 **Components:** Monolithic LED numeric declares price war on Nixie tubes.
- 104 Data Processing
- 109 Microwaves & Lasers
- 113 Modules & Subassemblies
- 115 Packaging & Materials
- 115 Tools & Engineering Aids
- 128 Product Index

Departments

- 49 **Editorial:** Are you your own worst enemy?
- 13 Designer's Calendar
- 46 Sidelights
- 116 Evaluation Samples
- 117 Design Aids
- 118 Application Notes
- 120 New Literature
- 126 Advertisers' Index

Information Retrieval Service Card inside back cover

Cover: Tri-state TTL flip-flops from National Semiconductor Corp., Santa Clara, Calif. Photo by Richard Steinheimer.

ELECTRONIC DESIGN is published biweekly by Hayden Publishing Company, Inc., 850 Third Avenue, New York, N.Y. 10022. James S. Mulholland, Jr., President. Printed at Brown Printing Co., Inc., Waseca, Minn. Controlled circulation postage paid at Waseca, Minn., and New York, N.Y. Copyright © 1970, Hayden Publishing Company, Inc. 81,801 copies this issue.

In less than one second

you've got it

Permanent gas-tight
electrical connections
with Gardner-Denver
Wire-Wrap* tools

These light, quiet air tools wrap wires at a high rate of speed for solderless connections that are permanent, gas-tight, and reliable. Model 14XL1 weighs 13½ ounces, takes bits and sleeves for 20 through 32 gauge wire.

Pneumatic Wire-Wrap tools have pistol grip or straight handles. Or you may prefer our electric-powered models. Or the model with rechargeable battery. Manual wrapping and unwrapping tools are available for service kits. Bulletin 14-1 describes them all. Write for your copy today.

GARDNER-DENVER

Gardner-Denver Company, Quincy, Illinois 62301

*Registered Trademark

INFORMATION RETRIEVAL NUMBER 4



wired



See these
Gardner-Denver
Wire-Wrap Tools
at NEPCON CENTRAL
BOOTH 703
Sherman House,
Chicago
April 7, 8 & 9

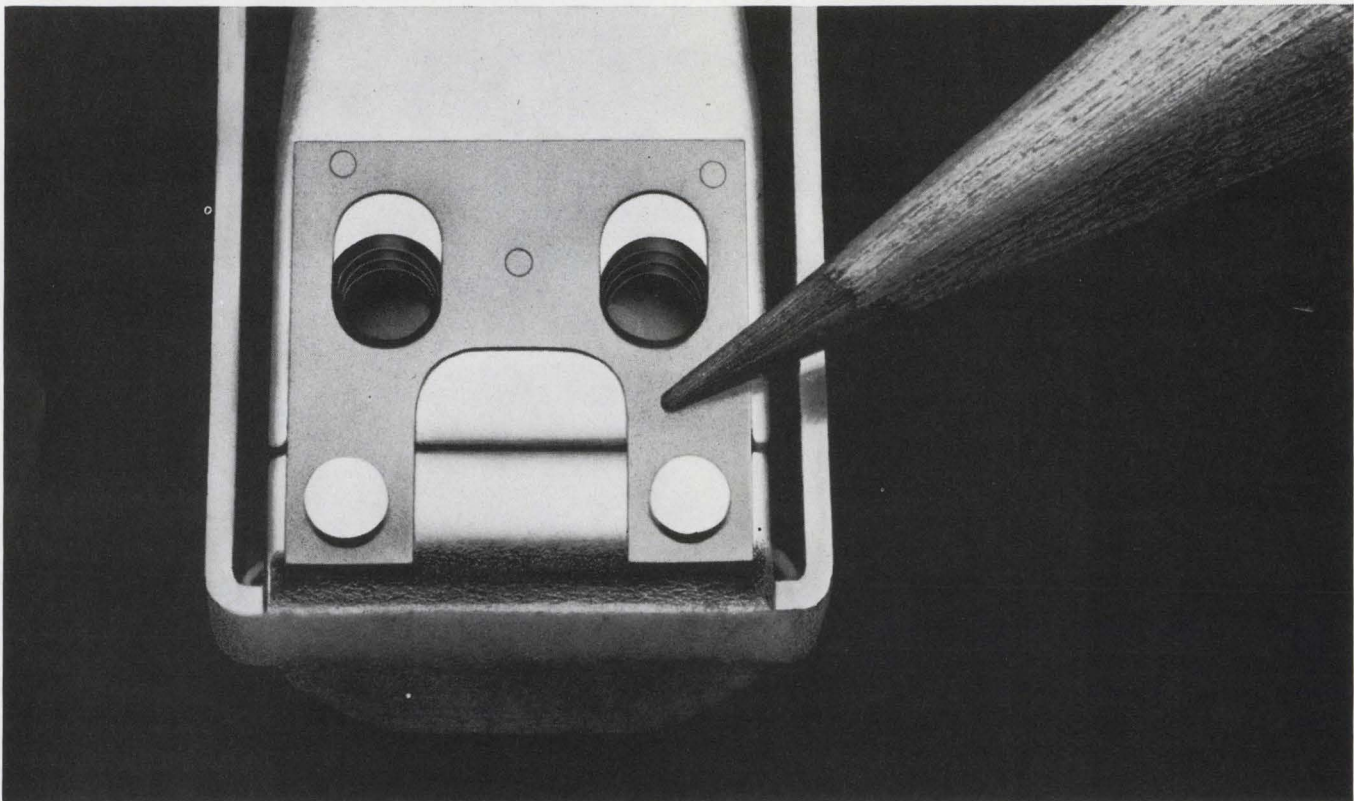

A new type relay hinge eliminates mechanical wear entirely.

It's called a reed hinge and we've substituted it for the conventional rocker type assembly in our imported JMR Miniature 5 Amp. Cradle Relay. The blade (reed) reduces 4 parts to 1. Simple, lastingly dependable and entirely free of mechanical wear. It's a Line Electric exclusive.

Other significant improvements are in the housing: Pure polycarbonate plastic which has 48% higher heat and 31% greater fracture resistance than nylon, styrene or butyrate. And gold-diffused silver contacts to ensure even greater reliability at low power levels while retaining full load switching capabilities. Also outgassing of all phenolic parts to prevent contact contamination.

Available in 2PDT, 4PDT, 6-12-24-48 or 110 VDC. Priced as low as \$1.40 (5000 or more per year). You can't buy better. Write or call us at 201-887-2200.

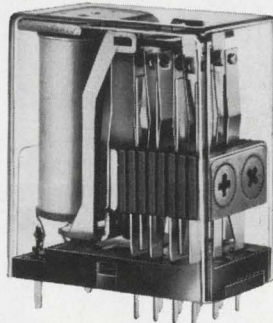

SINGER
LINE ELECTRIC CO.

Line Electric Company, U. S. Highway 287, Parsippany, N. J. 07054 201/887-2200

INFORMATION RETRIEVAL NUMBER 5

INFORMATION RETRIEVAL NUMBER 6 ►

with sense amps.

The LM354A/SN7524 completes the logic and interface package for designers of mini-computers. Proprietary MSI circuits and a full line of the most popular second source DTL and series 54/74 TTL; everything into and out of the memory. Logically from National.

The LM354A and LM354. Pin-for-pin replacements for the SN7524 and SN7525 monolithic dual sense amps. Independent channel strobing built to fit the specs of the most demanding mini-computer designer.

Our LM354A features plus or minus 4mV maximum threshold voltage tolerance. Parts to even tighter tolerances are available on special order. All circuits are 16-pin dual-in-line silicone.

LM354A/SN7524—\$6.25 @ 100 up.

LM354/SN7525—\$4.80 @ 100 up.

We've taken a strong position in supplying production quantities of advanced ICs for the mini-computer manufacturer. Everything you need. Take it from National. Delivery, performance and competitive pricing always. Write for specs. National Semiconductor, 2900 Semiconductor Drive, Santa Clara, California 95051. (408) 732-5000. Telex: 346-353. Cables: NATSEMICON

TTL, DTL & linear ICs for the mini-computer.

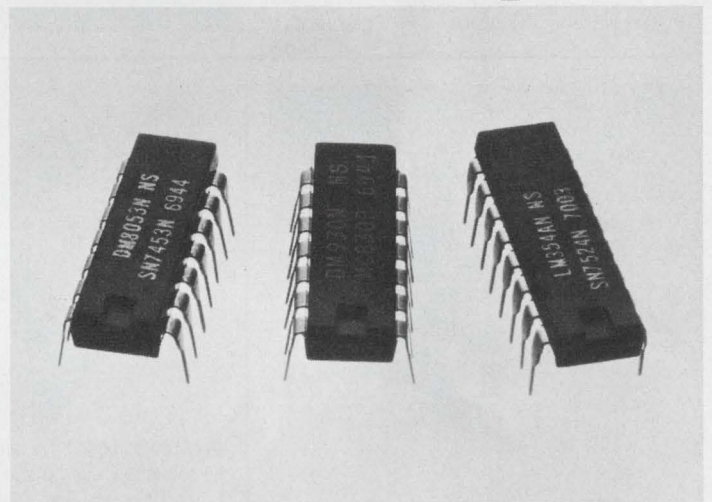

National/Linear

Discovering



IN ELECTRONICS ... Electronic Glass, Lucalox® and Quartz Solve Challenging Problems

Epitaxial films grow to high resistivity and greater uniformity in this GE type 204 quartz horizontal reactor tube. Manufactured by Hugel Industries, Sunnyvale, California, the rectangular shape of the tube provides more uniform gas velocities around silicon wafers than can be achieved in round tubes. The reaction of silane or silicon tetrachloride at a temperature up to 1200°C creates epitaxial growth. Purity in the susceptor and quartz envelope is a must. And Hugel found that General Electric always meets their critical standards. A purely logical reason to grow with GE 204 quartz. **CIRCLE 811**

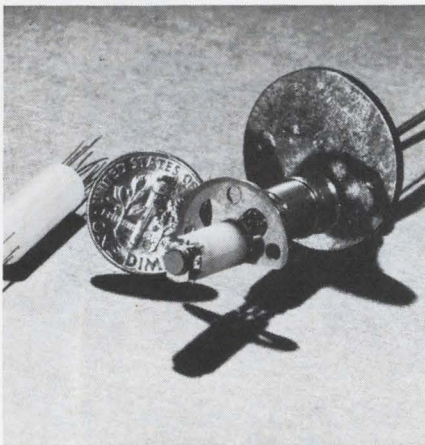
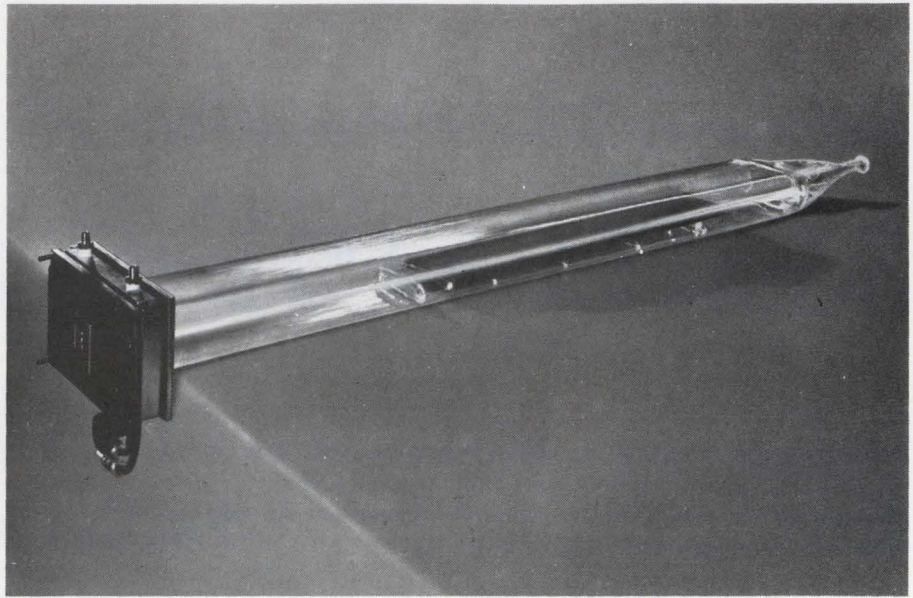

Lucalox® Ceramic plays the "Great Protector" role in this prototype pressure transducer developed for a nuclear space electric power system. The assembly, designed for NASA by Consolidated Controls Corporation, uses bellows and a thermionic sensor to measure pressures of circulating liquid potassium. Should the bellows fail, the Lucalox ceramic prevents leakage of 1000°C. liquid metal. Consolidated Controls experimented with many materials before discovering Lucalox, an extraordinary polycrystalline material that remains stable at 1600°C., and retains strength and form even at temperatures near its 2040°C. melting point. To save the time Consolidated Controls spent searching, why not begin today to learn more about Lucalox, a great protector. **CIRCLE 812**

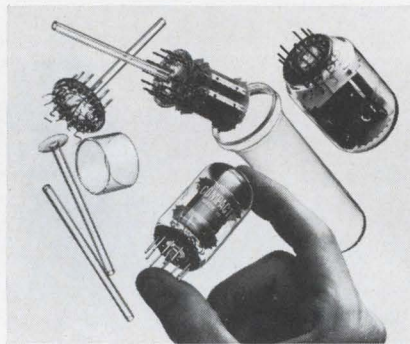

Over 100,000,000 have been made, so there must be something special about the GE Compactron tube. There is. One Compactron, as produced by the GE Tube Dept., can do the work of up to three conventional vacuum tubes. But right here, we at the Lamp Glass Dept. think the Compactron can be used to illustrate our own capability in selecting specific glass types for specific applications. We provided three types for the Compactron: Type 008 lime glass, best for close tolerance forming of bulbs; Type 012 lead glass, best for preventing glass electrolysis in stems; Type 001 glass, best for close tolerance cutting of tubulations, in this case ± 0.5 mm. If you want electronic glass to do something for you, call us. We have the types and we know when to use which one. **CIRCLE 813**

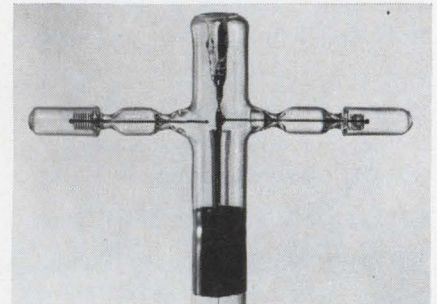

GE fused quartz tubing chimes in with the "sound source" for an amplified quartz bell carillon. Produced by G. Finkenbeiner, Inc., Waltham, Mass., the system weighs less than 40 pounds as opposed to bronze bells of 10 tons. General Electric's type 204 clear fused quartz was selected for its low coefficient of expansion, inherent strength, and absence of fatigue under vibration. To form the "bells" the quartz is drawn to desired length and diameter at 1800°C; then sealed inside a high vacuum, borosilicate glass tube. The quartz is fused to the borosilicate glass with GE graded sealing cane. Another example of how General Electric's glass technology can make sweet music for the electronic industry. **CIRCLE 814**

WORLDWIDE SERVICE. For sales and application assistance, contact your nearest regional office:

CALIFORNIA, Los Angeles	213 723-2541
ILLINOIS, Chicago	312 282-7905
MASSACHUSETTS, Boston	617 332-6200
NEW JERSEY, Newark	201 824-5200
OHIO, Cleveland	216 266-4001
CANADA, Toronto	416 537-4481

Write for illustrated technical literature

LAMP GLASS DEPARTMENT

GENERAL  ELECTRIC

24400 Highland Road • Richmond Heights, Ohio 44143
MANUFACTURERS OF LUCALOX® CERAMIC — ELECTRONIC GLASSWARE —
FUSED QUARTZ PRODUCTS—JET-TEMP® AND JET-B.O.P. THERMOCOUPLES.



Sonotone—the industry's broadest line of nickel-cadmium sealed cells—now has our name on it.

The new name for Sonotone sealed cell nickel-cadmium batteries is Marathon. The name is the only thing that has changed. The batteries are still made in the same way. In the same plant. By the same people. And they are still available through the same sales representatives and distributors.

Marathon has been growing and expanding for 47 years.

Now we have added the world's most versatile rechargeable to our diversified battery line.

Because you have relied on Sonotone for so many years, we want to be certain that you know the name — and only the name — is changed. So the next time you need Sonotones, ask for Marathon. Cold Spring, New York 10516.

marathon  battery company

INFORMATION RETRIEVAL NUMBER 8

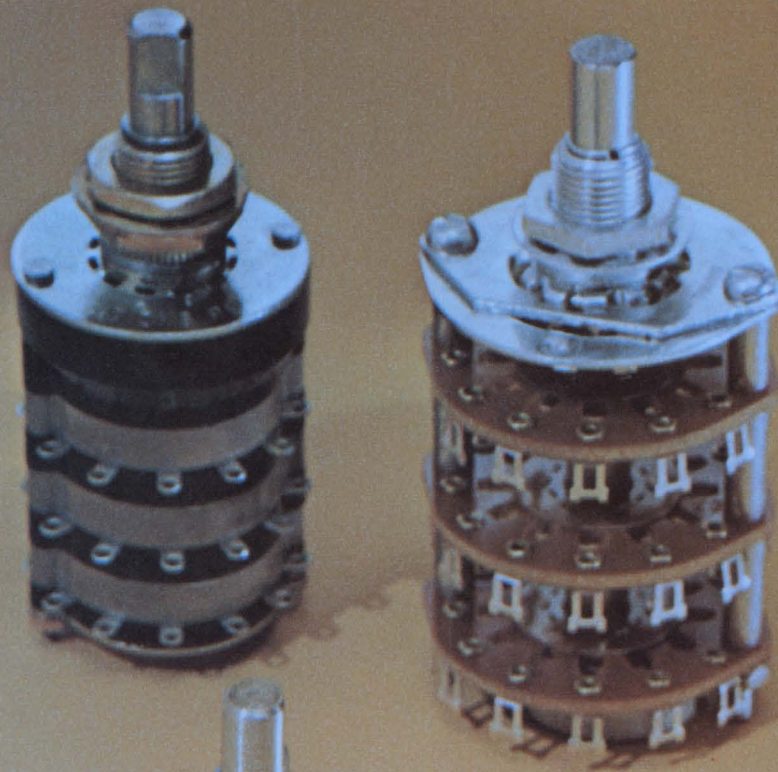

The Competition And Us.

More than an open and closed case.

Three fine rotary switches. Two competitors'. And ours.

The open deck rotary switch on the right is probably the most versatile type switch available today. It is simple. Functional. And very inexpensive.

However, an open switch is highly susceptible to contamination, damage, even tampering. It must be handled carefully. Both in production and in end use.

At Stackpole, we've designed a *totally enclosed* rotary for only pennies more and without sacrificing flexibility. And tough as they come.

To the left is a closed type rotary often considered as top-

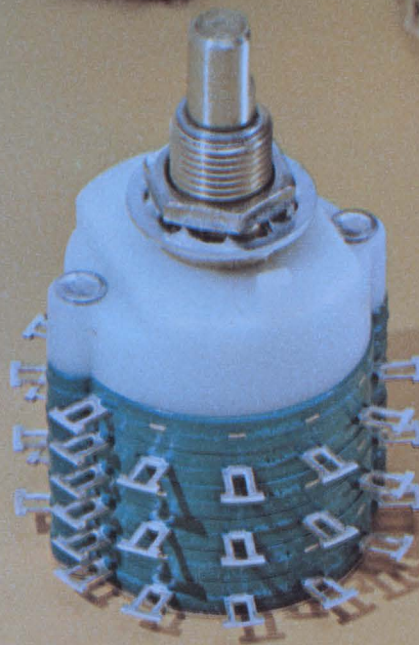

of-the-line. Rugged. Well made. Expensive.

Unfortunately it is severely limited. No interconnection of adjacent terminals or decks is possible.

The slots through which riveted terminals protrude in this so-called closed rotary prevent total enclosure. Permit looseness. Stackpole molds contacts and terminals right into the switch body. Everything's

rigid. Tight. We call it "Environment proof." And it costs a lot less.

That leaves the Stackpole Series 100 rotary switch. Front and center. A totally new concept in rotary construction. Decks interconnect internally. Adjacent terminals may be interconnected internally or externally. At no extra cost.

Another feature is compactness. Note the shorter build-up in length. Then there's the wear compensating dual-ball detent. Rotation is precise. Positive.

Compare. Send for a sample. Made to your specifications in 2 to 3 days. Production quantities in 2 to 3 weeks. For data, quotation or samples, contact: Stackpole Components Company, P.O. Box 14466, Raleigh, N.C. 27610.

Right in the middle is value. Stackpole rotary switches.

Now in two sizes

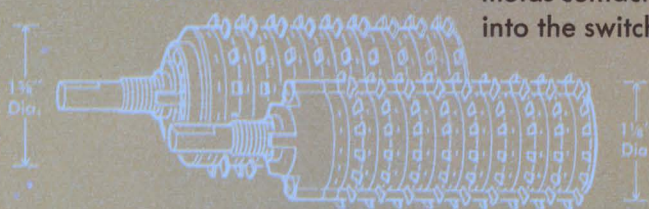

Also the leading producer of quality slide and rocker switches and linear potentiometers.



STACKPOLE
COMPONENTS COMPANY

Designer's Calendar

APRIL 1970

S	M	T	W	T	F	S
			1	2	3	4
5	6	7	8	9	10	11
12	13	14	15	16	17	18
19	20	21	22	23	24	25
26	27	28	29	30		

For further information on meetings, use Information Retrieval Card.

Apr. 14-17

International Geoscience Electronics Symposium (Washington, D. C.) Sponsor: IEEE. Ralph Bernstein, IBM Corp., 18100 Frederick Pike, Gaithersburg, Md. 20760.

CIRCLE NO. 455

Apr. 16-17

Conference on Semiconductor Packaging in the 70s (New York City) Sponsor: Polytechnic Institute of Brooklyn. George J. Fischer, Polytechnic Institute of Brooklyn, 333 Jay St., Brooklyn, N. Y. 11201.

CIRCLE NO. 456

Apr. 21-24

International Magnetics Conference (Washington, D. C.) Sponsor: IEEE, D. S. Shull, Bell Telephone Labs., 3300 Lexington Ave., Winston-Salem, N. C. 27102.

CIRCLE NO. 457

Apr. 22-24

Southwestern IEEE Conference & Exhibition (Dallas) Sponsor: IEEE. A. P. Sage, Inst. of Technology, SMU, Dallas, Tex. 75222.

CIRCLE NO. 458

Apr. 27-30

National Telemetry Conference (Los Angeles) Sponsor: IEEE. A. V. Balakrishnan, UCLA, Rm. 3531, 405 Hilgard Ave., Los Angeles, Calif. 90024.

CIRCLE NO 459



Abbott Offers Dependable Power Supplies at Reasonable Prices

Are you tired of buying electronic power supplies that don't work... don't meet specifications... don't operate for very long? Are you concerned about the long term operation of your system? Then take a long look at Abbott's power supplies. They are built to operate trouble free for many years.

Abbott is pleased to announce its new line of dependable 60 Hertz to DC power supplies. Abbott engineers spent two years developing this model "R" family. Their performance and reliability characteristics were "designed in" from the start. With a choice of any output voltage from 5 to 100 volts DC and output currents from 15 milliamperes to 20 amperes, their principle specifications are:

INPUT: 105-125 VRMS, 50-420 Hertz, 1 phase

LINE REGULATION: $\pm 0.05\%$ or 10 mv (whichever is greater) for input change of 105-125 VRMS

LOAD REGULATION: $\pm 0.05\%$ or 10 mv (whichever is greater) for change from no load to full load

RIPPLE: 0.02% or 5 mv RMS (whichever is greater)

TEMPERATURE: Operating: -4°F (-20°C) to $+160^{\circ}\text{F}$ ($+71^{\circ}\text{C}$) without derating, forced air, or heatsinking. Storage: -67° to $+185^{\circ}\text{F}$.

TEMPERATURE COEFFICIENT: 0.03% per degree Centigrade

SHORT CIRCUIT PROTECTION: Each unit is completely protected against an overload or short circuit of any duration.

SERIES OPERATION: Two or more power supplies can be operated in series.

RELIABILITY: The mean time between failure (MTBF) per MIL-HDBK-217 under worst case operating conditions of full output current, maximum input voltage and $+160^{\circ}\text{F}$ ambient, is 22,026 hrs. for 20 amp. models, increasing to 47,281 hrs. for 0.15 amp. models. At $+104^{\circ}\text{F}$ ambient, the MTBF increase to 63,898 hrs. and 141,243 hrs., respectively. (Complete reports available on request.)

Abbott also manufactures 3,000 other models of power supplies with output voltages from 5.0 to 10,000 volts DC and with output currents from 2 milliamperes to 20 amperes. They are all listed with prices in the new Abbott catalog with various inputs:

28 VDC to DC, regulated
28 VDC to 400 Hz, 1 ϕ or 3 ϕ
28 VDC to 60 Hz, 1 ϕ

400 Hz to DC, regulated
60 Hz to DC, hermetically sealed
60 Hz to 400 Hz, 1 ϕ or 3 ϕ

Please write for your FREE copy of Abbott's new catalog or see EEM (1969-70 ELECTRONIC ENGINEERS MASTER Directory). Pages 1834 to 1851.

abbott transistor

LABORATORIES, INCORPORATED

5200 W. Jefferson Blvd./ Los Angeles 90016
(213) WEBster 6-8185 Cable ABTLABS

To: Abbott Transistor Labs., Inc., Dept. 91
5200 West Jefferson Blvd.
Los Angeles, California 90016

Sir:
Please send me your latest catalog on power supply modules:

NAME _____ DEPT. _____

COMPANY _____

ADDRESS _____

CITY & STATE _____

INFORMATION RETRIEVAL NUMBER 12

OVER 6 MILLION analog connections a second;

The Computer Labs Model MUX-810 Multiplexer will connect eight analog inputs to a single output at a rate of 6.6 million connections every second. Channels can be connected sequentially, with any number in the sequence; random access; or manually, with a front panel push button.

Equivalent "ON" resistance is 0.2 ohm, making the Model MUX-810 an ideal choice for switching 100-ohm lines.

INPUT CHANNELS: 8

Can be switched sequentially (any number); random access; or manually, with push button

INPUT VOLTAGE RANGE: 2.2 V P-P max. (-1.1 V to +1.1 V)

DC ACCURACY: ± 2 mV (Max. difference input to output)

LINEARITY: 0.05%

DC OUTPUT IMPEDANCE: 0.1 ohm

SETTLING TIME:

± 10 mV of final value = 150 ns
 ± 5 mV of final value = 400 ns

LOGIC LEVELS:

"1" = +2.5 V to +4.5 V
 "0" = 0.0 V to +0.5 V
 All loads 50 ohms or greater

LOGIC INPUT IMPEDANCE: 100 ohms

CHANNEL INPUT IMPEDANCE: 1000 ohms in parallel with 20 pF

CHANNEL BANDWIDTH (-3 dB): 15 MHz min.

CHANNEL CROSSTALK (@ 5 MHz): -60 dB

POWER: 120 V $\pm 5\%$; 300 mA

PRICE: \$2,400



followed by... converters that go from Analog to Digital and back again.



The HS Series A/D Converters extend from 4 bits at 25 MHz word rates through 9 bits at 5 MHz word rates. Sample-and-hold, test circuits, and power supplies are all included. No external test equipment required.

COMPUTER LABS
 for tomorrow's technology today

1109 South Chapman St. / Greensboro, N. C. 27403
 (919) 292-6427 / TWX 510 922-7954

The HS-2000 Series D/A Converters match the Computer Labs A/D line in high-speed capabilities. In addition, they can be used as function generators, programmable attenuators, or modulators, because of the ability to vary external bias and reference signals at frequencies up to 25 MHz.

Analog Multiplexers / Analog-to-Digital Converters / Digital-to-Analog Converters / Operational Amplifiers

INFORMATION RETRIEVAL NUMBER 9

Test drive the new Honeywell 2206 Visicorder

That's right. Go ahead and test drive it . . . mounted, for example, in an automobile. Or a tractor. Or on a piece of heavy machinery. Or even in a pleasure boat. This is the oscillograph that's built so rugged and so light-tight (with integral take-up), it goes where other recorders fear to tread. And that consumes only 150 watts . . . from a standard vehicle electrical system or from separate batteries . . . for complete portability.

What's more, when you choose our new 2206 Visicorder, you don't sacrifice performance for portability. In fact, this oscillograph does everything you'd expect a Honeywell Visicorder to do, recording up to 12 channels of data simultaneously, plus two event channels, at frequencies ranging from 0 to 13kHz.

Because this Visicorder uses a mercury lamp with true ultraviolet recording, it also gives you some other interesting bonuses, like high writing speeds (over 40,000 in/sec.). Plus

more stable records. Plus better trace density. And even offers you, as an option, an amplifier package that groups all signal conditioning into a single unit, and that fastens right to the Visicorder itself.

To arrange a test drive of our new Honeywell 2206 Visicorder or to just get more information, call your nearest regional sales manager (listed below), or write: Honeywell Test Instruments Division, P.O. Box 5227, Denver, Colo. 80217.

Regional sales offices: Albuquerque, NM (505) 345-1656, Dave Dimick; Chicago, IL (312) 674-9770, Frank Doherty; Long Island City, NY (212) 392-4300, John Paull; Los Angeles, CA (213) 724-3500, Durke Johnson; McLean, VA (703) 893-4660, Milt Womack.

Honeywell

Honeywell engineers sell solutions

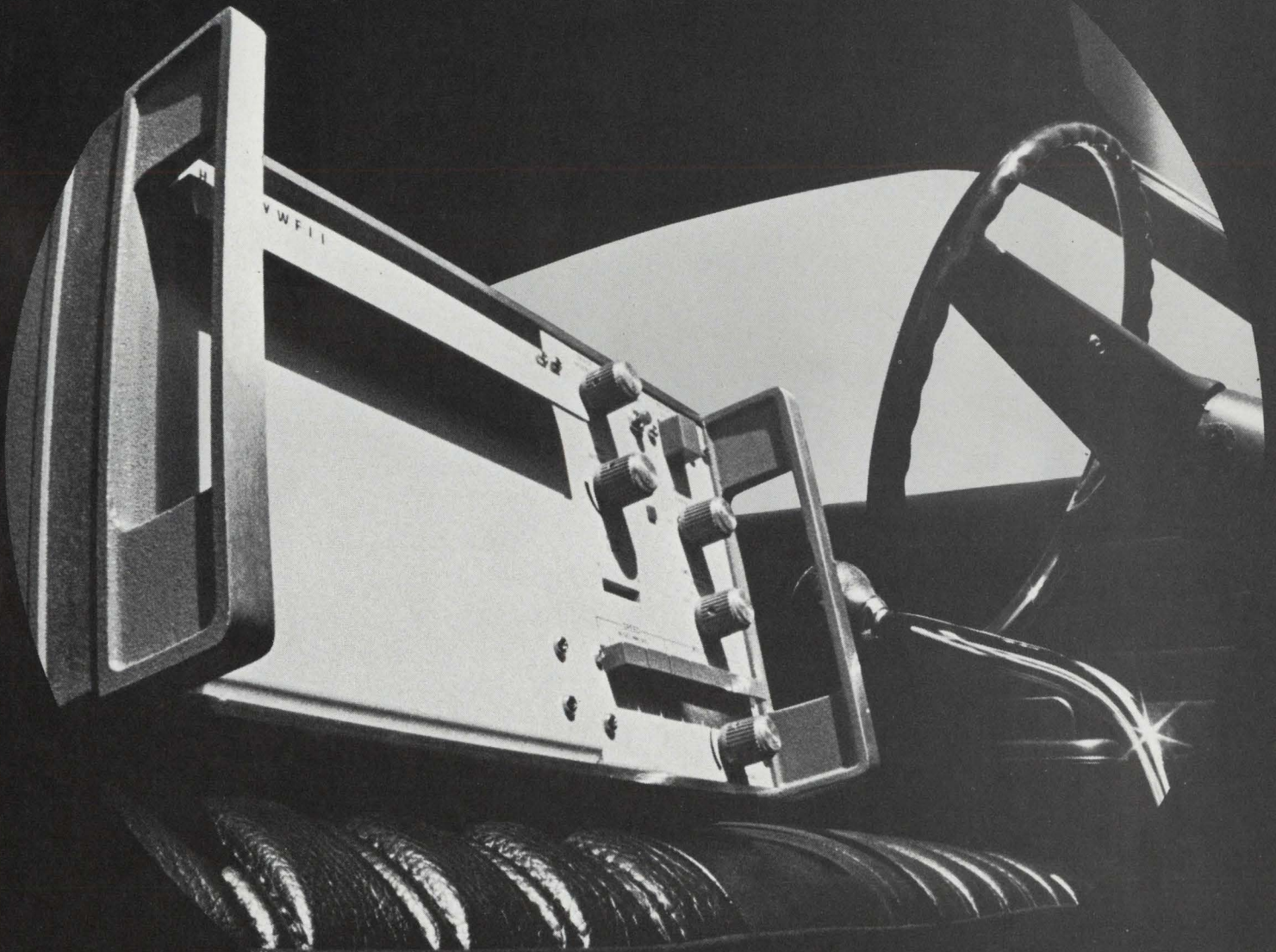

National comes full circuit

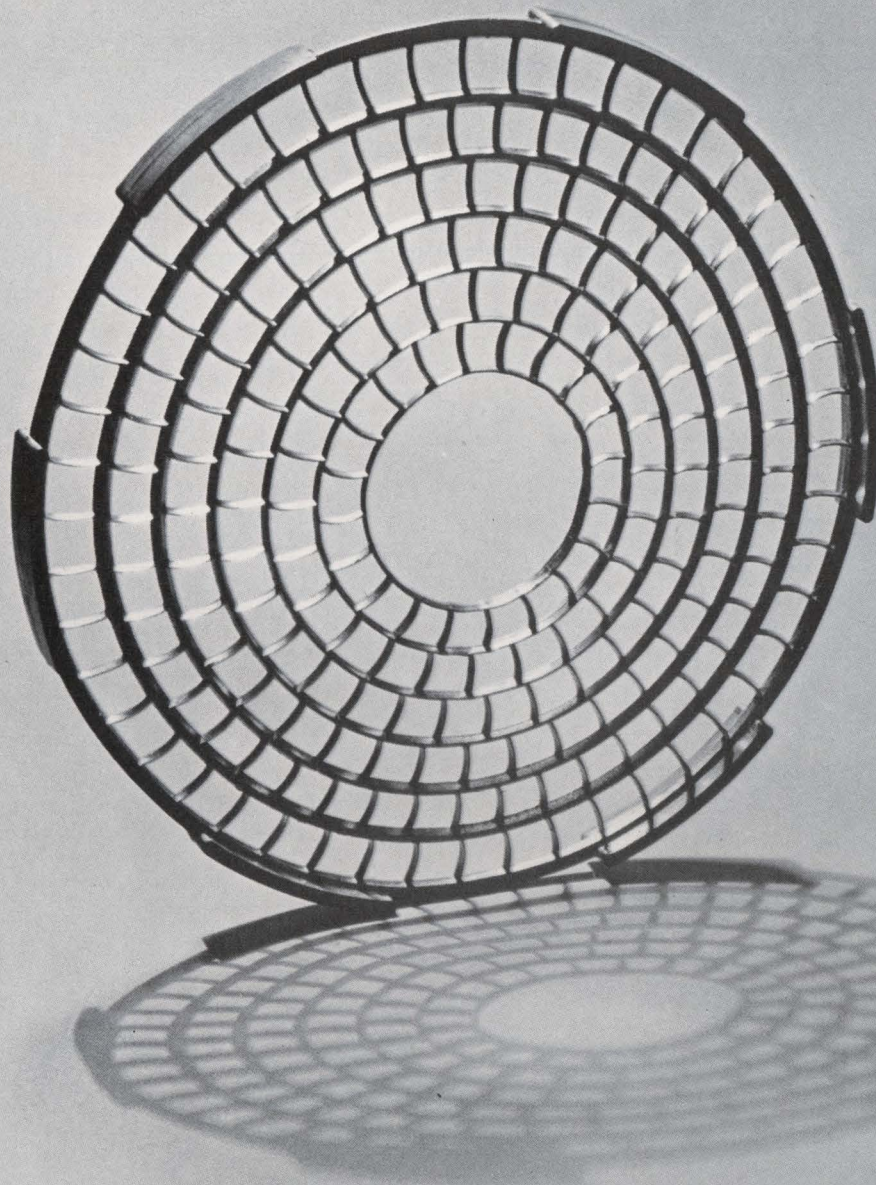

Battery in the Round

Throughout the Bell System, lead-acid storage batteries provide standby supplies in case commercial power fails. Because these batteries are costly to maintain and replace, Bell Laboratories scientists undertook a thorough study and redesign. The new battery, cylindrical in form, should last for more than 30 years, rather than the present 15, with performance actually improving during most of that time.

Most of the changes are in the positive plates. As in conventional lead-acid batteries, these are lead lattices into which a lead-dioxide "paste" is pressed. But the new plates are round, slightly dished (not rectangular, as at present), and are stacked in a self-supporting structure. This stronger construction allows us to use pure lead which, though soft, is more resistant to destructive corrosion than the usual lead alloys.

But all battery plates do corrode to some extent and this causes the lattices to expand or "grow." In conventional designs, this growth pulls the lattice away from the lead dioxide, causing loss of electrical contact. In the new circular plates, the sizes of the concentric lattice hoops are calculated so that, as growth occurs, the space between hoops remains constant. Thus, contact with the lead dioxide is always maintained. Since, in addition, corrosion produces lead dioxide—the cell's active material—the storage capacity of the cell actually increases with time.

The paste, too, has been improved. In standard batteries, the paste is a mass of tiny rounded particles. These gradually fall away from the plate, reducing its capacity, and sink to the bottom of the cell where they cause short circuits. In the new

design, the particles are elongated, almost fibrous. They interlock with one another and stay in place.

The new battery case is transparent non-flammable PVC (polyvinyl chloride). To seal it, we paint a black PVC solution onto a "dovetail" between case and cover and heat the assembly with infrared. The resulting joint is extremely strong and completely acid-tight.

Last year, Bell Laboratories invited battery makers to consider producing the new design. Western Electric, manufacturing and supply unit of the Bell System, will then buy batteries from them. This will benefit the industry and greatly reduce the Bell System's \$30 million annual outlay for battery maintenance and replacement.

From the Research and Development Unit of the Bell System—



Bell Labs

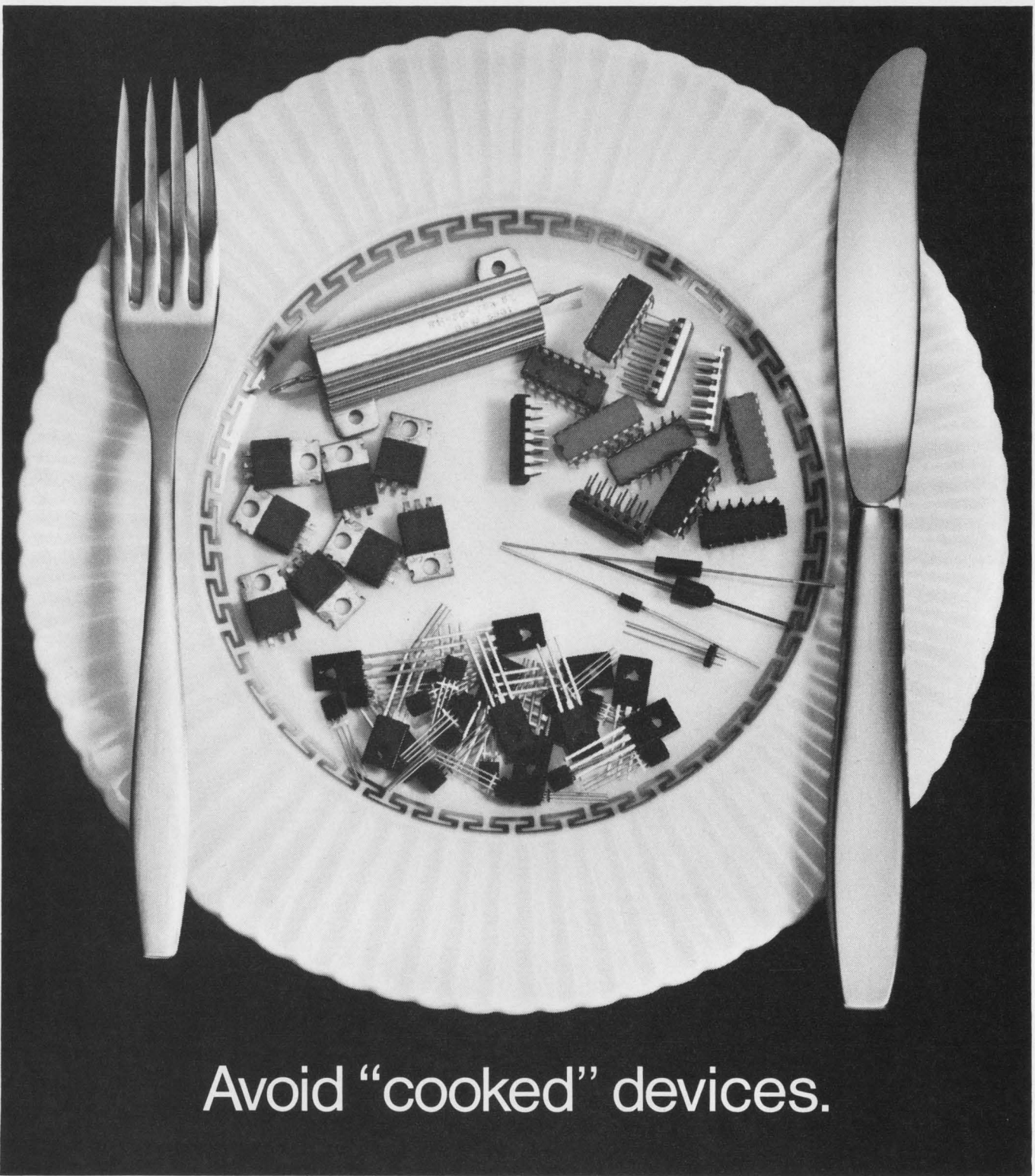

Avoid "cooked" devices.

Heat, built up by high-frequency voltage variations, can melt molding compounds made of organic plastic. So the semiconductor devices they enclose can fail. But they won't fail if they're encapsulated in Dow Corning® silicone molding compounds.

Dow Corning silicone molding compounds are stable over a wide range

of temperature and humidity conditions. Dielectric losses at high frequencies, junctions operating at high temperatures and soldering baths are not a problem with Dow Corning molding compounds. They are stable over a wide range of frequencies and temperatures, and are self-extinguishing, chemically compatible and easy to mold. They can make a significant contribution to your product's reliability.

For more information, write Dow Corning Corporation, Dept. C-9356, Midland, Michigan 48640.

Molding Compounds from

DOW CORNING

DOW CORNING

INFORMATION RETRIEVAL NUMBER 10

SEE BRIGHTER, MORE COLORFUL DIGITAL DISPLAYS WITH NUMITRON DEVICES

DR2100 NUMITRON Digital Display Devices

DR2000 NUMITRON Digital Display Devices

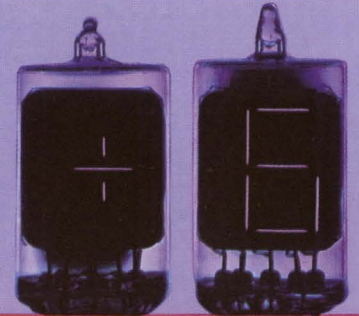

Your enthusiastic acceptance of RCA's DR2000 family of NUMITRON Digital Display Devices led to a decision to broaden the NUMITRON line with a new DR2100 family of smaller-size devices.

Both NUMITRON families give you the same unlimited filter-color selection for their sharp, bright and clean numerals. The DR2000 types are now available in production quantities. And, the new compact DR2100 types, which may be mounted on one-half inch centers, are only available in sample quantities.

Both families of NUMITRON Digital Display Devices feature:

- High contrast display ratio—bright segmented digits against a dark background
- Controllable high brightness
- Up-front planar numerals for wide viewing angle
- Rugged construction—high reliability

Here's another big benefit! Both NUMITRON families are designed for low voltage operation—4½ volts—and they are fully compatible with RCA's CD2500E and CD2501E 7-Segment Decoder Drivers.

Type numbers of RCA's NUMITRON Digital Display Devices:

- Numerals 0 through 9 DR2000, DR2100
- Numerals 0 through 9, with decimal DR2010, DR2110
- Plus-Minus and numeral 1 DR2020, DR2120
- Plus-Minus DR2030, DR2130

For further information on RCA's NUMITRON devices, see your RCA Representative or your local RCA Distributor. Also ask for information on RCA's 7-Segment Decoder Drivers especially designed for use with NUMITRON devices. For information on both of the two NUMITRON families and the Decoder Drivers, write to RCA Electronic Components, Commercial Engineering*, Harrison, N. J. 07029.

In Europe: RCA International Marketing, S.A., 2-4 rue du Lièvre, 1227 Geneva, Switzerland.

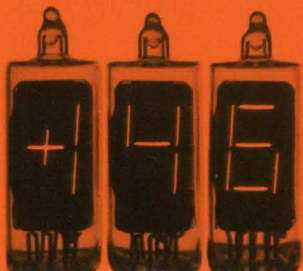
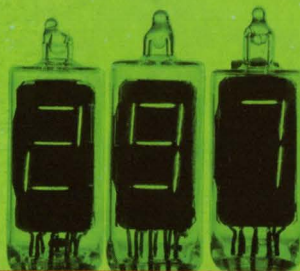
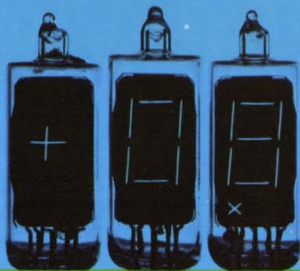
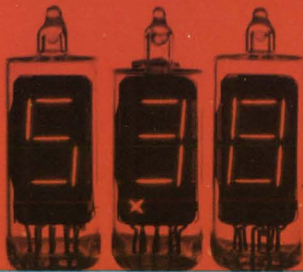
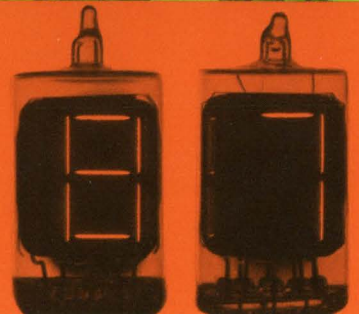
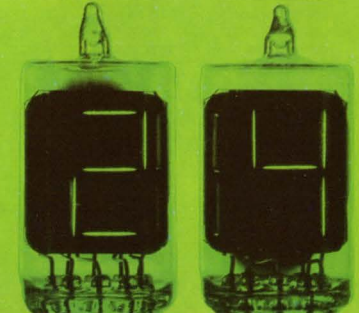
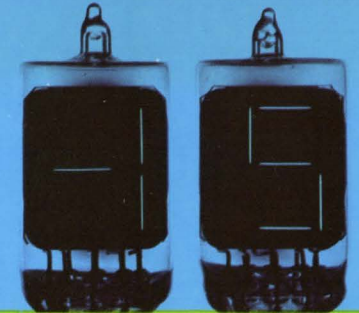
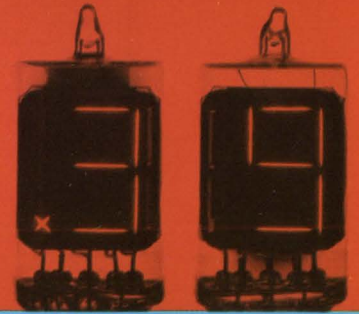

Behind the new versatility and lower costs of digital displays...

RCA's New 7-Segment Decoder-Drivers

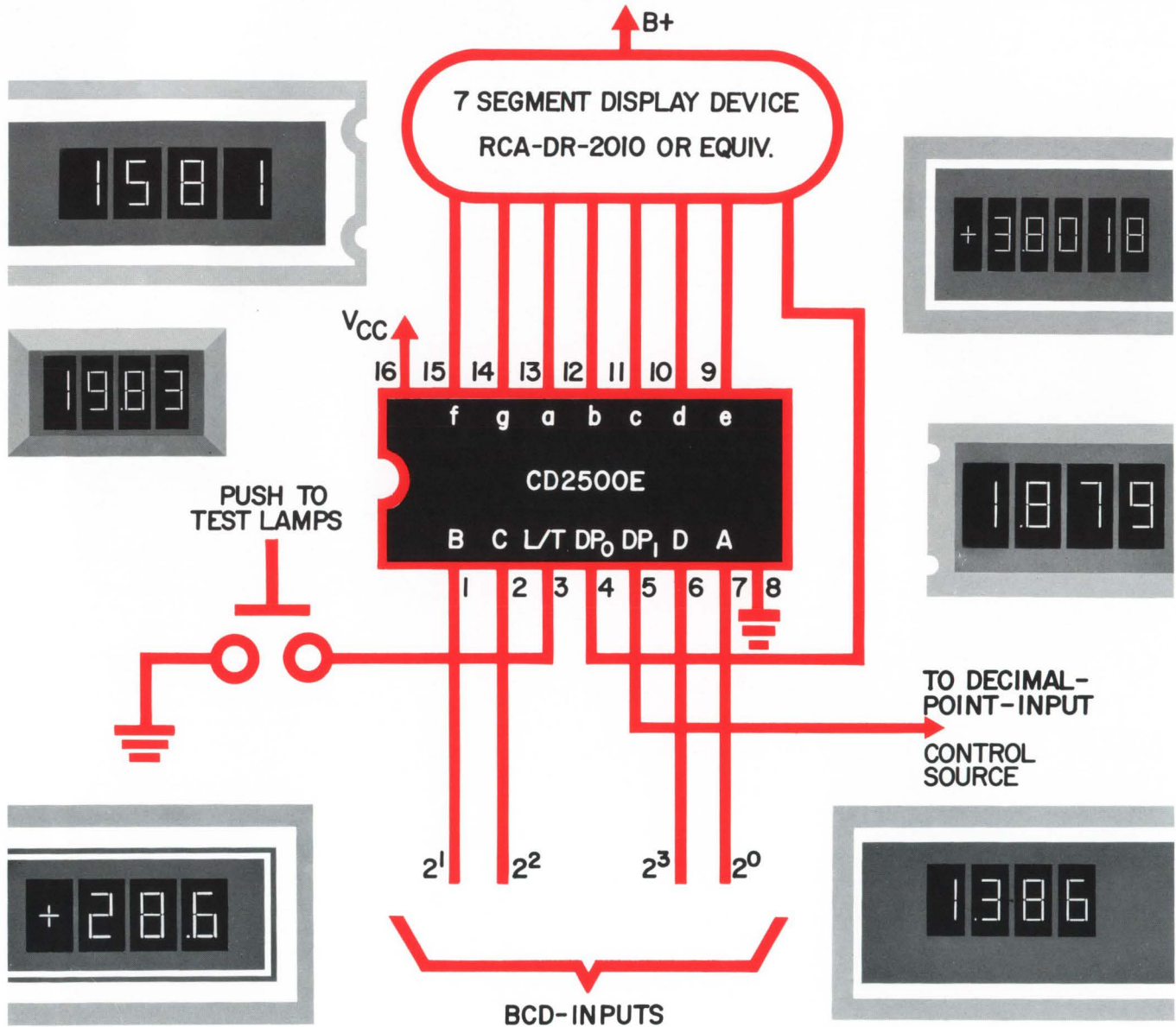

Whether you drive your digital displays with low current or high current, your drive circuits can now be more versatile—simpler—lower in cost. RCA's new CD2500E series of 16-lead DIP 7-segment Decoder Driver MSI integrated circuits includes both 30 mA devices for driving RCA's new NUMITRON 7-segment Digital Display Units and 80 mA devices to drive miniature low-voltage lamps or relays.

Look at the tabulation of the new CD2500E devices. Compare their prices and their advantages with present decoder-drivers and decoder and driver combinations. Then contact your local RCA Representative for details. For technical data, write to RCA Electronic Components, Commercial Engineering, Section ICG 25, Harrison, N. J. 07029.

RCA's 7-segment Decoder-Drivers		
Operating Current per Segment	Type Number	Price (1,000 units)
30 mA 80 mA	CD2500E CD2502E	\$6.75 \$8.00 with decimal point
30 mA 80 mA	CD2501E CD2503E	\$6.75 \$8.00 with ripple blanking
ADVANTAGES		
<ul style="list-style-type: none"> * Power supply and input voltages compatible with DTL and TTL devices * Lamp test provision * High current sinking capability for direct display driving 		<ul style="list-style-type: none"> * Clamp diodes on all inputs * Intensity control capability * Over-range detection * 0° to 75°C temperature range * Lamp supply voltage up to 8 V

RCA Integrated Circuits



What you hear about our new dry test bath is true.

The tape recorder is operating in a dry bath of Fluorinert® Brand Electronic Liquids. Just as your electronic and microelectronic units will.

Fluorinert Liquids give you an accurate method of temperature testing or testing for gross leaks. They keep their efficiency over a wide range of temperatures. They

do not react with even the most sensitive of materials. They won't deteriorate with use.

And you can ship or use parts directly out of the test bath without cleaning because Fluorinert Liquids evaporate, leaving no residue.

If you've been listening, you know that Fluorinert Electronic

Liquids are specified for Mil-Standard 883 and Mil-Standard 750A gross leak tests for microcircuits.

The coupon will bring you copies of both Mil-Standards and a lot of good solid information about test baths. Send it or call your local 3M man.

Fluorinert® Electronic Liquids 3M BRAND COMPANY

3M Company, Chemical Division, 3M Center
St. Paul, Minn. 55101

KAP 4-70

Send me all the details about Fluorinert Brand Electronic Liquids.

Name _____

Company _____ Title _____

Address _____

City _____ State _____ Zip _____

INFORMATION RETRIEVAL NUMBER 32

Now...new, lower capacitance values!

Type 192P PACER[®] FILMITE[®] 'E' CAPACITORS

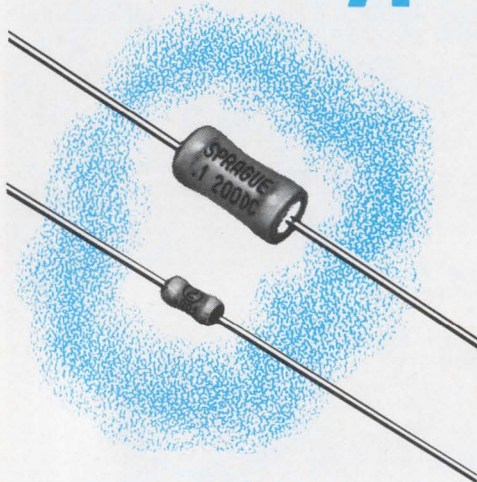

INFORMATION RETRIEVAL NO. 823

- Low-cost film capacitors with one-third the size of conventional tubulars
- Eight new low-capacitance values (100 pF thru 390 pF @ 200V) added to broad range of standard ratings
- Special construction—extended foil sections terminated in metal end caps, assuring positive contact with every turn of the electrodes
- End caps are also effective moisture barriers
- Entire assembly protected by special sleeve of high dielectric strength
- Request Engineering Bulletin 2066B

4SC-0105R1

Newly broadened low-cost line!

Type 196D Dipped Solid-Electrolyte Tantalex[®] Capacitors

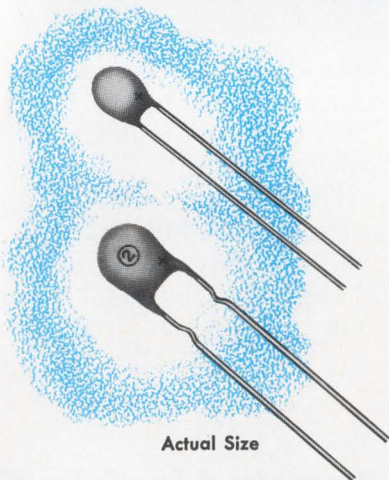

Actual Size

INFORMATION RETRIEVAL NO. 824

- Here's a capacitor design that admirably fills the need for low-cost yet dependable solid tantalum capacitors suitable for printed wiring boards
- Straight leads as well as crimped leads are readily available to meet your manufacturing needs
- Covering a broad range of capacitance values from .1 μ F to 330 μ F, with voltage ratings from 4 to 50 VDC, Type 196D Capacitors are protected by a tough insulating coating which is highly resistant to moisture and mechanical damage
- Request Engineering Bulletin 3545A.

4SC-9124R1

For Engineering Bulletins as noted above, write to:
Technical Literature Service, Sprague Electric Co., 347
Marshall Street, North Adams, Massachusetts 01247.



'Sprague' and '®' are registered trademarks of the Sprague Electric Co.

THE BROAD-LINE PRODUCER OF ELECTRONIC PARTS

Highlighting

THE ISSUE



For decades the vitality of the American economy has testified to its superiority in management methods. But the traditional experience-based management style is now becoming unfashionable according to Charles Anderson, president and chief executive officer of Stanford Research Institute. He explains that engineering is moving to knowledge-based management, not only because of the increasing complexity of technology but because the younger generation requires it.

PAGE 70



"By the year 2000, the concept of a wristwatch will give way to a more complete communications center that includes a means of keeping accurate time, has both transmitting and receiving capabilities, and perhaps has a miniature computer."

PAGE 25

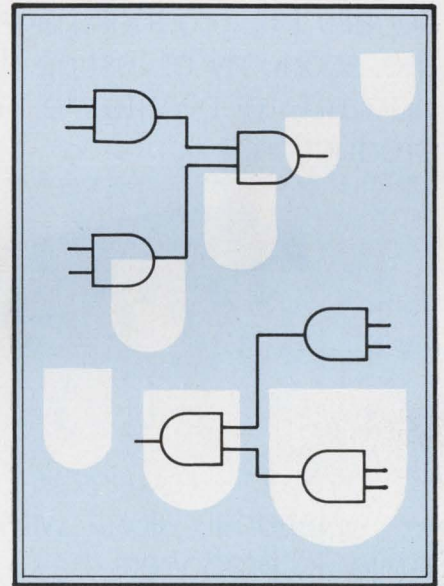

Now designers can get an extra gate function at no extra cost with a three-logic-state digital circuit from National Semiconductor Corp. The new TTL flip-flop can assume one of three output conditions—low-impedance ON, low-impedance OFF, or a high-impedance state. This means that the DM8551 quad D flip-flop can be wire-OR'd (its four outputs can be joined together directly without using an OR gate).

In addition there is no sacrifice in gate speed or fanout. The device also has the advantage of TTL-type switching, and can drive active loads.

PAGE 101

Why National Semiconductor buys Teradyne J259's by the dozen

National Semiconductor can trace its considerable success as an IC manufacturer to many factors. One of the most important is the productivity of its testing facility, built around a lineup of 12 Teradyne J259 computer-operated test systems. "The Teradyne systems," according to Jeff Kalb, National's TTL product manager, "give us the economy of testing that is so important to profitable high-volume production."

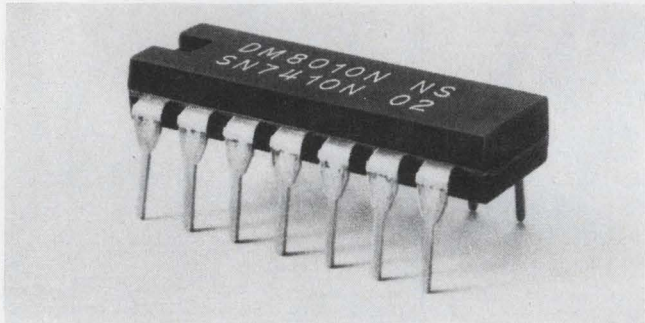

National, along with most other major IC producers, has found that the J259 boosts productivity in many ways. No other test system, for example, gives its user as much multiplexing freedom as does the J259, which lets National leverage its investment by making each J259 support several test stations doing several different jobs.

Reliability is another all-important key to productivity. National experiences minimal downtime with its J259's. This is as it should be; we design and build our equipment to work shift after shift, year after year, in *industrial* use. Teradyne systems are right at home on production lines like National's, where the workload is heavy and continuous. And operation never has to be interrupted for calibration; the J259 has no calibration adjustments.

The J259's great versatility is also put to good use at National. The same systems that test wafers and packages also generate the distribution and end-of-life data that engineers need to control production processes and ensure high device reliability. Production, engineering, QC, and final test—all share simultaneously in the benefits from National's J259's.

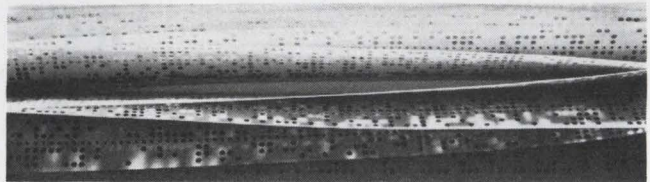

A computer-operated system is only as good as its software, which in the case of the J259 is the best there is. National's J259's are orchestrated by Teradyne-supplied master operating programs for datalogging, classification, and evaluation. As Teradyne updates and improves its software, National is kept fully informed.



National's array of J259's handle the testing of its digital IC's smoothly and economically. For its linear-IC testing, National has turned to Teradyne's J263 computer-operated linear-IC test system.

Teradyne's J259 makes sense to National Semiconductor. If you're in the business of testing circuits—integrated or otherwise—it makes sense to find out more about the J259. Just use reader service card or write to Teradyne, 183 Essex St., Boston, Mass.

Teradyne makes sense.

Defense chiefs say restraints on R&D 'cripple' leadership

A strong bid to Congress not to "cripple" the research programs vital to the nation's technological leadership was made last month by Defense Secretary Melvin R. Laird and by John S. Foster, Jr., Director of Defense Research and Engineering.

The restrictions on research stem from two legislative actions—one under consideration by the Senate and the other already enacted. The bill under study would prohibit reimbursement for independent research and development under negotiated contracts, except where the costs have been specifically provided for in the contract and are of direct or indirect benefit to the work performed.

The other bill, the recently enacted Section 203 of the fiscal year 1970 Military Procurement Authorization Act, prohibits the use of funds for projects unless they have a "direct and apparent relationship to a specific military function or operation."

At the Electronic Industries Association Conference in Washington, D.C., Laird said, "While I understand the concern of the Congress I believe such restrictions would unnecessarily stifle new and imaginative efforts."

He stated that the result of such restrictions would reduce the technological effectiveness of defense-related industries. "We are working with the Congress to clarify the potential impact of this legislation. I deeply appreciate the parallel efforts of the EIA in that regard. It is particularly difficult," Laird said, "to identify in advance the ultimate applications of basic research." Laird's fear, he says, is that this will "tend to discourage talented scientists from potentially productive research areas." (For Navy's complaint see p. 40.)

Foster, the Pentagon's research

chief, made an even stronger plea later in the month at a dinner of the National Security Industrial Association in Washington, D.C. Unless the lag in research is reversed, Foster said, the United States will lose its world technological and economic leadership.

Foster said the U.S. is being challenged in military, space and atomic fields by the Soviet Union and in the consumer area by Japan and West Germany.

What role for the FCC in the future of CATV?

How the CATV industry is going to be regulated in the future is by no means clear. Speaking at the EIA Spring Conference, last month, Jack Mayer, deputy to the director of the FCC's Cable Television Bureau, pointed to five big issues that will soon be settled:

- Should CATV be allowed to develop as a separate competitive technology? (The FCC has been acting on the premise that CATV should be supplemental to broadcast TV, filling in only those service gaps that over-the-air television can't fill.)

- What is the future role of the telephone industry in the cable field?

- Will some form of licensing procedure be implemented instead of "present go-no-go authorizations for new systems?"

- Will cross ownership or multiple-ownership between TV broadcast and cable operations within the same markets be banned?

- What will be the role of the federal and state authorities in such matters as service standards, rates, franchising, and so forth?

So far, the FCC has resolved only one issue: it has decided that as of January 1, 1971, CATV systems with 3500 or more subscrib-

ers will be required to originate a substantial amount of broadcasting. At the same time, said Mayer, they will be allowed to sell commercial advertising to lessen the cost of such programming.

It's too early, Mayer declared, to predict which of the technologically feasible systems will prove most marketable. "Much less regulation," he said, "seems needed for a cable system that simply carries broadcast signals than one that originates programs of its own."

Computer terminal prints four alphabets

A quadri-alphabetic keyboard and printer was shown to the public March 15, opening day of Expo '70 in Osaka, Japan.

The experimental system, designed by IBM in Yorktown Heights and in Endicott, N.Y., prints any of 10,000 Kanji characters (Chinese graphics), the written language of Japan at the rate of 300 16-character lines per minute on standard business forms.

The printer also prints Hiragana and Katakana (Japanese phonetic alphabets) and the latin alphabet. Characters—one quarter inch square—are formed by overlapping dots made by tiny print wires inked by a ribbon.

The keyboard consists of 3520 symbols from the four alphabets. It can be used either as an on-line input terminal for a computer-controlled graphic display or to control a key punch.

'Second-sourcing' starts in minicomputer market

Indicative of the feverish activity in the minicomputer market, a relative newcomer has announced a model that it says can replace the mini-machine in widest use today—the PDP-8 series, manufactured by Digital Equipment Corp., Maynard, Mass.

The new mini is the DCC-112, built by Digital Computer Controls, Inc., Fairfield, N.J. It is described as a second source for the PDP-8—"plug, program and mechanically interchangeable."

This is the first time that any computer has been "second-sourc-

ed," industry observers say.

John N. Ackley, president of the one-year-old Jersey company, asserts:

"Although the price of the stripped down model is only slightly below the lowest-priced model in the PDP-8 line, the differential in favor of the DCC-112 rapidly increases as additional memory or other options are specified."

He adds that he expects the new mini to have higher reliability, because it uses only five circuit cards, compared with 110 in the PDP-8.

There are also fewer back panel connections, fewer individual semiconductor components and lower power dissipation—all of which tend to increase the mean time between failures.

Digital Computer-Controls doesn't plan to supply any software. It hopes that the original equipment manufacturers who buy the DCC-112 will make use of the extensive libraries of proprietary software that have been written for the PDP-8.

Small microwave relays are ready for Air Force

The military is getting its first "ultra lightweight" (67 pounds) wideband microwave relay unit that, despite its small size, "does not compromise performance," according to a spokesman for the Air Force's Rome (N.Y.) Air Development Center.

The all solid-state unit, which can be set up by one man and operating in less than 10 minutes, provides 300 voice channels or the bandwidth for transmitting video or radar data.

It is designated AN/TRC-92 and built by Motorola Inc.'s Government Electronics Div. in Scottsdale, Ariz. Ten of the units will be installed in 10 Air Force Mark 113 troposcatter communications systems. The Mark 113 was built by REL Div. of Dynamics Corp. of America in Long Island City,

N.Y., under contract to Page Communications.

The microwave units will relay transmissions from the tropo terminals to identical microwave units as much as 10 miles away set up in command posts in valleys or in places unsuitable for a tropo terminal. The microwave unit can also be used for transmitting high-density analog or digital data from one operational site on a base to another.

Raytheon, Co. in Norwood Mass., is building a similar microwave unit that will relay radar data from its AN/TPN-19 ground-based aircraft landing radar being readied for the Air Force air-transportable area defense system, the 407L. This relay unit won't be delivered to Rome for another year and a half.

The first microwave unit Rome tried out was built by ITT. Motorola won out, however, because of price.

Army favors beam scan for helicopter lander

Although the Army will look at other steep-angle landing systems for getting helicopters safely on the ground in rain or fog, it claims to be very pleased with the beam-scanning system now under test at FAA's research facility at Pleasantville, N.J.



Tactical instrument landing system for helicopters is tested by Army.

Developed and built by Cutler-Hammer's AIL Div., Deer Park, N.Y., and called A-Scan, the system uses a microwave scanning-beam technique that permits any descent angle from 2° to 29° above the local ground plane. The angle can be selected in the helicopter.

A-Scan provides a pulse-coded radio signal in an approach sector containing proportional signals 60° on either side of the chosen center line. By switches at the ground station, three approach lanes anywhere in the sector can be set to accommodate a helicopter in each lane, all landing at the same time.

The system was selected for testing over others, according to Lt. Col. E. D. Richards, the Army Avionics Laboratory's commanding officer and director, because its microwave scanning-beam technique offers sufficient versatility to bracket the wide range of guidance needs it will be required to satisfy. "Also, the scanning-beam guidance signals offer convenient selection of glide-slope angle, approach azimuth, and dimensions in space which correspond to the lateral and vertical boundaries of the intended descent path. And," he says, "the scanning-beam technique allows a precision to be designed into both ground and airborne equipment. The units are physically detachable and usable on an optional basis."

Data processor to cut communications costs

Motivated by the high and still-increasing growth rate of the computer communications market, the General Electric Co. has developed a new data-communications processing system, called Datanet-500. The device, the company says, will permit "more effective use of telephone lines and other common carrier facilities, and will greatly increase the reliability of data-communications functions."

The Datanet-500 contains memory, processor, communications, and input-output subsystems which can be interconnected to perform a variety of functions. Chief among its immediate applications are line-concentrating and store-and-forward message switching.

RCA-TA7487 is new.

It offers 2 W with 10 dB gain (min.)
at 2 GHz for solid-state microwave designs.

RCA-TA7487 is a ceramic-metal coaxial unit.

It can do a big job for engineers
designing to achieve minimal space without
sacrificing solid-state power and
performance at UHF/microwave frequencies.

By the nature of its package, TA7487 features
low parasitic capacitances and inductances.

This introduces stability into your designs
for point-to-point microwave relay links,
S-band telemetry, distance measuring equipment,
and collision avoidance systems.

Here's a suggestion:

Use TA7487 as a driver for RCA-TA7205—
another RCA "overlay" transistor
in the industry's champion RF power line.

Ask your local RCA Representative
about TA7487 and other "overlay" units.

For technical data, write:

RCA Electronic Components,
Commercial Engineering,* Harrison, N. J. 07029.
In Europe: RCA International Marketing S.A.,
2-4 rue du Lièvre, 1227 Geneva, Switzerland.

RCA

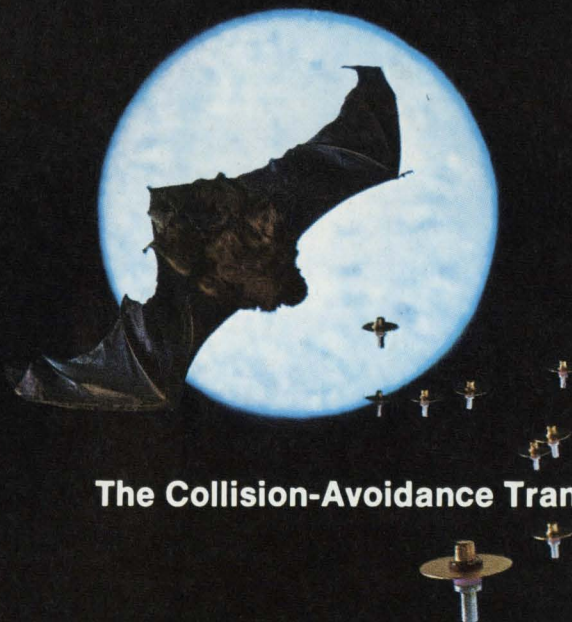

The Collision-Avoidance Transistor

The Tin is Free

(The chips we charge for.)

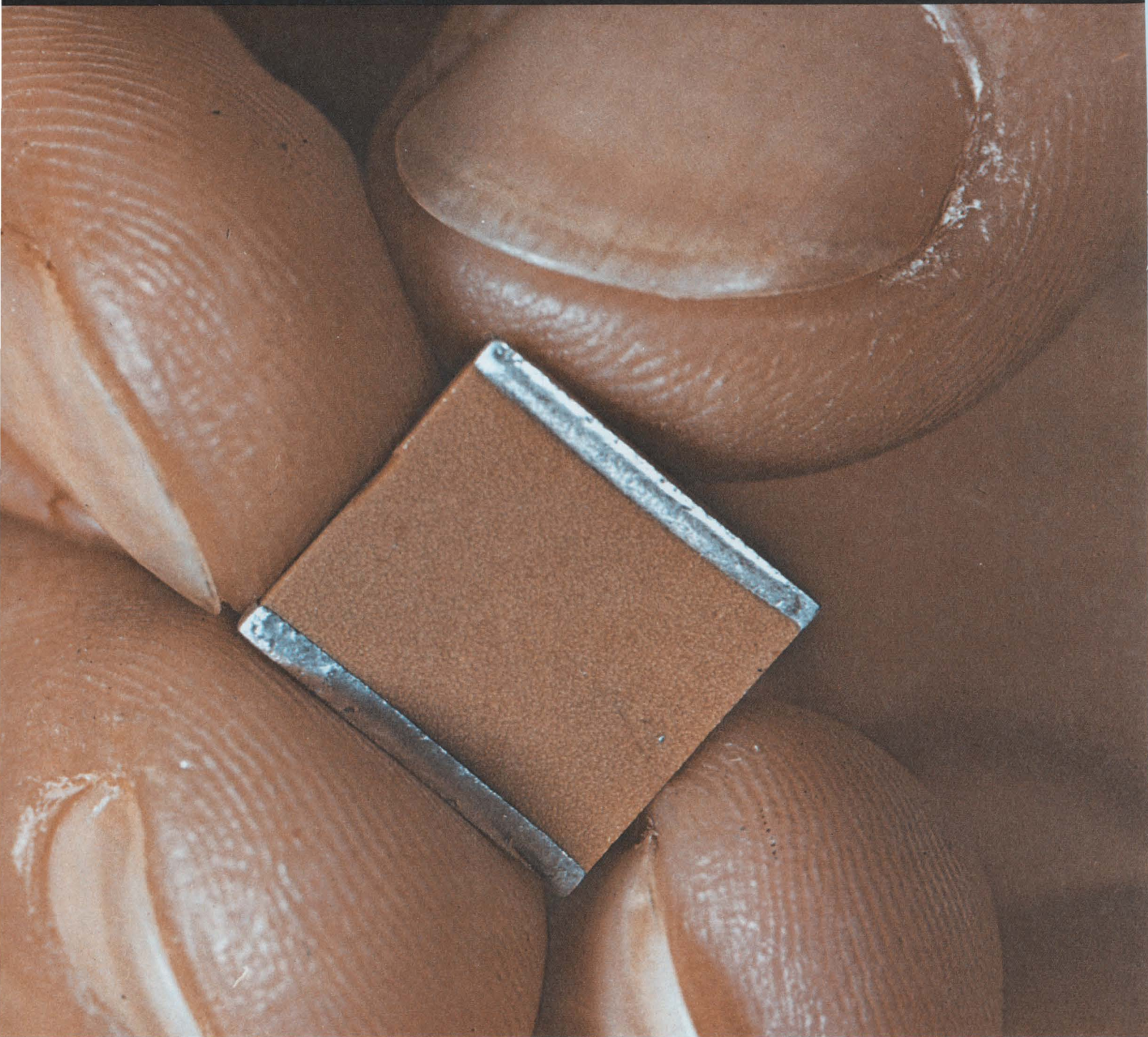

Save yourself a lot of time and money by getting pre-tinned Fast Chip capacitors from Electro Materials. When you order in production quantities, the end terminations come pre-tinned at no extra cost.

We'll be glad to send you samples. For free.



Electro Materials

Division Illinois Tool Works Inc.
11620 Sorrento Valley Road, San Diego, California 92121
Phone (714) 459-4355, TWX 910 322-1130

Represented by COMPAR

Time marches on—but electronically now

More and more, mechanical wristwatches are giving way to timepieces with microcircuitry

Jim McDermott
East Coast Editor

"By the year 2000, the concept of a wristwatch will give way to a more complete communications center that includes a means of keeping accurate time, has both transmitting and receiving capabilities, and perhaps has a miniature computer."

John B. Bergey, director of watch research and development at the Hamilton Watch Co., Lancaster, Pa., is talking, and his prediction, made matter-of-factly to *ELECTRONIC DESIGN*, dramatizes what is happening in the watch industry today. For years, a timepiece—whether for the wrist, pocket or mantle—was strictly a simple

mechanical device with fine springs and gears. But with inroads made by Bulova's Accutron and other electronic watches, the electronics industry is staking out a broad claim to the market. It is opening up new opportunities for designers to come up with accurate, ingenious, and yet relatively inexpensive, timepieces.

Bergey believes it's quite possible that there will be a number of central transmitters, either land-locked, or from orbiting satellites, transmitting accurate time and constantly updating the time of all watches within reception range.

In fact, the elements of such a system are already here. It could be a sophisticated combination of something like the transmitting system of the Seiko atomic-uhf time-distribution system now operating at the Japan World Exposition at Osaka (Fig. 1) plus the Bulova satellite clock in Mexico City (see photo). The latter clock receives signals from four timing satellites in polar orbits and displays them to one-tenth of a second. Located on the 39th floor of

the Torre Latinoamericana, Mexico's tallest building, the clock is accurate to 86 one-millionths of a second per day.

Batteries and displays lag

But Bergey cautions that the transition from the present crop of electrical and electronic wristwatches to an all solid-state wristwatch is beset by two widely recognized, and interrelated, problems that defy solution right now: solid-state displays and batteries.

Present solid-state displays need milliwatts of power—orders of magnitude greater than the 10 microwatts required to operate today's electronic watches. And the only batteries now small enough to run a wristwatch are already pushing their limit in delivering the 10 microwatts for a year or more. What is really needed to overcome the problem is a great increase in the energy density of batteries plus a tremendous decrease in the power now needed to operate the solid-state displays.

However, this doesn't mean the industry is limited for the next couple of decades to the performance of the electrically or electronically driven balance wheel (ac-



The Bulova satellite clock in Mexico City has a quartz-crystal time base and is updated from satellite signals.

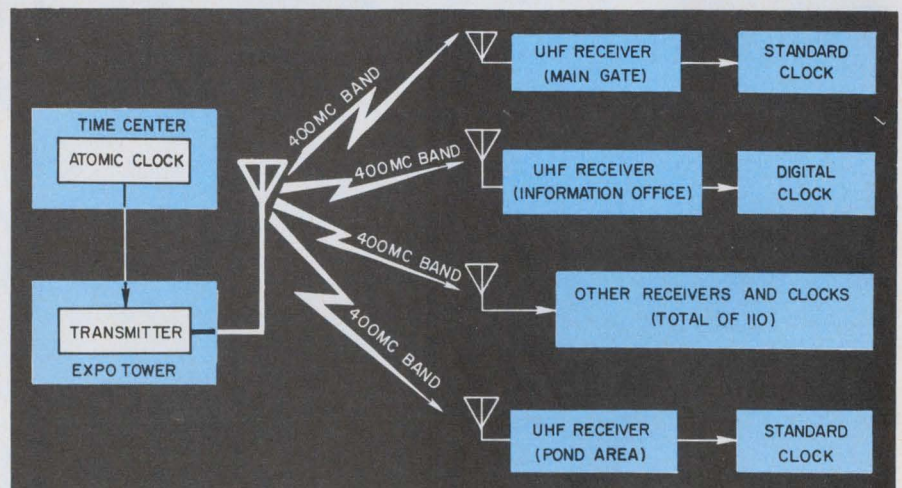

1. An atomic clock at the Japan World Exposition feeds controlling signals to uhf receivers and clocks at over 100 locations in the fair, maintaining highly accurate time.

(wristwatch, continued)

curacy of 5 to 20 seconds a day) or even the tuning-fork Accutron (2 seconds a day). Major watch manufacturers questioned by ELECTRONIC DESIGN admit to much closely guarded research and development on the electronic wristwatch of the future, with principal emphasis on ultimately providing the wearer with timekeeping accuracies once obtained only by observatory clocks.

In fact, if you're a timekeeping buff who needs to be accurate to a fraction of a second a day—less than one minute a year—the quartz-crystal wristwatch is here in three versions. None has the conventional balance wheels or escapements, but the hands are still retained.

One version was announced for sale in Japan last Dec. 31 by Seiko Watch-K, Hattori & Co., Ltd.—Japan's leading watchmaker—in an effort to scoop two Swiss competitors: a 19-company combine called the Center of Electronic Horology (CEH) and Longines, which independently developed its own quartz-crystal watch.

The Seiko model sells for \$1250 in an 18-carat gold case, but the prices will be substantially lower in subsequent models with less

costly cases. The gold model will be sold in the United States "some-time in 1970," according to Shoji Hattori, president of Seiko. But CEH and Longines have also announced essentially the same availability and competitive pricing in the race for U. S. introduction.

All three quartz watches use the same type of hermetically sealed crystal oscillating at 8192 Hz, which is either divided down to a substantially lower frequency or otherwise applied to drive or control an electromechanical "motor" arrangement. The motor turns the hands through gearing.

In the Seiko watch (Fig. 2) the 8192 Hz is fed to a 13-divider chain ($2^{13}=8192$) the output of which is one pulse per second. Each pulse activates a geared, six-pole stepping motor, rotating in one-second increments of 60° per step.

In the CEH watch (Fig. 2) the 8192 Hz is divided down to 256 Hz, a reduction of 320 to 1. The 256 Hz is applied to a resonant-reed motor driving a ratchet arrangement and gearing to the hands. Like the Seiko watch, the electronic system is "open-loop," so that no means are provided for correcting timing errors that occur at the motor-driving frequency.

Longines designers have produced the most unique circuitry

of the three: a closed-loop system in which the frequency of the motor-driving circuit is servo-controlled by the quartz-crystal oscillator (Fig. 2).

Unlike its two competitors, Longines does not count down the output of its 8192-Hz crystal oscillator. Instead, the quartz output is used as a frequency standard, against which the frequency of the 170-Hz torsion-balanced vibrator motor, which drives the hands, is compared and accurately controlled.

This is accomplished by making the resonant motor and its driving electronics an independent, 170-Hz, electromechanical oscillator that can free-run by itself. The outputs of the quartz oscillator and the motor-driving circuit are then applied to a comparison circuit. If the drive motor frequency is exactly 170.666 Hz, the error signal is zero and the motor is exactly in step with the crystal. But if the motor-driving frequency is higher or lower, the comparison circuit produces a correcting signal that is applied to the driving circuit to keep the vibrating motor armature in exact step.

Interestingly enough, the same basic, readily available type of 8192-Hz quartz crystal was chosen for the watches of all three competitors.

As far as the driving and counting electronics are concerned, the Seiko watch uses hybrid circuitry, the Swiss CEH has integrated circuits, and the Longines watch has discrete components that consist of 14 transistors, 19 resistors and 7 capacitors.

Quartz designs still use hands

While the new quartz wristwatches have increased the accuracy over current electronic watches by better than an order of magnitude, the quartz designs still rely on electromechanical drives and gearing to turn the hands and other indicators, such as the date. But the designer who would eliminate all mechanical elements and come up with an all-electronic wristwatch, including displays, faces the formidable problem of useful solid-state displays and batteries.

"For a timepiece the size of a small clock, no such problems

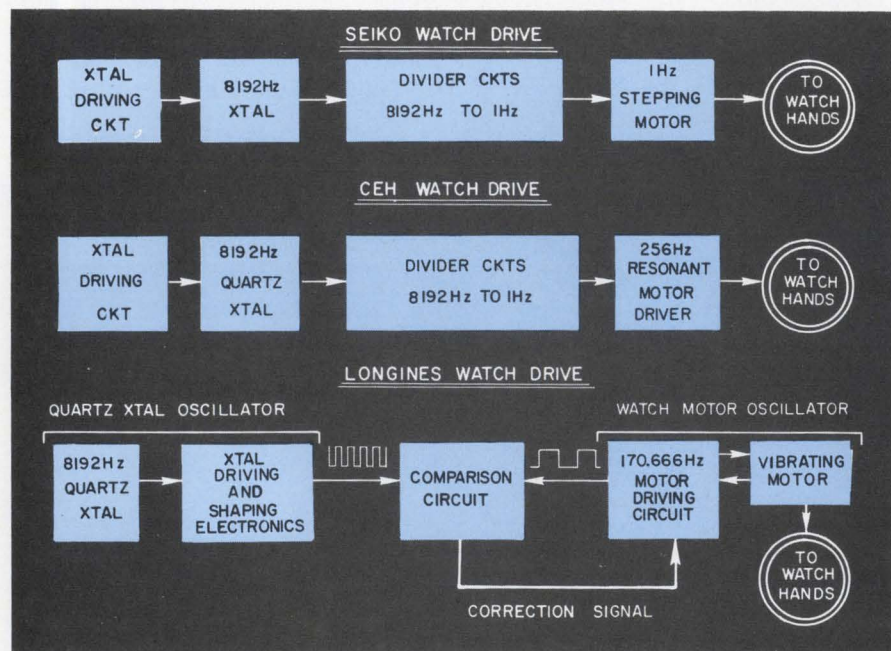

2. Quartz-crystal wristwatch hands are driven by three methods at present. The first two (by Seiko and CEH) use counter chains, while the third (Longines) has a servo system.

Inflation?

What inflation?

COMPATIBLE DCL HIGH-SPEED LOW-POWER ELEMENTS IN SILICONE DUAL IN-LINE PAK (0°C to +75°C).

CATALOG NUMBER	DESCRIPTION	Single Type 100-999
N8200N	Dual 5-Bit Buffer Register	\$ 9.32
N8201N	Dual 5-Bit Buffer Register with D Complement	9.32
N8202N	10-Bit Buffer Register	9.32
N8203N	10-Bit Buffer Register with D Complement	9.32
N8230B	8-Input Digital Multiplexer	2.98
N8231B	8-Input Digital Multiplexer	2.98
N8232B	8-Input Digital Multiplexer	2.98
N8233B	2-Input, 4-Bit Digital Multiplexer	2.72
N8234B	2-Input, 4-Bit Digital Multiplexer	2.72
N8235B	2-Input, 4-Bit Digital Multiplexer	2.72
N8241A	Quad Exclusive OR	1.62
N8242A	4-Bit Comparator	1.62
N8243N	8-Bit Position Scaler	12.60
N8250A	Binary-to-Octal Decoder	3.88
N8251B	BCD-to-Decimal Decoder	3.88
N8260N	Arithmetic Logic Element	18.90
N8261A	Fast Carry Extender	1.26
N8262A	9-Bit Parity Generator and Checker	3.62
N8263N	3-Input, 4-Bit Digital Multiplexer	9.15
N8264N	3-Input, 4-Bit Digital Multiplexer	9.15
N8266B	4-Bit Multiplexer	2.72
N8267B	4-Bit Multiplexer	2.72
N8268A	Full Adder	2.45
N8270A	4-Bit Shift Register	3.99
N8271B	4-Bit Shift Register	4.38
N8275B	Quad Latch	2.47
N8276A	8-Bit Shift Register	4.99
N8280A	Presetable decade counter/storage reg.	3.53
N8281A	Presetable binary counter/storage reg.	3.53
N8284A	Binary Up/Down Counter	5.85
N8285A	BCD Up/Down Counter	5.85
N8288A	Presetable Divide-by-12 Counter	3.53
N8290A	Presetable Decade Counter	3.92
N8291A	Presetable Binary Counter	3.92
N8292A	Presetable Decade Counter	3.92
N8293A	Presetable Binary Counter	3.92
N8T01B	*Nixie Decoder/Driver	5.04

*Trademark of Burroughs Corporation

Effective immediately, Signetics announces lower-than-ever MSI prices. On both military and industrial temperature range devices. In both flat pack and dual-in-line packages.

Largest line. Longest experience. And now: lowest price.

But—if you'll allow us one inflated remark—what else would you expect from the most exciting name in MSI?

(For complete list of new low MSI prices, write Signetics. Or contact our local representative.)

Signetics

Signetics Integrated Circuits, 811 E. Arques Ave., Sunnyvale, Calif. 94086 / A subsidiary of Corning Glass Works

INFORMATION RETRIEVAL NUMBER 15

NEWS

(wristwatch, continued)

exist," Bergey points out. "But when you attempt to reduce this to wristwatch size, you run into power problems, particularly in solid-state designs using present and relatively high-priced technologies."

Power consumption an obstacle

Since it requires only about 10 microwatts to run both balance-wheel and quartz-crystal electronic watches, a small mercury or silver cell can last over a year, Bergey points out. But in going to an all solid-state, active readout, the power consumption jumps orders of magnitude because of required decoding circuits as well as the light-emitting devices themselves.

However, the technology is here to overcome the problem, and a step in applying it has already been taken by Longines in a hand-held, quartz-controlled electronic sports timer, which displays down to 1/100th of a second (see photo). Working on a rechargeable battery, it uses integrated circuits and light-emitting diodes (LEDs) supplied by Hewlett-Packard Associates, Palo Alto, Calif.

With all six solid-state numerals glowing, each comprised of a 5×7 dot matrix, the display consumes about 1/2 W, according to Richard Kniss, Hewlett-Packard product planning engineer. The IC decoder/drivers, operating at 5 V, are integral with each numeral and require only a four-line binary-coded decimal input. The LEDs themselves need only 4.2 V.

Passive displays investigated

But other types of displays are also of interest to the watchmakers, including passive displays operating from ambient light, such as liquid crystals. Considerable work has been done in this area by RCA Laboratories in Princeton, N. J., where the company demonstrated an all-electronic clock with a liquid crystal readout in May, 1968.

But Dr. George Heilmeier, director of device concepts research at RCA Laboratories, holds little hope for application of the crystals to wristwatch displays.

Their big limitation for wristwatch applications, he told ELECTRONIC DESIGN, is in the fact that they require voltages ranging from 6 to 50 V—far higher than that of currently available cells. Although the power consumption of 0.1 mW per cm^2 of display area is promising, particularly when it is only intermittently required for changes in display, Dr. Heilmeier says that the threshold at which the phenomenon occurs is voltage-dependent and cannot, with present materials, be lowered.

What is needed is a research break-through, and Dr. Heilmeier is frank to admit he's not very enthusiastic about the prospects.

Battery progress pushed

Even with the optimum solid-state displays of the future, wristwatch power requirements will

certainly be increased. And as for traditional batteries, Bergey of Hamilton doesn't look for dramatic improvements.

"Traditional batteries, be they silver oxide or mercuric oxide, have distinct limitations," he says. "Their energy densities are fairly low, based on electrochemical relations. And the watch industry alone can't support the vast research necessary for a quantum improvement in battery performance."

But the problem may not be so bad as he thinks. One battery expert who refused to be quoted, told ELECTRONIC DESIGN that industry efforts have uncovered a new cell with a non-aqueous electrolyte. Its voltage ranges from 3 to 3.5 V, and it's considered to have good potential as a watch cell. Energy density is substantially improved—about twice that of mercuric oxide. And if made rechargeable, it can't be overcharged. But it's still in the laboratory stage and not expected to reach the market for three to five years.

The quartz-crystal time base for wristwatches is still new. But already R&D is going on to replace that element with a more accurate, rugged standard. For example, John Carpenter, vice president of the Electronics Div. of the Bulova Watch Co., New York, says that his advanced research department has been working on nuclear systems that use about a milligram of an Alpha particle-emitting radioactive isotope as a time base.

The Alpha emanations are picked up by a solid-state detector to provide a long-term count, which, on the average, is very stable. The pulse-count output of the detector is amplified and applied to a series of binary dividers.

The radioactive time base needs no external power to activate it. And since it is not affected by temperature, no frequency variations would be produced by putting it in a wristwatch. Such a system, Carpenter says, has a potential accuracy of better than one minute a year.

But complex unsolved problems are involved in microminiaturizing the count down and detection circuitry. And no present prediction can be made as to when it could be reduced to wristwatch size. ■



The basic technology for the wristwatch of the future is incorporated in this quartz-crystal stopwatch for sports, using solid-state displays.

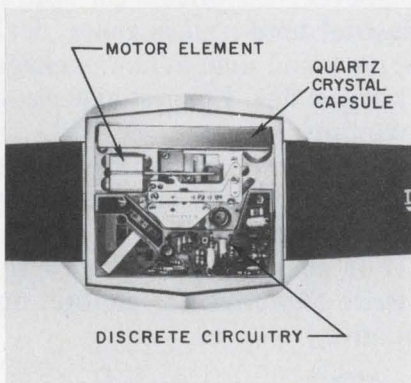

The electronics and motor element of the Longines Ultra-Quartz crystal-controlled wristwatch are shown.

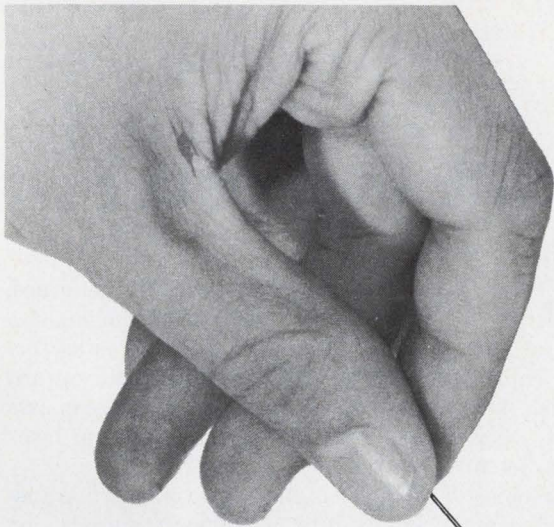

**That bread 'n' butter
JAN 1N3611
you've been using all along
suddenly
isn't so bread 'n' butter!**

**now available...
TX 1N3611
100% process screened
by Unitrode**

**the one and only voidless
monolithic fused-in-glass
controlled avalanche
JAN TX 1N3611 Series
2 amp rectifiers.**

competitively priced

Unitrode also provides TX 100% process screening on JAN 1N4942 Series Fast-Recovery Rectifiers. Also available in stock for off the shelf delivery, JAN 1N4245 Rectifiers, and JAN 1N4956 Zener diodes.

Contact the factory, or your local Unitrode representative.

WHAT'S INSIDE MAKES THE DIFFERENCE . . . THIS IS WHAT'S INSIDE EVERY UNITRODE DIODE

Hard glass fused to all silicon and pin surfaces creates a voidless monolithic structure. Perfect seal against all moisture and contaminants.

Temperature coefficient of glass and pins is matched to silicon. No degradation under severe thermal stress of high transients or repeated temperature shock — even from -195°C to $+300^{\circ}\text{C}$.

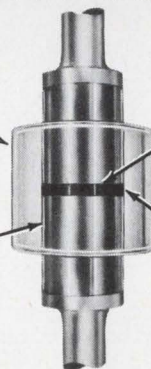

Metallurgical bonds of pins to die faces at 1000°C allows extremely high surge capability, low thermal resistance. Virtually indestructible construction.

Controlled avalanche and permanently stable surface leakage characteristics. Hyperclean silicon surface fused only in hard glass. No oxides, silicones, or varnish are used.



Send for our Short-form Catalog C-146 and samples of the 1N3611. The catalog is just loaded with charts, graphs, curves, specs, and all kinds of goodies you'll enjoy.

For fast action, call Dave Greene COLLECT (617) 926-0404.

UNITRODE

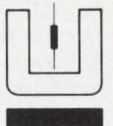

580 Pleasant St., Watertown, Mass. 02172 • (617) 926-0404

Curing engine failures BEFORE they occur

Ampex R&D system uncovers worn parts by displaying the audio frequencies of equipment

Elizabeth de Atley
West Coast Editor

You drive up to the computer terminal at your local auto diagnostic center and leave the motor running.

"Another '72 Mustang," says the attendant with a glance at your car. Out of the file, he pulls a black card, riddled with holes, and inserts it into a slot. Lifting the hood of your car, he connects a wire from the terminal to a plug in the motor. This plug contains connections from sonic transducers placed throughout the engine. Almost immediately a typewriter terminal begins to type:

"Replace main bearing within 500 miles . . . replace intake hydraulic lifter on cylinder 7 immediately. . ."

A dream? Right now it is—but closer to reality than you might imagine, says Gordon R. Knight, a staff member of the Research and Advanced Technology Div. at Ampex Corp., Redwood City, Calif. Already the equipment necessary to isolate and display a broadband

of audio frequencies exists in the laboratory at Ampex. This equipment can quickly distinguish between two sounds that are very close together in frequency—such as, for example, the rotating noise produced by two slightly different types of ball bearings. What does not yet exist, says Knight, is the mechanical data to determine what frequencies are emitted by specific moving parts in automobile engines as they wear out.

However, he points out, considerable data on jet engines has been supplied by the Airesearch Manufacturing Div. of the Garrett Corp., Torrance, Calif., and other companies in connection with the Mechanical Failures Prevention Program of the Office of Naval Research. This information has been used with considerable success in interpreting outputs from the Ampex equipment.

Optical technique used

One day such data should be available for automobiles, Knight

believes.

For the work with jet engines, the Ampex equipment includes a cathode-ray tube with a raster format of 512 lines and an optical spectrum analyzer, which consists of a transform lens and a laser source.

The engine vibrations are translated into electrical signals by microphones or accelerometers. These signals are used to intensity-modulate the electron beam of the CRT. On the tube screen, the original variations in amplitude of sound appear as variations in the intensity of the trace. The click-click sound of a broken gear tooth, for example, would appear as a recurring bright spot on the screen. The CRT scanning equipment tracks the jet engine speed to compensate for changes in speed.

The screen is photographed and a transparency is made. This transparency is placed between the lens and the source of the laser, causing a complex diffraction pattern to appear at the focal point of the lens. This diffraction pattern looks like a cluster of dots of varying intensity. Because of the nature of the lens, the diffraction pattern is

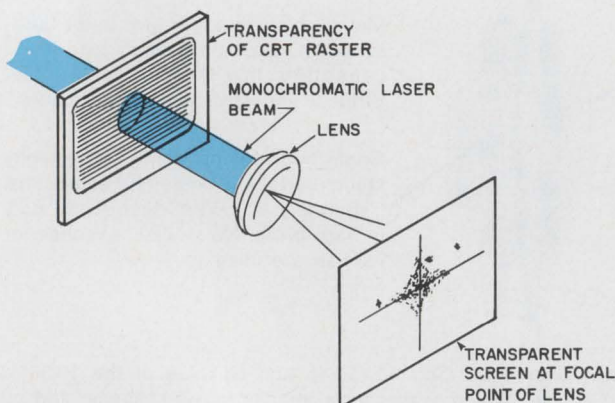

To obtain the frequency spectrum of sounds from a jet engine displayed on a CRT screen in raster format, Ampex engineers photograph the CRT display, pass a monochromatic laser beam through a transparency of the display and then through a transform lens. The frequency spectrum of the original sounds is immediately projected onto a screen at the focal point of the lens.

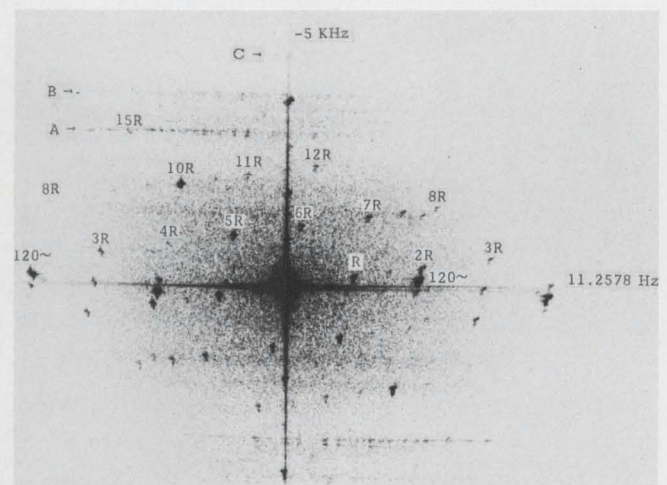

The sounds from a jet engine look like this in an optical diffraction pattern. Frequency is a function of position on the X and Y axes. R is a rotor frequency in the jet engine. Harmonics of this frequency are shown as 2R, etc. One day such data could be used to predict component failures in automobiles. A method for reproducing the CRT screen in real time is needed.

actually the Fourier transform of the original CRT display, or the frequency spectrum of the engine vibrations that occurred during the time of the trace. Each frequency is represented by a dot in a particular location on the diffraction pattern. The intensity of the dot is proportional to the amplitude of the frequency.

How can one relate a spot on the diffraction pattern to a particular frequency, and from there to a particular component in the engine?

"We know the dimensions of the optical system," says Knight. "We also know how we laid the data on the film in the first place. So we know that a particular spot on the diffraction pattern represents a particular frequency. The mechanical engineers have given us a handbook of mathematically calculated frequencies for particular components. For example, certain frequencies, due to the passage of air through the compressor blades, are conspicuous in every display. We list all of these frequencies in our computer program, and it tells us that if we lay a piece of grid paper over the diffraction pattern, a particular frequency appearing so many units over and up from the center means a defective ball bearing—or whatever."

How far off is the computerized diagnostic center that does real-time trouble-shooting?

"As far as the equipment is concerned," says Knight, "the only thing missing for real-time, trouble-shooting of any mechanism is a technique for providing a visual reproduction of the CRT screen in real time.

"For every kind of engine," Knight explains, "we would need a piece of black paper with holes or slits in it at particular frequencies that we know mean particular kinds of trouble for that engine. We would insert this mask into the optical analyzer at the focal point of the lens and put photodiodes, or a vidicon, and threshold devices at the output. When the light through a particular hole got above a certain intensity, that would mean the vibrations at that frequency had increased to the danger point, and we would know that that component was going to fail. ■■

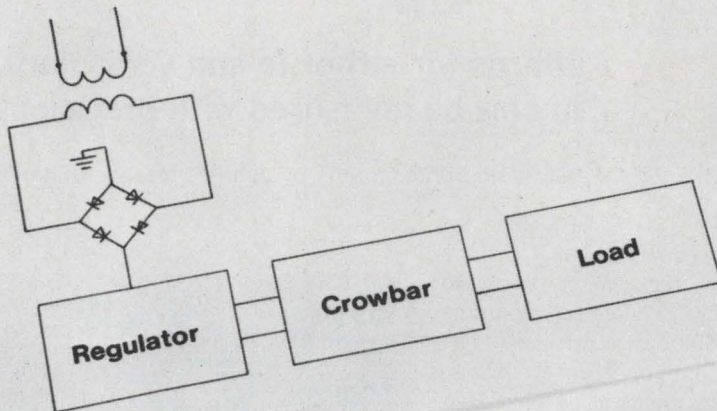

Is a crowbar enough?

It's a good beginning, but that's all. To protect semiconductor devices from the hazards of transients and overvoltages, you need more.

For example, most designers realize that protective crowbar circuitry must itself be protected by some form of line disconnect. That way, additional energy is prevented from entering the power supply and destroying the crowbar. (Once the crowbar goes, of course, it's curtains for the protected equipment.)

Transient/over voltage protection with line disconnect is what Heinemann's JA/Q™ electronics protector is all about.

The JA/Q performs a crowbar function with a transient response time of 500 nanoseconds. By shunting the load, the crowbar causes the JA/Q's hydraulic-magnetic circuit breaker to

trip, removing the equipment from the line within 10 milliseconds of firing time.

In the case of ordinary overcurrent faults, the JA/Q protector functions just like an ordinary hydraulic-magnetic circuit breaker, with instantaneous operation or specific time delays available at your option.

JA/Q protector poles can be mixed with Heinemann Series JA circuit breaker poles of all types to match your exact protection requirements. Undervoltage JA/Q's are also available.

Why design what's already been designed? Write for Bulletin 3370 and find out how the JA/Q fits into your schematic. Heinemann Electric Company, 2616 Brunswick Pike, Trenton, N.J. 08602.



HEINEMANN

4650

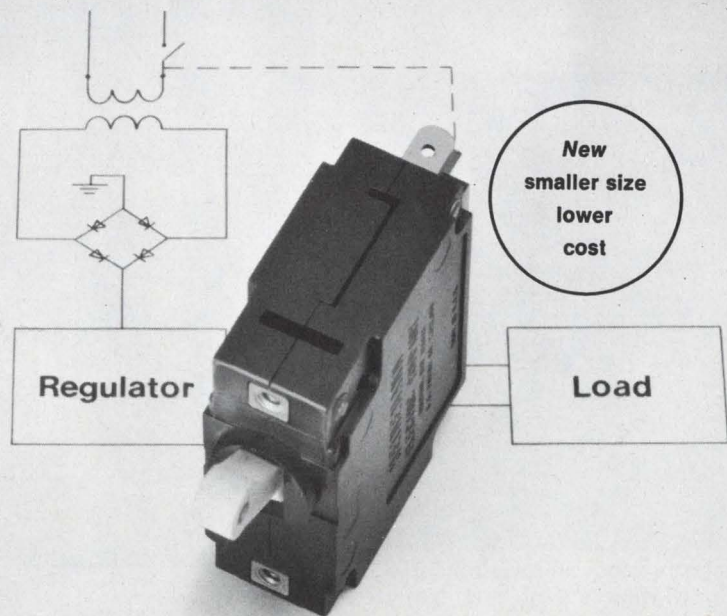

Antenna design aid rises in the desert

Patterns for airborne and vehicular radio antennas can now be measured with precision on the ground

Story and photographs by **John F. Mason**, Military-Aerospace Editor

Rising 104 feet above the flat Arizona desert, a skeletal pyramid supports a slender white arc 140 feet long (shown, right). Along the arc, from about 30 feet above the ground to its nearly horizontal end, five radio receivers are fixed. Underneath, a rotatable platform, resembling a scaffold, holds a gutted Army Mohawk surveillance aircraft, strapped upside down. The purpose of the setup is to test aircraft antennas.

Signal generators on the plane, transmitting up to the five receivers on the arc, simulate the Mohawk's radio transmitters, as if they were transmitting to planes below them or to the ground. Ground returns are avoided because the platform holding the plane is 28 feet high.

When completed, this unique test facility will make life simpler and cheaper for Army engineers who write specifications for airborne antennas, for those who test prototypes, and for manufacturers who design and build radios and antennas.

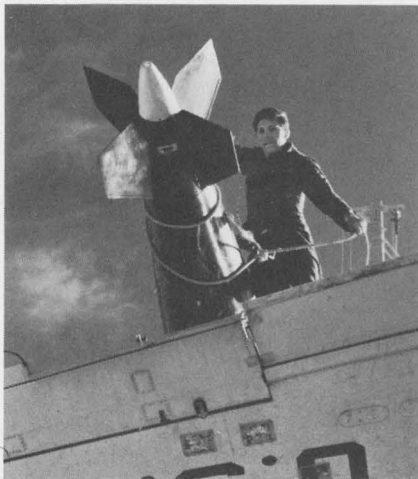

Operator straps an electronic jammer on to wing of Army's Mohawk to measure its effectiveness.



"Designers, we hope, will eventually be able to come here and run a quick-and-dirty test early in the game instead of going through a whole design cycle and then having to backtrack," says the facility's designer, Nicholas Glauber. He is an electronics technician in the Avionics, Meteorology and Electronic Warfare Div. of the Army Electronics Proving Grounds at Fort Huachuca, Ariz.

Glauber adds, "The results from ground tests are far more precise than those from the air.

"In flight there's an aircraft attitude problem," he explains. "Wind causes a plane to pitch and roll, and unless we've got instrumentation that can correlate that pitch and roll with variations of signal strength on the ground, the data is not accurate."

Glauber is pleased with the system's accuracy. "With five receivers we get five cuts of a transmitter at the same time. The signals are fed to a van equipped with amplifiers and recorders. Here we make rectilinear plots of all five signals simultaneously. The time correlation is perfect."

The reason for five antennas and for taking measurements each time the platform is turned five degrees is to measure the antenna pattern in relation to the antenna's position on the aircraft to every elevation and direction.

"We might have to change the location of an antenna or redesign it, or at least let the pilot know where his blind spots are," Glauber says.

"Up to now, industry has been guessing what antennas would do. Now, for the first time, we can run a performance test and check it against the technical characteristics of the system, including the antenna pattern. As more tests are

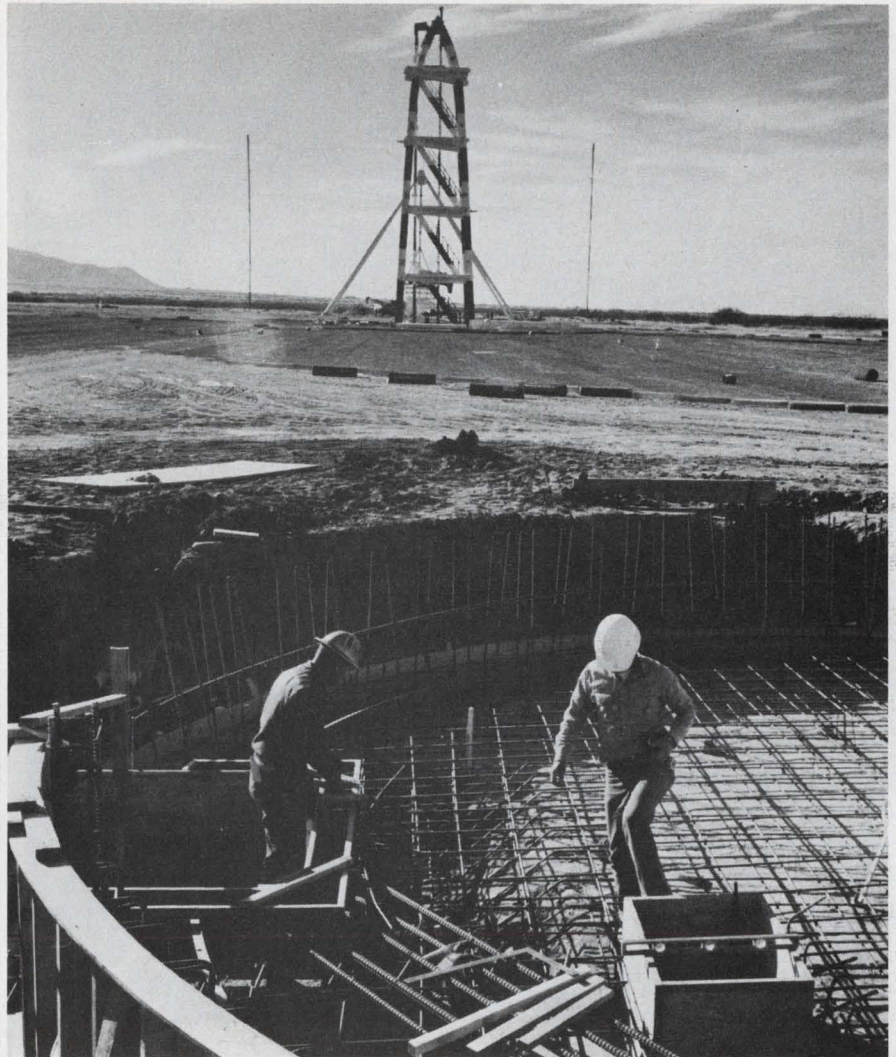

When this turntable is completed, vehicular radio antennas will transmit to five receivers in the 100-foot tower 500 feet away. Buried steel-wire mesh will provide a swamplike or saltwater environment to the transmission.

made, we are going to find most of our answers right in our antenna patterns."

The receivers used now vary in frequency. Some are 30 MHz to 400 MHz and use a half-wave dipole; others, between 400 and 1000 MHz, use a dipole with corner reflector; and some, above 1000 MHz, use a directive antenna with side-lobe attenuation at least 16 dB down from the main lobe.

For polarization measurements, two orthogonally polarized but otherwise identical sensor antennas such as crossed linear, are used.

Each of the arc's five receivers reveals:

- Relative antenna gain (dB) vs azimuth and elevation angle in degrees
- Phase, or phase difference, in degrees vs azimuth and elevation

angle in degrees.

- Polarization data vs azimuth and elevation angle.

By July, a new, and very important, dimension will be added to the facility. Besides antennas for aircraft, antennas for vehicular and other ground-based radios will be tested in both desert and swampland environments.

Five hundred feet to the east of the airborne testing platform, a tower, 100 feet high, is being equipped with five receivers. And 500 feet east of it, an automatic turntable is being built. To simulate the marshland or saltwater environment, a steel-wire mesh is being laid a few inches below the surface of the new turntable all the way to the central tower. For convenience of trucks and personnel, the mesh will be covered by asphalt. ■■

Electronics tunes in on muscle fatigue

Electronics is being used to study muscle fatigue of production-line workers at Western Electric's Kansas City Works. Electrodes pick up impulses less than 1/1000 V that are emitted as muscle fibers contract in the course of normal job activity. These impulses are then transmitted from a tiny radio on a worker's shoulder and sent to electromyographic (EMG) recording equipment.

The purpose of the EMG study is to improve the environment of employees engaged in making products for the Bell System.

The new EMC approach is being made with the participation of the University of Michigan department of industrial engineering under a research grant from Western Electric.

Results from the Ann Arbor campus have shown that there is definite relationship between muscle power and frequency. University of Michigan researchers found that there is a continual shifting of signal power from higher to lower frequencies. The greater the fatigue, the greater the shift. ■■



Nothing shocking about her signals. Only 1/1000th V is generated by muscles at the elbow, but this is enough for study of causes of muscle fatigue. The girl is testing small components at Western Electric's Kansas City Works.



Meet the "Mite".
Only .218" diameter. The toughest ceramic disc trimmer capacitor its size.

New from E. F. Johnson. And it's this small: 
Designed for printed circuit applications where space is at a premium. Stator of High Alumina for greater shock and vibration resistance. The rotor plate is encapsulated in ceramic for environmental stability and long life. The Q factor at 1 MHz is 500 minimum. Precision lapped bearing surfaces give you smooth linear tuning. Pick from a wide capacitance range: 1.0-3.0 pF, 2.5-9.0 pF, 3.5-20.0 pF, 5.0-25.0 pF. Designed to meet or exceed applicable requirements of MIL-C-81A.

Return the coupon today for information on Johnson's new Micro-J.[™] And if you have a special capacitor need, we'd like to work with you. The same engineering that made our air variable capacitors the standard of excellence goes into every new Johnson product.

E. F. JOHNSON COMPANY/3312 Tenth Ave. S.W./Waseca, Minnesota 56093

- Send product specification information on new Micro-J capacitor.
 Include information about your full capacitor line and other Johnson components.

NAME _____ TITLE _____

FIRM _____ ADDRESS _____

CITY _____ STATE _____ ZIP _____



E. F. JOHNSON COMPANY

INFORMATION RETRIEVAL NUMBER 18

THE WORLD OF ENCLOSURES



EMCOR BY PROFESSIONALS FOR PROFESSIONALS



In our world we build enclosures to help you do your thing more professionally. It's a world of: **CAPABILITY** that gets you the right sizes and quantities of enclosures for your needs; **COMPETENCE** that provides top quality, consistently; **SERVICE** that means technical assistance when you design and delivery help when you buy; and **PROGRESSIVE THINKING** to meet the ever-changing demands of styling, color, and decor. ■ Why not explore our world?

Ingersoll Products 1221 W. 120th St., Chicago, Ill. 60643 DIVISION OF BORG-WARNER CORPORATION



TI's quiet revolution in TTL/MSI

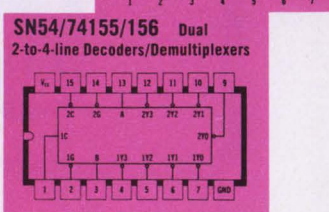
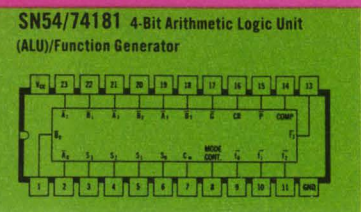
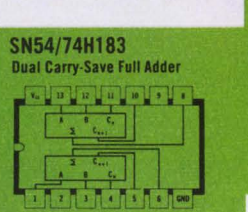
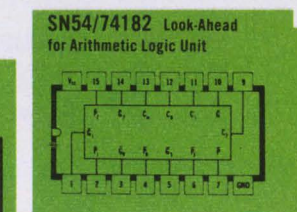
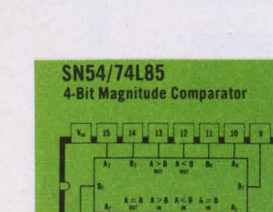
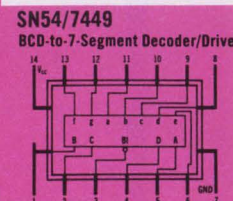
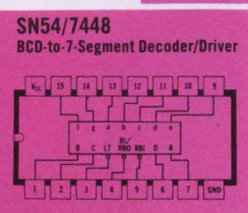
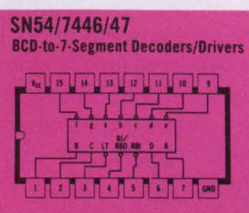
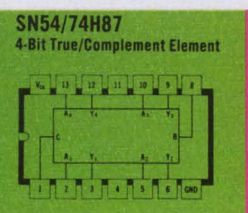
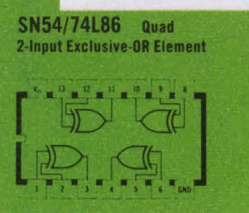
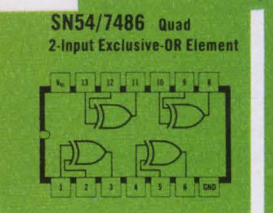
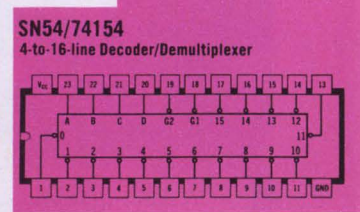
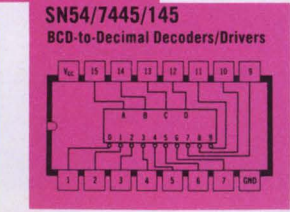
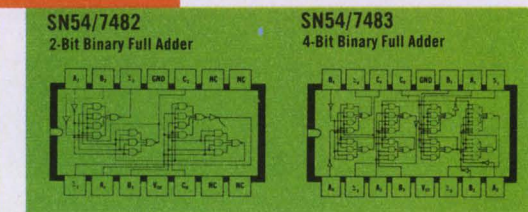
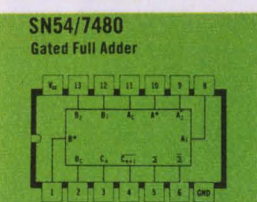
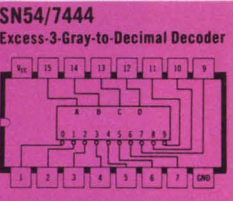
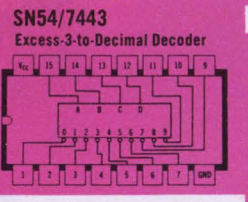
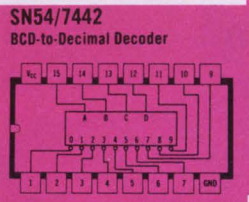
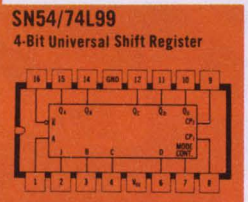
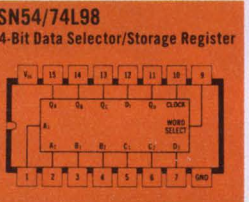
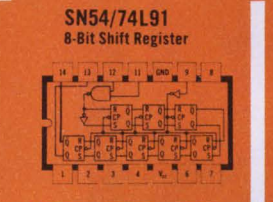
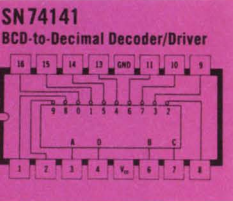
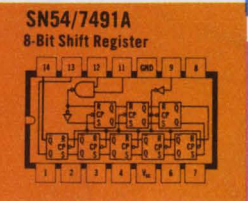
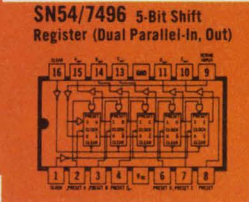
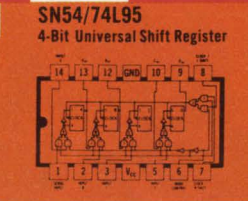
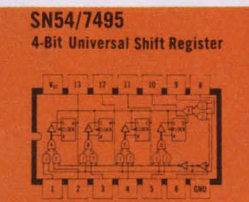
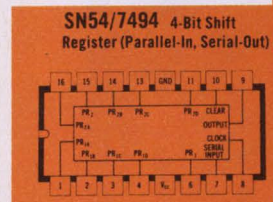
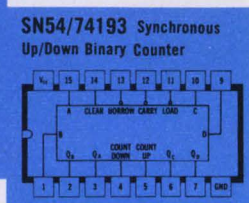
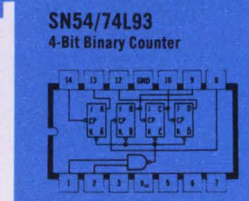
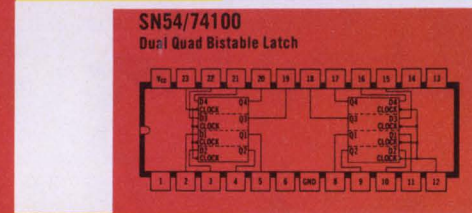
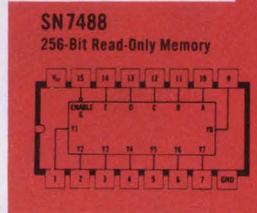
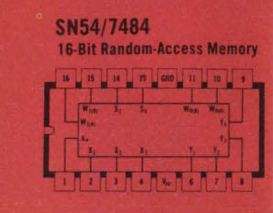
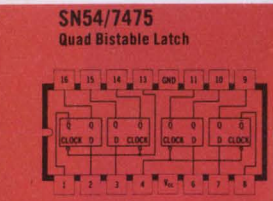
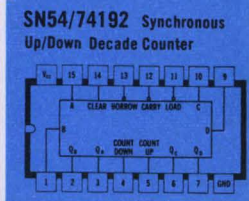
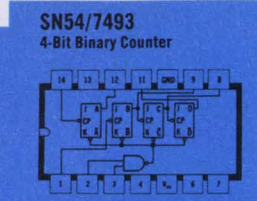
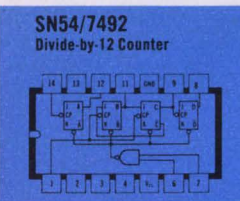
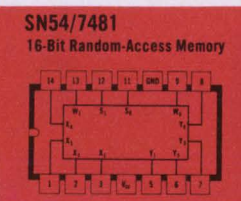
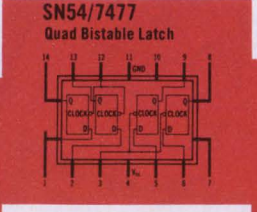
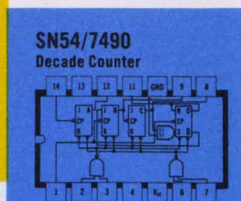
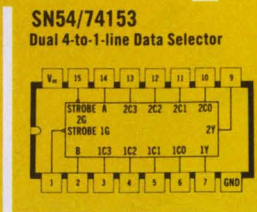
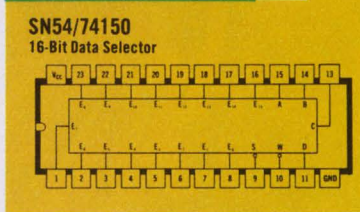
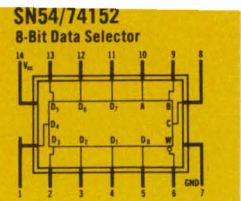
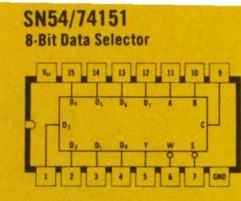
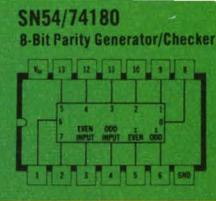

Take a realistic look at MSI. Compare the choice of functions. Compare circuit complexity. Compare availability. Compare price.

(Then you'll know why more of TI's 54/74 MSI
is second-sourced by second sourcers.)

Start your comparison with the left-hand page.

FACT: You see that TI lays 48 separate, distinct MSI functions on the line—your broadest choice by far. **4 data selectors/multiplexers, 13 decoders, 6 memories/latches, 8 shift registers, a parity generator, 6 counters and 10 arithmetic elements.**

No numbers game this. We're talking basics—not every variation made possible by a choice of two temperature ranges and three package styles.

FACT: More complexity—more performance—is packed into Series 54/74 MSI packages. The average com-

plexity of TI's MSI line is more than 30 gates—an order of magnitude higher than competitive TTL/SSI lines. So when you want **all** the benefits of MSI, come to where not only the choice is wider but also the overall complexity is greater.

FACT: Availability is unequalled. Huge in-house inventories (averaging more than 100,000 MSI parts) are maintained in all packages—plastic and ceramic DIP and flat pack—and in both temperature ranges.

FACT: Prices are low. TI has been committed to MSI price leadership since we introduced the first one in 1967. We've made more MSI than

anyone... and it's manufacturing know-how and high yields that keep TI costs, and prices, consistently low.

Make yours a tough comparison on us and our competition. For facts on our availability and prices, call your TI salesman or authorized TI Distributor. To compare choice and complexity, get the 184-page supplement to our TTL catalog. It'll bring you up-to-date on our 48 MSI functions. Circle 286 on the Reader Service Card or write Texas Instruments Incorporated, P.O. Box 5012, M. S. 308, Dallas, Texas 75222. That's where the quiet MSI revolution is going on.



TEXAS INSTRUMENTS
INCORPORATED

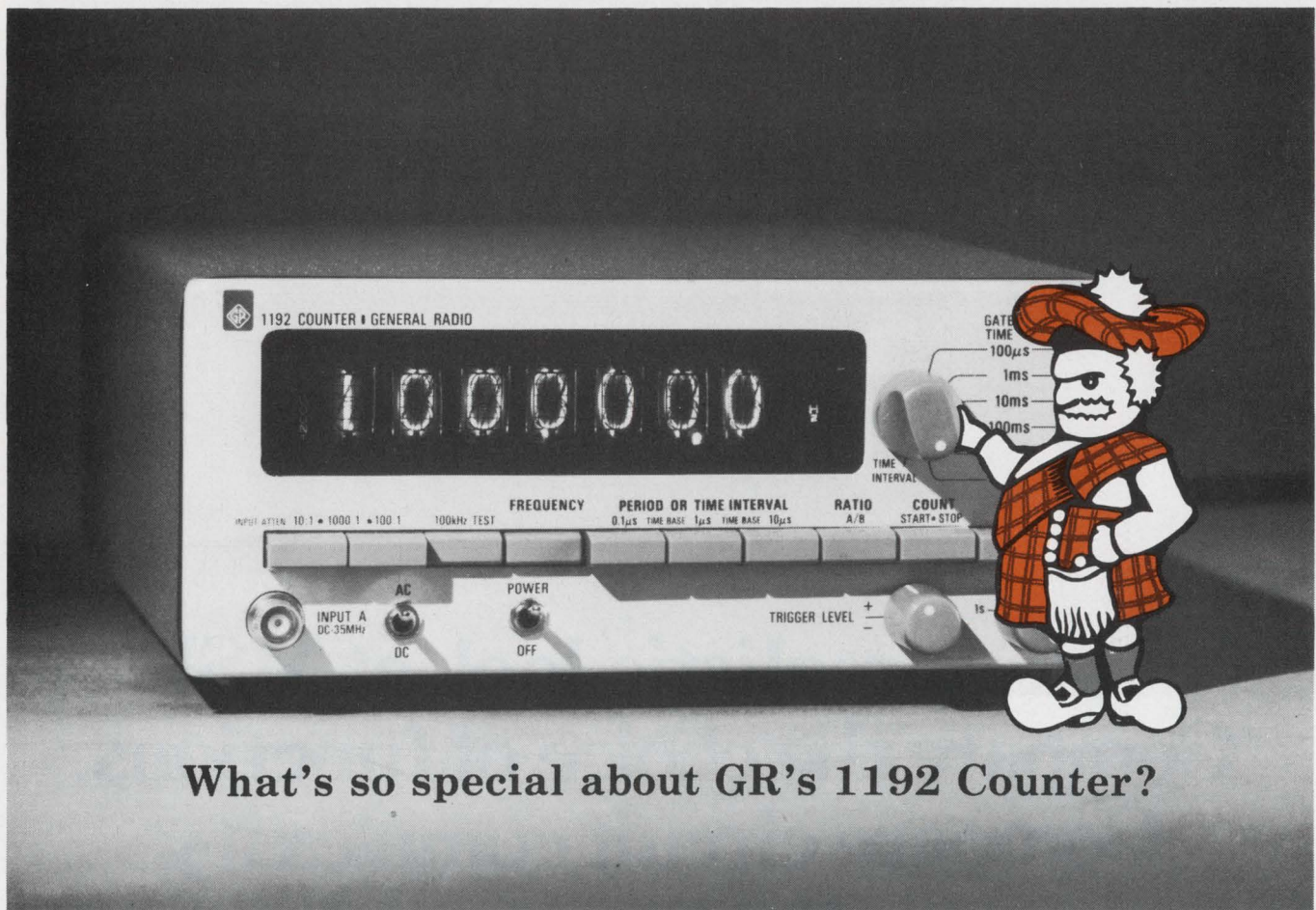

What's so special about GR's 1192 Counter?

The answer has to be VALUE.

Where else could you get a \$575, 5-digit counter that measures frequency (dc to 32 MHz), period (single or multiple), frequency ratio, and time interval? Or 10-mV input sensitivity up to 20 MHz, a 10-MHz crystal time-base with a stability better than $\pm 2 \times 10^{-6}$ per month, or manual attenuation up to 60 dB?

You say you want more for your money? How about automatic units-of-measurement and decimal point displays, and SPILL and COUNT indicators?

For a few more dollars we can really make it worthwhile! Get a 6-digit counter for \$675, or 7 digits for \$775; add a BCD data output for \$50 and a rack mounting for \$20. And if you have higher frequencies to look at, tack on our 500-MHz scaler for \$850.

Now that you're interested, why not get all the details from the General Radio Company, West Concord, Mass. 01781; telephone (617) 369-4400? In Europe write Postfach 124, CH 8034 Zurich, Switzerland. To sweeten the deal, we'll tell you about our quantity discounts and Annual Purchase Agreement.

Prices apply in USA.

GENERAL RADIO 

INFORMATION RETRIEVAL NUMBER 20

ELECTRONIC DESIGN 7, April 1, 1970

Washington Report

CHARLES D. LA FOND, WASHINGTON BUREAU

Underseas missile program faces budget test

The 1971 federal budget includes a request of \$44-million to proceed with engineering development of the Navy's Undersea Long-range Missile System. Many in industry here and on Capitol Hill believe this to be a pivotal point: If the full request is approved, it will be difficult in the future to curtail the program. Congress will certainly look closely at a request for funds that quadruple 1970 appropriations.

The new submarine and weapon vehicle, compared with existing Polaris/Poseidon submarines, will be larger, quieter and dive deeper. It may carry over 20 extra-long missiles in a horizontal position, externally. The missile system will have a range capability of over 5000 miles and will carry a MIRV-type cluster of warheads. And the missile electronics may very much resemble those used in Minuteman III, according to Washington industry informants.

No official estimates have been released, but cost for the total program, if it replaces the existing ballistic-missile submarines, could total \$25-billion, according to the House Democratic Study Group.

Deep-submergence vehicle could take a dive

Also under close inspection is the Navy's Deep Submergence Rescue Vehicle program. The General Accounting Office has made a detailed study of it and reports an enormous growth curve in six years—from a planned \$36.5-million for 12 craft to \$463-million for six vehicles. Furthermore, the GAO study notes that, in 1964, the Navy said it could build the 12 vehicles in four years; now it claims it will require 10 years to build six.

Needless to say, members of Congress are concerned over conduct of the program, the costs of which have escalated by over 2000%. Sen. John J. Williams (R-Del.) declares his support for the development of the craft but says: "There can be no justification for such a wide error in the estimate presented to Congress."

Congressman lowers the boom on NASA

"NASA must consider the members of Congress a bunch of stupid idiots—worse yet, they may believe their own estimates." This blast, aimed at the space agency's penchant for underestimates of program costs, was delivered recently by Rep. Joseph Karth (D-Minn.) before the Earth Resources Observations and Information Systems Meeting in Annapolis, Md. He warned that the present low NASA budget could even go lower—and he emphasized that this downward trend might be reversed by Congress "if we make appropriate decisions to redirect the program along lines more acceptable to the man in the street."

Karth, who is chairman of the House Subcommittee on Space Sciences and Applications, has been for years an outspoken critic of what he considers the great imbalance in the U.S. space program between too large a manned effort and too small an applications and scientific effort.

Are foreign imports hurting U.S. electronics?

Watch for some effort by Congress this year to partially wedge the door on foreign electronics imports. This will be a response to data, recently released by the Electronic Industries Association, which shows sharply rising electronics imports both in dollars and in market percentage. The 1969 figures show imports totaling \$1.8-billion, an increase of nearly 35 per cent over 1968.

"It is totally unrealistic to expect that our domestic electronics industries can compete effectively with products imported from abroad produced by competent 25-cent-an-hour labor," says Rep. Clark MacGregor (R-Minn.). The time has come, he suggests, when either the governments involved—principally Japan—will have to reach some agreement to limit exports to this country or the U.S. will have to provide some more direct assistance, probably in the form of restrictive tariffs.

Restrictions threaten oceanography research

"The majority of 'first-string' oceanographic research being done in the country today is either done directly by Navy in-house laboratories or is sponsored by Navy requirements and funding in industry and in the universities," declares a top Navy official.

This program is now endangered by the Mansfield Amendment, enacted in the 1970 Military Procurement Authorization Act, says George B. Anderson, director of the Ocean Sciences Dept., Naval Undersea R&D Center, San Diego. Speaking here recently before the American Oceanic Organization, he notes that Section 203 of the procurement act, introduced by Sen. Mike Mansfield (D-Mont.), denies use of the authorized funds for "any research project or study unless such project or study has a direct and apparent relationship to a specific military function."

Anderson argues that the line between basic and applied research is unclear. Typical of past research gains now being applied by the Navy, he points out, was the discovery and definition of the deep scattering layer now known to be responsible for acoustic scattering of sonar transmissions. "Let us therefore," he says, "be very concerned about jeopardizing some of these efforts for the sake of fiscal tidiness."

Do data banks invade personal privacy?

Are computerized data systems so different from previous record systems that new policies will be needed to protect individual liberties?

That is the question, according to Dr. Alan F. Westin, professor of public law and government at Columbia University, and director of a 2 1/2-year study sponsored by the National Academy of Sciences. At present, he asserts, there are no laws or court decisions in the country supporting the individual's right to see, contest, change or eliminate any of the information about him in a data bank. The study, supported by \$150,000 from the Russell Sage Foundation, will for the first time attempt to learn the impact of such computerized information on the privacy of individuals and the legal aspects of using such data banks.

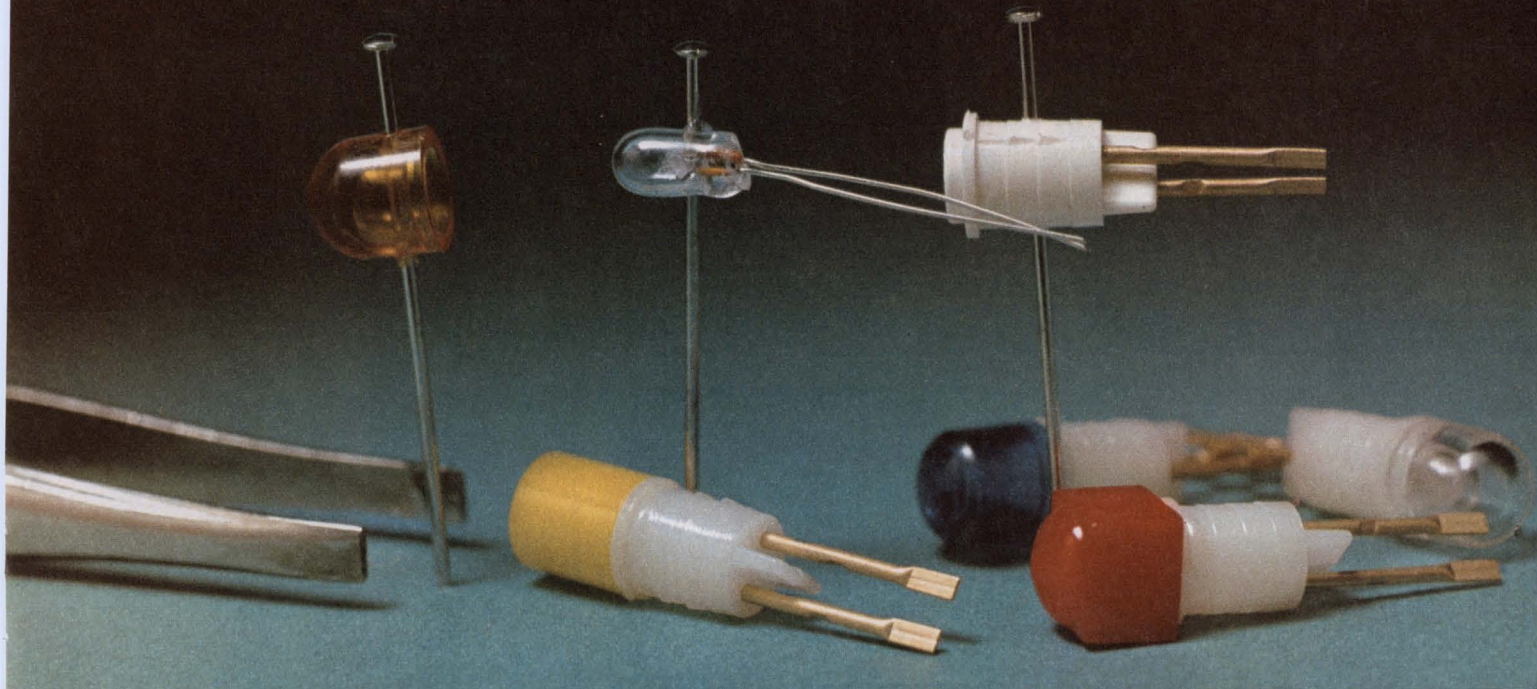

Relamping is simple with Chicago Miniature's CM-25 "Brite-Lites." No tools are required. You merely unsnap the cap and remove the unbased T-1 lamp with your fingers. Our engineers devised an ingenious way to simplify lamp insertion, too. The new lamp easily inserts into internal wire lead guides. The lead guides are indented (patent pending) to assure positive contact with the lamp leads. There's no need for lead soldering. Relamping is all done from the front of the panel, so base removal is unnecessary.

Here's another engineering exclusive close plus and minus tolerances.

Holding light tolerances improves parts interchangeability and panel appearance. Also, "Brite-Lites" are available with cylindrical caps that can be easily hot stamped with legend information.

These "Brite-Lites" mount on .250" centers and have a strong polycarbonate base with leads for panel or printed circuit wiring. You can specify any of six different cap colors in translucent or transparent types.

Our Lited Devices catalog CML-2 gives details on our complete line of quality indicator lamps, just circle the reader service number to receive your copy. Write on your company

letterhead to receive a sample "Brite-Lite" so you can dissect one yourself.

For application assistance contact your Chicago Miniature Sales Representative. For off-the-shelf delivery, contact your local authorized Chicago Miniature Electronic Distributor.



CHICAGO MINIATURE
LAMP WORKS
4433 N. Ravenswood Ave.
Chicago, Illinois 60640
(312) 784-1020

a GENERAL INSTRUMENT company

THE LIGHTING BUGS

How to dissect a lighting bug.

Signetics springs the lock.

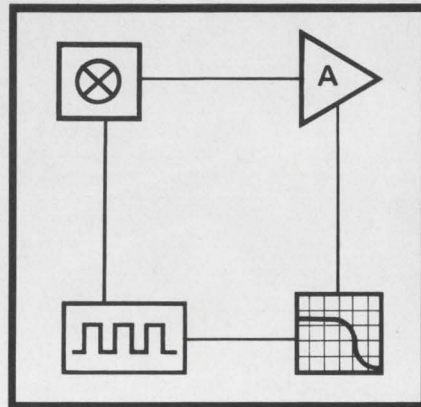

The Phase Locked Loop has hit the market. It's better known as the monolithic phase locked signal conditioner and demodulator. And it's available from Signetics.

This small wonder has all kinds of applications for designers of communication and data equipment. Like 1) FSK and FM demodulation (without tuned circuits), 2) signal locking, reconstitution and conditioning, 3) tone and marker detection, 4) AM synchronous detection, 5) frequency multiplication and division, 6) signal searching and tracking.

In short, the phase locked loop, a complete system on a chip, eliminates tuned circuits altogether. And it reduces the cost and size of designs while improving their stability and reliability.

There are two versions—the 560 and the 561 (the latter adds an AM synchronous detector to the 560). And both operate from less than 1Hz up to 30MHz.

The device has so many possibilities. It will be the universal building block that the op amp has become.

So get in on it now. Write for a complete description of performance, applications and spec sheets.

And lock it up.

Signetics

Signetics Corporation 811 E. Arques Ave., Sunnyvale, Calif. 94086 / a subsidiary of Corning Glass Works
Signetics International Corporation, Zug Switzerland (042) 21-25-44

INFORMATION RETRIEVAL NUMBER 22

ELECTRONIC DESIGN 7, April 1, 1970

Announcing a new panel savings plan.

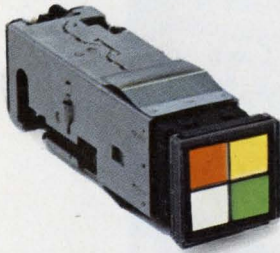

Big dividends from small pushbuttons.

It doesn't take much to reduce the size of your control panels and cabinet fronts.

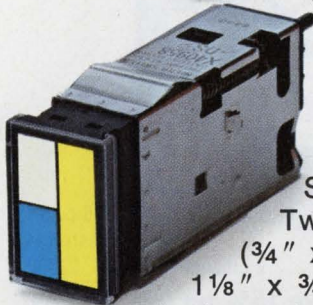

All it takes is compact miniature pushbuttons. Like the new MICRO SWITCH illuminated DS.

Two sizes are available ($\frac{3}{4}$ " x $\frac{3}{4}$ " for our 1-unit and $1\frac{1}{8}$ " x $\frac{3}{4}$ " for our $1\frac{1}{2}$ -unit). And both can be matrix mounted on $\frac{3}{4}$ " or $1\frac{1}{8}$ " centers. So there's no need for spacers or barriers.

A long-term investment.

A rugged metal housing encloses each switch and protects against the bumps and bangs of military and commercial use.

The housing also helps provide our DS pushbuttons with exceptional RFI attenuation capability. Incorporated into the housing are welded skirts that assure positive metal-to-metal grounding between the switch and adjacent units. And also between the switch and our rigid, box-girder matrix frame.

Your choice of options.

Pick the mounting that best fits your application. Either individually mounted switches (meet the requirements of MIL-S-22885) or custom matrix configurations featuring plug-in switches that are best for remote stations or indicating functions.

You can have up to four lamps in every switch. And either one, two, three or four-way split section screens. (The $1\frac{1}{2}$ -unit provides more than one-third additional legend area.) Full guards are available for single-unit switches.

Then save even more space by combining both 1-unit and $1\frac{1}{2}$ -unit switches in the same matrix. A single frame will handle up to sixteen 1-unit switches or up to ten $1\frac{1}{2}$ -units.

Who can participate in the plan.

MICRO SWITCH DS pushbuttons meet both commercial and military requirements. So they can be used in almost any panel from power plant control to tactical ground support equipment.

For more information, call your MICRO SWITCH Branch Office or Distributor (in the Yellow Pages under "Switches, Electric"). He'll show you how little it takes to participate in our savings plan.

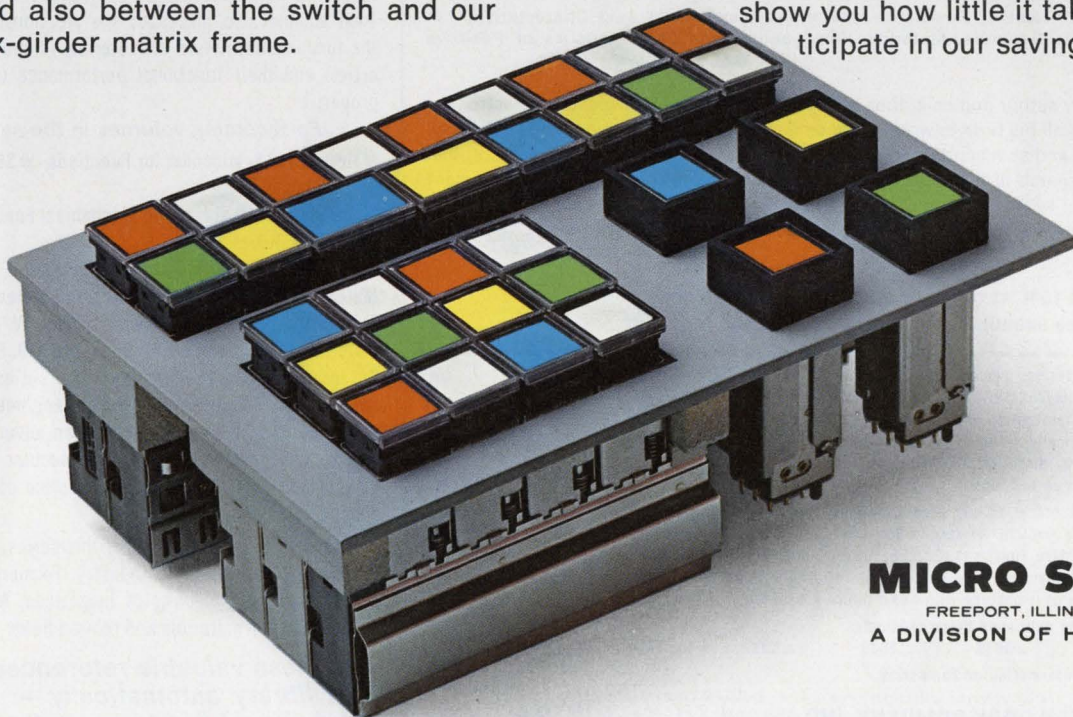

MICRO SWITCH

FREEPORT, ILLINOIS 61032
A DIVISION OF HONEYWELL

An indispensable design tool...

the inaugural volume in the Hayden Series in
Materials for Electrical and Electronics Design!

MATERIALS FOR CONDUCTIVE AND RESISTIVE FUNCTIONS

G. W. A. DUMMER, Formerly Superintendent Applied Physics
Royal Radar Establishment, British Ministry of Technology

Written by an internationally recognized authority, this volume satisfies the need for a comprehensive, applications-oriented reference on conductive, superconductive, contacting, and resistive functions. It is exceptionally broad and detailed in coverage, setting forth the basic phenomena for each specific function, describing how the materials for each are used in component parts, and providing sufficient basic data to prepare the reader for problems which may be met in specific applications.

In cases where combined materials are part of the design, such as cables and wires, brief data is given of dielectrics, etc. in order that reasonably complete coverage is available. More than one-hundred-forty charts, tables, and diagrams provide rapid access to properties of materials for a specific requirement. Extensive references are included to facilitate further study.

Thorough descriptive coverage . . . more than 140 charts, tables, and diagrams.

Conductive Functions. Introduction to the Principles of Conduction in Low- and High-Resistivity Metals. Tables of Physical Properties of Conducting Materials. Materials, Applications, and Characteristics of Hook-up Wires, Covered Wires, Bus Bars, Transmission Cable, and Microwires. Materials, Applications, and Characteristics of Magnet Wires. Materials, Applications, and Characteristics of RF Cables, Materials Applications, and Characteristics of Printed Wiring Conductors. Materials, Applications, and Characteristics of Integrated Circuit Conductors. **Superconductive Functions.** Phenomena and Environments Associated with Superconductivity. Superconducting Switching Devices. Materials with High Field Superconducting Capabilities. **Contacting Functions.** Contact Functions and the Physics of Contact Phenomena. Contact Materials, Applications, and Tables of Properties. Basic Connection Methods in Electronics. Make and Break Contacts, Plug and Socket Functions, Switching Functions. Relay Functions. Sliding Contacts, Wear, and Noise Phenomena. **Resistive Functions.** Conductivity, Resistivity, Resistance, and Temperature Coefficient of Resistance. Materials, Applications, and Characteristics of Fixed and Variable Resistors. Materials, Applications, and Characteristics of Resistive Films. **Index.**

G. W. A. Dummer, author and co-author of scores of books on all aspects of electronics, presently devotes all his time to writing and consulting activities. A pioneer in reliability, thin-film circuits, and semiconductor integrated circuits, he initiated much of the British Government's research in microelectronics. His earlier contribution to the development of radar and radar synthetic trainers earned him Britain's award, Member of the British Empire, and America's Medal of Freedom. Mr. Dummer is a Fellow of the I. E. E. E., the I. E. E., and the I. E. R. E.

**Subscribe at 15% savings, or order individual volumes
on 15-day free examination . . . mail this coupon today!**

Subscription terms: Please enter my subscription to the Hayden Series in Materials for Electrical and Electronics Design. Each title will be automatically shipped as published, and billed at 15% discount. This subscription may be cancelled at any time.

Name _____

Firm _____

Address _____

City _____ State _____ Zip _____

ED-1

Single volume order: 15-day Free Examination. Please send #5636, Materials for Conductive and Resistive Functions, \$13.95, on a 15-day Free Examination basis. At the end of that time I will remit payment, plus postage, or return the book without further obligation. Payment enclosed. (Hayden pays postage with same return guarantee).

Ship and bill as published those checked:

#5638 #5635 #5639 #5637 #5634 #5640

Send further information on the series.

On all overseas orders payment in U.S. dollars must be enclosed.



HAYDEN BOOK COMPANY, INC., 116 W. 14th St., N. Y., N. Y. 10011

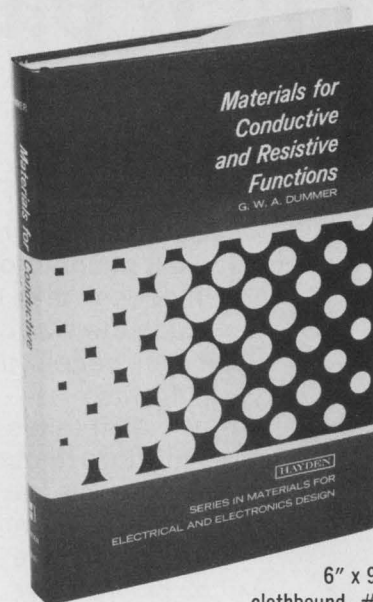

326 pages,
6" x 9", illustrated,
clothbound, #5636, \$13.95

**Save 15% on this volume!
Enter your subscription to this
valuable new series today!**

Hayden Series in Materials for Electrical and Electronics Design

Alex E. Javitz, Editor-in-Chief

A series of integrated engineering books designed to meet the practical needs of all who design electrical and electronic components, devices, equipment, and systems. Offering a unified approach which treats materials according to functional classes, the books provide an essential background in fundamental principles, combined with immediately workable data and techniques for both conventional and advanced applications. Each volume also discusses the relationship between the fundamental nature of materials (microscopic properties) and their functional performance (macroscopic properties).

Forthcoming volumes in the series:

Materials for Semiconductor Functions, #5638,

E. G. Bylander

Materials for Structural and Mechanical Functions,

#5637, G. Koves

Materials for Magnetic Functions, #5635, F. N. Bradley

Materials for Electrical Insulating and Dielectric

Functions, #5634, H. L. Saums and W. W. Pendleton

Materials for Combined Functions, #5639, E. Scala

An interdisciplinary volume in the series, **Materials Science and Technology for Design Engineers, #5640**, edited by Alex. E. Javitz, provides an advanced exposition of the basic structure and molecular behavior of all relevant materials. Approximate price of each forthcoming volume, \$18.00.

Alex. E. Javitz, Editor-in-Chief of this series, is currently a technical consultant to industry. Formerly an editor of electrical and electronics magazines, Mr. Javitz is widely known in materials and related fields.

**Add these valuable references to
your library automatically —
enter your subscription today!**

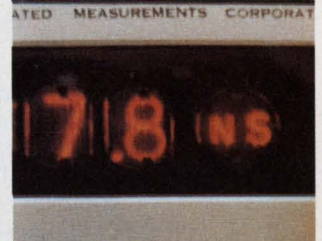
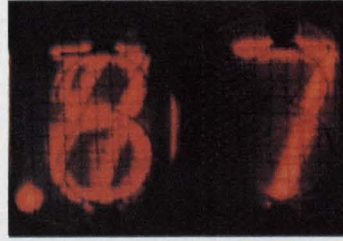
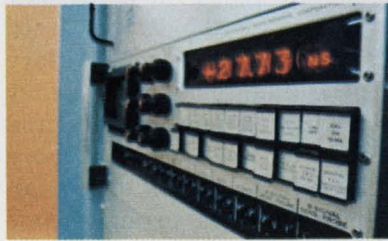
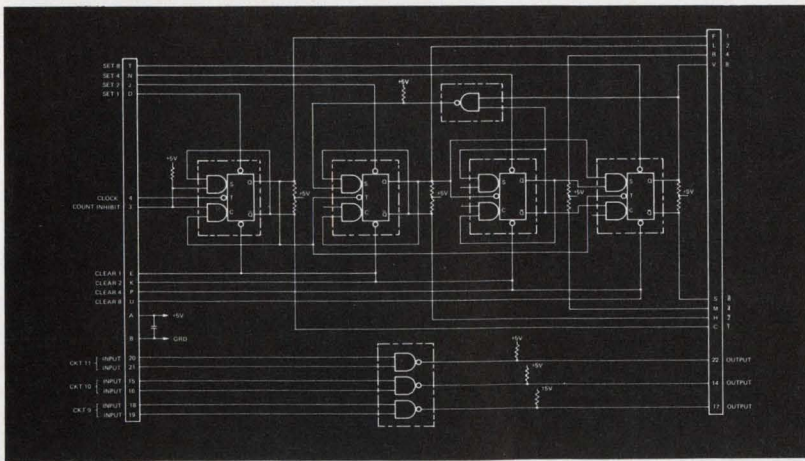

E-H the systematic solution

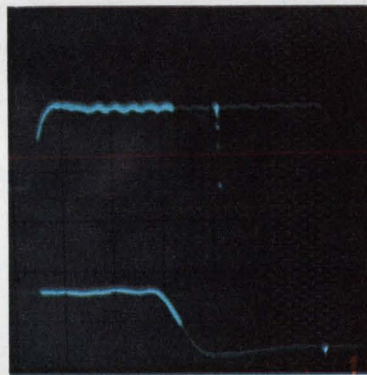

Whether you need a complete dynamic test system or the ideal components to integrate with your present system, look no further. E-H Research Laboratories, Inc. and its subsidiary, Automated Measurements Corporation, offer you the perfect solution.

For example, the **E-H 1139/1420 programmable timing unit and pulse driver combination** is a new generation in pulse instruments that fits the needs of any systems designer. These two rack-mounted units are so completely programmable that there are no front-panel knobs to twist. They're ideal for any systems applications requiring pulses from 1kHz to 10MHz. And they offer the designer such features as complete waveform control, with programmable width and delay from 10ns to 100 μ s, amplitude from $\pm 3V$ to $\pm 10V$ with programmable attenuation from X1 to X40 and rise and fall times programmable from 5ns to 13 μ s.

The perfect mate to the E-H 1139/1420 is the **AMC Model 1000 Waveform Analyzer**. The AMC 1000 was designed specifically for programmed systems application. It combines in one compact box the functions of sampling oscilloscope, digital counter and digital voltmeter to provide time and voltage measurements of sampled waveforms. The AMC 1000 is the most advanced instrument of its kind, with features including $\pm 1\%$ time measurements all ranges, fastest measurement rates, 10 remote sampling channels, all solid-state construction, serial-by-character or parallel programming, built-in program memories, stored BCD outputs, built-in floating DVM, and digital readout.

This is just a sample of the broad line of E-H and AMC equipment available from your E-H representative. He can offer you a complete system or the most advanced components to give you the systematic solution to your problems today. And tomorrow.



E-H RESEARCH LABORATORIES, INC.

515 Eleventh Street • Box 1289, Oakland, California 94604 • Phone: (415) 834-3030 • TWX 910-366-7258

In Europe: E-H Research Laboratories (Ned) N.V., Box 1018, Eindhoven, The Netherlands, Telex 51116

In Japan: Iwatsu Electric Company, Ltd., 7-41, 1-Chome Kugayama Suginami-Ku, Tokyo 167, Japan

INFORMATION RETRIEVAL NUMBER 24

Our D servomotor is mad with power.

That's our SU-680D-29 permanent-magnet D-C servomotor. We call it our D motor for short. It's small, rugged and powerful. It delivers 12.7 watts of continuous power output at 8600 rpm and is a natural for any servomechanism that requires a prime mover. It has a high repeatability-to-time ratio which makes it immensely stable, a 0-10,000 rpm speed range and a high acceleration Torque/Inertia. Torque peaks at 15 oz-in., 2 oz-in. continuous at 8600 rpm. It measures only 1 1/8 inches in diameter and weighs just 8 1/4 ounces.

SERVO-TEK PRODUCTS COMPANY
1086 Goffle Road, Hawthorne, New Jersey 07506.

SERVO-TEK
PRODUCTS COMPANY

For full details write for our interesting technical sheets and get mad with power yourself.

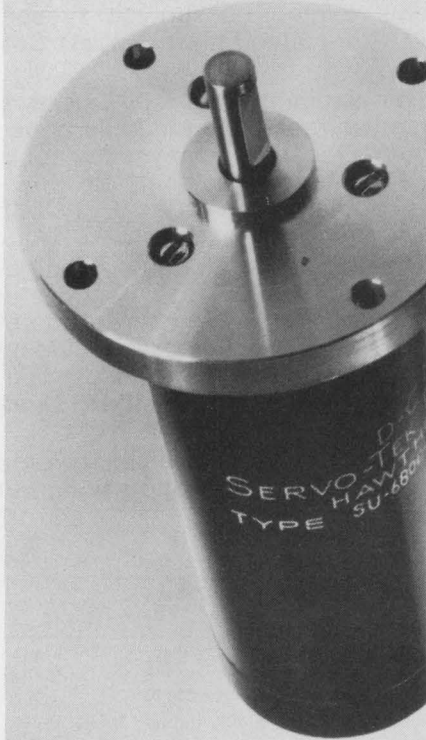

INFORMATION RETRIEVAL NUMBER 25

SIDELIGHTS

Timekeeping—from caveman to engineer

More than 50 centuries have passed since the caveman first attempted to keep track of time by simply pushing a stick into the ground. When the stick's shadow reached a certain point, the caveman knew it was time to get back into his cave for supper. But today the art of timekeeping has reached a degree of sophistication and accuracy not dreamed of even a generation or so ago.

Standards for time, according to John Carpenter, vice president of the Electronics Div., Bulova Watch Co., New York City, have always been based on a periodic event—in particular, the rotation of the earth. Until well after World War II, the most accurate observatory timekeepers were gigantic pendulum clocks on heavy foundations, operating in a controlled temperature and atmosphere. Just when the quartz clock became more accurate than the pendulum type, the atomic clock appeared on the scene, displacing both as a primary time standard.

These are just a few of the interesting facts that Jim McDermott, East Coast Editor, learned while digging up material for his story on electronic wristwatches (p. 25).

EE finds writing right down his line



Is it hard to write tech articles? Not for Mitchell P. Marcus, senior engineer of IBM Corp., Systems Development Div., Endicott, N. Y. He's had 26 articles in various publications, and the 26th appeared in Electronic Design's 26th issue of 1969. Called "Single-Map Method Speeds Design," it discusses sequential logic circuits.

INFORMATION RETRIEVAL NUMBER 26 ►

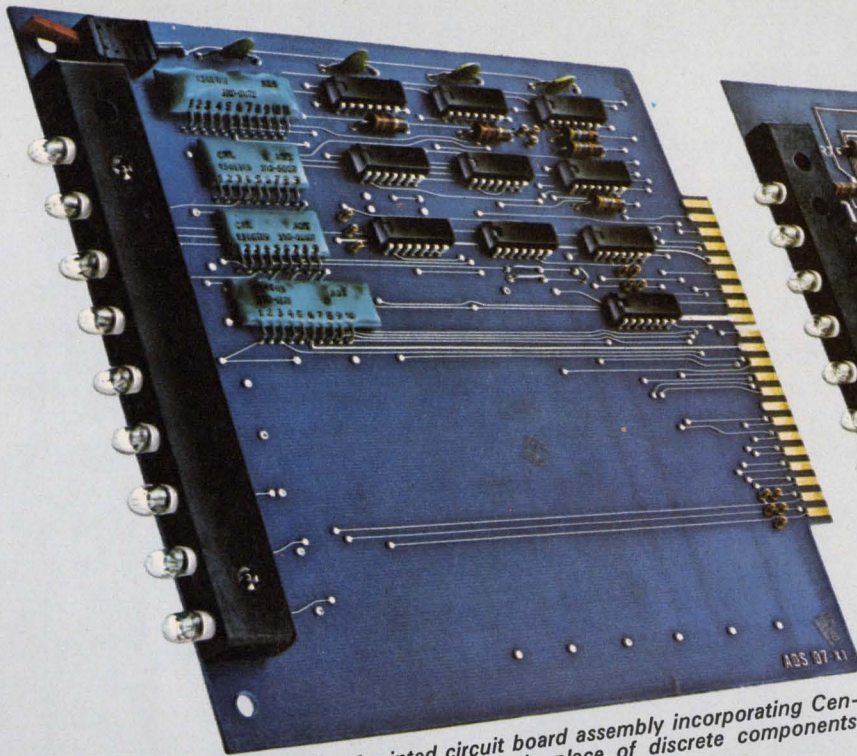

Redesign of printed circuit board assembly incorporating Centralab hybrid microcircuits in place of discrete components.

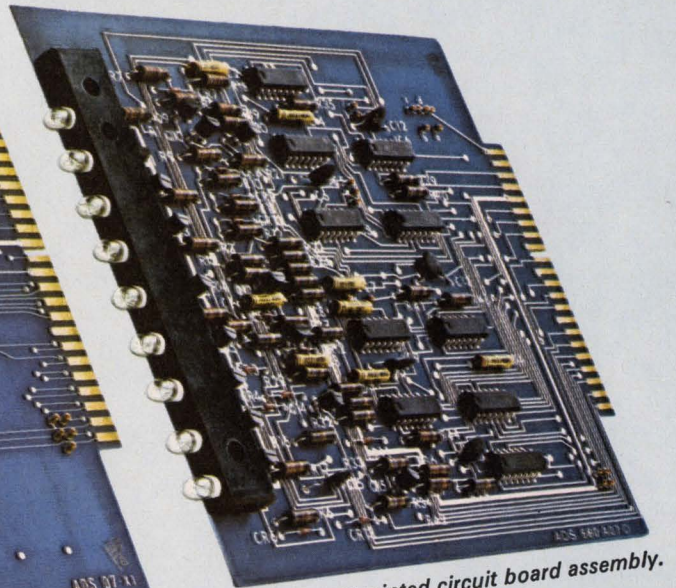

Initial ADS printed circuit board assembly.

Centralab makes a difference for

AMERICAN DATA SYSTEMS

**Microcircuitry simplifies assembly,
improves performance**

American Data Systems is a new company, just a little over one year old, experiencing a meteoric growth in data communications equipment. The heart of their ADS-660 Data Distribution System is a number of printed circuit board modules. These card modules are compatible with a variety of low-speed data terminal devices.

Initially, these plug-in boards were assembled as shown on the right — using discrete components. ADS, with help from Centralab Electronics Division, was able to redesign using thick-film hybrid circuits. The four blue hybrid microcircuits (shown on the board at the left) have replaced 9 diodes, 48 resistors, 16 transistors and 5 capacitors. The change resulted in lower circuit assembly time, fewer rejects due to faulty assembly, and increased the reliability of performance — all contributing to a significant cost saving for ADS.

Centralab capability in customer design-specified microcircuits has helped improve the performance and reliability of the data communications products of American Data Systems. For information on how Centralab hybrid microcircuits might benefit your products' reliability, write: Sales Manager, Centralab Electronics Division, Globe-Union Inc.

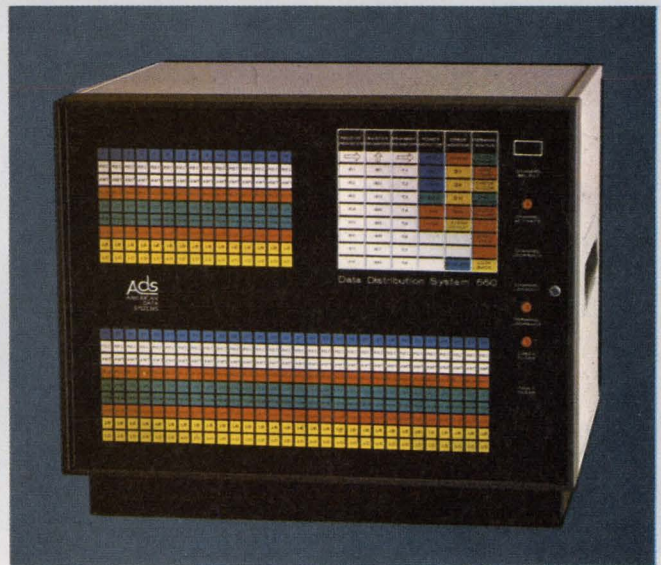

ADS-660 time-division-multiplexer provides for the transmission of several low-speed data circuits over a single high-speed voice grade line.



CENTRALAB

Electronics Division
GLOBE-UNION INC.

5757 NORTH GREEN BAY AVENUE
MILWAUKEE, WISCONSIN 53201



When you want radar as pure and coherent as a laser beam...

Symbolic electronic signal undistorted by EMI —
photographed by Howard Sochurek

bring ERIE in early.

31,000 feet...heavy traffic...ugly weather over the Plains. This isn't the time for "noise" in the radar. But, no sweat! RCA's exciting new AVQ-30X Weather Radar is up front, sweeping the sky...protected from EMI by 39 special ERIE filters. No other airborne radar has ever approached the single or dual system reliability of the AVQ-30. From the start, RCA has called on the outstanding research and component capability of ERIE TECHNOLOGICAL to help in the development of this great new unit. Proof, once again, that it pays to bring ERIE in early.

INFORMATION RETRIEVAL NUMBER 27

ERIE TECHNOLOGICAL PRODUCTS, INC.

644 West 12th Street, Erie, Pennsylvania 16512
(814) 456-8592

Publisher

Hugh R. Roome

Editors

New York Office
850 Third Ave.
New York, N.Y., 10022
(212) 751-5530

Editor: Frank Egan

Managing Editor: Ralph Dobriner

Managing Editor: Raymond D. Speer

Microelectronics, Steven A. Erenburg

Computers, Milton J. Lowenstein

Circuits, Don Mennie

Microwaves, Michael J. Riezenman

Management, Richard L. Turmail

News, John N. Kessler

Military-Aerospace, John F. Mason

New Products, Roger Allan

New Products, Lucinda Mattera

Directory Manager, Greg Guercio

Copy, Marion Allen

Field Offices

Washington

Charles D. LaFond
P.O. Box 138
Burke, Va. 22015
(702) 461-7210

Massachusetts

Jim McDermott
P.O. Box 272
Easthampton, Mass. 01027
(413) 527-3632

San Francisco

Elizabeth de Atley
2051 Wellesley St. (Suite D)
Palo Alto, Calif. 94306
(415) 321-7348

Los Angeles

David Kaye
2930 Imperial Highway
Inglewood, Calif. 90303
(213) 757-0183

Editorial Production

Dollie S. Viebig
Richard D. Grissom

Art

Art Director, Clifford M. Gardiner
Assistant, William Kelly
Rita Jendrzewski
Lynn Thompson
JoJo Miskimmon

Production

Manager, Thomas V. Sedita
Helen De Polo
Kathleen McConkey
Leslie Stein

Circulation

Manager, Nancy L. Merritt

Information Retrieval

Genate Piccinetti

EDITORIAL



Are you your own worst enemy?

Work, work, work. Attend that meeting, schedule that project, design that circuit . . . But are you taking on too much?

Industry managers tell us that many engineers do. They allow themselves to be overloaded. They take on so much technical work and responsibility that their duties become drudgery, and their performance lags. And if work is drudgery, creativity is at a pretty low ebb.

If you are overloaded and harried, if you don't have a moment to spare and you're keeping track of five projects at once, you probably can't perform any of your work to your own satisfaction. So your personal reward from your work is minimal. What's worse, you may not be impressing your management. To your boss you may just seem tired and disorganized.

Sure, performance counts and you want that promotion, but you may be emphasizing quantity in your work at the expense of quality. And your management expects quality. Remember the law of diminishing returns? Added effort, past a certain point, may not show much in your over-all performance.

What's the answer? Planning. Start planning now for next month, and next year. Examine your daily schedule realistically. Does it allow for communication, a few moments of conference with your boss and with other engineers? Does it allow time to keep up with your technical reading, with expanding your knowledge? Can you attend the odd lecture? Does your daily routine allow time for simple, creative thought?

And how about broadening your interests? Do you have time to develop the nontechnical side of your life? Can you spend some time with your family, so that they are as happy about your career as you are?

Your company needs managers who are happy, confident, dynamic and well-rounded. And you can be all of these—if your schedule permits. Plan it carefully.

RAYMOND DANIEL SPEER

An Electronic Design practical guide for synchro-to-digital converters

Written by: Hermann Schmid, Senior Engineer, General Electric Co., Binghamton, N. Y.

Edited by: Don Mennie, Circuits Editor

Part 2: Type II converter based on standard resolver bridge

The first portion of this Practical Design Guide (ED 6 March 15, 1970) introduced resolver-to-digital angle converters, described octant selection circuitry and detailed Type I converters which require precision RC networks for stable operation.

Unlike the Type I design, the Type II converters presented here require octant selection circuits. This method of encoding resolver output signals is based on the operation of standard resolver bridges. It is also referred to as the automatic or self-balancing resolver bridge.^{10 to 17}

The type II converter's octant selection network generates V_X' and V_Y' (resolver bridge inputs), plus ϕ_C (the three most significant bits of digital angle ϕ) while the remaining circuitry provides ϕ_F (the n-3 significant bits of digital angle ϕ). Note that $\phi = \phi_C + \phi_F$ (Fig. 11).

The output signals of a resolver, V_X and V_Y , can be converted into a digital angle ϕ in the following way. ϕ_F is processed into two signals, $\sin\phi_F$ and $\cos\phi_F$, by two function generators. These function generator outputs are multiplied with the outputs of the resolver. Since V_X is proportional to $K \cos\theta$ and V_Y is proportional to $K \sin\theta$, the outputs of the two multipliers are

$$V_1 = K \cos\theta \sin\phi_F \text{ and } V_2 = K \sin\theta \cos\phi_F \quad (18), (19)$$

where θ is the resolver shaft angle and ϕ the output of the converter. V_1 and V_2 are then subtracted to give the error voltage

$$\Delta V = V_1 - V_2 = K \sin(\theta - \phi_F) \quad (20)$$

From Eq. 20 it can be seen that if the output angle ϕ_F is larger than the resolver angle θ , presented by V_X and V_Y , ΔV will be negative, or if ϕ_F is smaller than θ , ΔV will be positive. The error voltage, ΔV , indicates whether the digital number representing ϕ_F must be increased, decreased, or is a correct presentation of the resolver angular position.

Numerous implementations of this basic principle are possible. Each incorporates an octant selection circuit, resolver bridge, amplifier, threshold detector and digital logic circuits. Because these five basic circuits can be built in several ways and the number of alternate combinations is large, only the important variations in the basic principle will be described here.

To produce the binary number ϕ_F , the error voltage ΔV , must be converted into the digital error signals $+\Delta\phi_F$ and $-\Delta\phi_F$. ΔV can be either a dc or an ac voltage. The method described here assumes that ΔV is an ac voltage.

The circuit in Fig. 12 sums the multiplier output voltages V_1 and V_2 into the error voltage, ΔV , with a conventional operational amplifier, which also multiplies ΔV by a constant, K . K is chosen so that the magnitude of the threshold voltages, V_{Th} , di-

Adapted from ELECTRONIC ANALOG/DIGITAL CONVERSION by Hermann Schmid, Copyright © 1970 by Van Nostrand Reinhold Company, by permission of Van Nostrand Reinhold Company.

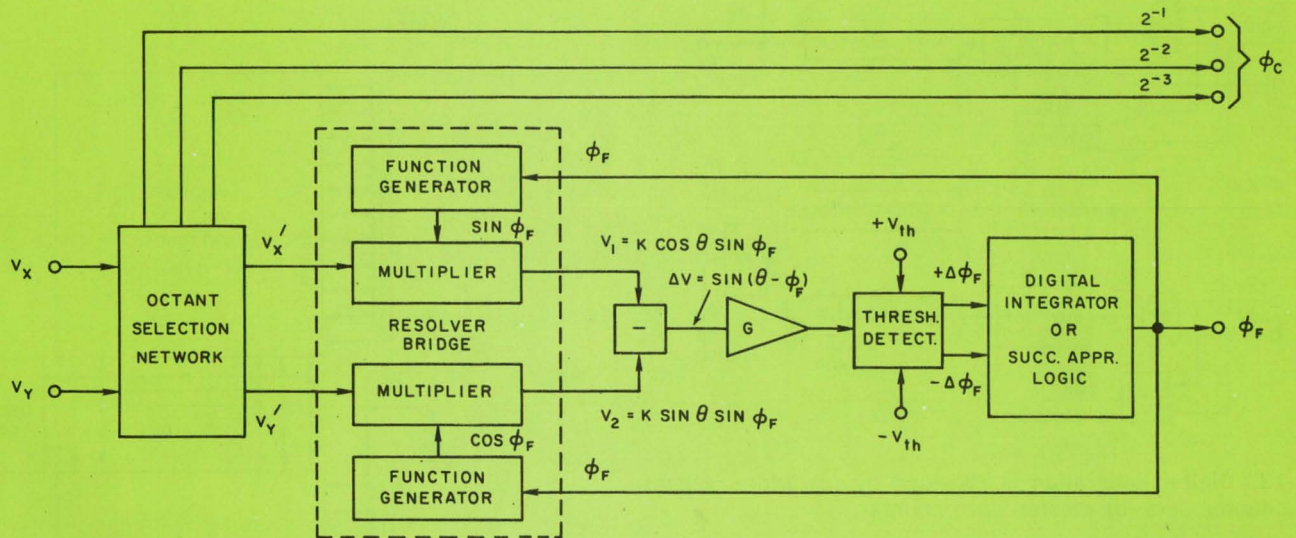

11. Type II converter employs resolver bridges in an analog/digital feed back system.

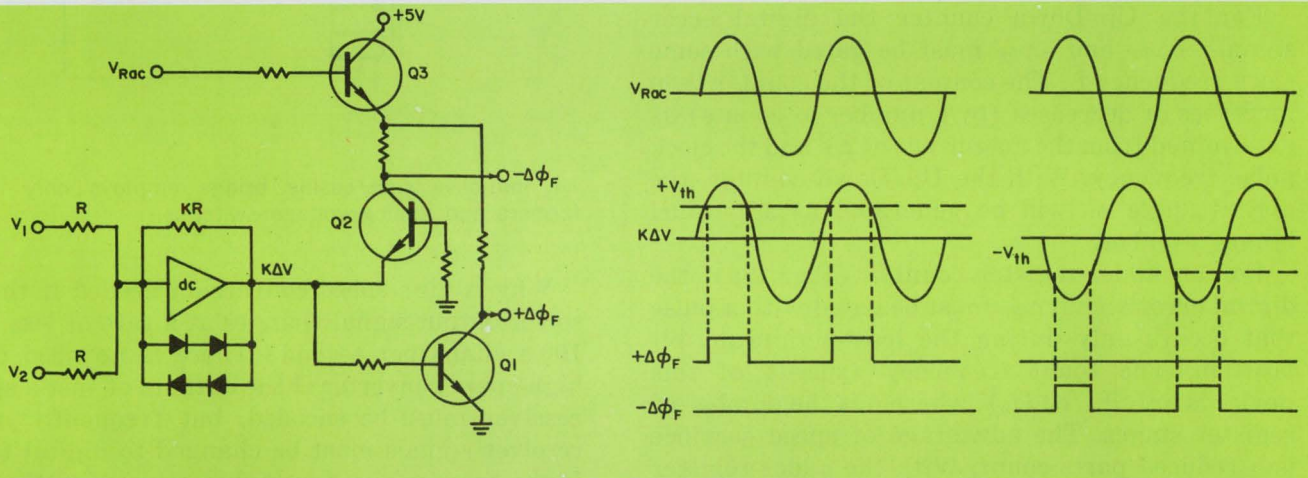

12. Digital error generation is provided by summing multiplier output voltages V_1 and V_2 . Q_1 and Q_2 are

threshold detectors providing $+\Delta\phi_F$, and $-\Delta\phi_F$ as output signals.

vided by K is equal to the magnitude of one least-significant bit of output signal. For example, if the resolution of the converter is 12 bits and the maximum value of the input signal 10 V, then the least-significant bit is equal to 2.5 mV.

With $V_{Th} \approx 750$ mV, the gain of the ac amplifier must be approximately $750 \text{ mV}/2.5 \text{ mV} = 300$. The output of the ac amplifier drives the two threshold detectors, Q_1 and Q_2 . When the ac voltage $K\Delta V$ is larger than +0.75 V, Q_1 turns ON; when $K\Delta V$ is smaller than -0.75 V, Q_2 turns ON; and when $K\Delta V$ is between +0.75 V and -0.75 V, both transistors are turned OFF.

The design must assure that $+\Delta\phi_F$ does not become ONE during the positive portion of the sine wave and that $-\Delta\phi_F$ does not become ONE during the negative portion. To account for this, Q_3 connects the +5-V power supply to both Q_1 and Q_2 ,

but only during the positive half of the ac reference voltage. The three transistors now perform as a phase-sensitive error detector. In addition, the ON-time of the digital error signals, $+\Delta\phi_F$ and $-\Delta\phi_F$, will change as a function of the ΔV amplitude (Fig. 12). This means the error detection circuit maintains proportional control. If ΔV is large, the $\Delta\phi_F$ ON time will be large; if ΔV is small, the $\Delta\phi_F$ ON time will be small.

The following methods process the threshold detector output into the binary number ϕ_F .

■ *The digital integrator method.* The simplest method of generating a binary number ϕ_F from the digital error signal $\Delta\phi_F$ is to accumulate the error signals in a digital integrator, so that

$$\phi_F = \sum \Delta\phi_F \Delta t \quad (21)$$

where Δt is a basic time unit, such as the period of

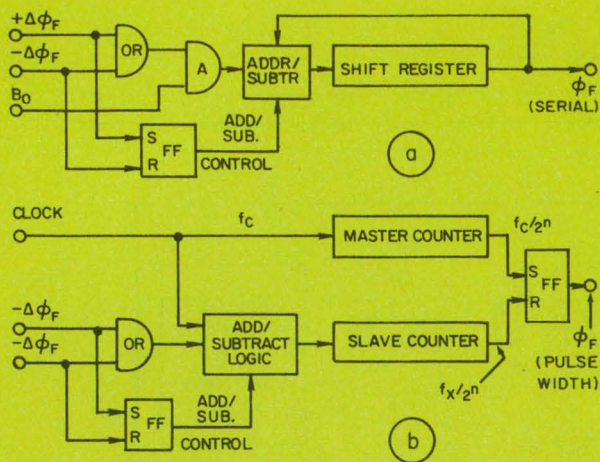

13. Digital integration is provided by (a) adder-register counter and (b) master-slave counter.

a clock pulse. At least three types of counting systems which serve as digital integrators are available. They are the Up/Down, adder-register, and master-slave.

For the Up/Down counter the digital error signals $+\Delta\phi_F$ and $-\Delta\phi_F$ must be gated with some clock frequency f_c . The content of the counter then increases or decreases (by a number of counts) as determined from the magnitude of ΔV and the clock pulse frequency. With the Up/Down counter, the digital angle ϕ_F will be generated as a parallel binary number.

For an adder-register counter (Fig. 13a), the digital error signal $\Delta\phi_F$ must be gated with a pulse that occurs only during the least-significant bit position. The count frequency (speed) of this device is only $(1/n)(f_c)$, where n is the number of register stages. The advantage of speed sacrifice is a reduced parts count. With the adder-register counter, the output signal ϕ_F is in serial binary form.

For the master-slave counter combination (Fig. 13b), $+\Delta\phi_F$ and $-\Delta\phi_F$ can be utilized directly the way they are. Although this method of integrating has severe frequency limitations, it is fast enough for this application since error signals are generated only once every cycle. Because this type of integrator has a pulse-width signal output, it can be used only when the sine and cosine function generators can accept pulse-width signals as input.

■ *The successive-approximation method.* All of the circuit designs using digital integrators can follow small input signal changes quickly, but become slew-limited with large input signal deviations. The successive-approximation approach overcomes this difficulty by comparing the internally generated angle ϕ_F with the data representing the resolver angle θ on a bit-by-bit basis, starting with the most significant bit first. With this technique a resolver output signal can be encoded in a fraction of one ac cycle.

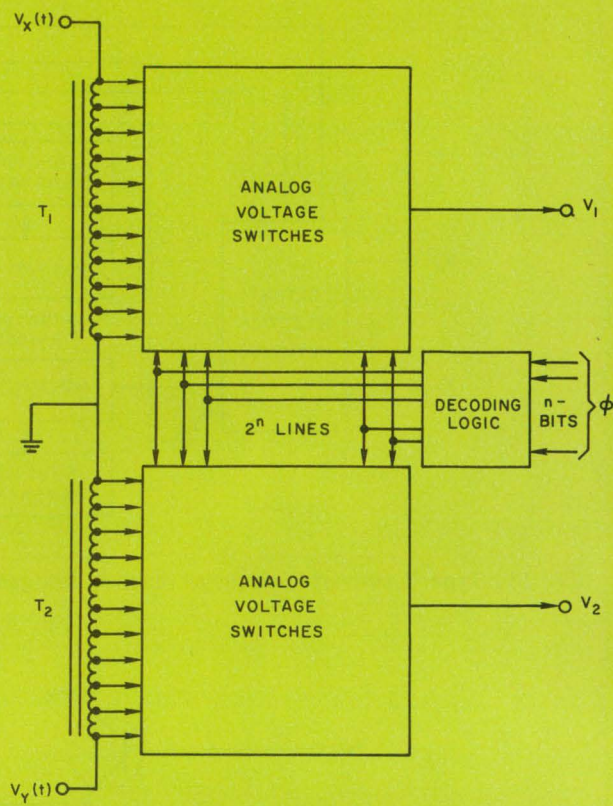

14. Inductive sine/cosine bridge employs only transformers and analog voltage switches.

Why is high-speed conversion needed if the resolver output signal changes at a rate of less than 100 radians per second? There is no need for a high-speed converter if the outputs of just a single resolver must be encoded, but frequently many resolver signals must be changed to digital form. If the encoder speed is high compared to the rate of change of the resolver signals, one a/d converter can be time-shared between all resolver output signals, thus reducing the cost per conversion.

For further processing of the resolver output signal, a resolver bridge is required. The inductive sine/cosine bridge, resistive sine/cosine bridge and tangent bridge can all perform this task. Tradeoffs between accuracy, stability and size determine the designer's final choice.

Resolver bridge produces error voltage

The purpose of the automatic resolver bridge is to process the octant-selected resolver output signals $V_{X'} = K \cos\theta$ and $V_{Y'} = K \sin\theta$, into voltages V_1 and V_2 , which represent the trigonometric cross products defined in Eqs. 18 and 19, respectively. These two voltages are then added or subtracted to produce the digital error voltage ΔV . The automatic resolver bridge is comprised of two function generators and two multipliers (Fig. 11). Normally, one function generator and one multiplier

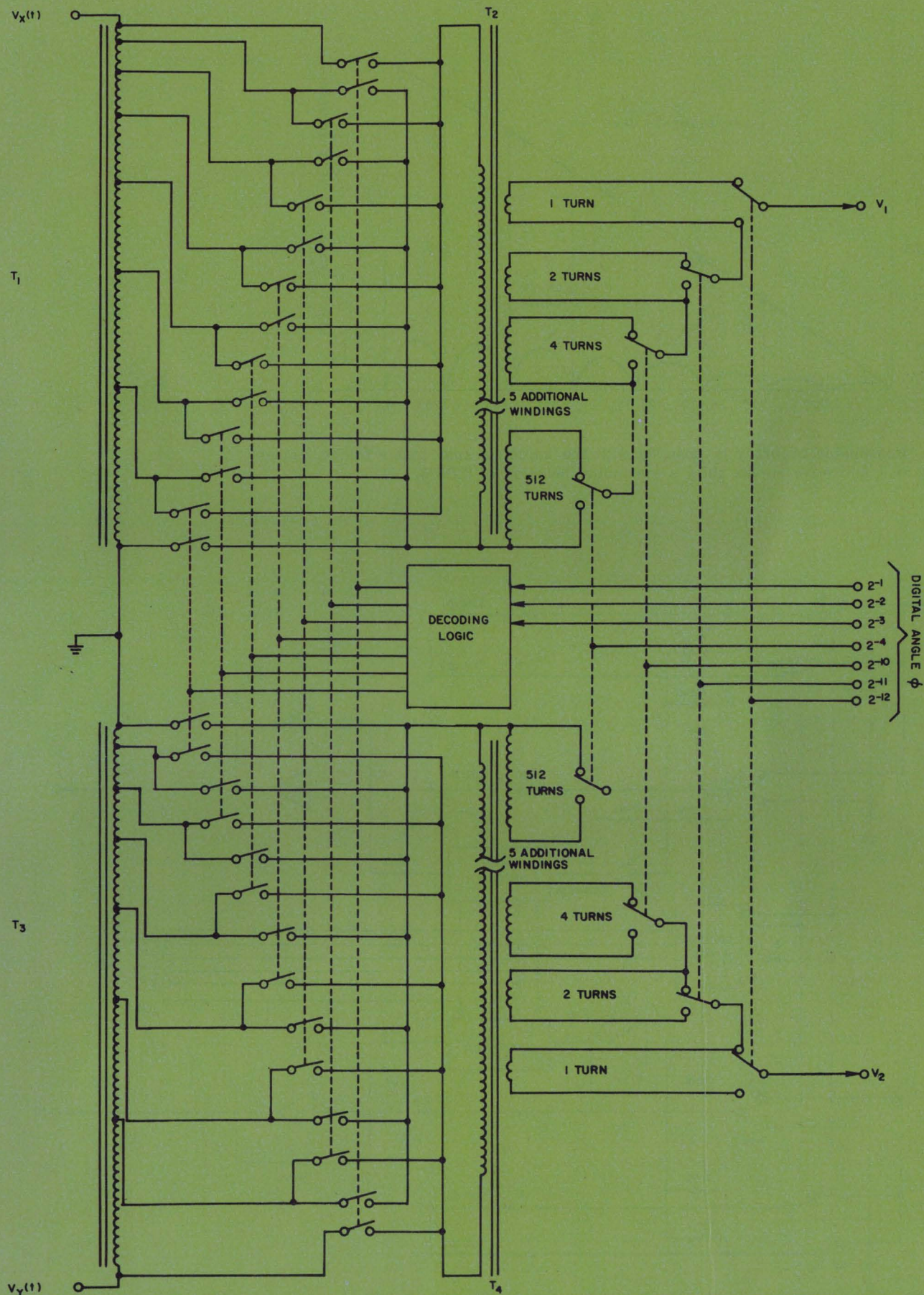

15. Linear interpolation between neighboring tap voltages on the primary transformer (T_1 , T_3) is provided

by interconnection with the multiwinding transformer (T_2 , T_4).

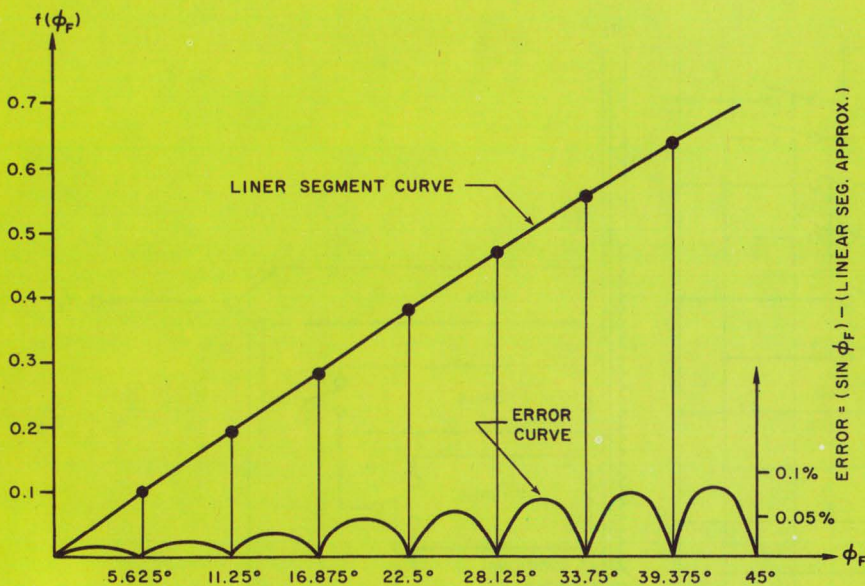

16. Reasonable accuracy is possible with the inductive sine/cosine bridge. Linear-segment and error curves show a maximum deviation of 0.08%.

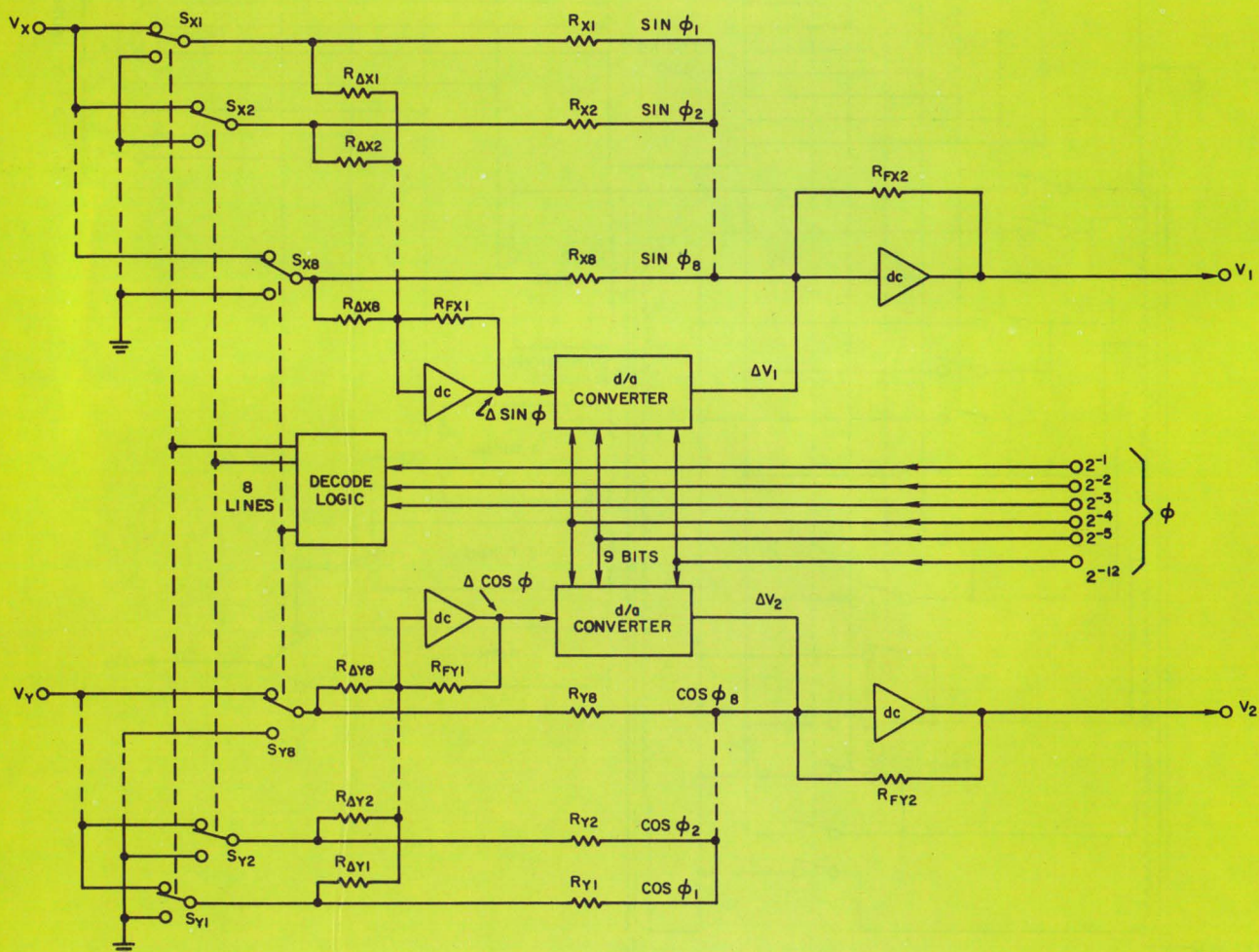

17. Resistive sine/cosine bridge is compact but lacks the accuracy and stability of transformer designs.

are combined into a single unit.

For the purpose of illustration, assume that the cosine-function generator and its multiplier are replaced by a sine-function potentiometer, and that the sine-function generator and its multiplier are replaced by a cosine-function potentiometer. Both potentiometers are connected to the same shaft ϕ . If V_X is now connected across the sine potentiometer and V_Y across the cosine potentiometer, then the wiper outputs are:

$$V_1 = V_X \sin\phi, \quad V_2 = V_Y \cos\phi \quad (22), (23)$$

This is another form of writing Eqs. 18 and 19.

Practical automatic resolver bridges are just electronic analogies of this sine and cosine potentiometer arrangement.

The inductive sine/cosine bridge

One popular approach, the inductive sine/cosine bridge employs only transformers and analog voltage switches (Fig. 14). In its simplest form, an inductive divider is an autotransformer, permitting the selection of precise, predetermined ratios of output to input voltage.

Taps are provided on each transformer so that obtainable ratios are related to each other by the sine or cosine function. Since the number of usable taps is limited, additional resolution must be obtained by connecting a multiwinding transformer, or a resistive voltage divider, across two adjacent taps of the first transformer (Fig. 15). This permits linear interpolation between the voltages of two neighboring taps of the primary transformer. With the voltage on each tap representing the breakpoint of the linear-segment curve or the value of the function, $f(\phi_i)$ at some fixed argument ϕ_i , any ratio set up on the second transformer will perform linear interpolation, since

$$f(\phi) = f(\phi_i) + \Delta\phi_i \frac{f(\phi_{i+1}) - f(\phi_i)}{\phi_{i+1} - \phi_i} \quad (24)$$

where $\Delta\phi_i$ is defined as $\phi - \phi_i$. With this technique reasonably accurate sine and cosine functions can be generated from linear segments, as shown in Fig. 16.

Arranging the taps on auto transformer T_1 according to a sine function and the taps on auto transformer T_3 according to a cosine function, with V_X across T_1 , and V_Y across T_3 , produces voltages at the taps that can be expressed as

$$V_{1i} = V_X \sin\phi_i \quad \text{and} \quad V_{2i} = V_Y \cos\phi_i. \quad (25) (26)$$

As a compromise between practical design and high resolution, assume ϕ_i takes on the values of $0^\circ, 5.625^\circ, 11.25^\circ, 16.875^\circ, \dots$ up to 45° . Each primary of multiwinding transformers T_2 or T_4 , can be connected across any adjacent pair of T_1 or T_3 autotransformer taps by energizing one of the seven pairs of single-pole switches. The volt-

ages produced across the T_2 or T_4 primaries are

$$V_{P1} = V_{1(i+1)} - V_{1i} = V_X (\sin\phi_{i+1} - \sin\phi_i) \quad (27)$$

$$V_{P2} = V_{2(i+1)} - V_{2i} = V_Y (\cos\phi_{i+1} - \cos\phi_i). \quad (28)$$

The multiwinding transformers are similar to those used in digital-to-ac converters where the turns ratios between the secondary windings are 1, 2, 4, 8, etc. The two multiwinding transformers in Fig. 15 are assumed to have nine secondary windings with 1, 2, 4, . . . to 512 turns. Any combination of these windings can be interconnected with the nine single-pole, double-throw switches, to generate any desired fraction of the primary voltage within the nine-bit resolution. If the nine least-significant bits of the digital angle ϕ are expressed as $\Delta\phi$, then the voltage across the selected combination of secondary windings becomes

$$\Delta V_1 = V_{P1} \Delta\phi, \quad \Delta V_2 = V_{P2} \Delta\phi. \quad (29), (30)$$

Substituting Eqs. 25, 27 and 29 into Eq. 24, and assuming that $\phi_{i+1} - \phi_i = 1$, gives

$$V_1 = V_X [\sin\phi_i + \Delta\phi (\sin\phi_{i+1} - \sin\phi_i)] \quad (31)$$

which can be approximated by $V_1 \approx V_X \sin\phi$.

Similarly, substitution of Eqs. 26, 28 and 30 into Eq. 24 gives

$$V_2 = V_Y [\cos\phi_i + \Delta\phi (\cos\phi_{i+1} - \cos\phi_i)] \quad (32)$$

or $V_2 \approx V_Y \cos\phi$.

So it has been proved that a pair of switched transformers can perform the operation of a function generator and multiplier. Extremely high accuracies are possible with the inductive resolver bridge if precision toroidal transformers and matched transformer-coupled switches with low ON resistance are used. Accuracies of 1 part in 20,000 are claimed¹⁸.

The resistive sine/cosine bridge

Figure 17 illustrates that the resolver-bridge function can also be performed with resistors and analog voltage switches. Due to the inherent tolerances, plus temperature, life and load instabilities, a bridge circuit using resistors can never be as accurate and stable as a design using transformers. The resistive bridge does have size and weight advantages, especially if thin film resistors and MOSFET switches are used.

The resistive bridge consists of two linear-segment function generators with parallel-binary input and analog output. Each of these linear-segment function generators is comprised of two resistor groups. One resistor group (R_{X1} to R_{X8} or R_{Y1} to R_{Y8}) generates the values of the function $f(\phi_i)$ at the breakpoints on the linear segment curve, and the other resistor group ($R_{\Delta X1}$ to $R_{\Delta X8}$ or $R_{\Delta Y1}$ to $R_{\Delta Y8}$) determines the slope between adjacent breakpoints.

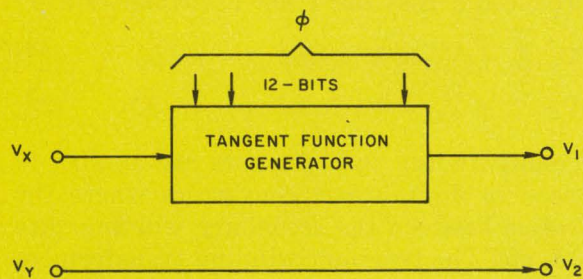

18. Tangent resolver bridge eliminates half the hardware associated with sine/cosine bridges.

Two sets of switches (S_{X1} to S_{X8} and S_{Y1} to S_{Y8}) connect the input voltages (V_X and V_Y) to the four resistor networks. Only one switch is closed in each set at a time, so that V_X and V_Y are connected to just one resistor in each group. The two sets of eight switches are controlled from the three most-significant bits of the parallel binary word that represents the digital angle ϕ . The three bits are converted into octal form, by conventional decoding logic. The logic outputs are eight switch control lines, of which only one is energized at a time.

Each junction of the four resistor sets is connected to the summing point of an operational amplifier. The current flowing into each summing point and the associated amplifier output voltage is a function of the selected resistor value and the amplitude of V_X or V_Y . The values of R_{Xi} and $R_{\Delta Xi}$ are chosen to generate amplifier output voltages representing the breakpoints and slopes of an eight-segment sine function. The values of R_{Yi} and $R_{\Delta Yi}$ are selected to generate the cosine-function breakpoints and slopes.

The slope voltages [$f'(\phi)$] must first be multiplied with $\Delta\phi$ before they can be added to the breakpoint voltages [$f(\phi_i)$] since

$$f(\phi) = f(\phi_i) + \Delta\phi f'(\phi) \quad (33)$$

where $\Delta\phi$ is defined again as

$$\Delta\phi = \phi - \phi_i \quad (34)$$

The multiplication of $f'(\phi)$ by $\Delta\phi$ is executed by the d/a converter, where $f'(\phi)$ is the analog input (usually the reference voltage) and $\Delta\phi$ is the nine-bit parallel digital input. The output of the d/a converter is an analog voltage (ΔV_1 or ΔV_2) that can be added directly to $f(\phi_i)$ by connecting it to the summing point of the operational amplifier. Adding ΔV_1 or ΔV_2 to the function's breakpoint value allows the desired interpolation between breakpoints.

The two linear-segment function generators (Fig. 16) generate the sine and cosine functions while performing the multiplications (V_X) ($\sin\phi$) and (V_Y) ($\cos\phi$), regardless of whether V_X and V_Y are ac or dc voltages. The output voltages of this resistor bridge are

$$V_1 = K_X V_X \sin\phi, \quad V_2 = K_Y V_Y \cos\phi \quad (35), (36)$$

where K_X and K_Y are scaling constants determined by the feedback resistors of the four amplifiers.

The tangent resolver bridge

Almost half the hardware required to build either the inductive or resistive sine/cosine bridges can be eliminated if the sine and cosine function generators are replaced with one tangent generator.^{14, 15}

A tangent-function generator is no more complex than a sine or cosine-function generator if the argument ϕ is kept between 0° and 45° . In this range the tangent is well behaved and varies between zero and unity. Use of the tangent-function generator can be justified by dividing the expression for V_1 and V_2 by $\cos\phi$ hence

$$V_1 = V_X \sin\phi / \cos\phi = V_X \tan\phi \quad (37)$$

$$V_2 = V_Y \cos\phi / \cos\phi = V_Y \quad (38)$$

As illustrated in Fig. 18, the only resolver output signal V_X is processed by the tangent-function generator, whereas V_Y is the output signal V_2 . The tangent function generator can be designed with transformers (Fig. 15) or with resistors (Fig. 17).

The linear resistor bridge

In the sine/cosine resolver bridge just described, considerable effort was spent generating precise sine and cosine functions. The exact values of the sine and cosine functions, however, are not critical. Of great significance is the ratio of these two functions since this ratio contains the transmitter information. This ratio is a tangent function that must be determined with high precision. The theory behind this approach says the bridge needs to be accurate only when the digital angle ϕ becomes equal to the resolver angle θ . That is when

$$\cos\theta \sin\phi - \sin\theta \cos\phi = 0 \quad (39)$$

or when

$$\frac{\sin\theta \cos\phi}{\cos\theta \sin\phi} = \frac{\tan\theta}{\tan\phi} = 1 \quad (40)$$

The problem is finding two functions $f_1(\phi)$ and $f_2(\phi)$ that can be generated by linear circuit means and that satisfy the condition

$$f_1(\phi)/f_2(\phi) = \tan\phi \quad (41)$$

Intuition predicts that

$$f_1(\phi) = \frac{1}{1 + 1/K\phi} \quad (42)$$

and

$$f_2(\phi) = \frac{1}{1 + 1/[K(90^\circ - \phi)]} \quad (43)$$

are two such functions, because their ratio is 0, 1 and ∞ when ϕ equals 0° , 45° and 90° (regardless

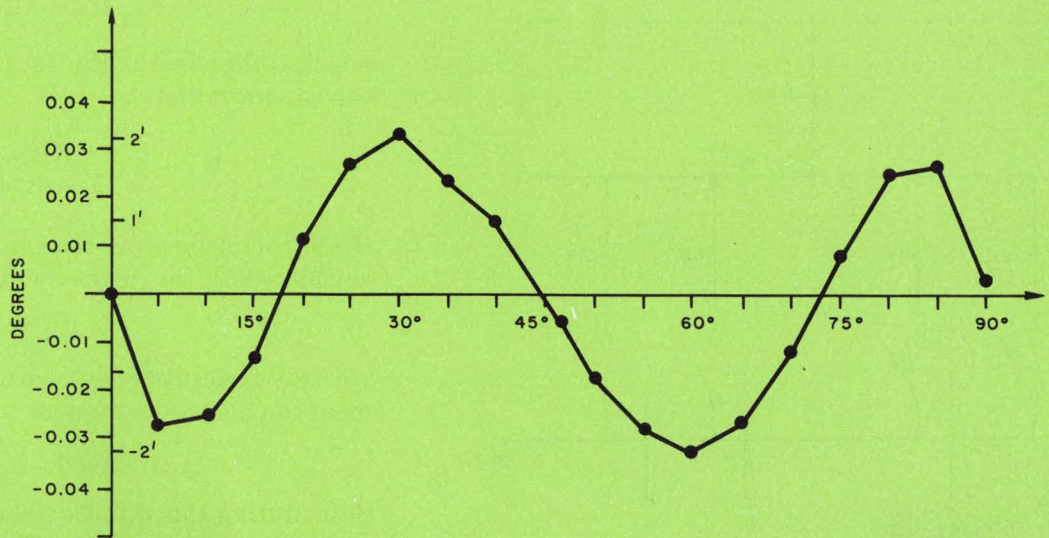

19. Tangent function is approximated within $\pm 0.03^\circ$ with $K=0.006$ per Eqs. 42 and 43.

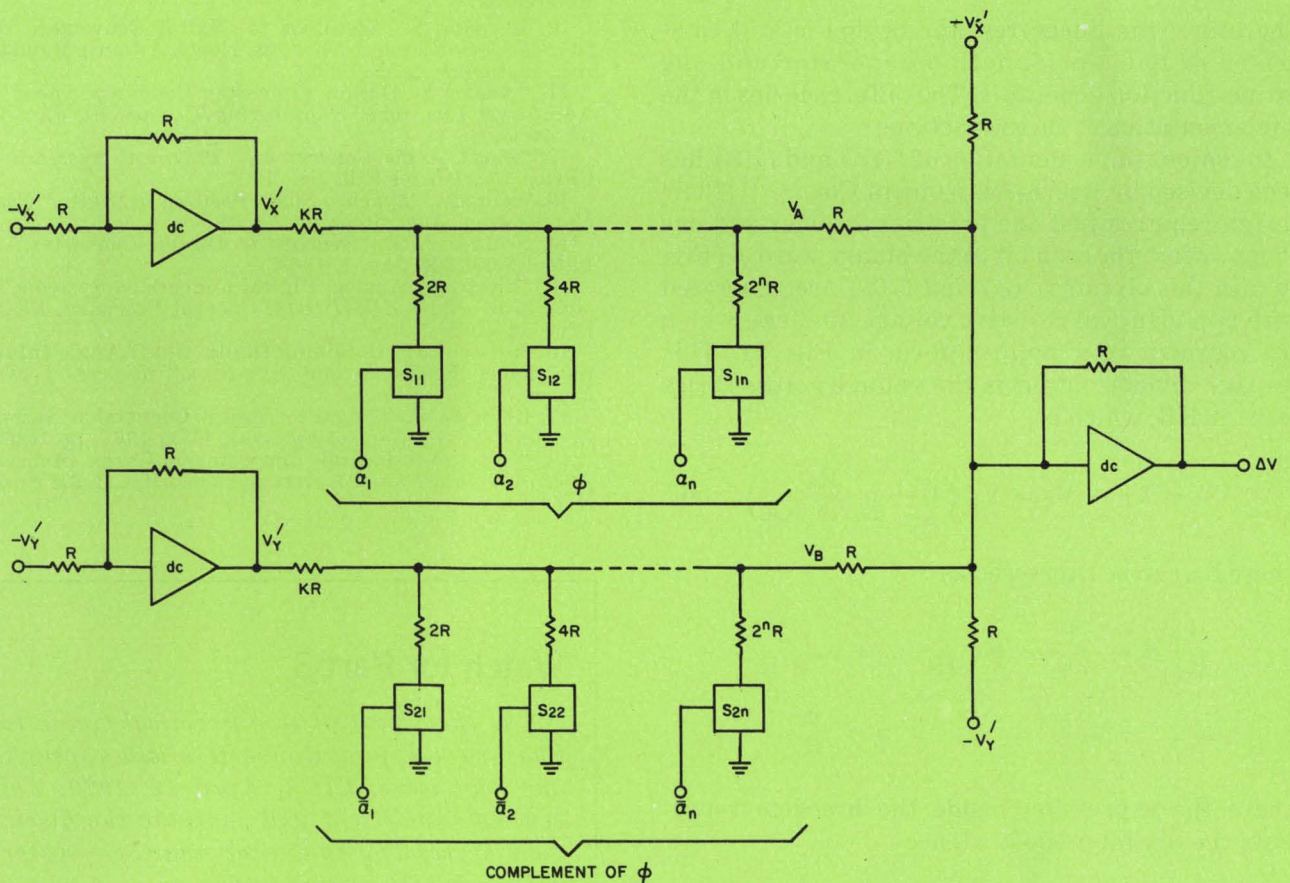

20. Single resistor and shunt switch are all that's required for each bit in the binary word ϕ with this design.

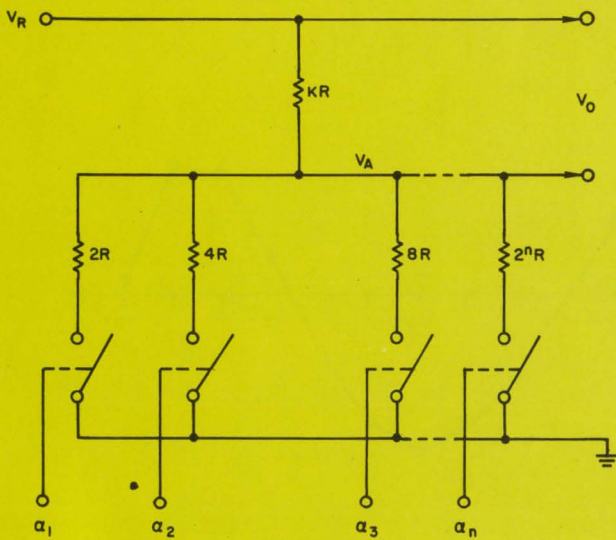

21. Resistive voltage divider of Fig. 19 is shown in simplified form.

of the value of K). Selecting the value of K in Eqs. 42 and 43 equal to 0.006 approximates the tangent function to within $\pm 0.03^\circ$ from $\phi = 0^\circ$ to $\phi = 90^\circ$ (Fig. 19).

The derivation above also implies that

$$f_1(\phi) \approx K \sin \phi \quad \text{and} \quad f_2(\phi) \approx K \cos \phi. \quad (44), (45)$$

Therefore, the linear resistor bridge is still comprised of one sine-function generator and one cosine-function generator. The difference lies in the implementation of these functions.

Ingenuous implementation of $f_1(\phi)$ and $f_2(\phi)$ has been devised by Reeves Instrument Corp.^{16, 17} Their design requires just one precision resistor and one shunt switch for each bit in the binary word ϕ (Fig. 20). In this circuit $f_1(\phi)$ and $f_2(\phi)$ are generated with two identical resistive voltage dividers, which are redrawn in simplified form in Fig. 21. This resistor divider output is the voltage across series resistor KR , which is

$$V_{o1} = V_R - V_A = V_R \left(1 - \frac{R_\phi}{R_\phi + KR} \right) \quad (46)$$

where R_ϕ can be expressed as

$$\begin{aligned} \frac{1}{R_\phi} &= a_1 \frac{1}{2R} + a_2 \frac{1}{4R} \dots + a_n \frac{1}{2^n R} \\ &= \frac{1}{R} (a_1 2^{-1} + a_2 2^{-2} \dots + a_n 2^{-n}) = \frac{\phi}{R} \end{aligned} \quad (47)$$

where the expression inside the brackets represents the digital angle ϕ . Hence

$$R_\phi = R/\phi \quad (48)$$

substituting Eq. 48 into 46 gives

$$V_{o1} = V_R \left(1 - \frac{R/\phi}{R/\phi + KR} \right) = \frac{K\phi}{1 + K\phi} \quad (49)$$

which is the same as Eq. 42. In a similar fashion it can be shown that

$$V_{o2} = V_R \frac{K(\phi_{\max} - \phi)}{1 + K(\phi_{\max} - \phi)} \quad (50)$$

if the complement of the binary number (i.e., $\bar{\phi}$) is controlling the shunt switches, S_1 to S_n , and if

$$\bar{\phi} = \phi_{\max} - \phi \quad (51)$$

where ϕ varies between zero and unity, the complement can also be written as

$$\bar{\phi} = 1 - \phi. \quad (52)$$

Substituting this into Eq. 50 results in Eq. 43. The two resistor networks in Fig. 20 are thus proved capable of generating the two functions $f_1(\phi)$ and $f_2(\phi)$.

Because the outputs from the two voltage dividers (V_{o1} and V_{o2}) appear across the series resistors KR_1 and KR_2 , the subtraction $\Delta V = V_{o1} - V_{o2}$ requires special handling. The simplest method is to subtract $V_{X'}$ from V_A and $V_{Y'}$ from V_B by connecting $-V_{X'}$ and $-V_{Y'}$ to the voltage dividers (Fig. 20). The voltages $-V_{X'}$ and $-V_{Y'}$ are the buffer amplifier inputs and are readily available. ■ ■

References:

10. Herman, S., "Resolver to Digital Converter, Model 545," *Technical Report No. 1008*, North Atlantic Industries, Inc., Plainview, N.Y., 1966.
11. "Analog to Digital Converter Combines Speed with Accuracy," *Electronic Engineering Equipment*, Jan. 1968, pp. 44-48.
12. "Shaft Angle Converters," *Technical Specifications*, Clifton Co., Drexel Hill, Pa., 1967.
13. Wang, A., "Synchro Shaft Position to Digits," *Control Engineering*, Aug., 1968, pp. 71-72.
14. Schroeder, G., "Synchro to Digital Converter," U.S. Patent 3,071,324, Jan. 1, 1963.
15. "Electronic Analog/Digital Conversion Systems," *Capability Brochure EDMDD-15*, General Precision, Kearfott Division, 1962.
16. Carlstein, J., "Obtaining Digital Shaft Angle Information From Resolvers and Synchros," *Reeves Technical Report*.
17. Klein, G. P., "Angle to Digital Conversion Systems," *Instruments and Control Systems*, Feb., 1967, pp. 126-130.
18. "Synchro-to-Digital Converter-on-Cards Model No. A6025A," *Data File 125*, Astrosystems, Inc., Lake Success, N.Y.

Watch for Part 3

The third part of this Practical Guide for Synchro-to-Digital Converters will appear in our next issue, ED 8, April 12, 1970. This coming installment will continue the discussion of resolver-to-digital angle converters with Type III converter design.

HIGH POWER PULSE GENERATORS

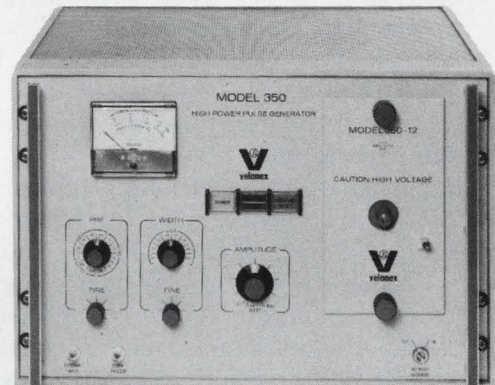
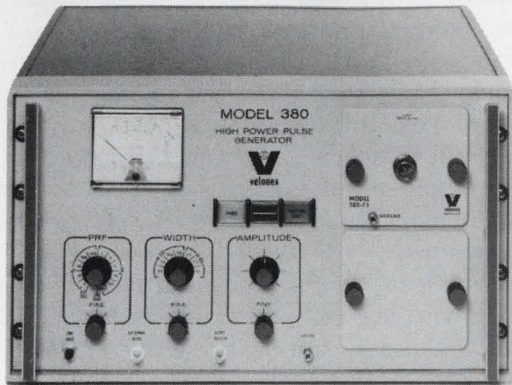

50 to 500 V @ 10 A 100 Amp @ 50 V 1 KV @ 5 A	Output Voltage (Pulse)	0 to 2,100 V @ 10.5 A 400 Amp @ 40 V 19 KV @ 0.95 A
5 KW	Output Power (Peak)	22 KW*
< 8 NS†	Rise Time	< 30 NS†
< 11 NS†	Fall Time	< 50 NS†
25 NS to 25 μS	Pulse Width	0.1 μS to 300 μS
< 3% @ max. pulse width	Drop	< 3% or 0.05% per μS
< 5%	Overshoot	< 5%
Negligible	Ripple on Pulse Top	Negligible
1% @ 5 KW peak	Duty Factor	1% @ 22 KW peak, 5% @ 4.2 KW peak
3 pps to 400,000 pps, plus manual (single pulse)	Pulse Repetition Rate	3 pps to 100,000 pps (for high duty-factor bursts, ask about Model 570)
\$4,500	PRICE	\$3,990

†Rise and Fall Times variable with accessory plug-in units * 26 KW @ 0.1% duty factor

Here are the finest versatile, high power, clean waveform pulse generators for testing noise susceptibility, developing semiconductor microwave devices and LEDs, pulsing lasers, ultrasonic investigations, and for many forms of laboratory research. The specifications tell the story and Velonex guarantees them.

For data application notes on precision High Power Pulse Generators, including

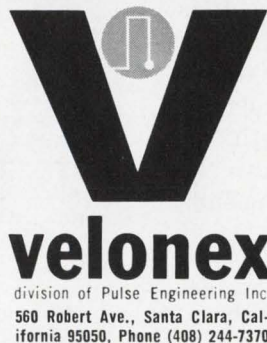

information on a wide selection of accessory plug-ins, write or call Velonex.

Also available upon request is information on Velonex Precision bench, rack, and "NIM" bin High Voltage Power Supplies, featuring digital voltage settings; as well as corona-free Miniature DC to DC Power Supplies, designed to withstand aerospace environments.

System design means trade-offs,

as shown by this one designer's approach to a state-of-the-art airborne computer.

The system designer is faced with the problems of system requirements, design philosophy and cost and delivery schedules. And the tools he uses to solve these problems include an evaluation of trade-offs between conflicting needs based on the current state-of-the-art.

An example of how the system engineer approaches his job is the design of a master computer for the Short Range Attack Missile (SRAM). Although a military system design of this type contains unique features not usually found in commercial systems, such as environmental and reliability specifications, the design process is similar in many respects.

The primary mission of this particular airborne digital computer is to perform aircraft navigation and missile fire-control computations. However, it must also incorporate enough design flexibility to be able to accept new mission requirements, and it must interface with other avionic components. Because of this last requirement, the first design decision made was to separate conversion electronics from the central computer.

System trade-offs required

Among the many compromises to consider were the number of modules vs volume and weight; memory capacity vs physical size; word length vs precision and efficient use of memory; and arithmetic operations vs speed of computation. In most cases speed or precision or some other aspect of computation is limited by a non-computational requirement such as size or cost. But in this case the computer must also fly. It is up to the system designer to find the answer.

The first computer characteristic to be determined is word length. This choice is influenced by both instruction and data word-length requirements, and the two may not always be compatible. The instruction word length depends upon the number of different instructions, larg-

est block of memory to be accessed directly, and indexing and indirect addressing. Data word length is primarily a function of computational precision required. Since the memory has by far the strongest influence on the cost and complexity of an aerospace computer, the prime objective in the choice of the word length is to minimize total memory capacity through efficient use of the memory.

An analysis of guidance and control functions has shown that data word length in the range of 24 to 32 bits is adequate. With a 24-bit word most computations can be performed in single precision, requiring only a small percentage of double precision computations. A 32-bit data word permits practically all computations to be performed in single precision, but, since most computations do not require such high precision, a 32-bit word would result in inefficient utilization of computer memory.

The designer has two basic choices: he can have the instruction word length identical to the data word length, or he can shorten it to half the size of the data word and pack two instructions into each memory word.

The latter scheme, generally referred to as a split-word or half-word instruction, may appear to offer some savings in storage and has been adapted in some aerospace computer designs. However, the number of bits in the instruction

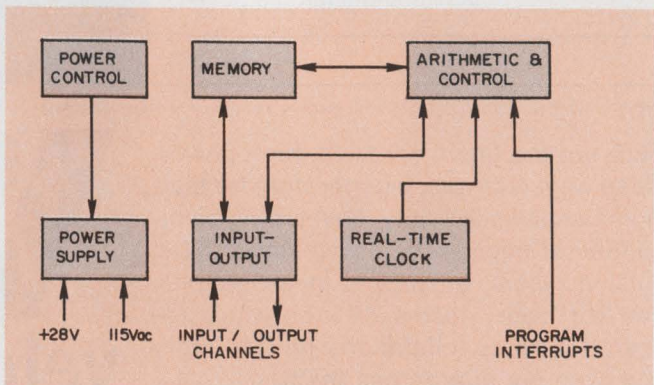

1. All components of the computer system are inter-related in this over-all block diagram.

is limited. As a result, such designs have several shortcomings: the number of instructions is limited; only part of the memory can be addressed directly; and address modification options such as multiple indexing or indirect addressing are limited. These serious programming constraints add more instructions to the total program, thus reducing the expected memory savings and increasing the software costs due to programming complexity.

Thus, for this design a 24-bit instruction and data word length was chosen. Double precision arithmetic for add, subtract, store and fetch op-

erations was incorporated to provide adequate speed for operations requiring more than 24 bits of data.

Design the central processor

Once the word length was chosen, the detailed design of the central processor was initiated. The design goal was to provide an efficient arithmetic and control section capable of meeting typical inertial navigation and fire-control requirements. A basic arithmetic and control section with an adequate instruction set was defined

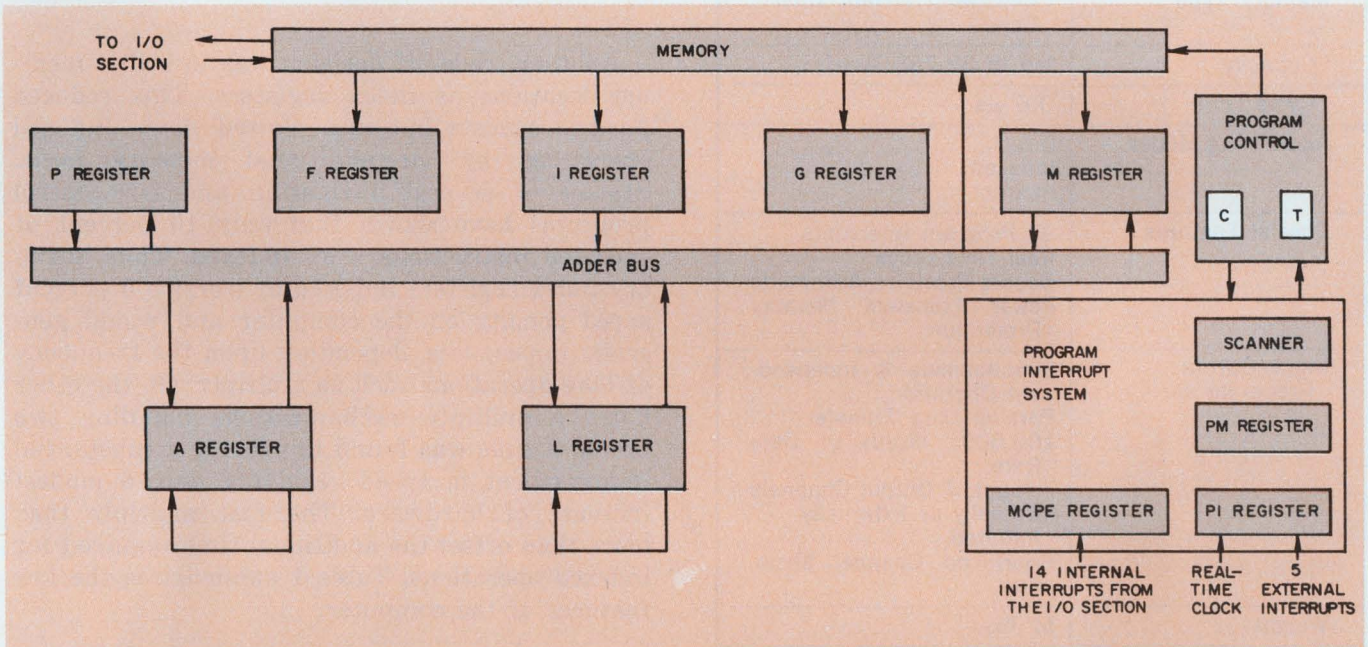

2. The central processor of the computer is made up of the arithmetic and control section and the memory.

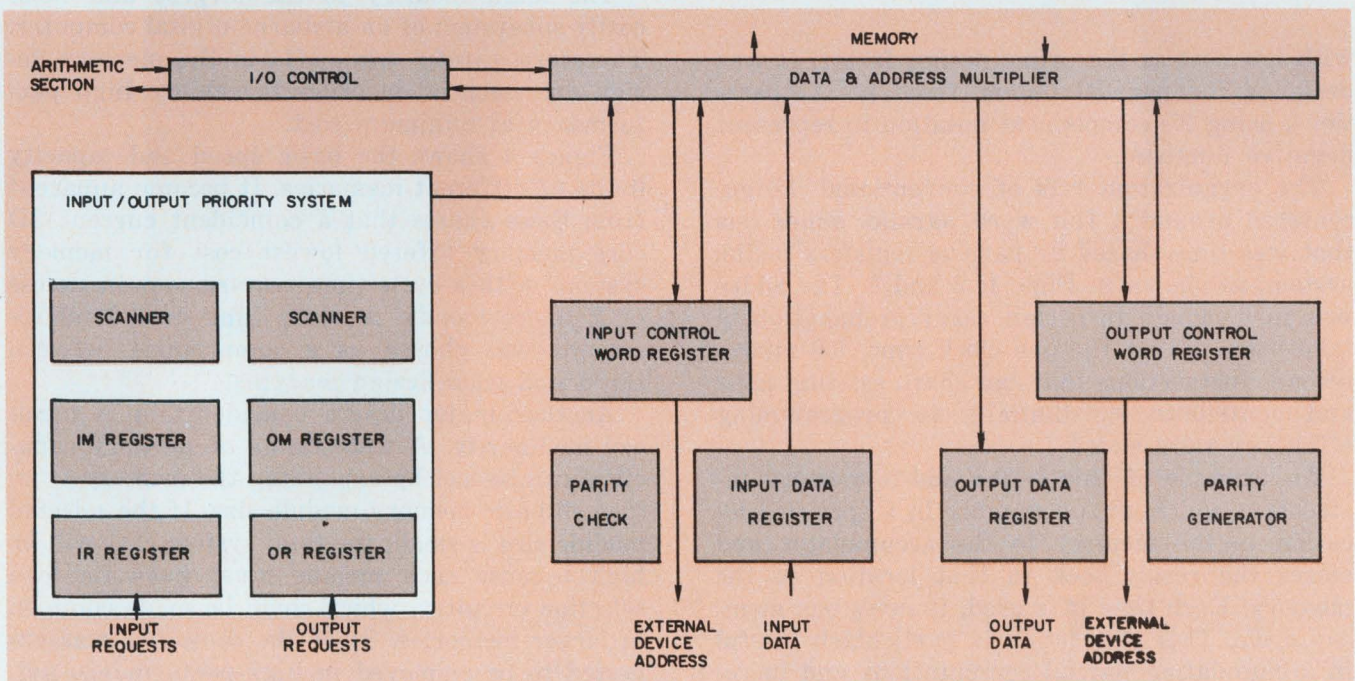

3. The input/output block is the interface between the central processing unit and the outside world.

Table 1. Computer parameters

Organization	General purpose parallel processor
Number System	Binary, Fixed Point 2's Complement
Word Length	24 Bits, Including Sign
Instruction Format	24 Bits, Single Address
Number of Instructions	67
Execution Times	
Add/Subtract	7.2 μ s
Multiply	15.3 μ s
Divide	30.6 μ s
Memory Type	Coincident Current DRO Core
Capacity	Up to 32,768 Words
Cycle Time	3.6 μ s
Addressing Modes	Direct Indexed Indirect
Special Features	20 Program Interrupts Real Time Clock Double Precision Arithmetic Power Transient Memory Protection
Input/Output Processor	Simultaneous & Independent Operation Parallel Data Transfer 100,000 Words/s Data Rate 7 Input, 7 Output Channels Internally or Externally Initiated Prioritized Channel Structure
Weight	52 lbs.
Volume	0.85 cu .in.
Power	225 Watts

with low cost as the prime design factor. It was designed for parallel binary fixed point operations, using 2's complement notation to represent negative numbers.

The organization was of conventional design, centered around a full word parallel adder bus that was time-shared by various registers in the system, as shown in Figs. 1, 2 and 3. The adder was fast enough to permit carry propagation to take place within the one clock time, 0.9 microsecond. Instructions that can share existing logic and contribute substantially to programming efficiency were added.

An example of this is the add-to-memory instruction which adds a number in a specified location in the memory to the accumulator and stores the result back in that location in the memory. Each time it is used, it saves one memory cycle. This instruction is particularly useful in accumulating partial computations and incremental accelerometer data.

Table 2. Comparison of gates

	TTL	DTL
Speed (Gate Propagation Delay)	13 ns	25 μ
Power (per gate)	10 mW	8.5 mW
Noise Margin (at maximum fan-out)	400 mV	375 mV
IC's Required (per system)	N	1.3 N

Another trade-off decision was to utilize memory locations as index registers. This reduced hardware costs but also slowed down indexed operations by an additional memory cycle. Studies of several navigation and fire-control programs have shown that only 10 percent of executed instructions were indexed. Thus, memory index registers imposed at worst a 5 percent speed penalty on the computer and would generally impose less, depending upon the frequency of long operations such as multiply. On the other hand, a multiply mechanizations handling two bits at a time was found to provide a substantial improvement in speed requiring only a modest increase of hardware. The fast multiply then more than offset the additional time required for indexed operations. Table 1 summarizes the key features of the computer.

Consider memory design

The main memory is the largest and most costly subsystem of an airborne digital computer. Therefore, careful trade-offs in the memory design are essential in order to achieve high performance at minimum cost.

Figure 4 shows the basic speed and capacity limits of different memories. It became apparent from these charts that a coincident current 3D core memory offered lowest cost for memory systems with a cycle time requirement in excess of 2 microseconds. A cycle time of 3.6 microseconds was chosen as a compromise between speed and good design margins.

Another major design consideration is memory modularity. A wide range of memory capacities can be met by expanding the memory from a small basic memory module size. If the selected module size is small, the total system cost will be high because each module must have its own selection circuitry, which could be made common in larger memories. Since the computer was expected to be employed in high-performance avionic systems, memory capacities of less than

Table 3. Modules

Module type	No. of modules per computer
Arithmetic	1
Control	1
Power control & clock	1
Digit	3
Selection	2
Current source & timing	1
Input/Output #1	1
Input/Output #2	1
Total	11

12K were not considered. A 16,384 (2^{14})-word design with a single core stack appeared to offer best economy. It required less selection circuitry than several small stacks and was the lowest in cost.

The expansion of up to 32,768 words for future growth was found to be cheapest if additional memory was added in a separate package. Thus, users with minimal memory requirements would not be penalized for size and weight if spare space were left in the computer chassis.

Experience has shown that space is always at premium in an aircraft installation, and, by the time programs have outgrown the original memory capacity, space may not be available in close proximity to the computer. Therefore, spare space and interconnections were provided in the computer chassis for a line drive/receiver module, which could provide means of reliable communication over long data lines with an external memory without any redesign of the existing computer and without the cost penalty for these line drivers and receivers in the 16,384-word system. The approach offered an additional ad-

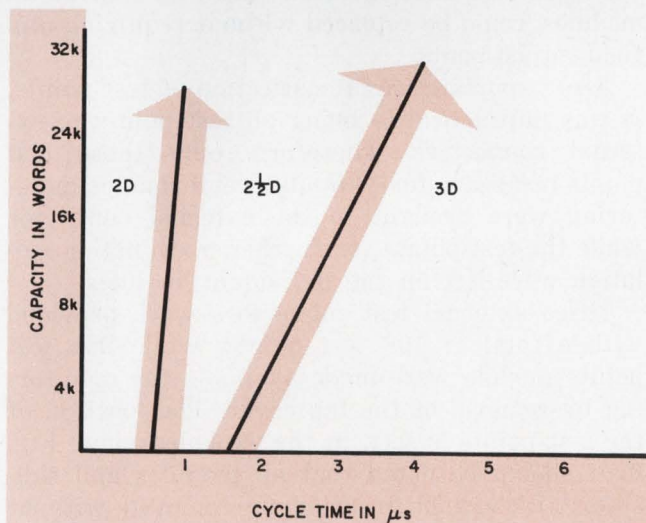

4. Core memory organization is one of the choices that must be made. This diagram defines the ranges of core types as functions of memory size and cycle time.

vantage in that the user would have the freedom of specifying the external memory in the desired modularity, size and shape necessary to meet his requirements.

In order to operate over the temperature ranges encountered in military aircraft, a wide temperature 30-mil core was selected, and a temperature-compensated current source was designed. The drive current for the X and Y drive lines were staggered to offer adequate design margins over temperature and worst-case tolerances. The drive-current rise and fall times were also controlled to minimize drive-line kickback voltage. Sense lines were grouped in 4096-word quadrants to provide good signal-to-noise characteristics.

Choose logic and module design

The logic circuit selection is normally based upon cost, speed, power, noise margin and availability of logic functions. DTL and TTL met system speed requirements with adequate production and second source capability. RTL and RCTL logic circuits were eliminated due to fan-out, noise margin and speed limitations. Table 2 is a summary of the trade-offs. In the final selection TTL was chosen because it offered minimum parts count and thus lower cost, higher reliability and greater speed margin.

Module choice was among two layer modules, four layer modules and multilayer modules. Although the module cost increases as the number of layers increases, it was found that the multilayer approach minimized the number of modules and therefore was the most cost-effective. With the use of multilayer boards, the number of integrated circuits could be increased to an average of about 250 per module, while allowing

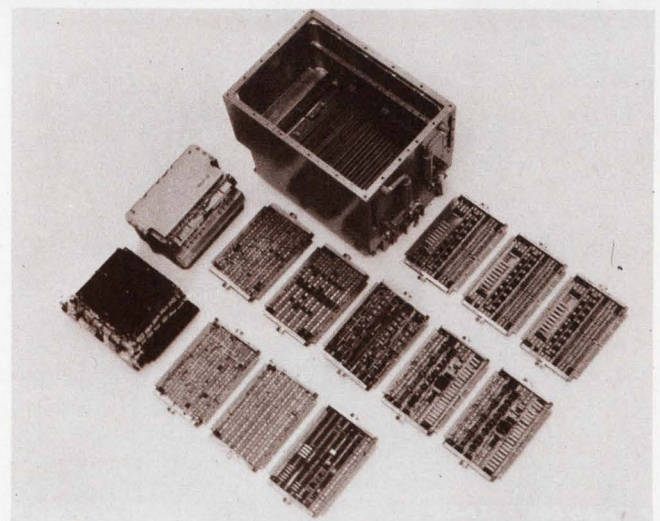

5. The logic is organized onto 11 circuit cards of eight different types as shown in this photograph of the computer.

an adequate number of test points to be brought to the top of each module. This permitted the system designer to apportion the logic to reduce the number of interconnections between modules. The number of interconnecting layers on individual modules varied from six to 10.

Operational needs are important . . .

Aerospace computers of older vintages have been frequently limited in their efficiency of handling real-time control problems because of lack of adequate program interrupt. A powerful and flexible program interrupt system was considered a necessity for the computer system under consideration.

Twenty interrupts were provided in the system, grouped into three types in order of descending priority: real-time clock, external and internal interrupts. The real-time clock interrupt establishes a precise periodic reference for real-time computations and facilitates efficient interleaving of computer subroutines. Five external interrupts and the real-time clock interrupt can be enabled or disabled by selectively setting corresponding bits in the interrupt mask register. In addition, the capability to test the contents of the interrupt, as well as the interrupt mask register, are provided.

The remaining 14 interrupts are internal to

the computer and are generated by the input/output section upon completion of a message or in case of a persistent parity error. The enabling or disabling of these interrupts is controlled by the input/output control word.

The primary power sources in an aircraft experience many transients. It is, therefore, essential that the computer operation and its memory contents be protected from any malfunction due to these power transients. The computer has two protective features designed to prevent loss of memory contents and system malfunction. First, a voltage sensing circuit in a power supply detects the loss of primary ac power and switches the computer to a secondary dc supply. If the power transient ends in less than 7 ± 2 seconds, the switching circuitry will switch the operation back to ac power when it is restored to normal. However, if the power transient lasts longer than 5 to 9 seconds, battery switching circuitry will initiate shut-down cycle. When power returns, the memory operation is inhibited by a timing circuit until all secondary voltages are within proper tolerances. Program operation is then started at a predetermined memory location.

. . . so are nonoperational needs

Maintainability was considered early. Functions were grouped to minimize the number of different modules and the number of interconnections. Grouping also facilitated localizing of malfunctions. The task was complicated by power dissipation and noise considerations. After several trade-offs, the logic was divided between a total of 11 modules of eight different types, as shown in Table 3 and Fig. 5. All arithmetic registers were located on one module, while the control logic was placed on a second module. All identical memory modules were made fully interchangeable so that the core stack, as well as all modules, could be replaced without requiring any field adjustments.

Also important was the selection of test points. It was impractical to bring all test points to external connectors. Therefore, only those test points necessary for computer performance monitoring were brought to the external connector while the test points for further malfunction isolation were left on the individual modules.

Three external test connectors were provided with a total of 198 test points, while 262 test points/module were made available for monitoring by removal of the top cover. The location of the test points is seen in the exploded view, Fig. 6. It should be noted that all modules and sub-assemblies can be inserted or removed without the use of a soldering iron. The system designer must consider even these minor requirements if he wants his design to be complete. ■■

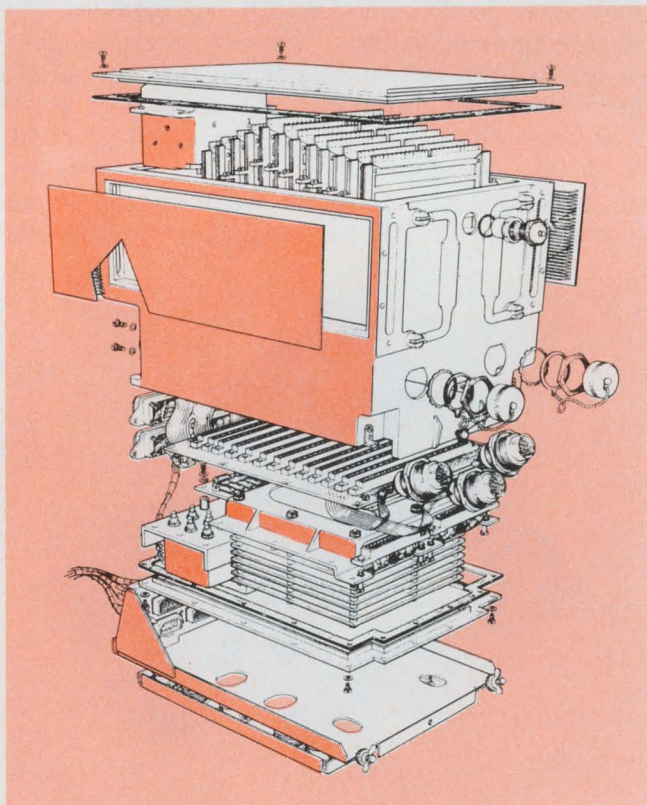

6. Relative locations of all the components are shown in this exploded view of the computer. Note the three connectors (center) that contain 198 test points.

NEW AUTO-POLARITY FET V-O-M SPEEDS TESTING

You've probably imagined the convenience and time-saving you'd enjoy if you could just clip one of the V-O-M leads to ground or to the chassis, and have your meter always read upscale regardless of the polarity of any other terminal you touched.

No need to imagine it any more . . . you can see it and try it right now at your Triplet distributor. Called the Triplet Model 602, it's probably the most convenient V-O-M ever built. Its convenience goes well beyond the auto-polarity feature, though . . . to AC and DC measurements from 10 mV to 1000 V in 8 ranges at 11 megohms DC and 10 megohms AC input resistance . . . AC and DC from 0.02 to 1000 mA in 4 ranges . . . resistances from 0.2 ohms to 1000 megohms in 6 ranges. And with an accuracy of 3% on voltage measurements, and a rugged suspension-type meter movement, the Model 602 has what it takes to make your job easier.

This great new V-O-M is available at your Triplet distributor for **\$100** suggested USA user net. For more information, or for a free, no-obligation demonstration, call him or your Triplet sales representative. Triplet Corporation, Bluffton, Ohio 45817



The World's most complete line of V-O-M's . . . choose the one that's just right for you.

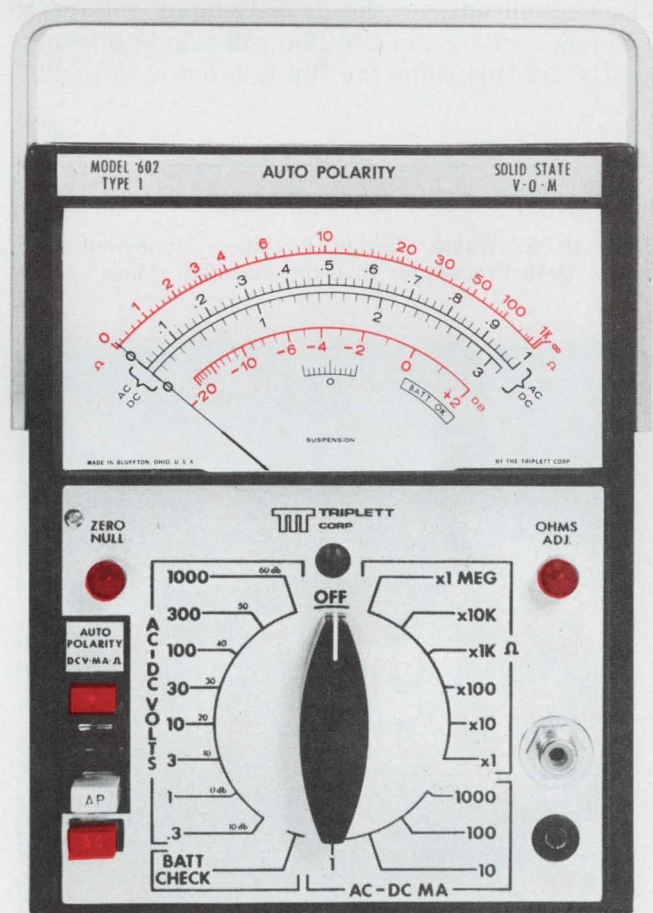

1. Auto Polarity . . . convenient and time-saving; creates memory and suppressed scale.
2. High sensitivity (.3V AC and DC) at constant 11 megohms input resistance.
3. Simplified scale with only 2 arcs for 24 AC/DC ranges.

Check flip-flops automatically.

Measure preset times and thresholds accurately with this new closed-loop system.

Manual tests of IC flip-flop preset times, clock thresholds and input-gate thresholds are extremely difficult. The behavior of the circuit changes with temperature, and the internal temperature of the IC changes with time and depends on the state of the output. If results are to be repeatable, the tests must be done quickly and accurately. Manual testing is not fast, and it is often not accurate.

But simple digital test circuits can do the job extremely well. (Fig. 1). The key circuits to this system are an integrator and a voltage-controlled one-shot. They are arranged in a closed-loop system with the flip-flop under test to provide an automatic means of setting the data input, the clock amplitude, or the dc gate-input voltage to the point where the flip-flop will toggle intermittently. At this point the flip-flop has a 30-to-40%

duty cycle instead of the normal 50% duty cycle it would have if it were not connected in the closed-loop system.

Schematics and operating curves of the integrator and voltage-controlled one-shot are shown in Figs. 2 and 3.

Examine the closed loop

Consider first the preset time test circuit (Fig. 1). If power is turned on and the flip-flop under test is removed from the test socket, the following conditions exist:

- The 500-ns one-shot is not triggered, and the input to the integrator is a logic ZERO, corresponding to a 0% duty-cycle signal.
- Due to the 0% duty-cycle input to the integrator, its output is at a maximum positive dc voltage (approximately +8 V).
- The voltage-controlled one-shot is continuously triggered by the 1-MHz input. Its pulse width, controlled by the dc output voltage of the integrator, is at a minimum value of approximately 385 ns.

Kenneth C. Waive, Design Engineer, Honeywell Electronic Data Processing Division, Waltham, Mass.

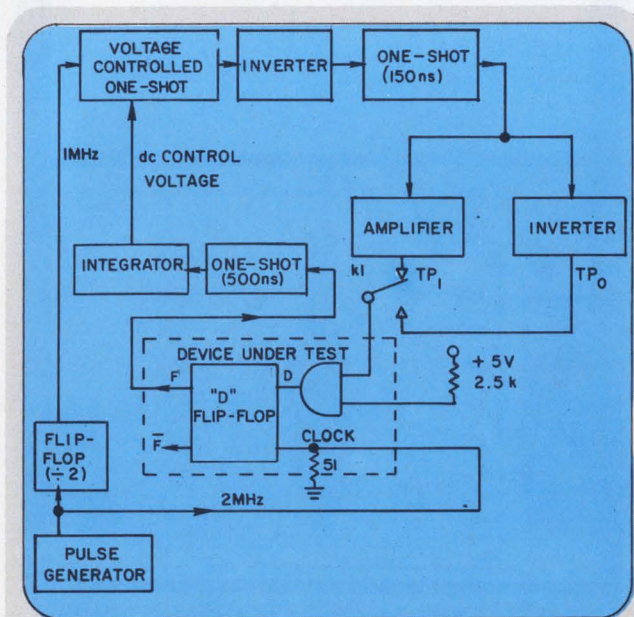

1. A simple digital closed-loop system tests for preset times by adjusting the data input time until the flip-flop under test toggles intermittently. The result is accurate, repeatable dynamic measurement under operating conditions.

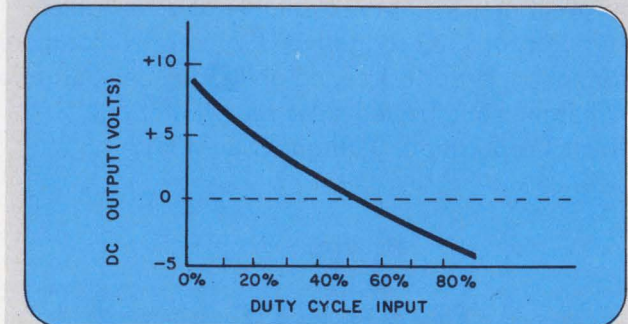
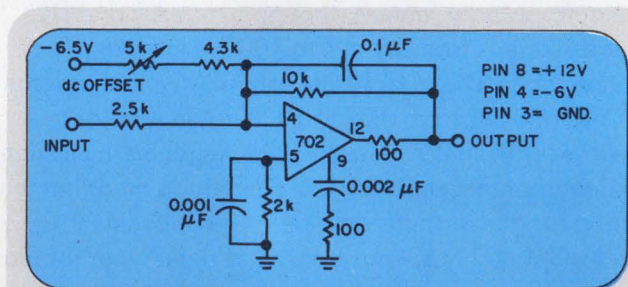

2. The integrator is a simple circuit composed of an op amp and a few discrete components. It provides an output, inversely proportional to the input duty cycle, which is used to control the pulse width of the voltage-controlled one-shot.

The output of the voltage-controlled one-shot is inverted, and it triggers the 150-ns one-shot on the falling edge of its output pulse. (Fig. 4). The output of the 150-ns one-shot is fed to an amplifier and an inverter (to provide inversion for the T_{p0} measurement). Either the amplifier (preset ONE measurement) or the inverter (preset ZERO measurement) output is selected by the relay (K1) and applied to the flip-flop under test as the data input.

For our purpose, T_{p1} (preset ONE) time is defined as the minimum amount of time that data may switch to a ONE before the rising edge of clock time and still be recognized as a ONE, thus setting the flip-flop. T_{p0} (preset ZERO time) is defined as the minimum amount of time that data may switch to a ZERO before the rising edge of clock time and still be recognized as a ZERO, thus resetting the flip-flop if it was set. The preset times are measured between the rising or falling edge of data input to the rising edge of clock input.

Note that in Fig. 4 the conditions for a 0% duty-cycle signal from the 500-ns one-shot (and flip-flop under test) is such that data input (positive-going or negative-going pulse) is centered over the rising edge of every other clock (labeled 1) for either preset condition selected. Thus, when a flip-flop is inserted into the test socket, it will start switching at a 1-MHz rate.

However, since the duty cycle of the flip-flop (and 500-ns one-shot) is no longer 0%, but 50%, the integrator's output will begin to decrease. And as the dc input to the voltage-controlled one-shot decreases its pulse width increases.

As its pulse width increases, the 150-ns one-shot is triggered later with respect to its initial condition, thus moving data to the right with respect to the rising edge of clock. For a preset ONE condition the rising edge of the data pulse approaches the rising edge of the clock. For a preset ZERO condition the falling edge of the data pulse approaches the rising edge of clock (labeled 1).

Check your flip-flop's preset

For a preset ONE measurement, then, the flip-flop will continue to toggle until data is moved to the right, past the preset time of the flip-flop, so that it represents a logic ZERO input. When this happens the flip-flop will cease to toggle and its output will have a 0% duty cycle.

The resulting 0% duty cycle input to the integrator will cause its output voltage to begin to increase, decreasing the pulse width of the voltage-controlled one-shot and moving data to the left with respect to the clock, to a point where the flip-flop begins to toggle again. This closed-

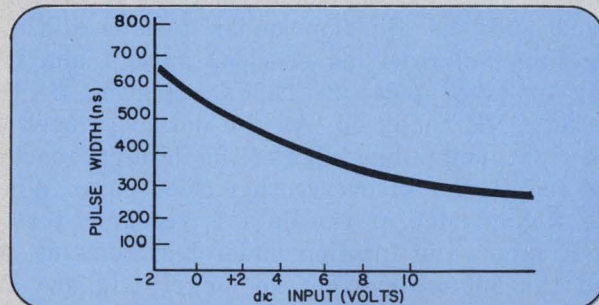
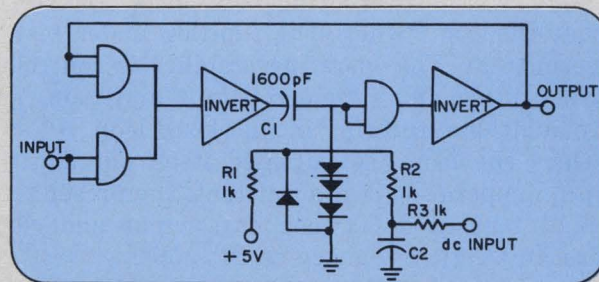

3. The voltage-controlled one-shot provides pulses with width inversely proportional to the dc voltage received from the integrator, and is essential to the operation of the feedback loop.

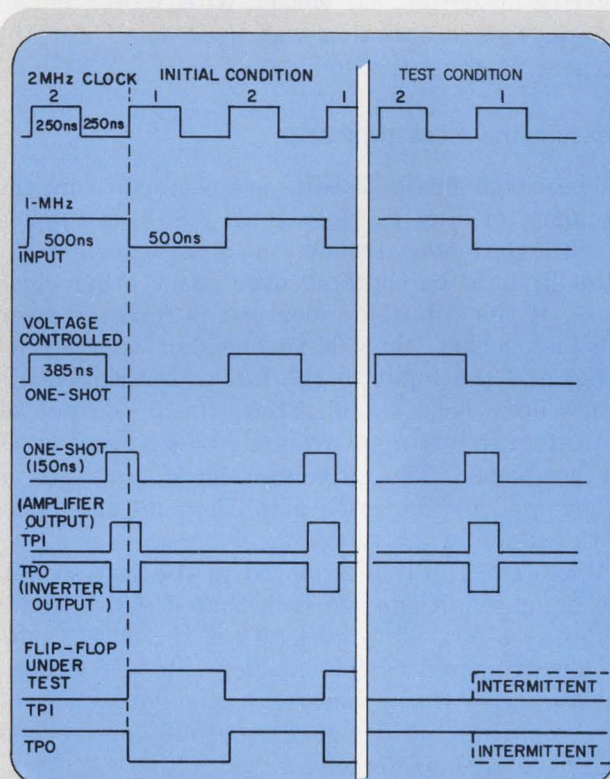

4. The preset test circuit of Fig. 1 accepts the 2-MHz clock, divides it down to 1 MHz, and applies the result to the voltage-controlled one-shot. The output of this one-shot, after inversion, triggers the 150-ns one-shot on its falling edge. Thus the rising edge of the output of the 150-ns one-shot is delayed from the 1-MHz clock by an amount determined by the voltage-controlled one-shot (VCOS). This delay is adjusted by the circuit until the flip-flop under test ceases to toggle.

loop system, operating like a servo-mechanism system will hunt continuously back and forth about the point where the flip-flop under test is intermittent. The operating stability is controlled by the integrator's time constant and gain, and any additional filtering in the closed loop.

Once the loop has adjusted itself so that the flip-flop operation is intermittent, the preset time can be measured between data input and clock with any high frequency oscilloscope.

For a preset ZERO condition relay K1 is energized and the flip-flop under test is initially toggling, but resetting on clock pulse 1 and setting on clock pulse 2. This is opposite to the preset ONE condition. As the data is moved to the right, the falling edge of the data approaches the rising edge of every other clock pulse. When the falling edge of the data is recognized as a ONE input, the flip-flop under test remains set and the 500-ns one-shot no longer triggers. Its output is a 0% duty-cycle signal, which is the input to the integrator. The integrator's output voltage increases, forcing the data back to the left. The flip-flop operation becomes intermittent again, as in the preset ONE condition.

In the normal testing of flip-flops they are not inserted into the test socket with power on, of course. This description was used solely for the purpose of simplification.

Measure the clock threshold

The clock threshold tests are performed by the circuitry of Fig. 5. Note that +8 V is applied to the voltage-controlled one-shot, causing the data input to be centered over every other clock pulse. If the flip-flop under test is removed from the test socket, the 500-ns one-shot is not triggered and the input to the integrator represents a 0% duty-cycle signal. Thus, the dc output of the integrator is approximately +8 V, and D₁ is reverse-biased. The maximum clock amplitude is determined by the clock amplifier and should be in the range of 3.5 to 4.5 V.

When the flip-flop is placed in the test socket, the input conditions are such that it will initially toggle at a 50% duty cycle. Thus the 500-ns one-shot is triggered at the flip-flop rate and the input signal to the integrator has a duty cycle of 50%, causing the integrator output voltage and clamp voltage to decrease.

As the clamp voltage drops below the initial clock amplitude, D₁ becomes forward-biased and the clock amplitude is clamped to the value of the clamp voltage, which is derived from the integrator. Once the clock amplitude decreases below the clock threshold value, the flip-flop stops toggling, the 500-ns one-shot is no longer triggered and the integrator output voltage begins to increase.

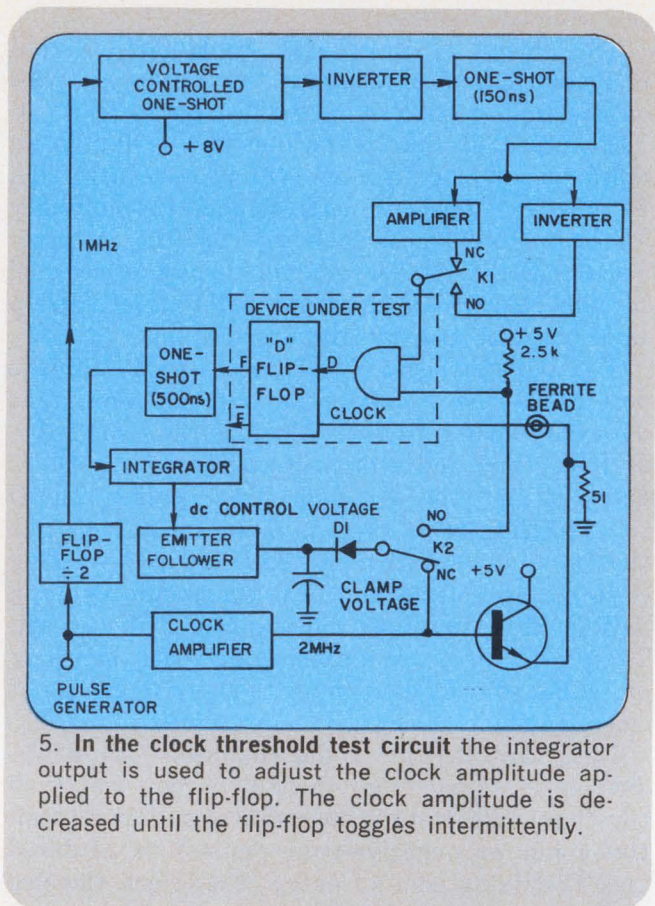

5. In the clock threshold test circuit the integrator output is used to adjust the clock amplitude applied to the flip-flop. The clock amplitude is decreased until the flip-flop toggles intermittently.

As in the preset testing, the flip-flop becomes intermittent and the clock amplitude is clamped to the clock threshold value. Again, a high frequency oscilloscope of good quality can be used to measure the clock threshold.

A ferrite bead will normally have to be added to the clock input wire to cancel out the inductance of the line to eliminate ringing and overshoot. The size of the ferrite bead is determined experimentally.

Test for gate-input thresholds

The operation for gate-input threshold testing is similar to the clock threshold test. Relay K2 is energized and the clamp voltage is applied to the flip-flop input through D₁, along with the data input. The data remains centered over every other clock pulse, and the amplitude of the clock pulse returns to the initial value of 3.5 to 4.5 V. The flip-flop becomes intermittent, and the dc gate-input voltage is clamped to the gate threshold voltage.

The 150-ns and 500-ns one-shots for the test circuits can be constructed in the same manner as the voltage-controlled one-shot. All that is required is to remove R₂, R₃, and C₂ from the voltage-controlled version and change the values of C₁ to approximately 330 pF and 1200 pF, respectively. ■■



**That's right. It's a commercial connector.
Our Molex Standard. Millions are finding their
way into some of the most exciting circuitry man
can imagine. For that's our business: creating
connectors that simplify
wiring. Speed produc-
tion. Assembly. Instal-
lation. Servicing.**

**For the men who are
looking for new ideas and
ways to cut costs.**

**In the area of one circuit to sixty
connections or more, Molex has the
product. And the design and engineer-
ing capabilities to solve the most com-
plex wiring and production problems . . .
fast! We'd like to talk to you about it.**

**If you would like a free sample of our
Molex connector, please
write or phone (312)
969-4550. You
can make con-
nections at . . .**



Management is in metamorphosis

says this research director. A knowledgeable generation, he notes, is replacing experience-based administrations.

Richard L. Turmail, Management Editor

This is the first of a three-part series on the management of change in technology, including (1) changes in management style; (2) managing the generation gap; and (3) exploring the management of technology. Because methods of technical management today change almost as often as technology itself, we think our readership will be interested in knowing what the current and projected trends in technical management are.

For decades the vitality of the American economy has testified to its superiority in management methods. The traditional experienced-based management style, whereby orders are given with an expected immediate, highly disciplined response, has been instrumental in giving the U.S. an extraordinary leadership in business. That style is now becoming unfashionable, at least in the area of technology, according to Charles Anderson, president and chief executive officer of Stanford Research Institute, Menlo Park, Calif. He explains that engineering is moving from experienced-based to knowledge-based management not only because of the increasing complexity of technology but because the younger generation requires it.

These young people feel the need:

- To express themselves.
- To participate in establishing company policies and guidelines earlier in their careers than they have in the past.
- To revitalize their educational process.
- To participate in an activity of social benefit that they believe to be important, not only to society but to themselves as well.

These needs are going to have to be recognized by management if the jobs that need doing are to be filled.

Contrasts in styles

Anderson says that 15 to 20 years ago the executive organization of most industries was made up of people who had many years of experience. They had demonstrated their reliability and dependability under a variety of circumstances, and

had proved they could be counted on. But more and more businesses, particularly those related to higher technology, are requiring the inputs of people who have new knowledge to contribute.

"I certainly don't want to suggest that experience in engineering isn't useful, desirable and a necessary component," Anderson says. "What I am suggesting is that the acquisition and effective utilization of new knowledge is becoming so important that the successful company is the one that can take this new knowledge and use it without having to wait for an engineer to get 20 years of experience. I suggest that this increased emphasis on knowledge, as distinct from experience, requires a management that embraces imagination, flexibility and creativity."

To enhance his argument, Anderson cites the contrasts of his own management experience:

"Before coming to Stanford Research Institute I was chief executive officer of a farm and construction-equipment manufacturing business, a company that evolved and grew largely as a result of experience—the experience of its people and its organization.

"SRI, on the other hand, is an organization that is almost exclusively knowledge-based. Its only mission is the application of knowledge to the needs of our society. The people here are knowledge workers. Thus, I am experiencing the contrasting management requirements of yesterday's industry with that of tomorrow. I find the contrast to be very significant."

Needs of a new generation

Anderson continues, "I see the trend setting in around SRI. The real hot comers are guys that are charged up with the new kind of technology. They want to get it to work. In some respects they're difficult to work with. They don't have a lot of respect for some of the traditions of an organization, because this has not been a part of their experience.

"For example, some months ago a young SRI staff member walked into my office and wanted to know why the staff had not been consulted about a fence that was being erected at one of

SRI and the demonstrations—a brief inquiry.

ELECTRONIC DESIGN: Mr. Anderson, why did Stanford University students demonstrate against SRI last spring?

ANDERSON: We were harassed because some of our research is in defense work. Both students and faculty members tried to achieve control of SRI's research programs in order to concentrate them on areas they felt would be morally acceptable to them. Needless to say, research could not be conducted very well under the watchful eye of a morality review board, and SRI's professional and scientific staff flatly rejected such a suggestion. In the midst of the uproar, the Stanford Board of Trustees decided to terminate the formal ties between SRI and the university—a decision fully supported by SRI.

But then the dissidents, seeing their opportunity to achieve control over SRI's research policies fading, turned to lawlessness. This led to a rather serious confrontation, with considerable damage to one of our buildings, before local police could restore order.

ELECTRONIC DESIGN: How many engineering students took part?

ANDERSON: Almost none. The engineering students with whom I come into contact constitute a very important anchor on the campus. Their background, career objectives, and training give them a more realistic view about solving world problems.

ELECTRONIC DESIGN: Why do other parts of the campus community hold such dissident views?

ANDERSON: The radicals are intent upon tearing down our society's institutions because they have no confidence in them. They believe those institutions are not responsive to their own interests and objectives, but

they haven't quite decided what to replace them with. I had a discussion with an SDS leader, a brilliant mind, and I tried desperately to find out what it was they wanted to do. He said, "I don't know what we would do if we got you guys out of business, but I can tell you one thing—we wouldn't screw it up as badly as you have." He felt that, with all the hunger and war in the world today, he and his kind wouldn't have to try very hard to improve on the record of the establishment.

I know I can't reason with the radical. I am more concerned about the moderate group of students with constructive objectives. I think it's extremely important that we communicate with these people. It's difficult to do so in a hysterical environment.

ELECTRONIC DESIGN: Have college administrations changed their policies to meet a changing world?

ANDERSON: University administrators have been faced with a more difficult problem than our society has realized. Frequently the college president has been caught between faculty, public and alumni. He has less authority to deal with these problems than most administrators because the traditions of the university usually allow the faculty to exercise a very high degree of control on campus activities. In many instances there is a good deal of sympathy for the students by the faculty. I'm not suggesting that this is wrong, but I do think faculties have not always taken the leadership to help find constructive solutions.

Important processes are, however, taking place on many campuses providing a non-violent way of meeting the requirements of students, such as the development of judicial systems. I don't think we are over the crisis, but I do think progress is being made.

Stanford demonstrators ignite police barricade last May in protest against SRI defense projects.



our facilities in Menlo Park. In some ways this was amusing, in some ways disconcerting, but I can assure you that this would not have happened at the tractor works."

The differences between running the tractor works and SRI, Anderson points out, relate to the people involved, and he suggests that the people he is now dealing with at SRI are the types that the electronics industry relies on to provide the manpower and brainpower to run its companies. What are they like? And what does it take to manage them?

According to Anderson, today's students have been reared in affluence and don't worry much about economic security; they see it as a right. Instead, they have had time to concentrate on social and political problems.

When Dr. Joseph Katz, Executive Director of the Institute of Human Problems at Stanford, talked to an SRI conference last year, he noted: "There is an increasing erosion of respect for that authority which rests primarily on status, whether it be that of university president, faculty member, political leader, or the corporation president. There is no erosion if that authority is based on a competence, particularly if the competence is relevant to the lives of the young." They do not reject authority, he pointed out, but rather make an attempt to participate in it. He observed further that "as former students enter professional and business life, they are apt to try to continue their ways in their new environments."

Anderson summarizes briefly the traits and characteristics of today's students and young employees:

- Because they're young, knowledge is more important to them than experience.
- They are highly trained and specialized.
- Their views of authority tend to be quite different from the traditional concepts. They don't "dig" the "organization man," they are likely to have more loyalty to their profession or

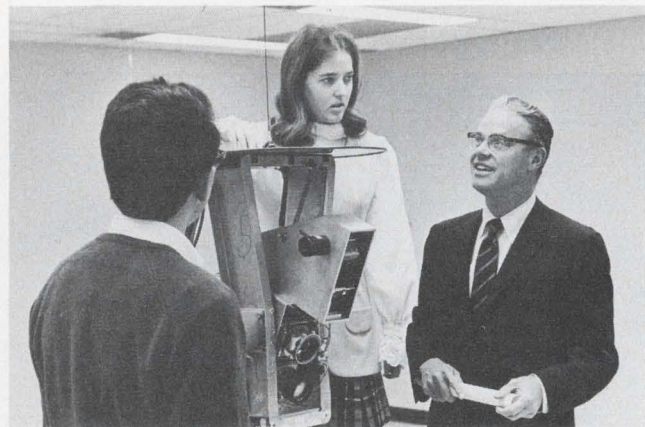

Knowledgeable members of a young generation, SRI researchers, Ann Robinson and Jeff Rulifson, discuss with Anderson the engineering problems of building a robot.

academic discipline than to the organization with which they happen to be associated.

- They feel a commitment to do something about our society.

- They want to see their professional capabilities devoted to this end, and this may be more important to them than contributing to your earnings per share. Indeed, because management's job is concerned with earnings per share it tends to breed mistrust. This is a manifestation of the differences in value systems.

"The management process required to coordinate the efforts and energies of such a group," Anderson says, "is clearly different from that needed at the tractor works. But the rewards will be great for those organizations that can develop a management style that can both accommodate the needs of the knowledgeable professional and benefit economically and commercially from his efforts."

Patience with the precocious

In an attempt to explain how to manage the new generation, Anderson says that you can't deal with the precocious employee by putting him in a disciplinary straitjacket. The more creative and industrious he is the less successful is that tactic.

Give him an atmosphere that allows him to express himself, and pretty soon he learns that life is a little more complicated than he originally thought. It has been his experience here and elsewhere says Anderson, that after you've provided a means for people to express themselves, even though they disagree with your objectives, policies and plans, they'll support them much better. They feel that they're qualified to give an input, and management should back them up wherever possible.

Management must have patience with these new engineers, he believes, and put them in an environment where others will listen to them. "Soon, and I've seen this happen," he says, "the young employee will understand the need for exercising some discipline and will eventually become part of the team. Each one has to decide for himself whether or not he is going to be part of the team, and he must be in a comparatively free climate to do so. And the company must be very demanding—the young respect firmness. It's harder as a management process because it takes more time and patience than many of us have used. Talking to people and especially listening to people is a very difficult exercise."

Anderson concludes: "My favorite philosopher, Charlie Brown of the Peanuts comic strip, says: 'The world is filled with people anxious to function in an advisory capacity.' And it seems as if there are more of them every day." ■■

FAIRCHILD

Wanted: Catalysts.

Technical knowledge can be absorbed, administrative ability can be learned, but without the ability of one man to demand and get the utmost from other men's knowledge and skills little can be accomplished. This catalytic ability is the unique mark of a successful technical manager at Fairchild.

Working within a framework of unusual authority, he is personally responsible for the realization of a complex development product — on time, within cost and to customer specifications. He is a technical realist whose tools are the diverse talents of professional specialists.

He is a new breed of entrepreneur, operating with near-autonomy in Fairchild's flexible corporate structure, designed around the technological interrelationship of semiconductors, controls, graphics, systems, optics, microwaves, display devices, ordnance devices, reconnaissance systems and electrometrics.

To those who possess sound knowledge in their discipline and an alertness to the practical economics of technical management, we offer the opportunity to explore the full import and rewarding potential of a career with Fairchild.

Write to Michael D. Hawkins,

Fairchild Camera and Instrument Corporation, 464 Ellis Street, Mountain View, California 94040.
An equal opportunity employer.

SUDDENLY ALL OTHER VOLTAGE REGULATORS ARE SECOND BEST.

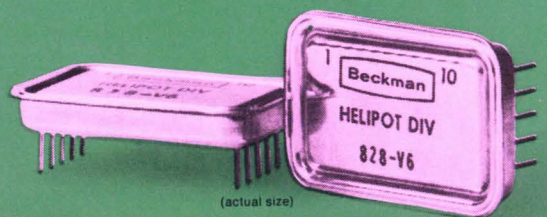

HERE'S WHY:

- $\pm 0.01\%$ line & load regulation
- $\pm 0.5\%$ preset output voltage
- Short-circuit proof
- MIL-STD-883 hermetic package
- \$40 (1-9 quantity)
- Model 828 (plus) and Model 838 (minus) from stock
- Many other outstanding features; contact your local Helipot representative.

Beckman[®]

HELIPOT DIVISION

FULLERTON, CALIFORNIA • 92634

INTERNATIONAL SUBSIDIARIES: AMSTERDAM; CAPE TOWN; GENEVA; GLENROTHES,
SCOTLAND; LONDON; MEXICO CITY; MUNICH; PARIS; STOCKHOLM; TOKYO; VIENNA

Ideas For Design

Use a complementary stage to extend IC output level

Most IC operational amplifiers can deliver output satisfactorily up to about ± 10 V. If an application appears where a ± 20 -V output is needed, the designer usually discards the integrated circuits for a new design using discrete components or buys a packaged op amp. An alternative solution is to use the IC in combination with some additional circuitry.

As shown in the figure, an IC (A_1) is used to drive A_2 , a discrete amplifier. A_2 is a simple complementary pair dc amplifier¹ using ± 30 V as its supply. Diode CR_1 is used to compensate for V_{be} of Q_1 . The overall gain of A_2 is set by

R_5 and R_8 . This amplifier is equivalent to an op amp in the inverting connection.

A_1 is an 809C IC dc amplifier with feedback applied at the noninverting input, since A_2 provides a phase inversion. R_2 and R_3 set the overall gain to 39. C_1 , C_2 , and R_4 are used to stabilize the system against oscillations.

A breadboard of this circuit had a voltage gain of 39, input impedance of 10 K Ω , dc offset of 0.2 V, E_o of ± 20 V into a 6-K Ω load, and a bandwidth of 40 kHz.

This amplifier was primarily designed for low cost and thus lacks higher power output and

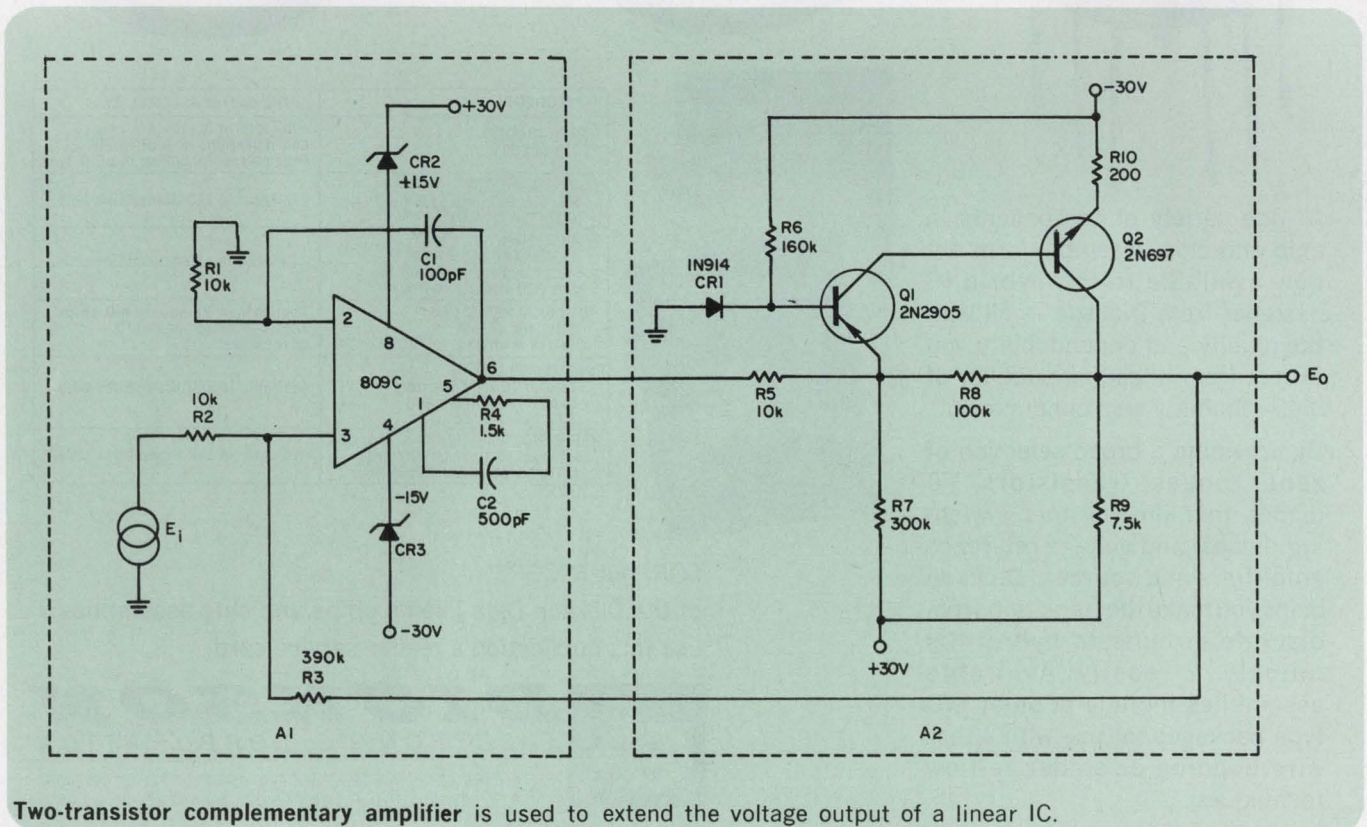

Two-transistor complementary amplifier is used to extend the voltage output of a linear IC.

DICKSON ...

prime
source
for
CHIPS,
ASSEMBLIES
and **LIDS...**



for
HYBRID
IC's

A wide variety of components in chip and chip assembly form are now available to the hybrid IC designer from Dickson — all with the quality and dependability you expect from a leading supplier of high-reliability semiconductors.

By providing a broad selection of zener diodes, transistors, TC diodes, thin film resistors, switching diodes, and voltage reference amplifiers and sources, Dickson helps you make the transition from *discrete circuits to hybrid ICs* quickly . . . easily. Available assemblies include popular LID type packages for use with either wire bonding or solder re-flow techniques.

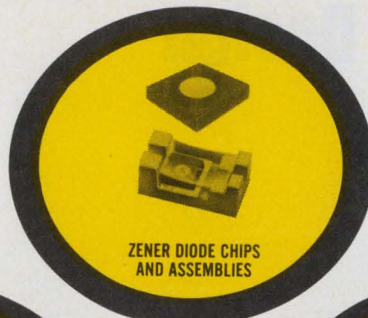

ZENER DIODE CHIPS
AND ASSEMBLIES

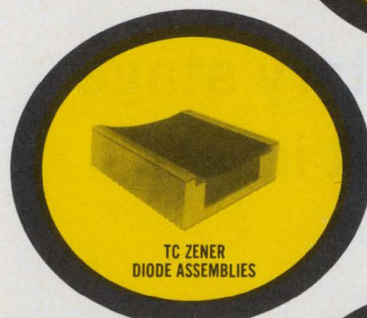

TC ZENER
DIODE ASSEMBLIES



FET & BIPOLAR
TRANSISTOR
ASSEMBLIES



THIN FILM
RESISTOR CHIPS
AND ASSEMBLIES

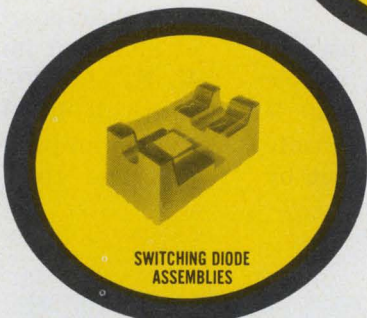

SWITCHING DIODE
ASSEMBLIES



REFERENCE AMPLIFIERS
& SOURCES

COMPONENT	CHIPS and/or ASSEMBLIES
ZENER DIODES 1.8 to 200V	Available in 3 separate chip configurations or 4 different assemblies, including the LID type
TC ZENER DIODES 6.2, 6.4, 9.0, and 11.7V .0002%/°C to .01%/°C.	Available in LID assemblies only.
TRANSISTORS Popular FET and Bipolar units electrically similar to over 200 discrete devices.	Available in LID assemblies only.
THIN FILM RESISTORS Standard RETMA Values from 33Ω to 470 kΩ	Available in 25 square mil chips with centertap, or in LID assemblies.
SWITCHING DIODES Similar to 1N914 series. Available in single and dual assemblies.	Available in LID assemblies only.
REFERENCE AMPLIFIERS & SOURCES with temperature coefficients of 10, 25, 50 and 100 PPM/°C.	Available in LID assemblies only.

FOR YOUR COPY
of the Dickson Data File on chips and chip assemblies,
use this publication's reader service card.



DICKSON
ELECTRONICS CORPORATION

PHONE (602) 947-2231 TWX 910-950-1292 TELEX 667-406
P. O. BOX 1390 • SCOTTSDALE, ARIZONA 85252

greater bandwidth. Using an IC of higher quality and a suitable modification of the output stage would improve these parameters.

Reference:

1. Mollinga, T., "D. C. amplifier design," *EEE*, Febru-

ary, 1969.

Jerome Lyman & M. Wenstein, Senior Electronic Engineers, Servo Corp. of America, Hicksville, N. Y.

VOTE FOR 311

Solid-state isolation relay has nonpolarized terminals

The circuit shown provides the equivalent to an electromechanical spst relay. High isolation is provided between input and output terminals by means of a ferrite transformer.

Diode bridge B_1 routes the dc input signal to Q_1 so that the input terminals are nonpolarized. Q_1 functions as a Hartley oscillator (at about 10 MHz). Oscillations are controlled by the input signal. The oscillator output is coupled to a rectifier/voltage doubler through the secondary of transformer T_1 which is wound on a small fer-

rite toroid.

The filtered dc output of the rectifier is used to switch Q_2 on. R_6 provides a return for the I_{cbo} of Q_2 . Diode bridge B_2 provides nonpolarized output terminals. The additional components D_3 , C_7 , and R_7 , and R_8 are used to protect Q_2 when the circuit controls inductive loads, such as teletype equipment.

Charles A. Herbst, Consultant Engineer, Dumont, N. J.

VOTE FOR 312

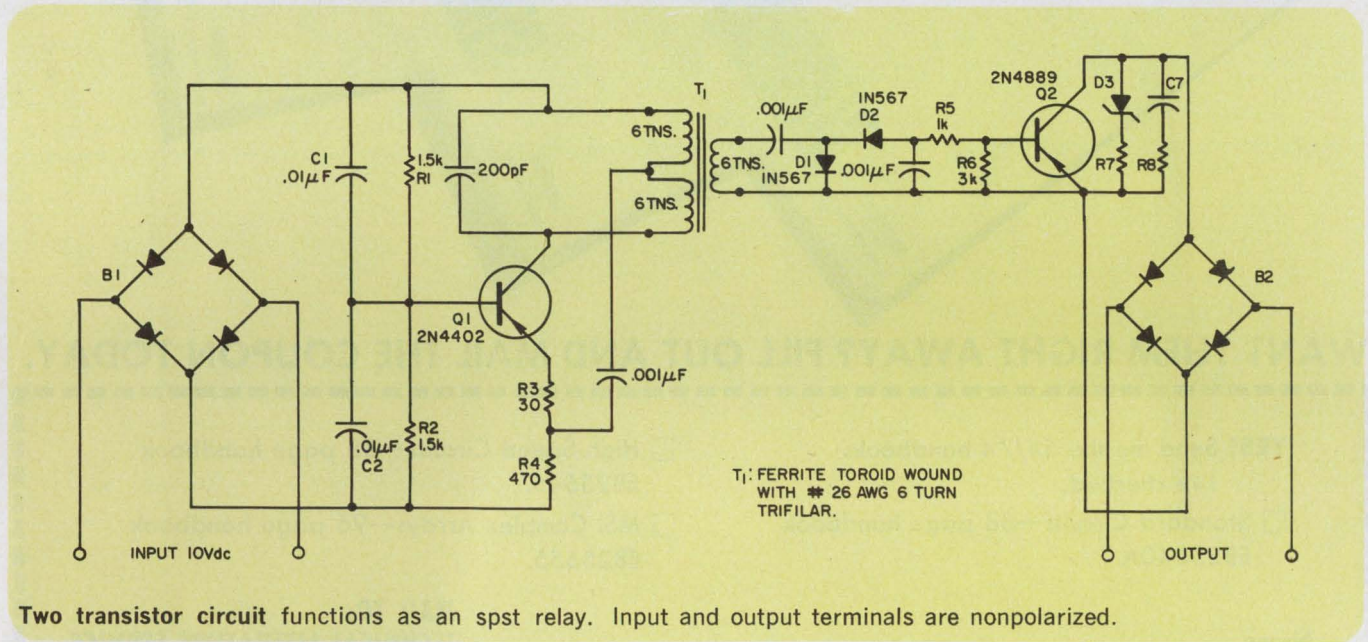

Etching improves multilayer board soldering

Due to the mass of copper in multilayer interconnection board (MIB) ground/voltage planes acting as a heat sink, soldering to these points can produce weak, poorly formed connections. Applying extra heat can burn or delaminate the

MIB or printed-circuit cable.

But copper can be etched away from two annular areas around the mounting location in the ground/voltage plane, thus reducing heat dissipation. Retention of heat at the component

FREE ALL YOU NEED TO KNOW ABOUT SERIES 54/74 TTL CIRCUITS.

272 pages of data list specs, illustrate logic diagrams, give test conditions for

- 54/74 STANDARD CIRCUITS
- 54H/74H HIGH SPEED CIRCUITS
- 54/74 MSI COMPLEX ARRAYS



WANT THEM RIGHT AWAY? FILL OUT AND MAIL THE COUPON TODAY.

YES! Send me the 54/74 handbooks I've checked.

- Standard Circuits—88 page handbook EB25640A.
- High Speed Circuits—88 page handbook EB25645.
- MSI Complex Arrays—96 page handbook EB25655.

Name _____

Title _____

Company _____

Address _____

City _____

State _____ Zip _____

MAIL TO:
TECHNICAL LITERATURE SERVICE
SPRAGUE ELECTRIC COMPANY
347 MARSHALL STREET
NORTH ADAMS, MASS. 01247

SPRAGUE
 THE MARK OF RELIABILITY

Circle Reader Service Number 882
 for 54/74 Standard Circuit Handbook

Circle Reader Service Number 883
 for 54H/74H High Speed Circuit Handbook

Circle Reader Service Number 884
 for MSI Complex Array Handbook.

mounting location means that a shorter soldering-iron dwell time is required to achieve a good solder joint, thus preventing damage.

MIBs must supply a capacitance and impedance match between external components and must shield low power circuits from stray noise and transient pickup. The normal industrial method used to make a noise-free matched impedance MIB is shown in Fig. 1.

With a ground or shield plane or copper above and below each layer of circuit lines, the capacitance and impedance can be adjusted, and the lines are shielded from external noise. Horizontal

transients (line-to-line on the same layer) can be controlled by ground-line placement. MIBs of this type have up to six copper ground planes. These are connected to each other by plated-through holes.

Standard practice in connecting a plated-through hole to a solid copper plane is to drill through the MIB, then copper-plate the drilled hole. This will create a 360° connection between the copper-plated cylinder and the copper ground shield. The soldering of component leads into the plated-through hole is an exacting process, whether soldering is automatic or manual. Due to the heat-sinking characteristics of a ground plane in comparison to a circuit line, the two configurations will not accept solder at the same rate when subjected to identical time/temperature soldering applications.

The ground plane will dissipate heat away from the plated-through hole at a much greater rate than will a circuit line. Ground planes can dissipate heat in a 360° direction from the hole over the entire size of the MIB, but heat dissipated by a circuit line is slower because it must follow a restrictive path defined by the width of the circuit line.

The solution to this problem lies in restricting the amount of heat dissipated by the ground planes so it remains in the plated-through hole area. Making an acceptable solder connection without damaging the insulation is then possible. A minor change to the ground-plane artwork was incorporated which permitted two half-moon areas to be etched through the copper during the manufacturing process.

This special etching reduces the heat-dissipation area from 360° (Fig. 1b) to approximately 72° (Fig. 2c). The only path available for heat dissipation to the solid plane is through the two connections between the plane and internal pad. The heat-dissipation area for a normal internal circuit line (as shown in Fig. 2a) is 36°.

By retaining the heat in the plated-through hole area, soldering problems have been greatly reduced. Cold solder joints and poor solder penetration are no longer a major concern when soldering to a plated-through hole with two or more attached ground planes.

Peter Burke, Component Engineer, IBM Electronics Systems Center, Oswego, N.Y.

VOTE FOR 313

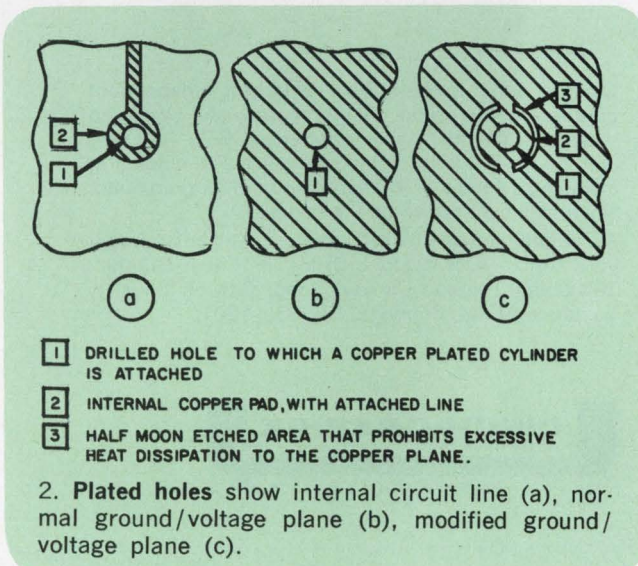
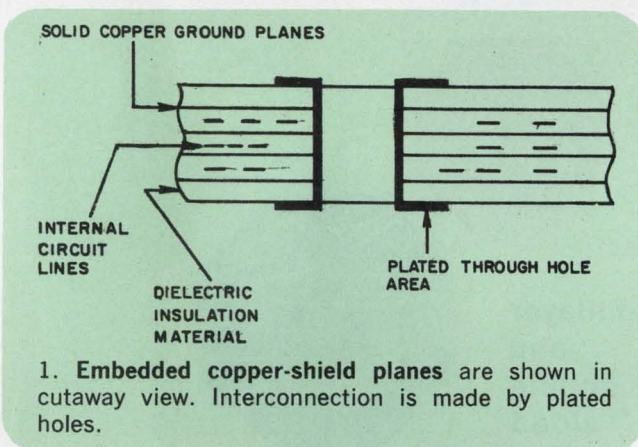

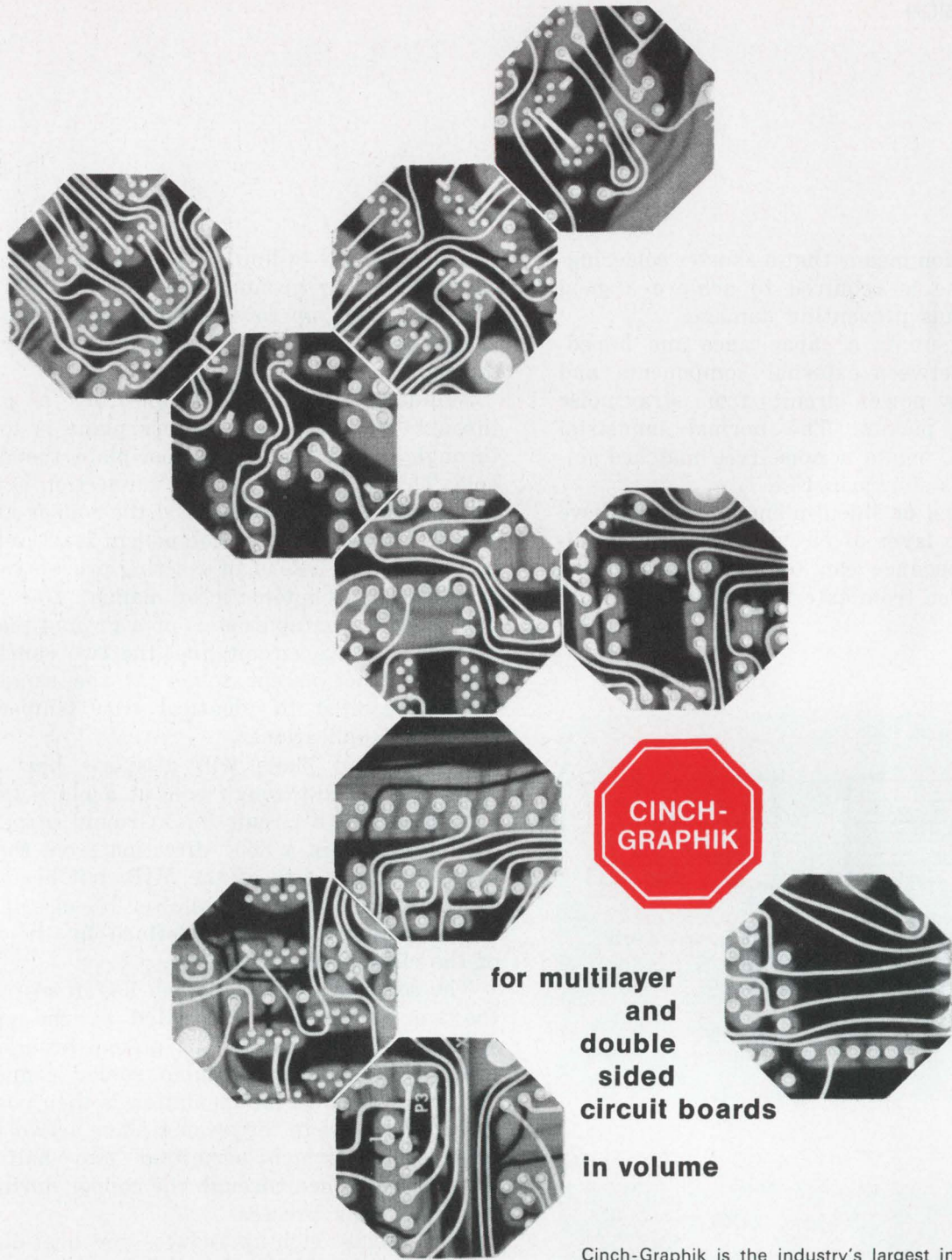

**for multilayer
and
double
sided
circuit boards**

in volume

Cinch-Graphik is the industry's largest independent producer of precision circuit boards, and we keep getting larger. Plant space increased 35% last year and we filled it with highly sophisticated equipment, including a computer for manufacturing programming, so we will continue to be the largest.

For information on Cinch-Graphik capabilities, contact your Cinch-Sales District Office or Cinch-Graphik, 200 South Turnbull Canyon Road, City of Industry, California 91744, Phone: (213) 333-1201.

CINCH-GRAPHIK
DIVISION OF UNITED-CARR

Program determines worst-case part values

Instead of using your time to compute parameter values for computer aided worst-case analysis, why not let the computer do the whole job?

This program calculates the effective tolerance due to the temperature range and temperature

coefficient, sums this with the purchase tolerance plus variations allotted for aging effects, and applies the total deviation factor to the nominal parameter value, thus determining the worst-case minimum and maximum.

The program is written in Fortran II. To use this material, first load it into a memory address at a computer terminal. Thereafter, when worst case parameter determinations are to be made, one simply dials in, supplies data the computer requests, and is then furnished with the desired component values in a well organized manner.

Table 1 is a typical computer output from the program in which worst-case parameter values have been determined for a MIL-type resistor. Other worst-case component parameters are determined in a similar way. After each colon, the user has typed in the information requested by the computer, and at the bottom of the computer output the worst-case parameter values are presented.

The only restrictions inherent in the program (listed in Table 2) are: tolerances and temperature coefficients are assumed to be plus or minus values; five or less alphanumeric characters must be used for the first two entries (see Table 1); and the program assumes a nominal temperature of 25°C.

William J. Budt, Design Engineer, Communications Development Center, Honeywell, Inc., St. Petersburg, Fla.

VOTE FOR 314

Table 1

WORST-CASE PARAMETERS FOR: R1

```

PART TYPE: RN
NOMINAL VALUE: 1E3
PURCHASE TOLERANCE (%): 1
AGING DEGRADATION (%): 1
MAXIMUM TEMPERATURE COEFFICIENT (PPM/°C): 25
TEMPERATURE RANGE (LOW, HIGH): -55,125
AGING DEGRADATION FOR TEMPERATURE COEFFICIENT (%): 1
SUMMING THE WORST-CASE TOLERANCES, AND APPLYING THE
SUM TO THE NOMINAL VALUE, THE FOLLOWING WORST-CASE
VALUES ARE OBTAINED.
LOW TEMP. MIN.  LOW TEMP. MAX.  HIGH TEMP. MIN.  HIGH TEMP. MAX.
.9780E3          .1022E4          .9775E3          .1023E4
    
```

Table 2

```

TYPE 1
1 FORMAT (////////$WORST-CASE PARAMETERS FOR:$)
ACCEPT 2,A
2 FORMAT (A)
TYPE 3
3 FORMAT ($-----$,/)
TYPE 4
4 FORMAT (SX,$PART TYPE:$)
ACCEPT 5,B
5 FORMAT (A)
TYPE 6
6 FORMAT (SX,$NOMINAL VALUE:$)
ACCEPT 7,C
7 FORMAT (E)
TYPE 8
8 FORMAT (SX,$PURCHASE TOLERANCE (%):$)
ACCEPT 9,D
9 FORMAT (E)
TYPE 10
10 FORMAT (SX,$AGING DEGRADATION (%):$)
ACCEPT 11,E
11 FORMAT (E)
TYPE 12
12 FORMAT (SX,$MAXIMUM TEMPERATURE COEFFICIENT (PPM/C):$)
ACCEPT 13,F
13 FORMAT (E)
TYPE 14
14 FORMAT (SX,$TEMPERATURE RANGE (LOW, HIGH):$)
ACCEPT 15,G,H
15 FORMAT (2E)
TYPE 16
16 FORMAT (SX,$AGING DEGRADATION FOR TEMPERATURE COEFFICIENT (%):$)
ACCEPT 17,P
17 FORMAT (E)
FF=F*(1.0+1.0E-2*P)
AA=FF*1.0E-4*(25.0-G)
BB=FF*1.0E-4*(H-25.0)
TYPE 18
18 FORMAT (SX,$SUMMING THE WORST-CASE TOLERANCES, AND APPLYING THE$/)
TYPE 19
19 FORMAT (7X,$SUM TO THE NOMINAL VALUE, THE FOLLOWING WORST CASES/)
TYPE 20
20 FORMAT (7X,$VALUES ARE OBTAINED.$/)
TYPE 21
21 FORMAT (SX,$LOW TEMP. MIN.  LOW TEMP. MAX.  HIGH TEMP. MIN.
+ HIGH TEMP. MAX.$/)
TYPE 22
22 FORMAT (SX,$-----
+ -----$/)
CC=AA+D+E
DD=BB+D+E
A1=C*(1.0-CC*1.0E-2)
A2=C*(1.0+CC*1.0E-2)
B1=C*(1.0-DD*1.0E-2)
B2=C*(1.0+DD*1.0E-2)
TYPE 23,A1,A2,B1,B2
23 FORMAT (SX,E10.4,$      $,E10.4,$      $,E10.4,$      $,E10.4,/)
END
    
```

VOTE! Go through all Idea-for-Design entries, select the best, and circle the appropriate number on the Reader-Service-Card.

SEND US YOUR IDEAS FOR DESIGN. You may win a grand total of \$1050 (cash)! Here's how. Submit your IFD describing a new or important circuit or design technique, the clever use of a new component or test equipment, packaging tips, cost-saving ideas to our Ideas-for-Design editor. You will receive \$20 for each accepted idea, \$30 more if it is voted best-of-issue by our readers. The best-of-issue winners become eligible for the Idea Of the Year award of \$1000.

IFD Winner for November 22, 1969

E. J. Kennedy and J. K. Millard, Development Engineers, Oak Ridge National Laboratory, Oak Ridge, Tenn. Their Idea "Active Clamp Circuit Uses Only Two Transistors" has been voted the Most Valuable of Issue Award.

Vote for the Best Idea in this Issue.

WE'VE MADE AN UNBREAKABLE CASE FOR THE MICRO-D.

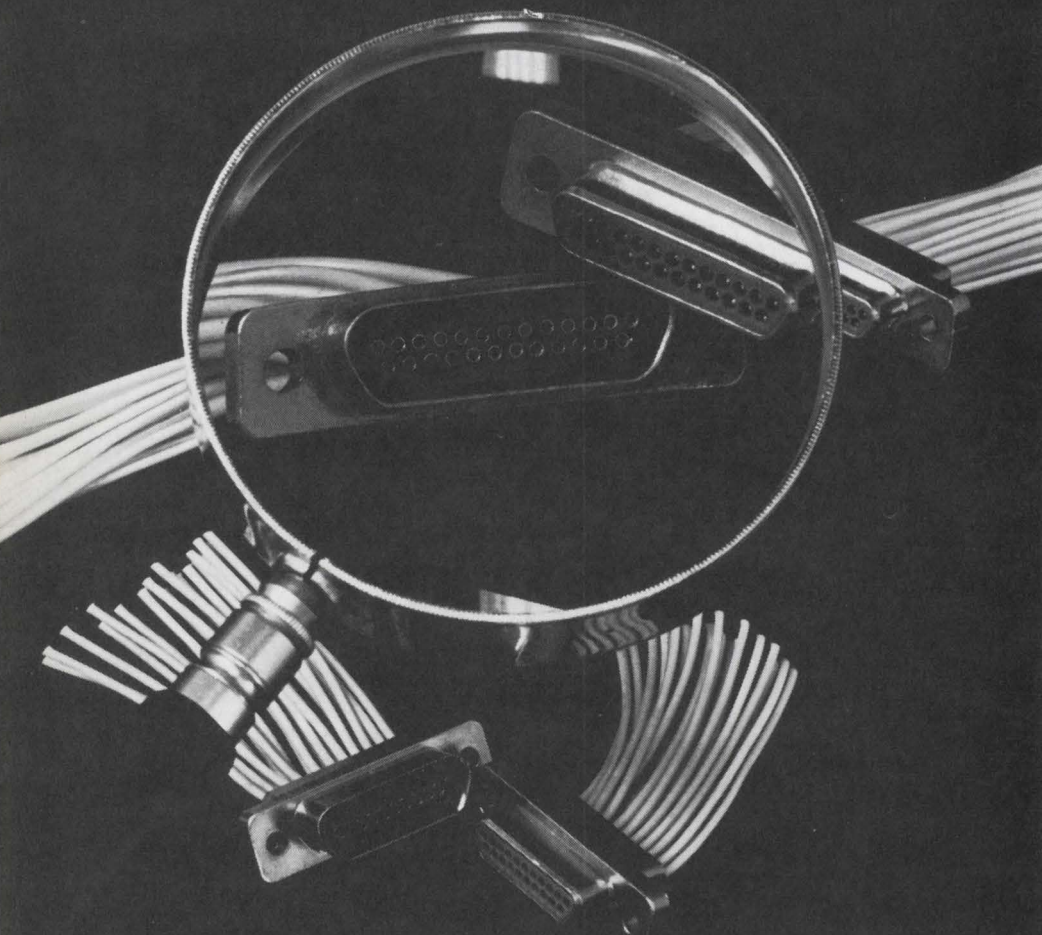

The case for buying our MICRO-D Mark II connector is as solid as the diecast aluminum shell that protects it. This rugged shell gives you all the proof you need. Chip, crack, moisture and EMI proof. Receptacles, plug shrouds and mounting ears take severe punishment without breaking. It's the strongest microminiature available.

Our MICRO-D employs #24 size MICROPIN®/MICROSOCKET® contacts on .050" centers. In a mated condition, there is protection of 40 db attenuation at 1000 MHz. Epoxy sealing at the rear and a silicone elastomer compression interfacial seal enable the Mark II to easily pass the humidity cycle of MIL-STD-202, Method B.

So when you want the best in microminiature connectors, our MICRO-D Mark II's are for you. For more details, pricing and fast delivery, contact your authorized ITT Cannon distributor or write ITT Cannon Electric, 3208 Humboldt Street, Los Angeles, California 90031. A division of International Telephone and Telegraph Corporation.

Twist pin contacts licensed by New Twist.

CANNON **ITT**

Product Source Directory

Multitestors

This Product Source Directory, covering Multitestors, is the tenth in a continuing series of product selection data that will list comparative specifications and prices for products frequently purchased by design engineers. All categories will be arranged according to some primary parameter so that items having similar functional capabilities can be instantly compared.

How to use the tables

The tables in this section list the specifications for multitestors. The following abbreviations ap-

ply to all instruments listed:

n/a—not applicable

ina—information not available

req—request

An index of models by manufacturer is included at the end of each table.

For each table, the instruments are listed in ascending order of one major parameter. The column containing this parameter is color-coded white, and arranged by ascending order of dc sensitivity. Manufacturers are identified by abbreviation. The complete name of each manufacturer can be found in the Master Cross Index.

Abbrev.	Company	Reader Service No.
AUL	AUL Inc. 139-30 34th Rd. Flushing, N.Y. 11354 (212) 886-0600	460
AVO	AVO Gencom Div. 80 Express St. Plainview, N.Y. 11803 (516) 433-5900	461
Connolly	Connolly & Co., Inc. 914 N. Ringstorff Ave. Mt. View, Calif. 94040 (415) 967-6988	462
Heath	Heath Co. Benton Harbor, Mich. 49022 (616) 983-3961	463
Inst Labs	Instrument Labs. Corp. 315 W. Walton Pl. Chicago, Ill. 60610 (312) 642-0123	464
Keithley	Keithley Instrument Corp. 28775 Aurora Rd. Cleveland, Ohio 44139 (216) 248-0400	465
Millivac	Millivac Instrument Inc. 1100 Altamont Ave. Box 997 Schenectady, N.Y. 12301 (518) 355-8300	466

Abbrev.	Company	Reader Service No.
RCA	RCA Electronic Components & Devices Harrison, N.J. 07029 (201) 485-3900	467
R-S	Rohde & Schwarz 111 Lexington Ave. Passaic, N.J. 07055 (201) 773-8010	468
SEP	Scientific Educational Products Corp. 30 E. 42nd St. New York, N.Y. 10017 (212) 867-9480	469
Sigma	Sigma Instruments International Instruments Div. Braintree, Mass. 02185 (617) 843-5000	470
Simpson	Simpson Electric Co. 5220 W. Kinzie St. Chicago, Ill. 60644 (312) 379-1121	471
Triplet	Triplet Electrical Instrument Co. 286 Harmon Rd. Bluffton, Ohio 45817 (419) 358-5015	472
Yokogawa	Yokogawa Electric Works Inc. 1995 Palmer Ave. Larchmont, N.Y. 10538 (914) 834-3550	473

	Mfr.	Model		VOLTAGE RANGES				CURRENT RANGES				OHMS RANGES			Misc Features	Price \$	
				Sensitivity kΩ/V	Min. V	Max. kV	No.	Acc. %	Min. mA	Max. A	No.	Acc. %	Min. kΩ	Max. MΩ			No.
M T 1	AVO	12	dc	0.2	3.6	0.036	4	1	3600	900	6	1	0.0005	0.01	2	ac	135
			ac	0.09	9	0.36	4	2.25									
	Inst Labs	102	dc	1	1	0.5	6	2	1	25	7	2	1	100	2	d	195
			ac	1	5	0.5	5	3	250	25	4	3					
	Triplet	666R	dc	1	10	5	5	3	10	1	3	3	3	3	3	aj	46
			ac	1	10	5	5	4	n/a	n/a	n/a	n/a					
	Simpson	209	dc	1.66	0.06	0.6	5	1.5	120	12	4	1.5	0.001	0.2	2	jq	68
			ac	1.66	12	0.6	4	2.5	6	12	6	2.5					
	Simpson	208	dc	10	0.6	0.6	6	1.5	0.6	3	6	1.5	0.005	1	2	jq	72
			ac	10	12	0.6	4	2.5	0.6	3	6	2.5					
	Triplet	310-C	dc	20	3	0.6	5	3	0.6	0.25	4	3	20	20	4	i	56
			ac	15	3	0.6	5	4	n/a	n/a	n/a	n/a					
AVO	20	dc	20	0.1	1	8	1	0.1	3	10	1	0.002	100	4	a	99	
		ac	2	1	1	7	1	3	3	7	1						
Simpson	160	dc	20	0.25	1	8	2	0.05	0.5	6	2	0.001	30	5	i	55	
		ac	5	2.5	0.1	6	3	n/a	n/a	n/a	n/a						
Simpson	255	dc	20	0.05	1	8	2	0.05	0.5	5	2	0.2Ω	20	3	jt	90	
		ac	5	2.5	1	6	3										
Simpson	250	dc	20	0.05	1	8	2	0.05	10	6	2	0.2Ω	20	3	i	70	
		ac	5	2.5	1	6	3	n/a	n/a	n/a	n/a						
M T 2	Triplet	310	dc	20	3	1.2	5	3	0.6	0.25	4	3	20	20	4	i	44
			ac	5	3	1.2	5	4	n/a	n/a	n/a	n/a					
	Triplet	631	dc	20	3	1.2	5	3	0.06	12	6	3	1.5	150	4	j	86
			ac	5	3	1.2	5	4									
	Sigma	VOM-22	dc	20	5	1.5	5	3	0.5	0.5	4	3	2	2	4		45
			ac	15.5	15	1.5	5	5									
	Connolly	Super 55	dc	20	0.25	2.5	8	1	50	10	8	1	2	20	3	a	90
		MkII	ac	2	2.5	2.5	7	2.25	25	10	6	2.25					
	AVO	8 MkIII	dc	20	2.5	2.5	8	2	0.05	10	7	1	0.0005	20	3	a	115
			ac	1	2.5	2.5	7	2.25	100	10	4	2.25					
	Triplet	800	dc	20	0.3	3	7	1.5	0.12	12	6	1.5	1	100	6	agj	116
			ac	10	1.5	3	6	3	n/a	n/a	n/a	n/a					
			dc	10	0.6	6	7	1.5	0.06	6	6	1.5					
			ac	5	3	6	6	3	n/a	n/a	n/a	n/a					
	Simpson	263	dc	20	0.15	3	9	1.5	0.075	7.5	6	1.5	0.05Ω	50	6	js	97
			ac	10	2.5	0.75	5	3	n/a	n/a	n/a	n/a					
			dc	10	0.3	6	9	1.5	0.15	15	6	1.5	0.05Ω	50	6	i	
			ac	5	5	1.5	5	3	n/a	n/a	n/a	n/a					
Triplet	630-NA	dc	20	0.3	3	7	1.5	0.06	6	6	1.5	1	100	6	i	98	
		ac	10	1.5	3	6	3	n/a	n/a	n/a	n/a						
		dc	10	0.6	6	7	1.5	0.12	12	6	1.5						
		ac	5	3	6	6	3	n/a	n/a	n/a	n/a						
AVO	9 MkII	dc	20	3	3	8	2	0.05	10	7	1	0.0005	20	3	a	115	
		ac	1	3	3	7	2.25	10	10	4	2.25						
Simpson	262	dc	20	1.6	4	7	3	0.08	8	7	3	0.05Ω	50	6	i	83	
		ac	5	3	0.8	6	4	n/a	n/a	n/a	n/a						
M T 3	RCA	WV-38A	dc	20	0.25	5	8	3	0.05	10	6	3	0.2Ω	20	3	a	55
			ac	5	2.5	5	6	5									
	Simpson	261	dc	20	0.25	5	7	1.5	0.05	10	6	2	0.2Ω	20	3	gfw	73
			ac	5	2.5	5	6	3									
	Simpson	260-5	dc	20	0.25	5	7	2	0.05	10	6	2	0.2Ω	20	3	jr	65
			ac	5	2.5	5	6	3									
	Simpson	270	dc	20	0.25	5	7	1.25	0.05	10	6	2	0.2Ω	20	3	gju	78
			ac	5	2.5	5	6	2	n/a	n/a	n/a	n/a					
	Heath	MM-1	dc	20	1.5	5	7	3	0.15	15	5	3	0.01	0.01	3		32
			ac	5	1.5	5	7	3	n/a	n/a	n/a	n/a					
	Triplet	630-L	dc	20	2.5	5	6	ina	0.1	1.2	5	1.5	1	100	4	aj	69
			ac	5	3	5	6										
Triplet	630-APLK	dc	20	2.5	5	6	1.5	0.1	10	5	1.5	0.1Ω	100	4	aj	110	
		ac	5	3	5	6	3										
Triplet	630-APL	dc	20	2.5	5	6	1.5	0.1	10	5	1.5	1	100	4	aj	75	
		ac	5	3	5	6	3	n/a	n/a	n/a	n/a						
Triplet	630-PLK	dc	20	2.5	5	6	2	0.1	10	5	2	1	100	4	aj	98	
		ac	5	3	5	6	3										
Triplet	630-PL	dc	20	2.5	5	6	2	0.1	10	5	2	1	100	4	i	64	
		ac	5	3	5	6	3	n/a	n/a	n/a	n/a						
M T 4	Triplet	630-A	dc	20	3	6	6	1.5	0.06	12	5	1.5	1	100	4	i	75
			ac	5	3	6	6	3	n/a	n/a	n/a	n/a					
	Triplet	630	dc	20	3	6	6	2	0.06	12	5	2	1	100	4	j	64
			ac	5	3	6	6	3	n/a	n/a	n/a	n/a					
	Simpson	256	dc	25	0.1	5	10	1	0.1	5	7	1	0.001	50	4	irs	105
			ac	2	0.5	5	9	1.5	0.5	5	7	1.5	20	50	1		
SEP	30061	dc	50	0.25	1	7	2	0.025	10	5	2	20	200	5	k	61	
		ac	10	2.5	1	6	3	200	10	1	3						

Meet Skinny Mini.

The first
2 amp 2PDT relay
skinny enough
to mount on
0.5 PCB centers.

Never has anything
so flat caused so
much excitement
... since Twiggy.

Here she is, the skinniest,
miniest 2 amp 2PDT re-
lay in captivity. Only
0.340 inches maximum
off the board height.

Cheaper than a crystal
can! Handles more power
than a TO-5 relay! Has ver-
satility of Form C compared
to Pico-reeds! And is smaller
than all other 2 amp indus-
trial relays!

Now Skinny Mini, or as she
is sometimes affectionately
called, Midtex/AEMCO Type
181, with its maximum off-the-
board height of 0.340, mounts
neatly on printed circuit boards
using 0.5 centers. The height
is also compatible with semi-
conductor component mount-
ings.

Skinny as it is, the 181 pro-
vides 1/16" clearance through air
and 1/8" over surface. Terminals
are 0.025" pins. The relay mounts
on four raised pads to permit
proper PCB cleaning and soldering.

Skinny Mini ... the skinniest news
to hit the relay market this year. For
more information about Mini, write or
call Midtex/AEMCO, 507 388-6288, or
see a Midtex/AEMCO representative.

Cheaper than
crystal cans
Handles more power
than a TO-5
More versatile
than Pico-reeds
Smallest 2 amp
industrial relay

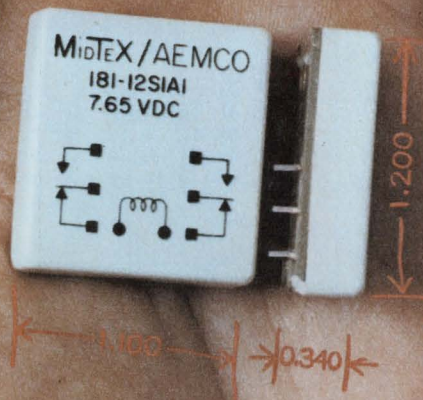

MIDTEX 
INCORPORATED
AEMCO DIVISION

10 STATE STREET
MANKATO, MINNESOTA 56001

PROGRAMMERS/TIME DELAY RELAYS
MINIATURE COAXIAL RELAYS/INDUSTRIAL RELAYS
MERCURY-WETTED CONTACT RELAYS

	Mfr.	Model		VOLTAGE RANGES				CURRENT RANGES				OHMS RANGES			Misc Features	Price \$	
				Sensitivity k Ω /V	Min. V	Max. kv	No.	Acc. %	Min. mA	Max. A	No.	Acc. %	Min. k Ω	Max. M Ω			No.
M T 5	Yokogawa	3201	dc	100	0.3	1.2	8	2	0.012	1.2	6	2	2	20	3		56
			ac	10	3	1.2	6	3									
	Simpson	269	dc	100	1.6	4	8	1.5	0.016	8	7	1.5	0.2 Ω	200	6	i	98
			ac	5	3	0.8	6	2.5	n/a	n/a	n/a	n/a					
	Simpson	257	dc	100	0.1	5	9	1.5	0.01	1	8	1.5	0.001	500	4	jr	95
			ac	20	10	1	4	2.5	n/a	n/a	n/a	n/a	20	50	1		
	Triplet	630-NS	dc	200	0.3	0.6	6	1.5	0.005	12	7	1.5	1	100	6	i	116
			ac	20	1.5	0.6	5	3	n/a	n/a	n/a	n/a					
			dc	100	0.6	1.2	6	1.5	0.06	6	6	1.5					
			ac	10	3	1.2	5	3	n/a	n/a	n/a	n/a					
	R-S	URI	dc	m	0.02	0.3	6	2	n/a	n/a	n/a	n/a	5 Ω	1000	3	mn	595
			ac	m	0.1	0.3	6	4	0.1	1	7	n/a	4				
	R-S	URU	dc	m	5	30	8	6	n/a	n/a	n/a	n/a	0.5 Ω	3000	7	m	595
			ac	m	0.1	1	5	3									
Triplet	630-M	dc	1000	0.3	0.15	5	1.5	0.001	12	7	1.5	1	100	6	ix	231	
		ac	20	1.5	0.6	5	3										
AVO	EA113	dc	1000	0.01	1	11	1.25	0.001	3	8	1.25	0.001	100	5	b	250	
		ac	10M Ω	0.01	1	11	1.25	0.01	3	7	1.25						
AUL	TVOM4	dc	3000	0.15	1.5	7	3	1.5 μ A	1.5	5	3	10 Ω	1	4	g	55	
		ac	ina	1.5	0.5	5	5	n/a	n/a	n/a	n/a						
AUL	TVM4	dc	3000	0.15	1.5	9	3	0.15	1.5	9	3	10 Ω	1	6	g	70	
		ac	ina	1.5	1.5	7	5										
M T 6	AUL	TVOM3	dc	3000	0.5	5	7	3	0.01	1	5	3	20 Ω	0.2	4	g	44
			ac	ina	10	5	5	4	n/a	n/a	n/a	n/a					
	Triplet	310-FET	dc	Zin 10M	0.3	0.6	6	3	0.12	.0012	2	3	5	50	3	ij	74
			ac	5	3	0.6	5	4									
	Simpson	303	dc	Zin 10M	1.2	1.2	6	3	n/a	n/a	n/a	n/a	0.0002	1000	6	hj	92
			ac	275k	1.2	1.2	6	5									
	Triplet	601	dc	Zin	0.1	1	9	2	0.01	0.01	4	3	1	1000	7	dgi	158
			ac	11M	0.01	1	11	3	0.01	0.01	4	4					
	Heath	IM-17	dc	Zin 11M	1	1	4	3	n/a	n/a	n/a	n/a	0.01	10	4		22
			ac	1M	1	1	4	5									
	AUL	DM-1000	dc	Zin	1	1	4	1	0.1	10	6	3	0.1	100	7	ghn	reg
			ac	11M Ω	1	1	4	2	0.1	10	6	4					
	Heath	IM-25	dc	Zin 11M	0.15	1.5	9	3	0.015	1.5	11	4	0.01	10	7		85
			ac	1M	0.15	1.5	9	5	0.015	1.5	11	5					
Heath	IM-16	dc	Zin 11M	0.5	1.5	8	3	n/a	n/a	n/a	n/a	0.01	10	7		47	
		ac	1M	0.5	1.5	8	5										
Triplet	850	dc	Zin	0.5	1.5	11	3	n/a	n/a	n/a	n/a	1	1000	7	gj	98	
		ac	11M	1.5	1.5	7	3										
M T 7	RCA	WV-500B	dc	Zin 11M Ω	0.5	1.5	8	3	0.5	1.5	8	3	0.2 Ω	1000	7	i	88
			ac														
	RCA	WV-98C	dc	Zin 11M Ω	0.5	1.5	8	\pm 3	n/a	n/a	n/a	n/a	0.2 Ω	1000	7	i	99
			ac														
	Heath	IM-18	dc	Zin 11M	1.5	1.5	7	3	n/a	n/a	n/a	n/a	0.01	10	7		30
			ac	1M	1.5	1.5	7	5									
	RCA	WV-77E	dc	Zin 11M Ω	1.5	1.5	7	3	n/a	n/a	n/a	n/a	0.2 Ω	1000	7		63
			ac														
	Triplet	600	dc	Zin	0.4	1.6	10	3	n/a	n/a	n/a	n/a	1	100	6	gj	86
			ac	11M	4	0.8	7	3									
	Simpson	312	dc	Zin 16M	0.5	1.5	8	3	n/a	n/a	n/a	n/a	0.2 Ω	1000	7	jp	95
			ac	Zin 1M	1.5	1.5	7	3									
	RCA	WV-510A	dc	Zin	0.5	1.5	8	3	0.5	1.5	7	3	0.2 Ω	1000	7	gjm	128
			ac	21M Ω	1.5	1.5	7	3									
Simpson	311	dc	Zin 22M	1.5	1.5	7	3	n/a	n/a	n/a	n/a	0.0002	1000	7	jp	91	
		ac	Zin 2.2M	1.5	1.5	7	5										
Millivac	MV-852A	dc	Zin	10 μ V	1	17	1	10pA	0.01	19	2	n/a	n/a	n/a	f	625	
		ac	10-100M Ω														
Millivac	MV-952A	dc	Zin	10 μ V	1	17	1	10pA	0.01	19	2	n/a	n/a	n/a	gh	695	
		ac	10-100M Ω														
M T 8	Millivac	MV-07C	dc	Zin 1-200M Ω	10 μ V	1	17	1	10pA	0.001	17	2	n/a	n/a	n/a	f	575
			ac														
	Millivac	MV-964A	dc	Zin 10-200M Ω	0.0001	1	15	1	0.0001	1	15	2	0.0001	5000	9	gh	525
			ac														
	Millivac	MV-864A	dc	Zin 10-200M Ω	0.0001	1	15	1	0.0001	1	15	2	0.0001	5000	9	fg	445
			ac														
	Millivac	MV-77B	dc	Zin 10-200M Ω	0.001	1	13	1	0.001	1	13	2	0.001	5000	16	g	475
		ac															
Keithley	602	dc	10 ¹⁴	0.001	0.01	9	1	10 ⁻¹¹	0.3	28	2	0.1	10 ⁷	23	e	695	
Keithley	600B	dc	10 ¹⁴	0.01	0.01	7	2	10 ⁻¹⁰	0.3	26	3	1	10 ⁷	21	e	445	
Keithley	610C	dc	10 ¹⁴	0.001	0.1	11	1	10 ⁻¹¹	0.3	28	3	0.1	10 ⁸	3	e	615	

- a. Overload protection.
- b. Center zero.
- c. Special probes available for automotive application.
- d. Pushbutton switching.
- e. Sensitivity: This is the specified input resistance over all voltage ranges.
- f. Requires 105-125V ac, 60 Hz.
- g. Solid state.
- h. Battery or line power.
- i. Measures peak to peak values.
- j. Battery operated.
- k. Overload protection.
- m. Input resistance, dc, 500k Ω ; ac, 150 k Ω .
- n. Also differential voltmeter.

- p. Also measures p-p.
- q. Illuminated scales for use as a continuity checker.
- r. Model 256, 257 accuracy 2.5% and 5% respectively on 5000 V range. Can measure capacitance and ac resistance with use of external ac voltage from 100-240V, 60 Hz.
- s. Dual sensitivity, 1.5% accuracy to 1500V, 2.5% accuracy 3000-6000V.
- t. Also measures temperature 100-1050°F.
- u. Full scale voltage accuracy at 5000V dc 2.25%, ac, 3%.
- w. Full scale voltage accuracy at 5000V dc, 2.5%, ac, 4%.
- x. 0.6-300V at 200 k Ω /V sensitivity, 5 ranges. 0-1200V at 125 k Ω /V, 0-600V at 250 k Ω /V, dc; AC, 3-1200, 5 ranges 10 k Ω /V.

Name	Model	Code
AUL	DM-1000	MT6
AUL, Inc.	TVM4	MT5
	TVOM3	MT6
	TVOM4	MT5
	8MkIII	MT2
AVO	8MkIII	MT2
Avo, Gencom Div.	9MkII	MT2
	12	MT1
	20	MT1
	EA113	MT5
Connolly	Super 55 MkII	MT2
Connolly & Co. Inc.		
Heath	IM-16	MT6
Heath Co.	IM-17	MT6
	IM-18	MT7
	IM-25	MT6
	MM-1	MT3
	102	MT1
Inst Labs	102	MT1
Instrument Labs Corp.		
Keithley	600B	MT8
Keithley Instrument Corp.	602	MT8
	610C	MT8
Millivac	MV-07C	MT8
Milivac Instrument Inc.	MV-77B	MT8
	MV-852A	MT7
	MV-864A	MT8
	MV-952A	MT7
	MV-964A	MT8
RCA	WV-38A	MT3
RCA, Electronic Components & Devices	WV-98C	MT7
	WV-500B	MT7
	WV-510A	MT7
R-S	URI	MT5
Rohde & Schwarz	URU	MT5
SEP	30061	MT4
Scientific Educational Products Corp.		
Sigma	VOM-22	MT2

Name	Model	Code
Sigma Instruments, International Instruments Div.		
Simpson	160	MT1
Simpson Electric Co.	208	MT1
	209	MT1
	250	MT1
	255	MT1
	256	MT4
	257	MT5
	260-5	MT3
	261	MT3
	262	MT2
	263	MT2
	269	MT5
	270	MT3
303	MT6	
311	MT7	
312	MT7	
Triplet	310	MT2
Triplet Electrical Instruments Co.	310-C	MT1
	310-FET	MT6
	600	MT7
	601	MT6
	630	MT4
	630-A	MT4
	630-APL	MT3
	630-APLK	MT3
	630-L	MT3
	630-M	MT5
	630-NA	MT2
	630-NS	MT5
	630-PL	MT3
	630-PLK	MT3
	631	MT2
666R	MT1	
800	MT2	
850	MT6	
Yokagawa	3201	MT5
Yokagawa Electric Works Inc.		

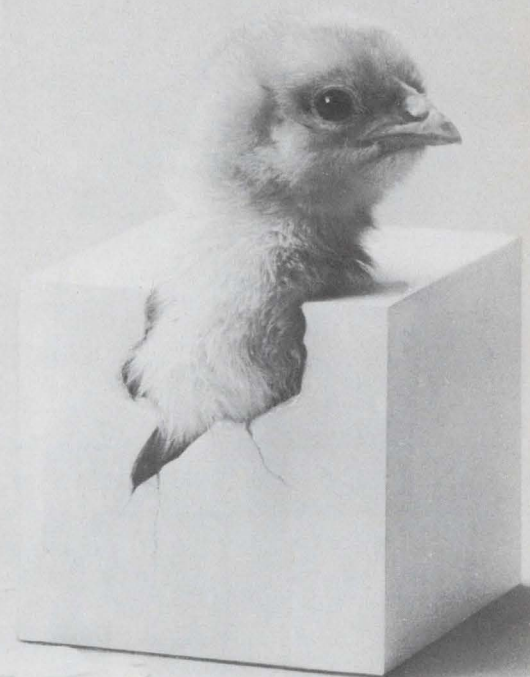

**One of the
 unique qualities
 of Electro Cube
 is to produce
 non-standard
 packages readily**

electro cube

We also make 4,000 or more standard capacitors with wound dielectrics. If case style is a problem, ask. We'll help. Electro Cube, Inc., 1710 South Del Mar Road, San Gabriel, California 91776. (213) 283-0511



When you can't afford a "wrong number"...

Symbolic representation of the TV, voice, ranging data and biomedical telemetry signals from the moon. Photograph courtesy of NASA.

bring ERIE in early.

Where are they? How are they? What do they see... and say? NASA and the world want to know. And, the only way to find out is over the special Motorola S-band equipment on both the Command and Lunar Modules. Once the Apollo Astronauts are over 30,000 miles out, it's their *only* communications link with Earth. It simply can't fail. That's why Motorola called on ERIE TECHNOLOGICAL to develop the EMI filters and Monobloc capacitors that would help this equipment perform flawlessly on every Apollo mission since Motorola has been involved. Proof, once again, that it pays to bring ERIE in early.

ERIE TECHNOLOGICAL PRODUCTS, INC.
644 West 12th Street, Erie, Pennsylvania 16512
(814) 456-8592

INFORMATION RETRIEVAL NUMBER 44

Electronic Design presents the 'top-ten' winners

The following pages display the 10 outstanding advertisements that appeared in our Jan. 4 issue, which featured the "Top Ten" contest. The contest attracted thousands of readers who attempted to match their ratings of the 10 most memorable advertisements with the "recall-seen" scores from ELECTRONIC DESIGN's regular Reader-Recall survey.

The winning advertisements combine attractive colors, tasteful design and well-written copy. The result: impact. The winners, in order of highest Reader-Recall score, are as follows:

- 1. Comar Electric Co.**
- 2. Sylvania General Telephone & Electronics**
- 3. Monsanto**
- 4. Magnecraft Electric Co.**
- 5. Erie Technical Products, Inc.**
- 6. Corning Glass Works, Electronic Products Division**
- 7. Burroughs Corp.**
- 8. Kurz-Kasch, Inc.**
- 9. Centralab Electronics Div., Globe Union, Inc.**
- 10. Potter & Brumfield Div. of American Machine and Foundry**



We make components for guys who can't stand failures.

Everybody hates failures in their electronic gear. It's just that some guys hate failures a little bit more than others.

These are the guys that we try to please.

At Corning, we make our resistors and capacitors to perform like your whole system depended on them, because many times it does. We build an extra measure of performance into all our components to let you build extra reliability into the equipment you design.

Take our precision tin oxide resistors, for example. They're the best of the metal film class. Because the resistive tin film is completely oxidized and molecularly bonded to the glass substrate, our tin oxide resistors are impervious to moisture and environmental degradation. No other resistor can deliver the same stability and reliability over load life. They offer guaranteed moisture resistance across all ohmic values to set a standard of reliability that can't be matched by metal film, wire wounds, carbon comps or metal glaze resistors.

After a recent 56-day-long heat

test in an environment of extremely high humidity, our tin oxide resistors showed a resistance change of just 0.2 per cent. And in an ambient temperature test—now in its ninth year—not one of the 600 tin oxide resistors being tested has exceeded a resistance change of 1.5 per cent.

Take our glass capacitors. The U.S. Air Force has found that our glass capacitors have much better stability and much higher insulation resistance than the ceramic, mica and the other capacitor types they tested. That's why glass capacitors are designed into so many major aerospace and missile projects.

And we've got something to offer when economy and value are the prime considerations. We've developed the Glass-K™ capacitor to give you the volumetric efficiency and economy of monolithic ceramic capacitors, but with the much improved stability and reliability that only a glass dielectric can add. In resistors, our tin oxide resistors already offer long term economy over metal film, precision wire wound and metal glaze resistors.

Our new C3 resistors, in addition to giving you a small case size, compete costwise with carbon comps.

Another important Corning development is the flame proof resistor. These resistors can withstand overloads of up to 100 times rated power without any trace of flame. And because they open under overload, they provide protection for the rest of the system.

At Corning we make components for guys who can't stand failures. Guys like your most important customers. Guys like you. So, next time you're designing a system, reach for your CORNING® capacitor and resistor catalogs and call your local Corning authorized distributor for off-the-shelf delivery. They'll help you design-in an extra measure of performance.

If you don't have our catalogs, ask your Corning distributor for copies or drop us a line at: Corning Glass Works, Electronic Products Division, Corning, New York 14830.

CORNING
E L E C T R O N I C S

Sorry fellows, but we just ran out of ideas.

Ever since we began the Sylvania IDEAS insert, the readers of Electronic Design have placed it in the top ten best-read ads in the January contest issue. Usually, we have re-run our winning insert in an April issue of ED. This year, however, we were caught with our supply of reprints down. We just didn't have enough to meet the needs of the publisher.

However, we do have a limited supply in our files. If

you would really like a copy just circle the reader service number or write to Sylvania Electronic Components, CADD, 1100 Main Street, Buffalo, N.Y. 14209. Another alternative is to wait for our May issue of IDEAS.

Meanwhile, if you can't wait, Sylvania is donating the remainder of this page for you to come up with some new IDEAS of your own.

SYLVANIA
GENERAL TELEPHONE & ELECTRONICS
INFORMATION RETRIEVAL NUMBER 46



One-track mind.

Only need one make-and-break?
Now that's all you have to buy:
this new one-pole relay by Comar.
Gives you the exact number
of poles needed.

If you only need one or two
functions performed,
specify the single-pole relay.

Need two makes-and-breaks?
Specify the two-pole relay.
Same for the three-pole relay.

They're all the same compact size:
 $1\frac{1}{4}'' \times \frac{5}{8}'' \times \frac{5}{64}''$.
They're compatible with one another
so that two three-pole relays

placed side by side, for example,
will give you six poles . . .
in less space than you needed
before for two 4-pole relays.

Less expensive than the 4-pole
relay too. Better balanced.
Yet built with the same exacting
quality that Comar builds
in all their relays.

If you've designed a circuit
that has but one function in mind,
try our one-track mind.
The CR-2 single-pole relay.

Complete with dust cover.
Socket available.

Contact Rating: 4 amps at 120 volts A.C.
resistive and 4 amps at 30 volts D.C.
resistive.
Coil Voltage Range: Up to 115 volt D.C.



3349 Addison Street/Chicago, Ill. 60618
Phone: (312) JU 8-2410

Send me one free!
 Single-Pole Double-Pole Three-Pole
Available to qualifying purchasing agents and
engineers. Please fill in completely.

Name _____
Title/Function _____
Company _____ Phone _____
Address _____
City _____ State _____ Zip _____
Your Product Line _____

New! Comar CR-2 Relays • Single-Pole • Double-Pole • Three-Pole

Try to do this with semiconductors

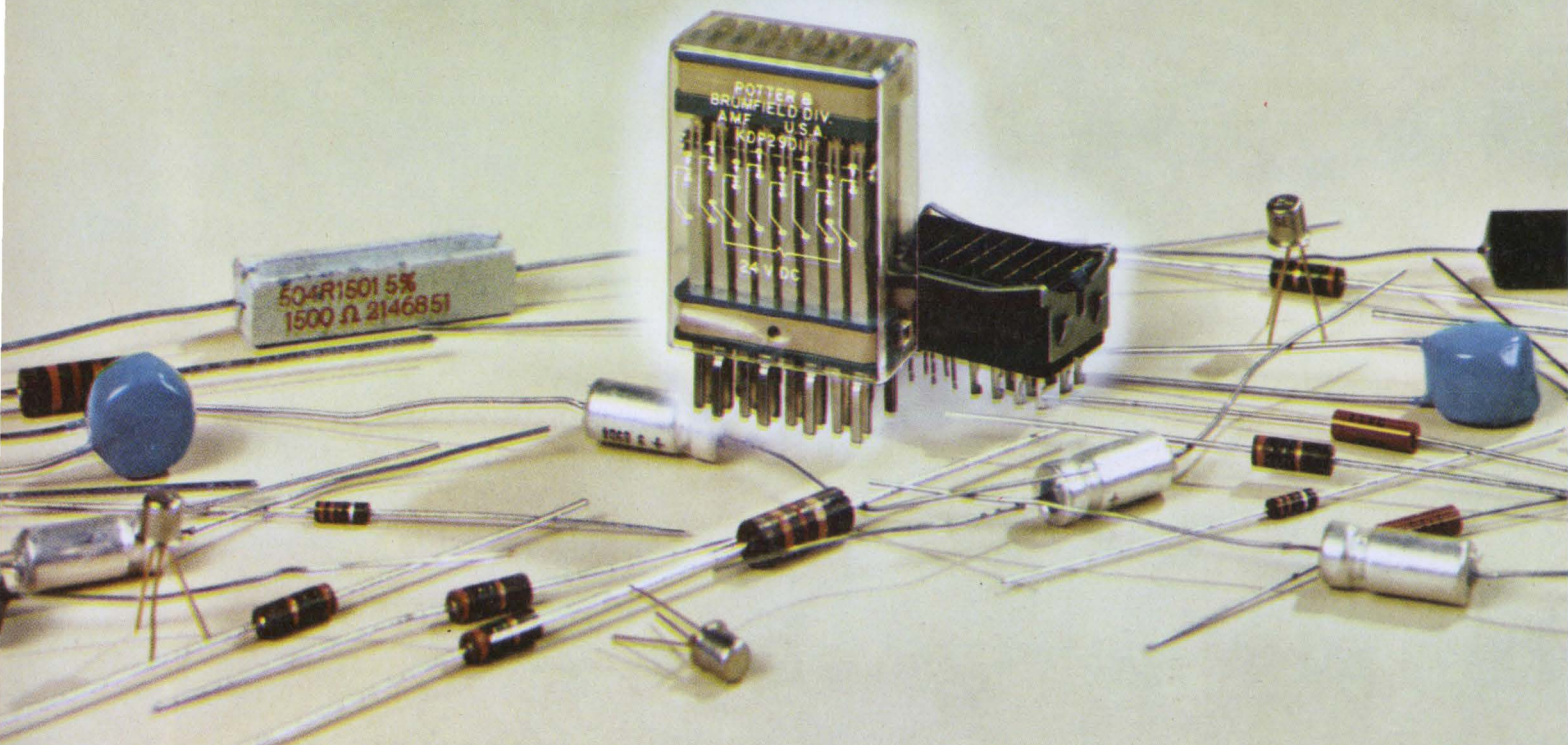

Where else can you get 8 Form C switching in a package that measures just over a cubic inch and costs less than 50¢ per pole?* You can't with semiconductors. You'd wind up with a much larger, more expensive array.

Speaking of cost, the KDP has a single lot price of \$9.35. The list price, by the way, is less than two of our most popular 4-pole relays.

The compact KDP is ideal for logic circuits where a single input will give you a fan-out of eight. Open-minded engineers will find that a strong case for this relay over solid state switching. Remember, too, you get electrical isolation on both the input and switching sides.

Bifurcated contacts are rated at 1 ampere at 30V DC or 120V AC, resistive. Standard relays have an 8 Form C contact arrangement. Combinations of Form C and Form D (make-before-break) are available on special order. Coil voltages range from 6 to 48V DC.

Order prototype models today from your local P&B representatives or call us direct. Potter & Brumfield Division of American Machine & Foundry Company, Princeton, Indiana 47570. 812-385-5251.

*Maximum discount

KDP SPECIFICATIONS

General
Temperature range -45° to +70°C.

Contacts
Arrangements: 8 Form C (8PDT).
Rating: 1 amp at 30V DC or
120V AC, resistive.

Coils
Voltages: To 48V DC
Duty: Continuous
Pick-up @ 25°C: DC, 75% of nominal
voltage.
Operate Time: 15 ms maximum at nomi-
nal voltage @ 25°C.

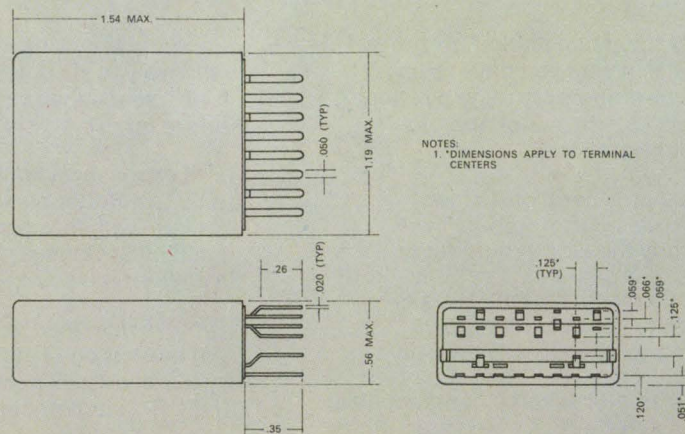

POTTER & BRUMFIELD



**This counter fell off a plane.
It didn't need service
(but when one does, we're ready).**

This Model 100A Counter-Timer was enroute to a customer. A freight handler laid it on the wing of the airplane—and forgot it. The package finally slid off as the wheels left the runway. Instantly freed of its container, the “Small Wonder,” as our customers sometimes call it, chased the plane for about a hundred yards, then ground-looped.

Our nearby Service Center, bored with inaction, brightened at the thought of a real challenge when it was brought in. But they were disappointed: electrically, the “Small Wonder” picked up right where it left off in Final Inspection. (Of course, *mechanically* there were a few abra-

sions to take care of, as you can see.)

Please help us keep our 37 Service Centers with their factory-trained technicians alive and well. Call the one nearest you anytime you feel that a Monsanto instrument requires service or calibration...or even verification of its performance. In addition to their expertise and factory specified test equipment, all carry a complete stock of spare parts. If there should be a defect in materials or workmanship during the 2-year warranty period, it won't cost you anything.

Monsanto Company, Electronic Instruments, West Caldwell, New Jersey 07006.

MOST DIVERSIFIED LINE OF 512 STOCK RELAYS FOR CUSTOM APPLICATIONS
general purpose • telephone type • dry reed • mercury-wetted contact • industrial power • plug-in
coaxial • hermetically sealed • time delay • solid state • printed circuit • latching • high voltage

Magnecraft®

STOCK RELAYS

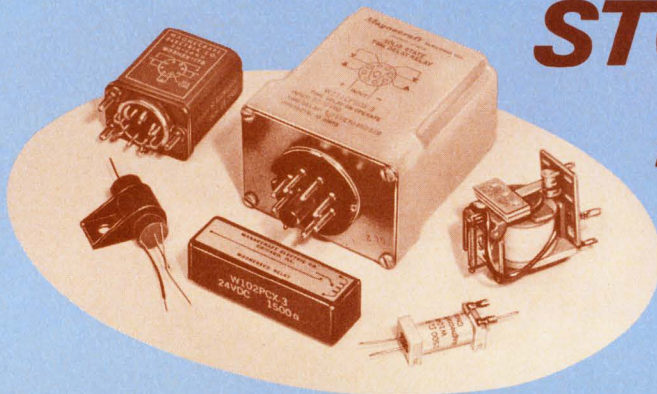

**CATALOG
NO. 271**

*Specifying relays? You need our
new catalog of 512 stock relays for
immediate delivery. Send for it!*

MAGNECRAFT ELECTRIC CO. • 5575 N. LYNCH AVE. • CHICAGO, ILL. 60630 • 312 282-5500 • TWX 910-221-5221

MAGNECRAFT'S CATALOG INSERT WAS ONE OF THE TOP TEN WINNERS!



25 years in the thick of it

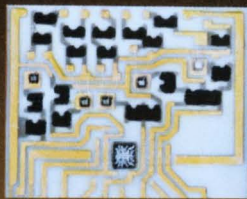

Centralab introduced thick film technology in 1945.

The result—microcircuits with superior design and performance today.

No one offered thick film microcircuitry as a serious answer to reliability and miniaturization requirements 25 years ago. But Centralab got right into the thick of it. And it's difficult to catch someone with a 25 year head start. In numbers alone our lead is commanding. We've produced more than 500,000,000 units, with some 5,000 custom designs. No one can approach this production record. In material selection our experience again gives us a sharp edge. Ceramics, metallizing compounds, resistor inks, glaze and sealing materials have all been

specially developed by Centralab's Material Sciences Group to our specifications for durability in processing and application. The Semiconductor Division is a ready source for a wide variety of chips. We even manufacture our own ceramic substrates through an exclusive thin sheet process that is superior to any other method in the industry. And our computer-aided analysis service provides prompt, practical answers to circuit design problems. We don't mean that thick film chip hybrids are the answer to every problem in microcircuitry.

But you'll be surprised at how many solutions these low-cost custom units provide. For more information on how you can get into the thick of it with Centralab, turn the page.



CENTRALAB

Electronics Division
GLOBE-UNION INC.

5757 NORTH GREEN BAY AVENUE
MILWAUKEE, WISCONSIN 53201

1945-1970

A quarter century of technology on your side



First use of Centralab's thick film microcircuit

Centralab pioneered thick film microcircuitry in 1945 when we developed a miniature oscillator-amplifier circuit for a mortar shell proximity fuse. This first-of-a-kind unit, admittedly crude by today's standards, consolidated carbon composition resistors, silver-ceramic capacitors and silver circuit paths screened onto a ceramic substrate, which met tough shock requirements. The completely sealed unit was about 3 inches in diameter and 4 inches long.



100,000,000th microcircuit

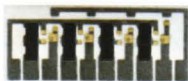
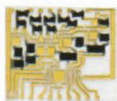

Centralab's new thick film chip hybrid

This assembly, which became known as a Packaged Electronic Circuit (PEC), opened the door to an entirely new technology. By 1959, we had produced our 100,000,000th unit. A plaque commemorating this historic production is on permanent display at the Smithsonian Institute, a milestone in the electronic industry.

PECs are still being used extensively for industrial, military and consumer applications. But continued technological developments have brought a new degree of sophistication to the art of thick film microcircuitry. So we've developed our new thick film chip hybrid microcircuits. Chip active devices — diodes, transistors, and ICs — are combined with fired on resistors, wiring and capacitors to provide a reliable circuit module. These are smaller, harder working, more sophisticated devices that are custom designed for specific applications.

We're uniquely qualified to provide thick films because our 25 years of experience have given us an intimate knowledge of materials, technology, design, production and service. Following, in more specific terms, is what we mean:

Materials to service: The Centralab capability

Basic to the ultimate performance of thick film chip hybrid microcircuits is the evaluation, selection and development of materials that will withstand sophisticated manufacturing processes as well as demanding applications. The Centralab Material Sciences Group of specialized technical personnel determines what materials will best support the special requirements of our design and production facilities.



Materials developed specifically by Centralab

One example of the work of this group is the ceramic substrate used in our thick film circuits. To meet design parameters for maximum thermal conductivity and mechanical strength, as specified by our engineers, an exclusive thin sheet ceramic production process was developed that produces substrates of unexcelled surface finish and reliability. These are so superior to others available, that Centralab is a leading supplier to other microcircuit manufacturers. Our ceramic capability has also provided high performance hermetic packages.

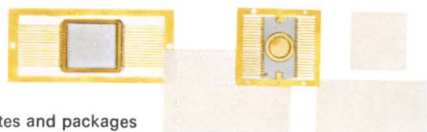

Centralab substrates and packages

Another joint effort of our materials and engineering development personnel resulted in a monolithic chip capacitor (Mono-Kap) that has virtually eliminated pin holes that destroy capacitor reliability and long life.

Micrographs of Mono-Kaps and competitive units

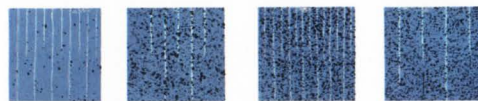

Mono-Kap Competitor A Competitor B Competitor C

We've also produced molybdenum/gold substrates with amazingly complex pattern geometry. These substrates, and our proprietary process (patent applied for) for producing them, permit thicker gold deposits and are ideally suited to ultrasonic and thermocompression bonding methods.



Molybdenum/gold substrates

Our computer-aided design and circuit analysis services can provide optimum design to minimize failures, enhance performance, and reduce cost. Our comprehensive thick film background gives us another head start in being able to program our computer so that improved design is assured at the most reasonable cost.

All of our experience and technological skills are reflected in the design and production of Navy Standard Hardware Modules. These plug-in modules combine circuit functions to constitute a complete electronic system that is reliable, flexible and economical.

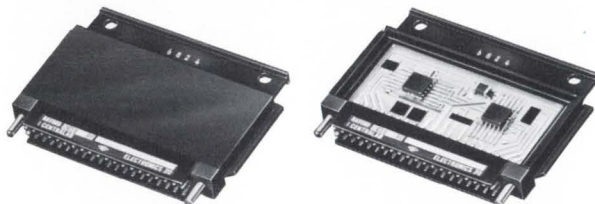

Navy Standard Module

One more thing. With all our capabilities, we realize that speed is often the most important criteria for judging a thick film microcircuit manufacturer. That's why we are geared to provide production samples to your specifications in as little as three weeks; production quantities eight weeks after prototype approval.

It all adds up to one fact: No other manufacturer is better qualified to help you find the most efficient use of thick film chip hybrids in your circuit design. And if you'd like to find out precisely how we can help you, send your requirements or circuit design to Centralab Application Engineering. There's no better way to get into the thick of it.



CENTRALAB

Electronics Division
GLOBE-UNION INC.

5757 NORTH GREEN BAY AVENUE
MILWAUKEE, WISCONSIN 53201

Ernst Greenberg - New York

Kurz-Kasch instrument knobs turn the action on!



Write for new catalog
and free knob samples.

A knob is to start something. Or stop it. Or make it faster or or slower. Or more or less.

But a well designed knob on a well designed piece of equipment (electronic or otherwise) does more than this. It not only turns the equipment on—it turns the user on!

After all, the knobs are what an equipment user (and buyer) sees first, last, and most often. If they don't do more for him than turn the equipment on, the whole design leaves him cold.

Kurz-Kasch knob designers know this. They've put together a line of 347 instrument knobs in a variety of sizes, colors and thermosetting plastic materials. Each one is calculated to turn the action on—with *your* equipment, *your* users, *your* buyers.

You can join 4,000 action oriented original equipment manufacturers who already turn on with KK Knobs. Write today for free Kurz-Kasch Designer Catalog.



Kurz-Kasch, Inc.

Standard Parts Division • Dayton, Ohio 45401

INFORMATION RETRIEVAL NUMBER 52

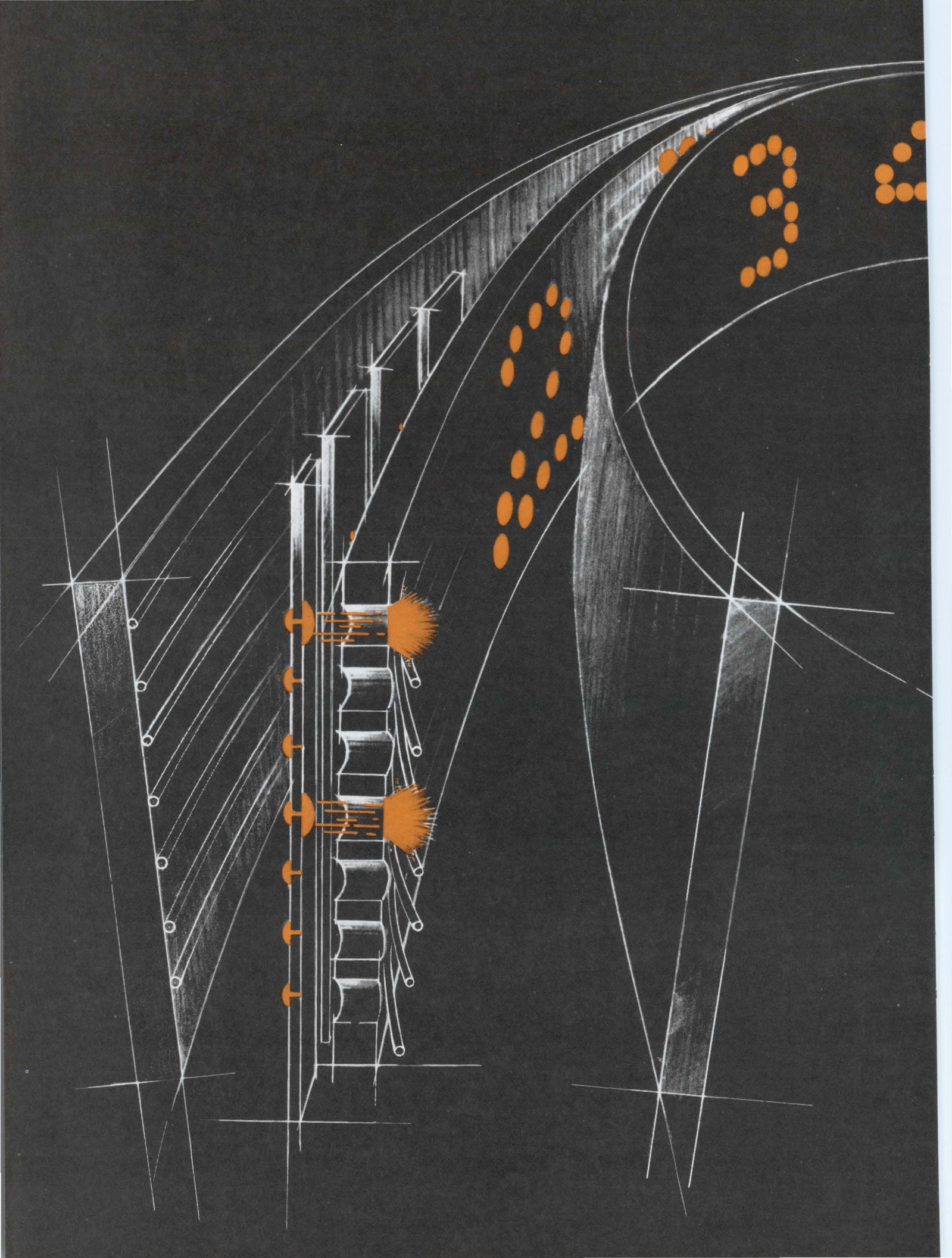

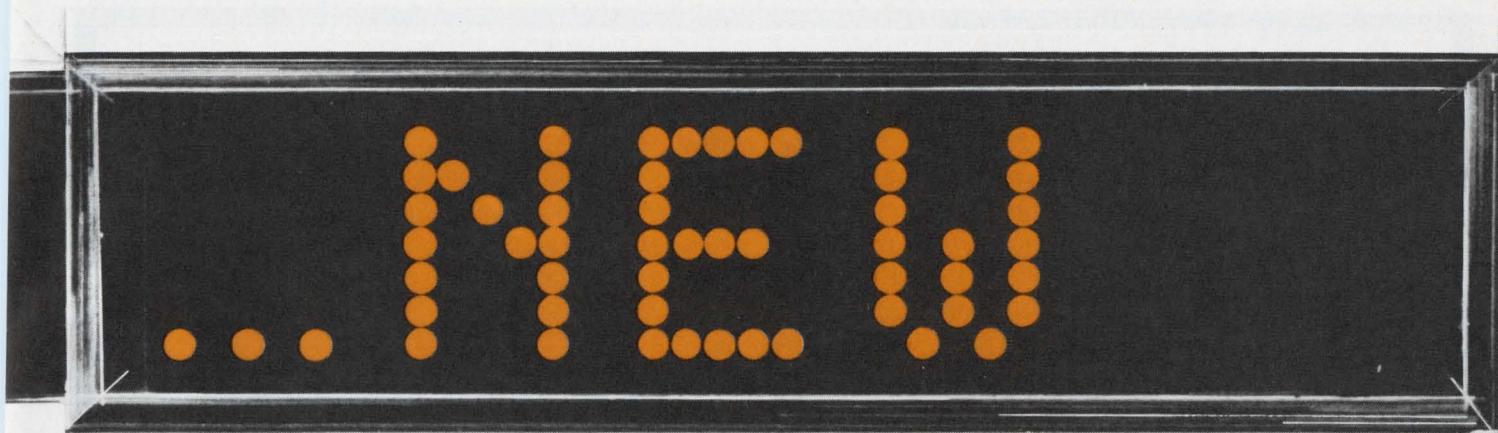

SELF-SCAN™ PANEL DISPLAY eliminates up to 90% of drive electronics

SELF-SCAN panel displays represent a Burroughs invention of panel design and circuitry that permits time sharing of the cathode electrode drivers in a flat panel display using gas discharge light emitters. Consequently a savings of up to 90% of the electronics required to drive the dot matrix display is realized.

For informational purposes the SELF-SCAN panel display can be thought of as a dot matrix panel with common cathode strips capable of glowing on both front and back sides. The glow on each side of the cathodes is independently controlled by a set of anodes located on the front and back of the panel. The rear portion of the display consists of 7 glow-priming anodes which work in conjunction with 111 vertical cathode strips (common to both sets of anodes). These cathodes are interconnected in three groups of 37 cathodes each and connected to a three

phase clock which sequentially brings each cathode to ground potential. As each cathode is grounded in sequence, the glow is transferred to the adjacent cathode. This transferred glow at the rear of the panel is not discernible from the front. (The illustration shows the first cathode grounded and glow at the 7 rear anode intersections.)

When it is desired to display a dot on the viewing surface, the front glow transfer anodes are utilized. (The glow transfer anodes and common cathodes make up the front matrix.) The appropriate transfer-anode is selected in synchronism with the cathode and the glow transfers forward to the panel front for viewing. (The illustration shows the top and center dots on the first cathode trans-

ferred for viewing.) The whole display panel is refreshed and updated to produce a bright flicker-free display.

As a normal dot matrix panel requires a cathode driver for each cathode (80 high-voltage drivers required for a 16 digit display) and the SELF-SCAN panel display requires *only* 3 clock controlled cathode drivers regardless of the number of digits, the significance of this development is immediately apparent.

The SELF-SCAN panel display has unlimited applications, as alphanumeric and graphic messages can be presented with simplicity.

Write today for descriptive brochure, Burroughs Corporation, Box 1226, Plainfield, N.J. (201) 757-5000.



Burroughs





Frequency converters

50-60 cps to 400 cps

TFC Line
FC Line

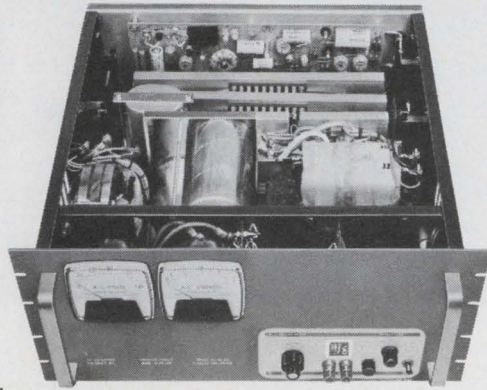

DESIGN CONCEPT: Completely solid state, Silicon power rectifiers, silicon zener diode reference, germanium control and power transistors.

Model No.	OUTPUT			400 CPS OUTPUT CHARACTERISTICS					TRANSIENT RESPONSE				INPUT POWER			DIMENSIONS		App. Ship. Wgt.	Price
	AC Volts	* Volt. Amps	Δ Freq.	Dis-tortion	Ampli-Mod.	Static Regulation			Recovery		Over Shoot	±10% Line	Volts Single Phase	Δ Freq.	Max. Amps.	H x W x D			
						Load	Line	Freq.	NL-FL	FL-NL									
TFC-26-100	24-30	0-100	380-420	5%	3%	±1%	±1/2%	±1/2%	30MS	10MS	5 volts	2%	105-125**	50-60	3.5	4 1/2" x 8" x 14 3/8"	30	\$ 420.	
TFC-26-200	24-30	0-200	380-420	5%	3%	±1%	±1/2%	±1/2%	30MS	10MS	5 volts	2%	105-125**	50-60	7	5 1/4" x 19" x 16 5/8"	60	640.	
TFC-115-100	105-130	0-100	380-420	5%	3%	±1%	±1/2%	±1/2%	30MS	10MS	15 volts	2%	105-125**	50-60	3.5	4 1/2" x 8" x 14 3/8"	30	410.	
TFC-115-200	105-130	0-200	380-420	5%	3%	±1%	±1/2%	±1/2%	30MS	10MS	15 volts	2%	105-125**	50-60	7	5 1/4" x 19" x 16 5/8"	60	630.	
FC-26-500	24-30	0-500	380-420	5%	3%	±1%	±1/2%	±1/4%	100MS	30MS	5 volts	2%	105-125**	50-60	15	8 3/4" x 19" x 16 5/8"	150	1180.	
FC-115-500	95-135	0-500	380-420	5%	3%	±1%	±1/2%	±1/4%	100MS	30MS	15 volts	2%	105-125**	50-60	15	8 3/4" x 19" x 16 5/8"	150	1120.	
FC-115-1000	95-135	0-1000	380-420	5%	3%	±1%	±1/2%	±1/4%	100MS	30MS	15 volts	2%	188-228†	50-60	17	17 1/2" x 19" x 16 5/8"	300	1920.	

* All output ratings are given for unity power factor loads. Ratings may be increased linearly to 125% for FC models and to 140% for TFC models at zero lagging power factor loads.

Δ CONTACT NJE SALES DEPT. FOR OTHER INPUT AND OUTPUT FREQUENCY REQUIREMENTS.

** Available with 210-250 Volts input at half input current shown in chart above (no extra charge). When ordering specify model number followed by (-230) suffix, i.e. TFC-26-200-230.

† Available with 198-242 Volts input at 15 amps input current at no extra charge. When ordering specify FC-115-1000-220.

VOLTAGE STABILITY: After a 1/2 hour warm up with constant load and constant ambient temperature, the voltage will not drift more than 0.1% for an 8 hour period.

VOLTAGE TEMPERATURE COEFFICIENT: After a 1/2 hour warm up with constant load the average temperature coefficient will not exceed 0.1%/°C.

FREQ. STABILITY: After a 1/2 hour warm up with constant load, and constant ambient temperature, the frequency will not drift more than 0.2% for an 8 hour period.

FREQUENCY TEMPERATURE COEFFICIENT: After a 1/2 hour warm up with constant load, the average temperature coefficient will not exceed 0.05%/°C.

METERS: Ammeter and voltmeter furnished. Meters are accurate to 3% of full scale rating.

POLARITY: All supplies can be floated up to 500V peak off ground. Either line may be grounded to the chassis ground terminal provided.

DUTY: Continuous at unity power factor at ambient temperatures from 0° to 45°C for FC models and 0° to 40°C for TFC models (35°C at 50 cps input). FC models may be operated above 45°C provided that the output current is derated linearly to zero at 60°C. Consult factory for derating characteristic on TFC models.

REMOTE SENSING: The FC Supplies are provided with circuitry to sense and regulate the voltage at the load rather than at the output terminals, eliminating the otherwise unavoidable load regulation due to the resistance of the wire connecting the supply to the load.

REMOTE PROGRAMMING: The output voltage and/or frequency may be accurately controlled from a remote point, if desired, by inserting a resistance across "Remote Program" terminals provided on rear.

OUTPUT ADJUSTMENT: Output Voltage and Frequency adjustments are accomplished by a dual potentiometer on front panel.

EXTERNAL SYNCHRONIZATION: All models may be synchronized to an external standard by the use of terminals on rear of chassis.

TERMINATION: A barrier type terminal strip is provided at the rear of the unit for all input, output, sensing, remote programming and external synchronization connections. Output is also available on the front panel through binding posts.

PROTECTION: During overloads or short circuit the load is electronically disconnected on FC models and electronically limited on TFC models. If the overload persists on TFC models, the load is disconnected from the supply by a fuse. Internal components are protected by an automatic resetting thermal switch.

MOUNTING: All Models supplied with full dust cover. All Models except the two 100VA units are supplied as 19" rack equipment: The 100VA units are supplied for laboratory bench use. Rack mounting is obtainable by means of the following rack adapter panels.

RP1 — 5 1/4" high, 19" wide, with cutout for one unit.

RP1A — Same as RP1 except cutout is offset to leave half of panel blank.

RP2 — 5 1/4" high, 19" wide, with cutouts for two units.

FINISH: Front Panel finished in dark grey enamel equivalent to FED STD 595 Chip No. 26132. Marking is white. All other finishes are appropriate paint, plating or chemical film as required.

INSPECTION: MIL-I-45208A.

OPTIONAL FEATURES:

The following optional features are available on any given unit. Consult Field Representative for option prices not provided on price page.

MULTIPHASE OPERATION: Single phase models can be combined to produce a three phase 4 wire or two phase 4 wire output, by using the multiphase adapters which have a maximum phase shift of 2.5° per phase and maximum line to line output distortion of 3%. When operating in the multiphase mode the single phase regulation and VA specifications become the line to neutral specifications.

TUNING FORK: For frequency stability up to 0.005%. Can be mounted within units on all models except 100 VA units.

Bench Adapter: Available for all 19" rack models up through 8 3/4" panel sizes. Add suffix (-B) to model number.

Power Cord: All models available with power cord. Add suffix (-P) to model number.

427

NJE CORPORATION
A Subsidiary of Corporation

20 BORIGHT AVENUE, KENILWORTH, N. J. 07033
Phone: (201) 272-6000 / Telefax: FFP / TWX: (710) 996-5967

New Products

TTL quad flip-flop with three logic states eliminates need for OR gates on output

National Semiconductor Corp., 2900 Semiconductor Dr., Santa Clara, Calif. Phone: (408) 732-5000. P&A: \$9.60; stock.

Actually a three-logic-state digital circuit, a new TTL flip-flop can assume one of three output conditions — low-impedance ON, low-impedance OFF, or a high-impedance state. This means that the DM8551 quad D flip-flop can be wire-OR'd (its four outputs can be joined together directly without using an OR gate).

Now designers can get an extra gate function at no extra cost since the DM8551 is cost-competitive with previous techniques and offers simplified circuitry. In addition, there is no sacrifice in gate speed or fanout. The device also has the advantage of TTL-type switching, and can drive active loads.

Normally, when a TTL circuit is in the logical 1 state, the pull-up transistor is ON and the pull-down transistor is OFF. When the circuit is in the logical 0 state, the pull-down transistor is ON and the pull-up transistor is OFF.

Besides the conventional low-impedance ON and low-impedance OFF logic states, the DM8551 has a third high-impedance output state in which both of the output transistors are OFF. This third state is made possible by a third output transistor that is connected to the phase-splitting internal transistor, but actually has no external connection.

In the DM551, the third transistor is placed so as to divert base current from both of the output transistors, thus turning them both OFF. Since these transistors are the only two outputs, the outside world sees a high impedance.

The third transistor will normally be ON. Stored data will not appear at the output unless it is specifically addressed with the output enable lines.

The logical structure of the DM8551 is shown in the figure. The output enable lines lead into a NOR gate, so that there will be a pulse to enable the output only when both inputs are at 0. In effect, there is a single-pole single-throw switch between the output transistors and the output pads.

Fully compatible with the rest of National Semiconductor's series 54/74 circuits, the new quad flip-flop lets the user run many subsystems with a minimum number of lines, inside or outside of a computer. It is a 4-bit interface latch intended for use where information is being handled in word-serial and bit-parallel formats.

One set of input and output enable lines control all four flip-flops, and all four are clocked simultaneously. It is possible to tie together (wire-OR) as many as 40 packages and still have the full fanout of 10 on the other side of the drive line.

By including input enable cir-

cuitry, the DM8551 greatly simplifies its application. In a D flip-flop such as this one, with a single data entry line, an output will appear at Q one clock pulse after the data has been entered.

Normally, the designer must inhibit the clock to prevent the device from changing states at each clock pulse. This can unnecessarily complicate a system; and if the clock control is skewed even slightly, the circuit will switch falsely anyway.

The DM8551's input enable circuitry, however, frees the designer from all concern about clock control. In a sense, the circuit will simply sample itself until the proper signals are applied to the input enable lines. When that happens, the Q feedback will be blocked from its AND gate, and only new data will enter the flip-flop.

The DM8551 quad D flip-flop has an operating temperature range of 0 to 70°C.

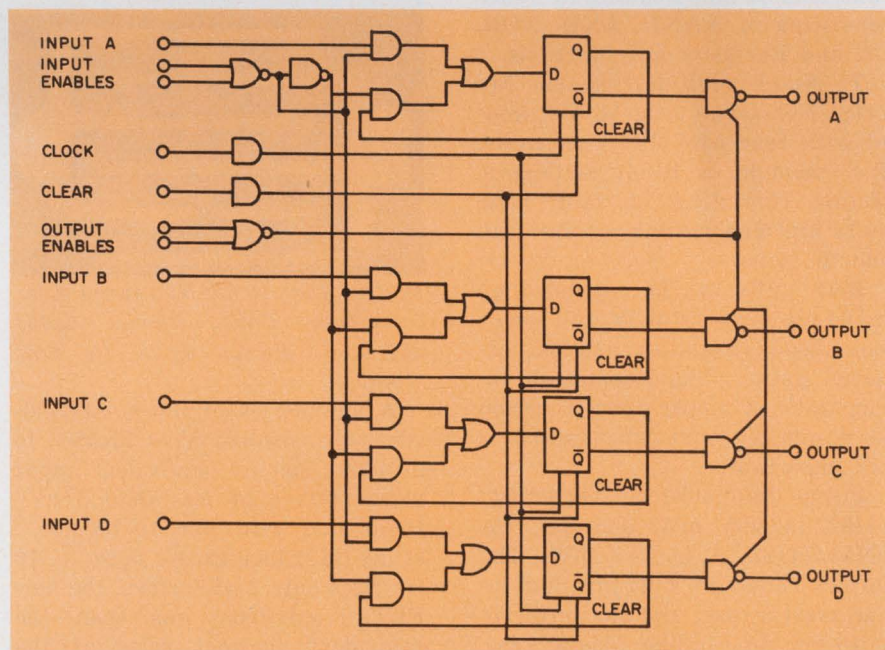

TTL quad D flip-flop with three logic states lets its outputs be tied together directly, without using an OR gate. A third transistor on each of its outputs makes possible a high-impedance state besides the conventional low-impedance ON state and low-impedance OFF state. **CIRCLE NO. 250**

Low-cost TTL MSI IC pair enhance arithmetic logic

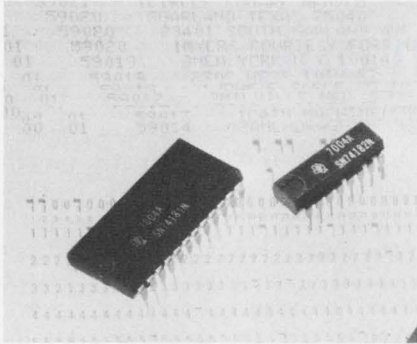

Texas Instruments Inc., Components Group, 13500 N. Central Expwy, Dallas, Tex. Phone: (214) 238-3741. P&A: \$16.50, \$3.63; stock.

Two new low-cost TTL MSI integrated circuits producing a fast arithmetic-logic-unit/function-generator are the SN54/74181 arithmetic-logic unit and the SN54/74182 carry look-ahead generator.

The SN54/74181 unit features 75 equivalent gates on a single chip and does 16 binary arithmetic manipulations on two 4-bit words.

Manipulations include adding, subtracting, decrementing and direct transfer. Typical addition/subtraction time is 24 ns.

It can also perform 16 logic functions of two Boolean variables consisting of NAND, AND, NOR, OR and Exclusive OR functions.

To reduce addition time, one 54/74182 look-ahead generator is needed with four 54/74181 logic units. For example, a 16-bit arithmetic section consisting of four logic units and one look-ahead unit can add in 36 ns.

Both units can be expanded up to 64-bit sections with full carry look-ahead capability and no external gating. The ladder unit incorporates a ripple carry function to minimize count when speed is not important.

Power dissipation for the SN54/74181 is 455 mW and for the SN54/74182 it is 180 mW. The former comes in a 24-pin dual-in-line plastic case, and the latter in a 16-pin dual-in-line plastic case. Both units can be supplied to operate over the temperature range of -55 to +125°C or 0 to 70°C.

CIRCLE NO. 251

Hermetic SCRs boast 70¢ tag

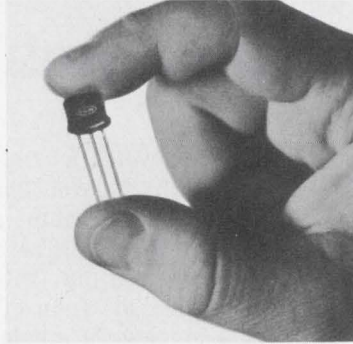

Unitrode Corp., 580 Pleasant St., Watertown, Mass. Phone: (617) 928-0404. P&A: from 70¢; stock.

With prices starting at 70¢ each for 1000-unit quantities, series ID200 hermetically sealed industrial SCRs offer voltage ratings from 50 to 200 V at a continuous forward dc current of 1.6 A and a case temperature of 70°C. The devices, which are packaged in a TO-39 metal can, have a gate trigger current of 200 μ A maximum. They can replace relays and drive lamps.

CIRCLE NO. 252

Junction FETs put down noise

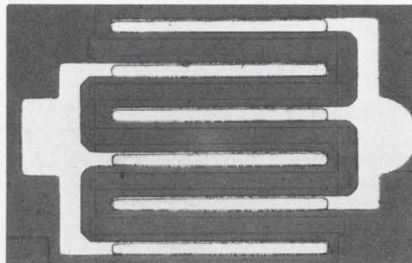

Intersil Inc., 10900 N. Tantau Ave., Cupertino, Calif. Phone: (408) 257-5450. P&A: \$2.75 to \$20; stock.

A new series of low-noise field-effect transistors, types 2N4867 to 2N4869, has an equivalent input noise voltage of less than 5 nV/Hz^{1/2} at 1 kHz, and 10 nV/Hz^{1/2} at 10 Hz. Since excess noise at 10 Hz rises only 2 dB/octave, the new FETs contribute less than the equivalent thermal noise of the signal source from 100 Hz to 10 kHz, for generator resistances from 5 k Ω to 10 M Ω .

CIRCLE NO. 253

Silicon transistors switch 150-W pulses

Mullard, Mullard House, Torrington Pl., London, W.C.1, England.

Three new silicon planar transistors can switch 150-W pulses having durations that do not exceed 50 μ s and with a duty factor of 0.1. Types BDY60, BDY61 and BDY62 also provide saturation voltages of 0.9 V maximum and a continuous power rating of 15 W. Applications include high-frequency inverters and converters, and use as pulse modulators in communications and radar systems.

CIRCLE NO. 254

Npn/pnp power pairs can carry up to 20 A

Solitron Devices, Inc., Semiconductor Div., 1177 Blue Heron Blvd., Riviera Beach, Fla. Phone: (305) 848-4311. Availability: stock.

Particularly suitable for amplifier and switching applications, industrial complementary silicon power transistors cover current ratings from 1 through 20 A. These general-purpose npn/pnp power pairs include: types 2N2033 (npn) and 2N3740-41 (pnp) rated at 1 A, and types 2N3771-72 (npn) and 2N5737-44 (pnp) rated at 20 A.

CIRCLE NO. 255

Transistor chips match to 10 μ A

Dionics Inc., 65 Rushmore St., Westbury, N.Y. Phone: (516) 997-7474.

A new line of npn silicon matched-pair transistor chips for hybrid circuits and differential amplifier circuits offer a close parameter match from 10 μ A to 1 mA. Types 4044/4878, 4100/4879 and 4045/4880 have collectors that are isolated from each other, and from the bottom of the chip. The chips are gold-backed, permitting conventional eutectic die-bonding techniques.

CIRCLE NO. 256

Intech's trimming their sales.

It may be nautical nonsense, but our customers are helping us do just that.

Using creative technology and a firm below-the-market standard price, we've launched another flagship: the A-125. With its ultra-low bias current, it's creating quite a wake for the competition.

Advantages? A low noise, high common mode rejection, junction FET input stage with less than 0.5 pA (0.2 typ.) bias current through either input.

This capability-in-a-package enables the A-125 to take over where electrometer or MOS-FET amplifiers used to excel. And watch the improvement in noise, thermal stability and reliability.

Try us out, even if you think our sails are full of wind. We would like nothing better. Then you'll see why Intech's trimming the sales of the Op Amp Boys.

The A-125 is \$95.00 and it is immediately available from stock. Quantity discounts available on request.

For more information on our high performance modular products, contact your local Intech representative, or write us directly.

Intech Incorporated, 1220 Coleman Avenue, Santa Clara, California 95050
Phone: (408) 244-0500  **intech**

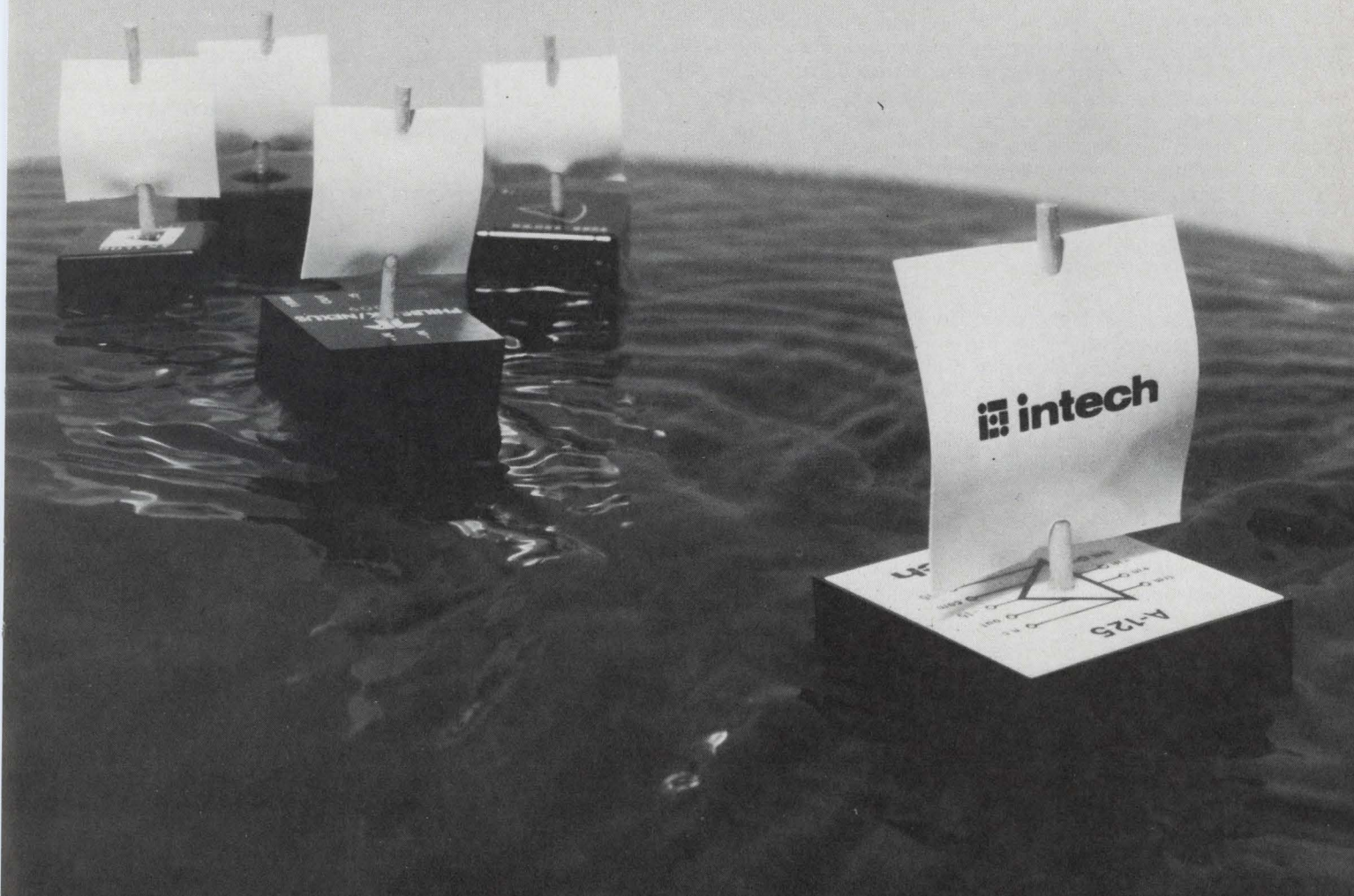

Intech takes on the Op Amp Boys.

**When our
*Chips come in
you will enjoy
smooth sailing
on the Sea of
Hybrid Circuitry.**

***West-Cap**

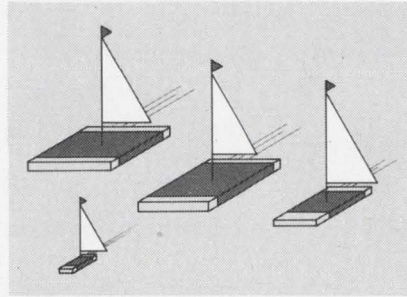

To help you smooth out your design problems you can choose from a large selection of values and sizes of **WEST-CAP** "SC" Series, highly reliable capacitor chips.

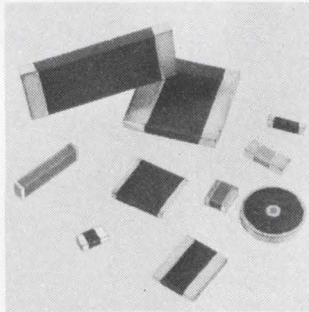

West-Cap Chips, the ceramic capacitors with built-in reliability, are of a monolithic structure, consisting of alternate layers of a proprietary dielectric material and noble metal electrodes. A closely-controlled firing in production kilns produces a rugged, fused "Monoceram" Chip. The end terminations are applied by recently developed automatic equipment, coating the chip ends uniformly and precisely. Prior to launching, "the chips" are given a final inspection mechanically and electrically by automatic equipment. Strict quality control is maintained throughout the entire process.

- West-Cap Monoceram Ceramic Chips are available in more than 50 sizes
- NPO, intermediate and Hi-K materials available
- Working Voltage: 25 to 100 VDC
- Tolerance: down to 0.5% or .25 Pf
- Temperature Range: -55°C to $+125^{\circ}\text{C}$
- Capacitance Range: .50 Pf to 5 Mfd
- Physical Size: Extra thin chips .010 to .020 available for I.C. applications

West-Cap Chips can be furnished with terminations compatible with all bonding techniques.

For Hybrid Circuit Designers—Just off the press, "Ceramic Chip Capacitor Handbook."
Send for your copy today.

san fernando
electric manufacturing company
Specialists in capacitor design

West-Cap Division
1501 First Street
San Fernando, California

INFORMATION RETRIEVAL NUMBER 56

DATA PROCESSING

Cassette transport separates channels

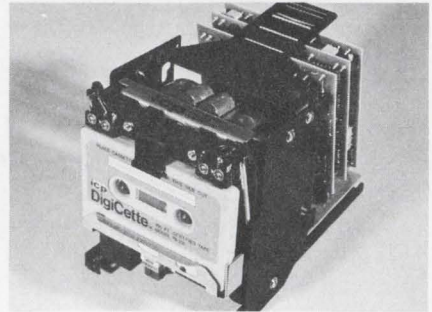

International Computer Products, Inc., P.O. Box 34484, Dallas, Tex. Phone: (214) 239-5381. Price: \$300.

Intended for small computer and computer terminal applications, a new cassette tape transport has two independent bit serial data recording channels that may be operated simultaneously or independently in various modes. Digi-Deck minimizes tape wear through the use of a spindle drive. Writing speed is 7000 bits per second and reading speed is 20,000 bits per second.

CIRCLE NO. 257

Read/write memory drives IC logic

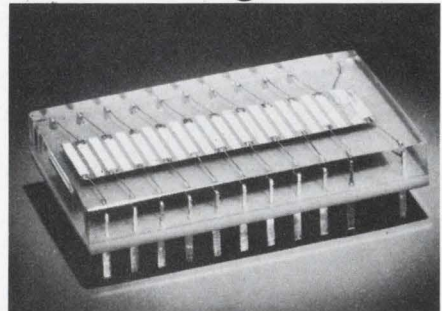

Litton Industries, Poly-Scientific Div., 1111 N. Main St., Blacksburg, Va., Phone: (703) 552-3011.

Able to be altered as desired, a new non-destructive non-volatile digital read/write memory is capable of directly driving high-impedance low-level integrated-circuit digital logic. Write time is several microseconds for write voltages of 90 to 360 V. Inquire pulses can be 10 to 90 V peak for pulse, square-wave or sine-wave functions.

CIRCLE NO. 258

CRT video terminal plugs into Teletype



Alphanumeric Data Corp., Princeton-Hightstown Rd., Cranbury, N. J. Phone: (609) 799-1559. P&A: \$3500; 45 to 60 days.

Developed for time-share and small-computer users, a new data-window video terminal features 25 lines of 72 characters each, and complete plug-to-plug compatibility with the ASR-33 Teletype machine. Actually a video teletypewriter, Model DW-33 offers rapid file access, editing flexibility, and complete functional and software compatibility.

CIRCLE NO. 259

Asynchronous coupler converts Teletypes

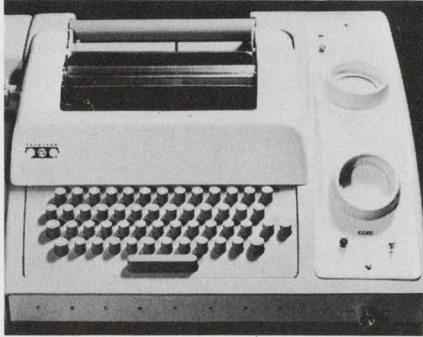

Source Data, 664 N. Michigan Ave., Chicago, Ill. Price: \$305.

The model 101 asynchronous coupler converts any Teletype model 33 into a data terminal that uses standard voice-grade lines for error-free transmission of digital data. This all-integrated-circuit unit features active filtering and a carrier-detect circuit that eliminates Teletype chatter prior to hook-up. Either full or half-duplex operation is possible. The self-contained coupler can be installed without special tools.

CIRCLE NO. 261

Low-cost minicomputer operates 16 terminals

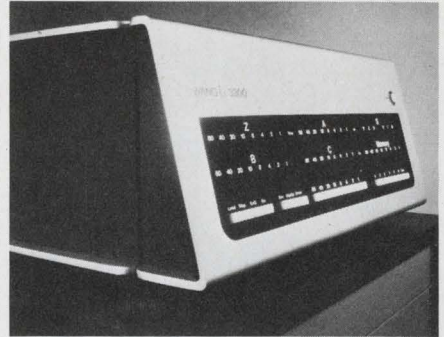

Wang Laboratories, Inc., 836 North St., Tewksbury, Mass. Phone: (617) 851-7311. Price: from \$15,250.

Accommodating up to 16 terminals, the model 3300 BASIC is a low-cost minicomputer time-sharing system that includes a central processor and two teletypewriter terminals. The central processor, which is an 8-bit computer, features a 1.6- μ s full-cycle memory in 4k units expandable to 65k, binary and decimal arithmetic, and a repertoire of 70 instructions.

CIRCLE NO. 263

Data transfer system stores and decodes

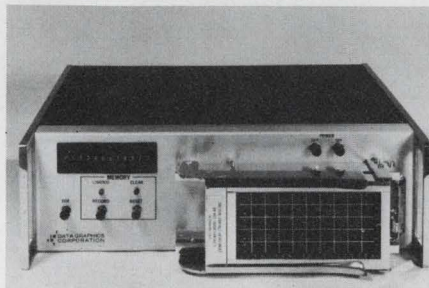

Data Graphics Corp., 8402 Speedway Dr., San Antonio, Tex. Phone: (512) 342-9486.

After accepting data from any digital output device, a new universal data transfer system stores the data in memory, decodes it, and then presents it to a recording device (i.e. keypunch, typewriter, magnetic tape recorder). Model DGC-300 has a 200-point program patch panel that allows data to be recorded in any sequence. Programming is done via jumper wires.

CIRCLE NO. 260

Portable calculator does not cut corners



Singer Co., Friden Div., 2350 Washington Ave., San Leandro, Calif. Phone: (415) 357-6800. P&A: \$495 to \$695; April, 1970.

Weighing just eight pounds and fitting easily into an attache case, a new electronic calculator incorporates all the necessary features of a fully automatic heavy-duty office machine. The 1115 performs a wide range of calculations, including chain multiplication and division functions without the need for pre-setting.

CIRCLE NO. 262

Textured tape safeguards itself



3M Co., 3M Center, St. Paul, Minn. Phone: (612) 733-5426.

Designed to safeguard itself and recorded information, Black Watch Scotchbrand 700 computer tape protects itself against physical damage—both on the transport and in transit—through an exclusive textured substrate. This substrate resists windowing and cinching, and virtually eliminates scratching. In addition, an electrically conductive backing protects against static hang-ups and reduces drop-outs.

CIRCLE NO. 264

Measuring system eases interfacing

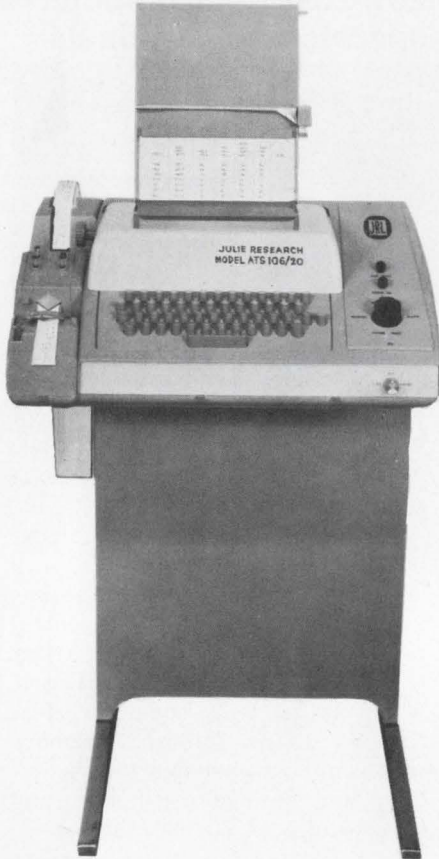

Julie Research Laboratories, Inc., 211 W. 61st St., New York, N.Y. Phone: (212) 245-2727. P&A: \$19,900 complete; 120 days.

Without degrading instrumentation accuracy, the ATS-106/20 automated measuring system allows universal interfacing of programmable precision instruments, regardless of the manufacturer and available computer-oriented system hardware. This new interface data terminal enables users to take full advantage of their instrument capabilities, whether used in automated, programmable or conventional operations.

Simple cable connections are all that are necessary to interconnect a system using the ATS-106/20; no additional interface engineering is required. The new terminal can be used with any equipment employing 10-line decimal or BCD program format.

The ATS-106/20 includes a modified Teletype keyboard, an automatic paper-tape punch and reader, and special digital logic cards for interfacing the instrumentation and an external computer system.

CIRCLE NO. 265

Five-digit panel meter counts ± 39999 at \$695

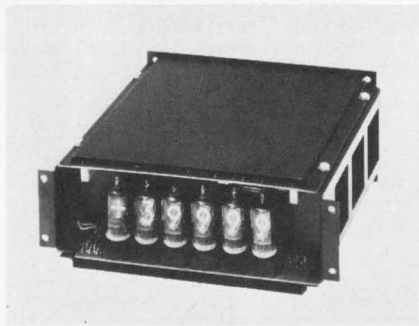

Electro-Numerics Corp., 2191 Ronald St., Santa Clara, Calif. Phone: (408) 248-5020. P&A: \$695; 2 to 4 wks.

With a five-digit capacity, a new digital panel meter displays a count of ± 39999 for under \$695. The model 3412 offers a choice of three voltage ranges from ± 3.9999 V to ± 399.99 V full scale, and five current ranges from $39.999 \mu\text{A}$ to 399.99 mA full scale. It also has five resistance ranges from 3999.9Ω to 39.999 M Ω .

CIRCLE NO. 266

Starmark Electronics, 3710 Main St., Kansas City, Mo.

Able to be cascaded in multiple units, series 200 digital stop-watches are now available in a wide range of full-scale values and resolutions. All models feature easy-to-use remote-control provisions, plus convenient front-panel controls. They come equipped with either a precision internal or external 60-Hz time base. A BCD data output and resolutions to 0.001 seconds are also standard.

CIRCLE NO. 267

Digital clocks can be cascaded



Lightweight probes checkout flatpacks

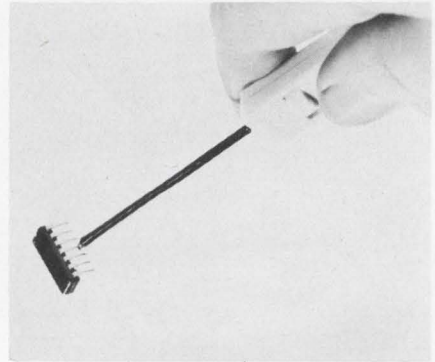

Data Display Systems, Inc., Willow Grove, Pa.

Designed specifically for testing flatpacks and dual-in-line packages, a new family of small general-purpose test probes can grip and retain their hold on individual device leads. Available in several models, the probes are lightweight to reduce the risk of damage to the test module. In addition, the strength of their connecting mechanism allows them to hold their position while the user controls the amount of force.

CIRCLE NO. 268

Function generator is size of a book



Esterline Angus Div., Esterline Corp., P.O. Box 24000, Indianapolis, Ind. Phone: (317) 244-7611. Price: \$310.

Costing only \$130, a new book-sized function generator supplies one of three waveforms—sine, square or triangle—over the frequency range of 0.01 Hz to 100 kHz. Model F-1000 performs with less than 1% amplitude change from 0.01 Hz to 1 kHz, and less than 4% amplitude change at 100 kHz. Output voltage level is adjustable.

CIRCLE NO. 269

Air Gap. Pull. Shape.

The only factors you have to know with this faster method of holding magnet design.

Only three factors are needed for quick, accurate design calculations with this helpful system. This method works because geometrically similar magnet systems have similar characteristics. Specifically, if you multiply air gap and each magnet dimension by the same factor (K) the pull force of the new magnet system will be proportional to K^2 —the area of the new pole face.

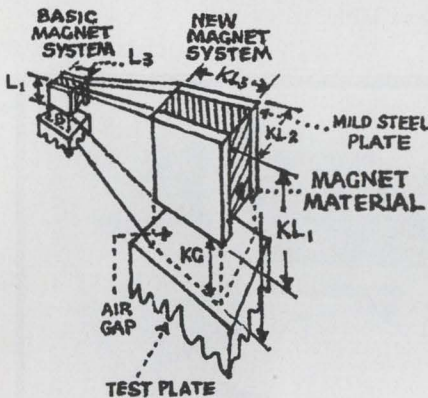

Using this method

In designing a holding magnet with this system you first determine the pull and air gap requirements of your application. From curves showing the performance of several holding magnet designs you then select the basic geometric shape that meets your design needs most efficiently. Since

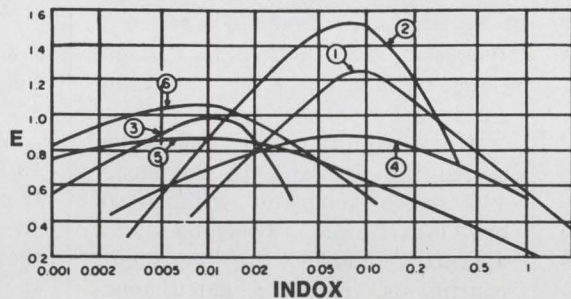

the pull effectiveness remains constant for geometrically similar magnet systems, the effectiveness of your final design can be read directly from the curve selected. The weight of your completed magnet assembly is determined and from this figure you establish the multiplication factor (K) for scaling the selected design. Your completed design now represents the optimum configuration meeting your air gap and pull requirements. You can also use this system to quickly develop a holding magnet design meeting specific size or weight requirements.

A sample calculation

Problem: Design a holding magnet producing a 10 lb. pull at 0.05 inch air gap. The reach factor (G/\sqrt{P}) measures the air gap size for a specific pull. In this example, the reach factor is $\frac{0.05}{\sqrt{10}} = 0.0158$. The effectiveness curves shown here indicate that designs 2, 3, and 6 have about the same effectiveness at this reach factor. Design 2 is selected because it is the simplest in construction. From

the curve for design 2, $E=1.06$. Weight of permanent magnet material required is

$$\frac{(PULL)(GAP)}{E} = \frac{(10)(0.05)}{1.06} = 0.472 \text{ LB.}$$

$$K \text{ IS } \sqrt[3]{\frac{\text{MAGNET WT. REQUIRED}}{\text{MAGNET WT. OF MODEL}}} =$$

$$\sqrt[3]{\frac{0.472}{0.273}} = 1.205$$

Multiplying all dimensions of Design 2 by 1.205 yields:

Diameter = 3.013 in.

Thickness of steel back plate = 0.072 in.

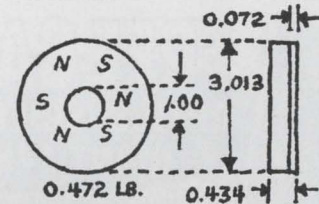

Free design aids

If your design problem has anything to do with magnets and magnetic systems, you can get the information you need at Indiana General. Our engineers are always ready to work with you. For your general reference, we will be glad to send you a complete set of curves for 24 basic holding magnet designs. With these design aids and your slide rule, you can quickly design permanent magnet assemblies for any holding requirement. Just write Indiana General, Magnet Products, Valparaiso, Indiana 46383.

indiana general

a division of Electronic Memories & Magnetics Corporation

INFORMATION RETRIEVAL NUMBER 57

DMM selling for \$545 resolves 1 μ V/digit

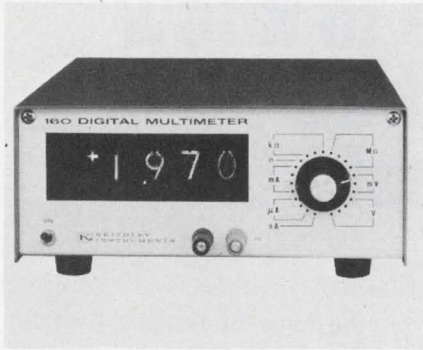

Keithley Instruments, Inc., 28775 Aurora Rd., Cleveland, Ohio. Phone: (216) 248-0400. Price: \$495 or \$545.

Costing only \$545, a 3-1/2-digit dc multimeter features a resolution of 1 μ V per digit. Model 160 can measure dc voltages to ± 1000 V, currents to ± 2 A, and resistances to 2000 M Ω . For all ranges, the instrument has an accuracy of ± 1 digit or $\pm 1\%$ of reading. Also available is the 163 digital voltmeter for \$495.

CIRCLE NO. 270

Function generator has log/lin sweep



Wavetek, Box 651, San Diego, Calif. Phone: (714) 279-2200. P&A: \$695; stock.

Sine, square and triangular waves are available in the model 135 sweep generator with linear or logarithmic sweeping. Six operating modes are available: continuous, triggered, gated, tone-burst, continuous-sweep and triggered-sweep. They can be swept over a 1000:1 ratio over their full frequency range of 20 Hz to 20 kHz.

CIRCLE NO. 271

Sine wave generator dials Hz digitally



J & J Instruments, 8141 Engineer Rd., San Diego, Calif. Phone: (714) 277-2471. Price: \$495 or \$595.

Model 2000 digital oscillator is a 10-Hz-to-12-MHz sine wave generator that uses digital front-panel switches for frequency selection, thereby achieving good repeatability and spectral purity. The unit also has a multi-phase output that allows a 180-degree phase change in the output signal. A fully programmable model, the 2010, is also available.

CIRCLE NO. 272

FREE CATALOG!

OPTICS! SCIENCE! MATH!

GIANT 148 PAGES

1000's OF UNUSUAL BUYS FOR INDUSTRY

Many on-the-job Helps . . . Quality Control Aids! Write for this completely new, 1970 Catalog. New items, new categories, new illustrations, 148 easy-to-read pages packed with hundreds of charts, diagrams, illustrations. A treasure-house of optical and scientific information . . . unusual bargains galore. Optics for industry, research labs, design engineers, experimenters, hobbyists! Instruments for checking, measuring — to speed work, improve quality, cut production costs. We give you facts: what it is — how it works — where it's used.

Comparators, Magnifiers, Microscopes
Hard-to-get war surplus bargains — ingenious scientific tools — imported — domestic. Thousands of components: lenses, prisms, wedges, mirrors, mounts, accessories of all descriptions. Dozens of instruments: lasers, magnifiers, stereo microscopes, telescopes, binoculars, infrared equipment, photo attachments. Shop by mail. No salesman will call. Use the Catalog of America's greatest Optics — Science — Math Mart. Known for reliability. Mail the coupon below to:

Edmund Scientific Co., 300 Edscorp Building, Barrington, New Jersey 08007. Ask for Catalog "DA"

MAIL COUPON FOR GIANT FREE CATALOG

EDMUND SCIENTIFIC CO. 300 EDS CORP BUILDING
BARRINGTON, N.J. 08007

Please send FREE Giant 148-page Catalog "DA"

NAME

ADDRESS

COMPANY

CITY STATE ZIP

INFORMATION RETRIEVAL NUMBER 58

NEW sensiflex Fluidic Switches

Special Features

Switches operate on as little as 0.001 psi air pressure. Can be made to work with other sensitivities or to work on vacuum. Service-proved precision SPDT switch, to 25A; also DPDT. Flex-tested polyurethane bellows, or high temperature silicone diaphragms. Enclosed protective aluminum cases with conduit outlets. Mounting plates permit any-position mounting. Switch dimensions for 2.25" long, 1.69" wide, 2.31" high.

Priced from \$8.95; quantities 100 or more from \$5.95.

Write for further information. Dept. 4EE-34.

sensiflex

Gagne Associates, Inc., 50 Wall St., Binghamton, N.Y. 13901 Phone: 607 723-9556

INFORMATION RETRIEVAL NUMBER 59

Tiny X-band source spans 8.5 to 10 GHz

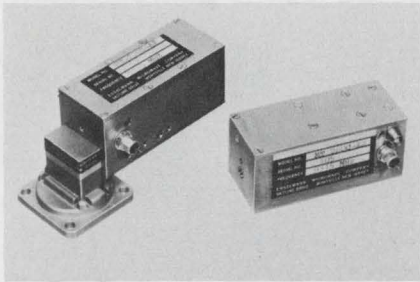

Engelmann Microwave Co., Skyline Dr., Montville, N. J. Phone: (201) 334-5700. Availability: stock to 30 days.

Developed for klystron replacement applications, a miniature solid-state X-band source spans the frequency range of 8.5 to 10 GHz. It delivers a minimum of 10 mW of output power from -30 to +70°C at a stability of ±0.2%. Tuning is over ±100 MHz and output power is delivered through an OSM connector or a waveguide flange.

CIRCLE NO. 273

Low-noise TWT amplifier range over 12 to 18 GHz

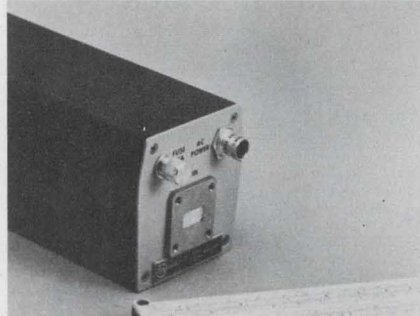

Varian, TWT div., 611 Hansen Way, Palo Alto, Calif. Phone: (415) 326-4000. Availability: 30 to 60 days.

Incorporating a single-reversal-permanent-magnet focusing structure, two new low-noise TWT Ku-band amplifiers span the range of 12 to 18 GHz. The VTU-4490P1 and VTU-4490H1 devices offer noise figures of 8.5 and 10 dB and output powers of +14 and +15 dBm, respectively. They have integral power supplies and produce low external magnetic fields of 30 to 50 gauss.

CIRCLE NO. 274

Solid-state duplexer handles 40-W inputs

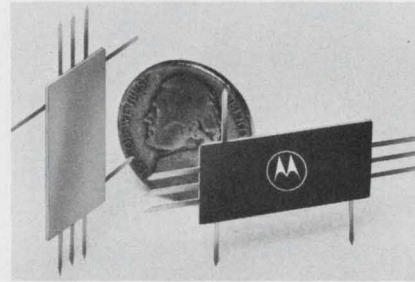

Motorola Semiconductor Products Inc., P.O. Box 20912, Phoenix, Ariz. Phone: (602) 273-6900. Price: \$13.50.

Operating at frequencies between 400 and 500 MHz, a new microwave solid-state duplexer accepts input powers as high as 40 W. Model MCH-5890 features a typical 0.1-dB transmit-mode insertion loss and a typical 25-dB transmit-mode isolation figure. This spdt device was primarily developed for use as a transmit/receive switch.

CIRCLE NO. 275

Bandpass filter units dial 50 to 4000 MHz



Texscan, Technical Products Div., 4610 N. Franklin Rd., Indianapolis, Ind. Phone: (317) 454-6481. P&A: \$320 to \$510; 2 to 3 wks.

Ranging over 50 to 4000 MHz is a series of bandpass filters that are tunable with a calibrated dial. Models of the VF series filters are available with a three or a five-section response. Bandwidth at the 3-dB points is 5% and insertion loss is 0.2 to 1.5 dB. Indicated center frequency on the dial is within ±1/2%.

CIRCLE NO. 276

**Find it fast!
in the**

**FREE
NEW
1970**

**Newark
industrial
electronic
catalog**

A \$9,000,000 INDUSTRIAL ELECTRONIC INVENTORY
720 PAGES • OVER 70,000 ITEMS; 500 MAJOR LINES
INCLUDING THE COMPLETE LINE OF



PRECISION POTS

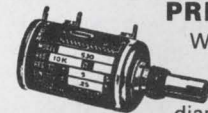

Wirewound, single and multi-turn, linear and non-linear, diameters from 1/2" to 3".



TRIMMER POTS

Wirewound and non-wirewound, to 1 Megohm. Single, 15, 25, 42 turn, square, round, rectangular and TO-9 case size.



**URNS—COUNTING
DIALS**

Digital or concentric readout.

Immediate delivery from stock—factory OEM prices
—fast efficient service from 11 Newark warehouses.
One source for the products
you need, in the quantities
you need.



For your free catalog write to:

Main Office & Warehouse

NEWARK ELECTRONICS CORPORATION

500 North Pulaski Chicago, Illinois 60624
(312) 638-4411

WAREHOUSES IN

- * Minneapolis, Minn. (612) 331-6350
- * Cincinnati, Ohio (513) 421-5282
- * Denver, Colorado (303) 757-3351
- * Detroit, Michigan (313) 548-0250
- * Los Angeles Area (213) 678-0441
- * Grand Rapids, Michigan (616) 452-1411
- * Houston, Texas (713) 782-4800
- * Dallas, Texas (214) 271-2511
- * New York City (212) 255-4600

INFORMATION RETRIEVAL NUMBER 60

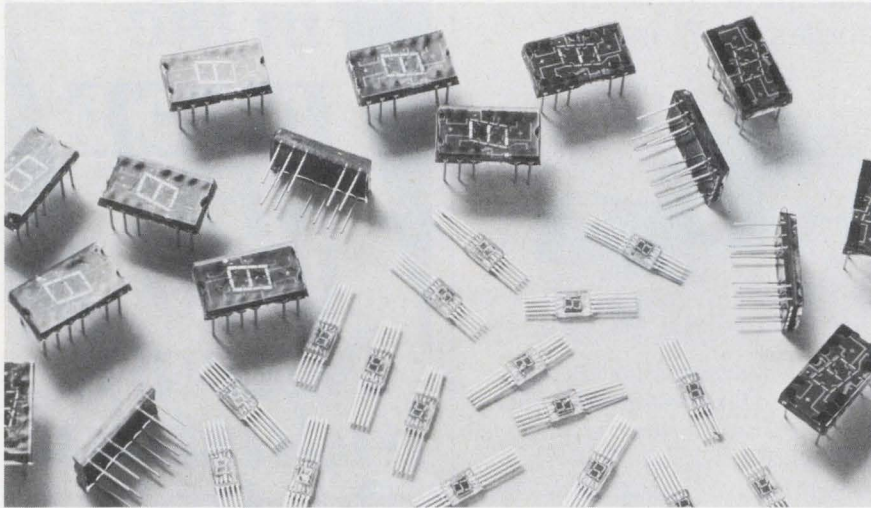

Monolithic LED numeric competes with Nixie prices

Monsanto Electronic Special Products, 10131 Bubb Rd., Cupertino, Calif. Phone: (408) 257-2140. P&A: \$12.45; stock.

Available for the first time is a monolithic light-emitting-diode numeric display that you can really go out and buy—and that gives you solid-state performance at Nixie-tube prices. The MAN-3 seven-segment readout with decimal point costs only \$12.45 in single-unit quantities and \$7.55 in 1000-unit quantities. For orders in the 20,000-unit range, the new numeric is expected to be comparably priced with Nixies.

Like its discrete-type MAN-1 predecessor, the monolithic MAN-

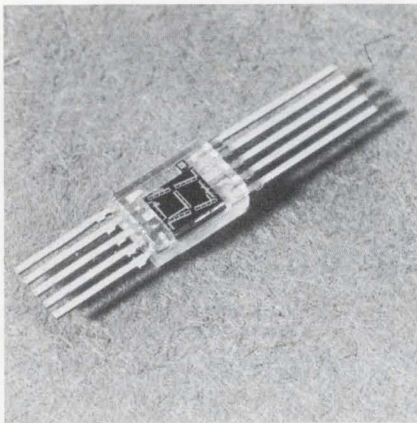

Monolithic numeric readout with decimal point matches price tag of Nixie tubes. The chip is housed in a clear cast epoxy package.

3 requires an external decoder/driver, which costs approximately \$5. Both of these readouts are seven-segment numeric displays, while the MAN-2 is a discrete-type 35-dot LED array with alpha-numeric capabilities.

The planar active areas of the MAN-3 are formed by zinc diffusion into n-type gallium arsenide phosphide. Each of the seven segments consists of five light-emitting diodes, which are interconnected by evaporated aluminum.

This interconnecting aluminum layer divides each diode into two equal halves. When the diodes are lighted, each segment appears as 10 distinct lights. Each of these lights measures 0.0035 by 0.0015 in.

Tilted 10 degrees from the vertical position, the numeral itself can be seen over a viewing angle of 150 degrees. Its dimensions are 0.116×0.067 in.

Housed in a clear cast epoxy housing, the IC-compatible MAN-3 measures only $0.24 \times 0.168 \times 0.09$ in. This allows a packing density of at least five numerics per inch.

Readout brightness, which is directly proportional to input current, can be varied from 50 to 500 foot-lamberts by applying 1 to 10 mA per segment. Light wavelength ranges from 6300 to 7000 Å.

CIRCLE NO. 277

Seven-segment readout holds down power drain

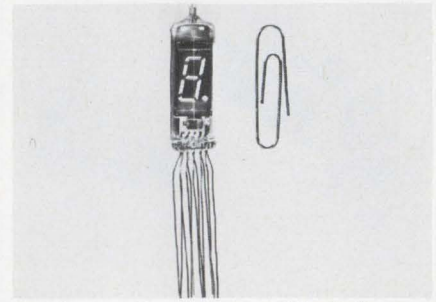

Legitron Corp., 3118 W. Jefferson Blvd., Los Angeles, Calif. Phone: (213) 733-9105. P&A: \$5.50; stock.

The DG-12H is a seven-segment digital indicator that provides low-voltage and low-current drain in a planar-readout device. Its digits, symbols and letters are composed of highly efficient phosphor-coated segments providing clarity between digits up to 40-foot distances. A wide spectral bandwidth makes available different color outputs with the use of proper filtering.

CIRCLE NO. 278

Binary resistance unit trims in decades

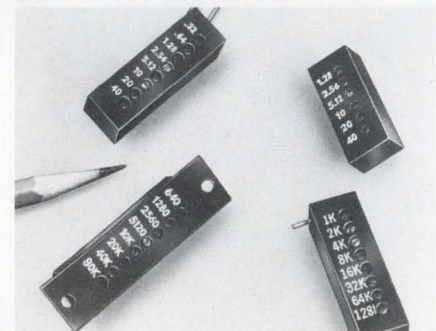

Consolidated Resistance Instruments, Inc., 44-46 Prospect St., Yonkers, N. Y. Phone: (914) 963-5900. P&A: from \$14; stock to 6 wks.

Supplying resistances from 0.01 to 2.5 MΩ, a new trimmer combines its characteristics with those of a decade. The Verni-step has 6 to 16 wire-wound resistors in series, each connected in a binary sequence and shunted by adjustable switches. The user adjusts the trimmer by shorting its resistances.

CIRCLE NO. 279

In our first act we introduced our precision miniature line of snap-action switches. Now comes a beautiful new addition—the sub subminiature line.

All we ask is a chance to prove our ability to give you real quality at a competitive price. With old-time service and on-time delivery a part of the deal. We invite comparisons.

For example. The unique design of our sub subminiature incorporates a floating contact blade and a low stressed C-spring which provides an overtravel tolerance minimum of .010 inch. Less than half as critical as competition.

And it has a minimum electrical life of 50,000 operations—at rated load.

As you can see, we're making a real play for your next switch order. Sub subminiature or miniature. Let your Cutler-Hammer Sales Engineer or Switch Distributor give you our product/service story. He could bring down the curtain on your old supplier.

CUTLER-HAMMER 
SPECIALTY PRODUCTS DIVISION, Milwaukee, Wis. 53201

INFORMATION RETRIEVAL NUMBER 61

Our SS10KT40 with gold contacts is one of the many stars in our sub subminiature line.
16 switches, all U.L. listed. 4 terminal variations (single turret, double turret, pin, and quick connect). 6 industry standard external actuators (leaf, reverse leaf, roller leaf, reverse roller leaf, lever, and roller lever). Gold contacts. Switches in stock for immediate delivery.

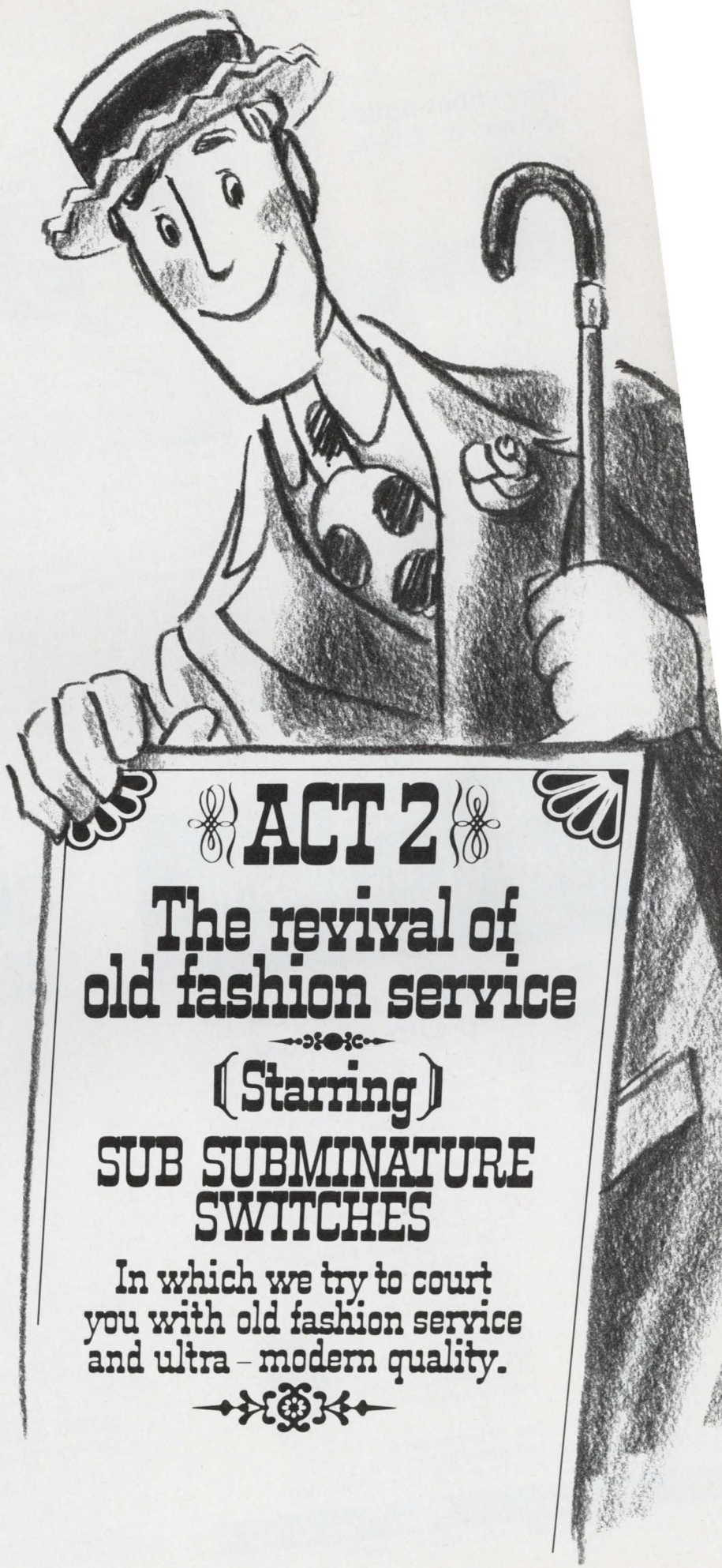

ACT 2

The revival of old fashion service

(Starring)

SUB SUBMINATURE SWITCHES

In which we try to court you with old fashion service and ultra - modern quality.

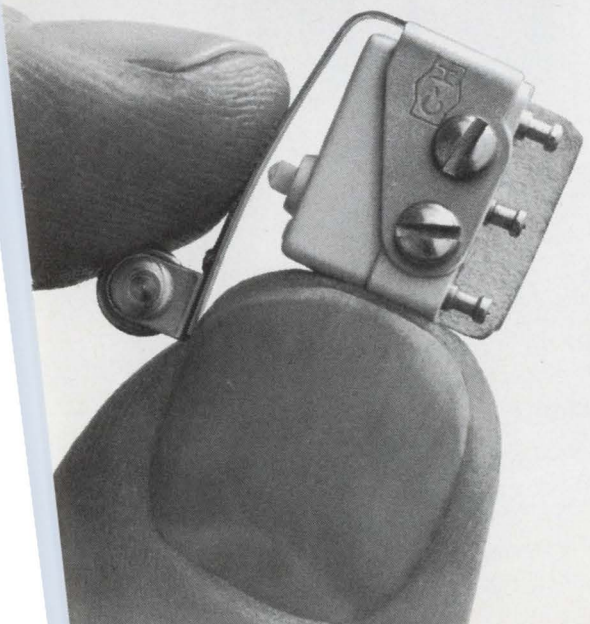

Tiny fiber-optics CRT shows a 1.5-in. face



Panasonic Div., of Matsushita Electric Corp. of America, 200 Park Ave., New York, N.Y. Phone: (212) 973-5700.

Containing a fiber-optics face-plate, a new miniature cathode-ray tube measures only 1.5 in. across its face. The model MTT-130 is designed for use in direct printing of TV images and graphic displays. It uses magnetic deflection and electrostatic focusing. Its heater requires a minimum amount of operating power.

CIRCLE NO. 280

Plastic bridge rectifiers bring down cost to 51¢

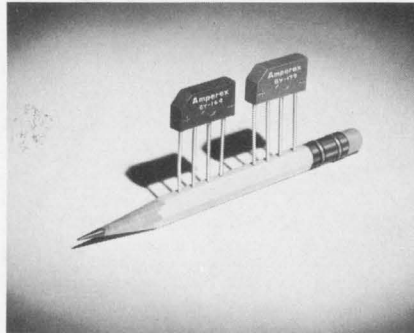

Amperex Electronic Corp., Semiconductor Div., Slatersville, R. I. Phone: (401) 762-9000. Price: 51¢, 56¢.

Two new plastic-encapsulated bridge rectifiers provide increased input and output ratings at low unit costs of 51¢ (BY164) and 56¢ (BY179) in thousand-lot quantities. The BY164 provides an output of 1.2 A at 45 V and the BY179 provides an output of 1 A at 255 V. Both units operate into resistive-inductive loads.

CIRCLE NO. 281

Fast multi-scan tube makes alphanumerics



Gencom Div. of Varian/EMI, 80 Express St., Plainview, N. Y. Availability: 3 to 4 wks.

The Printicon 9788 is a small electrostatic low-voltage tube designed for the electrical generation of alphanumeric symbols at high speeds. Character scanning can be in a sawtooth, sinewave or zig-zag form. In the standard array 64 characters are arranged in an 8 x 8 matrix. Any number or style of characters can be manufactured to particular specifications.

CIRCLE NO. 282

FOR EXCELLENCE IN PUSH BUTTON SWITCHES SPECIFY GRAYHILL

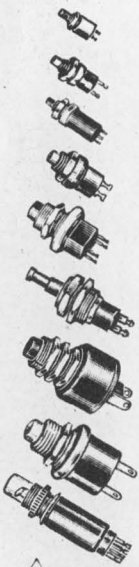

A WIDE SELECTION TO CHOOSE FROM...

- Ratings To 10 Amp.
- SPST, SPDT, DPST, DPDT
- Diameters From 1/4" To 7/8"
- Behind Panel Dimension As Small As .32"
- Momentary - Push-Pull - Lighted - Alternate Action (Push-On, Push-Off)
- Wiping, Snap Action And Butt Contacts
- Solder Lug, "Faston" Or Printed Circuit Terminals
- Life Expectancy Up To 1,000,000 Operations

For your Grayhill Engineering Catalog offering complete technical data—contact



565 Hillgrove Avenue
LaGrange, Illinois 60525
Area Code 312, Phone 354-1040

... the Difference Between Excellent and Adequate

INFORMATION RETRIEVAL NUMBER 62

GOOD BUY, MR. CHIPS

BY MONOLITHIC DIELECTRICS



CHIP KIT NO. 1 consists of 300 monolithic ceramic capacitor chips for hybrid circuits. Browse, examine, and test. There are 10 chips of each standard RETMA values from 1.2 pf to 330 pf in $\pm 10\%$ tolerances at 50 VDCW.

CHIP KIT NO. 2 consists of 300 sample chips, 10 chips each of all standard RETMA values from 390 pf to .1 MFD in $\pm 10\%$ tolerances at 50 VDCW.

KIT NO. 1 or KIT NO. 2—\$49.50 ea. A GOOD BUY! Delivery from stock. Call direct and ask for Jim Waldal.

Monolithic Dielectrics Inc.

P.O. Box 647, Burbank, Calif. 91503 • (213) 848-4465

INFORMATION RETRIEVAL NUMBER 63

Low power-drain op amp consumes but 100 μ A

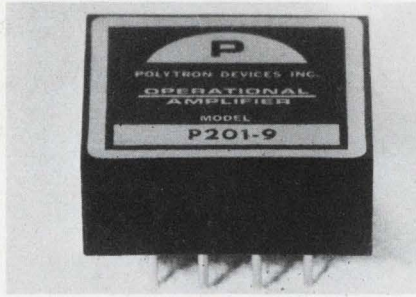

Polytron Devices, Inc., 844 E. 25 St., Paterson, N.J. Phone: (201) 523-5000.

Operating over a wide voltage range, a new operational amplifier features a current drain of only 100 μ A at ± 15 V dc. The P213-9 operates from ± 2 to ± 22 V dc. Among its other characteristics are a bias current of 5 pA and voltage drift of 3 μ V/ $^{\circ}$ C. Input impedance is 10^{12} Ω , and frequency compensation is 6 dB/octave. Case dimensions are 1.12 \times 1.12 \times 0.45 in.

CIRCLE NO. 283

Fast-settling op amp reaches 0.01% in 0.9 μ s

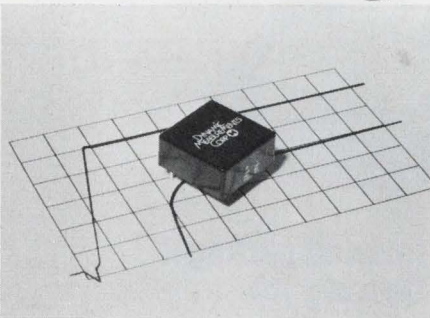

Dynamic Measurements Corp., 108 Summer St., Arlington, Mass. Phone: (617) 648-3610. P&A: \$33; stock.

Featuring an input current drift of 100 pA/ $^{\circ}$ C, a new operational amplifier settles to 0.01% of its final value in only 0.9 μ s. The model FST-102B has a slewing rate of 25 V/ μ s and an offset voltage drift of 5 μ V/ $^{\circ}$ C. Its gain is 250,000 and its bandwidth is 12 MHz. A common-mode rejection of 90 dB is also featured. The unit measures 1.12 \times 1.12 \times 0.57 in.

CIRCLE NO. 284

Adder/subtractor offsets to 2.5 mV

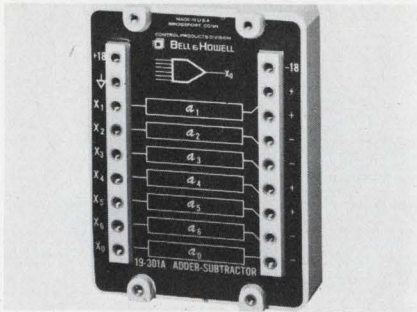

Control Products Div. of Bell & Howell, 706 Bostwick Ave., Bridgeport, Conn. Phone: (203) 368-6751. P&A: \$110; 2 to 4 wks.

The model 19-301A is an adder/subtractor that features high accuracy with the use of 0.01% scaling coefficients and an amplifier offset voltage of 2.5 mV. It contains two microcircuit op amps that feature a thermal voltage offset error of 20 μ V/ $^{\circ}$ C. Bias current error is 5 nA/ $^{\circ}$ C and long-term drift for each amplifier is 50 μ V/month, non-accumulative.

CIRCLE NO. 285

BCD 3-decade ladders track to 3 ppm/ $^{\circ}$ C

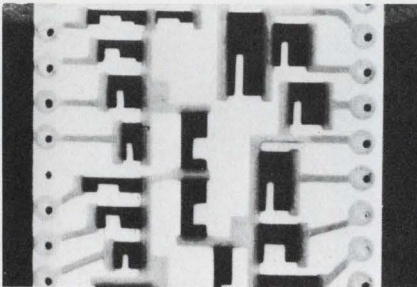

Helipot Div., Beckman Instruments, Inc., 2500 Harbor Blvd., Fullerton, Calif. Phone: (714) 871-4848.

Designed for FET switching, the series 862 three-decade 12-bit BCD ladder networks track to 3 ppm/ $^{\circ}$ C. These cermet thick-film units are offered in four models depending on the required temperature range. Standard resistance values are 50 and 100 k Ω , and maximum output voltage ratio error is ± 300 ppm. Settling of the output voltage to 0.1% of final value is within 0.5 to 1 μ s.

CIRCLE NO. 287

TRYGON systems power supplies are...

FOR IMMEDIATE DELIVERY

Slot & Wide Range Sub-Rack & Modular Single and Multiple Output

- For Systems, OEM and Lab applications
- Proven high quality and reliability
- Modules to 210 VDC; 18A
- Sub-Racks to 161 VDC; 25A
- Full Racks to 320 VDC; 70A
- A full choice of standard rack adapters and accessories

Write today for your copy of Trygon's 1970 Power Supply Handbook

TRYGON POWER SUPPLIES

111 Pleasant Avenue, Roosevelt, New York 11575
Tel: 516-378-2800 TWX: 510-225-3664
Trygon GmbH 8 Munchen 60, Haidelweg 20, Germany

Matched multifilters keep noise to 25 μ V

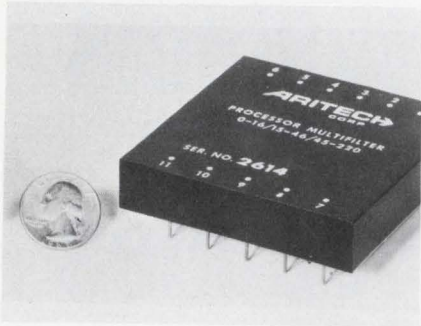

Aritech Corp., 130 Lincoln St., Brighton, Mass. Phone: (617) 254-2990. P&A: \$200; 6 wks.

Exhibiting typical output noise levels of only 25 μ V rms, a new series of active multifilters features amplitude matching of better than 0.25 dB and phase matching of 2 degrees. These multifilter modules contain combinations of low-pass, high-pass, band-pass and band-reject filters, packaged together in a single shell, for frequencies from 0.01 Hz to 100 kHz.

CIRCLE NO. 288

IC signal conditioner varies voltage widely

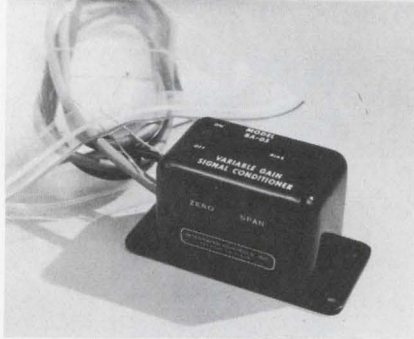

Integrated Controls, Inc., Box 17296, San Diego, Calif. Phone: (714) 453-5800. P&A: \$85; stock.

Designed for amplifying remote mounted passive and active transducers, a new self-powered IC signal conditioner varies its voltage gain continuously from 1 to 1000. The BA 05 allows threshold levels of 5 μ V from source impedances up to 10 k Ω . Its input impedance is 100 M Ω on lower gain ranges and its input overvoltage capability is \pm 30 V dc continuously.

CIRCLE NO. 289

Unity-gain amplifiers are accurate to 0.03%



Intech Inc., 1220 Coleman Ave., Santa Clara, Calif. Phone: (408) 244-0500. Price: \$18 or \$28.

In an IC-compatible dual-in-line package, the A-190 and A-191 FET unity-gain amplifiers guarantee accuracies of 0.1% and 0.03%, respectively. Maximum initial offset voltage is less than 5 mV for the A-190 and 3 mV for the A-191; input voltage drift is 50 and 25 μ V/ $^{\circ}$ C, respectively. For both units, typical common-mode rejection is 86 dB.

CIRCLE NO. 290



Vee Jewels from the Classic Collection of R.H. Bird, Waltham.

Beauty is what beauty does. And Bird precision industrial Vee Jewels perform beautifully in all instruments requiring low torque bearings. They're available in glass or sapphire, set or unset, in a wide variety of shapes and sizes. You'll find Bird Vee Jewels in some of the swankiest instruments around. In addition, Bird also makes low cost precision jewels in many other configurations. Send for our showcase catalog today.

Bird Precision Jewels

1 Spruce Street, Waltham, Massachusetts 02154
Tel: (617) 894-0160

Motorola temperature compensated crystal oscillators



Come in small packages Do a big job

Where low power, small size and instant warm-up are required, choose a Motorola TCXO. They're ideal for a wide variety of industrial applications.

Small Size. They come in packages as small as 1.5 cubic inch.

Wide Frequency Range. From 500 KHz to 40 MHz. Extended ranges on special order.

Stability. \pm 1 ppm from 0 $^{\circ}$ to + 55 $^{\circ}$ C. Higher stability on special order.

Low Aging. Less than 1 x 10 $^{-6}$ per year.

And if you need a non-standard TCXO, just let us know. Variations in input voltage, frequency, output level and wave shape are available on special order.

For complete information, send for your free copy of Bulletin TIC-3213 today. Write Component Products, Dept. 40F, Motorola Communications & Electronics, Inc., 4501 W. Augusta Blvd., Chicago, Illinois 60651; or call (312) 772-6500.



Hybrid IC substrates interconnect 36 chips

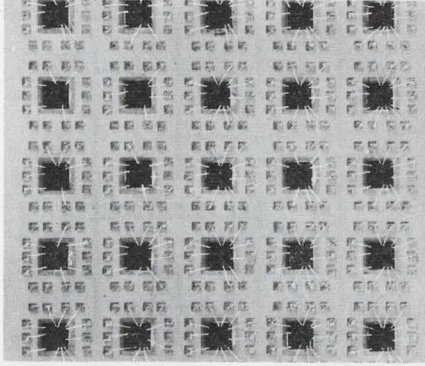

Microelectronics Corp., Regional Technology Park, 4901 Stenton Ave., Philadelphia, Pa. Phone: (215) 329-8681.

Measuring only 1-in. square, large-scale hybrid IC substrates allow interconnection of as many as 25 to 36 chips, either beam lead or wire bonded. Using thick-film screening techniques to interconnect several layers of metalization, these substrates can have up to 11 conductive planes, each dielectrically isolated from adjacent layers.

CIRCLE NO. 291

Miniature fuse holder plugs into PC boards

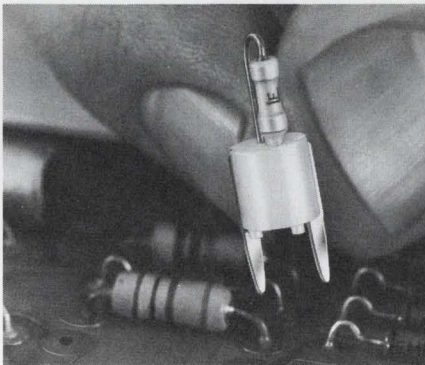

Littelfuse, Inc., sub. of Tracor, Inc., 800 E. Northwest Highway, Des Plaines, Ill. Phone: (312) 824-1188.

Able to mount directly on printed circuit boards, a new subminiature fuse holder measures only 0.25 in. in diameter by 0.236-in. high. The unit is rated at 10 A maximum, 125 V ac. Nominal pin contact insertion force is 500 grams. There are four supporting legs molded in the base of the body for mounting stability.

CIRCLE NO. 292

Flatpack forming tool handles 5/8-in. devices

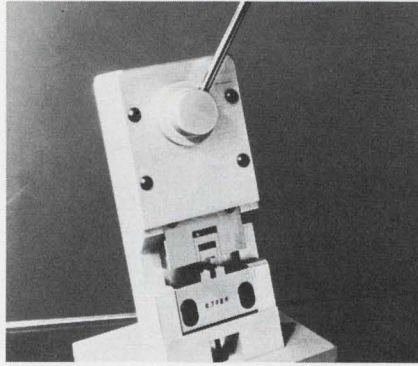

Electronic Tool Co., 3324 White Plains Rd., Bronx, N.Y. Phone: (212) 231-7760. Price: from \$560.

Using many different-size dies that can be interchanged in only minutes, a new tool will cut, bend or stagger-bend any flatpack up to 5/8-in. wide. Model 8023 has a large throat clearance that speeds loading and unloading. Staggered packs are automatically isolated from the dies after bending for quick and easy removal. The unit leaves burr-free lead ends.

CIRCLE NO. 293

Extractor for TO-5 cans prevents board damage

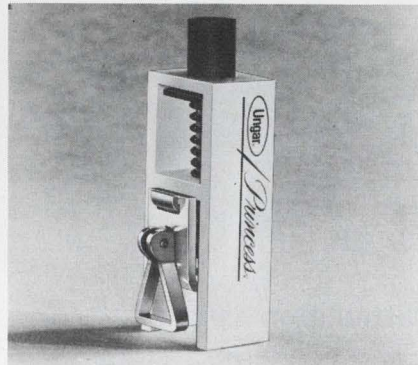

Ungar, Div. of Eldon Industries, 223 E. Manville St., Compton, Calif. Phone: (213) 774-5950.

Assuring quick safe removal of TO-5 cans, a spring-loaded automatic extractor prevents board damage during desoldering. Model 6983 fits over the TO-5 can and locks on by lever action; as soon as the solder on all leads is melted, it automatically pops off the board. Board damage is prevented by the extractor's metal clamps that act as an effective heat sink.

CIRCLE NO. 294

ADVANCE

your avionic cooling system with AiResearch.

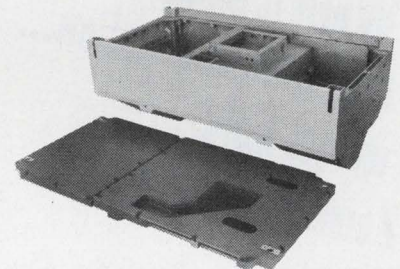

Your entire system will move ahead with maximum savings in time, weight, size, and power consumption if you let AiResearch work with you from the beginning to optimize avionic cooling.

How about starting by letting us help you conduct your thermal optimization studies?

An example of our work is shown above: a 3,000 watt cooling capacity enclosure for a pod-mounted ECM system. It is integral with the pod structure and part of the pod skin.

AiResearch capability includes over 30 years of experience and complete in-house component and system control.

For detailed specifications contact: AiResearch Manufacturing Company, 9851 Sepulveda Blvd., Los Angeles, Calif. 90009. Ph. (213) 776-1010 or (213) 670-0131.



AiResearch
Heat Transfer Systems

one of The Signal Companies

INFORMATION RETRIEVAL NUMBER 67



When it comes to microminiaturization... we get right down to business.

Designed to be ultrastable with excellent spectral purity, our crystal-controlled sources are really microminiature! The largest is only 0.7" x 0.9" x 1.0" ... and weighs only 15 grams. □ Oscillators are available between 60 MHz and 1.2 GHz ... with frequency stability of ± 0.005 percent ... from -55°C to $+85^{\circ}\text{C}$. □ Let's get down to business! More information is available by contacting **Scientific Research Corporation**, 4726 Eisenhower Blvd., Tampa, Florida 33614. Phone (813) 884-2989.

A subsidiary of Trak Microwave Corporation.

INFORMATION RETRIEVAL NUMBER 68

Evaluation Samples

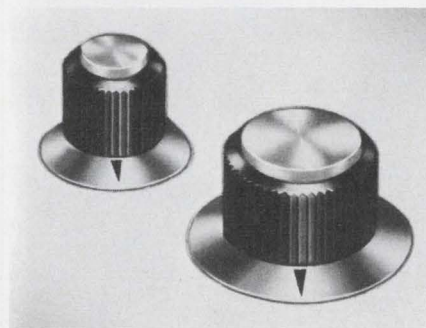

Knurled indicator knobs

Series KNS straight knurl machined aluminum knobs feature an aluminum skirt, an engraved arrowhead indicator, and a contrasting natural top for distinctive appearance. They are available with #6-32 set screws in two places. Knob body sizes are 0.5 and 0.75 in. with 1/8 or 1/4-in. shafts. The new knobs, which normally retail for \$1 (the KNS-501) or \$1.15 (the KNS-701), are now available to the readers of *ELECTRONIC DESIGN* as free evaluation samples. Alco Electronic Products, Inc., Alcocnob Div.

CIRCLE NO. 295

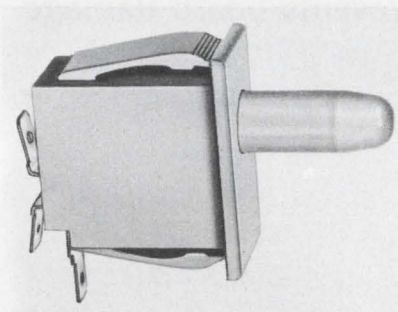

Push-button switch

A free evaluation sample of a new molded nylon snap-in panel-mount push-button switch is now available. Model E69-00A is rated at 10 A, 125 or 250 V ac. Primarily intended for use as a door interlock and machine start switch, the unit is housed in a long-life white molded nylon case. This basic momentary-action device is supplied in single-pole double-throw or single-pole single-throw configurations, normally open or normally closed. Cherry Electrical Products Corp.

CIRCLE NO. 296

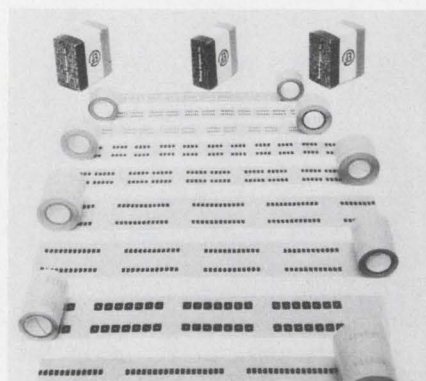

DIP artwork patterns

Matching the latest dual-in-line packages, a new line of multi-pad artwork patterns include all 8, 10, 14, 16, 24 and 36-lead configurations. There are eight different drafting styles to meet specific circuitry requirements. All these pressure-sensitive patterns come in 1:1, 2:1 and 4:1 scales, and in opaque black, and photographically compatible transparent red and transparent blue. Free evaluation samples are available. Bishop Graphics, Inc.

CIRCLE NO. 297

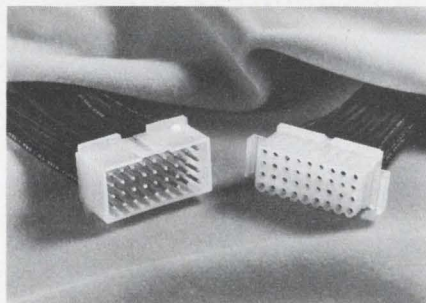

Nylon connector

Accommodating as many as 36 circuits, a new miniature connector is ideal for applications in business machines, computers, home entertainment units and appliances. Designated the 1625-36, the unit has a nylon body with integrally molded mounting ears on both the plug and receptacle, plus a positive-lock design. It accepts crimp-type terminals, which may be tin-plated brass, phosphorus bronze, and gold or silver-plated brass. A free evaluation sample is available. Molex Products Co.

CIRCLE NO. 298

Design Aids

Programmer's calendar

Devised especially for computer users is a new calendar that is being offered free. It features machine-tested, change-maker sub-routine, data finder, and even slot-machine simulator programs. This 8-1/2 x 11-in. calendar includes program flow charts each month on the front monthly page and instructions and related information on the reverse side of the page. Limited quantities are available. Spiras Systems, Inc.

CIRCLE NO. 299

Line conditioning guide

Characteristics and requirements for unconditioned, C1, C2 and C4 conditioned telephone channels are available in a free easy-to-read sturdy slide chart. It shows specifications for communications channels as described in AT&T's Bell Systems Practices and FCC Tariff 260. For those who are involved in data communications, this guide offers a proper understanding of line requirements for effective utilization of communications channels. Rixon Electronics Inc.

CIRCLE NO. 301

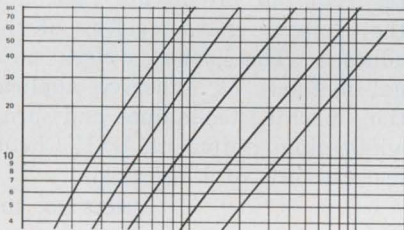

Core loss curves

A new four-page folder illustrates high-frequency core loss curves for nickel-iron strip-wound cores. Data for the curves, which are supplements to existing design manuals, was obtained by recording the voltage and current waveforms across a one-turn winding on a representative miniature tape-wound core. Rather than representing maximum or minimum values, the core loss curves show typical losses for ultra-thin nickel-alloy tape-wound cores. Magnetics div. of Spang Industries, Inc.

CIRCLE NO. 300

New SOLID-STATE FET-INPUT MULTIMETER

from
SIMPSON
of course

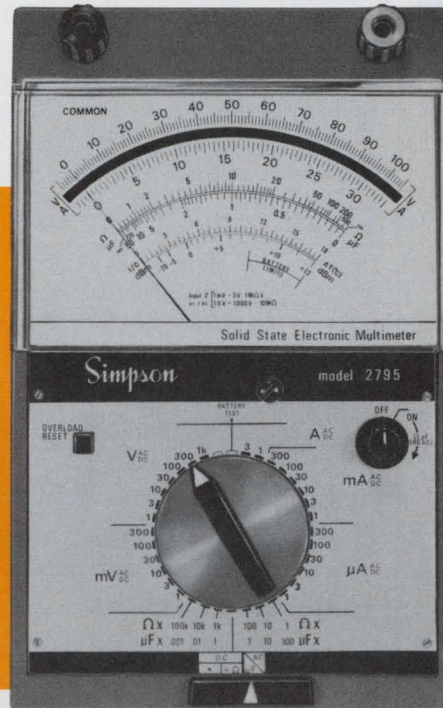

Model
2795

**PORTABLE,
LABORATORY
ACCURACY,
SOLID-STATE
MULTIMETER**

- 68 Switch Selectable Functions:
 - 13 AC and DC Voltage Ranges (as low as 1 MV, full scale)
 - 14 AC and DC Current Ranges (as low as 1 μ A, full scale)
 - 6 low power (IC compatible) Resistance Ranges
 - 6 completely self-contained Capacitance Ranges
- Plus 12 Output Ranges
- Circuit Breaker Overload Protection
- High FET-Input Impedance
- $\pm 1\%$ Accuracy for AC and DC
- Negligible Voltage Drop
- Simple, Straight-Forward Operation
- Size: 8.07" High, 5.04" Wide, 3.94" Deep. Only 3.3 lbs.

2795 MULTIMETER supplied complete with batteries, test leads and operator's manual. Complete accessories available.

\$230⁰⁰

WRITE FOR BULLETIN 1010 . . . OR CONTACT YOUR SIMPSON INSTRUMENTATION PRODUCTS DISTRIBUTOR FOR OFF-THE-SHELF DELIVERY

Simpson
INSTRUMENTS THAT STAY ACCURATE



SIMPSON ELECTRIC COMPANY

5200 W. Kinzie Street, Chicago, Illinois 60644

Phone (312) 379-1121

EXPORT DEPT.: 400 W. Madison St, Chicago, Ill 60606. Cable Simelco

IN CANADA: Bach-Simpson Ltd., London, Ontario

IN INDIA: Ruttonsha-Simpson Private Ltd., International House, Bombay-Agra Road, Vikhroli, Bombay

INFORMATION RETRIEVAL NUMBER 69

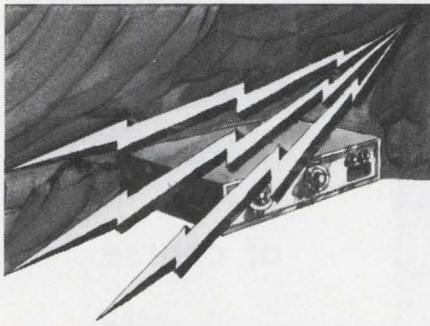

Rent- a Volt

Not very long ago, when your lab needed a precision amplifier or a voltage standard or almost any other piece of sophisticated electronic instrumentation, about the only way to obtain one was to buy it.

Not any longer. Now . . . through R.E.I. . . . you can rent almost any electronic instrument you can think of — without delay; without worrying about service and calibration; without wondering if it will become obsolete before you have a chance to turn it on; and without investing capital funds or making any sort of major commitment.

R.E.I. can give you the fastest service, the widest selection and the lowest rates of any rental firm in the country. One of our inventory centers is located near you, wherever you are, for instant delivery. Let us tell you more about the many advantages of renting vs. buying. Send today for your free copy of the new R.E.I. Instrument Rental Handbook.

Amplifiers	Filters	Power Supplies
Analyzers	Generators	Recorders
Attenuators	Meters	Sources
Bridges	Oscillators	Stroboscopes
Cameras	Oscilloscopes	Synthesizers
Counters	Plug-In Units	Test Chambers
Detectors	Generator/Synchronizer	

INSTANT INSTRUMENTS FROM THESE INVENTORY CENTERS:

Waltham, Mass. 02154
69 Hickory Drive
(617) 891-7610—Telex 923472

Anaheim, Calif. 92801
159 East Freedom Ave
(714) 879-0561—Telex 655473

Gaithersburg, Md. 20760
16600 Oakmont Ave.
(301) 948-0620—Telex 898446

Rosemont, Ill. 60018
5607 Pearl St.
(312) 671-2464—Telex 726488

Ft. Lauderdale, Fla. 33308
4808 N.E. 10th Ave.
(305) 771-3500—Telex 51-4467

MORE INVENTORY CENTERS
COMING SOON



Rental Electronics inc.

A PEPSICO LEASING COMPANY

Application Notes

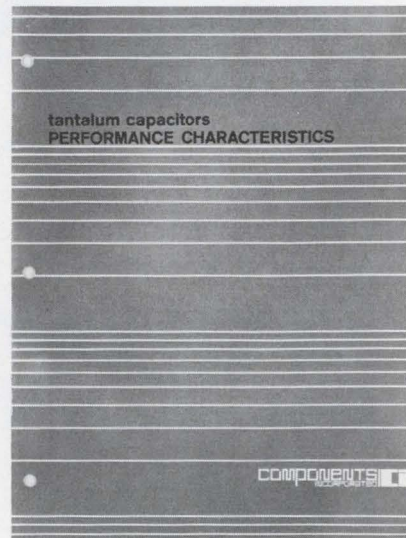

Tantalum capacitors

The performance characteristics of tantalum capacitors is the subject of a new eight-page booklet. It is crammed with 29 characteristic curves that include voltage versus temperature, minimum and maximum ripple voltage and dc leakage. Other characteristic curves show impedance, capacitance change and frequency. A complete review of tantalum construction and basic parameters is also included. Components, Inc.

CIRCLE NO. 302

Inductive elements

Applications information for transformers, inductors and delay lines is contained in a new 33-page manual. It begins with a definition of terms and symbols, test methods and design aids, and follows up with three sections for applications. The first section is on transformers and delay lines, the second is on instrumentation and the third is on power supplies. The sections contain calculations, nomographs, specification preparations and circuit selections. Circuits illustrated are arranged in groupings. Methods for specifying and testing core and winding performances are also included. Pulse Engineering Inc.

CIRCLE NO. 303

SCR/triac triggering

A new application bulletin entitled "Selecting a Trigger Transformer for SCR/triacs" is available. It describes in practical terms the methods and steps in selecting the proper pulse transformer for coupling trigger pulses into the gates of SCRs and triacs. A six-step summary shows how to select a transformer, with additional design footnotes included. This application information eliminates the mysteries of pulse transformers that have plagued the designers of motor controls and process control equipment. Aries Technology.

CIRCLE NO. 304

Adhesive application

Selection guidance for the proper method and equipment to use when applying liquid adhesives is provided in an illustrated 20-page booklet. Considered are such factors as: the size and shape of the parts to be bonded, the areas to which the adhesive is to be applied, the number of assemblies to be produced, the required production rate, and the property characteristics of the adhesive. The booklet covers manual methods of adhesive application, machine techniques and spray application equipment. USM Chemical Co., div. of USM Corp.

CIRCLE NO. 305

Pulse code modulation

The basics of pulse code modulation telemetry are thoroughly explained in a 12-page article reprint. It starts off with the explanation of pulse code modulation and the processes involved in a pulse code modulation system. This is followed with a discussion on how a typical system operates from a source to a display. The discussion is fortified with several illustrations and block diagrams. Data-Control Systems, Inc.

CIRCLE NO. 306

Introducing the first bipolar compatible MOS ROM.

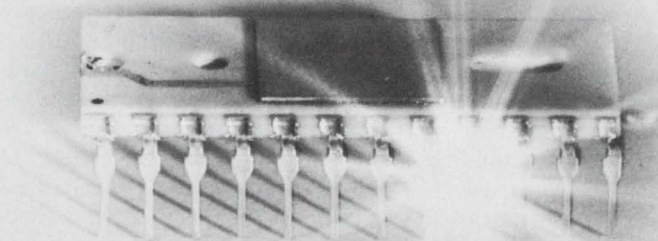

No ifs, ands or external resistors.

A lot of people have said their MOS ROM's were bipolar compatible. For output only. Or just for typical case. Or only if you hung on a resistor.

Solitron's is "worst case" bipolar compatible. Period.

Input can be as low as 0.4v for logic 0. 2.4v for logic 1. Any temperature between -55°C and $+125^{\circ}\text{C}$. Put it with any DTL or T²L and it'll work.

Of course compatibility isn't everything. Which is why we made our MOS ROM fast and versatile. (And static.)

Typical response 500ns. Worst case, 900ns. 1024 bits in four standard word-bit configurations.

Programmable chip select.

We also made it available. Order UC 6525/7525 now and you'll have it in four to six weeks with your bit pattern. Or contact us for details.

Solitron Devices, Inc., P.O. Box 1416,
San Diego, California 92112
Telephone (714) 278-8780
TWX 910-335-1221

Solitron DEVICES, INC.

(A part of Union Carbide is now part of Solitron.)

New Literature



Series 54/74 ICs

A 32-page brochure describes integrated circuits of the 5400 and 7400 TTL series. The publication covers the first 24 products in the series and indicates the recommended operating conditions for these circuits. Descriptions of the circuits include information about electrical characteristics, switching characteristics, logic diagrams and pin configurations. Illustrations are abundant, with nine pages devoted to diagrams and schematic drawings showing test circuits and voltage waveforms. Additional illustrations show packaging dimensions and provide parameter measurement information. Fairchild Semiconductor

CIRCLE NO. 307

Display switches

Miniature lighted push-button display switches are illustrated in a 12-page brochure. They provide control flexibility and display versatility and are adaptable to military and commercial applications. The brochure describes matrix or single-mounted switches with front-of-panel replacement for both switches and lamps. Also listed are dimensions, terminal options, display-color options, lamp data, leg-
ending information and ordering and pricing data. Micro Switch, div. of Honeywell.

CIRCLE NO. 308

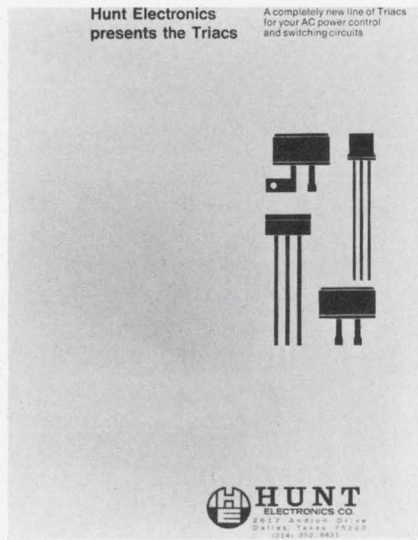

Triacs

Specifications for 88 devices of a line of triacs for ac power control and switching circuits are detailed in a new catalog. The triacs are available in a wide range of voltages and currents and feature static power switching with no contact bounce, arcing or replacement. A wide variety of packages to fit most specifications are shown. Applications, electrical characteristics, and mechanical specifications are listed. Hunt Electronics Co.

CIRCLE NO. 309

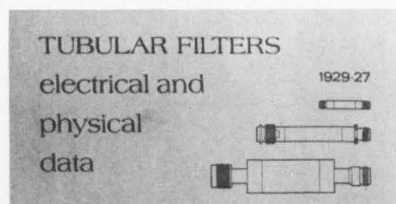

Tubular filters

Electrical and physical characteristics for over 2000 tubular filter designs are compiled in a catalog supplement. Included are such data as filter function (band-pass, high-pass, low-pass), insertion loss, center or cutoff frequency, bandwidth, number of elements, impedances, and attenuations at several points. Graphs illustrate frequency-attenuation and VSWR characteristics. Physical dimensions include body diameter and length. I-TEL, Inc.

CIRCLE NO. 310

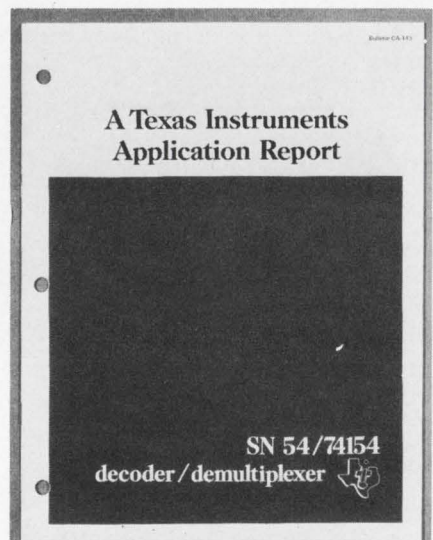

Decoder/demultiplexer

A new application report on the SN54/74154 decoder/demultiplexer TTL/MSI integrated circuit is available in an eight-page publication. It discusses the ICs internal logic design and performance capabilities. Included are the circuit's logic description, block diagram, a switching characteristics chart, and a truth table listing all 16 outputs plus enable and data inputs. Additionally, the report covers its applications as a decoder, minterm generator, code decoder, and as a demultiplexer. Texas Instruments Inc.

CIRCLE NO. 315

Thick-film coatings

Data sheets and reprints of a recent paper describing screen-printable thermistor coatings are available. These unique new coatings are described in a paper "Improved NTC Thermistor Thick Film Coatings" which was presented at the 1969 Hybrid Microelectronics Symposium. A data sheet lists available resistivity ranges, and typical resistor temperature coefficients. It also gives processing instructions for producing printed-in-place negative temperature coefficient thermistors on ceramic substrates. Electro-Science Laboratories, Inc.

CIRCLE NO. 316

Electronic calculators

The series 1600 electronic scientific/engineering calculators are shown in a 24-page catalog. Described are display, programming and printing calculator models. General descriptions, specifications and display and decimal systems are included. The various calculator keyboards are discussed in detail with respect to operations. Three pages in the back of the catalog are devoted to sample program sheets. The Monroe Calculator Co., a Div. of Litton Industries.

CIRCLE NO. 317

Single-turn pots

Twenty-four standard models and 96 variations of the new B-Line series of single-turn precision potentiometers are described in detail in a six-page brochure. The series comes in 7/8-in., 1-1/16-in. and 2-in. diameters with servo or bushing mounts, in a choice of four elements. They offer a standardized thin profile for a new concept in interchangeability that allows designing for a specific package size without concern for the type of potentiometric element used. Bourns Inc., Trimpot Products Div.

CIRCLE NO. 318

Rf coils

Fourteen different series of molded variable and fixed coils in all sizes and shapes for rf applications are listed in a new 16-page catalog. Tables of information include such data as inductance values, Q, resonant and testing frequency, dc resistance, and current ratings and core material. All dimensions are fully illustrated for each series. A separate page includes a list of distributors and sales representatives. Delevan Electronics Div, A.P.I.

CIRCLE NO. 319

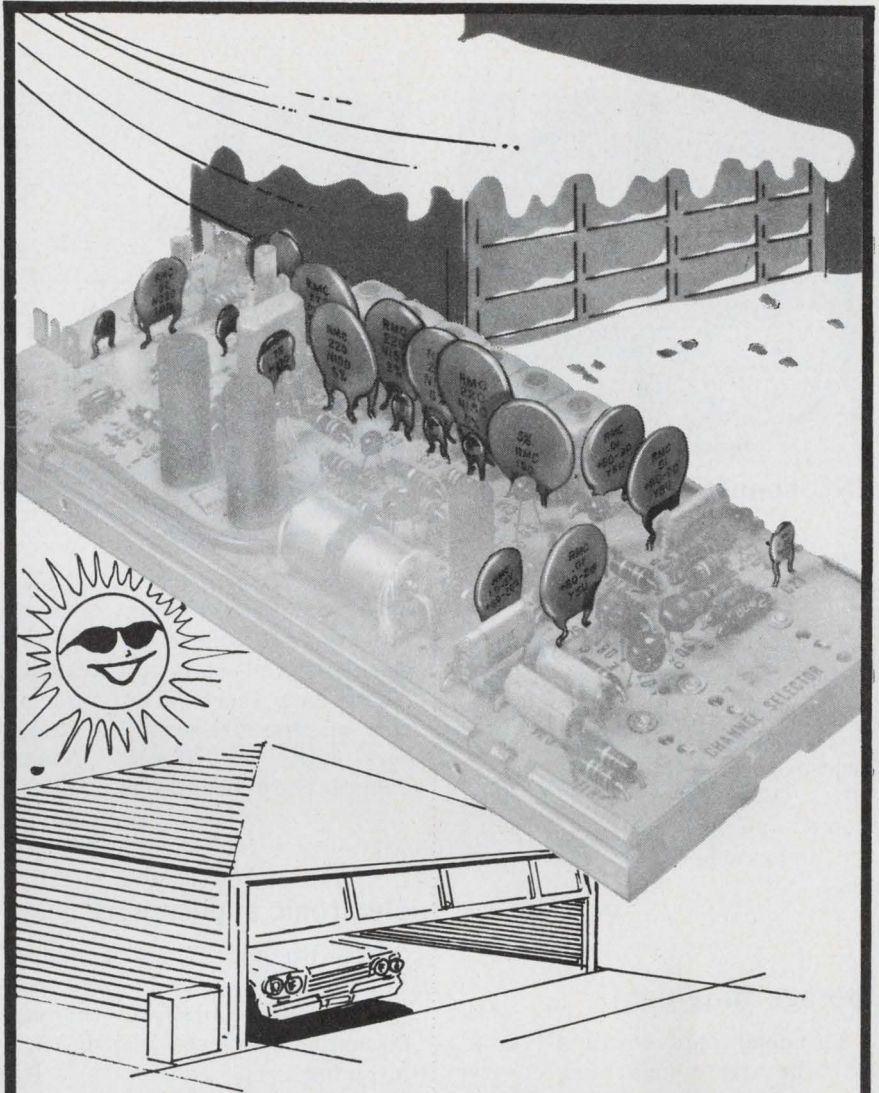

RMC DISCAPS FOR TEMPERATURE SENSITIVE APPLICATIONS

Perma-Power, a division of Chamberlain Mfg. Corp., a leading manufacturer of radio controlled garage door openers, specifies RMC DISCAPS to assure reliability under extreme environmental conditions.

RMC produces a full range of DISCAPS for temperature sensitive circuitry or applications requiring exact temperature compensation. Frequency and temperature stable types, as well as units of predictable variability, are available.

DISCAPS are produced to the highest standard of quality and may be specified with complete confidence.

If your application requires special physical or electrical characteristics, contact RMC's Engineering Department.

*Write today on your company letterhead
for your copy of the complete RMC catalog.*

DISCAP
CERAMIC
CAPACITORS



RADIO MATERIALS COMPANY
A DIVISION OF P. R. MALLORY & CO., INC.
GENERAL OFFICE: 4242 W. Bryn Mawr Ave., Chicago 46, Ill.
Two RMC Plants Devoted Exclusively to Ceramic Capacitors
FACTORIES AT CHICAGO, ILL. AND ATTICA, IND.

INFORMATION RETRIEVAL NUMBER 72

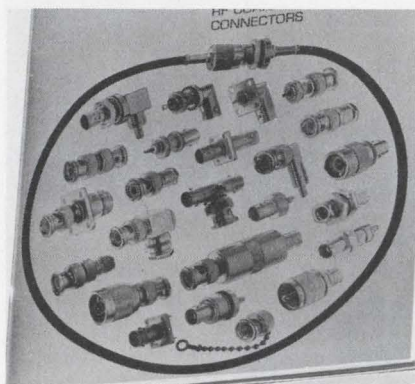

BNC connectors

A new comprehensive 48-page catalog lists a BNC series of rf coaxial connectors. Construction and cable group data are given for 658 items. They include a wide variety of adapters, jacks, panel jacks, bulkhead jacks, plugs, angle plugs, panel and bulkhead receptacles, terminations and accessories. Each item is photo-illustrated and pertinent dimensions are indicated. Kings Electronics Co.

CIRCLE NO. 320

Storage tube data

Technical data for a 4-1/2 × 5-1/2-in. rectangular direct-view storage tube is included in an eight-page brochure. The tube, which can be operated in black-and-white or in half-tone storage modes, provides a resolution of 150 television lines per inch. It includes a viewing screen brightness of 150 foot-lamberts, and meets the requirements for displaying graphical and alphanumeric information. Hughes Aircraft Co.

CIRCLE NO. 321

Hewlett-Packard Journal

The February 1970 issue of the Hewlett-Packard Journal is available. This 24-page publication is devoted to a discussion of a system for automatic network analysis. It begins with a description of the system and discusses its applicable software. Articles on developing the system's accuracy specifications and typical applications are also included. Hewlett-Packard Co.

CIRCLE NO. 322

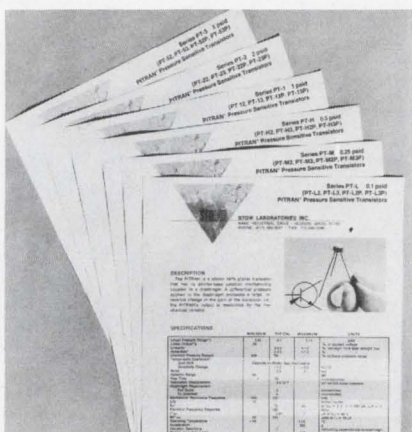

Pressure transistors

Six new complementary data sheets for a recently released eight-page brochure on pressure-sensitive transistors are available. These data sheets detail information on pressure-sensitive transistors with six different pressure ranges. Stow Laboratories, Inc.

CIRCLE NO. 323

Electronic applications

"Technical Communications," Vol. 10, No. 93, is a 120-page publication that contains a thorough discussion of several applications involving semiconductors and ICs. Applications such as infrared heat-locator and intruder-alarm detectors, and fire alarm systems are described. Also included are discussions on thermometers for high-temperature and room-temperature radiation, infrared microscopes and closed-circuit television systems. The booklet has pertinent schematic layouts, equations and graphical information. Mullard, Inc.

CIRCLE NO. 324

Integrated circuits

Linear ICs, FET-switch drivers and driver/switch combinations, and FET chips are described in detail in a new catalog. Applications information is included in right-hand columns of the catalog's pages. The left-hand columns contain electrical and physical specifications and the device model numbers. This facilitates IC device selection by application as well as by number. Siliconix Inc.

CIRCLE NO. 325

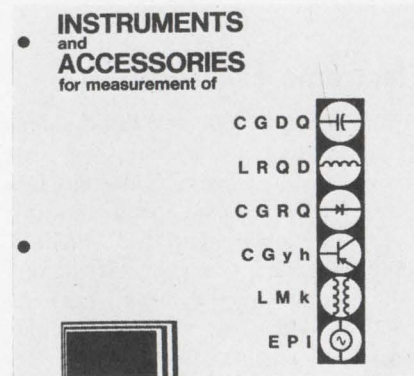

Measurement instruments

Twenty-four instruments and their related accessories are listed on unique selector charts in a new eight-page abridged catalog. An engineer can now quickly select and find the instruments and accessories needed to measure a wide variety of parameters for many electronic components. Summarized specifications of all instruments and accessories are provided, each with its current price. Boonton Electronics Corp.

CIRCLE NO. 326

Communications devices

A wide line of standard-size and miniature terminals, plate caps and sockets are described in a 16-page bulletin. It details and illustrates high-voltage feed-through safety terminals, binding posts, ceramic insulators and crystal sockets. Also shown are special industrial sockets for large tubes such as thyratrons, insulated plate caps, hold-down clamps, coil sockets and aluminum shield cans. James Millen Mfg. Co., Inc.

CIRCLE NO. 327

IC testing

An analogical-circuit test instrument and a line of its accessories are described in a 12-page brochure. The bench-top instrument is card-programmed for testing digital ICs. Though primarily an incoming-inspection system, it is readily adapted for engineering use through the addition of such accessories as an analog programmer, an evaluation test deck, and a pattern control unit. Teradyne, Inc.

CIRCLE NO. 328



PASS ME THE AVO!

SIL VOUS PLAIT • POR FAVOR

Worldwide, "Pass the AVO" means someone wants the most accurate, most reliable multimeter...anywhere. Twenty four ranges for AC and DC current, voltage and resistance. Full meter protection includes fuse, velocity actuated mechanical cutout and diode protection for meter movement.



This internationally famous AVO Model 8 has for over 50 years set the highest standard in multimeters. Over a million in use today!

Calibration, parts and service by factory trained personnel are available at our Plainview, N.Y. facility and in most countries throughout the world.

GENCOM DIVISION

varian/EMI

80 EXPRESS STREET, PLAINVIEW, N. Y. 11803
TELEPHONE: (516) 433-5900

INFORMATION RETRIEVAL NUMBER 73

SNOB KNOB



The first new styling innovation in fifteen years!

900 Series Snob Knobs come in four bright, handsome models. Spun aluminum cap. Spun aluminum inlay. Decorative metallic ring. And Black. From 1/2" to 1 3/4" diameter.

Kurz-Kasch is known as the quality knob source by electronics manufacturers the world over. If you're not familiar with the outstanding Kurz-Kasch line, we'll send you a complete catalog. And if you're just anxious to see the new Snob Knob, we'll send you a free sample.



Kurz-Kasch, Inc.

Standard Parts Division • 1415 S. Broadway
Dayton, Ohio 45401 • Phone 223-8161

INFORMATION RETRIEVAL NUMBER 74

ELECTRONIC DESIGN 7, April 1, 1970



Sperry's magnetic transducer (OPMAG) is a low cost magnetic sensing device, designed as a versatile module for many applications.

New OPMAG magnetic transducer- sensitive enough to do all these things

- | | |
|--|---|
| <input type="checkbox"/> Stop pilferage | <input type="checkbox"/> Alarm remotely |
| <input type="checkbox"/> Detect intruders | <input type="checkbox"/> Route assembly lines |
| <input type="checkbox"/> Sense proximity | <input type="checkbox"/> Check positioning |
| <input type="checkbox"/> Control traffic | <input type="checkbox"/> Detect contamination |
| <input type="checkbox"/> Protect machinery | <input type="checkbox"/> Spot hidden weapons |
| <input type="checkbox"/> Sort production | <input type="checkbox"/> Count items |

Check your application(s). Then ask us to tell you how magnetic detection can solve your problems at low cost . . . or suggest a new application for OPMAG in the space below. We'll send you a free copy of our newly-published "Magnetics Handbook" (Retail price \$1.25).

SPERRY
MARINE SYSTEMS DIVISION
CHARLOTTESVILLE, VIRGINIA 22901

I suggest _____

Name _____

Title _____

Company _____

Address _____

City _____

State _____ Zip _____

INFORMATION RETRIEVAL NUMBER 75

ELECTRONIC DESIGN'S function is:

- To aid progress in the electronics manufacturing industry by promoting good design.
- To give the electronic design engineer concepts and ideas that make his job easier and more productive.
- To provide a central source of timely electronics information.
- To promote two-way communication between manufacturer and engineer.

Want a subscription? ELECTRONIC DESIGN is sent free to qualified engineers and engineering managers doing design work, supervising design or setting standards in the United States and Western Europe. For a free subscription, use the postfree application form inside the back cover. If none is included, write to us direct for an application form.

If you do not qualify, you may take out a paid subscription for \$25 a year in the U.S.A., \$35 a year elsewhere. Single copies are \$1.50 each.

If you change your address, send us an old mailing label and your new address; there is generally a prepaid postcard for this inside the back cover. You will have to requalify to continue receiving ELECTRONIC DESIGN free.

The accuracy policy of ELECTRONIC DESIGN is:

- To make reasonable efforts to ensure the accuracy of editorial matter.
- To publish prompt corrections whenever inaccuracies are brought to our attention. Corrections appear at the end of the Letters column.
- To refuse any advertisement deemed to be misleading or fraudulent.

Microfilm copies are available of complete volumes of ELECTRONIC DESIGN at \$19.00 per volume, beginning with Volume 9, 1961. Work is now in process to complete the microfilm edition of Volumes 1-8. Reprints of individual articles may be obtained for \$2.00 each, prepaid (\$.50 for each additional copy of the same article) no matter how long the article. For further details and to place orders, contact the Customer Services Department, University Microfilms, 300 North Zeeb Road, Ann Arbor, Michigan 48106; telephone (313) 761-4700.

Want to contact us? If you have any comments or wish to submit a manuscript or article outline, address your correspondence to:

Editor,
ELECTRONIC DESIGN,
850 Third Avenue,
New York, N.Y. 10022.

Design Data from

DRAFTING AIDS CATALOG



Send today for the By-Buk Printed Circuit Drafting Aids P-45 Catalog featuring the most comprehensive listings of basic pressure sensitive printed circuit drafting shapes, tapes and aids. Contains thousands of pads, tees, elbows, corners, donuts, connectors, fillets, colored tapes, multi-pads for dual in-lines, flat packs, TO cans and more. Here is your guide to better printed circuit drafting. Scores of ideas to speed master artwork preparation time and reduce drafting costs. Send for your free catalog and samples.

By-Buk Company

4326 West Pico Blvd., Los Angeles, Calif. 90019
Phone: (213) 937-3511

174

Terminal Block Selector

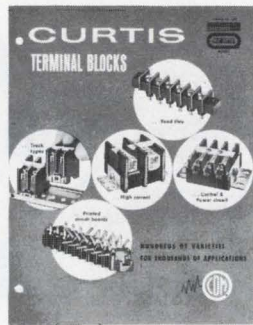

A new 24-page, completely illustrated catalog contains photos, descriptions, ratings, engineering drawings, and prices of the complete line of Curtis terminal blocks. Included are printed circuit, insulated feed-thru, quick disconnect, track type, and high current terminal blocks. Handy selection chart quickly locates the perfect block for your particular requirements. Send today for your free copy.

Curtis Development & Mfg. Co.

3236 North 33rd Street
Milwaukee, Wisconsin 53216

See us at booth 4E11 - IEEE Show

175

When Non-Standard Capacitors are Needed

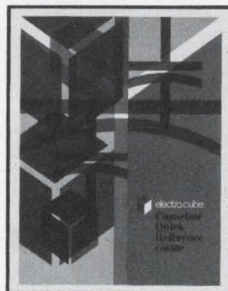

This brochure outlines Electro-Cube's capability to design to requirements, or produce to specifications, capacitors in a wide variety of shapes, sizes and values. Typical information on seven dielectrics including electrical ratings, are presented. Typical sizes for wrap and fill, epoxy, metal and hermetic sealed cases are also given. Representative examples of 4,000 standard Electro Cube capacitors, in addition to custom units, are presented. Copies of the six-page brochure are available on request.

Electro Cube, Inc.
1710 South Del Mar Road
San Gabriel, California 91776

176

Manufacturers

Advertisements of booklets, brochures, catalogs and data sheets. To order use Reader-ServiceCard.
(Advertisement)

Plastic Parts



CUSTOM production to your specs from patented, low-cost tooling. Any size, any quantity in Nylon, Delrin, other thermoplastics. Let us quote. We have 20 years experience.

STANDARD gears, racks, bearings, sprockets, pulleys, washers, insulators, many other components available quickly from stock tools. Over 2,500 items described in our 48-page catalogue. Write today for a free copy.

Nylomatic

28 Nolan Ave., Morrisville, Pa. 19067

177

New Portable Real-Time Analyzer

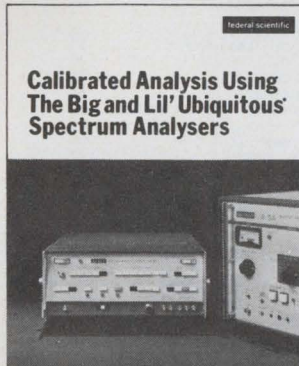

Calibrated Analysis Using
The Big and Lil' Ubiquitous[®]
Spectrum Analyzers

The new 200-line UA-10, the lil' Ubiq[™], is compared to the 500-line UA-6A Ubiquitous[®] Spectrum Analyzer, highlighting savings possible for less demanding production and field applications. On-line frequency domain measurements of vibration, noise, underwater signals, and machine signatures are described. UA-10 is 100 times faster than traditional sweeping systems and has greatly increased resolution over 1/3-octave. The UA-10 is specially designed for accurate testing by inexperienced operators. Advantages of the big precision UA-6A for R&D requiring higher resolution and wider dynamic range are included.

Federal Scientific Corporation

a subsidiary of Elgin National Industries, Inc.
615 West 131st Street, New York, N.Y. 10027

178

Design Guide for Auto. PC Board Assembly

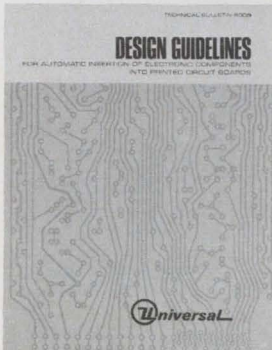

Send for Universal Instruments' 16-page Bulletin 600B . . . comprehensive design guidelines for automatic insertion of electronic components into printed circuit boards. Covers axial lead components (fixed and variable center span insertion), dual in-line package integrated circuits (DIPs), transistors (axial and radial lead forming), and component sequencing. Fully applicable to pantograph, N/C, and new mini-computer controlled systems. Guide liberally illustrated with photos, diagrams and drawings. An important educational reference for both design and assembly engineers.

Universal Instruments Corporation

East Frederick Street
Binghamton, New York 13902
(607) 772-1710/TWX: 510-252-1990

179

Electronic Design

Advertising Sales Staff

Keith Aldrich
Sales Manager

New York 10022

Robert W. Gascoigne
Thomas P. Barth
Samuel M. Deitch
850 Third Avenue
(212) Plaza 1-5530
TWX: 867-7866

Philadelphia 19066

William C. Repetto
P. O. Box 206
Merion Station, Pa.
(215) MA-3-5888

Boston 01945

Joseph F. Palmer
P. O. Box 645
14 Peter Hobart Drive
Hingham, Mass.
(617) 742-0252

Chicago 60611

Thomas P. Kavooras
Berry Conner, Jr.
200 East Ontario
(312) 337-0588

Cleveland

Thomas P. Kavooras
(Chicago)
(312) 337-0588
(call collect)

Los Angeles 90303

Stanley I. Ehrenclou
W. James Bischof
2930 Imperial Highway
Inglewood, Calif.
(213) 757-0183

San Francisco 94022

Arthur R. Shields, Jr.
175 San Antonio Rd., S 243
Los Altos, Calif.
(415) 941-3084

London W. 1

For United Kingdom and Holland
Brayton C. Nichols
44 Conduit Street
Tel: REGent 4714

Verviers, Belgium

For Continental Europe
Andre Jamar
1, Rue Mallar, 1
(087) 253.83 Telex 41563

Tokyo

Haruki Hirayama
Electronic Media Service
Rm. 601, Daini Miyouchi Bldg.
6-8-14, Roppongi,
Minato-ku
Phone: 402-4556
Cable: Electronicmedia, Tokyo



The next time postal service breaks down, it's your fault.

In 1966, the Chicago Post Office ground to a halt. For three weeks, the mail was almost at a standstill.

If you want that to happen in your town, just wait.

Today's U.S. Post Office is probably the most inefficient, most antiquated big business in the United States. Unless something is done right now—by people like you—the situation is going to get worse.

Are you interested in straightening out the mess?

Right now, there's a bill before a committee of Congress called HR 11750. HR 11750 is, in brief, the recommendations of a bipartisan committee for the reorganization of the U.S. Post Office on a business like basis (along the lines of TVA). HR 11750 is designed to take the Post Office out of politics, to apply modern business methods to its operation and, in the process, to save taxpayers the \$1,200,000,000 annual deficit that today's horse-and-buggy Post Office incurs.

You can help get HR 11750 out of committee and enacted into law by letting your congressman know how you feel. Tear out this column, pin it to your letterhead and mail it to your congressman today. Let your voice be heard.

If the Post Office in your city breaks down next, you can't say you haven't been warned.

Citizens Committee for Postal Reform











1725 Eye Street, N.W., Washington, D.C. 20006
Lawrence F. O'Brien/Thurston B. Morton
National Co Chairmen

Advertisers' Index

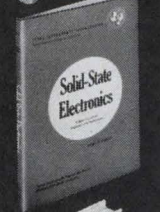
Advertiser	Page
Abbott Transistor Laboratories Incorporated	13
AiResearch Manufacturing Company	115
Beckman Instruments, Inc., Helipot Division	74
Bell Laboratories	15
Bird Precision Jewels	114
Burroughs Corporation	98, 98
By-Buk Company	124
Centralab Electronics Division of Globe-Union, Inc.	47, 96A-B
Chicago Miniature Lamp Works	41
Cinch Graphic Division of United Carr	80
Comar Electric Company	93
Computer Labs	14
Corning Glass Works, Electronic Products Division	90, 91
Curtis Development & Mfg. Co.	124
Cutler-Hammer	111
Dale Electronics, Inc.	Cover II
Dickson Electronics Corporation	76
Dow Corning Corporation	16
E-H Research Laboratories, Inc.	45
Edmund Scientific Co.	108
Electro Cube, Capacitors	87, 124
Electro Materials	24
Erie Technological Products, Inc.	48, 88
Federal Scientific Corp.	125
Gardner-Denver Company	4, 5
Gagne Assocs., Inc.	108
Gencom Division, Varian/EMI	123
General Electric Company	10
General Radio Company	38
Grayhill, Inc.	112
Hayden Book Company, Inc.	44
Heinemann Electric Company	31
Hewlett-Packard	1
Honeywell Test Instruments Division	7
ITT Cannon Electric, A division of International Telephone and Telegraph Corp.	82
Indiana General Corporation	107
Ingersoll Products, Division of Borg Warner Corporation	35
Intech, Incorporated	103
Johnson Company, E. F.	34
Kurz-Kasch, Inc.	97, 123

Advertiser	Page
Line Electric Company	6
3M Company, Chemical Division	17
McGraw-Hill Book Co.	127
Magnecraft Electric Company	96
Marathon Battery Company	11
MicroSwitch, A Division of Honeywell	43
Midtex, Incorporated Aemco Division	85
Molex Products Company	69
Monolithic Dielectrics, Inc.	112
Monsanto Company	95, Cover III
Motorola Communications & Electronics, Inc.	114
NJE Corporation	100
National Semiconductor Corporation	8, 9
Newark Electronics Corporation	109
Nylomatic Corporation	125
Potter & Brumfield Division of American Machine & Foundry Company	94
RCA Electronic Components and Devices	16A-B, 23, Cover IV
Radio Materials Company	121
Rental Electronics, Inc.	118
San Fernando Electric Manufacturing Company	104
Scientific Research Corporation	116
Servo-Tek Products Company	46
Signetics Corporation	27, 42
Simpson Electric Company	117
Solotron Devices, Inc.	119
Sperry Marine Division/Sperry Rand Corporation	123
Sprague Electric Company	18, 78
Stackpole Carbon Company	12
Sylvania Electric Products, Inc.	92
Systron-Donner Corporation	2
Teradyne	20
Texas Instruments Incorporated, Components Group	36, 37
Triplett Corporation	65
Trygon Power Supplies	113
Unitrode Corporation	29
Universal Instruments Corp.	125
Velonex, A Division of Pulse Engineering, Inc.	59
<i>Career Advertising:</i>	
Fairchild Camera and Instrument Corporation	73

Special introductory offer to new members of the ELECTRONICS AND CONTROL ENGINEERS' BOOK CLUB

	A042/500 NUMERICAL CALCULATIONS AND ALGORITHMS by Beckett & Hurt Pub. price, \$10.50 Club price, \$8.95		A494/754 ENGINEERING MANUAL, 2/e by R. H. Perry Pub. price, \$12.50 Club price, \$9.95
	A101/094 MICROELEC- TRONIC CIRCUITS AND APPLICATIONS by J. M. Carroll Pub. price, \$12.00 Club price, \$10.25		A523/401 CHARACTER- ISTICS AND OPERATION OF MOS FIELD- EFFECT DEVICES by P. Richman Pub. price, \$10.00 Club price, \$8.50
	A286/507 SOLID-STATE ELECTRONICS by R. G. Hibberd Pub. price, \$9.50 Club price, \$7.95		A037/604 DIGITAL LOGIC AND COMPUTER OPERATIONS by Baron & Piccirilli Pub. price, \$14.50 Club price, \$11.95
	A287/457 SUCCESSFUL ENGINEERING MANAGEMENT by T. G. Hicks Pub. price, \$8.95 Club price, \$7.25		A423/814 PULSE, DIGITAL AND SWITCHING WAVEFORMS by Millman & Taub Pub. price, \$18.00 Club price, \$15.30
	A347/506 ELECTRONIC DIGITAL TECHNIQUES by P. M. Kintner Pub. price, \$12.50 Club price, \$10.65		A565/031 AMPLIFIER HANDBOOK by R. F. Shea Pub. price, \$37.50 Club price, \$29.50

ANY ONE

of these great professional books

for only \$ **1.00**

VALUES FROM \$8.95 to \$37.50

Special \$1.00 bonus book
comes to you with your
first club selection

	A637/377 TRANSISTOR CIRCUIT DESIGN by Texas Instruments, Inc., Staff Pub. price, \$16.50 Club price, \$14.05		A126/070 PRINTED CIRCUITS HANDBOOK by C. F. Coombs, Jr. Pub. price, \$17.75 Club price, \$14.95
	A610/037 MODERN COMMUNICA- TION PRINCIPLES by Stein & Jones Pub. price, \$15.00 Club price, \$12.75		A259/607 COMMUNICA- TION SYSTEM ENGINEERING HANDBOOK by D. H. Hamsher Pub. price, \$29.50 Club price, \$24.95

Save time and money by joining the Electronics and Control Engineers' Book Club

HERE is a professional club designed specifically to meet your day-to-day engineering needs by providing practical books in your field on a regular basis at below publisher prices.

How the Club operates: Basic to the Club's service is its publication, the *Electronics and Control Engineers' Book Club Bulletin*, which brings you news of books in your field. Sent to members without cost, it announces and describes in detail the Club's featured book of the month as well as alternate selections which are available at special members' prices.

When you want to examine the Club's feature of the month, you do nothing. The book will be mailed to you as a regular part of your Club service. If you prefer one of the alternate selections—or if you want no book at all for that month—you notify the Club by returning the convenient card enclosed with each *Bulletin*.

As a Club member, you agree only to the purchase of four books over a two-year period. Considering the many books published annually in your field, there will surely be at least four that you would want to own anyway. By joining the Club, you save both money and the trouble of searching for the best books.

MAIL THIS COUPON TODAY

ELECTRONICS AND CONTROL ENGINEERS' BOOK CLUB
330 West 42nd Street, 18th fl., New York, N. Y. 10036

Please enroll me as a member of the Electronics and Control Engineers' Book Club and send me the two books indicated below. I am to receive the bonus for just \$1.00, and my first selection at the special Club price shown. These books are to be shipped on approval, and I may return them both without cost or further obligation. If I decide to keep the books, I agree to purchase as few as four additional books during the next two years at special Club prices (approximately 15% below list).

Write Code No. of
bonus book
here

Write Code No. of
first selection
here

Name _____

Address _____

City _____

State _____ Zip _____

E33128

Product Index

Information Retrieval Service. New Products, Evaluation Samples (ES), Design Aids (DA), Application Notes (AN), and New Literature (NL) in this issue are listed here with page and Information Retrieval numbers. Reader requests will be promptly processed by computer and mailed to the manufacturer within three days.

Category	Page	IRN
Components		
capacitors (AN)	118	302
caps, tube plate (NL)	122	327
character generator	112	282
coils, rf (NL)	121	318
connector (ES)	116	298
connectors, BNC (NL)	122	320
core loss curves (DA)	117	300
CRT, fiber-optics	112	280
delay lines (AN)	118	303
filters, bandpass	109	276
filters, tubular (NL)	120	310
indicator, 7-segment	110	278
inductors (AN)	118	303
insulators, ceramic (NL)	122	327
knobs (ES)	116	295
potentiometers, single-turn (NL)	121	318
readout, numeric	110	277
rectifiers, bridge	112	281
sockets, tube (NL)	122	327
switch, (ES)	116	296
switches, display (NL)	120	308
terminals (NL)	122	327
thermistor coatings (NL)	120	316
transformers (AN)	118	303
transformers, trigger (AN)	118	304
trimmer, resistance	110	279
Data Processing		
calculator	105	262
calculators (NL)	121	317
calendar programming (DA)	117	299
coupler	105	261
data transfer system	105	260
interface system	106	265
memory, read/write	104	258
minicomputer	105	263
storage-tube data (NL)	122	321
tape, computer	105	264
tape transport	104	257
terminal, video	105	259
ICs & Semiconductors		
chips, FET (NL)	122	325
decoder/demultiplexer, TTL MSI (NL)	120	315
duplexer, IC	109	275
FETs (NL)	122	325
IC & semiconductor applications (NL)	122	324
IC testing (NL)	122	328
ICs, linear (NL)	122	325
ICs, TTL (NL)	120	307
FETs, low-noise	102	253
flip-flop, 3-state	101	250
generator, unit/function	102	251
SCR triggering (AN)	118	304
SCRs, hermetic	102	252
signal conditioner, IC	114	289
thick-film coatings (NL)	120	316
transistor chips	102	256
transistors, power	102	255

Category	Page	IRN
transistors, pressure-sensitive (NL)	122	323
transistors, switching	102	254
triac triggering (AN)	118	304
triacs (NL)	120	309
Instrumentation		
alarm systems (NL)	122	324
analyzer, network (NL)	122	322
digital panel meter	106	266
generator, character	112	282
generator, function	106	269
generator, function	108	271
generator, unit/function	102	251
instrument knobs (ES)	116	295
instruments (NL)	122	326
interface system	106	265
multimeter, digital	108	270
oscillator, digital	108	272
probes, test	106	268
stopwatch, digital	106	267
tester, circuit (NL)	122	328
Microwaves & Lasers		
coils, rf (NL)	121	319
communications (NL)	122	327
coupler	105	261
duplexer, IC	109	275
filters, bandpass	109	276
filters, tubular (NL)	120	310
line conditioning (DA)	117	301
pulse code modulation (AN)	118	306
source, X-band	109	273
TWT amplifiers	109	274
Modules & Subassemblies		
adder/subtractor	113	285
amplifiers, FET	114	290
amplifiers, TWT	109	274
conditioner, signal	114	289
display switches (NL)	120	308
filters, active	114	288
indicator, 7-segment	110	278
ladders, 3-decade BCD	113	287
operational amplifier	113	283
operational amplifier	113	284
source, X-band	109	273
switch (ES)	116	296
Packaging & Materials		
adhesives (AN)	118	305
artwork, DIP (ES)	116	297
coatings, thick-film (NL)	120	316
connector (ES)	116	298
connectors, BNC (NL)	122	320
fuse holder	115	292
knobs (ES)	116	295
substrates, hybrid	115	291
Tools & Engineering Aids		
calendar, programming (DA)	117	299
curves, core loss (DA)	117	300
extractor, TO-5	115	294

Category	Page	IRN
flatpack bender	115	293
line conditioning (DA)	117	301

New Literature

calculators, electronic	121	317
chips, FET	122	325
coils, rf	121	319
communications devices	122	327
connectors, BNC	122	320
decoder/demultiplexer, TTL MSI	120	315
display switches	120	308
FETs	122	325
filters, tubular	120	310
Hewlett-Packard Journal	122	322
IC & semiconductor applications	122	324
IC testing	122	328
ICs, linear	122	325
ICs, TTL	120	307
instruments	122	326
insulators, ceramic	122	327
potentiometers, single-turn	121	318
plate caps, tube	122	327
sockets, tube	122	327
storage-tube data	122	321
terminals	122	327
tester, circuit	122	328
thermistor coatings	120	316
thick-film coatings	120	316
transistors, pressure-sensitive	122	323
triacs	120	309

Application Notes

adhesives	118	305
capacitors, tantalum	118	302
inductive elements	118	303
pulse code modulation	118	306
SCR/triac triggering	118	304

Design Aids

calendar, programming	117	299
core loss curves	117	300
line conditioning guide	117	301

Evaluation Samples

artwork, DIP artwork	116	297
connector, nylon	116	298
knobs	116	295
switch, push-button	116	296

From Monsanto: 130,000,000 discrete frequencies with almost perfect purity.



Programmable, of course

DC to 1.3 MHz

**Resetable with 0.01 Hz resolution
over total range**

**Less than 20 μ sec switching time from
any frequency to any frequency**

Calibrated output level

AM or FM—or both simultaneously

Here is the sinewave source of the future . . . all the accuracy, stability and resettable that only a frequency synthesizer can give you, plus such signal generator advantages as accurately calibrated output level, AM or FM modulation capability (or both), and built-in sweeps with

provision for sweeping externally.

Now add digital programmability of frequency, analog programmability of output level and the benefits of computer-aided IC design, and you see a classic example of Monsanto's "4th generation" instrumentation.

The Model 3100A-016 Programmable Frequency Synthesizer is \$4950. Our non-programmable version, Model 3100A, is \$4250. An 8-page Technical Bulletin fills out the story. For your copy write: Monsanto Company, Electronic Instruments, West Caldwell, N. J. 07006.

Monsanto

New IC Switch from the Triac Leader

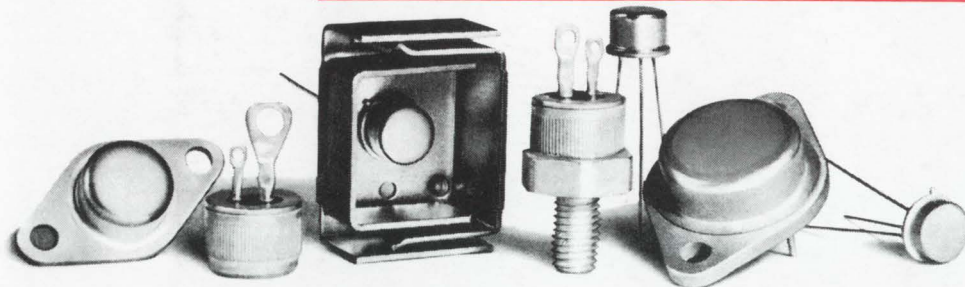
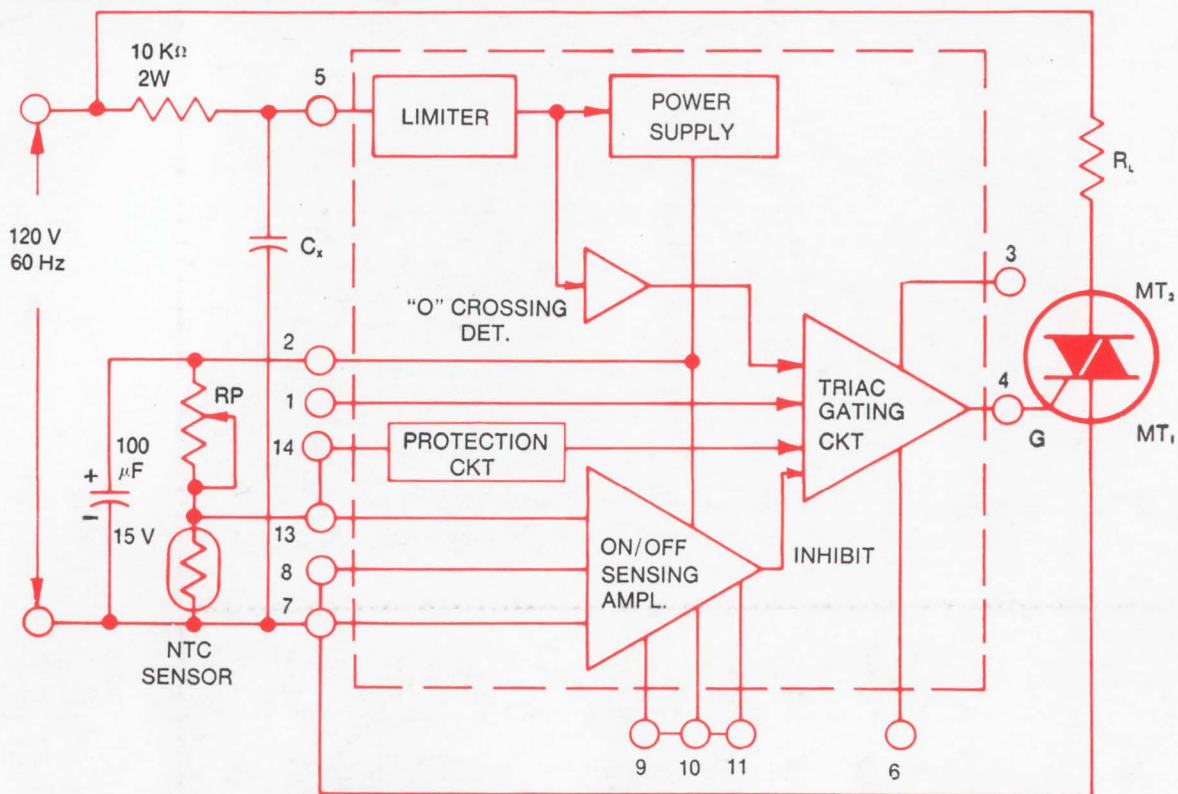

RCA-CA3059 Zero-Voltage Switch for New Economy, New Simplicity in Thyristor Trigger Circuits \$1.95 (1000-unit level)

Here's RCA's economical, new approach to Thyristor triggering—the CA3059 monolithic zero-voltage switch, at \$1.95 (1000 units). For efficient triggering of Triacs and SCR's with current ratings to 40 amperes—in applications such as electric heating, motor on/off controls, one-shot controls, and light-flashing systems—CA3059 offers these important new design advantages:

- Triggers Thyristors at zero-voltage crossing for minimum RFI in applications at 50, 60, 400 Hz.
- Self-contained DC power supply with provision for supply of DC bias current to external components.
- Built-in protection against sensor failure.
- Flexible connection arrangement for adding hysteresis control or proportional control.
- External provisions for zero-current switching with inductive loads.

- On/off accuracy typically 1% with 5 k Ω sensor; 3% with 100 k Ω sensor.

- Triacs in RCA's 2.5–40 Amp, 100–600 Volt series, Types 40693–40734, are selected to operate over the entire CA3059 temperature range.

- 14-lead DIP pkg. for -40°C to $+85^{\circ}\text{C}$ operation. For further details, check your local RCA Representative or your RCA Distributor. For technical data bulletin, file no. 397, and Application Note ICAN4158, write RCA Electronic Components, Commercial Engineering, Section ICG4-1/CA0014, Harrison, N.J. 07029. In Europe, contact: RCA International Marketing S.A. 2-4 rue du Lièvre, 1227 Geneva, Switzerland.

RCA Integrated Circuits