

Electronic Design 14

VOL. 17 NO.

FOR ENGINEERS AND ENGINEERING MANAGERS

JULY 5, 1969

Navy reacts to submarine threat by updating sub-hunting systems in the air (such as inside this patrol plane), aboard destroyers, subs and on the sea floor. For

better detection, identification and kill, emphasis is on signal processing, automation, improved displays and sonar configurations. For the story, turn to page 34.



350 ps rise time — plus all these knobs!

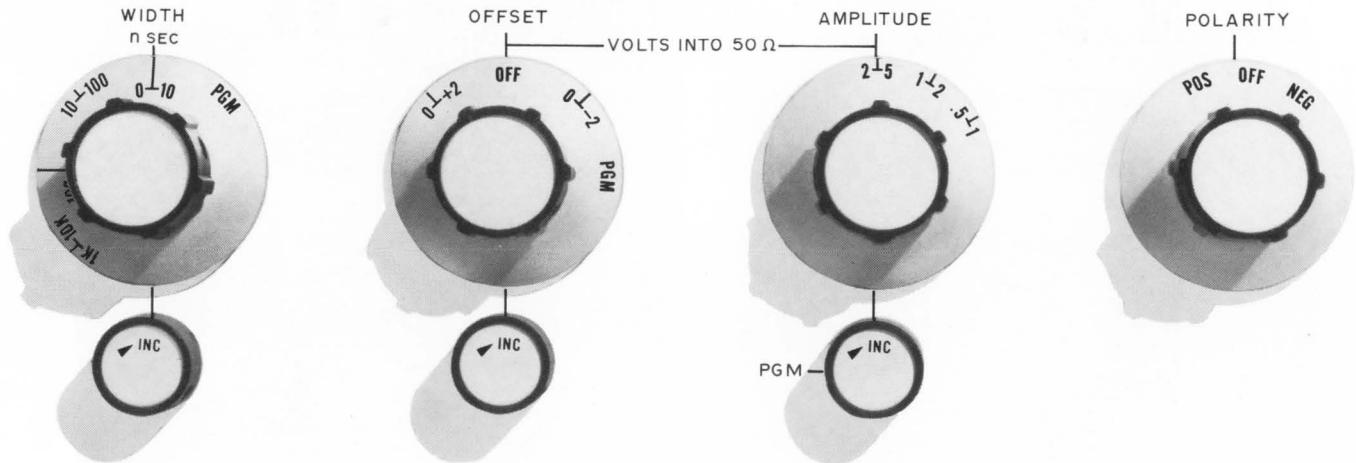

And each of those knobs adds to the capability of the 350 ps HP 1920A Pulse Output plug-in and the 1900 pulse system!

When you specify a pulser, the first spec you want to know is the rise-time. Well, the 350 ps rise and 400 ps fall times of this plug-in will satisfy any requirements you have — past, present or future.

But don't stop there — not if you intend to use the pulser for more than one test. And, at the rate new IC's, new devices, and new systems are appearing, it's a very rare engineer who is planning on only one type of test.

The only logical answer to the proliferation of today's logic circuits and systems is a pulser that can handle them all. Need a special offset voltage for testing MECL? The 1920 with dc offset from +2 to -2 volts can handle it. Will you need extremely short duration pulses for impulse testing? The 1920 can do (this is one of the cases where the 400 ps fall-time is very important).

Change amplitude? Switch polar-

ity? Vary pulse width? You can do all of these and more. The 1920 provides continuously variable pulses of 0.5 to 5 volts amplitude, either polarity, terminated in 50 ohms across a frequency range of 0 to 25 MHz. When you don't know for sure what you may be testing tomorrow or next week, be sure that the pulser you specify is capable of changing to meet your requirements.

But even the HP 1920 won't satisfy all your testing requirements. What about the high current requirements for testing magnetic memory cores or the high voltage requirements for MOS devices — logic or otherwise? As you review the extent of your testing, a complete pulse system makes more and more sense.

The HP 1900 pulse system which starts with a standard mainframe and offers seven functional plug-ins is the system that makes the most sense of all. You put what you need in your pulse generating system. The performance and cost of the system are determined by your requirements. But most important, you can add to

the system as your needs grow or change.

Take the logical step to solve your changing pulse system requirements, get the pulse system that's able to keep up with the changing times. For more information call your local HP Field Engineer. For additional data, consult your 1969 HP catalog starting on page 500. Or, write to Hewlett-Packard, Palo Alto, California 94304. Europe: 1217 Meyrin-Geneva, Switzerland.

Price: Mainframes, \$450 and \$750. Plug-ins: HP 1920A, \$1750; others from \$150 to \$1600.

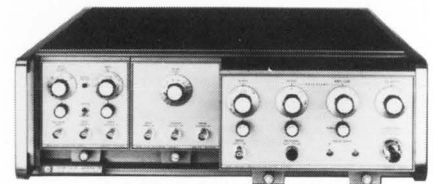

089/19

HEWLETT  PACKARD
S I G N A L S O U R C E S

THE INVESTIGATORS



1863



1864

FOR TRACKING DOWN INSULATION LEAKS

The 1863 for production and inspection testing of insulation

This versatile new "leak detective" is a high-performance megohmmeter priced at only \$385*. Five test voltages (50, 100, 200, 250, and 500 V) cover the range specified by most MIL and EIA Standards for testing the insulation resistance of mica-, glass-, paper-, ceramic-, and plastic-dielectric capacitors. The 1863 is equally suitable for insulation-resistance investigations on cables and electrical machinery; its 50-k Ω to 20-T Ω total resistance range covers most insulation specifications.

The 1864 for R and D applications

Another hundred dollars give you an even more versatile investigator, the Type 1864 Megohmmeter. It has an additional resistance range and 200 test voltages from 10 to 1000 V (1-volt steps from 10 to 109; 10-volt steps from 110 to 1000 V). The 1864

is an excellent instrument for low-voltage leakage (resistance or current) investigations of diodes, transistors, and aluminum and tantalum electrolytics. Its resistance range is from 50 k Ω to 200 T Ω . Price: \$485*.

Both have these features:

- They are direct reading.
- Basic accuracy is $\pm 3\%$ at low end of range.
- Correct meter multiplier is automatically indicated for each range.
- Super-stable meter circuitry eliminates need for meter calibration (CHECK) adjustments.
- No warmup drift.
- Safe, 5-mA, current-limited test voltage sources.
- Warning light indicates whenever potential exists across instrument terminals.
- Strap-connected guard and ground terminals permit either grounded or ungrounded measurements.

- Output provides a voltage proportional to meter reading for semi-automatic limit-testing and data-recording applications.
- Available in either rack-mounting model or in a unique Flip-Tilt cabinet that provides protection and doubles as an adjustable bench stand.

For complete information, call or write General Radio Company, W. Concord, Massachusetts 01781; telephone (617) 369-4400. In Europe: Postfach 124, CH 8034, Zurich 34, Switzerland.

*Prices apply only in the U. S. A.

GENERAL RADIO 

This newest of 13 data generators from Datapulse fires 16-bit words at clock rates from 10 Hz to 75 MHz. At \$2715, it's the first (and only) economical high-speed data generator.

Our Model 212 is fast enough to challenge your most advanced digital circuits, and variable enough to simulate nearly any input requirement. Baseline zero level can be independently adjusted from +2v to -2v on both the "positive true" and "negative true" outputs. The "true" level of each output is adjustable to 5v from the baseline, and word complement is available by front panel switch.

Model 212 is only the fastest. Other Datapulse data generators produce words up to 100 bits long, have as many as 13 channels, and provide NRZ and/or RZ outputs. Applications range from PCM simulation to pattern sensitivity testing with pseudo-random data. Prices start at \$680.

Our catalog will give you the whole story of the types, models, and options available. Contact Datapulse Division, Systron-Donner Corporation, 10150 W. Jefferson Blvd., Culver City, Calif. 90230. Phone (213) 836-6100.

A fast talker to test your hottest logic circuits

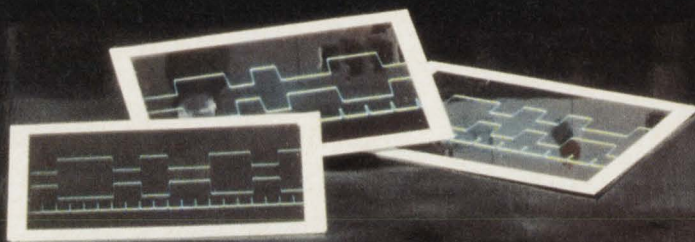
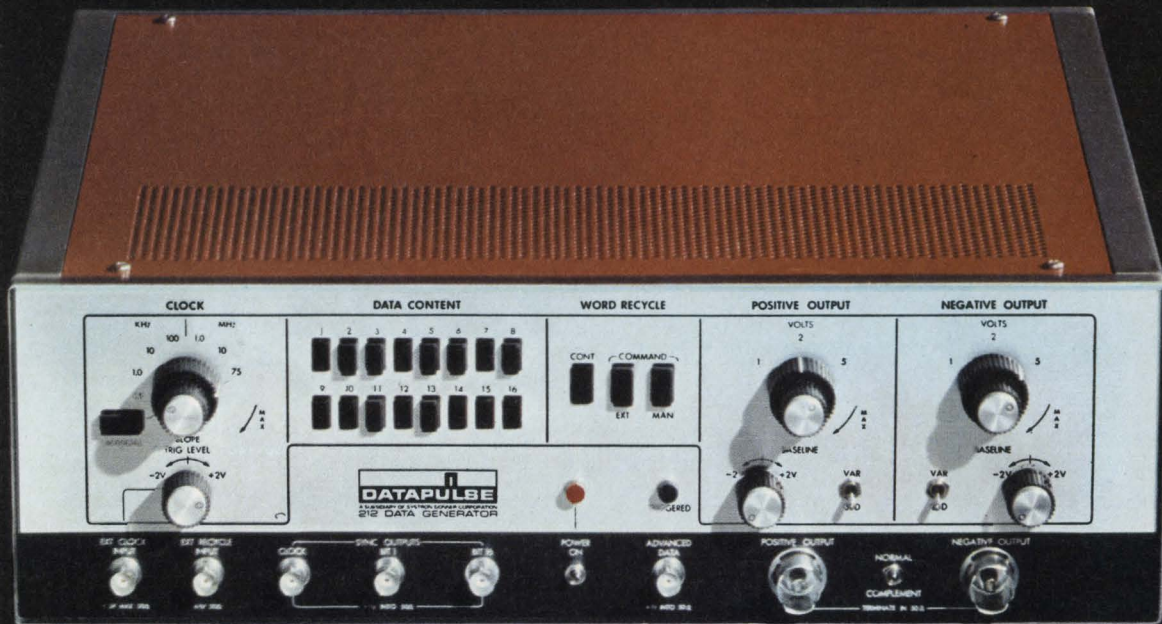

Another first. One of 144 Systron-Donner instruments

DATAPULSE
DIVISION
SYSTRON  DONNER

Electronic counters	Digital voltmeters
Pulse generators	Digital panel meters
Microwave frequency indicators	Microwave signal generators
Digital clocks	Laboratory magnets
Memory testers	Data acquisition systems
Analog computers	Microwave test sets
Time code generators	
Data generators	

NEWS

- 21 News Scope
 - 25 **94-GHz radar to 'picture' objects in space**
Chirp system will have enough bandwidth to give a range profile of irregularities six inches apart
 - 30 **Cold power: Tomorrow's electric system?**
Superconductive cable nets proposed for U.S. cities
 - 34 **Anti-sub warfare and the hostile sea: A special report**
 - 47 Washington Report
 - 50 Sidelights of the Issue
 - 53 **Editorial.** Aren't engineers entitled to job security, too?
-

TECHNOLOGY

- 64 **Design T feedback networks with ease.** Here's a method for directly synthesizing them from the desired transfer function.
 - 70 **Don't shun the shunt regulator.** It may have lower efficiency than the series type, but its advantages sometimes outweigh its shortcomings.
 - 74 **So you want to start a company . . .** Don't unless you're an entrepreneur, says this company founder, who began as a successful engineer.
 - 80 **Ideas for Design**
 - 80 Simple duplexer requires only inexpensive components
 - 80 Linear pulse stretcher has wide dynamic range
 - 82 Three extra parts give astable multi a wide frequency range
 - 84 Bridge amplifier compensates for strain gauge variations
 - 86 Darlington inverter features turn-off drive and low $V_{ce(sat)}$
-

PRODUCTS

- 90 **ICs & Semiconductors:** Low-cost TO-8 hybrid amplifier goes to 70°C.
 - 93 **Instrumentation:** Digital multimeter measures and computes.
 - 96 **Components:** Identical resonators make possible do-it-yourself filters.
 - 99 Modules & Subassemblies
 - 102 Microwaves & Lasers
 - 105 Production
 - 108 Data Processing
 - 110 Packaging & Materials
-

Departments

- | | |
|------------------------|-----------------------------------|
| 16 Designer's Datebook | 115 Annual Reports |
| 112 Evaluation Samples | 116 New Literature |
| 113 Design Aids | 122 Advertisers' Index |
| 114 Application Notes | 124 Information Retrieval Service |

Information Retrieval Service Card inside back cover

COVER PHOTO by John F. Mason, Military/Aerospace Editor.

Tactical coordinator in ASW patrol plane, the P-3 Orion, watches scope that displays computerized signals from sonobuoys.

ELECTRONIC DESIGN is published biweekly by Hayden Publishing Company, Inc., 850 Third Avenue, New York, N.Y. 10022. James S. Mulholland, Jr., President. Printed at Brown Printing Co., Inc., Waseca, Minn. Controlled circulation postage paid at Waseca, Minn., and New York, N.Y. Copyright © 1969, Hayden Publishing Company, Inc. 77,523 copies this issue.

If you're going to mass-produce Hybrid IC's... you'd better aim for yields of 90% or more!

Here's a comparison of how the available semiconductor packages meet the **12 KEY REQUIREMENTS** for high circuit yields at lowest cost.

	 LIDS	 CHIPS	 FLIP CHIPS	 BEAM LEADS	 T-PAKS
1 Are they available in production quantities for a wide range of applications?	YES	YES	NO	NO	NO
2 Can you get them in a wide range of custom-types? ...economically? ...quickly?	YES	YES	NO	NO	YES
3 Is the package an industry-standard configuration?	YES	NO	NO	NO	YES
4 Are they available off the shelf? ... in quantity? ...from well-stocked distributors?	YES	NO	NO	NO	YES
5 Do they permit you to estimate your circuit yields and production costs in advance?	YES	NO	YES	YES	YES
6 Are they available in matched pairs as standard types? ... off-the-shelf? ...economically?	YES	NO	NO	NO	NO
7 Do they eliminate the need for large capital investment in expensive bonding or lead-forming machinery?	YES	NO	NO	NO	NO
8 Are they designed for economical mass-production assembly and mounting?	YES	NO	YES	YES	NO
9 Can you get choppers with guaranteed on-resistance for your critical D-A telemetering circuits?	YES	NO	YES	NO	YES
10 Do they use low temperature attachment-techniques which prevent variations from the original parameters?	YES	NO	YES	YES	YES
11 Can they be tested simply, when required, without special test probes and fixtures?	YES	NO	NO	NO	YES
12 Are they color-coded for identification and orientation to simplify mass-production techniques?	YES	NO	NO	NO	YES

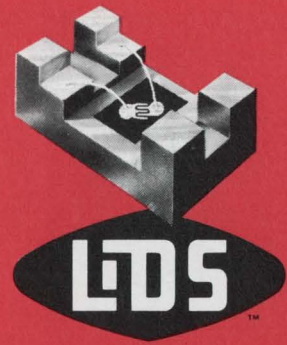

The entire Amperex semiconductor line of small signal RF and IF amplifiers and switches is available in the LID package.

Amperex will customize any LID semiconductor type you require... for quick delivery... in any quantity.

All Amperex LIDS are E.I.A. REGISTERED TO-122's.

The entire line of Amperex LIDS is available in production quantities, from well-stocked inventories, all around the country.

LIDS come fully characterized, specified, and pre-tested for all parameters. You can anticipate your circuit yields and quote with confidence.

Bipolar and FET LID semiconductors are available in closely-matched pairs right out of the Amperex catalog!

LIDS have no external leads... do not require expensive bonding or lead-forming machines... nor the skilled labor to operate them.

LIDS were specifically designed for automatic, mechanized production of Hybrid IC circuits. Can be mounted simultaneously for mass-production economy.

Where extreme accuracy is required, Amperex LIDS come to you pre-tested, characterized and specified... with GUARANTEED ON-RESISTANCE.

LIDS are bonded to the substrate via low-temperature soldering (200°C for 10 seconds). There is no drift... no change of parameters.

You can perform any required test on LIDS... simply, speedily, economically, without special sockets or test fixtures.

LIDS are color-coded or similarly marked for identification and for ease of positioning on the substrate.

Amperex LIDS are available in production quantities for every sophisticated hybrid IC application. Included are logic diodes (including duals), matched pairs (FETs and bipolar), zener diodes, NPN and PNP general purpose amplifiers and switches, low level amplifiers, logic switching transistors and core drivers and low on-resistance D / A switches.

Applications in which LID semiconductors are currently in wide use include RF and UHF / VHF amplifiers, digital-to-analog converters, low frequency instrumentation amplifiers, logic applications in computer peripheral equipment, active filters, ladder networks, multiplexers and decoders and operational amplifiers.

For additional information and applications assistance, write: Amperex Electronic Corporation, Semiconductor and Microcircuits Division, Slatersville, Rhode Island, 02876... or pick up your telephone and call the Amperex Microelectronic Specialist nearest to you:

**on the East Coast,
Phone**

**Al Ligorner in Hicksville, New York
516-931-6200**

**in the Midwest,
Phone**

**Chuck Duncan in Northlake, Illinois
312-261-7878**

**on the West Coast
Phone**

**Charles Shaw in Palo Alto, California
415-327-0461**

Amperex®

TOMORROW'S THINKING IN TODAY'S PRODUCTS

A NORTH AMERICAN PHILIPS COMPANY

INFORMATION RETRIEVAL NUMBER 4

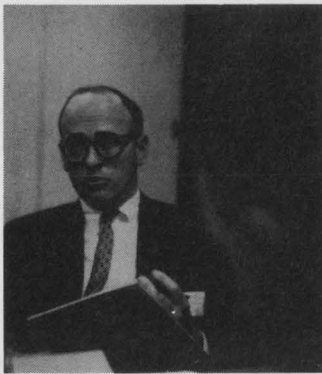

SWITCHCRAFT FORUM

You'd think I was asking for the moon! All I need is an audio connector that's quality made, looks

good and doesn't need a Ph.D. to put it together.

Let's look at our Series "Q-G" connector (Fig. 1.) It's style will complement today's modern equipment; microphones, amplifiers, etc. Plus, it's unique design guarantees fool-proof disassembly or assembly on the production line or in the shop.

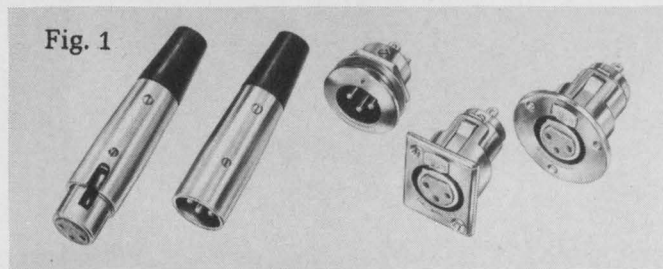

That's great! I've seen some connectors really mangled because somebody forgot to make it simple. How does your's work?

We literally patented easy-assembly when it comes to the "Q-G" connector.

Fig. 2. shows how Switchcraft's "Captive Design" (left-hand threaded) insert screw turns down into the insert assembly so that it may be removed for installing cable. The screw never leaves the one-piece insert assembly. Once the cable is installed, the insert assembly is positioned in the shell and the insert screw is turned out until it engages the shell once more.

Sounds like you've really simplified the assembly process. What else is different about these connectors?

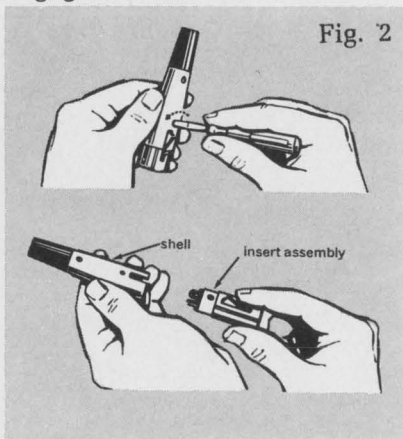

Positive grounding or shielding. The insert mounting screw provides electrical continuity between the ground terminals, ground contactors and the connector housing, when it is tightened against the connector shell.

This ground path means you can gain an extra pin for circuit use, or any circuit can be readily grounded to the connector shell by "jumping" the contact to the "ground terminal".

I like the idea of getting that extra pin for circuit use. That would take care of my standard size 3, 4 & 5 conductor needs. But, we also get into single conductor circuits, miniaturization and even special styling.

No problem.

The Switchcraft Series 2500 microphone connectors are specifically made for single conductor, shielded applications. Each connector has a flexible "cord protector spring" for cable strain relief. This Series can also be furnished with the connector molded directly to the cable. The Series 5500 "Mini-Con" connectors are half the size of our Series 2500 connectors. Lapel microphones, musical instruments, any miniaturized audio equipment are ideal applications for these connectors.

Switchcraft Series 2504, 4-pin "Slim-Line" connectors are compactly designed for the more stylized audio equipment. Just circle the reader service number for complete catalog information which, incidently, includes a complete line of phono plugs and jacks, RF phono plugs & jacks and AC receptacles and adapters.

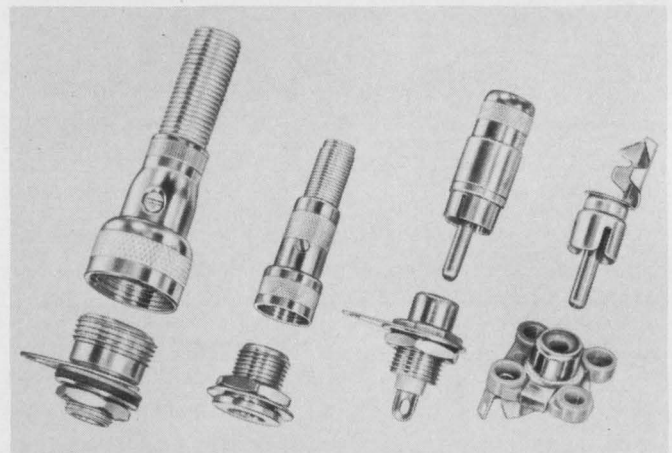

Just have them request our "Forum Facts on Connectors" handbook on your company stationery. We'll be glad to send them a copy and also add their names to our TECH-TOPICS mailing list. Every other month they'll receive this application engineering magazine that often features connector application stories. 10,000 design engineers tell us the publication is very worthwhile in posting them on current application trends.

SWITCHCRAFT
INC.

5529 North Elston Avenue • Chicago, Illinois 60630

FETs

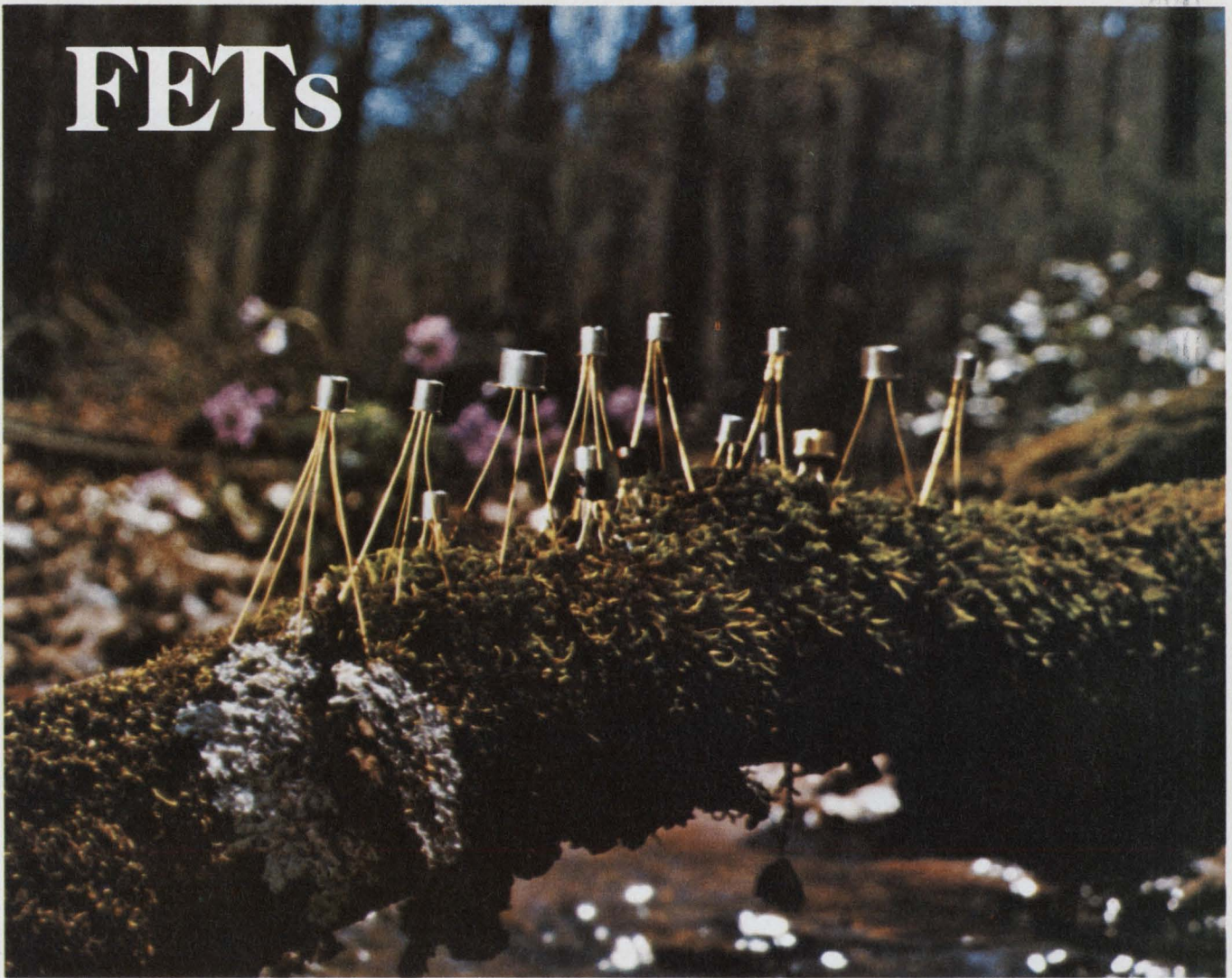

15 from the forest

From the forest of 977 FETs now available,* TI has selected 15 that satisfy 85% of all FET applications.

They're part of TI's line of 285 preferred semiconductors, selected after months of computer demand analysis to save you time and money in specifying discrete components.

TI's preferred 15 FETs are popular, proven and readily available from TI distributor and factory stocks.

Volume production of these devices allows TI to offer many of them at new low prices.



TI Preferred FETs			
Type	100-999 piece price**	Type	100-999 piece price**
TIS69	\$1.85	2N3822	\$1.80
TIS73	1.54	2N3823	1.65
2N5245	.62	2N3909	1.40
2N2386	1.80	2N3993	5.00
2N2498	2.45	2N4416	1.55
2N3330	2.50	2N4857	2.60
2N3819	.49	2N5045	8.40
2N3820	.63		

**Manufacturer's suggested price.

If one of the preferred 15 doesn't fit your specific circuit requirements, remember TI makes over 100 standard FETs in addition to many special ones.

Write for TI's new *Preferred*

Semiconductors and Components catalog: Texas Instruments Incorporated, PO Box 5012, MS308, Dallas, Texas 75222. Or just circle reader service card No.123



*1969 worldwide figure from D.A.T.A. Inc., publisher of *Electronic Data*.

TEXAS INSTRUMENTS
INCORPORATED

together for the first time in one package

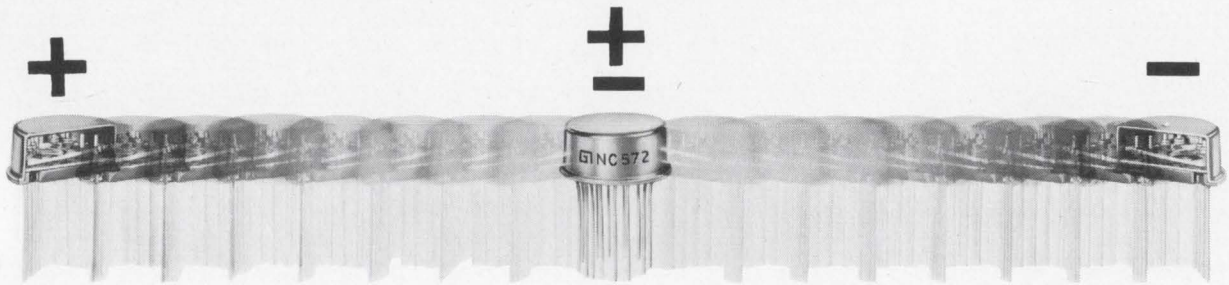

the \pm hybrid voltage regulator internally preset to ± 15 VDC

If you use Op Amps, General Instrument's Complementary/Dual Polarity IC Voltage Regulator (NC 572) is made for you. For the first time, $+$ and $-$ 15 V regulators are combined in one IC package providing two isolated and independent control sections of complementary polarity. The NC 572 also provides a combination of features that are superior to those available in any individual positive or negative voltage regulator...

For example:

- Output voltages are internally preset to the most popular Op Amp supply voltages, $+15$ and -15 VDC. Where required, the output voltage can be externally adjusted to any value from ± 13 to ± 38 VDC or factory preset to any voltage within this range.
 - Its high efficiency performance is demonstrated by a minimum required output/input voltage differential of only 1V for the positive regulator and 2V for the negative regulator.
 - Other features include: line regulation of 0.0005% V_o/V_{in} , load regulation of 0.0005% V_o/mA , input isolation of 74 dB min., and a full military operating temperature range.
 - The unit price at 1-24 pcs. is \$30.80; at 500-999 pcs., \$24.20 each.
- The \pm NC 572 hybrid voltage regulator in one 16-lead TO-8 style package is now in stock and immediately

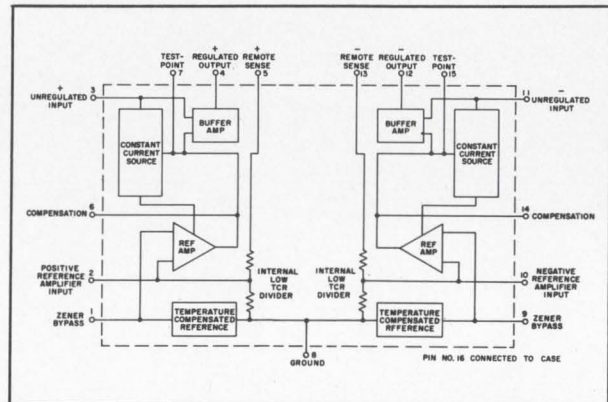

Functional Diagram

available from your authorized General Instrument Distributor.

For complete information, call (516) 733-3244 or write, General Instrument Corporation, Dept. I, 600 West John Street, Hicksville, N.Y. 11802.

(In Europe write to: General Instrument Europe, S.P.A., Piazza Amendola 9, 20149, Milano, Italy. In the U.K. to, General Instrument U.K., Ltd., Stonefield Way, Victoria Road, South Ruislip, Middlesex, England.)



GENERAL INSTRUMENT CORPORATION • 600 WEST JOHN STREET, HICKSVILLE, L. I., NEW YORK

NEW PRODUCT NO.77

μ A715 HIGH-SPEED OP AMP

The new Fairchild μ A715 is the fastest linear IC op amp available today.

For applications where power bandwidth, acquisition time or slew rate is the prime consideration, the μ A715 stands alone. It's ideal for applications such as wide-band amplifiers, high-speed integrators, precision comparators, sample-and-holds and video or deflection amplifiers. You can start raising the performance of your data acquisition, control, communications or display systems today.

The μ A715 is a 3-stage amplifier, with a Darlington cascode input for optimized ac and dc performance, a differential second stage and a class AB output for low distortion. Bandwidth is 60MHz, open loop gain is 92dB, input offset current is only 80nA and both input and output are short-circuit protected.

And, even though op amps are available with slew rates higher than the μ A715's $60V/\mu s$ ($A_v = 100$), it's *still* the fastest op amp available. The curve shown represents the typical response of any op amp to a step input at time T_0 . First, there's a short delay, then the output starts rising to its final value at a rate determined by the slew rate ($\Delta V/\Delta T$). But, in most op amps made, there is first an overshoot, then ringing. The final output value is not achieved until the end of the settling time, when the excursions no longer exceed the bounds of the error band. The total time to achieve the final value (acquisition time) is the sum of the first delay, the rise time and the settling time. In most other op amps, the settling time is just 300ns. Combine this with a maximum initial rise time plus delay of 350ns (for a 10V swing) and you've got a total acquisition time of just 650ns. And the fastest op amp made.

You can get it now in quantity from your Fairchild distributor.

To order the μ A715, ask for:

Part No.	Package	Temperature Range	Price
U5F7715312	TO-5	-55°C to +125°C	\$48.00
U5F7715393	TO-5	0°C to + 70°C	15.00

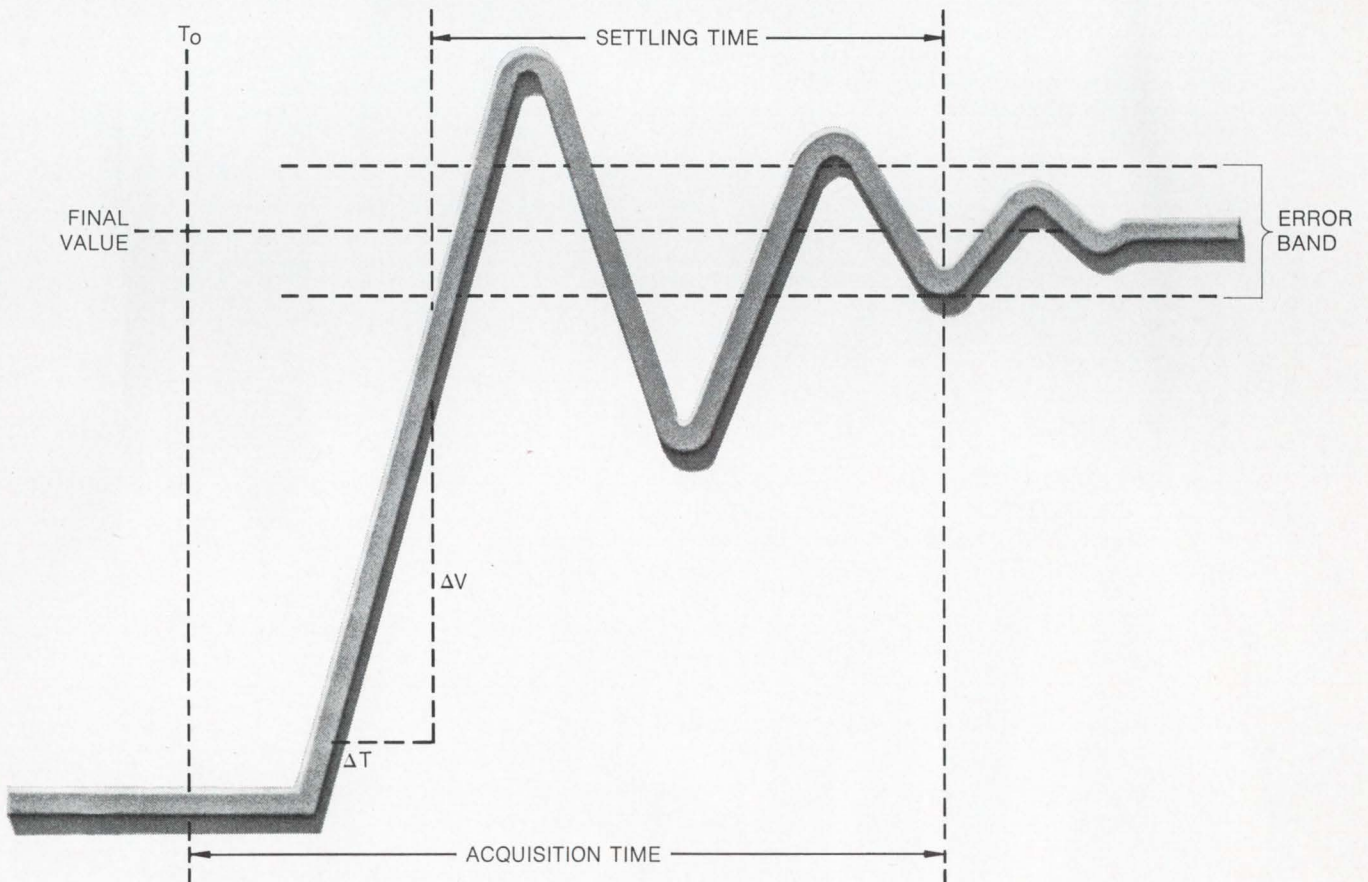

FAIRCHILD
SEMICONDUCTOR

FAIRCHILD SEMICONDUCTOR A Division of Fairchild Camera and Instrument Corporation Mountain View, California 94040, (415) 962-5011 TWX: 910-379-6435

INFORMATION RETRIEVAL NUMBER 7





Several hundred thousand unfair advantages.

There you are, busting your back trying to beat another company to market with a new, improved electronic Thing.

Everything looks good — up to the point where sub-assembly X has to be connected to board B. And you've never seen a connection like that before.

What do you do now? Take an R&D break? Give a connector-maker a panic call, and half your budget, to develop a special?

Sweat not. We're sitting over here with several hundred thousand different connectors. Most of them were specials, once. Many of them are patented. And all of them are ready. Now.

Card edge connectors. Two-piece PC connectors. Board-to-board connectors. Miniatures. Sub-miniatures. Dual-in-Line receptacles. Back panel metal plates. Rack and panel connectors. Mil spec cylindrical connectors. Tube and transistor sockets. Even new Mojo™ modular card edge connectors which you sort of invent as you go along. All available with the respected Varicon™ metal-to-metal connection that fully meets Mil-E-5400.

Because they're ready, you get a jump on your competitor while he re-invents one. Because they're standard, you put your Thing together for less money than he can. It may be unfair. But it's fun. And profitable.

But what if we *don't* have a standard for you? Still no problem. Because, with hundreds of thousands of different connectors already behind us, your special will just be a not-quite-standard. So we'll be able to save a lot of time and R&D, too.

We have several pounds of catalog, containing more information about connectors than you probably care to have. So don't just send back a reader information card. Call, write, wire, or TWX us, and tell us either your specific problem or your general field of interest. We'll send you the pertinent few ounces.

Elco Corporation, Willow Grove, Pa. 19090. (215) 659-7000 TWX 510-665-5573.

ELCO Connectors

INFORMATION RETRIEVAL NUMBER 8

attention readers:

What does **DMT** mean to you? **DMT** is **Electronic Design's Data Marketing Technique**. It is a technique we have evolved for a special kind of advertisement, one that gives you complete information about a product — sufficient information to allow you to make a specifying decision.

Here is what you will find in a **DMT** advertisement:

- Types of applications** and uses for product.
- Product features** and advantages.
- Specifications** of weight, dimensions, composition, speed, capacity, power requirements, MIL approval, etc.
- Performance data**, operating ranges, key performance parameters, accuracy ratings, reliability, sensitivity, interconnections, etc.
- Test results.**
- Maintenance information.**
- Cost and delivery time.**

The **Data Marketing Technique** is ideal for many manufacturers who advertise in **Electronic Design**. You will probably recall a number of **DMT** advertisements that have appeared during the past year. Very likely, you have already made use of **DMT** advertisements by specifying directly from them.

Our advertisers who utilize **DMT** go to considerable lengths to provide you with complete data that will help solve your design problems. In addition to problem solving, they also save your valuable time.

Look for **DMT** advertisements in **Electronic Design**. You will see more of them in this magazine because, like yourself, all of our readers are either engineers or engineering managers in the EOEM who can make immediate use of such information.

Electronic Design

DMT
DMT
DMT
DMT
DMT

With these resistance meters...



you can go to extremes.

Use the HP 4329A High Resistance Meter for high-voltage components, leakage current, testing insulation qualities of PC boards and materials used in switches and relays—or use it as a picoammeter.

At the opposite extreme, use the 4328A Milliohmeter for contact resistance, trouble-shooting grounds, semiconductor junction or contact lead bond quality.

The compact, solid-state 4329A has a resistance range from 5×10^5 ohms to 2×10^{16} ohms, with selectable test voltages from 10 to 1000 volts. Lighted range and scale indicators afford fast, accurate readings. Analog output. Price: \$750; model 16008A Resistivity Cell for volume and surface resistivities, \$200.

The 4328A gives you 20 microohm sensitivity from 100 ohms down to the milliohm range. It has a built-in phase discriminator for making precise measurements

on samples with series reactance up to twice their resistance values. And each probe combines both current drive and voltage sensing. At only seven pounds, it's a convenient package for either field or production line. Price: \$450; with option 01, internal rechargeable battery, \$475.

Call your local HP field engineer for the details, or write Hewlett-Packard, Palo Alto, California 94304; Europe: 1217 Meyrin-Geneva, Switzerland.

HEWLETT  **PACKARD**

RESISTANCE METERS

18903

INFORMATION RETRIEVAL NUMBER 9

Hybrid I.C. Active Filters

under **\$30** *per pole pair!*

and off-the-shelf delivery!

KTI Model FS-20 Hybrid UNIVERSAL Active Filters.

Band-pass, high-pass and low-pass outputs simultaneously.
Any desired form of the second order transfer function.
Complex zeros anywhere in the S-plane.
Multi-loop negative feedback for added stability.
 F_c and Q of basic unit can be tuned by adding external resistors.
Frequency range from D.C. to 50 kHz.
Q Range from 0.1 to 500.
Voltage gain is adjustable to 40 dB.
Supply voltage from ± 9 to ± 15 V with 250 mW power consumption.
Size: 0.804" x 0.366" x 0.474"; 14 pin DIP.

Price:

1 - 5	\$47.00	26 - 99	\$37.00
6 - 10	\$42.00	100 - 999	\$35.00
11 - 25	\$39.00	1000 - 2000	\$28.00



K I N E T I C T E C H N O L O G Y , I N C O R P O R A T E D

17465 Shelburne Way/Los Gatos, California 95030/(408) 356-2131/TWX: 910-597-5390

The name to remember for Hybrid Integrated Systems and Active Filters . . .

Send more information on

- FS-20 Put Me On Your Mailing List
 All Active Filters Hybrid Subsystems

Name _____

Company _____

Address _____

City _____

State _____ Zip _____

My application is

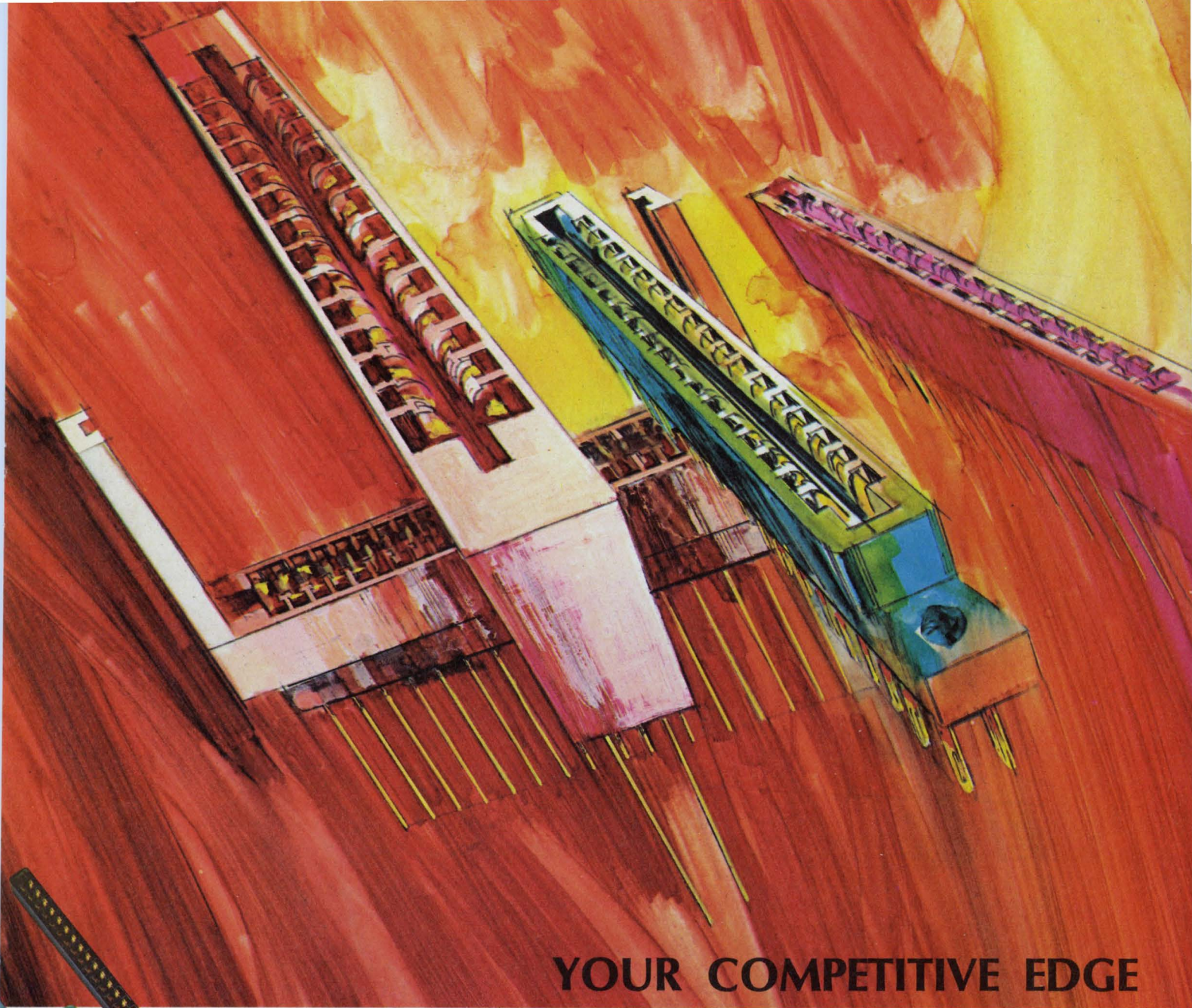

YOUR COMPETITIVE EDGE

CINCH PRINTED CIRCUIT CONNECTORS

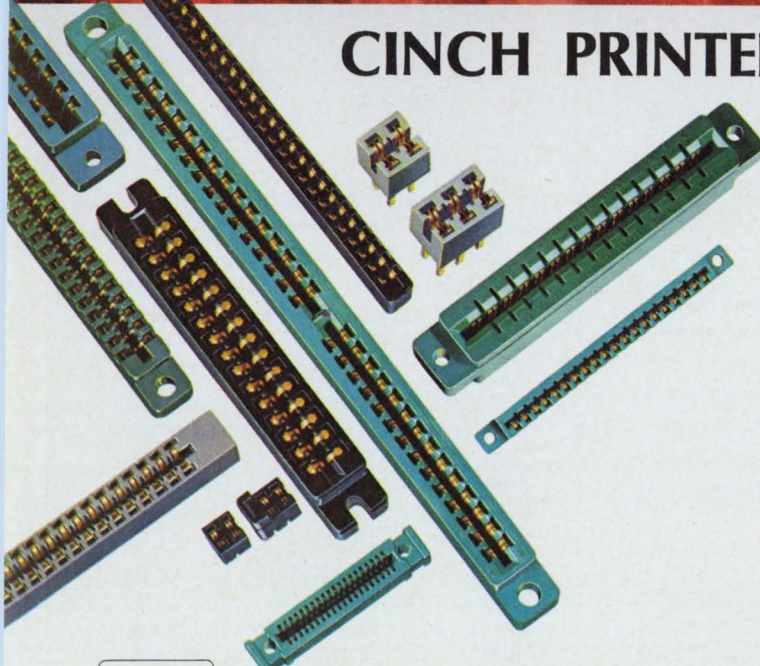

Improved performance and lower cost are the best competition beaters . . . and you get either or both with Cinch PC connectors.

There are 22 basic designs described in the new Cinch PC Connector catalog. If the one you need isn't there, Cinch can develop a special connector for your application.

It can incorporate any of six methods of gold deposition (including two selective plating techniques), eight types of contacts, eight types of terminations and six insulator materials . . . whatever best gives you your competitive edge. The resulting product can be produced in quantity in a surprisingly short time.

Write for the Cinch Printed Circuit Connector catalog to Cinch Manufacturing Company, 1501 Morse Avenue, Elk Grove Village, Illinois 60007.

IMMEDIATE DELIVERY of many Cinch printed circuit connectors—from stock—can be obtained through Cinch Electronic distributors.



New VICTOREEN Mini-Mox Resistors for higher resistance/size ratios

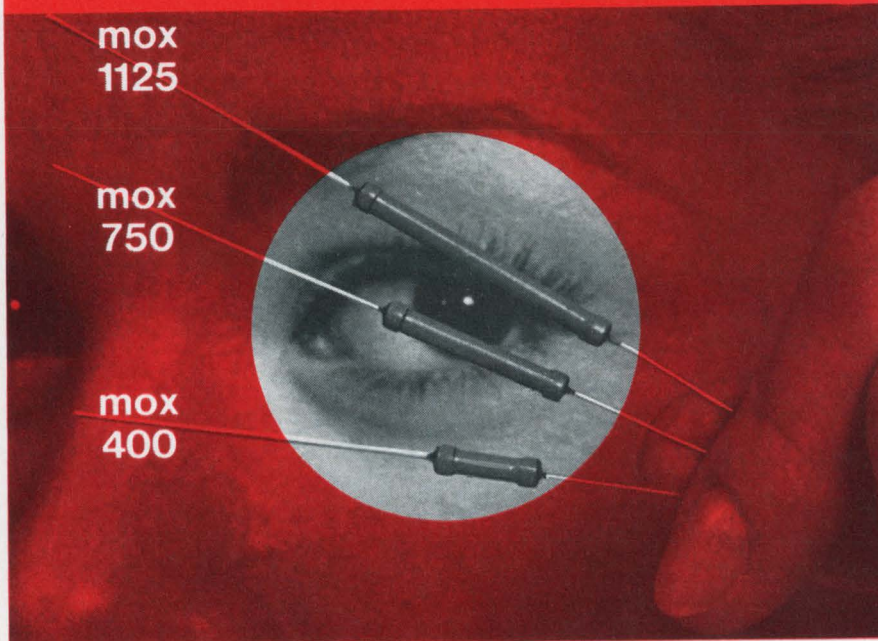

We promised you a wider range of quality Victoreen MOX (metal oxide glaze) resistors for sophisticated electronic applications. And we're delivering on our promises, too, for we're now in volume production on the subminiature Mini-Mox resistor line. Just eyeball these specifications:

Model	Resistance	Rating @70°C	*Max. Oper. Volts	Length Inches	Diameter Inches
MOX-400	1-2500 megs	.25W	1000V	.420±.050	.130±.010
MOX-750	1-5000 megs	.50W	2000V	.790±.050	.130±.010
MOX-1125	1-10,000 megs	1.00W	5000V	1.175±.060	.130±.010

*Max operating temp 220°. Encapsulation — Si Conformal.

*Applicable above critical resistance.

Stability is better than $\pm 2\%$ for 2000 hours at full load, shelf-life drift less than 0.1% per year. Standard tolerances are 1 to 10% depending on resistance value. $\frac{1}{2}\%$ resistors in limited values, on request.

So let your circuit design imagination run rife. Victoreen MOX and new Mini-Mox Resistors can satisfy all your requirements for ultra-critical applications involving high voltage... high impedance... high stability... high wattage. Check our Applications Engineering Department today. Call (216) 795-8200.

A-3876

VICTOREEN INSTRUMENT DIVISION
10101 WOODLAND AVENUE · CLEVELAND, OHIO 44104
EUROPE: ARNDAL HOUSE, THE PRECINCT, EGHAM, SURREY, ENGLAND · TEL: EGHAM 4887



INFORMATION RETRIEVAL NUMBER 13

Designer's Datebook

For further information on meetings, use Information Retrieval Card.

July 20-25

Engineering in Medicine & Biology (Chicago) Sponsor: IEEE, L. Stark, Univ. of Illinois, Chicago 60612.

CIRCLE NO. 401

Aug. 5-7

Joint Automatic Control Conference (Boulder, Colo.) Sponsor: IEEE, G-AC, W. E. Schiesser, Dept. of Chemical Engineering, Lehigh Univ., Bethlehem, Pa. 18015

CIRCLE NO. 402

Aug. 12-15

International Photoconductivity Conference (Stanford Univ., Palo Alto, Calif.) Sponsor: ONR, American Physical Society, Robert J. Keyes, Massachusetts Institute of Technology, Lincoln Laboratory, Lexington, Mass. 02173

CIRCLE NO. 403

Aug. 19-22

Western Electronic Show & Convention (WESCON) (San Francisco) Sponsor: IEEE, WEMA, T. Shields, WESCON, 3600 Wilshire Blvd., Los Angeles, Calif. 90005

CIRCLE NO. 404

Aug. 19-22

Science and Technology of Information Display Seminar (Farmingdale, N. Y.) Sponsor: Polytechnic Institute of Brooklyn, Mrs. H. Warren, Adm. Officer, L.I. Grad. Center, Polytechnic Institute of Brooklyn, Farmingdale, N. Y. 11735

CIRCLE NO. 406

Aug. 24-27

Electronic Materials Technical Conference (Boston, Mass.) Sponsor: AIME, Edward L. Kern, Metallurgical Society of AIME, 345 E. 47th St., New York, N. Y. 10017

CIRCLE NO. 405



INSTRUMENTATION AMPLIFIER

The differential input single-ended output instrumentation amplifier is one of the most versatile signal processing amplifiers available. It is used for precision amplification of differential dc or ac signals while rejecting large values of common mode noise. By using integrated circuits, a high level of performance is obtained at minimum cost.

Figure 1 shows a basic instrumentation amplifier which provides a 10 volt output for 100 mV input, while rejecting greater than $\pm 11V$ of common mode noise. To obtain good input characteristics, two voltage followers buffer the input signal. The

LM102 is specifically designed for voltage follower usage and has $10,000 M\Omega$ input impedance with 3 nA input currents. This high of an input impedance provides two benefits: it allows the instrumentation amplifier to be used with high source resistances and still have low error; and it allows the source resistances to be unbalanced by over 10,000 ohms with no degradation in common mode rejection. The followers drive a balanced differential amplifier, as shown in Figure 1, which provides gain and rejects the common mode voltage. The gain is set by the ratio of R_4 to R_2 and R_5 to R_3 . With the values shown, the gain for differential signals is 100.

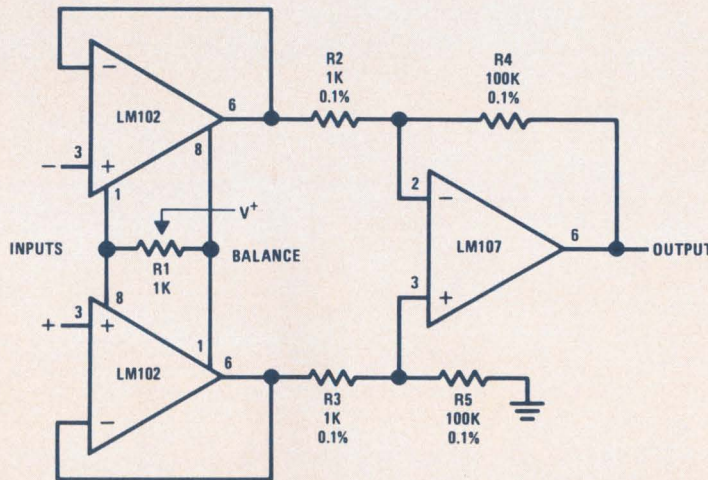

FIGURE 1. Differential-Input Instrumentation Amplifier

Figure 2 shows an instrumentation amplifier where the gain is linearly adjustable from 1 to 300 with a single resistor. An LM101A, connected as a fast inverter, is used as an attenuator in the feedback loop. By using an active attenuator, a very low impedance is always presented to the feedback resistors, and common mode rejection is unaffected by gain changes. The LM101A, used as shown, has a greater bandwidth than the LM107, and may be used in a feedback network without instability. The gain is linearly dependent on R_6 and is equal to $10^{-4} R_6$.

To obtain good common mode rejection ratios, it is necessary that the ratio of R_4 to R_2 match the ratio of R_5 to R_3 . For example, if the resistors in circuit shown in Figure 1 had a total mismatch of 0.1%, the common mode rejection would be 60 dB times the closed loop gain, or 100 dB. The circuit shown in Figure 2 would have constant common

mode rejection of 60 dB, independent of gain. In either circuit, it is possible to trim any one of the resistors to obtain common mode rejection ratios in excess of 100 dB.

For optimum performance, several items should be considered during construction. R_1 is used for zeroing the output. It should be a high resolution, mechanically stable potentiometer to avoid a zero shift from occurring with mechanical disturbances. Since there are several ICs operating in close proximity, the power supplies should be bypassed with .01 μF disc capacitors to insure stability. The resistors should be of the same type to have the same temperature coefficient.

A few applications for a differential instrumentation amplifier are: differential voltage measurements, bridge outputs, strain gauge outputs, or low level voltage measurement.

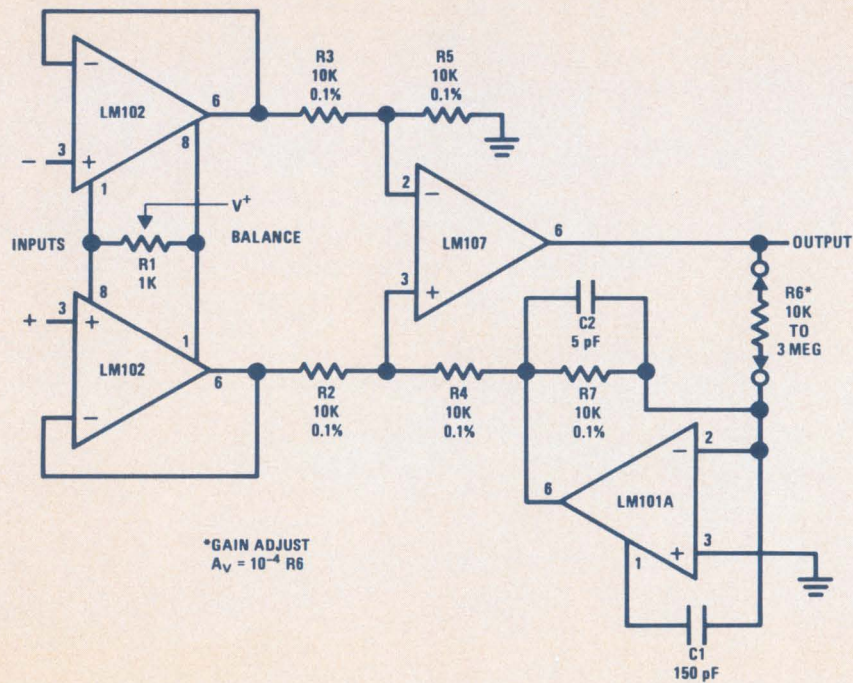

FIGURE 2. Variable Gain, Differential-Input Instrumentation Amplifier

National Semiconductor Corporation

2975 San Ysidro Way, Santa Clara, California 95051
 (408) 245-4320/TWX (910) 339-9240



3-69 PRINTED IN U.S.A.

New ways in digital automation with:

- Shaft Encoders, 34 types
- Synchro-to-Digital Converters, 6 types
- Analog-to-Digital Converters, 10 types
- Solid-State Digital Modules, 136 types

FREE ... 58 Pages

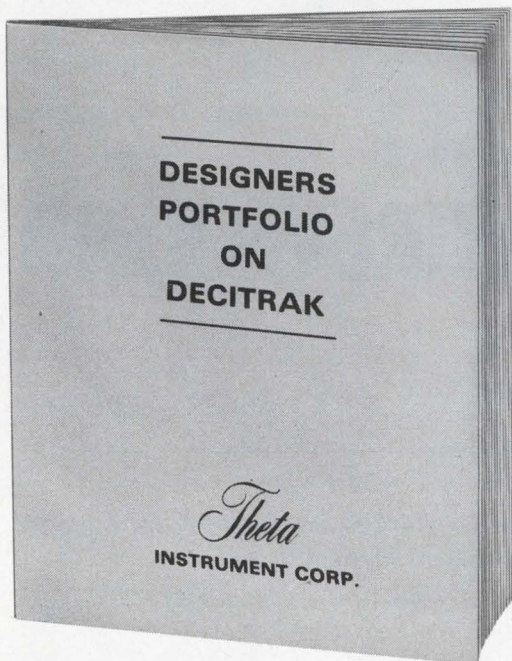

Includes copy of
"A Primer on Shaft Encoders"

We call it the DECITRAK® SYSTEM

Selecting from hundreds of off-the-shelf digital transducers and circuits, we assemble a remarkably low-cost, customized digital system for control/display/logging. DECITRAK can perform as simple a job as providing remote digital display of antenna pedestal position. Or, as impressive a task as the precise control of massive prime movers in response to punched-card commands.

Need a computer interface? A code converter? A typewriter driver? Set-point controls? Let a Theta Application Specialist tailor a system to your specific needs from the field-proven line of DECITRAK digital components.

More than 1,000 of these systems are now in use in nuclear installations, satellite tracking stations, wind tunnels, and aboard ships.

Theta

INSTRUMENT CORPORATION

FAIRFIELD, NEW JERSEY 07006 • PHONE: 201-227-1700 • TELEX: 138353

INFORMATION RETRIEVAL NUMBER 14

...want a tantalum capacitor with proven performance?

Buy TYPE 150D TANTALEX[®] SOLID-ELECTROLYTE CAPACITORS

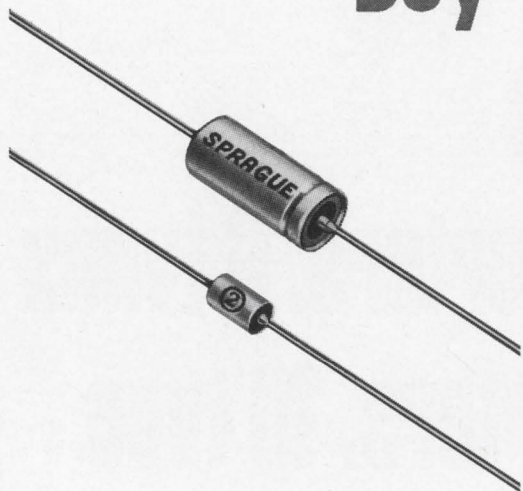

INFORMATION RETRIEVAL NO. 821

More Sprague solid tantalum capacitors are in use than all other brands of solid tantalums combined. Hermetically-sealed in metal cases. Value-packed performance characteristics—low impedances at high frequencies, low dissipation factor, minimal capacitance drift with temperature, practically no change in capacitance with life. Low leakage current limits. Investigate new higher capacitance ratings.

48C-9144

Buy resistors with built-in dependability...

Vitreous-enamel BLUE JACKET[®] POWER WIREWOUND RESISTORS

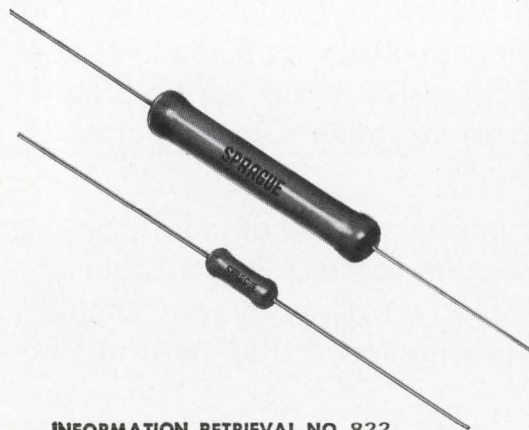

INFORMATION RETRIEVAL NO. 822

All-welded end-cap construction eliminates moisture along the leads, also anchors leads securely to resistor body. Expansion coefficients of vitreous enamel coating, ceramic core, and end caps are closely matched. Standard wattage ratings include 1, 2, 2.5, 3, 5, 7, 10, and 11 watts. Also available with radial tab terminals in ratings from 8 to 230 watts.

For complete technical data on Type 150D Tantalex Capacitors, write for Engineering Bulletin 3520F. For information on Blue Jacket Resistors, request Bulletin 7410D. Write to: Technical Literature Service, Sprague Electric Co., 347 Marshall Street, North Adams, Massachusetts 01247.

48R-9145



*Sprague' and '®' are registered trademarks of the Sprague Electric Co.

THE BROAD-LINE PRODUCER OF ELECTRONIC PARTS

News

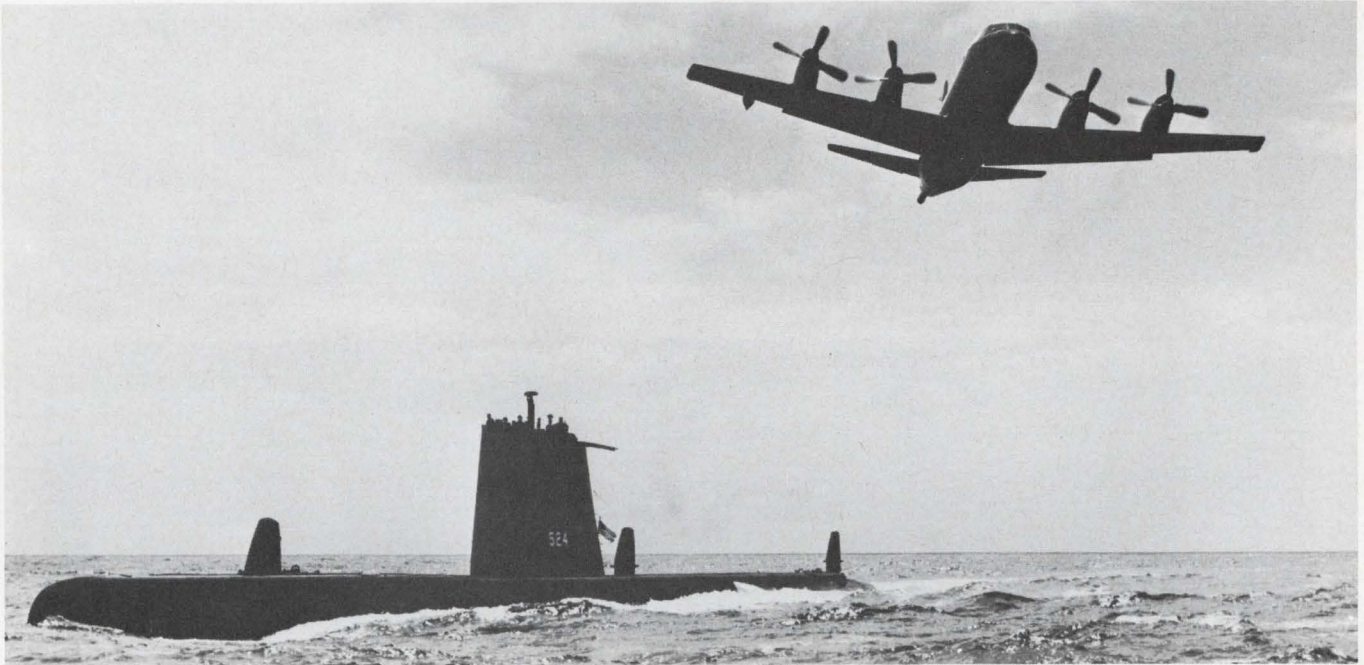

The Navy is expanding its ASW force to combat the Soviet's growing undersea armada.

Involved is equipment in the air, on ships, in subs and on the sea floor. p. 35

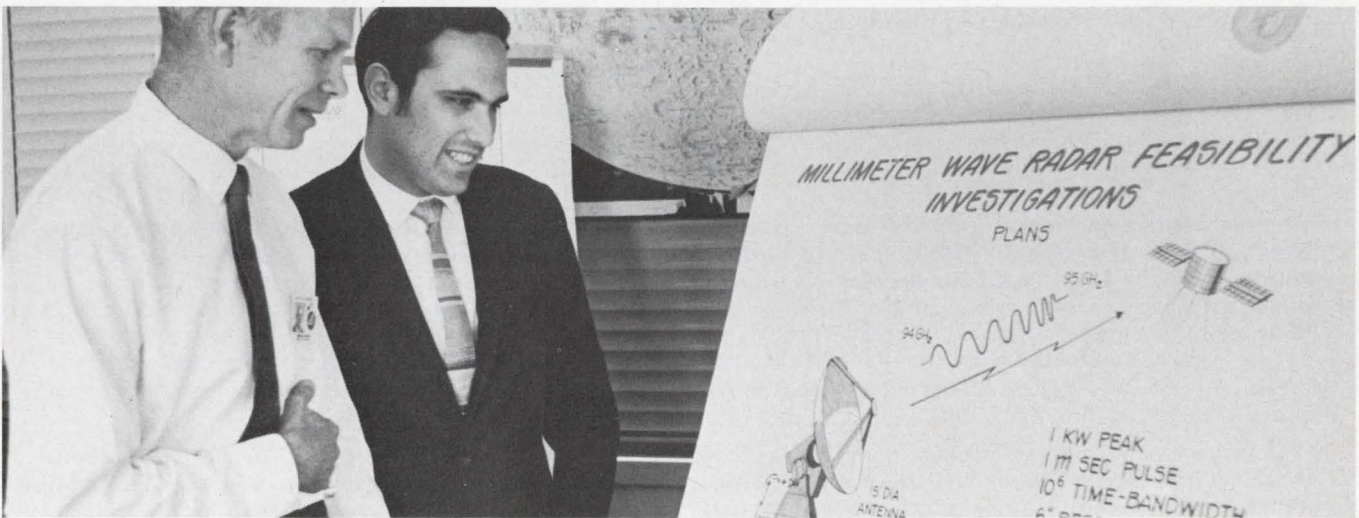

Manager of chirp radar program, Keith Hurlbut (left) and editor David Kaye discuss milli-

meter radar system which will resolve space objects down to six inches. p. 25

Also in this section:

Cold power: Tomorrow's electric system? p. 30

Microwave radiation called growing hazard. p. 28

News Scope, p. 21 . . . **Washington Report**, p. 47 . . . **Editorial**, p. 53

This readout tube never tells a lie

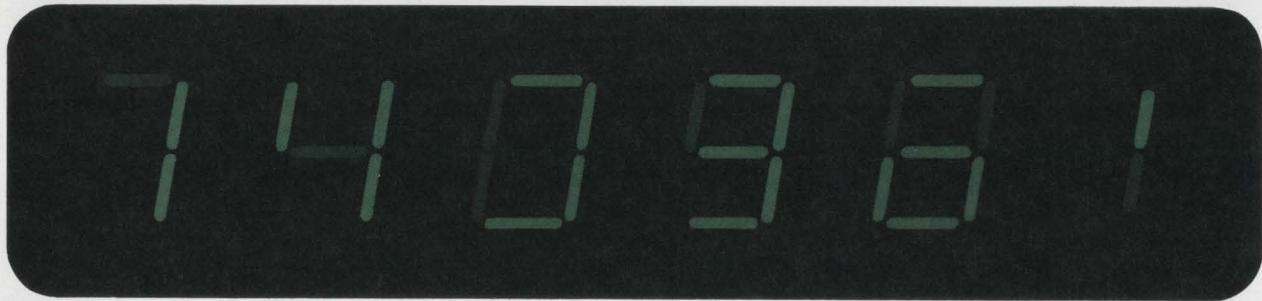
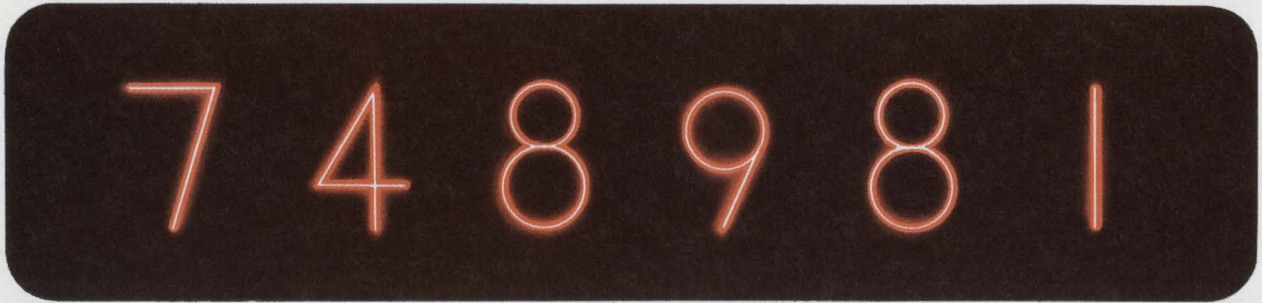

Others do

(and you never know when they fail)

Whatever data you input, a NIXIE® tube reads out. Exactly! You always have reliably accurate readouts, with no risk of a 1 when there should be a 7, a 0 instead of an 8, or a 3 instead of a 9. Rather than tell a lie, honest NIXIE tubes give you no reading ... protect you against false readouts caused by multiple segments that break down, blank out ... and don't indicate that they're wrong. You never know when they are faulty.

Selecting a readout display involves more than truth, so weigh every aspect. Check NIXIE tubes for their unmatched reliability, their proven long life (over

200,000 hours), natural readability, and uniform brightness (200 ft. lamberts, with no chance of partial fade-outs). See how only NIXIE tubes are unaffected by static charge ... meet mil specs ... offer unsurpassed packaging and design flexibility (no extra top leads required for decimals). All this, in the most complete and advanced line of tubes and accessories. No wonder NIXIE tubes lead the field.

For information, call or write: Burroughs Corporation, Electronics Components Division, P.O. Box 1226, Dept. N5, Plainfield, N. J. 07061; tel. (201) 757-5000.



View above display from 6 ft. distance for complete realism

the leader
in the world of displays

Burroughs



NASA prepares to name orbiting lab contractors

While most engineers in the National Aeronautics and Space Administration await the historic hop to the surface of the moon starting July 16, one group at the space agency in Washington is busy studying proposals for another historic mission in space—a manned, earth-orbiting laboratory.

Three industry teams have submitted proposals.

The NASA plan is to orbit an expandable space station. It would house 12 men by 1975 and 50 by 1985. Reusable shuttle craft would carry supplies and construction crews aloft to add new modules and to modify others. The modules are to be new, original configurations, and the boosters two-stage Saturn 5's.

Projects that scientists plan to work on include biological experiments with plants and possibly small animals; biomedical studies on themselves, and earth resources surveys—meteorology, geodesy, geology, oil exploration, forestry and crop control. Also planned are communication experiments, studies of solar activity and tests of

techniques for producing certain components in the zero-gravity, vacuum conditions of space.

The three teams bidding on the program are made up of nine companies, all members of the so-called "space club"—the handful of companies that have the capability to act as prime contractors for a space project.

One team consists of Grumman Aerospace, Lockheed Aircraft, General Dynamics-Convair and TRW Systems. Another is made up of North American Rockwell and General Electric. And the third entrant combines McDonnell-Douglas, IBM and Martin Marietta.

Next month NASA will select two of these teams to begin 11-month studies under contracts amounting to approximately \$2 million each.

Consumer imports soar to new highs

U.S. imports of consumer electronic products have risen from less than \$150 million to over \$225

million for the first four months of '69, compared with the same period in '68, according to the U.S. Commerce Dept.

Almost a quarter of a million color TV sets and over one million black-and-white TV sets, representing a \$75-million market, have been imported. This is more than double the number of foreign sets brought into the country last year. Although a high percentage of the black-and-white TV sets were supplied by Japan, an increasing share of this market is shifting to American-owned plants abroad, including those operated by Sylvania in Hong Kong, Warwick in Mexico and Admiral and Philco in Taiwan.

Evidence of the booming and highly competitive market was apparent at the Consumer Electronics Show in New York, where thousands of imported audio sets, auto-tape players, cassette recorders and color and black-and-white TV sets were displayed.

Electronics trade joins fight on U.S. car thieves

A sharp increase in the number of stolen cars in the U.S.—25 per cent in 1968 alone—along with rising theft of auto accessories, is prodding attack on the problem by the electronics industry.

Two anti-theft items were displayed at the Consumer Electronics Show in New York—one designed to thwart the theft of the car, the other aimed specifically at preventing the theft of stereo recorders from the vehicles.

The first device, produced by Ballistics Control Corp. of New York City, combines a four-track, stereo tape player with an under-the-hood bullhorn speaker. The speaker sounds off if the car is stolen.

As the thief drives away, the tape starts and a voice shouts (in a typical case): "I'm being stolen! I'm a 1969 brown Ford Galaxie! My registration number is New York N3047G! I'm being stolen! I'm a 1969..."—and so on, repeatedly.

To permit the owner to turn the system off when he enters his car, a 10-second delay is incorporated into the system. But to foil car thieves, a cover locks down

Apollo 11 schedules moon TV programs

The greatest show in the history of television begins, live and in color, from the Apollo 11 spacecraft as it hurtles toward the moon, on July 17 at 7:32 p.m. Eastern Daylight Saving Time. Subsequent telecasts from the first men to walk on the moon are scheduled for:

July 18—7:32 p.m. (color) On the way to the moon.

July 19—4:02 p.m. (color) Approaching the moon.

July 20—11:52 p.m. (color) Circling the moon.

July 21—2:12 to 4:32 a.m. (black and white) On the moon's surface.

July 21—7:27 p.m. (color) Circling the moon, seeing the lunar module jettisoned.

July 22—9:02 p.m. (color) Returning to earth.

July 23—7:02 p.m. (color) Approaching earth.

News Scope

CONTINUED

over the stereo cartridge, so that it's not accessible. And the volume control is bypassed, with full power output to the bullhorn speaker.

In theft-proof stereo tape players, the Tenna Corp., Cleveland, has incorporated in its latest lines an alarm switch that is held in the off position by the tape player's mounting brackets under the dashboard. When a thief loosens the brackets to steal the unit, the switch is released and a horn blows. The lead to the horn is disguised to prevent its destruction.

In a related development, Allstate Insurance Co. is offering a \$20,000 prize to the inventor of a simple low-cost gadget to foil the car thieves. This prize will be awarded to the winner of an anti-car-theft device competition now being conducted by *Popular Science* magazine. The winning device will be made available to all manufacturers free of charge.

A \$25-billion year seen for electronics

U.S. factory sales of electronics should climb 3.1 per cent this year and reach nearly \$25 billion, the Electronic Industries Association predicts.

The rise would compare with a 4.4 per cent increase to \$24.2 billion last year.

The slower growth rate matches that of the U.S. economy, Mark Shepherd Jr., the EIA's president, said in a statement. Downward pressures on consumer spending are expected to develop in the second half of 1969 and to continue into 1970, he said.

Airline communications surge expected by '85

By 1985, the airline industry will need 428 communication channels to "accommodate projected communication requirements," according to John Anderson, board

chairman of Aeronautical Radio, Inc. (Arinc) of Annapolis, Md.

In a recent statement before the House Subcommittee on Regulatory and Enforcement Agencies, the Arinc chief pointed out that 64 channels are available at present for cockpit units and 10 for air-terminal use. However, the large-capacity subsonic and supersonic aircraft "will impose far greater demands for the additional aeronautical communication services, as well as create unique new requirements," Anderson said.

Projecting further, Anderson said the increase in total channels should reach 581 by the year 2000.

On the subject of spectrum allocation, Mr. Anderson told the subcommittee that the best available spectrum space appeared to be the 806-960 MHz band.

Industry awaits impact of IBM's 'unbundling'

IBM's decision to cut equipment prices about 3% and begin charging for certain systems engineering services it has been performing free is expected to have a profound impact on the computer industry and its customers.

These so-called "free" services, including system engineering programs to make the equipment work, training of customer personnel and equipment maintenance have been one of the principal issues in five civil antitrust suits filed against IBM by the Justice Dept. and four competitors.

Now, the "unbundling" of IBM prices—as it's come to be called in the industry—is expected to enhance the ability of smaller software and computer service companies to compete with the world's dominant computer maker.

IBM believes, however, that with its new, relatively high, pricing structure on its support systems engineering services, it can effectively answer any future suits.

One industry observer predicted that, as a result of the new software policy, some 1000 engineers will eventually be shifted from the company's data processing division in Washington, D.C., to IBM's Federal Systems Div. in Gaithersburg, Md. Some of these engineers,

he speculated, will eventually leave IBM and form their own systems engineering companies. The purpose would be to sell their support services at considerably cheaper rates than IBM.

Navy holds up work on antisubmarine plane

The Navy has slowed its machinery for starting development of the S-3 antisubmarine aircraft. It wants to be sure the two contractors in the running—Lockheed and General Dynamics—won't run into any trouble they aren't anticipating.

The S-3 is a carrier-based twin-engine jet intended to seek and destroy enemy subs. Both Lockheed and General Dynamics have received contracts for preliminary studies, and one is to be chosen to develop the plane.

The Navy is mindful that Lockheed has had design difficulties with the Army's Cheyenne helicopter that caused cancellation of that contract, as well as trouble holding in costs for the Air Force C-5A cargo jet. General Dynamics was responsible for the overweight, and now canceled, F-111B Navy fighter jet.

Moreover the Navy and Defense Dept. still can't agree on how many S-3's should be purchased.

At this point all the Navy is saying is: "No decision has been made on the S-3."

Superfast printer built for remote operations

In one second, 66,000 discrete droplets of ink, modulated by a 66,000-Hz ultrasonic signal, can print 250 characters on a variety of business forms. That's the performance promised by a new Videojet process developed by A. B. Dick Co., Chicago, for its "non-impact" output printer.

The printer—Model 960—has a single head, or nozzle, that (as "non-impact" implies) never touches the paper directly. Each of the ink droplets is charged by a voltage as it breaks away from the stream in the nozzle. A 9-by-11-inch dot matrix is used to form the characters.

What this country needs is a good nickel cigar... and a $3\frac{11}{8}$ square industrial cermet trimmer.

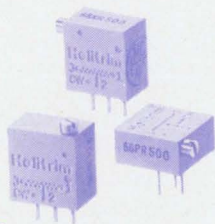

★
Helipot has the trimmer for \$3.50 list...
now available in local stock.

(But you'll have to find the cigar.)

Beckman®

INSTRUMENTS, INC.

HELIPOT DIVISION

FULLERTON, CALIFORNIA • 92634

INTERNATIONAL SUBSIDIARIES: AMSTERDAM; CAPE TOWN; GENEVA; GLENROTHES,
SCOTLAND; LONDON; MEXICO CITY; MUNICH; PARIS; STOCKHOLM; TOKYO; VIENNA

15

TTL solutions to complex problems

For simplified, "low package-count" digital system design, these 15 new Motorola TTL complex functions offer improved circuit performance, lower system costs and are ideal for interfamily (MDTL, TTL) compatibility.

- MC4004F, P **16-BIT SCRATCH PAD MEMORY CELL** — a basic building block for 100 ns scratchpad memory systems.
- MC4005F, P **16-BIT SCRATCH PAD MEMORY CELL** — provides 16 words of one-bit memory operating in the NDRO mode.
- MC4006F, P **BINARY TO ONE-OF-EIGHT LINE DECODER** — a 3-input/8-output decoder. Inhibit capability provided by the enable line and allows decoder to be expanded for larger systems.
- MC4007P **DUAL BINARY TO ONE-OF-FOUR LINE DECODER** — a dual 2-input/4-output decoder consisting of high and low-level gates internally connected for minimum power consumption, maximum driving capabilities.
- MC4008L **8-BIT PARITY TREE** — consists of eight 2-input Exclusive NOR gates connected to form an 8-bit Parity Checker/Generator and an extra 2-input gate for expansion capability.
- MC4010L **DUAL 4-BIT PARITY TREE** — three Exclusive NOR gates are connected together to form each of two 4-bit parity trees in one package.
- MC4012L **4-BIT SHIFT REGISTER** — can be operated in the parallel or serial mode, determined by the logic state of the mode control input.
- MC5493L/
MC7493L **4-BIT BINARY COUNTER** — consists of two sections: a simple flip-flop and a divide-by-eight counter. Can be used independently or connected to provide the divide-by-16 function.
- MC15482L/
MC17482L **2-BIT FULL ADDER** — each bit performs the logical addition of two binary numbers. The sum outputs, the carry output for the second bit, and Exclusive OR outputs for each bit are available. Look-ahead carry is provided internally.
- MC25482L/
MC27482L **2-BIT FULL ADDER** — Exclusive OR outputs can be used for look-ahead carry when adding more than two bits.
- MC4038P **INVERTING/NON-INVERTING ONE-OF-EIGHT DECODER** — has a 3-bit binary address with inversion control which selects the desired word for the 8-bit output.
- MC4039P **SEVEN SEGMENT CHARACTER GENERATOR** — can directly operate low-voltage lamp indicators, enable inputs can be used for automatic blanking.
- MC4040P **BINARY TO TWO-OF-EIGHT DECODER** — has two enable inputs, transforms any 4-bit binary number to a 2-of-8-bit coded number, or can be used as a dual binary to 1-of-4 decoder.
- MC4041P **SINGLE-ERROR HAMMING CODE DETECTOR AND GENERATOR** — a programmed 128-bit ROM for a variety of error detection and correction applications.
- MC7475P **QUAD LATCH** — consists of four bistable latch circuits in one package. Both Q and \bar{Q} outputs are available on all four devices.

Interested? For detailed specifications on these MTTL complex functions circle the reader service number below or write us at Box 20912, Phoenix, Arizona 85036. We'll also include two newly available application notes on MTTL in system applications. For immediate evaluation units call your local franchised Motorola distributor.

F suffix = TO-86 ceramic flat pack, P = TO-116 dual-in-line plastic, L = TO-116 dual-in-line ceramic.

— where the priceless ingredient is care!



MOTOROLA Integrated Circuits

MOTOROLA SEMICONDUCTOR PRODUCTS INC., P. O. BOX 20912, PHOENIX, ARIZONA 85036

INFORMATION RETRIEVAL NUMBER 17

94-GHz radar to 'picture' objects in space

Chirp system will have enough bandwidth to give a range profile of irregularities six inches apart

David N. Kaye
West Coast Editor

The new radar will do more than show objects as blips on a scope. It will also give some idea of what the objects look like.

Such a radar—the first pulse-compression (chirp) millimeter type—is being developed at the Aerospace Corp. in El Segundo, Calif. It will have a 1-GHz bandwidth at 95 GHz and will be capable of range resolution of six inches. The radar is to be used by the Air Force for identification of objects in space. Information gathered by it will not give an actual picture of an object, but it will provide a range profile—that is, it will note irregularities on an object that are within six inches of one another.

An additional feature that the system will have is the ability to measure precisely the spin rate for tumbling satellites. This is due to the radar's high doppler sensitivity at 94 GHz.

Keith H. Hurlbut, manager of the Applied Electronics Section at Aerospace, explains that "for high

resolution, you need large bandwidths." "A 1-GHz bandwidth allows about six-inch range resolution," he notes. "In addition, at shorter wavelengths, the small irregularities on the target become scattering sources. At the longer wavelengths those irregularities appear quite smooth. This is due to the fact that at millimeter wavelengths the objects that you are interested in seeing are becoming large compared to the wavelength of the impinging radiation."

According to Herbert J. Wintroub, head of the Electromagnetic Techniques Dept. at Aerospace: "This is the first pulse-compression, 94-GHz radar. There have been a couple of short-pulse radars built elsewhere, but they were only short-range radars."

Hurlbut says: "With the pulse-compression radar, we transmit 1 kW of energy for a time duration of 1 ms. We could achieve the same resolution with a short pulse duration and 1-GHz bandwidth. Since our pulse duration with the short-pulse radar would be only one millionth as long as that with

the pulse-compression radar, in order to put the same energy on the target, and in turn realize the same signal-to-noise ratio on the return, our peak energy would have to be one million times greater. That would therefore require one million kilowatts, and we don't know how to do anything approaching that."

Feasibility is demonstrated

A 10-mile test range has been set up to demonstrate the feasibility of the system concept. The range consists of two corner reflectors, a pair of two-foot antennas and the associated electronics. The signal is transmitted by one of the antennas and received by the other. One of the corner reflectors is fixed, and the other is movable along a 20-foot track. Therefore one reflector can be moved anywhere from 0 to 20 feet from the other. Because of the test range's round-trip propagation time of approximately 124 microseconds, the pulse length is limited to 100 microseconds. Also, because of the shorter pulse length, the transmitted signal consists of only a 100-MHz frequency sweep instead of the full

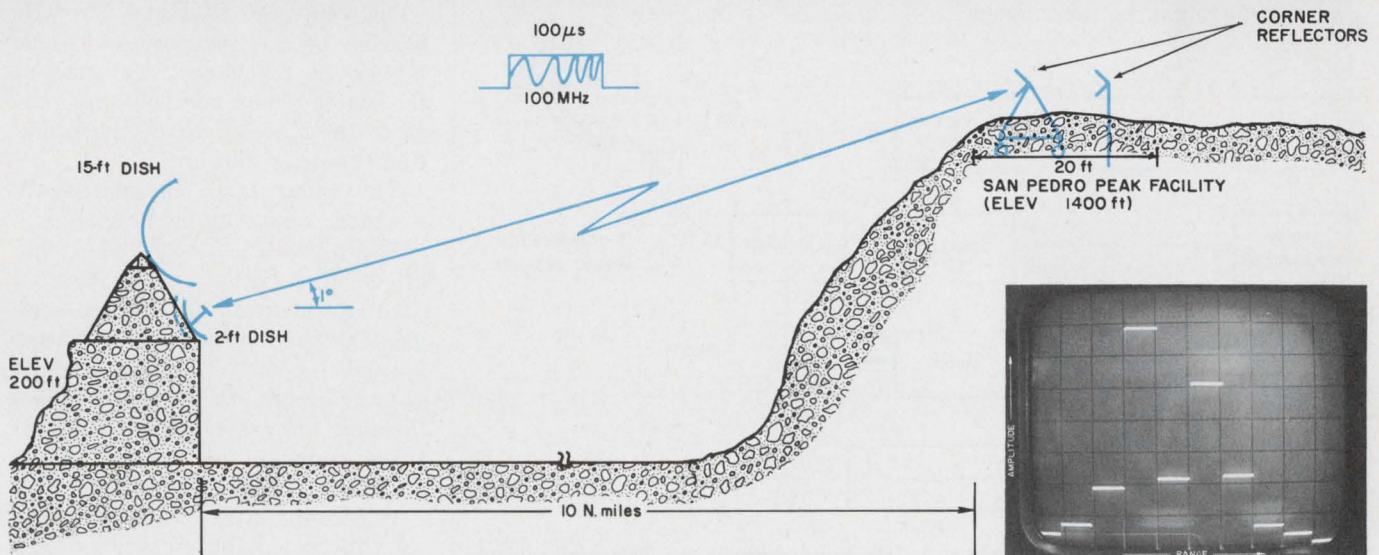

Scope displays 50 feet of this 10-mile chirp radar test range (above). Each horizontal box represents five feet

of range. The two high bars indicate that the corner reflectors are within five feet of each other.

(chirp radar, continued)

1 GHz. Consequently the range resolution becomes approximately five feet instead of six inches.

A linear frequency modulated pulse is transmitted, and the return radar echo is compared with a reference pulse, which is offset in time. The difference frequency output thus derived from the mixer is therefore a constant frequency within the pulse period for a fixed target. An actual target will, however, return a multiplicity of echoes as well as doppler data. Each of these echoes yields range profile information.

Two of the major components in the experimental radar transmitter are the millimeter-wave tubes operating at 94 GHz. The driver is a 3-watt, backward-wave oscillator,

and the final amplifier is a 1-kilo-watt-peak, traveling-wave-tube amplifier. Both of these tubes were built by the Hughes Research Laboratories.

The expected range resolution of 5 feet has been met successfully by the feasibility model on the test range, according to Aerospace.

Sweep linearizer is key

The sweep linearity requirements for the backward-wave oscillator are difficult to meet. It is here that the most unique design feature of the system has been incorporated. Only if the sweep is extremely linear will target echoes be properly correlated with the repeated reference pulse, so that the range can be determined.

Linearization of the frequency swept signal is achieved by setting

up a phase-locked loop. The sweep linearizer consists of two antennas, each six inches in diameter, a corner reflector, a coupler, a phase detector, a stable oscillator and a modulator. Part of the backward-wave oscillator's rf output is coupled off and radiated from the six-inch transmitting antenna to the corner reflector. The energy bounces back to the six-inch receiving antenna, resulting in a nondispersive delay of 860 nanoseconds. Since the backward-wave oscillator sweeps at 1 kHz per nanosecond, the delayed signal arrives back after the oscillator has swept 860 kHz. The delayed signal is then mixed with the undelayed signal in a homodyne system, which would produce a constant frequency difference signal if the rf sweep were linear. This 860-kHz difference signal is compared in a phase detector with the output of an 860-kHz stable crystal reference oscillator. The output of the phase detector is a voltage proportional to the difference in phase between the two signals. This phase error voltage is then applied as a correction to the backward-wave oscillator through the modulator. Linearization to within a 6-degree rms phase error has been achieved. Hurlbut expects that this can be somewhat improved in the final system.

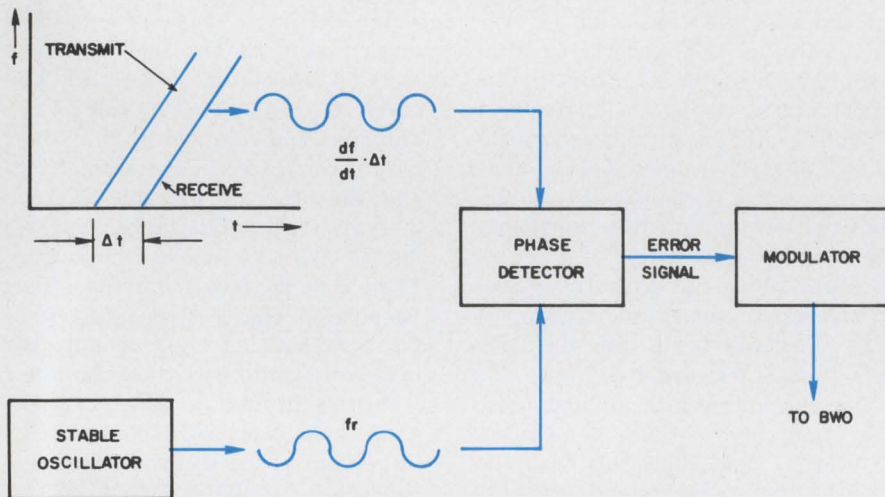

Sweep linearizer, the key to the success of the chirp system, assures that target echoes are properly correlated with the repeated reference pulse so that the range can be determined.

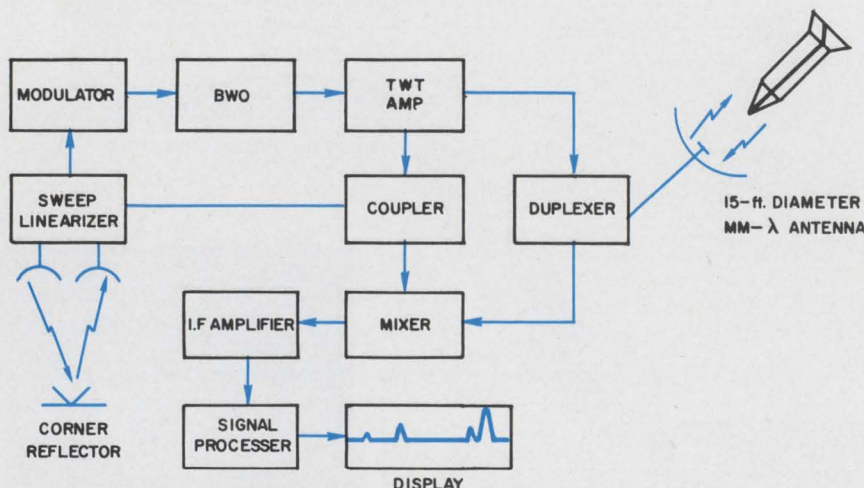

Pulse compression radar will have a 1-GHz bandwidth at 94 GHz and will be capable of range resolution of six inches. It's being developed for the Air Force by Aerospace Corp. in El Segundo, Calif.

Why 94 GHz?

Wintroub reports: "We are investigating the spectrum from dc to light. From an earth-based station, 94 GHz looks better than the windows at 140 GHz and 220 GHz because of water vapor. As you go higher in frequency, the size of the water vapor particles, compared to the wavelength of the radiation, becomes larger."

The radar is by no means all-weather. Wintroub explains:

"Rain wipes you out. The attenuation on a rainy day is tens of dBs. However, on an average summer day the test range attenuation is only about 6 dB. Looking straight up, the attenuation through the atmosphere on an average summer day is only on the order of tenths of dBs."

Wintroub says that "hopefully, we will be looking at targets later this year of reasonable size at altitudes of 200 to 800 miles." ■■

Good heavens. If we still haven't mesmerized you with all the magic arrays Signetics makes, what do we have to do? Conjure up a picture?

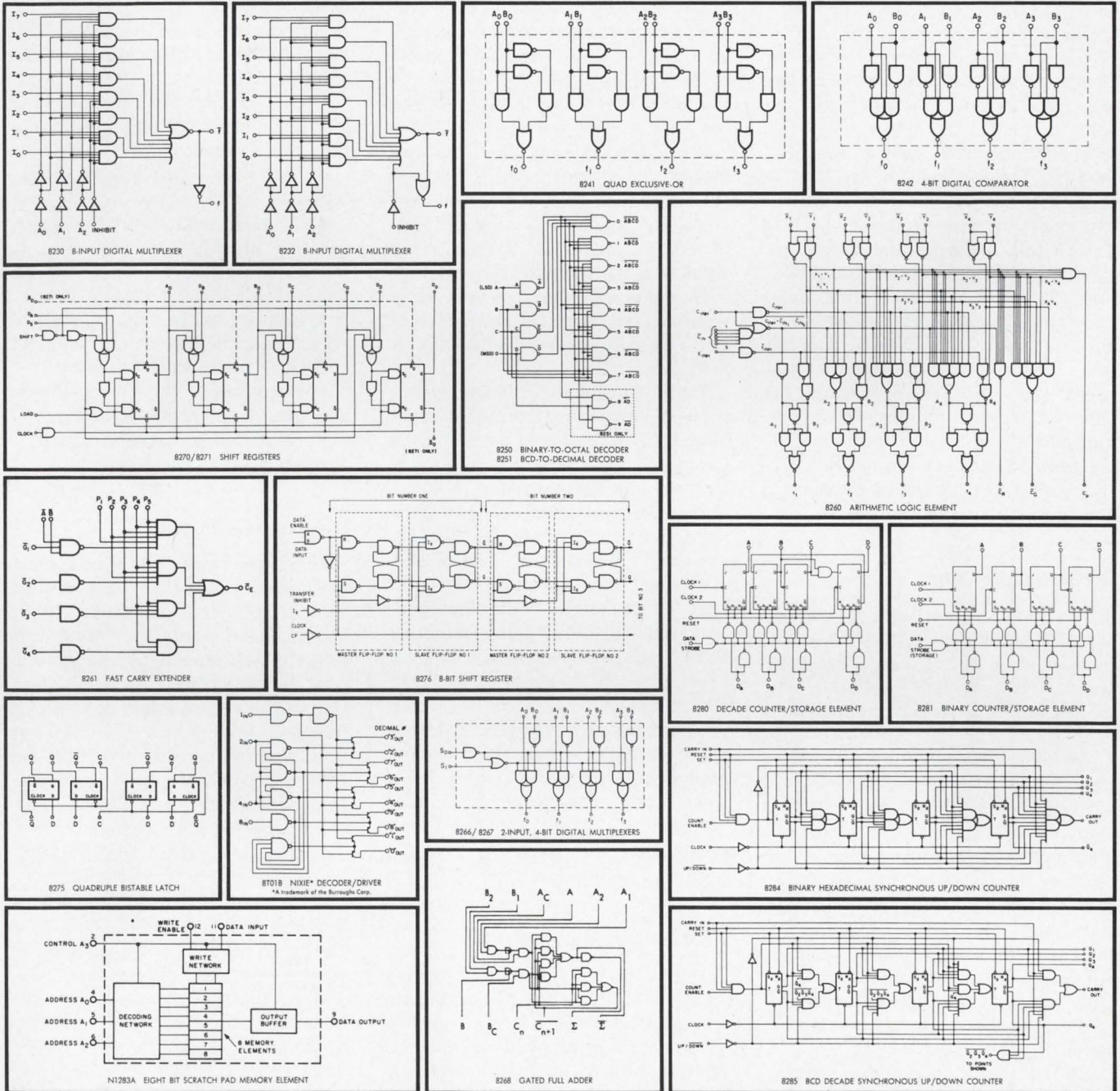

P.S. To keep you posted on our whole array of arrays, we've made a king-sized poster of this ad. (Just the thing for your rumpus room—or your purchasing agent's wall.) Offer limited; send today. And please: stop squinting!

More complex magic from **Signetics** **MSI**

Signetics Corporation / 811 E. Arques Ave., Sunnyvale, Calif. 94086 / A subsidiary of Corning Glass Works

INFORMATION RETRIEVAL NUMBER 18

Microwave radiation called growing hazard

To the growing list of air-pollution hazards that must be controlled, engineers at the 1969 IEEE International Symposium on Electromagnetic Compatibility were told to add microwave radiation.

The increasing power and diversity of microwave-energy radiators, the symposium was warned, can cause harm to humans.

In a talk defining microwaves as the frequencies between 100 MHz and 100 GHz, Leo P. Inglis, engineering supervisor at the Atomics International Div., North American Rockwell Corp., noted that radar transmitters operating in this range "have increased in average power radiated from about 10 watts in 1940 [peak power, 10 kW] to present-day levels in excess of 1 megawatt average power."

Greater power due

Moreover, he went on, transmitters are being developed with average powers between 5 and 10 megawatts, while "power levels to 100 megawatts are being contemplated."

And microwave equipment is not only being developed for military activities, said the supervisor of the Canoga Park, Calif., company. There are industrial applications, such as for heating, drying, communication and navigation. In the home there are color TV sets and microwave ovens. The medical profession is also turning to devices that subject the human body to electromagnetic radiation, Inglis noted.

Clinical data, he reported, shows that the human body—particularly the eyes and the testes—is vulnerable to microwave radiation, even though only a slight increase in body temperature is noted.

The danger is that although no symptoms are apparent, there may be severe damage that will appear after the body has been exposed to

radiation.

By looking through a waveguide carrying microwave energy, an engineer is subjecting himself to the possibility of eye damage in the form of cataracts. Microwaves can oxidize the transparent material in the lens of the eye and render it opaque. Inglis likened such a change to that which occurs when an egg is heated and the albumen is converted from a clear fluid to a white solid. He said that such damage to the eye was irreversible and that the transformation might continue after radiation has ceased.

Inglis documented his statements with reports from the U.S. Army Medical Research and Development Command. The military used rabbits in its experiments because they have an optical system similar to that of human beings. By exposing rabbits to a level of 950 mW/cm² the experiments found that "irreversible opacification" occurred in only eight minutes, Inglis said. At 650 mW/cm² it took approximately 40 minutes to cause the damage.

These power levels are far above those normally encountered by human beings in the course of their work, but, according to Inglis, "there is disturbing evidence to indicate that the human eye is vulnerable at much lower levels."

Heat causes damage

When the body is unable to dissipate heat, it is damaged, he noted. The proportion of microwave energy absorbed by the body as heat is, he said, approximately 40 per cent for frequencies below 1000 MHz, between 20 and 100 per cent at frequencies ranging from 1000 to 3000 MHz, and about 40 per cent above 3000 MHz.

A person in good health, can dissipate at about 0.01 to 0.1 watts/cm² of body surface, Inglis said. This means, he explained, that a

person can absorb "100 to 1000 watts of energy from a source such as microwave irradiation and still maintain an equilibrium, but elevated, temperature."

Inglis urged that the following precautionary steps be taken to contain the hazard.

- Establish suitable safety regulations.
- Develop self-powered measuring instruments.
- Conduct more research on effects of microwave irradiation.
- Require more rigorous medical examinations to detect incipient effects of microwave exposure.
- Encourage the development and use of protective clothing.
- Establish a national board to formulate safety controls.

U.S. standards cited

Exposure limits for electromagnetic radiation set by the United States Standards Institute, Inglis noted, warn that the "radiation levels which should not be exceeded without careful consideration of the reasons for doing so" are as follows:

Power density: 10 mW/cm² for periods of 0.1 hour or more.

Energy density: 1 mWh/cm² during any 0.1 hour period.

Inglis then quoted the limits established in the Soviet Union:

- In case of irradiation during the working day—no more than 0.01 mW/cm² (this is a factor of 1000 below U.S. standards).

- In the case of irradiation not exceeding more than two hours per working day—no more than 0.1 mW/cm².

- In the case of irradiation not exceeding more than 15 to 20 minutes per working day—no more than 1.0 mW/cm² (in this case, the use of protective goggles is mandatory).

The IEEE Electromagnetic Compatibility symposium was held in Asbury Park, N.J., June 17-19. ■■

Preamp temperature compensation isn't a circuit problem.

If you've been using preamps for signal conditioning, instrumentation or analog computation, you've been paying for circuit solutions to temperature stability problems. Paying in dollars and paying in space, weight and design time. The new Fairchild $\mu A727$ Temperature-Controlled Differential Preamp solves the problem on the chip. No more FETs, choppers or ovens. Offset voltage drift is $0.6\mu V/^{\circ}C$, offset current drift is $2pA/^{\circ}C$, while long term drift is $5\mu V$ per week. All specifications apply over the full military, temperature range from $-55^{\circ}C$ to $+125^{\circ}C$.

Our Second Generation Linear technology gives you this premium performance with no premium on the price. The $\mu A727$ has a built-in temperature regulating circuit that ensures accurate operation whatever your needs. Besides the low drifts, it has an input impedance of $300M\Omega$,

a common mode rejection ratio of 100 dB and a low frequency noise output of only $3\mu V$ rms. Here are three ways to use it. Our data sheets and application notes list a few more.

To order the $\mu A727$, ask your Fairchild distributor for:

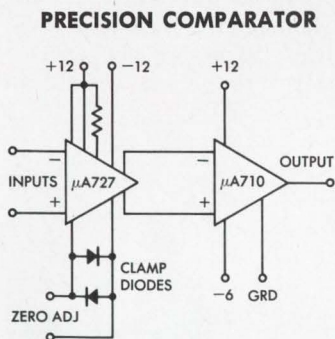

Input Resistance: $300M\Omega$
 Differential Input Voltage: $\pm 10V$
 Input Voltage Range: $\pm 8V$

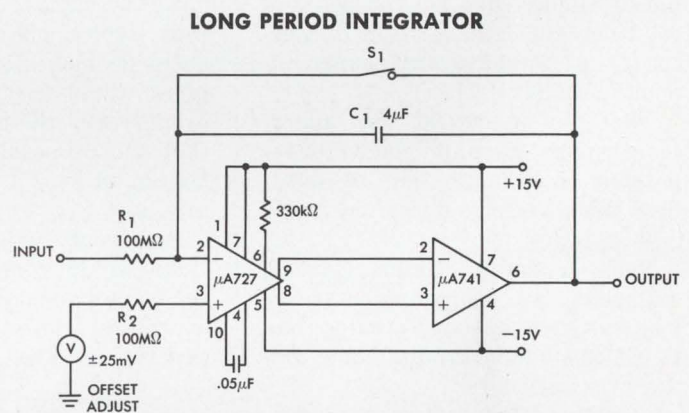

Error accumulation rate: 0.05%/minute

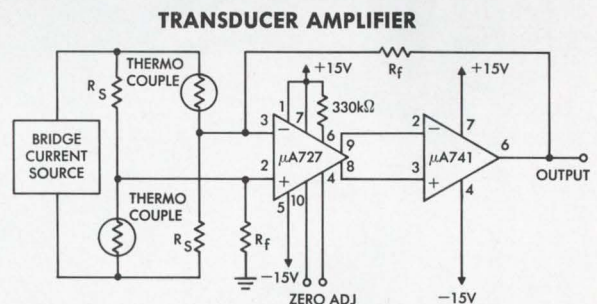

Accuracy: 0.01%
 Input impedance: $300M\Omega$
 Open-loop gain: 140dB

PART NUMBER	PACKAGE	TEMPERATURE RANGE	PRICES		
			1-24	25-99	100-999
U5J7727312	TO-5	$-55^{\circ}C$ to $+125^{\circ}C$	\$50.00	\$40.00	\$34.00
U5J7727333	TO-5	$-20^{\circ}C$ to $+85^{\circ}C$	22.50	18.00	15.00

FAIRCHILD
SEMICONDUCTOR

Cold power: Tomorrow's electric system?

Superconductive cable nets proposed to handle the enormous loads that U.S. cities are demanding

John N. Kessler
News Editor

Electric power requirements in major cities of the United States have been doubling every 10 years. If the trend continues, say scientists at the Union Carbide Corp., present underground cable systems won't be able to transmit the load without burning up. Union Carbide's Linde Div. has proposed a solution: the transmission of electricity by underground superconductive cables.

The system would use super-cooled pure niobium conductors—possibly not more than 0.00001-inch thick—electro-deposited inside copper pipes.

Such a setup, Union Carbide scientists say, could handle power loads at least 25 times greater than the largest underground cable sys-

tem in the U.S. today.

At a press conference at the company's Park Avenue headquarters in New York City, details of a superconductive transmission research project were released. Hugh M. Long, head of the project, said that power loads of 1000 to 10,000 MVA for 138 to 345 kV could be handled by the proposed three-phase ac cables. A mockup showed four cables placed inside a pipe about 25 inches in diameter. Three pipes would carry electricity; one would carry the coolant. Long said that the proposal called for liquid helium to keep the superconductor at -452°F .

Refrigeration and pumping stations would connect terminals of the superconductive system to an overhead transmission line or a generating station transformer

bank at one end, with a distribution substation or another overhead line at the other. Refrigeration and pumping stations would be spaced at intervals of about five miles.

Long said that cables carrying ac were more economical than those carrying dc power, because "the cost of terminal equipment to integrate dc segments into the present ac power system is very high." Heretofore one problem of transmitting ac power has been that of electrical loss. Union Carbide says that pure niobium—electro-deposited by a proprietary process in a high-temperature salt bath—opens the door to underground ac superconductors.

8-watt loss per mile

Tests of niobium 0.002-inch thick electro-deposited inside a pipe with a diameter of 0.398 inch show that current densities of 685,000 amperes per square inch could be sustained, the company reported. With a superconducting current of 1700 amperes, it said, the ac losses were only 1.5 milliwatts per foot, or about 8 watts per mile. The largest conventional cables for power transmission today have current ratings of less than 1000 amperes, current densities of 650 amperes per square inch and losses of about 10 watts per foot—losses more than six thousand

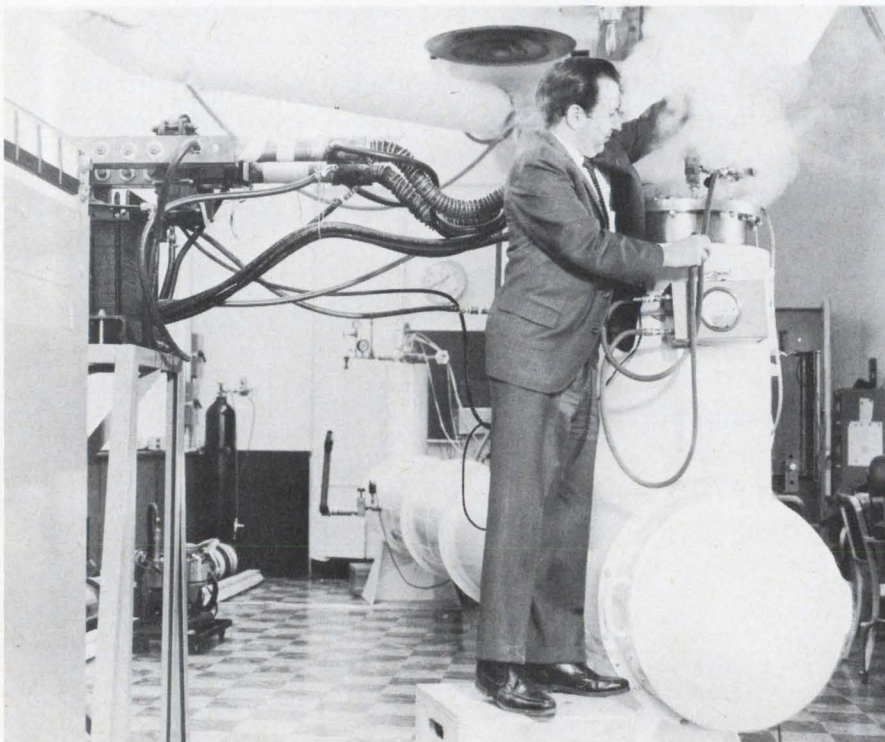

Liquid helium is transferred into a 23-foot-long dewar, being used to test Union Carbide's proposed superconductive power-transmission system. At 452° below zero Fahrenheit, niobium has been found to be an excellent superconductor of electric power.

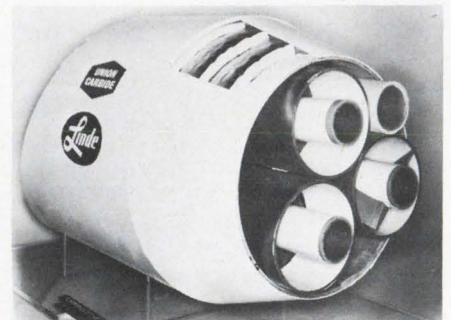

Mockup of superconductive cable. Three of the pipes within the cable would carry electricity. The fourth would carry liquid helium.

times greater than those for the superconductor.

There are problems in any underground electrical power system, but a system handling the huge amounts of power proposed by the Union Carbide scientists intensifies such problems as these:

- A malfunction in a single refrigeration pumping station could black out very large areas.

- Earth tremors, earth moving machines or explosives could break some of the superconductive paths, but the external pipe might not be visibly damaged.

Long said that if the superconductive system warmed to ambient temperature, it would take at least a day to cool it down. He also pointed out the need for redundant power and liquid helium supplies at the pumping stations.

Future looks bright

The research project was sponsored by the Edison Electric Institute, a trade association of the electric utility industry. One of the members of the institute committee that set up the program, L. H. Fink, supervising engineer at the Philadelphia Electric Co., is optimistic about the future of such systems. He told *ELECTRONIC DESIGN*: "With proper development, none of the malfunction problems should preclude ultimate use of this system." Fink pointed out that the problems were not qualitatively different from those now being faced by underground power transmission systems.

New "hot superconductors"—with transition temperatures approaching -420° F—are too experimental and have not been developed as ac superconductors, Long noted. He also said that Union Carbide's proposed system had to operate considerably below the transition temperature. This, he felt, ruled out materials that go superconductive at just below the boiling point of liquid hydrogen.

Union Carbide says that an \$8 million 12 to 15 year program will be required to develop a superconductive cable system. This would include further research and development, prototype tests, evaluation and design. To meet the needs of the 1980's Union Carbide says "We must begin now." ■■



Why do engineers hate inductors?

Well, primarily because inductors stubbornly resist integration. Nytronics started taming them about 30 years ago, and our R&D boys have been concentrating on improving their quality and performance ever since. Today we think our line of inductors is the most nearly perfect it is possible to make.

WEE-DUCTOR — Magnetically shielded with inductance range 0.1 to 180,000uH, designed to MIL-C-15305, Grade 1, Class B. Encapsulated Envelope: 0.157" diameter x .450" length.

SUPER WEE-DUCTOR/90537 TYPE — Manufactured in accordance with MS90537, Molded Magnetically shielded with inductance range 0.1 to 100,000uH $\pm 10\%$ tolerance. Molded Envelope: 0.163" diameter x 0.410" length.

SUPER WEE-WEE-DUCTOR — Miniature shielded with inductance range 0.1uH to 10,000uH. Designed to MIL-C-15305, Grade 1, Class B. Epoxy-Molded Envelope: 0.125" diameter x 0.335" length.

DECI-DUCTOR — Subminiature with inductance range 0.1 to 1000uH. Designed to MIL-C-15305, Grade 1, Class B. Molded Envelope: 0.100" diameter x 0.250" length.

S-M-L INDUCTORS — Non-shielded with inductance range 0.1 to 10,000uH. Designed to MIL-C-15305, Grade 1, Class B. Molded Envelope: "S" Type — 0.188" diameter x 0.44" length, "M" Type — 0.25" diameter x 0.60" length, "L" Type — 0.31" diameter x 0.90" length.

VARIABLE INDUCTOR — Unshielded with adjustable range 0.1 to 4700uH. Designed to meet MIL-C-15305, Grade 1, Class B. Encapsulated Envelope: 0.400" diameter x 0.500" length. Vertical or Horizontal mounting.

WEE V-L — Magnetically shielded adjustable range 0.1 to 100,000uH. Designed to MIL-C-15305, Grade 1, Class B. Epoxy Molded 0.300" diameter x 0.400" length.

WEE CHIP-INDUCTOR — Magnetically shielded, wrap-around termination permitting contact to either face or ends. Designed to meet MIL-C-15305, Grade 2, Class B. .280" x .195" x .100". Presently available .15uH to 1000uH.

■ Send for our new 44-page catalog with the quality line of standard components.



NYTRONICS, INC.

The quality line of standard components

550 Springfield Ave., Berkeley Heights, N.J. 07922 ■ (201) 464-9300 ■ TWX: 710-984-7977

INFORMATION RETRIEVAL NUMBER 20



We make components for guys who can't stand failures.

Everybody hates failures in their electronic gear. It's just that some guys hate failures a little bit more than others.

These are the guys that we try to please.

At Corning, we make our resistors and capacitors to perform like your whole system depended on them, because many times it does. We build an extra measure of performance into all our components to let you build extra reliability into the equipment you design.

Take our precision tin oxide resistors, for example. They're the best of the metal film class. Because the resistive tin film is completely oxidized and molecularly bonded to the glass substrate, our tin oxide resistors are impervious to moisture and environmental degradation. No other resistor can deliver the same stability and reliability over load life. They offer guaranteed moisture resistance across all ohmic values to set a standard of reliability that can't be matched by metal film, wire wounds, carbon comps or metal glaze resistors.

After a recent 56-day-long heat

test in an environment of extremely high humidity, our tin oxide resistors showed a resistance change of just 0.2 per cent. And in an ambient temperature test—now in its ninth year—not one of the 600 tin oxide resistors being tested has exceeded a resistance change of 1.5 per cent.

Take our glass capacitors. The U.S. Air Force has found that our glass capacitors have much better stability and much higher insulation resistance than the ceramic, mica and the other capacitor types they tested. That's why glass capacitors are designed into so many major aerospace and missile projects.

And we've got something to offer when economy and value are the prime considerations. We've developed the Glass-K™ capacitor to give you the volumetric efficiency and economy of monolithic ceramic capacitors, but with the much improved stability and reliability that only a glass dielectric can add. In resistors, our tin oxide resistors already offer long term economy over metal film, precision wire wound and metal glaze resistors.

Our new C3 resistors, in addition to giving you a small case size, compete costwise with carbon comps.

Another important Corning development is the flame proof resistor. These resistors can withstand overloads of up to 100 times rated power without any trace of flame. And because they open under overload, they provide protection for the rest of the system.

At Corning we make components for guys who can't stand failures. Guys like your most important customers. Guys like you. So, next time you're designing a system, reach for your CORNING® capacitor and resistor catalogs and call your local Corning authorized distributor for off-the-shelf delivery. They'll help you design-in an extra measure of performance.

If you don't have our catalogs, ask your Corning distributor for copies or drop us a line at: Corning Glass Works, Electronic Products Division, Corning, New York 14830.

CORNING
ELECTRONICS



Anti-sub warfare

John F. Mason, Military/Aerospace Editor

Under water researchers, interested in learning how far sound might be detected in water, decided in 1960 to put it to the test. A group from Columbia University's Lamont Geological Observatory dropped several 300-pound explosive charges into the sea off the coast of Australia. Colleagues cooperating in the experiment picked up the sound off the coast of Bermuda, some 12,000 miles away.

A novice might conclude that detection of enemy submarine sounds should be easy in such a medium. But this is not the case.

"Trying to detect and identify targets in the water by sound is like trying to listen to television while a helicopter is flying through the room," one sonar producer says.

The sea is filled with noises that bedevil the designer, according to Stanley A. Peterson, associate tech-

nical director for plans and programs at the Navy's Underwater Sound Laboratory in New London, Conn.:

"Ships and explosions; rain on the water's surface and waves; whales, porpoises and other creatures that grunt and click; and shrimp that snap their claws together making a noise like water sprinkled into a pan of frying oil.

"Besides these obstacles," Peterson goes on, "sound is attenuated in water. It's absorbed by the ocean floor, dissipated by the surface and scattered by millions of small fish and organisms. Targets can hide easily below or above thermal layers. And the tortuous route an echo might travel can easily conceal the real location of its source.

"But if the medium is understood, it can be used. An environment that permits you to hear a sound made 12,000 miles away

can't be all bad."

The sea and the design problems it poses are receiving renewed interest in the Defense Dept. under a new policy of strengthening the nation's submarine warfare potential. Contracts will be awarded soon for a fleet of sub-hunting destroyers designed as integrated weapon-systems, a new fixed-wing, carrier-based ASW aircraft called the S-3 and a new line of fast submarines. Coming into the inventory in a matter of weeks is a new ASW patrol plane, the P-3C.

This activity has been spurred by the knowledge that the Soviet Union has stepped far out in front in submarine power. The Russians have between 350 and 400 submarines; the U.S. has 146. Between 250 and 312 of the Soviet's undersea fleet are attack submarines; the U.S. has 105 of these craft, only 33 of which are nuclear-powered.

And more Soviet submarines are being built.

"The Soviets are producing both ICBMs and nuclear submarines at a rapid rate," the U.S. Senate Preparedness Investigating Subcommittee reported last September.

Last June the Congressional Joint Committee on Atomic Energy reported: "The Defense Dept. has grossly underestimated the rate at which the Soviets are improving their nuclear submarines." The committee added: "Unless immediate and major improvements are made by the Defense Dept. in their treatment of the nuclear submarine program, the United States may find itself unable to counter the rapidly increasing submarine threat."

In the light of this background, the Navy is seeking improvements in design for all sea and air

weapons "platforms"—both existing and proposed—that it uses in submarine detect-and-kill operations. But bigger and more sophisticated hardware isn't necessarily the answer. The Navy has learned the hard way that only so much acoustical power, and no more, can be introduced into the water. If the power is too great, an air-vapor pocket forms and separates the sonar and water. The result is comparable to a short-circuit.

Trends in antisubmarine equipment that appear to be shaping up at present include:

IN THE SEA

- Active sonars for the heretofore silent submarines.
- Conformal planar arrays that line the hull of a ship.
- Towed arrays that use both

cw and pulse sonars.

- Deep submersibles with acoustic facilities.
- Data-processed signals and selective displays.
- Sharing of computers and displays.

IN THE AIR

- A quantum jump in automation, freeing the sensor operator to make decisions.
- Low-light-level television.
- Magnetic anomaly detectors to spot subs at deeper depths.
- Lasers to look below the surface of the sea.

Tying the force together

One of the big efforts is to integrate the hundreds of diverse elements of an ASW task force, which

and the hostile sea



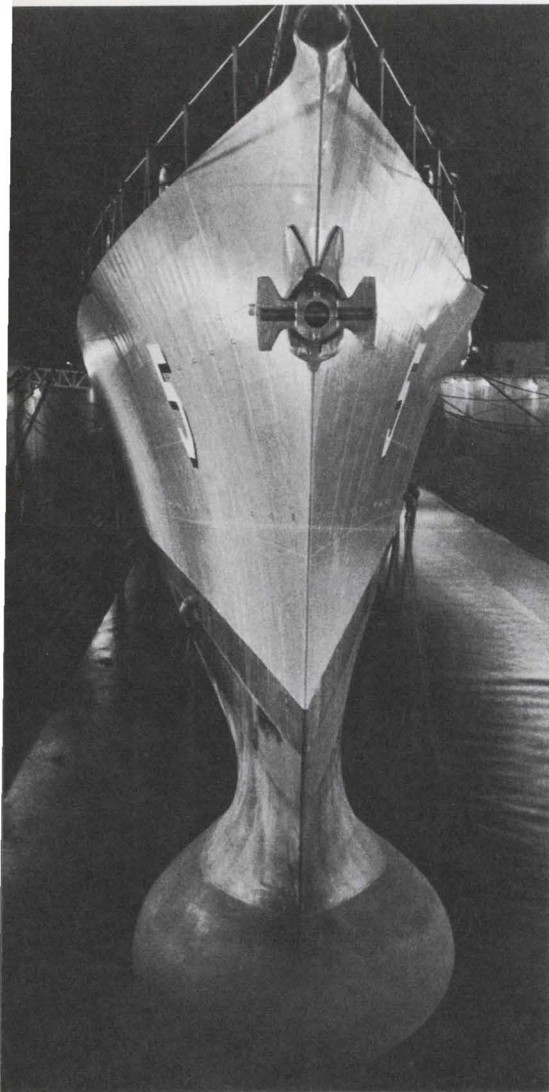

Biggest hull-mounted sonar in the fleet is the AN/SQS-26, built by GE.

may be spread out over more than 100 miles of open sea.

The main platform to be considered is the aircraft carrier, which serves as the command and control center of the entire force and as a base for the sub-hunting, S-2 fixed-wing aircraft and the sonar-carrying SH-3 helicopter. The S-2 will eventually be replaced by the S-3, formerly known as the VSX. A contract for the S-3 will be awarded soon.

The other surface platform is the destroyer, which is equipped with hull-mounted sonars, variable-depth sonars, towed arrays and (experimentally) planar arrays strung along the length of the ship's keel.

Destroyers carry torpedoes plus either the Asroc rocket-torpedo or Dash, a drone helicopter that is guided to its target by shipboard

radar and radio and drops its torpedo by parachute.

Airborne platforms include carrier-based aircraft equipped with ejectable sonobuoys, magnetic anomaly detectors for locating submerged submarines and high-resolution radars for picking up periscopes and snorkels. Helicopters based on carriers dip sonar into the water by cables.

The main shore-based patrol aircraft is the P-3 series—the A, B models and, soon to be operational, the C with its avionics systems tied together by a computer. Besides “dipping” sonar, ejectable sonar and magnetic anomaly detectors, the P-3C crew will see in the dark with low-light-level television.

Both nuclear and non-nuclear subs are used as underwater ASW platforms.

A final platform is the ocean floor, where for years implanted hydrophones have listened to the noises of the sea, transmitting them by cable to sonobuoys and on by radio to carriers or shore bases for analysis.

Where the action is

Besides integrating the whole task force with better electronic communications, the Navy must integrate each individual weapon system. Submarine sonars, for example, still function individually rather than with shared computers and displays.

Systems need to be automated, the data processed and selectively displayed. Sonar operators in multimillion-dollar nuclear submarines are still looking at raw data on their scopes—data hidden by noise.

A means of predicting sonar results by analyzing the sea state is receiving emphasis now. Detection and identification at greater ranges are further goals. And a non-acoustic means of “seeing” in the sea is being sought.

Learning to live with it

Study of the sea itself is undergoing a renaissance.

“The sea is noisy and deceptive, but sound is the only thing that gets through it to any extent,” says Stanley A. Peterson, associate technical director for plans and pro-

grams at the Navy's Underwater Sound Laboratory in New London, Conn.

“We've tried most other forms of energy. Light, for example, is useful to distances of tens of feet. Infrared doesn't travel at all. Radio energy—even very low frequency—is attenuated very quickly; losses are on the order of 1 dB per foot. And magnetic detection, which is good if the target has a strong magnetic field, is also limited in range. Eventually,” Peterson says “we always get back to sound. Now, we're learning to live with sound and the sea. We're studying the characteristics of the world's oceans, what their major features are, the limitations they impose and how we can transmit the most energy through the medium and extract the needed information.”

Peterson is backed up by the Commander of the Antisubmarine Warfare Force of the U.S. Atlantic Fleet in Norfolk, Va.—Vice Admiral Paul Masterton.

“There haven't been any sensational hardware type breakthroughs in recent years, and I don't think there will be,” Admiral Masterton says, “We've just got to keep working with the medium and trying to understand it. It's tricky, and there's no cure-all. Sometimes, bottom bounce works and sometimes it doesn't. The ocean has all sorts of bottoms—rough, smooth, muddy and rocky, and we get different reactions from each one. We just have to study more.”

J. P. Costas, consulting engineer for Advanced Development Engineering of General Electric's Heavy Military Electronic Systems in Syracuse, N. Y., is a strong advocate of studying the environment and designing equipment to meet its demands. “A lot of wonderful ideas don't stand the test of working in the medium,” he says.

GE learned this not only by experience with equipment in the sea but by working with simulators. “We needed to know how the sea affected the signal as it passed from the transmitter array through the medium to the target and back,” Costas says. “It soon became evident that the discrepancy between predicted performance and theoretical performance was due to ignorance of the medium.

“There were two big effects on

the signal: time spreading due to multipath and frequency spreading due to the fact that the multipath was time varying.

"These two things are so important they can't be ignored in designing equipment. If you do, you're going to find yourself puzzled by the results you get. The detection performance will suffer, and the resolution data will be inconsistent.

"Recognizing that the medium effects were important, we went back and developed designing techniques that would take the medium into account. In most cases this caused us to end up with a hybrid design, a combination of coherent and non-coherent processing."

'Too much' technology

"Oddly enough," Costas continues, "we got further away from our environment because of the re-

markable things we found we could do with hardware. With modern technology, we were able to build very sophisticated pulse generators, signal processors and displays.

In fact, the sonar designer sometimes gets too carried away with his capability, building the most sophisticated equipment he can without fully recognizing whether it is practical to do so, and without regard for the fundamental problems in the environment.

A good parallel, Costas points out, occurred recently in the evolution of a tropospheric scatter network that was being periodically improved with bigger antennas. "Eventually, however," he notes, "a bigger antenna was put up and the predicted gain was not realized. The medium—the troposphere in this case—had been pushed as far as it would go."

A similar case of enthusiasm for bigger and better hardware has also resulted in sonar, Costas says.

"As hardware producers developed better components, allowing us to use longer pulses [for better doppler resolution], our first impulse was to buy them. But this can turn out to be a mistake. Instead of improving the situation with this modern design, you can end up with lower performance than the system you replaced."

The reason a very long pulse eventually stops improving doppler resolution is that the phase relationship at the start of the pulse is different from the phase relationship at the tail end of the pulse.

"When you try to process the pulse coherently, there is no improvement in detection," Costas points out. "On the same score, if the bandwidth is excessive, you find that you're not learning more about the detailed structure of the target but are, in fact, seeing more and more of the multipath structure. You are actually spreading your energy and suffering a loss.

"As for angular resolution, we have the ability to build arrays that theoretically would give us beams narrow enough for extremely fine angular resolution. But we know that there's a limit to the resolution that's useful; the environment permits just so much and no more. Trying to go beyond this decreases gain.

"The same thing is true in the design of the waveform. We can build pulsers and processors for very large bandwidth products, but in many applications we know that the medium effects will render such a system almost impotent. Why build a beam width of X degrees when the variation of the effective angle of arrival from the target is 20 times X?

"Some of the earlier techniques were simpler, because of lack of sophistication of hardware, but these techniques ironically, are more appropriate for the environment in which they have to work.

"For example, the earlier systems used shorter pulses, probably because the circuit designer was limited in what he could do. But when more complicated, longer pulses were possible to construct, we used them. We thought they'd tell us more."

One reason for this move, Costas points out, was pressure from the user. "The fire-control people wanted to get more accurate range and bearing information," he recalls. "This was natural. We tried to satisfy these needs. And theoretically the sophisticated systems would do it. We had not, however, examined their inherent limitations."

The many faces of sonar

The variety of sonars is growing along with the weapons platforms on which they are in use. Probably the most classified category is sonar that is fixed to the sea floor. These arrays have monitored the coastal areas of the United States for at least 18 years. They are both active and passive. The information they pick up is transmitted to control centers on shore by cable, if the shore base isn't too far away, or to a sonobuoy, from which it is transmitted by uhf or vhf radio. In the future, perhaps, buoys will transmit sonar findings to satellites for relay to ground stations.

"The effort now," Admiral Armstrong says, "is to improve the detection capability of these systems and their signal-processing techniques. Also we want to automate them."

The Navy would like more directional systems. "It's helpful to know that something is happen-



J. P. Costas at GE, Syracuse, advises more emphasis on study of the medium in which sonar operates.

ing," one sonar producer says, "but it's more helpful to know where it's happening; we want to know the range and bearing of a target. Even more difficult is identifying a target with these systems."

There is controversy now over where data should be processed. At the sonar itself, thereby cutting down on the data flow? On the buoy? Or on the shore? While there is a saving in minimizing the transfer of data, the cost of signal-processing equipment is far less when built for an air-conditioned shore facility than for an infrequently attended buoy or a submerged sonar installation.

Detecting subs from the air

Sonobuoys ejected from aircraft come in a wide variety, ranging in cost from less than \$100 to more than \$500,000. The big push this year involves Difar (directional low-frequency analyzer and ranging), designated the AN/SSQ-53. Launched from P-3 and S-3 aircraft, the half-million-dollar system will detect, classify and pinpoint submarines. The system includes an airborne analyzer, recorder and display. The contractor for Difar is Magnovox Co., Fort Wayne, Ind.

The carrier-based S-2 aircraft can carry 32 sonobuoys, which can be dropped from eight patterns that form a circular or a barrier line the enemy submarine must cross. The plane can monitor four buoys at a time, but it can relay data to shore or to a carrier from eight buoys.

Carrier-based helicopters are used to lower a sonar several hundred feet below the sea's surface, while hovering at an altitude of about 50 feet. They get the information they want and then haul the sonar back up for further use.

The SH-3D helicopter carries both active and passive sonars. The chopper has voice communications to an E-1B communications relay plane when the carrier is over the horizon.

Sonars for destroyers and subs

A lot is happening in the complex realm of sonars for ships and submarines. Sonars for submarines, for example, may be in for a change.

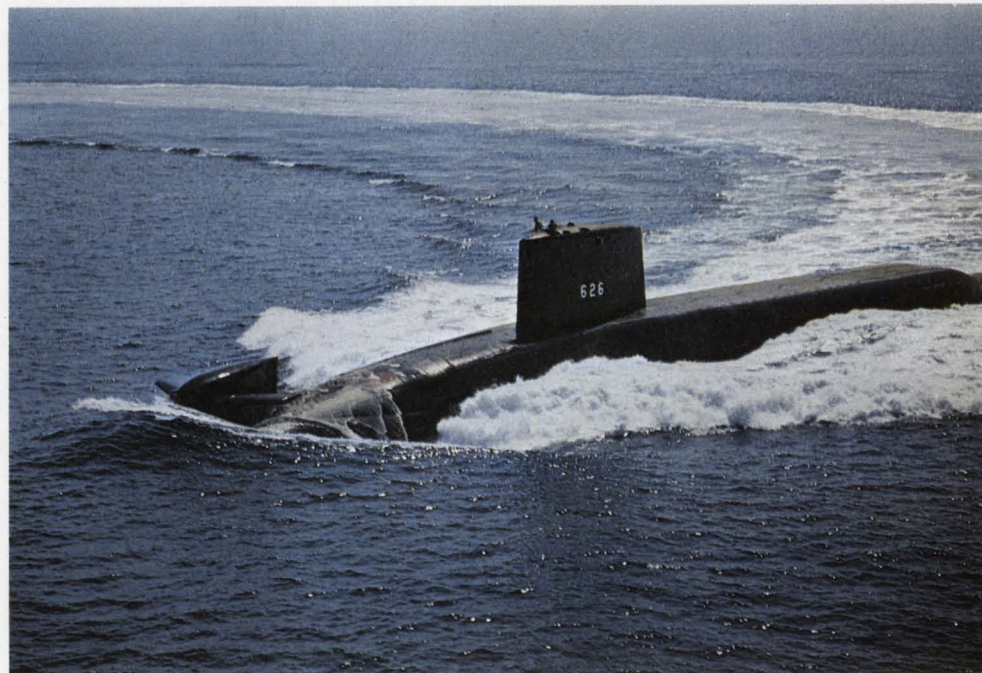

Polaris-missile submarines, like the SSBN Daniel Webster here, are often flanked by two nuclear attack subs to "brush off" the Soviet submarines that shadow them. Attack subs carry elaborate sonar and torpedoes. Both nuclear and non-nuclear undersea vessels are used as ASW platforms.

"Submarines have, for the most part, used passive sonar," says Admiral P. B. Armstrong, the Navy's Director of Undersea and Strategic Warfare Development. These receivers pass on all the sounds from the sea, natural and manmade. "Now, however, with the advent of the 'quiet' sub, active sonar will have to be used, Admiral Armstrong says. "A submariner might risk one ping [pulse] or two. This would require, however, a highly sensitive system with a computerized fire-control system that can fire a weapon with information from just one ping."

Others disagree that active sonar is necessary. An executive at Raytheon's Submarine Signal Div. at Portsmouth, R. I., believes it will be a long time before the submarine will have to resort to active sonar.

"There's so much that can be done to improve passive sonar," he says. "Improvements are possible in the greater use of digital techniques, signal processing by computer, improved displays and, finally, total integration of the combat ship system. The sonar must be integrated with the other systems—the fire control, navigation, communications and command.

"Some people believe you can't get range with a passive system. Signal amplitude gives you range to some extent. If the echo is strong, the target must be fairly near. If it's faint, then it's farther away.

"A passive system can also be an aid to target classification. Different countries use different types of motors, and these emit characteristic sound patterns.

"Passive and active sonar will both be more effective with greater use of data processing," the Raytheon official says.

"Raw analog data can be converted into digital data and stored in a computer. By various signal processing methods, the data can be treated and analyzed to extract the vital information it contains. Then after having wrung everything out of it, it can be converted back to analog and displayed.

"Stored information is useful because of the number of ways it can be presented. If you're interested in doppler, you can look at that. If you want to eliminate your own doppler and just display the target's doppler, you can do that."

J. A. Edwards, consultant for Advanced Sonar Development at GE, in Syracuse, N. Y., foresees

better results from both passive and active sonar with greater use of computers for signal processing. "The transmitted waveform can be stored in the computer and cross correlated with the return," he says. "This will be done digitally. Instead of using conventional type filters and detector circuits, we will use digital filters to convert the signals coming in to a sequence of numbers. These will undergo numerical convolutions or integrations or Fourier transforms and be processed in a numerical fashion.

"Digital processing could go right down to our beam former function, signal-processing function, detection and filtering, and on to handling the data and deciding what to show the operator."

A Raytheon engineer says:

"Data processing should be integrated. It would be a waste for each sonar to have its own computer. One big data-processing computer might do the job for all sonars on board. Or to guard against computer breakdown, there might be two.

"Displays can also be shared. You don't use all your sonars at the same time—the depth finder, navigation and search. One display could handle all three."

GE's Costas warns that there is danger in too much reliance on the computer. "Anyone who designs a system with the idea that the computer is going to do the man's job is making a serious mistake. The computer is a valuable tool, but man can do some very important things better.

"The computer can be used to process data, arrange data and prepare it for display."

Making your own noise

Most active sonars are pulsed, but some use a continuous-wave, swept-frequency transmission.

Pulse sonar is normally associated with very-long-range echo ranging, when the direction and range of the target are important, and it is also to avoid obstacles. For example, if a submarine is speeding between two points—another submarine and a surface ship or sea mountain—it needs this kind of sonar to avoid collision.

Cw swept-frequency sonar is used for looking at stationary tar-

gets, such as mines and sunken objects. The system can actually paint a picture of an entire area. It can give both direction and range, which can be plotted on a PPI scope; cw swept-frequency is also used to distinguish thermal layers from real targets, enabling a trained operator to distinguish between biological life and submarines.

"You get a crisp audio return from a metallic object and a dull one from a whale," according to Arthur J. Stanziano, vice president of Electro-Acoustic Systems Laboratory, a division of Hazeltine Corp., Braintree, Mass.

The Navy has under consideration a cw, fm sonar for mine detection. The advantage of continuous transmission is that it illuminates the entire target, thus making signal processing easier. The information doesn't have to come from a single pulse.

Controversy is growing over the best size and shape for sonar,



Operator tests AN/SQS-30 hull-mounted, active sonar aboard destroyer Borie. Far scope is for variable-depth sonar.

Catapult crewmen prepare an S-2E Tracker antisubmarine aircraft for launch from the ASW-support aircraft carrier Essex. The S-2 can eject 32 sonobuoys, can listen to results from four and relay signals from eight.



Chasing subs from the air

The Navy's newest land-based ASW aircraft is the P-3C Orion, built by the Lockheed-California Co. in Burbank. Outwardly the plane differs little from the P-3A and B; the same four-engine turboprop airframe is used. Inside, there are many advances. Equipped with the A-New avionics suite, the new plane houses more than 300 pieces of avionic equipment, some 200 of which were not in the A and B models.

A-New, developed by the Naval Air Development Center, Johnsville, Pa., is built around a digital, general-purpose computer, the ASQ-114, developed by the Univac Div. of Sperry Rand. The computer integrates the ASW system components and provides an accessible memory. It multiplies the speed and accuracy of information display, transmission and retrieval.

The P-3C's tactical coordinator can call on the computer to produce a large volume of information on ASW sensors, communications, navigation, tactical armament status and other data to solve problems. The computer keeps track of sonobuoys in the water; it codes and transmits messages, pinpoints the aircraft's exact location, determines when to fire weapons and troubleshoots itself for mechanical failure.

The computer permits the tactical coordinator to devote up to 85 per cent of his time to making the tactical decisions necessary to outwit his submarine quarry.

Previous ASW planes have required the coordinator to spend about 85 per cent of his time gathering data and making computations.

"This system will supplement the human being in a fantastic fashion," says Cmdr. Raymond N. Winkel, Staff Logistics Officer, Commander Fleet Air Wings, Atlantic, in Norfolk. Commander Winkel, who has spent years working with these land-based planes, says: "The computer helps decide when the sonobuoys should be ejected from the plane. It does this from stored information obtained from the radar and other sensors. The computer then proceeds to sweep the frequencies to monitor those sonobuoys that

are active.

"When the tactical coordinator chooses the wrong frequency, the computer reminds him, by flashing a message on the display, that the particular frequency is already in use by another sonobuoy."

The long, stinger-like tail of the P-3C houses the magnetic anomaly detector. This device reports disturbances in the earth's magnetic field, like those made by the metal hull of a submarine. The detector is used in the final moments of ASW problem-solving, to make certain that the object detected by sonar or other techniques is metal.

A low-light-level television system on the P-3C replaces the searchlight used on the 3A and 3B models for visual identification of surface objects at night. This closed-circuit system is designed to display surfaced submarines and other vessels in almost complete darkness.

The P-3C has a search radar with greater capability and reliability than that on the 3B, but like the 3B model, it is two radars in one. For complete coverage, there's an antenna in the front of the aircraft and one in the rear. The returns from both are blended and presented on one display. In this way there's no blind spot. The display is new, presenting information in alphanumeric form from the computer.

Aircraft get new displays

A tactical data display, designated ASA-70 and built by General Dynamic's Stromberg Datagraphics in San Diego, presents stored and real-time data on a Charactron tube for the tactical coordinator.

The system consists of two display consoles and two auxiliary displays placed at three aircraft stations. The display console accepts computer-generated information and converts it to a form suitable for driving a 16-inch Charactron-shaped beam CRT.

The system utilizes a time-shared, line-writing mode of operation that permits single or combinations of a variety of data; random alphanumeric

symbol data; tabular alphanumeric symbol data; graphics in separate or connected dots; lines and vectors; PPI radars; A-scan radar; IFF and ECM signals; television or low-light-level TV; scan converted sensor data; and conic sections.

Another display, the ASA-66, built by Loral Corp., Scarsdale, N. Y., gives the pilot a complete visual presentation of tactical situations: sonobuoy positions, points to fly to and fixes. The information is displayed on a 7 1/2-inch CRT.

The pilot is able to insert information into the computer and control the tactical display through a key on the center pedestal. The key contains 25 monofunction and 10 numeric switches. This allows the pilot to vary the display size from two nautical miles to 1024 miles; to enter navigation stabilization information; to drop smoke markers, and to enter information on visual contacts.

In spite of the additional navigation systems in the P-3C, the computer does such a smooth job of solving problems and handling communications that one crewman can now handle both the navigator's and radio operator's jobs, the Navy says.

A digital link allows the navigator/communicator to transmit accumulated computer information automatically to other ASW aircraft or to shore units. He is also able to type out a message on a solid-state teletype set, check his message for errors as it appears on a small CRT, then push a button that automatically transmits it at 3000 words a minute.

For navigation, the P-3C has an inertial system. For obtaining position fixes to update the inertial, there are doppler, radar, loran and celestial facilities.

The A-New avionics system in the P-3C will also be used in the S-3, formerly known as the VSX, a carrier based ASW aircraft that will replace the S-2. A contract for the S-3 will be awarded soon.

The ordnance system is integrated with the search, detection and data-processing systems to release weapons automatically at a predetermined point.



Operator in S-2E carrier-based patrol plane looks at magnetic anomaly detector display below radar scope. ECM is upper right.

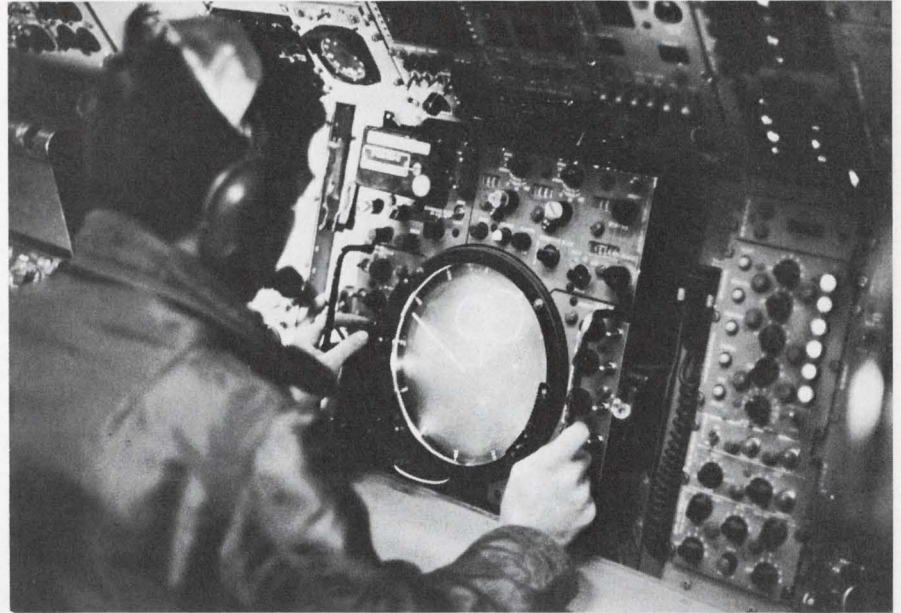

Tactical coordinator in a patrol plane, the P-3 Orion, watches the computerized display on his AN/ASA-16 indicator for sonobuoy positions and signals. Circles show sonobuoy range, while straight lines show range and bearing. The Orion is the Navy's newest land-based ASW aircraft.

where it should be placed on the ship—if, indeed it should be on the ship at all—and how it can be improved.

Some destroyer commanders like the big, brute-force sonar mounted on the forward hull—like the AN/SQS-26, the biggest of all, which is on a number of new destroyers and is scheduled to go on the DX class that will be built soon.

The SQS-26 is a multimode, high-power sonar system that can operate in active and passive modes at the same time. In the active mode it operates in the three basic propagation paths—surface duct, convergence zone and bottom bounce.

In surface duct, or direct propagation, the signal goes out from the transducer at the transducer's level. It remains in the same sound duct, not descending below the first thermal layer. The range is limited in this mode.

"A more sophisticated route, and one that reaches greater distances," explains the Navy's Peterson, "is the convergence zone. In the upper region of the ocean, temperature generally decreases with increasing depth which makes the pulse travel in a downward direction. Below the axis of the sound channel, temperature is constant and increasing pressure causes the pulse to move toward the surface

again. The sound from a transducer tilted down at the right angle will reach the surface again about 30 miles away. If the water is too shallow and the pulse hits bottom before the proper temperature pressure balance is reached, the convergence zone approach won't work.

"The third route is to utilize the bottom for bouncing pulses back to the surface. This approach is good when the bottom is too close for the convergence phenomenon to work or when the sonar operator wants to look at a range shorter than 30 miles."

The SQS-26 can introduce sound in the surface duct with either a 360-degree omnidirectional transmission or a 120-degree directional transmission. The bottom bounce and convergence zone paths extend over a 120-degree arc. Simultaneous operation of several combinations are possible: bottom bounce and omnidirectional surface; and 120-degree and 360-degree surface.

But the SQS-26 is an enormous piece of equipment. Besides a gigantic dome covering the entire forward hull of the ship, it requires 50 cabinets. A General Electric official says:

"The size of sonar systems must be drastically reduced. If the Navy says it wants three times as much power as the SQS-26 now has, what

do we do? Build a system that needs 150 cabinets? There'd be no room on the ship. The physical size of sonar must come down by using microcircuitry. And the efficiency must be improved to get more out of less power. We have to move in both directions."

Making the SQS-26 reliable has been a career in itself. John Fleischmann, special assistant for program planning of the SQS-26 project office in Washington, says:

"We designed reliability into the equipment and spelled it out in the contract. Our problem was not any specialized environmental thing, but one of sheer quantity and mass of components. There are literally millions of components for the SQS-26 in one ship. How did we make it reliable?"

"We determined the real requirements. We didn't say we want 100 per cent. We decided on what we did want, realistically, and stuck to it. We didn't take less."

"Often a design engineer when developing a new circuit will sacrifice reliability to achieve the design. Or for early delivery or cost. We don't want this. Reliability is written into the contract as a requirement, as well as a strong incentive."

Fleischmann explains how the project officer goes about getting reliability:



Crewmen aboard a P-3 Orion patrol aircraft load a sonobuoy into an ejector. The computer helps decide when the sonobuoys should be ejected, then proceeds to sweep the frequencies to monitor those sonobuoys that are active.

"First, we make reliability predictions based on the historical data on the components and circuits. As you design, you continue to predict, using historical data, all based on component stress. If a certain component is 100 volts and you operate at 25 volts, it is a 25 per cent stress. Generally we rate below 10 per cent. A 100-watt resistor is operated at 10 watts. We do a great deal of derating, often 10 per cent or below.

"Besides derating, there is redundancy, on-line—automatic redundancy. When one component fails, the other automatically takes over. An automatic sensing device—a multivibrator or something of that nature—puts the standby into the circuit.

"Redundancy is the major reliability technique used by the Soviets. The disadvantage of redundancy is that you have two parts and there's a space problem. Sometimes you just don't have room for two of everything.

"What you do is to eliminate the components that have high failure rates and redesign that portion of the system. We want circuits as simple as possible. And we want fewer parts. The more parts you have, the more failures you have. This is one of the guides we give designers.

"Electro-mechanical components have been a problem, but they're being replaced by solid state, IC and SCR."

Admiral Armstrong in Washington notes:

"The SQS-26 has tremendous power. But you can put just so much energy into the water, and no more, because of cavitation."

Cavitation, explains the Navy's Peterson, "is an air-vapor pocket that forms in front of a transducer when high power is emitted. This pocket, unfortunately, separates the transducer from the water and cuts off transmission. This is the main limitation on radiating energy into water."

Besides interrupting transmis-

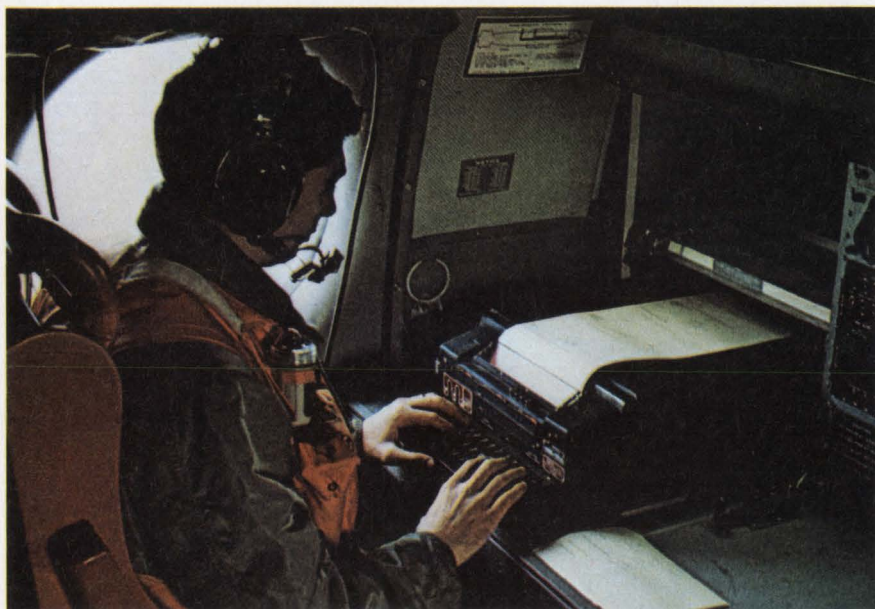

Radio operator on P-3 Orion can send teletypewriter messages over two AN/ARC-94 high-frequency transceivers.

Long, stinger-like tail of the P-3C houses the magnetic anomaly detector. This reports disturbances in the earth's magnetic field, like those made by the metal hull of a submarine. Effort now is to improve the detector's range.

sion, says Capt. William Wicks, director of the Navy's Sonar Systems Office in Washington, "this implosion between pulses causes another problem: The cavitation vacuum bubble bursts, creating a broadband noise that physically injures the transducer and erodes the propeller."

Peterson notes:

"Hull-mounted sonar at a depth of 17 to 20 feet invariably begins to cavitate when power begins to build up. On a submarine or towed sonar you can go deeper, which alleviates the cavitation problem, but begins to create a materials problem. The greater the pressure, the stronger the ceramic material must be to keep out water or water vapor.

"The transducer element must be impervious to water," Peterson says, "because of the high voltages involved. Water creates corona problems with the electrodes, and a voltage breakdown can occur."

The SQS-26 transducer is made from an electrorestrictive material, barium titanate.

"So with cavitation limiting us, where do we go from here?" Admiral Armstrong asks. "We're working with the British on an array system of hydrophones around the hull of a ship. With this, we believe we can get longer ranges at higher speeds."

More power with tradeoffs

A General Electric official says:

"A conformal planar array is one way to get more power into the water. This lines the hull of the ship with transducer elements. The trade off is the introduction of technical problems, though.

"Beaming the element forward is difficult. Strung from fore to aft, the elements beam best in a perpendicular direction from the ship. Techniques are being developed, however, to get the beam directional."

Admiral Armstrong says that "all kinds of possibilities" are be-



ing studied.

"A destroyer might control a system that's working 2000 or 3000 feet deep," he says. "It could be a manned submarine, an unmanned sonar platform or a very deep, variable-depth sonar dragged by cable through the water. We lower our variable-depth sonar now to a depth of 500 feet.

"The French and Canadians are looking at variable-depth sonars that go down to 1000 feet. But there's a tremendous mechanical problem just getting this thing off and on the ship and towing it. A tremendous drag. Also, you don't know where the sonar is.

Captain Wicks agrees that variable-depth sonar offers an advantage in getting the detector below thermoclines, which imprison sound in their layers the way waveguides channel radio waves. "But," he

says, "there's a loss of power in the signal's passage up the cable to the ship."

Cmdr. J. R. Pouliot, captain of the destroyer Borie, disagrees with ASW commanders who don't like variable-depth sonar. "A lot of people can't get used to it or are afraid of it in some way," he notes. "All I know is I use it and like it, even though it does weigh 500 pounds. For us, it works as well if not better than the hull-mounted sonar."

Towed linear arrays, which have the advantage of operating to the rear of the ship's noise, are being developed for both surface ship and submarines. Their disadvantage is that they don't see in front of the ship. Also, they are fairly unwieldy for submarines.

Raytheon points out a mechanical problem for the sonar maker—

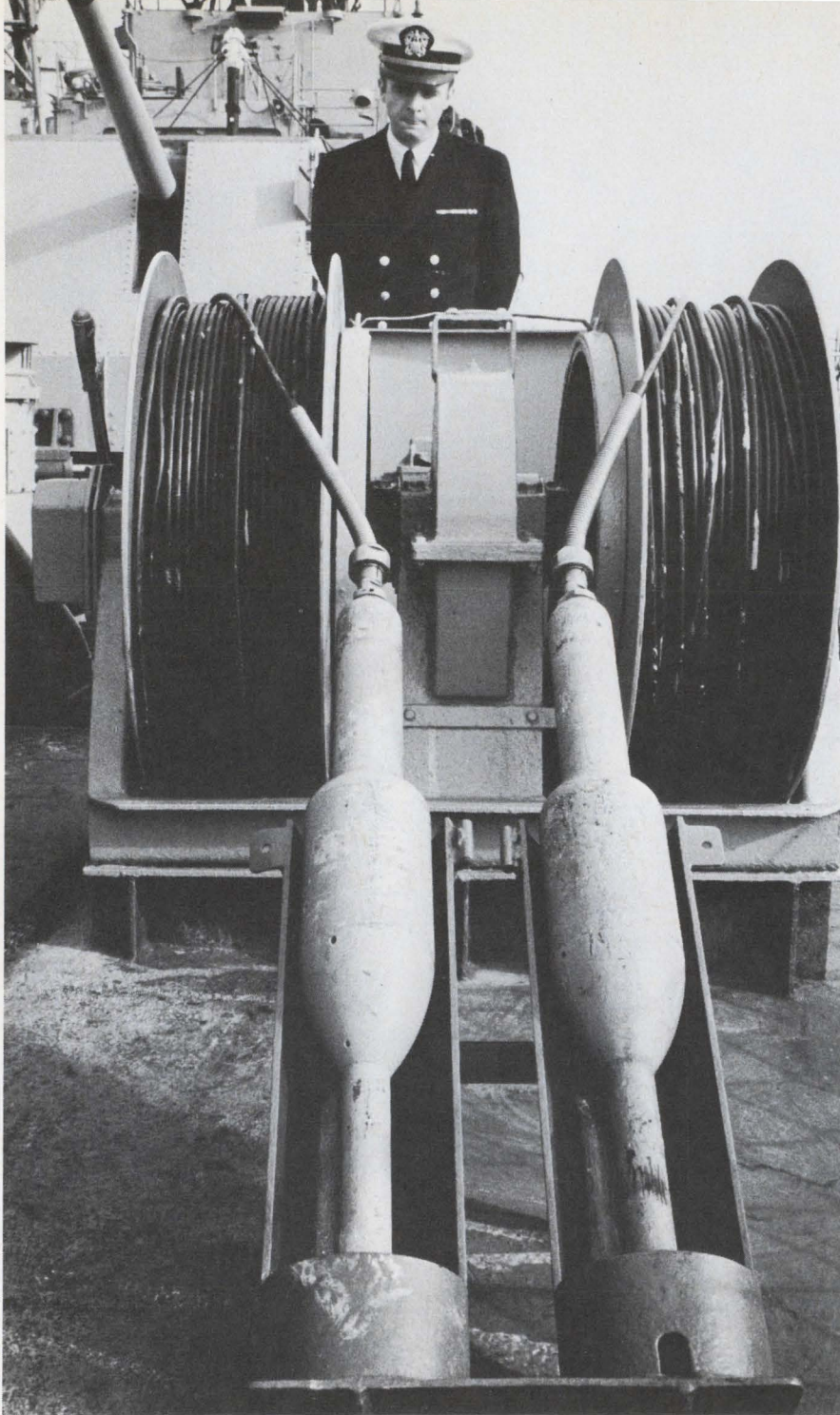

To mislead enemy sonar, these decoys, called Fanfare, are reeled out to a considerable distance behind the ship, where they put out more destroyer-like noise than a real destroyer. Hopefully, they will draw the enemy fire.

particularly with submarine sonars—that is getting worse: the need to dispose of the heat generated by the electronic equipment without injecting it into the submarine's environment. This is becoming more and more difficult because the amount of sonar equipment is increasing and is being crammed into less and less space. A typical sonar today requires more than 30 cabinets of electronic equipment.

One solution is to dissipate the

heat on water rather than into the air. Hollow plates, through which water is continually circulated, can be placed within the electronic cabinets.

Bonding materials used to fasten a water-protective rubber boot over the ceramic transducer are sometimes a problem, according to Thaddeus G. Bell, head of the systems analysis staff at the Navy Underwater Sound Laboratory in New London. The bond often comes

loose, damaging the transducer.

"Noise reduction is another goal," Bell says. "The transducer must be mounted properly, so the panels and surfaces don't vibrate." Peterson noted that the dome construction must be a compromise; it must be structurally strong but also streamlined and quiet and acoustically transparent.

Commander Pouliot, who works with big, hull-mounted sonar, says he has trouble with the transducers.

"They short out and deteriorate and we don't get new replacements," he reports. "The Navy just takes the old ones and revamps them. This can be bad. A dead transducer puts you out of business. And getting it repaired is a big job. It means dry-docking the ship, taking the dome off, putting a new transducer on and sending the old one back to the factory.

"We know when a transducer is about to go—when we need more and more power to maintain the signal level. At a point, this eventually begins to burn out the internal system. Vacuum tubes start to burn out. A gradual deterioration takes about seven or eight months."

Preventive maintenance

Testing a sonar system is a big job. There are hundreds of points to test. A typical sonar, for example, has more than 600.

"When a single pulse goes out from a sonar," a Raytheon engineer says, "we monitor the voltage, the phase, amplitude, phase angles, power, impedance—all of its elements. This used to take time. Now, with a single ping, we can do it. We put the ping into the computer, store it and measure all its aspects at once.

"Many things need to be tested in a large array of transducers. There is often interaction between the elements. Sometimes you get a negative impedance from one due to the way the sound happens to meet at the face of that particular element. In some cases you can almost get a negative impedance which acts like a real short-circuit. Dumping a lot of power into negative impedance obviously means trouble."

The Raytheon engineer tells how examining a single pulse can add

to the efficiency of the system. "A transducer beam by itself," he says, "can be measured very accurately. From the measurement, you can extrapolate all you want, both sideways and up and down. You can calculate what kind of beam should be formed. But when you put the unit on a sub or a test vehicle and start checking under actual conditions, the interaction between the elements—depending on where they are spaced—can give you beam patterns you never dreamed possible. But by monitoring essentially the impedances and the phase angles of the various transducers on a single ping, you can determine how the array will work and what the beam pattern is going to be.

"Built-in test equipment for on-line monitoring is more important for digital equipment than for analog. A digital console in a submarine sonar system might contain up to 1200 integrated-circuit modules. If one flip-flop goes bad, you want to know where it is. Also, technicians aren't familiar with digital systems yet; their experience has been with analog. We're now putting test features in our sonars that will localize a fault down to a 10-module area."

Seeing Raytheon's newest submarine sonar bears out the last statement. The transducer is large enough to walk into—and the electronics are contained in more than 30 cabinets.

Processing the signal

General Electric's Heavy Military Electronics Dept. in Syracuse, N. Y., has done considerable work on signal processing and data handling for a conformal planar array sonar. Signals were both surface duct and narrow-band bottom bounce. The dominant philosophy in the signal processing was the use of coherent pre-detection processing and post-detection noncoherent combining of received signals.

Initially the design used specialized processors for each mode, surface and bottom bounce. This called for a hybrid of analog and digital techniques. Later the emphasis shifted to all-digital techniques capable of accommodating a large variety of signal waveforms on a flexible basis. As a result, the con-

cept for the processor was modified to handle all the waveform with the same digital stored reference correlators. Design studies are in progress to define further the exact configuration.

The high data rates expected from a planar array demand automatic handling of the data. From a single ping, the signal processor must detect the target, classify it as a threat or non-threat and continue to track it.

GE has also worked on the design of a beam former for the planar array. The beam former is digital, and it uses both phase and delay for the beam-forming functions. It compromises the desirable aspects of both the time-delay beam former and the phase-steered beam former. Its major advantage results from the fact that the sampling rate is dictated by the signal bandwidth, not the highest

continues in this area. Reportedly such systems would be used in ASW aircraft to look deep below the surface of the sea.

One far-out technique for "seeing" through water is called sonography—a combination of holography and sonar being worked on by CBS Laboratories, Inc., at Stamford, Conn., under contract from the Office of Naval Research. The result is a television-like image of targets under water at distances up to 100 yards.

CBS is to develop a breadboard model of the device this year. The sonograph consists of an active transducer that emits sonar waves; specially designed hydrophones to monitor the acoustic sound waves that come back from the target, and an electron gun in a specially designed tube to scan the sonic information onto thermoplastic film. A stereoscopic image pair is then

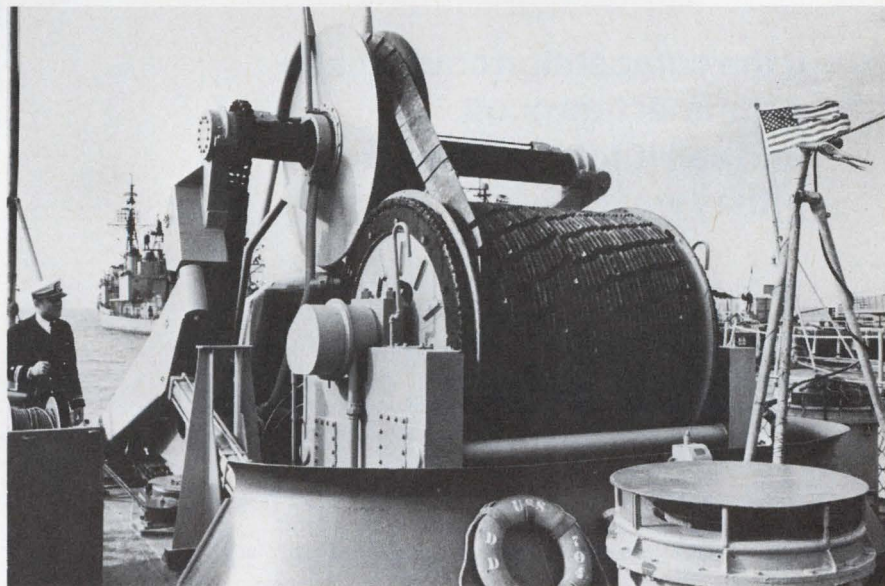

Variable depth sonar on board the destroyer Borie is lowered by this cable to a depth of 500 feet. The transducer weighs an unwieldy 500 pounds, but the Borie's electronics officer likes it better than the hull-mounted sonar.

frequency of the received signal. This allows the sampling rate to be reduced significantly and reduces the signal storage requirements.

Finding new ways to see subs

Although sound is still the best way to penetrate water, other techniques are under study. Blue-green lasers have met with some success, and highly classified work

projected by a helium-neon laser from the thermoplastic film onto a screen. The result is an acoustic holograph.

The director of the project, William E. Glenn, who is general manager of applied research for CBS Laboratories, says, "We're investigating use of different frequencies as a means of simulating color to distinguish details of the objects, such as distinguishing a submarine from a whale." ■■

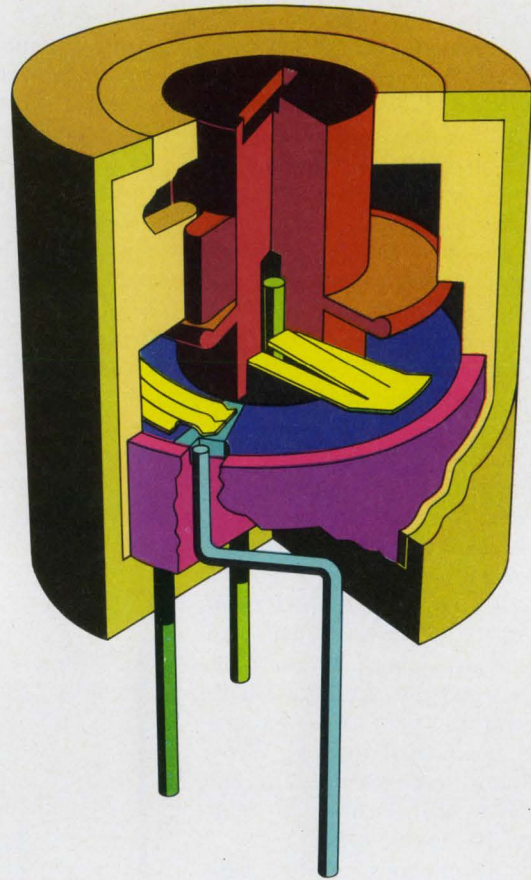

**If the competition could make
a trimmer this good
and sell it for less than \$1
— they would!**

The Spectrol Model 53 is the smallest industrial trimmer yet devised to incorporate all of these quality features:

BEST SETTABILITY — A unique mechanical design and extra-long cermet element (up to one-third longer than the competition's) that provide the fastest, most accurate settability and best mechanical stability available in a subminiature industrial trimmer.

NONCONDUCTIVE SEAMLESS CONSTRUCTION — An insulated, sealed, seamless housing (with standoffs) that guards against leakage, moisture, voltage breakdown, and accidental shorting . . . permits safe maximum-density packaging.

QUALITY WITH ECONOMY — The highest quality available at the lowest price in the industry — both top and side adjust lower than \$1 in quantity.

For the full specs and how to get free samples, just write, or circle the reader service card. You'll also learn about a trimmer "settability test" that could save you time and money. Meanwhile, you'll find 53's stocked at your local distributor today.





ABM: Will Nixon Compromise?

A "best guess" consensus at the time of this writing is that Nixon will not budge on his ABM stand. Although, after the sudden cancellation of the Manned Orbit Laboratory project last month, few are willing to make serious predictions about what will happen next, many believe that the Nixon Administration made its major concessions with the cancellation of MOL and the withdrawal of troops from Viet Nam. It is believed that these actions were made to appease both Defense Dept. critics and doves—and that now President Nixon will strive for the two-site deployment of Safeguard. It is further believed that he will continue to take his case by commercial TV to the American people (as with the recent televised press conference) and that pressure from the public—either way—will decide the issue in Congress.

At present, however, there seems little doubt that a majority of Congressmen in both houses would support a continuance of the ABM program, as long as it remains in the R&D phase. The crux of the argument seems to be the weapons deployment part of the program. That is, if one ignores the arguments concerned with the vulnerability of the largely exposed but critical missile site radars.

There is considerable discussion here within Congress and among industry representatives as to the possibility of compromise. Such an approach would involve the Administration's accepting only the installation and testing of the two major radar facilities in the Northwest. In such a compromise there would be no deployment of either Spartan or Sprint ABMs, although both would be involved in considerable flight testing at White Sands Missile Range and the Kwajalein test site in the Pacific. Others say that such a compromise would be self-defeating to the avowed purpose of the Nixon Administration in its quest for limited ABM deployment—that is, it would be impossible with such an approach to meet the global strategic threat expected by 1973-74.

Washington Report

CHARLES D. LAFOND
WASHINGTON BUREAU

The first vote following considerable debate on the money bill for the ABM should come up shortly in the Senate. If President Nixon does, in fact, carry his case to the people, the belief here is that the bill will be passed by a very narrow margin. It will then be passed by a heavy majority of the House. Should the Administration fail to see passage of a bill supporting the President's cause, many here believe he will have suffered a devastating blow to his leadership and very possibly to his political future.

MIRV battle due to be renewed

With the heat of conflict over the ABM rising to a peak, arguments against MIRV testing have been reduced, but only temporarily. Opponents of MIRV (Multiple Independently-Targetable Reentry Vehicle) are expected to take up arms again for suspension of testing later this summer.

At his recent televised press conference, President Nixon said that the United States might suspend tests on MIRVs if the Soviet Union would suspend testing on its own multiple-warhead missiles.

"We are considering," the President said, "the possibility of a moratorium on tests as part of any arms control agreement." He stressed, however, that he would not agree to a "unilateral" suspension of such tests.

The argument for at least a one-year suspension by the Defense Dept. of planned testing is that continued testing of MIRV—which ultimately would be loaded on Minuteman III and Poseidon missiles—can only lead to nuclear arms escalation. This would, they say, reduce hopes for success in any arms control negotiations with the Soviet Union.

The counterargument from the Defense establishment is that the Soviets are known to be testing long-range missiles with multiple warheads—but what is not known is whether these test weapons have a capability for independent targeting (individual guidance

Washington Report

CONTINUED

for each warhead). It has been reported by Pentagon research chief Dr. John S. Foster that the Soviets have deployed over 200 SS-9 long-range ICBMs, that at the current production rate Russia will have 500 by 1974, and that each of these could carry at least three warheads giving them an attack force of at least 1500 individual warheads.

United States began MIRV testing on the Eastern Test Range last August, firing downrange to a splash area near Ascension Island. Over a dozen launches have been made, and military informants state that the weapons have shown high accuracy. Two more years of testing were planned before MIRV could be considered ready for deployment.

Seismic devices detect intruders

No matter how furtive and catlike an intruder's tread may be, it won't help him if his goal—the family jewels or a military secret—is protected by a new seismic type of detection device.

The detector is one of a family of seismic surveillance devices under development by Defense Electronics, Inc., Rockville, Md. One such unit being produced for the Army, provides four channels and can detect personnel movement within 100 yards of each implanted geophone. A second, now operational with one of the U. S. law enforcement agencies, can handle ten multiplex channels of four geophones each, or a total of 40 seismic detectors. The firm claims the latter system can provide surveillance coverage of up to 3.6 million square feet.

The 4-channel Army unit, called PERSID-4A Personnel Seismic Intruder Detector, is being developed under a \$65,000 contract. It employs passive geophones similar to those used by petroleum firms in oil exploration. The sensors are buried and linked to the control unit by wire at distances of up to two miles. The control unit amplifies the detected sub-audible ground vibrations caused by intruders, processes the signals, and produces an output sound similar to the original, the designers disclosed. Each channel has a separate light to indicate intrusions, thus permitting simultaneous monitoring of all four channels by an operator. Sensitivity is good: minimum

detectable signal at 14 Hz is less than 1 microvolt rms. Eight units will be built for the Army to undergo 60 days of field tests. The company claims that in production quantities the 3-1/2-pound detectors will cost less than \$1000 each.

The larger unit, called AIDS-10 Automatic Intruder Detection System, has undergone operational use in the field for about one year. The police agency using it reportedly claims a 95% capture ratio since deploying the detection system and has indicated it believes the other 5% represents intruders who avoided the surveillance net.

Jungle antenna developed for Army

Setting up radio antennas in the dense jungles of Southeast Asia has been a prime headache for our military—and one that may have been solved by Avco Corp. The company demonstrated a lightweight broadband vhf antenna kit at the recent annual Armed Forces Communications and Electronics Association conference in Washington, D. C. Developed by the firm's Electronics Division in Cincinnati, Ohio, for the U. S. Army Electronics Command, Fort Monmouth, N.J., the entire unit, including 87 feet of very thin flat rf transmission line and a 3-foot-long nylon carrying bag, weighs only 5 pounds.

According to Avco, the unit breaks down into sections and can be assembled in the field to its full 12.3-foot length on the mast in from 2 to 3 minutes, and can then be worked upward through heavy foliage with an 87-foot maximum reach. Once it is clear of vegetation, a nylon lanyard, attached to a ratchet and pawl mechanism, is pulled six times (a device prevents accidental deployment) to release the spring-loaded antenna elements. A similar operation collapses the antenna before the mast is retracted.

The vhf antenna operates in the 30-76 MHz range with no tuning required, has a 70-watt power capability, and weighs 3.3 pounds. It was designed to operate atop a Ryan Aeronautical Co. lightweight mast, and with standard Army field radios: AN/PRC-25, PRC-77, and VRC-12.

The antenna is essentially a broadband biconical dipole and is mainly of stainless steel construction. The center mast is aluminum alloy tubing. The assembly is designed as a better than 1/2 wavelength ground-wave antenna. Coverage is omnidirectional.

NEW

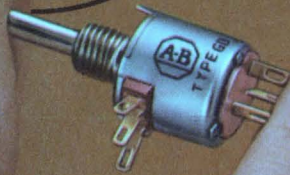

*New Allen-Bradley
hot-molded Type GD
dual variable resistor
shown actual size*

TWO
IN
ONE

Allen-Bradley hot-molded dual variable resistor

Here's the most compact two section variable resistor currently available—the new Allen-Bradley dual Type GD. It's one-half inch in diameter and only a fraction of an inch longer than the popular single section Type G control. The case is dust-tight as well as watertight. ■ Both resistance tracks in the dual Type GD are solid, hot-molded elements, which provide long operating life. As with the single Type G, the noise level is low initially and actually decreases with normal use. Adjustment is smooth at all times with virtually infinite resolution. And low inductance permits operation at frequencies far beyond the usable range of wirewound controls. ■ In addition to standard application, these new dual Type GD controls are ideally suited for use in compact attenuators. ■ Dual Type GD controls are available with nominal resistance values from 100 ohms to 5.0 megohms. For complete specifications on tolerances, tapers, and options, please write Henry G. Rosenkranz, Allen-Bradley Co., 1201 South Second Street, Milwaukee, Wis. 53204. Export Office: 1293 Broad Street, Bloomfield, N.J., U.S.A. 07003. In Canada: Allen-Bradley Canada Limited.



ALLEN-BRADLEY
QUALITY ELECTRONIC COMPONENTS

18.6 MHZ SELECTIVE LEVEL METER... EXCEPTIONAL ACCURACY... THE SPM-6

A field instrument with laboratory accuracy was our objective — a selective level meter with -100 dBm sensitivity and a phase locked, digitally indicated frequency setting to 18.6 MHz that could operate from rechargeable batteries or from the power line in a field environment.

To accomplish it we developed a new automatic calibration system which continually readjusts the amplifier circuits to

compensate for warm up drift, attenuator errors, frequency response errors and the majority of other causes of measuring uncertainty. The result is level measurements 5 to 10 times more accurate than can be made by most precision "laboratory" type instruments. The SPM-6 is, consequently, used in the lab and on the production line as much (and maybe more) than in the field.

Our philosophy is to produce only the finest measuring instrument current technology allows and to back them up with comparable service.

Wandel & Goltermann West Germany
represented in U.S.A. by W & G INSTRUMENTS, INC. 6 Great Meadow Lane, Hanover, N. J. 07936 • Tel: (201) 887-8700



SIDELIGHTS OF THE ISSUE

Anti-sub warfare—where the action is

There's a lot of activity going on down under the sea and high above it: It's the U. S. answer to reports of the growing superiority of the Russian submarine fleet. Security problems are firm, as Military/Aerospace Editor John F. Mason found out when he went after the story. He visited the Atlantic Fleet's ASW headquarters in Norfolk, Navy officials in Washington and the Underwater Sound Laboratory in New London, Conn. He also interviewed a number of engineers in ASW-oriented companies. The result is a comprehensive report, starting on page 34.



Vice Admiral Paul Masterton, commander of the ASW Force of the Atlantic Fleet in Norfolk, describes operational and equipment requirements to Military/Aerospace Editor John F. Mason.

Store this data in your memory bank

ELECTRONIC DESIGN has a new computer editor—Milton J. Lowenstein. He was previously with Ford Instrument Co. in New York City, where he worked, as principal engineer, on analog computers, and digital and logic design. Before that, he was a senior engineer at Fairchild Camera and Instrument Corp. at Hicksville, N. Y. There he worked in computers and controls for airborne photo systems.

Milt earned his BSEE at Rose Polytechnic Institute, Terre Haute, Ind., and his MSEE at Columbia University.

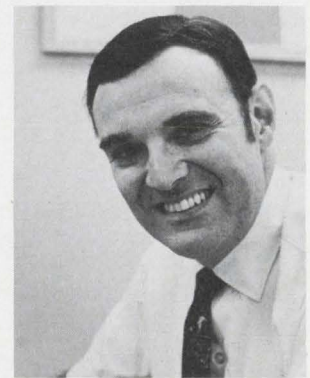

Milton J. Lowenstein

Allen-Bradley's experience in resistor production reaches...

to the moon and back!

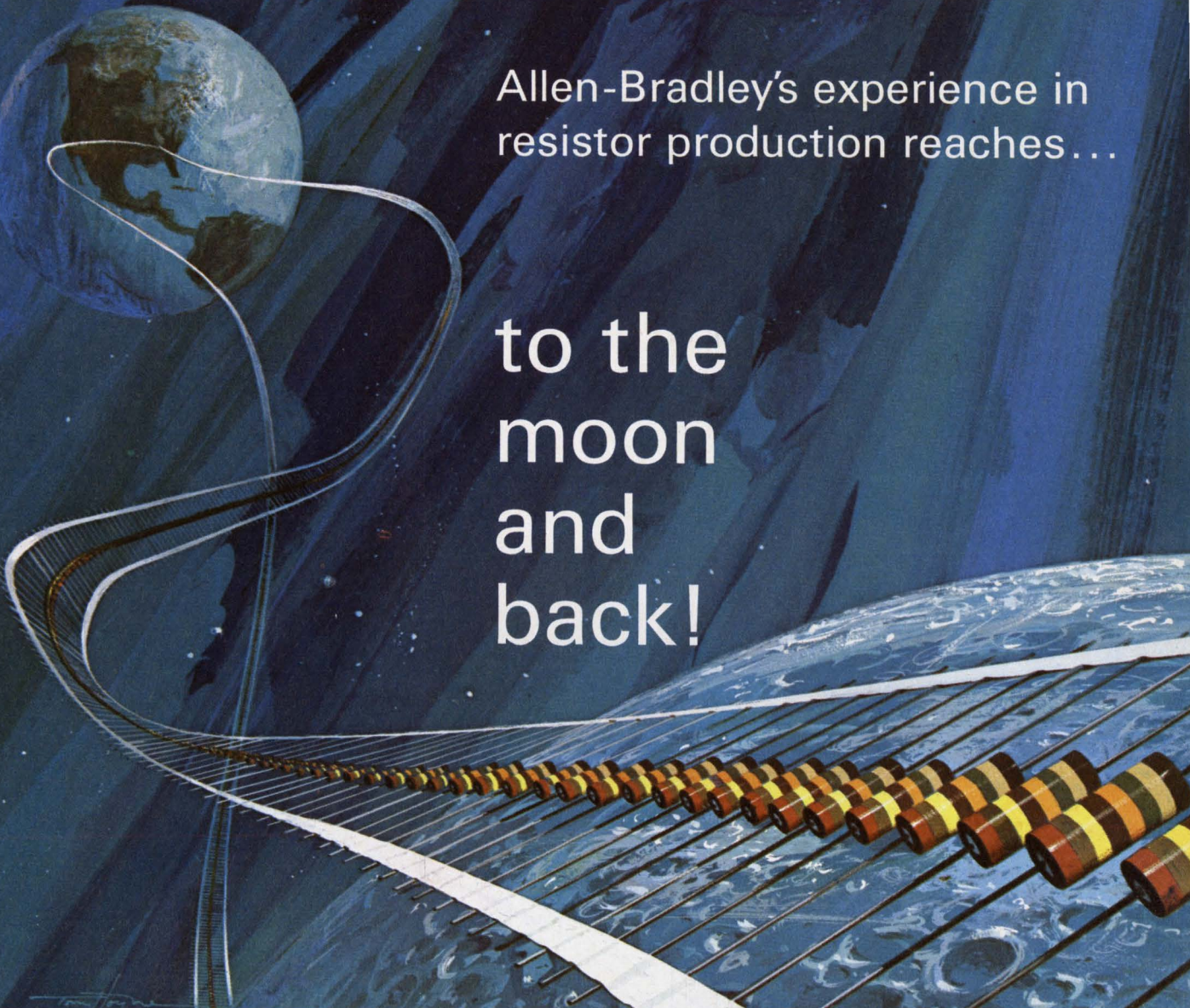

TYPE BB 1/8 WATT



TYPE EB 1/2 WATT



TYPE HB 2 WATTS



TYPE CB 1/4 WATT



TYPE GB 1 WATT

A-B hot-molded fixed resistors are available in all standard resistance values and tolerances, plus values above and below standard limits. **A-B hot-molded resistors meet or exceed all applicable military specifications including the new Established Reliability Specification at the S level.** Shown actual size.

After more than three decades and untold billions of hot-molded resistors, Allen-Bradley has accumulated manufacturing "know-how" which cannot be approached by anyone else. The fact that the resistors made by A-B over the years—if placed side by side—would more than reach to the moon and back, may be impressive. But "how" they are made is the key.

Allen-Bradley resistors are produced by an exclusive hot-molding technique—developed by A-B. They're made by completely automatic machines—also developed, built, and used only by Allen-Bradley. The human element of error is removed. Uniformity is so precise from one resistor to the next—year in and year out—that long-term resistor performance can be closely predicted.

And there has been no known incident of catastrophic failure of an A-B hot-molded resistor.

The reputation for quality and performance established by Allen-Bradley hot-molded resistors is reflected in the fact that they have been an integral part of virtually every U.S. space probe. And they are "on" the moon. No other resistor applications demand a higher measure of reliability.

For detailed specifications on this superior line of hot-molded resistors, please write Henry G. Rosenkranz and request a copy of Technical Bulletin 5000: Allen-Bradley Co., 1201 South Second Street, Milwaukee, Wisconsin 53204. Export Office: 1293 Broad St., Bloomfield, N.J., U.S.A. 07003. In Canada: Allen-Bradley Canada Limited.

EC 6815

QUALITY ELECTRONIC COMPONENTS



ALLEN - BRADLEY

We invented the world's fastest TTL. We sell the industry's broadest TTL line. We're at full production now.

But we're improving.

In January Raytheon bur-geoned their TTL line by introducing Ray III, the market's fastest saturated logic. With $4\frac{1}{2}$ nanosecond gate delays and 9 ns flip flops, it's nearly twice as fast as Ray II, SUHL II and 54H/74H.

But speed's just a chunk of it. Ray III is electrically and pin-compatible with Ray I, Ray II and the rest, but doesn't use any more power. Rise and fall times are the same, so you don't inherit any new wiring problems. We've put split outputs on some functions to provide you with wire-OR capability. As for function selection — just check this list of Ray III types. All 26 are available from your friendly Raytheon distributor.

And you ain't seen nothing yet. Here come de MSI. On the way right now we have a parity generator/checker; a 4-bit adder and carry decoder; a program-able up/down counter; and a 4-bit universal shift

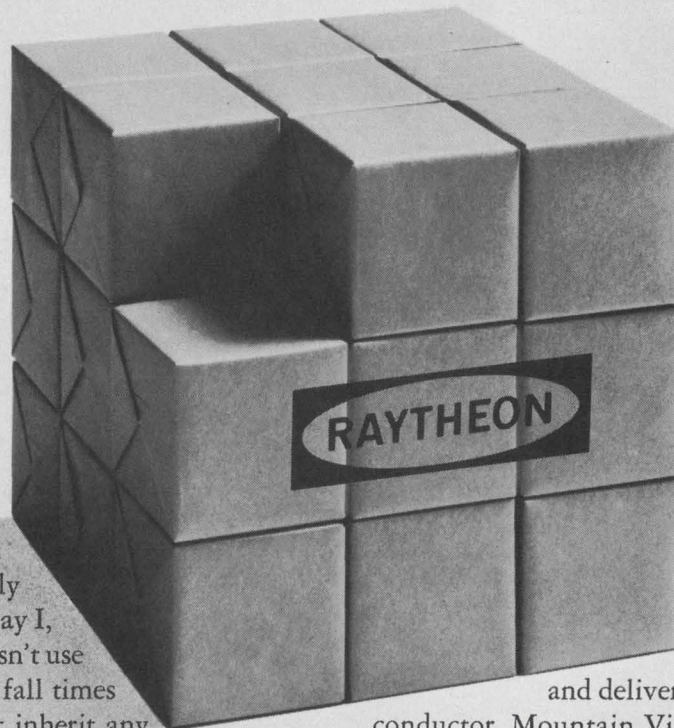

register, with more to fol- low. After that? Ray VI, a 2 ns T^2L MSI line with shallow diffusions, washed emitters, Shottky barrier Baker clamps, high den- sity gold interconnects and tunneling Shottky barrier resistors.

Send for Ray III data sheets and franchised dis- tributor list from the com- pany that gets the ideas

and delivers the goods. Raytheon Semi- conductor, Mountain View, Calif. (415) 968-9211.

RAY III HIGH SPEED TTL

Type No. -55°C to +125°C	Type No. 0°C to +75°C	Description
RG3180	RG3182	Dual 4 Input AND Expander
RG3200	RG3202	Expandable Single 8 Input NAND Gate
RG3240	RG3242	Dual 4-Input NAND Gate
RG3260	RG3262	Single 8-Input NAND Gate
RG3220	RG3222	Quadruple 2-Input NAND Gate
RG3320	RG3322	Triple 3-Input NAND Gate
RG3420	RG3422	Dual 4-Input NAND Gate, Split Outputs
RG3430	RG3432	Single 8-Input NAND Gate, Split Outputs
RG3210	RG3212	Expandable 2-wide, 4-Input AND-NOR Gate
RG3230	RG3232	4-Wide 2-2-3-3 Input AND-NOR Expander
RG3250	RG3252	Expandable 4-Wide, 2-2-2-3 Input AND-NOR Gate
RG3270	RG3272	2-Wide, 4-Input AND-NOR Expander
RG3300	RG3302	Expandable 3-Wide, 3-Input AND-NOR Gate
RG3310	RG3312	Dual 2-Wide 2-Input AND-NOR Gate, One Side Expandable
RG3440	RG3442	2-Wide 2-Input AND-NOR Gate, Split Outputs
RG3450	RG3452	4-Wide 2-2-3-4 Input AND-NOR Gate
RG3380	RG3382	Hex Inverter
RG3390	RG3392	Dual 4-Input AND Gate, Split Outputs
RG3400	RG3402	Quad 2-Input AND Gate
RG3410	RG3412	Quad 2-Input NOR Gate
RF3200	RF3202	AND Input JK Flip Flop
RF3210	RF3212	OR Input JK Flip Flop
RF3120	RF3122	Dual JK Flip Flop (Separate Clocks)
RF3130	RF3132	Dual JK Flip Flop (Common Clock)
RF3220	RF3222	Triple Latch Cell
RF3230	RF3232	60 MHz Dual-D Flip Flop

All types available in hermetic or plastic DIP's, or in flatpacks.

Publisher

Hugh R. Roome

Editor

Howard Bierman

Managing Editor

Frank Egan

Technical EditorsMilton J. Lowenstein
Michael J. Riezenman
Raymond D. Speer
Stella Lawrence**Management and Careers Editor**

Richard L. Turmail

News EditorsRalph Dobriner, Chief
John N. Kessler**Washington News Bureau**

Charles D. LaFond, Chief

Military/Aerospace Editor

John F. Mason

East Coast Editor

Jim McDermott

West Coast EditorsElizabeth deAtley
David N. Kaye**New Products Editor**

Lucinda Mattera

Copy Editor

Marion Allen

Editorial ProductionDollie S. Viebig
Phyllis Gura**Art Director**

Clifford M. Gardiner

Art Assistant

William Kelly

Technical IllustratorsWilliam Alvarez
Rita Jendrzewski
Lynn E. Thompson**Production Manager**

Thomas V. Sedita

Asst. Production Manager

Helen De Polo

Production AssistantsBernard Wolinsky
Carl A. Merkin**Circulation Manager**

Nancy L. Merritt

Information Retrieval

Genate Piccinetti



Aren't engineers entitled to job security, too?

The engineering profession is in one of its recurrent crises. As usual, defense policy is the culprit. When Congress is generous with Defense Dept. appropriations, contracting increases and industry proclaims the existence of a "shortage of engineers." When Congress tightens the purse strings, as is now the case, defense projects are stretched out, engineers are laid off, and no one mentions any shortage.

Some recent publications point up the problems. *The Professional Engineer in Industry Newsletter*, a publication of the National Society of Professional Engineers, reports that a study in the San Francisco area showed defense contracts canceled on short notice and engineers laid off on equally short notice. What is more, inadequate severance pay was given, and older, presumably higher paid men were the first to go. No correlation to "skill obsolescence" was found. An adjacent column in the same newsletter deplored union activity among engineers on the grounds that "collective bargaining for professional engineers is in conflict with the basic principles of a professional individual." The national society favors "constructive relations between professional engineers and management."

But can "constructive relations" come about without some form of coercion? Perhaps the National Society of Professional Engineers should attempt to provide the needed coercion before an established labor union fills the vacuum.

Or perhaps the coercion will come from another source. The Engineers Joint Council has just published the results of a survey, "The Engineering Profession: A New Profile." Among other facts, it reveals that younger, less experienced, engineers make up a smaller fraction of the total work force than older men do. This is exactly the reverse of what is to be expected from a growing, prosperous occupation and it could lead in time to a real scarcity of engineers. But in the meantime what of the engineer who is trapped in a period of sudden layoffs? Is he not entitled to the same basic job rights that teamsters, say, enjoy?

Survival in the modern world requires organization. Business is well aware of this—a fact that can be confirmed by a look behind the facade of any large company. Moreover the advent of the computer has not only increased the need for organization; it has also increased the ability to organize. With this degree of economic power arrayed on the side of business, should not engineers attempt to balance the scales by effective professional organization?

When such diverse groups as policemen, ballplayers, professional golfers, teachers and medical doctors find that effective organization is the key to survival in the modern world, can engineers settle for anything less?

MILTON J. LOWENSTEIN

RCA Solid-State Data for Designers

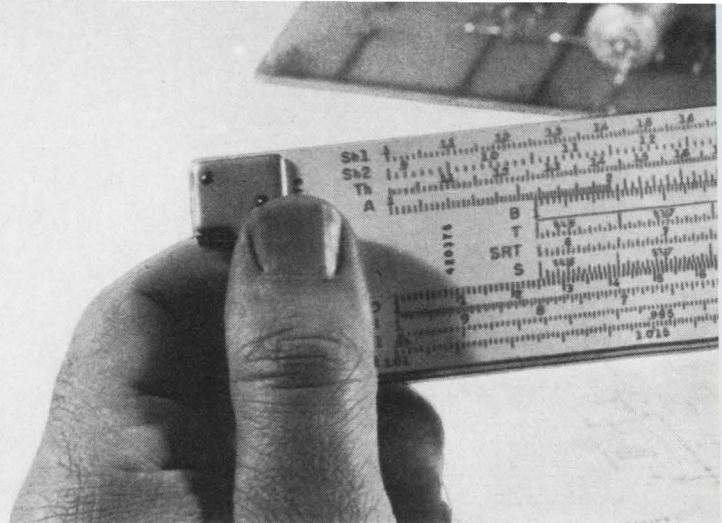

Design with New Dual-Gate MOSFET and Forget About Transient Voltages

RCA's new 40673 permits you to take full advantage of the superior high-frequency performance characteristics of dual-gate MOSFETs without concern for transient breakdown problems. Back-to-back diodes—Transient Trappers—diffused within the same silicon pellet as the MOS Field-Effect Transistor, guard each gate against:

- Static discharge during handling operations without the need for external shorting mechanisms
- In-circuit transients

Typical characteristics of the RCA-40673 are:

- Power Gain (MAG) = 20 dB @ 200 MHz
- Noise Figure (NF) = 3.5 dB @ 200 MHz
- Superior Cross-Modulation Characteristics

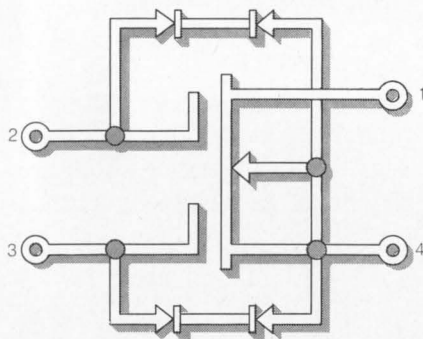

- Wide Dynamic Range Without Diode Current Loading
- Reduced Spurious Response
- Extremely Low Feedback Capacitance = 0.02 pF
- Simplified AGC Circuitry

Recommended for RF Amplifier applications up to 400 MHz, RCA-40673 MOSFETs may also be used as RF Amplifiers, Mixers and IF Amplifiers in:

- TV Receivers
- FM Radios
- Aircraft and Marine Vehicular Receivers
- CATV and MATV Equipments
- Telemetry and Multiplex Equipments

For more detailed information, circle Reader Response No. 231.

5 Transistor IC Array In DIP—CA3046, 98¢ (1000 Units)

For design flexibility and big economy in all types of signal processing systems, from DC to 120 MHz, investigate RCA-CA3046 Linear Integrated Circuit Array. In this five-transistor monolithic array, transistor pairs are V_{BE} matched to within ± 5 mV, with a $2 \mu\text{A}$ Input Offset Current at I_C of 1 mA. Noise Figure is 3.2 dB (typ.) at 1 kHz.

Use this array as five discrete transistors in conventional circuits, or as differential pairs in your custom circuit configurations.

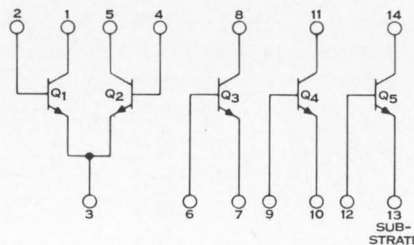

This array is also available in dual-in-line ceramic package at \$1.50 (1000 units) for use over the full military temperature range. Circle Reader Response No. 232 for full information, including pertinent Applications Notes and a copy of "Design Ideas for RCA Linear Arrays."

MSI Adds New Cost Effectiveness To COS/MOS Technology

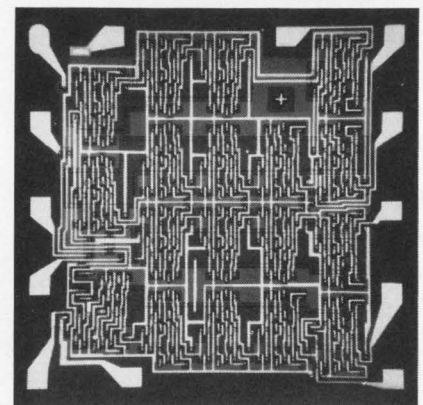

The new RCA-CD4006D, 18-stage Complementary Symmetry MOS Static Shift Register, with over 200 MOS transistors, provides the unique performance advantages of COS/MOS circuits with real-world economics.

The CD4006D @ \$17.25 (1000 units) provides military-temperature range operation at less than \$1.00 per flip-flop. Design features are:

- -55° to $+125^\circ\text{C}$ operation
- 100 nanowatts quiescent dissipation (typ.)
- 18 stages in 4 and/or 5 bit sections
- Static to 2 MHz shift rate
- Single phase clock
- Single 6- to 15-volt power supply
- 4-volt noise margin (10-volt logic)

CD4006D in ceramic dual-in-line package is \$25.00 (1-99 units).

Effective July 1, 1969, CD4006 in ceramic flat pack is \$26.50 (1-99 units).

For technical information, circle Reader Response No. 233.

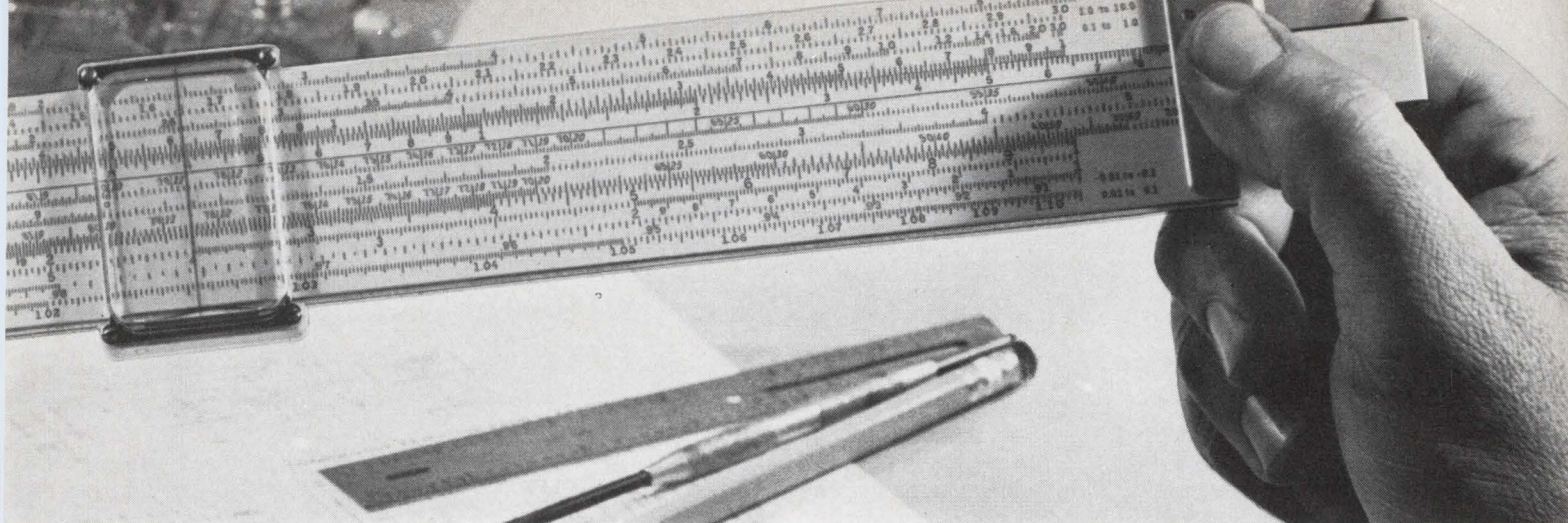

Sock It to These Triacs—at 10 A and 15 A (RMS)

More and more users are finding more and more uses for RCA Triacs. Join them with these additions to the growing RCA line of Thyristors:

10-ampere types 2N5567, 2N5568 (press-fit) and 2N5569, 2N5570 (stud types) handle 10 A (RMS) at T_c of $+85^\circ\text{C}$ and conduction angle of 360° . Repetitive peak off-state voltages are rated at 200 V for 2N5567 and 2N5579, and 400 V for types 2N5568 and 2N5570. Gate characteristics are controlled in all four firing modes.

15-ampere types 2N5571, 2N5572, 2N5573 and 2N5574 have 15 A (RMS) on-state current rating at the same repetitive peak off-state voltage ratings and T_c as their 10 A "brothers."

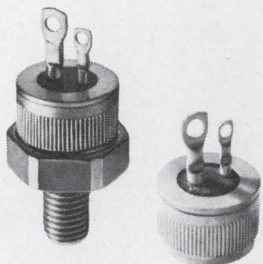

Check RCA for the widest line of Thyristors—from low-signal units to heavy-duty industrial-type devices. And Circle Reader Response Number 234 for details on the complete line.

Top Performance Point for 100 W Silicon Power Transistors

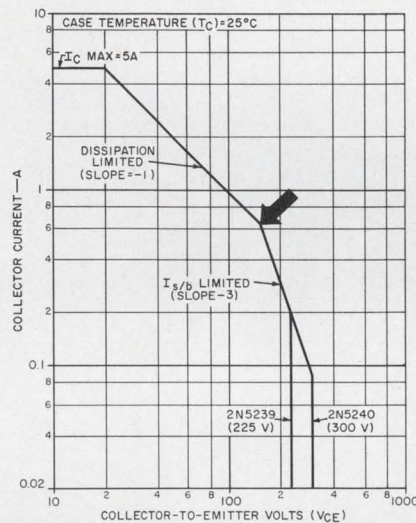

Full second breakdown protection up to 100 W and 150 V—plus safe area rated up to 300 V! That's a power level, performance and reliability no other high-voltage silicon transistor can match.

To you, this means better performing, more reliable performance for high-voltage regulators, series regulators, high-speed inverters for off-the-line operation, switching bridge amplifiers for servo motor controls, and ultrasonic power amplifiers.

Choose between the 2N5240 with a V_{CER} (sus) of 350 V or the 2N5239 with a 250 V rating. Both have an I_C (max.) of 5 A and P_T (max.) of 100 W. Both are in TO-3 packages.

For more information, circle Reader Response No. 235.

For price and availability information on all solid-state devices, see your local RCA Representative or your RCA Distributor. For specific technical data, write RCA Electronic Components, Commercial Engineering, Section No. QG7-1, Harrison, N. J. 07029.

Class C Power for 470 MHz Mobile Communications

Here's a driver-amplifier combination for your mobile two-way radio designs (and anywhere else you can use a 6-W plus output at 470 MHz). Drive with the RCA developmental type TA7408. Use the RCA-TA7409 for the final. Both units are epitaxial silicon n-p-n planar transistors. And both types feature RCA's overlay emitter electrode construction in a hermetically-sealed ceramic-metal package with electrically-isolated mounting stud.

The TA7408 and TA7409 have low-inductance, radial leads which make them particularly suited for strip-line circuits, as well as for lumped-constant designs. Both types operate from a 12-V supply.

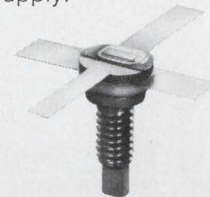

Key ratings and electrical characteristics include (for both types): $V_{CBO} = 36$ V; $V_{CEO} = 14$ V; $V_{CES} = 36$ V; and $V_{EBO} = 3.5$ V. Driver unit TA7408 has 0.5 A I_C and P_T rating of 5.7 W. The TA7409 has I_C of 1.5 A and P_T of 10.7 W. The driver offers 7 dB gain at 470 MHz, to take the TA7409 up to its full-rated 6 W minimum output.

Circle Reader Response Number 236 for details.

RCA

Sunrise, Sunset Courtesy of Amersil-Spectrolab- NASA.

NASA needed an earthbound sun...technically, a Solar Simulator.

They went to Spectrolab.

Spectrolab needed a lens, 36" in diameter, 6" center thickness, that would conform to the stringent requirements set forth by NASA.

They came to Amersil.

Working closely with the Spectrolab designers and engineers, Amersil determined that Infrasil Grade T-18 Fused Quartz had the characteristics to meet the specifications for the Solar Simulator. The lens was molded by Amersil, assembled into the Simulator by Spectro-

lab, and is now being placed into research operation at the NASA Langley Research Center, Hampton, Virginia.

This cooperation from the raw material to the finished products is common practice at Amersil. Our scientists, engineers and designers have the experience, know-how and facilities to meet the needs of industry for high purity Fused Quartz and Fused Silica. These include the finest casting, molding and drawing equipment available.

Get full information and/or technical assistance by writing Amersil today.

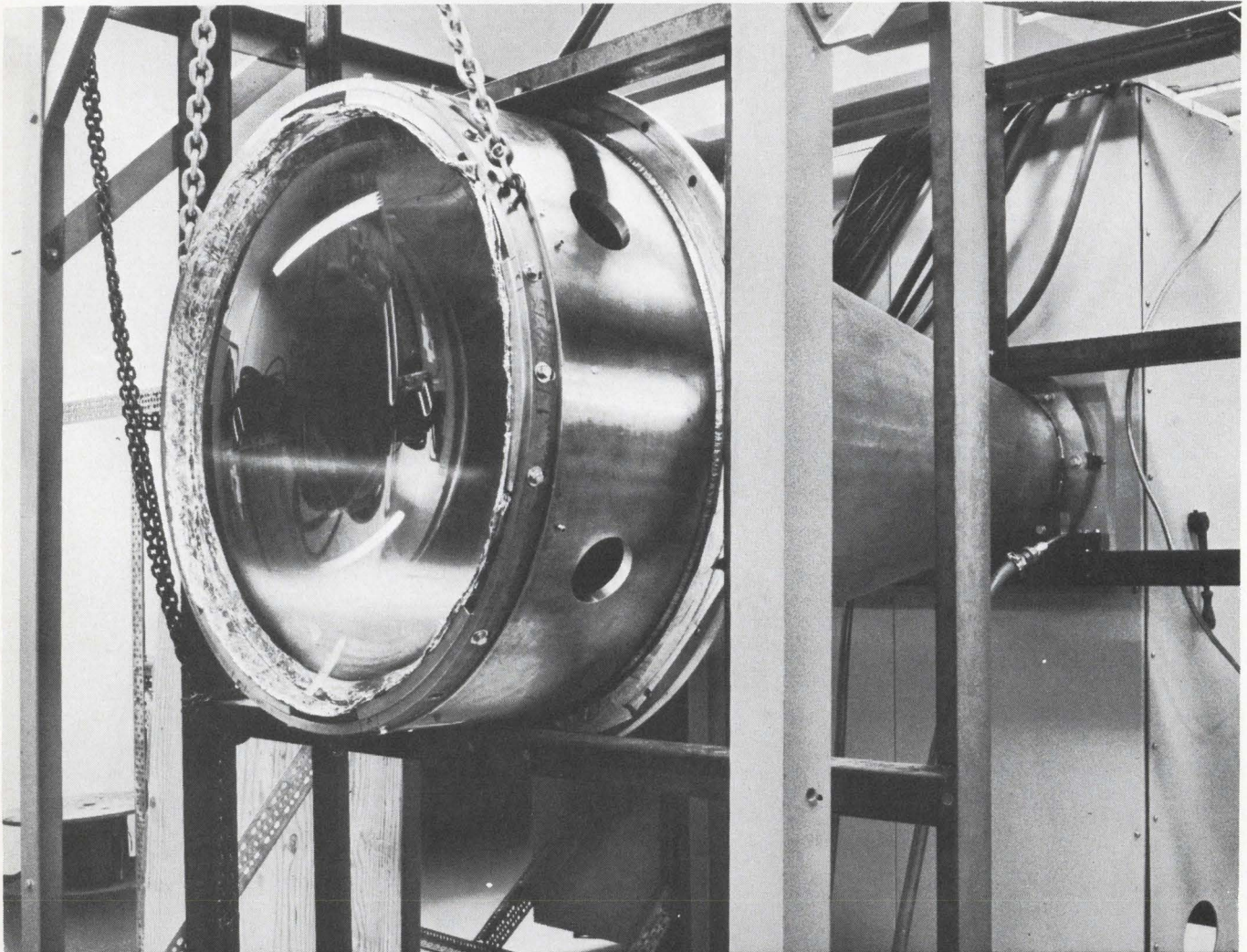

AMERSIL
INC.

**FUSED SILICA
AND QUARTZ**

685 RAMSEY AVE., HILLSIDE NEW JERSEY 07205

New complementary NPN/PNP power transistors from GE

Color-molded to end assembly mix-up

Now available in volume from General Electric . . . two new 1-amp and 3-amp pairs of low-cost complementary power transistors. These NPN/PNP pairs feature low saturation voltage, excellent gain linearity and fast switching . . . all in a sensible package, at a sensible price. GE's flat silicone-encapsulated power tab package is rugged enough to withstand hard use, and *with the new narrow leads (25 mils), can easily be formed to either TO-66 or TO-5 configurations.* To help eliminate NPN/PNP confusion during your assembly, each type is molded in distinctive color. No need for separate storage and production facilities for each type.

GE's new complementary power transistors are ideal for any class B audio application—everything from auto radios, tape players to televisions and stereo phonographs—from 3 to 20 watts output. These new NPN/PNP pairs are also well suited for use as drivers for higher power transistors, regulators, inverters, motor controls, lamp controls, solid-state relays, core drivers and many other applications. The 2.1W P_T free air rating allows simple printed circuit board assembly with no additional heat sinking. With added heat sinking, as much as 12W power

dissipation can be achieved. Performance at these levels is everything you'd expect from General Electric, leader in power semiconductors.

TYPE NUMBER	D40D (NPN)	D41D (PNP)	D42C (NPN)	D43C (PNP)
new				
previous	D28D	D31B	D27C	D27D
I_C (continuous) (peak)	1A	1.5A	3A	5A
V_{CE} (sat.) Max.	0.5V @ 0.5A		0.5V @ 1A	
V_{CE0} (sus.)	30V, 45V and 60V		30V, 45V and 60V	
Total Power Dissipation				
Free air @ 25 C	1.25W		2.1W	
Tab @ 25 C	6.0W		12.0W	
h_{FE} (min.)	50 @ 0.1A/2V 10 @ 1A/2V		40 @ 0.2A/1V 20 @ 1A/1V*	
f_T (typ.)	60MHz		45MHz	

*Types available with $h_{FE}=20$ min. @ 2A/1V

For more information on these and other General Electric semiconductor products, call or write your GE sales engineer or distributor, or write General Electric Company, Section 220-72, 1 River Road, Schenectady, N.Y. 12305. In Canada: Canadian General Electric, 189 Dufferin Street, Toronto, Ont. Export: Electronic Component Sales, IGE Export Division, 159 Madison Avenue, New York, N.Y. 10016.

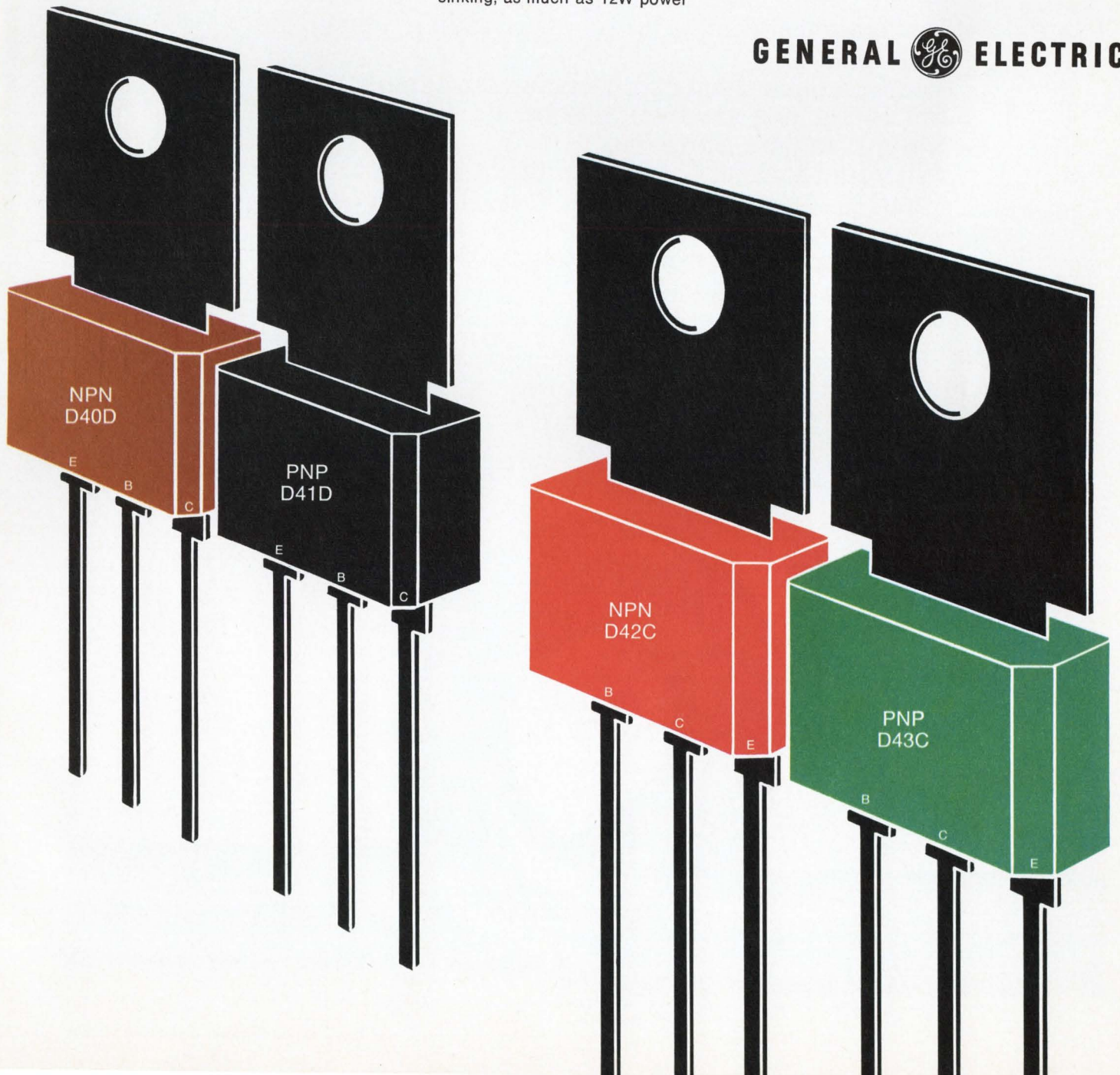

GENERAL  ELECTRIC

We go to any length and shape for effective heat transfer...with RCA Heat Pipes.

RCA can make Heat Pipes square, rectangular, or oval. Perhaps you want them spherical, serpentine, or re-entrant. We'll make them any shape in which a two-phase vapor-liquid system can exist.

Out of our long experience with vacuum technology and material compatibility, RCA has successfully demonstrated the unique abilities of Heat Pipes to transport and dissipate thermal energy in a variety of sizes and configurations, over a range of operating temperatures from below zero to 3,000° F.

Currently, the Heat Pipe is being used to cool semiconductors, electron tubes, and space power systems. Other application areas are limited only by imagination. Essentially isothermal along its length, the sealed Heat Pipe has a proved long life —making it attractive for unattended or inaccessible locations.

These unusual devices, characterized by high thermal efficiency, can save you electrical power as well as weight, volume, and area.

Ask your local RCA Representative to tell you more about RCA activities in Heat Pipe development. Or, write directly to: Manager, Heat Pipe Marketing, RCA Electronic Components, Lancaster, Pennsylvania.

RCA



Centralab's got your Zener number

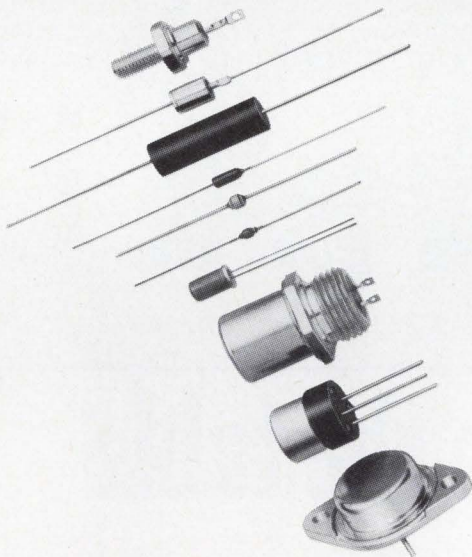

Centralab's broad range of zener regulators covers almost every conceivable JEDEC number, rating, case style and application. From 150mW to 50 watts. From Hi Rel military types and precise industrial types to quality, low-cost units for entertainment applications. Plus all the case styles shown. And, we'll work with your engineers to design a zener to match your specific parameters.

For further information and samples, call the zener specialists, Centralab Customer Service Engineering, (213) 686-0567. Now you've got *our* number.

The following is a list of 2,234 parts for direct replacement but represents a far greater number of additional replacement possibilities.

1N200 - 1N222 • 1N225 - 1N239 • 1N225A - 1N229A • 1N429 • 1N430, A, B • 1N431 • 1N465, A, B - 1N470, A, B • 1N471, A - 1N475, A • 1N702, A - 1N707, A • 1N708, A - 1N745, A • 1N746, A - 1N759, A • 1N761 - 1N769 • 1N821 - 1N829 • 1N821A, 1N823A, 1N825A, 1N827A, 1N829A • 1N935, A, B - 1N940, A, B • 1N941, A, B - 1N946, A, B • 1N957, A, B - 1N992, A, B • 1N1313, A - 1N1327, A • 1N1351, A, R, RA - 1N1375, A, R, RA • 1N1530, A • 1N1591, A - 1N1598, A • 1N1602, A - 1N1609, A • 1N1735, A - 1N1742, A • 1N1766, A - 1N1802, A • 1N1804, A, R, RA - 1N1815, A, R, RA • 1N1816, A, R, RA - 1N1836, A, R, RA • 1N1957, A, B - 1N1980, A, B • 1N1981, A, B - 1N2005, A, B • 1N2008, R - 1N2012, R • 1N2043 - 1N2049 • 1N2498, A, R, RA - 1N2500, A, R, RA • 1N2804, A, B, R, RA, RB - 1N2846, A, B, R, RA, RB • 1N2937 • 1N2970, A, B - 1N3015, A, B • 1N3016, A, B - 1N3051, A, B • 1N3112 • 1N3154, A - 1N3157, A • 1N3181 • 1N3477, A • 1N3506 - 1N3534 • 1N3553 • 1N3558 • 1N3763 • 1N3779 - 1N3784 • 1N3785, A, B - 1N3820, A, B • 1N3896 - 1N3898 • 1N3949 • 1N4095 - 1N4135 • 1N4295, A • 1N4296, A • 1N4321 • 1N4370, A - 1N4372, A • 1N4460 - 1N4496 • 1N4535 • 1N4565, A - 1N4584, A • 1N4611, A, B, C - 1N4613, A, B, C • 1N4765, A - 1N4774, A • 1N4775, A - 1N4784, A • 1N4954 - 1N4990 • 1N5118 - 1N5128 • C4011 - C4029* • CZ4097, A,* • CZ4098, A,* • CZ4881, A* - CZ4883, A* • CZ5063, A - CZ510, A* • HM6.8, A, B - HM200, A, B* • HR2.3 - HR11.0* • HS6 - HS14* • HW6.8, A, B - HW200, A, B* • JAN 1N429 • JAN 1N746A - 1N759A • JAN 1N821, 1N823, 1N825 • JAN 1N935B, 1N937B • JAN 1N962B - 1N973B • JAN 1N2979B, RB - 1N3004B, RB • JAN 1N3016B - 1N3032B

*Centralab house part numbers. Ask for our new catalog which defines the electrical parameters of these zener regulators.

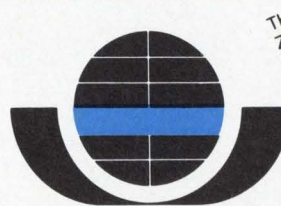

THE
ZENER
SPECIALISTS

CENTRALAB

Semiconductor Division
GLOBE-UNION INC.
4501 NORTH ARDEN DRIVE
EL MONTE, CALIFORNIA 91734



Let's lay our cards on the table

When it comes to Series 54/74 TTL, Transistron holds a full deck . . . twenty-six Series 54 devices, in ceramic DIP (J) or Flat (F) packages, twenty-eight Series 74 devices, in ceramic DIP (J) or plastic DIP (E) packages. The 54/74J and 74E units are pin-for-pin identical, and all circuits in all packages are completely interchangeable with those of the original 54/74 manufacturer. Prices are competitive and we can deal you a pat hand right off the shelf.

Ranging from basic gates to more complex functions such as adders, counters and shift registers, Transistron's family of TTL devices now numbers more than 450, including a broad range of Series I and Series II types.* This gives you breadth of choice virtually unmatched in the industry.

Find out what's in the cards for you.
Send for complete data and specifications
on the devices that interest you.

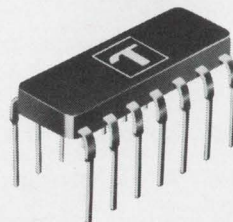

Transistron
electronic corporation
168 Albion Street Wakefield, Massachusetts 01880

* Electrically and mechanically interchangeable with SUHL I and II.

Here's the DVM they won't dare mention



\$695
Model 350

Why?

Is it because it offers equal or superior performance at a savings of typically \$500?

The 350 performs to:

An ACCURACY of .01% of reading \pm .01% of full scale

A RESOLUTION of 100 microvolts standard (1 microvolt option)

An INPUT IMPEDANCE of 1000 megohms

And, available options include mV, ACV, ohms and ratio.

 **DATA
TECHNOLOGY
CORPORATION**

Hard to believe? Try us!
Call collect: (415) 321-0551 x 216

1050 East Meadow Circle
Palo Alto, California 94303

ANOTHER BOURNS FIRST...

10 MIL-SPEC TRIMPOT® POTENTIOMETERS

MIL-R-27208



RT10



RT11



RT12

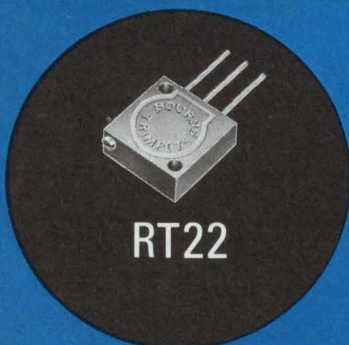

RT22



RT24

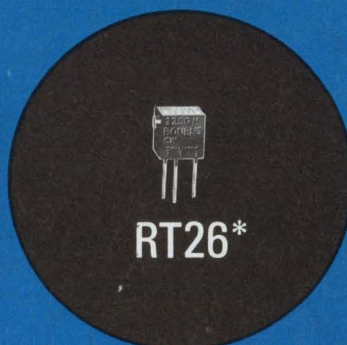

RT26*

MIL-R-22097



RJ11



RJ12

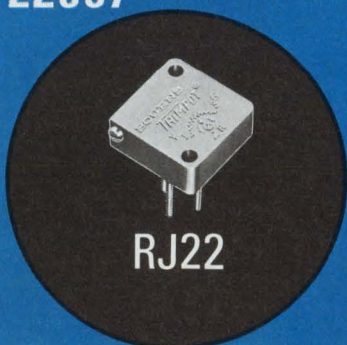

RJ22

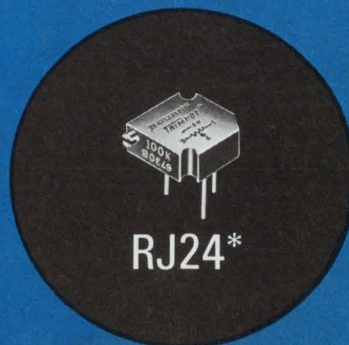

RJ24*

AVAILABLE FROM YOUR LOCAL BOURNS DISTRIBUTOR!

Bourns is the world's largest manufacturer of Adjustment potentiometers with 22 years of leadership. Bourns is also the largest manufacturer of MIL-Spec potentiometers backed by a total of 10 RT and RJ models in our line.

The 6 RT and 4 RJ models not only meet the specifications of MIL-R-27208 and MIL-R-22097, but each is designed and manufactured to consistently exceed each facet of these requirements.

As in the past, you can depend on Bourns to deliver the potentiometer you need. In this tradition of service, we now offer the MIL-Spec unit you may need for your next critical application with 10 RT and RJ models.

Full data is available from the factory, local field office, representative or your stocking distributor.

* Not yet stocked in depth by distributors.



BOURNS, INC., TRIMPOT PRODUCTS DIVISION
1200 COLUMBIA AVENUE, RIVERSIDE, CALIFORNIA 92507
714 684-1700 • TWX: 910 332-1252 • CABLE: BOURNSINC

Technology

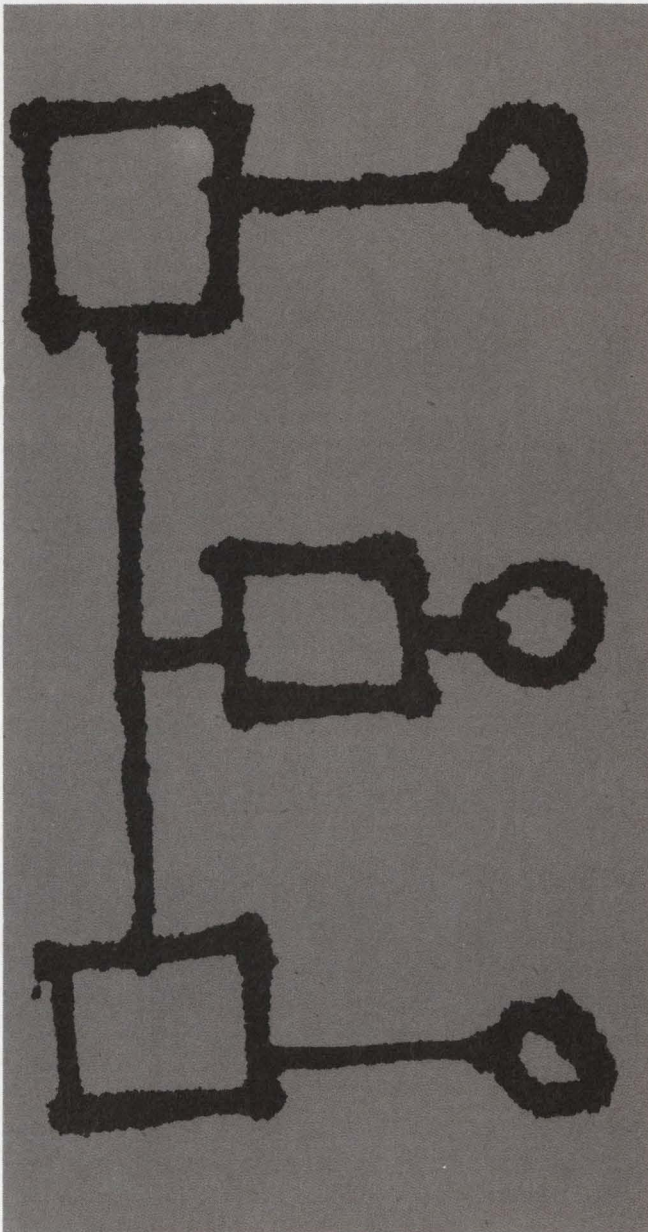

A handy method for designing T feedback networks synthesizes them directly from the desired transfer function. p. 64.

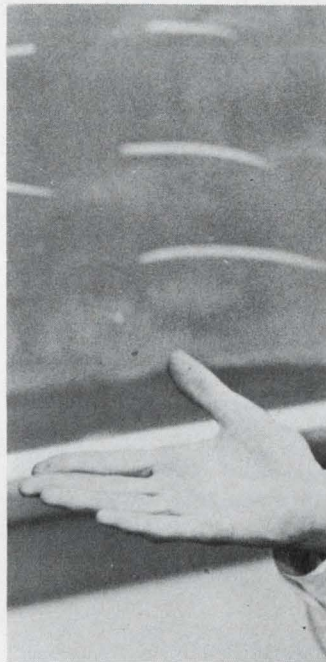

These hands belong to an enterprising engineer who has molded a successful electronics business. He tells how. p. 74.

Also in this section:

Don't shun the shunt regulator. It may have unexpected advantages. p. 70.
Ideas for Design, p. 80.

Design T feedback networks with ease

Here's a method for directly synthesizing them from the desired transfer function.

Designers often spend a lot of time designing feedback networks for their operational amplifiers—and one of the most widely used is the T-type. They can save much of that time by using a direct method of synthesizing the T-type network from the desired transfer functions. The method is suitable for applications involving a single op amp and up to second-order feedback circuits.

Basically the technique involves selecting a network and calculating the component values in six easy-to-follow steps.

First choose your network

Figure 1 shows a basic T-network used as the feedback loop of an operational amplifier. The effective feedback impedance, Z_f , is the ratio of the output voltage to the feedback current, or:

$$Z_f = e_o / i_f.$$

Since the summation point is a virtual ground,

$$i_f \simeq e_{in} / Z_{in}$$

where e_{in} can be defined, in terms of e_o , as a straightforward voltage divider.

$$e_{in} = e_o \frac{Z_1 Z_2 / Z_1 + Z_2}{Z_2 + (Z_1 Z_3 / Z_1) + Z_3};$$

therefore,

$$e_{in} = e_o \frac{Z_3}{Z_2 (Z_1 + Z_3) + Z_1 Z_3}$$

and

$$e_o / i_f = Z_1 + Z_2 + Z_1 Z_2 / Z_3 = Z_f. \quad (1)$$

It is the $Z_1 Z_2 / Z_3$ term that the designer uses to obtain the desired transfer function.

Three general types of transfer functions are of interest:

$$Z(s) = \frac{Z_1(s) Z_2(s)}{Z_3(s)} = \frac{F(s)}{s^n} \quad (2)$$

where $n=0, 1, 2$.

s⁰ network: If Z_1, Z_2 and Z_3 are all resistors, $s^n = s^0 = 1$. This type of network is used to obtain

very high feedback impedance. For example:

If $Z_1=Z_2 = 100 \text{ k}\Omega$, and $Z_3 = 1 \text{ k}\Omega$, then from Eq. 1

$$\begin{aligned} Z_f &= Z_1 + Z_2 + \frac{Z_1 Z_2}{Z_3} \\ &= 10^5 + 10^5 + \frac{10^{10}}{10^3} = 10.2 \text{ M}\Omega \end{aligned}$$

s¹ network: A transfer function of order 1 can be realized if only one arm of the T is capacitive, as shown in Fig. 2. In this case,

$$\begin{aligned} Z_f &= Z_1 + Z_2 + \frac{Z_1 Z_2}{Z_3} \\ &= R_1 + R_2 + \frac{1}{sC_2} + \frac{R_1 \left(R_2 \frac{1}{sC_2} \right)}{R_3} \\ &= \frac{s(C_2 R_3 / R_1 + R_3) + (R_1 + R_2 + R_1 R_3 / R_3) + 1}{s(C_2 R_3 / R_1 + R_3)} \end{aligned}$$

The same transfer function can be realized with a simple RC combination in series, but as a trade-off the effective capacity, $C = C_2 R_3 / (R_1 + R_3)$, is decreased by a smaller ratio than the increased effective resistance, $R = R_1 + R_2 + R_1 R_3 / R_3$.

Another first-order network arises when the desired transfer function must have a low gain at dc and a higher gain at some frequency ω_o . Z_1 and Z_2 must be resistive and Z_3 must have a capacitor in series with it. Figure 3 shows both this network and its transfer function.

It is also possible to combine these two first-order transfer functions as shown in Fig. 4. This type of network is commonly used to compensate a mechanical system.

s² network: A transfer function of order 2 can be realized if Z_1 and Z_2 are both capacitive, and Z_3 is resistive (Fig. 5). In this case:

$$Z_1 Z_2 / Z_3 = 1 / s^2 C_1 C_2 R$$

and thus an s^2 function is generated. Of course there are other possible variations.

Six-step design procedure

To determine the design equations, once a particular network is selected, consider the network of Fig. 4. The desired transfer function is of

William B. Crittenden, Design Engineer, Westinghouse Electric Corp., Baltimore, Md.

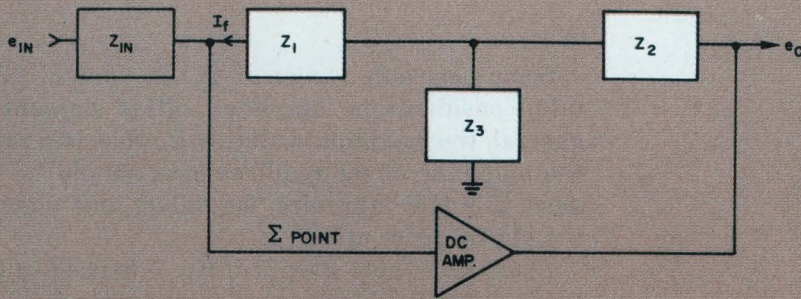

1. The basic T feedback network permits a large range of transfer functions to be generated.

2. A capacitive element in only one arm of the T (a) results in a first order transfer function (b).

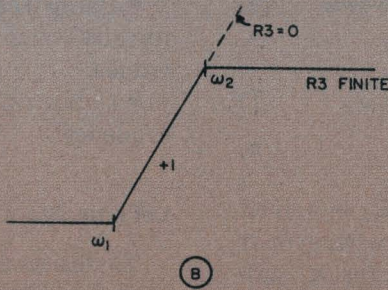
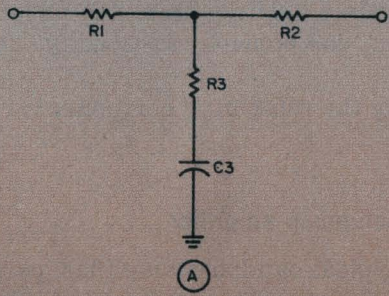
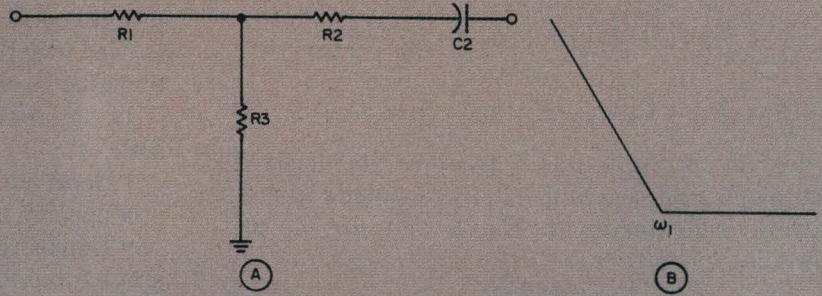

3. Relocation of capacitive element in first order network (a) alters the response (b).

4. Combining first order transfer functions permits tailored response.

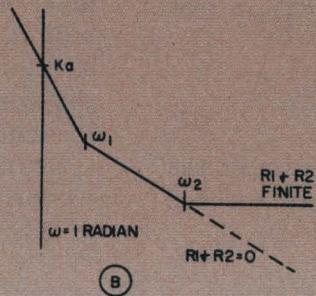
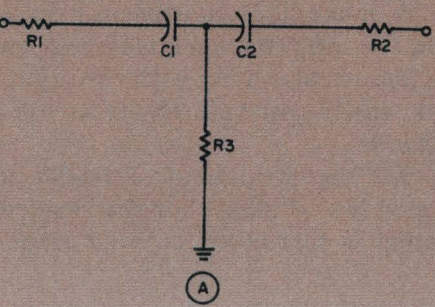
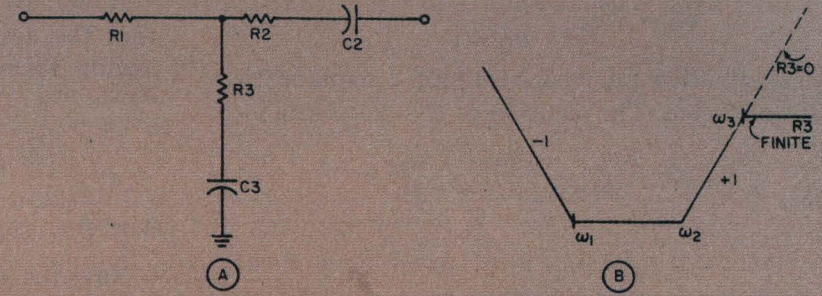

5. A second order transfer function is generated when Z₁ and Z₂ are capacitive and Z₃ is resistive.

the form:

$$M(\omega) = \frac{K_v(s/\omega_1 + 1)(s/\omega_2 + 1)}{s(s/\omega_3 + 1)}$$

$$= \frac{K_v s^2 \left(\frac{1}{\omega_1 \omega_2} \right) + s \left(\frac{1}{\omega_1} + \frac{1}{\omega_2} \right) + 1}{s(s/\omega_3 + 1)} \quad (3)$$

For the actual network the gain is:

$$A_v = Z_f/Z_i$$

$$= \frac{1}{C_2 R_{in}} \left\{ \left[s^2 C_2 C_3 R_3 \left(R_1 + R_2 + \frac{R_1 R_3}{R_3} \right) \right] + s[C_2(R_1 + R_2) + C_3(R_1 + R_3)] + 1 \right\} / s(C_3 R_3 + 1) \quad (4)$$

The design situation itself specifies the desired values of K_v , ω_1 , ω_2 , and ω_3 . By equating corresponding order terms in Eq. 3 and Eq. 4, we obtain:

$$K_v = 1/C_2 R_{in} \quad (5)$$

$$C_2 C_3 [(R_1 + R_2) R_3 + R_1 R_2] = 1/(\omega_1 \omega_2) \quad (6)$$

$$C_2 (R_1 + R_2) + C_3 (R_1 + R_3) = 1/\omega_1 + 1/\omega_2 = (\omega_1 + \omega_2) / (\omega_1 \omega_2) \quad (7)$$

$$C_3 R_3 = 1/\omega_3 \quad (8)$$

From Eq. 6 and Eq. 8 either R_1 or R_2 is solved for by inserting $1/\omega_3$ in place of $C_3 R_3$ wherever it appears. In this example, the solution for R_2 will be found:

$$R_2 = \frac{(\omega_3/\omega_1 \omega_2 C_2) - R_1}{1 + \omega_3 C_3 R_1} \quad (9)$$

By substituting Eq. 9 back into Eq. 7, a quadratic in R_1 is obtained. The solution of the quadratic is:

$$R_1 = \frac{\omega_2 \omega_3 + \omega_1 (\omega_3 - 2\omega_2)}{2\omega_1 \omega_2 \omega_3 (C_2 + C_3)}$$

$$\pm \frac{\sqrt{\omega_3^2 (\omega_2 - \omega_1)^2 - 4\omega_1 \omega_2 \frac{C_2}{C_3} [\omega_3^2 + \omega_1 \omega_2 - \omega_3 (\omega_1 + \omega_2)]}}{2\omega_1 \omega_2 \omega_3 (C_2 + C_3)} \quad (10)$$

For R_1 to be real, the term under the square root must be ≥ 0 . For this to be true,

$$C_3 \geq \frac{4\omega_1 \omega_2 (1 + \omega_1 \omega_2 / \omega_3^2 - \omega_1 \omega_2 / \omega_3) C_2}{(\omega_2 - \omega_1)^2} \quad (11)$$

This is a desirable starting point because of the limited number of values of capacitors and the many values of resistors available.

Some desirable range of R_{in} is known, taking into consideration amplifier offset current. In general, the maximum value of R_{in} that will satisfy the amplifier offset requirements should be used since this will minimize the value, and therefore the physical size of C_2 .

Since R_{in} is now specified, Eq. 5 is used to solve for C_2 . Then Eq. 11 is used to solve for the minimum possible value of C_3 and the next available higher value is selected. Since C_3 is now known, Eq. 8 is used to solve for R_3 , and once R_3 is known, Eq. 10 is used to solve for R_1 . Finally, with R_1 known, Eq. 9 is used to solve for R_2 . This completes the design.

In summary, then, the general procedure consists of:

- Specifying the desired transfer function.
- Specifying the closed-loop gain.
- Equating coefficients of like power of s from steps 1 and 2.
- Specifying the desired gain and corner frequencies.
- Using restraints such as amplifier offset and physical size of components to specify design values.
- Determining the remaining components in the sequence.

Let's design a bandpass amplifier

To design a typical bandpass amplifier, parallel-T and bridged-T networks will be used. This is shown in Fig. 6.

It will be assumed throughout this discussion that the desired transfer function is of the following form:

$$M(\omega) = \frac{-Ks(s/\omega_1 + 1)}{[(s/\omega_2 + 1)(s/\omega_3 + 1)]^2}$$

where $\omega_1 < \omega_2 < \omega_3$,

Now the form of the input and feedback networks necessary for this response must be determined. Because of the Ks in the numerator, the input network must have a capacitor in series with it. Since the input network most generally is a series RC , there is also a lag with the input C , so that we could easily generate $Ks/(s/\omega_2 + 1)$ with the input network.

The most that any straight or T feedback network could give is a -1 slope, but the requirement of this function is to roll off on a -2 slope. The

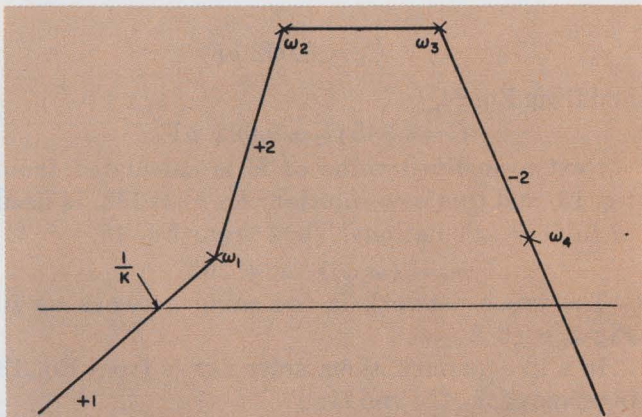

6. Bandpass amplifier with this transfer function can be synthesized by determining the appropriate component values.

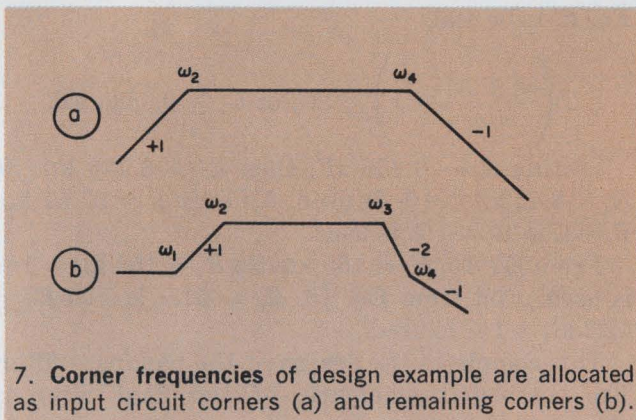

7. Corner frequencies of design example are allocated as input circuit corners (a) and remaining corners (b).

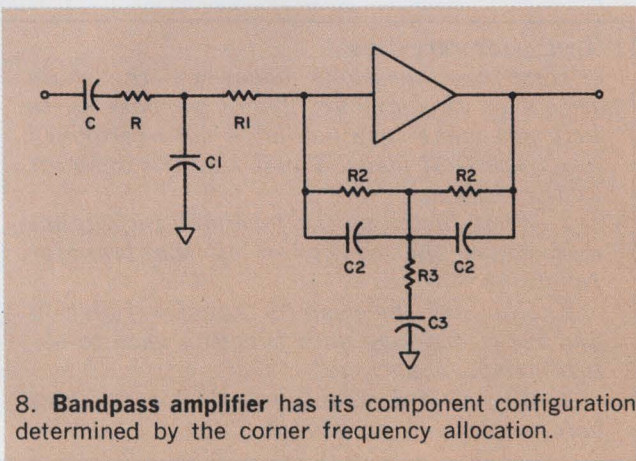

8. Bandpass amplifier has its component configuration determined by the corner frequency allocation.

second lag should therefore be picked up in the input network.

Assume that Z_{in} has the ω_2 and ω_4 corners shown in Fig. 7a. The other corner frequencies still to be determined are shown in Fig. 7b. If a network like that in Fig. 3 is put around the amplifier, and $R_1=R_2$, then we have the lead corner ω_1 and the lag corner ω_2 . The double lag corner, ω_3 , with its subsequent lead ω_4 , can be realized by examining Z_1Z_2/Z_3 . If $Z_1=Z_2$, and R_2 is in parallel with some C_2 , then

$$Z_1Z_2 = R_2^2/(sC_2R_2 + 1)^2$$

where $\omega_3 = 1/C_2R_2$.

Figure 8 shows the amplifier with the components included. The gain is

$$A = Z_f/Z_{in}$$

where

$$Z_f = \frac{2R_2 (sC_2R_2 + 1) (sC_3R_3 + 1) + sC_3R_2/2}{(sC_2R_2 + 1)^2 (sC_3R_3 + 1)}$$

and

$$1/Z_{in} = sC/\{s^2CC_1RR_1 + s[C_1R_1 + C(R + R_1)] + 1\}.$$

Again we equate terms with corresponding powers of s :

$$K = 2CR_2 \quad (12)$$

$$1/CC_1RR_1 = \omega_2\omega_4 \quad (13)$$

$$1/\omega_2 + 1/\omega_4 = C_1R_1 + C(R + R_1) \quad (14)$$

$$1/\omega_3 = C_2R_2 \quad (15)$$

$$1/\omega_2 = C_3R_3 \quad (16)$$

From the numerator of Z_f

$$C_2C_3R_2R_3 = 1/\omega_1\omega_4 = 1/\omega_2\omega_3 \quad (17)$$

and from Eq. 17,

$$\omega_4 = \omega_2\omega_3/\omega_1 \quad (18)$$

and

$$1/\omega_1 + 1/\omega_4 = C_2R_2 + C_3R_3 + C_3R_2/2. \quad (19)$$

Equation 18 shows that only three of the four corner frequencies are independent.

The problem now is where to start in the choice of values. From the fact that capacitors come in limited values, a desirable starting equation would be one that expressed capacitor ratios as a function of $\omega_1, \omega_2, \omega_3$.

From Eqs. 19, 15, 16, 18:

$$C_3 R_2 / 2 = \frac{1}{\omega_1} + \frac{\omega_1}{\omega_2 \omega_3} - \frac{1}{\omega_2} - \frac{1}{\omega_3} \quad (20)$$

From Eq. 20:

$$\frac{C_3 R_2}{2} = \frac{1}{\omega_1} + \frac{\omega_1 - \omega_2 - \omega_3}{\omega_2 \omega_3} \quad (21)$$

From Eqs. 21 and 15:

$$\frac{C_3}{2C_2} = \frac{\omega_3}{\omega_1} - \frac{(\omega_2 + \omega_3) - \omega_1}{\omega_2} \quad (22)$$

which may or may not be realizable from a component selection viewpoint. Next, from Eqs. 20 and 12 we obtain:

$$\frac{\omega_3 K C_3}{4C} = \frac{\omega_3}{\omega_1} - \frac{(\omega_2 + \omega_3) - \omega_1}{\omega_2} = \frac{C_3}{2C_2} \quad (23)$$

and from Eq. 23:

$$C/C_2 = \omega_3 K / 2 \quad (24)$$

At this point, let us pick some ω_1 , ω_2 , ω_3 , and realize that we may only be able to pick some range of K from Eq. 24:

$$\omega_1 = 276.5$$

$$\omega_2 = 875$$

$$\omega_3 = 925$$

$$K = 1/138.25.$$

Then from Eq. 22,

$$C_3 = 3.21 C_2,$$

picking

$$C_2 = 0.0068 \mu\text{F}$$

and

$$C_3 = 0.022 \mu\text{F}$$

and from Eq. 24,

$$C = 3.345 C_2 \cong 0.022 \mu\text{F}.$$

Next a modified value of K is calculated from Eq. 13, and this new solution, $K_m = 1/143$, is used in further calculations. Then from Eq. 18,

$$\omega_4 = (\omega_2 \omega_3) / \omega_1 = 2927.$$

The input network is the same network as in Fig 4, with $R_3 = 0$.

In a like manner, then, solve for R from Eq. 13 in terms of R_1 , C_1 , and C :

$$R = 1/\omega_2 \omega_4 (CC_1 R_1).$$

Substituting this into Eq. 14,

$$R_1^2 C_1 (C_1 + C) \omega_2 \omega_4 - R_1 C_1 (\omega_2 + \omega_4) + 1 = 0$$

$$R_1 = \frac{\omega_2 + \omega_4 \pm \sqrt{\omega_2^2 + \omega_4^2 - 2\omega_2 \omega_4 (1 + 2C/C_1)}}{2(C_1 + C)\omega_2 \omega_4}.$$

For R_1 to be real,

$$C_1 \left(\frac{\omega_2^2 + \omega_4^2}{\omega_2 \omega_4} - 1 \right) \geq 2C, \text{ or } C_1 \geq 0.0535 \mu\text{F}.$$

Letting $C_1 = 0.056 \mu\text{F}$, then $R_1 = 8.436 \text{ k}\Omega$. So $R_1 = 8.45 \text{ k}\Omega \pm 1\%$ is used. And for $R = 37.51 \text{ k}\Omega$, $R = 37.4 \text{ k}\Omega \pm 1\%$ is used.

From Eq. 15, $R_2 = 159 \text{ k}\Omega$. So $R_2 = 158 \text{ k}\Omega \pm 1\%$ is used. And from Eq. 16, $R_3 = 51.9 \text{ k}\Omega$, so $R_3 = 52.3 \text{ k}\Omega \pm 1\%$ is used.

This completes the design of the bandpass filter. The completed schematic of the final filter is shown in Fig. 9. ■■

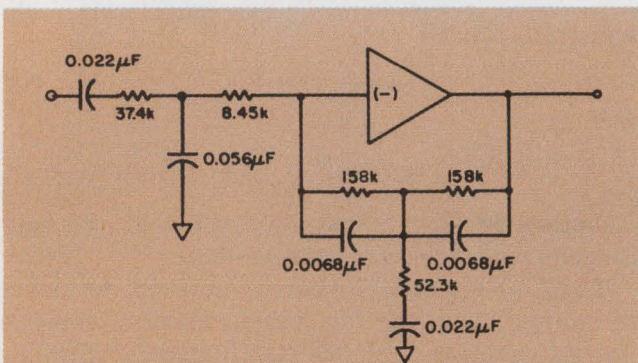

9. Completed bandpass amplifier with all component values of synthesized from the desired transfer function.

Test your retention

Here are questions based on the main points of this article. Their purpose is to help you make sure you have not overlooked any important ideas. You'll find the answers in the article.

1. What factor in the feedback impedance determines the character of the transfer function?

2. How are the desired transfer function and the closed-loop gain function used to obtain design equations?

3. Why is it desirable to select capacitors before selecting resistors?

In a world that offers a million different connectors, who needs 7 more?

We don't want to complicate your life.
We want to make it easier for you.

And we think these 7 printed circuit
connectors are just the ones that can do it.

Each one started as a special order for a
customer like Univac, Automatic Electric,
or Mohawk. Each had so many possibilities
that we got permission to make them for
everybody.

So here's the biggest little line of connec-
tors in the business. Utterly unique, not
available as standard items anywhere else.

216-pin, 8-position

196-pin, 2-position

44-pin, 1-position

27-pin, 1-position

220-pin, 5-position

All connectors are made with our famous
welded gold-dot contact design that puts
gold only where it's needed, yet holds
contact resistance below 5mV drop
at 5A.

Until recently, you couldn't
buy off-the-shelf connectors
like these for love or money.

You still can't buy them
for love. Sylvania Metals &
Chemicals, Parts Division,
Warren, Pennsylvania 16365.

98-pin,
1-position

40-pin, male-connecting module

SYLVANIA
GENERAL TELEPHONE & ELECTRONICS

Don't shun the shunt regulator.

It may have lower efficiency than the series type, but its advantages in some applications outweigh its shortcomings.

More often than not, modern power supplies use series regulation, because of its inherently high efficiency. Yet the shunt regulator may fill the bill better in the long run. In some applications its desirable features outweigh its disadvantages. Consider these excellent qualities of the shunt regulator:

- Inherent short-circuit protection.
- Relative insensitivity to input transients.
- Automatic protection against overvoltage transients at the output.

That last feature is particularly important in large integrated-circuit systems.

All of the advantages can be attained, along with remarkable levels of performance, if you design the shunt regulator simply.

The basic object of any shunt regulator is to maintain a constant terminal voltage. To accomplish this, the regulator senses the terminal voltage and varies conduction of a shunt element accordingly. As shown in Fig. 1, the basic parts of such a regulator are a reference element, a comparison amplifier and the driven shunt element.

The amplifier, A_1 , compares the reference voltage on its negative input to the sample of the output voltage, provided by R_1 and R_2 , on its positive input. The resulting amplified error signal drives Q_1 , which conducts to the degree necessary to maintain the output, E_o , at the level established by D_1 and R_1 - R_2 .

Aside from the obvious need for a proper Q_1 —one that can handle the required current and power—the performance of the regulator depends mainly on the reference diode and the input characteristics of the amplifier (assuming adequate loop gain). Good temperature stability and drift performance dictate a temperature-compensated element for D_1 and a differential amplifier with a good input drift characteristic for A_1 . A large forward transconductance will

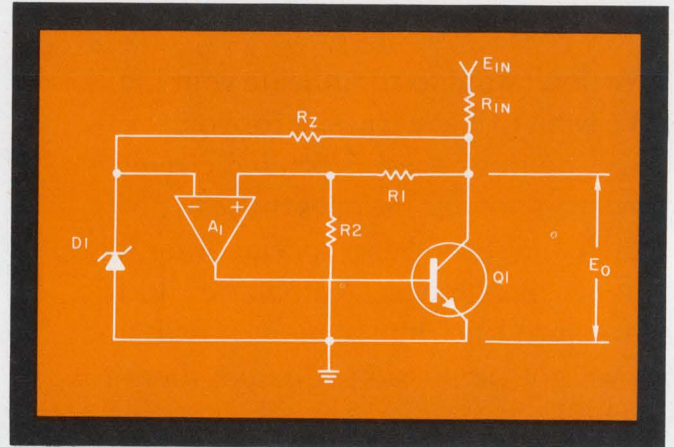

1. Basic shunt regulator consists of a reference element, D_1 , a comparison amplifier, A_1 , and a driven shunt element Q_1 .

result in minimal load-voltage changes as the load current varies.

Practical approach exploits advantages

A practical circuit that fully exploits the inherent advantages of the shunt regulator is shown in Fig. 2. In the circuit, R_9 , R_{10} and R_{11} constitute the sampling element, while the reference element is a 2N3638, which is operated as a temperature-compensated zener diode (see reference). The differential input operational amplifier consists of Q_1 through Q_5 , with Q_1 and Q_2 being a matched monolithic pair having a typical offset temperature drift of $10 \mu V/^\circ C$. The discrete power transistor, Q_6 , functions as the shunt element. The configuration is ideally suited for responding to dynamic current changes because of the multiplication of transconductance that occurs within the loop. This results in high sensitivity to voltage changes.

A number of features contribute to the usefulness of this approach in shunt regulation:

- The active device complement consists of only 4 components: an integrated circuit, diode D_1 and transistors Q_3 and Q_6 .

- The operating current of D_1 (and the temperature coefficient) is quite predictable, since

Walter G. Jung, Senior Engineer, Maryland Telecommunications, Div. of KMS Industries, Inc., Cockeysville, Md.

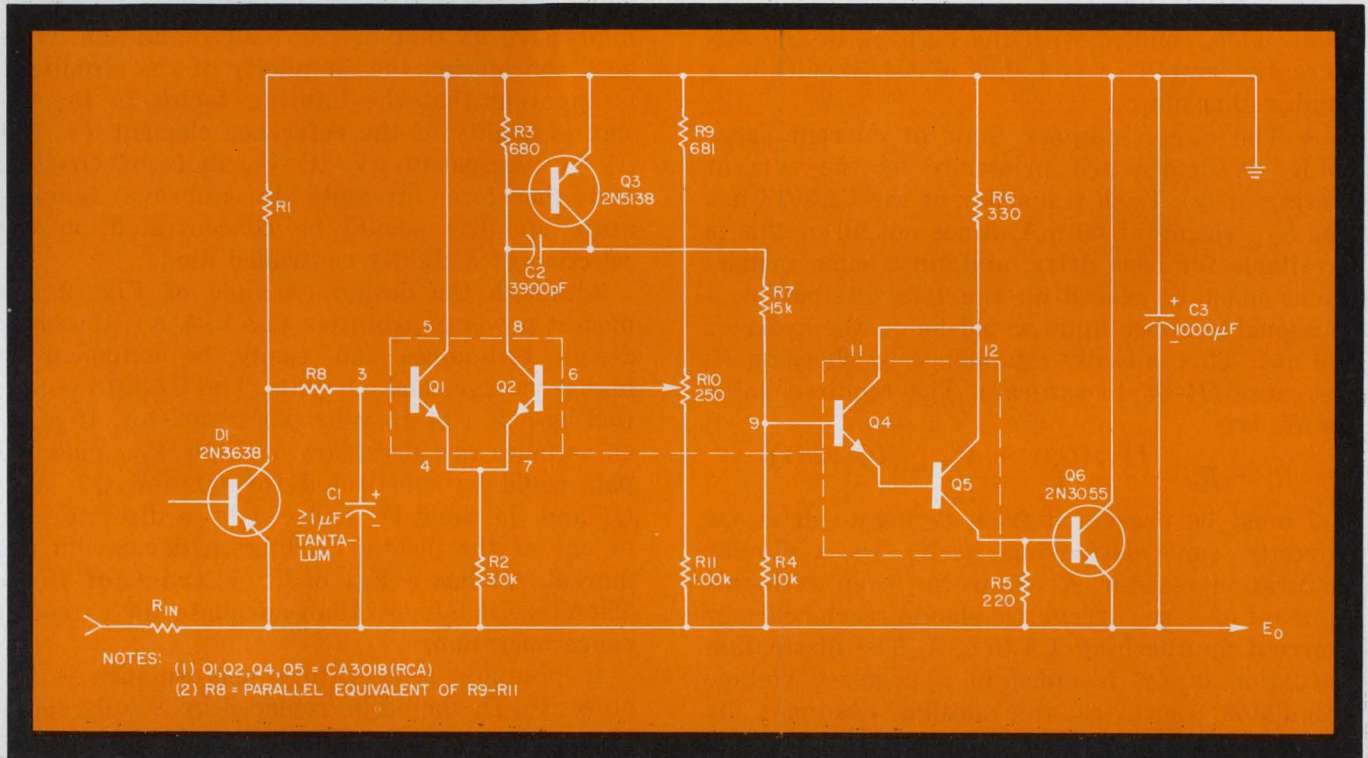

2. Only four active components are required to implement the shunt regulator circuit: three transistors, one

the diode is fed from a constant voltage source through R_1 . R_1 is given by

$$R_1 = (E_o - E_{D1}) / I_z,$$

where E_o is the required output voltage, E_{D1} is the reference voltage, and I_z is the current for zero temperature coefficient. A typical value of E_{D1} is 6.6 V, and a good figure for I_z is 5 mA. For ultimate stability, the operating current of D_1 should be trimmed for the temperature at which the regulator will operate.

A significant feature of the circuit is the fact that there is no current shift in the reference diode with variations in load. This is an advantage of a shunt regulator, which is basically a two-terminal device.

■ The matched transistor pair, $Q1$ and $Q2$, are ideally suited for differential connections. Typical input offset voltages for this pair of tran-

sistors, $D1$, is operated as a zener diode, and a single integrated circuit.

sistors is less than 1 mV. At the operating level of 1 mA, the offset drift is typically $10 \mu\text{V}/^\circ\text{C}$. To take full advantage of this stability, the dc base impedances must be matched. This necessitates the inclusion of resistor R_s , which has a value equal to the equivalent parallel resistance of the R_9 - R_{11} divider network.

■ Transistor $Q3$ serves two purposes: First, it level-shifts the high collector voltage of $Q2$ (by necessity $\geq E_{D1}$) down to the base requirement of $Q4$ ($3V_{be}$'s). It is also a convenient point to frequency-compensate the amplifier with a Miller capacitor, C_2 , from collector to base. $Q3$ also contributes significant forward gain to the amplifier.

■ The triple Darlington connection of $Q4$ - $Q6$ exhibits a phenomenally high h_{FE} characteristic. Thus large collector-current variations of $Q6$ re-

sult in minimal variations in current through level-translation transistor Q3, and even smaller variations in the differential pair Q1-Q2. The differential amplifier therefore experiences a constantly balanced operating point, where Q1 and Q2 conduct equal current, the condition of maximum g_m .

Typical gain figures for Q4 and Q5 show the natural h_{FE} to be 7000-8000 at an I_c of 5 to 10 mA. The V_{be} of Q6 (about 1 volt), together with R_5 , force Q4 and Q5 to operate near this gain peak. In addition Q6 exhibits a typical h_{FE} of 100 or more at an I_c of 300-500 mA. The resultant combination exhibits large forward transfer gain over all reasonable operating levels of current. This, coupled with the high g_m of the differential amplifier and that of Q3, results in a high composite g_m .

■ The circuit's upper limit of current capability is determined primarily by the current rating of Q5. Each transistor of the CA3018 has an $I_{c_{max}}$ rating of 50 mA. Since not all of this is available for base drive, and since some restrictions must be placed on the IC's dissipation, a reasonable upper limit would be on the order of 30 mA. This is easily established by choosing R_6 to cause Q4-Q5 to saturate. The required value of R_6 is:

$$R_6 = E_o - \frac{[V_{be}(Q6) + V_{ce(sat)}(Q4, Q5)]}{I_{max}}$$

Q3 must be prevented from trying to drive Q6 directly (and destroying itself) by a similar saturation resistor, R_7 . However, even with this amount of base current, Q6 should reach collector current approaching 1.5 to 2 A. The dissipation situation of Q6 is aided in a negative voltage regulator (such as this design example) by clamping the collector shell directly to a grounded heat sink and avoiding the additional thermal interface of an insulating washer.

High-level performance achieved

The design approach of Fig. 2 results in a regulator that achieves some remarkable levels of performance. At the design level of 12 volts, the circuit exhibits a current threshold, or "knee," of 18 mA, beyond which little or no change in voltage is measurable. Within the current design limit of 1 ampere, the voltage change is less than 1 mV, which is better than 0.01%.

A better figure of merit for the degree of regulation can be arrived at by an ac test. If an ac ripple current is superimposed in series with the dc input current (sometimes called "purring"), the resultant voltage swing attributable to the regulation impedance can be observed with a high-gain oscilloscope. The equivalent regulation impedance, R_o , is

$$R_o = \Delta E_o / \Delta I_o,$$

where ΔE_o = the peak-to-peak ac voltage observed on the scope, and ΔI_o is the peak-to-peak input ripple. For the circuit of Fig. 2, ΔI_o is 0.4 A and ΔE_o is 200 μ V, giving a regulation impedance of

$$R_o = 2 \times 10^{-4} / 4 \times 10^{-1} = 0.5 \text{ milliohms.}$$

The figure of 200 μ V for a 0.4-A change in current tends to justify the assumption of the dc case—namely, that the ΔE_o is less than 1 mV per 1 A load change.

Temperature tests on the circuit bear out the claims for the 2N3638 temperature-compensated zener (see reference). The measured temperature coefficient of the circuit of Fig. 2 is less than 0.01%/°C. Although this percentage is not as impressive as that of the load regulation, it is good considering the simplicity of the circuit. It is apparent that the limiting factor in the design is quality of the reference element ($\approx 700 \mu$ V/°C versus 10 μ V/°C V_{be} drift of Q1-Q2), and therefore attempts to improve temperature stability should be concentrated on the selection of a tightly controlled diode.

Although the design example of Fig. 2 has modest power capabilities (12 V, 1 A), the basic design techniques can easily be extended to higher voltages and currents. The CA3018 is limited by a V_{ceo} of 15 volts per transistor. If higher voltages are necessary, a high V_{ceo} matched pair could be substituted for Q1 and Q2. Also Q4 and Q5 could be replaced by a discrete pair or one of the plastic Darlington devices on the market. Q6 has a V_{cer} of 70 V and I_c of 15 A. Therefore it is more than adequate for extended range operation.

If premium temperature performance is the objective, D_1 should be replaced by a fully specified temperature-compensated diode, such as the 1N829. And the zener current should be carefully maintained at the test level. ■■

Reference:

E. J. Kennedy, "Inexpensive 6-V Reference Is Also Temperature Stable," ELECTRONIC DESIGN, ED 23, Nov. 8, 1967, p. 112.

Test your retention

Here are questions based on the main points of this article. Their purpose is to help you make sure you have not overlooked any important ideas. You'll find the answers in the article.

1. What is the basic disadvantage of a shunt regulator?
2. What are its advantages?
3. Why is a high h_{FE} and g_m desirable in a shunt regulator?

THE 5000 PERM TOROID

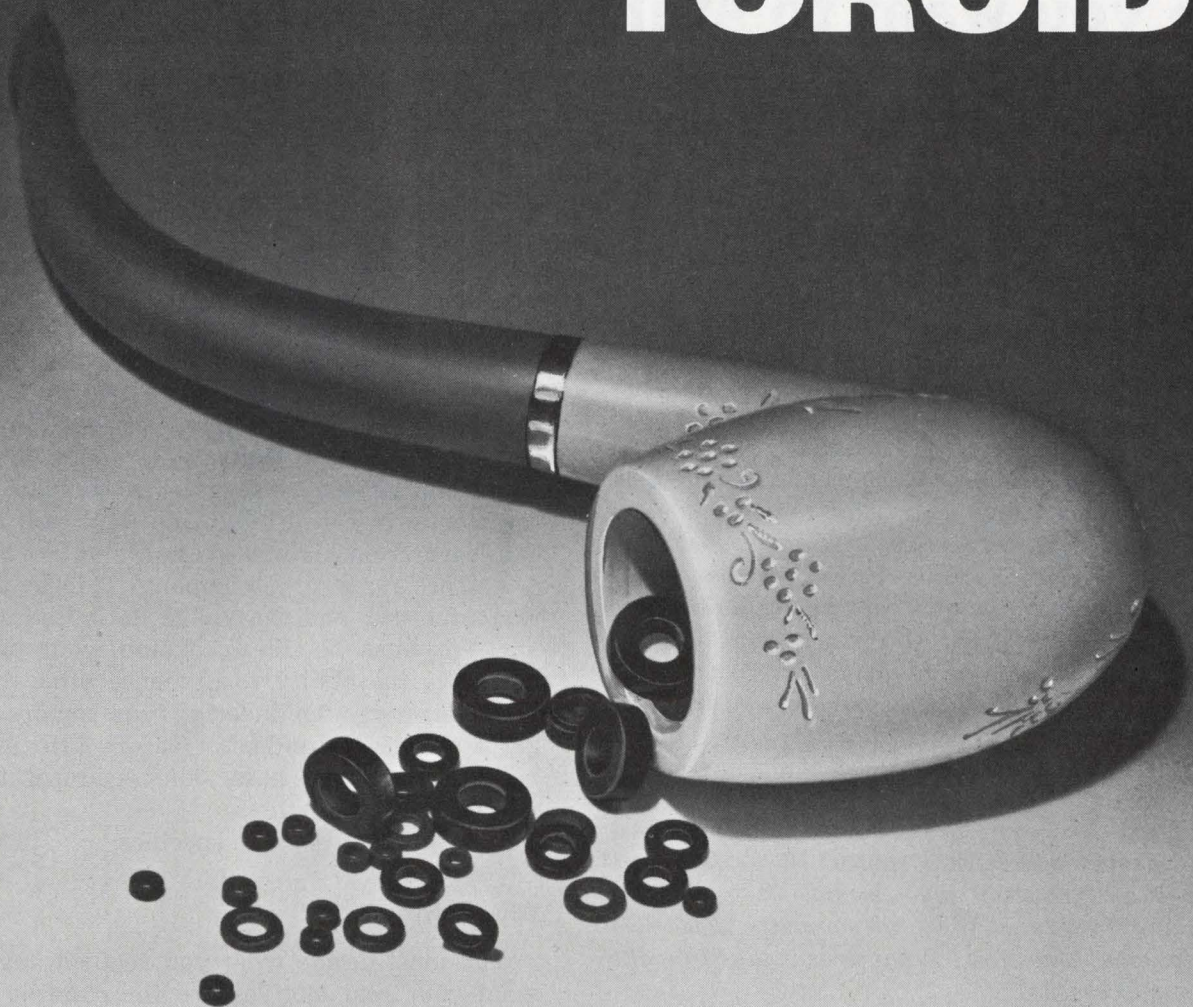

NO LONGER A PIPE DREAM

That's right. 5000 initial permeability. And we mean it!

Perhaps your designs for pulse transformers have gone up in smoke for want of a powerful enough material. Well, now you've got it. And then some. Stackpole Ceramag® 24H ferrite material.

Ceramag® 24H is a precision engineered product. Exact processing, density checks, rigid kiln controls and precise

sintering. You get more out of it simply because we put more into it.

Here are a few more conservative characteristics. Maximum permeability, 6900. Typical. Saturation flux density, 4100 gauss and residual magnetism of 850 gauss. If curie point is significant to your operation, how about one of 175° C. Then there's temperature coefficient. Ceramag® 24H goes $\pm 0.700\%$ / ° C at -25°

C to 25° C and -0.450% / ° C at 25° C to 75° C. And all of this with a disaccommodation factor of 1.4×10^{-6} .

Ceramag® 24H is ready. Are you? Drop us a line and we'll send you some even more interesting facts about this fantastic new material. And the charts to prove it. Stackpole Carbon Company, Electronic Components Division, St. Marys, Pa. 15857. Ph: 814-834-1521



STACKPOLE
Electronic Components Division

ALSO A LEADER IN THE MANUFACTURE OF QUALITY FIXED COMPOSITION RESISTORS

So you want to start a company... So don't, unless you're an entrepreneur, says this company founder, who began as a successful engineer.

Richard Turmail, Management & Careers Editor

You're employed by a large electronics company. Your job isn't too exciting, and you often disagree with company policy. One day at work you get an idea for a new electronics product. You believe that the product idea is good enough to start your own company to produce it in quantity. But you need advice, assistance and capital.

So you approach two co-workers and tell them about your idea and your plan to start a company. They are, of course, honored that you sought them out. Secretly they have wanted to start their own company, too. They eagerly agree with your plan, and with their help, and the help of a few others, you're your own boss within six months. Within another six months, you're bankrupt.

Why? How could such a good plan for starting a company fail?

Because many engineers ask those same questions every year, ELECTRONIC DESIGN interviewed an engineer who is also a successful company founder. "Why do so many new electronics companies fail? What does it take to make one a success?"

Nicholas DeWolf, engineer and co-founder and president of Teradyne, a Boston electronics corporation specializing in test equipment, answered our questions with following comments:

Potshots

First, I'll offer some opinions of a general nature:

- A good product idea is probably the worst reason of all for starting a company. There are about 750,000 new product ideas from engineers each year, but only 0.01 per cent of them are worth justifying production.

- You must be an entrepreneur to succeed at starting a company, and entrepreneurs are born, or at least made or broken, by the age of 16. If you're an entrepreneur, the chances of your operating a successful company before you're 35 are good.

- Managers usually do not make good company founders because they're too cautious. They

do not want to break eggs. They do not work well in shirtsleeves.

- The inventor and the researcher know the product, but they tend to overestimate the imagination of customers and investors.

Now let's get to some specifics.

If you're still determined to start a company, DeWolf offers four broad suggestions that should help the fledgling founder:

- Help someone else start a company. Since the mortality rate is high, he may fail, but you can learn from his mistakes.

- Work for a large company. They're the ones that innovate, and they have unlimited services.

- You must be able to explain your proposals and have the ability to influence others.

- University engineering instructors should get a job in the industry before attempting to become their own boss. The practical training will be worth the effort.

Now let's get to some specifics.

What drives you?

You must decide what you really want in life, what your real motives are for starting a company, because you're about to risk everything, including your reputation. What drives you varies widely, but the standard motives are:

1. The need to be fashionable.
2. The desire to be rich.
3. The fatherhood instinct.
4. The fact that you can't get along with other people.
5. A good idea.
6. The need for a sex substitute.

Be honest with yourself. Is your motive on the list? Do you have the right temperament for the job? The thing to think out is: what would happen if you failed? Could you take it if you lost a large amount of money, or if you had to let your employees go?

Seek an opposite partner

A partner is a necessity for me in owning a company because he shares the load of responsibility, and he is experienced in areas I am not.

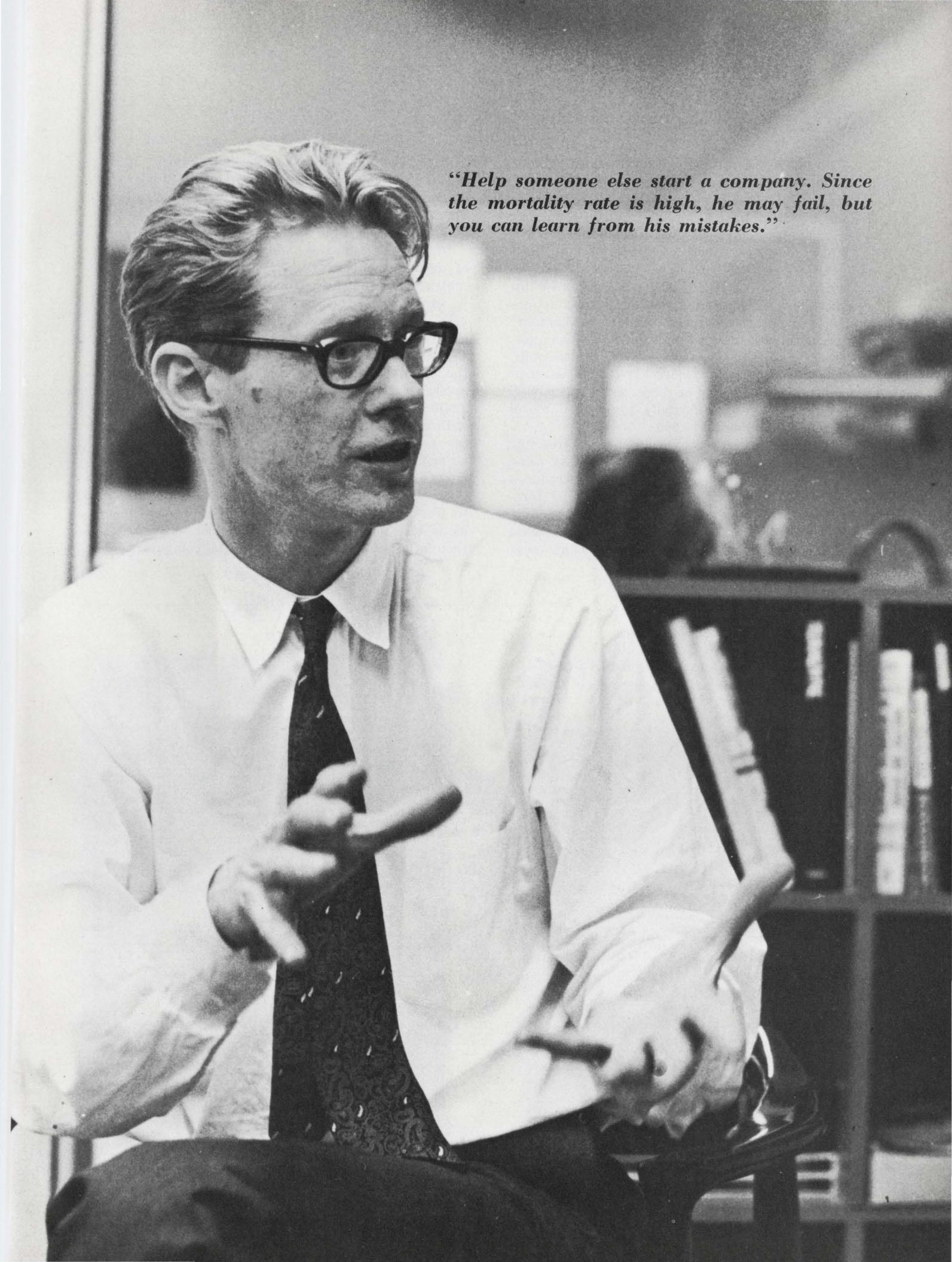

“Help someone else start a company. Since the mortality rate is high, he may fail, but you can learn from his mistakes.”

An electronics company success story

Teradyne has doubled its growth in six of its last eight years. Starting at ground zero, the Boston-based electronics house that specializes in automatic test equipment, has a current annual sales volume of over \$10 million.

The founders, Nicholas DeWolf and Alexander d'Arbeloff, both of MIT's class of '48, determined in 1960 to make rugged test instruments that would stand up in production-line applications. The first product was a four-test automatic diode instrument, which performed each go/no-go test in 35 milliseconds. The success of this model led to the development of an entire line of diode test instruments, including a 10-test, digitally programmed model that sold for about \$13,000.

Teradyne then successfully tackled resistor test instruments and classifiers, and next came zener diodes. In 1963 the company introduced two new transistor test instruments, the forerunners of one of the company's major product lines. Once again Teradyne chose to make what it describes as "Mack-truck" equipment—rug-

ged rather than delicate laboratory units. It underscored this approach by putting a 10-year warranty on the sealed modules used in all Teradyne equipment and by rigorous avoidance of all user calibration adjustments.

In 1965 the company entered the second stage of its growth by offering the first test systems controlled by general-purpose digital computers. A key part of this new venture was the development of a strong library of test software and consumer training programs.

Two acquisitions in 1968 put the company in the connector business and rounded out its coverage of component testing. They are Triangle Systems of Encino, Calif., owned jointly with E-H Research Laboratories, that is producing a large, computer-operated system for both ac and dc testing of ICs and Teradyne Components in Lowell, Mass.

Spokesmen for the company say that one key to Teradyne's success is that all of its early diode test instruments were designed with the thought of eventual control of digital computers.

"What makes a company go are the people willing to 'go to war' if necessary to push ideas across."

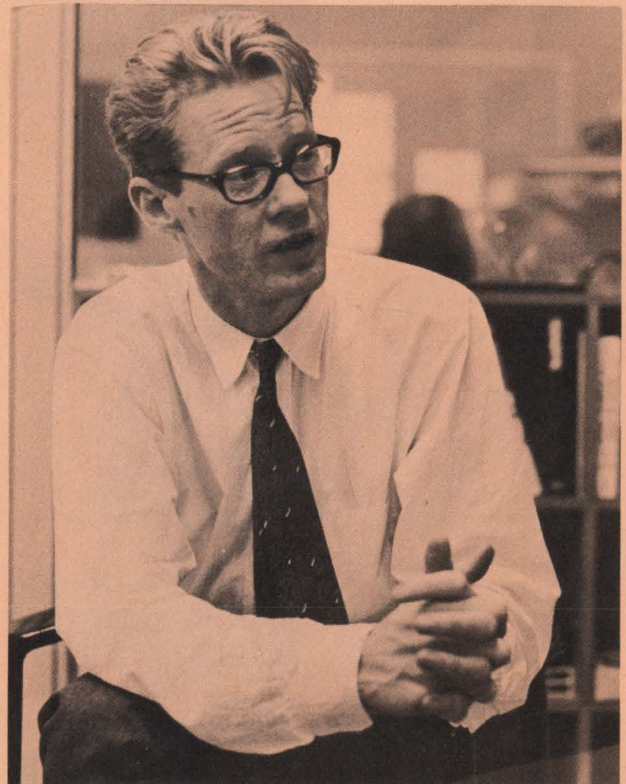

"There is a great deal of imagination on the part of financiers on how they propose to invest . . ."

Make real sacrifices to get a partner of comparable status. In our company I am "engineering" and take care of tomorrow, my partner is "marketing" and takes care of today. Least desirable as a partner is someone you are now working with; you need someone who is a pole apart from you in experience and temperament. I did not know my partner when we were students at MIT. I found him much later by scanning the school yearbook.

A good partner must be adjustable. He must be able to negotiate finances at the bankers' club and negotiate equipment in his shirt sleeves later the same day.

An electronics business is considered to be a highly speculative investment. Such businesses succeed or fail widely. However, most investment portfolios include a small percentage of electronics stock for the excitement of speculation. As a result, there is more money available for electronics investment than there is demand.

It is, however, difficult to raise funds for a new enterprise on favorable terms. Banks and private investors usually demand 25 to 33 per cent of the controlling interest in the company. Therefore it is necessary to employ a good lawyer. There is a great deal of imagination on the part of the financiers on how they propose to invest. But fear not, common sense still prevails.

The first money you raise will go quickly, because expenses always run higher than anticipated. Most important are the terms under which you raise the second money. If second money is necessary, it's usually a sign that you didn't do your homework pertaining to your initial financial needs. If you're not careful, you could lose your company in the attempt to raise the funds. Often you must auction company stock in the public market. Rather than go bankrupt, you are sometimes forced to auction away the controlling interest in the company. Usually the second financing comes at a time when company morale is at its lowest ebb. You haven't made a profit yet, and you're tired and depressed. That's a bad time to negotiate terms.

To obtain the best possible second-financing terms, try to anticipate when you will need the money, so that you can be prepared to make terms of your own. Also, stay friends with your stockholders. Don't promise them too much the first time around.

Hire a 'war' staff

The most valuable job any new company undertakes is that of recruitment, for people are more important than any product. What makes a company go are the people who are willing to "go to

"If the product is easy to make and exciting, the market for it is overcrowded."

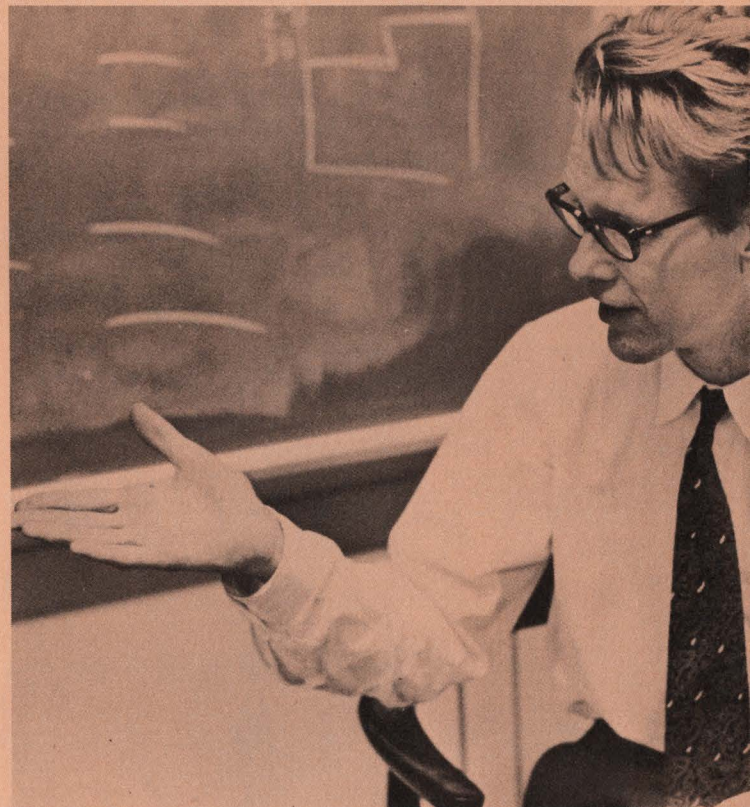

"Make real sacrifices to get a partner of comparable status but different experience."

war," if necessary, to push ideas across.

Too often you'll hire people with whom you've worked successfully. An amazing percentage of them will not work out, because you are involved in an entirely different environment than before. Sooner or later you and your employees will become disenchanted with the situation, and if they don't quit, you'll have to let them go.

A new company should hire the people who are receptive to new ideas and who can adjust to a variety of situations. Hire also the people whose work background is at variance with your own.

De-emphasize the new-product idea

A new product fulfills either a need or a demand.

The engineer who devises a novel service or object is speculating that it will fulfill a need. This type of product, from the company viewpoint, promises a wide range of success or failure—and it is extremely risky.

It's more traditional and safer to build a new product for which there already is a demand. It's easier to sell, even though profit margins are slimmer because there is more competition.

The most common invention in electronics is the "new twist" in a measurement instrument, because these tools are the favorite playthings of electronic engineers. Such ideas are cheap.

Almost all engineers underestimate the diffi-

culties of selling a new product. The number of units sold in the first three years is rarely greater than one-third of the estimate. To make ends meet, a company must overcharge. And to overcharge, the company will have to oversell, which is far more difficult than the work on the product.

The key to marketing success is to get a good product into production and turn it out as fast as possible. Don't stop to listen to the applause of those who admire technical innovations—that doesn't pay your bills.

Three points to remember about new-product ideas:

1. If the product is easy to make and exciting, the market for it is overcrowded.
2. The fundamental idea for a new product must be explainable in three sentences and understood by a 16-year-old.
3. A new product may fail because of superior competition. Therefore the market that first new product created is often more unusual than the product itself.

Why engineers start companies

I feel strongly that large companies invest a great amount of money hoping to stumble onto something worthwhile. When they do, their own inertia frustrates the people involved in a project, and as a result, those people want to start their own company. Sometimes the project workers will stumble onto something very promising, while the company has been backing a loser.

Unfortunately, most companies are reluctant to change and are afraid of novelty. Almost any exciting new product that emerges from the lab produces a frustrated would-be entrepreneur. I've never heard of a committee being emotionally excited over change.

This year 750 companies exhibited at the IEEE Convention in New York City. Not too long ago there were 1200 exhibitors at the convention. Although fewer exhibitors does not necessarily mean there are fewer companies in business, I believe that due to a number of mergers, the number of small companies is dwindling. If good times continue, "risk" capital will be available for investment in the electronics industry, but there will be a shortage of entrepreneurs to organize the forces necessary for company founding.

The country is now weathering the silent generation of the 50's. They are not a generation of entrepreneurs. Until the "hip generation" comes of age and takes charge, I believe there will be many more failures than usual in the attempts to start companies in the electronics industry. If you're not an entrepreneur, your new company will most probably be one of those failures. ■■

"Don't stop to listen to the applause of those who admire technical innovation; that doesn't pay your bills."



TRW Announces Ultra-Linear RF Power Transistors... 2 to 150 MHz

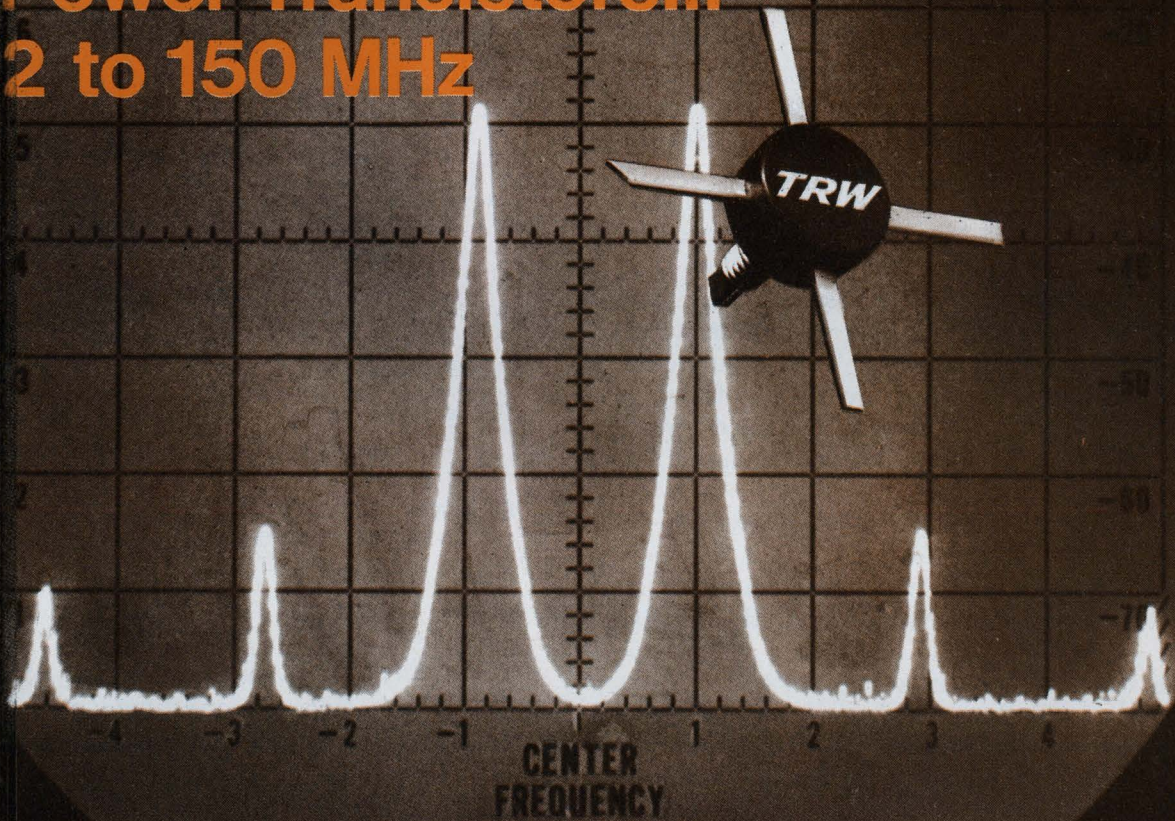

20 to 100 watts...- 32 dB intermodulation guaranteed

TRW offers three new 28-volt RF transistors to meet a range of output power needs in either SSB or CW. All are designed for Class A, Class AB, or Class C operation. All will withstand severe output mismatch. All are available in low profile, strip-line packages.

The 2N5707 provides 20 Watts

P.E.P. in SSB use from 2 to 30 MHz, and 30 Watts CW output to 150 MHz. The 2N5708 provides 40 to 50 Watts respectively over the same frequencies, and the 2N5709 furnishes 80 and 100 Watts in the same operating modes. All three have excellent broadband capabilities.

Contact any TRW Distributor or

INFORMATION RETRIEVAL NUMBER 35

TRW Semiconductors, 14520 Aviation Boulevard, Lawndale, California 90260. Phone: (213) 679-4561. TWX 910-325-6206. TRW Semiconductors Inc. is a subsidiary of TRW Inc.

TRW®

Simple duplexer requires only inexpensive components

Simplicity and low cost are important objectives in any circuit design, and duplexers (transmit-receive switches) are no exception. Here is a duplexer for use in the 10- to 50-MHz region that uses very inexpensive components and does not require external bias supplies or switching signals. The insertion loss is low, being less than one dB in both transmit and receive modes, and transmit-receive port isolation is greater than 26 dB for a 30-V peak signal. This is sufficient in some applications, but if further isolation is needed, the design of a second, cascaded switch is greatly simplified because of the reduced signal level.

Operation of the duplexer is as follows: in the transmit mode, all diodes conduct. In addition, C_1 and L_1 form a parallel-resonant circuit that blocks the transmitter signal from the receive port.

When the transmitter is off, low-level incoming signals from the antenna are blocked from the transmitter port by $CR1$. Also, C_1 is blocked by $CR2$, and $CR3$ does not shunt the signal to ground. C_2 cancels the series reactance of L_1 , providing a low-impedance series-resonant path to the receive port.

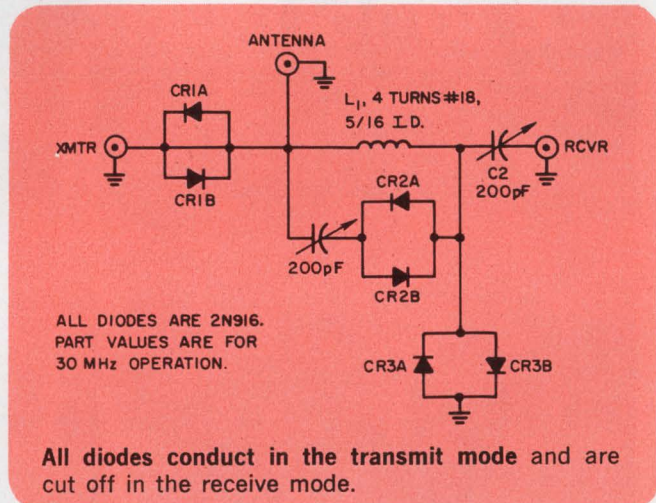

A modification of this design, employing 1/4- and 1/2-wave line sections, instead of lumped-component resonant circuits, has been operated satisfactorily at 300 MHz.

R. Van Sickle, Design Engineer, KMS Industries, Ann Arbor, Mich.

VOTE FOR 311

Linear pulse stretcher has wide dynamic range

A pulse-stretcher circuit having a linear output and wide range can be designed economically with two IC operational amplifiers. The circuit uses negative feedback to achieve an over-all gain of unity. This approach allows the output to be independent of the diode turn-on characteristics when charging the stretching capacitor.

Circuit operation is as follows: a positive pulse with a risetime of 2 μ s or more is fed to the non-inverting input of $IC-1$. The positive output of $IC-1$ charges stretching capacitor C_1 through R_1 and $CR1$. As the pulse dies away, diode $CR1$ be-

comes reverse biased, allowing the stretching capacitor to discharge with a long time constant. The stretched output is obtained from the voltage follower, $IC-2$.

The output of $IC-2$ is fed back to the inverting input of $IC-1$, and since the input impedance of the LM101 is high (800 k Ω), the closed-loop gain is unity. This forces $IC-1$ to make up for the loss in turning on $CR1$, and therefore allows linear stretching below the knee of the diode. This result can not be achieved in other pulse-stretching circuits commonly used. Input pulses

Double duty Double metals

H. A. Wilson Thermometals® are thermostatic bimetals that (1) change shape with temperature and (2) build up force with change of temperature when constrained.

They can be used for Temperature Indication, Temperature Control, Temperature Compensation or Sequence Control.

The many varieties of Thermometal available offer a choice of properties for an unlimited number of applications.

Thermometals can be rolled to any thickness, formed into almost any shape . . . plated, brazed or welded.

We have more engineering know-how and manufacturing facilities than anyone in this field. For information and/or technical assistance call or write the H. A. Wilson Technical Service Department.



ENGELHARD

ENGELHARD INDUSTRIES DIVISION
ENGELHARD MINERALS & CHEMICALS CORPORATION
2655 U. S. ROUTE 22, UNION, NEW JERSEY 07083

36

INFORMATION RETRIEVAL NUMBER 36

*Quick Henry,
the prints!*

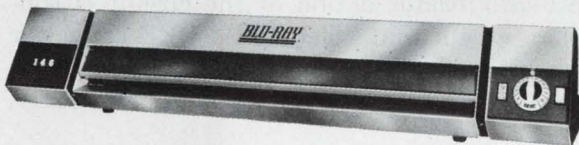

If you need quick copies, stop waiting and start saving with the Blu-Ray 146 whiteprinter.

With the Blu-Ray 146 semi-automatic, diazo printer-developer, you make check prints on-the-spot—fast and cheap—much cheaper than sending out for blueprints.

The table-top 146 is inexpensive to buy, yet a rugged performer that will work for you all day long. It's the sturdy, quality machine in the compact whiteprinter field and backed by Blu-Ray's exclusive 1-year warranty.

Anyone (even Henry) can operate the table-top 146, just set it up where it's handiest and its 47" throat will take up to 46-inch wide prints and expose and develop them sharply for 1c per sq. ft.

Send today for Free brochure and/or a demonstration by one of our 600 dealers coast to coast.

BLU RAY
INCORPORATED

3724 Westbrook Road
Essex, Conn. 06426
Phone (203) 767-0141

INFORMATION RETRIEVAL NUMBER 37

ELECTRONIC DESIGN 14, July 5, 1969

New Motorola frequency calibrator sets two-way radios precisely on frequency in seconds.

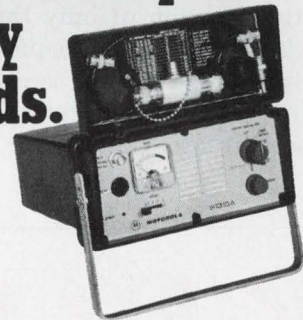

Here's a whole new method of frequency calibrating from Motorola. Our all solid-state S1315A frequency calibrator's .00001% accuracy, exceptional speed, and simplicity of operation result in performance that makes other heterodyne type meters obsolete.

This major innovation provides ultra-fast frequency checks of all AM or FM multi-channel units: base stations, mobile telephone system mobile units, citizens band equipment, and marine radio, as well as single-channel mobiles and portables. Low power consumption, fast warm-up, and battery or optional AC line operation make the Motorola S1315A truly versatile and ideal for field use.

At 4¼" high x 8" wide x 11½" deep, the unit weighs only 7 lbs. Get all the details in our Bulletin TIC 3455. Write to Motorola Communications and Electronics, Inc., Precision Instruments Products Dept., 4501 W. Augusta Blvd., Chicago, Illinois 60651.

 **MOTOROLA**

INFORMATION RETRIEVAL NUMBER 38

81

as low as 25 mV have been stretched with this circuit.

The upper range of the pulse stretcher is determined by the new slew rate of the ICs and the amount of charging current available from IC-1. For the risetime and stretching time shown on the diagram, a maximum output of 5 to 6 V can be obtained. This gives a dynamic range of 200 or more. If longer risetimes, or shorter stretching times, are used, a maximum swing of 10 V can be realized from the circuit. (The values of R_1 and C_2 may be adjusted to suit the particular stretcher application. Also, the output of IC-1 may be buffered with an emitter follower or another LM102, if desired.)

The stretcher time constant is made up largely of the value of C_1 and the input impedance of the voltage-follower LM102 (IC-2). The input leakage of the LM102 is typically 3 nA, giving a pulse-stretching RC time of 1 second for a 3-volt pulse. The capacitor and diode leakages do not enter into the time constant since their combined impedance is at least two orders of magnitude above that of the voltage-follower. (The maximum leakage of CR1 at 10 volts reverse bias is 5 pA).

During the decay of the input pulse, the negative feedback forces the output of IC-1 to go

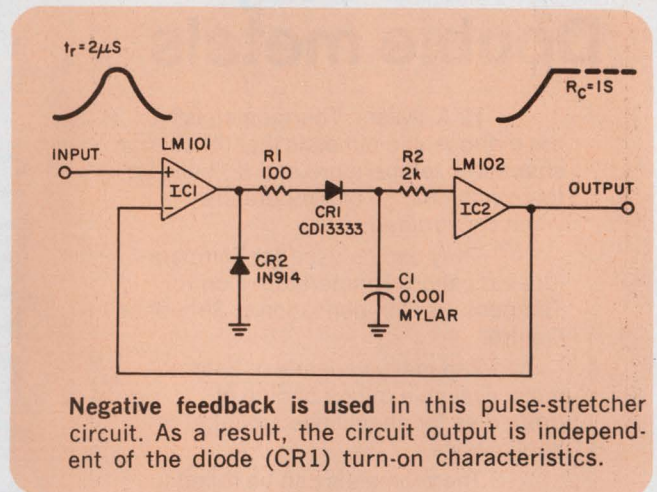

Negative feedback is used in this pulse-stretcher circuit. As a result, the circuit output is independent of the diode (CR1) turn-on characteristics.

negative, since the output of the circuit decays with a long time constant. CR2 clamps the output of IC-1 to ground, preventing it from reaching the negative supply voltage. In this manner, CR1 is not subjected to a large reverse bias.

This work was performed under the auspices of the U. S. Atomic Energy Commission.

James H. McQuaid, Design Engineer, University of California, Livermore, Calif.

VOTE FOR 312

3 extra parts give astable multi a wide frequency range

With the addition of only three components it is possible to vary the frequency of an astable multivibrator over a wide range while maintaining the mark-space ratio constant. The additional parts (see circuit) are diodes D1 and D2 and

variable resistor R.

The multivibrator action of the circuit is conventional, except that when Q1 is OFF capacitor C1 discharges through D1 and R, as well as through R_{B1} (D2 is reverse biased). Similarly,

VOTE

VOTE! Go through all Idea-for-Design entries, select the best, and circle the appropriate number on the Reader-Service-Card.

SEND US YOUR IDEAS FOR DESIGN. You may win a grand total of \$1050 (cash)! Here's how. Submit your IFD describing a new or important circuit or design technique, the clever use of a new component or test equipment, packaging tips, cost-saving ideas to our Ideas-for-Design editor. You will receive \$20 for each accepted idea, \$30 more if it is voted best-of-issue by our readers. The best-of-issue winners become eligible for the Idea Of the Year award of \$1000.

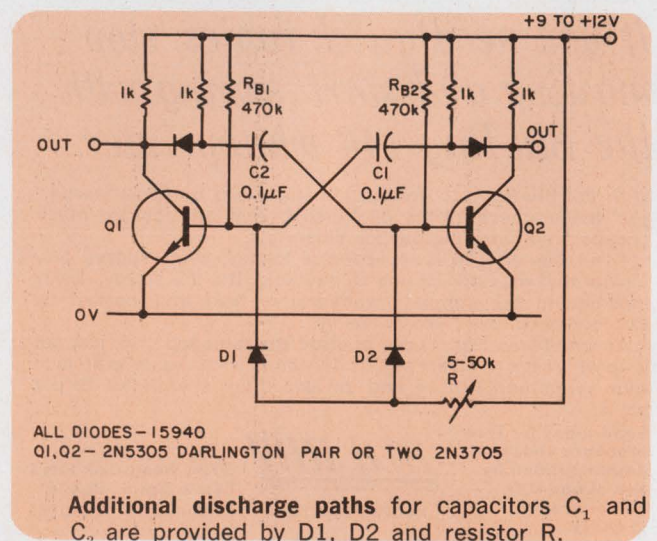

Electrical Engineers:

Join a small, hard-hitting logic design team at IBM.

Here's your chance to really get involved with designing the logic for sophisticated new systems for both military and commercial projects.

New Engineering Center

Here at IBM's new Communications and Engineering Sciences Center, near Washington, D.C., we work in small groups. This allows each member to dig into the project from the very beginning—from sitting down with the customers before we begin to conducting the maintenance training after we finish.

The entire group is involved with everything from hardware design to systems acceptance and program management.

You should have a degree in electrical engineering. Experience in logic design, digital systems or some other data processing area would be helpful.

Projects now underway

Several high-priority projects are already underway. They range from an advanced reservations system for commercial airlines to highly classified ground-based military systems.

We are also helping to develop greater mission capability for the post-Apollo period.

Why choose IBM?

Today's major growth industry is information handling and control. And IBM is a leader in that field. This growth environment can bring out the best of your talents and abilities, because in a growth company like IBM you can work constantly toward greater achievement. This means more opportunities to achieve distinction and personal recognition.

So if you're a problem-solver who wants a personal sense of achievement and recognition for your hard work in an exciting growth company, consider IBM.

Call or write

If you are an Electrical Engineer and want to join a small, hard-hitting team, call Jim Dunn at (301) 921-7650 collect any weekday between 9 and 4:30. Or, send a brief letter or resume to him at IBM Corporation, Federal Systems Division, Dept. CG1016, 18100 Frederick Pike, Gaithersburg, Maryland 20760.

An Equal Opportunity Employer

IBM®

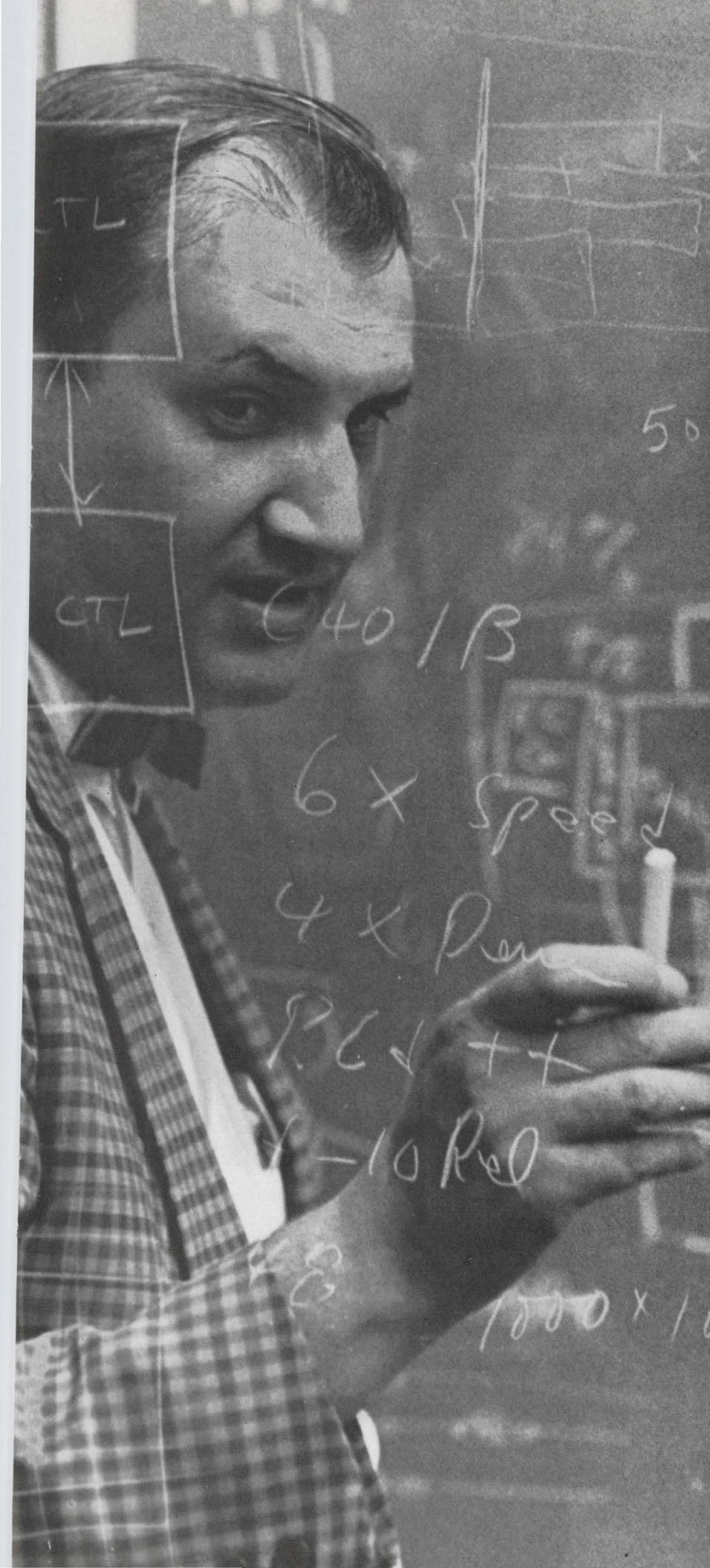

when $Q2$ is OFF, C_2 discharges through $D2$ and R , as well as through R_{B2} ($D1$ is reverse biased).

If R is much smaller than R_{B1} and R_{B2} , then

$$T_1 \approx 0.7 C_1 R$$

$$T_2 \approx 0.7 C_2 R$$

and if $C_1 = C_2 = C$, then the multivibrator frequency, f , is given by:

$$f = 1/1.4CR$$

Thus, the frequency may be varied over a wide range by varying R only. And if $C_1 = C_2$, the mark-space ratio will remain 1:1 throughout the frequency range.

It should be noted that it is not essential that R be much smaller than R_{B1} and R_{B2} . However, if it is not, the simple frequency formula previously given does not apply.

With the component values shown, the circuit can be varied over the frequency range of 140 Hz to 1.4 kHz, with constant 1:1 mark-space ratio.

S. H. Dolding, Design Engineer, Kent, England

VOTE FOR 313

Bridge amplifier compensates for strain-gauge variations

A transducer amplifier circuit is sometimes required to operate with a variety of strain-gauge transducers, and thus must be able to compensate for a wide range of gauge factor and input resistance. The method usually used (1) is to put a variable resistor in series with the excitation voltage source and the transducer. This provides a higher or lower excitation voltage to the transducer to compensate for variations in strain-gauge resistance change versus pressure. The addition of the variable resistor is acceptable as long as the input resistance is relatively constant for different transducers. Although this is true for transducers of the same type, compensation is required if different types of transducers are to be used.

With the technique shown in 2, it is possible to compensate for resistive-type strain-gauge transducers having large variations in input resistance and gauge factor.

In the circuit of (1), $A1$ is the source of excitation voltage for the transducer, R_1 is a variable control to compensate for variations in gauge factor, and $T1$ is a strain-gauge transducer. If (a) the value of R_1 is set for some given value, (b) the transducer has an input resistance of a given value, and (c) V_1 is constant, there will be definite voltage drops across R_1 and $T1$, to provide a constant excitation voltage, V_2 . But if the $T1$ input resistance value, R_{in} , is not the same for all transducers, a problem arises—namely, that the excitation voltage, V_2 , across $T1$ will change. This will give a different voltage output versus pressure for a given setting of R_1 .

The problem can be corrected with the circuit of (2). Here, a fixed 1% resistor, R_2 , is added to provide a constant load for R_1 and a constant voltage into the emitter-follower transistor stage, $Q1$. The ratio of R_2 to R_1 can be selected to pro-

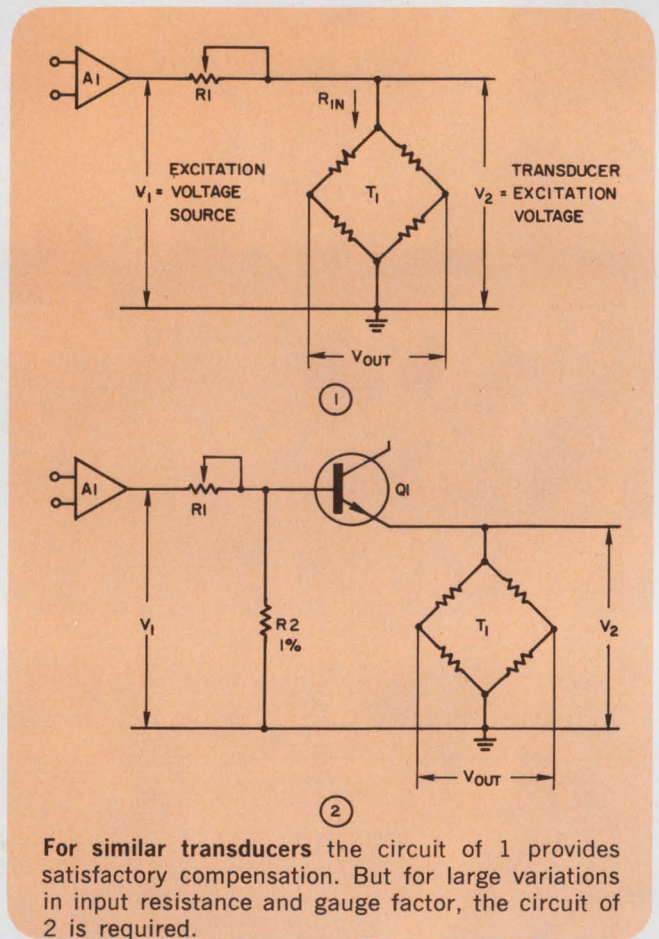

vide gauge-factor adjustment over a relatively large range. The input resistance of $Q1$ has negligible loading effect on R_2 .

The load of $Q1$ is the transducer input resistance, R_{in} . Wide variations of this input resistance have a negligible effect on the R_1 - R_2 voltage divider, thereby providing a constant excitation voltage.

Andrew Stemple, Senior Engineer, Zenith Radio Corp., Chicago, Ill.

VOTE FOR 314

Ceramic thermoelectrics for your critical temperature control problems

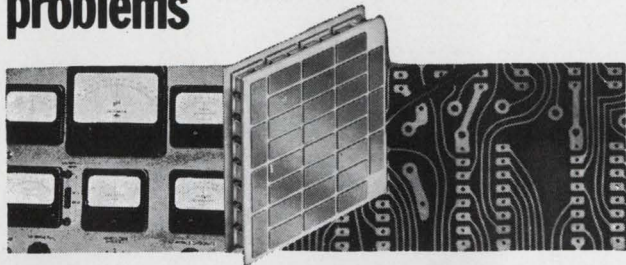

Specify CAMBION® ceramic thermoelectric components where highest performance, maximum packing density, maximum uniformity and maximum durability are prime requisites for demanding temperature control applications.

Military, space and avionics systems, baths, ovens, liquid-to-liquid and air-to-air heat exchange systems . . . for all sensitive component temperature control . . . CAMBION thermoelectric devices or systems can provide you extremely precise control, reliability and on-time delivery.

Designed to be used separately or incorporated in larger systems as series parallel arrays, a wide range of sizes and heat-pumping capacities may be obtained. CAMBION ceramic modules are available for immediate delivery from stock.

Get more information on these high-performance ceramic thermoelectrics for your temperature control problems. Talk to Gordon Bird at (617) 492-7082, or write to him direct in Cambridge - Cambridge Thermionic Corporation, 507 Concord Avenue, Cambridge, Massachusetts 02138.

Standardize on

CAMBION®

The guaranteed electronic component assemblies
INFORMATION RETRIEVAL NUMBER 39

FREE CATALOG! OPTICS! SCIENCE! MATH! GIANT 148 PAGES

1000's OF UNUSUAL BUYS FOR
INDUSTRY

Many on-the-job Helps . . . Quality Control Aids! Write for this completely new, 1969 Catalog. New items, new categories, new illustrations, 148 easy-to-read pages packed with hundreds of charts, diagrams, illustrations. A treasure-house of optical and scientific information . . . unusual bargains galore. Optics for industry, research labs, design engineers, experimenters, hobbyists! Instruments for checking, measuring — to speed work, improve quality, cut production costs. We give you facts: what it is — how it works — where it's used!

Comparators, Magnifiers, Microscopes

Hard-to-get war surplus bargains — ingenious scientific tools — imported — domestic. Thousands of components: lenses, prisms, wedges, mirrors, mounts, accessories of all descriptions. Dozens of instruments: magnifiers, stereo, microscopes, telescopes, binoculars, infrared equipment, photo attachments. Shop by mail. No salesman will call. Use the Catalog of America's greatest Optics — Science — Math Mart. Known for reliability. Mail the coupon below to:

Edmund Scientific Co., 300 Edscorp Building,
Barrington, New Jersey 08007. Ask for Catalog "DA"

MAIL COUPON FOR FREE CATALOG "DA"

EDMUND SCIENTIFIC CO.
300 EDSCORP BLDG., BARRINGTON, N.J. 08007

Please send FREE Giant 148-page Catalog "DA"

NAME

ADDRESS

COMPANY

CITY STATE ZIP

INFORMATION RETRIEVAL NUMBER 40

ELECTRONIC DESIGN 14, July 5, 1969

Don't buy too much relay.

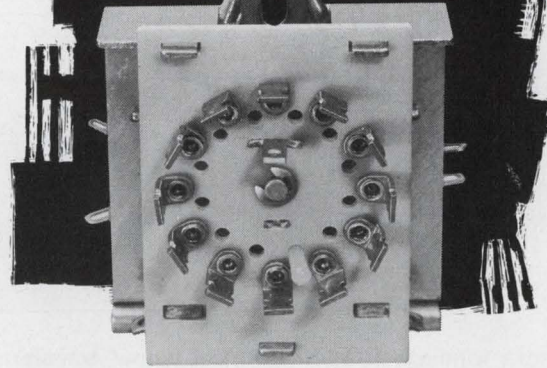

Dale Steppers do telephone-type jobs in less space at half the cost!

In just over 8 cubic inches, Dale's 4100 Series can handle your telephone-type stepping requirements. Uni-directional, bi-directional, AC, DC, 4, 6, 10, 12 or 13-throw sequence. The cost: \$6.00 in quantities of 100.

Dale steppers have been thoroughly proven in a number of industrial and commercial control applications. They offer a reliable method of reducing size and cost without sacrificing product quality. We're ready to prove it. Phone 605-665-9301 or write us today!

DALE STEPPING RELAY SPECIFICATIONS

Uni-directional or bi-directional, AC or DC with plate (2.5 watt) or wafer (4.5 watt) switch. Single pole with 4, 6, 10, 12 or 13-throw sequence. Contact rating: From dry circuit to 1 amp at 24 VAC. Auxiliary power switch can be located at any specified position. Plurality of poles makes 3-5 throws possible. Can be provided with interrupter switch for automatic stepping. Adjustable physical stops provide reliable selection limiting. Dimensions: 2.200" H x 2.190" W x 2.005" D.

DALE ELECTRONICS, INC.

Sioux Division, Dept. ED
Yankton, South Dakota 57078

Write for new Electromechanical Products Brochure

INFORMATION RETRIEVAL NUMBER 41

Darlington inverter features turn-off drive and low $V_{CE(sat)}$

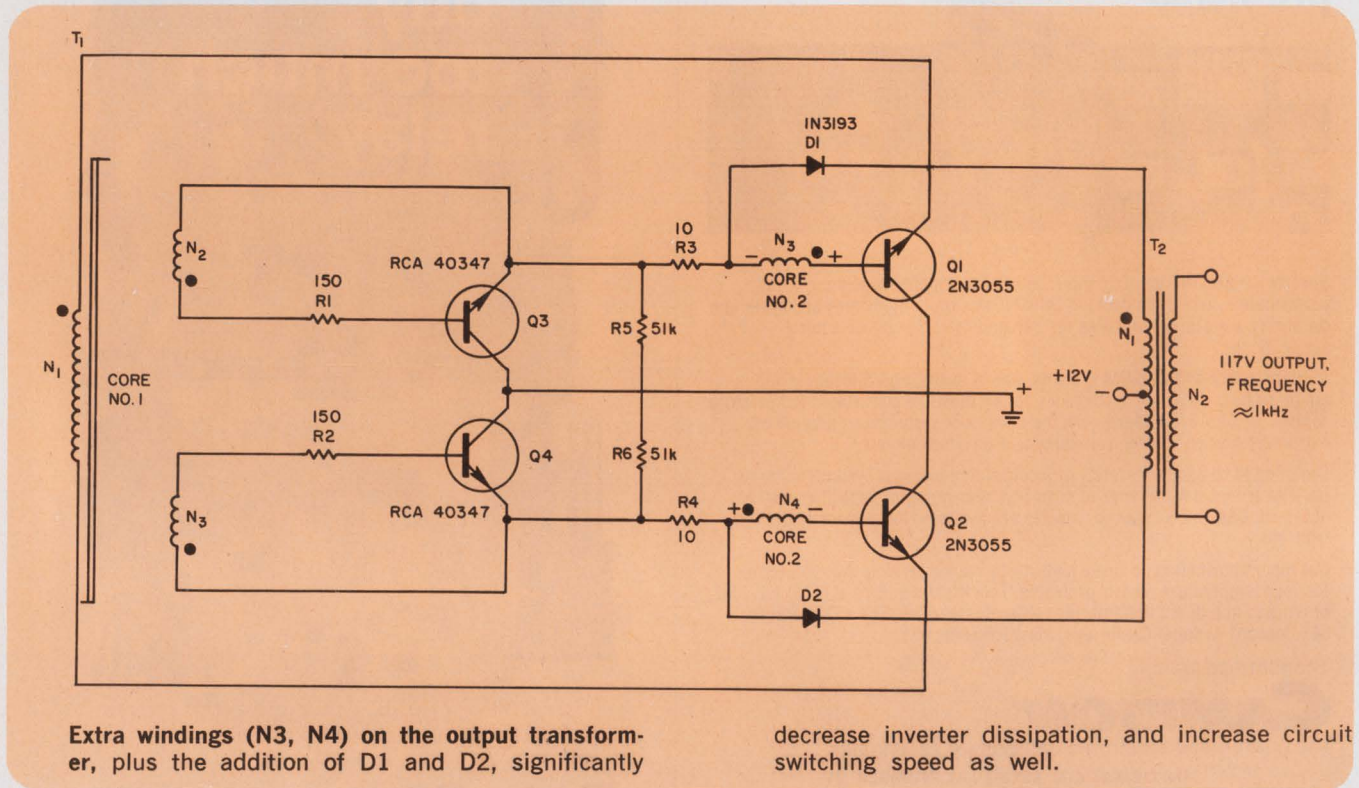

Many two-transformer inverters require a square-loop transformer as a driver element. The size and weight of this transformer depend upon operating-frequency and output-power requirements; and low-frequency operation at high power levels requires relatively large transformers.

For economic reasons, it is often desirable to use a Darlington connection to reduce transformer size and cost. However, the following problems are encountered when a straightforward Darlington approach is used.

- The collector-to-emitter saturation voltage, $V_{CE(sat)}$, of the ON output transistor is high. This is because it cannot decrease below a value determined by the active base-to-emitter voltage, V_{BE} , of the output device plus the $V_{CE(sat)}$ of the driver device. This effect produces excessive dissipation.

- Because no turn-off drive is available to the OFF output device, switching is slow and, again, excessive dissipation results.

Both of these problems can be resolved by the addition of extra turns on the output transformer ($N3$ and $N4$ of $T2$) and the use of two diodes ($D1$ and $D2$), as shown in the illustration. The polarity of $N3$ and $N4$ of $T2$ are shown for transistor $Q1$ ON and $Q2$ OFF. During this time, the function of transformer winding $N3$ is to

provide a boost voltage to the base of $Q1$ so that the transistor fully saturates. The function of winding $N4$ is to provide reverse-bias turn-off current through $D2$ to $Q2$. When $Q2$ turns on and $Q1$ turns off, $N3$ and $D1$ provide reverse bias to $Q1$, and $N4$ provides a boost voltage to $Q2$.

Resistors $R1$ and $R2$ limit base drive to the drivers, while $R3$ and $R4$ limit base drive to the output stages. Because the emitters of the drivers present a high-impedance to ground when the driver stage is off, resistors $R5$ and $R6$ have been added to permit viewing of waveforms without pickup problems.

D. M. Baugher, Design Engineer, RCA, Somerville, N.J.

VOTE FOR 315

IFD Winner for March 1, 1969

Jacek H. Kollataj, Design Engineer, Oy Nokia AB Electronics, Helsinki, Finland. His Idea "Linearize your TTL gates—then build useful circuits with them" has been voted the Most Valuable of Issue Award. Cast your vote for the Best Idea in this Issue.

The great digital systems kit!

step 3:

**COLLECT DATA FASTER WITH
A NEW 12-BIT 90, 135 OR 180 KHz
MINIVERTER™**



These three new MINIVERTERS™ combine multiplexer, sample-and-hold amplifier and analog-to-digital converter with throughput rate choice of 90KHz, 135KHz or 180 KHz. And each unit goes faster when short cycled; for example, the 180 KHz MINIVERTER runs at 360 KHz with 8-bit resolution.

They come in 19" by 5¼" drawers only 17" deep. And that includes power supply, exhaust fan and input/output cable breakout. Mode selection, short-cycle and channel selection switches; data display indicators and other controls and indicators are available as options.

These new high-speed data acquisition instruments are more of the fast-moving products in our great digital systems kit for 1969. Write or call today. Raytheon Computer, 2700 S. Fairview St., Santa Ana, Calif. 92704. Phone (714) 546-7160. Ask for Data File DK-169.

RAYTHEON

FOR BELDEN ULTRA-FINE MAGNET WIRE—

New protection against mashers and bashers

A new, ultra-strong shipping and storage package for Belden Ultra-Fine Magnet Wire! Now, even the most butter-fingered, ten-thumbed package handler can't accidentally damage your investment. You get your wire in perfect shape. Wound on high-impact spools with its own air suspension system and packed in chipboard boxes . . . labeled distinctly so you know what you've got. We've padded around them securely, and put the boxes in a one-way, reusable polyethylene case. We ship this in a heavy corrugated box. You wind up protected all down the line. With dimensionally perfect magnet wire as only Belden makes it. Uniquely concentric in its insulation. Without thin spots to cause shorting. Without thick spots to cause uneven coil diameters. It's all described in the "Belden Magnet Wire Handbook." Make a start toward problem-proofing your magnet wire activities—ask your local Belden Magnet Wire Distributor or Belden Representative for your copy today. Or write: Belden Corporation, P.O. Box 5070-A, Chicago, Illinois 60680.



...new ideas for moving electrical energy

BELDEN 

1-1-8

INFORMATION RETRIEVAL NUMBER 43

Products

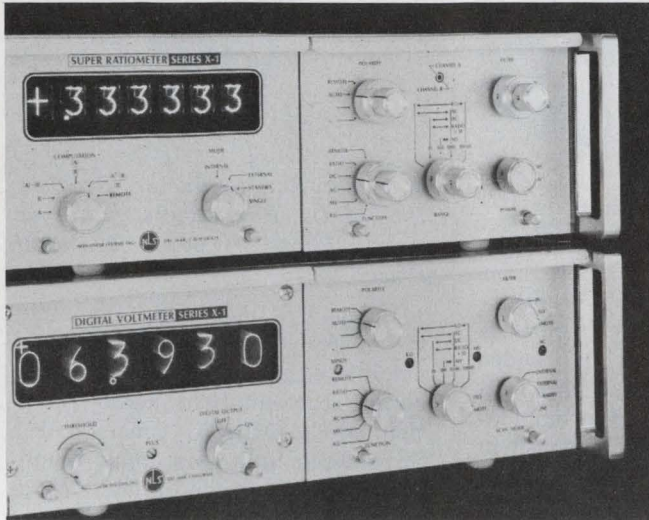

Digital computing multimeter can find input ratios, deviations or differences. p. 93.

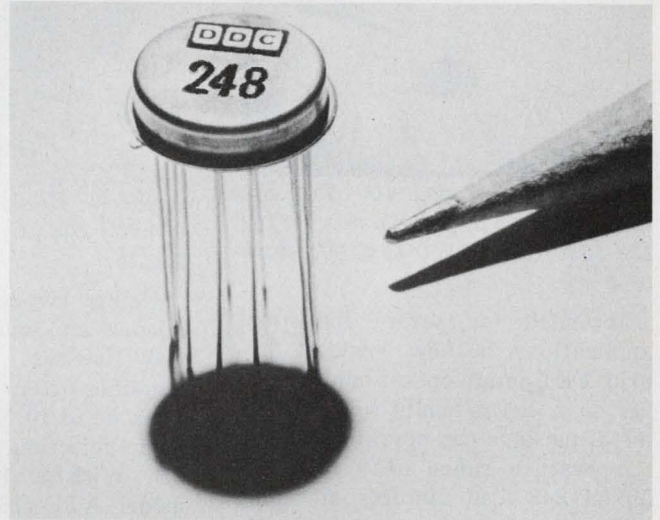

Low-cost industrial TO-8 hybrid amplifier with 5-pA bias goes up to 70°C. p. 90.

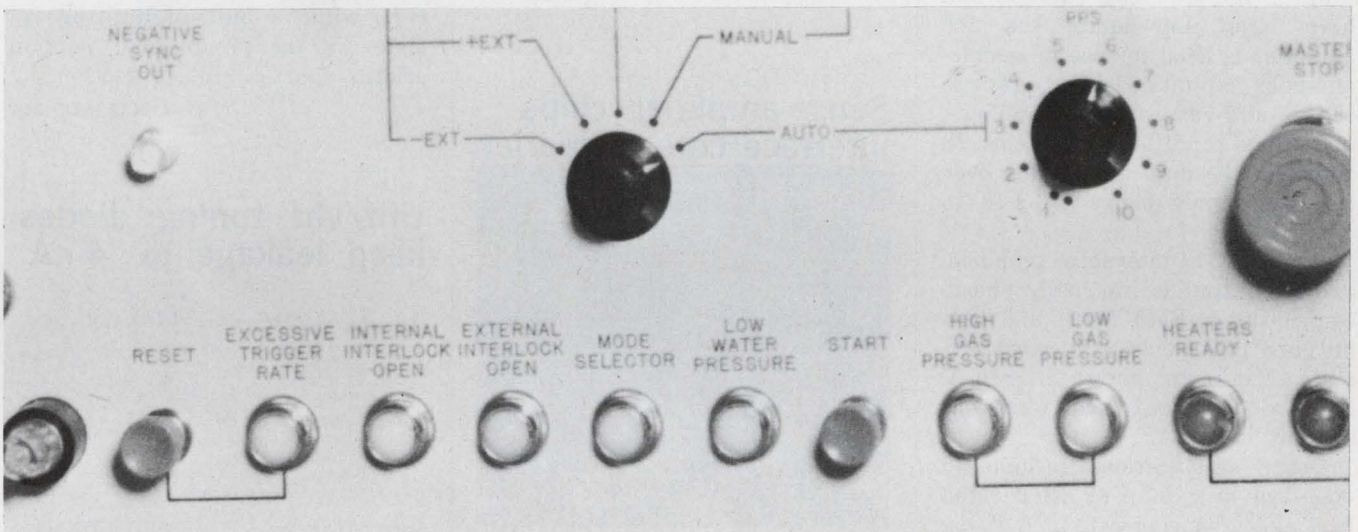

Pulsed variable gas laser costs half as much as previous units. In 60 s, it can change its

wavelength from UV to green by a simple switch in input gas. p. 102.

Also in this section:

Identical resonators make possible do-it-yourself filters, p. 96.

FET op amp selling for \$16 keeps voltage drift to $10\mu\text{V}/^\circ\text{C}$, p. 99.

Ultrasonic fluxless soldering system tins aluminum and ceramics, p. 105.

Evaluation Samples, p. 112 . . . **Design Aids**, p. 113 . . . **Annual Reports**, p. 115.

Application Notes, p. 114 . . . **New Literature**, p. 116.

Low-cost TO-8 op amp meets industrial needs

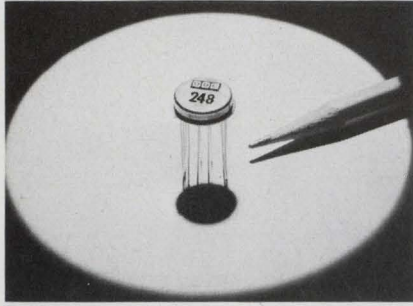

Data Device Corp., 100 Tec St., Hicksville, N. Y. Phone: (516) 433-5330. P&A: \$50 to \$100; stock to 2 wks.

Intended for severe industrial applications, a new low-cost hybrid FET-input operational amplifier in a hermetically sealed TO-8 metal package can operate over the temperature range of 0 to 70°C. Model 248 also features an input bias current of 5 pA and a voltage drift as low as 5 μ V maximum. Differential and common-mode input impedances are 10^5 M Ω .

With its low bias current and high input impedance, the 248 amplifier is ideal for use in sample-and-hold circuits, integrators, charge and electrometer amplifiers, and signal conditioning systems. In addition, the unit can operate over a power-supply range of ± 10 to ± 22 V.

Its offset is internally trimmed, and its output is internally phase-compensated. Both input and output are protected from short circuits. Minimum output is ± 10 V at 5 mA, while typical quiescent current is 3 mA.

Other specifications include an open-loop dc gain of 88 dB at rated load and a slewing rate of 3 V/ μ s. Frequency for full output is 30 kHz, while frequency for unity gain is 4 MHz.

Seven versions of the 248 are available. Types A-1, A-2, B-1 and B-2 offer an initial maximum offset voltage of 1 mV and maximum voltage drifts of 5, 10, 25, and 50 μ V/°C, respectively. Type B-3 has a maximum initial offset of 2 mV and a maximum voltage drift of 75 μ V/°C. Types C-1 and C-2 have a maximum initial offset of 5 mV and maximum voltage drifts of 100 and 150 μ V/°C, respectively.

CIRCLE NO. 251

Hybrid video amplifier gains 52 dB at 10 MHz

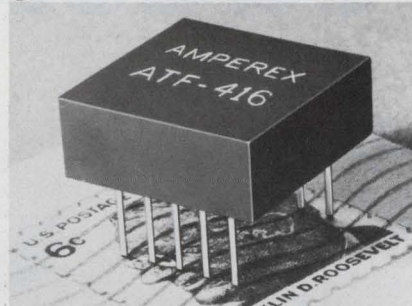

Ampere Electronic Corp., Micro-circuits Div., Cranston, R. I. Price: \$14.75.

Using low-noise LID semiconductors and sputtered thin films, a new low-cost hybrid IC video amplifier offers a gain of 52 ± 3 dB from dc to 10 MHz and a common-mode rejection ratio of at least 40 dB. With a 1000- Ω 20-pF load, model ATF-416 has a bandwidth of 8 MHz. It can be used as a gain- or bandwidth-controlled device or as a straight broadband amplifier.

CIRCLE NO. 252

Sense-amplifier chips interface core memories

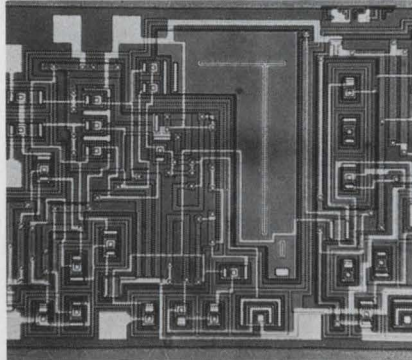

Transitron Electronic Corp., 168 Albion St., Wakefield, Mass. Phone: (617) 245-4500. P&A: \$22.50 or \$38; stock.

Two new sense amplifiers, the military TSA1150 and the commercial TSA2150 with flip-flop outputs, convert low-level differential pulses from core memories into higher-level data compatible with digital logic circuitry. They incorporate a threshold circuit with a narrow uncertainty window for the amplitude discrimination of incoming signals.

CIRCLE NO. 253

Monolithic sound circuit betters audio reception

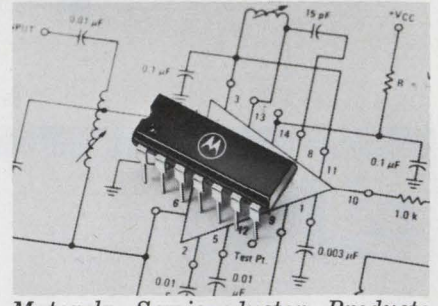

Motorola Semiconductor Products Inc., P.O. Box 20924, Phoenix, Ariz. Phone: (602) 273-6900. Price: \$2.75.

Primarily designed for television receivers and fm-radio i-f amplifiers, a new monolithic sound circuit can improve audio reception. Model MS1351 consists of a three-stage high-gain input amplifier with amplitude-limiting capability, a full-wave fm quadrature detector, and a three-stage audio preamplifier/driver. An integral zener diode provides built-in supply voltage regulation for the circuit, while a built-in limiting resistor in the preamplifier portion affords short-circuit protection.

CIRCLE NO. 254

Uhf/vhf tuning diodes keep leakage to 4 nA

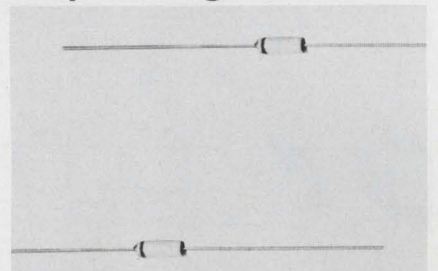

MSI Electronics Inc., 34-32 57th St., Woodside, N. Y. Phone: (212) 672-6500. P&A: \$9; 2 wks.

Tunable with high-impedance voltage sources, series SQ5461A varactors maintain a leakage current of less than 4 nA at 30-V breakdown rating. These diodes are available in standard nominal capacitance values from 6.8 to 100 pF. Their low leakage minimizes the possibility of spurious noise generation in uhf and vhf circuits.

CIRCLE NO. 255

Introducing a little revolution in fail-safe reed switching.

This new Cunningham Hystareed™ Magnetic Latching Relay operates *without permanent biasing magnets* or holding currents. Latches and

stays latched. Won't change its programmed state because of vibration, shock, power interruptions or transients. Needs no adjustment or calibration. Available up to 6 form A's, 4 form C's in a single assembly. Operates as standard relay for scanning.

Ideal for: data acquisition, low-level switching, computer interfacing, logic control, industrial machinery control.

Samples available. For complete facts, request Brochure No. 606B. Write or phone Cunningham Corporation, Carriage St., Honeoye Falls, N. Y. 14472. Phone (716) 624-2000.

Cunningham Corporation

SUBSIDIARY OF GLEASON WORKS

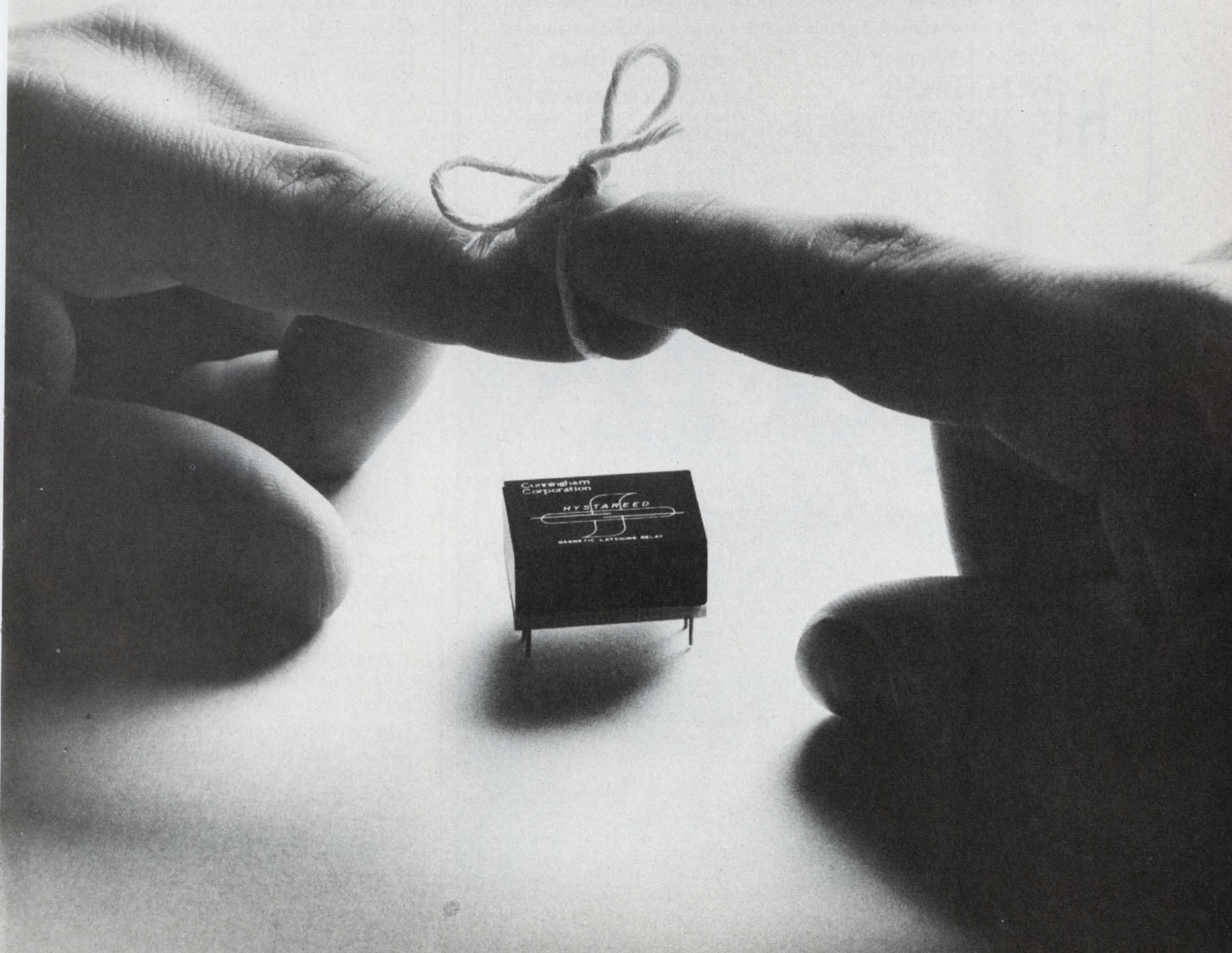

what's the
biggest
fault with
quality
castings?...

miserable
delivery!



True. The casting industry is famous for missed delivery promises. So we did something about it. We built a professional crew of specialists in the field of "Devise-a-system-and-make-it-work". And we bought a new computer to work with them. The computer doesn't take any guff or excuses from anyone. Now our deliveries are on time **94%** of the time. No other computer can make that statement. And no other investment casting foundry can make that statement . . . and mean it. We mean it.

HITCHINER
MANUFACTURING CO., INC.
MILFORD, NEW HAMPSHIRE 03055
Tel. (603) 673-1100, TWX (710) 366-1863

AEROSPACE DIVISION
Wallingford, Connecticut 06492
DELTA MICROWAVE CORP.
Hackensack, New Jersey 07601
FERROUS DIVISION
Milford, New Hampshire 03055
Nashua, New Hampshire 03060
NONFERROUS DIVISION
O'Fallon, Missouri 63366

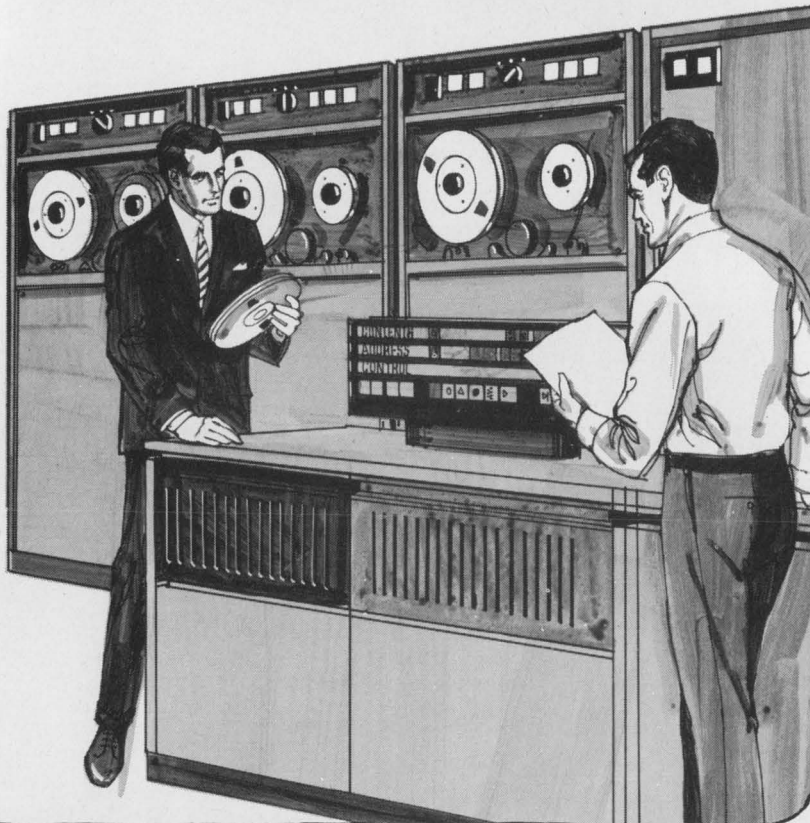

INFORMATION RETRIEVAL NUMBER 45

ICs & SEMICONDUCTORS

Silicon rectifiers work up to 20 kV

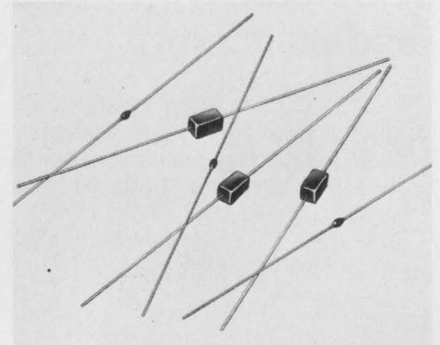

*Erie Technological Products, Inc.,
644 W. 12th St., Erie, Pa. Phone:
(814) 456-8592. P&A: 60¢ to
\$1.20; 2 to 4 wks.*

Available in glass envelopes or molded packages, a new line of miniature high-voltage silicon rectifiers features working ratings from 1 to 20 kV at temperatures from -55 to $+125^{\circ}\text{C}$. They are designed to achieve a high power-to-volume ratio with extremely low leakage currents in high-voltage circuits.

CIRCLE NO. 256

Miniature triacs take 250-A surge

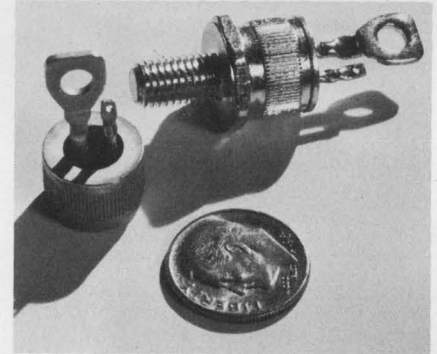

*General Electric Co., Semiconductor Products Dept., 1 River Rd.,
Schenectady, N. Y. Phone: (518)
374-2211. P&A: \$7.50 to \$12.51;
stock.*

Available in a stud-mounted (the SC60) or press-fit (the SC61) package, a new 25-A miniature triac offers a high surge current of 250 A peak (one cycle), as well as high dv/dt ; for example, the device can handle up to 6 kW at 240 V. Voltage ratings range from 200 to 500 V. Dc gate trigger current is 50 mA maximum.

CIRCLE NO. 257

Computing multimeter compares two inputs

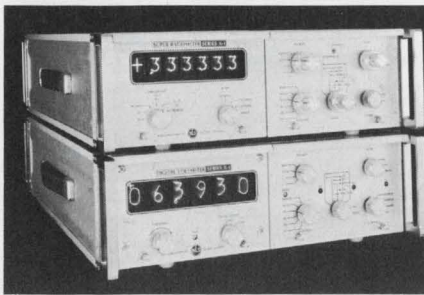

Non-linear Systems, P. O. Box N, Del Mar, Calif. Phone: (714) 755-1134. Price: from \$7500.

Using TTL integrated circuits, a new computing digital multimeter can measure two inputs and then find their ratio, their deviation, or their difference in a single automatic operation. Called a Super ratiometer, the new instrument measures 0 to 350 V ac, 0 to 1000 mV dc, 0 to 350 V dc, and 0 to 12 MΩ. Any one of these four quantities on one input can be compared with the same or any other quantity on the other input.

CIRCLE NO. 258

Program register controls instruments

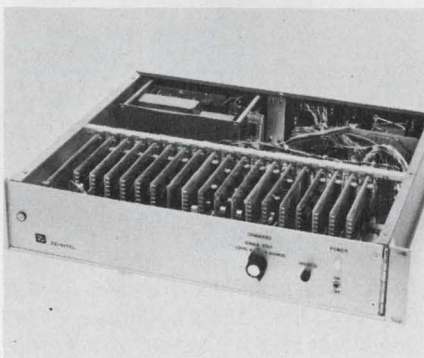

Zehntel, Inc., 1450 Sixth St., Berkeley, Calif. Phone: (415) 527-5440. Availability: July, 1969.

A new program storage register provides for the storage of information required to control the measuring instruments used in automatic test systems. The new instrument accepts and stores information from punched-paper-tape readers, magnetic-tape readers, computers and other digital information sources. It also can store limits for test comparisons.

CIRCLE NO. 259

FET OP AMP

10 $\mu\text{V}/^\circ\text{C}$

\$16.00

SINGLE LOTS

10 Picoamperes

GAIN - 10^6

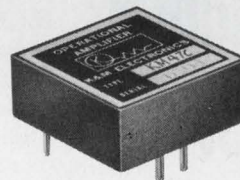

Model KM 45

INPUT IMPEDANCE: $10^{12} \Omega$

OUTPUT: ± 11 VOLTS @ 5 MILLIAMPERES

COMMON MODE REJECTION (CMR): 10,000

COMMON MODE VOLTAGE (CMV): ± 10 VOLTS MAX.

DIMENSIONS: 1.12" x 1.12" x 0.4"

AVAILABLE FROM STOCK

from  and their NATIONWIDE DISTRIBUTORS

K and M ELECTRONICS Corp.

408 PAULDING AVENUE
NORTHVALE, NEW JERSEY 07647

(201) 768-8070

My Requirements: Immediate Within 90 days Need technical help
 Rush Job - have salesman call

INFORMATION RETRIEVAL NUMBER 46

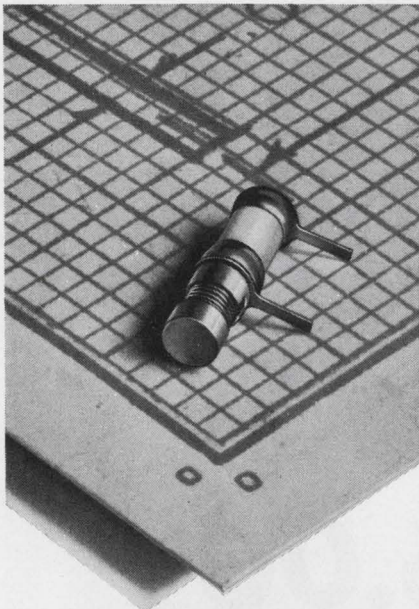

Sub-Miniature Low-Inductance Capacitor

High Q > 1500 @ 500 mc

10:1 capacitance ratio in micro miniature size — extra fine tuning <.35 pF per turn. High Q, (greater than 1500 at 500 mc).

Specifications

Size: 1/8" diameter, 1/2" length
 Capacitance Range: 0.35 pF to 3.5 pF
 Working Voltage: 250 VDC
 (test voltage, 500 VDC)
 Q @ 100 mc: >5000; @ 250 mc, >2000
 Insulation Resistance: >10⁶ Megohms
 Temperature Range: -55°C to 125°C
 Temperature Coefficient: 50
 ± 50 ppm/°C

Features 570° Solder. Prevents distortion. Not affected by conventional soldering temperatures.

Call or write for complete information.

Johanson

**MANUFACTURING
CORPORATION**

400 Rockaway Valley Road
 Bonton, N.J. 07005 • (201) 334-2676
 Electronic Accuracy Through Mechanical Precision
 INFORMATION RETRIEVAL NUMBER 47

INSTRUMENTATION

Low-cost generator pulses out to 2 MHz

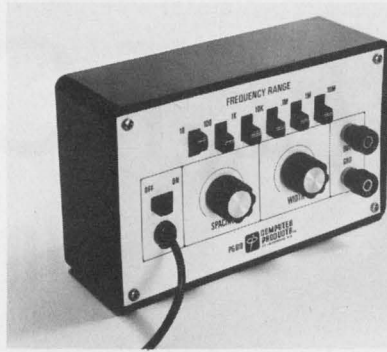

Computer Products, 2801 E. Oakland Park Blvd., Fort Lauderdale, Fla. Phone: (305) 565-9565. P&A: \$119; 10 days.

With an output that is compatible with TTL, DTL and RTL logic levels, a low-cost compact digital pulse generator provides output pulses at repetition rates from 10 Hz to 2 MHz, in six overlapping ranges. Model PG610 has independent adjustments for spacing and pulse width. It can be operated at high-output-pulse duty cycles.

CIRCLE NO. 260

Tiny accelerometer has replaceable cable

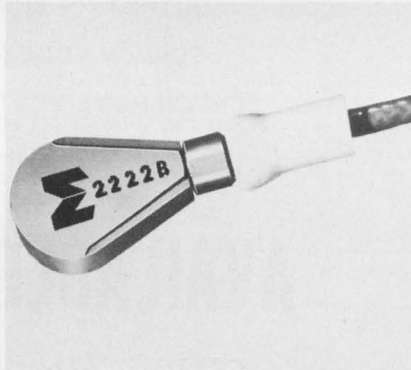

Endevco, sub. of Becton, Dickinson and Co., 801 S. Arroyo Parkway, Pasadena, Calif. Phone: (213) 795-0271.

Said to be the world's smallest accelerometer with an integral replaceable cable, the 2222B self-generating shear-type piezoelectric transducer is designed for adhesive mounting in confined spaces. Weighing only 0.018 oz, excluding its cable, the unit measures 0.25 in. wide by 0.375 in. long by 0.125 in. thick.

CIRCLE NO. 261

Phase indicator uses neon lamps

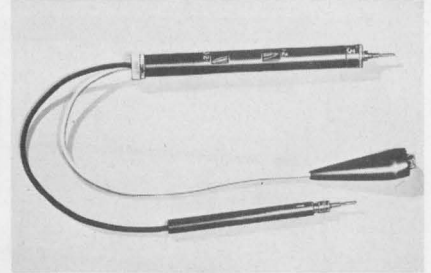

Eastern Specialty Co., 3617 N. 8th St., Philadelphia. Phone: (215) 228-0500.

With two neon lamps, a new instrument, called Tesco, determines the phase sequence of polyphase circuits without the need for a range-changing switch. When voltages are symmetrical and equal, one lamp is always off; the on lamp indicates phase sequence. For unsymmetrical voltages, one lamp will always be dimmer than the other; the bright lamp indicates phase sequence.

CIRCLE NO. 262

Electronic micrometers resolve 0.00001 in.

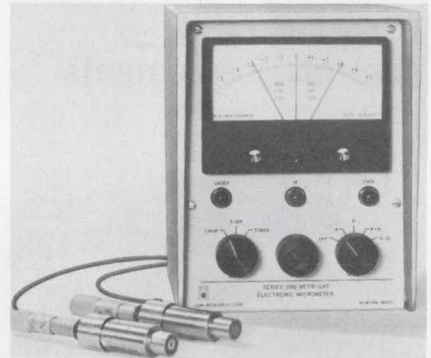

Lion Research Corp., 60 Bridge St., Newton, Mass. Phone: (617) 969-4710. P&A: \$700 or \$1000; stock.

With an accuracy of 0.0001 in. and a resolution of 0.00001 in., series 300 electronic micrometers measure both moving and fixed parts. Employing all-solid-state circuitry, the instruments make both contact and non-contact measurement by using an adapter over their gauge (probe) head. Four models are available: the 300-1 and 300-2 with single gauge heads; the 300-3 and 300-4 with dual gauge heads.

CIRCLE NO. 263

Digital stop watches resolve 0.1 to 10 s



Digital Instruments, Inc., 5441 Merriam Lane, Shawnee Mission, Kan. Phone: (913) 236-8717. Price: from \$210.

Complete with integrated circuits and Nixie display, a new line of digital stop watches is available with a resolution of 10, 1 or 0.1 seconds. Series 330/340 units feature a BCD output and will accumulate more than one time interval. They are supplied with either a three- or four-digit display.

CIRCLE NO. 264

Tri-axial accelerometers trim size and weight

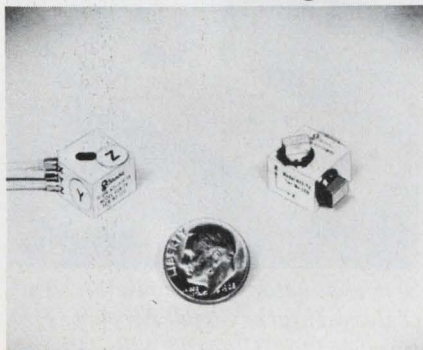

Columbia Research Laboratories, MacDade Blvd. & Bullens Lane, Woodlyn, Pa. Phone: (215) 532-9464.

Two new microminiature tri-axial accelerometers are said to be 50% lighter and 70% smaller in volume than previously available devices. Models 612TX and 614TX have a sensitivity, for each axis, of 5 peak millivolts per peak gram. Their frequency response is flat within $\pm 5\%$ from 1 Hz to 5 kHz, with an amplitude linearity rating of $\pm 1\%$.

CIRCLE NO. 265

INFORMATION RETRIEVAL NUMBER 48 ►
ELECTRONIC DESIGN 14, July 5, 1969

HOW TO IMPROVE SYSTEM PERFORMANCE IN THE HIGH VOLTAGE FIELD...

If your system operates at elevated voltage, the proper high voltage cable can measurably improve its performance. We know from experience, because high voltage cable is our field. A BIW specialist is available to discuss your particular H.V. problem from a total system standpoint.

SILICONE HV CABLE — BIW leads the field in silicone processing technology. Insulating and semi-conducting silicone rubbers are combined to yield cables of extraordinary flexibility and high corona initiation voltage. Suitable for satellite systems, power supplies, radars, Xenon flash tubes, CRT leads and most systems under 100 KVDC where flexibility and ease of termination are required at temperatures to 200°C.

BUTYL HV CABLE — Butyl-rubber-insulated, single and multi-conductor cables combine high dielectric strength and flexibility with low cost. Voltages to 200 KVDC with high reliability for a variety of applications including X-Ray, electron beam welding, electron microscopy and many others.

TFE HV CABLE — An exclusive BIW process combines thin tapes of TFE with high dielectric strength oil and an FEP jacket to produce exceptionally small diameter High Performance cables for use in general high voltage wiring to 30 KVAC. May be used in dielectric coolant systems. Extremely tough and reliable.

LAMINATED SYNTHETIC HV CABLE — Layers of thin irradiated polyethylene tape plus high-dielectric-strength oil result in cables suitable for voltages from 100 KVDC to 1000 KVDC. Designed especially for linear accelerator feeds, electron beam welders, pulse discharge devices, ion separators and other systems requiring extra high voltage cable.

If you have a high voltage wire or cable problem BIW will solve it with a proprietary, pre-engineered cable or will quickly design one to meet your need. Call or write.



**Boston Insulated
Wire & Cable Co.**

54 Bay Street, Boston, Mass. 02125

El Segundo, Calif. 90245; Hamilton, Canada;
Kingston-upon-Thames, U.K.; GEDEBIW, S. A. — Clichy, France



The Model 912 Digital Data Generator is the most versatile, multi-purpose unit on the market today. With its 960 bit capacity, at clock rates from DC to 10 MHz in serial data stream or 5 MHz in parallel, it is ideal for exercising core memory logic, checking data communications lines, or computer interfaces; for exercising LSI's, IC's, MOS and logic cards. It's even a programmer — it replaces a paper tape reader for industrial control applications. Other functions include testing D to A converters and CRT displays for example.

No other Digital Data Generator can provide 12 independent data streams in parallel (simultaneously) with capacities of 80 bits each, or 960 bits in a serial data stream without repetition.

For detailed description and specifications on the Model 912 Digital Data Generator, contact Jerry Heyer, SRC Division, Crescent Technology Corp., 2222 Michelson Drive, Newport Beach, California 92664, (714) 833-2000.



Start testing those LSI's, IC's, MOS & Logic Cards with this!

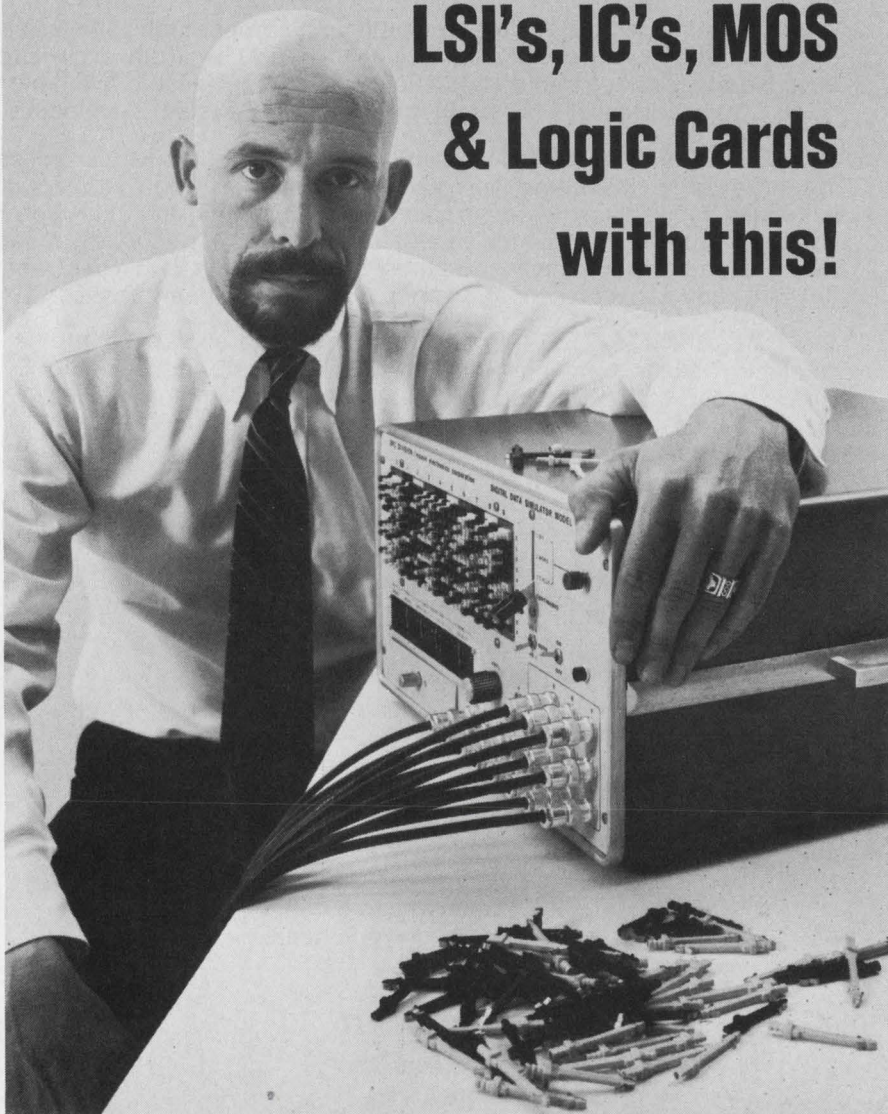

COMPONENTS

Do-it-yourself filters use identical resonators

Clevite Corp., Piezoelectric Div., 232 Forbes Rd., Bedford, Ohio. Phone: (216) 232-8600. P&A: 35¢.

Bringing the do-it-yourself concept to filters, a new line of identical resonators, when used with standard capacitors, allows the designer to build his own 455-kHz filters. The filters can be of any complexity with a continuous range of bandwidths and selectivities. A set of tables, supplied with the resonators, shows the required capacitance values for a given filter response. By interconnecting known capacitors and the resonators in a prescribed network configuration, the designer can easily build filters to his own specifications.

CIRCLE NO. 266

Custom filter kits include capacitors

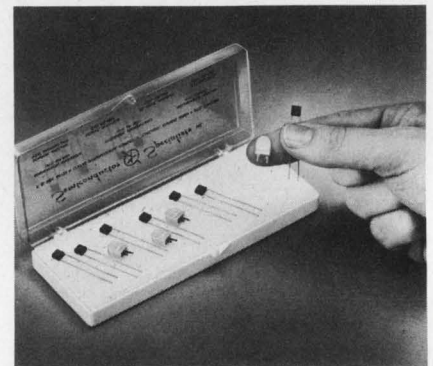

Semiconductor Specialists, Inc., O'Hare International Airport, P.O. Box 66125, Chicago, Ill. Phone: (312) 279-1000. P&A: \$5.95; stock.

Two new do-it-yourself kits permit the circuit designer to build low-cost 455-kHz i-f bandpass filters using Clevite Piezoelectric Div.'s identical resonators. Each kit contains four identical resonators and seven capacitors, with complete instructions, curves, design tables and specifications required to build the filters. Kit SSK10 has an identical-resonator network with a peak bandwidth of 26 kHz. Kit SSK11 has a network with a peak bandwidth of 40 kHz.

CIRCLE NO. 267

Fluidic diode/resistor seals bubble-tight

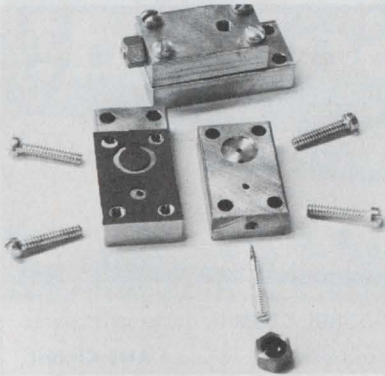

Gagne Associates, Inc., 50 Wall St., Binghamton, N. Y. Price: \$7.80.

Providing a bubble-tight seal on reverse pressure, a new fluidic diode/resistor combination permits large fan-in in logic circuits without degrading the input signals; it also facilitates the design of passive circuits. When the diode (check valve) is supplied with a bypassing needle valve, the resistors can be used as time-delay devices with quick reset capabilities.

CIRCLE NO. 268

Pneumatic sensor includes amplifier

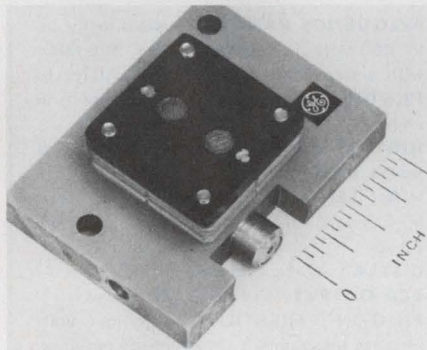

General Electric Co., Specialty Fluidics Operation, 1 River Rd., Schenectady, N.Y. Phone: (518) 374-2211.

Typically used in material handling and automation sequencing controls, model 24PS11BA pneumatic proximity sensor/amplifier detects the presence of objects up to a distance of 0.2 in. Its built-in three-stage digital amplifier provides a high output signal (6 psig) with response to 150 Hz, thus eliminating the need for an interface valve for many applications.

CIRCLE NO. 269

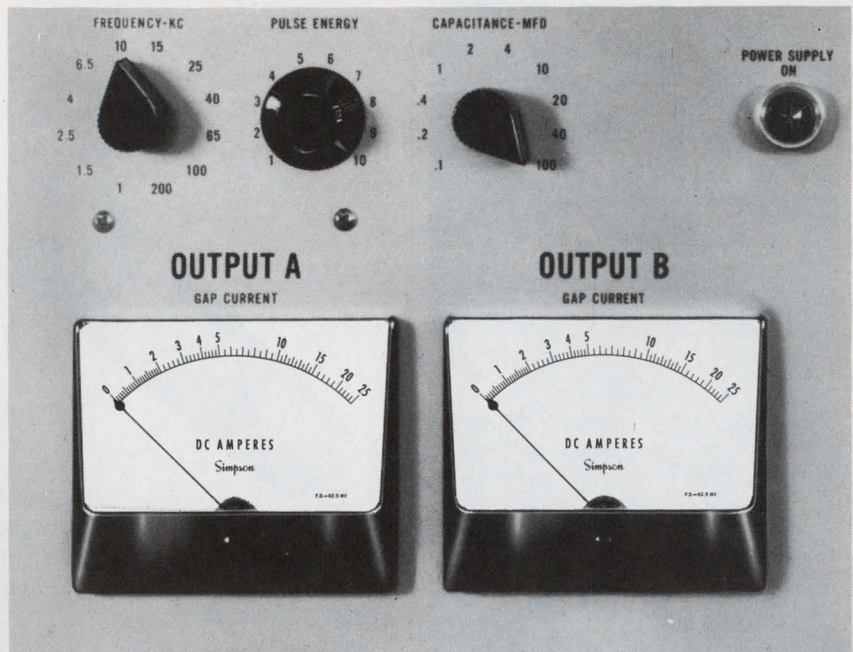

the sure way to let customers know you care about quality...

Simpson panel instruments on your equipment

Simpson's advanced self-shielding annular and core magnet construction provides optimum torque-to-mass ratio. Rugged Taut Band and Pivot & Jewel movements can withstand punishing shock and vibration. Your assurance of an instrument that will *stay* accurate. No wonder so many manufacturers with reputations to protect (or build!) specify Simpson.

Over 1,400 stock ranges, sizes, and types. Get "off the shelf" delivery from your local electronic distributor.

For special needs contact your local Simpson Representative. He's ready to help.

Simpson

ELECTRIC COMPANY



5200 W. Kinzie Street, Chicago, Illinois 60644 • Phone (312) 379-1121

EXPORT DEPT.: 400 W. Madison Street, Chicago, Illinois 60606. Cable Simelco
IN CANADA: Bach-Simpson Ltd., London, Ontario • IN INDIA: Ruttonsha-Simpson Private Ltd., International House, Bombay-Agra Road, Vikhroli, Bombay

INSTRUMENTS THAT STAY ACCURATE

INFORMATION RETRIEVAL NUMBER 50

You can't beat the \$600 system

So, order one from Honeywell's free Statham Transducer Catalog.

Our new, 16-page Catalog features model descriptions of all transducers and readout accessories as well as notes on industrial, research and scientific applications. Write for yours today: Tom Culhane, MS 216 B, Honeywell, Test Instruments Division, P.O. Box 5227, Denver, Colorado 80217.

Honeywell

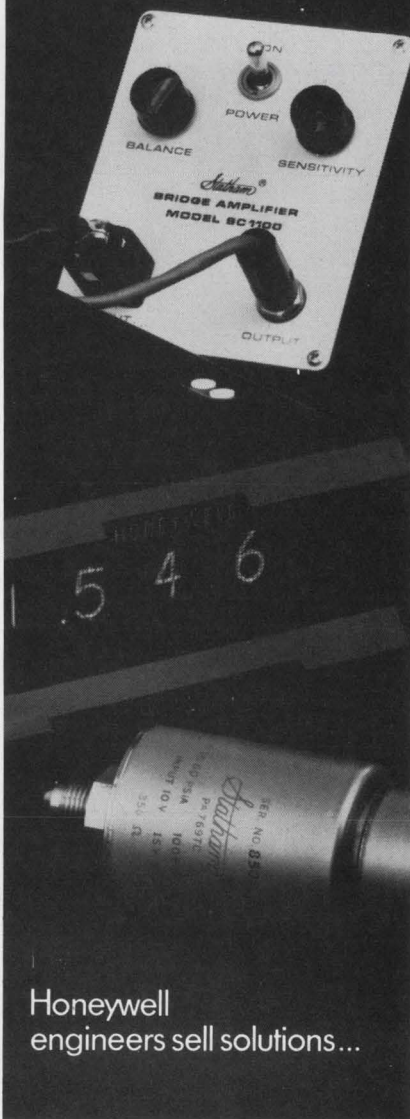

Honeywell
engineers sell solutions...

INFORMATION RETRIEVAL NUMBER 51

COMPONENTS

Vidicon camera tube employs fiber optics

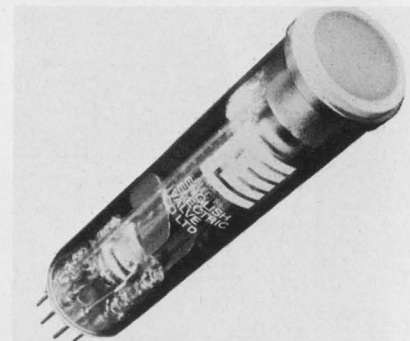

Visual Electronics Corp., English Electric Valve Co., Ltd., 356 W. 40th St., New York, N. Y. Phone: (212) 736-5840.

Model P831F vidicon camera tube, which uses standard magnetic deflection and focusing, has a 1-in.-diameter faceplate constructed from 9-micron-diameter fiber optics. The new vidicon is ideal for applications that involve coupling to other devices with fiber-optic window outputs, such as image intensifiers. Often, optical efficiency can be increased 50 times over that of a normal lens system.

CIRCLE NO. 270

Carbon potentiometer offers 3/16-in. dia

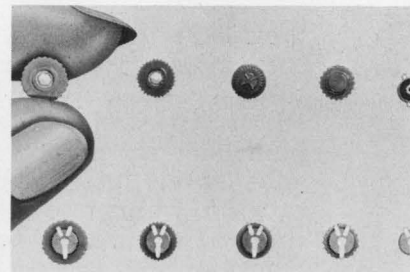

Centralab, Electronics Div., Globe-Union Inc., 5757 N. Green Bay Ave., Milwaukee, Wis., Phone: (414) 228-2769. P&A: \$2.90; 3 to 6 wks..

Model 10 microminiature carbon potentiometer boasts a body diameter (without knob) of less than 3/16 in. The unit comes in four knob styles and two terminal configurations. It is available in linear and audio tapers for left- and right-hand rotation. Power rating is 0.05 or 0.1 W.

CIRCLE NO. 271

Superimposed Noise Problems Solved!



-TR-5589L 250MHz Universal Counter

This counter employs a unique **ANS Circuit** (Automatic Noise Suppressor...patent pending) in its input circuit. If a large signal to be measured and superimposed noises are fed to a counter, the counter may count both the signal and noise since the trigger threshold level is extremely narrow.

The **ANS** solved the noise problems by keeping the input signal level constant at all times regardless of the magnitude of the input, thereby maintaining the trigger threshold level at the optimum value.

When considered from the input side, the trigger threshold level will increase when a large signal is received, or, decrease when a small signal is received. These operation reduces the error due to noise mixed in the input signal. Since the counter has an input sensitivity of 10mV rms, frequency measurement of an extremely low voltage signal is possible, and measurement of 100V rms signal is also possible with the single range without the use of an attenuator because of the 80dB dynamic range.

FREQUENCY RANGE—Counts directly up to 250 MHz in decimal, up to 500 MHz with prescaler plug-in unit, covers 10Hz to 12.5 GHz with frequency converter plug-in unit.

HIGH STABILITY—Long term stability 5 parts in 10^{10} per day.

HIGH SENSITIVITY—10mV to 100V rms in a single range...wide dynamic range...80dB.

DISPLAY—9-digit storage display.

BCD OUTPUT—8-4-2-1 code output.

PLUG-IN VERSATILITY—8 plugin units increase the counter's versatility as required.

Universal Counter, Digital Voltmeter, Digital Integrator, Electrometer, Frequency Counter, Frequency Synthesizer, Frequency Standard, Data Acquisition System, Operational Amplifier.



Takeda Riken Industry Co., Ltd.

1-32-1, Asahi-cho, Nerima-ku, Tokyo, 176, Japan. Tel: Tokyo 930-4111 Telegramme: TRITRONICS TOKYO
Agents:
Litton Precision Products International Inc.—(West Germany, France, Belgium, Switzerland, England)
Ing. S & Dr. Guido Belotti Ltd.—(Italy) Nores & Co.—(Finland)
Ingensfirma Carl-Eric Larsson AB—(Sweden)
Semco Semlar & Co.—(Denmark)

INFORMATION RETRIEVAL NUMBER 52

ELECTRONIC DESIGN 14, July 5, 1969

Low-cost FET op amp holds drift to $10\mu V/^\circ C$



K & M Electronics Corp., 408 Paulding Ave., Northvale, N. J. Phone: (201) 768-8070. P&A: \$16; stock.

Costing only \$16, a new economy FET operational amplifier features a voltage offset drift of only $10\mu V/^\circ C$ and a low bias current of only 10 pA. Model KM45 includes internal frequency compensation and short-circuit protection. Its voltage gain is 10^6 and input impedance is $10^{12}\ \Omega$.

CIRCLE NO. 272

Magnetic flatpacks match mounted ICs

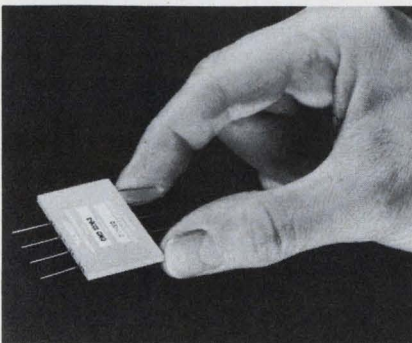

General Magnetics Inc., 135 Bloomfield Ave., Bloomfield, N. J. Phone: (201) 743-2700.

Supplied in a flatpack configuration, a new line of magnetic modulators, analog voltage multipliers and demodulators can be mounted directly on PC cards along with integrated circuits. Typical dimensions are 0.1 in. thick by 0.5 by 0.75 in. These flatpack magnetic modules are characterized by essentially drift-free circuitry with good phase and gain slope stability.

CIRCLE NO. 273

How about acceleration better than $140,000\text{ rad/sec}^2$ for a 200W motor?

It's yours.

New Diehl moving coil motors are high response D.C. servo motors ideal for use in high speed printers, capstan motors and wherever high speed response is called for. In addition they offer these important advantages:

- High efficiency.
- Low armature inertia... much lower than normal DC motors.
- Less force cooling required, due to superior motor design.
- Very low inductance.
- Straight line speed-torque characteristics.
- High pulse acceleration torques.
- High overcurrent pulse capability... over 10x rated current with no harm to commutator or loss of field flux.
- Output torque, smooth and cogging free.

Hi-Accel Motor Characteristics — Model HD5520-10-1



Typical Performance Data

Motor Rating

Output	200 Watts
Speed	2500 RPM
Voltage	48 Volts
Current	6.2 Amps.
Torque (Continuous)	110 oz. in.
Torque (Stall)	840 oz. in.
Efficiency	69%

Intrinsic Data

K_t (Torque Const.)	22 oz. in./Amp.
K_e (Back EMF Const.)	16 Volts/ KRPM
J_m (Arm. Inertia)0062 oz. in. sec. ²
R_A (Arm. Resistance)	1.25 OHMS

Derived Constants

R_M (Regulation)	3.6 RPM/oz. in. a (Acceleration from stall)
	140,000 Rad/Sec ²
R_p (Power Rate)	1258 KWatts/Sec.

Mechanical Data

Weight	14 lbs.
Housing Dia.	5.50 in.
Length	5.25 in.

39A

THE SINGER COMPANY Diehl Division

Finderne Avenue, Somerville, N.J. 08876/(201) 725-2200 • TWX 710-480-9325

3/8" trimmers *with* established reliability for MIL-R-39015/RTR24

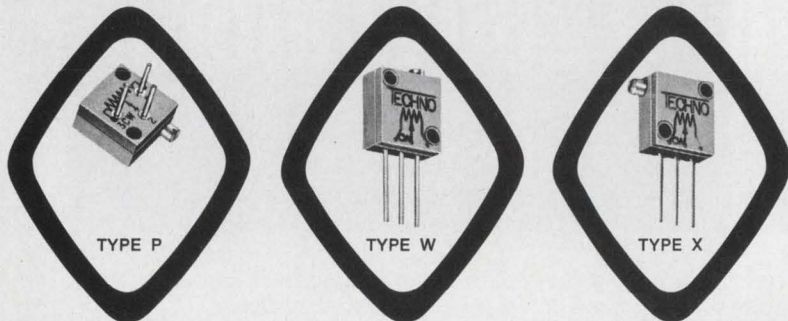

- ✓ Statistically Documented Reliability
- ✓ Complete Traceability
- ✓ 10,000-Hour Life Test
- ✓ One Hundred Percent Screening
 1. 100% burn-in for 96 hours at full rated power.
 2. 100% immersion test.
 3. 100% mechanical inspection before and after assembly.
 4. 100% peak noise and total resistance test.

CONFIDENCE LEVEL	FAILURE RATE PER 1000 HOURS
M	1%

SPECIFICATIONS

Resistance Values: 10 to 10k ohms
 Power Rating: 3/4 watt at 85°C
 Standard Resistance Tolerance: ±5%
 Operating Temperature: -65° to 175°C

Call or write for complete technical data:

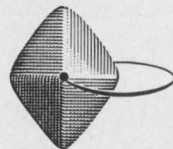

TECHNO-COMPONENTS CORP.

A SUBSIDIARY OF OAK ELECTRO/NETICS CORP.

7803 Lemona Avenue, Van Nuys, California 91405
 (213) 781-1642 TWX 910-495-2015

MODULES & SUBASSEMBLIES

Amplifier module boosts load current

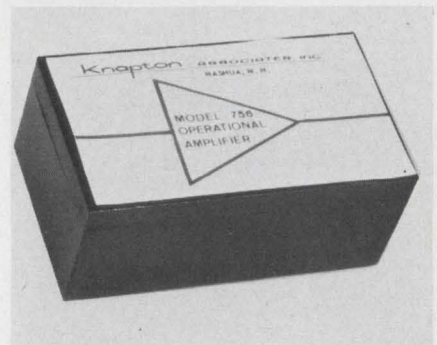

Knapton Associates, Inc., Mulberry at Elm, Nashua, N. H. Phone: (603) 883-3462. P&A: \$175; stock.

Constituting a compact solid-state plug-in module, a new amplifier puts out ±500 mA into a load as low as 30 Ω. This means that the unit can directly drive dc permanent-magnet motors, torque motors, electro-hydraulic servo valves, voice-coil force motors, or any low-impedance resistive or inductive load. Model 756 incorporates short-circuit protection on both its input and output.

CIRCLE NO. 274

Thick-film circuit steadies motor speed

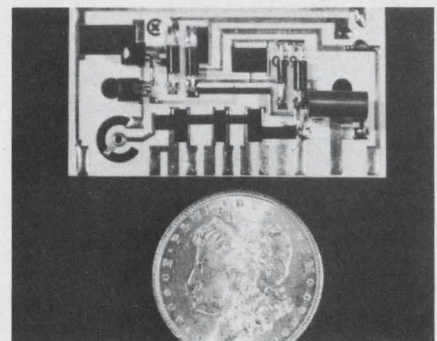

Cermex Div., Frenchtown/CFI, Inc., sub. of Alloys Unlimited, Inc., 8th & Harrison Sts., Frenchtown, N. J. Phone: (201) 996-2121. Price: \$3.

Designed for fractional-horsepower ac/dc series-wound motors, a new all-solid-state eight-speed control circuit keeps motor speed constant under varying load conditions. Model CX-0595 contains 14 cermet resistors, a fired-on thick-film trimmer pot and seven solid-state active devices.

CIRCLE NO. 275

Current sources smooth output

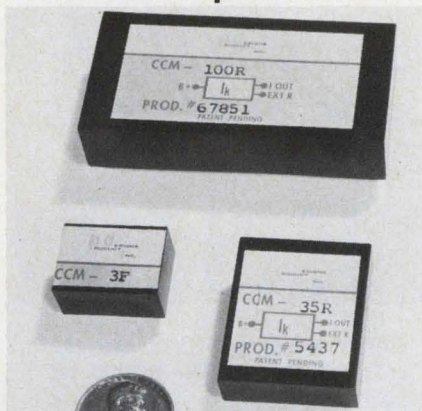

Product Designs, Inc., 111 Cardenas, N. E., Albuquerque, N. M. Phone: (505) 265-3551. Price: from \$10.

A new line of constant-current modules provides an output that is essentially independent of variations in input voltage and load resistance. Currents from 1 μ A to 100 mA are available preset or remote-controllable with an external fixed resistor or potentiometer. The new units operate from supply voltages of 10 to 35 V dc.

CIRCLE NO. 276

Operational amplifiers boost voltage by 10^5

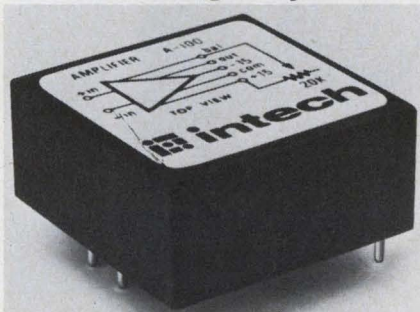

Intech Inc., 1220 Coleman Ave., Santa Clara, Calif. Phone: (408) 244-050. P&A: \$20 or \$25; stock.

Two new FET operational amplifiers guarantee a minimum dc voltage gain of 100,000 and a minimum slewing rate of 10 V/ μ s. Both units also feature a typical settling time of 5 μ s to reach within 0.01% of final output value. Model A-100 has a maximum drift of 50 μ V/ $^{\circ}$ C; model A-101, 20 μ V/ $^{\circ}$ C. Minimum unity gain frequency is 2 MHz.

CIRCLE NO. 277

Reed Relays that deliver more of what you need most...

VERSATILITY ■ RELIABILITY ■ ECONOMY



Standard and Miniature
Reed Relays



Special Design
Reed Relays

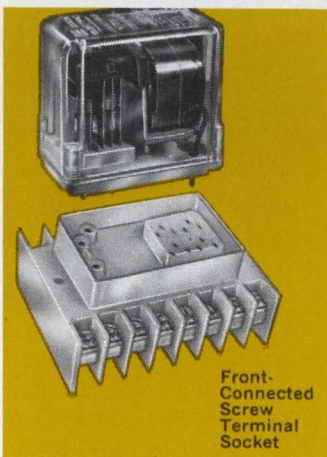

Front-
Connected
Screw
Terminal
Socket

Automatic Controls' Reed Relays — standard, miniature, or your special designs — offer individually supported reed switches, magnetic foil wrapped coils, non-magnetic terminals, and rhodium plated contacts, providing peak performance and reliability. Standardized contact configurations assure off-the-shelf delivery and maximum economy. For more of what you need most — specify Automatic Controls' Reed Relays everytime!

NEW from Automatic Controls...
Front-Connected Screw Terminal Socket.

Accommodates the Automatic Controls' "family" of general purpose plug-in relays and time delay relays.

Automatic Controls

Division



COOK ELECTRIC

200 East Daniels Rd., Palatine, Ill. 60067

FREE LITERATURE!

Write for illustrated brochures and technical information:

- #800 Industrial Relays
- #800 Industrial Relays Pressure Switches
- #940 Reed Relays
- #720 Military Relays
- #830 Ice Detection Systems
- #874 Contactors
- #859 Program Timers

Specify above by numbers

condenser products
has capability,
reliability, versatility...

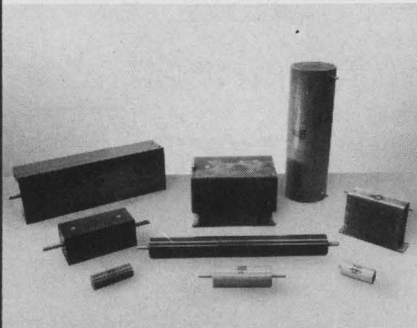

Special OEM designs to suit customer applications and space limitations. A wide range of voltages, capacities and constructional styles available to meet your specifications.

for all your high voltage
component needs.

DC FILTER CAPACITORS

Miniature glass — 1 to 50 KV standard; Rugged bakelite — 40 to 150 KV standard; CP70 type — 600 V to 50 KV standard.

TRANSMITTING CAPACITORS

Pulse or RF Series — 1 to 30 KV standard. Temperature ranges up to 210°C without derating.

LABORATORY AND INSTRUMENTATION CAPACITORS

Glass or CP70 containers to 60 KV at 0.1 mfd.

HIGH VOLTAGE POWER SUPPLIES

Modular compact and capacitor charging — output from 1 to 75 KV standard. OEM specials promptly quoted.

PULSE FORMING NETWORKS

Designed to your specifications and applications.

ULTRA LOW INDUCTANCE CAPACITORS

For laser, simulation and spark discharge technology.

Call or write for complete technical information. Special requirements tailored to your applications and specifications are promptly quoted.



**CONDENSER
PRODUCTS
CORPORATION**

Box 997, Brooksville, Florida
Phone: 904-796-3562
California: 213-277-2050

WESCON BOOTH 4813

INFORMATION RETRIEVAL NUMBER 56

MICROWAVES & LASERS

Variable gas laser
halves price tag

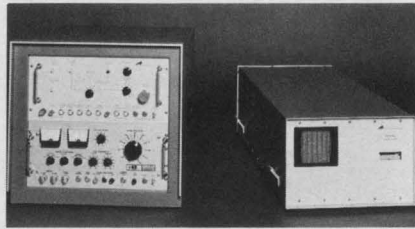

Avco Everett Research Laboratory,
2385 Revere Beach Parkway, Ever-
ett, Mass. Phone: (617) 389-3000.
P&A: \$9800; stock to 90 days.

Costing 43% less than a previous unit, a new pulsed gas laser changes its wavelength from ultraviolet (3371 Å) to green (5401 Å) in less than 60 seconds with a simple change in the input gas from nitrogen to neon. Model C950 has a peak output power of 100 kw at 3371 Å and 10 kW at 5401 Å. Pulse repetition rate is continuously variable from 1 to 100 pps.

CIRCLE NO. 278

Hybrid balanced mixers
swing 15% at 12.4 GHz

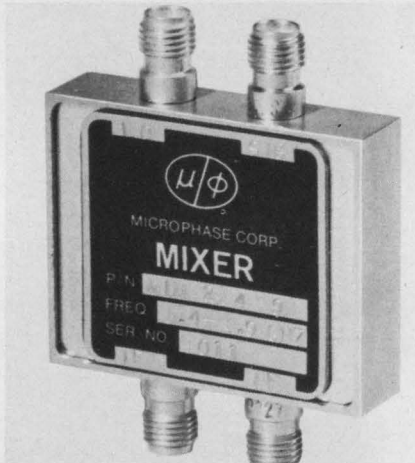

Microphase Corp., 35 River Rd.,
Cos Cob, Conn. Phone: (203) 661-
6277. P&A: \$250 to \$350; 30 to 60
days.

Employing hybrid thin-film techniques, series 2000 balanced mixers cover the frequency range of 1 to 12.4 GHz with 15% bandwidths. Noise figures vary between 7 and 9.5 dB, with isolation typically at 10 dB. The new mixers use beam-lead Schottky-barrier-type diodes, welded into the circuit and passivated.

CIRCLE NO. 279

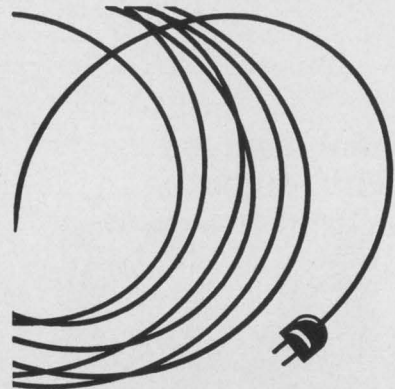

OBSOLETE!

Harsh judgement? Yes, but the only one that applies to this old fashioned method of pouring hot, high voltage AC into a battery operated product to add the capability of house current operation — or using it with a low voltage DC operated product!

Modern manufacturers now use the simple, low cost, DYNAMIC SYSTEM which keeps hot AC at the wall outlet and delivers only cool, low voltage DC to the product and completely eliminates the need for a bulky internal transformer in the product!

Go MODERN with the U/L listed SAFE-T-PLUG, the heart of the DYNAMIC SYSTEM!

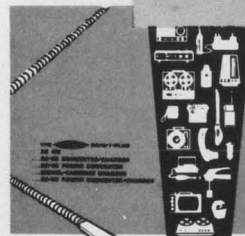
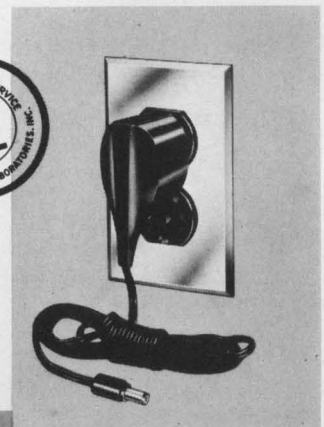

SEND FOR...
your free copy of
Dynamic's Technical
Brochure which de-
scribes the Dynamic
System TODAY!



Dynamic Instrument CORP.

Dept. ED 7115 E. Bethpage Rd., Plainview, N.Y.
INFORMATION RETRIEVAL NUMBER 57

ELECTRONIC DESIGN 14, July 5, 1969

E-band oscillator socks out 50 W

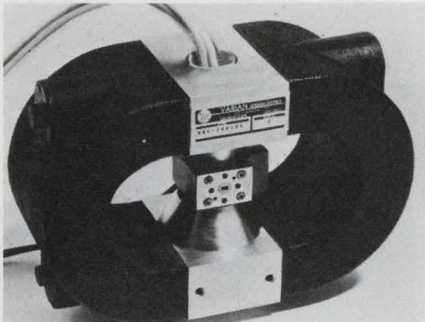

Varian Associates of Canada Ltd.,
45 River Drive, Georgetown, Ontario,
Canada.

Model VKE-2401A1 extended interaction oscillator delivers 50 W of cw power at a center frequency of 60 GHz. The new tube can also be used in pulsed systems. A dynamic electronic frequency tuning of over 100 MHz can be obtained by modulating the 7-kV beam supply. Electronic efficiency is almost 9%, and frequency stability is good.

CIRCLE NO. 280

Small L-band module delivers 700-W peak

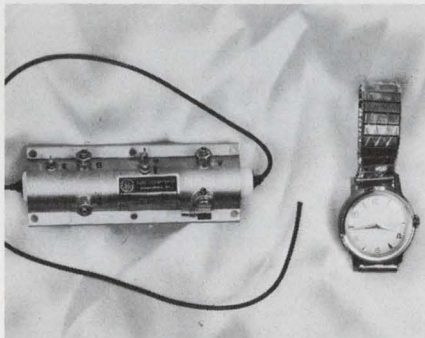

General Electric Tube Dept., 316
E. Ninth St., Owensboro, Ky.
Phone: (502) 683-2401.

Intended for pulsed transponder applications at 1090 MHz, the C-2003C microwave circuit module supplies a peak power output of 700 W. Using planar ceramic triodes, the compact unit provides stable operation under adverse temperature conditions, wide ranges of duty factor and severe load mismatch conditions.

CIRCLE NO. 281

Convert any X-Y scope into a curve tracer: \$595*

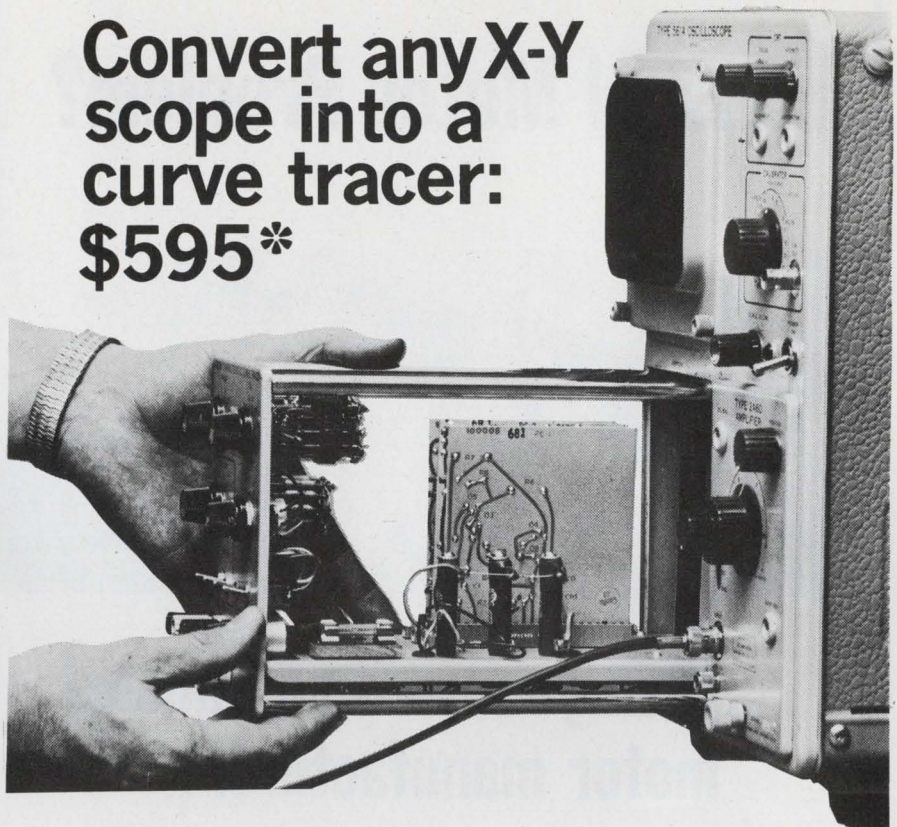

Now U-Tech's plug in and console units are all your oscilloscope needs to become a curve tracer. Save 1/2 to 1/3 the cost!

For the price of one curve tracer, you can now buy two to three of these U-Tech units that use the facilities of your present scope to display the dynamic characteristics of both NPN and PNP transistors, N Channel and P Channel junctions, FETs, MOS-FETs, bipolars, uni-junctions, diodes, tunnel diodes and SCRs.

Ask your distributor about these U-Tech curve tracer units or order direct from:

*Prices apply to purchase and shipments within U.S.A. fob Salt Lake City, Utah

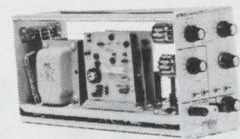

U-Tech plug-in Model 681: \$595.00*. For use with Tektronix 560 series Oscilloscopes.

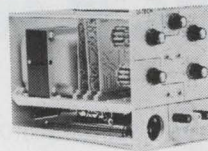

U-Tech plug-in Model 682: \$615.00*. For use with Tektronix 530, 540, 550, 580 series Oscilloscopes.

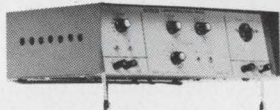

U-Tech Console Model 683: \$625.00*. For use with any X-Y Oscilloscope.

U-TECH

A Division of Industrial Physics and Electronics Company

4190 South State Street, Salt Lake City, Utah 84107 Tel. (801) 262-2663

Yes, send me curve tracer model.....

Enclosed is: Check P.O. Bill me Send literature

NAME _____ TITLE _____

COMPANY NAME _____

COMPANY ADDRESS _____ PHONE _____

CITY _____ STATE _____

INFORMATION RETRIEVAL NUMBER 58

Unusual Motor Problem?



... then you need an unusual motor manufacturer!

THAT'S McLEAN

We make very special motors. Special induction motors. Special hysteresis synchronous motors. Special polarized synchronous motors. You name the motor and the problem. We'll solve it . . . We've done it thousands of times . . . fast . . . reliably . . . and we can predict performance. That's because we program all our motors on our own computer . . . the fastest and the finest in the industry. Our motors will mate to perfection with your systems requirements. Try us . . . we'll prove it.

Send for Data Sheets!

McLEAN ENGINEERING LABORATORIES



Princeton Junction, New Jersey 08550 • Phone: 609-799-0100 • TELEX: 84-3422

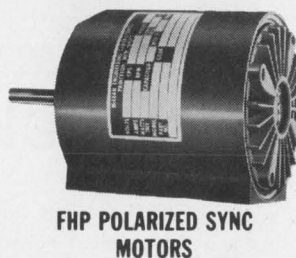
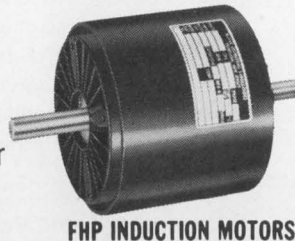
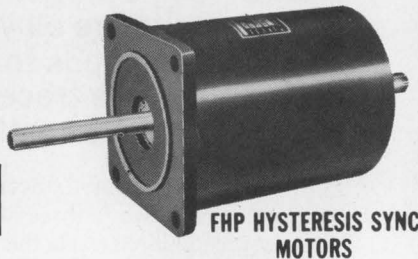

MICROWAVES & LASERS

Frequency stabilizer goes out to 40 GHz



Microwave/Systems, 1 Adler Drive, East Syracuse, N. Y. Price: \$3850; 30 to 60 days.

Over the frequency range of 1 to 40 GHz, the MOS-5 microwave frequency stabilizer converts any conventional microwave signal source to a highly stabilized frequency source. The new instrument features continuous tuning, simplified operation and interface compatibility with a variety of oscillators. It easily phase-locks klystrons, BWOs, solid-state sources and diode oscillators.

CIRCLE NO. 282

Radiation detector senses down to 1 Å

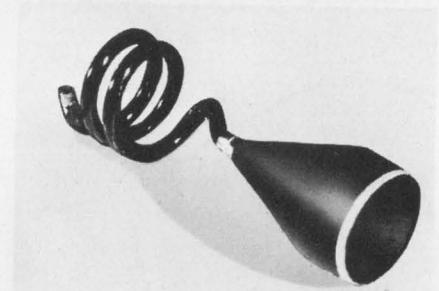

Bendix Corp. Research Laboratories, Bendix Center, Southfield, Mich. Phone: (313) 352-7613. P&A: \$600 to \$800; 60 days.

Designed for low-intensity applications in the 500-to-1500-Å wavelength range, a new windowless vacuum ultraviolet detector senses radiation as energetic as 1 Å. In its pulse-counting mode, the S 3029-X Channeltron electron multiplier can be used as a secondary standard for fluxes from 0.1 to 10⁶ photons per second per cm².

CIRCLE NO. 283

See us at the WESCON Show, Booth 1721
INFORMATION RETRIEVAL NUMBER 59

Ultrasonic solderer tins Al without flux

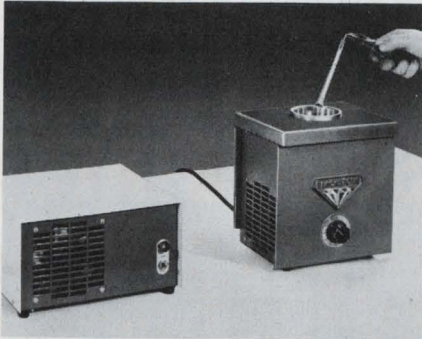

Blackstone Ultrasonics, Inc., 1120 Center St., Sheffield, Pa. Phone: (814) 968-3221.

Model TP3C ultrasonic soldering system is designed for fluxless soldering and tinning of small aluminum and ceramic parts and electronic components at high speeds. Its ultrasonic action forms and collapses microscopic bubbles, producing a scrubbing action that disperses oxides and promotes superior wetting.

CIRCLE NO. 284

Drafting device bridges work gap



Vanberg Industries, Inc., P.O. Box 976, Alliance, Ohio. Phone: (216) 821-1100. Price: \$95.

A new drafting aid brings those hard-to-reach areas on the drafting board down to where they belong—within easy access of the draftsman. Speedraft is a bridge across the drafting board that is attached to a plastic sheet. When a work piece is attached to the plastic sheet, it can slide up and down the board for the most convenient working distance without requiring realignment.

CIRCLE NO. 285

try
these
BERLOX®
packages
for

**SIZE
PERFORMANCE
RELIABILITY
THERMAL
CONDUCTIVITY**

the results may surprise you.

40 pin plug-in . . . 42 pin flat pack . . .
36 pin dual in-line . . . you name it,
Cermetrol Division can make it, with
built-in features and reliability you
only find in beryllia:

- Thermal conductivity equal to, or better than, that of most metals
- Excellent dielectric and loss characteristics. Integral bonding with metallized circuitry
- Capability of greater packaging density because of super heat dissipation

These advantages are available to design engineers because of the unique

inherent characteristics of beryllia, and the technological skills of Cermetrol design and manufacturing specialists.

When you face a problem of heat—in power output, miniaturization, package density, system reliability, the maximum in radiation hardening and cost effectiveness, take a long, hard look at Cermetrol metallized devices.

A new technical brochure gives you all the details—just ask for it. Better yet, let Cermetrol Division specialists become involved with your problems from the start.

10995



CERMETROL DIVISION

National Beryllia

Haskell, N.J. 07420 Telephone: 201 • 839-1600

CORP.

INFORMATION RETRIEVAL NUMBER 60

They said it couldn't be done!

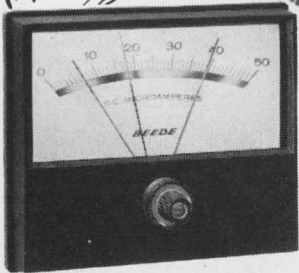
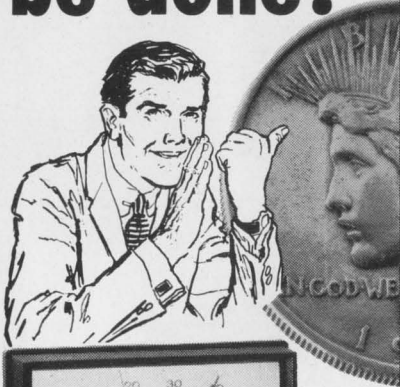

**a CONTROL METER RELAY
with 50% savings and
high performance**

WELL, THEY WERE WRONG! After a year of customer use in the field, our customers report that our units are consistently providing high accuracy and high reliability — and they must be right because they are re-ordering and pocketing cost savings of up to 50%. Why not join our increasing list of satisfied customers now?

Beede's Non-Contacting Control Meter Relay was initially designed to offer a wide choice of design options for the greatest application versatility. For instance:-

- 8 or more choices of power supply
- 4 choices of fail-safe configuration
- 10 or more choices of output mode
- 9 choices of alarm lights and reset switches
- Many special features such as tamper-proof units, fixed set pointer stops, etc.
- Pyrometers and resistance thermometers

Write for complete literature today!

BUY VALUE / BUY BEEDE

BEEDE

ELECTRICAL INSTRUMENT CO., INC.
PENACOOK, NEW HAMPSHIRE
Area Code: 603-753-6362

PRODUCTION

IC handlers use fluidics

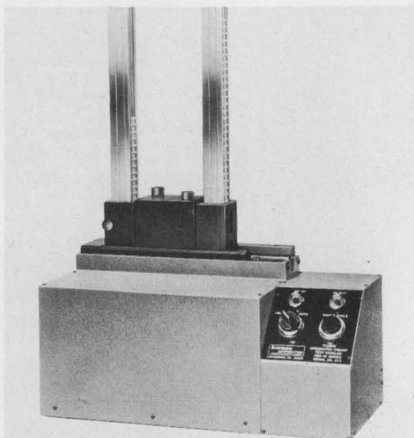

Barnes Corp., 24 N. Lansdowne Ave., Lansdowne, Pa. Phone: (215) 622-1525. P&A: \$2750 to \$8950; 4 to 6 wks.

Series 450-10 handling machines use a fluidic logic control system to facilitate the rapid and convenient handling of integrated circuit packages through all phases of test. Designed to be slaved to an electronic IC tester, the all-pneumatic IC handlers do not introduce any electrical noise or spurious signals into the tester circuits.

CIRCLE NO. 286

Metal-braid stripper saves insulation

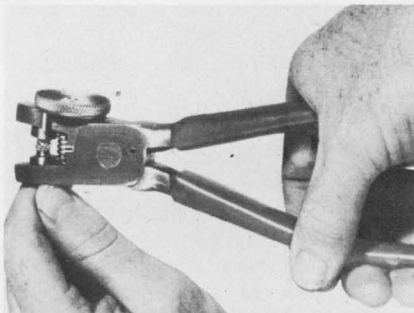

Henry Mann Co., P.O. Box 237, Cornwells Heights, Pa. Phone: (215) 639-4048.

The Shield Stripp hand tool easily and cleanly removes metal-braid shielding without damage to inner plastic insulations, since no heat or razor blades are used. The shielding on the wire is cut clean and left slightly flared—ready to receive a ferrule and ground connector. Thirteen interchangeable dies cover shielding outside diam-

CIRCLE NO. 287

A 2 KVA 400 CYCLE, SOLID STATE BIPPY?

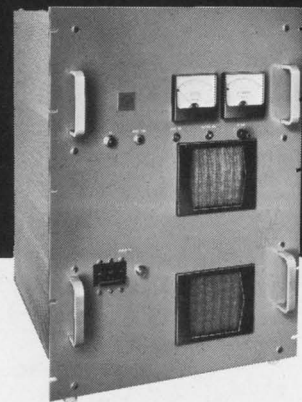

Around here, it's affectionately called just that. But you can simply refer to our newest creation as the CML Model CRS-2000A Frequency Converter until you get used to the idea of a Bippy hanging around. It features low distortion sine wave output and excellent regulation... less than 1% voltage regulation, less than 0.5% frequency regulation. Full power is available into leading and lagging power factor loads. The Bippy is solidly built (as all Bippys are), air cooled, and extremely quiet (as all Bippys are not)... measures 19" x 26 1/4" x 20". Ideal for marine and ground support installation, portable shelters, communications vans, radar systems, aircraft maintenance depots. This truly is the Bippy you can bet on. It socks the power to you!

CML, Inc.

a subsidiary of
Tenney Engineering, Inc.

350 Leland Avenue
Plainfield, N.J. 07062
(201) 754-5502 • TWX 710-997-9529



99

Cold-light illuminator beams 11k candlepower

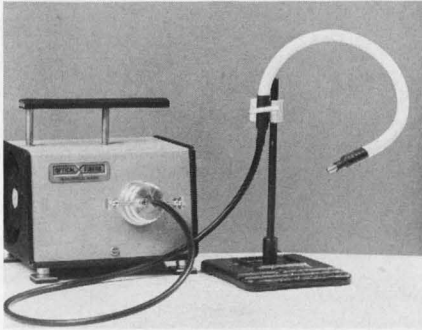

Optical Fibers, Inc., 28 Teal Rd., Wakefield, Mass. Phone: (617) 245-9393.

Producing a cool 60°F cone of light, Flex-i-lite cold-light illuminator can shoot a light spot with 5000 to 11,000 candlepower into tight places. Its flexible fiber optics are directed and fixed in place by bending a gooseneck tube wherever desired. Two power supplies are available: the Q1-150 (500-W quartz iodine lamp) and the Q1-250 (850-W quartz iodine lamp).

CIRCLE NO. 288

Mechanical die bonder reduces chip waste

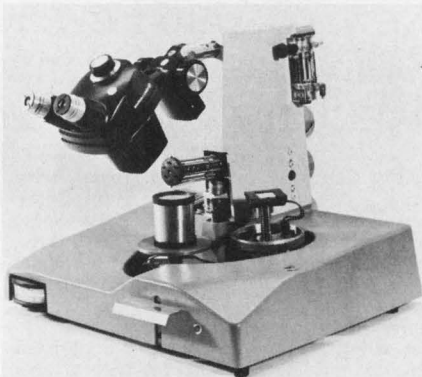

Kulicke and Soffa Industries, Inc., SAE Div., Fort Washington, Pa. Phone: (215) 646-5800.

Eliminating the manual bonding of chips to substrates with old-fashioned tweezer methods, a new mechanical die bonder reduces chip waste and speeds bonding. Model 642 orients die precisely on the workpiece. Then a low-frequency scrub is applied to assure a firm, void-free bond. Scrub force can be varied as needed for different-sized chips.

CIRCLE NO. 289

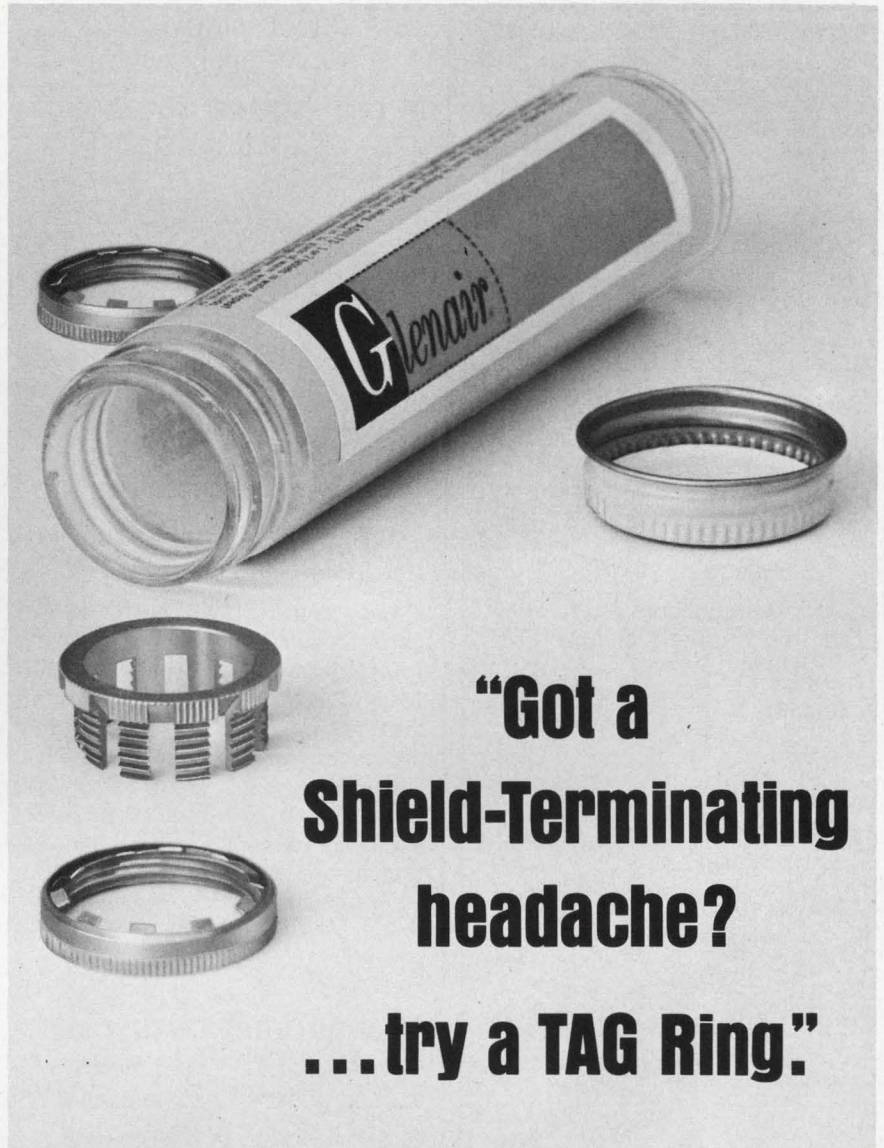

**"Got a
Shield-Terminating
headache?
... try a TAG Ring."**

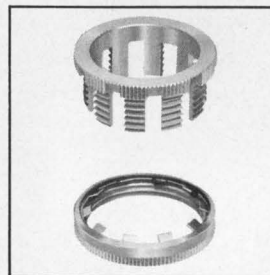

Without a TAG Ring* remedy, terminating of shielded wires can still be a pain.

A true prescription for connector/cable grounding miseries, TAG Ring is . . .

- "Quick-Acting" (fast assembly/disassembly)
- Totally repairable
- Assembled without special tools
- Low in installed cost

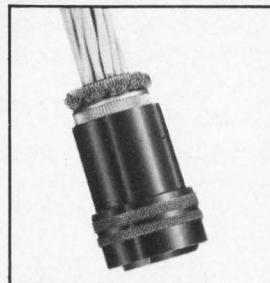

Before you chance another upset, we recommend you see your GLENAIR TAG Ring Specialist.

He'll help terminate your shield grounding problems.

R_X for connector-cable compatibility . . . GLENAIR

* PATENTS PENDING

Ask for brochure and sample . . . Today.



Glenair, Inc.

1211 Air Way, Glendale, California 91201
Phone (213) 247-6000, TWX 910-497-2066

INFORMATION RETRIEVAL NUMBER 63

SCHAUER

1%

tolerance

1 WATT ZENERS ARE A REAL BUY!

ANY voltage from 2.0 to 16.0
at the industry's **LOWEST
PRICES!**

Quantity	Price each
1-99	\$1.07
100-499	.97
500-999	.91
1000-4999	.86
5000 up	.82



THE HI-RELIABLE!

No fragile nail heads.
Silicon junction aligned between two, parallel, offset tantalum heat sinks... great lead tension strength.
All welded and brazed assembly.
High pressure molded package.
Gold plated nickel-clad copper leads.

Write or phone for Form 68-4 for complete rating data and other tolerance prices.

Semiconductor Division

**SCHAUER
MANUFACTURING
CORP.** 4511 Alpine Avenue
Cincinnati, O. 45242
Ph. (513) 791-3030

INFORMATION RETRIEVAL NUMBER 64

DATA PROCESSING

Microfilm camera sees 3k documents



3M Co., Dept. Mi9-21, 3M Center,
St. Paul, Minn. Phone: (612) 733-
1661. Price: \$2425.

Converting office, business, scientific, educational and engineering information to microfilm, a new 16-mm cartridge camera can miniaturize up to 3000 letter-sized documents on a single cartridge. When combined with its model 400C reader-printer, the model 3400 camera makes possible retrieval and print-out of microfilmed information within seconds.

CIRCLE NO. 290

Alphanumeric display forms 300 characters/s

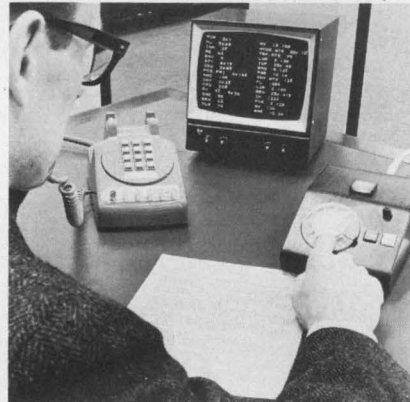

Canadian Westinghouse Co., Ltd.,
P. O. Box 510, Hamilton, Ontario,
Canada.

Providing video readout for a wide range of digital inputs, a new display terminal converts digital information to alphanumeric form at speeds up to 300 characters per second. Called the Wand display series, the new system utilizes such data sources as teletypes, data links, computers, and keyboards. All input data is stored permanently until it is updated or erased.

CIRCLE NO. 291

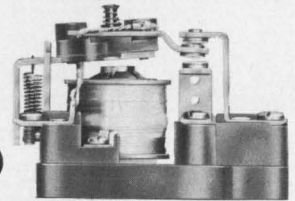

TWO Relays in ONE!

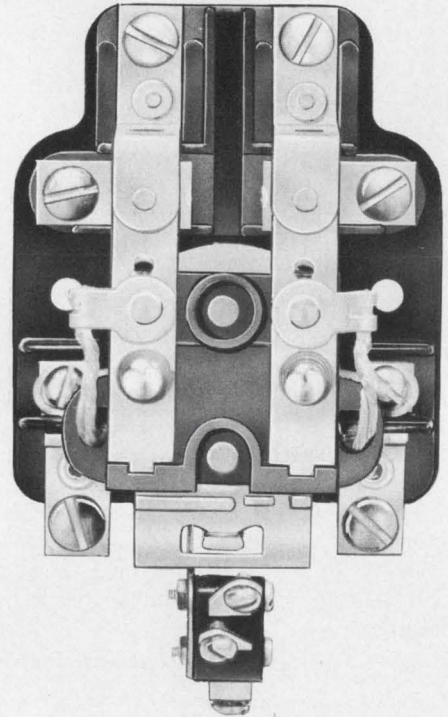

New 25 Amp Power Relay has a 10 Amp Auxiliary Switch

Deltrol Controls' New 900-1C Power Relay has a snap-action, 10 amp, 1/3 hp, SPDT auxiliary switch for switching signal lights or other sensing devices—and— heavy duty, 25 amp, contacts for motor control, heater loads, or other power switching applications. *You get two relays in one!* All 900 Series Power Relays are rugged, built to last: ■ coil terminal breakage is eliminated because coils terminate on the base ■ long-life, extra heavy gold-flashed, silver cadmium oxide contacts ■ 9.5VA nominal power ■ recognized under the UL & CSA component listing. Get the complete story by asking for *Engineering Bulletin No. 1372.*



RELAYS SOLENOIDS TIMERS

DELTROL CONTROLS

1375

2745 So. 19th St. Milwaukee, Wis. 53215
Phone (414) 671-6800 Telex 2-6871

INFORMATION RETRIEVAL NUMBER 65

ELECTRONIC DESIGN 14, July 5, 1969

**CRT displays
resolve 10 bits**

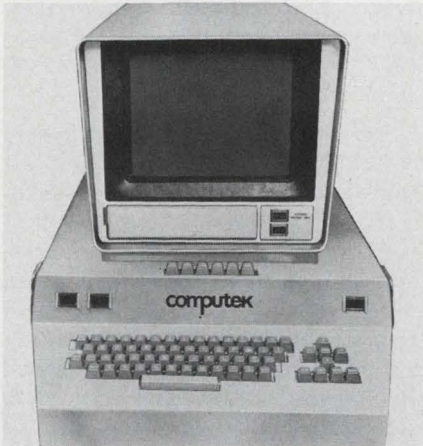

CompuTek, Inc., 143 Albany St., Cambridge, Mass. Phone: (617) 864-5140. Price: \$6700 to \$8400.

Three new display terminals can generate complex pictures with only a few commands, without flicker or jitter and with 10-bit resolution. Model 400/12 is a full-duplex unit, while model 400/10 is a local incremental vector graphics display. Model 400/15 provides local vector and alphanumeric character generators, plus absolute and incremental communication modes.

CIRCLE NO. 292

**Airborne data system
samples at 50 kHz**

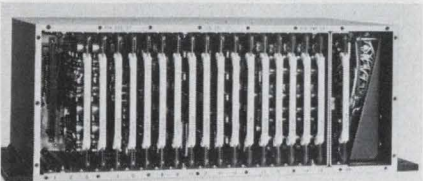

Dynamic System Electronics, 1040 West Alameda Drive, Tempe, Ariz. Phone: (602) 967-8644. P&A: from \$10,000; from 90 days.

Incorporating MOSFET switches and low-power high-reliability circuitry, a new airborne data acquisition and conversion system features a resolution to 12 bits, sampling accuracy to 0.01% and sampling rate to 50 kHz. Model 460 includes a multiplexer, differential amplifier, a/d converter, d/a converter, sample-and-hold data distributor, inverter power supply, control and timing circuitry.

CIRCLE NO. 293

See where you can't be with COHU TV.

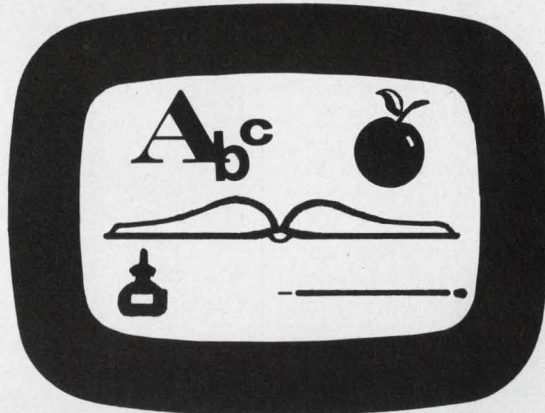

CLASSROOM INSTRUCTION



SPORTING EVENTS

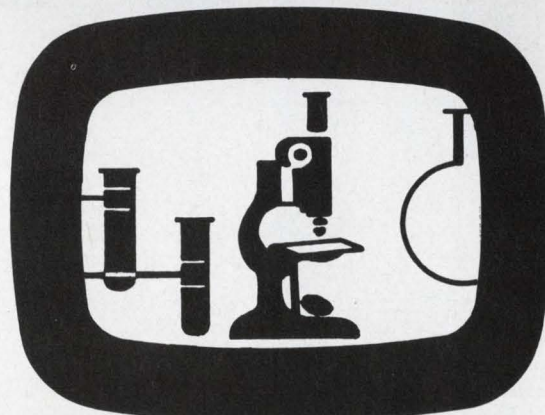

MICROSCOPIC EXAMINATION

For more details contact your nearest Cohu representative or the TV Product Line Manager direct at 714-277-6700, Box 623, San Diego, Calif. 92112, TWX 910-335-1244.



Cohu will be at WESCON - Booth 2001

INFORMATION RETRIEVAL NUMBER 66

Our D servomotor is mad with power.

That's our SU-680D-29 permanent-magnet D-C servomotor. We call it our D motor for short. It's small, rugged and powerful. It delivers 12.7 watts of continuous power output at 8600 rpm and is a natural for any servomechanism that requires a prime mover. It has a high repeatability-to-time ratio which makes it immensely stable, a 0-10,000 rpm speed range, and a high acceleration Torque/Inertia. Torque peaks at 15 oz-in., 2 oz-in. continuous at 8600 rpm. It measures only 1 1/8 inches in diameter and weighs just 8 1/4 ounces.

SERVO-TEK PRODUCTS COMPANY
1086 Goffle Road, Hawthorne, New Jersey 07506.

SERVO-TEK
PRODUCTS COMPANY

For full details write for our interesting technical sheets and get mad with power yourself.



INFORMATION RETRIEVAL NUMBER 67

PACKAGING & MATERIALS

Woven cable carries electropneumatic power

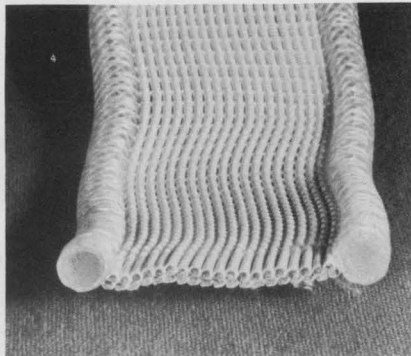

The Zippertubing Co., 13000 S. Broadway, Los Angeles. Phone: (213) 321-3901.

A new electropneumatic woven ribbon cable has pneumatic tubing at either side, with electric conductors between. The whole cable package is woven together in a computer-controlled weaving process. Similar cables with air tubes can be produced for control equipment, instrument reading, etc., or lines for carrying liquid or gas can be part of the combination.

CIRCLE NO. 294

Silicone ribbon conducts heat

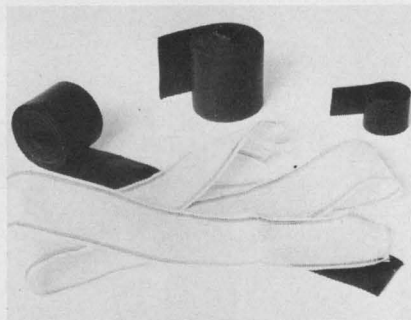

Harden Enterprises, ETR Div., P. O. Box 16, Marlton, N. J.

Able to provide heat wherever it's needed, a new thermionic ribbon consists of a heating element of a conductive silicone polymeric elastomer, vulcanized into a woven fibrous glass tape with conductors in the selvage edges. ETR ribbon is available in 1/4, 1/2, 3/4 and 1 in. widths with thicknesses of 0.006 to 0.01 in. The over-all resistance of any section of ribbon is inversely proportional to its length.

CIRCLE NO. 295

IC breadboard kit prototypes circuits

Vector Electronic Co., 12460 Gladstone Ave., Sylmar, Calif. Phone: (213) 365-9661. P&A: \$59.75, stock.

Breadboarding of IC and hybrid circuits is simplified by a new kit that contains all essential hardware in a single package. Even if you are mixing TO-5s, flatpacks, and dual in-line packages, you can wire up your circuit quickly and reliably. The 29X breadboarding kit is built around a perforated epoxy-paper board and aluminum side rails that snap together to form the chassis. Associated hardware includes: 14- and 16-pin DIP sockets; 4-, 8-, and 10-lead TO-5 sockets; and a variety of contacts, terminals, adapters, pins, and leads. Installation and extraction tools are included.

CIRCLE NO. 296

Emi shielding kit paints and epoxies



Epoxy Products Co., div. of Allied Products Corp., 166 Chapel St., New Haven, Conn. Price: \$50.

A convenient new kit for various electrostatic/electromagnetic shielding and adhesive applications includes four silver conductive paint formulations and two epoxy-based adhesives. The adhesives are: E-Solder 3021 for room-temperature curing and E-Solder 3044 for low-temperature curing. The paints include: E-Kote 3050 for elevated temperatures, E-Kote 3042 flexible coating, E-Kote 3030 for accepting conventional tin-lead solder, and E-Kote 40 aerosol for general-purpose shielding.

CIRCLE NO. 297

*Got an 'over heat'
problem?*

COOL IT!

Get Littelfuse miniature heat fuses for thermal overload protection. 7/8" L x 7/64" dia. Fully insulated. Crimp style connections.

LITTELFUSE

DES PLAINES, ILLINOIS

INFORMATION RETRIEVAL NUMBER 68

SERIES P
THE
MOST
COMPLETE
LINE OF
**PANEL
MOUNTED
COUNTERS**



Model P-4A

Key resettable counter. U.L. listed. Lock on counter permits reset by key only for security measures. 115 V., 60 Hz. std.

ENM now offers the most complete line of panel mounted counters manufactured by a single source in the U.S.A.

Seven separate and distinct panel mounted models encompassing both resettable and non-resettable counters, key lock types and elapse time indicator with 9999.9 time scale.

All units feature six digits with a standard counting speed of 500 cpm. Higher speeds and various voltages available. Specials on request.

Write for 4-page full line panel mounted counter brochure. ▶



ENM COMPANY

5306 W. Lawrence Ave., Chicago, Ill. 60630

PHONE: (312) 282-8787

Representatives in principal cities

INFORMATION RETRIEVAL NUMBER 69

ELECTRONIC DESIGN 14, July 5, 1969

Build a Better Modes Trap

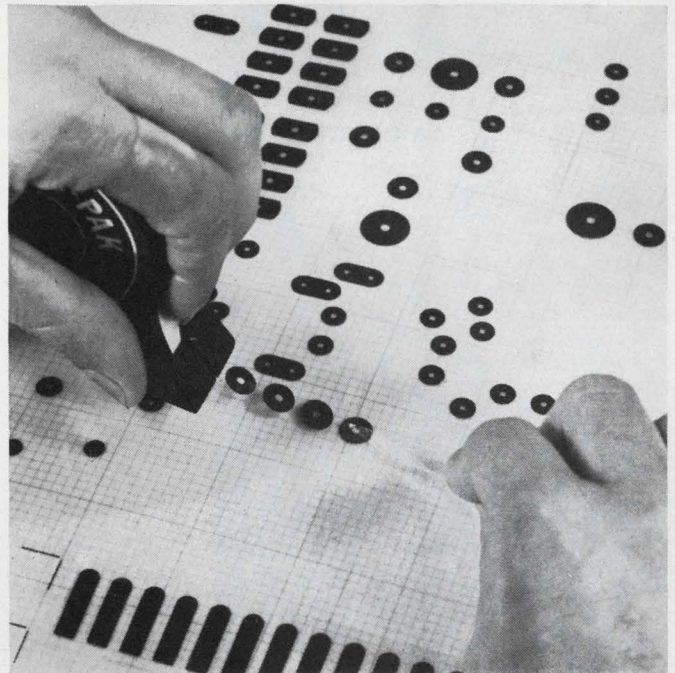

With New Chartpak[®] Pressure Sensitive Electronic Circuitry Drafting Aids

Now Chartpak offers engineers and draftsmen the complete range of pressure-sensitive materials for making electronic circuitry masters. Our precision line of time-saving, cost-cutting drafting aids is bigger and better than ever.

With Chartpak, you get it all. The most complete spectrum of precision tapes, pads, clusters, connector strips, sequential reference designations, letters, numbers, die-cut symbols, targets and accessories. Over 500 standard electronic circuitry drafting aids plus unlimited special order capabilities are available to you from one dependable source. Chartpak!

Manufactured to meet the most exacting requirements in the preparation of electronic circuitry artwork. All Chartpak tapes are precision-slit guaranteed to $\pm .002$ " accuracy. And Chartpak will fill special, individual requirements on a custom-order basis. See all the many ways our pressure-sensitive materials can help you build that better modes trap. Easier. Faster. More economically. Write for our new free catalog detailing the full line of Chartpak Pressure Sensitive Electronic Circuitry Drafting Aids.

CHARTPAK ROTEX

A Division of Avery Products Corp
Santa Ana, Calif. & Leeds, Mass.
Look in The Yellow Pages under Drafting Supplies.

6/69

INFORMATION RETRIEVAL NUMBER 70

push with ALCOSWITCH

These miniature push button switches control heavy currents with outstanding reliability and consistent performance. Snap-action mechanism allows quick make-and-break along with solid silver contacts for efficient switching operations.

LIGHTED MODELS

The illuminated push button Series MSPN have over 50 varied colored buttons and sizes to fit your specific applications. Versatile DPDT model with isolated lamp terminals.

WATERPROOF

The "E" Series is made to rigid specifications exceeding industry standards. Miniature in size, but exceptional in performance. Available as momentary, or Push-ON or Push-OFF, in one, two and 4PDT models.

Whether you need one or one thousand switches you have a greater variety to choose from when you specify an ALCOSWITCH.



SEND FOR COMPLETE
ALCOSWITCH CATALOG

ALCO

ELECTRONIC PRODUCTS, INC.
Lawrence, Massachusetts 01843

Evaluation Samples

Pretinned aluminum

Aluminum can now be easily soldered to copper, brass, steel and a variety of other metals with a solder-coated aluminum strip that makes the soldering of aluminum as simple as sealing an envelope. Since the right amount of solder is integrally preplaced on the surface of the strip, just where it is required, all that is needed to produce a reliable soldered joint is heat. The strips are available in a variety of aluminum alloys and with a choice of solder compositions. The solder coating can be placed over the entire surface or in accurately located strips. Widths as large as 4 in. and thicknesses up to 0.05 in. can be supplied. A free sample is available for evaluation. Sherman Industries Inc.

CIRCLE NO. 341

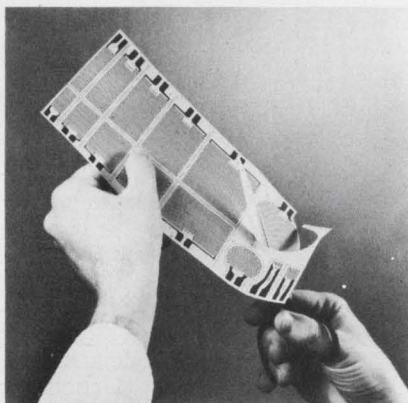

Flexible heaters

Thermofoil flexible heating elements can solve many temperature problems. These thin, lightweight, etched-element heaters are especially suited for applications requiring high reliability, fast warmup, rapid heat transfer and close temperature control. They use Kapton film or silicone rubber insulation and are easily installed with pressure-sensitive adhesive. Either uniform or characterized heat patterns can be specified. A free sample heater may be obtained by a qualified engineer for evaluation. Minco Products, Inc.

CIRCLE NO. 342

STABILITY & QUALITY



MATSUO METALLIZED POLYESTER FILM CAPACITOR - "TYPE FNX-H"

Sub-miniature size and oval section ideal for space economy. Lightweight, self-healing and with high insulation resistance. Capacitance values up to 10 MFD. Outer wrap of tough polyester protects against moisture. Perfect in both transistorized and low voltage tube circuits and others where size and cost are paramount.

Specifications:

Operating Temperature Range: -40°C to $+85^{\circ}\text{C}$
Standard Voltage Rating: 100, 200, 400, 600VDC
Standard Capacitance Value: .1 MFD to 10 MFD.
Standard Capacitance Tolerance: $\pm 20\%$ (available $\pm 10\%$)

MATSUO'S other capacitors include:

Solid Tantalum Capacitors: MICROCAP

for hybrid ICs, Type TAX hermetically sealed in metallic case, Type TSX encased in metallic case and sealed with epoxy resin, Type TSL encased in metallic case and sealed with epoxy resin

Polyester Film Capacitors: Type MFL epoxy dipped, Type MFK epoxy dipped, non inductive, Type MXT encased in plastic tube, non inductive.

For further information, please write to:

MATSUO ELECTRIC CO., LTD.

Head Office: 3-5, 3-chome, Sennari-cho, Toyonaka-shi, Osaka, Japan
Cable: "NCCMATSUO" OSAKA Telex: 523-4164 OSA
Tokyo Office: 7, 3-chome, Nishi-Gotanda, Shinagawa-ku, Tokyo

INFORMATION RETRIEVAL NUMBER 72

ELECTRONIC DESIGN 14, July 5, 1969

INFORMATION RETRIEVAL NUMBER 71

Design Aids

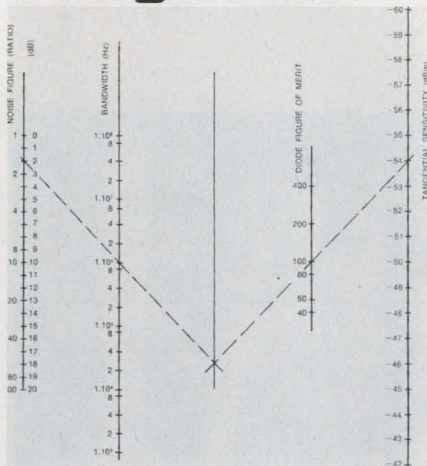

Video-detector nomogram

Copyrighted by the Microphase Corp., a nomogram aids in finding the tangential-signal sensitivity of video detectors. This nomogram solves an equation that relates tangential-signal sensitivity and figure of merit to video-amplifier noise figure and bandwidth. When three of these values are known, the nomogram provides the magnitude of the fourth. A laminated version of the nomogram is available free. Microphase Corp.

CIRCLE NO. 343

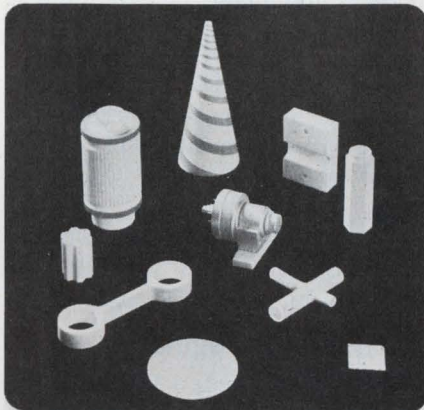

Ceramics chart

A two-color chart outlines the electrical, thermal and mechanical properties of some popular ceramic materials. In addition, highlight applications are listed for each type of ceramic. Enumerated properties include dielectric constant, loss tangent and strength, electrical resistivity, thermal conductivity and expansion, and maximum continuous-use temperature. Technical bulletins on several of the ceramic materials listed are supplied along with the chart. National Beryllia Corp.

CIRCLE NO. 344

The
Trend
is TTL.

Series 54H 6 ns TTL (flatpacks or ceramic DIP)

4 WEEKS AHEAD

(Same day shipment on 250 pieces or less)



Faster deliveries on all TTL circuits—made possible by greatly expanded manufacturing capability. Get full information on the IC types you need. Call your TI representative—now!

TEXAS INSTRUMENTS
INCORPORATED

WHICH DEFLECTION YOKE ? FOR YOUR DISPLAY ?

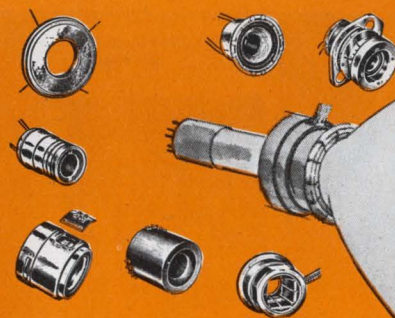

Consult **SYNTRONIC**

YOKE SPECIALISTS

Syntronic's team of experts knows more about yoke design, engineering and quality control than anyone else. A solid 10-year record of leadership—acknowledged throughout the industry. Benefit from it.

syntronic **INSTRUMENTS, INC.**
100 Industrial Road, Addison, Illinois
Phone: Kingwood 3-6444

INFORMATION RETRIEVAL NUMBER 73

brite glo[®] ALCOLITE

Alco's new Brite Glo[®] miniature lamp series is achieved through painstaking workmanship that assures the best pilot assembly on the market.

The new T-1 3/8 MNE neon series has an exclusive ring electrode construction that glows on the entire surface with direct current. Available as individual lamps or as miniature panel assemblies.

All our miniature incandescent pilot assemblies contain the most popular and long-life MIL-grade T-1 5 volt lamps. Choice of domed or cylindrical assemblies, in a variety of colors.

Our standard neon series are all equipped with NE2 lamps and are available in many lens styles and colors, with or without built-in series resistors.

For design-service assistance and price quotations, call (Area 617) 686-3887.

SEND FOR COMPLETE
ALCOLITE
CATALOG



ALCO

ELECTRONIC PRODUCTS, INC.
Lawrence, Massachusetts 01843

Application Notes

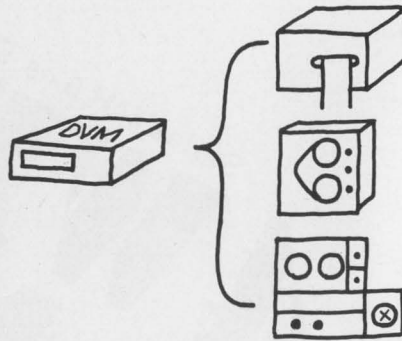

Digital voltmeters

The meaning of digital voltmeter specifications is discussed in a new 40-page brochure. This discussion includes interpretation of accuracy, resolution, noise rejection, measurement speed, and other parameters commonly specified in DVM literature. The publication also provides a complete listing of 33 DVM models in 300 different configurations. The spectrum of digital voltmeters listed ranges from a four-digit instrument to a unit with an accuracy of $\pm 0.0025\%$. Dana Laboratories, Inc.

CIRCLE NO. 345

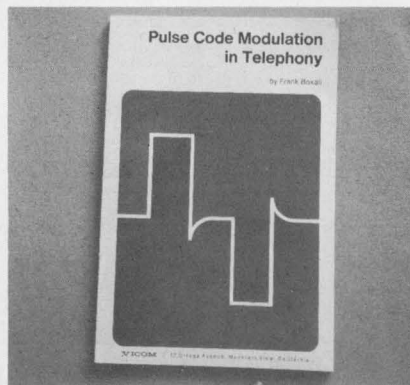

Pulse code modulation

Intended for telephone operating people and transmission engineers, a new 72-page illustrated booklet is an easy-to-read guide to pulse-code-modulation (PCM) concepts, techniques and hardware. Current, as well as future, PCM carrier systems, digital transmission and the T1 line, along with PCM voice and data terminals are fully covered. There is also a short history of pulse code modulation. VICOM.

CIRCLE NO. 346



Aerospace solvent

A 42-page brochure, "Dowclene WR . . . The Space Age Solvent," covers advantages, performance characteristics, major applications, and storage and handling of a specially inhibited trichlorethane, as well as a suggested analytical method with the material. The booklet explains the factors to be considered in selecting a cleaning solvent for use under rigidly controlled conditions designed to reduce contaminants to the lowest possible levels. These factors include nonvolatile residue content, solvency towards contaminants, and effects upon nonmetallic and metallic materials. The Dow Chemical Co., Inorganic Chemicals Dept.

CIRCLE NO. 347

Ac thyristor regulator

Application note AN-3886 describes a basic ac voltage regulating technique that uses thyristors to prevent ac, rms, or dc voltage from fluctuating more than $\pm 3\%$, in spite of wide variations in input line voltage. Load voltage can also be held within $\pm 3\%$ of a desired value despite variations in load impedance through the use of a voltage-feedback technique. The voltage regulator described in this six-page note can be used in photocopying machines, light dimmers, dc power supplies, and motor controllers (to maintain fixed speed under fixed load conditions). RCA Electronic Components.

CIRCLE NO. 348

Annual Reports

Learn how to read annual reports in "How to investigate a company." For a copy, circle No. 474.

Canoga Electronics Corp., 1901 Ave. of the Stars, Century City, Los Angeles, Calif.: test and communications systems, packaging hardware, plastics, hydraulic equipment; net sales, \$14,528,900; net income, \$410,300; assets, \$7,784,100.

CIRCLE NO. 349

Electronic Associates, Inc., 185 Monmouth Parkway, West Long Branch, N. J.: computers, computer servicing, graphic peripherals, instruments; net sales, \$43,917,664; net income (loss), \$245,530; assets, \$44,493,435.

CIRCLE NO. 350

International Electronics Corp., Melville, Long Island, N. Y.: tubes, capacitors, panel meters, components; net sales, \$7,489,299; net income, \$316,363; assets, \$4,125,871; liabilities, \$2,579,210.

CIRCLE NO. 351

Markite Corp., 155 Waverly Place, New York, N. Y.: conductive plastic potentiometers; net sales, \$4,452,861; net income, \$128,613; total assets less total liabilities, \$2,153,305.

CIRCLE NO. 352

Pacific Industries, Inc., 26 Broadway, New York, N. Y.: electronic counters, carbon paper, steel; net sales, \$35,420,584; net income (loss), \$2,602,055; assets, \$12,784,689; liabilities, \$4,955,629.

CIRCLE NO. 353

Richardson Co., 2700 Lake St., Melrose Park, Ill.; metals, plastics, chemicals, rubber products; net sales, \$104,385,000; net income, \$4,901,000; assets, \$35,161,000; liabilities, \$12,752,000.

CIRCLE NO. 354

The Trend
is TTL.

SN7441AN MSI Nixie* driver
**3 WEEKS
AHEAD**
(Same day shipment on 250 pieces or less)



Faster deliveries on all TTL circuits—made possible by greatly expanded manufacturing capability. Get full information on the IC types *you* need. Call your TI representative—*now!*

*Burroughs trademark

TEXAS INSTRUMENTS
INCORPORATED

Last Month
PICS
COMPUTERS
MATCHED
2,217 PEOPLE
TO BETTER
JOBS

Join PICS' 30,000 Executive, Technical and Professional members who share computer time to zero in on *immediate openings* in today's boiling job market. Employers like Honeywell, Chase Manhattan, National Airlines, Kennecott, Parke Davis, Raytheon and 333 others feed in openings *as they occur*. You receive detailed print-outs describing each opening that matches your career goals, qualifications, salary requirements, etc.

For membership information call (802) 442-3141 Collect—or mail coupon.

NOT AN EMPLOYMENT AGENCY—NO EMPLOYMENT FEES!

PICSystem, Inc., DEPT. #835
BENNINGTON, VT. 05201

Please send details without obligation.

Name _____ (please print)

Address _____

City _____ State _____ Zip _____

INFORMATION RETRIEVAL NUMBER 75

variety with ALCOSWITCH

The greater the variety, the more flexibility you have when designing a miniature ALCO-SWITCH into your quality equipment. The broad ALCOSWITCH line offers over a hundred different models.

Miniature Toggle Switches are available in five series including high performance water-proof types, locking handles, and switches with 15/32" bushings.

Miniature Push Button Switches include the new illuminated series, top-grade SPDT-DPDT-4PDT types, 15/32" bushings, and economy priced miniatures.

1/2" Dia. Miniature Adjustable-Stop Rotary Switches are built to meet the highest reliability standards and are available with or without their own specially mated knobs.

Whether you need one or one thousand switches you have a greater variety to choose from when you specify an ALCOSWITCH.

SEND FOR
20-PAGE
ALCOSWITCH
CATALOG



ALCO

ELECTRONIC PRODUCTS, INC.
Lawrence, Massachusetts 01843

NEW LITERATURE

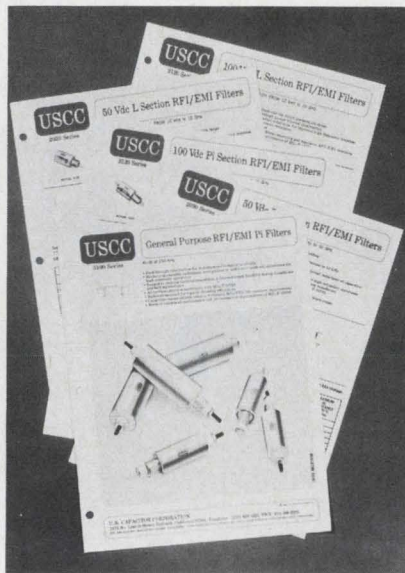

Rfi/emi filters

Providing detailed technical descriptions of five new series of miniature ceramic filters, a series of two-color bulletins covers Pi and L-section rfi/emi filters. Designed for low-pass operation from 10 kHz to 10 GHz, the filters offer voltage ratings of 50 or 100 V, ac or dc, and attenuations of 40 dB at 150 kHz. U. S. Capacitor Corp.

CIRCLE NO. 355

Packaged insulation

Standard packaged insulation products and other fabricated parts are the subject of an illustrated 32-page catalog. Described are formed fiber and polyester wedges, dispenser-packaged cuffed insulation coils and separators, shaped wood wedges, and crimped paper transformer coils. Inmanco Inc.

CIRCLE NO. 356

Microwave relay links

Discussed in an eight-page bulletin are all-solid-state television microwave relay links that provide high-fidelity color transmission and full compatibility with NTSC, SECAM and PAL formats. Block diagrams with accompanying copy describe the operations of both the receiver and transmitter units. RHG Electronics Laboratory, Inc.

CIRCLE NO. 357

Captive hardware

An illustrated, eight-page catalog describes stainless-steel captive hardware for soft or thin metal panels, as well as parts or chassis. The publication lists seven types of captive fasteners that won't pull, push or torque out after simple press-fit installation. These include flush, extension, self-locking, and floating nuts designed to correct chassis hole misalignment. A variety of stainless-steel studs are also shown. Full details on threads, sizes and other ordering information are included. Precision Metal Products Co.

CIRCLE NO. 358

Data transmission

A 35-page bulletin describes the functional specifications, interfaces and applications of DigiNet 400 data-transmission equipment. Operating at rates to 50 kilobits per second, the wideband series includes digital information systems for computer data, facsimile and digitized voice in government and military complexes, private microwave networks and dedicated transmission lines. They handle synchronous or nonsynchronous binary digital data. General Electric Communication Products Dept.

CIRCLE NO. 359

Semiconductor catalog

A 12-page condensed catalog contains product data on silicon transistors and microcircuits. This edition lists over 200 single and dual n-channel junction FETs. Listings include p-channel single and dual MOSFETs, dielectrically isolated monolithic dual npns, dual npn and pnp transistors, and monolithic low-voltage MOS shift registers, MOS micropower counters, and MOS voltage comparators. Also included are FET analog gates and a wide variety of flip-chips. Intersil Inc.

CIRCLE NO. 360

Ceramic capacitors

Containing graphs, performance curves and dimension charts, a 32-page catalog describes a line of ceramic capacitors and multilayer monolithic chips. Four pages of the catalog are devoted to test specifications for capacitors. Also outlined are high-voltage disc capacitors, feedthrough capacitors, post insulators and spark gaps. Maida Development Co.

CIRCLE NO. 361

Copper-clad materials

A comprehensive 12-page guide to copper-clad materials for use in rigid, multilayer and flexible printed circuits provides complete technical data on specifications, properties, methods of testing, and applications. Westinghouse Industrial Plastics Div.

CIRCLE NO. 362

Laboratory Instrument Mart

Laboratory Instrument Mart, Inc. 788 E. Duane St., Phoenix, Arizona 85011 (212) 944-1000
A Subsidiary of Instrument Exchange Corporation, Lake, LA 70001
No. 10 Date April-May 1969

INDEX	Page No.
Amplifiers	1
Balance	11
Bole and Counters	11
Calculus	1
Cryostat	11
Cytometer	11
Dielectric Apparatus	14
Electron Microscopes	2
Electronics	11
Formulas	11
Frequency	14
Gas Analyzers	9
Gas Chromatographs	9
Leak Detectors	11
Incubators	11
Microscopes and Accessories	13
Microfilm	11
MS and LSS Systems	7
Radio Equipment	7
Refrigerators	11
Other Equipment	11
SI Units	11
Statistics	4
Printers	10
Relays	11
Recording Oscilloscopes	11
Signal Analyzers	11
Spectrophotometers and Mass Spectrometers	2
Spectrophotometers (IR)	4
Spectrophotometers (UV and Visible)	4
Stimulators	11
Tape Recorders	4
Thermometers	11
Ultrasonic Cleaners	11
Vacuum Evaporators	11
Vacuum Enclosures	11
Vacuum Evaporators	11

Eastern Regional Office: P. O. Box 34, Fairwood Station, Mt. Vernon, N. Y. 10552. (914) 469-1274

Instrument markets

Infrared and ultraviolet spectrophotometers, gas chromatographs, oscilloscopes and laboratory computers are among the many guaranteed new and used instruments listed at bargain prices in the latest issue of Laboratory Instrument Mart. Also described in this publication are details on how to buy, sell, trade and lease laboratory instruments. Laboratory Instrument Exchange, Inc.

CIRCLE NO. 363

The Trend is TTL.

3 WEEKS ARO

SN7496N MSI 5-bit shift register

(Same day shipment on 250 pieces or less)



Faster deliveries on all TTL circuits—made possible by greatly expanded manufacturing capability. Get full information on the IC types *you* need. Call your TI representative—*now!*

TEXAS INSTRUMENTS INCORPORATED

BUILD MDS "DATA-RECORDER QUALITY" INTO YOUR SYSTEMS

Transcription . . . verification . . . all the advantages of magnetic tape . . . in the MDS 701 and 901 Buffered Tape Units. These units are buffered magnetic tape transports; each providing three modes of operation . . . Write, Read and Search.

MDS 701 . . . Handles data on 7-channel tape at 200 bpi. MDS 901 . . . Handles data on 9-channel tape at 800 bpi. Input and output communication between a parent machine and the magnetic tape is via a program controlled buffer. The controller is your own, designed to fit your application.

Easy integration with a system is made possible through the asynchronous bit parallel, character serial interface provided with the 701 and 901. And you get the high speed, solid state electronics, quiet operation and versatility that are engineered into all MDS Data-Recorders.

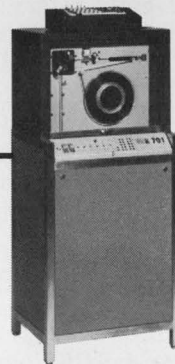

MDS BUFFERED TAPE UNIT

Ask for: Folder file on MDS 701/901 Buffered Tape Units
FOR MORE — MEET YOUR MAN FROM MDS

MOHAWK MS
DATA SCIENCES CORPORATION
OEM MARKETING

P. O. Box 630, Palisade St., Herkimer, N.Y. 13350
Telephone 315/866-6800
Every MDS Office is an OEM Marketing Office
Digital Strip Printers • Buffered Tape Units
High-Speed and Low-Speed Line Printers
Card Punches and Readers

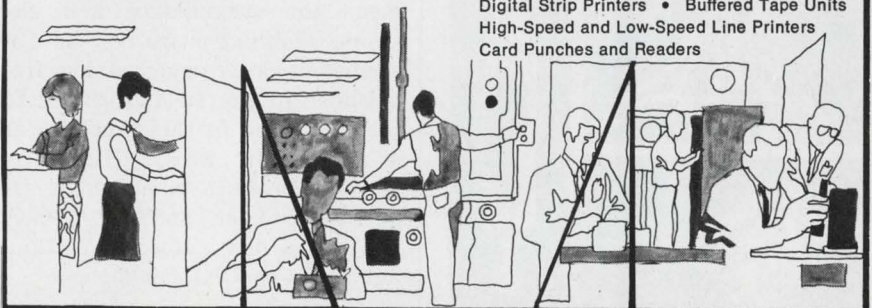

INFORMATION RETRIEVAL NUMBER 77

Opportunities for

CIRCUIT DESIGNERS

Expanding activity on long-range programs and advanced projects has created many stimulating growth-assignments for Circuit Designers at Hughes.

Some of our most urgent requirements exist in the following areas:

- Development of high-power airborne radar transmitters, the design of which involves the use of the most advanced components
- Design of low-noise radar receivers using parametric amplifiers and other advanced microwave components
- Design of digital radar signal processing subsystem circuits, including range and speed trackers, doppler filter banks and a variety of display circuits
- Design of high-efficiency power supplies for airborne and space electronic systems
- Development of telemetering and command circuits for space vehicles and communications satellites

Requirements: an accredited Engineering degree, a minimum of two years of directly relatable experience and U.S. citizenship.

For immediate consideration, please airmail your resume to:

MR. ROBERT A. MARTIN
Head of Employment
Hughes Aerospace Divisions
Dept. 48
11940 W. Jefferson Blvd.
Culver City, Calif. 90230

HUGHES

HUGHES AIRCRAFT COMPANY
AEROSPACE DIVISIONS

An equal opportunity employer—M & F

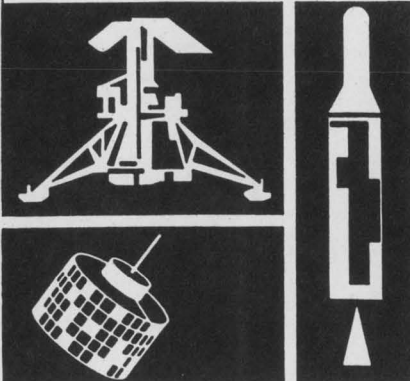

NEW LITERATURE

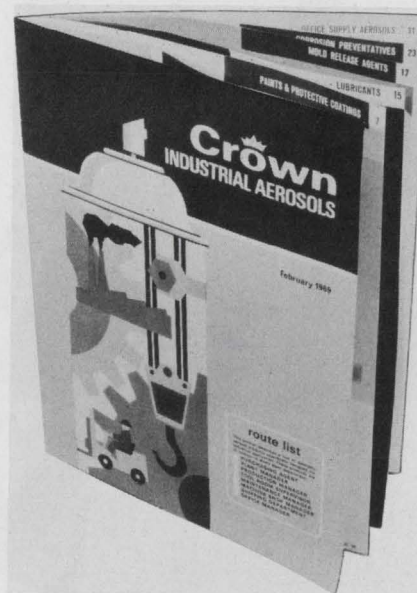

Industrial aerosols

Describing nearly 100 aerosol products for industrial and commercial use, a 36-page catalog tells of specialized paints and protective coatings (some in as many as 35 different colors), lubricants, mold releases, solvents and cleaners, corrosion preventatives and adhesives. Crown Industrial Products Co.

CIRCLE NO. 364

Switch catalog

Consisting of 130 illustrated pages, a new switch catalog gives information on both rotary and pushbutton units. Most types of rotary switches are presented, including those for high- and low-power switching, rf applications, along with miniature low-profile units for direct soldering to printed circuit boards. ITT Components Group.

CIRCLE NO. 365

Surveillance and ECM

A broad line of receiving equipment for surveillance and electronic counter-measures is described in a 17-page catalog from a leader in the field. Included for the first time in this brochure are a single-unit, 1-to-12-GHz microwave receiver, a combination frequency-extender and signal-monitor, and a new autoscan. Watkins-Johnson Co., CEI Division.

CIRCLE NO. 366

Diamonds in ceramics

Numerous diamond applications in the ceramic industry are described and illustrated in a 16-page booklet, "Diamonds and Ceramics." The properties for which ceramics are so valued—hardness and resistance to physical and chemical attack—are exactly the reasons why they are difficult to shape accurately and to machine. To cut them quickly, precisely and economically, industrial diamonds have proved to be essential. Industrial Diamond Information Bureau.

CIRCLE NO. 367

Infrared spectroscopy

A 32-page bulletin describes a wide variety of liquid-sampling supplies, variable-temperature accessories, gas-sampling supplies, solid-sampling supplies, ATR accessories, and beam condensers for infrared spectrophotometers. The bulletin also includes several handy equipment reference tables, along with useful guides for selecting liquid-sample cells and for choosing window materials for cells. Beckman Instruments, Inc., Scientific Instruments Div.

CIRCLE NO. 368

Test accessories

Electronic test accessories are the subject of a 52-page catalog. The complete line comprises standard and miniature banana plugs, adapters, patch cords, and accessories; component-mounting plastic black boxes and four series of shielded metal boxes; cable assemblies with a wide selection of connectors and cables. Pomona Electronics Co., Inc.

CIRCLE NO. 369

Molded inductors

One of the industry's largest and most complete lines of molded inductors is detailed in a 32-page brochure. Included are many types of inductors for numerous applications, as well as a custom-design capabilities section of variable inductors, rf and i-f transformers and other types of wound components. San Fernando Electric Mfg. Co.

CIRCLE NO. 370

Electronic Design

ELECTRONIC DESIGN's function is:

- To aid progress in the electronics manufacturing industry by promoting good design.
- To give the electronic design engineer concepts and ideas that make his job easier and more productive.
- To provide a central source of timely electronics information.
- To promote two-way communication between manufacturer and engineer.

Want a subscription? ELECTRONIC DESIGN is sent free to qualified engineers and engineering managers doing design work, supervising design or setting standards in the United States and Western Europe. For a free subscription, use the postfree application form inside the back cover. If none is included, write to us direct for an application form.

If you do not qualify, you may take out a paid subscription for \$25 a year in the U.S.A., \$35 a year elsewhere. Single copies are \$1.50 each.

If you change your address, send us an old mailing label and your new address; there is generally a prepaid postcard for this inside the back cover. You will have to requalify to continue receiving ELECTRONIC DESIGN free.

The accuracy policy of ELECTRONIC DESIGN is:

- To make reasonable efforts to ensure the accuracy of editorial matter.
- To publish prompt corrections whenever inaccuracies are brought to our attention. Corrections appear at the end of the Letters column.
- To refuse any advertisement deemed to be misleading or fraudulent.

Microfilm copies are available of complete volumes of ELECTRONIC DESIGN at \$19.00 per volume, beginning with Volume 9, 1961. Work is now in process to complete the microfilm edition of Volumes 1-8. Reprints of individual articles may be obtained for \$2.00 each, prepaid (\$.50 for each additional copy of the same article) no matter how long the article. For further details and to place orders, contact the Customer Services Department, University Microfilms, 300 North Zeeb Road, Ann Arbor, Michigan 48106; telephone (313) 761-4700.

Want to contact us? If you have any comments or wish to submit a manuscript or article outline, address your correspondence to:

Howard Bierman, Editor,
ELECTRONIC DESIGN,
850 Third Avenue,
New York, N.Y. 10022.

The
Trend
is TTL.

Series 74F MSI flatpacks
**1 WEEK
AROUND**
(Same day shipment on 250 pieces or less)



Faster deliveries on all TTL circuits—made possible by greatly expanded manufacturing capability. Get full information on the IC types *you* need. Call your TI representative—*now!*

TEXAS INSTRUMENTS
INCORPORATED



**ELECTRO-OPTICS
ENGINEERS**

Comprehensive knowledge of detectors, optics and scanning techniques. Design of near, intermediate and long-wave IR systems with experience in effects of launch environments on sensor systems. □ For more information please write Mr. H. W. Bissell, Professional Placement Manager, P.O. Box 504, Sunnyvale, California 94088. An equal opportunity employer.

LOCKHEED
MISSILES & SPACE COMPANY
A GROUP DIVISION OF LOCKHEED AIRCRAFT CORPORATION

INFORMATION RETRIEVAL NUMBER 901

Florida opportunities

for a special breed of communication engineer

If you're going to enjoy your job, you might as well enjoy where you're living! At Electronic Communications, Inc., you can have both: professional challenge and career opportunity plus the advantages of living in St. Petersburg on Florida's subtropical Gulf Coast.

We don't offer comfortable grooves where you can get lost . . . and your work overlooked. At ECI you'll work on projects that push the state-of-the-art in satellite communications, multiplexing, electronic switching and advanced radio communications to supply advanced systems and equipment for many of the nation's key military and space programs. You'll work on projects beginning with applied research and advance development through prototype and product design. In fact, two-thirds of all advanced development at ECI is done in regular engineering development areas.

CHECK THESE OPPORTUNITIES IN ENGINEERING AT ECI

RF Circuit Engineers
Systems Analysis Engineers
Systems Integration Engineers
Industrial Engineers
Digital Engineers
Reliability Engineers

CHALLENGE, GROWTH . . . AND LOCATION TOO!

If you'd like a challenging engineering position, growth instead of a groove, and stimulating, comfortable living in sunny St. Petersburg, send your resume — in confidence — to P. D. Jordan, Supervisor of Professional Placement, Electronic Communications, Inc., Box 12248, St. Petersburg, Florida 33733.

(An equal opportunity employer, M/F.)



ELECTRONIC COMMUNICATIONS, INC.
St. Petersburg Division a subsidiary of NCR

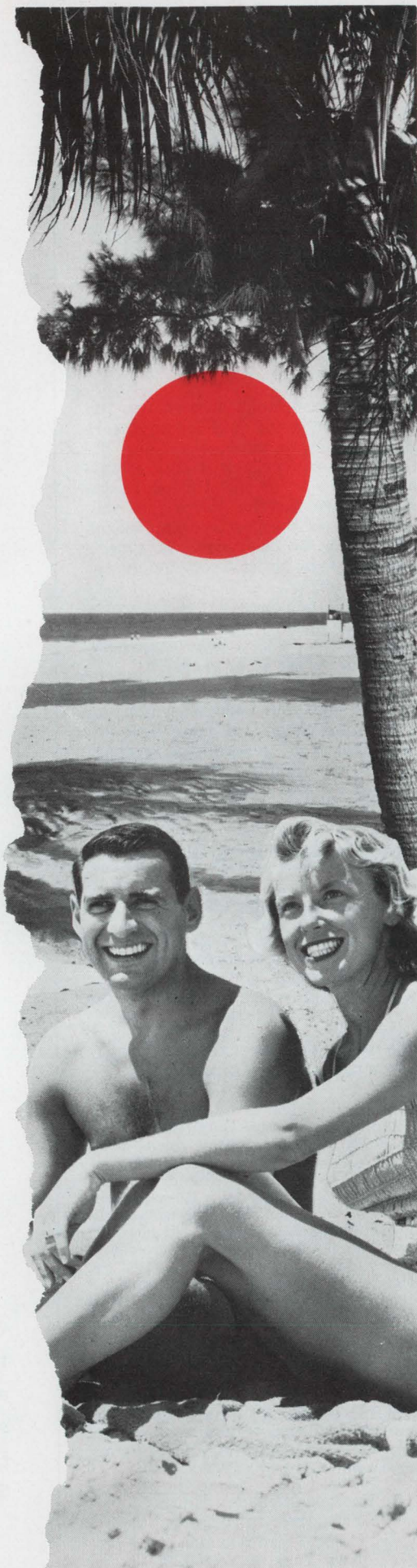

Free Career Inquiry Service

Absolutely Confidential

Respond to the career opportunities advertised in this issue. Fill out and send us this handy resume. **Electronic Design** will do the rest – neatly typed copies of this form will be mailed to the companies of your choice, indicated by the circled Career Inquiry Numbers at the bottom of this page.

14

Name		Home Phone	
Home Address (Street)		City	State
			ZIP Code
Age	U.S. Citizen	Security Clearance	
	<input type="checkbox"/> Yes <input type="checkbox"/> No		

Prime Experience	Secondary Experience

Desired Salary	Availability Date
-----------------------	--------------------------

Employment History – present and previous employers

Company	City, State	Dates	Title
		to	
		to	
		to	

Education – indicate major if degree is not self-explanatory

Degree	College	City, State	Dates
			to
			to
			to

Additional Training – non-degree, industry, military, etc.

Professional Societies

Published Articles

- Career Inquiry Numbers:**
- | | | | | | | | | | | |
|-----|-----|-----|-----|-----|-----|-----|-----|-----|-----|-----|
| 900 | 901 | 902 | 903 | 904 | 905 | 906 | 907 | 908 | 909 | |
| 910 | 911 | 912 | 913 | 914 | 915 | 916 | 917 | 918 | 919 | 925 |

ELECTRONIC DESIGN
 850 Third Avenue
 New York, New York 10022

PRECISION WIRE

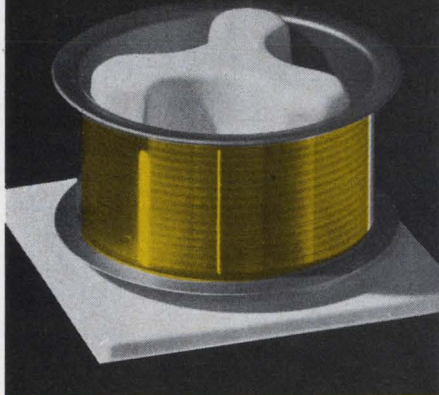

for electronic applications

CRM specializes in wire for precision electronic applications. All CRM wires are made with absolute uniformity of composition, smooth surface finish, and freedom from contamination. Packaging on unique platform-mounted spools in vapor-proof double plastic containers protects quality in storage and use.

.. Spectrographically controlled Gold and Aluminum bonding wire

.. Platinum alloys for potentiometers

.. 6-9's aluminum and other metals for vacuum deposition

.. Fine wire for thermistors

.. Custom enameled fine wire

Call or write CRM for a quotation or a copy of the latest, complete CRM catalog.

**CONSOLIDATED
CRM REACTIVE
METALS, INC.**

a Division of CONSOLIDATED REFINING CO., Inc.
117 Hoyt Avenue, Mamaroneck, N.Y. 10543
Tel: (914) 698-2300 □ TWX 710-566-1112

INFORMATION RETRIEVAL NUMBER 78

Advertisers' Index

Advertiser	Page	Advertiser	Page
Alco Electronic Products, Inc.	112, 114, 116	K and M Electronics Corp.	93
Allen-Bradley Co.	49, 51	Kinetic Technology Incorporated	14
Amersil, Inc.	56		
Amperex Electronic Corporation	4, 5		
Automatic Controls Division of Cook Electric	101	Leach Corporation	96 A-B
		Littlefuse	111
Beckman Instruments, Inc., Helipot Division	23	McLean Engineering Laboratories	104
Beede Electrical Instrument Co., Inc.	106	Matsuo Electric Co., Ltd.	112
Belden Corporation	88	Mohawk Data Sciences Corporation	117
Bishop Graphics, Inc.	123	Motorola Precision Instruments Products	81
Blu-Ray Incorporated	81	Motorola Semiconductor Products, Inc.	24
Boston Insulated Wire and Cable Co.	95		
Bourns, Inc.	62	National Beryllia Corporation	105
Burroughs Corporation	20	National Semiconductor Corporation	16 A-B
		Nytronics, Inc.	31
CML, Inc.	106	PIC Systems, Inc.	115
Cambridge Thermionic Corporation	85		
Centralab, Semiconductor Division of Globe-Union, Inc.	59	RCA Electronic Components and Devices	13, 54, 55, 58, Cover IV
Chartpak Rotex, A Division of Avery Products Corp.	111	Raytheon Computer	87
Cinch, Division of United Carr	15	Raytheon Company, Semiconductor Division	52
Cohu Electronics, Inc.	109		
Condenser Products Corporation	102	Schauer Manufacturing Corp.	108
Consolidated Reactive Metals, Inc.	122	Servo-Tek Products Company	110
Corning Glass Works, Electronic Products Division	32, 33	Signetics Corporation	27
Crescent Technology Corp.	96	Simpson Electric Company	97
Cunningham Corporation	91	Singer Company, The, Diehl Division	99
Curtis Development & Mfg. Co.	123	Spectrol Electronics Corporation	46
		Sprague Electric Company	18
Dale Electronics, Inc.	85, Cover III	Stackpole Carbon Company	73
Data Technology Corporation	61	Switchcraft, Inc.	6
Detroit Controls	108	Sylvania Electric Products, Inc.	69
Dynamic Instrument Corp.	102	Syntronic Instruments, Inc.	113
		Systron-Donner Corporation	2
EMN Company	111	TRW Semiconductors	79
Edmund Scientific Company	85	Takeda Riken Industry Co. Ltd.	98
Elco Corporation	10, 11	Techno-Components, Corp.	100
English Electric Valve Co., Ltd.	96E	Texas Instruments Incorporated	7
		Texas Instruments Incorporated, Components Group	113, 115, 117, 119
		Theta Instrument Corporation	17
		Transitron Electronic Corporation	60
Fairchild Semiconductor, A Division of Fairchild Camera and Instrument Corporation	9, 29	U-Tech, A Division of Industrial Physics and Electronics Company	103
Federal Scientific Corp.	123		
		Victoreen Instrument Division	16
General Electric Company, Electronic Components	57	W. & G. Instruments, Inc.	50
General Electric Company, Semiconductor Products Department	96F	Wilson, H. A., A Division of Engelhard Minerals & Chemicals Corporation	81
General Instrument Corporation	8		
General Radio Company	1		
Glenaire, Inc.	107		
Hewlett-Packard	Cover II, 13	Career Advertising:	
Hitchner Manufacturing Co., Inc.	92	Electronic Communications, Inc.	120
Honeywell Test Instrument Division	98	Hughes Aircraft Company, Aerospace Divisions	118
Johanson Manufacturing Corp.	94	IBM Corporation	83
		Lockheed Missiles & Space Company	119

Advertising Sales Staff

New York 10022

Edward F. Clancy
Sales Service Manager
Robert W. Gascoigne
Thomas P. Barth
Samuel M. Deitch
Byron K. Adams
850 Third Avenue
(212) Plaza 1-5530
TWX: 710-581-2874

Philadelphia 19066

William C. Repetto
P. O. Box 206
Merion Station, Pa.
(215) MA-3-5888

Boston 01945

Richard Parker
P.O. Box 645
Clifton Station
Marblehead, Mass.
(617) 742-0252

Chicago 60611

Thomas P. Kavooras
Berry Conner, Jr.
200 East Ontario
(312) 337-0588

Cleveland

Thomas P. Kavooras
(Chicago)
(312) 337-0588
(call collect)

Los Angeles 90303

Stanley I. Ehrenclou
John V. Quillman
W. James Bischof
2930 Imperial Highway
Inglewood, Calif.
(213) 757-0183

San Francisco 94022

Arthur R. Shields, Jr.
175 San Antonio Rd., S 243
Los Altos, Calif.
(415) 941-3084

London W. 1

For United Kingdom & Holland
Brayton C. Nichols
44 Conduit Street
Tel: REGent 4714

Verviers, Belgium

For Continental Europe
Andre Jamar
1, Rue Mallar, 1
(087) 253.83 Telex 41563

Tokyo

Yoshiro Takemura
IPS Group Ltd.
Box 36, Ohsaki Post Office
Phone (504) 1485
Cable Joshplans, Tokyo



AMERICAN BUSINESS PRESS, INC.

Design Data from Manufacturers

Advertisements of booklets, brochures, catalogs and data sheets. To order use Reader-Service Card.
(Advertisement)

NEW 68-PAGE DRAFTING CATALOG — FREE

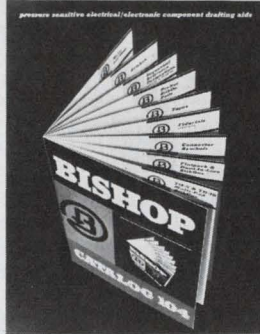

Bishop Catalog 104 — the most comprehensive manual type catalog of pressure-sensitive electrical/electronic component drafting aids ever assembled. Filled with thousands of printed wiring symbols and patterns to speed artwork preparation time and cut drafting costs. Featuring the latest information on printed wiring drafting techniques. Contains multi-pad component symbols, including flatpacks and dual in-lines. Also, general purpose wiring symbols, logics, schematics, reference designations, tapes, pads, shapes and many, many more. Send today for your free copy and samples.

Bishop Graphics, Inc.
7300 Radford Ave.
North Hollywood, California 91605
Phone: (213) 982-2000

174

Calibrated Frequency-Domain Measurements

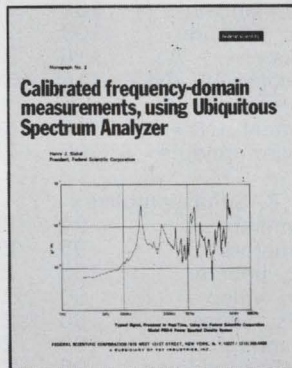

A theoretical discussion of the methods of performing calibrated frequency-domain measurements using narrow-band and wide-band signals are detailed. Methods of calibrating real-time spectrum analyzers, such as with the Ubiquitous® Spectrum Analyzer, are discussed using pure sine waves and broadband noise to obtain power spectral density plots. The calibration method described provides accurate, quantitative measurement of noise, vibration, and underwater acoustic signals which have been processed by a power spectral density system using the well-known Ubiquitous® Spectrum Analyzer. Send for free Technical Monograph #2.

Federal Scientific Corporation
a subsidiary of Elgin National Industries, Inc.
615 West 131st Street, New York, N.Y. 10027

175

Terminal Block Selector

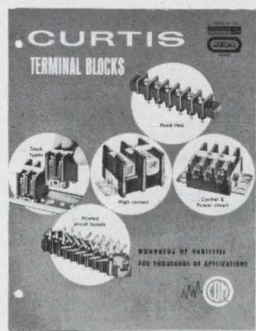

A new 24-page, completely illustrated catalog contains photos, descriptions, ratings, engineering drawings, and prices of the complete line of Curtis terminal blocks. Included are printed circuit, insulated feed-thru, quick disconnect, track type, and high current terminal blocks. Handy selection chart quickly locates the perfect block for your particular requirements. Send today for your free copy.

See us at WESCON - Booth 4911

Curtis Development & Mfg. Co.
3236 North 33rd Street
Milwaukee, Wisconsin 53216

176

From Dale—the pots you don't ship back...

<1% customer rejection rate!

Less than 1% customer rejection for all causes. That's the record established by Dale T-Pots. Consider the savings this can bring you in time, paper work. Then consider the added efficiency of consolidating more of your buys at this versatile source. Almost 50% more models added in two years. Military (RT-10, 11, 12, 22, 24), Industrial, Commercial ... wirewound and film elements. All are very competitively priced. Check today and find out. We can deliver them quickly—and you won't have to send them back.

MILITARY GRADE T-POTS

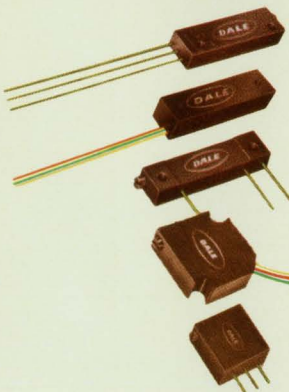

600 Series: Mil. Equiv. RT-10; 10Ω to 100KΩ, ±5%; 1 watt at 70°C, derated to 0 at 175°C; .18 H x .32 W x 1.00 L.

1200 Series: Mil. Equiv. RT-11; 10Ω to 100KΩ, ±5%; 1 watt at 70°C, derated to 0 at 175°C; .28 H x .31 W x 1.25 L.

1600 Series: Mil. Equiv. RT-12; 10Ω to 100KΩ, ±5%; 1 watt at 70°C, derated to 0 at 175°C; .19 H x .32 W x 1.25 L.

5000 Series: Mil. Equiv. RT-22; 10Ω to 50KΩ, ±5%; 1 watt at 70°C, derated to 0 at 175°C; .19 or .22 H x .50 W x .50 L.

5800 Series: Mil. Equiv. RT-24; 10Ω to 50KΩ, ±5%; 1 watt at 70°C, derated to 0 at 175°C; .145 or .150 H x .375 W x .375 L.

COMMERCIAL GRADE ECONO-TRIM T-POTS

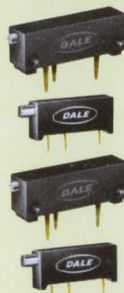

WIREWOUND ELEMENT

2300 Series: Sealed/Unsealed; 10Ω to 50KΩ, ±10%; 0.5 watt at 25°C, derated to 0 at 105°C; .36 H x .28 W x 1.00 L.

2400 Series: Sealed/Unsealed; 10Ω to 50KΩ, ±10%; 1 watt at 40°C, derated to 0 at 125°C; .31 H x .16 W x .75 L.

FILM ELEMENT

8300 Series: Sealed/Unsealed; 10Ω to 2 Meg., ±10% 100Ω thru 500K, ±20% all other values; .75 watt at 25°C, derated to 0 at 105°C; .36 H x .28 W x 1.00 L.

8400 Series: Sealed/Unsealed; 10Ω to 2 Meg., ±10% 100Ω thru 500K, ±20% all other values; .75 watt at 25°C, derated to 0 at 125°C; .31 H x .16 W x .75 L.

INDUSTRIAL GRADE T-POTS

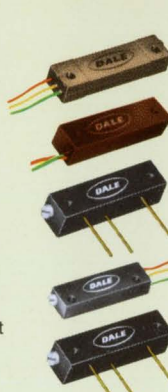

WIREWOUND ELEMENT

100, 200, 300 Series: 10Ω to 100KΩ.

100 Series: ±5%; 0.8 watt at 70°C, derated to 0 at 135°C.

200 Series: ±10%; 0.5 watt at 70°C, derated to 0 at 105°C.

300 Series: ±15%; .25 watt at 70°C, derated to 0 at 85°C.

Dimensions: .22 H x .31 W x 1.25 L (also 1.32 L for 100, 200).

1100 Series: 10Ω to 100KΩ, ±10%; 1 watt at 70°C, derated to 0 at 175°C; .28 H x .31 W x 1.25 L.

2100 Series: Industrial counterpart RT-11; 10Ω to 100KΩ, ±10%; 1 watt at 70°C, derated to 0 at 125°C; .28 H x .31 W x 1.25 L.

2200 Series: Industrial counterpart RT-10; 10Ω to 100KΩ, ±10%; 1 watt at 70°C, derated to 0 at 125°C; .18 H x .32 W x 1.00 L.

FILM ELEMENT

8100 Series: Industrial counterpart RJ-11; 10Ω to 2 Meg., ±10% 100Ω to 500K, ±20% other values; .75 watt at 70°C, derated to 0 at 125°C; .28 H x .31 W x 1.25 L.

Call 402-564-3131 for complete information or write for Catalog B



DALE ELECTRONICS, INC., 1328 28th Ave., Columbus, Nebraska 68601
In Canada, Dale Electronics Canada, Ltd. • A subsidiary of The Lionel Corporation



When RCA quietly calls its RF power transistors "reliable," RCA means "highly reliable." Read why.

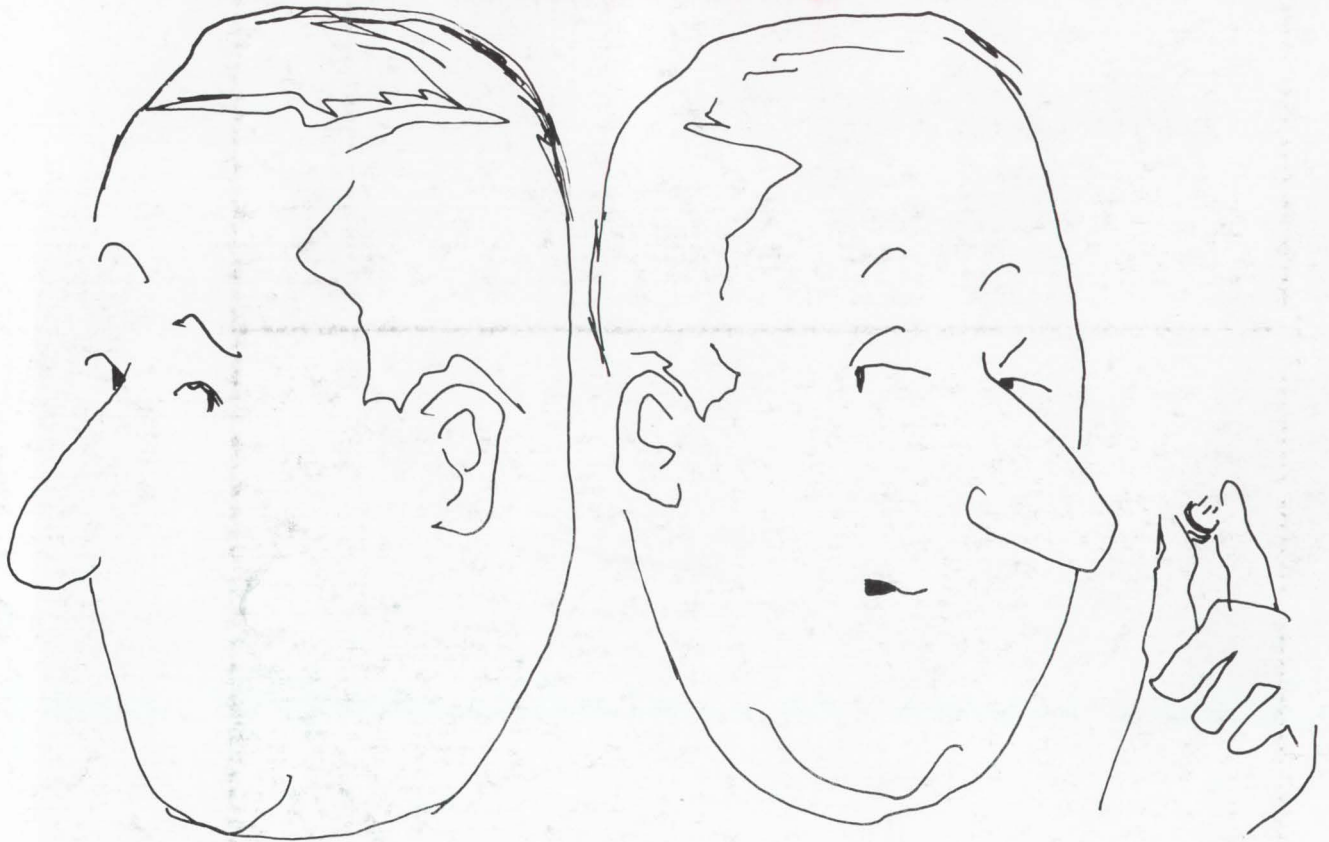

RCA

The reliability of RCA RF Power Transistors is designed-in, built-in and finally proved-in.

Evaluation criteria of every RCA RF Power Transistor are determined initially by design engineering—and are used during the analysis of first yields of prototypes. Procedures include tests to destruction, examination of failure mechanisms, checking the expectability of results, and extensive life tests under various rigorous conditions—all aimed at the final determination that every aspect of the new design is "go" for volume production.

In the second stage of assuring reliability, RCA follows a program of *dual* factory-process control: in-line testing at every major point of manufacturing, plus continuous quality audits on samples. The program consists of life tests, data analysis and failure analysis. Results are fed back to every technical group concerned with each product's evolution—from design through applications engineering.

The final stage, the proving-in of RCA reliability, is high to ultra-high screening. This follows four reliability levels: two meeting MIL-STD requirements and two meeting even more exacting criteria set by RCA—many of which precede the issuance of the military specs. Note the following chart of high-reliability RCA RF Power Transistors—all immediately available.

RCA RF Power Transistors—High-Reliability Types

Parent Type	Jan Type Or Equivalent	Jan TX Type Or Equivalent	High-Reliability Type	Premium High-Reliability Type
2N3553	JAN 2N3553	JAN TX 2N3553	40305	40605
2N4440	JAN 2N4440	JAN TX 2N4440	—	—
2N3632	—	—	40307	40606
2N3375	JAN 2N3375	JAN TX 2N3375	40306	40279
2N3118	JAN 2N1493	—	—	40577
2N3866	TA7090*	TA7327*	—	40578
2N5016	TA7091*	TA7359*	—	40607
2N5071	TA7360*	TA7358*	—	—

*Developmental number; military specification pending

For detailed information on any of these RCA high-reliability RF Power Transistors, see your local RCA Representative or your RCA Distributor. For technical data, write: RCA Electronic Components, Commercial Engineering, Section PG7-1, Harrison, N. J. 07029.