

# Electronic Design 19

VOL. 15 NO.

FOR ENGINEERS AND ENGINEERING MANAGERS.

SEPT. 13, 1967

**Liquid crystals plot the hot spots** in microcircuits, printed circuits and almost anything in between. Cholesteryl benzoate mapping is a low-cost alternative to infrared

scanning. Testing is reversible and exhibits a colorful 'readout.' Use the high-resolution technique in the lab or on production lines. For full details, turn to page 71.

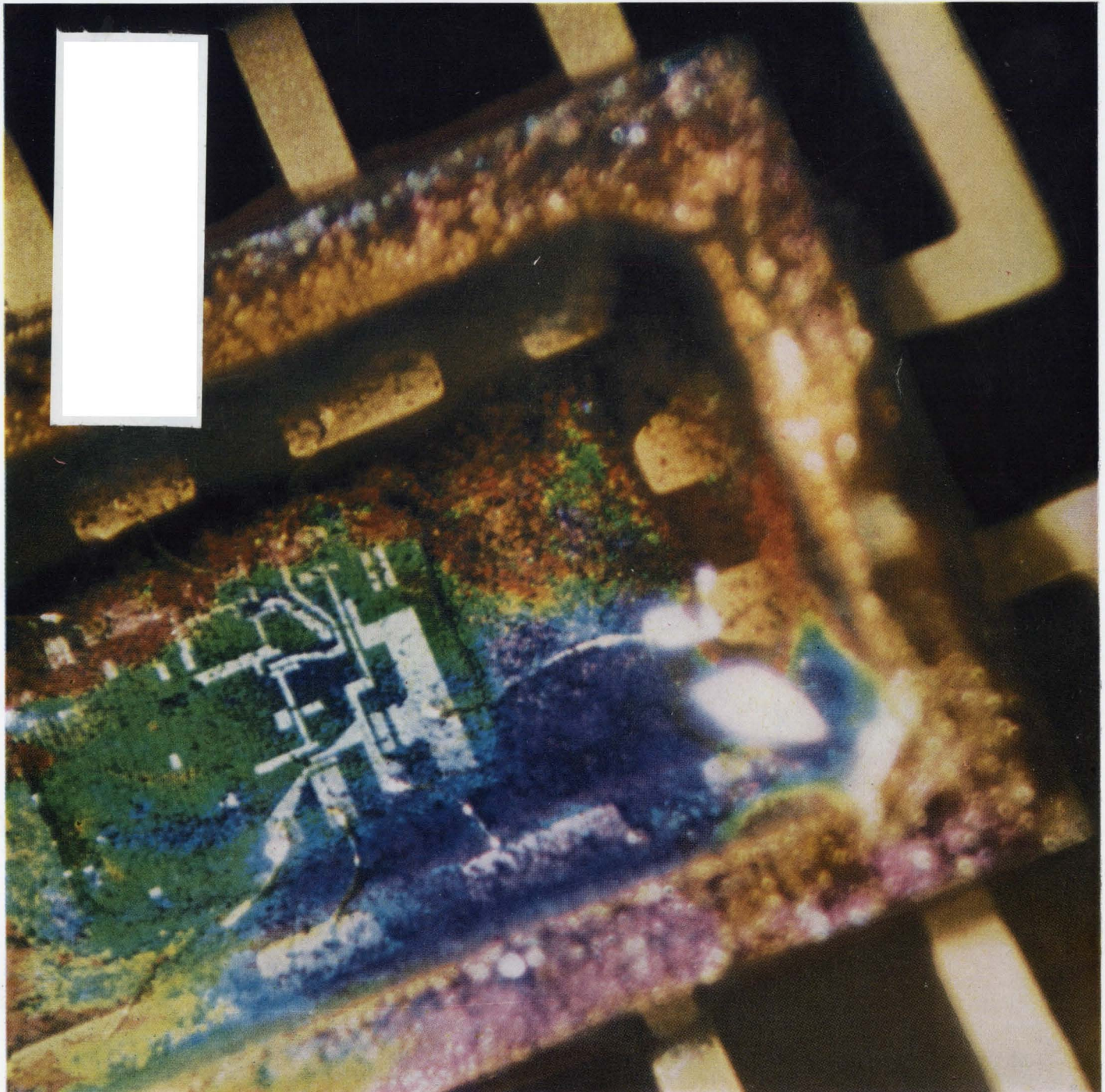



# "SPECIAL" CUSTOM BUILT FILTERS

## TO YOUR SPECIFICATIONS

ILLUSTRATED ARE  
TYPICAL SPECIAL FILTERS

RANGE OF FREQUENCIES ON SPECIAL UNITS  
IS FROM 0.1 CYCLE TO 400 MC.

Over thirty years of experience in the design and production of special filters have resulted in UTC being a first source for difficult units. Present designs both military and commercial incorporate a wide variety of core structures, winding methods, and capacitors to provide maximum performance, stability, and reliability. Fully experienced, top engineering talent backed by complete environmental testing and life testing facilities assure the highest standard in the industry. Full analysis and evaluation of materials are conducted in UTC's Material and Chemical Laboratories. Rigid quality control measures coordinated with exhaustive statistical findings and latest production procedures results in the industry's highest degree of reliability.

MILITARY AND COMMERCIAL TYPES FOR  
EVERY PHASE OF THE ELECTRONICS ART

POWER TRANSFORMERS • AUDIO TRANSFORMERS • INDUCTORS • PULSE TRANSFORMERS • ELECTRIC WAVE FILTERS • LUMPED CONSTANT DELAY LINES • HIGH Q COILS • MAGNETIC AMPLIFIERS • SATURABLE REACTORS • REFERENCE UNITS

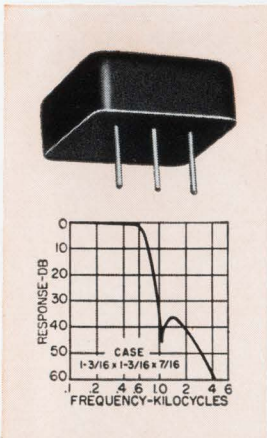

560 — Telemetry low pass filter. Available from 400 — to 70 KC.  $\pm 7.5\%$  band-width flat to 1 db. Attenuation greater than 35 db beyond the 2nd harmonic of — 7.5% frequency. Impedance 47K ohms. MIL-F-18327C. Wt. 0.8 oz.

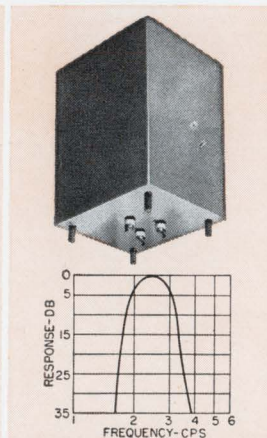

Low frequency band pass filter. Designed for 2.5 cps center frequency. At 2 to 3 cps within 3 db. At 1.5 cps and lower, and 4 cps and higher, greater than 30 db. Source and Load 10K ohms. Size: 4 x 4-11/16 x 6". MA MIL case, MIL-F-18327C.

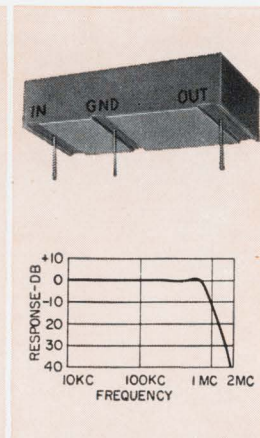

High frequency low pass filter. Zero to 700 KC within 1 db. 1.95 mc to 10 mc 40 db minimum. Source and Load 1000 ohms. Molded flat construction for printed circuit applications. Size: 1 x 2 x 1/2"; Wt: 1 oz. MIL-F-18327C.

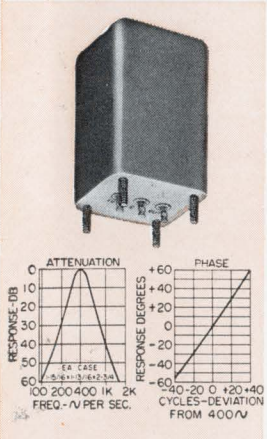

Band pass 400 cycle Gaussian filter. Linear phase response in pass band. Attenuation 380 cps to 420 cps within 0.5 db. 2nd harmonic down 25 db, 3rd harmonic down 45 db. Source and load 5K ohms. MIL-F-18327C. Wt., 0.9 lbs.

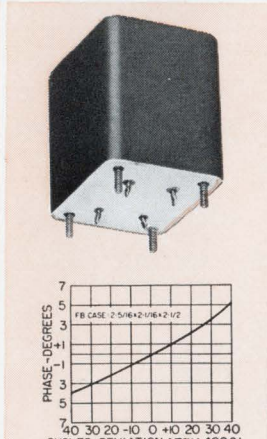

Minimum phase shift 400 cycle band pass filter. Within  $\pm 1.5$  db 370 to 430 cycles, greater than 45 db beyond 1100 cycles. 1K ohms to 100K ohms. MIL-F-18327C. 1 lb.

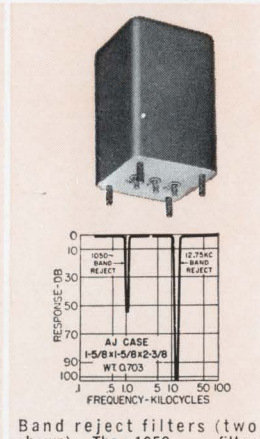

Band reject filters (two shown). The 1050 — filter has 50 db attenuation and is only 3 db at 950 and 1150 cycles. The 12.75 KC filter has more than 100 db attenuation and is only 3 db at 10.8 and 15 KC. Source and load 600 ohms, both are MIL-F-18327C.

Write for catalog of over  
1,300 UTC TOP QUALITY  
STOCK ITEMS  
IMMEDIATELY AVAILABLE  
from your local distributor.



**UNITED TRANSFORMER CO.**

DIVISION OF TRW INC. • 150 VARICK STREET, NEW YORK, N. Y. 10013

# DISTORTION ANALYZERS

## GO SOLID-STATE

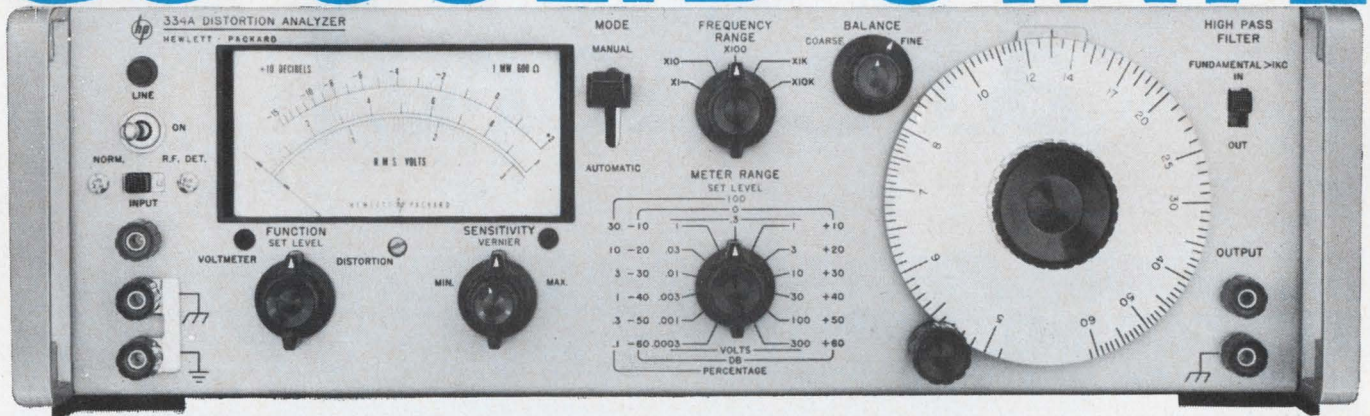

to offer you harmonic distortion measurements 5 cps to 600 kc with 0.1% full-scale distortion sensitivity... plus these features:

**"AUTOMATIC NULLING" for simple, fast measurements**

**0.3 v rms input sensitivity for 100% Set Level reference**

**300  $\mu$ v rms voltmeter full-scale sensitivity (residual noise <25  $\mu$ v)**

Solid-state design in four Hewlett-Packard distortion analyzers offers you extended frequency range, greater Set Level sensitivity, improved selectivity, greater overall accuracy, unprecedented ease of use. All four measure total distortion down to 0.1% full scale, 5 cps to 600 kc, with harmonics indicated to 3 mc. They measure voltage 300  $\mu$ v to 300 v full scale, have flat frequency response 5 cps to 3 mc. Distortion analyzer and voltmeter input terminals are the same. One-megohm input impedance. Floating input and floating, low-distortion output for scope or true rms voltmeter monitoring.

Two models feature automatic fundamental nulling (>80 db rejection): Manually null to less than 10% of the Set Level reference, flip a switch, and nulling is completed automatically. No more tedious tuning on the more sensitive ranges! Two other models employ high reduction gear drive to aid manual tuning.

Two of the analyzers provide a switchable high-pass filter which attenuates frequencies below 400 cps on signals greater than 1 kc... removes hum and gives you pure distortion measurements.

Two models incorporate an amplitude modulation detector that covers 500 kc to greater than 65 mc, measures distortion at carrier levels as low as 1 v. Options include an indicating meter with VU ballistic characteristics (01) and rear terminals in parallel with front input terminals (02).

Ask your Hewlett-Packard field engineer for a demonstration of the model incorporating features most useful to your application. Or write for technical data on all four models to Hewlett-Packard, Palo Alto, Calif. 94304, Tel. (415) 326-7000; Europe: 54 Route des Acacias, Geneva; Canada: 8270 Mayrand St., Montreal.

| Model | Automatic Fundamental Nulling | High-Pass Filter | AM Detector | Gear Reduction Tuning | Price |
|-------|-------------------------------|------------------|-------------|-----------------------|-------|
| 331A  |                               |                  |             | ✓                     | \$625 |
| 332A  |                               |                  | ✓           | ✓                     | \$655 |
| 333A  | ✓                             | ✓                |             |                       | \$825 |
| 334A  | ✓                             | ✓                | ✓           |                       | \$855 |

Data subject to change without notice. Prices f. o. b. factory.

421R

**HEWLETT**  **PACKARD**  
An extra measure of quality

ON READER-SERVICE CARD CIRCLE 2

# IC counters are here!



100 MHz counter-timer

Step into the future with the Thin Line – the sleek, ultra-reliable counters Systron-Donner now builds with integrated circuits. Seven different counters pack unprecedented range and utility into 1¾ inches of rack space.

A spectrum-spanning microwave counter measures frequency from dc to 100 MHz and 300 MHz to 12.4 GHz, displaying final answer instantly and automatically.

Other counters, with 5 MHz, 10 MHz or 100 MHz range, measure frequency, period, time interval, frequency ratio, and voltage. All Thin Line

counters offer heretofore unavailable features—like 9-digit resolution, stability of 5 parts in 10<sup>10</sup> per day, and modern slide switches to reduce operator errors.

And everything comes in a 1¾"-high chassis that slips easily into a crowded system and operates under complete remote control.



100 MHz frequency counter



10 MHz counter-timer

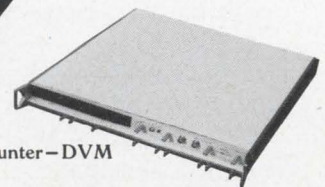

Counter-DVM

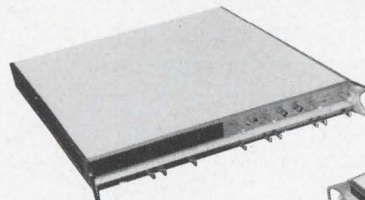

5 MHz frequency counter

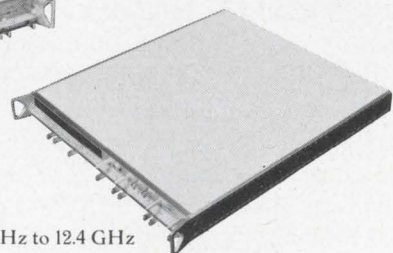

Microwave counter, dc to 100 MHz and 300 MHz to 12.4 GHz

Systron-Donner Corporation, 888 Galindo Street, Concord, California, Phone: (415) 682-6161

**SYSTRON**  **DONNER**

ON READER-SERVICE CARD CIRCLE 3

ELECTRONIC DESIGN 19, September 13, 1967



## lowest profile— only .4" high,

the Clare HGSR (.33 cu. in. over-all) puts more switching capacity on a board than ever before possible with long life mercury-wetted contacts.

It's fast and tough—serves most process control operations . . . provides over 22 billion operations without fail or falsing. And like the widely recognized Clare HGM and half-size HGSM, it provides a combination of high speed and low contact noise generation . . . the elimination of contact bounce and chatter and resulting false signalling. Advanced circuits can be designed with power gain up to 5000 . . . sensitivities as low as 20 mw. For solid state buffering you get built-in input/output isolation . . . for measurement circuitry, minimal contact resistance, constant over billions of operations.

For complete information, circle reader service number—ask Clare for Data Sheet 855C . . . Write Group 8A8.

C. P. Clare & Co., Chicago, Illinois 60645 . . . and worldwide.

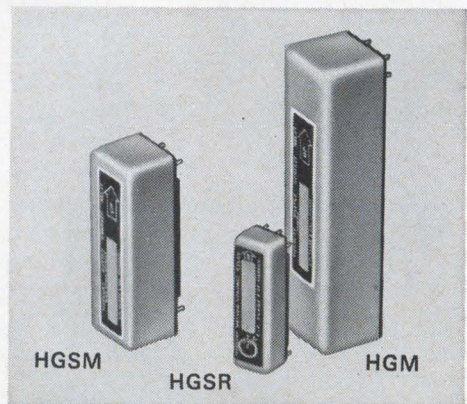
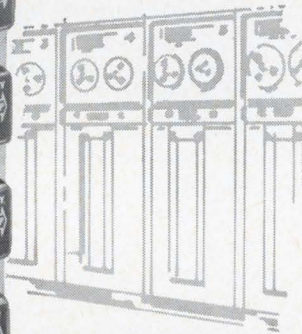
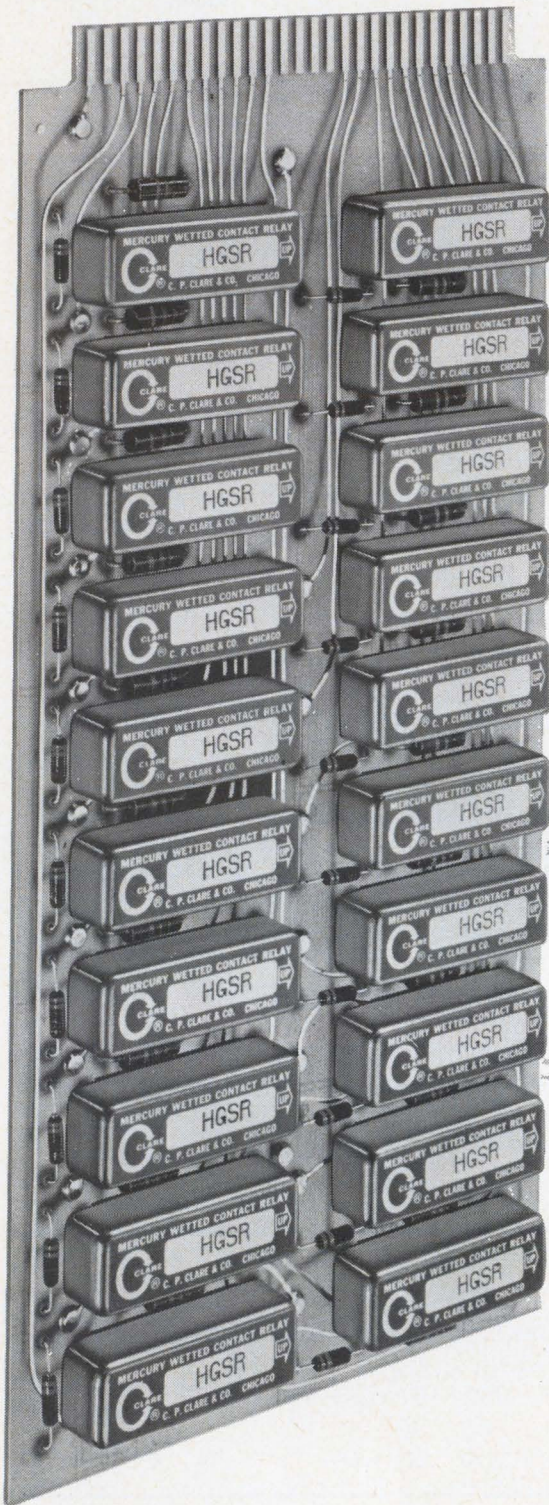

- Life:  $22 \times 10^9$  operations—with no maintenance
- Low, constant contact resistance—no mechanical wear or electrical erosion
- No contact bounce
- Switching speeds to 1 ms
- Versatile contact load capabilities—low level to 250 va
- High power gain—to 5000 with no noise sensitivity
- Sensitivities as low as 20 mw

## CLARE MERCURY-WETTED CONTACT RELAYS

for input analog switching, output power conversion switching,  
solid state input and output buffering

ON READER-SERVICE CARD CIRCLE 4

# In less time than it takes to read this page, you could learn to use this new Universal Impedance Bridge.

## Ready? One, two, three, go.

2. Adjust the range switch for an on-scale reading.



3. Obtain a null with the CRL dial. Now, read your measurement.

1. Select the function you want.

Nothing to it. No interacting controls to adjust and readjust. No multipliers. No non-linear dials. AUTO-BALANCE eliminates all that.

This new Hewlett-Packard Bridge is the first one that takes human beings into account as well as impedance. It's made for engineers who don't have time for a half-hour refresher course every time they want to use it.

You get direct digital readout of all C, R, and L values. Indicator lights show up-scale or down-scale unbalance. Decimal point and an equivalent circuit are automatically indicated. No problem with false or sliding nulls either: unique electronic AUTO-BALANCE takes care of that.

For a D or Q measurement, just switch from AUTO to low or high D or Q and turn the DQ control until you obtain another null. Simple. Particularly for low Q and high D cases.

So if you're the kind of engineer who's tired of complicated impedance bridges, Hewlett-Packard has your number: Model 4260A, \$550.

Ask your Hewlett-Packard field engineer for a demonstration. Or write us for complete specs: Palo Alto, California 94304. Tel. (415) 326-7000. Europe: 54 Route des Acacias, Geneva.

**HEWLETT**  **PACKARD**  
An extra measure of quality.

ON READER-SERVICE CARD CIRCLE 5

# "Hello...Acopian...Do you people power supply shipments in

Yes, we do. In fact, we haven't failed to meet this promise in more than five years. Place an order for any of Acopian's 62,000 different AC to DC plug-in power supplies and three days later your order will be on its way to you. To save more time, your buyer can phone your order, then follow with the paperwork. For complete information, contact your local Acopian representative or call us directly at (215) 258-5441.

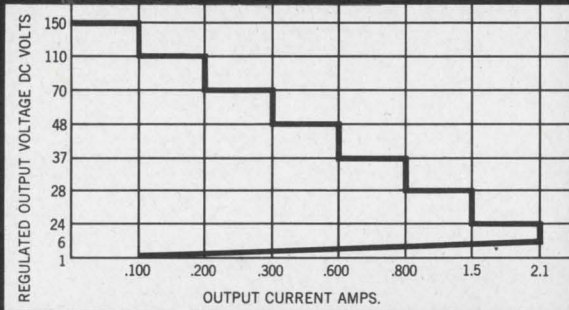

## ACOPIAN SINGLE OUTPUT POWER SUPPLIES

Output voltages from 1 to 150 volts available in 1-volt increments. Graph shows range of maximum current ratings. Most models have  $\pm 1$ -volt adjustments.

**Input voltage:** 105-125 volts AC, 50 to 400 cycles, single phase.

**Line regulation:** Choice of  $\pm 0.05\%$  or  $\pm 0.5\%$

**Load regulation:**  $\pm 0.05\%$  to  $\pm 0.5\%$  depending on model

**Polarity:** Output is floating; either positive or negative side may be grounded.

**Ripple:** 1 to 5 mv, depending on model

**Size:** Housing size varies according to voltage and current rating. Sizes range from 3 $\frac{3}{8}$ " x 3 $\frac{1}{4}$ " x 4-11/16" high to 3-5/16" x 5" x 5-9/16" high.

**Features:** Short circuit protection. No additional heatsinking required.

**Prices:** From \$45.00 to \$175.00.

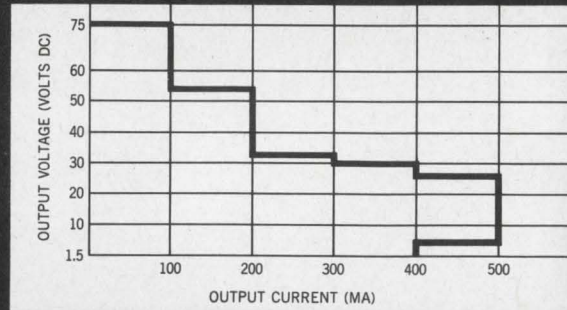

## ACOPIAN DUAL OUTPUT POWER SUPPLIES

Two independent power supplies in one housing. Output voltages from 1 to 75 volts per section, available in 1-volt increments. Graph shows range of maximum current ratings per section. Most models have  $\pm 1$ -volt adjustments.

**Input voltage:** 105 to 125 volts AC, 50 to 400 cycles, single phase.

**Line regulation:**  $\pm 0.05\%$

**Load regulation:**  $\pm 0.05\%$  (most models)

**Polarity:** Outputs are floating. Each power supply may be connected as a separate supply with floating output. Either the negative or positive side of one power supply may be grounded irrespective of the other supply.

**Size:** 3-5/16" x 4-5/32" x 4 $\frac{3}{4}$ " high.

**Features:** Short circuit protection. No additional heat sinking required.

**Prices:** From \$110.00 to \$174.00.

**VOLTAGE REGULATED LABORATORY POWER SUPPLY FOR ONLY \$98**

Acopian's new K55 laboratory power supply delivers 300 ma over an adjustable range of 1.25 to 30 volts. Load regulation is  $\pm 0.5\%$  or 50 mv, whichever is greater. Ripple is 1 mv rms. The K55 contains all-silicon semi-conductors and is short circuit proof. It stands only 5 $\frac{1}{4}$ " high, weighs only 3 pounds, and costs only \$98. Availability . . . only 3 days.

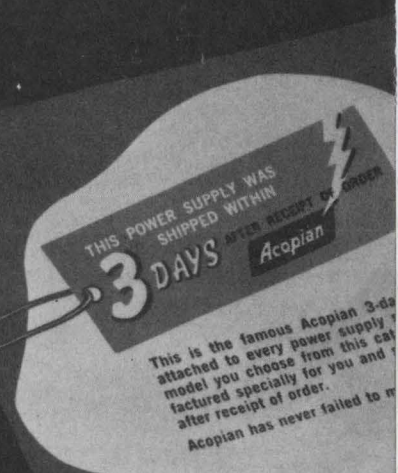

**Do you have Acopian's new catalog?** It contains complete information about 62,000 different power supplies, all available for shipment in 3 days. Included are single and dual regulated supplies, unregulated supplies to 900 volts, supplies for relay and lamp operation, and chassis assemblies for rack mounting. Write or call for your copy.

**MAINE, N.H., VT., CONN., MASS., R.I.**  
American Dynamics Corp.  
17 Dunster St., Cambridge, Mass. 02138; Tel: (617) 491-6800

**NEW YORK STATE (EXCEPT METRO)**  
L-Tron Corp.  
P.O. Box 147, Skaneateles, N.Y. 13152; Tel: (315) 685-6172  
P.O. Box 114, Latham, N.Y. 12110; Tel: (518) ST 5-5032  
75 Thornton Rd., Rochester, N.Y. 14617; Tel: (716) ID 6-4410

**METRO N.Y., LONG ISLAND, N.J. (NORTH)**  
Crane & Egert Corp.  
127 Rockaway Ave., Valley Stream, N.Y. 11582  
Tel: (516) 561-7791

**METRO PHILA., N.J. (SOUTH)**  
Martin Electric Corp.  
6741 No. 13th St., Philadelphia, Pa. 19126; Tel: (215) WA 7-5858

**PENNA. (EAST)**  
Beil & Whitaker, Inc.  
3623 Jacksonwald Ave., Reading, Pa. 19606; Tel: (215) 779-2610

**PENNA. (WEST), OHIO**  
J. C. Hofstetter Co.  
742 Kenbridge Dr., Cleveland, Ohio 44124; Tel: (216) 449-0944  
3605 N. Dixie Dr., Dayton, Ohio 45414; Tel: (513) 278-6721

**DEL., MD., VA., W.VA., WASH., D.C.**  
NAECO Associates, Inc.  
1925 No. Lynn St., Arlington, Va. 22209; Tel: (703) 524-4551

**N.C., S.C., TENN.**  
Jake Rudisill Associates, Inc.  
2009 No. Tryon St., Charlotte, N.C. 28206; Tel: (704) 377-6901

**FLA., GA., ALA., MISS.**  
Gentry Associates, Inc.  
2517-B E. Colonial Dr., P.O. Box 11096, Orlando, Fla. 32803  
Tel: (305) 424-0730; Tel: (305) 424-4949  
P.O. Box 13513, Station K, Atlanta, Ga. 30324  
Tel: (404) 233-3816  
Rm. 418, 2109 W. Clinton Ave., Huntsville, Ala. 35805  
Tel: (205) 534-9771; Tel: (205) 536-5306

**IND., ILL. (NORTH), WISC.**  
Potter-Mac Co.  
6027 N. Northwest Hwy., Chicago, Ill. 60631; Tel: (312) 775-6626

**MINN., N.D., S.D.**  
Kirkeby & Associates, Inc.  
821 2nd Ave. N., Minneapolis, Minn. 55405; Tel: (612) 377-3239



really guarantee  
only 3 days?

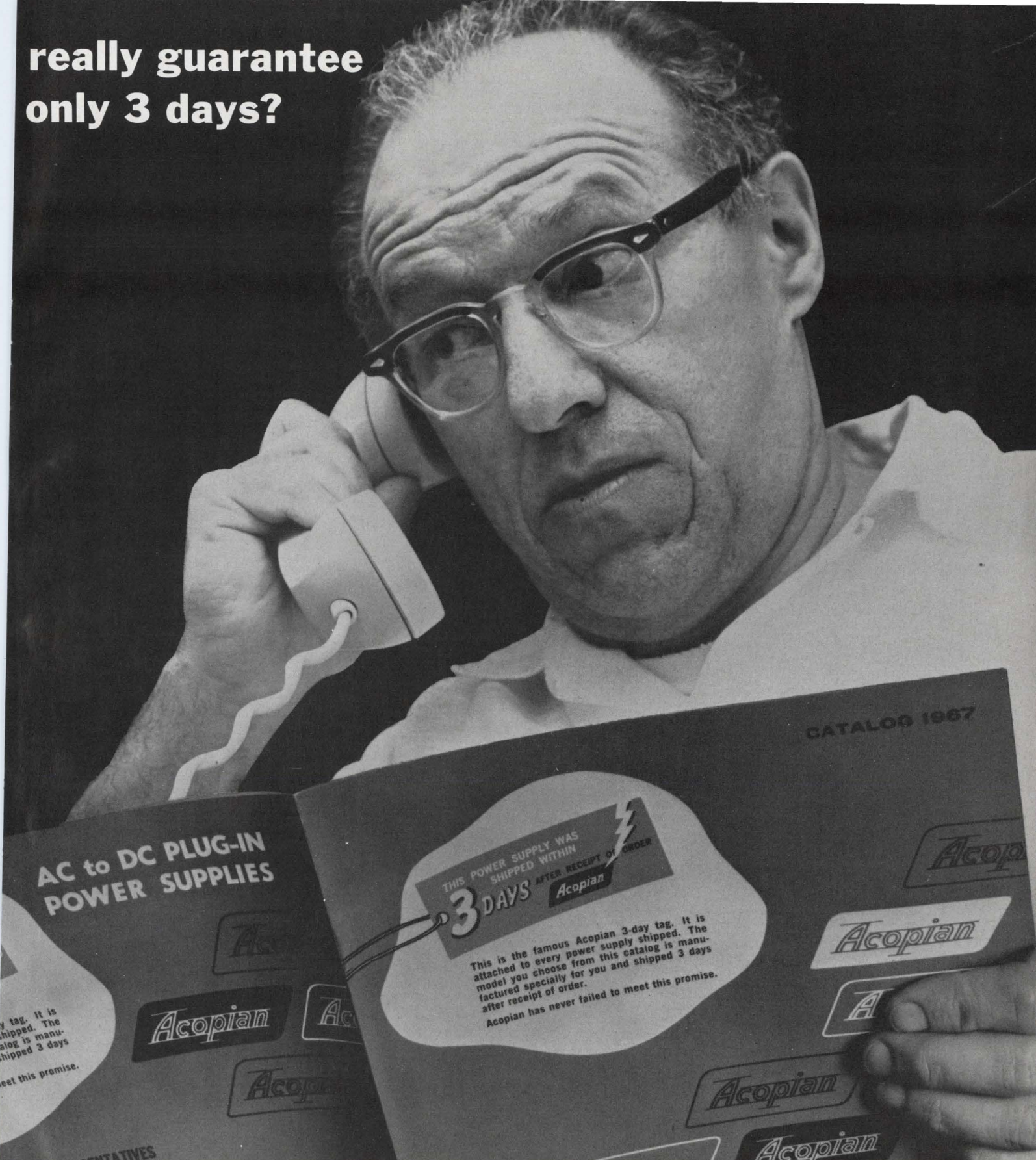

**CALIF. (NORTH)**

Held & Mollard, Inc.  
1494 Oddstad Drive, Redwood City, Calif. 94063  
Tel: (415) 369-4871

**CALIF. (SOUTH)**

Wieler & Co.  
10842 So. Paramount Blvd., Downey, Calif. 90241  
Tel: (213) 861-9223; Tel: (213) 773-5982  
San Diego; Tel: (714) ZE 2-9047

**WASH., ORE., MONT. (WEST), IDAHO (WEST), ALASKA**

Jud Le Brun Co.  
1123 S.W. Yamhill St., Portland, Ore. 97205; Tel. (503) 224-7710

**CANADA**

Ahearn & Soper, Ltd.  
844 Caledonia Rd., Toronto 19, Ont.; Tel:(416) RU 9-4325

**COLO., UTAH, N. MEX., ARIZ., IDAHO (SOUTH), MONT. (EAST)**

Compar Rocky Mountain  
P.O. Box 1607, Scottsdale, Ariz. 85252; Tel: (602) 947-4336  
TWX: (602) 949-0182  
300 E. Hampden Ave., Suite 315, Englewood, Colo. 80110  
Tel: (303) 781-0912; TWX: (303) 789-2418  
2125 San Mateo Blvd., N.E., Albuquerque, N. Mex. 87110  
Tel: (505) 265-1020; TWX: (505) 243-9570

**TEXAS, OKLA., ARK., LA.**

Lawrence Sales Co.  
P.O. Box 1038, 921 Bowser, Richardson, Texas 75080  
Tel: (214) AD 5-5504

**NEVADA**

Systems Design Corp.  
900 W. Bonanza Rd., Suite 1, Las Vegas, Nev. 89106  
Tel: (702) DU 2-3037

**MO., KANS., IOWA, NEBR., ILL. (SOUTH)**

Engineering Services Co.  
6717 Vernon Ave., St. Louis, Mo. 63130; Tel: (314) PA 6-2233  
TWX: (314) 556-0173  
7546 Troost St., Kansas City, Mo. 64131; Tel. (816) EM 3-6000  
TWX: (816) 556-2347  
1026 Third Ave., S.E., Cedar Rapids, Iowa 52403  
Tel: (319) 366-1591



Acopian Corp., Easton, Pennsylvania 18042, (215) 258-5441.



**Gallium  
arsenide aren't  
for sissies.**

No argument there, champ. We know gallium arsenide can take a punch, bounce back and still go the limit. That's why we matched it with our optical encoders and came up with rugged, crowd-pleasing combinations in several sizes and almost any code you can think of.

Check out our stable of encoders today. You'll find them lean, tough and ready. So help us Litton. Encoder Division, 20745 Nordhoff Street, Chatsworth, California.

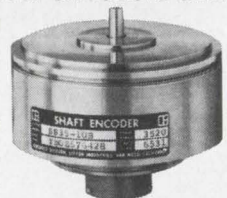

 **LITTON INDUSTRIES  
ENCODER DIVISION**

# ANNOUNCING . . .

The *WORLD'S* most compact *QUALITY*

## CERAMIC TRIMMER CAPACITOR

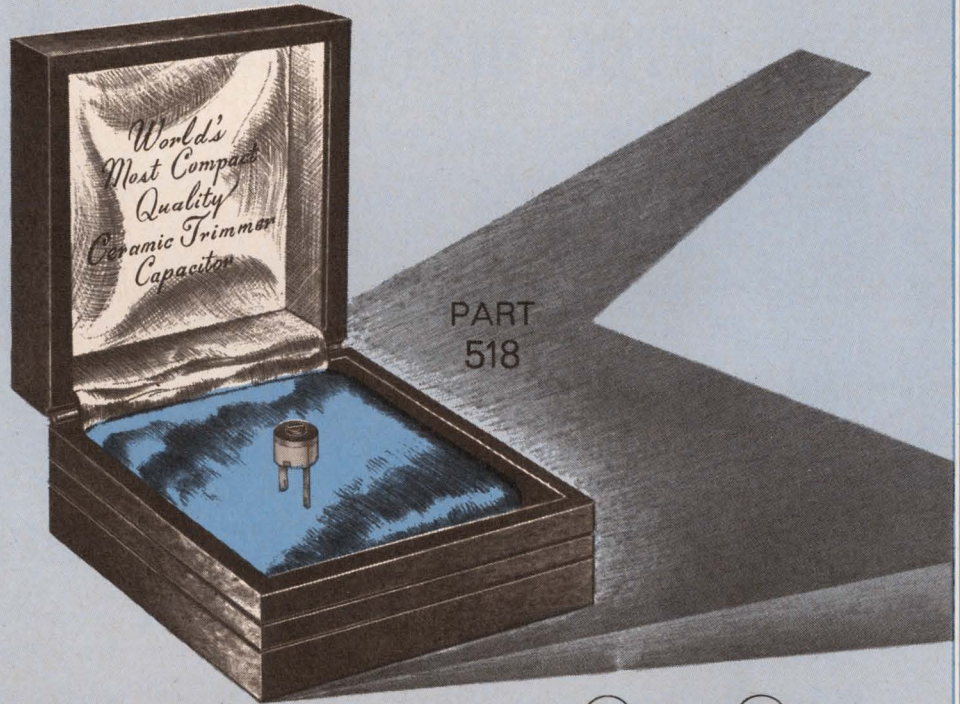

### AMAZING 1.0 to 25 pF. CAPACITANCE RANGE IN LESS THAN .007 CUBIC INCH

- Two mounting arrangements.
- Occupies less than .007 cubic inches.
- Has the ruggedness and range of much larger Trimmers.
- Unique design insures rigid mounting stability.
- Sealed-in-ceramic rotor electrode guarantees environmental stability.
- Precision lapped bearing surfaces insure smooth linear tuning.

#### GENERAL SPECIFICATIONS

|                                  |  |
|----------------------------------|--|
| Capacitance Ranges.....          | 1.0pF - 3pF<br>2.5pF - 9pF<br>3.5pF - 20pF<br>5.0pF - 25pF |
| Operating Temperature Range..... | - 55°C to +125°C   |
| Working Voltage.....             | 100 WVdc to 85°C<br>50 WVdc to 125°C                       |
| Dielectric Strength.....         | 200 Vdc 1 - 5 sec.   |

ERIE OFFERS THE MOST COMPLETE SUBMINIATURE TRIMMER CAPACITOR LINE IN THE INDUSTRY . . .



CERAMIC

AIR

GLASS AND QUARTZ

PLASTIC

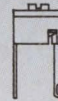

VERTICAL  
TUNING



HORIZONTAL  
TUNING

ERIE

TECHNOLOGICAL

PRODUCTS, INC.



Erie, Pennsylvania

ON READER-SERVICE CARD CIRCLE 7

**Now from Sprague!**

# ECONOLINE\* SILICON PLANAR PLASTIC TRANSISTORS

can save you **30 to 40%**  
over metal-encased types



**56 POPULAR N-P-N TYPES IN VOLUME PRODUCTION  
FOR OFF-THE-SHELF DELIVERY**

- Small-signal amplifiers
- Medium-speed switches
- Large-signal amplifiers
- High-frequency amplifiers
- Oscillators
- High-voltage indicator drivers

Sprague Econoline transistors . . . quality planar devices in plastic packages. You save the cost of metal cans. And with dual source back-up, too. For further information and prices call your local Sprague office today.

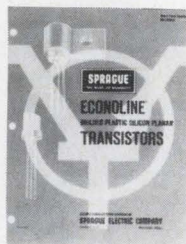

For comprehensive specifications write for Catalog CN200A to the nearest organization listed below or Sprague World Trade Corp., P.O. Box 73, North Adams, Mass., U.S.A.

\*trademark

**EUROPE** Sprague World Trade Corporation, Utoquai 41, 8008 Zurich, Switzerland  
Electromag Division, 2 Rue de Merode, Renaix, Belgium  
Sprague-CREAS S.p.A., Viale Legioni Romane 27, Milano, (S.O. 18), Italy  
Sprague G.m.b.H., 6000 Frankfurt/Main, Kettenhofweg 131, W. Germany  
Sprague France S.A.R.L., 14-16, Rue Gabriel Péri, 92-Montrouge, France  
Sprague Electric (U.K.) Ltd., Trident House, Station Road, Hayes, Middlesex, Eng.

**FAR EAST** Sprague World Trade Corporation, G.P.O. Box 14289, Hong Kong, BCC

**WESTERN HEMISPHERE** Sprague International, Ltd., 347 Marshall St., North Adams, Mass., U.S.A.  
Sprague Electric of Canada, Ltd., 10 Bertal Road, Toronto 15, Ontario, Canada



\*Sprague' and '@' are registered trademarks of the Sprague Electric Co.

480-7144

ON READER-SERVICE CARD CIRCLE 9

# News

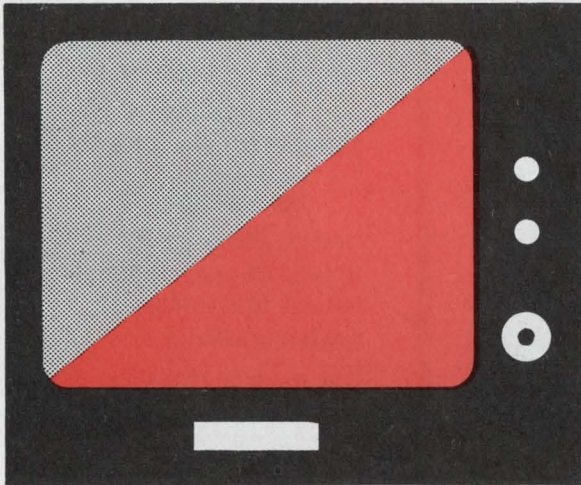

Ultrasound produces holographic images on film without the aid of lasers. Page 17



Process causes flashes of color to appear on black-and-white TV screens. Page 38

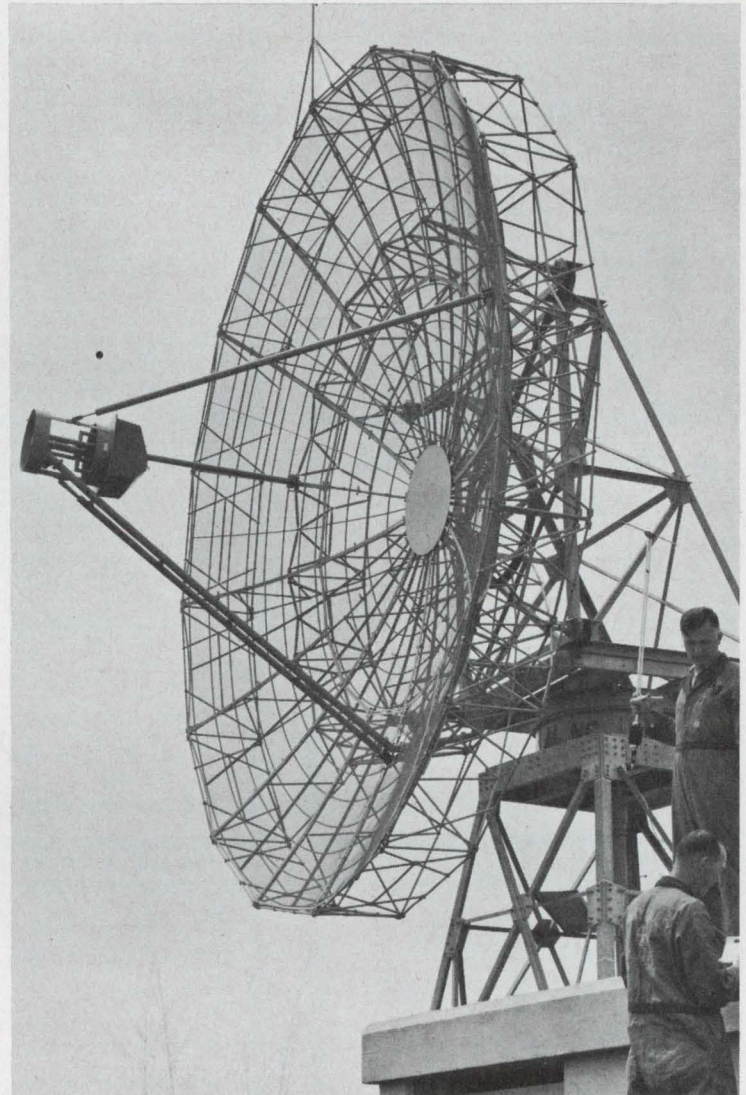

'Chirping' (pulse compression) betters radar range and resolution but keeps peak power down. Page 23

## Also in this section:

GaAs laser on 1-mm die hits 150-W peaks without cracking. Page 36

Laser 'suicide' study taps heat buildup as cause of destruction. Page 42

News Scope, Page 13 . . . Washington Report, Page 29 . . . Editorial, Page 67

# Did You Know Sprague Makes 51 Types of Foil and Wet Tantalum Capacitors?

## FOIL-TYPE RECTANGULAR TANTALEX® CAPACITORS



Type 300D polarized plain-foil  
Type 301D non-polarized plain-foil  
Type 302D polarized etched-foil  
Type 303D non-polarized etched-foil

ASK FOR BULLETIN 3650

ON READER-SERVICE CIRCLE 162

## FOIL-TYPE TANTALUM CAPACITORS TO MIL-C-3965C

CL20, CL21 tubular 125C polarized etched-foil  
CL22, CL23 tubular 125C non-polar etched-foil  
CL24, CL25 tubular 85C polarized etched-foil  
CL26, CL27 tubular 85C non-polar etched-foil  
CL30, CL31 tubular 125C polarized plain-foil  
CL32, CL33 tubular 125C non-polar plain-foil  
CL34, CL35 tubular 85C polarized plain-foil  
CL36, CL37 tubular 85C non-polar plain-foil  
CL51 rectangular 85C polarized plain-foil  
CL52 rectangular 85C non-polar plain-foil  
CL53 rectangular 85C polarized etched-foil  
CL54 rectangular 85C non-polar etched-foil

ON READER-SERVICE CIRCLE 163

## 125 C FOIL-TYPE TUBULAR TANTALEX® CAPACITORS



Type 120D polarized plain-foil  
Type 121D non-polarized plain-foil  
Type 122D polarized etched-foil  
Type 123D non-polarized etched-foil  
ASK FOR BULLETIN 3602C

ON READER-SERVICE CIRCLE 161

## 85 C FOIL-TYPE TUBULAR TANTALEX® CAPACITORS



Type 110D polarized plain-foil  
Type 111D non-polarized plain-foil  
Type 112D polarized etched-foil  
Type 113D non-polarized etched-foil  
ASK FOR BULLETIN 3601C

ON READER-SERVICE CIRCLE 164

## SINTERED-ANODE TUBULAR TANTALEX® CAPACITORS



Type 109D elastomer seal 85 C  
Type 130D elastomer seal 125 C  
Type 137D hermetic seal 125 C

ASK FOR BULLETINS 3700F, 3701B, 3703

ON READER-SERVICE CIRCLE 165

## SINTERED-ANODE CUP STYLE TANTALEX® CAPACITORS

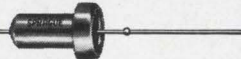

Type 131D 85 C industrial-type  
Type 132D 85 C vibration-proof  
Type 133D 125 C vibration-proof

ASK FOR BULLETINS 3710B, 3711

ON READER-SERVICE CIRCLE 166

## SINTERED-ANODE CYLINDRICAL TANTALEX® CAPACITORS



Type 140D  
up to 175 C operation,  
5/8" diam.  
Type 141D  
up to 175 C operation,  
1 1/8" diam.

ASK FOR BULLETIN 3800

ON READER-SERVICE CIRCLE 167

## SINTERED-ANODE RECTANGULAR TANTALEX® CAPACITORS



Type 200D negative terminal grounded  
Type 202D both terminals insulated

ASK FOR BULLETIN 3705A

ON READER-SERVICE CIRCLE 168

## SINTERED-ANODE TANTALUM CAPACITORS TO MIL-C-3965C

CL14 cylindrical, 7/8" diam.  
CL16 cylindrical, 7/8" diam., threaded neck  
CL17 cylindrical, 1 1/8" diam.  
CL18 cylindrical, 1 1/8" diam., threaded neck  
CL44 cup style, uninsulated  
CL45 cup style, insulated  
CL55 rectangular, both terminals insulated  
CL64 tubular, uninsulated  
CL65 tubular, insulated

ON READER-SERVICE CIRCLE 169

For complete information,  
write to:  
the nearest  
affiliated organization  
listed below  
or

Sprague World Trade Corporation  
P. O. Box 73  
North Adams, Mass., U.S.A.

**EUROPE** Sprague World Trade Corporation, Utoquai 41, Zurich 8, Switzerland  
Electromag Division, 2 Rue de Merode, Renaix, Belgium  
Sprague-CREAS S.p.A., Viale Legioni Romane 27, Milano, Italy  
Sprague G.m.b.H., 6000 Frankfurt/Main, Kettenhofweg 131, W. Germany  
Sprague France S.A.R.L., 14 Rue Gabriel Peri, 92 Montrouge, France  
Sprague Electric (U.K.) Ltd., Trident House, Station Road, Hayes, Middlesex, Eng.

**FAR EAST** Sprague World Trade Corporation, G.P.O. Box 14289, Hong Kong, BCC

**WESTERN HEMISPHERE** Sprague International, Ltd., 347 Marshall St., North Adams, Massachusetts  
Sprague-TCC (Canada), 50 Bertal Road, Toronto 15, Ontario

450-5172R4

# SPRAGUE®

THE MARK OF RELIABILITY

\*Sprague' and '©' are registered trademarks of the Sprague Electric Co.

## Congress seeks general radiation safety standard

Public concern over the potential X-ray hazard of color-TV sets appears to have died down—at least for the time being. But the reverberations may affect more electronic products than just TV sets.

The Senate Commerce Committee recently concluded hearings on a bill to “protect the public health from radiation emissions from electronic products” (Senate Resolution Bill 2067). Hearings are expected to resume in January. In the meantime, a public health subcommittee of the House Commerce Committee is holding hearings on a house version of the same bill.

The clamor arose earlier this year with the disclosure that some 100,000 General Electric sets had left the assembly line without adequate shielding. The Government warned of potential danger to viewers who might sit too close to the sets for too long a time. Most of the sets were recalled by the manufacturer, and the defect in them—a misaligned shunt regulator tube—was corrected. But about 1500 of the X-ray-emitted sets have still not been located.

The news caused such other major color-TV manufacturers as Magnavox, Philco, RCA and Zenith to make elaborate checks of their own sets. And it set in motion a parade of witnesses—health, industrial and



Congress looks beyond television radiation controversy.

technical—before the House subcommittee.

One witness, James G. Terrill, Jr., director of the National Center for Radiological Health in the Dept. of Health, Education and Welfare, noted that service technicians might convert a seemingly harmless color-TV set into a possible X-ray hazard by turning the voltages up far beyond the levels recommended in manufacturers' specifications.

But another witness, Lauriston S. Taylor, president of the National Council on Radiation Protection and Measurements, a nongovernmental expert organization founded 38 years ago, scoffed at the notion that a widespread X-ray peril existed in the TV industry. Exposures as high as 1000 roentgens, or 2 million times the TV safety standard, would not even produce skin irritation under ordinary TV use, he said.

“TV equipment generally,” Taylor testified, “is made to reduce radiation to an unimportant level, certainly for the general public and usually for the serviceman.”

The Senate hearings appeared to signal a broader Government approach to the investigation of all forms of potentially hazardous radiation, from microwave frequencies to X-rays. In the view of a spokesman for the Electronic Industries Association, radiation safety standards may eventually be set—not only for medical and dental X-ray equipment—but for such equipment as microwave ovens, ultrasonic diathermy machines, ultraviolet sunlamps and so forth.

This broader approach to radiation safety has been hinted at by the National Center for Radiological Health. In a speech in Montreal, Canada, on Aug. 18 to the International Conference on Guidelines to Radiological Health, Terrill said:

“In many of the developed nations . . . electronic products, some

of them with a high potential for hazardous radiation emission, are being manufactured in increasing numbers and sophistication and for an ever widening variety of uses. Generally speaking, circumstances for the control of radiation hazards are more favorable in industry than in the home.

“Partially for this reason, all of us with radiological-health responsibilities must be especially concerned about the advent of electronic home appliances, among other new electronic products, not to mention color-television sets already in use in households throughout both our countries.”

### IR-scanning satellite proposed by Honeywell

Honeywell Inc. is looking for backing for an infrared-scanning orbital-spacecraft series to investigate the Earth's limb, the haze that encompasses this planet. Promotion for the estimated \$10 million program began with a series of briefings before NASA officials, members of Congress and the press in Washington, D. C.

The firm's Systems and Research Div. pointed up the success of the two Scanner high-altitude probes launched last year by Langley Research Center and the conclusions of a recently completed feasibility study for Langley. The scanner vehicles were rocketed to 400-mile-altitudes to obtain the first high-resolution horizon-radiance profiles in the 14-16-micron range. The 15-month \$700,000 feasibility study recommended development of an unmanned, fully automated 725-pound Orbital Scanner to study and accurately plot variations in the apparent vs the true horizon. To improve accuracy, an artificial horizon would be used, based on the 15-micron carbon dioxide band, 50 to 70 miles above the Earth.

With a complete definition of the horizon, said Honeywell study manager Larry G. Larson, the problem of determining true local vertical will be almost overcome. This could yield greatly improved space navigation and attitude determination with less complex and costly onboard in-

strumentation. A minimum improvement in horizon-sensing to an accuracy of  $0.81^\circ$  would be the aim of the program, Larson pointed out.

## Time-sharing systems found to be inadequate

A single large-computer center with many terminals will not necessarily suffice for an industrial user, according to Thomas O'Sullivan, manager of the Data Systems Section of Raytheon's Space and Information Systems Div., Sudbury, Mass.

Speaking at a recent Association for Computing Machinery conference in Washington, D.C., O'Sullivan based his conclusions on Raytheon's experience with time-sharing systems. The company initially used just one terminal linked to a remote computer service. After only two years, requirements had grown to 500 terminal hours a month, which involved 12 terminals and, unexpectedly, nine different centers.

The reasons for using several different centers ranged from the need for larger data files to crowding at one college-based center, where periodic pile-ups of student assignments reduced the time available to Raytheon.

Recently, Raytheon attempted to evaluate the services it employed from an economic and operational standpoint. The conclusions, strangely enough, were that the better the command language and diagnostics, the less efficient the time-sharing system. According to O'Sullivan, the easier the system is to use, the longer the program takes to be executed.

The most economic way to run a time-sharing system, he said, would be to charge only for the elements of service used—for example, for central-processor time and telephone lines.

Looking to the future, O'Sullivan argued that higher-speed output terminals and channels capable of transmitting larger volumes of data (more than 1200 bits per second)

would be necessary. He also criticized current typewriter terminals as too noisy and inflexible.

## Honeywell to market French digital voltmeter

Honeywell Inc.'s Test Instruments Div. will sell a French-built three-digit voltmeter in late October.

The portable ac-dc volt-ohm-amp meter, which was introduced onto the European market earlier this year, is built by Schneider Radio Television, S. A., Ivry-sur-Siene, France. It is expected to sell in the U.S. for about \$500.

C. M. Perkins, vice president of the division in Denver, said the test instrument is capable of covering 23 different measurement ranges for a variety of testing requirements.

He described the accuracy as  $\pm 5\%$  for dc voltage and  $\pm 1\%$  for ac voltage ranges. The seven-pound instrument operates either off ac line outlets or rechargeable nickel-cadmium batteries.

## 2500 computer projects indexed by Government

How much money is NASA spend on all its projects in the computer sciences? How many of these projects are being carried out by Company A or Company Z?

Answers to questions like these are now available in an index of almost 2500 Government-sponsored R&D projects in the computer sciences. The index is available for study in the form of computer tape printout at the National Bureau of Standards Center for Computer Sciences and Technology, Gaithersburg, Md.

## Microwave unit set up by Texas Instruments

With an eye toward worldwide markets, Texas Instruments, Inc., has set up a new microwave products branch in its Semiconductor Components Div.

The branch, which will consolidate a number of diversified microwave activities in the division, will develop, manufacture and sell "a full range of silicon, germanium and gallium arsenide microwave

semiconductor products." Included, the company has announced, will be amplifier and oscillator transistors; switching, varactor and noise diodes; and Schottky-barrier mixer diodes.

The developmental efforts will focus on bulk-effect devices, beam-lead switching and varactor diodes, and integrated circuits and modules.

## Command system aids firing of nuclear devices

Lawrence Radiation Laboratory at Livermore, Calif., reports final testing has been completed on a telemetry command and control system for firing nuclear devices.

The system is being developed under the Project Plowshare program which is exploring peaceful uses for nuclear explosions.

The control system is described by a Livermore spokesman as a simpler, safer and more efficient method of checking out and sending commands over the complex circuits that are needed to fire multiple nuclear devices.

All power and control signals as well as return monitoring signals to a remote firing site are sent over a single coaxial cable.

Scientists have proposed using multiple underground nuclear explosions for the purpose of digging new harbors or canals at considerably lower cost than by conventional techniques. In fact there are reports that plans for building a new Middle East canal parallel to Suez but completely through Israeli territory are now under active consideration.

## Tape producers spurred by advent of Crolyn

Dupont's announcement of its new line of Crolyn (chromium dioxide) recording tape appears to have gotten its competitors worried. Faced with the prospect of competition with a superior recording tape, other manufacturers are trying either to join Dupont or to come up with a tape of comparable or higher quality.

Sony is reported to have taken a license for the manufacture of Crolyn tape. Minnesota Mining and Manufacturing (3M) Company is said to be making an all-out effort to develop techniques that bypass Dupont's patents.





## For hot and cold insulation...Mystik 7000!

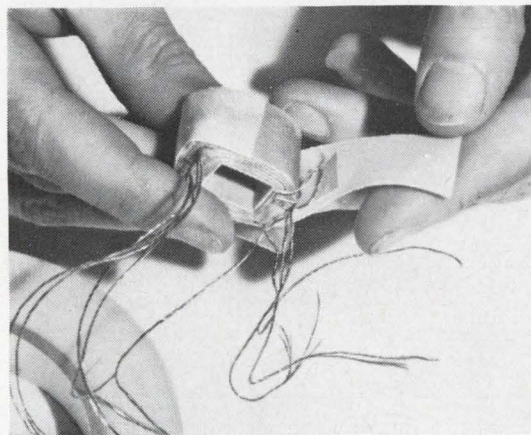

Superior thermal and electrical properties make Mystik 7000 suitable for an unusual range of cryogenic and elevated temperature applications. Uniquely inorganic, it has a tightly woven high tensile glass cloth backing with a pressure-sensitive silicone adhesive. Mystik 7000 has exceptionally high dielectric strength and offers high conformability and excellent shear resistance.

Here is a remarkable tape, perfect for insulating motors, generators or other components which must perform in critical operating environments.

This is only one of the Mystik family of tapes for the electrical industry. If you have an insulating problem or extreme temperature requirement, call your Mystik distributor. He's in the Yellow Pages under "Tape". Or write: The Borden Chemical Company, Mystik Tape Div., 1700 Winnetka Ave., Northfield, Illinois.



**BORDEN  
CHEMICAL**

ON READER-SERVICE CARD CIRCLE 11

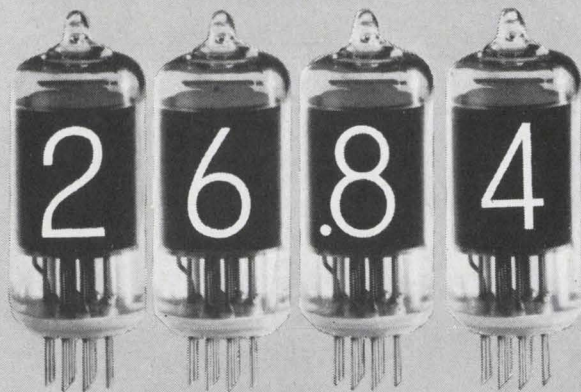

# new readout tube made for volume production... and priced accordingly!

The Amperex ZM1000 is the first digital numerical indicator tube, designed from the ground up to provide big economies both in initial cost and in application. It sells at over a dollar below competitive types, and the price-break grows with the volume.

We scrapped every notion about how to make numerical indicator tubes and developed a completely new design that offers unsurpassed performance and reliability at mass-production prices.

Every ZM1000 has a built-in decimal-point indicator. Use it if you wish—or ignore it...in either case, there's no

additional cost for the decimal. The ZM1000's large numerals are clearly legible at 35 feet, yet an 8-digit readout can be installed in only 6 inches of panel.

Superior design makes the ZM1000 more economical to use, too; it plugs directly into its printed circuit board and then the whole board is dip-soldered—high-temperature tube base and all. Tube sockets are eliminated—hand assembly is eliminated!

As for driver circuits, we can provide you with complete designs, data, parts and instructions for many driver types, including silicon-controlled-switch

(SCS) memories or ring counters and diode/transistor decoders.

- Dynamic life expectancy 200,000 hours
- Height of numeral .....0.6"
- Tube diameter .....0.75"
- Height of Tube .....1.67"

For complete information on the ZM1000 digital, numerical indicator tube and on Amperex components for indicator-driver circuits, write: Amperex Electronic Corporation, Semiconductor and Receiving Tube Division, Dept. 371, Slatersville, Rhode Island 02876.

**Amperex®**  
TOMORROW'S THINKING IN TODAY'S PRODUCTS

ON READER-SERVICE CARD CIRCLE 12

# The sound of holography is ultra

## Quartz transducers, even hi-fi tweeters, resolve three-dimensional objects onto film

Richard N. Einhorn  
News Editor

Holography, up to now dependent on the coherent light of the laser, has been found to work with sound waves far beyond the range of human hearing.

Scientists in at least four laboratories have been illuminating their subjects with ultrasonic beams and forming holograms that can be reconstructed with the aid of lasers. The resolution is that of the sound waves—much coarser than that of the light waves. But ultrasonic energy has penetrating power, and acoustic holograms have been taken of the interior of an object.

The obvious application of ultrasonic holograms is in medical diagnosis.<sup>1</sup> A bodily organ can be imaged without risk by means of ultrasound. Laser holography, however, is something else again. Dr. Robert J. Collier, a Bell Telephone Laboratories scientist, was once asked by a physician to record an optical hologram inside a patient's body. But, as Collier wryly commented, "The doctor did not realize that current holographic techniques would require rigor mortis to set in

before a successful hologram could be obtained."

The phenomenon that makes ultrasonic holography feasible is the analog of laser holography: interference of an illuminating beam and a reference beam, and reconstruction of the wavefront.

At Bendix Research Laboratories, Southfield, Mich., a technique that closely resembles the offset reference beam approach of Emmett N. Leith and Juris Upatnieks<sup>2</sup> is being investigated. R. K. Mueller and N. K. Sheridan<sup>3</sup> of Bendix say that holography may be extended to scalar acoustic wave fields, because "the principles underlying holography are commonly described by treating the electromagnetic field in a scalar approximation."

In this scheme, advantage is taken of the interference produced at the interface between air and water by ultrasonic waves. Two ultrasonic transducers immersed in a water bath (see Fig. 1) are excited by a single rf generator, so that their outputs are coherent with respect to each other. They may be considered as point sources beaming out at the surface. Where the beams intersect

(between points 1 and 2 in Fig. 1), the surface is deformed by the radiation pressure.

When an object (such as a metal plate with a design punched out) is fixed in the path of one of the coherent acoustic beams, the radiation pressure over the surface is constant. The pressure pattern opposes the restoring forces of gravity and surface tension to form a stationary ripple pattern. The deformed water surface represents a recording of the intensity of the impinging sound waves; the amplitude of the ripple pattern is proportional to the acoustic intensity at the surface. Thus, the ripple pattern has all the characteristics of a hologram.

To reconstruct the sound hologram optically, a laser positioned above and to the right of point 2 illuminates the ripple pattern. Its beam is phase-modulated by the surface pattern. A telescope focused at infinity and aimed at the hologram collects the light reflected from the surface. Someone peering through the eyepiece would be able to see the object as though he were looking down into the water, except that it would appear to be lighted from below instead of from above. The image's orientation is the same as when the object was exposed to



Acoustic hologram of array of aluminum panels is formed by detecting ultrasonic waves that reflect from their surfaces. Raster scanning causes the horizontal bands,

while the sound waves produce the vertical fringes. The photographic reconstruction is on the right. The length of the array is 84 cm along the long diagonal.

**(ultrasound, continued)**

the ultrasonic beam. If the telescope field of view covered only part of the ripple pattern, there would still be an image of the submerged object, as with ordinary holograms.

There is one great advantage to this type of hologram: the acoustically illuminated object can be viewed in real time.

The image quality of the holograms so far produced is not very high, Mueller and Sheridan report. They think that the poor quality is due to the deviation from sphericity of the acoustic reference beam. Furthermore, the optically reconstructed image is demagnified roughly by the ratio of the sound wavelength to the light wavelength, and optical magnification has to be used to yield useful images. Since the resolution in the acoustic image is limited by the acoustic wavelength, however, demagnification should not reduce resolution.

An alternative approach, retaining the essential features of the offset-reference beam approach but dispensing with the acoustic reference wave, has been developed by Gail A. Massey<sup>4</sup> of Sylvania Elec-

tronic Systems, Mountain View, Calif.

Massey points out that acoustic transducers, including loudspeakers and microphones, are for all practical purposes linear devices. Their voltage or current output therefore represents the acoustic field that they sample. Systems which operate on the transducer output voltages can thus be used to record the hologram.

**It's done in air, too**

Massey used a James B. Lansing model 075-105 loudspeaker fed by a 25-kHz oscillator as his illuminating transducer and a Turner model 141-11 microphone as his scanning transducer (see Fig. 2). Energy reflecting off the subject (an array of aluminum plates) is detected linearly by the microphone, which is translated over the hologram X-Y plane, located 5 meters from the aluminum plates. This plane is intentionally tilted so that the surface is offset 25° with respect to the plane of the object. Massey says this is equivalent to the spatial frequency translation provided by the offset reference in the Leith-Upatnieks scheme.

As the microphone scans, its output is filtered, amplified and combined with the direct output of the oscillator that feeds the loudspeaker. The sum voltage is the electronic analog of the hologram's optical field. This voltage is applied to a light driver to vary the intensity of a tungsten lamp attached to the scanning microphone. The light output is recorded by a camera that is set for a time exposure equal to the scanning interval. Since the output of the lamp is linear with respect to the electrical input, the film in the camera is exposed to intensity distributions similar to those obtained in laser holography, but with much lower spatial frequencies.

Asked whether the losses in air relative to water were not too great, he said, "A hi-fi tweeter puts out ample sound for our purposes. Even 20 or 30 dB of mismatch is not serious because enough power can be reflected. Our basic problem is pickup (of the reflection)."

As for the resolution afforded by the 25-kHz frequency, Massey said, "We scan over a raster that is 100 cm by 100 cm. We're working with a 1-cm wavelength, and our resolution is 2 degrees; the theoretical resolution is equal to twice the

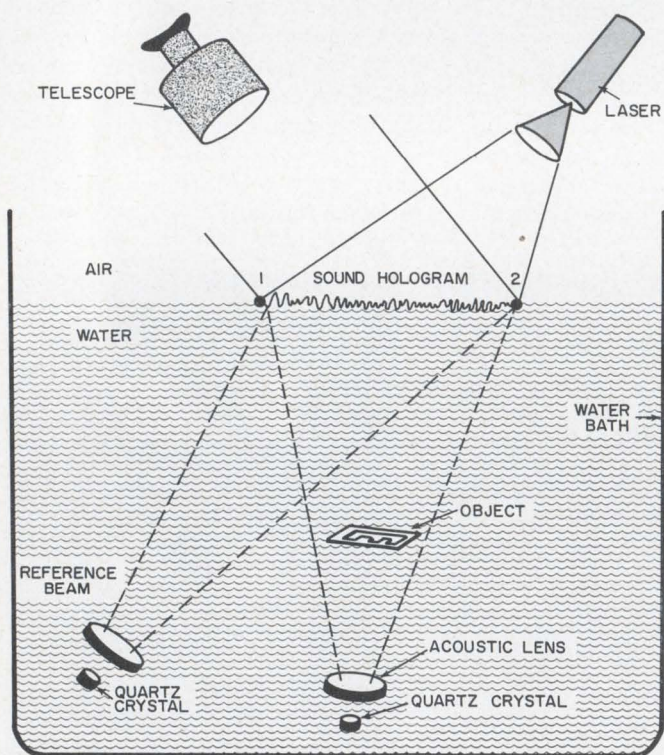

1. Laser illumination of water surface permits optical reconstruction of submerged object. The air-water interface is the hologram. An rf generator excites both crystals to produce coherent ultrasonic beams.

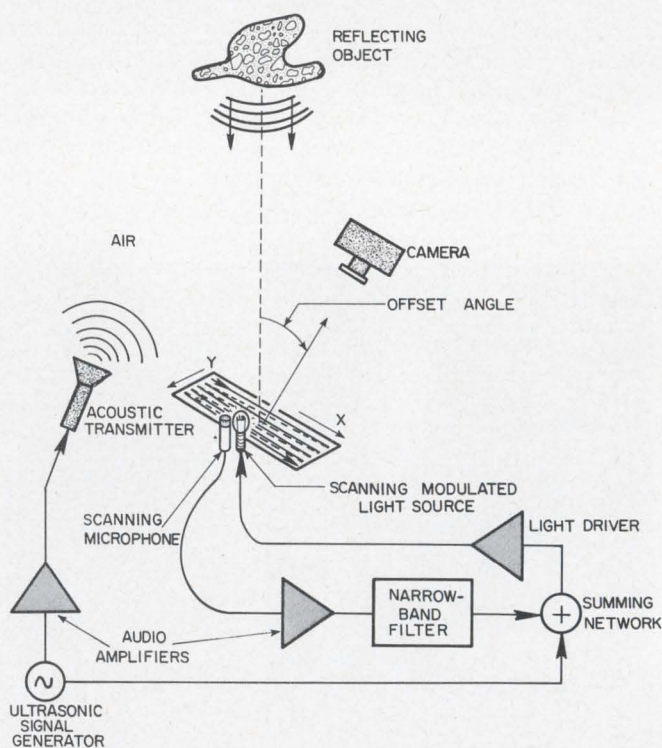

2. Hi-fi tweeter beams 25-kHz acoustic energy at array of reflectors in air. A scanning microphone detects reflected sound waves and translates them over the hologram plane, which is scanned by a light beam.



This is a multi-contact connector. Type MS-M. It works with standard, subminiature and twisted pair contacts.



This means versatility. And using one block insures uniform shop instructions; quality controls.

That saves time and money. For extra safety add polarizing guides,

jack screws, strain relief hoods and pin protect- ing skirts.



Also available with low cost formed contacts.



Get the complete story. Write for your new MS-67 catalog.



NORWALK, CONNECTICUT

INTERNATIONAL SALES HEADQUARTERS AND MANUFACTURING FACILITIES:  
CANADA: Scarborough, Ontario / ENGLAND: St. Helens, Lancs. / BELGIUM: Mechelen  
MEXICO: Naucalpan de Juarez / BRAZIL: Sao Paulo / JAPAN: Tokyo / Sales Offices in Other Major Cities.

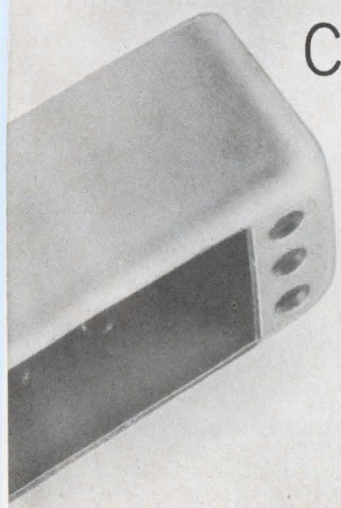



# introducing the "PIXIEPOT"<sup>TM</sup> at an IMPossibly low price!

Duncan Electronics now offers for the first time in the history of the potentiometer industry a PRECISION, TEN-TURN WIREWOUND pot for less than \$6.00. In fact, the new Model 3253 "PIXIEPOT" potentiometer is yours for as low as **\$3.97** each in production quantities and only **\$5.95** each for 1-24 units.

#### Outstanding "PIXIEPOT" potentiometer features:

- Length: ONLY 3/4"
- Diameter: 7/8"
- Linearity: ±0.25%
- Resistance Range: 100 ohms to 100K ohms
- Power Rating: 2 watts @ 20°C
- Temperature Range: -25°C to +85°C
- Resolution: Better than any precision pot twice its size.

The Model 3253 "PIXIEPOT" potentiometer incorporates all of the fine engineering workmanship you've come to expect from other Duncan products. Only our new, unique production techniques enable us to bring this potentiometer to you at these unheard of prices.

And if you need your "PIXIEPOT" potentiometers in a hurry, we guarantee they'll be on an airplane out of Los Angeles within 24 hours after receipt of your order!

How can a "PIXIEPOT" potentiometer help you?

Call or write your Duncan representative (listed on the facing page). He will personally deliver to you, FREE, a 1K "PIXIEPOT" potentiometer for your evaluation in exchange for the filled out certificate.

#### This certificate redeemable for one 1K "PIXIEPOT"



(TYPE OR PRINT)



MY APPLICATION IS \_\_\_\_\_

NAME \_\_\_\_\_

COMPANY \_\_\_\_\_ TITLE \_\_\_\_\_

ADDRESS \_\_\_\_\_ DIVISION \_\_\_\_\_

CITY \_\_\_\_\_ STATE \_\_\_\_\_ ZIP \_\_\_\_\_

This offer expires December 1, 1967



DUNCAN ELECTRONICS, INC. • 2865 FAIRVIEW ROAD, COSTA MESA, CALIFORNIA 92626

## ENGINEERING SALES REPRESENTATIVES

### AUSTRALIA

North Belwyn, Victoria  
Rutherford Electronics Pty. Ltd.  
P.O. Box 30  
Tel: 857-6044

### CANADA

Rexdale, Ontario  
Aero Sales Engineering Company  
Division of Garrett Manufacturing Ltd.  
4 Racine Road  
Tel: 249-9139  
TWX: (610) 492-4352

### FRANCE

92 Neuilly-Sur-Seine  
Radio Television Francaise  
73, Avenue de Neuilly  
Tel: 772-70-40  
TELEX: 21933

### GERMANY

Dortmund 46  
Elektronik Bauelemente GmbH  
Bruderweg 26

### HOLLAND

Amsterdam  
Nijkerk's (Buitenveldert)  
Handelsonderneming N.V.  
Drentestraat 7-Buitenveldert

### ISRAEL

Tel-Aviv  
STG International Ltd.  
52 Nachlat Benyamin St.  
Tel: 53459

### ITALY

Milano  
Ingg. S. & Agostino Belotti  
Piazza Trento N. 8  
Tel: 54 20 51 - 54 33 51  
Cable: Ingbelotti - Milano

### JAPAN

Tokyo  
Shoshin Shoji Kaisha, Ltd.  
P.O. Box Nihonbashi-173  
Tel: (270) 5921-6

### NEW ZEALAND

Lower Hutt  
P. H. Rothschild & Co., Ltd.  
83 Pretoria Street  
Tel: 63-581

### PORTUGAL

Lisbon  
Sociedade Comercial Romar Lda.  
Rua da Boavista 83-1. D.  
TELEX: 300

### SWEDEN

Stockholm 49  
ALLHABO  
Allmanna Handelsaktiebolaget  
Box 49044  
Tel: 520030  
Cable: Allhabo

### UNITED KINGDOM

London WC2, England  
Walmore Electronics Limited  
11-15 Betterton Street  
Drury Lane  
Tel: Temple Bar 0201-5  
Cable: Valvexpor



DUNCAN electronics, inc.

## NEWS

### (ultrasound, continued)

wavelength divided by the aperture (the width of the hologram), or 20 milliradians."

He explained that with the very large scan and small angle he uses, the blurring is low, since the resolution is roughly linear with the width of the hologram. Increasing the angle of scanning decreases the resolution.

Elimination of the acoustic reference is claimed to offer several advantages:

- In principle it permits the synthesis of an apparent reference wave with any desired phase or amplitude characteristics.

- It obviates the need for a second sound source in the medium. Massey says this is convenient for work in solids, where the object space might be inaccessible.

Massey mentioned medical diagnosis as the most likely application for ultrasonic holograms. "For medical uses, you are concerned with the physical resolution rather than the angular resolution," he said. "The shorter the sonic wavelength, the smaller the object you can image."

He said that his experiments were intended to demonstrate feasibility, and that if he were operating in a water medium he would use 5 MHz. In his present work he is scaling up the water experiment.

### Miners could use holograms

He mentioned other applications as well, particularly underground exploration. "This could be very useful in mapping faults or locating ore thousands of feet down, using a long wavelength to penetrate scattering layers."

Still another technique was announced by Preston and Kreuzer<sup>5</sup> of the Perkin-Elmer Corp., Norwalk, Conn. A transducer, excited by a 5-MHz signal generator, coherently illuminates a small hole in an opaque object in a water bath. An X-Y scanner positions a tiny receiving transducer over the surface of the water, so that it scans a pattern similar to a TV raster. This maps the sound field. The output of the receiving transducer, which resonates at 5 MHz, is electronically

summed with the direct output of the signal generator, as in Massey's setup. The resultant output is rectified, filtered and used to modulate the light of a tungsten bulb that is fastened to the transducer. The modulated light pulses are 2 to 10 ms in duration. A camera then makes a time exposure of the scanning light, and the transparency produced from the film constitutes the hologram.

To reconstruct the image, Preston and Kreuzer illuminate the ultrasonic hologram with a laser beam. Using a lens system that diffracts the light, they photograph the object. They have formed three-dimensional holograms of machine screws and even of a small hole inside an aluminum block.

Like Sheridan and Mueller, they report slight degradation of the image by spherical aberration. This is caused by recording the hologram at one wavelength and reconstructing it at another.

A fourth technique, which most closely resembles that of Preston and Kreuzer, but with simpler apparatus, was reported by Dr. Frederick L. Thurstone of the Bowman Gay School of Medicine, Winston-Salem, N. C.<sup>6</sup>

Thus far all the work in this budding field has been experimental, and no products are in sight. Preston points out that the scanning techniques, including his own, are too slow for diagnosis.

"A patient can't hold his breath for 20 minutes," he says. ■ ■

### References:

1. Richard N. Einhorn, "New Uses for Medical Ultrasonics Reported," *ELECTRONIC DESIGN*, XV, No. 17 (August 16, 1967), 42-52.
2. Leith and Upatnieks, "Reconstructed Wavefronts and Communication Theory," *Journal of the Optical Society of America*, LII, No. 10 (Oct. 1962), 1123-1130.
3. Mueller and Sheridan, "Sound Holograms and Optical Reconstruction," *Applied Physics Letters*, IX, No. 9 (Nov. 1, 1966), 328-329.
4. Massey, "Acoustic Holography in Air with an Electronic Reference," *Proc. IEEE*, LV, 1967, 1115.
5. K. Preston, Jr., and J. L. Kreuzer, "Ultrasonic Imaging Using a Synthetic Holographic Technique," *Applied Physics Letters*, X, No. 5 (March 1, 1967), 150-152.
6. Thurstone, "Three-Dimensional Imaging by Ultrasound Holography," *Digest of 7th International Conference of Medical and Biological Engineering* (Stockholm, Sweden: Organizing Committee of 7th ICMBE, 1967), p. 313.

## Phased-array power increased by 100

A technique for the design of solid-state phased arrays that could handle power densities 100 times greater than those of conventional arrays has been reported by scientists of RCA's Missile and Surface Radar Div., Moorestown, N. J.

For the first time thousands of low-impedance solid-state power sources, each driving a separate element, have been successfully paralleled, Dr. Arthur S. Robinson, technical director, says. Robinson claims that the degree of isolation between adjacent elements prevents chain-reaction failures, a common liability of paralleled power devices.

"We expect this development to be of major importance in the development of high-power, high-efficiency solid-state phased arrays," he says.

Dr. Willard T. Patton, one of the inventors of the new device, explained that by end-loading the radiating dipoles he has achieved nearly uniform current distribution in each element. He says previous investigators erroneously assumed that current is distributed sinusoidally along the radiating elements, and that the reactance becomes prohibitively large.

Patton states that RCA has achieved "an almost completely resistive driving-point impedance."

His experimental array consists of four rows of 25 dipoles each—a total of 100 elements (1/40 wavelength at 410 MHz) in the area normally occupied by a single half-wave radiating element. This array is actually a "wavefront amplifier" with back-to-back receiving and transmitting elements connected by stripline amplifier circuits. ■ ■

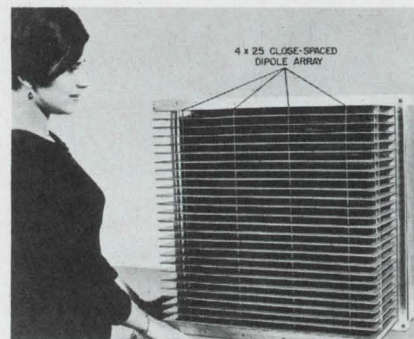

100 phased-array elements occupy same space as one conventional unit.

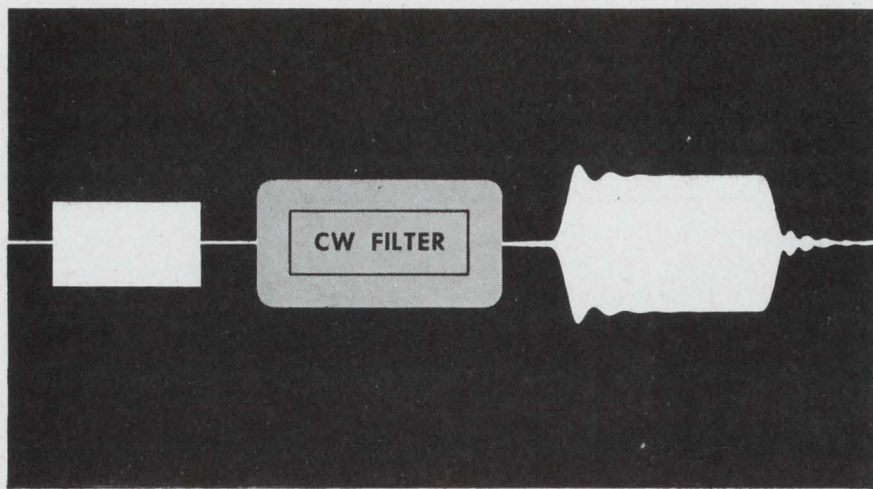

# SUPERIOR PULSE RESPONSE

with Matched Crystal  
Filters by DAMON



Matched Crystal Filter Model 5399A  
Center Frequency: Every 10 KHz  
from 5000 KHz to 5150 KHz  
Size: 3" L x 1" H x 7/8" W

Optimization of the signal-to-noise ratio of a pulse receiver is now possible with the Damon Matched Crystal Filter.

The illustration, above, compares the response of a conventional crystal filter with that of a Damon Matched Crystal Filter. The Damon Matched Crystal Filter not only minimizes overshoot and ringing, but since the filter is matched to the transform of the input pulse, maximum signal-to-noise ratio is also achieved.

Solutions to complex pulse modulation crystal filter designs cannot be "picked from a chart". Consultations between circuit designers and Damon engineers are the best route to proper filter selection. As a starter, may we invite you to write for our Technical Bulletin on Matched Crystal Filters. Damon Engineering, Inc., 115 Fourth Avenue, Needham Hts., Mass. 02194 (617) 449-0800.

## DAMON

ON READER-SERVICE CARD CIRCLE 15



# New 'chirping' schemes sharpen radar returns

## Compact signal-processing components improve performance without an increase in peak power

Neil Sclater  
East Coast Editor

"Chirping"—a technique for pulse compression—is becoming a highly popular way to improve the resolution and accuracy of radars without increasing their peak power.

Recent improvements in solid-state electronics and dispersive delay lines are making pulse chirping more attractive than when it was introduced over 10 years ago. The new signal-processing systems are more reliable and compact and cost less than earlier lumped-constant, matched-filter delay line systems.

Chirping refers to a pulse-power-modulation scheme that forms long frequency-modulated output pulses that are analogous to the high pitched squeaks of a bat. The technique is used to avoid the conflict in ordinary pulsed radars between the requirements for long range and simultaneous high resolution. It does with long pulses what ordinary radars do with extremely short pulses.

By avoiding the necessity for using short pulses to transmit large amounts of peak power, fm chirping is especially valuable when the transmitter power is limited or there is a danger of waveguide breakdown. The large frequency

content, or bandwidth, of a narrow pulse accounts for its high resolution capability. Frequency modulation provides the equivalent bandwidth of a narrow pulse with a wider pulse. As a consequence, the chirped system may have range and resolution equal to an ordinary pulse system operating at far higher peak power. The receiver is designed to compress the wide fm pulse back to a narrower one.

Engineers in two leading companies in the field agree that the future for pulse-compression systems in radar is bright, but they differ in their methods of system design.

Andersen Laboratories, Inc., of Bloomfield, Conn., advocates the use of acoustic dispersive delay lines in systems for compact, reliable, low-cost performance. The Hazeltine Corp., of Little Neck, N. Y., favors printed-circuit, quarter-wave shorted lines for the same reasons. Both agree that the lumped constant-matched filters are difficult to use in airborne or lightweight radars.

An Andersen Laboratories' vice president, Stanley Rittenburg, referring to experimental progress, says:

"We have demonstrated that we can achieve radar resolution on the order of two feet with our equipment. This means that the radar op-

erator can distinguish targets that are this close together thousands of yards away. A very narrow four-nanosecond pulse would be required to do this in a normal pulsed radar system using 250 times more output peak power."

Rittenburg adds that this performance has been achieved with an fm chirp pulse only one microsecond long and with the use of miniaturized components.

### 40-dB noise improvement shown

The experimental system uses simple small filters to reduce the sidelobes, or unwanted signals, that accompany the desired return signal as a result of recompression. These Taylor weighting filters permit 40-dB suppression—an improvement of 10 dB over Andersen's present production systems.

The company is building compact chirp subsystems for improving a Navy destroyer distant warning search radar, the SPS-40. This radar formerly used large matched filters that occupied several standard equipment racks to do the same processing. The complete subsystem for this radar is packaged in a case that weighs 5 pounds and occupies about 0.1 cubic foot (see photo).

Rittenburg says that there are more than 100 SPS-40 radars in the Navy fleet at present and that 40 new ones will be added under existing contracts.

Navy interest is high because of the possibility that "chirp" radars can pick out submarine periscopes, of obvious advantage in anti-submarine warfare.

Andersen Laboratories also has supplied pulse chirp circuits for the Air Force's AN/FPS-85 phased-array space-detection and tracking radar system.

Other Andersen equipment is being built for radars on missile-range tracking ships. A miniature prototype system has also been developed for Texas Instruments' solid-state airborne phased-array radar, MERA.

David D. Holmes, head of the radar research laboratory at Hazel-

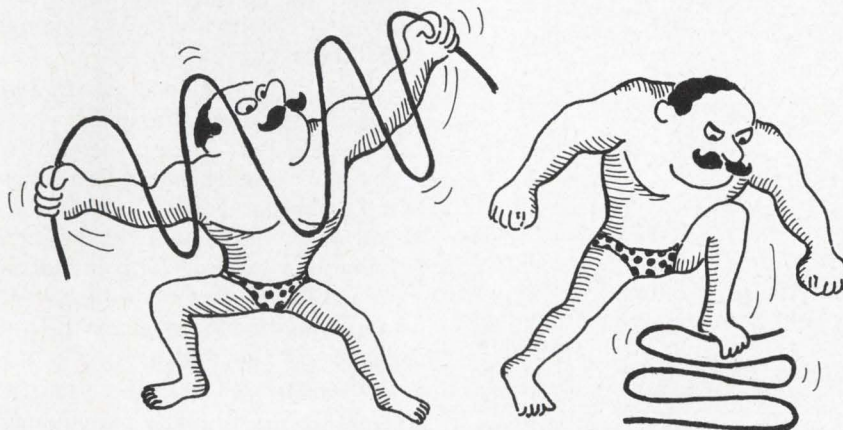

Pulse compression is the key to increased range and resolution in radars.

## ('chirping', continued)

tine says that a cascaded series of miniature quarter-wave shorted lines are competitive with acoustic delay lines if compactness, light weight and low cost are essential.

He notes, however, that Hazeltine has experimented with all techniques but finds the lumped-constant, bridged-tee network to be of most value in the work it is doing in ground-based, long-range surveillance and instrumentation radars. The instrumentation radar is used to determine the re-entry radar signatures of ballistic missiles.

Holmes says that the new lumped-constant filters are smaller and far more reliable than the first units made years ago at Bell Telephone Laboratories and in Europe. They have characteristics not yet attainable with the acoustic delay lines.

Hazeltine pulse-compression sys-

tems will be used on the Air Force Ramsite radar, being built by the Ballistic Systems Div. at White Sands, N. M. Other radars using its systems are the Advanced Research Project Agency's (Altair), Lincoln Laboratory's (Alcor), North Atlantic Treaty Organization (Nadge) and an English experimental radar.

Rittenburg predicts increased use expansion compression systems in such applications as airborne and manpack radars, because acoustic delay lines have made these applications practical. Earlier matched filter systems included bulky transversal equalizers that required continuous adjustment and maintenance to obtain "clean" returned pulses following recompression.

## Commercial uses seen

There are numerous commercial applications for these systems, he said. In addition to their use in all kinds of radars, they can be used in

digital communications systems and microwave spectrum analyzers. They lend themselves to systems with solid-state transmitters where high peak power is difficult to obtain, Rittenburg adds.

The key element in a pulse expansion-compression system is the dispersive delay line, Rittenburg and Holmes say. This line of lumped-constant filter or acoustic—converts incident signals to fm signals and stretches them in time. Radar energy modulated with the output of this delay line will return to the receiver in a similar stretched form. It is then processed with another dispersive delay line that recompresses the signal into a narrow pulse. This pulse furnishes more information than could be obtained by demodulating conventional pulses of much higher power. The returned pulse is "cleaned up"—that is, the unwanted sidelobes can be reduced, by the use of weighting filters and phase equalizers or the bulkier transversal equalizers.

Richard McLean, an Andersen engineer, explains that his company pioneered in acoustic dispersive delay lines for pulse compression. He says the company makes many types of the lines, depending on system requirements. One, a metallic strip line of steel or aluminum, reorganizes incident signals on the basis of the acoustic velocities of their frequency components. RF signals to be processed are first converted to acoustic signals by a transducer, before they are introduced into the thin strips of metal that act as waveguides for the acoustic energy.

After the signal is stretched and reformed into an fm signal, it is reconverted to rf by terminal transducers. But, McLean says, they are limited in their ability to handle wide frequency bands.

Newer techniques use quartz and sapphire as the acoustic delay medium. Incident rf energy is transformed to acoustic energy by solid-state cadmium sulfide transducers before it enters a wedge-shaped delay line. An expanded fm signal is obtained by tapping transducers set in a grating-like array along the hypotenuse of the wedge.

A variation of the acoustic diffraction grating, the perpendicular delay line, has a series of input

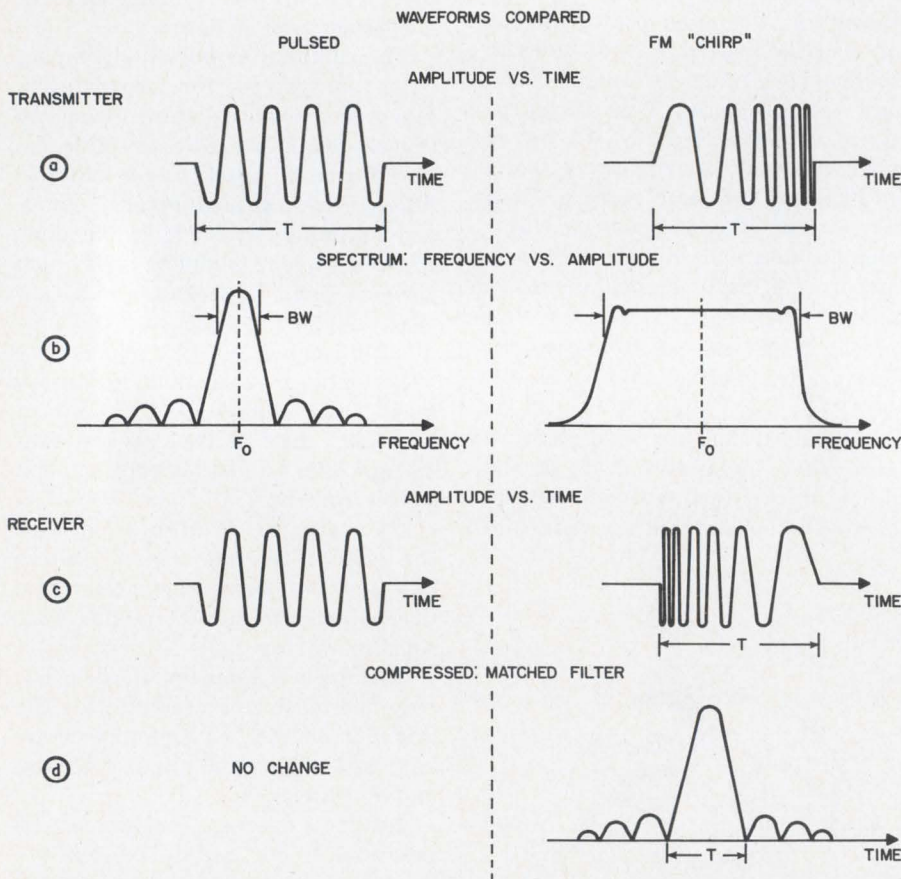

'Chirp' radar waveforms, compared with ordinary pulse waveforms: (a) Representations of transmitted pulses (the chirp pulse is frequency-modulated by dispersive delay). (b) Spectrum of waveforms, showing relative bandwidth differences for equal pulse lengths. (c) Returned signals after mixing, and after reversal in the case of the chirp. (d) Envelopes after detection, and after recompression in the case of the chirp. Resolution is related directly to bandwidth. Pulse compression is the ratio of time, or  $T$ , in (c) to  $T$  in (d).

# Replace 80% of all FET types with one!

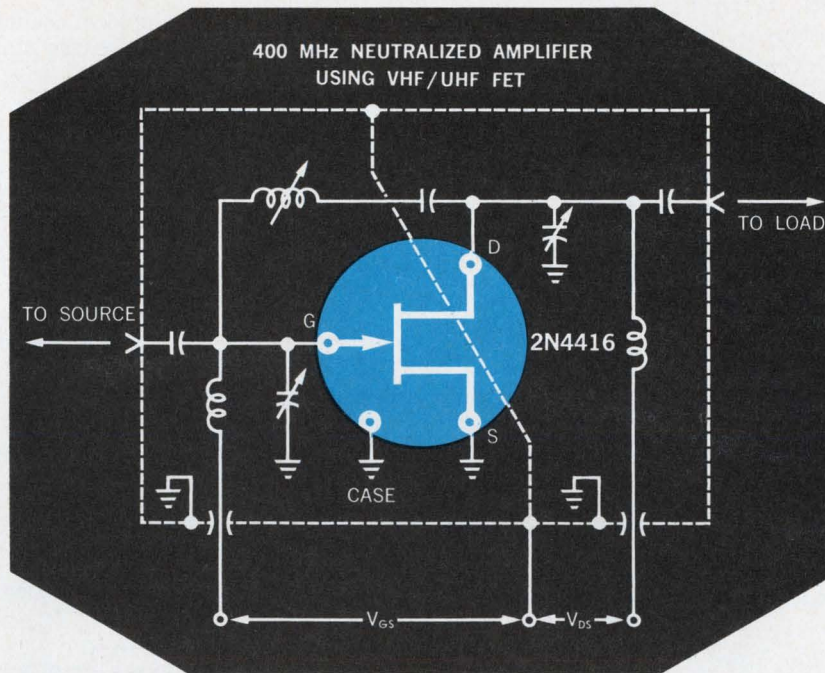

**Here's how:** Buy the Union Carbide 2N4416 universal FET in quantity, and you can select transistors over the entire frequency range covered by 80% of all field effect types. The 2N4416 is specified below as a VHF/UHF amplifier. However, from any class lot of this device you can select (1) general purpose, low noise, high gain amplifiers from D.C. to 900 MHz, or (2) ultra low noise devices for low frequency applications. This device is also available in a ribbon lead ceramic package (.138" dia.) as the low capacitance 2N4417. Use for TV tuners, FM sets, IF strips, mixers, oscillators, or even switches. Write for complete specifications.

| CHARACTERISTICS<br>Small Signal, Common Source @ 25°C | 2N4416<br>TO-72 | Frequency |
|---|-----------------|-----------|
| Forward Transconductance RE ( $Y_{re}$ ) (min.)       | 4000 $\mu$ mhos | 400 MHz   |
| Input Capacitance, $C_{iss}$ (max.)                   | 4.0 pf          | 1.0 MHz   |
| Output Capacitance, $C_{oss}$ (max.)                  | 2.0 pf          | 1.0 MHz   |
| Reverse Transfer Capacitance, $C_{rss}$ (max.)        | 0.8 pf          | 1.0 MHz   |
| Spot Noise Figure<br>(Neutralized), NF (max.)         | 4.0 dB          | 400 MHz   |
| Spot Noise Figure, NF (max.)<br>(Neutralized)         | 2.0 dB          | 100 MHz   |
| Power Gain, $G_{ps}$ (min.)<br>(Neutralized)          | 10.0 dB         | 400 MHz   |

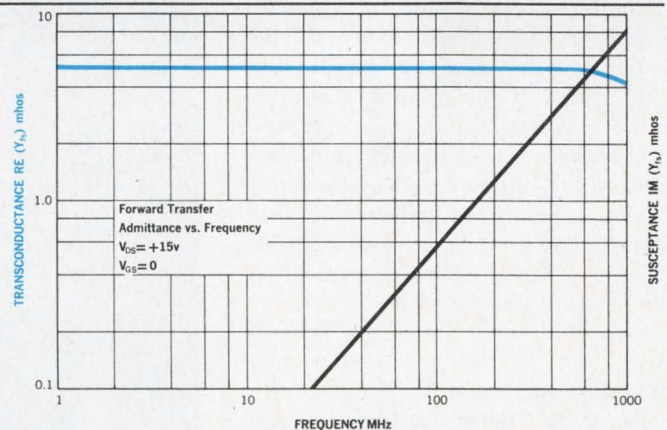

**ELECTRONICS**

Semiconductor Department / 365 Middlefield Road, Mountain View, California 94040 / Telephone: (415) 961-3300 / TWX: 910-379-6942

ON READER-SERVICE CARD CIRCLE 16

## ('chirping', continued)

and output transducers arrayed along adjacent perpendicular surfaces of a wedge. The geometry of the transmission paths between transducer elements accounts for dispersion in the lines, McLean says.

In addition to improved matched filters, Holmes says that Hazeltine is using what he terms an rf strip line. It is a cascade of quarter-wave-coupled transmission lines embedded in a dielectric. Ground planes are attached to both sides.

Hazeltine says it has achieved center frequencies of from about 200 to 2000 MHz with bandwidths of 100 to 1000 MHz with its quarter-wave strip lines.

## 2-ns resolution predicted

Andersen Laboratories has developed dispersive delay lines that cover center frequencies from 1 to 500 MHz, and it is working on one at 1250 MHz. Bandwidths over this range vary from 1 to 250 MHz.

McLean reports that efforts to develop sapphire as a delay medium and to adapt cadmium sulfide as a transducer element has led to these advances. He predicts that with these materials and improved electronic components, resolution in the 2-nanosecond range will be practical within a year.

Both Holmes and Rittenburg agree that the design of an expansion-compression, signal-processing scheme calls for the solution of impedance-matching and other design problems. The performance of the radar system, they say, depends on the ability of the designer to minimize all phase and amplitude errors.

Andersen Laboratories and Hazeltine are extending the frequency and bandwidth capabilities of dispersive delay lines, because these will give improved radar resolution in future systems. ■ ■

## Bibliography

Cook, C. E. "Pulse Compression: Key to More Efficient Radar Transmission," *Proc. IRE*, XLVIII, March 1960, 310-316.

Klauder, J. R., et al. "The Theory and Design of Chirp Radars," *Bell System Tech. Jour.*, XXXIX, July 1960, 745-808.

Skolnik, M. I. *Introduction to Radar Systems*. New York: McGraw-Hill Book Co., 493-500.

## Adding the 'chirp' to transmitter-receiver

Pulse-compression, or "chirp," signal processing affects both the transmitter and receiver of a radar system, as this block diagram shows. Six basic component blocks (shaded) are necessary to improve the radar's performance.

A timer triggers a pulse from the impulse generator. This pulse is a signal whose spectrum is flat—typically 3 cycles at the receiver's intermediate frequency.

After amplification the pulse is applied to the dispersive delay line, which expands the signal by dispersing its frequency components linearly in time. The resultant expanded "up chirp" linear fm signal is amplified for modulation of the transmitter.

The transmitted signal will

have the same waveform as the modulated signal. When this energy strikes the target, it returns to the receiver also as a "up chirp." After mixing with the local oscillator and being amplified, the signal appears at the spectrum inverter. This circuit reverses the direction of the chirp. After the signal is amplified, it goes to a dispersive delay line with the same characteristics as the pulse stretcher.

The output of the delay line is an unweighted, compressed pulse. It is amplified, processed by a weighting filter and made available for display.

The dispersive delay line may be lumped-constant filters, acoustic and rf strip lines or crystal diffraction gratings.

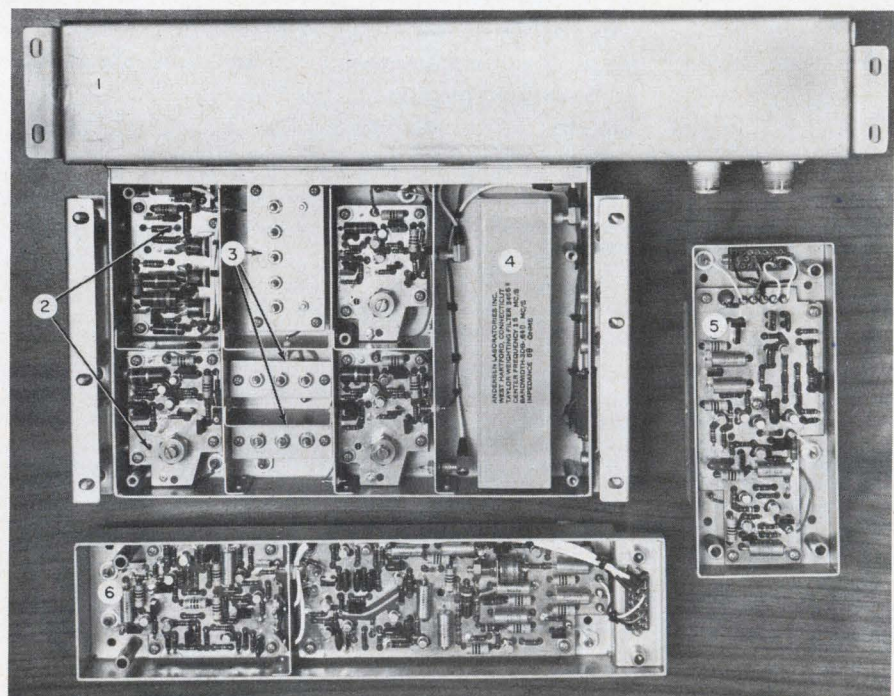
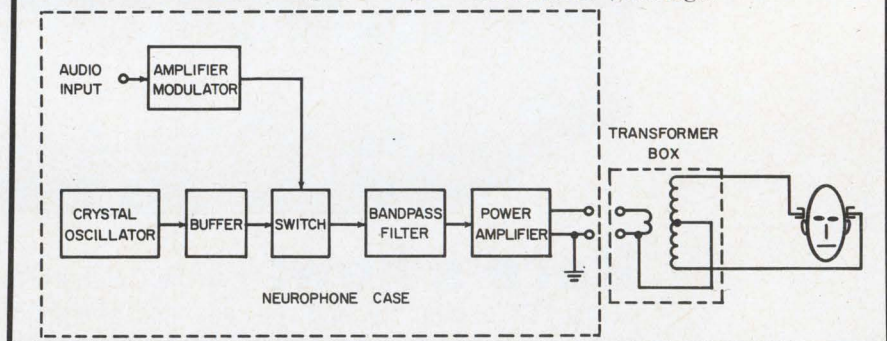



Compact, lightweight pulse-compression subsystems are being installed on Navy SPS-40 search radar. This Andersen Laboratories system uses a steel acoustic strip line to obtain linear fm dispersion. Components include (1) temperature-controlled delay line, (2) amplifiers, (3) bandpass filters, (4) weighting filter (5) gate circuit, and (6) impulse generator and input switch.

# Designed Sealed Delivered



## Helipot's New Model 77P Cermet Trimming Potentiometer

Here's the new Model 77P, the first low-cost, general purpose trimmer with a sealed housing and cermet resistance element! DESIGNED to wider performance parameters than any other adjustment potentiometer in its price range. It is directly interchangeable with competitive Models 3067 and 3068—SEALED to permit p.c. board solvent cleaning and potting without trimmer contamination or failure—DELIVERED from local stock at the low list price of \$1.95. In large quantities, Model 77P sells for as little as \$1.10. ■ Compare Model 77P specifications with those of unsealed trimmers, then call your local Helipot representative for an evaluation sample.

|                            | <br>Helitrim<br>Model 77P | <br>Model 3067<br>Wirewound | <br>Model 3068<br>Carbon |
|----------------------------|--|--|---|
| Resistance Range, ohms     | 10 - 2 meg   | 50 - 20K   | 20K - 1 meg   |
| Resolution                 | Essentially Infinite   | 1.7 (100) to 0.3 (20K)   | Essentially Infinite  |
| Sealing                    | Yes  | No   | No  |
| Power Rating, watts        | 0.75   | 0.5  | 0.2   |
| Maximum Operating Temp. °C | 105  | 85   | 85  |

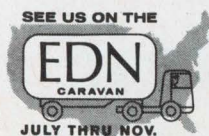

**Beckman** INSTRUMENTS, INC.  
HELIPOT DIVISION  
FULLERTON, CALIFORNIA • 92634

INTERNATIONAL SUBSIDIARIES: GENEVA; MUNICH; GLENROTHES, SCOTLAND; TOKYO; PARIS; CAPETOWN; LONDON; MEXICO CITY  
ON READER-SERVICE CARD CIRCLE 17



# Semiconductors

NEW IDEAS IN APPLICATION AND DESIGN

■ **NO OTHER PHOTO TRANSISTOR CAN MATCH IT**  
 . . . IN LOW PRICE  
 . . . IN HIGH SENSITIVITY

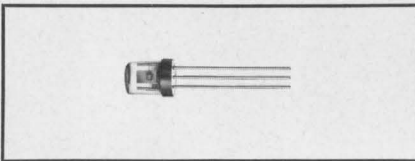

New L14B photo transistor shown actual size

Save with them now. They're priced as low as 97¢ in lots of 100-999.

Housed in a clear epoxy encapsulant, GE L14B photo transistors can sense the presence (or absence) of either visible or infra-red light. They're more sensitive than competitive devices, too, with 75% light response at  $\pm 40^\circ$ . Light current, typically, is 7 milliamps at 10 volts with irradiance at 5 milliwatts per square centimeter. And a base lead is also provided to control the sensitivity of the device, even though only the collector and emitter leads are needed for many applications.

Typical applications include machine controls, counters, coin machines, burglar alarms, solid state relays and frictionless potentiometers . . . also position controls, pyrometers, light meters, cameras, day-night controls and limit switches.

Circle Number 811.

■ **STILL ANOTHER NEW GE ECONOMY IC:**  
**THE PA223 OPERATIONAL AMPLIFIER**

Go ahead and compare these features with those of any other *low cost* operational amplifier IC:

Input impedance . . . 2.5 megohms  
 Offset current . . . . . 20 nanoamps  
 Offset voltage . . . . . 4 millivolts  
 Voltage gain . . . . . 8,000

The PA223 IC is fabricated on a single monolithic silicon substrate and housed in a 14-lead dual-in-line economy plastic package. By virtue of its darlington amplifier input configuration, it requires very little input current. PA223's also provide a current limiting feature for short circuit protection. Output is Class B. Circle Number 812.

**New high in solid state load control:  
 up to 4150 Watts with GE 15-AMP TRIACS**

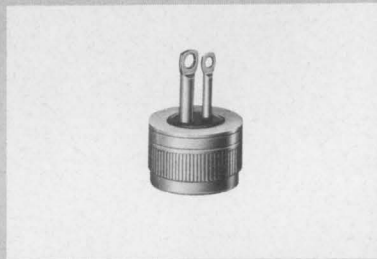

SC51 15-amp press-fit type Triac (shown actual size)

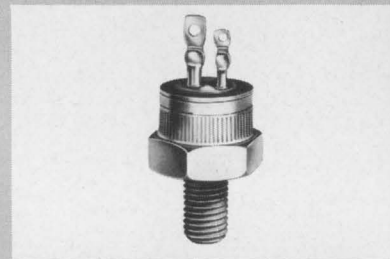

SC50 15-amp stud-mounted Triac (shown actual size)

That's 50% more power than you can now control with 10-amp Triacs, and 150% more than you can control with 6-amp units. Yet the new 15-amp models are housed in the same size packages as your lower-rated GE Triacs.

SC50 and SC51 devices are particularly useful for temperature control in residential and commercial

heating applications. Or you can use them for static switching in motor control, power conversion applications, and as overvoltage protective devices. 200-, 400-, and 500-volt ratings are ready for delivery now for use on 120-, 240- and 277-volt lines. 50- and 100-volt ratings are also available.

Circle Number 813.

Complete 3600-watt Temperature Control Circuit using the SC51 Triac and General Electric PA424 zero-voltage switch IC. (Circle Reader's Service Card Number 814 if you'd also like more information on the PA424.)

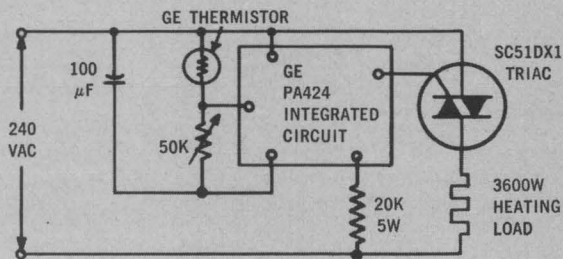

These are just three more examples of GE's total electronic capability. For more information, call your GE engineer/salesman or distributor. Or write to Section 220-60, General Electric Com-

pany, Schenectady, N.Y. In Canada: Canadian General Electric, 189 Dufferin St., Toronto, Ont. Export: Electronic Components Sales, IGE Export Division, 159 Madison Ave., New York, N.Y., U.S.A.

**GENERAL ELECTRIC**

Senate to scrutinize space budget

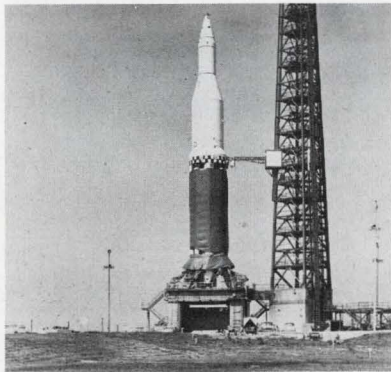

### Senate to reexamine NASA budget

Passage of the \$4.58-billion Fiscal 1968 NASA appropriation bill by the House was only a prelude to further Senate machinations against the bill. At the time of writing, no date had been set by the upper chamber's appropriations subcommittee to restudy the bill, but whenever it is, there will be a fight over it. Subcommittee chairman Sen. Warren G. Magnuson (D-Wash.) is expected at least to strive to hold the budget to the level passed by the House. Others, probably led by Sen. William Proxmire (D-Wis.), will seek deeper cuts in the already emasculated space funds. It might be recalled that only last month the two houses agreed on a \$4.87 billion NASA budget ceiling.

While the requested \$516.6 million slash in funds has not seriously hurt the Apollo program per se, many major programs planned for 1970 have been set back by the more than 10 per cent cut. Drastic surgery has been applied to Voyager (unmanned exploration of Mars and Venus in preparation for manned missions), the Apollo Applications Program, and nuclear-rocket development. The worst loss to be suffered will be the breakup of industry and NASA project teams, organizations not easy to replace.

### Military appropriation bill passed

Despite arguments over defense policy during three days of heated debate, the Senate passed a whopping \$70.1 billion Dept. of Defense appropriation bill. For the electronics industry, prime interest centers on the \$22 billion allocated for procurement and the \$7.1 billion for research, development, test, and evaluation. Market experts expect about \$9.8 billion of the former and \$3 to \$4 billion of the RDT&E money to end up in the industry's coffers.

One of the severer cutbacks, affecting avionics manufacturers, was the Senate's refusal to give a limited production go-ahead to the Navy

# Washington Report

CHARLES D. LAFOND  
WASHINGTON BUREAU

version of the F-111 variable-wing fighter-bomber. Only six of 20 aircraft requested were authorized.

Meanwhile, pressure is mounting in Congress for some positive action on the Nike-X antiballistic-missile program. In its report to the President, the Armed Forces Committee urged an immediate start on a program to deploy the system. The Committee pointed out that over \$300 million of the \$730 million authorized for Nike-X is tagged for initial deployment. It also reminded the President that \$153 million appropriated for the system last year remains intact.

### Vast arrays proposed for space listening

The development of a 36-dish radio telescope, the expansion of a new 130-ft-dia antenna facility into an eight-reflector array, and a major modification of a 1000-ft-dia antenna at Arecibo, P. R., have been recommended if the U.S. is to stay competitive with Soviet astronomy. An expert advisory panel, established by the National Science Foundation to evaluate proposed large radio-astronomy facilities for foundation grants, selected these projects as most likely to advance the U.S. radio-astronomy effort.

Continuation of a three-year-old design study by the National Radio Astronomy Observatory was urged. The project involves use of thirty-six 85-ft reflectors arranged in a Y formation, each leg measuring 13 miles in length. Estimated cost is \$52 million. The California Institute of Technology suggested the eight-antenna array. The first 120-ft dish is now nearing completion at a site in Owens Valley, Calif. Seven more would be added to form a T-shape, the east-west leg extending 9000 ft and the north-south leg 16,000 ft. Total cost would be \$15 million.

Cornell University, designer of the Arecibo spherical antenna, has proposed replacing the

# Washington Report

CONTINUED

existing wire-mesh surface with a nearly solid reflector to improve receiving sensitivity greatly and to permit operation to the 10-cm wavelength. Estimated cost is \$3 million.

## Airlines seek millions for traffic control

The Air Transport Association has asked Congress for an additional \$101.5 million for the Federal Aviation Administration to begin a five-year airport-improvement program. Association president Stuart G. Tipton cited inadequacies at high-density U.S. terminals and gross deficiencies at 292 of the 526 airports served by scheduled carriers. Testifying before the Senate Appropriations Subcommittee, Tipton urged that all these terminals should at least be provided with a control tower, radar service, and an instrument landing system.

The Association's recommendations for Fiscal 1968, involve purchase above all of electronic instrumentation, including 75 surveillance radars (\$35 million), 85 bright-tube radar displays (\$1.5 million), 150 instrument landing systems (\$15 million), 100 visual-approach slope indicators (\$1.5 million), 15 beacon alphanumeric (\$10 million), and 50 system backups for auxiliary power, radar and communications (\$3 million). Tipton also requested an added \$10 million for research and development.

For the future, Tipton proposed the acquisition of 232 towers and 360 instrument landing systems. By 1972, he declared, the en-route air traffic control automation program and the installation of alphanumeric radar displays at all terminals should be completed. Tipton urged the FAA to press development of lower-cost versions of existing instrumentation and to consider the cost savings possible through quantity procurements.

## IBM space scientists look to the Seventies

A computer-controlled, self-adapting unmanned space laboratory in Earth orbit could achieve with a single payload what might otherwise require a whole series of missions, according to IBM scientists. Conceptual studies performed by the firm's Federal Systems Div. support this belief, a company spokesman said. Such spacecraft could be developed for use by the

mid-1970s, he added.

Called a Spacecraft Computer-Managed Laboratory, the system would employ programmable logic for control. Its design would permit the automatic recombination of both logic and laboratory elements as dictated by in-flight findings. The functions of calibration, failure detection, simple assay sequencing, and instrumentation control could all be governed by the on-board computer. Experiment control would also be fairly adaptive—if the results of one experiment showed the following experiment to be impractical, then it would be bypassed and the next experiment after that begun.

More down-to-earth applications of the design could be geared to civil problems as a spin-off during development of the necessary technology. These might include specialized systems for a Food and Drug Administration drug-testing laboratory, pharmaceutical research or clinical laboratories.

## Here-and-now not neglected

Meanwhile, despite recent conflicting reports in the trade press, Washington insiders assert that IBM Federal Systems Div. has been selected by the Navy to perform avionics integration for the new A-7D and E aircraft. Negotiations are underway to complete a firm contract and an announcement of the award is expected to be made soon.

## Biosatellite success hangs on electronics

A second attempt to orbit and recover biological experiments was scheduled to begin on Sept. 7 at Cape Kennedy, Fla. Much of the success or failure of Biosatellite B will depend on its on-board electronic subsystems during three days of Earth orbit, reentry and final parachute (or sea) recovery. Electrical failure in the retro-rocket-firing circuits prevented recovery of the first spacecraft launched last Dec. 14. To ensure proper ignition this time, NASA officials disclosed that an intensive system study had "resulted in addition of a duplicate firing circuit, and improved checkout circuits and procedures for all de-orbit systems."

A principal goal in the experiments is to determine the effects of radiation and zero gravity on biological specimens. To assist in maintaining minimum induced gravity, the orbital package will employ a stabilization system to control rotational forces to less than  $10^{-5}$  g for 95% of the time. Rotation of the craft must be held to less than 0.05 rpm.



# if your meter problem is . . .

## space . . .

**Small Panel Area Meters**—Miniature, stackable, edgewise meters—and Simpson's new minimum-height Designer Series.

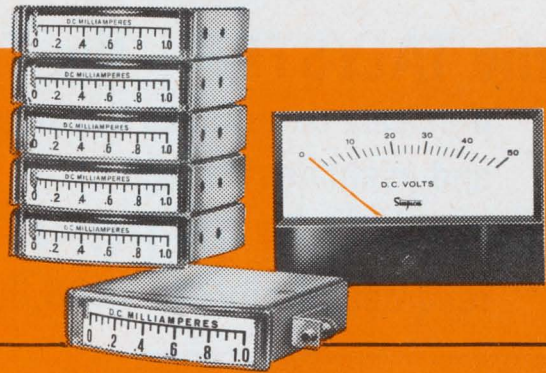

## time . . .

**Elapsed Time Meters**—Matching panel meter styles, in 110 and 220 volt stock models.

## control . . .

**Meter Relays**—Contactless and contact types, one and two control point models.

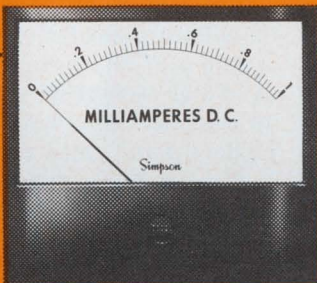
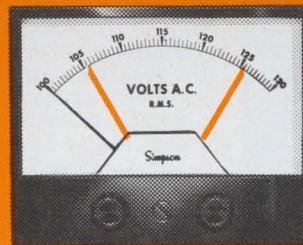

## environment . . .

**"Rugged Seal" Construction**—Sealed from dust and moisture.

# SIMPSON HAS THE ANSWER . . .

and it's probably available from stock.

Simpson makes more ranges, more special types, and in more sizes—as regular stock items. Over 1,325 different panel meters are stocked. If you have a meter problem, Simpson can usually solve it faster. Check your electronics distributor for immediate delivery . . . or write for a "problem solver" quotation on special order models.

Write for bulletin 2077 which gives complete information.

# Simpson

## ELECTRIC COMPANY

5200 W. Kinzie Street, Chicago, Illinois 60644 • Phone: (312) 379-1121

Export Dept: 400 W. Madison Street, Chicago, Illinois 60606, Cable, Simelco

IN CANADA: Bach-Simpson Ltd., London, Ontario

IN INDIA: Ruttonsha-Simpson Private Ltd., International House, Bombay-Agra Road, Vikhroli, Bombay



DIVISION

ON READER-SERVICE CARD CIRCLE 19

**new generation**

# the TALYSTEP — the TALYSURF

precisely determines thickness  
and evaluates surface of  
**THIN FILM DEPOSITS**  
recorded at 500x to 1,000,000x

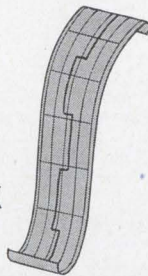

## the TALYSTEP

Measures and records thickness of evaporated and other thin film deposits. Step heights are recorded at eight magnifications, from 5000X to 1,000,000X; a variable stylus pressure of 0 to 30 milligrams prevents damage to even soft deposits. Stylus tips of 0.0001", 0.0005", 0.003" are interchangeable. Three traverse speeds are available — a viewing microscope assists in selecting area of specimen to be measured. Step heights below 25 angstroms can be measured and permanently recorded electronically on the inkless rectilinear teledeltos graph. Compensation for small surface curvature is provided.

## the TALYSURF

Evaluates variation in surface finish of substrates and deposits; and thickness of deposits. Eight magnification values range from 500X to 100,000X. Traceable calibration masters are furnished with each instrument.

With one traverse the low pressure fine stylus electronically traces actual surface profile—recording every irregularity on an inkless rectilinear graph. The Tallysurf record is your guarantee of surface finish precision—on hard or soft material, flat or curved shape.

- Electronic units for both the Tallystep and the Tallysurf have fully transistorized circuitry in one compact assembly — for greater convenience, accuracy, stability, and linearity.
- The Rank Taylor Hobson Tallystep and Tallysurf are recognized

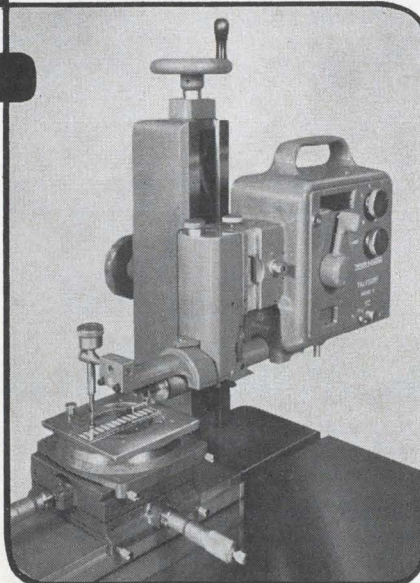

as master instruments for checking surface characteristics and step height of thin film, parts, components that require accurate evaluation.

**ENGIS EQUIPMENT COMPANY**

ENGINEERING INSTRUMENTATION DIVISION

8035 AUSTIN AVENUE, MORTON GROVE, ILL. 60053

ON READER-SERVICE CARD CIRCLE 20

**Engis**

NEWS

## 125-kG supercooled magnet weighs 40 lb

A 125,000-gauss superconducting magnet, described as "smaller than a one-gallon can," has been delivered to the Physics Department of Rutgers University, New Brunswick, N. J., by the Radio Corp. of America's Industrial Tube Div., Harrison, N. J.

According to Walter F. Lawrence, manager for superconductive products, the device is the first commercially available magnet with such a powerful field.

The device was made with three superconductive ribbons of niobium-tin vaporized onto a flexible, stainless-steel substrate. Since the three ribbons are electrically compatible, only one power supply is required, Mr. Lawrence said.

He added: "Because each of the three ribbons is specifically designed for . . . a particular field region of the magnet, a substantial savings in superconductive material cost is realized by employing the correct combination of the three."

The magnet fits into a case with an outside diameter of 6-1/8 inches and an over-all length of 8-1/2 inches. Total weight is approximately 40 pounds. The current required to produce a full rated field of 125 kG is 82 amp  $\pm 5\%$ . ■ ■ ■

## Solar satellite belt

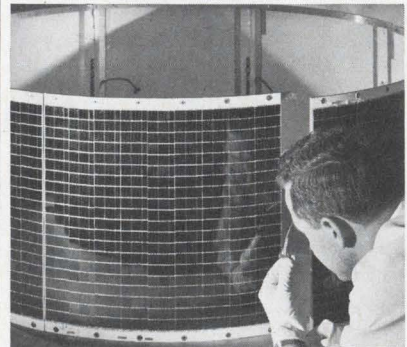

Curved solar panels on board the recently launched experimental communications satellite, LES-5, permit all panel surfaces to be evenly exposed to solar radiation during rotation cycle of the spin-stabilized vehicle. It was constructed by Electro-Optical Systems in Pasadena, Calif.

# New $\mu$ -PAC Prices

Up to 46% reduction on 75% of the more than 50 I/C  $\mu$ -PAC modules — including lower prices for flip-flops, gates, amplifiers,

I/O modules, power supplies, and hardware. New quantity discounts are also available. Write for detailed price list.

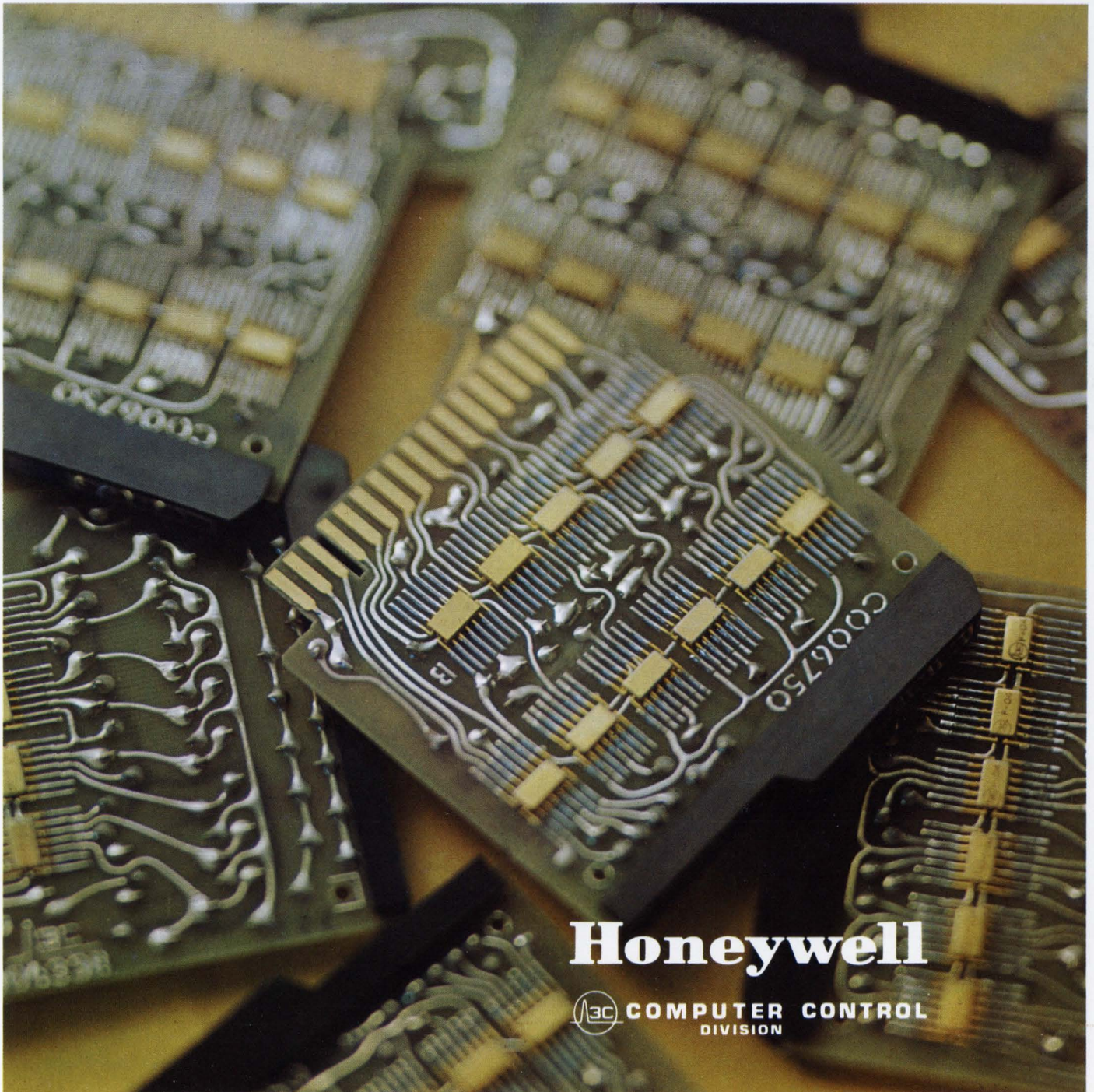

**Honeywell**

 **COMPUTER CONTROL**  
DIVISION

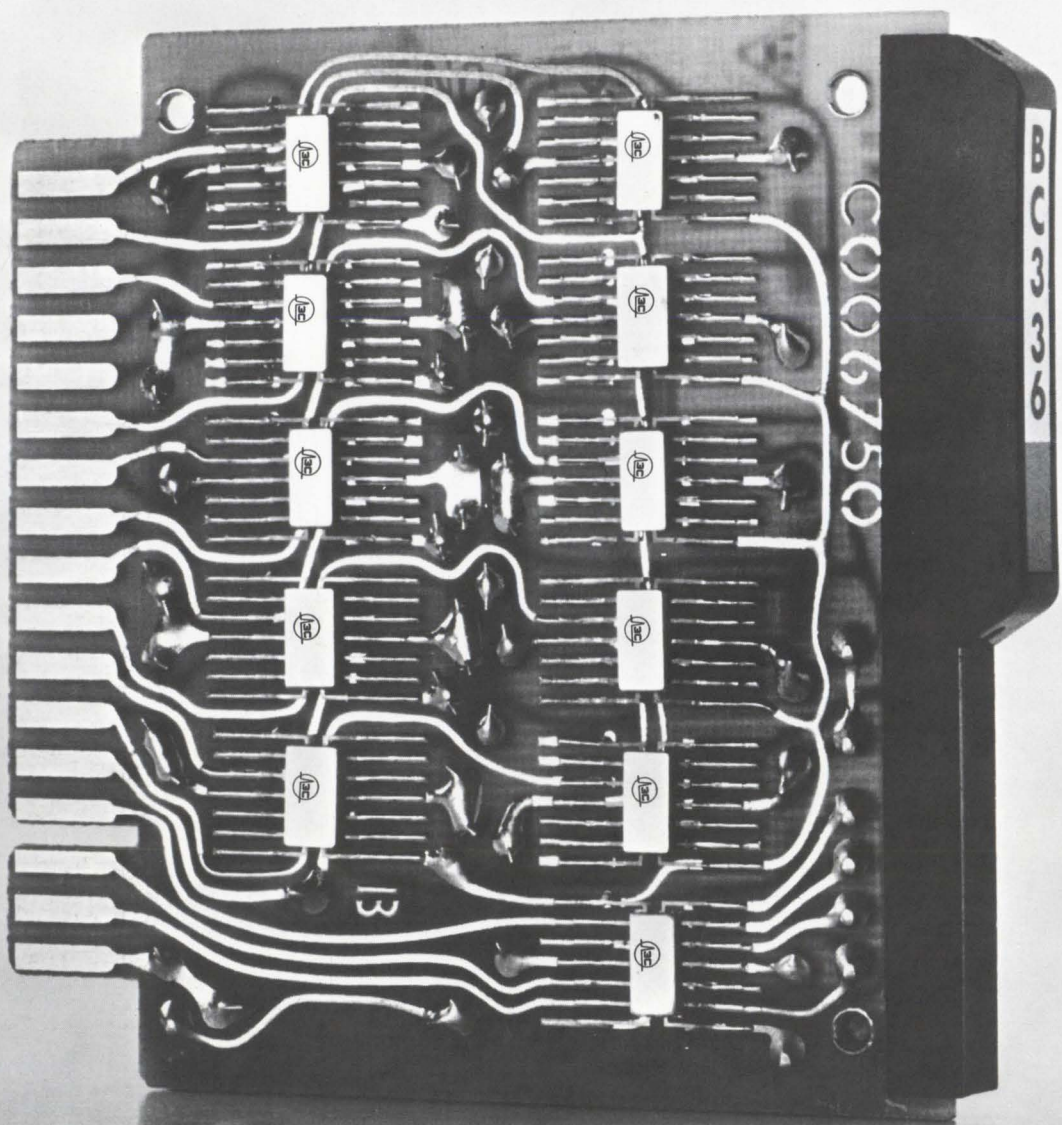

## INTRODUCTION

Honeywell Computer Control Division  $\mu$ -PACS are a broad line of general purpose 5 mc monolithic integrated circuit modules designed for digital systems applications.  $\mu$ -PACS retain the straightforward logic design and flexibility of Honeywell's long established discrete building block lines, while incorporating the greater reliability, size, and price advantages of integrated circuits.

Special design features of the line include —

- High packaging density
- Wide selection of module types
- Noise protection in excess of 1 volt
- DC coupled circuitry throughout
- Low power consumption

This summary brochure is intended to serve as an introduction for the logic designer currently engaged in the selection of a line of digital logic modules. It contains technical data on the  $\mu$ -PAC line and highlights Honeywell's capabilities as a leading supplier of digital logic modules. Whether your design requirements involve a one-time logic interface or volume systems assembly, you'll find  $\mu$ -PACS the ideal answer to your hardware problems. A reply card has been included to assist you in obtaining complete  $\mu$ -PAC specifications.

**EXPERIENCE** — In the past 14 years, Honeywell has delivered over a million digital logic modules. PACS have become the standard for quality and value in major industrial, research, and defense organizations throughout the world. PACS have helped make Honeywell a leading supplier of digital computers, core memory systems and special memory test systems. This broad experience has, in turn, contributed to the user-oriented design of  $\mu$ -PACS.

**SERVICE** — Honeywell maintains world-wide sales and service offices staffed by highly qualified applications engineers to provide technical assistance and design support.  $\mu$ -PACS are fully documented by comprehensive instruction manuals, application notes, wiring and assembly notes, schematic parts lists and logic design aids.

**BREADTH OF LINE** — Only one supplier is necessary when you design with  $\mu$ -PACS — a complete line including interface modules, memory modules, and analog modules as well as the widest, most versatile selection of standard logic functions. All necessary mounting hardware, power supplies, and special wiring and design accessories are available at minimum cost. Honeywell maintains a special  $\mu$ -PAC design and fabrication capability to aid the systems designer in solving custom problems on any given system design. The standard  $\mu$ -PAC product line is continually expanding to provide new approaches in solving systems design problems. In addition, custom solderless-wrap wiring capabilities are offered to assist customers with volume systems fabrication.

**WARRANTY** — All  $\mu$ -PAC modules are covered by a full one-year warranty. A repair service is available at our main plant for modules damaged due to misuse or misapplication.

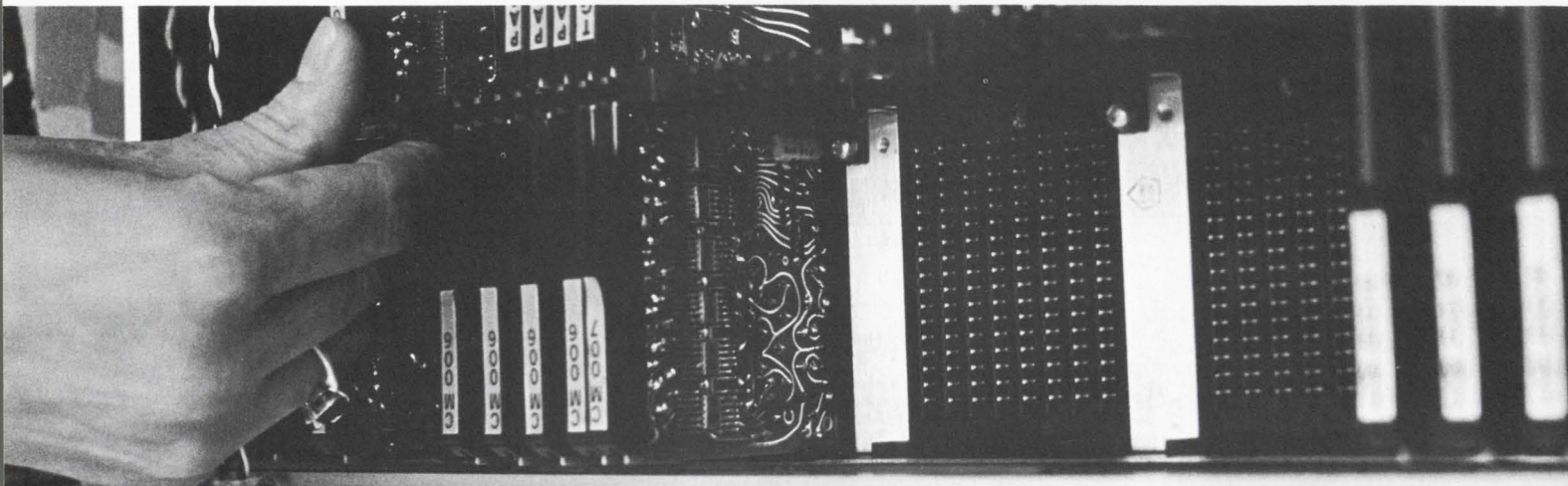
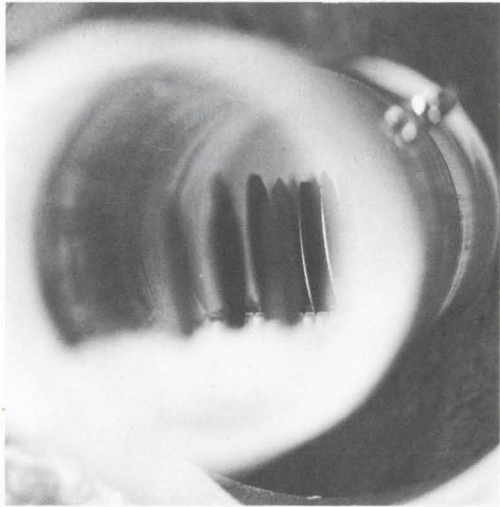

## CAPABILITIES

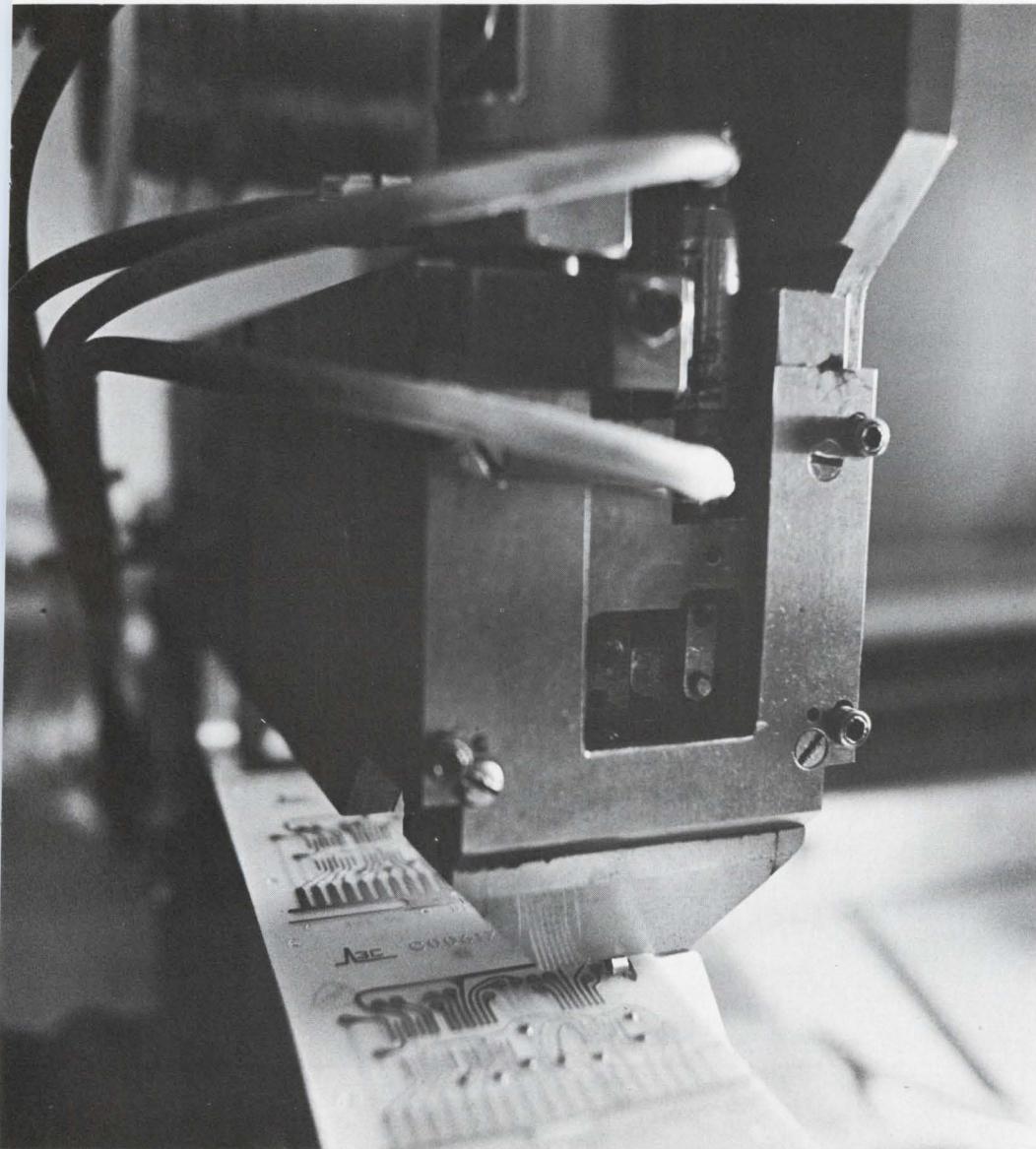

Honeywell's leadership as a major supplier of I/C digital logic modules can be attributed to two major factors. First, nearly 14 years' experience in the design and manufacture of an extensive range of electrically, mechanically, and logically complete building block circuit lines. Second, its ability to meet major technological challenges — from digital use of the vacuum tube to transistors and, most recently, integrated circuits. To continue our leadership, Honeywell spent more than two years' in research and development of I/C design, fabrication and modular product application techniques. The result — in 1965 — was  $\mu$ -PAC, the industry's first line of general purpose I/C digital logic modules.

With  $\mu$ -PACS, Honeywell offers a broad range of capabilities to meet a variety of logic circuit design and packaging problems. A unique combination of extensive facilities, modern equipment, and talented engineering and manufacturing personnel assure Honeywell a leading role in digital technology. These same capabilities and facilities represent a continuing commitment to market demands — pose significant advantages to be considered in your make-or-buy evaluations.

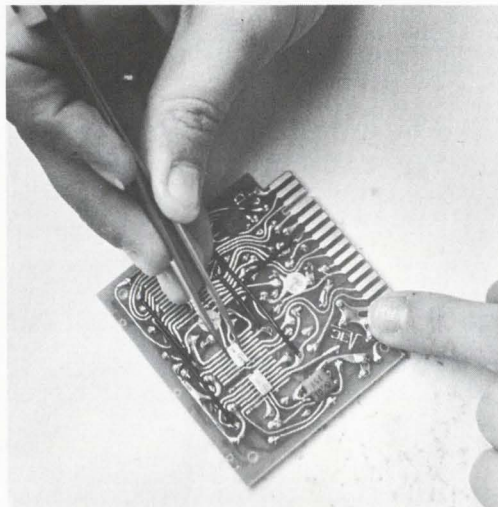
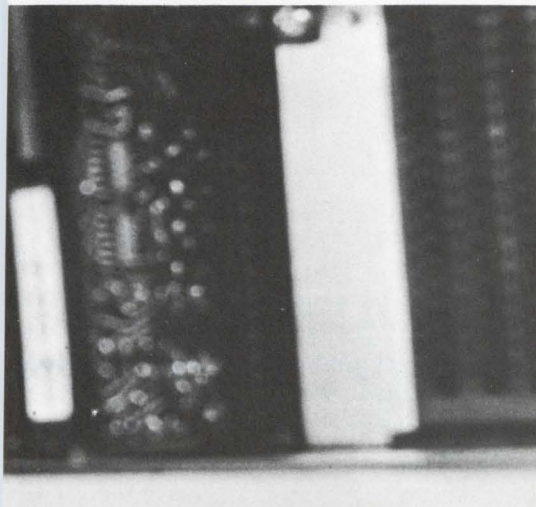

## RELIABILITY

Reliability is a total approach at Honeywell.  $\mu$ -PAC reliability is first, the result of active research and development programs. The vastly more reliable monolithic I/C approach in logic module design was perfected after a dozen years' experience in a variety of logic design approaches. Conservative specifications with worst-case, end-of-life techniques were selected as basic design parameters. Rigid manufacturing procedures with proven assembly and fabrication techniques have been formulated to achieve design reliability specifications.

100% static and dynamic electrical test are performed on all circuits against tight standards for speed, driving capability and noise immunity using automatic, custom-designed test equipment to speed up testing and eliminate human error. Extensive quality control programs which include operating life, storage, shock vibration, centrifuge, solder, heat, temperature cycle, thermal shock, moisture resistance, salt atmosphere and lead fatigue are used to monitor  $\mu$ -PAC manufacturing operations.

Reliable implementation of  $\mu$ -PACS — without costly user re-design — is a key factor in the overall reliability of a  $\mu$ -PAC system. Comprehensive documentation consisting of instruction manuals, reliability manuals, wiring and assembly notes, complete engineering specifications, schematic drawings, application notes, and logic design aids are provided.

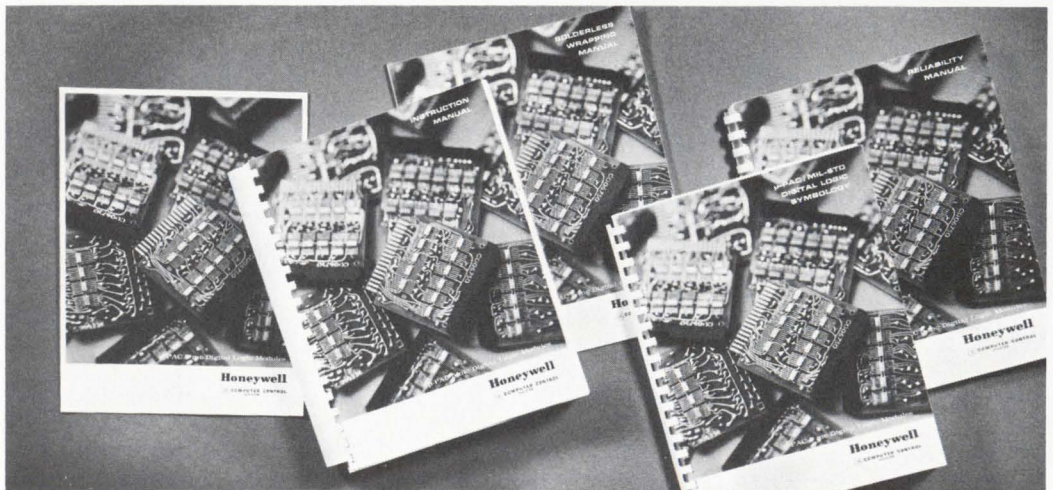
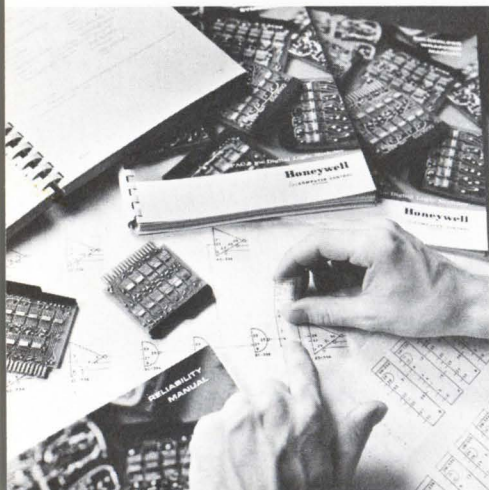
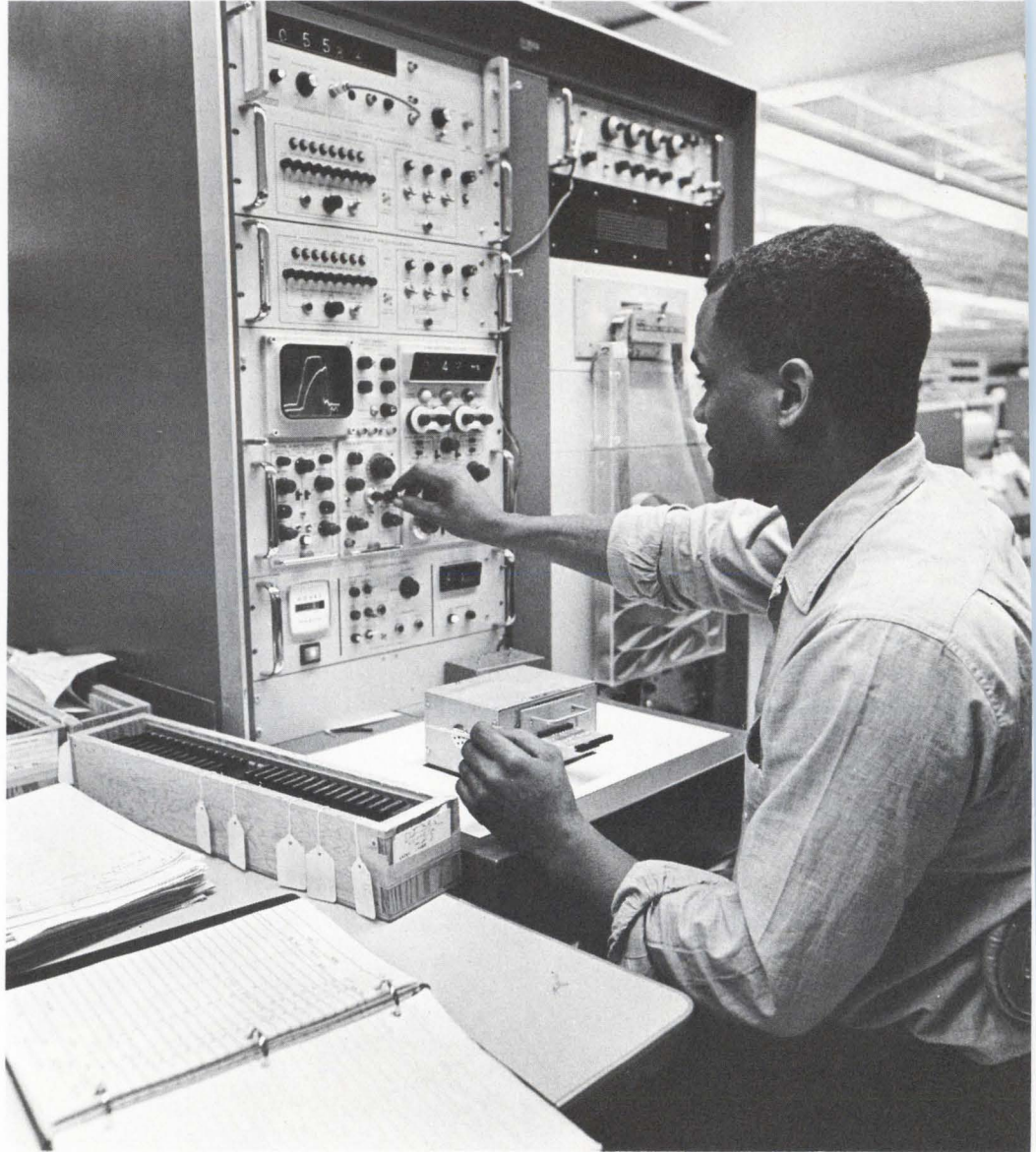



## μ-PAC SPECIFICATIONS

### ELECTRICAL & ENVIRONMENTAL

#### Circuit Characteristics

|                         |   |
|-------------------------|---|
| Frequency               | DC to 5 mc*   |
| I/C Logic Type          | Diode Transistor Logic  |
| Logic ONE               | +2.5 volts to +6.3 volts (or an open circuit at the input)                                |
| Logic ZERO              | 0 volt to +1.1 volts, maximum   |
| Noise Rejection         | 1.35 volts, typical<br>1.05 volts, minimum  |
| Ambient Operating Temp. | 0°C to +55°C  |
| Power Supply Voltage    | +5.1 volts to +6.3 volts (-6 volts also available for some auxiliary non-logic circuits.) |

#### NAND Gate

|   |  |
|---|--|
| Fan In  | 12   |
| Fan Out   | 8  |
| Stray Capacitance**   | 40 picofarads                                      |
| Circuit Delay (measured at + 1.5 volts, averaged over 2 stages) | 24 nanoseconds, typical<br>30 nanoseconds, maximum |

#### J-K Flip-Flop

|   |  |
|---|--|
| Inputs:                                     | Loading  |
| DC Set Input                                | 2/3 unit load                                      |
| DC Reset Input                              | 2/3 unit load                                      |
| Clock                                       | 1 unit load  |
| Control                                     | 1 unit load  |
| Fan Out                                     | 8  |
| Stray Capacitance**                         | 40 picofarads                                      |
| Circuit Delay (measured at 1.5 volts) Clock | 45 nanoseconds, typical<br>60 nanoseconds, maximum |
| DC Set/Reset                                | 45 nanoseconds, typical<br>80 nanoseconds, maximum |

#### Power Amplifier

|  |  |
|--|--|
| Output Drive Capability  | 25 loads   |
| Stray Capacitance**  | 250 picofarads                                     |
| Circuit Delay (measured at +1.5 volts, averaged over 2 stages) | 24 nanoseconds, typical<br>30 nanoseconds, maximum |

### MECHANICAL

|                    |  |
|--------------------|--|
| Physical Size      | 2.9 x 2.7 x .24 inches   |
| Connector          | Etched type. 34 pin, gold plated, mating to solderless-wrap or taper pin                                     |
| Board Material     | .24 inch glass impregnated epoxy   |
| I/C Assembly       | 14 lead, .250 x .125 x .065 inch flat packs soldered to etched wiring. Up to 22 flat packs on a single card. |
| Power Distribution | Factory pre-wired in all μ-BLOCS   |

\*At a 5 mc clock rate there is enough usable logic time in one clock cycle to preset and propagate through the clocked flip-flop, and pass through 3 series NAND gates.

\*\*Specified at maximum delay times. Additional stray capacitance affects only circuit delay times. See μ-PAC Manual for additional details.

μ-PACS are static asynchronous digital logic circuits. Diode transistor logic (DTL) is employed for its noise rejection, speed and expandable input capabilities. Circuits meet all design requirements of a 5 megacycle line, featuring input gate expansion, output cascading, high fan-out, high noise thresholds, and low propagation delays.

Performance specifications are conservative — based on "worst case" stack-up of tolerances and will usually exceed the specifications listed. The basic logic unit, the NAND gate, performs a NAND function for positive logic and a NOR function for negative logic. Inputs are generally expandable by addition of diode clusters available on selected gate modules.

Most μ-PAC flip-flop modules utilize a single, versatile flip-flop circuit. This basic circuit is a double rank J-K flip-flop. In addition, a flip-flop consisting of two cross coupled NAND circuits is used to provide an RS type flip-flop module.

The Power Amplifier PAC adds high drive capability gating to the line with the added feature of short delay time. Built-in short circuit protection (patent applied for) limits the output current when the output is short circuited.

Loading numbers are expressed in easy-to-use unit numbers, and include wide safety margins at maximum operating frequency. In addition to indicated fan-out, ample margin is included for the specified stray capacitance to permit greater freedom in PAC-to-PAC wiring. Nominal μ-PAC unit load is 1.6 milliamperes.

## $\mu$ -PACS

### FLIP-FLOP PACS

**COUNTER BC-335** — Contains six independent flip-flops with appropriate inputs for operation as binary counters. Individual DC set and reset inputs allow presetting in all modes. A common DC reset input is shared by all circuits.

**BINARY COUNTER BC-336** — Contains between 8 and 20 prewired binary counter stages. The standard stocked BC-336 contains 8 stages and is custom assembled to 20 stages as specified by the user. The PAC also contains one independent two input NAND gate.

**FAST CARRY COUNTER BC-337** — Contains a prewired eight-stage counter. By utilizing a few jumper connections at the PAC terminals, the counter can be operated in either a binary or an 8421 BCD mode.

**BUFFER REGISTER BR-335** — Contains six independent flip-flops for use in serial and parallel transfer applications. Independent DC set inputs are available at each flip-flop for presetting operations.

**GATED FLIP-FLOP FA-335** — Contains four independent general purpose flip-flops, each with clocked and DC inputs and a common reset.

**BASIC FLIP-FLOP FF-335** — Contains eight independent, low-cost DC operated flip-flops. Individual DC set and DC reset inputs are provided.

**SHIFT REGISTER SR-335** — Contains between 8 and 16 prewired shift register stages. The standard stocked SR-335 contains 8 stages and is custom assembled to 16 stages as specified by the user.

**UP/DOWN COUNTER UD-335** — Contains four counter stages prewired to provide the counting operation in both the Up mode and Down mode, depending upon the command provided at the control input.

**UNIVERSAL FLIP-FLOP UF-335** — Contains three independent general purpose flip-flops, each with independent clocked and DC input gating and a common DC reset.

### GATE PACS

**MULTI-INPUT NAND DC-335** — Contains 2 six-input NAND gates with nodes and 4 three-diode clusters. The diode clusters can be tied to the gate nodes of this or other  $\mu$ -PACS to expand the number of gate inputs.

**NAND TYPE 1 DI-335** — Contains 10 two-input NAND gates. Two of the gates have disconnected collector loads which are brought out on separate terminals.

**NAND TYPE 2 DL-335** — Contains 6 four-input NAND gates. Two of the gates have disconnected collector load resistors which are brought out on separate terminals.

**EXPANDABLE NAND DN-335** — Contains 6 three-input NAND gates with nodes. Two of the gates have disconnected collector loads which are brought out on separate terminals.

### AMPLIFIER PACS

**POWER AMPLIFIER PA-335** — Contains 6 three-input high drive NAND gates, each capable of driving 25 unit loads and 250 picofarads stray capacitance.

**POWER AMPLIFIER PA-336** — Contains 6 three-input high drive NAND gates, each capable of driving 25 unit loads and 250 picofarads stray capacitance.

**NON-INVERTING POWER AMPLIFIER PN-335** — Contains 6 three-input high-drive AND gates, each capable of driving 25 unit loads and 250 picofarads stray capacitance.

### DELAY PACS

**DELAY MULTIVIBRATOR DM-335** — Contains two independent monostable (one-shot) multivibrators capable of generating assertion and negation pulses in a variety of widths. Each circuit has two NAND inputs, an enable, a range control and three discrete variable delay taps.

**ADJUSTABLE DELAY MULTIVIBRATOR DM-336** — Contains two independent monostable (one-shot) multivibrators capable of generating assertion and negation pulses in a variety of widths. Each circuit has two NAND inputs, an enable, and three discrete variable delay taps and is continuously variable in ranges.

### MEMORY PACS

**SERIAL MEMORY SM-330** — Is a complete storage system capable of storing up to 256 bits of serial  $\mu$ -PAC data at a maximum rate of one million bits per second. The PAC contains two independent storage circuits which can either function separately or in series and operate by a common system clock input.

### CLOCK PACS

**MASTER CLOCK MC-335** — Contains a crystal controlled oscillator, a pulse shaper, and a power amplifier. The Negation pulse is available at the output of the power amplifier section. The additional power amplifier circuit is available to provide the Assertion output when tied in series with the Negation output.

**MULTIVIBRATOR CLOCK MV-335** — Contains a self-starting, free running, variable frequency multivibrator, a pulse shaper section, and a power amplifier section. The Negation pulse is available at the output of the power amplifier section. The additional power amplifier circuit is available for providing an Assertion output when tied in series with the Negation output.

### FUNCTIONAL GATING PACS

**ADDER AP-335** — Contains 8 two-input half-adder (exclusive OR) stages which can be connected to form full adders, parity generators, and comparators.

**SELECTION GATE TYPE 1 DG-335** — Contains four independent functional gate structures. Each gate structure has 3 two-input NAND gates with separate load circuits and performs the AND-OR-INVERT function.

#### **SELECTION GATE TYPE 2 DG-336** —

Contains two independent functional gate structures. Each gate structure has 4 three-input NAND gates with separate load circuits and performs the AND-OR-INVERT function.

**EXCLUSIVE OR EO-335** — Contains five independent functional gate structures and one independent single input NAND gate. Each gate structure contains 3 two-input NAND gates and performs AND-OR and AND-OR-INVERT functions.

#### **OCTAL/DECIMAL DECODER OD-335**

— Contains a prewired binary-to-octal decoder and two additional independent NAND gates to expand the matrix for BCD-to-decimal decoding. Three additional inputs, in addition to the six binary inputs, are provided to permit the matrix to be expanded to 16, 32, or 64 outputs by connecting additional decoders.

#### **TRANSFER GATE TG-335** —

Contains four independent functional gate structures. Two of the structures have 4 two-input NAND gates, one input on each gate being common to the other four gates.

#### **SYSTEM INPUT/OUTPUT PACS**

**DISPLAY DRIVER DD-330** — Is designed to drive remote projection type digital display devices from a 4-bit binary-coded-decimal (BCD) input. On external command, the BCD input data is converted to decimal and stored in the output driver.

#### **NEGATIVE LOGIC LEVEL CONVERTER LC-335** —

Contains 10 independent circuits which accept negative voltage logic signals and convert them to  $\mu$ -PAC signals. Each circuit has 2 inputs. The N input accepts signals at ground and  $-4$  to  $-15$  volts and provides a  $\mu$ -PAC output (0 volts and  $+6$  volts). The  $\mu$ -input uses a  $\mu$ -PAC signal to control or gate the negative voltage logic signal.

**LAMP DRIVER LD-330** — Contains twelve identical independent lamp

driver circuits. Each circuit is capable of switching up to 70 milliamperes of current from any positive voltage up to 20 volts at a maximum frequency of 100 kc.

#### **HIGH DRIVE LAMP DRIVER LD-331**

— Contains 8 independent lamp driver circuits. Each circuit is capable of switching 300 milliamperes of current from any positive voltage up to 35 volts at a maximum frequency of 10 kc.

#### **NEGATIVE LOGIC LEVEL DRIVER LD-335**

— Contains 8 identical independent circuits. Each circuit is capable of converting standard  $\mu$ -PAC signals to negative voltage levels of 0 volts and a minus voltage of up to 25 volts.

**RELAY RC-330** — Consists of eight microminiature reed relays which can operate independently or together, when properly connected.

**SOLENOID DRIVER SD-330** — Contains three independent circuits for driving heavy resistive, capacitive or inductive loads in such applications as solenoid or relay driving. The PAC also contains an independent two-input NAND gate.

**SCHMITT TRIGGER ST-335** — Contains two independent trigger circuits, each capable of converting arbitrarily shaped inputs into  $\mu$ -PAC compatible outputs.

#### **ADJUSTABLE SCHMITT TRIGGER ST-336**

— Contains two independent trigger circuits, each capable of converting arbitrarily shaped inputs into  $\mu$ -PAC compatible outputs.

#### **TRANSMISSION LINE DRIVER XD-335**

— Contains 6 two-input driver circuits. Each circuit is capable of driving standard 50 ohm, 75 ohm and 93 ohm coaxial cable or twisted pair cables at up to 5 mc repetition rates.

#### **TRANSMISSION LINE DRIVER XD-336**

— Contains 6 two-input driver circuits. Each circuit is capable of driving 50 feet of standard 50 ohm,

75 ohm or 93 ohm coaxial cables or twisted pair cables at up to 5 mc repetition rates.

#### **ANALOG/DIGITAL PACS**

#### **SIX-BIT DIGITAL-TO-ANALOG CONVERTER LN-330**

— Contains a six-bit ladder network with the output buffered by a differential amplifier. The amplifier includes an offset/scaling network for bipolar or unipolar operation, and a potentiometer for zero offset adjustment.

The following 5 D-A PACS are new:

#### **FOUR-BIT D-A CONVERTER LP-330**

— contains a four-bit ladder network with solid state switching. It requires an external reference voltage of  $-10$  volts nominal. Conversion accuracy is  $\pm 0.05\%$  full scale, relative to the DC reference voltage.

#### **SIX-BIT D-A CONVERTER LP-331**

— contains a six-bit ladder network with solid state switching. It requires an external reference voltage of  $-10$  volts nominal. Accuracy is  $\pm 0.5\%$  full scale, relative to the DC reference voltage.

#### **OPERATIONAL AMPLIFIER OA-330**

— is a high gain, wide band DC amplifier primarily intended for use as a D/A output buffer. The DC gain of the amplifier is typically  $-5 \times 10^5$ , and the gain bandwidth is 3 megacycles.

#### **DC-DC POWER CONVERTER PC-330**

— uses the  $+6$  volt and  $-6$  volt supply voltages to generate  $+24$  volts and  $-24$  volts. The PAC supplies the additional required voltages for the analog series of PACS, such as LP-330, LP-331, OA-330 and PR-330.

#### **PRECISION REFERENCE PR-330**

— is a precision, shunt regulated  $-10$  volt supply. The PAC is intended for use with the LP-330 and LP-331 PACS which require a current sink reference regulator.

## ASSEMBLY AIDS

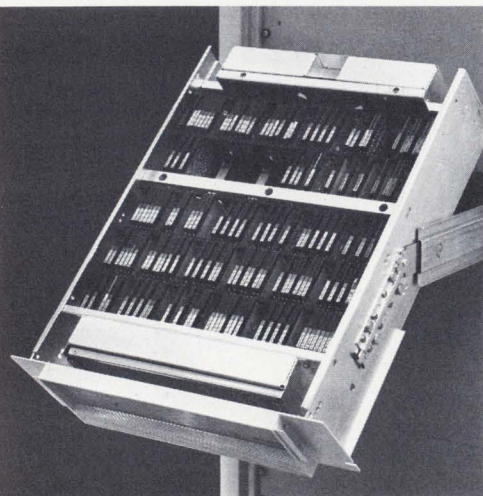
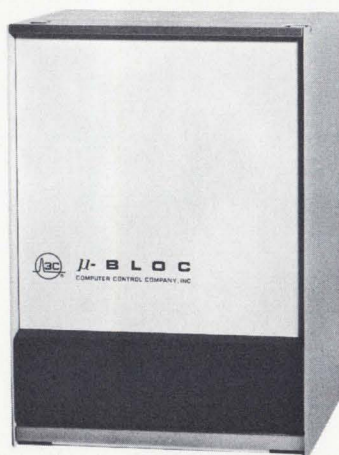
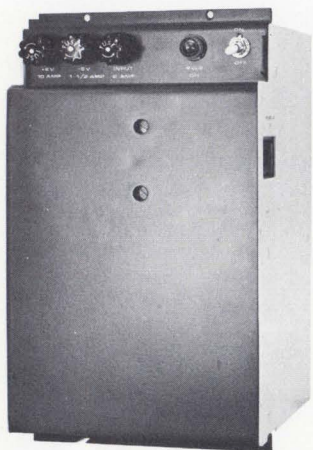

### POWER SUPPLIES

**PLUG-IN** — models PB-330 and PB-331, are integrally packaged units that can be mounted directly into  $\mu$ -**BLOCS**. The PB-330 mounts directly in model BM-BLOCS and the PB-331 mounts into model BL-BLOCS. They supply current at both  $\mu$ -**PAC** voltage levels, +6 and -6 volts, and are designed to drive all modules contained in their respective BLOCS.

| Power Supply | +6 Volts DC | -6 Volts DC | Line Current Full Load | Overall Dimensions                                  | Weight  |
|--------------|-------------|-------------|------------------------|---|---------|
| PB-330       | 2.5 A       | .25 A       | 0.3 A @ 100 VAC        | 8 $\frac{3}{4}$ x 2 $\frac{3}{4}$ x 4 $\frac{1}{2}$ | 8 lbs.  |
| PB-331       | 10 A        | 1.0 A       | 5.0 A @ 100 VAC        | 8 $\frac{3}{4}$ x 5 $\frac{1}{2}$ x 4 $\frac{1}{2}$ | 17 lbs. |

**RACK MOUNT** — model RP-330 rack-mounting power supply is a regulated power source capable of supplying current at both +6 volts and -6 volts  $\mu$ -**PAC** voltage levels.

Overall supply voltage variations due to worst-case combinations of input line voltage, DC load regulation, dynamic load regulation, ripple and long-term drift are less than  $\pm 2\%$ . This is well within  $\mu$ -**PAC** voltage level tolerances.

| Power Supply | +6 Volts DC | -6 Volts DC | Line Current Full Load | Overall Dimensions        | Weight  |
|--------------|-------------|-------------|------------------------|---------------------------|---------|
| RP-330       | 25 A        | 2.5 A       | 5.0 A @ 100 VAC        | 5 $\frac{1}{4}$ x 15 x 19 | 60 lbs. |

### MOUNTING HARDWARE

$\mu$ -**BLOCS** — Seven different  $\mu$ -**BLOC** units are available for housing  $\mu$ -**PACS**. All BLOCS use the same basic structure but differ in width dimension, provisions for plug-in power supply and types and number of connectors (see table).

Mounting ears are detachable and allow front or back mounting of the connector plane. Laminated copper strips insulated by mylar are used for power distribution. PAC connectors are prewired for +6 volts and ground. Height and depth dimensions are standard for all BLOCS at 12 $\frac{1}{4}$ " by 5 $\frac{1}{4}$ " respectively.

#### SPECIFICATIONS

| Model  | PAC Capacity | Connector Type  | Height            | Depth            | Width             | Housing for Power Supply | Weight (Lbs.) |
|--------|--------------|-----------------|-------------------|------------------|-------------------|--------------------------|---------------|
| BM-330 | 24           | solderless-wrap | 12 $\frac{7}{32}$ | 5 $\frac{5}{16}$ | 5 $\frac{1}{16}$  | PB-330                   | 8.2           |
| BM-335 | 24           | taper pin       | 12 $\frac{7}{32}$ | 5 $\frac{5}{16}$ | 8 $\frac{7}{16}$  | PB-330                   | 9.6           |
| BM-337 | 36           | taper pin       | 12 $\frac{7}{32}$ | 5 $\frac{5}{16}$ | 8 $\frac{7}{16}$  | (none)                   | 10.4          |
| BL-330 | 96           | solderless-wrap | 12 $\frac{7}{32}$ | 5 $\frac{5}{16}$ | 16 $\frac{1}{16}$ | PB-331                   | 16.0          |
| BL-331 | 48           | taper pin       | 12 $\frac{7}{32}$ | 5 $\frac{5}{16}$ | 16 $\frac{1}{16}$ | PB-331                   | 16.0          |
| BL-332 | 144          | solderless-wrap | 12 $\frac{7}{32}$ | 5 $\frac{5}{16}$ | 16 $\frac{1}{16}$ | (none)                   | 18.3          |
| BL-333 | 72           | taper pin       | 12 $\frac{7}{32}$ | 5 $\frac{5}{16}$ | 16 $\frac{1}{16}$ | (none)                   | 18.3          |

**MOUNTING PANELS** — models PM-330 and PM-331, are used to mount the BM series  $\mu$ -**BLOCS** to 19 inch RETMA relay racks. They can be fastened to either the PAC side or connector side of the BLOC. Panel space can be used to mount switches, indicator lights, meters, etc.

The **PM-330** is 8 $\frac{7}{16}$  inches across and mounts the BM-330. The **PM-331** is 5 $\frac{1}{16}$  inches across and mounts the BM-335 and BM-337.

**TILT DRAWER UNIT** — model BT-332 contains 240  $\mu$ -**PAC** slots employing solderless-wrap connectors.

#### SPECIFICATIONS

| Model  | PAC Capacity | Connector Type  | Height           | Overall Depth     | Panel Width | Weight (lbs.) |
|--------|--------------|-----------------|------------------|-------------------|-------------|---------------|
| BT-332 | 240          | Solderless Wrap | 5 $\frac{5}{16}$ | 22 $\frac{5}{16}$ | 19          | 60            |

## SUPPLEMENTARY PACS AND ACCESSORIES

### COPPER CLAD PAC KIT AS-330 —

Consists of a standard  $\mu$ -PAC card, a separate handle, and retaining roll pins. The card portion contains the standard 34 gold plated fingers attached to 5.5 square inches of copper plate on each side of the card. This allows for custom etching of desired interconnection patterns.

**BLANK PAC BP-330** — Is a standard  $\mu$ -PAC card with etched power and ground busses originating at the appropriate connector terminals and distributed around the card's periphery. The remainder of the card space (approximately 3.5 square inches) is available for the mounting of any desired special circuits or components by use of standard lugs and point-to-point wiring.

**JUMPER LEAD SET JT-330** — Contains 420 assorted lengths of taper pin jumper leads. The leads are made of plastic insulated #24 stranded wire with gold-plated AMP taper pins at each end.

### SYSTEM NORMALIZER PAC SN-330

— Contains a time delay circuit which preconditions system control flip-flops to the proper state at the instant of power turn-on.

**TEST POINT PAC** — Facilitates the observation of waveform characteristics for various circuit positions within the system. It contains 34 test points, each of which is prewired to a connector terminal and bears the number of the appropriate terminal. The PAC is plugged into a prewired  $\mu$ -PAC connector.

### UNIT INDICATORS UI-110, UI-330 —

Are self-contained transistorized neon indicators for displaying the state of any  $\mu$ -PAC flip-flop, gate, or other logic unit. The UI-110 uses a +90 volt supply and is driven by standard  $\mu$ -PAC signals. The UI-330 is identical in performance to the UI-110 except that it can be powered from +6 volts.

### SOLDERLESS-WRAP KIT WK-330 —

Is designed to provide all associated equipment and material necessary to facilitate the implementation of  $\mu$ -BLOC interwiring.

### SOLDERLESS-WRAP TOOLS —

The **Battery Operated Solderless-Wrap Gun** provides a simple method for interwiring  $\mu$ -BLOC solderless-wrap connectors with the prescribed 30 gauge wire. Its nickel-cadmium battery provides sufficient power to make up to 4,000 connections without recharging.

The **Manually Operated Solderless-Wrap Tool** provides a simple inexpensive method of solderless wrapping 30 gauge wire to  $\mu$ -BLOC solderless-wrap connectors. It is useful for small one-shot wiring tasks, for prototype checkouts, demo units, etc.

The **Taper Pin Insertion Tool** is used to insert taper pin jumper leads into taper pin connectors. The tool's spring loaded action and ease of use greatly facilitates the taper pin wiring operation.

### LOGIC SYMBOL SHEETS —

Logic Symbol Sheets are available for each applicable product type in the  $\mu$ -PAC line. Use of the logic symbol sheets greatly simplifies system logic design and wiring, and effectively minimizes drafting requirements for the production of final engineering drawings. Printed on each sticker are logic symbol, pin connections and circuit identifiers. Space is provided for designating physical location in the respective  $\mu$ -BLOC.

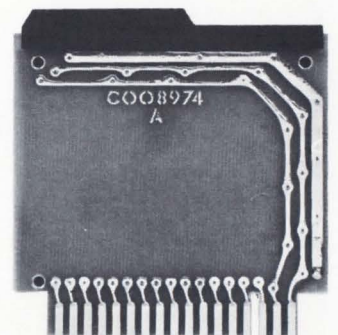
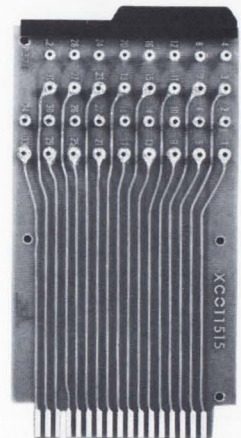

# New $\mu$ -PAC Modules

**5 D-A Modules** have been added to the standard  $\mu$ -PAC line to provide 4- and 6-bit converter capability for systems designers requiring analog output control.

Like all  $\mu$ -PACS, they're backed by in-depth documentation, 14 years' logic design experience, and high reliability standards. Write for detailed specs.

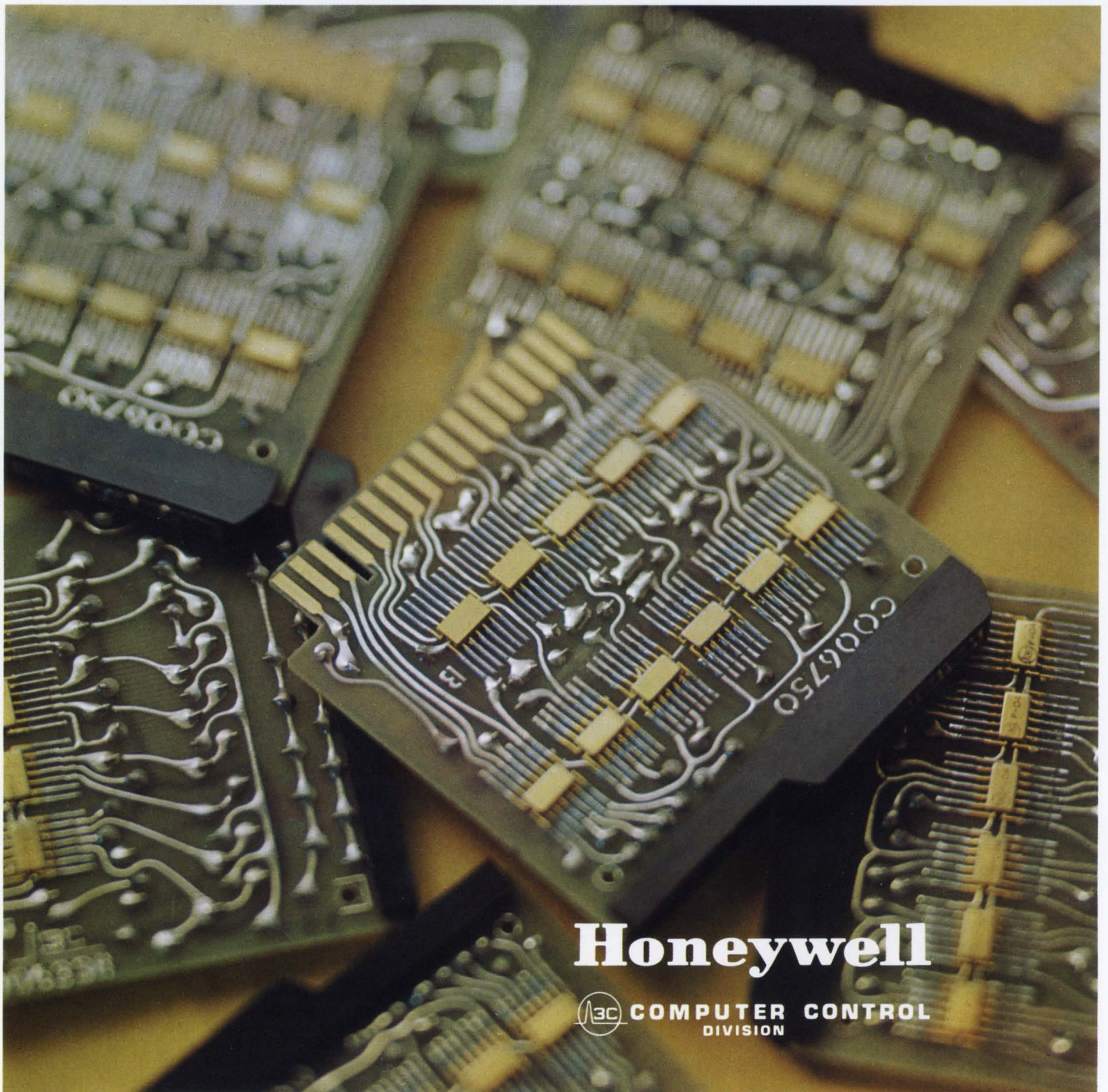

**Honeywell**

 **COMPUTER CONTROL**  
DIVISION

CIRCLE READER SERVICE NUMBER 91

# Computer display shows 3-D pictures



Computer-generated 3-D pictures are created at Brown University. Charles Strauss, the developer, views twin pictures which merge when viewed through a stereoscope.

Ingenious programing and the use of a stereoscope permit three-dimensional pictures to be viewed on the face of a conventional computer display unit.

The computer technique was developed at Brown University, Providence, R.I. Brown professors say it might eliminate the need, for instance, to build physical models of complex piping systems to eliminate interference problems.

Pairs of images, differing slightly in perspective, are displayed on the one-foot-square screen. By looking at the screen through the stereoscope, the viewer sees the two images merged into one with the added dimension of depth.

The images—geometric drawings stored in the computer's memory—can be enlarged, reduced or positioned with the display controls.

The program also permits creation and alteration of both pictures with an attached light pen.

Spatial relations are easier to see with this scheme than with the display of a single isometric drawing, the university says.

Brown mathematicians believe that time and money could be saved by presenting the data from architectural plans to the computer and then inspecting the 3-D results.

The project was executed by Charles Strauss during work for a doctorate in applied mathematics. He used an IBM 360 computer and 2250 display unit. ■ ■

# Flip To The Fets That Fit

(see next page)

... then send the special offer coupon today to one of these

FRANCHISED



MOTOROLA DISTRIBUTORS

## EASTERN

- ALABAMA, Huntsville 35805..... Gulf Semiconductors, Inc. (205) 881-7737
- 8100 Memorial Parkway, S.W.
- CONNECTICUT, Hamden 06514..... Cramer Electronics Inc. (203) 288-7771
- 60 Connolly Parkway
- D.C., Washington 20001..... Electronic Wholesalers, Inc. (202) Hudson 3-5200
- 2345 Sherman Ave., N.W.
- FLORIDA, Miami 33142..... Gulf Semiconductors, Inc. (305) 887-6541
- 7495 N.W. 48th Street
- GEORGIA, Atlanta 30318..... Jackson Electronic Supply Co., Inc. (404) 355-2223
- 1135 Chattahoochee Ave., N.W.
- MARYLAND, Baltimore 21230..... Pyttronic Industries Inc. (301) 539-6525
- 2035 Worcester St.
- MARYLAND, Baltimore 21229..... Electronic Wholesalers, Inc. (301) 646-3600
- 3200 Wilkens Ave.
- MASSACHUSETTS, Cambridge 02139..... R & D Electronics Supply Co., Inc. (617) 864-0400
- 71 Pearl St.
- MASSACHUSETTS, Newton 02164..... Cramer Electronics, Inc. (617) Woodward 9-7700
- 320 Needham St.
- NEW JERSEY, Moorestown 08057..... Angus, Inc. (609) 235-1900
- P.O. Box 126, Pleasant Valley Avenue
- NEW YORK, Binghamton 13902..... Federal Electronics, Inc. (607) 748-8211
- P.O. Box 1208
- NEW YORK, Buffalo 14202..... Summit Distributors, Inc. (716) TT 4-3450
- 916 Main St.
- NEW YORK, Flushing 11369..... Cramer/Esco (212) GR 8-4000
- 96-10 23rd Ave.
- NEW YORK, New York 10013..... Milgray Electronics, Inc. (212) YUkon 9-1600
- 160 Varick St.
- NEW YORK, Syracuse 13211..... Cramer/Eastern (315) 454-9247
- P.O. Box 8725, O'Hare International Airport
- NEW YORK, Westbury, L.I. 11591..... Schwebel Electronics (516) ED-4-7474
- NORTH CAROLINA Winston-Salem 27102..... Electronic Wholesalers Inc. (919) Park 5-8711
- 938 Burke St.
- PENNSYLVANIA, Philadelphia 19106..... Radio Electric Service Co. of Pa. (215) WA 5-6900
- 701 Arch St.
- PENNSYLVANIA, Pittsburgh 15218..... Semiconductor Specialists, Inc. (412) 351-3611
- 2011 Waverly Street

## CENTRAL

- ILLINOIS, Chicago 60680..... Allied Electronics Corp. (312) HA 1-6800 — TA 9-9100
- 100 N. Western Ave.
- ILLINOIS, Chicago 60624..... Newark Electronics Corp. (312) 638-4411
- 500 N. Pulaski Rd.
- ILLINOIS, Chicago 60666..... Semiconductor Specialists, Inc. (312) 279-1000
- P.O. Box 8725, O'Hare International Airport
- IOWA, Cedar Rapids 52406..... Deeco, Inc. (319) 365-7551
- 618 First St., N.W.
- KANSAS, Kansas City 66103..... Hall-Mark Electronics Corp. (913) AD 6-4343
- 2707 West 43rd Street
- LOUISIANA, New Orleans 70112..... Sterling Electronics, Inc. (504) 522-8726
- 537 S. Claiborne Avenue
- MICHIGAN, Detroit 48240..... Semiconductor Specialists, Inc. (313) 255-0300
- 25127 West Six Mile Road
- MICHIGAN, Detroit 48227..... Radio Specialties Co., Inc. (313) BRowway 2-4212
- 12775 Lyndon Ave.
- MINNESOTA, Minneapolis 55403..... The Lew Bonn Co. (612) 339-9461
- 1211 LaSalle Ave.
- MINNESOTA, Minneapolis 55423..... Semiconductor Specialists, Inc. (612) 866-3434
- 7742 Morgan Avenue South
- MISSOURI, St. Louis 63134..... Semiconductor Specialists, Inc. (314) JA 1-8866
- 6154 Jefferson Ave.
- OHIO, Cincinnati 45237..... Sheridan Sales Co. (513) 761-5432
- 100 Knollcrest Drive, P.O. Box 37646
- OHIO, Cleveland 44103..... Pioneer-Standard Electronics Inc. (216) 432-0010
- 5403 Prospect Ave.
- OHIO, Cleveland 44133..... Sheridan Sales Co. (216) 237-9145
- P.O. Box 8226
- OKLAHOMA, Tulsa 74115..... Hall-Mark Electronics Corp. (918) TE 5-8458
- 5708 E. Admiral Blvd.
- TEXAS, Dallas 75220..... Sterling Electronics (214) Fleetwood 7-9131
- 2642 Andjon Drive P.O. 20069
- TEXAS, El Paso 99903..... Midland Specialty Co. (915) 533-9555
- 2235 Wyoming Avenue
- TEXAS, Dallas 75231..... Hall-Mark Electronics Corp. (214) AD 1-6111
- 9100 Markville Drive
- TEXAS, Houston 77042..... Hall-Mark Electronics Corp. (713) SU 1-0011
- 8000 Westglen
- TEXAS, Houston 77001..... Lenert Co. (713) CA 5-1465
- 1420 Hutchins P.O. Box 2184

## WESTERN

- ARIZONA, Phoenix 85009..... Hamilton Electro of Phoenix 1741 No. 28th Ave. (602) 272-2601
- CALIFORNIA, Inglewood 90301..... Liberty Electronics Corp. (213) ORegon 8-8111
- 339 S. Isis Ave.
- CALIFORNIA, Los Angeles 90230..... Hamilton Electro Sales 10912 West Washington Blvd. (213) UP 0-7171
- CALIFORNIA, Los Angeles 90022..... K-Tronics (213) OV 5-5888
- 5645 E. Washington Blvd.
- CALIFORNIA, Oakland 94607..... Elmar Electronics (415) TEmplebar 4-3311
- 140 11th St.
- CALIFORNIA, Mountain View 94040..... Elmar Electronics 2288 Charleston Road (415) 961-3611
- CALIFORNIA, Mountain View 94040..... Hamilton Electro Sales-North 340 Middlefield Road (415) 961-7000
- CALIFORNIA, San Diego 92123..... Kieruff Electronics, Inc. (714) BRowning 8-2112
- 8797 Balboa Ave.
- CALIFORNIA, San Diego 92109..... San Delcor, Inc. (714) 274-3131
- 4618 Santa Fe
- COLORADO, Denver 80204..... Kieruff Electronics Co., Inc. (303) Tabor 5-7033
- 1200 Stout St.
- NEW MEXICO, Albuquerque 87108..... Kieruff Electronics Co., Inc. (505) 268-3901
- 6405 Acoma Road, S.E.
- UTAH, Salt Lake City 84110..... W. H. Bintz Company 433 West Third South (801) 363-5821
- WASHINGTON, Seattle 98121..... Hamilton Electro of the Pacific Northwest 2320 Sixth (206) ATwater 2-3836
- Mailing Address: P.O. Box 9252 / Seattle, Washington 98109

# If 1 of These 24 New Motorola FET's Doesn't Fit Your Application...

## Let Us Know!\*

(We have many others that may)

### SPECIAL \$1.00 OFFER ■ FET APPLICATIONS-SAMPLERS

- Send me the Amplifier Kit (Includes 2 MPF157-158 MOSFETs and 2 App Notes).
- Send me the Switching Kit (Includes 2 MPF159-160 MOSFETs and 2 App Notes).
- Send me the data sheets for:  20 New Amplifier/Mixer FETs  4 New Chopper/Switching FETs

NAME \_\_\_\_\_ TITLE \_\_\_\_\_

COMPANY \_\_\_\_\_ DEPT. \_\_\_\_\_

ADDRESS \_\_\_\_\_

CITY \_\_\_\_\_ STATE \_\_\_\_\_

(See preceding page for the name & address of your nearest franchised Motorola Semiconductor distributor – be sure \$1.00 is enclosed with coupon)

**SPECIAL  
OFFER!**  
Offer Expires — 10/31/67

\*Just drop us a line, on your company letterhead. Describe your application. Our Applications Engineers will tell you what FET we have that *will* fit! Send to Box 955, Phoenix, Arizona 85001.

*-where the priceless ingredient is care!*





## 20 New Motorola FETs for Amplifier and Mixer Applications

| Device Number | N.F. @ Freq. |         | G <sub>ps</sub> (dB) | C <sub>rss</sub> (pF) | Y <sub>rs</sub>   (μmhos) | Pol. | Type | Pkg.  | Price (100-up) |
|---------------|--------------|---------|----------------------|-----------------------|---------------------------|------|------|-------|----------------|
|               | (dB)         |         |                      |                       |                           |      |      |       |                |
| 2N4416        | 2.0          | 100 MHz | 18                   | 0.8                   | 7500                      | N    | JFET | TO-72 | \$3.35         |
|               | 4.0          | 400 MHz | 10                   |                       |                           |      |      |       |                |
| MFE2002       | 2.5          | 100 MHz |                      | 2.0                   | 6500                      | P    | JFET | TO-72 | 4.05           |
| MFE2001       | 2.0          | 100 MHz | 18                   | 1.0                   | 800                       | N    | JFET | TO-72 | 2.95           |
|               | 4.0          | 400 MHz | 10                   |                       |                           |      |      |       |                |
| MFE2000       | 2.0          | 100 MHz | 18                   | 1.0                   | 6000                      | N    | JFET | TO-72 | 2.65           |
|               | 4.0          | 400 MHz | 10                   |                       |                           |      |      |       |                |
| MPF157        | 4.5          | 200 MHz | 16                   | 0.2                   | 2000                      | N    | MOS  | TO-92 | .80            |
| MPF158        | 4.5          | 400 MHz | 10                   | 0.2                   | 2000                      | N    | MOS  | TO-92 | 1.00           |
| MFE4001       | 2.5          | 100 Hz  |                      | 2.0                   | 4000                      | P    | JFET | TO-72 | 7.40           |
| MFE4002       | 2.5          | 100 Hz  |                      | 2.0                   | 5000                      | P    | JFET | TO-72 | 4.30           |
| MFE4003       | 2.5          | 100 Hz  |                      | 2.0                   | 6000                      | P    | JFET | TO-72 | 5.40           |
| MFE4004       | 2.5          | 100 Hz  |                      | 2.0                   | 4000                      | P    | JFET | TO-72 | 7.90           |
| MFE4005       | 2.5          | 100 Hz  |                      | 2.0                   | 5000                      | P    | JFET | TO-72 | 4.80           |
| MFE4006       | 2.5          | 100 Hz  |                      | 2.0                   | 6000                      | P    | JFET | TO-72 | 5.90           |
| MPF151        | 2.5          | 1 KHz   |                      | 2.0                   | 4000                      | P    | JFET | TO-92 | .67            |
| MPF152        | 2.5          | 1 KHz   |                      | 2.0                   | 5000                      | P    | JFET | TO-92 | .50            |
| MPF153        | 2.5          | 1 KHz   |                      | 2.0                   | 6000                      | P    | JFET | TO-92 | .67            |
| MPF154        | 2.5          | 1 KHz   |                      | 2.0                   | 4000                      | P    | JFET | TO-92 | 1.00           |
| MPF155        | 2.5          | 1 KHz   |                      | 2.0                   | 5000                      | P    | JFET | TO-92 | .80            |
| MPF156        | 2.5          | 1 KHz   |                      | 2.0                   | 5000                      | P    | JFET | TO-92 | 1.00           |
| MFE3004       | 4.5          | 200 MHz | 16                   | 0.2                   | 2000                      | N    | MOS  | TO-72 | 4.25           |
| MFE3005       | 4.5          | 400 MHz | 10                   | 0.2                   | 2000                      | N    | MOS  | TO-72 | 4.50           |

## 4 New Motorola FETs for Chopper/Switch Applications

| Device Number | r <sub>ds(on)</sub> (ohms) | C <sub>rss</sub> (pF) | I <sub>gss</sub> (pAdc) | Pol. | Type | Pkg.  | Price (100-up) |
|---------------|----------------------------|-----------------------|-------------------------|------|------|-------|----------------|
| MFE3002       | 100                        | 1.0                   | 100                     | N    | MOS  | TO-72 | \$5.40         |
| MFE3003       | 200                        | 1.0                   | 100                     | P    | MOS  | TO-72 | 5.40           |
| MPF159        | 300                        | 1.3                   | 100                     | N    | MOS  | TO-92 | 2.75           |
| MPF160        | 600                        | 1.3                   | 100                     | P    | MOS  | TO-92 | 2.75           |

**in amplifiers:** If your primary interest is in amplifier or mixer circuit design, you'll want to order this outstanding applications-sampler. The two application notes parallel papers presented at WESCON; and, the two evaluation units, valued at \$2.00, are the MPF-157-158 MOSFETs. Send \$1 with the completed coupon from the opposite page.

*Here's How to  
Design with and/or  
Evaluate Motorola FETs*

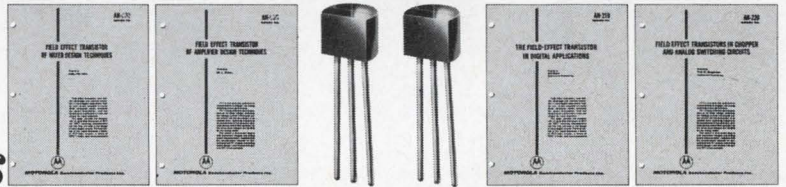

**in switching:** This comprehensive applications-sampler is designed for the engineer who is primarily interested in chopper or complementary switching circuits. The two application notes cover a wide-range of applications ideas; and, the two evaluation units are the exciting new MPF159 and MPF160 complementary MOSFETs, valued at \$6.00. This package is also available for \$1, with the coupon from the opposite page.

**MOTOROLA** Semiconductor Products Inc.

P. O. BOX 955 / PHOENIX, ARIZONA 85001

ON READER-SERVICE CARD CIRCLE 22

# GaAs laser hits 150-W peaks without cracking

**Troughed construction minimizes surface damage; 100-W units on 1-mm die survive 40-hour life tests**

Using a single gallium arsenide die, a British engineer has succeeded in developing a semiconductor laser that radiates 150-watt peak pulses and 1-watt mean output level when operated at 77°K (the temperature of liquid nitrogen). Moreover, he says he has overcome the problem of surface damage.

C. D. Dobson of Standard Telecommunication Laboratories, Ltd., Harlow, England, says that his selection of a novel troughed-junction geometry permits him to work with dice that measure 1 mm square—colossal in comparison with the typical 4-mil-by-5-mil chips assembled into arrays in the United States.

High-power semiconductor lasers are known to have been destroyed because arsenic vaporized from the output surfaces of the optical lenses, leaving a highly reflective gallium-rich surface. This occurs because absorption of radiation by inhomogeneities in the crystal results in local surface heating. Once initiated, surface damage proceeds in runaway fashion until the output face collapses. Microphotographs reveal furrows and globules that suggest the surface of the moon.

With a troughed-junction construction, damage to the front face can be avoided, Dobson says. The device has a diffuse junction which becomes rapidly shallower near the polished output surface. Thus the laser radiation, generated slightly to the p-side of the junction, exits from the low-absorption n-side.

The feedback from the front face of a troughed laser is said to be lower than that of normal lasers. Diffraction spreading in the region between the junction and the cleave reduces the total radiation reflected back into the junction. Dobson says that this construction successfully avoids surface damage and permits peak powers of 150 watts from 1-mm-square dice for 5  $\mu$ s.

Daniel J. Horowitz, a physicist at the Night Vision Laboratory, Fort Belvoir, Va., heard Dobson read a

paper in March at the Conference on Laser Engineering and Applications held in Washington, D. C. Horowitz commented that the power outputs claimed by Dobson were at least on a par with the best results reported in the United States. To the best of his knowledge, no one had ever done this with a single die.

The crucial question concerns deterioration—the laser may last for only a few pulses—and on this Dobson was not specific. “When you operate at low powers, gallium arsenide lasers last almost indefinitely,” Horowitz pointed out. “But when you try for high power, there is massive scattering. The crystal cracks and the surface deteriorates. The laser may even continue to lase, but at much lower efficiencies.”

In a subsequent letter to *ELECTRONIC DESIGN*, Dobson wrote:

“The lasers were tested with 5- $\mu$ s pulses at 100-Hz repetition frequency. Output powers were increased until the device was destroyed. This generally occurred between 100 and 155 watts output. The power was increased in steps and run at each level for about 15 minutes. No life tests at these power levels have been carried out by us. “However,” he said, life tests of production lasers by Standard Telecommunication Laboratories gave following results:

■ “Fifty-watt lasers have been operated at 250-mW mean power levels for over 200 hours without deterioration; 90- and 100-watt devices have been life-tested for the

standard test period of 40 hours at 1.5 kHz (5- $\mu$ s pulse length).

■ “The 90- and 100-watt devices were lasers which occurred in the normal production spread and so far no special efforts have been made to test selected devices.

“Most were capable of 1 watt mean and were run for approximately 8-hour periods. The pulse length used in these experiments was 20  $\mu$ s with the laser producing 50 watts. A number of the more efficient devices were capable of 1.5 watts mean.”

Gallium arsenide lasers are used in such military applications as:

- Secure communications.
- Missile tracking beacons.
- Invisible beams that when broken by an intruder set off an alarm.
- Illumination of battlefields so that it is possible to observe the action with special infrared viewers at night. If the enemy doesn't have these viewers, he sees nothing.

■ Nighttime aerial photography.

Horowitz remarked that it is not necessary to have ideal lasers for these applications, since the laser is used mainly as an intense source of infrared light.

Dobson mentioned some difficulties:

“Gallium arsenide has not really been capable of producing very high average or peak powers. Therefore you assemble an array of sources and connect them optically in parallel as a source of infrared light. The poor directionality and coherence are unimportant. You can use an optical system with lenses to focus it down into a beam—an infrared searchlight. Or, you could have a more diffuse infrared floodlight.”

He explained why most scientists were not attempting to get very high power out of a single gallium arsenide laser, as Dobson had done.

“Usually, to get very good efficiency, you make the laser very tiny, about 4 by 5 mils. Then you don't have to put in much current before the device starts to lase. This is important, because current put in below the laser threshold doesn't contribute to lasing.” ■ ■

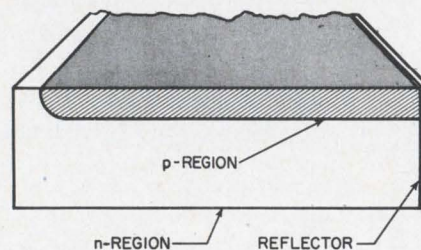

**Troughed laser avoids surface damage by causing beam to exit from low-absorption n-region.**

# you get a choice,

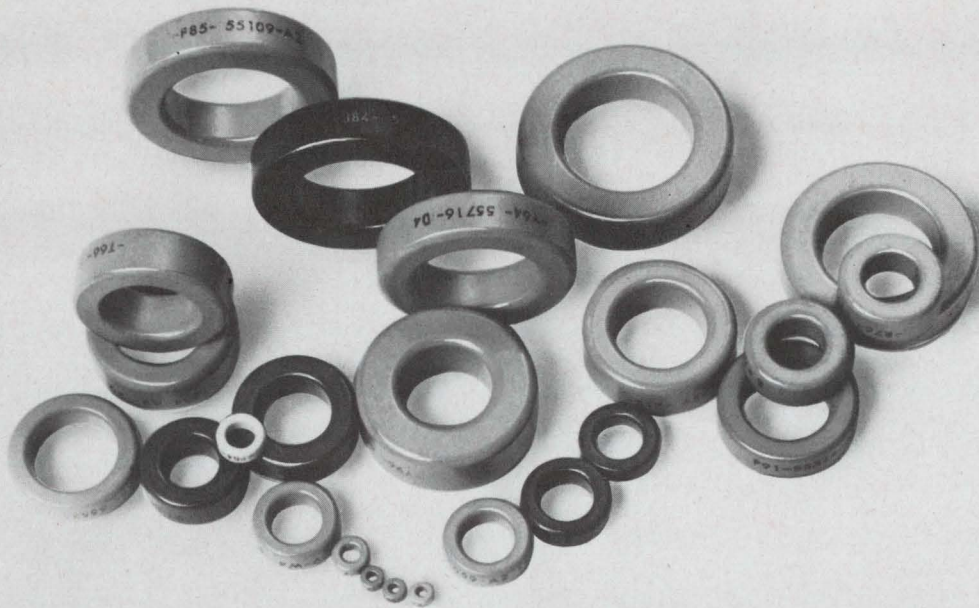

# not a challenge

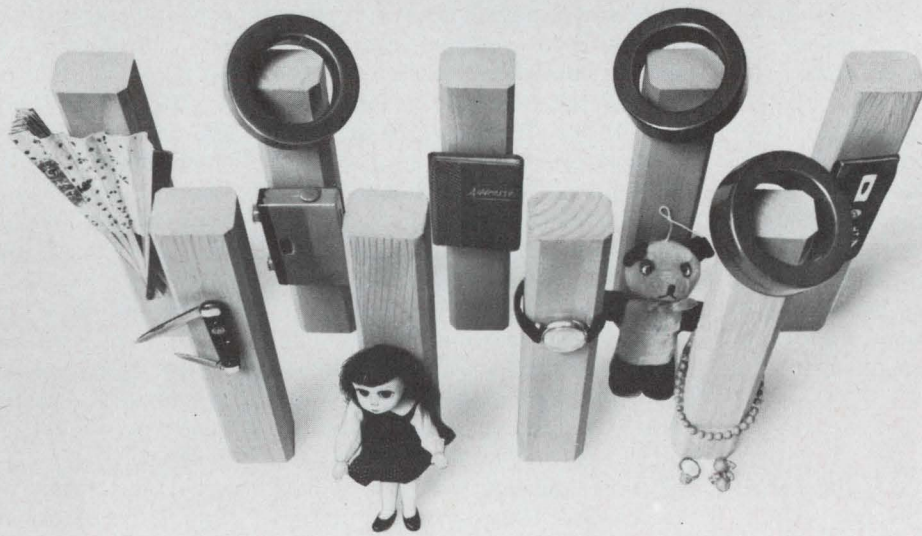

## Industry's widest selection of powder cores gives you greater design flexibility

The trend toward smaller circuits and higher density packaging has posed a compaction problem for electrical design engineers—finding quality components small enough to do the job. Magnetics gives the designer more “elbow room” by providing the industry's most complete line of moly-permalloy powder cores—sizes as small

as 0.110" I.D. in the widest range of permeabilities and stabilizations.

We also give the designer involved with highly critical inductor stability factors more latitude with guaranteed temperature stabilization in miniature powder cores. All of these types are designed so they can be wound on present miniature toroidal winding equipment. The “M” type limits the change in inductance to  $\pm 0.25\%$  from  $-65$  to  $+125^\circ\text{C}$ . The “D” type limits the

change to  $\pm 0.1\%$  from 0 to  $55^\circ\text{C}$ . The “W” type limits the change to  $\pm 0.25\%$  from  $-55$  to  $+85^\circ\text{C}$ . These stabilizations are available in all sizes and permeabilities.

If condensing a circuit design is your bugaboo, check Magnetics' powder core line—the one that gives you a choice, not a challenge. For the complete story, write Magnetics Inc., Butler, Pa. 16001

**MAGNETICS inc.**  
®

# Process flashes color on monochrome TV

Unannounced transmissions over a local Los Angeles television station recently brought telephone calls and letters from viewers saying they were seeing colors flashing on their black-and-white television sets.

What they actually saw was a process called Electronic Color. The process simulates color by a principle of vision that causes a person to perceive color even when there is no color actually present in the scene. The process requires no attachments to the TV set.

The developer of the process, James Butterfield of the Color-Tel Corp. in Los Angeles, and his associates approximated the primary (red, green and blue) color codes that the eye normally generates. By properly pulsing white light, they were able to make the brain perceive the original color of the scene, even though the eye in fact saw only pulses of white light.

In color perception, Butterfield explained, the eye sends pulses of electrical energy to the brain. These pulses vary according to the color in the scene and the brain perceives color by detecting these pulse changes. The theory is not new but had never before been applied in this manner to television, he said.

## Three color filters used

A scene viewed by a TV camera is analyzed into its primary colors

by a device called a Color Translator attached to the front of the camera. The translator is a rotating disk containing six frames: three opaque frames and three frames each containing a primary color filter. The three filters are cyan (blue-green), magenta (reddish-purple) and yellow.

To produce red on a black-and-white receiver, the red object is transmitted in black during the first TV frame, followed by two consecutive frames that are all white. Blue is perceived by transmitting two completely white frames, followed by one frame in which the blue object is transmitted in black. Green can be perceived by transmitting a white frame, followed by one in which the image appears in black, then an all-white frame and finally an all-black frame.

These code sequences are generated by rotating the filter disk in front of the television camera (see illustration). To cause the letter R to appear in red on a monochrome TV, the first filter (cyan) is placed in front of the camera lens. The cyan filter blocks the red from entering the camera, so that the letter appears in black on the screen.

When the rotation of the disk places the magenta and yellow filters in front of the camera lens during the next two successive frames, the red color in the scene will pass through. Since a monochrome TV camera cannot detect

colors, only the absence or presence of light, the red color is displayed in white during these two successive frames. So, the code required for generating red—a black image followed by two successive frames in white—is produced.

Other colors are simulated by mixing various combinations of the primary colors.

## No threat to color TV

The three opaque frames are needed because the simulated color is not perceived well when the coding sequence immediately repeats itself. An electric motor synchronized with the vertical sweep of the television camera rotates the disk. According to Butterfield, the disk speed could be as low as 3 revolutions per second and as high as 20 rps, but 5 rps seems to work the best.

"Because of this slow revolution, the color seems to flash on and off when viewed. This tends to limit the process to special effects and would pose no threat to regular color television," Butterfield said. Moreover, the color does not appear as bright as a regular colorcast. When a colorcast is viewed on a color set, the transmitted colors tend to add to the regular color to produce a deeper color than would normally be seen.

So far the new process has been used only in television commercials to flash a product in color, in one area of the screen. The process can be coded on video tape and even photographed on black-and-white film.

Battelle Development Corp., of Columbus, Ohio, holds the patent rights to the process and has authorized Color-Tel Corp. to employ the process in making television commercials. So far it is being used by one soft-drink company to advertise its products. A spokesman for Battelle said the company is investigating other applications, such as computer readout systems, sonar displays, tactical display consoles, and even traffic lights. ■ ■

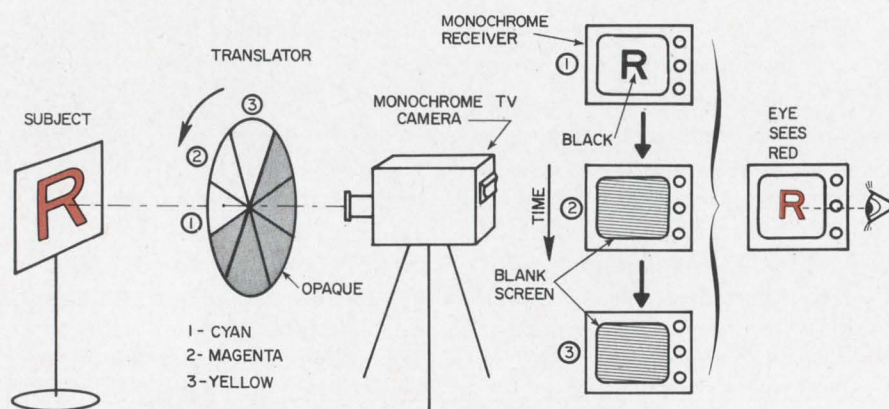

Television perceives color on his black-and-white receiver by means of the optical effect produced when a rotating Color Translator filter disk is placed in front of the lens of a regular monochrome TV camera.

- 7 STANDARD single, dual, and triple units, including units with concentric shaft and vernier operation.

---

- 16 STANDARD resistance values from 50 ohms to 5 meg.

---

- 2 STANDARD tolerances 10% and 20%.

---

- 5 STANDARD resistance tapers.

---

- 18 STANDARD electrical tap options.

---

- 46 STANDARD shaft lengths from 3/8" to 6.0".

---

- 3 STANDARD shaft endings.

---

- 9 STANDARD variations of bushings.

---

- 4 STANDARD locating lug options.

---

- 4 STANDARD switch options with single and double pole.

# Allen-Bradley offers a 1,000,001 standard variations of Type J Potentiometers

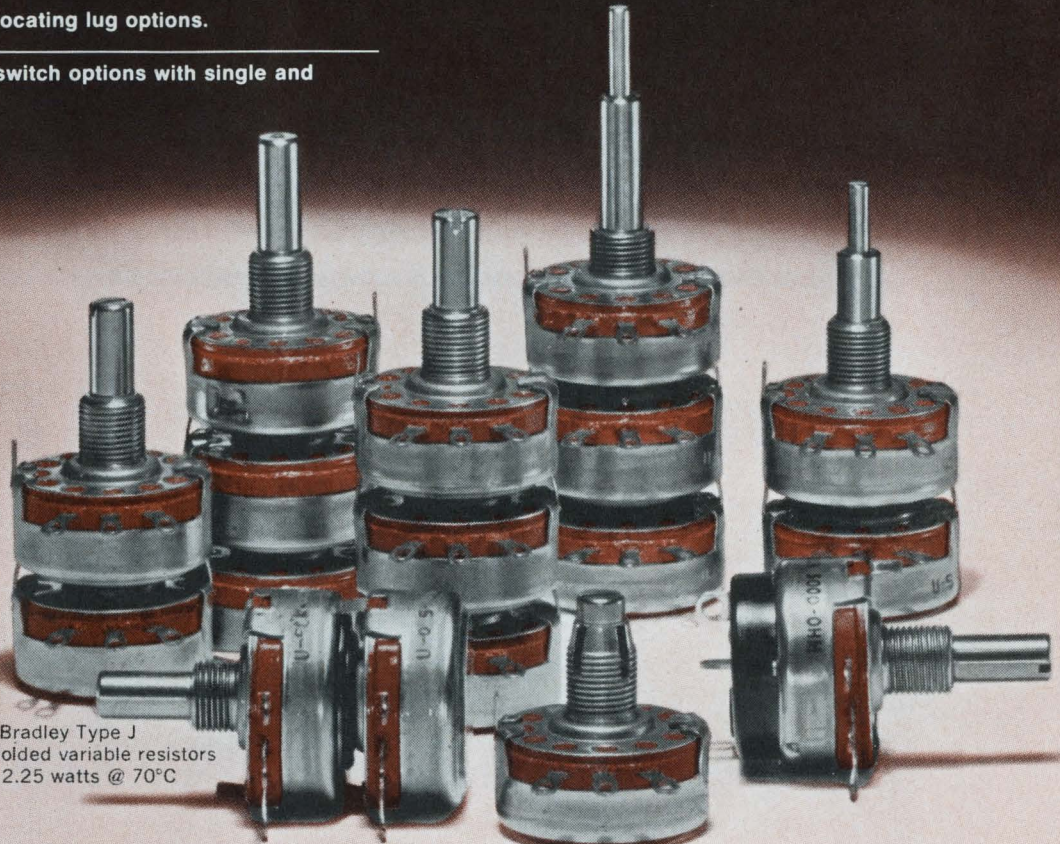

Allen-Bradley Type J hot molded variable resistors rated 2.25 watts @ 70°C

These *standard* variations in the Allen-Bradley Type J hot molded potentiometer line eliminate the need for a "special" control. When you include the numerous special resistance values and tapers in which the Type J can be supplied, the variations become virtually infinite.

Yet, all of these Type J variable resistors have one thing in common—each and every one is made by the same A-B hot molding process—your guarantee of "tops" in quality. The solid hot molded resistance track assures extremely long life—exceeding well beyond 100,000 complete operations on accelerated tests with less than 10% resistance change. Control is always smooth and free from the sudden turn-to-turn resistance changes of wire-

wound units. And being essentially noninductive, Type J controls can be used at the higher frequencies—where wire-wound units are totally impractical.

Let Allen-Bradley Type J variable resistors be the answer to your special requirements—it's almost certain there's a "standard" unit in the Type J line. And you *know* you're obtaining the ultimate in reliability and performance. For more complete information on Allen-Bradley Type J potentiometers, please write for Technical Bulletin 5200: Allen-Bradley Co., 1315 S. First St., Milwaukee, Wis. 53204. In Canada: Allen-Bradley Canada Limited. Export Office: 630 Third Ave., New York, N.Y., U.S.A. 10017.



**ALLEN - BRADLEY**  
QUALITY ELECTRONIC COMPONENTS

367-1AB

ON READER-SERVICE CARD CIRCLE 24

**General Instrument announces  
another MTOS breakthrough**

**compatible**

---

**now you can use MTOS  
with bipolar voltages...  
without  
input-output interfaces**

For all information relating to MTOS in Europe, write to: General Instrument Europe, Via Turati 28, Milano, Italy.

# MTOS/5\*

---

You can take advantage now of the lower cost, greater packaging densities and lower power consumption inherent in MTOS technology side by side with TTL or DTL systems in your existing equipments for such functions as: memory and storage, logic, decoding, counting, format conversion, multiplexing and A/D-D/A conversion.

\*Compatible MTOS/5 is a unique General Instrument development that provides MTOS circuits designed to interface directly with low level bipolar devices and circuitry operating at 5 volts. Already available in the new compatible MTOS/5 form are the just-announced 32-bit Random Access Memory Cell (MEM 5132) and the familiar 20-bit D.C. Serial Shift Register (MEM 3020).

Write for full information.



GENERAL INSTRUMENT CORPORATION • 600 WEST JOHN STREET, HICKSVILLE, L. I., NEW YORK

ON READER-SERVICE CARD CIRCLE 25

# U.S. studies costly 'suicides' among lasers

## Air Force survey concludes that self-destructive heat buildup is a threat to high-power progress

High-power pulsed lasers are showing an alarming tendency to destroy themselves and their component parts. This self-destructive behavior, reported in an Air Force survey, is not only costly but is posing a serious threat to wider applications for high-power lasers.

Nicks and fractures in laser oscillator rods, mirrors, prisms and lenses were analyzed in the survey by Carl Pitha, a research physicist in the Solid-State Sciences Laboratory at the Air Force Cambridge Research Laboratories, Bedford, Mass. He found that a heat buildup within the laser's oscillator rod apparently caused the self-destructive damage. In some cases the damaged lasers exploded, and in others the efficiency dropped.

The physicist's findings were based on a survey of current international literature in high-power laser research. He determined correlations between self-inflicted damage and the characteristics of the materials.

"All high-power laser systems are still essentially experiments,"

he said. "At the present time it is not possible to predict useful laser life; it may be hundreds of hours or just a few minutes."

A powerful laser, according to the physicist, is one that can produce power of at least  $10^7$  W/cm<sup>2</sup> on a remote target.

Pitha found from his survey that no laboratories were carrying out comprehensive studies of laser damage and that the mechanisms of damage were not understood by scientists. Further, he found that there were no foolproof passive tests that could be conducted on laser oscillator rod materials that would predict their performance and life.

Even after purchasing high-quality laser components and examining them closely to be sure they are free of visible defects, one still must take his chances, the researcher stated.

Of the hundreds of reports on laser research, Pitha selected 57 published in the last three years that gave descriptions and possible causes for damage to laser compo-

nents when operated under high-power conditions.

The physicist wanted to know more about how energy accumulates in all laser components, to the point where it becomes destructive, but he was most concerned with the vulnerable oscillator elements—usually ruby or neodymium-doped glass. The growth, processing and composition of these costly elements (up to \$9000 each) is critical to all further high-power applications.

Damage to oscillator rods was classed as either internal or superficial and was related to the lasing conditions. Three primary mechanisms were suggested in the literature to account for energy buildup sufficient to touch off self-destruction:

- Self-focusing.
- Stimulated Brillouin scattering.
- Multiphoton absorption.

These were believed to result in microplasm generation, which could produce both the internal and the superficial damage.

The damage to laser rods was often dramatic: the energy buildup was so great in some cases that the ends of the rods fractured and dropped off. In other cases nicks and fractures appeared at the ends or bubbles developed along the central axis. Internal hot spots created by the mechanisms appeared to be to blame.

Pitha said that some rods that appeared perfect in all respects had failed after a few minutes of use, while others with slight visible defects had lased effectively for hundreds of hours, but perhaps at decreased efficiency.

### Internal 'lens' effect noted

One of the destructive causes, Pitha concluded, may be self-focusing cause of nonuniform refractive index within the rod. This "lens" effect may focus light energy into a small region, where it traps the laser beam. The intense energy concen-

*(continued on p. 46)*

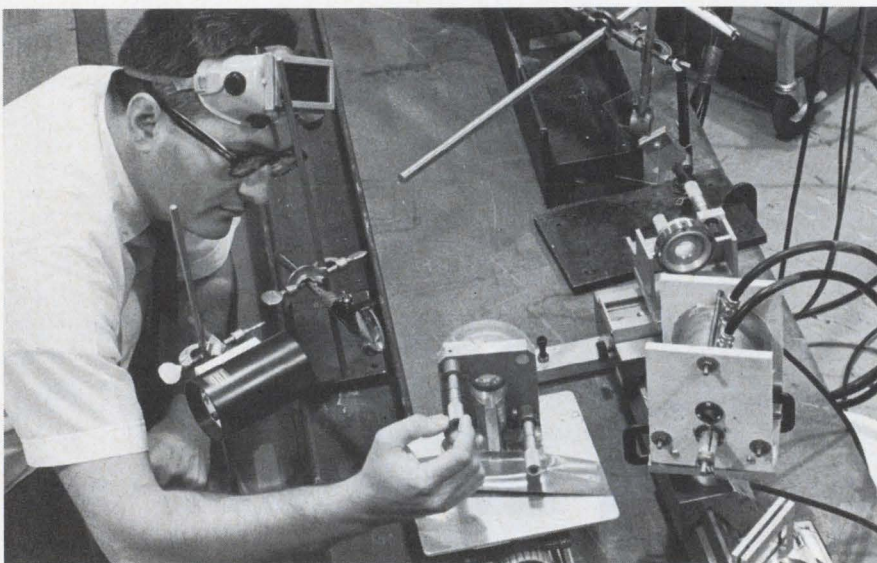

**Self-destruction of laser components** could impair development of high-power systems. The Air Force is investigating theories to explain the costly damage.





**Frequency synthesizers custom made... at off-the-shelf prices**

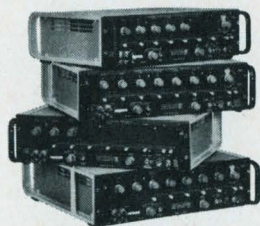

Think you need a frequency synthesizer? A note of caution . . . it can be expensive. You can end up buying a lot more synthesizer than you really need or can use. Why not select one that's essentially custom built to your requirements?

With the GR series of 1160 Frequency Synthesizers you can do just that . . . your choice is not limited by a lack of variety. Start with any of four basic models; dc to 100 kHz, dc to 1 MHz, 30 to 12 MHz, or 10 kHz to 70 MHz. Next, select the amount of resolution you need; you can start with as few as three decades of resolution and add more later as your requirements expand, to give you up to nine significant figures. Need programmability? You can have that too, in up to 1-MHz steps. How about sweep and search func-

tions? Choose it if you need it. There are over 80 different combinations to select from, and the price of your "custom-built" synthesizer can be as low as \$3640.

For complete information or a demonstration, write General Radio Company, W. Concord, Massachusetts 01781; telephone (617) 369-4400.

**GENERAL RADIO**

**What did the president of National Semiconductor say to Ken Moyle upon learning that he had come up with a dual-50 shift register with the lowest operating voltage and the highest speed in the entire world?**

# “That’s nice. Where’s the dual-100?”

Everybody thought it would be impossible to take our dual-25 and double the capacity, yet extend the size by only one quarter, and still keep the specs intact. Everybody that is except Ken Moyle.

We’ve dubbed it the MM402.

It needs only 10 volt VDD and 16 volt clock pulse amplitude. This is 11 volts better than anything but our MM400, the dual-25 we introduced last month. It works at 1MHz at temperatures up to 125°C. And power dissipation is 1.0 mw/bit which is ideal for both ground instruments and airborne computers.

Each one goes for \$40 in 100 lots. You can pick up a lot at any of our distributors.

They’re stacking them on shelves right now.

Write or call National Semiconductor Corporation,  
2950 San Ysidro Way, Santa Clara, California  
95051. (408) 245-4320.

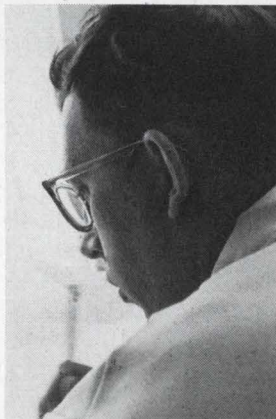

Ken Moyle, *Manager-Can't  
Leave Well Enough Alone Dept.*

## National Semiconductor

ON READER-SERVICE CARD CIRCLE 29

(Laser 'suicides', *continued*)

tration may lead to catastrophic fracturing or deformities.

Pitha says that lasing action is not uniform, even at high-power levels, and filaments of high energy tend to form axially in the rods.

Stimulated Brillouin scattering was cited as possible cause of destruction, although Pitha admits that there is little experimental evidence to support this cause in solids. Scientists are not overlooking the possibility that internally excited acoustic and optical waves can couple in such a manner that destructive forces build up within the crystal or glass structures.

Multiphoton absorption is seen as a cause of degeneration of rubies, but it is not known if it causes catastrophic failure. It refers to a process in which the electronic structure of the ruby is altered by overstimulation from the flash-tube pumping radiation.

A ruby rod is a sapphire ( $\text{Al}_2\text{O}_3$ ) host lattice, doped with active chromium ( $\text{Cr}^{+3}$ ) ions. Under high, intense light stimulation, the chromium ions tend to change valence to  $\text{Cr}^{+4}$ , leaving free electrons in the lattice. Under the influence of the laser beam, they

could cause self-destruction of the rods. Rubies that are subjected to intense illumination over long period change from a red to an orange hue as a result of this action.

Possibly related to the three primary mechanisms for energy accumulation—to the extent that damage results—is the secondary mechanism called microplasma generation. This plasma, according to Pitha, is a local, ionized pocket within the solid. One or more of the primary mechanisms could create the heat necessary to cause the ionization. The ionized region is thought to absorb the laser beam so efficiently that the resulting superheating causes gross damage.

Pitha's research report is entitled *Laser Damage: A Selected Literature Survey*, and it is identified as AFCRL-67-0137.

A program is now under way in the Solid-State Sciences Laboratory to improve the techniques for forming laser materials. Pitha and other Air Force scientists would like to know more about factors involved in failure of lasing materials.

Ruby oscillator rods are important in Air Force special weapons projects because of their ability to produce the most powerful laser beams. As higher power applications are sought, the problem of predicting useful life will become more critical, Pitha says. ■ ■



## The old master has met its match.

For more than twelve years, our 250 DA Universal Impedance Bridge ruled supreme in its field. No instrument could match its measurement performance.

Now along comes a serious challenger—our new 250 DE (at right). It has all of the reliability and accuracy of the classic model. As you can see, they look alike from the outside.

But inside, we've made many improvements. The new 250 DE is completely self reliant on its four flashlight batteries. It has a new solid-state detector with greatly improved sensitivities: better than 20 microvolts on DC, 10 microvolts on AC. For simplicity, there is a single meter null detector on the front panel. And for versatility, some useful front terminals have been added.

Why did we improve on the old master when it has delighted so many thousands with its performance in countless plants, laboratories and schools? Well, we figured eventually somebody would make a truly portable impedance bridge even better than the 250 DA. And we wanted it to be us. ESI, 13900 NW Science Park Drive, Portland, Ore. (97229).

### 250 DE Portable Universal Impedance Bridge Specifications

#### Range:

Resistance: 0 to 12 Megohms  
 Capacitance: 0 to 1200 Microfarads  
 Inductance: 0 to 1200 Henrys  
 Resistance: 0.1% + 1 dial division  
 Capacitance: 0.2% + 1 dial division  
 Inductance (Series and Parallel):  
 0.3% + 1 dial division  
 Sensitivity: Better than 20 microvolts  
 DC, 10 microvolts AC  
 Frequency: 1 kc internal  
 (External terminals provided.)  
 Batteries: 4 D size flashlight batteries  
 provide 6 months of normal service.  
 Weight: 12 lbs. Price: \$475.00

Note: The 250 DA features exactly the same accuracy specifications as the 250 DE. However, the 250 DA is AC line-operated. Price: \$550.00

Electro Scientific Industries **esi**®

ON READER-SERVICE CARD CIRCLE 30

## Japanese device corrects color blindness

Japanese scientists have reported the correction of color blindness by means of an electronically controlled headset that transmits an electric current to the color-blind person. The subject, who wears the headset on his temples for 20 minutes a day while reading or watching television, is said to learn to recognize colors after a three- to six-month training period.

The device that stimulates color discernment is called the Sunvister and was designed by Dr. Susumu Imamura of Kansai University. Dr. Makota Seki, who has conducted extensive clinical tests, reported that 77 and 42.5 Hz appear to be the most effective frequencies for stimulating a subject's sensitivity to red, green and blue, the primary colors. Apparently the brain perceives the color. ■ ■



Electric current stimulates sensitivity to color in color-blind subject. Headset is controlled by solid-state circuits.

ON READER-SERVICE CARD CIRCLE 31 ➤

# Only new Lambda LP Series lab power supplies provide all these big system features in a small, low-cost package.

## Starting at only \$114.

- High power output—up to 28 watts.
- Wide voltage range versatility—0-10 VDC up to 0-250 VDC.
- Bench or rack use—without adapters.
- Unusually wide automatic current limiting—from 1% (or 5 MA) to 105% of rated output current.
- Two meters for voltage and current.
- Both coarse and fine adjustment of voltage and current.
- Over-temperature protection by thermal relay—prevents overheating.
- Convection cooled—no blower failures.

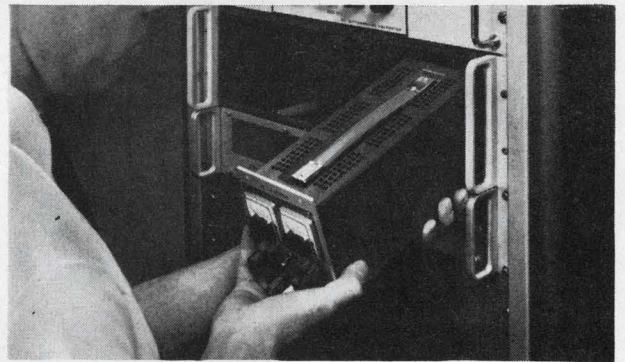

You can mount up to 4 units in a standard LRA-1 or LRA-2 rack adapter.

### Other features

- Regulation (line or load): .01% + 1 MV.
- Ripple: 500  $\mu$ V RMS, 1.5 MV p-p
- Temperature coefficient: .015% + .5 MV/°C.
- CV/CC with automatic crossover.
- A-C input: 105-132 VAC 45-440 Hz (ratings based on 57-63 Hz operation).
- All Lambda power supplies are guaranteed for 5 years.

### Select from six models

| Model  | Voltage Range         | MAX. CURRENT AT AMBIENT OF: |       |       |       | Price <sup>1</sup> |
|--------|-----------------------|-----------------------------|-------|-------|-------|--------------------|
|        |                       | 30°C                        | 40°C  | 50°C  | 60°C  |                    |
| LP 410 | 0-10 VDC <sup>o</sup> | 2A                          | 1.8A  | 1.6A  | 1.4A  | \$129              |
| LP 411 | 0-20 VDC <sup>o</sup> | 1.2A                        | 1.1A  | 1.0A  | 0.8A  | 119                |
| LP 412 | 0-40 VDC <sup>o</sup> | 0.70A                       | 0.65A | 0.60A | 0.50A | 114                |
| LP 413 | 0-60 VDC <sup>o</sup> | 0.45A                       | 0.41A | 0.37A | 0.33A | 129                |
| LP 414 | 0-120 VDC             | 0.20A                       | 0.18A | 0.16A | 0.12A | 149                |
| LP 415 | 0-250 VDC             | 80MA                        | 72MA  | 65MA  | 60MA  | 164                |

<sup>o</sup>Overvoltage Protection available as an accessory—\$40.00 each.

<sup>1</sup>Prices are for non-metered models. For metered models, add suffix (FM) and add \$10.00 to price.

 **LAMBDA**  
ELECTRONICS CORP.  
515 BROADHOLLOW ROAD • MELVILLE, L.I., NEW YORK 11746 • (516) 694-4200  
A  SUBSIDIARY

VEECO HIGH VACUUM EQUIPMENT/LAMBDA POWER SUPPLIES

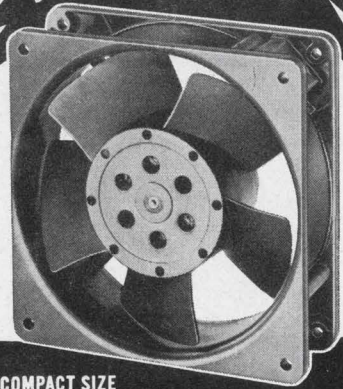

Compare the  
All-New PAMOTOR  
Model 4500 with  
the miniature  
axial fan  
you're now using!

**COMPACT SIZE**

Only 4<sup>11</sup>/<sub>16</sub>" x 4<sup>11</sup>/<sub>16</sub>" x 1<sup>1</sup>/<sub>2</sub>". Weighs just 1<sup>1</sup>/<sub>4</sub> lbs. Interchangeable with similar, less reliable 4<sup>11</sup>/<sub>16</sub>" fans.

**POWERFUL MOTOR**

Dependable shaded-pole motor operates with low internal heat rise. Efficient inside-out design.

**ALL-METAL CONSTRUCTION**

Precision die cast housing, hub, impellers. Corrosion resistant. Natural heat sink. Warp-free, unlike conventional plastic fans.

**115 CFM WITH LESS  
THAN 37.5 dB SIL\***

\*Speech Interference Level

- Lubrication-free life in excess of 20,000 operational hours, continuous duty at 55° C.
- Delivers more air at a lower noise level, yet priced under similar conventional plastic fans.
- Model 4500 designed for 117V/50-60 Hz operation. Model 4550 operates at 230V/50-60 Hz.
- Immediate delivery through distributors or from factory stock.
- Has Underwriters' Laboratories Inc. Yellow Card Component Recognition Number E41168.

**ONLY  
\$855  
EACH**  
in lots  
of 100

PAMOTOR, INC., 312 Seventh St.  
San Francisco, California 94103.

**PAMOTOR, INC.**

2P-7104R1

ON READER-SERVICE CARD CIRCLE 32

## Army chooses radar altimeter for copters

The Army has found that existing radar altimeter circuits will meet its requirements for helicopters that hedge-hop over such ground cover as dense vegetation and snow.

Researchers at the Electronics Command, Fort Monmouth, N. J., found that two important characteristics in the altimeters will permit helicopter pilots to determine height precisely. The altimeter should transmit extremely short (nanosecond) pulses, and its receivers should find altitude by measuring the transit time from the leading edges of these pulses.

A spokesman at the Avionics Laboratory in Fort Monmouth explained that the altimeter for guiding a helicopter as it skims treetops or snowy ridges must determine its height accurately above this cover rather than over the terrain below it. Many altimeters studied by the

Army transmitted pulses that penetrated the ground cover and gave the pilot misleading information about his actual height above the obstructions.

An Army team flew hundreds of hours, testing the radar altimeter circuits over Panamanian jungles and polar regions.

The altimeter characteristics that were found suitable included a transmitter frequency of 4.3 GHz and a repetition rate of greater than 30,000 pulses per second. A special rangefinder, able to give readings accurate to a few feet, was used by the Army research team to verify the altimeter readings.

The team believes that its readings were more consistently accurate than any previously obtained over tricky terrain. However, it noted that they were not quite the 98 per cent accuracy obtained over concrete runways. ■ ■



Radar altimeters for Army helicopters must tell the pilot his altitude over the top of dense ground cover.

# TTL Trends

## from Texas Instruments

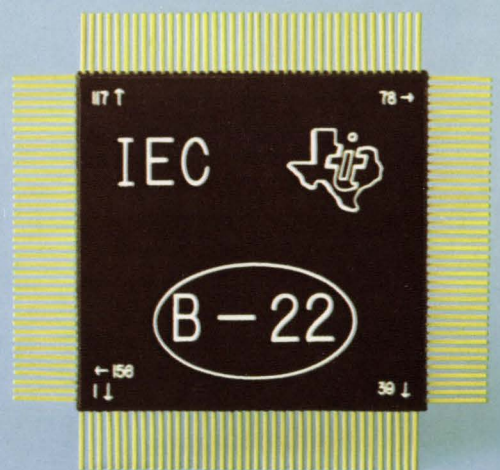
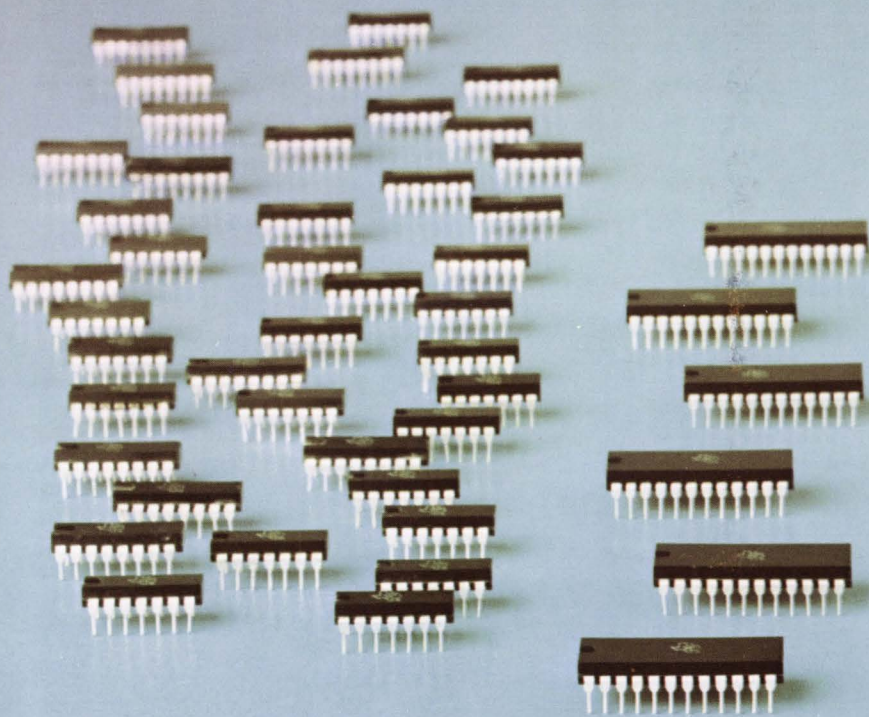

Today's Series 54/74 ICs point the way to the next dramatic step in solid state... MSI and LSI integrated equipment components.

Although vastly advanced in circuit complexity, this next generation of semiconductor devices will have much in common with today's Series 54/74 circuits (shown

at left above), including utilization of the same basic TTL logic building blocks. In this and other ways, IECs will be natural extensions of today's Series 54/74 family of 39 functions and 180 device types.

By far industry's most complete logic line, Series 54/74 has been consistently expanded since the in-

roduction of a few basic devices in 1964. The new high-speed and low-power circuits shown on the following pages are further additions to this growing family.

This provides you with new design opportunities now... and it also assures you a better interface with the TTL trends of the future.

# New TTL additions to industry's most complete logic family

Industry's broadest family of TTL integrated circuits is now more complete than ever. To help you simplify designs, improve performance and reduce overall costs, we have added new circuits to our Series 54H/74H and 54L/74L lines.

## New Series 54H/74H high-speed circuits feature 6 nsec propagation delay

New additions bring the number of circuits in this line to the 18 shown on page C.

Series 54H/74H circuits offer the highest speed available in saturated logic today...six nanoseconds per gate.

This means that, by using 54H/74H in the critical logic paths of your digital systems, you can achieve advanced levels of performance with minimum design complexity.

The circuits may also be combined with standard speed and low-power TTL circuits in a single

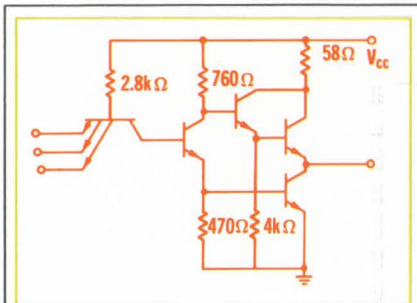

| Typical Characteristics | Gate            | Flip Flop |
|-------------------------|-----------------|-----------|
| Propagation delay       | 6 nsec          | 17 nsec   |
| Power dissipation       | 22 mW           | 80 mW     |
| Noise immunity          | 1 V             | 1 V       |
| Temperature range       |                 |           |
| Series 54H              | -55°C to +125°C |           |
| Series 74H              | 0°C to 70°C     |           |

system . . . giving fast response while keeping overall system power consumption low.

Check number 100 on the attached TI information service card for comprehensive data sheet.

## New Series 54L/74L low-power circuits feature 1 mW per gate power drain

Six new additions bring the number of circuits in this line to the ten shown on page D.

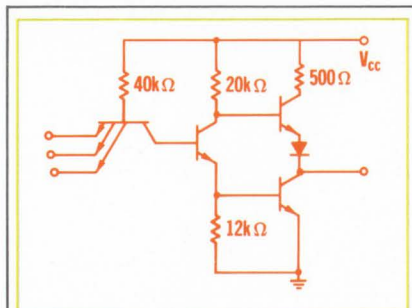

| Typical Characteristics | Gate            | Flip Flop |
|-------------------------|-----------------|-----------|
| Propagation delay       | 33 nsec         | 47 nsec   |
| Power dissipation       | 1 mW            | 3.8 mW    |
| Noise immunity          | 1 V             | 1 V       |
| Temperature range       |                 |           |
| Series 54L              | -55°C to +125°C |           |
| Series 74L              | 0°C to 70°C     |           |

At 1mW per gate, Series 54L/74L circuits offer a ten-fold power savings...yet are approximately twice as fast as other circuits with similar power dissipation.

This line is specifically designed for space systems, avionic systems and other applications where power consumption and heat dissipation are critical.

Check number 101 on the attached TI information service card for comprehensive data sheet.

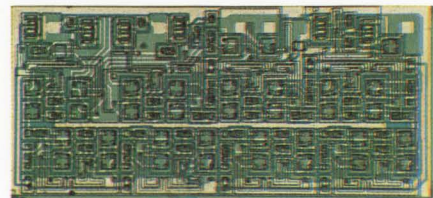

## Complex-function ICs help you reduce costs

You cut costs two ways when you use Series 54/74 complex-function integrated circuits in your designs. Overall savings in excess of 50 percent are often possible!

First, you pay less per circuit function! Since a major portion of all IC manufacturing costs are in the package assembly, fewer packages mean reduced costs to you.

Second, fewer packages also help you realize big savings at your plant...in inspection, handling, assembly, and inventory costs.

You also simplify designs because TI has already done a lot of the design work...and you improve reliability because more circuits per package mean fewer soldered joints and plug-in connectors.

## Series 54/74 family is industry's most complete

Your new system can perform better and cost less when you employ Series 54/74 ICs, since you have the broadest choice of speed, power dissipation and cost-per-function available. Now you can tailor the characteristics you desire into your system...to a degree never before possible.

Any way you look at it, today's best buy in digital integrated circuits is Series 54/74 from TI.



# “Tougher than military”



Recently-completed reliability tests, such as the one for temperature-cycling shown here, have proved the ruggedness and durability of TI's plastic dual-in-line package for integrated circuits. Now you can take advantage of reduced initial costs—plus big savings in handling, assembly and testing—*without compromising essential reliability.*

Many of the tests in TI's plastic package reliability program far exceeded the requirements of applicable military specifications (such as MIL-STD-750A and 202C). For example, evaluations were made for shock to 5500 G, constant acceleration to 100,000 G, temperature cycling from  $-65^{\circ}$  to  $+250^{\circ}\text{C}$  and flammability to  $+1100^{\circ}\text{F}$ . Units were exposed to salt, moisture and detergent bombs. They were vibrated at 60 G over a 100 to 2000 Hz range. They were subjected to solder-heat tests at  $350^{\circ}\text{C}$ . They were also life-tested for a total of 479,000 successful device-hours. Check No. 104 on the Service Card for the complete report.

What does this mean to you? It means that whether your application calls for Series 74 (industrial temperature range) or Series 54 (full-military temperature range) you can now specify, *with complete confidence*, the plastic “N” package for our entire family of TTL standard and high-speed circuits. TTL performance, reliability and convenience are now yours...at a new low cost.



**TEXAS INSTRUMENTS**  
INCORPORATED

# High-speed TTL

**SN74H00N**

Quadruple 2-input NAND gate

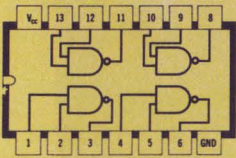

**SN74H10N**

Triple 3-input NAND gate

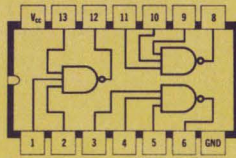

**SN74H11N**

Triple 3-input AND gate

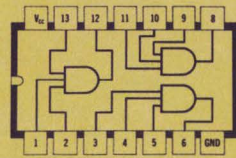

**SN74H20N**

Dual 4-input NAND gate

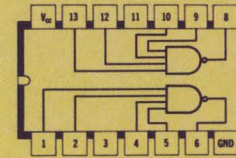

**SN74H21N**

Dual 4-input AND gate

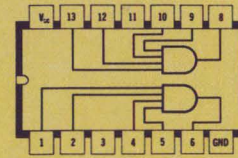

**SN74H30N**

8-input NAND gate

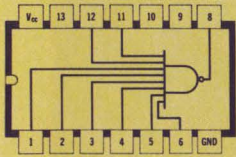

**SN74H40N**

Dual 4-input NAND buffer

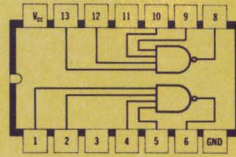

**SN74H50N**

Expandable dual 2-wide 2 input AND-OR-INVERT gate

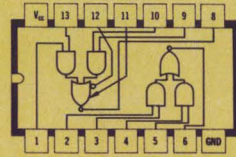

**SN74H51N**

Dual 2-wide 2-input AND-OR-INVERT gate

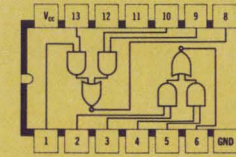

**SN74H52N**

Expandable 4-wide 2-2-2-3-input AND-OR gate

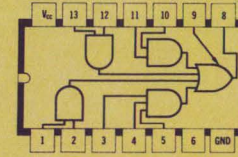

**SN74H53N**

Expandable 4-wide 2-2-2-3-input AND-OR-INVERT gate

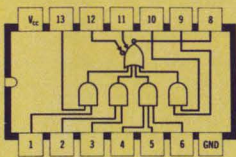

**SN74H54N**

4-wide 2-2-2-3-input AND-OR-INVERT gate

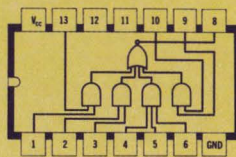

**SN74H55N**

Expandable 2-wide 4-input AND-OR-INVERT gate

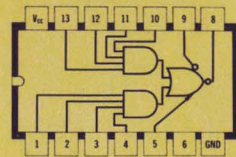

**SN74H60N**

Dual 4-input expander

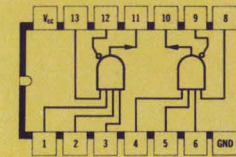

**SN74H61N**

Triple 3-input expander

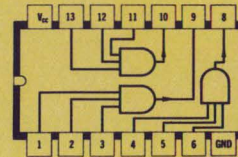

**SN74H62N**

4-wide 3-2-2-3-input AND-OR expander

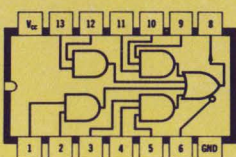

**SN74H71N**

J-K flip-flop with AND-OR inputs

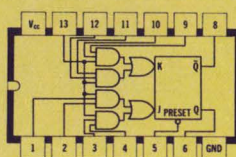

**SN74H72N**

J-K master-slave flip-flop

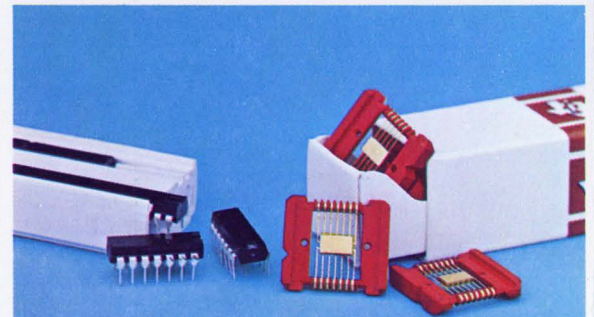
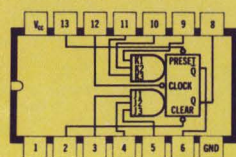

Series 54H/74H offered in both dual-in-line and flat packages

# 3 new bulletins just off the press



**TTL integrated circuits.** This 48-page brochure contains catalog information on all 180 Series 54/74 circuits . . . plus never-before-published design and performance data on all three lines and 39 circuit functions of industry's most complete logic family. Check number 102 below for your copy.

**Total Reliability at TI...**The behind-the-scenes story of TI's approach to integrated circuit reliability. Twenty-three color photographs—plus charts and graphs—in this 16-page brochure show the unparalleled facilities and organization behind TI's exceptional reliability record. Check number 103 below for your copy.

**Monitor.** This 84-page report provides results of TI's "Tougher-than-military" testing program for plastic IC packages. Data is presented on more than 539,000 device-hours of exhaustive testing... many exceeding the requirements of military specifications. Check number 104 below for your copy.

*Please send the following information*

100  101  102  103  104

NAME \_\_\_\_\_

TITLE \_\_\_\_\_

COMPANY \_\_\_\_\_

ADDRESS \_\_\_\_\_

CITY \_\_\_\_\_ STATE \_\_\_\_\_ ZIP \_\_\_\_\_

 **TI  
Airmail  
Information  
Service**

To get the literature you want, check the appropriate numbers, fill out the card, and drop it in the mail. If you prefer, circle the same numbers on the magazine Reader Service card.

# Low-power TTL

**SN54L00R/SN74L00R**  
Quadruple 2-input NAND gate

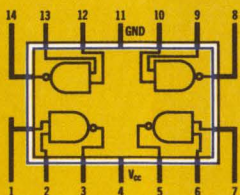

**SN54L10R/SN74L10R**  
Triple 3-input NAND gate

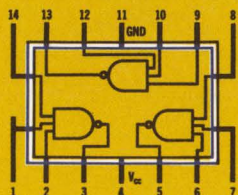

**SN54L20R/SN74L20R**  
Dual 4-input NAND gate

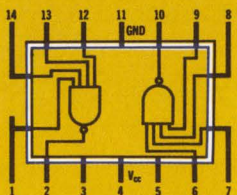

**SN54L30R/SN74L30R**  
8-input NAND gate

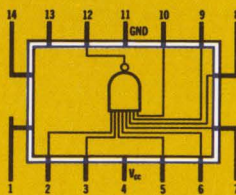

**SN54L51R/SN74L51R**  
Dual 2-wide 2-input/2-wide 3-input AND-OR-INVERT gate

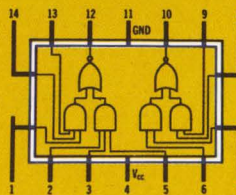

**SN54L54R/SN74L54R**  
2-2-3-3 Input AND-OR-INVERT gate

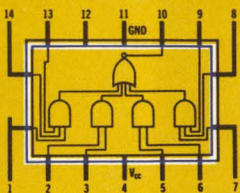

**SN54L55R/SN74L55R**  
2-wide 4-input AND-OR-INVERT gate

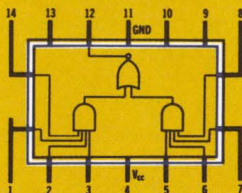

**SN54L71R/SN74L71R**  
R-S master-slave flip-flop

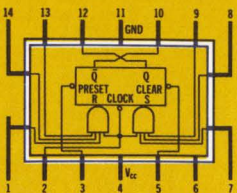

**SN54L72R/SN74L72R**  
J-K master-slave flip-flop

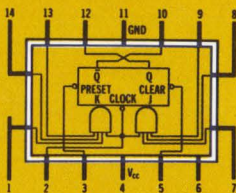

**SN54L73R/SN74L73R**  
Dual J-K master-slave flip-flop

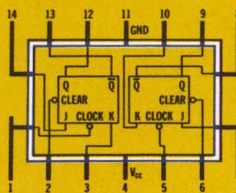

For fast service on TI literature, fill out this card and drop it in the mail.

**AIR MAIL**

First Class  
Permit No. 7284  
Dallas, Texas

**BUSINESS REPLY MAIL**

NO POSTAGE STAMP NECESSARY IF MAILED IN THE UNITED STATES

Postage Will Be Paid By

**TEXAS INSTRUMENTS INCORPORATED**  
P. O. Box 5474  
Dallas, Texas 75222

Attention: Bob Crane  
Mail Station 407

# Pours like a pitcher. Flows like a faucet.



**(Looks like a jug)**

Meet the new Mallinckrodt "No-Glug Jug." It now comes to you as standard safety equipment with our Hydrofluoric Acid TransistAR® and Ammonium Fluoride TransistAR.

This ten-pound, siphon-action jug makes pouring much safer, because it puts you in complete control of the pour. Tilt it, and you get an even, steady stream—free of spurts and gurgles. No splashing

or overshooting. Great for close-quarters pouring under the hood or into small containers. The big "pitcher" handle makes it easy to pour a little or a lot. And the "No-Glug Jug" empties three times faster than ordinary, old-fashioned gurglers.

More semiconductor devices have been processed with Mallinckrodt TransistAR chemicals than any other kind. So why be bugged by jugs that glug?

**Mallinckrodt**

**MALLINCKRODT CHEMICAL WORKS • ST. LOUIS • NEW YORK • LOS ANGELES**

ON READER-SERVICE CARD CIRCLE 33

Throw  
away  
your  
old '67  
Burr-Brown  
Catalog.  
It's 1967½!



## NEW OPERATIONAL AMPLIFIERS

Model 3049/15—SMALLEST CHOPPER STABILIZED UNIT. Only 1.80" x 1.20" x .60". Maximum voltage drift:  $1 \mu\text{V}/^\circ\text{C}$ . Maximum current drift:  $.002 \text{ nA}/^\circ\text{C}$ . 500 kHz full power response. 160 dB gain. \$165.00

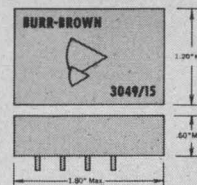

Model 3038/25 — HIGH COMMON MODE VOLTAGE, HIGH SUPPLY REJECTION LOW CURRENT OFFSET. Rated output: 100 V at 20 mA, minimum. 100 V common mode limit. Operates from any power supply voltage from  $\pm 40 \text{ V}$  to  $\pm 135 \text{ V}$  with output voltage 20 volts less than supply. Input impedance  $10^{11} \text{ ohm}$ . Input current offset:  $0.1 \text{ nA}$ . In a 2.40" x 1.80" x .60" package. \$175.00

Model 3071/25 — LOW FLICKER NOISE ( $6 \mu\text{V}$  peak to peak), FAST OVERLOAD RECOVERY (less than  $1 \mu\text{sec}$ ). Voltage drift less than  $0.5 \mu\text{V}/^\circ\text{C}$  max. Current drift  $0.001 \text{ nA}/^\circ\text{C}$  max. From  $-25^\circ\text{C}$  to  $+85^\circ\text{C}$ . \$175.00

Model 3044/15 — HIGH SUPPLY REJECTION ( $2 \mu\text{V}$  per Volt and  $0.5 \text{ nA}$  per Volt) VARIABLE POWER SUPPLY ( $\pm 6$  to  $\pm 32 \text{ V}$ ) Output Voltage = supply voltage minus 4 Volts. Output current:  $\pm 10 \text{ mA}$ . \$75.00

Model 3063/40 — HIGH OUTPUT CURRENT ( $\frac{1}{2}$  Amp) — HIGH SUPPLY REJECTION ( $2 \mu\text{V}$  per Volt and  $0.2 \text{ nA}$  per Volt). Ideal for servo applications. Completely encapsulated in 2" x 2" x 1" package. No external heat sinks required. Operating temperature range:  $-40^\circ\text{C}$  to  $+85^\circ\text{C}$ . \$135.00

## NEW QUARTER SQUARE MULTIPLIER

Model 4012/25 — Fully encapsulated in 2.40" x 1.80" x .60" package. Accuracy:  $\pm 0.15\%$ , 3 db response is 1 mHz. Rated output: 10 Volts at 10 mA. Will operate in multiply, divide, square, and square-root modes. Requires no external amplifiers. \$695.00

## NEW SAMPLE AND HOLD MODULE

Model 4013/25 — Fully encapsulated in 2.40" x 1.80" x .60" package. Accuracy:  $\pm 0.1\%$ . Aperture time: 50 nsec. Acquisition time as low as  $1 \mu\text{sec}$ . Frequency response: 500 kHz. \$225.00

## NEW 20-PAGE FALL CATALOG

These and many other important new product developments are included in the new Burr-Brown 20-page fall 1967 catalog. It's available from your Burr-Brown Representative . . . or, use this publication's reader service card.

**BURR-BROWN**  
RESEARCH CORPORATION

International Airport Industrial Park • Tucson, Arizona 85706  
TELEPHONE: 602-294-1431 • TWX: 910-952-1111 • CABLE: BBRCORP



Operational Amplifiers  
Instrumentation Amplifiers  
Function Modules  
Analog Simulators  
Geophysical Instruments

ENGINEERING REPRESENTATIVES: ALABAMA, HUNTSVILLE (205) 534-1648 / ALASKA, ANCHORAGE (907) 272-5231 / ARIZONA, PHOENIX (602) 254-6085 / CALIF., LOS ANGELES (213) 665-5181, SAN FRANCISCO (408) 245-3321 / COLO., DENVER (303) 388-4391 / CONN., ENFIELD (203) 749-7888 / D.C., WASHINGTON (SEE MARYLAND) / FLORIDA, ORLANDO (305) 425-2764 / ILLINOIS, CHICAGO (312) 286-6824 / LA., NEW ORLEANS (504) 888-2266 / MD., SILVER SPRING (301) 588-8134 / MASS., BOSTON (617) 245-4870 / MICH., DETROIT (313) 353-3822 / MINN., MINNEAPOLIS (612) 781-1611 / MO., ST. LOUIS (314) 524-4800 / N.C., GREENSBORO (919) 273-1918 / N.J., CAMDEN (215) 925-8711 / N.M., ALBUQUERQUE (505) 255-1638 / N.Y.,

ALBANY (518) 436-9649, BINGHAMTON (607) 723-9661, MT. VERNON (914) 968-2200, NEW HARTFORD (315) 732-3775, ROCHESTER (716) 473-2115 / OHIO, CINCINNATI (513) 761-5432, CLEVELAND (216) 237-9145, DAYTON (513) 277-8911 / OKLA., TULSA (918) 835-2481 / OREGON, PORTLAND (503) 292-8762 / PENN., PHILADELPHIA (SEE CAMDEN, N.J.), PITTSBURGH (412) 243-6655 / TEXAS, DALLAS (214) 363-1671, HOUSTON (713) 928-5251 / UTAH, SALT LAKE CITY (801) 466-3709 / VIRGINIA, (SEE MARYLAND) / WASH., SEATTLE (206) 767-4260 / CANADA, TORONTO (416) 293-7011

ON READER-SERVICE CARD CIRCLE 106 FOR AMPLIFIERS AND 107 FOR MODULES

# TUNG-SOL 28 GP SERIES POWER SUPPLIES

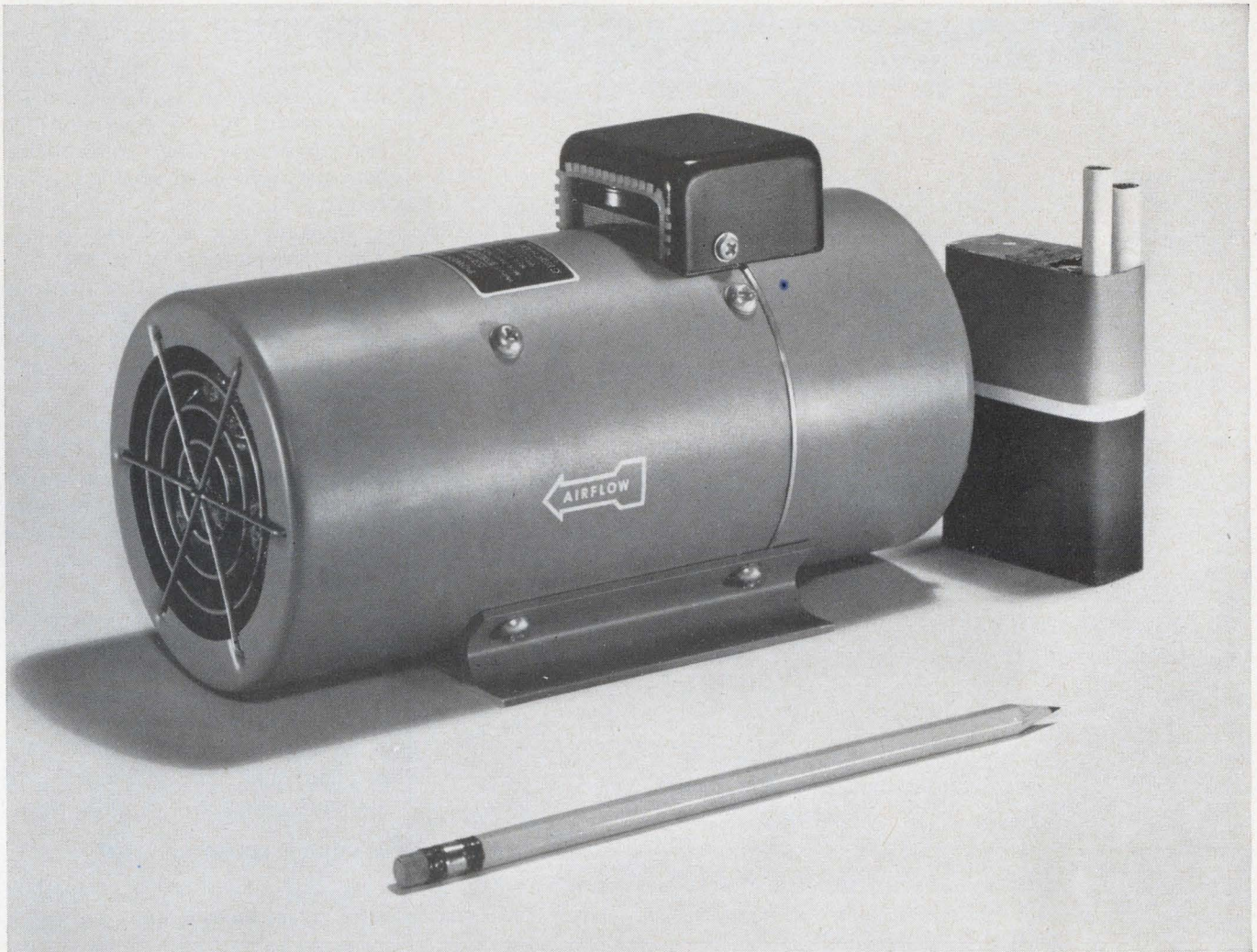

## up to 400 AMPS. D.C. in new weight-saving package

A tremendous break-through was achieved in space and weight reduction of air-borne power supplies when the Tung-Sol Y-series configuration was first developed. Now, this unique design has been adapted to the requirements of ground-based equipment, to provide the same advantages for applications in the 100 amp. to 400 amp. range.

The Tung-Sol 28 GP series consists of four standard units that supply 100, 200, 300 or 400 amps. at 28 volts D.C. from an input of 115 volts, three phase, 400 c.p.s. They are production items available on an off-the-shelf basis. All units embody high-performance characteristics. They have high environmental adaptability and are especially suited to seaborne installations. Important, also, is the fact that they can be mounted in any attitude. For air transportable equipment, the weight factor is an exceptional advantage.

|  |  |
|--|--|
| <p><b>28 GP 100</b></p> <p>Output: 100 Amps.<br/>Size: 8½" L x 4" W x 5½" H<br/>Weight: 7.5 lbs.</p> | <p><b>28 GP 300</b></p> <p>Output: 300 Amps.<br/>Size: 10½" L x 6" W x 7½" H<br/>Weight: 19 lbs.</p> |
| <p><b>28 GP 200</b></p> <p>Output: 200 Amps.<br/>Size: 10½" L x 5" W x 6¾" H<br/>Weight: 13 lbs.</p> | <p><b>28 GP 400</b></p> <p>Output: 400 Amps.<br/>Size: 13" L x 6" W x 7½" H<br/>Weight: 26 lbs.</p>  |

For full technical information write for Bulletin.

**TUNG-SOL DIVISION**  
**Wagner Electric Corporation**

630 West Mt. Pleasant Ave. • Livingston, N.J. 07039

ON READER-SERVICE CARD CIRCLE 34

# Moonstruck

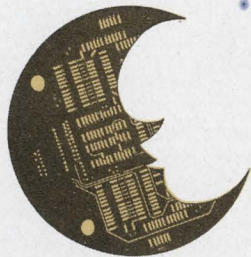

Each of the Ranger spacecraft which bit the lunar dust utilized ultra-precise multilayer circuitry by Cinch-Graphik. To meet the exacting demands of NASA, Military, or *your own* special requirements, there are no more reliable circuits on earth... or the moon. Write for a sample section of our lunar type circuitry.

## CINCH-GRAFIK

D I V I S I O N   O F   U N I T E D - C A R R



200 South Turnbull Canyon Road, City of Industry (Los Angeles), Calif. 91744 • Phone (213) ED 3-1201. Sales offices in 33 principal cities throughout the United States, Great Britain, Canada, Australia and West Germany.

MEMBER  
THE CINCH ELECTRONICS FIRM GROUP  
CONSISTING OF CINCH MANUFACTURING COMPANY, CINCH-GRAFIK, CINCH-MONADNOCK, CINCH-NULINE, UCINITE (ELECTRONICS) AND PLAXIAL CABLE DEPT.

ON READER-SERVICE CARD CIRCLE 35

## Air Force conducts fm-digital 'contest'

The Air Force is comparing digital troposcatter equipment with conventional fm, to determine the best technique for transmitting data at high speed and low error rates.

Engineers at the Rome, N. Y., Air Development Center are conducting a five-month test program aimed at developing future systems for command and control transmission of video information and similar high-speed data.

Two test links have been established in New York State. Transmission equipment has been set up so that it is directed to a transmitter-receiver 200 miles away and to a receiver along the same path 100 miles away.

The data are being transmitted along the two links simultaneously, with use of both frequency-time code modulation and fm. The digital equipment for the tests was built by Martin Marietta's Orlando, Fla., division. The fm equipment is a standard AN/MRC-98 radio set.

### Multiple frequencies used

Martin says its equipment transmits pulses sequentially on multiple frequencies to obtain fourth-order diversity gain. It uses time division multiplex and pulse code modulation to provide 24-channel operation.

Most troposcatter systems use fm with frequency division multiplexing for information processing, Martin Marietta engineers say. But they add that even with vast improvements, the digital data and error rates would not be adequate for the future needs of the Air Force and the Defense Communications Agency.

The Martin Marietta equipment is said to minimize fading by sending signals separated in frequency over a wide band, but it uses only a single antenna, transmitter and receiver at each terminal. Conventional equipment calls for multiple antennas, receivers and transmitters, to minimize signal loss during the rapid fading caused by multipath propagation. ■ ■

ON READER-SERVICE CARD CIRCLE 36 ➤



With the capacitor  
you take for granted  
take out your  
entire system?

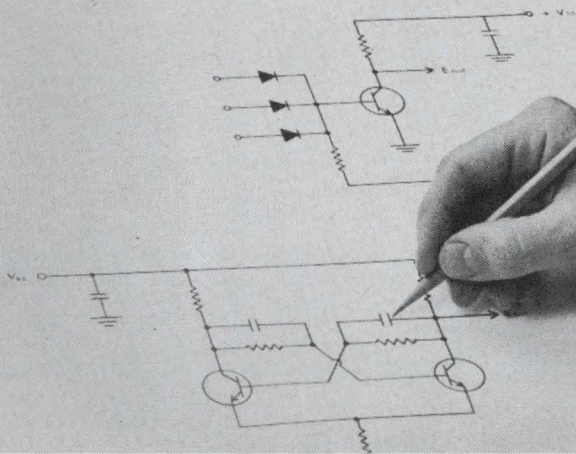

## Specify CORNING® Capacitors for confidence.

Considering the finality of capacitor failure, anything less than the reliability of glass is false economy.

Protect all the critical design work you put into your active circuits.

Back them up with the documented reliability of glass dielectric capacitance in the vital roles of coupling, bypass, filtering.

Corning offers this confidence in a full range of types, sizes, values and costs.



CORNING® CYFR Capacitors, from .5 to 10,000  $\mu\text{f}$ , substantially exceed the requirements of Mil-C-11272, including environmental performance and Quality/Reliability Assurance, and are backed by a heritage that includes use in Surveyor, Minuteman, Gemini, among others.



CORNING® CYFM Capacitors offer low cost, high reliability, from .5 to 10,000  $\mu\text{f}$ . Give you CYFR-type environment-proof performance at substantial savings.

CGW  
TYO7  
7531

CORNING® TYO Capacitors from 1 to 2700  $\mu\text{f}$ , radial leads, precision case for snug, upright mounting. Dense circuitry without doubts. Meet or exceed all performance requirements of Mil-C-11272.

CGW  
GLK

CORNING® Glass-K Capacitors cram from 1000 to 100,000  $\mu\text{f}$  in a quarter-inch case size with a new dielectric material for guaranteed reliability.

In all types, standard items are shipped in two weeks or less. Tell us what you want in capacitance; we'll tell you which CORNING® Capacitor will give you the confidence you need.

For complete specs, write to:  
Corning Glass Works,  
Electronic Products Division,  
3909 Electronics Drive, Raleigh, N.C.

**CORNING**  
ELECTRONICS

# State of the design art

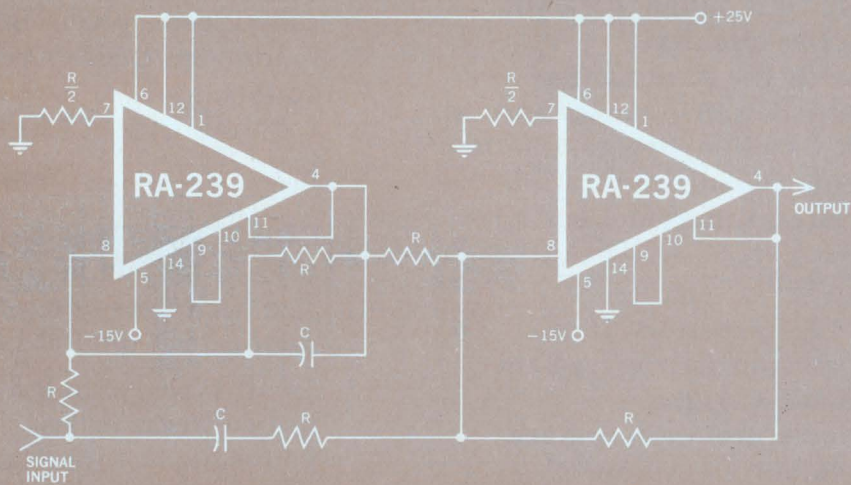

## Now...simplify design of phase-delay filters with Radiation's IC Amplifiers

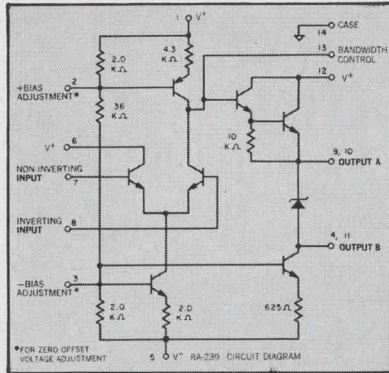

Radiation Operational Amplifiers offer a new dimension in the design of monolithic phase-delay filters. They simplify design, provide unconditional stability without external compensation, and allow accurate determination of phase shift. Only Radiation IC Amplifiers offer the characteristics needed for such an application.

For example, Radiation's RA-239 Broadband Amplifiers are used in the all-pass phase-delay filter shown at left.

Feed-back components are selected to determine the 90° phase-shift frequency, without regard to the active elements in this configuration.

The transfer characteristic is:

$$\frac{E_{out}}{E_{in}} = \frac{1-jx}{1+jx}, \text{ where: } x = \frac{f}{f_0}$$

90° phase-shift frequency is:

$$f_0 = \frac{1}{2\pi RC}$$

X is the normalized frequency ratio referenced to the 90° phase-shift frequency.

For  $f_0 \leq 1$  MHz, output voltage is 21.6 V<sub>P-P</sub>.

A new line of universal building blocks for integrated analog circuitry is now available to design engineers. Radiation supplies three different types of IC operational amplifiers to serve your individual requirements: general-purpose, broadband, and high-gain amplifiers.

These amplifiers provide outstanding performance. Parasitics are eliminated, thanks to our unique dielectric isolation technique. Tighter tolerances and improved temperature coefficients are achieved through use of precision thin-film resistors over the oxide.

Thus, Radiation's technology simplifies system designs which were hampered by limitations imposed by conventional integrated circuit

fabrication techniques.

Only Radiation can provide production quantities of inherently stable IC operational amplifiers.

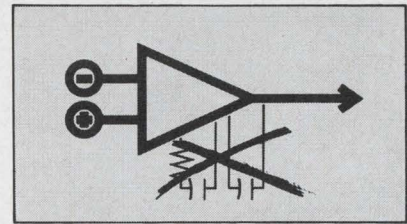

These circuits are stocked for immediate shipment in TO-84 flat packages.

Write or phone for our data sheets, which include *worst-case limits* as well as all information required by design engineers. We'll also be glad to supply our new manual, Operational Amplifier Technical Information and Applications. For your copy, write on your company letterhead to our Melbourne, Florida office.

### Radiation IC Operational Amplifiers\*

| Typical characteristics<br>(T <sub>A</sub> = +25°C) | GENERAL PURPOSE | BROADBAND | HIGH GAIN | UNIT             |
|---|-----------------|-----------|-----------|------------------|
|   | RA-238          | RA-239    | RA-240    |                  |
| Phase margin  | 60              | 60        | 45        | Degrees          |
| Bandwidth (unity gain)                              | 7               | 15        | 6         | MHz              |
| Slew rate   | 3.2             | 23        | 3.2       | V/μs             |
| Voltage gain  | 2,700           | 2,700     | 33,000    |                  |
| Offset voltage                                      | 2.0             | 2.0       | 2.0       | mV               |
| Offset current                                      | 80              | 400       | 80        | nA               |
| Thermal drift                                       | ±5<br>±1        | ±5<br>±5  | ±5<br>±1  | μV/°C<br>nA/°C   |
| Undistorted output swing                            | 21              | 21        | 9(11.6)†  | V <sub>P-P</sub> |
| Power dissipation                                   | 90              | 160       | 90        | mW               |
| Common mode rejection                               | 100             | 100       | 100       | dB               |
| Power supply rejection                              | 100             | 100       | 100       | dB               |
| Input bias current                                  | 0.4             | 1.0       | 0.4       | μA               |

\*Standard temperature range: -55°C to +125°C. V<sup>+</sup> = +25V; V<sup>-</sup> = -15V.  
†V<sup>+</sup> = +20V; V<sup>-</sup> = -20V.

All Radiation integrated circuits are dielectrically isolated.

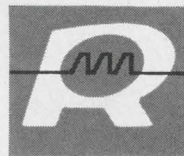

**RADIATION  
INCORPORATED**  
MICROELECTRONICS DIVISION

Sales offices: Suite 622, 650 North Sepulveda Blvd., El Segundo, Calif. (213) 772-6371—P.O. Box 738, Islington, Mass. (617) 762-3470  
Suite 232, 600 Old Country Road, Garden City, N. Y. (516) 747-3730—Suite 704, 2600 Virginia Ave., N.W., Washington, D.C. (202) 337-4914  
P.O. Box 37, Melbourne, Fla. (305) 723-1511, ext. 554

ON READER-SERVICE CARD CIRCLE 37

# LOOKING FOR RELAYS?

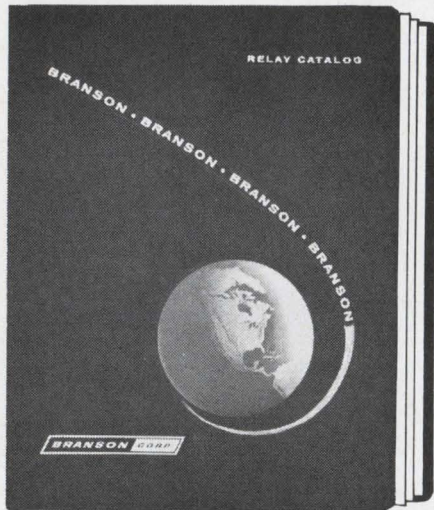

**THIS NEW DESIGNERS CATALOG BY BRANSON INCLUDES:**

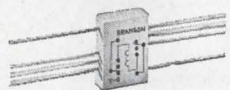

- TO-87 Flat Pack Relay



- 1/6 Size Relays  
2 & 4 pole •  
2 pole latching

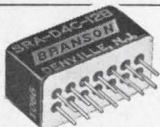

- 1/2 Crystal Can Relays  
2 & 4 pole •  
2 pole latching



- Solid State Time Delay Relays

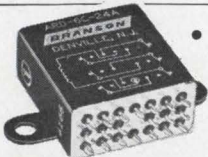

- Crystal Can Relays  
2, 4 & 6 pole

The Branson relay manual is complete with design data, application data, photos, type numbers, environmental, mechanical & electrical specifications.

**Relays...  
Our Only Business**

Write for your FREE Copy Now . . .

**BRANSON CORP.**

VANDERHOOF AVENUE  
DENVER, NEW JERSEY  
(201) 625-0600

ON READER-SERVICE CARD CIRCLE 38

# Letters

## Astable multi has 20% fewer parts

Sir:

I wish to point out a drafting error in the circuit I submitted with my Idea for Design, "Astable multivibrator has timing interval as long as one cycle per 6.7 minutes," ED 11, May 24, 1967, p. 110. *C2* should be connected to the junction of *R8* and *C3*, and the junction of *R8* and *B1* of *Q4* should be connected to the anode of the SCR.

I have since improved the circuit and reduced the component count. *Q3*, *R5*, *R6*, *R8* and *C2* have been eliminated from the original circuit, and *CR1* (1N4148) has been added. The operation of the circuit (see below) remains functionally the same with the improved reliability inferred by the 20% reduction in parts.

The turn-on of the SCR is still accomplished with the positive

pulse generated on the *B1* connection of *Q1* at the end of the initial timing cycle. At this point the anode voltage of *Q2* drops to approximately zero. *C3* now begins to charge through *R9*, *R10* and the forward resistance of *Q2*. At the end of *Q3*'s timing cycle, a negative pulse is generated across *Q2*, momentarily biasing the pn junction in the SCR. This causes degeneration in the pnpn loop of the SCR, shutting the device off.

It is worth noting that this version of the circuit draws only minuscule current unless the SCR is on.

George W. Barrowcliff

President

G. W. Barrowcliff Associates, Inc.  
Eules, Tex.

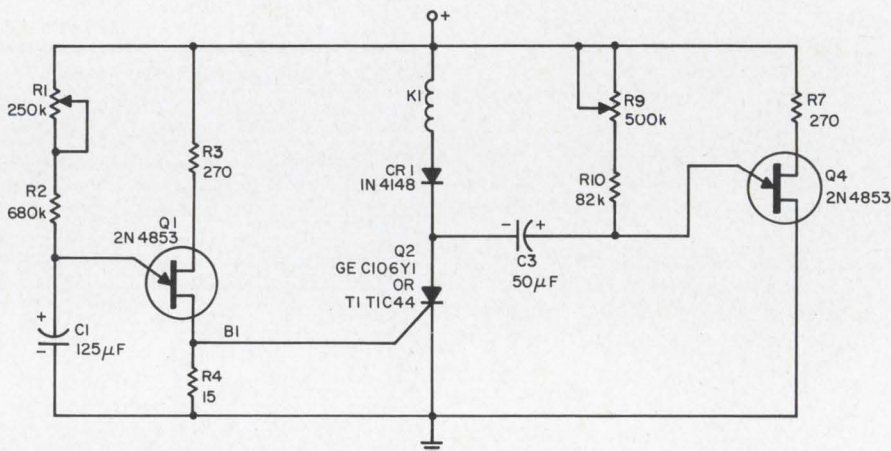

Astable multivibrator has greater reliability with fewer components.

## Closed hollow tubing needs perforation

Sir:

Although Paul Moskowitz does not say so, his Idea for Design, "Standing waves eliminated within antenna elements," ED 12, June 7, 1967, pp. 90, 92, deals with *acoustical* standing waves, and not electrical waves as most readers might assume at first. Could the organ tones produced by tubes be a source of annoyance?

However, in Moskowitz's scheme there is one point of importance and potential danger that should not be overlooked: the effect of unidirec-

tional transportation of atmospheric moisture. This is a peculiarity of any system consisting of a closed volume of air communicating with the outer atmosphere through a pinhole or capillary tube.

If one attempts to seal up a structure of this type, it is usually impossible to avoid pinholes through which air is pumped as atmospheric pressure and temperature vary with the day and season. Whenever the temperature falls, warm, moist

(continued on p. 60)

With the L and S bands covered, the overall frequency of the Polarad generator line is now extended from 21.0 to 0.95 GHz. Model 1105 covers 0.95 to 2.4 GHz. Model 1106 ranges from 2.0 to 4.6 GHz.

Both generators provide single-band continuous UNIDIAL® tuning with digital frequency indication accurate to  $\pm 0.5\%$ . Frequency stability is 0.0008% per line volt change, 0.005% per  $^{\circ}\text{C}$  change in ambient temperature. Output is calibrated from 0 to  $-127\text{ dbm}$  for

Model 1105,  $+3$  to  $-127\text{ dbm}$  for Model 1106, accurate to  $\pm 2\text{ db}$ . A rear tuning shaft extension permits motor-driven programming.

Use these generators alone, or rack or stack them with other Polarad modules to meet specific testing needs. Add a Model 3815 Frequency Stabilizer, for example, to obtain phase lock with crystal stability at any generator frequency. Add a Model 1001 Modulator for full FM, squarewave and pulse modulation. Signal sources, covering the

same frequency ranges, are available too. Prices:

Model 1105 (0.95 — 2.4 GHz).. \$1900  
Model 1106 (2.0 — 4.6 GHz)... \$1900  
For information or a demonstration, contact your local Polarad field engineer or write Polarad Electronic Instruments, 34-02 Queens Boulevard, Long Island City, N. Y. 11101. Telephone: (212) 392-4500.

**POLARAD**

## two new microwave signal generators extend Polarad's modular line down to 0.95 GHz.

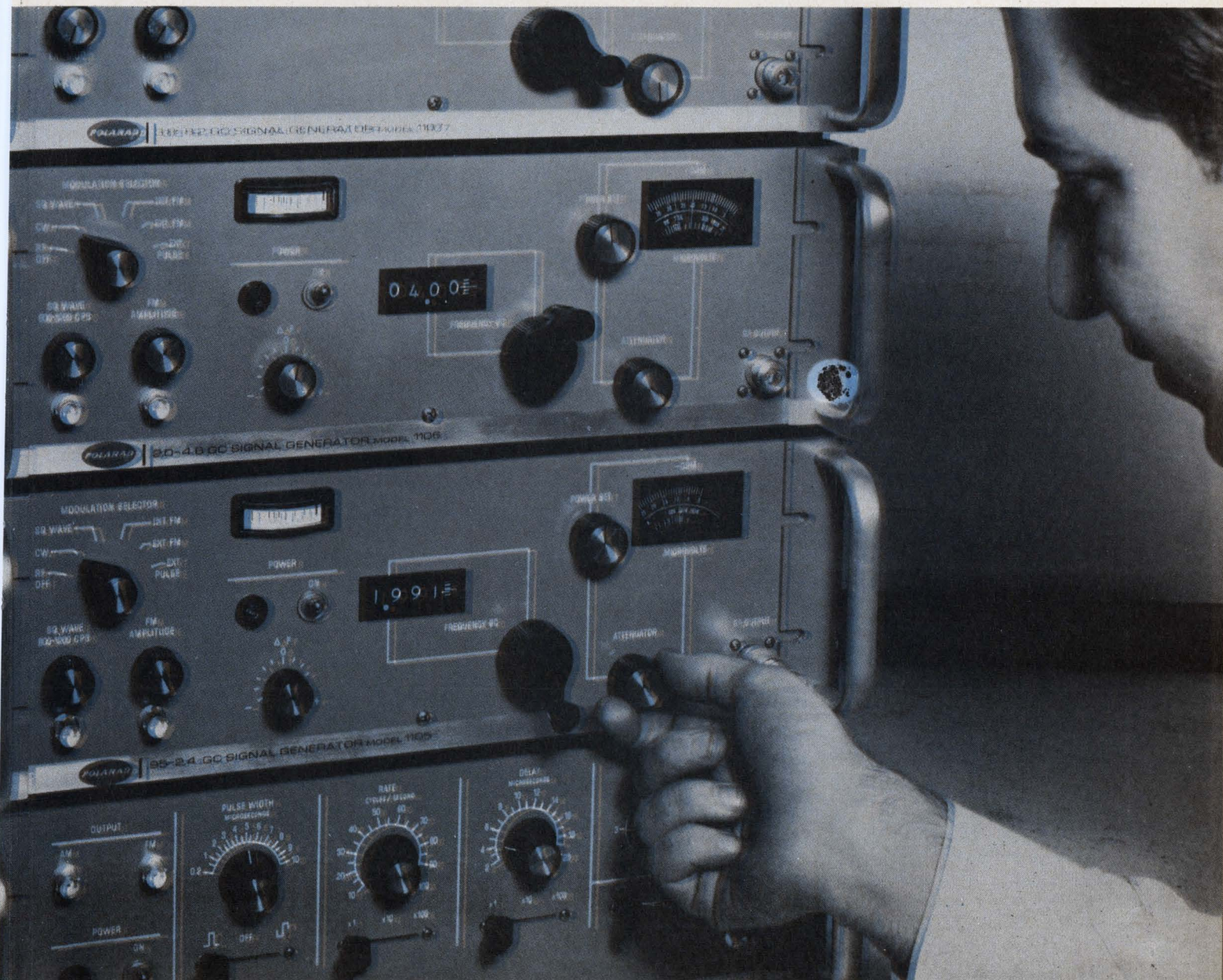

The new series 100 from AAI tests integrated circuits at a rate of about 180 tests per second. At this speed, crisp, clear readout is imperative. That's one of the reasons AAI specified IEE rear projection readouts. It's the World's most readable readout, because of the exceptionally bright, single-plane display.

AAI also wanted a readout as attractive as their circuit tester. In addition, they needed displays in various sizes, colors, symbols, characters and words. This they could only get with rear projection readouts. And this they got with the IEE Series 340, 120 and 10.

If you design, manufacture or market a product requiring visual display, specify IEE readouts. They can't be matched for readability, aesthetics or versatility. That's what AAI discovered.

The Rear Projection Readout: When a lamp at the rear of the readout is lighted, it illuminates one of 12 film messages, focuses it through a lens system, and projects it onto the front viewing screen. The displayed message is clearly projected on a single plane, with no obstruction from unlighted filaments. It is extremely versatile, since anything that can be put on film can be displayed on an IEE readout.

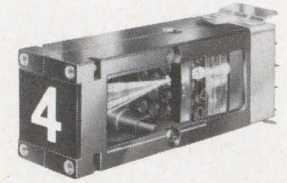

"I-Double-E," the world's largest manufacturer of rear projection readouts. Industrial Electronic Engineers, Inc., 7720 Lemona Avenue, Van Nuys, California 91405. Represented in principal cities around the world.



**"When you're testing  
6,000 circuits an hour,  
readout makes the difference."**



Raymond W. Wells, V.P. & General Manager, AAI Pacific Division

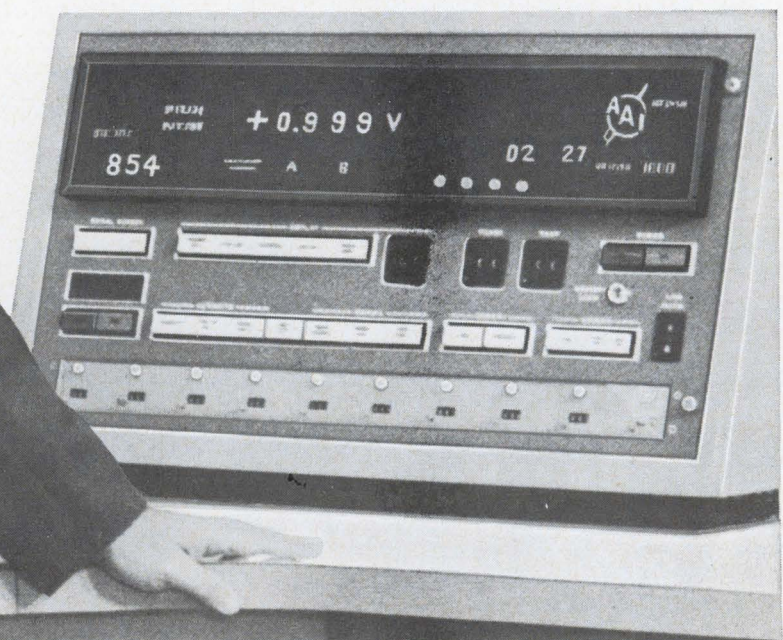

ON READER-SERVICE CARD CIRCLE 40

ON READER-SERVICE CARD CIRCLE 41 ➤

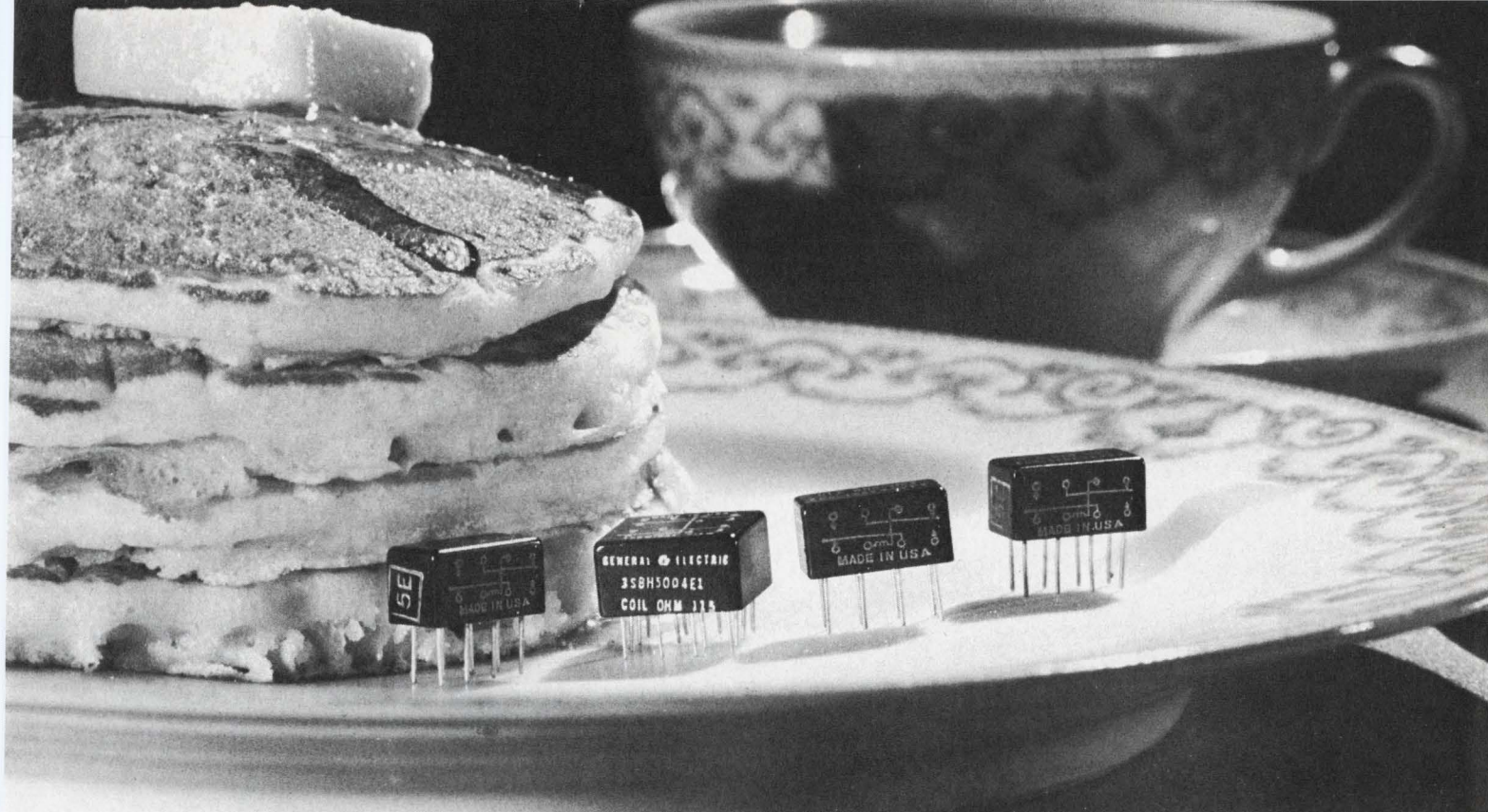

# Flat as a pancake... and selling like hotcakes

And why not?

General Electric's new high performance 150-grid sealed relays are smallest where it counts most—only 0.320" high. What's more they come in 4 versions: 4 Form C, 2 Form C, 4 Form C AND-logic type, and a 50 milliwatt sensitivity 1 Form C (or 1A+1B).

Result: for the first time you can get really small size, a variety of forms to choose from, and exceptional performance all in one relay type.

These General Electric 150-grid space relays meet or exceed the environmental and mechanical specs of much larger Mil Spec micro-miniature relays. And compared to relays of comparable size, GE 150-grid space relays have 3 times the magnetic force and over twice the contact force of the nearest competitor.

Outstanding features include:

- High vibration capability
- Excellent minimum current switching ability
- Excellent thermal resistance
- High overload capability—can withstand 5 amps each contact and make and carry 10 amps for short periods
- No flux contamination because of all-welded construction and design.

For more information on the small relay that's going over big, contact your General Electric Electronic Components Sales Engineer. He can tell you more about them and help with your individual application. Or write for bulletin GEA-8042B, Section 792-41, General Electric Company, Schenectady, New York 12305.

*Specialty Control Department, Waynesboro, Virginia*

**GENERAL**  **ELECTRIC**

# GREAT NEW WAY TO BUY DC POWER



## ERA's Wide-Range, Variable, All-Silicon DC Power Modules at Low, Low Prices

ERA's new Value-Engineered DC Transpac® power modules provide all-silicon, DC power in a wide-range, variable, low cost module.

Stocking problems are reduced to a minimum and power module obsolescence is practically eliminated. Design changes are easily accommodated since all units can be set to desired voltages by a simple external tap change.

| Output Voltage (DC) | Current (71°C) | Model  | Price    |
|---------------------|----------------|--------|----------|
| 4-32                | 0-750 ma       | LC32P7 | \$ 89.00 |
| 4-32                | 0-2 amps       | LC322  | \$115.00 |
| 4-32                | 0-5 amps       | LC325  | \$179.00 |
| 4-32                | 0-10 amps      | LC3210 | \$215.00 |
| 30-60               | 0-1 amp        | LC601  | \$145.00 |

Over-Voltage Protector Option: Add \$35.00 to above prices and Suffix V to Model No. (i.e. LC325V, etc.).

### SPECIFICATIONS

- Input:** 105-125 VAC, 50-400 cps
- Ripple:** Less than 800 microvolts RMS or .005%, whichever is greater
- Line Regulation:** Better than  $\pm 0.01\%$  or 5 mv for full input change
- Load Regulation:** Better than 0.05% or 8 mv for 0-100% load change
- Voltage Adjustment:** Taps and screwdriver adjustment
- Short Circuit Protected:** Automatic recovery
- Vernier Voltage:** External provision
- Transient Response:** Less than 50 microseconds
- Operating Temperature:** -20°C to + 71°C free air, full ratings
- Maximum Case Temperature:** 130°C
- Temperature Coefficient:** Less than 0.01% per degrees C or 3 millivolts
- Long-Term Stability:** Within 8 millivolts (8 hours reference)

Write Today for Catalog #147



## ELECTRONIC RESEARCH ASSOCIATES, INC.

Dept. ED-9, 67 Sand Park Road  
Cedar Grove, N. J. 07009 • (201) 239-3000  
Subsidiaries: ERA Electric Co. • ERA Acoustics Corp.  
ERA Dynamics Corp. • ERA Pacific, Inc.

ON READER-SERVICE CARD CIRCLE 42

LETTERS

(continued from p. 56)

air is freed of its moisture, which condenses into drops of water. This water stays inside the tube or hollow structure and gradually fills it up. Holes should therefore be drilled at the lowest points in order to relieve any pressure differentials and to let the water escape as soon as it condenses.

The writer's experience has shown this usually unheeded phenomenon to be a real source of corrosion and other damage, as shown by a few examples.

In earlier years street lighting was provided by incandescent lamps enclosed in glass "bells" or "jars" which were screwed in place with a rubber gasket to prevent the entry of moisture (it was fondly imagined). As a result it was a common thing to see these jars half filled with water collected by this moisture transportation mechanism, the lamp itself being half immersed in the collected water. Today there is always a hole provided at the lowest point of the glass enclosures and the gasket is no longer necessary.

In wartime Norway (1940-1945) private radios were confiscated, but some were hidden away. The writer was asked after Liberation Day to service a radio of a well-known U.S. make. The power transformers of these radios were famous for the care which went into their design and manufacture, and were specially sealed with insulating asphalt compound. Since pinholes were inevitable, the transformer contained a quantity of water in the windings after some 30 months of storage in a basement. So the transformer sizzled, gave off steam and failed electrically as soon as power was applied. Transformers of open design fared better.

Kaye Weedon

Civil Engineer  
Oslo, Norway

## Analysis challenged in ladder network design

Sir:

In reference to the article, "Ladder networks are easy to design" [ED 14, July 5, 1967, pp. 68-71], Eq. 17 is questionable.

The contribution of  $V_1$  to the Thévenin equivalent circuit in Fig. 7 is not considered. By superposition:

$$V_{TH} = V_1[x/(x+1)]/[1+y+x/(x+1)] + V_2[y+x/(x+1)]/[1+y+x/(x+1)].$$

From this, Eq. 18 is in error (volts  $\neq$  ohms—a small oversight) and affects the remaining analysis, which assumes  $R_{TH} = V_{TH}$  in Eq. 21.

The method is good and the article most interesting, but please clarify procedure if I have overlooked something.

Two other comments: Fig. 2b should be:

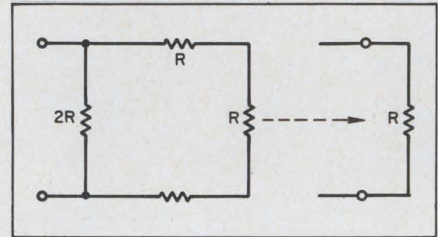

and Fig. 5:

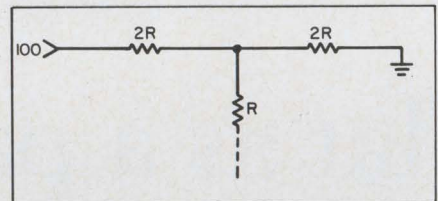

Dave McFerrin

Engineer  
EG&G, Inc.  
Las Vegas, Nev.

## The author replies

Sir:

McFerrin's comments about Figs. 2b and 5 are quite right. However, I plead innocent: those are drafting errors.

I disagree with him on Eq. 18 and Fig. 7, although the clarity could be improved—something for which I am to blame. Let me clarify the point by saying that either  $V_1$  or  $V_2$  could be used to compute  $V_{TH}$ .  $V_{TH}$  is not the total Thévenin source, but only the contribution of one of the input voltages at node 1. This is all that is required.  $Z$  is determined by setting its value so that  $V_2$  contributes 1/20 of  $V_3$  or  $V_1$  contributes 1/240 of  $V_3$ . With either  $V_1$  or  $V_2$ , the Thévenin resistance, and the corresponding voltage division (Eq. 19 for the case of  $V_2$ ), the same answer will be ob-

(continued on p. 64)



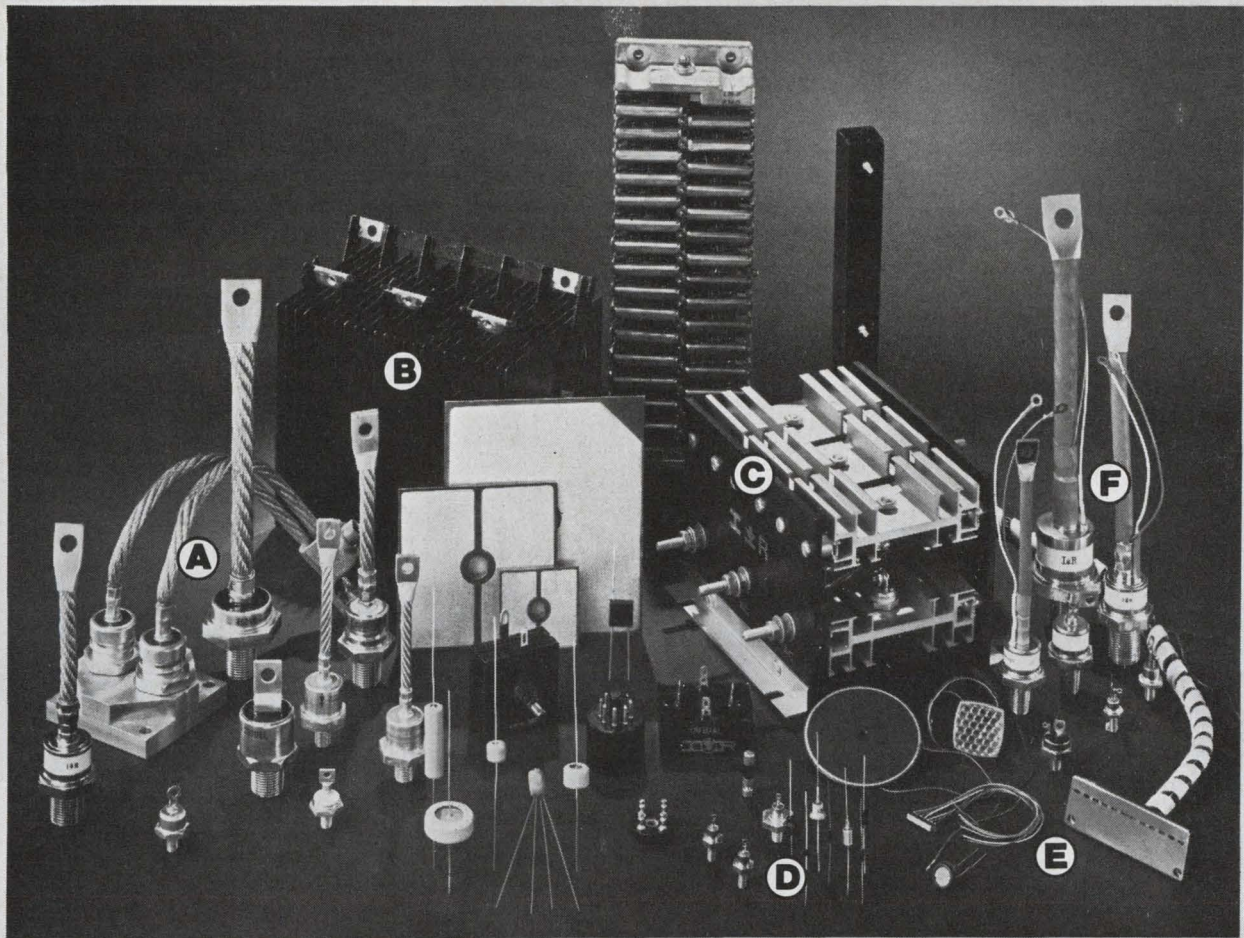

## The great IR family portrait

Whatever you need in rectifiers, you'll find it fastest and best at International Rectifier. We can make that statement because we're rectifier specialists. We make more—and more types—than anybody else in the business. And each device shown here represents a whole series or sub-family of units having a wide range of values and sizes.

Whether your need is electrical or electronic, you're assured of finding the exact rectifier you need among the Great Family of International Rectifier. And we can offer you the most comprehensive catalog and application data in the industry. Write for information on any of the groups shown above.

These are just a few of the outstanding members of the full IR family: **A** SILICON POWER RECTIFIERS 15 amps to 500 amps **B** SELENIUM RECTIFIERS AND ASSEMBLIES car-tridges, Klip-Sels® (voltage surge suppressors), split cells, single cells, and stacks **C** SILICON RECTIFIER ASSEMBLIES columns, stacks (rectifier and SCR types), encapsulated assemblies, molded circuits, tube replacements **D** ZENER REGULATORS, VOLTAGE REFERENCES, AND LOW POWER RECTIFIERS 150 milliwatt to 50-watt zeners, 1-amp to 12-amp silicon rectifiers **E** LIGHT SENSITIVE DEVICES selenium and silicon photovoltaic cells (mounted and unmounted), silicon readout arrays, CdS photoconductive cells **F** SILICON CONTROLLED RECTIFIERS 4.7 amps rms to 550 amps rms, epitaxial and alloy diffused types.

INTERNATIONAL RECTIFIER



SEMICONDUCTOR DIVISION □ 233 KANSAS STREET, EL SEGUNDO, CALIF. 90245 □ PHONE (213) 678-6281  
FIELD OFFICES AND DISTRIBUTORS IN MAJOR CITIES AROUND THE WORLD  
ON READER-SERVICE CARD CIRCLE 43

# CAUSE:

THE ANNULAR PROCESS AND  
"FIELD RELIEF ELECTRODE" TECHNIQUES  
HAVE MADE POSSIBLE INCREASED-VOLTAGE DEVICES  
WITH INFINITELY GREATER ASSURANCE OF RELIABILITY.  
TODAY, A LARGE PERCENTAGE OF "GREATER PERFORMANCE"  
SILICON TRANSISTORS MAKES USE OF  
ONE OR BOTH OF THESE TWO KEY INVENTIONS.  
BOTH ARE PATENTED BY MOTOROLA.\*

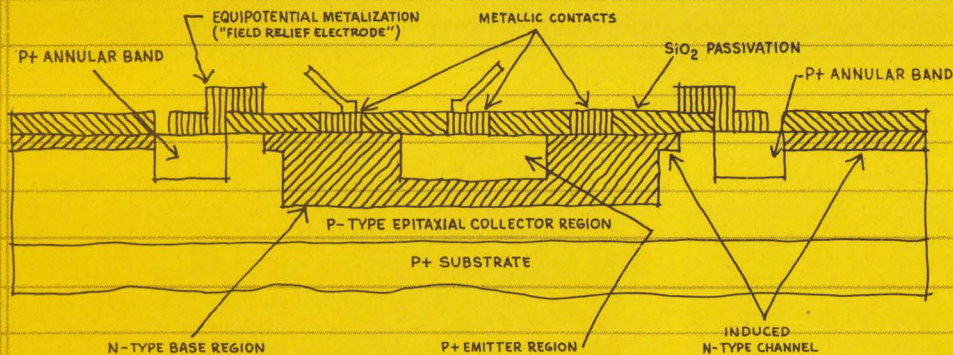

\*Field Relief Electrode — Patent #3,302,076  
Annular Structure — Patent #3,309,245 and #3,309,246

*-where the priceless ingredient is care!*



# EFFECT:

...Total NPN/PNP Silicon Transistor Coverage

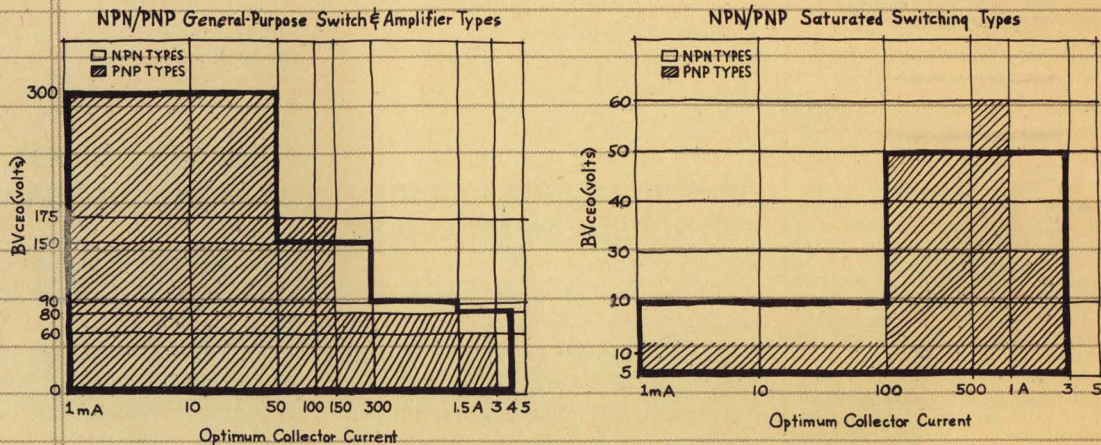

No matter what your application, chances are Motorola has a Silicon Annular transistor to fit it. The charts above are indicative of the broad voltage and current ranges covered. All are fabricated using the Annular Process, Field Relief Electrode or both. Result: State-of-the-art devices -- free of failure due to surface or bulk defects!\*

If you've been hemmed-in by designs that you had to put "on the shelf" for lack of an appropriate or inexpensive Silicon transistor -- drag 'em out and dust 'em off! We've prepared a simplified, yet comprehensive cross-reference and selector guide for all types of Silicon transistors -- General Purpose Switches and Amplifiers, Saturated Switches and Small-Signal RF devices -- that shows you the kind of performance available. Send for it.

\*Includes all 38 MIL-qualified switches and 34 low-power, general purpose transistors.

**MOTOROLA Semiconductor Products Inc.**

P. O. BOX 955 / PHOENIX, ARIZONA 85001

ON READER-SERVICE CARD CIRCLE 44

ELECTRONIC DESIGN 19, September 13, 1967

Digital Onmmeter with  
0.1% accuracy, 0.001  $\Omega$   
to 1000M  $\Omega$  range



DMS-3200 Main Frame     **\$320**  
DP-170 Ohmmeter Plug-in   **\$240**  
  **\$560**

The type DP-170 Ohmmeter Plug-in, when used with the DMS-3200 Main Frame, provides digital display of resistance measurements from 0.001 ohm to 1,000 megohms in ten ranges. The system offers accuracy capability of  $\pm 0.1\%$  FS  $\pm 0.1\%$  of reading. Direct linear readout of resistances above 1 megohm at the accuracies specified represents an industry first in digital instruments.

The measurement system is that of a true wheatstone bridge, with internal electronic automatic null-out and resultant resistance value display. Of special interest is the unusually low power applied to the resistor under measurement — maximum 1 milliwatt. Four-terminal input, with "guard" terminal permits accurate measurement of both extremely low and high resistances. Response time on all ranges except the highest is 1 second and a "null indicator" indicates when the bridge is balanced and a reading may be taken.

The three-digit, all-electronic display uses "Nixie" type readout tubes and includes automatic decimal point indication. 100% over-range capability is provided and display time is variable from .5 second to 6 seconds per reading with provision for holding a reading indefinitely.

Like other DP series plug-ins, the DP-170 is all-solid-state, uses glass-epoxy printed circuit boards, and is complete within a compact plug-in housing which slides into the plug-in port of the DMS-3200 Main Frame. Main Frame size is approximately 9"x7"x13" and combined weight is 13 pounds. Combination price is \$560.00.

The DP-170 is but one of a complete line of plug-ins designed for use with the Hickok DMS-3200 Digital Measuring System Main Frame. All plug-ins are available from stock through franchised Hickok Industrial Distributors.



DC Voltmeter Plug-in  
0.1 mv to 100 v;  
0.1% accuracy  
DP-100 — \$175

1 Mc Counter Plug-in  
0.1 cps to 1 Mc;  
0.005% accuracy  
DP-150 — \$175

Ohmmeter Plug-in  
0.001 ohm to  
1000 Megohms;  
0.1% accuracy  
DP-170 — \$240

Capacity Meter Plug-in  
1.0 pf to  
10,000 Microfarads;  
0.1% accuracy  
DP-200 — \$240

Event Counter Plug-in  
Counting Speed  
1,000,000 pps  
DP-140 — \$75

**THE HICKOK ELECTRICAL INSTRUMENT COMPANY**  
10514 Dupont Avenue • Cleveland, Ohio 44108

ON READER-SERVICE CARD CIRCLE 45

LETTERS

(continued from p. 60)

tained for Z. The confusion perhaps arises from my reference to  $V_{TH}$  as a Thévenin voltage, when it is in fact only one of two independent sources, which can each be treated as a Thévenin source.

I hope this clarifies the matter. I also wish to thank McFerrin for going through all that analysis and for his interest in the subject.

Jay Freeman

Electronic Engineer  
Sperry Gyroscope Co.  
Great Neck, N. Y.

## Aluminum and sodium can substitute for copper

Sir:

We have read with considerable interest your recent editorial, "A systems approach is needed to cope with copper shortages" [ED 15, July 19, p. 45]. The arguments you advance against the substitution of aluminum and sodium for copper may be correct for the electronics industry, based on today's technology, but we question their long-term validity. We know for certain, however, that these arguments do not apply to the power-cable industry where large quantities of aluminum and relatively small quantities of sodium are replacing copper. Perhaps some of this power-cable technology will prove useful in electronics applications in the future. Under any circumstances, it is our conviction that we should use every means at our disposal to cope with the copper shortage, including substitution where feasible, and not be limited exclusively to the systems approach.

We would also like to lay to rest a misconception about sodium. Your statement, "only the fine lettering reminds us of the violence of the reaction when a trace of moisture penetrates the metal's polyethylene sheath," is not supported by experimental evidence. We have run innumerable moisture transmission tests at 20°C and 80°C without any semblance of a violent reaction. Further, we have repeatedly demonstrated, as have others, that sodium is essentially self-sealing when insulation punctures of less than 1/4

inch in diameter are encountered under water.

We would be the first to admit that under certain circumstances sodium can create a hazardous condition. This also holds true for electricity, certain chemicals and gases, and gasoline. With today's technology, these relatively dangerous commodities can be handled safely. The same now applies to sodium with which we have made considerable technical progress in recent years.

L. E. Humphrey

Vice President  
Nacon Corp.  
New York

## Bloated bumpers don't alter the problem

Sir:

In reference to David H. Sur-gan's editorial, since when do autos have nickel bumpers that weigh more than the entire auto? There are about 50 million autos in the U.S.A. with, according to the editorial, 100 million tons of bumpers. From this it may be computed that each auto has about 2 tons of nickel bumpers!

Despite this flaw, the theme of the editorial is important and timely. It is about time that engineers took stock of other things besides the inputs and outputs of their black boxes and the nuisance of designing around the shortage of the moment. Engineering should involve an interest in the proper use and management of all resources. Let's get away from those black boxes occasionally and consider the broad picture.

Kenneth Hoffman  
Electronic Engineer  
New York

(The weightiness of the problem influenced the figures! It should have been 2 million pounds (1000 tons) not 2 million tons.—Ed.)

## Accuracy is our policy

In "Eye-catchers on display," ED 15, July 19, p. 22, the "Four-in-one 'personal console,'" illustrated at the bottom left, is made by Westing-house Electric Corp., not General Electric as stated.

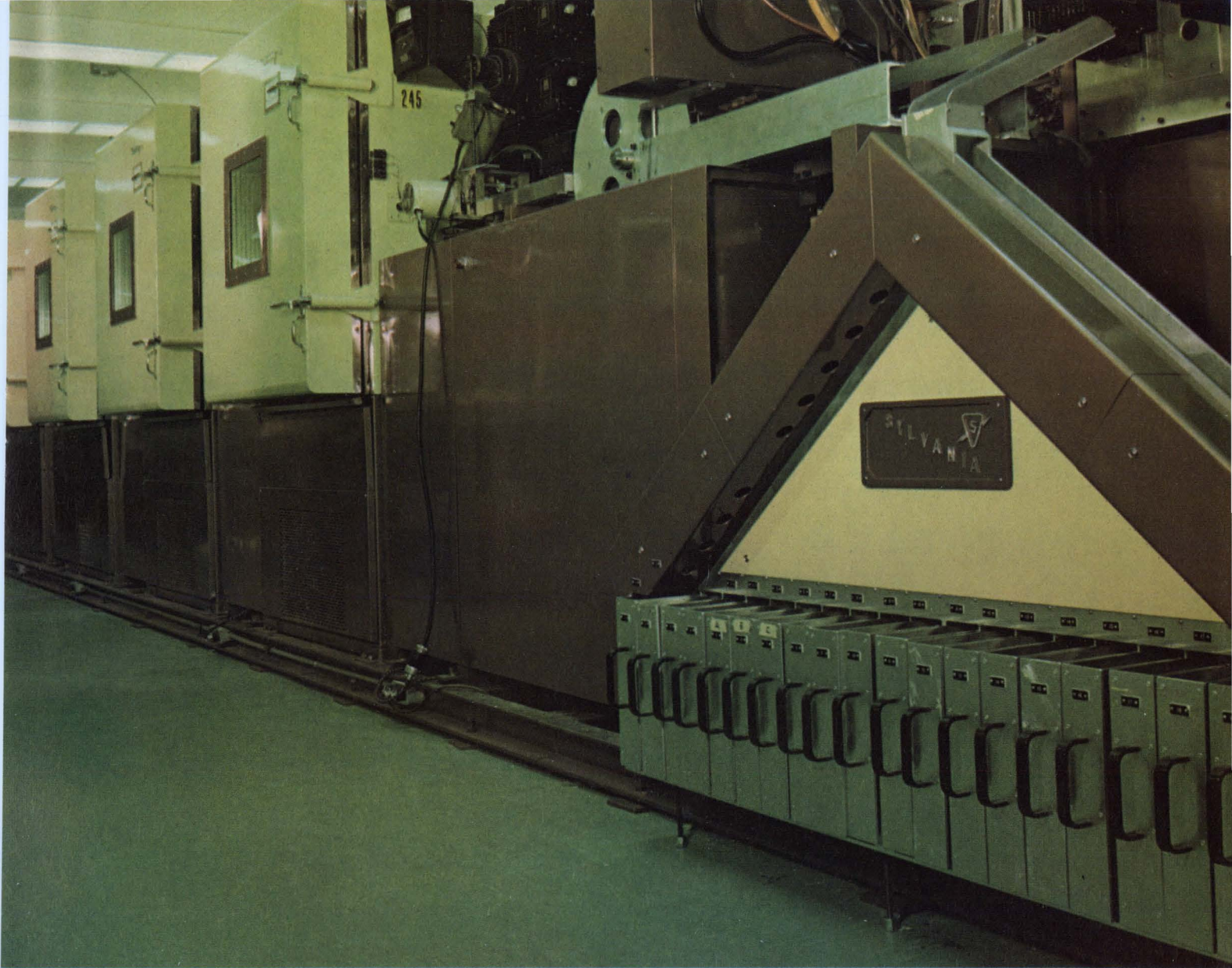

## Every military IC must operate at temperatures from $-55^{\circ}\text{C}$ to $125^{\circ}\text{C}$ in our test chambers.

In order to pass its final test, each Sylvania IC must operate in four consecutive temperature-controlled chambers while a computer records the parameters of each circuit. We call this ultimate testing equipment "Mr. Atomic"—a system with a capacity of about a quarter-million ICs a week.

In each "torture chamber," the ICs are automatically inserted in a wheel that rotates them to the testing point while they're stabilized at test temperature.

The temperature of the first chamber is  $75^{\circ}\text{C}$ . The second is  $0^{\circ}\text{C}$ . The next is  $125^{\circ}\text{C}$ . Then,  $-55^{\circ}\text{C}$ . In these four chambers, up to 100 D.C. tests are automatically performed. A fifth testing station, maintained at  $25^{\circ}\text{C}$ , tests up to 30 switching parameters

accurately down to a few nanoseconds. (See inset). Each input is individually tested.

Then Mr. Atomic (for Multiple Rapid Automatic Test of Monolithic Integrated Circuits) directs the circuits to any of 20 bins, according to the computer's priority programs. You get only circuits that are fully guaranteed at temperature extremes—not at just room temperature only.

Sylvania Semiconductor Division, Electronic Components Group, Woburn, Massachusetts 01801.

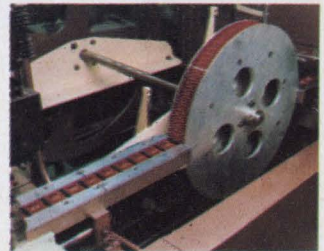

**SYLVANIA**  
SUBSIDIARY OF  
GENERAL TELEPHONE & ELECTRONICS **GTE**

Good, old-fashioned, Scottish thrift.

We've become so thrifty at Honeywell that we've pared the prices of taut-band meters down even lower than the prices of pivot-and-jewel meters. (About 10% lower, on the average.)

Now, if your shrewd business sense tells you we've left something out, you're right.

We've left out half

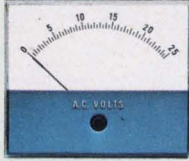

the parts. (All the unnecessary ones.) Which doesn't make the meter less sophisticated. Just less complicated.

This taut-band meter is so ingeniously simple, there's hardly anything to go wrong.

There's no friction in the moving system, so the pointer doesn't stick. (Better readout accuracy and repeatability.) And the meter's self-shielded.

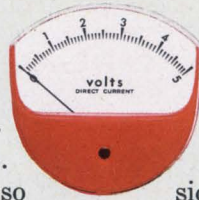

The low-cost taut-band meter from Honeywell. It comes in just about any style you'd like. Write Honeywell Precision Meter Division in Manchester, N.H. 03105 and we'll send you a brochure with all the sizes, styles and prices.

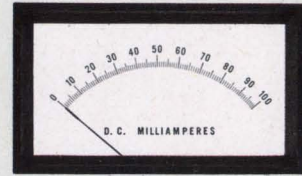

## What's the secret of Honeywell's taut-band meter success?

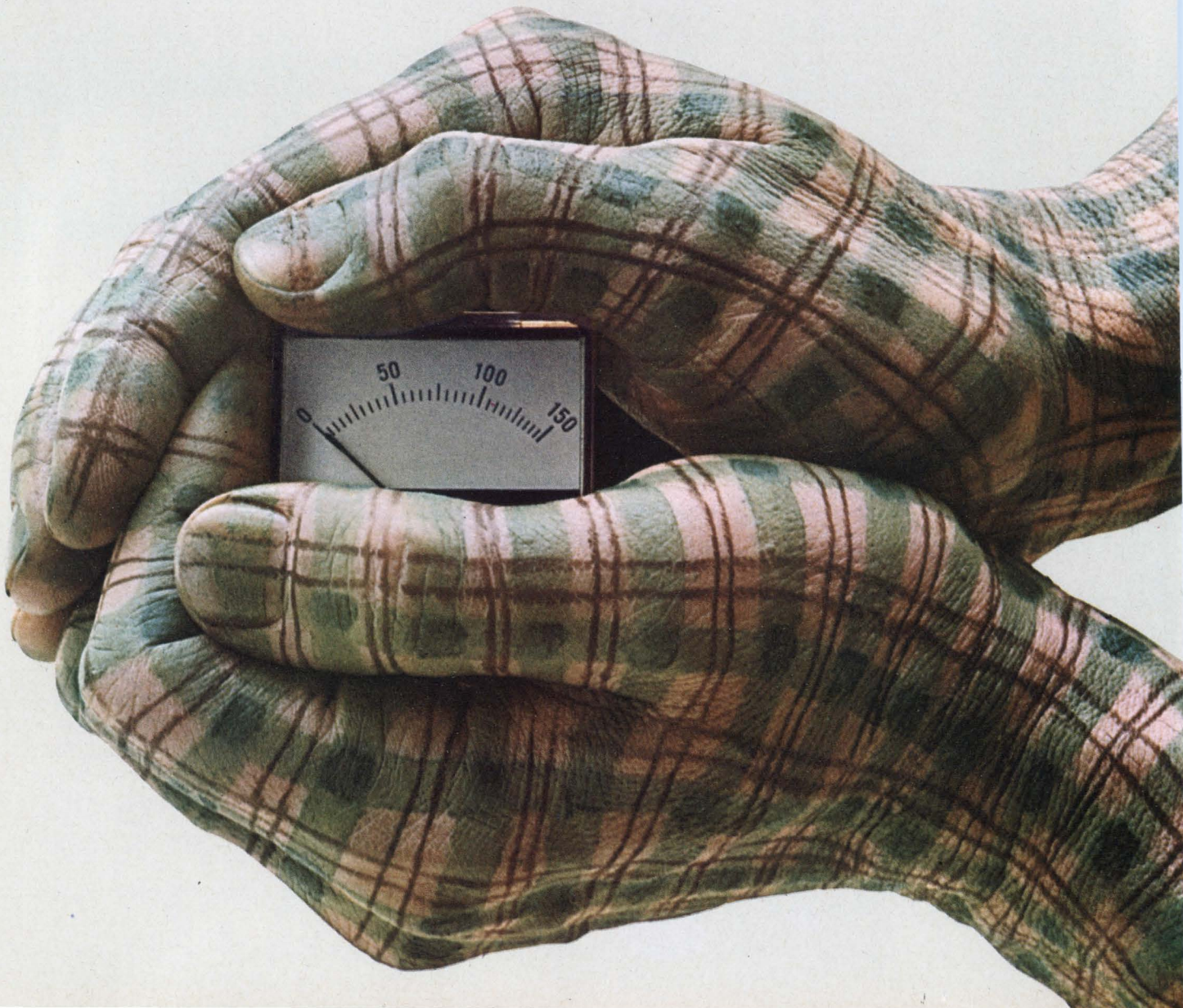

**Co-Publishers**

James S. Mulholland, Jr.  
Hugh R. Roome

**Editorial Director**

Edward E. Grazda

**Editor**

Howard Bierman

**Managing Editor**

Robert C. Haavind

**Technical Editors**

Jeffrey N. Bairstow  
Peter N. Budzilovich  
Maria Dekany  
Roger K. Field  
David H. Surgan

**Management and Careers Editor**

Howard S. Ravis

**News Editors**

Ralph Dobriner, Chief  
Richard N. Einhorn

**Washington News Bureau**

Charles D. LaFond, Chief

**East Coast Editor**

Neil Sclater

**West Coast Editor**

Ron Gechman

**New Products Editor**

Steven B. Futterman

**Copy Editor**

Peter Beales

**Directory Editor**

William Alvarez

**Editorial Production**

Dollie S. Viebig  
Marian Arkin

**Art Director**

Clifford M. Gardiner

**Art Assistant**

William Kelly

**Technical Illustrators**

Cheh Nam Low  
Sheila F. Ward  
Richard Hartman

**Production Manager**

Thomas V. Sedita

**Asst. Production Manager**

Helen De Polo

**Production Assistants**

Bernard Wolinsky  
Robert M. Henry  
Murray Friedman

**Circulation Manager**

Nancy L. Merritt

**Reader Service**

Diane Mandell

## EDITORIAL



## The solution to your problem may be sitting on a shelf

There is no question that the foundation of the electronics industry is a cataclysmic explosion of technology. Marketing managers all over the country call it the name of the game. Unlike other explosions, however, there is no danger that this one will get out of hand. On the contrary, it's the responsibility, indeed, the obligation, of each engineer and each manager to make the technology explosion work to the advantage of his designs, his company, and his industry.

Paradoxically, the main thrust of the electronics industry is communications. And yet, it is exactly in this area that a good deal of improvement is needed. Suppose, for example, that you or one of your engineers thinks up a great design, but your company, for marketing reasons, chooses not to use it. Would you tell your idea to your nearest competitor? This may come as a shock: it probably pays to divulge the idea, and, if your firm's legal department knows its business, it can pay well.

License arrangements can bring in cash for many designs and ideas that your company may not even know it has. Chances are that a perfectly "rentable" idea is sitting under a nearby blotter simply because it doesn't answer an immediate problem and someone upstairs lazily branded it proprietary. Properly marketed, even to a competitor, that idea can command a regular income, income that is pure profit to your company. Or your firm might swap the idea for an even more profitable cross-license, which solves one of its own sticky problems.

The chemical industry has demonstrated how profitable the rights to a license can be: DuPont, 3M, and Monsanto derive 57% of their combined total profits from products invented outside the firms.

It is a pity to see thousands of ideas, ideas that can move this industry forward, lie fallow just because they weren't needed by the company where they were developed. Perhaps they're unrented or untraded because no one's sure whether or not they are proprietary. Or maybe nobody has taken the trouble to clear them through security or the legal department.

Look around your firm. Dig up an idea, dust it off and suggest that it be used, sold or swapped. In one swap, your firm might get more than it gives. In another, it might give a little more than it gets. But one thing is certain: industries like the movie industry that have traditionally refused to trade information and licenses have withered and given way to newer, more vital industries.

Look around our industry. Those companies that are ready to use and swap licenses are the companies that move ahead. They are receptive to the ideas of others. Remember: a hundred thousand heads are often better than one.

ROGER KENNETH FIELD

# 4 ways to view displays with the Tektronix Type 564

## split-screen storage oscilloscope

The Tektronix Type 564 is virtually two instruments in one. It offers all the advantages of a storage oscilloscope plus those of a conventional oscilloscope.

### Split-Screen Displays

An unique split-screen display area enables you to simultaneously use either half of the screen for storage and the other half for conventional displays, or use the entire area for stored or conventional displays.

Independent control of both halves of the screen permits you to take full advantage of the storage facilities. For example, you can use half the screen to store a reference waveform, the other half to display waveforms for comparison. You can erase or retain either half of the display area as you choose.

### Bistable Storage Advantages

With bistable storage oscilloscopes, such as the Type 564 and Type 549, the contrast ratio and brightness of stored displays are constant and independent of the viewing time, writing and sweep speeds, or signal repetition rates. This also simplifies waveform photography. Once initial camera settings are made for photographs of one stored display, no further adjustments are needed for photographs of subsequent stored displays.

Storage time is up to one hour, and erase time is less than 250 milliseconds. An illuminated 8 cm by 10 cm graticule facilitates measurements and aids in taking photographs with well-defined graticule lines. Adding to the operating ease is a trace position locator that indicates, in a nonstore area, the vertical position of the next trace or traces.

Tektronix bistable storage cathode ray tubes are not inherently susceptible to burn-damage and require only the ordinary precautions taken in operating conventional oscilloscopes.

### Plug-In Unit Adaptability

The Type 564 accepts Tektronix 2 and 3-series plug-in units for both vertical and horizontal deflection. Display capabilities of these units include single and multi-trace with normal and delayed sweep; single and multiple X-Y; low-level differential; dual-trace sampling; spectrum analysis, and many other general and special purpose measurements.

|  |        |
|--|--------|
| Type 564, without plug-in units . . . . .  | \$ 925 |
| Rack-Mount RM564 . . . . .   | \$1025 |
| Similar electrical characteristics to Type 564. 7" high.   |        |
| Type 3A6 Dual-Trace Amplifier Unit . . . . .   | \$ 525 |
| DC to 10 MHz from 10 mV/div to 10 V/div. 5 display modes. Internal signal delay line.  |        |
| Type 3B4 Time Base Unit . . . . .  | \$ 425 |
| Sweep speeds from 0.2 $\mu$ s/div to 5 s/div. Single sweep. Up to X50 direct-reading magnifier extends fastest sweep to 50 ns/div. |        |

U.S. Sales Prices FOB Beaverton, Oregon

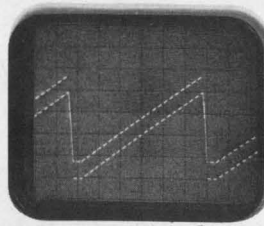

Entire screen can be used for a stored display.

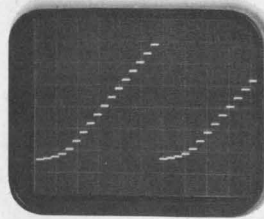

Entire screen can be used for a nonstored display.

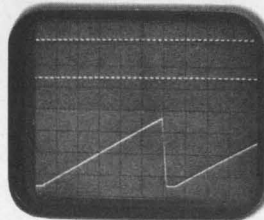

Each half of split-screen can be used independently for stored displays.

Either half of the split-screen can be used for a stored display, the other half for a nonstored display. (Shown below).

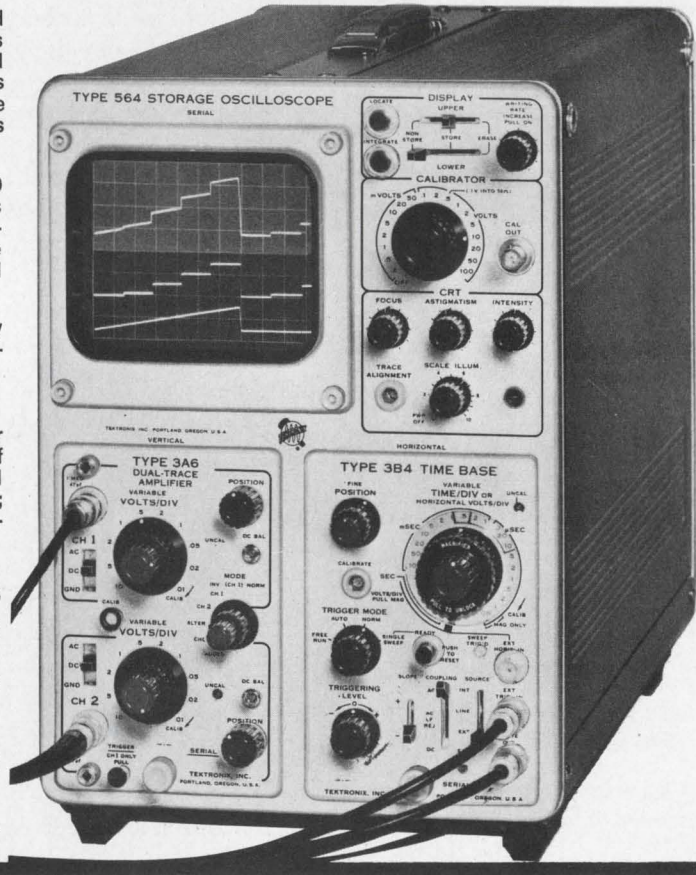

**Tektronix, Inc.**



For a demonstration, contact your nearby Tektronix field engineer or write: Tektronix, Inc., P. O. Box 500, Beaverton, Oregon 97005.

ON READER-SERVICE CARD CIRCLE 48



# Technology

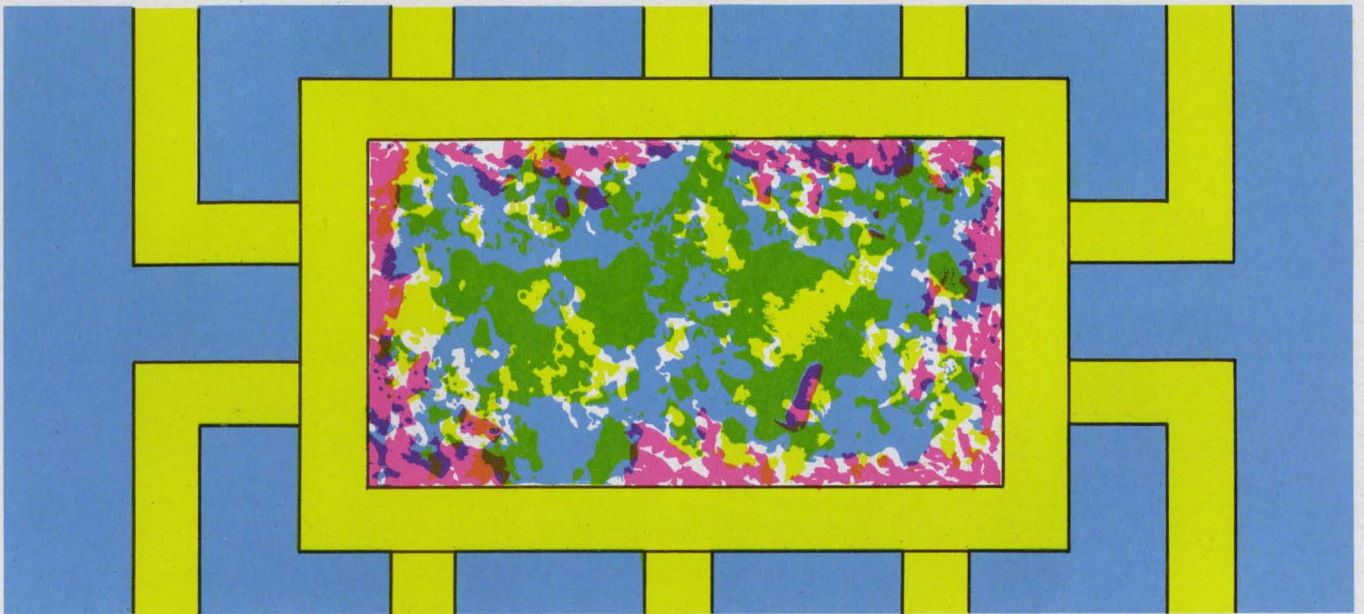

The vivid colors of cholesteryl esters enhance high-resolution thermographic mapping. Easy

to apply and cheap, nondestructive liquid crystals can be used repeatedly. Page 71

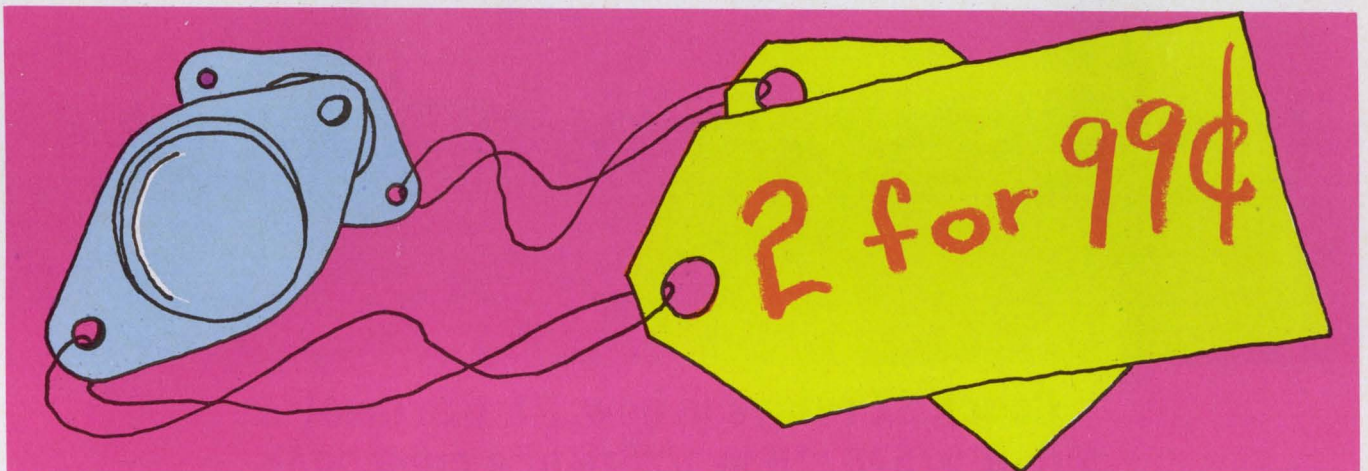

Keep the price tag for power transistors low by looking beyond quantity breaks. Know how

to avoid overspecification and how to make the most out of available devices. Page 110

## Also in this section:

**Complementary MOS arrays open the gate** to nanopower IC logic. Page 81

**Error-detecting codes** need not present a design problem. Page 90

**Unilateralization boosts the gain** of hf FET amplifiers. Page 98

**Delay distortion in amplifiers is minimized** by an analytical approach. Page 116

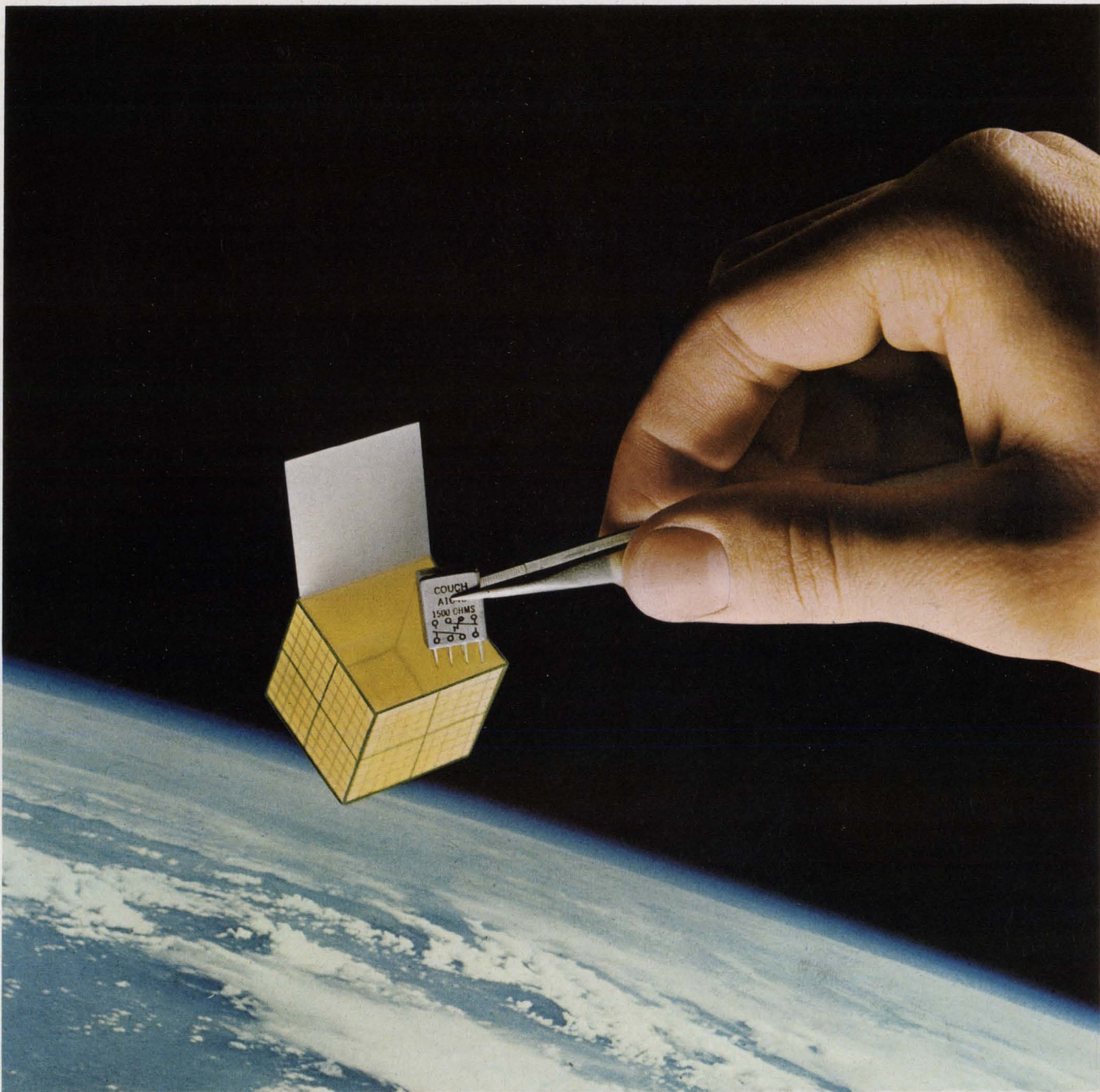

NASA

## Couch 2X relays in new 1/7 size meet MIL-R-5757D/19 in 1/25th of a cubic inch

The new Couch 2X 1/7 size rotary relay helps solve switching problems where space and weight are critical factors. Predecessors of the Couch third generation relays delivered unfailing performance in the missile, aircraft and space fields — and they still do. Today the new Couch 2X offers the same high degree of reliability in microminiature. Use them with complete confidence for signal switching with other circuit board components. Each relay delivered is fully tested. Additional screening tests are available at your option. Couch 2X relays are made in a variety of coil resistances, three terminal styles and in a wide choice of mounting styles. Other products available include: 10 amp rotary relays, ultra-sensitive crystal can relays and full-size rotary switches.



|                 | 2X (DPDT)<br>2-pole              | 1X (SPDT)<br>1-pole |
|-----------------|----------------------------------|---------------------|
| Size            | 0.2" x 0.4" x 0.5"               | same                |
| Weight          | 0.1 oz. max.                     | same                |
| Contacts        | Low Level to 0.5 amp<br>@ 30 VDC | same                |
| Sensitivity     | 100 mw                           | 70 mw               |
| Coil Resistance | 60 to 4000 ohms                  | 125 to 4000 ohms    |
| Temperature     | -65°C to 125°C                   | same                |
| Vibration       | 20 G to 2000 Hz                  | same                |
| Shock           | 75 G, 11 Ms                      | same                |

Write for Data Sheets No. 9 and 10.

RUGGED ROTARY RELAYS  Dynamically and Statically Balanced

**Couch**  
1894

**COUCH ORDNANCE, INC.**  
3 Arlington Street  
North Quincy, Mass. 02171  
(617) 298-4147  
A subsidiary of S. H. COUCH COMPANY, INC.

ON READER-SERVICE CARD CIRCLE 49

ELECTRONIC DESIGN 19, September 13, 1967

# Liquid crystals plot the hot spots.

Nondestructive thermal mapping of ICs is easy with low-cost cholesteryl esters.

Cholesterol, said to wreck havoc on your arteries, can work magic in a laboratory or on a production line. Certain cholesteric compounds exist in an unusual, suspended state between solid and liquid, with properties of both. In this *liquid crystal* form, (see box) cholesterol derivatives exhibit remarkable physical behavior, evidenced by brilliant color changes when the compound is subjected to changes in environment. These changes can be put to work thermally mapping electronic devices with the aid of cholesteryl esters, such as cholesteryl benzoate.

## Cholesterol maps electronic arteries

Thermographic mapping with cholesteric liquid crystals can be a valuable nondestructive test for evaluating semiconductor devices and printed-circuit assemblies. The technique is versatile enough to be used both in the laboratory and in production. The high resolution (20 line pairs per millimeter) of the temperature profiles under dynamic test conditions makes the technique especially attractive for measuring integrated-circuit performance. Many standard methods fail because of the microscopic scale of critical areas of interest.

Other advantages offered by the technique are:

- It is straightforward and expeditiously gives a direct display of information.
- It demands no knowledge of the emissivity of different surfaces, because the iridescent display depends only on temperature and the angle of incident light.
- It requires none of the complicated and expensive scanning equipment necessary with infrared techniques.
- Experiments can be repeated over and over, because liquid crystals, unlike temperature paints, have reversible temperature dependence.
- The material is inexpensive. The cost of bulk cholesteryl esters is about \$25 for 50 cm<sup>3</sup> and 1 cm<sup>3</sup> of solution will cover about 100 cm<sup>2</sup>; thus \$25 will pay for testing some 5000 cm<sup>2</sup>.

Cholesteryl esters can be compounded to display

**Michael Lauriente**, Advisory Engineer, Aerospace Materials, Westinghouse Electric Corp., Defense & Space Center, Baltimore, and **James L. Ferguson**, Associate Director, Liquid Crystal Inst., Kent State Univ., Kent, Ohio.

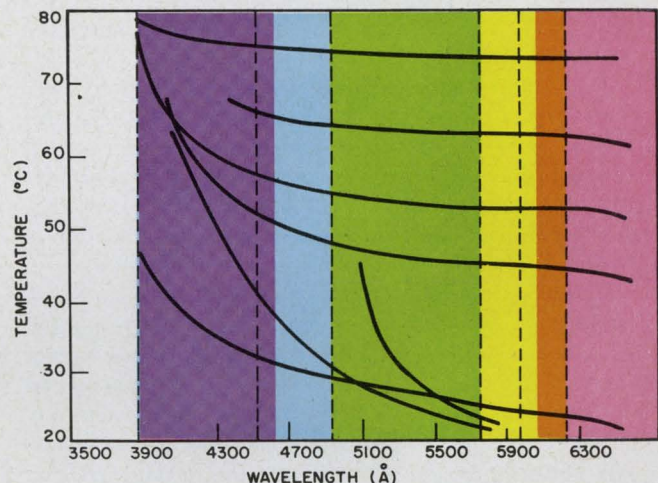

1. **Temperature-vs-wavelength curves** show wide range of temperature dependences for seven different mixtures. Cholesteryl esters are available over a  $-20^{\circ}$  to  $350^{\circ}$  C range in increments from  $3^{\circ}$  to  $50^{\circ}$  C. Flatter curves indicate higher sensitivity over a smaller temperature range.

the entire visible color spectrum within any temperature range from as small as  $3^{\circ}$  C to as large as  $50^{\circ}$  C. The extremes within which it will operate are  $-20^{\circ}$  to  $350^{\circ}$  C. Since the compounds are applied in very thin layers (10 to 25 microns), they have low thermal mass and can rapidly follow thermal effects that generate minute amounts of heat.

The color scattered by the liquid crystals is peculiar to a specific temperature, making the quantitative measurement of temperature possible. As the materials are heated, they will change from black to red, to orange, to yellow, to green, to blue, to violet, to black again. The temperature at which a specific color occurs and the temperature range from red to violet may be varied by the proper choice of compound.

The temperature dependence of a representative group of materials is shown in Fig. 1. The sensitivity and operating temperature of these compounds are a function of composition. A quantitative evaluation of a thermal pattern, as required for a thermal map, may be made with liquid crystals provided that certain criteria are observed. For qualitative purposes, however, the requirements may be relaxed. The criteria are:

- The heat capacity of the object should be larger

# Liquid crystals:

what we know...

Matter is thermodynamically classified into one of three phases—solid, liquid, or gaseous. While this classification ordinarily identifies the mechanical characteristics of a material, it does not necessarily identify its molecular arrangement. For this reason, crystalline classifications are also used. In the amorphous state, molecules form in random array and remain in random motion. In the crystalline state, molecules are firmly fixed in a three-dimensional crystal lattice.

In an intervening mesomorphic state (*liquid crystal*), large groups of molecules are able to move and turn about, yet retain some structural arrangement. Such mesomorphic substances simultaneously have properties of liquids and solids. The properties and combinations, however, are so diverse that subclassification is required. The cholesteric phase is such a subgroup.

In 1888, Reinitzer, an Austrian botanist, found that cholesteryl benzoate appeared to have two melting points: at 145°C the solid turned into a cloudy liquid, then at 179°C, the cloudiness suddenly disappeared and the liquid became clear. The first melting point occurs at the temperature at which the solid and mesomorphic phases are in equilibrium; the second melting point occurs at the temperature at which the mesomorphic and isotropic liquid phases are in equilibrium.

The cloudiness is due to the unusual optical properties of the substance in a mesomorphic state. Whereas ideal liquids would be optically isotropic—their optical properties are the same measured in all directions, liquid crystals exhibit optical characteristics similar to birefringent crystals, which are optically anisotropic. Their optical properties depend on the orientation of the crystal structure. The cloudy liquid state of cholesteryl benzoate is the result of many randomly oriented regions—ordered areas that are spontaneously anisotropic.

The color change of cholesteric materials is directly related to a change of shape of the delicately balanced component molecules. Upon heating, the helical “twist” of the over-all molecular configuration alters. This temperature dependence of the liquid crystal’s optical properties is inherent and reversible.

The crystals selectively reflect only one wavelength at each angle. The resultant reflected beam is circularly polarized. When light is incident from several directions at once, a different wavelength is reflected at each angle and the resulting mix of colors is seen as iridescence. The change in temperature causes a shift in molecular structure and, thus, a different color at the same angle.

## ... And what we don't know

Research is still going on into the complete mechanisms under which cholesteric liquid crystals operate. And, designers are still uncovering new applications. Medical researchers have applied the technique to mapping veins and arteries, checking blood circulation, even detecting cancer. Liquid crystals can also detect vapors, such as unburned hydrocarbons in carbon monoxide,

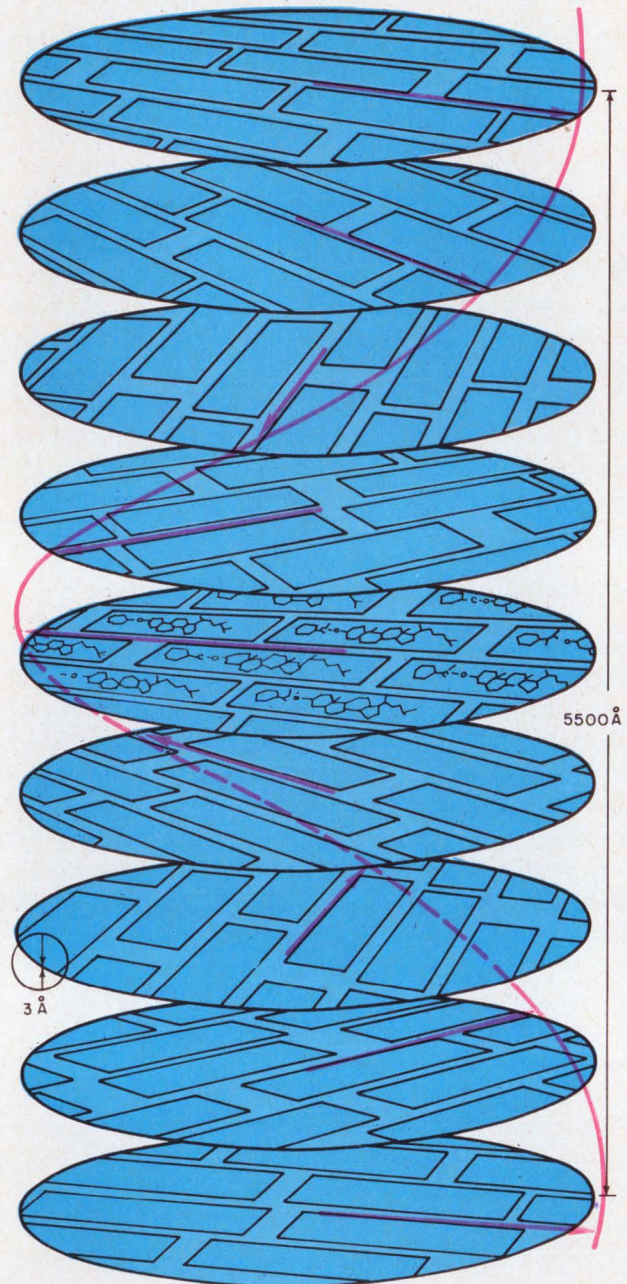

**Cholesteric liquid crystals** have a readily alterable helical structure.

and offer the possibility of cheap warning devices. Aircraft manufacturers have painted entire wing structures to unearth poor welds.

As a result, suppliers of liquid crystals are loath to make any claims for the material—other than that it meets your temperature specifications. They are eager for all the feedback they can get. Westinghouse states that its Insulating Materials Div. “would appreciate information at your convenience concerning the results of your application.”

than the heat capacity of the cholesteric film. The specific heat of most cholesteric materials is  $1.5 \text{ J/cm}^3$ . Since a film of 0.02 mm (20 microns) is required, the heat capacity per square centimeter of surface to be measured should be  $3 \times 10^{-3} \text{ J/cm}^2$ .

- The background should be black. This may be achieved artificially by using a black paint or black dye which is not oil-soluble. Dyes are preferable, for they allow the black background to be added with little increase in thickness.

- The device to be mapped must be larger than the limit of resolution of the liquid crystal. Practically, this is about 0.02 mm. If the heat pattern has significant structure below this limit, a cholesteric material is impractical.

- The rate of thermal change must be sufficiently slow to allow the cholesteric liquid to follow. The rate of change of color with temperature has a time constant which is variable from a few hours to 30 milliseconds. That is, if the temperature is changed instantaneously the liquid crystal will be within  $1/\epsilon$  of its final color in one time constant.

- The temperature of the object to be measured must be in a range where cholesteric materials are available. Figure 1 shows curves for some typical types.

- The surface must be oil-resistant. This can be sometimes achieved by use of a water-soluble film such as polyvinyl alcohol.

### Actual test procedure is simple

For applications where it is undesirable or impractical to place the material directly on the surface of the test specimen, the liquid crystal can be put on a hoop-supported Mylar film (Fig. 2) that can then be placed against the surface to be studied. Since the crystals scatter the incident light selectively, rather than absorbing it, the side against the surface should be painted black for high-contrast response. Clean the unblackened side of the Mylar with chloroform and/or acetone. With an eyedropper, apply the desired amount of liquid crystal to the cleaned Mylar surface and allow the solvent to evaporate. To aid evaporation, artificial means such as a 200-W light bulb 12 to 18 inches away may be used. Do not, however, fan or blow on the film. If the film is exposed to air currents before complete solvent evaporation, the coating will be uneven. The prepared hoop may now be placed over the area to be inspected.

To deposit the material with an eyedropper, it is best to wet the inside of the pipette first by drawing some of the liquid crystal solution up into it once or twice before attempting to expel it onto the film. Care should be taken not to allow any of the liquid to reach the rubber bulb of the eyedropper as the solvent will react to it and contaminate the liquid crystal sample.

If an area larger than 8 to 10 inches in diameter is

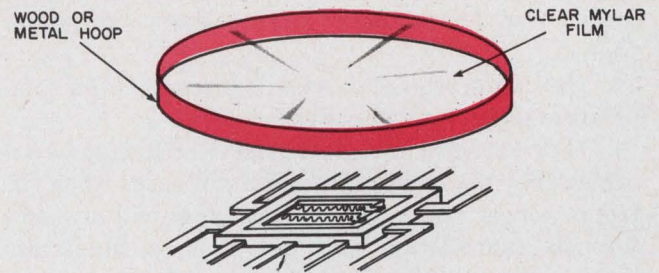

2. **Hoop-supported Mylar film is used** in situations where it is impractical to place the liquid crystals directly on the surface of the test specimen. Surface of the Mylar facing specimen can be painted black for better "readout."

to be covered, the cholesteryl ester can be sprayed on. For direct application, the following procedure should be followed:

- Clean the area with chloroform and acetone, petroleum ether, or some other solvent to remove contaminants such as oil, grease, dirt and fingerprints. Care should be taken that the solvent does not attack the surface it is in contact with.

- If not dark enough, the area should be coated with a black paint or other coating that is not vulnerable to chloroform or petroleum ether. Allow to dry.

- Apply a coat of the cholesteryl ester. The solvent must completely evaporate before use.

- When the solvent has evaporated, heat the coating approximately ten degrees above its operating temperature, then allow it to return to its operating temperature and color range. This is not essential but will improve the brightness of the colors.

- After the test is completed (it may be repeated as many times as desired), the cholesteryl ester layer can be removed with chloroform and either acetone or alcohol.

### Thermal analysis is also possible

Another application of temperature distribution is to find discontinuities in diffusivity caused by voids, cracks, bad bonds or even pinholes in the dielectric.

The conduction of heat by diffusion, not radiation, is given by:

$$\nabla^2 T = \partial T_K / \partial t. \quad (1)$$

This equation may be used to define the propagation of thermal waves in solids. Take for example a semi-infinite solid with a sinusoidal temperature at the surface which varies around a temperature  $T_0$  and has a frequency:

$$f = \omega / 2\pi. \quad (2)$$

The wavelength of the thermal wave is:

$$\lambda = 2\pi(2K/\omega)^{1/2}, \quad (3)$$

where  $K$  is the diffusivity and  $\omega$  is the angular frequency. It is propagated with a velocity of:

$$V = (2K\omega)^{1/2} = \lambda\omega / 2\pi. \quad (4)$$

As a typical problem to be solved in this manner, consider a block of material containing wires which are pulsed with current to heat them. The material has a diffusivity of 0.1. The wires are 1 mm below the

surface and 1 mm apart. Two questions can be answered:

- How soon after a pulse will the maximum temperature pattern appear at the surface?
- How long will it remain readable? It may be assumed that the maximum signal will occur when the 1-mm waves reach the surface and will dwindle through cancellation and damping as the 2-mm waves arrive at the surface.

First  $\omega$  is found for 1 and 2 mm by means of Eq. 3:

$$\omega = (4\pi^2/\lambda^2)2K = (4\pi^2)(0.2) = 0.8\pi^2 \quad (5)$$

for 1-mm waves; and

$$\omega = 0.2\pi^2 \quad (6)$$

for 2-mm waves.

Then a 1-mm wave will reach the surface at:

$$t = 2\pi / 0.8\pi^2 = 2.5/\pi \text{ seconds.} \quad (7)$$

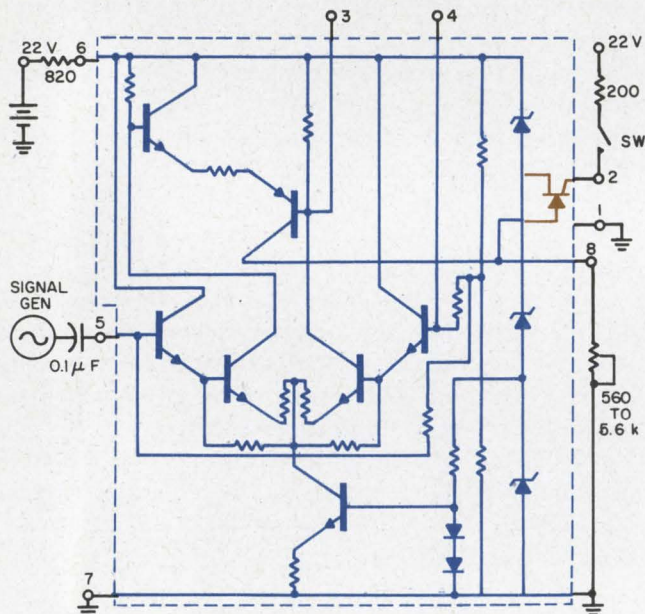

3. Differential-amplifier—SCR microcircuit is fired up to show SCR in off and on states (photos, opposite page).

A 2-mm wave will reach the surface in  $5/\pi$  seconds. Thus a clear-cut pattern of the wire will be on the surface between  $2.5/\pi$  and  $5/\pi$  seconds. This result would also indicate that a  $2.5/\pi$ -s pulse could be expected to yield maximum information.

This technique is useful in estimating the results of a test. It is not an exact solution but can be used as a guide. A point to remember is the low velocity of propagation of a thermal wave. A good picture of thermal defects in a plate can be obtained just by watching the heat flow across the plate.

In general, the temperature pattern indicates the magnitude of energy liberated or absorbed by thermal diffusion. For electronic devices, an obvious test would be to correlate temperature with power dissipation. For example, a rectifying junction in the process of deteriorating or breaking down would exhibit a localized area of high temperature caused by high current density at the fault.

### Microcircuit mapping is easy

Putting the technique to work is disarmingly simple. Several examples will illustrate this. A linear differential amplifier with an SCR firing circuit on a single chip (WC185T) is to be mapped. The equivalent circuit is shown in Fig. 3; the external firing circuit is connected as shown. In the breadboarded firing circuit of Fig. 4, three such chips are hooked up. Cholesteryl benzoate is applied directly to one of them (see the black area on middle chip). By dialing the appropriate chip, the SCR circuit is fired. The results are shown in the color photos on p. 75; the off state displays the red streaks.

A simple series resistor-diode combination (quad DTL NAND gate WM246G) is fired up with voltages from 6 to 12 volts (p.76). At the lowest voltage, the

(continued on page 79)

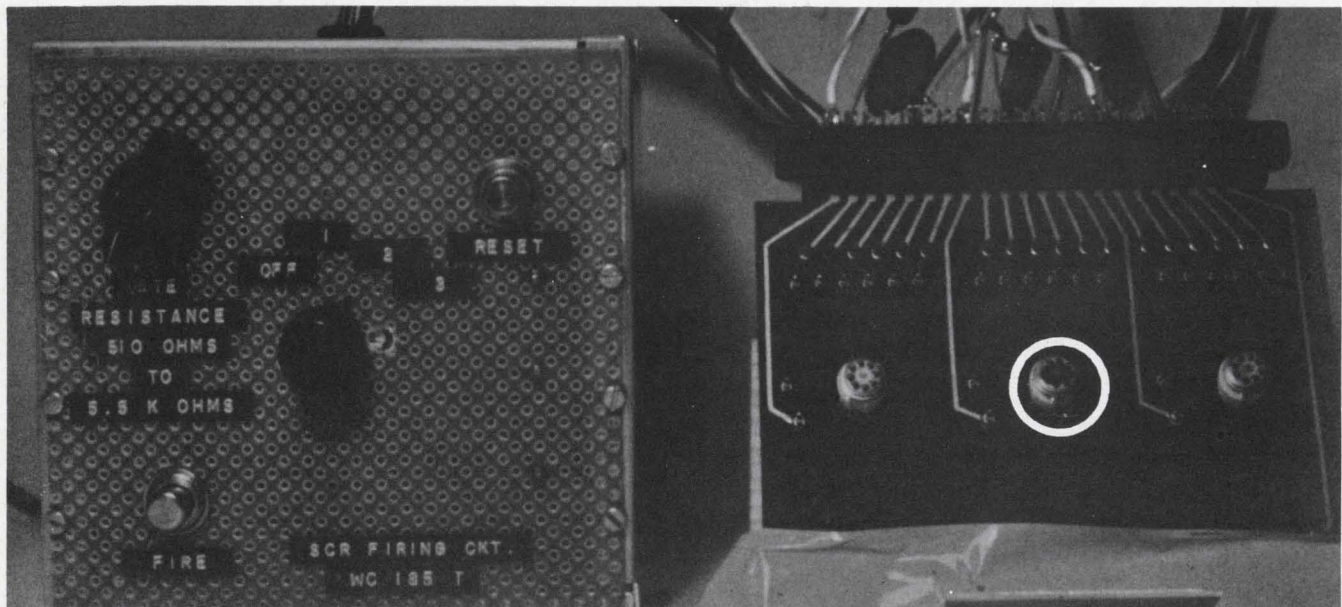

4. Breadboarded circuit fires SCR. Middle chip (note black cholesteryl benzoate) is under test.

**SCR in off state** is represented by red streaked areas. Rest of chip is dissipating more heat; thus the green-blue background.

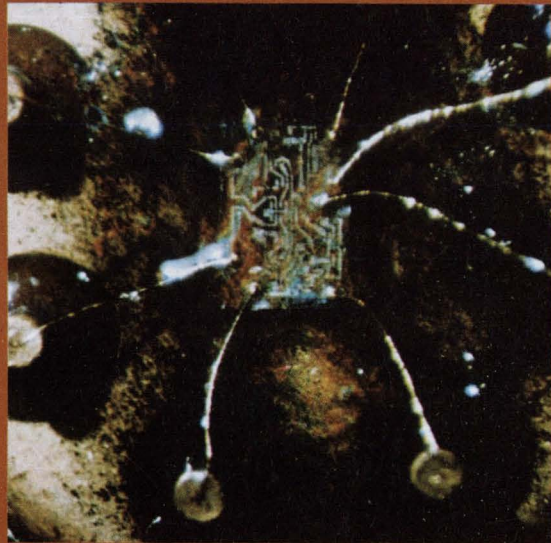

**SCR in on state** is dissipating more heat than rest of chip. Red streaks pass to green and blue and background gets bluer.

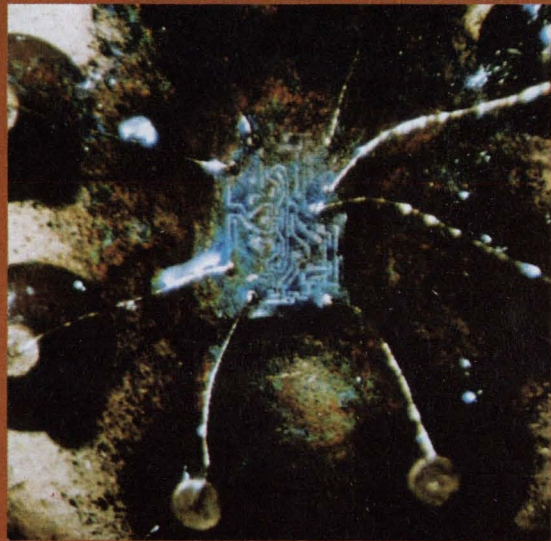

**Deeper and deeper blues** result as operating temperature increases. SCR here is still in on state, and is as blue as rest of chip.

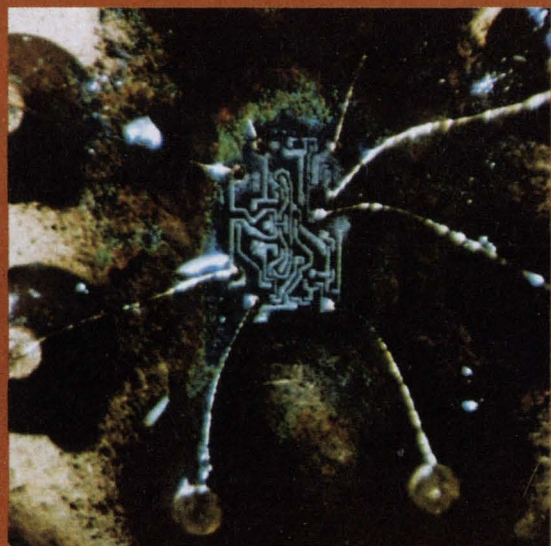

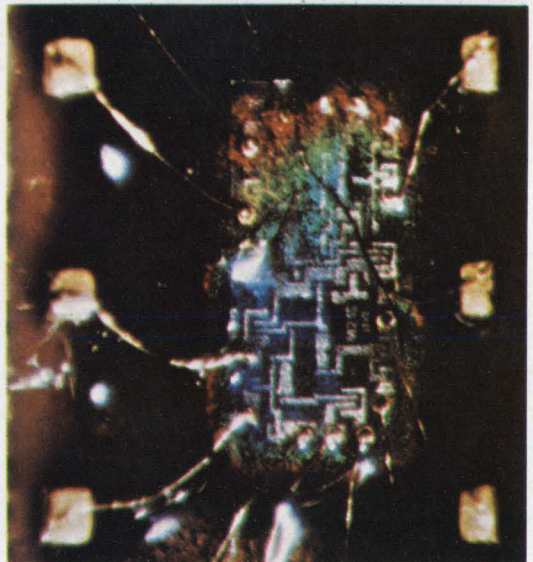
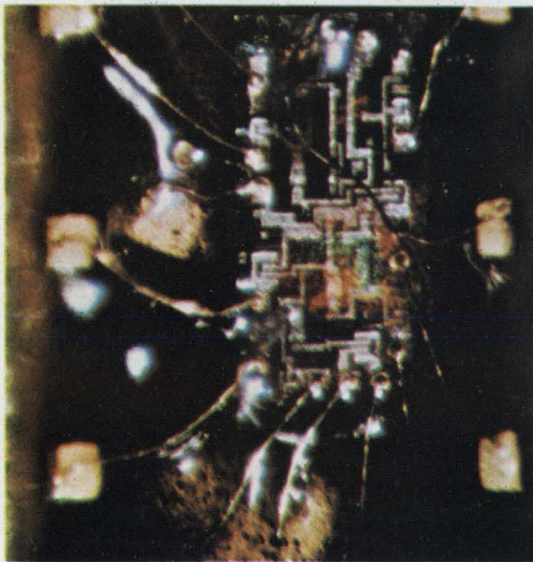
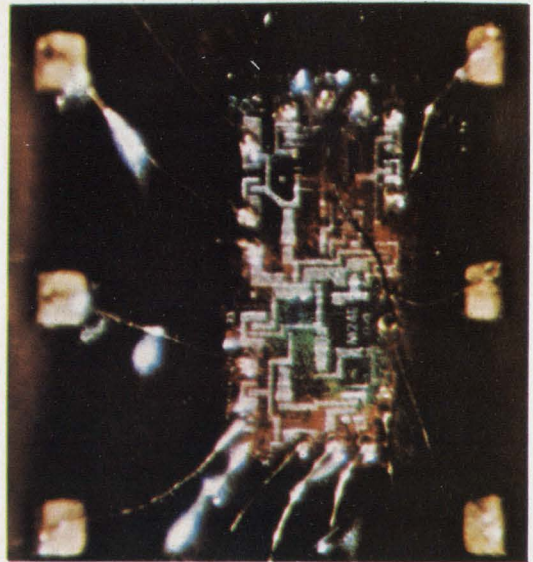
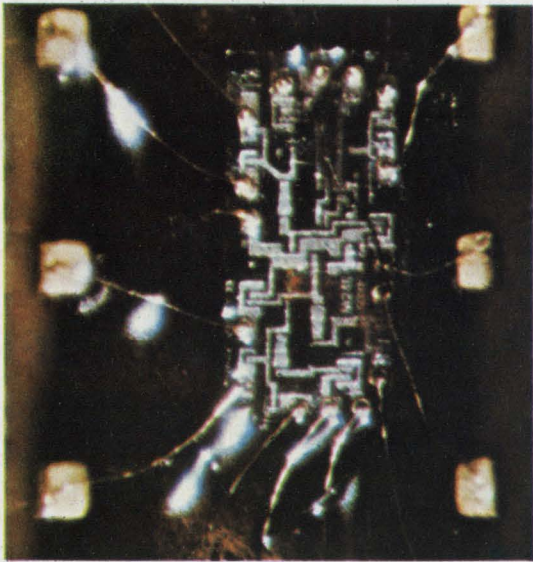

**Resistor-diode combo** is fired up with voltages from 6 to 12 volts. At the lowest voltage (upper left), the resistor is barely visible as a red spot. As the voltage is progressively increased, this spot turns green to blue (lower left, upper right). The red area finally advances to the edge of the device. Circuit is Westinghouse WM246G quad DTL NAND gate.

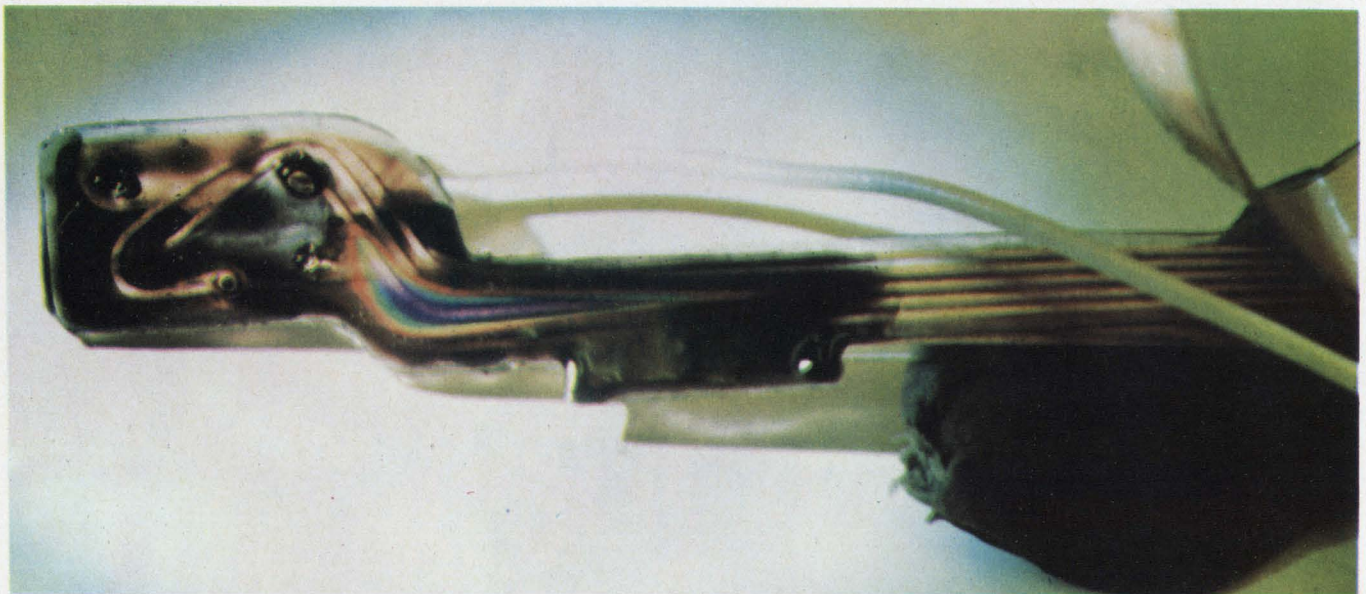

**Flexible strip of printed circuitry** has one of its conductors fired up. Smaller color area (red) represents 1 ampere, the other (green) 2 amperes.



**Silicon chip has assortment of devices**  
with flying leads so you can  
breadboard a custom IC. Corner  
resistor has progressively increasing  
voltage applied to it. At the lowest  
voltage, the green area indicates the

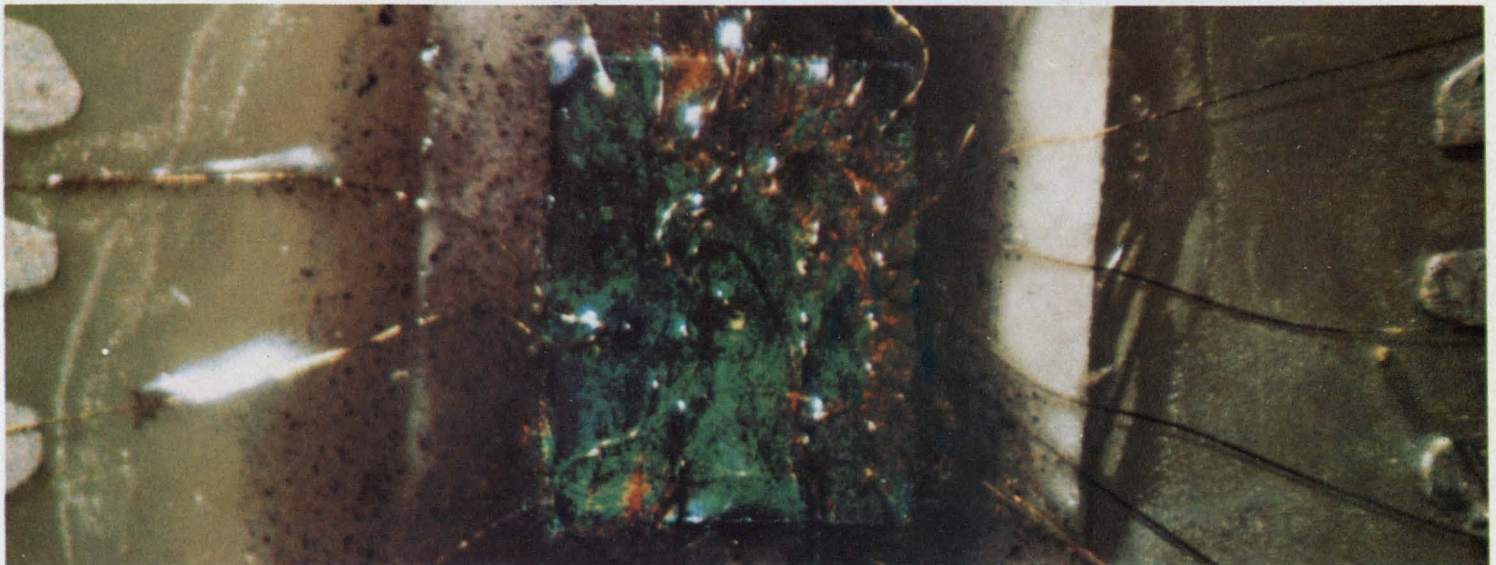
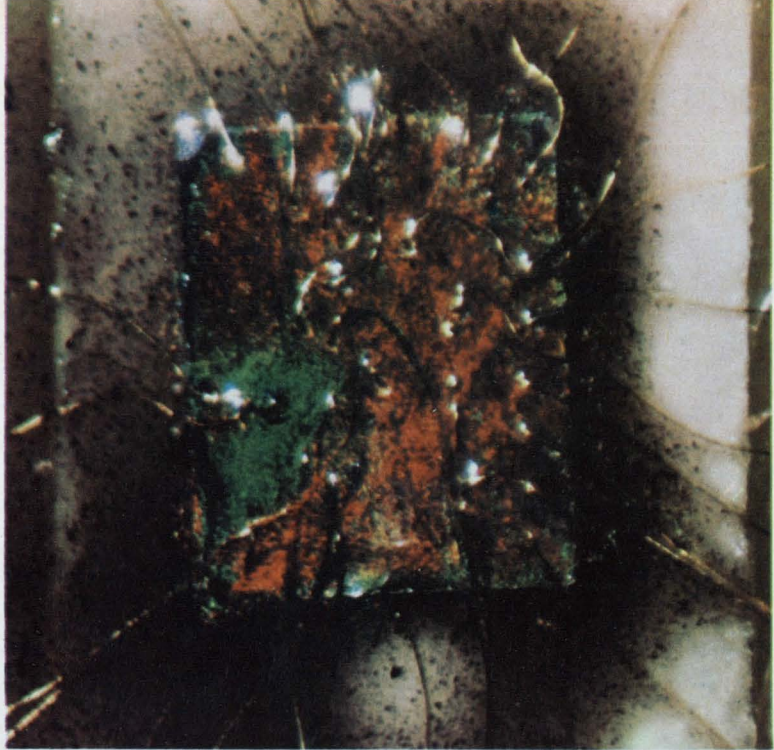

high thermal dissipating area. The  
red area is at a lower temperature.  
With increasing voltage, the  
colors gradually progress to the  
deep blue.

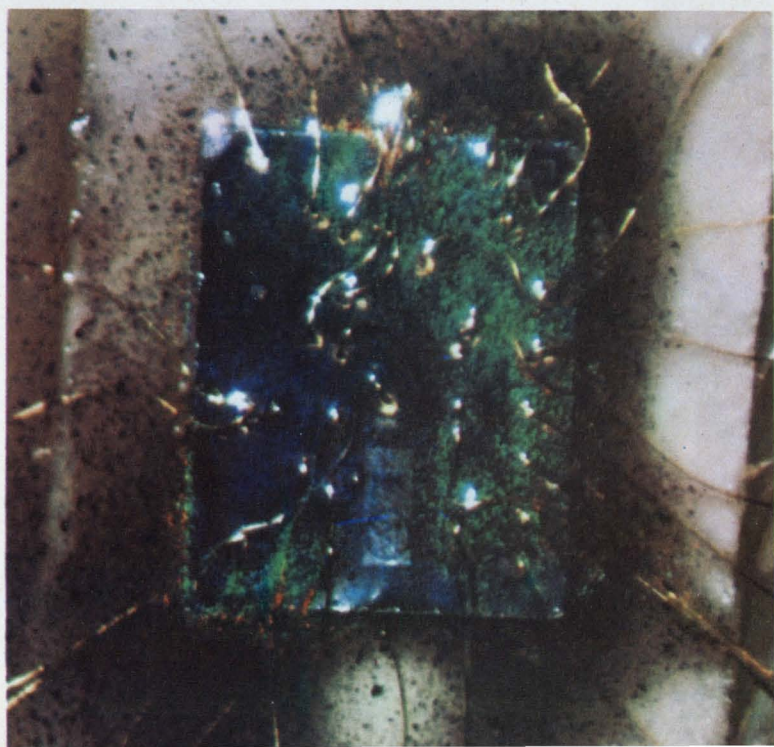

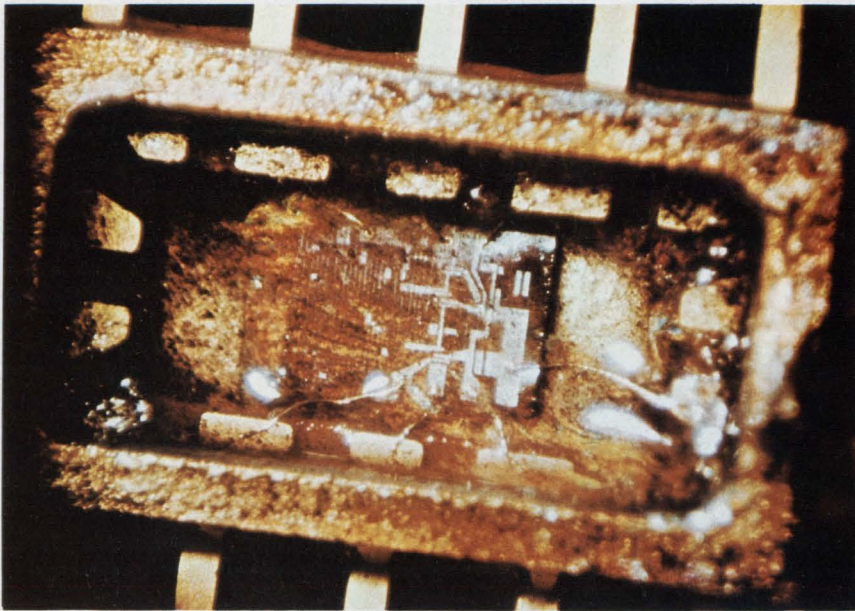

**Video amplifier** in contact with a cold sink has 5 to 8 volts applied. "No voltage" state is colorless. . . .

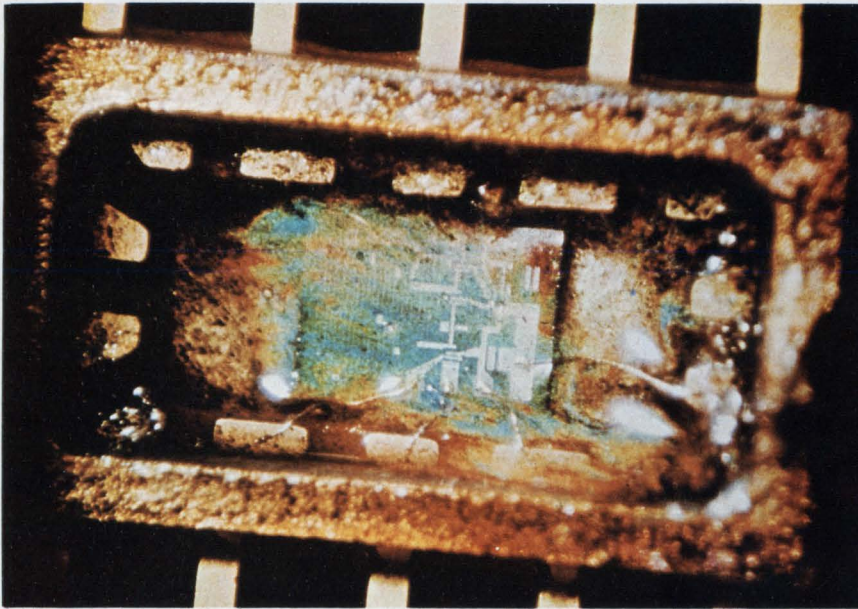

. . . low voltage is yellow-green,

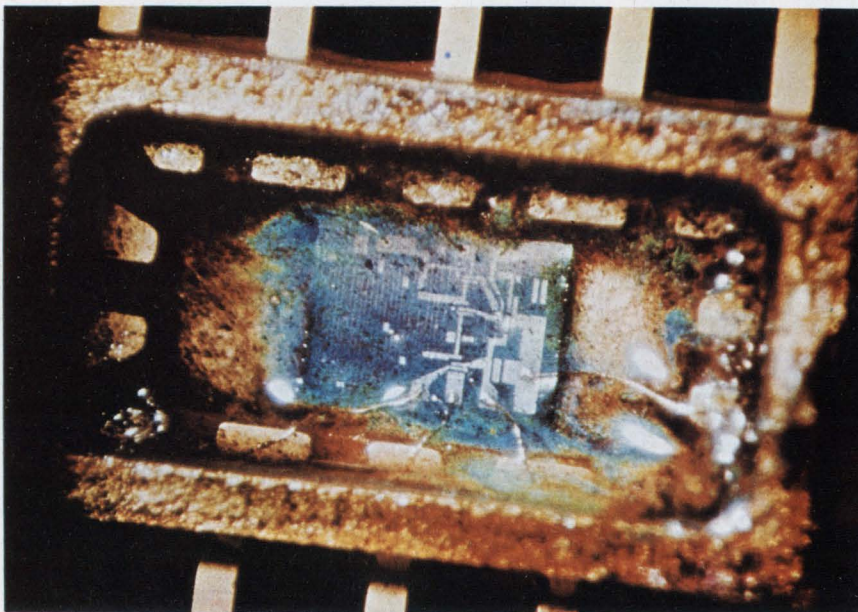

and high voltage is green-blue.

resistor is barely visible as a red spot. As the voltage progressively increases, this spot turns through green to blue and the red area advances to the edge of the device.

The versatility of the technique is underscored by its use with flexible printed circuitry (p. 76). One conductor is fired up. The smaller color area represents 1 ampere; the other, 2 amperes

The silicon chip shown on p. 77, has an assortment of devices on it with flying leads to a PC board, such as might be used to breadboard a "custom IC." It is significant in thermal mapping that the flying leads do not obscure the readout. In the photos a resistor in one corner has been fired up with increasing voltages. At the lowest voltage (top), the green indicates the area of high thermal dissipation, surrounded by a red area which is at a lower temperature. With increasing voltage, the colors gradually progress (middle) to the deep blue (bottom).

A video amplifier (WA1532) is shown on p. 78, fired up with voltages ranging from 5 to 8 volts while in contact with a cold sink. The photos show the effect of zero voltage (colorless, top), low voltage (yellow-green, middle), and high voltage (green-blue, bottom).

Other applications could be in testing plated-through holes of PC boards for thermal faults, heat sink evaluation, in-process testing, reliability and quality control testing.

### Applications beget applications

The same experiments that have led to the applications already described have suggested several other interesting potential uses for the material.

Liquid crystals, for example, could be useful in taking temperature profiles of the human body. In a typical experiment, a man's hand was painted with cholesteric compounds. A color change was evidence of a temperature change in the veins when the blood was blocked by pressure, or when the fingertips were cooled with ice cubes. A temperature drop at the fingertips, due to the dilation of blood vessels, was shown to occur when the subject inhaled cigarette smoke. Temperature profiles of the body could have applications in such medical areas as the detection of certain types of cancer.

Color changes also occur when the material is exposed to certain vapors. This might be exploited for chemical sensing simply, inexpensively and continually. A cholesteric material that detects unburned hydrocarbons associated with carbon monoxide might, for instance, be put to work as a warning device.

Cholesteric compounds are also sensitive to changes in shear. The reaction to rate of shear can be demonstrated by mounting liquid crystal material between a pair of glass slides and sliding, bending

or pressing the slides together. The shear applied then produces a predictable color change.

### Where do you buy cholesteryl esters?

Cholesteryl benzoate and other esters are available in bulk or in solution. Solutions are compounded with any organic solvent, such as benzene. Particular temperature ranges and sensitivities are dependent on the concentration of cholesteryl.

The Vari-Light Corp., 9970 Conklin Rd., Cincinnati, sells a complete kit for \$50. The kit contains three 50 cm<sup>3</sup> liquid crystal solutions, 50 cm<sup>3</sup> of black undercoat, an instruction book, four six-inch-square black plastic films, a five-inch-diameter hoop, eye-droppers, brushes and other equipment. For further information, circle Reader Service No. 471.

The Insulating Materials Div. of Westinghouse Electric Corp., Trafford, Pa., markets the compound under the trade name Spectratherm. Prices run from about \$20 for 50 cm<sup>3</sup> to \$250 for 1000 cm<sup>3</sup> (bulk) and \$20 for 5 grams to \$250 for 100 grams (solution). Westinghouse also sells a water-soluble black paint for the black undercoat. Prices run from \$4 a quart to \$22.50 a gallon. For further information about Westinghouse's products, circle Reader Service No. 472.

The Distillation Products Industries Div. of Eastman Kodak, Rochester, N.Y., also sells cholesteryl benzoate. For further information, circle Reader Service No. 473.

A free reprint of this article is available, while supplies last. Circle Reader Service No. 474. ■ ■

### Acknowledgment:

The authors are grateful for the cooperation and assistance of photographer William K. Staben, chemical technician Frederick Davis, and electronic technician Charles E. Lake.

### Bibliography:

- Brown, Glen, H., and Shaw, W.G. "The Mesomorphic State," *Chemical Reviews*, LVII (1957), 1049-1157.
- Brown, Glenn H. "Liquid Crystals," *Industrial Research*, VIII, No. 5 (May, 1966), 53-58.
- "Cholesteric Liquid Crystals," *Perspective* (Technical Information Dept., Westinghouse Electric Corp., Pittsburgh), Dec., 1964.
- Davis, Frederick. "Liquid Crystals: A New Tool for NDT," *Research/Development*, XVIII, No. 6 (June, 1967), 24-27.
- Ferguson, J.L. "Liquid Crystals," *Scientific American*, CCXI, No. 2 (Aug., 1964), 77-85.
- Foot, H.W. "Liquid Crystals" in *International Critical Tables*, ed. Edward W. Washburn (Washington, D.C.: National Research Council, 1926), I, 314-320.
- Gray, G.W. *Molecular Structure and the Properties of Liquid Crystals*. London: Academic Press, 1962.
- "Liquid Crystals," *Chemical Week*, XCVII, No. 13, (1965), 106-110.
- "Liquid Crystals Demonstrate Research Utility," *Chemical and Engineering News*, XLIII, No. 35 (Aug. 30, 1965), 52-53.
- Proceedings of Liquid Crystal Conference 1965*. London: Gordon and Breach.
- Radt, F. (ed.). *Encyclopedia of Organic Chemistry*. (New York: American Elsevier Pub. Co.), XIV, (1940), 50-56, and XIV, supplement 3 (1954), 1568-1689.
- Weissberger, Arnold (ed.). *Technique of Organic Chemistry* (Vol. I, "Physical Methods of Organic Chemistry," Part 1 2nd ed., 1949 ). New York: Interscience Publishers, Inc. P. 890-893 and 897-902.

# *Smallest 4-pole relays to qualify for U/L Component Recognition Program*

*P&B Quality, too!*

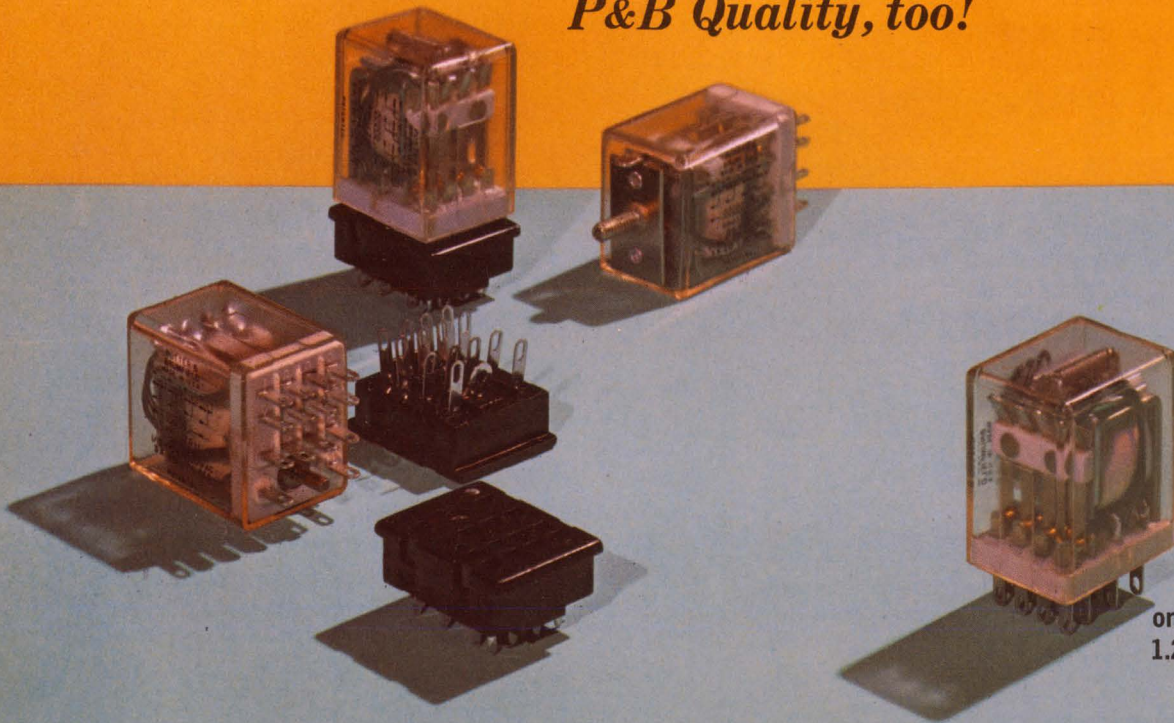

only  
1.281" x 1.109" x .859"

## *Meet our new KHU relays... companions to our KHP series*

These new 4-pole relays have an extraordinary combination of features. Small size (only slightly larger than one cubic inch), 4-poles, exceptional electrical stability over a long life, a wide choice of mountings . . . all of these and Underwriters' recognition, too. Spacings provided are 1/16" through either air or over the surface and are maintained between any uninsulated live part of opposite polarity or grounded part, including the grounded frame.

### ***Switch four circuits from low level to 3 amps***

The KHU, available in both AC and DC versions, has gold flashed silver contacts rated 3 amps 120V AC (80% PF), 3 amps 28V DC (resistive), and 1/10HP 120V AC (40-50%PF). Coil ratings are to 120V 60Hz, and to 120V DC.

Minimum power requirement for AC relays is 0.55 volt amperes at 25°C. DC relays will operate on only 0.5 watts at 25°C. Expected mechanical life is exceptionally great; 100 million cycles for DC relays; 50 million for AC relays.

### ***Variety of mountings***

The relay has pierced solder terminals with a No. 3-48 mounting stud. Three sockets are available, two having solder terminals and one having printed circuit tabs. Each is acceptable for mounting under U/L File No. E22575 when the combination is found suitable by Underwriters' Laboratories.

Send for complete specifications or contact your local P&B representative or the factory direct for complete information.

P&B STANDARD RELAYS ARE AVAILABLE AT LEADING ELECTRONIC PARTS DISTRIBUTORS



**POTTER & BRUMFIELD**

Division of American Machine & Foundry Company, Princeton, Ind. 47570  
Export: AMF International, 261 Madison Avenue, New York, N. Y. 10016

# Open the gate to nanopower IC logic with complementary MOS arrays. Here's how to put the most on a chip.

The key to both large-scale arrays and micro-power circuits is the development of a logic that dissipates very little power—particularly in the quiescent state. In a large logic array, transistors actually switch a rather small fraction of the time (they have, on the average, a duty cycle of from 0.1 to 10 per cent). Thus, most of the time they stand idle.

A magnetic core operating in a memory system is a good example of an element that does not dissipate at all in the quiescent 1 or 0 state, but only during each switching transient.

Logic microcircuits can be fabricated with complementary MOS transistors—p-channel and n-channel devices on the same chip—and they dissipate nanowatts of power when clocked at low frequencies.

The features of complementary MOS transistors that make them extremely suitable for large-scale arrays and micropower circuits are the following:<sup>1,2,3</sup>

- Microwatt stand-by power.
- Operation that is highly tolerant of device characteristics.
- Simplified logic functions.
- Simple one-supply, direct-coupled logic.
- Large fan-out capability.
- Good noise immunity.
- High-speed operation.
- Attractive potential for large-scale arrays.

A number of complex complementary MOS arrays have been designed. Figures 1 and 2, for example, show a 36-bit complementary memory on a chip. A BCD-to-16-output decoder<sup>4</sup> has been built that is effectively the equivalent of 16 four-input NAND gates on one chip. Rise times as low as 50 ns have been measured, with fall times as low as 20 ns at each output into a 7-pF capacitor. Another large array is the 12-stage binary counter.<sup>5</sup> A complementary MOS gate has also recently

---

**Richard W. Ahrons**, Advanced Applications, and **Peter D. Gardner**, Advanced Integrated Circuits, Radio Corp. of America, Electronic Components and Devices Div., Somerville, N. J.

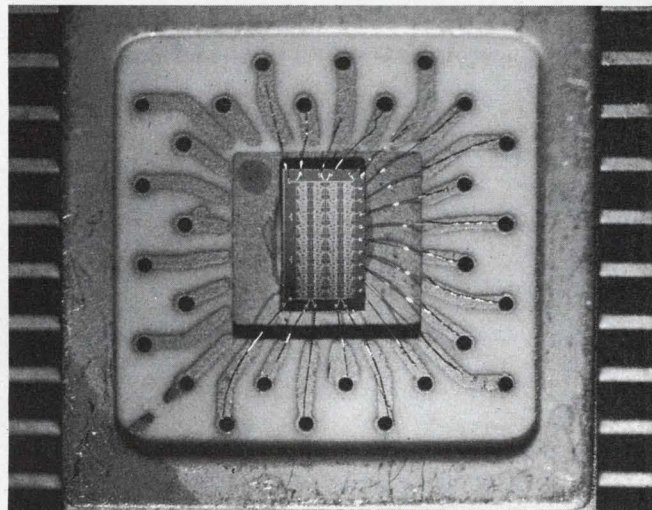

1. This 36-bit memory was made with complementary MOS units for the U.S. Air Force.

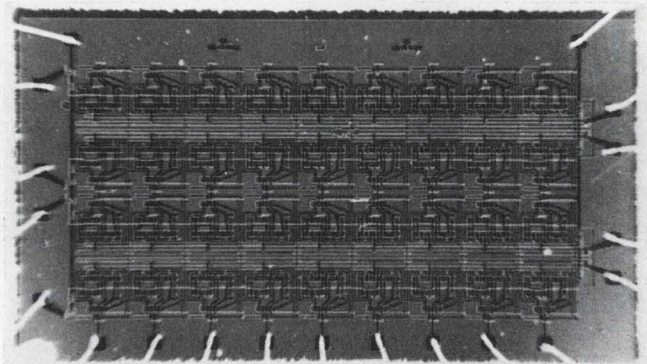

2. These 4-32 transistors dissipate mere microwatts of quiescent power when the memory stands idle.

been offered for sale.<sup>6</sup>

One of the most important advantages of complementary MOS logic to the systems designer is its extremely low power dissipation. In noncomplementary logic, a major portion of the dissipated power is expended even while the circuit stands idle. Complementary MOS circuits dissipate very little power in this quiescent state. This is accomplished by the substitution of an opposite-polarity transistor for the load resistor of conventional transistor logic. Thus, the bulk of the power dissipation in complementary MOS logic takes place during the charging and discharging of ca-

# The basic MOS transistor

The MOS transistor is a device comprising source and drain diffusions, such as n<sup>+</sup> into p-type silicon. The wafer is p-silicon, and the region between the source and drain diffusions is called the channel. An insulator (usually thermally grown SiO<sub>2</sub>) is placed above the channel, and a metallic contact (the gate) is placed on the oxide directly above the channel. When the gate of an n-channel unit is positively charged, a negative charge is induced in the channel at the interface between the silicon dioxide and the silicon. This negative charge permits conduction between the source and the drain. The induced n-type channel at the interface penetrates only about 10 to 100 angstroms into the silicon. The device is basically a voltage-controlled switch with a capacitive input. The voltage at which the device initially turns on is called the threshold voltage,  $V_T$ .

## N-channel MOS

The device shown is an n-channel MOS transistor. A complementary structure in which p<sup>+</sup> material is diffused into n-type silicon is called a p-channel MOS transistor. Its operation is analogous to that of the n-channel unit: a negative voltage on the gate induces positively charged holes in the channel, which flow when a negative voltage is applied from drain to source. Figure 4 shows the transfer characteristics ( $I_D$  vs  $V_G$ ) of typical n-channel and p-channel units. These transfer characteristics are obtained when the units are operated in the high-impedance region, that is, with a reasonably high drain voltage.

The curve of drain current  $I_D$  as a function of drain voltage  $V_D$  and gate voltage  $V_G$  is divided into three regions of operation: low-impedance on, high-impedance on, and high-impedance off. These regions are described by the following equations for the n-channel unit.

## MOS design equations

Low-impedance on:

$$I_D = 2K_n[V_D(V_G - V_{TN}) - (V_D/2)^2] + I_L; \quad (A)$$

$(V_D < V_G - V_{TN})$

High-impedance on:

$$I_D = K_n[V_G - V_{TN}]^2 + I_L; \quad (B)$$

$(V_D \geq V_G - V_{TN})$

High-impedance off:

$$I_D = I_L; \quad (V_G \leq V_{TN}) \quad (C)$$

where

$$K_n = (\mu_n \epsilon W/2l t_{ox}), \quad (D)$$

and where  $V_{TN}$  is the threshold voltage,  $\mu_n$  is the effective surface mobility for electrons (less than bulk mobility),  $\epsilon$  is the dielectric constant of the insulation,  $t_{ox}$  is the thickness of the insulator,  $W$  is the width (periphery) of the channel,  $l$  is the

length of the channel between source and drain, and  $I_L$  is the leakage current.

The equations for a p-channel MOS device are analogous to those for the n-channel unit except that the effective surface mobility of holes is taken into account.

The threshold voltage for an enhancement-type is given by:

$$V_{TN} = (t_{ox} S/\epsilon), \quad (E)$$

where  $S$  is the initial density of surface charge from the bulk material plus that contributed by surface states.

In the early days of the development of MOS transistors, instabilities in the gate oxide caused threshold voltage shifts on the order of one volt. With the advent of clean oxide processing, however, these MOS instabilities have been reduced to the point that shifts in the transfer curves (with a

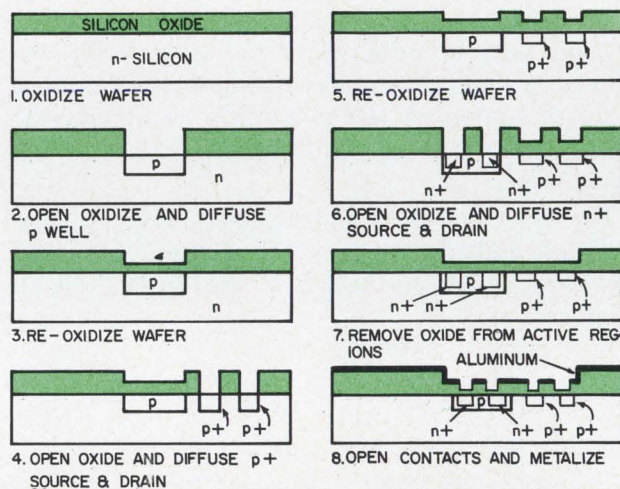

positive gate bias of 10 volts on both n- and p-channel units) is less than 100 mV after 600 hours at 125°C. With a negative gate bias of 10 volts, the shift is less than 50 mV. These tests were made under actual conditions for normal logic-circuit operation.

For switching, it is important to know the input capacitance. This value can be represented to the first order by the capacitance of the oxide,  $C_{ox}$ , given by:

$$C_{ox} = (\epsilon W/t_{ox}). \quad (F)$$

This value is increased by the capacitance of the gate metallization which is not over the channel, as well as the case and stray wiring capacitance. For present MOS transistors,  $t_{ox}$  is in the order of 500 to 2500 angstroms and  $l$  is in the order of 0.1 to 1.0 mil. When  $l$  is decreased, the input capacitance is decreased and the current capability is increased; however, the drain-to-source breakdown voltage is decreased.

capacitance. This power, called the transient power, increases with the following:

- Clock rate.
- Increasing voltage difference between the 1 and 0 logic levels.
- Increasing capacitance of the logic elements.

Take, for example, a common circuit element such as the flip-flop. The total power,  $P$ , dissipated in a complementary MOS set-reset flip-flop circuit (Fig. 3) is given by:

$$P = 2 C_o V_i^2 f + P_s, \quad (1)$$

where  $C_o$  is the node capacitance at each output node,  $V_i$  is the supply voltage,  $f$  is the operating frequency, and  $P_s$  is the stand-by power. The term  $(2 C_o V_i^2 f)$  represents the switching or transient power.

For minimum switching power, the supply voltage,  $V_i$ , must be reduced to the lowest possible value. The gate threshold voltages for the p-channel units,  $V_{TP}$ , are usually larger than the gate threshold voltages for the n-channel units,  $V_{TN}$ , and therefore determine the minimum limit for the supply voltage.

From practical considerations, the supply voltage must be appreciably larger than  $V_{TP}$  to preserve circuit stability and speed capability. As shown in Fig. 4, typical values for  $V_{TN}$  and  $V_{TP}$  are 2 and 2.5 volts, respectively. The internal node capacitance,  $C_o$ , for the flip-flop circuit (Fig. 3) is given by:

$$C_o = 2C_{ds(p)} + 4[C_{dg(p)} + C_{gs(p)}] + C_{gs(n)} + C_{st}. \quad (2)$$

In this equation, only the third and fourth terms,  $C_{gs(p)}$  and  $C_{gs(n)}$ , are considered active capacitances, because they are the terms which modulate the channel conductance to produce the MOS action. The remaining terms are anomalous and tend to reduce speed and increase power dissipation. They therefore should be minimized. This minimization of inactive capacitances requires a device design in which the gate-to-drain and gate-to-source metallization-overlap capacitance is minimized.

Figure 5 shows the total power dissipation of the unloaded flip-flop circuit of Fig. 3 as a function of frequency (repetition rate). Figure 6 shows power dissipation as a function of capacitive load  $C_L$  (representing fanout) at a fixed frequency of 200 kHz and a supply voltage of -4 volts. As Eq. 1 may lead one to expect, the data indicate a linear relationship with each of the independent variables  $C_L$  and  $f$ . The value of the stand-by power (which is given by the zero-frequency intercept of Fig. 5) is about 0.3 microwatt at 25°C. The stand-by power is proportional to the drain-to-source leakage current, which tends to be higher for n-channel units.

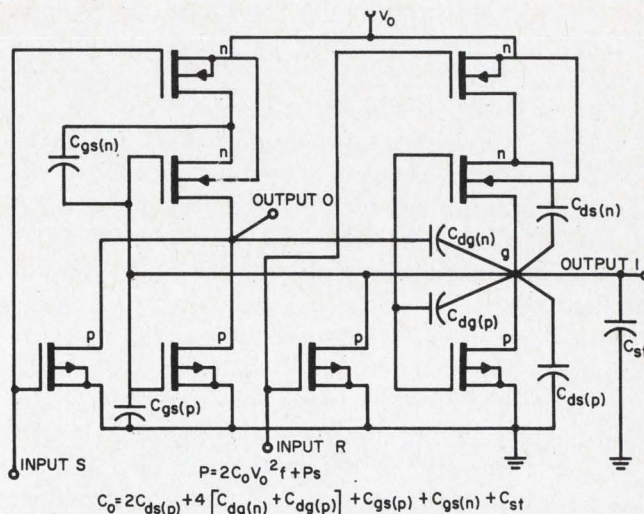

3. An R-S flip-flop made with four n-channel and four p-channel units. The capacitances indicated are those associated with the units that are germane to the operation of the flip-flop.

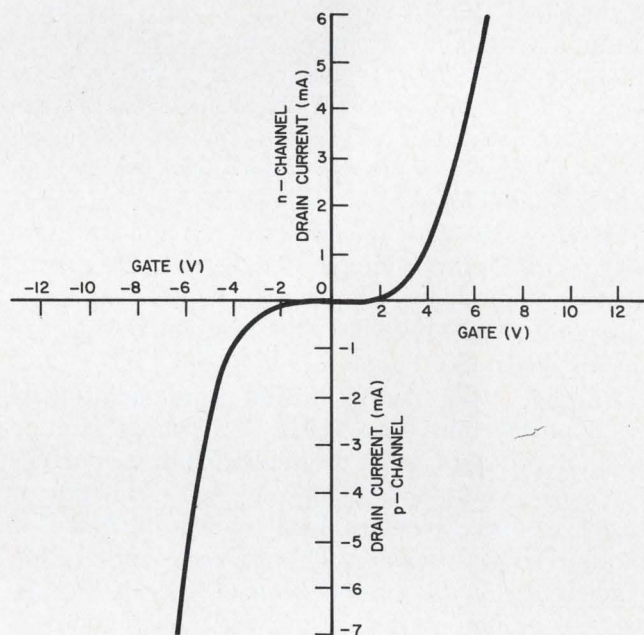

4. The transfer characteristics of both n- and p-channel MOS transistors are described by an equation of the form  $I_d = K_n (V_G - V_{tn})^2$ , where  $K_n = 1.2 \times 10^{-4} \text{ A/V}^2$ , its counterpart,  $K_p = 4.7 \times 10^{-4} \text{ A/V}^2$  and  $V_{ds} = 6 \text{ V}$ .

### The inverter: keystone of the functional approach

The fundamental building block in the functional design of complementary MOS arrays is the complementary inverter. The basic inverter circuit is shown in Fig. 7. The logical voltage swing is from zero to the supply voltage,  $-V$ . When a voltage of  $-V$  (logical 1) is applied at the input, the n-channel unit is turned off and the p-channel unit is turned on; the output is then in the low state (logical 0). This state is illustrated in the left-hand curve in Fig. 7 by the intersection of the characteristics of the two units. When zero volt-

age (logical 0) is applied at the input, the p-channel unit is turned off and the n-channel unit is turned on. The resulting output of  $-V$  volts (logical 1) is shown in the right-hand curve.

Because in either state one unit is off while the other is on, the quiescent power is only that of the supply voltage multiplied by the leakage current of the off unit. The transient power is that resulting from the charging of input and output capacitances.

The basic inverter may be extended to true complementary logic. The following gates use negative logic, that is, negative supply voltage with negative-going logical 1. The logic NOR gate (see Fig. 8) has the p-channel units in parallel and the n-channel units in series. If this arrangement is reversed, that is, the n-channel units in parallel and the p-channel units in series, a NAND gate results. The MOS set-reset flip-flop is formed by the cross-coupling of two NOR gates, (see Fig. 3).

Because MOS complementary logic employs only one supply and a logic swing of the full supply potential, either negative- or positive-going logic can be easily used for the same gate. For example, in the gate of Figure 8, the pin connected to the  $V_i$  supply can be grounded and the ground pin can be connected to a positive supply. However, the gate which was formerly a NOR gate with negative logic becomes a NAND gate with positive logic. Thus the use of negative- or positive-going logic becomes the prerogative of the design engineer.

Another very useful circuit configuration is the transmission gate<sup>7</sup> (Fig. 9), which can be used in counters, shift registers, and memories.<sup>8</sup> The single-channel transmission gate charges or discharges a capacitive load such as a gate of another MOS transistor. This reversal of direction of current flow is possible because the MOS transistor is a bilateral device, that is, the functions of source and drain can reverse. The transmission gate, however, operates as a drain-loaded stage in one current direction and as a source-follower stage in the other current direction. The latter type of operation results in slow speed in large-signal applications and also causes the MOS transistor to shut off when the voltage difference from gate to source equals the threshold voltage. In other words, cutoff can occur prematurely in comparison with an ideal switch. Both these problems can be reduced or eliminated if the voltage swing at A (Fig. 9) is larger than the required output (capacitive-load) voltage swing.

Alternatively, the complementary transmission gate can be used. In this arrangement, one of the transistors always operates as a normal drain-loaded stage. Transmission gates have been used in counters, shift registers and memories. For ex-

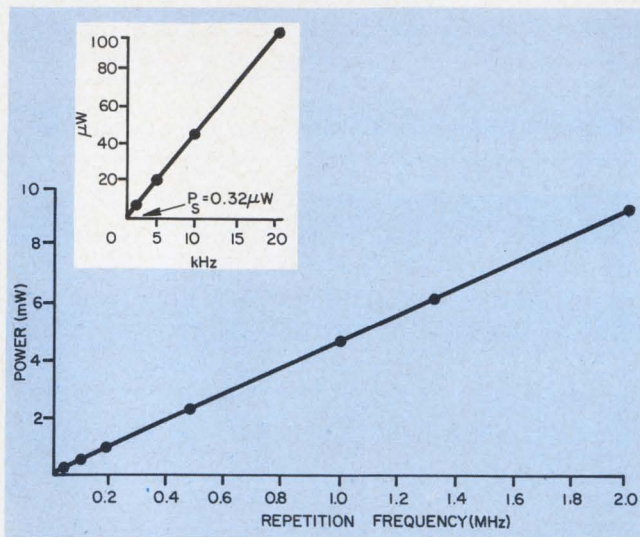

5. Power dissipation increases linearly with repetition frequency in a complementary MOS R-S flip-flop. The floating graph (upper left) shows the power dissipation as the origin is approached.

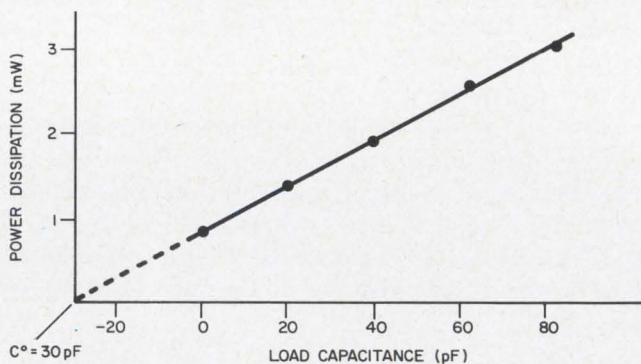

6. Power dissipation is a linear function of output load capacitance (fan-out) in the R-S flip-flop. These points were plotted at 200 kHz and a supply voltage of 8 V.

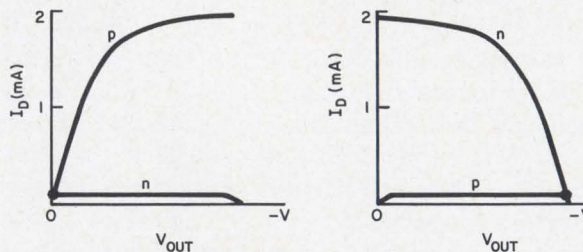
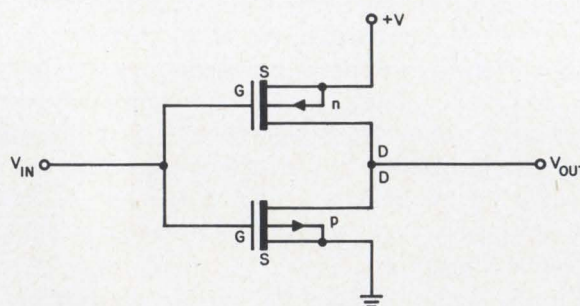

7. In the basic complementary inverter, the p-channel device is off when the n-channel device is on and vice versa. The input voltage that represents a logical 1 is  $+V$ ; the zero voltage output that results from this input represents a logical 0.



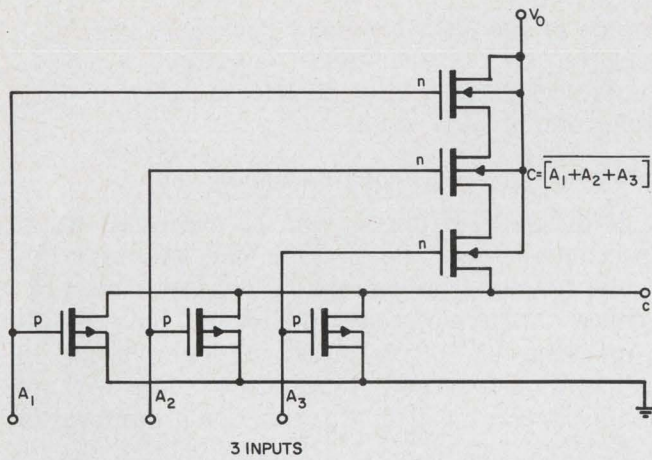

8. The output of this three-input NOR gate is  $\overline{A_1 + A_2 + A_3}$ , when the p-channel units are in parallel and the n-channel units are in series. Putting the n-channel units in parallel and the p-channel units in series produces a NAND gate. This gate is a basic logic element.

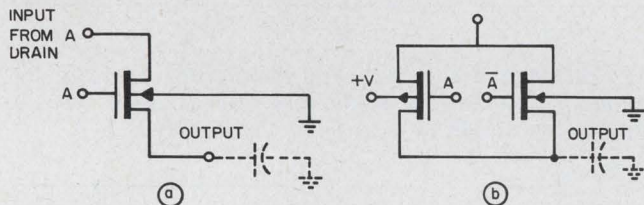

9. The p-channel transmission gate (left) can charge or discharge the gate of another MOS transistor. But premature cutoff can occur if the voltage between gate (A) and source equals the threshold voltage. The complementary transmission gate (right) always has one of its transistors operating as a normal drain load, so the voltage swing at A need not be large and there is no danger of premature cutoff.

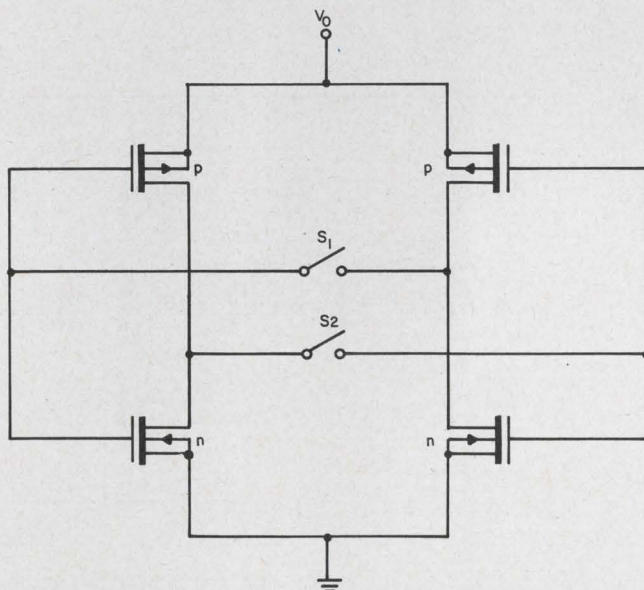

10. When  $S_2$  closes, in this simplified schematic of a complementary MOS shift register, the bit stored on the left side of the flip-flop moves onto the gates of its right side.  $S_1$  locks data in the closed loop of the delay stage. In an actual device,  $S_1$  and  $S_2$  are implemented with complementary MOS pairs (see Fig. 5.).

ample, a shift register based on the circuit of Fig. 10 uses transmission gates for  $S_1$  and  $S_2$ .

Capacitive storage and complementary MOS units can be used to form a true complementary-logic shift register consisting of two flip-flops per bit for two-phase operation. A significant reduction in components can be obtained, however, by use of the excellent capacitance-storage feature of the MOS gates. As shown in Fig. 10,  $S_1$  and  $S_2$  are in series with the cross-coupling connections of the flip-flop. When these switches are opened, two separate storage elements are formed — the left side and the right side of the flip-flop. Each side can store information for an extended but finite period of time. Digital information from the preceding stage is transferred to the left side. At the same time, the right side transfers its information to the left side of the next stage. If switch  $S_2$  is closed first, and then  $S_1$ , the 1 or 0 information transferred from the preceding bit is locked into the left side. A shift register based on these principles and using MOS units for switching is shown in Fig. 5. Effectively, this circuit is a simple MOS flip-flop for two-phase operation comprising only a few components.

Logic designs may be achieved by use of only NOR gates, and inverters. However, a somewhat more economical gate-design approach is to consider that common source and drain regions can exist in integrated-circuit form, and that the MOS transistor is topologically symmetrical. Thus, the designer can easily have access to more than one gate. For example, these ten different four-input functions can be made by simple interconnection changes on a quad of p-channel units:

- $\overline{A + B + C + D}$  [NAND]
- $\overline{A} \overline{B} \overline{C} \overline{D}$  [NOR]
- $(\overline{A} + \overline{B})(\overline{C} + \overline{D})$  [Exclusive-OR when  $C=A$  and  $D=B$ ]
- $(\overline{A} + \overline{B})\overline{C} + \overline{D}$
- $(\overline{A} + \overline{B} + \overline{C})\overline{D}$
- $\overline{A} \overline{B} + \overline{C} \overline{D}$
- $(\overline{A} \overline{B} + \overline{C}) \overline{D}$
- $\overline{A} \overline{B} + \overline{C} + \overline{D}$
- $\overline{A} \overline{B} \overline{C} + \overline{D}$
- $(\overline{A} + \overline{B})\overline{C} \overline{D}$

The quad consists of five diffusion strips for source or drain and four gate strips. Figure 11 shows formations of the gate for the function  $(\overline{A} + \overline{B})(\overline{C} + \overline{D})$ , which is the exclusive-OR function when  $C = \overline{A}$  and  $D = \overline{B}$ . This type of design can be used for more complex functions such as half adders, half shift registers, and full adders.

The gates described have measured stage delays of 25 ns. Higher speeds will be achieved by reducing stray capacitance and increasing the gain of the MOS transistors. The speeds can be calculated

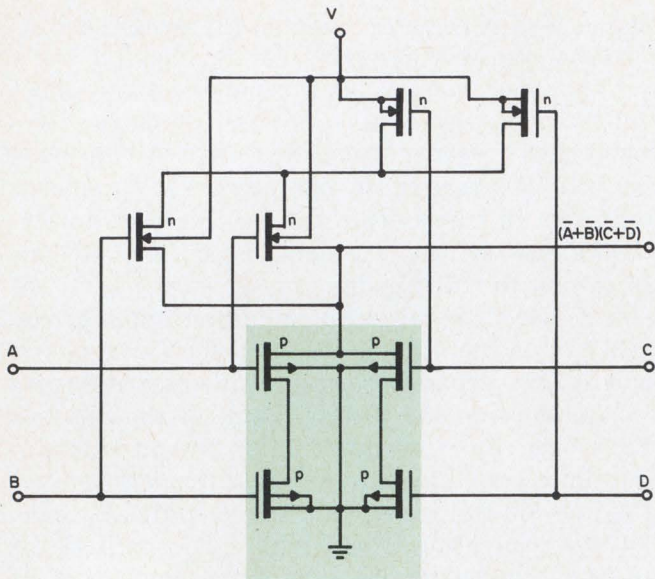

IF  $C = \bar{A}$  AND  $D = \bar{B}$   
 OUTPUT  $(\bar{A} + \bar{B})(A + B) = A\bar{B} + \bar{A}B$  EXCLUSIVE-OR FUNCTION

11. With this all-purpose complementary MOS gate, merely changing the metal interconnect pattern on the p-channel quad can produce any one of 10 four-input gate functions. As shown above, the unit is a gate, the output of which is represented by  $(A+B)(C+D)$ .

by use of the MOS nonlinear equations (see box) and the circuit capacitance. Operation at maximum clock rates of up to 20 MHz is easily predictable from present results.

### Design arrays using minterm equations

If the desired function can be expressed easily in equation form, the designer can use the truth table or minterm expression directly and then reduce the number of transistors. This procedure is similar to relay (switch) logic design. In this method the designer essentially starts with an outline such as that in Fig. 12. For a minterm of

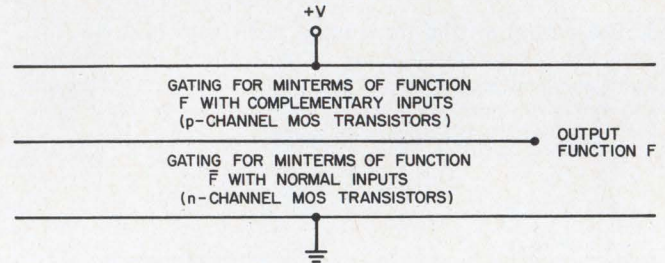

12. This logic design outline is the starting point for the minterm approach to eliminating excess MOS transistors in the design of a particular function.

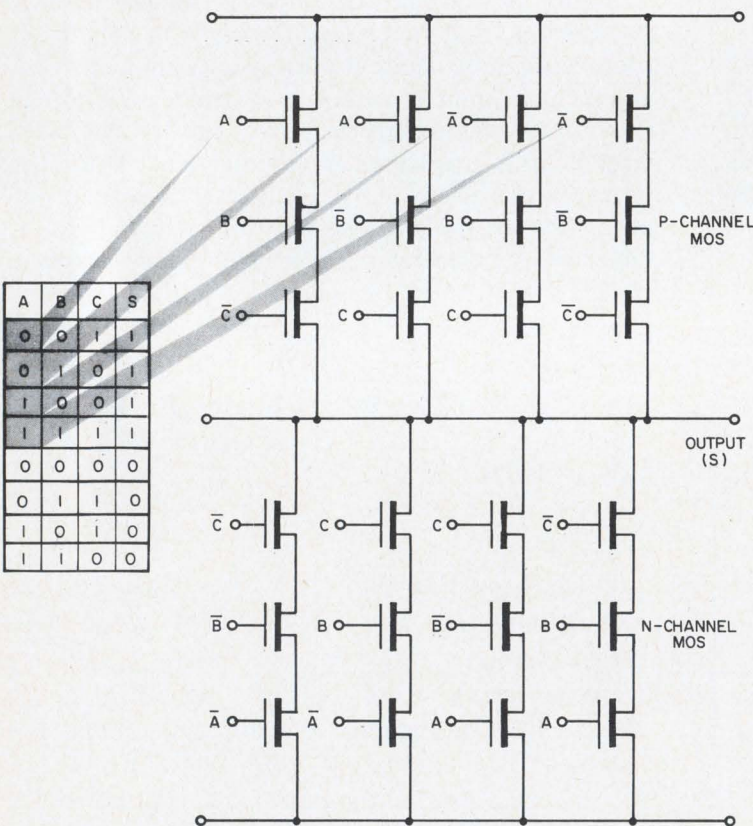

13. The design of this adder has the function and its complement arranged on top of each other, just as in the truth table (left). When excess transistors are eliminated, the same circuit has eight fewer transistors (see right). This is done by scanning across the matrix and eliminating redundant variables. Reading left to right from the top, for example, A and A can be combined into one

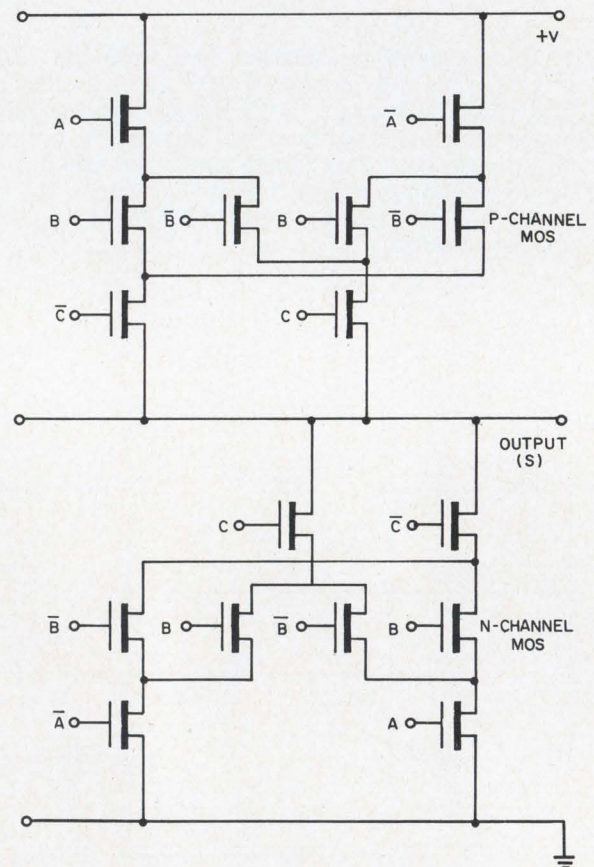

transistor, as can be  $\bar{A}$  and  $\bar{A}$ . The second line has no adjacent redundant functions, so no terms involving B can be eliminated. On the third line, the two middle C transistors can be combined and, since the two  $\bar{C}$  units share a common conductor, either of the  $\bar{C}$  transistors can go. Similar operations on the lower half of the circuit produce the minimized summing circuit at the right.

function  $F$ , the output should be shorted to the supply  $+V_a$ ; for the minterms of  $\bar{F}$ , the output should be shorted to ground. For example, Fig. 13 (left) shows the nonminimized logic design of the sum function of a full adder. The top four terms of the truth table show the minterms of the function  $S$ , and the bottom four terms show the minterms of the function  $\bar{S}$ :

$$S = \bar{A} \bar{B} C + \bar{A} B \bar{C} + A \bar{B} \bar{C} + A B C$$

$$\bar{S} = \bar{A} \bar{B} \bar{C} + \bar{A} B C + A \bar{B} C + A B \bar{C}$$

Of the 8 possible minterms for three input variables, this particular case breaks into four each in  $S$  and  $\bar{S}$ . (This even division is not necessarily the general case.) For the upper, or p-channel, MOS units, each series string represents a minterm of  $S$ . The complement of each variable in the minterm expression for  $S$  drives a gate in that string. In the lower, or n-channel, expression, the minterms of  $\bar{S}$  are used directly and each variable drives a gate of the series strings. If the common  $C$  and  $A$  units, and  $\bar{C}$  and  $\bar{A}$  units, are connected together, a minimized expression is obtained, as in Fig. 13 (right). The sum function requires 16 transistors. Two exclusive-OR circuits and one inverter also provide the sum function, using a total of 18 transistors by the gate approach. If the complements of the variables are not available, however, six additional transistors are required for inversion, for a total of 22 transistors.

Transistor count should not be the only criterion for design choice. Topological layouts that minimize silicon area and maximize the operating speed of the circuit must also be considered. Often, for example, two simple stages in cascade operate faster than one complex stage. A fair comparison between any two designs would be to adjust transistor sizes for equal speed in each design and then compare chip size. ■ ■

#### References:

1. A. H. Medwin and B. Zuk, "Using MOS Transistors in Integrated Switching Circuits," Part 1, *ELECTRONIC DESIGN*, XII, No. 24 (Nov. 23, 1964), 74-79, and Part 2, *ibid.*, No. 25 (Dec. 7, 1964), 74-80.
2. R. D. Lohman, "Some Applications of Metal-Oxide Semiconductors to Switching Circuits," *Semiconductor Products and Solid State Technology*, May, 1964.
3. J. E. Annis *et al.*, *Personal Communications* (Somerville, N. J.: RCA).
4. R. Feryszka, S. Katz and A. K. Yung, "Monolithic Complementary-Symmetry MOS Decoder," *1967 International Electronics Conference Digest of Technical Papers, Toronto* (New York: IEEE, to be published).
5. A. K. Rapp *et al.*, "Complementary-MOS Integrated Binary Counter," in *1967 International Solid-State Circuits Conference Digest of Technical Papers*, X (New York: IEEE, 1967), 52-53.
6. "Complementary MOS Arrays Going to Market," *ELECTRONIC DESIGN*, XV, No. 9 (April 26, 1967), 21.
7. J. Wood and R. G. Ball, "The Use of Insulated-Gate Field-Effect Transistors in Digital Storage Systems," in *1965 ISSCC Digest of Tech. Papers VIII* (New York: IEEE, 1965), 82-83.
8. J. R. Burns *et al.*, "Integrated Memory Using Complementary Field-Effect Transistors," in *1966 ISSCC Digest of Tech. Papers* (New York: IEEE, 1966), 118-119.

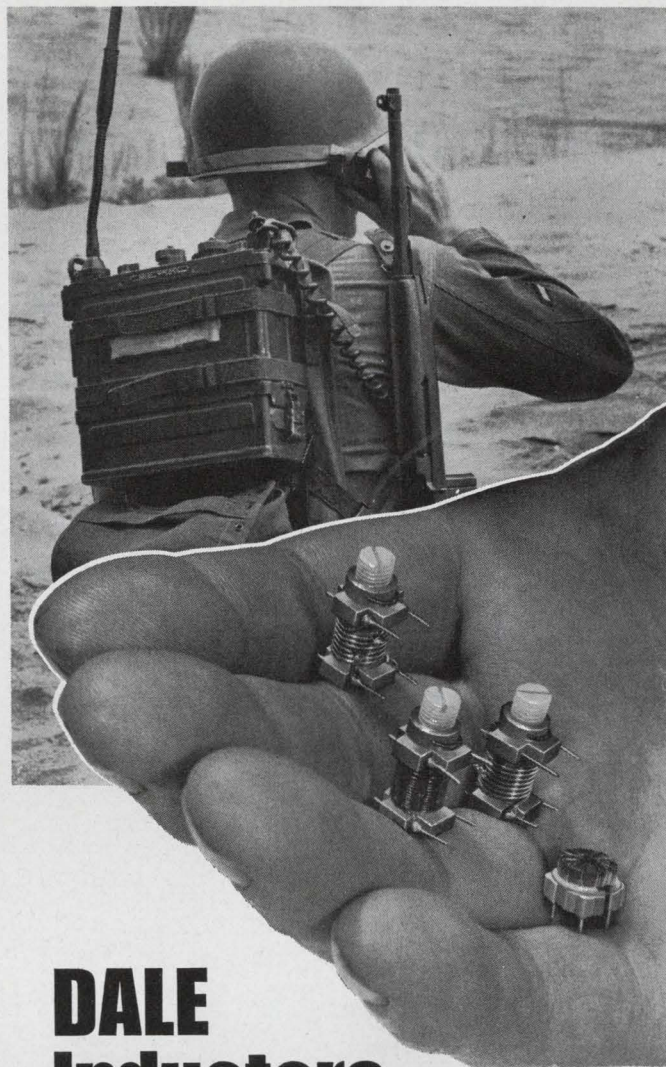

## DALE Inductors... high Q in a back-pack

Few radios can take as much abuse as the Army's AN/PRC-25 Back-Pack. Designed for rugged field conditions, this RCA-built transceiver uses specially-developed Dale miniature high frequency inductors. These tiny core-tuned inductors provide high Q (approx. 170 @ 75 MHz) over a wide inductance range. Once tuned, they stay tuned—because of the positive action of a special core tension spring. Ability to meet the rigid requirements of MIL-C-15305C with mass-produced parts is only one of many broad inductive capabilities of Dale's Sioux Division.

Get the complete story—phone 605-665-9301 or write for new Facilities Report.



**DALE ELECTRONICS, INC.**  
**SIoux DIVISION** Dept. EP  
Yankton, South Dakota 57078

Producers of: Toroids, Series Resonant Traps, Variable Pitch Inductors, Miniature High Frequency Inductors, Degaussing Coils, Industrial and Military Coils, Sub-Miniature Coils, Surge and Lightning Arresters, Custom Assemblies, Motor Driven Potentiometers.



**Here's Amphenol's new  
square version of the  
low cost 2600 trimmer**

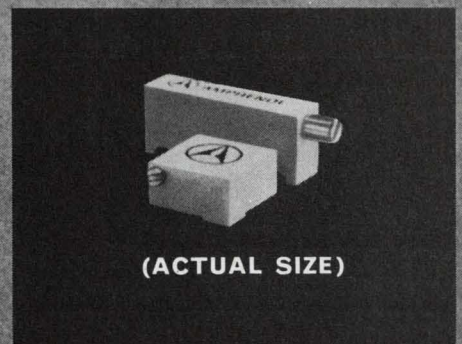
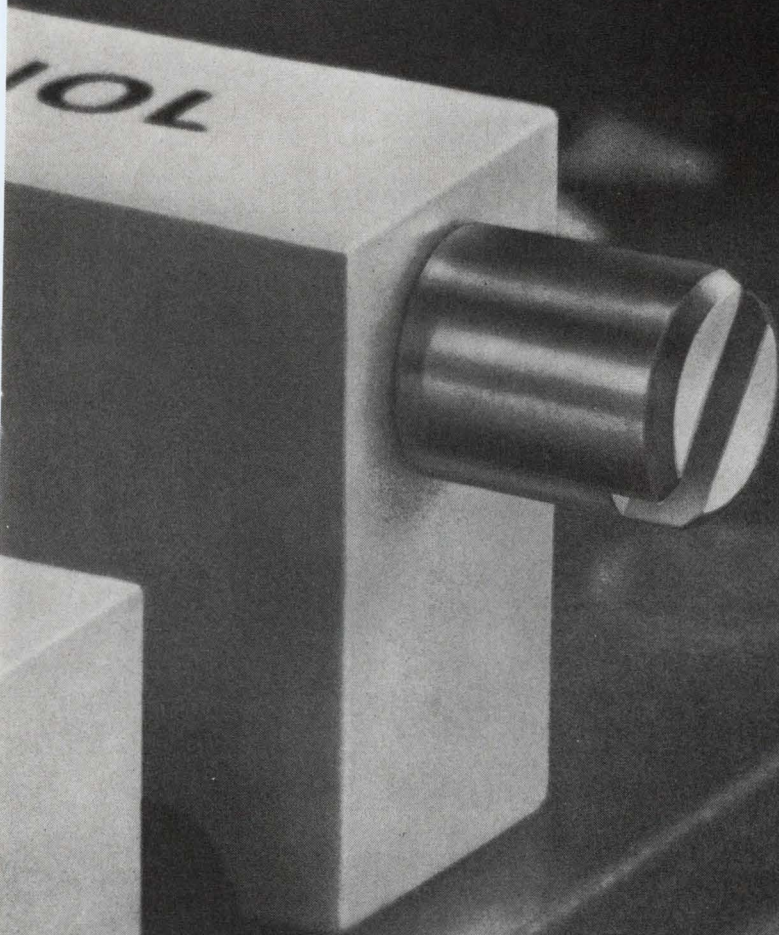

Amphenol's new  $\frac{3}{8}$ " square commercial trimmer offers you half the height of our renowned 2600 trimmer above, and half the cost of any  $\frac{3}{8}$ " square trimmer—less than \$2.00 each in production quantities.

**REPLACES  $\frac{3}{8}$ " OR  $\frac{1}{2}$ " SQUARE TRIMMERS** The PC pins of the new

3600 trimmer fit the cards of any standard  $\frac{3}{8}$ " or  $\frac{1}{2}$ " square trimmer. And, it's only .200" high for low card space applications. It's also available in a humidity-proof model, the 3610.

**SAME 2600 QUALITY SPECS** The 3600 performs like the 2600 with 85% better resolution than MIL-

R-27208B, RT24. Order the 2600 or 3600 from your Amphenol Distributor or Sales Engineer. **Amphenol Controls Division**, Janesville, Wis.



**AMPHENOL**

ON READER-SERVICE CARD CIRCLE 52

Specify Amphenol . . . the leading name in cable, connectors, assemblies, RF switches, potentiometers, motors, microelectronics

# Error detecting codes are simple

to implement. Compare some of the popular detecting and correcting codes and the hardware needed.

*Error detection correctn communicatns easily applied if mantoman.*

The previous sentence is a mess, but the astute reader will quickly pick the "message" it carries from the "noise." The human brain does an amazing job of error detection and correction despite all kinds of aberrations in aural or visual transmission.

Electronic systems, unfortunately, are not nearly so clever. Computers, digital communications links, and other digital systems will faithfully follow any inaccurate instructions or transmit any faulty data fed to them. That is, unless the designer builds into them some sort of systems to sense, or even to correct, errors. There are several approaches to error control that have evolved over the last few years. Choosing the one to use and then implementing the error coding properly are important, because the error control circuitry can affect the speed and efficiency of the entire system.

Here are some of the more popular error control techniques, and a look at the hardware involved.

## Parity check is most basic method

The most basic of all error-checking methods is the parity check. Validity is recognized by the parity of the transmitted word; that is, an extra digit makes the total number of 1s in the word odd or even. This extra digit is called a parity bit. The choice of a parity generator is governed to some degree by the type of code used, but odd parity is most generally used. With even parity an all-zero character can occur. This is undesirable since it may look as though the machine is off. It is possible to incorporate more than one parity digit in a word, as in the Hamming code, which will be examined later.

Figure 1a shows how a single-digit parity generator may be implemented in a typical six-bit data register. The clock input to the parity generator can be derived from either output of the final flip-flop. If even parity is to be generated, the double dotted line must be connected; the single line is used for odd parity.

It works like this: If the data register is loaded at

$t_0$ , during clock times  $t_1$  through  $t_6$  data are shifted out of the high-order position of the register, that is to say, flip-flop  $F$ . The parity flip-flop changes state every time a 1 is shifted out. At  $t_7$  the state of the parity flip-flop is gated onto the transmission channel. The parity bit must follow the data word since the parity flip-flop only counts bits as they are shifted out of the data register.

To recognize parity at the receiving station, a similar arrangement is used where the parity generator is clocked by the serial input data rather than the output (Fig. 1b). When the entire word has been shifted into the register at the receiving station, the parity flip-flop will indicate whether an odd or even number of bits will be received. This will show whether an error

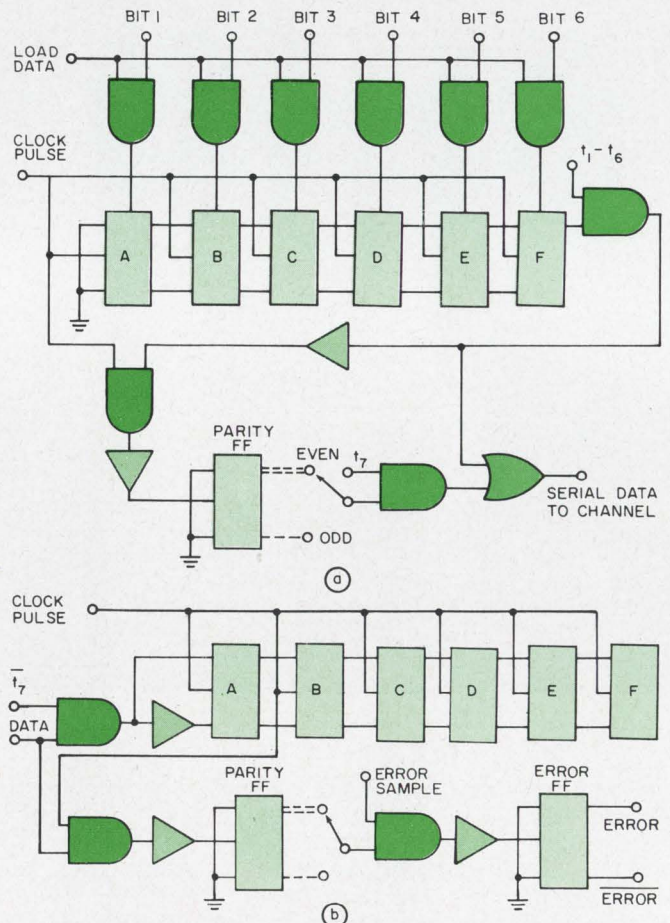

1. Parity check circuitry is similar for transmitting (a) and receiving (b). The parity bit is derived from a flip-flop.

Robert K. Jensen, Applications Engineer, Fairchild Semiconductor, Mountain View, Calif.

exists; it will not detect the position of the error.

It is important to note that, since a parity check detects only an odd number of errors, slightly under half of all errors will be detected, if the probability of an error is 0.5. The number of errors detected is not exactly half, because errors may occur in the parity bit itself during transmission or reception. In many systems, such as magnetic-tape recording, the probability of an error is much less than 0.5. This means that the probability of more than a single-bit error will be very low, so a parity check will catch considerably more than half the errors. A further minor disadvantage is that the transmission rate is decreased by the addition of parity bits. Against these shortcomings must be weighed the advantages. The parity check is simple to implement and is relatively effective in serial transmission over interface channels, as errors here are generally of the impulse type.

### Longitudinal redundancy check is parallel code

In contrast to the serial parity check, the longitudinal redundancy check is a parallel type of checking code. A check bit, generated in a somewhat different fashion from the parity bit, is used for *each* bit within a word. To explain the basic notion, take two words of four bits each and operate on them to gen-

erate the check bits. The data words are:

data word 1: 1110

data word 2: 0010

These words will be added together by binary arithmetic but all borrows and carries will be ignored. For example,  $1 + 1 = 0$  with a 1 to carry, but here we forget about the carry. Thus adding the two data words gives:

check word 1: 1100

As this addition is performed, the transmitter sends out first data word 1, then data word 2, and then the check word. At the receiver the two data words are added together, just as they were at the receiver, and a similar check word is produced. Now the receiver's check word is compared with the one sent from the transmitter, to see if they agree. This is done by means of an interesting property of this type of binary arithmetic: unlike symbols added together generate a 1, like symbols generate a 0. If the two check words are exactly alike, then all 0s will be produced; but if an error has been made, it will cause a 1 to appear in the answer:

|                        | No error | With an error |
|------------------------|----------|---------------|
| Transmitter check word | 1100     | 1101          |
| Receiver check word    | 1100     | 1100          |
|                        | 0000     | 0001          |

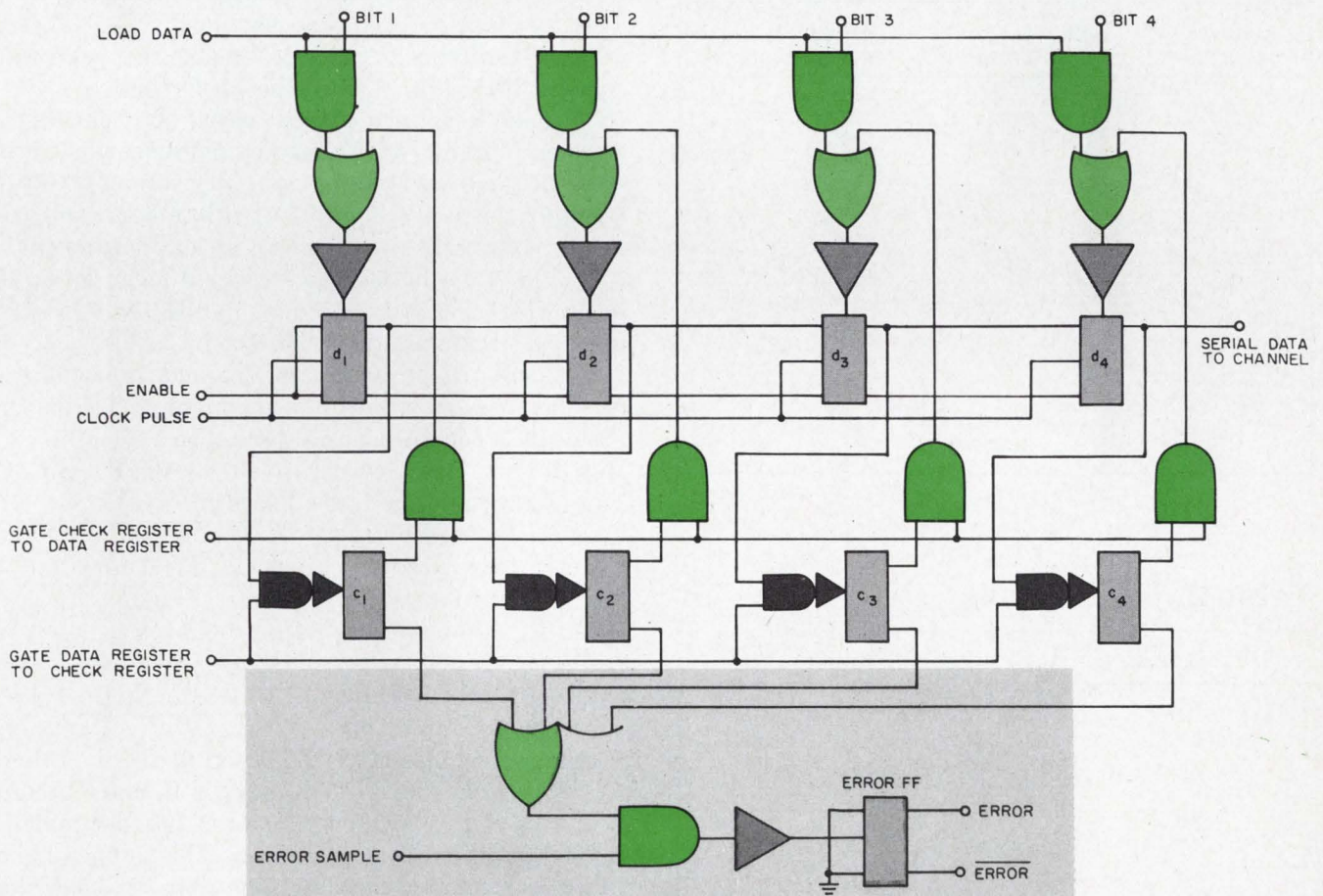

2. **Two registers are needed** for the longitudinal redundancy check. Gating enables the check word to multiply

further data words or to be transmitted. Color block shows the error detector used at the receiver only.

Initially data word 1 is the check word. This is then added to data word 2 to generate a new check word. It is then possible to add the new check word to a third data word, and so on. Thus the check word can be used to check a sequence of as many data words as desired.

Accuracy is not necessarily better than that of the parity check approach. Longitudinal redundancy is expensive to implement because it requires a flip-flop for each binary digit in the code word.

An actual implementation for four-bit words is shown in Fig. 2. The sequence of events is as follows, using the previous example.

Initially a data word is loaded into the data register,  $d_1$  through  $d_4$ . The data register is then gated to the check register, giving the same word in both. The data word is then shifted onto the transmission channel, most significant bit first ( $d_4$ ). At this stage the check word could be gated into the data register and transmitted, or a second data word formed and a composite check word generated. Assume the second case. The data word is gated into the data register in the same manner as before, and then into the check register, causing a binary addition to the already existing check word. The data word is shifted

out of the data register and then the check word is transmitted by gating it into the data register and shifting it out onto the transmission channel. At the receiver end, a check word is being generated in the same way. When the check word is received in the data register of the receiver, the two check words are added together in the check register, which should produce all 0s. The check register is then sampled to detect any 1s (color block in Fig. 2).

### Hamming code is commonest in digital systems

The most widely used method of error detection and correction in digital systems is probably the Hamming code.<sup>1</sup> It provides an efficient approach to error detection and correction and is quite easy to implement. There is, however, a practical limit on the use of this code in that the number of checking digits required for a given word can become quite large (see Table 1). The code is constructed by incorporating more than one parity digit in any given word, that is, each parity digit checks the parity of certain groups of information digits within the word.

If an error occurs within the word, the parity bits taken together will give a binary number, the decimal equivalent of which will indicate the position of the error in the word. This locates the error, thus making it easy to correct.

As an example of the Hamming code, take data word, 0101, with the most significant bit at the left. The Hamming code requires that check bits are inserted at bit positions 1, 2, 4, 8, 16, etc., so this word will contain  $101P_41P_2P_1$  after the check bits,  $P_1, P_2, P_4, \dots$ , are generated. Each parity bit checks a group of word bits determined by reference to a truth table. If there are no errors, a parity sum of 000 will result for the parity digits. The truth table shows that a 1 in position  $P_1$  would mean an error in position 1, 3, 5 or 7; a 1 in position  $P_2$  would mean an error in positions 2, 3, 6 or 7; and a 1 in position  $P_4$  would mean an error in positions 4, 5, 6 or 7.

The parity digits are determined by an even parity rule and inserted in the following manner. Taking  $P_4$  first, bits 5, 6 and 7 have only one 1, so a 1 goes in  $P_4$ . Bits 3, 6 and 7 have two 1s, so a 0 goes in  $P_2$ . Bits 3, 5 and 7 have only one 1, so a 1 goes in  $P_1$ :

| Position                       | 7   | 6   | 5   | 4     | 3   | 2     | 1     |
|--------------------------------|-----|-----|-----|-------|-----|-------|-------|
| Digit type                     | $d$ | $d$ | $d$ | $P_4$ | $d$ | $P_2$ | $P_1$ |
| Word                           | 0   | 1   | 0   |       | 1   |       |       |
| Insert $P_4$ , (4-5-6-7) check | 0   | 1   | 0   | 1     | 1   |       |       |
| Insert $P_2$ , (2-3-6-7) check | 0   | 1   | 0   | 1     | 1   | 0     |       |
| Insert $P_1$ , (1-3-5-7) check | 0   | 1   | 0   | 1     | 1   | 0     | 1     |

If the received message is 0 1 1 1 1 0 1, then the  $P_4$  binary sum is 1,  $P_2$  sum is 0, and  $P_1$  sum is 1. This gives a position number of 101 (decimal 5), indicating an error in position 5. This is one of the nicest properties of the Hamming code—the position number has the value of the position it represents (see Table 2). Thus complementing position 5, and re-

**Table 1: Hamming-code check digits.**

| Total number of digits ( $n$ ) | Number of information digits ( $d$ ) | Number of checking digits ( $P$ ) |
|--------------------------------|--------------------------------------|-----------------------------------|
| 1                              | 0                                    | 1                                 |
| 2                              | 0                                    | 2                                 |
| 3                              | 1                                    | 2                                 |
| 4                              | 1                                    | 3                                 |
| 5                              | 2                                    | 3                                 |
| 6                              | 3                                    | 3                                 |
| 7                              | 4                                    | 3                                 |
| 8                              | 4                                    | 4                                 |
| 9                              | 5                                    | 4                                 |
| 10                             | 6                                    | 4                                 |

**Table 2: Truth table.**

| Digit position | Position number $P_3P_2P_1$ |
|----------------|-----------------------------|
| No error       | 000                         |
| 1              | 001                         |
| 2              | 010                         |
| 3              | 011                         |
| 4              | 100                         |
| 5              | 101                         |
| 6              | 110                         |
| 7              | 111                         |



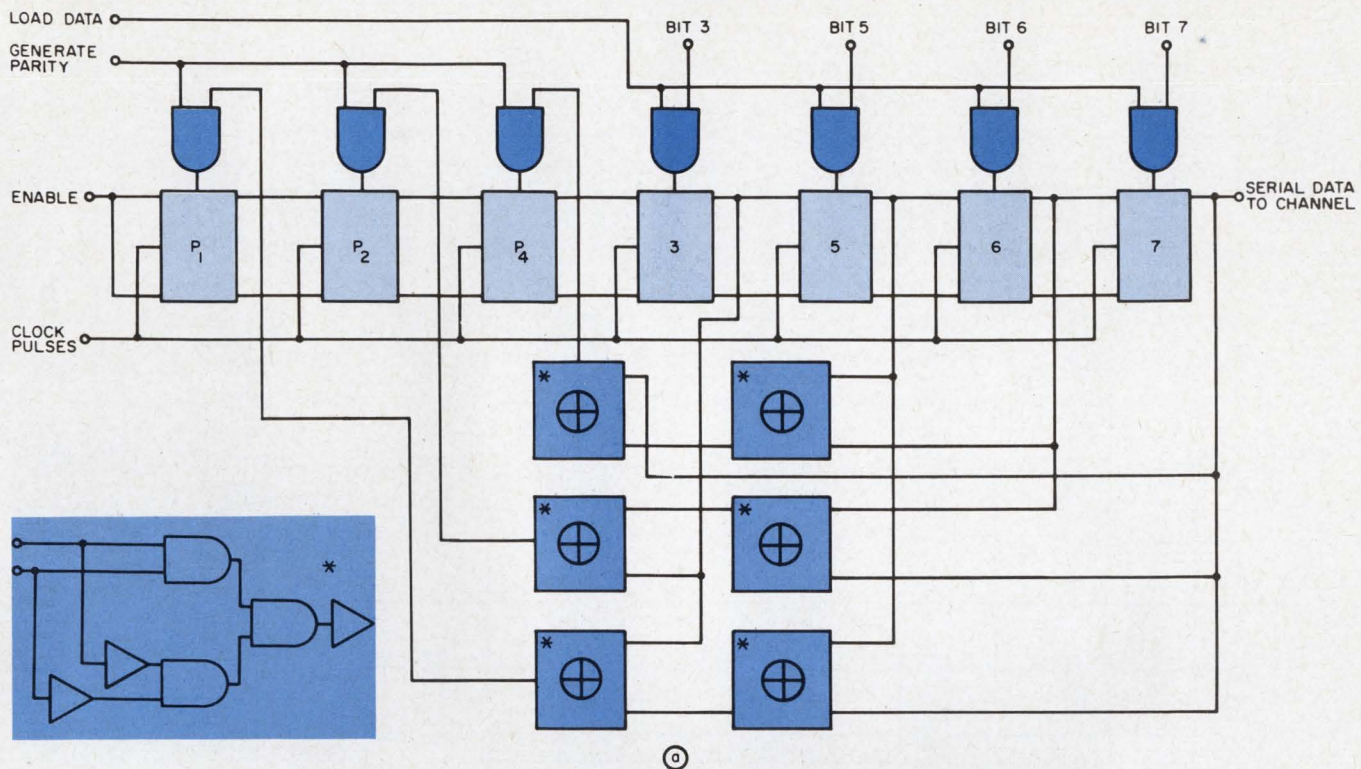

ⓐ

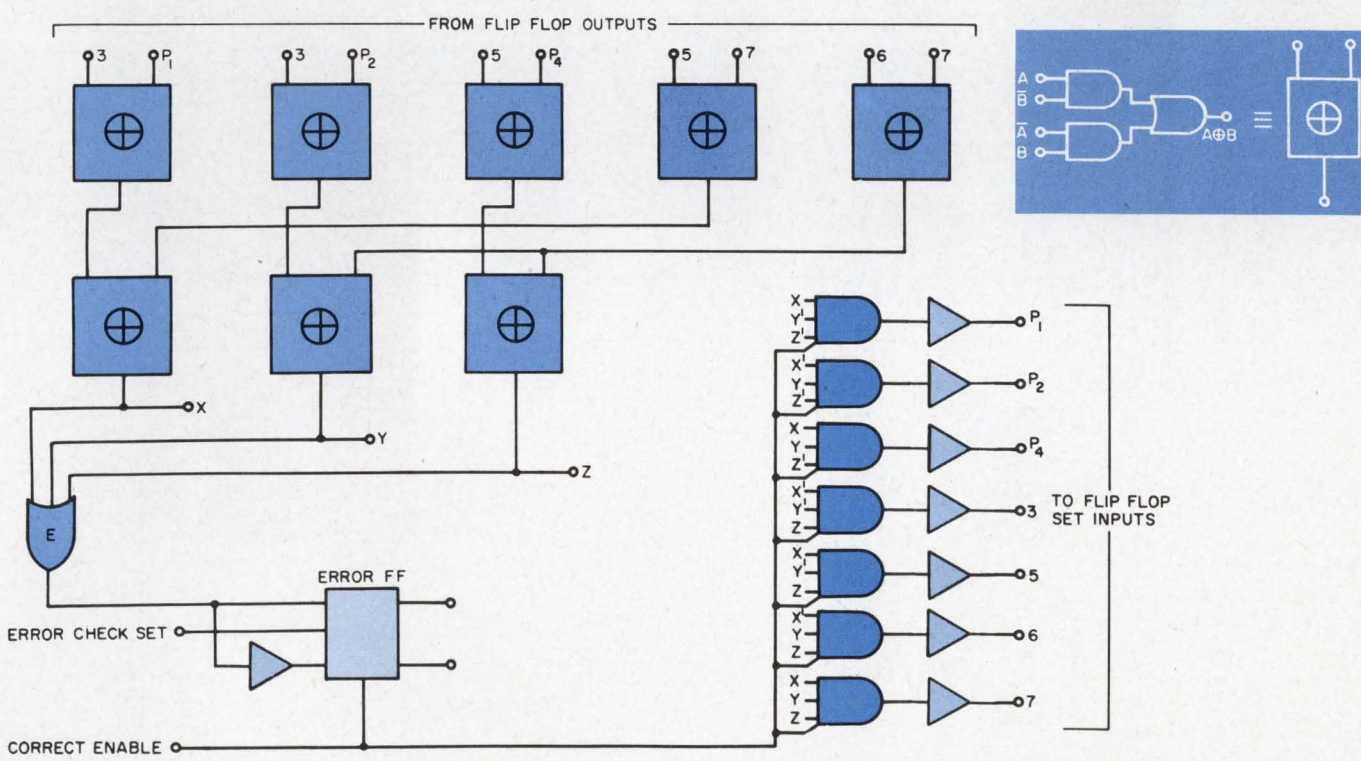
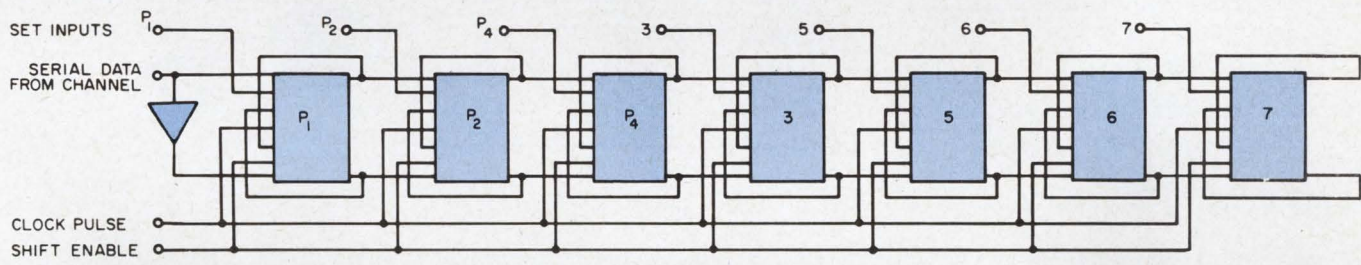

ⓑ

3. A Hamming-code transmitter (a) has three parity generators tied together. The receiving station (b) detects the error (colored section) and corrects by complementary addition (reversed color).

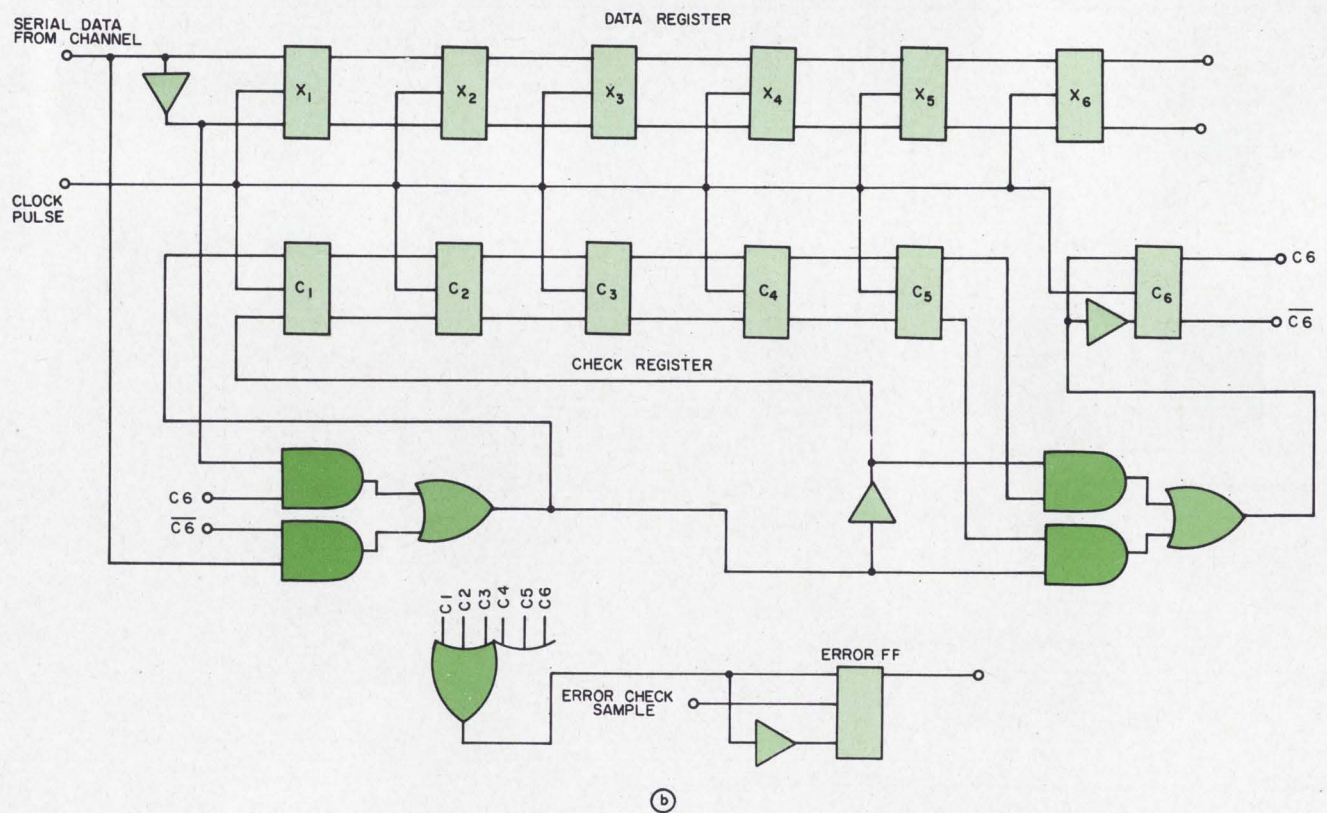
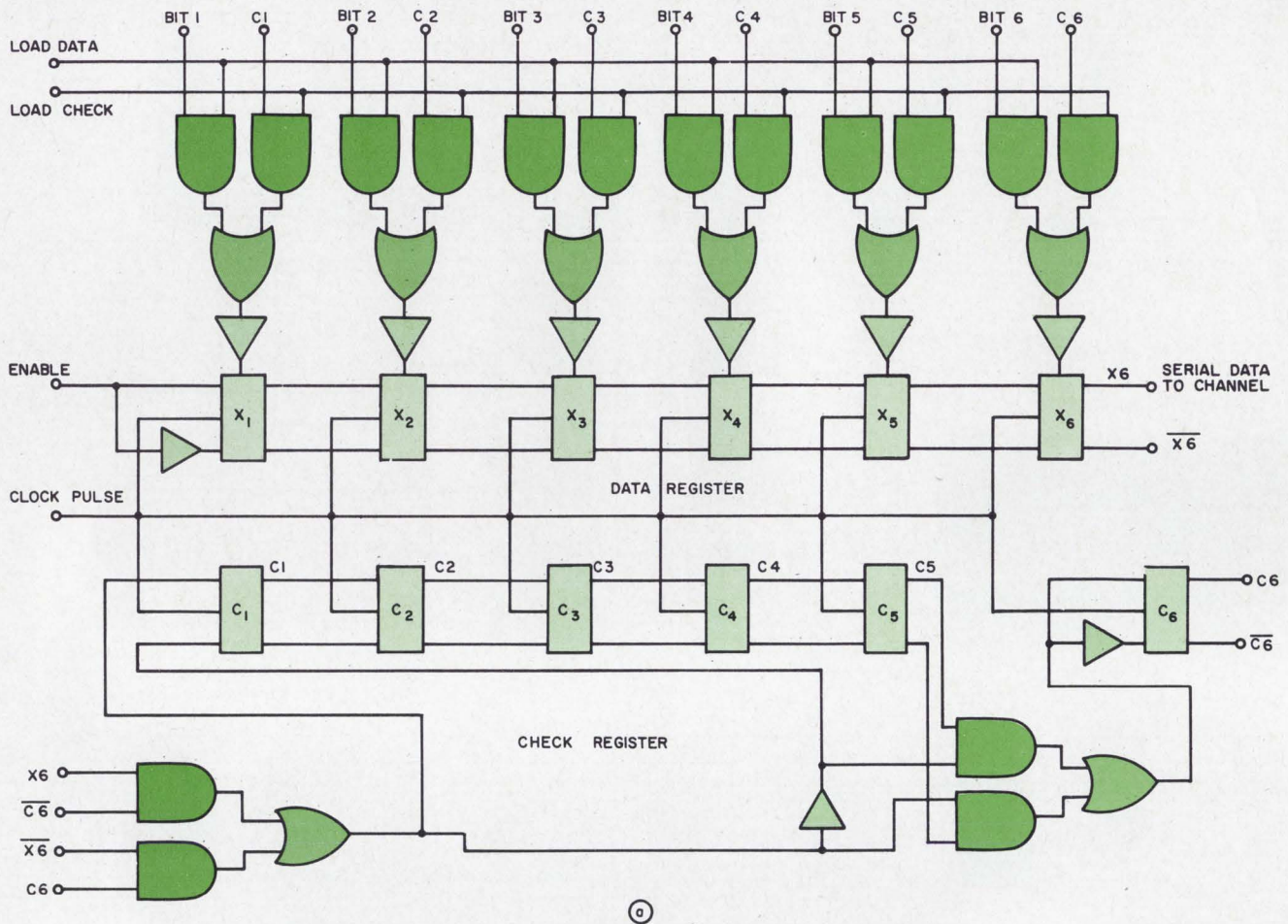

4. **Modulo-2 addition** is used to generate the cyclic check coded data (a). The received code will cancel the check

register content (b). If the check register does not cancel, the error flip-flop will indicate an error.

**Table 3: Cyclic-code generator polynomials**

| Generator polynomial<br>$P(X)$ | Will detect  | Maximum message digits<br>$k_{max}$ | Check Digits<br>$n-k$ |
|--------------------------------|--|-------------------------------------|-----------------------|
| $1 + X^1$ (11)                 | Any ODD number of errors   |                                     | 1                     |
| $1 + X^1 + X^4$ (11001)        | Two errors;<br>burst of 4 bits or less,<br>88% of bursts of 5 bits,<br>94% of larger bursts.   | 11                                  | 4                     |
| $1 + X^4 + X^9$ (etc.,)        | Two errors;<br>burst of 9 or less,<br>99.6% of bursts of 10 bits,<br>99.8% of larger bursts.   | 502                                 | 9                     |
| $1 + X^2 + X^{13} + X^{22}$    | Two bursts of combined length of 12 or less<br>any odd number of errors,<br>a burst of 22 or less,<br>99.99996% of the bursts of 22 bits,<br>99.99998% of larger bursts. | 22,495                              | 22                    |

moving the parity digits, gives the original message word 0101.

Figure 3a shows a typical implementation for a Hamming-code transmitter. The word is loaded into the data register and the check digits determined by the array of exclusive-OR gates. At the receiver, Fig. 3b, the parity of each group of digits is examined by the set of exclusive-OR gates, giving a position number  $ZYX$ . If this number is 0, the error flip-flop will not be set and the received number is correct. A position number other than 0 will be detected by NOR gate  $E$ , and the error flip-flop will be set. The position number  $ZYX$  is decoded by the series of NAND gates. In the foregoing example, there was a position number of 101 (5). This will set gate 5, which complements flip-flop 5 and removes the error.

**Cyclic codes becoming widely used**

Because cyclic codes are well suited to random-burst error detection and relatively easy to implement, they have recently come into wide use. The name cyclic is used because any cyclic permutation of a code word will result in another code word.

A cyclic code message  $m$ , of  $n$  binary digits, will consist of  $k$  information digits and  $(n - k)$  check digits. The message  $m$ , or code polynomial, is derived from two algebraic representations of two binary words, that is to say, two arguments: a generator polynomial  $P(X)$  and a message polynomial  $G(X)$ . The choice of a generator polynomial  $P(X)$  is directly related to the particular error pattern(s) which are to be detected. This can be seen from Table 3, which

shows a few typical generator polynomials and the error patterns that they will correct. Their derivation is difficult<sup>2</sup> and will not be shown here.

The usual representation of these polynomials is an algebraic form where the binary digits are represented by  $X^0$  (or 1),  $X^1$ ,  $X^2$ ,  $X^3$ , . . . . As an example, assume a generator polynomial,  $P(X)$ , to be 11001. Algebraically represented, this quantity would be described as  $1 + X + X^4$ . (It is convenient to show the high-order digit in the rightmost position as this is how it would normally appear in the transmission channel.)

By definition, a polynomial of degree (or highest power) less than  $n$  is a code polynomial and is said to be valid if, and only if, it is evenly divisible by the generator polynomial,  $P(X)$ . Since the division is serial, bit by bit, the operations are in binary arithmetic but without carries or borrows.

**Find the right code polynomial**

The objective then, given a message polynomial and a generator polynomial, is to construct a code polynomial,  $F(X)$ , which is evenly divisible by  $P(X)$ . This is done in the following manner:  $X^{n-k}G(X)$  is divided by  $P(X)$  and the remainder is added to  $X^{n-k}G(X)$ . A handy rule to remember is that the number of check bits,  $(n-k)$ , is always less than the number of bits in the generator polynomial being used (Table 3). This is because binary division without carries or borrows will always give a remainder of one bit less than the divisor.

The received message,  $H(X)$ , at the destination

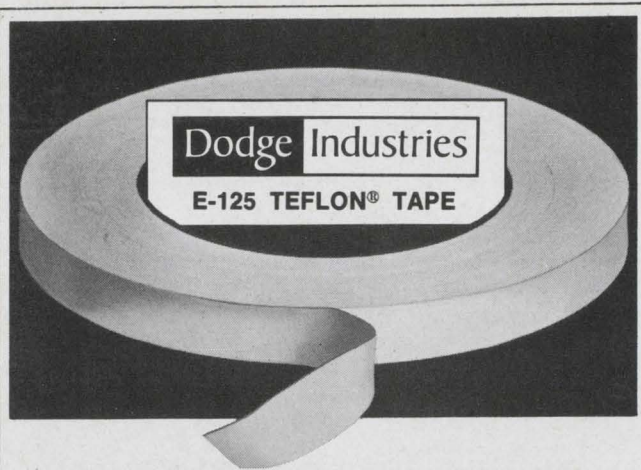

**Heat this electrical tape to 621F and it becomes an encapsulant!**  
**Use it between -400F and 500F, and it is ...**

- AN EXCELLENT DIELECTRIC
- EXTREMELY CONFORMABLE
- SELF-STICKING (WITHOUT ADHESIVE BACKING)
- MECHANICALLY STABLE
- IMPERVIOUS TO ALL ACIDS, GASES, SOLVENTS

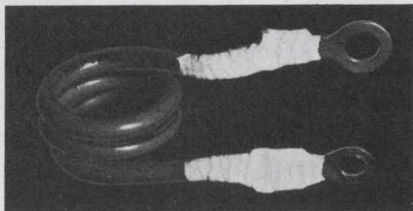
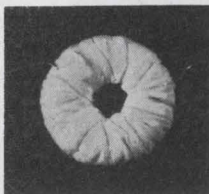
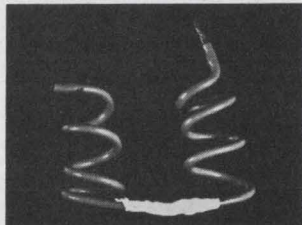
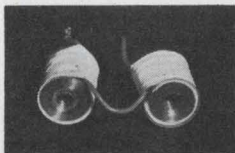
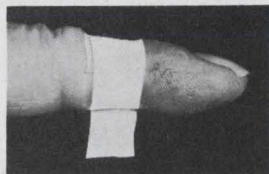
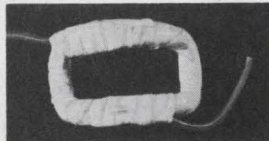

When heated above 621 F, Type E-125 TEFLON® tape sinters to form a rigid, tough, hermetic seal around coils, cables, or other forms. It won't burn either. Teflon just melts. Available in thicknesses from 0.002" to 0.010" and widths from 1/8" to 3", with tensile strengths from 1100 to 1800 PSI and dielectric strength from 700 to 800 VPM.

WRITE FOR COMPLETE DATA & SAMPLES to Dodge Industries, Fluorglas Division, Hoosick Falls, N. Y. 12090. You'll receive a prompt answer.

**Dodge Industries**

ON READER-SERVICE CARD CIRCLE 53

may contain an error or errors which must be detected.  $H(X)$  is, in essence,  $F(X)$  plus error(s), if any, introduced during transmission. This message,  $H(X)$ , is then divided by  $P(X)$  at the receiving station, and any non-zero remainder will indicate that an error has occurred. Conversely, a zero remainder will indicate that either a correct message, or a message with an undetectable error has been received.

Suppose, for example, that the message word,  $G(X)$ , is 101010, or  $1 + X^2 + X^4$ . This word has six information bits ( $k = 6$ ) and the generator polynomial is 11001, or  $1 + X + X^4$ , which will generate four check bits ( $n - k = 4$ ). Multiplying  $G(X)$  by  $X^{n-k}$  will give 0000101010, which when divided by 11001 leaves a remainder of 0101. The division without carries or borrows is:

$$\begin{array}{r}
 11001 \overline{)0000101010} \\
 \underline{00011} \phantom{000} \\
 01101 \phantom{000} \\
 \underline{01101} \phantom{000} \\
 0101
 \end{array}$$

The division proceeds from right to left because both divisor and dividend are written with the most significant bit at the right. The quotient is ignored since it is only the remainder that is to be added to the message word, to make it evenly divisible by the generator polynomial.

The four-bit remainder is one digit less than the generator polynomial, as noted in the rule stated previously.

When the remainder is added to the message word, a cyclic code message of 0101101010 is produced. At the receiver the code message is divided by the same generator polynomial; an all-zero result will indicate no error, while a non-zero result will indicate an error.

To correct errors in cyclic code systems, it would be necessary to construct a table of remainders, because each error pattern yields a unique remainder. Correction is thus possible with reference to a table, but this is not very practical from a hardware standpoint.

The algorithm that has been described lends itself to implementation with shift registers and modulo-2 adders (exclusive OR). The size of the shift register is determined by the degree of  $P(X)$  (Fig. 4). ■ ■

**References:**

1. R.W. Hamming, "Error Detecting and Error Correcting Codes" *Bell System Tech. Jour.*, XXVI, No. 2 (April, 1950)
2. W. Wesley Peterson, "Cyclic Code for Error Detection," *Proc. IRE*, XLVI, No. 1 (Jan., 1961), 228-235.

**Bibliography:**

- Peterson, W. Wesley. *Error Detecting Codes*. Cambridge, Mass.: MIT Press, and New York: John Wiley & Sons, 1961.
- Shannon, C. E. "A Mathematical Theory of Communication," *Bell System Tech. Jour.*, XXVII, No. 3 (July, 1948).

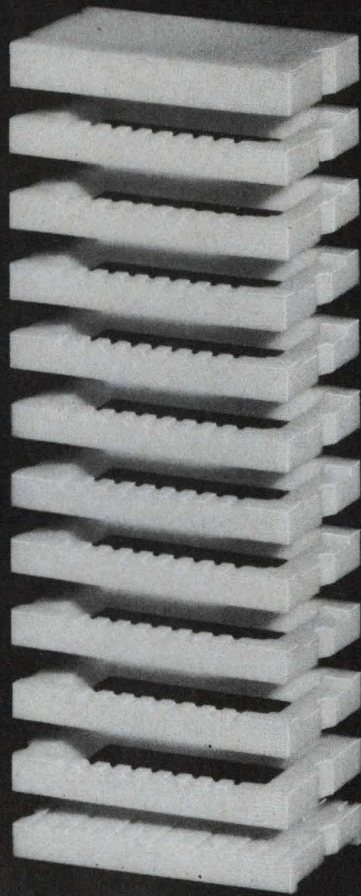

## For reliable High Density Packaging

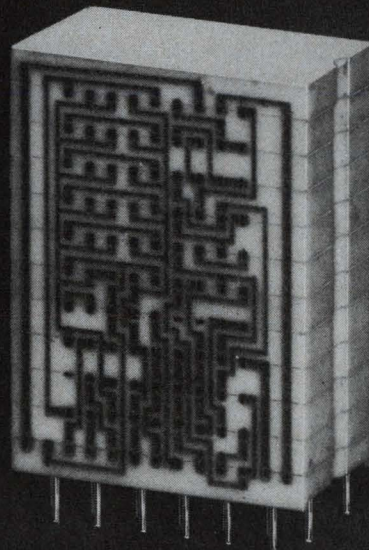

If you are working with a single chip or with complex circuit networks, Coors micro-ceramic modules offer you high reliability packaging. In the example above, the design engineer utilized base, frame, and lid modules to form a universal stacked package that can grow to fit any circuit density required. Each module is approximately 5/16" wide, 11/16" long and .050" high - indexed for high speed assembly. Because of the unique properties of Coors Ceramics, modules can be joined by epoxy, glass, low temperature solder, or high temperature brazes. Thin film or thick film technique can be used. The high mechanical strength, high surface resistivity and high thermal conductivity of Coors Ceramics combine to make the package reliable under widely varying operating conditions. Precision tolerances can be held even on complex designs. Whether your requirements call for thousands a week, or millions a week, Coors has complete facilities to offer you on-time delivery of alumina or beryllia packaging modules. Faced with a packaging decision? Get on-the-spot answers. Dial Coors - 303/279-6565, Ext. 361. For complete design criteria, write for Coors Alumina and Beryllia Properties Handbook No. 952.

*consider  
Coors  
ceramics*

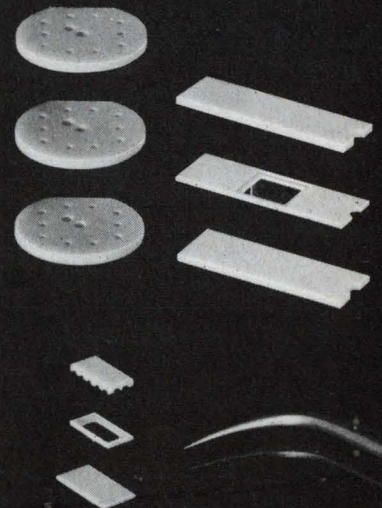

# Coors

## CERAMICS

ALUMINA • BERYLLIA • MAGNESIA • SPECIAL OXIDES

Coors Porcelain Co., Golden, Colo.

# Boost FET amplifier gains at high frequencies.

Unilateralization allows the FET's stable gain to be increased from 10.3 to 37 dB at 100 MHz.

Higher stable gains are possible when the principle of unilateral two-port networks is applied to the design of practical high-frequency (100 MHz) FET amplifiers.

A unilateral two-port network is a "one-way system"—a signal applied to the input produces an output, but not vice versa. Mathematically it means that  $y_{rs}$ , the reverse transfer admittance, is made equal to zero (Eq. 1). Thus it is stable for all values of gain.

To demonstrate the usefulness of this approach, the stable gain of a nonunilateralized FET will first be computed. After detailed explanation of the unilateralization technique for a common-source FET, its gain will be calculated and shown to be considerably higher than its nonunilateralized equivalent (37 dB vs 10.3 dB).

Finally, to show the technique in practice, the design of a high-performance, single-stage unilateralized FET amplifier will be followed step by step. This 100-MHz amplifier has a stable power gain of 18 dB and a noise figure of less than 2 dB.

## Look at a FET as a two-port network

The common-source configuration of a FET is illustrated as a two-port network in Fig. 1. It is completely characterized by Eqs. 1 and 2:

$$I_1 = y_{is} E_1 + y_{rs} E_2; \quad (1)$$

$$I_2 = y_{fs} E_1 + y_{os} E_2. \quad (2)$$

The  $y_s$  (short-circuit admittances) in these equations are defined in Table 1.

These parameters are functions of frequency and the bias conditions of the FET. Their numerical values are typical 100-MHz values obtained from the 2N4416 data sheet. For convenience these values are listed in Table 2 and are valid for a drain-to-source voltage ( $V_{DS}$ ) of +15 volts and a gate-to-source voltage ( $V_{GS}$ ) of zero volts.

## Linville-Gibbons technique defined

Linville and Gibbons have developed a technique

**James M. Phalan**, Section Head, Application Dept., Union Carbide, Mountain View, Calif.

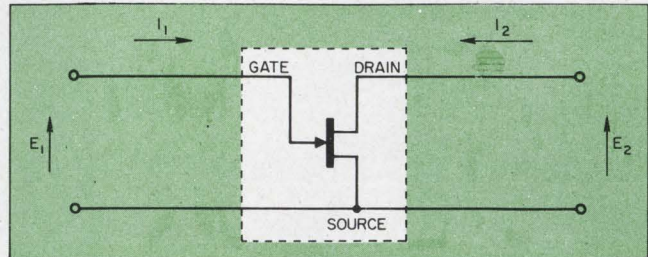

1. Common-source connection of a FET demonstrates the meaning of Eqs. 1 and 2. The  $y$  parameters are defined in Table 1.

for determining the stability of two-port networks. The network is first terminated in the complex conjugate of its output admittance. Then a power gain,  $G_{oo}$ , for the network is defined as:

$$G_{oo} = |y_f|^2 / [4g_i g_o - 2\text{Re}(y_f y_r)], \quad (3)$$

where  $g_i$  and  $g_o$  are the real components of the input and output admittances, respectively, and  $\text{Re}(y_f y_r)$  is the real part of  $y_f \times y_r$ . A critical factor,  $C$ , is also defined:

$$C = 2G_{oo} |y_r/y_f|. \quad (4)$$

The stability criterion for a two-port network is then stated as follows: A two-port network is potentially unstable if the critical factor  $C$  is greater than unity or the power gain  $G_{oo}$  is negative. If, however,  $C$  is less than unity and  $G_{oo}$  is positive, the network is unconditionally stable and  $G_{oo}$  is within 3 dB of the maximum available gain,  $G_{MAX}$ , where:

$$G_{MAX} = 2G_{oo} [1 - (1 - C^2)^{1/2}] / C^2, \quad (5)$$

for  $C < 1$ .

## Linville-Gibbons technique applied to a FET

The Linville-Gibbons technique can be applied to a common-source-connected 2N4416 FET. First  $G_{oo}$  is computed from the 100-MHz  $y$  parameters in Table 2:

$$\begin{aligned} G_{oo} &= \frac{|4.5 - j0.58|^2}{4(0.05)(0.02) - 2\text{Re}(-j0.42)(4.5 - j0.58)} \\ &= 42 = 16.2 \text{ dB}, \end{aligned} \quad (6)$$

and:

$$\begin{aligned} C &= 2 \times 42 | -j0.42 / (4.5 - j0.58) | \\ &= 7.78. \end{aligned} \quad (7)$$

$G_{oo}$  is positive but  $C$  is greater than unity, so the common-source configuration of the 2N4416 is potentially unstable at 100 MHz.  $C$  can be reduced to

unity by decreasing power gain  $G_{oo}$  by a factor of 7.78. This is done by shunting a conductance of the proper magnitude across the output of the FET. This conductance is then considered part of the output conductance of the device. The reduced power gain,  $G_{oo}$ , is:

$$G_{oo} = G_{oo}/7.78 = 42/7.78 = 5.4 = 7.34 \text{ dB}, \quad (8)$$

and  $C$  is now unity. Thus the maximum power gain,  $G_{MAX}$ , obtainable from the modified FET can be calculated from Eq. 5:

$$G_{MAX} = 5.4 \times 2 \left[ 1 - (1-1)^{1/2}/1 \right] = 10.8 = 10.3 \text{ dB}. \quad (9)$$

Hence 10.3 dB is the maximum stable gain that can be obtained from the common-source connection of a 2N4416 operating at 100 MHz.

### What is unilateralization?

As stated, a unilateral two-port network has a one-directional property. A signal applied to the network's input port causes a current or voltage to appear at the output port; applied to the output port, no current or voltage is developed at the input network. Analytically this property is shown in the characterizing equations for a unilateral two-port network:

$$I_1 = y_i E_1; \quad (10)$$

$$I_2 = y_f E_1 + y_o E_2. \quad (11)$$

Since  $y_r = 0$ , critical factor  $C$  must also be zero. Thus a unilateral two-port network is unconditionally stable.

A technique for unilateralizing the FET is given in the box. The characterizing equations for this configuration are:

$$I_1 = (y_{is} + y_{rs}) E_1, \quad (12)$$

$$I_2 = (y_{fs} - y_{rs}) E_1 + (y_{os} + y_{rs}) E_2. \quad (13)$$

Substituting the unilateral common-source  $y$  parameters of Eqs. 12 and 13 into the expression for  $G_{oo}$  (Eq. 3) yields:

$$G_{oo} = \frac{|y_{fs} - y_{rs}|^2}{4(g_{is} + g_{rs})(g_{os} + g_{rs})} \quad (14)$$

Since critical factor  $C$  is zero,  $G_{oo}$  is equal to the maximum available power gain. With the values in Table 2:

$$G_{oo} = G_{MAX} = \frac{|4.5 - j0.58 + j0.42|^2}{4(0.05 + 0)(0.02 + 0)} = 5000 = 37 \text{ dB}. \quad (15)$$

Consequently, 37 dB is the maximum power gain that can be obtained from a 100-MHz, unilateralized, common-source amplifier with the 2N4416 FET. In contrast, only 10.3 dB of stable power gain can be obtained from the same device in a nonunilateralized amplifier.

### Design a 100-MHz FET amplifier

A simple, single-stage amplifier design shows how unilateralization is applied to the design of a common-source FET amplifier. Its specifications are:

- 50-ohm source and load resistances.

- Center frequency = 100 MHz.
- Bandwidth  $\Delta f \approx 5$  MHz.
- Power gain = 63 = 18 dB.
- Noise figure < 2 dB.

The first steps in the design are to specify the source and load conductances that will produce the desired 18 dB of gain. The source conductance,  $g_s$ , influences the noise figure of the amplifier. From manufacturer's specifications, a noise figure of less than 2 dB at 100 MHz for the unilateralized, common-source connection of the 2N4416 can be obtained when  $g_s = 1.0 \mu\text{mho}$ . Before the load conductance,  $g_L$ , can be specified, however, an expression for the amplifier power gain must be introduced. This gain,  $G_{TU}$ , is the transducer power gain for a unilateralized two-port network and is expressed in terms of the unilateralized common-source  $y$  parameters:

$$G_{TU} = \frac{4 |y_{fs} - y_{rs}|^2 g_L g_s}{[(g_{is} + g_{rs} + g_s)(g_{os} + g_{rs} + g_L)]^2}, \quad (16)$$

where:

$$G_{TU} = \frac{P_o}{P_{AVS}} = \frac{\text{power output}}{\text{power available from the source}} \quad (17)$$

All the values in Eq. 16 are known, with the exception of the load conductance,  $g_L$ , so that:

$$63 = \frac{4 |4.5 - j0.58 + j0.42|^2 g_L}{[(1 + 0.05)(g_L + 0.02)]^2} \quad (18)$$

Solving Eq. 18 yields,  $g_L = 1.24 \mu\text{mhos}$ .

With the source and load conductances specified,

**Table 1: Definition of short-circuit admittance parameters for common-source connection**

|          |  |
|----------|--|
| $y_{is}$ | — Input admittance, output shorted.            |
| $y_{rs}$ | — Reverse transfer admittance, input shorted.  |
| $y_{fs}$ | — Forward transfer admittance, output shorted. |
| $y_{os}$ | — Output admittance, input shorted.            |

**Table 2: 100-MHz common-source  $y$  parameters for 2N4416**

|          |                               |
|----------|-------------------------------|
| $y_{is}$ | $= 0.05 + j2.3 \text{ mmhos}$ |
| $y_{rs}$ | $= -j0.42 \text{ mmho}$       |
| $y_{fs}$ | $= 4.5 - j0.58 \text{ mmhos}$ |
| $y_{os}$ | $= 0.02 + j0.82 \text{ mmho}$ |

## Unilateralization of an active device

Unilateralization is generally accomplished by neutralizing the effect of the reverse transfer parameter ( $y_{rs}$  in Eq. 2) of an active device, which in itself, is not unilateral. This involves making the input port of the resultant two-port network independent of the output port. A technique for unilateralizing a field-effect transistor is illustrated in the accompanying figure.

The two-port networks in the figure are in parallel. The short-circuit admittance matrix for the composite network can therefore be found by adding the short-circuit admittance matrices for the FET and the neutralizing admittance:

$$[Y] = [Y_{N_1}] + [Y_{N_2}], \quad (A)$$

where:

$[Y]$  = Composite short-circuit admittance matrix,  
 $[Y_{N_1}]$  = Short-circuit admittance matrix for FET

$$= \begin{bmatrix} y_{is} & y_{rs} \\ y_{fs} & y_{os} \end{bmatrix}, \quad (B)$$

$[Y_{N_2}]$  = short-circuit admittance matrix for neutralizing admittance

$$= \begin{bmatrix} Y_N & -Y_N \\ -Y_N & Y_N \end{bmatrix}. \quad (C)$$

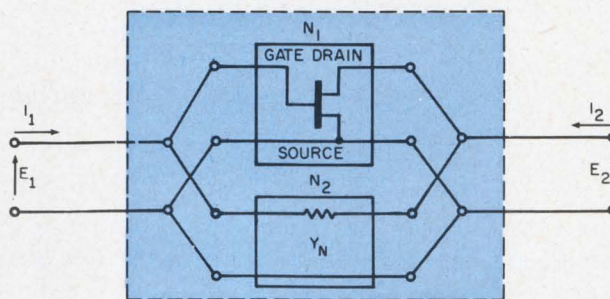

Thus:

$$[Y] = \begin{bmatrix} y_{is} + Y_N & y_{rs} - Y_N \\ y_{fs} - Y_N & y_{os} + Y_N \end{bmatrix} \quad (D)$$

The reverse transfer admittance term,  $y_{is} - Y_N$ , of the composite two-port network is now set equal to zero, so that:

$$y_{rs} - Y_N = 0 \text{ or } Y_N = y_{rs}. \quad (E)$$

Unilateralization is thus accomplished by letting

$$Y_N = y_{rs}$$

The equations characterizing the unilateral common-source transistor are then:

$$E_1 = (y_{is} + y_{rs})I_1; \quad (F)$$

$$E_2 = (y_{fs} - y_{rs})I_1 + (y_{os} + y_{rs})I_2. \quad (G)$$

the input and output circuit configurations can be selected. The configuration to be used is that in Fig. 2.

The input and output tuned circuits in Fig. 2 are identical, so only the design of the output circuit need be examined. The equivalent circuit of the output of the common-source amplifier is shown in Fig. 3.

The amplifier load,  $R_A$ , was specified as 50 ohms, but the load resistance that must be presented to the output of the amplifier is  $1/g_L$ ; if  $g_L = 1.24 \mu\text{mhos}$ , it is 808 ohms. An impedance transformation is therefore necessary and is accomplished by series capacitor  $C_A$  in Fig. 3.  $C_A$  is specified to transform load resistance  $R_A$  to 808 ohms at 100 MHz. This transformation is shown in Fig. 4. The value of  $C_A$  is found as follows:

$$X_{C_A} = R_A [(R_L/R_A) - 1]^{1/2}$$

$$= 50 [(808/50) - 1]^{1/2} = 195 \text{ ohms}; \quad (19)$$

and:

$$C_A = 1/\omega X_{C_A}$$

$$= 1/(2\pi \times 10^8 \times 195) = 8.15 \text{ pF}. \quad (20)$$

The equivalent circuit capacitance,  $C_L$ , is similarly obtained:

$$X_{C_L} = X_{C_A} [1 + (R_A/X_{C_A})^2]$$

$$= 195 [1 + (50/195)^2] = 208 \text{ ohms}; \quad (21)$$

and:

$$C_L = 1/\omega X_{C_L}$$

$$= 1/(2\pi \times 10^8 \times 208) = 7.65 \text{ pF}. \quad (22)$$

The circuit in Fig. 3, then, is equivalent to that in Fig. 5 for the frequencies in the vicinity of 100 MHz.

The output capacitance,  $C_o$ , and conductance,  $g_o$ , of the unilateralized common-source FET are:

$$C_o = \text{Im}(y_{os} + y_{rs})/\omega$$

$$= 0.4/(2\pi \times 10^8) = 0.635 \text{ pF}; \quad (23)$$

and:

$$g_o = \text{Re}(y_{os} + y_{rs}) = 0.02 \mu\text{mho}. \quad (24)$$

To obtain the specified 5-MHz bandwidth, the  $Q$  of the output circuit should be:

$$Q = f_o/\Delta f = 20. \quad (25)$$

where  $f_o$  = center frequency and  $\Delta f$  = bandwidth.

The  $Q$  of the input circuit is set equal to 7 to provide a much greater bandwidth than the output circuit's, so the input circuit has negligible effect on the amplifier bandwidth.



The only unspecified components in the output circuit are  $L_2$  and  $C_2$ . Their values are dependent on the bandwidth requirements of the output circuit. In the case of  $L_2$ :

$$R_L/\omega L_2 = Q = 20. \quad (26)$$

$R_L$ , the total load across the amplifier's output, is the parallel combination of  $R_L = 808\Omega$ , and the FET's output conductance,  $g_o$ :

$$R_L = 1/(1/R_L + g_o) = 1/(1/808 + 0.02) \approx 800\Omega. \quad (27)$$

Inductance  $L_2$  is therefore:

$$\begin{aligned} L_2 &= R_L/\omega Q \\ &= 800/(2\pi \times 10^8 \times 20) = 0.068\ \mu\text{H}. \end{aligned} \quad (28)$$

The capacitance that resonates with  $L_2$  at 100 MHz is  $C_T$ . Its value is:

$$\begin{aligned} C_T &= 1/\omega^2 L_2 \\ &= 1/[(2\pi \times 10^8)^2 \times 0.068] = 39.6\ \text{pF}, \end{aligned} \quad (29)$$

where:

$$C_T = C_o + C_2 + C_L = 39.6\ \text{pF}. \quad (30)$$

Thus, from Eqs. 22 and 23:

$$1C_2 = C_T - C_o - C_L = 31.3\ \text{pF}. \quad (31)$$

$L_1$  the final circuit (Fig. 6),  $C_2$  consists of 27 pF in parallel with a 1-12-pF trimmer.

The design of the input tuned circuit proceeds in exactly the same manner as that of the output circuit. Calculations have therefore been omitted.

This amplifier design has been based on a FET unilateralized by the method outlined in the box. However, the unilaterlizing admittance,  $Y_N$ , has not yet been specified.  $Y_N$  must be inductive since  $y_{rs}$  is imaginary and negative:

$$Y_N = y_{rs} = -j0.42 \times 10^{-3}. \quad (32)$$

The required inductor is thus computed from:

$$\begin{aligned} L_N &= 1/\omega Y_N \\ &= 1/(2\pi \times 10^8 \times 0.42 \times 10^{-3}) = 3.8\ \mu\text{H}. \end{aligned} \quad (33)$$

The complete schematic diagram of the 100-MHz, unilateralized common-source amplifier appears in Fig. 6. Note that a 100-pF capacitor has been added in series with  $L_N$ .

### Test data compared with design goals

An amplifier was constructed with the values of Fig. 6. The 7.32-pF input capacitor and the 8.15-pF output capacitor, since they are within 2% of the design values, provide the correct impedance transformation for the input and output networks.

The amplifier was designed to have a 5-MHz bandwidth; however, only 3MHz was obtained in the test amplifier (see Table 3) because of the nature of the unilaterlizing scheme. Unilaterlization is achieved by neutralizing the effect of the reverse transfer admittance,  $y_{rs}$ , with an inductance,  $L_N$ .  $L_N$  is adjusted to form a high-Q resonant circuit with  $y_{rs}$  at 100 MHz ( $y_{rs}$  is capacitive at 100 MHz). The resulting unilaterlization is good at 100 MHz, but is less so at slightly higher or lower frequencies. A narrow-bandwidth neutralizing circuit in turn limits the over-all bandwidth of the amplifier. This narrow-band effect can, however, be eliminated by employ-

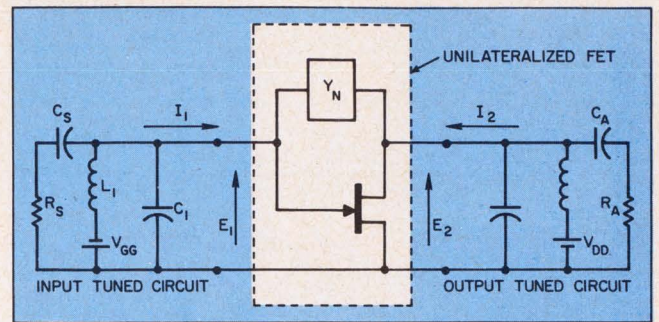

2. Unilaterlized common-source FET amplifier configuration shows the meaning of unilaterlization: decoupling of input-output. Component values are computed in Eqs. 16 through 33.

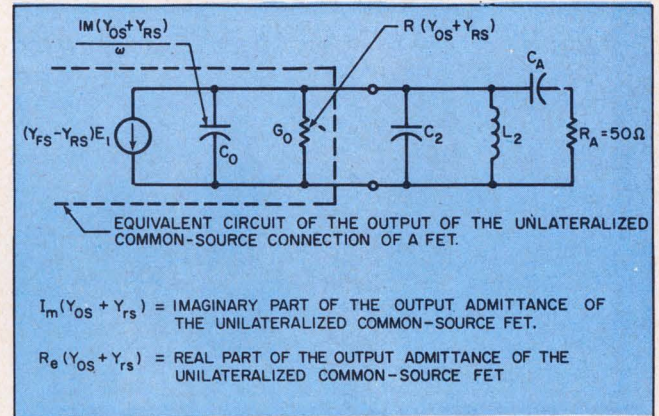

3. Equivalent output circuit of a unilaterlized common-source amplifier forms the basis for the design procedure. All components are defined in terms of the y parameters of Table 1.

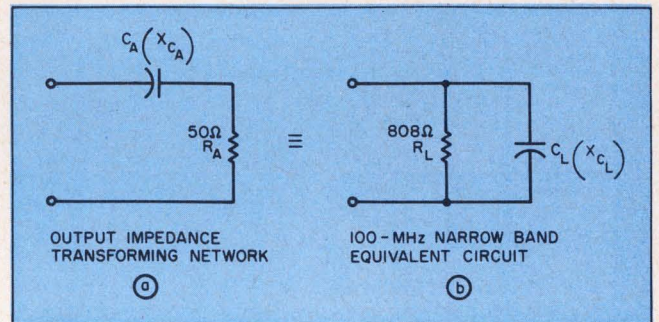

4. 50-ohm output impedance requirement is met by a simple impedance transformation step. See Eqs. 19 through 22.

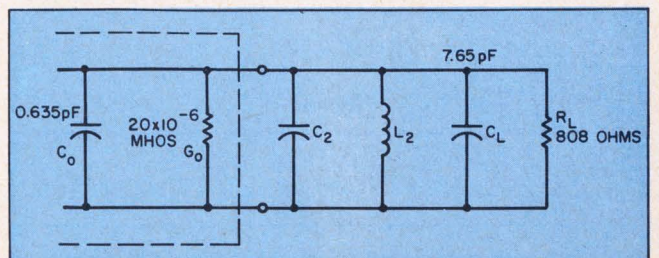

5. 100-MHz narrow-band equivalent output circuit of a FET amplifier shows some of the values for the circuit of Fig. 3.

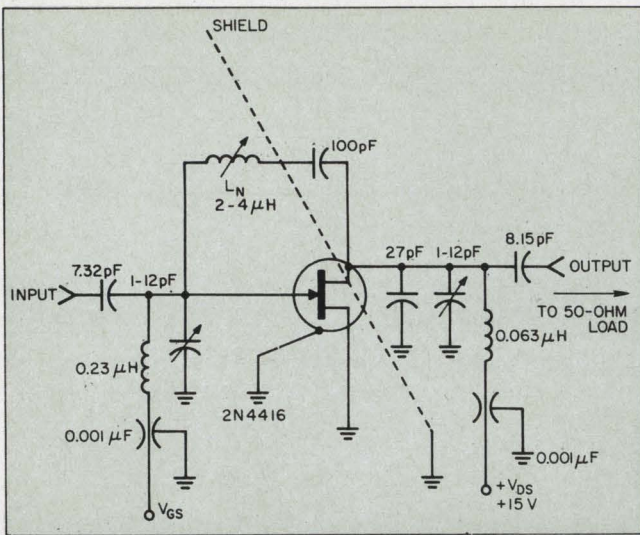

6. Complete schematic of the 100-MHz, unilateralized, common-source FET amplifier summarizes the design procedure. Note the shielding between input and output circuits. Gain can be adjusted over almost 50 dB by varying  $V_{GS}$ .

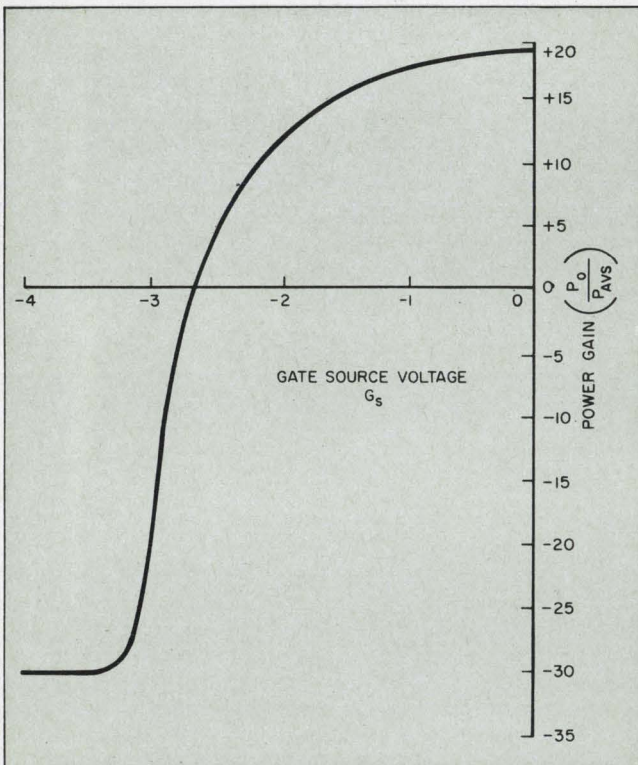

7. Large gain variation can be obtained. Any gain value is stable due to the unilateralization ( $C=0$ ).

Table 3: Test results

|              | Design goals | Test results |
|--------------|--------------|--------------|
| Power gain   | 18 dB        | 18.5 dB      |
| Bandwidth    | 5 MHz        | 3 MHz        |
| Noise figure | 2 dB         | 1.5 dB       |

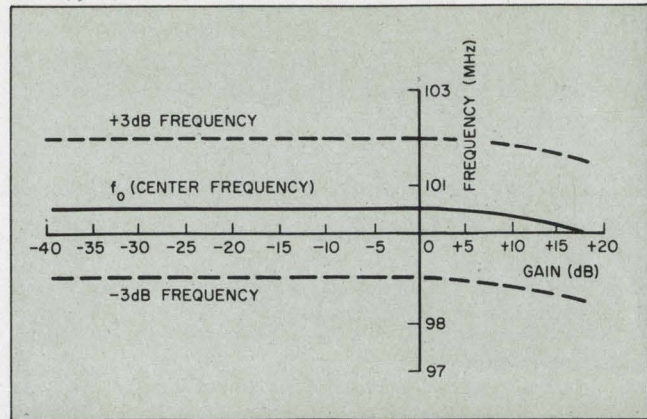

8. 0.5-MHz shift in the center frequency occurs as gain varies from minimum to maximum. This is due to the change in the gate-to-source capacitance caused by the change in  $V_{GS}$ .

ing a more complex, wide-bandwidth unilateralizing scheme.

### Wide gain control is possible

The unilateral FET amplifier has several other interesting properties. For example, almost 50 dB of power gain reduction is achieved by decreasing the gate-to-source voltage,  $V_{GS}$ , from zero volts to  $-3.2$  volts (the pinch-off voltage of the 2N4416 FET employed in the test circuit). This ability to vary the gain over such a wide range gives the designer more freedom in applying agc. This gain-voltage characteristic is illustrated in Fig. 7.

The amplifier's center frequency,  $f_o$ , and 3-dB frequencies are plotted as functions of gain in Fig. 8. This curve reveals a 0.5-MHz shift in center frequency as gain varies from maximum to minimum. This frequency shift is due to the change in gate-to-source capacitance caused by a change in gate-to-source voltage. The result is a slight change in the resonant frequency of the input tuned circuit.

The unilateralized common-source amplifier provides better noise performance than an amplifier without unilateralization. Moreover, the unilateralized common-source configuration has better noise characteristics than either cascode or common-gate amplifiers employing the same 2N4416 transistors. The one drawback to unilateralization, in fact, is that it can be a tedious, time-consuming adjustment. With careful design and construction procedures, however, fixed component values may be used in the unilateralizing circuit, thus eliminating special adjustments. ■ ■

### Bibliography:

- Hunter, L.P. *Handbook of Semiconductor Electronics* (2nd ed.). New York: McGraw-Hill Book Co., 1962.
- Linville, J.G., and Gibbons, J.F. *Transistors and Active Circuits*. New York: McGraw-Hill Book Co., 1961.
- Terman, F.E. *Electronic and Radio Engineering* (4th ed.). New York: McGraw-Hill Book Co., 1955.
- Weinberg, L. *Network Analysis and Synthesis*. New York: McGraw-Hill Book Co., 1962.

# ±0.05% regulation is only one of twelve outstanding specs in Helipot's exclusive new microcircuit dc voltage regulator series.



MODEL 803 DC Voltage Regulator, one of a complete family of six miniature, hybrid cermet thick film units with outputs from 3 to 32 volts.

## The other eleven:

- short circuit proof models
- small size—0.5 sq. in.
- low profile—0.170"
- up to 5 amps load current
- output range—3 to 32 volts
- fixed and adjustable outputs
- fully sealed
- hybrid cermet construction
- operating temperature range: -55°C to +125°C
- 60 db ripple rejection
- mil spec tested

## The price:

- \$30.00—fixed output models
- \$35.00—adjustable output models

(prices are 1-9 quantity, delivery from factory stock)

## The applications:

Helipot Series 800 DC Voltage Regulators are physically compatible with dual in-line and flat pack integrated circuits. This permits system use of unregulated power with precise regulation at the point of use. In addition to the 1,000:1 ripple rejection capability, these units provide excellent circuit decoupling and protection from transients and sudden power surges.

|                   | Application                            |  |   |
|-------------------|--|--|---|
|                   | Digital Circuits<br>3 to 9 Volts       | Analog Circuits<br>9 to 21 Volts       | Airborne and<br>General Purpose<br>Circuits<br>20 to 32 Volts |
| Fixed Output      | Model 805<br>Reader Service<br>No. 241 | Model 801<br>Reader Service<br>No. 242 | Model 803<br>Reader Service<br>No. 243                        |
| Adjustable Output | Model 806<br>Reader Service<br>No. 244 | Model 802<br>Reader Service<br>No. 245 | Model 804<br>Reader Service<br>No. 246                        |

Ask your local Helipot sales representative for information or circle the appropriate number on the reader service card.

**Beckman**

INSTRUMENTS, INC.  
HELIPOT DIVISION

FULLERTON, CALIFORNIA • 92634

INTERNATIONAL SUBSIDIARIES: GENEVA; MUNICH; GLENROTHES, SCOTLAND; TOKYO; PARIS; CAPE TOWN; LONDON; MEXICO CITY

ON READER-SERVICE CARD CIRCLE 55

# Cut operational-amplifier noise effectively by choosing the right unit for your needs and optimizing the input source resistance.

If your circuit calls for an operational amplifier, you have a noise problem. But there is no need to worry just because the noise specification for the amplifier seems high; the high gain of an operational amplifier steps up the signal as well as the noise. The way to minimize the noise is to match the source resistance to the optimum noise impedance of the operational amplifier.

Know the basics before beginning. The design will be better if you understand what causes noise, how noise figures are derived, why test circuits can help, and how the source-resistance optimization procedure works.

Considerable time will also be saved with the aid of a nomogram to help calculate the amplifier noise figure on the basis of the manufacturer's specifications.

## Examine various noise sources

Ideally, in a signal-amplifying device, the signal is assumed to enter the device undisturbed by noise. Thus the limit placed on the sensitivity of the amplifier is set by the noise it introduces itself. A useful measure of the noise internally introduced by an amplifier is the noise factor, defined as the quotient of the noiseless amplifier signal-to-noise ratio over the actual amplifier signal-to-noise ratio:

$$F = \frac{(S/N) \text{ noiseless amplifier}}{(S/N) \text{ actual amplifier}} \quad (1)$$

Transistorized operational amplifiers for low-noise applications are very often discounted by designers after a cursory examination of the specifications of available devices. That is to say, the specifications quite often give a figure for noise voltage that, taken by itself, may look very high. For example, a typical figure may be 10  $\mu$ V. When this figure is considered along with techniques for optimizing noise performance, however, the noise introduced by such an amplifier is quite small. In some devices, notably those using field-effect transistor input stages, noise perform-

ance is equal or superior to that obtainable with vacuum tubes.

Sources of noise originating outside the circuit can be reduced to tolerable levels by careful shielding, grounding, and filtering; but the noise generated in the amplifier and the surrounding circuitry—or, for that matter, in the signal source itself—creates a much more difficult problem. Transistorized amplifiers generate thermal noise (broad-band or white), flicker noise ( $1/f$ ), shot noise, and partition noise. Generally, the amplifier manufacturer will optimize his circuit design to give the best results commensurate with cost and general-purpose requirements, but certain trade-offs and component selections can further reduce noise in critical applications.

## Understand noise figure

In the case where the input noise to the amplifier is thermal noise generated in a signal-source resistance, the amplifier noise factor,  $F$ , may be defined in terms of input and output signal-to-noise ratios:

$$S_o/N_o = (1/F)(S_i/N_i), \quad (2)$$

where:

- $S_o$  = signal power output of the amplifier,
- $S_i$  = signal power input to the amplifier,
- $N_o$  = noise power output of the amplifier,
- $N_i$  = noise power input to the amplifier.

Noise factor is usually expressed in decibels and termed noise figure:

$$NF \text{ (dB)} = 10 \log_{10} F. \quad (3)$$

Alternatively, noise figure may be expressed in terms of rms signal and noise voltages as:

$$NF \text{ (dB)} = 10 \log_{10} [(E_i/N_i)^2 / (E_o/N_o)^2], \quad (4)$$

where:

- $E_i$  = rms signal voltage input to amplifier,
- $E_o$  = rms signal voltage output from amplifier,
- $N_i$  = rms noise voltage input to amplifier,
- $N_o$  = rms noise voltage output from amplifier.

If the voltage gain of the amplifier,  $A = E_o/E_i$ , is substituted into Eq. 4, the equation reduces to:

$$NF \text{ (dB)} = 10 \log_{10} [(1/A^2)(N_o/N_i)^2]. \quad (5)$$

The rms thermal-noise voltage generated by a

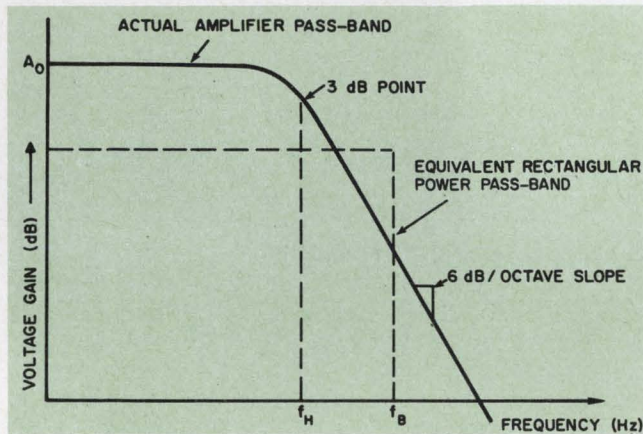

1. The effective noise bandwidth of an operational amplifier is defined as the rectangular power pass-band equivalent to the actual power pass-band, as shown in the amplifier gain-vs-frequency plot.

source resistance,  $R_s$ , is:

$$N_i = (4 k T b R_s)^{1/2}, \quad (6)$$

where:

$k$  = Boltzmann's constant ( $1.38 \times 10^{-23}$  J/°K),

$T$  = temperature (°K),

$b$  = noise bandwidth (Hz),

$R_s$  = source resistance ( $\Omega$ ).

At room temperature  $4 k T = 1.6 \times 10^{-20}$  joules.

Substituting this expression for  $N_i$  into Eq. 4 yields:

$$NF \text{ (dB)} = 10 \log_{10} [(N_o/A)^2 / 4 k T f_B R_s]. \quad (7)$$

The noise bandwidth in Eq. 7 is now an effective noise bandwidth,  $f_B$ , to be defined. The term  $N_o/A$  is the output noise voltage referred to the input and may be considered an equivalent rms input noise voltage,  $e_i$ .

### Examine effective noise bandwidth

The effective noise bandwidth of an amplifier is defined as the rectangular power pass-band equivalent to the actual power pass-band of the amplifier (Fig. 1), or:

$$f_B = (1/G_o) \int_0^\infty |G(j\omega)| df, \quad (8)$$

where:

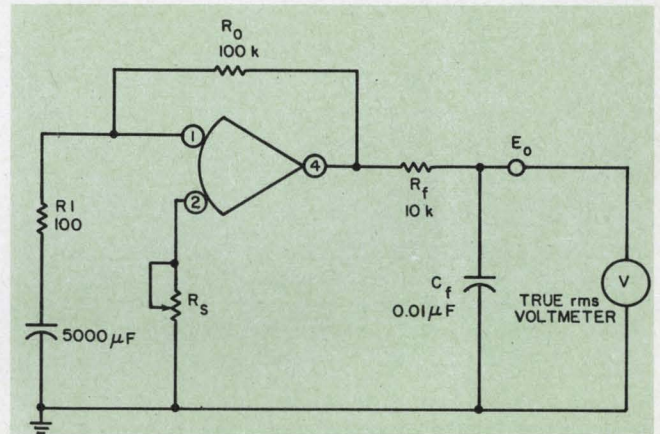

2. Simple amplifier noise test circuit can be put together quickly. Care must be taken to use proper lead and input-output shielding to avoid hum pickup. The 5000- $\mu$ F capacitor at the input gives a very low cutoff frequency.

$f_B$  = effective noise bandwidth,

$G_o$  = amplifier power gain at dc,

$|G(j\omega)|$  = magnitude of amplifier power gain as a function of frequency.

In Fig. 1, amplifier voltage gain is down 3 dB at frequency  $f_H$ . This frequency corresponds to the half-power point ( $-6$  dB) of the power pass-band. When an amplifier is compensated for a 6 dB/octave rolloff, or filtered externally at 6 dB/octave with a simple RC network, the voltage gain as a function of frequency is:

$$A(j\omega) = A_o / [1 + j(\omega/\omega_H)], \quad (\omega = 2\pi f) \quad (9)$$

where  $A_o$  is the dc voltage gain. Squaring this equation gives an expression proportional to the power gain as a function of frequency. Substituting this result into Eq. 8 and evaluating the integral give:

$$\begin{aligned} f_B &= \int_0^\infty |1/[1 + j(\omega/\omega_H)]|^2 df \\ &= (\omega_H/2\pi) \int_0^\infty [d(\omega/\omega_H)]/[1 + (\omega/\omega_H)^2] \\ &= (\omega_H/2\pi) (\pi/2) = (\pi/2)f_H. \end{aligned}$$

Thus the effective noise bandwidth for an amplifier rolled off at 6 dB/octave is  $\pi/2$  times the 3-dB frequency of the voltage response.

Having defined the effective noise bandwidth

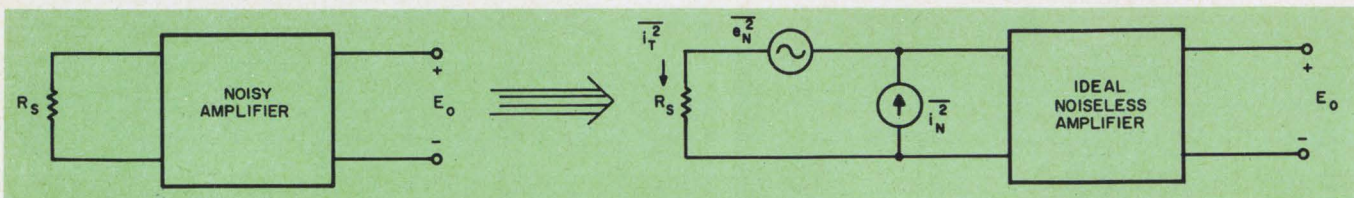

3. An equivalent circuit of an actual amplifier (a) can be constructed by including voltage and current noise sources (b).

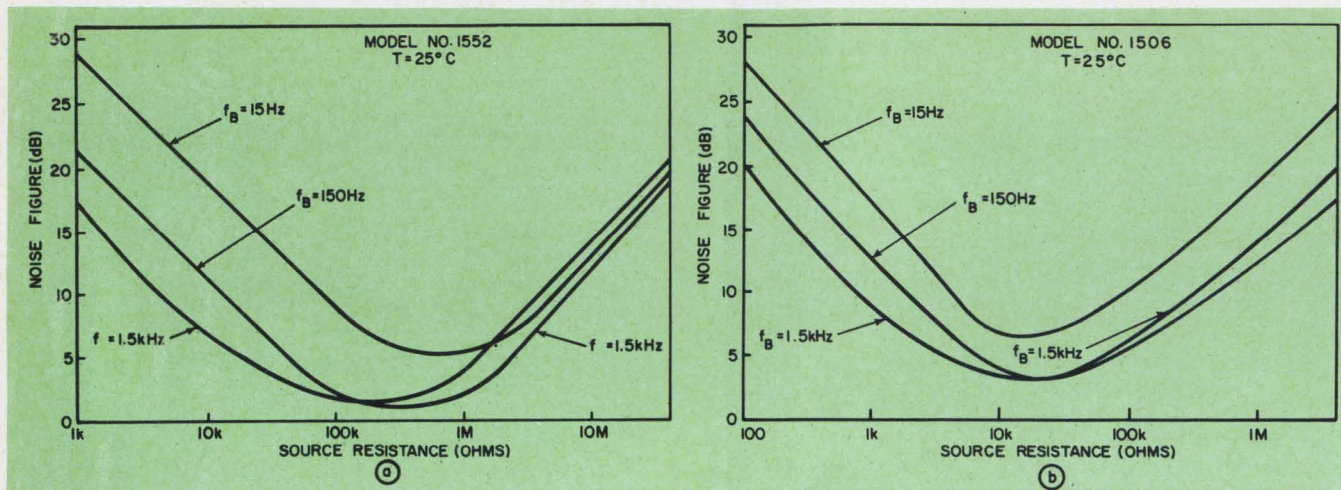

4. Plots of NF vs source resistance indicate the difference between operational amplifiers with FET (a) and bipolar (b) input stages. While these curves were obtained with

specific units, the results apply generally to a variety of operational amplifiers. Note the big improvement in the noise figure in (a).

the next step is to look at some of the noise voltage measurement methods and techniques.

Only the most obvious few have been mentioned above. An additional one would be to provide good, solid grounds.

### Measure amplifier noise voltage

A simple test circuit for measuring broad-band amplifier noise voltage output is shown in Fig. 2. The 5000- $\mu\text{F}$  capacitor gives a very low cutoff frequency that may be considered as dc for most measurements. Filter components  $C_f$  and  $R_f$  are selected to attenuate the output signal  $-3$  dB at the desired bandwidth, with further attenuation at 6 dB/octave beyond this point. Dividing the measured output voltage by the circuit gain (1000, in this case) gives the equivalent noise voltage,  $e_i$ . The expression for the noise figure then becomes:

$$NF \text{ (dB)} = 10 \log_{10}(e_i^2/4 k T f_B R_s). \quad (10)$$

Extreme care must be taken when making the noise measurements. The test circuit should be well-shielded to avoid such things as hum pickup, input-to-output coupling and long leads that may induce measurement errors. When large source resistances are used, stray capacitance shunting  $R_s$  (not taken into account in Eq. 10) will cause attenuation of the high-frequency components of the noise voltage. In fact, this may even result in seemingly negative noise figures, which are physically impossible by definition.

In general, the techniques used in breadboarding any high-frequency circuit should be used.

### Use a noise-equivalent circuit

The evaluation of noise in operational amplifiers may be carried a step further without resorting to investigation of the inner workings of the amplifier. Figure 3 shows a noisy amplifier with an input terminated in a source resistance  $R_s$  and an equivalent circuit consisting of an ideal, noiseless amplifier and two noise generators,  $e_N^2$  and  $i_N^2$ .

Noise generators  $e_N^2$  and  $i_N^2$  represent mean square noise voltage and current, both proportional to noise power. They are not entirely independent of one another, but the results will not be seriously impaired if it is assumed that they are.

Since the input impedance of the ideal amplifier is infinite, the total noise power in the input circuit is proportional to  $\overline{i_T^2}$  of Fig. 3, which consists of the contributions from the noise generators and the thermal noise in  $R_s$ :

$$\overline{i_T^2} = (4 k T f_B / R_s) + (\overline{e_N^2} / R_s^2) + \overline{i_N^2}. \quad (11)$$

The total rms input noise voltage is then:

$$\begin{aligned} (\overline{e_T^2})^{1/2} &= R_s (\overline{i_T^2})^{1/2} \\ &= (4 k T f_B R_s + \overline{e_N^2} + \overline{i_N^2} R_s^2)^{1/2}. \end{aligned} \quad (12)$$

The equivalent input noise voltage of an op-

erational amplifier at any given bandwidth, then, can be completely characterized with only two measurements:  $(\overline{e_N^2})^{1/2}$  is found by measuring the output noise when  $R_S = 0$ ; and  $(\overline{i_N^2})^{1/2}$  is determined by measuring the output noise with  $R_S$  very large.

Equation 12 may be substituted into the expression for noise figure in Eq. 10, and an optimum source resistance can be found by taking the derivative with respect to  $R_S$  and setting the result equal to zero:

$$NF \text{ (dB)} = 10 \log_{10} \left\{ \left[ (\overline{e_N^2})^{1/2} \right]^2 / 4 k T f_B R_S \right\} \quad (13)$$

$$= 10 \log_{10} \left[ 1 + (\overline{e_N^2} / 4 k T f_B R_S) + (\overline{i_N^2} R_S / 4 k T f_B) \right]. \quad (14)$$

Differentiating Eq. 14 with respect to  $R_S$ , and letting the derivative equal zero yield the value of  $R_{S(opt)}$ :

$$R_{S(opt)} = (\overline{e_N^2} / \overline{i_N^2})^{1/2}. \quad (15)$$

If the amplifier input is terminated in  $R_{S(opt)}$ , the best possible signal-to-noise ratio will be obtained. Experimentally,  $R_{S(opt)}$  is found to be much less than the input impedance of the amplifier; it is independent of closed loop gain and is somewhat dependent on the effective noise bandwidth.

### Optimize noise performance

The curves in Figs. 4a and 4b show typical noise performance of two general-purpose operational amplifiers. The model 1552 has FETs in the input stage; model 1506 has a bipolar transistor input stage. The curves apply at an ambient temperature of 25°C. The two types of input stages afford the designer considerable latitude in choosing the correct amplifier for a given application. The FET type is ideally suited for source resistances in the range of 100 kΩ to 1 MΩ, while the bipolar-transistor type gives good results with smaller source resistances between 10 kΩ and 100 kΩ. In applications where the source resistance may be chosen somewhat arbitrarily, it should be matched to  $R_{S(opt)}$  of the amplifier for best noise performance. The selection of the bridge resistance of a strain-gauge transducer is an example. When the source impedance is fixed and amplifier response down to dc is not required, the usual alternative is to use a coupling transformer with a turns ratio of  $n^2 = R_{S(opt)} / R_S$  to give optimum noise figure.

### Nomogram gives NF at a glance

The nomogram in Fig. 5 is useful for rapid calculation of amplifier noise figure at 25°C, given the effective noise bandwidth, source resistance and equivalent input noise voltage. Alternatively, if the noise figure is known, the magnitude of the input noise voltage may be determined for variable source resistances and effective bandwidths. As an example, assume the measured equivalent

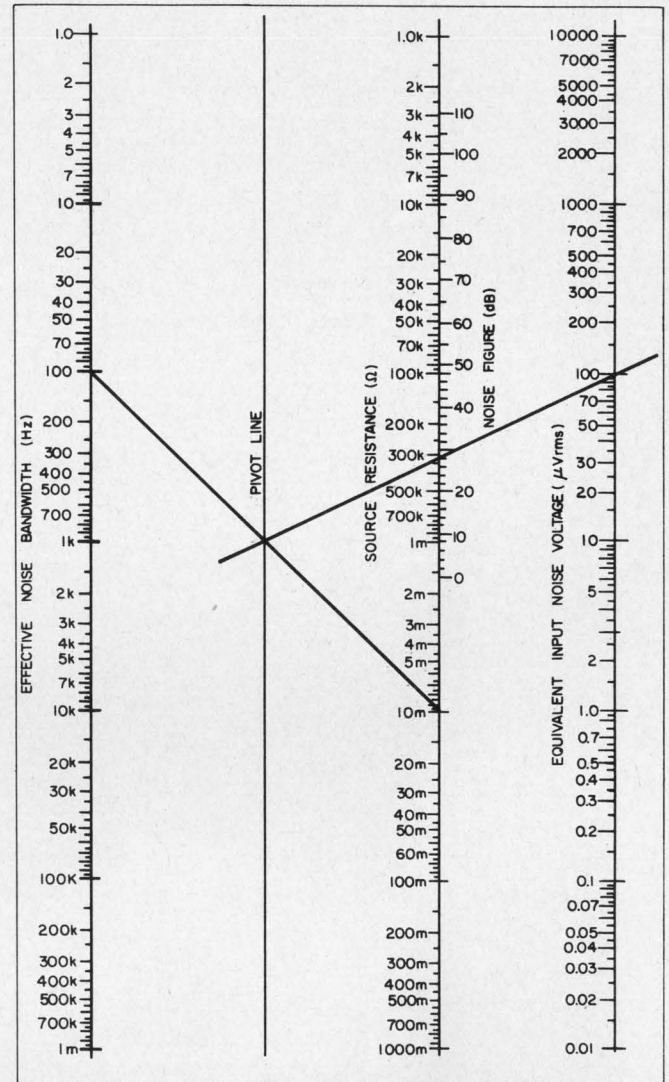

5. Quick check of an amplifier NF can be made by using this nomogram, if the effective noise bandwidth, source resistance and equivalent input noise voltage are known.

input noise voltage of an amplifier, operating with a 10-MΩ source resistance and 100-Hz noise equivalent bandwidth, is 100 μV rms. To determine the noise figure, connect a straight line between 100 Hz on the bandwidth scale and 10 MΩ on the source resistance scale. The point of intersection of this line and the pivot line is then connected with a straight edge to 100 μV rms on the noise-voltage scale. The resulting straight line passes through 28 dB, which is the approximate noise figure. A detailed calculation of the noise figure for this example yields 27.96 dB. ■ ■

### Bibliography:

- Cleary, J. F. (ed.). *Transistor Manual*. Syracuse, N. Y.: General Electric Co., 1962.
- "IRE Standards on Methods of Measuring Noise in Linear Two-Ports," *Proc. IRE*, XLVIII, No. 1 (Jan., 1960), 60-68.
- Schwartz, Mischa. *Information Transmission, Modulation and Noise*. New York: McGraw-Hill Book Co., 1959.

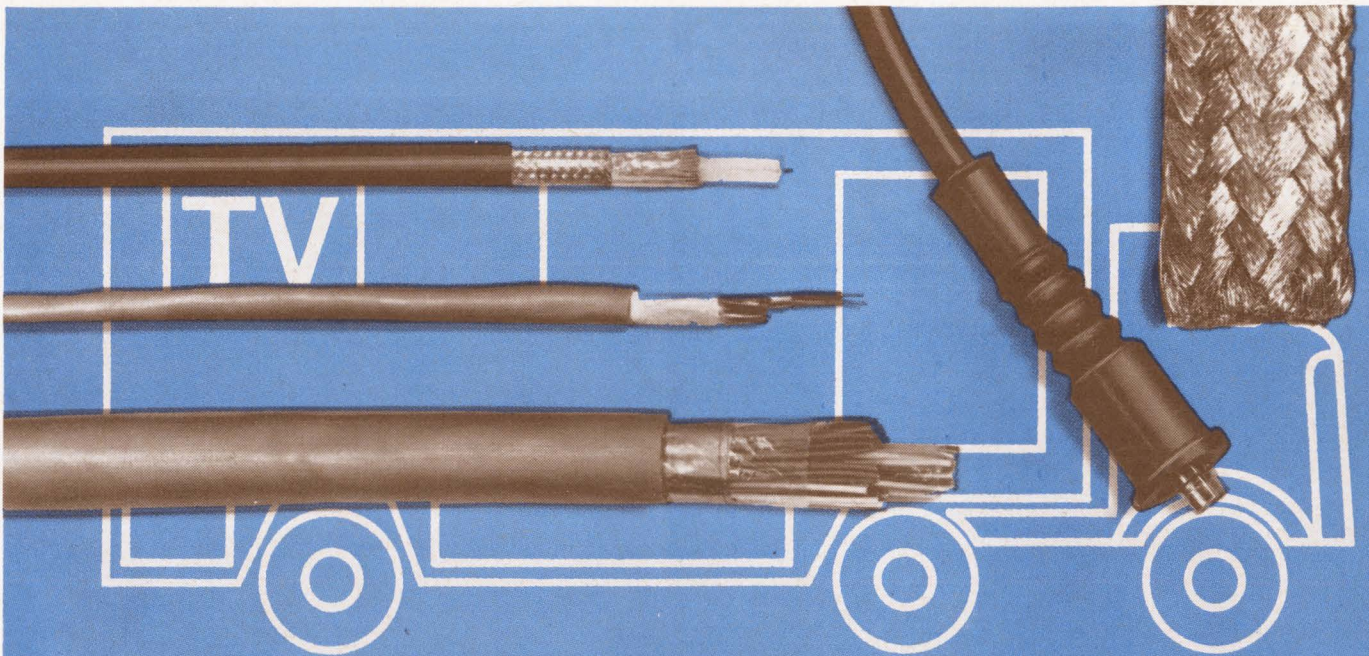

**talk about systems...**

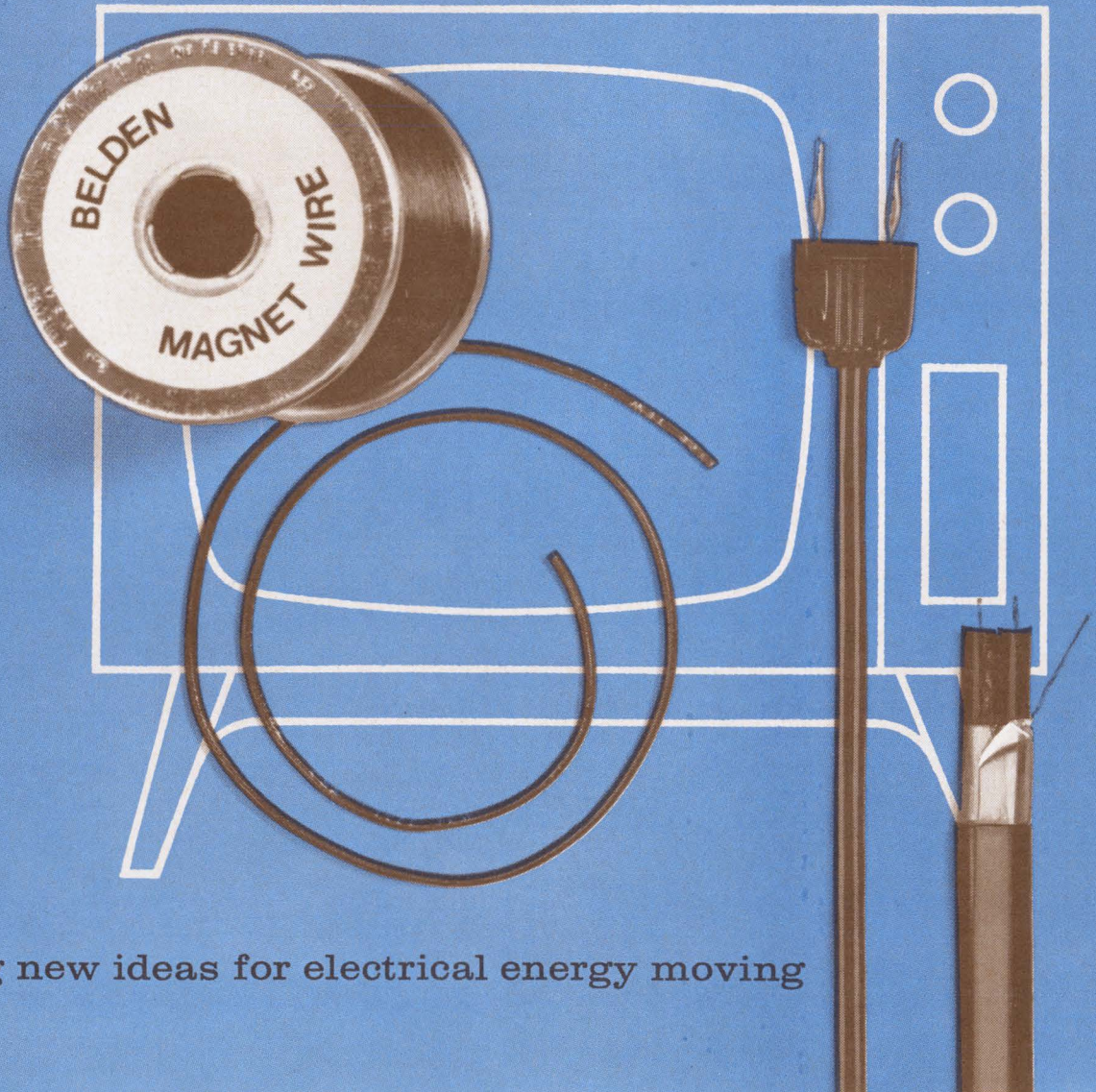

keeping new ideas for electrical energy moving

G-2-7



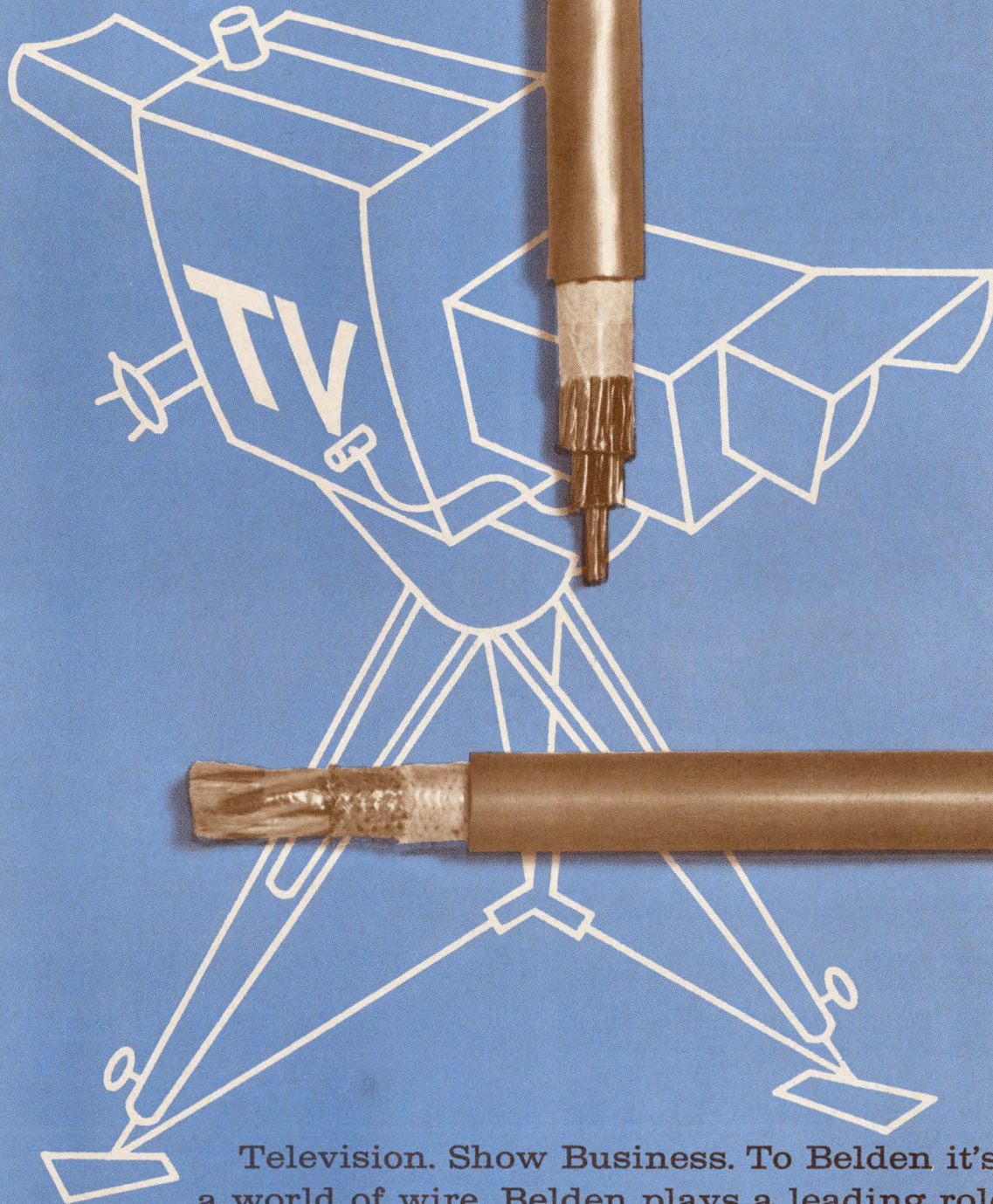

Television. Show Business. To Belden it's all a world of wire. Belden plays a leading role in many complex systems of sight and sound communication. By delving into design, processing, packaging and a host of factors, Belden's team of wire specialists have helped many people wring out hidden costs. Success takes a supplier that is really perceptive — one who makes all kinds of wire for all kinds of systems. Want to join us in wringing out values and costs? Just call us in . . . Belden Corporation, P.O. Box 5070-A, Chicago, Illinois 60680.

**Belden**

# Get bargains in power transistors.

The tricks of the trade extend far beyond just looking for quantity breaks.

Saving money on power transistors is not just a matter of squeezing pennies through quantity buying, purchase agreements and similar trade practices. It also requires good circuit design and proper specification of the best available device, based on actual measurements instead of wishful thinking.

There are pitfalls to avoid when specifying power transistors. Take care to know them, and you may find yourself buying a perfect device for \$5 instead of \$50. Here are the rules to follow.

## Consider device parameter trade-offs.

Compatibility of all desirable transistor characteristics is an ideal situation that is seldom realized. In actual practice, designs that optimize one or two groups of parameter usually conflict with other parameters. For example, the combination of semiconductor material resistivity, base width and dopant that gives high voltage and good safe operating area also results in relatively low gain. As indicated in Fig. 1, gain, frequency response, voltage, current capability, and cost must be balanced against each other in device design. Every transistor on the market represents one of many possible compromises. The user must decide which parameter, or parameters, are most important for an application and then select a device that is adequate in all respects, but which emphasizes these.

The thing to keep in mind is that the additional effort to optimize a circuit during the design stage is well justified by the possible savings that will accrue in the quantity production.

## Don't specify nonexistent devices

Once a design has been settled, the transistor is essentially specified. When transistors first became available, many engineers started to use them with the same design approach that they took with tubes. That is, they would design for an arbitrary device and then look for a unit to meet the required speci-

fications. All too frequently the result was a requirement for a high-voltage, high-gain transistor that was very costly, if available at all. Much better practice is to start the design with a survey of existing transistors and their availability in the required quantities.

To satisfy high-voltage or high-current requirements, for instance, the possibility of a series or parallel arrangement of lower-rated transistors should be considered. Frequently, slight circuit modifications will reduce total costs by permitting the replacement of a premium device with two or more less expensive ones.

## Avoid an arbitrary requirement

Silicon transistors have been widely acclaimed for their high temperature capability, low leakage and high voltage. In fact, this acclaim has been so general that the sales appeal of "all-silicon" systems has prompted many manufacturers to disregard germanium power transistors for many applications. But germanium power transistors do have their advantages in many cases. In fact, despite silicon's appeal,

**Table: Power transistors:  
germanium vs silicon**

| Germanium advantages               | Silicon advantages                    |
|------------------------------------|---------------------------------------|
| Lower $V_{CE(sat)}$                | Higher voltages                       |
| Higher current capability          | Lower leakage ( $I_{CBO}$ )           |
| Lower $V_{BE}$ (high $g_{FE}$ )    | Higher operating temperature          |
| Higher gain at most current levels | Good thermal stability                |
| Lower prices                       | Higher frequency and faster switching |
| Good availability and delivery     | Npn and pnp configurations            |

---

Merrill Palmer, Applications Engineer, Motorola Semiconductor Products, Phoenix, Ariz.

the 1966 sales volume of germanium power transistors was greater than that of silicon power devices. Some of the reasons for this are summarized in the Table.

### Don't overlook the many standard devices

When a semiconductor manufacturer successfully designs a transistor for a specific but broad market, an EIA-registered or "in-house standard" device is normally established, with specifications which best represent the product. Good factory volume, standard testing and reasonable yields lead to low price and wide availability, which are important arguments in favor of selecting standard types. Standard types are usually stocked at the factory, and frequently at local electronics distributors as well. Second sources often exist for many standard types.

### Don't plump for a special in haste

Special devices have their place, too. These include premium selections, substandard specials, and mechanical specials. Premium selection refers to devices which are standard types except for some additional testing, such as a higher minimum or lower maximum limit on some parameter, the addition of a parameter not covered by the standard specification, or matched pairs. For example, assume that the selection criterion for a device indicates the 2NXXX2, 2NXXX3, 2NXXX4, series, which have  $BV_{CEOS}$  of 50, 75, and 100 volts, respectively. If a  $BV_{CEO}$  of 120 volts minimum is required, perhaps a factory screening of 2NXXX4s could be arranged to provide premium-selection specials with the required  $BV_{CEO}$ . Some price increase would probably be necessary to pay the cost of the extra factory testing. If  $BV_{CEO}$  of 90 volts minimum is adequate, it may be less expensive to purchase a 2NXXX3 selected for 90-volt minimum  $BV_{CEO}$  than to purchase a 2NXXX4.

### Don't overlook bargains in substandard devices

If the application in question does not require all the parameters or limits of a standard type of device, it may be possible to cut costs by relaxing the standard specification in some parameter. Because of the many variables of transistor production, a manufacturer may have a quantity of devices which are otherwise good transistors, but which fail to meet every specification of the standard. Such "fall-out" devices may be of limited marketability and therefore available at considerable savings.

### Check the production yield of specials

The price tag of special devices is strongly influenced by the number of them that is yielded from the source device or product line. Histograms of raw line data for  $BV_{CEO}$  and  $h_{FE}$  of a repre-

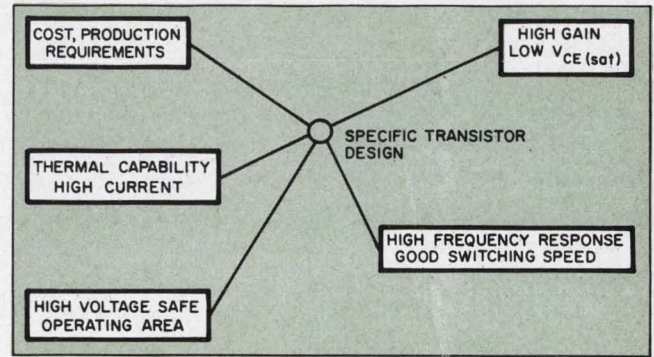

1. **Parameter trade-offs** must be considered in specifying a power transistor. Time spent on circuit design and preparation of an "easy" specification will be well rewarded by the price of the transistor.

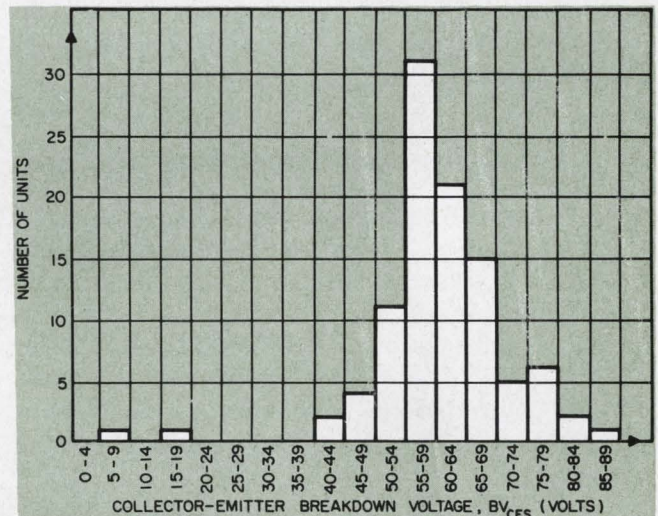

2. **A typical distribution** of a number of power transistors vs. collector-emitter breakdown voltage indicates that, to select 100 transistors with  $BV_{CEO}$  of 80 volts minimum, over 3300 devices would have to be tested.

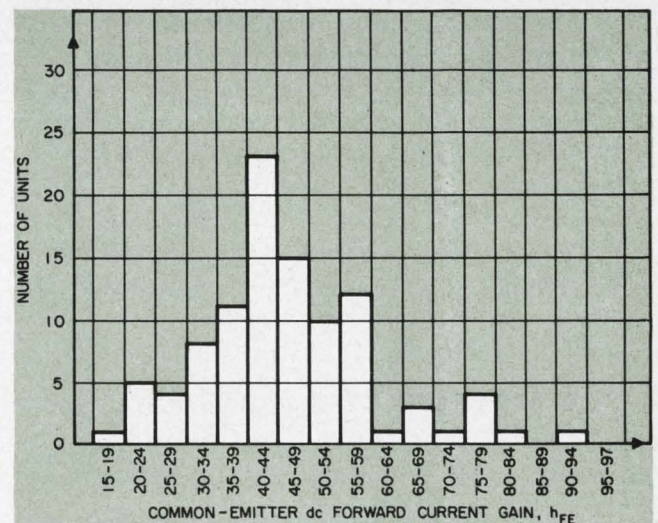

3. **Specifying a 1:1.25 ratio of minimum to maximum  $h_{FE}$**  without restricting the actual values of  $h_{FE}$  indicates that a lower price could be obtained by buying devices with  $40 < h_{FE} < 50$  than in the range of 20 and 25, or 80 and 100.

sentative silicon-power-transistor line are shown in Figs. 2 and 3. From Fig. 2, the yield of this product to a  $BV_{CEO}$  greater than 80 volts is seen to be 3%, while 98% of the devices exhibit  $BV_{CEO}$  of 40 to 80 volts. To select 100 devices having a minimum  $BV_{CEO}$  of 80 volts will require testing over 3300 devices, compared with testing just over 100 devices if a  $BV_{CEO}$  of only 40 volts is required. For additional parameters, more testing is required. Thus the number of devices that have to be tested can be very large indeed if the yield to several parameters is low. From the standpoint of test costs alone, then, a low-yield special selection will be more expensive than one of high yield. Furthermore, if a manufacturer has no prospect of profitably disposing of the extra devices that he must produce to supply a given quantity of a low-yield special device, he may find it necessary to reflect this risk in his price. Obviously, the buyer of the device will ultimately pay for the luxury of specifying such a low-yield unit reflecting careless circuit design.

#### Don't hobble the manufacturer with rigid specs

Yield also comes into play in the specification of the limits that are subject to the designer's control. Suppose, for example, that a 1:1.25 ratio of minimum to maximum  $h_{FE}$  is desired, but that there is some room for choice of the actual values. From Fig. 3 it can be seen that under these conditions yield is maximized by specifying an  $h_{FE}$  of 40 to 50, and that yield is lower for  $h_{FE}$ s of 20 to 25, or 80 to 100.

#### Don't call out incompatible parameter values

Another potential yield problem in specifying special devices is the interdependence of many parameters. Care must be taken not to specify nearly impossible combinations. Figure 4 shows by scatter plot the interdependence of  $h_{FE}$  at 20 amps and  $h_{FE}$  at 5 amps for a given power-transistor line. Approximate limits of correlation are shown by the dashed envelope. Very poor yield would be expected from a combined specification of  $h_{FE} = 30$  to 60 ( $I_C = 5$  A,  $V_{CE} = 2$  V) and  $h_{FE} \geq 25$  ( $I_C = 20$  A,  $V_{CE} = 2$  V). As shown by the shaded area of Fig. 5, these two specifications are almost mutually exclusive within the envelope of correlation.

#### Don't ignore the factory representative

Perhaps the paramount rule to observe in considering the electrical parameters of devices that are premium or substandard specials is frankly and openly to discuss actual needs with the semiconductor salesman. His knowledge of his entire product line and access to information on factory yields, test costs, and "fall-out" inventory enables

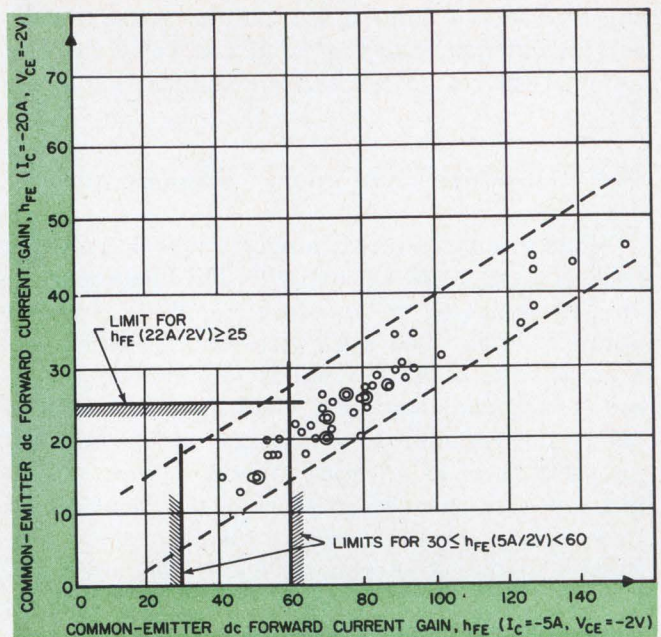

4. A high price can be paid by the designer specifying contradictory parameters. In the graph above, very poor yield occurs for devices that have a combined specification of  $h_{FE} = 30$  to 60 ( $I_C = 5$  A,  $V_{CE} = 2$  V) and  $h_{FE} \geq 25$  ( $I_C = 20$  A,  $V_{CE} = 2$  V).

him to recommend the best device for the need, be it special or standard.

#### Try to save on assembly costs

Mechanical rework such as shortened leads, attachment of solder lugs or lead extensions, is usually available at a price, if it can be accomplished on completely assembled devices after they have been screened to the electrical specification. Additional expense associated with such mechanical specials may be more than offset by savings in assembly costs, for instance. The buyer should remain aware, however, that such modification may make it impossible for the manufacturer to market the devices elsewhere, should the buyer alter his design or place an excess order.

#### Hold down the testing, if possible

The cost of quality assurance and reliability testing must ultimately be reflected in the selling price of transistors. This cost is a function of the nature and amount of testing required. Compared with military specifications, money can usually be saved on industrial quality controls by permitting less than 100% processing, taking smaller samples, and making shorter life tests. Manufacturers' reliability programs can sometimes be used to bypass the high cost of extensive life and environmental testing as a means of reliability assurance. The specifier of industrial power transistors favors his pocketbook when he avoids unrealistic quality assurance requirements. ■ ■

# Five reasons why so many engineers specify Sigma relays.

Longer mechanical life

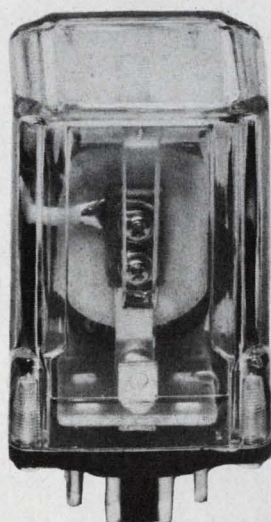

Series 50

Better conductivity

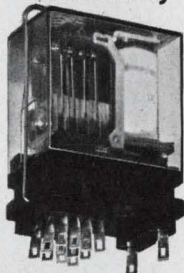

Series 62

Price: 75¢



Series 65

Faster installation

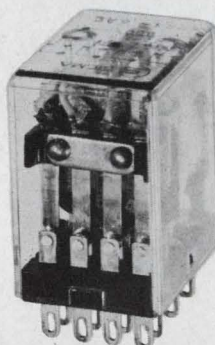

Series 67

Solid-state design

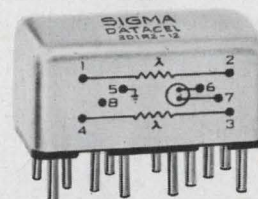

Datacel®

And there are more reasons why each of these Sigma relays give you superior performance:

**New Series 50:** Rated for at least 10 million mechanical operations and fully recognized under the U.L. component program. These 1, 2 and 3 pole, 5 and 10 amp relays also feature an exclusive contact base design that extends contact life.

**New Series 62:** The larger contacts of this new Series (.093" & .058" dia.) assure excellent conductivity. And it has a thicker base for greater contact stability than other 2, 4 and 6 pole, 2 amp relays.

**New Series 65:** In addition to low price economy, this new 1 amp SPDT relay provides superior switching performance through its precision knife-edge hinge armature design. It has greater mechanical strength and better thermal stability than similar competitive types.

**New Series 67:** It not only assures faster in-

stallation with its simple snap-in socket but will outperform other 4PDT, 3 amp, AC-DC relays in life, adjustment stability and thermal resistance.

**New solid-state Datacel®:** This optoelectronic switching device provides greater reliability and complete input-output circuit isolation. It also features AC-DC capability, compact construction and broad application versatility.

**We'd like to give you one of these relays or any standard Sigma type.** It's the best way we know to prove what we say about Sigma relay performance. Just fill in and return the post-paid reply card—or the Reader Service Card. We'll send you the new Sigma relay catalog and a "free relay" request form. Return the form and your Sigma representative will see that you get the relay you need.

**Need fast delivery? The Sigma Line is available off-the-shelf from your Sigma distributor.**



**SIGMA INSTRUMENTS INC**

Assured Reliability With Advanced Design / Braintree, Mass. 02185

Sigma Instruments (Canada) Ltd., P.O. Box 43, Toronto 18

ON READER-SERVICE CARD CIRCLE 57

this 5 ampere, 4PDT  
miniature telephone type  
direct plug-in Relay  
gives you everything—

**Reliability**  
**Space saving**  
**Versatility**  
**and ECONOMY**

**IN STOCK**  
for immediate delivery

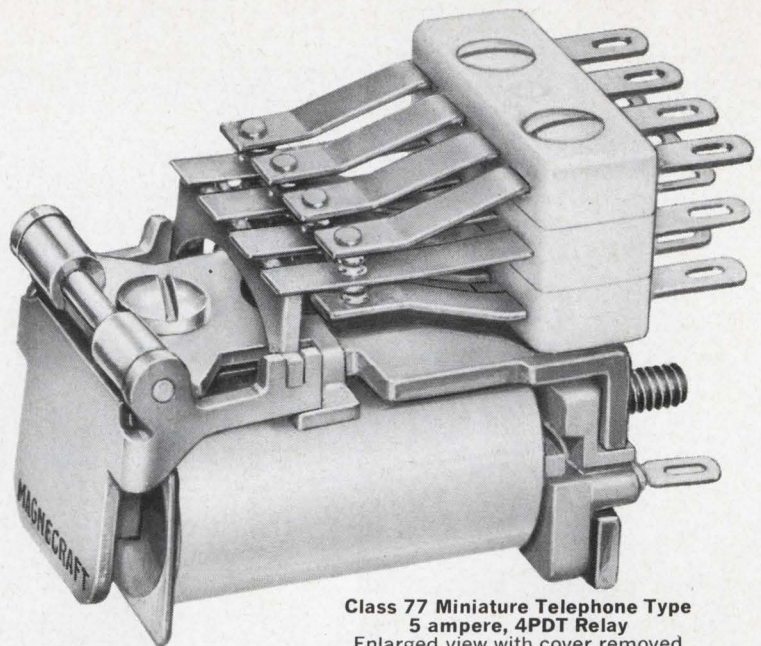

**Class 77 Miniature Telephone Type  
5 ampere, 4PDT Relay**  
Enlarged view with cover removed  
Designed and Manufactured in USA

**Direct, Plug-in Terminals** give you plug-in relay assembly for the mere extra cost of the socket.

**Plug-in Terminals are Pierced and Tinned** for solder connections where required.

**Telephone Type Relay Design** assures unsurpassed adjustment stability through long life.

**One-piece Combination Contact Arms and Plug-in Terminals** avoid internal wiring.

**Oversize Insulating Blocks of Molded Resin** rigidly secure the combination contact arm/terminals for mechanical and electrical stability through long life.

**The Basic Design** provides greatly increased contact pressure without added coil power.

**Precision-built, Hinge-pin Armature Bearings** assure lowest friction for maximum contact pressure and stabilized adjustment through long life.

**The Crackproof See-through Plastic Snap-on Cover** protects the relay from dust and stray electrical contacts.

**The Application Versatility of Class 77 Relays** is illustrated in Figures 1 through 6.

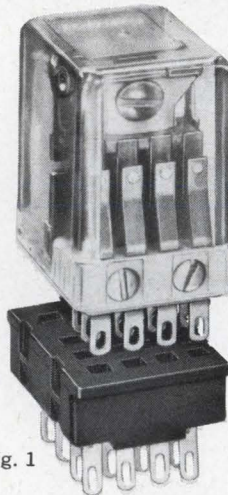

Fig. 1

**Standard Class 77  
Relay and Socket**  
(approx. actual size.)  
Socket is Optional

The socket can be wired as quickly as the relay; plug-in assembly adds only cost of the socket.

**IN STOCK**  
for immediate delivery  
Standard Class 77,  
5 amp. 4PDT with coils  
for commonly used  
AC and DC voltages.

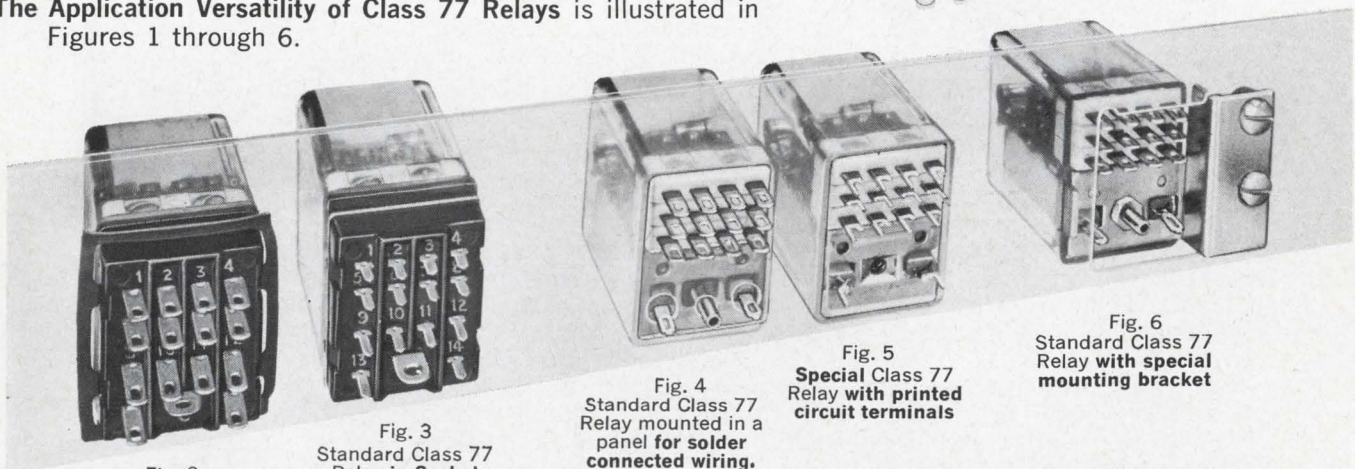

Fig. 2  
Standard Class 77  
Relay in **Socket with  
solder terminals**  
(same combination as  
shown in Fig. 1)

Fig. 3  
Standard Class 77  
Relay in **Socket  
with printed circuit  
terminals.**

Fig. 4  
Standard Class 77  
Relay mounted in a  
panel for **solder  
connected wiring.**

Fig. 5  
**Special Class 77  
Relay with printed  
circuit terminals**

Fig. 6  
Standard Class 77  
Relay with **special  
mounting bracket**

Try our new Class 77 Relay. See how it can help complete tough circuits in close space as well as meet tight budgets. Phone the MAGNECRAFT REPRESENTATIVE or contact us direct for literature and samples.

**MAGNECRAFT ELECTRIC CO.**

5575 N. Lynch Avenue, Chicago, Ill. 60630 Phone 312-282-5500

ON READER-SERVICE CARD CIRCLE 58

ELECTRONIC DESIGN 19, September 13, 1967



## Our vacuum capacitor testing is the next best thing to the worst field conditions.

Only ITT Jennings maintains the facilities to test vacuum capacitors in an environment that exactly duplicates actual operating conditions—and then some. In fact, as a government-approved facility equipped to perform capacitor qualification testing under MIL-C-23183A, we carry our testing to extremes far beyond the worst possible field conditions.

Our vacuum capacitors are rf tested at rated voltage and current or to customer specifications on transmitters ranging in frequency from 17 kc to 600 mc and up to 100 kw cw power.

ITT Jennings environmental testing includes capacitance shift versus temperature from  $-65^{\circ}\text{C}.$  to  $+125^{\circ}\text{C}.$ ; dynamic vibration; static vibration; shock; salt spray; humidity; and bellows life testing.

All of this testing is done to assure you the most reliable performance from every vacuum capacitor we make: units up to 5000 pf in the 15 kv range, 1000

pf to 55 kv and 200 pf to 120 kv. Current ranges of our ultra high vacuum dielectric capacitors are available up to 250 amps rms at 16 mc with convection air cooling and 1000 amps rms with water cooling. Small units for lower power or space-saving use range from less than 1 pf to 25,000 pf.

### TYPICAL SPECIFICATIONS

|                        | CADA<br>600 | CVTW<br>1600 | CVDD<br>1000 |
|------------------------|-------------|--------------|--------------|
| Capacity Range (PF)... | 40-600      | 100-1600     | 25-1000      |
| Peak Test Voltage (kv) | 10,15       | 55, 60, 65   | 7.5, 10, 15  |
| Amps rms (16MHz)....   | 65          | 600          | 125          |
| Overall Length.....    | 5.8 in.     | 23 in.       | 8 in.        |

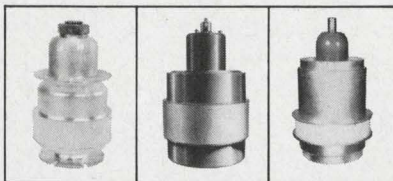

CADA 600

CVTW 1600

CVDD 1000

ITT Jennings has more to offer than the industry's only complete testing facility. To back up our reputation for design leadership—which began with the first vacuum variable capacitor ever built and has been responsible for virtually every significant new development since—we rely on a staff of experienced communications engineers. This staff directs its capacitor design capabilities toward meeting the anticipated communication equipment needs of the future. This is why new developments in advanced vacuum capacitor design are always on their way from ITT Jennings. Before they ever reach you, however, they must first pass the most rigid quality control in the industry: testing in our own testing facility.

For complete information on vacuum capacitors, write for Catalog No. 101. ITT Jennings, a division of International Telephone and Telegraph Corporation, 970 McLaughlin Avenue, San Jose, California 95108.

**JENNINGS** **ITT**

# Reduce delay distortion at the source

in amplifiers, and end the need for complicated phase equalizers. Trouble usually lies in 3 circuit areas.

Delay distortion is a villain in an amplifier. It can wreck the fidelity of signals in analog equipment; it can cause time echoes, or ghosts, in video systems. Many engineers build complicated phase equalizers to counteract the trouble. But there is a simpler, more economical way to go about it: track the villain to its lair.

By analyzing three major areas in the amplifier and changing components that should not have been installed in the first place, you can usually cut delay distortion to a tolerable minimum.

This analytical approach is not hard to master. To understand it, examine a typical common-emitter amplifier, since this configuration contains all the sources of phase distortion in any amplifier.

But, first, how low should delay distortion be before it is considered tolerable? The answer depends on the precise way in which the circuit is being used and the types of signal being processed. In present voice-channel signal-processing equipment, attempts are being made to hold over-all delay distortions to 300 to 500  $\mu$ s. Since the bulk of the distortion is usually caused by various types of filters, such as multiplexing and single-sideband filters, the amount that can be tolerated in all amplifiers of the system is generally limited to somewhere around 50 to 100  $\mu$ s. Thus a low-distortion amplifier might have only 5 or 10  $\mu$ s of delay distortion.

## Phase vs frequency should be linear

The usual way to check phase distortion is to analyze the phase-vs-frequency function. Find the difference between the maximum and minimum phase slopes as follows:

$$\begin{aligned} (\partial\phi/\partial\omega)_{max} &= \tau_{max}, \\ (\partial\phi/\partial\omega)_{min} &= \tau_{min}. \end{aligned} \quad (1)$$

The difference is:

$$(\partial\phi/\partial\omega)_{max} - (\partial\phi/\partial\omega)_{min} = \tau_{max} - \tau_{min} \leq \Delta\tau_{max}. \quad (2)$$

The expression  $\partial\phi/\partial\omega = \tau$  is commonly known as the group delay. Group-delay distortion refers to variations in  $\tau$  with frequency. These variations in the delay distort the waveform.

In Eq. 2,  $\Delta\tau_{max}$  is the allowable group-delay distortion. A positive value of  $\Delta\tau$  is actually a group advance; negative values, however, represent delay.

Three simple circuits that can have a significant effect on  $\tau$  are found in the popular R-C-coupled common-emitter transistor amplifier (Fig. 1). But the data apply to all similar R-X networks. For example, the R-C low-pass and high-pass data are equally valid for R-L networks.

## Three circuits cause distortion

The three sections of circuitry that contribute to delay distortion in this amplifier are the emitter (Fig. 2a); the high-pass filter, formed by the coupling capacitor and the load resistor (Fig. 2b); and the low-pass filter, formed by the shunt capacitance and the collector and load resistors in parallel (Fig. 2c).

The delay distortion caused by R-C low-pass and high-pass circuitry (Figs. 2b and 2c) is identical. The transfer functions in each case are:

(Low pass)

$$\begin{aligned} e_o/e_{in} &= [1/j\omega C]/[R + (1/j\omega C)] \\ &= 1/(1 + j\omega CR); \end{aligned} \quad (3)$$

(High pass)

$$\begin{aligned} e_o/e_{in} &= R/[R + (1/j\omega C)] \\ &= j\omega CR/(1 + j\omega CR). \end{aligned} \quad (3a)$$

The phase is:

$$\phi_l = -\arctan \omega CR, \quad (4)$$

$$\phi_h = \pi/2 - \arctan \omega CR. \quad (4a)$$

Differentiate the phase to obtain the group delay:

$$\tau_l = \partial\phi/\partial\omega = -\{RC/[1 + (\omega CR)^2]\}; \quad (5)$$

$$\tau_h = \partial\phi/\partial\omega = -\{RC/[1 + (\omega CR)^2]\}. \quad (5a)$$

Let  $RC = 1/\omega_0$ :

$$\begin{aligned} \tau &= -\{1/\omega_0\}\{1/[1 + (\omega/\omega_0)^2]\} \\ &= -\{1/\omega\}\{[\omega/\omega_0]/[1 + (\omega/\omega_0)^2]\}. \end{aligned} \quad (6)$$

Equation 6 can be plotted in two ways. One method is based on values for  $\omega_0\tau$ , using the middle term in Eq. 6 (see color curve in Fig. 3); the other way is based on  $\omega\tau$  (the black curve in Fig. 3), using the last term in Eq. 6.

To determine the distortion at various frequencies for a given filter, use the curve for  $\omega_0\tau$ . To determine the constants that yield a desired response at a given frequency, use the curve for

Jerome H. Horwitz, Staff Engineer, TRW Electronic Components Div., Camden, N. J. \*Work was done at General Atronics Corp., Philadelphia.



$\omega\tau$ . Remember to consider all frequencies in the band and not just those at the band edge.

The third source of delay distortion is the emitter circuitry (Fig. 2a). Its effect may be computed by analyzing its input impedance. The current in the collector is:

$$I_c \angle \theta = i_c = e_{in}/Z, \quad (7)$$

and its phase angle is:

$$\theta = -\arctan(\text{Im}|Z|/R_e|Z|). \quad (8)$$

Now the impedance may be read off from the circuit diagram as:

$$Z = R + \{ [R_E(1/j\omega C)] / [R_E + (1/j\omega C)] \} \\ = (R + R_E + j\omega C R R_E) / (1 + j\omega C R_E). \quad (9)$$

The phase angle of the impedance is:

$$\phi = -\{ \arctan[\omega C R R_E / (R + R_E)] - \arctan \omega C R_E \} \\ = \arctan \omega C R_E - \arctan[\omega C R R_E / (R + R_E)]. \quad (10)$$

Let:

$$R_E C = 1/\omega_a \quad (11)$$

and

$$[R_E R / (R_E + R)] C = 1/\omega_b = R / [(R_E + R) \omega_a].$$

Notice that  $\omega_b \geq \omega_a$ . Then Eq. 10 becomes:

$$\phi = \arctan(\omega/\omega_a) - \arctan(\omega/\omega_b), \quad (12)$$

yielding the group delay:

$$\tau = \partial\phi/\partial\omega = \frac{1}{1 + (\omega/\omega_a)^2} \frac{1}{\omega_a} - \frac{1}{1 + (\omega/\omega_b)^2} \frac{1}{\omega_b}. \quad (13)$$

There are three independent variables in Eq. 13:  $\omega_a\tau$ ,  $\omega_b\tau$  and  $\omega\tau$ . Therefore normalizing  $\tau$  with any one of the variables still leaves it necessary to plot a family of curves.

To plot these curves, Eq. 13 has first to be solved for the variable of interest. The three equations are:

$$\omega_a\tau = \frac{1}{1 + (\omega/\omega_a)^2} - \frac{\omega_a/\omega_b}{1 + (\omega_a/\omega_b)^2 (\omega/\omega_a)^2}; \quad (14)$$

$$\omega_b\tau = \frac{\omega_b/\omega_a}{1 + (\omega_b/\omega_a)^2 (\omega/\omega_b)^2} - \frac{1}{1 + (\omega/\omega_b)^2}; \quad (15)$$

$$\omega\tau = \frac{[\omega/\omega_b] [(\omega_b/\omega_a) - 1] [1 - (\omega_b/\omega_a) (\omega/\omega_b)^2]}{[1 + (\omega_b/\omega_a)^2 (\omega/\omega_b)^2] [1 + (\omega/\omega_b)^2]}. \quad (16)$$

The curves for  $\omega_a\tau$  are plotted in Fig. 4; the curves for  $\omega_b\tau$  in Fig. 5; and those for  $\omega\tau$  in Fig. 6.

### The errors of approximation

At the expense of precision, the delay distortion may be determined quickly by approximation.

For the high- and low-pass filters, the result will be high by less than 1% if  $\omega/\omega_0$  is smaller than 0.1 or larger than 10. Following are the approximations:

$$\lim_{(\omega/\omega_0) \rightarrow 0} \omega_0 \tau = -1, \quad (17)$$

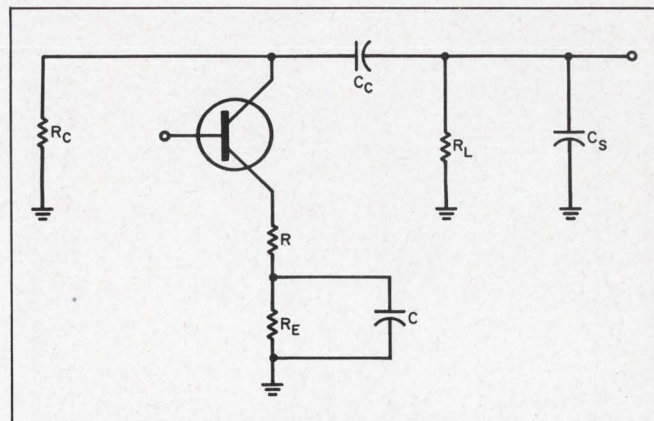

1. The R-C-coupled common-emitter transistor amplifier includes all troublesome circuitry that causes delay (or phase) distortion in amplifiers.

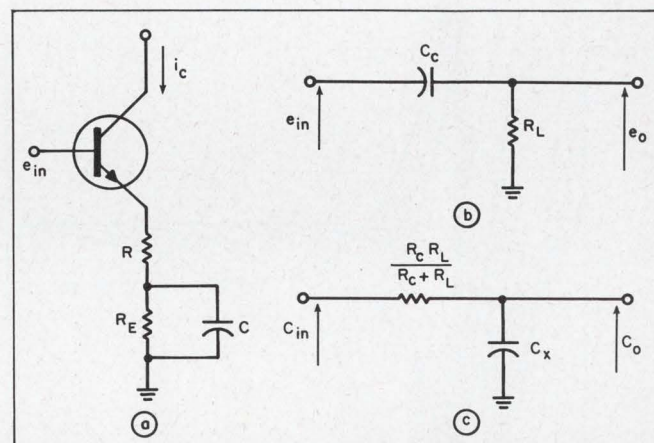

2. The three causes of delay distortion are the emitter (a), the high-pass filter, formed by the coupling capacitor and the load resistor (b), and the low-pass filter, formed by the shunt capacitor and the collector and load resistors in parallel (c).

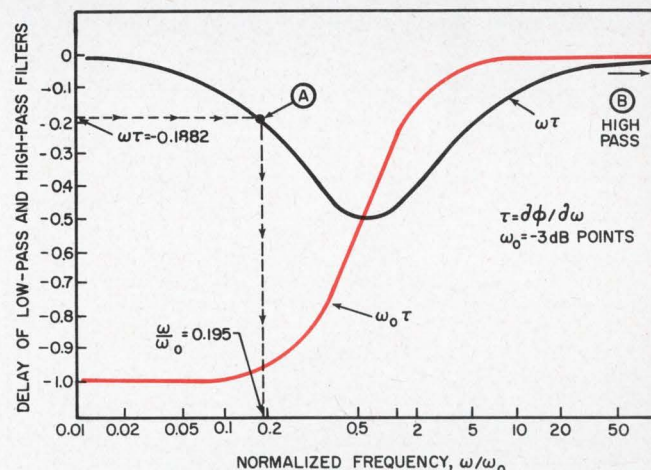

3. Delay distortion of the high-pass and low-pass filters. One curve (color) represents the distortion in terms of  $\omega_0$ , where  $\omega_0 = 1/RC$ ; it should be used to determine the distortion at various frequencies of a given filter. The other curve (black) is based on a given frequency,  $\omega$ ; it is useful when the constants that yield a desired response at a given frequency must be found.

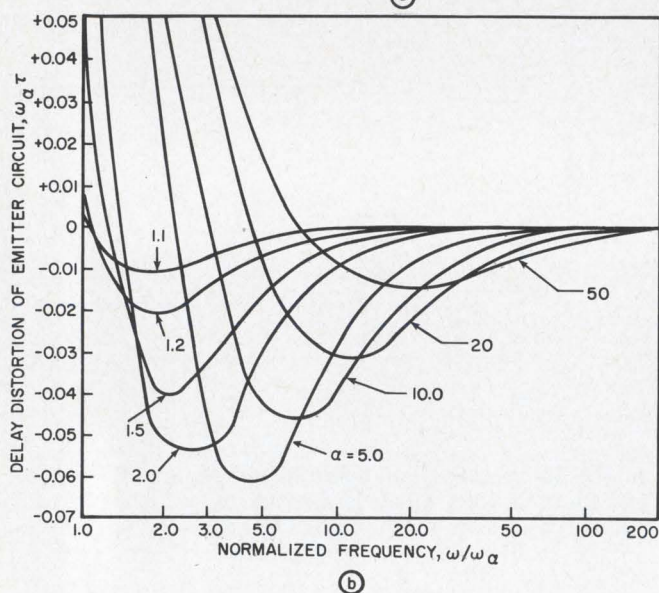
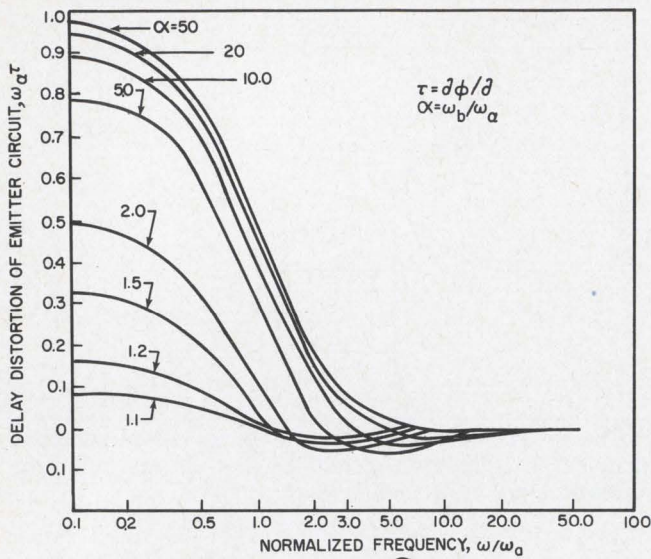

4. The delay distortion of the emitter circuitry (a) is normalized with respect to  $\omega_a$  (or  $1/R_E C$ ). An expanded view of the zero crossover area is shown in (b). The emitter resistor,  $R_E$ , is bypassed by  $C$ , as shown in Fig. 2.

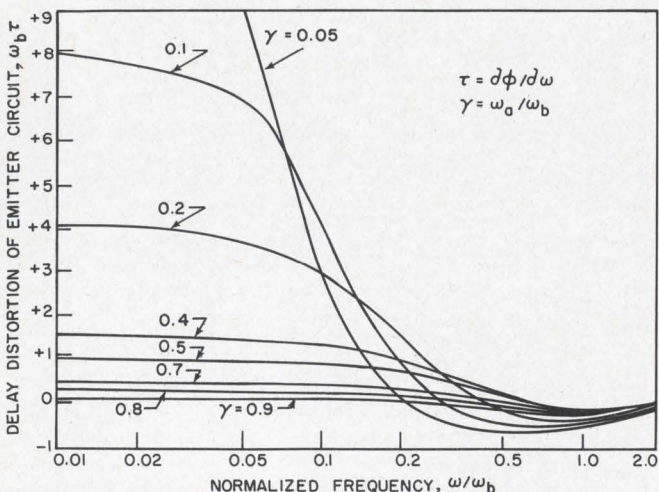

5. Delay distortion is normalized with respect to  $\omega_b$ , which includes the emitter resistor,  $R$ , the bypassed emitter resistor,  $R_E$ , and the bypass emitter capacitor,  $C$ .

$$\lim_{(\omega/\omega_0) \rightarrow \infty} \omega_0 \tau = -(\omega_0/\omega)^2, \quad (18)$$

$$\lim_{(\omega/\omega_0) \rightarrow 0} \omega \tau = -\omega/\omega_0, \quad (19)$$

$$\lim_{(\omega/\omega_0) \rightarrow \infty} \omega \tau = -\omega_0/\omega. \quad (20)$$

For the emitter circuitry three groups of approximations may be devised.

1. The solution will be low by less than 3% if  $\omega/\omega_a$  is smaller than 0.1 or larger than  $10(\omega_b/\omega_a)$  with these approximations:

$$\lim_{(\omega/\omega_a) \rightarrow 0} \omega_a \tau = [(\omega_b/\omega_a) - 1]/(\omega_b/\omega_a), \quad (21)$$

$$\lim_{(\omega/\omega_a) \rightarrow \infty} \omega_a \tau = -\{[(\omega_b/\omega_a) - 1]/(\omega/\omega_a)^2\}. \quad (22)$$

2. The values will be low by less than 3% for  $\omega_b/\omega < 0.1$  with the approximation:

$$\lim_{(\omega_b/\omega) \rightarrow 0} \omega \tau = (\omega_b/\omega)[(\omega_a/\omega_b) - 1]. \quad (23)$$

3. If  $(\omega_a/\omega_b)(\omega_b/\omega) > 10$ , the following approximations will yield errors of less than 3%:

$$\lim_{(\omega_b/\omega) \rightarrow \infty} \omega \tau = \frac{1 - (\omega_a/\omega_b)}{(\omega_b/\omega)(\omega_a/\omega_b)}, \quad (24)$$

Then there are some simplifications that cannot be easily grouped by tolerances. These, however, help the designer to assess the trends associated with their limits.

$$\lim_{(\omega_b/\omega_a) \rightarrow 1} \omega_a \tau = 0, \quad (25)$$

$$\lim_{(\omega_b/\omega_a) \rightarrow \infty} \omega_a \tau = 1/[1 + (\omega/\omega_a)^2], \quad (26)$$

$$\lim_{(\omega_a/\omega_b) \rightarrow 0} \omega \tau = -\{(\omega_b/\omega)/[1 + (\omega_b/\omega)^2]\}, \quad (27)$$

$$\lim_{(\omega_a/\omega_b) \rightarrow 1} \omega \tau = 0. \quad (28)$$

### Wide-band design starts at collector

Suppose that an amplifier stage is to be built with delay distortion of 25  $\mu$ s or less between 250 and 6000 Hz. Assume a total stray and shunt capacitance of 30 pF, a load of 5000 ohms, a desired voltage gain of 10, and a total dc emitter resistance of 2000 ohms.

The collector circuitry should be designed first, because it will normally cause lower delay than the emitter circuitry. Designing the collector area first will also leave the engineer with a more realistic goal for the emitter design.

The delay in the collector circuit will be limited to 5  $\mu$ s at each end of the band. This is an arbitrary choice, based on the fact that, since there is voltage gain, the emitter resistance will be considerably less than that in the collector and this will make it more difficult to reduce delay distortion at the lower band edge. The low-pass

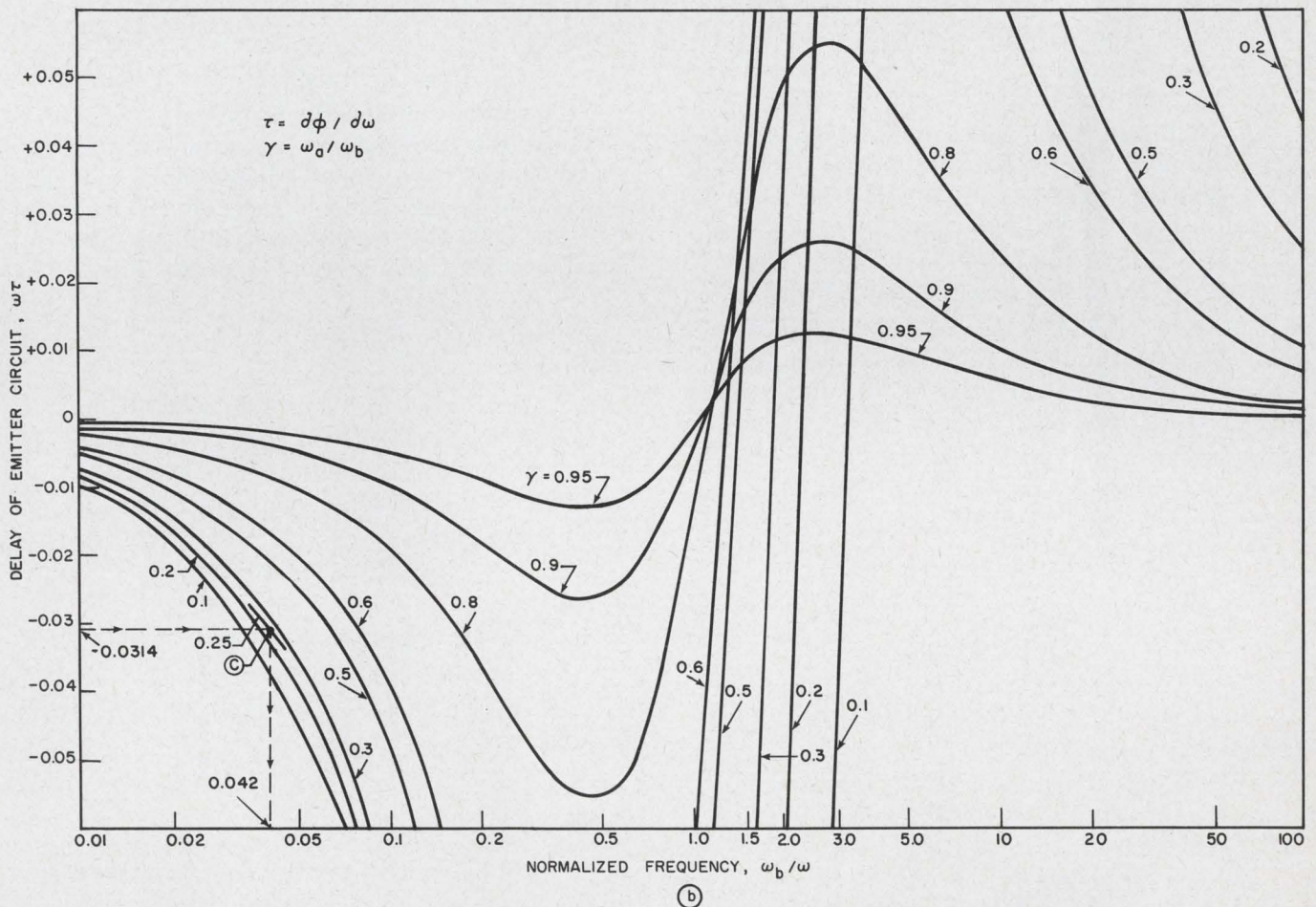
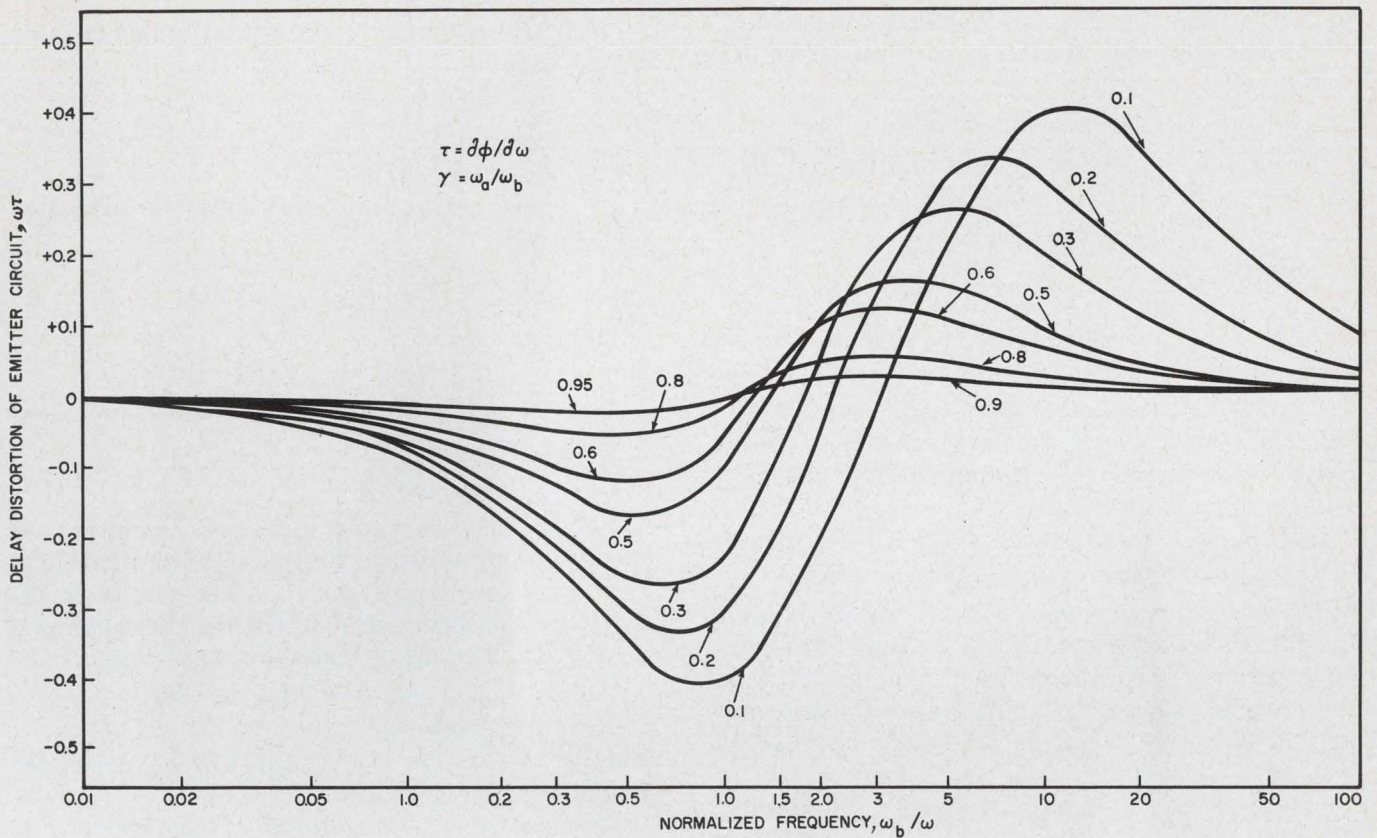

6. Delay distortion is normalized with respect to the frequency,  $\omega$  (a). The zero crossover region is expanded in (b). The curves in both figures are plotted with the

aid of Eq. 16. Point C in (b) represents one step in the design example worked out in the text. It yields the frequency,  $f_b$ , which is needed to find capacitor C.

and high-pass circuitry will be treated separately.

For the low-pass circuitry,  $\omega = 2\pi \times 6000$  Hz. Therefore:

$$\omega\tau = 2\pi \times 6000 \times 5 \times 10^{-6} = 0.06\pi = 0.188.$$

From Fig. 3 (point A), this normalized delay can be seen to occur for a normalized frequency of:

$$\omega/\omega_0 = 0.195.$$

This gives:

$$\omega_0 = \omega/0.195;$$

$$f_0 = f/0.195 = 6000 \text{ Hz}/0.195 = 30,769 \text{ Hz}.$$

Since  $f_0$  is the frequency at the 3-dB points, the low-pass cutoff must be greater than 30,769 Hz. The 5-k $\Omega$  load and the 30-pF capacitor give a cutoff ( $R = 1/\omega C$ ) of approximately 1 MHz—a wide margin of safety.

For the high-pass case,  $\omega = 2\pi \times 250$  Hz; hence:

$$-\omega\tau = 2\pi \times 250 \times 5 \times 10^{-6} = 0.0025\pi = 0.0078.$$

This value of normalized delay occurs outside the range of the graph in Fig. 3. Since high-pass is being dealt with, the desired value lies off scale to the right (see point B). Therefore the approximation of Eq. 20, which is valid for a large  $\omega/\omega_0$ , is used:

$$\lim_{(\omega/\omega_0) \rightarrow \infty} \omega\tau = -\omega_0/\omega = -1/(\omega/\omega_0).$$

Thus:

$$\omega_0/\omega = -\omega\tau = 0.0078;$$

$$\omega_0 = 0.0078\omega;$$

$$f_0 = 0.0078f = 0.0078 \times 250 = 1.95 \text{ Hz}.$$

The high-pass cutoff must be less than 1.95 Hz then. To meet this requirement with a 5-k $\Omega$  load, the capacitance must be calculated:

$$R = 1/\omega C = 1/(2\pi f C);$$

$$C = 1/(2\pi f R) = 16.4 \mu\text{F}.$$

A 22- $\mu\text{F}$  off-the-shelf capacitor may be used.

Before proceeding to the emitter design, check the delay distortion in the collector circuitry.

At 250 Hz, the total delay is the sum of the high-pass and low-pass delays:

(High pass)

$$f_0 = 1/(2\pi RC) = 1/(2\pi \times 5 \times 10^3 \times 22 \times 10^{-6}) \\ = 1000/220\pi = 1.448 \text{ Hz};$$

$$f/f_0 = 250/1.448 = 172.7.$$

From Eq. 20:

$$\omega\tau = -1/172.7;$$

$$\tau = -1/(172.7 \times 2\pi \times 250)$$

$$= -1/(500\pi \times 172.7)$$

$$= -2000/172.7\pi = -3.7 \mu\text{s}.$$

(Low pass)

$$f_0 = 1 \text{ MHz};$$

$$f/f_0 = 250/10^6 = 0.00025.$$

From Eq. 19:

$$\omega\tau = -0.00025;$$

$$\tau = (-0.25 \times 10^{-3})/(2\pi \times 250) = -0.159 \mu\text{s}.$$

Thus:

$$\tau_{total} = -3.9 \mu\text{s}.$$

At 6 kHz, the delay is again the sum of the two:

(High pass)

$$f/f_0 = 6000/1.448 = 4143.6.$$

From Eq. 20:

$$\omega\tau = -1/4143.6;$$

$$\tau = -1/(4143.6 \times 2\pi \times 6000) = -0.0064 \mu\text{s}.$$

(Low pass)

$$f_0 = 1 \text{ MHz};$$

$$f/f_0 = 6 \times 10^3/10^6 = 6.10^{-3}.$$

From Eq. 19:

$$\omega\tau = -6 \times 10^{-3}$$

$$\tau = (-6 \times 10^{-3})/(2\pi \times 6 \times 10^3) = 0.159 \mu\text{s}.$$

Thus:

$$\tau_{total} = 0.165 \mu\text{s}.$$

For R-C low-pass and high-pass circuitry, the magnitude of  $\tau$  always decreases with increasing frequency (see Eqs. 5 and 5a). The minimum delay therefore occurs at 6000 Hz and the maximum at 250 Hz. The delay distortion thus becomes:

$$\Delta\tau = \tau_{max} - \tau_{min} = -0.165 - (-3.9) \\ = -3.7 \mu\text{s}.$$

This is well within the 5- $\mu\text{s}$  distortion permitted in the collector circuitry.

The last step is the design of the emitter. It can have up to 20  $\mu\text{s}$  of delay distortion at 250 Hz. Hence:

$$\omega\tau = 2\pi \times 250 \times 20 \times 10^{-6} \\ = 10^4\pi \times 10^{-6} = 0.0314.$$

To meet the specifications for gain and dc resistance, the two resistances in the emitter circuitry should have values of 500 ohms and 1500 ohms. The larger value is that of the bypassed resistor. The unknown factor is the bypass capacitance. Its value is found with Eq. 11:

$$\omega_a = 1/R_E C,$$

$$\omega_b = (R_E + R)/R_E C.$$

Then:

$$\omega_a/\omega_b = R/(R_E + R) = 500/2000 = 0.25.$$

Point C on Fig. 6b shows that  $\omega_b/\omega < 0.042$ . In this chart the values for the lower band edge can be found at the left-hand side, which corresponds to  $\omega \gg \omega_b$ . Thus:

$$f_b < 0.042 \times 250 = 10.5 \text{ Hz}.$$

Then:

$$C = (R_E + R)/(R_E R 2\pi f_b)$$

$$= 2.10^3/(500 \times 1500 \times 2\pi \times 10.5)$$

Thus a 47- $\mu\text{F}$ , or perhaps a 100- $\mu\text{F}$ , unit could be used. ■ ■

#### Bibliography:

- Papoulis, Athanasios. *The Fourier Integral and Its Applications*. New York: McGraw-Hill Book Co., 1962. Chaps. 6 and 7.
- Terman, F. E. *Electronic and Radio Engineering*. New York: McGraw-Hill Book Co., 1955. Chaps. 8, 9 and 12.
- Wheeler, Harold A. "An Interpretation of Amplitude and the Phase Distortion in Terms of Paired Echoes," *Proc. IRE*, XXVII, June, 1939, 359-385.

# THE NEW GENERATION



## **SILVERLINE** T.M.\*

**a new, superior line of Clifton Synchros**

- Higher Accuracy. 5' standard
- Outstanding Repeatability of Calibration Pattern
- Stability of Calibration over Temp.
- 150°C Standard Operating Temp.

Keeping pace with the developing aerospace field, Clifton announces SILVERLINE, a new, superior line of standard synchros. □

These units, a natural evolution from our present line of quality synchros, embody certain new manufacturing techniques and space age materials. The result is a standard synchro which outperforms pres-

ent synchros in four distinct ways shown above. □ SILVERLINE synchros are in the field now. Call your local Clifton Sales Office for price, delivery and further information.

**CLIFTON**   
DIVISION OF LITTON INDUSTRIES

\*Trademark of Clifton Division of Litton Industries

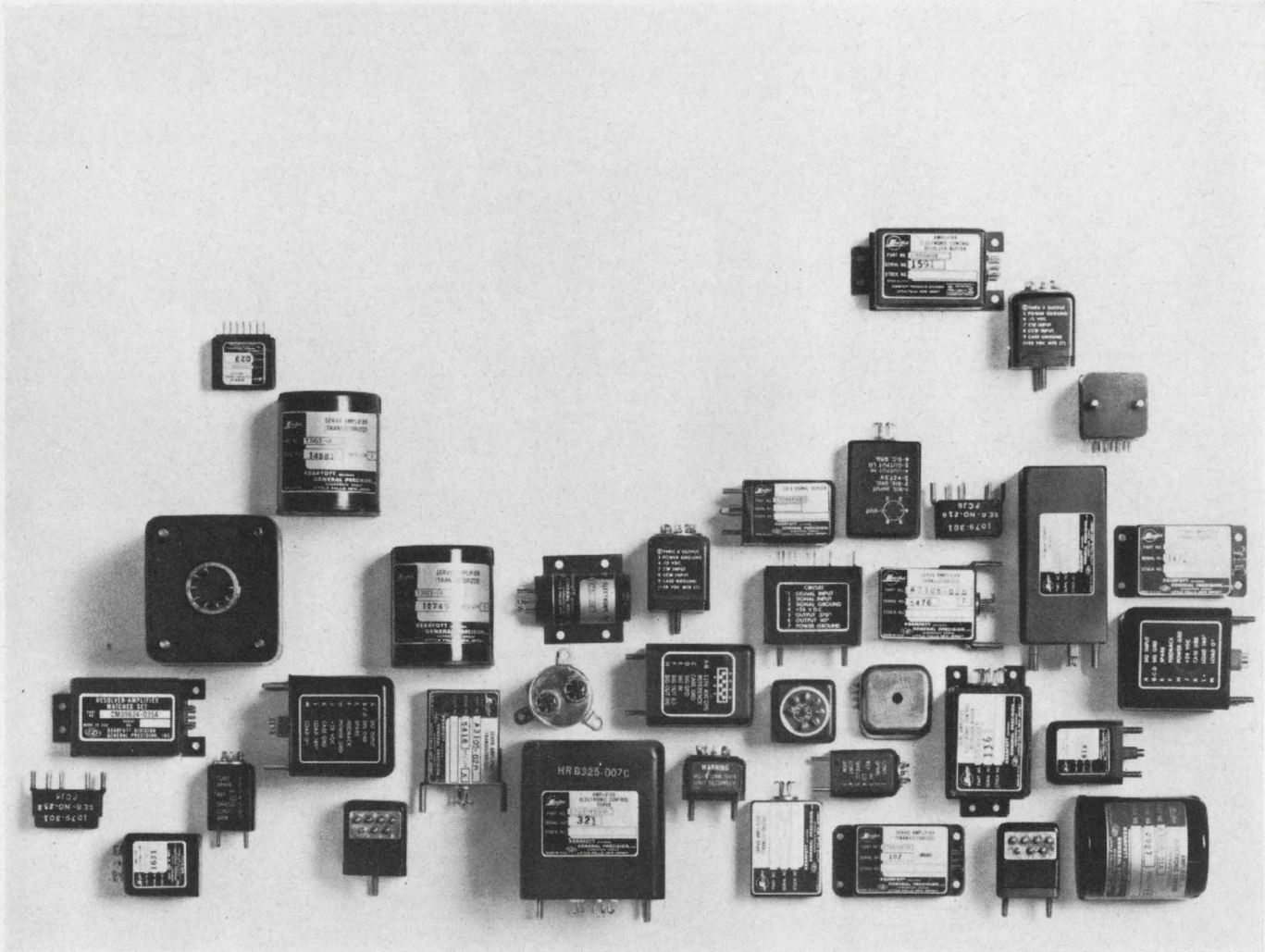

We make a pile of electronic assemblies at

# KEARFOTT

SERVO AMPLIFIERS, PREAMPLIFIERS QUADRATURE REJECTION CIRCUITS, SOLID STATE CHOPPERS, MODULATOR/DEMODULATORS, AMPLIFIER-DEMODULATORS, BUFFER AMPLIFIERS, ISOLATION AMPLIFIERS, SUMMING ISOLATION AMPLIFIERS, AC-DC AMPLIFIERS, SIGNAL SENSORS, COMPARATOR AMPLIFIERS, MAGNETIC AMPLIFIERS, STEPPER MOTOR DRIVERS AND LOGIC.

In fact, we have just added another 24 new units in our latest catalog on electronic assemblies bringing the total to over 115 miniature solid state problem solvers. Among the units added is a 50-watt-output, 90°-phase-shift servo amplifier that weighs only 14 ounces. We also have a 16-watt unit for less demanding applications. We've been producing solid state half-wave and full-wave choppers for some time, and to these we've now added DC-to-AC modulators and AC-to-DC demodulators featuring full-wave modulation or demodulation at frequencies from 50-5000 Hz. Major new additions to the product line are fourteen new stepper motor driver/logic assemblies to

satisfy almost every size 8, 11, or 15 stepper motor. Like all our electronic modules, these are transistorized, lightweight, potted in high-strength epoxy and can operate over a wide temperature range. Typically, these driver/logic assemblies consist of sequential logic controlled by CW or CCW input pulse commands and output drivers to control motor-winding current.

Operating in the switching mode, these drivers minimize internal power dissipation.

For further information write Kearfott Products Division, General Precision Systems Inc., Kearfott Group, 1150 McBride Avenue, Little Falls, N.J. 07424 Dept. 3-1450.

**GENERAL  
PRECISION  
SYSTEMS INC.**

**KEARFOTT PRODUCTS DIVISION**  
A SUBSIDIARY OF GENERAL PRECISION EQUIPMENT CORPORATION

ON READER-SERVICE CARD CIRCLE 61

# For micro-accuracy... Starrett measures up

When it comes down to the ultimate in measurement control, or even for fine increments of movement with or without linear measurement, it's time for Starrett. Starrett micrometer heads are precision built to give you the preciseness that your design requires. Starrett is world-known as the leader in precision tools. When you just can't afford to be wrong, be precision-perfect with Starrett.

Starrett micrometer heads are stocked in a wide range of standard designs, and custom-built heads can be manufactured for special applications.

Write today for additional information about what Starrett can do for you to make your design better.

The L. S. Starrett Company,  
Athol, Massachusetts.

**Starrett®**  
WORLD'S GREATEST TOOLMAKERS

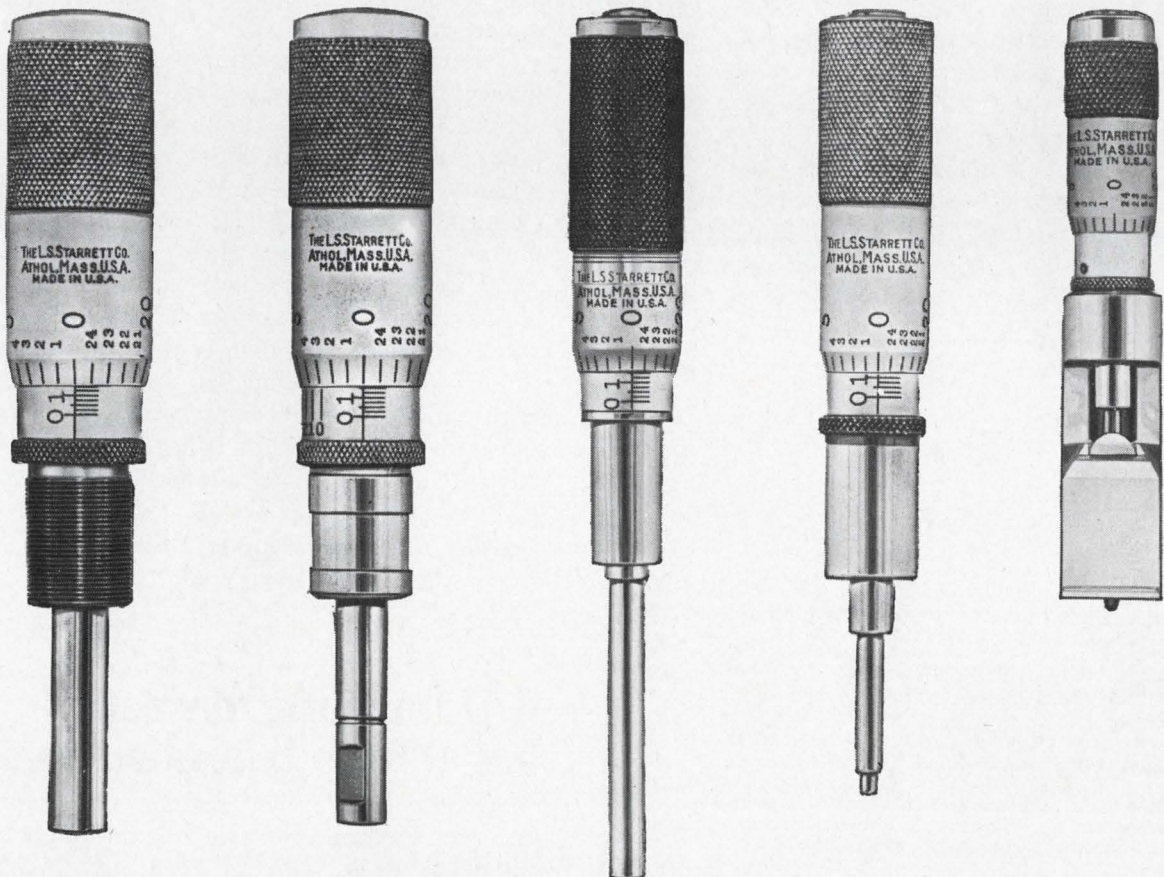

ON READER-SERVICE CARD CIRCLE 62

# Voltage follower has high impedance can handle large signals

Figure 1a shows a unity-gain voltage follower which can be built easily and is useful for coupling high-impedance sources into low-impedance loads. The circuit consists of a differential amplifier-emitter-follower combination with direct (unity) feedback to the inverting input of the amplifier. The collector of input transistor *Q1* is also bootstrapped to the output. For signal input changes of a given direction, all signal points in the circuit move in the same direction by nearly the same amount. There are no antiphase voltage components in the circuit with respect to ground. Other characteristics are:

- Input impedance is over 50 MΩ at dc and low frequencies.
- Input capacitance is less than 0.5 pF. This value can be further reduced by placing the entire circuit in a shield can connected to the output.
- The offset voltage ( $e_o - e_{in}$ ) can be adjusted to zero at zero volts input by trimming either *R1* or *R2*.
- *Q1* operates at  $V_{CB} = 0$  V. The  $I_{CBO}$  for this transistor is thus zero, and the input current consists of only the bias current for *Q1* plus  $i_o/\beta_1\beta_3$ .
- *Q2* operates at  $V_{CB} = 0.5$  V. The  $I_{CBO}$  term for this transistor is also negligible.
- Output impedance is 10 ohms for the values shown. If *Q1* and *Q2* are operated at  $I_c = 50 \mu A$  (by reducing *R1* and *R2*), output impedance can be as low as 2 ohms. It may be necessary to add *C1* to prevent high-frequency oscillations. The circuit

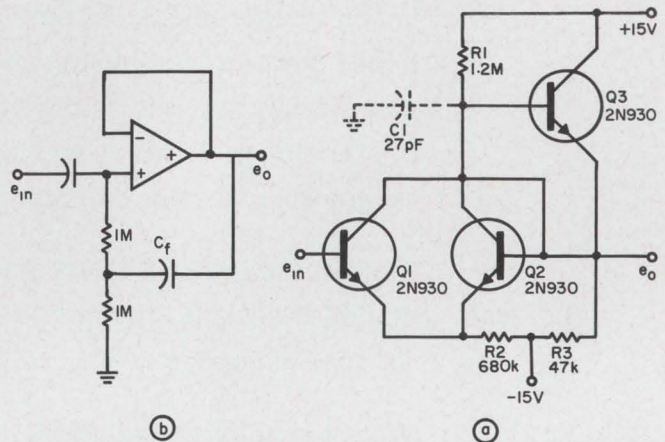

Input impedance of 50 megohms at dc and low frequencies is obtained in this unity-gain voltage follower (a). For ac input coupling, two capacitors and two resistors should be added (b).

is useful to over 500 kHz. By replacing *Q1*, *Q2*, and *Q3* with high-frequency types and increasing the current level, operation into the megahertz range can be achieved.

▪ Large signal-handling capability. Replacing *Q3* with a high-voltage type and increasing the supply voltages allows the circuit to handle large voltage swings. Large negative excursions may be obtained by increasing the ratio *R1/R2* at the expense of nonzero offset voltage. *Q1* and *Q2* are low-voltage types regardless of the signal level. If more output current is required, an additional emitter-follower can be inserted between *Q2* and *Q3*. The circuit as shown requires a dc return for the input bias current. If ac input coupling is required, the input resistor can be bootstrapped to the output as shown in Fig. 1b. Open-loop gain measured 115 and the closed-loop gain measured  $e_o/e_{in} = 0.995$ .

Allan G. Lloyd, Project Engineer, Avion Electronics, Inc., Paramus, N. J.

VOTE FOR 110



**VOTE!** Go through all Idea-for-Design entries, select the best, and circle the appropriate number on the Reader-Service-Card.

**SEND US YOUR IDEAS FOR DESIGN.** You may win a grand total of \$1050 (cash)! Here's how. Submit your IFD describing a new or important circuit or design technique, the clever use of a new component or test equipment, packaging tips, cost-saving ideas to our Ideas-for-Design editor. You will receive \$20 for each accepted idea, \$30 more if it is voted best-of-issue by our readers. The best-of-issue winners become eligible for the Idea Of the Year award of \$1000.

## A/D multiplier/divider has UJT as relaxation oscillator

A simple multiplier/divider is based on the unijunction transistor as a relaxation oscillator. A simplified block diagram (Fig. 1) illustrates the



# How to eliminate a transformer, two SCR's and a triggering device...

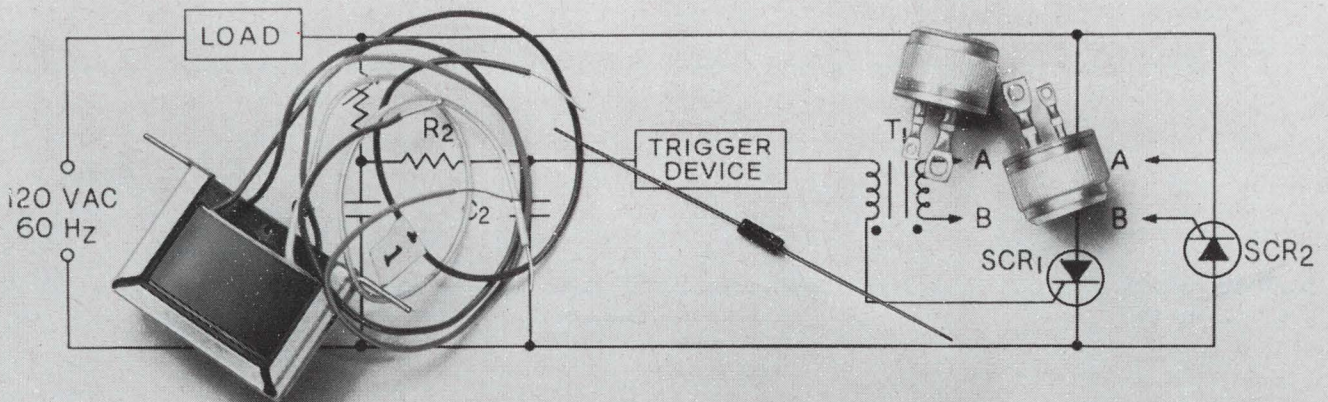

# use one of RCA's new 6A Triacs with integral trigger!

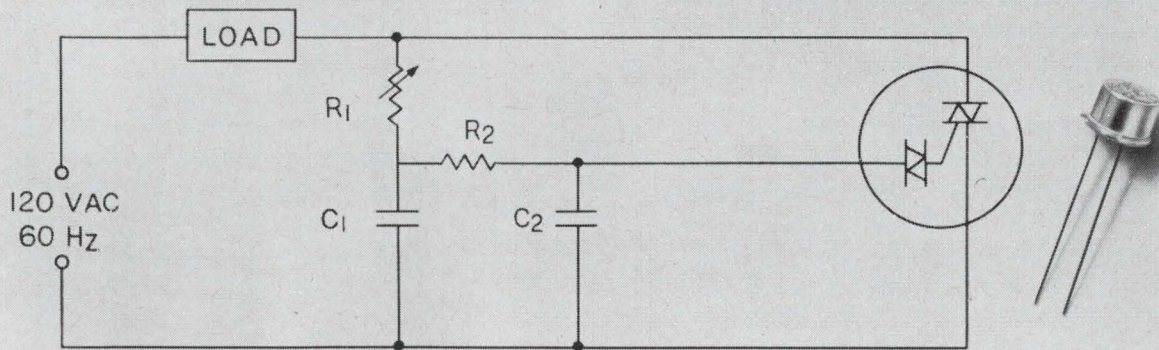

Why design in RCA's new 6A Triacs? Here are just a few of the more important reasons:

Because the triggering device and the firing characteristics of the 40431 and 40432 Triacs are integrated inside the compact TO-5 case by RCA before they sell you the device...you don't have to worry about designing in additional triggering components.

Because a Triac, by its very nature and construction, can replace two SCR's and a pulse transformer in ac circuits...you achieve significant savings in engineering and manufacturing costs, and you improve packing density.

And because RCA's 40431 and 40432 have excellent gate symmetry and surge current protection up to 100 amps...you get top circuit performance and reliability.

The 40431 controls 720 watts at 120 volts, 60 Hz. It costs only \$1.80\*. The 40432 controls 1440 watts at 240 volts, 60 Hz. It costs only \$2.28\*. So for modern, efficient phase control of ac loads in applications such as light dimming, universal and induction motor control, and heater control, specify RCA's new Triac with built-in trigger. Your RCA Field Representative can give you complete information, including price and delivery. Or for additional technical data, write RCA Commercial Engineering, Sec. RG9-2, Harrison, N.J. 07029. See your RCA Distributor for his price and delivery.

\*Prices in quantities of 1,000 and up.

RCA Electronic Components and Devices



The Most Trusted Name in Electronics

ON READER-SERVICE CARD CIRCLE 63

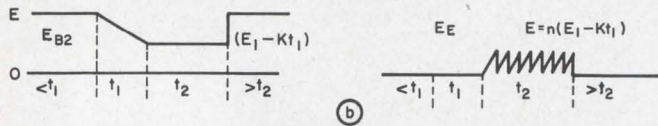
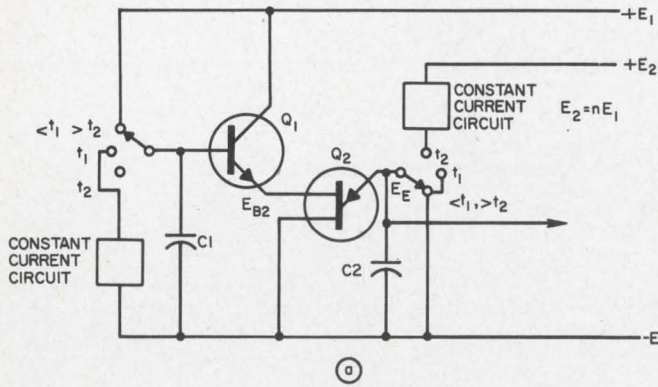

1. Multiplier/divider circuit (a) operates as shown in the timing diagram (b).

basic principle. The inputs required are two consecutive gate pulses with durations respectively proportional to the two given quantities, and a third gate pulse equal to the sum of the other two. The output is a number of sawtooth pulses proportional to the product or ratio of the consecutive pulses.

During the quiescent period ( $<t_1, >t_2$ ), capacitor  $C_1$  is connected to the  $+E_1$  line, and capacitor  $C_2$  is grounded. During interval  $t_1$ ,  $C_1$  is grounded through a constant-current circuit, so that its voltage drops linearly; at the end of interval  $t_1$ , the residual voltage on  $C_1$  is equal to  $E_1$  less a voltage proportional to  $t_1$ . During interval  $t_2$ ,  $C_1$  is floating;  $C_2$  is connected through a constant-current circuit to voltage  $+E_2$  equal to  $nE_1$ , where  $n$  is the intrinsic standoff ratio of the UJT. The UJT then operates as a relaxation oscillator during  $t_2$ , and the number of sawtooth pulses is proportional to the duration of  $t_2$ .

The number of pulses is inversely proportional to  $V_{B2}$ , and therefore directly proportional to the product of  $t_1$  and  $t_2$ . By proper choice of  $C_1$ ,  $C_2$ ,  $R_3$  and  $R_8$ , the number of pulses can be made equal to the product of the numerical values of the gate generating functions. Since  $V_E$  cannot go above  $nV_{B2}$ , there is no output for  $t_1 = 0$ , and the constant term ( $E_1$ ) has no effect. There is a minimum operating voltage for the UJT, and there is a small nonlinear interval for voltages greater than the minimum.

As a divider or ratio computer (Fig. 2), the constant-current source charges  $C_1$  during interval  $t_1$ . The number of pulses is then inversely proportional to  $t_1$  and directly proportional to  $t_2$ , and is therefore proportional to the ratio  $t_2/t_1$ .

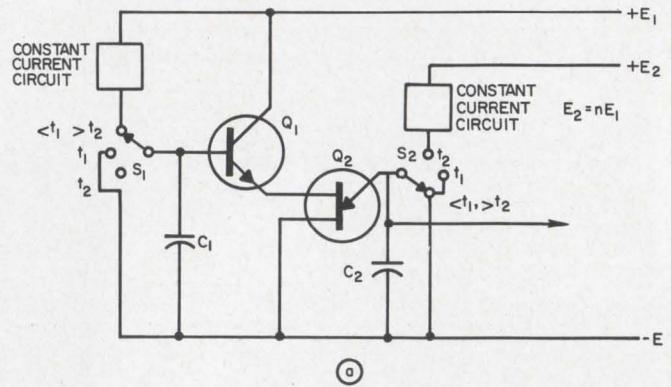

2. Ratio computer circuit is used to determine ratio of  $t_2:t_1$ , which is proportional to the number of input pulses.

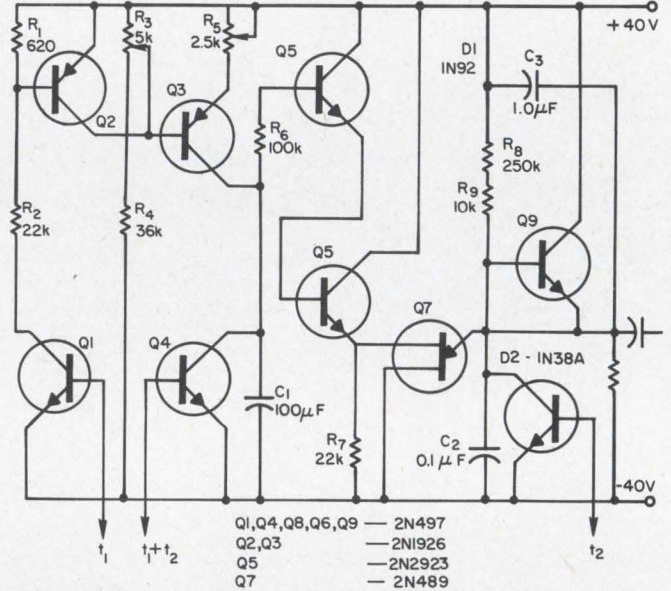

3. Length of objects passing a point with constant, unknown velocity is determined by this circuit.

The circuit shown in Fig. 3 was developed to measure the length of objectives passing a point with constant but unknown velocity. A pulse is generated proportional to the time required for the object to cover a known distance between two points; this is  $t_1$ . A second pulse is then generated proportional to the time required for the object to pass the second point; this is  $t_2$ . Hence:

$$t_1 \propto \text{known length } (L_k) / \text{velocity } (V);$$

$$t_2 \propto \text{unknown length } (L_u) / \text{velocity } (V).$$

Then:

$$t_1/t_2 = (L_k/V) / (L_u/V)$$

$$= (L_k/V) (V/L_u) = L_k/L_u.$$

REPLACE THE BRIDGE WITH A VECTOR IMPEDANCE METER

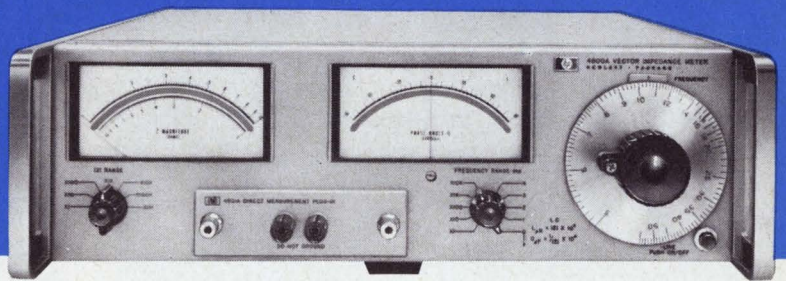

## *Vector Impedance Meter makes measurements in seconds*

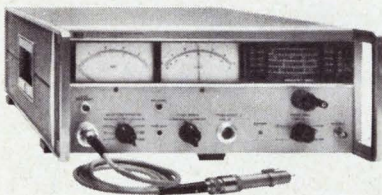

**MODEL 4815A OFFERS DIRECT READOUT OF HIGH FREQUENCIES IN OPERATING CIRCUITS**  
The 4815A offers direct readout of impedance and phase angle measurements from 500 kHz to 108 MHz with continuous tuning. Probe on five-foot cable simplifies in-circuit measurements. Price: \$2,650.00. Complete specifications are yours on request.

Now there's no excuse for not making all the impedance measurements that previously have been too bothersome to make. The Hewlett-Packard 4800A Impedance Meter eliminates bridge balancing and nulling. It does for AC measurement what the ohmmeter does for DC testing. Just plug it in and read it. The 4800A may be mechanically swept to produce measurements over its full frequency range. You get direct readings of impedance and phase angle from 5 Hz to 500 kHz. Analog outputs of frequency, impedance and phase are available for X-Y recording.

The 4800A is an all solid-state integrated vector impedance *system* that reads out directly in  $Z$  and  $\theta$ . Low-level signal strength prevents overloading of the test component. Price: \$1,650.00. For complete specifications, contact your local Hewlett-Packard field engineer or write: Hewlett-Packard, Green Pond Road, Rockaway, N.J. 07866.

**HEWLETT  PACKARD**

IMPEDANCE INSTRUMENTS

1071B

The solution for  $L_k$  is:

$$L_u = L_k(t_2/t_1).$$

Charles D. Volz, Fishery Research Biologist,  
U.S. Department of the Interior, Seattle.

VOTE FOR 111

## Get sharp edges from an astable multivibrator waveform

The waveform usually obtained at either collector of the basic astable multivibrator of Fig. 1a is shown in Fig. 1b.

The negative-going edge is sharp because as soon as one transistor, say,  $Q1$ , turns on, the base-emitter junction of  $Q2$  is reverse-biased, restrict-

ing the load on  $Q1$  to  $R_1$  and  $R_2$  in parallel. Furthermore, the transistor has a low output resistance in the on condition.

During the positive-going transition, not only is the transistor in a high resistance condition with its base-emitter junction reverse-biased, but it also is necessary to recharge  $C_1$ . The charging current path for  $C_1$  is  $R_1$  and the base-emitter junction of  $Q2$ ; the time constant of this path is approximately  $C_1R_1$ . This is what causes the positive-going edge to exhibit the exponential rise shown in Fig. 1b.

To change  $C_1$  in order to reduce the time constant would necessitate a corresponding change in  $R_2$  to avoid affecting the frequency of oscillation. Reduction of  $R_1$  in an increase in  $Q1$  collector current. Both these approaches have only limited application, so essentially the same defect in the output waveform persists.

The solution to the problem involves the use of another transistor to supply the charging current to  $C_1$  (Fig. 1c).

When  $Q1$  collector voltage begins to rise,  $Q3$  is turned on and supplies the necessary charging current to  $C_1$ . Thus the charging current which passes through  $R_1$  is reduced by the current gain of  $Q3$ . Diode  $D1$  is placed in parallel with and in opposition to the base-emitter junction of  $Q3$  in order to maintain the signal path between  $Q1$  collector and  $Q2$  base when  $Q1$  is turning on.

If outputs are to be taken from both  $Q1$  and  $Q2$  collectors, a similar modification can be made to the  $C_2$  charging path. The same improvement can also be applied to monostable circuits, should it be necessary to obtain an output from the capacitance driving collector.

Figure 1d shows an astable circuit with the modification applied to one collector. The resulting collector waveforms, in which the improvement is clearly seen, are shown in Fig. 1e.

T. M. Jarvis, Products and Instruments Div.,  
Bell Aerosystems, Buffalo, N. Y.

VOTE FOR 112

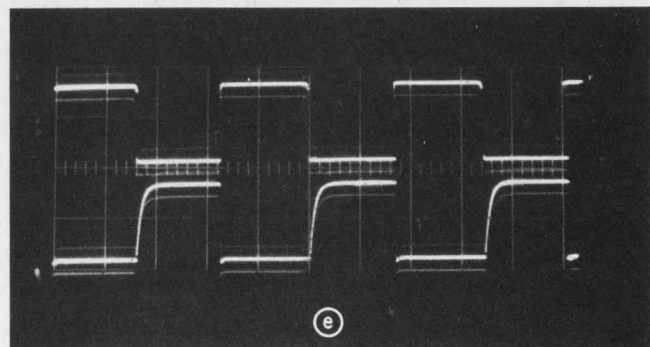
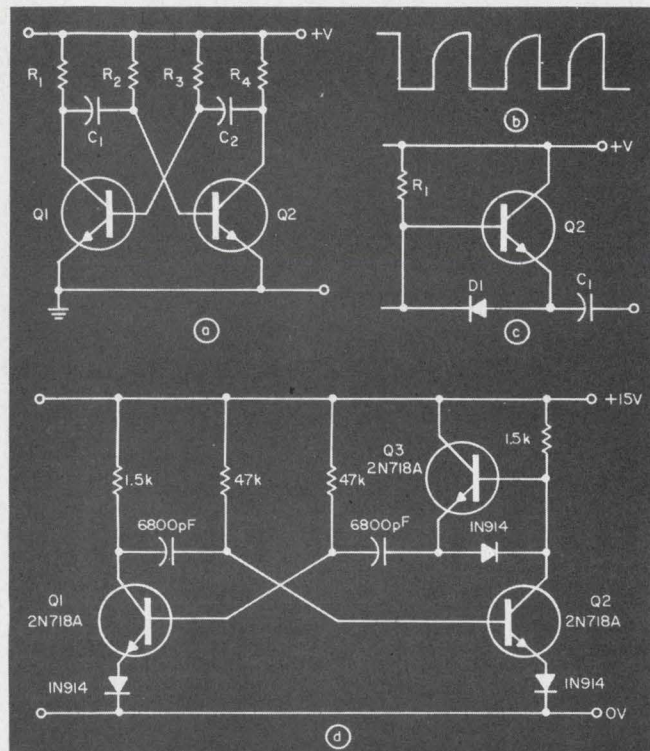

Sharp pulses are obtained (e) from an astable multivibrator (d) by modifying standard configuration (a) with the addition of  $Q3$  (c) to supply charging current for the capacitor. The waveforms before modification appear in (b).

## Switch your ac loads at zero voltage or current

The purpose of the circuit (Fig. 1a) is to reduce the level of radio frequency interference (RFI) usually generated when an ac device is turned on and off. The RFI can be reduced by turning the device on when the line voltage is near zero and turning it off when the current is near zero.

This is accomplished by controlling the device with a Triac, which is triggered on when the voltage is near zero and commutates off when the

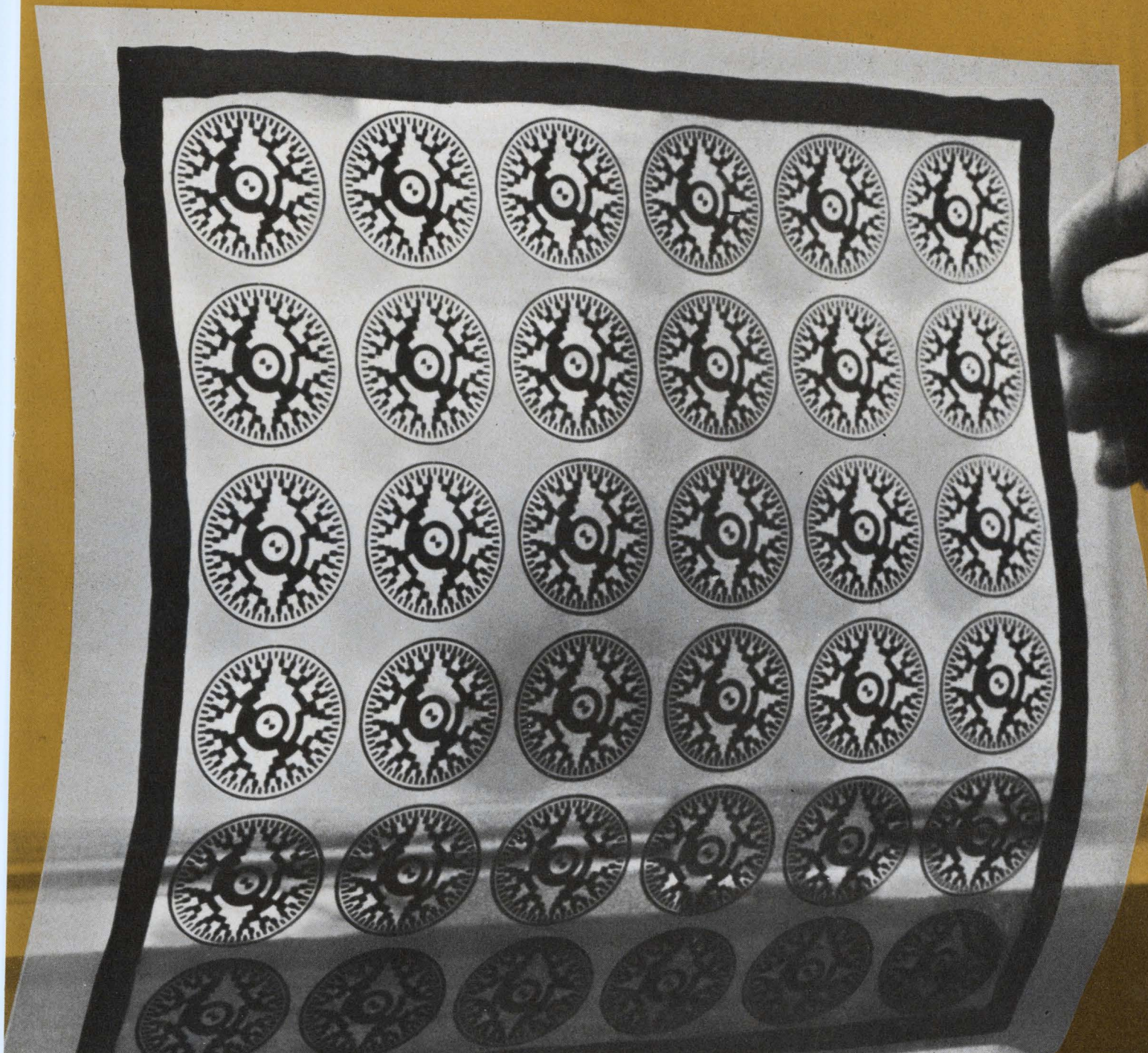

For 14 years now, the pattern has been firmly established...

## Librascope is No. 1 in shaft encoders

1952: Librascope coins the word "encoder", a year later develops the V-scan. 1962: Librascope's hybrid magnetic-brush encoder takes on radar-picket-ship duty. (No failure to date.) 1964: our hybrid was adopted for the Apollo mission and F-111 simulator systems. Today: our advanced-concept hybrid brings magnetic encoder reliability at lower system cost to a widening range of *industrial* as well as military/aerospace applications. In the interim, we've designed and built hundreds of standard model encoders to serve any need. Right now, we'd like an opportunity to quote on *your* application—and to send you our new capability brochure (on request).



The Librascope hybrid encoder: built to rigid military specs with a life-factor 64 times greater than that of a brush encoder.

**GENERAL PRECISION SYSTEMS INC.**

**LIBRASCOPE GROUP**  
A SUBSIDIARY OF GENERAL PRECISION EQUIPMENT CORPORATION  
808 WESTERN AVENUE • GLENDALE, CALIF. 91201

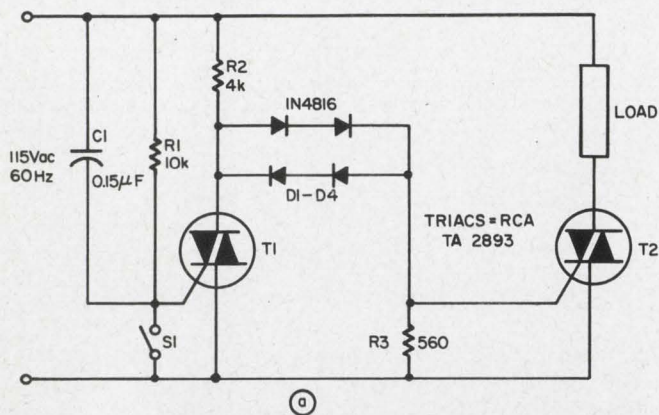

load current goes through zero.

The circuit works as follows. If switch *S1* is open, *T1* will fire at the beginning of every line alternation and prevent *T2* from firing. Capacitor *C1* introduces enough leading phase shift to ensure that *T1* always fires before *T2* can. Diodes *D1* through *D4* prevent the  $V_{on}$  of *T1* from appearing at the gate of *T2*.

When *S1* is closed, *T1* commutates off at the next zero crossing. Resistor *R2* can now supply gate current to *T2* so that it fires at the beginning of each following line alternation until *S1* is again opened. When *S1* opens, *T1* turns on and again prevents *T2* from receiving any gate current. *T2* therefore turns off the next time its anode current goes through zero. *T1* is not controlled synchronously with the line, but since its anode voltage never exceeds  $\pm 3$  volts, the RFI generated is

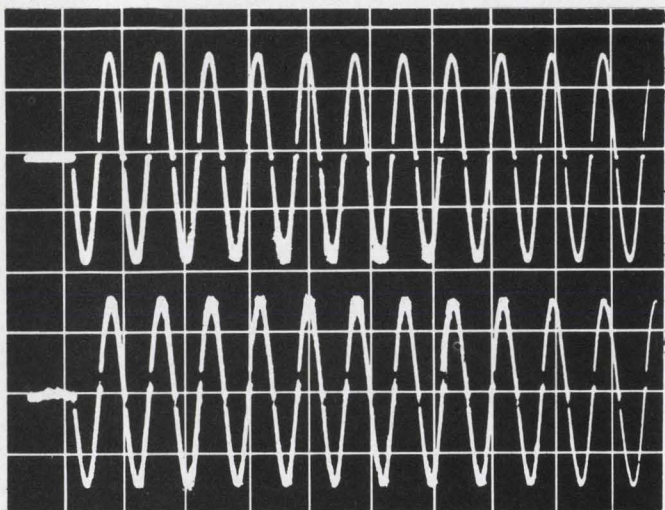

(b)

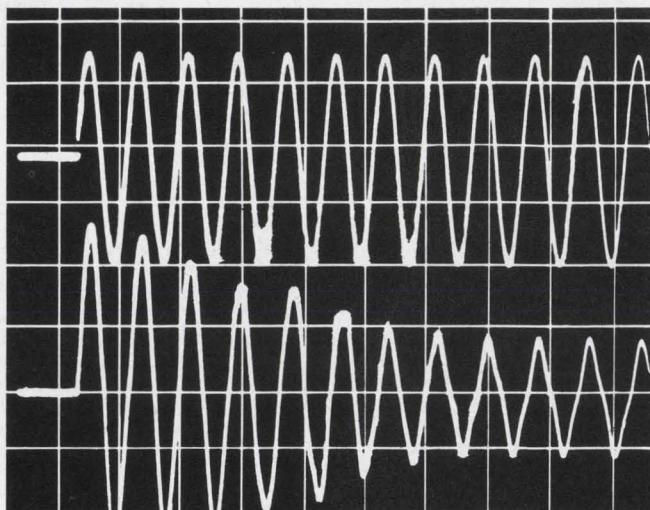

(c)

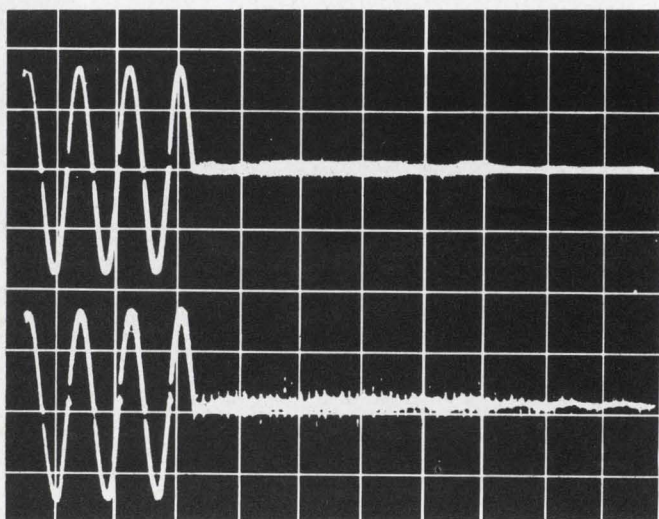

(d)

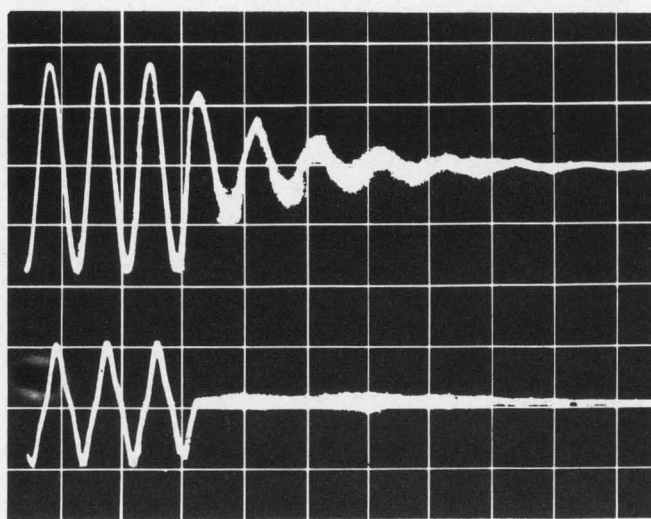

(e)

1. Zero voltage or zero current switching of an ac load on and off, respectively, is possible with the simple circuit (a). In all waveshape photographs upper traces are load voltages, lower traces are load currents. On characteristics

(zero voltage) for a resistive and inductive load are shown in (b) and (c), respectively. Off characteristics (zero current) for a resistive and inductive load appear in (d) and (e), respectively.

# Two new IRC metal films you should know about

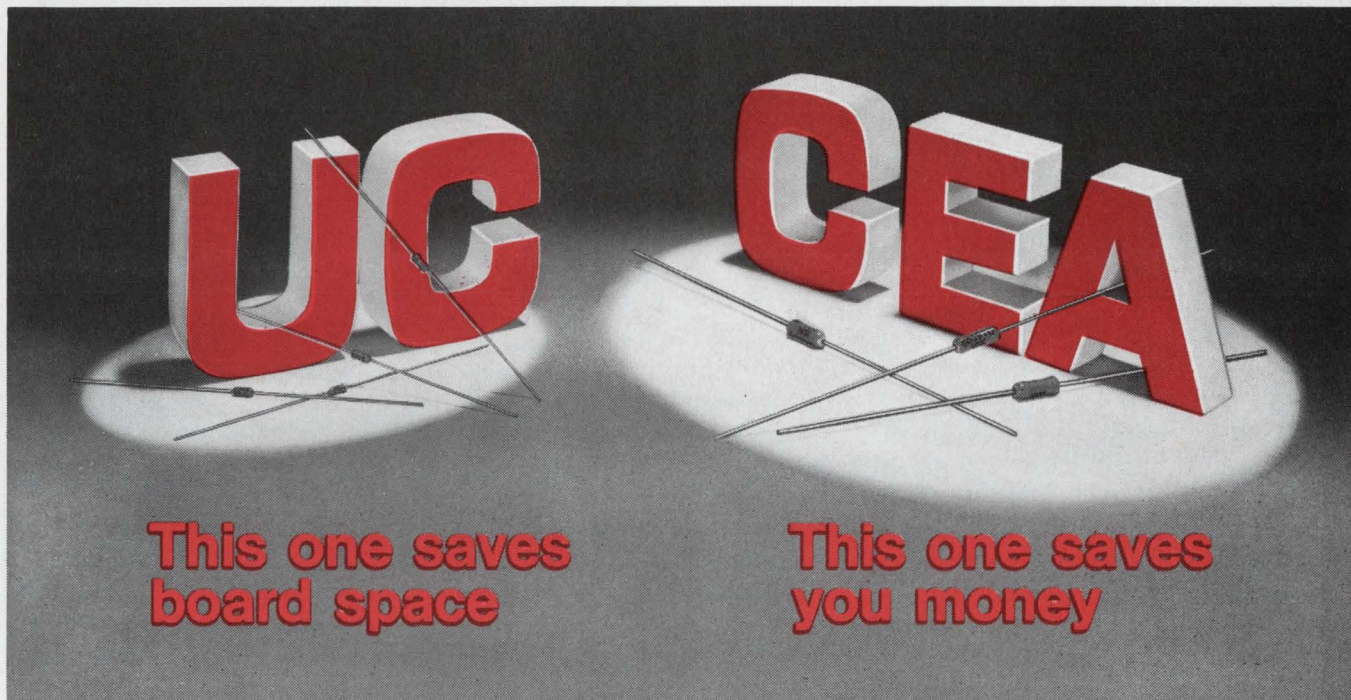

These new IRC metal film resistors can solve many of your space and cost problems. Both offer IRC's superior metal film performance. Both meet or exceed the requirements of MIL-R-10509.

**TYPE UC.** An ultra-miniature unit that fills the gap between discrete resistors and microcircuits. It has stability and reliability of higher rated units, and a tolerance that most microcircuits can't match. Gold dumet leads, reliable high alumina substrate and rugged end cap termination.

**TYPE CEA.** Handles four different power ratings. You can combine your metal film needs to save money and simplify stocking.  $\Delta R$ 's are all well within MIL limits. Rugged end cap termination.

$\frac{1}{2}W @ 70^{\circ}C \ 1\% \ \Delta R$   
 $\frac{1}{4}W @ 125^{\circ}C \ 1\% \ \Delta R$

$\frac{1}{4}W @ 70^{\circ}C \ .5\% \ \Delta R$   
 $\frac{1}{8}W @ 125^{\circ}C \ .5\% \ \Delta R$

#### CAPSULE SPECIFICATIONS

|               | Type UC                    | Type CEA  |
|---------------|----------------------------|---|
| Resistance:   | 50 $\Omega$ to 10K         | 10 $\Omega$ to 1.5 meg.   |
| Tolerances:   | $\pm 1, 2, 5\%$            | $\pm 1\%$   |
| Temp. Coeff.: | $\pm 50, 100ppm/^{\circ}C$ | $\pm 100ppm/^{\circ}C$  |
| Power:        | 1/20W @ 100 $^{\circ}C$    | $\frac{1}{2}$ and $\frac{1}{4}W @ 70^{\circ}C$<br>$\frac{1}{4}$ and $\frac{1}{8}W @ 125^{\circ}C$ |
| Body Size:    | .145" x .057" dia. max.    | .281" x .100" dia. max.   |

Write for complete data and evaluation sample. IRC, Inc., 401 N. Broad St., Philadelphia, Pennsylvania 19108.



ON READER-SERVICE CARD CIRCLE 66

negligible for all practical purposes.

The photographs (Figs. 1b through 1e) show that T2 always turns on when the voltage is near zero and turns off when the current is near zero.

*William B. Miles, Charles Bruning Co., Mount Prospect, Ill.*

VOTE FOR 113

## Small fuses measure pulse duration

In applications such as the measurement of voltage breakdown, relay contact-bounce, dynamic mechanical system operation or dynamic response in electrical circuits, it is sometimes necessary to get an indication of transient or sequence time which exceeds a fixed interval. When this situation occurs infrequently and at unpredictable times, commonly used methods such as CR oscillographs and chart recorders become difficult to use, particularly if the expected time intervals are short.

A convenient and inexpensive way to make such measurements is to use a circuit with low-current fuses and a simple transistor switch. Figure 1 shows a transistor switch circuit which is responsive to positive-going pulses. A fuse rated for low current and a series current-limiting resistor make up the collector load. When the switching transistor saturates, its collector supply voltage appears essentially across the series fuse-resistance combination. The time for fuse burn-out after saturation will depend on the fuse rating, resistor value and applied voltage and can be adjusted by choosing these parameters. The occurrence of a burned-out fuse is an indication of the occurrence of a voltage pulse longer than the adjusted value.

In some applications the fuse and resistor can be used without a transistor. However, the use of a transistor offers these advantages:

- The voltage across the fuse circuit is always the same during the pulse interval, regardless of the pulse characteristic. This means calibration is easier and lends itself well to analysis.
- The lower limit of measured time intervals is extended because of the power gain of the transistor.
- The measuring circuit can be effectively isolated from the source.

Two transistor-fuse-resistor circuit combinations, adjusted for fuse burn-out at different times, can be used to measure the occurrence of a pulse between the set limits of these two circuits. A second transistor feeding the input to the

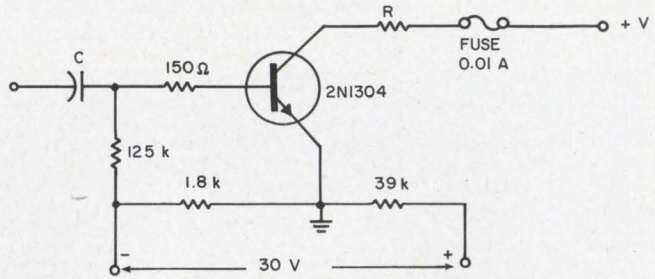

FOR MEASUREMENT OF 0.1 ms PULSES: V = 15 VOLTS, R = 200 Ω  
 V = 10 VOLTS, R = 150 Ω  
 V = 75 VOLTS, R = 100 Ω  
 V = 5 VOLTS, R = 90 Ω

1. Value of R in series with a fuse determines the width of the pulses that can occur at the input before the fuse "goes." A range of values is given for various supply voltages. 30-V dc bias across 1.8 kΩ and 39 kΩ secures "hard" off condition for the transistor switch.

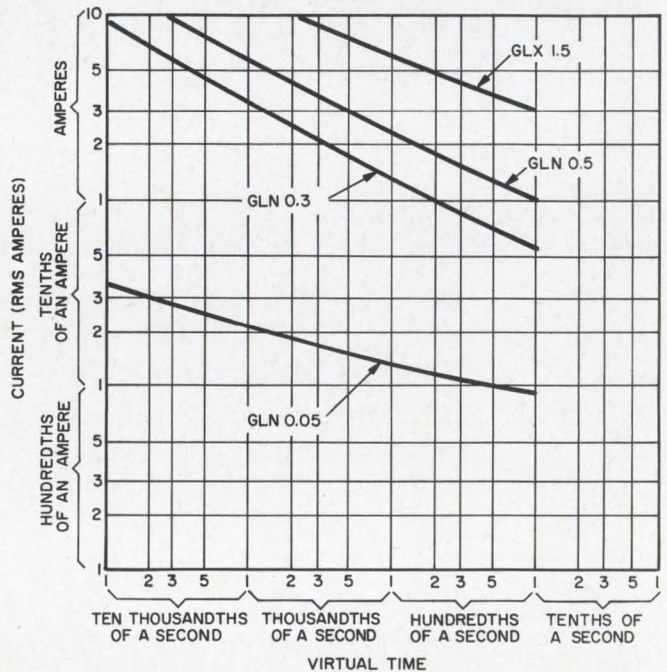

2. Current vs time for burn-out of a variety of fuses gives an idea of the wide choice available.

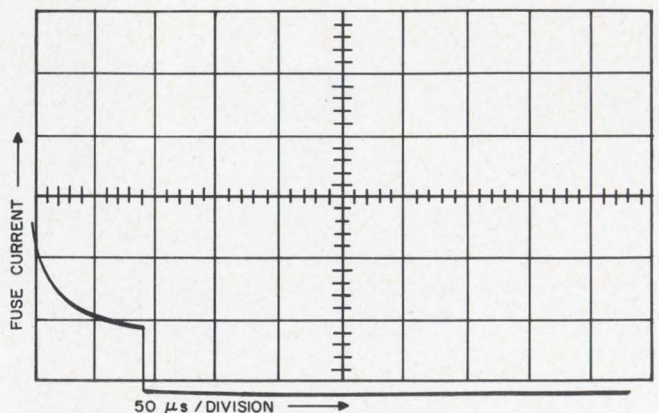

3. Fuse burn-out time for capacitor discharge test. Burn-out time was adjusted for 100 μs. The timing was within 10% from fuse to fuse.





## You won't find the new Alfred 10-watt amplifier here.

**Lowest price 10-watt amplifiers:** Alfred's 1 to 11 GHz TWT amplifiers with 30 db gain at 10 watts are designed for continuous performance under rigorous conditions. To protect the PPM-focused TWT, each unit includes Alfred's unique "total protection" circuitry. You can choose from 4 basic models:

### Frequency Range

| Model | (GHz) | Price   |
|-------|-------|---------|
| 5010  | 1-2   | \$3,600 |
| 5020  | 2-4   | 3,400   |
| 5030  | 4-8   | 3,700   |
| 5040  | 7-11* | 3,850   |

\*Model 5040 delivers 2 watts at 12.4 GHz.

**1-watt amplifiers for every application:** The 1 to 12.4 GHz amplifiers, capable of delivering 1 watt at 30 db gain, are priced within your budget. Only Alfred amplifiers provide 50 db gain and amplitude modulation range. Each unit contains "total protection" circuits; exceptional gain and phase stability are built in.

### Frequency Range

| Model | (GHz)  | Price   |
|-------|--------|---------|
| 560A  | 1-2    | \$2,150 |
| 561A  | 2-4    | 2,150   |
| 562A  | 4-8    | 2,550   |
| 563A  | 7-12.4 | 2,550   |

**For more information:** To arrange a demonstration and get complete details, call a full service Alfred Sales Engineer (see EEM), or, if you wish, write to 3176 Porter Drive, Palo Alto, California 94304. Phone (415) 326-6496.

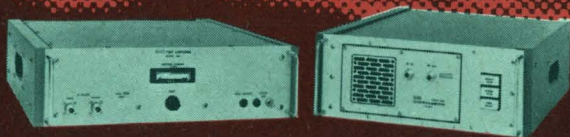

# ALFRED ELECTRONICS

Project responsibility opportunities are available for qualified engineers on Alfred Electronics' growing technical staff. An equal opportunity employer.

But here—  
or in the laboratory  
or on the production  
line where the work's  
hard—you will!

switching transistor can of course be used as a signal conditioner or to isolate further the measuring circuit from the circuit under observation. With this circuit, no expensive equipment is involved and the test can be left unattended. At any subsequent time a burned fuse shows that the adjusted pulse time was exceeded.

Figure 2 shows the time-current characteristics for various Bussman fuses. A selection can be made from this to produce some desired time interval.

A number of these fuses were tested for burn-out time at fixed voltage and series resistance and found to be surprisingly uniform. Of the ones tested all had a burn-out time within about 10%. The current-limiting resistance includes about five times the fuse "cold-resistance."

Fuses of 1/20- and 1/100-ampere rating were tested with various series resistance values and applied voltages from about 10 to 25 volts dc with no transistor. Time to fuse burn-out was found to be variable from about 50  $\mu$ s to 3 ms by adjustment of the voltage and series resistor.

Seventy capacitors were given a continuous 140-hour test under voltage at elevated temperature to measure the occurrences of breakdown voltage pulses which lasted longer than 0.1 ms. A multiple-channel circuit like that of Fig. 1 was used. Figure 3 shows the time-current response to burn-out taken with this circuit adjusted for 0.1 ms.

Taft R. Wrathall, Lockheed Missiles & Space Co. Sunnyvale, Calif.

VOTE FOR 114

## Single IC generates wide-range, variable-width pulses

A variable-width, one-shot circuit with a ratio of maximum-to-minimum pulse widths of more than about 100:1 is difficult to design. A circuit which overcomes this difficulty is described here.

Figure 1a shows a circuit for a conventional one-shot with a minimum width of  $T_1$  and a maximum width of  $T_2$ . The delay line is chosen to

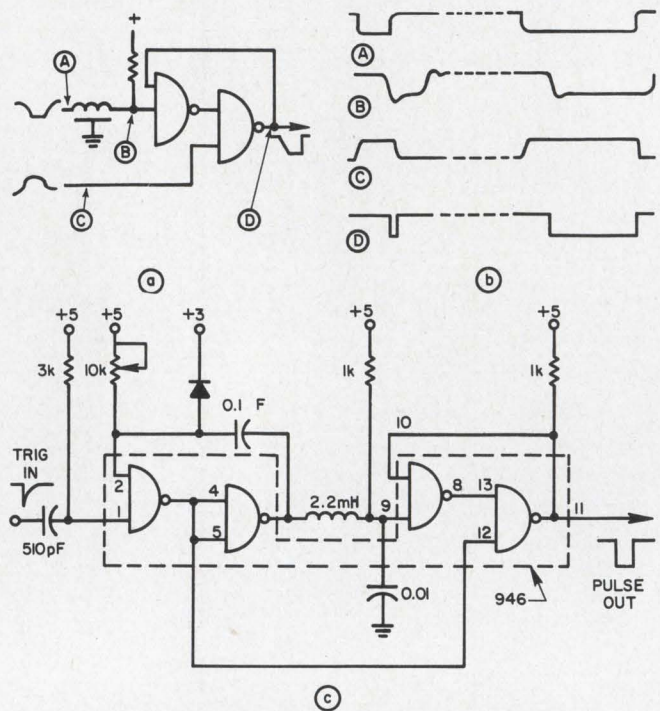

Pulse widths variable from 0.1 to 180  $\mu$ s are obtained from the circuit (c) using a single 946 quad two-input gate. It has rise and fall times of less than 40 ns. Basic arrangement is shown in (a) with its waveshapes in (b).

have a delay,  $T_D$ , slightly longer than  $T_1$ . The output pulse then has a minimum width of  $(T_1 - T_D)$  and a maximum width of  $(T_2 - T_D)$ . In practice this easily covers a range from 0.1  $\mu$ s to several hundred microseconds, a ratio of several thousand to one. Figure 1b shows waveshapes for two different input pulse widths.

Figure 1c shows a practical circuit using a single 946 IC quad two-input gate to generate pulse widths variable from 0.1 to 180  $\mu$ s. Rise and fall times are less than 40 ns. For simplicity, the delay line was replaced with a simple LC ringing circuit. The output pulse begins about 5  $\mu$ s after application of an input trigger.

(This work was performed under the auspices of the U.S. Atomic Energy Commission.)

Curtis Sewell, Jr., Lawrence Radiation Laboratory, University of California, Livermore, Calif.

VOTE FOR 115

### IFD Winner for May 24, 1967

Peter F. Moulton, Design Engineer, Research Section, Science Committee on Psychological Experimentation, Cambridge, Mass.

His Idea, "FET stabilizes Zener current in a simple voltage regulator," has been voted the \$50 Most Valuable of Issue Award.

### IFD Winner for June 7, 1967

Gordon J. Deboo, Ames Research Center, NASA, Moffett Field, Calif.

His Idea, "A novel integrator results by grounding its capacitor," has been voted the \$50 Most Valuable of Issue Award.

Cast Your Vote for the Best Idea in this Issue.

# STOP BEING REJECTED

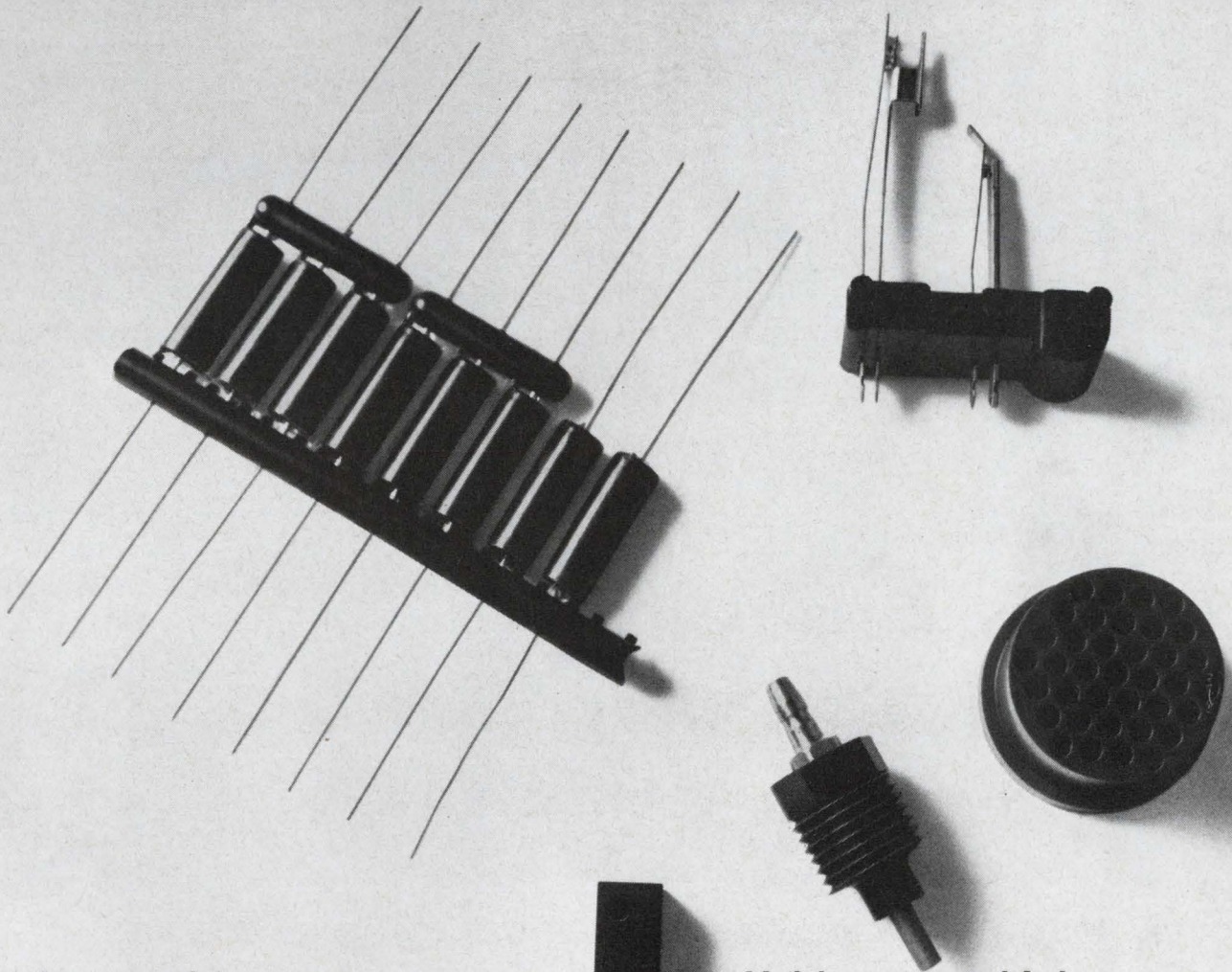

Achieve zero defects.

Use Plaskon® Epoxy molding compounds.

And minimize outgassing problems, even on the toughest, most exacting molding job.

Since system and component applications of epoxies operate in heat environments, outgassing is a critical factor. Outgassing can cause deposits to build up, which in turn cause failures.

Plaskon Epoxy molding compounds overcome this. Make your molding runs easy. Simple. Sure. So call Allied. Stop those rejects.

And here's something else of interest. We also carry a complete line of thermosets: Plaskon, Diall® DAP, alkyd, and amino molding compounds. One of them is sure to have the technical specs that makes it right for your job.

Mail the coupon and find out.

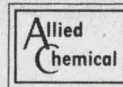

Allied Chemical, Plastic Division  
Post Office Box 365, Morristown, N. J. 07960

Gentlemen:

Please send me complete information on Plaskon Epoxy Molding Compounds. I would also like technical data on the following thermoset molding compounds.

Diall DAP

Plaskon Alkyds

Plaskon Amino Compounds

Name \_\_\_\_\_

Title \_\_\_\_\_

Company \_\_\_\_\_

Street \_\_\_\_\_

City \_\_\_\_\_ State \_\_\_\_\_ Zip \_\_\_\_\_

MAKES EVERYONE LOOK GOOD...

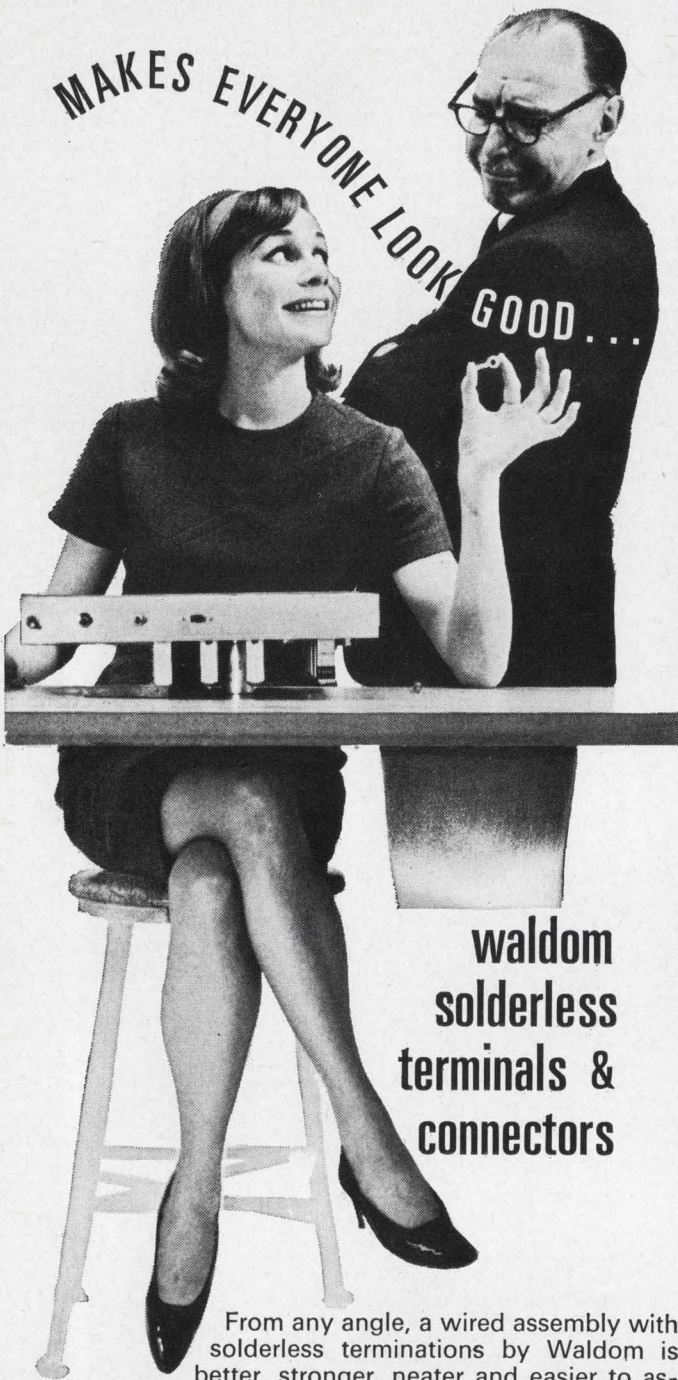

## waldom solderless terminals & connectors

From any angle, a wired assembly with solderless terminations by Waldom is better, stronger, neater and easier to assemble. Everyone gains . . . the pretty assembler on the line, her foreman, the company officers and stockholders and, most of all, the user of the completed product.

Waldom Solderless Terminals and Connectors make positive connections, are vibration and temperature proof and they will never wear out or lose their grip. If that's not enough, check these other benefits. . . .

- \* Broad selection including Quick Disconnects. \* All construction styles. \* Absolute dependability. \* Saves time and labor. \* Easier servicing. \* All types made to military specs.

Fast delivery from your electronics or electrical distributor. Write for FREE Waldom catalog listing more than 3000 electronic hardware items.



**waldom** ELECTRONICS, INC.

4643 West 53rd Street,  
Chicago, Illinois 60632

ON READER-SERVICE CARD CIRCLE 69

## NASA TECH BRIEFS

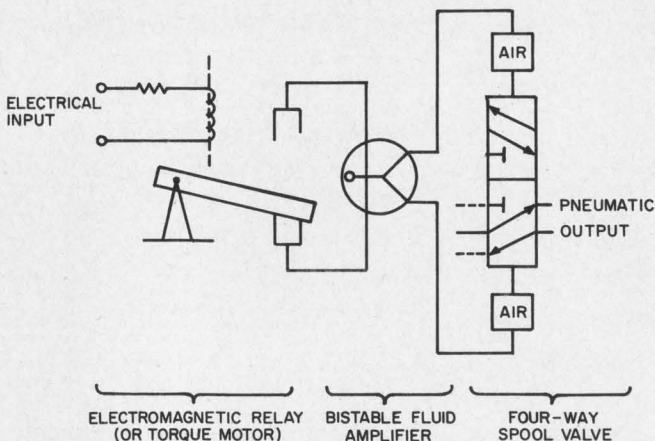

## Fluid control circuit operates on low power

**Problem:** Actuate fluid control circuits with low-level electrical signals. Commercial solenoid-driven valves have been used for this application but they require relatively high power levels.

**Solution:** A standard, commercially available electromagnetic relay switches a fluid amplifier that, in turn, drives a spool valve.

The relay contacts are replaced by nozzles connected to the control ports of a bistable fluid jet amplifier. In operation, the spring-loaded armature of the relay caps one nozzle or the other as the relay is activated and deactivated. The fluid jet amplifier controls the spool of a mechanical valve handling high volumes and flow rates.

The electromagnetic relay reduces the power requirement to only 10 mW, compared with 10 watts required by a solenoid.

Cascading the fluid amplifiers and replacing the relay with a torque motor (permanent-magnet polarized relay) would make it possible to reduce the power required to less than 0.1 mW.

Frequency response greater than 20 Hz may be obtained with the torque motor arrangement; solenoid valve rates are below 5 Hz.

The low input power needed permits direct connection with digital computer outputs without amplification.

*Inquiries concerning this innovation may be directed to: Technology Utilization Officer, Lewis Research Center, 21000 Brookpark Rd., Cleveland, Ohio 44135 (B67-10042).*

## Bifilar winding on relays suppresses high transients

**Problem:** Rid electromagnetic devices such as relays and solenoids of transients. High transients are caused by the rapid decay of the electromagnetic field when the current to a device is removed.

*(continued on p. 138)*

# We're all set to double-Cross you.

[and you'll love it.]



**We've doubled our plant and manufacturing facilities. So you can hand us twice as many of those tough jobs... or tough jobs twice the size. We mean the ones where you want zero defects. Which Cross promises and delivers.**

For instance, molybdenum and tungsten rolled down to  $\pm .0001$ " on a production run. Or rhenium tungsten, rhenium moly, columbium, zirconium, titanium, copper, nickel, alloys and other metals rolled to  $\pm .00005$ ". You name it . . . you've got it.

Cross has built its business by handling the tough jobs that had to be perfect. So pile your ribbon and strip problems on us . . . big, medium or small. *Challenge us with your close tolerance requirements. We're twice as ready as before to roll right over them.*

**H.CROSS**  
COMPANY

Isn't  
this  
the  
darndest  
cable  
you  
ever  
saw?

It just goes to show you that Markel can make just about any cable you can dream up! We make not only a wide variety of standard constructions, including all standard RG/U coaxial cables, but also a tremendous number of special constructions to customers' specifications. These may provide single, twisted pair or multiple conductors—bare copper or with tin, silver or nickel coatings; may combine insulations of Teflon\*, silicone rubber, fiberglass and nylon; braided metal shields; fillers, liners and jackets of various materials. Just give us your specs . . . we'll make your cable. For free samples, write:



**L. FRANK MARKEL & SONS**  
Norristown Pa. 19404 • 215-272-8960  
INSULATING TUBINGS AND SLEEVINGS  
HIGH TEMPERATURE WIRE AND CABLE

® TM of DuPont



**COAXIAL CABLES  
AND SPECIAL  
CONSTRUCTIONS**

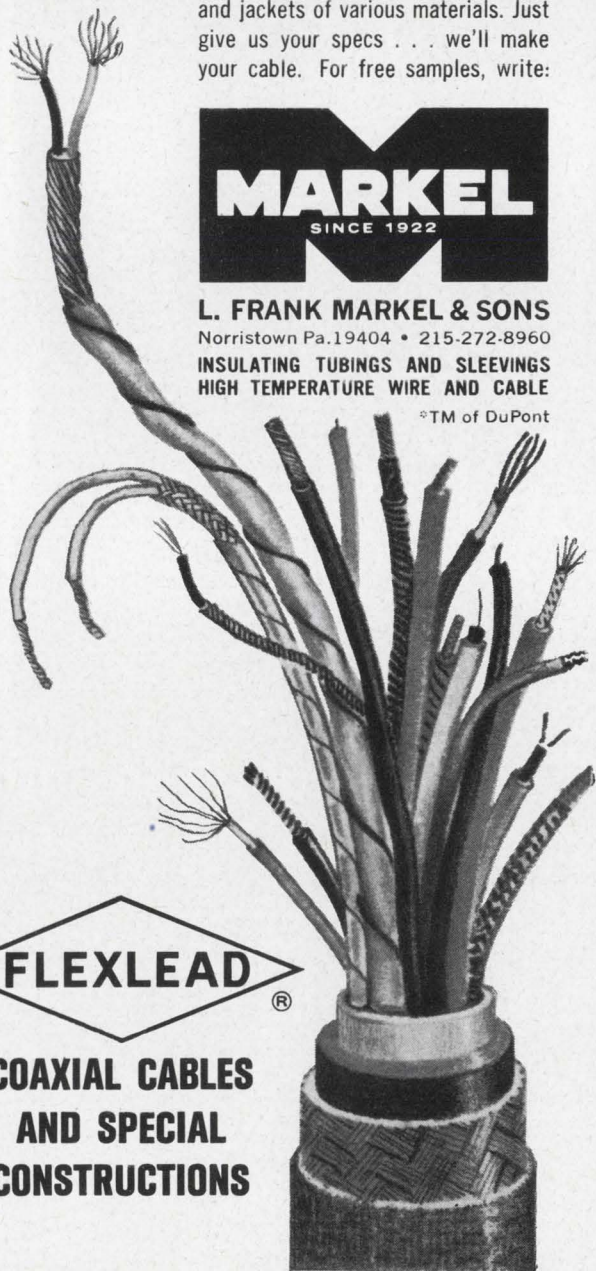

ON READER-SERVICE CARD CIRCLE 71

NASA TECH BRIEFS

Previous methods of suppressing these transients caused polarity dependence and increased size, weight, and contact resistance due to outgassing.

**Solution:** Create a high coupling coefficient by putting a bifilar winding around the magnetic core, alternately spaced vertically and radially from the core.

Actuation winding  $W1$  about the core (see schematic) is connected to a power supply through switch  $S1$ . A transient voltage-suppression coil,  $W2$ , is wound alternately, with its ends connected to form a short-circuited winding. Leg  $L1$  projects laterally from the base of the core. It has a vertical leg  $L2$  extending upward to slightly above the top of the core, where spring-loaded contact assembly  $C$  extends laterally. A load is connected in series with the device through  $S2$ .

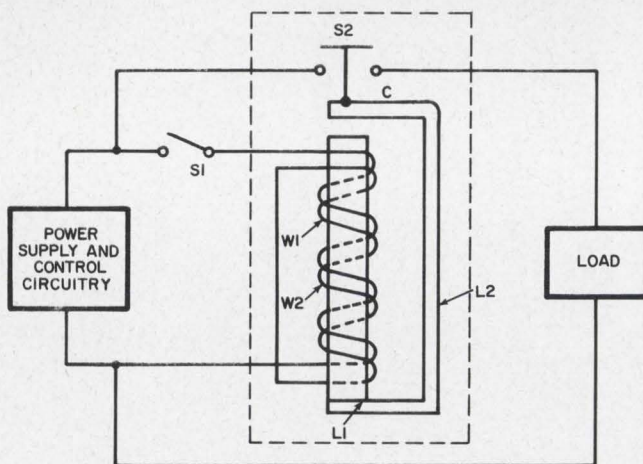

When  $S1$  is closed, current flows through  $W1$ , creating a strong magnetic field that pulls  $C$  down to contact the core. At the same time it closes  $S2$ , connecting the load to the power supply.

Opening  $S1$  de-energizes  $W1$ , causing the magnetic field to decay rapidly. This produces a transient voltage. The high coefficient of coupling between  $W1$  and  $W2$  makes the transient bleed off through  $W2$  rather than through any other dissipative path. When the magnetic field has decayed sufficiently, spring-loaded contact  $C$  returns to the horizontal, opening  $S2$  and removing the load.

This method affords a simple and inexpensive suppression of high transient voltages that would otherwise cause interference in the operation of sensitive components adjacent to the device.

To control the effect on relay release time, it is necessary to select the proper wire size for  $W2$ .

*Inquiries concerning this invention may be directed to: Technology Utilization Officer, Kennedy Space Center, Fla. 32899 (B67-10031).*

*This is the invention of a NASA employee and a patent application has been filed. Inquiries concerning license rights may be made directly to the inventor, Charles Wayne Marion, at Kennedy Space Center, Fla. 32899.*

ON READER-SERVICE CARD CIRCLE 72 ➤



## production, price, and delivery—they're **STANDARD**

Collins' prototype crystal filters with the response illustrated above are now available in the 100-kHz to 500-kHz region both in upper and lower sideband designs and to the following specifications:

|                              |  |
|------------------------------|--|
| Bandwidth at 1 db:           | 2780 Hz.                                     |
| Bandwidth at 60 db:          | 3300 Hz.                                     |
| Carrier rejection:           | 60 db min.                                   |
| Passband ripple:             | 1/2 db max.                                  |
| Differential delay:          | 500 $\mu$ sec. max. over<br>70% of passband. |
| Operating temperature range: | -20° C to +70° C.                            |
| Typical case size:           | 1.9" X 2.8" X 0.7" max.                      |

Collins' crystal filters meet most narrow band needs (from 5 kHz to 20 MHz) in designs such as Butterworth, Tchebycheff, and Linear Phase. Prototypes to your specifications are

generally available in four to six weeks. Collins' crystal filter capability is expanding rapidly. Send your specifications for design analysis. As one of the largest suppliers, Collins satisfies delivery requirements for all major programs.

Collins' entire filter product line covers the practical spectrum from 1 kHz to 100 MHz, offering LC and mechanical filters for applications where crystal filters are not suitable. If an advantage can be obtained in performance, price, or delivery through LC or mechanical filters, Collins is in a position to recommend these filters rather than crystal filters.

Send or call your performance requirements to Components Division, Collins Radio Company, Newport Beach, California 92663 Phone: (714) 833-0600.

COMMUNICATION / COMPUTATION / CONTROL

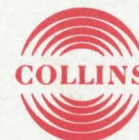

# EE openings on SRAM, Minuteman and other Boeing programs

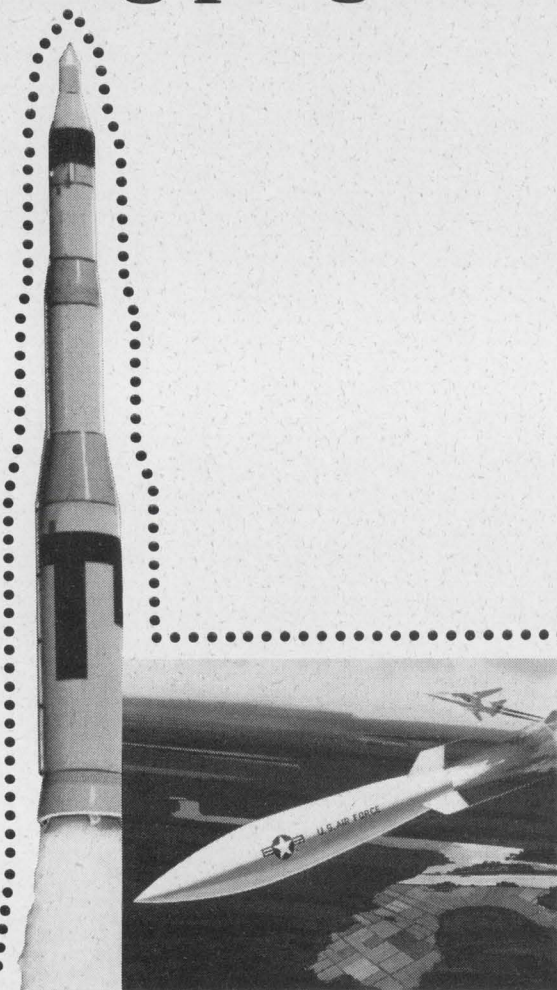

*I'm interested in a Boeing career; please contact me with details.*

Name \_\_\_\_\_

Address \_\_\_\_\_

Phone (incl. area code) \_\_\_\_\_

City \_\_\_\_\_ State \_\_\_\_\_ Zip \_\_\_\_\_

I'm usually home between \_\_\_\_\_ and \_\_\_\_\_ (hours) on \_\_\_\_\_ (days)

Degree/Field of Interest \_\_\_\_\_

*Please mail to the location of your choice and qualifications: SEATTLE: Mr. R. R. Laurie, The Boeing Company, P.O. Box 3999-EDE, Seattle, Washington 98124. HUNTSVILLE: Mr. Lee Batt, The Boeing Company, P.O. Box 1680-EDE, Huntsville, Alabama 35807. KENNEDY SPACE CENTER: Mr. G. S. McDaniel, The Boeing Company, P.O. Box 1698-EDE, Cocoa Beach, Florida 32931.*

Boeing's deep involvement with the nation's major missile and space programs provides immediate career opportunities for electrical/electronic engineers at Seattle, Huntsville, and Kennedy Space Center.

Boeing is system integration contractor for SRAM, the U.S. Air Force's new Short-Range Attack Missile. The company also is weapon system integrator for the USAF advanced Minuteman II ICBM. In space, Boeing is prime contractor for the National Aeronautics and Space Administration's Lunar Orbiter, the moon-circling spacecraft which is helping NASA scientists select the best landing sites for Apollo astronauts. In addition, Boeing is a major mission-support contractor to NASA on the Apollo/Saturn V program, and is building the first stage of the Saturn V launch vehicle.

Immediate openings exist at Seattle on the SRAM, Minuteman and Lunar Orbiter programs. Assignments in test technology include data systems and instrumentation and test data handling and processing. Qualifications include a B.S. or M.S. in electrical engineering and two to five years applicable experience. Flight technology positions are available in flight control and flight mechanics. Qualifications include a B.S. or M.S. in electrical engineering with two to five years experience.

Additional Seattle openings exist in developmental design and electronic packaging. Design assignments are in airborne control systems, ground system electrical power systems, and environmental control, and require a B.S. degree in an applicable discipline plus related experience. Electronic packaging qualifications include a B.S. in electrical engineering plus applicable experience.

A number of openings also exist on the Apollo/Saturn V program. At Huntsville, assignments in flight mechanics and flight evaluation include operational trajectories, mission analysis, trajectory analysis, post-flight trajectories, flight simulation development, and flight dynamics. Qualifications include a B.S., M.S. or Ph.D. in electrical engineering. Openings also exist for electrical/electronic engineers at Kennedy Space Center.

Salaries are commensurate with experience and educational background. Moving and travel allowances are paid to newly employed personnel. Boeing is an equal opportunity employer.

Please fill in and mail the coupon to the location of your choice and qualifications. A Boeing representative will get in touch with you.

## **BOEING**

MISSILE & INFORMATION SYSTEMS DIVISION  
SPACE DIVISION

Other Divisions: Commercial Airplane • Vertol • Wichita  
Also, Boeing Scientific Research Laboratories



# Free Career Inquiry Service

## Absolutely Confidential

Respond to the career opportunities advertised in this issue. Fill out and send us this handy resume. **Electronic Design** will do the rest – neatly typed copies of this form will be mailed to the companies of your choice, indicated by the circled Career Inquiry Numbers at the bottom of this page.

# 19

|                              |   |                           |              |
|------------------------------|---|---------------------------|--------------|
| <b>Name</b>                  |   | <b>Home Phone</b>         |              |
| <b>Home Address (Street)</b> |   | <b>City</b>               | <b>State</b> |
|                              |   | <b>ZIP Code</b>           |              |
| <b>Age</b>                   | <b>U.S. Citizen</b><br><input type="checkbox"/> Yes <input type="checkbox"/> No | <b>Security Clearance</b> |              |

| Prime Experience | Secondary Experience |
|------------------|----------------------|
|                  |                      |
|                  |                      |
|                  |                      |
|                  |                      |
|                  |                      |

|                       |                          |
|-----------------------|--------------------------|
| <b>Desired Salary</b> | <b>Availability Date</b> |
|-----------------------|--------------------------|

**Employment History – present and previous employers**

| Company | City, State | Dates | Title | Specialty |
|---------|-------------|-------|-------|-----------|
|         |             | to    |       |           |
|         |             | to    |       |           |
|         |             | to    |       |           |

**Education – indicate major if degree is not self-explanatory**

| Degree | College | City, State | Dates |
|--------|---------|-------------|-------|
|        |         |             | to    |
|        |         |             | to    |

**Additional Training – non-degree, industry, military, etc.**

---



---

**Professional Societies**

---

**Published Articles**

---

- Career Inquiry Numbers:**
- |     |     |     |     |     |     |     |     |     |     |
|-----|-----|-----|-----|-----|-----|-----|-----|-----|-----|
| 900 | 901 | 902 | 903 | 904 | 905 | 906 | 907 | 908 | 909 |
| 910 | 911 | 912 | 913 | 914 | 915 | 916 | 917 | 918 | 919 |

**ELECTRONIC DESIGN**  
850 Third Avenue  
New York, New York 10022



## Interested in Instrumentation?

Hercules, a leading chemical manufacturer with over 40 plants in the United States, has immediate openings for instrument engineers in its home office engineering department in Wilmington, Delaware. These openings have been generated by continued growth which is indicated by the planned expenditure of about \$110 million on new facilities this year.

Recent Graduate Electrical Engineers (or Mechanical and Chemical Engineers with strong electronic or instrumentation backgrounds) interested in getting into instrumentation. No experience necessary. To be trained to design, prepare specifications, and coordinate the purchasing, installation, and start-up of instrumentation systems for chemical process plants. Salaries commensurate with experience and background.

To learn more about these and/or other opportunities with Hercules, call collect: (302) 656-9811, Ext. 8825, or send resume in confidence to:

David W. Austin, Personnel Department  
**HERCULES INCORPORATED**  
 WILMINGTON, DELAWARE 19899

EQUAL OPPORTUNITY EMPLOYER GR67-21

ON CAREER INQUIRY FORM CIRCLE 901

let's put

our heads together...

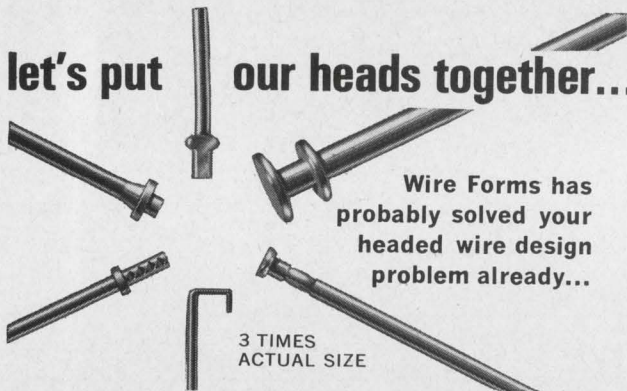

Wire Forms has probably solved your headed wire design problem already...

3 TIMES ACTUAL SIZE

Wire Forms' product design and development engineers are used to "problem cases" . . . that's their business. From straight, square cut heads to exotic, double flare heads with multiple diameters on expanded shanks.

Totally automated, modern production facilities are designed to handle your specific production run.

Let's put our heads together . . . let us show you how to eliminate design problems . . . production problems . . . easily, quickly, and inexpensively.

**EMPORIUM**  
**Wire Forms**

**SPECIALTIES INC.**  
**Division**

Plant and Engineering: Austin, Pennsylvania  
 General Sales Office: 2800 East 116th Street  
 Cleveland, Ohio 44120  
 Telephone: (216) 795-1640

ON READER-SERVICE CARD CIRCLE 73

## Book Reviews

### ELECTRONIC COUNTING CIRCUITS

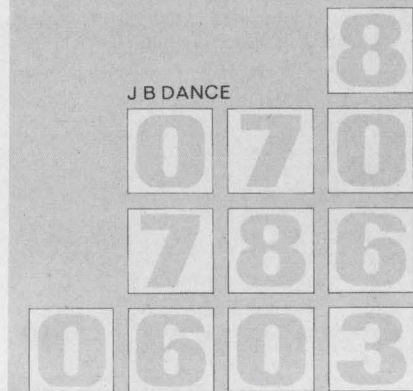

### Counting circuits

*Electronic Counting Circuits*, J. B. Dance (American Elsevier, New York), 390 pp. \$16.75.

This book demonstrates the difficulty of publishing simultaneously in the U.K. and the U.S.A. Although English is the common language, there are distinct differences between the two countries in technology and practice. Nowhere is this more true than in electronics, where European research and development lags behind current U.S. practice in many areas.

The author aims to provide "a comprehensive account of the functioning of all electronic counting circuits." While he may have written a book that adequately covers the British state of the art, it does not do the same for the U.S. Too much emphasis is on tube circuits, particularly where they have been superseded in U.S. practice, as in driver circuits for Nixie tubes. The chapters on gas-filled counting tubes and beam-switching tubes do adequately cover the operation of these tubes, however, and may be of use where they relate to U.S. practice.

Since the book contains a great deal of information that may be helpful to the junior engineer, the book may find its way into college libraries. But its readers will suffer because so little has been done to



# EE'S

with military communications  
equipment experience

## call us collect

area code 317/459-2808

Rapid expansion of our ground based and airborne military communications capability has created urgent requirements for electrical engineers (B.S. or M.S.) at Delco Radio.

Opportunities at all levels—beginning, through supervisory, with 2-10 years experience—in the following areas:

Digital communications in the HF, VHF, and UHF bands

Single side band design, HF, and VHF

Frequency synthesizer techniques in all frequency ranges

Wide range electronic tuning

Retransmission techniques

Secure communications techniques

Man-portable and vehicular battle area communications equipment

Acoustic transducers, antennas, and micro-electronics applications.

Call us collect for an interview or more information. Area Code 317/459-2808. Ask for C. D. Longshore. Or send your resume to Mr. Longshore, Supervisor, Salaried Employment, Dept. 203, Delco Radio Division of General Motors, Kokomo, Indiana.



MARK OF EXCELLENCE

## DELCO RADIO

DIVISION OF GENERAL MOTORS • KOKOMO, INDIANA

An equal opportunity employer

# NOW 2 REED RELAY SERIES

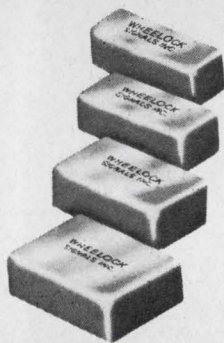

ACTUAL SIZE

## ULTRA MINIATURE REED RELAYS SERIES 442

- Smallest multi-pole relays in industry (1-4 poles Form A)
- P.C. Board Mount
- Contacts rated at a full 4 watts
- Occupies 0.055 cu. in. per pole

**SMALL  
ENOUGH  
TO  
CHANGE  
YOUR  
DESIGN  
IDEAS!**

MIL QUALITY AT  
COMMERCIAL PRICES



ACTUAL SIZE

## ULTRA MINIATURE NEEDLE REED RELAYS SERIES 373

- Occupies only 0.02 cu. in.
- Operates on only 50 mw of power
- Operate time 190 microseconds (typical)
- Insulation resistance as high as  $1 \times 10^{14}$
- Contacts rated at a full 4 watts

BY *Wheelock* OF COURSE

Contact Wheelock first for any of your relay design problems.

Write for new literature on Wheelock's big family of small relays!

WHEELOCK SIGNALS, INC.  
273 Branchport Avenue • Long Branch, N. J.  
(201) 222-6880



edit it for American engineers. It should not have been too much effort to eliminate "thermionic valves," "H.T. supply" and similar terms not common in the U.S.

That there is a need for a good reference work on counting circuits is undeniable. That Mr. Dance has failed to provide a suitable one for U.S. engineers is an object lesson for future authors.

—Jeffrey N. Bairstow

### Laser guide

*Gas Lasers*, C. G. B. Garrett (McGraw-Hill, New York), 135 pp. \$10.95.

This book on gas lasers is a simple guide to their origin, development, physical properties and construction. The treatment is basic enough to be applicable to other types of lasers. It traces the development of the gas laser and the origin of optical gain, and discusses the interaction between the gaseous medium and optical cavities. The mechanisms of specific laser systems are then dealt with.

Detailed descriptions are given of the helium-neon, argon ion, carbon dioxide and far infrared lasers, as well as the power output, directional distribution, and phase and amplitude fluctuations of the emerging light beam. The effects of intercavity modulation, frequency and amplitude stabilization, Q switching and the application of magnetic fields are touched on.

### Switching circuit theory

*Basic Switching Circuit Theory*, Moshe Krieger (Macmillan, New York), 256 pp. \$9.95.

This is an introduction to switching-circuit theory. Emphasis throughout is on general principles rather than on particular devices. Its aim is to provide the student with the theoretical tools necessary to understand complex digital systems such as digital computer units, automatic telephone exchanges, and digital telemetering devices. Many excellent graphs and illustrations are included, as well as a large number of problems designed to clarify the topics further.

# Any way you figure it...

you can count on Beckman EiD.

We back this claim with a new line of modular counting instruments that can take the measure of any man's business.

For the first time, you can tailor your cost of a frequency-and-time measuring system to suit your desired function and frequency. These new all-integrated circuit counters employ a unique *duo-module* technique—utilize dual sets of interchangeable, plug-in modules you specify and use as your needs dictate. You change the single- or dual-channel input module to change frequency range (0Hz – 20MHz single; 0Hz – 200MHz dual). You change the function module to change measurement criteria. Three basic models offer choice of 6-, 7- or 8-digit display with an optional 9th.

This new two-module concept lets you buy for today's need, expand for tomorrow's. Any way you figure it, EiD's up front with what counts. To button down the details, contact your local EiD Sales Representative...or write direct to our nearest regional office, listed at right.

EiD more than measures up.



INSTRUMENTS, INC.  
ELECTRONIC INSTRUMENTS  
DIVISION

2400 Harbor Blvd., Fullerton, Calif. 92634,  
(213) 691-0841

7360 N. Lincoln Ave., Lincolnwood, Ill.  
60646, (312) 583-1020

12051 Tech Rd., Montgomery Ind. Park,  
Silver Spring, Md. 20904, (301) 622-2500

International Subsidiaries: Geneva;  
Munich; Glenrothes, Scotland; Tokyo; Paris;  
Capetown; London; Mexico City

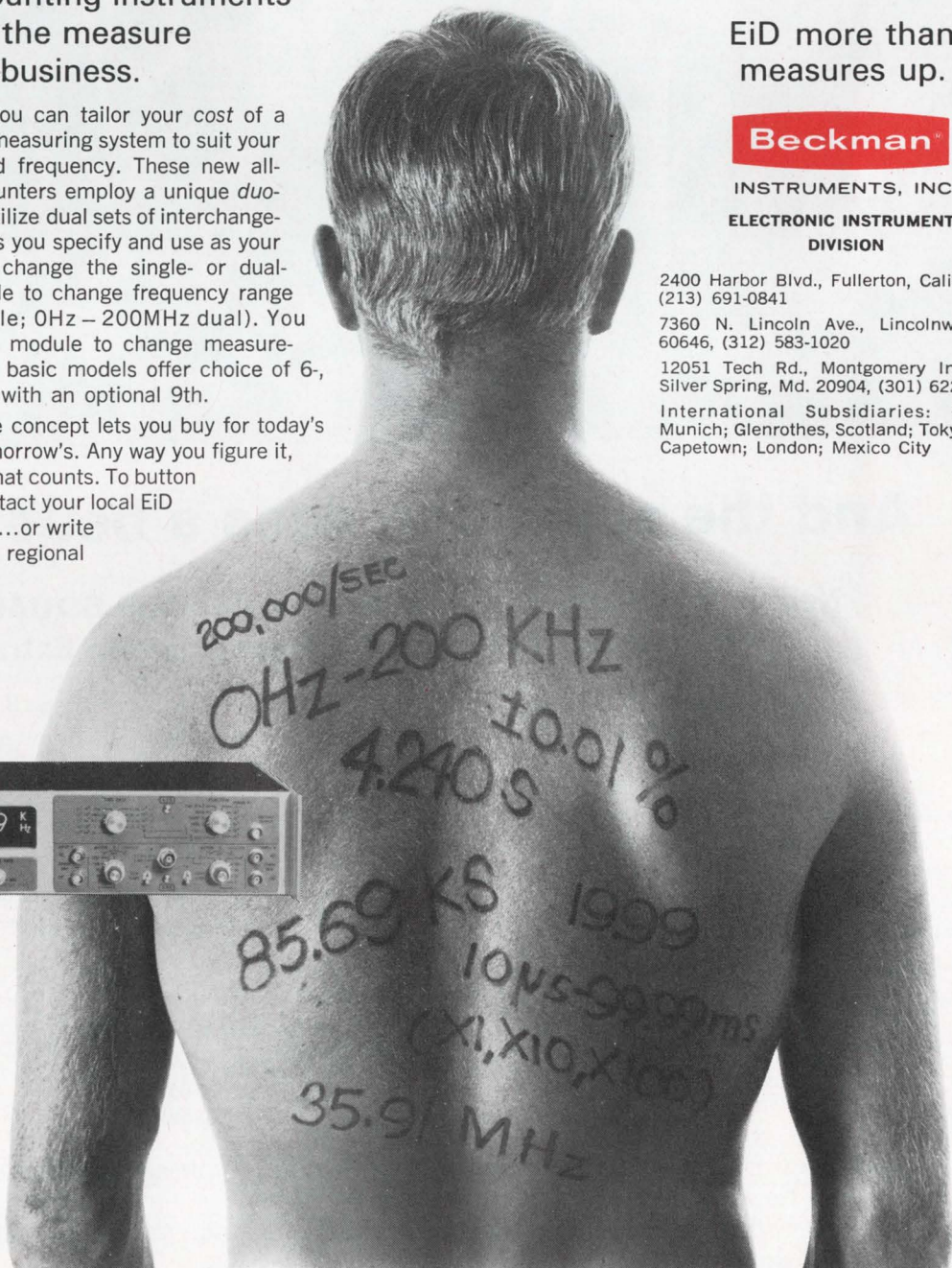

ON READER-SERVICE CARD CIRCLE 75

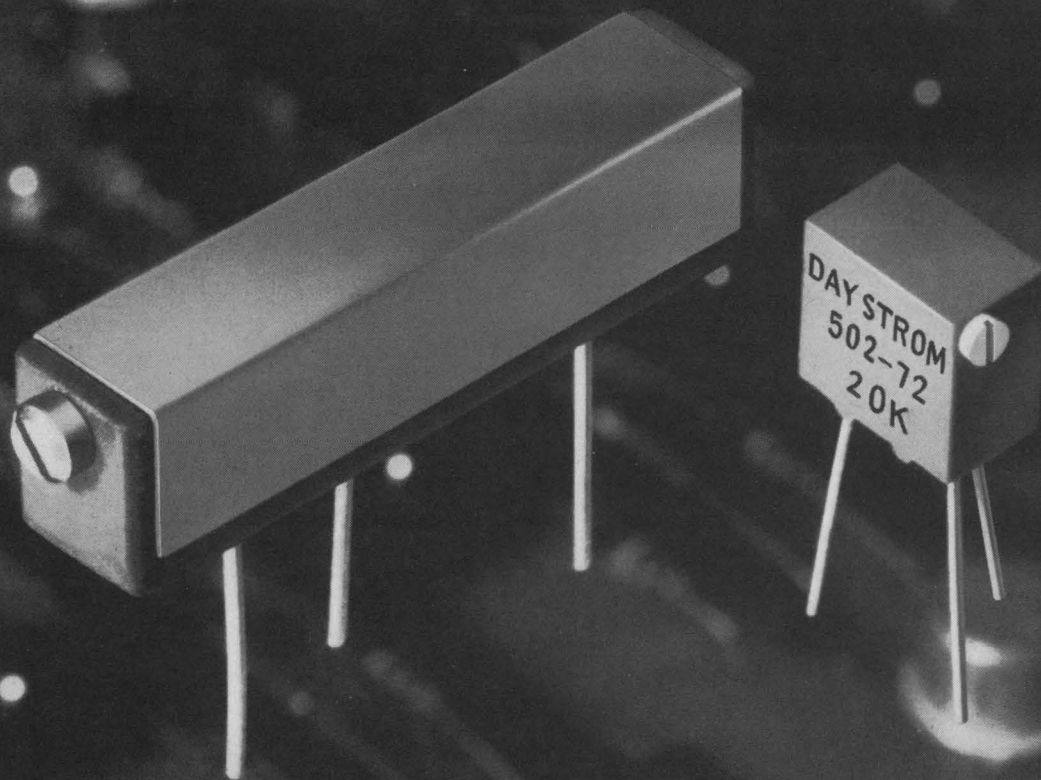

## And the small one does a better job

### New 5/16" DAYSTROM® Commercial 501-505 SQUARETRIM® Potentiometers Take About 1/6 Space At No Extra Cost

Notice how much space you save: 0.0185 inch cubic volume releases five-sixths of the space formerly required by conventional rectilinears—and you save that space at no increase in price. Nor do you pay extra for:

**Sureguard™ Terminations**—for better protection against vibration, shock and humidity—no pressure taps.

**Better Tolerance**— $\pm 5\%$  (100% better than many rectilinears).

**Superior Resolution**—0.125% or less.

**Adjustability**—15 mechanical turns or single turn.

**Slip Clutch**—eliminates wiper damage, cuts production delays.

**Wide Range**—10 ohms to 20K ohms.

**High Power**—0.6 watt in still air at 70 C.

**Wide Temperature Range**— $-55$  C to  $+150$  C.

**Low Temperature Coefficient**— $\pm 70$  ppm max.

**Low Noise**—100 ohms max. ENR.

**Convenience**—5 different configurations to choose from: with adjusting screw on top, side or end.

**Value Engineered**—Models 504 & 505 (single turn) priced at only \$1.95 each in 500 lot quantity. Models 501 & 502 (15 turn) priced at only \$2.10 each in 500 lot quantity.

Add it up and you can see why so many large users already have turned to the New DAYSTROM® Models 501-505 SQUARETRIM® Potentiometers. Get the facts and you will too. **Weston Instruments, Inc., Weston-Archbald Division, Archbald, Pa. 18403, a Schlumberger company**

**WESTON®** *prime source for precision... since 1888*

# Products

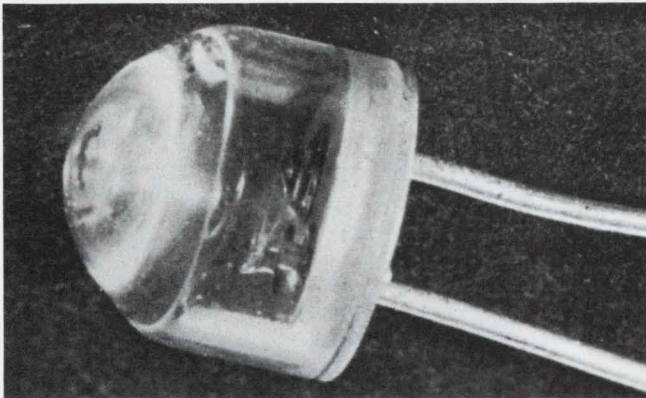

**Tiny tophatted light-emitting diode** produces a visible 0.8 footlamberts per mA. Page 148

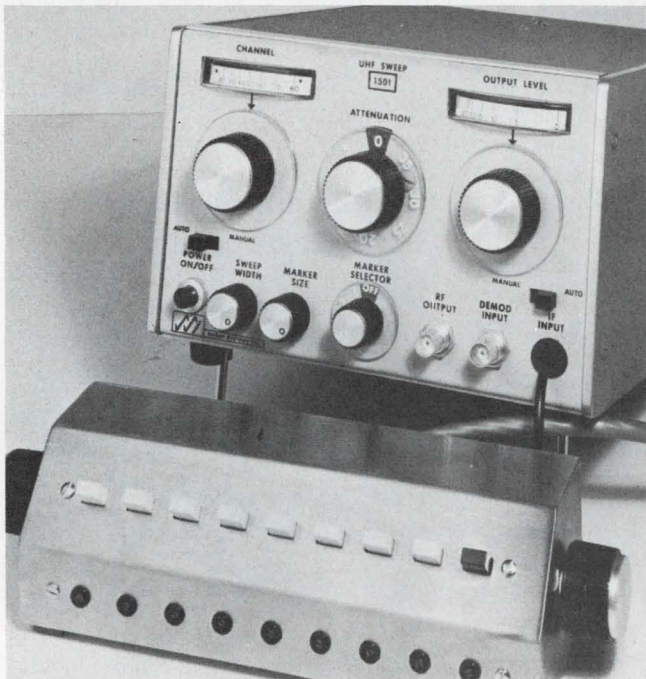

**Self-tuning sweeper runs automatically.** An electronic attenuator is the key. Page 190

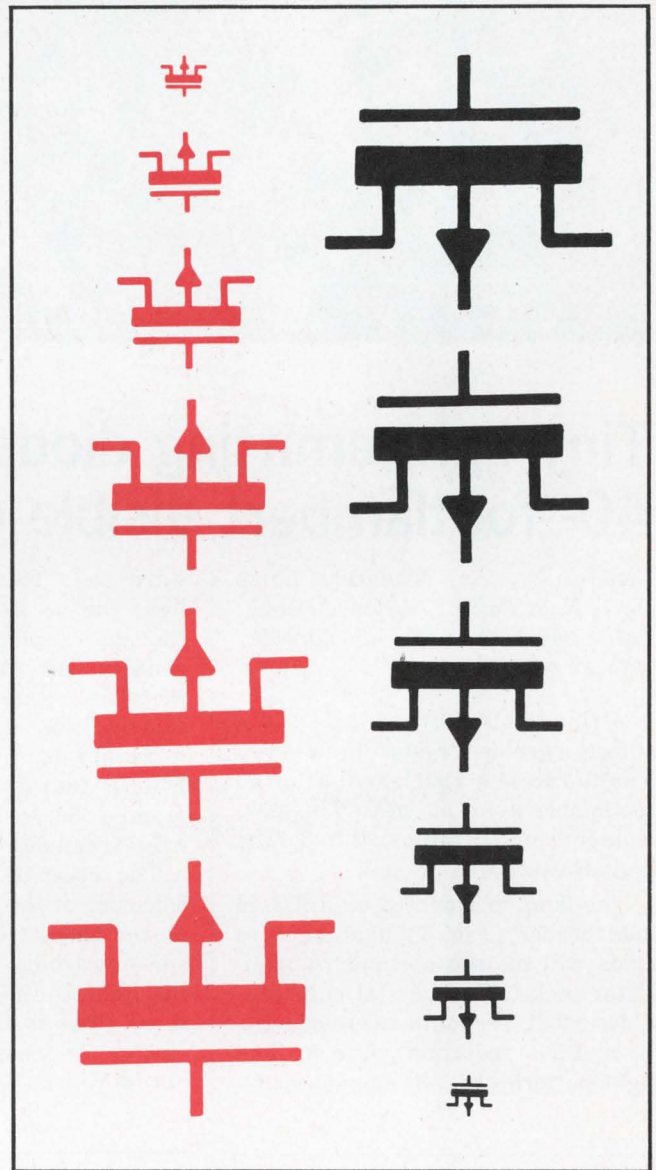

**Complementary MOS arrays open the gate to LSI.** Coming . . 500 per chip. Page 174

## Also in this section:

**Resistors trimmed ultrasonically** to 0.5% of specifications. Page 186

**Frequency counter ranges to 18 GHz** with an 8-digit display. Page 192

**Alloy diffused epitaxial germanium transistor** handles 25 amperes. Page 179

**Design Aids, Page 210 . . . Application Notes, Page 212 . . . New Literature, Page 214**

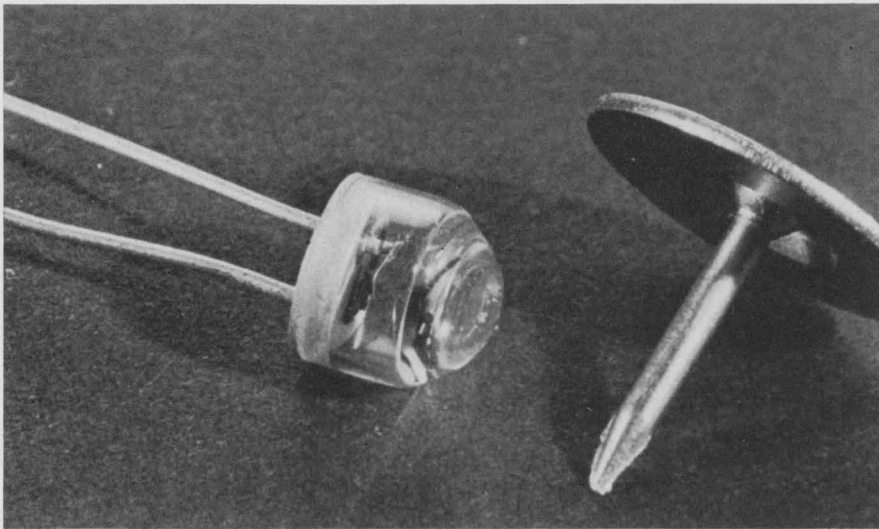

## Tiny light-emitting diode has 40-footlambert visible output

General Electric, Miniature Lamp Dept, Nela Park, Cleveland. Phone: (216) 266-2121. P&A: \$16.60 each; 6 to 12 wks.

A tiny light-emitting diode uses a silicon carbide crystal in a glass lens to create a visible output of 40 footlamberts at 50 mA. The low-voltage lamp operates at 2 to 5 volts and draws 50 to 75 mA.

The lamp is mounted on a TO-46 gold header (Fig. 1) and the wire leads will fit into a standard transistor socket. The crystal chip provides 0.8 fL per milliampere of light in a 180° radiation pattern. The light pattern (Fig. 2) emanates for-

ward as a focused beam and the light can be seen from all sides of the glass tophat. There is no suspended filament in this diode and the glass encapsulation is solid. Because of this, the lamp is not prone to failure due to vibration or shock. If operated at 5 V at 75 mA and from -65° to 125°C an unlimited life expectancy is claimed.

The color of the light and the efficiency of the diode are dependent on the amount of impurities in the silicon carbide chip. The color of the light is yellowish with a green tinge. This is the only color available as the glass encapsulation cannot be tinted. The lamp operates on

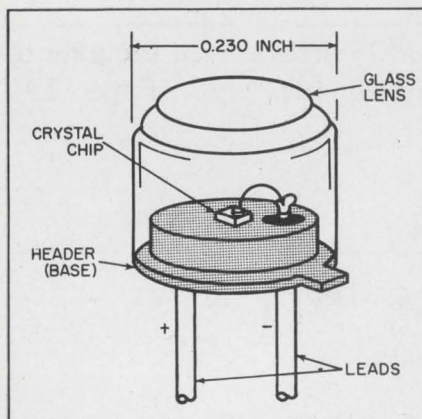

1. Forty-footlamberts from a tiny crystal. The silicon carbide chip mounted on a TO-46 header is capped by a glass tophat and lens.

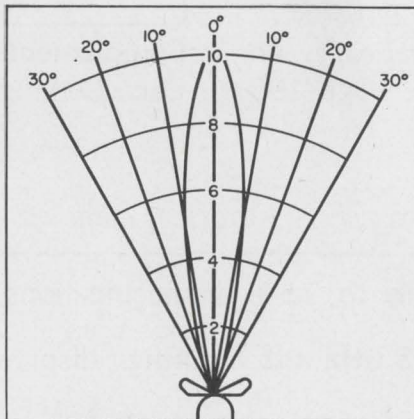

2. Full 180° visibility is afforded. The radiation pattern emanates from the lens as a focused beam visible anywhere in a 180° arc.

a narrow spectral emission band (5500-6300 Å) and any tinting would severely limit its light-producing capabilities.

The efficiency of the device is reported to be  $10^{-6}$  photons per electron and its peak light wavelength is about 5900 Å. Early manufacturing problems with silicon carbide crystals and their repeatable characteristics on a production-line basis have to be eliminated.

Used as warning lights, the lamps were subjected to a shock and stress test and no failures were reported. They lend themselves to aviation uses and to applications in computers and space equipment as indicator or action-triggering lamps. With a rise and fall time of 100  $\mu$ s there is virtually no delay in response. Design and development is under way for more lamps of the tophat configuration; other sizes and shapes, even less lamplike in appearance, are on the drawing boards.

CIRCLE NO. 250

## Self-luminous light uses Krypton 85



American Atomic Corp., 425 S. Plumar, Tucson, Ariz. Phone: (602) 622-4881. Price: from \$101.

This unit incorporates a one-millicurie self-luminous light source in a temperature-compensating oven for stability. It has application wherever low-level light is used as a secondary standard for accurate light measurement. The light source can be made with any one of a group of standard phosphors covering the complete visible spectrum to match spectral characteristics of the light being measured. The source also offers the benefit of Krypton 85 half-life of 10.3 years and constant availability.

CIRCLE NO. 251



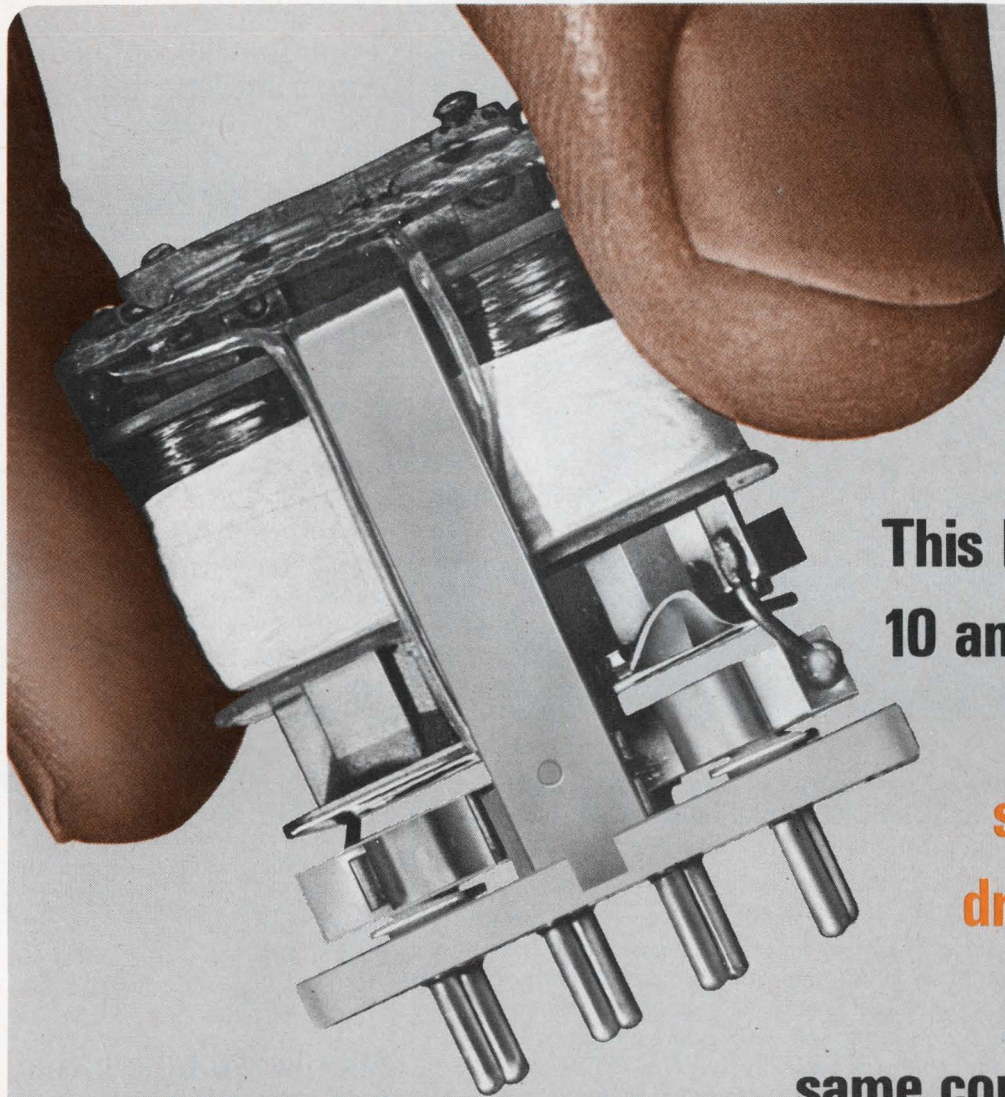

**This Babcock  
10 amp. relay  
also  
switches  
dry circuit  
with the  
same contact set**

Now, your Babcock 10 amp. full size crystal can relay will also switch dry circuit with the same set of contacts. These exclusive universal contacts have greatly simplified your relay stocking requirements. You can order one model to meet a given set of performance parameters without concern for load requirement —at no cost premium. Get complete information about this versatile relay, and the entire Babcock line, all with universal contacts.

Write Babcock Relays, Division of Babcock Electronics Corporation, 3501 Harbor Boulevard, Costa Mesa, California 92626; or telephone (714) 540-1234.



The Babcock Model BR7 relay will perform from dry circuit to 10 amps., with universal contacts, and is designed to meet critical aerospace applications.

**SPECIFICATIONS**

**SIZES**  
1.300" h. x 1.075" l. x .515" w  
**WEIGHT:**  
Approx. 1.0 oz.  
**CONTACT ARRANGEMENTS:**  
SPDT and DPDT

**PULL-IN POWER:**  
Low as 80 mw.  
**LIFE:**  
100,000 operations, min.  
**TEMP. RANGE:**  
-65°C to +125°C

**FROM THE BABCOCK FAMILY OF CRYSTAL CAN RELAYS**



**WATCH FOR BABCOCK RELAYS ON THE EDN MOBILE DISPLAY — SOON IN YOUR AREA.**

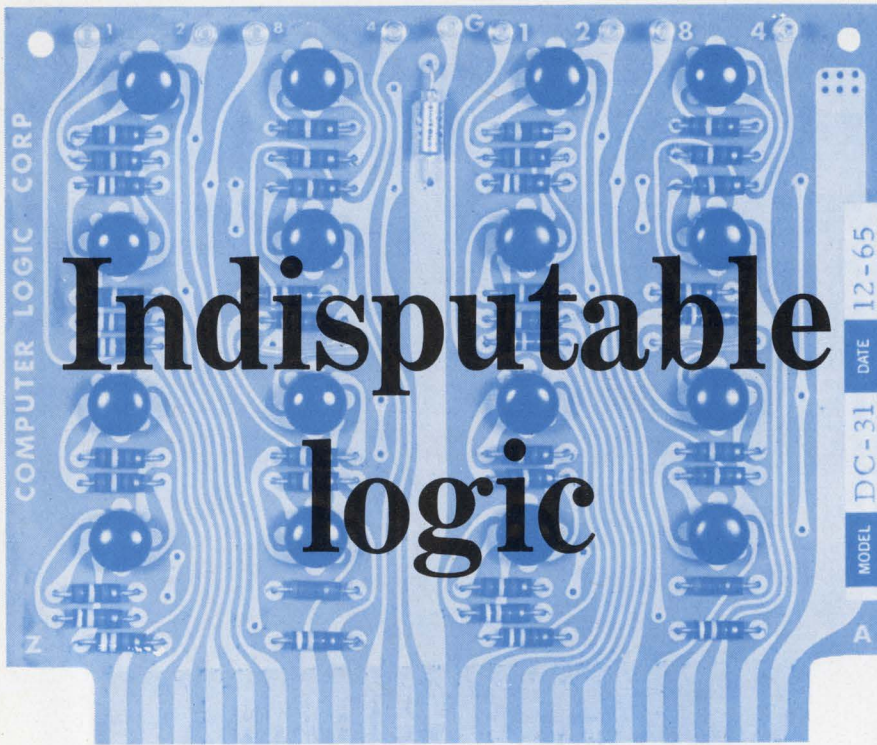

You can't beat Computer Logic Corp.'s complete family of integrated circuit DC to 5 MC DTL cards. So why not join them and put these advantages to work in your system.

**3 times  
greater fan-out,  
greater  
performance  
per dollar**

■ Fan-out is 30 from all sources without power drivers. Why pay for unnecessary cards? You can drive 20 flip-flops and 10 gates directly. How? CLC unit load is only 0.35 ma or less. Thus IC's are loafing well within device ratings. If your fan-out is typically 10, then MTBF jumps 3 to 1 due to lowered internal dissipation.

**Eliminate inverters,  
simplify design,  
pack maximum logic  
in minimum space**

■ Only CLC offers *both* HIGH-NAND and LOW-NAND gates in one IC card family. Your AND-TO-AND, OR-TO-OR, AND-OR, OR-AND gating no longer requires costly inverters. This simplifies design and saves card space and power.

**Higher noise  
rejection,  
greater reliability**

■ Everyone claims good noise rejection at inputs. Ours is 1 volt. But only CLC specifies noise rejection at outputs of 4V. You can wire gate and flip-flop outputs directly together to save more cards. And large output rejection prevents costly noise-chasing during checkout. This adds to reliability as does the low dissipation and 100% final test before shipment.

**Fast delivery  
response**

■ CLC will not be beat on delivery, price, or service. At CLC, it's performance that counts. Write or order directly now.

Silicon and Germanium discrete cards are also available from CLC.



**COMPUTER LOGIC CORP.**

1528 20TH ST., SANTA MONICA, CALIF. 90404/TELEPHONE (213) 451-9754

ON READER-SERVICE CARD CIRCLE 78

## COMPONENTS

### Transponder delay line codes and decodes



Computer Devices Corp., 63 Austin Blvd., Commack, N. Y. Phone: (516) 543-4220. P&A: \$200; 8 weeks.

The model D120 has 28 taps, which have the basic 1.45  $\mu$ secs spacing, and a maximum delay of 25  $\mu$ secs. Characteristic impedance is 180  $\Omega$ . The unit is stable over an operating temperature of  $-40^{\circ}\text{C}$  to  $+71^{\circ}\text{C}$ . Built to military specifications, it has a 6 dB maximum attenuation, and maximum distortion is held to under 8%. The delay line, hermetically sealed and mounted on a plug-in printed circuit board measures 4-3/8 x 5 x 3/4-inches high.

CIRCLE NO. 252

### Microwave tube base has ceramic seal

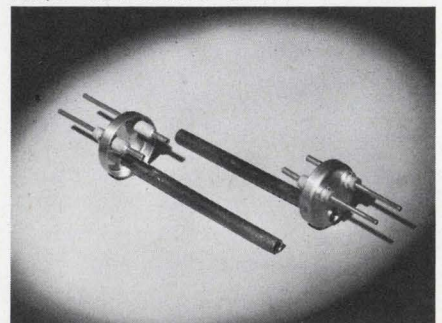

Ceramic International, 39 Siding Pl., Mahwah, N. J. Phone: (201) 529-2800.

These metalized units can withstand a 1000 V breakdown test and will not leak after a 72 hour bake-out  $550^{\circ}\text{C}$ . In the manufacture of the tube base, the nickel tubes, solid at one end, are sealed into the ceramic insulators. Then, the outside diameter of the ceramic is sealed to the nickel tube base. In addition, an evacuation tube of copper is also sealed into the nickel base.

CIRCLE NO. 253

## if your military stack doesn't have this trademark, it's a modified commercial design

And you're taking an unnecessary chance if you use it in a severe environment. Our exclusive design, the SEMSTAK™ militarized stack, is the only one on the market specifically designed for military environments. A proprietary contact design eliminates riser wires between planes and cuts solder terminations by half. The stack is metal, providing excellent heat dissipation and a nominal thermal gradient of only 2°C. No plastic or printed circuit cards are used within the stack.

And we successfully tested it at 30g's vibration at 2000 cycles per second. This is three times more than the requirements of MIL-T-5422E, the current test specification for airborne electronic equipment.

We just printed a handsome new brochure on this compact design. Write or call us and we'll be happy to send you one. Ask for Litpak 4E.

### **electronic memories**

12621 Chadron Avenue, Hawthorne, California  
Telephone (213) 772-5201

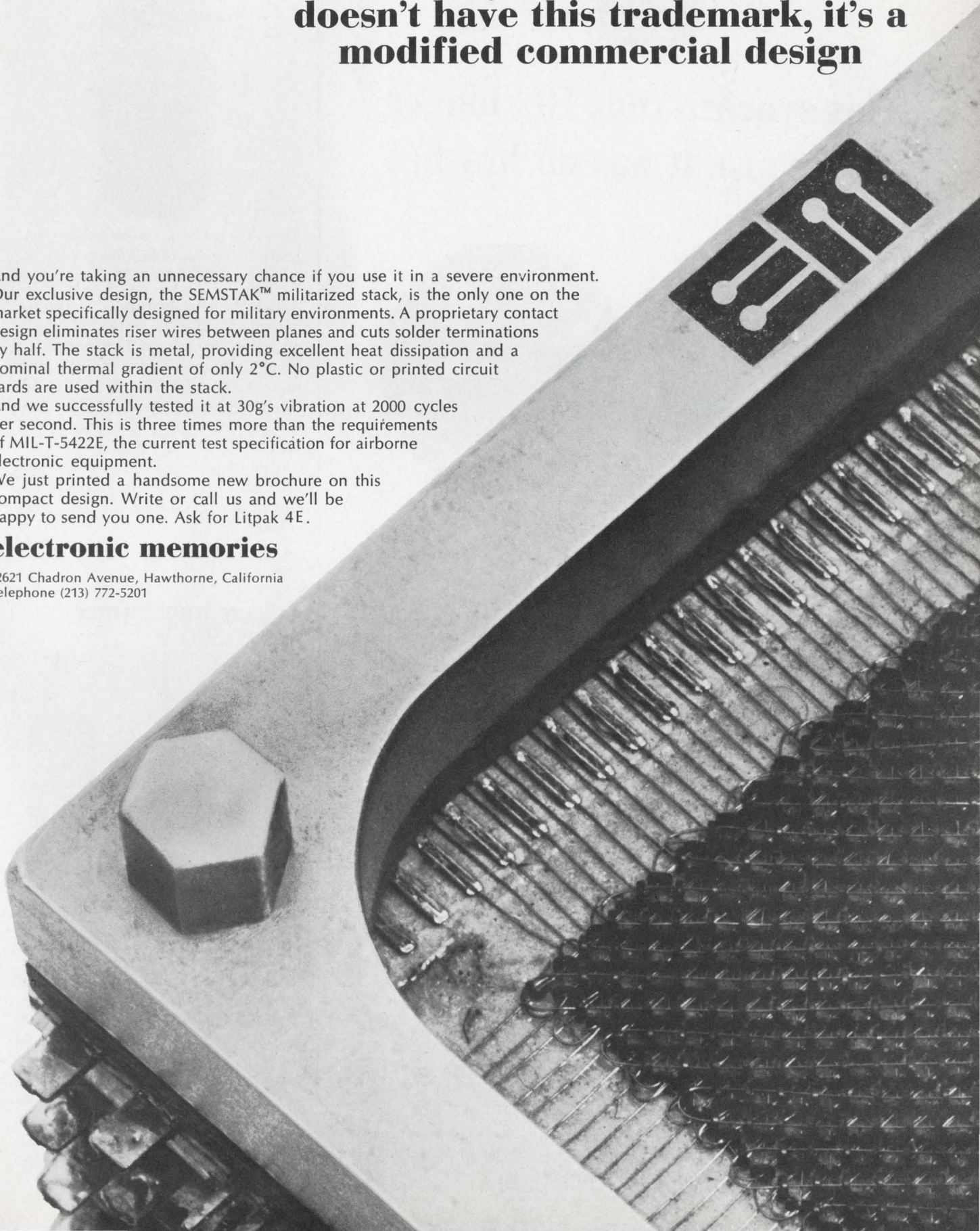



## This synchro runs 10x longer ...because it has no brushes



Brush assembly of conventional synchro after 1000 hours

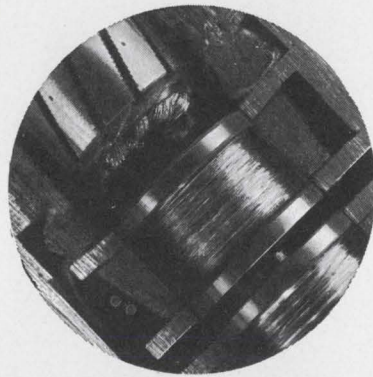

Harowe rotary transformer after 10,000 hours

Harowe Brushless synchros use patented rotary transformers to couple signals to rotors without contact. There are no brushes; no slip rings; nothing to wear but bearings. Operating life averages 10,000 hours in most applications—ten times the requirements of MIL-S-20708.

In avionics systems, brushless synchros are cutting maintenance and stretching hours between inspections. On machine tools, they transmit reliably under slamming vibration—because there's no brush bounce without brushes. In communications gear, they simplify shielding—because RFI is 100 times less without brushes. And in process indicators, they read out more accurately—because synchro friction is  $\frac{2}{3}$  less without brushes.

Harowe brushless synchros come in sizes 8 through 11 as standard, larger sizes as special, for all common functions. Write for complete specs—

 **arowe SERVO CONTROLS, INC.**  
20 Westtown Road • West Chester, Pa. 19380  
Servo, Stepper & Synchronous Motors • Motor Generators  
Synchros • Resolvers • Pancakes • Gearheads

ON READER-SERVICE CARD CIRCLE 80

## COMPONENTS

### Half-inch characters in smaller Nixies

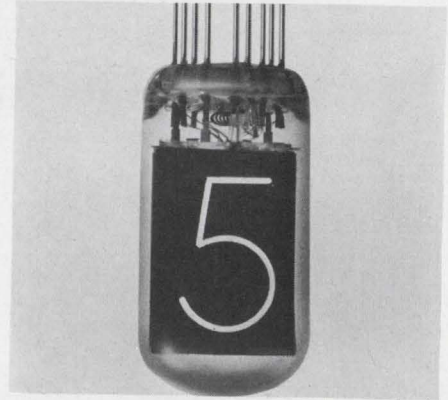

Burroughs Corp., Electronic Components Div., Plainfield, N. J.  
Phone: (201) 757-5000.

This tube features character height of 0.52-inch in the tube bulb diameter of 0.6-inch. This permits a small display while maintaining high readability. The B-5560 is designed to mount upside-down to allow the driving circuitry to be mounted above the readout and the control knobs directly below the tube display. The tubes are designed for mounting on 0.62 inch centers.

CIRCLE NO. 254

### Trigger transformer draws 300 V

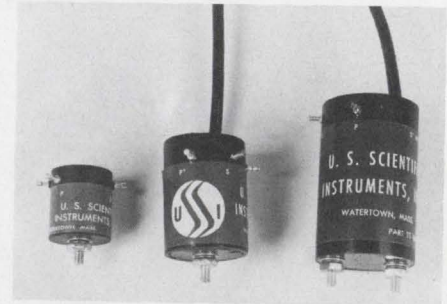

U.S. Scientific Instruments, Inc., 36 Pleasant St., P. O. Box 9, Watertown, Mass. Phone: (617) 923-0940.  
P&A: \$12 to \$25; stock.

Input drive, compact trigger transformers provides coverage of flash tube external triggering. Trigger pulses up to 12 kV, 22 kV, and 42 kV are provided. These units are designed specifically for solid state driving circuitry. Rated outputs are obtained with a maximum of 300 V input drive. All units are vacuum potted in epoxy.

CIRCLE NO. 255

# In less time than it takes to read this page, you could learn to use this new Universal Impedance Bridge.

## Ready? One, two, three, go.

2. Adjust the range switch for an on-scale reading.



3. Obtain a null with the CRL dial. Now, read your measurement.

1. Select the function you want.

Nothing to it. No interacting controls to adjust and readjust. No multipliers. No non-linear dials. AUTO-BALANCE eliminates all that.

This new Hewlett-Packard Bridge is the first one that takes human beings into account as well as impedance. It's made for engineers who don't have time for a half-hour refresher course every time they want to use it.

You get direct digital readout of all C, R, and L values. Indicator lights show up-scale or down-scale unbalance. Decimal point and an equivalent circuit are automatically indicated. No problem with false or sliding nulls either: unique electronic AUTO-BALANCE takes care of that.

For a D or Q measurement, just switch from AUTO to low or high D or Q and turn the DQ control until you obtain another null. Simple. Particularly for low Q and high D cases.

So if you're the kind of engineer who's tired of complicated impedance bridges, Hewlett-Packard has your number: Model 4260A, \$550.

Ask your Hewlett-Packard field engineer for a demonstration. Or write us for complete specs: Palo Alto, California 94304. Tel. (415) 326-7000. Europe: 54 Route des Acacias, Geneva.

**HEWLETT**  **PACKARD**  
An extra measure of quality.

ON READER-SERVICE CARD CIRCLE 81

1844

# Tolerances to $\pm .5$ ohms with this new miniature coax!

Now, here is a new miniature coaxial cable providing extremely tight electrical characteristics and a greatly extended parameters in a variety of applications including low noise amplifiers, microwave transmission, high speed computers, airborne instrumentation and radar.

Offered in three sizes off-the-shelf: .141", .085" and .070" and in random lengths from 12 feet to 200 feet, construction consists of a silver-plated Copperweld inner conductor with a TFE Teflon dielectric and solid copper sheath. Electro-plated silver, gold and tin outer sheaths are also available from stock.

The new miniature coax offers very low attenuation across Gc band, low VSWR, no radiation or performance deterioration at environmental extremes

and maintains impedance despite extreme bends. This latter feature makes it possible to cut, bend or form the coax into coils for the achievement of signal delay or a variety of shapes for the fabrication of special assemblies for RF front ends and amplifiers without problems of loss or coupling to impair reliability.

This new miniature coax has been qualification tested for severe aerospace applications and has performed remarkably well where desired electrical performance cannot be achieved with conventional braided cables.

Why not write today for your free miniature coaxial cable folder which includes actual samples of the coax plus complete descriptive data?

## COMPONENTS

### Solid-state power supply offers 2 or 3 phase

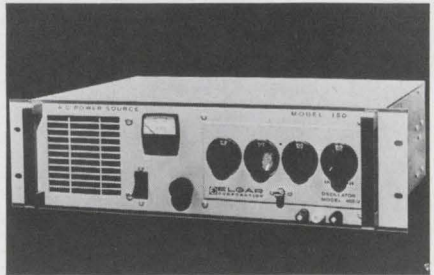

Elgar Corp., 5267 Linda Vista Rd., San Diego, Calif. Phone: (714) 297-3892.

This ac power source is an all-silicon solid-state instrument with output power of 0 to 150 VA, two or three phase. It offers operational flexibility through a family of interchangeable plug-in oscillator modules. The model 150 is designed for continuous operation in powering test equipment for airborne or overseas use, synchronous frequency instruments and also for general laboratory use. The basic power amplifier unit accepts any of 40 standard plug-in oscillators with fixed or variable output frequencies from 45 Hz to 10 KHz; accuracies range from  $\pm 0.1\%$  to  $\pm 0.0001\%$ . Special oscillators are available to provide dual frequency and programmable operation. Output may be shorted indefinitely as the unit recovers immediately when the short is removed. The model 150 is packaged for rack mounting and has front-panel on-off switch, meter, and control for output voltage.

CIRCLE NO. 256

### Trimmer capacitors in two configurations

Erie Technological Products, 12030 W. 12th. St., Erie, Pa. Phone: (814) 456-8592.

The vertical tuning style and the horizontal tuning style both have a diameter of 0.218-inches and occupy .007 cubic inches of space. Each now offers four capacitance ranges, a 5-25 pF tuning range, and the additional ranges of 1.0 to 3 pF, 2.5 to 9 pF and 3.5 to 20 pF. Rated at 100 WVdc to 85° C and 50 WVdc to 125° C, the units operate over a temperature range of -55° C to 125° C.

CIRCLE NO. 257

**PHELPS DODGE** ELECTRONIC PRODUCTS  
NORTH HAVEN, CONNECTICUT

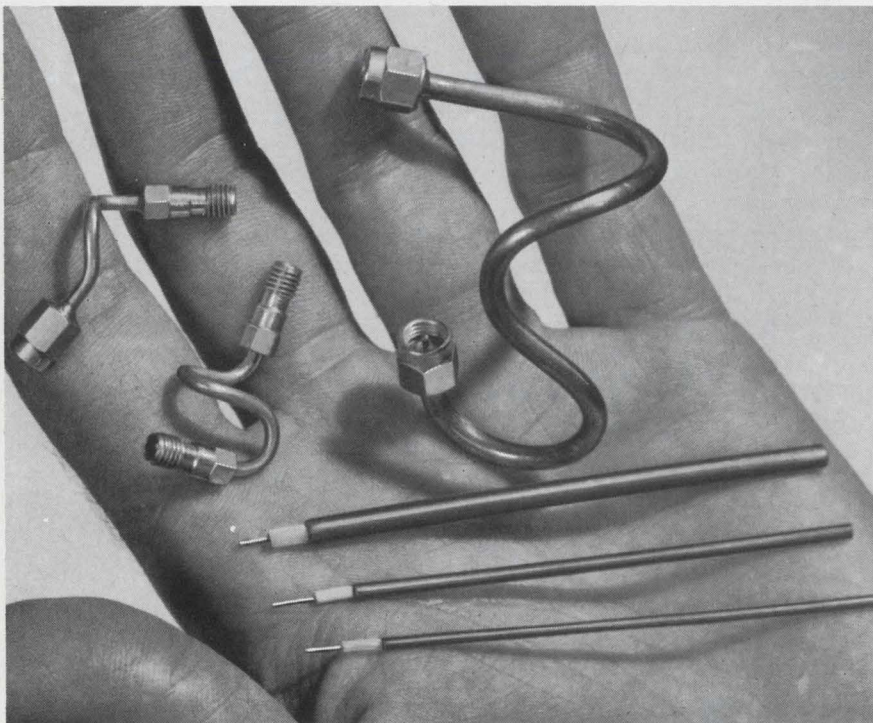

ON READER-SERVICE CARD CIRCLE 82

**NOW  
THERE'S A  
QUALITY  
MINIATURE  
POTENTIOMETER  
THAT'S A**

**SNAP TO USE ...**

The rotary action switch we've added to our Model 3 Potentiometer eliminates the need for a separate switch (or a larger potentiometer — line switch combination) and gives added design flexibility for compact military, instrument and communication applications. The Model 3 was



explicitly designed for these demanding applications. Its enclosed housing makes it impervious to dust, contamination and moisture. In addition to these design features, the Model 3 is available in many styles with wirewound and carbon composition resistor elements for wide applications.

**... SO SWITCH TO IT**

| POTENTIOMETER |           |                                  |   |  |                         |                          |                         | SWITCH              |                            |  |
|---------------|-----------|----------------------------------|---|--|-------------------------|--------------------------|-------------------------|---------------------|----------------------------|--|
| Wattage       | Dia.      | Element                          | Number of Styles Available                | Terminals Available                                      | Constructions Available | Operating Temp.          |                         | Resistance Range    | Type                       | Rating                                 |
| 1/4 & 1/2     | 43/64     | Composition                      | Single                                    | Solder type terminals and PC terminals parallel to shaft | Industrial              | Mil<br>-55° C to +120° C | Ind<br>-55° C to +85° C | 100 ohms to 10 meg. | S.P.S.T.<br>Left End Throw | 1 AMP @ 125V AC-DC<br>4 AMPS @ 20V DC  |
| 1-1/2 & 2     |           |                                  | Dual-concentric shafts, multiple sections |  |                         | Military                 | -55° C to +135° C       | -55° C to +105° C   | 4 ohms to 30 KΩ            | S.P.S.T.<br>Right End Throw            |
|               | Wirewound | Single shafts, multiple sections |   |  |                         |                          |                         |                     | D.P.S.T.<br>Left End Throw | 1 AMP @ 125 V AC-DC<br>4 AMPS @ 20V DC |
|               |           |                                  |   |  |                         |                          |                         |                     |                            |  |



**CENTRALAB** Electronics Division • GLOBE-UNION INC.  
5757 NORTH GREEN BAY AVENUE • MILWAUKEE, WISCONSIN 53201

*For complete information on how our Model 3 product line can make your design problems a snap, use the reader service card. We'll also send you information on our other products.*

capacitors / packaged circuits / rotary and push button switches / potentiometers / technical ceramics / solar cells / semiconductors

ON READER-SERVICE CARD CIRCLE 83

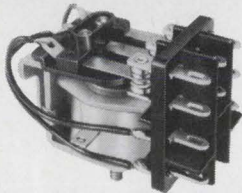
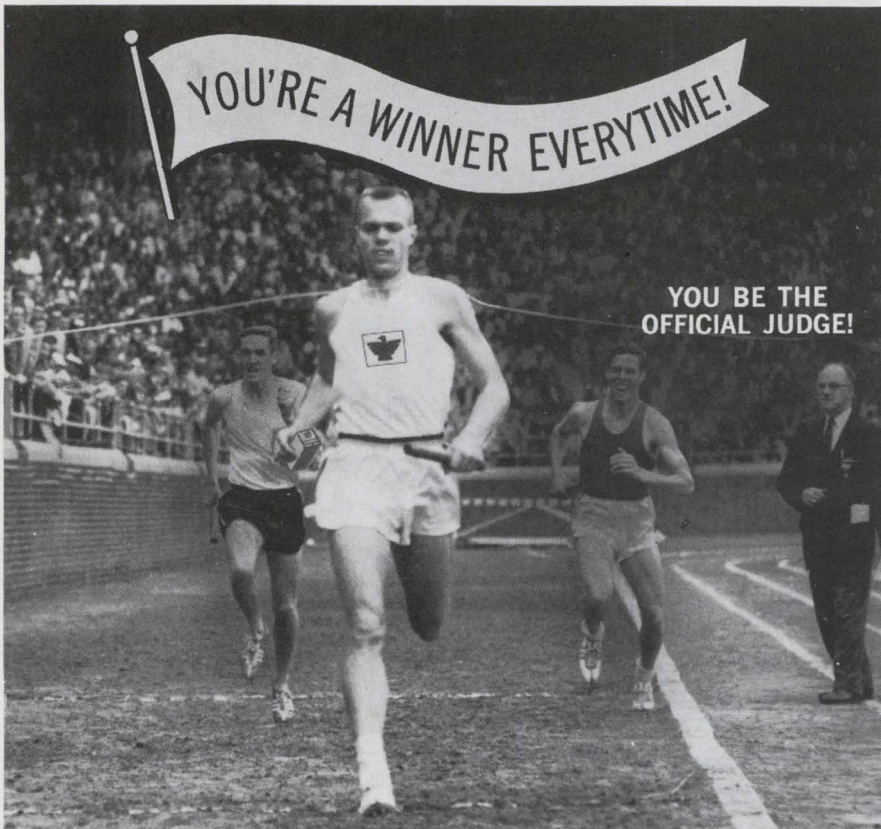

## In "THE GREAT RELAY RACE"

You always come out ahead with Eagle relays. After all, we developed them because we use relays in our other products, and we just couldn't find any relays on the market to meet our standards of reliability.

The chart below shows that we have succeeded in building a better relay.

Now, we ask that you be the official judge! **FREE RELAYS AND OFFICIAL SCORE CARDS** are available for your own test . . . under your own conditions. To receive an official entry blank to the great relay race, contact R. W. Emelander, Eagle Signal Division, E. W. Bliss Company, 736 Federal Street, Davenport, Iowa 52808. Or circle the reader service number below.

| CONTACTS          | COMPETITIVE BRANDS    |                       |                       |                       |                       |                       | EAGLE RELAYS          |
|-------------------|-----------------------|-----------------------|-----------------------|-----------------------|-----------------------|-----------------------|-----------------------|
|                   | "A"                   | "B"                   | "C"                   | "D"                   | "E"                   | "F"                   |                       |
| Arrangement       | 3 PDT                 | 3 PDT                 | 3 PDT                 | 3 PDT                 | 3 PDT                 | 3 PDT                 | 3 PDT                 |
| Rating            | 5 Amp.                | 5 Amp.                | 5 Amp.                | 5 Amp.                | 5 Amp.                | 5 Amp.                | 5 Amp.                |
| <b>LIFE</b>       |                       |                       |                       |                       |                       |                       |                       |
| Mechanical        | 15,061,261 Operations | 14,077,866 Operations | 28,808,000 Operations | 21,625,333 Operations | 16,923,133 Operations | 29,433,600 Operations | 34,492,950 Operations |
| <b>ELECTRICAL</b> |                       |                       |                       |                       |                       |                       |                       |
| 5 Amp. Resistive  | 295,466 Operations    | 490,433 Operations    | 129,600 Operations    | 235,700 Operations    | 778,200 Operations    | 921,400 Operations    | 948,675 Operations    |
| 1.6 Amp Inductive | 488,666 Operations    | 1,071,666 Operations  | 496,000 Operations    | 284,333 Operations    | 3,529,466 Operations  | 1,842,000 Operations  | 3,102,200 Operations  |

These "track records" show that Eagle Relays have a consistently longer life. A 20% greater life than the closest competitor at 5 amps resistive. An almost 70% greater electrical life than the average of the six competitors tested.

Like to prove us wrong? Chances are you're more likely to set a new "track record!"



A DIVISION OF THE E. W. BLISS COMPANY

ON READER-SERVICE CARD CIRCLE 84

## COMPONENTS

### Instrument servo is gearless



Vernitron Corp., Torrance Division, 1742 S. Crenshaw Blvd., Torrance, Calif. Phone: (213) 328-2504. P&A: \$500; 4 to 6 wks.

This remote positioner converts synchro data input to shaft position in 26 V systems. It is contained in a standard BuOrd size 23 synchro housing. This unit weighs 23 ounces. Offering high torque, high accuracy, fast response and high input impedance this gearless servo can be driven by any size synchro transmitter (it requires signal level power only). Torque gradient is 7.5 oz.-inch per degree and peak torque is 3.5 ounce-inch.

CIRCLE NO. 258

### Dual power supply has one knob

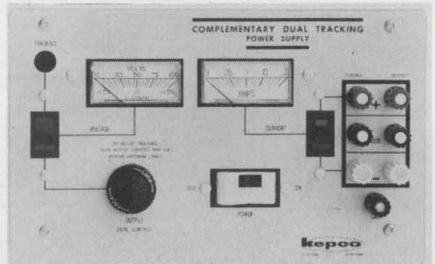

Kepco, Inc., 131-38 Sanford Ave., Flushing, N. Y. Phone: (212) 461-7000.

For balanced loads, op-amps, or circuits requiring a tracked plus and minus voltage this power supply provides balanced plus and minus voltages with ratings of  $\pm 15$  V at 1.5 A,  $\pm 40$  V at 0.5 A and  $\pm 100$  V at 0.2 A, all adjustable from zero to the rated voltage, with a single control. Fully metered, including the current from each section and its voltage, the power supplies may also be used in series.

CIRCLE NO. 259



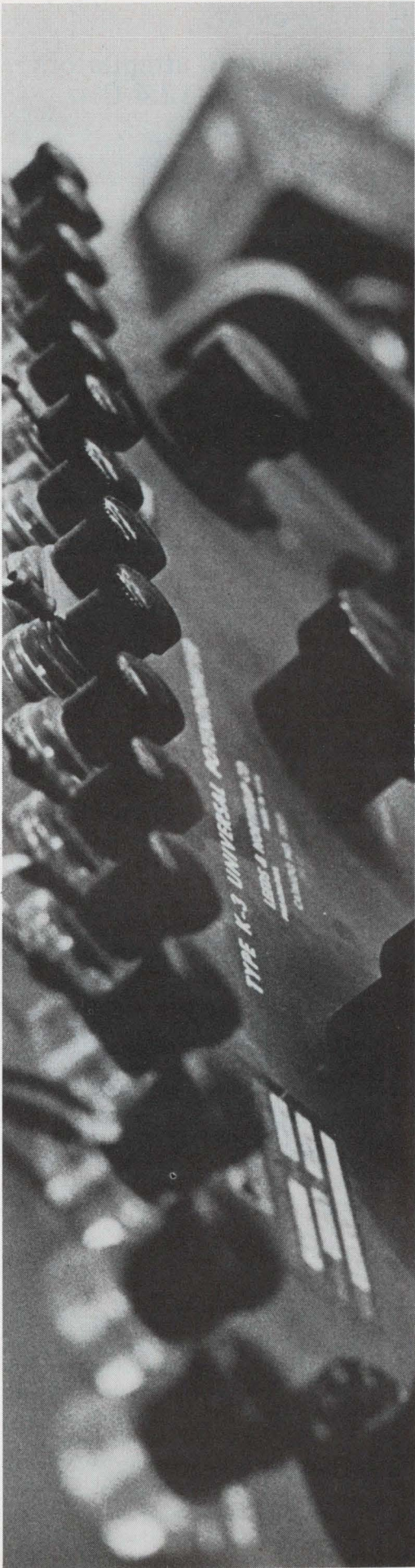

Most complete line  
of reference zeners —  
with stability  
to 0.5 mv/year . . .

### Semcor TCRE's!

Semcor pioneered the first silicon diffused junction TCRE in 1957. And kept right on going and growing. Today, many call its line of precision zener reference elements "the finest, most reliable and complete in the industry." Look it over and you'll agree. Voltage from 6.2 V to 200 V. Temperature coefficient from .01 % / °C to .0002 % / °C. Temperature range as wide as -55°C to +185°C. And long-term stability as low as .5 mv/year. Whether your need is for a standard or custom unit, don't speculate. Get everything you seek in a reference element — plus prompt delivery — by specifying Semcor. A division of Components, Inc. — industry's leader in fair pricing, prompt delivery and superior reliability of electronic components. For full information, see your nearest dealer or write: 3540 W. Osborn Road, Phoenix, Arizona 85019. Phone 602-272-1341.

LONG TERM STABILITY TEST

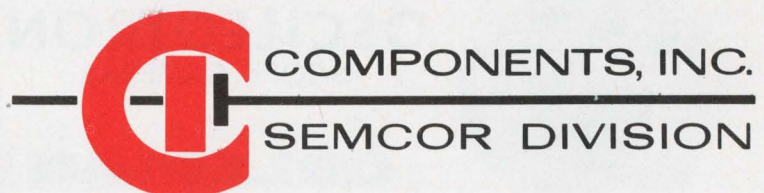
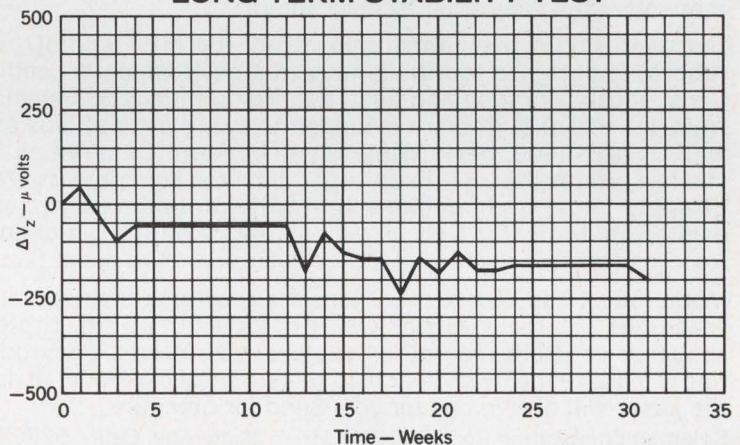

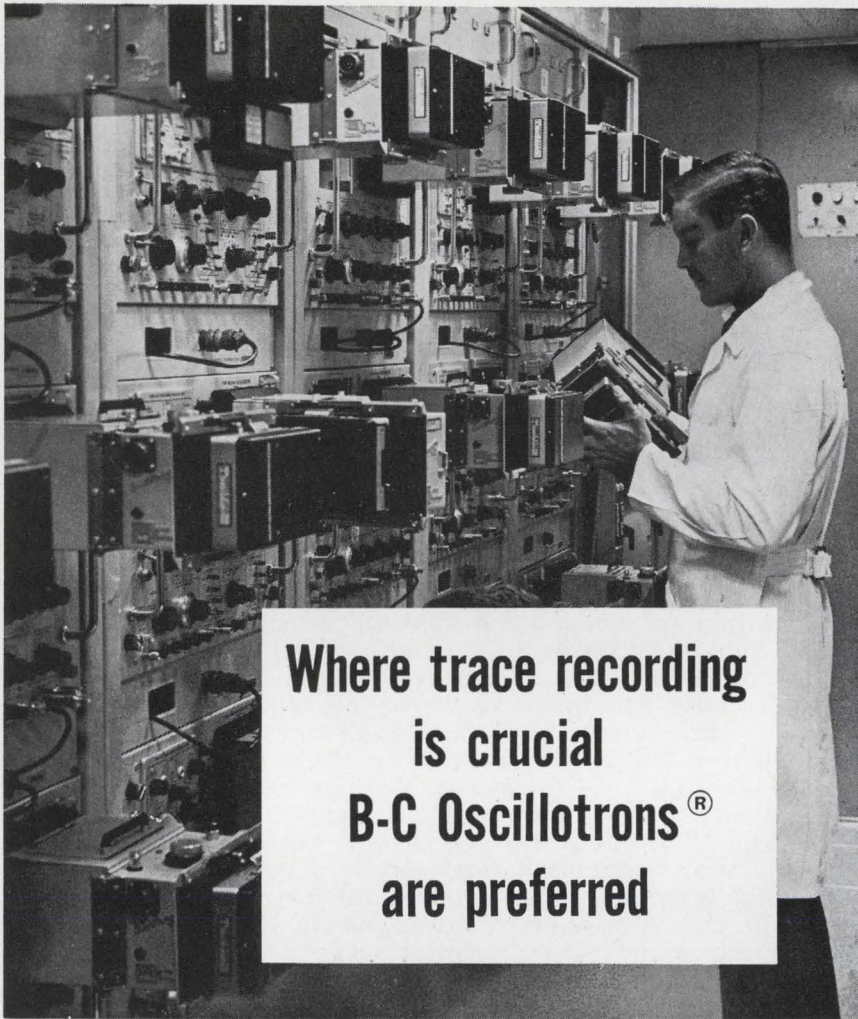

**Where trace recording  
is crucial  
B-C Oscillotrons<sup>®</sup>  
are preferred**

In critical situations where reliable, accurate recording of CRT phenomena is vital, Beattie-Coleman Oscillotrons are specified more often than any other 'scope camera.

For use in field test instrumentation, the MII Oscillotron (above) is designed to withstand severe environmental conditions, shock, vibration and dust. Recording ratio is adjustable from 1:1 to 1:0.5. Camera is hinged to swing away at lens as well as at 'scope, permitting camera mount to serve as a shadow box for the CRT. Result: parallax-free adjustments are possible under high ambient light with minimum phosphor excitation. Indicator light gives assurance shutter is open. Records fast transients with either Polaroid or 4x5 sheet film.

Model 565A has 86mm f/1.2 lens for recording nanosecond traces at 1:1 ratio. Other Oscillotrons for 35mm rapid sequence or streak recording. Whatever your needs, from routine lab use to highly critical field tests, we have a model to do the job or will design one for you. Send for brochure.

Coleman Engineering Co Inc., Box 1974, Santa Ana, Calif 92702

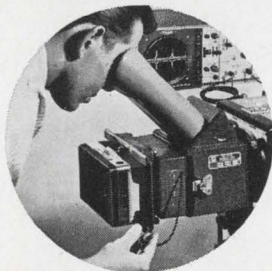

**BEATTIE-COLEMAN  
OSCILLOTRON  
'SCOPE CAMERAS**

**COLEMAN**

ENGINEERING COMPANY, INC.

ON READER-SERVICE CARD CIRCLE 86

## COMPONENTS

### Broadband attenuators from dc to 12.4 GHz



*Omni Spectra, 24500 Hallwood Ct., Farmington, Mich., Phone: (313) 255-1400. P&A: \$80 (1-9); stock.*

The units are available in values of 3 dB, 6 dB, 10 dB and 20 dB with tolerances of  $\pm 5\%$  for attenuation values of 6 dB or greater and  $\pm 0.3$  dB for the 3 dB units. All models are 3/8 inches diameter by 1-1/4 inches in length. The VSWR is 1.20 max. from dc to 4 GHz and 1.35 max. from 4 to 12.4 GHz. Temperature stability is  $10^{-4}$  dB/dB/ $^{\circ}$  C. Maximum average power rating at 85 $^{\circ}$  C is 0.5 W.

CIRCLE NO. 260

### Solid-state delay in module form



*Parko Electronics Co., 1540 S. Lyon, Santa Ana, Calif. Phone: (714) 547-0184. P&A: \$10; stock.*

The module, together with an electromechanical relay, may be used in most applications requiring an electronic time delay relay, or individually as a series element in a relay logic system. Factory preset time delays are available from 100 ms to 90 seconds over an operating temperature range of  $-20^{\circ}$  to  $75^{\circ}$  C. The unit is also available in an adjustable version designed for through-panel mounting.

CIRCLE NO. 261

 DUAL RM930's  DUAL HLT<sup>2</sup>L's   
 DUAL RM709  DUAL RM930's  DUAL HLT<sup>2</sup>L's  
 DUAL RM709  DUAL RM930's   
 DUAL HLT<sup>2</sup>L's  DUAL RM709  DUAL RM930's  
 DUAL HLT<sup>2</sup>L's  DUAL RM709   
 DUAL RM930's  DUAL HLT<sup>2</sup>L's  Dual IC's?

Go to the head of the line!

You'll save 20% when you replace two IC's with a Raytheon Dual. Our line includes the RF 120 and RF 130 HLT<sup>2</sup>L 50 MHz Dual J-K Flip-Flop, the Dual RM709 High Gain Op Amp, and a full complement of RM930 Series Dual J-K Flip-Flops.

All Raytheon RM Duals feature full Military Quality guaranteed over a temperature range of -55°C to 125°C and true hermetic seals guaranteed to 5x10<sup>-8</sup>cc/sec Helium. Raytheon's quality assurance program guarantees a product that exceeds MIL Spec requirements.

For complete information on our line of duals write:  
 Raytheon Company, Semiconductor Operation,  
 350 Ellis Street, Mountain View, California 94040.



# UNMATCHED ACCURACY AND RELIABILITY WITH MIDGI-TRIM<sup>®</sup> 1/2" and 3/8" SQUARE TRIMMERS



MIDGI-TRIM wirewound-square trimming potentiometers are the most reliable and accurate square trimmers available in the industry. They meet or exceed the most demanding requirements of all applicable missile and aerospace specs, including MIL-R-27208B.

MIDGI-TRIM pots are designed with fewer moving parts than most conventional square trimmers. A drive wheel replaces six parts or functions common to other square trimmers and functions as a mechanical actuator, slip ring, spring preload, slip clutch, and positive rotating stop.

MIDGI-TRIM pots feature a stainless steel adjustment screw insulated from the contact mechanism, which makes the case completely non-conductive.

MIDGI-TRIM pots contain precious metal alloys of platinum, silver, and gold, together with low-temperature coefficient resistance material, that provide minimum resistance change over wide temperature ranges.

MIDGI-TRIM pots offer many other features that you can't find in other square trimmers. A new four-page, two-color brochure details them.

Write for yours today — no obligation, of course.

## CONELCO COMPONENTS

Subsidiary of **SYSTRON**  **DONNER**  
CORPORATION

cermet/metalfilm/wirewound/slidewire/multi-element trimming potentiometers

465 WEST FIFTH STREET, SAN BERNARDINO, CALIFORNIA 92401  
PHONE: (714) 885-6847, TWX (910) 390-1157

ON READER-SERVICE CARD CIRCLE 88

## COMPONENTS

### SCR firing circuit all solid-state

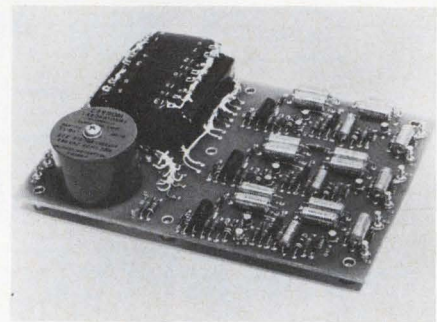

Crydom Laboratories, Santa Ana, Calif. Phone: (714) 540-1390.

A three phase 440-V  $\pm 10\%$ , 47-to-63-Hz input solid-state firing circuit module meets MIL-E-16400, MIL-F-14072, MIL-Std-130, MIL-Std-202 and MIL-Std-454. Calculated mean time between-failure is at least 50,000 hours. The module features hard gate firing, 50- $\mu$ W control sensitivity, high linearity, negative gate bias, and 100-ns rise time to protect against SCR failures.

CIRCLE NO. 262

### Pre-insulated splice cuts through insulation

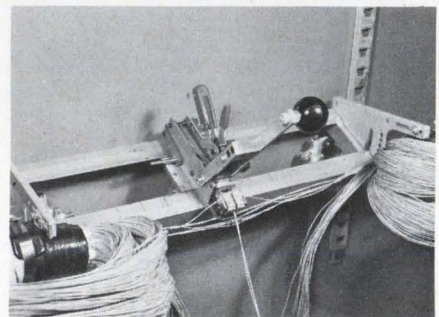

AMP, Inc., Harrisburg, Pa., Phone: (717) 564-0101.

Splicing connectors can be applied at rates of 1400 to 2400 connections in an 8-hour shift. Each connector accepts up to four wires. The unstripped conductors and the splicing connector are placed in the crimping tool. Then the wires are cut to length and forced into position between slotted lances of the connector. Further closing of the handles drives the wires deeper into the slots, which cut through the insulation and make contact with the wire conductor. Used with solid wires from AWG #19 to #26, the connectors make contact with each wire at four points.

CIRCLE NO. 263

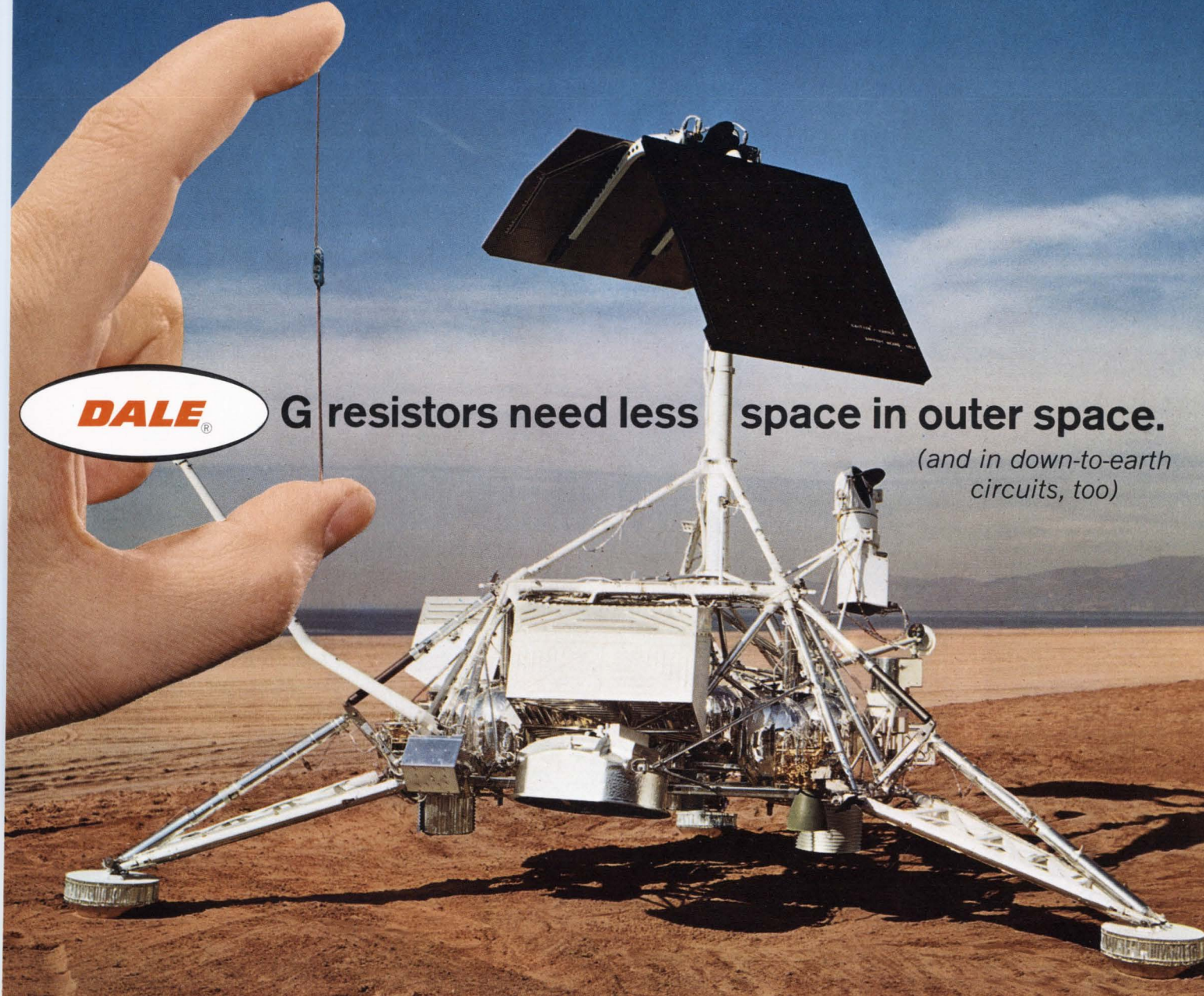

**G resistors need less space in outer space.**

*(and in down-to-earth circuits, too)*

Dale G resistors give you precision power in the smallest packages available. Test them with equivalent size wirewounds and you get 1.4 to 4 times *more* power. Run them at mil power levels and you get stability that can't be challenged. Dale's silicone-coated G Series combines the superior conductivity of beryllium oxide cores with the exclusive wire and wire-winding techniques perfected in the Minuteman High Reliability Development Program. When you need more precision power in less space, or more stability without increasing size—call Dale. Only the G Series gives you this freedom of choice.

**SURVEYOR RELIABILITY**

*demands are met by AGS wirewounds—the established reliability version of Dale's G Series. Supplied to Hughes Aircraft Company, builder of the Surveyor, AGS resistors have a proven failure rate of .000113% per thousand hours (60% confidence level, 50% rated power at 25° C ambient). They are the world's most reliable wirewounds.*

**G SERIES SPECIFICATIONS**

| DALE TYPE | MIL-R 26D TYPE | DALE RATING |       | RESISTANCE RANGES (OHMS) |             |
|-----------|----------------|-------------|-------|--------------------------|-------------|
|           |                | U           | V     | .05%, .1%, .25%          | .5%, 1%, 3% |
| G-1       | RW-81          | 1.0 W       | —     | 10 to 950                | 1 to 3.4K   |
| G-2       | —              | 1.5 W       | —     | 10 to 1.3K               | 1 to 4.9K   |
| G-3       | RW-80          | 2.25 W      | —     | 1 to 2.7K                | .1 to 10.4K |
| G-5       | —              | 4.0 W       | 5 W   | 1 to 6.5K                | .1 to 24.5K |
| G-5A      | —              | 4.5 W       | 6.5 W | 1 to 11.4K               | .1 to 42.1K |
| G-5C      | —              | 5 W         | 7 W   | 1 to 8.6K                | .1 to 32.3K |
| G-6       | —              | 6 W         | 8 W   | 1 to 12.7K               | .1 to 47.1K |
| G-10      | —              | 7 W         | 10 W  | .5 to 25.7K              | .1 to 95.2K |
| G-12      | —              | 10 W        | 12 W  | .5 to 41.4K              | .1 to 154K  |
| G-15      | —              | 15 W        | 18 W  | .5 to 73.4K              | .1 to 273K  |

**MIL SPEC:** G Series resistors meet the requirements of MIL-R-26D as well as the older MIL-R-26C and MIL-R-23379 specifications.

**STABILITY:** G Series resistance shift is less than 50% than that of conventional wirewounds of equivalent size (Dale RS) operated at the same ratings.

**STANDARD VARIATIONS:** G Series resistors are available with radial leads (Type GL) and with non-inductive (Aryton-Perry) winding (Types GN and GNL).

**COMPARATIVE SIZE:**



Dale G-5C resistance element (left) rated at 5 watts compared with conventional RS-5 watt wirewound element.

**For action, call Dale: 402-564-3131. For information, circle 181 for Catalog A.**



**DALE ELECTRONICS, INC.**  
 1300 28th Ave., Columbus, Nebraska 68601  
 In Canada: Dale Electronics Canada, Ltd.



Printed in U.S.A.

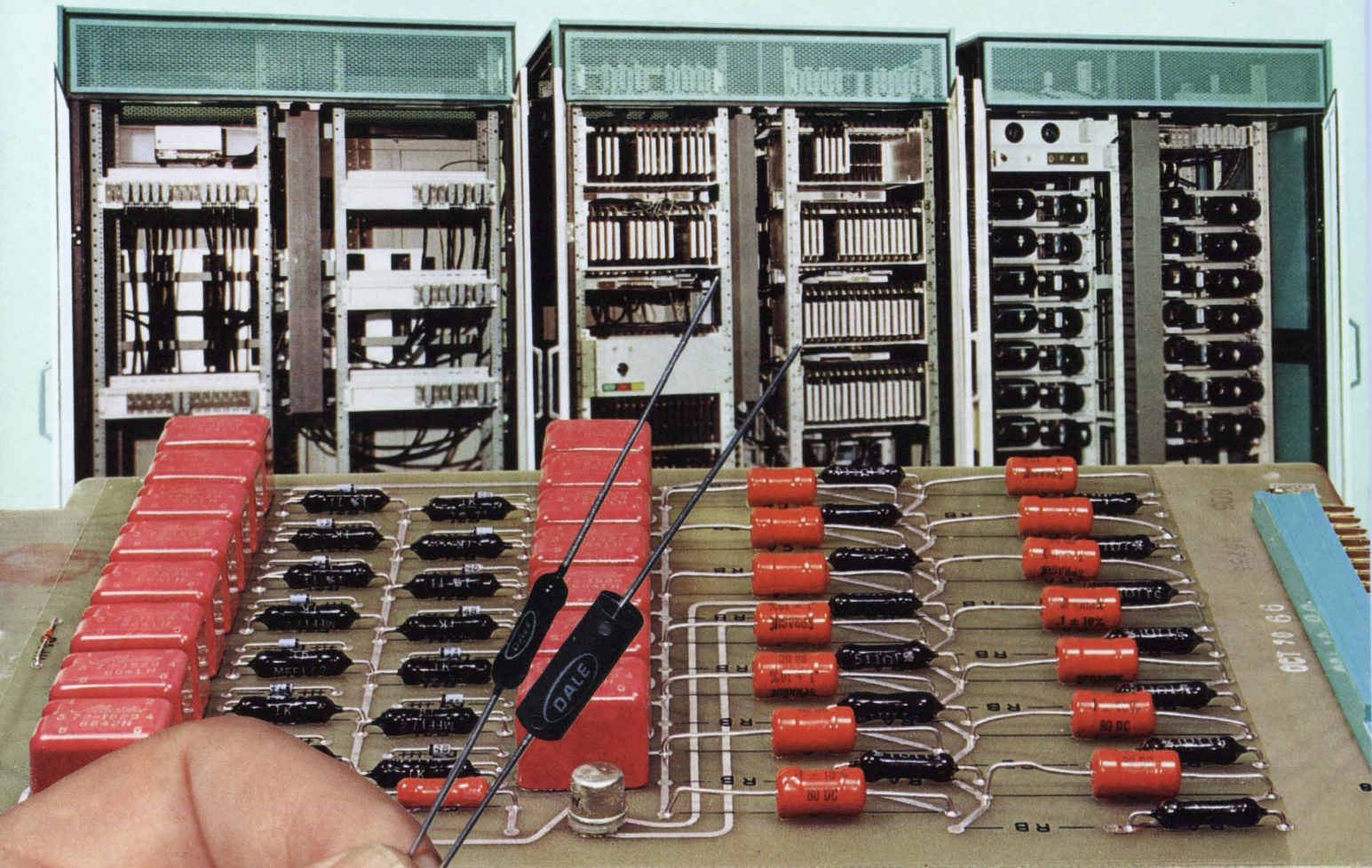

**DALE**

## Metal Film Resistors ...chosen for long life in the Westinghouse PRODAC System

### GENERAL SPECIFICATIONS TYPE MF\* MIL-R-10509F

| DALE TYPE | MIL. TYPE | 125°C RATING<br>(Char. C & E) | 70° C RATING<br>(Char. D) | RESISTANCE RANGE (Ohms) |
|-----------|-----------|-------------------------------|---------------------------|-------------------------|
| MF50      | RN-50     | 1/20 w                        | 1/10 w                    | 30.1 to 80.6K           |
| MF-1/10   | RN-55     | 1/10 w                        | 1/8 w                     | 30.1 to 301K            |
| MF-1/8    | RN-60     | 1/8 w                         | 1/4 w                     | 10 to 1MΩ               |
| MF-1/4    | RN-65     | 1/4 w                         | 1/2 w                     | 10 to 1 MΩ              |
| MFS-1/2   | RN-70     | 1/2 w                         | 3/4 w                     | 10 to 1.5 MΩ            |
| MF-1      | RN-75     | 1 w                           | —                         | 25 to 2.6 MΩ            |
| MF-2      | RN-80     | —                             | 2 wt                      | 100 to 10 MΩ            |

\*Also available in conformal coated (MFF) styles. †Char. B.  
Tolerance: ±1%, ±5%, ±25%, ±10% standard.  
Characteristics D, C, or E apply depending on T.C. required.

Computers for industrial process control demand long resistor life. To insure this, Dale Metal Film resistors are used extensively in the versatile Westinghouse PRODAC System. Value analysis dictated the choice—with the long life characteristics of metal film winning over the lower price of carbon and carbon composition types. Dale verifies this reliability with long-term load life tests (see below). Delivery is reliable, too. Expanded production facilities can put quantities up to 50,000 in your plant in 2 weeks (1% tolerance units). We'll prove it—call 402-564-3131 today.

### NEW METAL FILM LOAD LIFE DATA

Dale MF resistors have undergone 16,320,000 hours of load life testing without a failure (100% rated power, 70°C; failure defined as  $\Delta R > 1\%$ ). Based on these tests, the MF resistor has a proven failure rate of .004% per 1,000 hours (60% confidence at 50% power, 70°C ambient). Write Dale for complete test data.

FOR COMPLETE INFORMATION CIRCLE NO. 181

**DALE**

for optimum value in industrial resistors

DALE ELECTRONICS, INC., 1300 28th Ave., Columbus, Nebr. 68601 In Canada: Dale Electronics Canada, Ltd.

## Variable delay line withstands 600 G's

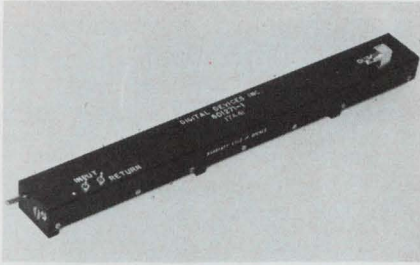

Digital Devices, Inc., 200 Michael Dr., Syosset, N. Y. Phone: (516) 921-2400.

This delay line provides a continuously variable delay between 2  $\mu$ s and 35  $\mu$ s and will operate at frequencies up to 2 MHz. The unit is housed in a milled, o-ring sealed package and has performed in severe military environments, operating from  $-40^{\circ}$  to  $+85^{\circ}$  C, and surviving mechanical shock of 600 g. It is 1-1/4 x 3/4 x 10-inches, and mounting is by threaded #6-32 holes in base. Connectors are solder pins at input, coaxial connector at output. Delay is varied by turning a shaft which protrudes from one end of the case. Normal performance is 167 ns/turn. Linearity is better than  $\pm 0.25\%$ .

CIRCLE NO. 264

## 10 stage photomultiplier 0.75-inch in diameter

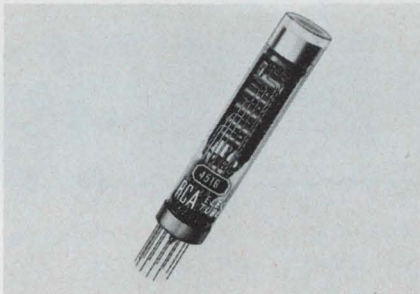

RCA Electronic Components and Devices, Harrison, N. J. Phone: (201) 485-3900.

This tube is a 3/4-inch diameter, 10-stage head-on-type having an overall length, excluding semi-flexible leads, of 3.94 inches. It employs a bi-alkali photocathode, has copper-beryllium dynodes, and features high quantum efficiency, low-dark current, and good time resolution characteristics. The RCA-4516 is intended for compact systems and measurement applications.

CIRCLE NO. 265

◀ ON READER-SERVICE CARD CIRCLE 181

# VICTOREEN HIGH VOLTAGE VACUUM TUBES SOLVE SWITCHING PROBLEMS



Victoreen high-voltage vacuum tubes make ideal components for switching circuits... as series or shunt regulators... as deflection amplifiers... or as inputs to pulse forming networks. Other uses which can capitalize on their superior performance, longer life, and compactness include—dunking, clamping, and crowbar circuits

Tube illustrated above, the Victoreen 6842 pentode with plate voltages to 4 kV, is shown in a typical shunt regulator circuit with two Victoreen Corotron corona type voltage regulators. Other tubes in the Victoreen line include —

- 7683** — Triode or pentode with plate voltages to 1 kV
- VX-80** — Triode with plate voltages to 4 kV
- VX-76** — Pentode with plate voltages to 5 kV
- 7235** — Triode with plate voltages to 10 kV
- 7234** — Pentode with plate voltages to 10 kV
- VX-107** — Beam pentode with plate voltages to 15 kV
- VX-68** — Vacuum high-voltage rectifier with 28,000 PIV; application as rectifier or clipper

8982-A

**VICTOREEN INSTRUMENT DIVISION**  
10101 WOODLAND AVENUE • CLEVELAND, OHIO 44104  
IN EUROPE: GROVE HOUSE, LONDON RD., ISLEWORTH, MIDDLESEX, ENGLAND



ON READER-SERVICE CARD CIRCLE 89

"Another unusual hermetic seal problem?"



STANDARD TYPES AND SPECIALS —

## E-I Glass-to-Metal Seals *more than meet today's highly critical electro-environmental specs*

— IN MILITARY/COMMERCIAL APPLICATIONS!

Service-proven in every type of electrical and electronic requirement, E-I hermetic seals are finding even wider application in the more sophisticated under-sea/aero-space instruments, equipment and systems. These high dielectric strength seals are being produced to meet unusually severe shock and vibration conditions, and wide fluctuations in

temperature and humidity. E-I glass-to-metal terminations offer the advantages of vacuum-tight sealing with maximum rigidity and durability, miniaturization and design standardization. Where custom seals or unusual lead configurations are required, E-I sales engineers will make recommendations from your blueprints, sketches or data.

**Write for the E-I Catalog** — A practical, concise volume edited and compiled for the engineer / designer / specifier. Contains data and specifications covering a diversity of glass-to-metal seals in a wide range of types and sizes, including hundreds of stock items. Please address requests on company letterhead.

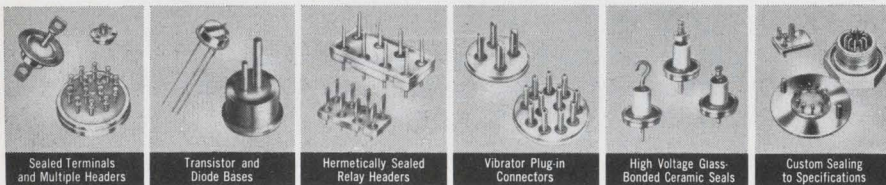

**Electrical Industries**

A Division of Philips Electronics and Pharmaceutical Industries Corp.  
Murray Hill, N. J. 07971 — Tel. (201) 464-3200

Patented in U.S.A., No. 3,035,372; in Canada, No. 523,390; in United Kingdom, No. 734,583; other patents pending.

ON READER-SERVICE CARD CIRCLE 90

### COMPONENTS

#### Rectifier modules handles 10 A

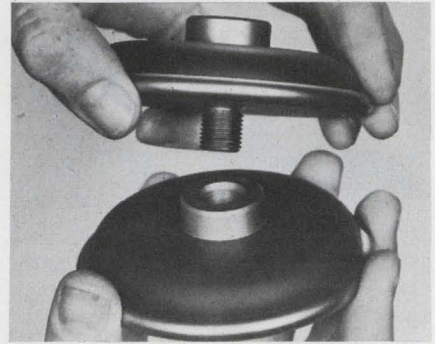

Unitrode Corp., 580 Pleasant St., Watertown, Mass. Phone: (617) 926-0404.

The UG series of high-current, high-voltage "doorbell" rectifier modules has ratings up to 8.25 A in air and 10 A in oil and from 2.5 kv to 10 kv. Modules are available in both regular and fast recovery versions. Each module has individual controlled-avalanche, voidless, glass-sealed, whiskerless junctions. Modules are vacuum encapsulated with high-thermal-conductivity filled epoxy. Each module has threaded connectors for stacking.

CIRCLE NO. 266

#### Modular memory systems fully expandable



Interdata, 17 Lewis St., Eatontown, N. J. Phone: (201) 542-3094.

Expandable, 2 1/2 D core memory modules have read-write cycle time of 900 ns and 1.4 ns. Drivers and readout circuits are included in basic modules of 16 or 18 bits, 2048 or 4096 words, and 8 or 9 bits, 1024 or 2048 words. Input/output signals are zero and five volts; logic levels are compatible with DTL and TTL logic. Standard interface options are available using Interdata logic components including random access address register, data register and control; and also, direct memory access channel control with priority logic.

CIRCLE NO. 267



# NEW

# NPN / PNP HI-QUALITY! HI-VOLTAGE! SILICON TRANSISTORS

*...Attention Designers! Satisfy Your Most Demanding High Voltage Requirements with the Following Premium Devices From...*



## NPN

| TO-5 OUTLINE      | $V_{CER}$<br>$V_{CBO}$ | $V_{CEO}$ | $I_{CBO}$ | $V_{CE(SAT)}$ |
|-------------------|------------------------|-----------|-----------|---------------|
| 2N5092            | 400V                   | 350V      | 500NA     | 0.5V          |
| 2N5095<br>2N5101* | 500V                   | 400V      | 500NA     | 0.5V          |
| 2N5097            | 600V                   | 450V      | 500NA     | 0.5V          |
| 2N5098            | 700V                   | 500V      | 500NA     | 0.5V          |
| 2N5099            | 800V                   | 550V      | 500NA     | 0.5V          |

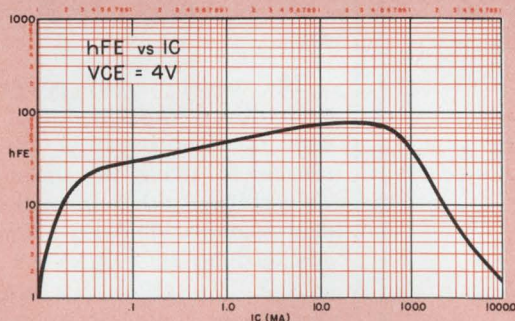

$h_{FE} > 25$  from  $I_C = 1.0$  MA to  $I_C$  100 MA  
\*MD-14 OUTLINE

## PNP

| TO-5 OUTLINE      | $V_{CER}$<br>$V_{CBO}$ | $V_{CEO}$ | $I_{CBO}$ | $V_{CE(SAT)}$ |
|-------------------|------------------------|-----------|-----------|---------------|
| 2N5091            | 350V                   | 300V      | 500NA     | 3.0V          |
| 2N5093            | 400V                   | 350V      | 500NA     | 3.0V          |
| 2N5094<br>2N5100* | 450V                   | 400V      | 500NA     | 3.0V          |
| 2N5096            | 500V                   | 450V      | 500NA     | 3.0V          |

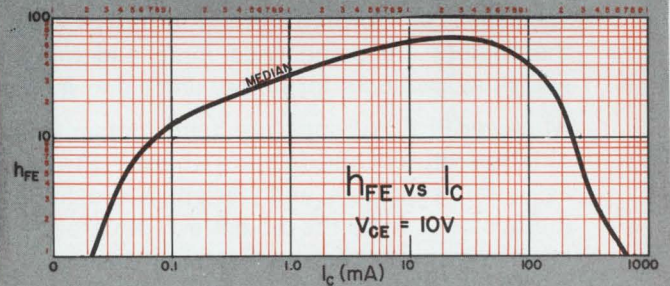

$h_{FE} > 20$  from  $I_C = 1.0$  MA to  $I_C$  100 MA  
\*MD-14 OUTLINE



**INDUSTRO TRANSISTOR CORP.**

35-10 36th Avenue • LONG ISLAND CITY, NEW YORK 11106  
TELEPHONE (212) 392-8000

ON READER-SERVICE CARD CIRCLE 127

VICTORY sets  
the pace  
with

# THERMISTORS

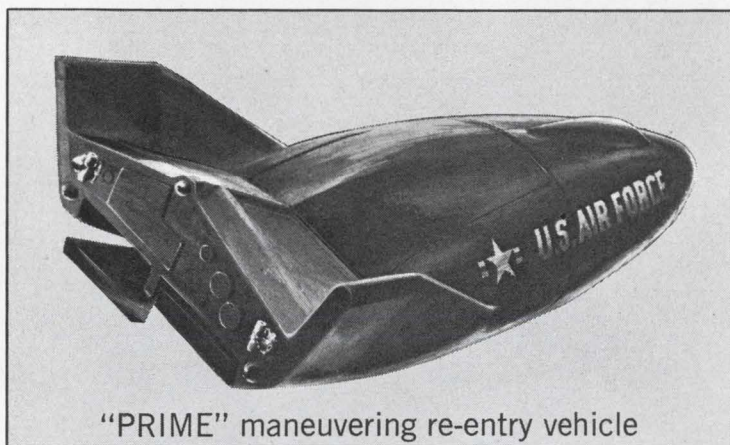

"PRIME" maneuvering re-entry vehicle

Designed by MARTIN MARIETTA for the U.S. Air Force, "PRIME" is a research vehicle which may lead to a generation of lifting body spacecraft which will fly home from space to landings at conventional airports. VECO was recently awarded the "PRIME" Achievement Award for its thermistor contribution to this successfully concluded Air Force program.

There is no denying that PRIME is "way out." However, VECO specializes in "down to earth" thermistor applications. VECO thermistors are being used more and more frequently in every-day products for home, office and industry.

Wherever PRECISE measurement, compensation and control of temperature is needed and where INSTANT RESPONSE is essential, engineers and designers are finding that VECO thermistors can do the job better, with greater reliability and often at less cost than conventional devices.

VECO's engineering staff is available to assist you in the application of thermistors to your products.

Write for Catalog MGP681

VECO First in Progress • First in Service



**VICTORY ENGINEERING CORP.**

Springfield Ave., Springfield, N. J. 07081  
Tel: 201-379-5900 TWX: 710-983-4430

ON READER-SERVICE CARD CIRCLE 128

## COMPONENTS

### Center jack connector eases mating

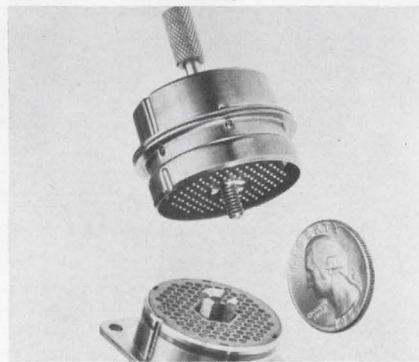

Hughes Aircraft Co., 500 Superior Ave., Newport Beach, Calif. Phone: (714)-548-0671.

This connector utilizes a center jack screw instead of the conventional coupling nut, thus decreasing the wasted space. Increase in contacts per shell over existing connectors ranges from 20% to 30%. Available in environmental, non-environmental, and potting types, the connectors are designed for military, space and computer applications. The new connectors have non-magnetic stainless steel shells and glass-filled diallyl phthalate inserts. They will be available in sizes 8, 10, 12, 14, 16, and 18.

CIRCLE NO. 268

### Digital power supply ranges to 30 kV

Cober Electronics, Inc., 7 Gleason Ave., Stamford, Conn. Phone: (203) 327-0003. Availability: 90 days.

The model G-1367 power source meets the requirements of Mil-E-5400 and is used as the power source to drive advanced direct-view storage tubes in airborne display systems. The six-pound package includes two 13 kV at 1.2 mA and one 2.5 kV at 2.2 mA power supplies as well as digital logic. The digital logic permits the unit to respond to remote commands and provides self-monitoring. A special circuit affords turn-off of 13 kV in a way that overcomes the effects of long (RC) time constants. Regulation is  $\pm 0.5\%$  ripple, less than 0.005%, and 25,000-hour MTBF, assured by the use of microminiature IC's.

CIRCLE NO. 269

# ARNOLD IS

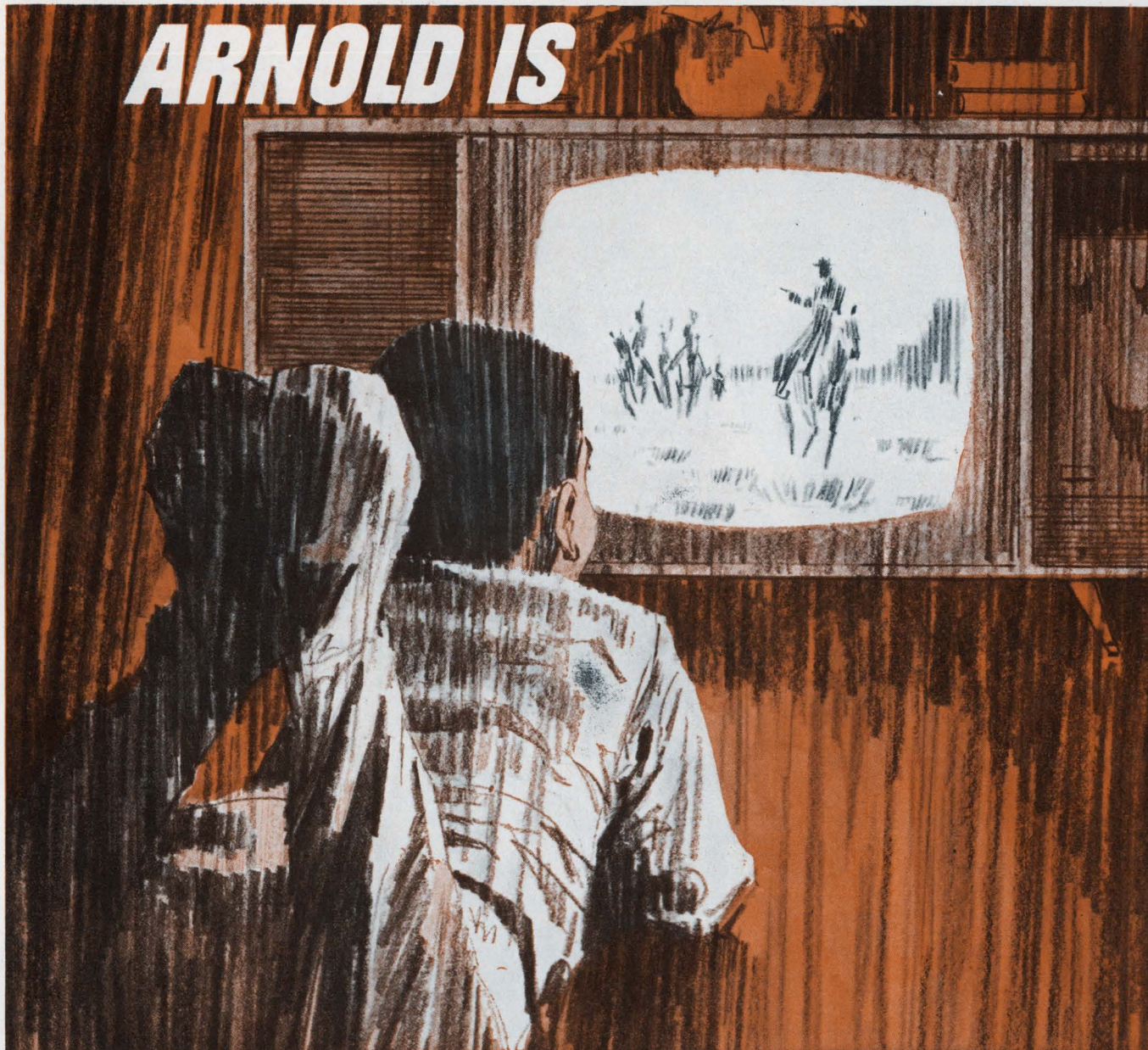

## IRON POWDER CORES

From 5" dia. to Subminiature Toroids

Arnold has total capability across all design configurations—toroids, insert cores, threaded cores, plain cores, bobbin cores, sleeve and hollow cores, cup cores and subminiature toroids. All the necessary raw materials are carried in stock to provide optimum performance over the specified frequency spectrum. Our facilities include the most modern powder processing, pressing, quality control and final test equipment available in the industry.

Call us, write us, TWX us, we can handle any problem.

Arnold is also ■ Permanent Magnets ■ Tape Wound Cores ■ MPP Cores  
■ Magnetic Shielding ■ Electrical Alloy Transformer Laminations ■ Trans-  
former Cans and Hardware ■ Silectron Cores ■ Special Magnetic Materials.

 **ARNOLD**  
SPECIALISTS in MAGNETIC MATERIALS

THE ARNOLD ENGINEERING COMPANY, Main Office: MARENGO, ILL.  
BRANCH OFFICES and REPRESENTATIVES in PRINCIPAL CITIES

ON READER-SERVICE CARD CIRCLE 129

# NEW...

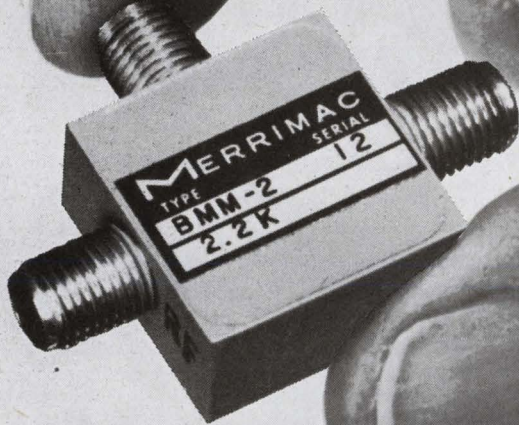

## miniature microwave mixers

The new BMM-2 Series of miniature balanced mixers measure less than  $\frac{1}{4}$  cubic inch and weigh only 12 grams. Their small size was made possible by use of Merrimac's novel ultraminiature hybrid coupler. Various mixers in this series can be supplied from 1 GHz to 5 GHz. The BMM-2-2.2K, for example, covers the 2.1 GHz to 2.3 GHz range. Its noise figure is 6.5 db. These mixers were designed for such applications as telemetry, radar, communications and navigation systems.



**MERRIMAC RESEARCH AND DEVELOPMENT, INC.**

41 FAIRFIELD PLACE, WEST CALDWELL, N. J. 07006 • 201-228-3890

ON READER-SERVICE CARD CIRCLE 130

## COMPONENTS

### Trimmer resistors from $100 \Omega$ to $15 M\Omega$

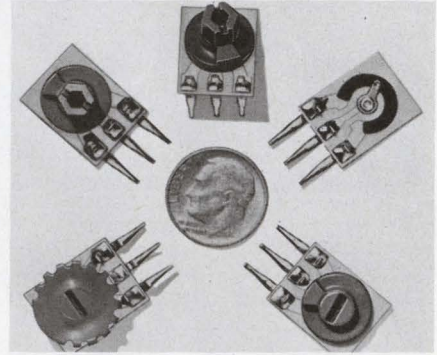

Centralab Electronics Division of  
Globe-Union Inc., 5757 N. Green  
Bay Ave., Milwaukee. Phone: (414)  
962-9200.

Rated at  $\frac{1}{4}$  W per section at  $70^\circ\text{C}$ , these trimmers offer resistance values ranging from  $100 \Omega$  to  $15 M\Omega$ . The maximum voltage is 350 V; this voltage may be exceeded in special applications. The unit is built upon a base plate of alumina to provide head dissipation. Thickness of the plate is 0.025 inch. The carbon composition resistance is bonded directly to the plate. In addition to variable resistors, units can be supplied with fixed resistance. Multiple units with two, three or four sections are also available. Leads are furnished in three tab styles for insertion into printed board, chassis-wire leads are also available.

CIRCLE NO. 270

### Hybrid FET op amp self-stabilizing

Zeltex, Inc., 1000 Chalomar Rd.,  
Concord, Calif. Phone: (415) 686-  
6660. P&A: \$90; 2 weeks.

A subminiature differential FET op amp of hybrid IC construction permits installation without the need for external stabilizing networks. In contrast to conventional monolithic chip amplifiers, the cube has a constant 6-dB-per-octave roll-off characteristic. It requires only the addition of input and feed back components to become operational. Dc open loop gain is 200,000 (typical); voltage drift,  $20\mu\text{V}/^\circ\text{C}$  max; input impedance  $10,000 M\Omega$ ; common mode rejection 5000:1. Output capability is  $\pm 10$  V at 4 mA with shortcircuit projection.

CIRCLE NO. 271

...AL, Engineering degree...  
 ...such as plant layout...  
 ...bonding, equipment er...  
 ...test evaluation and meth...  
 ...Starting salary to \$12,000

**URGIST-PROJECT: PR...**  
 ...SING. Familiarity with cer...  
 ...t high alloy grades. Dev...  
 ...evaluate new process...  
 ...rol of strip, gage, etc. Spa...  
 ...rience. LOCAL \$11,100

**STANT CHIEF METALL...**  
 ...T. Processing ni-alloy...  
 ...perature product from ne...  
 ...uch rolling, forging...  
 ...ding to produce nece...  
 ...chanical physics and met...  
 ...al properties. LOCAL \$11,100

**TALLURGIST-MELTING: A...**  
 ...EIGN. Work with alloy...  
 ...fractory alloy grades. Cou...  
 ...development or semi-pr...  
 ...n lab. LOCAL \$11,000

**TALLURGIST: Equipment...**  
 ...ure analysis and impro...  
 ...manufacture. Mostly te...  
 ...terials. Requires mecha...  
 ...ins, metallurgy and m...  
 ...of knowledge. LOCAL app...  
 ...\$12,000

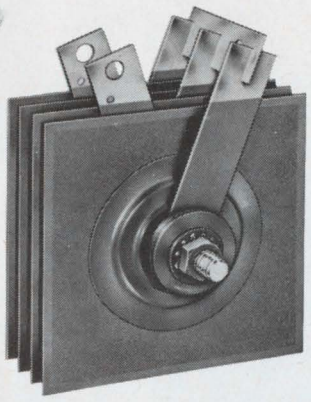

**MECHANICAL DEVEL...**  
 ...Engineering degree...  
 ...Mechanical, 2 or mo...  
 ...experience. Familiar wit...  
 ...ment and processes use...  
 ...forming, stamping, and m...  
 ...of metal parts. Job inc...  
 ...product development and...  
 ...metal fabricator. Sold...  
 ...company. LOCAL Starting...  
 ...\$12,000

**ELECTRICAL: Degree 2 or...**  
 ...years experience in the appl...  
 ...of sensing, measuring and c...  
 ...ing circuits and devices to...  
 ...facturing equipment. Mill...  
 ...ence and. Development gra...  
 ...medium size. LOCAL com...  
 ...starting salary to \$12,000

**CIRCUIT DESIGN EE or P...**  
 ...egree, 3 or more years...  
 ...ence. Circuit design of...  
 ...ensing, measuring and con...  
 ...systems, improv. of them...  
 ...ing, utilizing solid state...  
 ...and. Progressive. LOCAL...  
 ...of larger company. Starting...  
 ...\$12,000

**INDUSTRIAL: Degree, 4-15...**  
 ...experience. Familiar with...  
 ...ing and material handling...  
 ...of specialty areas. Positi...  
 ...product variety and in...  
 ...smaller division of large...  
 ...not a steel firm

# Position Wanted

Capable, handsome, hard-working  
 young rectifier with good references . . .

Designing new circuits? High Density Cells and Stacks produce up to quadruple the current rating with the same size, reduce cell size for given ratings. Replace present units without changing mounting requirements. Inherent Selenium reliability, lower voltage drop and lower initial cost. More information? Send coupon . . .

Send catalog data about 283  
 Syntron Uni-Sel Rectifiers

Name/Title \_\_\_\_\_

Company \_\_\_\_\_

Street \_\_\_\_\_

City, State \_\_\_\_\_ Zip \_\_\_\_\_



Just out!  
 New catalog with full  
 information on Silicon  
 Diodes and Assemblies.



**SYNTRON COMPANY**  
 283 LEXINGTON AVE. • HOMER CITY, PA. 15748  
 TELEPHONE 412-479-8011  
 Sales Representatives Coast-to-Coast

67R10

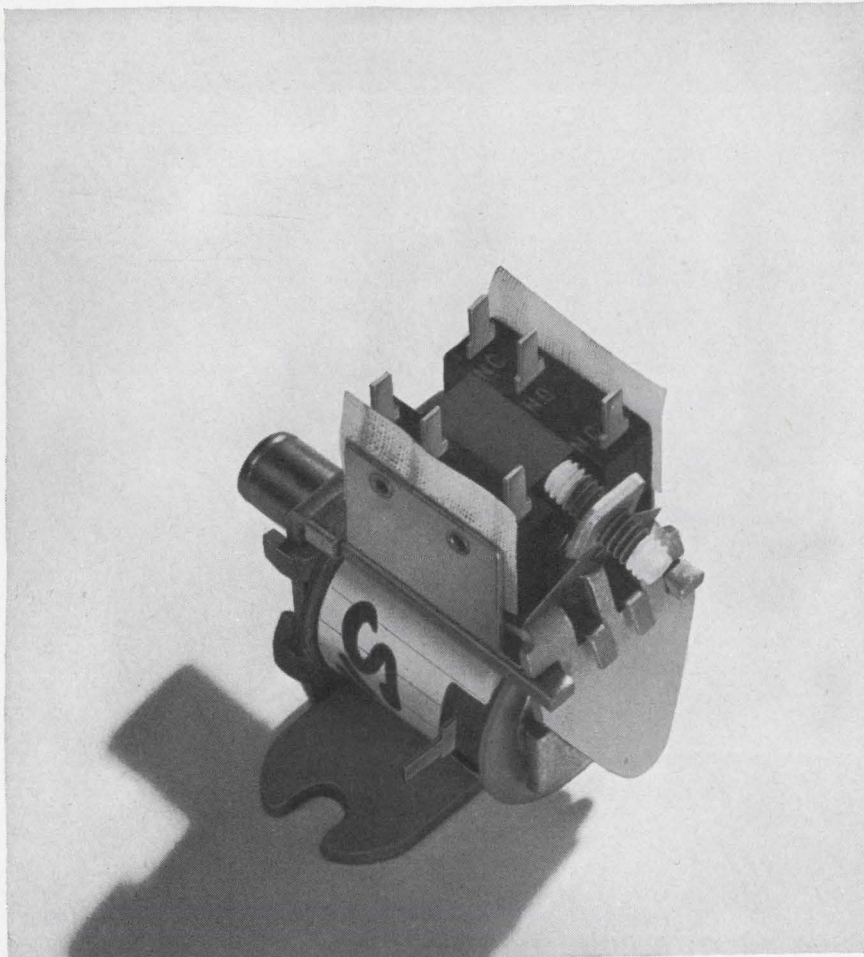

# Little Emancipator

You can often do away with a separate slave relay or lock-in circuitry, simply by using a Heinemann Silic-O-Netic® time-delay relay. Its continuous-duty coil can remain energized indefinitely after actuation, and its SPDT or DPDT contacts are rated up to 5 amps (for the Type B shown). Your saving shows up not only in circuit simplicity but in the remarkably low price of the one relay that'll be doing two jobs extremely well.

The five Silic-O-Netic models offer a combination of fast recycling, good repeatability, and low power consumption—virtues inherent in their hydraulic-magnetic actuation. No thermal elements, and therefore no

“heat-loading” on frequent recycling, and only minor effect on delay from ambient-temperature changes.

We offer sixteen standard timings,  $\frac{1}{4}$  to 120 seconds, with reset time about 25% of the rated delay; coil ratings (for continuous duty, mind you) up to 250 vac or 120 vdc; plug-in models, hermetic models, open-frame and enclosed-contact models. Bulletin 5006—yours for the asking—will tell you all you want to know about these versatile little t/d relays. Heinemann Electric Company, 2616 Brunswick Pike, Trenton, N. J. 08602.



**HEINEMANN**

ON READER-SERVICE CARD CIRCLE 132

## COMPONENTS

### Low pass filter cuts off from 2 Hz to 20 kHz



Data-Control Systems, Inc., East Liberty St., Danbury, Conn. Phone: (203) 743-9241.

The variable low pass filter has a cutoff frequency range from 2 Hz to 20 kHz. The characteristics of this filter may be switched from a 4-pole Butterworth Filter to a four-pole linear phase filter. The error in switching between these two characteristics at any cutoff frequency is 1 dB. The magnitude of the cutoff frequency is controlled by a 4-position range switch and a continuously variable multiplier which is calibrated from 2 to 20. The cutoff frequency depends on the multiple of the particular range and the value of the continuous frequency control. With the frequency control at any fixed value, the error in switching between any two ranges is one-tenth of an octave.

CIRCLE NO. 272

### Quadrature rejector denies at 30 to 1

Control Technology, Inc., 41-16 29th St., Long Island City, N. Y. Phone: (212) 361-2133. P&A: \$135; stock.

The model 324 accepts 400 Hz ac input signals and converts them to phase sensitive dc signals for use in instrumentation and servo systems. The maximum output voltage is  $\pm 20$  V dc. This output voltage is proportional only to the inphase component of the input voltage. The effective quadrature rejection ratio is 30 to 1 minimum. The input impedance of the unit is 19 Kv and the voltage gain is 30. This gain may be externally adjusted. The only power supply for this solid-state unit is 28 V dc and an ac reference. The temperature range is  $-55^{\circ}\text{C}$  to  $100^{\circ}\text{C}$ .

CIRCLE NO. 273

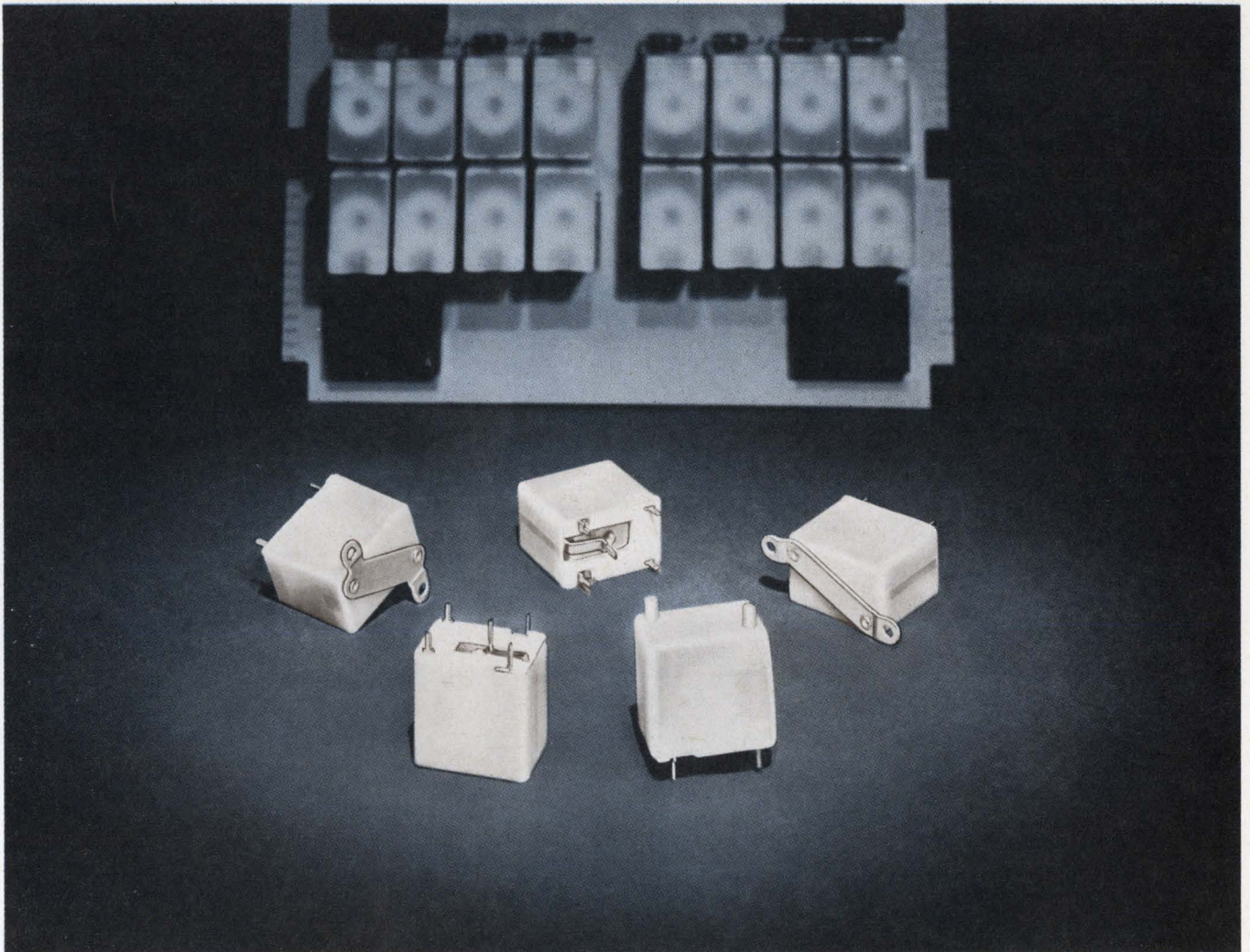

## A new miniature sensitive relay from RBM CONTROLS IT WILL BE COPIED BUT NEVER EQUALED

Reason—RBM CONTROLS has more production and quality control experience and has built more sensitive miniature relays than any other manufacturer in the industry.

The new miniature Type 64 is an isolated contact relay for maximum sensitive applications where reliability, rugged construction and low cost are of major importance. This low level circuit switching relay is designed for compact areas and may be stack assembled in close proximity to each other. A protective nylon cover eliminates physical contamination or mishandling. A variety of mounting brackets are available making this relay the most versatile in the industry.



*Serving Major Markets Since 1921*

# RBM CONTROLS

Division Essex Wire Corporation  
Logansport, Indiana

### ENGINEERING SPECIFICATIONS

#### CONTACTS

Ratings: 28V DC or 115 V AC 1 Amp (Non-inductive)  
Form: SPNO, SPNC, SPDT  
Type: Cross-Bar

#### COIL RATINGS

Maximum—1 Watt  
Minimum—.050 Watt  
Resistance—10,000 Ohms Max.

#### TERMINALS

Contact: To Mount To Printed Circuit Board

#### APPROXIMATE DIMENSIONS

(Overall Including Brackets and Mountings)  
Printed Circuit L 1-3/16" x W 3/4" x H 1-3/8"  
Bottom L 1-3/16" x W 3/4" x H 1-9/16"  
Top L 1-11/16" x W 3/4" x H 1-15/32"  
Parallelogram L 1-3/16" x W 1-7/16" x H 1-15/32"

#### MOUNTINGS

Printed Circuit Board  
Bottom  
Top—Parallelogram Replacement  
Top Mounting Also Available

**RBM**  
STANDARD CONTROLS  
ARE AVAILABLE FROM YOUR  
ELECTRONIC PARTS DISTRIBUTORS

ON READER-SERVICE CARD CIRCLE 133

# What do we know about switches and military relays? We wrote the "books"!

Free: four new catalogs from Cutler-Hammer—  
covering the most versatile line  
of switches and relays in the industry.  
Order the ones you want!

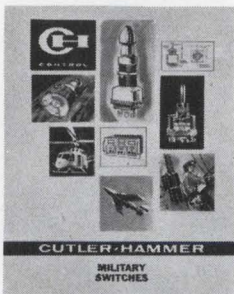

## Military Switches

Here is complete descriptive data on the Cutler-Hammer switch line, designed especially for military applications—everything from push-buttons to "Positive Action" switches (nearly everything that flies uses Cutler-Hammer "Positive Action" switches!).

Reader Service No. 202

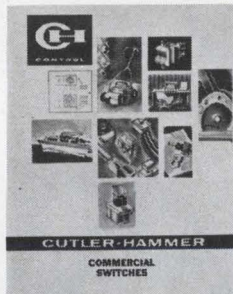

## Commercial Specialty Switches

New 36-page catalog is filled with detailed information on hundreds of switches for every application . . . appliances . . . power and hand tools . . . photo equipment . . . business machines . . . you name it! Truly a buyer's guide for quality switches.

Reader Service No. 203

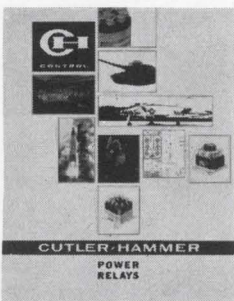

## Power Relays

Here is the book on performance-tested relays designed for electrical control on aircraft, space vehicles, ordnance, ground-support equipment. Contains illustrative photos, engineering data, drawings and ratings on our full line of power relays.

Reader Service No. 204

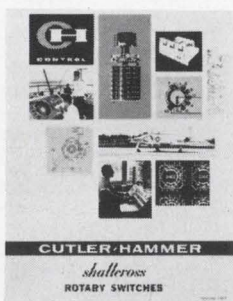

## Shallcross Rotary Switches

A brief but complete booklet on all Shallcross rotary switches. Series 1 (1-inch deck), Series 2 (1 3/4-inch deck), Series 4 (2 1/2-inch deck) round ceramic switches and oval ceramic switches. Includes description, design characteristics and selection tables.

Reader Service No. 205

## COMPONENTS

### Transducers function on 60 Hz level

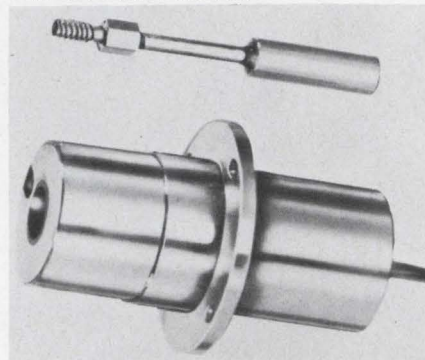

Robinson-Halpern Co., 5 Union Hill Rd., W. Conshohocken, Pa. Phone: (215) 825-1700.

These high sensitivity linear position transducers which provide infinite resolution are available in 20 different models providing ranges of travel from  $\pm 0.010$  to  $\pm 4.0$ -inches. Features of the 230 series are high sensitivity (to 100 mV/mil) and linearity to 0.05%. Long life is assured because there is no wearing of the parts during operation. These transducers are electromechanical transformers that convert the linear displacement of a ferro-magnetic core to an ac output signal by changing the differential flux linkage between windings. For installation ease, a wide variety of mounting options are available.

CIRCLE NO. 274

### FET preamplifier uses 6 V battery

United Detector Technology, P. O. Box 2251, Santa Monica, Calif. Phone: (213) 393-3785.

An internal 6 V mercury battery provides the total power requirements for the amplifier and provides bias voltage for a silicon photodiode or other radiation detectors. It is only necessary to connect the photodiode to the input connector of the model 100 and an oscilloscope or ac-vtm to the amplifier output connector to form a sensitive photodetection system. The internal batteries and completely shielded case enclosure eliminate ground loop hum pickup. Wideband input noise voltage is less than 15  $\mu$ v rms. The input impedance is 1 m $\Omega$ , giving a wideband noise equivalent current input of less than 15 pA.

CIRCLE NO. 275

# CUTLER-HAMMER

Milwaukee, Wisconsin 53201





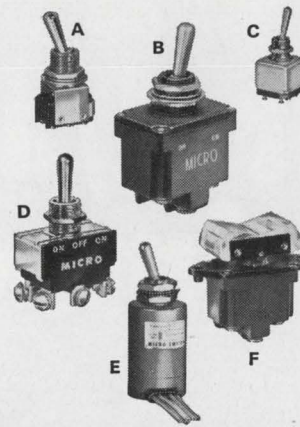

**A AT Series Assemblies**  
—Combine up to 12  
SPDT Switches.

**B TL Series**—Meets  
MIL-S-3950A.  
Momentary, maintained,  
pull-to-unlock. 1, 2, or  
4 pole.

**C TW Series**—Miniature,  
5 amp. SPDT or DPDT,  
2 and 3 position.

**D TS Series**—Up to 25  
amp. 1 or 2 pole.

**E ET Series**—Magnetic-  
hold, remote-release.  
Environment-proof.

**F TP Series**—Rocker-  
actuated, 20 amp. 1, 2,  
or 4 pole.

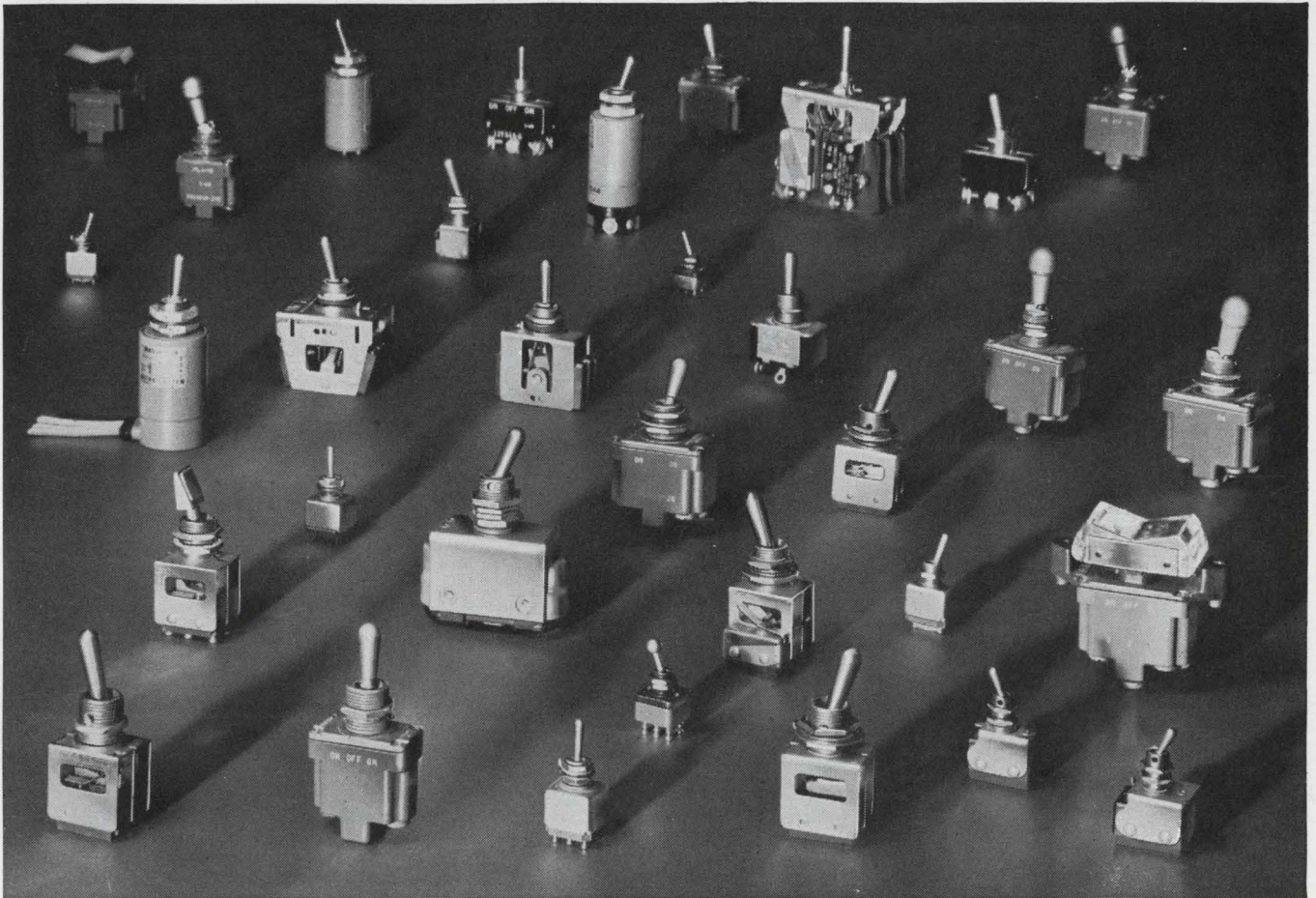

## Here's a little extra design freedom in toggle switches

You are free to select the exact combination of features you need when you look in the broad MICRO SWITCH line. Size, circuitry, capacity and toggle action to answer most any requirement. Special features too, right off the shelf. For example, environment-proof construction, magnetic-hold-in, electric memory and dry circuit capabilities.

You may even pick up some extra design ideas as well—ways to simplify circuit design, combine functions in fewer controls, improve operator efficiency.

Catalog 73 gives details. Call a Branch Office or Authorized Distributor (see Yellow Pages, "Switches, Electric"). Or write . . .

**MICRO SWITCH**  
FREEPORT, ILLINOIS 61032  
A DIVISION OF HONEYWELL

**HONEYWELL INTERNATIONAL**—Sales and service offices in all principal cities of the world. Manufacturing in United States, United Kingdom, Canada, Netherlands, Germany, France, Japan.

ON READER-SERVICE CARD CIRCLE 134

# control/alarm time-cut

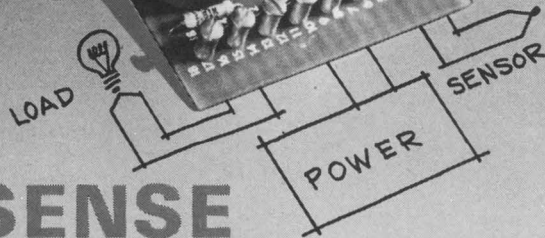

## MAGSENSE

control/alarm for temperature, pressure, speed, flow

**Here's how** to cut the time it takes to solve your control/alarm problem. Hook up sensor, load and power source to a MAGSENSE® control/alarm module and adjust the setpoint. That's it. No time wasted designing and debugging a circuit. And while you're saving time you'll be saving money, getting *proven-in-service* reliability.

**Capabilities?** All MAGSENSE modules offer 100-billion power gain, accept inputs as low as 10 microvolts or 1 microamp *directly* without preamplification. Completely isolated inputs are unaffected by common mode voltages as high as 110vac, 60Hz, or overloads as large as 1000-times full scale input. Typical accuracy is  $\pm 0.5\%$  full scale. And they all

operate from a *single* DC power source (either 28v or 12v).

**Options?** The list includes remote and dual setpoints, adjustable hysteresis, choice of output action, transducer excitation voltage, and cold junction and copper compensation on thermocouple models. There's a MAGSENSE model for your application.

**Price?** Get MAGSENSE control/alarm modules for as little as \$35 in quantity. Compare that with the cost of developing and building your own circuit.

**More information?** Write or call, or circle the reader service number and we'll send you complete specifications and prices.

ANALOG-DIGITAL SYSTEMS DIVISION

**CONTROL DATA**

CORPORATION

4455 Eastgate Mall, La Jolla, Calif.

MAGSENSE Sales, Dept. 205  
Analog-Digital Systems Division  
Control Data Corporation  
4455 Eastgate Mall  
La Jolla, Calif. 92037  
Phone 714/453-2500

ON READER-SERVICE CARD CIRCLE 135

## COMPONENTS

### Dc potentiometer accurate to 0.1 ppm

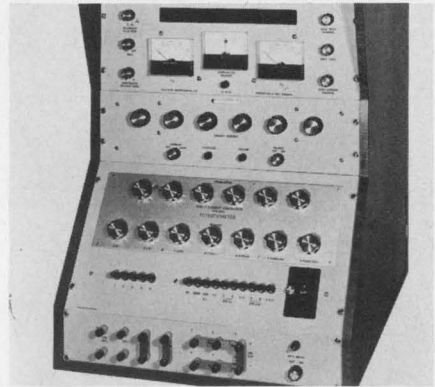

Hallmark Standards Inc., 145 Library La., Mamaroneck, N. Y.  
Phone: (914) 698-8460. P&A:  
\$7890; 120 days.

The current comparator operates on the principle that when the ampere-turns imposed on a magnetic core by current in two windings are equal and opposite, the flux in the core is zero. The zero flux condition is used in a feedback circuit to automatically adjust the current in one winding so that it maintains ampere-turn balance. A constant current source supplies current to a winding in which the turns are variable from zero to 1000 in steps of 1 in  $10^7$  of the total.

CIRCLE NO. 276

### Military relay handles 10 A

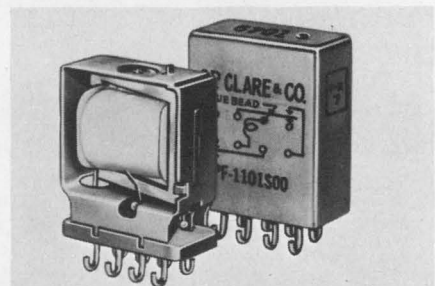

C. P. Clare & Co., 3101 Pratt Blvd.,  
Chicago. Phone: (312) 262-7700.

Incorporating all of the features of Clare F relays, the PF provides contact ratings from low level to 10 A, with an operate and release time of 7 ms and initial circuit resistance of 10 m $\Omega$  (20 m $\Omega$  after 100,000 operations at 10 A, 28 vdc.) The PF is rated at  $-65^{\circ}\text{C}$  to  $+125^{\circ}\text{C}$ , with a vibration of 20 g's peak acceleration, 10-2000 cps, and shock of 50g's half sine wave, 11  $\pm$  1 ms.

CIRCLE NO. 277

**V<sub>CEO</sub> (SUS)**  
**30 TO 250 VOLTS**

A NEW CONCEPT OF POWER

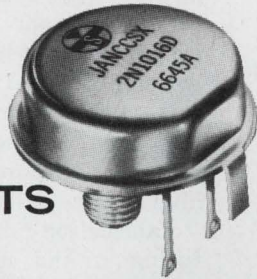

**150 WATTS**  
 AT 45°C

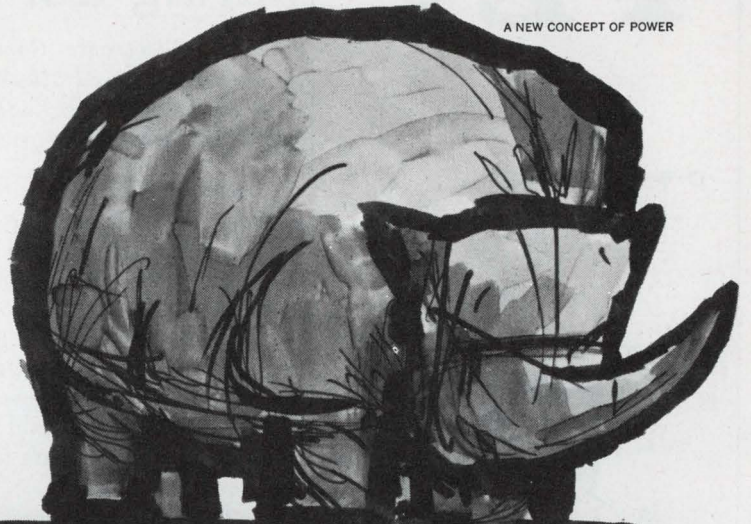

# POWER

These high power diffused silicon transistors in the TO-82 package are also available as JAN devices for your military requirements.

## ELECTRICAL CHARACTERISTICS

(T<sub>c</sub>=25°C, unless otherwise noted)

| CHARACTERISTIC   | TEST CONDITIONS  | 2N1015 SERIES                                  |      | 2N1016 SERIES                                  |      | UNITS  |
|--|--|--|------|--|------|--|
|  |  | MIN.   | MAX. | MIN.   | MAX. |  |
| Breakdown Voltage, Collector to Emitter, BV <sub>CEO</sub> (sus) | *I <sub>c</sub> =100mA, I <sub>B</sub> =0  | 30<br>A-60<br>B-100<br>C-150<br>D-200<br>E-250 |      | 30<br>A-60<br>B-100<br>C-150<br>D-200<br>E-250 |      | Volts<br>Volts<br>Volts<br>Volts<br>Volts<br>Volts |
| Collector Cutoff Current, I <sub>CX</sub>                        | V <sub>CE</sub> =rated voltage<br>V <sub>BE</sub> =1.5V, T <sub>c</sub> =150°C               |  | 20   |  | 20   | mA   |
| Emitter Cutoff Current I <sub>EB0</sub>                          | V <sub>EB</sub> =25V, I <sub>c</sub> =0, T <sub>c</sub> =150°C                               |  | 20   |  | 20   | mA   |
| D.C. Forward Current Gain, h <sub>FE</sub>                       | *I <sub>c</sub> =2 Amps, V <sub>CE</sub> =4V<br>*I <sub>c</sub> =5 Amps, V <sub>CE</sub> =4V | 10   |      | 10   |      |  |
| Saturation Resistance, r <sub>CE</sub> (sat)                     | *I <sub>c</sub> =2 Amps, I <sub>B</sub> =300mA   | 0.3  | 0.75 |  |      | Ohms   |
|  | *I <sub>c</sub> =5 Amps, I <sub>B</sub> =750mA   | Typical  |      | 0.2<br>Typical                                 | 0.5  | Ohms   |
| Base to Emitter Voltage, V <sub>BE</sub>                         | *I <sub>c</sub> =2 Amps V <sub>CE</sub> =4V  | 1.5<br>Typical                                 | 2.5  |  |      | Volts  |
|  | *I <sub>c</sub> =5 Amps, V <sub>CE</sub> =4V   |  |      | 1.7<br>Typical                                 | 3.5  | Volts  |

\*Pulse Cond. 300 μ sec., 2% duty cycle.

Available from stock.

For further information contact your local representative, distributor or

**SILICON TRANSISTOR CORPORATION**



EAST GATE BLVD., GARDEN CITY, N.Y. 11532 (516) Pioneer 2-4100, TWX 510-222-8258

ON READER-SERVICE CARD CIRCLE 136

# VCR FET

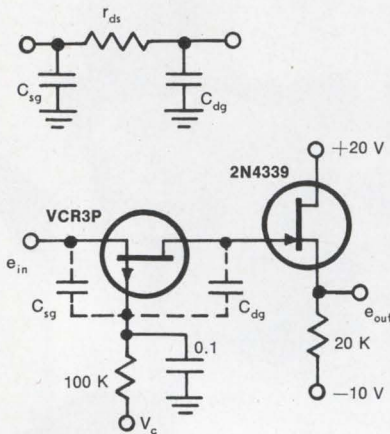

## TUNABLE LOW PASS FILTER

SILICONIX ASSUMES NO RESPONSIBILITY FOR THE CIRCUIT SHOWN, OR DO THEY REPRESENT OR WARRANT THAT IT DOES NOT INFRINGE ANY PATENTS.

Corner frequency of this RC pi-filter is voltage tunable over a 100:1 range. A Siliconix VCR\* has the equivalent circuit—drain resistance and gate capacitances form the pi.  $V_c$  controls the variation by changing  $r_{ds}$ . To change the frequency range... shunt the gate and source with fixed capacitors.

Build this or other circuits with the VCR FET Designer's Kit "DK6"—includes 6 VCR FETs worth \$30—available from your distributor for \$19.50. Check inquiry card or write... we'll be happy to send literature.

\* VCRs are voltage controlled resistors—a new family of FET devices—featuring a variable resistance range of typically 10,000 to 1.



**Siliconix incorporated**

1140 W. Evelyn Avenue,  
Sunnyvale, California 94086  
Telephone (408) 245-1000  
TWX: 910-339-9216

## Complementary MOS ICs bring LSI a bit closer

RCA, *Electronic Components and Devices*, 415 S. 5th St., Harrison, N. J. Phone: (201) 485-3900. P&A: \$17.50; evaluation quantities.

Monolithic n- and p-channel complementary MOS ICs provide one low-cost approach to large scale integration (LSI) of complex functions. RCA's type TA5361 is a dual 3-input NOR gate plus inverter mounted in a 14-lead ceramic dual-in-line package. Reversing power supply and ground connections makes the NOR gate a NAND gate (see schematic.)

The complementary mode of operation provides advantages over both bipolar transistor and single-channel MOS transistor logic circuits. It eliminates the need for multiphase clocks, permitting operation from a single power supply. It provides distinct hard logic levels at ground and power supply voltages, increasing fan-out capability to 50, and greatly reduces power supply requirements because of the low quiescent power characteristic.

The new chip is designed for use in computer memories, calculators, displays and peripheral equipment as well as communications and data

transmission systems.

In most digital equipment only a very small fraction of the digital elements are switching during any given time period. MOS transistors that are connected in the complementary mode of operation offer very significant power saving opportunities inasmuch as all the power dissipated by the circuit occurs during switching and practically none (nanowatts) is dissipated when the circuit is in either the high or low quiescent state.

Fabrication difficulties in diffusing p and n-channel enhancement-type MOS transistors on the same substrate have kept technology on the advanced development level. However, operating circuits with more than 500 MOS transistors have already been fabricated (see page 81).

Complementary MOS processing has fewer steps and requires fewer photo masks than the bipolar process, thus cutting costs and lead times on delivery. MOS transistors are less than one-quarter the size of bipolars, and resistors are not required in complementary circuits. Transistors of opposite polarity take the place of load resistors.

CIRCLE NO. 278

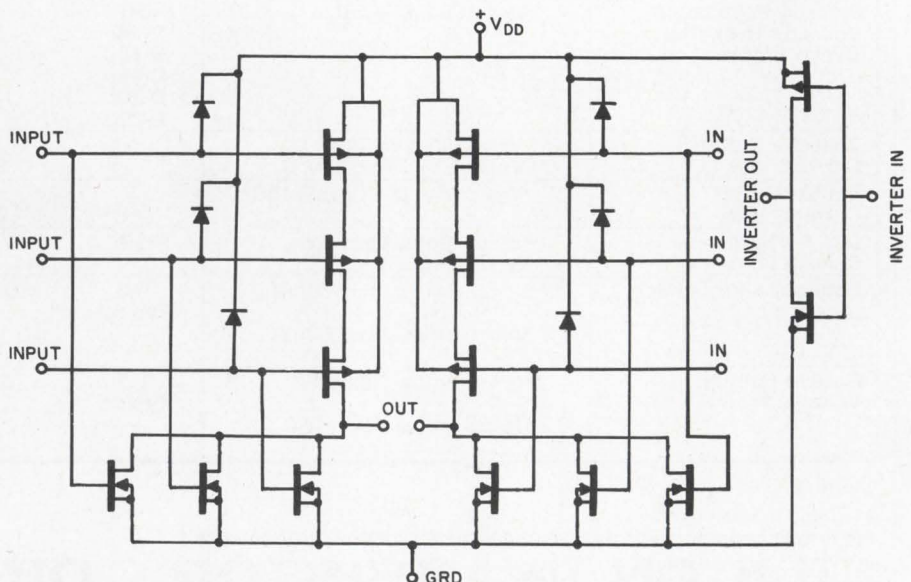

Current cannot flow directly to ground in this complementary MOS array. It dissipates 10 nanowatts when idle and 400 microwatts at 100 kHz.

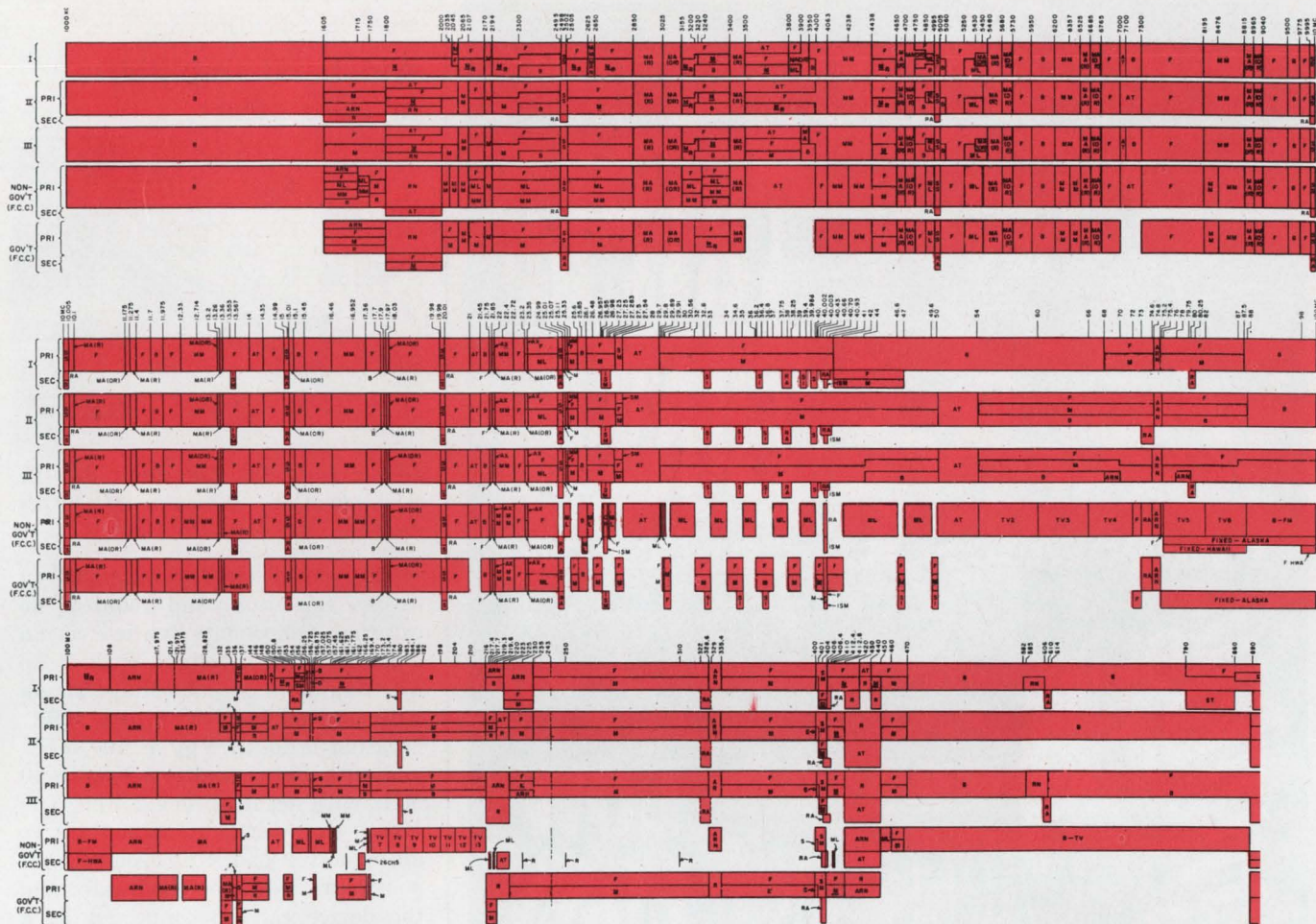

# The HD-1A sweeps this entire spectrum 1000 kHz to 900 MHz

Significant? Yes, because the HD-1A Sweep Generator can thereby replace a half dozen or more instruments at a cost less than most any one of them. It will do the work of a number of signal generators and provide a swept output instead of a single frequency. Its wide range includes an area of the spectrum normally covered by several ordinary sweep generators.

The HD-1A can also be used as a frequency analyzer providing data for frequency identification and stability, signal purity, and signal strength.

And it does all this at a cost of only \$995.00

## SPECIFICATIONS

Center Frequency 1-910 MHz  
Sweep Width . . . 200 kHz-10%  
Output . . . . . .3-1.0v P-P

Source VSWR . . . Below 1.3:1  
Impedance . . . . . 50 ohms  
Flatness . . . . . ± 5%

Catalog #70 includes complete data on the HD-1A, 30 other Telonic Sweep Generators and accessories as well as a complete section on Applications. Write for your copy today.

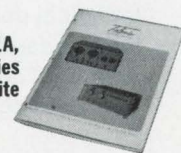

**Telonic** INSTRUMENTS

A DIVISION OF TELONIC INDUSTRIES, INC.  
60 N. First Ave., Beech Grove, Indiana 46107 Tel: (317) 787-3231 TWX: 810-341-3202  
ON READER-SERVICE CARD CIRCLE 138

**μsec/millisecond delays**

**VIDEO**

**5 to 500 MHz**

**MULTI-CHANNEL**

**TRIPLE TRAVEL**

**PROPORTIONAL CONTROL**

**Analog**

**ISOTHERMAL**

**WIDEBAND**

**AMPLIFIERS**

**LOW LOSS**

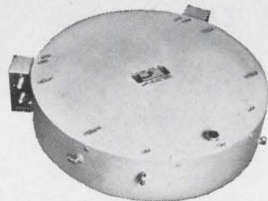
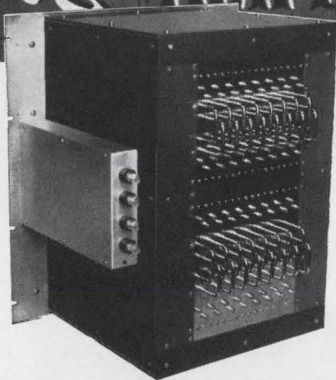

**In a word, LFE**

**for quartz or glass ultrasonic delay lines**

You'll find the complete text — applications information — theory — technical data — specifying information for standard and custom delay lines for your application — in these authoritative LFE Catalog-Handbooks. Get them, now!



**ELECTRONICS DIVISION**

Laboratory For Electronics, Inc.  
WALTHAM, MASSACHUSETTS 02154  
Tel: 617-894-6600 • TWX: 710-324-0681

ON READER-SERVICE CARD CIRCLE 139

MICROELECTRONICS

**Wideband amplifier in TO-5 case**

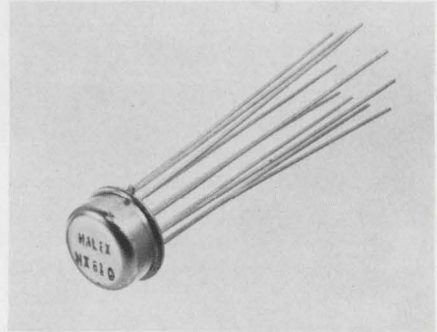

Halex, Inc., 139 Maryland St., El Segundo, Calif. Phone: (213) 772-2545.

The model HX610 has built-in bypass capacitors and requires no external components for use as an amplifier with a voltage gain of 26 dB. Maximum output voltage swing with no load is 20 Vpp to 8 MHz; derating is to 2.5 Vpp at 100 MHz, and with 100 Ω load is 5 Vpp to 40 MHz with derating to 1.2 Vpp. The Hx610 can switch up to 200 mA to an inductive load. Numerous circuit points are available externally and the device can be connected as a flip-flop, monostable multivibrator, phase detector, voltage controlled oscillator, or, by adding a crystal, as a crystal oscillator. By adding an external 150 Ω resistor, unity gain can be achieved.

CIRCLE NO. 279

**Amplifier array uses ICs**

RCA, 30 Rockefeller Plaza, New York. Phone: (212) 265-5900. Price: \$1.50 (1000 up).

An ultra high-gain, wideband IC amplifier array, designed for application in circuits such as remote control amplifiers in TV receivers and in hearing aids, has a gain of 129 dB at 40 kHz. This linear monolithic silicon IC offers opportunity for amplifier compactness with good low-noise performance, high-frequency response and maximum system flexibility. The CA3035 and CA 3035VI arrays consist of three separate amplifiers. Each can be operated independently or in cascade with the others. The gain and bandwidth for each can be adjusted separately with suitable external circuitry.

CIRCLE NO. 280



# Don't risk it!

These wires were subjected to a transient current overload in a normal atmosphere. The insulation smoked, then burst into flame. This won't happen with insulation of Du Pont TEFLON® fluorocarbon resins.

TEFLON will not propagate flame. It is *nonflammable* . . . by all recognized vertical and horizontal flame tests. The point is simply this: for proven reliability you need the combined benefits offered *only* by TEFLON. Nonflammability is just one. Among others: • *TEFLON is rated for continuous use from -450°F. to +500°F. (TFE)* • *Inert to virtually all chemicals and corrosives* • *Provides space and weight savings without sacrificing performance or long-term reliability.*

It comes as no surprise, then, that when reliability is considered, TEFLON answers the need. Its reliability has been proven in use for more than 20 years.

We'd like to send you detailed performance data on nonflammability. Write Du Pont Company, Room 5268, Wilmington, Del. 19898. **TEFLON®...for an extra measure of reliability!**



Better things for better living  
...through chemistry

# Today...the switch is to TECH LABS

For high quality, precision switches designed for long service life, industry turns to Tech Labs. All Tech Lab switches are manufactured for rugged service and exacting performance. They meet all applicable Military Specifications and are available in a wide range of sizes and types to fit your most demanding designs.

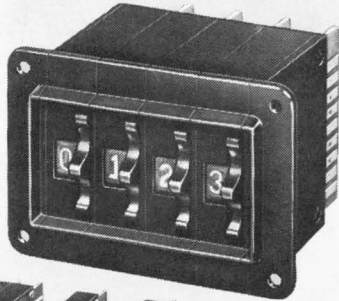

## THUMBWHEEL SWITCHES

A compact, molded, printed-circuit wafer switch for limited space and in line readout. Modular type for either front or back of panel mounting; Modules  $\frac{1}{2}$ " between center lines, height 2". Single or double pole, 10 position, binary or complementary codes, standard. Other codes available on request. Available with adjustable stops.

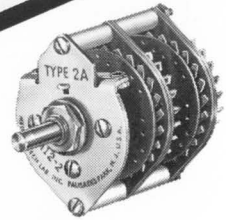
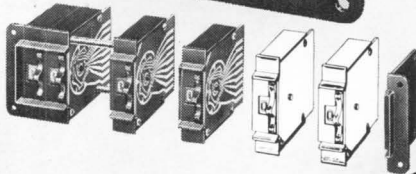

**Type 2A:** An instrument control switch of the highest quality possible with a reasonable price. This switch is a must for all applications where the rating and requirements are high. Rating 5 amp carrying. Size  $1\frac{3}{4}$ " by  $2\frac{1}{4}$ ". Available in all combinations with up to 26 decks and 2 to 26 positions. Has adjustable stop. Solenoid operated if required.

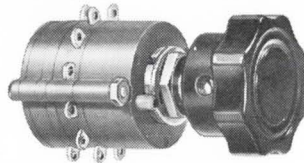

**Type 3A:** A molded miniature switch used in military and commercial applications where space is a premium and a superior switch is required. Can be furnished with up to 8 decks, 12 positions per deck single pole, or 6 positions double pole, adjustable stop. Rating is 5 amps carrying and it can be solenoid operated and hermetically sealed. Only  $\frac{1}{4}$ " diameter.

## TAP SWITCHES

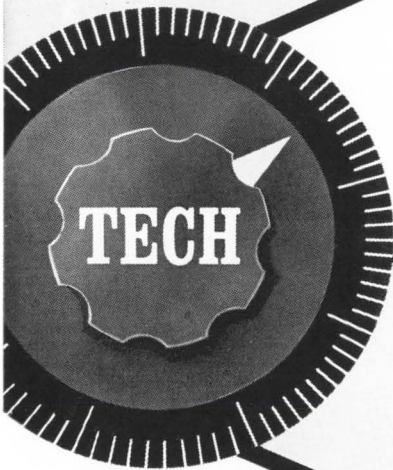

## ATTENUATORS

We also manufacture a complete line of attenuators, both audio and RF. These include potentiometers, ladders, T-pads, H-pads, etc., in many varieties of sizes. Our attenuators are approved by the most particular users in this country.

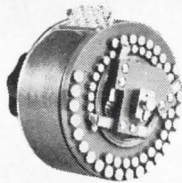

## STEPPING SWITCHES

All our switches can be fitted with a stepping mechanism and can be furnished HERMETICALLY SEALED, EXPLOSION PROOF, if desired. We have built stepping switches with 500 positions per deck.

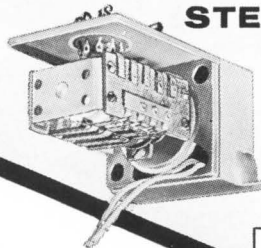

## HEAVY DUTY CONTROL SWITCHES

We manufacture a line of heavy duty control switches in various sizes, which are extremely flexible in the combinations available. These switches are particularly useful where a large number of poles are required.

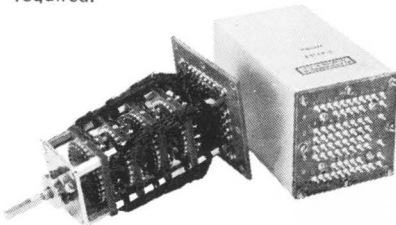
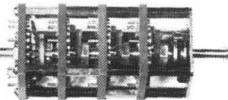

## SPECIAL SWITCHES

When standard switches will not meet the requirement, we design and manufacture special switches to order. Send us your specs.



FREE!

Send today for our 24 page Switch Catalog

Telephone: 201-944-2221 • TWX: 201-947-4730

**TECH LABORATORIES, INC., Palisades Park, N.J.**

ON READER-SERVICE CARD CIRCLE 249



# Here's our best price yet for a high-gain, low-noise 200 MHz (MOS) FET

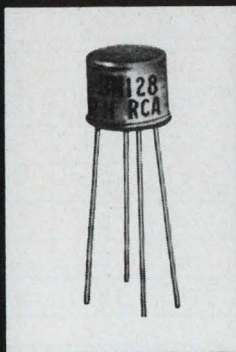

**RCA  
3N128  
is now only  
88¢ (1,000+)**

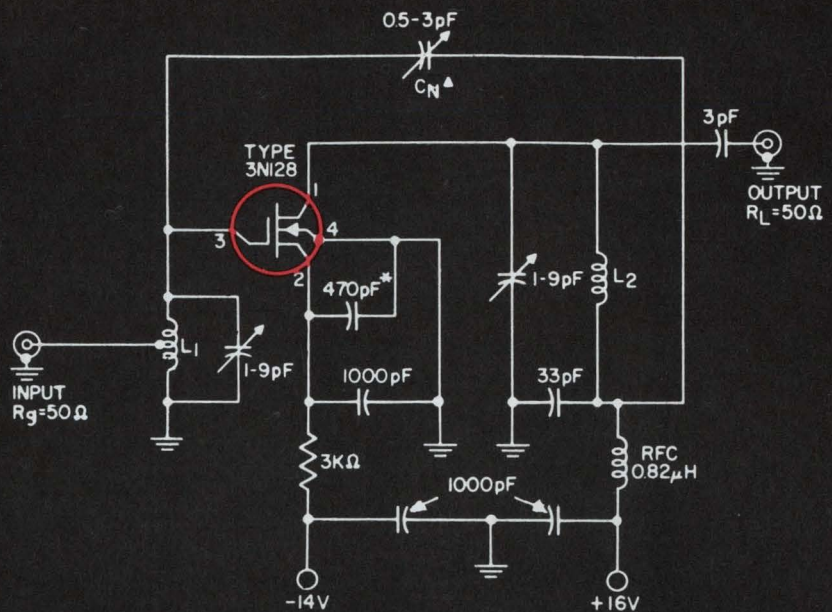

200 MHz RF Stage using RCA 3N128

RCA's 3N128 N-channel, depletion-type MOS field-effect transistor actually offers dynamic range 10 times greater than conventional bipolar transistors. Because of the resulting improvement in cross modulation and spurious response, the 3N128 is recommended as an RF amplifier and a mixer to further improve performance in these areas. You can use standard vacuum-tube-type biasing and AGC requires virtually no power.

Extremely low feedback capacitance (0.2 pF max.) and high transconductance (5,000  $\mu$ mhos min.) allow the 3N128 to deliver more useable VHF power gain without neutralization than a junction-gate FET can deliver with neutralization. Even more stable gain can be achieved with neutralization.

Operation over wide temperature ranges is possible because the extremely low gate leakage current (0.1 pA typ.) is not temperature sensitive. In fact, when you consider the combination of large signal-handling capability, exceptional performance characteristics, and low, low price, the 3N128 is an absolute necessity for critical front-end designs—and for a broad range of industrial, commercial and military applications in instrumentation, controls, and appliances, where high input resistance ( $10^{14}$  ohms typ.) is important.

So call your RCA Field Representative for complete information. For technical literature and application notes AN-3193 and AN-3341, covering RF amplifiers and mixers, write RCA Commercial Engineering, Section EG9-1, Harrison, N.J. 07029. Check your RCA Distributor for his price and delivery.

## RCA 3N128 Features

LOW FEEDBACK CAPACITANCE  
0.2 pF max.

HIGH TRANSCONDUCTANCE  
5,000  $\mu$ mho min.

HIGH POWER GAIN @ 200 MHz  
18 dB typ.

LOW NOISE FIGURE @ 200 MHz  
4 dB typ.

LOW GATE LEAKAGE  
50 pA max.



RCA Electronic Components and Devices

The Most Trusted Name in Electronics

ON READER-SERVICE CARD CIRCLE 140

# Deltron's C SERIES SILICON POWER MODULES

SET A NEW STANDARD FOR MORE REGULATED POWER... AT LESS COST

Model for model... every unit gives more 0.02% regulated power than any other comparable unit on the market

All models adjustable  $\pm 5\%$  about the nominal voltage. All current ratings are for 40°C ambient (operation to 71°C with moderate derating.)

**HOW TO ORDER**  
(typical example of model no.)

**C**    **5-23**

Series    Nominal    Amps  
Volts

Deltron's C Series Silicon Power Modules are available in 300 standard models... the broadest line in the industry. And even though they are priced lower than any others for comparable power, there has been absolutely no compromise on quality or specification excellence. "BE A HERO"... buy Deltron Power Modules... save money for your company... and get the very best in quality.

### DESIGNED TO MEET MIL SPECS

**Reliability:**  
MTBF up to 100,000 hours

**Components:**  
MIL T-27, MIL R-10509, MIL R-11, MIL P-18177, MIL W-16878, Computer equals to... MIL C-62, MIL C-5541

**Environmental:**  
Shock— E-4970, T-4807  
Vibration—T-4807, E-16400  
Humidity—STD-810  
Altitude— E-4970  
RFI-EMI— I-16910, I-6181  
Marking— STD-130  
Quality— Q-9858

### PERFORMANCE SPECS

- .02% Regulation
- 500 microvolts ripple & noise
- Convection cooled to 71°C
- Input voltage: 105-125 VAC; 45-440Hz
- Overvoltage protection—Accessory Crowbar \$30.

### RACK ADAPTER

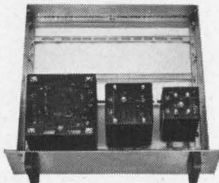

This Deltron Module Rack Adapter lets you create custom power supply packages in just minutes... saving valuable engineering time and money. Price: \$45.00

|               | PACKAGE AA | PACKAGE AB | PACKAGE AC | PACKAGE AD | PACKAGE AE | PACKAGE AF | PACKAGE AF | PACKAGE AG | PACKAGE AH | PACKAGE AI |
|---------------|------------|------------|------------|------------|------------|------------|------------|------------|------------|------------|
| Nominal Volts | AMPERES →  |            |            |            |            |            |            |            |            |            |
| 3             | .8         | 1.5        | 3.8        | 5.3        | 11         | 14         | 20         | 24         | 32         | 36         |
| 5             | .76        | 1.45       | 3.7        | 5.2        | 10.5       | 13.5       | 19         | 23         | 31         | 35         |
| 6             | .74        | 1.4        | 3.5        | 5.2        | 9          | 13         | 18         | 22         | 30         | 34         |
| 9             | .53        | 1.2        | 3          | 4.4        | 8          | 12         | 15         | 20         | 27         | 32         |
| 12            | .53        | 1          | 2.8        | 4          | 7.3        | 10.5       | 15         | 17         | 22         | 28         |
| 15            | .42        | .75        | 2.7        | 3.5        | 6.3        | 10         | 13         | 17         | 21         | 28         |
| 18            | .39        | .69        | 2.6        | 3.2        | 5.8        | 9          | 12         | 16         | 19         | 25         |
| 21            | .35        | .6         | 2.2        | 2.9        | 4.7        | 8.5        | 11         | 14         | 17         | 22         |
| 24            | .34        | .53        | 2          | 2.7        | 4.6        | 8          | 9.2        | 13         | 16         | 20         |
| 28            | .34        | .53        | 1.9        | 2.5        | 4.6        | 7.5        | 9.2        | 12         | 15         | 19         |
| 32            | .22        | .51        | 1.2        | 2.2        | 3.9        | 6          | 8.7        | 11         | 13         | 18         |
| PRICE:        | \$65.      | \$75.      | \$115.     | \$135.     | \$175.     | \$195.     | \$255.     | \$295.     | \$390.     | \$420.     |
| 36            | .21        | .44        | 1.1        | 2          | 3.6        | 5.7        | 7.3        | 10         | 12         | 17         |
| 40            | .21        | .37        | 1.1        | 1.8        | 3.3        | 5.5        | 6.2        | 9          | 12         | 15         |
| 48            | .21        | .35        | 1          | 1.7        | 3          | 5          | 6.1        | 8.5        | 10         | 12         |
| 54            | .21        | .34        | .85        | 1.6        | 2.8        | 4.1        | 6.1        | 7.4        | 8.7        | 11         |
| 60            | .2         | .30        | .75        | 1.4        | 2.6        | 3.7        | 5          | 6.5        | 7.8        | 9.5        |
| 68            | .19        | .28        | .7         | 1.3        | 2.4        | 3.5        | 4.7        | 5.9        | 7.2        | 9          |
| 76            | .17        | .25        | .65        | 1.2        | 1.7        | 3.3        | 4.4        | 5.5        | 6.6        | 8.5        |
| 84            | .17        | .24        | .6         | 1.1        | 1.6        | 3.1        | 4.2        | 5.1        | 6          | 8          |
| 92            | .088       | .23        | .5         | 1          | 1.5        | 3          | 4          | 4.4        | 5.6        | 7          |
| PRICE:        | \$75.      | \$85.      | \$125.     | \$145.     | \$185.     | \$235.     | \$285.     | \$375.     | \$405.     | \$455.     |
| 100           | .088       | .16        | .37        | .58        | 1          | 1.8        | 2.1        | 2.8        | 3.3        | 4.3        |
| 120           | .088       | .16        | .3         | .54        | .98        | 1.7        | 2          | 2.6        | 3.1        | 4          |
| 135           | .084       | .15        | .28        | .52        | .88        | 1.6        | 1.9        | 2.4        | 2.9        | 3.5        |
| 150           | .08        | .14        | .25        | .48        | .81        | 1.4        | 1.8        | 2.1        | 2.7        | 3.1        |
| 165           | .078       | .11        | .23        | .42        | .59        | 1.3        | 1.6        | 2          | 2.4        | 2.9        |
| 180           | .072       | .11        | .2         | .36        | .58        | 1.2        | 1.5        | 1.8        | 2.2        | 2.5        |
| 195           | .062       | .1         | .17        | .33        | .52        | 1.1        | 1.3        | 1.7        | 2.1        | 2.3        |
| 210           | .052       | .09        | .14        | .28        | .5         | .8         | 1.1        | 1.6        | 1.9        | 2.2        |
| 230           | .042       | .07        | .12        | .24        | .46        | .73        | 1          | 1.5        | 1.8        | 2.2        |
| 250           | .026       | .06        | .1         | .21        | .42        | .63        | .84        | 1.4        | 1.7        | 2.1        |
| PRICE:        | \$95.      | \$105.     | \$135.     | \$160.     | \$195.     | \$245.     | \$295.     | \$395.     | \$420.     | \$470.     |

For complete information, write to...

**Deltron inc.**

WISSAHICKON AVENUE, NORTH WALES, PENNA. 19454 • PHONE: (215) 699-9261 • TWX: (510) 661-8061

.....300 DIFFERENT MODELS

# Deltron

RELATIVE SIZES OF  
C-SERIES PACKAGES



AA

3.25" Deep x 3.25" Wide x 4.75" High



AB

4.25" Deep x 4.25" Wide x 4.75" High



AC

5" Deep x 5" Wide x 4.75" High



AD

6.25" Deep x 6.25" Wide x 4.75" High



AE

7.5" Deep x 7.5" Wide x 4.75" High



AF

7.125" Deep x 7.125" Wide x 8.25" High



AG

7.75" Deep x 7.75" Wide x 8.25" High



AH

8.5" Deep x 8.5" Wide x 8.25" High



AI

9" Deep x 9" Wide x 8.25" High

## SEMICONDUCTORS

### Op amp rises in 2 $\mu$ s

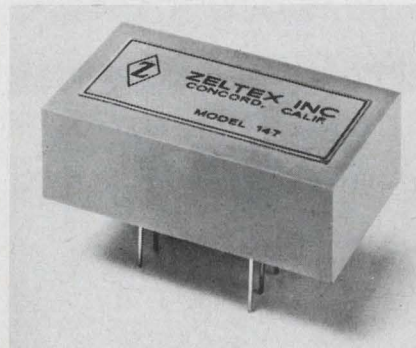

Zeltek, Inc., 1000 Chalomar Rd.,  
Concord, Calif. Phone: (415) 686-  
6660. P&A: \$75; 1 wk.

This single-ended inverting amplifier is for use in analog computation, voltage comparators, high speed integrators, D/A conversion and buffering applications. Settling time is less than 2  $\mu$ s to reach 0.01% of full output when it is used as a 10 K inverter. The model 147 requires a power supply of  $\pm 15$  V dc (10 mA quiescent) and has a rated output voltage of  $\pm 10$  V at 20 mA. The gain-bandwidth is adjustable between 10 and 100 MHz.

CIRCLE NO. 362

### Germanium transistor handles 25 A

Motorola Semiconductor Products,  
Inc. P. O. Box 955. Phoenix. Phone:  
(602) 273-6900. Price: \$2.25 to  
\$2.60.

These transistors have a power handling capacity of 80 to 120 W at 8 A. In addition, they have a current gain of 25 at 8 A, low saturation voltage of 0.6 V at 25 A and a switching time of 9  $\mu$ s at 10 A.

Using the alloy diffused epitaxial construction process, the MP2200A-2400A switch family is ideal for core driver, power conversion and high-voltage switching. Starting with a low resistivity diffused base (for high gain), an aluminum doped emitter is alloyed into the die (for sustained  $h_{fe}$  at high current) to form a comparatively wide base width for good safe operating area. Presence of the diffused structure in the base minimizes the switching losses ordinarily incurred as a result of a wide base width.

CIRCLE NO. 281

# COOL

KLYSTRONS • MAGNETRONS • TRANSFORMERS  
TRAVELING-WAVE TUBES • SWITCH TUBES  
WAVE GUIDES • DUMMY LOADS • LASERS

with New **ELLIS and WATTS**  
**Liquid-to-Air Heat Exchangers\***

One of the new Ellis and Watts Heat Exchangers may be the answer to a need for tailoring a cooling system to your type of electronic equipment. Minimum space, low noise level and optimum performance have been achieved in each of a wide range of designs which include indoor/outdoor types in ratings from 5 to 300 KW. Proved in military, aerospace and commercial applications, these designs offer flexibility for quick modification to meet any specific cooling requirements.

Why not put the widely recognized Ellis and Watts custom-cooling "know-how" to work for you. Write us at the address below.

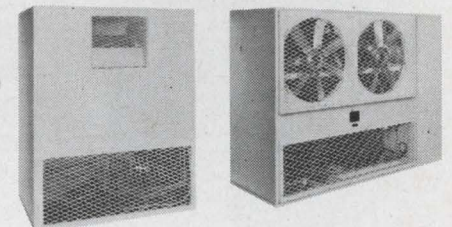

\*Liquid-to-Liquid Heat Exchangers also available.

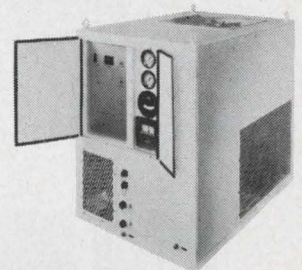

**ELLIS AND WATTS COMPANY**  
Ellis and Watts Company, P.O. Box 36033  
Cincinnati, Ohio 45236

ON READER-SERVICE CARD CIRCLE 142

SEMICONDUCTORS

**Varactor chips  
eight mils thick**

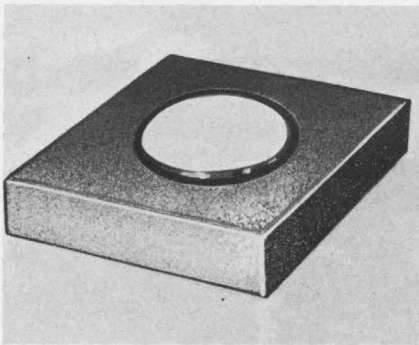

MSI Electronics, Inc., 34-32 57th St., Woodside, N. Y. Phone: (212) 672-6500. Price: \$4.50 to \$16.50.

Eight-mil-thick varactor diode chips are available in capacitance ranges from 3 to 18 pF. The junction contact depends upon the capacitance value, and varies from 0.002 to 0.011 inches diameter. Each chip can dissipate up to 300 mW when suitably mounted for heat dissipation. Operating junction temperature is 150°C, although the chip will withstand temperatures for a short period of up to 400°C.

CIRCLE NO. 282

**Bridge rectifiers  
rated to 2500 V**

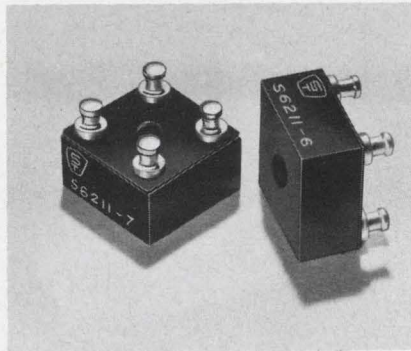

Sarkes Tarzian Inc., 415 N. College Ave., Bloomington, Ind. Phone: (812) 332-1435. Price: \$3.27 to \$8.47.

Insulated-case rectifier assemblies reduce assembly time, since they mount to PC board or chassis with one screw. Terminals are silver-plated brass for easy soldering. The rectifiers are 3/4 inch square and 3/8 inch thick. Electrical ratings include PIVs of 1500, 2000 and 2500 with current ratings of 1.2, 0.8 and 0.6 A for resistive-inductive loads with ambient operating temperatures up to 75°C.

CIRCLE NO. 283

**Silicon rectifiers  
handle 200-A surges**

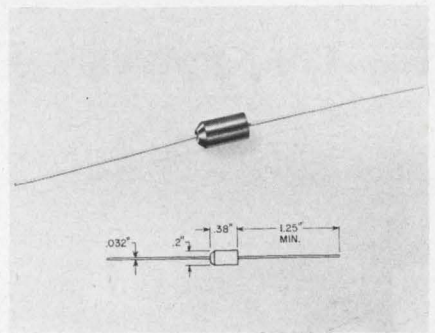

Electronic Devices, Inc., 21 Gray Oaks Ave., Yonkers, N. Y. Phone: (914) 965-4400. P&A: 64¢ (100 lots); stock.

A series of 2-A axial lead silicon rectifiers with a surge rating of 200 A is 0.2 inches in diameter and 0.38 inches long with a transfer molded, void-free body. PIV ratings range from 50 to 1200 V. The 2-A rectifiers replace 7/16-inch units and eliminate heat sinks. They are designed for mounting on component boards or for use as bridge assemblies.

CIRCLE NO. 284

**FREE!** SEND FOR THIS **NEW** COMPREHENSIVE GUIDE TO

**KEYSTONE**

BATTERY HOLDERS  
TERMINALS  
TERMINAL BOARDS  
PRE-PUNCHED BOARDS  
PLUG-IN HOUSINGS  
BUSHINGS  
STAKING TOOLS

designed and manufactured by

**KEYSTONE**

KEYSTONE ELECTRONICS CORP.  
49 BLEECKER ST. NEW YORK, N.Y. 10012  
(212) 476-4600

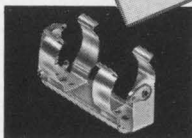

Battery Holders

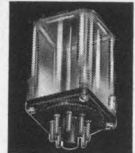

Plug-in Housings



Terminal Boards

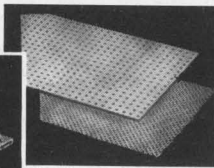

Pre-Punched Boards

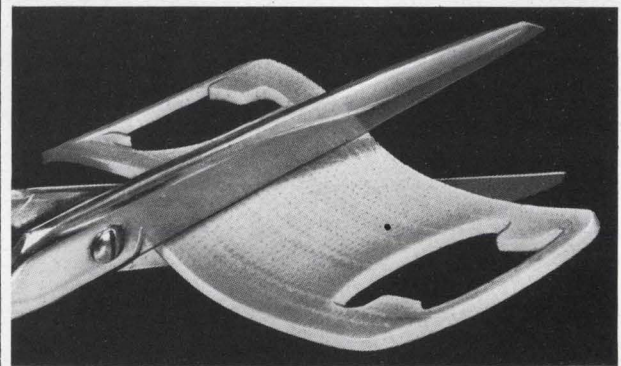

U.S. Patent No. 3,126,440

**POLASHEET II**

**flexible, compressible, cutable  
pressure and RFI connector seal**

With sealing pressures up to 30 psi, Polasheet II yields overall system attenuation of 125-135 db. Polasheet is oriented wire imbedded in silicone rubber sheets from .062" that can be cut or

stamped into resilient, flexible gaskets of any shape. Requires no machined surfaces because it's compressible. About 12¢ per sq. in. Free samples, prices, literature. Write today.

**METEX Corporation**

970 New Durham Road, Edison, N.J. 08817  
(201) 287-0800 • TWX 710-998-0578  
West Coast: Cal-Metex Corp., 509 Hindry Ave., Inglewood, Calif.



53A

ON READER-SERVICE CARD CIRCLE 144

**KEYSTONE ELECTRONICS CORP.**

49 Bleecker Street • New York, New York, 10012

ON READER-SERVICE CARD CIRCLE 143

# CONTROL CABINETS HAVE NEVER BEEN IN BETTER SHAPE

A new innovation in cabinet design with wide applications in the realm of enclosures for controls. The cross section of the frame is a replica of the widely recognized Bud Radio insignia.

Rigid frame is all steel welded construction. Removable front panel and hinged door of equal size permits easy installation of components.

Skillfully planned so that entire contents are available for service and inspection when door is opened. Viewing angle of both panel and door

provides comfortable observation of dials, meters, switches, lights, etc. Attractively finished with scratch resistant vinyl texture charcoal gray body with light gray enamel front panel and rear door. Three sizes available.

These exciting new housings are available from your nearby authorized Bud distributor. If you don't know him, let us introduce you. Write us for his name. You can obtain complete descriptive literature from him, or we'll be glad to send it to you.

## MARK-T CABINETS

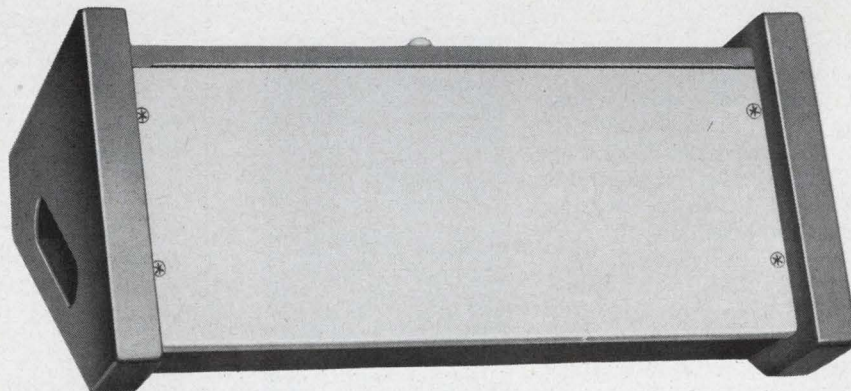

your product *Belongs* in a BUD cabinet



**BUD RADIO, INC.**

4605 East 355 Street, Willoughby, Ohio 44094

ON READER-SERVICE CARD CIRCLE 145

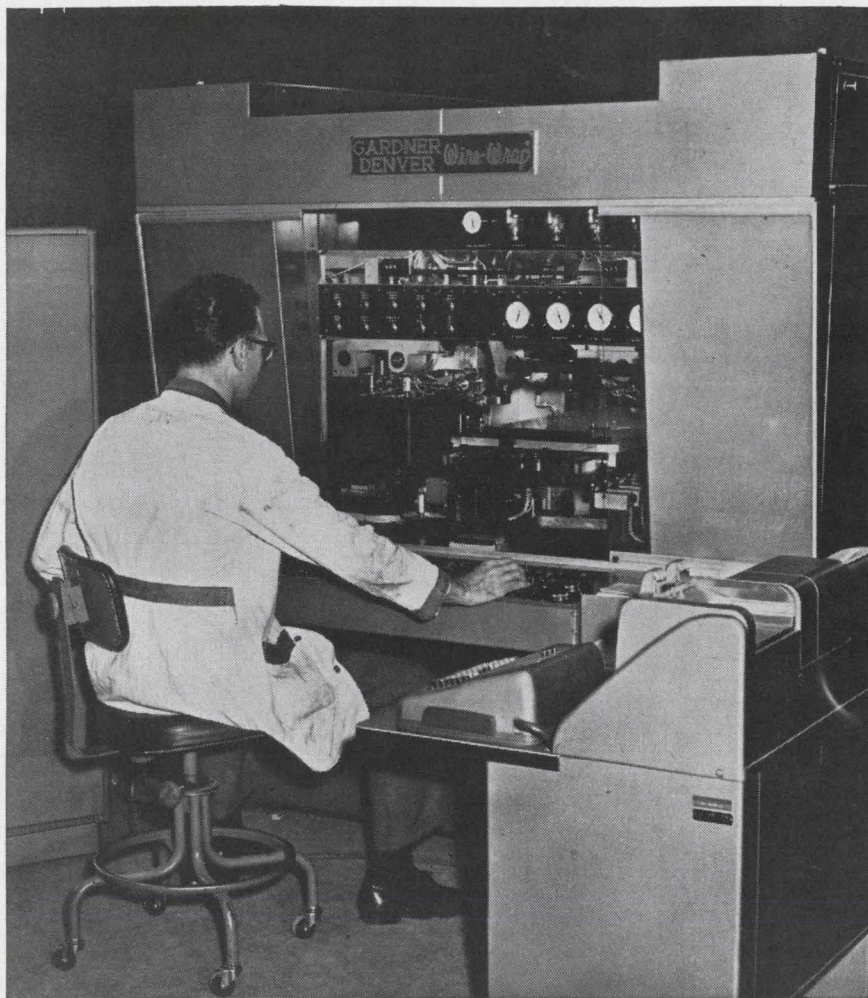

## Program wiring patterns from A to Z with automatic *Wire-Wrap*<sup>®</sup> machines

Only automatic "Wire-Wrap" machines provide the flexibility required for point to point wiring of modular electronic panels. Just program the circuit with punched cards or tape. Then "Wire-Wrap" machines take over—connecting wires at an average of 5 seconds per wire—as much as 25 times faster than hand soldering in most applications.

**Reliability**—These solderless wrapped connections are permanently tight—unaffected by temperature changes, atmospheric corrosion, vibration. More than 37 billion such connections are in use today without a single reported failure.

**Economy**—Cost savings in excess of 92% are common when compared to soldering and other techniques. Additional benefits include: No thermal damage to heat-sensitive materials . . . elimination of fire hazards . . . connections that are easily removed in plant or in the field.

Write for Bulletins 14-1, 14-121.



SEE WHAT AIR IS DOING NOW...SEE

**GARDNER - DENVER**

Gardner-Denver Company, Quincy, Illinois

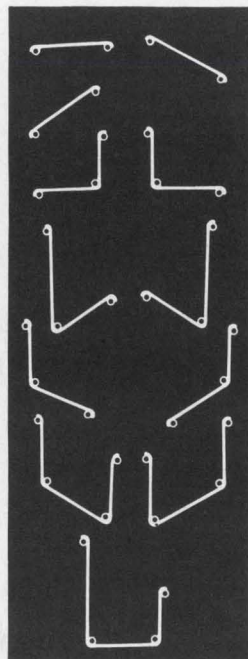

Typical wiring patterns made with automatic "Wire-Wrap" machines.

ON READER-SERVICE CARD CIRCLE 146

## SEMICONDUCTORS

### Npn Darlington for small signals

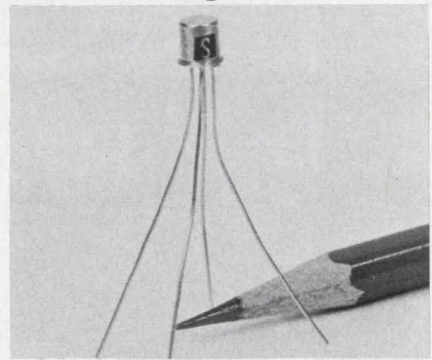

*Solitron Devices, Inc., Transistor Div., Riviera Bch., Fla. Phone: (305) 848-4311. stock.*

These npn silicon planar Darlington transistors contain two transistor chips mounted in either a 3-lead or 4-lead TO-18 package.

These signal transistors are also available as matched pairs. Typical characteristics include  $B_V$  greater than 85 V, emitter break-down voltage greater than 12 V, gain at  $V_{CE}=5V$ ,  $I_C=10$  mA typically 10,000 to 50,000.

The Darlington transistors can be used as constant current supplies, voltage comparators, power supplies, high input impedance networks and boot-strap timers.

CIRCLE NO. 285

### Current regulating diodes use field effect

*Motorola Semiconductor Products, Inc., P. O. Box 955, Phoenix, Phone: (602) 273-6900. P&A: \$4.90 100 up; stock.*

A series of current regulating diodes covers the current range from 0.22 to 4.7 mA. The 1N5283 through 1N5314 current regulators are field-effect diodes that establish a constant current flow independent of voltage. The current regulating function is for use as a constant current source in differential amplifier circuits, ramp generators, transistor biasing, or as an active, high impedance load for high voltage-gain amplifiers. In voltage reference circuits, the current regulator can supply a temperature compensated zener diode with a constant current to limit zener voltage changes caused by large current excursions in an unregulated circuit.

CIRCLE NO. 286

# REDUCE CONTACT SILVER USAGE UP TO 70% AND SLASH COST OF CONTACT SUB-ASSEMBLIES

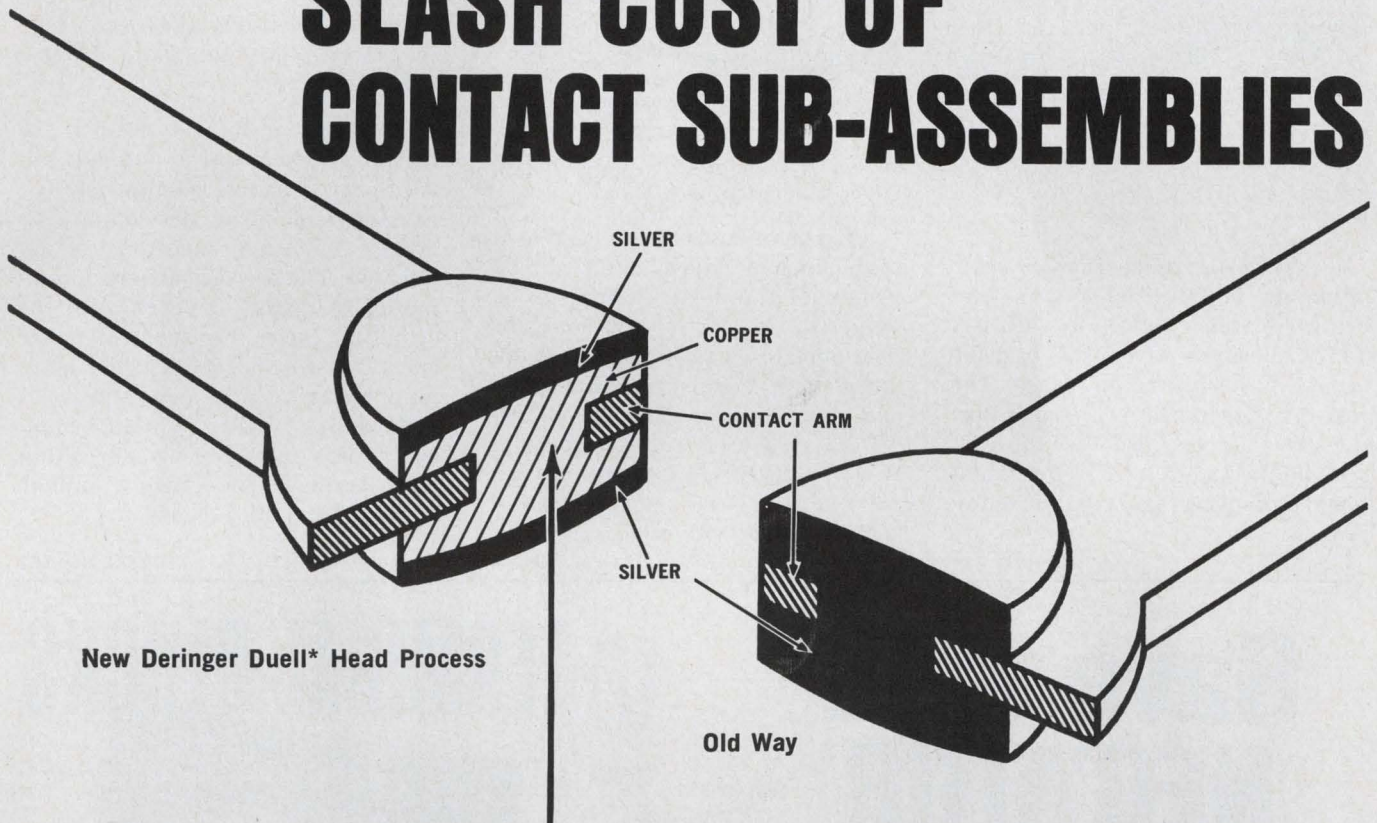

New Deringer Duell\* Head Process

Old Way

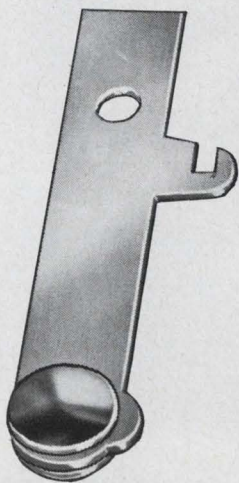

Typical Contact Blade Sub-assembly manufactured under the patented Deringer Duell\* Head Process.

Base metal here instead of silver can mean tremendous savings to you at no sacrifice in contact reliability. In certain applications, arcing and erosion have been reduced and improved mechanical life has resulted.

This very substantial reduction in the amount of silver used in a contact is particularly important when you consider the scarcity of silver and the increasing cost of silver. *To coin a phrase, Deringer gives you more for your silver dollar!* How much more? Well, in sub-assemblies of the type shown above, Deringer can provide the entire sub-assembly for what was the cost of the contact alone.

The exclusive new Deringer Duell\* Head Process is just one new development aimed at helping you reduce the cost of your electrical contacts and sub-assemblies. For a review of your contact applications to determine if one of Deringer's unique manufacturing processes can save you money while maintaining or improving reliability, contact Deringer.



FOR CONTACTS—CONTACT  
**DERINGER**

METALLURGICAL CORPORATION

1250 Town Line Road - Mundelein, Illinois 60060

ON READER-SERVICE CARD CIRCLE 147

\*U.S. Patent 3,311,729

### Laser system trims resistors

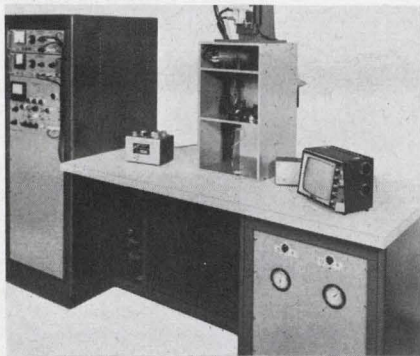

Spacerays, Inc., Northwest Industrial Park, Burlington, Mass. Phone: (617) 272-6220. Price: \$17,500.

A complete production resistor trimming unit, this system can bring resistance values to within a 0.1% tolerance after the resistor has been hermetically sealed. The resistor is installed by the operator, the value is classified and the system begins a step-by-step evaluation, trimming, and repositioning process.

CIRCLE NO. 359

### Transistors analyzed go/no-go

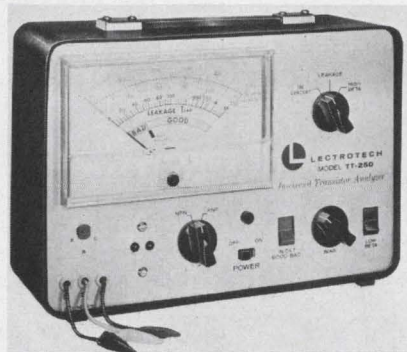

Lectrotech, Inc., 1221 W. Devon Ave., Chicago. Phone: (312) 764-7005. P&A: \$87.50; stock.

Transistor leads do not have to be unsoldered or clipped for in-circuit tests with this tester to measure ac gain. Out-of-circuit tests measure beta or gain on two scales: 0 to 250 and 0 to 500. Biasing is automatic and no calibration is required. The TT-250 measures transistor leakage ( $I_{CBO}$ ), directly in microamperes. All testing is nondestructive, whether in or out of circuit.

CIRCLE NO. 360

### Photoresist dispenser for microcircuit coating



Headway Research, Inc., 3713 Forest Lane, Garland, Tex. Phone: (214) 272-1566.

Once this machine is loaded, the rest of its cycle works automatically. Spray rinsing, photoresist dispensing and spray developing following the image exposure are automated. The speed is changed automatically during a cycle. In the complete cycle the substrates are spray rinsed and dried while spinning. Spinning then stops and resist is dispensed. Wafers spin at the second preset speed, evenly spreading and drying. The basic spinner comes with 1 to 5 heads.

CIRCLE NO. 287

# Save with NEG'ATOR<sup>®</sup> counter-balances



Save space, save weight, save more on production costs too, with Hunter's NEG'ATOR springs in your products. A strip of spring steel forming a pre-stressed coil, the NEG'ATOR resists uncoiling with uniform pull, thus providing the same rated force at any extended length. So with the NEG'ATOR constant-force spring, you'll eliminate deadweights and linkages, and simplify mountings. For complete information on the cost and design advantages of the NEG'ATOR spring write Ametek, Inc., Hunter Spring Division, 27 Spring Street, Hatfield, Pennsylvania 19440.

**AMETEK / Hunter Spring**



ON READER-SERVICE CARD CIRCLE 148

# CURTIS TERMINAL BLOCKS

CURTIS

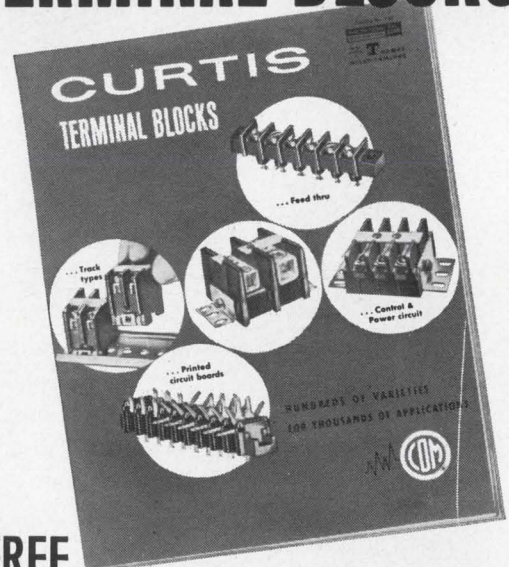

## FREE NEW, INFORMATIVE SELECTION GUIDE

A new, 24-page, completely illustrated catalog contains photos, descriptions, ratings, engineering drawings, and prices of the complete line of Curtis terminal blocks. Included are printed circuit, insulated feed-thru, quick disconnect, track type, and high current terminal blocks.



Send today for your free copy.  
**CURTIS DEVELOPMENT & MFG. CO.**  
3236 N. 33rd Street, Milwaukee, Wisconsin 53216

ON READER-SERVICE CARD CIRCLE 149



## NICE TRY, GUYS

Man's first aerospace project, Babel I, utilized a straight-forward design concept: Travel into outer space would be effected by climbing a tower. However, it did not meet noise specifications, and the mission was aborted.

Now that Genisco offers a complete selection of power line filters and shielded enclosures you can avoid analogous difficulties.

Rated from 30 amps to 200 amps, 120 V to 250 V, single or three-phase power lines, the three series are designed for typical circuit breaker panelboards with or without requirements for power line filtering, and for use in shielded rooms and for installations requiring electrical distribution.



Although these power line filter assemblies meet MIL-F-15733, we do not recommend their use in towers extending beyond terrestrial limits. This application is not approved by The Chief Design Engineer.

**ON READER-SERVICE CARD CIRCLE 121**

## DIDJA HEAR THE ONE ABOUT THE BI-PLANAR NAB 14" REELS?

Seems like there's this Model 10-276 magnetic tape recorder for aircraft, shipboard, or field portable use. Now, it has this low inertia capstan drive motor, and 6 speed selectable servo to eliminate belts, pulleys, and like that. And get this: no pinch rollers and solenoids to create flutter and skew! Well, these Genisco guys are making a mint on the thing, but they

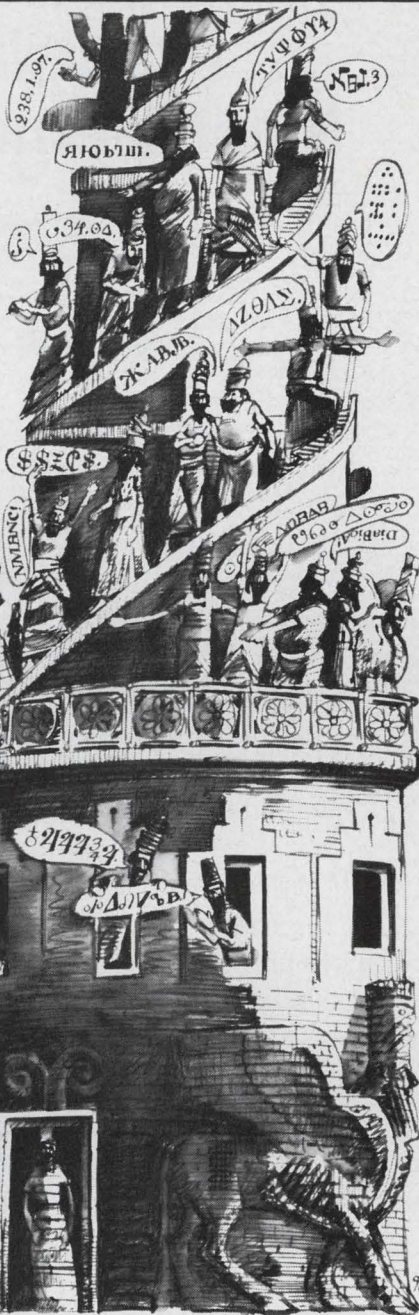

figure they'll come out with a Model 10-286 with 14" instead of 8.5" reels for customers who need longer record time! Then they go and stack the reels in a bi-planar configuration to save space. The funny thing is it works great. Not much of a story maybe, but they sure are nice tape recorders.

**ON READER-SERVICE CARD CIRCLE 122**

## EARN BIG \$\$\$\$ AS A TELEMETRY PERSON !!!

Now you can learn telemetry in the privacy of your own home! Take this free aptitude test NOW!

1. (T) (F) A telemeter is what they put on the back of the TV to find out what you watch.

2. (T) (F) A telemetering checkout station is where you sign out for a telemetering.

Congratulations! You've just won our free correspondence course! Naturally you'll now want a Model A-180 or A-186 completely portable ground station. The A-180 completely de-multiplexes any standard FM/FM Signal. Ideal for checkout of airborne or sledborne applications. The A-186 has fourteen stunning channels. Its receiver is continuously tunable over the 215MC to 260MC band. So get on the road to success! Buy some of our telemetry stuff.  
**ON READER-SERVICE CARD CIRCLE 123**

## WHEEP! WHEEP! WHEEP!

As your missile speeds downrange you are secure in the knowledge that its electro-explosive device can be armed only by the precise signal you alone can send.

Or, horror of horrors, by an unfiltered random burst of identical frequency and duration.

As perspiration beads your brow you feel a sudden fondness for Genisco, renowned experts in RF hazard testing. How nice of them, you think, to have in stock or to design just the filters for the RFI and EMI protection my firing circuits need.

By golly, you conclude, next one of their ads I see I think I'll just

**ON READER-SERVICE CARD CIRCLE 124**

## IT JUST KEEPS ROLLIN', KEEPS ON ROLLIN' AROUND.

Going round and round is our new Model 1147 rate-of-turn table's main trick. It keeps at it no matter how much you abuse it.

Hydrostatic bearings give precise dimensional stability, excellent alignment, low runout and eccentricity, low mechanical noise, and long happy life. It rotates smoothly at less than sidereal rates (0.004°/sec.). And it's just as smooth up to 1500°/sec. Which is why particularly brilliant (and handsome) engineers picked it as the AGE gyro test table for the F-111 Aircraft System.

Great for the lab or just to tote around de field.

**ON READER-SERVICE CARD CIRCLE 125**

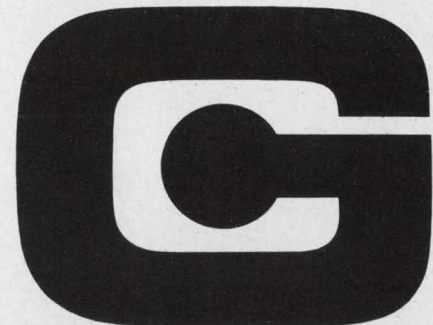

GENISCO TECHNOLOGY CORPORATION  
18435 SUSANA ROAD  
COMPTON, CALIFORNIA 90221

## PRODUCTION EQUIPMENT

### Ultrasonic trimmer specs resistors

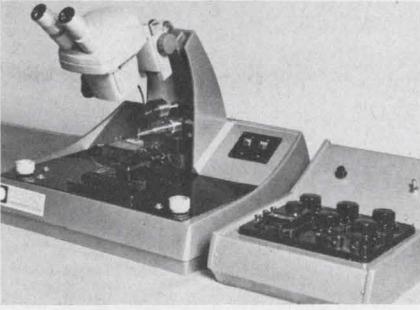

Axion Corp., 6 Commerce Park,  
Danbury, Conn. Phone: (203) 743-  
9281.

Avoiding the hazard and exhaust system of the abrasive dust method, this unit removes resistor material by ultrasonically vibrating a diamond tip. The substrate is moved in the X or Y direction automatically.

The resistor to be trimmed is connected by probes into a bridge circuit which automatically turns off the ultrasonic action when the resistor is within 0.5% of the target value.

The substrate is held on a motorized X-Y table by a vacuum chuck. Up to twenty probes can be set to contact various resistors, and are selected two at a time.

CIRCLE NO. 288

### Vapor solvent cleaner sweeps ultrasonically

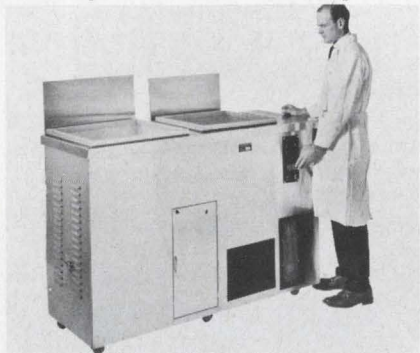

Tronic Corp., P. O. Box 247, Bel-  
mont, Calif. Phone: (415) 593-  
1487.

A portable solvent boil-chill-vapor cleaning system uses ultrasonics. Incorporating automatic continuous solvent reclamation and refrigerated coil cold condensation technique, the unit is a completely portable console. It requires no external plumbing, water, or venting.

CIRCLE NO. 289

# Direct Reading Precision Phase Measurements to 1MHz



The Aerometrics Model PM-720 Phase Meter covers from 0 to 180 degrees in four ranges. For measurements above 180 degrees, the PM-720 utilizes automatic lead-lag indicator lights to give direct reading capability to 360 degrees. The amplitude ratio of the two input signals can be as high as 5000 to 1 with sensitivity of 100 mv (p-p) to 500 v (option available to 1 mv). For direct meter readings the accuracy is  $\pm 2\%$  but increase accuracy of  $\pm .2\%$  can be obtained by utilizing the DC voltage output which reads directly in degrees on a DVM. The compact, all solid state construction offers true portability (total weight 7 pounds). Aerometrics also offers Model PM-730 which covers 0 to 360 degrees in four ranges. The frequency is extended to 1 MHz. The PM-730 also offers the unique advantage of measuring phase relationship between dissimilar wave forms.

### Do you have Phase Measurement Problems to 750 MHz?

The PM-730 can be used with the Aerometrics Model SA-300 pulse sampler to give precision phase measurements to 750 MHz. For further information, write or visit us at the ISA.

See us at ISA Exhibit Booth No. 544

 **AEROMETRICS**  
San Ramon, California 94583 • P.O. Box 216

# 750 MHz Sampling Oscilloscope for \$995

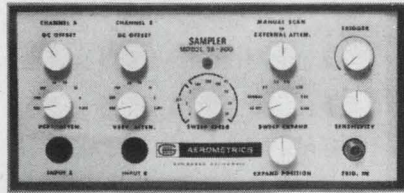

If your present oscilloscope has a minimum band width of 50 KHz, you can convert it into a high speed sampling oscilloscope using the Aerometrics dual channel pulse sampler. The Model SA-300 may also be used with an inexpensive X-Y recorder for permanent recording of fast computer wave forms, radar pulses, semiconductor characteristics, etc. The all solid state Aerometrics sampler offers rise time of typically one nanosecond and sweep speeds from 10 nanoseconds to 5 microseconds per full sweep. Like other Aerometrics instruments, the SA-300 features portability through compactness and light weight.

## Multimeters, Pulse Generators & Electronic Counters

A full range of instruments which excel in precision, compactness, ruggedness, portability and flexibility—the most dependable instruments you'll ever use—and all in competitive price ranges. Be sure and check Aerometrics' specifications before investing in test equipment.



See us at ISA Exhibit Booth No. 544

**AEROJET**  
GENERAL TIRE  
GENERAL

# AEROMETRICS

San Ramon, California 94583 • P.O. Box 216

## Flip-chip bonder uses tape input

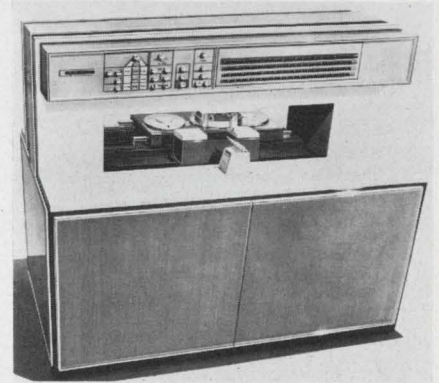

Bulova Watch Co., Valley Stream, N. Y. Phone: (516) 561-2600.

This unit will place and bond up to 1,000 flip-chips an hour. It uses standard 1-inch EIA 8-channel 1-2-4-8 coded tape prepared by commercial tape-punching equipment. It extracts semiconductors from magazines and then bonds them to circuits either ultrasonically or by thermo-compression. Prior to each bonding cycle one of three magazines is selected and positioned at the pickup station by tape instructions while the substrate is repositioned to the required placement coordinates. The machine will accept thin or thick film substrates in a variety of sizes containing any number of subcircuits. An automated keyboard control permits selective skipping of substrate circuits which have been classified as defective in prior testing operations. Optional devices permit automatic probing and marking of defective substrate circuits prior to bonding.

CIRCLE NO. 290

## Thermoplastic cases in many shapes

Skydyne, Inc., River Road, Port Jervis, N. Y. Phone: (914) 856-5241.

MIL-spec cases are available with shock-absorbing interior equipment mounting facilities and a selection of optional hardware. The thermoplastic, A.B.S., withstands high and low temperature extremes, has a high strength-to-weight ratio and ductility and the resulting energy-absorbing capability.

CIRCLE NO. 291

PRODUCTION EQUIPMENT

**Pencil soldering side by side**



Development Associates Controls, 725 Reddick Ave., Santa Barbara. Phone: (805) 963-3708. P&A: \$315; stock.

This unit includes a pencil type hand piece with miniature parallel gap electrodes. The walnut cased soldering controller is 6 x 4 x 4-inch. Both the time and current may be preset to control the amount of energy delivered to the connection. Time settings from .1 to 1.0 seconds may be adjusted by the time control knob while the current may be preset at any level from 10 to 35 A.

CIRCLE NO. 292

**Double-barrel kiln operates to 1600°C**

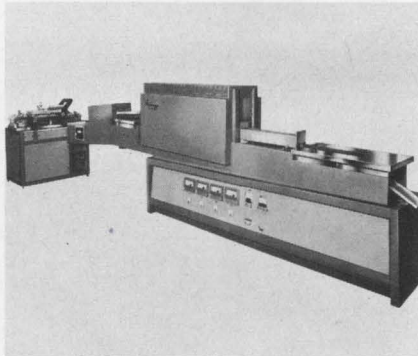

BTU Engineering Corp., Bear Hill, Mass. Phone: (617) 894-6050. P&A: \$15,000 to 16,000. 12 weeks.

For metallizing titanites, ferrites, and ceramic parts including co-firing of moly-manganese and alumina substrates, this kiln is capable of brazing, annealing, and sintering processes. Using twin tubes, the unit has an operating range of 800° to 1600°C, with an accuracy of ±1°C.

CIRCLE NO. 293

**Card extractors for data systems**

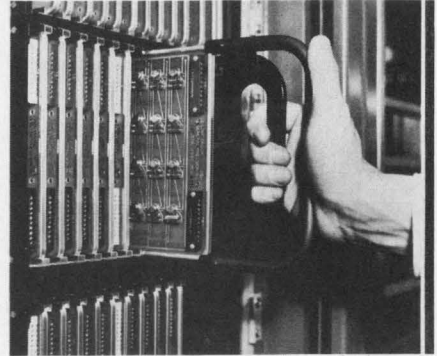

Protolab, 294 Polaris Ave., Mountain View, Calif. Phone: (415) 961-8033. P&A: \$10 to \$35; 3 to 6 wks.

This self-storing card extractor is designed for removing PC cards. It can be used by manufacturers of computer, data handling, telemetry, instrumentation, telephone and ground-support equipment. The spring-loaded unit will protect systems and instruments from damage caused by hand handling and reduce card changing time.

CIRCLE NO. 294

**Momentary or Push On, Push Off**  
**MINIATURE**  
**Push Button Switches**



Exceptionally high current. Positive snap-action with fast make and break contacts. SPDT, DPDT & 4PDT, useable as either a Normally Open or Normally Closed switch. Silver contacts and terminals.

**FREE**  
12-PAGE CATALOG WRITE!  
**ALCOSWITCH**

DIV. OF ALCO ELECTRONIC PRODUCTS INC., LAWRENCE, MASS.

ON READER-SERVICE CARD CIRCLE 151

**Small — Positive Grip**  
**MINIATURE**  
**"Locking" Switches**

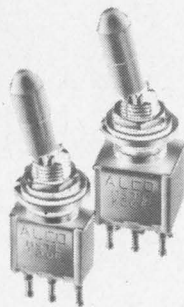

Alco has managed to reduce the size of the handle on this unusual miniature switch series and still have a perfect grip. Currently available in single and double pole in maintained and momentary locking configurations. Designed for accident-proof applications. 6 amps @ 125 VAC.

**FREE**  
12-PAGE CATALOG WRITE!  
**ALCOSWITCH**

DIV. OF ALCO ELECTRONIC PRODUCTS INC., LAWRENCE, MASS.

ON READER-SERVICE CARD CIRCLE 152

**ECCO REFLECTOR®**  
**RADAR TARGET**

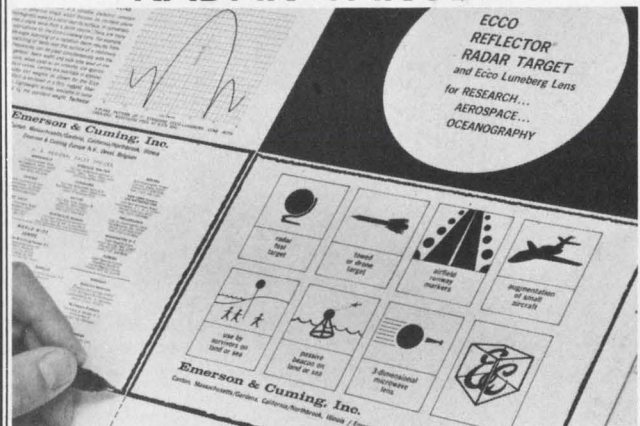

**NEW FOLDER**

Based on the Luneberg Lens, the Ecco Reflector is a wide-angle, constant cross section radar reflective device. Four-page folder in color describes monostatic, bistatic, omnidirectional and omni-directional types. Send for FREE copy.



**Emerson & Cuming, Inc.**  
CANTON, MASS.  
GARDENA, CALIF. • NORTHBROOK, ILL.  
Sales Offices in Principal Cities  
EMERSON & CUMING EUROPE N.V., Oevel, Belgium

ON READER-SERVICE CARD CIRCLE 153

**Design engineer Bob Alden searched for nearly an hour to find he didn't have the information he needed.**

**iri could have told him that in less than 5 minutes.**

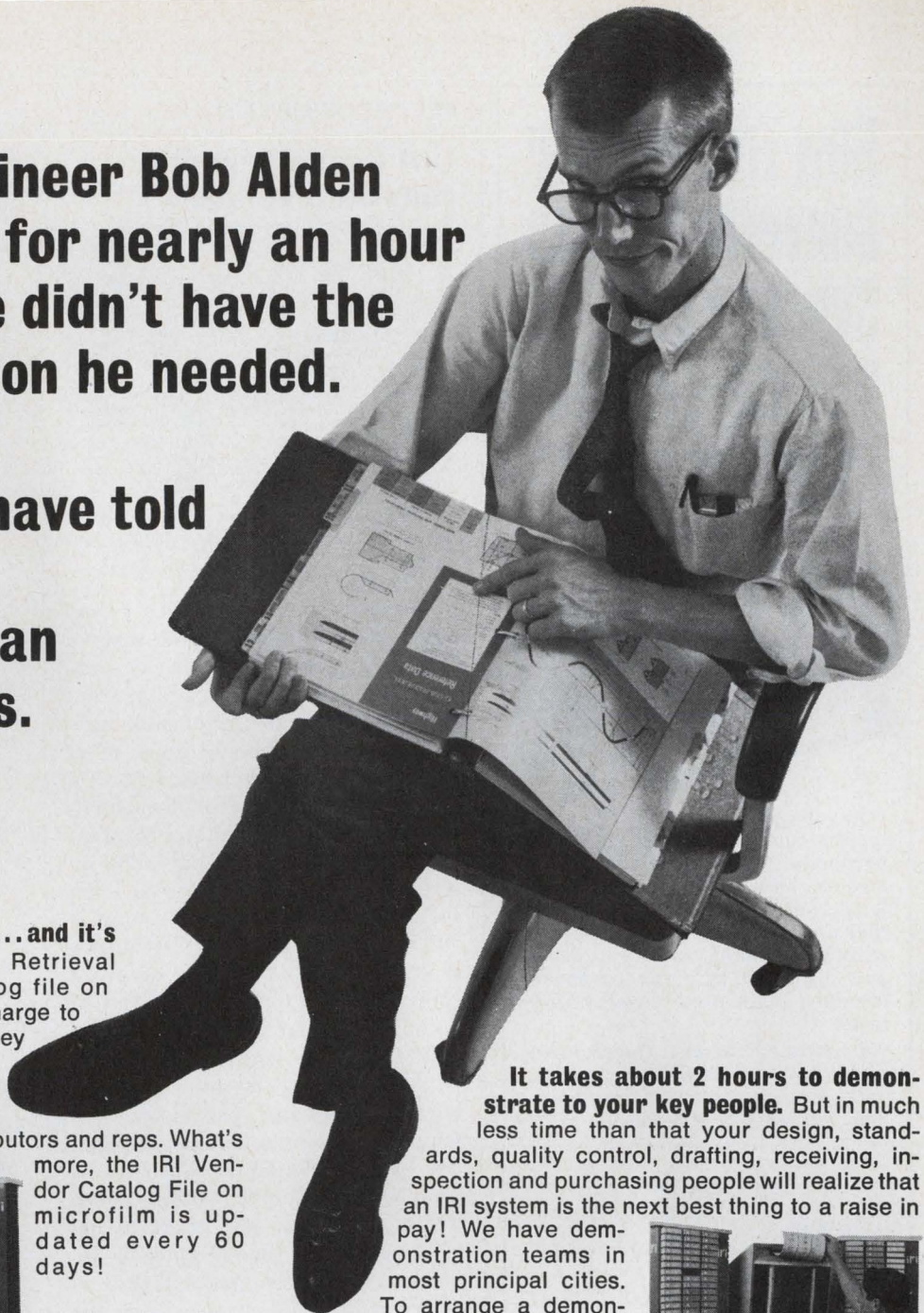

**But chances are 10-1 IRI has it... and it's up-to-date, too!** IRI—Information Retrieval Incorporated—is a vendor catalog file on microfilm. Because we make no charge to vendors, and microfilm everything they have in print, IRI has more than 600,000 pages of vendor data including application notes, reliability tests, price lists and names of distributors and reps. What's more, the IRI Vendor Catalog File on microfilm is updated every 60 days!

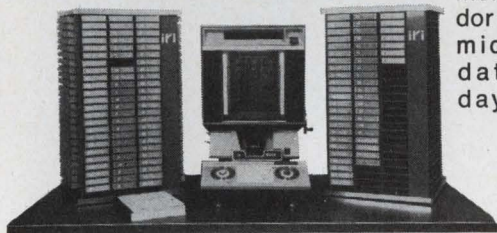

Small wonder.

**In addition, the IRI system is tailored to your needs by adding the vendors you want — at no extra cost.** We start with a basic file of the most wanted information. Up-date it regularly, and then—to top it off—"personalize" the file by adding the complete vendor information you request. Small wonder IRI enables you to eliminate your hard copy central catalog file. It also reduces storage area by 98%, cuts redundancies in design efforts and increases sources and use of standard items.

**You can install an IRI vendor catalog file on an annual subscription for less than the cost of a file clerk.** IRI vendor catalog files are in use in plants with as few as fifty employees. The "user-orientated" idea not only provides current knowledge of the component state-or-the-art, but also expedites the purchasing function. Because of its complete coverage, more than 60% of our recent installations have replaced other microfilmed vendor catalog systems.

**It takes about 2 hours to demonstrate to your key people.** But in much less time than that your design, standards, quality control, drafting, receiving, inspection and purchasing people will realize that an IRI system is the next best thing to a raise in pay! We have demonstration teams in most principal cities. To arrange a demonstration, send the coupon today.

Find it fast.  
Make a print-out in 6 seconds.



**iri INFORMATION RETRIEVAL INCORPORATED**  
801 Welch Road, Palo Alto, California 94304  
Dept. # F-38R

- I'd like to see a demonstration of the IRI Vendor Catalog File. Have your representative call me for an appointment.
- I'm not ready for a demonstration at this time, but please send further information.

Name \_\_\_\_\_ Title \_\_\_\_\_

Company \_\_\_\_\_

City \_\_\_\_\_ State \_\_\_\_\_ Zip \_\_\_\_\_

Telephone \_\_\_\_\_ Ext. \_\_\_\_\_

Number of employees at this location \_\_\_\_\_.

We  have  have not had experience with a vendor catalog file on microfilm.

In addition to the Vendor Catalog File on microfilm we're interested in  Mil Specs  Mil Standards.

**iri INFORMATION RETRIEVAL INCORPORATED**  
801 Welch Road, Palo Alto, California 94304

# New Transformer Converts 3-Phase Synchro Input To 2-Phase Resolver Output

With 30 Seconds Of Arc Accuracy

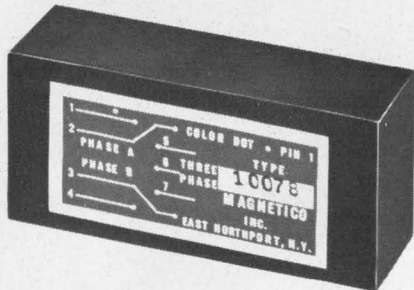

Now you can replace cumbersome and inaccurate techniques for conversion with Magnetico's new toroidal transformers. Small enough to mount on PC boards, they can be used in virtually any application requiring synchro to digital and digital to synchro conversion, including multiplexed conversion systems.

We call them Scott-T transformers and originally built them for military data systems. They meet the requirements of Mil-T-27B, Grade 5.

## SPECIFICATIONS

|                                    | 9652            | 9514           |
|------------------------------------|-----------------|----------------|
| Input Voltage (line to line)       | 11.8 V          | 90 V           |
| Input Impedance (at rated voltage) | 100 K $\Omega$  | 1 Meg $\Omega$ |
| Output Impedance                   | 11 $\Omega$     | 11 $\Omega$    |
| Null                               | <1 mv           | <1 mv          |
| Output Voltage (RMS)               | 5 V             | 4.25 V         |
| Frequency                          | 400 Hz          | 400 Hz         |
| Accuracy (depending on load)       | 30 secs         | 30 secs        |
| Temperature Range                  | -55°C to +125°C |                |

GO THE OTHER WAY, TOO. Units for resolver to synchro conversion also available. Ask for data.

Circle the Readers Service Card Number for complete electrical, mechanical and price information.

## MAGNETICO, INC.

6 Richter Court/E. Northport, N.Y. (516) 261-4502

## TEST EQUIPMENT

### Uhf sweep generator runs automatically

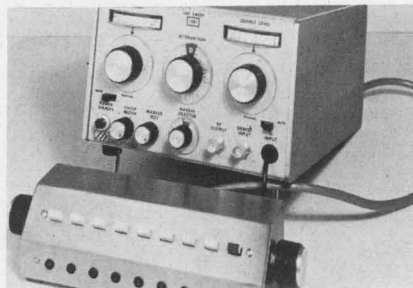

Sweep Systems Inc., 3000 Shelby St., Indianapolis. Phone: (317) 787-8275. P&A: \$425; 60 to 90 days.

This solid-state uhf sweep generator features completely automatic frequency tuning and rf attenuation eliminating all operator control. An electronic attenuator provides a 30-dB dynamic range of rf output level, and the tuner i-f or TV receiver second detector demodulated curve is maintained at a constant amplitude over this range. The instrument automatically tunes itself to keep the signal in the center of the display regardless of frequency or sweep width. In the event of shorted tuning plates or of loss of output, the instrument provides a 460-MHz sweep width until a signal is located. It then returns to the normal operating parameters for which it was preset. A remote control head is available which can be programmed to control tuning, sweep width, rf output and markers depending upon the alignment sequence. The instrument and the circuitry will operate either from the tuner i-f output or the demodulated i-f signal of the TV receiver second detector.

CIRCLE NO. 295

### Ac power supply ripples 1% rms

Pek, Inc., 825 Evelyn Ave., Sunnyvale, Calif. Phone: (408) 245-4111. P&A: \$675; stock.

This unit is designed for low current operation of short arcs and similar lamps. It features a current ripple of less than 1% rms. Power output, rated at 200 W, is adjustable over a 60 W range. The M703 is metered for lamp voltage and current, and has a built-in starter. The unit operates on 117 VAC  $\pm 5\%$ .

CIRCLE NO. 296

### Current drivers give 20-ns pulses

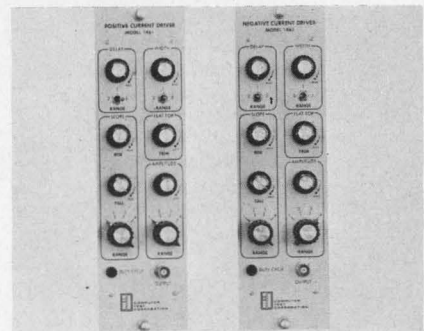

Computer Test Corporation, 3 Computer Dr., Cherry Hill, N. J. Phone: (609) 424-2400.

An external range switch permits changing the amplitude of the output current pulse of these drivers in steps which are adjustable to within  $\pm 15\%$  of the nominal setting.

Amplitude is continuously variable from 10 mA to 1 A in four overlapping ranges. The drivers are designed to operate with forward and back voltages of 75 V. Both pulse width and delay can be independently varied. Width is adjustable from 20 ns to 10  $\mu$ s and delay from 10 ns to 10  $\mu$ s.

CIRCLE NO. 297

### Monitor scope sensitive to 1 mV per inch

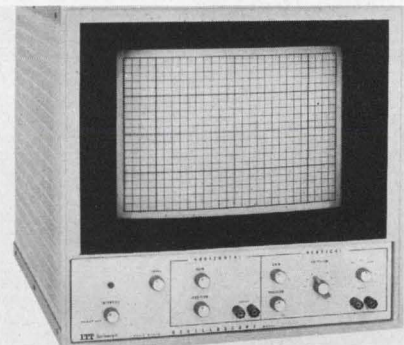

ITT, 320 Park Ave., New York. Phone: (212) 752-6000.

A large-screen monitor oscilloscope has a sensitivity of 1 mV per inch with differential input. The instrument is applicable to telemetry, analog computer readout, high-speed X-Y plotting, sweep generation, data sampling and detection of envelopes. It has solid-state design, a 17-inch aluminized CRT and may be adapted for rack or bench mounting. Resolution is 20 lines per cm and linearity is 1%.

CIRCLE NO. 298

# Reed Relay Problems?

A special hi-reliability relay for the Hawk Missile.

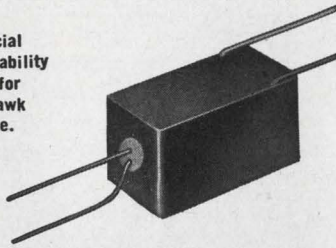

## Can We Solve Your Problem?

**Operating Inputs:** low as 1mA. and 15mW.  
**Standard Coil Voltages:** 6, 12, 24, 32, 48V in stock for immediate delivery.  
**Special Voltage or Resistance,** multiple windings for flip flop, memory and crosspoint selection applications — to customer specifications.  
**Relay Contacts** in Form A, B, C and latching. Also high vacuum type 5000V Form A.

Write for catalog and prices of our standard line of magnetic reed relays. For special requirements, give complete details for quotation.

**Coto-Coil COMPANY INC.**  
 59 Pavilion Ave.  
 Providence, R. I. 02905  
 Phone: (401) 941-3355

ON READER-SERVICE CARD CIRCLE 155

**FOR THE GUARANTEED ANSWER TO YOUR AIR MOVEMENT NEEDS ASK FOR THESE BULLETINS**



In the Howard CYCLOHM Fans and Blowers they describe, you get this unique combination of values:

### MORE AIR AT LESS COST

For proof, see the performance data and price schedules in the Bulletins.

### GUARANTEED PERFORMANCE

All CYCLOHM air movement units are Powered by the Howard Unit Bearing Motor, guaranteed for 5 years to require no maintenance or re-lubrication.

### IMMEDIATE DELIVERY

of standard models. For availabilities contact Standard Motor Product Sales, 23 Broadway, Des Plaines, Ill. 60016 (TWX 910-233-1658).

3 Good Reasons for Requesting Bulletins 8-01 and 9-03 describing Fans and Blowers with Air To Spare.



**HOWARD INDUSTRIES**  
 MSL INDUSTRIES, INC./MOTOR GROUP  
 1760 STATE STREET  
 RACINE, WIS. 53404

ON READER-SERVICE CARD CIRCLE 156

ELECTRONIC DESIGN 19, September 13, 1967

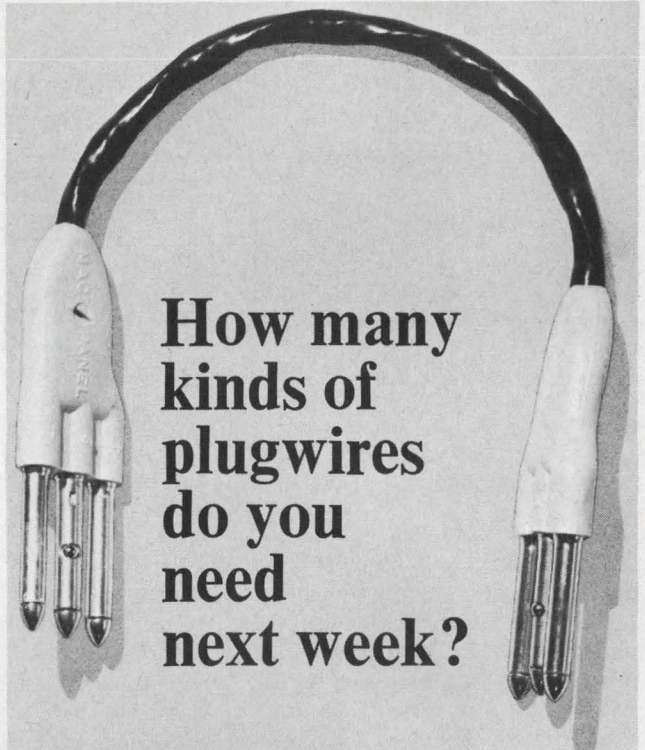

How many kinds of plugwires do you need next week?

## MAC ships off-the-shelf!

Getting a signal from P to Q—or from P<sub>1</sub>, P<sub>2</sub>, P<sub>3</sub> to Q, or from P to Q<sub>1</sub>, Q<sub>2</sub>, Q<sub>3</sub>, etc.—is the function of the plugwire. MAC maintains a programmer's paradise of plugwires in inventory: single conductor, coaxial, dual conductor, two conductor shielded twisted pair, Y-type with 3, 4, 5 or 6 pin common, just to start the list. Color coded, 6" to 36". Bring order out of chaos. Off-the-shelf. You supply the order, we'll take care of the chaos.

**MAC**

O.E.M. DIVISION

MAC Panel Co., Box 5027, High Point, N.C. 27261

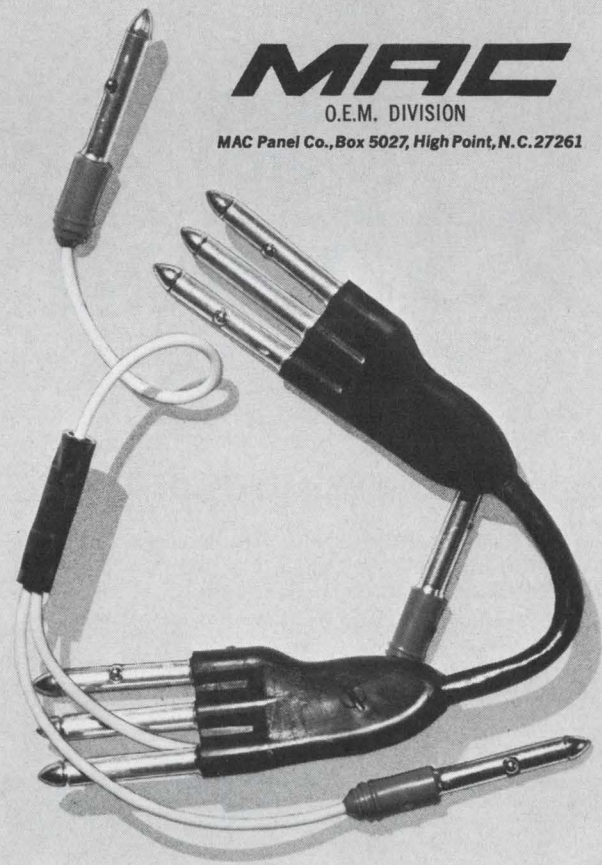

ON READER-SERVICE CARD CIRCLE 157

TEST EQUIPMENT

**Frequency counter ranges to 18 GHz**

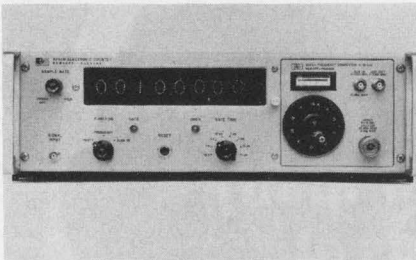

Hewlett-Packard, 1501 Page Mill Rd., Palo Alto. Phone: (415) 326-7000. Price: \$3000; stock.

A frequency counter counts directly from 10 Hz to 135 MHz. With available frequency converter plug-ins, its measurement range can be extended up to 18 GHz. The stability provided by the time base oscillator makes 11-digit resolution practical (3 digits displayed by a frequency converter plug-in, 8 digits displayed by the counter itself.) The circuit handles input levels from 100 mV rms up to 10 V rms without requiring any signal level adjustment.

CIRCLE NO. 299

**Null detectors get nanovolt ranges**



Julie Research Laboratories, Inc., 211 W. 61 St., N. Y. Phone: (212) 245-2727. P&A: \$500; 30 days.

When combined with a modified basic null detector, this nanovolt preamp provides the user with a universal detector capable of all nV-to-mV measurement applications. The device, which has a sensitivity or noise threshold of 1 nV and a resolution of 1 nV on the X1000 range, is for applications where standard galvanometers won't do because of inadequate sensitivity, low input impedance or insufficient stability. The input range of the unit is  $\pm 1$  nV to  $\pm 30$  mV full scale in 15 steps.

CIRCLE NO. 311

**L-band signal generators to 21 GHz**

Polarad Electronic Instruments, 34-02 Queens Blvd., Long Island City, N. Y., Phone: (212) 392-4500. Price: \$1900.

With the introduction of a new L-band microwave signal generator, Polarad now offers a complete line of generators from 0.95 to 21 GHz.

The L-band unit, model 1105, covers the 0.95 to 2.4 GHz range. Like the other generators in the line, it can be used alone or racked or stacked with other modules. A frequency stabilizer can be added for phase locking the generator over its active range to crystal stability. FM, squarewave and pulse modulation is obtainable by the addition of a modulator. The line also includes signal sources covering the 0.95 to 11.0 GHz range. Frequency stability is 0.0008% per line voltage change and 0.005% per °C change in ambient temperature.

CIRCLE NO. 312

16 amp  
35 amp  
55 amp  
110 amp  
**235 amp**  
**SCR's**  
and still growing

- ⊕ Standard dv/dt 10 to 400 v/ $\mu$  sec. depending on type.
- ⊕ Special dv/dt 500 v/ $\mu$  sec. and greater.
- ⊕ Fast turn-off types giving 12 to 20  $\mu$  sec. turn-off time.
- ⊕ Industry's highest surge current and I<sup>2</sup>t ratings
- ⊕ Immediate delivery

**NATIONAL**  
ELECTRONICS, INC.  
a varian subsidiary  
PHONE: (312) 232-4300 • GENEVA, ILLINOIS 60134

REQUEST BULLETIN

ON READER-SERVICE CARD CIRCLE 158

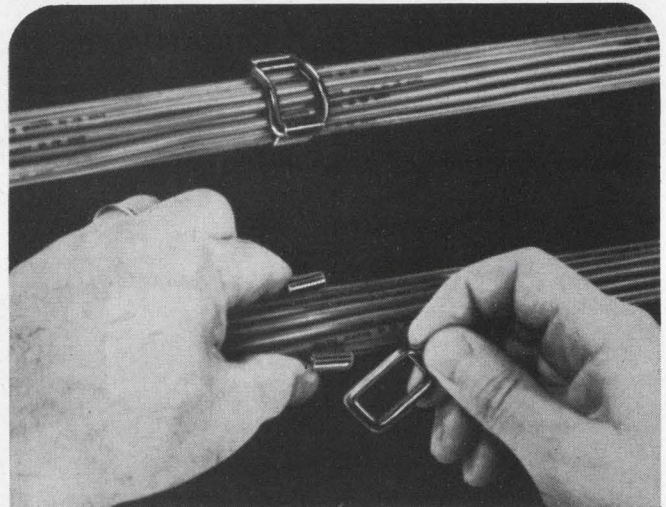

**CRADLECLIPS**

Versatile high quality harnesses for both supported and unsupported wiring systems. Fast and simple to use. Permit on-the-spot wiring changes without replacement or use of tools. Insuloid Cradleclips can be attached to panels by conventional means either from front or rear. Provide better air circulation and heat dissipation because harnesses are raised.

Send for Free Samples  
**ELECTROVERT** INC.  
Components Division  
86 Hartford Ave., Mt. Vernon, N. Y. 10553  
Milwaukee, Wis. • Burbank, Calif.



SOLD COAST-TO-COAST THROUGH AUTHORIZED DISTRIBUTORS.

ON READER-SERVICE CARD CIRCLE 159

ELECTRONIC DESIGN 19, September 13, 1967



# A payroll savings plan to benefit employee and employer alike.

**As an employer, you and thousands more can have a voice in the stability of our economy and country by encouraging employee participation in the Payroll Savings Plan for U. S. Savings Bonds.**

The reasons for setting up such a plan have always been sound — security for our country and systematic savings for your employees. Today these reasons are sounder than ever. So too are the rewards.

A brand new U.S. Savings Note called the "Freedom Share" carrying a new high rate of interest is available from the Treasury Department. Freedom Shares are companion notes to the popular Series E Bonds, and available through a regular plan like Payroll Savings.

When your employees purchase E Bonds they have the option to buy Freedom Shares, too, to an approximate one-for-one basis. Freedom Shares earn 4.74% when held to maturity of 4½ years and must be held for at least one year. They are available in four denominations ranging from \$25 to \$100, and only one deduction is necessary to apply toward the Bond/Freedom Share "package."

A complete kit is available with all the information and material you'll need to set up the plan. Write for it today.

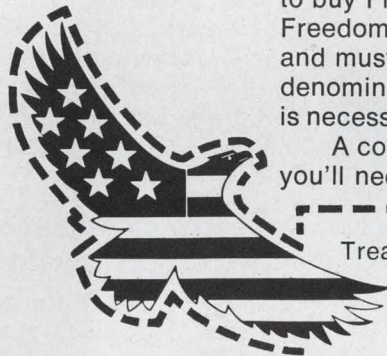

Treasury Department, U. S. Savings Bonds Division  
Washington, D. C. 20226

Dear Sirs:

Please send me a kit containing all I will need to set up a Payroll Savings Plan in my plant.

Name \_\_\_\_\_

Position \_\_\_\_\_

Company \_\_\_\_\_

Number of Employees \_\_\_\_\_

Address \_\_\_\_\_

City \_\_\_\_\_ State \_\_\_\_\_ Zip \_\_\_\_\_



**In your plant... promote the PAYROLL SAVINGS PLAN for U.S. Savings Bonds**



*The U. S. Government does not pay for this advertisement. It is presented as a public service in cooperation with the Treasury Department and the Advertising Council.*

# NEED HIGH VOLTAGE CAPACITORS FAST?

... Prompt Delivery -

## NO!

... Immediate Delivery

## YES!



GLASS  
CONTAINERS



METAL CAN  
CONTAINERS

Our list of satisfied "blue chip" customers is growing and growing which necessitated a large expansion of our manufacturing and engineering facilities. Now, we can supply a complete range of voltages from 2,000 to 50,000 volt capacitors from our expanded "stock on hand". Don't take excuses, we'll supply you faster than at any time in our many years in the field—**BETTER PRODUCTION FROM US—  
BETTER DELIVERY FOR YOU!**

Write for complete list of Standard High Voltage Capacitors in stock—or, send specifications for custom quotations.



## Plastic Capacitors, Inc.

2620 N. Clybourn • Chicago 14, Ill.  
DI 8-3735

### TEST EQUIPMENT

#### Rms-dc standard is 0.01% accurate



Metrics Div. of the Singer Co., 915  
Pembroke St., Bridgeport, Conn.,  
Phone: (203) 366-3201.

This automatic true rms transfer standard is capable of making a transfer measurement in under 10 seconds for frequencies from 2 Hz to 10 MHz. Accuracies range from .01% for ac signals up to 1000 V and to 20 kHz to 5% for ac signals up to 8 V and to 10 MHz. Readout may be made with any convenient dc measuring system such as a digital voltmeter, differential voltmeter or potentiometer and volt ratio box system. All the operator has to do to make connection to the ac input and dc output terminals is apply the unknown ac signal and read out in less than 10 seconds directly with an accurate dc measuring device.

CIRCLE NO. 313

#### Portable ohmmeter reads to 50 k $\Omega$

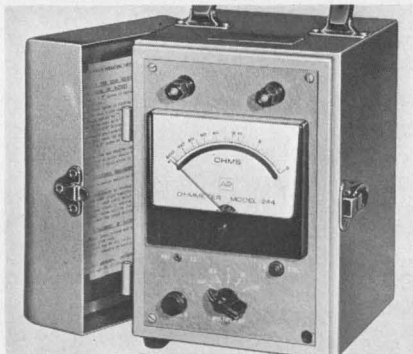

Associated Research, Inc., 3777 W.  
Belmont Ave., Chicago. Phone:  
(312) 267-4040. P&A: \$139; stock.

This instrument is suited for determining resistance of leads, grounds, resistors, coils and similar electrical components.

The unit permits direct readings of resistances from 0.05 to 50,000  $\Omega$ . It is calibrated in four ranges: 0 to 50; 0 to 500; 0 to 5000 and 0 to 50,000  $\Omega$ . The unit weighs 12 pounds and measures 8-7/8 x 6 x 8-1/4-inches.

CIRCLE NO. 314

#### Tracking filter ranges to 20 KHz



Agac-Derritron, Inc., 600 N. Henry  
St., Alexandria, Va., Phone: (703)  
836-4641.

This automatic tracking filter is for use in combined sine-random vibration tests, resonant search and identification studies, mechanical impedance investigations, and narrow band random signal analyses. The unit can be turned by any audio signal with an allowable amplitude variation of 40 dB over the frequency range from 3 Hz to 20 kHz. It has all solid-state circuitry, provision for five plug-in crystal filters, automatic bandwidth switching between all five filters, sine rejection output for performing automatic sine-random vibration testing, an internal 2 kHz calibration signal and a dc output proportional to the filter output. Power requirements are 100-125 V, 60 cps and 25 W. Size is 5-1/4 x 19 x 16-inches.

CIRCLE NO. 315

#### Transistor test sockets of Dupont resin

DuPont Co., Wilmington, Del.,  
Phone: (302) 774-4315.

Transistor sockets, a part machined from DuPont's polyimide resin, allow testing of TO-5 type transistors IC's in extreme-temperature environments not previously possible. The test sockets operate continuously in a range of -60 to 575 ° F while maintaining good dimensional stability and wear resistance. The volume resistivity of the parts at 575 ° F is 10<sup>11</sup>  $\Omega$ -cm, which provides exceptional electrical insulation. The parts are not brittle and can be machined to close tolerances which bring about smooth, hard surfaces.

CIRCLE NO. 316

# Telrex

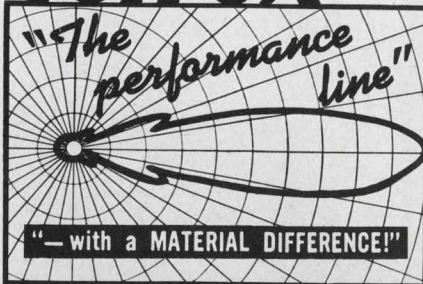

Telrex Communication Engineering Laboratories provides the Most Technically-Perfectured Finest Communication Arrays — Precision Engineered, Manufactured, Tuned, Matched, Calibrated and "Balun" Fed for "Balanced-Pattern" and Maximum S/N Ratio.

**Telrex "Beamed-Power"  
"Balanced-Pattern"**

## ANTENNAS AND ANTENNA SYSTEMS

The Standard of Comparison, and the Choice of the Discriminating, Successful, Communication Engineer.

Telrex Antennas and Antenna Systems provide Optimum Performance and Reliability per element, per dollar, from 500 Kc to 1500 Mc.

Send for free Military, Commercial Tech Catalog CMS67, illustrating Antennas and Systems, Rotator-Selsyn-Indicator Systems, "Baluns," Towers, Masts and Accessories.



ON READER-SERVICE CARD CIRCLE 183

CUSTOM-MADE

# R-C Networks

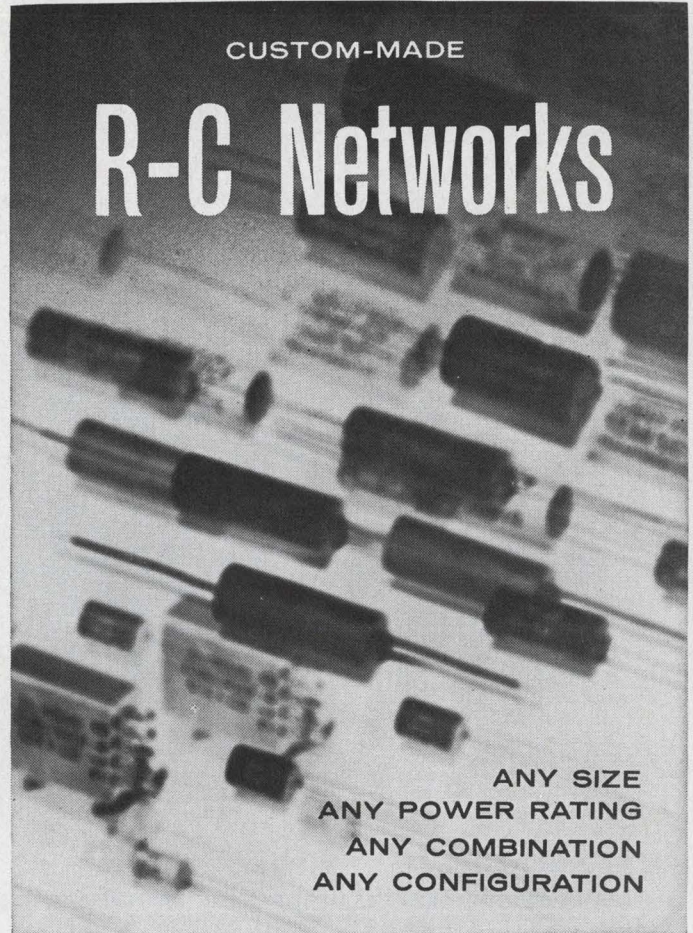

ANY SIZE  
ANY POWER RATING  
ANY COMBINATION  
ANY CONFIGURATION

- For • RFI Suppression • Arc Suppression  
• Relay Contact Protectors • Noise Filters  
• Spark Suppression

*R-C Networks available in any combination, for example:*

**Capacitor Section can be** ... Mylar, Metalized Mylar, Polystyrene, Polycarbonate ... any voltage or tolerance.

**Resistor Section can be** ... Composition, Wire-wound, Metal Film, Deposited Carbon ... in any wattage or tolerance.

Total Networks available in tolerances as close as  $\pm 1\%$ .

All Networks are manufactured under rigid Quality Control to meet your specific requirements.

Send us your specifications for quotation. Prototype quantities furnished prior to production.

For Complete details write Dept. ED-9



1065 W. Addison Street, Chicago, Illinois 60613  
ON READER-SERVICE CARD CIRCLE 185

# NOW

## illuminated panel switch

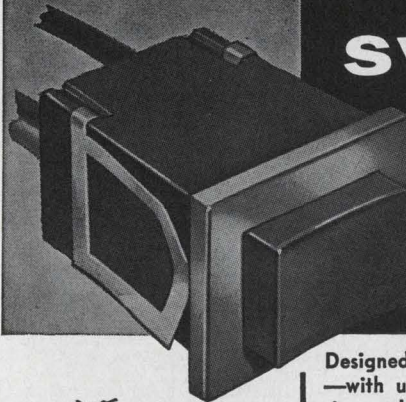

- UL LISTED  
2 amps 115 V a-c
- Combination Light and Switch
- Low Cost per unit

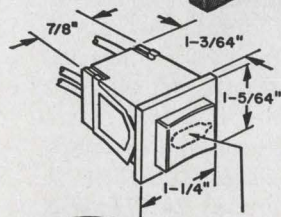

NEON BULB

Designed for functional beauty —with unlimited button and trim ring color combinations. Unique snap-in mounting available for panel installations from 1/32" to 7/16" thickness. Diffused lens. Legend identification on button available. Switch is available in push-on-push-off and momentary contact units. 115 V a-c (neon) 6 thru 28 V (incandescent). Specials up to 8.5 amp. rating.

For complete details ... write to



5235 Katrine Ave., (312) 969-4550  
Downers Grove, Ill. 60515  
TWX 910 695-3533

ON READER-SERVICE CARD CIRCLE 184

ELECTRONIC DESIGN 19, September 13, 1967

# LOW PROFILE IC PACKAGING SOCKET

**New**

Directly interchangeable! Exclusive socket configuration, identical to IC package, saves time, simplifies mounting on P C board.

- Permits card stacking on 1/2" centers
- Accepts packages with flat or round leads
- Easy IC insertion with wiping type beryllium copper contacts
- Easy extraction, minimum lead damage — optional extractor tool available
- Available in diallyl phthalate or black phenolic with gold or tin-plated contacts
- Dimensions .79 L x .49 W x .31 H

Request Data Sheet 166.

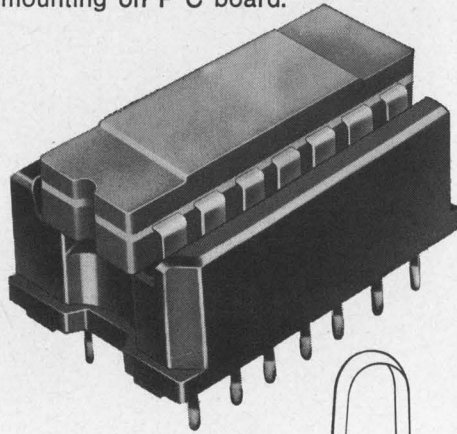

Extractor tool



**AUGAT**

INC. 31 PERRY AVE., ATTLEBORO, MASS. 02703

ON READER-SERVICE CARD CIRCLE 186

## TEST EQUIPMENT

### Solid-state oscilloscope has seven modes

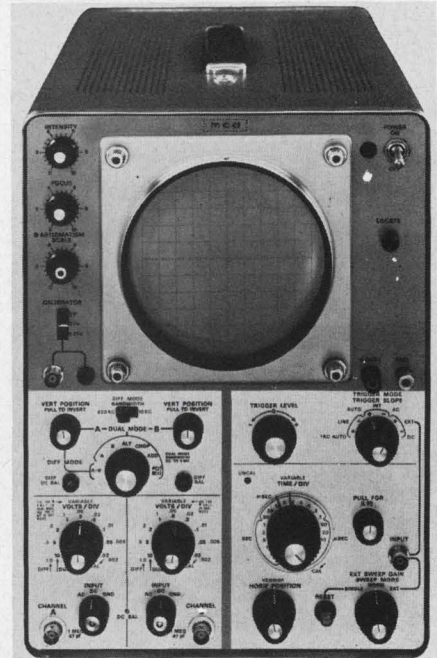

Measurement Control Devices, Inc.,  
2445 Emerald St., Philadelphia.  
Phone: (215) 426-8602.

A solid-state oscilloscope can be switched to any of the seven operating modes by simply turning a knob. Incorporating complete dual-channel and high-gain differential circuitry, the unit makes possible selection of either channel alone; dual-trace with both channels displayed alternately or chopped to 100 kHz and both channels added algebraically. X-Y plotting or high-gain differential operation is also possible. In addition to the switching between modes without any plug-ins, the scope features fast warm-up, a dc-to-5-MHz bandwidth, and selectable low and high-speed automatic triggering. Polarity reversing switches permit 180° inversion of either channel in all dual modes, or inversion in the differential mode. Full triggering capability is provided for either positive or negative signals with either internal, external or line source, ac or dc-coupled. Automatic triggering provides a reference base line at 25 Hz or 1 kHz.

A construction arrangement has the model 0531's board assemblies edge-mounted for adequate cooling without fans or blowers.

CIRCLE NO. 317



The precise angle indicator measures and displays the angular displacement of a remote synchro or resolver.



## PRECISE ANGLE INDICATORS

An input sensor translates the signal into an error voltage which is amplified and used to drive the input sensor to null within a closed servo loop. A counter mechanism then provides direct digital readout of the input sensor's angular position, which corresponds identically to the remote shaft's displacement. A feed-back voltage damps the internal loop, providing the stability required for precise measurement.

### STANDARD SPECIFICATIONS:

ACCURACY: ± 6 minutes  
REPEATABILITY: 1.0 minutes  
READABILITY: 0.5 minutes  
POWER (SINGLE SOURCE): 115 volts.  
400 cps, single phase, 30 va  
SENSITIVITY: 1.0 minute  
SLEWING SPEED: 12°/sec.  
WEIGHT: 4 lbs.

SEND FOR NEW CATALOG.



NORTHERN PRECISION LABORATORIES INC.  
202 FAIRFIELD ROAD • FAIRFIELD, NEW JERSEY 07006 • AREA CODE 201-227-4800

ON READER-SERVICE CARD CIRCLE 187

# Let Honeywell extend your EMI measuring capabilities with these off-the-shelf products.

**6846 VHF RECEIVER** – For EMI evaluation, countermeasures and surveillance applications. High sensitivity; all solid-state; bandwidth variable 20kHz, 200kHz, 5MHz; powered from AC line or batteries.



\$3130

**4881 TRANSIENT GENERATOR** – For making conducted transient susceptibility tests to interference specs, such as: MIL-STD-826 and A, MIL-E-55301(EL), MSFC-STD-279 and others. High peak pulse power, 60 and 400Hz synchronization, plus 0.5 to 500 PPS free running, 360° pulse positioning.

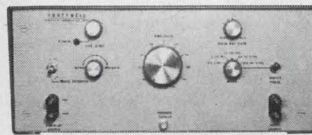

\$690

**2880 MULTICOUPLER** – Provides up to 20 outputs from 50 or 72 ohm input. Low noise, all solid-state, modular, 0 db insertion loss from 1 to 54 MHz.

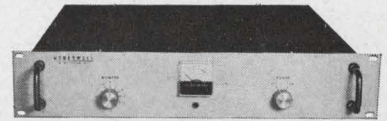

\$980

**7870 METERING PANEL** – To convert any general purpose receiver with an IF output from 10kHz to 65MHz into a tuned voltmeter for EMI measurements. Wide bandwidth, slideback detector, average or peak reading voltmeter, high level video out to 50 ohm load, all solid-state.



\$600

**4857 LOW FREQUENCY IMPULSE GENERATOR** – Provides flat spectrum of calibrated amplitude signals in 120Hz – 250kHz range for signal substitution or calibration of receivers and field intensity meters. Solid-state electronics.



\$550

**AW-204 TRANSISTORIZED WIDEBAND AMPLIFIER** – Used as a preamplifier with standard EMI meters and calibrated signal sources to provide rapid, remote measurement of extremely low level electric field signals in the 14kHz – 30MHz frequency range.

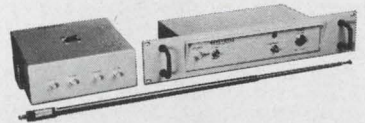

\$880

**PLT-1/PP REGULATED AC POWER SUPPLY** – A solid-state, 60Hz, 115v rms supply for use in any application requiring extreme amplitude and phase stability. Low distortion; 1 KVA.

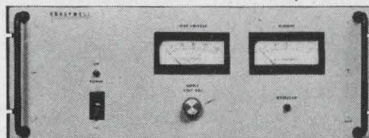

\$2450

**3858 – 3861 LOW FREQUENCY POWER LINE IMPEDANCE STABILIZATION NETWORKS** – Used for conducted interference testing of equipment requiring high level input power line current. Frequency range: 14kHz-5MHz; 50ohm line impedance.

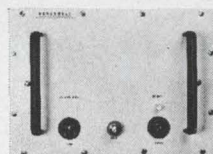

\$230 – \$290

**3862 HIGH FREQUENCY POWER LINE IMPEDANCE STABILIZATION NETWORK** – Same as 3858 – 3861 networks, but for 4MHz – 1GHz frequency range; 80 amp capability.

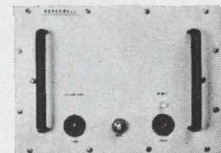

\$220

## Honeywell engineers sell solutions

The instruments shown here are more examples of how Honeywell's broad line, backed by local sales and service, can provide the *precise* solution to your instrumentation problems. For full details on any or all of these fine products, call your local Honeywell Representative, or write: Honeywell, Test Instruments Division, Annapolis Operation, Box 391, Annapolis, Md. 21404.

**Honeywell**

ON READER-SERVICE CARD CIRCLE 188

# Digital db.

## An Easy-to-Read Unit With Direct Dialing

Dial your way from 0 to 50 db attenuation in 1 db steps with the RA-54, 50 ohm, and RA-74, 75 ohm, miniature dual concentric, rotary attenuators. Easy to read and easy to install being only 1 7/8" dia. by 3 3/4" long and weighing 14 ounces. The RA-54 provides accuracy of better than  $\pm 0.5$  db at 500 MHz,  $\pm 1$  db at 1000 MHz and  $\pm 1.5$  db at 1500 MHz, with a VSWR of less than 1.25 and insertion loss of less than 0.3 db at 1000 MHz. The RA-54 can be supplied with BNC, TNC or Type N connectors. Lightweight, easy-to-read, easy-to-dial and only **\$165.00**.

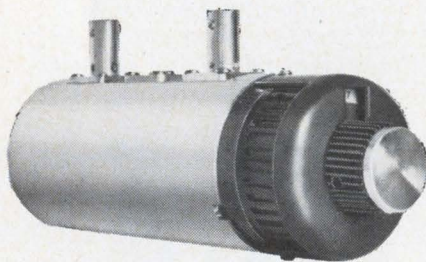

Specialists In Electronic Instrumentation

**Texscan**  
CORPORATION

**tc**

51 Koweba Lane  
Indianapolis, Indiana 46207  
Ph. (317) 632-7351

ON READER-SERVICE CARD CIRCLE 189

## TEST EQUIPMENT

### Ac-to-dc converter has zero impedance



Natel Engineering Co., 7129 Gerald Ave., Van Nuys. Phone: (213) 782-4161. P&A: \$570; 3 wks.

A miniature, solid-state ac-dc converter with zero output impedance is especially designed for airborne, ground support, and laboratory use. Automatic ranging of the input signal in the unit eliminates problems of range adjustment. A 5-range and 11-range model are available with full scale signal inputs from 1 mV rms to 10 V rms for full scale output. Other features of the converter include input impedance of 500 K and isolation of 50 M $\Omega$  between input, output, reference, and power ground. Temperature range is  $-55^{\circ}$  to  $+71^{\circ}$ C.

CIRCLE NO. 318

### Digital IC tester rises in 1 ns

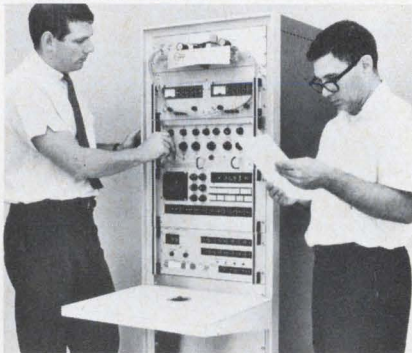

Automated Measurements Corp.  
638 University Ave., Los Gatos, Calif. Phone: (408) 354-6491.

This system performs every dynamic testing function, including toggle testing. The system's prime measurement instrument, the model 1000 waveform analyzer, can automatically deliver up to 200 measurements per second. It readily communicates with the computer and engineer through variable word-length

CIRCLE NO. 319

programming language. The AMC 9001 is compatible with all devices up to 16-pins, low or high impedance. It can be programmed manually, or automatically by tape, magnetic disc, drum or computer. Rise-time capability of the system is under 1 ns with less than 5% waveform distortion. The system can be converted from one device configuration to another. The model 9001 uses a field-coded, variable-word length, serial-by-character method of programming, with information supplied to the system at the rate of 1,000 characters per second. Test results are presented visually on the system's control module, and automatically signaled to external data logging equipment.

CIRCLE NO. 320

### High frequency probe for dc voltmeters

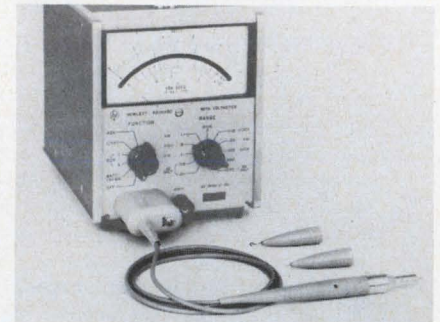

Hewlett-Packard, Loveland Div., 1501 Page Mill Rd., Palo Alto, Calif. Phone: (415) 326-7000. P&A: \$45; 60 days.

A high frequency probe converts dc voltmeters into ac voltmeters capable of measuring signals in a range from 100 kHz to 500 MHz. Accuracy within this frequency range is better than 1 dB but probe response extends both above and below the 100 kHz-500 MHz range. The probe can be used for relative measurements from 1 kHz to 1 GHz. Probe input impedance is 4 m $\Omega$  shunted by 2 pF. The probe works with any voltmeter, either analog or digital, that has an input resistance of 10 m $\Omega \pm 10\%$  and there is no need to adjust the voltmeter calibration. The probe accommodates ac signals within an amplitude range between 0.25 and 30 V rms. Accessories provided include a straight tip adapter, a hook tip adapter, a ground clip, and a high frequency adapter.

CIRCLE NO. 321

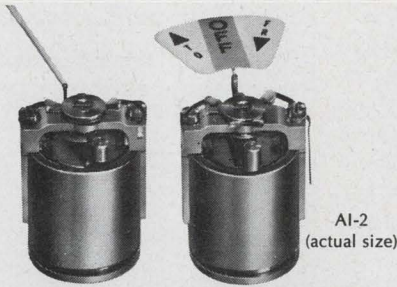

AI-2  
(actual size)

## High torque, Self-shielded moving coil mechanism

When critical indicating and control is essential this versatile mechanism will fill your requirements. Available with "On-off", "+, -", "go-no go", null, left-right or scale indicators. High torque, self-shielded core magnet design permits multi-function groupings in small space. Moving coil is 100 mg lighter than most comparable mechanisms, yet provides 10% more torque. Choice of many sensitivities; synchro or standard mounting.

# AMMON

AMMON INSTRUMENTS, INC.  
345 Kelley St., Manchester, N.H. 03105

ON READER-SERVICE CARD CIRCLE 190

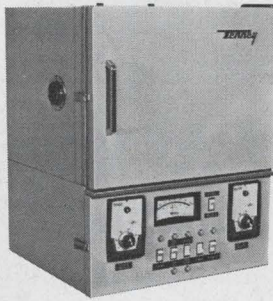

## Low cost, benchtop humidity test chamber 24" W x 26" D

Tenney Humidity Jr. is a compact, self-contained, full range benchtop chamber for low-cost humidity simulation. Plug into 115 V outlet for lab work, product development, Mil-spec testing, quality control testing, incubation, etc.—maintenance-free.

- Humidity Range: 20-95%
- Humidity Tolerance:  $\pm 1\%$
- Temperature Range:  $+20^{\circ}$  F to  $+200^{\circ}$  F
- Control Tolerance:  $\pm 1/2^{\circ}$  F
- Interior Dimensions: 20" W x 12" D x 15" H (2 cu. ft.)
- Off the shelf delivery.

Write or call today for complete details.



# Tenney

ENGINEERING, INC.

1090 Springfield Rd., Union, N.J. 07083 • (201) 686-7870  
Western Division: 15700 S. Garfield Ave., Paramount, Calif. 90723 446

ON READER-SERVICE CARD CIRCLE 191

## Profitable programming with electronic timing and control

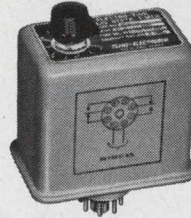

### CLARE-ELECTROSEAL Solid State Timers

Clare-Electro Seal timers serve a wide variety of applications for industrial interval timing... actuating an electrical circuit (up to 10 amp.) after a pre-set time. Solid state circuitry eliminates mechanical maintenance costs... assures reliable, trouble-free operation. For complete data, circle Reader Service Number. 231.

#### Model TMA1 TIME DELAY RELAY

Application of power starts pre-set timing period... load contacts transfer at the end of period. 100 ms removal of power resets timer. Time will repeat within 1%. For complete data, circle Reader Service Number 232.

- All model dimensions are:  $1\frac{1}{4}$ " deep;  $2\frac{1}{2}$ " wide;  $3\frac{1}{4}$ " high including knob
- Standard 8 (Model TMA1) and 11-pin (Models TMR1 and TSV1) plug-in mounting
- Dust-tight housing
- Operating voltages; 24 vdc, 115 and 230 vac
- Load contacts: 10 amp. DPDT

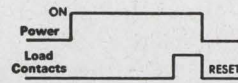

#### Model TMR1 MONITOR TIMER

Used to monitor events occurring on a predictable time basis. If external contact is not interrupted within pre-set time, load contacts transfer. Remove power to reset relay. For complete data, circle Reader Service Number 233.

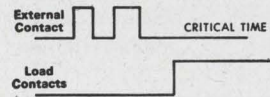

#### Model TSV1 SUMMATION TIMER

Operates from external contact for a summing mode of operation. Timer actuates load contacts after pre-set time. Operate time will be the cumulative sum of closures of the external contact. Interruptions up to 15 minutes will not alter summing operation. For complete data, circle Reader Service Number 234.

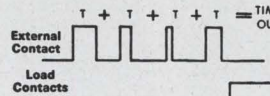

#### Model TBR1 DELAY-ON-BREAK TIMER

Closure of external contact causes immediate transfer of the load contacts. The load contacts will remain in transferred position for an adjustable time after opening of external contact. Reclosure of external contact prior to timing out, initiates a new timing period. For complete data, circle Reader Service Number 235.

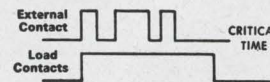

For complete information, circle Reader, Service Number—or write Group A9



## CLARE-ELECTROSEAL CORP.

Subsidiary of  
C. P. CLARE & CO.

946 North Ave., Des Plaines, Ill. 60016

ON READER-SERVICE CARD CIRCLE 192

MICROWAVES

**Power klystron produces 500 kW**

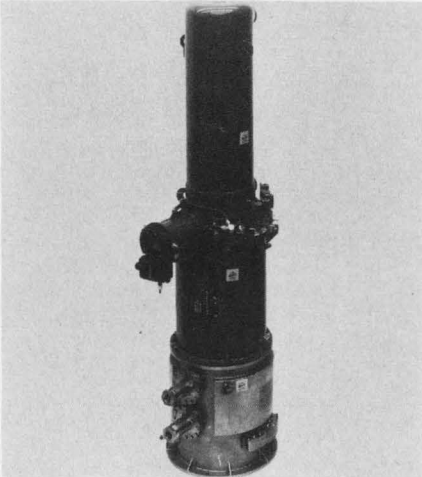

*Eimac Div. of Varian, 301 Industrial Way, San Carlos, Calif. Phone: (415) 592-1221.*

With a minimum output power of 450 kW, cw, this klystron features 55% efficiency and 55 dB gain, with 20-MHz instantaneous bandwidth at the 1-dB point. Beam voltage may be varied from 45 kV dc (130 kW) to 62 kV dc (500 kW) without returning. The klystron is tunable and op-

erates in the 2.32-to-2.45-GHz band. The klystron has five cavities, and features a half-wave beryllium oxide window, protected by an arc detector. The klystron is equipped with a nonintercepting modulating anode permitting pulsed operation, in addition to the normal cw mode. The collector is rated at a MW allowing a-m of the drive level without overheating.

CIRCLE NO. 322

**Telemetry amplifier responds at 7.5 kHz**

*Bourns, Inc., Instrument Division, 6135 Magnolia Ave., Riverside, Calif. Phone: (714) 684-1700.*

This telemetry amplifier is designed for use with a thermocouple, strain gage and other sensor systems. The model, measuring 1.0 x 1.0 x 0.5-inches and weighing 0.6 oz., is capable of producing up to 0-5 V DC output with a 5 mv input. In addition, various input levels, gain values anywhere between 100 to 1,000, and parameters other than those of the standard configurations are available.

CIRCLE NO. 323

**Broadband dipoles cover 150 to 2000 MHz**

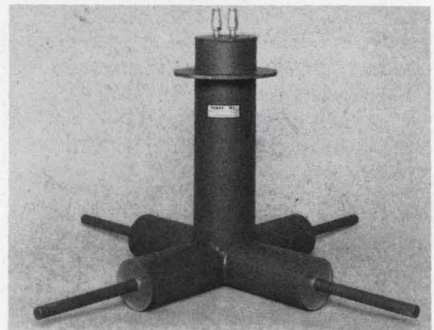

*Nurad, Inc., 2165 Druid Park Dr., Baltimore. Phone: (301) 664-8300. P&A: \$400 to \$600; 45 days.*

A complete series of octave bandwidth crossed dipoles covering 150 through 2000 MHz are made of aluminum. The antennas contain two electrically independent linearly polarized elements which can be used separately or arrayed to provide orthogonal circularly polarized operation. Isolation between each element exceeds 25 dB at all frequencies. The antennas can be used with or without a reflector.

CIRCLE NO. 324

**DELAY TIMERS**



Any mounting style; voltage specification; time cycle; operational method. No special engineering required. Good delivery schedules. Our stock is ample.

**INDUSTRIAL TIMER CORPORATION**

U. S. Highway 305, Parsippany, N. J.

Subsidiary of General Precision Equipment Corporation

ON READER-SERVICE CARD CIRCLE 193

**"IT'S GOOD BUSINESS TO HIRE THE HANDICAPPED."**

**ISN'T THAT A GREAT IDEA, SNOOPY?**

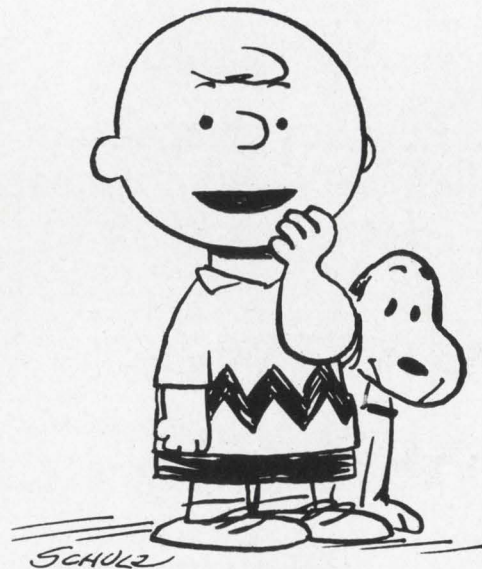

**THE PRESIDENT'S COMMITTEE ON EMPLOYMENT OF THE HANDICAPPED, WASHINGTON, D. C.**



# This AE Type 44 Rotary Stepping Switch Thrives on Solitude.



So do all the rest of our hermetically sealed stepping switches. That's because we build switches so they can't bind, never overthrow.

Most of the secret's in our stepping mechanism. We don't use a pawl stop block. Instead, we use a unique "free-floating" pawl—with a set of stopping teeth on the end of the armature.

This way, the armature not only steps the wiper or cam assembly to the next position—it

also *locks* the rotor in the correct position. Overthrow is impossible. So is pawl wear and bind against a pawl stop block—even at low temperatures.

*Where* can you use these sealed switches? Almost anywhere. Some people take them out in the desert or down to the bottom of the ocean. Others fly them above 40,000 feet, where the mean temperature is  $-55$  degrees Centigrade. You might want them for a particularly dusty location in your shop.

*How* can you use reliable, versatile rotary stepping switches? There's a lot of helpful design information in our Circular #1698. It's yours for the asking. Just write the Director, Relay Control Equipment Sales, Automatic Electric Company, Northlake, Illinois 60164.

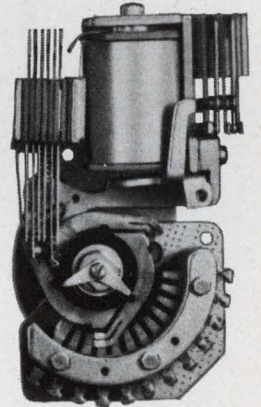

**AUTOMATIC ELECTRIC**  
SUBSIDIARY OF  
GENERAL TELEPHONE & ELECTRONICS **GT&E**

ON READER-SERVICE CARD CIRCLE 194

# Dialco Sub-Miniature Illuminated PUSH BUTTON SWITCHES and matching INDICATOR LIGHTS

can solve many indication problems for you!

Dialco silent, momentary type switches—with matching (or companion) lights can offer you the switching/indication combination you require.

Check these features:

**Switching capabilities:** require 24 oz. (approx.) operating force. Contact arrangements are S.P.S.T., normally open or normally closed; two circuit (one normally open, one normally closed).

**Switch ratings:** 3 amps, 125V AC; 3 amps, 30V DC (non-inductive). Switches are completely enclosed and independent of the lamp circuit.

**Mounting:** units are made for single hole (keyed) mounting in panels up to 3/16" thick; mount from back in 1/2" clearance hole.

**Display capabilities:** 1/2" or 3/4" interchangeable push-button caps are available, with round or square shape. Caps may be had with rotatable or non-rotatable feature with a choice of 7 color combinations.

Get all the data! Write for our  
new catalog today.

(Illus. approx. 75% actual size)

**DIALCO**

Foremost Manufacturer of Indicator Lights

**DIALIGHT** CORPORATION

60 STEWART AVE., BROOKLYN, N.Y. 11237

AREA CODE 212 497-7600

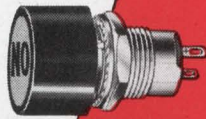

188-9730-5071-602



185-9830-1871-604



183-0301-1471-604



187-0101-1871-604

ON READER-SERVICE CARD CIRCLE 195

## YOKE SPECIFYING PROBLEM?

ASK AN  
EXPERT...

A SYNTRONIC  
DEFLECTION  
YOKE SPECIALIST



Since we make more types of yokes than anyone else, it's natural enough for our team of experts to know more about yoke design, application engineering, and quality control.

Specifying can be a challenging problem, and with this in mind, we put our experience at your disposal. Don't hesitate to call or write us when you're puzzled as to the right deflection yoke for your display.

*syntronic*

INSTRUMENTS, INC.

100 Industrial Road, Addison, Illinois  
Phone: Area 312, 543-6444

ON READER-SERVICE CARD CIRCLE 196

## MICROWAVES

### Coherent synchronizer spans 500 MHz to 40 GHz

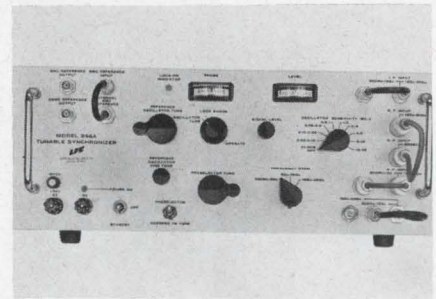

LFE Electronics, a division of Laboratory for Electronics, 1075 Commonwealth Ave., Boston. (617) 254-4233. P&A: \$4195; 60-90 days.

This microwave synchronizer spans the frequency range from 500 MHz to 40 GHz. The LFE model 246 will phase-lock any voltage tunable microwave source such as a klystron, BWO, VTM or sweep generator to a quartz crystal. Long-term frequency drift of 1 part in 10<sup>7</sup> can be achieved over a period of 30 minutes. This stability can be improved through the use of an external rubidium or crystal standard. Two waveguide mixer-harmonic generators are supplied as external accessories. This allows generation of the IF at the source, and transmission to the synchronizer through a flexible cable. A coaxial fitting and mixer are supplied internally at frequencies between 0.5 and 18 GHz. A selection of nine phase-lag networks insures that the proper compensation for source modulation sensitivity will be achieved. Modulation sensitivities from 0.05 MHz/V to 38 MHz/V can be chosen. The lock-in range of the model 246 can be varied from 0 to  $\pm 40$  V providing a greater frequency hold-in range.

The 5 MHz crystal oscillator in the multiplier-harmonic generator is also used as the reference source for the phase detector to make the system coherent. A selection of sixteen crystals can be sequentially chosen and pulled until the proper lock-line is noted on the signal level and phase meters. Simply inserting the synchronizer output between the voltage control element of the source to be stabilized and its power supply is all that is necessary to place the system in operation.

CIRCLE NO. 325

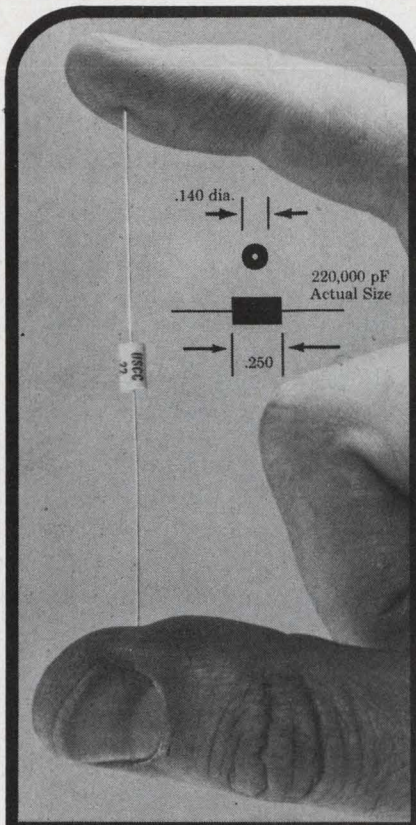

## USCC announces the highest capacitance density in a micro-miniature size

If you have problems obtaining high capacitance values in your microelectronic circuits, let USCC's C20 Series help you. These Ceramolitic® capacitors feature the best capacitance per unit volume available anywhere in a ceramic capacitor for filtering, bypass, coupling and blocking in micro-miniature circuits.

Here's what you get:

| C20 SERIES<br>Capacitance (pF) | Size (in.)<br>Diameter Length |
|--------------------------------|-------------------------------|
| 10 - 12,000                    | .080 x .150                   |
| 15,000 - 27,000                | .095 x .185                   |
| 33,000 - 56,000                | .095 x .250                   |
| 68,000 - 120,000               | .125 x .250                   |
| 150,000 - 220,000              | .140 x .250                   |

Designed for "cordwood" applications, epoxy resin encapsulation offers outstanding insulation resistance, adhesion qualities and high temperature characteristics. Axial leads of .016" diameter Nickel per MIL-STD-1276 N-1 are excellent for soldering and welding. ■ Ceramolitic® capacitors of the C20 Series give you large size performance in a small size with no sacrifice in electrical characteristics.

**CERAMOLITHIC®**

... advanced design in ceramic capacitor construction  
For complete technical information  
on the new C20 Series, contact:

**USCC**

U. S. CAPACITOR CORPORATION  
2151 NO. LINCOLN STREET • BURBANK, CALIFORNIA 91504  
(213) 843-4222 • TWX: 910-498-2222

## Rising sun magnetron delivers 3.2 mm output



Amperex Electronic Corp., Hicksville, N. Y. Phone: (516) 433-9045.

A conventional magnetron that delivers 5 ns pulses of 95 GHz energy at 10 kW is designated the DX287. It has a 3.2mm wave-length output. This output figure lies squarely in the center of an atmospheric window where the attenuation is much lower than at other frequencies in the millimeter region.

The short pulses possible with this unit, down to 5 ns, give range resolution of better than a meter. The duty cycle of 0.0002 allows any practical repetition rate up to 40 KHz, producing bright, detailed PPI displays—or even TV-type rasters.

CIRCLE NO. 361

## Voltage-tuned oscillator ranges 1.2 to 1.8 GHz

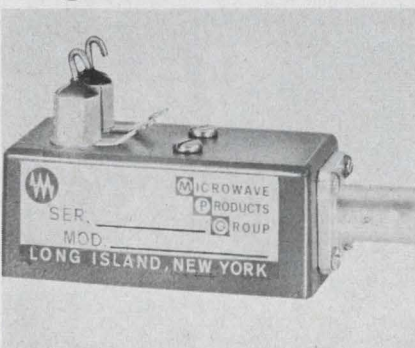

Microwave Products Group, 115 Old Country Rd., Carle Place, N. Y. Phone: (516) 741-1500.

Voltage tuned oscillators covering 1.2 to 1.8 GHz offer a linearity of within  $\pm 1\%$  over 75% of the tuning range and within 7% of the full tuning range. The 1 x 1 x 2-1/4-inch device provides a power output of greater than 50 mW.

CIRCLE NO. 326

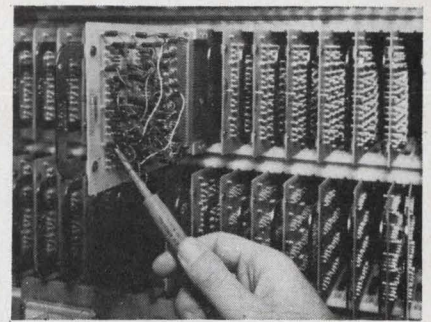

## You're right on top with pluggable/patchable Cambi-Cards®

This new idea in logic card make-up lets you go from original function patch-up to final system check-out without tear-down or breadboard change. What's more, your final system configuration built with Cambi-Cards is ready for production — no breaking down or production re-design is required. All three steps — initial IC logic function assembly to intermediate rack mounting to system incorporation — are possible with Cambi-Cards.

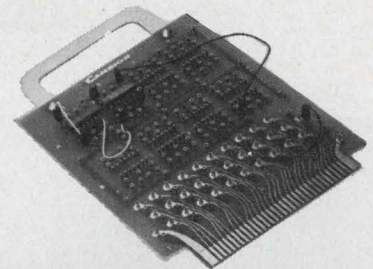

Because patching and IC pluggability are both on the same side of the card, you can see what you are doing — no mis-wiring. Find out how successfully and quickly your design and system ideas can prove their value with Cambi-Cards. Ask for a demonstration, contact: Cambridge Thermionic Corporation, Digital Products Division, 433 Concord Avenue, Cambridge, Massachusetts 02138. Phone: (617) 491-5400. ® REG. U.S. PAT. OFF.

CAMBRIDGE THERMIONIC CORPORATION  
**CAMBION®**

Standardize on CAMBION...  
21,541 guaranteed electronic components

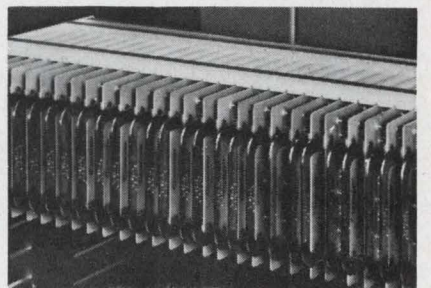

ON READER-SERVICE CARD CIRCLE 198

## Compare these two precision miniature bearings:

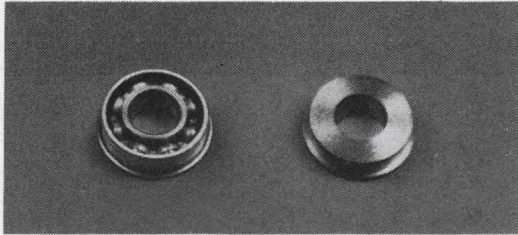

This one is a precision miniature ball bearing.

This one is a Northfield precision sintered bronze bearing.

In every respect save one, the two are perfectly interchangeable. The Northfield bearing, precision made of sintered bronze (per MIL-B-5687 Type 1, Comp A), will meet your closest dimensional requirements. Only in performance at high speeds with heavy loads do they differ, and even there the Northfield bearings rate high. Their coefficient of friction is low, and they are vacuum impregnated with instrument oil, per MIL-L-6085A.

Yet Northfield bearings cost only  $\frac{1}{3}$  as much as miniature ball bearings.

Northfield precision bearings come in a full range of miniature sizes — flanged and sleeve types. Call or write for complete information and prices.

Northfield Precision Instrument Corp., 4400 Austin Blvd., Island Park, L. I., New York 11558.

Tel.: (516) 431-1112.



Maybe you've been overspending for years.

ON READER-SERVICE CARD CIRCLE 199

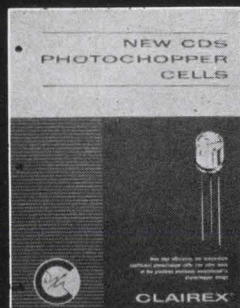

Write for  
bulletin  
describing

# New CDS type 6C Photochopper Cells

- High Efficiency
- Low Temperature Coefficient
- Resistance Tolerance  $\pm 50\%$
- Internal Electrostatic Shielding
- Dumet Leads



INC. ■ 1239 BROADWAY, NEW YORK, N. Y. 10001

ON READER-SERVICE CARD CIRCLE 200

## MICROWAVES

### Cw lag laser with 3 W output

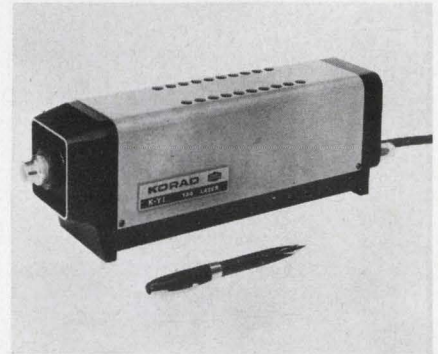

Korad Corporation, 2520 Colorado Ave., Santa Monica. Phone: (213) 393-6737. P&A: \$7000; 30 days.

A portable yttrium aluminum garnet (YAG) laser with a typical continuous-wave output of 3 W can be used for trimming of resistors, interferometry, alignment of optical systems and real-time data display. The device also would be useful for Raman spectroscopy, infrared microscopy, and studies of nonlinear optics and parametric amplifiers. Emission is at 1.06 microns, with a half-angle beam divergence of 2.5 milliradians at threshold. The power supply is contained in a 10 x 10 x 20-inch cabinet. The laser head measures 4 x 4 x 12 inches, and the combined weight is 64 pounds. Input power is 117 V, 60 Hz, 1800 W. The unit is cooled by a closed-cycle, water recirculation system.

CIRCLE NO. 327

### X-band power source delivers 100 Mw

RCA, 30 Rockefeller Plaza, New York. Phone: (212) 265-5900.

The type S198 power source is designed for use as a local oscillator, low-power relay transmitter, pump for parametric amplifier or low-power radar transmitter. This X-band device provides a power output of 100 mW over a mechanical tuning range of 100 MHz. It employs a transistor oscillator-multiplier driving a two-stage varactor frequency multiplier chain. The chain consists of a broadband bar-type doubler circuit follower and a quadrupler output. The S198 can be adapted for electronic tuning.

CIRCLE NO. 328

# DESIGN PROBLEMS?

solve them with

# PIONEER PHOTOCELLS

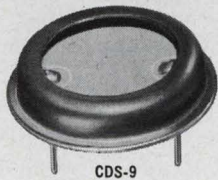

CDS-9

A 1" photocell, especially designed for numerous applications in outside or inside lighting, flame control, and relay applications where the light source is incandescent. Proven by

hundreds of thousands of photocell years of service. Shown actual size—standard models available.



CDS-7

Has the same general characteristics as the CDS-9 but a smaller size (1/2") for use where space is at a minimum. Shown actual size—standard models available.

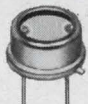

CDS-5

A very compact unit with a T.O. 5 housing, produced to your specifications.

Our engineering department will work with you on any special application of photosensitive layers.

### STANDARD MODELS

| CDS Type No. | 1 FC Simulated Daylight 50 V AC Mean* Output | Nominal Resistance 50 FC 2800° K Incand. | Max. Dark Current** or Min. Dark Resistance | Max. Dissip.        | Max. Volt Dark |
|--------------|--|--|---|---------------------|----------------|
| 701          | 1.5 ma                                       |  | 25 ua                                       |                     | 500 V          |
| 702          | 3 ma   |  | 25 ua                                       | all rated           | 500 V          |
| 703          | 6 ma   |  | 40 ua                                       | 1/4 watt continuous | 350 V          |
| 710          |  | 1330 ohms                                | 4 meg.                                      | 1 watt              | 500 V          |
| 711          |  | 670 ohms                                 | 4 meg.                                      | 1 minute            | 500 V          |
| 712          |  | 330 ohms                                 | 2.5 meg.                                    |                     | 350 V          |
| 901          | 1.5 ma                                       |  | 25 ua                                       | All rated           | 1000 V         |
| 902          | 3 ma   |  | 25 ua                                       |                     | 1000 V         |
| 903          | 6 ma   |  | 40 ua                                       | 1/2 watt            | 700 V          |
| 904          | 12 ma  |  | 200 ua                                      | contin-             | 500 V          |
| 910          |  | 1330 ohms                                | 4 meg.                                      | uous                | 1000 V         |
| 911          |  | 670 ohms                                 | 4 meg.                                      | 2 watts             | 1000 V         |
| 912          |  | 330 ohms                                 | 2.5 meg.                                    | 1 minute            | 700 V          |
| 913          |  | 165 ohms                                 | 0.5 meg.                                    |                     | 500 V          |

\*Range of values in any category equal to ±33% of mean.  
 \*\*Measured at 100 V, 5 seconds after 50 FC light extinguished.

THE **PIONEER**  
 ELECTRIC & RESEARCH CORPORATION  
 Subsidiary of PECO Controls, Inc.  
 743 Circle Ave., Forest Park, Ill. 60130  
 Telephone: (312) 771-8242

ON READER-SERVICE CARD CIRCLE 206

## S-band multicouplers use stripline transistors

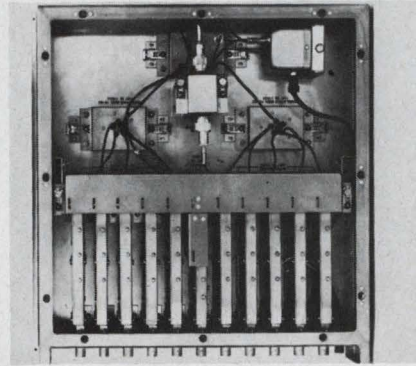

Micro State Electronics Corp., 152 Floral Ave., Murray Hill, N. J. Phone: (201) 464-3000.

Stripline transistors are used in these multicouplers. They cover the L and S-band telemetry channels. Isolation between outputs is 50 dB with an input-output VSWR of less than 2. The isolation is obtained by using power splitters of the hybrid N-way type with resistive networks included to terminate incident energy at the outputs. The units consist of a preamp, eight postamplifiers and power dividers. Gain is from 2 to 5 dB.

CIRCLE NO. 329

## L-band circulator has Y and T styles



Raytheon Co., Special Microwave Devices Operation, 130 Second Ave., Waltham, Mass. Phone: (617) 899-8080.

A low-power coax L-band circulator has a maximum VSWR of 1.2, maximum insertion loss of 0.3 dB and minimum isolation of 20 dB. The unit comes with type N connectors in a Y configuration package. It can also be supplied with one port terminated for isolator applications, and in a T configuration.

CIRCLE NO. 330

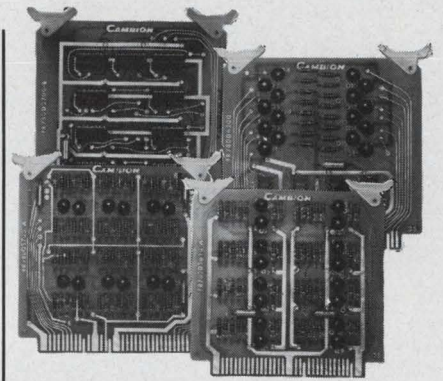

## You've got a bigger logic selection with Cambion® IC Assemblies

We started with the idea of providing the widest selection of standardized integrated circuit assemblies anywhere in the industry. We're over 200 already and continuing to add.

You name the function you want and chances are we have a standard assembly for it, whether it's a counter, decoder, or register. We've even tried to anticipate your needs and have some complex functions available.

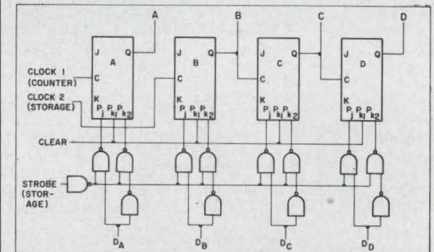

Up to 5 digit decade counters per card.

And we'll help you design digital logic assemblies into efficient, low cost systems for a variety of special applications, if you wish.

For complete information and specifics on integrated circuit assemblies, contact: Cambridge Thermionic Corporation, Digital Products Division, 453 Concord Avenue, Cambridge, Massachusetts 02138. Phone: (617) 491-5400.

REG. U.S. PAT. OFF.

CAMBRIDGE THERMIONIC CORPORATION  
**CAMBION®**

Standardize on CAMBION...  
 21,541 guaranteed electronic components

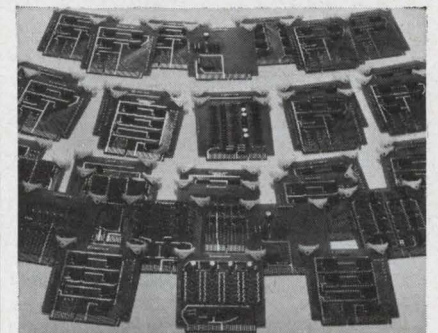

ON READER-SERVICE CARD CIRCLE 207

**new  
miniature  
low-cost**

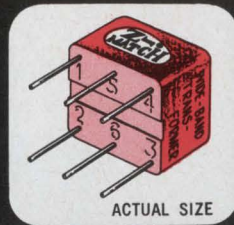

**Z-MATCH™**

# WIDEBAND TRANSFORMER

Now you can buy just the component — sans the bulky package, and at low cost

**20 TYPES OFF-THE-SHELF  
plus short-order specials such as our  
NEW DOUBLY-BALANCED MIXER**

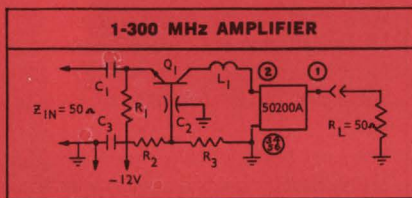

**A full range of impedance values  
and winding combinations**

**COVERAGE:** 0.1-1000 MHz  
**VSWR:** 1.3:1 maximum  
**INSERTION LOSS:** 0.5 dB max

**PRICES:**  
\$12.90 to \$20.80 each;  
quantity discounts.

**VARI-L CO INC** 207 GREENWICH AVENUE, STAMFORD/CONN/06904 / 203-323-2176

ON READER-SERVICE CARD CIRCLE 208

## NEW! *smallest axial shielded inductor available* the "NANO-RED"

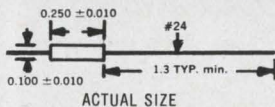

**Range:** 0.10 $\mu$ h to 1,000 $\mu$ h in 49 stock values  
**Size:** 1/10 dia. by 1/4 lg.  
**Inductance Tolerance:**  $\pm 10\%$

This new "NANO-RED" offers the highest inductance to size ratio available in an axial shielded inductor. Exceptional "Q" and self-resonance characteristics. Max. coupling 2% units side by side. Non-flammable envelope. Designed to MIL-C-15305C. Operating temperature  $-55^{\circ}\text{C}$  to  $125^{\circ}\text{C}$ .

**Other Lenox-Fugle Subminiature Shielded Inductors:**

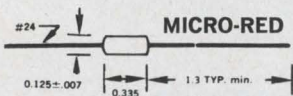

The "Micro-Red" is a shielded inductor that offers the largest inductance range in its size: 0.10 $\mu$ h to 10,000 $\mu$ h. "Q" to "L" ratio unsurpassed, with excellent distributed capacity. Inductance tolerance  $\pm 10\%$ . Designed to MIL-C-15305C. Stocked in 61 predesigned values.

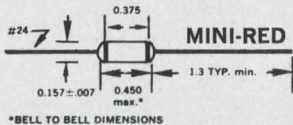

The "Mini-Red" offers the highest "Q" to "L" ratio available over inductance range 0.10 $\mu$ h to 100,000 $\mu$ h in its size. Inductance tolerance  $\pm 10\%$  measured per MIL-C-15305C. Stocked in 73 predesigned values.

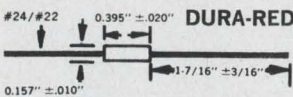

The "Dura-Red" is designed to MS-90537 with inductance range 0.10 $\mu$ h to 100,000 $\mu$ h with tolerance  $\pm 10\%$ . Stocked in 73 predesigned values.



Data Sheets: write or phone

**LENOX-FUGLE ELECTRONICS, INC.**

475 Watchung Avenue, Watchung, N. J. 07060

Telephone: Code 201, 756-1164-1165

ON READER-SERVICE CARD CIRCLE 209

## SYSTEMS

### Physiological monitor displays 8 channels

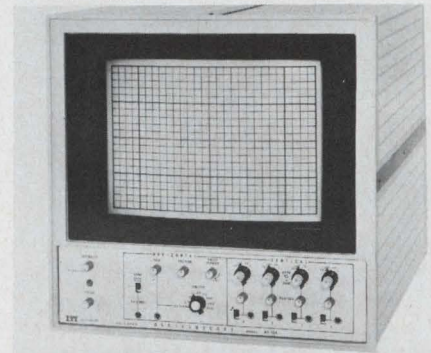

ITT Corp., 320 Park Ave., N. Y.  
Phone: (212) 752-6000.

A large-screen physiological monitor that displays simultaneously 8 channels of transducer data such as ECG, EEG and a variety of similar signals is now available. Time sharing allows from one to eight channels of data to be displayed simultaneously on the 17-inch CRT screen area. A "chopped" communication method of multichannel display assures high resolution, uniform trace intensity, and faster recognition of short transients. Commutation rate is selected to assure faster continuous traces on all beams at sweep frequencies.

The aluminized CRT has 20 lines per centimeter resolution, 20 mV per centimeter sensitivity and 1% linearity. Drift-free performance without warm-up is accomplished because of its solid-state design. The unit may be rack-or bench-mounted.

CIRCLE NO. 331

### A to D converters are solid-state

RC-95, Inc., 9 E. 38th St. New York.  
Phone: (212) 689-9776.

Standard models in the 510 series provide any data-word length from 4 to 10 bits, at 2 to 4  $\mu$ s per bit, yielding corresponding conversion rates from 25,000 to over 125,000 conversions per second. These ADC modules, employing IC's and sub-miniature components, occupy less than 11 cubic inches of space, and weigh 9 ounces. All circuitry is p.c. board-mounted, fully accessible, field repairable and rigidly mounted in an internally-finned, one piece aluminum shell.

CIRCLE NO. 332

# Buy Bonds where you work.

## They do.



They work for freedom. And more than seven out of ten of them are supporting freedom with their dollars, too — through investment in U.S. Savings Bonds. When *you* buy Bonds, you can save up for a rainy day, a home, a free and comfortable future — and at the same time show these brave men you're on their side. Join the Payroll Savings Plan where you work or buy Bonds where you bank. You'll walk a bit taller.

### New Freedom Shares

Now, when you join the Payroll Savings Plan or the Bond-a-Month Plan, you are eligible to purchase new Freedom Shares. They pay 4.74% when held to maturity of just four-and-a-half years (redeemable after one year), and are available on a one-for-one basis with Savings Bonds. Get the facts where you work or bank.

Join up. America needs your help.



The U.S. Government does not pay for this advertisement. It is presented as a public service in cooperation with the Treasury Department and The Advertising Council.

### Microwave receiver listens to 40 GHz



Scientific-Atlantic, Inc., Box 13654, Atlanta. Phone: (404) 938-2930. P&A: \$5800; Nov.

Suitable for field or laboratory use, the 1710 receiver has a range of 940 MHz to 40 GHz and will handle cw, sine-wave, square-wave, or pulse-modulated input signals. The unit has a dynamic range of 40 dB, three switch-selectable IF bandwidths, and uses the crystal-harmonic mixing technique that permits wide-range coverage without plug-in units. Options include a low-frequency converter that extends the frequency range down to 20 MHz, an extended dynamic range (60 dB), a signal level compensation a precision IF attenuator, and a battery inverter for field use.

CIRCLE NO. 333

### Digital replacement for cam programmer

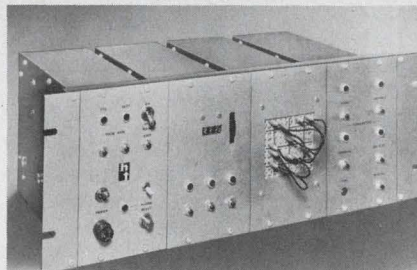

Hafstrom Technical Products, Inc., 4616 Santa Fe, San Diego, Calif. Phone: (714) 274-8822.

Using digital techniques, this programmer provides one or more variable control resistances suitable for programming temperature, voltage and currents. It is possible to program functions with rates of change or durations outside the limits of the average cam program unit. Programs can be changed by simply rearranging a patch panel.

CIRCLE NO. 334

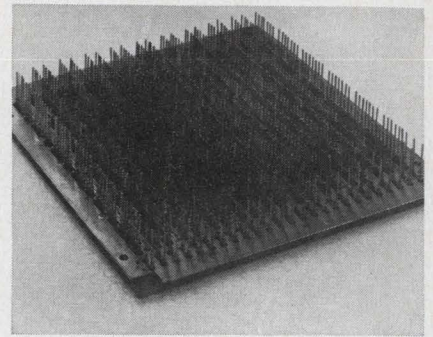

### You're more productive with back-plane wiring

These new panels let you get the most out of wire-wrapping techniques. By combining specially drawn Wire-Wrap\* terminals (for machine or hand-gun interconnection) with CAMBION®'s exclusive cage jack (for IC pluggability) you can have both packaging density and high production.

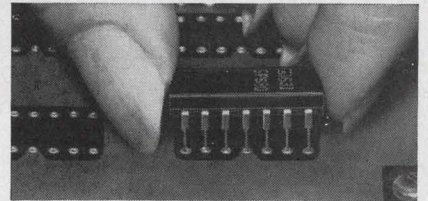

The concept of these panels allows you to order a size to meet your space or function requirements whether you're mounting 50 or 500 dual in-line IC's. If you are redesigning with integrated circuits, let CAMBION help you make the most of your design effort. For complete specifications on this reliable interconnection technique, contact: Cambridge Thermionic Corporation, Digital Products Division 455 Concord Avenue, Cambridge, Massachusetts 02138. Phone: (617) 491-5400.

® REG. U.S. PAT. OFF.  
\* T. M. Gardner-Denver

**CAMBRIDGE THERMIONIC CORPORATION**  
**CAMBION®**

Standardize on CAMBION . . .  
21,541 guaranteed electronic components

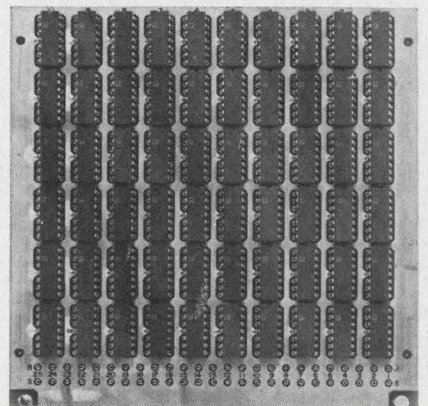

ON READER-SERVICE CARD CIRCLE 211

## New! RF Shielded New! Front-Mounting

Eldema's C-Lite Cartridge and D-Holder combination provides both incandescent or neon panel lites. Now D-Holders with the added reliability of RF shielding and the added flexibility of front-mounting. Eldema plug-in cartridge lites are inherently reliable, simple to in-

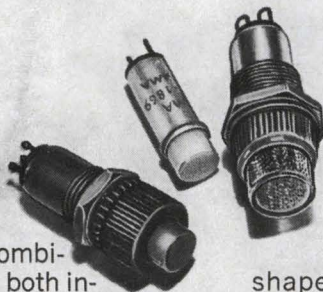

stall, and easy to replace. Available in a large range of lens shapes, styles, and colors. Matching push switches utilizing C-Lites are also available. Eldema cartridge lites and holders conform to MIL-L-3661. Write for complete brochure and free samples, or use reader service card.

### ELDEMA

A Division of Genisco Technology Corporation  
18435 Susana Road / Compton, California / (213) 774-1850

ON READER-SERVICE CARD CIRCLE 212

## it costs you nothing to call on experience:

Reeves-Hoffman design and manufacture is 100% custom . . .  
let us quote **your** needs!

★ quartz crystals

★ crystal filters

★ oscillators

★ discriminators

★ standards

★ ovens



400 WEST NORTH STREET, CARLISLE, PENNSYLVANIA 17013  
Telephone 717-243-5929

**Md., Del., D.C., Va., W.Va., N.C.**  
Valley Electronics, Inc.  
Baltimore, Maryland  
(301)668-4900; (202)659-1760

**New England**  
Howard Jappe Company  
Wakefield, Mass.  
(617)245-9359

**Pa. (except Pittsburgh), So.N.J.**  
Eastern Components, Inc.  
Philadelphia, Pa.  
(215)927-6262

**New York (except N.Y.C.)**  
Midstate Research Sales Co.  
Syracuse, New York  
(315)478-8314; (315)478-0715

**New York City, No.N.J.**  
G. M. Moch Company  
Ridgefield, New Jersey  
(201)945-0080; (212)279-6758

**So. California**  
Ash M. Wood Company  
Arcadia, California  
(213)283-1201; (213)287-0449

**No. California**  
L & M Engineering  
Santa Clara, Cal.  
(408)243-6661

**Ill., Ind., Wisc., Minn.**  
PGM Sales, Inc.  
Chicago, Illinois  
(312)622-8183

**Ohio, W.Pa., Mich., Ky.**  
Tri-State Marketing, Inc.  
Cincinnati, Ohio  
(513)631-5060

**Texas, Okla., Ark.**  
Carter Associates, Inc.  
Garland, Texas  
(214)276-7151

**Ariz., N.M., Las Vegas**  
Carter Associates, Inc.  
Scottsdale, Arizona  
(602)947-4355

ON READER-SERVICE CARD CIRCLE 213

## MATERIALS

### Freon aerosol spray removes rosin flux



Sprayon Products, Inc., Industrial Supply Div., Bedford Heights, Ohio. Phone: (216) 292-7400.

For removal of rosin flux as used on printed circuits, relays or semiconductors, this aerosol Freon spray is gentle enough for use on plastics and elastomers. The spray is also used in cleaning computer parts. It is nonflammable and non-toxic and comes in a 16-oz can with an extension tube for pinpoint application.

CIRCLE NO. 335

### Conductive adhesive for rf gaskets

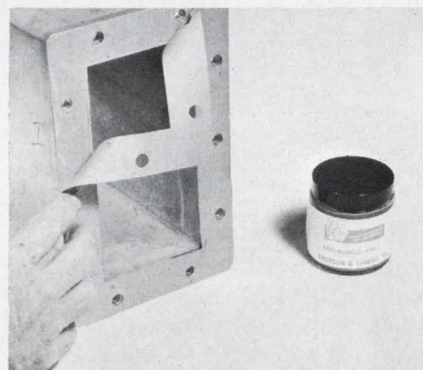

Emerson & Cuming, Inc., Canton, Mass. Phone: (617) 828-3300. Price: \$10 up.

This silicon resin adhesive has a volume resistivity of approximately 0.001Ω-cm. It can be used continuously at 400°F. Eccoshield RVS contains solvent which makes application easy. As solvent evaporates, the adhesive develops tack. Gaskets are applied, or closure is made while in this condition. If tack is lost, it can be regained by surface application of solvent, such as toluene.

CIRCLE NO. 336



# R-3000

## SOLID STATE AC VOLTAGE REGULATORS

Write  
today  
for new  
Brochure

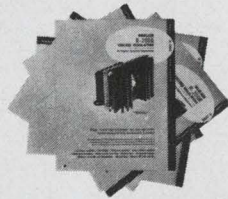

Designed Especially for OEM Application.  
Two Lines Available.

### SPECIFICATIONS

|  | R-3100                             | R-3200                                   |
|--|------------------------------------|--|
| Type of Voltage Regulation                   | True RMS                           | Peak                                     |
| Regulation Technique                         | Peak Clipping                      | Peak Clipping                            |
| Type of Reference                            | RMS Sensor                         | Zener Diode                              |
| Input  | 100-130 VAC<br>47-63 Hz<br>115 VAC | 100-130 VAC<br>47-63 Hz<br>115 VAC (RMS) |
| Output                                       |                                    |  |
| Line Regulation ( $\pm 10\%$ line variation) | $\pm 0.5\%$                        | $\pm 1.0\%$                              |
| Load Regulation (10% to Full Load)           | $\pm 0.5\%$                        | $\pm 1.0\%$                              |
| Frequency Regulation (47-63 Hz)              | $\pm 0.5\%$                        | $\pm 1.0\%$                              |
| Power Factor Regulation ( $+0.7$ to $-0.7$ ) | $\pm 0.5\%$                        | $\pm 1.0\%$                              |
| Phase Shift                                  | None                               | None                                     |
| Response Time                                | 10-50 $\mu$ sec.                   | 10-50 $\mu$ sec.                         |
| Models Available                             | 15-1000 va                         | 15-1000 va                               |

## WANLASS ELECTRIC CO.



A Subsidiary of American Bosch Arma Corporation  
2175 South Grand Avenue/Santa Ana, California 92705

ON READER-SERVICE CARD CIRCLE 214

## MEDIUM POWER SERVO REPEATER 893A/GT-879A

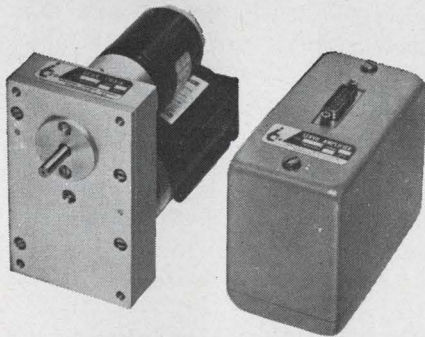

- Follows 60 cps, 3 wire synchro data
- 100 rpm max., 350 oz./in. stall torque
- 10 watts shaft output
- Requires only 117v, 60 cps

A light-weight servo system for medium power loads with precision gearing and solid state electronics. For heavy duty industrial and military applications.

WRITE FOR OUR GENERAL CATALOG describing our complete line of Servo Systems, Servo Amplifiers and Servo Testers.

**INDUSTRIAL CONTROL COMPANY**  
CENTRAL AVENUE FARMINGDALE, L. I., N. Y.  
AT PINELAWN 516-694-3000

ON READER-SERVICE CARD CIRCLE 215

ELECTRONIC DESIGN 19, September 13, 1967

## Epoxy molding powder cures in 1½ minutes

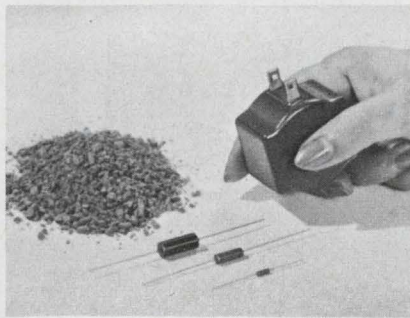

Mitchell-Rand Manufacturing Corp.,  
Torne Valley Rd., Hilburn, N. Y.  
Phone: (914) 357-2700.

A one-component epoxy molding powder is designed for encapsulating electronic components by transfer molding. A mineral molding powder yields a rigid and highly moisture resistant encapsulation with thermal stability at 155°C. After molding it is self-extinguishing and exhibits good electrical properties over a broad range of temperatures. Supplied in three flow ranges it insures optimum molding properties for individual molds, component configuration, and press designs. A cure time of 1 1/2 minutes in the mold is suggested for initial evaluations.

CIRCLE NO. 337

## Fluorochemical liquid boils at 90° F

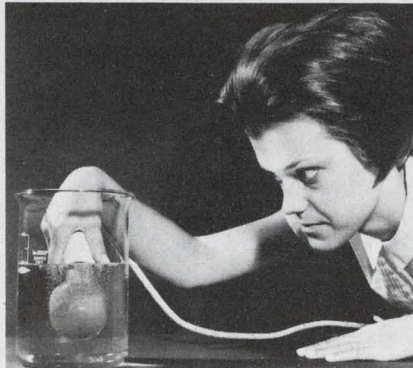

3M Co., 2501 Hudson Rd., St. Paul.  
Phone: (612) 733-1804.

The liquid, called FC-32 has many applications as a non-corrosive, low temperature refrigerant and as a coolant for electronic systems including computers. The dielectric strength this liquid at 77° F is 42 kV/0.1. Its dielectric constant is 1.72 at 1 KHz and its dissipation factor is less than 0.0003 at 1 kHz.

CIRCLE NO. 338

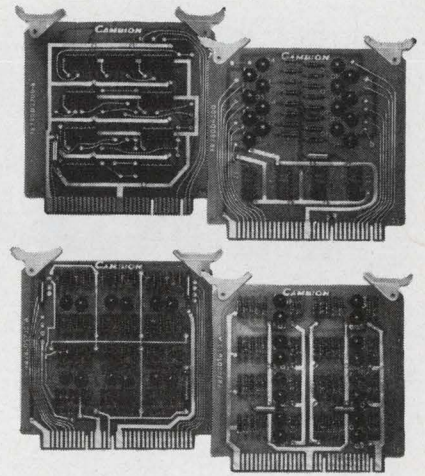

## You've got it made with Cambion® Logic Assemblies

Difficult digital application? Noisy environment? Need high speed or a large variety of functions? Ask for CAMBION DTL, TTL or HTL logic assemblies. CAMBION gives you more functions per card and all cards are compatible.

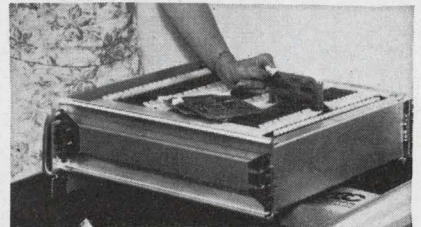

Choose from over 200 assemblies with high package densities and 70-pin input/output capability. That's twice the number of any competitor, and CAMBION assures you the lowest cost per function. The complete line includes power supplies, card files, drawers . . . available off the shelf, in the widest variety.

For more information on CAMBION's IC assemblies, contact: Cambridge Thermionic Corporation, Digital Products Division, 457 Concord Avenue, Cambridge, Massachusetts 02138. Phone: (617) 491-5400.

REG. U.S. PAT. OFF.

**CAMBRIDGE THERMIONIC CORPORATION**  
**CAMBION®**

Standardize on CAMBION . . .

21,541 guaranteed electronic components

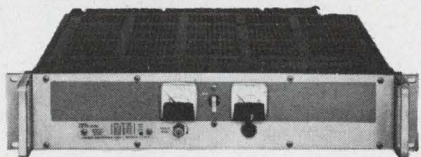

ON READER-SERVICE CARD CIRCLE 216

# HIGHEST

$m_T/t_{SU}$

We call your attention to a whole new parameter by which to compare IC testers: number-of-test-measurements-per-time-spent-setting-up. You get more of it from the Birtcher Model 800. □ Not only can you make up to 50 separate measurements with one programming of the Model 800's matrix; you can also perform complete functional testing of digital-type IC's without reprogramming. Test speeds like 24 microcircuit parameters in 30 seconds are routine. And the Model 800 is a manual tester, with a manual tester's price tag. □ It has five digitally-settable integral power supplies (one of them a constant current source), and provision for five more external inputs. The matrix is the convenient crossbar type, rather than a pin board. □ Other features include push-button test sequencing; 1% accuracy of internal readout; and hook-up for external readout. A full complement of adapters is available, covering all types of IC's. □ Construction is modular, and there are options on matrix size and accessory modules. □ Price is in the \$2000-\$3000 range.

Write for catalog and applications data.

**the BIRTCHER CORPORATION**  
INSTRUMENT DIVISION

1200 Monterey Pass Road • Monterey Park, California 91754 • (213) 264-6610



ON READER-SERVICE CARD CIRCLE 217

## Design Aids

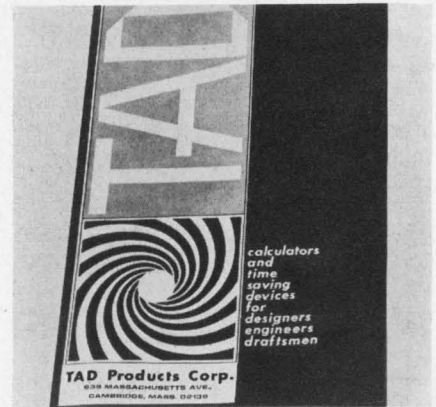

### Design aids catalog

This 16-page, 1967-68 catalog contains full descriptions of slide and rotating type calculators, comparators, charts, handbooks, manuals, nomographs, curves, rules, converters, drawings, and other devices and reference works. The design aids are intended for electronics, fluid, mechanical, and structural designers, engineers, and draftsmen. These time-saving devices and reference works are designed to provide answers to a myriad of problems and questions. TAD Products Corp.

CIRCLE NO. 339

### Semiconductor cooling

In addition to an established line of standard cooling products, the 20-page catalog contains new data on filled epoxy systems for bonding or encapsulating insulating wafers, clips for plastic transistors, thermal links for fused glass diodes, thermal equalizing links for dual TO-18 units, and two heat sink/retainers for TO-5S. Wakefield Engineering, Inc.

CIRCLE NO. 340

### Guide for nut fastening

Basic information on nut assembly is contained in a pocket-size guide. Particularly helpful is the inclusion of the nut application index. The proper nut fastening for 14 different types of nut applications and requirements can be seen at a glance. In each instance, the index thoroughly explains the reasons for making the specific nut fastening selection. Shakeproof, a division of Illinois Tool Works, Inc.

CIRCLE NO. 341

# KuBAND RADAR

## Bomac Orthospan® Mixers

with a  
power  
handling  
capability  
of  
200 mW.

**Frequency:** any 1 GHz range between 12.4 and 18.6 GHz.

**Noise, nominal:**

At 1 GHz bandwidth: 8.5 dB  
At 4 GHz bandwidth: 10.0 dB

**Warranty:** 5000 hrs.

Bomac Orthospan Mixers are also available in X band and K band. For details, write: Varian Bomac Division, Salem Road, Beverly, Massachusetts 01915. In Europe: Varian A.G., Zug, Switzerland. In Canada: Varian Associates of Canada, Ltd., Georgetown, Ontario. In Australia: Varian Pty. Ltd., Crows Nest, Sydney, Australia.



ON READER-SERVICE CARD CIRCLE 218  
ELECTRONIC DESIGN 19, September 13, 1967

# KuBAND RADAR

## TR-Limiters\* from Bomac

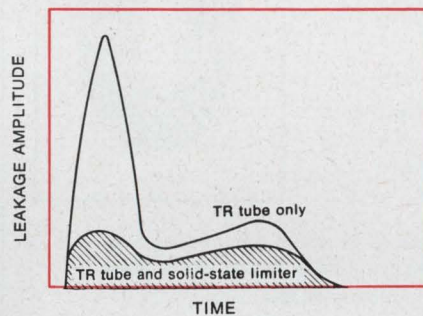

**Frequency Coverage:** 15.8 to 17.2 GHz.

**Operating Range:** 0.5 GHz.

**Recovery Time:** 0.5  $\mu$ s.

**Insertion Loss, typical:** 0.8 dB.

**Power Level, maximum:** 10 kW.

**Warranty:** 2000 hrs.

Bomac TR-Limiters are also available in X band; they will operate over any 0.5 GHz range between 8.5 and 9.6 GHz. For details, write: Varian Bomac Division, Salem Road, Beverly, Massachusetts, 01915. In Europe: Varian A.G., Zug, Switzerland. In Canada: Varian Associates of Canada, Ltd., Georgetown, Ontario. In Australia: Varian Pty. Ltd., Crows Nest, Sydney, Australia.

\*Combined gas-switching TR tube and solid-state limiter.



ON READER-SERVICE CARD CIRCLE 219

# KuBAND RADAR

## Bomac Orthospan® Modulators

with a  
power  
handling  
capability  
of  
500 mW.

**Carrier Frequency:** any 1 GHz range between 12.4 and 18.6 GHz.

**IF Frequency\*:** 5 to 250 MHz.

**Conversion Loss, maximum:** 10.0 dB.

**Warranty:** 5000 hrs.

Bomac Orthospan Modulators are also available in X band and K band. For details, write: Varian Bomac Division, Salem Road, Beverly, Massachusetts 01915. In Europe: Varian A.G., Zug, Switzerland. In Canada: Varian Associates of Canada, Ltd., Georgetown, Ontario. In Australia: Varian Pty. Ltd., Crows Nest, Sydney, Australia.

\*Under special conditions, this can be extended to 1.5 GHz.



ON READER-SERVICE CARD CIRCLE 220

You just figure out  
what you need in a

**SPRING WIRE**

We'll "draw"  
the conclusions.

Little Falls Alloys specializes in custom work in non-ferrous spring wire. You name the size, shape, tolerance, temper, alloy and quantity . . . and we draw it that way. In fact, we diamond draw it, to ensure the best possible surface and the highest degree of uniformity.

Little Falls Alloys is particularly known for its ability with Beryllium Copper — age hardenable or pre-tempered "Silvercote"® or bare. We are the leader in the development of this wire for commercial use.

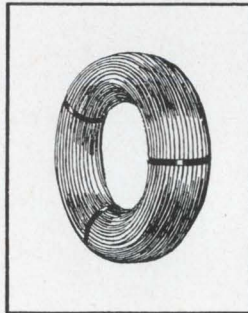

So, whether you want us to meet your specifications or you want engineering help in designing your nonferrous spring wire, come to Little Falls Alloys. It's a great place to be when you have a nonferrous wire requirement to fill.

## beryllium copper

Phosphor Bronze ■ Nickel Silver  
Brass ■ Titanium ■ Zirconium Copper  
Nickel (NASA 270) ■ Beryllium Nickel  
OFHC Copper

**CLOSE TOLERANCES**



We meet and certify  
all standard specifications

**ROUND, FLAT, SQUARE, RECTANGULAR AND SPECIAL SHAPES**

Write for our technical metals catalog

# Little Falls Alloys, Inc.

189 CALDWELL AVE., PATERSON, N. J. 07501 / 201 - 525-1014

ON READER-SERVICE CARD CIRCLE 225

## Application Notes

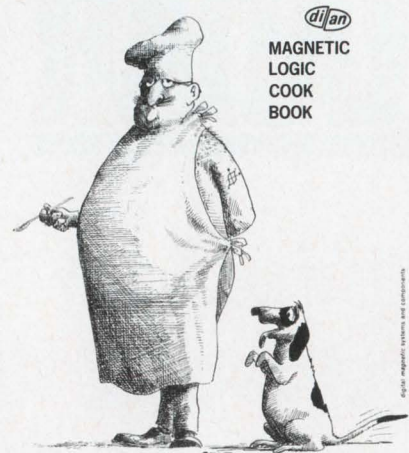

Di/An Controls, Inc.

### Magnetic logic cook book

A 90-page magnetic logic book covers logic fundamentals and circuit packaging and specifications. It is the purpose of this book to make it easy to design digital equipment using magnetic circuitry. It is a cook book because all the ingredients and techniques a designer will need to build such circuitry without resorting to a long dissertation on the chemistry of the processes are included. The real secret is simply to read the book, take the proper ingredients and assemble them in the prescribed way.

Chapter 5 is, for the practical designer, the heart of the book. It gives in detail the best and most useful circuit designs originated over the years. Di/An Controls, Inc.

CIRCLE NO. 342

### Uses unlimited

This new edition covers a dozen ideas in unique switch application in such areas as aero-space, die-casting, data processing, drill press applications, dentistry, vending machine cup dispensing, and parts production. Switch applications include the environment-proof aircraft switches, BZ basic switches, V3 low force, new terminal on the SM1 and SX1, KB switch/display matrix, toggle switches, rotary switches, limit switches and the PD pulse switch. Micro Switch, a division of Honeywell.

CIRCLE NO. 343

# Here's why you should now be using Datavue\* Indicator Tubes

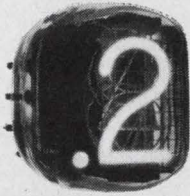

CK1904—Interchangeable with B59956 and NL809.



8422—Interchangeable with B5991 and NL8422.

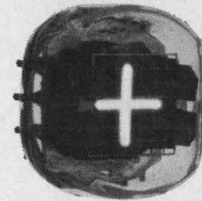

CK1903—Interchangeable with B5992 and NL5992.

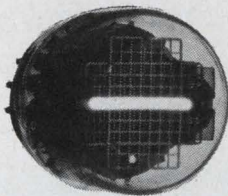

CK1901—Interchangeable with B5016 and NL5016; CK1902—Interchangeable with B5032, NL5032, B50911 and NL50911.

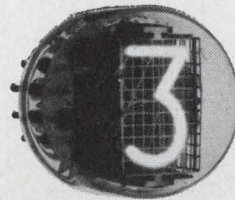

8421—Interchangeable with B5092 and NL8421; 8037—Interchangeable with B5031 and NL8037. Also available: 6844A.

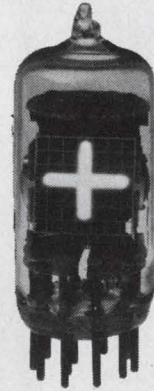

CK1900 (used with CK8650, CK1905, CK1906); CK1907 (used with 8754)—Interchangeable with NL843.



8754—Also available with right- and/or left-hand decimal points; Interchangeable with NL840/8754. Decimal-point types interchangeable with NL841, 842, 848.



CK1905; CK1906 (right-hand decimal point).

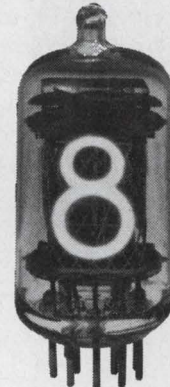

CK8650

These indicator tubes—just a few of Raytheon's wide selection—offer you advantages in design, economy and performance. For example:

**You don't need to revise designs.** Raytheon's Datavue round and rectangular end-view tubes conform to EIA ratings—interchange with other brands. And Raytheon also offers you a selection of side-view types—and "specials" with up to 12 characters,  $\pm$  signs, symbols, etc., to your specifications.

**You can buy them at low cost.** All Datavue Indicator Tubes are priced

competitively—or lower. Most side-view types, for example, cost less than \$5 each in lots of 500 or more.

**Reliably trouble-free readouts.** All Datavue characters are fully formed—not segmented. The fully formed characters are brightly displayed and easy to read—at distances up to 30 feet.

**They last for years.** They're made better because of Raytheon's experience—40 years of producing more than 100,000,000 cold cathode gas-filled tubes with carefully controlled electrical performance. Ultra-long-

life types, for example, have dynamic life expectancies of 200,000 hours or more.

**They're readily available**—in sample and production quantities. For samples, prices, or technical information, call your Raytheon regional sales office or distributor. Or write: *Raytheon Company, Industrial Components Operation, Quincy, Mass. 02169.*

\*Trademark of Raytheon Company



Industrial Components Operation—A single source for Circuit Modules/Control Knobs/Display Devices/Filters/Hybrid Thick-Film Circuits/Industrial Tubes/Optoelectronic Devices/Panel Hardware.

ON READER-SERVICE CARD CIRCLE 226

# New Literature

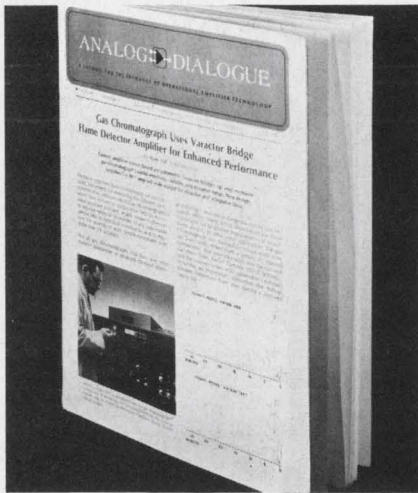

## Analog catalogue

The second issue of "Analog Dialogue" with 16 pages of technical information about operational amplifier fundamentals, circuits, and applications is offered.

An eight-page treatment entitled "Operational Amplifier Principles," by C. V. Weden of Fairchild Instrumentation, covers basic op amp theory and describes the major circuits and their purposes.

A NEREM paper on varactor bridge amplifier fundamentals shows how these important but neglected amplifiers achieve ultra-low drift and noise, and accommodate up to nine decades of signal variation. The last page summarizes some ten published papers and technical articles and invites readers to participate in two-way technical discussions. Analog Devices.

CIRCLE NO. 344

## Shock control

A four-page, two-color monograph presents basic information on types of shock disturbances, how to analyze shock, principles of attenuation and methods for calculating the required protection. The monograph discusses force excitation, the two major types of shock, and provides examples of eight specific shock problems with their corresponding solutions. Shock is a phenomenon with many sources, thus shock protection is a requirement in good product design. Lord Manufacturing Co.

CIRCLE NO. 345

## 6,051,045 thermocouples

Con-O-Chart One utilizes a new coding system for thermocouples that allows you to order in six numbers and words instead of giving verbal description that can run to ten pages. It covers thermocouples to 2500 ° F.

The form includes the "I" type of wire (3% rhenium/tungsten) and updates all data to accord with current technology. Incorporated are all the tables and data necessary to thermocouple specification: melting-points of metals, material selection by temperature, temperature mV scales, temperature conversion tables etc. Sixteen pages of data are presented as a letter size folder that opens to fit a desk or wall chart. A feature is continental sensing specification #3421, which gives the complete specification, including methods of process, tests and calibration. Con-O-Chart.

CIRCLE NO. 346

## Electron tubes

A 32-page, short-form catalog describing Machlett's electron tubes is now available. Described are large power tubes (triodes, tetrodes, and pulse modulator tubes), uhf planar triodes, high-vacuum diodes, variable capacitors (vacuum) and vapor cooling systems. The large power tubes described cover the cw power spectrum from 3 to 440 kW and offer pulsed powers to 25 MW. Included is a description of Machlett's magnetically beamed electron tubes, which require 10 to 100 times less power than conventional tubes. Machlett Laboratories, Inc.

CIRCLE NO. 347

## Magnetic shielding

A 16-page catalog covering EMI materials and magnetic shielding alloys has been announced. A large variety of wire mesh constructions, wire and elastomer combinations, RFI Honey comb ventilation panels, and specialized gasket formations are described. Magnetization curves on high permeability and high saturation shielding alloys are included with fabrications considerations. Primec Corporation.

CIRCLE NO. 348

## Transformer handbook

A description of basic transformer construction and operation is covered in this handbook. Such subjects as insulating, isolating and shielded winding operation of 60-Hz transformers on 50-Hz frequency and paralleling transformer connections using single-phase transformers on 3-phase service are covered. A full range of connection diagrams shows how to use transformers for distributing power at high voltage, insulate circuits, eliminate separate high-voltage and low-voltage wiring and connect and insulate a 4-winding transformer for auto transformer service. Acme Corp.

CIRCLE NO. 349

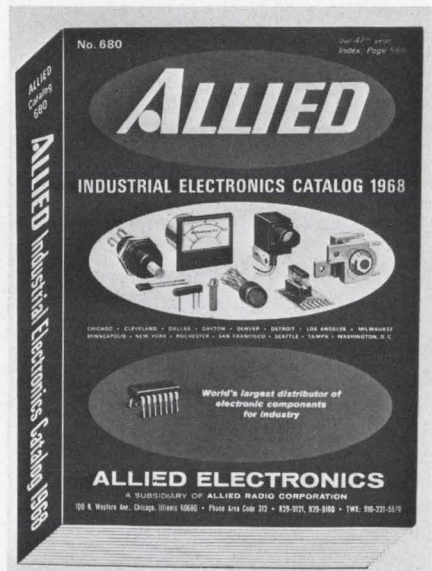

## Allied 1968 catalog

This 600-page book lists over 50,000 separate stock items from over 500 manufacturers for research and development, production, communications, education, controls and entertainment. Listings show prices for purchase in various quantities of every type of component, including integrated circuit devices, semiconductors, vacuum tubes, relays, timers, transformers, resistors, capacitors, connectors, coils, chokes, sockets, plugs, jacks, switches, fuses, batteries, clips, lamps, wire and cable. Detailed specifications, descriptions and illustrations are provided for all products. Allied Electronics Corporation.

CIRCLE NO. 350

# low cost

# Soliton's ISOLTAXIAL<sup>TM</sup>

## NPN SILICON TRANSISTORS

PAT. PENDING

### PROVE THEIR HIGH RELIABILITY!

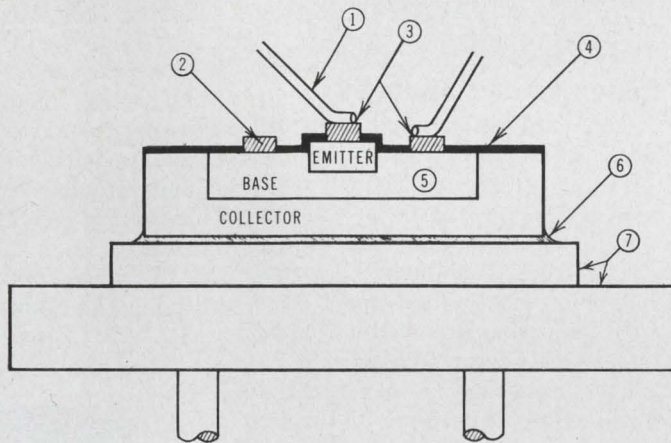

#### ISOLTAXIAL

(Oxide Passivated Single Diffused Transistor)

#### REFERENCE INDEX

1. Aluminum Leads
2. Aluminum Metalization for low contact resistance
3. Ultrasonic Bonded (aluminum to aluminum)
4. Silicon Dioxide Passivated (low leakage)
5. Uniform Base Concentration for high secondary breakdown
6. Gold-Silicon Eutectic for permanent mounting
7. Moly Pedestal silver brazed to nickel plated copper package for improved thermal expansion matching

Initial customer response to Soliton's ISOLTAXIAL NPN Silicon Transistors has proven the wide acceptance of these devices for high reliability applications. Their special construction innovations and processing techniques have resulted in a combination of high secondary breakdown resistance and low leakages never before achieved. As shown in the cross-sectional drawing, the key is in the planar surface and the uniform base. Available in a TO-3 or TO-61 case, the ISOLTAXIAL may be used in power supplies, audio amplifiers, inverters, converters, relay drivers and series regulators.

All types include these specifications:

Gain 20-60 @ 5 A  
 $V_{CE} \text{ (sat)}$  0.5 V Max. @ 5 A  
 $V_{BE} \text{ (sat)}$  1.2 V Max. @ 5 A  
 ft. 1.0 MHz Min.

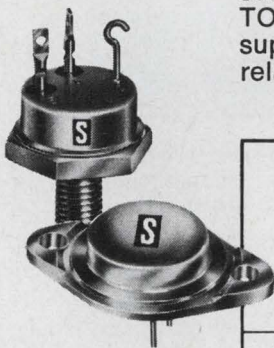

| Type Number | Pkg. Size | Type Number | Pkg. Size | DESIGN LIMITS |                         |            | PERFORMANCE SPECS.     |       |
|-------------|-----------|-------------|-----------|---------------|-------------------------|------------|------------------------|-------|
|             |           |             |           | $BV_{CBO}$    | $V_{CE0} \text{ (SUS)}$ | $BV_{EBO}$ | $I_{CEX} @ V_{CE}$     |       |
|             |           |             |           | Volts         | Volts                   | Volts      | $(V_{EB} = 1.5V)$      |       |
|             |           |             |           | Min.          | Min.                    | Min.       | $\mu A \text{ (Max.)}$ | Volts |
| SDT9801     | TO-3      | SDT9901     | TO-61     | 60            | 40                      | 12         | 100                    | 40    |
| SDT9802     | TO-3      | SDT9902     | TO-61     | 80            | 60                      | 12         | 100                    | 60    |
| SDT9803     | TO-3      | SDT9903     | TO-61     | 100           | 80                      | 12         | 100                    | 80    |
| SDT9804     | TO-3      | SDT9904     | TO-61     | 120           | 100                     | 12         | 100                    | 100   |

*When you think of semiconductors...think Soliton!*

Dial 1-800-327-3243 for a "No Charge" telephone call and further information

# Soliton DEVICES, INC.

1177 BLUE HERON BLVD. / RIVIERA BEACH, FLORIDA / (305) 848-4311 / TWX: (510) 952-6676

ON READER-SERVICE CARD CIRCLE 227

# The Lightweights From Glenair

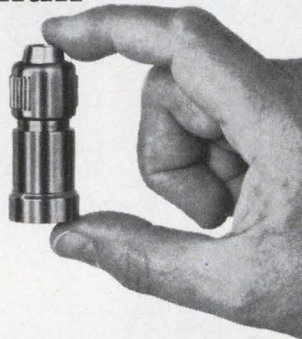

... a "new breed" of adapters!

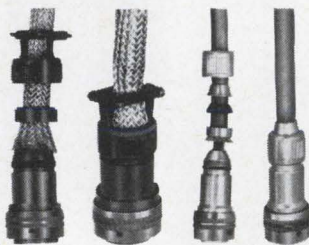

Designed to provide reliable 360° RFI shield termination for the "new breed" of high-density microminiature circular connectors, these lightweight adapters from Glenair insure connector performance and integrity under the most restrictive weight limitations.

Available in environmental or non-environmental versions, these adapters come in a choice of cable entry sizes for each connector and accommodate overall shielded cables and harnesses, or shielded and jacketed cables alike.

These new adapters are easy to assemble and are available for all circular connectors including such high-density microminiatures as Amphenol Astro 348, Bendix JT-JTRE, Cannon Centi-K, Deutsch STK, Matrix Mini-Mate, Microdot Marc 53 and others. They are also available for MIL-C-26482, MIL-C-26500, MIL-C-38300, NAS 1599 and similar connectors.

For more information, write, wire or phone today.



GLENAIR, INC. / 1211 AIR WAY  
GLENDALE, CALIFORNIA 91201

Phone: (213) 245-8587 • TWX: 910-497-2066

## NEW LITERATURE

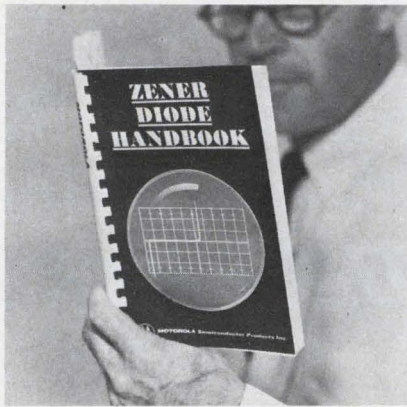

### Zener diode handbook

This publication supplies applications information for the product advances in zener diodes and zener-like devices. It covers applications for temperature compensated zeners, reference standards, current regulator diodes, and zener transient suppressors as well as the latest types of zener diodes.

The handbook is organized to give the circuit designer all the data necessary for the efficient use of zener components with the major emphasis on circuit design. Proven, basic circuits are also provided as take-off points for the designer's own requirements.

Available for \$2 from Motorola Semiconductor Products, Inc., Box 13408, Phoenix.

### Microwave transistors in coaxial package

RCA, Electronic Components and Devices, Harrison, N. J. Phone: (201) 485-3900. P&A: \$90 ea.; samples.

This device should find applications as a microwave straight-through amplifier or fundamental frequency oscillator in L- and S-band equipment designs including telemetry, radar, ECM equipment or as a driver for microwave tubes and varactors. The TA7003's microwave performance can be seen from the following specifications; as an amplifier (1  $\mu$ W power output at 2 GHz with 5 dB gain and 30% efficiency, as an amplifier) 2 W output at 1 GHz with 10 dB gain and 50% efficiency and as an oscillator (1.5 W power output at 1 GHz). Both modes of operation use a 28-V power source.

CIRCLE NO. 351

### Quality evaluation

Guidelines for equipment and system manufacturers in evaluating quality assurance systems of vendors and for component vendors in assuring prospective customers of the quality of their products, have been published by the EIA. The guidelines include standard questionnaires which provide answers to the questions buyers want answered before they buy parts. The procedure sets forth in logical sequence questions about component manufacturers' quality and reliability assurance systems and their compliance with military specifications and standards, and provides a means of exchanging survey results.

Available for \$1 from Electronic Industries Association, 2001 Eye St., N.W., Washington, D. C.

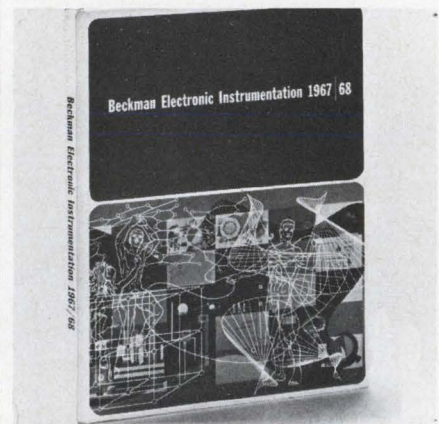

### Instruments catalog

The entire product line of the electronic instruments division of Beckman Instruments, Inc., as well as useful applications information and measurement techniques, are detailed in a new 224-page, hard-bound catalog. The 1967/68 catalog features sections on data acquisition recorders and system elements, electronic instruments and medical recorders. Within each section are complete product specifications and pricing information. The catalog also devotes space to application information and data. Subjects include "Characteristics of Direct-Writing Oscillographs," "Frequency and Time-Interval Measurement," "Accuracy in Data Systems," and a "Physiological Measurement Guide." Electronic Instruments Division of Beckman Instruments, Inc.

CIRCLE NO. 352

ON READER-SERVICE CARD CIRCLE 228



# JUST CUT TO PATTERN

Netic & Co-Netic Magnetic Shields



## HAND FORM IN SECONDS

A great convenience to design engineers, packaging engineers, R/D, etc. A fast inexpensive empirical tool to determine and shield the necessary components of systems. Use multiple layers if needed. Thicknesses from .002". Also widely used in automated or manual production line techniques.

Netic attenuates high intensity fields, Co-Netic low intensity fields. Permanently Pre-Annealed. Not affected by bending, vibration or shock. Minimum retentivity. Increases systems reliability.

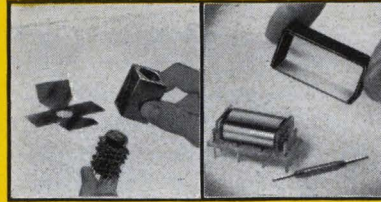

Module Shielding

Reed Relay

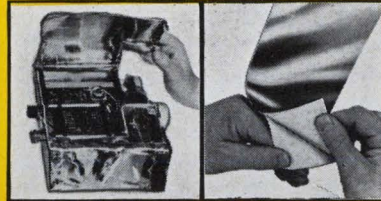

Wein Bridge Oscillator

Peelback Adhesive Foil



## MAGNETIC SHIELD DIVISION

Perfection Mica Company

1322 N. ELSTON AVENUE, CHICAGO, ILLINOIS 60622

ORIGINATORS OF PERMANENTLY EFFECTIVE NETIC CO-NETIC MAGNETIC SHIELDING

ON READER-SERVICE CARD CIRCLE 229

# FREE TECHNICAL MICA MANUAL K-6

*gives electrical and physical data on all types of mica*

No tooling cost on numerous fabricated parts of natural and built-up mica.

Pre-punched insulating wafers to electrically isolate transistors, diodes, etc. from heat sinks.

Corrugated mica to reduce handling and fabrication costs for thermal elements.

All grades of mica offered.

Immediate delivery from stock on many items.

## PERFECTION MICA CO.

1322 No. Elston Ave.

Chicago, Illinois 60622

Phone: 312, EV 4-2122

ON READER-SERVICE CARD CIRCLE 230

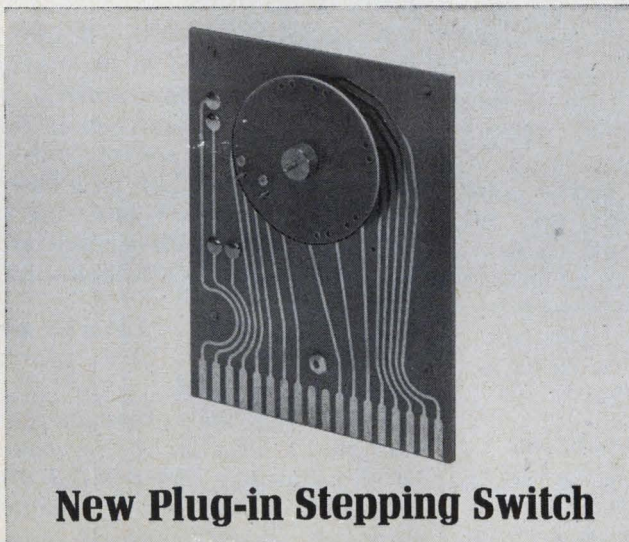

## New Plug-in Stepping Switch

Here's a printed-circuit stepping switch that can solve many of your remote control problems. You can use it for sequential circuit switching, pulse counting, and programming. It plugs into a standard printed circuit board connector so you can conveniently and easily mount the switch and make your electrical connections at the same time.

You can choose AC or DC operation, with or without homing. The step rate is up to 15 steps per second; switches are available with 3, 4, 5, 6, 10, or 12 positions. Life is over 6,000,000 steps at rated load. Send for technical data now.

**THE AWHAYDON COMPANY**

Timing & Stepper Motors • Electromechanical & Electronic Timing Devices & Systems

232 North Elm Street  
Waterbury, Conn. 06720

4060 Ince Boulevard  
Culver City, Calif. 90231

ON READER-SERVICE CARD CIRCLE 231

ELECTRONIC DESIGN 19, September 13, 1967

## Smallest 3-Phase Electronic Frequency Converters Ever Made!



Now, from CML, comes a series of the smallest 3-phase Electronic Frequency Converters ever made... featuring fixed or adjustable plug-in oscillators at frequencies ranging from 45 to 6,000 cycles. Write today for details on Models T500A through T2500A!

| Model  | 3 $\phi$ Output VA | Dimensions<br>(For standard 19" relay rack mounting) |
|--------|--------------------|--|
| T500A  | 500                | 8 $\frac{3}{4}$ " h x 21" d                          |
| T750A  | 750                | 14" h x 21" d  |
| T1200A | 1200               | 14" h x 21" d  |
| T1750A | 1750               | 14" h x 21" d  |
| T2500A | 2500               | 14" h x 21" d  |



**CML, Inc.**

A Subsidiary of Tenney Engineering, Inc.  
350 Leland Avenue • Plainfield, New Jersey  
Telephone (201) 754-5502 • TWX: 201-756-2064

ON READER-SERVICE CARD CIRCLE 232



## NEW / FROM NORTRONICS

### EXTENDED POLE PIECE TAPE HEADS FOR READING SOUND FROM FILM



Nortronics extended pole piece record/play heads read sound from 8 mm or 16 mm film without touching the film's optical or sprocket areas. This avoids scratching of the optical surfaces and eliminates possible picture bounce or sound flutter from sprocket hole-to-head contact. The extended tip on these heads is available with Alfenol laminations for long wear or Mu-metal laminations for maximum sensitivity.

These heads are also appropriate for a variety of other applications requiring a projecting track, such as card readers, drums and discs. As small as a 1/4 inch cube, the heads can be supplied with track widths from .006" to .070", with a choice of sizes and case styles. Complete technical data is available upon request.

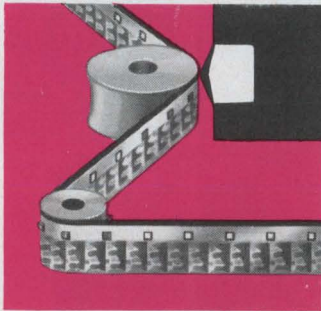

Like all Nortronics tape heads, the extended pole piece type has a fine laminated, precision lapped core structure for low loss, a deposited quartz gap for optimum high frequency resolution, and superb shielding for protection from external magnetic fields. The world's largest manufacturer of tape heads and pace-setter for the industry, Nortronics offers a complete line of heads, including many for replacement and prototype applications off-the-shelf from your local distributor.

**Nortronics**  
COMPANY, INC.

8101 Tenth Avenue North  
Minneapolis, Minnesota 55427

## NEW LITERATURE

### SDS telemetry systems

An 8-page brochure describes the company's capabilities in the design and production of computer-based systems for processing telemetry data. SDS telemetry systems are standard modules in conjunction with SDS sigma computers to acquire and process PCM/PAM/PDM telemetry data-on-line in real time. The building-block design of SDS telemetry hardware offers the user a greater degree of system flexibility than is possible with custom-designed systems. Other features include computer-controlled signal conditioning that automatically adjusts to changing input conditions, automatic data compression, and special telemetry-oriented software. The telemetry systems capabilities brochure describes SDS telemetry hardware and software, sigma central processors, system organization and typical applications. Scientific Data Systems.

CIRCLE NO. 353

### Plastic rectifiers

All the important electrical and mechanical characteristics of plastic-encapsulated rectifiers are presented in a 12-page, illustrated booklet. Included in the booklet are characteristic curves and dimensional diagrams for all nine rectifier types, rated from 1.5 to 40 A. A useful feature of the booklet is an interchangeability chart that relates these rectifiers, both mechanically and electrically, to established industry types. Westinghouse Semiconductor Division.

CIRCLE NO. 354

### Bulletin on thermocouples

This bulletin reviews the factors in selecting and specifying the primary temperature-measuring elements designed and manufactured by the Foxboro Company. A five-page section includes a temperature guide for selection of protected thermocouples, data on time constants and limits of error and also includes a list of industrial applications. In addition, the illustrated 25 page bulletin describes the features of the spring-loaded Minox thermocouple assembly and the tube wall thermocouple. Foxboro Company.

CIRCLE NO. 355

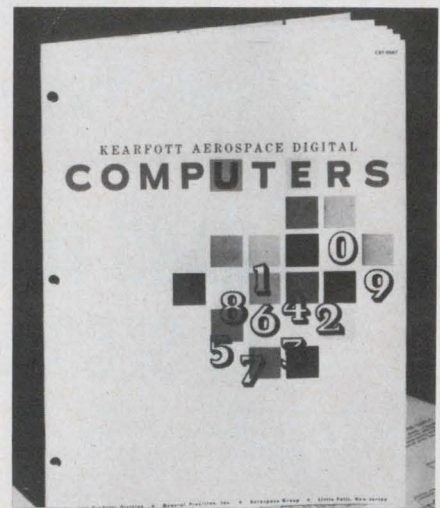

### Aerospace digital computers

A 24-page catalog describes nine different aerospace digital computers and their variations. With descriptive text, pictures and other features, the catalog details a variety of general-purpose and special purpose navigation and guidance computers designed for more than 25 different applications aboard aircraft, missiles, boosters, and spacecraft. General Precision Systems.

CIRCLE NO. 356

### Filter definitions

A six-page glossary of terms most commonly used in describing filters and their characteristics is offered. The definitions given in the illustrated glossary are intended to assist those unfamiliar with filter terminology in specifying filters. More than 50 specialized terms are also defined. Electro-Mechanical Research, Inc.

CIRCLE NO. 357

### Merrimac catalog

The 72-page catalog contains photographs, schematics, performance curves, drawings and detailed descriptions of Merrimac's quadrature (90°) hybrids, hybrid junctions, power dividers, directional couplers, attenuators, phase shifters, balanced mixers, monopulse comparators and terminations. An introduction to each product category covers characteristics, operation and applications. Of interest are details of Merrimac's new miniature components, including its ultra-miniature quadrature hybrid and balanced mixer. Merrimac Research and Development Inc.

CIRCLE NO. 358

# NEW RASTER GENERATOR



Model 2SG-2BR

## DUAL SWEEPS

- Wide Range of Raster Frequencies
- Sweeps from 20  $\mu$ sec to 100 msec
- 10% to 90% Duty Cycle
- Linearity Better than 0.5%
- External Trigger or Sync
- Compatible with CELCO Drivers

Two CELCO Ramp Generators have been mounted together to produce a wide selection of ramp combinations, bias voltages, and triggers.

Clearly your best choice for lab, test, displays. Available from stock. Write or call:



*Constantine Engineering Laboratories Company*

MAHWAH, N. J.

UPLAND, CAL.

ON READER-SERVICE CARD CIRCLE 234

## BERYLLIUM COPPER INTRICATE STAMPINGS

CUSTOM DESIGNS  
STANDARD RINGS,  
STRIPS, CLIPS,  
WASHERS, SHIELDS,  
CONTACTS,  
HOLDERS

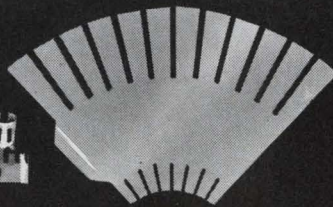
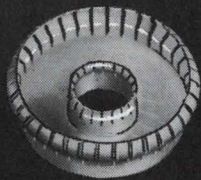

BRAUN's consulting engineers stand ready to evaluate and solve your beryllium copper stamping problems. They speak your language. They know the scope of BRAUN's technology and how to apply it to your problem, plus quote a price for the required stamping. This problem solving technique can be obtained by a simple phone call to our engineers. **CALL TODAY!**

**BTI BRAUN**

TOOL & INSTRUMENT CO., INC.

140 Fifth Avenue, Hawthorne, N. J. 07507  
Phone 201-427-1773 • TWX 710-988-4136

ON READER-SERVICE CARD CIRCLE 235

ELECTRONIC DESIGN 19, September 13, 1967

## New 20 pg. Catalog makes it Easy to Select

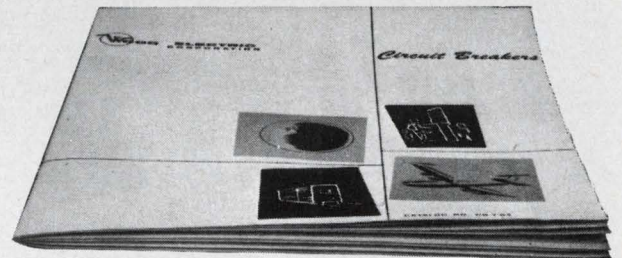

## the right Thermal or Magnetic Circuit Breakers

Write for your **FREE COPY**



**WOOD ELECTRIC CORPORATION**

244 Broad Street, Lynn, Mass. (617) LY8-5313

ON READER-SERVICE CARD CIRCLE 236

# Advertisers' Index

| Advertiser  | Page               |
|---|--------------------|
| Acopian Corporation   | 6, 7               |
| Aerometrics   | 186, 187           |
| Alcoswitch Division of Alco Electronic Products, Inc.               | 188                |
| Allen-Bradley Co.   | 133                |
| Allied Chemical, Plastic Division                                   | 39                 |
| Ametek/Hunter Spring Division                                       | 135                |
| Ammon Instruments, Inc.   | 184                |
| Amperex Electronic Corporation                                      | 199                |
| Amphenol Controls Division, Amphenol Corporation                    | 16                 |
| Arnold Engineering Company, The                                     | 88, 89             |
| Augat, Inc.   | 165                |
| Automatic Electric, A Subsidiary of General Telephone & Electronics | 196                |
| Babcock Relays, Division of Babcock Electronics Corporation         | 201                |
| Beckman Instruments, Inc., Electronic Instruments Division          | 149                |
| Beckman Instruments, Inc., Helipot Division                         | 145                |
| Belden Corporation  | 27, 103            |
| Birther Corporation, The  | 108, 109           |
| Borden Chemical Co., The Mystic Tape Division                       | 210                |
| Branson Corp.   | 15                 |
| Braun Tool & Instrument Co. Inc.                                    | 56                 |
| Bud Radio, Inc.   | 219                |
| Burdny Corporation  | 181                |
| Burr-Brown Research Corporation                                     | 19                 |
| By-Buk Company  | 50, 222            |
| CML, Inc.   | 217                |
| Cambridge Thermionic Corporation                                    | 203, 205, 207, 209 |
| CELCO Constantine Engineering Laboratories Co.                      | 219                |
| Centralab Electronics, Division of Globe-Union, Inc.                | 155                |
| Cinch-Graphik, Division of United-Carr                              | 52                 |
| Clairex Electronics, Inc.   | 204                |
| Clare & Co., C. P.  | 4                  |
| Clare Electroseal Corp.   | 199                |
| Clifton, Division of Litton Industries                              | 121                |
| Coleman Engineering Company, Inc.                                   | 158                |
| Collins Radio Company   | 139                |
| Components, Inc.  | 157                |
| Computer Logic Corp.  | 150                |
| Conelco Components  | 160                |
| Control Data Corporation  | 172                |
| Coors Porcelain Co.   | 97                 |
| Corning Glass Works, Electronic Products Division                   | 53                 |
| Couch Ordnance, Inc.  | 70                 |
| Coto Coil Company, Inc.   | 191                |
| Cross Company, H.   | 137                |
| Curtis Development & Mfg. Co.                                       | 184                |
| Cutler-Hammer   | 170                |
| Dale Electronics, Inc.  | 87, 160A-B         |
| Damon Engineering, Inc.   | 22                 |
| Deltron, Inc.   | 178, 179           |
| Deringer Metallurgical Corp.  | 183                |
| Dialight Corporation  | 202                |
| Dodge Industries, Fluorglas Division                                | 96                 |
| Duncan Electronics, Inc.  | 20, 21             |
| Du Pont Company   | 176A               |
| ESI/Electro Scientific Industries, Inc.                             | 46                 |
| Eagle Signal, A Division E. W. Bliss Company                        | 156                |
| Eldema, A Division of Genisco Technology Corporation                | 208                |

| Advertiser  | Page                      |
|---|---------------------------|
| Electrical Industries   | 162                       |
| Electronic Design   | 223                       |
| Electronic Memories, Inc.   | 151                       |
| Electronic Research Associates, Inc.  | 60                        |
| Electrovert, Inc.   | 192                       |
| Ellis and Watts Company   | 179                       |
| Emerson & Cuming, Inc.  | 188                       |
| Emporium Specialties, Inc., Wire Form Division                                      | 142                       |
| Engis Equipment Company   | 32                        |
| Erie Technological Products, Inc.   | 9                         |
| Gardner-Denver Company  | 182                       |
| General Electric Company  | 28                        |
| General Electric Company, Specialty Control Department                              | 59                        |
| General Instrument Corporation  | 40, 41                    |
| General Precision Systems Inc., Kearfott Division                                   | 122                       |
| General Precision Systems, Inc. Librascope Group                                    | 129                       |
| General Radio Company   | 43                        |
| Genisco Technology Corporation  | 185                       |
| Glenaire, Inc.  | 216                       |
| Harowe Servo Controls, Inc.   | 152                       |
| Hayden Book Company, Inc.   | 222                       |
| Haydon Company, A. W.   | 217                       |
| Heinemann Electric Company  | 168                       |
| Hewlett-Packard   | 1, 5, 127, 153, Cover III |
| Hickok Electrical Instrument Co., Inc., The Honeywell, Computer Control Division    | 64                        |
| Honeywell, Precision Meter Division   | 32A-L                     |
| Honeywell Test Instrument Division, Annapolis Operation                             | 66                        |
| Howard Industries, MSL Industries, Inc.   | 191                       |
| IRC, Inc.   | 131                       |
| ITT Jennings, a subsidiary of International Telephone and Telegraph Corporation     | 115                       |
| ITT Semiconductors, A Division of International Telephone and Telegraph Corporation | 224                       |
| Industrial Control Company  | 209                       |
| Industrial Electronic Engineers, Inc.   | 58                        |
| Industrial Timer Corporation  | 200                       |
| Industro Transistor Corporation   | 163                       |
| Information Retrieval, Incorporated   | 189                       |
| International Rectifier   | 61                        |
| Keystone Electronics Corp.  | 180                       |
| Kistler Instrument Corporation  | 223                       |
| LFE Electronics, Division of Laboratory of Electronics, Inc.                        | 176                       |
| Lambda Electronics Corp.  | 47                        |
| Lenox Fugle Electronics, Inc.   | 206                       |
| Little Falls Alloys, Inc.   | 212                       |
| Litton Industries, Encoder Division   | 8                         |
| Mac Panel Co.   | 191                       |
| Magnecraft Electric Co.   | 114                       |
| Magnetics, Inc.   | 37                        |
| Magnetic, Inc.  | 190                       |
| Mallinckrodt Chemical Works, Electronic Chemicals                                   | 49                        |
| Markel & Sons, L. Frank   | 138                       |
| Merrimac Research and Development, Inc.   | 166, 222                  |
| Metex Corporation   | 180                       |
| MicroSwitch, A Division of Honeywell  | 171                       |
| Molex Products Co.  | 195                       |
| Motorola Semiconductor Products, Inc.   | 33, 34, 35, 62, 63        |

| Advertiser  | Page               |
|---|--------------------|
| National Electronics, Inc.  | 192                |
| National Semiconductor Corporation                                | 44, 45             |
| Northfield Precision Instruments Corp.                            | 204                |
| Northern Precision Laboratories, Inc.                             | 196                |
| Nortronics, Inc.  | 218                |
| Pamator, Inc.   | 48                 |
| Perfection Mica Co.   | 217                |
| Phelps Dodge Electronic Products                                  | 154                |
| Pioneer Electric & Research Corp.                                 | 205                |
| Plastic Capacitors, Inc.  | 194                |
| Polarad Electronic Instruments, Polarad Electronics Corporation   | 57                 |
| Potter & Brumfield Division of American Machine & Foundry Company | 80                 |
| RBM Controls Division   | 169                |
| RCA Electronic Components and Devices                             | 125, 177, Cover IV |
| Radiation, Incorporated   | 54, 55             |
| Raytheon Company, Industrial Components Operation                 | 213                |
| Raytheon Company, Semiconductor Operation                         | 159                |
| Reeves Hoffman Division of DCA                                    | 208                |
| Sigma Instruments, Sigma Instruments, Inc.                        | 112A-B, 113        |
| Silicon Transistor Corporation                                    | 173                |
| Siliconix Incorporated  | 174                |
| Simpson Electric Company  | 31                 |
| Solotron Devices, Inc.  | 215                |
| Sprague Electric Company  | 10, 12             |
| Standard Condenser Corporation                                    | 195                |
| Starrett Company, The L. S.                                       | 123                |
| Sylvania Semiconductor Division Electronic Components Group       | 65                 |
| Syntron Company   | 167                |
| Syntronic Instruments, Inc.                                       | 202                |
| Systron-Donner Corporation  | 2                  |
| Tech Laboratories, Inc.   | 716B               |
| Tektronix, Inc., Oscilloscopes                                    | 68                 |
| Telonic Instruments, A Division of Telonic Industries, Inc.       | 175                |
| Telrex Laboratories   | 195                |
| Tenney Engineering, Inc.  | 199                |
| Texas Instruments Incorporated, 48A-F                             | 198                |
| Texscan Corporation   | 198                |
| Tung-Sol Division, Wagner Electric Corporation                    | 51                 |
| Union Carbide Corporation   | 25                 |
| United Transformer Corp.  | Cover II           |
| U.S. Capacitor Corp.  | 203                |
| Varian Associates   | 213                |
| Vari-i L Co., Inc.  | 206                |
| Victoreen Instrument Company, The                                 | 161                |
| Victory Engineering Corporation                                   | 164                |
| Waldom Electronics, Inc.  | 136                |
| Wanlass Electric Co.  | 209                |
| Weckesser Company, Inc.   | 223                |
| Weston Instruments, Inc.  | 146                |
| Wheelock Signals, Inc.  | 144                |
| Wood Electric Corporation   | 219                |

## Career Advertising

|                                      |     |
|--------------------------------------|-----|
| Boeing Company, The                  | 140 |
| Delco Radio Division, General Motors | 143 |
| Hercules Incorporated                | 142 |

# The most dangerous shift your employees can work

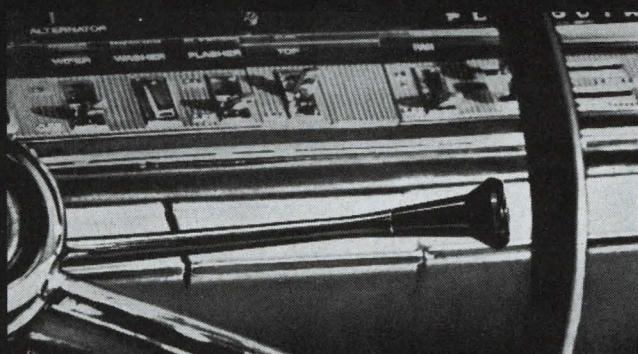

is this one.

In-plant safety records tell the smallest part of your plant safety record.

Look at what happens after your employees leave the plant.

During 1966, American industry lost more than one and one-half times as many employees killed in off-the-job traffic accidents as were killed in *all* on-the-job accidents. In addition, 800,000 workers were injured severely enough to keep them away from their jobs for periods of a day or more.

Many companies, like Western Electric, have done something about it. They teach the National Safety Council's Defensive Driving Course to their employees.

It's a short, interesting—and effective—course on defensive driving skills. The results are a significant drop in traffic accidents. And the cost is as low as a dollar per employee. It's a good investment. Shift into high gear and find out more with this coupon.

#### Special Projects—Public Information

**National Safety Council**  
425 North Michigan Avenue  
Chicago, Illinois 60611

Published to save lives  
in cooperation with  
The Advertising Council  
and the National Safety Council.



Please mail me full details on the  
Defensive Driving Program.

Name \_\_\_\_\_

Title \_\_\_\_\_

Firm Name \_\_\_\_\_

Street \_\_\_\_\_

City \_\_\_\_\_ State \_\_\_\_\_ Zip Code \_\_\_\_\_

## Electronic Design

ELECTRONIC DESIGN's function is:

- To aid progress in the electronics manufacturing industry by promoting good design.
- To give the electronic design engineer concepts and ideas that make his job easier and more productive.
- To provide a central source of timely electronics information.
- To promote two-way communication between manufacturer and engineer.

**Want a subscription?** ELECTRONIC DESIGN is sent free to qualified engineers and engineering managers doing design work, supervising design or setting standards in the United States and Western Europe. For a free subscription, use the postfree application form inside the back cover. If none is included, write to us direct for an application form.

If you do not qualify, you may take out a paid subscription for \$25 a year in the U.S.A., \$35 a year elsewhere. Single copies are \$1.50 each.

**If you change your address,** send us an old mailing label and your new address; there is generally a prepaid postcard for this inside the back cover. You will have to requalify to continue receiving ELECTRONIC DESIGN free.

**We strive for accuracy,** but despite our efforts, an occasional error does slip through. Whenever this occurs and it comes to our attention, we publish a correction. Corrections appear at the end of the Letters column.

**We will not knowingly accept** advertisements that make false claims. Readers are asked to bring any misleading or fraudulent data they see in advertisements in ELECTRONIC DESIGN to the attention of the Editor.

**Microfilm copies are available** of complete issues of ELECTRONIC DESIGN and of individual articles published since the beginning of 1961. Complete issues cost 4¢ a page, articles cost 50¢ a page; shipping and handling charges are extra. The minimum charge is \$3. For further details and to place orders, contact University Microfilms, Inc., 300 N. Zeeb Road, Ann Arbor, Mich. 48106; telephone (313) 761-4700.

**Want to contact us?** If you have any comments or wish to submit a manuscript or article outline, address your correspondence to:

Howard Bierman, Editor,  
ELECTRONIC DESIGN,  
850 Third Avenue,  
New York, N.Y. 10022.

## New "Tape Lift" Printed Circuit Drafting



### Aids

No engineer or draftsman should be without the most up-to-date cross-reference guide to better Printed Circuit Drafting Catalog. It is complete with prices and illustrations of over 1200 sizes of "Tape Lift" pads, shapes and other aids for faster, more accurate, distortion-free printed circuit master drawings. Write for FREE catalog.

### By-Buk Company

4326 West Pico Blvd., Los Angeles, Calif. 90019  
Telephone: (213) 937-3511

# 174

## New Component Designs—Audio Through Microwave

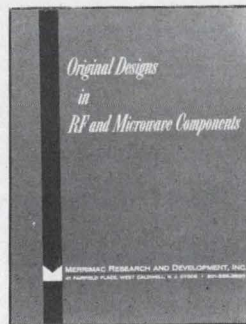

Every engineer will find this new 72-page bound catalog a valuable tool in his day-to-day work. Contains photos, schematics, curves, drawings and detailed descriptions of Merrimac's quadrature (90°) hybrids, hybrid junctions, power dividers, directional couplers, attenuators, phase shifters, balanced mixers, monopulse comparators and terminations. New low prices offered for many listed units. Also included is information on facilities, methods of ordering, and sales representatives. Available free on request.

### Merrimac Research and Development, Inc.

41 Fairfield Place  
West Caldwell, New Jersey 07006

# 175

## Engineers' Relay Handbook

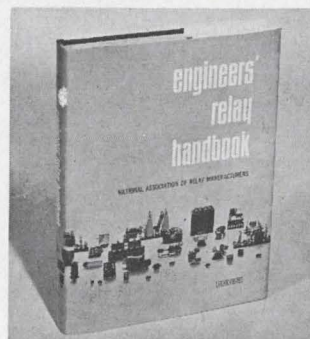

A definitive work that is fast becoming a standard reference text for the relay user. Prepared and edited by the National Association of Relay Manufacturers, this book is a complete guide to the principles, properties, performance characteristics, application requirements, specifications, and testing of relays. Systems and product engineers will find the *Handbook* an indispensable help in determining the correct types of relays for their applications. For further information about this unique sourcebook, write Dept. ED.

### Hayden Book Co., Inc.

116 W. 14th Street  
New York, N.Y. 10011

# 176

# Manufacturers

Advertisements of booklets, brochures, catalogs and data sheets. To order use Reader-ServiceCard (Advertisement)

## Non-Pendulous Servo Accelerometer



Four-page, illustrated Bulletin 315467 explains through description and drawings the design and basic operation of the only non-pendulous, linear, "force balance," servo accelerometer available today. Key features of the Model 305A, such as unique flexure suspension, true-translational motion of the seismic element, closed-loop operation, and simple installation, are fully covered. Specifications are given for both voltage mode and current mode operation. Graphs supply additional performance data.

**Kistler Instrument Corporation**  
8969 Sheridan Drive  
Clarence, N. Y. 14031

**177**

## How To Write Technical Articles

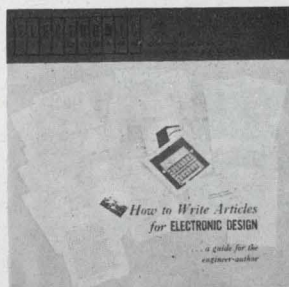

A guide for the engineer-author, "How to Write Articles for Electronic Design" shows how easy it is to write for publication—once the engineer knows what to write and how to write it. The Author's Guide includes a complete run-down of the types of articles published by Electronic Design—plus detailed instructions on how to prepare technical articles and short special features. A MUST for every "would-be-writer" in the electronics industry. Send for your complimentary copy by circling the number to the right.

**Electronic Design**  
850 Third Avenue  
New York, N.Y. 10022

**178**

## Self-Aligning Molded Nylon Clamps



These new cable clamps have self-aligning molded-in ribs that prevent slipping during installation. They hold their circular shape superbly, and cost considerably less than conventional clamps of the same size. New bulletin gives full details.

**Weckesser Company, Inc.**  
4444 West Irving Park Road  
Chicago, Illinois 60641

**179**

# Designer's Datebook

| SEPTEMBER |    |    |    |    |    |     |
|-----------|----|----|----|----|----|-----|
| S         | M  | T  | W  | T  | F  | S   |
|           |    |    |    |    |    | 1 2 |
| 3         | 4  | 5  | 6  | 7  | 8  | 9   |
| 10        | 11 | 12 | 13 | 14 | 15 | 16  |
| 17        | 18 | 19 | 20 | 21 | 22 | 23  |
| 24        | 25 | 26 | 27 | 28 | 29 | 30  |

| OCTOBER |    |    |    |    |    |    |
|---------|----|----|----|----|----|----|
| S       | M  | T  | W  | T  | F  | S  |
| 1       | 2  | 3  | 4  | 5  | 6  | 7  |
| 8       | 9  | 10 | 11 | 12 | 13 | 14 |
| 15      | 16 | 17 | 18 | 19 | 20 | 21 |
| 22      | 23 | 24 | 25 | 26 | 27 | 28 |
| 29      | 30 | 31 |    |    |    |    |

For further information on meetings, use Reader Service card.

**Sept. 21-22**  
**Microelectronics Applications Symposium** (Garden City, N. Y.)  
Sponsor: IEEE; L. I. Kent, Executive Secretary, c/o Airborne Instruments Laboratory, Commack Road, Deer Park, N. Y. 11729.  
CIRCLE NO. 465

**Sept. 25-27**  
**International Electronics Conference and Exposition** (Toronto, Canada)  
Sponsor: IEEE; R. G. deBuda, 1819 Yonge St., Toronto 7, Ont., Canada.  
CIRCLE NO. 466

**Oct. 2-4**  
**International Telemetering Conference** (Washington, D. C.)  
Sponsor: IFT; E. J. Stockwell, NASA, Code TN, Office of Tracking and Data Acquisition, Washington, D. C. 20546.  
CIRCLE NO. 467

**Oct. 9-10**  
**'Managing Engineering Manpower' Conference** (San Francisco)  
Sponsor: ASME; R. J. Wilson, Muller, Jordan & Herrick, 125 East 50 St., New York, N. Y. 10022.  
CIRCLE NO. 468

**Oct. 16-19**  
**Users of Automatic Information Display Equipment Meeting** (Washington, D. C.)  
Sponsor: UAIDE; G. E. Perez, UAIDE Program Chairman, P. O. Box 6749, Fort Davis Station, Washington, D. C. 20020.  
CIRCLE NO. 469

**Oct. 18-20**  
**International Electron Devices Meeting** (Washington, D. C.)  
Sponsor: IEEE; W. S. Patton, Publicity Chairman, Litton Industries, 960 Industrial Way, San Carlos, Calif. 94070.  
CIRCLE NO. 470

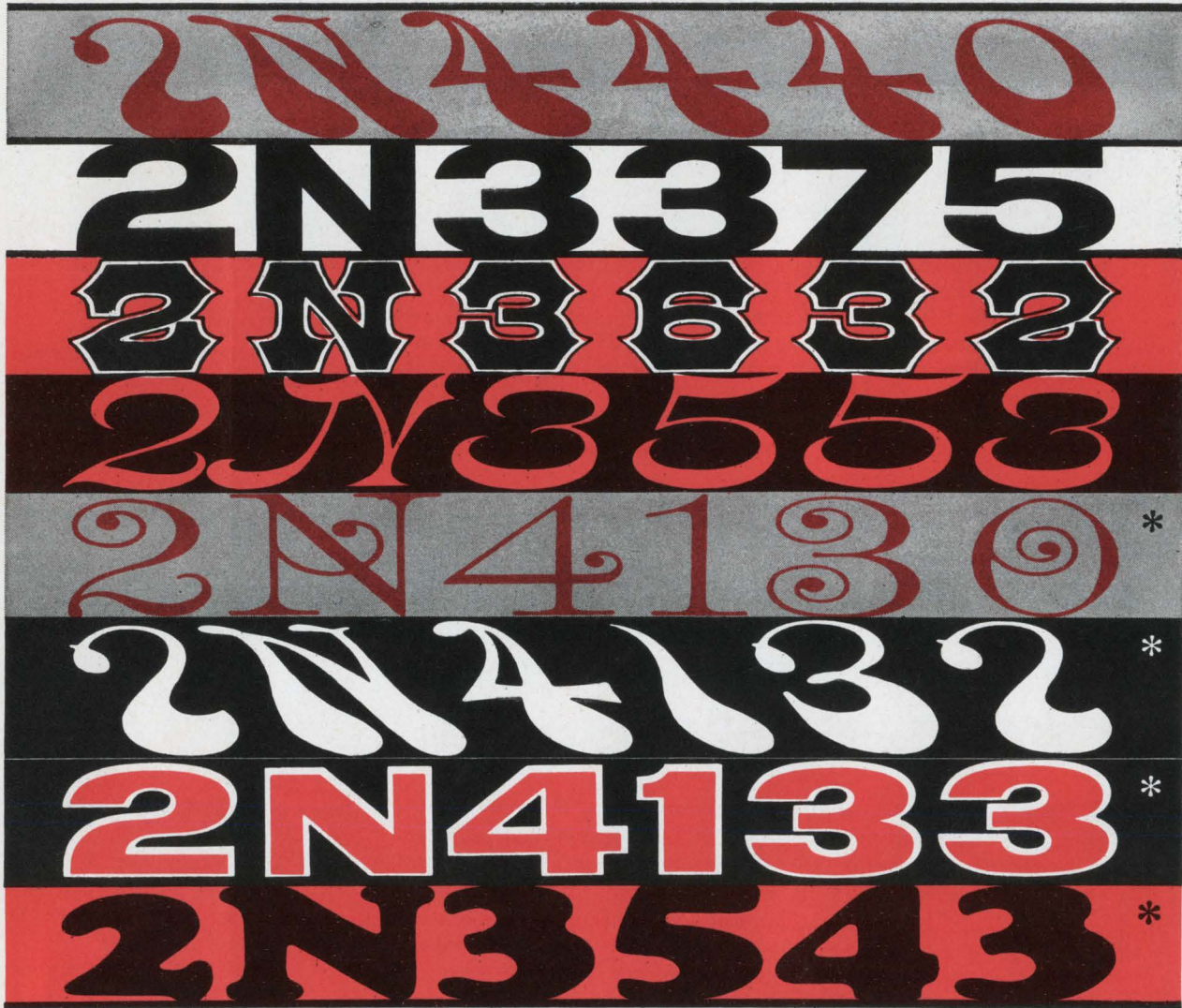

**ITT has eight instant solutions  
to your VHF/UHF  
power transistor procurement problems.**

Is there something missing from your procurement cycle for RF power transistors? Is it predictable delivery? Better-than-competitive pricing? Superior performance?

Let ITT "crack" your RF power vacuum. The eight popular part numbers listed above are in stock and

ready to go — at the ITT factory and at every one of ITT's distributors. Next time you send out an RFQ, send it to The Predictables, and fill your power vacuum.

ITT Semiconductors is a Division of International Telephone and Telegraph Corporation, 3301 Electronics Way, West Palm Beach, Florida.

\*New state-of-the-art devices, exclusive from ITT, 1 to 50 W, 30 to 70 MHz.

**semiconductors ITT**

FACTORIES IN WEST PALM BEACH, FLORIDA • PALO ALTO, CALIFORNIA • LAWRENCE, MASSACHUSETTS • ENGLAND • GERMANY • PORTUGAL • AUSTRALIA

ON READER-SERVICE CARD CIRCLE 238



UNRETOUCHED PHOTOS

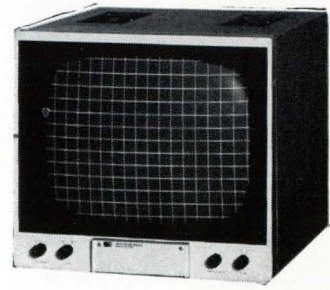

## **hp** VIDEO MONITOR

### THE NEW STANDARD OF PERFORMANCE

**Advanced Circuit Techniques Achieve Increased Reliability and Improved Picture Quality**

#### **MAINTENANCE FREE OPERATION**

All Solid State Circuitry • No periodic alignment or adjustment required • Highest quality components and workmanship.

#### **EASE OF OPERATION**

Display linearity independent of size adjustment • Unique deflection circuits have feedback **active** over entire raster • No sync controls — synchronization is automatic on both North American and CCIR Standards.

#### **IMAGE QUALITY**

Displays sine<sup>2</sup> T/2 pulse without distortion (62.5nsec) • Feedback **active** over full video band • Unity interlace results from novel sync circuitry • Keyed back porch clamp assures less than 1% black level shift for 100% video amplitude change • Less than 1.5% geometric distortion overall.

#### **OTHER IMPORTANT FEATURES**

Fully regulated high voltage and low voltage power supplies • Balanced input with loop-through facility • 46 db input common mode rejection.

Model 6946A—Price \$950.

Contact your nearest Hewlett-Packard Sales Office for full specifications.

**HEWLETT**  **PACKARD**

COMMUNICATION INSTRUMENTS

100 Locust Ave., Berkeley Heights, New Jersey 07922  
Telephone 201-464-1234 TWX 710-984-7972

ON READER-SERVICE CARD CIRCLE 223

21704

BRIGHTNESS

LINE

# The world's smallest scan-conversion tube designed for multi-sensor display capability

## RCA-C22007 PERMITS DESIGN OF ULTRA-COMPACT SYSTEMS FOR TV AND RADAR READOUT ON A SINGLE MONITORING DEVICE

RCA-C22007 is the smallest Scan-Converter ever built for multi-sensor displays. Designed especially for use in combination with a TV monitor for ultra-compact, airborne detection and surveillance systems, this tube can revolutionize your design thinking regarding radar and TV input capability for readout on a single monitoring device.

Type C22007 is the ideal answer for multi-sensor display where critical space requirements make larger scan-converter systems impractical. This 10" tube uses a magnetic-focus, magnetic-deflection type reading gun and an electrostatic-focus writing gun.

**RESOLUTION:** Intended primarily for use in systems employing TV monitors utilizing 500-1000 scanning lines.

**SIZE:** 10" long. (Longer variants are also available, such as RCA-C22001, 16" long, for applications requiring higher resolution.)

**STORAGE TIME:** Adjustable over a wide range to provide signal persistence times of from 0.5 to 20 seconds.

RCA-C22007 and other RCA Scan-Converter Tubes may be customized for size, resolution, and other characteristics to provide optimum performance for a specific system. Your RCA Representative has complete information on prices and delivery. For technical data, write: Manager, Marketing, Display Tubes, RCA, Lancaster, Pa.

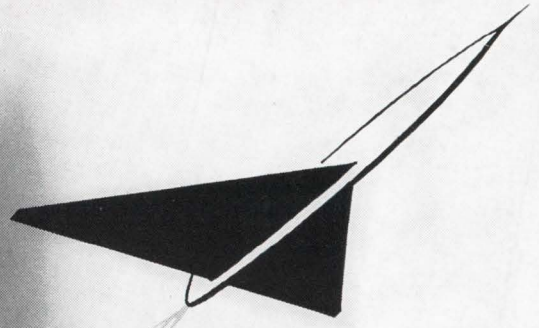

RCA Electronic Components and Devices, Harrison, N.J.



**The Most Trusted Name in Electronics**

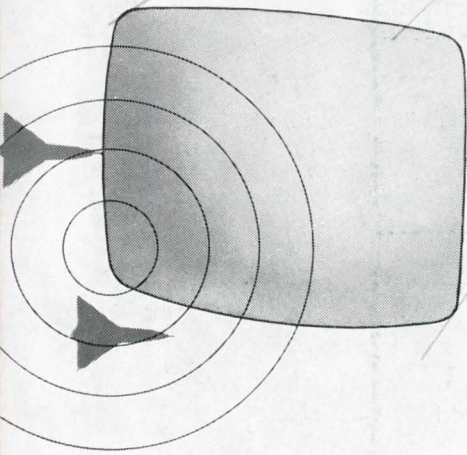

**Some members of RCA's family of scan-conversion devices are particularly suited for the conversion of TV signals from one scanning rate to another.**

ON READER-SERVICE CARD CIRCLE 224

RCA-C22007  
Actual Size