

# Electronic Design

THE MAGAZINE OF ESSENTIAL NEWS, PRODUCTS AND TECHNOLOGY

VOL. 14, NO.

# 8

APRIL 12, 1966

**Use the Linville technique** for high-frequency amplifier design. It's illustrated by the shapes below: the parabola represents  $P_{out}$ ; and the plane,  $P_{in}$ . Their

intersection is projected as a circle on a Smith chart. Then, with geometric simplicity, the graphical approach leads to a complete design. (starting on page 48).

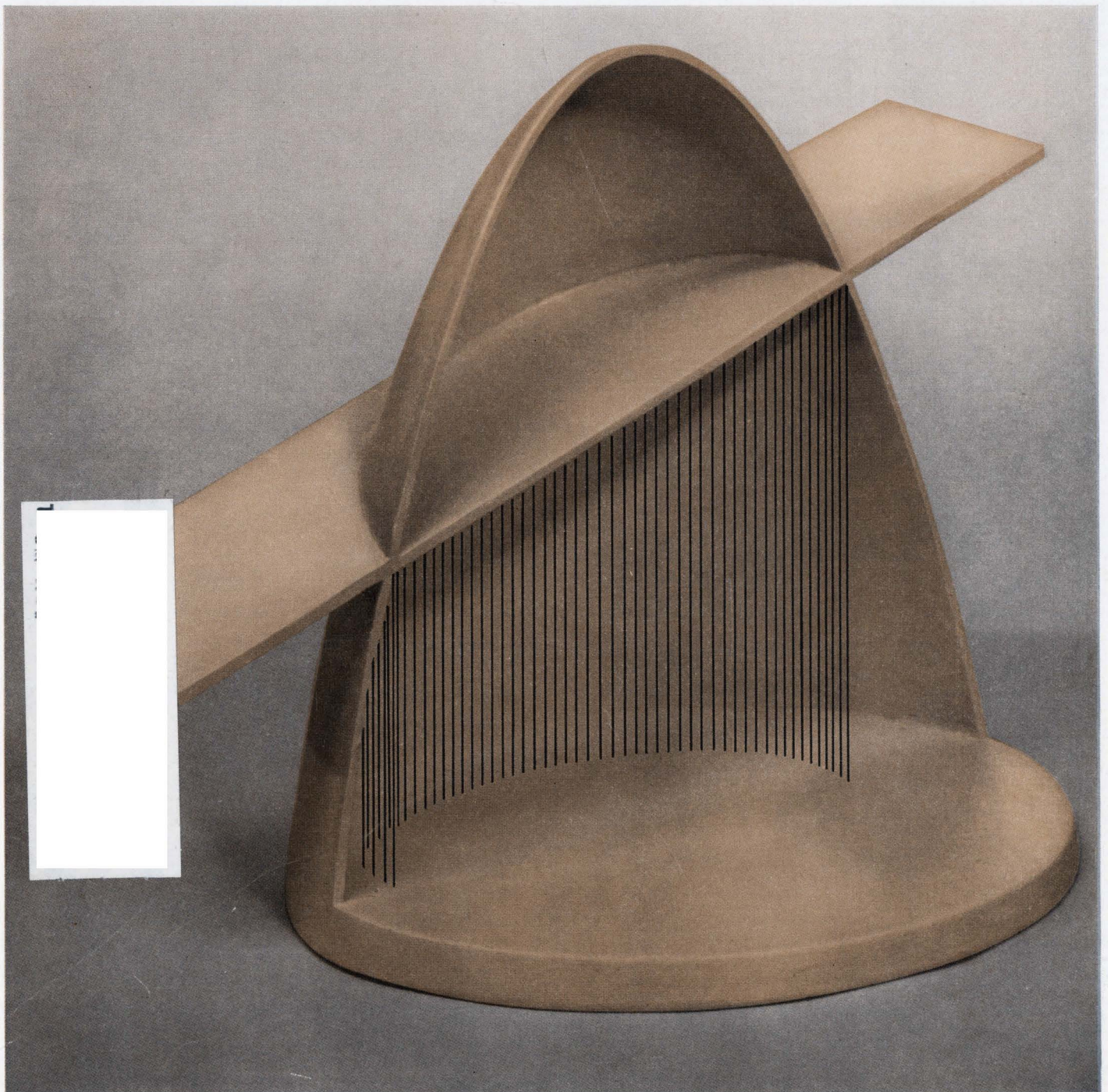

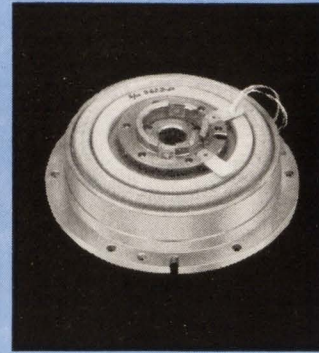
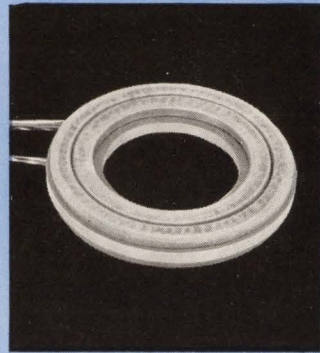
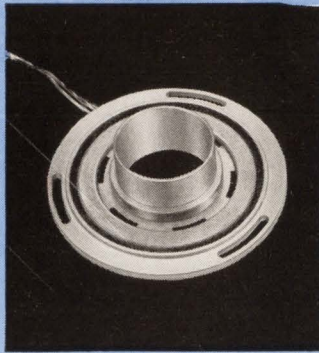

**cppe**

# Multispeed Gimbal Pickoff Synchros and Resolvers

The table below shows a small sample of the multispeed pickoff units produced by CPPC for such high reliability programs as Apollo, SIDS, Titan, Pace.

The data listed below are representative of the input/output parameters that we have supplied to meet customer requirements. The accuracies reflect the maximum errors allowed. Clifton units usually are well below these specified maximums.

The outline dimensions given in the table are applicable to rotor-stator combinations; although, as the photographs on this page show, our multispeed units are usually supplied in housings.

If you have a requirement for a high accuracy, high

reliability multispeed component, contact CPPC Sales Engineering for additional information.

Clifton Precision Products, Division of Litton Industries, Clifton Heights, Pa., Colorado Springs, Colo. 215 622-1000, TWX 215 623-6068.

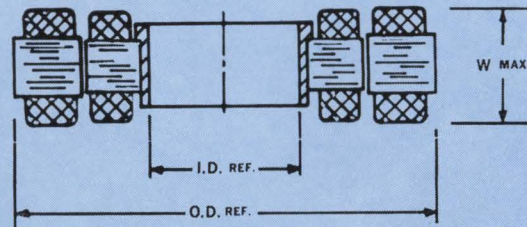

**CLIFTON Multispeed Gimbal Pickoff Synchros and Resolvers**

Function	Input	Primary	Common Input Impedance	Output Imp.		TR & Phase Shift		Accuracy		Dimensions		
				1x	Prim.Shorted Nx	1x	Nx	1x	Nx	I.D.	O.D.	W.
1x, 8x Resolver	26v 800-	Rotor	85 + j190	100 + j20	20 + j15	.220 - 9°	.220 - 24°	10'	1'	1.437	2.687	.500
1x, 15x Synchro	26v 400-	Rotor	105 + j165	150 + j25	160 + j130	.390 - 21°	.390 - 47°	10'	20"	1.500	3.400	.600
1x, 16x Resolver	28v 800-	Rotor	175 + j600	200 Max	100 Max	1.00 - 4°	.179 - 12°	2'	20"	1.687	3.687	.675
16x Resolver	28v 800-	Stator	40 + j350	-	450 + j800	-	1.00 - 6°	-	20"	1.687	3.687	.675
1x, 32x Resolver	15v 3200-	Rotor	100 + j300	100 Max	350 Max	.333 - 3°	.333 - 13°	10'	15"	2.187	3.750	.500
1x, 16x Resolver	28v 800-	Rotor	165 + j600	175 + j100	100 Max*	1.00 - 3.5°	.179 - 12°	4'	20"	2.187	4.000	.610
36x Resolver	28v 800-	Stator	120 + j200	-	230 + j200	-	.300 - 28°	-	8"	1.400	3.500	.850
1x, 64x Resolver	28v 4800-	Rotor	70 + j220	70 + j45	80 + j120	.400 - 2°	.270 - 15°	30'	7"	2.250	4.000	.700
64x Resolver	28v 800-	Rotor	260 + j200	-	350 + j260	-	.179 - 55°	-	5"	2.250	4.000	.700

**cppe**

**CLIFTON PRECISION PRODUCTS**  
DIVISION OF LITTON INDUSTRIES



# Thousands of these Oscillators are in use today



**HIGH OUTPUT • BROAD RANGE • LOW COST**

All these oscillators have typical outputs in the order of several hundred milliwatts. All have single-dial control and an input jack for a modulating signal. All are available for rack- or bench-mounting. All operate from any of several compact, inexpensive power supplies that range in price from \$65 for the basic unregulated supply to \$170 for the unit providing regulated dc heater and plate voltages. Another power supply, the Type 1263-C Amplitude-Regulating Power Supply (\$425), provides 1-kHz square-wave modulation and levelled output for any oscillator except the Type 1208-C. For 100% pulse and square-wave modulation, the Type 1264-A Modulating Power Supply (\$285) is available for use with any oscillator except Types 1208-C and 1211-C.

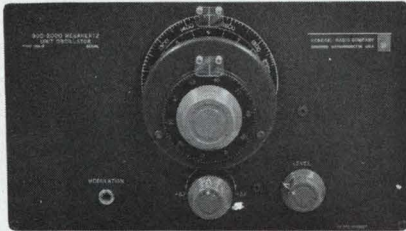

**Type 1218-B**  
\$595 in U.S.A.

Typical output >300 mW over most of frequency range. Calibration accuracy  $\pm 1\%$ .

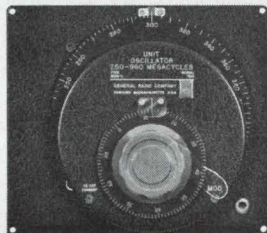

**Type 1209-C**  
\$330 in U.S.A.

Typical output >250 mW over most of range. Calibration accuracy  $\pm 1\%$ .

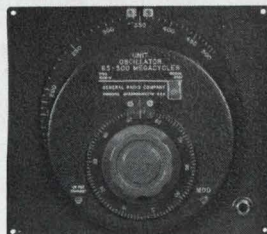

**Type 1208-C**  
\$295 in U.S.A.

Typical output >400 mW over most of range. Calibration accuracy  $\pm 2\%$ .

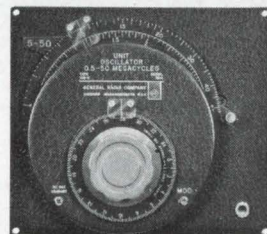

**Type 1211-C**  
\$375 in U.S.A.

Typical output >300 mW over entire range, >1 W from 0.7 to 5 MHz. Calibration accuracy  $\pm 2\%$ .

**900 MHz  
to  
2 GHz**

**450  
to  
1050 MHz**

**250  
to  
960 MHz**

**180  
to  
600 MHz**

**65  
to  
500 MHz**

**50  
to  
250 MHz**

**0.5  
to  
50 MHz**

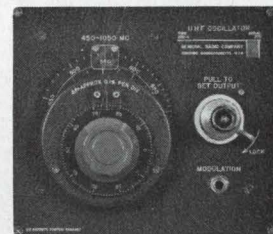

**Type 1361-A**  
\$315 in U.S.A.

Typical output >200 mW over most of the range. Calibration accuracy  $\pm 1\%$ .

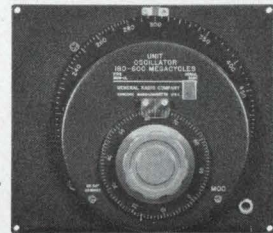

**Type 1209-CL**  
\$330 in U.S.A.

Typical output >500 mW over most of the frequency range. Calibration accuracy  $\pm 1\%$ .



**Type 1215-C**  
\$250 in U.S.A.

Typical output >200 mW over most of range. Calibration accuracy  $\pm 1\%$ .

*Write for complete information.  
Also ask about our new series of  
"sync-able," low-frequency,  
high-performance oscillators.*

BOSTON • NEW YORK • CHICAGO • PHILADELPHIA • WASHINGTON, D.C.  
SYRACUSE • DALLAS • SAN FRANCISCO • LOS ANGELES • ORLANDO  
CLEVELAND • TORONTO • MONTREAL

BOURNE END, ENGLAND

ZURICH, SWITZERLAND

## GENERAL RADIO

WEST CONCORD, MASSACHUSETTS

ON READER-SERVICE CARD CIRCLE 212

# instant systems

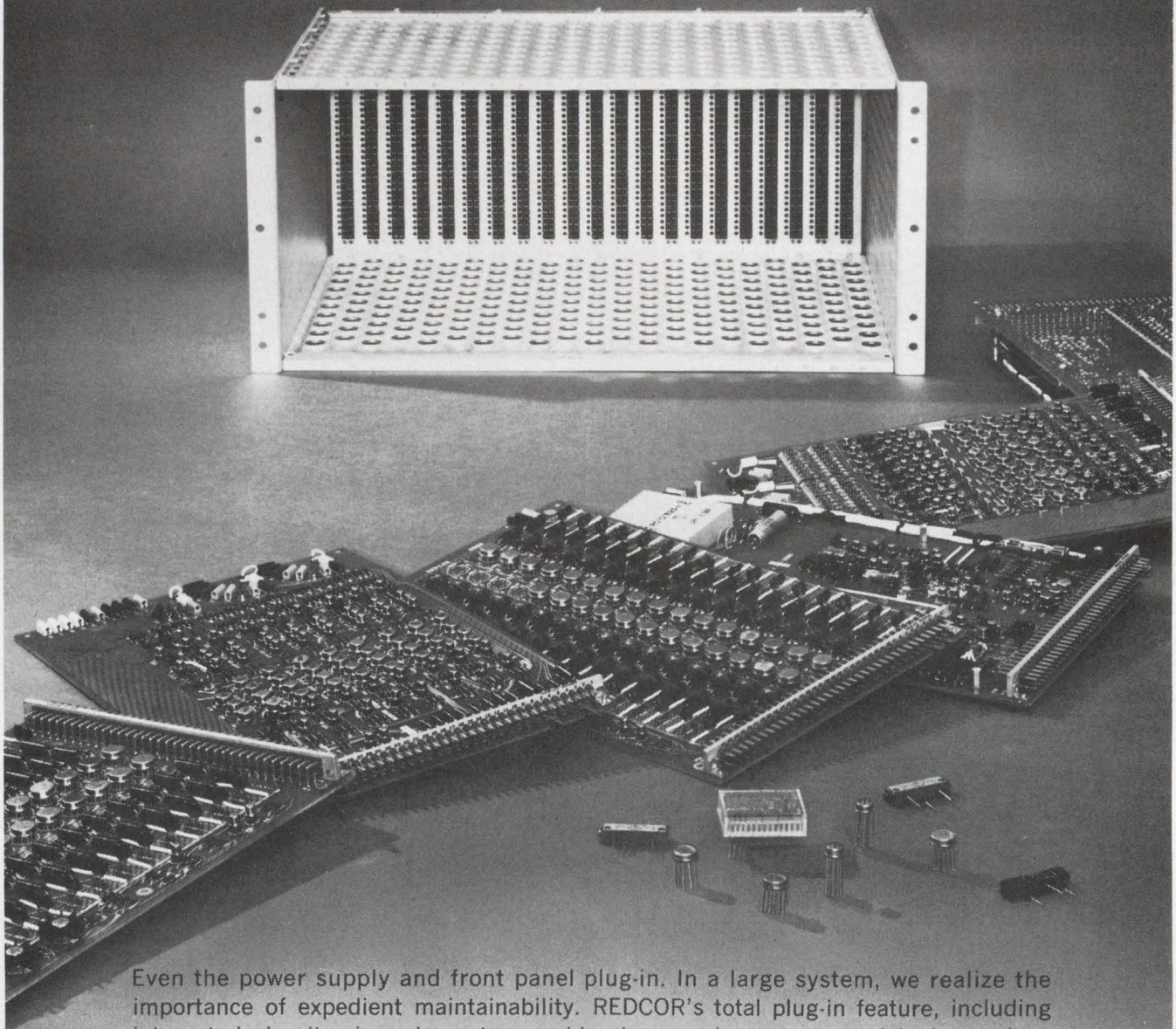

Even the power supply and front panel plug-in. In a large system, we realize the importance of expedient maintainability. REDCOR's total plug-in feature, including integrated circuit micro-elements, provides inexpensive spares provisioning and reduces "mean-time-to-repair" to seconds which minimizes troubleshooting costs. Total plug-in capability also provides proven reliability, optimum performance and prompt delivery.

#### ANALOG-TO-DIGITAL-TO-ANALOG DATA ACQUISITION SYSTEMS

Engineers: If your field is analog/digital data systems or component design, a career opportunity awaits you at REDCOR. Write to Personnel Director.

**REDCOR**<sup>®</sup>  
CORPORATION

P. O. Box 1031 / CANOGA PARK, CALIFORNIA 91304 / PHONE: (213) 348-5892 / TWX: 213-348-2573

Speed Inquiry to Advertiser via Collect Night Letter  
ON READER-SERVICE CARD CIRCLE 2

---

## NEWS

- 13 News Report
- 17 **Electroacoustic amplifiers about to leave laboratory**  
Practical devices operating at several hundred MHz are expected within a year. A 60-MHz prototype has already been announced.
- 21 **Wire modules fast with sticks and stacks**  
Two firms introduce unusual methods for wiring modules. Will their growing use displace the circuit designer?
- 26 Are you up on power supplies?
- 28 Gunn effect invades millimeter region
- 31 Washington Report
- 36 Letters
- 43 **Editorial:** Engineers are too often silent on social issues.
- 

## TECHNOLOGY

- 48 **Design high-frequency amplifiers graphically**, relating stability, gain, bandwidth and sensitivity with Linville-Smith charts.
- 58 **Swamp out distortion in wide-range agc systems** by using a diode bridge variable attenuator in the feedback loop. Stability and high accuracy also result.
- 62 **Use an IC counter next time!** You can build a completely integrated counting circuit by using sequential majority-logic elements.
- 68 **Speed control system response** and cut system cost with potentiometer padding. Here's a graphical technique that makes it easy.
- 72 **Need a pedestal-free gate?** Use a diode bridge circuit and balance out those unwanted spurious gating signals.
- 76 **Cut radar hardware needs and costs** with a special multi-mode antenna feed that requires only two hybrids to measure azimuth and elevation.
- 80 **Test system uses telemetry data** to check performance of relays in airborne electronic package. The results are displayed visually on a counter.
- 84 Ideas for Design
- 100 NASA Tech Briefs
- 

## PRODUCTS

- 104 **Test Equipment:** Variable resistor for precision uses
- 116 **Components:** Stepless control with a \$1 Triac
- |                      |                     |
|----------------------|---------------------|
| 146 Semiconductors   | 156 Production      |
| 148 Materials        | 160 Power Equipment |
| 150 Microelectronics | 161 Systems         |
| 152 Microwaves       |                     |
- 

## Departments

- |                       |                         |
|-----------------------|-------------------------|
| 166 New Literature    | 174 Advertisers' Index  |
| 170 Application Notes | 176 Designer's Datebook |
| 172 Design Aids       |                         |
-



**Bendix announces the  
B-5000: (25 watts at 2.5 amps,  
10 volts and 100° C)  
a significant cost  
breakthrough in silicon  
power transistors.**

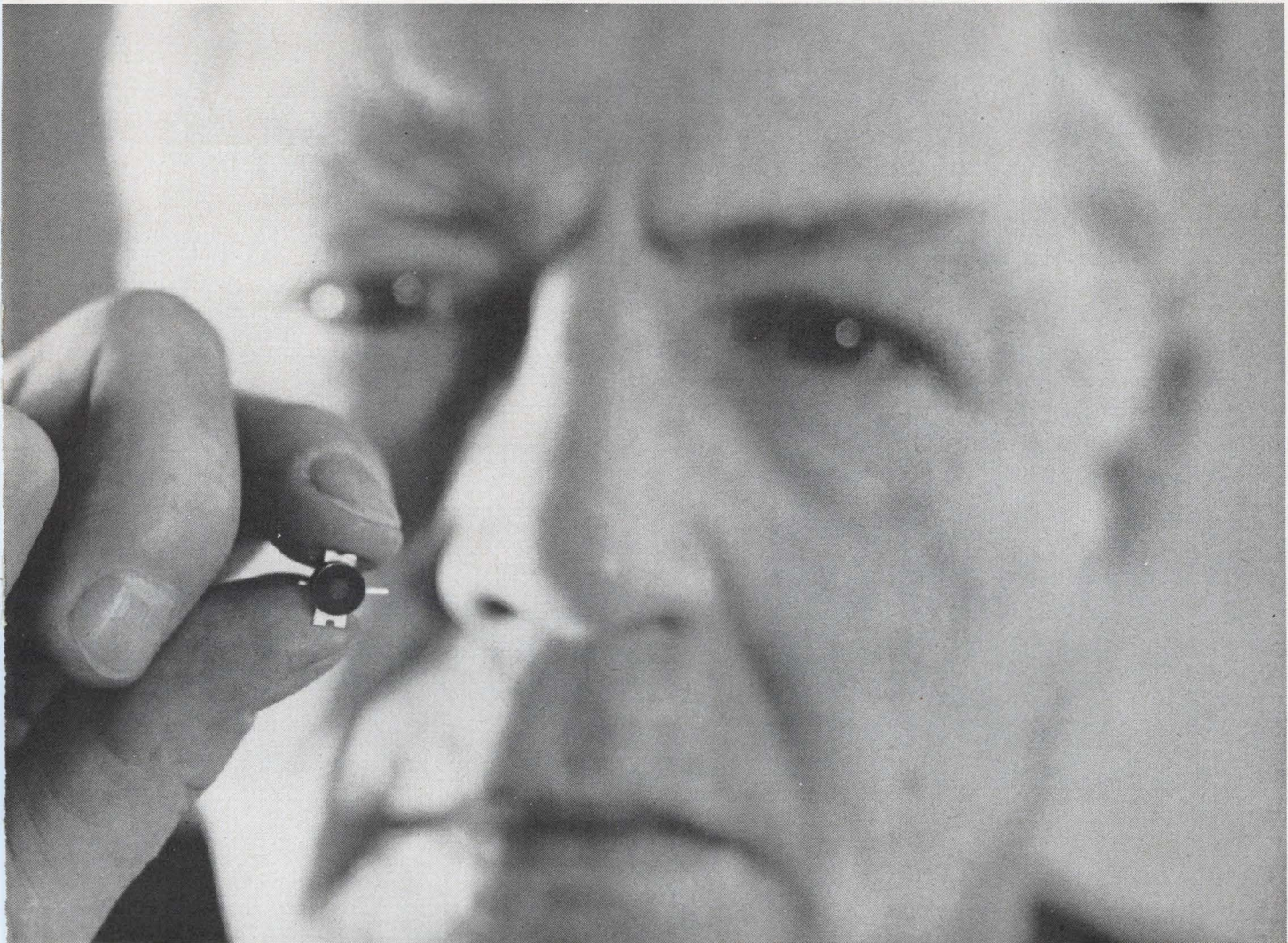

# It costs under 40¢.\*

New manufacturing and packaging techniques make the B-5000 possible. These techniques include new internal device element assembly, along with new-concept plastic molding operations. The result is a simple, low-cost, reliable silicon power transistor *with no power compromise*, when mounted upon the normal heat sink.

**B-5000's low cost opens up whole new application areas for you.** Now you can afford to put silicon power to work in many industrial and consumer products. Lighting equipment, TV sets, audio amplifiers, appliance sensing amplifiers and industrial controls, to mention a few. Compare the cost of the Bendix® B-5000 with any other silicon power unit of equal rating. You'll discover significant savings.

**B-5000 offers advances in size, weight and thermal resistance.** Leads and collector strips are highly conductive silver, offering excellent solderability, strength and ability to withstand flex and pull. Plastic encapsulant offers outstanding insulation resistance, hermeticity, adhesion ability and high temperature characteristics. In no way does B-5000 compromise traditionally accepted reliability practices.

**With B-5000 you can tailor mounting techniques to fit your needs exactly.** Depending on heat sink, available space and degree of assembly line mechanization, B-5000 can be mounted in the fashion best suited to your operation. For example, B-5000 is readily adaptable to the newer assembly solder techniques without degradation.

B-5000 lends itself equally well to other commonly used production line techniques.

#### Electrical specifications

Characteristic	Limits			Test Conditions								
	Min.	Max.	Unit	V <sub>CB</sub> V	V <sub>CE</sub> V	I <sub>C</sub> A	I <sub>B</sub> mA	T <sub>J</sub> °C				
V <sub>CEO</sub>	35	—	V	14	25	0.2		150				
I <sub>CEO</sub>	—	10	mA									
I <sub>CBO</sub>	—	1.5	mA									
V <sub>BE</sub>	—	1.2	V									
h <sub>FE</sub>	30	250	—									
h <sub>FE</sub>	20	—	—									
V <sub>CE(s)</sub>	—	1.2	V						14	14	1.0	50

#### Absolute maximum ratings

V<sub>CEO</sub> = 35 volts, I<sub>C</sub> = 3 amps, I<sub>B</sub> = 1 amp, T<sub>stg</sub> = -65 to 175°C, T<sub>J</sub> = -65 to 150°C.

For complete information about the new Bendix B-5000 silicon power transistor, write to us in Holmdel, New Jersey.

\*In volume quantities

**Bendix Semiconductor Division**  
HOLMDEL, NEW JERSEY



ON READER-SERVICE CARD CIRCLE 3

April 12, 1966

# Like to see our new T Series modules perform?

## Warm up your scope, we'll be right over.

Our new T Series integrated circuit logic modules are so fast and flexible that we can hardly blame you if you doubt the

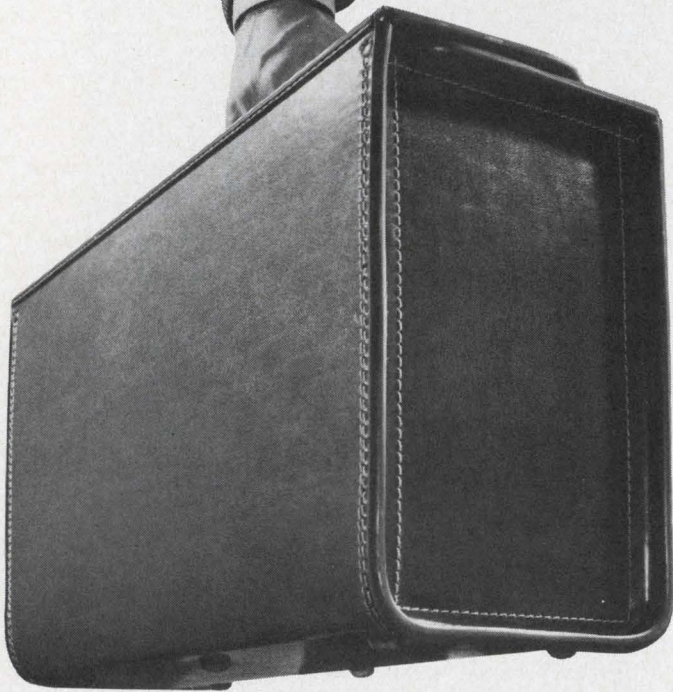

amazing specs: Fan out of 14. Noise rejection up to 1.8v. 18 nanosecond gates. 40 nanosecond flip-flops.

So we've given our men demonstration kits and you can see for yourself.

Each kit contains an assortment of module cards and has its own power supply and timing source. You furnish the problems and the oscilloscope.

Our man may even leave the kit a few days for you to play with. Fun.



### Scientific Data Systems

1649 Seventeenth Street, Santa Monica, California  
U. S. sales offices in New York, Boston, Washington, Philadelphia, Pittsburgh, Huntsville, Orlando, Chicago, Houston, Dallas, Albuquerque, Denver, Seattle, San Francisco, St. Louis, Detroit.

The logo for Scientific Data Systems, consisting of the letters 'SDS' in a bold, sans-serif font, enclosed within a rectangular border.

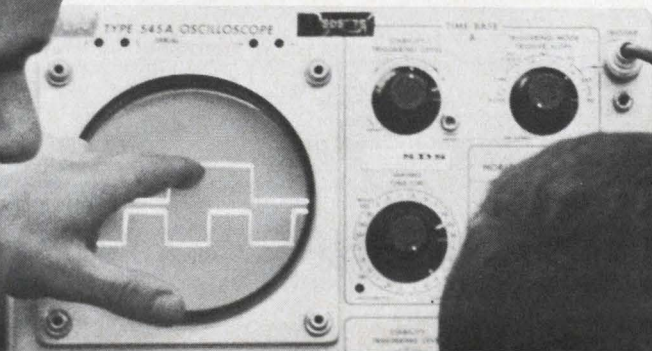
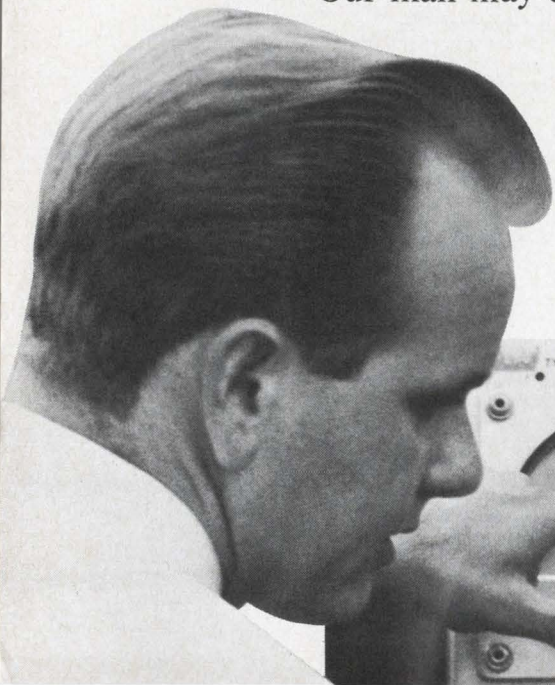



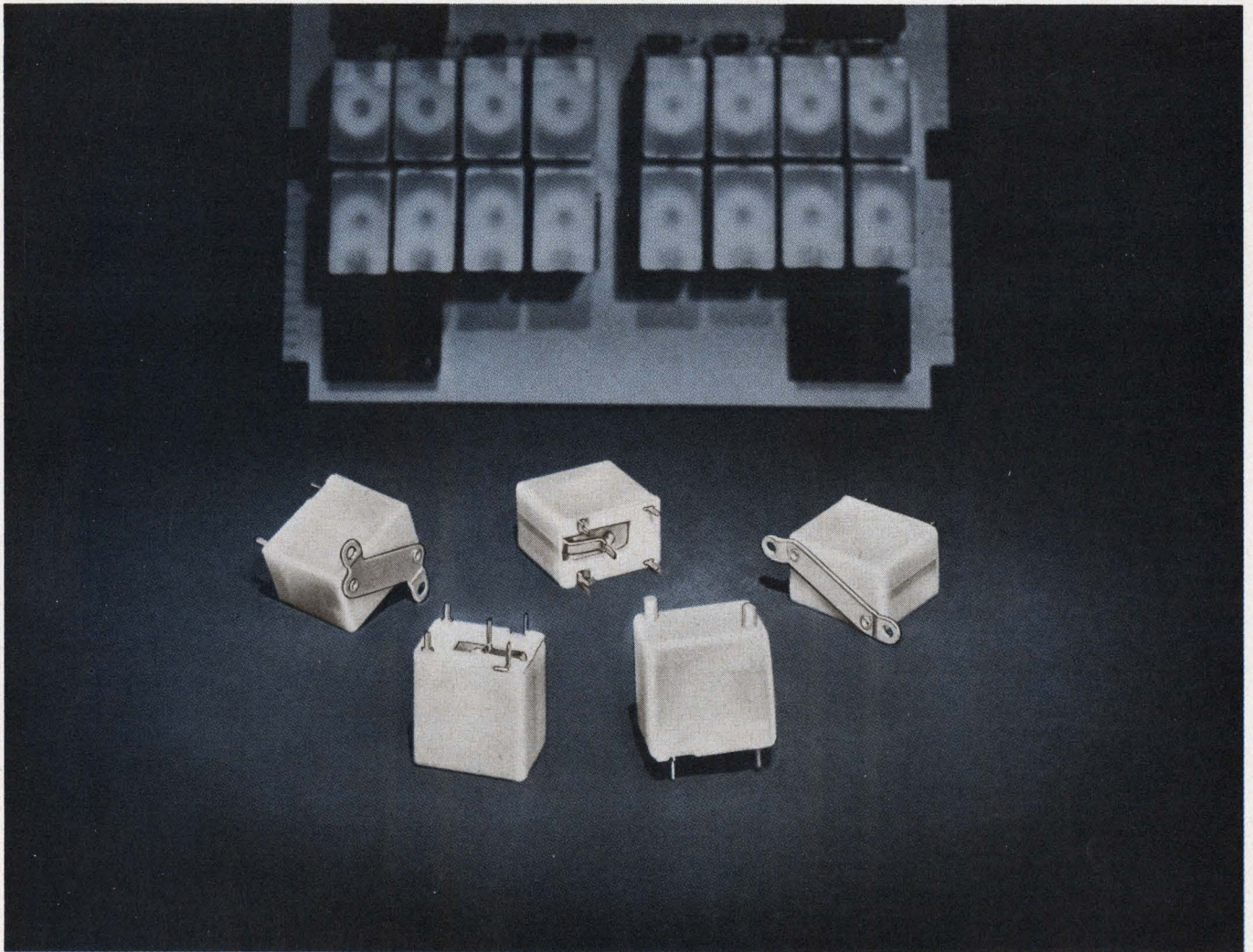

## A new miniature sensitive relay from RBM CONTROLS IT WILL BE COPIED BUT NEVER EQUALED

Reason—RBM CONTROLS has more production and quality control experience and has built more sensitive miniature relays than any other manufacturer in the industry.

The new miniature Type 64 is an isolated contact relay for maximum sensitive applications where reliability, rugged construction and low cost are of major importance. This low level circuit switching relay is designed for compact areas and may be stack assembled in close proximity to each other. A protective nylon cover eliminates physical contamination or mishandling. A variety of mounting brackets are available making this relay the most versatile in the industry.



*Serving Major Markets Since 1921*

# RBM CONTROLS

Division Essex Wire Corporation  
Logansport, Indiana

### ENGINEERING SPECIFICATIONS

#### CONTACTS

Ratings: 28V DC or 115 V AC 1 Amp (Non-inductive)  
Form: SPNO, SPNC, SPDT  
Type: Cross-Bar

#### COIL RATINGS

Maximum—1 Watt  
Minimum—.050 Watt  
Resistance—10,000 Ohms Max.

#### TERMINALS

Contact: To Mount To Printed Circuit Board

#### APPROXIMATE DIMENSIONS

(Overall Including Brackets and Mountings)

Printed Circuit	L 1-3/16" x W 3/4" x H 1-3/8"
Bottom	L 1-3/16" x W 3/4" x H 1-9/16"
Top	L 1-11/16" x W 3/4" x H 1-15/32"
Parallelogram	L 1-3/16" x W 1-7/16" x H 1-15/32"

#### MOUNTINGS

Printed Circuit Board  
Bottom  
Top—Parallelogram Replacement  
Top Mounting Also Available

**RBM**  
STANDARD CONTROLS  
ARE AVAILABLE FROM YOUR  
ELECTRONIC PARTS DISTRIBUTORS

Speed Inquiry to Advertiser via Collect Night Letter  
ON READER-SERVICE CARD CIRCLE 4

# No one has a larger line of disc memories.

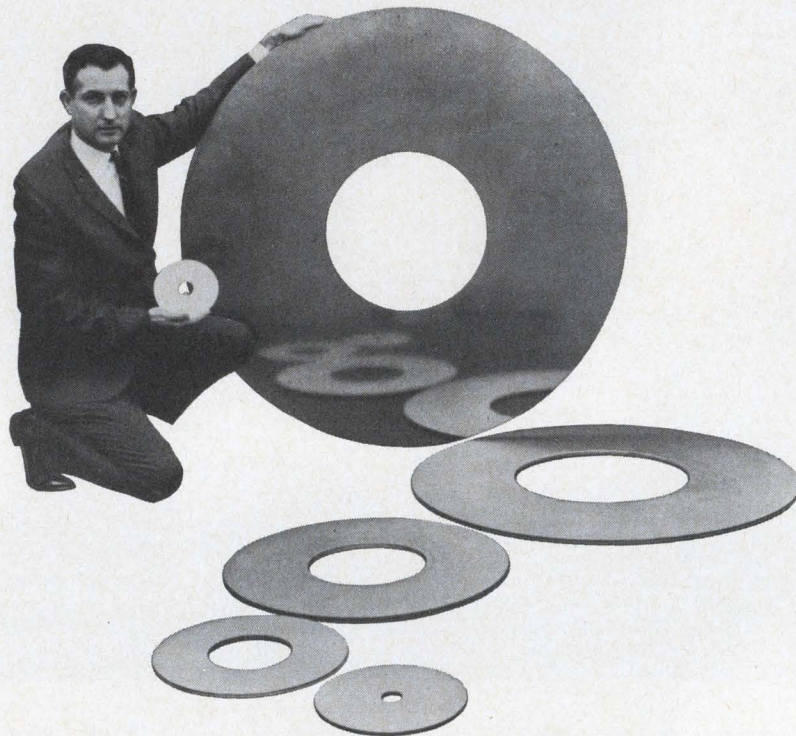

See the largest line of disc memories available at the Spring Joint Computer Conference, Booth 913-916

Whether your information storage requirements are small or require data stored in millions of bits, Librascope Group of General Precision, Inc., has a disc memory system for every application. These systems have a proven history of reliable performance in computing systems designed for military, business, engineering, and educational applications.

**LIBRAFILE mass memories:** Large-capacity, high-speed, random-access information storage systems. Two disc sizes available. 48" discs capable of storing up to 400 million bits. 38" discs with a capacity of 200 million bits. LIBRAFILE mass memory information retrieval is either fixed-address search or search-by-record content. Access time less than 20 ms. Data transfer rates in the megacycles.

**Militarized disc-memory systems:** High-speed, random-access, information-storage systems. Consists of disc memory for data storage and an electronic subsystem that provides complete interface, control, and read/write electronics. These systems can be used as a data base for shelter, van, or shipboard applications. Storage capacity of 25 million bits on 24" discs. Customized capacity up to 80 million bits.

**L-400 magnetic-disc memory systems:** Provide data storage and transfer in computer systems, peripheral equipment, and other systems where rapid-access memory is a requirement. 24" disc storage capacity up to 36 million bits.

**Airborne disc file:** Small, compact file designed for airborne (MIL-E-5400 class 2) applications, as well as for shipboard and mobile field operations. 6 1/4" disc with capacity of 1 million bits. Customized airborne memories available with

capacity up to 50 million bits.

**L-300 disc memory:** For use in computer systems and peripheral equipment as main storage, buffer storage, or as a supplemental memory. 10" disc with a capacity of 275,000 bits.

For complete details, write for our technical bulletins.

**Engineers:** For career openings, call or send resume in confidence to B. Larson, General Precision, Inc., Librascope Group, 808 Western Avenue, Glendale, California 91201. An equal opportunity employer.

A Plans-for-Progress Company.

**GP GENERAL  
PRECISION INC.**

**LIBRASCOPE GROUP**

□ □ □ 808 Western Avenue □ □ □  
□ □ □ Glendale, Calif. 91201 □ □ □

ON READER-SERVICE CARD CIRCLE 55

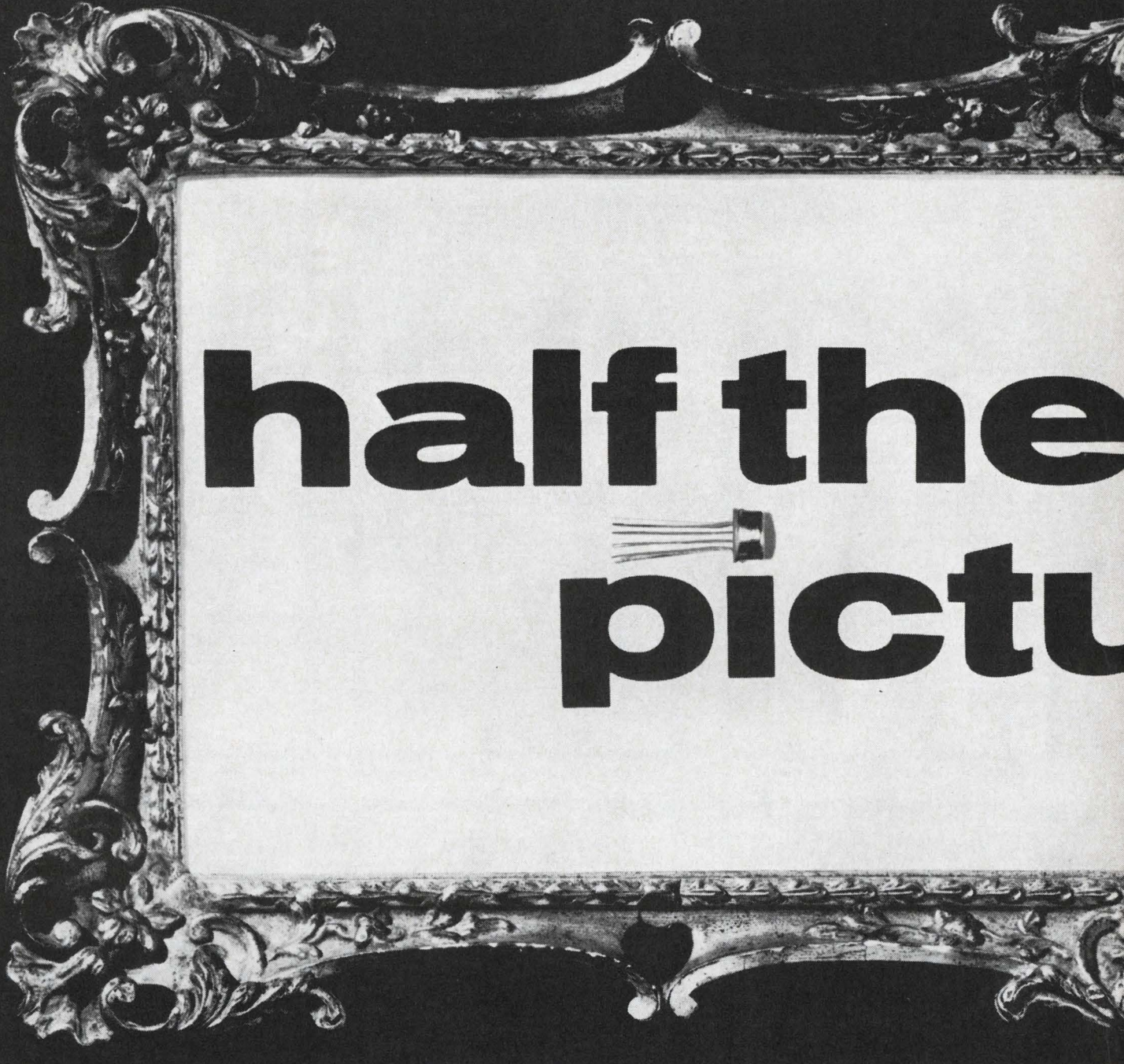

# half the picture

## *When you look at electronic components are you seeing only half the picture?*

We're the last people to argue with component purchasers who put performance, price and delivery first — meeting these three basic requirements is what keeps us in business. But most engineers are also on the lookout for something more, and many of them find it at Mullard.

Take research and development for instance. Out of Mullard R&D have come outstanding devices such as the travelling wave tubes for the New York—San Francisco and Montreal—Vancouver microwave links. Production resources? Mullard

plants are among the most efficient anywhere, with a reputation for the production of tight-tolerance devices to proved standards of reliability. As for circuit know-how, Mullard has the best equipped applications laboratories in Britain. And when it comes to technical services, you will find that Mullard provides the kind of comprehensive performance specs, survey documents and application reports that are just that much more useful. If you want to get the *whole* picture, why not ask us to help you with some of your component problems?

ON READER-SERVICE CARD CIRCLE 214

DIODES · TRANSISTORS · PHOTO-DEVICES AND RADIATION DETECTORS · RECTIFIER DIODES AND STACKS · THYRISTORS AND STACKS · INTEGRATED CIRCUITS · CATHODE RAY TUBES · RECEIVING TUBES · ELECTRON OPTICAL DEVICES · PHOTSENSITIVE DEVICES · COLD CATHODE DEVICES · POWER DEVICES · TRANSMITTING TUBES · MICROWAVE DEVICES · CAPACITORS · FERRITE MATERIALS AND ASSEMBLIES · COMPUTER COMPONENTS AND ASSEMBLIES · MAGNETIC MATERIALS · SPECIAL PURPOSE MAGNETS · VACUUM DEVICES · WOUND COMPONENTS.

# Mullard

*where the product is only part of the deal*  
MULLARD LIMITED · TORRINGTON PLACE · LONDON WC1 · ENGLAND

# Did you know Sprague makes...?

## UNICIRCUIT® RCTL INTEGRATED CIRCUITS

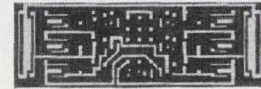

(8x actual size)

Sprague Series US-0100 . . . a complete line of monolithic digital building blocks featuring low power consumption (2 mW typ.)

ON READER-SERVICE CARD CIRCLE 820

## UNICIRCUIT® RTL INTEGRATED CIRCUITS



TO-5 CASE

Types US-0708 through US-0721 . . . Fully interchangeable mW digital building blocks featuring power consumption of 4 mW/node and propagation delay of 40 nanoseconds.

ON READER-SERVICE CARD CIRCLE 821

## DIFFERENTIAL AMPLIFIER TRANSISTOR PAIRS

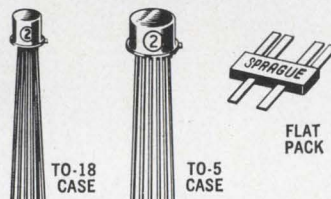

NPN or PNP • Matched characteristics.  
 $h_{FE} = 10-20\%$ .  $\Delta V_{BE} = 5-20$  mV.  
 $\Delta V_{BE}/Temp = 5-20$   $\mu V/^\circ C$ .

ON READER-SERVICE CARD CIRCLE 822

## MULTIPLE TRANSISTORS (NPN-PNP PAIRS/QUADS)

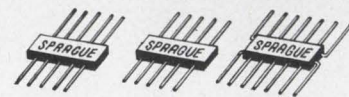

AMPLIFIERS SWITCHES CHOPPERS

Pairs	Quads
2 NPN	4 NPN
2 PNP	4 PNP
1 NPN—1 PNP	2 NPN—2 PNP

ON READER-SERVICE CARD CIRCLE 823

## UNICIRCUIT® CUSTOM HYBRID CIRCUITS

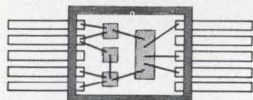

Combine monolithic silicon circuits with Ni-Cr alloy resistors. Close resistance tolerances, low temperature coefficient,  $\pm 2\%$  resistor matching.

ON READER-SERVICE CARD CIRCLE 824

## LOW-COST HERMETICALLY- SEALED PLANAR TRANSISTORS

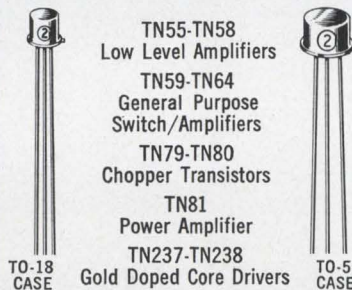

TN55-TN58  
Low Level Amplifiers  
 TN59-TN64  
General Purpose  
Switch/Amplifiers  
 TN79-TN80  
Chopper Transistors  
 TN81  
Power Amplifier  
 TN237-TN238  
Gold Doped Core Drivers

ON READER-SERVICE CARD CIRCLE 825

## SILICON ALLOY REPLACEMENT TRANSISTORS

### FULL PLANAR RELIABILITY

2N327A	2N945	2N1026
2N328A	2N946	2N1469
2N329A	2N1025	2N1917

Sprague makes 82 standard high-emitter-voltage full planar silicon alloy replacement types.

ON READER-SERVICE CARD CIRCLE 826

## DUET\* HIGH-VOLTAGE DUAL-EMITTER TRANSISTORS

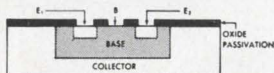

New Type 3N123 low-cost transistor with 25-volt rating now available.

Sprague makes more dual-emitter chopper transistors than any other source.

★Trademark

ON READER-SERVICE CARD CIRCLE 827

## TWIN DUET\* DUAL-EMITTER TRANSISTORS IN FLAT PACKS

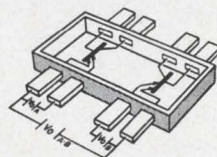

Sprague leads again with two dual-emitter chopper transistors in one flat-pack case, with tight  $V_{OFF}$  matching of both devices.

★Trademark

ON READER-SERVICE CARD CIRCLE 828

For complete technical data on any of these products, write to Technical Literature Service, Sprague Electric Company, 347 Marshall Street, North Adams, Massachusetts 01248.

455-5152

# SPRAGUE®

THE MARK OF RELIABILITY

\*Sprague' and '®' are registered trademarks of the Sprague Electric Co.

# ED News

Electroacoustic amplifiers leaving laboratory PAGE 17

Giant lasers have high light intensity PAGE 20

New packaging speeds wiring of modules PAGE 21

Gunn effect invades millimeter region PAGE 28

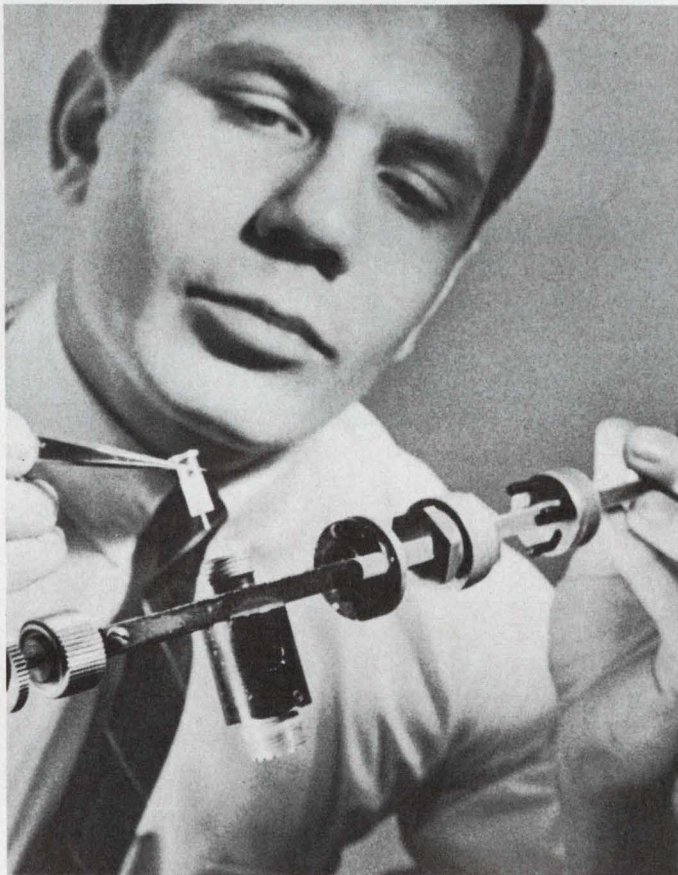

Gunn power ... 28

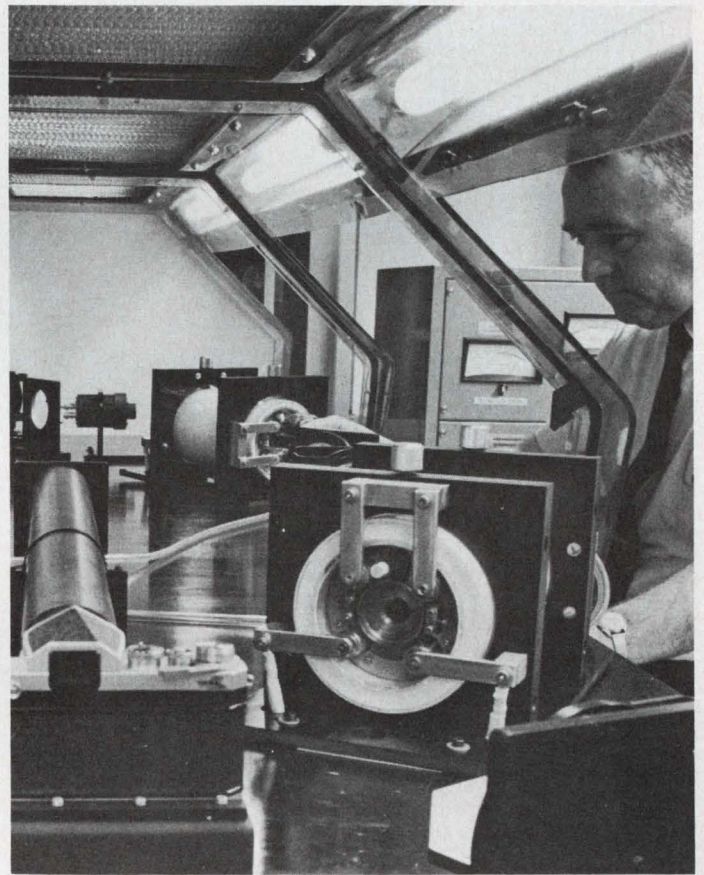

Putting rubies to work ... 20

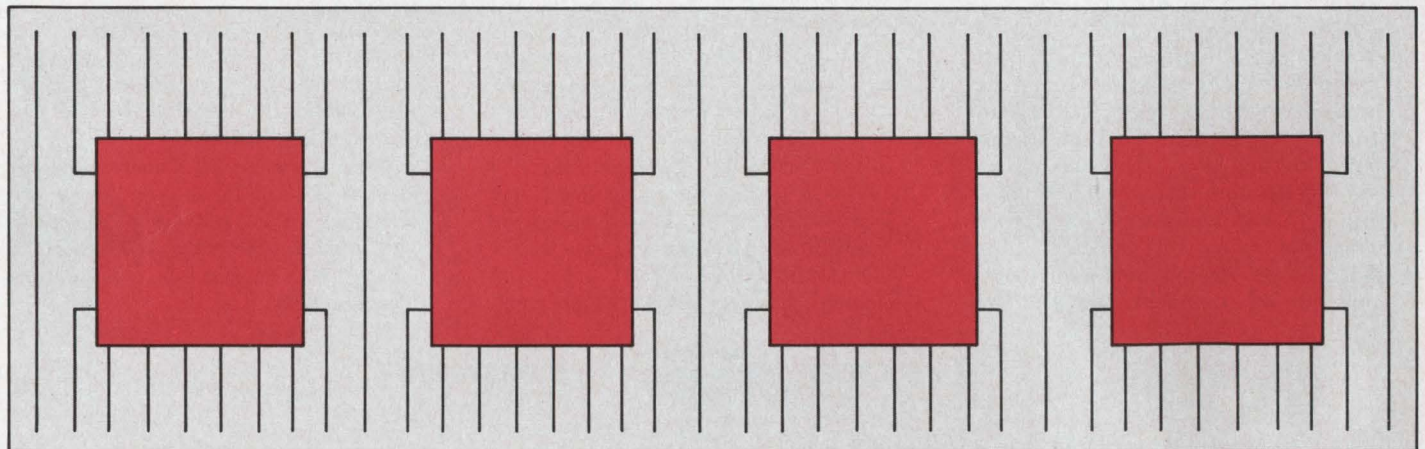

Sticks and stacks ... 21

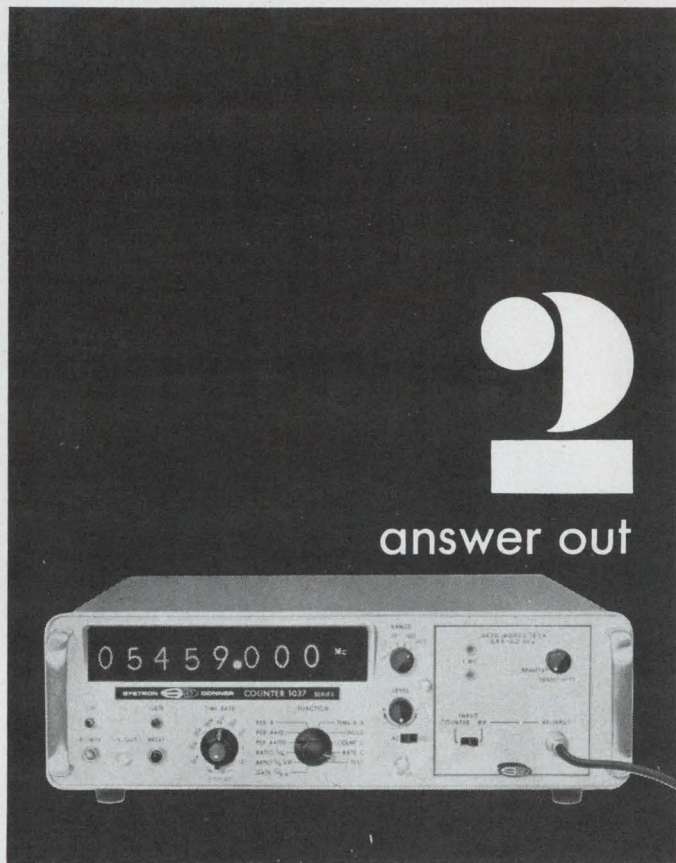

# yes, it's that simple to measure microwave frequencies directly

**(and with counter accuracy!)**

Just connect the input signal and read the answer! Systron-Donner's new frequency measuring system is completely automatic. No calculations, no manipulations of any kind. This great new tool for the lab and production testing will prove to be as necessary as a digital voltmeter.

S-D can deliver this automatic system now for measurements between 3.95

and 8.2 GHz. Soon we'll offer coverage over the rest of the microwave spectrum. The system shown here illustrates the basic concept—a combination of the S-D 50 Mc Model 1037 Counter and the S-D Model 1254 Automatic Computing Transfer Oscillator. Other plug-ins will cover L, S and X bands.

FOR MAXIMUM STABILITY—Systron-Donner exclusively offers a high stabil-

ity oscillator with an aging rate of 1 part in  $10^9$  per 24 hours. That's a three-fold increase in stability over the best previous oscillators!

Prices: Model 1037 Counter, \$2,550. Model 1254 ACTO Plug-in, \$1,950. To learn more about automatic GHz counting, please write to us in Concord or contact your nearest S-D sales engineer (listed in EEM).

**SYSTRON  DONNER**  
CORPORATION

888 Galindo Street • Concord, California  
Speed Inquiry to Advertiser via Collect Night Letter  
ON READER-SERVICE CARD CIRCLE 6



## Time is ripe for commercial diversification

If a defense-oriented firm is considering diversifying into the commercial market, now is the time to do it. So says the Denver Research Institute of the University of Denver in a recent study entitled "Defense Industry Diversification."

The researchers' conclusion followed an analysis of recent diversification programs by U.S. defense manufacturers. They found that the prospects for successful diversification appeared best when defense spending and the demand for defense hardware were expected to increase. The study found that a substantial time lag occurred between the start of diversification programs and first profits. Therefore, a program should be begun in time to make its contributions to corporate profits when these contributions are most needed—when defense demand is cut back.

In discussing the problems of diversification, John S. Gilmore, who led the study, pointed up the crucial role of management. He said: "Responsibility for diversification rests with the management of defense firms, and the commitment and participation of top management is the key item in any successful diversification program. This type of commitment is often difficult to achieve due to a number of diverse factors, including a discouraging history of failure in commercial diversification efforts, strong doubts that the defense customer wants diversification, and the seeming lack of stockholder interest in diversification efforts."

## No hiding from new air recon system

The use of additive color techniques has led to an aerial reconnaissance system that makes interpretation much surer and gives more valuable intelligence data.

The new system facilitates detection by making objects which might be indistinguishable in conventional color or black-and-white infrared photography stand out from their background.

Developed by Fairchild Space and Defense Systems, it uses a single panoramic camera equipped with four rotating lenses. The lenses record images of the same target, through

# News Report

blue, green, red and near-infrared filters, side-by-side on a strip of infrared film. The resultant black-and-white negatives are then converted to positive transparencies.

To interpret the photographs, the transparencies are placed in a special four-lens viewer and superimposed on a screen in various combinations through a selection of filters. Varying the brightness, saturation and hue of each image, either separately or in combination, brings out maximum contrast between targets and their surroundings.

With conventional photo-reconnaissance a military tank standing in deep shadow and covered with an infrared-absorbing camouflage net was invisible on regular color, panchromatic or infrared film. But with the new system, all shadows appear achromatic (gray or black), while the tank is clearly visible in vivid color.

## System sought to avert air collisions

Development of an airborne system to prevent mid-air collisions of commercial aircraft is nearing success, according to the Operations Executive Committee of the Air Transport Association (ATA).

This optimism stems from progress made on a collision-avoidance system under development by McDonnell Aircraft. In its present form the system is not suitable for airline use, especially as it must be carried in an externally mounted pod. But the airlines and McDonnell have been examining ways to make it suitable for more than three years. These investigations are believed to be so close to a payoff that the ATA has directed its Air Traffic Control Committee to take all possible steps to further McDonnell's efforts to adapt the system for early in-flight evaluation by airlines.

The system is of the cooperative type: both the "intruding" aircraft and the "protected" aircraft must carry cooperating equipment. In a non-cooperative system only the protected aircraft need carry collision-avoidance equipment. Although the non-cooperative type is more desirable, it is universally agreed that a practical system of this sort is still far beyond current capabilities. McDonnell's system uses the time-frequency

technique, which recent research has shown to be the most promising for cooperative collision-avoidance systems. In a time-frequency system each aircraft is assigned its individual time to transmit on a shared frequency.

Successful operation of such a system requires both frequency and time to be measured with great precision.

## Teaching aids offer growth opportunities

Increasing student enrollment, continuing shortage of teachers and expanding Federal and state expenditures for education—put these three together and they spell “growth market” for audio-visual and other electronic educational aids.

Commenting on this, Robert L. Rice, president of Graflex, Inc., told the spring conference of the Electronic Industries Association that education is the fastest growing segment of the economy. Combined Federal and local spending on education now reaches \$23-25 billion annually, second only to defense. According to Rice, this market's greatest potential for the electronic industry is in basic audio-visual electronic aids, not in sophisticated items such as computers. He said that companies should concentrate on building simple, durable equipment for untrained teachers to operate. In view of many teachers' fear of electronic aids, he advised against over-emphasis on the development of new or revolutionary equipment.

## Full-scale experiment uses “supermagnet”

A milestone in high-energy physics has been reached with the first use of a supermagnet in a full-scale experiment. Built at the Atomic Energy Commission's Argonne National Laboratory, the supermagnet is so called because it uses the principle of superconductivity to create a strong magnetic field.

Compared with the electromagnets used today in high-energy physics experiments, the supermagnet is relatively small. It has an outer diameter of 24 inches and an inner diameter of 11 inches. Despite its size it can sustain a magnetic field that is stronger than the fields of almost all larger conventional magnets. Furthermore, it does so at a great savings in power. Only a small laboratory-type power supply is required to energize the supermagnet,

which then functions indefinitely without further electrical power as long as it is kept cold. Comparable electromagnets, on the other hand, require millions of watts of electrical power.

The supermagnet was used at Argonne in a bubble-chamber experiment to track energetically-charged particles. Liquid helium is used both in the bubble chamber to track the particles and to cool the supermagnet.

## Cooperative researchers sought by NBS

The National Bureau of Standards has announced new areas of research open in its cooperative program of joint Government-industry research. Under the program, scientists and engineers from industry are invited to work temporarily at NBS laboratories on projects of value to their companies as well as to the scientific and technical community at large.

The new areas include investigation of the use of lasers for length measurement, computer languages, data-processing systems and studies of cryogenic fluids in flow. Complete details on the program are available from the Office of Industrial Services, National Bureau of Standards, Washington, D.C.

---

**Acquisition of Computer Control Co., Inc.**, by Honeywell, Inc., has been agreed upon subject to final approval by the boards of directors of both companies. According to Honeywell, the operations of 3C will complement the operations of the company's electronic data-processing division. The present 3C organization will operate as a separate unit of Honeywell under its present management and personnel.

**NASA has named the crew** for the first manned Apollo earth-orbital mission. Prime crew are Lt. Col. Virgil I. “Gus” Grissom (USAF), Lt. Col. Edward H. White, II, (USAF), and Lt. Roger B. Chaffee (USN). Back-up crew are Lt. Col. James A. McDivitt (USAF), Major David R. Scott (USAF), and Mr. Russell L. Schweickart, a civilian. The first manned Apollo mission is tentatively scheduled for the first quarter of 1967.

**Formation of a joint study group** to investigate the potential of electronic systems in the broad field of education has been announced by The Reader's Digest Association, Inc., and Sylvania Electric Products, Inc. According to the two companies the study group will seek the best methods of integrating electronic capabilities and educational materials into practical systems that will help meet the rapidly expanding needs of education.





Portable Five-Dial Potentiometer: \$535



Volt Box: \$135

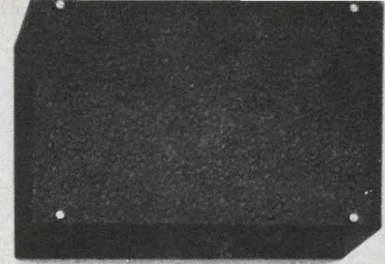

Pico-ammeter: \$485

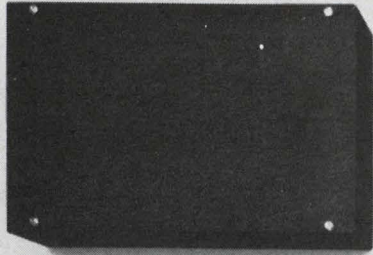

Five-Dial Voltage Divider: \$320

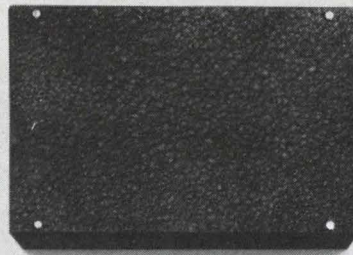

Portable Wheatstone Bridge: \$600

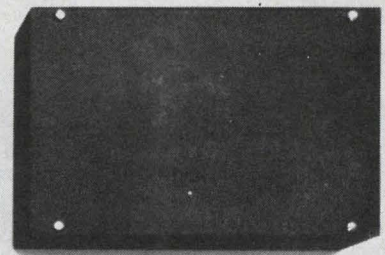

Portable Kelvin Bridge: \$650



Direct Reading Comparison Bridge: \$500



Direct Reading Ratiometer: \$450

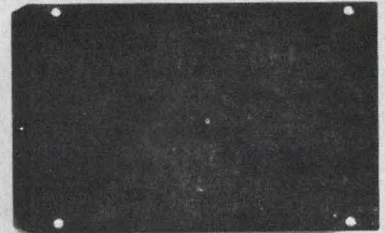

Electronic Null Detector: \$325

We packed \$4,000 worth of measuring capability into this new portable package.

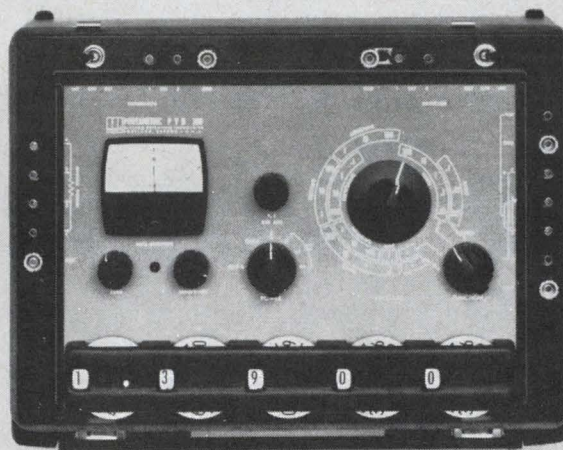

For \$750 it does the work of 9 devices.

We call this versatile instrument our Portametric PVB. That stands for Potentiometric Voltmeter Bridge.

Actually, it's more than a potentiometric voltmeter and more than a bridge. But how many words can we reasonably put in an instrument name?

At the moment, you may not feel you need all the capabilities, or the degree of accuracy the PVB can deliver. But extra measuring power is something like reserve horsepower in

your car. When you need it, you need it bad. Then you're glad you didn't buy just one or two of those black boxes above when you could have had the works at our price.

If you know ESI, you know we put a lot more emphasis on performance than price. We only mention price here so you will appreciate the technical advances represented by the specifications on the right—and send for details. ESI, 13900 NW Science Park Drive, Portland, Oregon (97229).

Function	Ranges	Full Scale	Minimum Step
Voltmeter	5	0.051110 to 511.10 volts	1 microvolt
Ammeter	8	0.51110 $\mu$ a to 5.1110 amperes	10 picoamperes
Resistance Bridge (4 terminal, guarded)	10	0.51110 ohms to 511.10 megohms	10 microhms
Comparison Bridge (4 terminal, guarded)	To 5.1110 times reference standard	1.0000	0.01%
Ratiometer (Direct reading)	3	0 to 1.00000 0 to 0.051110 0 to 0.0051110	1 part in 10-5 1 part in 10-6 1 part in 10-7

Null detector: Sensitivity—5 microvolts; Input impedance—approximately 1 megohm; AC rejection 60 cps and up; 80 db, guarded, battery operated. Accuracy:  $\pm$  0.02% of reading or 1 switch step on virtually all ranges and functions. Comes in portable case; battery operated; 2,000 hour battery life.

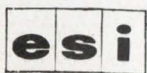

Electro Scientific Industries, Inc.

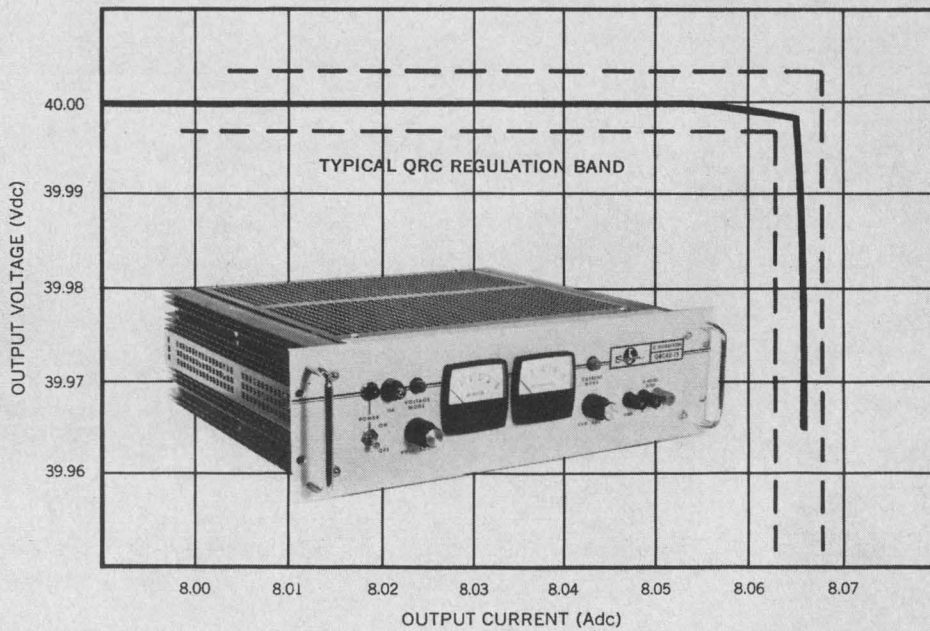

Automatic crossover between constant voltage and constant current modes

# Power Supply Specs That Set The Standard.

The Sorensen QRC series—wide range, transistorized power supplies—provide constant voltage/constant current regulation so sharp the units operate without ever leaving the specified regulation band. Voltage regulation is  $\pm .005\%$  for line and load combined. The QRC's are provided with front panel dial set adjustment of voltage and current limits, as well as voltage/current mode indicator lights. Other design features include: Low ripple...1 mV rms • No turn-on/turn-off overshoots • Re-

mote sensing and programming • Series/parallel operation • Input voltage 105-125 or 201-239 Vac, 50-400 c/s • Easily replaceable plug-in control boards • High efficiency and compact packaging. All Sorensen power supplies conform to proposed NEMA standards. For QRC details, or other standard/custom power supplies, AC line regulators or frequency changers, contact your local Sorensen rep, or write: Sorensen, A Unit of Raytheon Company, South Norwalk, Connecticut 06856.

#### ELECTRICAL & MECHANICAL SPECIFICATIONS

MODEL NUMBER	OUTPUT VOLTAGE RANGE (Vdc)	CURRENT OUTPUT RANGE (Adc)	VOLTAGE REGULATION (LINE & LOAD COMBINED)	RIPPLE VOLTAGE (rms)	CURRENT REGULATION	RIPPLE CURRENT (rms)	RACK HEIGHT (INCHES)	PRICE
QRC20-08	0-20	0-8	$\pm .005\%$ or $\pm 1$ mv	1 mv	$\pm .05\%$ or $\pm 4$ ma	2 ma	3½	\$410.00
QRC20-15	0-20	0-15	$\pm .005\%$ or $\pm 1$ mv	1 mv	$\pm .05\%$ or $\pm 8$ ma	4 ma	5¼	525.00
QRC20-30	0-20	0-30	$\pm .005\%$ or $\pm 1$ mv	1 mv	$\pm .05\%$ or $\pm 16$ ma	8 ma	7	700.00
QRC40-4	0-40	0-4	$\pm .005\%$ or $\pm 1$ mv	1 mv	$\pm .05\%$ or $\pm 2$ ma	1 ma	5¼†	315.00
QRC40-8	0-40	0-8	$\pm .005\%$ or $\pm 1$ mv	1 mv	$\pm .05\%$ or $\pm 4$ ma	2 ma	3½	450.00
QRC40-15	0-40	0-15	$\pm .005\%$ or $\pm 1$ mv	1 mv	$\pm .05\%$ or $\pm 8$ ma	4 ma	5¼	575.00
QRC40-30	0-40	0-30	$\pm .005\%$ or $\pm 1$ mv	1 mv	$\pm .05\%$ or $\pm 16$ ma	8 ma	7	775.00

†Half rack



A UNIT OF RAYTHEON COMPANY

Sorensen represented in California by Ward-Davis Assoc., 770 S. Arroyo Parkway, Pasadena, Phone 213-684-2840; 1020 Corporation Way, Palo Alto, Phone 415-968-7116; 3492 Pickett Street, San Diego, Phone 714-297-4619.

# Electroacoustic amplifiers about to leave lab?

## Motorola develops 60-MHz prototype with 60-dB gain. Higher frequency devices expected soon.

Ralph Dobriner  
West Coast Editor

Bulk-effect electroacoustic amplifiers may soon move out of the research laboratory and become available for practical application.

This is the view of spokesmen at Motorola's Military Electronics Div., in Phoenix, Ariz., who informed ELECTRONIC DESIGN about development of a prototype 60-MHz, cw-operated electroacoustic amplifier with a 60-dB net gain.

N. A. Sakiotis, head of the division's applied microwave research section, said: "Within a year we hope to have a practical 200- to 500-MHz amplifier working within an equipment environment."

### Transducer loss problem

The phenomenon of amplification of ultrasonic waves through their interaction with moving charge carriers in piezoelectric semiconductors has been known for several years. But it has so far been difficult to realize net gain from an amplifier structure because of transducer losses. In addition, said Sakiotis, the first experimental net gain amplifier, which he helped develop in 1963,

had to be pulsed to prevent excessive crystal temperature rise.

"Since then," the scientist declared, "not only have we reduced transducer losses, but design, fabrication and heat sinking techniques have been developed so that cw operation at room temperature is now possible."

The electroacoustic amplifier, which consists of a single, homogeneous cadmium sulfide (CdS) crystal 6-mm long by 2-mm square, is being developed by Motorola, partially under Air Force sponsorship.

The company said it plans eventually to build similar amplifiers at microwave frequencies, perhaps as high as 1 or 2 GHz, for use in space and military hardware. Sixty-MHz versions have already been delivered to the Air Force and Motorola is presently delivering a 200-MHz device.

Sakiotis observed that the 60-MHz amplifier "provides performance which would conventionally require several stages of transistor amplification consisting of at least 50 circuit elements." By comparison, the electroacoustic amplifier can provide the same am-

plification with three circuit elements at most.

Thus, he said, the amplifier is eventually expected to be to microwave RF and IF amplifiers what monolithic integrated circuits have been to digital circuitry.

### It works on the lines of a TWT

In principle (see illustration), the basic amplifier consists of the active crystal—in this case CdS, though gallium arsenide and cadmium selenide have been used—with piezoelectric transducers at each end. The input transducer converts the applied electrical signal into an acoustic wave. As the acoustic wave progresses through the crystal it increases in amplitude, drawing energy from the dc drift source, in a manner analogous to a signal being amplified in a traveling-wave tube. At the output the amplified wave is converted back to an electrical signal.

In the 60-MHz Motorola configuration, the 6-mm-long CdS crystal is oriented with its hexagonal axis normal to the direction of acoustic wave propagation.

Thin-film transducers, consisting of high resistivity cadmium sulfide, are deposited on metal contacts which are evaporated on opposite ends of the crystal to provide ohmic contact.

The dc bias voltage is isolated from the RF signal by coupling the signal through a transformer to the transducer at the high voltage side. Appropriate electro-mechanical matching is accomplished by using inductors which give essentially resistive input and output impedance of about 50 ohms. The total loss through the amplifier with a crystal resistivity of  $10^6$  ohm-cm is 20 dB at 60 MHz.

Total gain of 60 dB is achieved with RF input-signal levels of up to 10 mV. For higher signal-level inputs, the output is slightly greater than one volt. A dc drift voltage of 600 volts is maintained across the crystal. The bandwidth of the amplifier measured at the half-power points is about 5%. To-

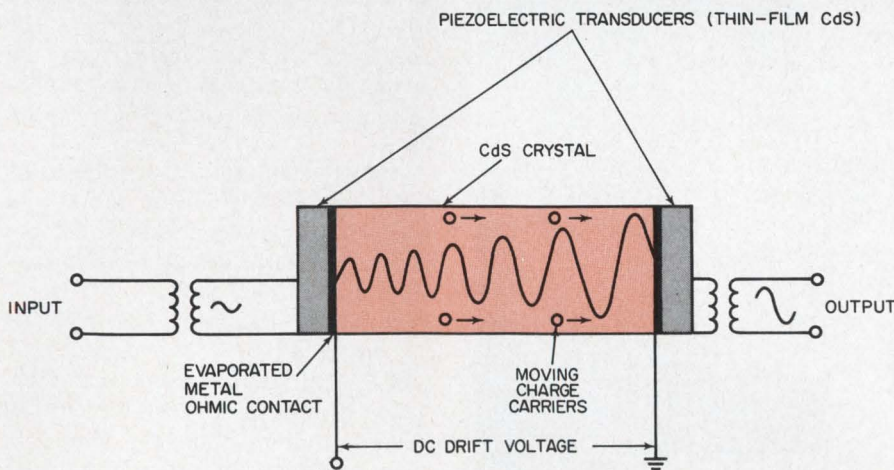

The basic amplifier consists of an active crystal, such as cadmium selenide, with piezoelectric transducers (high-resistivity CdS) at each end. The input transducer converts the RF input to an acoustic wave which increases in amplitude drawing energy from the dc drift source. At the output the amplified wave is converted back to an electrical signal.

(electroacoustic, continued)

tal power consumption in the amplifier is less than one watt.

### 8- to 14-dB noise figure

According to Sakiotis, the amplifier's noise figure, which is essentially controlled by the input transducer loss, is now between 8 and 14 dB at 60 MHz. There is no reason why this figure could not be reduced to 3 or 4 dB with the lower-loss transducers, presently under development, he said.

"This would make the device competitive with transistor and even integrated circuit amplifiers, not only in terms of noise and compactness," the scientist observed, "but also because they're a lot easier to make."

Motorola is presently working on hybrid IF amplifiers using electroacoustic devices in combination with transistors for use at the lower frequencies. The company, however, expects electroacoustic amplifiers to become really competitive with conventional devices at frequencies above 500 MHz.

One big advantage of electroacoustic devices is that frequency selectivity is inherent, being controlled by the resistivity level of the crystal and the design of the

transducers. Also, gain is a direct function of crystal length and frequency.

At a particular frequency, doubling the crystal length will double the gain within certain limits. Gain also increases with frequency, whereas in transistors, gain goes down as the frequency rises.

An electroacoustic amplifier is, furthermore, bilateral and particularly suited for transceiver applications. It could function as a small-signal RF amplifier for reception, and by reversing the drift voltage, as a power RF amplifier. As a power amplifier, the 60-Mc Motorola device produces about 500 mW for transmission.

### Other companies also at work

Organizations such as the Stanford Research Labs, Bell Telephone Laboratories, Sperry Rand, General Electric, Westinghouse and IBM are also conducting research into electroacoustic devices. Most of the work is still primarily of an R&D nature with little practical hardware development.

Opinions differ among researchers in this field not only on the design and fabrication of the amplifiers, but also on their ultimate use.

Don White, scientist at Bell Telephone's Murray Hill Labs, declared: "We've been working on

these devices for a long time and we have more or less come to the conclusion that we would have a hard time selling the electroacoustic amplifier—particularly at the low frequencies where transistors would do a better job."

White said the Labs were looking into possible uses of the amplifier at very high frequencies. They have developed a workable device but "it's still essentially a laboratory curiosity," he observed.

The real question, he said, is whether the amplifier will have anything to offer that cannot be done better in other ways. As an example, White noted that the use of such amplifiers in delay lines was limited because of reflection problems and because the signals can equally well be amplified electrically.

Another scientist, at BTL's Allentown laboratories, agreed that in terms of gain Motorola's amplifier was significant.

He said that the consensus among researchers in the electroacoustic field was that the noise figure, of perhaps 8 dB even in the hundreds of MHz range, is one of the basic limitations of the device. "Although it's not so bad that it can't be lived with, it's still not as good as other amplifiers."

The BTL scientist foresaw its widest application as a long-delay device at microwave frequencies where it would be used in some sort of composite ultrasonic system to counteract losses in other parts of the system.

Today's ultrasonic delay lines, he said, are useful primarily below 100 MHz, and in that range the loss is not so high that it cannot be made up with standard amplifiers external to the ultrasonic delay line.

Other scientists are working not only on amplifiers, but also on a variety of electroacoustic devices using the bulk effect in semiconductors.

Stanford Research Laboratories is investigating the properties of low-loss thin-film transducers. Herbert Carleton, at Sperry Rand's Research Center, Sudbury, Mass., is close to announcing development of an operational electro-optical modulator which will generate acoustic longitudinal waves in a suitable optical material with a moderate amount of RF power. ■ ■

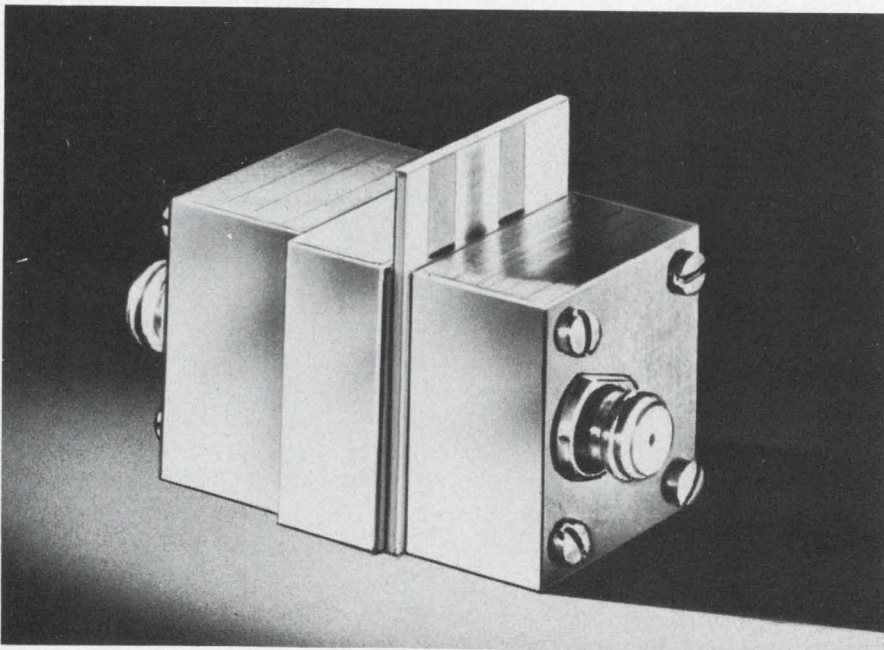

**Prototype electroacoustic amplifier** produces 60 dB gain at 60 MHz and measures one inch long by one-half inch square. Motorola plans to eventually build similar amplifiers at frequencies as high as 1 to 2 GHz for use in space and military hardware.

# Here are 50 applications, in alphabetical order, for Fairchild Linear Monolithic Circuits:

(If we left out your favorite, let us know. We'll include it next time.)

- |  |   |  |
|--|---|--|
| 1. A to D converter                                  | 18. Go/No-go detector                           | 35. Scaling amplifier                        |
| 2. A. C. amplifier                                   | 19. Hysteresis comparator                       | 36. Sense amplifier (20 mil cores)           |
| 3. Astable (free-running) multivibrator (20V output) | 20. Integrator (D. C. or A. C.)                 | 37. Schmitt trigger                          |
| 4. Averaging amplifier                               | 21. Isolation amplifier                         | 38. Summing amplifier (subtractor amplifier) |
| 5. Bi-stable (flip-flop) multivibrator (20V output)  | 22. Lag amplifier                               | 39. Sweep generator (wave form amplifier)    |
| 6. Bridge amplifier                                  | 23. Lead amplifier                              | 40. Servo amplifier                          |
| 7. Buffer amplifier                                  | 24. Level shifting amplifier (clamping circuit) | 41. Time delay amplifier                     |
| 8. Current source amplifier                          | 25. Logarithmic amplifier                       | 42. Unity gain amplifier                     |
| 9. Chopper stabilized amplifier                      | 26. Meter amplifier                             | 43. Video amplifier                          |
| 10. Clipping amplifier                               | 27. Oscillators (sine wave and square wave)     | 44. Voltage comparator                       |
| 11. D. C. amplifier                                  | 28. One shot (high speed, precision)            | 45. Voltage controlled oscillator            |
| 12. Deflection coil amplifier                        | 29. Peak detector                               | 46. Voltage detector                         |
| 13. Difference amplifier                             | 30. Phase discriminator                         | 47. Voltage follower                         |
| 14. Differential amplifier                           | 31. Preamplifier                                | 48. Voltage regulator                        |
| 15. Differentiator                                   | 32. Pulse height detector                       | 49. Wave form generator                      |
| 16. Digital clock                                    | 33. Rectifier                                   | 50. Window detector                          |
| 17. Gain control amplifier                           | 34. Sample and hold amplifier                   |  |

## Here are 4 Fairchild IC's, in numerical order, for use in the above applications:

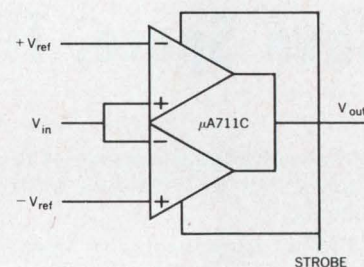
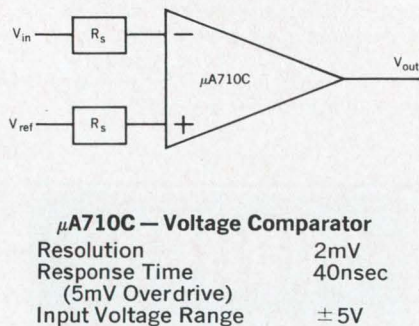
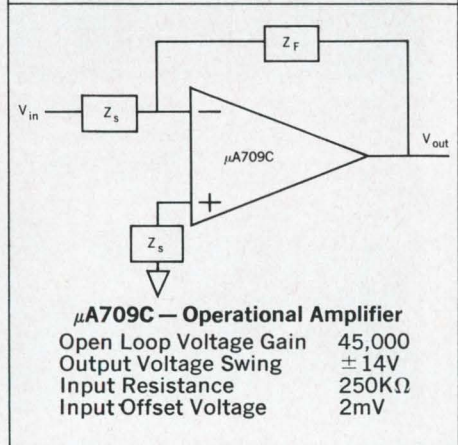
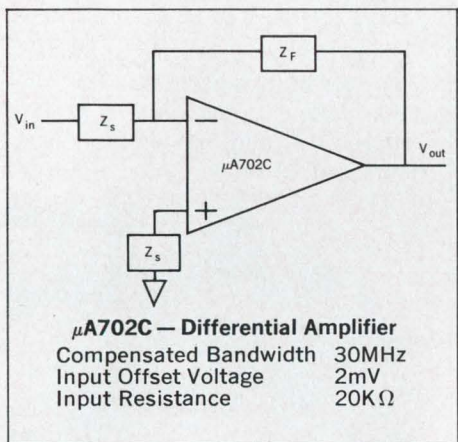

For complete product information and pricing, contact Fairchild Distributors, or write us.

**FAIRCHILD**  
 SEMICONDUCTOR

## New from Sprague!

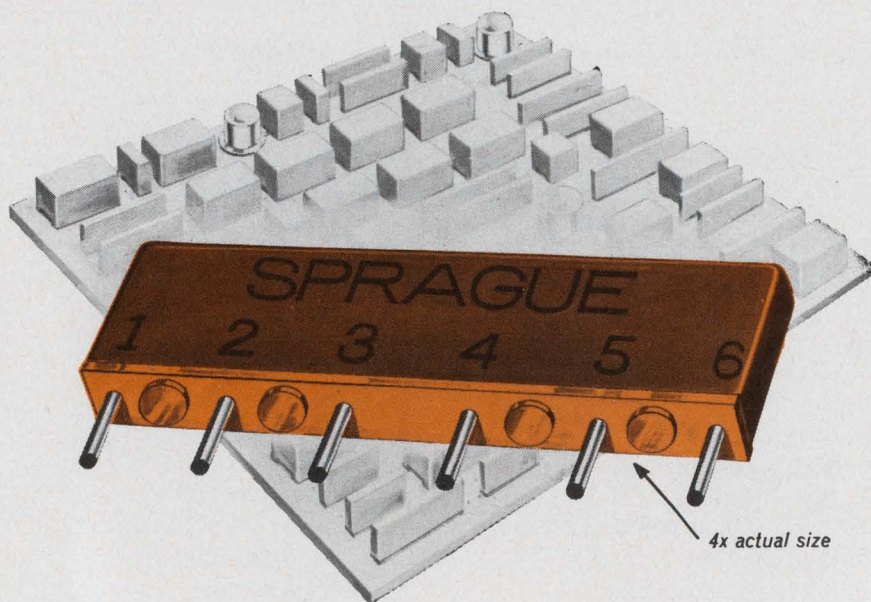

# METANET<sup>®</sup>

TRUE METAL-FILM PRECISION RESISTOR

# NETWORKS

## Save Space, Time, and Money

- High packaging density—4 to 8 times that of individual components.
- Fewer components to stock, handle, inspect, install. Entire module can be hand-inserted faster than one axial-lead component.
- Permit substantial savings over equipment assembled with individual components.
- Epoxy terminal board keeps pin terminals free of resin coating, unlike conventional dipped components, and provides uniform lead spacing.
- Stand-off bosses permit effi-

cient flux removal after soldering. Also prevent dirt and moisture traps around leads.

- Extremely stable and reliable. Meet performance requirements of MIL-R-10509E. Resistance tolerances to  $\pm 1\%$ .
- Ceramic capacitors can be incorporated for further savings and size advantages over individual components.



For complete information write to Integrated Circuit Application Engineering Department, Sprague Electric Company, 347 Marshall Street, North Adams, Mass. 01248

### SPRAGUE COMPONENTS

RESISTORS  
CAPACITORS  
TRANSISTORS  
INTEGRATED CIRCUITS  
THIN-FILM MICROCIRCUITS  
INTERFERENCE FILTERS

ASM-4145 RS

PACKAGED COMPONENT ASSEMBLIES  
FUNCTIONAL DIGITAL CIRCUITS  
MAGNETIC COMPONENTS  
PULSE TRANSFORMERS  
CERAMIC-BASE PRINTED NETWORKS  
PULSE-FORMING NETWORKS



<sup>®</sup>'Sprague' and <sup>®</sup>'M' are registered trademarks of the Sprague Electric Co.

ON READER-SERVICE CARD CIRCLE 9

### NEWS

## Giant pulse lasers emit intense beams

Two companies have independently developed giant, super-bright lasers. Each will produce many pulses of more than one billion watts peak power. This power is controlled by new approaches to Q switching.

One laser, developed by Westinghouse under special contract with the French government, uses two eight-inch ruby rods with Brewster ends. The oscillator ruby feeds 250 MW of peak power to the amplifier ruby in a 20-ns pulse. The amplifier rod, 7/8 inches in diameter, then releases its billion watts within 20 ns. Westinghouse guarantees the laser for a minimum of 100 shots at one GW, with beam divergence less than 1 milliradian.

The laser is air-cooled and can be shot once in ten minutes. Q switching, which keeps the rod from lasing until full power is built up, is effected with a saturable filter made of vanadium phthalocyanine in nitrobenzene.

The other laser, made by Korad, a subsidiary of Union Carbide, in Santa Monica, Calif., also uses two rubies of unlike dimensions. The Korad laser's beam diverges less than two milliradians, but the company claims its rubies will sustain between 400 and 500 shots at maximum output. ■ ■

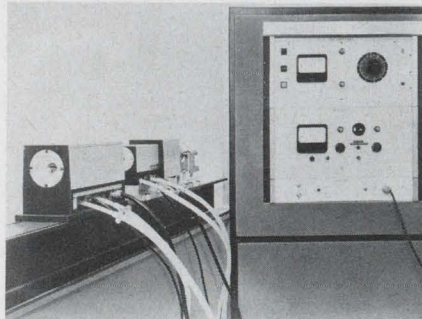
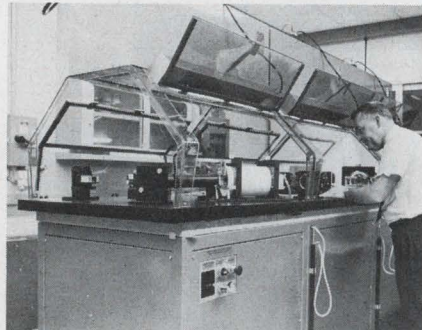

Billion watt lasers made by Westinghouse (above) and Korad (below).

# Sticks and stacks speed wiring of modules

## New IC packaging techniques are part of a growing trend that may change the circuit designer's future

**Roger Kenneth Field**  
News Editor

Notable advances in the packaging of integrated circuits have been achieved by two manufacturers. One company has developed a stick that holds the integrated circuits in flat packs. Another stacks the flat packs in tiny ceramic shells, one on top of another. Both methods lend themselves to automatic wiring techniques.

These developments are typical of the rapid changes taking place in a burgeoning module industry. Some observers have speculated that the industrial and commercial use of modules may displace the circuit designer. Others are more optimistic: ICs and modules will free the designer for more creative work, they say.

The new stick modules, called MicroSystem, allow the engineer to design his circuit with a few strokes

of the pencil. He merely indicates which leads of the flat pack are to be interconnected. Within two weeks the finished prototype is in his hands. The modules, now on the market, are manufactured by the Engineered Electronics Co. of Santa Ana, Calif. Design charges range around \$85 a module.

The other new module, called Norpac, comprises ceramic layers, each of which contains a flat pack. This configuration is said to withstand temperatures up to 200°C and vibrations as great as 250 Gs. All connections are external, and conductors can even transverse the module. The conductors are pushed through holes in the ceramic and interconnected by an evaporated-metalization process. Manufactured by the Norden Div. of United Aircraft, in Norwalk, Conn., the modules will go on sale later this year.

These are true modules. Other

products on the market that are called modules often are not. The term has been misused in advertising to connote "modern," such that everything from a switch to a tape deck has been dubbed "module." Module makers use the term strictly for complete circuits, composed of more than a single component and arranged either in a three-dimensional configuration (usually encapsulated in epoxy) or on a printed-circuit card with a plug-in connector.

The two latest module lines are important because their automatic-wiring potential makes possible large production runs.

The MicroSystem can accommodate ten or even more flat packs. In place, the ICs look like spiders on a stick. Any lead can be connected to any other by the mylar-insulated conductors inside the stick. Thus, John Fahy, Engineered Electronics Co.'s district manager, reports that the firm took only five days to make an interface between a computer and a transducer that determines the

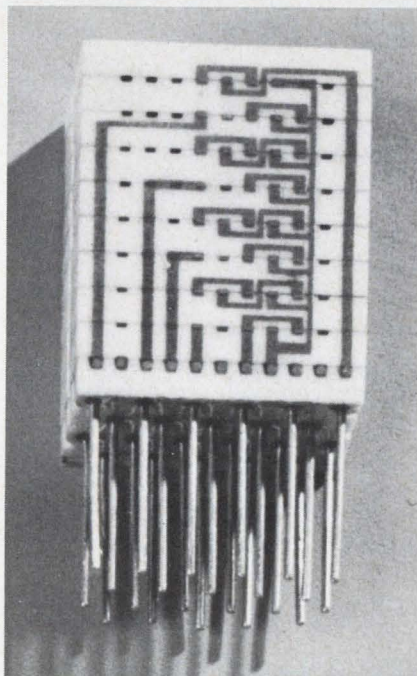

United Aircraft's new Norpac houses ICs in a stack of ceramic shells.

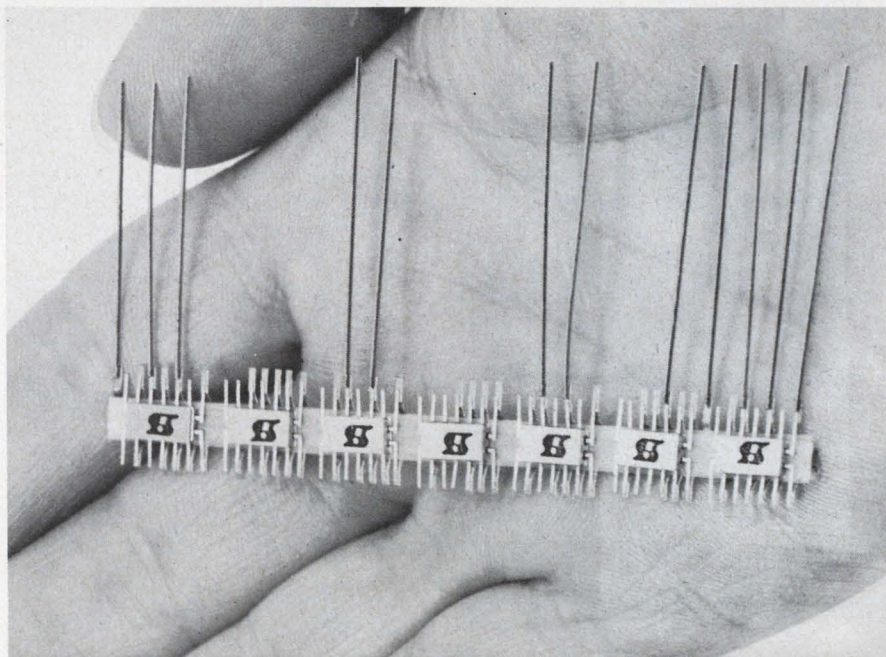

Engineered Electronics Co.'s stick holds ten flat packs in a row. Leads can be connected any way through conductors in the stick.

(modules, continued)

nature of the ocean floor. This included design, construction of two systems and testing. "It is on the testing that you really save time with these modules," says Fahy, "because the temperature range and shock and vibration limits are a function of the stick itself and the flat packs that you choose. The behavior of our stick is known and presumably the flat packs meet their specifications. Thus much of the time-consuming testing is pre-empted."

The Norpac arranges each flat pack in a ceramic shell, bonds them together in stacks, and vaporizes a layer of metal on to the module's smooth outer faces. Standard photo-etching techniques then remove excess metal between the desired conductors. Each shell can accommodate either a flat pack or any discrete component provided its dimensions do not exceed 1/4-inch x 3/8-inch x 75 mils. Typical set-up charges for the Norpac run around \$500.

As price competition forces manufacturers to improve assembly methods, questions are being raised in the electronics industry about the circuit designer's future. Might he gradually lose his key position in the electronics industry to the applications and systems engineers?

Prof. Peter Elias, chairman of M.I.T.'s department of electrical en-

gineering, has expressed concern about what engineers now being trained will be doing. He notes: "Presently it seems likely that integrated circuits and modules will affect our program at the Institute, and their impact may well alter our curriculum."

Robert Larsson, senior design engineer at Nexus Research Laboratory in Canton, Mass., feels that widespread use of standard modules will make the systems approach usual for problems of electronic-equipment design. But far from eliminating the circuit designer, Larsson feels that modules will "free the designer to design new and wonderful things rather than make him design the same old circuits over and over again." Nexus, producers of a range of modules, recently introduced an \$85 FET operational amplifier at the IEEE show in New York.

Gerald Leeds, president of the Data Device corporation, does not foresee the demise of circuit designers either. He believes that modules will make it necessary to have even more circuit designers. As their uses multiply, he says, "there will be a greater need for many more circuits, and someone will have to design them. The module eruption does, however, throw a greater emphasis on packaging and it is necessary for the modern circuit designer to pay more attention to the mechanical aspects of design." The Data Device Corp. offers a line of

modules that includes some rather specialized circuits, such as an amplifier-relay combination that requires only 10<sup>-12</sup> watts to actuate it.

Perhaps the most incisive observation about the circuit designers' coming role was voiced recently by David Taskett, vice president in charge of sales for Zeltex, Inc., of Concord, Calif. He told ELECTRONIC DESIGN: "Pretty soon modules will be so cheap that designers will be using them just like they presently use components. After all, an operational amplifier module makes a great transistor! ■ ■

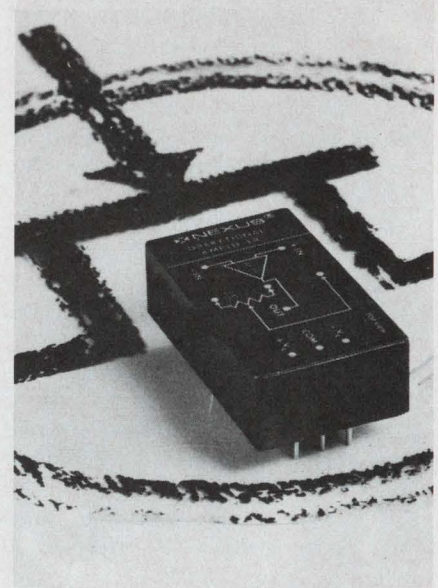

\$85 FET operational amplifier made by Nexus Research Laboratory.

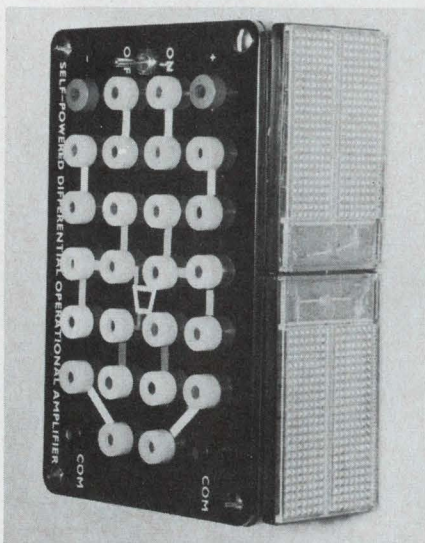

Ambient light powers module by Optical Electronics, Tucson, Ariz. This amplifier is one of many new imaginative modules.

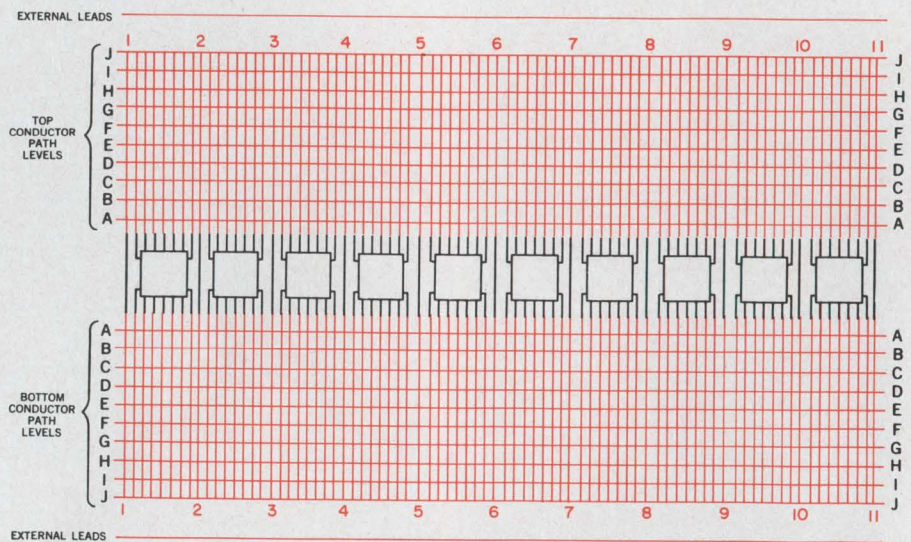

Customer designs interconnections by filling in this form. Any lead may be connected to any other. Engineered Electronics Co. then makes its stick directly from this drawing. The firm says this method holds initial design charges down to as little as \$85.



## IEEE panel split on education changes

Should a master's degree be the minimum qualification for professional engineers?

The American Society on Engineering Education (ASEE) says yes, but a six-man panel at the IEEE Convention in New York was not so sure. The panelists were evenly divided on the Society's recommendation, which was published last October in a preliminary report, "Goals of Engineering Education."

Two other Society recommendations also split the IEEE panel. One proposed that the bachelor's degree should be considered an introductory degree for engineers. The other urged the Engineer's Council for Professional Development to put its official stamp of approval on engineering colleges as a whole rather than on the specific courses they offer. Four of the panelists were educators and two were industry representatives.

J. W. Rittenhouse of the Joslyn Manufacturing and Supply Co. questioned whether the profession wanted the engineer to become "a research-oriented, basic scientist." Industry must help faculties determine the changes needed in engineering education, he said.

Dean W. B. Boast of the Iowa State University of Science and Technology said that while a five-year master's program was suitable for those engineers who aimed at design, research, development or teaching, a four-year bachelor's course was adequate for professional engineers in other categories.

Opponents of change in the curriculum-approval system said that if entire schools, rather than individual courses, were to be accredited, differences in faculty ability between departments would be overlooked. Proponents of change argued that it would secure uniform quality standards.

In addition to Rittenhouse and Boast, other members of the panel were Dr. John G. Brainerd, of the University of Pennsylvania; B. H. Caldwell, General Electric Co.; Dean J. M. Pettit, Stanford University; and Dean J. D. Ryder, Michigan State University; and Dean Charles H. Weaver of the University of Tennessee. ■ ■

April 12, 1966



basic measuring tools from

**HEWLETT  
PACKARD**

### Field-proven hp 241A Pushbutton Oscillator

Accurate, stable test signals for lab or production  
 4500 discrete frequency selections, 10 Hz (cps) to 1 MHz (mc),  
 vernier overlap  
 3-digit pushbutton frequency resolution  
 Frequency response flat  $\pm 2\%$  over entire range  
 Frequency accuracy within  $\pm 1\%$   
 Output  $-30$  dbm to  $+10$  dbm, 600 ohm output impedance  
 Low hum and noise

#### Use it for:

Production line and repetitive testing  
 Calibrating ac-to-dc converters  
 Response testing, narrow or wide band  
 Low-distortion source in presence of shock, vibration, hf radiation  
 Special versions for transmission line testing

In addition to the 241A, portable, solid-state oscillator, Hewlett-Packard offers the H30-241A (30 v, \$675) and H48-241A (48 v, \$650) battery-operated versions for transmission line testing, 100 Hz to 10 kHz. These versions offer balanced output, 600 and 900 ohm output terminals. The 241A itself is a true standard of the industry as a simple, fast, convenient source of test signals. \$490.

Call your Hewlett-Packard field engineer for a demonstration or write for full specifications of the model of your choice: Hewlett-Packard, Palo Alto, California 94304, Tel. (415) 326-7000; Europe: 54 Route des Acacias, Geneva.

Data subject to change without notice.  
 Prices f.o.b. factory.

**HEWLETT**  **PACKARD**  
 An extra measure of quality



ON READER-SERVICE CARD CIRCLE 10

# EXPANDED

# DTL line

# 7 nsec at 10

speed ↑  
isolation ↑ dissipation ↓

All Radiation integrated circuits are *dielectrically* isolated.

# provides mw

## Having procurement problems? Check our delivery time on monolithic DTL circuits!

Why compromise on DTL performance or delivery? Radiation offers immediate shipment of industry's finest line of circuits! Radiation's dielectric isolation technique assures the best combination of speed, power dissipation and noise immunity.

And Radiation supplies a full line of DTL integrated circuits—17 in all. They include Series 200 and 300, designed for military use, and Series 500 for industrial applications. Compatible fan outs in each series are maintained over the full specified temperature ranges.

Other characteristics include: 7.0 nsec propagation delay ( $t_{pd}$ ); 250mv "0" output voltage ( $V_{sat}$ ); and 10.0na "1" input current ( $I_{inT}$ ).

All circuits are specially engineered to provide superior performance for their specific applications. All are supplied in TO-84 flat packages.

Why not keep up to date on the latest advances in integrated circuits! Write or phone for our data sheets which include worst-case limits, and contain all information required by design engineers. We'll also send a brochure describing our broad range of engineering and manufacturing capabilities.

Radiation Incorporated, Physical Electronics, Department ED-04, Melbourne, Florida 32901. Phone: (305) 723-1511, extension 554.

Expanded Radiation DTL Line*						
Circuit	RD 200 SERIES		RD 300 SERIES		RD 500 SERIES	
	Type	FO†	Type	FO†	Type	FO†
Gates						
Dual 4	210	8	310	5	510	8
Triple 3	205	8	305	5	505	8
Quad 2	206	8	306	5	506	8
RS Flip Flop	208	7	308	4	508	7
Line Driver	209	12	309	8	509	12
Expander	111	—	111	—	711	—

\*New high-speed JK Flip Flop soon to be introduced.

†Maintained over full temperature range.

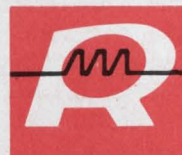
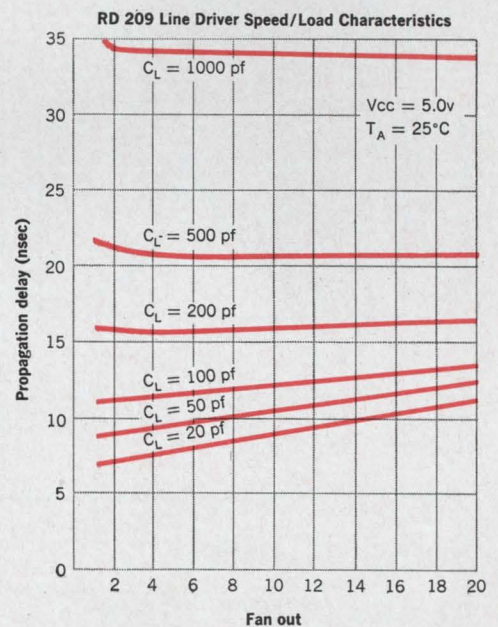

**RADIATION  
INCORPORATED**

Sales offices: 650 North Sepulveda Blvd., Suite 622, El Segundo, Calif. (213) 772-6371—600 Old Country Road, Suite 438, Garden City, N. Y. (516) 747-3730

Speed Inquiry to Advertiser via Collect Night Letter

NO READER-SERVICE CARD CIRCLE 11

## What's your power supply IQ?

One of the more popular exhibits at last month's IEEE Show was a "Power Supply IQ Machine." Set up by Deltron, Inc., of Philadelphia, it tested visitors' knowledge of power supply technology and terminology.

After seeing the results of some 500 persons tested at the show, ELECTRONIC DESIGN thought its readers might like to see how they stack-up against these 500. So here is the complete test together with a rough distribution curve of the results recorded at the Show.

Each correct answer is worth 20 points, and a perfect score is 200. Only ten persons, or about two per cent of those tested, turned in perfect scores. The correct answers are given on page 28.

The testing machine posed ten multiple-choice questions of varying difficulty. Answers to the questions were registered by depressing appropriate buttons. When asked if there were complaints or protests on any of the questions, officials of Deltron stated that there had been some but with a little discussion they had all been resolved. ■ ■

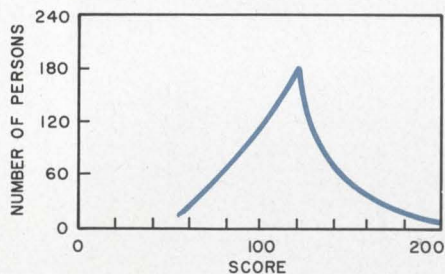

Most usual score at the IEEE Show was 120. Only ten of those tested scored a perfect 200.

### Deltron test

- The percentage output voltage in a dc power supply as a result of a minimum rated current change is a definition of:
  - line regulation
  - load regulation
  - output impedance
  - voltage gain
- A periodic voltage change, harmonically related to the input power frequency, appearing on the output of a dc power supply is termed:
  - ac fluctuation
  - noise
  - ripple
  - line disturbance
- The ratio of output voltage changes to corresponding load changes in a dc power supply defines:
  - stabilization ratio
  - control ratio
  - load ratio
  - output impedance
- The time required for the output voltage of a dc power supply to return to within a specified closeness of its initial value, following a full load current change, defines:
  - recovery time
  - settling time
  - slaving period
  - rise time
- The minimum error in adjusting a dc power supply to a specified value expressed as a percentage of the maximum voltage is termed:
  - linearity
  - precision
  - accuracy
  - resolution
- The output capacitor and amplifier gain-frequency characteristics in a dc voltage-regulated supply are the principal elements affecting:
  - dynamic regulation
  - ripple and noise
  - overload rating
  - power factor
- The average change in output voltage of a dc supply in response to a change in ambient temperature of one degree expressed as a percentage is termed:
  - voltage coefficient
  - thermal deviation
  - thermal drift
  - temperature coefficient
- The ability of a dc power supply to change from voltage to current regulation is called:
  - current limiting
  - automatic crossover
  - voltage limiting
  - foldback
- Which of the following devices could be used to produce the fastest acting regulator for a dc power supply:
  - SCR
  - diode
  - transistor
  - pentode
- A device used on a dc power supply to reduce the output voltage to a low value in a few microseconds in the event of a malfunction is referred to as a:
  - clamp
  - overvoltage relay
  - limiter
  - crowbar

## Samples rolled to customers' door

The Furnas Electric Co., of Batavia, Illinois, drives their sample case right to their customers' doors.

The company has fitted a van with several thousand dollars worth of magnetic starters, overload relays,

oil-tight pushbuttons, timers and other electrical devices that they manufacture.

Air-conditioning, radiant heating, and a clean modern interior make the customers' stay pleasant. A generator supplies 60-cycle, 110-volt current for the van's film-strip projector, tape recorder and fluorescent lights. ■ ■



# IRG

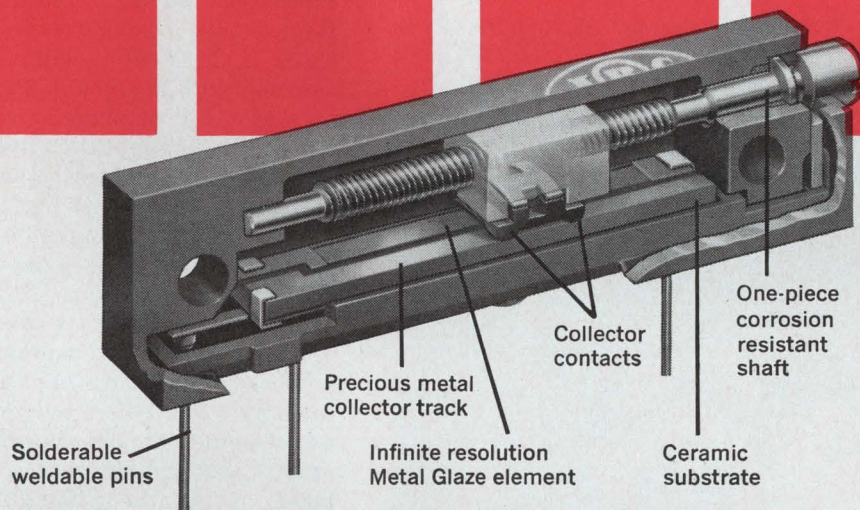

## TERMINAL STYLES

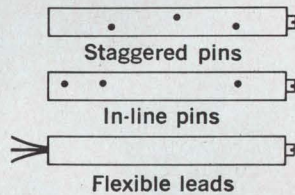

## Infinite Resolution Rectangular Trimmer

Now in all 3 popular terminal styles

IRC's new infinite resolution rectangular trimmer is now available with all three popular terminal arrangements . . . staggered pins, in-line pins and flexible leads. Completely interchangeable with other rectangular units, it offers improved performance for the majority of your rectangular trimmer needs.

Superior stability and reliability are the direct result of glass-hard, thick-film Metal Glaze element. "Set and forget" stability, even under severe MIL shock and vibration, means no sudden resistance changes.

Load life is 70% better than MIL allowance . . . maximum resistance change is only 3% after 1000 hour, 1/2-watt at 70°C. The thinnest MIL unit available, it is up to 30% smaller than most popular rectangular trimmers. For complete performance data, write to: IRC, Inc., 401 North Broad Street, Philadelphia, Pa. 19108.

**ONLY IRC OFFERS ALL 4 POPULAR STYLES**  
Wirewound or infinite resolution elements



## CAPSULE SPECIFICATIONS

**SIZE:** MIL-R-22097B/RJ-12 style  
**POWER:** 1/2-watt @ 70°C  
**TEMPERATURE:** -55°C to 125°C  
**RESISTANCE:** All standard values between 100 Ω and 1 meg Ω  
**TOLERANCES:** ±10% and ±20%  
**IRC TYPES:** 450-20—RJ-11 pin configuration  
 450-10—RJ-12 pin configuration  
 450-00—Flexible leads



Speed Inquiry to Advertiser via Collect Night Letter  
ON READER-SERVICE CARD CIRCLE 12

## Gunn-effect devices invade millimeter bands

Gunn-effect oscillators formed by gallium arsenide epitaxial growth techniques now operate in the millimeter wave regions. Devices grown at RCA's David Sarnoff Research Center in Princeton, N. J., are producing useful power at fundamental frequencies between 20 and 40 GHz. Under pulsed conditions, 40 mW at 40 GHz have been recorded.

Prior to the RCA announcement the highest fundamental frequen-

cies reported from Gunn-effect devices were about 15 GHz.

RCA spokesmen are optimistic that the new units may replace conventional oscillators in millimeter-band systems. They say the new technique has clear economic and technical advantages over the slicing and grinding formerly used to fabricate microwave Gunn-effect devices. (See ED, Jan. 18, 1966, p. 17).

Active layers of GaAs are grown

on low-resistance GaAs substrates to thicknesses between two and five microns. Precise control of growth permits the formation of devices that can operate at discrete frequencies within the millimeter region, according to Dr. Martin Steele, project director. He says that, as in other Gunn-effect devices, frequency is determined by active layer thickness. Therefore the new technique promises higher precision at lower cost than was previously attainable.

The laboratory versions of the device are packaged in conventional ceramic crystal holders. After growth of the wafer to the desired thickness, ohmic contacts are formed on opposing faces and the wafer is diced into small chips for assembly into the mount. Dr. Steele says that for commercial versions, the mount configuration would be determined by application and heat-dissipation considerations.

Low voltages obtainable from commercial signal generators are used to trigger Gunn action. Dr. Steele says that further efforts will be directed toward improving cw power and achieving higher power in both cw and pulsed modes by the use of phased groups of devices. He expects that full advantage will be taken of advanced integrated-circuit methods in the fabrication of multiple units. Dr. Steele says that the low input voltage requirements (5 to 6 volts) and the inherent simplicity of the devices make them especially attractive to systems designers. ■ ■



Millimeter-wave Gunn-effect device packaged in standard crystal mount is inserted into waveguide by RCA scientist. Forty milliwatts at 40 GHz is reported from the new epitaxially grown unit.

## New tooth puts "bite" into electronics

An electronic tooth employing a six-transistor flat pack has been built at the University of Michigan School of Dentistry to study occlusal forces during chewing, biting and other jaw movements. The tooth contains a six-channel radio transmitter and six force sensors.

Each sensor is identified by a different subcarrier frequency which varies over a limited range in accordance with the forces applied to the tooth. The subcarrier frequencies then modulate the main transmitter frequency. Usable transmission range of the tooth is from 6 to 12 inches.

Although instrumented teeth have been used previously in dental research, they have been limited to simple measurements. By using the flat-pack packaging technique the new tooth has greatly increased both the complexity and the precision of measurement. Unijunction transistors are used because of their ability to generate stable oscillations without complex compensating circuits.

The bases of the six transistors are connected together and returned to B+ through a low impedance. The frequency of each unijunction oscillator is controlled by its respective sensor. The main RF

frequency is produced by a tunnel-diode oscillator.

The instrumented tooth was developed by Ian Scott, project engineer, and Dr. M. M. Ash, Jr., professor of dentistry. ■ ■

### Answers to power supply IQ test

- |        |         |
|--------|---------|
| 1. (b) | 6. (a)  |
| 2. (c) | 7. (d)  |
| 3. (d) | 8. (b)  |
| 4. (a) | 9. (b)  |
| 5. (d) | 10. (d) |

Questions on any part of the test will be answered by Mr. Terry Burcaw, Deltron, Inc., Wissahickon Ave., North Wales, Pa.

"molding" makes the  
difference  
in axial-lead  
wire-wound  
resistors

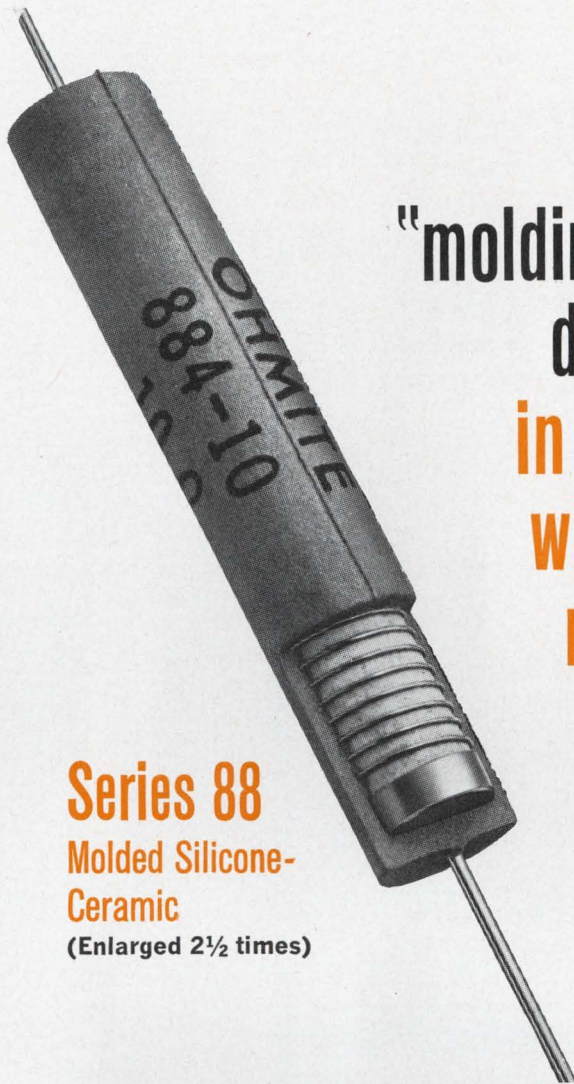

**Series 88**  
Molded Silicone-  
Ceramic  
(Enlarged 2½ times)

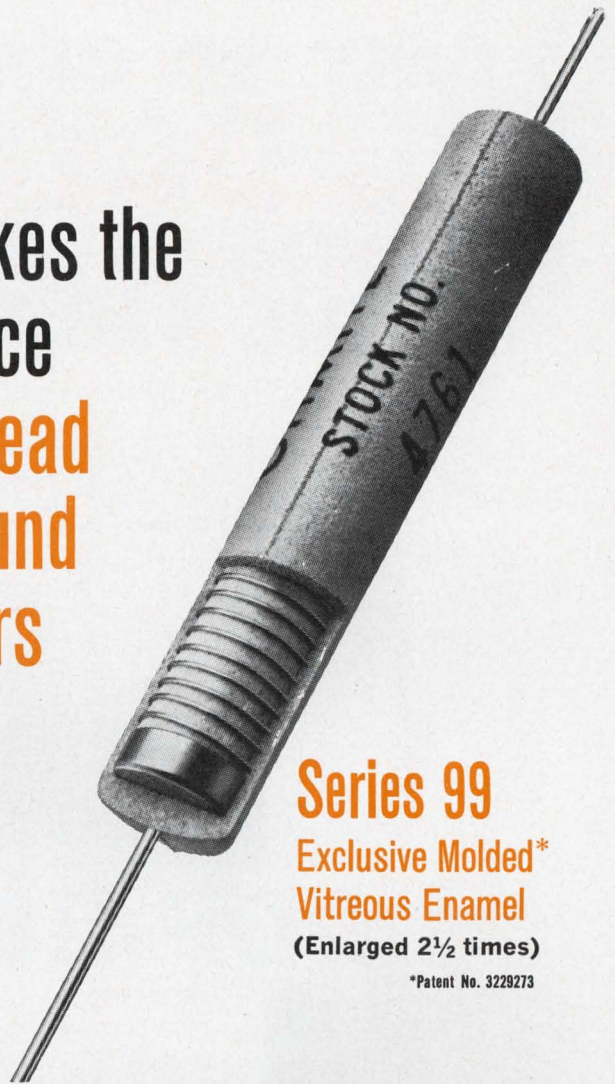

**Series 99**  
Exclusive Molded\*  
Vitreous Enamel  
(Enlarged 2½ times)

\*Patent No. 3229273

"Molding" provides superior electrical insulation (1000 VAC minimum breakdown) plus exceptional protection against abrasion and rough handling because it produces a thicker, more dense coating. The size and shape uniformity of Ohmite molded resistors is valuable in the automated assembly of equipment, as well as facilitating mounting in metal clips. The latter capability can provide a heat-sink advantage of up to 100%. Molded Series 88 and 99 units provide durability unsurpassed in axial-lead resistors today.

**Series 88**—Low temperature coefficient and overall excellent stability. Patented "Ohmicone®" coating is tough, resilient, moisture-resistant, silicone-ceramic of high dielectric strength. Three types available . . . for specification MIL-R-26, commercial power, and high stability, precision-power applications. 1% units stocked in 526 resistance values. Write for Bulletin 101.

**Wattage Ratings:** 1.5, 2.25, 3.25, 6.5, 9, 11 watts at 25° C.  
**Resistance Range:** 0.1 to 226K ohms.

**Tolerances:** To 0.05%. Std. commercial tolerance, 3%.  
**Temperature Coefficient:** 0±20 ppm/° C, 10 ohms and above.  
**Stability:** Av. 0.213% Δ R after 2000 hours of cyclic testing for Type 884.

**Series 99**—Exclusive "molded" vitreous enamel coating withstands applied temperatures of 1500° F without distortion. Vitreous markings, fired into coating, stand up under cleaning solvents, abrasion, and burnout overloads. Supplied in three types . . . for MIL-R-26 styles, commercial, and precision, high stability applications. *Commercial units are stocked in 5 sizes and 146 resistance values. Write for Bulletin 103.*

**Wattage Ratings:** 1.5, 2.25, 3.25, 5, 6.5, 9, 11 watts at 25° C.  
**Resistance Range:** 0.1 to 187K ohms.  
**Tolerances:** 0.25% to 5%.  
**Temperature Coefficient:** 0±30 ppm/° C at 25° C to +350 C for 10 ohms and above.  
**Stability:** Less than ±2% Δ R after 2000 hours of cyclic testing for Type 994.

RHEOSTATS • POWER RESISTORS • PRECISION RESISTORS • VARIABLE TRANSFORMERS • RELAYS  
TAP SWITCHES • TANTALUM CAPACITORS • SEMICONDUCTOR DIODES • R.F. CHOKES

**OHMITE**

MANUFACTURING COMPANY  
3643 Howard Street • Skokie, Illinois 60076  
Phone: (312) ORchard 5-2600

ON READER-SERVICE CARD CIRCLE 13



# ONLY 3C OFFERS **30 DAY DELIVERY** ON THE HOTTEST COMPUTER IN THE \$28,500 PRICE RANGE

DDP-116 computers are now operational in over 50 installations including communications, data acquisition, hybrid and other real-time control applications. Specifications include: 16-bit word, 1.7  $\mu$ sec cycle, expandable 4096-word memory and keyboard with paper tape I/O unit.

Software is a proven factor! The compact DDP-116 offers as many as 134 subroutines in its ASA FORTRAN IV library. Also, it is compatible with the DAP assembler and desectorizing loader. A/D and D/A subsystems, a full peripheral line and special purpose systems capability are available to extend the flexibility of the basic DDP-116.

Write for full details, or telephone today to test operate the DDP-116 at a selected 3C regional office nearest you.

## DDP-116

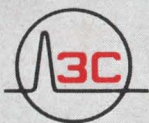
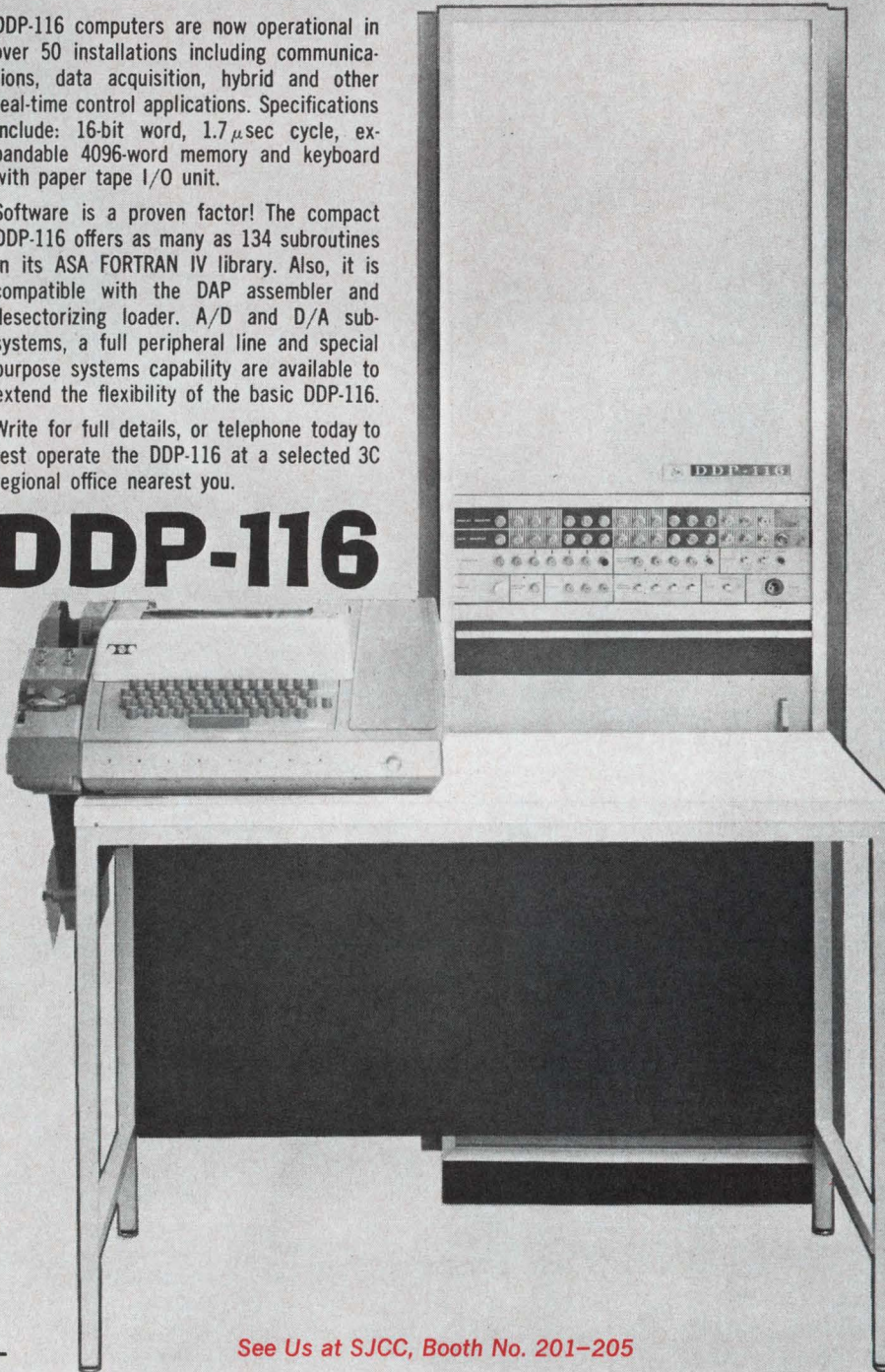

See Us at SJCC, Booth No. 201-205

COMPUTER CONTROL COMPANY, INC.  
OLD CONNECTICUT PATH, FRAMINGHAM, MASSACHUSETTS, U.S.A.  
**LONDON**                      **PARIS**                      **FRANKFURT**

3C SALES OFFICES: NEEDHAM, MASS.; FOREST HILLS, N.Y.; LEVITTOWN, PA.; SYRACUSE, N.Y.; SILVER SPRING, MD.; HOUSTON, TEXAS; HUNTSVILLE, ALA.; COCOA BEACH, FLA.; DES PLAINES, ILL.; DETROIT, MICH.; WEST CARROLLTON, OHIO; LOS ANGELES, CALIF.; KENT, WASH.; ALBUQUERQUE, N.M.



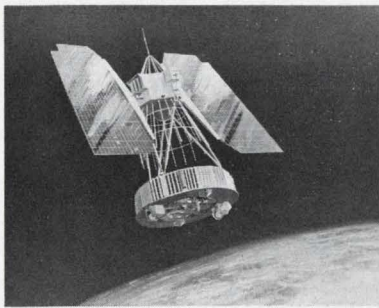

### Agriculture to adopt space electronics

The Federal scientific community is hailing a NASA contract awarded to the Agricultural Department for studies of the role of space-borne electronics systems in agriculture and exploitation of resources by underdeveloped nations. The contract is looked on as a concrete opportunity for space technology to prove itself as a truly civilian tool.

Under the contract, remote sensing equipment will be used to make quick large-area surveys of use of land and of agricultural conditions. A variety of sensing equipment for remote observations—including cameras, other optical and electro-optical devices, and infrared and ultraviolet sensors—will be used by the department's Agricultural Research and Forest Services to classify agricultural and forest soil, water and crops.

The program will be conducted in three stages, the third definitely programmed to use satellite-borne equipment. The latter is expected to start "shortly," according to Agriculture Secretary Orville L. Freeman. Observers interpret this to mean late 1967.

The second stage, observation from aircraft, will begin this year. Information collected from aerial observations will be correlated with data already collected on the ground. This first stage has been under way for several years in anticipation of the eventual use of satellites.

Over the past three years, the Agricultural Research Service has tested a variety of remote sensors at its Weslaco, Texas, laboratory. Soil and water specialists have evaluated equipment for remote recording of the effects of salt, moisture and soil type on plant growth. Infrared (IR) and ultraviolet (UV) sensors have been proved so capable of detecting otherwise unnoticeable color changes in foliage that researchers have had reliable advanced information about the health and yields of crops.

The Weslaco experiments as well as studies at Purdue, the University of California (Berkeley) and the University of Michigan provided the basic assurances that Secretary

# Washington Report

S. DAVID PURSGLOVE,  
WASHINGTON EDITOR

Freeman insisted on before announcing the contract. He said: "Remote sensing will provide information never before available to improve productivity of natural resources all over the world.

"Detection of plant diseases and insect infestations in early stages will be one of the sensing equipment's most beneficial uses. Equipment that will be used on spacecraft will furnish undeveloped countries information on the ability of their resources to produce certain needed crops. The equipment can be used to determine moisture content of soil and, by relating this to the type and distribution of plants in the area, it can predict what will grow in the soil."

### Agriculture program surprises officials

Much of Washington's scientific community was surprised at the extent of the groundwork already laid for the satellite program. The terms of the NASA contract call for use of various optical and electronic sensors in identifying and measuring land use; in detecting calamitous situations such as plant diseases, insect infestations and drought; in assessing crop stands and vigor to predict future yields; and in determining whether soils in selected locations are suited to growth of specified crops.

Already, Purdue University researchers, in cooperation with the Agricultural Research Service, have evaluated IR and UV equipment for classifying soils and plant growth from great distances. They have used the equipment to determine the degree to which corn, soybeans and other crops in the Midwest can be distinguished from afar by their spectral signatures. They have also used multispectral sensing equipment to identify crop diseases on the basis of reflectivity differences between healthy and diseased crops.

At the University of California at Berkeley, a program under way for several years seeks to apply new photogrammetric techniques to identification of forest and agriculture species, growth and vigor, and early detection of disease and insect infestation. A complete

# Washington Report

CONTINUED

range of remote sensors is being tested at Berkeley.

The University of Michigan is perfecting several of its own instruments and techniques, but its chief job is to set up systems to interpret the data to be received from the sensors.

## FBI seeks electronic industry aid

The Federal Bureau of Investigation has asked 35 major electronic firms to research ways of transmitting fingerprint information over the FBI's growing national crime data computer network.

In a related move, the FBI has concluded a contract for a \$72,000 study of U.S. telecommunications to determine what form of network could best handle computer crime data, and link existing networks in California, New York, Pennsylvania, Chicago and St. Louis. The study will be made by the Institute for Telecommunications in the Commerce Department's Environmental Science Services Administration.

## Lid to be kept on secret data

The electronic industry's planners who use Defense Department contracting information to draft their forecasts had better resign themselves to working part of the time in the dark. This was the substance of comments made during a panel discussion at the Electronic Industries Association's Spring Conference by Samuel F. Zark, a key official in the office of the Defense Department comptroller.

In answer to a floor request for full information to be made available on all prime and first- and second-tier subcontract awards, Zark said that "not very much more is likely to be forthcoming." He cited as reasons security and proprietary information, and shortages of manpower and ADP equipment.

## NASA electronics programs revealed

NASA's electronics programs for the coming year will include development of a strapped-down electrostatic gyroscope inertial guidance system, laser gyroscopes, improved horizon seekers, laser radars and myriad equipment for rendezvous operations. The agency's plans were spelled out to several Congressional committees by Francis J. Sullivan, NASA's Director of Electronics and Control.

Sullivan said that strapped-down electrostatic gyros would be cheaper and more reliable

than systems now in use. However, he looked to development of totally new systems using sensors with no moving parts. One such system would incorporate a laser gyroscope which Sullivan says "offers the promise of future simplification and increased reliability." Laser radars, he said, would be devised especially for use in rendezvous, and would reduce weight and size as well as improve the performance and reliability of rendezvous radars.

## Comsat U.S. net faces troubles

Communications Satellite Corporation may run into more than the anticipated legal difficulties when it tries to set up the domestic service requested by AT&T. In addition to attacks from carriers and from Capitol Hill, Comsat will have to decide who will own the ground stations. If Comsat owns the stations, then it will have gone into the domestic communications business, one Capitol Hill source points out, and can expect Congress to take a hard look at its charter with an eye to amending it. Many lawmakers already dispute Comsat's right to provide domestic service and contest the claim that Comsat was intended by Congress to be the only U.S. company to operate in space.

AT&T wants Comsat to provide a high-capacity communication satellite service within the U.S. The role of Comsat's foreign associates in any domestic venture has not been made clear. On the other hand, these associates have already made it clear that, when and if they need domestic communications satellite service, they do not want Comsat.

For its international operations, Comsat recently asked the Federal Communications Commission for permission to build a fourth ground station near Moorefield, West Virginia. At a cost of \$5 million, this would provide a second ground station on the East coast to supplement Comsat's facility at Andover, Maine. The need for the West Virginia station is predicated on the fact that Comsat is scheduled to begin operating a second Atlantic satellite for NASA this fall.

## Federal engineers get pay raise

The Government has granted small pay raises to 15,000 of its engineers and physical scientists. The increases range from \$192 to \$254 a year for new personnel and those in Government grades 6 through 9. The raises were made under a law that permits them when "the Government is significantly handicapped in retaining and recruiting well-qualified employees because of private industry pay rates." A Civil Service Commission spokesman admitted that "the Government is handicapped."

Yes—Allen-Bradley hot molded potentiometers cost more, but—

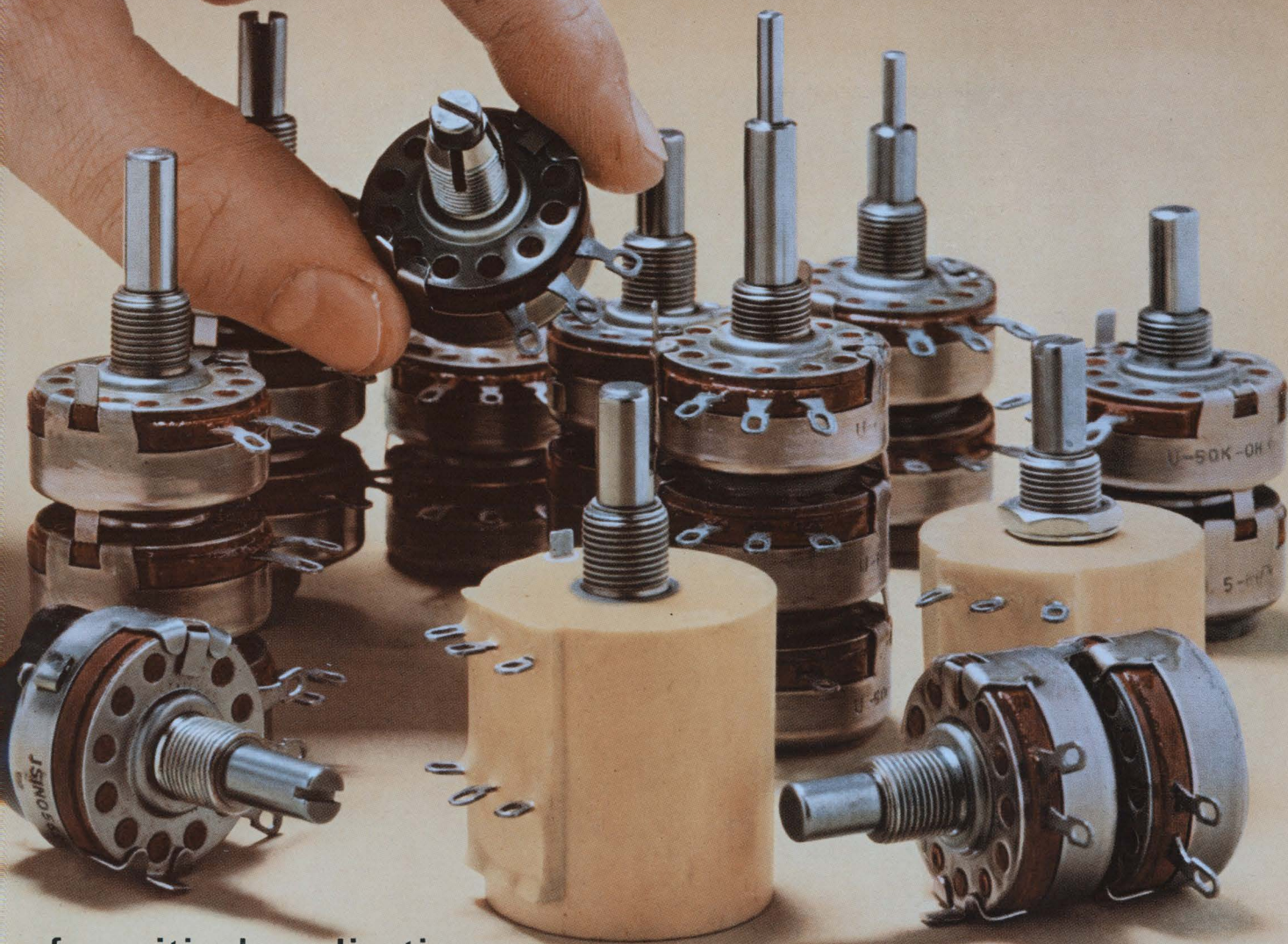

**for critical applications  
they prove themselves far superior—and well worth the price**

■ When a potentiometer in your equipment does not provide the kind of service expected of it—or fails completely—it is only natural for the user to blame you, the manufacturer of the respective instrument. After all, you selected the lower cost component, and your engineer or your purchasing agent decided that “it was good enough.” Correcting the mistake usually runs into real money—it does not necessarily eliminate your customer’s dissatisfaction. However, you can protect yourself and your customers against such potentiometer failures by joining the ever growing list of the nationally recognized equipment manufacturers who are standardizing on Allen-Bradley potentiometers.

The resistance track of all Allen-Bradley potentiometers is hot molded—a process developed and used only by Allen-Bradley. Resistance adjustment is always smooth—never an abrupt change. Though the initial noise level is very low, it is still further improved with use. The long life of all A-B potentiometers is a fact, established by

performance during the many years that these controls have been on the market. For instance, on “speeded up” tests this “life” will exceed 100,000 complete operations, with less than 10% resistance change. And during the 30-year history of this control there has never been recorded a single catastrophic failure.

Protect your reputation as a quality equipment manufacturer by having your purchasing specification call for Allen-Bradley hot molded potentiometers. They are available in single, dual, and triple units. Can be equipped with a 2 ampere 125 volt line switch. Dual units can be supplied with vernier control that provides 20 times finer setability than obtainable with a single control. Units for T, L, and Bridged T and H attenuators are also available. Yes—Allen-Bradley controls *cost slightly more*, but they are *worth much more*. For more details please write: Allen-Bradley Co., 222 W. Greenfield Ave., Milwaukee, Wisconsin 53204. In Canada: Allen-Bradley Canada Ltd. Export Office: 630 Third Ave., N.Y., N.Y., U.S.A. 10017.



**ALLEN-BRADLEY**  
QUALITY ELECTRONIC COMPONENTS

# Allen-Bradley hermetically sealed hot molded resistors help guidance computer in Saturn I space vehicle put payload into orbit

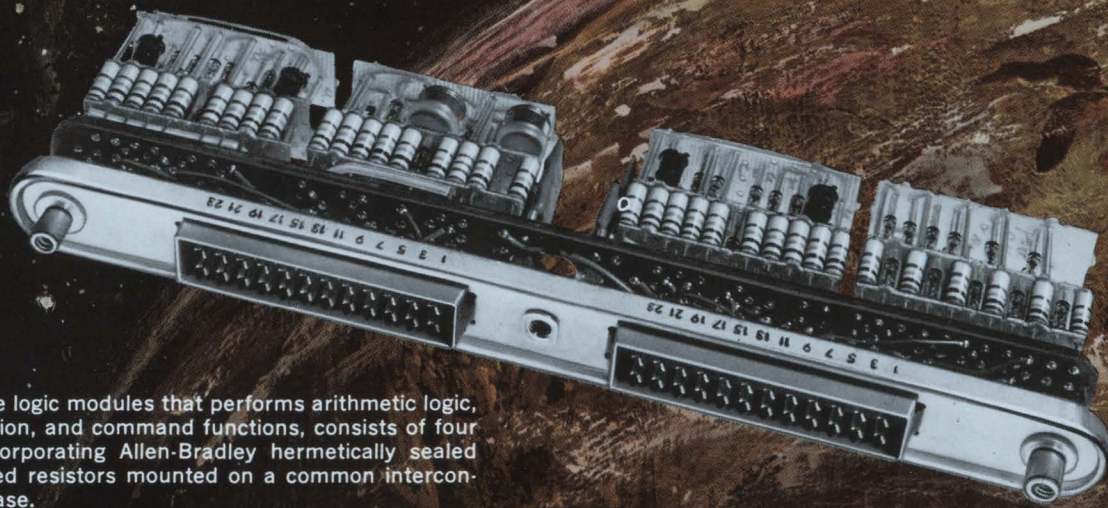

One of the logic modules that performs arithmetic logic, interrogation, and command functions, consists of four units, incorporating Allen-Bradley hermetically sealed hot molded resistors mounted on a common interconnecting base.

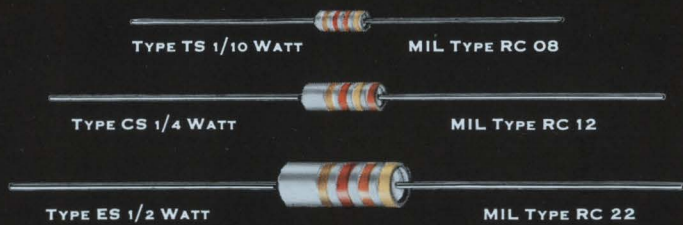

**HERMETICALLY SEALED HOT MOLDED RESISTORS** available in all standard EIA and MIL-R-11 resistance values and  $\pm 2\%$  or  $\pm 5\%$  tolerances. Other than standard values can be furnished. Shown actual size.



**Saturn I guidance computer** continuously determined the v course to achieve orbit. In six test flights, these computer NASA Saturn I vehicle controlled the direction and thrus second-stage engines. The computer on four of the flights co four of the first-stage engines as well, and also timed engine

■ From the instant of "blast-off" this guidance computer set the course of the space vehicle. The ultimate in precision was essential, for even the slightest misdirection could mean total failure. Reliability had to be maintained under hardly believable conditions of shock and vibration. Given such conditions, it is small wonder that the A-B hermetically sealed hot molded resistors were selected for this assignment.

All Allen-Bradley resistors are made by an exclusive process—pioneered and perfected by A-B—in which the resistance element and the insulating jacket are hot molded into a solid integral element. For the ultimate in environmental protection, this unit is then hermetically sealed in a ceramic tube. The hot molding process results in such exact uniformity from one resistor to the next—and from one year to the next—that long term resistor performance can be accurately predicted. Furthermore, unlike film resistors, no A-B hot molded resistor has ever been known to fail catastrophically.

For more complete specifications on the Allen-B hot molded resistors, please write for Performance fications 5003: Allen-Bradley Co., 222 W. Gre Ave., Milwaukee, Wis. 53204. In Canada: Allen-B Canada Limited. Export Office: 630 Third Ave York, N.Y., U.S.A. 10017.

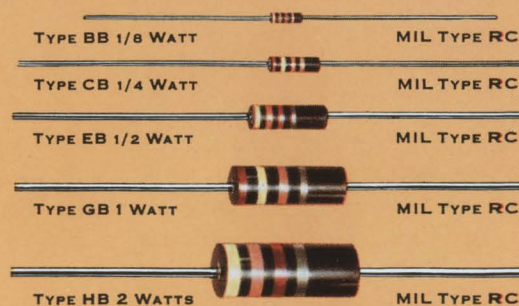

These are the same hot molded resistors as used in the her sealed construction described above. Shown actual size.



# WHEN SOMEONE LOWERS PRICES ON HIGH-FREQUENCY GERMANIUM TRANSISTORS BY AS MUCH AS 91%...

# That's News!

The reason we did it is really very simple. Since we first announced our new "selective metal etch" process for fabricating germanium mesa transistors, we've found our production yields going up, up, up — and, at the same time, we found such added benefits as lower noise performance, narrower beta spread, and tighter overall parameter distributions on both switching and amplifier types.

When you add to this the fact that we can now obtain complete freedom of emitter geometry and, at the same time, achieve much better resolution and closer spacing than ever before — with obvious improvement in all high-frequency characteristics — you'll understand why Motorola is now able to announce significant price reductions on line and core driver transistors and small-signal RF and IF amplifier devices!

Take that order you have *right now* and call your Motorola representative — and be sure you get the most device for the price. If you would like detailed technical information on any of these types, simply drop a note to the Technical Information Center, Motorola Semiconductor Products Inc., Box 955, Phoenix, Arizona 85001.

## HERE ARE THE BOLD NEW PRICE CHANGES:

	Old Price	New Price*	Reduction %
<b>Line and Core Drivers</b>			
2N1204, 2N1204A	\$ 4.25	\$ 1.10	74
2N1494, 2N1494A	5.00	1.45	71
2N1495	5.35	2.20	62
2N1496	5.70	2.55	55
2N2096	4.75	1.10	76
2N2097	6.50	2.20	66
2N2099	3.50	1.45	58
2N2100	5.25	2.55	51
2N2381	5.00	3.10	38
2N2382	5.70	3.45	39
2N3883	1.50	.90	40
<b>RF and IF Amplifiers</b>			
2N2415	17.50	4.00	77
2N2416	25.00	2.25	91
2N3279	5.00	3.00	40
2N3280	4.50	2.75	38
2N3281	3.00	1.75	41
2N3282	2.70	1.45	46
2N3283	1.40	1.00	28
2N3284	1.35	.95	29
2N3285	1.20	.75	37
2N3286	1.10	.65	40
2N3323	.70	.60	14
2N3324	.65	.55	15
2N3325	.60	.50	16
2N3783	30.00	20.00	33
2N3784	20.00	10.00	50
2N3785	9.95	4.50	54

\* 100-999 quantities



**MOTOROLA**  
**Semiconductor Products Inc.**

Speed Inquiry to Advertiser via Collect Night Letter  
ON READER-SERVICE CARD CIRCLE 14

# New Tektronix *Automatic* Oscilloscope System SEEKS and presents a measurable display

## *New Type 3B5 Time Base Unit Makes Automatic Operation Possible*

The Tektronix Automatic Oscilloscope System, with the new Type 3B5 Automatic/Programmable Time Base Unit, now makes DC-to-15 MHz measurements faster and simpler than ever before.

The automatic system package includes the Type 3B5, the companion Type 3A5 Automatic/Programmable Amplifier Plug-in Unit, a P6030 Probe and a Type 561A, RM561A, 564 or RM564 oscilloscope.

Upon SEEK command, the oscilloscope automatically presents an optimum display. The SEEK command to the plug-in units automatically controls the time and amplitude settings, eliminating the need for continuous front-panel adjustments. Indicators on the plug-ins light automatically to show these settings. Measurements can then be made quickly and accurately from the CRT display.

Using the P6030 Probe and Automatic/Programmable Plug-In Units simplifies trouble-shooting, other applications where measurements on electrical equipment can be made without remaining within arm's length of the oscilloscope.

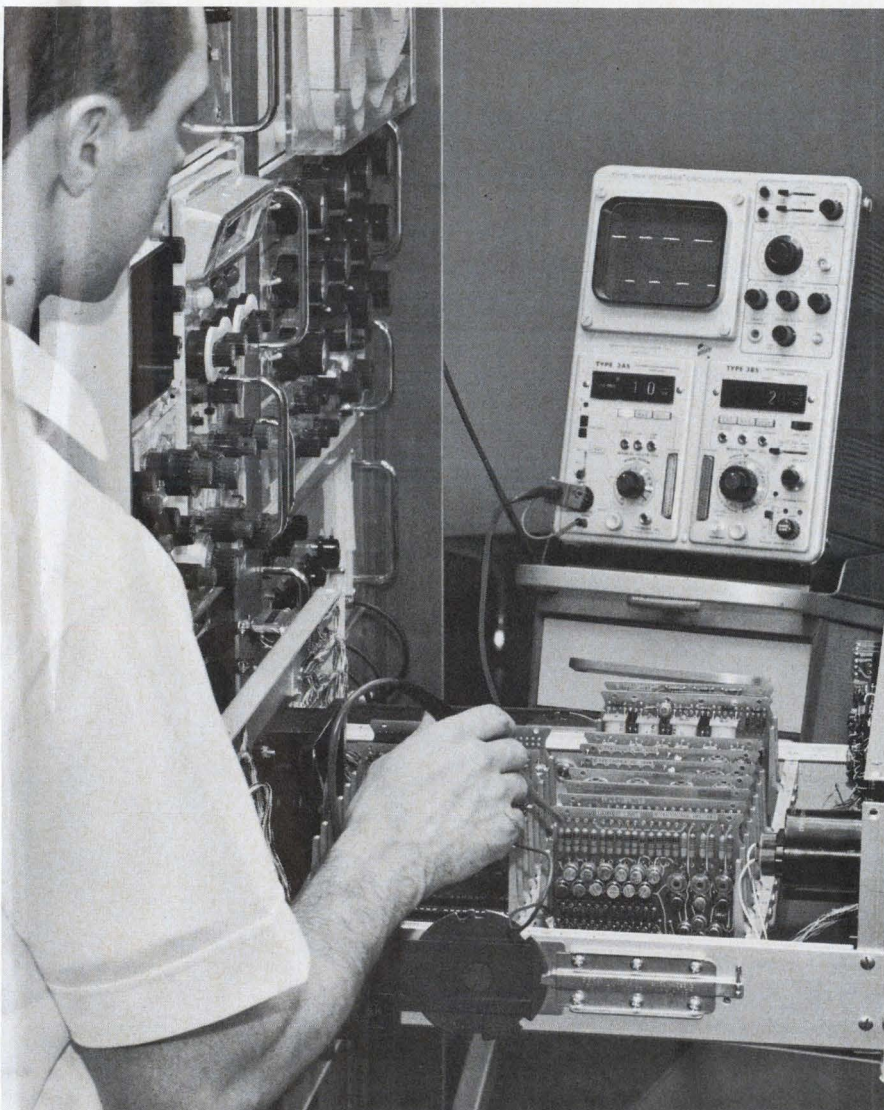

### ● AUTOMATIC SEEKING

... will operate upon SEEK command from the probe or from the Automatic/Programmable Plug-Ins.

### ● MANUAL OPERATION

... overrides the SEEK command  
... extends sweep range and deflection factors beyond capability of Automatic Seeking Mode. Indicators light to show SWP MAG'D and UNCAL warnings, set manually.

### ● REMOTE PROGRAMMING

... overrides the SEEK command and Manual Operation.  
... uses the Type 263 Programmer for remote control of the Automatic/Programmable Plug-In Units.

## WHEN PLUG-INS RECEIVE SEEK COMMAND

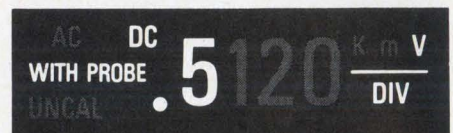

### TYPE 3A5

automatically establishes the optimum deflection factor. Indicators light to show readout with input coupling, such as .5 V/DIV, DC (coupled) WITH PROBE.



### TYPE 3B5

automatically establishes optimum trigger settings and automatically selects time per division setting. Indicators light to show readout, such as .2 μs/DIV, and to show NOT TRIG'D condition.

## Add a Type 263 Programmer and Speed Up Sequential Measurements



### TYPE 3A5

**Operating Modes:** SEEK, Manual, and External.

**Deflection Factor:** 10 mV/div to 50 V/div in SEEK and External Modes. 1 mV/div to 50 V/div in Manual Mode.

**Bandwidth:** DC-to->15 MHz, from 10 mV/div to 50 V/div. 5 MHz at 1, 2, or 5 mV/div, in Manual Mode only.

**Risetime:**  $\leq 23$  ns at a deflection factor of 10 mV/div to 50 V/div.

**Input RC:** 1 megohm by  $\approx 24$  pF.

**Programmable Functions:** V/div, 10X probe attenuation, and AC, DC or AC stabilized coupling, by contact closure to ground. Vertical positioning by analog current.

P6030 Probe supplied with Type 3A5—has SEEK COMMAND button and 6 ft. cable.  
Type 3A5 Automatic Programmable Amplifier Unit . . . . . \$760

### TYPE 3B5

**Operating Modes:** SEEK, Manual, and External.

**Sweep Range:** 5 s/div to 0.1  $\mu$ s/div in SEEK Mode.

5 s/div to 10 ns/div in Manual and External Modes.

**Delayed Sweep Magnifier:** X10 or X100. A calibrated delay control selects starting point of the magnified sweep, allows viewing of both the normal sweep (before start of the magnified sweep) and the delayed magnified sweep. With the magnifier operative, readout is automatically corrected to indicate the setting and SWP MAG'D condition.

**Trigger Modes:** Internal, either AC-coupled or AUTO (combined level-seeking and bright-line Automatic); External, either AC-coupled or DC-coupled.

**Programmable Functions:** Time/div, magnifier range, trigger mode with coupling, and trigger slope, by contact closure to ground. Horizontal positioning, trigger level, and magnifier delay, by analog current.

Type 3B5 Automatic/Programmable Time-Base Unit . . . . . \$890

• **Remote Program Feature** in the Automatic Oscilloscope System permits the instrument to be externally preset for a given measurement. With selection of eleven different programmable functions from Automatic/Programmable Plug-Ins, the combination offers new convenience for applications involving many measurements, as in production-line testing and systems checkouts, and also simplifies "away-from-the-oscilloscope" tests, where manual manipulation of the front-panel controls would be inconvenient.

• **Plug-In Type Program Card Feature**

The Type 263 accepts up to six plug-in type program cards, each of which can be programmed for a specific measurement. Each program card, after initial set-up, establishes the plug-in control functions required for a particular test or measure-

ment. Programming each card can be done simply by changing jumper wires and potentiometer settings. Any number of programmers can be cascaded for applications requiring pushbutton control of more than six measurement set-ups.

Once set up, the programs on the Automatic Oscilloscope System can be carried out by non-technical personnel with little or no training, since the instrument settings are all pre-selected. Actual measurements can be made conveniently from the CRT display, as usual.

Type 263 Programmer . . . . . \$325  
(complete with 6 program cards)  
(Size: 5½" by 8⅞" by 9";  
Weight:  $\approx$  5 lbs.)

U.S. Sales Prices, f.o.b. Beaverton, Oregon

Using the Type 263 Programmer and Automatic/Programmable Plug-In Units facilitates such applications as production testing on limited production items not justifying full automation, where most or all of the controls can be preset for each test.



For complete information, call your nearby Tektronix field engineer, or write Tektronix Inc., P. O. Box 500, Beaverton, Oregon 97005.

**Tektronix, Inc.**

ON READER-SERVICE CARD CIRCLE 15

# LETTERS

## Readers sound off in Editorgrams—and we listen

The response to our first Editorgram in the Jan. 18 issue was gratifying. Many readers welcomed the opportunity to express their opinions about the magazine. We are carefully considering all suggestions, and at least one new feature of the magazine will result from a suggestion in the first batch of cards that we received. You'll notice that another Editorgram requesting your comments is included with the cards at the back of this issue. Use it. It's free!

Here are a few of the many comments received so far. To encourage candidness in the comments, we omit names and company identifications whenever publishing Editorgrams:

Sir:

I especially liked the article "How Does Your Company Rate?" because nine out of 10 people in our plant came within 10 points of each other in using the rating sheet. The other one is particular about flavor. engineer, components company

Sir:

I especially liked "How Does Your Company Rate?" because it is a guide that will enable me to better determine how to run my plant. manager, electronics company

Sir:

"Eureka!" The new size makes me rate your magazine as tops in the electronic field (the contents always was the best). I dislike bi-weekly publication. Every week would do me fine.

QC engineer, instruments company

Sir:

Please put "Accuracy Is Our Policy" in a conspicuous place, and index the corrections as well as making it possible to tear them out to file with back issue. When looking through back issues, there is presently no way to find the possible corrections.

engineer, systems company

• We will be putting formal corrections in one spot from now on:

*at the end of the Letters section in the magazine. Thus all corrections will appear either in the letters themselves (from authors and others) or in a separate listing immediately following the letters. Any page with corrections can be pulled out easily and the individual items clipped and put with the articles they refer to. We will continue to keep mistakes at a minimum, but when they do occur we intend to correct them. Please continue to let us know whenever you spot any, so that other readers may be posted.*

Other pieces that received critical acclaim from many readers were two news stories ("Pace of Gunn-Effect Research Quickens," and "MOS Arrays Diffuse into Commercial Market") and two technical articles ("Treat the Flip-Flop Logically" and "Shunt-Motor Speed Control"). One reader lauded our Reader-Service Card, saying that it tore out more easily than that of any other magazine (a note of thanks to the perforating machine is in order).

In an editorial in the Jan. 18 issue we urged readers to pick a subject to learn this year. We asked them to use The Editorgram to let us know what subjects they picked. So far we've received more than 40 replies, ranging from very practical things to some blue-sky ideas. Here's a sampling:

"Study of clarinet, resumed after 20 years' lapse."

"Algebra of the discrete (includes aspects of logic, number theory, combinatorial analysis, etc.) with emphasis on simplicity of application."

"Stock market performance of electronic and aerospace issues."

"Parapsychology and other psychic phenomena."

"Orbital mechanics."

"Interrelation of electric, magnetic, electromagnetic wave and gravitation theories."

"Taxidermy."

"Electrical-sound amplification and experiments."

"Astronomy."

"Creative art and investment class."

"Spanish" (a California engineer).

"I'm going to study the telemetry field—little by little." (This engineer took seriously our advice that learning comes a little at a time. Incidentally, two others named telemetry.)

"Oceanography and sonar."

"MOS and MNS-device fabrication and operation."

"Folk guitar."

"Quantum theory."

"Development and variations of Adams percussion revolvers in England, 1851-1870."

"SCRs."

"FETs."

"Complex variable at SMU—a course taken as a result of your editorial."

"Biblical Greek—but I bet I am the only one picking that subject."

(He is. One other Midwestern engineer will be studying the Bible.)

"Side effects of electromagnetic energy in all disciplines."

"Management techniques."

"Computer programing" (named by four readers, two of whom mentioned Fortran.)

## Car-safety proposal is still backfiring

Sir:

A hearty "bravo" for the several readers who criticized your editorial on auto safety. [E]D Dec. 20, 1965, p. 23. Comments from readers were published in the March 1 issue, p. 32.] I think you are way off base in intimating that auto designers are "murdering" citizens.

I am astounded at the fuzzy thinking you and others demonstrate in your campaign for Federal control of auto design. You seem to think that Federally controlled auto design will compensate for poor roads, irresponsible drivers, poorly maintained cars and all the other factors that actually cause the accidents. Maybe we could all play "dodgem" on the freeways, if we were strapped into General Sherman tanks, but who wants this?



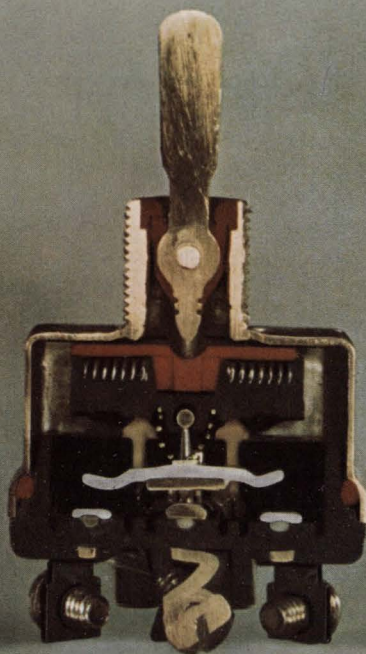

You can have Cutler-Hammer positive action switches in all standard pole configurations, in miniature and standard sizes.

No "in between"  
action here.  
It's positive.

We designed and built this line of military switches to give you the positive make-and-break you must have. There's no "maybe" about the way they work. They've proven themselves. In projects Mercury and Gemini.

You get butt-wiping contact action, too. Great for low-level switching circuits where the action wipes the contact clean first.

There's more. High shock, high vibration, better arc tracking resistance. And better sealing.

Cutler-Hammer military switches give you the truly "big" reliability you must have in aerospace and ground support. The kind you can't get in standard MIL-S-3950 switches. Our positive actions are built to MIL-S-8834.

You can choose exactly the military switch you need from the thousands we make. Just call your local stocking distributor or local Cutler-Hammer sales office. Or write us for a catalog.

**Cutler - Hammer**

Milwaukee, Wis. 53201



ON READER-SERVICE CARD CIRCLE 216

# FULL LINE OF FET OPERATIONAL AMPLIFIERS from BURR-BROWN

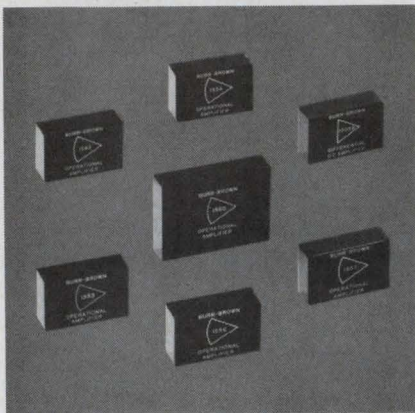

Burr-Brown now offers the industry's widest selection of operational amplifiers incorporating field effect transistors. Model 1552 is generally typical of all units except for the optimized features indicated.

## BURR-BROWN FET OPERATIONAL AMPLIFIERS

MODEL NUMBER	DESCRIPTION
1552	General purpose, $\pm 10V$ @ $\pm 20mA$ , $10^{10} \Omega$ input impedance, $\pm 5.0 \mu V/^\circ C$ , Current offset of $0.1nA$ at $25^\circ C$ , doubles every $10^\circ C$ , 106db gain, Bandwidth of 100Kc full power, 1.5Mc small signal, \$145
1553	Low current drift, $\pm 0.1 nA/^\circ C$
1554	Wide temperature range, $-55$ to $+125^\circ C$
1556	Low current & voltage drift, $\pm 2.0 \mu V/^\circ C$
1557	Commercial grade, \$110
1560	Wide band, fast slewing rate, 1 Mc full power.
1543	20 Volt general purpose, $\pm 20V$ @ $\pm 10mA$

FET chopper stabilized units and FET transducer amplifiers are also available. All units are stocked for immediate delivery.



**FOR COMPLETE  
TECHNICAL  
INFORMATION**  
Wire, write  
or phone  
Burr-Brown  
for NEW  
10-page catalog



Speed Inquiry to Advertiser  
via Collect Night Letter

ON READER-SERVICE CARD CIRCLE 16

## LETTERS

The three main accident-causing factors—roads, driver and defective cars—can be legally and sensibly controlled by the Government, and this control could greatly reduce accidents on the highways. For example, regular safety inspections, as a qualification for registering a car, would do a notable service toward protecting the innocent driver from the other guy's poor brakes or failing steering mechanism.

But why the talk of controlling the auto industry? Rather than attempting to control free enterprise, why doesn't the Government first clean out its own closets and control the issuance of drivers' licenses and auto registrations? And, even more important, why do you, as a representative of the electronics industry, recommend that we "demand" control over a free enterprise? Do you want Federal control over the electronics industry next, in answer to an equally unjustifiable charge of irresponsibility?

I cannot understand why there is this sudden and concerted attack on the auto industry, accusing it of being guilty for the accidents of the drivers. Can anyone who reads the newspapers seriously consider this to be the case? A head-on collision at high speed (caused by a sleepy driver, a narcotics user, or by an inherently irresponsible person) is not going to be any significantly less dangerous with a flexible steering wheel or seat belts. Your example of the scattering of cars on a freeway is a good example of an accident, caused not necessarily by all of the drivers involved but certainly by the first one who went into a skid. But why do you blame the consequences on the autos? Why not on that first driver?

I sincerely wish to urge you and others of your opinion to encourage the auto industry to continually improve designs. To encourage the use of electronic safety devices and equipment and to analyze auto designs is your role in industry. But please don't encourage Federal legislation where it serves only to reduce industry to a controlled status.

Robert W. Fleming

Electronic Engineer  
Beckman Instruments, Inc.  
Fullerton, Calif.

Sir:

I would like to comment on the subject of highway and auto safety after reading the letters on p. 32 of E]D, March 1, 1966.

I am in definite agreement with the editor's answer to Edward S. Donn. Mr. Donn is obviously opposed to Federal controls or regulations on anybody and anything for any reason. I would venture to say that he is probably a solid "states' rights" man. To be a firm believer in states' rights may have been fine in the 18th and 19th centuries, but I feel that today's situations require Federal intervention, controls, regulations, etc., in many areas. This is absolutely necessary if this country is to maintain prosperity, high standards of living, military preparedness and a host of other benefits, including safe travel.

Mr. Donn and many other people in this country are worried about the Federal Government becoming so powerful that our rights and liberty, and our free enterprise system, will be taken away from us. I agree with him to the extent that this is a possibility, but I feel that this cannot happen because of the checks-and-balances structure of our Federal Government. Congress consists of people elected by the citizens of every state. It may sound naive, but I believe that these Congressmen will never allow our liberties and freedom, and our free-enterprise system, to be diminished in any degree whatsoever. And if you don't like what your Congressman is doing, write him and tell him so. I do.

I believe that improvements in the structure of the automobile for the better protection of the occupants in case of accident should be the first concern of auto makers. Since the manufacturers were well aware that this was necessary and so far have done so little toward this end, there is no alternative but to impose legal regulations on auto construction.

As the editor stated, in the interest of uniform regulations and the resultant lower manufacturing costs, these regulations must be imposed by the Federal Government, whether some individuals like it or not. This does not mean that states should not also impose their own safety laws (even if it does raise the retail price of the vehicle).

But all the states could not possibly impose regulations as rapidly as the Federal Government could. If we were to wait for the states to impose the regulations, thousands of unnecessary deaths might result.

Mr. Donn should get off his high horse of idealism and face reality—and look at the facts and figures of highway deaths and injuries. He, and others like him, should try to imagine himself in a family grieving over the unnecessary death or deaths of loved ones in an auto accident—deaths that could possibly have been avoided by an automobile constructed according to improved safety standards.

Samuel Adams Gitlin  
Staff Consultant  
Westbury, N. Y.

Sir:

While reading your editorial in the Dec. 20, 1965 issue [p. 23] on legalized murder on the highways, I was reminded again of a simple winter safety device, whose installation should be required by law.

It is an electrically controlled grit dispenser, which sprays grit in front of the rear wheels in slippery weather. The grit containers could be built into the rear fender walls.

In our hilly, slick roads we have to wait for the local sanding trucks that usually arrive too late. It would not take too many cars, equipped with this device, to do the job of a sanding truck.

John A. Richards  
Los Alamos, N. M.

Sir:

I couldn't disagree with you more on federal action for highway safety (E/D Dec. 20, p. 23). The big problem is not unsafe cars but unsafe people.

Most accidents are the result of one, or both, drivers doing something wrong. For example, in one half of all fatal accidents, one of the drivers has been drinking. I doubt that laws that make driving illegal while intoxicated have saved many lives. What we really need are people who are determined to avoid accidents.

The FAA was a poor example. I'm a private pilot and find most FAA regulations unnecessary. Like automobiles, over 90% of aircraft accidents are resulting from human errors. Airlines and aircraft manu-

## The First 3/4" Lighted Pushbutton Switch With 6 Pole Double Throw Capacity and Plug-In Convenience



### USECO introduces ORCON\*

**New Breakthrough in Switch Design.** ORCON is the first lighted pushbutton switch that matches the needs of today's technology in design versatility, operational flexibility and ease of maintenance. Here's why:

- 25% Smaller — only 3/4" Diameter.
- Multicircuit capacity — 2 pole double throw through 6 pole double throw — other variations available.
- Plug-in convenience — optional connector simplifies installation and maintenance.
- Isolated self-aligning contacts — for increased reliability.
- Independent light circuit — accepts incandescent or neon without lens modification.
- Operating action versatility — choice of four actions.
- "Customized" to your exact requirements from standard options.

Developed by USECO engineers for Computer and Data processing equipment, Tape Recorders, Telemetry Devices, Control Panels, Broadcasting Consoles and Business Machines, ORCON's advanced features are adaptable to an expanding variety of new applications, and are available for immediate delivery. Please contact us with your specific needs.

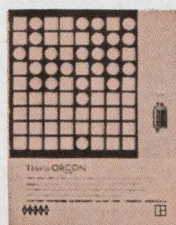

For complete information send for the illustrated technical brochure today. USECO DIVISION, 13536 Saticoy Street, Van Nuys, California. Phone (213) 786-9381.

\* USECO TRADEMARK, PATENT PENDING



DIVISION OF LITTON INDUSTRIES



ON READER-SERVICE CARD CIRCLE 17

Now you can

**Digitize**

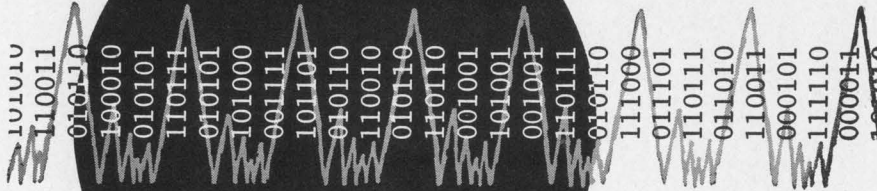

at a 10mc  
Rate

with the

**VIDEOVERTER<sup>®</sup>**

**10 million 6 bit words  
per second**



This all solid state "Video" Speed Analog to Digital Converter provides a new generation of ultra high speed measurements at 0.5% accuracy. Parallel output words are obtained at 100 nanosecond intervals. Here is a proven design that uses a delay line digitizing technique and "recognizes" high frequency pulses.

Epsco Analog to Digital Converter capability covers the entire spectrum of accuracy and speed.

Standard Units include:

- Model TWV-744 — Six Bit Videoverter operates at 10 Mc.
- Model TWV-745 — Seven Bit Videoverter operates at 5 Mc.
- Model MSA-8 — Eight Bit 1 Mc Analog to Digital Converter.
- Model AS-2 — Ten Bit integrated circuit Analog to Digital Converter operates at 50 Kc.
- DATRAC II — Ten to fourteen Bit Analog to Digital Converter operates at 25 Kc.

Compatible Digital to Analog Converters are available for all Models. Special Units are also available.



Write for  
Technical Literature.

411 Providence Highway, Westwood, Mass. 02090 Tel. (617) 329-1500

ON READER-SERVICE CARD CIRCLE 18

LETTERS

fabricators don't want accidents. Accidents hurt their business.

Accidents don't hurt auto-makers because people know that's not where the blame lies. If it would, automakers would emphasize safety instead of horsepower.

Most people aren't safety-minded anyway. The use of seat belts is one example. Regulations may help in a few cases. The people who will use seat belts are the same ones who would have bought them anyway—law or no.

If you really want to save lives on our highways, start trying to remake people, not redesign automobiles or pass laws. Who says it can't be done?

J. W. Streater

Gardenpark Drive  
Chagrin Falls, Ohio

**NASA corrects ED slip  
and defends its circuit**

Sir:

Your Oct. 11, 1965 issue published the NASA Tech Brief B65-10072, titled "Pulse Generator Needs No External Power" (p. 122). This gives a brief description of circuitry developed by us for use in scientific satellites. Your published schematic was in error in that the base of transistor  $Q_1$  was shown connected to both the diode  $D_3$  anode and the emitter of  $Q_1$ . The base of  $Q_1$  should be connected only to anode of  $D_3$ .

Your Dec. 6, 1965 issue published a letter by W. J. Godsey titled "NASA Took Hard Way to Pulse Generation," where he suggested that the circuit was "much more complex than necessary" and presented an alternate solution.

There are several reasons why the NASA Tech Brief circuit was presented in the form shown rather than in the form presented by Mr. Godsey. By comparing the two circuits, it can be seen that the two are identical except for the output stage. The Godsey circuit's output stage is a self-regenerative switch (the regenerative switch incorporates  $Q_1$ ). The self-regenerative switch is characterized by high susceptibility, spurious turn-on and difficulties with stable turn-off. To avoid these characteristics, the NASA Tech Brief circuit's output stage is a highly stable, limited-gain amplifier providing very good immunity to spurious turn-on and a

stable turn-off characteristic. Furthermore this circuit allows for wide variations in the base level of the input signal, a condition not tolerated by the self-regenerative switch because of its restrictive turn-off characteristics.

Obviously many different circuits may be used as the output stage. The choice depends upon the intended use. The circuit presented in the Tech Brief is considered generally applicable and ample to convey the principles of operation. As indicated in the Tech Brief notes, a tunnel diode may be used in the output stage. A limiting resistor connected in series with a tunnel diode from  $Q_1$  collector-to-common, gives an output pulse with a very fast rise time across the tunnel diode. The rise time is essentially independent of the input signal's fall time. If the required output voltage is greater than that provided by the tunnel diode, a limited-gain amplifier may be used as the output stage.

Ciro A. Cancro

Paul J. Janniche Jr.

Solid State Devices Section  
Flight Data Systems Branch  
NASA Goddard Space Center  
Greenbelt, Md.

### Accuracy is our policy

The author of "Avoid over-integration . . .," beginning on page 56 of our Feb. 1 issue, points out the following corrections and additions:

Fig. 3 (p. 58)—The signs for values along the  $y$  axis of the transfer function should be reversed. Starting from the origin, these values should read +10, +5, -5, -10.

Fig. 4 (p. 59)— $R_{13}$  should be 2k. The zener diode coming off this resistor is a 1N759A.

Fig. 5 (p. 60)— $R_8$  and  $R_{13}$  are both five-watt resistors.

The first sentence of paragraph four of Idea for Design #115 (E/D, February 15, 1966, p. 98) states:  $R_p = 1.87$  ohms. This is incorrect and should read  $r = 1.87$  ohms.

The procedure cannot be blindly and mechanically done without thought. It must be kept in mind that the first of his operations is to determine the ratio  $R/r$ , and its up to the operator to carefully read what that ratio is.

## WHY 9 CUTS?

Because it takes 9 different crystal cuts to cover the frequency spectrum. Hughes makes quartz crystal units in all 9 cuts, from 1kc to over 150 mc!

There's another reason for making 9 cuts. Usually any one frequency can be handled by several different cuts, but some cuts display better frequency tolerance with temperature than others. Hughes has the capability to provide the cut needed over any operating temperature range for minimum frequency drift.

Whether you need custom or MIL spec units in prototype or production quantities, why not call on Hughes' broad experience and engineering depth for all your crystal requirements. For specific information call or write Hughes Electronic Devices, Newport Beach, Calif.



Leader in Frequency Control Devices

**HUGHES**

HUGHES AIRCRAFT COMPANY  
ELECTRONIC DEVICES  
NEWPORT BEACH, CALIFORNIA

## TRW ANNOUNCES NEW MILITARY MYLARS



### Up to 72% smaller than MIL-C-25C paper capacitors!

MIL-C-19978B/2 reduces capacitor size drastically—down to .125" diameter by 1/2" long. At the same time electrical characteristics are upgraded sharply.

MIL-C-19978B/2 hermetically sealed mylar\* capacitors are available now from TRW with immediate delivery in production quantities.

- **REDUCED SIZE**—35% to 72% smaller than MIL-C-25C.
- **VOLTAGE CHOICE**—30V, 50V, 100V, 200V, 600V, 1000V.
- **CAPACITANCE CHOICE**—.001 mfd through 10.0 mfd.
- **TOLERANCE CHOICE**—±10%, ±5%, ±2%, ±1%.

For full information contact: TRW Capacitors, 112 W. First St., Ogallala, Nebraska. Phone: 308-284-3611 • TWX: 910-620-0321.

These capacitors—when designated TRW Type 693—are available to high reliability specifications, and in custom capacitances and tolerances beyond the range of MIL-C-19978B/2.

\*Du Pont registered trademark

# TRW CAPACITORS

ON READER-SERVICE CARD CIRCLE 20

**Co-Publishers**

James S. Mulholland, Jr.  
Robert E. Ahrens Dorf

**Editorial Director**

Edward E. Grazda

**Editor**

Howard Bierman

**Managing Editor**

Robert C. Haavind

**Technical Editors**

Joseph J. Casazza  
Rene Colen  
Maria Dekany  
Richard Harnar  
Mark B. Leeds  
Neil Sclater

**News Editors**

Frank Egan  
Roger K. Field  
Alfred Rosenblatt

**West Coast Editors**

Ralph Dobriner  
Peer Fossen

**New Products Editor**

David Surgan

**Washington Editor**

S. David Pursglove

**Editorial Production**

Dollie S. Viebig  
Anne T. Lombardi

**Art Director**

Clifford M. Gardiner

**Art Assistant**

William Kelly

**Technical Illustrators**

Lewis D. Hill  
Leonard P. Levenson  
Cheh Nam Low

**Production Manager**

Thomas V. Sedita

**Asst. Production Manager**

Helen De Polo

**Production Assistants**

Carl Merkin  
Bernard Wolinsky

**Circulation Manager**

Nancy L. Merritt

**Reader Service**

Diane Pellechi



## Engineers are too often silent on major social issues

Today is a time of dynamic social action in our nation. Yet we seldom hear of engineers who are involved in social projects.

It is a time for solutions to urgent problems such as poverty, racial integration, public health. But the voice of the engineer is an inaudible whisper.

It is an era of "causes"—for or against this or that war; supporting or opposing traditions of free speech. Where does the engineer stand?

Too often he appears to stand in no-man's land on all these issues. Publicly he is neither for nor against; he is too occupied with mechanical things, observers are apt to generalize, to take any great interest in people and the world around him.

The results of such reticence are unfortunate. As professional people, engineers certainly have the capacity to be among the best-informed and most responsible members of the community. When they shirk—by inaction—their public duty to speak out on important issues, highly emotional and often poorly informed individuals frequently take over. The solutions proposed by these latter are usually over-simplified, unworkable.

We recently observed on New York's Fifth Avenue a march by hundreds of anti-war demonstrators. Their solution to the whole Far Eastern problem was simply to stop fighting there and pull out at once. It seemed to concern no one that a simple withdrawal without resolution of some of the underlying issues of the conflict would create more problems than it solved. On the side lines during this parade were an assortment of neo-Nazi hecklers. One of them proposed that the only way of dealing with the marchers was to set up machine guns at the street corner and mow them all down.

Do we want our Government to respond to such warped agitation? Or would we rather it view the major problems of the day with a broad perspective and develop realizable, constructive policies for the achievement of our national objectives?

In our kind of free society, government does respond to the pressures of the governed, but the voices of the governed must be heard. If the thousands of intelligent engineers in this country were to contribute in some small way by participating in community groups, some change could take place. It's not hard to imagine progress if the same cool, reasoned approach that engineers are expected to bring to their work were applied to the great issues of our day.

ROBERT HAAVIND

Infinite resistance at null to 1100 volts is one feature of our new solid state differential voltmeter. Accuracy to  $\pm 0.0025\%$  of dial setting is another. Price of \$1095 doesn't hurt our cause either. Ratio measurement lets you compare two external sources with a resolution of 0.0001%. In the TVM mode, input resistance is 100 megohms. Reference regulation is 0.0002%. Stability is 13 ppm peak-to-peak per 60 days.

Of course, that's not the whole story. Other features include 6 digit inline readout with a dial resolution of 1 ppm. The recorder output is well isolated and linear to within 0.5% of end scale. Ten percent overranging minimizes range changing and offers increased resolution on the lower end of each range. A continuously adjustable last digit allows exact null and eliminates meter interpolation for resolution. The half-rack Model 895A weighs 16 pounds.



FLUKE • Box 7428, Seattle, Washington 98133 • Phone: (206) 776-1171 • TWX: (910) 449-2850

ON READER-SERVICE CARD CIRCLE 231





AC metrology will never be the same after the Fluke 931A, the first true rms differential voltmeter. Measure the precise rms value of virtually any waveform within 0.05% from 30 Hz to 50 KHz. Overall frequency response is 10 Hz to 1 MHz. Range is 0.01 to 1100 volts. Ten to one crest factor accounts for effects caused by voltage spikes and pulse trains. Comes with or without probe. Both line or combination line/rechargeable battery powered versions are offered. Base price is \$895.

The new Fluke Model 931A True RMS Differential Voltmeter yields accurate rms measurements of any waveform which previously could be made only by ac to dc comparison with a thermal transfer standard. Other features include high input impedance, in-line digital readout (lighted decimal), solid state design, and linear recorder output. The null meter indicates percent deviation from the dialed voltage. Ten percent overranging minimizes range changing. Battery operation gives ideal isolation from ground loops. Model 931A meets MIL-SPEC shock and vibration requirements. For complete information, please call your Fluke Sales Engineer or write.



FLUKE • Box 7428, Seattle, Washington 98133 • Phone: (206) 776-1171 • TWX: (910) 449-2850

ON READER-SERVICE CARD CIRCLE 232

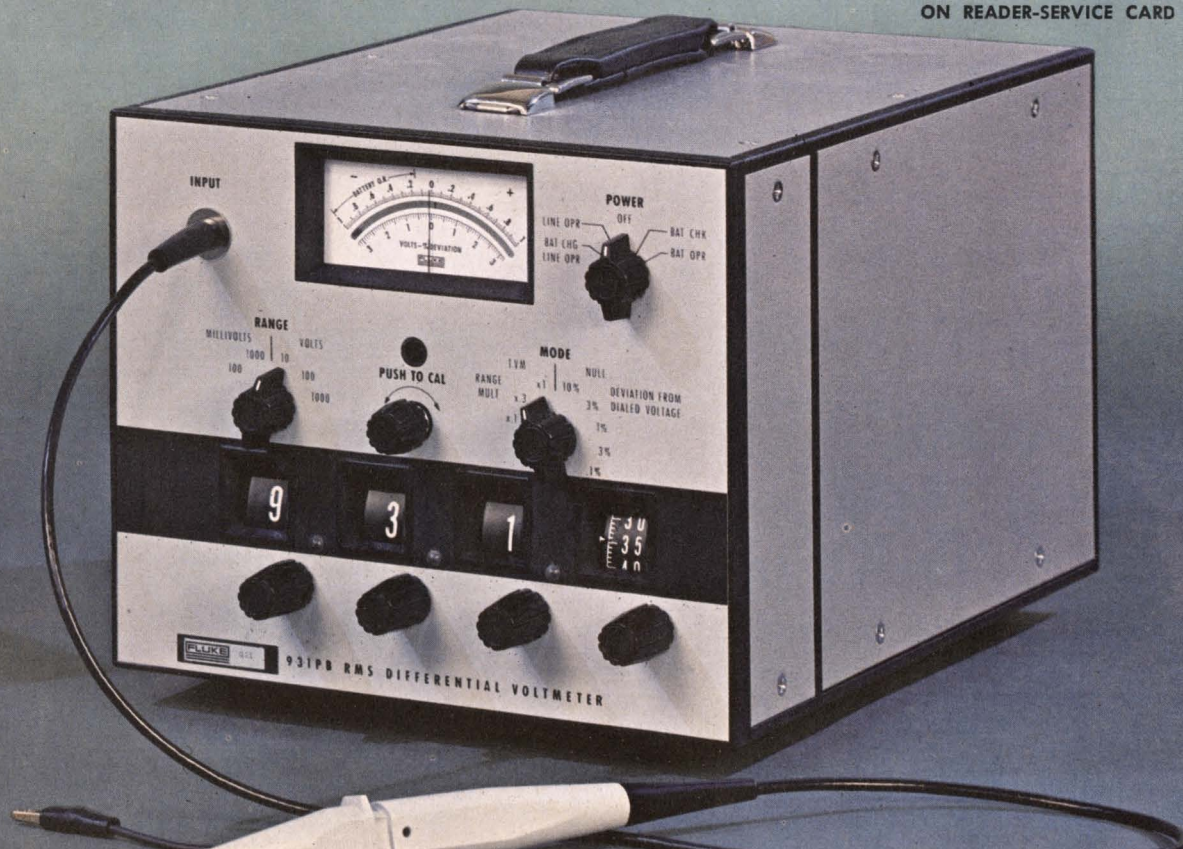

# Progress Report on ALSiMAG<sup>®</sup> PRECISION Ceramics

## CRITICAL TOLERANCES HELD WITHOUT GRINDING

Illustrated approximately actual size. Significant dimensions and tolerances are given.

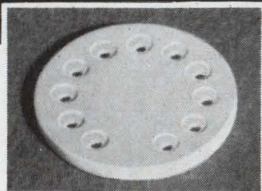

Holes  $.060 \pm .002$

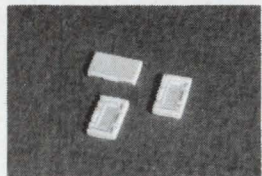

$.247 \pm .003 \times .140 \pm .003$   
Thickness  $.033 \pm .002$

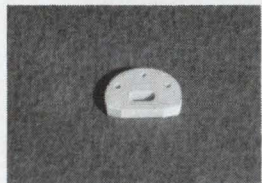

L 5 Steatite  
O. D.  $.3705 \pm .0015$

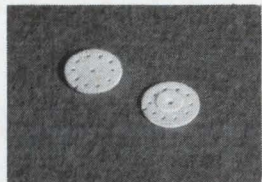

O. D.  $.280 \pm .005$   
Thickness  $.019 \pm .002$   
Holes  $.025 \pm .002$

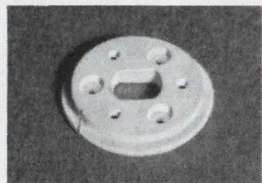

Center Pin  $.250 \pm .003 \times$   
 $.195 \pm .003$   
Holes  $.065 \pm .002$   
Shoulder Thickness  $.068 \pm .003$

The electronic industry has faced a continuous demand for more performance in less space and for reliability and long life. In many microelectronic applications, the key has been precision ALSiMag custom made ceramics. They are strong, have desired electrical characteristics and are useful in a wide range of temperatures.

Since 1960, American Lava has produced miniature ceramics in volume to close tolerances without grinding. Large plant areas are devoted to the special equipment and trained personnel required by the growth of this precision work. Volume production at favorable cost covers a wide range of designs, many of them intricate.

### Where Heat Dissipation Is a Primary Problem

ALSiMag precision ceramics are principally alumina ceramic compositions. As electronic devices became smaller and circuit densities became greater, a number of problems of heat dissipation were created. In some instances the answer has been found in ALSiMag 754 Beryllia\* ceramic composition which conducts heat rapidly and efficiently.

ALSiMag beryllia ceramics now can be processed to dimensional tolerances closely comparable to ALSiMag alumina ceramics. Certain flat shapes in ALSiMag beryllia ceramics can be supplied with an "as fired" surface as smooth as 15 micro-inches CLA... the only beryllia ceramic available in this range of smoothness.

Prototypes of ALSiMag ceramics to your specifications permit your complete evaluation. Many designs can be hand made promptly and at reasonable cost. Our technical people will give you their comments if you will send details of your requirements.

**\*WARNING:** It should be noticed that special precautions are necessary to insure safe handling of beryllium oxide ceramics.

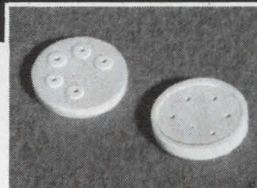

Holes  $.034 \pm .001$

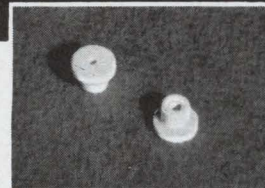

Shank O. D.  $.142 \pm .001$

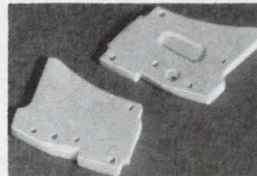

$.525 \pm .003$  On Contour  
Holes  $\pm .002$



Shank O. D.  $.063 \pm .002$   
Shoulder O. D.  $.110 \pm .002$

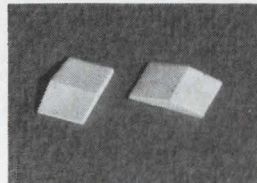

Width  $.400 \pm .005$   
Thickness  $.070 + .000$   
 $- .005$

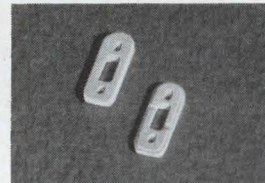

Hole  $.0775 \pm .0025 \times$   
 $.180 \pm .002$   
Hole Center  $.329 \pm .003$

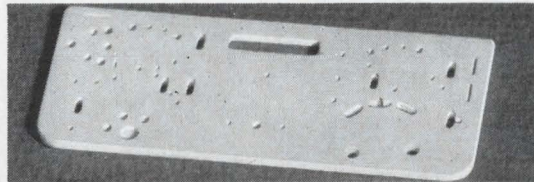

All Holes  $\pm .002$   
Thickness  $\pm .002$   
Hole Center  $\pm \frac{1}{2}\%$

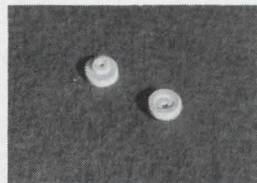

Shank Diameter  $.098 \pm .002$   
Shoulder Thickness  $.050 \pm .001$   
Hole  $.042 \pm .002$

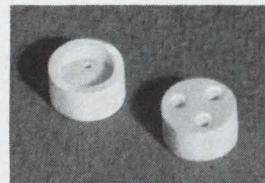

O. D.  $.372 \pm .002$   
Counter Bore Diameter  
 $.2825 \pm .0025$   
Holes  $.064 \pm .0015$

**American Lava Corporation** **3M**  
A SUBSIDIARY OF COMPANY

PHONE 615 265-3411, CHATTANOOGA, TENN. 37405

For service, contact American Lava representatives in Offices of Minnesota Mining and Manufacturing Company in these cities (see your local telephone directory): Atlanta, Ga. • Birmingham, Mich. • Boston: Needham Heights, Mass. • Chicago: Bedford Park, Illinois • Cleveland, Ohio • Dallas, Texas • Laurens, S. Carolina • Los Angeles, Calif. • Metropolitan New York: Ridgefield, New Jersey • Up-State New York: Baldwinsville, N. Y. • Philadelphia, Penn. • Roanoke, Virginia • South San Francisco, Calif. All export except Canada: Minnesota Mining and Manufacturing Co., International Division, 700 Grand Ave., Ridgefield, N. J.

65th  
YEAR  
OF  
CERAMIC  
LEADERSHIP

# ED Technology

Linville-Smith charts speed hf amplifier design PAGE 48

Diode bridge spans the agc gap PAGE 58

Why not try IC counters? PAGE 62

Close the door on spurious gating signals PAGE 72

Trim your radar antenna's feed costs PAGE 76

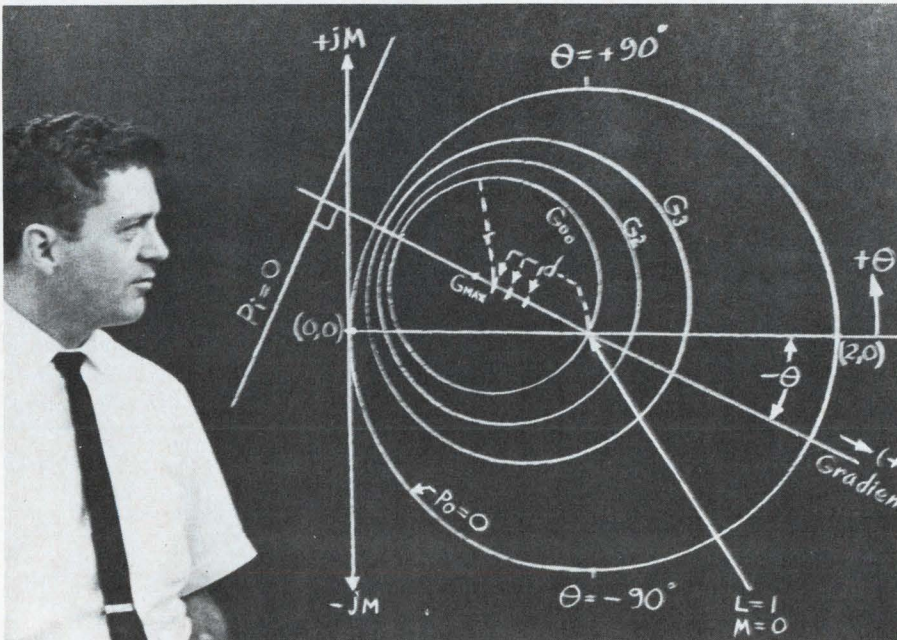

Throw a curve at hf amplifiers . . . 48

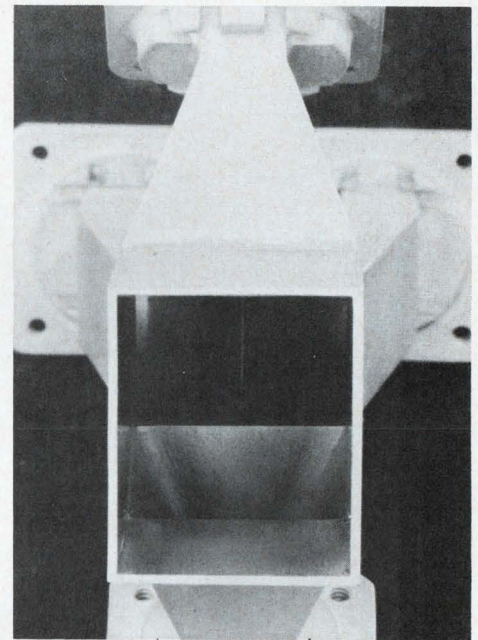

Keep your antenna well-fed . . . 76

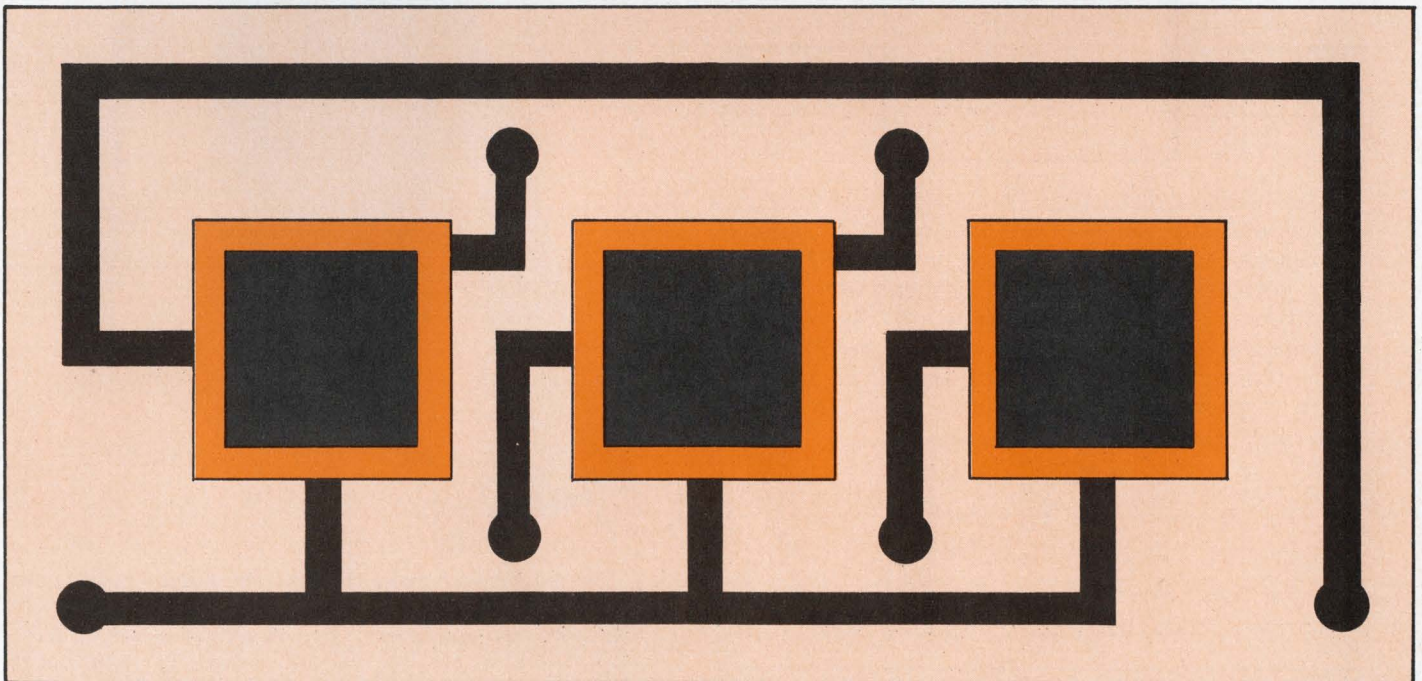

Take a logical look at IC counters . . . 62

# Design high-frequency amplifiers graphically, relating stability, gain, bandwidth and sensitivity with easy-to-construct Linvill-Smith charts.

When designing high-frequency amplifiers, the engineer must determine if the transistors are stable or potentially unstable at any specified frequency. If the devices are potentially unstable, he must select loads that assure stable operation.

A graphical technique can be used to relate device stability, gain, bandwidth and sensitivity. This approach permits the engineer to analyze and design high-frequency transistor amplifiers rapidly.

The general equations for input and output powers of a two-port, linear active network describe respectively, the geometrical forms of an inclined plane and a parabola of revolution. Projections of intercepts on these geometric surfaces can, in turn, be related to circles on a Linvill chart (modified Smith chart) that represents the performance of the network at a specific frequency. Any point on this chart can be shown to represent a specific gain and a value of load ( $Y_L$ ).

## Derivation of the Linvill technique

A transistor stage operating well below saturated conditions can normally be considered a linear active two-port network, and thus can be represented by the diagram shown below.

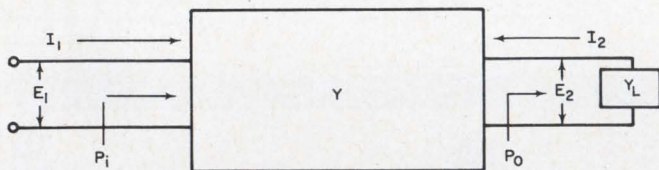

The positive directions of voltages and currents are arbitrarily selected as indicated.  $P_i$  and  $P_o$  represent the input and output powers of the two-port network for any set of current and voltage conditions. The  $Y$  parameters of the network under consideration,  $Y_{11}$ ,  $Y_{12}$ ,  $Y_{21}$  and  $Y_{22}$ , are indicated by the symbol  $[Y]$ . Each of the network  $Y$  parameters is, in turn, made up of real and imaginary parts as follows:

$$\begin{aligned} Y_{11} &= g_{11} + jb_{11} = \text{Re } Y_{11} + j\text{Im } Y_{11}, \\ Y_{12} &= g_{12} + jb_{12} = \text{Re } Y_{12} + j\text{Im } Y_{12}, \\ Y_{21} &= g_{21} + jb_{21} = \text{Re } Y_{21} + j\text{Im } Y_{21}, \\ Y_{22} &= g_{22} + jb_{22} = \text{Re } Y_{22} + j\text{Im } Y_{22}. \end{aligned} \quad (1)$$

For a specific frequency, applied voltage and

operating current, these  $Y$  parameters are fixed values.

Voltages  $E_1$  and  $E_2$  are the exact voltages at the input and output network terminals. The generator source and load terminal voltages can differ from  $E_1$  and  $E_2$ , due to voltage drops in source internal impedances and lead impedances in series with the load circuit.

If the value of  $E_1$  is selected to be of unity magnitude and zero phase angle, the proportional relationships between input and output powers, voltages and currents are not changed. Therefore in the following derivation the input voltage to the network is assumed to be

$$E_1 = 1 + j0. \quad (2)$$

This assumption simplifies the derivation for the geometrical surfaces that represent the network input and output powers with various loads.

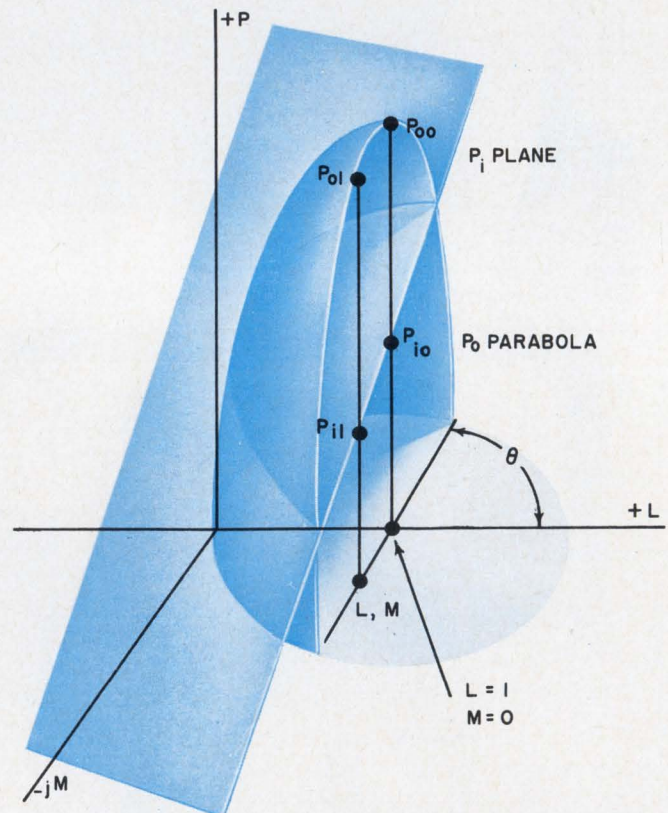

1. The input power plane ( $P_i$ ) and the output power parabola ( $P_o$ ) are represented in this three-dimensional figure. Maximum available power ( $P_{0o}$ ) is obtained from the  $P_{1o}$  input.  $L$  and  $M$  are the real and imaginary components, related by  $\theta$ , of the output voltage  $E_2$ .  $P_{0i}$  and  $P_{1i}$  are another arbitrary set of points.

From the two-port network shown,

$$E_2 = \frac{-I_2}{Y_L} \quad (3)$$

Also, the general network equations for input and output currents are:

$$I_1 = Y_{11} E_1 + Y_{12} E_2, \quad (4)$$

$$I_2 = Y_{21} E_1 + Y_{22} E_2. \quad (5)$$

In Eq. 3, let  $a + jb$  represent the complex notation of the value of  $E_2$ , the output voltage. Then  $a + jb$  can be represented, in turn by a constant  $(-Y_{21}/2\text{Re } Y_{22})$  times another arbitrary set of complex terms,  $L + jM$ :

$$E_2 = \frac{-I_2}{Y_L} = a + jb = (L + jM) \frac{-Y_{21}}{2\text{Re } Y_{22}} \quad (6)$$

This relationship and the constants  $L$  and  $M$  simplify the graphical representations of the network power equations. The input and output power equations for  $P_i$  and  $P_o$ , in terms of  $L$ ,  $M$  and the network  $Y$  parameters, can be derived:

$$P_i = \text{Re } Y_{11} + L \text{Re} \left[ \frac{-Y_{12} Y_{21}}{2 \text{Re } Y_{22}} \right] + M \text{Im} \left[ \frac{Y_{12} Y_{21}}{2 \text{Re } Y_{22}} \right] \quad (7)$$

and

$$P_o = L \frac{|Y_{21}|^2}{2 \text{Re } Y_{22}} - \frac{(L^2 + M^2) |Y_{21}|^2}{4 \text{Re } Y_{22}} \quad (8)$$

Since the  $Y$  parameters are assumed constant, the  $L$  and  $M$  terms are the only variables on the right side of Eqs. 7 and 8. In a three-dimensional coordinate system that has axes  $L$ ,  $M$  and  $P$ , the  $P_i$  equation results in an inclined plane and the  $P_o$  equation in a paraboloid. A pictorial representation of the three-dimensional power surfaces is shown in Fig. 1.

The intersection of the parabolic  $P_o$  surface with the  $L, M$  plane is a circle of unit radius with center at  $L=1, M=0$ . This circle represents zero output power.

The  $P_i$  plane intersects the parabolic surface at an angle to the vertical and the  $L, M$  axes, as determined by Eq. 7. Any point on the  $L, M$  plane represents a particular load that is applied to the network. Combining Eqs. 2, 3, 5 and 6, we get:

$$Y_L + Y_{22} = \frac{2 \text{Re } Y_{22}}{L + jM}. \quad (9)$$

This equation, which has the variables  $Y_L$ ,  $L$  and  $M$ , indicates that any load ( $Y_L$ ) can be represented by a particular set of  $L$  and  $M$  values.

### Power gain analysis

As shown in Fig. 1, a set of  $L$  and  $M$  values has a corresponding set of  $P_o$  and  $P_i$  values directly above on the two power surfaces.

If the  $P_i$  plane in Fig. 1 is viewed from the edge, and parallel with the  $L, M$  plane, the orientation presented in Fig. 2 is obtained.

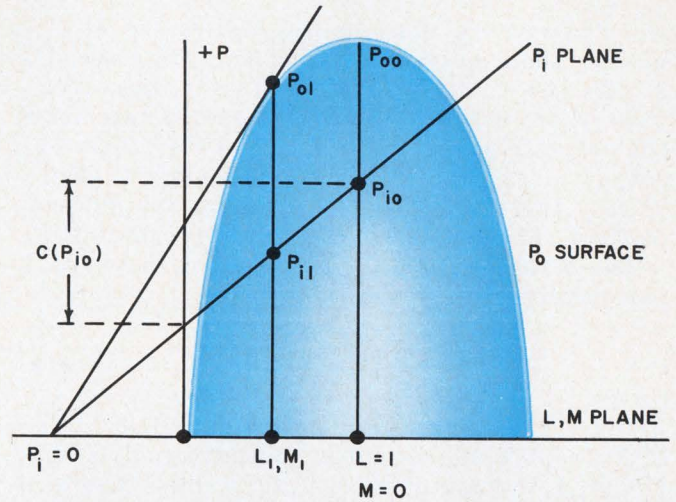

2. **Maximum-gain conditions** are determined from this view of Fig. 1 along the  $L, M$  plane. The ratio of points  $P_{o1}$  and  $P_{i1}$  gives the maximum gain  $G_{max}$  at the arbitrary point.  $G_{oo}$ , the maximum gain at the maximum output power, is similarly derived from  $P_{oo}/P_{i0}$ .

Note, from Figs. 1 and 2, that a power output point, labeled  $P_{oo}$ , is located at the apex of the parabola, directly above the  $L=1, M=0$  point.  $P_{oo}$  represents the maximum power that can be delivered to a load by the linear active network when  $E_i=1+j0$ . From Eq. 9, the load  $Y_L$  that produces  $P_{oo}$  is:

$$Y_L = -Y_{22} + 2 \text{Re } Y_{22} = Y_{22}^*, \quad (10)$$

where  $Y_{22}^*$  is the conjugate of  $Y_{22}$ .

Fig. 2 also shows that the input power  $P_{i0}$  for this maximum output power is directly below  $P_{oo}$  on the  $P_i$  plane. The values of  $P_{oo}$  and  $P_{i0}$  are determined from Eqs. 7 and 8 when  $L=1, M=0$ , and they are:

$$P_{oo} = \frac{|Y_{21}|^2}{4 \text{Re } Y_{22}} \quad (11)$$

$$P_{i0} = \text{Re } Y_{11} - \frac{\text{Re} (Y_{12} Y_{21})}{2 \text{Re } Y_{22}} \quad (12)$$

The resulting power gain for this set of load parameters is:

$$G_{oo} = \frac{P_{oo}}{P_{i0}} = \frac{|Y_{21}|^2}{4 \text{Re} (Y_{11}) \text{Re} (Y_{22}) - 2 \text{Re} (Y_{12} Y_{21})} \quad (13)$$

Note that the gain ( $G_{oo}$ ) at maximum power output ( $P_{oo}$ ) is *not* the maximum available gain from the network. On Fig. 2 a line is drawn from the  $P_i = 0$  intersection to a point of tangency with the  $P_o$  surface at  $P_{o1}$ . Directly below this point on the  $P_i$  plane is the input power point  $P_{i1}$  for the load  $L_1, M_1$ . This set of points yields the maximum ratio of  $P_o/P_i$ ; hence the maximum power gain  $G_{max}$ .

### Analyzing for stability

For unconditionally stable operations, regardless of the load connected to the linear active network, the value of  $C(P_{i0})$  in Fig. 2 must be less than

$P_{i0}$ . Therefore  $C$  must be less than unity. If  $C$  is greater than unity, the  $P_i$  plane will intersect the  $P$  axis below the  $L, M$  plane. Under these conditions, there would be points on the  $P_o$  surface above the negative points on the  $P_i$  plane. This means an output power for negative power input. Consequently the stage would be unstable for all loads on the  $L, M$  plane above the negative values of  $P_i$ .

The stability factor,  $C$ , in terms of network  $Y$  parameters, can be shown to be:

$$C = 2 \left( \frac{P_{00}}{P_{i0}} \right) \left| \frac{Y_{12}}{Y_{21}} \right|. \quad (14)$$

If  $1 < C < \infty$ , the circuit is potentially unstable. If  $0 < C < 1$ , the circuit is unconditionally stable. If  $C = 1$ , the circuit is critically stable—that is, it is on the threshold between regions of potential instability and unconditional stability.

Also, observe that all planes, drawn from  $P_i = 0$  with a slope less than the one passing through  $P_{01}$  but greater than the slope of the  $P_i$  plane, will intersect the parabolic  $P_o$  surface at a locus of equal gain points. The projection of these surface intersections to the  $L, M$  plane will result in a series of circles on the  $L, M$  plane, representing equal gain circles of various values as shown in Fig. 3. These gain circles are not concentric. The centers of the lower gain circles move toward the  $L = 1, M = 0$  point. Any point on a selected gain circle represents a load,  $Y_L$ , that will give that particular gain.

In Fig. 3 the values of the gains and the distances to the centers of the constant-gain circles, from the  $L = 1, M = 0$  point, as well as the radii of the circles, can be determined in terms of the  $C$  factor.

To determine the distance ( $d$ ) from  $L = 1, M = 0$  to the center of the various gain circles, the following derived equation is used:

$$(d) = -g \frac{C}{2}, \quad (15)$$

where  $g$  = the ratio of the power gain of the desired gain circle to the value of  $P_{00}/P_{i0}$ , and a unit of length is equal to the radius of the  $P_o = 0$  circle. (The negative sign refers to the opposite direction from the positive gradient line.)

For example, if the center of the constant-gain circle 3-dB below  $P_{00}/P_{i0}$  is desired, the distance to the center from the  $L = 1, M = 0$  point is  $-1/2(C/2)$ .

Note, from Eq. 15, that there is a constant gain circle of a  $P_{00}/P_{i0}$  value that has a center at  $-C/2$  from  $L = 1, M = 0$ . This circle represents all load values that yield a gain equal to the conjugately matched power gain,  $G_{00}$ .

The centers of the constant-gain circles all lie on the same straight line that passes through  $L = 1, M = 0$ . The positive direction of the gradient line and the angle with respect to the  $L$  axis can be calculated from

$$\theta = \tan^{-1} \frac{\text{Im} (Y_{12} Y_{21})}{-\text{Re} (Y_{12} Y_{21})}. \quad (16)$$

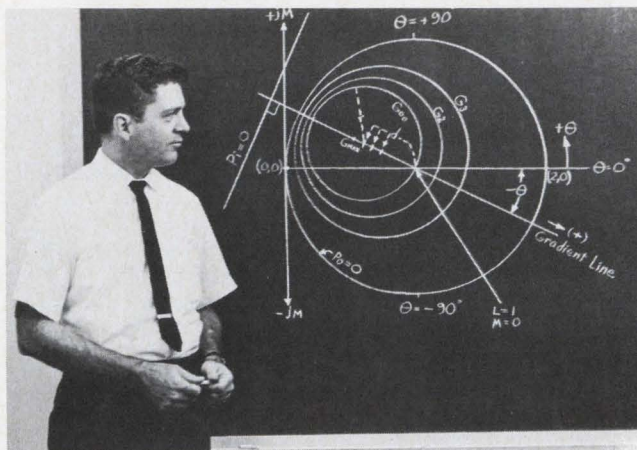

3. **Equal-gain circles** are projections of the intersection of the  $P_i$  plane and  $P_o$  paraboloid on the  $L, M$  plane. Any point on the selected gain circle represents a load. The centers of the lower-gain circles approach the  $L = 1, M = 0$  point. ( $d$  is the distance from this point to the circle center, and  $r$  is the radius.) These circles are superimposed on a Smith chart to complete the analysis.

The radii ( $r$ ) of the constant-gain circles is determined from

$$r = \sqrt{1 - g + \left( g \frac{C}{2} \right)^2} \quad (17)$$

In the special case of  $G_{max}$ , the value of  $g$  is  $K_g$ , where  $K_g$  is equal to the multiplier of  $(P_{00}/P_{i0})$  in Eq. 18. It can be shown that

$$G_{max} = 2 \left[ \frac{1 - \sqrt{1 - C^2}}{C^2} \right] \frac{P_{00}}{P_{i0}} = K_g \frac{P_{00}}{P_{i0}} \quad (18)$$

$G_{max}$  occurs only at a single point.

The inconvenience of converting with Eq. 9 a point,  $L + jM$ , to an actual load value,  $Y_L$ , can be simplified by converting the  $L, M$  coordinates to Smith-chart coordinates, as shown in Fig. 4. The conversion consists of superimposing the center of the Smith chart on the  $L = 1, M = 0$  point, with the zero-reactance line coincident with the  $L$  axis. Also, the circumference of the Smith chart is superimposed on the  $L, M$  plane circular intercept of the  $P_o$  surface, such that the  $L = 2, M = 0$  point is coincident with the zero-impedance point of the Smith chart.

If Eq. 9 is set equal to real and imaginary admittance values  $G_2$  and  $jB_2$ , such that

$$Y_L + Y_{22} = \frac{2g_{22}}{L + jM} = G_2 + jB_2, \quad (19)$$

where  $G_2 = \text{Re} Y_L + g_{22}$  and  $B_2 = \text{Im} Y_L + b_{22}$ , then  $G_2$  and  $jB_2$  values can be obtained from the superimposed Smith chart by the following:

(a) Let each of the real impedance value numbers printed on the Smith chart (horizontal axis) represent a conductance value ( $g_c$ ) that is equal to  $G_2/g_{22} - 1$ .

(b) Let each of the imaginary impedance numbers printed on the Smith chart (on fan-out lines) represent a susceptance value ( $jb_c$ ) that is equal to  $jB_2/g_{22}$ , with negative values on the same side

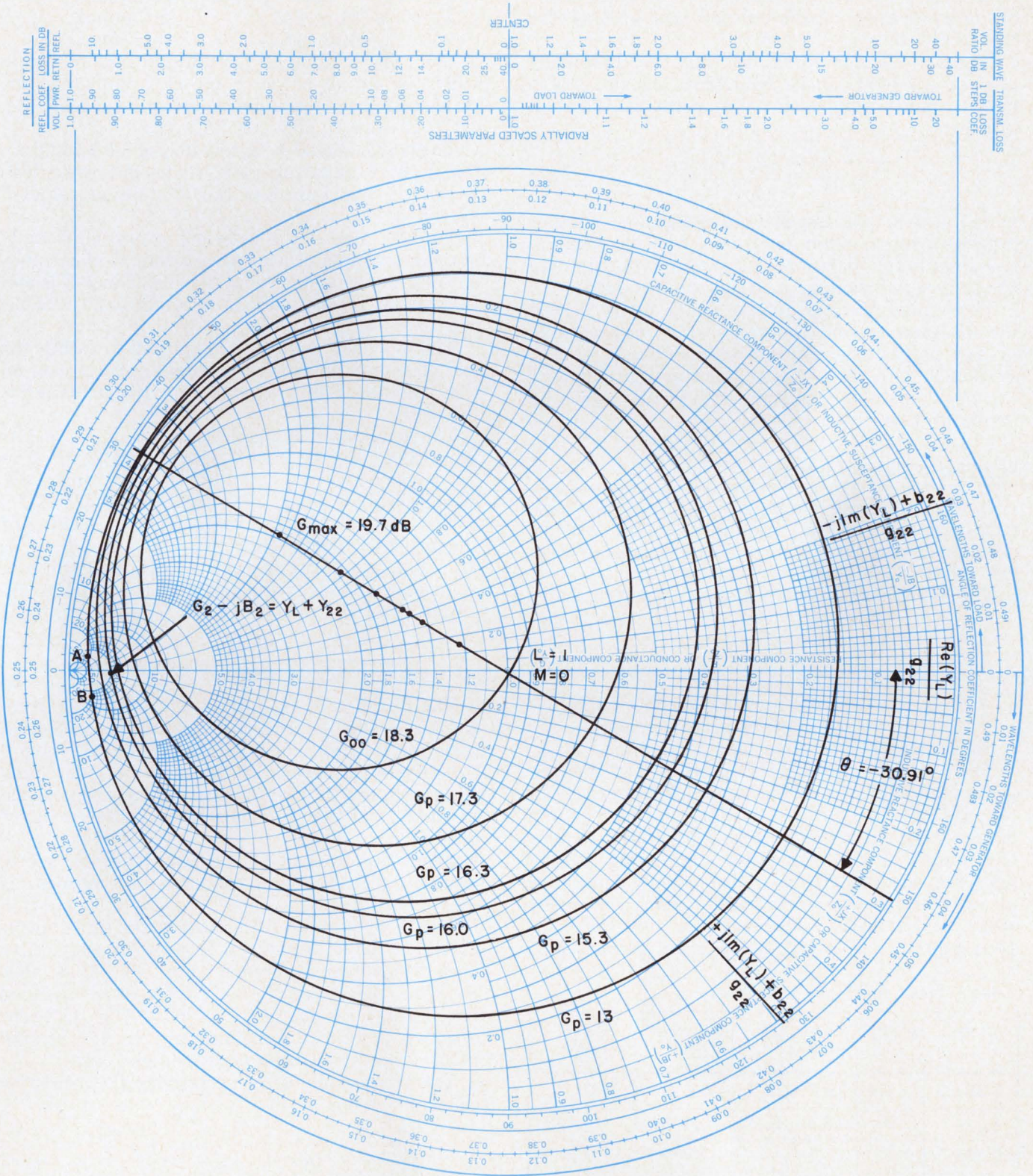

4. Smith chart with superimposed equal-gain circles relates stability, gain, bandwidth and sensitivity for amplifier analysis. Points A and B are used to find the desired load circuit for the design example.

er analysis. Points A and B are used to find the desired load circuit for the design example.

of the chart as are negative reactance values.

The above interpretation permits  $G_2$  and  $jB_2$  values to be obtained from the conventional Smith chart readings and then converted to the corresponding  $Y_L$  value. However, a further simplification can be made so that load values can be read directly from the chart.

The real part of the load can be read directly from any point on the superimposed Smith chart by multiplication of the printed real number for that point by  $g_{22}$ .

Similarly it can be shown that the imaginary part of the load can be read from the imaginary printed chart number for that point by the relationship

$$b_c = \frac{\text{Im}(Y_L) + b_{22}}{g_{22}}, \quad (20)$$

which states that the printed imaginary number representing a given point can be converted to the imaginary part of the load by multiplying by  $g_{22}$  and subtracting  $b_{22}$  from the product.

These modifications to the Smith chart permit the designer to find the value of  $Y_L$  represented by any point inside of the intersection of the  $P_o$  surface and the  $L, M$  plane. All terminations that can provide stable operation with positive gain lie inside of this circle.

### Applying a design example

In the following example a single-stage, common-emitter, 200-MHz amplifier design will be developed with the use of published  $Y$  parameters for the 2N3783 transistor.

The arbitrarily selected design parameters are:

$$\begin{aligned} V_{CE} &= 10 \text{ volts.} \\ I_C &= 4 \text{ mA.} \\ f_o &= 200 \text{ MHz.} \\ BW(3 \text{ dB}) &= 30 \text{ MHz.} \\ \delta &= 0.3 \text{ max (sensitivity factor).} \\ G_p &= 15 \text{ dB min (power gain).} \end{aligned}$$

Source and load terminations = 50 ohms.

The  $\delta$  term represents the sensitivity of changes in input admittance to the stage, with respect to changes in load admittances. This characteristic is particularly important in IF-strip design, because the change in load of a latter stage—due to temperature, loading changes, etc.—should not cause an appreciable change in load of each preceding stage, and thereby significantly detune the complete amplifier. Typical amplifier designs utilize a

$\delta$  value of 0.3 or less. Smaller values of  $\delta$  would represent greater mismatch of the load, resulting in reduced gain. Simultaneously increased isolation between output-load changes and input-impedance variations is, however, obtained.

The common-emitter  $Y$  parameters obtained from the 2N3783 data sheet are:

$$\begin{aligned} Y_{ie} = Y_{11} &= 20 + j13 && \text{millimhos.} \\ Y_{re} = Y_{12} &= -0.015 - j0.502 && \text{millimhos.} \\ Y_{fe} = Y_{21} &= 41.5 - j64 && \text{millimhos.} \\ Y_{oe} = Y_{22} &= 0.25 + j1.9 && \text{millimhos.} \end{aligned}$$

The power gain,  $G_{oo}$ , representing the gain when the output power is the maximum theoretical value for a given input, is determined from Eq. 13. It is equal to 68.04, or 18.3 dB.

This value should be a few decibels higher than the desired operating gain, to permit some load mismatch that improves the "nonunilateralness" of the stage.

To determine if the network is unconditionally stable regardless of load parameters,  $C$  is calculated from Eq. 14 and is equal to 0.895. Since  $C$  is less than unity, the network is unconditionally stable, regardless of load.

The gradient angle  $\theta$  is required to locate the loci of center points for constant-gain circles on the modified Smith chart. Eq. 16 yields  $\theta = -30.91^\circ$ .

The maximum available gain,  $G_{max}$ , as determined from Eq. 18, equals 93.89 or 19.72 dB. The difference between  $G_{max}$  and  $G_{oo}$  is less than 2 dB. Theoretically  $G_{oo}$  is always within 3 dB of  $G_{max}$ .

The distance in  $L, M$  units from the center of the modified Smith chart, or from the  $L = 1, M = 0$  points to the respective centers of the constant-gain circles, is indicated in Eq. 15. For example,  $g$  for the case of  $G_{max}$  is

$$g = \frac{G_{max}}{G_{oo}} = \frac{93.89}{68.04} = 1.38 = K_g.$$

The distance of  $G_{max}$  from the center is, from Eq. 15,  $-0.618$ . Notice that the voltage reflection scale (on the Smith chart) is a linear scale from 0 to unity in the length of the radius of the chart. This scale can be used to set a compass to position the centers of the circles from the center point of the chart.

From Eqs. 15 and 17, then, a listing of gains, location of centers, and radii can be compiled, as shown in Table 1.

The third through fifth rows in the table correspond to the constant-gain circles in one-decibel steps below the reference gain  $G_{oo}$  (18.3 dB). Drawing the constant-gain circles on a modified Smith chart results in the plots of Fig. 4. There are two additional constant-gain circles on the illustration. These will be considered later.

The exact value of the sensitivity factor can be calculated from

$$\delta = \frac{dY_{IN}}{Y_{IN}} = \left| \frac{Y_L}{Y_{22} + Y_L} \right| \cdot \left| \frac{g_{11}}{Y_{11}} \right|.$$

Table 1. Linvil chart gain circle data

g(ratio)	g(dB)	Power gain (dB)	Distance (d)	Radius (r)
1.38= $K_g$	1.4	19.7=( $G_{max}$ )	-0.618	0
1	0	18.3=( $G_{oo}$ )	-0.448	0.448
0.793	-1	17.3	-0.355	0.577
0.630	-2	16.3	-0.282	0.663
0.500	-3	15.3	-0.224	0.742



$$\frac{\left| \frac{Y_{12} Y_{21}}{g_{11}} \right|}{\left| Y_{22} + Y_L + \frac{Y_{12} Y_{21}}{Y_{11}} (e^{j\theta}) \right|} \quad (21)$$

where  $e^{j\theta} = \cos \theta + j \sin \theta$ . However, if  $Y_L$  is considerably larger than  $Y_{22}$ , as is the case for low values of  $\delta$ , and if  $\delta$  is chosen significantly smaller than unity,

$$\delta = \frac{|Y_{12} Y_{21}|}{|Y_{11}| \cdot |Y_L|}. \quad (22)$$

This equation will be used as a first approximation. After finding the resulting value of  $Y_L$  we can then calculate the actual value of  $\delta$  to verify that it is still equal to or less than the selected design value of 0.3.

Solving the simplified  $\delta$  equation for  $Y_L$  with  $\delta \leq 0.3$ , we get:  $|Y_L| \geq 5.33$  millimhos.

If it is assumed that the real part of the load,  $Re(Y_L)$ , is approximately equal to the absolute value of the load  $|Y_L|$ , then the following is true:

$$Re(Y_L) \doteq |Y_L| \doteq \left[ \frac{|Y_L|}{g_{22}} \right] g_{22} \doteq 21.3 g_{22}.$$

This assumption will be carried through to assist in determining the corresponding imaginary part of the load. Although this is not an exact approach, if the resulting final values of  $Re(Y_L) + jIm(Y_L)$ , when inserted in Eq. 21, do not give a value of  $\delta$  greater than 0.3, the load values are valid and usable.

If we consider the real part of the load equal to  $21.3 g_{22}$ , a constant-gain circle that is tangent to a constant-conductance circle, which represents all points for which  $Re(Y_L) = 21.3 g_{22}$ , will provide the maximum possible gain.

To locate this constant-conductance circle on the modified Smith chart, the chart's real numbers are read as  $Re(Y_L)/g_{22}$  values. Since the Smith chart is not highly detailed in this region, a constant-gain circle that is tangent to the printed  $Re(Y_L) = 20 g_{22}$  circle can be used instead. The additional error is small, and the determination of actual chart values is simplified.

None of the original set of computed constant-gain circles is tangent to the  $Re(Y_L) = 20 g_{22}$  constant conductance circle. However, by comparison with the 16.3-dB-gain circle, it is easy to see that a gain of about 16 dB would be tangent to the  $20 g_{22}$  circle. Calculating the center and radius of the 16-dB constant-gain circle, we get:  $g = -(18.3 - 16) = -2.3$  dB. From Eq. 15,  $d = -0.263$ , and, from Eq. 17,  $r = 0.695$ .

The resulting plot of the 16-dB constant-gain circle is tangent to the  $Re(Y_L) = 20 g_{22}$  circle, as shown in Fig. 4. From this point of tangency, the corresponding imaginary part of the load can be read as  $-j2.0$  from the standard Smith-chart scales. This represents an  $Im(Y_L)$  value of  $-2.0 g_{22} - b_{22}$ . Substituting values for  $g_{22}$  and  $b_{22}$ ,

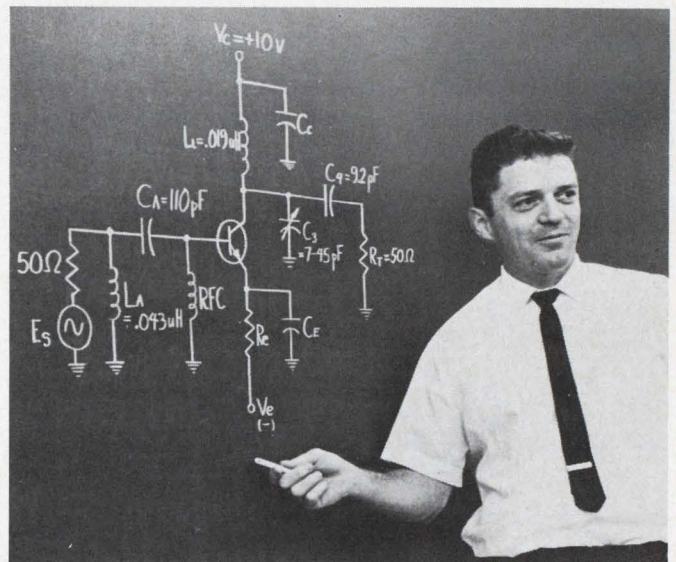

5. Author Lauchner describes the final design of the 200-MHz amplifier circuit in the example.

$$Re(Y_L) = 20(0.25) = 5 \text{ millimhos.}$$

$$Im(Y_L) = -2.0(0.25) - 1.9 = -2.4 \text{ millimhos.}$$

$$\text{or } Y_L = 5 - j2.4 \text{ millimhos.}$$

Inserting  $Y_L = 5 - j2.4$  millimhos into Eq. 21, we verify that  $\delta$  is equal to 0.227, which is less than 0.3. Thus  $\delta$  is within the originally specified limits. A slightly higher gain circle and corresponding lower  $Y_L$  could have been used in the calculation without exceeding a  $\delta$  value of 0.3. At the designer's option, this higher gain condition can be determined by modifying and repeating the previous steps until the maximum allowable value of  $\delta$  is achieved.

### Matching the circuit to its loads

The remaining analysis is directed toward matching the 50-ohm source and 50-ohm final termination to the transistor without changing the effective load that is presented to the transistor from the value of  $Y_L$  previously determined. Simultaneously the bandwidth requirements will be established by proper selection of matching component values.

Since the constant-gain circle passing through the 3-dB bandwidth points will be 3 dB below the 16-dB-gain circle previously determined, the 13-dB, constant-gain circle must be plotted for use in determining the load circuit that will provide the desired 30-MHz bandwidth:  $d = -0.132$ ,  $r = 0.850$

Drawing this circle, as shown in Fig. 4, we locate the values of the load susceptances at the 3-dB bandwidth extremes. Since the conductance will not change with frequency, these points will be at the intersection of the  $Re(Y_L) = 20 g_{22}$  constant-conductance circle, and the 13-dB, constant-gain circle indicated by points A and B on Fig. 4. The values of the standard Smith chart markings are  $-jb_{CA} = -j27$ , and  $jb_{CB} = j23$ .

The values in terms of  $Im(Y_L)$  are:

$$Im(Y_{LA}) = -27 g_{22} - b_{22},$$

$$Im(Y_{LB}) = 23 g_{22} - b_{22}.$$

Thus the change in susceptance over the frequency range of the 3-dB bandwidth is

$$\Delta B = Im Y_{LB} - Im Y_{LA} = 50 g_{22} = 12.5 \text{ millimhos.}$$

To calculate the output circuit capacitance necessary for the required bandwidth, consider the characteristics of a simple L-C parallel resonant circuit. The susceptance change, over the -3-dB bandwidth,  $\Delta B$ , is  $b_1 - b_2$ .

The general equation for  $b_1$  is

$$b_1 = \omega_1 C - \frac{1}{\omega_1 L}. \quad (23)$$

Therefore since  $b_1 = -b_2$ , it can be shown that

$$C_{TOT} = \frac{\frac{1}{2} [\Delta B (\omega_1 + \omega_2)]}{\omega_1^2 - \omega_2^2} = \frac{\Delta B}{2\Delta\omega}. \quad (24)$$

For the desired 30 MHz 3-dB bandwidth, then, the total capacitance necessary to establish the bandwidth is 33.2 pF. This value of capacitance includes the output capacitance of the network and the effective input capacitance of the load.

The above calculations assume that the over-all specified amplifier bandwidth is established in the network output load and is not influenced by the input circuits. This is valid, because in this example the bandwidth of the input matching circuit is purposely selected to be very broad, and hence will have negligible influence on the over-all bandpass.

Next, the output capacitance of the network must be calculated, to determine the portion of  $C_{TOT}$  required in the output load,  $Y_L$ . However, before the output capacitance of the network can be determined, it is necessary to determine the input admittance of the network plus load from

$$Y_{IN} = Y_{11} - \frac{Y_{12} Y_{21}}{Y_{22} + Y_L} = 25.83 + j17.28.$$

The source admittance ( $Y_G$ ) at the network input terminals is equal to the conjugate of the network input admittance for maximum power transfer; therefore, the source admittance is

$$Y_G = 25.83 - j17.28 \text{ millimhos.}$$

The output admittance of the network with the source connected is

$$Y_{OUT} = Y_{22} - \frac{Y_{12} Y_{21}}{Y_{11} + Y_G} = 0.918 + j2.391.$$

The value of  $C_{OUT}$  for the network with conjugate input source attached is

$$C_{OUT} = \frac{B_{OUT}}{\omega} = \frac{2.391 \times 10^{-3}}{2\pi (200 \times 10^6)} = 1.90 \text{ pF.}$$

The capacitance needed in the load to establish the bandwidth is  $C_L = C_{TOT} - C_{OUT} = 31.3 \text{ pF}$ .

Since the load susceptance from the determined value of  $Y_L$  is  $-j2.4$  millimhos, it is made up of the above capacitive susceptance, less the necessary amount of load inductive susceptance, or:

$$L_L = \frac{1}{\omega [\omega C_L - Im(Y_L)]} = 0.019 \mu\text{H.}$$

Next, the 50-ohm final termination must be transformed to an effective resistance at the transistor output, which is equal to the real part of the previously determined load immittance. Since the real part of the transistor load  $Re Y_L = 5.0 \times 10^{-3}$  mho,  $Re Z_L = 200$  ohms. Thus the 50-ohm final termination must be transformed up to 200 ohms at the center frequency. This is accomplished with a simple capacitive transformer.

Since the real part of  $Y_{IN}$  is a higher conductance than the generator ( $Y_G' = 20 + j0$  millimhos), the transistor input must be transformed to the generator admittance with a matching network. Inductive transformation should be used.

One way to obtain the required matching components is from a specially formulated Smith chart. This chart consists of a normalized admittance chart superimposed on a normalized impedance chart (basically two Smith charts back-to-back). By using the admittance chart for matching network shunt elements and the impedance chart for series elements (moving on the real circles in each case), it is possible to match to a 50-ohm source without introducing loss in the matching network.

Plot the normalized  $Y_{IN}$  point on the admittance chart, then move along the normalized constant-reactance circle on the other impedance chart for an indicated distance equal to  $-X_{series}$ . Then move along the constant-susceptance circle for an indicated distance equal to  $-Y_{shunt}$ , and read the actual values from the chart.

To complete the final design shown in Fig. 5, an RF choke is added to the base circuit for a dc-bias return. Capacitors  $C_C$  and  $C_E$  are RF by-passes, and resistor  $R_E$  and voltage  $V_E$  are used to set the desired bias current to 4 mA.

As indicated earlier, a device that is unconditionally stable at one frequency may be potentially unstable ( $C$  greater than 1) at another frequency with certain load terminations. However, with proper termination, as determined from the Linvill chart, stable operation can be obtained.

When accurate data cannot be interpolated on the Linvill chart, the designer can use a larger chart or employ these options:

(a) He can work, with reduced accuracy, in the crowded region.

(b) He can select a constant-gain circle tangent to a constant-conductance circle in the region of  $20 g_{22}$  on the chart, and accept the resulting larger sensitivity factor. The resultant sensitivity factor can be calculated from Eq. 21.

(c) He can select another device that will give more favorable working conditions. ■ ■

#### References:

- "Transistors and Active Circuits," John G. Linvill and James F. Gibbons, McGraw-Hill, 1961, Chapter 11.
- "High-Frequency Amplifier Design Using Admittance Parameters," G. Johnson, P. Norris, F. Opp, Elredio Technology, Nov.-Dec., 1963.

This article was developed from the Nov. 4, 1965 issue of the Motorola Engineering Bulletin, available from Motorola.

# YOU CAN BREADBOARD...

This MOS NAND Gate...

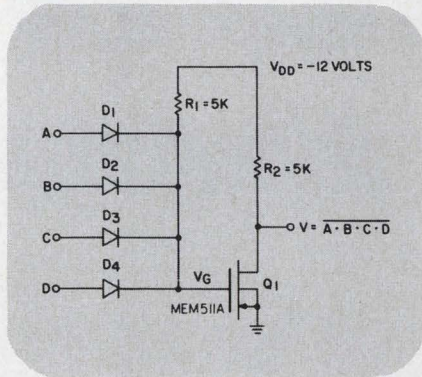

This MOS Shift Register...

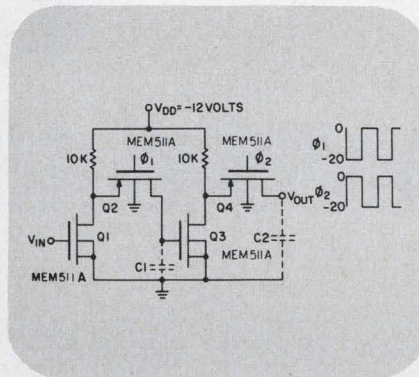

This MOS Memory Circuit...

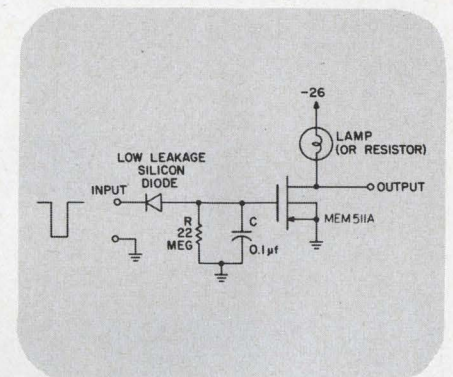

This MOS Tuned Amplifier...

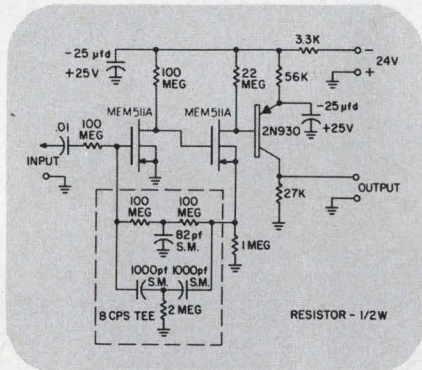

Plus these...

- Digital Differential Analyzers
- Multiplexers
- Up-Down Counters
- Choppers

# WITH THIS

## ...for only \$79<sup>50</sup>

**A \$250.00 VALUE (Includes 25 MEM511A MOSFETS)**

Here's an ideal way to bring your integrated circuit ideas to the breadboard stage at **extremely low cost** . . . General Instrument's MOSFET KIT provides 25 MEM 511A MOS field effect transistors, plus a special MOS CIRCUIT DIGEST containing a wealth of hard-to-get design information. That's a \$250 value for only \$79.50! Kits are available now, off-the-shelf, from your authorized GI Distributor. Call him today for immediate delivery.

**GENERAL INSTRUMENT CORPORATION  
SEMICONDUCTOR PRODUCTS GROUP**

600 West John Street, Hicksville, New York

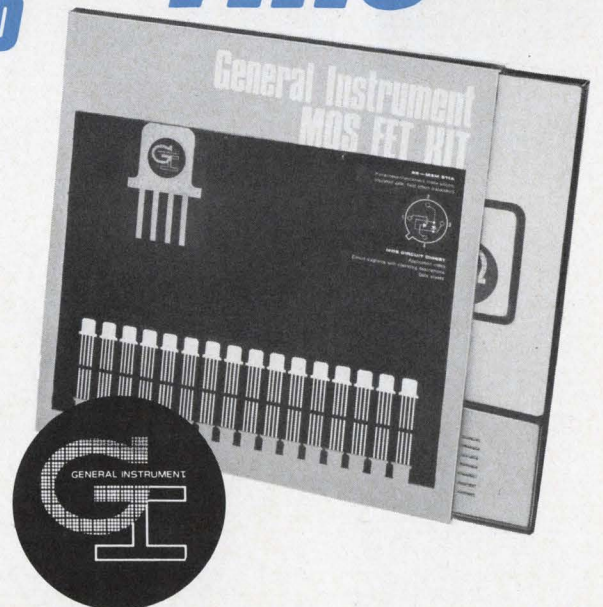

ON READER-SERVICE CARD CIRCLE 21



**LOOK TO THE LEADER**  
IN INTEGRATED CIRCUITS

# 930

**Immediately Available**

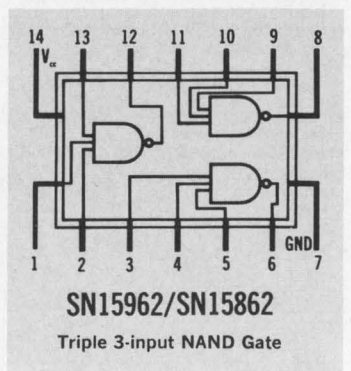
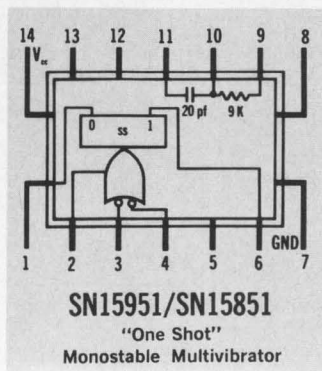
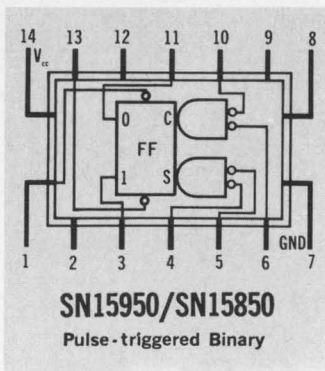
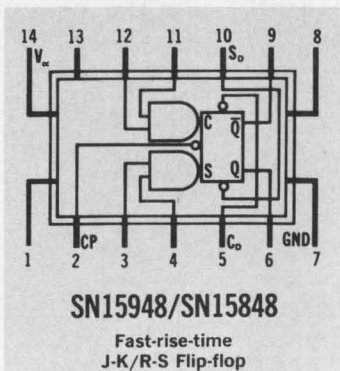
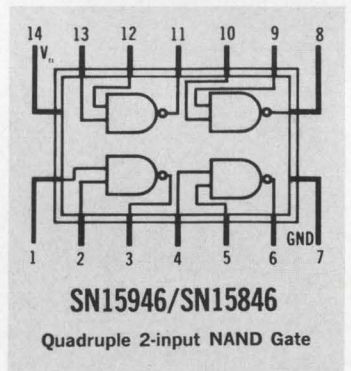
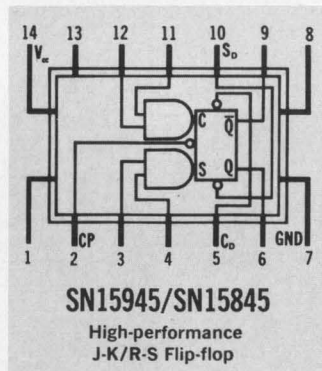
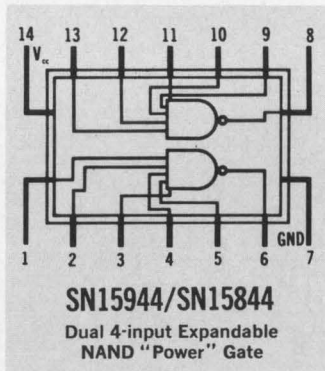
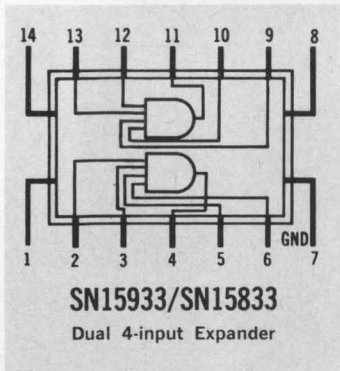
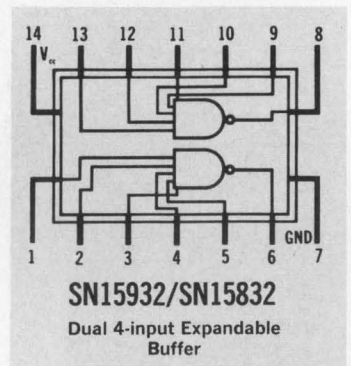
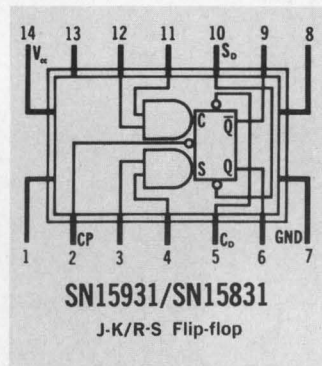
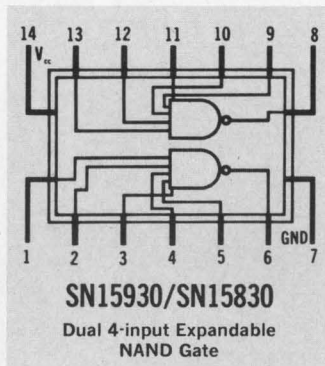
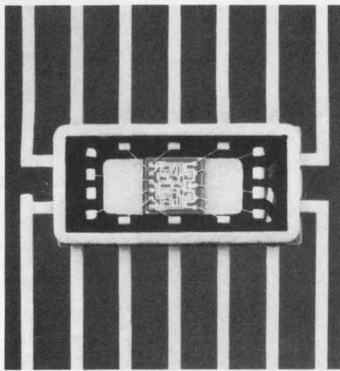

# DTL

## from Texas Instruments

Your production requirements for 930-series DTL integrated circuits can be filled by Texas Instruments — *today!* The full family of eleven circuit types is available off-the-shelf from TI and its nation-wide network of distributors.

TI's Series 15930 DTL integrated circuits are direct equivalents . . . pin-for-pin and spec-for-spec . . . of competitive types. You have a choice of temperature ranges — full military or industrial — in the standard TO-84 hermetically sealed flat package.

These units are available from the industry's largest and most advanced integrated-circuit manufacturing facility. TI's Series 15930 DTL circuits are being volume-produced to fulfill your largest requirements — whether they be 1,000 or 100,000 or 10,000,000 units.

For TI 930-series DTL circuits, contact your local TI sales engineer or distributor. He can also provide information on TI's full line of more than 125 types of digital and linear integrated circuits.

### TYPICAL CHARACTERISTICS

Parameter	Basic Gate	Flip-flop
Propagation delay	25 nsec	50 nsec
Power dissipation	5 mw	20 mw
Fan-out	8	7
D-c noise margin	750 mv	750 mv
Supply voltage	4.5 to 5.5 v	4.5 to 5.5 v
Temperature range		
Series 15930	-55° to +125°C	-55° to +125°C
Series 15830	0° to 70°C	0° to 70°C

Typical circuit diagram for Series 15930/15830 NAND gate

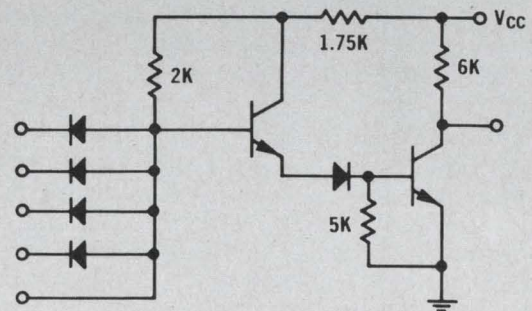

## TEXAS INSTRUMENTS

INCORPORATED

13500 N. CENTRAL EXPRESSWAY  
P. O. BOX 5012 • DALLAS 22, TEXAS

# Need a pedestal-free gate? Use a diode bridge circuit and balance out those unwanted spurious gating signals.

High-speed gates are often plagued by coupling of the gating signal to the output. The result is an output signal that rides on a "pedestal." To eliminate this spurious signal, a bridge circuit can be used to balance out the undesirable gating signal. Though this particular discussion deals only with diode gates, this concept can be easily extended to designs using transistors or other devices.

Let's consider the design of diode gates.

The choice of circuit configuration, a series or shunt type of gate, is dependent on the output and input impedances of the circuits to be gated.

A gate functions as a variable impedance connected between a source and a load. In diode gates the impedance varies from a few ohms, when the diodes are forward-biased, to a few megohms, when the diodes are back-biased. These limitations on impedance variation restrict circuit performance and dictate the choice of circuit configuration.

The two basic gate configurations are shown in Fig. 1. The variable impedances, connected either in series or in shunt with the load, are shown within the dotted lines and represent either single diodes or combinations of diodes.

The following analyses are for variable impedances using single diodes, where  $R_f$  is the diode forward-resistance,  $R_b$  is the diode back-resistance and  $C_b$  is the diode capacitance. It will be shown later that results obtained for the single diode are applicable to practical diode bridge circuits.

In this analysis, the ratio of the output voltage when the gate is on ( $e_{on}$ ) to the output voltage when the gate is off ( $e_{off}$ ) is used as a measure of circuit performance under static conditions only. Assume that the diodes are biased properly for each circuit condition analyzed. Transient considerations will be discussed later.

Consider first the series gate, Fig. 1a. The gate is ON if the switch is connected to  $R_f$  and OFF if the switch is connected to  $R_b$ . Poor gating results if the value of the load resistance is of the same order as the value of  $R_b$ , since the attenuation is then low for either position of the switch. If the value of  $R_L$  is of the same order as the value of  $R_f$ , the gate can function as desired. Let  $R_L$  equal  $R_f$ , assume  $R_s$  is equal to zero, and neglect  $C_b$  for

the moment. With the gate ON,

$$e_{on} = \frac{e_s}{2}.$$

With the gate OFF,

$$e_{off} = \frac{e_s R_L}{R_b + R_L} = \frac{e_s R_f}{R_b + R_f}.$$

Since  $R_b \gg R_f$  for a diode, this reduces to

$$e_{off} \approx \frac{e_s R_f}{R_b}.$$

The ratio of  $e_{on}$  to  $e_{off}$  is

$$\frac{e_{on}}{e_{off}} \approx \frac{R_b}{2R_f}.$$

A non-zero source resistance adds to  $R_f$  and decreases this ratio. For high-frequency input signals,  $C_b$  also decreases this ratio.

Now consider the shunt gate, Fig. 1b. The gate is ON if the switch is connected to  $R_b$ , OFF if the switch is connected to  $R_f$ . Poor gating action results if the value of the source resistance is of the same order as the value of  $R_f$ , since the attenuation is then low for either position of the switch. If the value of  $R_s$  is of the same order as the value of  $R_b$ , the gate can function as desired. Let  $R_s$  equal  $R_b$ , assume  $R_L$  is infinite, and again neglect  $C_b$ . Performing the same operations as for the series case, we find the ON to OFF ratio of a shunt

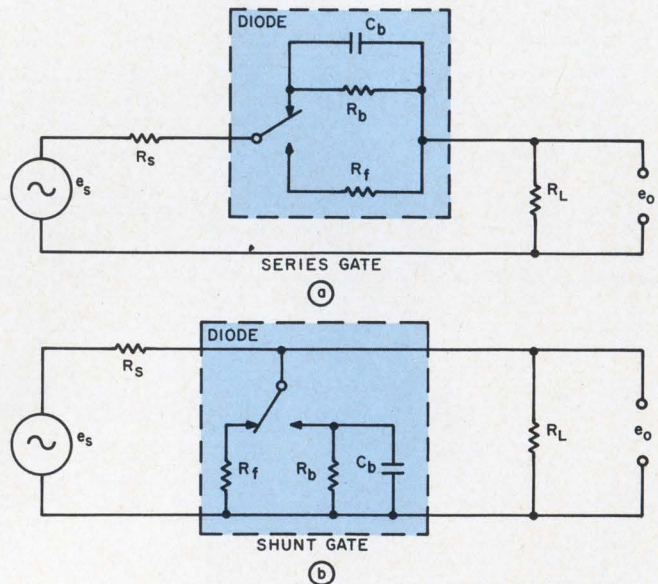

1. Basic gate configurations, series gate (a) and shunt gate (b), are shown in equivalent circuit form, within the dotted lines.

R. E. Morden and D. L. Hammond, E. O. Hulburt Center for Space Research, U. S. Naval Research Laboratory, Washington, D. C.

gate to be:

$$\frac{e_{on}}{e_{off}} = \frac{R_b}{2R_f}$$

A finite load resistance has the effect of decreasing  $R_b$  and so decreases the ON-OFF ratio.  $C_b$  again decreases this ratio at high frequencies.

The simplified analysis above emphasizes the following distinction between series and shunt gates:

- A series gate works well only if the source and load impedances are low relative to  $R_b$ , the diode back-resistance.
- A shunt gate works well only if the source and load impedances are high relative to the  $R_f$ , the diode forward-resistance.

### Eliminating the pedestal

The introduction of extraneous signals at the output by coupling of the gating signal to the load causes a severe problem in practical gating circuits. Consider, for example, the simple circuit of Fig. 2a. In addition to the desired signal present at the output terminal, there will be a voltage level due to  $e_g$ . When  $e_g$  changes from + for the ON condition to - for the OFF condition, the level at the output will change accordingly. The output signal will appear to be "riding on a pedestal," as shown in Fig. 2b. For many applications this pedestal is undesirable.

The most natural way to try to get rid of the gating signal levels at the output is to capacitively couple the output. This approach is sometimes satisfactory, but capacitive coupling has the following drawbacks:

- Direct coupling between input and output is impossible.
- Gating signal transitions are inevitably coupled to the output.
- If the gating rate is near the frequency of the

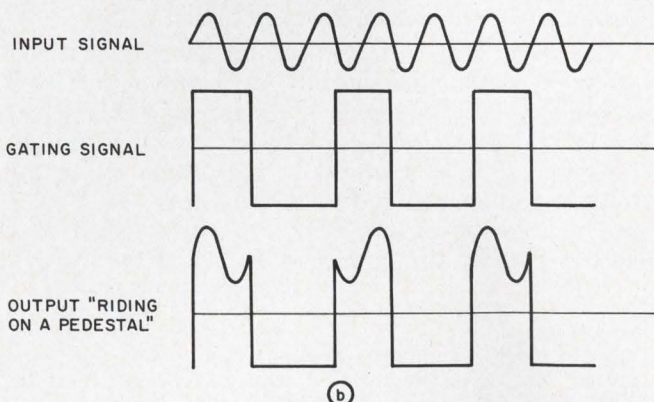
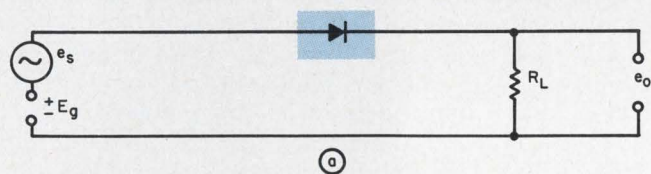

2. Basic series gate (a) and its associated voltage waveforms (b). Note that the gating signal feeds through to the output, giving a "pedestal" effect.

input signal, any capacitor that will couple the input signal will also couple the gating signal.

A more satisfactory way of eliminating the pedestal is to prevent its appearance in the first place. If the pedestal is to be avoided at the gate output, the diodes must function in such a way as to block the gating current from flowing to the load. This requirement can be met by a variety of circuit configurations, all of which share the characteristic of having the gating signal appear across a bridge circuit that is balanced at the output terminals. Obviously the pedestal is reduced only to the extent that the bridge is actually balanced; so care must be used in matching components.

A general bridge structure, with the input signal and gating signal current paths indicated, is shown in Fig. 3. The bridge resistors represent diodes that are either all biased forward or all biased backward, depending on the polarity of the gating signal. When the bridge resistors are all the same and equal to  $R$ , the resistance of the bridge at its output terminals is equal to  $R$ . Then the voltage divider formed by the series resistor  $R$  and the equivalent bridge resistor  $R$  divides the signal voltage equally. The two output ports will have equal voltages,  $e_o$ , due to  $e_s$ , and zero voltage due to  $e_g$ .

The position of the bridge with respect to the load resistor (series or shunt) determines whether  $R$  should be chosen on the order of  $R_f$  or of  $R_b$ , as discussed previously. Note that the analysis of the circuits shown in Fig. 1 applies directly to the diode bridge circuit, since the resistance at the bridge terminals is either  $R_f$  or  $R_b$ .

The requirement of a ground terminal in the bridge circuit complicates the situation to some extent, although the fundamental principle still applies. If one output terminal is grounded, the gating signal applied to the bridge must be balanced with respect to ground. On the other hand, if a gating terminal is grounded, both the input and the output must be balanced with respect to ground.

Even in the pedestal-free circuits, extraneous outputs in the form of voltage spikes often contaminate the gated signal. The causes of these spikes and the techniques for reducing them are

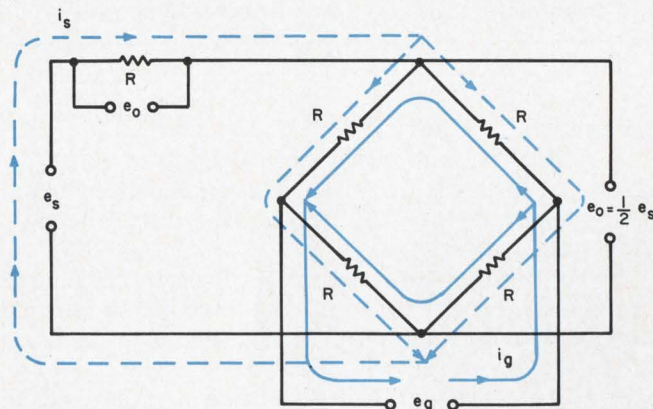

3. Diode bridge can be used as a gate circuit. The equivalent impedance of the bridge is equal to the impedance of any one of the diodes, if they are all matched.

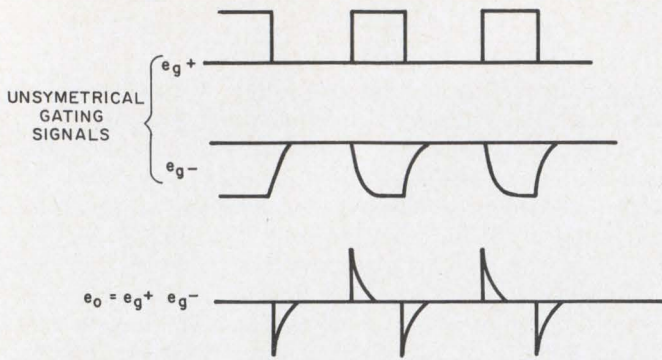

4. Unsymmetrical gating signals or poor diode matching will result in spikes at the output.

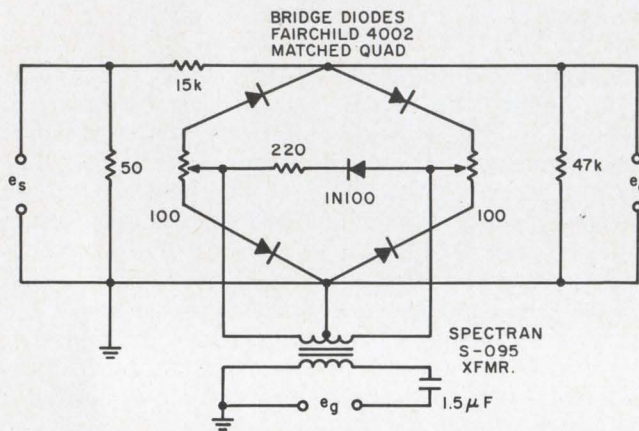

5. Practical shunt gate uses a transformer to isolate the gate driver from the gate.

#### Series and shunt gate specifications

	Shunt gate*	Series gate**
$f_g$	5 to 100 kHz	100 Hz to 1 MHz
$e_g$	2.5 V p-p square wave	2.0 V p-p negative square wave
$f_s$	dc to 100 kHz	100 kHz to 2 MHz
$e_s$	1.0 V p-p max	2.0 V p-p max
$e_{on}/e_{off}$	> 40 dB @ $f_s = 100$ kHz	> 40 dB @ $f_s = 1$ MHz
Extraneous output ( $e_s = 0$ )	< 50 mV p-p	< 50 mV p-p
Output risetime	0.5 $\mu$ s into 11.5 pF	25 ns into terminated 50 ohm cable

\*Fig. 5—\*\*Fig. 6

as follows:

- Gating signals must be precisely matched in shape as well as in amplitude. Otherwise spikes will appear during the output rise and fall time, as shown in Fig. 4.
- To prevent the coupling of high frequency transients to the output, the circuit should be designed to provide reactive balance over as wide a frequency range as possible.
- Careful design will eliminate any capacitive paths outside the bridge that may couple the gating signal to the output.
- Inequality in diode switching times can cause

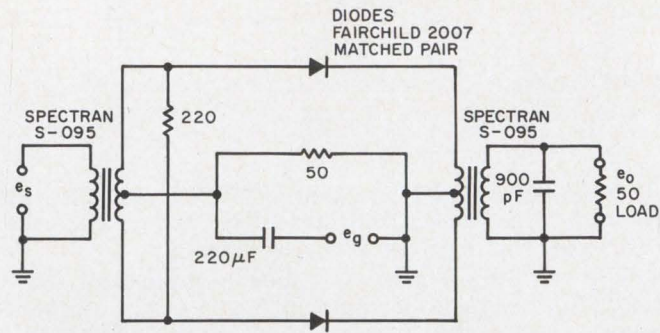

6. Series gate uses a grounded gate-driver circuit. Transformer coupling provides the required isolation.

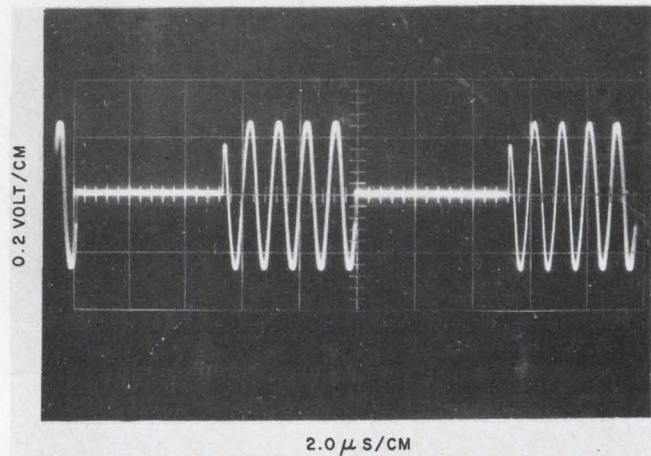

7. Gated one megahertz signal is unhampered by feed-through of the gating signal. Gating frequency is 100 kHz.

momentary unbalance, resulting in voltage spikes. This effect may be reduced by choosing fast switching diodes.

Small shunt capacitors can help reduce the spikes that remain, but only at the expense of output rise time.

#### Some practical circuits

The circuit shown in Fig. 5 is a shunt-gating circuit with a grounded input and output and a floated gating signal. This circuit is often used as a balanced modulator. The fifth diode is added to keep the transformer load approximately constant. When the bridge diodes are forward-biased, the gate is OFF. When they are back-biased, the gate is ON. The circuit's electrical characteristics are given in the accompanying table.

Fig. 6 shows a series-gating circuit with a balanced input and output and an unbalanced gating signal. When the diodes are forward-biased, the gate is ON. When they are back-biased, the gate is OFF. Ground is reestablished at the input and output by means of transformers. Fig. 7 is a photograph of a 1-MHz sine wave gated at a 100-Hz rate by the circuit of Fig. 6. ■ ■

#### References:

1. B. Chance et al, "Waveforms," Massachusetts Institute of Technology Radiation Laboratory Series, Vol. 19, Chapters 10 and 11, McGraw-Hill Book Company, Inc., New York, N. Y., 1949.
2. J. Millman and H. Taub, "Pulse and Digital Circuits," Chapter 14, McGraw-Hill Book Company, Inc., New York, 1956.



## CTS Cermet Trimmers

$\pm 100 \text{ PPM}/^\circ\text{C}$  T.C. Available (Series 185)

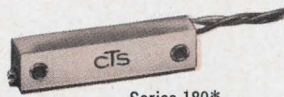

Series 180\*  
1-1/4" x .325 x .295  
Rectilinear



Series 170\*  
1/2" Square

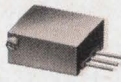

Series 171\*  
1/2" Square

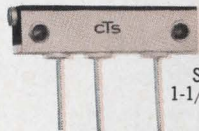

Series 180PC\*  
1-1/4" x .325 x .295  
Rectilinear

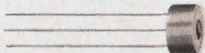

Series 385\*  
11/32" dia., single turn



Series 172\*  
1/2" Square



Series 660PC  
3/8" dia., single turn



Series 600LT\*  
2" dia., single turn  
locking bushing



Series 630  
1/2" dia., single turn



NEW Series 630 P  
1/2" dia.  
single turn

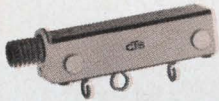

NEW Series B180  
1.30 X .378 X .385  
Rectilinear

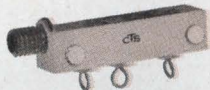

NEW Series B185  
1.30 X .378 X .385  
Rectilinear

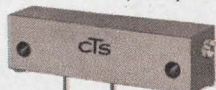

NEW Series 185 PC  
1-1/4" x .345 x .290  
Rectilinear



NEW Series 185  
1-1/4" x .345 x .290  
Rectilinear

## CTS Wirewound Trimmers

Infinite Resolution Available. Stability .025% (Series IRW)



Series K350\*  
1/2" dia., single turn  
knob operated

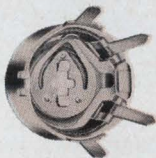

Series 110\*  
3/4" dia., single turn

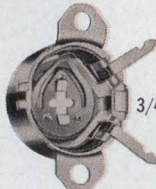

Series 112\*  
3/4" dia., single turn



Series P115\*  
3/4" dia., single turn

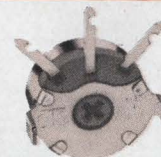

Series 115  
3/4" dia., single turn



Series 350\*  
1/2" dia., single turn



Series XPC110  
3/4" dia., single turn



Series 117\*  
3/4" dia., single turn

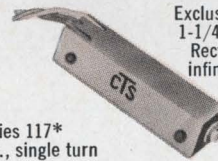

Exclusive Series IRW  
1-1/4" x .325 x .295  
Rectilinear spiral  
infinite resolution



Series 160  
1" x .320 x .180  
Rectilinear



NEW Series 116  
3/4" dia.  
single turn

## CTS Carbon Trimmers

for Lowest Prices

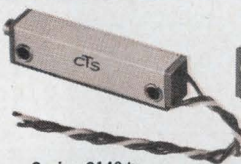

Series C140\*  
1-1/4" x .325 x .295  
Rectilinear

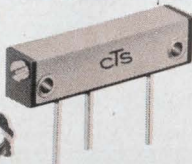

Series C140PC\*  
1-1/4" x .325 x .295  
Rectilinear



Series 220\*  
7/16" x 1/2" single turn



Series 330  
1/2" dia., single turn



Series U201\*  
19/32" dia., single turn  
knob operated









Series X201\*  
19/32" dia., single turn  
knob operated



NEW Series 330 P  
1/2" dia.  
single turn

# 7 New Trimmers added to CTS' Extensive Line

CTS TECHNOLOGICAL SUPERIORITY GIVES YOU:

-  Broadest Line of cermet trimmers.
-  Wide range of wirewound and carbon trimmers.
-  Prices from 10¢ to \$17.60 for industrial, military and entertainment applications.
-  Engineering versatility for challenging design requirements.
-  Precision controlled production from raw materials to finished product.
-  Unsurpassed mass production capability.

\*Immediately available from distributor stocks.

CTS will also design to your exact specifications. CTS is a major trimmer supplier.

Request New Time-Saving Trimmer Selection Catalog. Contains complete technical data for every CTS trimmer.

Sales Offices and Representatives conveniently located throughout the world



Founded 1896

**CTS**  
CORPORATION  
Elkhart, Indiana

### Principal Products

Variable Resistors  
Selector Switches  
Loudspeakers  
Trimming Potentiometers  
Microminiature Components  
& Circuit Packages  
Crystals, Filters,  
Oscillators & Ovens

### Subsidiaries:

CTS of Asheville, Inc., Skyland, N. C.  
CTS of Berne, Inc., Berne, Indiana  
CTS of Paducah, Inc., Paducah, Kentucky  
Chicago Telephone of California, Inc.,  
South Pasadena, California  
CTS of Canada, Ltd., Streetsville, Ontario  
CTS Microelectronics, Inc., Lafayette, Ind.  
CTS Research, Inc., Lafayette, Indiana  
CTS Knights, Inc., Sandwich, Illinois



# Use an IC counter next time!

You can build a completely integrated counting circuit by using sequential majority-logic elements.

Need a counting circuit? Why not use an integrated approach to your design and build a complete counter in the size of a standard flat-pack?

This can be done by using arbitrary length counters. Because of their iterative nature, these counters use circuits of extreme regularity and simplicity. This is a real advantage when designing integrated circuits since circuit complexity has to be avoided in order to achieve low power dissipations in the smallest possible circuit area. By using a novel circuit design, the integrated counter can be easily built with majority-logic gate elements.

## Majority-logic is versatile

A majority-logic element can be defined as an element whose output state corresponds to the majority of the input states. For a binary-valued majority-logic element with three inputs, the output will be a 1 only if two or more of the inputs are 1. For inputs  $A$ ,  $B$  and  $C$ , the output  $Z$  is expressed in Boolean algebra as:

$$Z = AB + AC + BC.$$

If the output  $Z$  is fed back to input  $A$ , the equation becomes:

$$Z = ZB + ZC + BC$$

Fig. 1 shows the symbolic representation of this element. The additional output  $\bar{Z}$  from the circular node is the complement of the normal output  $Z$ .

This element is the basic building block for the design of arbitrary length counters. The elements are connected in a network to perform, as shown in Fig. 2, the function:

$$Z_n = Z_n \cdot \bar{Z}_{n-1} + Z_n \cdot C + \bar{Z}_{n-1} \cdot C,$$

where  $Z_n$  is the output of the sequential majority-logic element  $M_n$ ,  $\bar{Z}_{n-1}$  is the complemented output of element  $M_{n-1}$ , and  $C$  is the clock signal. If any odd-number  $N$  elements are connected in a ring in this manner, a counter of sequence length  $N$  is realized. For example, a ternary counter and its sequences of output states are shown in Figs. 3(a) and (b). The network functions as a modulo 3 counter since it returns to its initial state after

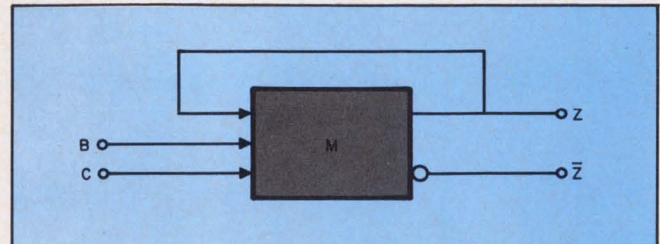

1. Majority-logic gate has its output fed back to the input, making the output dependent on the input sequence.

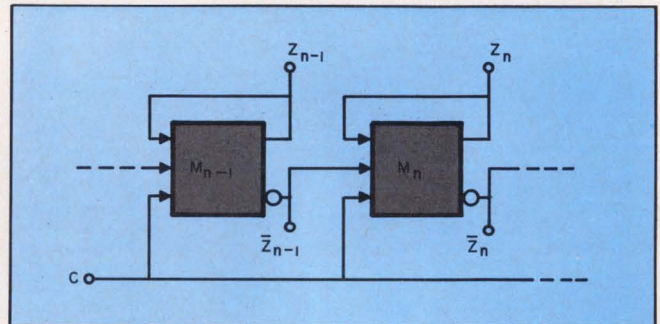

2. Arbitrary length counter is built by cascading majority-logic gates to obtain the required sequence length.

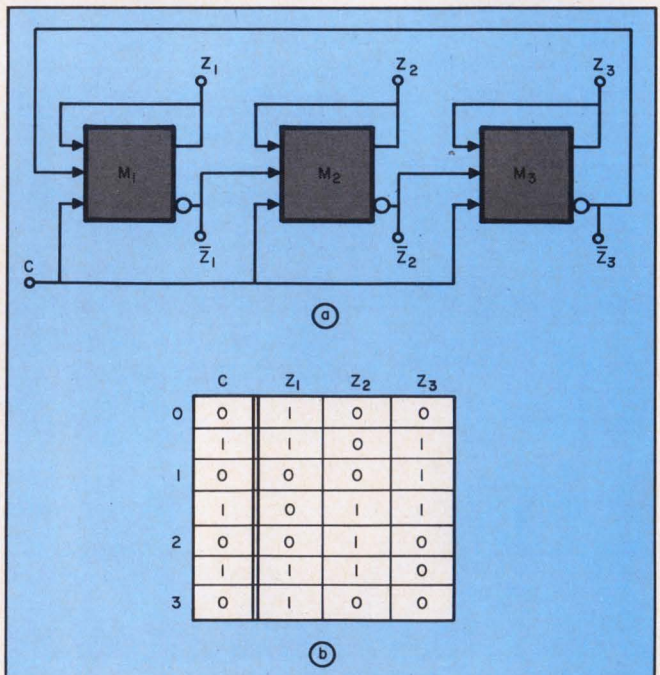

3. Ternary counter uses three majority-logic gates (a). Note that the output states (b) change singly and in the same direction as the clock signal.

three clock pulses. Also, for each change of state of the clock signal only one of the outputs changes state, and in the same direction as the clock signal: i.e., between counts 1 and 2, as  $C$  changes from 0 to 1,  $Z_2$  changes from 0 to 1; and as  $C$  changes back from 1 to 0,  $Z_3$  changes from 1 to 0. This operation ensures that the network is race-free. Since the clock signal is applied simultaneously to all the elements, the network is also essentially hazard-free. A quinary counter is realized by cascading five elements as illustrated in Fig. 4a.

Its sequence of output states is shown in Fig. 4b. A quick rule of thumb to determine which output changes state is:

- When two adjacent outputs are in state 0 and the clock changes from 0 to 1, the output to the right changes from 0 to 1.
- When two adjacent outputs are in state 1 and the clock changes from 1 to 0, the output to the right changes from 1 to 0.

To count an even sequence length, one of the elements in the network is modified slightly. The ternary counter can be modified by adding an AND gate as shown in Fig. 5a. The equations describing  $Z_1$  and  $Z_2$  remain unchanged, but  $Z_3$  is inhibited by  $Z_2$  and becomes:

$$Z_3 = \bar{Z}_2 Z_3 (C + \bar{Z}_2) + C \bar{Z}_2,$$

which simplifies to,

$$Z_3 = \bar{Z}_2 (C + Z_3).$$

Fig. 5b shows the sequence of output states for  $Z_1$ ,  $Z_2$  and  $Z_3$ . The network returns to its initial state after two clock pulses, thus functioning as a binary counter. Although multiple transitions are involved between counts 1 and 2 as  $C$  changes from 0 to 1, race conditions do not exist because the final output states are assured and the network operates reliably.

This method of binary counting can be easily extended to count any even sequence length  $N$  by connecting  $(N+1)$  majority-logic elements in series.

#### Circuit design uses current-mode technique

Current-mode switching techniques are used to maximize the operating speed of the counting circuit. The transistors thus operate in the non-saturated mode and are not subject to storage-time effects. A two-input, current-mode NOR gate is shown in Fig. 6. To implement the sequential majority-logic function, four of these gates can be connected as shown in Fig. 7. The emitter-follower outputs of the three, two-input NOR gates are wired directly together, and the resulting "wired-OR" output is inverted by the single-input NOR gate. However, this basic design must be somewhat modified since it achieves neither the circuit economy nor the low power dissipation that integrated technology requires. Also, the propagation delay from input to output is twice that of a single current-mode gate.

The modification involves adding resistors at one input and connecting the reference point to

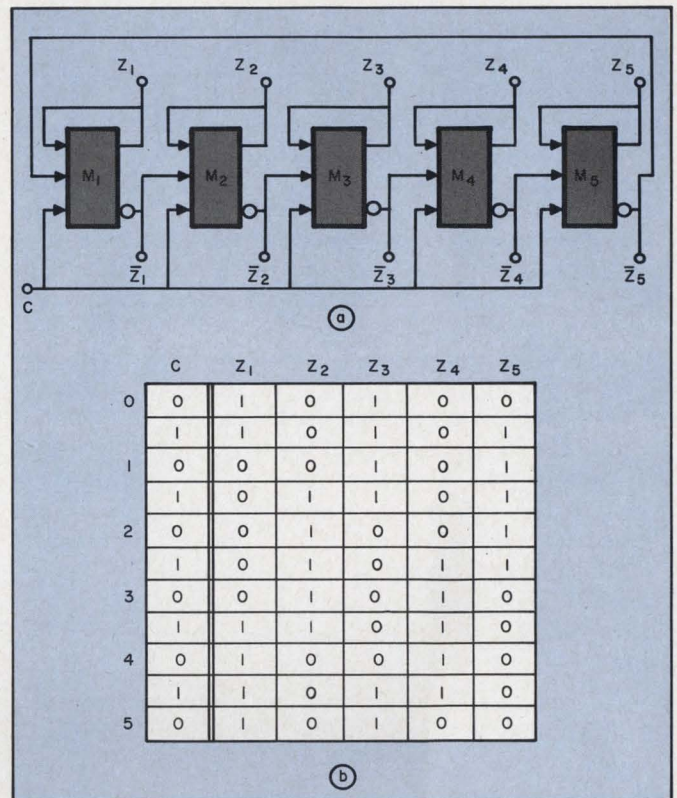

4. Quinary counter has five majority-logic gates (a). On the fifth pulse, outputs return to their initial setting (b).

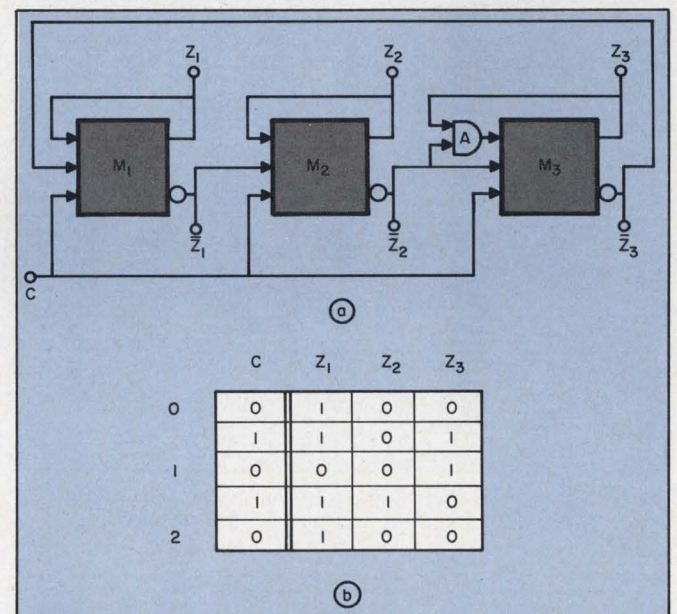

5. Binary counter uses an additional AND gate to inhibit  $Z_3$  (a). After two counts, the output states (b) return to their original setting.

the emitter-follower output. This circuit, shown in Fig. 8a has a voltage transfer characteristic with hysteresis. The two equal resistors ( $R$ ) provide a voltage  $V_{in}$  at the input which is the mean of inputs  $B$  and  $C$ . By inspecting Fig. 8b, it can be seen that the function performed by the circuit is,

$$\bar{Z} = \bar{B} \cdot \bar{C} + \bar{Z}(\bar{B} + \bar{C})$$

which is the same as,

$$Z = \overline{ZB+ZC+BC}.$$

Thus this circuit performs the complemented sequential majority-logic function. Compared to the conventional circuit of Fig. 7, there is a fourfold reduction in circuit complexity and power dissipation. The effect of the hysteresis and input resistors is to increase the propagation delay. A graph of propagation delay ( $T_{prop}$ ) vs input resistance ( $R$ ) is shown in Fig. 9. The propagation delay for zero-hysteresis, with the reference point connected to ground, is also given. By making the input resistors smaller, the propagation delay is decreased with a resulting increase in the input loading.

For this circuit, the 1 and 0 level input and output voltages are nominally plus and minus 0.4 volt. In the worst case, when  $B$  and  $C$  are in opposite states, the voltage across the input resistors will be 0.8 volt. If  $R = 80$  ohms, 5 mA will flow from  $B$  to  $C$ . To keep the input loading down, it is desirable to use input resistors larger than 80 ohms.

The optimized version of the sequential majority-logic gate is shown in Fig. 10. Absolute resistor values are determined by the power-speed trade-off criteria, and their relative values are determined by the signal-swing requirements and the

degree of temperature compensation desired.

The transistor current source  $T_3$ , supplies a current which is independent on input voltages and partially compensates for the variation of output voltage with temperature. This variation is largely due to the temperature dependence of the base-emitter voltage of  $T_3$ . Since the current source is also temperature-sensitive and this current flows through  $R_1$ , whether  $T_1$  or  $T_2$  is conducting, the 1 and 0 level output voltages both move outwards with increasing temperature and remain equidistant with respect to ground. This relationship is shown in Fig. 11.

Though current-mode logic circuits usually suffer from low noise margins, the hysteresis effect in this circuit provides considerable improvement in noise immunity. Input noise immunity is defined as the noise voltage impressed on an input which will just cause the output to change states.

Theoretical calculation and experimental verification have shown that the output of the circuit shown in Fig. 10 is triggered to its opposite state when the input base voltage is about 130 mV below the nominal output voltage ( $\pm 400$  mV). When inputs  $B$  and  $C$  are in opposite states, the noise immunity is twice the input base threshold voltage, due to the dividing action of the input resistors, or about 540 mV. Since the signal swing

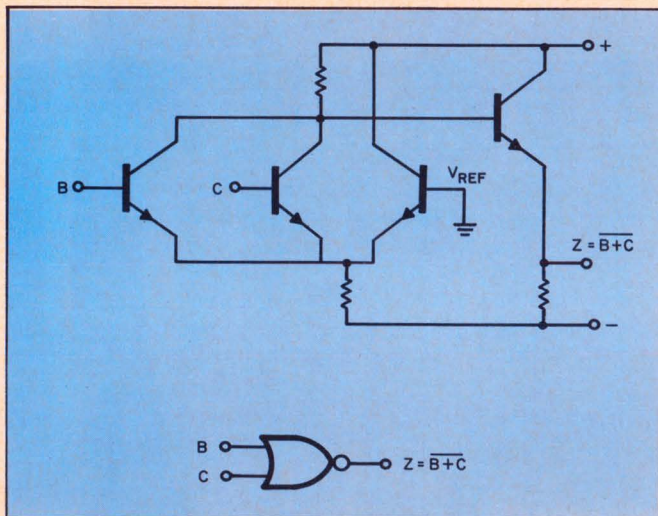

6. Current-mode NOR gate is simple to build in integrated form. Storage-time effects of saturated gates are avoided.

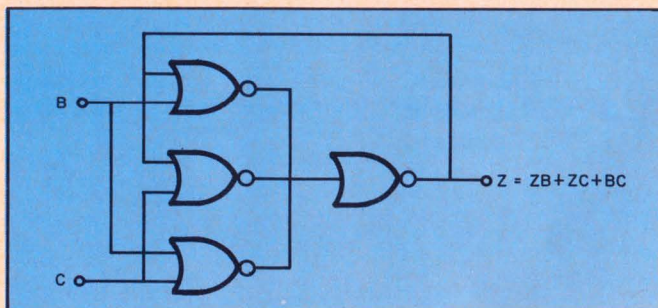

7. Sequential majority-logic element requires four NOR gates to achieve the required logic. This results in a complicated circuit design.

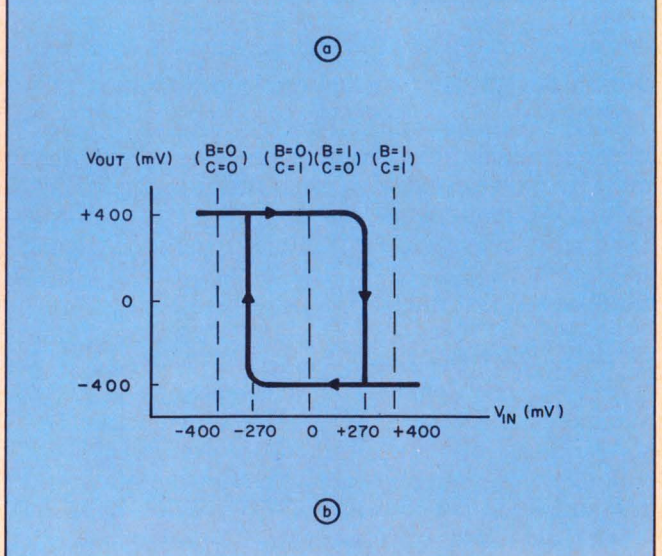
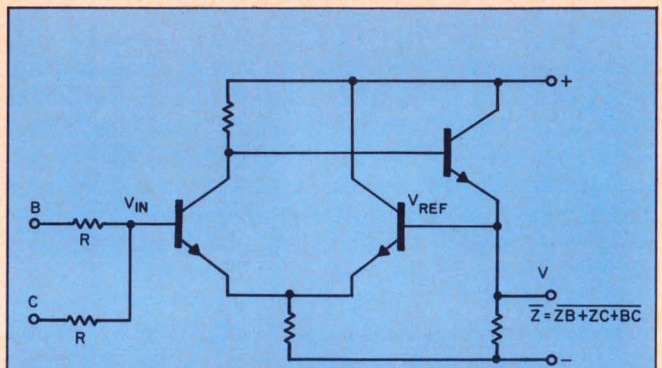

8. Majority-logic circuit is made by slightly modifying the current-mode NOR gate. Note the hysteresis in the transfer characteristic (b).

increases with increasing temperature, the input noise immunity also increases with increasing temperature. If a counting network comprised of several sequential majority-logic gates is integrated on a single silicon chip, the circuit parameters, such as beta, base-emitter voltage, sheet resistance, etc., are closely matched and the noise immunity within the network is equivalent to the noise immunity of a single gate.

### An integrated quinary scaler is built

The block diagram of an integrated quinary scaler is shown in Fig. 12. The circuitry for each gate is the same as in Fig. 10, except for  $M_5$  which has an additional emitter-follower output brought out. This terminal can drive a heavy external load without compromising the internal performance of the scaler.

The clock buffer stage, shown in Fig. 13, serves several purposes. First, since the clock signal must drive all five gates, buffering is necessary to present a high input impedance at the clock input terminal. Second, since the buffer stage has voltage gain, the scaler operates correctly with input signal swings as low as  $\pm 0.1$  volt. Third, since the input transistor has no collector resistors, the input signal can swing as high as  $\pm 1.0$  volt, without saturating the input stage.

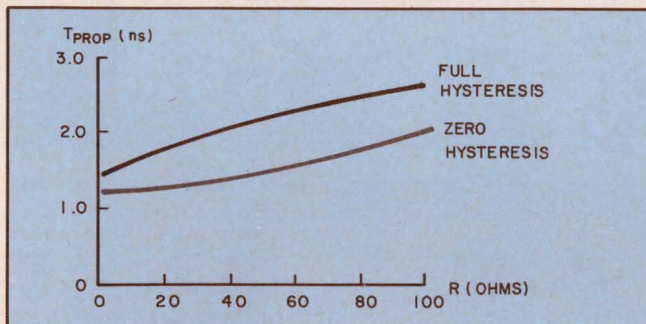

9. Propagation delay varies directly with the value of the resistors at the gate input. Zero hysteresis is achieved by grounding the reference point.

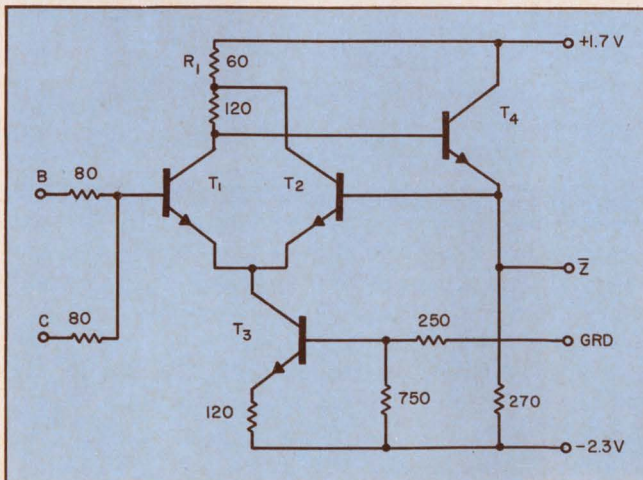

10. Absolute resistance values for the gate are determined by the power-speed criteria. Relative values are dependent on the signal-swing requirements.

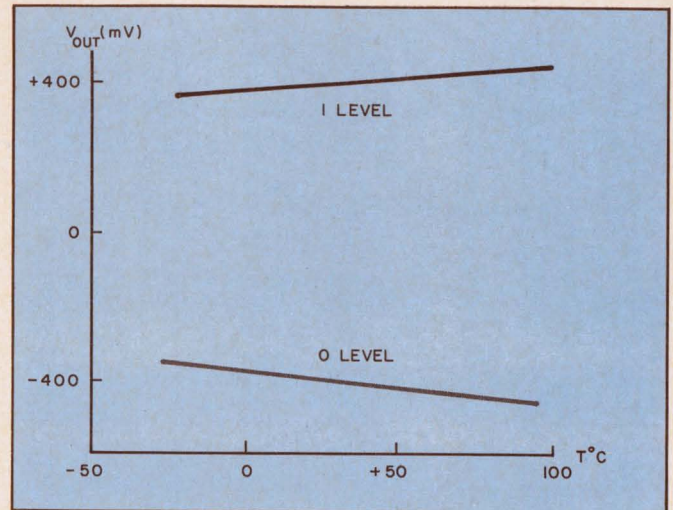

11. Output voltage, as a function of ambient temperature, remains equidistant with respect to ground.

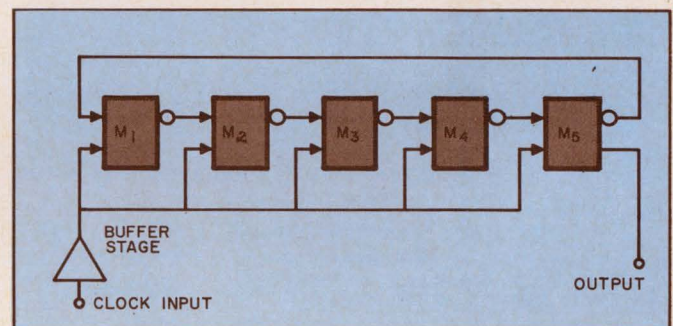

12. Integrated quinary scaler uses five majority-logic gates and a clock buffer stage.

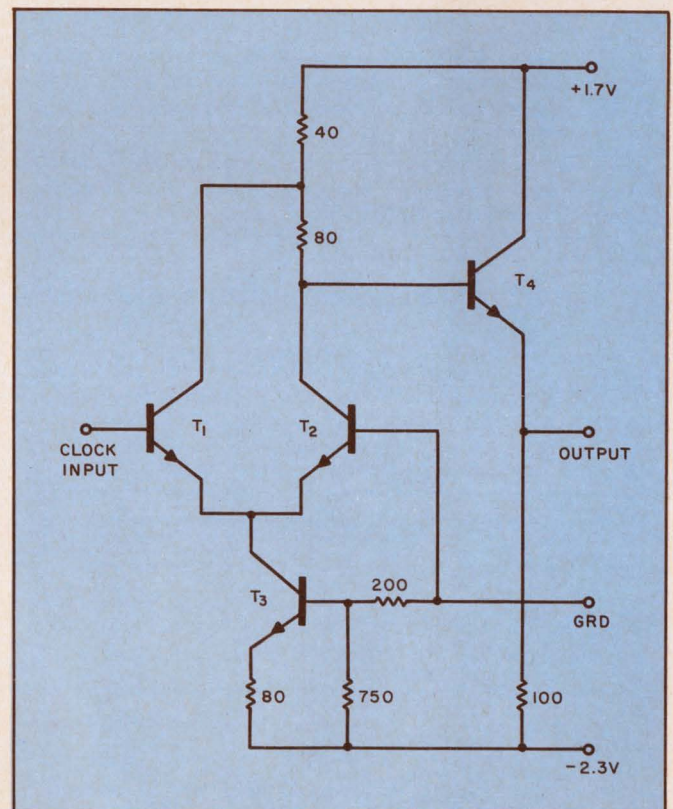

13. Clock buffer circuit is similar to the logic gates. The reference point is connected to ground instead of to the output and circuit values are changed.

# The Industry's Most Stable Oscillators

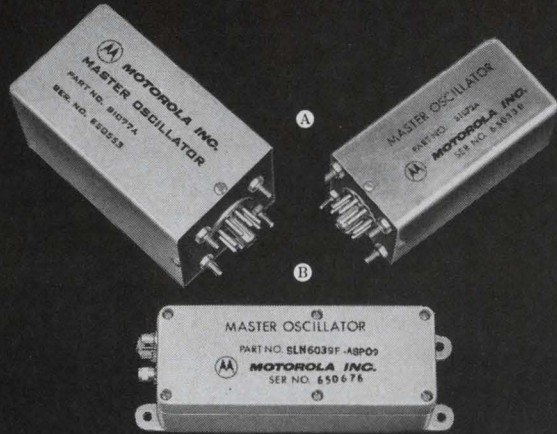

## Ⓐ SERIES S1077 OSCILLATORS—100 KHz to 10 MHz

- $1 \times 10^{-10}/C^\circ$  from  $-20^\circ$  to  $+55^\circ C$
- $1 \times 10^{-10}$  RMS Short Term Stability
- Less Than  $1 \times 10^{-9}$ /Day Aging
- Voltage Adjust
  - Coarse and Fine—Internal
  - Voltage Variable and
  - Mechanical Fine—External
- Flexible Power Input System

Ⓐ All silicon solid state design using proportional ovens with glass-enclosed crystals assures unexcelled performance—with *guaranteed specifications*—in frequency and time applications. Ideal for use in digital frequency counters, phase-locked receivers, synthesizers, SSB systems, missile guidance and satellite tracking systems, navigation, computer and communications equipment.

## Ⓑ SERIES SLN6039 OSCILLATORS—60 KHz to 10 MHz

- Industry's Fastest Warm-Up—within  $5 \times 10^{-9}$  in 10 minutes
- $5 \times 10^{-10}$  or  $1 \times 10^{-9}$ /Day Aging
- High MTBF

Ⓑ This oscillator with its wide dynamic range proportional oven and glass-enclosed precision crystal meets many MIL specifications for both airborne and ground equipment.

For full specifications call or write: Motorola Communications & Electronics, Inc., 4501 Augusta Blvd., Chicago, Illinois 60651. (312) 772-6500. A Subsidiary of Motorola Inc.



**MOTOROLA**  
Precision Instrument Products

ON READER-SERVICE CARD CIRCLE 24

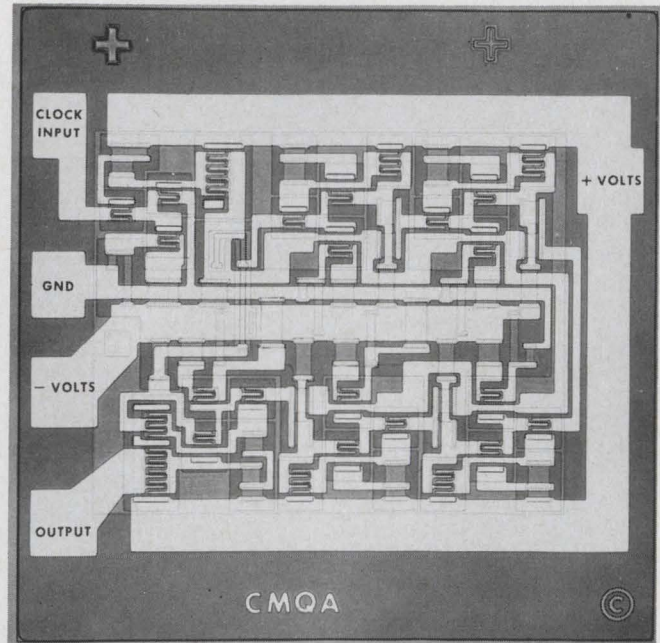

14. Completed quinary scaler is shown in this photomicrograph of the 50-by-50 mil chip.

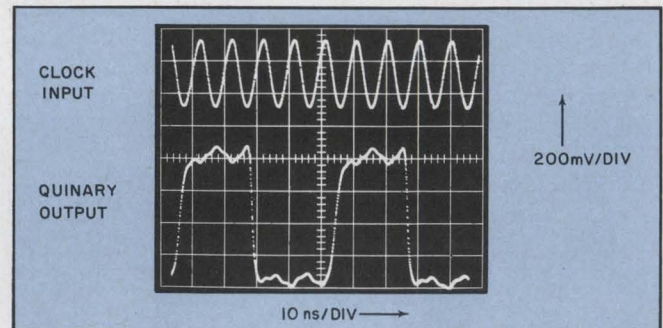

15. Input and output voltage waveforms for a 100-MHz clock signal. Output rise and fall times are under 2 ns.

A photomicrograph of the quinary scaler, integrated on a 0.05 x 0.05 inch chip, is shown in Fig. 14. It can be seen that several transistor geometries are used. The number of emitter stripes varies according to the current requirement of each transistor. The transistor characteristics are typically,

$$f_T = 1 \text{ GHz}$$

$$C_{ob} \text{ at zero bias} = 0.7 \text{ pF}$$

$$C_{te} \text{ at zero bias} = 0.7 \text{ pF}$$

$$r_b \text{ at } 250 \text{ MHz} = 50 \text{ ohms}$$

The quinary scaler operates correctly for clock frequencies from dc to over 100 MHz. Typical propagation delay through a gate is 3 nsec, and rise and fall times of the unloaded output are 2 nsec. Input and output voltage waveforms, with a 100 MHz clock frequency, are shown in Fig. 15. Power dissipation is about 450 mW when the supply voltages are +1.7 and -2.3 volts. ■ ■

### References:

1. J. E. Price, "Counting with Majority-Logic Networks," *IEEE Transactions on Electronic Computers*. Vol. 14, April 1965, pp 256-260.
2. J. A. Narud, "Characterization of Integrated Logic Circuits," *Proceedings of the IEEE*. Vol. 52, No. 12, Dec. 1964, pp 1551-1564.

# Tubethinkers awaken!

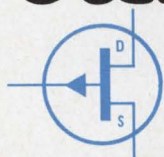
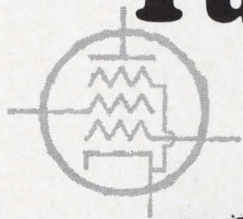

FETs fit most any old circuit!

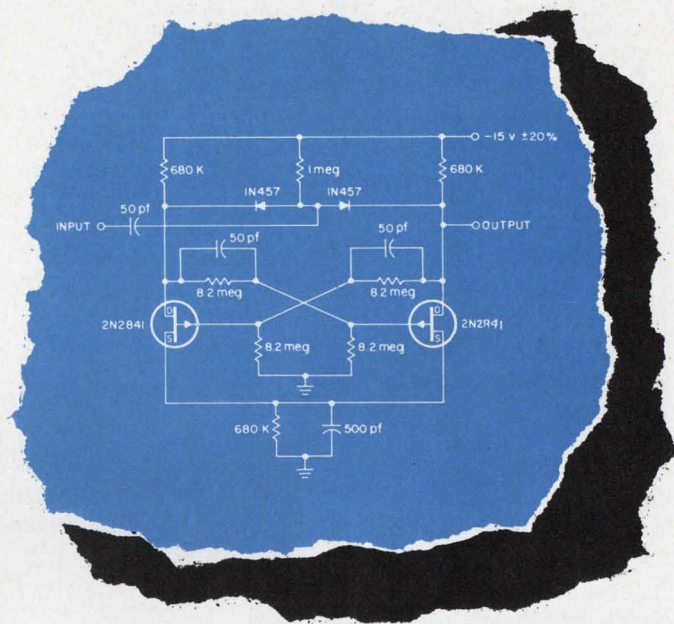
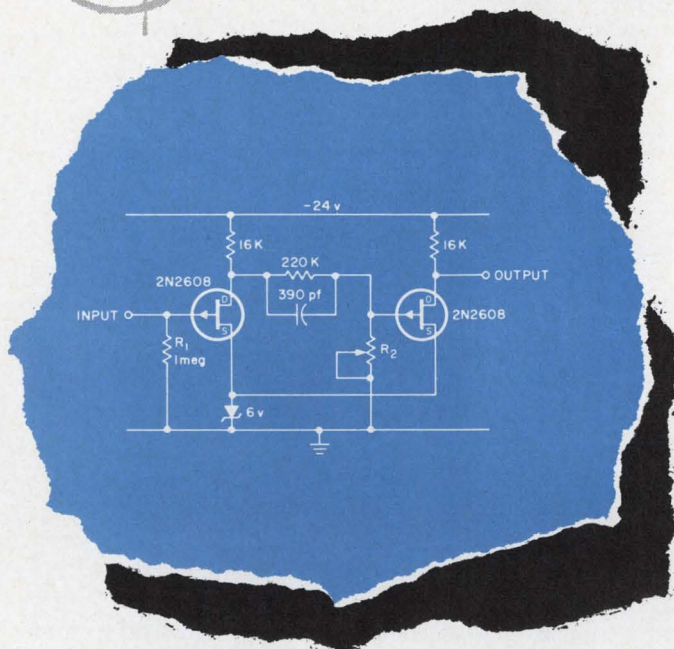

## Like a Schmitt Trigger or an Eccles-Jordan Flip-Flop

Siliconix assumes no responsibility for circuits shown, nor does it represent or warrant that they do not infringe any patents.

Still designing with tubes for high input impedance or low output-input feedback?

You can have both with FETs.

We're not talking about exotic applications, either; we mean the workhorse stuff you were designing before **any** transistors showed up.

Take the Schmitt Trigger above: You get high input impedance, the Zener eliminates FET matching, and the circuit is as ordinary as an old tube . . . without the power dissipation.

The flip-flop came from a Terman's Handbook. We added the FETs and **microwatt** power consumption. With 2N2841s you have low input C and a high  $g_{fs} / I_{DSS}$  ratio for the best trade-off of speed, power dissipation, and gain. These are only two applications (See earlier ads for others). For more ways to put FETs to work, consult your old tube manual . . . or us.

**Siliconix incorporated**  
 1140 W. Evelyn Avenue • Sunnyvale, California 94086  
 Phone 245-1000 • Area Code 408 • TWX 408-737-9948

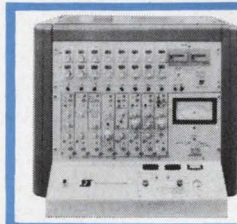

**MONITOR II FET/TRANSISTOR TEST SET** • Tests N-channel, P-channel, junction and MOS FETs • Go, no-go, analog readout • Compact, solid state, proven performance on our own production lines • Ideal for incoming QC or production testing • Drives digital voltmeter or printer without modification.

**FREE:** A bibliography of selected FET applications articles, culled for your edification and conversion from tubethinking. Write for it, please!

## FRANCHISED DISTRIBUTORS

ALA., HUNTSVILLE, Tec-Sel, Inc., 837-4541 • ARIZ., PHOENIX, Barnhill Associates, 959-2115 • CALIF., HOLLYWOOD, Hollywood Radio and Electronics, 464-8321 • LOS ANGELES, Kierulff Electronics Inc., 685-5511 • MENLO PARK, Hollywood Radio and Electronics, 322-3431 • SAN DIEGO, Kierulff Electronics Inc., 278-2112 • SAN JOSE, Weatherbie Industrial Electronics, Inc., 297-9550 • COLO., DENVER, Barnhill Associates, 934-5505 • CONN., HAMDEN, Cramer Electronics Inc., 288-7771 • FLA., WEST PALM BEACH, Perrott Associates, Inc., 585-8647 • WINTER PARK, Perrott Associates, Inc., 647-3038 • ILL., CHICAGO, Semiconductor Specialists, Inc., 622-8860 • MD., BALTIMORE, Wholesale Radio Parts Co., Inc., 685-2134 • MASS., NEWTON, Cramer Electronics, Inc., 969-7700 • MICH., DEARBORN, Semiconductor Specialists, Inc., 584-5901 • MINN., MINNEAPOLIS, Semiconductor Specialists, Inc., 866-3435 • MO., ST. LOUIS, Semiconductor Specialists, Inc., 521-8866 • N. J., BERGENFIELD, Technical Electronics Distributors, Inc., 384-3643 • N. Y., BUFFALO, Summit Distributors, Inc., 884-3450 • NEW YORK CITY, Milgray, 989-1600 • SYRACUSE, Eastern Semiconductor Sales, Inc., 455-6641 • OHIO, DAYTON, Alpine Industries, Inc., 278-5861 • Semiconductor Specialists, Inc., 277-9784 • OKLA., TULSA, Oil Capital Electronics Corp., 836-2541 • PA., PHILADELPHIA, Simco Electronics, Inc., 299-1880 • PITTSBURGH, Semiconductor Specialists, Inc., 731-2050 • YORK, Wholesale Radio Parts Co., Inc., 755-2891 • TEX., DALLAS, Sterling Electronics, 351-9921 • HOUSTON, Lenert Company, 224-2663 • WASH., SEATTLE, Garretson Radio Supply, Inc., 682-8981 • WASH., D. C., HYATTSVILLE, MD., Milgray, 864-6330.

CANADA: MONTREAL; Prelco Electronics, Ltd., 389-8051 • OTTAWA; Wackid Radio, Ltd., 232-3563 • TORONTO; Electro Sonic Supply Co., Ltd., 924-9251

ON READER-SERVICE CARD CIRCLE 25

# Speed control-system response and cut system cost with potentiometer padding. Here's a graphical technique that makes it easy.

Here is a money-saving design technique that gets the "workhorse" transducer of position-control systems—the potentiometer—to respond faster.

The key is the use of an inexpensive operational amplifier plus resistive padding of the output potentiometer. A graph selects the proper value padding resistance.

In a typical configuration shown in Fig. 1, the input,  $E_{in}$  is processed through a summing and a power amplifier. The latter drives the actuating device, which generates the desired output motion and has the potentiometer wiper slaved to it. The potentiometer senses the motion and feeds a voltage back to the summing amplifier equal and opposite in sign to  $E_{in}$ .

## Cheaper and more flexible

The configuration of Fig. 1 requires two reference power supplies, accurately balanced with respect to each other, to avoid null-shift errors. A grounded center-tap would eliminate null-shift errors, but positive and negative scale factors would differ if the supplies were unbalanced—and, of course, the need for two references remains.

The proliferation in recent years of high-quality, low-cost differential-input dc amplifiers makes the use of the configuration of Fig. 2 very attractive. Not only is the need for one of the two reference supplies and for a center-tapped potentiometer eliminated, but another advantage is obtained: By proper selection of resistor values, we can obtain not only linear but also nonlinear slopes that increase as a function of deviation from null. Thus loop-gain increases for large errors, resulting in a faster system response.

## Simplified circuit analysis

Analysis of the configuration in Fig. 2 is simplified if one makes an appropriate assumption. Since the summing junction of an operational amplifier can be assumed to be at ground potential, the equivalent circuit of the network takes the form shown in Fig. 3. The potentiometer output, read at the output of the amplifier, is then expressed as  $A(V_p - V_p')$ , where  $A$  is the amplifier gain.  $V_p$  is given by  $V_{ref}$  multiplied by the transfer function of the voltage divider formed by  $R_3$  and the parallel combination of  $R_1$  and  $R_2$ .  $V_p'$  is

similarly obtained, and  $V_o$  becomes

$$V_o = V_{ref} A \frac{Z}{R_3 + Z} - \frac{Z}{R_4 + Z} \quad (1)$$

where

$$Z = \frac{R_1 R_2}{R_1 + R_2} \quad (2)$$

and

$$R_3 + R_4 = R_p \quad (3)$$

Note that for  $R_1 \gg R_2$ ,  $Z$  can be replaced by  $R_2$ . Similarly for  $R_2 \gg R_1$ ,  $Z$  can be replaced by  $R_1$ .

## Design example illustrates technique

Appropriate selection of a design is readily accomplished with the aid of the curves plotted in Fig. 4. These give the normalized output of the amplifier, as a function of potentiometer deviation from null, for a large number of ratios of  $Z$  to  $R_p$ .

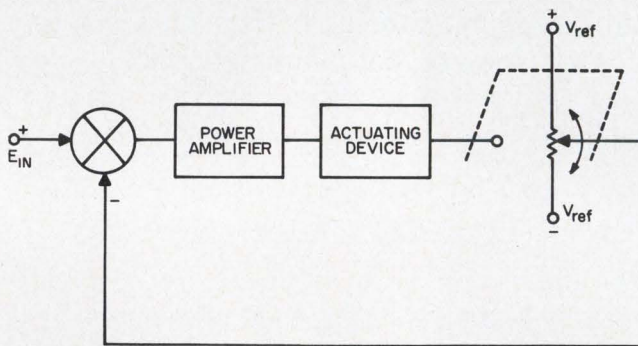

1. The feedback potentiometer in this conventional control system needs two reference voltage sources. Both sources must be precisely balanced.

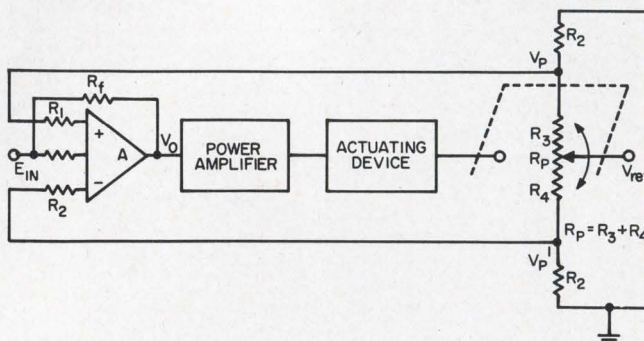

2. Resistive padding of the output potentiometer eliminates the need for one of the two reference sources. Balancing of sources is no longer a problem.

Gilbert Willems, Aerospace Research Engineer, U.S. Army Missile Command, Redstone Arsenal, Ala.



To illustrate use of the design chart, let's consider a design example:

Assume that a system uses a 30-k output potentiometer. A 10-volt reference supply is available, and a gain-slope (volts per degree of rotation of potentiometer shaft) change of approximately 2:1 is desired. The maximum operational amplifier output,  $V_{o\ max}$ , is to be 20 volts. Checking Fig. 4, we see that the slope, for large deviations from null, of the  $R_p = 20$ .  $Z$  curve is approximately twice the slope at null, thus meeting the requirement for gain slope = 2:1. Therefore an  $R_p$  value equal to 2.0  $Z$  yields the desired slope characteristics. Thus  $Z$  must equal 15 k ohms; a selection of  $R_1 = R_2 = 30$  k meets this requirement. The selection of the gain  $A$ , of the operational amplifier now remains. From Fig. 4, the following relationship is obtained:

$$\frac{V_{o\ max}}{V_{ref} A} = 0.67$$

With the introduction of the selected values of  $V_o$  and  $V_{ref}$ , the resultant gain  $A$  becomes 3. Since the selected value for  $R_1$  was 30 k, the amplifier will require a feedback resistor equal to 3(30 k) or 90 k. This completes the design.

The chart provides sufficient curves to satisfy most design requirements. Of course, additional ones can be calculated by means of Eq. 1. However, the curves for values of  $R_p$  greater than 4.0  $Z$  tend to differ little from the top curve in the chart. Linear interpolation in the chart is fairly accurate for  $R_p$  values up to 0.5  $Z$ . ■ ■

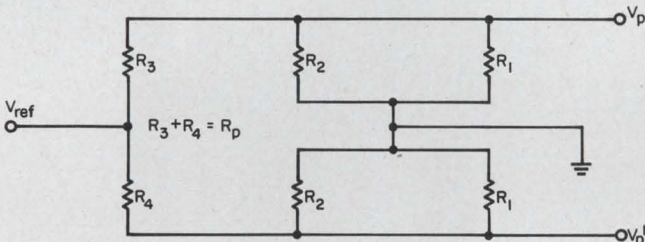

3. Equivalent circuit of the configuration in Fig. 3 simplifies analysis and yields design equations.

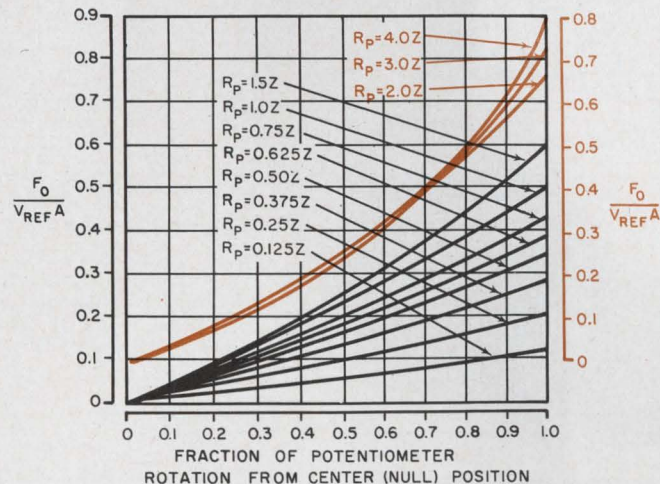

4. These curves permit selection of padding resistor and operational amplifier gain values. The righthand ordinate is for use with the upper three curves.

# NEW

from MR. MAGNETICIAN™...

# PRODUCTION AVAILABILITY

ON

# ALNICO 9

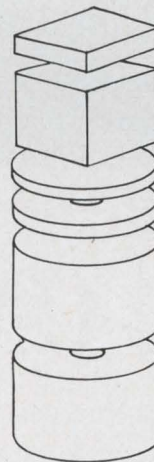
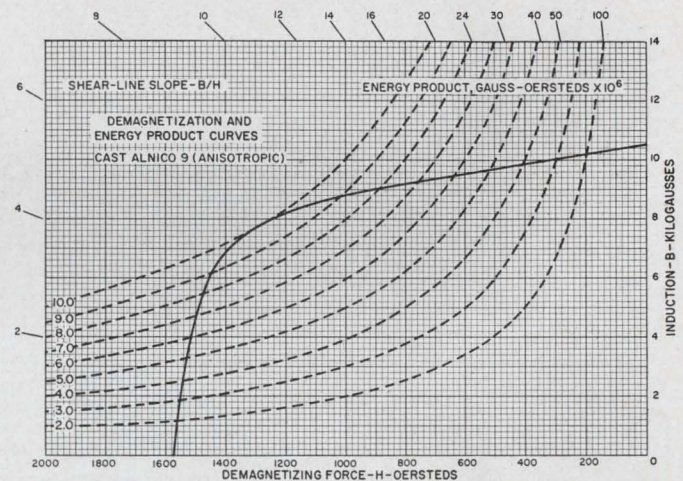

Thomas and Skinner is proud to announce the development and production availability of Alnico 9... a new permanent magnet material.

The energy product is typically 10.0 M.G.O. . . . almost double that of conventional Alnicos 5 and 8. The high coercive force of T & S's Alnico 9 is 1580 Oerstedes . . . equal to that of Alnico 8 and three times that of Alnico 5. The straight line magnetic axis of Alnico 9 permits its use in short sections such as flat squares, rectangles, discs and rings as well as cylinders, solid and cored, and blocks. For full information, write for Bulletin M-304-A.

## SPECIALISTS IN MAGNETIC MATERIALS

Thomas and Skinner is the leader in pioneering the application of advanced magnetic materials to provide desired magnetic fields in new and improved ways. To learn how T & S is prepared to help you with your magnetic problems, write for Catalog A-975.

Mr. Magnetician, symbol of over 60 years T & S experience in the field of magnetics.



**Thomas & Skinner, Inc.**

Box 120 1120 EAST 23rd STREET  
INDIANAPOLIS, INDIANA 46207 • PHONE 317-WA 3-2501

ON READER-SERVICE CARD CIRCLE 26

# BIG ON PERFORMANCE



**3 TIMES ACTUAL SIZE**  
so you can clearly see the  
many great design  
innovations

## ...SMALL ON SIZE

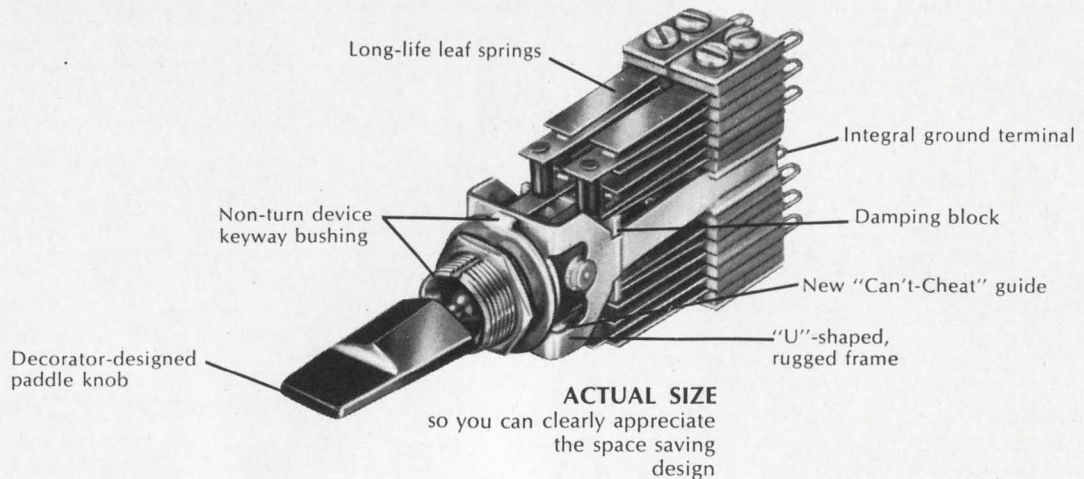

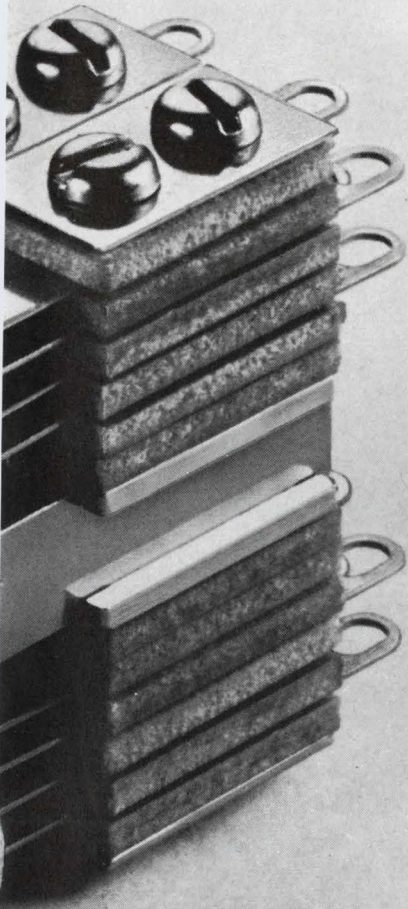

# The **LT** littel Telever\* Switch

Patent applied for

SERIES 41000 TELEPHONE TYPE

## A MARVEL OF COMPACT QUALITY

The time-tested and performance-proved features that have made Switchcraft "Tever" switches synonymous with trouble-free reliability are now engineered into a switch that is significantly smaller in size—with several all-new computer age design features that make it ideal for dozens of demanding applications. It takes only 2-1/8" behind-panel depth, and mounts on 23/32" centers!

## LOADED WITH EXCLUSIVE FEATURES

Special damping block guards against leaf-spring "bounce" . . . makes it singularly adapted to use in computers and transistorized equipment. It minimizes false triggerings, bad parity checking and premature readout due to switching transients. "Can't-Cheat" detent guide prevents accidental actuator by-pass of a switching position. Unique spring-loaded lifter-roller assembly rides in the frame's detent guide—assures smooth, easy lever operation over the entire life of the switch. "U" shaped twin girder frame guards against frame distortion. Special nickel-silver springs without "form" at flexing points for long operation without taking a "set." Stacks can be mounted individually to any of four mounting positions—can be removed and replaced without disturbing other stacks or wiring. Even the paddle-shaped knob is new and fresh appearing.

## DESIGNED FOR TODAY'S MODERN EQUIPMENT

Adds to the appearance and dependability of products ranging from computers, data processing, control panel, to test, communication, ground support, telephone and instrumentation equipment. Two and three position types, lock and non-locking and special "Talk-Listen" type for intercoms. For this application, lever locks on one side of neutral and operates non-locking on other side. Welded cross-bar palladium contacts standard, rated 2 amps, 200 watts max. A.C. non inductive load. Broad range of circuits available up to 8 PDT.

WRITE FOR BULLETIN 164 or see your local Switchcraft Authorized Industrial Distributor for immediate delivery at factory prices.

ON READER SERVICE CARD CIRCLE 190.

# SWITCHCRAFT<sup>®</sup>

INC.

. . . THE COMPLETE LINE OF LEVER SWITCHES

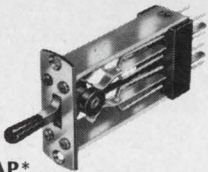

### LO-CAP\*

LOW CAPACITY LEVER SWITCH  
Specially designed, widely spaced flat actuator springs and round contact springs in an insulating block . . . eliminates build-up of induced alternating current between springs. Smooth, long-life roller-actuator. Available in 2 or 3 position models, locking and non-locking in a variety of circuits from DPST to 8PDT. SEND FOR BULLETIN 150.

ON READER SERVICE CARD  
CIRCLE 191

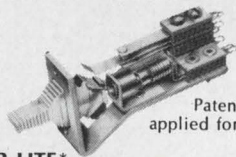

Patent  
applied for.

### LEVER-LITE\*

3-COLOR  
ILLUMINATED SWITCH  
Takes the confusion out of switching circuits. One glance tells what position it's in . . . 1 color illumination in "up" position, second color in neutral, 3rd color in "down" position. Choice of 6 colors, 2 or 3 position, locking and non-locking, from SPDT to 4PDT. Lamp changes in seconds. WRITE FOR CATALOG S-309.

ON READER SERVICE CARD  
CIRCLE 192

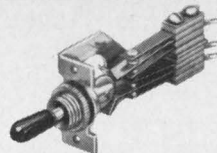

### FEATHER-LEVER\*

MINIATURIZED LEVER SWITCH  
Reduces panel and behind-panel space needs 25% . . . or more! Rugged, reliable positive "feel" —yet so compact they mount less than 1/2" apart in rows only an inch apart, requiring only 1-3/4" behind panel depth. Exclusive, exchangeable push-on knobs in 10 colors. 2 and 3 position, locking or non-locking, from SPST to 6PDT. WRITE FOR CATALOG S-309.

ON READER SERVICE CARD  
CIRCLE 193

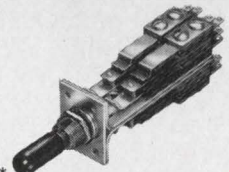

### TELEVER\*

TELEPHONE-TYPE SWITCH  
The standard of the industry. Exclusive changeable function feature . . . special insert for non-locking operation can be removed to make it a locking switch—even in the field. Exceptionally rugged. Materials and finish meet MIL specs, overall design meets rigid telephone company standards. 2 and 3 position, up to 8PDT. WRITE FOR CATALOG S-302.

ON READER SERVICE CARD  
CIRCLE 194

Switchcraft makes more kinds of Lever Type Switches than anyone . . . Write for Catalogs, or see your local Switchcraft Authorized Industrial Distributor for Immediate Delivery at Factory Prices.

## SWITCHCRAFT, INC.

5529 ELSTON AVE., CHICAGO, ILLINOIS 60630

\*Trademark.

# Swamp out distortion in wide-range agc systems by using a diode-bridge variable attenuator in the feedback loop. Stability and high accuracy also result.

Automatic gain control (agc) systems featuring 30 dB or more of correction are often plagued by error-signals and harmonic distortion appearing in the output. A simple means of overcoming these problems entails the use of a diode-bridge variable attenuator to automatically compensate for signal changes at the feedback loop summing point.

The diode-bridge effectively forms a controllable balanced diode L-pad to achieve the wide-range agc capability and the attendant low harmonic distortion. In addition, the over-all system provides less than 0.25 dB of error, shows a flat frequency response and is very stable with temperature changes.

## Attenuator solves impedance problems

The effectiveness of the diode-bridge attenuator hinges on its location in the system. It sums the signals coming from the line and the feedback (agc signal-developing) networks, processes and adjusts (compensates) them, and passes the resulting signal directly to the output transformer.

This action depends on the impedance characteristics of the attenuator. Fig. 1 is a block of diagram showing the important aspects and stages of the system. The impedance seen by the line is constant since the minimum impedance that the diode-bridge attenuator will approach is approximately 10 kohms. This figure has a negli-

ble effect on the 600 ohms fixed terminating resistance across transformer  $T_1$ .

A minimum output impedance of 100 kohms is presented to the diode-bridge by transformer  $T_2$ . This makes it possible to obtain the 44 dB of control because the diode-bridge is then the major determinant of how much attenuation is produced.

Transformer  $T_2$  must be well shielded and all leads to and from it must be as short as possible. The latter precaution is necessary because the signal level in this portion of the circuit is extremely low (approximately 0.6 mV across the secondary).

This signal is of constant magnitude, since the attenuation provided by the diode bridge is automatically varied in proportion to changes in the input signal. The ac amplifier then raises the signal to approximately 0.65 V rms at the output.

Observe that the system itself closely resembles the conventional wide-range agc network, the major exception being the inclusion of the diode-bridge. These traditional agc systems often incorporate the single-ended controlled diode L-pad stage to achieve 30 dB or more of correction.<sup>1</sup>

However, they exhibit 0.5 dB or more of output error and what may be a considerable amount of harmonic distortion. These unwanted signals may preclude the use of the traditional agc system in applications characterized by low-level inputs (below -30 dB) and the need for a flat audio frequency response. This is why the diode-bridge attenuator was incorporated.

S. A. Romano, Jr., Consultant, Brooklyn, N. Y.

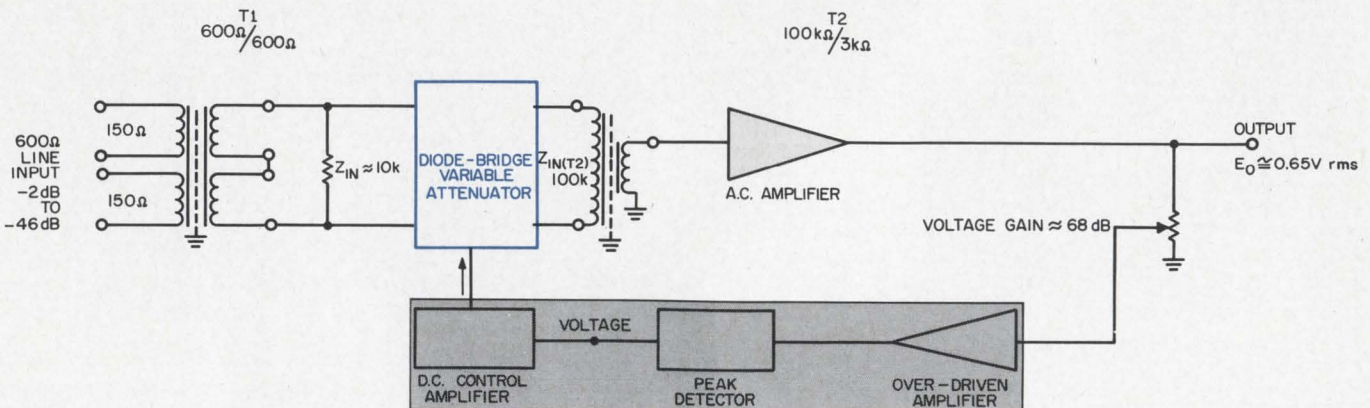

1. Use of diode-bridge attenuator in wide-range agc system compensates for signal changes at summing point.

Attenuator forms a balanced diode L-pad to produce 44 dB of agc and low harmonic distortion.

### Features of wide-range agc system

Input Impedance:	600 ohms
Output loading:	$\geq 2.7$ k
Total harmonic distortion:	Less than 1%
Maximum ambient temp:	55°C
Agc response:	44 dB for 0.25 dB error
Frequency response:	130 Hz to 20 kHz, flat
Maximum charging time:	$\approx 100$ msec
Maximum discharge time:	$\approx 4$ sec
Maximum input level:	-2 dBm
Output level:	0.65 volt rms

### Peak detector generates agc

Note also that the development of the agc voltage in the diode-bridge version resembles the method used in conventional agc systems. Here a portion of the output signal is taken, then amplified and half-wave rectified in the high gain, over-driven amplifier into a series of negative-going pulses.

The peak-detector unit charges a capacitor to the peak voltage of these pulses. This voltage is referred to as the agc. It varies in proportion to changes in input signal level and is used to vary the conduction of the control-amplifier.

The conduction of the control-amplifier in turn determines the current through the diode-bridge. This establishes the operating point on the diode characteristics and thereby produces the impedances desired (Fig. 2).

The operation of the diode-bridge variable attenuator (Fig. 3) is straightforward. The agc voltage across  $R_6$  determines the conduction of transistor  $Q_1$ , a pnp silicon transistor. A silicon type was used so that leakage current would be a negligible portion of the total conduction current in the temperature range encountered.

The current through  $Q_1$  passes through  $R_4$ , divides into two parallel paths through the diode bridge, and passes through  $R_3$  to the negative side of the power supply. Thus, as the condition of  $Q_1$  is varied, the impedance of the diodes is changed.

### Ac grounding produces L-pad

A controlled balanced L-pad is effectively created by ac grounding the center nodes of the bridge with capacitors  $C_1$  and  $C_2$ . When this is done, diodes  $D_1$  and  $D_2$  function in parallel and together become the shunt arm of an L-pad formed with resistor  $R_1$ . Diodes  $D_3$  and  $D_4$  similarly form an L-pad with resistor  $R_2$ .

Low distortion and wide control range are achieved because at any one time, each L-pad is

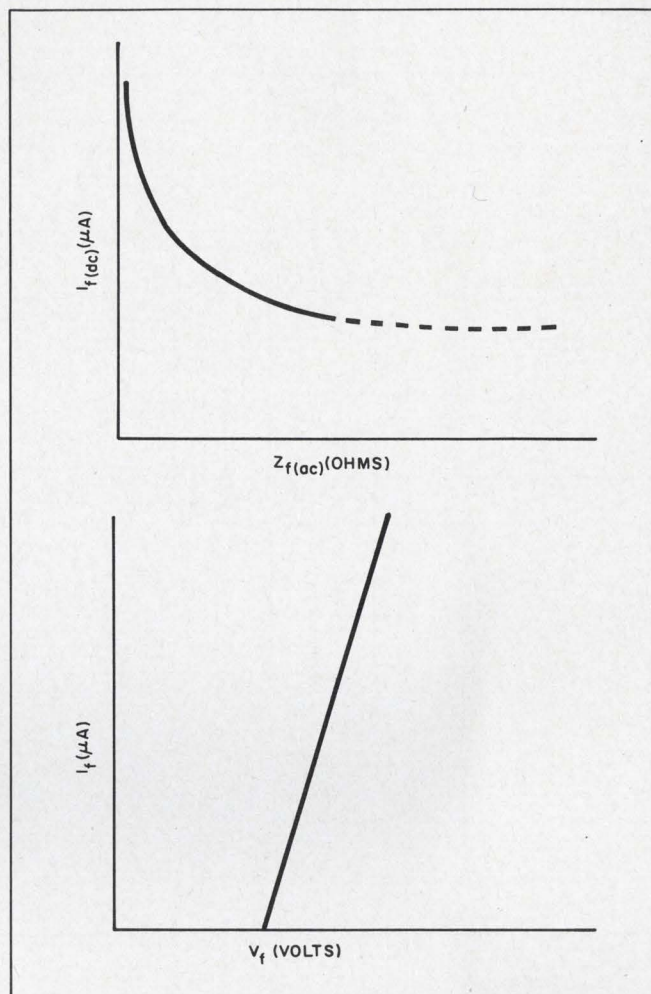

2. Diode-bridge control hinges on operating point of diodes. Dc  $I_f$  vs ac  $Z_f$  (a) and  $I_f$  vs  $V_f$  relationships (b) shape transfer characteristic.

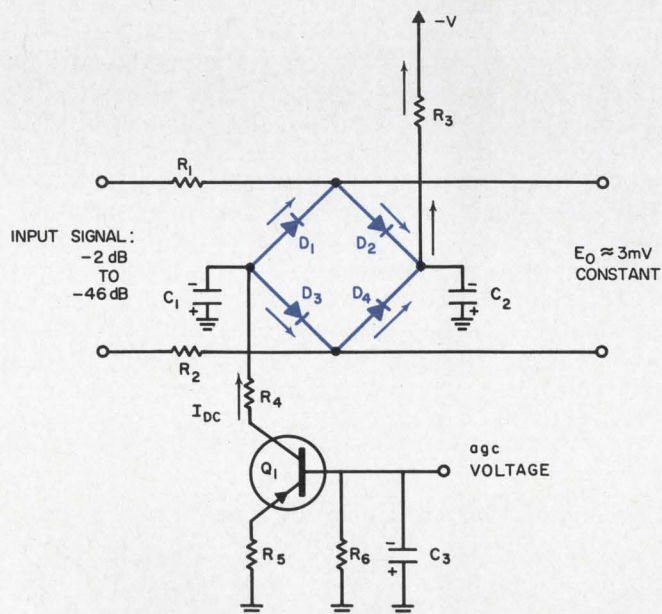

3. Controlled, balanced, L-pad is formed by the diode-bridge attenuator circuit. Input impedance of bridge is much higher than that of transformer, thus presenting constant impedance to line. L-pads are established by  $D_1$ ,  $D_2$  and  $R_1$ , and  $D_3$ ,  $D_4$  and  $R_2$ , respectively, acting with the transformer secondary. Transistor  $Q_1$  is a control amplifier that establishes the conduction levels of the diodes.

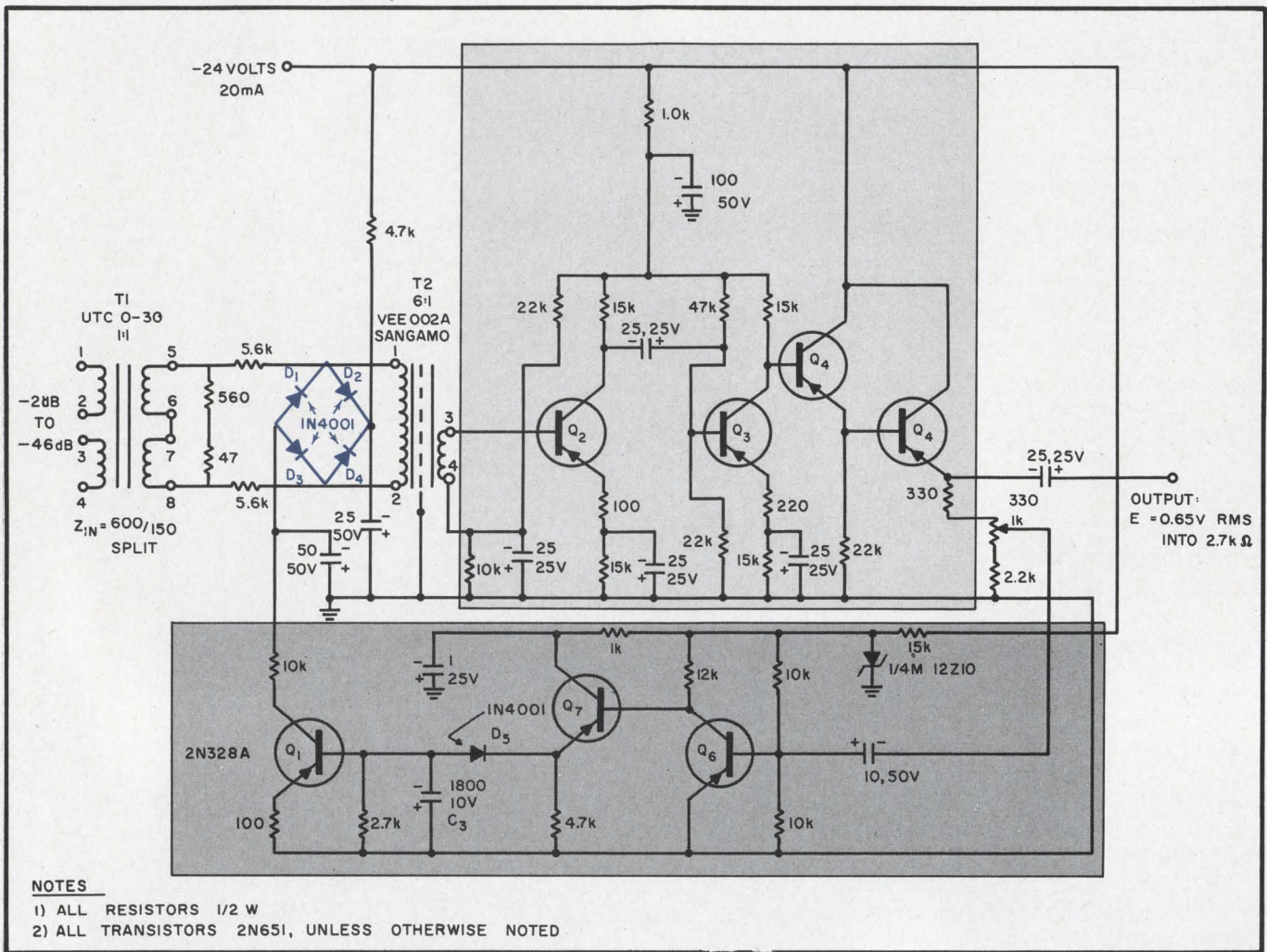

4. **Degenerative current feedback is used** in each stage of this wide-range agc system to provide for temperature stability.  $Q_2$  through  $Q_5$  make up the high-gain ac ampli-

operating on only half the wave of the input signal. Furthermore, the functioning of the diodes in parallel serves to degenerate characteristic differences between the diodes, while enabling a much lower shunt-arm impedance to be reached. This effectively increases the maximum attenuation attainable by the L-pad, while negligibly affecting the minimum attenuation achievable.

The diodes used were 1N4001 silicon, surface-passivated, diffused-junction rectifier types. They were chosen because their more gradually sloped characteristic curves accommodate the need for a wide control range.

#### Overdriving precludes gain shortage

The complete agc amplifier is exhibited in Fig. 4. Transistors  $Q_2$ ,  $Q_3$ ,  $Q_4$  and  $Q_5$  form the high-gain ac amplifier. Each stage has a very low current-stability factor and features degenerative current feedback. In this way the gain of the amplifier remains constant with temperature changes and unit-to-unit transistor parameter variations.

Transistors  $Q_6$  and  $Q_7$  form the over-driven

amplifier;  $Q_6$  and  $Q_7$  form an overdriven amplifier and the agc voltage is developed on  $C_3$ . Performance characteristics of feedback system appear in the table.

amplifier stage. This amplifier provides the necessary gain to achieve the desired stiffness ratio. Stiffness ratio, as used here, is a measure of the variation in the output for the maximum change of input signal.

System functioning is quite simple. When a change in input signal level takes place, an instantaneous change of equal magnitude occurs at the output. The charge on capacitor  $C_3$  immediately begins to readjust because the amount of signal entering the over-driven amplifier has likewise been altered.

The speed at which the agc voltage responds to this change is determined by the time constants designed into the circuit. The gain of the over-driven amplifier is such that a variation of 0.25 dB in the output level will produce the entire necessary change in agc voltage.

This agc level change is used by the dc control amplifier to cause the bridge-attenuator to correct a 44-dB change of input signal level. The characteristics of the system are given in the table. ■ ■

#### Reference:

1. "Designing a Stable Transistor AGC Amplifier", J. Shirman, *ELECTRONIC DESIGN*, May 11, 1960, pp. 44-47.

# Westinghouse offers the two IC op amps for low impedance drive applications

Drives 10 mA into 500  $\Omega$  load

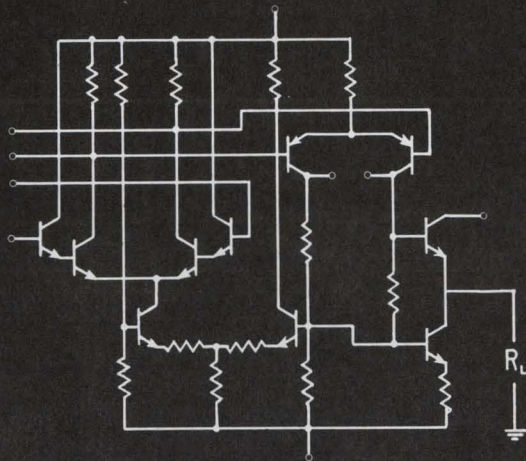

Westinghouse WS 161

Drives 20 mA into 500  $\Omega$  load

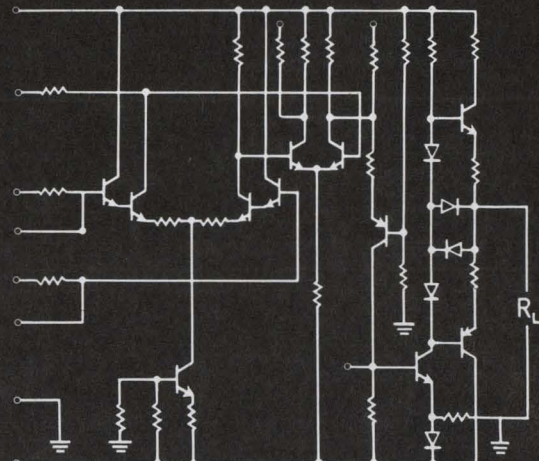

Westinghouse WM 174

You can drive sizable inductive, capacitive, or resistive loads directly with either of these two IC op amps. They're unmatched for "muscle". Using them, you can omit an intermediate driver stage or power amplifier in many applications. The driving power of the WS 161 and WM 174 can make equipment smaller, simpler, and lower in cost. With this pair, you can fill virtually all integrated op amp requirements. They come in 14-lead, 1/4" x 1/4" Q-style packages.

If you want maximum unity gain bandwidth, moderate open loop gain, and very high current output with low voltage drift, no other IC op amp comes near the WS 161.

If you want maximum open loop gain, maximum output cur-

rent, and very high unity gain bandwidth, the WM 174 is far and away your first choice.

Get the full data on these outstanding IC's now. They'll do difficult jobs for you. Call your Westinghouse distributor. Or write Westinghouse Molecular Electronics Division, Box 7377, Elkridge, Maryland 21227.

J-09126

	WS 161	WM 174
Open Loop Gain .....	2,000	50,000
Unity Gain BW .....	20 MHz	10 MHz
Output Current .....	10 mA	20 mA
Output Impedance .....	40 $\Omega$	70 $\Omega$
Input Current .....	120 nA	120 nA

You can be sure if it's Westinghouse



ON READER-SERVICE CARD CIRCLE 28

## Cut radar hardware needs and costs with a special multi-mode antenna feed that requires only two hybrids to measure azimuth and elevation.

A new design approach to multi-mode feed in radar eliminates four of the six hybrids that are usually needed to find azimuth and elevation.

The special feed is easy to build. And with the reduction in hardware needs, there is a saving in costs.

The common monopulse feed consists of four open-ended waveguides, as shown in Fig. 1.

To get an azimuth difference-pattern for azimuth information, hybrids are needed to obtain

$$[(\#1) + (\#3)] - [(\#2) + (\#4)].$$

Each addition and subtraction requires a hybrid; so, three hybrids are needed. The same is true for the elevation information.

The multi-mode feed developed here (Fig. 2) eliminates two of the hybrids in the azimuth and two in the elevation systems.

To help clarify the principles of this feed, assume that it is used for the reception of a linearly polarized wave with the polarization in the direction of the narrow dimension of the mouth.

If the signal comes from a point in the  $H$  plane of the antenna, only the  $TE_{10}$  and  $TE_{20}$  modes are excited in the mouth. The relative magnitudes and phases of the two modes indicate the angle of arrival. These modes excite the  $TE_{10}$  mode in the two side arms. If the signal comes from a point on the axis of the feed, only the  $TE_{10}$  mode is excited in the mouth. Then the modes excited in the two side arms will be equal in magnitude and phase. If the  $TE_{20}$  mode is excited, the corresponding components of the modes in the two side arms are equal in magnitude, but they are  $180^\circ$  out of phase.

Therefore the difference of the signals in the side arms indicates the amplitude of the  $TE_{20}$  mode in the mouth, and consequently the angle that the signal forms with the axis in the  $H$ -plane.

The signal may come from a point in the  $E$ -plane of the antenna. Then the  $TE_{10}$ ,  $TE_{11}$  and  $TM_{11}$  modes are excited in the mouth of the feed. If the signal comes from a point off the axis, the relative magnitudes of the  $TE_{11}$  and  $TM_{11}$  modes

indicate the angle. These modes excite components of the  $TE_{10}$  mode in the top and bottom arms, which are equal in magnitude and  $180^\circ$  out of phase. The difference of the signals in the top and bottom arms indicates the angle of the signal with respect to the axis in the  $E$ -plane.

If the signal comes from a point that is neither in the  $H$  plane nor the  $E$  plane, the  $TE_{21}$  and  $TM_{21}$  modes are also excited in the mouth. The coupling with the four arms is dependent on the angles of the signal with the axes in the  $H$  and  $E$  planes; so the differences for the two pairs of arms indicate these angles.

When the feed is constructed according to Fig. 2, the dimension  $A$  should be about  $0.7\lambda$ , where  $\lambda$  is the operating wavelength. The dimension  $L$  does not appear to be critical. The mouth of the feed should be large enough to permit the propagation of the  $TE_{10}$ ,  $TE_{20}$ ,  $TE_{11}$ ,  $TM_{11}$  and  $TM_{12}$  modes.

The only formulas used in designing the feed are those for the cut-off wavelength for the various modes that may be excited in the mouth of the feed. These formulas, for a rectangular waveguide, are:

$$TE_{10} \text{ mode: } \lambda_c = 2a$$

$$TE_{20} \text{ mode: } \lambda_c = a$$

$$TE_{11} \text{ mode: } \lambda_c = \frac{2a}{\sqrt{1 + (a/b)^2}}$$

$$TE_{21} \text{ mode: } \lambda_c = \frac{a}{\sqrt{1 + (a/2b)^2}}$$

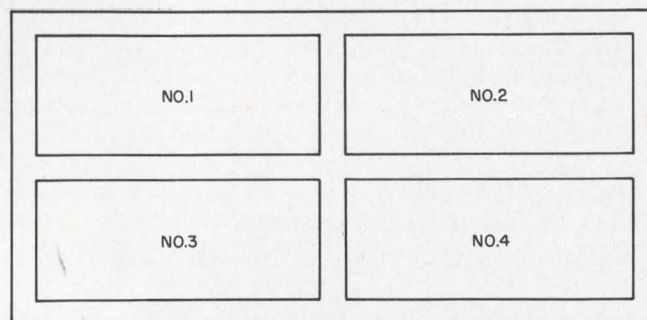

1. Conventional monopulse feeds consist of four open-ended waveguides. To obtain the azimuth-difference pattern for azimuth information, three hybrids are needed. The same is true for the elevation-difference patterns.

H. F. Mathis, L. A. Zurcher and R. J. Gunderman, Senior Technical Specialists, North American Aviation, Inc., Columbus, Ohio



$$TM_{11} \text{ mode: } \lambda_c = \frac{2a}{\sqrt{1 + (a/b)^2}} \text{ (same as } TE_{11}\text{)}$$

$$TM_{21} \text{ mode: } \lambda_c = \frac{a}{\sqrt{1 + (a/2b)^2}} \text{ (same as } TE_{21}\text{)}$$

The feed was built (Fig. 3) and tested in a cassegrain antenna at a frequency of 16 GHz. The complete antenna consisted of a 3-foot paraboloidal reflector with a focal length of 12 inches, an 8-inch hyperboloidal sub-reflector and the multi-mode monopulse feed, shown in Fig. 4. The dimension A for this feed is 0.622 inch. ■ ■

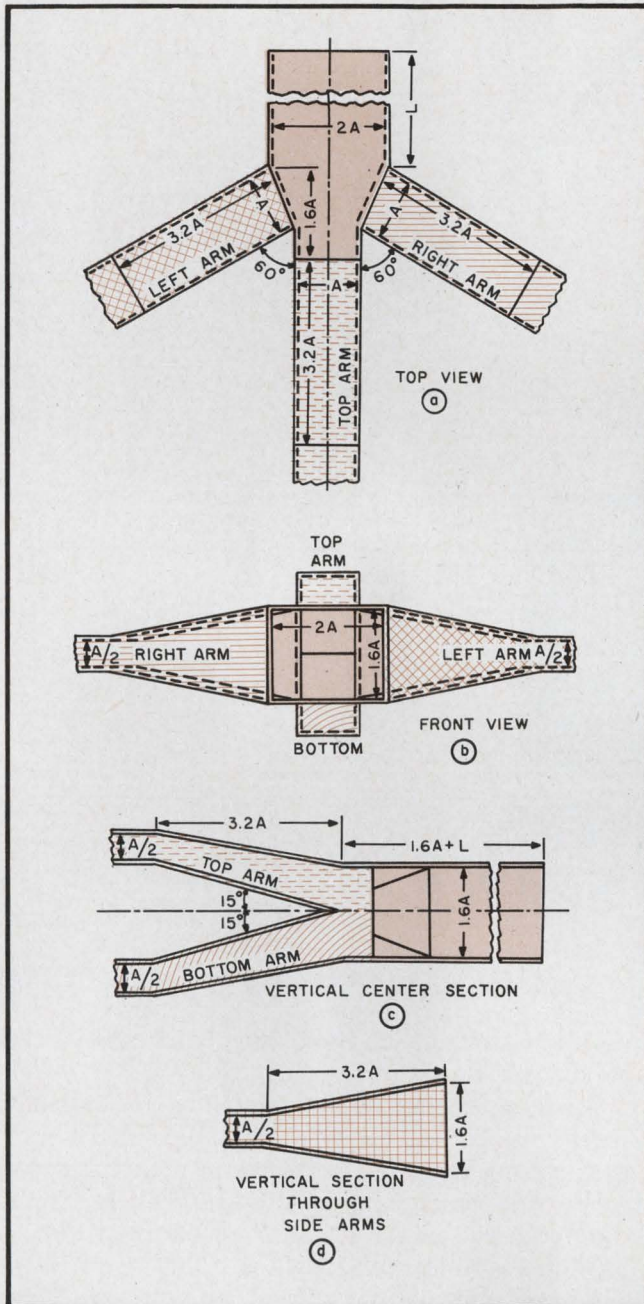

2. Multi-mode feed needs only one hybrid to get the azimuth or the elevation patterns. The difference of signals in the side arms (a, b) indicates the amplitude and angle of the incident signal, if the latter comes from a point in the H-plane. The top and bottom arms (c) are used for signals coming from the E-plane of the antenna. Vertical cross-section of side arms (d) is also valid for top and bottom arms.

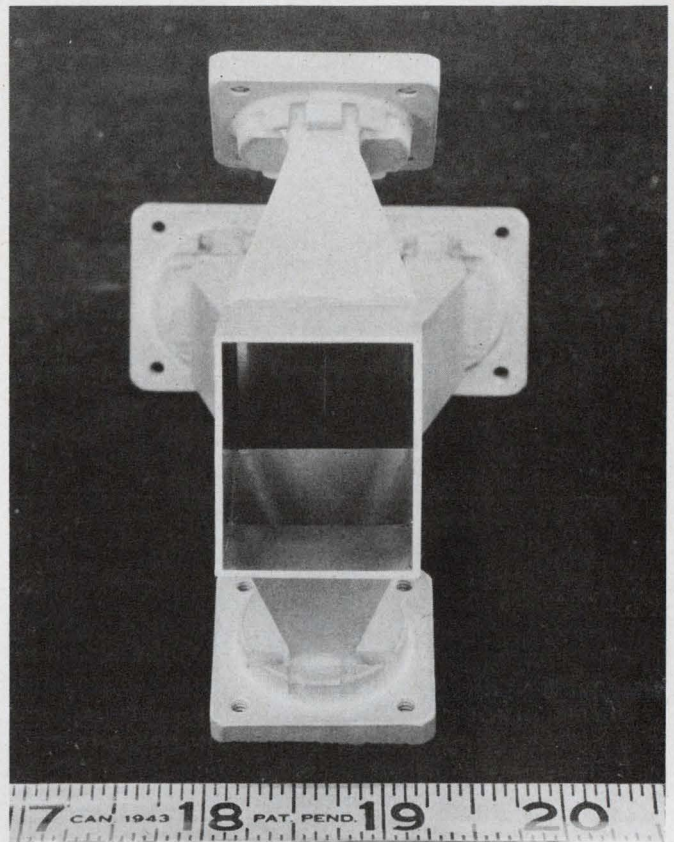

3. Multi-mode feed is designed for a 16-GHz antenna. Its critical dimension, A, is equal to 0.622 inches.

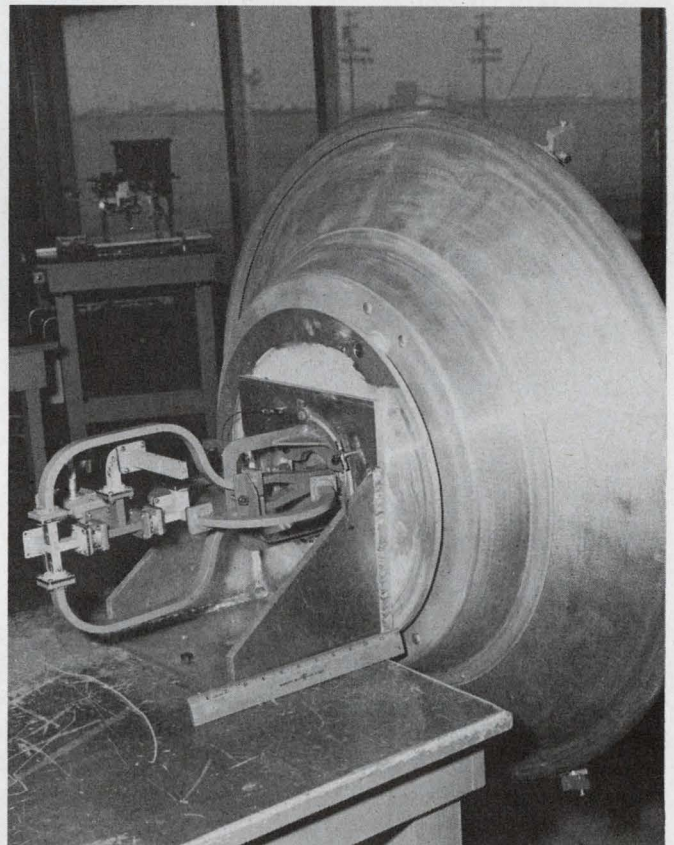

4. Installed feed at the back of a cassegrain antenna indicates simplified hardware. The antenna has an 8-inch hyperboloidal sub-reflector (not shown).

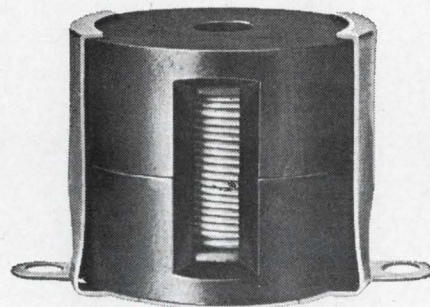
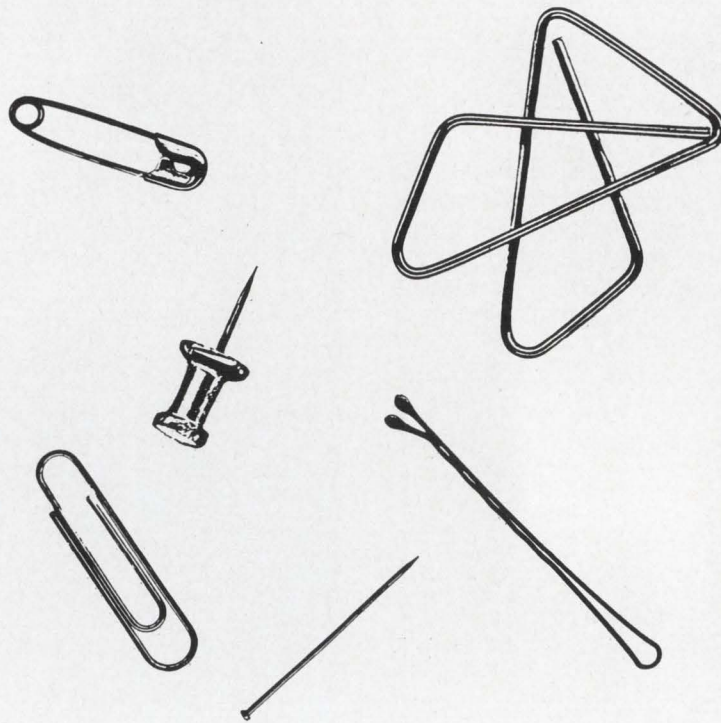

## TIMESAVERS, PURE AND SIMPLE

### Ferrite Pot Core Hardware Cuts Assembly Time 50%

A one-piece spring steel housing snaps the core assembly into place, secures it to the chassis or printed circuit board, whittles minutes out of each production hour. In applications involving high quality inductors for filters, the trimming device has been simplified for hairline adjustment.

In addition to saving time, our ferrites give you extra design advantages with their high Q values and low disaccommodation factors. We guarantee permeability over a wide temperature range ( $-55^{\circ}\text{C}$  to  $+70^{\circ}\text{C}$ ), and precision-ground air gaps

assure uniformity of inductance throughout each production lot.

Manganese zinc ferrite cores are furnished in permeabilities of 650, 900, 1300 and 2000 for frequencies up to 2 MC. A 100 perm nickel zinc core covers frequencies up to 10 MC. There are 13 different sizes, including the International Electro-technical Commission sizes—over 200 cores in all! For more information, write *Magnetics, Inc.* Dept. 31, Butler, Pa.



ON READER-SERVICE CARD CIRCLE 29

New low-cost Daystrom Model 333 commercial trimmer has knurled finger-tip adjustment knob. It also has an Allenhead for fine adjustment . . . 4 to 1 ratio, nominal. Designed for PC board use, it requires approximately 1/2 cubic inch of space. Price is another unusual feature—only \$1.45 in 100 lot quantities!

Model 333's unique resistance element is the same as used in MIL-type Squaretrim® pots for high resolution, linearity, and low noise. Also,

it is vibration and shock resistant.

This is just one of the special-purpose Daystrom units—from industry's broadest line of subminiature square-trimming potentiometers. Chances are that we can fill your most exacting requirements with a standard, off-the-shelf model.

See your Weston distributor for catalog, prices and evaluation units. **Weston Instruments, Inc., Archbald Division, Archbald, Pennsylvania 18403. Phone: (717) 876-1500.**

Only Weston's exclusive wire-in-the-groove offers **LOCKED-IN LINEARITY**

**From Weston's broad trimmer line**



actual size

**Model 333** — 1/2" by 3/16" by 3/16". Dual adjustment: knurled finger-tip knob and Allenhead. For PC board mounting. Resistance: 50Ω to 10k, up to 50k on special order. Rating: 0.2w @ 40°C in still air.



**Series 200** — 3/8" Square-trim, 0.150" thick, slotted or Allenhead adjustment screws. This is only one of a full line of 3/8" pots. Operation: from -55 to 150°C. Resistance: 10Ω to 50k. Rating: 1w @ 50°C in still air.

let your  
fingers  
do the  
trimming

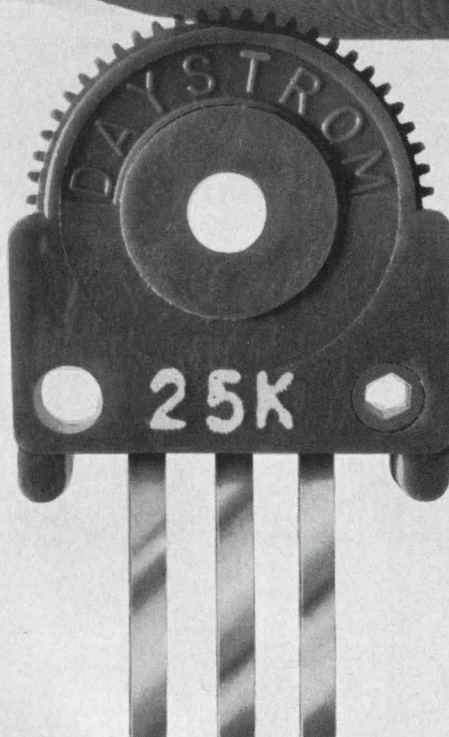

**WESTON®** prime source for precision... since 1888

ON READER-SERVICE CARD CIRCLE 30

# Test system uses telemetry data to check performance of relays in airborne electronic package. The results are displayed visually on a counter.

Pnpn-controlled switches, logic circuitry and sensitive relays are used in a ground-based test set-up to analyze telemetered pulse signals from four lines of an airborne electronic system. The test circuit determines the pull-in and hold-in times of 15 programmed relays in the airborne package and detects unprogramed or incorrect relay closures.

The block diagram in Fig. 1 shows the relationship of the airborne and ground systems. A binary-coded input signal, generated by the ground system, simultaneously starts the test system's clock pulses and energizes the selected relay in the system being tested. The pulses are counted by segment No. 1 of the dual counter, which also displays the count. The pulses resulting from the closure of the relay in the tested package energize the logic circuits. The dc-output levels of the logic circuitry are compared with the input signal to the system under test. If the signals are acceptable, a dc level is generated, stopping counter segment No. 1 and starting counter segment No. 2. Counter segment No. 1 thus measures the pull-in time of the relay under test. When this relay drops out, the dc level is removed from counter segment No. 2, and the

count stops. Counter segment No. 2 then indicates the hold-in time of the relay.

The closing or opening of one of the 15 relays in the airborne system is indicated by the appearance of binary-coded, polarized pulses on one or more of the four telemetry channels. Therefore, the operation of each individual relay can be checked and then displayed by the test system.

## Pulses show relay condition

To clarify the circuit's operation, let's number the relays being tested from 1 through 15 and label the lines from *A* through *D*. Closure of relay No. 11, for instance, will be indicated if positive pulses occur in parallel on lines *A*, *B* and *D*. We assume next that because of faulty programming, relay No. 2 is also energized. This would be indicated by a signal on line *B*. However, a pulse also appears on the line, due to the energized relay No. 11. If these two relays are energized simultaneously, only a single pulse will appear on line *B* (see Fig. 2). Drop-out of any of these relays is delayed from one-half to 10 seconds by electronic circuitry in the airborne package. The probability of two relays dropping out at the same time is very low. (This is due to the random time in which the relays drop out.) If two relays have been energized

H. D. Balcom and H. R. Weiss, Light Military Electronics Department, General Electric Company, Utica, N. Y.

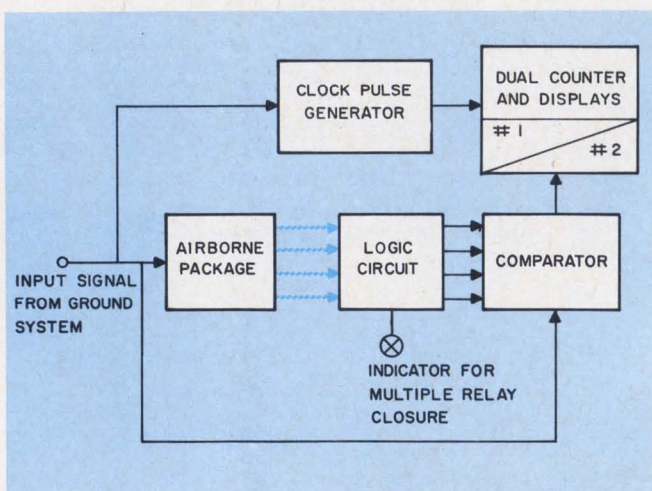

1. A telemetry link provides control/monitor path between the airborne package and the test system. A dual counter is used to display the test results. One clock signal triggers both airborne and ground systems.

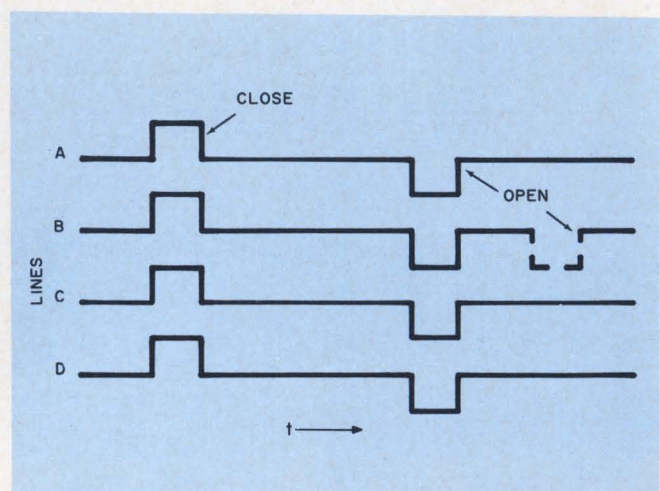

2. A binary-coded pulse input to the logic circuit. The solid lines indicate pulses associated with relay #11. The dotted pulse shows the only signal change required to identify relay #2.

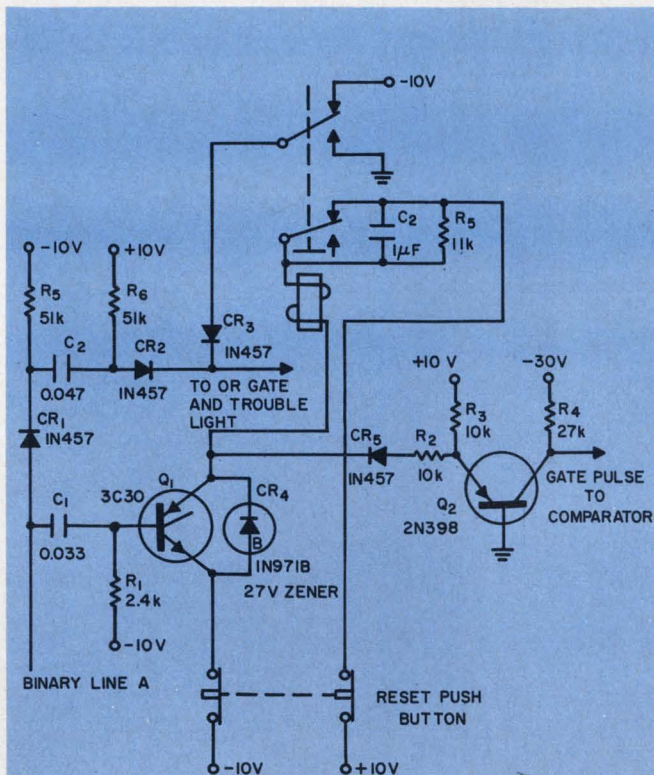

3. The logic circuit shown above is connected to one input line of the ground-based test system.

simultaneously, they will not drop out together. In this case two distinct negative pulses will appear on the same binary line.

Fig. 3 shows the circuitry connected to one binary line. Closure of the tested relay causes pnp-controlled switch  $Q_1$  to conduct. Transistor  $Q_1$  acts like a bistable flip-flop. A change in the state of  $Q_1$  stops conduction of transistor  $Q_2$ , which starts the negative gate for the counting circuit. Conduction of  $Q_1$  also energizes relay  $K_1$ . One contact set of  $K_1$  inserts  $R_5$  in series with the relay coil to reduce the current through  $Q_1$  to the necessary holding current for the relay.

The negative charge required to drive a controlled switch out of conduction is proportional to the anode current of such a device. It is therefore essential to reduce the existing anode current to avoid the need for excessive negative charge. The other set of  $K_1$  contacts biases  $CR_3$ , which, together with  $CR_2$ ,  $R_6$ , and  $R_7$ , forms an AND gate.

The first pulse that occurs when the tested relay opens makes  $Q_1$  nonconducting. This de-energizes relay  $K_1$  and turns on  $Q_2$ . Contacts of  $K_1$  now bias the AND gate to open it. The drop-out time of  $K_1$  must be slightly longer than the width of the negative pulse. This prevents the trailing edge of the pulse from passing through the AND gate.

A second pulse that occurs on the same binary line before another closure pulse does will therefore pass through this gate and turn on the "trouble" light, indicating that more than one relay has been closed.

While the procedures described here are particularly suitable for testing a remotely located system, similar techniques can be employed wherever a group of relays is to be tested. ■ ■

IF THIS  
MINIATURE METAL  
FILM RESISTOR  
DOESN'T CHANGE YOUR  
*design ideas*

...try one of these

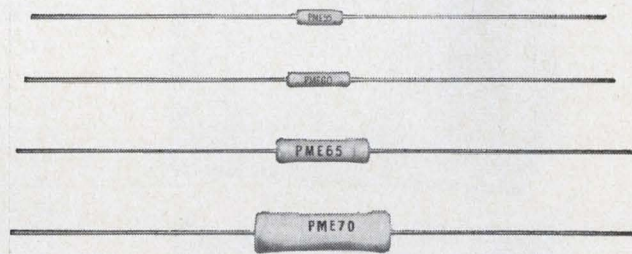

Part No.	Power	Ohms	Tol.	Temp. Coef.
PME 50	1/20 W	10Ω to 1M	±1% to .1%	T-0, T-2, T-9
PME 55	1/10 W	10Ω to 3M	±1% to .1%	T-0, T-2, T-9
PME 60	1/8 W	49Ω to 7.5M	±1% to .1%	T-0, T-2, T-9
PME 65	1/4 W	49Ω to 20M	±1% to .1%	T-0, T-2, T-9
PME 70	1/2 W	24Ω to 30M	±1% to .1%	T-0, T-2, T-9
PME 75	1 W	49Ω to 50M	±1% to .1%	T-0, T-2, T-9

The stability and accuracy of Pyrofilm's PME metal film resistors makes their use ideal in applications where before only wire wound resistors could be used. These resistors are virtually unaffected by environmental conditions and withstand constant exposure to high moisture conditions without change in specifications. PME resistors meet or surpass all requirements of MIL-R-10509F.

Send for fact-filled literature sheet!

**PYROFILM RESISTOR  
COMPANY, INC.**

3 SADDLE ROAD • CEDAR KNOLLS, NEW JERSEY • 201-539-7110

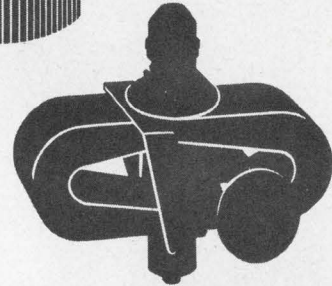
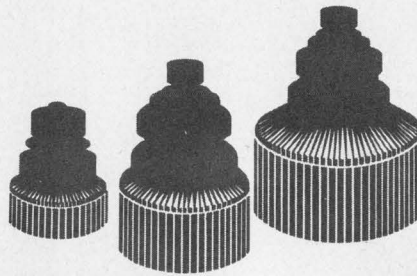

# NEED HIGH POWER at WIDE BANDWIDTHS?

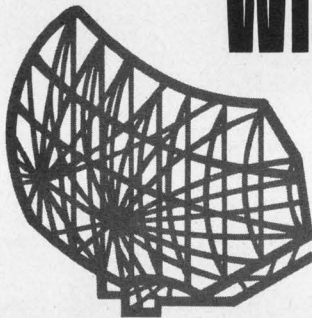

## TELONIC PD SWEEP GENERATORS DELIVER 4 WATTS OF SWEEP RF

*...for frequency testing of networks, filters, transmission lines, varactors, klystrons, and other systems at high power levels.*

Telonic's PD Series of sweep generators supplies maximum versatility for testing, aligning, and adjusting operations. First—they may be used in 4 modes, swept RF, modulated swept RF, CW, and modulated CW, and secondly—they supply as much as 4 watts of output, providing power levels at which the unit under test will actually be functioning.

Considering all this versatility and their ability to provide *more test data in less time*, the PD Sweep Generators become necessary instrumentation in any application using tedious, single-point, signal generator techniques.



PD-2



PD-3



PD-7

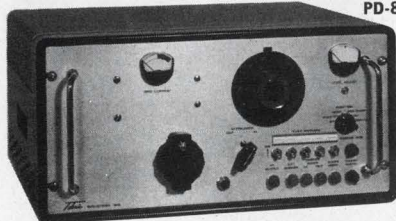

PD-8

SPECIFICATIONS	PD-2	PD-3	PD-7	PD-8
CENTER FREQUENCY	20-100 MHz	100-250 MHz	200-375 MHz	375-1000 MHz
SWEEP WIDTH	0.2-15%	0.2-15%	0.2-10%	0.2-15%
SWEEP RANGE	18-105 MHz	90-260 MHz	190-385 MHz	330-1010 MHz
SWEEP FUNCTION Attenuator out Attenuator in	14 v RMS into 50 ohms (4 watts) 10 v RMS into 50 ohms (2 watts)			
CW FUNCTION Attenuator out Attenuator in	2 watts into 50 ohms 1 watt into 50 ohms			
PRICE	\$2500			

*Complete specifications on the PD Sweep Generators and all Telonic swept frequency instrumentation is available in General Catalog 64-A-1. Yours on request.*



**INDUSTRIES, INC.**

60 NORTH FIRST AVE., BEECH GROVE, INDIANA

TEL.: (317) 787-3231 TWX: 810-341-3202

World Leader in Swept Frequency Instrumentation.

Representatives in all major cities in the U.S. and Overseas.

# Precision you can trust, because it's built in.

**±50 ppm TC.**  
**1/2% and 1% tolerances.**  
**<0.5% load-life ΔR guaranteed.**  
**Mil-R-10509E, Char. C.**

## New CORNING® NC-style Resistors.

NC4—1/10 watt at 125° C., 49.9 ohms to 150K

NC5—1/8 watt at 125° C., 49.9 ohms to 499K

NC6—1/4 watt at 125° C., 49.9 ohms to 1 Meg.

True precision resistors with all the long-term reliability you've come to expect from CORNING glass-tin oxide film. And not just tested into some. Nor sorted out of many.

But precision that's built in . . . in a continuous manufacturing process that provides the highest inherent reliability of any resistor made today. Here's how:

The tin oxide film is bonded *molecularly* to a glass cane substrate at red heat . . . it isn't plastered on, or sputtered on.

Temperature coefficient of film and substrate match perfectly.

The substrate is chemically inert to the film.

Once cooled, the film compares in hardness to high-carbon tool steel . . . you can't scrape it off.

We make CORNING NC-styles with these materials and this technique to guarantee you constant resistivity, constant quality . . . precision that's built in.

Call your CORNING distributor for technical data and samples or send the coupon today. Evaluate the new NC-styles, and see how their built-in precision gives you new design confidence.

**CORNING GLASS WORKS, 3909 Electronics Dr., Raleigh, N.C.**

Please send me new NC-style Resistors data and samples.

Name..... Title.....

Company.....

Address.....

City..... State..... Zip.....

**CORNING**  
ELECTRONICS

Speed Inquiry to Advertiser via Collect Night Letter  
ON READER-SERVICE CARD CIRCLE 32

# Coupling-irises arrangement solves microwave filter need

A circular "iris," cut into a metallic element to form an aperture, establishes a loose-coupling property. This feature is then used to satisfy narrow-band filter needs in microwave guides.

Both quarter-wave-coupled and direct-coupled waveguide bandpass filters often employ inductive irises as coupling elements. To construct the narrow-band filters, loose couplings with large, normalized iris susceptances are required. To obtain these loose couplings, just cut circular apertures in thin metallic inductive-coupling irises.

Usually these irises can be soldered to both the top walls and side walls of the rectangular wave-

guide. But by leaving small gaps in the irises near the waveguide side walls, we can eliminate the soldering of the irises to the side walls. This simplifies substantially the filter's solder assembly and eliminates some perturbations in circuit performance caused by the inability to control and reproduce solder fillets.

This technique was applied in an X-Band (RG-52/U) waveguide with an iris thickness of 0.031 in. and 0.031 in. gaps (see diagram, part "a"). Insertion-loss measurements were performed for various aperture diameters, and normalized susceptances were calculated from

$$B = 2 \sqrt{\text{antilog}_{10} (L/10) - 1}, \quad (1)$$

where  $B$  is the normalized iris susceptance and  $L$  is the insertion loss in dB.

Experimental curves of normalized susceptances vs aperture diameter are plotted in "b" of the accompanying diagram for various frequencies between 8.5 GHz and 11.0 GHz. The ensuing normalized susceptances in excess of 100 validate this technique for attaining loose coupling.

Triple inductive coupling posts are also practical coupling elements for normalized susceptances between 10 and 75. However, for larger susceptances ( $>75$ ), the proposed technique is both inexpensive and more fruitful. Under some circumstances the circular apertures in the coupling irises may be enlarged to final size subsequent to solder assembly (where assembly procedures warrant this step).

*Richard M. Kurzrok, Senior Engineering Scientist, Communications System Laboratory, RCA, New York, N. Y.*

VOTE FOR 110

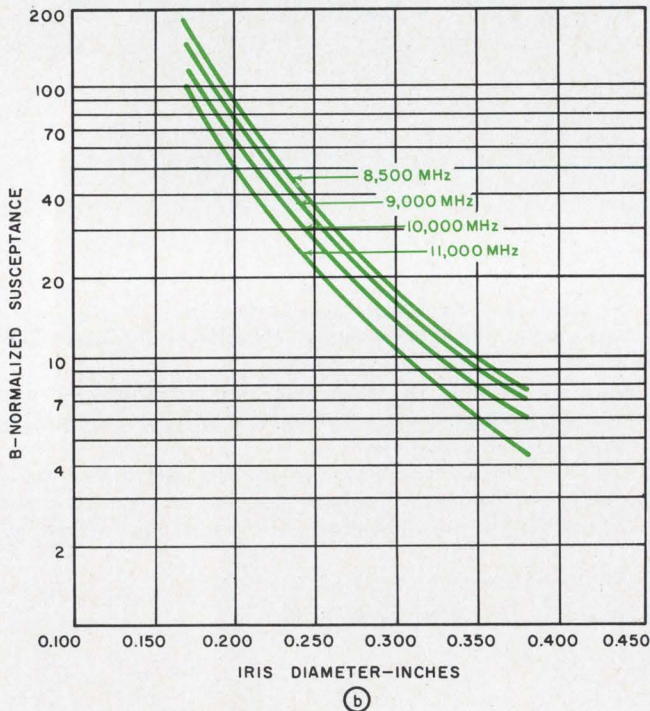
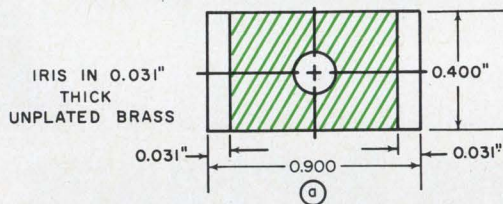

The loose-coupling needs of microwave narrow-band filters are inexpensively met by making a circular aperture in a metallic element (a). The irises thus formed exhibit large normalized susceptances at X-band frequencies (b).

IDEAS FOR DESIGN: Submit your Idea for Design describing a new or important circuit or design technique, the clever use of a new component, or a cost-saving design tip to our Ideas for Design editor. If your idea is published, you will receive \$20 and become eligible for an additional \$30 (awarded for the Best of Issue Idea) and the grand prize of \$1000 for the Idea of the Year.

## OR gate and RC timing control UJT pulse rate

You can get smooth control of a unijunction-transistor (UJT) output-pulse rate by combining a two-input diode OR gate with a pair of RC-timing networks. Simplicity and low cost also make this circuit attractive.

Networks  $R_1C_1$  and  $R_2C_2$  make up the time-decision portion of the circuit (see diagram). The time constant of  $R_1C_1$  is usually made larger than that of  $R_2C_2$ . The outputs of the two timing circuits appear at the emitter of the UJT.

The diodes insure that the UJT trigger control is established by the smaller (faster) of the tim-

(continued on p 86)



# Coors Strate-Breaks™

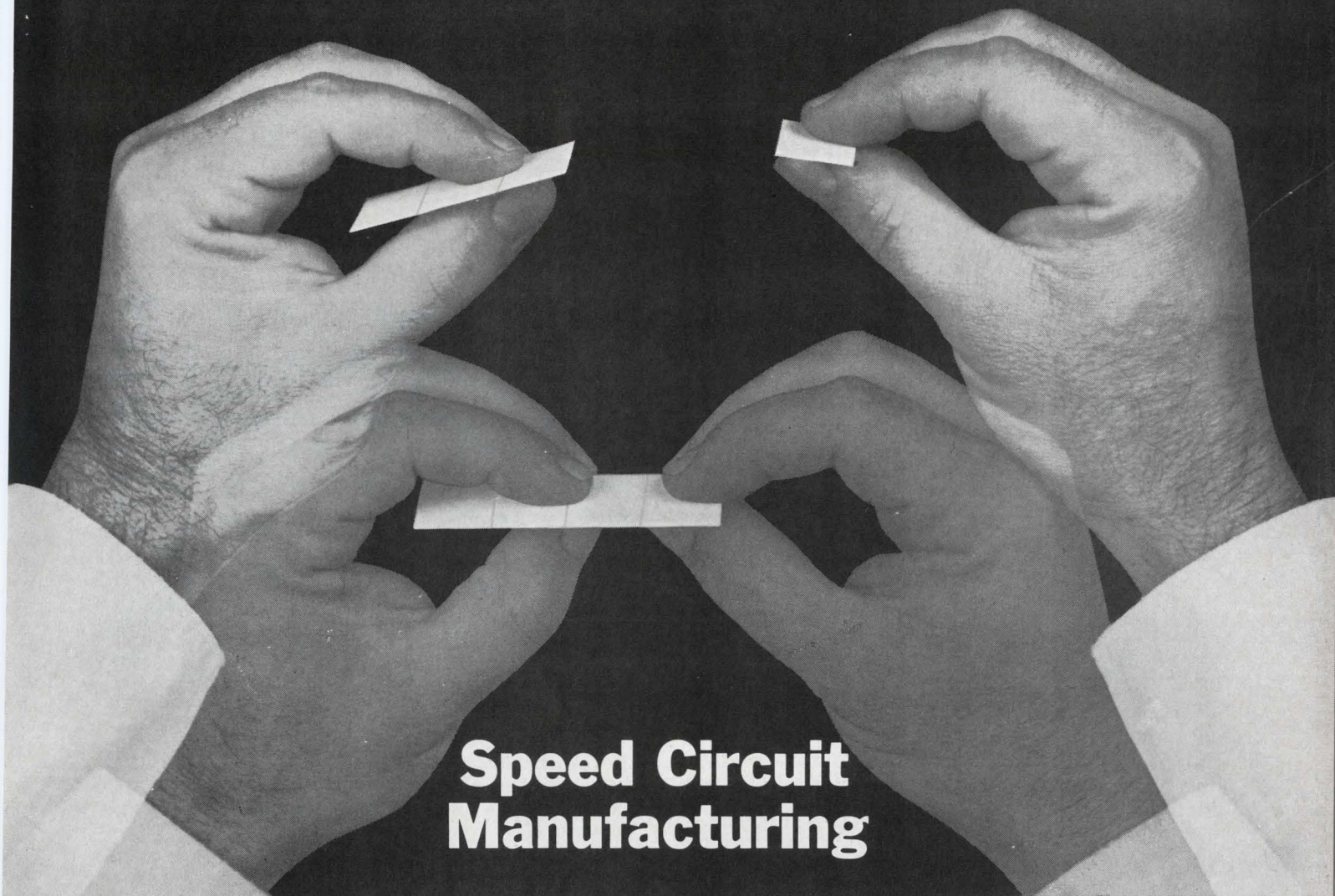

## Speed Circuit Manufacturing

High quantity production of integrated circuits with uniform quality, increased precision tolerances, greater economy in the production of micro-ceramic components—all these are yours by gang printing your circuits on Coors *Strate-Breaks*. No cutting apart, no multiple handling before assembly. Just SNAP!... and there are your individual components with a straight, smooth, precision edge.

Coors *Strate-Breaks* are made to your specifications in sizes from  $\frac{1}{2}$ " x  $\frac{1}{2}$ " to 4" x 4". They are available unglazed for thick-film circuits, and glazed or unglazed for thin-film circuits. For on-the-spot answers to your questions, dial the Coors "hot line"—303/279-4533, Ext. 351. For full details on Coors *Strate-Breaks*, write for Coors *Strate-Break* Data Sheet 7011.

Patent  
Pending

*consider  
Coors  
ceramics*

# Coors

## CERAMICS

ALUMINAS • BERYLLIAS • MAGNESIAS • SPECIAL OXIDES  
Coors Porcelain Co., Golden, Colo.

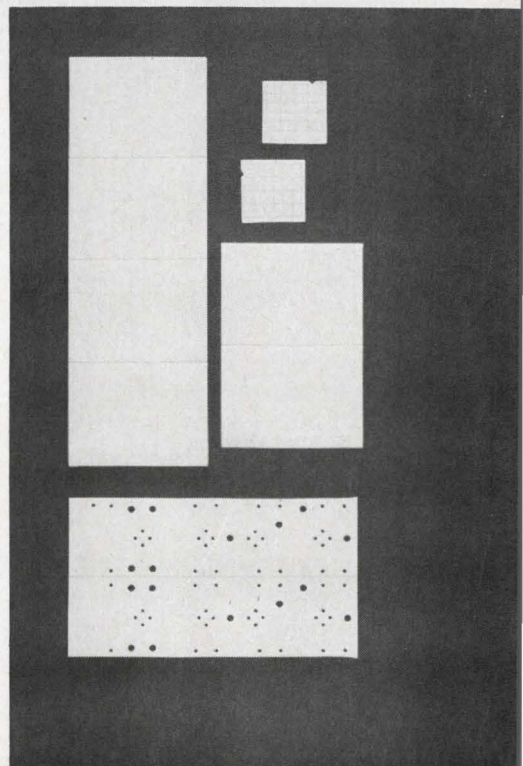

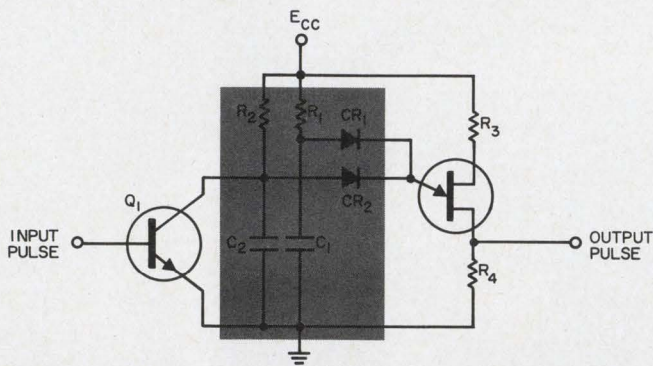

Timing networks  $R_1C_1$  and  $R_2C_2$  and diodes control the triggering of the UJT. Actual triggering is caused by the network with the shorter of the two time constants. The interval between trigger pulses is determined by  $R_1C_1$ .

(continued from p 84)

ing networks. This minimizes the input's influence on the trigger cycle. The time interval between UJT trigger pulses is determined by  $R_1C_1$ .

This circuit was designed for use in traffic-control systems.

Tetsuo Funaki, Research Engineer, Churitsu Electric Co. Nagoya, Japan.

VOTE FOR 111

## Tunnel diode and transistor form linear monopolar gate

A tunnel diode and a transistor may be combined to form a simple, bi-directional linear monopolar gate. The gate is then useful for time-sampling pulses, without disturbing their linearity, and for blanking applications.

This is especially advantageous in nuclear physics experiments, where it is frequently necessary to time-sample pulses and still maintain linearity. An example is the measurement of gamma-ray spectra corresponding to various neutron resonances, which are selected by time-of-flight parameters.

The monopolar gate (part "a" of diagram) is intended for use with positive pulses. When the pulses are to be gated out, the tunnel diode is pulsed into its high-voltage state. This saturates the transistor, which then bypasses most of the signal to ground. In this way an attenuation of 50:1 is obtained with a single gate.

When the gate is to be opened, the tunnel diode is pulsed to its low-voltage state. Pulses of 5 volts amplitude will set or reset the circuit. A positive pulse of 10 volts, applied to the derivative input, will close the gate on the leading edge and open it on the trailing edge. When the transistor saturates, it does not go all the way to zero. Also, some signals have a small dc component. For these reasons a pedestal adjustment is provided. By adjusting the pedestal, we limit transients to 50 mV or less.

Part "b" of the diagram displays the pulses

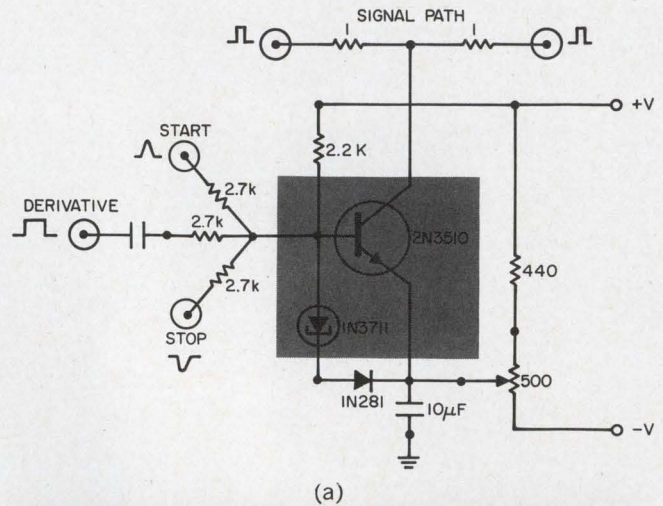

(a)

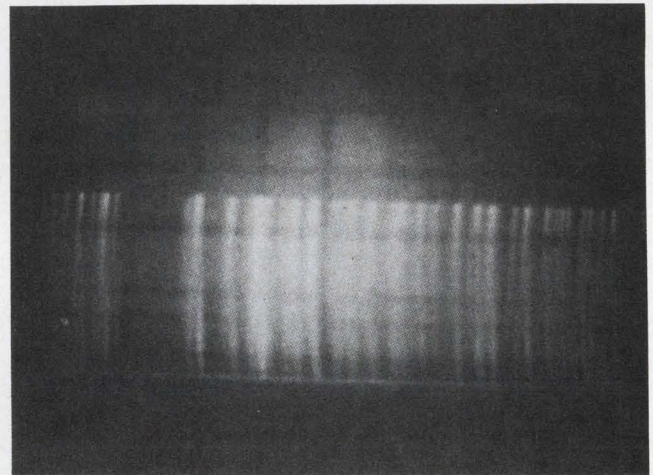

(b)

Combination of transistor and tunnel diode forms a simple, bi-directional linear monopolar gate (a). The gate is used for time-sampling and blanking applications (b) in pulse systems. This design does not impair linearity requirements.

from a free-running generator blanked out for 10  $\mu$ s with the gate.

R. R. Fullwood, Department of Nuclear Engineering and Science, Rensselaer Polytechnic Institute, Troy, N. Y.

VOTE FOR 112

## Inexpensive null detector is sensitive and accurate

Here's a useful, accurate, null-detection circuit that utilizes inexpensive components and has proved to be highly reliable. Null sensitivities of 25 mW are easily obtained with inputs having a signal swing of +6 volts.

The circuit (see illustration) operates as follows:

With no input signal present, transistors  $Q_1$  and  $Q_2$  are saturated by the base bias currents supplied through resistors  $R_3$  and  $R_4$ . This results in the cut-off of transistors  $Q_3$ ,  $Q_4$  and  $Q_5$ . The

(continued on p 88)

# Listen to this page.

The MC 4000 prints as silently as light striking this page.

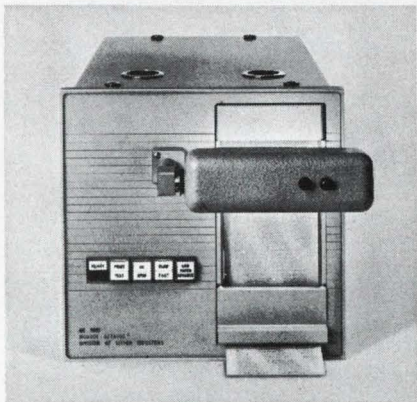

Monroe Datalog®'s ultra high speed MC 4000 is totally silent because it's an optical, not an impact printer. All solid state. Cathode ray tube with fiber optics. Absolutely reliable—only two moving parts.

Ultra high speed—records 6000 lines per minute, or any speed less that your application requires. Truly synchronous or asynchronous. Available in numeric or alphanumeric models—both 32 columns wide.

Features: character serial input, bit parallel. 6 microseconds per character

data transfer time. Exceptional compactness— $10\frac{1}{2}$ " x  $10\frac{3}{4}$ " x  $21\frac{1}{2}$ ". Any 4 or 6 line code with any logic level. Permanent copy option available.

And a full year's warranty. Price: \$5650 for numeric model; \$5850 for alphanumeric model.

For information, contact Monroe Datalog Division of Litton Industries, 343 Sansome St., San Francisco 94104. (415) 397-2813.

**MONROE DATALOG**   
DIVISION OF LITTON INDUSTRIES

ON READER-SERVICE CARD CICLE 33

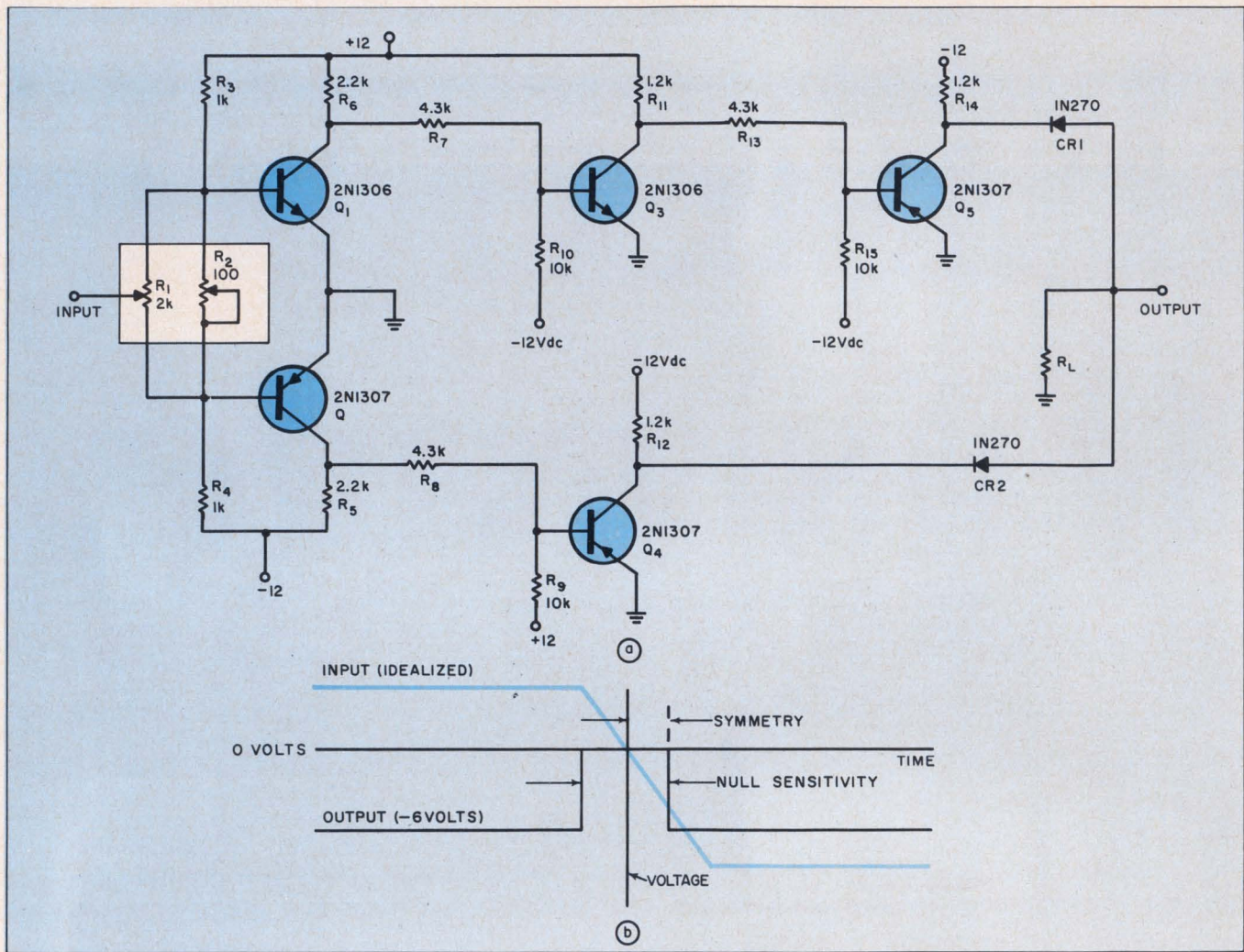

1. Null symmetry and sensitivity are easily varied by  $R_1$  and  $R_2$ , respectively, in this inexpensive null detector circuit (a). The transfer characteristic of the circuit (b) shows good linearity.

(continued from p 86)

output voltage remains at zero volts, due to the voltage divider action of  $R_{12}$ ,  $R_{14}$ ,  $CR_1$  and  $CR_2$ . These conditions exist quiescently and also for a null (zero-volt) input signal.

For any non-zero input signal, either  $Q_1$  and  $Q_2$  will cut off (depending upon polarity of the input signal), thereby resulting in the saturation of either  $Q_4$  or  $Q_5$ . The output voltage will shift to a negative level that may be conveniently used to inhibit some external system function. The magnitude of the output inhibiting voltage is easily adjusted by varying the ratio of  $R_L$  to either  $R_{12}$  or  $R_{14}$ .

The circuit's transfer characteristics are illustrated in Fig. 1b. Note that the null sensitivity is conveniently varied by adjusting  $R_2$ , while the symmetry of the null detection is variable by means of  $R_1$ .

The circuit was originally designed to indicate the presence of a null output signal from a magnetometer guidance system, but it is equally useful

in a variety of applications that require accurate determination of a null input signal.

Phil M. Salomon, Consultant, Impro Corp., Pasadena, Calif.

VOTE FOR 113

## Push-button monopulse unit shows clean, ring-free output

The use of a simple switch and two diodes insures that only one output pulse is produced by a pulse generator. Moreover, this circuitry helps keep the output clean and free of ringing effects.

Whenever an ordinary push-button switch is used for the initiation of the pulse in single-pulse generators, there is always the risk of obtaining more than one output pulse, due to the ringings of the switch contacts. The contact ringing plays havoc with the charge and discharge functioning

(continued on p 90)

# NEW ERIE Low Pass FILTERS

...LESS THAN  $\frac{1}{13}$  The Volume

## OF CONVENTIONAL FILTERS

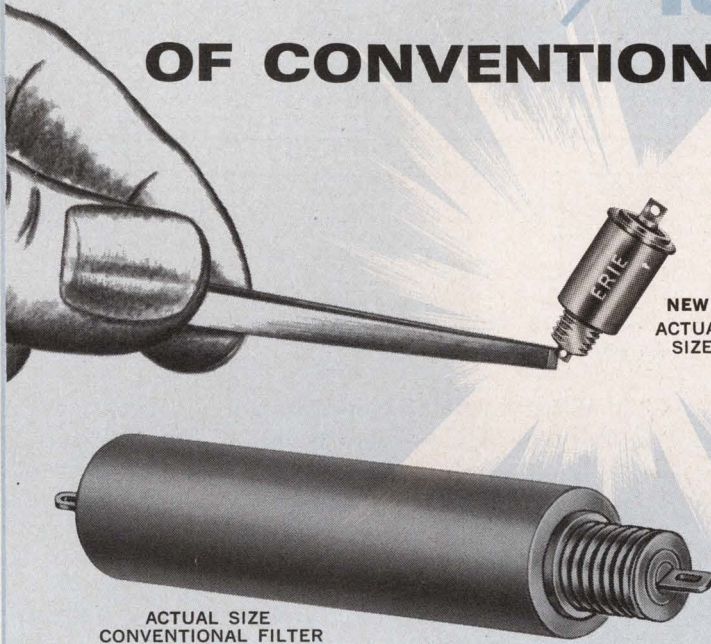

NEW...  
ACTUAL  
SIZE

ACTUAL SIZE  
CONVENTIONAL FILTER

### ERIE'S NEW FILTER TECHNOLOGY PERMITS DRASTIC REDUCTION IN SIZE

Now, from Erie's Project "ACTIVE" (Advanced Components Through Increased Volumetric Efficiency) comes a new line of subminiature high pass, low pass and band rejection L,  $\pi$  and T Section Filters.

Volume reduction of these high reliability filters ranges to 13 times smaller than conventional filters of equal capability. Weight is correspondingly reduced, thus providing ideal RFI (electromagnetic interference) Filtering for equipment in aerospace, military and commercial markets.

Erie's new filter technology permits insertion loss ratios of 67 DB @ .25A @ 150 KC ... volumetric efficiencies which were never before possible.

In addition to the standard line filters described at right, Erie offers a full line of compact Bypass Capacitor Systems for transmitting tubes. Also, if you have particular electromagnetic interference problems not covered by standard Erie filters, we will be happy to custom design a filter connector package to suit your application.

Write TODAY for Bulletin 9000 and the name of your nearby Erie Field Sales Engineer.

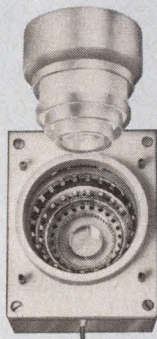

### AIR FLOW SOCKET SYSTEM AND SCREEN GRID BYPASS CAPACITORS

Erie now provides effective and reliable capacitive bypassing and coupling or filtering of all RFI signals in the range of 10 to 3,000 megacycles and beyond. Screen grid values from 1000 pf. to 10,000 pf. at 1000 WVDC. Variety of systems to meet your design requirements. Write for Bulletin 9800.

Erie's Project "ACTIVE"  
Advanced Components Through Increased Volumetric Efficiency

Actual Size

#### HERMETICALLY SEALED BROAD SPECTRUM REJECTION FILTERS



100 Volts DC line Filter; For L,  $\pi$  and T Circuits; Insertion Loss...67 DB at 150KC DC Current Ratings to 8.0 Amp.  $\frac{1}{4}$ -28 Thd. mounts in chassis.



115 Volts AC @ 60 cycles; Insertion Loss. 12 DB @ 150 KC and 60 DB @ 10 Mc.;  $\frac{1}{4}$ -28 Thd. mounts in chassis.

#### SUBMINIATURE STRIPELINE FILTERS



#### HERMETICALLY SEALED AIR DIELECTRIC STRIPLINE FILTER AND DIODE HOLDER

Two components in one for  $\pi$  circuits... 1. Precision capacitor values for selective bias... 2. Signal line filter network. Isolation shaped as required.



#### SUBMINIATURE STRIPLINE T and $\pi$ SECTION FILTERS

Ribbon leads; 50 DB @ 1 Gc. Excellent VSWR. Effective filtering beyond 4 Gc.

ERIE

TECHNOLOGICAL

PRODUCTS, INC.



Erie, Pennsylvania

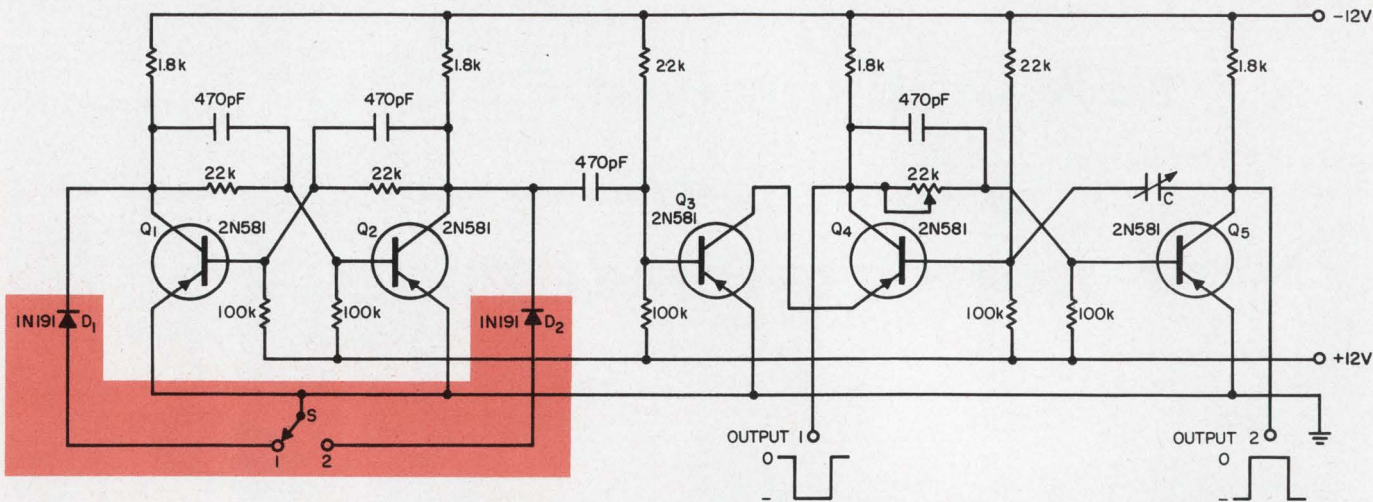

Switch and two diodes insure that output of monopulse generator is free of ringing. The result of this approach is

(continued from p 88)

of the timing capacitor. This problem can be easily overcome by the use of a modified switching network (see illustration).

In the new circuit, switch *S* is normally in position 1 and transistor *Q*<sub>1</sub> of the *R-S* flip-flop is thereby conducting. When *S* is brought to position 2, the flip-flop changes state, and a single positive step appears at the collector of *Q*<sub>2</sub>, independent of any ringings of the switch contacts in position 2. This step triggers the monostable circuit (*Q*<sub>4</sub> and *Q*<sub>5</sub>) via *Q*<sub>3</sub>.

a sharply defined waveshape that does not contain unwanted pulses.

When *S* returns to position 1, a negative step is produced at the collector of *Q*<sub>2</sub>, but this has no effect on the triggering transistor. Consequently the output pulse is independent of any ringings of the switch contacts in position 1. The duration of the output pulse may be varied by means of the collector-to-base coupling capacitor *C*.

*Dimitrios Doucas, Development Engineer, Nuclear Research Center Democritos, Athens, Greece.*

VOTE FOR 114

## SCR-UJT circuit gives economical time delay

A simple time-delay circuit built with a silicon-controlled rectifier (SCR) and a unijunction transistor (UJT) turns itself off after the time-delay period has elapsed.

In conventional designs the SCR stays on until it is turned off either by a current-interruption

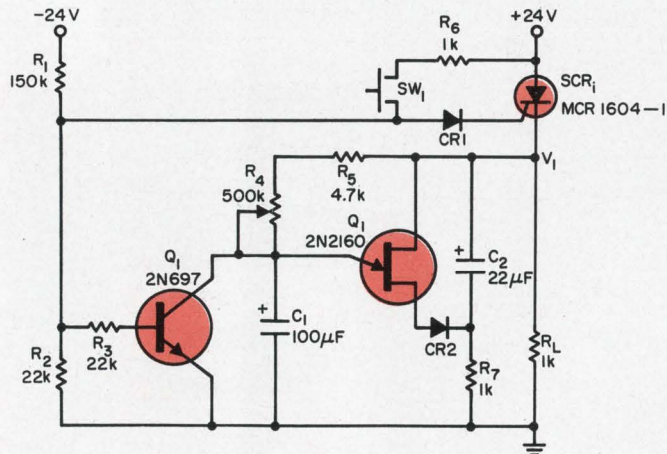

SCR does not remain on after elapse of the time delay in this UJT timing circuit. A portion of the UJT output pulse appears across *R*<sub>L</sub> and back-biases the SCR at the termination of the time-delay period.

method or some other commutation scheme.

In the new design (see illustration) the SCR is turned on when *SW*<sub>1</sub> is closed. The voltage across load resistor *R*<sub>L</sub> becomes approximately 23 volts. Capacitor *C*<sub>2</sub> is then charged to the 23-volt level in a short time, determined by the *C*<sub>2</sub>*R*<sub>7</sub> product. Similarly, capacitor *C*<sub>1</sub> is charged toward 23 volts through *R*<sub>4</sub> and *R*<sub>5</sub>.

The UJT fires when the voltage across *C*<sub>1</sub> reaches approximately 18 volts. The discharge current of *C*<sub>1</sub> through the UJT causes a voltage rise of approximately 18 volts to appear across resistor *R*<sub>L</sub>, thus reverse-biasing the SCR. If the discharge time constant is longer than the SCR turn-off time, the SCR will not conduct.

Transistor *Q*<sub>1</sub> is used to reset the voltage across *C*<sub>1</sub> to approximately 0.6 volt when *SW*<sub>1</sub> is closed. This will maintain the preset time-delay constant. The length of the delay is determined by the UJT emitter-charging network.

*S. Hao, Sr., Engineer, Westrex Communications Div. of Litton Industries, New Rochelle, N. Y.*

VOTE FOR 115

## IFD Winner for Jan. 4, 1966

**Gilbert Marosi**, Senior Engineer, Friden Inc., San Leandro, Calif.

His idea, "Bipolar current source simplifies triangle generator," has been voted the \$50.00 Most Valuable of Issue Award.

Cast Your Vote for the Best Idea in this Issue.

# NEW functions extend state-of-the-art capabilities of versatile HLTTL series

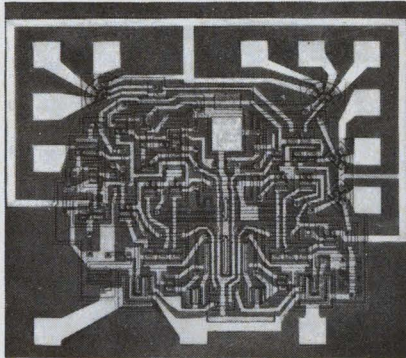

## new high-speed "D" type flip-flop

- Transiltron's TFF3512 and TFF3514 raceless, dual-rank, high-speed "D"-type flip-flops represent a new addition to what is already the broadest line of flip-flops in a single logic family
- The new high-speed unit complements, typically, on a 50-megacycle input signal. The unusually high operating speeds, which are particularly insensitive to heavy loading, have been achieved by dual steering of the second rank flip-flop.

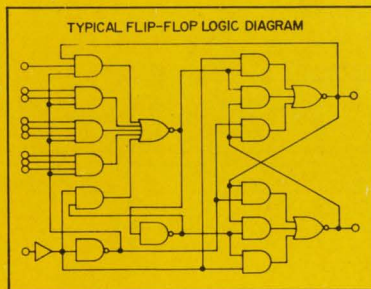

- A maximum of input gating is provided to simplify external gating requirements. The configuration chosen eliminates redundant inputs and the necessity of supplying the data complement to form the "set" function, thereby reducing interconnections. Connections for holding a logic "1" have also been incorporated into the flip-flop. A built-in clock buffer reduces the clock line driving requirements. Noise immunity in excess of 1.0 volt, and fanouts in excess of 15 are typical, with other characteristics and logic levels representative of HLTTL circuitry.
- The high speed and extended gating capability of these units make them extremely desirable for arithmetic and general register applications.

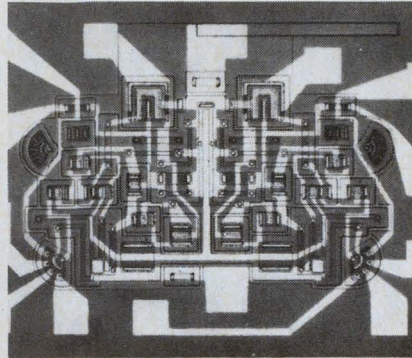

## new non-inverting gates

- A new generation of non-inverting "AND" and "OR" gates has been added to Transiltron's broad HLTTL family. Developed for use in systems where simplification and higher speeds are important factors, the new gates exhibit the high capacitive drive capability, high noise margin, and high speed characteristic of the HLTTL design.

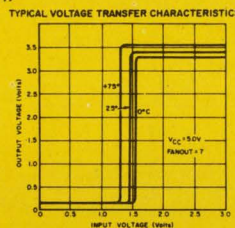

### Functions in the series include:

- TNG6222 and 6224 — Dual 4 input "AND" gate with transient control
- TNG6252 and 6254 — Expandable dual 4 input "AND" gate
- TNG6262 and 6264 — Expandable dual 3 input "AND" gate with transient control
- TNG6522 and 6524 — Expandable single 4 input driver gate with transient control
- TNG7252 and 7254 — Expandable dual 2 + 2 input "OR" gates
- TNG7712 — 8 + 3 input expander gate
- TNG7812 — 4 + 4 + 3 input expander gate
- TNG7912 — Dual 2 + 3 input expander gates

- Extremely sharp voltage transfer characteristics are provided by the series, resulting in noise margins typically in excess of 1.3 volts. Fast charge removal from the output transistor provides the ultimate in reduction of supply current during switching. Double inversion is utilized to provide the non-inverted feature with no sacrifice in propagation delay. Typical propagation delay times are 12 nanoseconds with 15 pf load and fanout of 1. Some of the circuits offer the possibility of controlling output transients through the use of an external capacitor. This is particularly useful in applications where length of interconnections would result in excessive noise coupling.

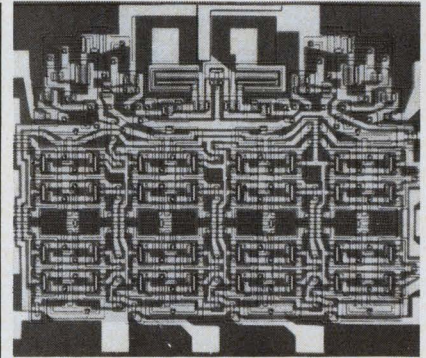

## new 16-bit memory cell

- A new 16-bit, bit-oriented, non-destructive readout, integrated circuit memory cell utilizing HLTTL technology is now available from Transiltron for "scratch pad" memory applications.
- The new memory cells, designated TMC3162 and TMC3164, consist of 16 two-transistor flip-flops arranged in a 4 X 4 matrix which provides the information storage. Two write amplifiers and two sense amplifiers are also built into the element. Extremely high speed operation is achieved through a unique circuit design. The unit exhibits delay times of less than 20 nanoseconds between addressing and writing or sensing. Both data and data complement are available at the sensing terminals, which can be paralleled with those of similar units to form larger arrays.

- The memory cell operates from a nominal supply voltage of 5 volts with addressing, writing and sensing voltage levels compatible with HLTTL logic circuitry. Typical high noise margins are in excess of 1.0 volt.

**PACKAGING** — All of the new HLTTL units shown here are available in a 14-lead flat package (designated by the suffix "F" added to the type number), or a 14-lead dual in-line package (suffix "P" added to type number).

### NEW LITERATURE

— Write today for complete specifications and details on these new additions to Transiltron's broad HLTTL line.



**Transiltron**  
electronic corporation  
Wakefield, Massachusetts

Speed Inquiry to Advertiser via Collect Night Letter  
ON READER-SERVICE CARD CIRCLE 35

# Is complementary symmetry the only way to sell audio transistors today?

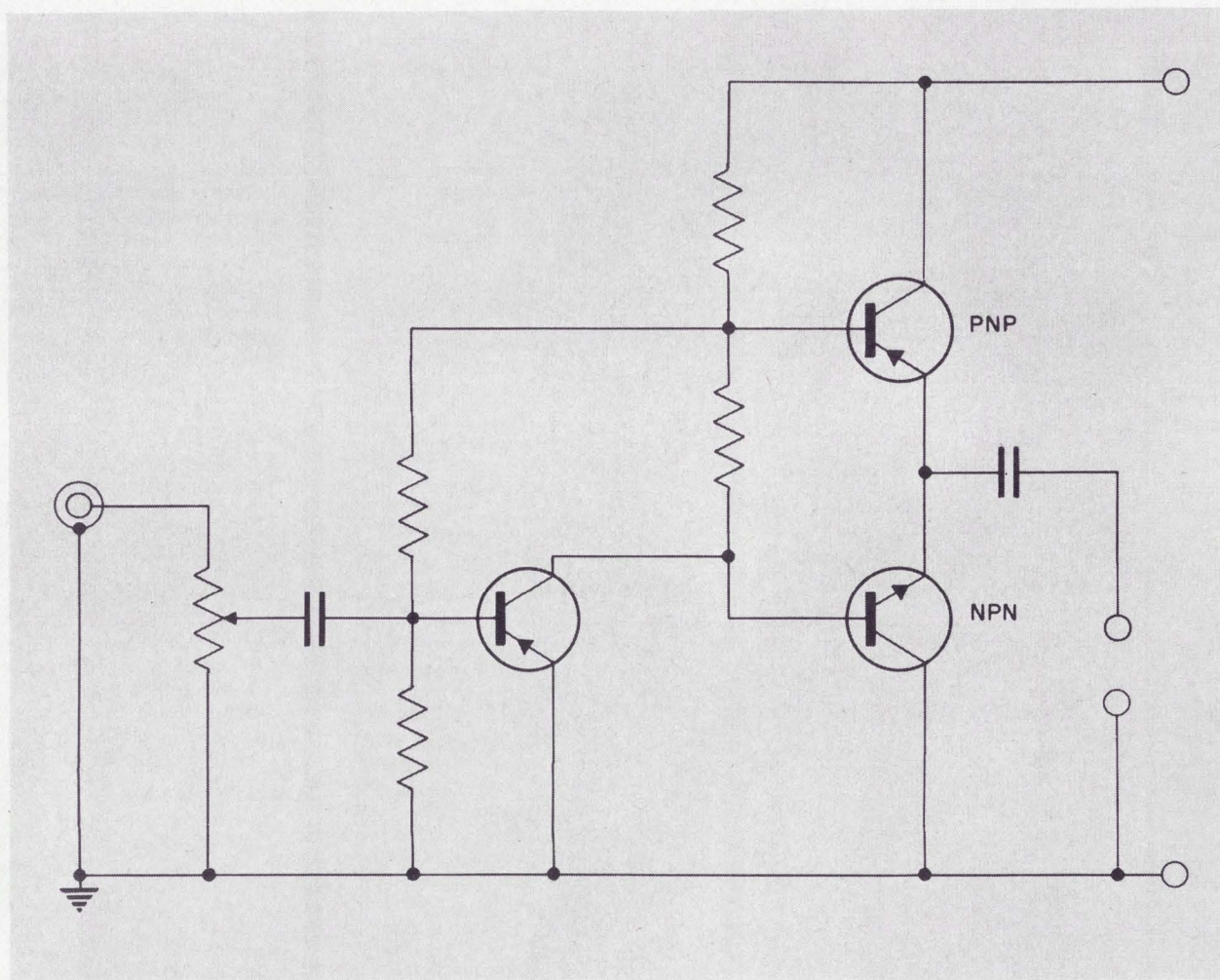



# You bet it is!

Complementary Symmetry is the ultimate in economical, reliable circuitry for audio applications up to 12 watts.

## FOR PHONOS (1 to 5 WATTS)

Complementary Symmetry achieves enormous manufacturing savings with no sacrifice in reliability, by using transistors as they should be used—as low voltage, low impedance, low temperature devices for Class B push-pull, instead of high voltage, high impedance (Class A) with transformers and associated components and high temperatures.

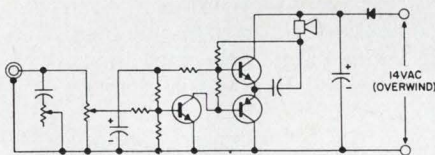

THE AMPEREX WAY

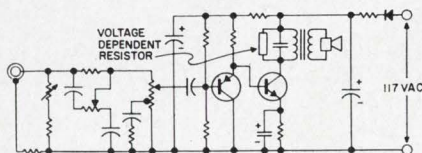

THE OLD WAY

**Low voltage** eliminates need for bottom plates, interlocks, etc. **Low temperatures** mean longer, more reliable component life. **Simple mounting clip** eliminates need for expensive heat sinks, mica insulating washers and mounting hardware. **No output transformers or VDR's**... low

output impedance of emitter follower output circuit obsoletes impedance-matching output transformer and related voltage dependent resistors.

Complementary Symmetry is not a new audio engineering approach! It has long been an audio designer's dream—a textbook approach! What is new, is that Amperex now provides the tools to make the textbook dream come true. We have the matched, paired transistors, dual heat-sinks, simplified circuits and application reports. Our applications department is at your service... and where required, complete bread-boarded prototypes will be provided.

**2N2707** matched pair 2N2430 (NPN) and 2N2706 (PNP) for power up to one watt for low cost phonos, amplifiers and radio; TO-1 cases in dual heat-sink clip.

**2N4136** matched pair 2N2430 (NPN) and 2N2431 (PNP) for power up to 2.5 watts; TO-1 cases in dual heat-sink clip.

**2N4107** matched pair 2N4105 (NPN) and 2N4106 (PNP) for power up to 7 watts; TO-1 cases in extruded aluminum heat-sink.

**2N4079** matched pair 2N4077 (NPN) and 2N4078 (PNP) for power up to 12 watts; TO-3 cases.

**FOR AUTO RADIO OUTPUTS**  
(5 watts at 13.6 volts)  
**THE NEW 2N4079 PAIR**  
**IS IDEALLY SUITED**

For data and for details of the Amperex "whole ball of wax" sales and applications program (transistors, circuits, prototypes, lab reports, etc.), write Amperex Electronic Corporation, Semiconductor and Receiving Tube Division, Dept. 371, Slatersville, Rhode Island 02876.

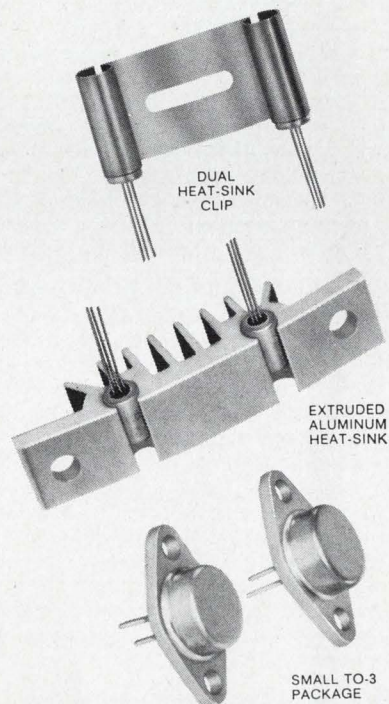

**Amperex®**



**CONSUMER  
ELECTRONICS  
OPPORTUNITIES**

**TV / CRT ENGINEERING AND MANUFACTURING**

**G.E.'S TELEVISION RECEIVER DEPARTMENT OFFERS YOU:**

- **A variety of career openings in professional engineering**
- **A chance to couple your personal progress with our long-range business growth**
- **Full G.E. benefits — including advanced education and stock/savings plan**
- **A good place to live and work in Syracuse, N. Y. or Portsmouth, Va.**

■ **At Television Receiver Department**, you'll be part of General Electric's broadly diversified consumer electronics business—contributing professionally to a growth curve that's on a steep upswing. We've always tried to encourage innovation, and it's paying off in new designs like our new Porta-color TV; our battery portable; the 12" personal portable, (plus a lot of other things due soon or a long way out that you'll be in the thick of). G.E. benefits are liberal—up to four weeks vacation, pension, insurance, and include a Savings and Security plan where the Company matches half your savings. TVR is headquartered at beautiful Electronics Park in Syracuse—a campus-like electronics center near one of Upstate New York's most progressive cities. And a positive indication of growth: our new plant in Portsmouth, Va. (right on the seashore ½ hour from Virginia Beach.)

■ **REVIEW THIS PARTIAL LIST OF OPENINGS.** ■ **Signal Circuit Design:** conceive, develop and apply signal processing circuits to development of monochrome and color TV. ■ **Deflection Circuit Design:** develop deflection and convergence circuits for TV receivers. Requires experience in design of deflection yokes and related magnetic deflection components. ■ **Mechanical Product Design:** requires 2-4 years experience in consumer electro-mechanical product design and packaging. ■ **Component Design and/or Application:** conceive, design and apply electronic components for monochrome and color TV receivers. Needs 2-4 years component design or application experience. ■ **TV QC, Process Control and Mfg. Engineering:** establish, plan and attain QC programs. Apply QC principles to engineering design; develop plan; determine quality capabilities methods, testing, evaluating; analyze failure data; recommend action. BSEE plus QC or TV production ■ **CRT Design, Mfg, Process and Quality Control Engineering:** Design and develop cathode ray tube products for both monochrome and color, including element, materials application, mfg. techniques, and QC. 2-10 years related experience needed.

■ **FOR MORE INFORMATION, OR TO ARRANGE A PERSONAL INTERVIEW**, send a resume in confidence to Mr. M. H. FitzGibbons, Television Receiver Dept., Box 122, General Electric Co., Electronics Park, Syracuse, N. Y. 13201. An Equal Opportunity Employer (M/F)

231-12

**GENERAL  ELECTRIC**

ON CAREER-INQUIRY FORM CIRCLE 901

# Looking for a New Job?

- **Fill out one application . . .**
- **Check off the companies that interest you . . .**
- **We do the rest**

Contacting the job market takes only ten minutes with ELECTRONIC DESIGN's Career Inquiry Service. To put Career Inquiry Service to work for you, fill in the attached resume. Study the employment opportunity ads in this section. Then circle the numbers at the bottom of the form that correspond to the numbers of the ads that interest you.

ELECTRONIC DESIGN will be your secretary, type neat duplicates of your application and send them to any number of companies you select—the same day the resume is received.

Career Inquiry Service is a fast, efficient way to present your job qualifications to companies recruiting engineering personnel—as confidentially and discreetly as you would in person. This service is the first of its kind in the electronic field, and one that engineers have used effectively since its inception in 1959.

We take the following precautions to ensure that your application receives complete, confidential protection:

- All forms are delivered unopened to one reliable specialist at ELECTRONIC DESIGN.
- Your form is kept confidential and is processed only by this specialist.
- The "circle number" portion of the form is detached before the application is sent to an employer, so that no company will know how many numbers you circled.
- All original applications are placed in confidential files at ELECTRONIC DESIGN and after a reasonable lapse of time they are destroyed.

**ELECTRONIC DESIGN CAREER INQUIRY SERVICE**

April 12, 1966

USE BEFORE MAY 24, 1966

After completing, staple, fold and mail career form to ELECTRONIC DESIGN, 850 Third Avenue, New York, N. Y. Our Reader Service Department will forward copies to the companies you select below.

(Please print with a soft pencil or type.)

Name \_\_\_\_\_ Telephone \_\_\_\_\_

Home Address \_\_\_\_\_ City \_\_\_\_\_ Zone \_\_\_\_\_ State \_\_\_\_\_

Date of Birth \_\_\_\_\_ Place of Birth \_\_\_\_\_ Citizenship \_\_\_\_\_

Position Desired \_\_\_\_\_

**Educational History**

College	Dates	Degree	Major	Honors

Recent Special Training \_\_\_\_\_

**Employment History**

Company	City and State	Dates	Title	Engineering Specialty

Outstanding Engineering and Administrative Experience \_\_\_\_\_

Professional Societies \_\_\_\_\_

Published Articles \_\_\_\_\_

Minimum Salary Requirements (Optional) \_\_\_\_\_

Use section below instead of Reader Service Card. Do not write personal data below this line. This section will be detached before processing.

Circle Career Inquiry numbers of companies that interest you

- 900 901 902 903 904 905 906 907 908 909 910 911 912 913 914 915 916 917 918 919 920 921 922 923 924
- 925 926 927 928 929 930 931 932 933 934 935 936 937 938 939 940 941 942 943 944 945 946 947 948 949

Fold here, staple and Mail.

FIRST CLASS  
Permit No. 725  
New York, N.Y.

**BUSINESS REPLY MAIL**

No Postage Stamp Necessary if Mailed in the United States

POSTAGE WILL BE PAID BY

**ELECTRONIC DESIGN**

**READER SERVICE**

850 THIRD AVENUE

NEW YORK, NEW YORK 10022

# The Future Is At MCDONNELL

**MCDONNELL AIRCRAFT CORPORATION**  
ST. LOUIS, MISSOURI 63166

**PERSONAL:**  
Name M. S. Donnell  
Address St. Louis, Missouri  
Age 27 years  
Health Billion Dollar Aerospace Backlog.  
Physical Appearance Complete, Modern Aerospace Engineering, Research Laboratories and Production Facilities.  
Size Over 35,000.  
**MILITARY SERVICE:** Contracts with U.S. Navy, U.S. Air Force, U.S. Army and the NASA.

**ACHIEVEMENTS:**  
FH-1 Phantom First Navy jet to take off and land on a carrier.  
F2H Banshee Saw extensive combat in Korea.  
F-101 Voodoo Set 10 world records.  
F3H Demon Served with the Navy in the Lebanon Crisis.  
Aeroballistic Lifting body research craft.  
Quail GAM-72 U.S.A.F. Secoy Missile.  
Mercury America's First Manned Orbital Spacecraft.  
ASSET Lifting Reentry Research Spacecraft.  
Talos Airframes and Engines.

**CURRENT ASSIGNMENTS:**  
Phantom II Fighter, Attack, and Reconnaissance aircraft for U.S. Navy, Marines and Air Force.  
British Royal Navy and Royal Air Force Gemini Two-man Spacecraft for Extended Missions and Orbital Rendezvous.  
F-111 Crew Module.  
TORS Systems utilizing Precise Time Reference.  
Automation Data Services for Business, Government and Industry.  
Model 204 Data Retrieval and Access Systems.  
BGRV Boost Glide Reentry Vehicle.  
MAW Medium Anti-tank Weapon for the Army.  
MOL Gemini B for the Air Force MOL.

**IN DESIGN FOR THE FUTURE:** Jet Fighters, Manned and Unmanned Spacecraft, Data Retrieval Systems, Collision Avoidance Systems, Advanced Missile Systems - both Tactical and Long Range, and a host of related basic system application studies.

Where Exploring Engineers  
Are Converging on  
Space Beyond the Moon  
and Fighter Aircraft  
to Win the Seventies

**LET'S  
SWAP  
RESUMES**

These vital programs in the national interest, now underway at McDonnell, have created exceptional opportunities for engineers, scientists, physicists, mathematicians, and other specialists in aerospace design, human factors, electronics, and data handling. For more information, complete the resume form below. For a comprehensive, immediate review of your qualifications, include your complete resume.

Mail This Form To: W. R. Wardle, McDonnell Employment, Dept. R-412, Box 516, St. Louis, Mo. 63166

Name \_\_\_\_\_ Phone \_\_\_\_\_ Age \_\_\_\_\_

Home Address \_\_\_\_\_ City & State \_\_\_\_\_ Zip \_\_\_\_\_

Education: BS \_\_\_\_\_ MS \_\_\_\_\_ PhD \_\_\_\_\_ Major Field: \_\_\_\_\_  
Date \_\_\_\_\_ Date \_\_\_\_\_ Date \_\_\_\_\_

Primary Experience Area: \_\_\_\_\_

Present Position: \_\_\_\_\_

Number of Years \_\_\_\_\_ I would like to receive application form

Openings now exist in the following areas:

Aerodynamics, Automation, Control and Structural Dynamics, Design, Electronics, Engineering Planning, Ground Support Equipment, Liaison, Materials, Mathematics, Metallurgy, Operations Analysis, Propulsion, Reliability, Research, Space Medicine, Structures, Systems Management, Thermodynamics.

An Equal Opportunity Employer

**MCDONNELL**

ON CAREER-INQUIRY FORM CIRCLE 902



**George Washington couldn't sleep here.**

**There's too much going on.**

"Here" is IBM's Federal Systems Center in Bethesda, Maryland.

What's going on? Plenty!

Our principal mission is to develop and build special information processing equipment to solve individual and unique problems for command/intelligence, marine, tactical and communications systems.

As a member of our creative Federal Systems Center team, you'll work on some of the most advanced, sophisticated systems development problems we believe you've ever seen.

If your discipline is listed below, we may have an immediate opening for you. Look and see if your talent and training are needed.

It's kind of great to get to the job when you know you're needed, important, and growing.

Sonar systems design • Advanced communications systems design • Systems engineering • Digital and analog circuit design • Digital systems logic design • Mechanical

packaging design • Electrical systems design • Optical mechanical design.

IBM is an Equal Opportunity Employer.

Direct your resume in complete confidence to:

Mr. J. B. Farrington, Dept. 555R,  
IBM Federal Systems Center,  
Federal Systems Division,  
7220 Wisconsin Avenue,  
Bethesda, Maryland.

**IBM®**

ON CAREER-INQUIRY FORM CIRCLE 903

*Engineers and Scientists:*

*The Hughes Aircraft Company  
is proud to announce the establishment of*

# THE HUGHES PROFESSIONAL CAREER DEVELOPMENT PROGRAM

This new Program emphasizes individual career growth through a sequence of selected work assignments for graduate engineers who have acquired between two and eight years of professional experience. It is designed primarily for two types of development:

**1. Specialized, in-depth assignments to develop unusual proficiency in a specific area of interest.**

**2. Broad, systems-types of assignments to prepare for system and project engineering responsibilities.**

There will be a maximum of three assignments which will be determined jointly by the participant and the Professional Development Section. The assignments, which are flexible in length would normally extend for one year each. They may be selected from a broad spectrum of aerospace electronics hardware and systems-oriented programs and will be designed to provide optimum backgrounds in specialized areas of interest.

The Program will be limited to 50 participants in 1966. These will be selected from candidates who are graduates in E.E., M.E. or Physics from fully-accredit-

ed universities and who have acquired from two to eight years of professional-level technical experience. U.S. citizenship is required.

Those in the Program will receive salaries commensurate with levels established by their overall experience and qualifications.

We invite interested Engineers and Physicists to submit their qualifications for consideration.

Please forward your resume including details of your educational and experience background to:

**Mr. Robert A. Martin**  
Head of Employment  
HUGHES Aerospace Divisions  
11940 W. Jefferson Blvd.  
Culver City 5, California



An equal opportunity employer

# engineering management opportunities with U.S. NAVY-BUREAU OF SHIPS in: ANTI-SUBMARINE WARFARE

The Navy's high-priority anti-submarine warfare program, involving multi-million dollar contracts with industry, needs qualified engineers for program management involving research, development, testing, evaluation, procurement planning, production, installation and maintenance in these fields:

- SURFACE SHIP, VARIABLE DEPTH AND SUBMARINE SONAR SYSTEMS
- UNDERWATER ACOUSTIC COMMUNICATIONS AND IFF SYSTEMS
- OCEANOGRAPHY ● DIGITAL SIGNAL PROCESSING
  - Transportable Underwater Ocean Area Surveillance Systems
  - Acoustic Navigation And Mine Avoidance Equipments
    - Inshore Undersea Warfare Equipment
    - Mine And Torpedo Detection Sonar
  - ASW Target Classification ● Transducer Design
  - Non-Acoustic Detection of Submerged Submarines
  - Display Engineering ● Systems Analysis

AND OTHER FIELDS: NAVAL ARCHITECTURE; MARINE, ELECTRICAL, ELECTRONIC, MECHANICAL ENGINEERING IN-SHIPS DESIGN, CONSTRUCTION AND MAINTENANCE; MACHINERY DESIGN; RADAR, COMMUNICATIONS, TEST EQUIPMENT, QUALITY ASSURANCE & RELIABILITY.

These positions, which are in Washington, D.C., involve travel and considerable contact with industrial organizations. Degree in mechanical or electro/electrical engineering and related experience desirable. Starting salaries range from \$7,987 to \$14,680 depending on experience. Most positions are at \$10,619 and \$12,510. Relocation expenses paid. These are career Civil Service positions with full benefits, regular salary increases.

Send resume or SF-57 to:

Civilian Personnel Division  
Bureau of Ships, Code 263R-08  
Department of the Navy, Room 2435  
Washington, D.C. 20360

An Equal Opportunity Employer

## NASA Tech Briefs

### Molded spacer protects transistors

**Problem:** Devise an insulated holder for mounting metal-case transistors in a chassis containing densely packed electronic components.

**Solution:** A molded insulating spacer which contains one or more cavities that conform to the shape of the transistor case.

The cylindrical holder, shown in the illustration, accommodates two transistors back-to-back in close-fitting cavities on either end of the holder. The transistors are mechanically supported on their bases and electrically isolated from each

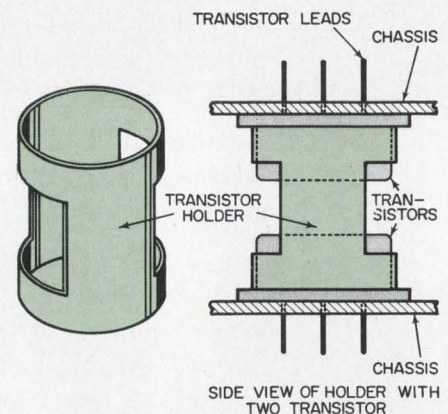

other by the holder.

An opening, extending laterally through the holder, allows potting resin to fill the gap between the transistors. The holders require little more space than the transistors themselves.

This type of holder may be used for insulation and support of other circuit components.

For further information, contact: Technology Utilization Officer, Manned Spacecraft Center, P. O. Box 1537, Houston, Texas 77001 (B65-10389).



# LATCH on to the EXCITEMENT in MICROELECTRONICS and SILICON DEVICE DEVELOPMENT at DELCO RADIO

Enthusiasm is running high at General Motor's Delco Radio Division.

Exciting developments in microelectronics and silicon devices have spawned a rapidly expanding research effort. New buildings . . . new equipment . . . and most importantly, new people!

The dynamic pace of accomplishment at Delco is pushing the state of the art clear out of sight. The opportunity is here for those who choose to capitalize on it.

## Microelectronics

Circuit oriented EE's—0 to 5 years experience. Here's a chance to get in on the excitement in microelectronics. Research programs in both linear and digital circuitry embrace monolithic . . . thick film . . . thin film . . . and hybrid microcircuits.

## Silicon Device Development

Lots of room here for the BS, MS, PhD in Physics, Chemistry, Physical Chemistry, or related fields. Development programs are underway in these areas:

Low power and very high power monolithic and hybrid circuits.

Silicon Transistors—from very high

frequency 10 milliamperes through 25 ampere, 1000 volts.

Thyristors—from 50 milliamperes through 500 ampere, 2000 volts.

Zener Diodes.

Silicon Rectifiers—from milliamperes through 250 ampere, 3000 volts.

Continuing R&D efforts already have led to Delco's leadership in high power, high voltage silicon transistors. Delco rectifiers—rated at 250 amps, 2000 volts—are going into alternators designed to handle the full power generated by the latest Diesel-electric locomotives.

Full-size, fully-transistorized TV sets now are in production, thanks to a Delco high powered transistor in the horizontal and vertical deflection circuits.

A tremendous momentum is building at Delco. The time is ripe—now—to join this outstanding research group.

If you'd like more information immediately, pick up the phone and call us collect, Area Code 317/459-2808. Ask for C. D. Longshore. Or, send your resume to Mr. Longshore, Salaried Employment, Dept. 101, Delco Radio Division, General Motors, Kokomo, Indiana.

*An equal opportunity employer*

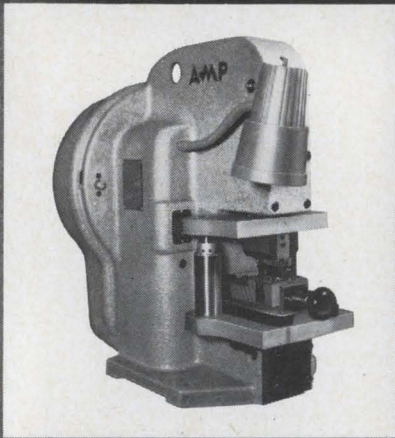
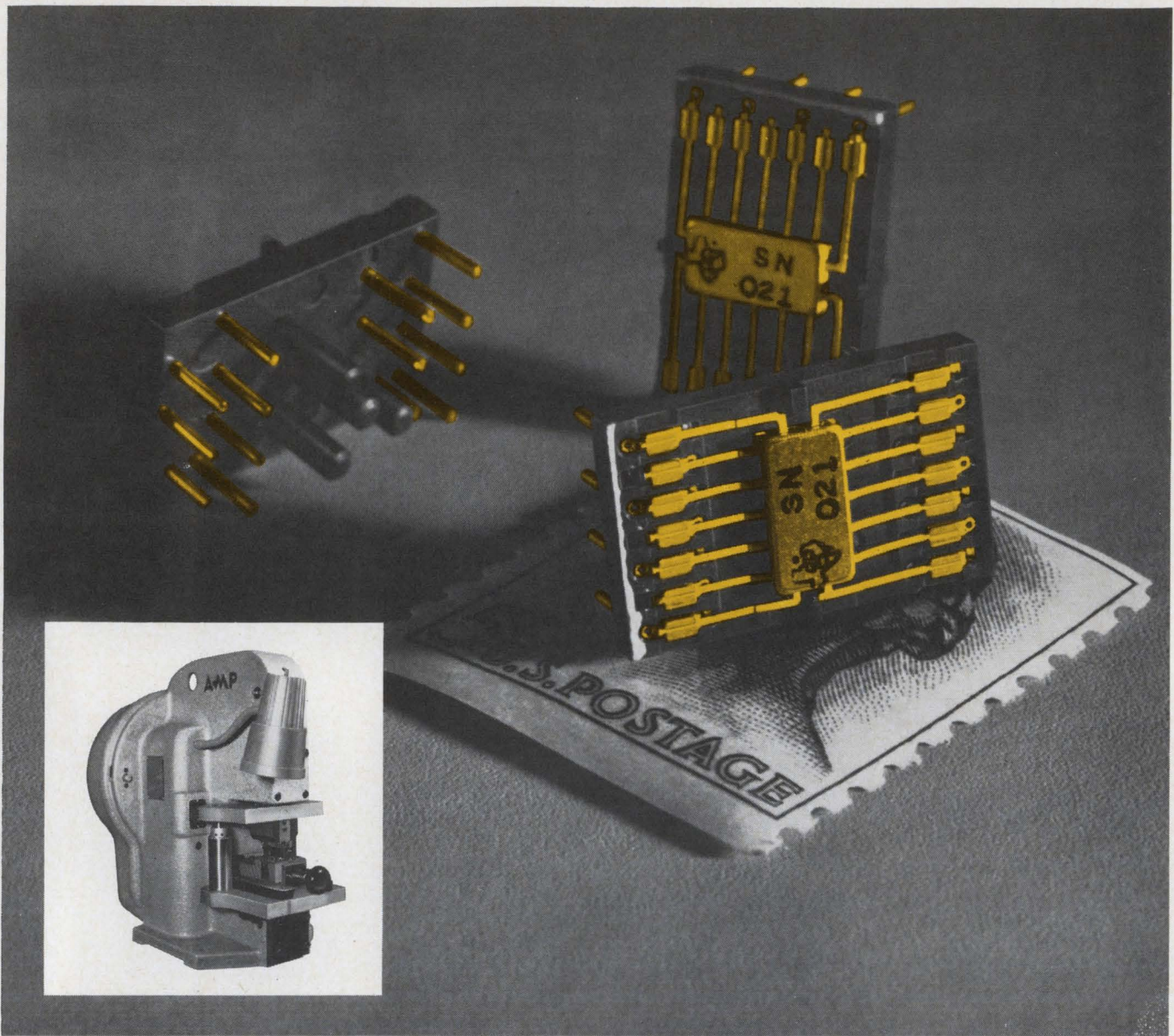

## GANG CRIMPING

### A new breakthrough in integrated circuits

All 14 ribbon leads of the flat pack above were crimped simultaneously to pins on our new AMP-CRIMPAC\* Header . . . a feat of engineering that only a leader in crimping techniques would attempt.

Frankly, it wasn't easy—even for us.

For one thing, we had to use plastic as the anvil for the crimping dies. Nobody had ever done that before. Then, we had to make the pack's .050" mounting centers compatible with existing wiring techniques. And, to top it off, the whole system had to be completely trouble-free and uniformly reliable.

Here's how we did it. We made the AMP-CRIMPAC Header of sturdy phenolic and molded in 14 pins, staggered so that they come through on .100" centers. We designed a precision automatic machine to gang crimp all 14 of the pack's leads at once. After encapsulation, the pack assembly is as rugged as a transistor can or other plug-in component. It can either be plugged and soldered directly onto printed circuit boards, or plugged into an AMP-CRIMPAC Receptacle.

The receptacle attaches to the system panel and is provided with posts that accept AMP's TERMI-POINT\* clips for automatic or manual back-panel wiring. Both the header and its mating receptacle are color-coded,

polarized, and keyed for optimum control during production and in field maintenance.

Why go to crimping in integrated circuits? Consider the evidence:

- Reliability is controllable and repeatable
- No heat damage to the circuit function
- No need for bending or pre-forming pack leads
- Exceptionally fast assembly
- Less capital outlay for equipment
- Available for all 1/4" x 1/4" or 1/4" x 1/8" flat pack applications

Now you can enjoy system maintainability right down to the single flat pack circuit. Write for more information on AMP-CRIMPAC Headers and Receptacles today.

\*Trademark of AMP INCORPORATED



AMP\* products and engineering assistance available through subsidiary companies in: Australia • Canada • England • France • Holland • Italy • Japan • Mexico • Spain • West Germany

Speed Inquiry to Advertiser via Collect Night Letter  
ON READER-SERVICE CARD CIRCLE 37

# ED Products

Adjustable resistor has standards-lab accuracy PAGE 104

Two heads cover vhf and uhf PAGE 104

Low cost Triacs bring stepless control PAGE 116

Pushbutton switch for marine use PAGE 116

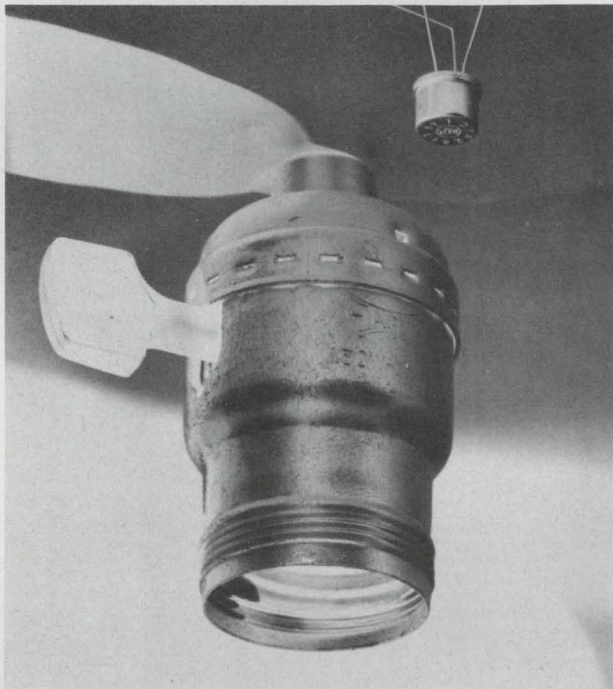

A dimmer in a socket? . . . 116



Sealed switch finds finny friends . . . 116

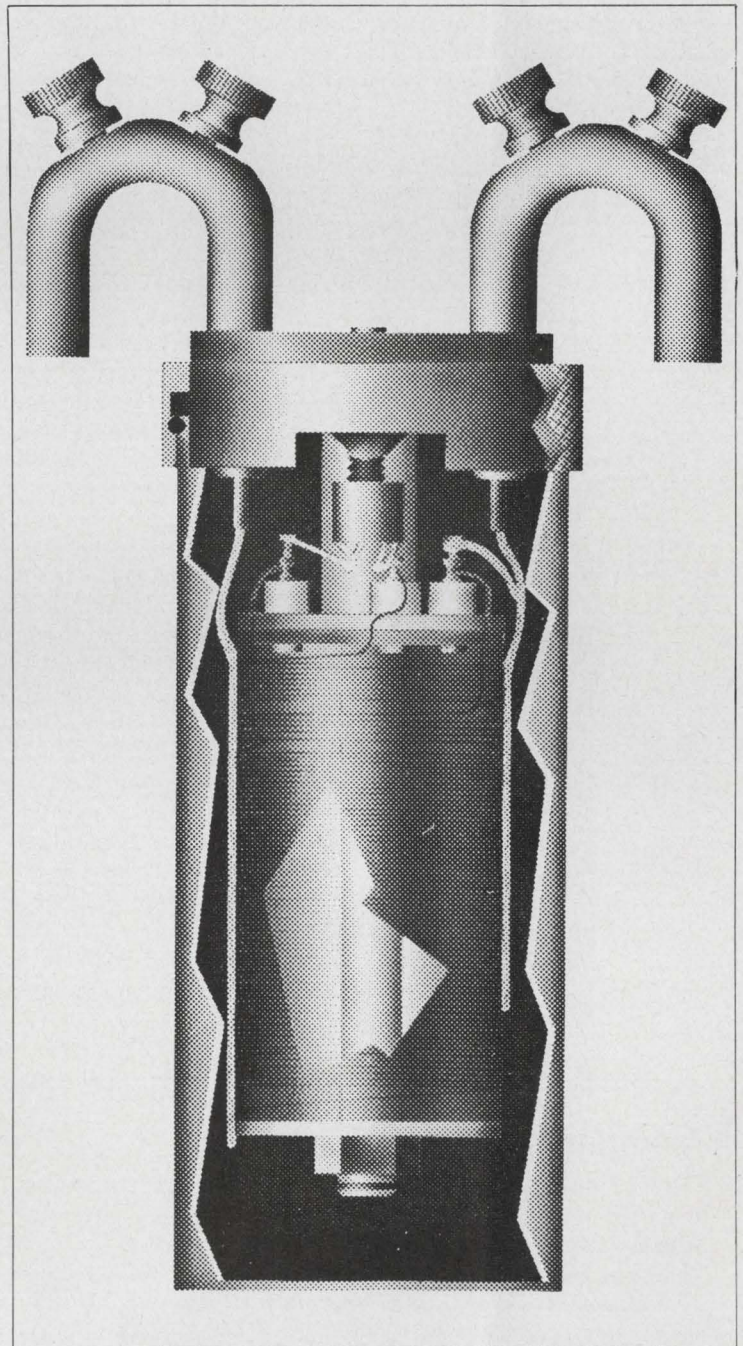

Resistance standards are variable yet accurate . . . 104

## Variable standard resistor exceeds NBS models

A new family of precise adjustable standard resistors is available. They are calibrated to  $\pm 6$  ppm for use as transfer standards in such precision measurements as setting voltage dividers. The manufacturer claims accuracy and time and temperature stability characteristics exceeding Rosa or National Bureau of Standards models. Improved construction and variability yield precise resistance values to suit the measuring situation.

Ac measurements using these standards are facilitated by low distributed winding capacitance. The concentric polyester cylinders upon which the resistors are wound hold capacitance to 12 pF in the 10 k $\Omega$  model.

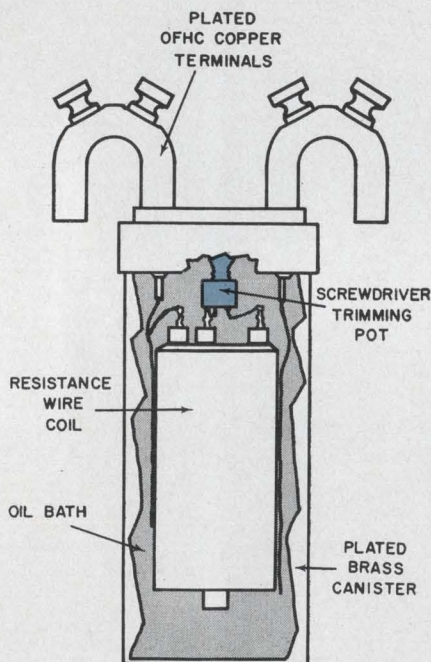

Four models are currently available: 100 ohms (model 11102A), 1000 ohms (model 11103A), 10 k $\Omega$  (11104A) and 100 k $\Omega$  (11105A). The temperature coefficient of resistance of all models is typically  $\pm 2$  parts per million per degree centigrade and specified performance is  $\pm 4$  ppm/ $^{\circ}\text{C}$  maximum. Drift with time is typically 3 ppm per year. Alpha and Beta values used to calculate resistance of the standard at various temperatures are supplied with each resistor. The variability range of each resistor is  $\pm 25$  ppm and a built-in screwdriver adjusted pot permits adjustments to 0.3 ppm.

All of the resistors are mounted in sturdy canisters having the same basic outside dimensions as the older standards. Mechanical strains which arose in traditional solid-core units because of differences in the temperature coefficients of the resistance element and the support structure are eliminated. The resistance element is supported by a flexible polyester film which reduces stress and improves stability. Careful selection of construction materials has eliminated ionic currents or "battery effect" often encountered in the NBS or Rosa models.

Applications cited include bridge calibration, ratio matching, divider calibration and dc current determination. Two thumb-screw terminals on each hook and a 0.302-in. thermometer well are provided.

P&A: \$75; 90 days. Hewlett Packard, 815 14th St. S.W., Loveland, Colo. Phone: (303) 667-5026.

Circle No. 250



## Field strength meter covers vhf and uhf

Instantly convertible with the flip of a switch, the FSM-2 field strength meter utilizes twin tuning heads for the 54 to 216 MHz and 470 to 890 MHz bands. Design features a broadband stepped RF attenuator and a continuous electronic attenuator to desensitize the IF amplifier. A multi-function output indicator can be switched to p-p or rms reading modes or used to check power supply voltage setting.

In addition to the 117 Vac line input, an 18 V battery pack is provided for operation independent of power line without adjustment. Both sources are regulated to 12 V thus stabilizing against line fluctuation or battery degradation. The regulator circuit is not simply a zener draining off extra voltage, but is a true regulator with a 1.5 V germanium pass transistor. This low drop increases useful battery life to a 13.5 V terminal voltage. Current consumption of 20 mA extends battery life to about 200 hours of intermittent operation. The entire circuitry is solid state, employing 9 transistors and 7 diodes. The meter is designed to measure RF signals at 75  $\Omega$  impedance, but a vhf/uhf balun is supplied for 300  $\Omega$  twin lead measurements.

The unit may be employed to compare signals by measuring the amount of attenuation needed to produce a zero dB reading for a second signal when the attenuators are adjusted to zero for the first. Other applications cited include measurement of per cent of sine wave modulation and measurement of antenna radiation patterns.

P&A: \$395; stock. Blonder-Tongue Laboratories, Inc., 9 Alling St., Newark, N. J. Phone: (201) 622-8151.

Circle No. 252

## Modular target generator

The LAS-T-2 target generator, a modular unit, can be incorporated into existing optical benches. It is designed for testing lenses and other components of an optical system or for use as a basic element of an automated modulation transfer

function analyzer. The generator produces pure sine wave moire patterns that are controlled by means of a shaft rotation.

Newtek, 39-25 62nd St., Woodside, N. Y. Phone: (212) 335-1424.

Circle No. 251

# INSTRUMENTATION SPECS in 250 KC tape recording

...now start at under \$9966

(7 CHANNELS, 6 SPEEDS, DIRECT MODE)

The design approach that made possible Sanborn true IRIG instrumentation performance at lower cost in low bandwidth tape recording is now available in intermediate band systems. Sanborn Models 3917B and 3924B 7- and 14-channel systems record and reproduce data up to 250 kc in direct mode, to 20 kc in FM mode. Pulse mode enables digital information as short as 2  $\mu$ sec wide to be recorded and reproduced. A complete 6-speed system ready for direct recording/reproducing costs \$9966 for 7 channels, \$15,977 for 14 channels. (Same systems may be ordered with fewer tape speed plug-ins, at correspondingly lower costs.)

These new systems have the same improvements in performance, reliability and operating ease as the low bandwidth models, for instrumentation tape recording with complete IRIG compatibility. The tape transport, key to superior system performance, is of a rugged and simple Hewlett-Packard design which reduces costs without sacrificing uniform tape motion; six electrical speeds are pushbutton-selected (1 7/8 to 60 ips) without idler or capstan change. Other standard features include provision for edge track for voice commentary, adjustable input/out levels, built-in 4-digit footage counter accurate to 99.95%, and easy snap-on reel loading. The transport needs no maintenance except occasional cleaning of the tape path.

Check the system specifications here and call the H-P Field Engineer in your locality for complete technical data and application engineering assistance. Offices in 48 U.S. and Canadian cities, and major areas overseas. Sanborn Division, Hewlett-Packard Company, Waltham, Massachusetts 02154. Europe: Hewlett-Packard S.A., 54 Route des Acacias, Geneva, Switzerland.

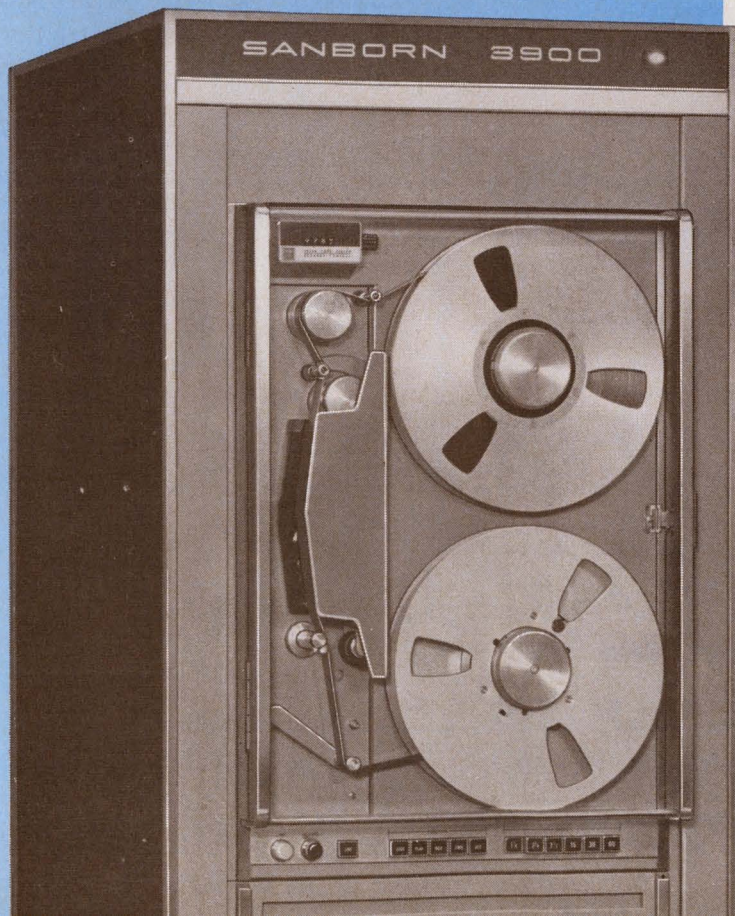

representative specifications

## DIRECT MODE

Tape Speed	Bandwidth	Frequency Response	S/N Ratio Filtered	Minimum RMS Unfiltered
60 ips	300-250 KC	$\pm 3$ db	35 db	29 db
15 ips	100-62.5 KC 300-44 KC	$\pm 3$ db	32 db 38 db	27 db
1 7/8 ips	50-7 KC 300-5 KC	$\pm 3$ db	30 db 39 db	26 db

\*Measured with bandpass filter at output with an 18 db/octave rolloff

## FM MODE

Tape Speed	Bandwidth	Frequency Response	FM Center Carrier Frequency (Nominal)	S/N Ratio* Without Flutter Comp.	Total Harmonic Distortion
60 ips	0-20 KC	+0, -1db	108 KC	45 db	1.5%
15 ips	0-5 KC	+0, -1db	27.0 KC	45 db	1.5%
1 7/8 ips	0-625 cps	+0, -1db	3.38 KC	40 db	1.8%

\*Noise measured over full bandwidth, min. rms at zero freq. dev., with lowpass filter placed at output. Filter has 18 db/octave rolloffs.

## TAPE TRANSPORT

Maximum Interchannel Time Displacement Error:  $\pm 1$  microsecond at 60 IPS, between two adjacent tracks on same head.

Tape Speeds: 60, 30, 15, 7 1/2, 3 3/4, 1 7/8 ips standard; 0.3 to 120 ips optionally available.

Tape: 3600 feet, 1.0 mil, 1/2" (7 channel), 1" (14 channel).

Controls: Line (Power), Stop, Play, Reverse, Forward (fast) and Record are pushbutton relays. A receptacle at the rear of the transport is provided for remote control operation.

Drive Speed Accuracy:  $\pm 0.25\%$ .

## FLUTTER

Speed	Bandwidth	Flutter (p-p)
60 ips	0-200 cps	0.2 %
	0-10 KC	0.6 %
30 ips	0-200 cps	0.2 %
	0-5 KC	0.8 %
15 ips	0-200 cps	0.25%
	0-2.5 KC	0.6 %
7 1/2 ips	0-200 cps	0.5 %
	0-1.25 KC	0.65%
3 3/4 ips	0-200 cps	0.5 %
	0-625 cps	0.8 %
1 7/8 ips	0-200 cps	0.8 %
	0-312 cps	1.2 %

HEWLETT  
PACKARD  SANBORN  
DIVISION

# BANTAM JACK PANELS offer TWICE AS MANY JACKS

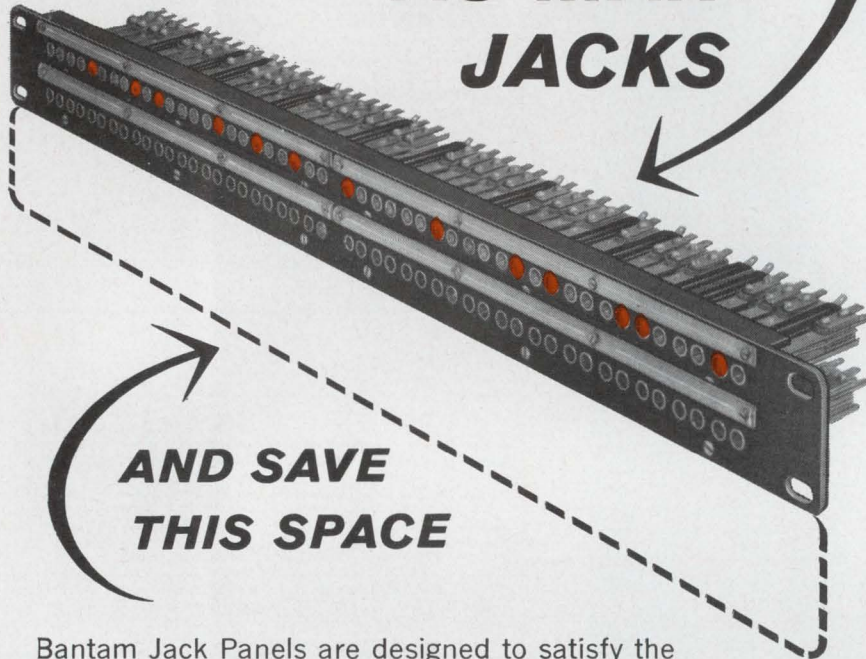

**AND SAVE  
THIS SPACE**

Bantam Jack Panels are designed to satisfy the increasing demand for more compact patchfields in modern electronic and communication equipment. Bantam Jack Panels, with miniaturized jacks, provide twice the number of jacks in a standard size panel. When weight and space are critical factors, specify Bantam Panels.

*Bantam*

**LITES**

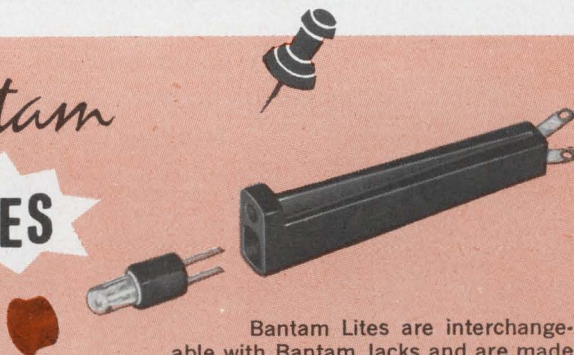

Bantam Lites are interchangeable with Bantam Jacks and are made for the Bantam Jack Panel. Bantam Lites are comprised of lamps and caps which are easily replaceable from the front of the jack panel. Lamp caps are available in red, green, white or amber colors.

For more information on Bantam Jack Panels, Bantam Lites and accessories write:



**ADC PRODUCTS**

6405 CAMBRIDGE STREET • MINNEAPOLIS, MINN. 55426

ON READER-SERVICE CARD CIRCLE 38

## TEST EQUIPMENT

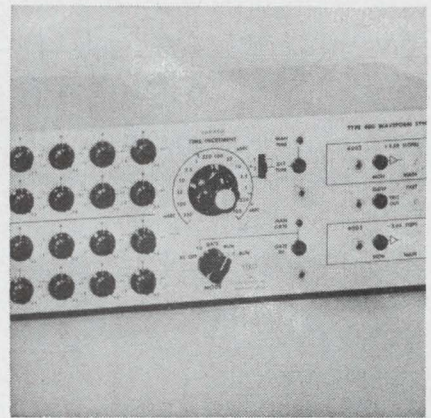

### Waveform synthesizer

With associated plug-ins this synthesizer can simulate signal combinations including high-speed telemetry or nerve pulses. The type 400 is basically a pair of clocked commutators sequentially switching 10 current sources into a single load. The sources are independently controlled through 20 panel-mounted pots. External or internal clocking may be free run, gated or triggered.

Exact Electronics, 455 S. Second, Hillsboro, Ore. Phone: (503) 648-6661.

Circle No. 253



### Analog readout

Designed for use with the Statham Universal Transducing Cell, Model UR4 provides all electronics for excitation, control, signal conditioning and readout. The battery-operated readout is accurate to 0.5% full scale. The unit can be used for measuring force, pressure, weight, linear displacement and other physical parameters.

P&A: \$150; stock. Statham Instruments, Inc., 12401 W. Olympic Blvd., Los Angeles, Calif. Phone: (213) 272-0361.

Circle No. 254

ON READER-SERVICE CARD CIRCLE 222 ➤

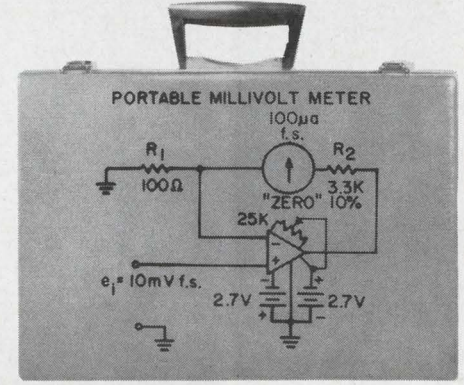
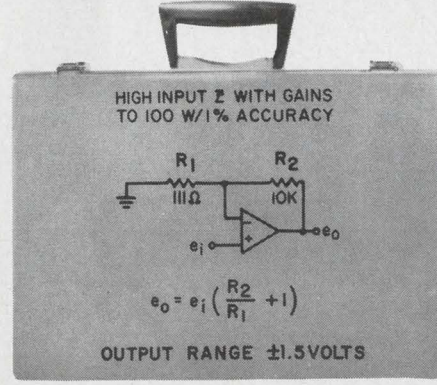
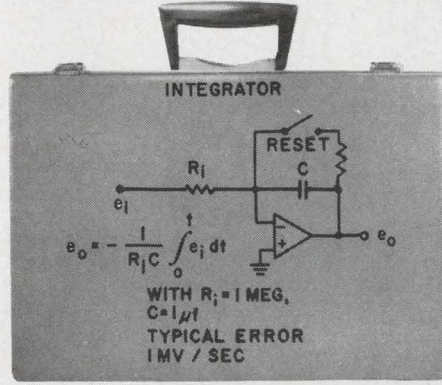
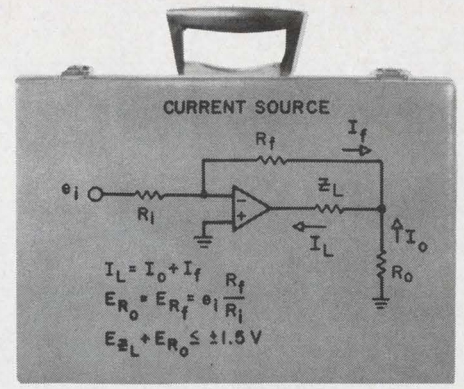
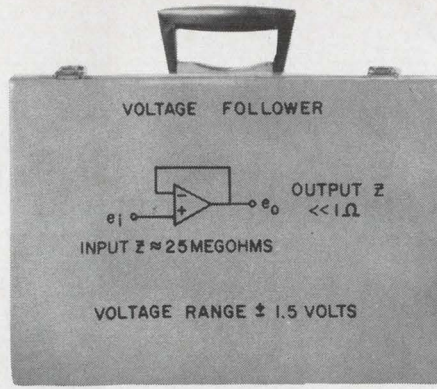
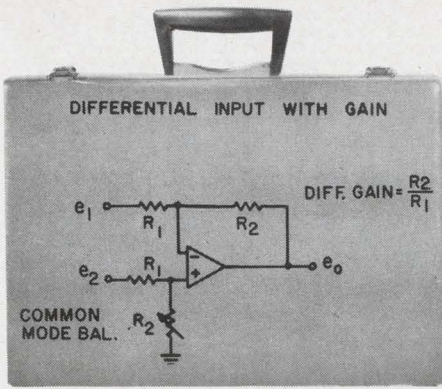

# The new Nexus 2LV-1 2.7 volt operational amplifier is VERY PORTABLE

Developed specifically for use in a wide range of remote and portable, battery-powered electronic equipment, the new 2LV-1 operational amplifier combines high reliability, excellent performance, and economical low-power operation.

The miniature, encapsulated unit operates on a supply voltage of  $\pm 2.7$  volts . . . has a low standby power drain of approximately 4 milliwatts.

Employing all-silicon semiconductors, the 2LV-1 operates over the range from  $-25^\circ$  to  $+85^\circ$ C. It is particularly well-suited to use in geophysical, medical, oceanographic and aerospace instrumentation where low power consumption is a critical requirement. The unit offers a d.c. open-loop gain of 10,000, with an output capability of  $\pm 1.5$  v at  $\pm 1.5$  ma.

Reliable and economical operation are important advantages of the 2LV-1. Two Mallory TR132R mercury batteries provide approximately 1000 hours of operation. For longer life, four RM-12R mercury cells will provide approximately 4000 hours, or four RM-42R cells may be employed for approximately 15,000 hours of operation. **Price, 1-9 \$35.**

**NEXUS**  
RESEARCH LABORATORY, INC.  
480 NEPONSET STREET, CANTON, MASS. 02021  
TEL: (617) 828-9000 TWX (617) 828-1022

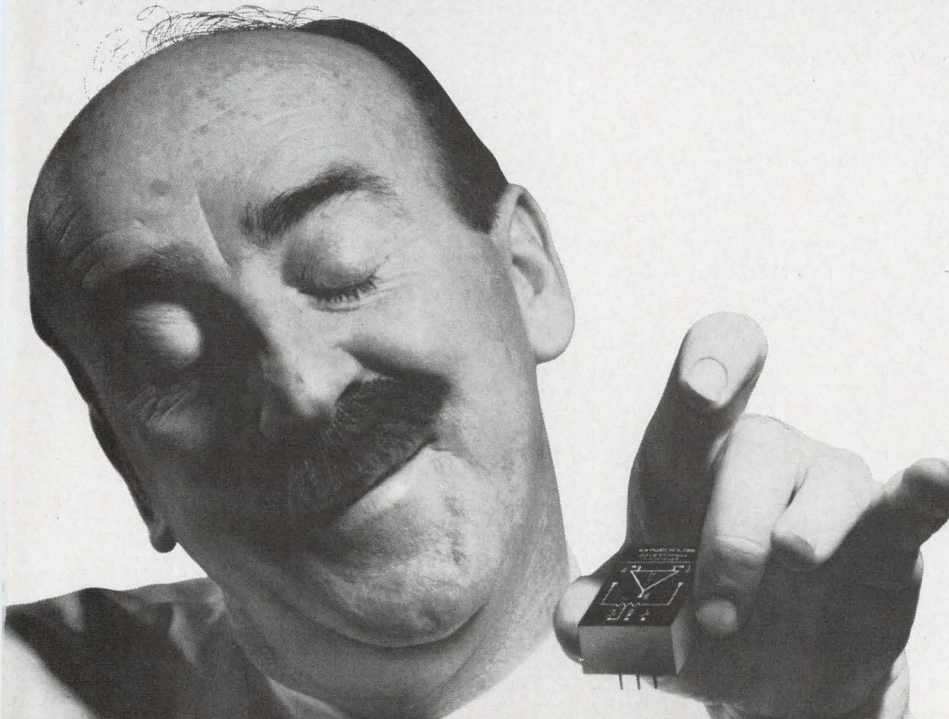

**TYPICAL ELECTRICAL CHARACTERISTICS**  
(@ 25°C unless noted)

Supply voltage	$\pm 2.7$ volts (nom.)
Supply current (quiescent)	$\approx 0.75$ ma
Output voltage range ( $R_L = 1K$ )	$\pm 1.5$ v @ 1.5 ma
$E_{CM}$	$\pm 1.5$ v
$\Delta E_{OS} / \Delta T$ ( $-25^\circ$ C to $+85^\circ$ C)	$\pm 5 \mu$ v / °C
$I_{OS}$	$\pm 1.0$ na
$\Delta I_{OS} / \Delta T$ ( $-25^\circ$ C to $+85^\circ$ C)	$\pm 0.5$ na / °C
$A_0$ ( $R_L = 1K$ )	10K
Input Z differential	0.2 megohms
Input Z common-mode	25 megohms

# MOL Resistors

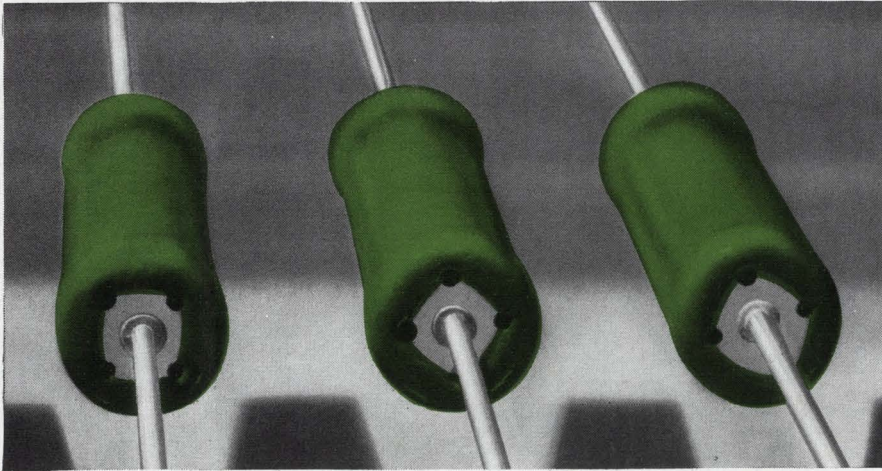

## Consistently high QUALITY

... is one of many reasons why every major TV manufacturer uses Mallory MOL film resistors. Out of millions made in the past two years, customer rejections have been practically nil. Reason: automated production backed by tight quality control. There are other reasons, too: temperature coefficient only 250 PPM/°C; proved flame resistance; less than 5% resistance change after 10,000-hour load-life tests; high stability in humidity. *And* prompt shipment of orders. Write for data and quotation. Mallory Controls Company, a division of P. R. Mallory & Co. Inc., Frankfort, Indiana 46041.

**50<sup>th</sup>**  
ANNIVERSARY

**MALLORY**

ON READER-SERVICE CARD CIRCLE 39

## TEST EQUIPMENT

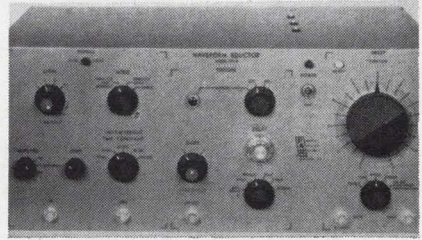

### Waveform eductor

This 100-channel memory analog averaging instrument extracts repetitive waveforms and transients from noise. The waveform of interest is divided into 100 segments which are switched through a resistor to the memory capacitors where the average is obtained and stored. The continuously observable information can be photographed or read out on an X-Y or strip-chart recorder. A sweep duration from 100  $\mu$ s to 11 s in 5 ranges and readout as slow as 100 s are available.

The 50 to 60 Hz unit has a  $\pm 10$  Vac output and is rated at 25 W.

Price: \$4200. Princeton Applied Research Corp., P. O. Box 565, Princeton, N. J. Phone: (609) 799-1222.

Circle No. 255

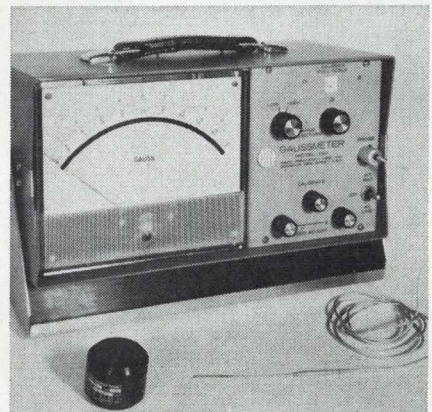

### Wide-range gaussmeter

The model 750 is a direct-reading, Hall-effect gaussmeter covering 0.02 gauss to 50 kilogauss in 24 ranges. A built-in power supply for 115/230 V, 50/60 Hz line operation accompanies internal battery holders for field work. Adaptability to a wide range of Hall-effect probes and direct readout of ac fields to 400 Hz are featured.

P&A: \$700; June. Radio Frequency Labs, Inc., Powerville, Boonton, N. J. Phone: (201) 334-3100.

Circle No. 256



Stark

RFL Model 212  
Direct-Reading  
Electrical Thermometer

# Measures fast- will travel...

The Model 212 gives you high-caliber liquid or gas temperature measurement with accuracy traceable to NBS. It has quick-draw response of 2.5 seconds and a 5-inch, TBS mirror-scale meter ... is loaded with seven temperature ranges from  $-100^{\circ}\text{C}$  to  $500^{\circ}\text{C}$ . Self-contained flashlight batteries power it. Carry it in any saddle bag. It's great for trail or test table. \$530. Complete with platinum resistance probe.

**Free 30-day trial!** Call John Carson for complete lowdown on specs or free 30-day trial—no strings. Or call your nearest RFL Representative listed below.



**Model 380S**—Direct-reading electrical thermometer measures liquid and surface temperature from  $-25$  to  $+280^{\circ}\text{C}$  with one probe. Two ranges. Operates on series D flashlight batteries. \$325. Complete with single crystal probe.



**Model 380T**—You choose the scale range on this direct reading electrical thermometer for fast liquid and surface temperature measurement. Series D flashlight batteries power it. \$245. Complete with thermistor probe.



## Radio Frequency Labs., Inc.

Temperature & Control Division / Boonton, New Jersey 07005, U.S.A.

Call your local RFL Representative:

Needham Heights, Mass.  
Cowperthwait & Brodhead  
617-444-9410

Oceanside, New York  
Electronic Equipment  
Engineers  
516-764-3745

Washington, D.C.  
Arco Engineering Company  
202-296-8735  
Huntsville, Alabama  
Space Engineering Sales, Inc.  
205-536-6811 or 539-2610

Cleveland, Ohio  
Electro Sales Associates  
216-486-1140  
Chicago, Illinois  
Hugh Marsland &  
Company, Inc.  
312-676-1100

Florissant, Missouri  
Hugh Marsland & Co.  
314-741-3779  
Denver, Colorado  
Hytronic Measurements, Inc.  
303-733-3701

Dallas, Texas  
Scientific Sales Company  
214-528-0553  
N. Hollywood, California  
O'Halloran Associates  
213-877-0173

Seattle, Washington  
Dewar & Associates  
206-722-1724

# DO-IT-YOURSELF MAGNETIC SHIELDS

*Cut Quickly—  
Wrap Easily*



With ordinary scissors, cut flexible Co-Netic and Netic foil to any size or outline. Your component is quickly wrapped and protected—within seconds. Component performance is dramatically enhanced. Co-Netic and Netic foils stop degradation from unpredictable magnetic fields. When grounded, they also shield electrostatically. Foils are not significantly affected by dropping, vibration or shock, and do not require periodic annealing. Available in thicknesses from .002" in rolls 4", 15", and 19-3/8" wide. High attenuation to weight ratio possibilities. Widely used in experimental evaluation and production line operations for military, commercial and industrial applications.

## MAGNETIC SHIELD DIVISION

Perfection Mica Company

1322 N. ELSTON AVENUE, CHICAGO 22, ILLINOIS

ORIGINATORS OF PERMANENTLY EFFECTIVE NETIC CO-NETIC MAGNETIC SHIELDING

ON READER-SERVICE CARD CIRCLE 40



**LIGHT  
TO FIGHT  
BY...**

*Portable military shelters require a  
very special kind of interior lighting.*

**WE MAKE THIS KIND.**

Literature on request



**BRUCE INDUSTRIES, INC.** 1528 West 178th Street, Gardena, California

ON READER-SERVICE CARD CIRCLE 41

## TEST EQUIPMENT

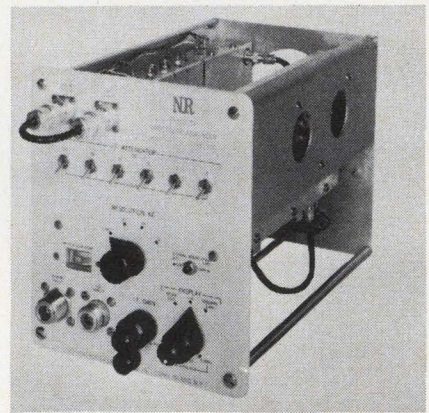

### Spectrum analyzers

Two plug-in spectrum analyzers are available, each featuring a 10 MHz to 15 GHz frequency range. Model PSA-510 is for use with Tektronix letter series oscilloscopes and model PSA-530 for use with Hewlett-Packard 140A/141A scopes. Both are designed for use with an external swept local oscillator. They offer scans of 0 to 1 GHz.

P&A: \$1250; 30 days. Nelson-Ross, 505 Burns, Hicksville, N. Y. Phone: (516) 433-2730.

Circle No. 257



### RF probe

Noise in the 20 to 30 MHz frequency range is detected and measured by this probe. A broadband, TRF amplifier, it weighs under 5 lbs, including carrying case. The probe consists of a pick-up device, radio frequency and audio amplifiers, earphones, rechargeable batteries and cabling.

P&A: \$695; 60 days. Honeywell Inc., Aeronautical Div., 2600 Ridgeway Rd., Minneapolis. Phone: (612) 331-4141.

Circle No. 258

ELECTRONIC DESIGN



at Hi-Q we still make the usual garden variety ceramic capacitors

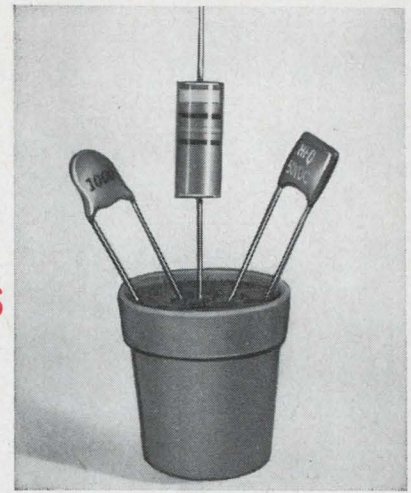

and these second generation ceramic capacitors

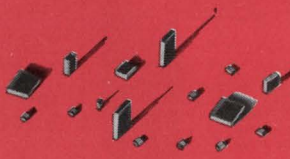
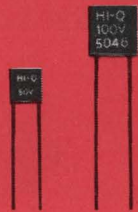
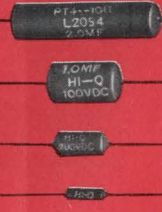
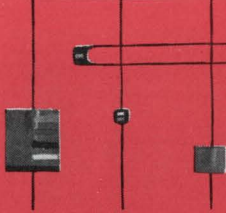
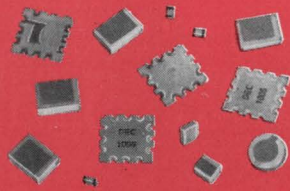
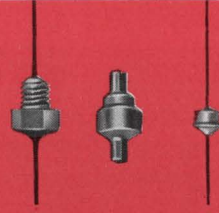
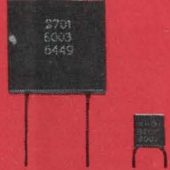
 <p><b>MC/20/70/90 Miniaturized Tubular Capacitors</b></p>	 <p><b>Microminiature Capacitor Chips for Hybrid Circuits</b></p>	 <p><b>MC 51/505 and MC 61/605 Extended Capacity and Increased Stability in CK05/06 Case Sizes</b></p>	 <p><b>CEROL® High Capacity Tubulars</b></p>
 <p><b>TP Ultra-Thin Capacitors for Tight Packaging Requirements</b></p>	 <p><b>Special Capacitor Designs to Meet Unique Packaging Requirements</b></p>	 <p><b>Miniature Feed-Thrus Featuring High Capacitance and Maximum Stability</b></p>	 <p><b>CERALAM® Capacitors Offer Maximum Volumetric Efficiency in Axial or Tubular Configurations</b></p>

The way things move in electronics, we expect to have to develop a third generation any day now. But in the meantime, everyday sees a new and different application of the unusual qualities of CERALAM. Sometimes it's used because its unique, densely stacked structure duplicates the reliability of solid-state devices. Sometimes because it can be "cut" to any configuration that will make your packaging simpler. And sometimes because it offers a higher capacity-to-volume ratio than anything else.

Of course CERALAM is just one of the outstanding state-of-the-art advances that have originated in a need created by our inquiring technology, and been achieved in the fertile imaginations of engineers at Hi-Q. And what's equally important is that Hi-Q turns these unique developments into

Selected commercial and military Hi-Q products are available off-the-shelf from Authorized Aerovox Distributors.

production realities, even coping with the seemingly impossible demands for reliability found in missile and space vehicle applications.

Of course, our garden variety ceramic capacitors are still the finest available for radio, TV or similar applications.

Or let us know what you need and we'll develop that third generation right away.



**AEROVOX**  
CORPORATION  
OLEAN, NEW YORK  
MYRTLE BEACH  
SOUTH CAROLINA

TEST EQUIPMENT

**Dc voltage calibrator**

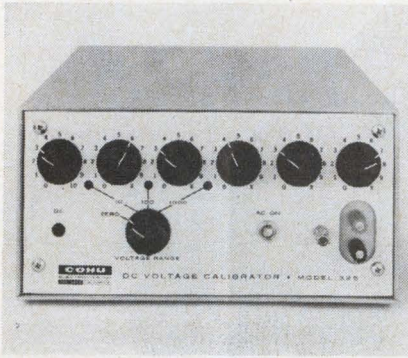

Model 325 calibrator is suitable for applications where a dc source with output-voltage accuracy within 0.02% at currents up to 25 mA are required. Output voltage is from 0 to  $\pm 1111.110$  V at maximum over-range, and is selected by a range multiplier dial and a six-place decade dial group. Noise and hum are under  $100 \mu\text{Vrms}$ .

P&A: \$995; stock. Cohu Electronics, Box 623, San Diego, Calif. Phone: (914) 277-6700.

Circle No. 259



**Fidelity test set**

A single measure of performance of a transmission line, network, or component over the voice spectrum is provided by model 701 Fidelity Test Set. The measurement is a peak to average ratio-reading, an outgrowth of the "eye ratio" pattern used to indicate line quality for digital data. A perfect reproduction reading is 100%.

P&A: \$890; 2 weeks. Wiltron, 930 East Meadow, Palo Alto, Calif. Phone: (415) 321-7428.

Circle No. 260

**RFI/EMI FILTERS**  
FOR COMMUNICATIONS AND DATA LINES

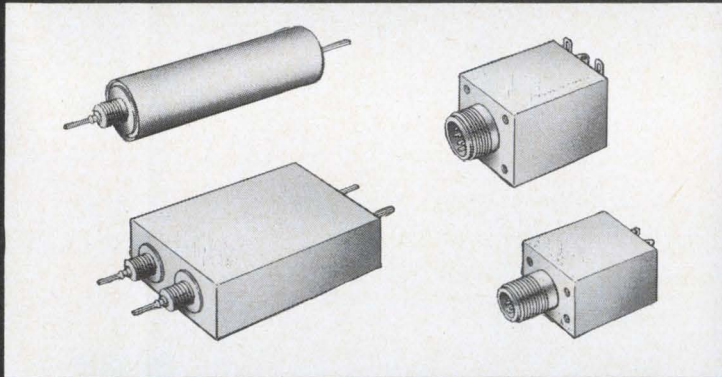

Reliability is the key word in literally thousands of filters currently in use on telephone, teletype, digital and audio transmission lines. ■ Your requirements for custom filter designs as well as standard products, can be met by Potter's extensive engineering capability and high performance criteria.

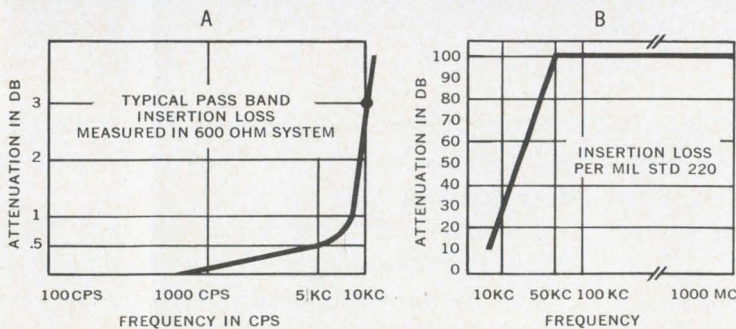

Graphs A and B show typical characteristics of Potter signal line filters. These filters are used on systems which must meet Defense Communications Agency criteria and provide maximum attenuation above the pass band with less than  $\frac{1}{2}$  db attenuation in the pass band. ■ Write for further information on these and other Potter filters.

**THE POTTER COMPANY**  
*Pioneering in Imagination Since 1925*  
7351 North Lawndale Avenue ■ Skokie, Illinois  
ON READER-SERVICE CARD CIRCLE 43

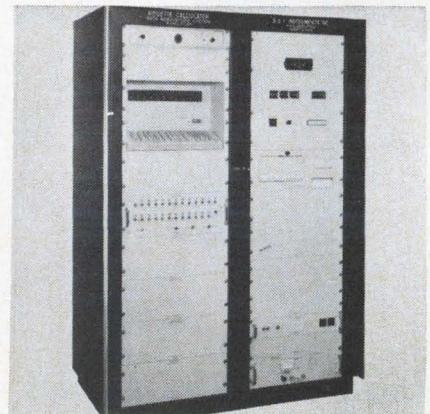
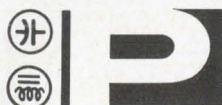

**Rosette calculator**

Said to be the only product of its type on the market, this rosette calculator presents calculated data directly on hard copy. Direct read-out of test data in engineering units is supplied while the tests are in progress. The unit adds, subtracts, multiplies, divides data and extracts square roots.

P&A: about \$45,000; 90 days. B&F Instruments, 3644 N. Lawrence, Philadelphia. Phone: (215) 425-4175.

Circle No. 261

ON READER-SERVICE CARD CIRCLE 235 ➤

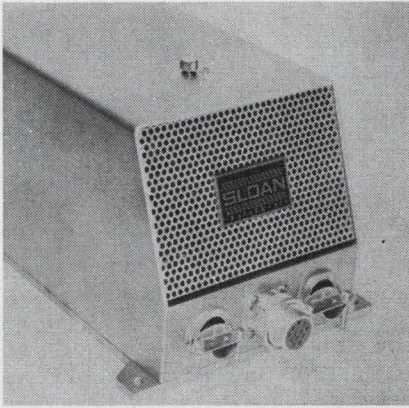

## Power controller

The model SCR-P is a 25-kVa SCR power controller for use in vacuum deposition systems. Instantaneous power adjustments are featured to maintain constant rates of deposition for filament, electron beam or RF power control. Control requirements are 0 to 9 Vdc for 0 to 100% line voltage. The SCR-P is also available in 2.5 and 7.5 kVa models.

Sloan Instruments Corp., P. O. Box 4608, Santa Barbara, Calif. Phone: (805) 963-4431.

Circle No. 340

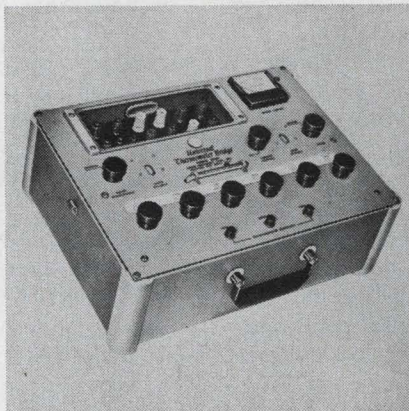

## Thermometer bridge

Use with a wider range of probes than other units is reported for model 2550 universal resistance bridge. It can be used with all base and precious metal probes which employ 2-, 3- or 4-terminal configurations. The unit can also be operated as either a Mueller or Callander-Griffiths type bridge. Range is 0 to 1111.11  $\Omega$ .

Radio Frequency Laboratories, Inc., Powerville, Boonton, N. J. Phone: (201) 334-3100.

Circle No. 341

## NYLON CUP WASHER FILLERS

Employed as insurance against damage, these quality fillers are molded from high strength Polyamide (nylon) and guarantee chip and crack free panel installation.

Available in Nos. 6, 8, 10 and 12 screw sizes.

CATALOG SERIES — NWF

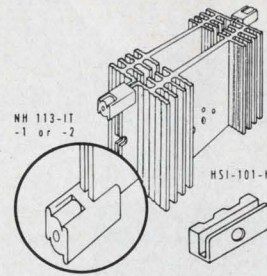
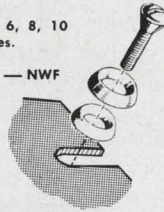

Many other heat sink, transistor pad and specialty items not shown are available. Write for additional information.

## NYLON TRANSISTOR PADS

Precision molded from Zytel 101 (MIL-P-20693), these pads provide an economical insulator and thermal barrier with high dielectric strength. Resist continuous exposure to 135° C.

CATALOG SERIES — TPN

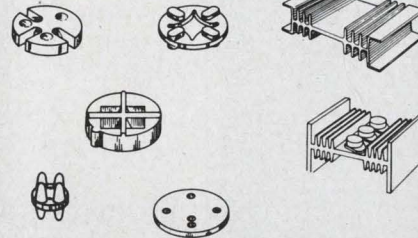

When custom designs or modifications of standard electronic hardware parts are needed, our years of experience in the molding, extruding, stamping and fabrication of metal and plastic parts enables us to supply you with parts unsurpassable in quality.

We can help you successfully meet competition in today's highly competitive market.

## THE DELBERT BLINN CO.

P. O. BOX 2007 • POMONA, CALIFORNIA • PHONE (714) 623-1257 (213) 628-8794

ON READER-SERVICE CARD CIRCLE 44

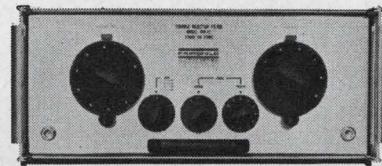

## Rejection to 100 DB with Fairchild's Tuneable Filters 14 KC to 1000 MC in five separate, shielded units

■ The TRF Series tuneable rejection filters cover the range from 14 KC to 1 GC by means of five individual precision units, each having a typical rejection capability of 100 DB for a signal within its range. And NO interchangeable plug-in coils!

■ Individual pass band for each of the five filters encompasses the complete range from DC to 1 GC, with typical insertion loss less than 3 DB outside the notch. Spurious filter response is 15 DB or less.

■ At 20 DB down the band rejection width is approximately 20% of the notch center frequency, while at 60 DB down the width is approximately 0.2%.

■ Filters can be obtained individually, or as a complete set. Each comes in its own well-shielded housing for use in laboratory or field measurements involving RFI/EMC instruments, or for other applications requiring rejection of interfering signals.

■ For complete technical information, contact:

## FAIRCHILD

### ELECTRO-METRICS CORPORATION

A SUBSIDIARY OF FAIRCHILD CAMERA AND INSTRUMENT CORPORATION

88 CHURCH ST., AMSTERDAM, NEW YORK 12011

ON READER-SERVICE CARD CIRCLE 45

## HEAT SINK MOUNTING INSULATOR

Delbert Blinn mounting insulators are precision molded of Microlon "202" and provide a practical, compact and economical method for mounting and insulating all standard heat sinks.

These insulators are capable of continuous operation to 175° C. and have a dielectric strength of 340 V/MIL.

CATALOG SERIES — HSM

## HEAT SINK DISSIPATORS

Efficiency, light weight and economy are incorporated in a complete line of professionally engineered heat sinks available in a variety of sizes and shapes. Material: Aluminum 6063-T5 alloy, mill finish. Lengths to 5 ft. available. (Serrations--U.S. Pat. No. 3163207). Can be cut, drilled, anodized or painted to your specifications.

CATALOG SERIES — AHS

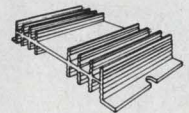

# INSULTITE

## heat-shrinkable tubing

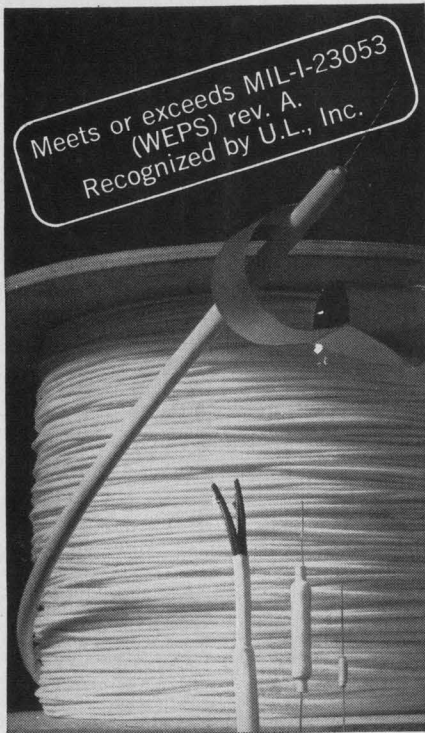

### first of the INSULRAD family of irradiated polyolefins from E.C.C.

Now there's an important new source of heat-shrinkable tubing—INSULTITE from Electronized Chemicals Corporation.

INSULTITE meets competitive heat-shrinkable tubing requirements spec for spec—outperforms other shrinkables in volume resistivity, longitudinal change, water absorption, and resistance to solvents.

INSULTITE is the answer wherever skin-tight packaging or encapsulating covers are needed. Apply heat: INSULTITE molds itself around smooth or irregular shapes to form a tight protective jacket. INSULTITE is available in standard colors and sizes and is supplied in four-foot or specified lengths... all competitively priced and available now. For more information on this new product, write, wire or call Electronized Chemicals Corporation, Burlington, Mass. Tel. 617-272-2850. Dealer inquiries are invited.



**ELECTRONIZED  
CHEMICALS  
CORPORATION**

*a subsidiary of*

**HIGH VOLTAGE ENGINEERING**

ON READER-SERVICE CARD CIRCLE 46

## TEST EQUIPMENT

### Dual trace oscilloscope

A dc to 200 KHz frequency response is featured in the OCA-12A dual trace scope. Sensitivity is 20 mV p-p/division. Linear time base is triggered or repetitive. Sampling display is from 3 to 300 Hz. The 9-lb. unit accepts either 115 or 230 V input, and can be converted for rack mounting.

P&A: \$295; stock. Waterman Instrument, 1919 E. Boston, Philadelphia, Pa. Phone: (215) 423-5161. *Circle No. 342*

### Stored charge meter

Five stored charge ranges of 10, 30, 100, 300 and 1000 picocoulomb are featured in model QS-3 stored charged meter. The solid-state unit is designed to measure stored charge of diodes. Touted as a new spec, stored charge is said to offer circuit designers a single figure of merit with minimal dependence on test conditions and jogs, and is measurable on inexpensive equipment.

The model QS-3 measures the stored charge recovered from a semi-conductor diode when the diode is switched from a known forward biased state to a reverse biased condition. It is designed to be useful as a substitute for sampling oscilloscope measurements of reverse recovery time as well as stored charge measurements or pulse capacitance measurements when minimum or maximum values are required for successful circuit operation. The instrument is completely self contained, requiring no external cables, pulse generator or oscilloscope. The value of the diode stored charge or pulse capacitance is presented on a panel meter.

An automatic zero adjustment circuit in the stored charge meter eliminates the need for any manual zero adjustment. Also an automatic polarity indicator eliminates the possibility of error due to incorrect insertion at diodes in the test clips. If the diode is properly inserted, a green indicator will be illuminated, whereas if the diode is placed in with the wrong

polarity, a red indicator will be illuminated.

Price: \$865. B-Line Electronics, 4 Music Hall Ave., Waltham, Mass. Phone: (617) 899-3880.

*Circle No. 343*

### Sweep generator

A solid-state sweep generator, the model 1001, incorporates wide frequency range, variable sweep width, high stability, swept or cw operation, and a completely new type of frequency marking system. Range of the new unit is 100 kHz to 20 MHz, covering applications for RF, IF, and video systems.

The width of the instrument's sweep may be varied through 3 ranges. On wide range, it covers 10 kHz to 20 MHz, on intermediate range, 1 kHz to 2 MHz and on narrow range, 100 Hz to 200 kHz. The sweeping rate is also variable, continuous from 0.01 Hz to 60 Hz or may be locked to the 50/60 cycle line. Output of the model 1001 is 1 V rms. The variable frequency marker output can be fed directly to a frequency counter. Stable power supplies designed for the model 1001, combined with temperature compensation in the oscillator, provide a high degree of stability.

A frequency marker system is operable in a 1-MHz harmonic or a variable mode. The harmonic marker is only 10-kHz wide. The variable frequency marker can be selected to be 10 kHz, 1 kHz, or 100 Hz wide. The narrow widths of the markers permit an extremely accurate determination of frequency. The marker system includes a "tilt" control permitting a more precise reading.

Telonic Industries Inc., 60 N. First Ave., Beech Grove, Ind. Phone: (317) 787-3231.

*Circle No. 344*

### Portable test gear

Two portable units are offered. The 5-lb. phasemeter measures the phase angle between two alternating voltages with a  $\pm 1^\circ$  accuracy, over a 5Hz to 500 KHz range. Its frequency range is 0 to 10 MHz.

P&A: \$950-\$1450; 45 days. Aerojet-General Corp., P. O. Box 216, San Ramon, Calif. Phone: (415) 837-5311.

*Circle No. 345*

# Solve any CCTV problem with one of these seven basic systems from Cohu.

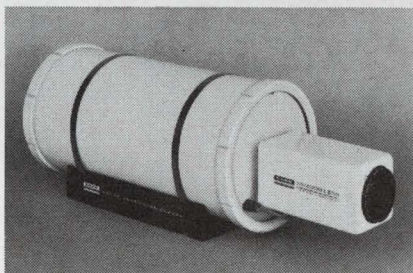

## High-fidelity color

1000 Series system includes the first CCTV camera with built-in references for correct registration and color balance. Compact, rugged, low-cost and easy-to-operate.



## Miniaturized

Series 2000 cameras feature 3" outside diameter cylindrical housings that will accommodate remote-controlled 4:1 zoom lens. Many lens options available, including 10:1 zoom. Operate on 10 or 20 megacycle bandwidths.

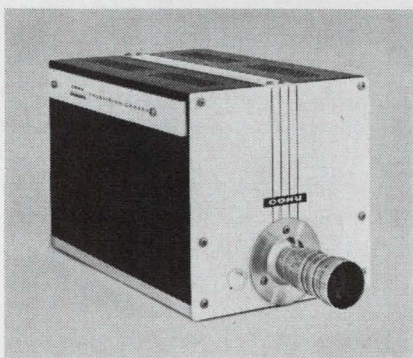

## High-resolution self-contained

Modular-designed 3100 Series offers choice of plug-in sync generators for EIA 525 or 729, 873 or 945-line scan rates. Automatically compensates for light level variations to 10,000:1.



## Industrial self-contained

Complete with all camera control circuits, Model 20/20 cameras need only video cabling and any standard TV monitor to make a complete CCTV system. Highly versatile.

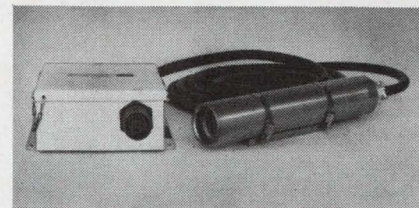

## Radiation-tolerant

Get top quality TV pictures from radiation environments up to a cumulative dosage of  $10^8$  roentgens and/or  $10^{12}$  neutrons/cm<sup>2</sup> with 3-inch diameter 2500 Series cameras. Readily de-contaminated.

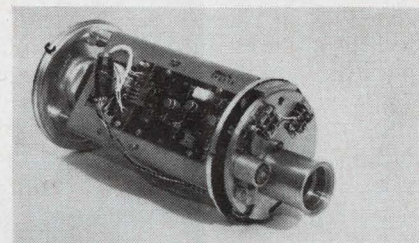

## Airborne

3" or 6" diameter cameras weigh as little as 5 lbs. Unaffected by extremes of temperature, humidity, dynamic pressure, altitude, noise, vibration, shock or acceleration, within broad limits.

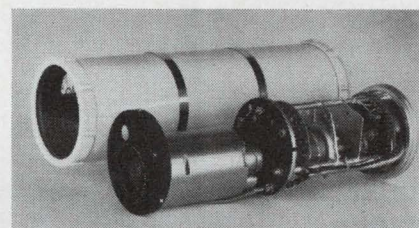

## Environment-resistant

3000 Series cameras provide continuous-duty operation in up to 100% humidity, at temperatures from  $-20^{\circ}\text{C}.$  to  $+60^{\circ}\text{C}.$ , ocean depths to 250 feet and altitudes out to deep space. Meet military explosion-proof specifications. Operate on 10 or 20 megacycle bandwidths.

## Which one solves yours?

For details on the industry's most complete CCTV line—including monitors, accessories and video switching systems—contact Cohu or your nearest Cohu representative.

**COHU**  
ELECTRONICS, INC.  
SAN DIEGO CALIFORNIA

BOX 623 • SAN DIEGO, CALIFORNIA 92112 • PHONE: 714-277-6700

ON READER-SERVICE CARD CIRCLE 47

## Low-cost Triac for 120 volt consumer and low-power use

A pair of low-current sensitive-gate Triacs has been developed for applications in low-power supplies and consumer appliances. The projected price is under \$1 for production quantities of these bi-directional ac switches.

The TA 2892 and TA 2893, with peak blocking voltages of 100 V and 200 V respectively, were made possible through all-diffused thyristor technology. Each Triac does the work of two SCRs and eliminates other components. Design tolerances now exceed those used for integrated circuits. The resulting small pellet area and high pellet-to-wafer yields contribute to the low price level, according to the manufacturer. The devices are packaged in standard TO-5 cans.

Economies in triggering circuitry are made possible by the high-gate sensitivity which is typically 1 mA (3 mA max). In many types of ac resistive circuits the active triggering device can be eliminated. The devices exhibit gate-triggering current of 1.0 mA (3.0 mA max) for either polarity of anode-to-anode or gate-to-anode voltage. The total combination of gate symmetry, high gate sensitivity and low current make design of full-wave control circuits more economical and compact.

The rms conduction current rating of both Triacs is 2.5 A for a 360° conduction angle and a  $T_c$  of +70°C. For a free-air temperature of +25°C the rating drops to 0.45 A. Average gate power is given as 0.025 W for both the TA 2892 and the TA 2893.

Other preliminary specifications include an 18 A peak surge current for one full cycle of sinusoidal anode-to-anode voltage. Peak gate current for both models is 0.5 A for 1  $\mu$ s max and for either polarity of gate-to-anode voltage. Steady state anode-to-anode drop is 1.1 V (2.2 V max) for a peak anode current of 10 A. The Triacs are operable over a -40 to +100° range.

Home appliances require a full-wave control device to proportionately control light, heat or motor speed. SCRs, which are basically a half-wave device, cannot provide full-wave control unless two are used with a more complicated circuit. It is stated that the new Triacs will satisfy the majority of circuit and size requirements in the home appliance control market.

P&A: \$1.62 (TA2892), \$1.57 (TA2893) in evaluation quantities. RCA, 415 S. Fifth, Harrison, N. J. Phone: (201) 485-3900.

Circle No. 346

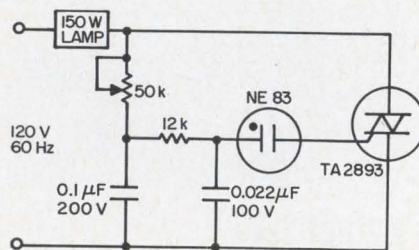
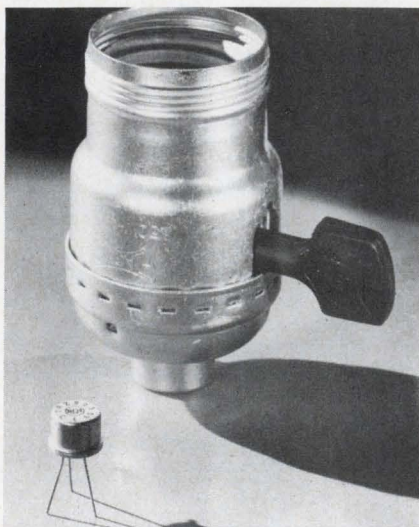

A dimmer in a socket complete with RFI suppressor circuitry will be made possible with the space-saving Triacs. Stepless control of light level from full-bright to dim would be possible and short-life three-way bulbs would be eliminated. Use in more than 75% of appliances now found in the home is projected.

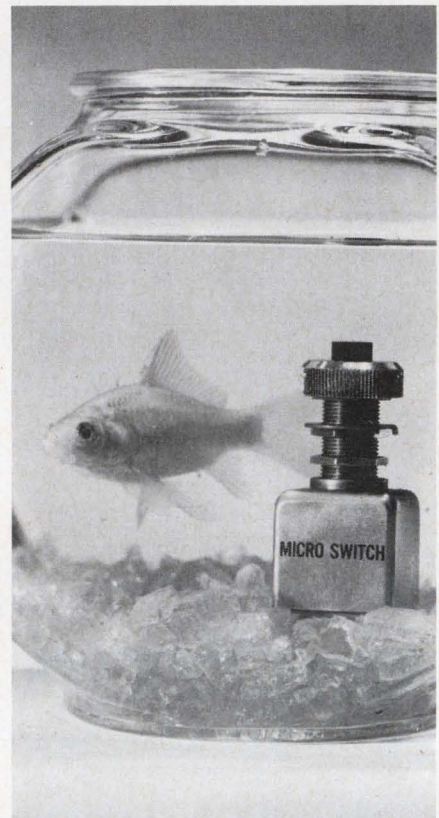

## Pushbutton switch withstands submersion

A new sealed pushbutton switch ready for the wettest possible weather has been introduced. Special watertight seals at the panel, bushing, plunger and terminals enable the switch to remain under water at 10 psi pressure for an hour and still perform perfectly.

Mechanically, the 2PB900 switch has push on/release off action with a dpdt contact. The heart of the pushbutton is a pair of subminiature snap-action switches potted in a plated brass enclosure to prevent contact contamination. The actuator mechanism has a pretravel/overtravel spring and overcenter snap mechanism.

The pushbutton is rated at 5 A at 250 Vac, 3 A inductive and 5 A resistive at 30 Vdc. Maximum inrush current is 24 A. The 2.5-oz unit is operable over a -65 to +158°F rang. Applications cited are in Marine equipment, airborne gear and wherever liquids, dust and dirt are a problem. Submergence requirements of MIL-108D are met.

P&A: \$12.75; stock. Micro Switch Div. Honeywell, 11 West Spring St., Freeport, Ill. Phone: (815) 232-1122.

Circle No. 347



BURNDY LABORATORY—MC35 PRINTED CIRCUIT CONNECTORS (35 CONTACTS)

Connectors tested: 172

Hours accumulated per connector: 1500

Connector operating hours (T): 258,000

Contact operating hours (T): 9,030,000

Number of contact failures observed (C): 0

From Poisson distribution for C: 0

and 60% confidence level T: 0.915

$$\begin{aligned} \text{connector} \\ \text{failure} \\ \text{rate} &= \lambda \text{ connector} = \frac{\lambda T}{T} = \frac{0.915}{258,000} = 0.0000036 \\ &= \lambda 0.36\% / 1000 \text{ hrs.} \end{aligned}$$

$$\begin{aligned} \text{contact} \\ \text{failure} \\ \text{rate} &= \lambda \text{ contact} = \frac{\lambda T}{T} = \frac{0.915}{9,030,000} = 0.0000010 \\ &= \lambda 0.01\% / 1000 \text{ hrs.} \end{aligned}$$

FAILURE: Criteria for failure were open circuits or voltage drop in excess of 30.0 millivolts (45.0 MV after salt spray.)

# BURNDY RELIABILITY TESTS ARE RELIABLE (HERE'S ABSOLUTE PROOF)

FIELD CONFIRMATION—MC35 PRINTED CIRCUIT CONNECTORS (35 CONTACTS)

Connectors in operation: 9451

Average number of hours accumulated to date: 1422

Connector operating hours (T): 13,439,322

Contact operating hours: 241,907,800

Number of failures observed (C): 0

From Poisson distribution for C: 0

and 60% confidence level  $\lambda T$ : 0.915

$$\begin{aligned} \text{connector} \\ \text{failure} \\ \text{rate} &= \lambda \text{ connector} = \frac{\lambda T}{T} = \frac{0.915}{13,439,322} = 0.000000068 \\ &= \lambda .0068\% / 1000 \text{ hrs.} \end{aligned}$$

$$\begin{aligned} \text{contact} \\ \text{failure} \\ \text{rate} &= \lambda \text{ contact} = \frac{\lambda T}{T} = \frac{0.915}{241,907,800} = 0.000000038 \\ &= \lambda 0.00038\% / 1000 \text{ hrs.} \end{aligned}$$

Two years ago a large systems manufacturer installed 9,451 Burndy MC35 printed circuit connectors to be used in a naval weapons system.

Their engineers reported not a single failure in more than 13 million connector operating hours—not one single contact failure in Burndy printed circuit connectors. In operation, not just the lab. 1422 hours per connector!

Just as Burndy reliability tests predicted, the rate of failure under vibration, varying temperature levels, and other environmental conditions was almost non-existent . . . performance far in excess of field expectations.

The operating performance proves Burndy connectors reliable in every way: millivolt drop, insulation resistance, connector separation force, individual contact separation, crimp-joint strength, capacitance, dielectric strength, re-

sistance to test prod damage. Just as Burndy reliability tests predicted.

The field tests mark our MC35 printed circuit connectors as reliable as we claim. More important—they prove you can rely on Burndy reliability tests.

BURNDY CORPORATION, NORWALK, CONNECTICUT

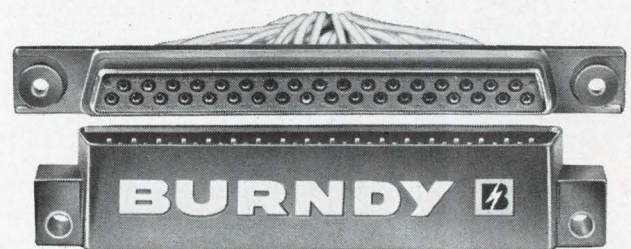

64-17

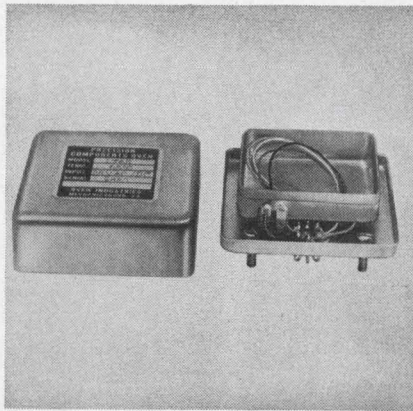

### PC mount oven

A miniature dc proportional controller in the case assembly and a stability of 0.008°C highlight this PC mount oven. Specifications include a 28 Vdc input, 3 to 4 W average and 10 W max power. The 0.865-in. thick oven will mount directly on PC cards. Standard mounting configuration is a 7-pin header and 4 studs.

Price: \$99.50, 1 to 10. Greenray Industries, 5235 E. Simpson Rd., Mechanicsburg, Pa., Phone: (717) 766-0721.

Circle No. 348

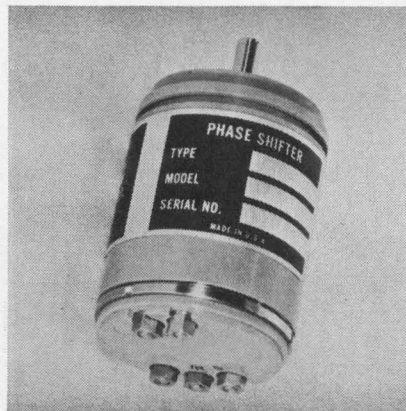

### Phase shifter

This family of phase shifters covers 60 Hz to 250 kHz at 6 to 30 minute accuracies. A fixed V out has phase directly proportional to shaft position. Featured is the use of two isolated input and output terminals. Components of the self-contained network have matched temperature coefficients, and thermistor compensation is optional.

P&A: \$200-400; 60-90 days. Reeves Instrument Co., Roosevelt Field, Garden City, N. Y. Phone: (516) 746-8100.

Circle No. 349

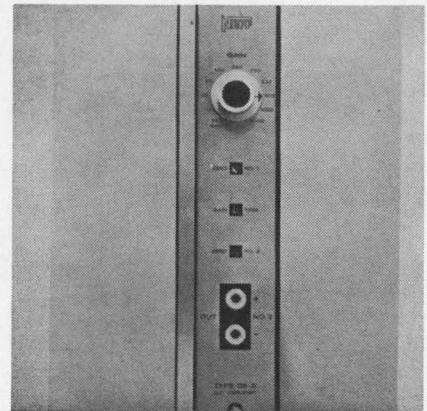

### Dual-output amplifier

Two transformer-isolated outputs from a single input are offered in the type 118-5 dc amplifier. Input circuitry is differential and utilizes a guard shield. The outputs may be separately grounded without ground loop problems. Outputs are ±5 V and 1 to 10 V full scale at 10 mA. Common mode rejection is 120 dB, dc to 100 Hz.

P&A: \$580; stock. Neff Instrument Co., 1088 E. Hamilton Rd., Duarte, Calif. Phone: (213) 357-2281.

Circle No. 350

## With EASTMAN 910<sup>®</sup> Adhesive...

### Strong yet destructible bond solves circuit board problem

Because the bonding of transistors to a fiberglass-epoxy circuit board with an epoxy adhesive results in an irreversible "weld", faulty transistors cannot be replaced without board destruction.

Scope, Incorporated, Falls Church, Va.

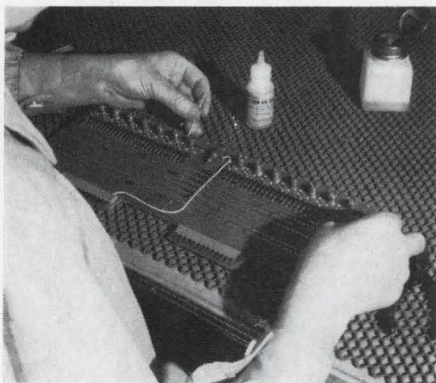

bypassed this problem with EASTMAN 910 Adhesive. A drop of EASTMAN 910 Adhesive is applied to the transistor collar cap to bond it in its slot. Although the bond is strong enough to withstand 1000 G's, the porosity of the surface permits easy rupture and ready transistor replacement.

EASTMAN 910 Adhesive will form bonds with almost any kind of material without heat, solvent evaporation, catalysts, or more than contact pressure. Try it on your toughest bonding jobs.

For technical data and additional information, write to Chemicals Division, EASTMAN CHEMICAL PRODUCTS, Inc., subsidiary of Eastman Kodak Company, Kingsport, Tennessee. EASTMAN 910 Adhesive is distributed by Armstrong Cork Company, Industry Products Division, Lancaster, Pa.

#### Here are some of the bonds that can be made with EASTMAN 910 Adhesive

Among the stronger: steel, aluminum, brass, copper; vinyls, phenolics, cellulose, polyesters, polyurethanes, nylon; butyl, nitrile, SBR, natural rubber, most types of neoprene; most woods. Among the weaker: polystyrene, polyethylene (shear strengths up to 150 lb./sq. in.).

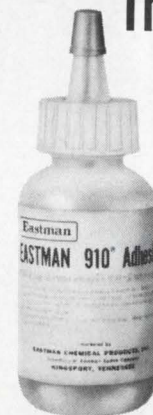

### There is no adhesive like EASTMAN 910<sup>®</sup> Adhesive

- SETS FAST**—Makes firm bonds in seconds to minutes.
  - VERSATILE**—Joins virtually any combination of materials.
  - HIGH STRENGTH**—Up to 5,000 lb./in.<sup>2</sup> depending on the materials being bonded.
  - READY TO USE**—No catalyst or mixing necessary.
  - CURES AT ROOM TEMPERATURE**—No heat required to initiate or accelerate setting.
  - CONTACT PRESSURE SUFFICIENT.**
  - LOW SHRINKAGE**—Virtually no shrinkage on setting as neither solvent nor heat is used.
  - GOES FAR**—One-pound package contains about 30,000 one-drop applications. (Or in more specific terms, approximately 20 fast setting one-drop applications for a nickel.)
- The use of EASTMAN 910 Adhesive is not suggested at temperatures continuously above 175°F., or in the presence of extreme moisture for prolonged periods.

See Sweet's 1966 Product Design File 8a/Ea.

**Now available! EASTMAN 910 Surface Activator**  
When certain surface conditions inhibit rapid bond formation, use of EASTMAN 910 Surface Activator is suggested to restore the rapid polymerization of EASTMAN 910 Adhesive.

Helipot's side-adjust  
Helitrim® cermet  
trimmer-world's  
smallest-costs as little  
as \$1.50 in quantity.

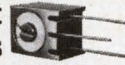

Helipot's side-adjust  
Helitrim® cermet  
trimmer-world's  
smallest-costs as little  
as \$1.50 in quantity.



Helipot's side-adjust  
Helitrim® cermet  
trimmer-world's  
smallest-costs as little  
as \$1.50 in quantity.

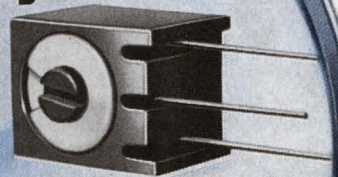

Helipot's side-adjust  
Helitrim® cermet  
trimmer-world's  
smallest-costs as little  
as \$1.50 in quantity.



The Model 62PA side-adjust is a new easy-access cermet trimmer with these quality features: virtually infinite resolution; excellent high frequency characteristics; and standard resistance from 10 ohms to 1 megohm. Its rugged cermet resistance element gives you long, trouble-free life and freedom from sudden failure. Inside its plastic case is a sealed metal housing identical to the popular 1/4" top-adjust Model 62P.

Focus in on delivery advantages, too... immediate stock availability. Call your Helipot sales rep for full specs.

**Beckman**

INSTRUMENTS, INC.  
HELIPOT DIVISION  
FULLERTON, CALIFORNIA • 92634

INTERNATIONAL SUBSIDIARIES: GENEVA; MUNICH; GLENROTHES, SCOTLAND; TOKYO; PARIS; CAPETOWN; LONDON

Speed Inquiry to Advertiser via Collect Night Letter  
ON READER-SERVICE CARD CIRCLE 50

**rugged high temperature  
plastic package**

**abrupt junction  
epitaxial construction**

**high capacitance  
ratios**

**high Q**

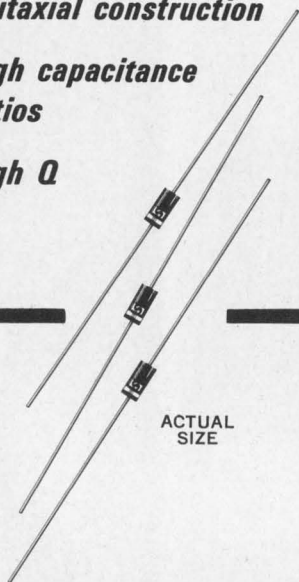

## Voltage-Variable Capacitance Diodes

SV-1748 and SV-1650 series feature minimum Q of 150 and 200 at 50 Mc., and a guaranteed capacitance ratio exceeding 2.6. Ideal for AFC and electronic tuning circuits in low cost consumer and industrial applications at frequencies as high as 1 Gc.

SV-2600 through SV-5700 series feature Q's to 300 at 50 Mc. &  $V_R = 4$  Volts, and a 10% tolerance on capacitance. DC voltage ratings are 40, 60, 80 and 100 volts with minimum Capacitance Ratios ( $C_{1V}/C_{M WV}$ ) of 4.0, 5.0, 5.6 and 6.4.

**AVAILABLE FROM STOCK**

**write for  
technical bulletins  
266, 366 and 466**

**S Somerset  
Electronics  
Corporation**

P. O. BOX 115, MANVILLE, N. J. 08835  
AREA CODE 201, 722-2340

ON READER-SERVICE CARD CIRCLE 51

## COMPONENTS

### Vacuum relay

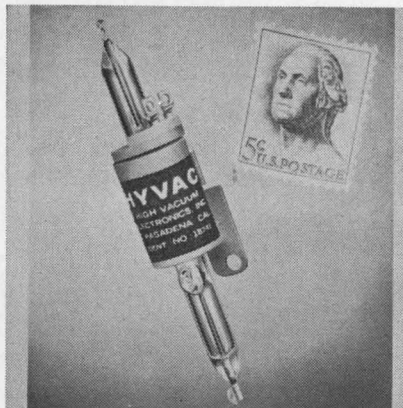

A new vacuum relay switching up to 10 kVdc in a 1/2-in. x 2-3/4-in. package is offered. This spst relay has a 10 ms max operating time, 170  $\Omega$  coil resistance and 24 Vdc coil voltage. The model H-5/S-10 carries up to 4 A. Applications include radar, communications, ECM and sonar.

P&A: \$130, 1 to 9; stock to 30 days. High Vacuum Electronics Inc., 538 Mission St., S. Pasadena, Calif. Phone: (213) 682-3661.

Circle No. 351

### FET chopper modules

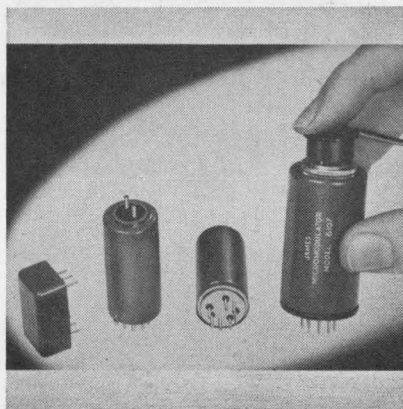

A line of FET chopper modules covers a 15-Hz to 1-MHz range. Four initial models incorporate driving systems, heat sinks and balanced FET units. Wideband noise of less than 5  $\mu$ V rms into 1 Meg and less than 3  $\mu$ V drift are provided. The "Micromodulators" come in a 7-pin, plug-in or a 0.25-in.<sup>3</sup>, encapsulated, wire-in PC board type.

P&A: \$21 to 42; 3 to 4 wks. James Electronics, Inc., 4050 N. Rockwell St., Chicago. Phone: (312) 463-6500.

Circle No. 352

### Switch

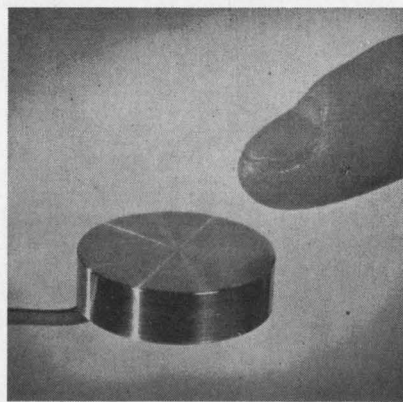

A new type of solid-state switch is offered. The touch-operated device is applicable for motor controls, safety and protective devices, data processing, or consumer products.

Two epoxy-encapsulated styles begin at 1-in. diameter by 1/4 in.-deep. Wire leads or solder studs are available. Very fast reaction times are claimed.

Hall-Barkan-Opticon, 173 Marbledale Road, Tuckahoe, N. Y. Phone: (914) 337-3431.

Circle No. 353

### Tachometer generator

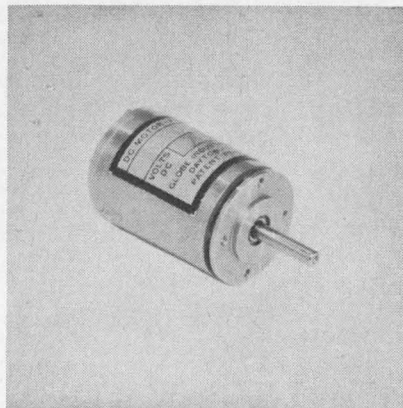

This new type miniature tach gen has an output of 3 Vdc  $\pm 5\%$  per thousand rpm over a 3000 to 6000 rpm range. Linearity is within 1% over 0 to 3600 rpm. Ripple is less than 3% rms between 900 and 6000 rpm in either direction.

Insulation resistance of this miniature is 100 Megs min at 200 Vdc between either terminal and the case.

Globe Industries, Inc., 2275 Stanley Avenue, Dayton, Ohio. Phone: (513) 222-3741.

Circle No. 354

# The Last Word in AC DPDT Relay Miniaturization

Here's the smallest AC relay yet—the TRIMPOT® Model 3105. It measures just 0.20" x 0.40" x 0.62" and can go directly into your AC circuits. We've built in a diode bridge so that you don't have to waste time, money or board space providing auxiliary rectification. It's a performance-multiplier, too—gives you nearly twice the sensitivity of the much larger crystal can size, twice the vibration resistance and three times the resistance to shock.

Like its time-proven DC TRIMPOT counterparts, Model 3105 has a self-damping return spring, rotary balanced armature, hermetically sealed case and long-life contacts. And it follows the same exclusive route to reliability: (1) 5000-cycle run-in for every unit; (2) 100 per cent final inspection, including pick-up and drop-out values, dielectric strength, operate and release time,

contact resistance, and mass spectrometer leak test; and (3) the double-check of the Bourns Reliability Assurance Program.

Performance is summed up in the name on the case. TRIMPOT means BOURNS and BOURNS means QUALITY. Write today for complete technical information.

Size	0.20" x 0.40" x 0.62"
Pick-up sensitivity	180 mva
Contacts	1 amp, 28 VDC or .75 amp, 115 VAC
Nominal coil voltage	28 VAC, 400/800 cps
Max. operating temp.	85°C
Shock	150G, 11 milliseconds
Vibration	40G to 3000 cps
MIL Spec	Meets or exceeds requirements of MIL-R-5757D
Terminals	Plug-in pins, solder hooks, wire leads



MODEL 3105, ACTUAL SIZE

BOURNS, INC., TRIMPOT DIVISION  
1200 COLUMBIA AVE., RIVERSIDE, CALIF.  
PHONE 684-1700 • TWX: 714-682-9582  
CABLE: BOURNSINC.

TRIMPOT is a registered trademark of Bourns, Inc.

TRIMPOT® AND PRECISION POTENTIOMETERS—RELAYS—MICROCOMPONENTS: TRANSFORMERS, INDUCTORS, RESISTORS AND CAPACITORS—MICROCIRCUITS

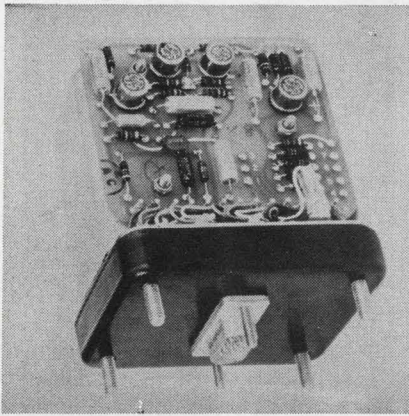

**Dc modulator**

This signal modulator is designed for closed-loop servo systems with dc input, but 60 to 400 Hz power supply, servo amplifier and motor. Featured are 3 inputs, full wave solid-state chopping, low drift, low offset and a self-contained power supply eliminating auxiliary equipment. The internal amplifier provides high gain or high input Z.

Westamp, Inc., 1522-15th St., Santa Monica, Calif. Phone: (213) 393-0401.

Circle No. 355

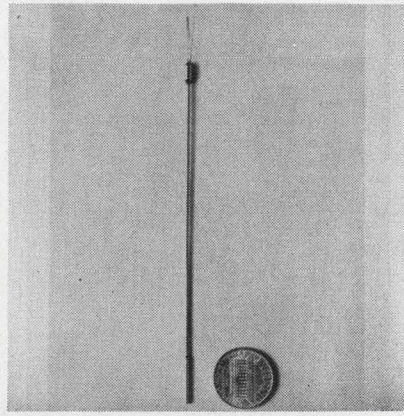

**Temperature sensor**

This subminiature temperature sensor offers 0.2 s response over -320°F to +1200°F. The transducer features a platinum or optional nickel wirewound sensing element hermetically sealed ( $3 \times 10^{-8} \text{cm}^3/\text{s}$ ) in a 0.046x0.50-in. housing. At 77°F R is 500 Ω. Insulation R of 10 Megs at 50 Vdc, and 32°F, 77°F and 212°F calibration points are available.

J. P. Pennington Corp., 333 Culver Blvd., Playa Del Rey, Calif. Phone: (213) 398-4720.

Circle No. 356

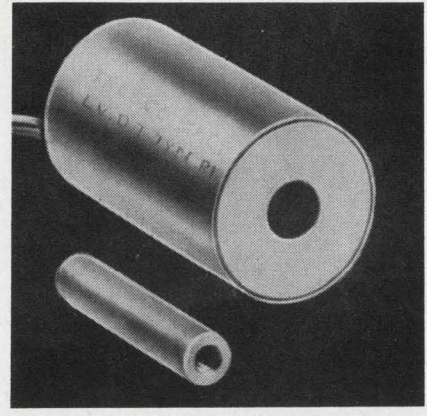

**Differential transformers**

A standard line of 1/2-in. OD linear variable differential transformers has been introduced. The transformers offer 0.5% over-all linearity, negligible drift and infinite resolution. They require no warm-up. The 65-SM series is directly coupled to the measurement, eliminating inertial lag, and functions over a -65°F to +300°F range.

Tresco, Inc., 3824 Terrace St., Philadelphia, Pa. Phone: (215) 483-1383.

Circle No. 357

**IN STOCK**

... standard **RBM** enclosed relays with all the advantages of "specials"

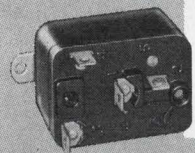

**TYPE 84**  
**\$2.90\***

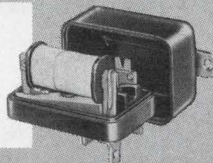

2 3/8" x 1 5/8" x 1 1/2"

millions in use—time tested and field proven under exacting operating conditions

**TYPE 84** 8 AMP (Inductive)  
SPNO or SPDT

**RBM TOTALLY ENCLOSED AC RELAYS... AT OPEN TYPE PRICES**

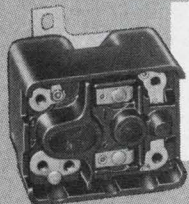

**TYPE 129**  
**\$3.94\***

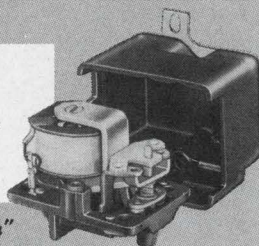

2 3/8" x 1 7/8" x 1 7/8"

\*SPNO—24 Volt 50/60 Cycle—Lots 1 to 24

**TYPE 129** 18 AMP (Inductive)  
SPNO or SPDT

**AUTHORIZED STOCKING DISTRIBUTORS**

ALLIED  
BLUFF CITY  
LEW BONN  
BURSTEIN-APPLEBY  
CRAMER  
DIXIE RADIO  
ELECTRONIC EQPT.  
ELECTRO TECH

FEDERATED  
FISHER SWITCHES  
GRAHAM  
HAMMOND  
INTERSTATE  
LOU JOHNSON  
KIERULFF  
NEWARK

PIONEER/SREPCO  
POWELL  
RISSI  
RADIO PARTS  
SPECIALTY  
STACK  
TEXAS INSTRUMENTS SUPPLY  
WESTERN ELECTRONICS



WRITE FOR 1966 STANDARD CONTROLS CATALOG

SOLD NATIONALLY THROUGH ELECTRONIC DISTRIBUTORS BY  
**ELECTRONIC MARKETING DIVISION**

3501 W. Addison Street • Chicago, Illinois 60618

ON READER-SERVICE CARD CIRCLE 52





## Start with the EI-620 DVM with **autoject** ...

Whether your signal levels are single ended or floating above ground, fool proof operation is provided by the 620's isolated-guarded differential input (140 db of CMR). Ground loops, offset or error due to noise are eliminated. The 620's constant high input impedance of greater than 1000 megohms eliminates errors due to source of loading. Fluctuating DC signals are accurately measured with the 620's integrating logic, the value being integrated over the sampling time base of 100 msec.

The exclusive autoject circuitry provides greater than 60 db of normal mode rejection to superimposed noise of any frequency above 30 Hz, without the delay required by filters. (See graph.) *All this at  $\pm .01\%$  accuracy!*

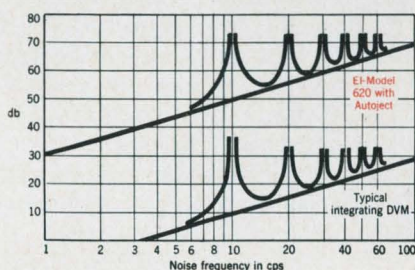

**620 features** — •  $\pm .01\%$  accuracy • 4 full digits plus 5th for 20% overrange • Automatic ranging and polarity • 4 readings per second • DC and Ratio • Differential inputs • Isolated electrical outputs • Remote control • Completely solid state circuitry including logic • From \$995.00

**620 Data System** — Now, a low cost portable measuring and recording system utilizing as its heart, the EI-620 DVM with *autoject*. Plug in your EI-620 and the system is complete.

Whether your application is for in house or field use, the 620 system provides a portable package everyone can use, anywhere!

**System features** — • 40 points of guarded scanning • High-Low limit channel selection • Automatic or manual channel selection • Single or continuous cycle operation • Printed record on

**then add  
this complete,  
low cost  
data system!**

*(only \$4,300, including DVM!)*

4 inch wide paper tape • Printed record includes channel ID, polarity, 5 digits of measured value and range • New, bold printed numerals • Automatic or single print operation • From \$4300.00 (including DVM)

**Additional systems extensions** — are also available to provide additional signal conditioning and printout capability. Write for systems brochure No. S25.512.

**Your choice of system** or portable DVM use. When systems operation is not required, the EI-620 is unplugged and used with its portable case with convenient carrying handle and bench stand. All features and specifications are identical in either instance.

Explore the benefits of a superior, low cost, fully solid state digital voltmeter or system with Autoject... the Series 620!



**Electro Instruments, Inc.** 

8611 BALBOA AVENUE, SAN DIEGO, CALIFORNIA 92112

41 EMMASTRAAT, VELDHOVEN, HOLLAND

ON READER-SERVICE CARD CIRCLE 53

## COMPONENTS

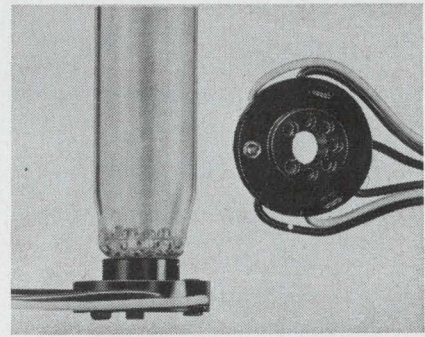

### CRT socket

This 7-pin socket has 0.375 pin circle and 0.040 pin diameter to mate with the miniature JEDEC E7-91 basing CRTs. Leads are automatically attached to the electro-tinned brass contacts. General purpose molded phenolic insulating material is used.

P&A: Dependent on lead length, quantity; 6 to 10 weeks. Connector Corp., 6025 No. Keystone Ave., Chicago. Phone: (312) 539-3108.

Circle No. 358

### Printed circuit connector

The series 6300 connector houses two rows of 26 card-edge contacts on 0.15-in. spacing. With 0.2-in. between rows, there are 52 contacts for a 1/16-in. PC card. The gold-over-nickel plated phosphor bronze contacts are rated at 3 A with a max contact resistance of 0.01  $\Omega$ . Insulation resistance of 25,000 Megs withstands voltage of 1800 V rms.

Price: \$.03 to \$.06 per contact. Elco Corp., Willow Grove, Pa. Phone: (215) 659-7000.

Circle No. 359

### Hall generator

This 3-axis device measures orthogonal components of a magnetic field vector without repositioning. The model BH-703 uses Hall elements which are aligned mutually perpendicular to within 2°. Sensitivity of 7.5 mV/kgauss  $\pm 20\%$  at 100 mA and  $\pm 1\%$  linearity from -10 to +10 kgauss are featured. The elements are contained in a 0.160-in.<sup>3</sup> epoxy package.

P&A: \$575; 30 days. F. W. Bell Inc., 1356 Norton Ave., Columbus, Ohio. Phone: (614) 294-4906.

Circle No. 360

**45 ohms**  
Very stable, minimum cross talk.

**125 ohms**  
High density packaging, very high impedance.

**50 ohms**  
Extremely low cross talk.

**75 ohms**  
Minimum cross talk, high speed.

**95 ohms**  
Very stable

**multi-conductor signal transmission** . . . aci Signaflo systems can be designed to specific customer needs of impedance value—excellent propagation properties—minimum cross talk—low capacitance



when required—shielded or unshielded.  
These Signaflo systems are solving interconnection problems. . . Call, wire or write to



. . . new connective dimensions  
DIVISION OF KENT CORPORATION  
206 Industrial Center, Princeton, N. J. 08540  
Telephone 609-924-3800 TWX. 609-921-2077

**90 ohms**  
**70 ohms**  
In one cable  
High speed.

**105 ohms**  
Minimum cross talk.  
High speed.

**90 ohms**  
Minimum layer to layer cross talk.

**100 ohms**  
High speed, very high insulation resistance.

**95 ohms**  
Very good attenuation, excellent mechanical properties.

**aci**  
**SIGNAFLO**  
**SYSTEMS**

ON READER-SERVICE CARD CIRCLE 54



# How to spot the highest-power 400 MHz transistor available

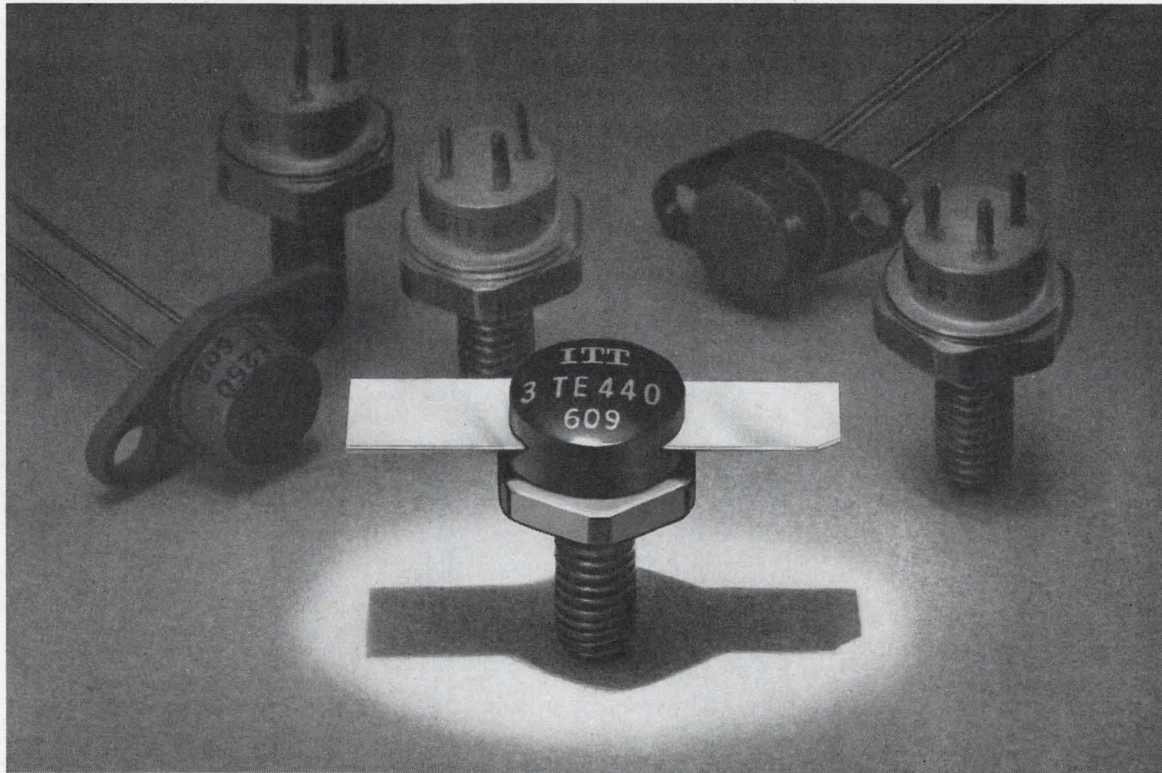

Look for the one with the strip line leads — ITT's 3TE440. The 3TE440 delivers 15 watts minimum at 400 MHz with 8.6 db gain. The low-inductance strip line package provides greatly-improved stability and circuit bandwidth. Typical efficiency is 60% when  $P_{oe} = 10$  watts at 400 MHz.

The planar passivated, interdigitated 3TE440 has a  $BV_{CEO}$  rating of 80 V, allowing better up-modulation and reducing danger of damage from transients. Resistor stabilization provides high second breakdown characteristics and built-in bias stability for Class A and AB amplifiers. In many applications, the 3TE440's higher performance can reduce the number of transistors required.

It is now available off the shelf. Contact any ITT distributor or your ITT factory representative. ITT Semiconductors, a division of International Telephone and Telegraph Corporation, 3301 Electronics Way, West Palm Beach, Florida.

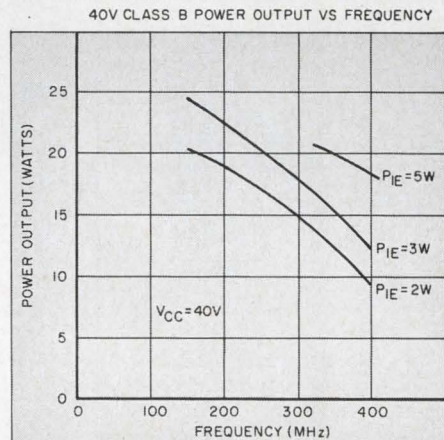

**ITT**  
SEMICONDUCTORS

# reed relay switches 3 amperes

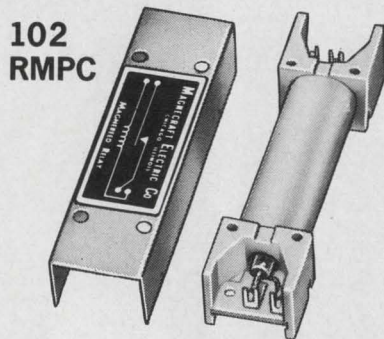

**MAGNECRAFT 102RMPC Power Reed**—rated 100 watts at 3 amperes max. or 250 VAC max. In stock for immediate delivery with 6, 12, 24, and 48 VDC coils.

Designed to switch power loads with reed relay reliability and low printed circuit board profile:

- Power contacts are hermetically sealed in a glass capsule.
- Printed circuit pins are rigidly positioned; stresses on the pins do not affect relay adjustment.
- Integrally molded coil bobbin and mounting base provides insulation plus mechanical protection for the capsule.
- The metal snap-on cover provides magnetic shielding and mechanical protection.

Available in Cost Reducing MPC Multiple-Reed Packages

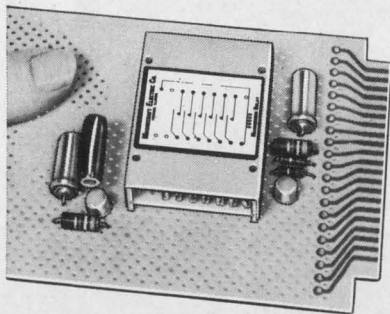

Class 102RMPC Power Reeds, standard form A dry reeds, form C dry reeds, and form A mercury-wetted contact reeds can be combined to order in MPC package sizes up to 7 form A.

This unique packaging provides the contact combinations you need for installation economy plus the reduced cost achieved by MPC multiple reed packaging.

Bulletin PDB661 tells the rest—send for your copy today.

## MAGNECRAFT ELECTRIC CO.

5575 N. Lynch, Chicago, Ill. 60630  
Phone 312-282-5500

ON READER-SERVICE CARD CIRCLE 56

## COMPONENTS

### Rotary switch

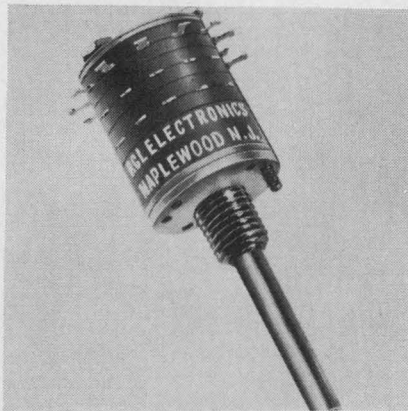

Up to 12 positions and 6 poles per deck are offered in this 1/2-in. miniature switch. Featured are self-contained deck parts with individual rotor and stator enabling bench assembly. The switch carries 0.75 A at 28 Vdc with a contact R of .0025  $\Omega$ . Current breaking capacity at 0.25 A is 115 Vac or 28 Vdc resistive and 28 Vdc inductive at 0.125 A.

P&A: \$3.39 in 1000 lots, 2 weeks. RCL Electronics, Inc., 1 Hixon Pl., Maplewood, N. J. Phone: (201) 763-2820.

Circle No. 361

### Power supply

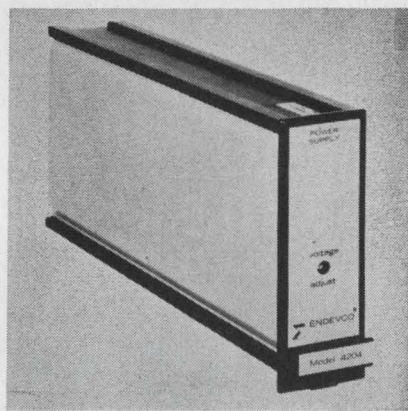

This short-proof, silicon power supply features  $\pm 0.01$  line and load regulation and total noise of 1  $\mu$ V p-p. Designed for floating, shielded performance, the model 4204 achieves 0.003%/°F temperature stability and 0.01% time stability. Output voltage is 1 to 30 Vdc and current 0 to 100 mA. Line transients within rated range bring no overshoot or ringing.

Endevco Corp., 801 S. Arroyo Pkwy., Pasadena, Calif. Phone: (213) 795-0271.

Circle No. 362

### Trimmer

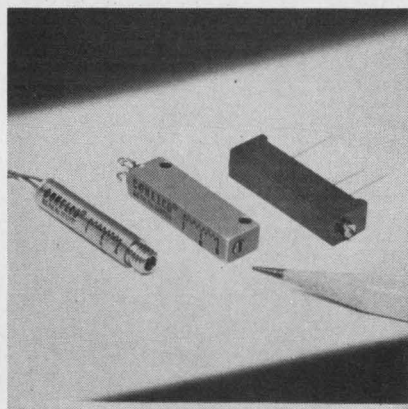

This 1 k $\Omega$  to 2 Meg infinite resolution trimmer offers 3% contact resistance variation. Both cylindrical and rectangular configurations maintain  $\pm 250$  ppm temperature coefficient to 180°C, and an over-all resistance tolerance of  $\pm 10\%$ . Vibration characteristics are to 30 G, 10 Hz to 4 kHz, using cermet element and 3-finger wiper.

P&A: \$3.11; 30 days. Conelco Components, 45 W. 5th St., San Bernardino, Calif. Phone: (714) 885-6847.

Circle No. 363

### Hybrid circuits

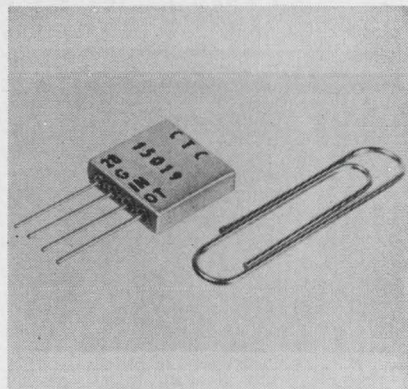

These custom cermet hybrid circuits are hermetically sealed in 0.025-in.<sup>3</sup> steel cases. Up to 8 leads can be provided on 0.1-in. centers. Resistor tolerances of  $\pm 1\%$  with temperature coefficients of  $\pm 250$  ppm/°C are available in the radiation-resistant cans. Power dissipation is 2 W, or up to 4.5 W with a heatsink. The units operate over a -65 to 145°C range.

Columbia Technical Corp., 24-30 B'klyn.-Queens Expwy. W., Woodside, N. Y. Phone: (212) 932-0800.

Circle No. 364

# GO ...20 Hz to 1 GHz

## Kay 1500 Sweep & Marker Generator



### TYPICAL PLUG-INS

Model	Center Freq.	Sweep Width
P-141	20 Hz-200 KHz	20 Hz-20 KHz
P-142	35 Hz-600 KHz	20 Hz-20 KHz
P-130	100 Hz-2 MHz	200 Hz-2 MHz
P-152	10 KHz-20 MHz	10 KHz-20 MHz
P-855	2-32 MHz	5 Hz-800 KHz
P-856	10-120 MHz	10 Hz-1 MHz
P-860	2-220 MHz	10 KHz-30 MHz
P-867	220-470 MHz	20 KHz-30 MHz
PI-123	100-1000 MHz ANY SINGLE OCTAVE	5 KHz-Octave
Freq. Marker		
PM-7631	6 Pulse & Ext.	
PM-7632	6 Pulse & Ext.	
PM-932	30 Pulse	
PM-861	6 Harmonic and CW Osc.	



Pulse-Type Markers

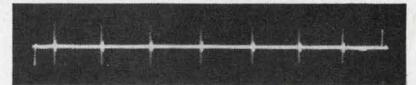

Harmonic (or Comb) Birdie Markers

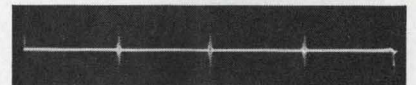

Single-Freq. Type Birdie Markers

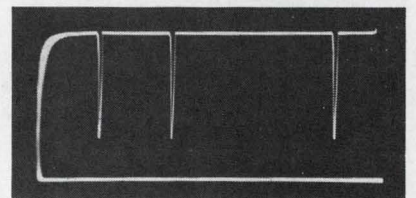

Detected Turn-Off Markers

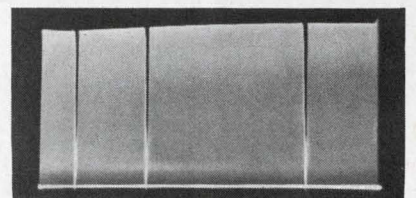

Undetected Turn-Off Markers

### ■ VOLTAGE CONTROLLED OSCILLATORS

#### ■ MARKERS

Pulse  
RF Turn-off  
Harmonic  
CW Birdie

#### ■ SWEEP

0.2 to 60 cps  
Log and Linear  
External Input  
Manual Control

The basic rack contains a variable, sawtooth sweep generator, a fast-acting AGC, frequency-marker control and output circuits, RF output circuits with precision attenuators, a calibrated output meter, an accurate RF detector, and carefully regulated power supplies.

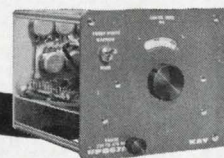
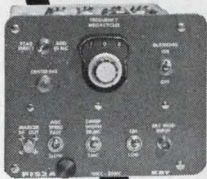
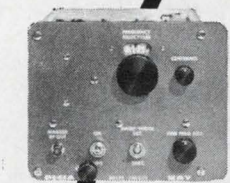

# KAY ELECTRIC COMPANY

Pine Brook, N. J. 07058 • (201) 227-2000 • TWX: 710-734-4347

ON READER-SERVICE CARD CIRCLE 57

**KLIXON**  
PRECISION CONTROLS

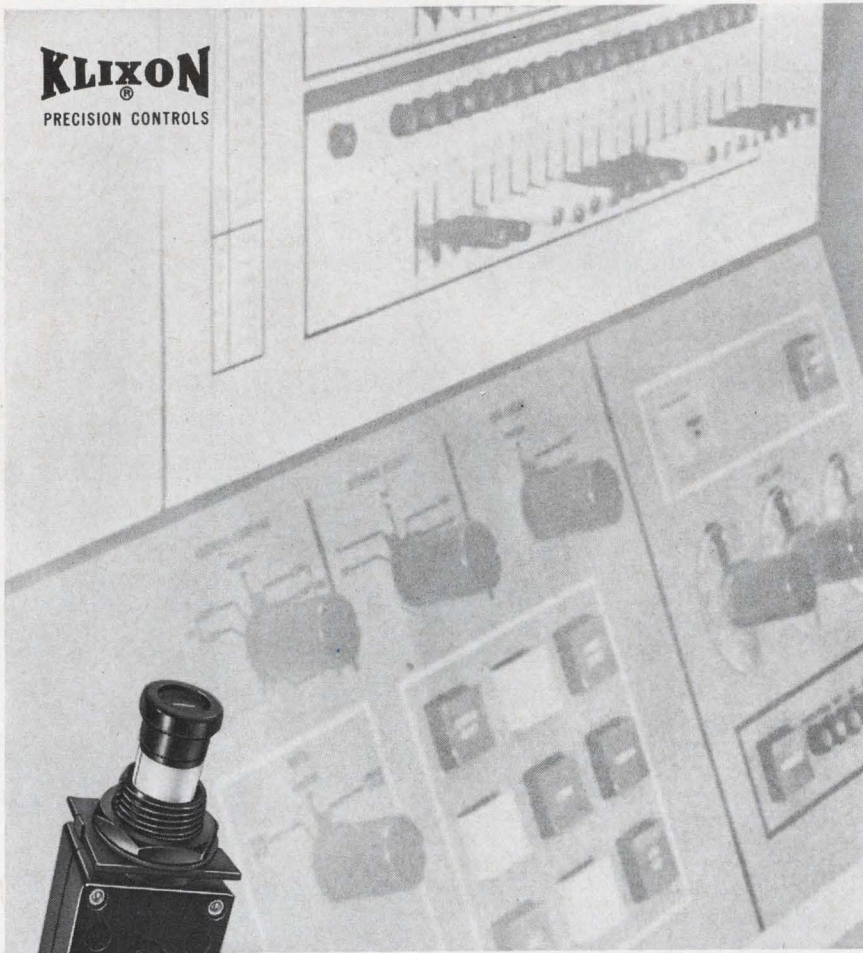

## When low-amp circuit breakers make slow-blow fuses obsolete... ... TI DELIVERS!

Designed to fit most fuse holder panel openings, new KLIXON® 7277 Series Circuit Breakers are now protecting circuits in data processing and communications equipment, power supplies, transformers, battery chargers and other industrial electronic equipment.

**Equipment downtime reduced!** The indicating reset buttons on these inexpensive push-pull devices signal location of circuit failure . . . eliminate the time-wasting search for blown fuses . . . prevent the possibility of incorrect fuse replacement. A built-in thermal element provides fast tripping response under overload conditions, while permitting harmless voltage surges to pass without tripping the breaker.

**Check the specs!** Ampere ratings from 1/2 to 10 amp 28V-dc, from 1/2 to 10 amp 120 V-ac. Dielectric strength 1500 volts. Insulation resistance 100 megohms. Calibration at 25°C, hold 110% and trip 150% rating, trip in 2 to 35 seconds at 200% rating. Endurance: 1000 cycles, 30 V-dc, 2500 cycles 120 V-dc.

Bulletin CIRB-29 contains complete data on KLIXON 7277 Series Circuit Breakers. Write for your copy today.



**METALS & CONTROLS INC.**  
5104 FOREST ST., ATTLEBORO, MASS.  
A CORPORATE DIVISION OF  
**TEXAS INSTRUMENTS**  
INCORPORATED

## COMPONENTS

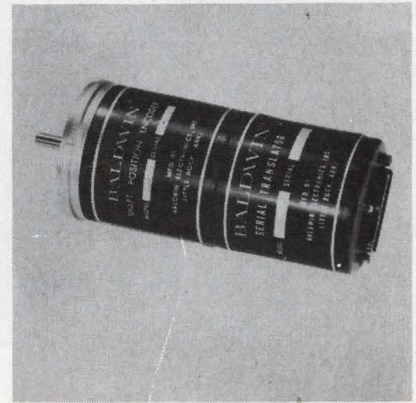

### Binary serial translator

The serial translator is offered as a plug-in for the 200 series encoder. It accepts an 11- or 12-bit parallel word input and converts it to a serial natural binary word.

The bits are 10  $\mu$ s wide and apart. Amplitude is 2.3 V into 50 ohms. A free running or externally driven clock furnishes interrogation.

Prices: 222 encoder (11-bit), \$450; serial translator, \$248; clock, \$269. Baldwin Electronics, 1101 McAlmont, Little Rock, Ark. Phone: (501) 375-7351.

Circle No. 365

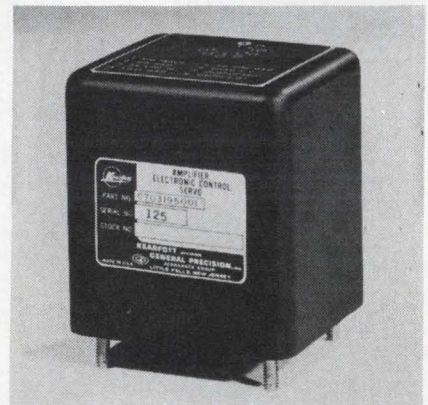

### Servo amplifier

A 16-oz, 400-Hz all-transistorized servo amplifier delivers a 16 W output. The amplifier has a 0° phase shift and 2000 dB max gain at 100  $\Omega$  impedance. Excitation is 28 Vdc  $\pm$ 10% with 1.4 W input at zero signal and 23 W at rated output. Rated output voltage is 40 V rms and signal input voltage 60 V rms.

General Precision Inc., 1150 McBride Ave., Little Falls, N. J. Phone: (201) 256-4000.

Circle No. 366

# OUTSTANDING PERFORMANCE... AT REASONABLE COST HIGHEST ACROSS-THE-BOARD

PERFORMANCE AVAILABLE FROM A WIDEBAND DIFFERENTIAL DATA AMPLIFIER

New Hewlett-Packard 2470A Differential Data Amplifier...\$585

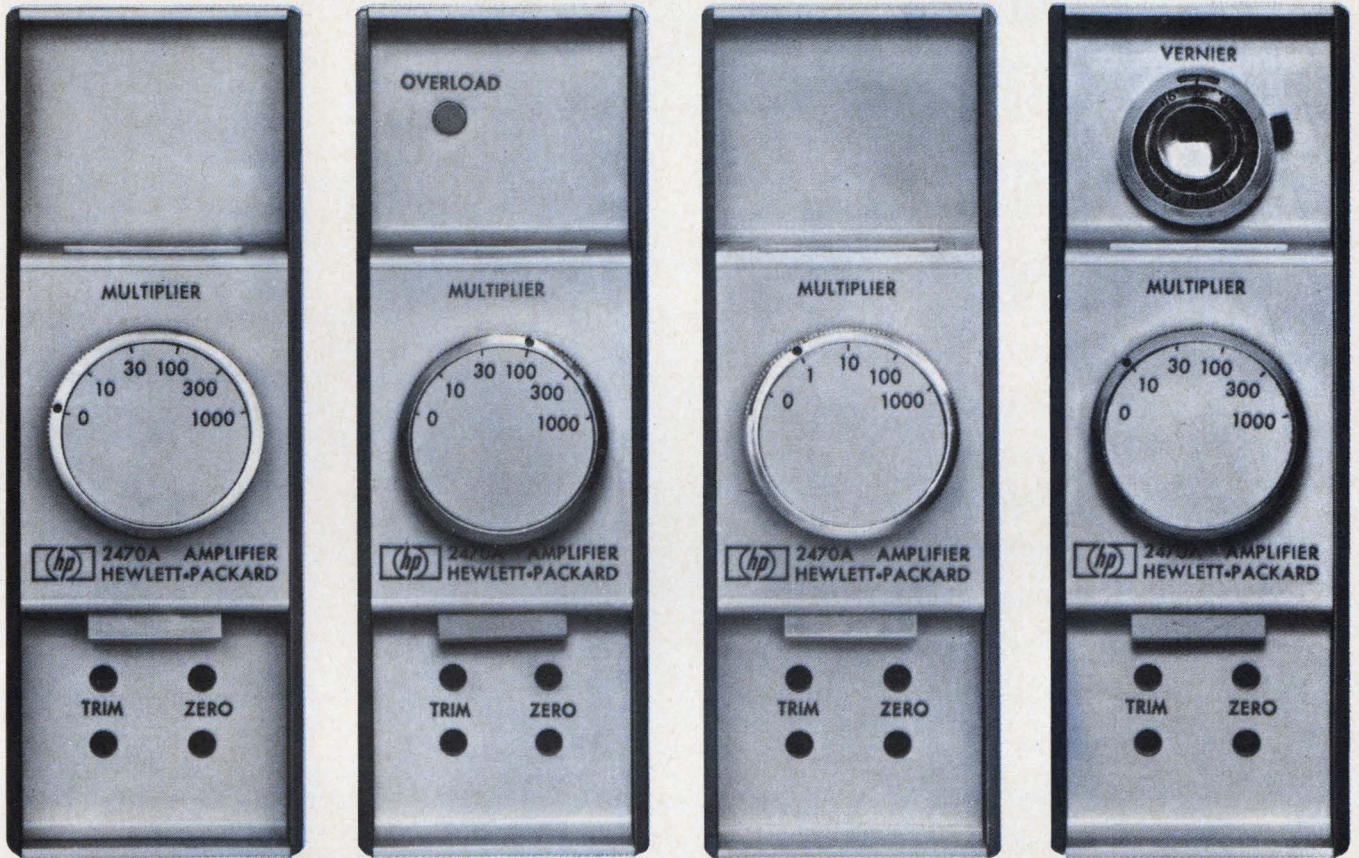

**Top electrical performance:** Compare, spec to spec—DC gain X10 to X1000 (optional precision vernier, X1 gain), output  $\pm 10$  v, 0-100 ma. Gain accuracy  $\pm 0.02\%$  range; constant 50 kHz bandwidth. Differential input for low drift, high cmr (120 db at 60 kHz on gains down to x30, 90 db at x1). Full output across full bandwidth ( $10^7$  v/sec RTO). High 1000-meg input impedance all gain settings, output impedance 0.1 ohm  $+10 \mu$ h. DC linearity of 0.002% on both polarities; dc gain stability of 0.005% per month achieved without chopper stabilization. Low drift and noise. Fast 100 microsecond settling, 100 microsecond overload recovery, excellent overload protection, optional overload indicator. Input and output isolated by internally driven guard shields; dual output available with fixed 2-pole filter.

**Built-in reliability:** The predicted MTBF of the 2470A is in excess of 20,000 hours. Silicon transistors are used throughout, and passive and active components are selected for dependability, as well as performance. Amplifier meets spec at 95% humidity at 40°C. Critical parameters (zero drift, full-scale accuracy, common mode rejection) are verified after 100 hours of "run-in" at elevated temperature.

**Packaging for value, compactness:** Amplifier and self-contained power supply are enclosed in a unique, rugged molded dielectric case. Combining case, bench stand, power and signal cables, plus many other accessories, are available.

**Use if for:** Amplifying signals from low-level resistive transducers, such as thermocouples, strain gages. High input and low output impedance make it ideal for amplification over long transmission lines; use it, with resistive or reactive loads, such as x-y, strip-chart or oscillographic recorders, digital voltmeters, null detectors and servo systems, telemetry systems... or use it as a high-performance bench amplifier.

Call your Hewlett-Packard field engineer for complete information or write the Dymec Division of Hewlett-Packard, 395 Page Mill Road, Palo Alto, California 94306, Tel. (415) 326-1755; Europe: 54 Route des Acacias, Geneva.

Price f.o.b. factory.  
Data subject to change without notice.

**HEWLETT  
PACKARD**  **DYMEC  
DIVISION**

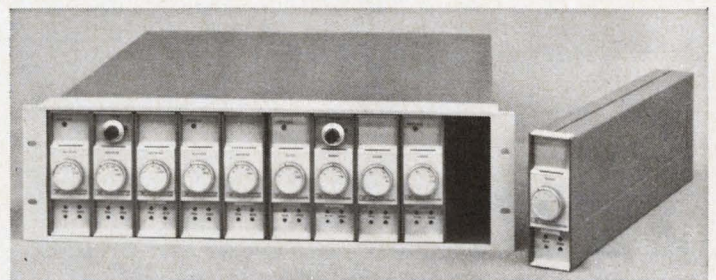

# Your incremental recorder should have these features:

- Stepper motor reliability
- Complete remote operation
- All silicon semi-conductors
- 300 step per second operation
- Binary zero to BCD 10 conversion
- Easy loading-completely visible co-planar reels
- Non-removable quick acting reel hubs
- 2½ million character capacity
- Extender card included



## Model 1400

\$3500 F.O.B. PASADENA

# Kennedy Co.

275 N. Halstead Ave., Pasadena, Calif. 91109  
(213) 681-9314

ON READER-SERVICE CARD CIRCLE 59

### COMPONENTS

#### Cermet trimmer

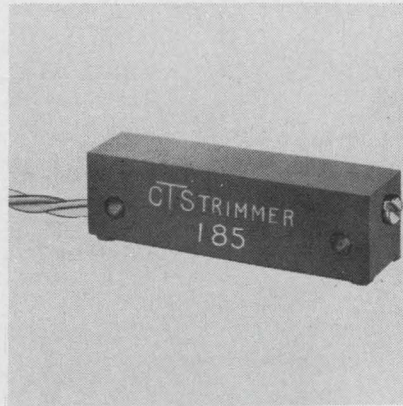

This 1-W 25-turn cermet trimmer has a  $\pm 100$  ppm/ $^{\circ}$ C temperature coefficient. The cermet resistance element provides infinite resolution, a 25  $\Omega$  to 1 Meg resistance range, low noise and a high wattage rating. An epoxy housing eliminates the possibility of shorting on PC boards. The units meet or exceed MIL-R-22097B.

P&A: \$2.95, (1000); 4 to 5 wks. CTS Microelectronics, Inc., 1201 Cumberland Ave., West Lafayette, Ind. Phone: (317) 743-9602.

Circle No. 367

#### Film capacitors

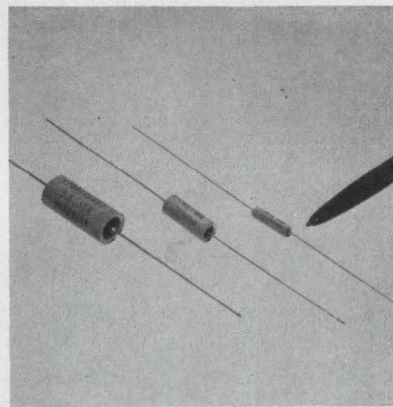

Polycarbonate-film capacitors, rated at 50 Vdc, are hermetically sealed for critical miniaturized electronic packaging. Typical is a 1.0  $\mu$ F capacitor in a volume under 0.07-in.<sup>3</sup>. They are rated for 50 Vdc up to 125 $^{\circ}$ C or 30 Vac at 400 Hz, 105 $^{\circ}$ C.

Values range from 0.047  $\mu$ F in a case 0.174-in. dia. x 0.531-in. long to 5.6  $\mu$ F, in a case 0.500-in. dia. x 1.125-in. long.

Dearborn Electronics Inc., P. O. Box 530, Orlando, Fla. Phone: (305) 838-3011.

Circle No. 368

#### Time delay relay

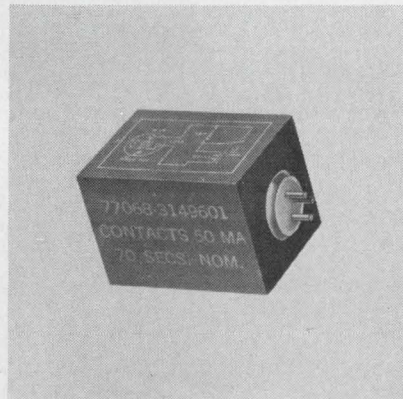

The DDR series of spst relays feature a current drain of less than 2.8 mA and reset time of less than 1 s. The epoxy-encapsulated silicon relay offers fixed time delays up to 180 s.

Specifications for the 1-oz relay include a 50 mA max current rating at 85 $^{\circ}$ C, tolerances of  $\pm 10$  and  $\pm 20$ % and an operating voltage of 28 V  $\pm 10$ %.

Dickson Electronics Corp., 310 Wells Fargo Ave., Scottsdale, Ariz. Phone: (602) 947-5751.

Circle No. 369

#### Current drivers

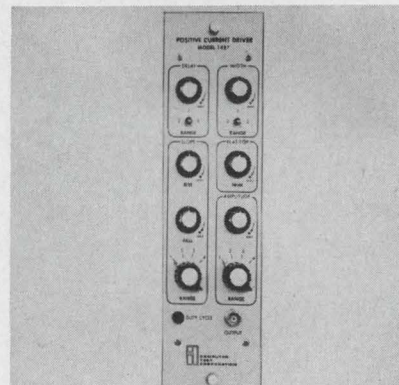

Two current drivers combine fast and highly linear pulse rise and fall times with complete controllability over the current pulse waveform shape. The positive polarity 1457 and negative 1458 drivers develop 20 ns current pulses with independently adjustable rise and fall from 20 ns to 2  $\mu$ s. Pulse width can be varied from 20 ns to 10  $\mu$ s and delay independently controlled up to 10  $\mu$ s.

Computer Test Corp., 12 Fellowship, Cherry Hill, N. J. Phone: (609) 665-5250.

Circle No. 370

**When you need a curve tracer for transistors, get it from someone who knows transistors.**

**The Fairchild 6200 curve tracer is newly designed to display important characteristics of the latest solid**



**state devices. It has the features you need when you want to display low current-high gain transistors, FET, unijunction, SCR, or diode curves. It has unique capabilities, such as a 1000 volt, 40mA collector sweep. The**

**portable and rugged 6200 has variable base drive over a wide range and pulsed base operation for high current tests. Its programmable option makes this curve tracer ideal for volume production testing. It has all the controls and accuracy of a lab instrument, yet is simple enough to use on the production line.**

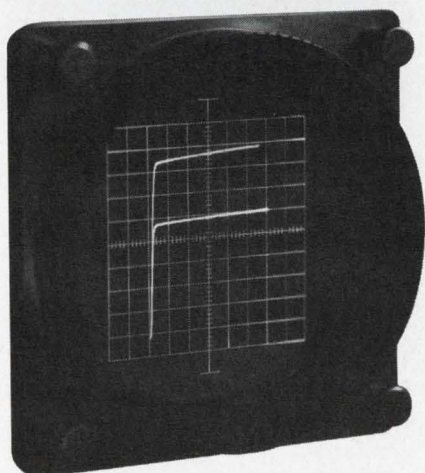

**FAIRCHILD**  
INSTRUMENTATION

**Send for complete technical details.**

START WITH THE BEST—ADD EVEN MORE ADVANTAGES—RESULT:  
**JENNINGS VACUUM CAPACITORS FOR 1966**

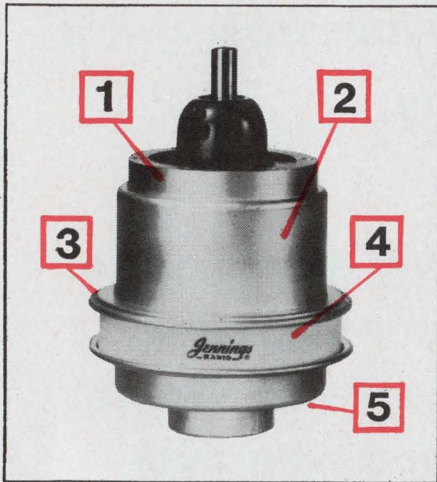

Featuring more efficiency, more reliability, more economy. For example:

1. High Current Capability. Additional copper surface area provides improved heat radiation and reduces the temperature coefficient of capacitance change.
2. Lighter Weight. Patented concentric cylinder, reentrant flange construction reduces excessive weight and size so detrimental to airborne or shipboard applications.
3. Built in Corona Rings. Offered on many models these corona rings lessen external

arc-over and minimize damage due to excessive over-voltage.

4. New Glazed Ceramic Envelope reduces cleaning maintenance costs due to a non-porous surface.

5. Wide Variety. Over 50 new standard models offer wide choice of voltage, current, and capacitance combinations.

Further, these new models are available at no increase in price yet they contain all the characteristics that have made Jennings vacuum capacitors famous. Advantages such as long life, low loss dielectric, highest maximum to minimum capacity change ratios, lowest inductance, and stable operation unaffected by ambient temperatures.

Jennings originated the vacuum variable capacitor. So well designed were these capacitors that they have been accepted as standard equipment by every high powered transmitter manufacturer in the western world. Ask any transmitter engineer.

Catalog literature describing these new capacitors is available at your request.

RELIABILITY MEANS VACUUM-  
 VACUUM MEANS

**ITT Jennings**

JENNINGS RADIO MFG. CORP., 970 McLAUGHLIN AVE., SAN JOSE, CALIF. 95108, PHONE 292-4025

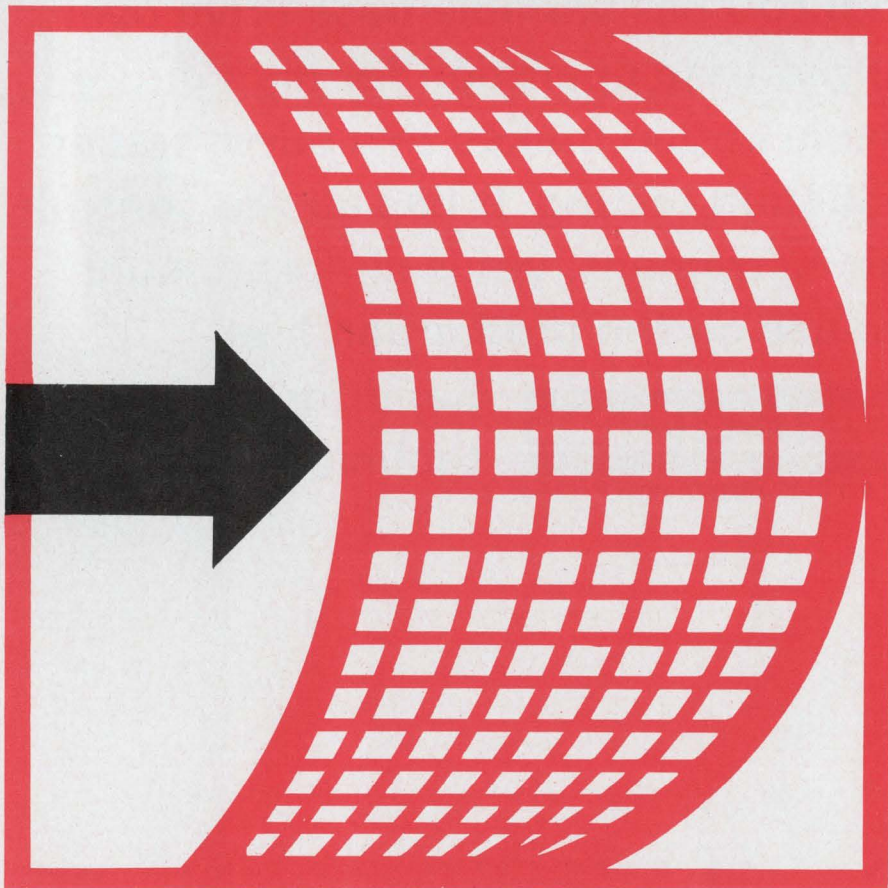

ON READER-SERVICE CARD CIRCLE 61

COMPONENTS

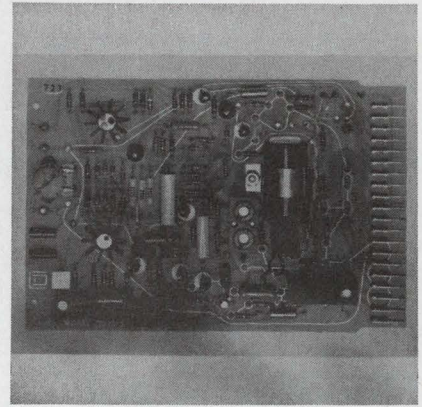

**Dc amplifier**

A series of operational dc amplifiers on digital computer cards uses solderless or solder connectors. The 10B1 is a differential op-amp with  $\pm 10$  V output,  $\pm 30$  mA, 200,000 gain, and drift of  $40 \mu\text{V}/^\circ\text{C}$ . The single-ended, chopper-stabilized 10B2 has 140 dB gain,  $1 \mu\text{V}/^\circ\text{C}$  drift, and 6 dB/octave rolloff. Gain bandwidth is 1.5 MHz. Other models are available with  $\pm 20$  and  $\pm 30$  V outputs.

P&A: \$150, 10B2; \$95, 10B1; stock. Computer Dynamics, 179 Water, Torrington, Conn. Phone: (203) 482-7621.

Circle No. 371

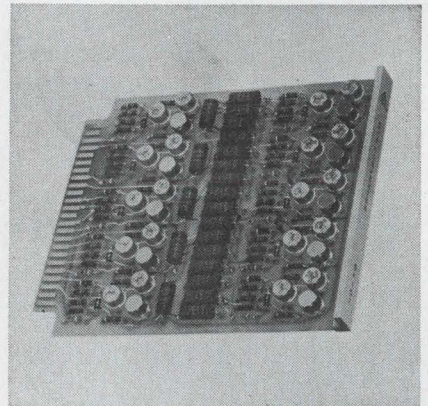

**D/A converter module**

The DA-101 digital-to-analog module consists of a precision resistor matrix and ten voltage-switching circuits designed to perform the conversion. The module has 10 digital inputs and one analog output. Conversion accuracy is  $\pm 0.05\%$  of full scale and settling time is less than  $2 \mu\text{s}$ .

Control Equipment Corp., 19 Kearney Rd., Needham Heights, Mass. Phone: (617) 444-7550.

Circle No. 372



*Paul Humphrey explains:*

## Why the RG28 gimballed rate gyro provides reliability at the lowest possible cost

"We developed this unique gyroscope (the RG28) because our customers needed a long-life, highly reliable instrument at low cost.

"High reliability is assured by regular qualification testing. Over 2100 units are in use.

"By eliminating the gimball, we reduced the moving parts in the RG28 to three. This means lower cost, less wear, less chance of failure, and longer, trouble-free life.

"Various types are available in a wide range of rate combinations with AC or DC motors and potentiometer pickoffs. All are hermetically sealed."

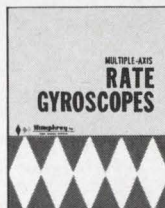

*If you're in the market for gyros, why not ask Paul Humphrey? SEND FOR A free brochure on RG28's and multiple-axis rate gyroscopes today. HUMPHREY, INC., Dept. ED-4, 2805 Canon Street, San Diego, Calif. 92106.*

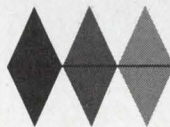

**Humphrey Inc.**  
ELECTRO-MECHANICAL INSTRUMENTS

**EASTERN OFFICE:** North Philadelphia  
Airport, Philadelphia, Pa. 19114  
U.S. Patents 2812647, 3194079



# VECTOR SUM MEANS PRECISION SOLID STATE AC POWER

What you're aiming for in AC power conversion is a near perfect sinusoidal wave. Microdot Magnetics does it uniquely (if, in essence, a method generally applied in rotary generators can be called unique) by first generating SQUARE waves. These are vectorially added and put in proper time sequence by means of digital techniques. It's called VECTOR SUM and the result is that perfect sinusoidal wave we're talking about. Now, if it's efficiency, reliability and high power in a small size you're talking about for lab, shipboard and airborne application, turn to Microdot Magnetics for solid state AC power conversion.

Single or three phase standard units from 80 VA to 25 KVA in frequencies of 60, 400 and 800 Hz with special frequencies available on request.

The new Microdot Magnetics catalog of power conversion units, static inverters, frequency converters, AC motor speed controls and line voltage regulators is just off the press. A copy is yours for the asking.

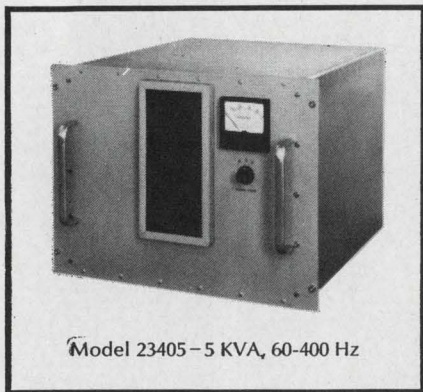

Model 23405 - 5 KVA, 60-400 Hz

**MICRODOT  
MAGNETICS, INC.**



5960 Bowcroft St./Los Angeles, Calif. 90016  
ON READER-SERVICE CARD CIRCLE 63

## COMPONENTS

### Photoconductive cells

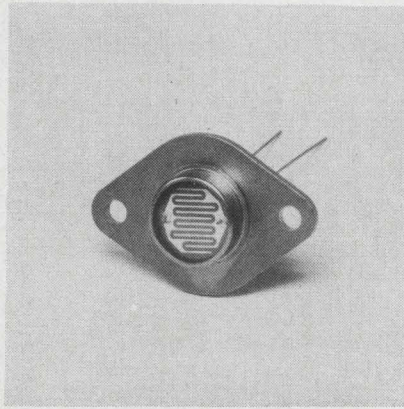

A line of hermetically sealed power photoconductive cells can dissipate more than 10 W when mounted in a TO-36 power transistor heat sink. The new CL5D series eliminates an amplification stage in the control of devices drawing at least 10 W. The CL5D series will be available with five different CdS and CdSe materials offering 0.25 to 55 k $\Omega$  resistances.

Clairex Corp., 1239 Broadway, New York. Phone: (212) 684-0940.  
*Circle No. 373*

### Polar relays

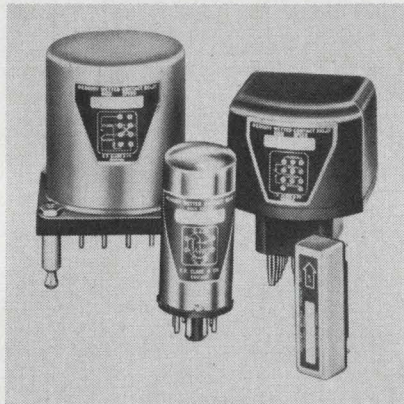

A new line of 100 VA mercury-wetted contact polar relays offers signal fidelity of 1% max initial and 2% max over  $20 \times 10^9$  operations without adjustment. Signalling capability is up to 120 baud at 1% max unbalance and 180 baud at 2% max unbalance. Contact efficiency is 95% total dwell. The relays will stand off 1500 V line surges.

C. P. Clare & Co., 3101 Pratt Blvd., Chicago. Phone: (312) 262-7700.

*Circle No. 374*

### Dc stepper motor



Model CRO 0193 750 is a new size 11 permanent-magnet stepper motor which operates at 45° increments. Operating at 28 Vdc, the 1-in. long stepper offers a max response rate of 400 pulses/second and a holding torque of 1.8 in.-oz. Total power input is 7.1 W with a dc resistance of 440  $\Omega$ /phase. The 3-oz motor operates through a -54°C to +165°C range.

Kearfott Div., General Precision, Inc., 1150 McBride Ave., Little Falls, N. J. Phone: (201) 256-5926.

*Circle No. 375*

### Metal film resistor

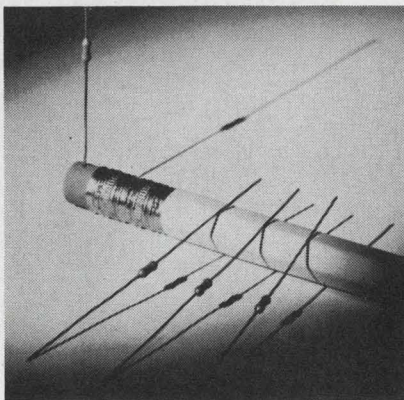

A miniature metal film resistor has a MIL rating of 0.05 W. The type PME 50, 0.147-in. long by 0.060-in. diameter, is available in resistances of 10  $\Omega$  to 500 k $\Omega$ . Standard temperature coefficients of  $\pm 25$  ppm/°C,  $\pm 50$  ppm/°C and  $\pm 100$  ppm/°C may be selected. Protection against moisture and environmental extremes is provided by special end cap construction.

Pyrofilm Resistor Co., Inc., 3 Saddle Rd., Cedar Knolls, N. J. Phone: (201) 539-7110.

*Circle No. 376*

# ECONOMY!

**Versatile,  
Value-priced  
x-y recorder  
...just \$895!**

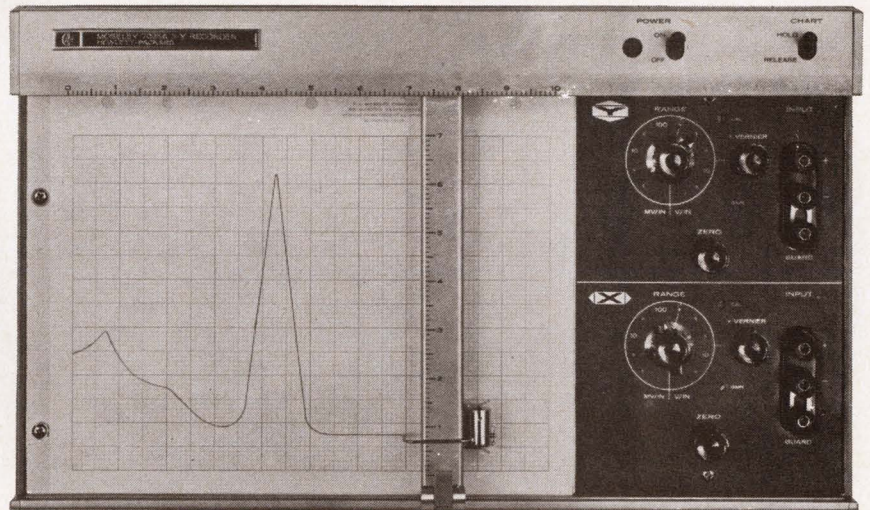

## *THE MOSELEY 7035A*

This is a high-performance, low-cost solid-state recorder for every-day applications not requiring high dynamic performance. Five fixed calibrated ranges 1 mv/inch to 10 v/inch. High input impedance, floating guarded input, 0.2% accuracy at full scale. Adjustable zero set.

Each axis has an independent servo system with no interaction between channels. Maintenance-free AUTOGRIP\* electric paper holddown, new writing system with inexpensive disposable unit. Options available include electric pen lift, locks for zero and variable range controls, rear input, re-transmitting potentiometers.

For general-purpose applications, you can't beat the Moseley Division 7035A. Ask your Hewlett-Packard field engineer for a demonstration. Or write for complete specifications to Hewlett-Packard, Palo Alto, California 94304, Tel. (415) 326-7000; Europe: 54 Route des Acacias, Geneva.

*Data subject to change without notice.  
Price f.o.b. factory.*

**HEWLETT  
PACKARD**  **MOSELEY  
DIVISION**  
*An extra measure of quality*

\*Trade Mark Pat. pend.

047

ON READER-SERVICE CARD CIRCLE 64

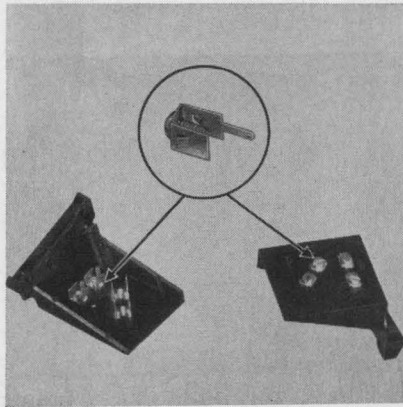

### Antenna fastener

A one-piece speed clip for mounting lead-in wires to TV sets cuts costs. The fastener is pushed into a 5/16-in. square mounting hole in the back panel. Retaining tabs hold the unit. Lugs for solderless holes for solder-connections are provided. Modifications available include screw pre-assembled to the clip, grounding lug joining the two clips, and spring loaded connector.

Tinnerman Products Inc., P.O. Box 6688, Cleveland. Phone: (216) 741-9300.

Circle No. 377

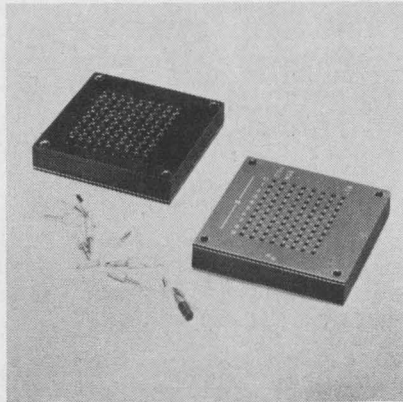

### Matrix program board

The switching matrices of this board have bussed contact strips in the top deck to connect with the isolated contacts in the bottom deck by inserting program pins. The cross-points accept 0.106-in. diameter shorting or coax pins. The boards come in two to five decks, 40 to 10,000 crosspoints.

P&A: \$.20 per cross-point; 2 to 3 wks. LVC Industries, Inc., 102-48 43rd Ave., Corona, N. Y. Phone: (212) 899-5588.

Circle No. 378

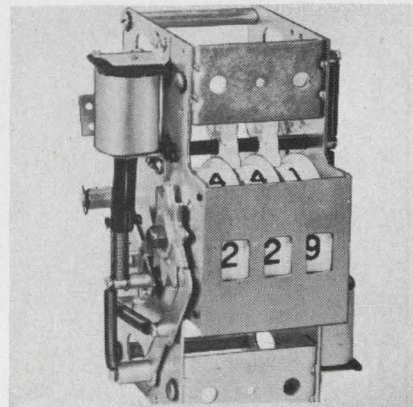

### Add-subtract counter

Series 160-2500 Geneva-movement add-subtract counters offer accurate count at high or low speeds. Large 3/8-in. black numerals on white nylon wheels facilitate reading. Seven stop adjustments are provided at hundred count intervals from 399 to 999. The counters are enclosed in a 7-in. x 5-in. x 5-in. box-constructed steel frame.

P&A: About \$18; 2 to 3 wks. Chicago Dynamic Industries, Inc., 1725 Diversey Blvd., Chicago. Phone: (312) 935-4600.

Circle No. 379

### Performance Proves:

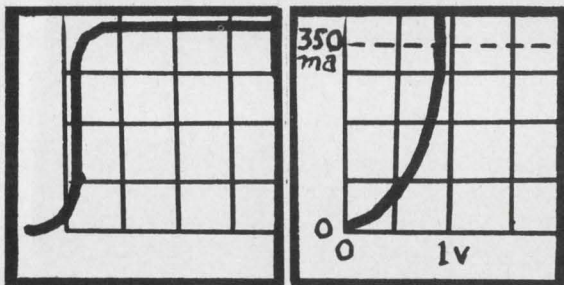

### Fastest Switching Diode With High Forward Current

Test waveforms show that International Diode Corp.'s ID3-050T alloy junction diode has a reverse recovery time (left) in the picosecond range, with a 200-to-400 milliamperere forward conductance (right). IDC can provide more than 100 types to solve your design problems, including Q6-100, Q5-100, ID3-050, 1N3146. Price as low as 45 cents in quantities; delivery mostly from stock. Write or phone for details.

### INTERNATIONAL DIODE CORP.

90 Forrest Street, Jersey City, N. J. 07304  
201 - 432-7151

## LUGS • CLIPS • TERMINALS

more than  
**1000**  
types!



STANDARD  
ELECTRICAL PARTS

delivered **FAST!**

Lugs • Clips • Terminals  
Wire Forms from Stock  
Send for your copy of  
Zierick catalog No. 24 TODAY!

### ZIERICK MANUFACTURING CORP.

96 Beechwood Ave., New Rochelle, N.Y. (914) NEW Rochelle 6-8520

ON READER-SERVICE CARD CIRCLE 66

ON READER-SERVICE CARD CIRCLE 65

ELECTRONIC DESIGN

## A case for all circuits

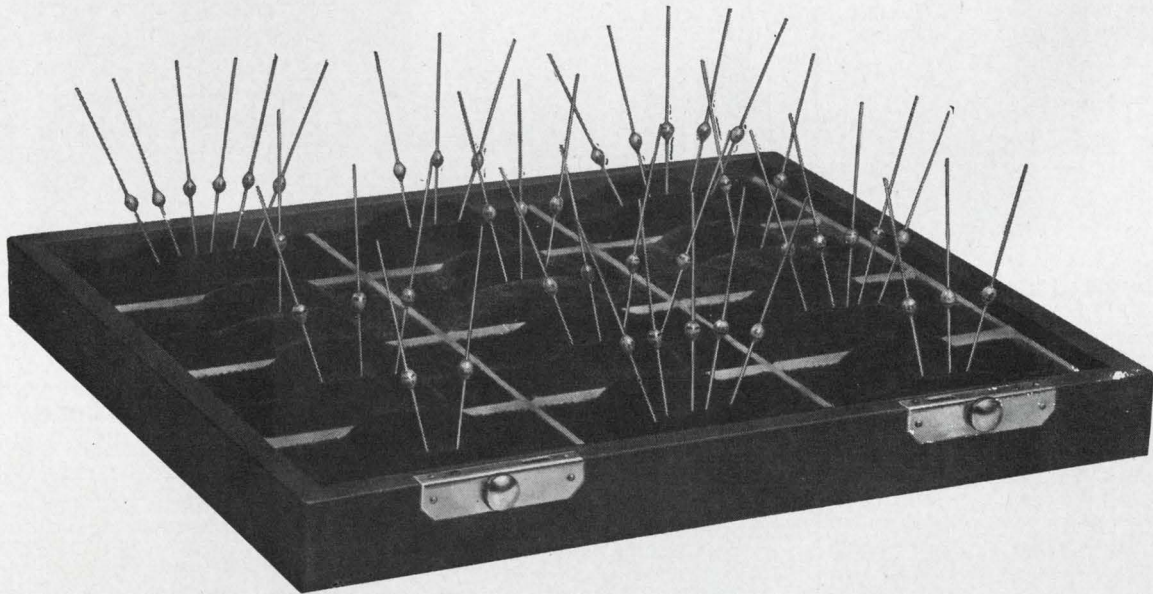

## G.E.'s new, low-current rectifier line

Use these new, G-E miniature devices anywhere you need low-current power rectification . . . in TV and radio power supplies, communication equipments, small appliances, power logic circuits, free-wheeling rectifiers, arc suppression, battery chargers, and general purpose power supplies.

Try them. See why we consider them our all-purpose line of low-current, silicon rectifiers. Every device in the line can withstand peak forward surge currents as high as 100 amperes. They're all-glass en-

capsulated to keep moisture out. And they're available at competitive prices.

If you'd like to learn more about G.E.'s new all-purpose rectifier line, ask for publication 130.55 from your local G-E engineer/salesman or distributor, or write to Section 220-29A, General Electric Company, Schenectady, New York. In Canada: Canadian General Electric, 189 Dufferin St., Toronto, Ontario. Export: Electronic Component Sales, IGE Export Division, 159 Madison Ave., New York, New York.

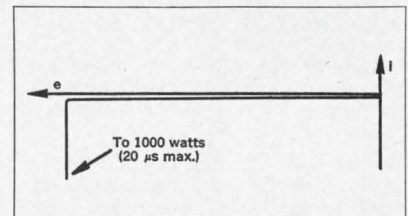

**OUTSTANDING TRANSIENT VOLTAGE PROTECTION, TOO.** Rated 1.5 amps and from 200 to 800 volts PRV, General Electric's new low-current rectifiers will dissipate voltage transients up to 1000 watts in the reverse direction without damage.

SEMICONDUCTOR PRODUCTS DEPARTMENT

**GENERAL  ELECTRIC**

ON READER-SERVICE CARD CIRCLE 67

# Add Real Time to Data Recordings

## ...with Develco Time Code Receivers

Two new Develco receivers transfer N. B. S. time-of-day signals broadcast from WWVB onto chart or magnetic-tape recordings. Units feature all-solid-state construction — crystal filters for temperature stability — AGC circuitry (approx. 100-db range) — and switchable bandwidths for optimizing performance under varying signal-to-noise conditions.



Portable Model 3202A: Operates on battery

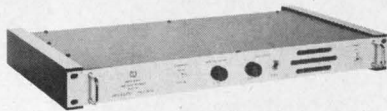

Bench or Rack Mounting Model 3202B

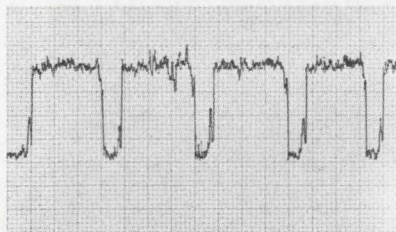

**Portable Model 3202A:** Operates on battery power; manufactured to U.S. Geological Survey specifications; weatherproofed fibreglass construction and built-in ferrite cored loop antenna make possible unattended field use for weeks at a time.

**Bench or Rack Mounting Model 3202B:** Incorporates all features of Portable Model 3202A, but has its own power supply; also includes a slicer circuit and an audio beep to denote signal presence; supplied with a 3' x 1 1/2" dia. external ferrite cored loop antenna and interconnecting cable.

For more timely data, send your signal to Develco, 440 Pepper Street, Palo Alto, California 94306. Or phone (415) 321-6504

**DEVELCO  
INCORPORATED**

... for advanced VLF instrumentation.

## COMPONENTS

### Operational amplifiers

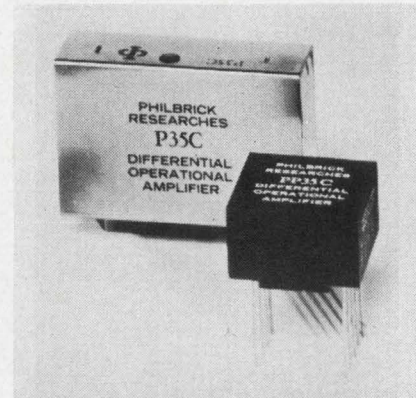

A new line of current-compensated op-amps is offered as an alternate to choppers. Featured is current offset adjustable through zero without input-loading. Gain is greater than 100,000 and offset voltage is less than 3 mV. The amplifiers employ active compensation, which tracks the current demand of the input bases over the entire rated operating range.

Philbrick Researches, Inc., Allied Drive, Dedham, Mass. Phone: (617) 329-1600.

Circle No. 380

### Shaft angle encoder

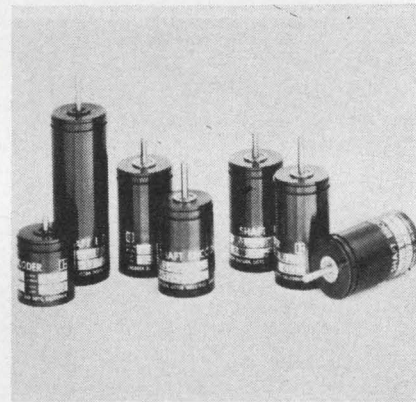

New multiple-pin contacts give this size 11 shaft angle encoder a mean time to first error of  $10^7$  revolutions. Commutator brushes are replaced by discrete series-wired pins for each track. Each pin contacts a different area so that data on the track cannot be lost. The encoders are available in 8, 13 or 18 bit models with optional isolation diodes.

Litton Industries, Inc., 7942 Woodley Ave., Van Nuys, Calif. Phone: (213) 781-2111.

Circle No. 381

### Time delay relays

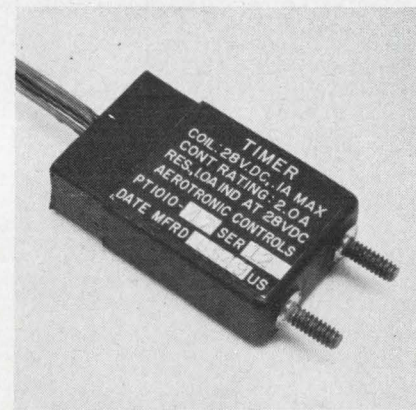

These 2.5-oz, 1-in.<sup>3</sup> time delay relays offer delay periods from microseconds to minutes at tolerances to 5%. Contact ratings are nominally 2 A resistive at 28 Vac or dc. The relays require 10 mA at 28 V unenergized and 55 mA energized. Output contacts may be spst, spdt or dpdt. The fully encapsulated devices are operable over a  $-54^{\circ}\text{C}$  to  $+130^{\circ}\text{C}$  range.

Aerotronic Controls, Inc., 59 Central Ave., Farmingdale, N. Y. Phone: (516) 293-8740.

Circle No. 382

### Terminal block

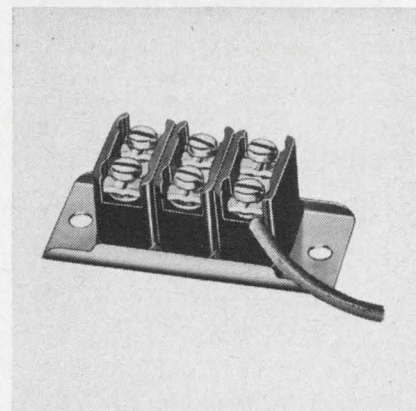

A new type terminal block features a 2-piece captivated clamp assembly and accepts #14 to #20 AWG without looping or lugging. The 1 to 24 terminal section blocks are mounted in a copper-nickel-plated steel mounting channel which locks each terminal in place. Terminals are brass bars with 2-piece #6-32 clamp assemblies. The blocks are rated at 15 A, 300 V.

Curtis Development & Mfg. Co., 3250 N. 33rd St., Milwaukee. Phone: (414) 445-1817.

Circle No. 383



## test under actual load conditions...

. . . the ultimate test for integrated circuits, transistors, diodes, thin films, logic cards or modules. The Model 553 Dynamic Test System performs both static (dc) and dynamic tests from dc to 50 megacycles on multi-lead devices in a single socket! Variable word-length mnemonic machine language simplifies programming . . . operators can be trained in a few hours. Unique program modification eliminates repetitive instructions, speeds additions and deletions to save up to two-thirds in programming time.

Let us tell you more about the 553.

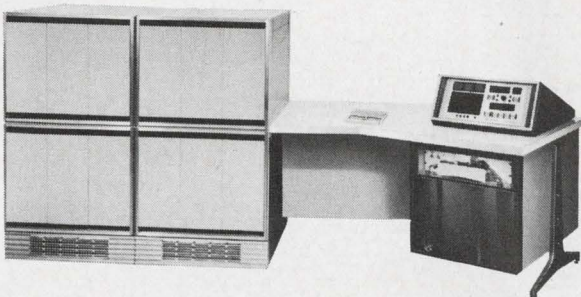

**TEXAS INSTRUMENTS  
INCORPORATED**

APPARATUS DIVISION  
P. O. BOX 66027 HOUSTON, TEXAS 77006  
118 RUE du RHONE GENEVA, SWITZERLAND

777

ON READER-SERVICE CARD CIRCLE 69

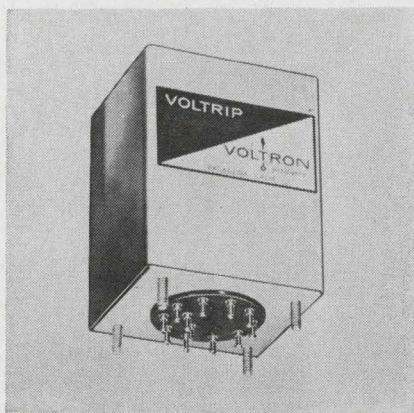

### Voltage monitor

This new voltage monitor contains an isolated power supply, a reference supply and a 2 A dpdt relay. The monitor detects signals from 0 to 5 Vdc with an input impedance of 1 Meg/V. Accuracy is  $\pm 0.25\%$  +5 mV absolute and repeatability is 1 mV. Response time of 15 ms allows programming rates up to 25 measurements/second.

Voltron Products Inc., 1020 S. Arroyo Pkwy., Pasadena, Calif. Phone: (213) 682-3377.

Circle No. 384

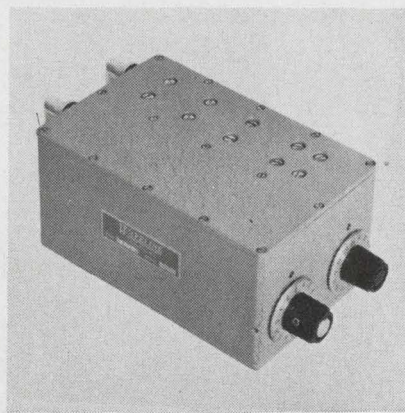

### Coax step attenuator

Two models of a variable coax attenuator covering dc to 100 MHz are offered. These step attenuators measure frequency response, attenuation and gain as well as source calibration. Both models cover 0 to 132 dB in one-dB steps. Impedance is 50  $\Omega$  nominal, vswr is 1.2 max, insertion loss is 0.2 dB max and average power dissipation is 0.5 W.

Waveline Inc., Caldwell, N. J. Phone: (201) 226-9100.

Circle No. 385

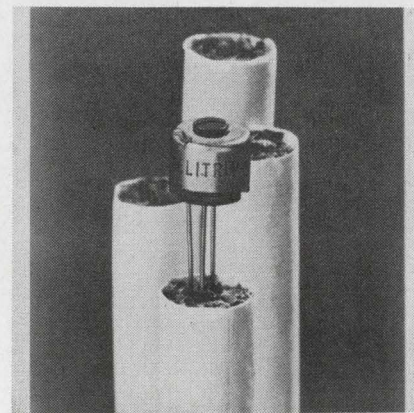

### Cermet trimmer

Model 62PF is a new 1/4-in. diameter cermet trimmer with 5/8-in. PC board pins. The single-turn unit offers infinite resolution and standard resistance values from 10  $\Omega$  to 1 Meg. Power rating is 1/2 W at 70°C derating to 0 at 125°C. The complete 0.01-in. unit weighs 0.75 grams.

P&A: \$2 (1 to 9); stock. Beckman Instruments, Inc., 2500 Harbor Blvd., Fullerton, Calif. Phone: (714) 871-4848.

Circle No. 386

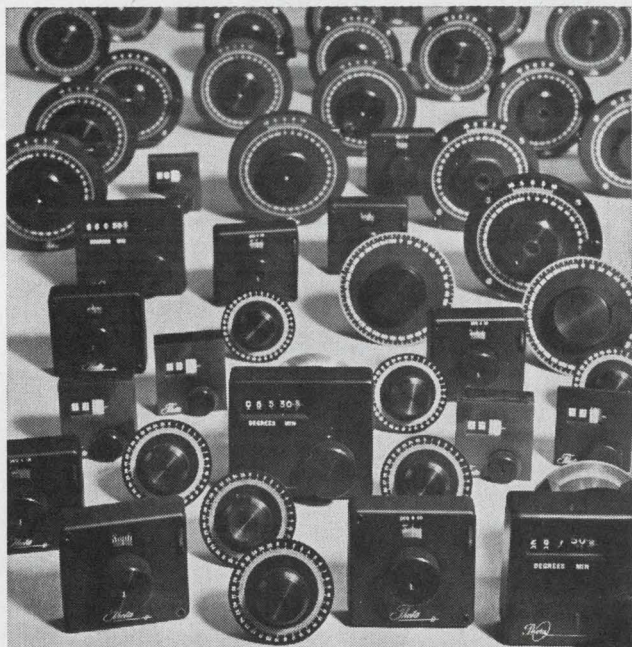

### DIALS, DIALS, and MORE DIALS

Theta catalogs over 432 sizes and styles, with continuous motion, vernier control and 0.1° accuracy. Our new 28-page engineering catalog has all the details.



*Theta* INSTRUMENT CORP.

Saddle Brook, N. J. • Phone (201) 487-3508 • TWX 510-230-5017

ON READER-SERVICE CARD CIRCLE 70

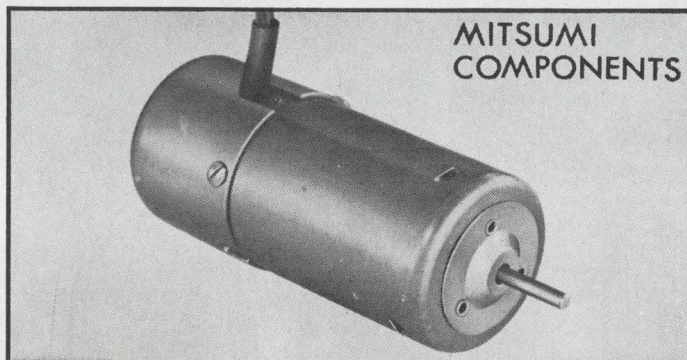

### NEW MICRO-MOTOR

The most excellent characteristics of Mitsumi micro-motor is in its extremely high efficiency. Formerly it has been considered impossible to attain an efficiency of more than 50% for micro-motors with a diameter of 20mm or less. We have, however, succeeded in breaking through this common concept through the adoption of a new system in the magnetic circuit. We serve many types of micro-motors to our customers with automated and quality-controlled mass production.

#### Main Products

Polyvaricon • IFT • Oscillator coil • Antenna coil • Composite coil • Special coil • Micro motor • Synchronous motor • Variable resistor • Trimming potentiometer • FM tuner TV tuner • Various sockets • CdS photo-conductive cell.



**MITSUMI ELECTRIC CO., LTD.**

New York office: 11 Broadway, New York, N.Y. 10004  
U.S.A. Phone: HA-5-3085, 3086  
Main office: 1056, Koadachi, Komae-machi, Kitatama-gun,  
Tokyo, Japan. Phone: Tokyo 415-6211/23

ON READER-SERVICE CARD CIRCLE 71

ELECTRONIC DESIGN





### Frequency standard

A new series of multiple-output crystal frequency standards covers a range of 250 Hz to 1 MHz with four models.

Accuracy of the series C is  $\pm .0005\%$  without oven control. A 3.5 Vdc input permits adaptation to integrated circuit equipment design. Base size is 1-19/32-in. square with an octal plug-in socket.

Melpar, Inc., 3000 Arlington, Falls Church, Va. Phone: (703) 534-6000.

Circle No. 387

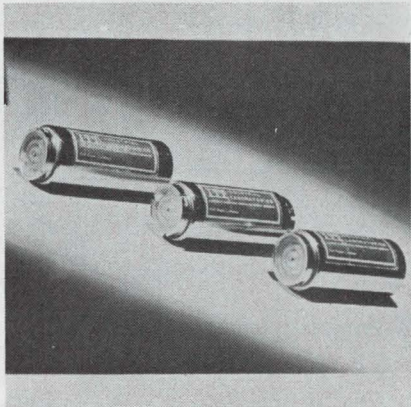

### Miniature hv power

A line of miniature hv power supplies for laser and allied applications uses a special-purpose photo-emissive tube.

Standard models take inputs of 1.5 V at 18 mA or 1.34 V at 15 Ma. Outputs are 12 kV and 16 kV at 1 mA, respectively. The new 4-oz units feature ripple of 1% max.

ITT Corp., 320 Park Ave., New York. Phone: (212) 752-6000.

Circle No. 388

**NEW CAPACITOR TESTER  
SAYS EXACTLY  
WHAT IT  
MEANS**



### MODEL 5340 DIGITAL CAPACITOR TESTER

- Measures true series capacitance
- Direct digital display with long-life Nixie® tubes
- Tests capacitance, leakage, DF, and ESR
- Test frequencies of 120 cps and 1 kc
- Internal dc bias supply with electronic current limiting

The dual-frequency 5340 provides an exceptionally flexible instrument for accurately measuring a wide range of capacitance, leakage, dissipation factor and equivalent series resistance values. Results (in picofarads, nanofarads, microfarads) are displayed immediately on a 4-digit Nixie® readout, with a separate 3-digit readout of DF or ESR. Five terminal guarded measurements prevent stray capacitance and lead resistance errors. A 25% over-range capability facilitates test operation procedures. Since capacitors are always specified in terms of series capacitance by the manufacturer, direct series capacitance measurements on the Model 5340 DCT are therefore much faster and easier. No need for conversion formulae. No table look-ups. Reduced operator error. Priced at \$4500.00. Single frequency capacitor testers from \$1995.00.

For complete information, including a new 4-page technical paper entitled "Theory and Application of Capacitance Measurements", contact the Micro Instrument representative near you or write directly to us.



13100 CRENSHAW BLVD., GARDENA, CALIFORNIA 90249  
PHONES: (213) 323-2700 & 321-5704 / TWX (213) 327-1312

ON READER-SERVICE CARD CIRCLE 72

# A new twist on handling light-- from Bulova

Now... scan, chop, twist—with a tuning fork!

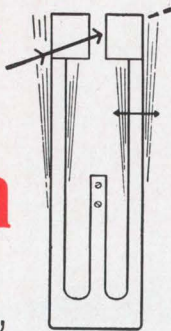

Bulova's American Time Products division has a patent pending on an important innovation in tuning forks: By affixing to the fork's tines a pair of vanes which can be slotted, notched or pierced as desired, the fork can be made to chop light or similar energy beams—making possible optical effects never before achieved.

Bulova fork light choppers offer great advantages over motor-driven types: There are no wearing parts—no lubrication is required—operational life is many times longer! Forks handle light more efficiently. They are smaller and lighter than any other chopper. Example: A 2 cu. inch package can chop 1,000 times per second!

And Bulova keeps coming up with important improvements. Among the latest— forks can now be supplied with peak-to-peak tine excursions of  $\frac{3}{8}$ " at 200 cps.

In addition, Bulova has recently patented torsional tuning forks. Each tine twists about its own axis independently, in opposite phase. This eliminates rate change due to attitude or acceleration, and results in the most constant and uniform movement known. Bulova torsional forks can be used for any number of scanner variations—in spectrophotometers, automatic star tracking units and densitometers. Write for information. Address: Dept. ED-19

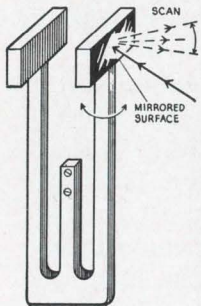

## BULOVA AMERICAN TIME PRODUCTS

Electronics Div. of Bulova Watch Co., Inc. 61-20 Woodside Avenue, Woodside, New York 11377 (212) DE 5-6000

ON READER-SERVICE CARD CIRCLE 73

## COMPONENTS

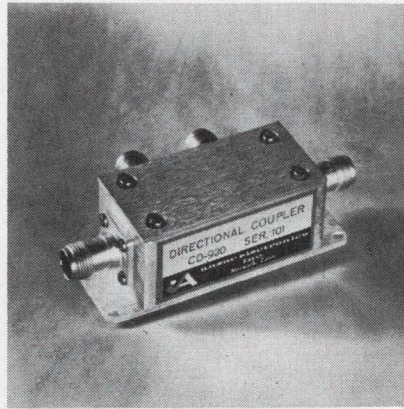

### Bi-directional coupler

These bi-directional couplers offer low loss and high directivity with 17-dB and 20-dB coupling factors in two models. The couplers may be left in a system with less than 0.2 dB loss in main line power. Flatness is  $\pm 0.25$  dB over 2 to 32 and vswr is less than 1.1 on all ports. Incident power may be measured to 0.25 dB accuracy.

P&A: \$130 with N connectors, \$10 extra for TNC or BNC; stock to 4 wks. Anzac Electronics, Inc., Moody's La., Norwalk, Conn. Phone: (203) 838-8451.

Circle No. 389

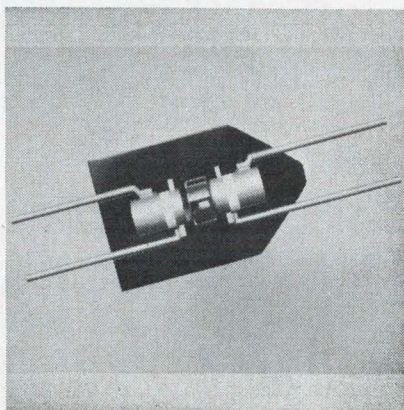

### Optoelectronic isolator

A new optoelectronic coupling device permits hv isolation to 5000 V. The TIXL101 optical isolator combines a planar Si light sensor with a GaAs light source in an 0.22-in. x 0.35-in. epoxy package. The isolator has a response beyond 10 kHz, a 1.5  $\mu$ s reverse switching time and a 15  $\mu$ s forward switching time. Input current rating is 50 mA and output is 250  $\mu$ A min.

P&A: \$34; stock. Texas Instruments, 13500 N. Central Expwy., Dallas. Phone: (214) 235-3111.

Circle No. 390

### Slip ring assembly

The CAY-150 slip ring assembly provides up to 50 shielded circuits at a minimum of 2 A. For gyro test stands, this unit operates at a noise figure of less than 0.006  $\Omega$  at 300 rpm and less than 0.002  $\Omega$  at 10 rpm at 50 mA. Power circuits can be provided to carry up to 10 A.

Airflyte Electronics, 535 Ave. B, Bayonne, N. J. Phone: (201) 436-2230.

Circle No. 398

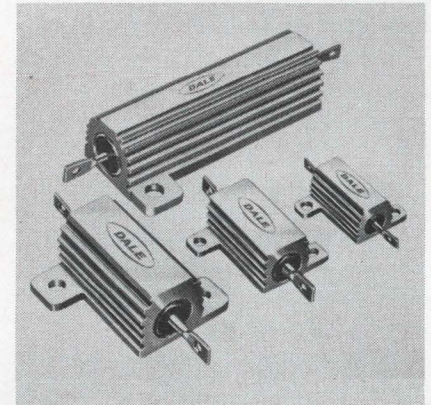

### Wirewound resistors

This MIL-spec, high-reliability series of housed power wirewound resistors contains 5, 10, 15 and 30 W models. Resistance range is 0.1 $\Omega$  to 39.2 k $\Omega$ . Tolerance is 1% and temperature coefficient is from 30 to 100 ppm, depending on resistance range.

The series uses high purity alumina cores molded inside a finned aluminum housing which screw-mounts to the chassis.

P&A: \$2.60; 6 wks. Dale Electronics, Inc., P. O. Box 488, Columbus, Neb. Phone: (402) 564-3131.

Circle No. 391

### Time code generators

Two new series of low-cost electro-mechanical time code generators are offered. Modularly constructed, they fit in a standard 19-in. rack and panel mount. The K42601 series supplies time information in decimal switch patterns and the K42602 provides binary coded decimal.

Seven models with various combinations of second, minute, hour, and day readouts are available.

A. W. Haydon, 232 N. Elm, Waterbury, Conn. Phone: (203) 756-4481.

Circle No. 392

# THEY ALL TURN, BUT...

HOW LONG WILL THE KNOB YOU'RE USING LAST?

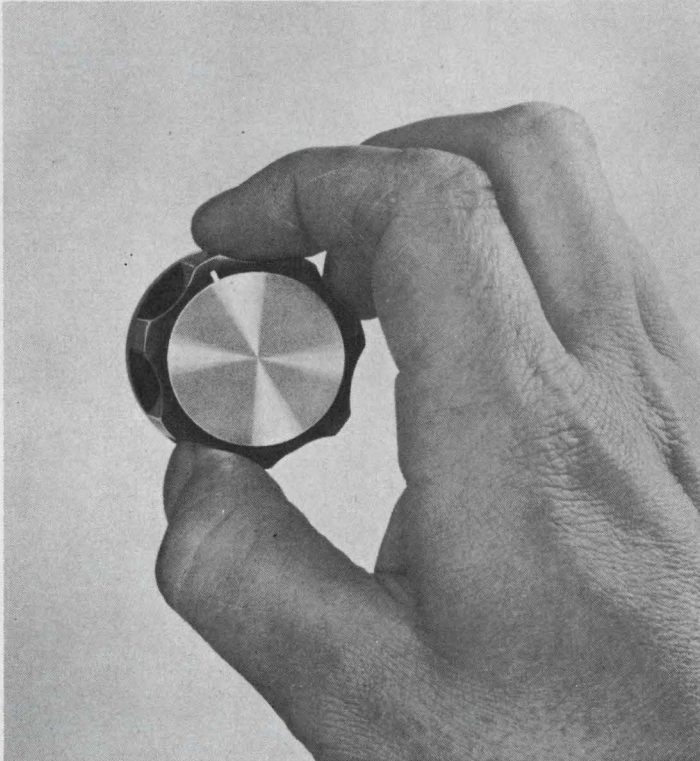

If it's a KURZ-KASCH knob, it will still be functioning 50 years from now or we'll replace it free! Kurz-Kasch "warrants for life" every knob they make. No matter whether you choose one of our four "Designer series" styles or whether you prefer the "Heavy Duty" types, you can rely on Kurz-Kasch knobs to do the job. See your local Industrial Electronic Wholesaler for your Free catalog and samples.

"the most respected name in plastics"

## KURZ-KASCH, INC.

1415 S. Broadway/Dayton, Ohio 45401  
(513) 223-8161

Circle reader service number for FREE designer catalog  
ON READER SERVICE CARD CIRCLE 74

FOR IMMEDIATE  
"OFF THE SHELF"  
LOCAL DELIVERY  
(at factory prices)  
CONTACT:

AUTHORIZED KURZ-KASCH  
INDUSTRIAL ELECTRONIC  
WHOLESALEERS

	Arizona	
Phoenix	R. V. WEATHERFORD CO.	272-7144
	California	
Oakland	BRILL ELECTRONICS	834-5888
	FORTUNE ELECTRONICS	826-8811
Long Beach	DEAN'S ELECTRONICS	636-9314
	ELWYN W. LEY CO. INC.	636-9781
Los Angeles	CALIFORNIA ELEC. SUPPLY	879-0760
	ELECTROSONIC COMPONENTS	872-6244
	HOLLYWOOD RADIO & ELEC.	466-3181
	R. V. WEATHERFORD CO.	849-3451
San Diego	RADIO PRODUCTS SALES	748-1271
	SHANKS & WRIGHT	239-0176
San Jose	R. V. WEATHERFORD CO.	278-7400
	QUEMENT INDUS. ELEC.	292-0464
	Connecticut	
Hamden	CRAMER ELECTRONICS, INC.	288-7771
	Delaware	
Wilmington	ALMO INDUS. ELECTRONICS	656-9467
	Florida	
Ft. Lauderdale	CRAMER/FLORIDA, INC.	566-7511
Miami	ELECTRONIC EQUIP. CO. INC.	635-0421
Orlando	ELECTRONIC EQUIP. CO. INC.	644-4833
Riviera Beach	ALMO INDUS. ELECTRONICS	848-4155
	Indiana	
Fort Wayne	PACE ELEC. SUPPLIES, INC.	Enter 3030
Indianapolis	RADIO DISTRIBUTING CO.	637-5571
	Illinois	
Champaign	ELECTRONIC PARTS CO.	356-1896
Schiller Park	PACE ELEC. SUPPLIES, INC.	678-6310
	Kentucky	
Louisville	P. I. BURKS COMPANY	583-2871
	Maryland	
Baltimore	D & H DISTRIBUTING CO.	717-5100
Salisbury	ALMO INDUS. ELECTRONICS	742-1393
	Massachusetts	
Boston	SAGER ELECTRICAL SUPPLY	542-2281
Newton	CRAMER ELECTRONICS, INC.	969-7700
	Michigan	
Battle Creek	ELECTRONIC SUPPLY CORP.	965-1241
Detroit	PACE ELEC. SUPPLIES, INC.	537-7400
Kalamazoo	ELECTRONIC SUPPLY CORP.	345-1133
	Minnesota	
Minneapolis	PACE ELEC. SUPPLIES, INC.	Zen 3030
	Nevada	
Las Vegas	MANLEY ELECTRONIC SUPPLY	384-3181
Reno	DUNLAP ELECTRONICS, INC.	329-1308
	New Jersey	
Camden	ALMO INDUS. ELECTRONICS	365-4524
	New York	
Bellmore, L.I.	CAR LAC ELEC. INDUS. SALES	231-1441
Buffalo	SUMMIT DISTRIBUTORS	884-3450
Binghamton	STACK INDUSTRIAL ELEC. INC.	723-6326
Elmira	STACK ELEC. OF ELMIRA	733-6513
Einhurst	CRAMER ELECTRONICS, INC.	478-4000
New York City	HARRISON ELEC. CORP.	227-7777
Rochester	SIMCONA ELECTRONICS CORP.	546-1280
Syracuse	CRAMER ELECTRONICS, INC.	455-6641
	North Carolina	
Greensboro	CAROLINA RADIO SUPPLY	273-8660
	Ohio	
Cleveland	RADIO & ELEC. PARTS CO.	881-6060
Columbus	HUGHES PETERS COMPANY	294-5351
Dayton	ESCO ELECTRONICS, INC.	298-0191
	Oregon	
Portland	LOU JOHNSON COMPANY, INC.	222-9551
	Pennsylvania	
Harrisburg	D & H DISTRIBUTING CO.	236-8001
Philadelphia	SIMCO ELECTRONICS, INC.	229-1880
	ALMO INDUS. ELECTRONICS	922-5918
Norristown	ALMO INDUS. ELECTRONICS	272-7580
	South Carolina	
Greenville	CAROLINA RADIO SUPPLY	232-6740
	Tennessee	
Nashville	ELECTRA DISTRIBUTORS CO.	255-8444
	Texas	
Houston	SOUTHWEST ELEC., INC.	666-2401
	Washington, D.C.	
	CAPITOL RADIO WHOLESALEERS	232-6000
	Wisconsin	
Milwaukee	PACE ELEC. SUPPLIES, INC.	Enter 3030
	RADIO PARTS COMPANY, INC.	276-4160

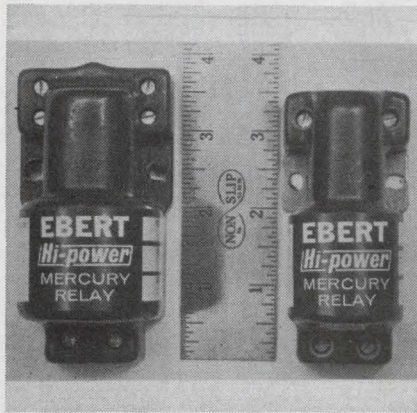

### Mercury plunger relays

Two compact epoxy-encapsulated metal-tube relays eliminate mounting enclosures with molded-in terminal connectors. The single-pole model S is rated at 25 A at 120 Vac and will accommodate loads to 550 Vac. The model T is rated at 50 A with the same load capacity. Both models are available with pole normally open or normally closed.

Ebert Electronics Corp., 130 Jericho Turnpike, Floral Park, N. Y. Phone: (516) 437-7777.

Circle No. 393

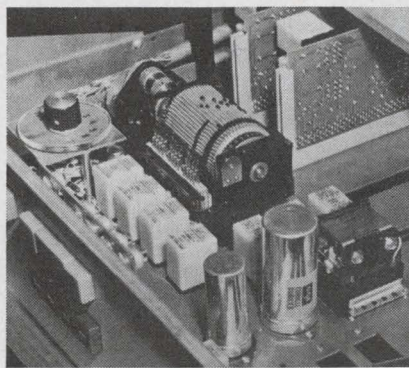

### Programming switch

An "Actan" programming switch with removable memory drum has been introduced for use with automated audio control systems for broadcasting. The 24-contact switch permits use of as many as eight channels and controls as many as 60 sequences.

The new series has removable pre-set program drums. Actuators are positioned in the drum grooves to trigger desired channel inputs. Changes can be made by shifting actuators or interchanging drums.

Price: \$85 to \$195. Sealelectro Corp., Mamaroneck, N. Y. Phone: (914) 698-5600.

Circle No. 394

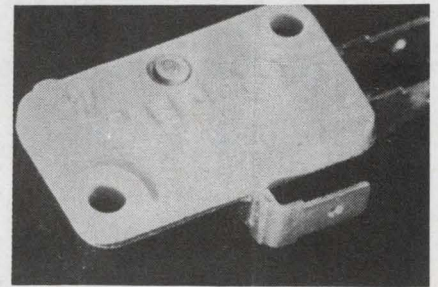

### Low-force switch

A new low-force switch requires operating forces of less than 3 oz. The switches are rated at 10 A at 125 or 250 Vac, 0.5 A to 125 Vdc or 0.25 A at 250 Vdc. At 30 Vdc, inductive and resistive ratings are 5 A and motor load is 5 A.

Micro Switch Div., Honeywell, 11 West Spring St., Freeport, Ill. Phone: (815) 232-1122.

Circle No. 395

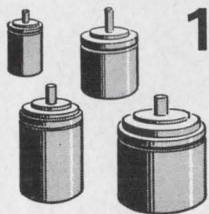

## 1001 uses for STEPPER MOTORS

Because their output is in discrete increments, Cedar stepper motors have many advantages over conventional motors for precise positioning applications. They are bi-directional and have high torque output. They can be run at high stepping rates or as slow as you wish. Because shaft rotation is incremental, damping is not required.

Some of the applications for which stepper motors have been used are: replace motor-tachometers in servo systems, control missile ailerons, shutter control on high-speed cameras, open loop positioner in checkout systems, high-speed counter in such applications as rapid firing weapons, replace ultra low-speed dc motors, incremental tape handlers, and digital-to-analog and analog-to-digital conversion equipment.

The uses for stepper motors are as unlimited as your imagination. New applications are constantly being discovered. What new use will you next make of stepper motors? Let us know about your ideas; we'll be happy to work with you.

Cedar Stepper Motors are available in sizes 5, 8, 11 and 15 in both permanent magnet and variable reluctance types, and with a wide variety of stepping angles. All meet the full requirements of MIL-E-5272. For free booklets on stepper motor application ideas, write or call:

<b>CEDAR</b> ENGINEERING DIVISION	<b>CONTROL DATA</b> CORPORATION
--------------------------------------	------------------------------------

5806 West 36th Street, Minneapolis 16, Minnesota. Phone 929-1681

ON READER-SERVICE CARD CIRCLE 75

# VersaTility

**ANYTHING YOU CAN PUT ON FILM  
YOU CAN DISPLAY ON IEE READOUTS  
(EVEN COLORS!)**

NUMBERS, LETTERS, WORDS, SYMBOLS, COLORS!  
There is literally no limit to the display versatility of IEE readouts. As rear-projectors, they operate by back-lighting display symbols arranged on film and projecting the selected message on a non-glare viewing screen.

VERSATILITY OF SIZES, TOO! Five sizes with maximum character heights of 3/8", 5/8", 1", 2", 3 3/8".

**SEND TODAY FOR COMPLETE INFORMATION!**

**INDUSTRIAL ELECTRONIC ENGINEERS, INC.**  
7720 Lemona Avenue • Van Nuys, California  
Phone: (213) 787-0311 • TWX (213) 781-8115

Representatives in Principal Cities

ON READER-SERVICE CARD CIRCLE 76

ELECTRONIC DESIGN

## COMPONENTS

### 20 A transistor

This series of 20 A high-power planar transistors is designed for continued operation at 100 W at 100°C case temperature. They feature minimum  $V_{BE0}$  of 80 V and 60 V at 400  $\mu$ A. Efficient performance at high currents is achieved by low collector-emitter  $V_{SAT}$  of 1.0 V at 10 A and 3.0 V max at 20 A. The monolithic silicon devices are offered in the TO-63 package.

Transitron Electronic Corp., 168 Albion St., Wakefield, Mass. Phone: (617) 245-4500.

Circle No. 262

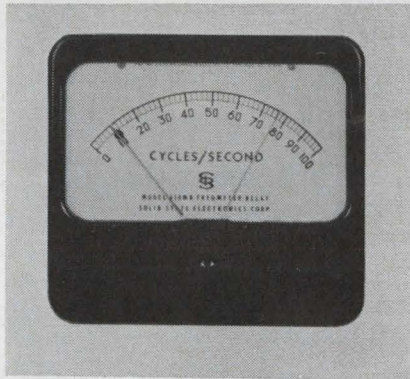

### Frequency meter relay

The series 400MR panel-mount frequency meter relay offers adjustable min and max pointer contacts. Input frequencies may range from dc to 100 kHz. The unit utilizes a solid-state silicon semiconductor circuit to linearly convert frequency or rep rate to a proportional Vdc. Supplementary outputs include a 0 to 5 Vdc min into 100 k $\Omega$ , which is linearly proportional to the input for monitoring or drive purposes. High level pulses synchronous with the input are also available.

The relays are virtually insensitive to supply voltage, temperature or waveform variation. They function with any repetitive wave and will indicate the average frequency of random signals. Four standard models are available over the 100 kHz range featuring 0.5% deviation from linearity at up to 5 Vdc out.

P&A: \$340; 3 weeks. Solid State Electronics Corp., 15321 Rayen St., Sepulveda, Calif. Phone: (213) 894-2271

Circle No. 263

## EVEN MISSILE THERMAL BLANKETS ARE FASTENED WITH VELCRO® CLOSURES

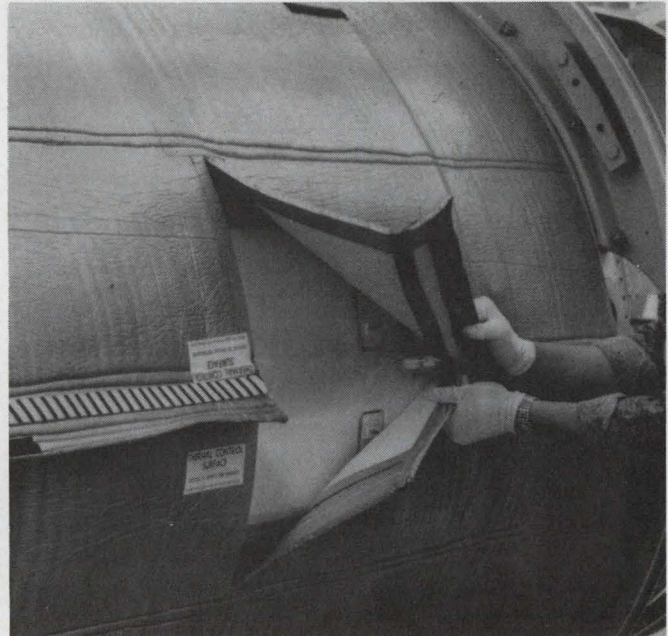

Velcro Hook and Pile Closure provides a mechanical fastening for all forms of rigid and non-rigid materials... yet may be instantly separated. Providing good lateral shear qualities, the closure forms a smooth, corrosion proof attachment along any contour, distributing stress along the entire surface—not at a few points. The material will not scratch, jam or rust... provides easy adjustment and may be opened and closed thousands of times.

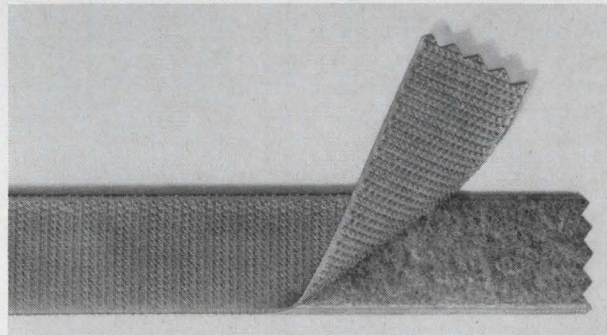

### NEW HIGH-TEMPERATURE VELCRO CLOSURES

**Mid-Temp Velcro** will withstand 450°F. Both hook and pile are fabricated from corrosion resistant steel with a high temperature Nylon backing.

**Hi-Garde Velcro** is fabricated entirely from corrosion resistant steel and withstands temperatures to 800°F.

For further information write:

 **THE HARTWELL CORPORATION**  
9035 Venice Boulevard, Los Angeles, California 90034  
Branch Offices: Chicago, Fort Worth, Hackensack

ON READER-SERVICE CARD CIRCLE 80

HAVING  
**FREQUENCY**  
PROBLEMS?



GET IN  
TUNE  
WITH THE  
**60KC**

**PHASE COMPARATOR  
RECEIVER**

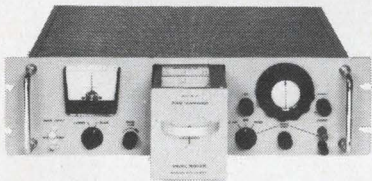

**Low Cost • Easy to Operate • Accurate**

The Model SR-60 is the first low cost VLF Phase Comparison Receiver designed to permit phase comparison measurements between a local oscillator and the National Bureau of Standards transmitted 60 Kc/s from WWVB, Fort Collins, Colorado. The receiver is a straight-forward Tuned Radio Frequency receiver and can be used in any location in the United States with highly satisfactory results.

The SR-60 permits accuracy measurements to parts in  $10^{10}$  with relative short measurements. Phase difference is displayed on a front panel meter or on a strip chart when more precise measurements are made over a long period of time.

Antenna input through a specially designed antenna coupler is made from the rear chassis. The antenna coupler allows the use of a high impedance antenna. Provisions are made to tune the coupler for any antenna. Connections are also available for scope monitoring the incoming signal (output of RF Amplifiers) the multiplied RF carrier signal and the multiplied (or divided) local oscillator signal.

**PRICE: \$850.00**

**Write, wire or phone for  
complete catalog information.**

*Specialists in Frequency Management*

**SPECIFIC  
PRODUCTS**

P.O. BOX 425  
21051 COSTANSO STREET  
WOODLAND HILLS, CALIFORNIA  
AREA CODE: 213 340-3131



SEMICONDUCTOR

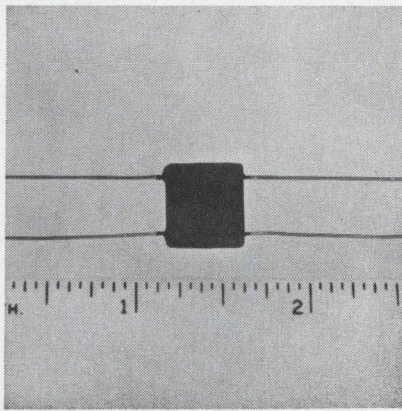

**Schottky diode quad**

The IL2590 series is a 4-diode GaAs bridge matched to within 20 mV of specified forward voltage. Capacitance is matched to an 0.2 pF max spread. Leakage current is less than 10 nA at -3 V and total capacitance is 1.2 pF max at 0 V. Minority carrier lifetime is 100 ps max.

P&A: \$40 to \$91; 2 to 3 wks. International Semiconductor Inc., 12 Unicorn St., Newburyport, Mass. Phone: (617) 465-9302.

*Circle No. 264*

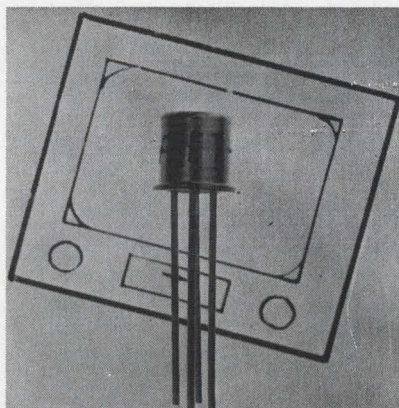

**MOS-FET amplifier**

A MOS-FET low noise RF amplifier offers low cross-modulation distortion. The FT57, an *n*-channel depletion mode MOS-FET in a 4-lead TO-72, features noise figure of 4.5 dB max reverse capacity of 0.8 pF and min neutralized power gain of 15 dB at 100 MHz. Drain current at zero gate voltage is nine to 26 mA.

Availability: stock. Fairchild Semiconductor, 313 Fairchild Dr., Mountain View, Calif. Phone: (415) 962-2530.

*Circle No. 265*

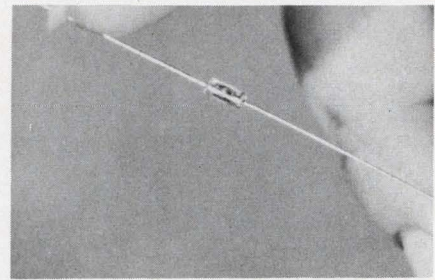

**Schottky mixer diode**

A new Schottky-barrier mixer diode features conversion loss of 6 dB typical at 900 MHz. Total capacitance is 0.65 pF, recovery time is 50 ps typical and noise is less than 0.5 mV.

P&A: \$1.75 to \$3.25; stock. Texas Instruments, 13500 N. Central Expwy., Dallas. Phone: (214) 235-3111.

*Circle No. 266*

**Ac semiconductor**

The QUADRAC line of integrated ac semiconductors is designed to do the work of two SCRs connected in inverse parallel. It also contains a built-in triggering diode. These units are rated up to  $\pm 400$  volts  $V_{bo}$  at 3 to 15 amps.

Quadrac is passivated and protected against high voltage transients. The case is fully electrically isolated.

Electronic Control Corporation, P.O. Box J, Euless, Texas. Phone: (817) 283-1596.

*Circle No. 267*

**Vhf/uhf transistors**

Two new vhf/uhf silicon npn transistors are designed for battery operated equipment. The RCA-40404 and RCA-40405 are suggested as class C frequency multipliers and amplifiers in communications equipment.

The RCA-40404 delivers 500 mW RF output as a class C amp up to 700 MHz, and doubles, triples and quadruples. The RCA-40405 is rated at 700 mW at frequencies up to 400 MHz.

RCA, 415 S. Fifth, Harrison, N. J. Phone: (201) 485-3900.

*Circle No. 268*

# NEW SIMPSON 7-INCH VTVM MODEL 312

Immediate delivery from Electronic Distributor stock.

## Extra Wide Frequency Response. 40% Less Circuit Loading Than Conventional VTVMs.

Here's a rundown on all the goodies Simpson has packed into this new VTVM. With its accessory probe, you can make measurements from 10 KC to 250 MC at  $\pm 1$  db. With its 16 megohm (rather than 11) input resistance, you don't have to worry about circuit loading. Moreover, you can run your tests with a tracking error of less than 1%. And don't worry too much about meter burnout. There's a specially designed protection circuit. You can handle solid state testing easily and accurately because of the 1/2-volt DC range. Accuracies are  $\pm 3\%$  (FS) on all AC and DC ranges. Resistance accuracy is  $\pm 3^\circ$  of arc. Model 312 has a big, easy-to-read 7-inch meter housed in a rugged phenolic case. Operating line voltage is 105/125 V, 50/60 cps. High voltage and RF probes available. See Bulletin 2070; copies sent on request. Model 312 price... **\$79<sup>95</sup>**

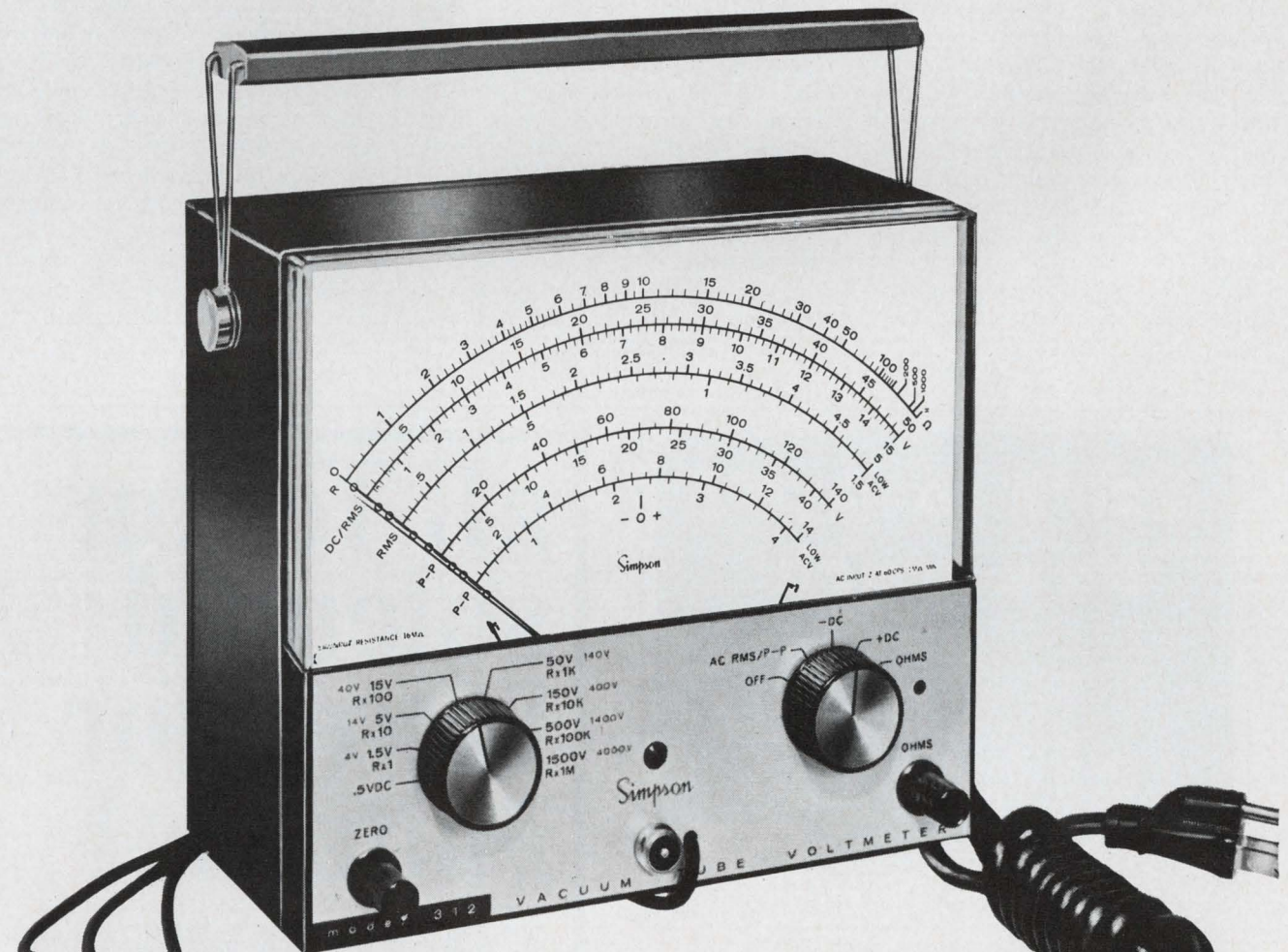

### RANGES:

- DC VOLTAGE: 0-0.5, 1.5, 5, 15, 50, 150, 500, 1500 (16 Megohms input impedance)
- AC VOLTAGE: (R.M.S.): 0-1.5, 5, 15, 50, 150, 500, 1500 (1 Megohm minimum input impedance)
- AC VOLTAGE: (Peak to Peak): 0-4, 14, 40, 140, 400, 1400, 4000
- RESISTANCE: RX1, RX10, RX100, RX1K, RX10K, RX100K, RX1M (10 ohm center)
- FREQUENCY RESPONSE:  $\pm 3\%$  from 15 cps to 3 megacycles per second on all AC voltage ranges through 150 volts. With R.F. Probe: 10KC to 250 MC  $\pm 1$  db. R.F. probe usable up to 40 volts rms.



**SIMPSON ELECTRIC COMPANY**  
5202 W. Kinzie Street, Chicago, Ill. 60644 • Phone: (312) Estebrook 9-1121  
Representatives in Principal Cities . . . . . See Telephone Yellow Pages  
Export Dept: 400 W. Madison St., Chicago, Ill. 60606 Cable, Amergaco  
In Canada: Bach-Simpson Ltd., London, Ontario  
In India: Ruttonsha-Simpson Private Ltd., Vikhroli, Bombay

WORLD'S LARGEST MANUFACTURER OF ELECTRONIC TEST EQUIPMENT  
ON READER-SERVICE CARD CIRCLE 82

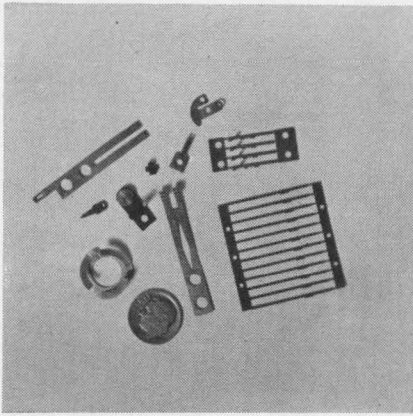

### Custom stampings

Materials ranging from beryllium/copper, phosphor/bronze, nickel/silver to precious metals such as gold and silver are available as custom stampings. Applications include relays, terminal board inserts, potentiometers, industrial controls and connectors for power transistors. The company can roll to size and slit to width.

Alloys Unlimited, 320 Long Island Expwy South, Melville, N. Y. Phone: (516) 694-7900.

Circle No. 334

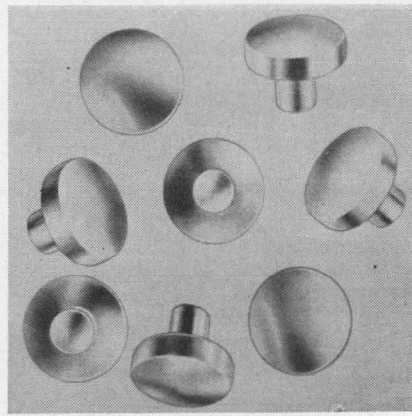

### Rivet-type contacts

Rivets with head diameters ranging from 0.040-in. for milliamp range uses, to 0.375-in. for carrying up to 50 amps at 220 Vac are offered. Applications range from dry circuit to heavy duty power switching. Contact rivets may be obtained cold headed from any malleable material, and solid rivets or angular indent shanks are available.

Contacts, Inc., 1100 Silas Deane Highway, Wethersfield, Conn. Phone: (203) 529-3386.

Circle No. 335

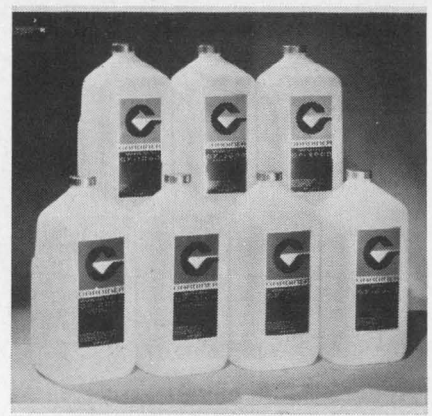

### Solder flux

A complete new line of solder fluxes for electronic applications is now available. Types include GF-1000 liquid water white resin, GF-2000 activate resin, GF-5000 activated organic and GF-6000 acid. The GF-2000 activated resin flux has been formulated to be more active during soldering yet completely inert afterwards.

Gardiner Metal Co., Gardiner Solder Div., 4816 S. Campbell Ave., Chicago. Phone: (312) 847-0100.

Circle No. 336

**-120°F to +350°F  
on a bench!**

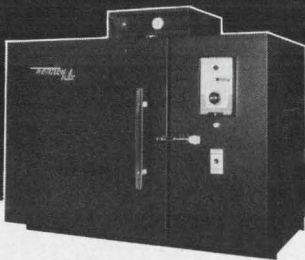

The New Improved Tenney Jr. Bench Model, Mechanically Refrigerated, High-Low Temperature Test Chamber features wider temperature range with  $\pm 1/2^\circ$  F control throughout with indicator. Full 1,400 cu. in. test area. New, faster pull down, greater load dissipation. New fan guard. 2¢ per hour average operating cost! Hermetically sealed inside and out. Weighs only 200 lbs. Simple plug-in operation.

Still priced at only \$990 complete. Available immediately.

To order, or for more information, write to  

**Tenney**  
 ENGINEERING, INC.  
 1090 Springfield Road • Union, New Jersey

Western div.: 15700 S. Garfield Ave. • Paramount, Calif. 90723  
 Oldest and Largest Manufacturer of Aerospace and Environmental Equipment

210

**all Teflon\*  
solenoid  
valves for  
epitaxial  
reactors**



Join the companies who are already using these corrosion-proof valves in the production of micro-circuits. For complete information and specifications write today for Catalog 108CE.

**Valcor Engineering Corp.**  
 5382 Carnegie Ave., Kenilworth, N. J.  
 (201) CH 5-1665

**VALCOR**  
 SOLENOID VALVES

\*duPont Company registered trademark

219



## Encapsulating material

Upon the application of moderate heat this polyvinyl chloride dispersion solidifies with essentially no weight or volume changes. Chem-O-Sol is supplied as a liquid and is applied or molded in that state. It can be die-wiped on fine wire or used for flexible encapsulation of wire harnesses. The material may be used for jacketing or potting many types of connectors.

Chemical Products Corp., 50 King Philip Rd., E. Providence, R. I. Phone: (401) 434-0770.

Circle No. 337

## Metallized record paper

Low voltage records traces at speeds up to 165 ft/s on a new metallized paper tape. Recording occurs when the 0.1 micron metal on 40 micron varnished paper is vaporized by writing electrodes. Approx 5 mA rms are needed in recorders for 8 in/s operation.

Robert Bosch, GmbH, 40-25 Crescent, Long Island City, N. Y. Phone: (212) 786-1644.

Circle No. 338

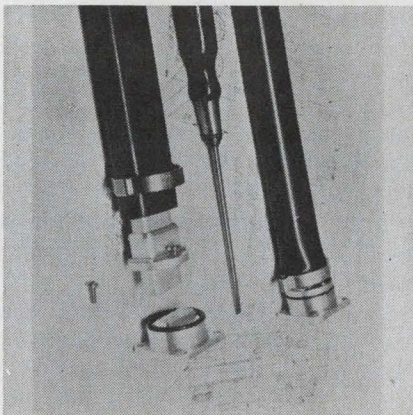

## Flexible waveguide

Flexible waveguide, known as Airflex can be cut to any length and flanges installed or replaced in the field.

In practice the tubing is cut to length, jacketing slipped on and flanges attached. Vswr, flexibility, and pressure meet previous standards. It is available now (kit or assembled) in WR-90 X-band and soon in all common sizes.

Litton Industries, 200 E. Hanover, Morris Plains, N. J. Phone (201) 539-5500.

Circle No. 339

April 12, 1966



# WOOD ELECTRIC

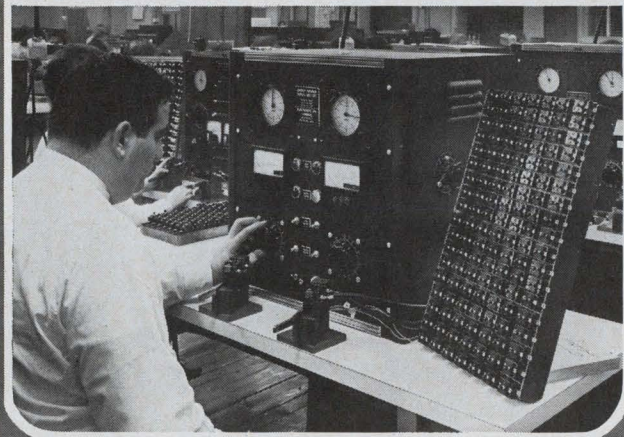
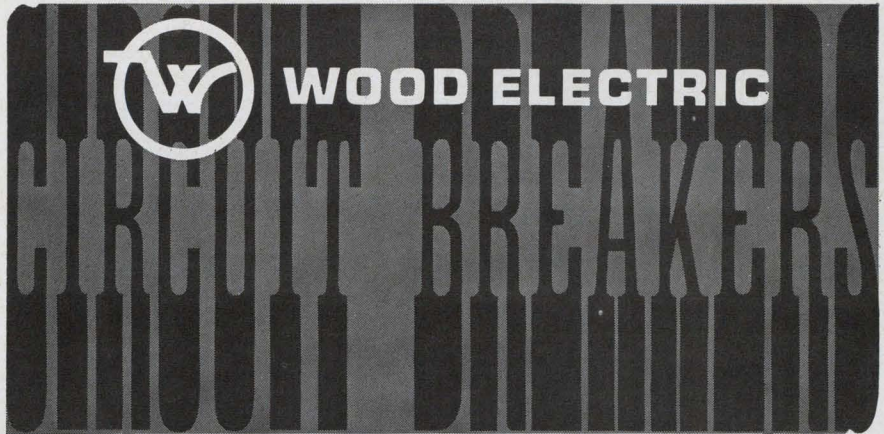

When the specs say . . .  
"Must trip between  
15 and 55 seconds"

## You can depend on us!

The above photograph shows a Thermal Circuit Breaker Calibration Test. All units are adjusted to trip within specified trip bands and hold 100% of rated current with ultimate trip at 135% of rated current. Transfer of auxiliary contacts for remote indication is also checked during this test.

There are other specs and other tests, lots of them, but they all have one purpose in common—to assure the most reliable performance in the industry. If it's by Wood Electric—you can depend on it!

Wood Electric also manufactures a complete line of Magnetic Circuit Breakers that hold 100% of rated current indefinitely and operate at specified trip settings regardless of ambient temperatures. Choose from a wide variety of proven commercial and military type Circuit Breakers to meet the specific needs of your application. Models are available with ratings from ½ to 50 amps . . . AC or DC . . . single pole, two pole and three pole.

Write for Circuit Breaker Catalog CB-10-65



# WOOD ELECTRIC CORPORATION

244 Broad St. Lynn, Massachusetts (617) 598-5313  
ON READER-SERVICE CARD CIRCLE 85

snapping bimetallic disc...

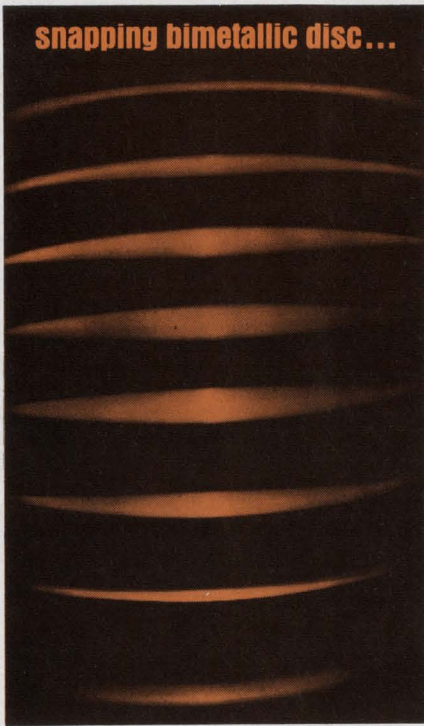

## snappy way to control temperature

If your problem is maintaining temperature in liquids, gases or metals, here's the answer:

Our hermetically-sealed thermal switches (standard or custom), which use a reliable, snap-acting bimetallic disc to open and close contacts, are engineered for military ordnance, spacecraft, aircraft, and industry. The standard 500-series, available on immediate order, gives you:

- Fast response.
- Operating life exceeding 100,000 cycles.
- A compact 5-gram capsule.
- Temperature ambients from  $-80^{\circ}$  F. to  $+300^{\circ}$  F.\*
- Vibration exceeding 50 g to 2,000 cps.
- Shock and acceleration to 100 g.

\*Higher temperature performance available on special order.

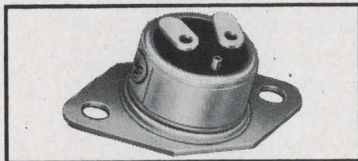

For detailed specs, call or write us:

**UNITED CONTROL**  
Aerospace Division

UNITED CONTROL CORP./ REDMOND, WN. 98052  
PHONE: (206) 885-3711 TWX: (206) 999-1874

ON READER-SERVICE CARD CIRCLE 86

## MICROELECTRONICS IC module

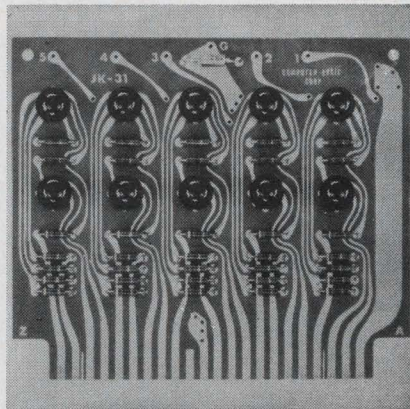

Utilizing modified DTL logic in dc to 5 MHz system design, the new JK-31 plug-in module card contains 5 universal flip-flops with fully buffered outputs. The JK-31 can be directly used for clocked or ripple counters in any number base without external gates. Each of the 5 flip-flops can be preset or reset on a dc basis.

Price: \$13.20 per flip-flop. Computer Logic Corp., 1528 20th St., Santa Monica, Calif. Phone: (213) 451-9754.

Circle No. 269

## IC operational amplifier

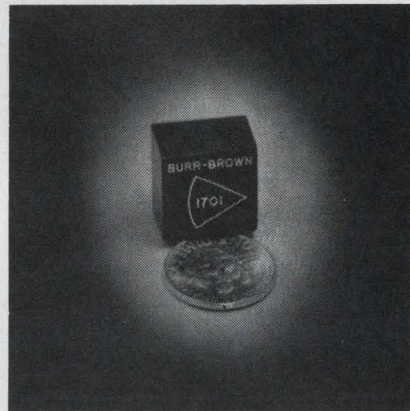

The new model 1701 integrated circuit operational amplifier has built-in over and short protection and an internal phase stabilization network. The 0.15-in.<sup>3</sup> module offers  $\pm 10$  V output at 10 mA, and a 92 dB open loop gain. Small signal response is 3 MHz and minimum full power response is 30 kHz. Input noise is  $3 \mu\text{Vrms}$ , dc to 10 kHz.

P&A: \$135; stock to 3 weeks. Burr-Brown Research Corp., 6730 So. Tucson Blvd., Tucson, Ariz. Phone: (602) 294-1431.

Circle No. 270

## Capacitor chips

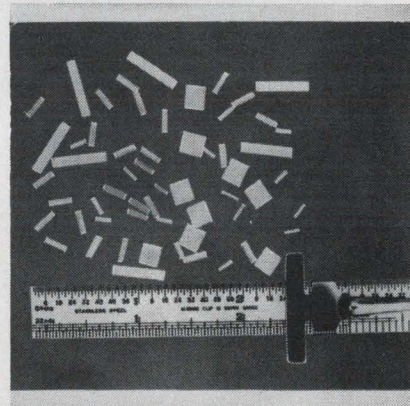

Uncased ceramic capacitor chips for use in hybrid and microcircuit assemblies are offered. The type U dense, homogeneous multilayer chips may be soldered directly into the circuitry. A range of 100 pF to 68,000 pF at 100 Vdc is covered with maximum change of  $\pm 15\%$ . A high capacity-to-volume ratio is the result of dielectric-noble metal electrode "sandwiching."

American Components, Inc., 8th Ave. at Harry St., Conshohocken, Pa. Phone: (215) 828-6240.

Circle No. 271

## Microcircuit connector

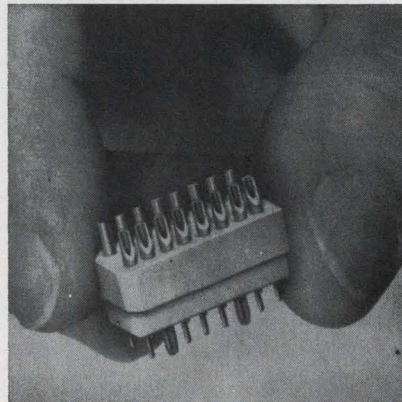

A new microconnection device for integrated circuits is offered in the rack and panel mate MPC7. It is a miniature pluggable male for rack and panel assembly, and mates with the TI MPC4 pin pack connector.

Sixteen gold-plated pins and solder cup terminals are features. Chamfers align for indexing.

Metals and Controls Div., Texas Instr., 34 Forest St., Attleboro, Mass. Phone: (617) 222-2800.

Circle No. 272



**Another star:**

## **Technicraft cast waveguide components**

Now, low cost precision cast waveguide components have been added to the famous ES/Technicraft line of high reliability flexible and rigid waveguide, and waveguide components. Utilizing the same careful selection of materials and advanced quality control methods, these precision castings provide an even greater number of microwave components now available from one well qualified source. Produced by Electronic



Specialty's Connecticut Division, the new line is available in 90° Cast Elbows, Precision Cast Hybrids, Narrow Band Cast Elbows and Miters and Cast Dual Choke Flanges. All castings are supplied either in beryllium copper or aluminum and are designed for rugged, long-life applications. If you're looking for precision cast waveguide components, look no further. Write for specifications and detailed information.



**ELECTRONIC SPECIALTY CO. Connecticut Division**  
**401 Watertown Road, Thomaston, Connecticut**

*Los Angeles, Calif./Anniston, Ala./Ft. Madison, Ia./Harrisonburg, Va./Hurst, Tex./Pomona, Calif./Portland, Ore./Thomaston, Conn./Toronto, Ont.*  
*In Europe contact Elektro-Metall, Dusseldorf, Germany.*

ON READER-SERVICE CARD CIRCLE 87

MICROWAVES

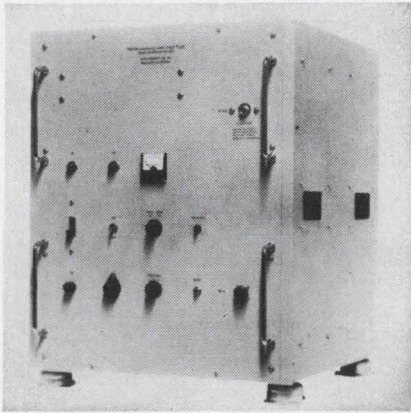

**Microwave amplifier**

These 100 W cw amplifiers are available in 1 to 2 GHz, 2 to 4 GHz, 4 to 8 GHz and 8 to 12.4 GHz bands. The amplifier is a TWT type with 30-dB small signal gain and 35-dB noise figure in each band. Type N RF connectors are standard.

Protective circuits include helix current overload and TWT collector temperature cutout. The TWTs are interchangeable so that one unit covers all bands with a minor adjustment. Power input is 105/125 Vac,

60 Hz.

Available options include an internal load isolator and internal power monitor.

P&A: About \$12,250 dependent on frequency band; 60 to 75 days. Alto Scientific Co., Inc., 4083 Transport St., Palo Alto, Calif. Phone: (415) 321-3434.

Circle No. 273

**Beacon magnetron**

This grounded-cathode, 35 W tunable beacon magnetron operates between 8.8 and 9.6 GHz. The model MA 212T uses a new low cost tuning technique to give narrow band tuning (50 MHz) at fixed frequency prices.

The 12-oz device exhibits low torque and less than 2 MHz backlash. The unit lends itself to use in applications where narrow band tuning or exact frequency setability is desired and cost is a major consideration.

Microwave Assoc., Inc., South St., Burlington, Mass. Phone: (617) 272-3000.

Circle No. 274

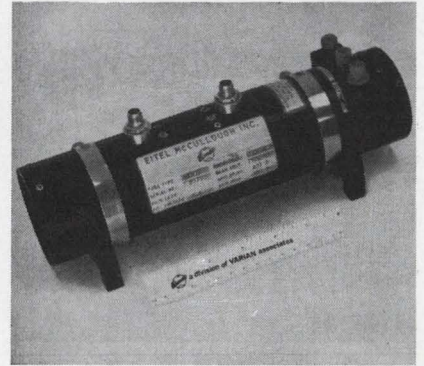

**"Window" TWT**

A new "window" type traveling wave tube increases output power by an order of magnitude. High-power pulsed or cw signals may be sent through it with max insertion loss of 1-2 dB since it is transparent to microwaves under off-beam conditions. On-beam, it is a 10-dB power amplifier.

The TWT operates at 2.8 to 5.2 GHz, 1.5 kW min peak output, 2% duty-cycle, 10 dB gain, and 25% efficiency.

Eimac Div. Varian, 301 Industrial, San Carlos, Calif. Phone: (415) 592-1221.

Circle No. 275



**ARNOLD / TOROIDAL COIL WINDER**

*sets up quickly...easy to operate...  
takes wide range of wire sizes*

**SPECIFICATIONS:**

- Min. finished hole size: .18 in.
- Max. finished toroid O.D.: 4.0 in.
- Winding speed: 1500 turns/min.
- Wire range: AWG 44 to AWG 26
- Dual, self-checking turns counting system
- Loading (wire length) counter
- Core range: 9/32" I.D. to 4" O.D. to 1 1/2" high

**LABORATORY USE**

- Change wire and core size in 45 sec.

**PRODUCTION USE**

- 1500 turns per minute
- Insert core and load in 20 sec.

**\$890.00** includes all rings, counters and accessories



*immediate delivery. literature on request*

**ARNOLD MAGNETICS CORP.**  
6050 W. Jefferson Blvd., Los Angeles, Calif. 90016  
(213) 870-6284

ON READER-SERVICE CARD CIRCLE 88



the latest in Heat Sink Extrusions  
**WAKEFIELD DISTRIBUTOR  
PRODUCTS CATALOG**

Your authorized WAKEFIELD Electronic Distributor stocks a wide variety of Heat Sink Extrusions in 3 ft. ± 1/4" lengths. This catalog will give you the name of your nearest distributor and full product information: milliwatt to high power coolers, circuit board heat sinks, extrusions, thermal joint compound DELTA BOND 152 Thermally Conductive Adhesive.

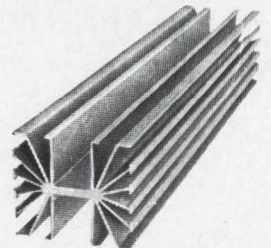

FOR YOUR COPY, WRITE

**WAKEFIELD**  
ENGINEERING, INC.

139 FOUNDRY ST. / WAKEFIELD, MASS. (617) 245-5900 • TWX 617-245-9213

ON READER-SERVICE CARD CIRCLE 89

ELECTRONIC DESIGN

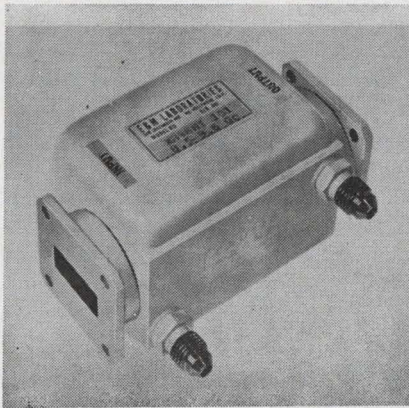

## Waveguide isolators

A new series of water-cooled, high-power waveguide isolators for 8.5- to 9.6-GHz use is available. These X-band units provide tube protection and stable operation at high average power levels. Units are rated at 1 cw kW when terminated in a load vswr of 1.5 max. Isolation is 20 dB min, insertion loss 0.5 dB max and bilateral vswr 1.1 max.

E&M Laboratories, 7419 Greenbush Ave., North Hollywood, Calif. Phone: (213) 875-1484.

Circle No. 276

## Two-cavity klystrons

High power output and low-noise characterize these new two-cavity oscillators. The VA-521 series covers center frequencies between 5.5 and 7.0 GHz. Each is frequency trimmable  $\pm 50$  MHz.

Typical of the series, the VA-521A operates at 5.5 GHz and delivers 2 W with a beam voltage of 4 kVdc and a beam current of 33 mA dc.

Varian Associates, 611 Hansen Way, Palo Alto, Calif. Phone: (415) 326-4000.

Circle No. 277

## Traveling wave tube

A new 2 kW cw traveling wave tube is available covering a full octave from 700 to 1400 MHz. The MA-2019 TWT provides 27 dB gain and utilizes a hollow electron beam and a precise solenoid controlled beam. Advanced state-of-the-art design is claimed. The tube is adaptable for operation in either pulse or cw mode for applications including ECM, pen aids and radar.

Microwave Associates, Inc., South St., Burlington, Mass. Phone: (617) 272-3000.

Circle No. 278

# PROPORTIONAL

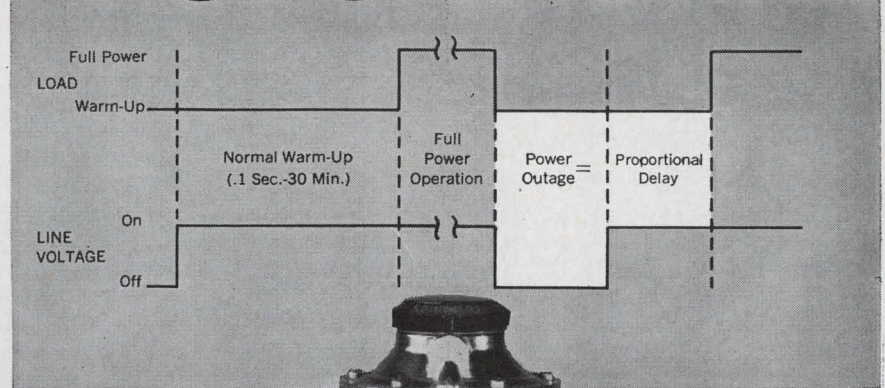

The new AGASTAT® Proportional time/delay/relay is the only timing device that offers automatic proportional compensation for time lost during power interruptions.

It is particularly suited for controlling equipment which requires a "warm-up" period at reduced voltage before full power is applied. After full power operation has started, it automatically provides proportionately shorter warm-up periods in the event of brief power interruptions.

In effect, the unit monitors the duration of the outage, and tailors the length

of the subsequent delay to match the "off" time. The equipment is thus returned to service in the shortest possible time, with maximum safety.

This unique model of the 2400 electro-pneumatic Series is available for operation on most popular ac and dc voltages, with time-calibrated adjustment dials in ranges from 0.1 second to 30 minutes. Proportionality (normally 1:1) may be varied on order.

For detailed information, write to the leader in time/delay instrumentation for over 30 years. Department A32.

## AGASTAT TIMING INSTRUMENTS



ELASTIC STOP NUT CORPORATION OF AMERICA  
ELIZABETH DIVISION • ELIZABETH, NEW JERSEY

IN CANADA: ESNA LIMITED, 271 PROGRESS AVENUE, SCARBOROUGH, ONTARIO

Speed Inquiry to Advertiser via Collect Night Letter

ON READER-SERVICE CARD CIRCLE 90

## When Motor Specifications demand

- HIGH INITIAL TORQUE
- FLEXIBLE SPEEDS
- CONTINUOUS USE
- RESISTANCE TO HEAT OR COLD



turn the job over to  
**SYNCHRON® MOTORS!**

No matter whether you need a motor that can "do tricks" or handle simple routine work, think of a SYNCHRON Motor first. Here at Hansen Manufacturing Co., we've helped designers and production people solve problems ranging from unusual cycling patterns, to meeting swiftly varying temperatures, and a hundred other special applications. And of course we've supplied industry with literally millions of motors for uncomplicated designs. We can help you, too; write or phone us!

**HANSEN**  
MANUFACTURING COMPANY, INC.



PRINCETON,  
INDIANA

HANSEN REPRESENTATIVES: CAREY & ASSOCIATES, Houston, Tex., R. S. HOPKINS CO., Sherman Oaks, Calif., MELCHIOR & MACPHERSON, INC., San Carlos, Calif., THE FROMM CO., Chicago, Ill., H. C. JOHNSON AGENCY, INC., Rochester, N. Y., WINSLOW ELECTRIC CO., Essex, Conn., Narberth, Pa., and New York, N. Y. EXPORT DEPARTMENT, 64-14 Woodside Ave., Woodside, N. Y.

ON READER-SERVICE CARD CIRCLE 91

## MICROWAVES

### X-band pump tubes

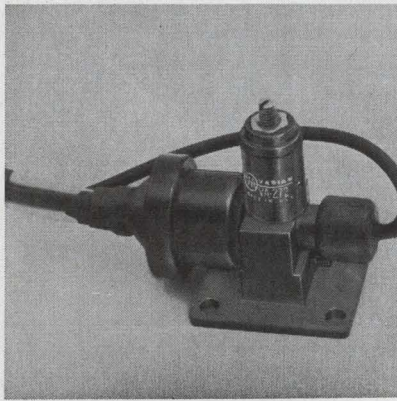

A series of 8-ounce X-band reflex klystrons, the VA-272, is available with a 5000-hour warranty.

They are molded to permit operation at high altitudes. Trimmable  $\pm 100$  MHz from center frequency, they put out 500 milliwatt min from 8.1 to 11.1 GHz. Beam power is 600 Vdc at 60 mAdc, temperature coefficient is  $\pm 150$  kHz/ $^{\circ}$ C max.

P&A: \$450; 90 days. Varian, 611 Hansen Way, Palo Alto, Calif. Phone: (415) 326-4000.

Circle No. 279

### Waveguide sliding short

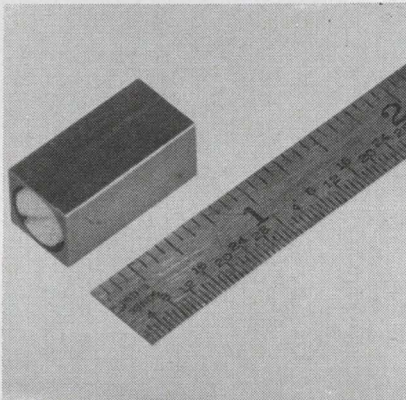

A 0.25-oz adjustable waveguide sliding short for WR-90 waveguide covers an 8.2 to 12.4 GHz range. The device consists of a 0.895-in. x 0.395-in. ID aluminum block with a nylon screw at one end. The short is secured in the waveguide by slightly withdrawing the screw before insertion so that the short binds at the desired plane of operation.

P&A: \$48; stock. Somerset Radiation Lab., Inc., P. O. Box 201, Edison, Pa. Phone: (215) 348-8883.

Circle No. 280

### X-band noise generator

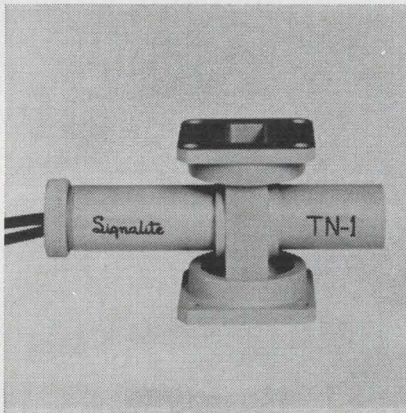

A miniature transmission-type 90 $^{\circ}$  E-plane noise generator, type TN-1, for use from 8.5 to 9.6 GHz in systems where space and weight are at a premium is available.

Specifications include 900 V starting spike and nominal operating V of 55 at 100 mA. Excess noise ratio is  $14.5 \pm 0.5$  dB, vswr is 2.1 max and cold vswr 1.25 max. Waveguide axis length is under 2-in., height, 4-in.

Signalite Inc., 1933 Heck, Neptune, N. J. Phone: (201) 775-2490.

Circle No. 281

### Dual frequency antenna

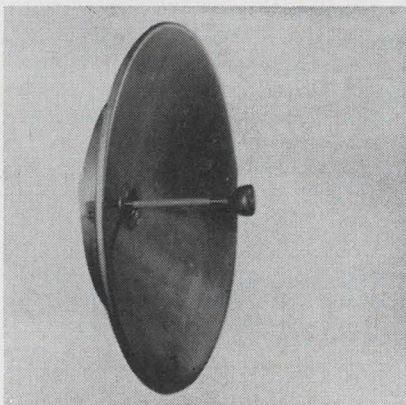

Simultaneous dual-polarized operation in both the 6 GHz and 11 GHz bands using a single parabola is possible with this dual-frequency antenna.

The antenna consists of a cylindrical feed with a fiberglass cap over the feed aperture and splash plate and an antenna disk. No radome required in direct radiator applications.

Availability: 2-3 months. Gabriel Electronics, North St., Saco, Maine. Phone: (207) 282-1526.

Circle No. 282

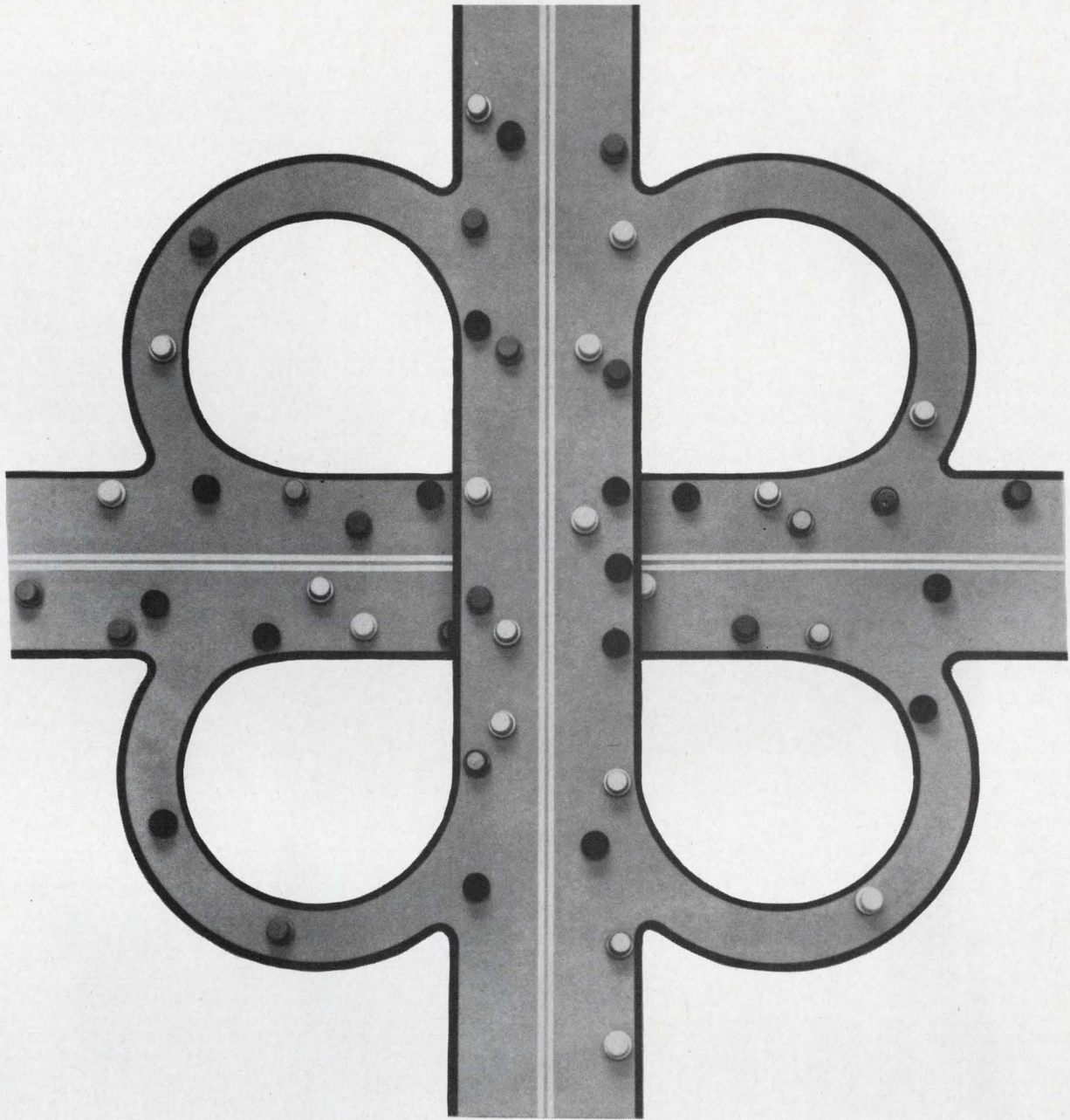

## 21,000,000 Car Owners Depend On Motorola Rectifiers

### For 1½¢\* per amp, you can, too!

Every day since 1960, the Motorola-developed — and patented — pressfit rectifier has been highway-proven in more than 100 billion device-hours of rugged operation in automotive alternators.

Now, this 25-ampere device is available for your medium-current industrial applications *up to 1000 volts* at low prices we defy you to find equaled anywhere else!

Consider these pressfit design advantages:

- you can save up to 75% mounting time — quick, economic, single-part mounting enables effective, secure heatsinking in about a fourth of the time necessary with stud devices
- Motorola pressfits give you 300-ampere current surge protection — unsurpassed by any other device in the up-to-25-ampere area
- life testing of the basic pressfit rectifier cell represent-

\*50-volt pressfit, large volume distributor quantities

ing over 1,400,000 device-hours at maximum ratings indicated a maximum expected failure rate as low as 0.005%/1000 hours

■ we test-sample and destroy nearly 1500 devices *each day* to ensure consistent rectifier quality and reliability

**FIND OUT NOW . . .**

How you can clip, clamp, saddle or “pressfit” these rectifiers into virtually *any* medium-current application *quickly* and *economically* — send for “Mounting Techniques for Pressfit Silicon Rectifiers” and a new “designers” data sheet . . . including “worst case” designs; see your Motorola distributor for evaluation units — do it today!



**MOTOROLA**  
Semiconductor Products Inc.

5005 EAST McDOWELL ROAD, PHOENIX, ARIZONA 85008

Speed Inquiry to Advertiser via Collect Night Letter  
ON READER-SERVICE CARD CIRCLE 92

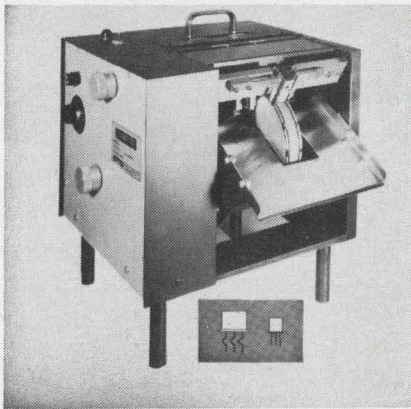

### Leads formed and cut

Transistor Leadmaster H-132 cuts transistor lead-wires and/or forms "dimples" for insertion into printed circuit boards.

Standard models operate on 110 Vac, 50-60 Hz with 220 V models available. Processing is up to 2500 transistors/hour, operator-controlled. Measurements are 14 x 13 x 13-in.

Heller Industries, 30 N. 15th St., East Orange, N. J. Phone: (201) 678-4131.

Circle No. 283

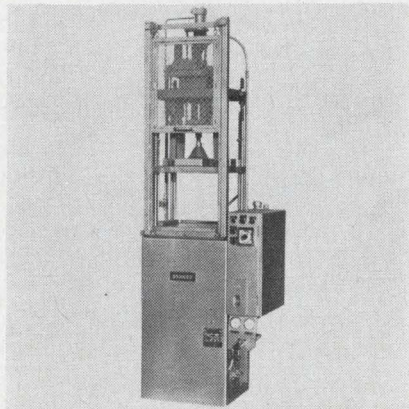

### Encapsulation press

This new 10-ton semi-automatic encapsulation press features bottom transfer with top clamp for quick mold servicing. The press, model 735-10, is designed for encapsulating components in low-pressure materials such as epoxies and silicones.

The press is powered by a 2 hp motor operating on 220/440 V, 60 Hz 3-phase current.

Pennsalt Chemicals Corp., 5500 Tabor Rd., Philadelphia. Phone: (215) 568-6700.

Circle No. 284



### Vacuum coater

This NRC 3116 high vacuum coater is designed to deposit substrate material 10<sup>-6</sup>-in. thick for micro-electronic operations. Features include a vacuum range to 10<sup>-8</sup> torr, log and linear scaled ionization gauge control, a 6-in. vacuum pumping system and a liquid nitrogen baffle. All controls are grouped in a one-position control panel.

Price: About \$4300. National Research, 160 Charlemont St., Newton, Mass. Phone: (617) 332-5800.

Circle No. 285

### PLASTIC SEALLESS PUMP

... for etching acids with no leakage  
Standard capacities are from 1/3 to 40 gpm

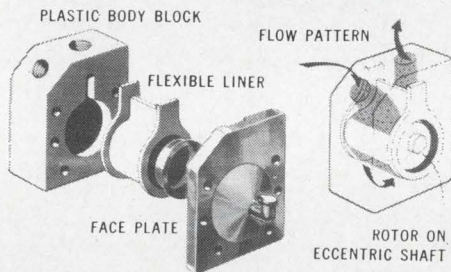

A rotor, mounted on an eccentric shaft in this plastic pump, rotates within a liner to create a progressive squeezing action on fluid trapped between the liner and the body block. All metal parts and mechanical action takes place inside the liner where fluid never reaches. This completely eliminates the need for stuffing boxes or shaft seals, guaranteeing no leakage.

The pump is self-priming, operates wet or dry and is suitable for extremely corrosive fluids, abrasive slurries or viscous materials. Applications include pumping of acids, alkalis, distilled water, diatomaceous earth slurries, electroplating solutions, ceramic tile glaze as well as shear sensitive emulsions.

Standard capacities are from 1/3 to 40 gpm with discharge pressure up to 50 psi. Materials of construction include Teflon, polypropylene, linear polyethylene, Bakelite or stainless steel for body blocks and Viton-A, Kel-F elastomer, Hypalon, Neoprene and Buna-N for the liner. These are the only parts in contact with the fluid.

For additional information, write Vanton Pump & Equipment Corporation, Hillside, New Jersey or telephone Area Code 201 926-2435.

ON READER-SERVICE CARD CIRCLE 93

Cut costs with world's smallest, uniquely produced Silvered Mica Capacitors

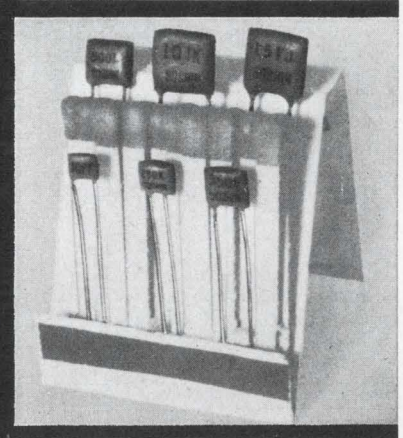

**SOSHIN**  
ELECTRIC CO., LTD.

18-18, Nakamagome 1-chome,  
Ohta-ku, Tokyo, Japan. Cables: SOSHINCAPACITOR TOYKO

### SOSHIN FMCON

- Smaller than and comparable in price to ceramic capacitors
- Excellent capacitance temperature characteristics

Type	Size (mm)			Maximum Capacitance (PF)	T. C.
	Area	Thickness (Max.)	Lead $\phi$		
FM05	5 x 5	5.0	0.3	10	D
FM06	6 x 6	5.0	0.4	25	D
FM07	7 x 7	5.0	0.4	43	D
FM08	8 x 8	5.0	0.4	75	E
FM09	9 x 9	5.0	0.5	110	F
FM10	10 x 10	5.0	0.5	150	F

Various other types are also available.

ON READER-SERVICE CARD CIRCLE 94



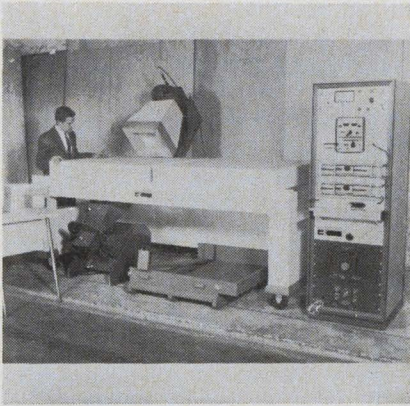

## Dielectric measurement

This series of interferometers provides a free space measurement of dielectric constant and loss tangent. Dielectric constants of 1 to 79 can be measured to  $\pm 2\%$  and loss tangents of 0 to 14 are determined to  $\pm 0.003$  or  $\pm 5\%$ . Sample size is 18-in. x 18-in. x 3-in. for best accuracy. The unit operates in a 0.95 to 1.50 GHz range.

P&A \$15,000 to 20,000 by frequency, 90 days. Emerson & Cuming, Inc., 59 Walpole St., Canton, Mass. Phone: (617) 828-3300.

*Circle No. 286*

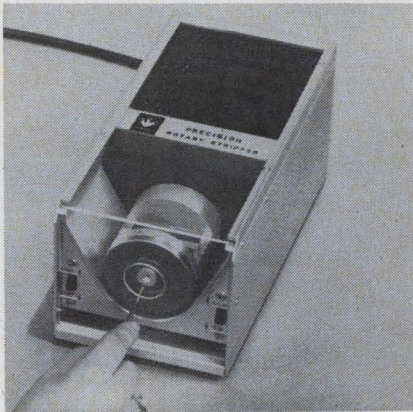

## Rotary wire stripper

Consistent nick-free wire stripping on a production basis is reported to be achieved with this rotary wire stripper. It handles solid or stranded conductors with single layer insulation in sizes from AWG #16 through #26. It will precision-strip slick insulation such as Teflon or PVC with thicknesses up to 1/32-in. and over-all wire diameters up to 1/4-in.

P&A: \$225; stock. Ideal Industries, Sycamore, Ill. Phone: (815) 895-5181.

*Circle No. 287*



## WE'RE PROLIFERATING!!

We've developed an entirely new line of Press-Lite switches and press-to-test indicator lights—including a high quality series of lights and switches that meet industry standards for appearance and performance.

We're proliferating in the catalog department, too. Write for complete details of the industry's finest line of neon lamps, indicator lights, illuminated push-button switches and their transistorized or EMI shielded versions. Many options available.



**MARCO-OAK INDUSTRIES**

A DIVISION OF **OAK ELECTRO/NETICS CORP.**

207 SOUTH HELENA STREET, ANAHEIM, CALIFORNIA 92803

PHONE: 714-535-6037 • TWX: 714-776-6111

ON READER-SERVICE CARD CIRCLE 95

# vactec photocells

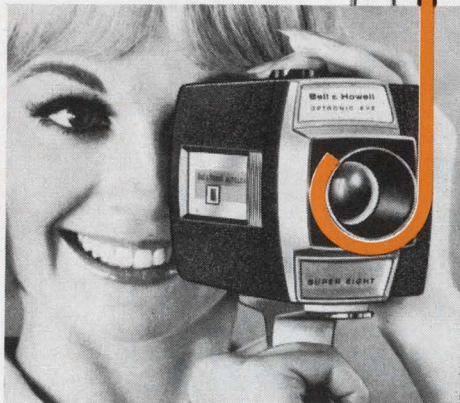

## An important component in Bell & Howell's New Autoload® 431 Super 8 Movie Camera

The Optronic Eye in Bell & Howell's Model 431 Super 8 Movie Camera is described as the most precise automatic exposure system ever developed. And Vactec was selected to supply the photocells which must automatically sense, adjust, and check exposure accuracy. One more example of how manufacturers who want the finest, specify Vactec light sensitive devices.

If your product requires dependable photocells, contact Vactec. A complete line of standard types is available, or Vactec will custom design units to meet special requirements.

Write for Bulletin PCD-3 for Cadmium Sulfide and Selenide types; Bulletin SPV-4 for Selenium photovoltaic types.



2423 Northline Industrial Blvd. • Maryland Hts., Mo. 63045  
Phone Area Code 314, HE. 2-4200

ON READER-SERVICE CARD CIRCLE 96

## NEON or INCANDESCENT SUB-MINIATURE INDICATOR LIGHTS

MEET OR EXCEED ENVIRONMENTAL AND OPERATIONAL REQUIREMENTS OF MIL-L-6723 AND MIL-L-3661

**Miniaturization** is made possible by the wide selection of Dialco Sub-Miniature Indicator Lights for mounting in 15/32" or 17/32" clearance hole. Among the features offered are: Watertight construction; resistance to vibration and corrosion; high-heat plastic or glass lenses; anti-rotation (locked) construction; phenolic insulation of military specification grade.

**Neon** assemblies accommodate T-2 lamps in two types: NE-2D (MS25252) for 105-125V AC-DC; and High Brightness NE-2J for 110-125V AC only. In DIALCO units, the current limiting resistor is built-in (U.S. Pat. No. 2,421,321).

**Incandescent** assemblies accommodate T-1¾ lamps in voltages from 1.35 to 28V—with life ratings to 50,000 hours.

SAMPLES ON REQUEST—AT ONCE—NO CHARGE.

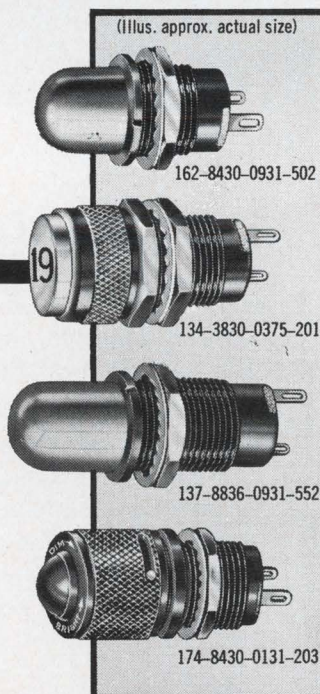

WRITE FOR CURRENT CATALOG

**DIALCO**®

Foremost Manufacturer of Indicator Lights

**DIALIGHT** CORPORATION

60 STEWART AVENUE, BROOKLYN, N.Y. 11237

212 HYACINTH 7-7600

ON READER-SERVICE CARD CIRCLE 97

## PRODUCTION

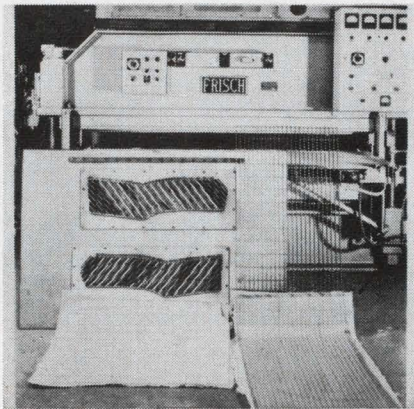

## Dielectric press

The Bondmaster dielectric press turns out a set of two panels every 10 to 20 seconds. The photo above shows a finished untrimmed set of panels.

The unit can emboss and bond sandwich laminations of plastic, metals, wood and other materials.

Features include leveled platens, shielding from RF interference, automatic cycling, and ease of loading and interchange.

Frisch Corp., div. of Allen Industries, Inc., 1414 W. Wabansia, Chicago. Phone: (312) 278-7440.

Circle No. 294

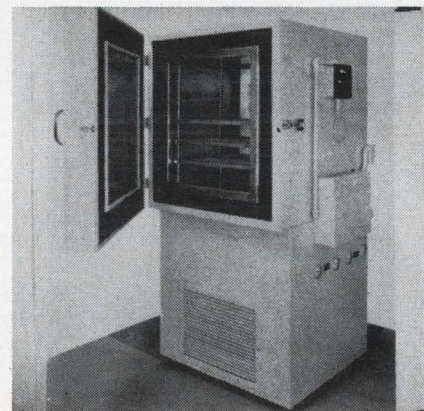

## Environmental chamber

Designed especially for the testing of electronic components, the model U-100-4 has a temperature range from ambient to -100°F. The stainless steel chamber is 20 x 20 x 18-in. An 8-in. air circulator is provided to minimize air stratafication. Three adjustable shelves are provided to ease parts handling.

Cincinnati Sub-Zero Products Inc., 2612 Gilbert Ave., Cincinnati, Ohio. Phone: (513) 715-8810. TWX: (513) 577-1793.

Circle No. 295

# 3 ways you can use the Raysistor<sup>®</sup> to improve your product, cut costs

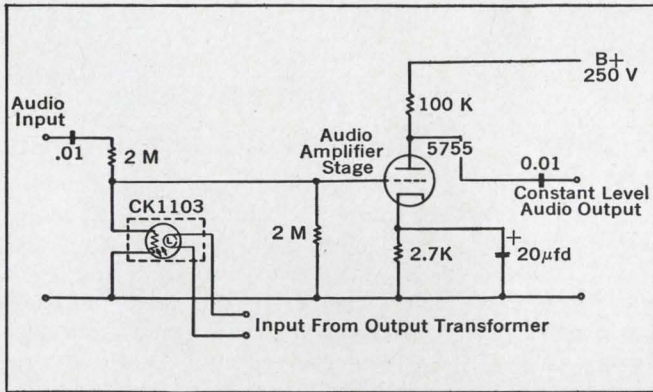

**1. Use the Raysistor<sup>®</sup>** as a simple remote or automatic volume control in SSB suppressed carrier receivers. Feeding part of the audio output into the control light source varies the resistance of the Raysistor's photocell, making it usable in place of a normal volume control.

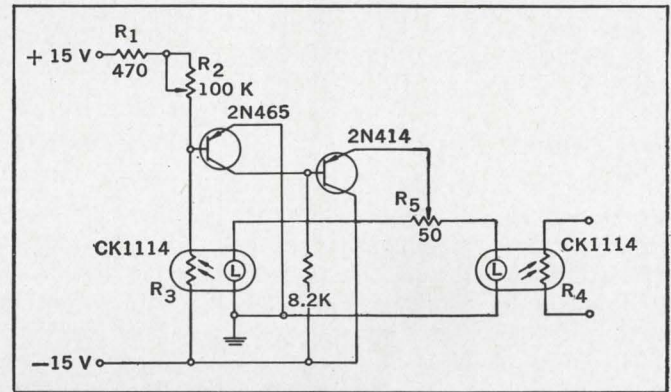

**2. As a remotely controlled linear potentiometer.** The Raysistor can be used as a remotely controlled linear potentiometer when used in the circuit shown above. Here the Raysistor forms a voltage divider between the positive and negative voltages.

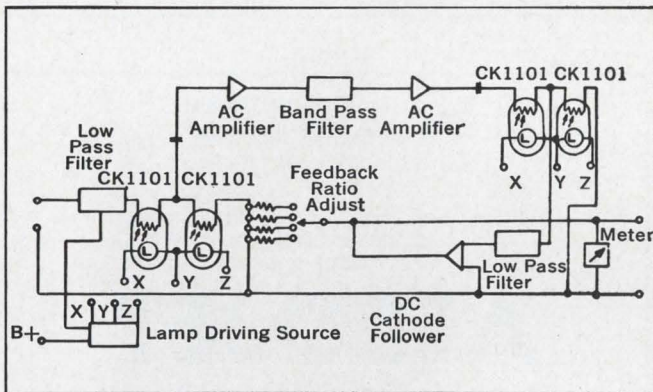

**3. As a photochopper stabilized D-C microvoltmeter.** Raysistors, used as photochoppers in both modular and demodular circuits, enable d-c levels to be measured to a fraction of a microvolt. They facilitate synchronous detection and demodulation with simple electrical coupling, have less noise than transistor choppers, while avoiding maintenance problems of mechanical choppers. Other photochopper applications: photochopper relay, series or shunt chopper, modulator circuit, and as a stabilizer to reduce long-term drift.

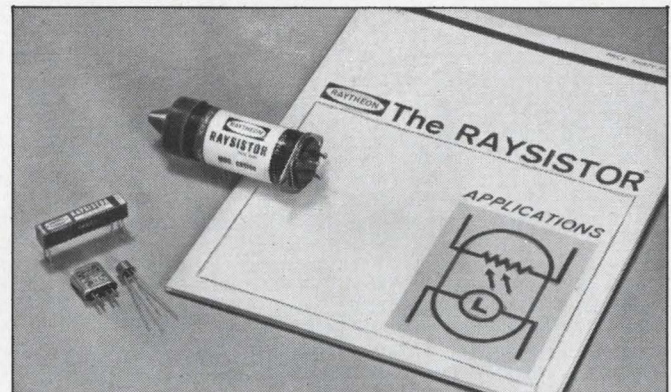

**Many more ways you can use the Raysistor.** Send for *The Raysistor Applications Manual* which describes ways you can use this unique optoelectronic component as a photochopper, variable resistor, solid-state switch, relay, voltage or signal isolator, nonlinear potentiometer, etc. For complete specifications and prices, call your Raytheon distributor or regional sales office. For a copy of this 28-page manual, circle the reader service card or write *Raytheon Company, Components Division, 141 Spring Street, Lexington, Mass. 02173.*



Raytheon Components Division—A single source for Transistors/Diodes/Integrated Circuits/Industrial Tubes/Control Knobs/Panel Hardware/Raysistors/Circuit Modules/Display Devices

ON READER-SERVICE CARD CIRCLE 98

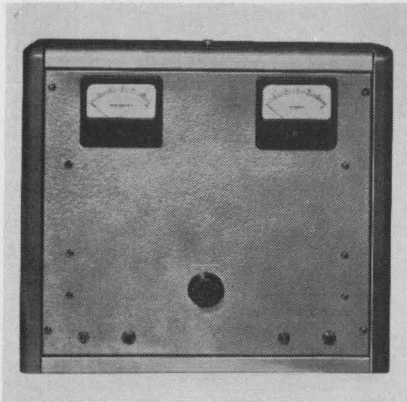

### Dc power supply

This new unit, model LAB-35, is a continuously variable 0 to 35 kVdc supply with a current output of 4 mA at 35 kV. Regulations against line and load are better than 0.5% with ripple less than 0.25%.

The units are supplied in a 19-7/8 x 21-3/4 x 18-in. all-metal cabinet.

Price: \$775 with hV and I meters. Spellman High Voltage Co., 1930 Adey Ave., Bronx, N. Y. Phone: (212) 547-0306.

Circle No. 288



### Programmable power

These 100% silicon twin amplifier power supplies control V or I with automatic crossover to either mode. Remote sensing and programmability and automatic series or parallel operation are provided in these 100 V, 5 A models.

These short-proof units reduce transistor dissipation without SCRs.

Price: \$185-199. Deltron, Inc., Wissahickon Ave., North Wales, Pa. Phone: (215) 699-9261.

Circle No. 289

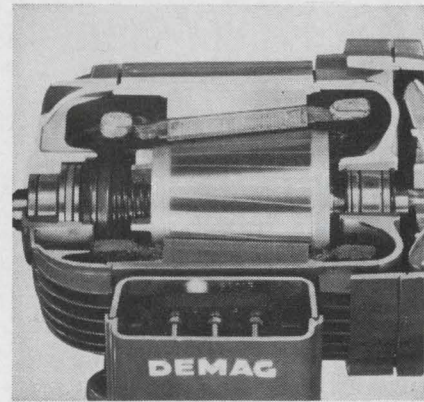

### Conical rotor brakemotor

These 1/4 hp to 40 hp brakemotors combine a conical-rotor ac motor and mechanical brake. With power off, the spring-loaded sliding rotor is displaced to the brake position. With power on, the brake is released. A "microspeed unit" permits programmed selection of high and vernier speeds for precise indexing.

P&A: \$79 to \$750; stock. American Demag Corp., 375 Park Ave., New York. Phone: (212) 752-7280.

Circle No. 290

# New DC Scope!

## ... the Heathkit® 10-14

- Sets New Standard for Performance & Value . . . \$299.00 Kit . . . \$399.00 Assembled
- DC to 8 mc Bandwidth—0.04 usec. rise time • Calibrated Vertical Attenuator — .05 v/cm to 600 v. (max.) Input • Triggered Sweep — 18 calibrated rates • Delay-Line Vertical Amplifiers for Fast Rise Signal Analysis • Electronically Regulated Power Supplies — Forced Air Cooling • Built for Continuous-Duty Industrial & Lab Use

A 5" DC scope with calibrated time base & 5X sweep magnifier. For 115/230 volt, 50-60 cycle operation.

Kit 10-14, 45 lbs. . . . \$299.00  
Assembled 10W-14, 45 lbs. . . . . \$399.00

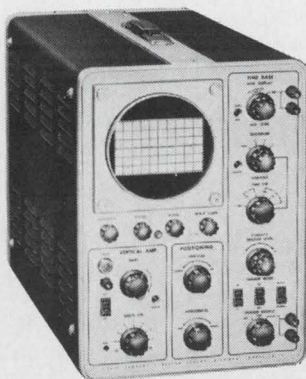

### FREE CATALOG!



Fully Describes Over 250 Heathkit Electronic Products

Heath Company, Dept. 520-26  
Benton Harbor, Michigan 49022

Please send FREE Heathkit Catalog & Information describing the New Heathkit 10-14 Oscilloscope

Enclosed is \$ \_\_\_\_\_, plus shipping. Please send model \_\_\_\_\_.

Name \_\_\_\_\_  
Address \_\_\_\_\_  
City \_\_\_\_\_ State \_\_\_\_\_ Zip \_\_\_\_\_

Prices & specifications subject to change without notice.

TE-141

ON READER-SERVICE CARD CIRCLE 99

## WANTED

at

Von Karman Center  
of

# AEROJET

(25 miles east of Los Angeles)

## CREATIVE ELECTRONIC CIRCUIT DESIGNERS

Our unique microelectronic circuit capability has entered the applications and production stage for both military/aerospace and commercial consumption.

Circuit designers with solid-state and/or integrated circuit experience are needed in the build-up required to meet our demands. Backgrounds in commercial design, in RF and video, in communications and telemetry are especially sought.

U.S. CITIZENSHIP REQUIRED

To expedite your interview, send personal resume to:

Mr. R. S. Lawrence

P. O. Box 303 ed, Azusa, California



A subsidiary of the  
General Tire & Rubber Co.

An equal opportunity employer

ON CAREER-INQUIRY FORM CIRCLE 907

ELECTRONIC DESIGN

## FM discriminator

A solid-state FM discriminator provides phase-locked-loop or pulse-averaging detection. The S26 discriminator, 26C channel selector, and 26F output filter form a unit 3-1/2-in. high by 2-in. wide. Seven units plus an S27 rack-mount, or eight units with optional internal power supplies, can be plugged in. Center frequency is 300 Hz to 1.2 MHz with output frequency response of dc to 50 kHz.

Sonex, Inc., 20 E. Herman, Philadelphia. Phone: (215) 843-6400.

Circle No. 291

## Memory system

The CD 50 memory system is a random-access ferrite-core storage system with a 750 ns read-write cycle time and a 300 ns access time. Memory organization is 3-wire X, Y and sense, thus allowing faster cycle times due to the lack of a sense-inhibit recovery period.

Clear/write, read/restore and read/modify/write are standard operating modes. The CD 50 provides a large word capacity (to 65,536 words) and long word lengths (to 80 bits per word). Stacks containing 32,768, 16,384 or 8,192 words can be built using a single frame type. The stacks employ 22-mil ferrite cores and are packaged as completely pluggable units. Temperature-compensated drive currents provide operation over a 0°C to +50°C range.

Lockheed Electronics Co., 6201 E. Randolph St., Los Angeles. Phone: (213) 722-6810.

Circle No. 292

## Spectral source

This spectral source system produces short duration light pulses of 4 ns, with less than 1.6 ns rise and fall times.

This unit can be used as a very short range measuring radar as an aid in the study of fast decaying tissue, chemicals, and even molecular structure, and for other laboratory and industrial uses. Pulse repetition rates are variable from 10 Hz to 5 kHz in eight discrete steps.

TRW Instruments, 139 Illinois, El Segundo, Calif. Phone: (213) 679-9101.

Circle No. 293



# TECHNO

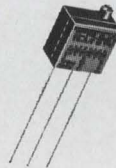

MODEL 12  
ACTUAL SIZE

**1/4" techno  
trimmer  
solves the  
space race!**

The small size advantage of a multitrans (25:1) trimming potentiometer that measures only 1/4" square and an equally valuable power rating of 0.5 watt at 50°C, that's what you'll get when you use Techno's Series 10 precision trimmers. Series 10, wire-wound trimmers, are available in resistance ranges from 100 ohms to 25K ohms with a standard ±5% tolerance. The standard TC is 50 PPM/°C throughout the operating temperature range of -65° to 175°C. Meets applicable MIL-SPECS, too!

Models are available with top or side screw adjustment and in bottom pin styles with printed circuit board standoffs or for flush mounting. All styles have standard printed circuit pin spacing of .100" center-to-center.

You'll find that Techno's exclusive "two-half" case construction signifies 100% inspection before and after assembly. This means the assurance of the highest trimming potentiometer quality and reliability for you. Can you use the advantage of a 1/4" trimmer from Techno? For full details, call or write:



## TECHNO-COMPONENTS CORP. TECHNO

7803 LEMONA AVENUE · VAN NUYS, CALIFORNIA 91405 · (213) 781-1642

ON READER-SERVICE CARD CIRCLE 100

# LOW-INDUCTANCE triggered discharge SWITCH

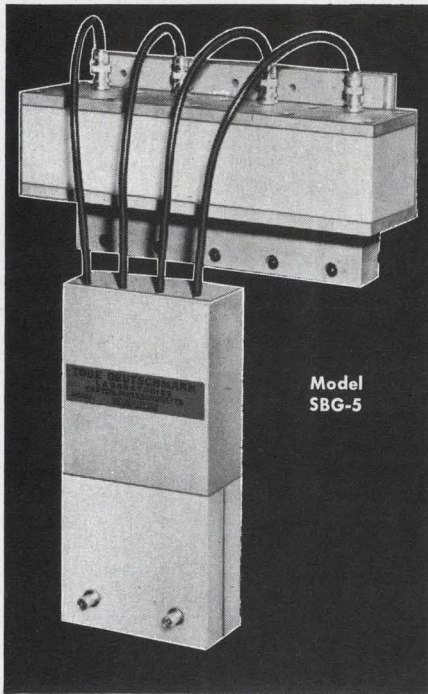

- **Operating voltage:** 20 kilovolts
- **Peak current:** 750 kiloamperes
- **Energy transfer:** 3000 joules
- **Self-inductance:** 5 nanohenries
- **Life:** 10,000 discharges

The TOBE Model SBG-5 Switch is of multi-channel spark-gap configuration, with a unique method of simultaneous gap-firing that achieves a 50-nanosecond delay, with total system-jitter below 5 nanoseconds.

The high-voltage trigger-system furnished with the switch fires on a 250-volt positive pulse. The necessary charge of 10 kv at 1 ma. can easily be taken from the 20-kv capacitor-charging supply, through a suitable dropping resistor.

Detailed information about dimensions, acceptance tests, and mountings is given in Bulletin EB365-60 available, on request:

*And write or call us  
whenever you have special or  
unusual requirements.*

**TOBE DEUTSCHMANN**  
LABORATORIES   
CANTON, MASSACHUSETTS 02021  
Telephone (617) 828-3366

ON READER-SERVICE CARD CIRCLE 101

## SYSTEMS X-Y recorder

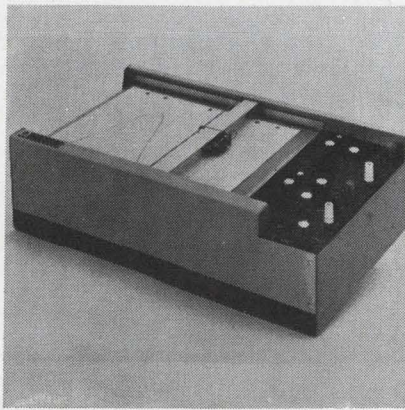

A 100  $\mu\text{V}/\text{in.}$  sensitivity is featured in the model F-60 X-Y recorder. The 8-1/2 x 11-in. unit offers 1 Meg input Z. Accuracy is 0.1% full scale and input is floating and guarded. The recorder uses a cartridge-type pen and enclosed feedback potentiometers. A vacuum system permits the operator to change position, load or remove paper while the system is in operation.

Varian, 611 Hansen Way, Palo Alto, Calif. Phone: (415) 326-4000.  
*Circle No. 296*

## Panel mounting printers

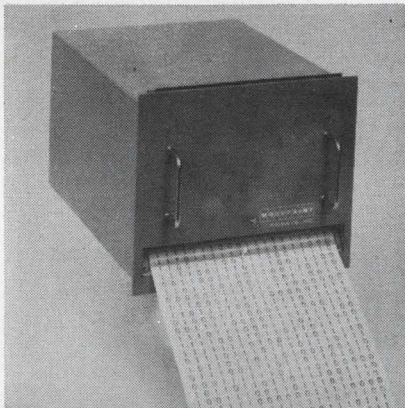

A series of panel mounting printers, the Moduprinters, presents tape printed data in binary form. According to size, they have capacities for 9, 14 or 20 bits. Each bit needs 6 ms minimum to reach 1 or 0. Maximum line printing rate is 6/s. The printer functions may be split up to print time, date or decimal serial count.

P&A: \$215; 4 to 6 wks. Presin Co., 226 Cherry, Bridgeport, Conn. Phone: (203) 333-9491.

*Circle No. 297*

## Digital strip printer



A full complement of 64 alphanumeric characters is featured in Model 120A digital strip printer. The unit prints a single line along a 1/2-in. wide paper tape.

Said to contain more characters than most typewriters, it is reported to be able to print out almost any kind of desired data. The printer measures 3 x 6-1/8 x 8-5/8-in. deep.

Anelex, Franklin Electronics, Bridgeport, Pa. Phone: (215) 272-4800.

*Circle No. 298*

## Sweep isolator head

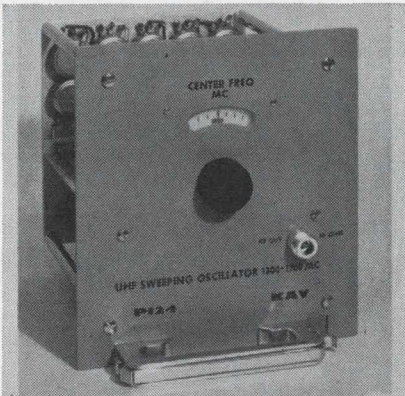

Designed for use with the company's model 121 oscillator, the P124 plug-in sweep oscillator head extends the frequency range from 1.3 to 1.7 GHz. The solid-state unit features a 400 MHz sweep width and a full 0.5 V rms output held constant to  $\pm 0.5$  dB by fast AGC circuits. Center-frequency and sweep-width are variable.

P&A: \$395; 5 to 6 weeks. Kay Electric, Maple Ave., Pine Brook, N. J. Phone: (201) 226-4000.

*Circle No. 299*

# Capacitor reliability makes the grade

$$F(x) = 1 - \exp\left[-\frac{x^B}{\alpha}\right]$$

**Graded reliability: exclusive with KEMET KG solid tantalum capacitors. Through accelerated test techniques, we establish reliability data covering your specific order. Graded failure rates range as low as 0.001% per thousand operating hours.**

This failure rate prediction comes from an adaptation of the Weibull distribution function, in a special control test sequence and chart form. Its validity has been confirmed by test data covering billions of capacitor hours.

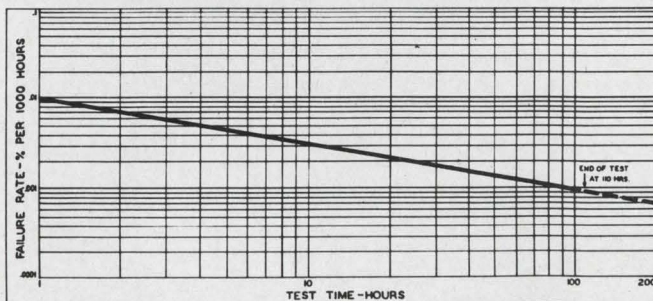

**REGIONAL SALES OFFICES. East Coast:** J. G. Egan, 1341 Hamburg Turnpike, Wayne, New Jersey 07472. Phone: 201-696-2710. **Mid-Atlantic:** R. H. Robecki, 1341 Hamburg Turnpike, Wayne, New Jersey 07472. Phone: 201-696-2710. **Mid-West and South:** K. S. Collart, P. O. Box 6087, Cleveland, Ohio 44101. Phone: 216-221-0600. **West Coast:** B. G. Bryant, 701 East Whittier Blvd., Whittier, California 90605. Phone: 213-698-8077.

KEMET is a registered trade mark of Union Carbide Corporation.

KEMET KG solid tantalum capacitors with predicted reliability are available from 0.0047 to 330 microfarads, 6 to 100 VDC, for continuous operation from -55 to 125°C. Standard tolerances 10 and 5%. Closer tolerances on request.

Graded reliability: another reason to think of KEMET capacitors. For details on these, or our other tantalum capacitors, call our nearest office, or mail the coupon.

Clip, fill in name and title, attach to letterhead

Union Carbide Corporation  
Linde Division, Dept. ED-42  
270 Park Avenue, New York 10017

Please send details on High-Reliability  
KEMET Solid Tantalum Capacitors

Name \_\_\_\_\_

Title \_\_\_\_\_

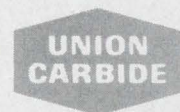

**ELECTRONICS**

ON READER-SERVICE CARD CIRCLE 102

## Coaxial load resistors

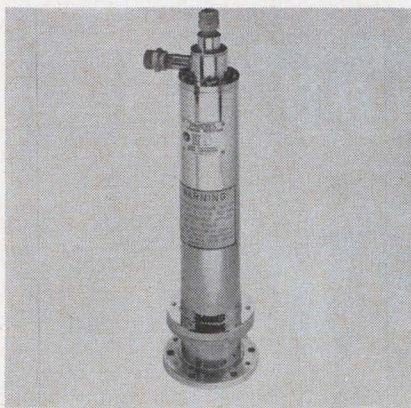

A 450 times smaller installation space and a 75 lb weight reduction are claimed for Model 8762 coaxial load resistor. The unit is directly water-cooled. Uses include termination of a 50- or 51.5-ohm system. Models 8762, 8752, and 8742 are rated at 50, 25 and 15 kilowatts, respectively.

P&A: \$3000 (model 8762); 120 days. Bird Electronic, 30303 Aurora, Cleveland. Phone: (216) 248-1200.

Circle No. 300

## Power amplifier

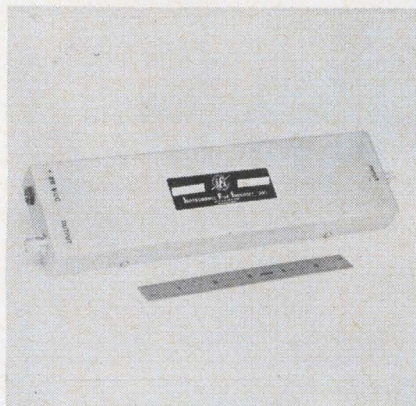

A series of low noise, silicon wide-band power amplifiers provide 1 W cw min into 50  $\Omega$  over 10 kHz to 100 MHz without tuning. Power gain is 50 dB min and frequency response is  $\pm 1$  dB at full power output. Input impedance is 50  $\Omega$  nominal. Power gain to 60 dB and impedances to 1 Meg are optional.

P&A: About \$1500; 45 days. Instruments for Industry, Inc., 101 New South Rd., Hicksville, N. Y. Phone: (516) 681-7100.

Circle No. 301

## Zig-zag antenna

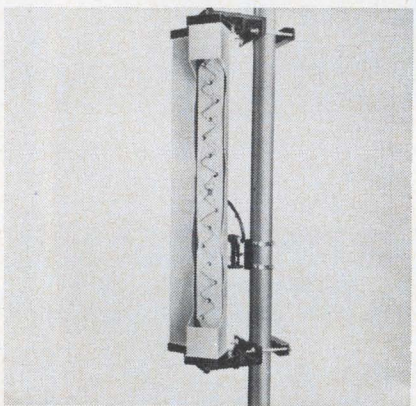

Designed for transmitting ETV signals at 2.5 GHz, a two-panel zig-zag antenna can be used for tailoring a transmission pattern to an area coverage. Panels can be used separately with azimuth beamwidth of about 65°, or combined in arrays to cover up to 360°. Gain is reported to exceed 20 dB for most arrays.

Jerrold Electronics, 15th and Lehigh, Philadelphia, Pa. Phone: (215) 226-3456.

Circle No. 302

## High-speed computer

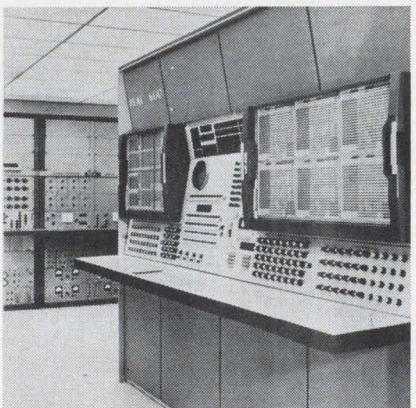

Operation up to 1,000 times faster than "real time" is possible with the new REAC-600 analog computer. The unit can be "married" to a digital computer to form a hybrid system combining analog speed with digital accuracy. The REAC-600 contains 300 high-speed op-amps. The computer can simulate the 12-hour activities of a space vehicle in less than a minute.

Dynamics Corp. of America, Roosevelt Field, Garden City, N. Y. Phone: (516) 746-8100.

Circle No. 303

## Printing counter

A new design approach reported to eliminate reset problems is featured in the Series 1968 Miniprint counter. A quick-lever-rest unit with printing wheels, the 4-figure unit measures 1-3/32 x 1-3/16 x 3-3/4-in. The wheels are locked when the power is off during the printing cycle to assure clear printout. Nominal power use is 8 W.

Veeder-Root, Hartford, Conn. Phone: (203) 527-7201.

Circle No. 304

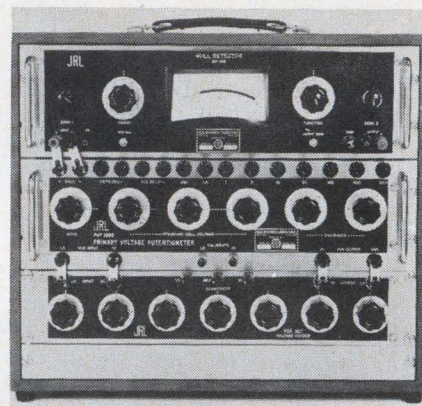

## Ratiometric system

With three plug-ins, this portable ratiometrics instrumentation package is a voltage measuring system covering 0 to 1100 Vdc. Accuracy is up to 0.0002%  $\pm$  0.1  $\mu$ V full scale with self-calibration. A null detector and voltage divider are basic modules to the system. The null detector provides general purpose galvanometer capabilities with a sensitivity of  $\pm$  0.1  $\mu$ V. The divider provides 1 ppm ratio capability with seven-digit resolution.

By substituting a primary resistance bridge plug-in for the pot, the system becomes an ohmmeter with 1 k $\Omega$  to 10 Meg full scale range, 7-digit resolution and accuracies to 0.0005%  $\pm$  1 ppm. Current measurements may be obtained by combining supplied resistance standards and voltage system plug-in.

Auxiliary plug-ins extend capabilities to the kV and nV ranges, or to the G $\Omega$  and  $\mu$  $\Omega$  ranges. The complete package measures 17-in. by 2-in. and weighs 40 pounds.

Julie Research Labs., Inc., 211 W. 61st St., New York, N. Y. Phone: (212) 245-2727.

Circle No. 305



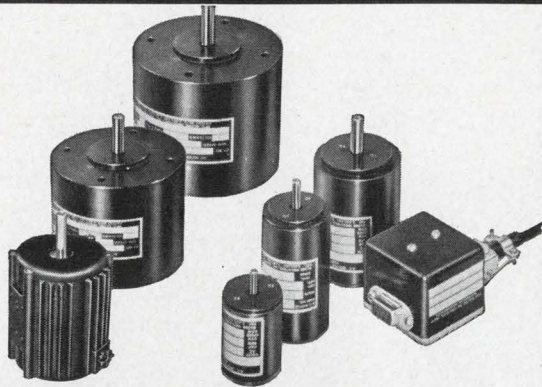

### 217 BRUSHLESS D.C. MOTORS

217 variations of 6 basic frame sizes—Globe offers you all the advantages of a brushless d.c. motor (no brush dust, no brush replacements, no arcing, extremely long life) in 217 standard, proven motors! No matter what your requirement in a brushless d.c. motor up to .1 HP, look to Globe. Our compact transistor inverter is mounted separately from the motor in its own enclosure. Separate mounting follows best engineering practice, by isolating the transistors from motor heat. Virtually any performance you require may be furnished. Be sure to ask Globe when you need one motor or 10,000 motors with brushless d.c. design.

Request Bulletin BR-3. **Globe Industries, Inc.**,  
2275 Stanley Ave., Dayton, Ohio 45404  
Tel. 513-222-3741

**GLOBE**

ON READER-SERVICE CARD CIRCLE 103

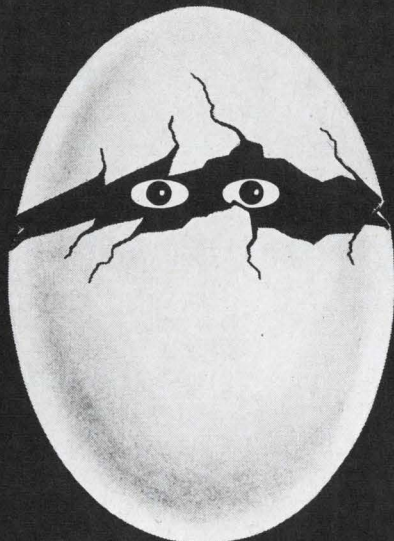

## LOOK WHAT'S HATCHED AT LITTELFUSE

The world's smallest fuse—Picofuse.  
1/8 thru 5 amps...1/6 grain...125 v.

**LITTELFUSE**

DES PLAINES, ILLINOIS

ON READER-SERVICE CARD CIRCLE 104

April 12, 1966

# who said you can't design a plugboard programming system to withstand severe shock?

## MAC Panel has done it!

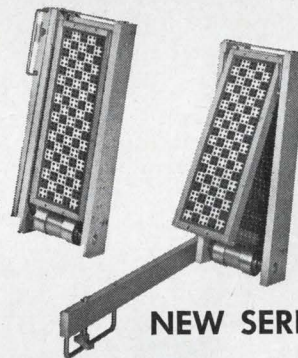

**NEW SERIES 140**

MAC Panel's Series 140 Plugboard Programming Systems are available in a wide range of sizes . . . each designed and engineered to withstand the severest shock and vibration under operating conditions. Tested to 50G without self-generated contact noise. And life tested to 10,000 cycles with only random variation in contact voltage drop.

Not enough facts? Here are more: You can only insert plugboards one way. Receptacles are available for standard taper pins or series 53 pins. Contacts are spaced on  $\frac{1}{4}$ " x  $\frac{1}{4}$ " grid to allow more positions in a minimum of space.

How about plugwires? The new Series 140 Plugwires are interchangeable with most existing systems. Ball-D-Tent design prevents accidental dislodging, won't mar the surface.

Want more facts? Write today . . . outline your specific needs and let MAC engineers come up with the answers. They usually do.

**MAC**  
O.E.M. DIVISION

**MAC PANEL CO. High Point, N.C.**

ON READER-SERVICE CARD CIRCLE 105

# New Literature

## RF connectors

This new 28-page catalog simplifies selection of RF connectors and coax. The 2-color catalog RF-2 tabulates 7 basic steps in connector selection. Mounting specifications, dimensions and cable matching information are included for over 30 types. The coax section offers electrical and dimensional information and matching connectors. Extensive attenuation rating tables aid in selecting coax for given frequency and power requirements. Amphel.

Circle No. 306

## Wire and cable guide

This new wire and cable specification guide cites the proper polyethylene and nylon resins for use in insulating and jacketing many kinds of wire and cable. Included are communication, power, signal and control cable, military and miscellaneous constructions. Du Pont.

Circle No. 307



## Servo amplifier guide

A new 6-page, 2-color dc servo power amplifier selection guide is offered. The illustrated guide describes a complete line of high power, solid state dc operational power amplifiers. Features include guidelines for selection of power rating and motor resistance, plus complete information on output, input and transfer characteristics. Inland Controls, Inc.

Circle No. 308

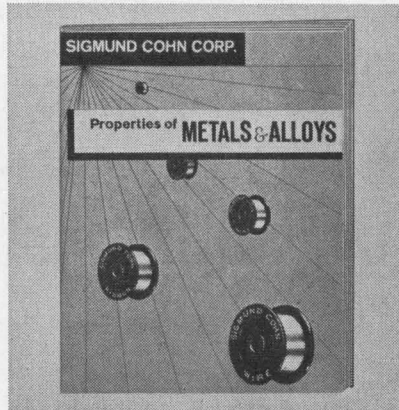

## Metals and alloys

Facts and figures pertaining to physical and electrical characteristics of over 50 precious metals and alloys are presented in chart form for reference purposes. Classifications covered include platinum group metals and alloys, pure base metals, gold and gold alloys, copper base alloys and iron and nickel base alloys. The availability of each in sheet, wire or ribbon is indicated. Sigmund Cohn Corp.

Circle No. 309

## Microwave packaging

A 2-color, 8-page catalog on "Tapered and Narrow-Height Components" is offered. Catalog 0-66 provides data and specifications on components ranging from waveguide-to-coax adapters to transformers. More than 50 models having waveguide sizes from MDL-A75 to MDL-A284 are tabulated. Microwave Development Labs.

Circle No. 310

## Process control

A comprehensive review of industrial process control instrumentation is contained in this new catalog. The 32-page brochure is illustrated with photographs, sketches, schematics and dimensioned drawings as well as selection charts and equipment listings. Included are such instruments as digital, dial and disc indicators, strip chart recorders, universal and transducer indicators, calibrators and accessory equipment. BLH Electronics.

Circle No. 311

## Sample and hold amplifier

This 2-page technical bulletin on model 101 sample and hold amplifier describes limiting conditions required for stability, reliability and accuracy in digital computerized analog-control and telemetry data systems. A sample and hold connection diagram for 1% analog holding per hour is given along with a digital-analog control interface diagram. Applications and specifications are included. Pacific Data & Controls.

Circle No. 312

## Sync generators

A 4-page technical data sheet 6-415 on miniaturized rack-mounting sync generators and accessories is offered. Included are specifications and details on sync generators, genlock, color standard, dot-bar generators and automatic changeover switching. Cohu Electronics.

Circle No. 313

## Technical daffynitions

This 16-page "glossy glossary of terms" relating to connectors and other areas of application is intended to add a little levity to the lives of serious-minded engineers. Pyle-National Co.

Circle No. 314

## Tunable LC networks

This illustrated 4-page bulletin MTLC-65-2 describes tunable LC networks in a TO-5 can for use in LC tuners, phase detectors and FM discriminators. Detailed information is given on these miniature circuits which typically consist of toroidal transformer, variable and fixed capacitor. Applications mentioned range from phase cancelling to impedance matching. Detailed specifications for ten standard tunable LC networks, schematic diagrams for typical circuits and a representative response curve are also shown. JFD Electronics Corp.

Circle No. 315

Hoffman provides semiconductors of inherent reliability completely compatible with the manufacturer's needs.

The Hoffman "N" series solar cell, an N/P, shallow diffused, photovoltaic device is optimized for operation in the spectrum of space. These cells are tested and qualified for radiation resistance in accordance with GSFC (NASA) Specification No. 63-106. An electrically conducting grid has been sintered to the active surface to reduce sheet resistance and thus increase conversion efficiency.

These physical characteristics are manufacturing tolerances for all Hoffman Semiconductor Solar Cell Types.

1. OHMIC CONTACT: (A) Electrically continuous and mechanically bonded. (B) Extends to .032 inches from the edge of the cell.
2. GRID LINES: Guaranteed to .100 inch tolerance. Hoffman's photo masking technique assures complete mechanical tolerances.
3. EDGE CHIPS: .010" wide, .100" long not to exceed one such chip per top and one per bottom edge of cell.
4. CORNER CHIPS: .030" on the hypotenuse of the chip.
5. WEIGHT: N120CG .18 Gr. Avg.    N220CG .36 Gr. Avg.  
                   N210CG .18 Gr. Avg.    N230CG .54 Gr. Avg.

Typical Electrical Specifications

2 x 2cm cell.....430 mV @ 135 mA  
 1 x 2cm cell.....430 mV @ 65 mA

Test Temperature: 28°C ± 2°C.

Hoffman solar cells are coated with silicon monoxide to render the active area anti-reflective to obtain maximum use of solar energy. These cells withstand temperature excursions from -196°C to +200°C.

STANDARD ENVIRONMENTAL TEST: Each lot of cells is immersed in boiling DI water for periods to one hour followed by a live steam test for a comparable period.

All of these advantages insure complete compatibility of products for industrial uses.

a little...

or a lot

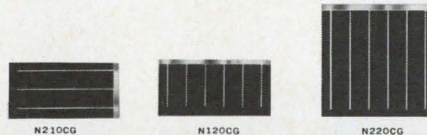

Hoffman solid state photo-sensing devices are now being used for measuring, cloth cutting, sequence counting, liquid level gauging, data processing and other manufacturing functions requiring absolute accuracy.

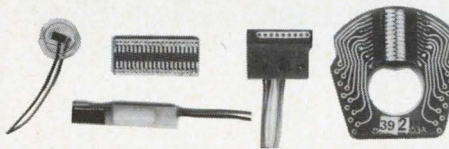

TYPICAL INDUSTRIAL COMPATIBLE PRODUCTS: A shaft encoder is currently being produced to mechanical tolerances of ±.0005" and electrical parameters matched within 2%. Data processing readouts are being produced with an I<sub>a</sub> of 3 μA max. at 1.5 volts reverse bias. Other sensing elements are being made with active areas as small as .002" x .023" and as large as 2.5" x 1.0".

For additional information regarding these products write: Hoffman Electronics, Dept. A, El Monte, Calif.



**SEMICONDUCTORS**

ON READER-SERVICE CARD CIRCLE 106

**Need a small 1, 5 or 10 mc crystal oscillator for use in synthesizers, timing systems, counters, communication systems, time-code generators, tape systems, or some other small black box?**

**Think TRACOR®**

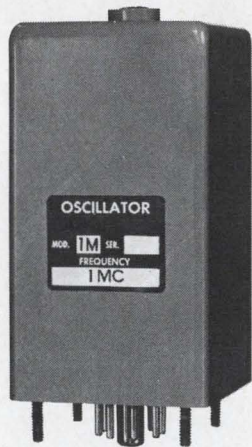

Shown half actual size

TFA 766

Volume 19.1 in.<sup>3</sup>  
That's about the size of it.

For further information:  
TRACOR, Inc.  
General Sales Office  
6500 Tracor Lane  
Austin, Texas 78721  
Phone: 512-926-2800



**SULZER  
DIVISION**

REPRESENTATIVES IN PRINCIPAL CITIES

We are looking for EE's, ME's and Physicists for design consultation or systems development in ASW and undersea problems—experience in penetrations aids—design studies, tests, analysis and reports on electronic and mechanical systems. Your reply strictly confidential.

ON READER-SERVICE CARD CIRCLE 107

## NEW LITERATURE

### Microphotography

This illustrated reprint gives four reasons for considering in-house production of circuits and interconnects. A high-resolution microphotography camera is described and its uses for producing fine-line circuit and interconnect photomasks are shown.

A closeup view of image measurement to 0.001-in. and an automatic step-and-repeat system for multiple-image work are described. HLC Engineering Co.

Circle No. 316

### Switch systems

This 16-page catalog 85d covering "Proximity Switch Systems" offers complete specifications on these sensor-amplifier systems. Component descriptions, characteristics, response graphs and photographs on all-metal and ferrous-metal systems are given. Supporting sections include accessories, mounting dimensions and application data. Micro Switch Div., Honeywell.

Circle No. 317

### Microwave power

The field of microwave power engineering is discussed in this issue of "Electronic Progress." The issue contains three technical articles covering concepts of industrial microwave heating, microwave power transmission, and components for microwave power systems. Raytheon Co.

Circle No. 318

### Silicon rectifiers

The four-page bulletin 107 offers details on a line of silicon rectifiers. It includes miniature silicon and flangeless, miniature and multiple circuitry, high-voltage circuits and rectifiers for power or moderate currents. Passivated, double-diffused junctions and controlled avalanche types are featured. Special constructions are described. Edal Industries, Inc.

Circle No. 319

### Computer circuits

A new illustrated bulletin describing Solid Logic Technology (SLT) is offered. The brochure describes advances in circuit technology, including a section on the 1.5 nA ASLT (Advanced Solid Logic Technology) circuits used in the company's system/360 model 90 series. Other sections of the booklet are devoted to explanations of the solid logic technology concept, the SLT chip, the SLT module and circuit packaging techniques. Fabrication and manufacturing techniques are outlined in the 20-page brochure which contains more than 30 photographs. IBM.

Circle No. 320

### Copper foil

A 14-page booklet on electro-deposited paper-thin copper is offered. The brochure features new information on the efficiency and economy of the product in RFI and pulse shielding. Included are specifications listing shielding properties in 1-oz, 3-oz and 7-oz gauge relative to those of competitive metals. Applications in die-stamped circuitry, flexible flat cables and circuitry and electrical coil windings are detailed. Anaconda American Brass Co.

Circle No. 321

### Delay lines

This new 12-page design guide for electromagnetic delay lines covers fundamental characteristics and properties. Features include the use of electromagnetic delay lines, selection of distributed or lumped constant delay lines, facts about total attenuation, parameters, loaded taps, stability and testing, with special notes on nanosecond and variable delay lines.

Also shown are a variety of schematics, formulas and graphs covering such aspects as pulse forming networks, pedestal forming, apparent attenuation, time delay to rise time ratios, impedance and related data. PCA Electronics.

Circle No. 322

## 60-cycle source?

**Stability  $\pm 0.2\%$   
to a second  
per month**

( $3 \times 10^{-6}$  per 24 Hour)

**Price \$60 up.**

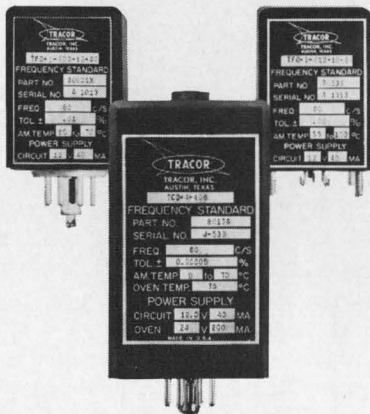

TFA-866

**Think TRACOR**

For further information:

TRACOR, Inc.

General Sales Office

6500 Tracor Lane

Austin, Texas 78721

Phone: 512-926-2800

**TRACOR COMPONENTS**

REPRESENTATIVES IN PRINCIPAL CITIES

We are looking for EE's, ME's and Physicists for design consultation or systems development in ASW and undersea problems—experience in penetrations aids—design studies, tests, analysis and reports on electronic and mechanical systems. Your reply strictly confidential.

ON READER-SERVICE CARD CIRCLE 108

April 12, 1966

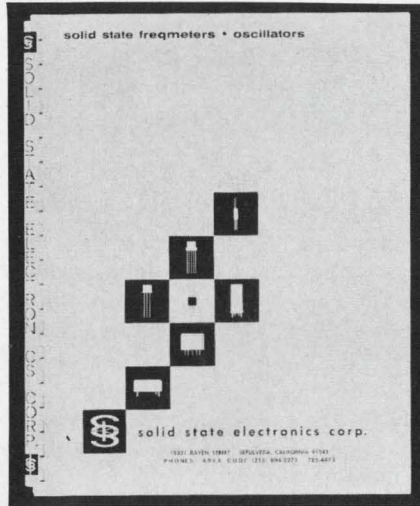

## Frequency-to-dc converters

This 30-page catalog describes a line of frequency-to-dc converters and oscillators. The converters cover a frequency range from 0 to 100 kHz and oscillators range from 25 Hz to 20 MHz. Solid State Electronics Corp.

Circle No. 126

## RF instruments

The 128-page catalog provides complete details on RF instruments and components. Included are connectors and reducers, impedance and transfer characteristic plotters, hybrids, tracking antenna feed assemblies, RF bridges, line stretchers, power dividers and dipoles. The catalog is complete with photographs, specifications, dimensions, graphs and prices. Alford Mfg., Co.

Circle No. 127

## Silicon diodes

An all-products brochure D-1000 describes silicon diodes in single and multi-junction types. Products include hv diodes, forward regulators, zener regulators and reference elements and voltage variable capacitors. Emphasis is on package styles including glass seals, metal welds, epoxy molded diodes and microdiodes. Computer Diode Corp.

Circle No. 128

## Cw klystrons

A technical paper describing the design advancements that have been made to improve the tunability and performance of CW klystrons is available. Redesign calls for bellows tuners to replace diaphragms, thus expending tuner life. Sperry Electronic Tube Div.

Circle No. 129

**What is really  
important when  
evaluating  
crystal frequency  
standards?**

**How much can  
you find out  
from aging-rate  
data?**

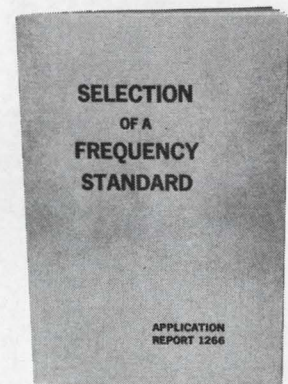

TFA-1166

Two reports will be of special help if you want to know the fine points in evaluating a crystal frequency standard.

One is "Selection of a Frequency Standard", Application Report 1266.

The other is a National Bureau of Standards report on a specific oscillator of this type.

Both are yours via the reader-service card in this magazine — or for faster response write directly to:

TRACOR, Inc.  
General Sales Offices  
6500 Tracor Lane  
Austin, Texas 78721

Phone: 512-926-2800

**TRACOR SULZER DIVISION**

REPRESENTATIVES IN PRINCIPAL CITIES

ON READER-SERVICE CARD CIRCLE 109

169

## Standards catalog

This 100-page document lists 2700 American standards approved through December 31, 1965. Included also are listings of some 500 recommendations of the International Organization for Standardization (ISO), the International Electrotechnical Commission (IEC) and specifications of the International Commission on Rules for the Approval of Electrical Equipment (CEE).

The organizational cross-index featured in the catalog provides listings of American Standards under the 40-odd national trade, technical, and professional societies and organizations whose designations they also bear. American Standards Assoc.

Circle No. 332



## Power supplies

Catalog 661 covering solid-state power modules and laboratory power supplies is offered. More than 3800 standard modules are listed with complete specifications and prices. Categories include regulated ac/dc, unregulated ac/dc, dc/ac inverters, dc/dc converters, dc/dc transformers, high power and wide-range adjustable modules. A broad spectrum of outputs and temperature capabilities is offered.

The catalog includes installation data with specific information on heat dissipation requirements for all modules. Also included are two lines of regulated laboratory power supplies. Technipower Inc.

Circle No. 333

# Application Notes

## Strain-gage manual

A manual covers semiconductor strain-gage theory and applications. Piezoresistivity, gage factors, doping, linearity, hysteresis, frequency response, and more are described. Technical data on the manufacturer's line is coupled with circuitry design considerations. Kulite Semiconductor.

Circle No. 323

## Wideband FM applications

A new bulletin describes applications of FM electronics to give magnetic tape recorders frequency responses from dc to vhf. Instructions for plug-in field installation and techniques to increase over-all signal-to-noise ratio are included. Data-Control Systems.

Circle No. 324

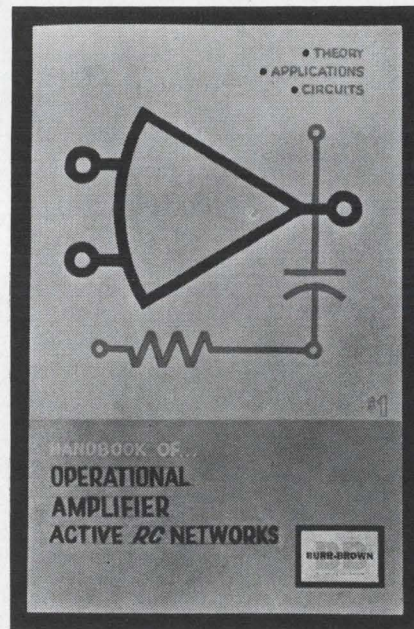

## Op-amp RC networks

Applications of active RC networks to the more common filtering problems are fully described in this 100-page illustrated handbook. Realization schemes for single and multiple feedback, infinite gain circuits and controlled source circuits are featured. Burr-Brown Research.

Circle No. 325

## Vacuum contactors

The new 12-page catalog 104 describes applications, characteristics and construction of vacuum contactors. These devices are designed for controlling dc, rf, and 50, 60, and 400 Hz circuits at all voltage levels. Much application information pertaining to vacuum power relays, overcurrent relays and three phase contactors is also contained. Jennings Radio Mfg. Co.

Circle No. 326

## Thermistor testing

A new 8-page, 2-color brochure entitled "Techniques for Testing Thermistors" is available. The bulletin contains detailed data on acceptance and design testing of negative temperature coefficient thermistors. Thermistor characteristics covered include resistance, temperature coefficient of resistance, voltage, dissipation constant and thermal time constant. Formulas, instrumentation suggestions and methods of measurement are completely detailed. Victory Engineering Corp.

Circle No. 327

## Laboratory fabrications

A series of sketched plans for do-it-yourself construction of filament holders, thin film sources, substrate heaters and vacuum gauges is offered. All items may be easily made with ceramic blocks, tungsten wire, copper bars and 10-32 machine screws. Mason-Renshaw Industries.

Circle No. 328

## Noise reduction

A new 2-page bulletin entitled "Reduction of Noise in Low-level Measurement and Control Systems Through Proper Use of Isolation Devices" is offered.

Bulletin #95-765 is complete with schematics and offers three common applications of isolation devices to substantially reduce or eliminate unwanted noise due to ground circuits. Halliburton Co., Elcor Div.

Circle No. 329



# QUICK

**name the one switch  
that gives you all these features:**

- hermetically sealed
- up to 45 amp. capacity or micro amp.
- no contact bounce
- no operating noise
- minimum operating force
  - long life
- no moving contacts
- temperature resistance to +300°F or -65°F

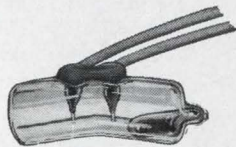

Pulse switch assures split-second pulse regardless of operating speed



Metal or plastic enclosures protect against damage



Subminiature switch less than one inch long



Low Cost—SPST

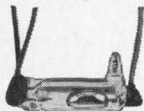

Ultra-sensitive switch makes or breaks on a 9 minute tilt angle

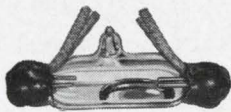

2 isolated circuits in a single switch

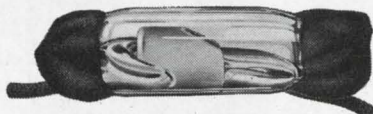

Heavy duty—mercury to mercury contact

You are right! It is a mercury switch. Actually, mercury switches have more unusual combinations of features than any other type of switch. They are easy to use and low cost, too.

The point is, you can often do it better with a mercury switch than you may think—especially when you have a complete line from which to choose. The broad MICRO SWITCH line includes types such as:

- SPST, SPDT or 2-CKT contact arrangement.
- Light loads—1 amp or less.
- Medium loads—1 to 8 amps.
- Heavy loads—8 to 45 amps.

For some interesting ideas and suggestions, contact a MICRO SWITCH Branch Office (see Yellow Pages under "Switches, Electric"). Or write for the industry's most complete catalog of mercury switches.

**MICRO SWITCH**  
FREEPORT, ILLINOIS 61033  
A DIVISION OF HONEYWELL

# Design Data from Manufacturers

Advertisements of booklets, brochures, catalogs and data sheets. To order use Reader-Service Card.

(Advertisement)

## New Particle And Photon Detectors



New Bendix Catalog describing three magnetic electron multipliers and accompanying power supply is now available. Bendix electron multipliers are rugged, miniature detectors with many applications in photon, ion, and neutral-particles radiation measurement. Three models . . . each with a different configuration to meet specific size and space requirements. Also featured is the compact, convenient Power Supply that is designed specifically for the electron multipliers.

**The Bendix Corporation**  
Cincinnati Division  
3625 Hauck Rd., Cincinnati, O. 45241

**171**

## Terminal Block Selector

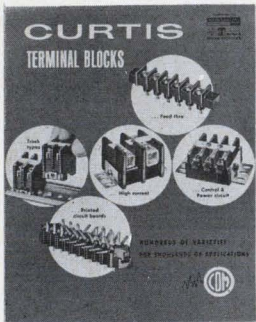

A new 24-page, completely illustrated catalog contains photos, descriptions, ratings, engineering drawings, and prices of the complete line of Curtis terminal blocks. Included are printed circuit, insulated feed-thru, quick disconnect, track type, and high current terminal blocks. Handy selection chart quickly locates the perfect block for your particular requirements. Send today for your free copy.

**Curtis Development & Mfg. Co.**  
3236 North 33rd Street  
Milwaukee, Wisconsin 53216

**172**

## New Continuous Plating Saves 40%!



New continuous reel-to-reel precious metal plating (gold, silver, Rhodium, etc.) on strip reduces materials cost up to 40%. Provides extremely accurate depositing to specifications, allows selection of plated area (i.e.: 20 microinches one side, 100 microinches on opposite side).

Process also permits plating of pre-die cut integrated circuits for semi-conductors, etc., and allows forming after plating.

**Burton Research Laboratories, Inc.**  
Division of  
Burton Silverplating Co.

**173**

## Design Aids

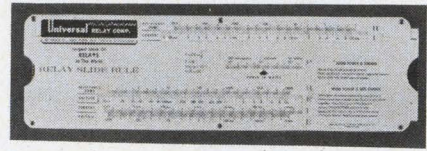

### Relay slide rule

A multiple scale slide rule gives slipstick solutions for the unknown in voltage, power, resistance, and current operations for relays and Ohm's law computations. Standard C and D slide rule scales are also included.

Available for \$.35 from Universal Relay Corp., 42 White St., New York, N. Y.

### Rectifier troubleshooting

A 10- x 18-in. wall chart lists common rectifier troubles, diagnostic steps and corrective measures. The reverse slide gives common chemical compound groups found in metal finishing operations, and gives first aid procedures for internal and external contact with the toxics. Ramm Rectifier.

Circle No. 330

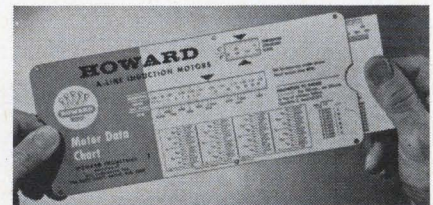

### Induction motors

A slide rule device for induction motor selection is available. You can determine full-load speed, type and frame size, capacitor size, and dimensional details of permanent split capacitor, capacitor start, and reluctance synchronous motors from 1/5 to 1.000 hp. It also shows temperature conversion scales, horsepower/torque/rpm tables, and metric to English linear conversions. Standard Motor Product Sales, Howard Industries, Div. MSL Industries.

Circle No. 331



## Oscillator guide

"The Designer's Guide for Specifying Oscillators" is a 24-page brochure covering oscillators in the 1 Hz to 100 MHz range. Crystal, tuning-fork, LC, RC, magnetostrictive, torsional, and integrated circuit oscillators are defined and described.

Output and interface design considerations are given, as are information on typical specifications, price guidelines, and specifications. Schematics, block diagrams, graphs, photographs, tables, and charts help with the presentation of information.

Available for \$2.50 from Accutronics, Inc., 12 South Island, Batavia, Ill.

## Reprints Available

The following reprints are available free and in limited quantities. To obtain single copies, circle the number of the article you want on the Reader-Service Card.

*High Volume, Low Cost: Designers Challenge* (No. 740)

*Harmonic Generators* (No. 741)

*Hall Effect Multiplier Simplifies Polar Displays* (No. 742)

## Subscription Policy

ELECTRONIC DESIGN is circulated free of charge to qualified design engineers in the U.S., Western Europe and England. To establish your qualifications, send ELECTRONIC DESIGN the following information on your company's letterhead: Your name, engineering title, description of your design duties and a list of your company's major products. The letter must be signed by you personally.

Subscription rates for nonqualified subscribers—\$25.00 per year in U.S.A., \$35.00 in all other countries. Single copy, \$1.50.

## Change of Address

An address change for a subscriber requires a restatement of his qualifications. To expedite the change, and to avoid missing any issues, send along a label from a back copy.

Microfilm copies of all 1961, 1962, 1963 and 1964 issues of ELECTRONIC DESIGN are available through University Microfilms, Inc., 313 N. First Street, Ann Arbor, Mich.

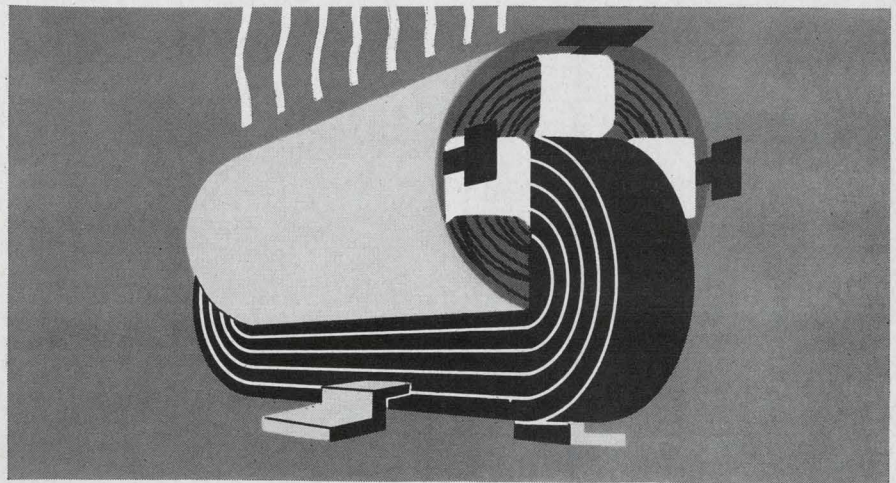

## HEAT BEATERS

PERMACEL® Film Tapes of Kapton\* provide outstanding thermal endurance, physical and dielectric strength in a wide range of high-temperature applications. At 200°C, these tapes have far greater tensile strength than any other available films. "Strength-with-thinness" makes them ideal for miniaturization and other critical insulating jobs. Two types, in 1 and 2-mil thicknesses, in 36-yard rolls from ½" to 17" wide. Write Dept. 919 for details and free sample.

\*Du Pont trademark for its Polyimide Film

**PERMACEL®**  
**TAPES**

New Brunswick, N.J. 08903 a Johnson-Johnson company



ON READER-SERVICE CARD CIRCLE 121

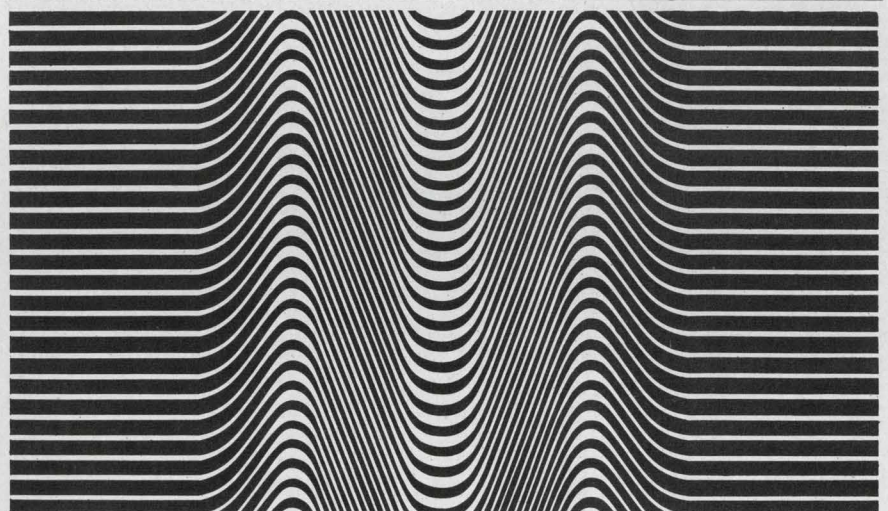

## optimizing the art ... in magnetostrictive delay lines

**LFE STANDARDS** • Designed for commercial and military applications □ Delays from 5 to 10,000 μsec □ Frequencies 300 Kc to 2 Mc □ Delay Drift due to temperature less than 1 PPM/C □ Compatible standard input and output circuitry available.

**CUSTOM DESIGNED** • For special commercial and exotic military applications □ Fixed, tapped, adjustable and variable □ Frequencies to 5 MC RZ and 10 MC NRZ □ Delay Systems to 100,000 μsec incorporating amplifiers and related interface circuitry.

To OPTIMIZE your design, OPT LFE



**LFE ELECTRONICS**

A Division of Laboratory For Electronics, Inc.  
WALTHAM, MASSACHUSETTS 02154

Delay Lines • Filters • Transformers • Amplifiers, and Associated Electronics  
Microwave Measurement & Signal Generation Equipment

ON READER-SERVICE CARD CIRCLE 122



Use  
**TUNING FORK OSCILLATORS**  
For Low Cost Frequency Control



**FOR CRYSTAL ACCURACY  
AT AUDIO FREQUENCIES**

**New Inexpensive Model G**  
Frequency—from below 1 CPS to 30 KC with choice of accuracy for each of five temperature ranges. Standardized construction allows excellent delivery of prototypes or production runs. Many special features are available.  
Long-term stability—2-year guarantee.  
Prices start at \$35.00. Send for complete information.

*Other style cases available, including models for printed circuit use.*



Catalogued in **eem** **VSMF**

**FORK STANDARDS, INC.**  
217 Main Street • West Chicago, Ill. 60185  
Telephone: Area Code 312 • 231-3511

# Advertisers' Index

## \*PARTICIPANTS IN NIGHT LETTER PROGRAM

Advertiser	Page
ACI Division, Kent Corporation	124
ADC Products Inc.	106
*AMP, Incorporated	102
Aerovox Corporation, Hi Q Division	111
Agastat Timing Instruments, Elastic Stop Nut Corporation of America	153
Allen-Bradley Co.	32A-B
American Lava Corporation	46
*Amperex Electronic Corporation	92, 93
Arnold Magnetics Corp.	152
*Beckman Instruments, Inc., Helipot Division	121
Bendix Corporation, The, Semiconductor Division	4, 5
*Bourns, Inc.	121
Bruce Industries, Inc.	110
Bulova, American Time Products Division	142
Burdny Corporation	117
*Burr-Brown Research Corporation	38
Burton Research Laboratories, Inc.	172
CTS Corporation	61
Cedar Engineering Division, Data Control Corporation	144
*Clifton Precision Products, Division of Litton Industries	Cover II
Cohu Electronics, Inc.	115
*Computer Control Company, Inc.	30
Coors Porcelain Company	85
*Corning Glass Works	83
Curtis Development & Mfg. Co.	172
Cutler-Hammer, Inc.	37
*Dale Electronics, Inc.	Cover III
Delbert Blinn Co., The	113
Develco, Incorporated	138
Dialight Corporation	158
ESI/Electro Scientific Industries, Inc.	15
Eastman Chemical Products, Inc.	118
Electro Instruments, Inc.	123
Electronic Marketing Division, Essex Wire Corporation	122
Electronic Specialty Co.	151
Electronized Chemicals Corporation	114
Epsco, Incorporated	40
Erie Technological Products Inc.	89
Fairchild Electro-Metrics Corporation	113
Fairchild Instrumentation, A Division of Fairchild Camera and Instrument Corporation	131
Fairchild Semiconductor, A Division of Fairchild Camera and Instrument Corporation	19
Fluke Mfg. Co., Inc., John Fork Standards, Inc.	44, 45, 174
Gardner-Denver Company	176
General Electric Company	137
General Instrument Corporation, Semiconductor Products Group	55
General Precision, Librascope Group	125
General Radio Company	1
Globe Industries, Inc.	165
Hansen Manufacturing Company, Inc.	154
Hartwell Corporation, The	145
Hayden Book Company, Inc.	175
Heath Company	160
Hewlett-Packard	23, 105, 129, 135
Hoffman Semiconductors	167
Hughes Aircraft Company, Electronic Devices	41
Humphrey, Inc.	133
*IRC, Inc.	27
ITT Semiconductors	8
Industrial Electronic Engineers, Inc.	144
International Diode Corp.	136
Jennings Radio Mfg. Corp.	132
Kay Electric Company	127
Kennedy Co.	130
Kurz-Kasch, Inc.	143
LFE Electronics, Division of Laboratory of Electronics, Inc.	173
Littlefuse	165
Mac Panel Company	165
Magnecraft Electric Co.	126

Advertiser	Page
*Magnetics, Inc.	78
Mallory Controls Company	108
Marco-Oak Industries	157
Metals & Controls, Inc.	128
Micro Instrument Co.	141
MicroSwitch, A Division of Honeywell	171
Microdot Magnetics, Inc.	134
Mitsumi Electric Co., Inc.	140
Monroe/Data Log, Division of Litton Industries,	87
Motorola Communications & Electronics, Inc.	66
*Motorola Semiconductor Products, Inc.	33, 155
Mullard Limited	9
Nexus Research Laboratory, Inc.	107
Oak Manufacturing Co.	112A-B
Ohmite Manufacturing Company	29
Perfection Mica Company	110
Permacel	173
Potter Company, The	112
Pyrofilm Resistor Company, Inc.	81
*RBM Controls Division and Devices	7, Cover IV
*Radiation, Incorporated	24, 25
Radio Frequency Laboratories, Inc.	109
Raytheon Company, Components Division	159
*Redcor Corporation	2
Scientific Data Systems Inc.	6
Siliconix Incorporated	67
Simpson Electric Company	147
Somerset Electronics Corporation	120
Sorensen, A Unit of Raytheon Company	16
Soshin Electric Co., Ltd.	156
Specific Products	146
Sprague Electric Company	10, 20
Switchcraft, Inc.	70, 71
*Systron-Donner Corporation	12
TRW Capacitors	42
Techno Components Corp.	161
Tektronix, Inc., Oscilloscopes	34, 35
Telonic Industries, Inc.	82
Tenney Engineering, Inc.	148
Texas Instruments Incorporated Apparatus Division	139
Texas Instruments Incorporated, Semiconductors-Components Division	56, 57
Thermosen, Inc.	172
Theta Instrument Corporation	140
Thomas & Skinner, Inc.	69
Tobe Deutchmann Laboratories	162
Tracor, Inc.	168, 169
Transitron Electronic Corporation	91
Union Carbide Corporation, Linde Division	163
United Control Corporation	150
Useco Division of Litton Industries	39
Vactec Inc.	158
Valcor Engineering Corp.	148
Vanton Pump & Equipment Corp.	156
Wakefield Engineering, Inc.	152
Westinghouse Electronic Tube Division	75
Weston Instruments, Inc.	79
Wood Electric Corporation	149
Zierick Manufacturing Corp.	136
<b>Regional Advertising</b>	
*Arnold Engineering Company, The	144A
*Brush Instrument Division of Clevite	144C
*JFD Electronics Corporation	144D
*Leach Corporation	144B
<b>Career Advertising</b>	
Aerojet General	160
Delco Radio Division General Motors	101
General Electric Television Receiver Dept.	94
Hughes Aircraft Company Aerospace Divisions	99
IBM Federal Systems Center	98
McDonnell	97
U.S. Navy Bureau of Ships	100

# Advertising Representatives

**New York 10022**  
Robert W. Gascoigne  
Thomas P. Barth  
Samuel M. Deitch  
Rick Brough  
850 Third Avenue  
(212) PLaza 1-5530  
TWX: 867-7866

**Philadelphia 19066**  
Fred L. Mowlds, Jr.  
P. O. Box 206  
Merion Station, Pa.  
(215) MO 4-1073

**Marblehead 01945**  
Richard Parker  
7 Redstone Lane  
(617) 742-0252

**Chicago 60611**  
Thomas P. Kavooras  
Berry Conner, Jr.  
720 N. Michigan  
(312) 337-0588

**Cleveland 44107**  
Robert W. Patrick  
8410 Treetower Drive  
Chagrin Falls, Ohio  
(216) 247-7670

**Los Angeles 90005**  
Stanley I. Ehrenclou  
Terrence D. Buckley  
W. James Bischof  
2930 W. Imperial Highway  
Inglewood, Calif. 90303  
(213) 757-0183

**San Francisco 94306**  
Ashley P. Hartman  
541 Del Medio  
Suite #301  
Mountain View, Calif.  
(415) 327-6536

**Southwestern 75235**  
Tommy L. Wilson  
6200 North Central Express-  
way  
Dallas, Tex. 75206  
(214) EMerson 1-2311

**London W. 1**  
Brayton C. Nichols  
44 Conduit Street

**Tokyo**  
Yoshihiro Takemura  
International Planning  
Service, Inc.  
Room No. 512 Nikkoh  
Mita Building  
1, Nishidaimachi, Shiba-  
Takanawa  
Minato-ku, Tokyo



**TRANS'**, *pp.* Changed in form.  
**TRANS'**, *pp.* Transforming; changing form.  
**TRANS'**, *pp.* (transfusing, transfused.) To be with a infused worship. (*Trans-*)  
**TRANS'**, *pp.* Pierced through.  
**TRANS'**, *pp.* Piercing through.  
**TRANS'**, *pp.* (transfusing.) 1. To transfer; to transmit the shape or appearance of one thing to another. 2. To change one nature to transmit. —3. In the same the natural disposition and nature. 4. To change the elements, as with the flesh and blood of Christ, the matter, to change the contents of a divine substance, by which it changed in the divine nature. —6. Showing an equation into another of the out of equal value.  
**TRANS'**, *pp.* To be changed in form; to be transformed.  
**TRANS'**, *pp.* 1. The act of operating the form or external appearance. 2. The change of form in insects, when a change of one metal into the change of the soul into a divine nature among the mystics. 3. Transubstantiation, a change of heart with its disposition and temper are the divine image. —7. In algebra, an equation into one of a different point value *Cyc.*  
**TRANS'**, *pp.* (transform) *pp.* Changed external appearance; metamorphosed;  
**TRANS'**, *pp.* 1. Changing the form appearance; metamorphosing; transcribing. 2. a. Effecting or able to effect a change of state. **TRANS'**, *pp.* (transfrate') *v. t.* To pass  
**TRANS'**, *pp.* [L. *trans* and *fretum*.] Over a strait or narrow sea. [*Little*  
**TRANS'**, *pp.* [L. *transfusus*.] To tran-  
**TRANS'**, *pp.* [L. *transfusus*.] 1. To pour, out one vessel into another. 2. To bleed, from one animal to another, to pass from one to another; to cause the labile.  
**TRANS'**, *pp.* (transfusio) *pp.* Poured from one vessel.  
**TRANS'**, *pp.* That may be transfused.  
**TRANS'**, *pp.* Pouring out of one vessel transfusing.  
**TRANS'**, *pp.* (transfusio) *n.* 1. The act of pouring, out of one vessel into another, of transferring the blood of one vessel, into another.  
**TRANS'**, *pp.* (transfusio) *v.* To trans-  
pass over or beyond any limit to which one is bound; to transcend any the limit of duty; to break or go beyond of moral.



## Mr. Webster didn't have a word for it...

but we do!

Three authoritative dictionaries for today's technologies:

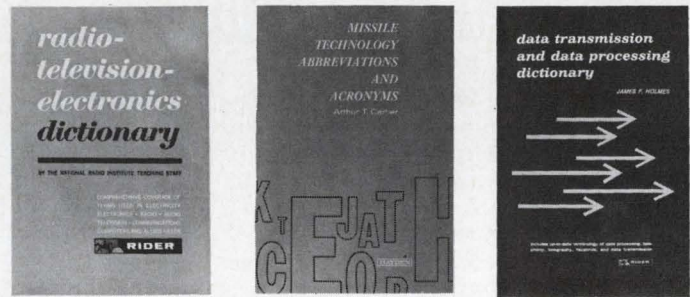

**Radio-Television-Electronics Dictionary.** National Radio Institute Staff. Over 5000 terms. 168 pages. #0307, paperbound, \$3.50

**Missile Technology Abbreviations & Acronyms.** Arthur T. Cartier. 8000 entries and 12,000 definitions. 130 pages. #5539, paperbound, \$3.95; #5540, clothbound, \$5.95.

**Data Transmission & Data Processing Dictionary.** James F. Holmes. More than 3000 terms. 103 pages. #0396, paperbound, \$2.50

### SPECIAL 30-DAY EXAMINATION OFFER!

**Dept. ED-4, HAYDEN BOOK COMPANY, INC.**

116 West 14th Street, New York, N.Y. 10011

Send me the book(s) checked below and bill me. At the end of 30 days I will either remit payment plus a few cents postage or return the book(s).

#0307    #5539    #5540    #0396    Free 1966 Catalog  
 Name \_\_\_\_\_  
 Street \_\_\_\_\_  
 City \_\_\_\_\_ State \_\_\_\_\_ Zip \_\_\_\_\_  
 You pay postage. I enclose payment of \$ ..... Same return privileges.

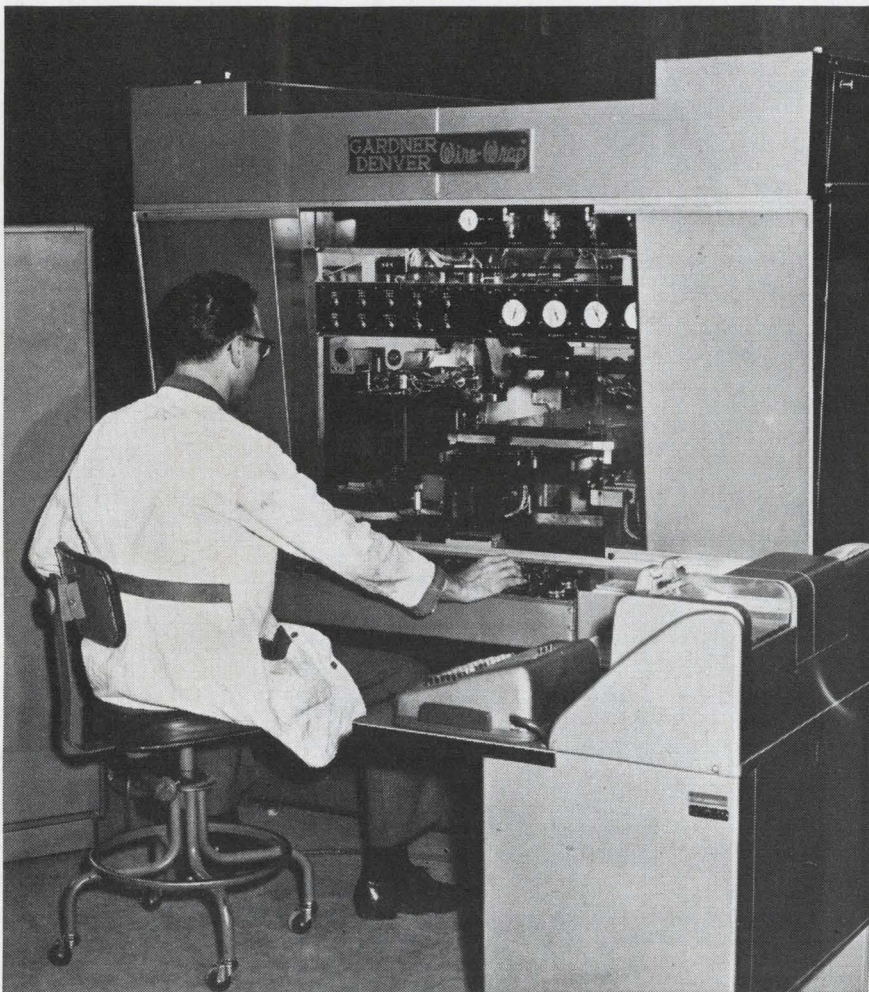

## Program wiring patterns from A to Z with automatic *Wire-Wrap*<sup>®</sup> machines

Only automatic "Wire-Wrap" machines provide the flexibility required for point to point wiring of modular electronic panels. Just program the circuit with punched cards or tape. Then "Wire-Wrap" machines take over—connecting wires at an average of 5 seconds per wire—as much as 25 times faster than hand soldering in most applications.

**Reliability**—These solderless wrapped connections are permanently tight—unaffected by temperature changes, atmospheric corrosion, vibration. More than 37 billion such connections are in use today without a single reported failure.

**Economy**—Cost savings in excess of 92% are common when compared to soldering and other techniques. Additional benefits include: No thermal damage to heat-sensitive materials . . . elimination of fire hazards . . . connections that are easily removed in plant or in the field.

Write for Bulletins 14-1, 14-121 and 14-127.

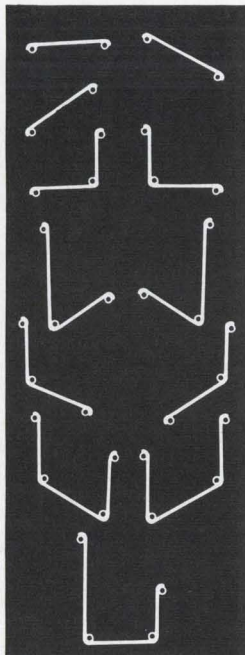

Typical wiring patterns made with automatic "Wire-Wrap" machines.



SEE WHAT AIR IS DOING NOW...SEE

**GARDNER - DENVER**

Gardner-Denver Company, Quincy, Illinois

ON READER-SERVICE CARD CIRCLE 124

# Designer's Datebook

APRIL						
S	M	T	W	T	F	S
					1	2
3	4	5	6	7	8	9
10	11	12	13	14	15	16
17	18	19	20	21	22	23
24	25	26	27	28	29	30

MAY						
S	M	T	W	T	F	S
1	2	3	4	5	6	7
8	9	10	11	12	13	14
15	16	17	18	19	20	21
22	23	24	25	26	27	28
29	30	31				

### April 12-15

**International Quantum Electronics Conference** (Phoenix) Sponsors: AIP/IEEE; Dr. J. P. Gordon, Bell Telephone Laboratories, Murray Hill, N. J.

### April 17-20

**International Conference on Electron and Ion Beam Technology** (New York) Sponsors: AIME and Electrochemical Society; Metallurgical Society of AIME, 345 East 47th St., New York, N. Y.

### April 18-20

**Symposium on Process Automation** (Newport Beach, Calif.) Sponsors: Beckman Instruments, Consolidated Electrodynamics, Control Data, SDS Data Systems; Dr. William Biles, Shell Development Co., Houston, Tex.

### April 20-22

**1966 InterMag** (International Conference on Magnetics) (Stuttgart, Germany) Sponsor: IEEE G-Mag; Dr. E. W. Pugh, IBM Corp., 1000 Westchester Ave., White Plains, N. Y.

### April 25-28

**Audio Engineering Society Convention** (Los Angeles) Sponsor: Audio Engineering Society; John C. Baumann, Ampex Corp., 8467 Beverly Boulevard, Los Angeles, Calif.

### April 26-28

**Spring Joint Computer Conference** (Boston) Sponsors: AFIPS, IEEE, ACM; Dr. Harlan Anderson, Digital Equip. Corp., Maynard, Mass.

### May 2-4

**Aerospace Instrumentation Symposium** (Philadelphia) Sponsor: Instrument Society of America; William Redstreak, Moore Products Co., Sumneytown Pike, Spring House, Pa.



**DALE**

**3-in-1 T-pot design  
gives you more  
for your money!**



## One simple, rugged design adds reliability to all three rectilinear Mil wirewound styles

**RT-10, RT-11, RT-12** – Dale meets all three with a single design. You benefit from this simplification through increased reliability, faster delivery, better price. Call us today!

- ① **ALL-MOLDED HOUSING** design eliminates seal problems. Meets MIL-STD-202 and MIL-R-27208A.
- ② **RUGGED COLLECTOR SYSTEM** assures you of noise levels well below mil requirements.
- ③ **FULL LENGTH WINDING** allows increased power handling capability. Permits use of large diameter thermoconductive mandrel which eliminates "hot spots" by acting as high mass heat sink.
- ④ **1-PIECE WIPER ASSEMBLY** of precious metal insures setting stability under all environmental conditions.
- ⑤ **STAINLESS STEEL ADJUSTMENT SCREW** has metal-to-metal clutching – prevents over-travel damage.
- ⑥ **CONSTANT LEAD SCREW SEAL** is assured by shaft-retaining spring which maintains unvarying pressure against high temperature silicone rubber "O" ring.

### DALE MIL-R-27208A MODELS

**RT-10**

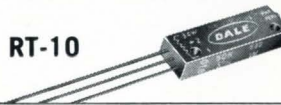

Model 691 P.C. Pin  
Model 697 Flex. Leads

**RT-11**

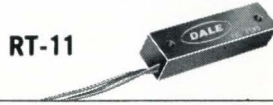

Model 1287 P.C. Pin  
Model 1288 Flex. Leads

**RT-12**



Model 1680 P.C. Pin  
Model 1697 Flex. Leads

**RT-22**



5000 Series – ½" square-trim models meet RT-22, made with same basic design considerations shown here.

**WRITE FOR CATALOG B – containing specifications on 57 Dale T-Pots including many special models.**



**DALE ELECTRONICS, INC.**

1328 28th Avenue, Columbus, Nebraska



Speed Inquiry to Advertiser via Collect Night Letter  
ON READER-SERVICE CARD CIRCLE 243



# 3 Low-Cost Hometaxial-Base Transistors From RCA...with High Gain and Low $V_{CE}$ (SAT) to 1 Amp

Here are three economical n-p-n silicon transistors which combine excellent gain and voltage characteristics with RCA's time-proved Hometaxial-Base construction. This combination means rugged, reliable operation—with no electrical collapse—for your low- to medium-power circuit designs.

RCA's low-cost 40347, 40348, and 40349 transistors in the TO-5 package provide real design savings with simpler circuits for audio amplifiers (low-power driver and output stages), AC/DC circuits, low- and medium-power switching circuits, and many other general-purpose applications. As part of RCA's extensive silicon power line, the 40347, 40348, and 40349 feature:

Electron injection point

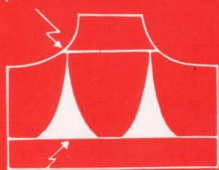

Electron collector area

Hometaxial-base means uniform junctions and homogeneous base construction free of fields in an axial direction.

- Useful gain with  $I_C = 1A$
- Low saturation voltage for greater switching efficiency—typically less than  $1V$  @  $1A$  for 40347 and 40348
- Sharp saturation voltage knee for greater circuit efficiency
- Safe operation without second breakdown within thermal ratings
- Improved beta characteristics for Class A or linear audio operation
- $P_T = 5W$  @ case temperatures up to  $50^\circ C$

For prices and delivery on these and other RCA Hometaxial Base Transistors, see your RCA representative or your RCA Distributor. For technical data and a copy of a new 4-page flyer (Publication HBT-400) describing RCA's Hometaxial-Base Transistor line, write: RCA Commercial Engineering, Section 1G4-2, Harrison, N. J.

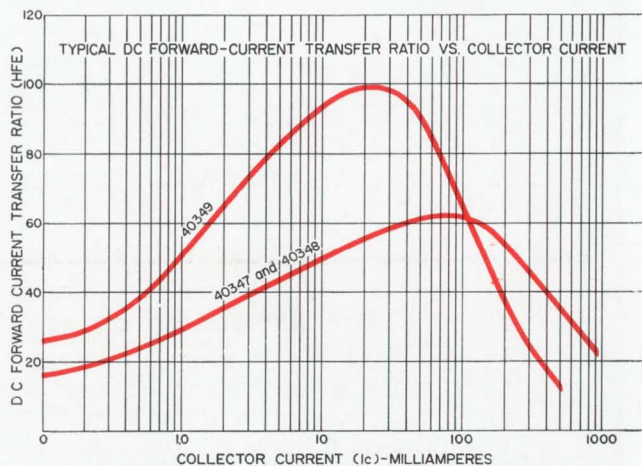

40347	40348	40349
$h_{FE} = 20-80$ @ $I_C = 450\text{ mA}$	$h_{FE} = 30-100$ @ $I_C = 300\text{ mA}$	$h_{FE} = 25-100$ @ $I_C = 150\text{ mA}$
$V_{CE}$ (Sat) = $1.0V$ max @ $I_C = 450\text{ mA}$ $I_B = 45\text{ mA}$	$V_{CE}$ (Sat) = $0.75V$ @ $I_C = 300\text{ mA}$ $I_B = 30\text{ mA}$	$V_{CE}$ (Sat) = $0.50V$ @ $I_C = 150\text{ mA}$ $I_B = 15\text{ mA}$
$V_{CEV}$ (Max) = $60V$	$V_{CEV}$ (Max) = $90V$	$V_{CEV}$ (Max) = $160V$

Also Available from your RCA Distributor

RCA Electronic Components and Devices

The Most Trusted Name in Electronics

