

Electronic Design 5

VOL. 14, NO.

THE MAGAZINE OF ESSENTIAL NEWS, PRODUCTS AND TECHNOLOGY

MARCH 1, 1966

Paris Show Report: Europeans form alliances in race to capture expanding microelectronics markets—Ferranti-Marconi and Westinghouse-Philips team up.

...British producing ME computer... French and Germans plan ICs for space and industry computers... Color TV slows down as system agreement lags (see p17).



**"SPECIAL"
CUSTOM BUILT**



POWER TRANSFORMERS & INDUCTORS

TO YOUR SPECIFICATIONS

Exceptional quality and reliability is provided in all UTC designs. Over 30 years of engineering knowledge and experience backed by complete environmental testing and life testing facilities assure the highest standard in the industry. Full analysis and evaluation of materials are conducted in UTC's Material and Chemical Laboratories. Rigid quality control measures coordinated with exhaustive statistical findings and latest production procedures results in the industry's highest degree of reliability. Range covered in Power Transformers is from milliwatts to 100 KVA. Some typical applications include: Current Limiting, Filament, Isolation, Plate, Transistor Inverter, Transistor Supply.

MILITARY AND COMMERCIAL TYPES FOR EVERY PHASE OF THE ELECTRONICS ART

POWER TRANSFORMERS • AUDIO TRANSFORMERS • INDUCTORS • PULSE TRANSFORMERS • ELECTRIC WAVE FILTERS • LUMPED CONSTANT DELAY LINES • HIGH Q COILS • MAGNETIC AMPLIFIERS • SATURABLE REACTORS • REFERENCE UNITS

		
<p>Low capacity current limiting filament transformer. Primary 118 V. 60 cycles to 6.3 V. at 3 A., 8 A. at short circuit. 25 MMFD capacity. 30 KV hipot and 200:1 capacity divider; 5 x 3$\frac{3}{4}$ x 4$\frac{1}{2}$", 9 lbs.</p>	<p>MIL-T-27B ultraminiature Scott connected power transformer, 5/16 Dia. x 13/32" H., 1/10 Oz. Primary 28 V.400 — with taps @ 50% & 86.6%. Two units provide 28 V two phase from three phase source.</p>	<p>Molded Power Transformer 3 Phase. Input 200V, 380-420 cps. Electrostatic Shield, 8 output windings, 26 terminals. MIL-T-27B, Grade 2 Class S. Max. Alt. 50K Ft. Size 6 x 2$\frac{1}{2}$ x 5", 8 lbs.</p>
		
<p>Commercial type molded power transformer. Primary 115/230 V., 50/420 cycles to 680 VCT-.015 A., 6.3 VCT-.1.2 A., 6.3 V.-.6A. Size: 2$\frac{1}{2}$ x 3 x 2$\frac{7}{8}$", weight: 1.6 lbs.</p>	<p>Three phase high voltage power transformer. Primary jumper hardware for easy conversion from delta to wye inputs. Made to MIL-T-27B specifications. Primary: 440 V 60 cycles delta or wye 3 phase input. Secondary: 2100 V line to line or 1215 V line to line @ 242 ma.</p>	<p>High current filament transformer. Primary 140/156 V., 47/63 cycles to 1.8 V.-1070 A. Current limiting through separate primary reactor, MIL-T-27B; 10 x 10 x 11$\frac{1}{2}$", 150 lbs.</p>

Write for catalog of over 1,300 UTC TOP QUALITY STOCK ITEMS IMMEDIATELY AVAILABLE from your local distributor.

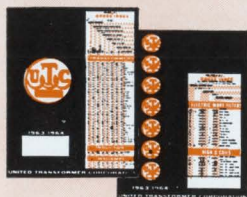

UNITED TRANSFORMER CORP.

150 VARICK STREET, NEW YORK 13, N. Y.

PACIFIC MFG. DIVISION: 3630 EASTHAM DRIVE, CULVER CITY, CALIF.
EXPORT DIVISION: 13 EAST 40th STREET, NEW YORK 16, N. Y. CABLE: "ARLAB"

Find Coax Cable Faults FAST!

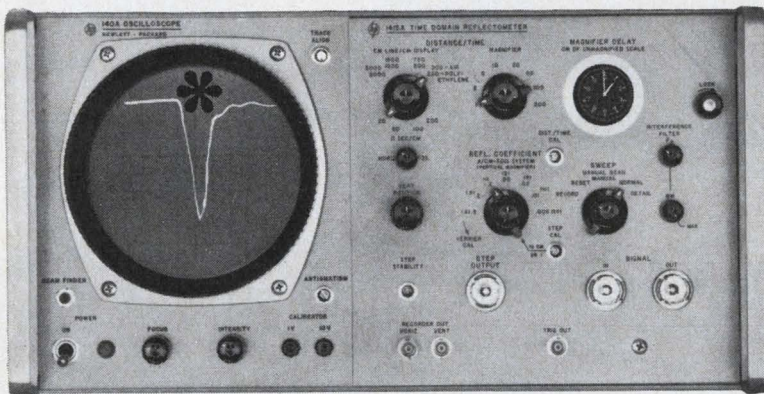
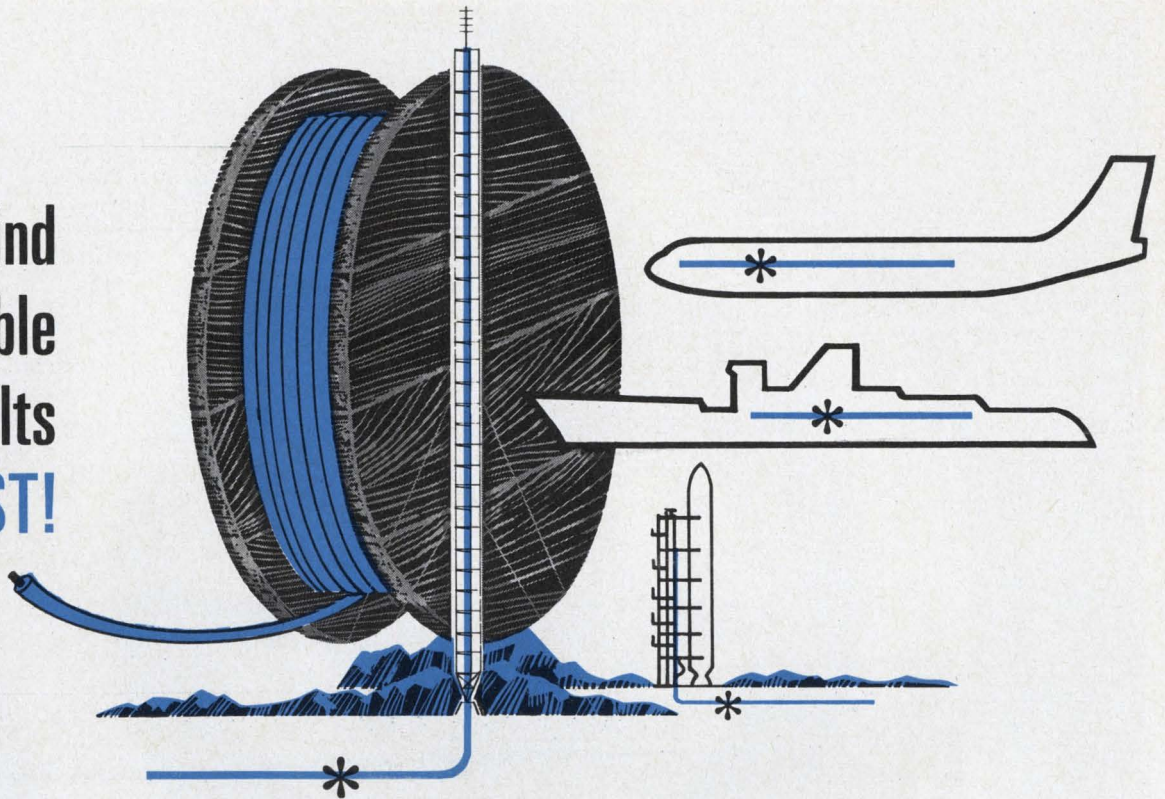

*Use the hp
140A Oscilloscope
and 1415A Time Domain
Reflectometer Plug-in!*

Quickly find and identify such problems as water in cables, crushed cables, damage caused by flex and bends in cables, transmission difficulties in buried or hard-to-reach cables, cables damaged by temperature extremes, and bad connectors joining cables.

With the 140A/1415A combination, you can instantly locate problems in cables up to 600 ft. (to 3000 ft. with Option 14), and you can identify their exact nature—opens, shorts, resistive or reactive discontinuities. You can separate, on the scope crt, discontinuities as close as one inch—making Time Domain Reflectometry (TDR) ideal for analyzing connectors and checking coax switches and attenuators.

The 140A/1415A is calibrated *directly* in distance for air and polyethylene dielectric cables, and a special slide-rule furnished permits quick conversion for other dielectrics. With the scope and TDR plug-in you can measure characteristic impedance and dielectric constant of unknown cables, and recorder outputs permit recordings on any x-y recorder, for applications such as studies of cable degradation with age.

The 140A costs \$575, the 1415A TDR Plug-in \$1050. Besides accepting double-size special-purpose plug-ins, such as the 1415A, the 140A is

useful as a general-purpose oscilloscope, accepting both vertical and horizontal plug-ins. Five vertical and two time base plug-ins provide maximum versatility. Performance includes sensitivities to $10 \mu\text{V}/\text{cm}$, bandwidths to 20 MHz.

Contact your Hewlett-Packard field engineer for more information on the versatile 140A General-Purpose Scope...and especially on the 1415A Time Domain Reflectometer. A technical discussion of TDR techniques and their application is available, for the asking, in Application Note 67, "Cable Testing With Time Domain Reflectometry."

You can get a copy from your hp field engineer or by writing Hewlett-Packard, Palo Alto, California 94304, Telephone (415) 326-7000; Europe: 54 Route des Acacias, Geneva.

Prices f.o.b. factory.

See them at IEEE, 3rd floor New York Coliseum, March 21-24

HEWLETT  **PACKARD**
An extra measure of quality

Speed Inquiry to Advertiser via Collect Night Letter
ON READER-SERVICE CARD CIRCLE 2

1053

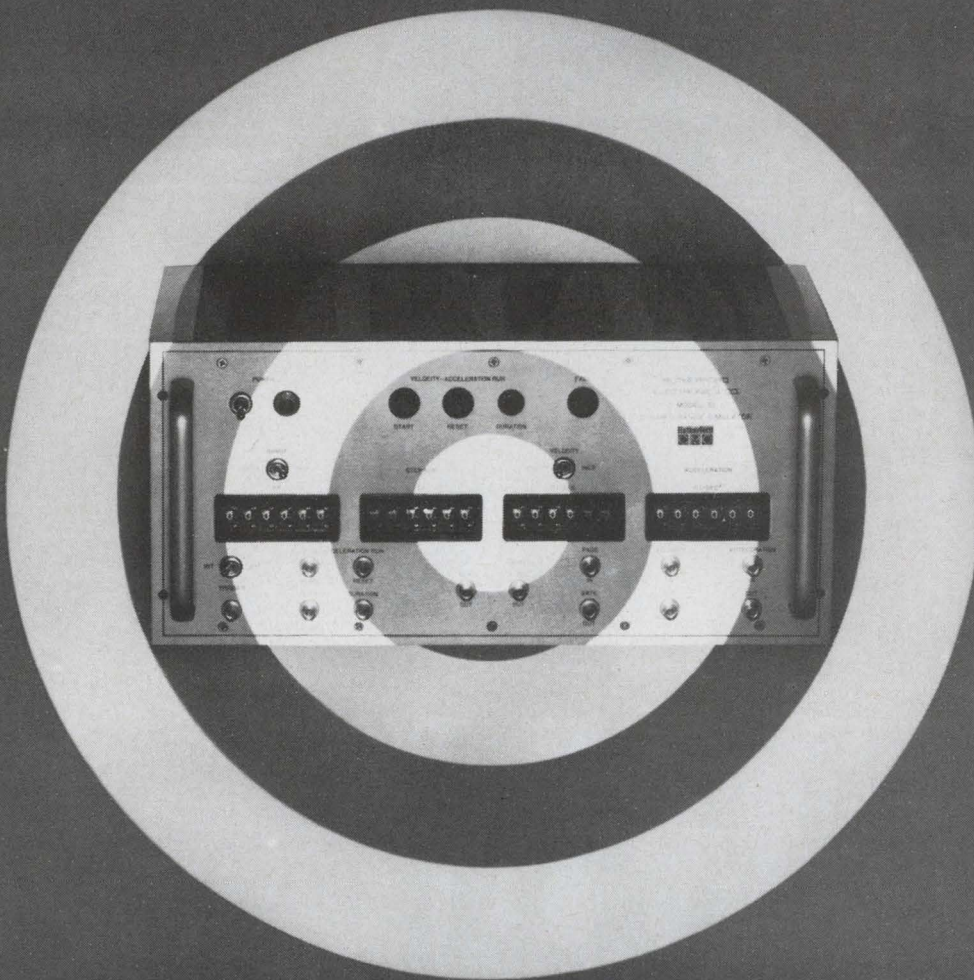

We make enemies

Simulated enemies are available in a compact package labeled the RUTHERFORD S1 Dynamic Range Simulator. It is the most accurate, reliable, stable video target simulator ever developed. With it you can evaluate, check, and calibrate range, range rate, target tracking, and tracking memory of the most sophisticated weapons control and tracking systems. Forget the limitations and problems built into old-fashioned analog simulators.

Check these parameters: Target Range in one-foot increments from 0 to 1 million feet. Target Velocity

from 0 to 100,000 ft/sec in 0.1 ft/sec increments. Target Acceleration from 0 to 10,000 ft/sec/sec with 0.01 ft/sec/sec resolution. Check all the specs. They meet or exceed the rigid performance requirements of any known weapons control system or tracking system used for air traffic control, satellite surveillance, etc. The Rutherford S1 is an example of

the advanced design that has established Rutherford as the leader in pulse and time delay instrumentation. Other sophisticated instruments will soon be developed by the new CMC/Rutherford team. Our intent is to give you a wide range of instruments that are always the best quality and best buy.

So join the Rutherford Rampage (a division of the CMC Crusade) and write today for the complete specs on the S1. Learn how you can earn your own glorious Crusading Engineers medal with special Rutherford stripe. You'll look so handsome!



12973 Bradley • San Fernando, California • Phone (213) 772-6321 • TWX 213-647-5170

THE RUTHERFORD DIVISION OF CMC IS A LEADING DESIGNER AND MANUFACTURER OF PULSE GENERATORS, TIME DELAY GENERATORS, AND DYNAMIC RANGE SIMULATORS.

ON READER-SERVICE CARD CIRCLE 3

NEWS

- 13 News Report
- 17 **Paris Electronics Show dominated by ICs**
European firms team up against U.S. in effort to compete in the fast-moving microelectronics market.
- 21 **Solutions sought for deep-space link problems**
Communications systems for interplanetary missions will require improved microwave and optical components and techniques.
- 19 Practical heat pipe developed
- 26 Cheap tools for budding physicists
- 29 Washington Report
- 32 Letters
- 35 **Editorial: Is electronics doing enough for puzzled astronomers?**

TECHNOLOGY

- 38 **Amplifier has 85% efficiency** while providing up to 10 watts power over a wide frequency band. A switching transistor is the key in the design.
- 46 **Show off your display system** to advantage by using magnetic deflection. It offers superior quality, small size, high reliability and design freedom.
- 52 **Why use IC gate-ring counters?** Because they often use less power than other counter types, and at the same time require no more wafer area.
- 60 **The ABC of dummy loads:** A variety of choices are open to the designer, depending on the power, vswr and the availability of auxiliary equipment.
- 66 **Committee meetings waste time**—unless strict standards to control them are enforced. Score your performance against this frank checklist.
- 78 **Ideas for Design**

PRODUCTS

- 84 **Components:** Chopper-stabilized amp has superior price/specs ratio
- 88 **Semiconductors:** Germanium planar transistor outdoes TWTs
- 92 **Test Equipment:** Null-detecting digital voltmeter adjusts itself
- 96 **Microelectronics:** Half-a-Meg resistance on a chip
- 98 **Systems:** Amplifier remembers an input after it's gone

Departments

- 101 Advertisers Index
- 100 Application Notes
- 104 Designer's Datebook

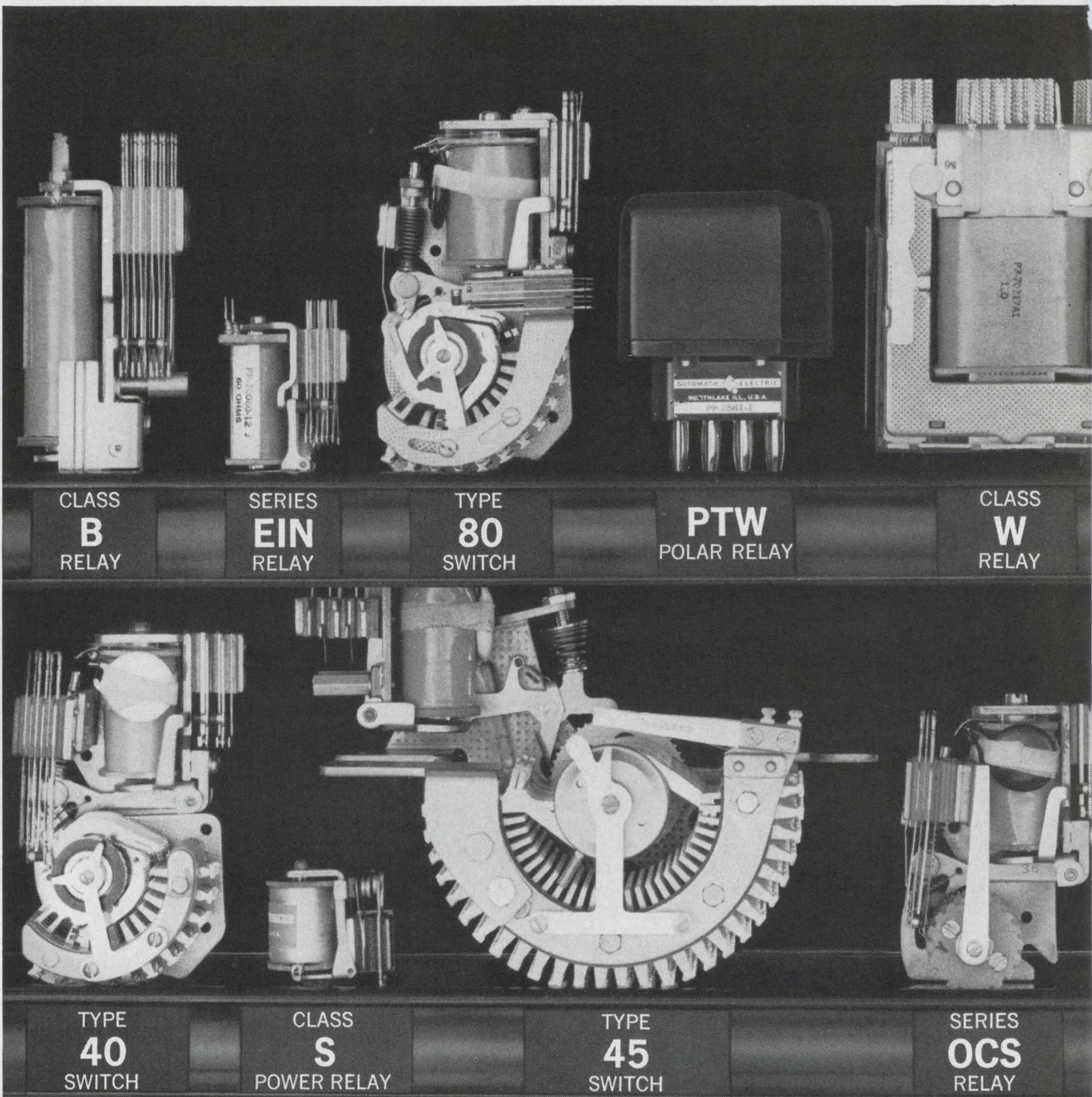

14 in-stock answers to your relay needs.

Fast delivery of relays and stepping switches direct from the manufacturer—yours at no extra charge, thanks to the AE Stock Program.

Under this growing program we keep more than 200 kinds of relays, switches and accessories on hand at all times, in sufficient quantities to fill your ordinary requirements within 7 days. These include many of the hottest types from AE's broad line: EIN (integral socket) relays with power

contacts; rotary stepping switches with Gold Levels for low-level circuits; ERM (magnetic latching) relays; Class E relays equipped with Taper Tab Terminals for easy adaptation to EIN; and many more.

Send for your free copy of AE's "Stock Letter," which is the latest complete listing of AE relays and switches in stock for quick delivery. Write to the Director, Control Equipment Sales, Automatic Electric, Northlake, Illinois 60164.

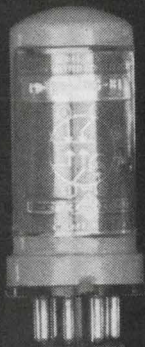

MERCURY-
WETTED-
CONTACT
RELAY

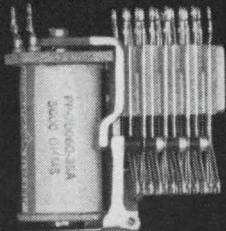

CLASS
E
RELAY

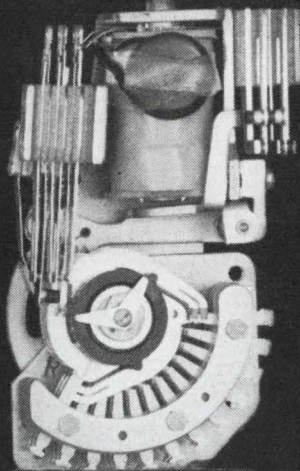

TYPE
44
SWITCH

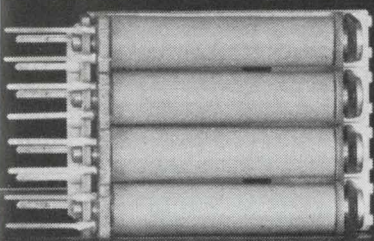

4 DIGIT
CODEL
RELAY

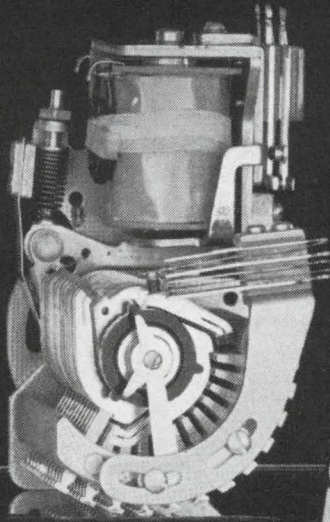

TYPE
88
SWITCH

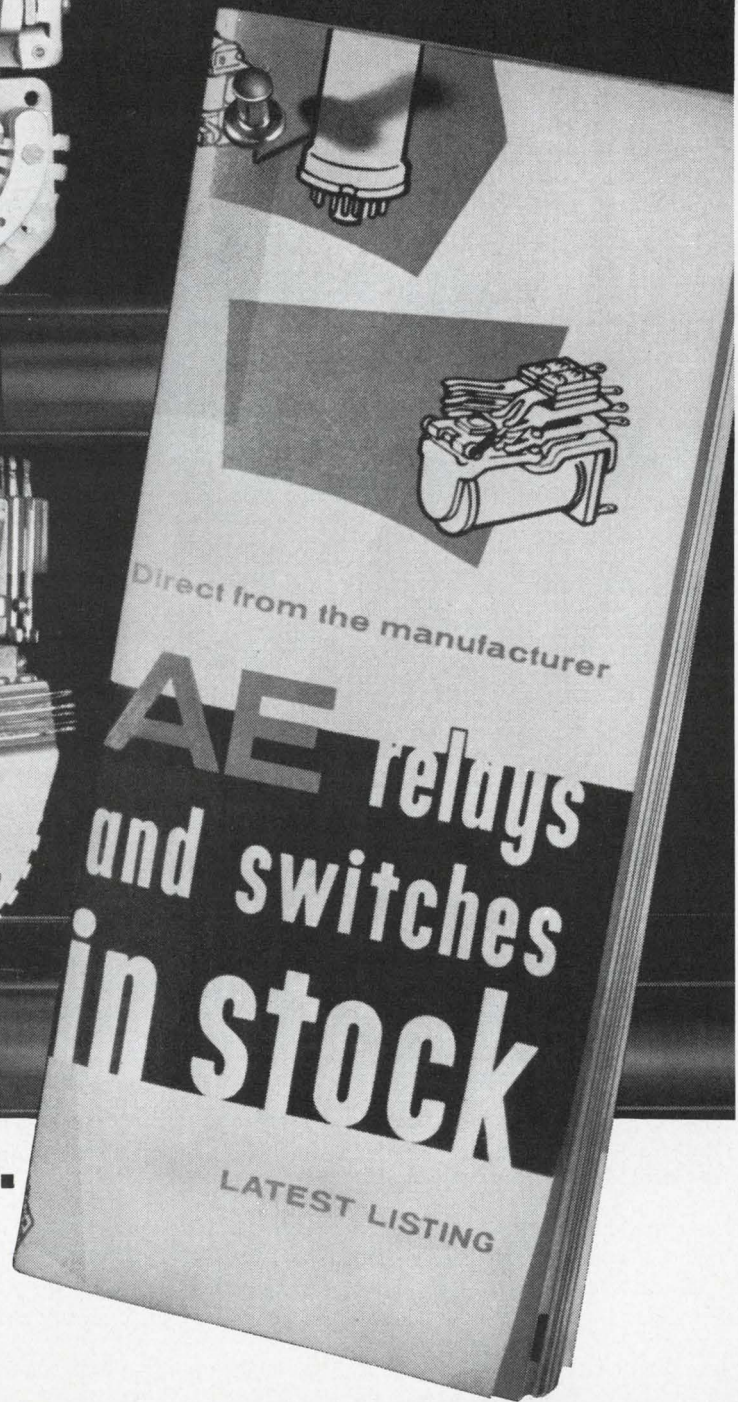

Get 191 more here.

AUTOMATIC ELECTRIC
SUBSIDIARY OF
GENERAL TELEPHONE & ELECTRONICS. **GTE**

March 1, 1966

ON READER-SERVICE CARD CIRCLE 4

now

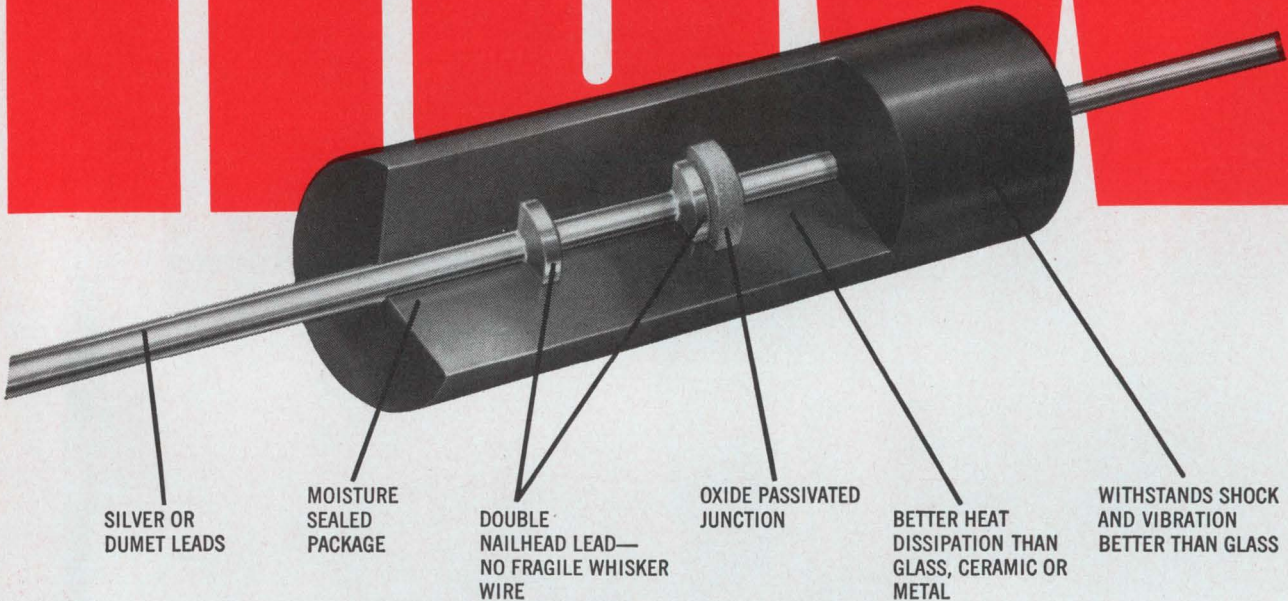

IRC Poly-Sil Zeners

Production quantities at production prices

With the addition of new production facilities, IRC Poly-Sil zeners are now immediately available from stock to meet your volume requirements. And with prices lower than ever you can use them for all your low-power zener applications with considerable cost savings.

Poly-Sil zener diodes are space savers too. They are up to 30% smaller than comparable units. Wattage dissipation is as much as 2½ times higher than glass packages of the same physical size.

Extremely tough and durable, Poly-Sil completely surrounds all internal parts. This solid construction provides greater thermal and mechanical strength and more dependable performance. Poly-Sil zeners are available in over 400 different JEDEC types. Write for samples, literature and quantity prices to:

IRC, Inc., Semiconductor Division (formerly North American Electronics, Inc.), 71 Linden Street, West Lynn, Massachusetts 01905.

CAPSULE SPECIFICATIONS

actual size

MIL:	Designed to meet MIL-S-19500
WATTAGES:	Up to 1 watt @70°C
VOLTAGES:	6.8 to 200 volts
DIMENSIONS:	DO-7 (.265" long x .10" dia.)
TOLERANCES:	±5%, ±10%, ±20%
LEADS:	Silver or Dumet



Speed Inquiry to Advertiser via Collect Night Letter
ON READER-SERVICE CARD CIRCLE 5

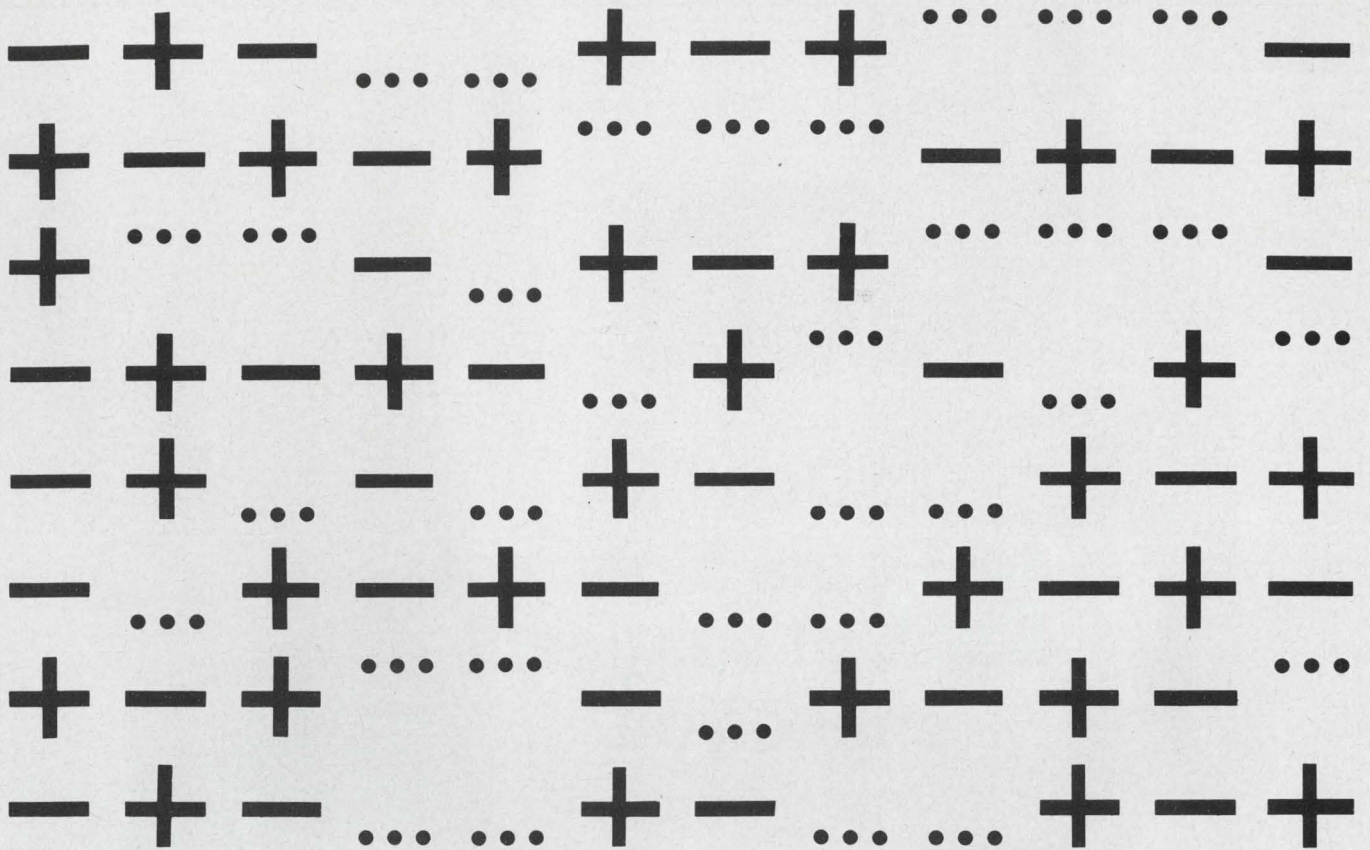

The Hoffman HCD-4 microminiature planar epitaxial passivated diode is designed for computer memory core driver and similar switching applications under 6 nanoseconds.

It features controlled forward conductance, with specified maximum limits on junction capacity and stored charge, to provide devices of uniform reproducible performance.

The conventional method of characterizing the switching speed of a diode by the measurement of the reverse recovery time is not used for fast switching diodes.

Hoffman uses a direct measurement of stored charge of the diode by integrating the reverse current of the diode. The stored charge represents an inherent characteristic of the diode and provides a single, unambiguous figure of merit which has minimal dependence on test conditions or jigs.

Repeatability of storage value measurement to within 5% can be made on direct reading low cost equipment.

For additional information regarding this product write Hoffman Electronics, Dept. A, El Monte, California.

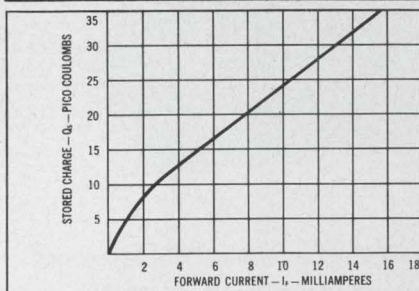
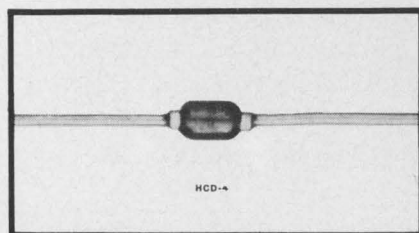

FIGURE 1 TYPICAL VARIATION OF STORED CHARGE WITH FORWARD CURRENT



HCD-4

MAXIMUM RATINGS

Power Dissipation: 500 Milliwatts (Derate 3.3mW/°C above 25°C)
 Operating Temperature Range: -65°C to +175°C
 Storage Temperature Range: -65°C to +200°C

Electrical Specifications: 25°C unless otherwise specified

Parameter	Symbol	Min.	Max.	Units
Forward Current (Note 1)				
$I_f = 100 \mu A$	V_{F1}	430	550	mV
$I_f = 1 \text{ mA}$	V_{F2}	540	660	mV
$I_f = 10 \text{ mA}$	V_{F3}	650	800	mV
$I_f = 100 \text{ mA}$	V_{F4}	790	990	mV
$I_f = 500 \text{ mA}$	V_{F5}	960	1350	mV
Breakdown Voltage				
$I_R = 100 \mu A$	B_{VR}	75		Volts
Reverse Current				
$V_R = 50 \text{ Volts}$	I_{R1}		100	nA
$V_R = 50 \text{ Volts } T_A = 100^\circ C$	I_{R2}		20	μA
Stored Charge (Note 2)				
$I_f = 10 \text{ mA}$	Q_s		60	P Coul
Capacitance				
$V_R = 1 \text{ Volt, } f = 1 \text{ mc}$	C_j		2.0	pf

Note 1 - Test time at each forward test current 30-40 milliseconds.
 Note 2 - Measured on B-Line Electronics Model QS-3 Stored Charge Meter.
 Conditions: Pulse Amplitude = 5 Volts
 Pulse Width = 50 nSec.
 Rise Time = 4 nSec.
 Source Impedance = 10 Ohms
 Stored charge measurement accuracy $\pm 4\%$ of full scale.

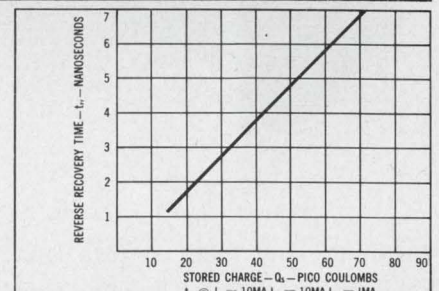
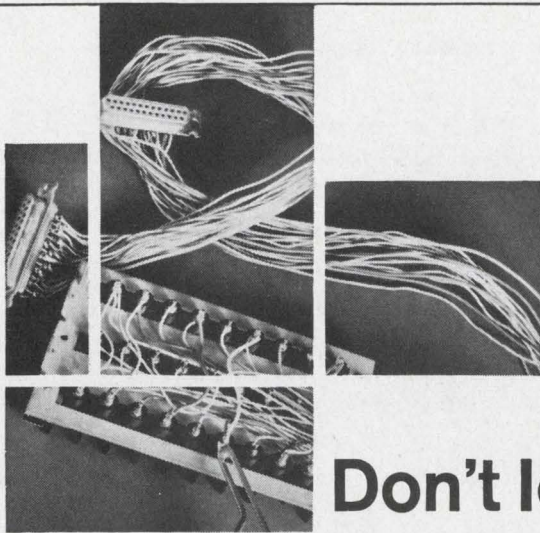

FIGURE 2 TYPICAL CORRELATION BETWEEN STORED CHARGE AND REVERSE RECOVERY TIME



SEMICONDUCTORS

ON READER-SERVICE CARD CIRCLE 6



Don't let
the high cost
of spaghetti
choke you

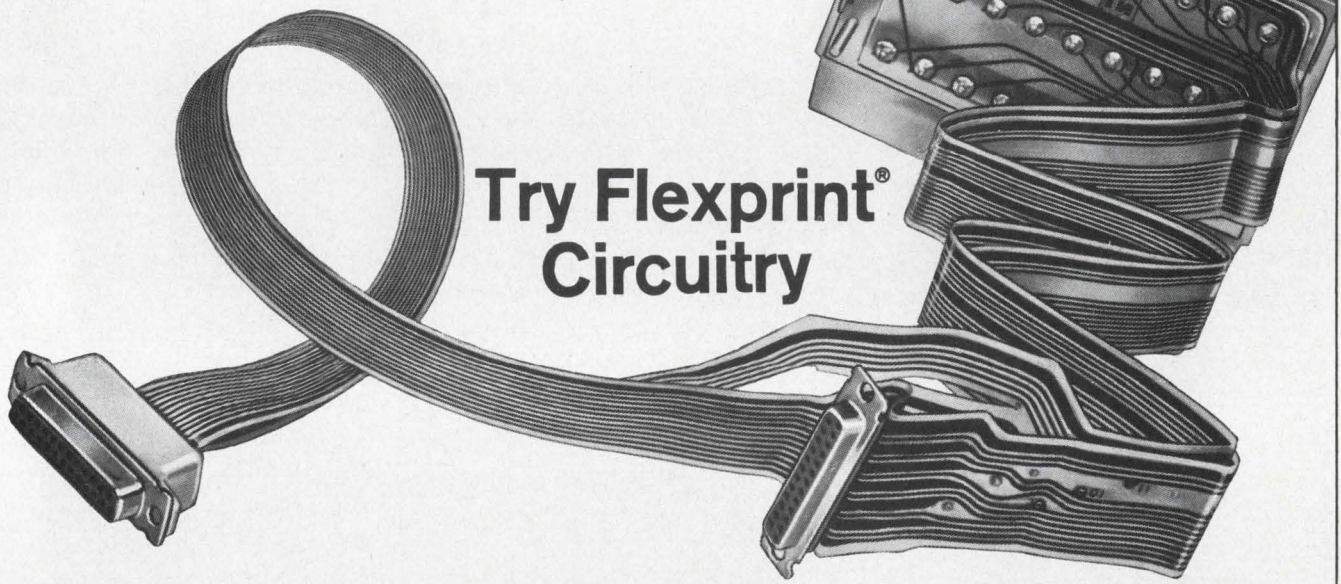

Try Flexprint®
Circuitry

Wiring up equipment is more economical with Sanders FLEXPRINT Flexible Printed Circuitry.

Whether you're producing components, instruments, computers or complete systems, FLEXPRINT circuitry provides superior reliability at lower installed cost!

The Leeds & Northrup's Modular Controller uses FLEXPRINT circuits for these benefits:

No rework — FLEXPRINT circuits keyed for fast fool-proof assembly.

Compact, self-storing accordion FLEXPRINT circuits

allow control to operate during module replacement.

FLEXPRINT circuits saved 15 to 20% over in-plant assembly with conventional "Spaghetti" wire.

Want help?

Tap the broadest application knowledge and capability in the business by contacting your local FLEXPRINT representative or the marketing manager, FLEXPRINT Products Division, Sanders Associates, Inc., 95 Canal Street, Nashua, New Hampshire 03060.

*T.M., Sanders Associates, Inc.

Sanders Associates, Inc.
Flexprint Products Division
CREATING NEW DIRECTIONS IN ELECTRONICS



ON READER-SERVICE CARD CIRCLE 7

ON READER-SERVICE CARD CIRCLE 211 ➤

And it should be. We make, stock, and can deliver right now more different materials than any other manufacturer. Sixteen at last count. Including some nobody else makes.

They're all production items, not just laboratory samples. Whether you're ordering an old faithful like Alnico 5 or an exotic new one like Alnico 8, we've got both the know-how and the facilities to live up to our production promises.

Magnet shapes don't give us any trouble, either. We can often ship what you want right off the shelf. We catalog some 105 standard shapes and sizes in Alnico 2 and Alnico 5 alone. If you want something that's not in the catalog, or need design assistance, we have the country's leading magnetic engineers ready to consult with you.

If you're looking for prompt delivery of any type or shape of Alnico, turn to

the world's largest manufacturer of magnetic materials. That's us. You can get our catalogs by writing Mr. C. H. Repenn, Manager of Sales, the Indiana General Corporation, Magnet Division, Valparaiso, Indiana. In Canada write Indiana Steel Products of Canada, Ltd., Kitchener, Ontario.

INDIANA GENERAL 

**Shipping any type and shape
of Alnico on time is duck soup for
Indiana General**



New from Sprague!

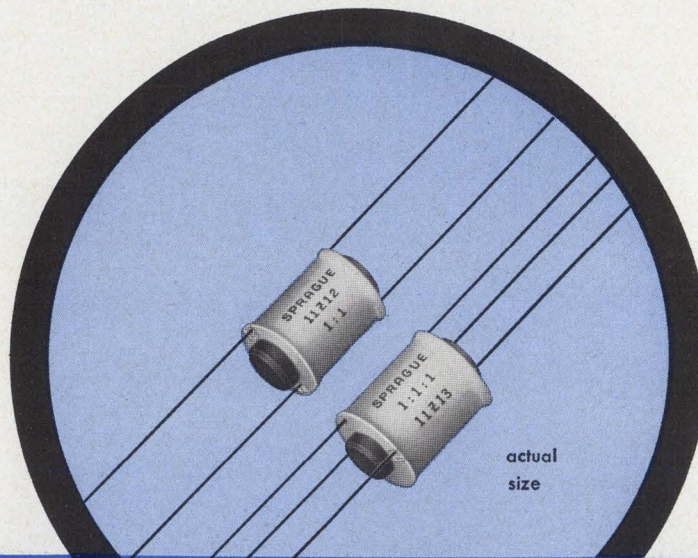

TRIGATE* PULSE TRANSFORMERS... the industry's lowest-cost SCR triggers!

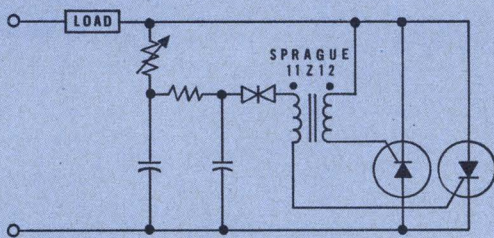

This breakdown-diode/transformer triggering circuit is a typical application for Type 11Z12 Trigate Pulse Transformers.

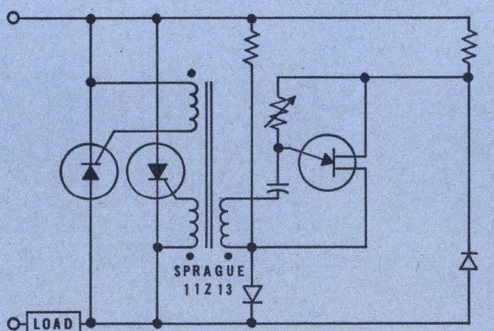

This unijunction-transistor/transformer triggering circuit is a typical application for Type 11Z13 Trigate Pulse Transformers.

*trademark

Dependable enough for industrial equipment, yet priced for high-volume commercial applications

Here's good news for designers of appliances; lighting controls; air-conditioning and heating controls; industrial controls. You can actually cut costs while upgrading your present method of SCR triggering!

Type 11Z Trigate* Pulse Transformers offer these unique features:

1. Balanced pulse characteristics and energy transfer from primary to secondary and tertiary windings.
2. Minimum saturation effect to allow operation where increased pulse widths are required.
3. Fast pulse rise time and increased current capability to prevent SCR di/dt failure.
4. Increased energy transfer efficiency.

Designed for operation over the temperature range of -10°C to $+70^{\circ}\text{C}$, Trigate Pulse Transformers are available in 2-winding and 3-winding configurations for half-wave and full-wave applications. Both designs are rated for use with line voltages up to 240 VAC.

For complete information, write for Engineering Bulletin 40,003 to the Technical Literature Service, Sprague Electric Co., 347 Marshall St., North Adams, Mass. 01247.

SPRAGUE COMPONENTS

PULSE TRANSFORMERS
CAPACITORS
TRANSISTORS
THIN-FILM MICROCIRCUITS
INTEGRATED CIRCUITS

455C-5176

RESISTORS
INTERFERENCE FILTERS
PULSE-FORMING NETWORKS
TOROIDAL INDUCTORS
ELECTRIC WAVE FILTERS

CERAMIC-BASE PRINTED NETWORKS
PACKAGED COMPONENT ASSEMBLIES
BOBBIN and TAPE WOUND MAGNETIC CORES
SILICON RECTIFIER GATE CONTROLS
FUNCTIONAL DIGITAL CIRCUITS

SPRAGUE[®]
THE MARK OF RELIABILITY

'Sprague' and '®' are registered trademarks of the Sprague Electric Co.

ON READER-SERVICE CARD CIRCLE 8

ED News

ICs dominate Paris Electronics Show PAGE 17

Practical heat pipe is developed PAGE 18

Improvements sought in deep-space data links PAGE 21

Cheap tools for budding physicists PAGE 26



All roads lead to Paris Electronics Show. 17

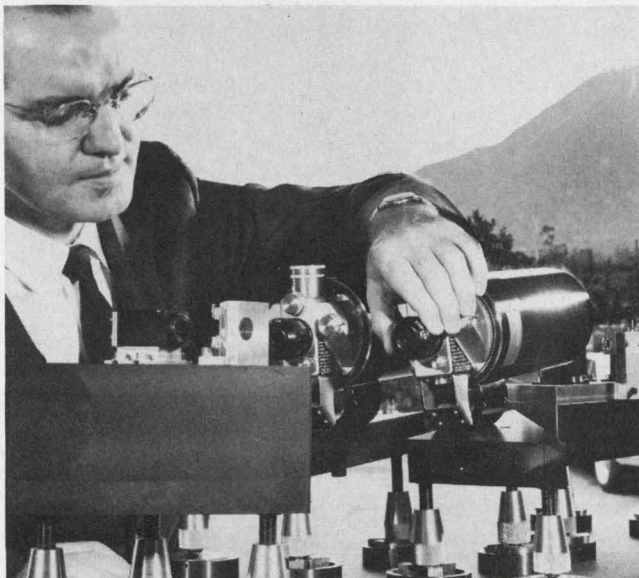

Laser communications. 21

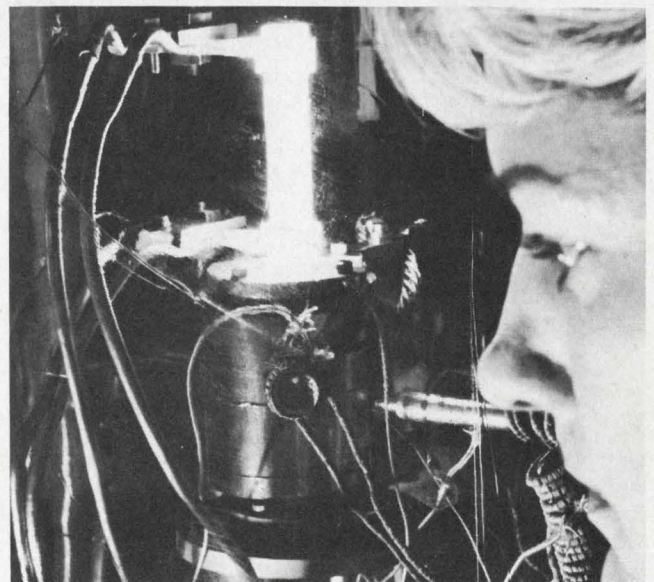

Glow little "heat pipe." 18

New from Sprague!

This Resistor has 5 Times the Resistance of a Conventional Metal-Film Resistor of Equal Size!

This Resistor is 21 Times Smaller than a Conventional Metal-Film Resistor with Equal Resistance Value!

Type	Wattage Rating	Size	Maximum Resistance
Extended-Range Filmistor Resistor	1/10	.095" D. .250" L.	1.5 MΩ
Conventional Metal-Film Resistor	1/10	.095" D. .250" L.	0.3 MΩ

Type	Maximum Resistance	Wattage Rating	Size
Extended-Range Filmistor Resistor	1.5 MΩ	1/10	.095" D. .250" L.
Conventional Metal-Film Resistor	1.5 MΩ	1/2	.250" D. .750" L.

Both Resistors are one and the same...they're Sprague's new **EXTENDED-RANGE FILMISTOR® METAL-FILM RESISTORS**

Substantial saving of space in all wattage ratings—1/20, 1/10, 1/8, 1/4, 1/2, and 1 watt—with absolutely NO SACRIFICE IN STABILITY!

New manufacturing techniques at Sprague Electric have made possible a major breakthrough in resistance limits for metal-film resistors. Extended-Range Filmistor Resistors now offer, in addition to accuracy . . . stability . . . reliability . . . extended resistance values in size reductions which were previously unobtainable. Size and weight advantages of Filmistor Resistors now make them the ideal selection for applications in high-impedance circuits, field-effect

transistor circuits, etc., where space is at a premium. Many designs which previously had to settle for the higher temperature coefficients of carbon-film resistors in order to obtain required resistance values can now utilize the low and controlled temperature coefficients of Filmistor Metal-Film Resistors.

Other key features are $\pm 1\%$ standard resistance tolerance, low inherent noise level, negligible voltage coefficient of resistance, and tough molded case for protection against mechanical damage and humidity.

For complete technical data, write for Engineering Bulletin 7025C to Technical Literature Service, Sprague Electric Company, 347 Marshall Street, North Adams, Massachusetts 01248.

SPRAGUE COMPONENTS

RESISTORS	PULSE TRANSFORMERS	CERAMIC-BASE PRINTED NETWORKS
CAPACITORS	INTERFERENCE FILTERS	PACKAGED COMPONENT ASSEMBLIES
TRANSISTORS	PULSE-FORMING NETWORKS	BOBBIN and TAPE WOUND MAGNETIC CORES
THIN-FILM MICROCIRCUITS	TOROIDAL INDUCTORS	SILICON RECTIFIER GATE CONTROLS
INTEGRATED MICROCIRCUITS	ELECTRIC WAVE FILTERS	FUNCTIONAL DIGITAL CIRCUITS



*Sprague' and '®' are registered trademarks of the Sprague Electric Co.

ON READER-SERVICE CARD CIRCLE 9

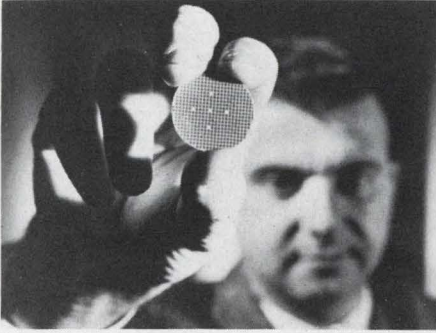

News Report

Ceramic insulation isolates IC elements

100 times greater voltage isolation between microcircuit elements results when they are embedded in a ceramic wafer, according to Arthur I. Stoller, of RCA Laboratories, Princeton, N. J., designer of the experimental process which accomplished this feat.

In this new mounting method the ceramic walls insulate the elements far better than the present method. Until now the rectangular elements had to be either "back biased"—adjacent element voltages matched so that no current flows between elements—or a large area of silicon dioxide was used as a separator. The former method hamstring the IC designer while the latter method wastes much space.

The majority of communications circuits require higher voltages than present IC arrays can handle. This new mounting method should eliminate these voltage restrictions that have prevented IC arrays from achieving widespread use in the communications field, according to C. Price Smith, director of the research project that developed this process.

The new process uses the same diffusion and interconnection techniques as previous IC arrays. And the ceramic mosaic is far more rugged than present IC array bases, according to Smith.

Apollo/Saturn IB to test hardware

The flight of the unmanned Apollo/Saturn IB, scheduled for late in February, is the first test in space of the craft that will send Americans to explore the moon.

Although this is not an orbital flight, the Apollo spacecraft is programmed to verify the performance of the launch vehicle and most of the major spacecraft systems during the approximately 39-minute flight. Almost 2000 measurements will be taken by the telemetry systems, making it the most highly instrumented space vehicle ever launched by NASA.

The launch will also result in other firsts for NASA. At 45,900 pounds, the Apollo

spacecraft is the heaviest payload launched so far by the agency. And the combined Apollo/Saturn vehicle, standing 224 feet high and weighing more than 1,300,000 pounds at liftoff, is the largest space vehicle ever mated at Cape Kennedy.

As impressive as the Saturn IB launch vehicle is, it pales in comparison with the Saturn V, which will eventually hurl three men toward the moon. The Saturn V, with its 7.5 million pounds of thrust, will stand about twice the height of the Saturn IB.

IC prices cut by Signetics

Price reductions in some of its integrated circuit lines was announced recently by Signetics Corp. Cuts of 20 to 40 percent have been made in the SE100J MIL-range DTL series, the SE400J MIL-range low-power aerospace series and the SE500 MIL-range series of linear circuits, according to the company. In addition, reductions of from 33 to 50 percent have been made in the NE100J series.

In announcing the price cuts, Signetic officials said that they can be attributed to a rise in the production volume of these lines, most of which were introduced at WESCON, 1965. Said a company spokesman, "High production volume in MIL-range IC products not only makes it possible to reduce prices of the premium lines, but makes available a sufficient volume of narrower temperature range products to make the marketing of these devices feasible."

Consumer electronics soared in 1965

The output of consumer products by the electronics industry reached new peaks in 1965 with further gains forecast through 1970, according to the Electronic Industries Association's Marketing Services Department.

Color TV sets paced the field with a record number of 2.7 million sets sold, practically double the sales recorded in 1964. Sales of black-and-white TV continued strong, rising

to 8.9 million sets during 1965. A heavy accent on portables and small-screen sizes in the black-and-white sales figures points up the trend toward families owning two or more TV sets.

In spite of the soaring popularity of television, the public demand for radios reached an all-time high of 41 million sets in 1965, with one out of every four radios produced being for automobile use. Tape recorder and phonograph sales were also up sharply over the 1964 figures.

The dollar volume of consumer electronic products also reached new heights in 1965. Factory sales totaled \$3.3 billion, a whopping increase over the \$1.5 billion recorded only ten years ago in 1955. The record dollar volume is even more remarkable in view of the steady decline in the prices of black-and-white TV sets and transistor radios. It is estimated that by 1970 the dollar volume will rise to \$4.5 billion.

While TVs, radios and phonographs will account for the lion's share of the electronics consumer products market for the foreseeable future, manufacturers anticipate a steady rise in sales of both sound and video tape recorders and electronic organs.

Metric system coming closer?

A federal study on the feasibility of switching to the metric system of weights and measures may not be too far off. The House Committee on Science and Astronautics has approved, with amendments, legislation to authorize such a study.

Passed by the Senate last year, the legislation would direct the Secretary of Commerce to conduct a three-year program to appraise the desirability, practicability and cost of a general conversion to the metric system in the United States. The House version would authorize \$500,000 for the first year of the study, with no budget limitations established for the final two years. Specifically, the Department of Commerce would:

- Conduct extensive comparative studies of the standards of weights and measures used in engineering, manufacturing, commercial and scientific areas and in educational institutions.
- Cooperate with other governmental

agencies and private organizations in determining the advantages and disadvantages of a general conversion to the metric system.

- Cooperate with foreign governments in determining the advantages to the United States in international trade and commerce, and in military and other areas of international relations to be derived from such a conversion.

British version of our IEEE International Convention will open in London on March 23 and run through March 30. An all-time record number of over 600 manufacturers will be displaying products at the exhibition, which is sponsored by the Association of Supervising Electrical Engineers.

The world's most powerful circular electron synchrotron moved another step closer to completion with the awarding by Cornell University of a contract for the construction of a 55,000 square foot laboratory building to house the synchrotron's support equipment. The 10 BEV synchrotron is being built at a cost of \$11,298,000 with National Science Foundation funds.

Price reductions on its entire line of solid-state low-noise preamplifiers have been announced by Applied Technology, Inc. of Palo Alto, Calif. The cuts range as high as 34 percent.

Dr. Edward M. Davis, Jr. has been named "1965's Outstanding Young Electrical Engineer" by Eta Kappa Nu, the national electrical engineering society. Dr. Davis, 33, is the assistant to the president of the IBM Data Processing Division in White Plains, N. Y.

The Foxboro Company has been awarded a contract for instrumentation to control what is reportedly the world's largest cement kiln at Dundee Cement Company's new \$55 million plant in Clarksville, Mo. Foxboro will furnish electronic transmitting, recording and controlling instruments for the plant.

A conversion of its contract with Grumman Aircraft Engineering Corp. for development of the Lunar Excursion Module (LEM) has been announced by NASA. Under the new contract, Grumman will deliver 15 flight articles, 10 test articles and two mission simulators. This adds four flight articles to the contract. Total cost of the new contract, ending Dec. 1969, is \$1.019 billion.

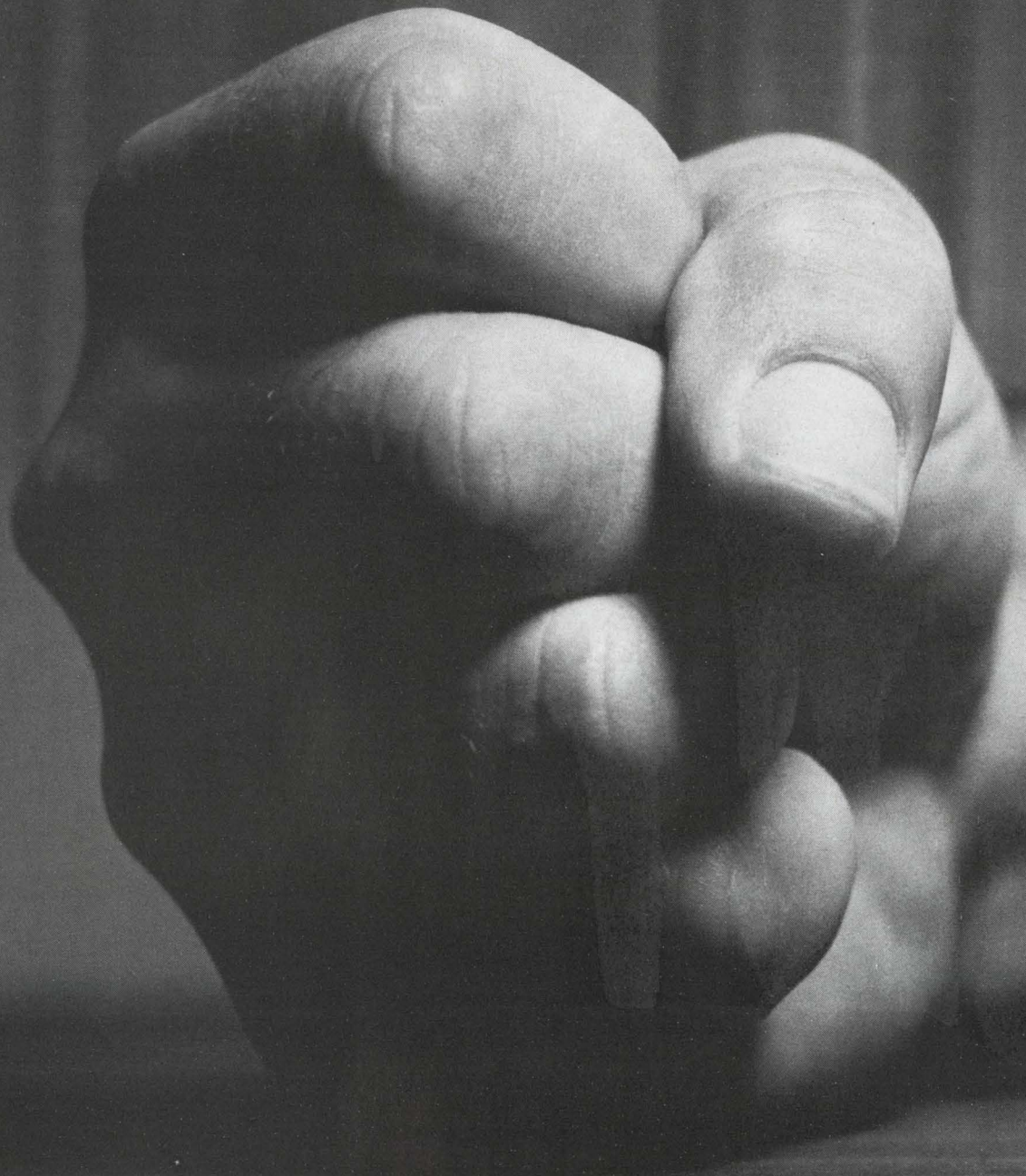

If you felt like this the last time your subminiature relay order was rescheduled, next time call Leach



We've got over 7,000 subminiature relays in stock at key locations throughout the country. Ready for immediate delivery. Relays like our SERIES E., a half-size unit rated for top performance in dry circuit to 2 amp switching. Designed for printed circuit and high environmental applications, this

subminiature relay offers space and weight economies of better than 50% over full size crystal can types. Available in voltages from 6 to 26.5 VDC, the SERIES E has an operate and release time of less than 4 milliseconds maximum, including bounce. It will withstand 100g shock, 30g vibration and operating temperatures from -65 to +125°C. Rated life is 1,000,000 cycles, dry circuit.

Need one tomorrow? A dozen, a hundred? Then call us today. You'll have them. Right on time.

Leach Corporation, Relay Division;
5915 Avalon Blvd., Los Angeles,
California; Phone: (213) 232-8221;
Export: LEACH INTERNATIONAL S. A.

LEACH CORPORATION

ON READER-SERVICE CARD CIRCLE 214

NEW:

Digital Thermometer / Temperature Controller

0.1°C accuracy* from -192.0°C to +999.9°C

features:

- High absolute accuracy
- Direct reading
- Easily calibrated
- Fully automatic operation
- Outputs for control, recording, or telemetry
- Modular construction
- High reliability

The PAR Model DTS-1 offers a new order of reliability, convenience, and accuracy in laboratory and process control thermometry. The unit operates by comparing the resistance of a sensor element of platinum (the material whose characteristics define the International Temperature Scale) with an internally generated reference function which employs a unique resist-

ance analog network** that precisely duplicates the temperature-versus-resistance change of platinum. This method allows an absolute accuracy* of 0.1°C to be achieved. A modified self-balancing Kelvin bridge eliminates sensor lead resistance errors, permitting precise remote temperature monitoring.

In addition to the direct visual readout, measured temperature information is available in binary coded or 10-line decimal form for printer or computer input as well as in pulse code modulated form for telemetry applications. For temperature control or strip-chart recording applications, an analog signal is provided which is proportional to the difference between the measured temperature and the desired temperature

selected by front panel thumb-wheel switches.

All circuits use solid state components except the comparator amplifier where two miniature nuvistor tubes are used to obtain high input impedance and the reference function generator where mercury-wetted relays are used. The entire Kelvin bridge, including the resistance analog network, is isothermally enclosed to assure a high degree of accuracy and good long-term stability. Rugged modular construction, utilizing printed circuit boards, contributes to reliable performance and extended service-free life.

Price: \$3,950.00 (excluding probe). Write for Bulletin #118.

*Subject to operating range of actual sensor used.

**Patent Pending

PAR **PRINCETON**
APPLIED RESEARCH CORP.
Dept. E
Box 565, Princeton, N. J., Tel. (609) 799-1222

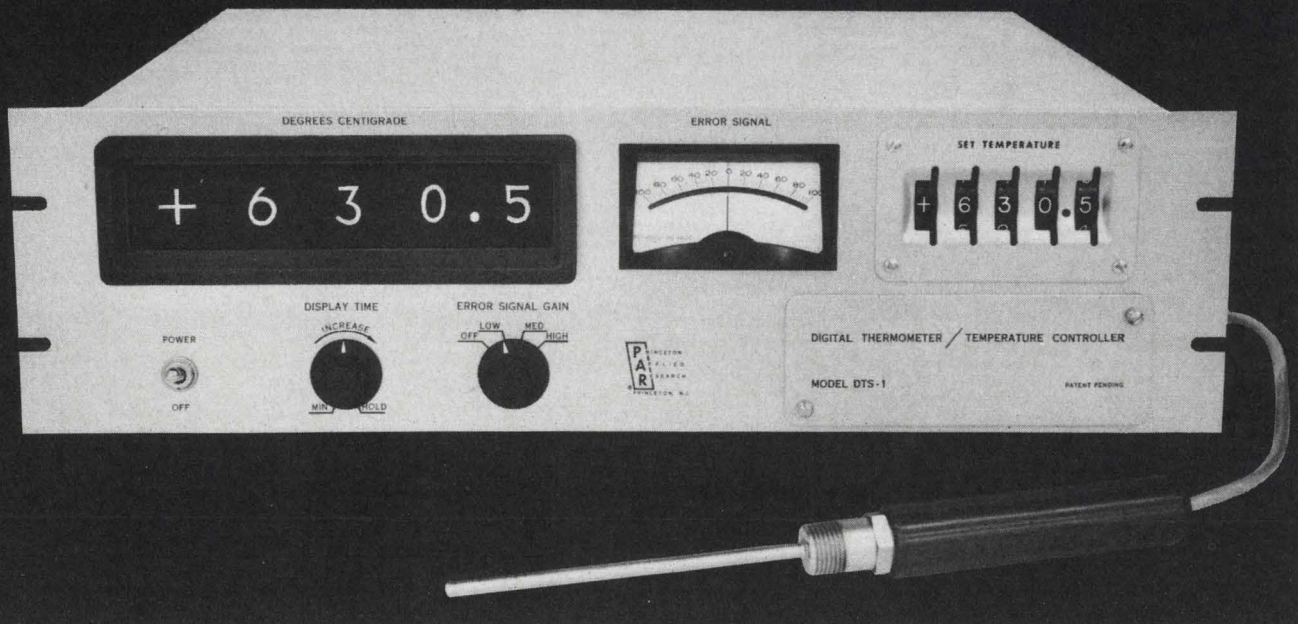

ON READER-SERVICE CARD CIRCLE 10

ICs dominate Paris electronics show

European manufacturers are teaming up to compete against U.S. concerns in the growing microelectronics market. Ferranti unveils an IC computer.

Howard Bierman
Editor

PARIS

With European integrated-circuit (IC) sales expected to soar from several million dollars last year to over \$100 million by 1970, electronics manufacturers in Europe are banding together in a race to control the market. They want to avoid a repetition of the pattern established several years ago with transistors, when United States concerns captured the bulk of the sales.

In Britain, Marconi and Ferranti announced a license agreement permitting Marconi to manufacture and sell Ferranti's Micronor silicon IC line. In France, two major semiconductor manufacturers, Cosem and SESCO, are completing an arrangement whereby each would concentrate on specific research efforts and then exchange technology. Finally the Molecular Electronics Div. of Westinghouse, through Westinghouse Electric International, has agreed to interchange licenses, patents and technological details with N. V. Phil-

ips Gloeilampfabrieken and North American Philips, Inc. These announcements were the main topic of discussion at the annual Salon International des Composants Electroniques, held here February 3-8.

European countries are faced with a difficult choice. Although not anxious to concentrate their purchases with U.S.-based electronics companies, they nevertheless want for their military and space programs the sophisticated devices that the Americans manufacture. European concerns are therefore rushing to set up production lines that can deliver comparable devices for prototype equipment.

At last year's components show, systems engineers showed considerable interest in microelectronic (ME) devices and were optimistic that hardware would soon be available. At this year's show, it was reported that the two major French computer manufacturers, IBM-France and GE-Ball, are relying heavily on ICs in their new designs. Although prototypes are

being assembled with U. S. types, French companies reported they would be in a position to deliver quantity supplies of similar devices at competitive cost within the year.

German concerns, such as Siemens & Telefunken, are counting heavily on using ICs in industrial-control systems. Telefunken has been giving customers samples of its DTZL (diode-transistor-zener diode-logic line); the zener-protection feature is said to insure reliable performance despite sharp line-voltage surges, common in European factories. Telefunken is also seeking sales in military and space computer designs with a micropower DCTL line; however, a spokesman at its booth added wryly that sales of ICs seemed way off. Siemens' spokesman said that the company planned to offer a line of TTL devices for the industrial-control market within the next few months.

British reaction to the coming IC revolution appeared the most volatile. Current estimates by companies in Britain see a \$50-million ME market by 1970. Marconi and Ferranti are determined to capture much of this. Ferranti has just invested more than \$3 million in new production facilities to fabricate its Micronor line; Marconi is completing a 100,000-square-foot plant as a second source for the Micronor line.

Ferranti's Argus 400 ME Computer

Details of Ferranti's recently completed Argus 400 microminiature computer, using Micronor ICs, were described at the show. The high-speed, general-purpose computer, slated for June delivery, uses approximately 8000 ICs in the central processor and more than 1000 in the remaining sections of the system.

In the central processor, the TO-5 packaged ME devices are soldered through six-layer printed-circuit boards, which are then connected to a multi-interconnection

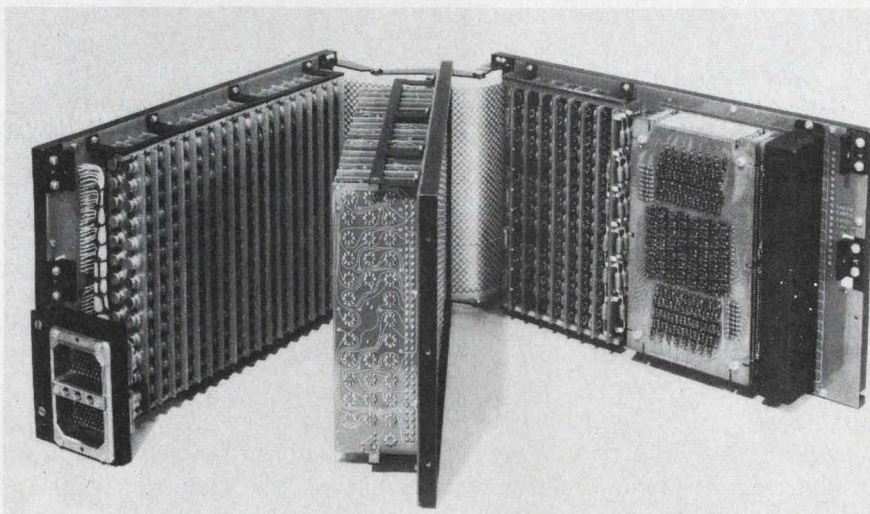

1. More than 9,000 ICs are used in Argus 400, a Ferranti, Ltd, general-purpose microminiature computer. The processor, storage and input-output units are interconnected by a flexible printed-circuit assembly to facilitate servicing.

(Paris show, *continued*)

circuit by miniature wrapped joints (see Fig. 1). The completed processor is housed in a 7-1/4-in.-by-12-in.-by-2-1/2-in. assembly.

The core-storage section includes six printed-circuit panels that contain 4096 storage cores; three panels of resistor-diode networks, and an interconnection board that includes timing circuits, driving circuits (ICs and conventional transistors), and thin-film sensing amplifiers. The complete storage section forms a 4096-word, 24-bit package in the same configuration as the central processor.

The processor, storage sections and input-output units are interconnected by wrapped joints to a flexible printed circuit, so that individual units are accessible when the outer case is removed. Ground planes formed on the printed-circuit boards, together with high operating threshold, offer a high degree of protection against induced transients.

The weight of the combined processor and storage section is only 16 pounds; the associated power unit weighs 13 pounds. The processor requires 20 watts; the first 4096-word core storage unit needs 30 watts (only 4 watts for each additional 4096-word storage unit), and 100 watts are required to deliver 80 watts output from the pow-



2. CGE's 280-watt cw laser is demonstrated by staff engineer M. Frappart. Laser demonstrations drew heavy attendance at the Paris Show.

er section.

Marconi revealed that close to 50,000 ICs would be used in 22 Myriad computers currently in production. Additional ICs will be used in the company's System 4 computer, similar in design to the RCA Spectra 70 line.

An attention-getting ME analog device, a VHF cascode circuit, was also announced by Marconi. The silicon device operates from dc to 200 MHz, with 17 dB gain and a 5-dB noise figure at 100 MHz. Marconi engineers say the TO-5 packaged device eliminates the time-consuming and costly neutralization techniques presently required in VHF wideband amplifiers.

Laser Activity Draws Crowds

Laser demonstrations at the show drew heavy attendance. The show management, in the interest of public safety, refused to allow exhibitors to set up operating lasers at the front of the booths.

Crowds jammed the rear quarters of E. Bradley, Ltd., and CGE (Campagne Generale d'Electricite) to inspect the lasers. CGE showed a 280-watt cw type with an efficiency of 10 per cent (see Fig. 2). The active material was a mixture of carbon dioxide, helium and nitrogen. Emission, at a wavelength of 10.59 microns, was produced by exciting helium ions, which then excited the carbon dioxide. CGE reports it has sold close to 100 lasers this year for research and commercial use.

Color TV fades from show

A disappointing note at this year's show was the absence of color TV displays. At last year's show a number of companies exhibited color picture tubes, deflection components and even prototype receivers. There was optimism then that agreement on a color broadcasting scheme would be reached in Europe before the end of 1965.

This year, with agreement among the countries even further away than before, there was considerable gloom among consumer-goods suppliers about color-TV prospects for the next few years.

RCA 'pipes' heat into electricity

A highly efficient "heat pipe" for transferring energy from a heat source to a thermionic converter for direct conversion into electricity was unveiled recently by RCA.

The device is essentially a metal tube that conducts heat from one of its ends to the other with negligible loss. When used in conjunction with a thermionic converter, the heat pipe is expected to find application in space-vehicle power systems that employ nuclear reactors as the primary energy source.

Until now it has been necessary to design a thermionic converter

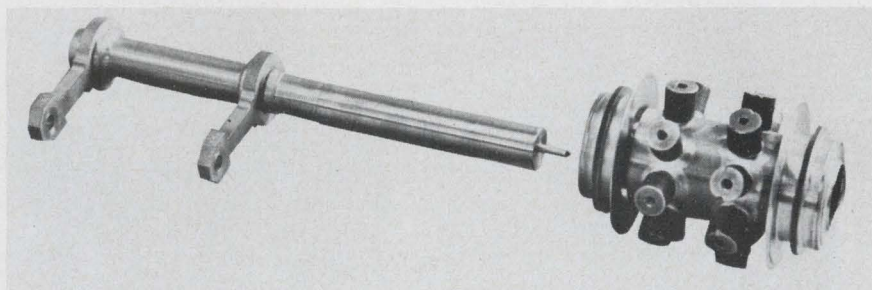

1. Heat pipe (left) and thermionic converter (right) team up to convert thermal energy directly to electricity.

as an integral part of the reactor. But with a heat pipe, the converter can be placed outside the reactor with no loss in efficiency.

Lithium carries the heat

The heat pipe consists of a mo-

lybdenum tube containing molten lithium. When one end of the pipe is heated, the lithium at that end vaporizes, and in doing so, it absorbs a great amount of thermal energy.

The vapor is then transferred by



ONE

STOP

SHOPPING

FOR ALL MAGNETIC MATERIALS
at IEEE Booths 2D15-2D17

PERMANENT MAGNETS: Cast Alnico, Sintered Alnico and Ceramic Magnets (Arnox). **MAGNETIC CORES:** Silectron-C Cores and Distributed Gap Cores. Tape Wound Cores of Deltmax, Supermalloy, Permalloy, Supermendur and Silectron. **POWDER CORES:** MO-Permalloy Powder Cores, Iron Powder Cores and MSS Iron Powder Cores. **TRANSFORMER LAMINATIONS AND HARDWARE:** Nickel-Iron, Silicon-Steel Laminations, Transformer Cans and Hardware, Tube Shields. **SPECIAL MAGNETIC MATERIALS:** Vicalloy, Permendur and Vibralloy.

And they are all precision engineered. The Arnold engineering facilities are among the world's largest and most complete, devoted exclusively to helping solve your magnetic device problems.

In addition, Arnold is a prime source for precision metal rolling . . . ferrous and non-ferrous strip, close tolerances and ultra-thin gauges . . .

Speed Inquiry to Advertiser via Collect Night Letter
ON READER-SERVICE CARD CIRCLE 11



ARNOLD
SPECIALISTS in MAGNETIC MATERIALS

THE ARNOLD ENGINEERING COMPANY, Main Office: MARENGO, ILL.
BRANCH OFFICES and REPRESENTATIVES in PRINCIPAL CITIES

Now from Sprague!

DIFFERENTIAL AMPLIFIERS IN FLAT PACKS!

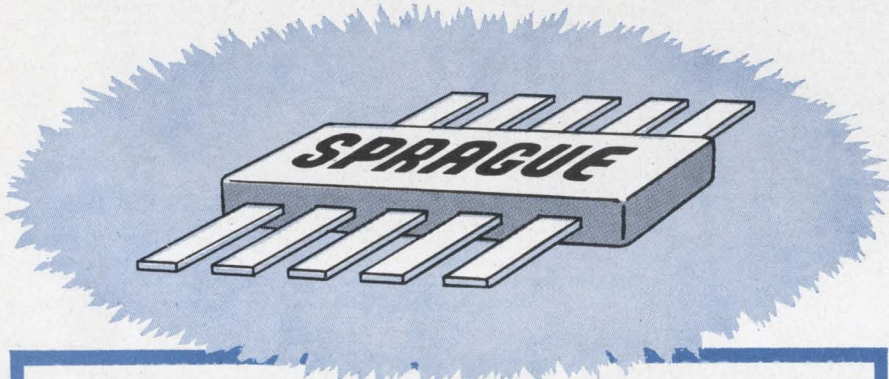

2N3043 2N3044 2N3046
2N3047 2N3049 2N3050 2N3051
2N3052 2N3520 2N3524

PNP or NPN • BETA MATCHING to 10%

V_{BE} MATCHING to 3mV

VOLTAGE CAPABILITY to 60 VOLTS

TEMPERATURE COEFFICIENTS to $5\mu\text{V}/^\circ\text{C}$

ALSO AVAILABLE IN 6-LEAD TO-5 OUTLINE PACKAGES!

For complete information, write to Technical Literature Service, Sprague Electric Company, 347 Marshall Street, North Adams, Mass. 01248

SPRAGUE COMPONENTS

TRANSISTORS
CAPACITORS
RESISTORS
THIN-FILM MICROCIRCUITS
INTEGRATED CIRCUITS
INTERFERENCE FILTERS

PACKAGED COMPONENT ASSEMBLIES
FUNCTIONAL DIGITAL CIRCUITS
MAGNETIC COMPONENTS
PULSE TRANSFORMERS
CERAMIC-BASE PRINTED NETWORKS
PULSE-FORMING NETWORKS

SPRAGUE®
THE MARK OF RELIABILITY

® 'Sprague' and '®' are registered trademarks of the Sprague Electric Co.

ON READER-SERVICE CARD CIRCLE 12

NEWS

(heat pipe, *continued*)

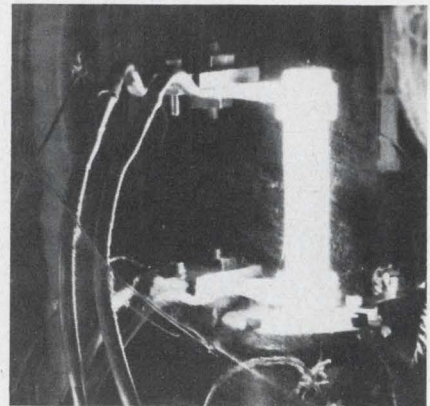

2. Heat pipe glows white hot during test with thermionic converter.

thermodynamic action to the opposite end of the pipe, where it condenses and releases this energy with a negligible temperature drop. A capillary structure on the inner wall of the pipe, similar to a wick, returns the condensate to the other end of the tube, where the continuous cycle is repeated.

Initial work on the heat pipe principle was carried out by scientists at the Los Alamos Scientific Laboratory. RCA has continued this work at its Direct Energy Conversion Department under contract to the Air Force Systems Command.

Put a head on it



Ultrasonic transducers are replacing the physical jarring formerly employed to foam beer, driving off the unwanted air before the bottles are capped. The Electronic Assistance Corp.'s device is made of nickel due to the moist environment.

Far-out improvements sought in data links

Aerospace convention told of need for better components and techniques to achieve high-rate microwave and optical communications on deep-space missions.

Ralph Dobriner
West Coast Editor

LOS ANGELES

In the next decade communications equipment aboard deep-space probes may be required to transmit information back to earth at rates of 10^6 bits per second and higher. This compares with the 8-bit-per-second performance of the Mariner IV mission to Mars.

Several technical papers at the recent Winter Convention on Aerospace and Electronic Systems held here revealed that considerable component development in microwave and optical communications is still needed before the high data rates can be achieved.

Microwave needs outlined

Research goals for future microwave deep-space communication systems were described in a paper by Drs. W. T. Patton and A. B. Glenn of RCA, Inc., Moorestown, N. J. Assuming a 10^6 bits-per-second requirement for future spacecraft-to-earth data links, the authors cited the need for improvements in the following microwave areas:

■ **Phase and frequency stability**—Stability of better than 1 part in 10^{12} and phase-locked loop bandwidths of less than 1 Hz are needed. State-of-the-art frequency stability is adequate for high-data-rate noncoherent systems. However, for low-data-rate coherent systems, improved frequency stability is important to reduce both frequency acquisition time and doppler noise for orbit tracking. At the same time very low values of phase jitter (less than 15 deg rms) are required for a high probability of maintaining phase lock over long periods of time.

■ **Transmitter power**—The quality rather than the quantity of RF power needs improvement. The frequency stability and phase co-

herence of the transmitters must be better, particularly for relatively low-data-rate missions to the outer planets. Tube efficiencies must also be increased.

Techniques, such as beam focusing and the use of tapered helixes and multiple collectors should be considered, the RCA authors said. Solid-state amplifiers should be integrated with the solar cells, antenna and cooling structures to improve the over-all efficiency of the system and minimize the weight of these components.

According to the authors, a space-qualified traveling wave tube that can deliver 100 watts at 50% efficiency should be available

by 1970. They noted that efficiencies as high as 57% have already been demonstrated in the laboratory. Current space-qualified TWTs deliver about 50 watts at about 2 GHz, with 40% efficiency.

■ **Low-noise receivers**—Improved maser materials and fabrication techniques, as well as better techniques for thermal isolation between components of the system, are needed.

More efficient and lighter closed-cycle cryogenic equipment and more efficient RF pump sources are also required. Multi-aperture receiving arrays will require many low-noise receivers at each station.

■ **Transmitting antenna gain**—A very lightweight spacecraft antenna that takes advantage of the relatively large surface tolerance compared with the ground receive-

Table 1: Microwave Performance, Past and Future

PROGRAM	Index M (dB)	P_t (watts) (dB)	G_t (dB)	A_r (m ²) (dB)	T_e (°K) (dB)	Freq. (MHz)
1959 Pioneer IV	-10.2	0.27 -5.7	2.5	290 24.6	1450 31.6	960
1962 Mariner II	+24	3 4.8	19	290 24.6	250 24	960
1965 Mariner IV	42	10 10	24	290 24.6	55 17.4	2290
1971 Voyager	70	50 17	34	1,770 32.5	25 14	2290
Future	90	10 10	45	63,000 48	20 13	
Future	90	100 20	40	20,000 43	20 13	

Table 2: Comparative Component Performance

Component	Type	Characteristic compared	Value
Lasers	Ar ³⁺ (0.488 μ)	Photons/Mode-Sec (n_T)	10^{18}
	Nd ³⁺ (1.06 μ)		10^{19}
	CO ₂ (10.6 μ)		10^{21}
Modulators†	Nitrobenzene KDP KTN	Max Trans/Mode	~ 1
			$\sim 10^{-1}$
			$\sim 1/4$ to $1/2$
Optics	10 cm 100 cm 1000 cm	Transmission Mode	~ 1
			< 1
			$\sim 10^{-2}$
Detectors	Si (0.488 μ) PbS (1.06 μ) (?) (10.6 μ)	Quantum Efficiency	$\sim 1/2$
			$\sim 1/2$ *

Notes

†Adequate modulation bandwidth and modulation depth is assumed

*Heterodyne detection not yet demonstrated

D

DAMON

R E A L T I M E
S P E C T R U M
A N A L Y Z E R

Gaussian or Chebyshev Crystal Filters
Solid State Electronic Commutation
Uniform Frequency Response

Damon's Multifilter Spectrum Analyzers are adaptive to signal rate, filter time constant or display response. A unique frequency-sharing principle permits optimum utilization of filters for maximum economy. In analysis bands from 100 cps to 10 Mc, multipole crystal filters with bandwidths from 5 cycles to 100 Kc resolve closely spaced signals having large amplitude ratios.

These state-of-the-art Analyzers are illustrative of Damon's capabilities in frequency information retrieval and analysis. Other significant examples include the Telstar Comb Filter and the SPASUR Detection Preselector.

**Write for Real Time Multiple Filter
Spectrum Analyzer Brochure.**



**Spectrum Analyzer
Model 5187A**

DAMON ENGINEERING, INC.

240 HIGHLAND AVENUE

NEEDHAM HEIGHTS, MASS. 02194 (617) 449-0800

Speed Inquiry to Advertiser via Collect Night Letter
ON READER-SERVICE CARD CIRCLE 13

NEWS

(data links, continued)

ing antenna is a primary goal. Also, RF-sensing and antenna beam-positioning techniques must be developed to handle beam-widths on the order of one degree or less. Single-channel RF error-sensing techniques should be developed to eliminate the cost and complexity of additional receiver channels for the sensing function, the authors noted. In addition there is a need for developing techniques for integrating the transmitting antenna, RF power source, prime power source and cooling structure, to improve the over-all reliability and reduce the combined weight of these components.

■ **Ground antenna system**—A large time-delay, collimated multi-aperture antenna system is sought, with noise contribution from the ground and low elevation angles on the order of 4°K. According to the authors, the techniques developed for this application must provide an average side-lobe level of about 80 db, with peak sidelobes or grating lobes on the order of 40 dB below the main beam. A 210-foot reflector, now being installed, represents nearly an order of magnitude increase in receiver aperture over the 85-foot reflector used for the Mariner IV mission. Future missions, the authors noted, will require an in-

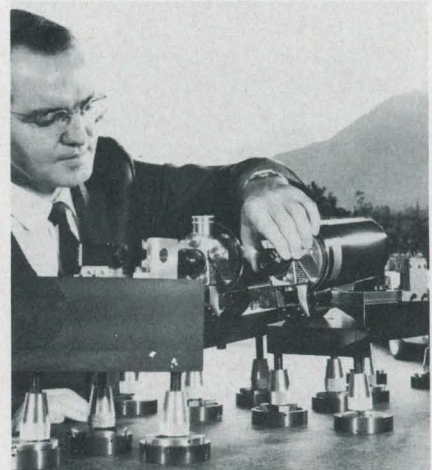

Optical telescope, being adjusted by Dr. George Clark of Electro-Optical Systems, is used in experiments to measure the effect of atmospheric attenuation on laser beams. A pulsed neodymium laser output is beamed at mountain in background and signal attenuation is measured.

crease in effective receiver aperture of at least another order of magnitude. Envisioned is development of multi-aperture antenna systems that are 700 feet in diameter.

Performance index indicated

The microwave performance of three completed deep-space missions and the expected performance on future missions are summarized in Table 1, which was prepared by the RCA scientists.

The performance index, M , is considered to be the product of the effective radiated power in watts at the transmitter and the ratio of the receiver aperture area to the system noise temperature. The decibel values of M are the sum of the transmitter power, P_t , the spacecraft antenna gain, G_t , and the area of the receiving aperture, A_r , minus the receiving noise temperature, T_e . The performance index listed for future missions represents a data rate of 10^6 bits per second on a Mars mission. This is about five orders of magnitude above the performance of Mariner IV.

According to Dr. Patton, the improvements recommended above are expected to be achieved after five years of R&D and will probably take another five years to put into operation.

For high bps, go optical

For the very-high-data rates— 10^7 to 10^9 bits-per-second—and especially for deep-space missions, it is generally accepted that optical communication systems, using the laser, will have to be considered. However, as discussed in a paper by George L. Clark, D. D. Erway, P. C. Fletcher and G. R. White of Electro-Optical Systems, Inc., Pasadena, Calif., many improvements in components and techniques are required before these systems can become practical.

According to Dr. Clark, a high-data-rate optical link will certainly be feasible between earth and the moon. He referred to the many favorable technical factors attributable to the fixed locations of both stations, though he expects the atmosphere to present a problem. Dr. Clark considers it far more difficult to set up a communication link between the earth and

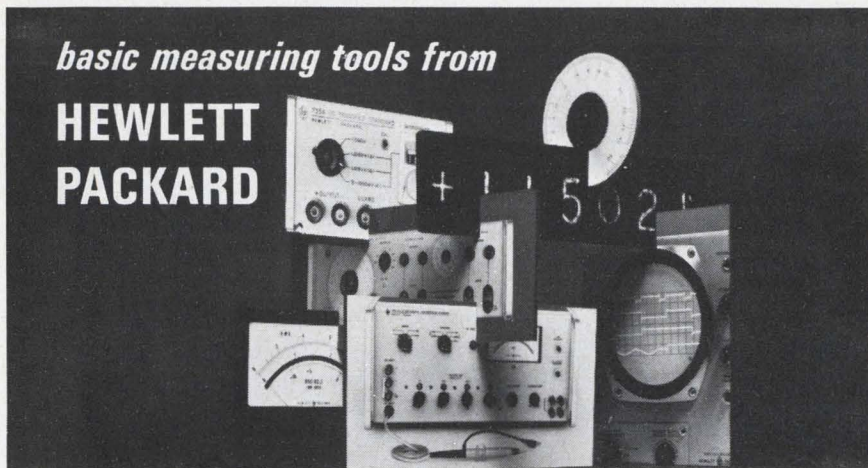

basic measuring tools from

**HEWLETT
PACKARD**

hp 331A, 332A

Solid-State Distortion Analyzers

Harmonic distortion measurements, 5 Hz (cps) to 600 kHz (kc)
 0.1% full-scale distortion sensitivity
 Input sensitivity 0.3 V rms for 100% set level reference
 Low-distortion output for scope or true rms VM monitoring
 300 μ v full-scale voltmeter sensitivity (residual noise < 25 μ v)
 Floating input, output

Use it to:

Measure total broadband distortion
 Measure voltage, 5 Hz to 3 MHz (mc)
 Measure noise and hum level as small as 50 μ v
 Measure envelope distortion of AM rf carriers
 Amplify signals (high gain, wideband)

Both analyzers consist of a broadband amplifier, a tunable frequency-selective rejection circuit and a high-impedance voltmeter. The rejection circuit provides fundamental rejection > 80 db. The voltmeter measures 300 μ v to 300 v rms full scale, using the same terminals, attenuated in 10 db steps. The two instruments are identical except that the 332A adds an amplitude modulation detector, 500 kHz to greater than 65 MHz. The ana-

lyzers are value-priced, too: 331A, \$590; 332A, \$620.

Call your Hewlett-Packard field engineer for a demonstration of the distortion analyzer most useful for your application. Or write for full specifications to Hewlett-Packard, Palo Alto, California 94304, Tel. (415) 326-7000; Europe: 54 Route des Acacias, Geneva.

*Data subject to change without notice.
 Prices f.o.b. factory.*

HEWLETT  **PACKARD**
An extra measure of quality

1045



332A

ON READER-SERVICE CARD CIRCLE 14

Problems switching Low-Level Signals in Process Control?

LOOK TO **JAMES**

"Micro-Scan" Relays

More in use in D. D. C. process control systems than any other

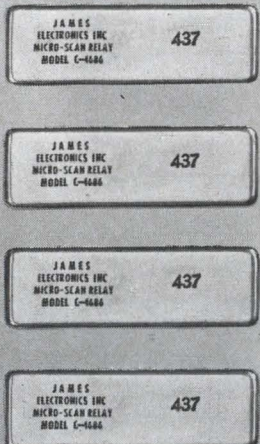
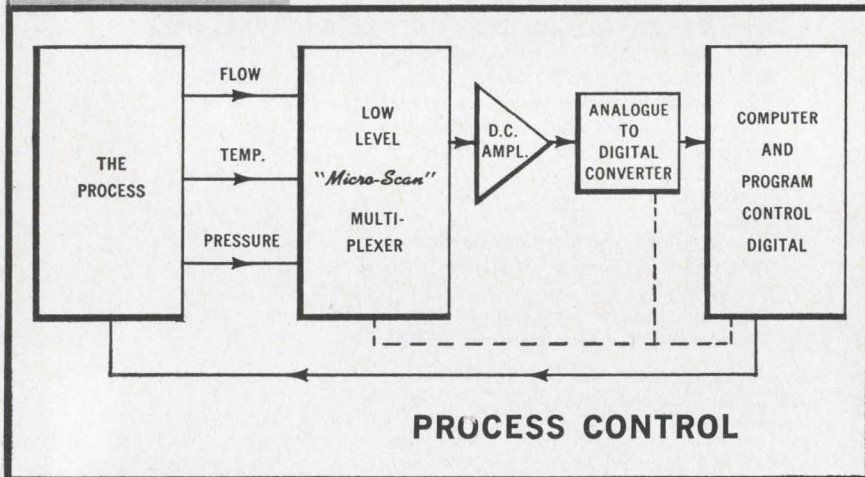
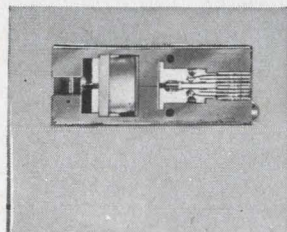

Operationally, they are the fastest and most reliable answer to low-level instrumentation . . . with numerous combinations available up to 3 PDT. You get a high on-to-off switching ratio not found in solid state devices. MICRO-SCAN relays are compactly built to meet the most exacting applications of industry and the military. Highly reliable in switching transducer inputs for reading strain, pressure, flow and temperature in process control systems. Here's why:

- **LOW THERMAL CIRCUITS**
Less than .5 microvolt offset for remote transducer switching.
- **HIGH SHIELDING**
Less than 1 pf. open circuit. Less than 10 pf. circuit to ground.
- **HIGH OPERATING SPEEDS**
As low as 650 microseconds.

Write direct for full specifications.

JAMES[®]

ELECTRONICS INC.

4050 North Rockwell • Chicago, Illinois 60618 • 312-463-6500 • TWX 312-222-0745

Visit us in Booth 2A01 I.E.E.E. Show

ON READER-SERVICE CARD CIRCLE 15

NEWS

(data links continued)

a deep-space probe at interplanetary distances. He observed that the earth station has all the bad effects of earth atmosphere, and the other station has all the difficulties of accurate tracking requirements plus limited size, weight and access.

A comparison of state-of-the-art lasers and components that make up optical communication systems is shown in Table 2, prepared by the authors.

The table shows that high-power gas lasers have the highest figure of merit, followed by solid-state crystal lasers and injection lasers. Although not as highly developed as sources, coherent optical detectors are nevertheless relatively far advanced.

Better materials and techniques to extend their capabilities to long wavelengths were forecast within the decade by Dr. Clark.

Modulators and optics lag

The third area of critical importance, that of propagation, modulation and control, is far behind in development, according to Dr. Clark.

The optical elements between the coherent source and coherent detector—including lenses, mirrors, modulators, phase shifters and turbulent atmosphere—must deliver the diffraction-limited output of the laser to the detector with the least possible loss of coherence.

Dr. Clark observed that at present these elements degrade communication systems by many orders of magnitude.

In Table 2 the concept of transmission per mode is used. The number of optical propagation modes in a beam is the ratio of the actual solid angle occupied by the beam to the diffraction limit.

Dr. Clark considers advances in pointing and beamwidth to be more important than increases in source power. In particular, he cited two functions in which diffraction limits are not even approached: modulation and penetration of the earth's atmosphere.

He pointed to the following areas in which coherence in optical communication systems is lost:

(data links, *continued*)

■ **Electro-optical modulators**—

At present all solid-state modulators introduce far more phase error, due to lack of optical quality, than phase control, in terms of the electrically variable phase induced in the wave. This means that the beams must be severely degraded to place the coded information on them.

■ **Earth's atmosphere**—A means of circumventing atmospheric fluctuations, through the use of low-frequency optical compensators in an adaptive array antenna, is needed to improve the data rate and characteristics of optical communication systems in which one station is earth-based.

In addition Dr. Clark cited the need for advances in detector materials and techniques for long wavelengths, for example, 10.6 microns.

He predicted that by 1975 a laser transmitter, operating in the 1-10 micron range, should be available. It would deliver up to 10 watts' output in a single mode. With suitable development, the unit would be able to meet the size, weight and reliability needs of space probes. Dr. Clark said that pointing accuracies of 0.2 second should be feasible corresponding to aperture diameters on the order of one meter at one micron. With an assumed detector quantum efficiency of 0.9 and an over-all transmission in the system of 0.4, the data rate would be about 90 million bits per second.

Accuracy is our policy

The path to international standards is tricky at times. We stumbled twice in our Feb. 15 issue.

On p. 17 the power-handling capability of Microwave Associates' all-diode duplexer should have been stated as 2 MW and 1 MW, instead of 2mW and 1 mW, respectively.

On p. 114 Fairchild's new microwave transistor was erroneously described as giving 200 MW output at 2 GHz. The correct figure should have been 200 mW.

March 1, 1966

MOL Resistors

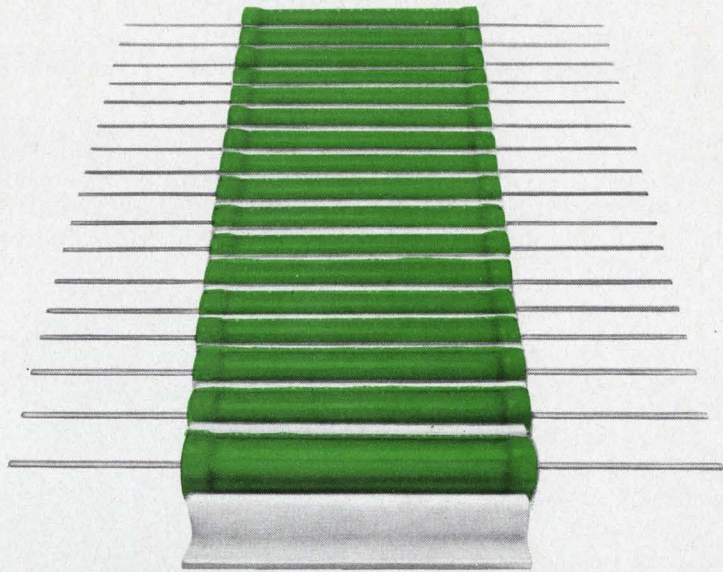

PROMPT DELIVERY

...is one reason why all major TV manufacturers use Mallory MOL film resistors.

Other reasons? Temperature coefficient only 250 PPM/°C; proved flame resistance; high stability in humidity; less than 5% resistance change after 10,000-hour load-life test. Write for data and quotation. Mallory Controls Company, a division of P. R. Mallory & Co. Inc., Frankfort, Indiana 46041.

50th
ANNIVERSARY

MALLORY

ON READER-SERVICE CARD CIRCLE 16

New physics gives new physicists new tools.

Roger Kenneth Field
News Editor

The new physics sweeps into the high schools of the country this year, and following the new broom is a whole new style of laboratory apparatus.

The new physics, like the new math, is a wholly coordinated and refreshingly intellectual approach to the teaching of a subject that has bamboozled students since Lucretius told his disciples about "The Nature of the Universe."

The apparatus is now so inexpensive that the budding young Nobel laureate can afford to own much of it himself. The emphasis of the new physics is to have the student duplicate famous experiments.

To keep production costs to a bare minimum, manufacturers must resort to using the cheapest possible materials. A list of "components" in this field includes such amusing entries as rubber bands, paper clips, drinking straws, coffee cans (see Fig. 2), colored water, balsa wood, fish tank pumps and strips of adhesive tape. It would also include, however, integrated flatpack arrays (Fig. 3) and klystron tubes (Fig. 1).

These electronic devices were displayed at the American Association of Science Teacher's Show in New York late last month.

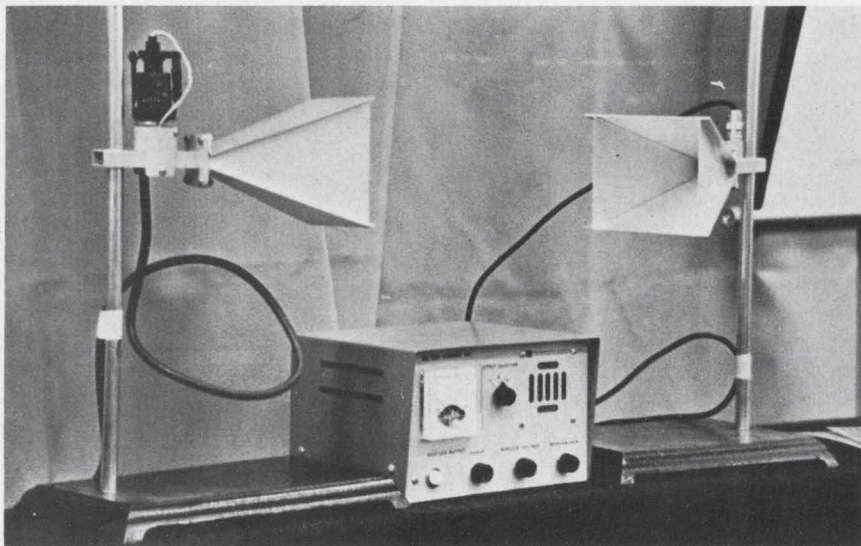

1. **Microwave experiment:** \$190, by Macalaster Scientific Corp., Watertown, Mass., includes polarizing grid, and deflector.

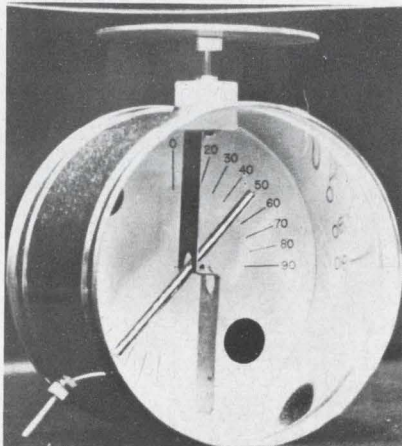

2. **\$3 electroscope** made from a Maxwell House coffee can, by Macalaster, uses an aluminized drinking straw for the pointer.

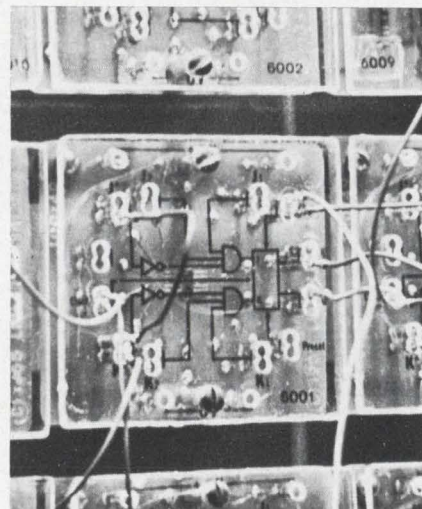
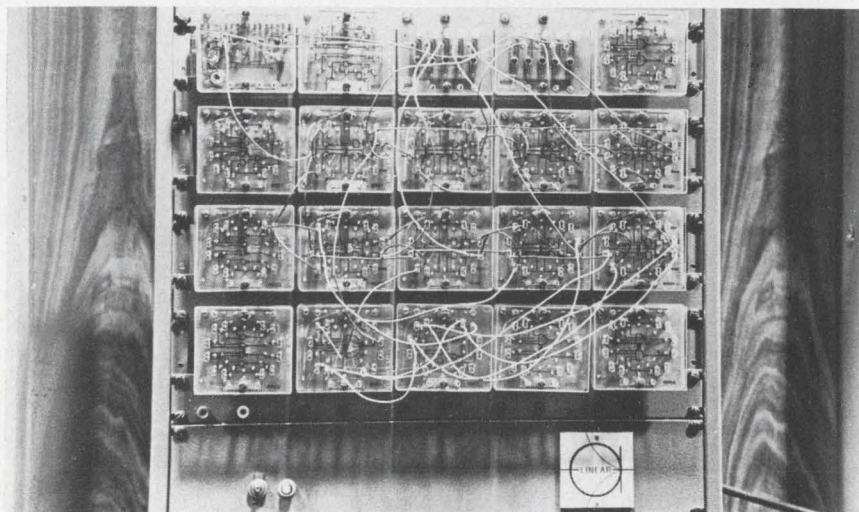

3. **"Log log lab"**—a digital logic patchboard system for classrooms: uses integrated circuits, from Linear Alpha, Inc., Evanston, Ill.



half the picture

*When you look at electronic components
are you seeing only half the picture?*

We're the last people to argue with component purchasers who put performance, price and delivery first — meeting these three basic requirements is what keeps us in business. But most engineers are also on the lookout for something more, and many of them find it at Mullard.

Take research and development for instance. Out of Mullard R&D have come outstanding devices such as the travelling wave tubes for the New York—San Francisco and Montreal—Vancouver microwave links. Production resources? Mullard

plants are among the most efficient anywhere, with a reputation for the production of tight-tolerance devices to proved standards of reliability. As for circuit know-how, Mullard has the best equipped applications laboratories in Britain. And when it comes to technical services, you will find that Mullard provides the kind of comprehensive performance specs, survey documents and application reports that are just that much more useful. If you want to get the *whole* picture, why not ask us to help you with some of your component problems?

ON READER-SERVICE CARD CIRCLE 213

DIODES · TRANSISTORS · PHOTO-DEVICES AND RADIATION DETECTORS · RECTIFIER DIODES AND STACKS · THYRISTORS AND STACKS · INTEGRATED CIRCUITS · CATHODE RAY TUBES · RECEIVING TUBES · ELECTRON OPTICAL DEVICES · PHOTSENSITIVE DEVICES · COLD CATHODE DEVICES · POWER DEVICES · TRANSMITTING TUBES · MICROWAVE DEVICES · CAPACITORS · FERRITE MATERIALS AND ASSEMBLIES · COMPUTER COMPONENTS AND ASSEMBLIES · MAGNETIC MATERIALS · SPECIAL PURPOSE MAGNETS · VACUUM DEVICES · WOUND COMPONENTS.

Mullard

where the product is only part of the deal
MULLARD LIMITED · TORRINGTON PLACE · LONDON WC1 · ENGLAND



■ ATTENTION: PHOTO-DEVELOPER DESIGNERS! HERE'S A LOW-COST CONTROLLER THAT KEEPS BATH TEMPERATURES CONSTANT.

The secret lies in the low-cost G-E C106B SCR. Here's how the circuit works:

The earlier the SCR turns on during each cycle of the a-c supply voltage, the greater is the voltage applied to the load. Conversely, the later the SCR "firing angle," the less the voltage applied.

Result: the low-cost SCR steplessly adjusts the voltage applied to the

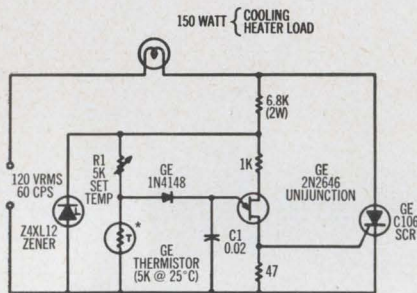

*REVERSE THERMISTOR AND R1 FOR COOLING LOAD
NOTE: ALL RESISTORS 1/2 WATT EXCEPT AS NOTED

heater so that the heat supplied the liquid bath load balances, exactly, the heat losses to the outside. Presto: the bath temperature must remain constant. Learn more about this profitable controller by circling Number 812 on the magazine Reader's Service Card.

■ NEW DESIGN TIPS—GET 'EM WHILE THEY'RE HOT! AT G-E IEEE SEMINARS!

Join us at the Barbizon Plaza on March 22nd for two vitally important G-E seminars. We've scheduled two excellent programs for you. On tap in the morning: *Innovations in Industrial Semiconductor Circuits*. And in the afternoon: *Semiconductor Control and Power Conversion Applications*.

Morning discussions will feature Rick Spofford on "Applications of the New Silicon Bilateral Switch and Silicon Unilateral Switch"; Bob Muth on "Digital Circuits with Visual Read-

What do you do when conventional transistors won't fit?

Try substituting G.E.'s new microtab transistors. They're even smaller than they appear in this picture—a mere 0.07 by 0.07 by 0.085 inches. Yet you'll find they deliver exactly the same performance their larger, conventional-sized counterparts give you.

Think of the advantages they offer equipments such as hearing aids, miniature operational amplifiers, and very small instrumentation products. Try them in your latest hybrid circuit developments, or in your linear and analog circuits.

MICROTAB TRANSISTOR TYPES AVAILABLE

Series	Description
D26E	a high gain, low noise amplifier type similar to 2N930, 2N2484
D26G	high frequency amplifier types similar to 2N918

And don't worry. Plenty more types are on the way. Cost: types less than \$1.00 in quantities. Circle Number 811 on the Reader's Service Card and find out all the facts.

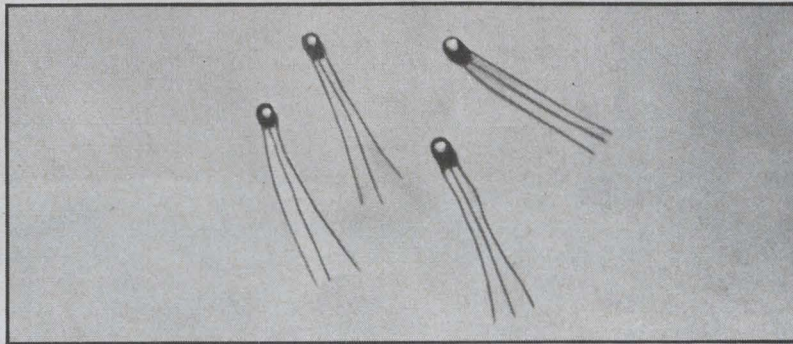

outs"; and Dwight Jones on "Semiconductor Timers and Low Frequency Oscillators."

And the afternoon agenda will include presentations on "Ingredients for Today's Power Semiconductor" by Ed VonZastrow; "Economy Semiconductors for the Light Industrial, Appliance and Housewares Industry" by Denis Grafham; "Using Triacs and Light-resistive Leads" by Jim Galloway; "7500-volt 2-ma Power Supply" by Andy Adem; and "Low-cost Ultrasonic Inverter Using an SCR" by Neville Mapham.

Try to attend both if you can. Or if you'd like more information on either, circle Reader's Service Card Number 813 for details on the morning session and Number 814 the afternoon program story.

More information on all G-E semiconductor products can be obtained by calling your G-E engineer/salesman or distributor. Or write to Section 220-27, General Electric Company, Schenectady, N. Y. In Canada: Canadian General Electric, 189 Dufferin St., Toronto, Ont. Export: Electronic Component Sales, IGE Export Division, 159 Madison Ave., New York, N. Y.

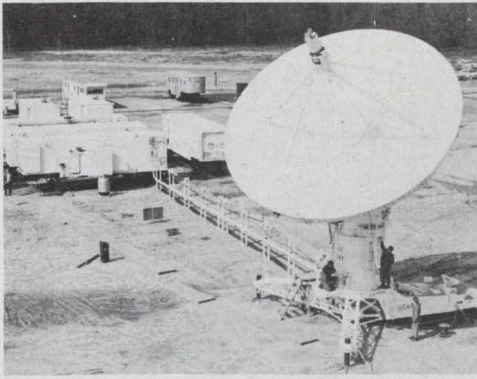

U. S. to test its electronic defense

How effective are anti-radiation missiles? Can they really home on protective radar and knock it out in a war? The Army plans to find out. It is setting up a program to study U. S. electronic detection and identification systems and radar-controlled defensive weapons. How vulnerable would they be to enemy anti-radiation missiles, the weapons that modern war doctrine says will be launched as a first wave to activate the defensive radar, home on it and destroy it?

Most details of the Army program are classified. It is known that it will be supervised from Fort Monmouth, N. J. An Army-industry team will have until sometime next January to complete the first phase of the program—the development of a master plan and a computer program for conducting the study.

R&D slated for linear-induction motor

A commerce Department R&D official says that research funds will be provided for the linear-induction motor, viewed by some as a science-fiction approach to high-speed rail transportation. The research will be conducted under the High Speed Ground Transportation Research and Development Act of 1965. Exactly what route of several the researchers will follow has not been decided yet, because, as the official put it, "We aren't in the specifications stage yet on this project."

Among the directions in which the Commerce Department is known to be looking are those followed by Westinghouse Electric in its "electropult" idea, dating to its 1946 concept for electric launching of aircraft. Another direction is being pursued by General Motors' Santa Monica laboratory in California; it is looking at linear-induction motors for powering GM's Hovair vehicles.

The Teletrans Corporation, a Detroit firm, is building a test track with vehicles propelled by linear induction motors. A prototype has been in use over a year.

Commerce officials also indicate that the present "formative status" of the engineering

Washington Report

S. DAVID PURSGLOVE,
WASHINGTON EDITOR

research program for high-speed ground transportation holds significance for electronic designers. Feasible projects still are being sought for inclusion in the program, they said, and almost any probable proposal will be given a hearing. On this count, Dr. Robert A. Nelson, director of the Office of High Speed Ground Transportation, has said often that he tries to listen to all comers. He hopes somebody can weed out the pure crackpots, but he cannot afford to refuse an audience to the rational proponent of even a "way-out" idea. "This kind of idea may contain the kernel of an approach we need," he says.

Senators urge nuclear-transport program

Senators Warren G. Magnuson (Dem., Wash.) and John O. Pastore (Dem., R.I.) want to see the many Federal projects in nuclear propulsion for transportation systems brought together in a coordinated program. They have introduced a resolution that, ultimately, would have that effect. It provides for a study to determine the best way to encourage the use of nuclear transportation on land and sea and in the air.

Both Senators have long expressed annoyance at the initiation and cancellation of nuclear-propulsion programs in aircraft, ship and other fields, without regard by officials in one field for the state-of-the-art or the implications of their actions in another field. Some observers anticipate a push for a new "bureau of transportation energy" in the Atomic Energy Commission to coordinate and later manage ship and aircraft reactors and any railroad and highway-vehicle reactors that might be developed.

Civilian role for military R&D?

The White House is expected to call on military and space R&D companies by early summer to apply their systems approach to solve big non-technical problems. Administration science and technology advisers are said to be planning to point to a forthcoming report study by the National Institute of

Public Affairs. The study is evaluating "possible new technological approaches to problems of crime and delinquency, government information, transportation and waste management." The institute is examining the results of a California experiment in which aerospace companies applied the military R&D systems approach to define and partly solve major statewide problems. If the California results are found promising and point to applicability in other non-technical areas, the Administration is prepared to call in dozens of military and space R&D companies to combat everything from pollution control and transportation to poverty and foreign aid.

Most observers expect the institute report to be positive. Carl F. Stover, director of the institute, said before the study began: "The defense and space programs demonstrate that we can govern modern technology and employ it to execute gigantic tasks. They have given us better tools for analyzing complex problems . . . they have shown that industry's talents can be soundly used in carrying out public programs."

The California experiment, set up by Gov. Pat Brown, involved five aerospace concerns. Aerojet-General studied waste management. The Lockheed Missiles and Space Company analyzed state government information needs and proposed the beginnings of an automated information system. North American Aviation examined the state's future transportation needs and proposed several preliminary approaches to solutions of the problems it foresaw. The Space General Corporation utilized specially adapted computers to examine California's crime and delinquency problem, and it turned up several unforeseen factors. The System Development Corporation provided technical advice to the state on all of the studies.

The results of the California experiment already have been highly praised by state officials and by many Federal officials. There also have been skeptics who have cried, "Boondoggle!"

Federal highway bills pushed

The provision for a traffic safety research center in the National Traffic Safety Bill introduced by Sen. Vance Hartke (Dem., Ind.) has been spelled out. As Hartke sees it, the research center will have all the facilities necessary to study every aspect of traffic accidents; to determine causes and to design,

develop and test systems and devices that suggest solutions. He wants to see the center equipped with the best possible library, laboratory and testing facilities.

Whether the Hartke bill will become part of President Johnson's over-all highway-safety program remains to be seen. The President's program calls for an outlay of \$3 million in fiscal 1967 for research on the possible establishment of safety standards. The program envisions spending \$20 million in fiscal 1968 to help states set up their own highway programs. And it includes \$10 million more in the same year for federal R&D on all aspects of highway system safety.

Common grave for dying programs?

NASA and the Defense Department, largely at the urging of Congressmen who don't want to see the two agencies duplicate each other's manned space programs, have set up a joint group to coordinate NASA's post-Apollo applications program and the Air Force's manned orbiting laboratory (MOL). As reported in this column (E/D, Jan. 18), both programs are in trouble. MOL funds were supposed to soar in the new budget; the program got no increase, supporting a widespread belief that it will never get off the ground. The post-Apollo applications program, which would use man-on-the-moon techniques and hardware for unmanned scientific missions beyond the lunar landing, received only half the budget that NASA had asked the White House for. In fact, the post-Apollo program has never been officially authorized by congress.

The new agreement signed by NASA and DOD calls for the "expeditious coordination of their manned space flight programs." The agreement establishes a joint committee, known as the Manned Space Flight Policy Committee.

Within guidelines to be provided by the Secretary of Defense and the Administrator of NASA, the committee will "determine top-level policy for the manned space flight programs, ensure the coordinated planning of the two agencies' programs in this area, and resolve matters concerning the mutual participation in and support of the manned space flight programs which cannot be resolved at a lower level."

Following announcement of the NASA-DOD coordinating group, the coffee-talk at both agencies was somewhat as follows: "Does this mean the White House is going to save a little more money by picking a common funeral director to handle both corpses?"

GUDEBROD LACING TAPE CAN SAVE YOU MONEY—



**HERE'S
WHY-**

1 SPECIAL FINISHES SPEED HARNESSING

Gudebrod has Lacing Tape that almost laces itself—the worker guides it instead of having to fight it. *Work goes fast!*

2 BETTER HARNESSES —FEWER REJECTS

Gudebrod Lacing Tape makes proper ties that do not slip. *Saves money on assembly! Saves costly rejects!*

3 WORKER SAFETY APPRECIATED

Gudebrod Lacing Tape is easy on the hands, feels good to work with . . . so the work goes better, is faster. *Saves money on harnessing time!*

4 GUDEBROD CABLE-LACER another money saver

Handle holds bobbin of lacing tape, feeds tape as needed, grips it for knotting. Speeds harnessing. Has paid for itself in a day. *Another money saver.*

Gudebrod Lacing Tape is engineered for the job it has to do—saves money where it counts—in the harness room. More than 200 different tapes in the Gudebrod Line—Write for our Product Data Book!



GUDEBROD BROS. SILK CO., INC.

FOUNDED IN 1870



Electronics Division

12 SOUTH 12th STREET, PHILADELPHIA, PENNSYLVANIA 19107

See us at the IEEE Show - Booth 4A24

ON READER-SERVICE CARD CIRCLE 18

Letters

Federal action for highway safety irks some readers

Sir:

The editorial "Legalized Murder on the Highways" (E/D, Dec. 20, 1965, p 23) asserts that the automobile manufacturers are guilty of murder and implies that the Federal Government should regulate or punish them.

This type of argument is at the center of nearly all the legislative activities of all the countries of the world. It should not be made or considered lightly.

The argument in its essential form is that the industrialist, the capitalist, is coercing (in your case murdering) his customers through his ability to produce and trade. But the Government, with its monopoly on compulsion and coercion, is capable of creating some vague societal excellence through its ever-increasing legislation, fines, taxes and jail sentences.

A cursory knowledge of political philosophy will tell you that the purpose of a government in a free society is to prevent the initiation of force. When government itself begins to use force on the citizenry—as in dictatorships and incipient dictatorships—it creates a living horror that no gang of murderers is capable of.

How much we dislike our unsatisfactory neighbors, steel prices, wheat prices, cars, medical costs, rent, etc., is trivial to the argument of whether or not the Government should "play a part"—which means whether or not the Government should initiate force for us against our neighbors.

The argument that capitalists and traders value the dollar sign, not human lives, is the stock-in-trade of every dictatorship on the globe. The dollar is a product of trade and capitalism. The results of dollars and capitalism vs. guns and statism on human lives is too obvious to be honestly disputed.

EDWARD S. DONN

Electrical Engineer
Phoenix, Ariz.

• We did not intend to imply in our editorial that the Government should "punish" the automobile industry for deaths on the highways. But we certainly did suggest that regulation, such as that applied to

airline operations, is in order. Because of the auto industry's long apathy, and the Federal Government's passive role, individual states are starting to take needed action. This is a poor situation, since rules will probably vary from state to state, causing much greater expense to the auto industry and its customers. The alternative is an intelligent and vigorous Federal program.

We dislike losing freedom, too, but we're glad the Federal Aviation Agency makes our air travel safer. And we don't feel less free because of it. We'd be even gladder if cars were available with collapsible steering wheels, padded dash boards, low-glare surfaces, front and rear seat belts and other safety features.

Also, the use of electronic systems to aid traffic control is, with a few exceptions, rudimentary or non-existent. Yet several techniques have proved useful in tests. A well-run federally sponsored R&D program could lead to greatly improved systems for state and local traffic authorities. Again, we believe in freedom, but we do stop for red lights and stop signs. We also pay taxes, and we like to see the money well spent.

Editor

Sir:

Re the editorial on highway safety:

You also fall for the holiday week-end syndrome of the National Safety Council. If you divide the total traffic deaths per year by 365, to obtain a figure of 120 per day, and multiply this by the number of days in the holiday (plus a little extra because NSC picks the worst parts of the first and last days), you will arrive at within 10 to 20% of the people killed during that holiday. Since this figure is so easily arrived at, one wonders about the sincerity of NSC in their misleading emphasis of the danger of holiday driving.

JOHN DARROW

Union Switch & Signal
Pittsburgh, Pa.

Sir:

While I am willing to concede the

good intentions of the editorial "Legalized Murder on the Highway," among those contributing to the problem are the members of the public media who, on the basis of the opinion of one special pleader or accident, become experts on highway safety.

May I suggest that you secure some facts concerning it from sources other than lawyers or legislators. The National Safety Council, Cornell's Crash Injury Research, Harvard's Fatal Accident Investigations and Northwestern's Traffic Institute are only a few of those who have spent years researching the problem.

I doubt that you would pay much attention to a lawyer explaining the problems of electronics for space vehicles, and those of highway safety are just as complex.

It will avail little to point out how both your and Mr. Nader's statements are in complete variance with the facts of highway safety. The information is available, if either of you has any actual interest in this problem.

ROSS C. MERRITT

18 Great Hill Rd.
Ridgefield, Conn.

Sir:

Regarding your editorial in the December 20 issue of ELECTRONIC DESIGN (p 23) on "legalized murder," may I offer a few suggestions? Perhaps New Jersey needs to outlaw certain tires as being suicidally unsafe in the wet. Maybe Nevada could prohibit others for use at high speed and high temperatures. Certainly you can't drive across Baltimore in a snow alert without snow tires.

What makes you think that some Federal program of compulsory "safety devices" would be more effective in reducing highway slaughter than the mealy, creeping predictions and idiotic slogans of the National Safety Council?

Consider the car-and-driver system from the view of reliability, before you seriously suggest the insertion of any complex electronic gadgetry, in series or parallel, between me and my highly reliable four-wheeled black box. Let me point out some of our more outstanding electronic successes in the automotive/traffic field.

How does your headlight dimmer work? Did you have one of the early alternator/rectifier systems? The microwave traffic light actuator, which used to look at the tops of our cars (without seeing) at US Highway 441, had to be ripped out

Simpson

LAB-LINE

precision instrument group

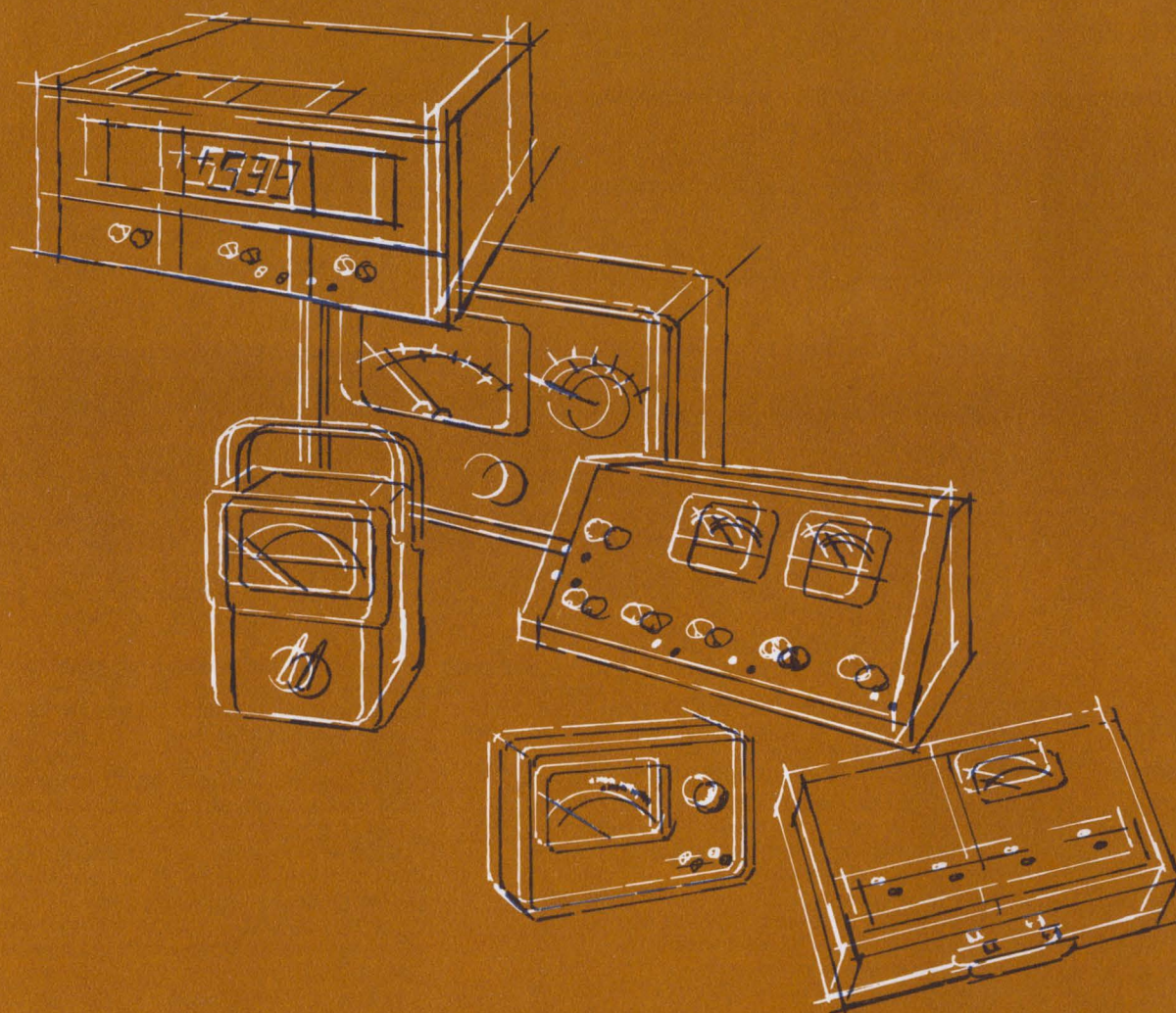

SIMPSON ELECTRIC COMPANY

5200 West Kinzie Street, Chicago, Illinois 60644 • Phone (312) 379-1121



DIGITAL VOLTMETER
model 111



ACCURATE

0.1% of reading (See specifications)

WIDE RANGE

Reads from .001 to 999. volts DC (same AC voltages with Model 115 Converter)

FAST

Less than one second per reading

DECISIVE

Digital display eliminates reading errors

RELIABLE

Solid state circuitry means minimum maintenance

EASY READING

Unique, high-intensity, wide-angle display

BINARY OUTPUT

Available as an optional feature

TYPICAL APPLICATIONS

The Model 111 DVM is ideal for production testing applications because its use saves time and eliminates errors. An operator having no specialized training can obtain accurate readings right from the start and continue doing so, day after day. The digital display reduces operator fatigue since it requires no interpretation.

The Simpson Model 111 is also ideal for incoming inspection and quality control applications. In the laboratory—in educational and other applications where added accuracy would be of no advantage—the instrument provides all the benefits of digital readout at a substantial cost-saving, with respect to comparable equipment.

Model 111 can be used as an analog-to-digital converter. An optional binary output is available to operate digital printing equipment or remote displays. The Model 111 DVM is frequently used in conjunction with transducers as a readout system for widely-varied electrical, mechanical, environmental and chemical parameters.

DESCRIPTION

The Model 111 DVM is basically a null seeking-balancing system. It samples a portion of the unknown input voltage and compares it to an opposing voltage which is developed internally from a zener reference standard.

The internal reference voltage is divided into 1000 equal increments through a digital-to-analog converter. A 1-kc/s clock then increases the output of the converter in 1000 discrete steps (producing a staircase waveform). Simultaneously, a 7-bar incandescent readout display connected to the 1-2-4-2 bcd logic counter-decades counts each progressive step.

When the staircase voltage attains a level equal and opposite to the sampled portion of the unknown input voltage, a null is produced at a summing point. A photo-electric chopper converts the summing point voltage to AC for precise and stable null-detection. Detection of the null stops counting. The unknown voltage can then be read on the display.

Should the input voltage exceed the selected range, a null cannot be reached. In such case, the counters will continuously re-cycle, indicating that a higher range must be selected.

If the polarity switch is not correctly set, the internal reference voltage will not oppose the input signal. This is sensed by a diode network which triggers a "change-polarity" sign and causes the readout to indicate zero.

DIGITAL VOLTMETER, model 111

SPECIFICATIONS

ACCURACY: 0.1% of reading ± 1 digit on upper ranges. On lowest range, 0.1% of full scale ± 1 digit

REFERENCE SOURCE: High stability, temperature-compensated zener diode

RANGES: 0 to 0.999, 9.99, 99.9, and 999. volts DC

RANGING: Manual

OVER-VOLTAGE: If voltage is beyond capability of selected range, display will continuously re-cycle until proper range is selected

DECIMAL POINT: Tracks with range switch. May also be remotely programmed

POLARITY INDICATOR: If input polarity is incorrect, a "change polarity" sign automatically appears on readout

MAXIMUM TIME FOR READOUT: One second (proportional to voltage)

READOUT: Incorporates Model RLA High Intensity Readout, described elsewhere on this page

NUMBER OF DIGITS: Three

READOUT LAMPS: 1764-D 28-volt type, operated at 20 volts; rated average half-life is 100,000 hours

AUTOMATIC DISPLAY TIME: Adjustable from 200 milliseconds to 10 seconds. There is also a "hold" position

MANUAL READING: When display time is set on "hold," additional readings may be taken by depressing manual reset button

REMOTE READ COMMAND: Accessible on rear panel

INPUT IMPEDANCE: 11.1 megohms except on lowest range, which is 1.1 megohms

STABILITY: Rated accuracy is attained after 15-minute warm-up at ambient temperature of 25°C (77°F)

ACTIVE DEVICES: 99 transistors, 1 Nuvistor, 49 diodes (No relays)

AMBIENT TEMPERATURE RANGE: Internal cooling fan with air filter permits operation between 32° and 110°F at 0-90% relative humidity

PROBE: Contains 100,000-ohm isolating resistor. Connects to front panel-type BNC connector

POWER REQUIREMENT: 117/230 volts, 50-60 cps AC, 30 watts

SIZE AND WEIGHT: 5¼" high x 12¼" wide x 10½" deep—16 lbs.

PRICE: Model No. 111 (Cat. No. 12591) \$500

OPTIONAL EQUIPMENT

DVM WITH BINARY OUTPUT CAPABILITY: Provides 1-2-4-2 bcd information for use with printing or data processing equipment or with remote displays.

Model No. 111-PR Catalog No. 12593
Price: \$550

AC INPUT CONVERTER: (Available May, 1966) Adds AC capability throughout entire voltage range when used in conjunction with Model 111 or Model 111-PR. Overall accuracy is .25% from 20 to 20,000 cps. All-solid state circuitry.

Model No. 115 Catalog No. 12592
Price: \$250

RACK MOUNT ADAPTER: For use with Models 111, 111-PR, or 115. Provides for mounting in standard 19¼" relay rack. Occupies 5¼" panel space.

Model No. RR-11 Catalog No. 01374
Price: \$15

MODEL 111 COMPONENTS AVAILABLE FOR OTHER APPLICATIONS

These assemblies can be used in numerous applications to provide convenient and inexpensive digital readout or counting capabilities.

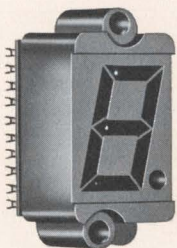

100,000-HOUR READOUT ASSEMBLY

High brightness 7-bar numerical display with wide-angle visibility can be read from as far as 20 feet under high ambient lighting. Each digit assembly has eight incandescent lamps (seven for the numerals, one for the decimal). The lamps are mounted on a rugged printed circuit board with Malco contacts. Lamps are type 1764-D, intended for operation at 20 volts at 33 MA per lamp for 100,000 hours rated average half-life.

Model No. RLA Catalog No. 01379 Price: \$12.50

DECADE-COUNTER BOARD

40-kc counter board for in-line applications. Incorporates 15 transistors, 10 diodes, and the Model RLA Readout Assembly. Requires only +11 volts and -20 volts. Sixteen-volt output pulse will drive next DC-3 decade. Board plugs into Amphenol #143-018-01 connector.

Model No. DC-3 Catalog No. 01378
Price: \$50

QUANTITY PRICES UPON REQUEST

SIMPSON ELECTRIC COMPANY



MULTI-RANGE DC SECONDARY STANDARDS

1700 series

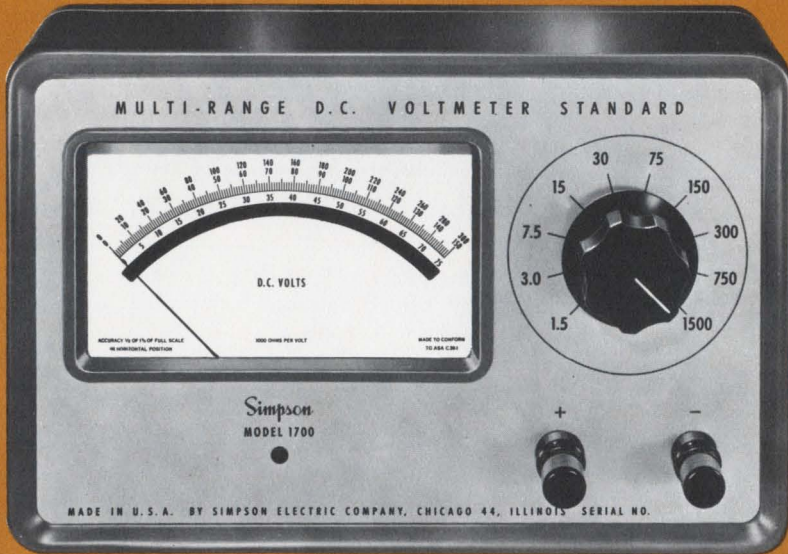

Model 1700



Model 1701



Ever-Ready Leather Carrying Case

FIVE MODELS MEET EVERY NEED

Volts—Model 1700; Amperes—Model 1701; Milliampères—Model 1702; Microampères—Model 1703; Millivolts—Model 1704

MULTI-RANGE SIMPLICITY

Each meter has several ranges—does the work of several instruments.

ACCURACY

±0.5% of full scale

TYPICAL APPLICATIONS

These improved multi-range secondary standards are ideal for such applications as:

- General laboratory testing
- Production line testing
- Incoming inspection
- College, high school and trade school labs

SIMPLE RANGE-CHANGE

Rotary switch provides five to ten ranges (except on Model 1701)

LOW COST PER RANGE

Exceptional economy due to innovations made possible by Simpson's extensive experience in the meter industry

EASY READOUT

Mirrored, 5½", hand-drawn scales provide superb readability, free from parallax errors

MULTI-RANGE DC SECONDARY STANDARDS, 1700 series

DESCRIPTION

These standards are designed for long-term accuracy under maximum usage. Spring-loaded sapphire jewels and hardened pivots insure high shock resistance and minimum friction. A high damping factor, added to high torque, provides rapid response to input level variations and minimizes overshoot.

The combination of a self-shielded, deep-core movement and a steel case makes these instruments impervious to most external magnetic fields found in industry.

These standards use a knife-edge pointer, painted black on the side toward the user. The other sides are a natural aluminum color. This Simpson feature positively eliminates parallax (see Figure 1).

A large-diameter, ceramic rotary switch with solid silver contacts provides range-change in Models 1700, 1702, 1703 and 1704 so that only two binding posts are necessary. On the Model 1701 Ammeter a separate set of 3-way binding posts is provided for each range.

All 1700-series standards are temperature-compensated for operation from 15°C to 35°C.

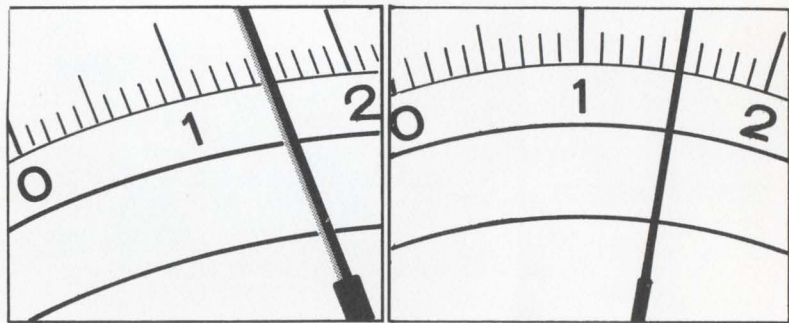

Fig. 1: When the aluminum underside of the pointer is visible (left), parallax is present because user is not looking at meter from correct angle. From the correct angle only the black topside of the pointer is visible (right) and user *knows* that parallax has been eliminated.

SPECIFICATIONS

FUNCTION	DC VOLTS	DC AMPS	DC MILLIAMPS	DC MICROAMPS	DC MILLIVOLTS
RANGES	0-1.5, 3, 7.5, 15, 30, 75, 150, 300, 750, 1500	0-0.75, 1.5, 3.0, 7.5, 15, 30, 75	0-1.5, 3, 7.5, 15, 30, 75, 150, 300, 750, 1500	0-75, 150, 300, 750, 1500	0-30, 75, 150, 300, 750, 1500
MODEL NUMBER	1700	1701	1702	1703	1704†
ACCURACY at 25°C††(*)	0.5% fs	0.5% fs	0.5% fs	0.5% fs	0.5% fs
MAXIMUM LOSS*	1 milliampere	45 mv	50 to 150 mv	.16 to .58 v	5 ma
SENSITIVITY	1000Ω/v	—	—	—	200Ω/v
SCALE LENGTH(*)	5.5"	5.5"	5.5"	5.5"	5.5"
ENCLOSURE	Steel case with etched aluminum panel, 11 3/8" x 7 3/8" x 3 1/4" deep‡				
NET WEIGHT	5 1/2 lbs.	8 lbs.	5 1/2 lbs.	5 1/2 lbs.	5 1/2 lbs.
CATALOG NUMBER	13300	13305	13310	13315	13316
PRICE	\$175	\$170	\$150	\$155	\$165

†Model 1704 includes special 0.026-ohm test leads (*)

††Influence of external temperature change is 0.25% per 10°C (*)

‡All units above have case-to-circuit dielectric breakdown of at least 3 kv. RMS (*)

(*) Characteristics so marked are the key ones required by American Standards Association Electrical Indicating Instrument Specification C-39.1-1959. The 1700 series conforms to this specification.

Eveready leather carrying case: Catalog No. 9808, \$19.95

Simpson

LAB-LINE

TECHNICAL DATA

LOW COST SECONDARY STANDARDS

models 9, 10, 880 • For AC, DC Voltage, Current, Power



MODEL 880



MODEL 9
IN ROLL-TOP CASE

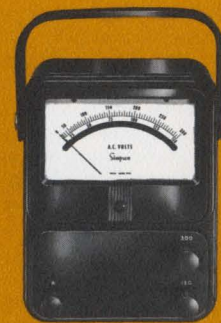

MODEL 10

PORTABILITY

Convenient handle permits easy carrying. Rugged phenolic case withstands rough usage.

LOW COST

Simpson's extensive experience achieves significant economy while keeping quality high.

VERSATILITY

Available with the following ranges:
50 microamperes to 50 amperes, DC
50 milliamperes to 50 amperes, AC
50 volts to 600 volts, AC and DC
100 watts to 10 KW, AC and DC

MULTIPLE RANGES

Most-often-used range combinations are available in single instruments.

ACCURACY

0.5% of full scale on DC
1% of full scale on AC and AC/DC models
.25% when used as transfer standard at 60 cycles

TYPICAL APPLICATIONS

As general-purpose, economically priced secondary standards for the laboratory, production line, incoming inspection, quality control and field engineering. Also suitable for other applications which require precise measurement of electrical parameters.

DESCRIPTION

These portable precision instruments are available in a wide variety of ranges to suit almost any requirement. * Scales are hand drawn, individually calibrated, and easy to read. Parallax errors are eliminated by knife-edge pointers, painted black on one side and read against a mirror. All units are temperature-compensated. They have hand-polished, hardened steel pivots and spring-backed, jewelled bearings.

DC Instruments (Model 9)

Annular, self-shielded movements offer excellent linearity and freedom from errors caused by nearby magnetic fields. Shunts are milled from a single section of manganin for wide-range temperature stability. Multiple-range units have a binding post for selection of each range.

AC Instruments (Model 10)

All Model 10 portables use the Simpson magnetically damped repulsion-attraction iron vane movement. The movement, designed to provide essentially linear deflection through the upper 80% of the scale, has excellent damping and an extremely rapid response time. These characteristics make possible rapid, accurate readings. Model 10 portables are RMS-reading. They are within rated accuracy over the frequency range of 25-125 cps (except for the milliammeters and ammeter models which are 25-500 cps).

AC/DC Instruments (Model 880)

Dynamometer movements operate on both DC and low audio frequency AC with no loss in accuracy, permitting the use of Model 880 instruments as exceptionally low cost transfer standards. Wattmeter models of the 880 have separate binding posts for voltage and current. These units measure true wattage, compensated for power factor, and not simply volt-amperes. If the power being measured approaches full-scale wattage, either the voltage or the current can be limited so that their product will not exceed the specified maximum. Range is selected by a front panel switch.

*Special ranges can be provided to meet unusual requirements. Send us your specifications for a quotation.

SPECIFICATIONS	MODEL 9	MODEL 10	MODEL 880
PARAMETERS	DC Voltage DC Current	AC Voltage AC Current	AC/DC Power AC/DC Voltage
ACCURACY*	0.5%	1%	1%
MOVEMENT	Self-shielded Annular	Iron Vane	Dynamometer
SCALE	4.03"; arc length, 100°	3.63"; arc length, 90°	3.63"; arc length, 90°
VOLTMETER SENSITIVITY	1000 Ω/V	100 Ω/V	52.5 Ω/V
SIZE, WEIGHT	5¼" x 3½" x 7"—approximately 2½ pounds		

*In horizontal position; temperature compensation per ASA Spec. C39.1-1964.

ORDER DATA

SINGLE RANGE UNITS

	RANGE	DC MODEL 9	CAT. NO.	AC MODEL 10	CAT. NO.
VOLTMETERS	50 V	\$55.00	12900	\$50.00	13060
	100 V	55.00	12910	50.00	13070
	150 V	55.00	12920	50.00	13080
	300 V	60.00	12930	55.00	13090
MICROAMMETERS	50 μA	77.00	12800		
	100 μA	73.00	12810		
	200 μA	70.00	12820		
MILLIAMMETERS	1 MA	63.00	12830		
	50 MA	55.00	12840	50.00	13030
	100 MA	55.00	12850	50.00	13040
	500 MA	55.00	12860	50.00	13050
AMMETERS	5 A	55.00	12740	50.00	12990
	15 A	55.00	12750	50.00	13000
	30 A	55.00	12760	50.00	13010
	50 A	55.00	12770	50.00	13020
	100 A	58.00	12780		
VOLTMETERS AC/DC	150 V	AC/DC MODEL 880 \$65.00			13130

MULTI-RANGE UNITS

	RANGE	DC MODEL 9	CAT. NO.	AC MODEL 10	CAT. NO.
VOLTMETERS	15-150 V	\$60.00	12940		
	150-300 V	65.00	12950	\$65.00	13100
	300-750 V	70.00	12960	65.00	13110
	15-150-300 V	70.00	12970		
	150-300-600 V	70.00	12980	65.00	13120
MILLIAMMETERS	10-100 MA	60.00	12870		
	25-250 MA	60.00	12880		
	100-500 MA	60.00	12890		
AMMETERS	2.5-5 A	60.00	12720		
	5-10 A	60.00	12710		
	2.5-10-25 A	65.00	12730		
	5-20-50 A	65.00	12792		
VOLTMETERS AC/DC	150-300 V	AC/DC MODEL 880 \$75.00			13140
	75-150-300 V	80.00	13150		
	150-300-600 V	80.00	13160		

POWER RANGES Single Current Range

WATTMETERS AC/DC Single Phase	MAXIMUM VOLTAGE* 150 V	MAXIMUM VOLTAGE* 300 V	MAXIMUM CURRENT*	AC/DC MODEL 880	CAT. NO.
	100 Watts	200 Watts	1.5 A	\$65.00	13170
200 Watts	400 Watts	3.0 A	65.00	13180	
500 Watts	1000 Watts	7.5 A	65.00	13190	
1000 Watts	2000 Watts	15 A	65.00	13200	
2000 Watts	4000 Watts	30 A	70.00	13210	
5000 Watts	10000 Watts	75 A	70.00	13220	

POWER RANGES Double Current Range

MAXIMUM VOLTAGE* 150 V	MAXIMUM VOLTAGE* 300 V	MAXIMUM CURRENT*		AC/DC MODEL 880	CAT. NO.
		LOW SCALE	HIGH SCALE		
250-500 Watts	500-1000 Watts	3.75 A	7.5 A	\$80.00	13230
500-1000 Watts	1000-2000 Watts	7.5 A	15.0 A	80.00	13240

*Maximum current and maximum voltage cannot be used simultaneously. Do not allow their product to exceed full scale of power range in use.

ACCESSORIES Roll-Top Safety Case for any model above—Catalog No. 6192—\$9.95.

SIMPSON ELECTRIC COMPANY



MULTI-RANGE PRECISION MILLIOHM METER
 model 1699



FULL-SCALE RANGES

.05 to 50 ohms

SENSITIVITY

0.001 ohms

ACCURACY

± 1% of full scale on all ranges. Unaffected by contact or lead resistance

TYPICAL APPLICATIONS

The 1699 has many applications, all of which involve precision measurement of low resistance values. Among them are:

Switches and relays: Checking contact resistance rapidly during inspection and production. Model 1699 usually eliminates the need for a Kelvin bridge or other complicated laboratory equipment.

Printed circuits: Checking contact resistance of connectors and resistance of soldered connections.

Motor commutators, slip rings, coils (especially, the larger sizes). Current measurements on these items are easily made, but measurement of actual resistance is often important. Model 1699 offers an exceptionally convenient means of making this measurement.

Automotive cables, connectors, and starting motor leads.

PORTABILITY

Self-powered. Completely self-contained, including resistance comparison standards

DISSIPATION IN SAMPLE

Less than 7.95 milliwatts

Cable and wire: Checking resistance for quality-control purposes or to determine length of wire or cable.

Instruments: Measurement of shunt resistances and calibration of instruments.

Welding and other high-current equipment: Model 1699 simplifies heretofore-complicated resistance measurements.

Transformers, yokes, coils: For accurate DC resistance measurements.

Fuses: For non-destructive quality control testing.

Metallurgical studies concerned with electrical conductivity.

Computers: Checking resistance of grounding and bonding connections when installing equipment.

Physical science laboratory experiments.

MULTI-RANGE PRECISION MILLIOHMMETER, model 1699

DESCRIPTION

This instrument was designed to measure low values of resistance accurately, rapidly, and at low cost. It compensates for the shortcomings of the conventional ohmmeter in the area of low-resistance measurement, while retaining the ohmmeter's simplicity of operation.

The Model 1699 Milliohmmeter determines the value of an unknown resistance by comparing it with a known standard internal resistance.

In low resistance measurements, the contact resistance of the meter probes and the resistance of the test leads become significant sources of error. However, these errors can be avoided by using test leads terminating in Kelvin Clips. (In the Kelvin Clip the jaws are electrically insulated from each other so that half of each jaw becomes a separate electrical contact.) In the model 1699 these special clips function as part of a unique circuit which is divided into two distinct paths—the Current Path (shown in color in Fig. 1), and the Voltage Path (shown in black).

The unknown resistance is connected between the Kelvin Clips, thus completing the Current Path. The calibration control is then adjusted until the voltage drop being measured across an internal standard resistance causes the meter to indicate full scale. Since the unknown resistance and the internal resistance are in series, the current flow through each of them is equal. As expressed in Ohm's Law, the voltage drop across these resistances will be directly proportional to their respective ohmic values.

Therefore, (See Fig. 2), by measuring the voltage drop across the unknown resistance we can read its value in ohms, directly from the linearly-calibrated scale on the meter. For example, if the unknown resistance and the internal standard are of the same value, the meter will indicate full scale because its scale is calibrated with the standard. If the unknown resistance is half the value of the standard, the meter will indicate half scale.

The 1699 is calibrated by measuring voltage drop across a standard resistance. This adjustment is made with contact and lead resistance as integral parts of a series circuit referred to as the Current Path; therefore, contact and lead resistance are automatically compensated for during calibration. They will not affect the rated accuracy of the instrument.

Inasmuch as the input resistance of Model 1699's transistorized differential voltmeter circuit is very high, normal lead and contact resistance in the Voltage Path will represent less than .05% of the total resistance of the circuit. Accordingly, these factors will not affect the rated accuracy of the instrument.

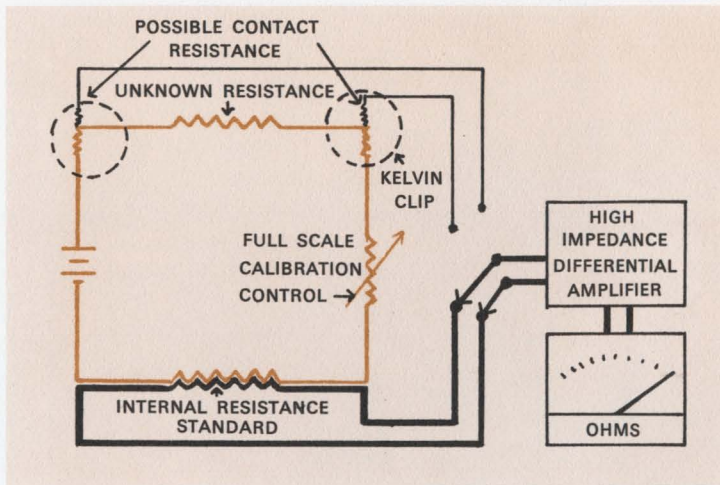

Fig. 1

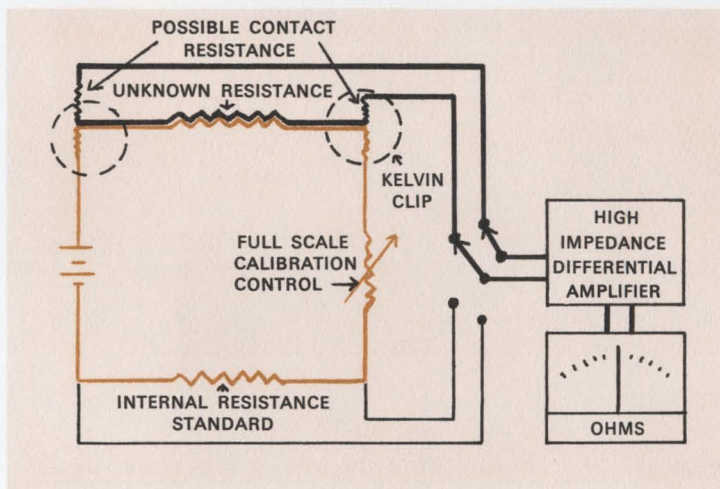

Fig. 2

SPECIFICATIONS

RESISTANCE RANGES

Ohms: 0.05 | 0.1 | 0.25 | 0.5 | 1.0 | 5.0 | 10.0 | 50.0

MAXIMUM OUTPUT CURRENT

Milliamperes: 460 | 231 | 97 | 47 | 26.5 | 5.0 | 2.7 | 0.5

MAXIMUM POWER DISSIPATION IN SAMPLE

Milliwatts: 7.95 | 5.16 | 2.15 | 1.10 | 0.694 | 0.121 | 0.069 | 0.012

SENSITIVITY

0.001 ohms (Smallest scale division)

ACCURACY

±1% of full scale on all ranges

WARM-UP TIME

None

READOUT

Seven inch analog meter, single arc, 90° dial; mirrored, 100-division linear scale, knife-edge pointer

POWER REQUIREMENTS

Self-contained batteries only: one NEDA #11, life 700 hours; one NEDA #1604, min. life, 160 hrs.

TRANSISTOR COMPLEMENT

Two 2N2716 (matched pair)

ACCESSORIES FURNISHED

Wired-in, Kelvin-type clip leads; instruction manual; batteries

SIZE AND WEIGHT

11 1/2" x 7 3/4" x 3 1/4"—5 lbs., 10 ozs.

PRICES

Model 1699 (Cat. No. 13299) \$160.00

Spare set of Kelvin Leads (Cat. No. 0140) \$5.50

SIMPSON ELECTRIC COMPANY



INSTRUMENT CALIBRATOR
model 2600



VERSATILITY

This calibrator can produce a variety of electrical parameters, most of which can be varied in amplitude continuously. The amplitude of the selected parameter is accurately indicated by front panel meters.

RANGES

AC/DC voltage, continuously variable from 0-1600 volts. Smallest voltage scale division: .01 volt

DC current, continuously variable: 0-16 amperes. Smallest current scale division: .01 microampere

Resistance: 1 ohm to 100 megohms, in steps, by powers of ten

TYPICAL APPLICATIONS

Trouble-shooting, incoming inspection, establishing or checking calibration and linearity of meter movements, meters and other measuring instruments by meter manufacturers, meter repair firms, and modification and calibration facilities. Instruments that can be calibrated with Model 2600

DEPENDABILITY

Extraordinarily heavy electrical and mechanical construction assure stable operation during long, continuous use.

EASY READING

Two rugged 7-inch meters with easy-to-read, mirrored linear scales are mounted on the front panel, which inclines 30° for additional reading convenience.

RAPID OPERATION

All output ranges are available at one set of terminals.

include DC analyzers, current shunts, galvanometers, microammeters, milliammeters, millivoltmeters, VOM's, recorders, voltmeters and wattmeters; also, AC voltmeters and AC voltmeters having a potential transformer.

INSTRUMENT CALIBRATOR, model 2600

DESCRIPTION

The Model 2600 Instrument Calibrator is a unit of extremely rugged construction, designed for continuous commercial service in the laboratory or in industry. Its sturdiness and simplicity of operation permit its use where highly skilled operators are not readily available.

Model 2600 is enclosed in a strong steel cabinet. All control functions are engraved in a satin silver-finished aluminum overlay on the front panel. The panel is inclined 30° to the rear for ease in taking readings and the meters are calibrated at this angle for greater accuracy. Easy access to the interior of the unit is obtained by tilting the front panel forward on its hinges.

Front panel knobs control the following: output level, coarse; output level, fine; parameter; range; output polarity, short, open; resistance value.

All power for the calibrator can be supplied by the AC power line. No batteries or other accessories are required.

Factory calibration of Model 2600 is based on primary standards traceable to the National Bureau of Standards.

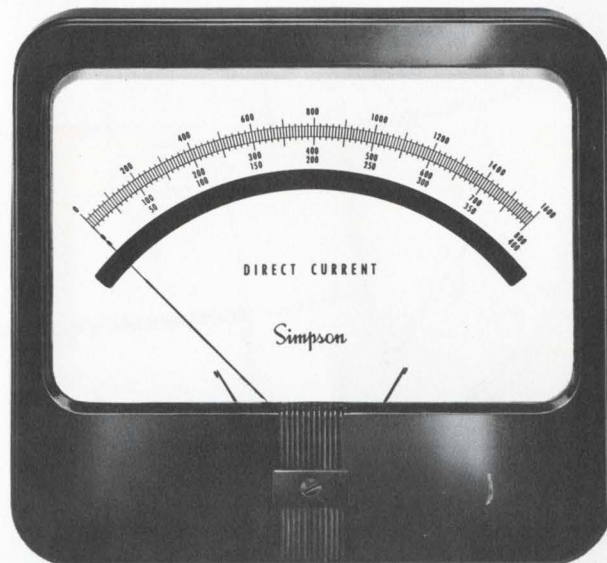

The meters of the Simpson Model 2600 Instrument Calibrator have 160 divisions for extra ease in reading.

SPECIFICATIONS

RANGES (continuously variable)

DC Microamperes:

0-1.6/4.0/8.0/16/40/80/160/400/800/1600

DC Milliamperes:

0-1.6/4.0/8.0/16/40/80/160/400/800/1600

Maximum output voltage = 6.0

DC Amperes: 0-16

Maximum output voltage = 5.0

DC Volts:

0-1.6/4.0/8.0/16/40/80/160/400/800/1600

Maximum output current = 8 ma.

AC Volts:

0-1.6/4.0/8.0/16/40/80/160/400/800/1600

Maximum output current increases from 100 to 250 milliamperes as range increases

Ohms: 1/10/100/1k/10k/100k/1M/10M/100 Meg. (fixed values)

Maximum power dissipation = 1 watt

ACCURACIES

DC Ranges: $\pm 0.50\%$ of full scale/@ 77°F

AC Ranges: $\pm 0.75\%$ of full scale @ 77°F

Resistors: $\pm 1\%$, one ohm through 10 megohms.
 $\pm 2\%$ at 100 megohms

CALIBRATION STANDARD

Each Model 2600 calibrated to primary standards traceable to National Bureau of Standards

AMBIENT TEMPERATURE

Instrument calibrated at 77°F.; correction chart supplied for range between 45°F. and 105°F.

DC OUTPUT RIPPLE

When operating from 60-cy. power line at maximum rated load: voltage and microamp. ranges, less than 0.25%; milliamp. ranges, less than 1%.

POWER REQUIREMENTS

During Use of AC Ranges:

105-125 volts, 25-2000 cps (maximum), approx. 50 watts (Designed to permit instrument calibration at frequencies other than 60 cycles)

During Use of DC Ranges:

110-125 volts, 50-60 cps, approx. 50 watts. 16-amp. range requires 150 watts. When using 220-v., 50-60 cps power source, use external 220-v. to 117-volt transformer

READOUT

Method: Two 7-in. meters, one for AC ranges, one for DC ranges

Movement: Deep core, self-shielded, temperature-compensated

Scale: Mirrored, 5.9" long, linear, individually calibrated at 160 points

Arc: 0-400/800/1600 full scale

SIZE AND WEIGHT

15" x 31" x 15"—132 lbs.

OUTPUT TERMINATION

One pair of terminals for all ranges and one ground terminal

PRICE

Model 2600 (Cat. No. 13250) \$1700.00



LAB-LINE SALES REPRESENTATIVES ARE AT YOUR SERVICE

The Lab-Line group of precision instruments is available only through your Lab-Line Representative:

1* PAUL R. STURGEON CO., INC.

1330 Boylston Street
Chestnut Hill, Massachusetts
(617) 734-7710

1 PAUL R. STURGEON CO., INC.

117 Broad Street
Milford, Connecticut
(203) 874-6080

2* LEONARD D. ALLEN INC.

115 Luther Avenue
Liverpool, New York
(315) 471-3108

2 LEONARD D. ALLEN INC.

232 DeKalb Street
Tonawanda, New York
(716) 694-2130

3* SIMPSON INSTRUMENT SALES & SERVICE INC.

130 Cutter Mill Road
Great Neck, L.I., New York
(516) 482-3103/(212) 683-0674

3 SIMPSON INSTRUMENT SALES & SERVICE INC.

521 Third Street
Palisades Park, New Jersey
(201) 944-7733

4* SAMUEL K. MACDONALD INC.

1531 Spruce Street
Philadelphia, Pennsylvania
(215) 545-1205

4 SAMUEL K. MACDONALD INC.

3303-14th Street, N.W.
Washington, D.C.
(202) 265-3933

4 SAMUEL K. MACDONALD INC.

5500 Harford Road
Baltimore, Maryland
(301) 254-3380

5* MURPHY & COTA

2110 Peachtree Rd., N.W.
Atlanta, Georgia
(404) 355-0472

5 MURPHY & COTA

P.O. Box 6365
Greensboro, N.C.
(919) 288-1923

5 MURPHY & COTA

712 W. Vassar Street
Orlando, Florida
(305) 424-2167

5 MURPHY & COTA

904 Bob Wallace Ave., S.W.
Huntsville, Alabama
(205) 536-9121

5 MURPHY & COTA

1106 Burke Street
Winston-Salem, North Carolina
(919) 723-1001

6* R. C. MERCHANT & CO., INC.

18411 W. McNichols Road
Detroit, Michigan
(313) 535-6000

6 R. C. MERCHANT & CO., INC.

98 Water St., Rm. No. 6
Benton Harbor, Michigan
(616) 925-4211

7* BAEHR, GREENLEAF & ASSOCIATES

14700 Detroit Avenue
Cleveland, Ohio
(216) 221-9030

7 BAEHR, GREENLEAF & ASSOCIATES

9505 Montgomery Road
Cincinnati, Ohio
(513) 891-3827

7 BAEHR, GREENLEAF & ASSOCIATES

3350 Maplewood Drive
Xenia, Ohio
(513) 426-5485

7 BAEHR, GREENLEAF & ASSOCIATES

Upper Arlington
Columbus, Ohio
(614) 486-4046

8* THOMAS & SUKUP INC.

2060 East 54th Street
Indianapolis, Indiana
(317) 251-4574

9* E. A. DICKINSON & ASSOCIATES INC.

3612 North Green Bay Avenue
Milwaukee, Wisconsin
(414) 264-1080

10* SIMPSON ELECTRIC CO.

5200 West Kinzie Street
Chicago, Illinois
(312) 379-1121

11* NORMAN W. KATHRINUS & CO.

2427 Brentwood Boulevard
St. Louis, Missouri
(314) 962-5627

11 NORMAN W. KATHRINUS & CO.

2336 South Boeke
Kansas City, Kansas
(913) 236-4108

11 NORMAN W. KATHRINUS & CO.

549 Ottumwa Street
Ottumwa, Iowa
(515) 684-6110

12* CARTWRIGHT & BEAN

560 S. Cooper Street
Memphis, Tennessee
(901) 276-4442

12 CARTWRIGHT & BEAN

3223 Cain's Hill Place, N.W.
Atlanta, Georgia
(404) 237-2273

12 CARTWRIGHT & BEAN

1812 Bullard Avenue
Metairie, Louisiana
(504) 834-8312

13* MEL FOSTER COMPANY, INC.

228 South Cedar Lake Road
Minneapolis, Minnesota
(612) 374-2612

14* J. Y. SCHOONMAKER CO., INC.

5328 Redfield Avenue
Dallas, Texas
(214) 631-8480

14 J. Y. SCHOONMAKER CO., INC.

107 Winnetka
San Antonio, Texas
(512) 631-0251

14 J. Y. SCHOONMAKER CO., INC.

6001 Gulf Freeway
Houston, Texas
(713) 926-9510

15* R. G. BOWEN CO., INC.

721 S. Broadway
Denver, Colorado
(303) 722-4641

15 R. G. BOWEN CO., INC.

31 South 3rd East
Salt Lake City, Utah
(801) 364-4632

16* C. T. CARLBERG & ASSOCIATES

2611 Quincy, N.E.
Albuquerque, New Mexico
(505) 265-1579

17* DON H. BURCHAM CO.

510 N.W. 19th Avenue
Portland, Oregon
(503) 226-4148

17 DON H. BURCHAM CO.

422 First Avenue West
Seattle, Washington
(206) 284-1121

18* WILLIAM J. PURDY ASSOCIATES

312 Seventh Street
San Francisco, California
(415) 863-3300

18 WILLIAM J. PURDY ASSOCIATES

6527 Westbrook Drive
Citrus Heights, California
(916) 725-4065

19* SIMPSON SALES

205 Pasadena Avenue
South Pasadena, California
(213) 254-5136

20* EARL ASSOCIATES

156 Mokauea
Honolulu, Hawaii
815-649

For: General Offices
Instrument Repair Department
Parts Sales Department
Lab-Line Marketing Department

Contact: SIMPSON ELECTRIC COMPANY
5200 West Kinzie Street
Chicago, Illinois
Telephone (312) 379-1121
TWX (312) 896-5391
WU Telex 02-53343

For: Canadian Sales and Service

Contact: BACH-SIMPSON LIMITED
1255 Brydges Street
London, Ontario
(519) 451-9490

BACH-SIMPSON LIMITED
1 Thorncliffe Park Drive
Toronto, Ontario
(416) 421-7511

For: Sales and Service in India

Contact: RUTTONSHA-SIMPSON PRIVATE LTD.
Bombay-Agra Road
Vikhroli, Bombay, India
Telephone 581688

For: All Other Export Sales and Service

Contact: SIMPSON ELECTRIC CO.
EXPORT DEPT.
400 W. Madison St.—Suite 2119
Chicago, Illinois
(312) 332-0646
Cable: SIMELCO

*Indicates main office

and replaced by a treadle switch. How many of your friends had to reconnect hastily their conventional ignition when the collector junction turned to germanium vapor?

Ask your dealer how many turn-signal blinkers, radios, printed-circuit dash wires, and so on, he has to replace under warranty, in spite of the lack of sophistication in them.

When we come down from our lovely solid-state circuits to the grim penny-pinching world of the showroom, the customer simply won't pay the high price of electronic reliability; so to compel him borders on the ridiculous. Rather than wasting money on electronic "innovations in safety," the owner is far ahead to buy some 125-mph-rated tires, heavy duty or racing brakes, heavy duty or export suspension (off-the-shelf) safety belts and/or harness. If we could just make roll bars and big hairy door latches appeal to the ladies, they might not get flung and squashed with such appalling frequency.

Rather than wave the magic editorial wand for the Federal Wizard, you interested editors could be plunking for a Federal rating system, similar to the "truth in packaging" measures, on tires, brakes, etc. Brake fluid already has Federal minimum specs.

JON P. RAMER

Orlando, Fla.

Down with standards that are earth-bound!

Sir:

If we are to adopt a new system of units, let's do the job right. The only advantage of the metric system over the English system is that units are in convenient multiples of 10. However, it is just as arbitrary in its concept as the English system is—that is, it is based on arbitrary conditions on an arbitrary planet (earth).

Let's use a system that is not only consistently decimal (or binary, or octal) but one that is based on some universal standard.

Let's not use a system whose length dimension is essentially based on the length of an arc of this arbitrary planet. Let's not use one whose standard of mass is based on a sample of an arbitrary fluid. Let's not use a system whose temperature unit is based on the freezing and boiling points of that arbitrary fluid under arbitrarily chosen pressure conditions. Let's not use one whose time unit is based on the time of revolution of this arbitrary planet.

Let's look at some universal constants, such as hydrogen atoms (or protons), and the speed of light and derive some basic units from these:

A mass unit could be equal to the mass of a proton (at relative rest).

The frequency unit (and, inversely, the time unit) could be that of the frequency of the emission line resulting from the transition of a hydrogen atom from the energy state 2 to state 1 (ground state).

The length unit could be the distance that light would travel (in vacuum) during the time of the time unit suggested above.

Temperature is a derived unit, but could be based on the energy given up by a hydrogen atom in the transition mentioned above.

Many of these units would likely be too small or large for convenient engineering usage. Therefore they could be called the "abunits," and engineering units might be derived from them by multiplication with convenient powers of 10 (or 2, 8, etc.).

If we are going to take our place in galactic society, we are going to have to conform to facilitate communication and trade. The adoption of a universal set of units will help alleviate many future problems.

DAVID A. BEAN

Earth Rep for
APC (Aliens for Progress in
Communications)
P. O. Box 4823
Chicago

... Early to rise keeps reader healthy and wise

Sir:

I was most interested to read the article "18 Ways to Save Time" in your issue of Nov. 8, 1965 (p 48), particularly item 17: "Get an early start." My personal experience shows that it pays handsome dividends.

Nothing is more exasperating and time-wasting than waiting for others; so why keep others waiting? This principle led me to start 30 to 45 minutes earlier each morning, and subsequently to walk to work, taking 30 minutes or so. This gives me such a feeling of mental and physical alertness that I can really get going as soon as I arrive, uninterrupted by day-to-day queries or telephone calls. In addition the time credit in the bank every day is invaluable.

V. O. STOKES

The Marconi Co., Ltd.
Marconi House
Chelmsford, Essex
England

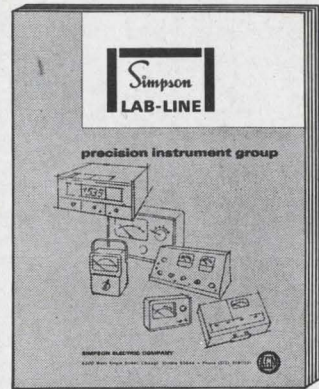

DID
SOMEONE
ALREADY
TAKE
THE
NEW
Simpson
LAB-LINE
CATALOG
BOUND IN
AT LEFT?

if so,
CIRCLE
NO. 248
on the reader
service card
at the back
of this magazine
...or write
Simpson

ELECTRIC COMPANY
5202 W. Kinzie Street
Chicago, Illinois 60644
Phone: (312) ESTebrook 9-1121

TRW ANNOUNCES

10 W 400 Mc 60% η

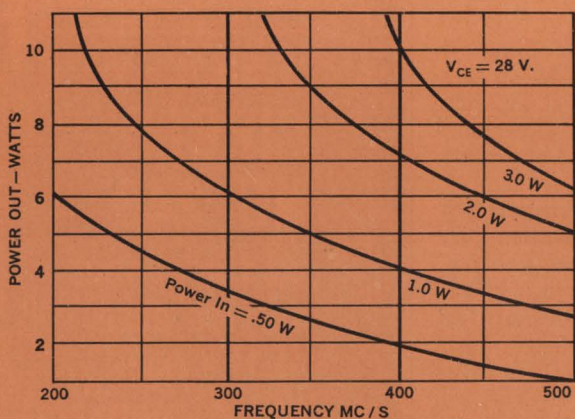

NEW UHF POWER TRANSISTOR

The new TRW 10W/400Mc (2N4040) UHF Power Transistor provides full rated performance in conventional circuits...no need to resort to emitter tuning or other techniques which contribute to circuit instability. TRW 2N4040 is available now at competitive prices.

For detailed technical information phone, write or wire: TRW Semiconductors, Transistor Plant, 14520 Aviation Blvd., Lawndale, Calif. 90260. Phone: (213) 679-4561, Ext. 477 TWX: 213 647-5113

TRW designs and manufactures high performance transistors for the communications industry and specialized types for military and industrial applications.

TRW SEMICONDUCTORS

ON READER-SERVICE CARD CIRCLE 19

Co-Publishers

James S. Mulholland, Jr.
Robert E. Ahrensdorf

Editorial Director

Edward E. Grazda

Editor

Howard Bierman

Managing Editor

Robert C. Haavind

Technical Editors

Joseph J. Casazza
Rene Colen
Maria Dekany
Richard Harnar
Mark B. Leeds

News Editors

Frank Egan
Roger K. Field
Alfred Rosenblatt

West Coast Editors

Ralph Dobriner
Peer Fossen

New Products Editors

Patrick Cook

Washington Editor

S. David Pursglove

Editorial Production

Dollie S. Viebig
Anne T. Lombardi

Art Director

Clifford M. Gardiner

Art Assistant

William Kelley

Technical Illustrators

Lewis D. Hill
Leonard P. Levenson
Cheh Nam Low

Production Manager

Thomas V. Sedita

Asst. Production Manager

Helen De Polo

Production Assistants

Carl Merkin
Bernard Wolinsky

Circulation Manager

Nancy L. Merritt

Reader Service

Diane Pellechi



Is electronics doing enough for puzzled astronomers?

Astronomers are grappling with a grand mystery that tops the best thriller yet to hit the best-seller list. Until recently they thought they had the universe pretty well figured out. Then, with shocking swiftness, their theories fell apart.

The upsetting data were provided by a combination of radio astronomy and spectrographic measurements of light-frequency shifts. Some radio sources that had been matched with visible objects, thought to be "stars" in our own Milky Way, turned out to have tremendous spectral shifts toward the red. These red shifts must be, according to accepted theory, doppler shifts caused by the fact that the universe is expanding and that objects far away from the earth are flying away from us at great speed. In 1929 Hubble postulated that the amount of red shift was proportional to the distance of an object from us.

The red shifts of these strange quasi-stellar radio sources, or quasars, made them the farthest objects ever located! At such great distances as the Hubble theory suggested, they had to be huge galaxies rather than stars.

But some curious data have been obtained from measurements of these radio sources. Their energy output has to be at least 40 times greater than that of any known galaxies, if our distance estimates are correct. No process described by our present knowledge of physics could explain such tremendous energy emission. In addition the quasars seem to be "flickering." Measurements over a number of weeks show surprisingly large variations in energy output. If we consider the assumed size, and assume that no process could be transmitted throughout these galaxies faster than the speed of light, such variations are impossible.

Most theories of the universe have been patched up to fit the new data, but without firm conviction. Astronomers are frankly puzzled. The question is: Is electronics doing enough to help?

The most vital data are optical, involving telescopes and spectrographic film recording. Our best telescope, at Mount Palomar, is over 20 years old. The best method available now for obtaining the long integration time needed for red-shift measurements of low-level light sources is photographic recording. Image intensifier tubes have only recently been improved enough to be used for astronomy. Monitoring of absorption paths to eliminate the background noise problem of city light reflections is just being explored.

The astronomers need better techniques for these measurements. They would like to figure out better ways to measure blue shifts, if any exist. They would like to have long-integration-time detectors for the infrared and far infrared.

The modern physics laboratory is loaded with useful electronic instrumentation. The optical astronomical observatory has virtually none. Can't we do better?

Robert Haavind

DUAL FET's

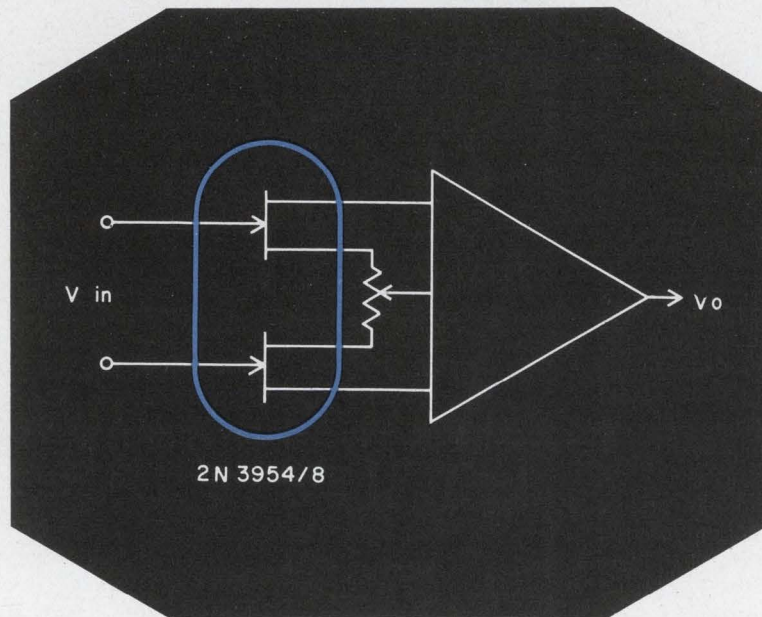

CHECK THE SPECS!

SPECIFICATIONS

	2N3954	2N3955	2N3956	2N3957	2N3958	Units
Breakdown Voltage (min.)	50	50	50	50	50	V
Leakage Current (max.)	100	100	100	100	100	pA
Saturation Current (min./max.)	0.5/5.0	0.5/5.0	0.5/5.0	0.5/5.0	0.5/5.0	mA
Transconductance (min./max.)	1000/3000	1000/3000	1000/3000	1000/3000	1000/3000	μ mhos
Pinch-off Voltage (min./max.)	1.0/4.5	1.0/4.5	1.0/4.5	1.0/4.5	1.0/4.5	V
$\Delta V_{GS1} - V_{GS2}$ (max.)	10	25	50	75	100	μ V/ $^{\circ}$ C

Why wait for Dual FET's! Place your order with your UNION CARBIDE ELECTRONICS Distributor today.



UNION CARBIDE CORPORATION 365 Middlefield Road, Mountain View, California 94041 TWX: 415-969-9166; Telephone: (415) 961-3300

Speed Inquiry to Advertiser via Collect Night Letter
ON READER-SERVICE CARD CIRCLE 20

ED Technology

Switching transistor gives high power in amplifiers PAGE 38

How to stay on the beam with deflection amplifiers PAGE 46

Reduce power drain by using IC gate-ring counters PAGE 52

How to select the right dummy load PAGE 60

Are your committee meetings worthwhile? PAGE 66

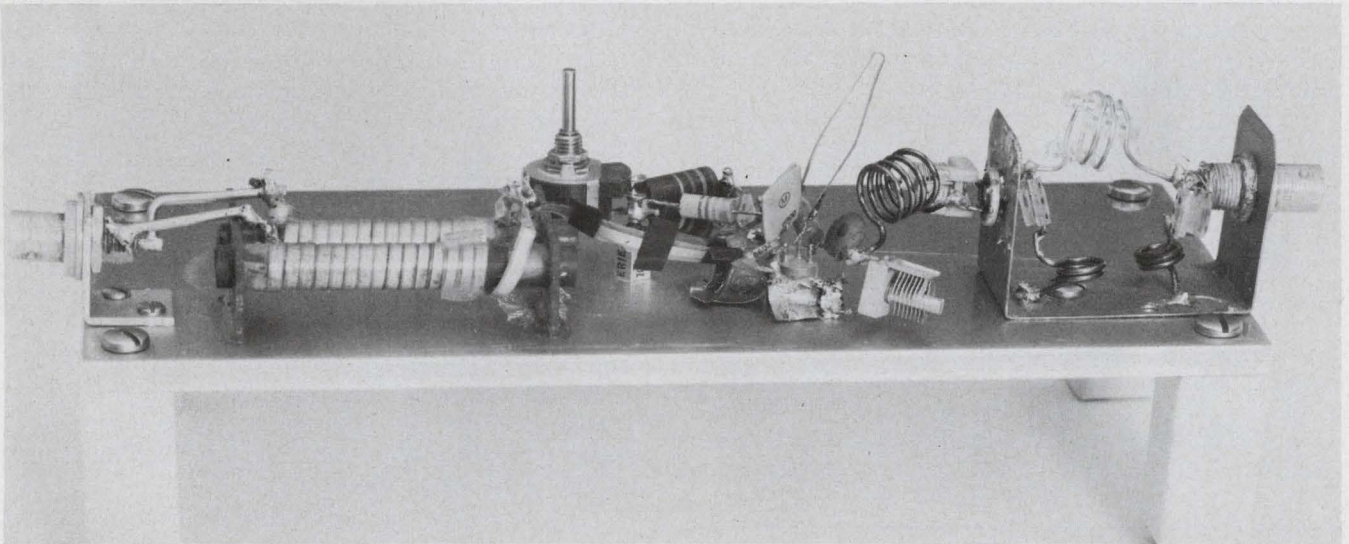

Squeeze your high-power amplifier into a small package 38

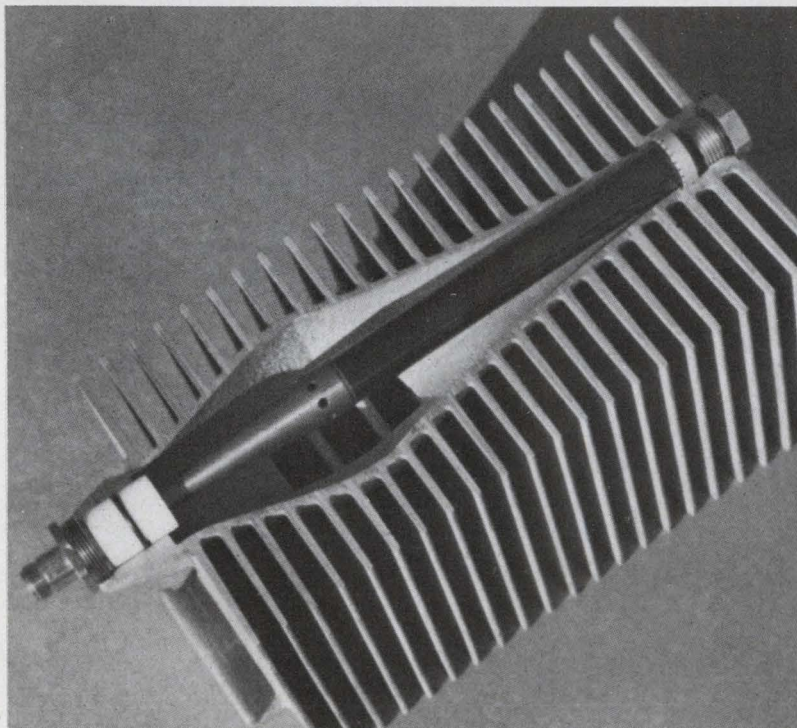

Pick the right dummy load 60

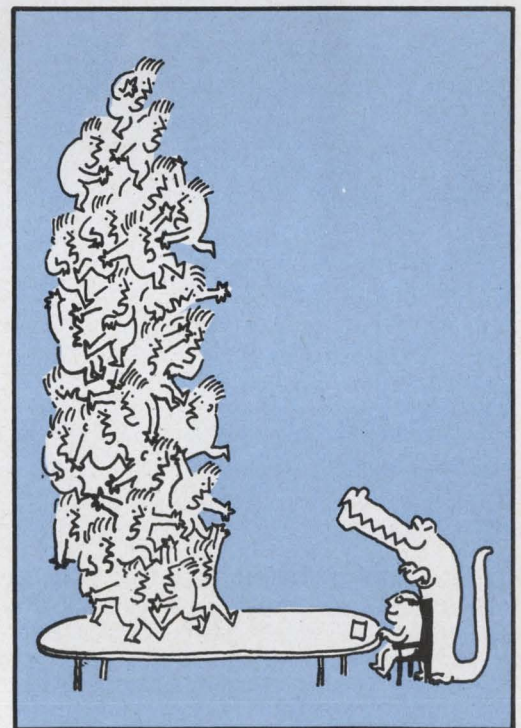

Orderly meetings are best 66

Amplifier has 85% efficiency while providing up to 10 watts power over a wide frequency band. A switching transistor is the key in the design.

The efficiency of transistorized power amplifiers for cw operations can go as high as 85%, if the design is right. What's more, the amplifier can maintain its broadband characteristic.

The design approach centers on a transistor, used in a switching mode, that gives very high collector efficiencies.

To illustrate the advantages of this design, consider the output power stages of conventional vhf communication equipment. The output powers are usually around 50 watts. If the efficiency of the cw power amplifiers is 60%, a bulky heat sink is needed to handle the dissipated power. If the efficiency is increased up to 80%, the dissipated power is halved.

A common requirement of communication systems, that the second harmonic be suppressed at the output, also helps achieve the high efficiency, since it lowers the bandwidth demands on the amplifier. The output circuit of the power am-

plifier has to cover a frequency range of less than 1:2 for each position of the range-selecting switch. This assumption is valid because the low-pass or bandpass filters used to suppress the second harmonic cover a frequency range of 1:1.8 to 1:1.5.

The criterion for achieving high collector efficiency is this: The impedance, seen from the base and looking into the matched circuit, should not be a short-circuit for the second harmonic over the whole frequency band.

The simplified equivalent circuit of the collector shows the transistor as a switch, being opened and closed periodically (Fig. 1). The choke L_o feeds a current to the collector of the transistor. The collector-emitter capacity is C , which, for simplicity, is assumed to be independent of voltage.

The dc blocking capacitor, C_o , charges to the battery voltage. For simplicity, an inductor L , in series with the load resistor R , has been substituted for a low-pass filter.

To understand the operation of the circuit, let us assume that the switch has just been closed. After a sufficient amount of dc current I_o has

Dieter R. Lohrmann, Development Engineer, USAECOM, Ft. Monmouth, N. J.

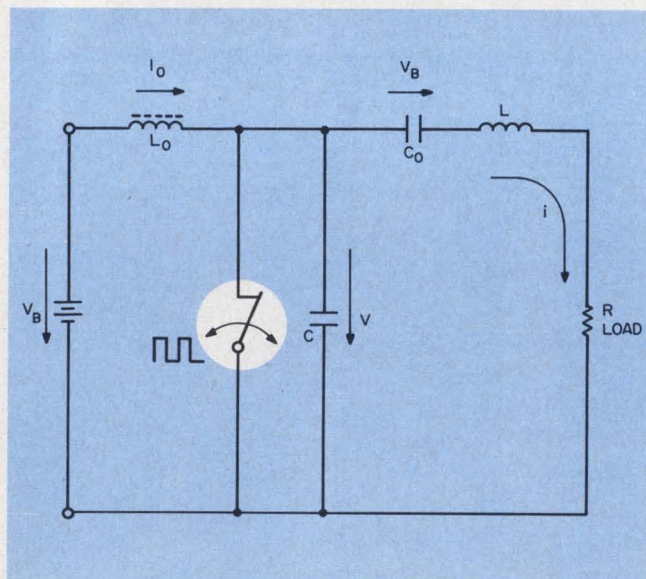

1. Simplified equivalent circuit of transistor's collector circuit. The ideal switch represents the transistor. It is operated by the signal fed to its base-emitter circuit by the dc current I_o . When the voltage across C crosses zero, the switch will be closed. The collector-emitter capacitance, C , is assumed to be independent of voltage. C_o , the dc blocking capacitor, charges to the battery voltage, V_B . The switch opens without any current.

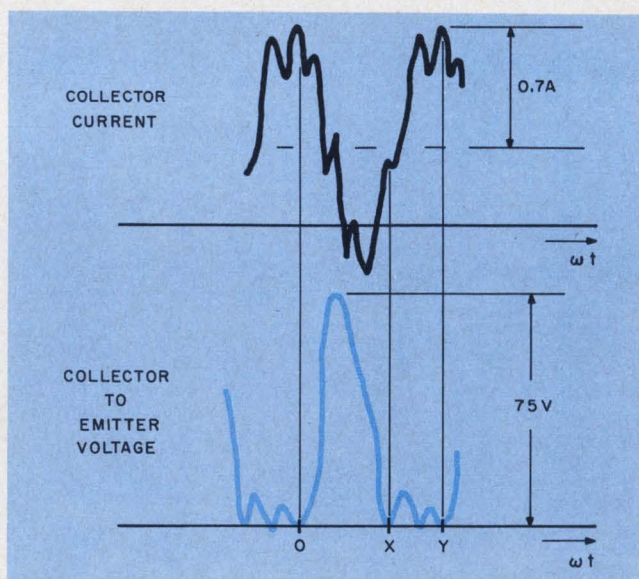

2. Traces of the collector voltage and collector current indicate the open and closed periods. During the interval OX, the switch is open; during XY, it is closed. The collector current does not go to zero during the OFF period, because the collector capacitance is parallel to the switch. The transistor in the experiments is a type 2N3632, operated at 69 MHz. $I_C = 0.45$ A, $V_B = 25$ V. The output RF power is 9 watts with an input of 1 watt.

built up in L_o , the switch is opened. If the circuit of C , L and R is underdamped, the voltage across C will be a damped oscillation.

After the first half cycle, when the voltage crosses zero again, the switch is closed. This collector voltage, v , is traced in Fig. 2. During the interval OX the switch is open; during XY it is closed. The collector current, recorded in proper phase, is not zero during the switch-off cycle, because the collector's capacity is parallel to the switch. (Fig. 2)

It seems reasonable to assume that one of the reasons why this circuit yields high collector efficiencies is this one:

At the end of the OFF cycle the collector-emitter voltage returns to zero by itself, due to the transient. Hence the voltage will go down to zero, switching in the transistor, without need for any current. Thus only a little power will be dissipated in the switching slopes.

Linear equations described actions

Switching actions are usually described by a set of nonlinear differential equations. However, we can linearize them by using one set of linear equations for the ON interval and another for the OFF state.

The boundary conditions are provided by voltages and currents that must fit at the end of the preceding interval to those at the beginning of the next one. The equations for the open position (Fig. 3) are:

$$C \frac{dv}{dt} + i = I_o, \quad (1)$$

$$v = V_B + Ri + L \frac{di}{dt}, \quad 0 \leq t \leq \frac{T_k}{2}, \quad (2)$$

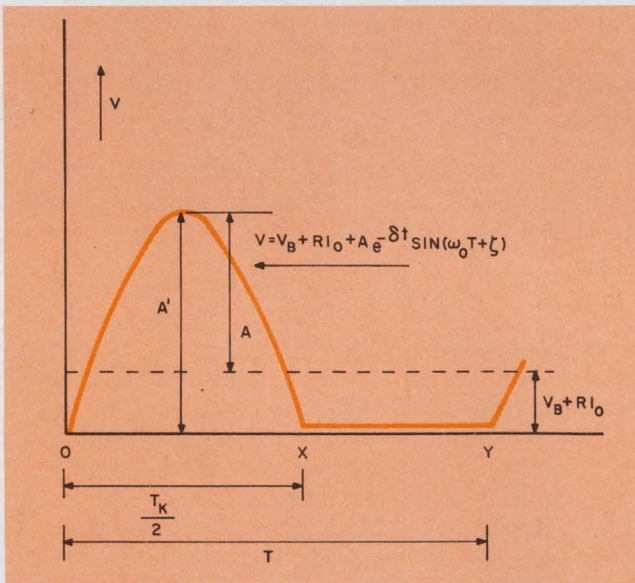

3. The basic switching action results in a simplified mathematical model. One set of linear equations describes the OFF condition, another is used for the ON state. Voltages and currents are used as boundary conditions, to match the two intervals. The time between zero crossings of the collector voltage during the OFF period, T_k , is about equal to the period time of the transient in the collector voltage.

and for the switch closed:

$$v = 0, \quad (3)$$

$$V_B + L \frac{di}{dt} + Ri = 0, \quad \frac{T_k}{2} \leq t \leq T. \quad (4)$$

These differential equations have very simple and well-known solutions. However, the equations for solving the boundary conditions become unwieldy and nonlinear. Therefore we may use an approximate solution. The exact solution during the interval OA would be:

$$v = V_B + RI_o + A e^{-\delta t} \sin(\omega_0 t + \phi). \quad (5)$$

For this, the approximate form is:

$$v \approx A' \sin \omega_k t, \quad 0 \leq t \leq \frac{T_k}{2} \quad (6)$$

with $\omega_k = 2\pi/T_k$. Using Fourier analysis, we can show that the peak value of the fundamental voltage in the waveform is:

$$v = \frac{A'}{1+k} \cdot \text{Sa} \left[\frac{\pi}{2} \left(1 - \frac{1}{k} \right) \right]. \quad (7)$$

Here $k = T/T_k$ and $\text{Sa } x = \sin x/x$. T_k is the time between the points of zero crossings of the collector voltage during the OFF period. It is approximately equal to the period time of a transient in the collector voltage—that is, in the case of Fig. 1 it is:

$$T_k = \frac{2}{\sqrt{\frac{1}{LC} - \frac{R^2}{4L^2}}}. \quad (8)$$

The output power at fundamental frequency is:

$$P_{out} = \frac{v^2}{2} G_\omega, \quad (9)$$

where G_ω is the real part of parallel admittance that the load circuit exhibits to the collector at the fundamental frequency.

Thus, in the case of Fig. 1:

$$G_\omega = \text{Re} \left(\frac{1}{R + j\omega L} \right) = \frac{R}{R^2 + \omega^2 L^2}. \quad (10)$$

Now A' is still unknown, but it can be found from dc considerations. The choke in Fig. 1 cannot have a dc drop. Therefore the dc component of the waveform in Fig. 3 must be equal to the battery voltage, V_B . In other words:

$$V_B = \frac{1}{T} \int_0^T v dt = \frac{1}{T} \int_0^{T_k/2} A' \sin \omega_k t dt. \quad (11)$$

This yields

$$A' = \pi V_B \left(\frac{T}{T_k} \right), \quad (12)$$

which is the peak collector voltage. If we put everything together, we have:

$$P_{out} = \frac{\pi^2}{2} \frac{V_B^2 k^2}{(1+k)^2} G_\omega \text{Si}^2 \left[\frac{\pi}{2} \left(1 - \frac{1}{k} \right) \right], \quad (13)$$

where:

$$P_{out} = \text{RF output power.}$$

V_B = battery voltage.

$T = 1/(\text{signal frequency})$.

T_k = twice the length of cutoff interval—that is, twice the time between the zero crossings of the collector voltage. It is about equal to the cycle-time of a transient in the collector circuit. In our example:

$$T_k \approx \frac{2\pi}{\sqrt{\frac{1}{LC} - \frac{R^2}{4L^2}}}$$

$$k = T/T_k$$

G_ω = the real part of the load circuit's admittance exhibited toward the collector at the fundamental frequency. The collector's capacity is part of the circuit.

A' = the peak voltage at the collector.

If we let $T = T_k$, we get:

$$P_{out} = \frac{\pi^2}{8} V_B^2 G_\omega, \quad (14)$$

and

$$A' = \pi V_B. \quad (15)$$

As can be seen from these formulas, A' tends to increase as the frequency decreases.

For all these calculations we assumed that the output circuit is less than critically damped. This means, in the case of Fig. 1, that:

$$\frac{1}{LC} \gg \frac{R}{4L^2}. \quad (16)$$

This condition is linked to the bandwidth of the load circuit, as shown in Fig. 4. The graph of the output power, P_{out} , over $V_B^2 G_\omega$ vs (signal frequency) (T_k), indicates a nonlinear dependence.

A filter (low pass) in the collector circuit slightly modifies the above equations. In principle, the same formulas apply. G_ω can be computed from the filter parameters. If $Z_\pi/R = 0.85$, then the eigenvalue of v will be $p_1 = (-0.168 + j0.895)$ ($2\pi f_g$), where f_g is the limiting frequency of the filter section—that is, the frequency at which the characteristic impedance turns imaginary. Hence $T_k = 0.895 f_g$.

Practice modifies theories

Special requirements in an FM communication system demanded a power amplifier having about 10 watts output with a 10-dB amplification figure. It had to cover the frequency range of from 48 to 70 MHz with collector efficiencies up to 85%.

In the calculations thus far we neglected the following facts:

- The collector capacity of the transistor is dependent on voltage.

- There is strong coupling between the input and output circuits via the base-to-collector capacity, which is nonlinear. As a matter of fact, part of the input power might go directly to the output over this path.

- The switching will not happen instantaneously, and, most likely, *not* at exactly zero collector voltage.

- There are losses in the collector junction,

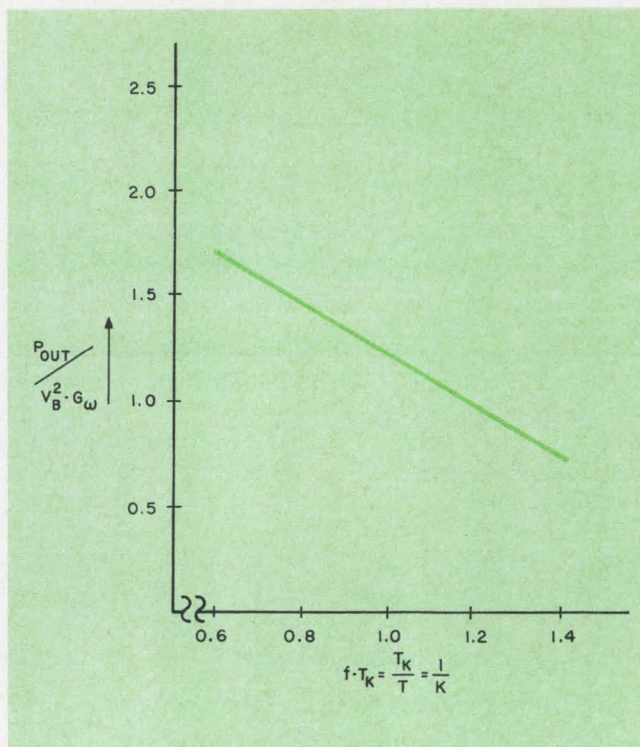

4. The normalized output power is a nonlinear function of the normalized frequency. The ordinate is $V_B^2 G_\omega$, and the abscissa is the signal frequency times T_k .

which must be represented by a nonlinear resistor.

- In the practical circuit we have a low-pass filter section in the collector circuit and not as simple a circuit as the one assumed in Fig. 1 for the calculation.

We got more accurate results by replacing V_B with $V_B - V_{CE sat}$, in Eqs. 13 and 14. The latter factor is the collector-emitter saturation voltage. This voltage is normally given by the manufacturer only for dc. For RF it seems to be on the order of 2 to 5 volts for a good transistor. So let us assume 3 volts, since a good guess is better than none.

The constant factor in Eq. 13 has been found to be 0.85, rather than $\pi^2/8$, in the practical circuit. Thus Eq. 14 becomes:

$$G_\omega = \frac{1}{R_\omega} = \frac{P_{out}}{0.85 (V_B - V_{CE sat})^2}$$

If P_{out} should be 10 watts at $V_B = 25$ V battery voltage, then $G_\omega = 24 \text{ mmho} \rightarrow 42 \text{ ohm}$ is the load admittance the collector will have to see at the signal frequency. Once this R_ω is known, the first low-pass filter section can be designed. For the required amplifier, the frequency range desired was 50 to 75 MHz. Of course, the limiting frequency of the low-pass filter section must *not* be set to $f_u = 75$ MHz, since the mismatch is much too large at the limiting frequency.

It works well if one arranges:

f_g = limiting frequency of low pass section = $1.5 f_u = 1.5 \times 75$ MHz.

The characteristic impedance of the low pass filter section is chosen as:

$$Z_\pi = 1.1 R_\omega = 1.1 \times 42 \Omega = 46 \Omega.$$

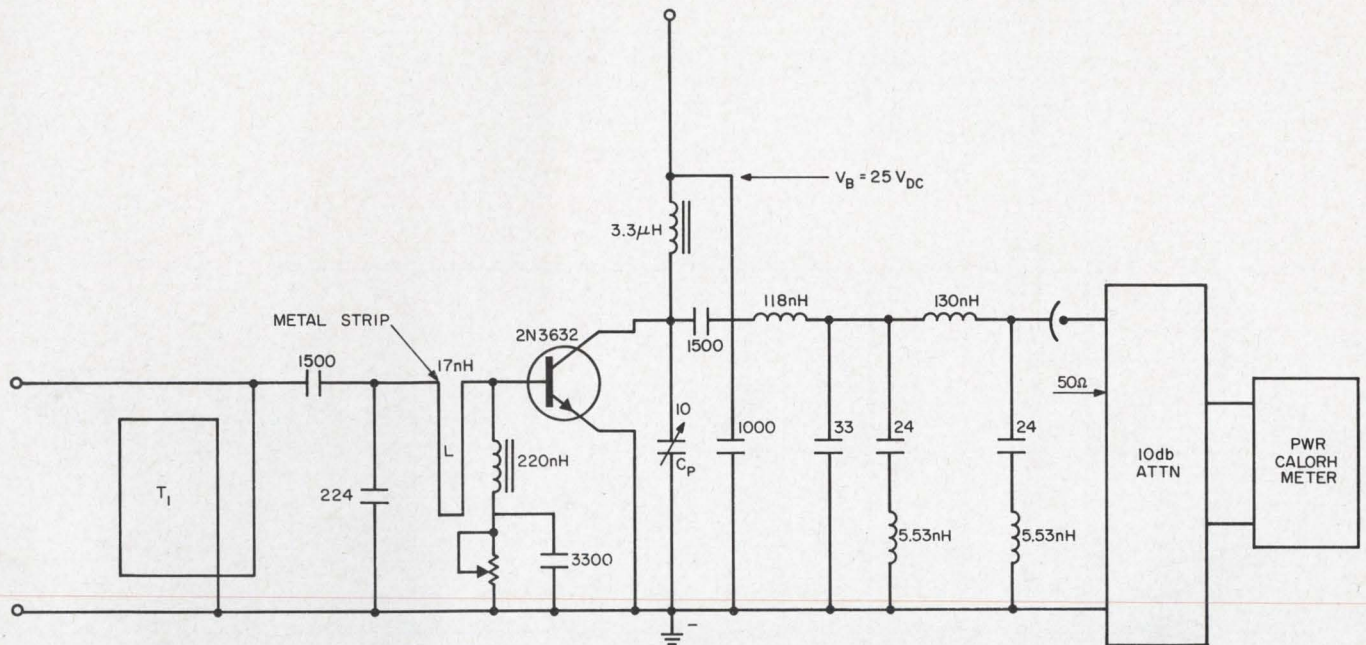

NOTE: $T_1 = 50\text{-TO-}12.5$ OHM LINE
TRANSFORMER
CAPACITOR VALUES IN pF

5. **Broadband power amplifier** covers the frequency range from 48 to 70 MHz and has about 10 watts output power with 10-dB gain even if the dc path in the base circuit is

eliminated. (The calorimeter monitors the output power.) To lessen the danger of parametric oscillation, feeding chokes should have the lowest possible values.

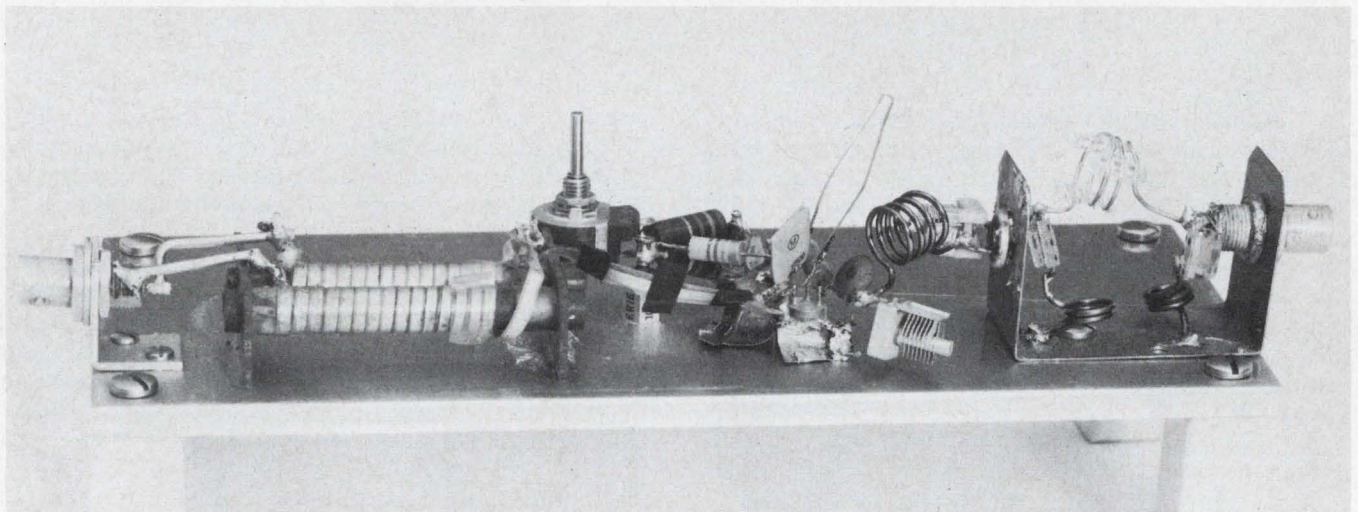

6. **Breadboard model** of the circuit in Fig. 5 illustrates construction gimmicks. The inductance of 17 nH, in the input matching circuit, is made of a piece of metal strip

The input capacity of the section is known from filter theory:

$$C = \frac{1}{2\pi f_g Z_\pi} = 31 \text{ pF.}$$

On the collector side, one has to deduct the collector's capacity from the value.

Again from filter theory:

$$L = \frac{Z_\pi}{\pi f_g} = 130 \text{ nH.}$$

The peak voltage between the collector and the emitter is expected to be in the midband:

folded like a hairpin. It can be adjusted very conveniently with a slug, soldered across the two legs. Mica capacitors satisfy the need for very low series lead inductances.

$$A' = \pi V_B = \pi 25 \text{ V} = 78 \text{ V,}$$

which roughly agrees with measurements.

The pi filter section is followed by another one, to give additional harmonic suppression. It has an attenuation pole at a frequency that is twice that of the midband value.

Match input with transformers

To match the input, a broadband transmission line transformer T_1 is used (Fig. 5). It transforms from 50 down to 12.5 ohms, covering the entire range from 30 to 75 MHz. It is followed by

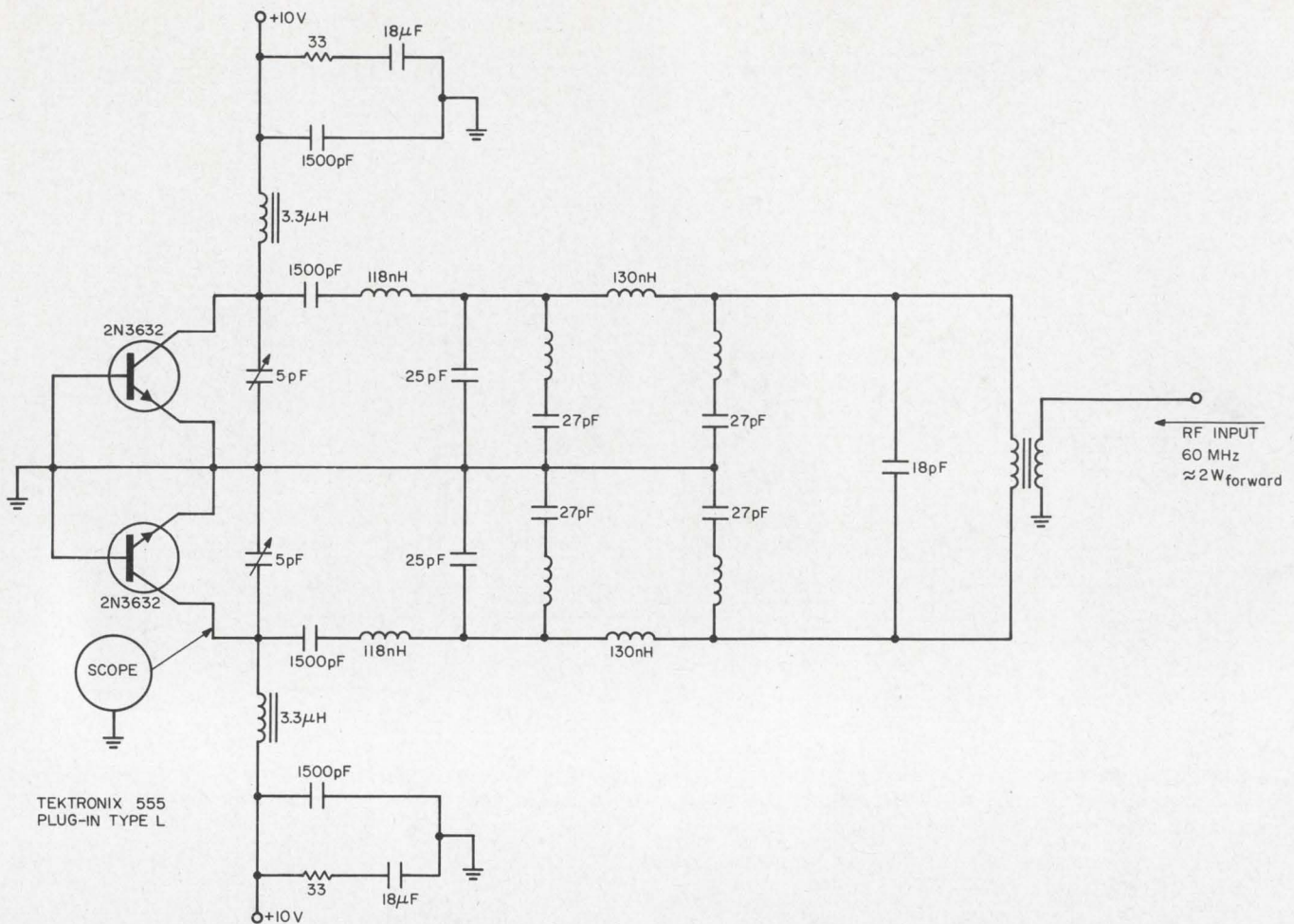

7. **Broadband push-pull amplifier** will brake out in parametric oscillations, even with its emitter and base leads grounded. (The oscilloscope picks up the parametric oscillations.) This proves the assumption that parametric os-

a matching section made up of a 224-pF capacitor and an inductor of 17 nH. The capacitor must have very low series lead inductance. Therefore a mica capacitor of the button type was used. The inductor was made of a piece of metal strip folded like a hairpin. It can be adjusted very conveniently by soldering a slug across it (Fig. 6).

Under operational conditions, the equivalent input circuit for the transistor has been found to be a series resistor of about 5 ohms in the base lead, followed by a 1000-pF capacitor to ground.

Parallel to the 1000 pF capacitor is a resistor of about 10 ohms. About 200 pF of these 1000 are believed to be exhibited by the base-to-emitter junction. The remaining 800 pF is due to the Miller effect, caused by the collector's capacity. The circuit is valid between about 30 and 70 MHz.

The 224-pF capacitor, the 17-nH inductor and the equivalent input circuit of the transistor (5 ohms in series with about 1000 pF) form a broadband transformation network. It transforms the 5 ohms to 10 ohms and compensates for the 1000 pF.

The base is zero-biased. The biasing resistor is set to 100 ohms. At a 1-watt input driving power, the peak base-to-emitter reverse voltage is exceeded during the cutoff cycle, and reverse current is flowing. This reduces the dc current in the exter-

cillations are caused by a voltage-dependent capacitance in the collector and base circuit of the transistor, which gives rise to an undampening action. The capacitance acts like a varactor diode in a parametric amplifier.

nal base circuit. As a matter of fact, the transistor still gives 10 watts of output power if the dc path in the base circuit is eliminated. According to the manufacturer, the transistor is not damaged, provided that less than 25% of the permissible dc power for the base junction is dissipated by back conduction. The back conduction effect seems to increase the steepness of the switching slopes, thus improving the collector's efficiency.

The resistance in the base circuit was chosen as 100 ohms, for dc stability.

A 3.3-μH choke supplies the dc current to the collector. The collector circuit is formed by two low-pass pi filter sections that use the collector's capacity as part of the filter's input capacity. The trimmer in the collector line adjusts this output capacity. The second pi filter section has a pole at 141 MHz, to keep residual second harmonic power from being dissipated in the load.

A laboratory model, designed for 40 watts output power, is already being tested. The unit is similar to the one described below. It has the same high efficiency and a power gain of 10 dB.

Parametric oscillation is common problem

The tendency to break out in parametric oscilla-

tions seems to be a common problem to all high-efficiency switched power-amplifier stages.

It is caused by the voltage-dependent capacitance in the collector and base circuits of the transistor. This capacitance is periodically varied by the signal itself. Therefore it acts like the varactor diode in a parametric amplifier (also called reactance amplifier). It is well known that such an amplifier may exhibit negative resistance under certain conditions, undampening the circuits. The circuit starts oscillating at some other frequency if this undamping action becomes too large. Therefore care must be taken to prevent the collector from sensing circuit resonances outside the passband, presumably at lower frequencies, down to dc. As a consequence, feeding chokes should have values as low as possible. On the power supply line, there must not be any resonant circuits at low frequencies. They can be eliminated by a resistor in series with a capacitor across the line.

The largest change of capacity of the collector junction occurs near zero collector voltage. Therefore linear stages, which do not use that portion of the characteristic, are much less likely to oscillate because of this effect; switched stages should be more troublesome.

A small collector capacity is more favorable than a large one for a given power output. Switching transistors with low losses—that is, with high efficiency—are more sensitive than those having higher losses. A small series resistor in the collector line helps, but it reduces the collector efficiency.

To prove this hypothesis of parametric oscillations, we took a broadband push-pull amplifier and grounded all emitter and base leads with short, broad-ribbon leads (Fig. 7). Then we fed signal power into the output terminals of the amplifier. Fig. 8 shows the voltage waveforms at the collector. At a 0.4-watt input (the normal output power of the amplifier in normal operation is 25 watts) we still had a sine voltage at the collector (Fig. 8, top). But at 1.7-watts input, an oscillation of lower frequency suddenly appeared (Fig. 8, middle). At 2.7 watts the oscillation became noise-like (Fig. 8, bottom). Since these oscillations tend to kill the transistors, the experiment was made with a 10-volt battery. The dc current in the transistors was zero until the oscillations started; then it jumped up to about 0.5 A, though the bases were grounded.

The differential equations describing these effects are basically of the Mathieu and Hill types, and the solutions have stable and unstable regions. ■ ■

Bibliography:

- Stephens, M. L., and Wittman, J. P., "Switched Mode Transistor Amplifiers." *Communication and Electronics*, No. 68, Sept., 1963, pp 470 to 472.
- Gundlach, Meincke. "*Taschenbuch der Hochfrequenztechnik*." Second edition, p 208.
- Page, D. F., and Hindson, W. D. "On Solid State Class D-Systems." *Proc. IEEE*, Vol. 53, No. 4, pp 423 and 424.
- Senak Jr., Peter, "Amplitude Modulation of the Switched Mode Tuned Power Amplifier." *Proc. IEEE*, Vol. 53, No. 10, pp 1658 and 1659.

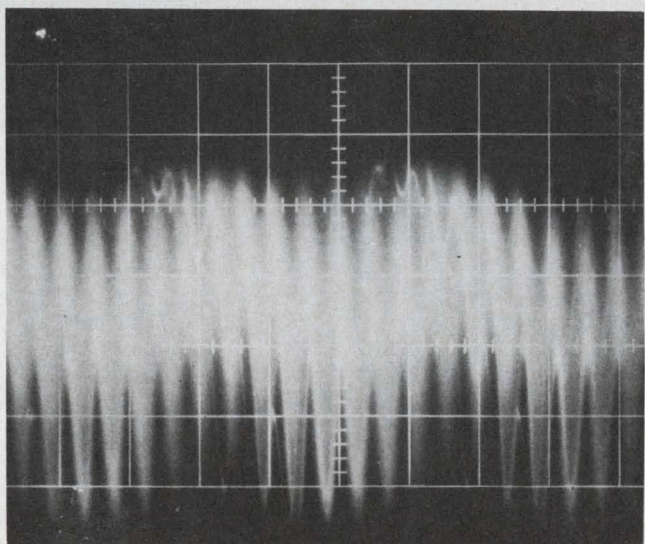
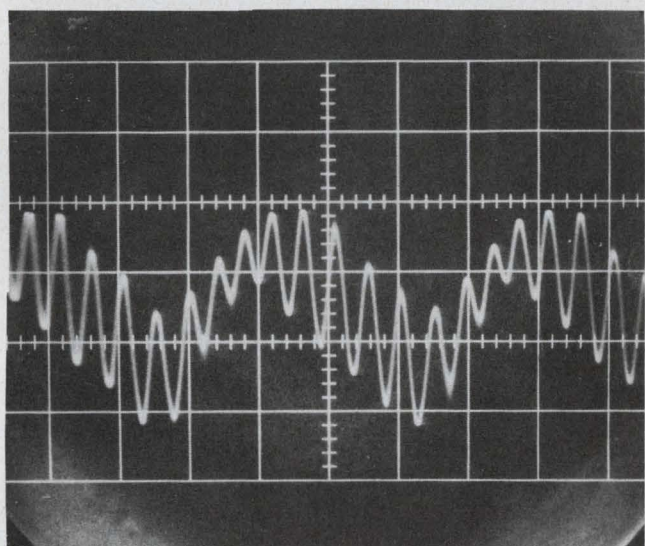
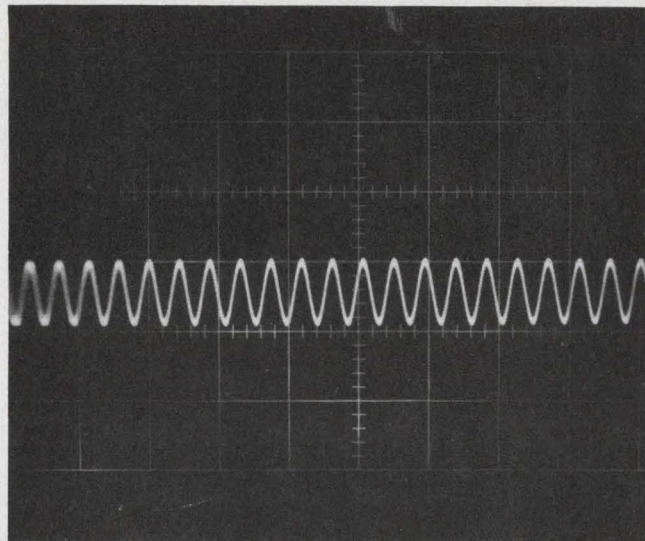

8. Collector waveforms show effects of increased input and the creation of parametric oscillation. At an input of 0.4 watt (top) the output is a sine voltage; at 1.7 watts (middle) a lower frequency oscillation appears, which becomes noise-like at a 2.7-watt input (bottom). The dc current jumped to 0.5 A from zero as oscillations started, despite the grounded bases.

Now—a wide choice of for industrial and consumer

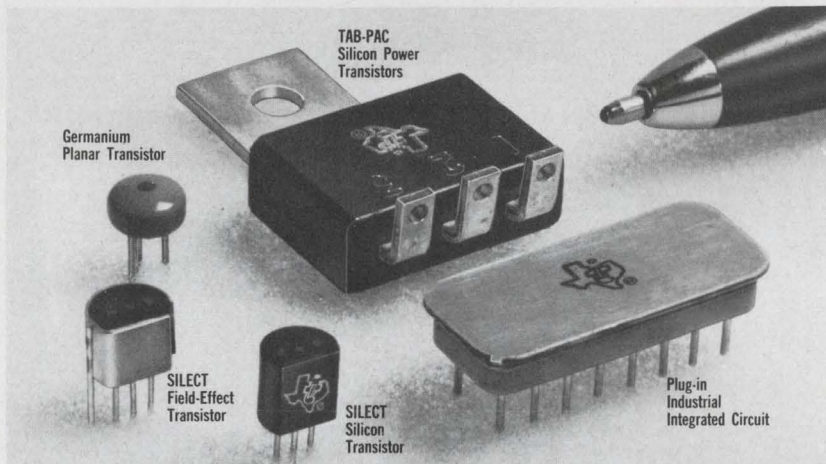

Figure 1. TI offers many economy semiconductors for industrial and commercial applications.

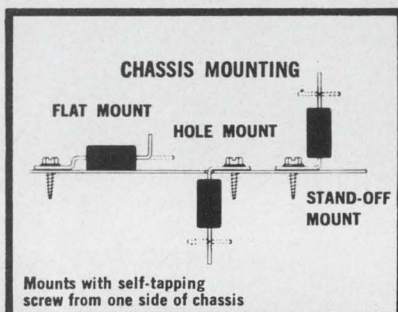

Figure 2. TAB-PAC silicon power transistors offer mounting flexibility as well as economy.

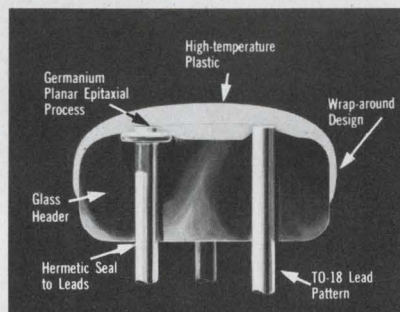

Figure 3. Note ruggedness of TIIXM01-08 plastic encapsulated germanium planar transistors.

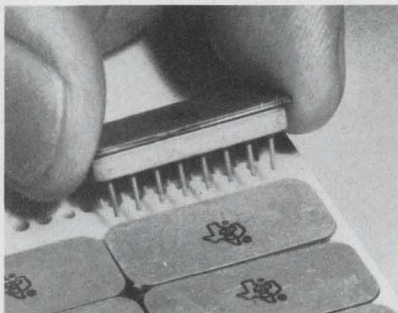

Figure 4. New plug-in flat packages for TI integrated circuits are easily handled and inserted into industrial-type PC boards.

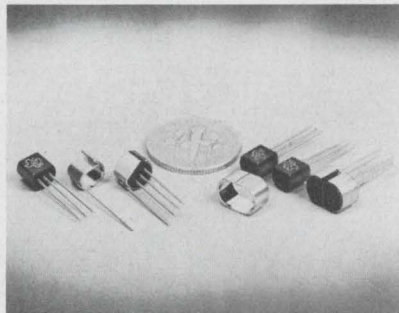

Figure 5. SILECT transistors and FET's are available with snap-on shield. Matched pairs may be factory-assembled with double clamps.

Reduce costs, simplify assembly with new plastic-encapsulated power transistors from TI

You save on both assembly and component costs when you use the new TAB-PAC™ silicon power transistor from TI. This new NPN planar device, typed TIP14, is designed especially for cost-critical industrial and consumer applications.

The low-profile, double-ended plastic package incorporates a mounting tab for simplified assembly. The transistor can be mounted on chassis or heat sink with a single self-tapping screw as shown in Figure 2.

Low saturation voltage ($V_{CE(sat)} = 0.1$ volt typical at 200 mA) provides high circuit efficiency with minimum internal losses.

High power dissipation (15 watts at 25°C case) and gain linearity over a wide current range (h_{FE} typically 35 at 50 mA and 30 at 1 amp) make the TIP14 ideal for use in amplifier applications. For more information circle 125 on the Reader Service Card.

Economy germanium planar transistors reduce costs and improve performance of TV, FM and industrial circuits

TIXM01-08 PNP epitaxial planar germanium economy transistors are designed for RF, oscillator, mixer and IF application in television and FM broadcast receivers and in industrial applications requiring low-noise, high-frequency amplifier devices.

Low noise (2.8 dB typical at 200 MHz), high gain (28 dB at 100 MHz), excellent forward AGC (>20.5 dB gain reduction through h_{fe} fall-off alone), low feedback capacitance (<1 pF), and low-cost plastic-and-glass package (shown in Figure 3) make these devices first choice for many applications.

TIXM01-04 transistors are for AM/FM, while TIXM05-08 are for TV. Circle 126 on Reader Service Card for data sheets.

Plug-in flat package for TI industrial integrated circuits reduces handling and assembly costs.

TI's new 16-pin plug-in flat package (shown in Figure 4) has been developed to reduce handling and assembly costs for industrial applications. The two rows of sturdy plug-in pins with 100-mil spacing facilitate automatic handling, assembly, and flow soldering to industrial-type PC boards. The hermetic package is designed for excellent reliability as well as for handling convenience and economy.

economy semiconductors solid-state designs

The new package is available at no additional cost for Series 74, 74 930, 1580, and most units in Series 73. Standard package for all series is the five-year-proved 1/4" x 1/8" flat pack. Circle 127 on Reader Service Card for data sheets.

Broad line of SILECT™ silicon plastic-encapsulated transistors offers economy, reliability

For proven reliability in economy silicon transistors, look to TI's broad line of SILECT plastic-encapsulated devices.

Documented results of recent tests show demonstrable reliability advantages over alternative plastic silicon types. In the areas most critical in plastic transistors — moisture resistance and encapsulant stability — SILECT transistors excelled. Copies of this data are available.

PNP types offer the added advantage of TRI-REL™ redundant stabilization — an exclusive TI process insuring NPN reliability in PNP devices.

The table at right summarizes the characteristics presently available in SILECT transistors. With current capabilities ranging from 1 μ A to 500 mA and frequency from 30 to 600 MHz, SILECT devices are well suited for a wide variety of industrial and consumer applications. Circle 128 on Reader Service Card for data sheets.

Get high performance at low cost with SILECT FET's from TI

Now you can improve sensitivity, reduce cross-modulation, reduce noise, and generally improve performance of much consumer and industrial equipment with SILECT field-effect transistors.

These low-cost, plastic-encapsulated, silicon junction units are available as N-channel (2N3819 and TIS34) and P-channel (2N3820) devices. Optional grounded or ungrounded snap-on clamps (shown in Figure 5) provide RF shielding and improved dissipation.

Applications include AM/FM tuners; mixers; low-, medium- and high-frequency amplifiers; and digital applications. Low-cost matched pairs for FET complementary circuits or differential amplifiers can be obtained by clamping matched units together as shown in Figure 5.

Electrical characteristics include extremely low leakage, high-frequency capability, superior cross-modulation, high transconductance, and low capacitance. Electrical characteristics of the three standard types available are shown in the lower table of Figure 6. Circle 129 on Reader Service card for data sheets.

SILECT SILICON TRANSISTORS						
Application	Polarity	Device	I _c Range	h _{FE} Min	BV _{CEO} MIN	f _T MIN
Low Level	NPN	2N3707	001-30 mA	100	30 V	30 MHz
High Gain		2N3708	001-30 mA	45	30 V	30 MHz
Small Signal		2N3709	001-30 mA	45	30 V	30 MHz
Amplifier		2N3710	001-30 mA	90	30 V	30 MHz
		2N3711	001-30 mA	180	30 V	30 MHz
Medium Power	NPN	2N3704	100 μ A	100	30 V	100 MHz
		2N3705	to	50	30 V	100 MHz
		2N3706	500 mA	30	20 V	100 MHz
Medium Power	PNP	2N3702	100 μ A	60	25 V	100 MHz
		2N3703	to	30	30 V	100 MHz
			200 mA			
High Frequency Low Noise AM RF	NPN	2N3825	1 μ A to	20	15 V	200 MHz
				100 mA		
High Frequency AM-FM IF	NPN	2N3826	1 μ A to	40	45 V	200 MHz
			2N3827	30 mA	100	45 V
High Frequency FM RF, IF UHF OSC	NPN	T1407	1 μ A to	20	12 V	450 MHz
		T1408	30 mA	15	12 V	300 MHz
		T1409		15	12 V	300 MHz
		T1S18		20	13 V	600 MHz
High Frequency TV last IF Citizens Band	NPN	2N3828	100 μ A	30	40 V	360 MHz
				to		
			100 mA			
SILECT FIELD-EFFECT TRANSISTORS						
Application	Polarity	Type	BV _{ESS} Min	Y _{fs}	C _{ISS} Max	V _{GS(off)}
Industrial, Consumer, Small-Signal Low Noise, High Input Impedance	N	2N3819	25 V	2000 to 6500 μ mho	8 pF	.5 to 7.5 V
VHF Amplifier and Mixer Applications			TIS34	30 V	3500 to 6500 μ mho	6 pF
Industrial, Consumer, Small-Signal Low Noise, High Input Impedance	P	2N3820	20 V	800 to 5000 μ mho	32 pF	.3 to 7.9 V

Figure 6. SILECT silicon transistors and FET's meet a wide range of industrial and consumer needs.



TEXAS INSTRUMENTS
INCORPORATED
13500 N. CENTRAL EXPRESSWAY
P. O. BOX 5012 • DALLAS 22, TEXAS

Show off your display system to advantage by using magnetic deflection. It offers superior quality, small size, high reliability and design freedom.

Part 1 of a two-part article.

Should electrostatic or magnetic deflection be used in display systems?

When faced with this choice, don't automatically select electrostatic deflection for the more sophisticated systems. Magnetic designs may not be quite as good from the standpoint of speed and bandwidth, but they possess a number of other redeeming qualities. These make them strongly competitive with electrostatic deflection, even in complex display systems.

The more sophisticated displays, such as radar, sonar or computer editing, often require rapid-access symbol presentations, occasionally mixed with real-time data (such as radar video). The displays frequently employ large tubes with large deflection angles. These characteristics are well met by magnetic deflection, in several ways.

Magnetic-deflection is attractive

In the first place, the quality of the display itself is superior to that obtained with electrostatic deflection, because the magnetic field does not interfere with the beam-forming process. This yields brighter displays and clearer, more controllable spot sizes.

Magnetic deflection also permits considerable design freedom:

- Easier reference to ground of tube element potentials within the display are achieved, because of the nature of the magnetic-deflection field. This is particularly important when wideband intensity modulation is required.

- Power-supply requirements like ripple and regulation are less stringent—again, because the beam-forming field is independent of the magnetic-deflection field.

- Packaging advantages accrue. The length of the tube is relatively small, because larger deflection angles are inherent. This also simplifies the size and complexity of its electron-gun.

- A lower voltage power supply is needed to form the magnetic-deflection field than is required

for electrostatic deflection. This permits the direct use of solid-state amplifiers, thus increasing the reliability and reducing the attendant power-dissipation requirements. Safety to personnel is also improved because of the lower voltages.

But magnetic deflection is not a panacea for display-system needs. One major drawback is the nonlinear relationship between the deflection current and the deflection of the spot (trace). If the cathode ray tube (CRT) had a spherical screen and a center of curvature that coincided exactly with the center of deflection, this would not be a problem. In practice, however, this is not the case, and a phenomenon called "pin-cushion distortion" results. However, it can be corrected.¹

Finally, the speed and bandwidth characteristics of magnetic-deflection designs can be made to approach and even equal (when large tubes are involved) those obtained with the electrostatic method. The design methods for achieving this are comparatively esoteric.

Let us then examine the design criteria and the interrelationships between the deflection coil and amplifying elements.

Tracing CRT deflection needs

One of the most important parameters of a

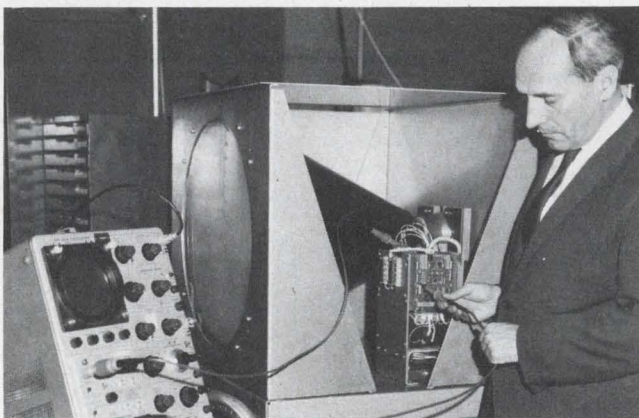

The case for magnetic deflection: design problems are ironed out. Co-author Popodi checks the performance of his push-pull magnetic amplifier design. Used in display systems, it is much smaller than an electrostatic counterpart and offers considerably more design freedom. The attendant power needs are also less stringent.

A. E. Popodi and R. M. Williams, Design Engineers, Westinghouse Electric Corp., Defense and Space Center, Baltimore, Md. (Mr. Williams is now affiliated with Sanders Associates, Inc., Nashua, N. H.)

deflection design is its bandwidth. Bandwidth has a major influence on the two important deflection criteria—settling time and ramp delay. In magnetic deflection the response is limited primarily by the output driver-deflection yoke combination. In general, high bandwidth requires both high power-supply voltages and small yoke inductances. These, in turn, demand large deflection currents, which must be provided by the output stage. These stages usually consist of high-frequency power transistors. The key to attaining high bandwidths and small settling times is the transistor and, to a larger extent, the deflection-coil design.

For a display tube with a given deflection sensitivity, the engineer must select and optimize judiciously a number of circuit parameters. His aim is to fulfill specifications and maintain maximum reliability. These main design parameters are:

- Supply voltage of the output stage.
- Deflection current.
- Amplifier bandwidth and gain.
- Degree of negative feedback.
- Circuit configuration (single-ended or push-pull, grounded-emitter or grounded-collector) of the output stage.

These requirements are generally specified as a given settling time and ramp delay of the deflection current. In addition specifications for the dc-stability, resolution and linearity must also be satisfied.

Deflection amplifiers for modern display applications must be capable of two primary modes of operation. The first (Mode 1) is the linear deflection of the CRT beam (scanning) over a wide range of frequencies, generally coupled with small retrace times and minimum ramp delay or time lag. The second requirement (Mode 2) is the presentation of alphanumeric symbols that require the fast displacement of the CRT beam in any direction, with no accompanying positional correlation from one step to the next. In this case,

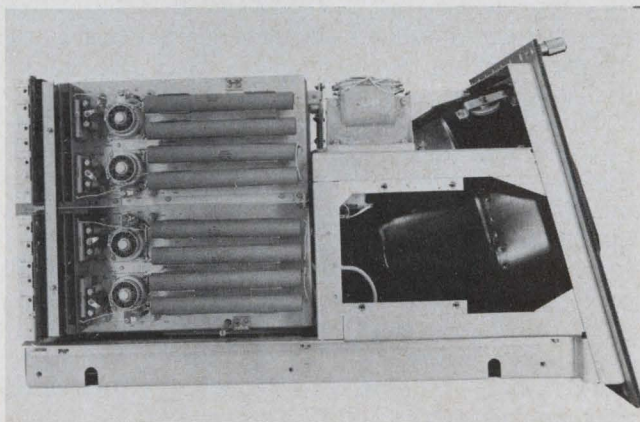

No longer on display . . .

Electrostatic deflection systems (such as the one shown above) are being hard-pressed by magnetic types in many display systems. Electrostatic types are larger, less-reliable, more complex and require higher power. Moreover, the frequency response of the magnetic types now approximate those of the electrostatic.

minimum rise and settling times (amplifier recovery) are of prime importance. A figure of $10 \mu\text{s}$ settling time to within 0.1% of the final value, when proceeding across the full CRT screen diameter, is representative.

Spot the significant error

The changeover between the two modes occurs in most cases on a random basis. Depending on the particular display application, one of two amplifier parameters—accuracy or recovery time—will be more important. In general, absolute accuracy plays a lesser role than the relative error between the data presented in Modes 1 and 2. In radar language, a target should appear at the same screen location as its computer-positioned target symbol. There should be no significant difference in results when a given spot on the screen is reached by either of the two following methods: starting at the center of the tube (PPI-sweep) and approaching the spot with constant velocity (linear ramp), or starting at any screen location and reaching the spot by instantaneous displacement. In the latter case ramp delay, a function of amplifier bandwidth, is of prime importance.

The total settling time of the CRT-spot depends on three factors: the deflection yoke inductance (L), the amplifier bandwidth and gain, and degradation effects. The yoke inductance determines the maximum obtainable current rise time, which is governed by the relationship $di/dt = E_s/L$, where E_s is the operating voltage of the output stage. The degradation of yoke characteristics is attributed to surrounding magnetic bodies, such as the magnetic shielding, armatures and the focus coils. Since it is not coil current but the actual magnetic flux that deflects the electron beam, great attention must be paid to maintaining a simple relationship between yoke current and flux.

The first design task is to choose the coil inductance on the basis of minimum power dissipation of the output stage. The next part of the design relates to the amplifier and its relationship with the deflection coil. Rise time and ramp delay for a single-pole feedback amplifier (second order system) will be calculated for single-ended and push-pull deflection systems, to illustrate this dependency. Finally a procedure to determine the total settling-time under actual overdrive conditions will be presented to demonstrate system performance.

To ease the analytical treatment, linear operation of the amplifier-yoke complex is assumed. Note that constant-frequency systems that feature a recovery of energy (such as television) do not apply to this discussion.

Deflection coil establishes di/dt

The deflection coil is part of the feedback loop, and, as such, its effect on amplifier performance is major. To determine the shortest obtainable rise and fall times of the deflection current, the equiv-

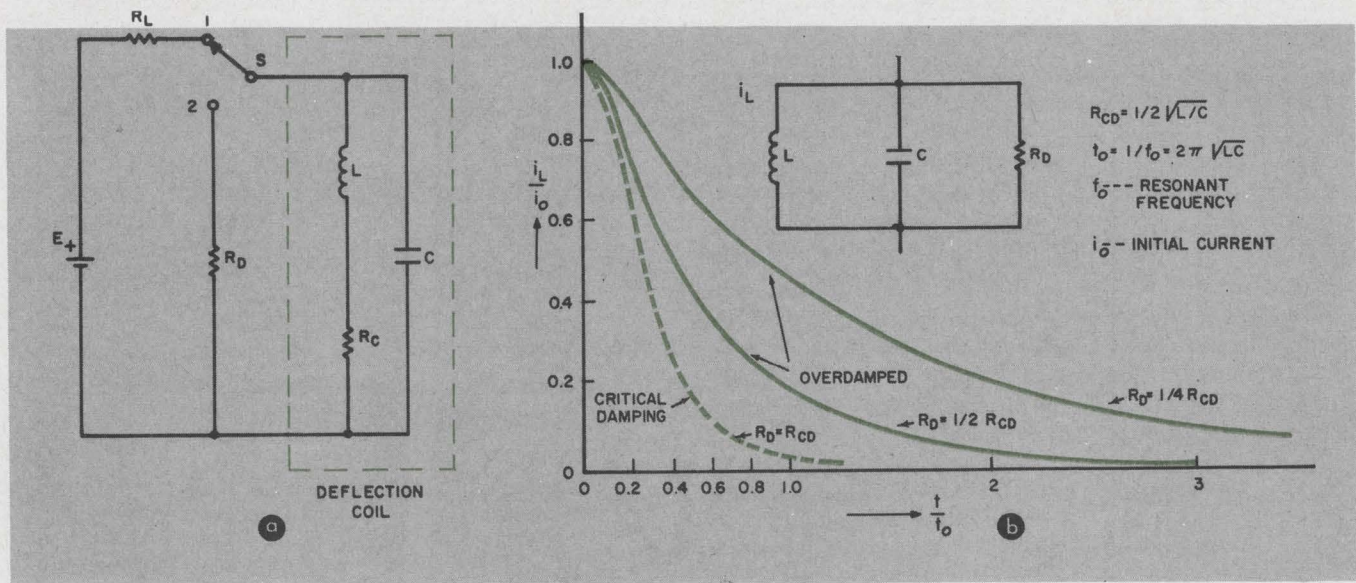

1. Deflection coil is a key part of the magnetic-deflection display system. Equivalent circuit (a) is used to determine coil current versus time relationships. In general, di/dt effects should be maximized, thus requiring that E_s be

alent circuit of Fig. 1a is analyzed. The coil element consists of coil inductance L , winding resistance R_c and coil capacitance C .

If the switch S is in the charging position (1), coil current increases exponentially toward its final value, as given by supply voltage E_s and charging resistor R_L (resistor R_c is small and can be neglected). Charging resistor R_L is also small, thus permitting coil capacitance to be neglected. Current build-up in the coil is then described by:

$$E_s = iR_L + L \frac{di}{dt}; \quad (1)$$

this may be rewritten as:

$$\frac{di}{dt} = \frac{E_s - iR_L}{L}. \quad (2)$$

To maximize di/dt , E_s must be large and both L and R_L small. For solid-state drivers, the practical limit for E_s is the maximum collector-to-emitter breakdown voltage of the output transistor. Minimum values for R_L depend on both the ratio of feedback voltage to noise in the system and the requirement that it be non-inductive (or that its inductance be small when compared to L). Typical values for R_L in high-bandwidth applications (settling times of 10 or 20 μ s) are from 0.1 to 10 ohms. Finally a practical limitation for the lowest coil inductance is the number of turns necessary to insure a uniform field distribution, especially in push-pull yokes. As the inductance decreases, the deflection current rises, and output transistor capabilities determine the minimum inductance. In high-bandwidth applications, coil inductances of 10 μ h may be encountered.

If S is in the discharge position (2), the coil capacitance C cannot be neglected, and a coil damping resistor R_D must be added to avoid excessive ringing. The value of R_D must be near or possibly slightly larger than a critical value given by $R_{CD} = 1/2 \sqrt{L/C}$. This is because a small amount of overshoot produces faster settling time. Figure 1b

large and L and R_L small. Normalized plot of coil current as a function of damping resistor value demonstrates the current-time relationship for one critically damped and two overdamped conditions (b).

shows the current decay for a critically damped case and for two overdamped cases.

The fastest possible current decay without overshoot is obtained if $R_D = R_{CD}$. At time $t = t_0$, where $f_0 = 1/t_0 = 1/2\pi\sqrt{LC}$ (the resonance frequency of the yoke), the current is approximately 1% of its final value. For this reason, L and C must be small for high bandwidth. The damping resistor in a practical circuit is established by the source impedance of the output. Thus it can be very low in the case of emitter-driven coil or relatively high with a collector configuration.

Easing the burden of yoke selection

In selecting a deflection yoke, it is assumed that the CRT has already been selected and that the fastest required spot displacement from center to edge is known. The type of yoke used depends on the particular display application. Several lines of yokes are available, depending on what aspect of performance is paramount. This can be the sensitivity, the linearity or the resolution.

To ease output-stage design, the engineer generally chooses the largest yoke inductance that, in conjunction with the amplifier, permits the attainment of a specified settling time. To find this inductance, the sensitivity constant of the particular yoke line must be determined. This is usually done by consulting data-sheet values for a sample yoke and sample tube, neither of which has to be final design values.

The energy required to magnetically deflect the electron beam of a CRT is given by

$$1/2 L_1 I_1^2 = W_1 = \frac{E_{a1} \times \sin^2 \theta_1}{k}. \quad (3)$$

Combining and solving for k yields:

$$k = \frac{2E_{a1} \sin^2 \theta_1}{L_1 I_1^2}, \quad (4a)$$

where L_1 is the yoke inductance of the sample

yoke (obtained from the data sheet), E_{a1} is the CRT anode voltage listed for the sample yoke, I_1 is the center-to-edge deflection current of the sample yoke, θ_1 is the center to edge deflection angle of the sample yoke and k is the sensitivity constant of the selected yoke line.

Because k depends only on the yoke geometry and construction, Eq. 4a can be rewritten:

$$k = \frac{2E_a \sin^2 \theta}{LI^2}, \quad (4b)$$

where E_a is the actual CRT anode voltage in the particular application, I is the actual required deflection current for center-to-edge deflection, θ is the actual center-to-edge deflection angle, and L is the actual yoke inductance.

Voltage sets speed of spot shift

This equation describes the static relationship between inductance, deflection current, deflection angle and anode voltage. Under dynamic conditions, the fastest possible spot displacement is obtained when the full supply voltage (E_s) of the output stage is applied to the yoke. Neglecting coil series resistance, the current rises as per:

$$E_s = L \frac{di}{dt} = \frac{LI}{t} \quad (5)$$

where E_s is the supply voltage of the output stage, L is the yoke inductance, I is the deflection current at the tube edge and t is the time allowed for spot displacement from center to edge. Substituting and solving for L , we get:

$$L = \frac{k}{2E_a} \left(\frac{E_s t}{\sin \theta} \right)^2 \quad (6a)$$

In practice the coil current does not rise linearly, because the coil resistance R_c is not zero and there is a voltage loss in the feedback resistor R_f . Moreover the deflection amplifier is not ideal. Depending on amplifier design and damping conditions, overshoot may occur and therefore additional time is needed until a given settling level is reached. With good amplifier design (less than 5% overshoot), the total settling time is about twice the value used in Eq. 6a, if a settling to within 0.1% is desired. Therefore,

$$L_{(practical)} = \frac{k}{2E_a} \left(\frac{E_s t}{2 \sin \theta} \right)^2 \quad (6b)$$

is a more realistic inductance expression.

The yoke inductance calculated from Eq. 6b is only a rough estimate of the final design value. The next step is to match the yoke to the amplifier and to determine the amplifier bandwidth required to obtain the specified settling time.

The deflection yoke is always the load of a limited-bandwidth deflection amplifier that often features a negative feedback arrangement. Basically there are two ways to connect the deflection yoke to the output stage. These are identified as the emitter and collector configurations.

Single-ended deflection used

In the emitter-follower configuration (Fig. 2), coil voltage is controlled by the output stage. Because large voltage excursions in both polarities ($+E_s$ and $-E_s$) are necessary for fast current rises, the preamplifier must be capable of supplying rather high base current drives. The preamplifier response, rather than the output stage response, is usually the bandwidth-limiting factor, because the former is more overtaxed. However, this does not present a great problem, because it is relatively easy to obtain high bandwidth at low-current levels with medium-power high-frequency transistors. One advantage of this connection is that the coil capacitance can be charged and discharged by the low-impedance emitter-followers; thus no damping resistor is required.

In a collector configuration, coil current is the controlled parameter. Here the preamplifier does not require large output voltage swings, because only the base of the output transistor must be driven. However, the large-power-transistor used has a high output capacitance (up to several hundred picofarads). This lies in parallel with the deflection coil and deteriorates the circuit time constant. Therefore, the gain-bandwidth product of the output stage becomes the limiting factor.

This is further complicated because the collector capacitance is not constant; it is voltage dependent. The damping resistor must therefore be selected for the largest possible capacitance—this entails an overdamping condition at all other values of C . In other words, a loss in current rise-time must be accepted.

The design characteristics and performance capabilities of a number of actual magnetic-deflection systems will appear in Part 2 of this article, in the next issue. ■ ■

Reference:

A. E. Popodi, "Linearity Correction of Magnetically-Deflected Cathode Ray Tubes," *Electrical Design News*, January, 1964.

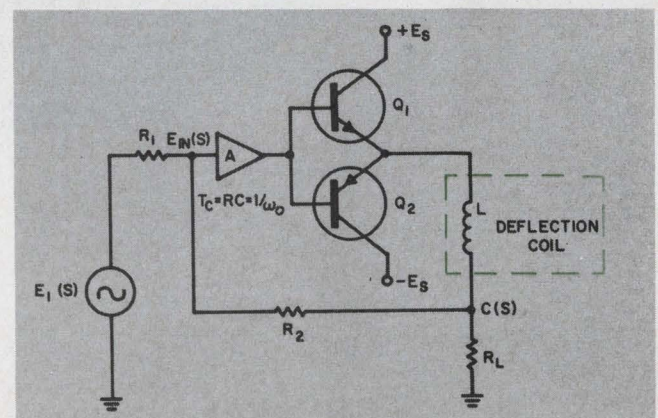

2. Single-ended and push-pull deflection stages often use an emitter-follower configuration to connect the deflection yoke as an amplifier load. Note that a damping resistor (in shunt with the coil) is not required. This is because the emitter-follower stages both charge and discharge the coil capacitance directly.

If we at AmpereX could develop a transistor that wouldn't have to be neutralized.... we'd all have something to smile about!





We've solved the circuit designer's problem of how to utilize the maximum available gain of his system and still maintain good stability. We've made this possible with the introduction of the first two of a series of extremely low-feedback-capacity silicon planar transistors in hermetically sealed TO-18 envelopes. With these transistors, types A467 and A473, the need for neutralization within their operating frequency ranges has been completely eliminated.

Type A467 is designed for forward gain controlled stages and features a typical feedback capacity of 150 mpf. Type A473

is designed for output stages where power handling capability is of paramount importance. Typical feedback capacity of type A473 is 230 mpf.

Typical applications include Television IF amplifiers, Wideband Radar IF amplifiers and premium performance FM-IF and RF service.

Types A467 and A473 combined with the new Amperex high performance general purpose silicon planar type A415 provides the design engineer with a range of silicon planar small signal transistors unequaled in the industry on price and performance.

For complete data on these and other Amperex silicon planar epitaxial RF amplifier transistors, write: Amperex Electronic Corporation, Semiconductor and Receiving Tube Division, Dept. 371, Slatersville, Rhode Island 02876.

Type	f_T	C_{re}	AGC Range	45 Mc Useable Gain	10.7 Mc Useable Gain
A467	330 Mc	150 mpf	55 db	33 db	—
A473	550 Mc	230 mpf	—	34 db	36 db
A415	200 Mc	0.7 pf	—	—	30 db

Amperex®

ON READER-SERVICE CARD CIRCLE 21

Why use IC gate-ring counters? Because they often use less power than other counter types do and at the same time require no more wafer area.

Part 2 of a two-part article. Part 1 (E/D, Feb. 15, 1966) described the types of gate-ring counters that can be built in integrated-circuit form.

The power dissipation of gate-ring counters is often less than that of other types. Moreover integrated-circuit gate-ring counters require no more wafer area than other commonly used types.

In deriving power-dissipation expressions, the engineer can ignore the dissipation in the pulse steering networks. This is because it is generally small, in comparison with the dissipation in the rest of the counter circuitry, to be of significance.

Power expressions for NAND counters

As Part I of this article has shown, NAND gate-ring counters can be built in integrated-circuit form using DTL gates. In such a counter the fan-out per gate varies with the number of gates in the counter. So for each gate (Fig. 1), the value of the fan-out parameter K (where $K = R_B/R_L$) varies with the number of gates, for a given value of transistor β . This is because R_B must supply enough base current to the inverter transistor for it to sink all the available current from the fan-out stages. Therefore, as the number of gates in the counter increases, the fan-out per gate must increase and R_B must decrease. This in turn increases the static power dissipation per gate. Since the total power dissipation is dependent on the fan-out—and therefore K —the value of K for a given counter size can be determined and then used to derive a simple formula for the total static power dissipation of the counter.

If G is the number of gates in the counter, then $G-1$ is the fan-out required to satisfy the basic counter interconnection. Add to this the external fan-out requirements, N , and the total fan-out of each gate is $N+G-1$. Therefore, referring to Fig. 1, we see that the condition for static stability is:

$$\left(\frac{V_{CC} - V_{BE} - V_D}{R_B}\right)\beta = \frac{(V_{CC} - V_{SAT})}{R_L} + (N + G - 1) \left(\frac{(V_{CC} - V_D - V_{SAT})}{R_B}\right)$$

where: V_{BE} = base emitter voltage of the transistor.

V_{SAT} = collector emitter voltage of the transistor when the transistor is ON, or conducting.

V_D = voltage drop of a forward biased diode.

So, since $K = K_B/R_L$,

$$K = \frac{(V_{CC} - V_{BE} - V_D)\beta - (G + N - 1)(V_{CC} - V_D - V_{SAT})}{V_{CC} - V_{SAT}}$$

In deriving a simple expression for the power dissipation, P_d , we find that the power dissipated in R_p of the DTL gate and the power dissipated in the ON transistor from external fan-out are small—and are consequently ignored. Therefore,

$$P_d = \frac{(V_{CC} - V_D - V_{BE})}{R_B} V_{CC} + \frac{(V_{CC} - V_{SAT})}{R_L} V_{CC} + (G - 1) \frac{(V_{CC} - V_D - V_{SAT})}{R_B} V_{CC}$$

which is the same as,

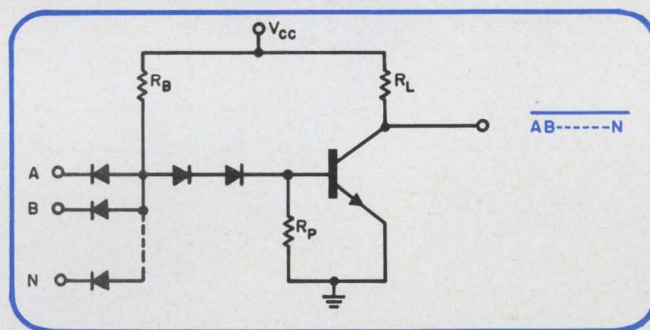

1. DTL NAND-gate can be used for integrated gate-ring counters.

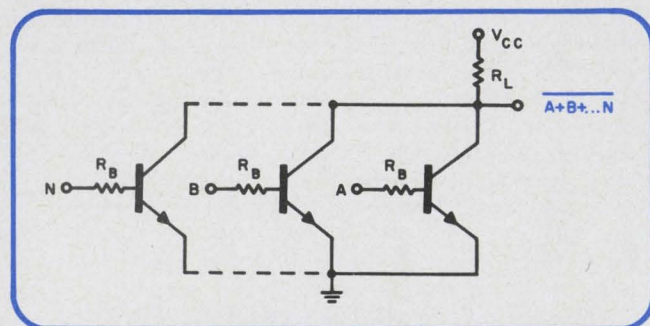

RTL NOR-gate is also realizable in integrated-circuit m.

G. J. Veth, Applied Physics Laboratory, Johns Hopkins University, Silver Springs, Md.

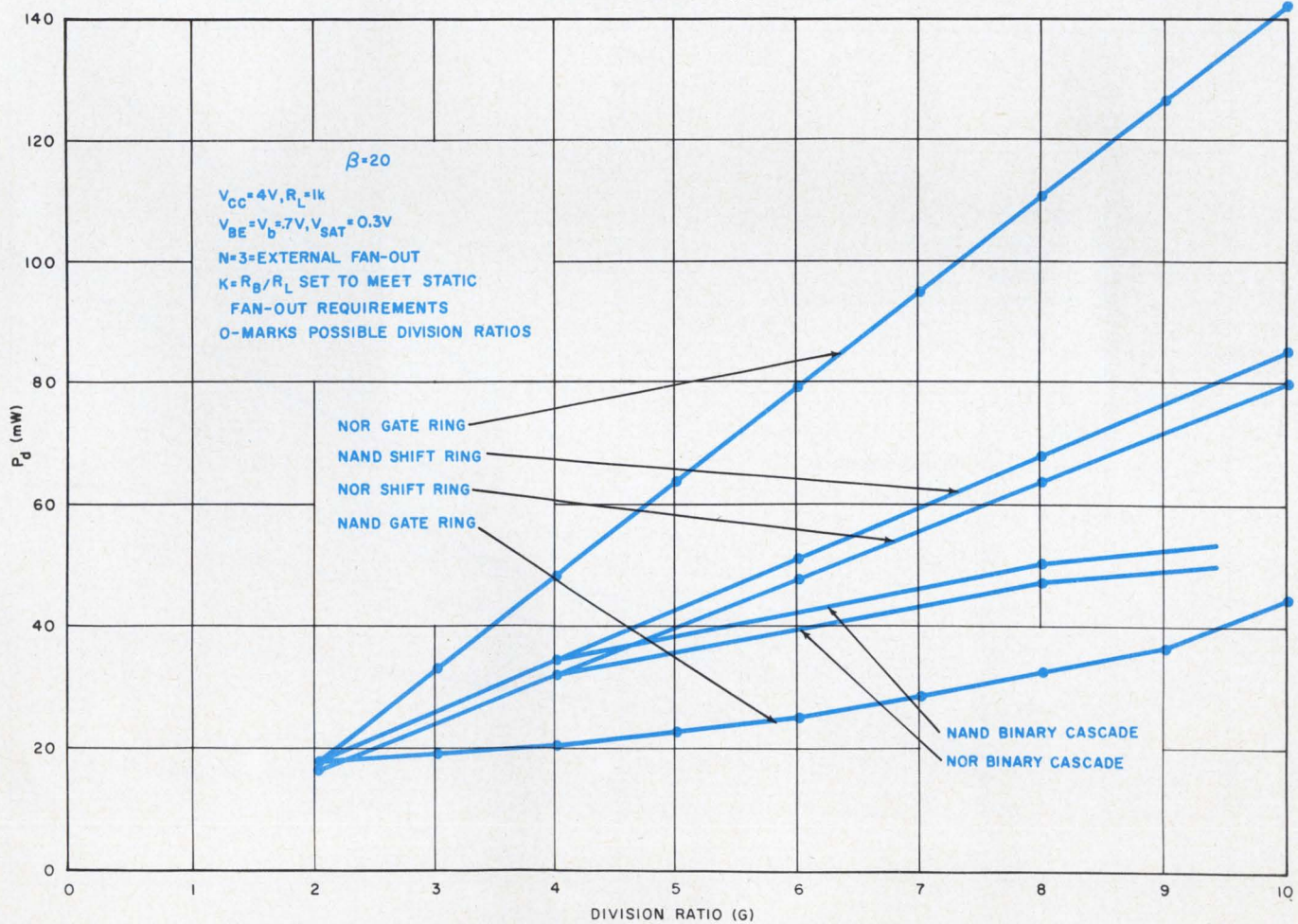
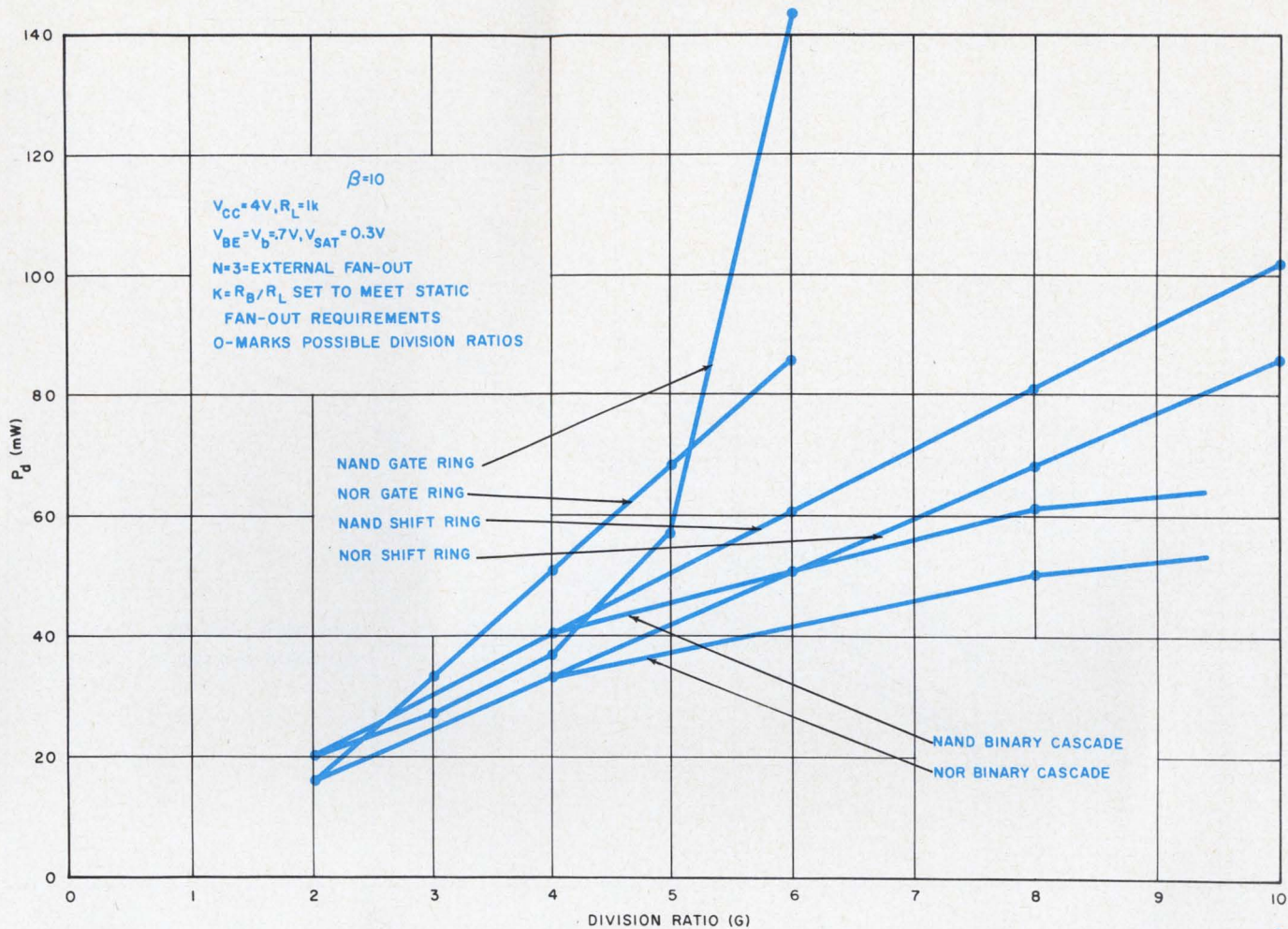

3. Static power dissipation vs counter length is shown for various types of counters.

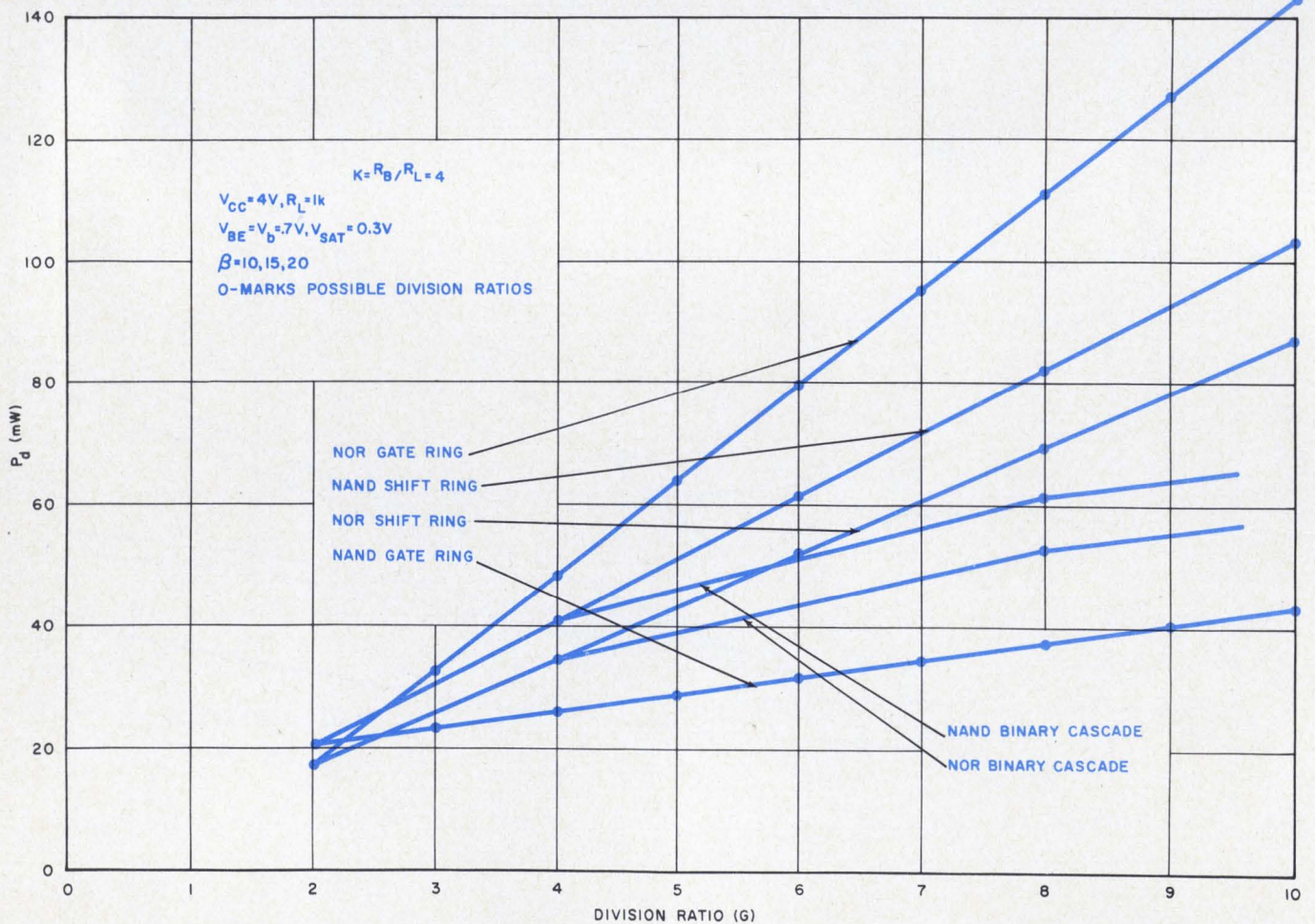
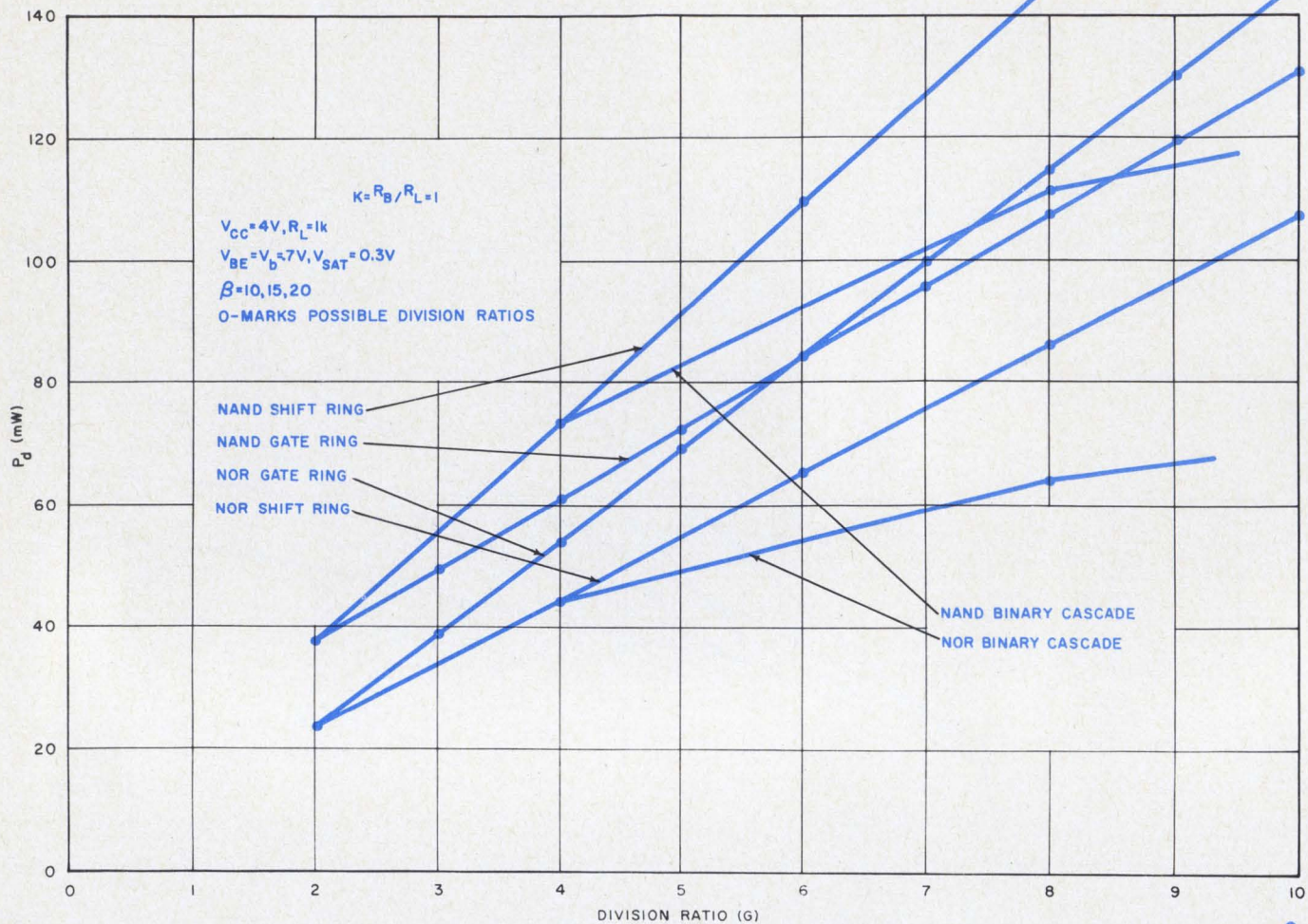

4. Static power dissipation vs counter length is shown for various types of counters when the value of K is fixed.

$$P_d = \frac{V_{CC}}{R_L} \left[\frac{(V_{CC} - V_D - V_{BE})}{K} + (V_{CC} - V_{SAT}) + \frac{(V_{CC} - V_D - V_{SAT})}{K} (G - 1) \right]$$

Power expressions for NOR counters

As shown in Part I, integrated-circuit NOR gate-ring counters can be built using RTL gates. As with the NAND gate-ring counter, the required fan-out per gate for this type of counter varies with counter size. The total fan-out is the same as in a NAND gate-ring counter, being $(N + G - 1)$, where N is the external required fan-out and $G - 1$ is the fan-out required by the interconnection of the gates.

To find first the value of K to satisfy the fan-out requirements (Fig. 2):

$$(G - 1)I_B + NI_B = \text{required fan-out current}$$

$$I_B = \frac{V_{OFF} - V_{BE}}{R_B}$$

where V_{OFF} is the output voltage of the OFF gate that is supplying the fan-out current.

$$V_{OFF} = V_{CC} - [(G - 1)I_B + NI_B]R_L = I_B R_B + V_{BE}$$

$$I_B = \beta I_E = \frac{V_{CC} - V_{SAT}}{R_L}$$

Combining these two equations, we find K to be:

$$K = \frac{R_B}{R_L} = \frac{(V_{CC} - V_{BE})}{V_{CC} - V_{SAT}} - (N + G - 1)$$

In deriving a simple expression, we ignore the power dissipated by the load resistor of the OFF gate as it supplies current for external fan-out. Thus:

$$P_d = \frac{(V_{CC} - V_{SAT})}{R_L} V_{CC}(G - 1) + \frac{(V_{CC} - V_{BE})}{R_L + R_B/G - 1} V_{CC}$$

or,

$$P_d = \frac{V_{CC}}{R_L} (G - 1) \left[(V_{CC} - V_{SAT}) + \frac{V_{CC} - V_{BE}}{K + G - 1} \right]$$

Power expressions for binary-type counters

Serial dividers employing binary-counter stages and ring dividers using shift-register stages can be considered together, inasmuch as both can be built from the same basic circuit through proper interconnection. The circuit is essentially a shift register and is identical to the two-gate ring counter. Thus we can determine the static-power dissipation per stage for RTL and DTL implementation from the formulas just derived, by letting $G = 2$.

It should be noted that K does not vary with the counter length, as G is now a constant. However, K still varies with the external fan-out demands.

Performance Proves:

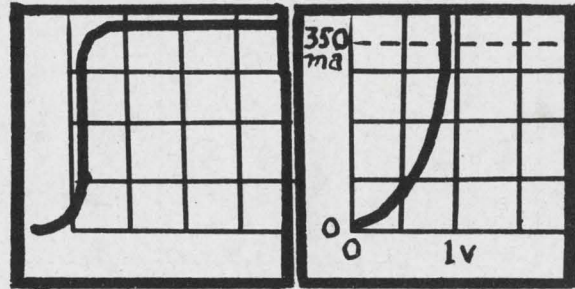

Fastest Switching Diode With High Forward Current

Test waveforms show that International Diode Corp.'s ID3-050T alloy junction diode has a reverse recovery time (left) in the picosecond range, with a 200-to-400 milliamperere forward conductance (right). IDC can provide more than 100 types to solve your design problems, including Q6-100, Q5-100, ID3-050, 1N3146. Price as low as 45 cents in quantities; delivery mostly from stock. Write or phone for details.

INTERNATIONAL DIODE CORP.

90 Forrest Street, Jersey City, N. J. 07304
201 - 432-7151

ON READER-SERVICE CARD CIRCLE 22

MASKS

for **integrated circuitry**
thin film devices
semiconductors

PHOTOMASKS

- NEW Perma-Chrome (metal film on glass).
- High resolution photo emulsion.

EVAPORATION MASKS

- Electroformed nickel.
- Etched molybdenum and stainless steel.
- Bimetal (electroformed nickel and copper).

Prompt quotations and deliveries.



TOWNE LABORATORIES, INC.
Somerville, N. J. • Tel. 201 - 722-9500

See us at IEEE, Booth 4A37
ON READER-SERVICE CARD CIRCLE 23

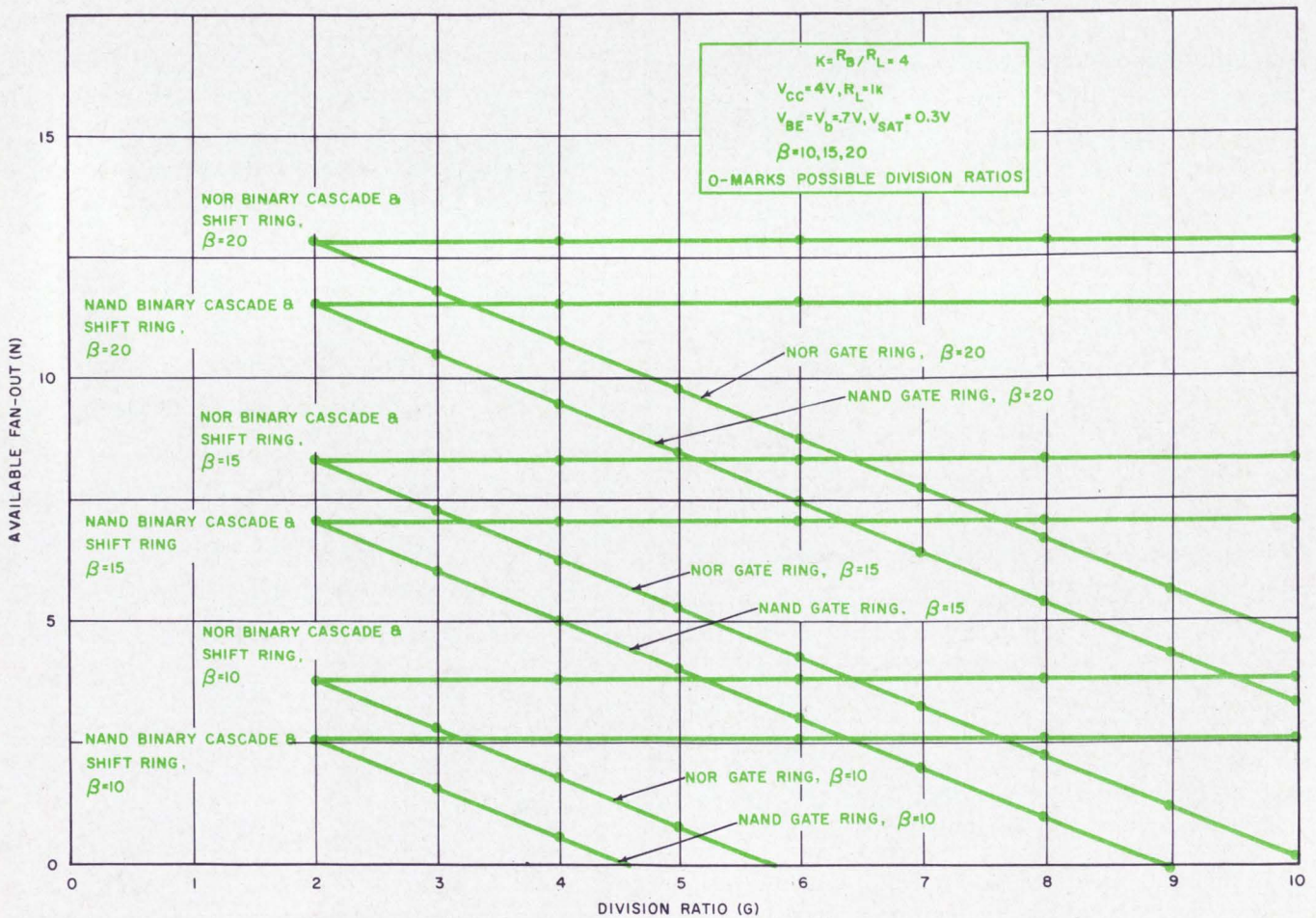
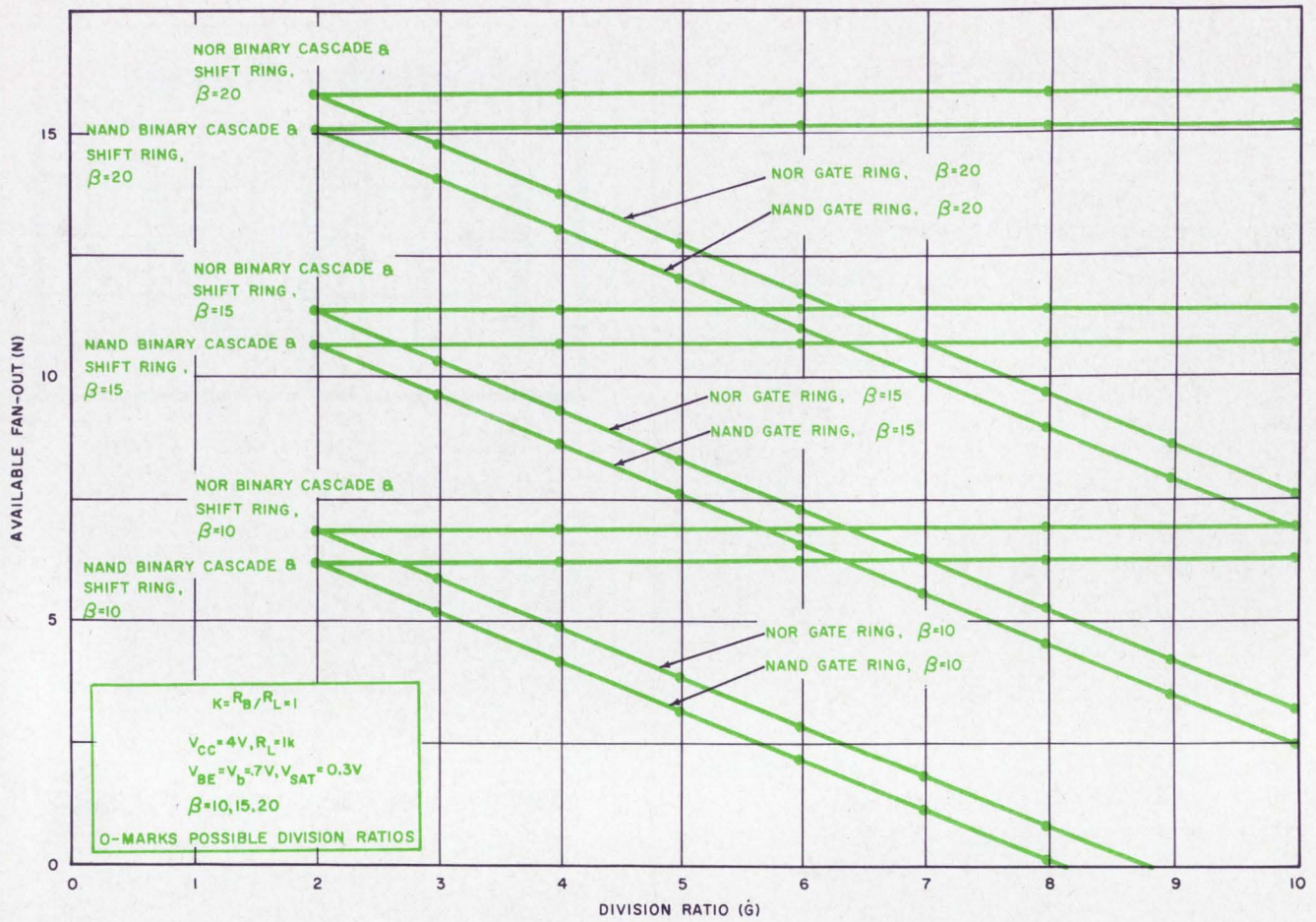

5. Fan-out vs counter length is shown for the fixed values of K used for Fig. 4; namely, $K = 1$ and $K = 4$.

Required area for integrated counters

Counter Length	Required Area		
	Gate Ring	Shift Ring	Binary Cascade
2	1	1	1
3	1.5		
4	2	2	2
5	2.5		
6	3	3	
7	3.5		
8	4	4	3
9	4.5		
10	5	5	

Therefore, from the previous formulas, we have:

$$K(DTL) =$$

$$\frac{(V_{CC} - V_D - V_{BE}) - (N + 1)(V_{CC} - V_D - V_{SAT})}{V_{CC} - V_{SAT}}$$

$$P_d/\text{Stage (DTL)} = \frac{V_{CC}}{R_L} \left[\frac{(V_{CC} - V_D - V_{BE})}{K} + (V_{CC} - V_{SAT}) + \frac{(V_{CC} - V_D - V_{SAT})}{K} \right]$$

and:

$$K(RTL) = \beta \frac{(V_{CC} - V_{BE})}{V_{CC} - V_{SAT}} - (N + 1)$$

$$P_d/\text{Stage (RTL)} = \frac{V_{CC}}{R_L} \left[(V_{CC} - V_{SAT}) + \frac{V_{CC} - V_{BE}}{K + 1} \right]$$

To determine the power of a cascade binary ring counter employing shift register stages, it is necessary to know only the relationship between the number of counter stages and the count cycle, or division ratio. The relationships for the simple cascade binary is:

$$\text{Count cycle} = 2^M,$$

where M is the number of binary stages. The relationship for the ring counter is:

$$\text{Count cycle} = 2M$$

where M is the number of shift register stages. These formulas have been solved for $V_{CC} = 4$ V, $R_L = 1$ k, $V_{BE} = V_b = 0.7$ V, $V_{SAT} = 0.3$ V, and $N = 3$, and are presented in Fig. 3 for $B = 10$ and 20, respectively.

In obtaining these curves, we determined first the ratio $K = R_B/R_L$, which satisfied the static fan-out requirements. Then the power dissipation was calculated for this value of K . It can be seen from the curves that the NAND gate-ring counter allows division by any whole number and can have a lower power dissipation than the other counters. To obtain this lower power dissipation, though, the NAND gate-ring counter requires higher transistor betas than other counters do, especially as the length of the counter increases.

It is also interesting to compare the various

counters discussed when the value of K is fixed. This has been done in Figs. 4 and 5. Figure 4 shows the static power dissipation vs counter length for two values of K , and Fig. 5 shows the available static fan-out for these same K values. To gain a power dissipation advantage with the use of a NAND gate-ring counter, K should be large, as can be seen, but if a large fan-out is required, K should be small or β large.

Size is no problem

Gate-ring counters should pose no fabrication problems in integrated-circuit form. The basic gates are already being realized in this form, and gate-ring counters with the required steering network components have also actually been realized, since flip-flop counters can be considered two-stage gate-ring counters.

The possibility of building entire gate-ring counters of reasonable lengths on a single chip is attractive. A comparison of the approximate wafer area required to build gate-ring, shift-ring and binary-cascade counters of given lengths in integrated form is given in the accompanying table. Since the gate-ring, shift-ring and two-stage binary-cascade counters are the same circuit, this circuit is assumed to require 1 unit of area. The lengths for the other counters are then given in multiples of this arbitrary unit of area.

To summarize:

Gate-ring counters can have important advantages over shift-ring and simple binary cascade counters. They are capable of counting by any whole number, they consume less power in many applications, and they require no more (or less) area in monolithic form. In addition they are quickly realized with the use of available integrated logic gates if conventional components are used in the steering networks, and, with minor modifications of available semiconductor gates, they can be constructed in fully integrated form.

Gate-ring counters have the disadvantage of requiring higher transistor betas for a given fan-out, or having lower available fan-out for a given beta. And, though not discussed here, gate-ring counters are subject to self-oscillations for certain combinations of circuit parameter values, especially as the length of the counter increases. ■ ■

It's Time To Renew Your Free Subscription To **ELECTRONIC DESIGN**

When you receive your renewal letter application please fill it in completely...and mail it immediately to insure uninterrupted receipt of ELECTRONIC DESIGN.

Our circulation policy requires that all subscribers requalify each year to continue receiving their free subscription to ELECTRONIC DESIGN.

Please help us serve you better by requalifying as soon as you receive the renewal letter.

26 ISSUES IN **'66**

PLUS 3

**SPECIAL
REFERENCE
ISSUES**

If you are not now a subscriber and would like to receive your own copy each issue circle Reader Service Number 800.

New, low-cost Philbrick Operational Amplifiers



Philbrick has always produced a wide variety of cool, reliable, solid state operational amplifiers for measurement, computing, control, data processing and testing. They provide premium performance and are priced accordingly. Their specified operating temperature exceeds -25° to $+85^{\circ}\text{C}$. Now Philbrick also offers economical equivalents of many of the most popular types in a utility grade, at substantially reduced prices. Savings generally exceed 50%. Yet, these utility grade amplifiers have identical performance with their premium grade equivalents within a limited temperature range, usually 0° to 60°C , but operate over the full range. And they too carry a two-year warranty. For a chart giving detailed comparative specifications of more than 60 Philbrick Operational Amplifier types write, wire or phone: Philbrick Researches, 46-H Allied Drive at Route 128, Dedham, Massachusetts. Telephone (617) 329-1600.

Engineering Representatives

Ala.: Huntsville (205) 536-8393, Mobile (205) 954-9298; Ariz.: Phoenix (602) 265-3629; Cal.: Los Angeles (213) 937-0780, Palo Alto (415) 326-9800, San Diego (714) 222-1121; Colo.: Denver (303) 733-3701; Conn.: West Hartford (203) 233-5503, Greenwich (203) 661-5140; Fla.: Ft. Lauderdale (305) 564-8000, Orlando (305) 425-5505; Ill.: Chicago (312) 676-1100, (312) 676-1101; Ind.: Indianapolis (317) 356-4249; La.: New Orleans (504) 242-5575; Md.: Baltimore (301) 727-1999; Mass.: Wakefield (617) 245-5100; Mich.: Detroit (313) 838-7324; Minn.: Minneapolis (612) 545-4481; Mo.: St. Louis (314) 741-3779; N. M.: Albuquerque (505) 268-3941; N. Y.: Buffalo (716) 835-6186, DeWitt (315) 446-0220, Valley Stream (516) 561-7791; N. C.: Winston-Salem (919) 725-5384, (919) 725-5385; Ohio: Dayton (513) 298-9964, Westlake (216) 871-8000; Okla.: Tulsa (918) 627-6199; Pa.: Philadelphia (215) 277-0559, Pittsburgh (412) 371-1231; Tex.: Dallas (214) 526-8316, Houston (713) 781-1441; Utah: Salt Lake City (801) 466-4924; Va.: Alexandria (703) 836-1800; Wash.: Seattle (206) 723-3320. EXPORT: N.Y.: New York (212) 246-2133.

CANADA: Quebec: Montreal (514) 482-9750, Ontario: Toronto (416) 789-4325.

ELECTRONIC ANALOG COMPUTING EQUIPMENT for MODELLING, MEASURING, MANIPULATING and MUCH ELSE



PHILBRICK

Visit us at the IEEE Show - Booths #3K51 and 3K52

ON READER-SERVICE CARD CIRCLE 24

The ABC of dummy loads: A variety of choices are open to the designer, depending on the power, vswr and the availability of auxiliary equipment.

Before you select a coaxial termination, check these important parameters for dummy loads:

- Vswr.
- Power dissipation capability.
- Input connector.

Then examine the types that are available for your application. They can be conveniently grouped according to the way in which they dissipate heat:

- Dry terminations.
- Dielectric-cooled terminations.
- Water-cooled terminations.

In checking parameters, don't lose sight of your application. For example, vswr is a prime consideration in a directional-coupler application. In transmitter terminations, power dissipation is important. In high-power or peak-power applications, the choice of RF connectors should be carefully considered.

Let's examine these parameters one by one.

Theoretically a coaxial termination, or dummy load, should absorb all of the incident power on a transmission system without any reflection. The ability of a termination to perform this function is

usually expressed either as its vswr or its reflection coefficient. (The reflection coefficient is the ratio of the reflected voltage to the incident voltage and, therefore, is always less than unity.) The vswr is the ratio of the maximum voltage to the minimum voltage appearing along the transmission line, and it is always greater than one. At frequencies approximately 400 MHz and above, the vswr is easily measured on a slotted line and is generally specified. At lower frequencies the reflection coefficient is often used.

The vswr is related to the reflection coefficient, ρ :

$$\text{vswr} = \frac{1 + |\rho|}{1 - |\rho|} \quad (1)$$

The reflection coefficient is related to the load impedance:

$$\rho = \frac{Z_L - Z_0}{Z_L + Z_0} \quad (2)$$

where Z_L = load impedance,

Z_0 = characteristic impedance of the coaxial system.

The reflection coefficient always has a phase angle, except when the load impedance is resistive. This time angle is ignored, and only the absolute value of reflection coefficient is used in the deter-

Goro R. Tahara, Development Engineer, Sierra Electronic Div., Philco, Menlo Park, Calif.

Facts and comments about connectors

Connector types	Peak voltage rating, volts	Equiv. peak power rating, kW	Comments
BNC	500	2.5	*Although rated to 10 GHz, Type TNC is not preferred above 3.0 GHz.
TNC	500	2.5	Rated to 10 GHz
UHF	500	2.5	Not recommended above 200 MHz
N	1000	10	Rated to 10 GHz
C	1000	10	*Although rated to 10 GHz, Type C is not preferred above 4.0 GHz
HN	5000	250	Rated to 4.0 GHz
LC	5000	250	Rated to 1 GHz

*Since the connectors are not rigidly mated in these bayonet type connectors, instability in vswr is observed at higher frequencies.

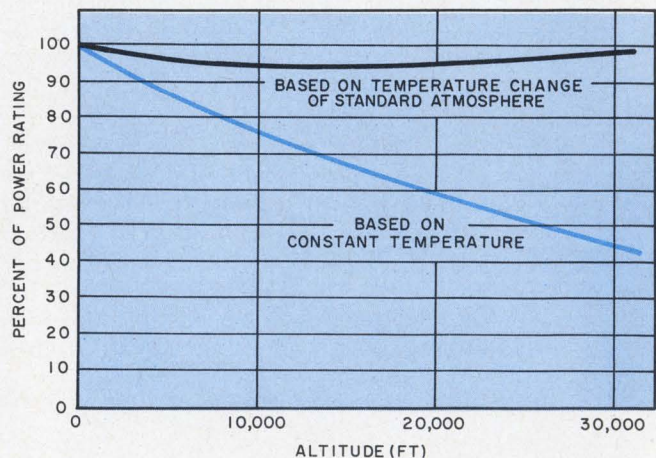

1. **Altitude-derating** curve indicates the drop in the power rating as the air pressure decreases with altitude and the temperature remains constant. If, on the other hand, the temperature decreases at about the same rate as the air pressure, the power-rating remains practically unchanged.

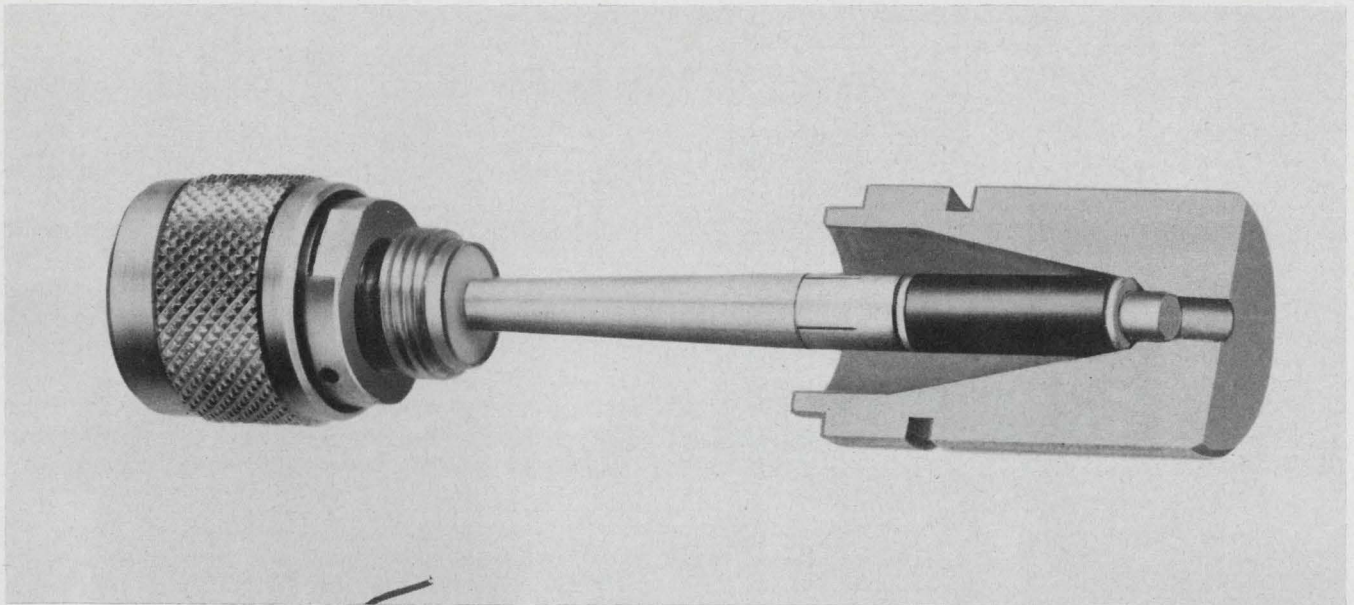

2. Cross-section of dielectric-loaded termination (Narda Model 375) shows how the dielectric is tapered for good match and maximum power dissipation. These dummy

loads offer higher power ratings at higher frequencies than the resistor types. However, at low frequencies, dielectric materials usually have lower losses than resistors.

mination of vswr. Therefore the load impedance cannot be calculated from the vswr information, except in a purely resistive case (zero phase angle). In a resistive case, where $Z_L = R_L$:

$$\text{vswr} = \frac{R_L}{Z_0} \text{ or } \frac{Z_0}{R_L},$$

depending on which one of Z_0 and R_L is greater than unity.

Environment changes power rating

The maximum power rating of a coaxial termination is based on several criteria. In some cases complete failure of the termination is used as the limit for the full power rating. A more conservative rating would be based on a change in vswr characteristics or change in the power resistor.

When coaxial terminations are used in environments other than that of the laboratory, a power derating factor should be considered. Most manufacturers specify the maximum ambient temperature at which the termination can dissipate the full-rated power (+40°C is commonly used). The derating factor to be used above this temperature should be available from the manufacturer.

The most often neglected or misused consideration in power rating is the change due to altitude above sea level. The density of air decreases with altitude, causing a reduction of cooling efficiency. The change in viscosity tends to increase the convection of air, but it is insufficient to make up for the loss of density, if the temperature remains constant (Fig. 1). On the other hand, if the standard atmospheric temperature—as defined by international civil aviation organizations—is considered, the decrease in temperature with altitude effectively nullifies the derating caused by the decreasing density. The drop in temperature

usually makes altitude derating negligible.

Find the right input connector

The input connector is an important part of the dummy load, since it has its own limitations of vswr, peak voltage rating and average power-handling capability. Some manufacturers are now offering medium and medium-large terminations, with interchangeable input connectors to accommodate various requirements. (For example, Sierra Twist-Off and Bird Electronic QC connectors). The characteristics of some of the more common connectors are listed in the table.

Information on the average power-handling capabilities of connectors is generally not available. In general, the coaxial cable's power rating is the limiting factor. The power ratings of coaxial cables vary with different manufacturers of cables and connectors.

Now let's take a look at the three major types of dummy loads: dry, dielectric-filled and water-cooled.

Structures to get rid of heat

Low-power terminations are usually dry and have a resistor as the dissipating elements. The usual means of cooling is the free convection of air. The power resistor is cooled by convection air currents and by direct radiation to the outer conductor, which is also the body. The heat is conducted to the external wall of the body and fins and is dissipated by the free convection of air around the termination. Many companies manufacture these terminations for maximum power levels from 1 watt to 20 watts. Dry terminations up to 100 watts are now available that operate up to 4 to 5 GHz.

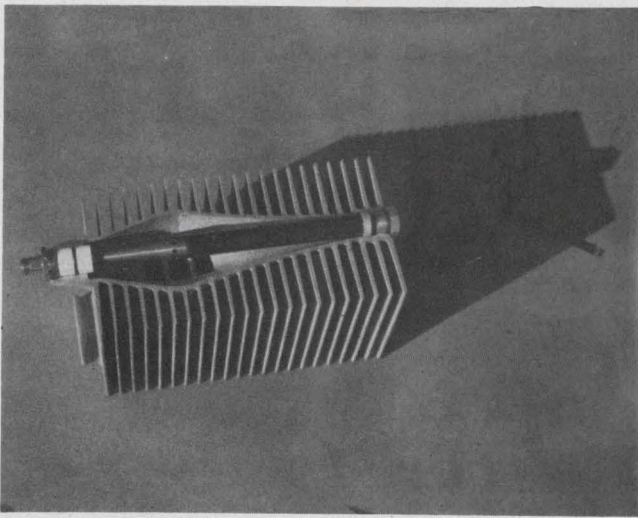

3. **Air-chamber**, cast as a part of a one-piece body, is large enough to handle expansion of dielectric coolant with temperature in this Sierra Model 160B-600. The tapered cone that surrounds the resistor matches the RF impedance.

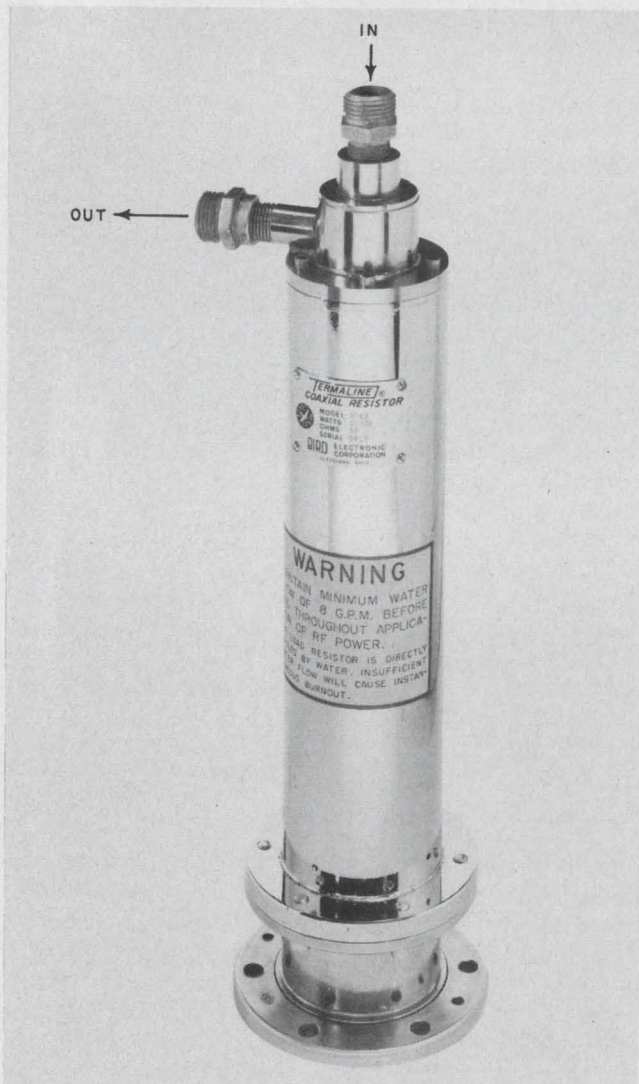

4. **The power resistor** inside this dummy load (a film deposited on ceramic substrate) is cooled directly with water at a rate of about 8 gallons per minute. This termination (Bird TERMALINE® Model 8762) is rated 50 kW.

These are the advantages of dry terminations:

- They are reliable and rugged.
- They do not deteriorate in storage.
- The mounting position is usually not critical.
- They cover a wide frequency range—from dc

into the gigacycle range.

The chief disadvantage of the dry termination is that it is available only in lower power units.

Instead of the resistor, a lossy dielectric may be used to dissipate the heat. The space between the center conductor and the outer wall is filled with a specially shaped dielectric material, which is lossy at high frequencies. Frequency coverage can be as low as 700 MHz and as high as 12.4 GHz. Power ratings extend to about 175 watts. The cross-section of such a device is shown in Fig. 2. Low-power units do not offer any particular advantage over a termination that uses resistors. At higher power levels, they have these advantages, when compared with the resistor types:

- They offer better performance in the upper gigacycle frequency range, especially in the high-powered units.

- There is no air between the heat source (lossy dielectric) and the outer body. Therefore the efficiency of the heat transfer is greatly increased.

The disadvantages of dielectric units are as follows:

- They are not usable below 700 MHz.
- At lower frequencies they are physically long in comparison with resistor-based terminations.

Available lossy dielectric materials exhibit less loss per unit length at lower frequencies than at higher frequencies. Therefore, to obtain a given amount of attenuation at lower frequencies, a longer load is required. In actual practice the length of the load is primarily determined by the lowest frequency for which the termination is designed, since any higher frequency will encounter higher attenuation.

In the resistive type of termination, the loss is constant for all frequencies within the design limit. Since the physical size is not a function of frequency, a small unit can be made for low frequencies as well as for higher frequencies.

There is no direct relationship between frequency, length, power, and dielectric constant. They are factors that must be adjusted empirically to find the best combination for the design requirement.

Dielectric-filled terminations: how to keep fluid in

Dielectric coolants that transfer heat from the resistor to the body greatly improve heat-transfer efficiency. In this type of termination, the heat energy is removed from the resistor by the free convection of the coolant encased in the termination body. The heat absorbed by the coolant is transferred to the inner wall of the body. It is then conducted to the fins and dissipated into the air by free convection. The dielectric-filled terminations are generally available in the middle power ranges of 100 to 2500 watts.

The use of a dielectric coolant in a termination is not without disadvantages. There is the problem of keeping the coolant in and of providing for its expansion with rising temperatures.

A small flaw on the unit results in the loss of the dielectric coolant and in subsequent failure. A termination made of cast aluminum (Sierra Models 160-150 and 160-500) circumvents the problem. However, it also increases the manufacturing cost and results in a relatively expensive unit.

Some types use an air vent to release the internal pressure. This has the disadvantage of coolant spillage in transit or storage. Also, the exposure to air tends to contaminate the dielectric coolant.

Metal bellows are used in some terminations to permit coolant expansion. If properly designed and assembled, they permit the termination to be mounted in any position. A word of warning: Forced-air cooling should be used if the cooling fins are placed in a horizontal position, since natural free convection of air will be cut off. However, the bellows do increase the probability of dielectric leakage.

In dielectric-filled terminations the outer conductor is a tapered cone, surrounding the resistor, for RF impedance matching. Although holes are provided for the coolant flow to the body, the cone impedes the circulation of the dielectric coolant and reduces the heat-transfer efficiency.

The most recent dielectric-filled termination design (Fig. 3) incorporates cast-aluminum construction, in which the fins, body and internal RF matching cones are all in one piece. This construction assures reliability, ruggedness, high heat transfer efficiency and low manufacturing cost. The cost of this type of unit is generally less than that of a fabricated termination.

The air chamber may be cast as part of the one-piece body, and its size may accommodate all anticipated pressure changes. These terminations must be operated in a horizontal position, with the feet down.

Cooling fluids: three choices

One final consideration is the quality of the dielectric coolant. Different types of dielectric coolant are used in terminations.

Transformer oil is very economical, but it has a limited life, since oil tends to carbonize at the high operating temperatures of the power resistors. Carbon deposits on the resistive film gradually build up and cause hot spots, which eventually lead to resistor failure. The length of service of this coolant depends upon the operating temperature of the resistor. Some oils have an inhibitor to reduce the carbonization. This increases the life of the oil, but not significantly.

Silicone fluid has ideal properties for dielectric coolant, since it does not carbonize and can withstand high temperatures. This fluid is only used in high-quality terminations, since it is very expensive.

Synthetic fluids of fluorocarbon base are also

used in some coaxial terminations. These fluids are generally not as expensive as silicone.

In general, the frequency ranges of dry terminations and dielectric-cooled ones are the same. The basis for comparison is usually the power rating.

Ways to increase power transfer

The power dissipation of a coaxial termination can be increased by a blower or fan to increase the flow of air through the fins. In general, forced air cooling on dry terminations is not very effective, since the large temperature drop occurs between the resistor and the body. The possible exception is in the lossy dielectric type of termination where material is in contact with the body.

The power rating of dielectric cooled terminations can be increased as much as two times, depending upon the termination operating temperature, the internal heat-transfer design, and the quantity and direction of the air flow. Some manufacturers offer a blower designed to fit their terminations. (For example, Sierra Model 160-1600AC and Bird Electronic Corp. Model BA-88).

The power dissipation can be further increased by cooling with water. Water-cooled loads are generally available in power ratings from 1 to 50 kW. There are two basic types of waterloads: indirectly cooled and directly cooled variations.

In the indirectly water-cooled loads, the termination resistor is cooled by a dielectric coolant (usually oil), which is circulated with a pump. The heat is transferred from the coolant to water by a heat exchanger. (An example is the Bird Model 502). In the direct-cooled termination the power resistor is cooled directly by the water. This method has higher heat transfer efficiency and results in a much smaller unit. For example, the Bird Electronic Model 8762 in Fig. 4 requires eight gallons of water per minute at 30°C. It operates up to 500 MHz, with a vswr of 1.1.

Water loads are also used in calorimetric applications where the rise in cooling water temperature is used to measure the input RF power accurately. In this application the heat loss to the environment must be kept at a minimum.

A look at the future

What will the future bring? There will be an increase in the variety of coaxial terminations of special design to meet the requirements of new applications. Small, lightweight dry terminations, handling power up to 100 watts, are already in the final stages of development. These are designed for missile and airborne equipment, where size, weight and reliability are prime factors.

Vswr performance is constantly being improved to meet more demanding applications, such as improved hybrids, couplers, etc. The power capabilities of dry terminations will continue to increase and the size of dielectric-filled terminations will shrink. Smaller loads are already being produced for use in miniaturized microwave systems. ■ ■



HECON QUALITY COUNTS

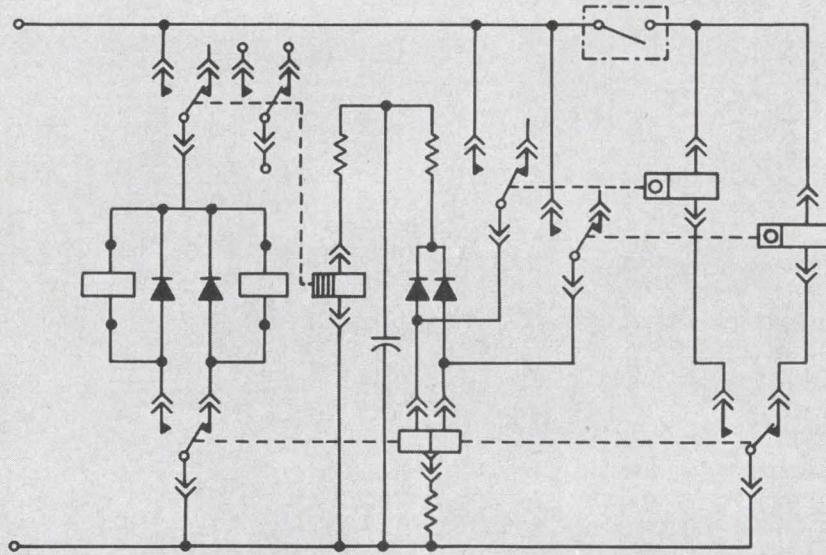

Complete Line of High Performance Electro-Magnetic Counters

Hecon counters do more than count. They are highly reliable control devices that exercise control by counting. Our exclusive building block design permits many system variations and applications. Used as an individual control instrument, or as part of a control system, Hecon counters can solve your control problems.

For reliable, low cost digital control systems, only Hecon offers a complete line of high performance electro-magnetic counters featuring closed loop design.

F 043 Totalizing Counter — Modular 6 digit plug-in unit, with either manual or electrical reset — speeds up to 60 counts per second — life in excess of 200 million operations.

FA 043 Predetermining Counter — Modular 6 digit plug-in unit, with manual, electrical or automatic reset, for speeds up to 35 counts per second — life in excess of 200 million operations.

FR 967 Single Decade Counter — Features electrical readout, transfer and reset, (optional push button preset available). Unique system of rolling ball contacts on flush rhodium plated circuit boards — escapement operation for fast and accurate pick-up — speeds up to 50 counts per second — life in excess of 200 million operations.

Hecon engineers can help you solve your counting and control problems with Hecon high performance counters — reliably and economically. Write or call today for full information on these and other Hecon counters.

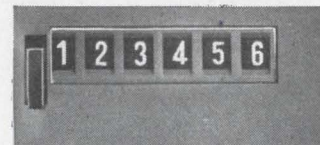

F 043

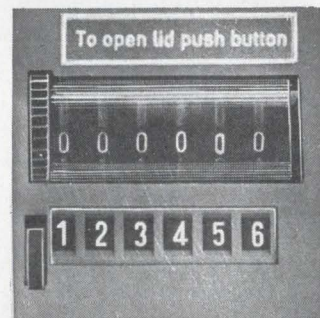

FA 043

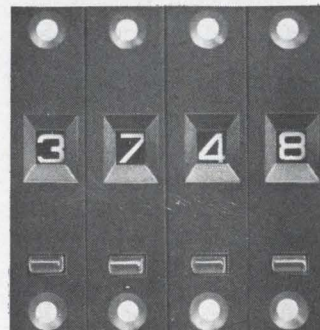

FR 967

HECON

HENGSTLER NUMERICS, INC., 318-320 Bergen Boulevard, Palisades Park, N.J. 07650

ON READER-SERVICE CARD CIRCLE 25

DALE

**3-in-1 T-pot design
gives you more
for your money!**



**One simple, rugged design adds reliability
to all three rectilinear Mil wirewound styles**

RT-10, RT-11, RT-12 — Dale meets all three with a single design. You benefit from this simplification through increased reliability, faster delivery, better price. Call us today!

- ① **ALL-MOLDED HOUSING** design eliminates seal problems. Meets MIL-STD-202 and MIL-R-27208A.
- ② **RUGGED COLLECTOR SYSTEM** assures you of noise levels well below mil requirements.
- ③ **FULL LENGTH WINDING** allows increased power handling capability. Permits use of large diameter thermoconductive mandrel which eliminates "hot spots" by acting as high mass heat sink.
- ④ **1-PIECE WIPER ASSEMBLY** of precious metal insures setting stability under all environmental conditions.
- ⑤ **STAINLESS STEEL ADJUSTMENT SCREW** has metal-to-metal clutching — prevents over-travel damage.
- ⑥ **CONSTANT LEAD SCREW SEAL** is assured by shaft-retaining spring which maintains unvarying pressure against high temperature silicone rubber "O" ring.

DALE MIL-R-27208A MODELS

RT-10

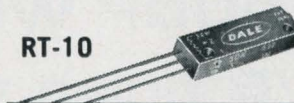

Model 691 P.C. Pin
Model 697 Flex. Leads

RT-11

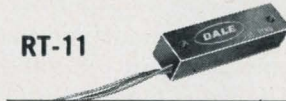

Model 1287 P.C. Pin
Model 1288 Flex. Leads

RT-12

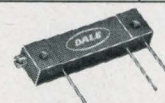

Model 1680 P.C. Pin
Model 1697 Flex. Leads

RT-22



5000 Series — ½" square-trim models meet RT-22, made with same basic design considerations shown here.

WRITE FOR CATALOG B — containing specifications on 57 Dale T-Pots including many special models.



DALE ELECTRONICS, INC.
1328 28th Avenue, Columbus, Nebraska



Speed Inquiry to Advertiser via Collect Night Letter
ON READER-SERVICE CARD CIRCLE 63

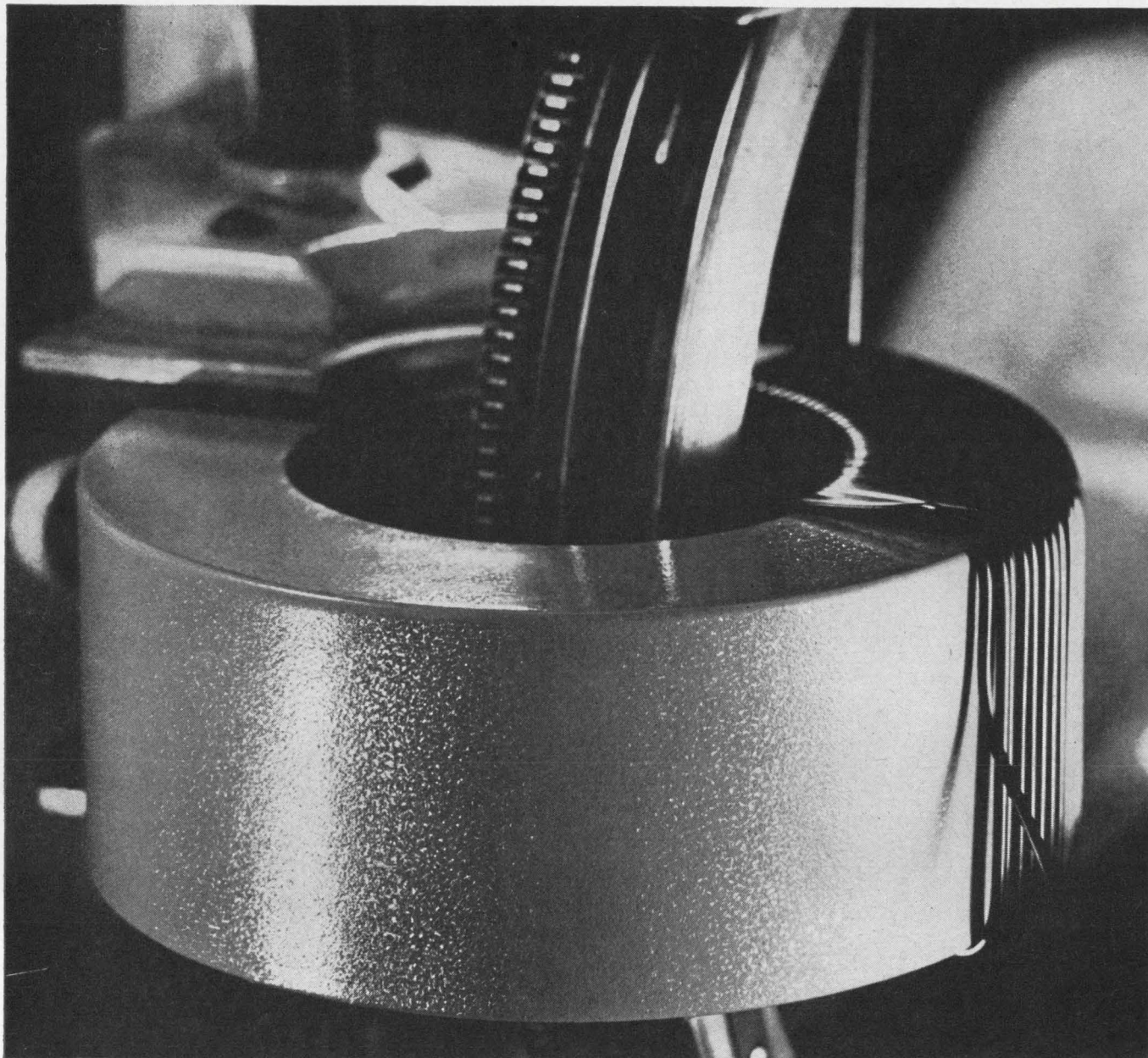

ROUGH WITH A REASON

Unique GVB finish cuts core winding costs

GVB encased cores mean fewer production delays because GVB does much more than seal the core box against potting material. Its matte finish provides a resilient, non-slip base for winding, and the tough epoxy skin prevents the wire from cutting through to the core box. Guaranteed not to fail, even when wound with heavy #6 wire, GVB surface also eliminates abraded wire problems. No prior taping of the core is required, so another winding operation is wiped out.

Magnetics doubles the normal guarantee on core box finishes by expressing it in this unique way: The guaranteed voltage breakdown (GVB) finish seals the box

and is capable of withstanding at least 1,000 volts at 60 cycles *between a bare winding and the aluminum case*. Quality control monitors the application and curing of GVB to assure dimensional and voltage breakdown fidelity. Performance characteristics are maintained between -65 and 200 degrees C.

To reduce production costs on your winding operations, try Magnetics' tape wound cores with GVB. Eight material types, in a wide range of sizes from $0.375''$ to $4.0''$ inside diameter, are stocked for immediate delivery. More information? Write *Magnetics Inc.*, Dept. ED-27, Butler, Pa.



Speed Inquiry to Advertiser via Collect Night Letter
ON READER-SERVICE CARD CIRCLE 62

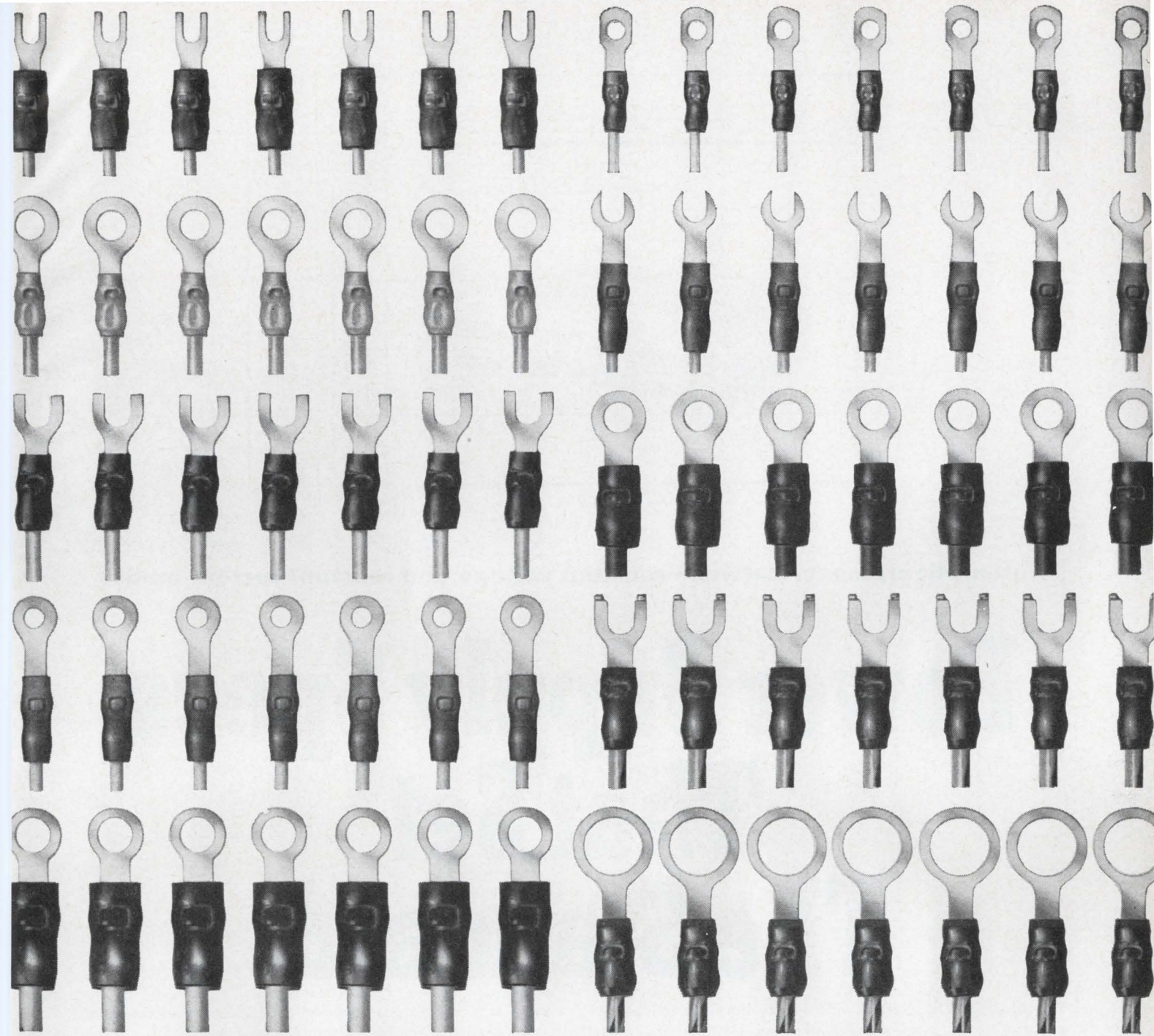

Bandolug reels off 1,500 perfect terminations an hour

Do you insist on highest quality? Do you want highest speed? Burndy Bandolug satisfies the most demanding engineers on both counts.

A change from one stud to another takes 10 seconds. From one wire size to another no more than 90 seconds. And Bandolug crimps a wide range on wire sizes #10 thru #26.

The machine automatically rejects inadequately stripped wires, delivers uni-

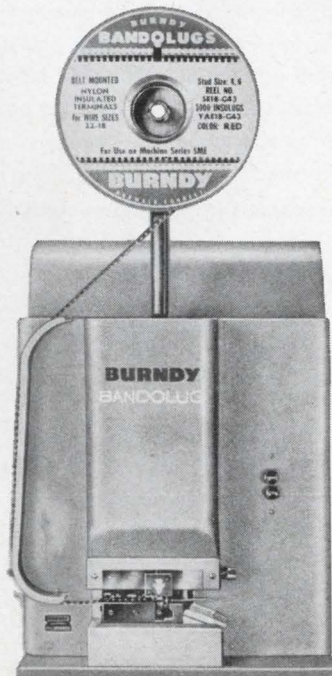

and it's a quick-change artist.

formly perfect results—no sheared or unplated edges. You can count on dependable performance year after year with noiseless operation and assured safety reducing operator fatigue to minimum.

So go ahead—be demanding. Demand top quality, top speed and lowest installation costs. Demand Bandolug®.

BURNDY

Norwalk  Connecticut

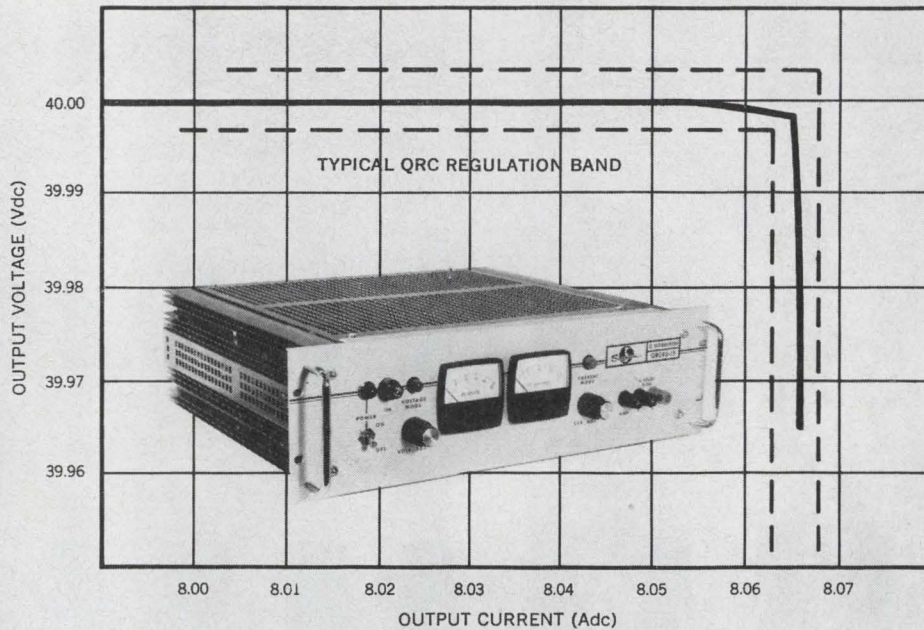

Automatic crossover between constant voltage and constant current modes

Power Supply Specs That Set The Standard.

The Sorensen QRC series—wide range, transistorized power supplies—provide constant voltage/constant current regulation so sharp the units operate without ever leaving the specified regulation band. Voltage regulation is $\pm .005\%$ for line and load combined. The QRC's are provided with front panel dial set adjustment of voltage and current limits, as well as voltage/current mode indicator lights. Other design features include: Low ripple...1 mV rms • No turn-on/turn-off overshoots • Re-

mote sensing and programming • Series/parallel operation • Input voltage 105-125 or 201-239 Vac, 50-400 c/s • Easily replaceable plug-in control boards • High efficiency and compact packaging. All Sorensen power supplies conform to proposed NEMA standards. For QRC details, or other standard/custom power supplies, AC line regulators or frequency changers, contact your local Sorensen rep, or write: Sorensen, A Unit of Raytheon Company, South Norwalk, Connecticut 06856.

ELECTRICAL & MECHANICAL SPECIFICATIONS

MODEL NUMBER	OUTPUT VOLTAGE RANGE (Vdc)	CURRENT OUTPUT RANGE (Adc)	VOLTAGE REGULATION (LINE & LOAD COMBINED)	RIPPLE VOLTAGE (rms)	CURRENT REGULATION	RIPPLE CURRENT (rms)	RACK HEIGHT (INCHES)	PRICE
QRC20-08	0-20	0-8	$\pm .005\%$ or ± 1 mv	1 mv	$\pm .05\%$ or ± 4 ma	2 ma	3½	\$410.00
QRC20-15	0-20	0-15	$\pm .005\%$ or ± 1 mv	1 mv	$\pm .05\%$ or ± 8 ma	4 ma	5¼	525.00
QRC20-30	0-20	0-30	$\pm .005\%$ or ± 1 mv	1 mv	$\pm .05\%$ or ± 16 ma	8 ma	7	700.00
QRC40-4	0-40	0-4	$\pm .005\%$ or ± 1 mv	1 mv	$\pm .05\%$ or ± 2 ma	1 ma	5¼†	315.00
QRC40-8	0-40	0-8	$\pm .005\%$ or ± 1 mv	1 mv	$\pm .05\%$ or ± 4 ma	2 ma	3½	450.00
QRC40-15	0-40	0-15	$\pm .005\%$ or ± 1 mv	1 mv	$\pm .05\%$ or ± 8 ma	4 ma	5¼	575.00
QRC40-30	0-40	0-30	$\pm .005\%$ or ± 1 mv	1 mv	$\pm .05\%$ or ± 16 ma	8 ma	7	775.00

†Half rack

ON READER-SERVICE CARD CIRCLE 64



A UNIT OF RAYTHEON COMPANY

Sorensen represented in California by Ward-Davis Assoc., 770 S. Arroyo Parkway, Pasadena, Phone 213-684-2840; 1020 Corporation Way, Palo Alto, Phone 415-968-7116; 3492 Pickett Street, San Diego, Phone 714-297-4619.

10-DAY FREE BOOK APPROVAL

HAYDEN BOOK COMPANY, INC.,
116 WEST 14th STREET, NEW YORK, N. Y. 10011

Please send me the books marked below on a 10-day examination basis. If I decide to keep them, I will remit payment. Otherwise I will return the books within 10 days and owe you nothing.

Cat. # title

Name & Title: _____

Firm: _____

Address: _____

City: _____ State: _____ Zip: _____

Payment enclosed and publisher pays postage. Same return privilege.

Save time and effort...

*by examining these
career-oriented books
at your desk... or in the
leisure of your home.*

Here are recent Hayden titles you may want to review without cost or obligation!

400 IDEAS FOR DESIGN SELECTED FROM ELECTRONIC DESIGN

Here are 400 tested ideas written by engineers and selected from the popular "Ideas for Design" column of Electronic Design magazine. #5537, 232 pp., cloth, \$8.50.

CONTENTS: Amplifiers. Calculation Short Cuts. Communications and Telemetry. Computer and Pulse Circuits. Control Circuits. Design and Laboratory Aids. Filters. Measurement and Test. Microwave Techniques. Oscillators and Modulators. Power Sources. Switching and Relay Circuits.



tains a multitude of time-saving graphs and design curves. #5014, 128 pp., cloth, \$5.50.

CONTENTS: The Noise Figure Concept. The Measurement of Noise Figure. Noise of Spectral Discontinuity. Tube and Transistor Noise. Design of Practical Circuits Above Approximately 100 Mc. The Design of Front Ends of Receivers to Approximately 100 Mc. Low Noise Audio Design. Typical Low-Noise Circuits. Appendices.

ELECTRICAL INTERFERENCE Rocco Ficchi

Written to give the design and field engineer, program manager, and technician a broad view of the importance of interference in modern electronics systems. #5512, 256 pp., cloth, \$8.75.

CONTENTS: Introduction. Interference Reduction as a System Problem. The Fundamental equipment Problem. Shielding. Filtering. Interference Reduction in Cables. Grounding. Interference Reduction in Equipment. Grounding of Structures and Buildings. Grounding Equipment. Grounding of Power Systems. Appendices.

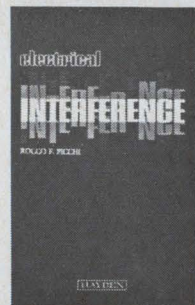

PRINCIPLES OF FEEDBACK DESIGN

G. Edwin and Thomas Roddam

A practical guide for the designer of feedback amplifiers and similar systems, this book brings together fundamental and advanced considerations. #5533, 220 pp., cloth, \$8.75.

CONTENTS: The Concept of Feedback Stability. Simple Response Characteristics. Combinations of First-Order Networks. Amplifier-Response Construction. The Responses of a Transformer. Loop Design and the Stability Margin. The Overall Response: The Mu-Beta Calculator. Amplifier Terminal Impedances. Distortion. Positive Feedback. Signal-Flow Diagrams. The Analytical Approach. Feedback Amplifiers as Filters. A Broader View. Index.

DIODES AND TRANSISTORS Guy Fontaine

Written to translate the language of semiconductors for their use in all kinds of circuits. The first section gives a comprehensive review of the principles underlying all semiconductor devices; section two covers diodes, the fundamental properties of point contact and PN junction diodes, plus an analysis of their performance characteristics; the balance of the book is devoted to transistors, and gives a detailed presentation of all the parameters of transistors that could interest engineers and methods of designing circuits with transistors. #5500, 480 pp., cloth, \$9.50.

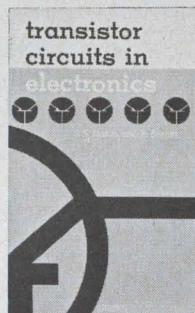

PRINCIPLES OF TRANSISTOR CIRCUITS Revised 3rd Edition

S. W. Amos

Keeping up with the rapid advance in transistor technology, this updated revision contains half again as much information as the successful second edition. #5649, 293 pp., cloth, \$7.95.

CHAPTERS: Semiconductors and junction diodes. Basic principles of junction transistors. Common-base amplifiers. Common-emitter amplifiers. Common-collector amplifiers. Bias stabilization. Small-signal a.f. amplifiers. I.F. amplifiers. Pulse amplifiers. Large-signal a.f. amplifiers. Sinusoidal oscillators. A.M. and F.M. sound receivers. Pulse generators. Sawtooth generators. Further applications of junction diodes and transistors. Further semiconductor devices. Appendices. Index.

TRANSISTOR CIRCUITS IN ELECTRONICS

S. S. Hakim and R. Barrett

For working engineers and students, this lucid book introduces the working principles of transistors in both amplifiers and oscillators and linear and switching circuits. #5034, 341 pp., cloth, \$10.95.

CONTENTS: Transistor Characteristics. Graphical Analysis. Small Signal Equivalent Circuits and Parameters. Amplifier Circuits. Feedback Amplifier and Oscillator Circuits. Switching Circuits. Regenerative Switching Circuits. Logic Circuits. Modulator and Demodulator Circuits. Appendix: Superposition Theorem; Thevenin's Theorem; Norton's Theorem.

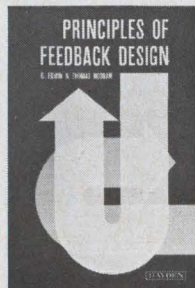

THE ELECTRON IN ELECTRONICS

Modern Scientific Concepts For Electronic Engineers

M. G. Scroggie

This volume deals with the revolutionary physical concepts of the twentieth century from the point of view of the electronic engineer, whose approach to the subject is somewhat different from the mathematical physicists who developed the concepts. The entire development of these vital concepts is expressed in terms and symbols familiar to the engineer. #5707, 275 pp., cloth, \$9.95.

CHAPTERS: Electronics and Physics. Classical Science. Discrepancies. The Quantum Theory. Waves and Particles. Atoms. Solids. Semiconductors. More About the Atom. Relativity. Appendices. Index.

DESIGN OF LOW-NOISE TRANSISTOR INPUT CIRCUITS

William A. Rheinfelder

For circuit design engineers and students interested in low-noise circuit design, this practical book con-

Hayden Book Company, Inc., N. Y. • a division of Hayden Publishing Company, Inc.

Committee meetings waste time—unless strict standards to control them are enforced. Here's some advice on how to make them useful.

As an engineer or manager, how much of your time do you spend at committee meetings? These meetings may be within your company, in professional societies, or in your everyday life. Most people spend more time this way than they would like to. Much of it is wasted time. What can you do about it?

Committee meetings can't be eliminated entirely; some are useful. But their number should be slashed drastically. Here's why:

One man working alone gets things done. Two working together may have an argument. But three or more make up a committee, and committees don't get things done; they should be used only for coordination and communication.

Here are some of the reasons why committee meetings are held, even though they shouldn't be. How many of them do you recognize?

1. To delay action or postpone decisions.

A manager may establish a committee to reconsider an idea. The objective, which may be hidden from the committee members, is to delay action or postpone the decision until a later date. But the pros and cons can be weighed only so many times. A decision must be made eventually. Why not now? The very nature of committees makes them slow and inept when speed is important.

2. To avoid or spread responsibility.

Instead of making a clear-cut decision, a person may establish a committee to make the decision for him. If the decision is wrong, nobody can pin the blame on any one person, especially if the committee members are all on the same level.

3. To mask individual incompetence.

A person assigned to a task, and lacking the ability to do it, often calls a committee meeting under the guise of seeking advice. He is really attempting to have the people on the committee do his job for him.

4. To provide an audience for the boss.

Many managers like to have their egos bolstered by calling a meeting. With the spotlight on them,

they then begin a monologue that is designed to prove they are managers.

5. To get together for a bull session.

Committee meetings that are scheduled on a regular basis can end up as bull sessions if the meetings are called simply to fulfill the schedule. Often there really is nothing to discuss.

6. To make unimportant decisions.

Committees sometimes meet to decide matters that are not worth a group decision in the first place. Like: decisions relating to the execution of different tasks, orders or plans.

7. To provide a "rubber stamp."

A committee meeting may be held to approve a decision after it has already been made and it is too late to do anything else about it.

8. To ease the pain of decisions.

Committee meetings offer opportunity for a compromise decision when such a decision is unwarranted. When a clear-cut decision is required, a committee involves a multiplicity of people, a diffusion of ideas and, ultimately, a compromise—which may be considerably less suitable than the decision sought.

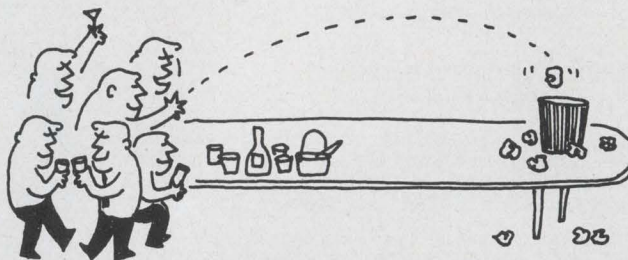

Committee meetings that are scheduled on a regular basis can end up as bull sessions. . . .

Committees can be useful

But let's look at the other side of the coin. Committees are valuable in specific areas, but where their very structure makes them useful. Here are some valid reasons for calling committee meetings:

1. To provide integrated group judgment.

In matters of extreme importance, a committee can provide broad depth of background and experience in evaluating decisions—for example, a properly run design review.

2. To promote coordination of inter-related efforts.

When a project extends beyond the responsibility of two or more people, it often is necessary to call meetings of the people involved to coordinate their efforts and understand the entire problem—for example, coordination among marketing, engineering and production personnel.

3. To obtain cross-fertilization of ideas.

When attempting to find new approaches to a problem, brainstorming can be a useful device. However, it must be used properly—for example, in R&D planning sessions.

4. To enlist cooperation.

To secure action outside of your area of responsibility, it may be necessary to call a number of people together, so that you can explain what you are doing and invite their cooperation—for example, functional management action.

5. To communicate in parallel.

A meeting is useful when information must be imparted to a large number of people at the same time. This is more a seminar or lecture than a committee meeting. Its advantage over written communication is that feedback is instantaneous.

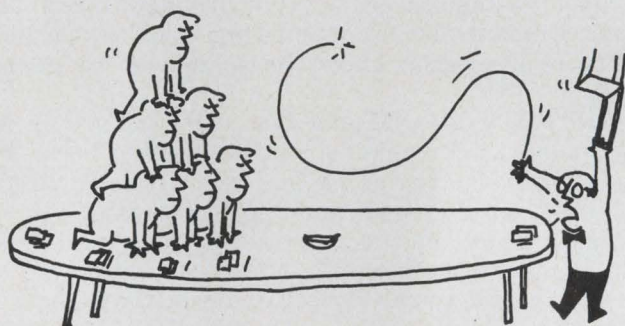

To secure action . . . it may be necessary to call a number of people together, so that you can explain what you are doing and invite their cooperation. . . .

How to hold a good meeting

Since you undoubtedly have to spend some time at committee meetings, make sure that they are held properly: that they conserve time and manpower and accomplish the objectives in a reasonable manner. Here are essential steps:

■ **Determine explicitly the purpose and the objectives of the committee meeting.** Are the objectives legitimate? Are they things that can be properly treated in a committee meeting? Or are

they best accomplished by individuals working alone?

■ **Organize the committee properly.** Define the duties and authority of the committee and its participants. Make sure everybody knows these objectives and is properly informed prior to the meeting. Limit the invitations to the meeting to those necessary to reach objectives.

■ **Staff the committee properly.** Make sure the members are qualified people who give you the representation you require. Be certain they have accompanying decision-making authority. Support the committee with necessary staff assistants.

■ **Establish committee procedures.** Set up the procedures in a way that insures bold and effective action. Formal procedures can be used when necessary.

■ **Appoint the right chairman.** This is, perhaps, one of the most important considerations, since a good chairman can make a meeting run efficiently, can stir participation by the rest of the committee.

■ **Know the participants.** Committees are made up of people with a variety of individual personalities. The action will result from the interplay of these personalities. Desirable traits must be encouraged; negative ones must be suppressed. Know the strong and weak points of the participants and play them accordingly.

■ **Indoctrinate the members properly.** Make sure they know the rules (and why not give them a reprint of this article to read prior to getting down to business?).

■ **Be prepared for the subject.** Too much committee time is taken up by detailed explanations of the subject. Be sure that all committee members are told in advance both what the subject is and what references are available—for example, memos, specifications or reports. Avoid restless waiting while one man—who has pleaded, “Too busy”—is brought up to date.

Committee personalities

To help you recognize and control the personality types that committee meetings attract, check this list:

1. **The loud one**—Likes to hear himself talk and is most reluctant to quit. A chronic time waster, he should be squelched. It takes either a strong chairman with a formal set of rules, or a gag, to keep this type quiet.

2. **The detached observer**—Is secretly amused by the proceedings and the people participating in them. Since he doesn't really consider himself a participant, he doesn't help. So get rid of him by not inviting him.

3. **The wallflower**—Afraid to open his mouth or commit himself. He may have something to contribute, but nobody ever knows it. An adept committee chairman will encourage him to participate. Once given a little confidence, he may have something important to say.

4. **The take-charge guy**—Has to have his way or else. He's apt to think he'd make a better chair-

Von Karman Center

of

AEROJET

(25 miles east of Los Angeles)

Has an immediate opening on the staff of its rapidly expanding Microelectronic Research Department for an experienced . . .

MICROELECTRONIC PACKAGING ENGINEER

Individual will have Senior responsibility over all packaging aspects of the microelectronic product line; therefore, he must possess

- A complete grasp of all major state-of-the-art packaging techniques used in advanced thin film and monolithic circuitry.
- Ability to design custom packaging for microelectronic circuitry.
- A knowledge of encapsulation and hermetic sealing techniques, interconnection schemes and electrical shielding methods.

u.s. citizenship required

Applicants meeting the above qualifications are invited to send their resume to:

R. C. SMITH

P.O. Box 303 p.e. Azusa, Calif. 91702

A subsidiary of the
General Tire & Rubber Company

An equal opportunity employer



ON CAREER-INQUIRY FORM CIRCLE 901

ELECTRONIC ENGINEERS

and

PHYSICISTS

Investigate this immediate requirement at . . .

VON KARMAN CENTER

of

AEROJET

(25 miles east of Los Angeles)

Specialists in Applied

INFORMATION THEORY

and

STOCHASTIC PROCESSES

Advanced work in adaptive passive pattern recognition systems has created immediate openings for Physicists, Mathematicians and Engineers with backgrounds and interest in Information Theory, Circuit Theory and Stochastic Processes. Stimulating work combines advanced theory and concepts of electro-optical signal processing, linear and non-linear filtering/spatial and spectral discrimination, pattern detection and correlation.

For your personal interview, direct your resume to:

Mr. R. S. Lawrence

P. O. Box 303 sp, Azusa, California

A subsidiary of the
General Tire & Rubber Co.

An equal opportunity employer



ON CAREER-INQUIRY FORM CIRCLE 908

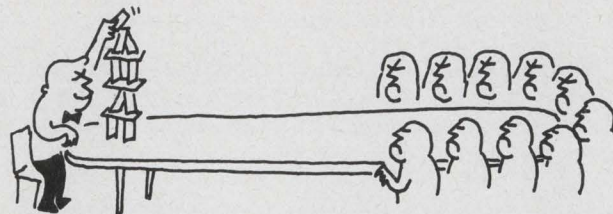

The detached observer is secretly amused by the proceedings and the people participating in them, since he doesn't really consider himself a participant. . . .

man than the appointed one, regardless of who the chairman is. He aims to dominate the meeting, regardless of the results or the wishes of others. Send him off with the "loud one" to a subcommittee, away from the rest of the members.

5. **The antagonist**—Against any idea, good or bad. He sometimes tries to sell himself as a "devil's advocate." He thinks he's a necessary adjunct to the committee. Nothing wrong with criticism, but let's make it constructive.

6. **The hedger**—Always wants to back off to some extent. Although no decision can satisfy everybody, this fellow always wants to try to modify it—in case it isn't right. Don't let him wreck the proceedings.

7. **The yes man**—Never disagrees. Since he never stands on his own, don't have him at the meeting, unless you are trying to pack it for a vote.

8. **The mediator or peacemaker**—Often serves a useful purpose when a stalemate is reached, but he may also dilute the impact of any decision that has to be made. He bears watching.

9. **The climber**—Talks to make an impression, even if his offering is worthless and he knows it. He'll usually delay proceedings by asking questions for which he already knows the answers, simply to impress everybody with how much he knows. Insult him by insinuating that he's stupid if he really doesn't know the answer to his question.

10. **The cynic**—Thinks the whole effort is a waste of time anyhow, so why bother? He is negative in the beginning and will be the same at the end; so place him and the "antagonist" in a separate subcommittee, where they can be miserable together—preferably in a remote location.

11. **The salesman**—Tries to sell his idea to the group, to the point of beating it to death. He just doesn't know when to stop. He requires preventative action by the chairman to keep him from defeating his own idea.

12. **The fanatic**—Has established his own doctrines and can't be budged from them, short of mayhem. When dealing with people, it helps to have an open mind. The fellow who doesn't is a real obstacle. The sole purpose of a committee meeting can often be to outvote or bring pressure to bear upon the fanatic.

Whether you're an engineer or manager, these guidelines will help you cut down wasted time. I know, because I've applied them. And now, if you'll excuse me, I'll quit writing. I have to attend a committee meeting, and. . . . ■ ■

The Hughes/NASA Syncom stands still at 6875 mph to talk to a billion people.

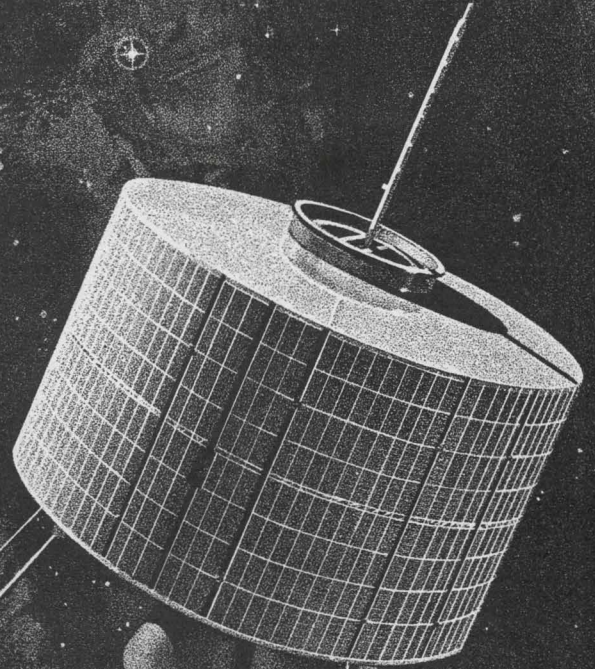

CIRCUIT DESIGNERS... is your appointment in space with Hughes?

Today, Hughes is one of the nation's most active aerospace/electronics firms: Projects include: F-111B PHOENIX Guided Missile System, TOW Anti-Tank Missile, SURVEYOR Lunar Spacecraft, SYNCOM, POLARIS, VATE, Hard Point Defense and others.

This vigor will assist the qualified engineers and scientists towards more and better opportunities for both professional and personal growth.

Many immediate openings exist. The engineers selected for these positions will be assigned to the following design tasks: the development of high power airborne radar transmitters, the design of which involves use

of the most advanced components; the design of low noise radar receivers using parametric amplifiers; solid state masers and other advanced microwave components; radar data processing circuit design, including range and speed trackers, crystal filter circuitry and a variety of display circuits; high efficiency power supplies for airborne and space electronic systems; telemetering and command circuits for space vehicles, timing, control and display circuits for the Hughes COLIDAR (Coherent Light Detection and Ranging).

If you are interested and believe that you can contribute, make your appointment today.

For immediate consideration, please airmail your resume to:

**Mr. Robert A. Martin
Head of Employment
Hughes Aerospace Divisions
11940 W. Jefferson Blvd.
Culver City 1, California**

Creating a new world with electronics

HUGHES

HUGHES AIRCRAFT COMPANY
AEROSPACE DIVISIONS

An equal opportunity employer.

U. S. CITIZENSHIP REQUIRED

RELIABILITY ENGINEERS

BSEE or BSME-Reliability design review:

Experienced with small electrical components and semiconductors. Prepare procurement, test and design specifications.

BSEE-Reliability analysis:

Experienced in circuit design and analysis. Perform detailed reliability analyses of complex electronic parts and circuits and recommend improvements in design reliability.

BSEE-Reliability test engineering:

Prepare test procedures for electrical and electronic packages and coordinate procedures with test laboratories, conduct proofing of test procedures and test equipment.

BSME-Reliability and inspection:

Perform mechanical and structural reliability analyses. Provide for inspection planning and review prints to determine inspection attributes. Experience in metallurgy and NDT helpful.

Non-destructive testing:

Background in electronics and applied physics plus knowledge of instrumentation related to the use of X-rays, sound waves, electrical fields and optics.

Write Mr. K. R. Kiddoo, Professional Placement Manager, Lockheed Missiles & Space Company, P.O. Box 504, Sunnyvale, California.

LOCKHEED
MISSILES & SPACE COMPANY
A GROUP DIVISION OF LOCKHEED-AIRCRAFT CORPORATION

AN EQUAL OPPORTUNITY EMPLOYER

ON CAREER-INQUIRY FORM CIRCLE 902

NASA Tech Brief

Simple oscillator for high power

Problem: Develop a compact square-wave oscillator that will operate with high efficiency at relatively high power levels.

Solution: A circuit that contains only simple resistor-capacitor combinations and solid-state devices.

It is a symmetrical bridge with a transistor in each arm. The base of each transistor is connected to a parallel resistor-capacitor combination. Each combination is connected to the collector of the diagonally opposite transistor.

The selection of transistors is the most important design consideration.

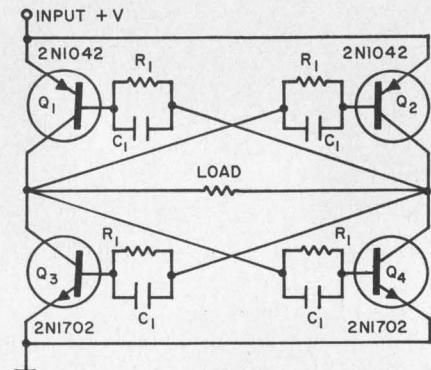

A smooth, balanced operation is provided by using a matched pair of *pnp* transistors, Q_1 and Q_2 , and a matched pair of *nnp* transistors, Q_3 and Q_4 . In addition, these pairs should be complementary.

This oscillator circuit is simple and compact. It operates with high efficiency at relatively high power levels. Since the circuit employs only simple resistor-capacitor combinations and solid-state devices, its performance and reliability should be excellent.

For further information, contact: Technology Utilization Officer, Goddard Space Flight Center, Greenbelt, Maryland 20771 (B63-10554).

Most engineers are lucky to be in on a handful of space missions during a lifetime.

In the next 5 years alone, you could help launch over 500

like these:

GEMINI
APOLLO
MOL
VOYAGER
DISCOVERER
BIOSATELLITE
MARINER
EXPLORER
OAO
OGO
OSO
PIONEER
SERT
SURVEYOR
SMS
SATURN 1-B & V
TITAN III
ATS
MINUTEMAN
PEGASUS
IMP
TIROS
POSEIDON
ETC.

Solving instrumentation problems like these:

COMMUNICATIONS Increase bandwidth and/or employ compaction techniques for expanded real-time bioastronautic, telemetry, and color TV data transmission...wideband data link using communication satellites.

CW & PULSE RADAR Improve sensitivity, reliability, and accuracy of GLOTRAC, MISTRAM and MIPIR...add multiple-slant-range measurement capability to down-range stations.

TELEMETRY Extend frequency coverage at all stations to 2300 mc...design a system which, upon command, will select the most important data from each station...replace obsolete telemetry equipment with modern receiving and recording stations...add automatic checkout and calibration.

OPTICS Add new fixed metric and tracking metric systems to cover increased launch activity...develop a new family of standard optical beacons for installation in missiles and space vehicles...new automatic optical calibration system...develop airborne optical systems equal in capability to ground telescopes.

INFRARED Add new high-resolution spectrometers for launch and re-entry coverage...new IR systems to extend mid-range coverage.

RANGE SAFETY Study and develop areas of explosive hazard assessment, including instrumentation to cover chemical fuel explosions and nuclear fuel excursions.

INSTRUMENTATION & VEHICLE CONTROL Add a 64-man central control at the Cape to direct operation of the entire range...new real-time dual-system computer facility (including 2 CDC 3600's) for failure-proof high-speed data handling.

CORRELATION Reduce time correlation uncertainty across the range to less than 10 microseconds...standardize the timing signal format on the Eastern Test Range to be compatible with other national ranges.

FREQUENCY CONTROL & ANALYSIS Monitor and control all electromagnetic radiation within the missile test area with a Spectrum Surveillance System...expand automatic interference control, spectrum signature collection, and quality analysis.

METEOROLOGY Improve cloud height and growth indication instrumentation...develop a system to measure atmospheric electrical potential and cloud movement.

SHIP & AIRCRAFT INSTRUMENTATION Improve the instrumentation to meet more stringent telemetry, navigation, tracking, communications, and data handling requirements...phase into operation new and/or modified tracking ships and aircraft.

UNDERWATER SOUND Refine the techniques employed to establish impact location points of nosecones and instrumentation cassetts.

BIOASTRONAUTICS Provide equipment to monitor and display physiological and environmental data to Air Force bioastronautic officers. Hook up this equipment into range computers and telemetry receiving sites.

In important technical and managerial positions like these:

Projecting program requirements and developing the advanced tracking system concepts required, including instrumentation, facilities, and logistic support.

Developing specifications for range instrumentation systems, evaluating bids from industry, monitoring development, fabrication, installation, and phasing of systems into operational status.

Planning, evaluating, and providing range support for all launches, coordinating all range support activities, providing data and command/destruct for range safety, and managing down-range island and ship stations.

Experience required in one or more of these areas: Pulse & CW radar / telemetry / infrared / data handling / communications / closed circuit TV / frequency analysis / command control / underwater sound / timing / shipboard instrumentation / meteorology.

Write to Manager, Professional Employment, Dept. 30C-1



GUIDED MISSILES RANGE DIVISION

PAN AMERICAN WORLD AIRWAYS, INC.
750 S. ORLANDO AVENUE, COCOA BEACH, FLORIDA
An Equal Opportunity Employer M/F

ON CAREER-INQUIRY FORM CIRCLE 903



"George . . . if we still lived back East, you'd be shoveling snow now instead of lazing in this gorgeous Arizona sunshine."

"I'm not lazing — I'm working on my Masters."

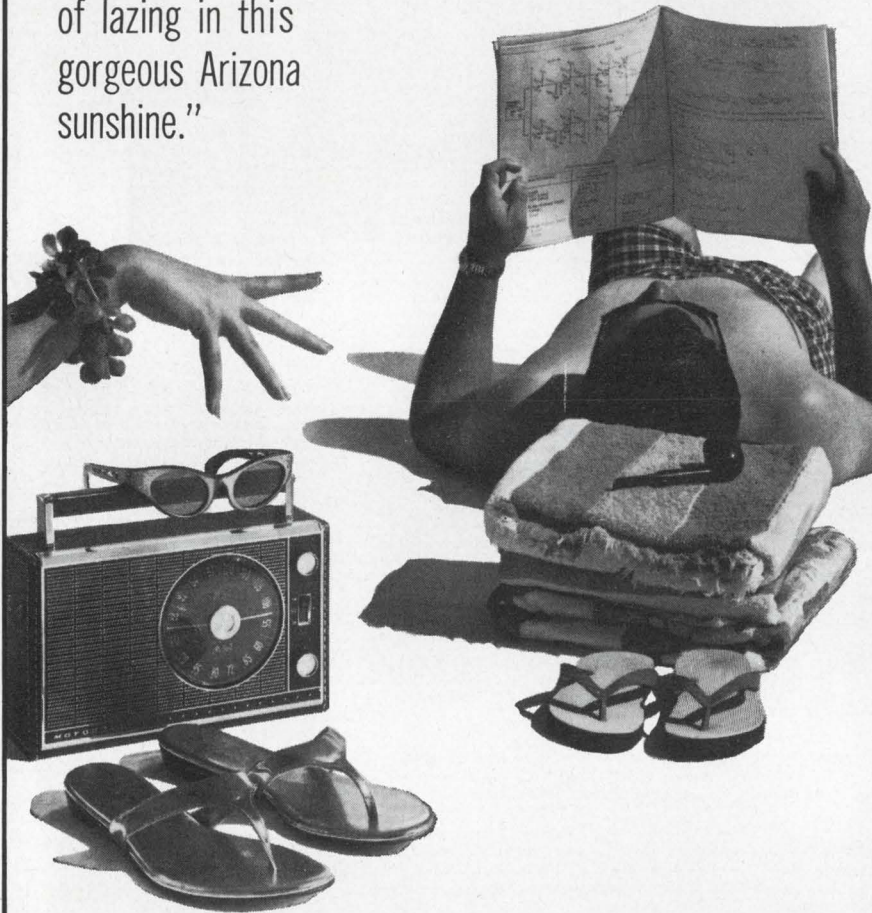

MOTOROLA in PHOENIX

offers excellent career opportunities to qualified engineers. And when the pool and golf course get tiresome, nearby Arizona State University offers a full range of graduate engineering courses through the Ph. D. level. Specific opportunities are:

Antennas & Propagation	Equipment Reliability Analysis	Guidance & Navigation
Solid State R.F.	Parts Reliability	Command & Control
Microwave Techniques	Data Acquisition, Processing	Space Communications
Missile & Space Instrumentation	& Display	Signal Processing
Operational Support	CW Transponders	ECM, CCM & Surveillance
Integrated Circuitry	Radar & Radar Transponders	Tracking & Telemetry
	Fuzes	

Contact Phil Nienstedt, Manager of Recruitment, Department 622

MOTOROLA • Military Electronics Division

Western Center • P.O. Box 1417, Scottsdale, Arizona

MOTOROLA ALSO OFFERS OPPORTUNITIES AT CHICAGO, ILLINOIS — AN EQUAL OPPORTUNITY EMPLOYER

NASA TECH BRIEF

TD improves monostable circuit

Problem: Design a better monostable multivibrator (MSMV).

Solution: A monostable multivibrator that incorporates a tunnel diode in the circuit has a rise time below $0.2 \mu\text{s}$, more constant quasi-stable time, and a 95% duty cycle.

In its stable state the tunnel diode conducts and the transistor Q_1 is saturated. If a positive trigger pulse is fed into the input, the tunnel diode switches OFF, which is a low-voltage state. This initiates a quasi-stable state. Its duration is controlled by the variable resistor and the choice of capacitor.

With D_1 back-biased and exhibiting a high impedance to node A, C_1 will begin to seek the steady-state voltage, where the low voltage resistance of the

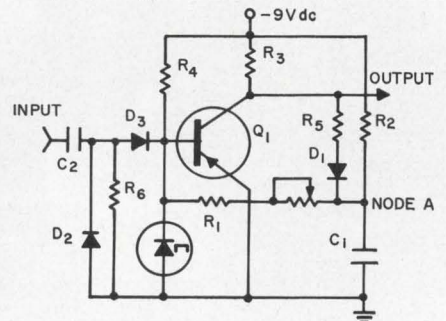

tunnel diode is approximately 50 ohms. Node A can be considered a changing voltage source that supplies current to the tunnel diode—the current through R_4 is insufficient to switch the tunnel diode. When the sum of the two currents from node A and R_4 peaks, the tunnelling process is started and the tunnel diode switches to the ON state. The voltage across the diode causes Q_1 to switch to its saturated state, thus terminating the quasi-stable state of the multivibrator. Capacitor C_1 will then discharge, through the low impedance of the now forward-biased diode D_1 , and saturated Q_1 , completing the transition back to the steady-state condition.

For further information, contact: Technology Utilization Officer, Goddard Space Flight Center, Greenbelt, Maryland 20771 (B63-10603).

Ever come up with an elegant solution only to discover that nobody appreciated the thorniness of the problem let alone the subtleties of your approach to it?

It's not likely to happen at Sanders.

ELECTROMECHANICAL DESIGN & DEVELOPMENT ENGINEERS

To be responsible for D&D of state-of-the-art inertial instruments. Requires BSME with 2 to 5 years experience in D&D of precision electromechanical inertial instruments, gyros or accelerometers, with knowledge of materials, bearings and assembly techniques, and ability to carry concept through to hardware stage.

PRODUCT ENGINEER

To be responsible for production processing, production improvement, preparation of methods and process sheets, design tooling and test equipment, cost and schedule estimates, and preparation of technical reports on precision parts fabrication and assembly. Requires BSME with 3 to 5 years experience in electromechanical instrumentation, hydraulic components or precision inertial instrumentation.

SENIOR ECM STUDY ENGINEER

To join a group engaged in the theoretical and practical evaluation of ECM systems problems. Will develop simple analytical models, bench and flight tests to verify models and study advanced radar and ECM systems and techniques. The most desirable background for this work would be 3-5 years in the development of radar hardware coupled with analytical experience in such phases as external parameters, system error, operations and use, or any aspect of system performance and trade-offs. ECM, Elint, or communications work will also be considered. Military experience highly desirable. BSEE or MSEE preferred.

SENIOR CIRCUIT DESIGN ENGINEER

Candidates should have 3 or more years in circuit design and analysis using vacuum tubes, transistors, and other solid state devices. Background should include extensive experience in the design and engineering of circuits of these types: digital and logic, video and pulse, RF and audio, power supplies and regulator circuits, etc., for military systems. Advanced degree desired.

SENIOR RECEIVER DESIGN ENGINEER

Require 5 or more years in the design and development of complex receivers for communications, radar and missile systems. These receivers are generally airborne, covering frequency ranges through UHF, and requiring the application of solid state devices. Must have specific experience designing sophisticated AFC, phase-lock loops, low noise front ends, stable local oscillators, IF strips, etc. Will supervise other engineers and technicians. BSEE or Physics with 5 or more years experience.

MECHANICAL ENGINEER—

Heat Transfer & Packaging. Desired background would include 5 or more years experience in military electronics involving high-density packaging of electronic equipment, design of components for severe shock and vibration, heat transfer as related to packaging, refrigerating and liquid coolants and applications of structural design. Assignment fields may include radar, missiles, ECM, ASW, communications systems or others. BSME required.

Write in confidence to Mr. Lloyd Ware, Staff Engineer.

sanders associates, inc.



NEW DIRECTIONS IN ELECTRONICS SYSTEMS

An Equal Opportunity Employer (M&F)

NASHUA, NEW HAMPSHIRE

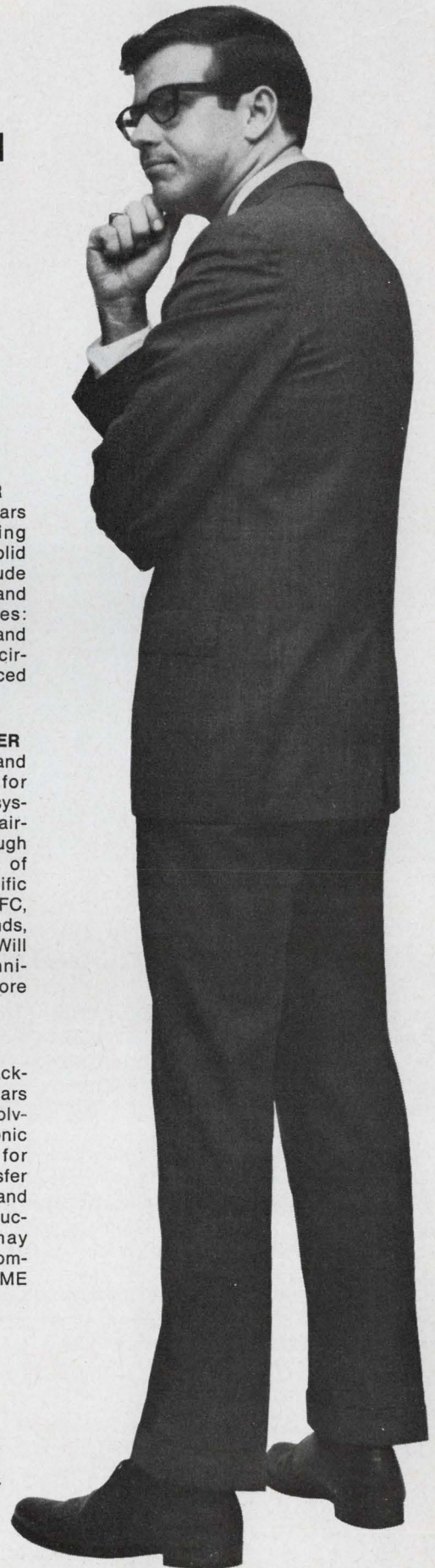

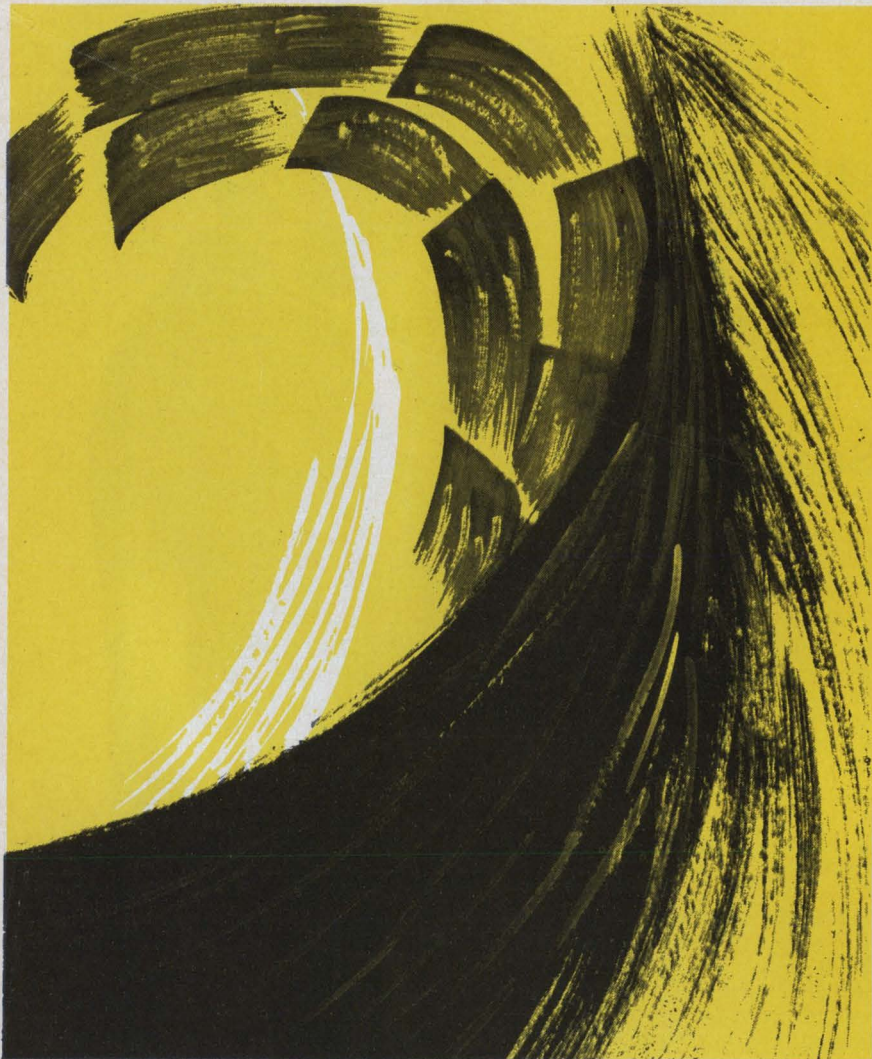

Painted by Gloria Velasco, a junior at Los Alamos High School. Sixth in the series.

The Road to Discovery

Now in the design stage, the \$55 million Los Alamos Meson Physics Facility (LAMPF) will serve as the world's first linear proton accelerator in the 800 MeV energy range. It will be capable of producing an average beam current of 1 milliamper, manifestly higher than that attained by any other machine of comparable output energy.

This 2,600-foot-long "meson factory" will open important avenues of basic and applied research. Such a meson producer will have many applications for studies in medium energy physics, particle physics, nuclear structure, biology, solid-state physics, radiation chemistry, and for neutrino experiments.

If you would like to join LASL scientists and engineers in this exciting venture, send your resume to Director of Personnel, Division 66-35, P.O. Box 1663, Los Alamos, New Mexico.



An equal opportunity employer. U.S. citizenship required.

ON CAREER-INQUIRY FORM CIRCLE 906

Looking for a New Job?

- Fill out one application . . .
- Check off the companies that interest you . . .
- We do the rest

Contacting the job market takes only ten minutes with **ELECTRONIC DESIGN's** Career Inquiry Service. To put Career Inquiry Service to work for you, fill in the attached resume. Study the employment opportunity ads in this section. Then circle the numbers at the bottom of the form that correspond to the numbers of the ads that interest you.

ELECTRONIC DESIGN will be your secretary, type neat duplicates of your application and send them to any number of companies you select—the same day the resume is received.

Career Inquiry Service is a fast, efficient way to present your job qualifications to companies recruiting engineering personnel—as confidentially and discreetly as you would in person. This service is the first of its kind in the electronic field, and one that engineers have used effectively since its inception in 1959.

We take the following precautions to ensure that your application receives complete, confidential protection:

- All forms are delivered unopened to one reliable specialist at **ELECTRONIC DESIGN**.
- Your form is kept confidential and is processed only by this specialist.
- The "circle number" portion of the form is detached before the application is sent to an employer, so that no company will know how many numbers you circled.
- All original applications are placed in confidential files at **ELECTRONIC DESIGN** and after a reasonable lapse of time they are destroyed.

CAREER INQUIRY SERVICE

After completing, staple, fold and mail career form to ELECTRONIC DESIGN, 850 Third Avenue, New York, N. Y. Our Reader Service Department will forward copies to the companies you select below.

(Please print with a soft pencil or type.)

Name _____ Telephone _____

Home Address _____ City _____ Zone _____ State _____

Date of Birth _____ Place of Birth _____ Citizenship _____

Position Desired _____

Educational History

College	Dates	Degree	Major	Honors

Recent Special Training _____

Employment History

Company	City and State	Dates	Title	Engineering Specialty

Outstanding Engineering and Administrative Experience _____

Professional Societies _____

Published Articles _____

Minimum Salary Requirements (Optional) _____

Use section below instead of Reader Service Card. Do not write personal data below this line. This section will be detached before processing.

Circle Career Inquiry numbers of companies that interest you

- 900 901 902 903 904 905 906 907 908 909 910 911 912 913 914 915 916 917 918 919 920 921 922 923 924
925 926 927 928 929 930 931 932 933 934 935 936 937 938 939 940 941 942 943 944 945 946 947 948 949

Fold here, staple and Mail.

FIRST CLASS
Permit No. 725
New York, N.Y.

BUSINESS REPLY MAIL

No Postage Stamp Necessary if Mailed in the United States

POSTAGE WILL BE PAID BY

ELECTRONIC DESIGN

READER SERVICE
850 THIRD AVENUE
NEW YORK, NEW YORK 10022



Sensor detects eyeball movement

Problem: Devise some means of extracting useful signals from the self-controlled movements of the human eye.

Solution: A small device combining an infrared (IR) source and sensor that can be attached to eyeglass frames or a headband. Operation of the device depends on the difference in IR absorption between the iris and the eyeball.

The device incorporates an IR source that consists of a battery-powered 6-volt or 10-volt lamp and high-pass infrared filter (to filter out visible light from the lamp), and a cadmium selenide IR sensor. A filter is also placed

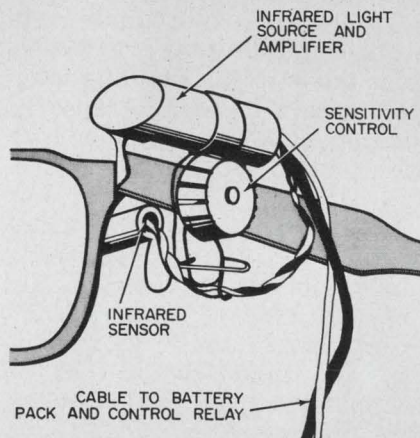

in front of the IR sensor to exclude all ambient visible light. When the eye is looking straight ahead, all of the IR radiation from the source is incident on the area of the eyeball lying on one side of the iris and the radiation on this area is reflected to the sensor. This is the normal, or OFF, condition of the device. When the iris is turned toward the IR source, a high percentage of the radiation is absorbed by the iris and the external control relay connected to the sensor is actuated. An amplifier is used to amplify the generated current. A sensitivity control adjusts the threshold value for proper switching action under different ambient lighting conditions.

For further information, contact: Technology Utilization Officer, Marshall Space Flight Center, Huntsville, Alabama 35812 (B65-10079).

March 1, 1966



CONSUMER ELECTRONIC OPPORTUNITIES
TELEVISION RECEIVER DEPARTMENT

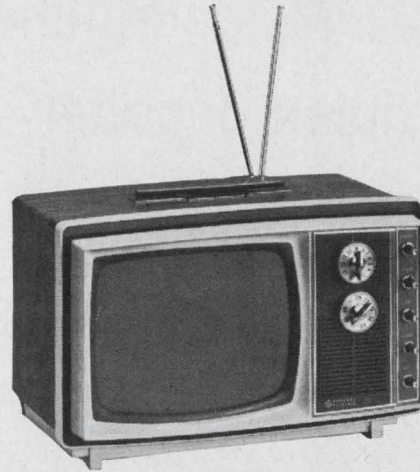

Our latest innovation: 11" Porta-color set with new G.E. picture tube.

TV/CRT ENGINEERS:

Want to be part of our next innovation? We're going places. We can get you growing, too.

■ Innovation means growth in this business. And our engineers—in circuit, set, CRT design and manufacturing engineering work in a climate that's aimed at producing the new and different approach—right now. Successful designs like the 12" personal portable; the 9" battery set; and our sensational low-cost Porta-color set are putting a steep pitch on our growth curve. Examples: expansion in our Electronics Park Headquarters operation; and a brand new facility now abuilding in Portsmouth, Va. We have other plans, too. You can figure in them—to your long-range personal profit. You can expect a full package of G.E. benefits, including our Savings and Security Plan; efficient work surroundings; a place in a diversified company with a history of 37 years in television research, design and production; and excellent local living conditions in Upstate New York or Eastern Virginia.

■ Investigate this partial list of openings now:

SIGNAL CIRCUIT DESIGN: conceive, develop and apply signal processing circuits to development of monochrome and color TV.

MECHANICAL PRODUCT DESIGN: requires 2-4 years' experience in consumer electro-mechanical product design and packaging.

DEFLECTION CIRCUIT DESIGN: develop deflection and convergence circuits for TV receivers. Requires experience in design of deflection yokes and related magnetic deflection components.

COMPONENT DESIGN AND/OR APPLICATION: conceive, design and apply electronic components for monochrome and color TV receivers. Needs 2-4 years' component design or application experience.

TV QC, PROCESS CONTROL AND MFG. ENGINEERING: establish, plan and attain QC programs. Apply QC principles to engineering design; develop plan; determine quality capabilities methods, testing, evaluating; analyze failure data; recommend action. BSEE plus QC or TV production.

CRT DESIGN, MFG., PROCESS AND QUALITY CONTROL ENGINEERING: Design and develop cathode ray tube products for both monochrome and color, including element, materials application, mfg. techniques, and QC. 2-10 years' related experience needed.

For more information, or to arrange a personal interview, send a resume of your experience in confidence to M. H. FitzGibbons, Manager, Professional Placement, Television Receiver Dept., Box 117, General Electric Co., Electronics Park, Syracuse, N. Y. 13201.

231-11

GENERAL ELECTRIC

AN EQUAL OPPORTUNITY EMPLOYER (M/F)

ON CAREER-INQUIRY FORM CIRCLE 907

Dual MOS-FET simplifies FM multiplex decoder

The use of a dual, p-channel MOS-FET instead of diodes or bipolars greatly simplifies the design of an FM decoder. Demodulation of stereo FM composite multiplex signals is thereby achieved with fewer components and without elaborate filter networks.

Conventional multiplex decoders usually have a balanced demodulator network consisting of four diodes with a number of associated resistors and capacitors. Two diode (or two transistor) unbalanced demodulators are somewhat simpler, but they generate unwanted signals which feature large amplitudes. These signals require elaborate filters following the demodulators to "clean up" the detected waveforms.

A much simpler demodulator (Fig. 1a) uses a device containing two MOS-FET's on a single monolithic chip. Six connections are brought out of the device: common source and substrate terminals, and separate gate and drain terminals. Note that each device is symmetrical with respect to source and drain.

The demodulator operates on a time-share basis. Both sides function as switches to extract left and right information samples from the composite signal. Each switches at a 38 kHz rate. The left sample is passed when the negative one-half cycle

of the 38 kHz reference voltage gates on side "A". The right sample is taken from the other side, "B", during the next half cycle when the out-of-phase 38 kHz reference signal supplies a negative voltage to its gate.

For this configuration, optimum switching operation is obtained when the substrate is near the potential of the sources (and drains). This is accomplished by resistively connecting the source and substrate. A direct connection is prohibited, because it would allow the multiplex signal to be coupled to the output via the source-substrate and drain-substrate diodes. This would disrupt the normal demodulator action.

Properly phased samples fed through the R-C de-emphasis networks produce left and right stereo signals. The de-emphasis network is adequate for filtering out the 38 kHz switching transients, which in this case are small because no unbalance exists in the MOS-FET demodulation process. Note that no additional filtering is required.

The waveforms in Fig. 1b illustrate the operation of the demodulator. The composite multiplex signal, less the trapped out 19 kHz pilot, is fed into the common-source terminal of the dual MOS-FET. Sampling is controlled by the 38 kHz reference and produces left and right waveforms at the drain. These are de-emphasized and filtered by the R-C networks before the output.

The demodulator is disabled by turning off the 38 kHz reference signal. In this monophonic mode

IDEAS FOR DESIGN: Submit your Idea for Design describing a new or important circuit or design technique, the clever use of a new component, or a cost-saving design tip to our Ideas for Design editor. If your idea is published, you will receive \$20 and become eligible for an additional \$30 (awarded for the Best of Issue Idea) and the grand prize of \$1000 for the Idea of the Year.

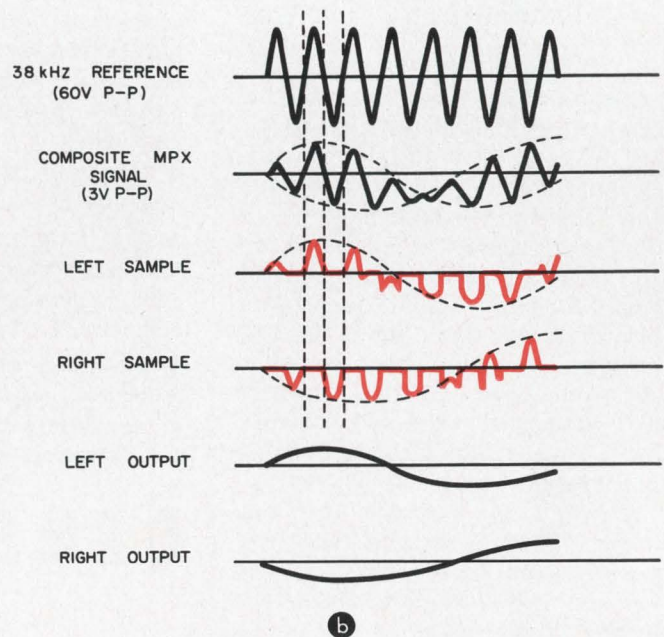
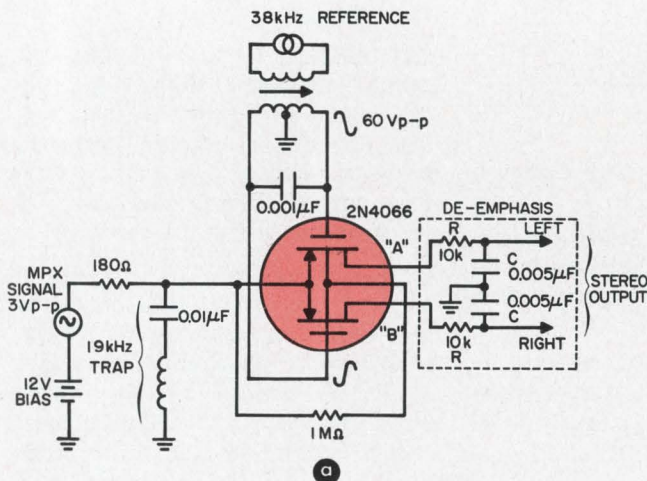

Dual p-channel MOS-FET simplifies the design of FM multiplex decoder (a). MOS device functions as a demodulator. R-C de-emphasis networks (dotted) filter out switching transients and produce left and right stereo signals. Key waveforms (b) illustrate demodulation process.

FAIRCHILD LOW POWER LOGIC

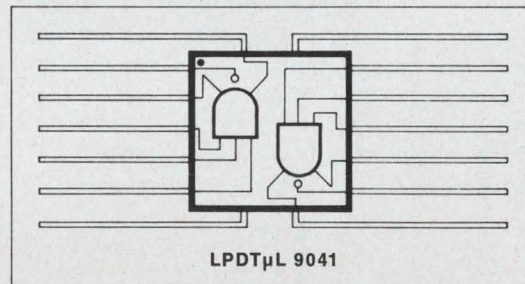
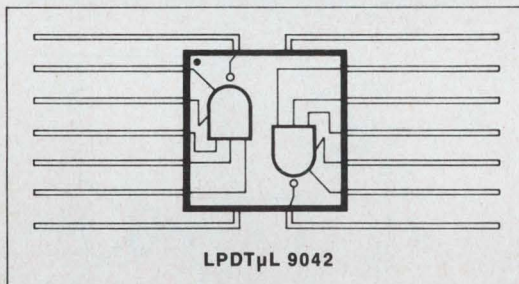
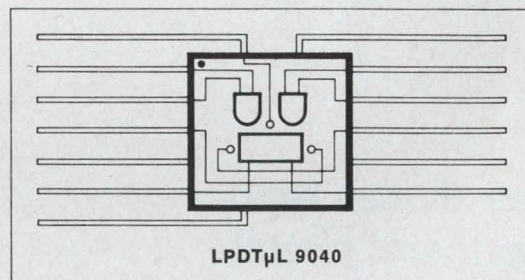
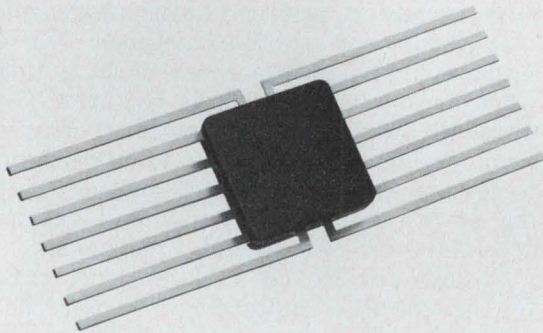

FEATURES:

Low Power drain	less than 1mW/gate (typ.) @ 50% duty cycle less than 4mW/clocked flip-flop
Single power supply requirement	5V optimum, 4.5V to 5.5V range
Guaranteed noise immunity	450mV min. at temperature extremes
Logic propagation delays	60nsec. typical
Binary clock rate	2.5Mc
Full temperature range	-55°C to +125°C

LPDT μ L LOW POWER DIODE-TRANSISTOR MICROLOGIC™ CIRCUITS

Fairchild LPDT μ L integrated circuits offer high performance in the low milliwatt range. High resistance values and small chip geometry hold down power consumption. The flip-flop element operates either in the R-S or J-K mode, with maximum dissipation of 6mW at a 2Mc toggle rate. Gates provide fan-out capability of 10 LPDT μ L low power logic unit loads, or one standard Fairchild DT μ L diode-transistor logic unit load. (Standard Fairchild DT μ L logic circuits can be used to extend the fan-out capability still further). The circuits come in Fairchild's Cerpak flat package, and can be used in satellites, battery-operated field equipment, or other instruments where reliability and high performance must be achieved with limited power. Fairchild LPDT μ L low power integrated circuits are available in evaluation quantities from distributors. For complete information write to:

FAIRCHILD
SEMICONDUCTOR

of operation both sides of the dual MOS-FET are on continuously, and the two de-emphasized outputs are identical.

Any switching-type demodulator (including the one just described) must be compensated to obtain optimum separation. This compensation may be accomplished by pre-emphasis of the 38 kHz sub-carrier information on the composite signal prior to demodulation. An alternative method involves adding an out-of-phase portion of each channel into the opposite channel in a matrix that follows the de-emphasis network. The requirement for compensating a switching type demodulator must not be overlooked in the over-all design of an FM multiplex decoder. For the sake of simplicity, and because the methods are fairly well known, the compensation networks are not shown here.

Larry Blaser, Senior Engineer, Fairchild Semiconductor, Mountain View, Calif.

VOTE FOR 110

Four-layer diodes form 'first one there' circuit

A circuit able to tell which input of a given number of inputs occurred first can easily be designed with four-layer diodes. It is especially useful for low-voltage applications.

Referring to the circuit (see diagram), we note that a negative pulse at any input energizes its respective indicator. At the same time it makes it

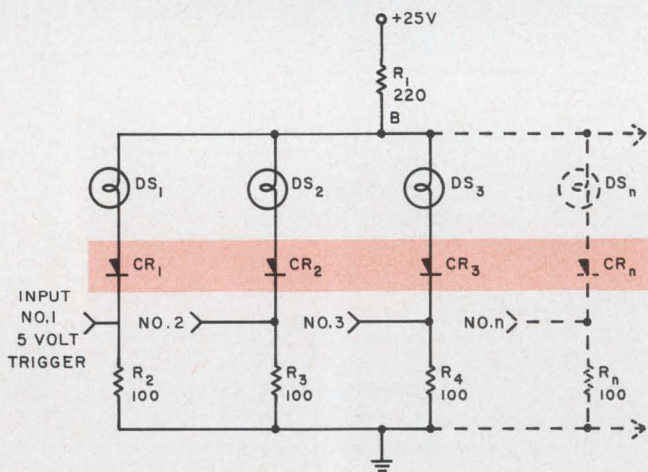

"First one there" circuit is easily designed with 4 layer diodes. Circuit tells which of "n" inputs occurred first.

impossible for any of the other indicators to actuate. Note that the device must be reset with the reset button after each operation.

Supply voltage V_{cc} set below the firing voltage of the four-layer diodes. The negative trigger required is the difference between V_{cc} and the firing voltage. R_1 is chosen so that the voltage drop at point B exceeds the trigger voltage when any

branch is actuated. Then the voltage at B plus the trigger in any other branch cannot cause their respective diodes to conduct.

B. McClaskey, Engineer, Bendix Corp., Baltimore.

VOTE FOR 111

Circuit provides constant gain and variable dc offset

Up to 10 volts variable dc shift for slow ac waveforms may easily be provided by a three-stage transistor network. This property is especially useful in analog systems.

Shifts in the dc level of an analog signal are often required for dc amplifiers, CRT displays and squaring and threshold circuits. The circuit (Fig. 1a) shifts the Q-point of a slow 5.0 Vac peak-to-peak waveform and maintains unity gain.

It is superior to other methods. For example, signal coupling with a zener diode is impractical when a variable dc offset is required. In another technique where the conventional dc resistor is used, problems arise when low-frequency waveforms are encountered. Still another, using floating power supplies, is bulky and expensive and does not work well at high frequencies.

Circuit operation is as follows: A constant 10-volt potential is maintained across R_5 , by the constant-current generator Q_2 . Thus, the ampli-

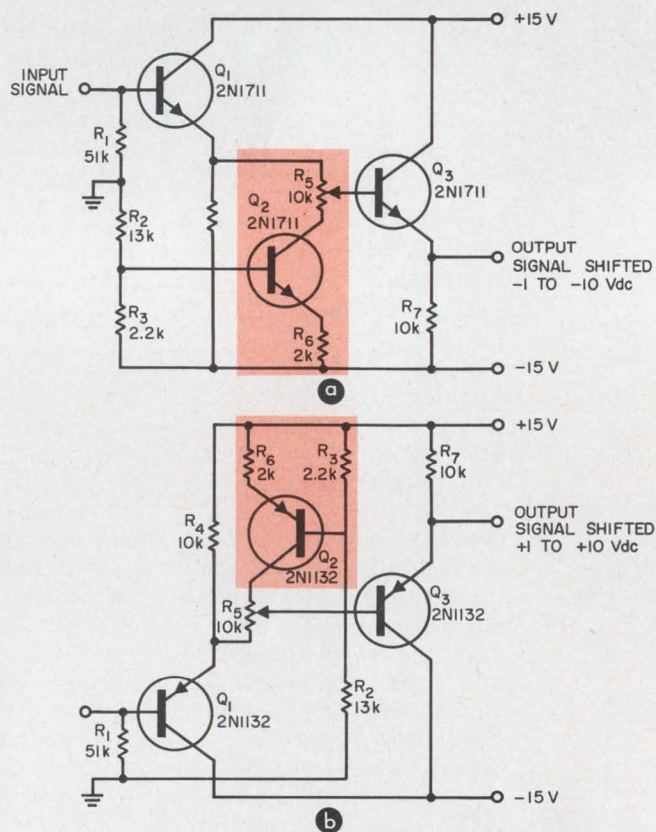

Unity gain with a variable dc offset is provided by this three-stage network. Negative dc shifts of up to 10 volts are produced by (a) and positive shifts by the circuit in (b). Constant-current generator Q_2 keeps the ac amplitude at base of Q_3 constant, independent of pot settings.

tude of the ac signal at the base of Q_3 is constant, regardless of the potentiometer setting. This assumes negligible base current in Q_3 and a low output impedance from Q_1 . The adjustment of potentiometer R_5 controls the dc offset of the signal.

Fig. 1b shows the same circuit modified for dc shifts that are positive with respect to the input dc level. In both circuits, CR_1 is used for temperature compensation.

Richard Peterson, Jr., Engineer, GM Defense Research Labs., Santa Barbara, Calif.

VOTE FOR 112

FET replaces vacuum tube in 1.0 MHz Miller oscillator

Because its typical input impedance is 1000 M Ω or greater, the FET can directly replace the vacuum tube in the Miller oscillator circuit. The FET's high input impedance in parallel with the crystal does not reduce the effective high-Q of the tuned circuit.

In this modified Miller circuit (see illustration), values of L and C are chosen to give resonance at a frequency slightly higher than the parallel resonant frequency of the crystal. The drain circuit must be inductive for oscillations to start, but since the amount of inductive reactance determines the amplitude of oscillations, care must be taken to prevent limiting. For this reason, and to allow some latitude for component tolerances, a variable inductor should be used in the drain.

Gate Resistor R_1 is a critical component. Its value must be high enough so that it does not reduce the effective high Q of the tuned circuit, and low enough so that temperature variations of I_{GSS} do not alter the FET bias point. Source Resistor R_2 determines the dc quiescent operating point of the FET. With $R_2 = 2.2k$, this operating point is typically 1.2 volts.

This circuit operates at a frequency of 1.0 MHz with an output voltage of 8 volts peak-to-peak. If a low output impedance is desired, a source-follower circuit is suggested for an output stage.

Charles MacDonald, Applications Engineer, Siliconix, Inc., Sunnyvale, Calif.

VOTE FOR 113

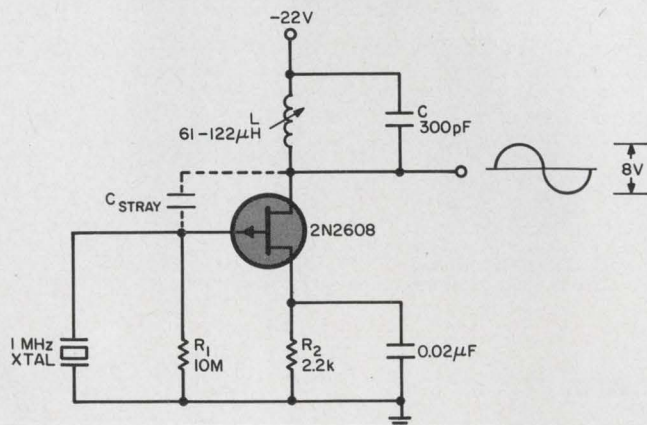

Miller oscillator uses a FET instead of a tube. High Z_{in} of FET does not reduce effective high-Q of tuned circuit.

March 1, 1966



EYELETS

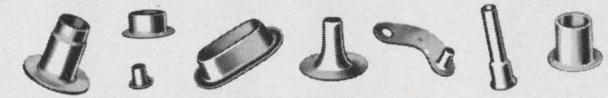

OF EVERY DESCRIPTION



If you use eyelets send for Catalog No. 110-E — over 1300 eyelets are shown with dimensions.

Automatic attaching machines.



ON READER-SERVICE CARD CIRCLE 27

INTRODUCING DELTA BOND 152 THERMALLY CONDUCTIVE ADHESIVE

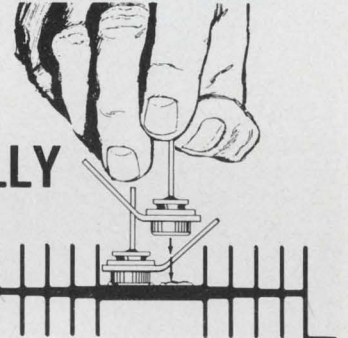

... To be used:

- For bonding thermally, yet isolating electrically, semiconductors to anodized or hard-coated chassis heat sinks.
- As a general adhesive. i.e. fabricating thermal links.
- For bonding when a thermally conductive interface is required.

Being 100% solid adhesive, it is effective on porous and non-porous surfaces. Features . . . high thermal conductivity, excellent dielectric strength, a coefficient of thermal expansion similar to Al and Cu, and produces a rigid high strength bond to most materials when cured.

Available in 4 oz. kits or 15 lb. cans . . . from authorized WAKEFIELD Electronic Distributors.

Write for BULLETIN 152.

WAKEFIELD ENGINEERING, INC.



139 FOUNDRY ST. / WAKEFIELD, MASS. (617) 245 5900 • TWX 617 245 9213

ON READER-SERVICE CARD CIRCLE 28

GET SET...



Kay 121-C
500 KHz to 1700 MHz

This solid-state instrument is an electronically swept VHF-UHF wide-sweep and marker generator which accepts a variety of UHF plug-ins to provide extended frequency ranges and sweep widths. With its plug-ins, the 121-C covers a range of 500 KHz to 1700 MHz, offers octave-wide sweeps at low UHF frequencies where most generators in this range are limited to narrow widths. Narrow sweep and wide sweep plug-ins cover special applications such as UHF-TV — full 440 to 920 MHz in a single wide sweep. A digital frequency dial provides smooth center frequency control and remarkable vernier adjustment for narrow sweep operation.

Performance characteristics include line-lock, cw, manual and variable sweep rates, and external input.

External modulation from dc up to more than 15 KHz, a built-in detector and switched attenuator are standard features.

Wide-Sweep



RF OUTPUT...Set

0.5 volt rms into 50 ohms
Flat: $\pm .25$ db to 800 MHz
 $\pm .5$ db to 1700 MHz



FREQUENCY...Set

digital frequency dial;
vernier control at all frequencies



SWEEP WIDTH...Set

5 KHz to 500 MHz
VHF: 50 KHz to 300 MHz
UHF: *P-121 — 124 Plug-ins

Marker Generator



harmonic (picket) birdie markers



single-freq. type birdie markers



*P-121: 200 MHz to 1050 MHz
Sweep: 35 KHz to 350 MHz @ 800 MHz
5 KHz to 50 MHz @ 220 MHz



*P-122: 900 to 1300 MHz
Sweep: 200 KHz to 400 MHz



*P-123: 100 to 1000 MHz
Sweep: 5 KHz to any octave



*P-124: 1300 to 1700 MHz
Sweep: 500 KHz to 400 MHz

KAY ELECTRIC COMPANY

Pine Brook, Morris County, New Jersey • (201) 227-2000

Visit Kay at the IEEE Show, Booths 3C11 - 3C17

ON READER-SERVICE CARD CIRCLE 29

ED Products

Chopper-stabilized amp at diff-op-amp prices PAGE 84

Automatic adjusting digital voltmeter PAGE 92

Germanium planar transistor beats TWT performance PAGE 88

High resistance chips for logic gates PAGE 96

Amplifier has an elephant's memory PAGE 98

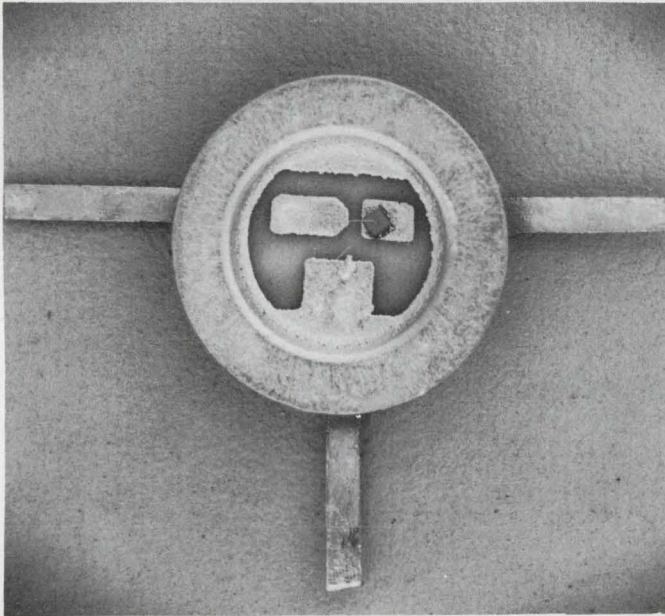

Germanium planars outdo TWTs 88

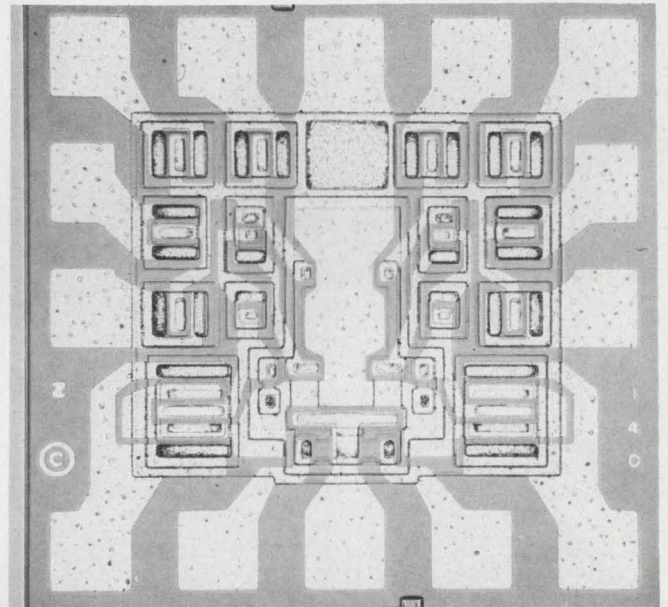

Half-Meg per chip resistance 96

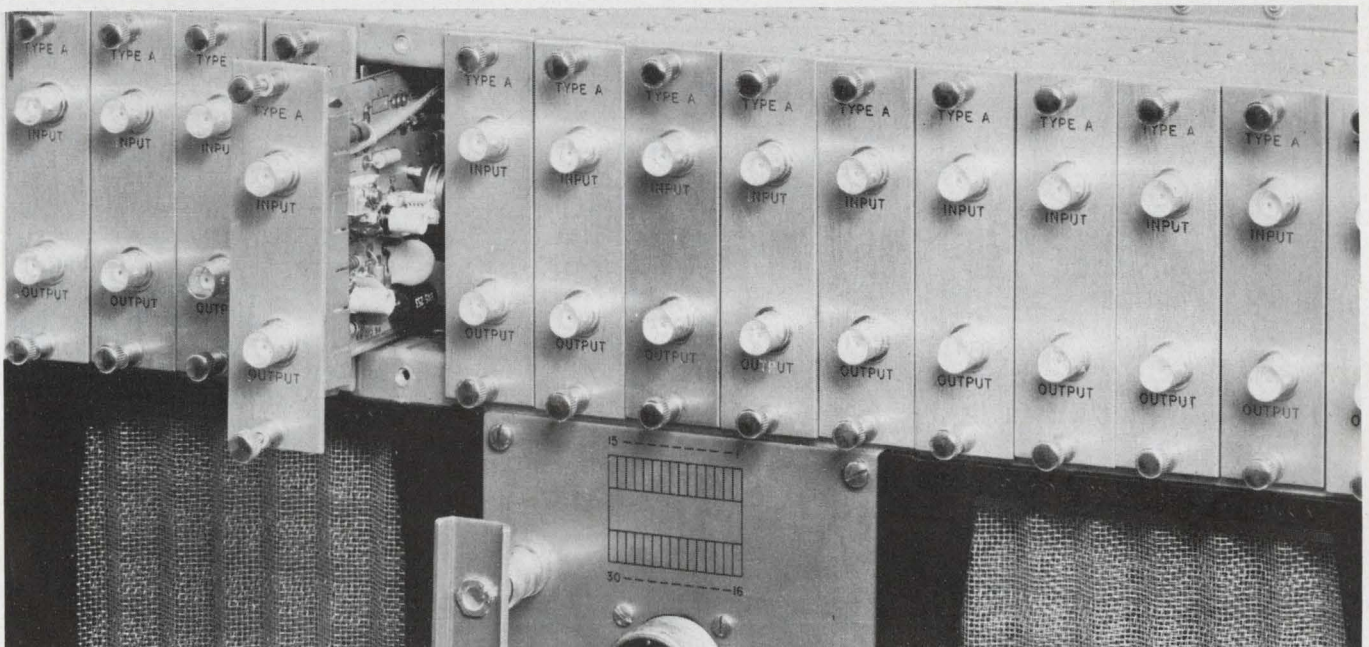

System of delay-line amps has 120 dB per channel isolation 99

Low price—high gain, chopper stabilized amplifier

A chopper-stabilized amplifier priced with premium differential op-amps gives orders of magnitude better performance. Pricing of the 210 is below any comparable chopper-stabilized model.

Specs include 20 MHz small-signal bandwidth, 100 V/ μ s slewing rate, 10^8 open-loop gain (160 dB), 3 μ V peak-to-peak noise, 1 μ V/ $^{\circ}$ C and 2 pA/ $^{\circ}$ C max drift, 50 μ V and 50 pA maximum initial offset, and 10 μ V and 10 pA equivalent offset for each 1% supply voltage change. Temperature range is -25 to $+85^{\circ}$ C. Input impedance is 500 K, output is ± 10 V, 20 mA. A saturation protection circuit re-enables the amplifier 0.2 μ s after overdriving, and the chopper-driver operates from the ± 15 Vdc supply, obviating the need for 60 Hz excitation, a notorious noise source. The package is a 3-in.³ epoxy-encapsulated module which mounts directly onto printed circuits. Most competitive units are socket mounted, adding noise and insulation leakage.

An inherent susceptibility of chopper-stabilized operational amplifiers is input overdrive. Once overcharged (usually by several or-

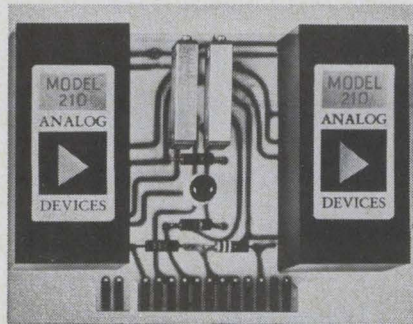

ders of magnitude), internal filter and coupling capacitors may require minutes to discharge. In the 210, a zener diode circuit "breaks down," paralleling the feedback impedance with a low resistance, and preventing the amplifier from reaching saturation. The network returns the amplifier to full operation within 0.2 μ s of overdrive.

Initial offset specifications enable the user to dispense with the external offset potentiometer control in many applications.

P&A: \$157 (1-9), \$128 (100-249); 10 days (3 weeks for production quantities). Analog Devices, 221-5th St., Cambridge, Mass. Phone: (617) 491-1650.

Circle No. 254

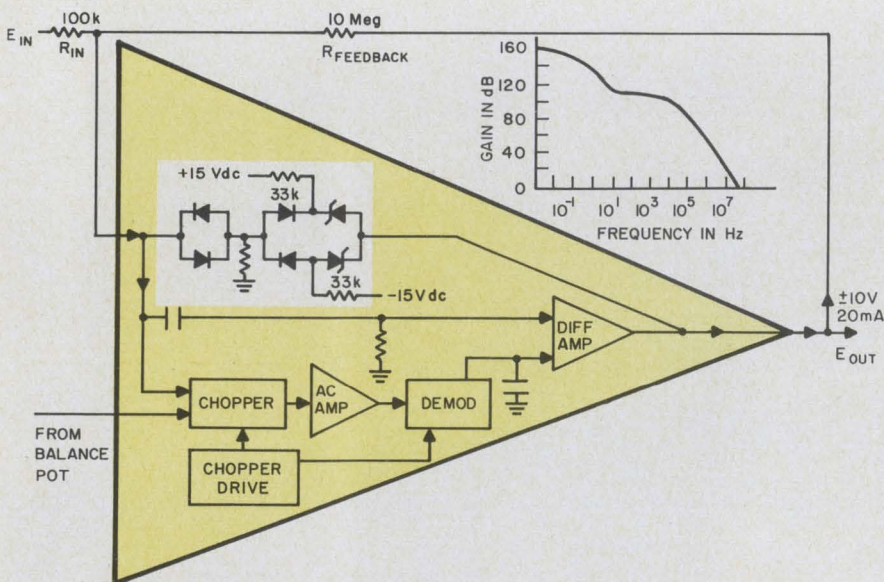

Model 210 chopper stabilized amplifier has feedback network paralleled by zener protection circuit (called out). Very low offset levels make external balance pot unnecessary in many applications.

FET input op-amp

The model 132 differential operational amplifier uses matched input FETs for improved thermal tracking. Input offset current is very low as a result, providing exceptionally high input impedance and low values of voltage drift.

Specifications for the miniature unit include 200,000 typical voltage gain at dc (100,000 minimum), 10 MHz typical gain bandwidth product with 5 MHz specified as minimum and a 6 dB/octave gain roll-off rate.

Input characteristics are 10 Megs input impedance in both differential and common modes; 50 μ V peak-to-peak noise from dc to 100 kHz; ± 10 V peak common-mode voltage, and common-mode rejection of 5,000:1 at dc and 2,000:1 at 400 Hz. The offset voltage can be externally adjusted to zero. Variations in offset voltage are according to a temperature coefficient of 20 μ V/ $^{\circ}$ C specified, 10 μ V/ $^{\circ}$ C typical. Input current is 0.1 nA at 25° C max, and doubles for every 10° C rise. Input difference current is 0.03 nA at 25° C, typically, and also doubles each 10° C increase.

The unit's output voltage swing is ± 10 V peak, minimum. Output current is 4 mA minimum and frequency for maximum output is 150 kHz typical and 75 kHz minimum. Slewing rate is 5 V/ μ s minimum, with 10 V/ μ s being more typical.

The model 132 is 1.125 x 1.125 x 0.625-in. over-all, and requires a ± 15 Vdc power source.

P&A: \$95; 30 days for sizable orders. Zeltex Inc., 1000 Chalomar Rd., Concord, Calif. Phone: (415) 686-6660.

Circle No. 255

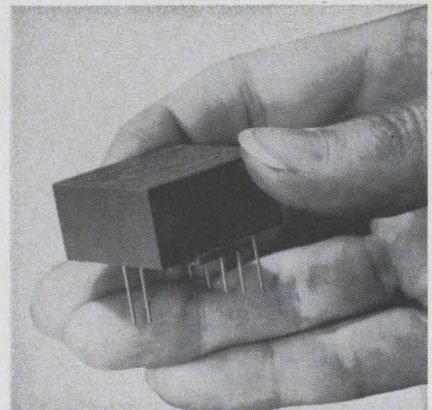

10,000 Megs minimum input impedance for the 132 op-amp—only \$95!



New JFD Air Variable Capacitors offer higher frequencies with negligible loss of Q

Plus

- Ultra Stability
- Highest Q
- Small Size
- Rugged Construction

Now JFD air variable capacitors offer circuit designers the advantages of extremely high "Q" and greater capacitance values in a rugged miniature size unit. Offered in both a printed circuit (VAM 010W) and a panel mounting model (VAM 010), the new units operate at far higher frequencies with negligible loss of "Q" in comparison to other types.

Internal air meshing shells are silver plated to provide good surface conductivity and to prevent corrosive effects. Three internal contact springs assure positive electrical contact of rotor at all times. Leads on printed circuit model are tinned for ease in soldering.

The high density insulator between stator and rotor has excellent electrical properties and contributes to overall structural strength. Rubber gasketed threaded end caps effectively seal the units against dirt entrance or atmospheric contamination after tuning.

WRITE FOR JFD BULLETIN VAM-65

JFD 120-A

JFD ELECTRONICS CORPORATION
 THE \neq AMERICA KNOWS BEST!

Components Division
 JFD ELECTRONICS CORPORATION, 15th Ave. at 62nd St., Brooklyn, N. Y. 11219
 Tel: 212 DE 1-1000
 JFD NORTHEASTERN, Ruth Drive, P. O. Box 228, Marlboro, Mass. 07152
 JFD NEW YORK-NORTHERN, Damiano Pl., P. O. Box 96, New Hartford, N. Y. 13507
 JFD MID-ATLANTIC, P. O. Box 5055, Philadelphia, Pa. 19111
 JFD MID-ATLANTIC-MARYLAND, P. O. Box 7676, Baltimore, Md. 21207
 JFD MIDWESTERN, 6330 W. Hermione St., Chicago, Ill. 60645
 JFD MIDWESTERN-OHIO, P. O. Box 8086, Cincinnati, Ohio 45208
 JFD WESTERN, 9 Morlan Place, Arcadia, California 91006
 JFD ISRAEL LTD., Industrial Area B, Bldg. 23, Azor, Israel
 JFD ELECTRONICS, EUROPE S A, 7 Rue de Rocroy, Paris, 10, France

Precision Piston Trimmer Capacitors ■ Metalized Inductors ■ LC Tuners ■ Ceramic Fixed and Variable Capacitors ■ Fixed and Variable Distributed and Lumped Constant Delay Lines

Visit JFD at IEEE Booth 1E12

Speed Inquiry to Advertiser via Collect Night Letter
 ON READER-SERVICE CARD CIRCLE 30

Same day shipment

ON 75 STOCK ITEMS



Chemtron*

REED RELAYS
OFFER YOU:

FAST DELIVERY

The large **CHEMTRON** line features prototype order shipment the **SAME DAY** on 75 STOCK ITEMS, plus an exclusive design flexibility that allows shipment the **SAME WEEK** on SPECIALS. This large stock and design flexibility also means fastest delivery on production quantities.

VACUUM ENCAPSULATION

A process developed specially for **CHEMTRON** relays insures maximum ruggedness and reliability.

0.1" PIN SPACING FOR PC MOUNT

Board layout for **CHEMTRON** reed relays is easier.

MAGNETIC SHIELDING

The attractive **CHEMTRON** outer case is a magnetic shield to prevent interaction between closely spaced relays.

HIGH SENSITIVITY COILS

These coils allow **CHEMTRON** reed relays to be driven with low power transistors to minimize drive circuit problems.

**WRITE TODAY FOR
YOUR FREE CATALOG**



SELF-ORGANIZING SYSTEMS, INC.

P.O. BOX 9918 • DALLAS, TEX. 75214 • (214) 276-9487
PLANT: 1910 N. FIRST ST., GARLAND, TEX.

*TM SELF-ORGANIZING SYSTEMS, INC.

ON READER-SERVICE CARD CIRCLE 31

Laminated bus bars

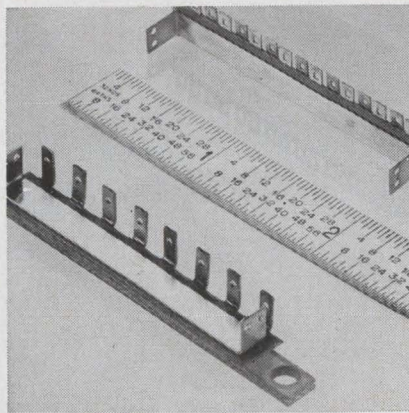

Conductors in thickness of 0.005 to 0.045-in. are available in a line of laminated bus bars that are said to reduce noise in power and signal distribution. Material and length and width of conductor levels and variable and ground levels and tabs can be incorporated to the customer's specifications. Each unit is encapsulated in Amron plastic insulation.

Eldre Components Inc., 1239 University Ave., Rochester, N. Y. Phone: (716) 244-2570.

Circle No. 256

High gain amplifier

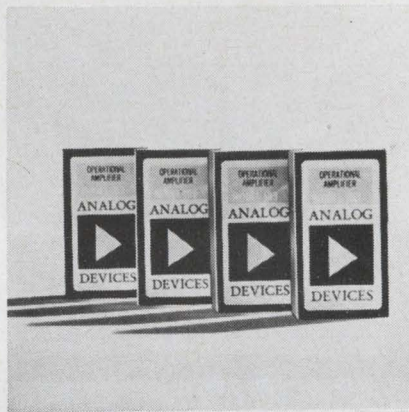

These dc differential operational amplifiers have low-frequency applications where high dc gain and good drift stability are primary requirements.

Models A, B and C of the 103 have 20 $\mu\text{V}/^\circ\text{C}$, 10 $\mu\text{V}/^\circ\text{C}$ and 5 $\mu\text{V}/^\circ\text{C}$ voltage drift, respectively. Current drift of 0.2 $\text{na}/^\circ\text{C}$ and supply voltage drift of 15 $\mu\text{V}/\%$ are the same for all three.

P&A: \$74, \$84, \$104-A,B.&C respectively; 3 weeks. Analog Devices, 221 Fifth St., Cambridge, Mass. Phone: (617) 491-1650.

Circle No. 257

Time delay relays

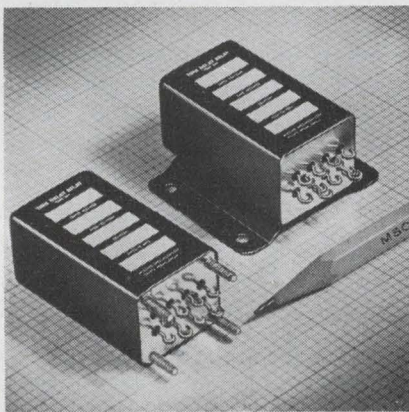

Series 700 time-delay relays feature $\pm 5\%$ accuracy in intervals as short as 0.050 seconds duration. Repeat accuracy is $\pm 2\%$, and the unit has a 100,000 cycle life expectancy.

The relays contain solid-state timing networks. Available in factory pre-set or adjustable units they offer delay times from 0.050 to 90 seconds. Housings are available with studs or flange and tabs for panel or chassis mounting.

Master Specialties Co., 1640 Monrovia, Costa Mesa, Calif. Phone: (714) 642-2427.

Circle No. 258

Rigid-tube connector

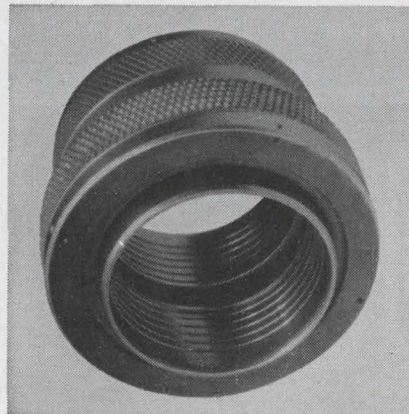

A new rigid-tube connector has been designed specifically for weight reduction and ease of installation. No tools are required for coupling. The connector can be used in such applications as hydraulic lines, cable-carrying tubes, electronic coolant transmission, and environmental low-pressure applications.

It is available in stainless steel, aluminum, and titanium. Sizes range from 1/4 to 6-in. inner diameter.

E. B. Wiggins, Dept. 30, 3424 E. Olympic, Los Angeles, Calif. Phone: (213) 269-918.

Circle No. 259

Power amplifier

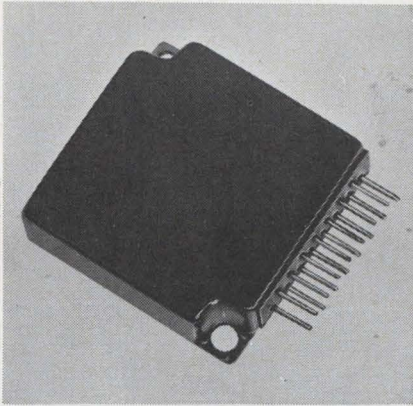

A microelectronic power amplifier delivers up to 5 watts for servo control. Gain of the 0.4 cubic inch amplifier can be adjusted from 100 to 1000 by an appropriate external input resistor.

Power input for max output is 11 watts; signal frequency is 400 ± 20 Hz. The unit is constructed with low θ silicon power resistors in a thin film resistor substrate.

Solitron Devices, 256 Oak Tree Rd., Tappan, N. Y. Phone: (914) 359-5050.

Circle No. 260

Press-fit terminals

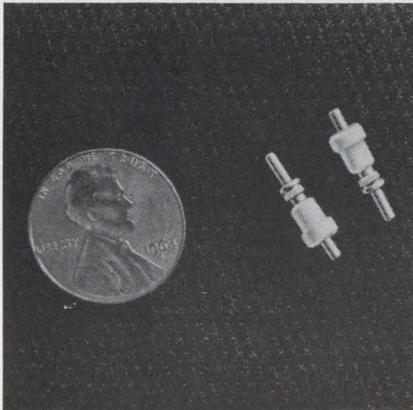

A new semi-assembled terminal is designated FT-2-SM-1163. A feed-through terminal with 0.06-in. solder posts, this unit is designed to mount on a 0.136-in. hole in a 0.047-in. thick chassis.

After installation in the chassis, a serrated shoulder expands the protruding minor diameter to "lock" the terminal in place. Teflon bushings insure reliability.

Sealectro Corp., 225 Hoyt St., Mamaroneck, N. Y. Phone: (914) 698-5600

Circle No. 261

Catheter tip transducer

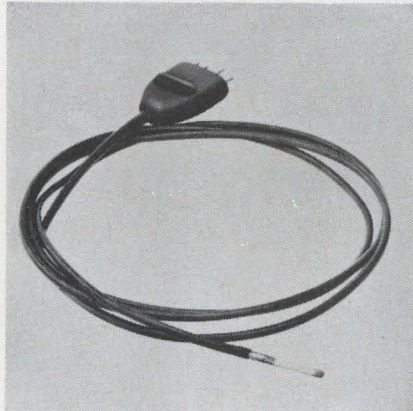

The model CP-1 catheter tip pressure physiological transducer is designed for pressure measurement. Mounted at the tip of a 5F cardiac catheter, it can be used for long periods as flushing is not needed.

Excellent dynamic response enables this unit to register all heart sounds. Any common method of sterilization, including autoclaving, is acceptable.

P&A: \$500; 60 days. Statham Instruments, Inc., 12401 W. Olympic Blvd., Los Angeles, Calif. Phone: (213) 272-0371.

Circle No. 262

Miniature ignitron

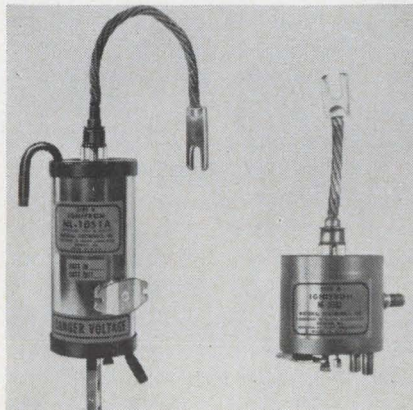

Miniaturized, size B ignitron NL-1031 is designed for resistance welding control equipment.

The unit is a water cooled, stainless steel jacketed, mercury pool ignitron with thermostat mounting plate. Two tubes connected in inverse parallel control 600 kVA in 380-600 V, 25-60 Hz power systems.

The photo compares the miniature and standard ignitrons.

Availability: stock. National Electronics, Geneva, Ill., Phone: (312) 232-4300.

Circle No. 263

Life before the PVB

Mr. Sy Rubin—Quality Assurance Manager of United Aero Test Laboratories, Deer Park, N. Y.—describes his working life before and after our Model 300 PVB (Portametric Voltmeter Bridge).



"Before the PVB, the same measurement capabilities would have cost us thousands."

"We're one of the largest testing labs in the country with complete metrology labs on the East and West coasts. As we grow, our calibration work keeps increasing. Invention of the PVB saved an outlay of many thousands of dollars. For \$750, we answered many of our needs in this single portable instrument.

"I use the PVB for all dc calibrations on the order of a half percent. We calibrate our environmental chambers with it using a certified thermocouple. It's also handy for digital voltmeters, to assure one digit resolution, and for ac measurement with thermal transfer equipment.

"For anyone with calibration responsibilities, I'd say the PVB has the all-round usefulness of an MD's little black bag." ESI, 13900 NW Science Park Drive, Portland, Oregon (97229)

In a single battery-operated unit, the PVB combines the functions of a potentiometric voltmeter, voltage source, ammeter, guarded Kelvin double bridge, resistance comparison bridge, ratiometer and electronic null detector. Accuracy: $\pm 0.02\%$ of reading or 1 switch step on virtually all ranges.

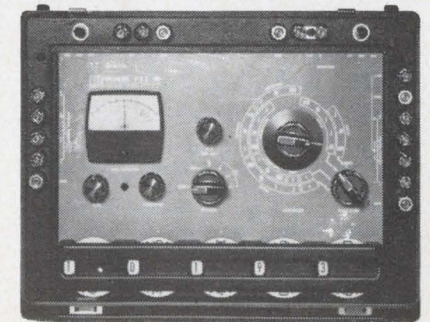

esi®

Electro Scientific Industries, Inc.

See ESI at IEEE.

Booth nos. 3A 48-49-50

ON READER-SERVICE CARD CIRCLE 32

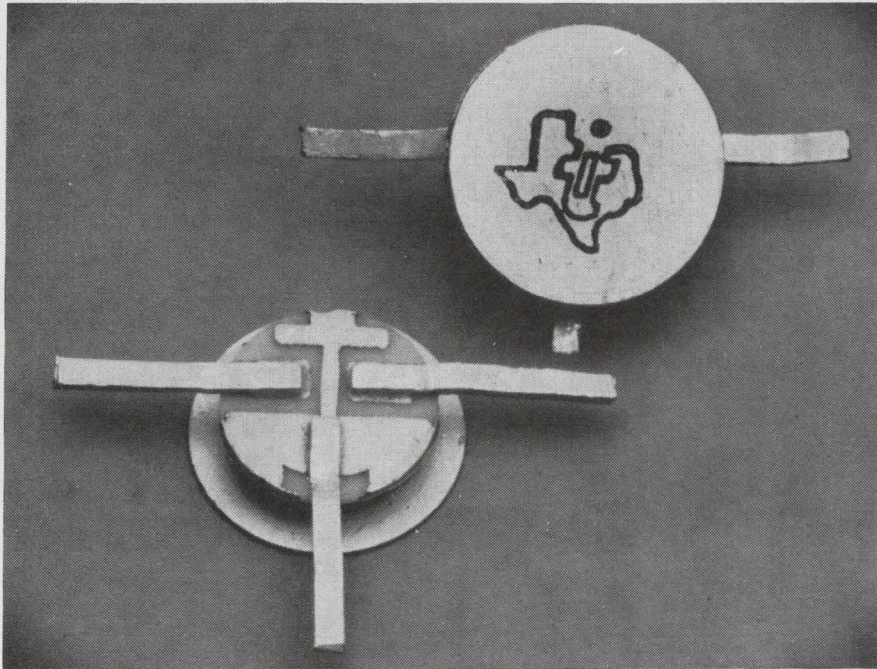

Germanium planar transistor for MW has low noise figure

A new Alloy Diffused Planar Transistor in the 1-4 GHz frequency range features low noise figures. The TIXM103 features a typical noise figure of 3.8 dB at 1.5 GHz and 5.5 dB at 3 GHz when adjusted for optimum noise figure.

Planar construction techniques used on germanium material result in improvements similar to those seen in silicon planar transistors. A frequency limitation imposed on other Ge manufacturing techniques is that base and emitter must have large enough physical dimensions to allow connections for bonding wires to connect the stripes to the package terminals. Planarization, and the ability to use expanded contacts, gives stripe-size independence, as the bonding is made to the expanded contact rather than the stripe.

Some of the microwave features of the TIXM103 include: un-neutralized, stable, common-emitter gain of 9 dB per stage at 1.3 GHz is readily attained; insertion power gain of 5 dB into a 50 ohm line is practical; noise figure has been measured to deviate less than ± 0.7 dB from its 25°C value from -55° to +85°C, and common emitter gain to deviate less than ± 1 dB with the same temperature condi-

tions. Other points include a readily attained system noise figure of 4.5 dB at 1.3 GHz, and 6.5 dB at 3 GHz. Noise figure does not degrade with age, as in TWTs, nor is warm-up time required. No gain drift will be encountered, as in parametric amplifiers, and no circulator is needed, as with tunnel-diodes.

The unit is produced in the TI-Line package with common-emitter configuration. Matched 50 ohm output and input impedances facilitate impedance matching. Leads are gold-plated silver for low lead loss and parasitics.

P&A: \$82.50; stock. Texas Instruments, Semiconductor Div., 13500 N. Central Expwy, Dallas, Texas. Phone: (214) 235-3111.

Circle No. 264

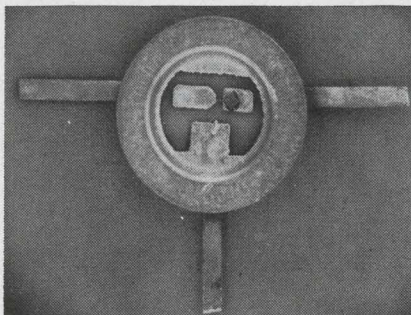

Planar stripline construction as seen without package cover.

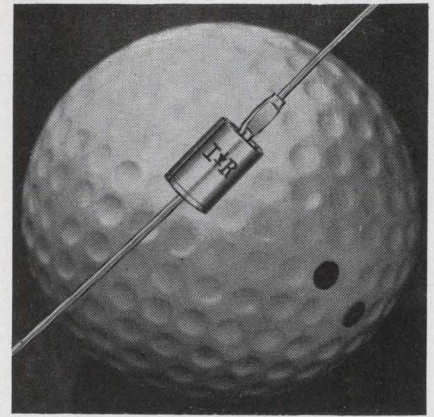

Flangeless rectifiers

A series of flangeless silicon rectifiers features hermetic glass-to-metal seal and a maximum continuous rating of 1.3 A at 50°C. Surge currents of 6 A and transient surges of 40 A can be sustained.

Operating ranges for the series 10C are from 100 to 1000 V at temperatures of -65° to +165°C. The printed-circuit design units are electroplated with tin.

International Rectifier, 233 Kansas, El Segundo, Calif. Phone: (213) 678-6281.

Circle No. 265

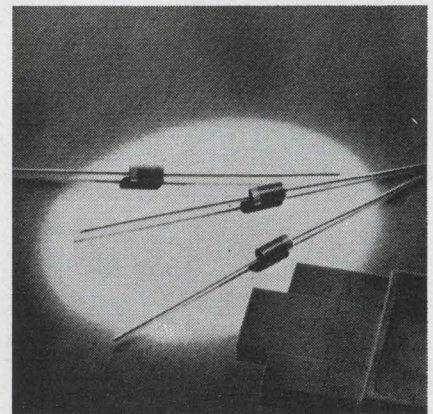

Fast recovery rectifiers

Silicon rectifiers with fast recovery and high current capability are offered in series 1N4942-1N4948.

Typical reverse recovery is 100 ns to 600 V and 250 ns to 1000 PIV; current capability is 1-A rectified at 55°C or 3-A with heat-sink per MIL-STD 750. Leakage current is 0.1 mA at rated PIV, 25°C. Solid silver leads have full area contacts, giving low thermal impedance.

Immediate availability. Semtech, 652 Mitchell Rd., Newbury Park, Calif. Phone: (213) 628-5392.

Circle No. 266

Chart showing the consistency of resistance change in Allen-Bradley Type HB 2-watt resistors in all resistance values from 10 ohms to 100 megohms during humidity test at 95%, 55°C for 113 hours.

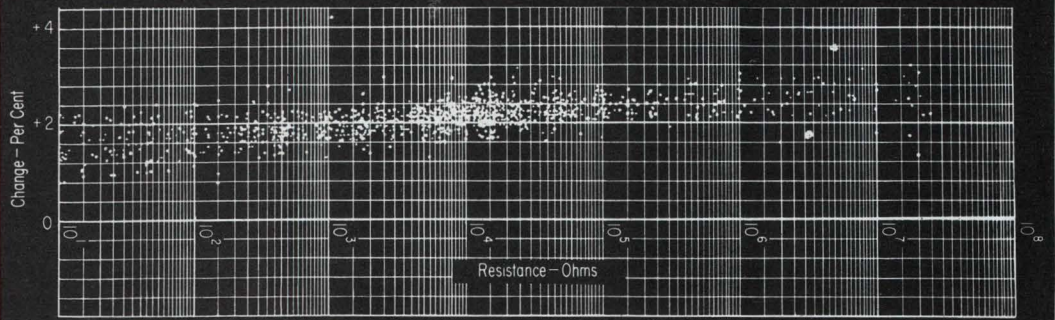

HOT MOLDED FIXED RESISTORS are available in all standard EIA and MIL-R-11 resistance values and tolerances, plus values above and below standard limits. **Shown actual size.**

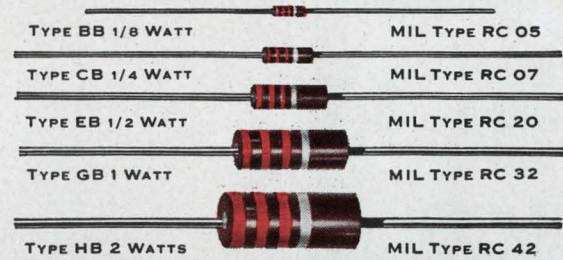

fantastically



uniform

...billion after billion!

Chart at right shows actual per cent resistance change after temperature cycling tests (5 cycles from -55°C to 85°C) on samples regularly taken from production of over 2½ billion Allen-Bradley Type EB ½ watt hot molded resistors.

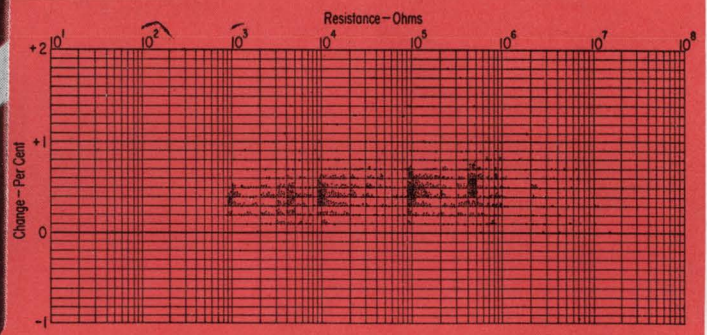

■ To maintain absolute uniformity, Allen-Bradley quality control engineers continuously take samples of resistors from production and test them. The results of these tests, as shown by the charts on this page, are truly amazing. One chart, covering the results of tests on 1248 samples representing production of more than 2½ billion resistors, shows a typical resistance change of only ½ of 1% after five cycles from -55°C to 85°C!

The other chart, plotting production sampling from more than 175 million resistors in a humidity test at 95%, 55°C for 113 hours, shows only a slight deviation in resistance—and complete freedom from any wide deviations.

So far as uniformity of electrical characteristics and physical properties are concerned, Allen-Bradley hot molded resistors have no equal. That's why they are so decidedly preferred by electronic engineers throughout the world. For complete specifications, please write for Technical Bulletin 5050: Allen-Bradley Co., 1344 South Second Street, Milwaukee, Wisconsin 53204. Export Office: 630 Third Avenue, New York, New York, U.S.A. 10017.



ALLEN-BRADLEY
QUALITY ELECTRONIC COMPONENTS

ON READER-SERVICE CARD CIRCLE 33

**ONLY
AUTOMATIC
OFFERS
ALL 5!**



WEDGE-LOCK™*



WEDGE-CRIMP™



X-CRIMP™

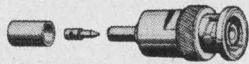

ECONO-CRIMP™

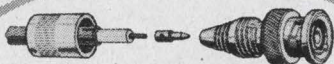

WEDGE-EZE™

*PATENTED

economical!
reliable! efficient!
**rf coaxial
connectors**

Now you can select the connector which best meets your requirements!

They can be supplied in most of the standard connector styles and series from Micro-miniature through LC/LT, and for virtually all popular cables from 1/16" through 9/16" diameter.

Write or phone for literature . . .

automatic
METAL PRODUCTS CORPORATION
323 Berry Street, B'klyn 11, N.Y. Tel: (212) EV 8-6057

AT THE IEEE SHOW • BOOTHS 2G02-4
ON READER-SERVICE CARD CIRCLE 34

SEMICONDUCTORS

Photon-coupled isolator

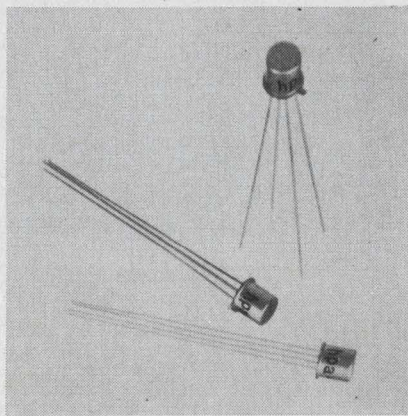

A new solid-state photon-coupled isolator, the hpa-4310 incorporates a gallium arsenide diode injection luminescent photon source and a silicon PIN diode photodetector.

Photon coupling between input and output is 2 pF and 10^{11} ohms. Working voltage is 200 V peak, max. Current transfer ratio is on the order of 0.001, dc to 10 MHz cutoff. Pulse rise is typically 50 ns.

Price: \$55. hp associates, 620 Page Mill Rd., Palo Alto, Calif. Phone: (415) 321-8510.

Circle No. 267

Schottky-barrier mixers

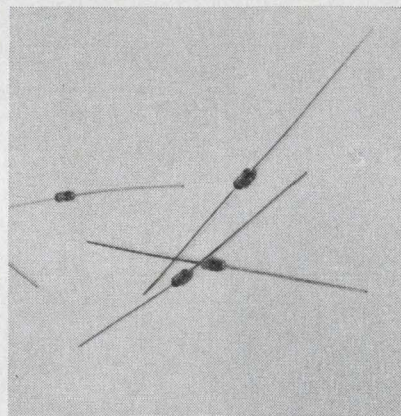

High-reliability Schottky-barrier junction mixer diodes are intended for series mounting in strip transmission-line circuits.

Specifications for the units are shown by model Ma-4855. Noise figure for the 4855 is 6.5 dB in L and S bands, and 8.5 dB in X-band. Cw burnout rating is 0.5 W.

These units meet the requirements of MIL-S-19500.

Microwave Assocs., South St., Burlington, Mass. Phone: (617) 272-3000.

Circle No. 268

Silicon rectifiers

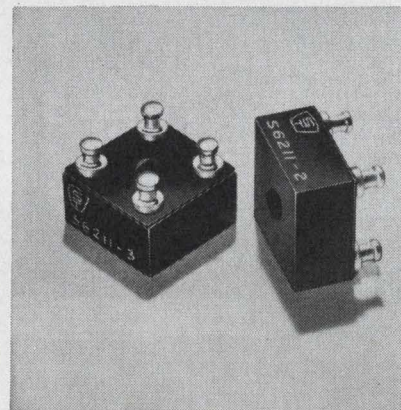

A line of full-wave bridge silicon rectifier assemblies has avalanche characteristics as protection against reverse voltage transients.

These assemblies, S-6211, have PIVs of 200 to 800 volts. A 2 amp dc current rating is common and neither voltage nor current derating is required to 75°C. Turret terminals are silver plated brass.

Sarkes Tarzian, Semiconductor Div., 415 North College Ave., Bloomington, Ind. Phone: (812) 332-1435. TWX: (812) 332-5846.

Circle No. 269

HV power transistors

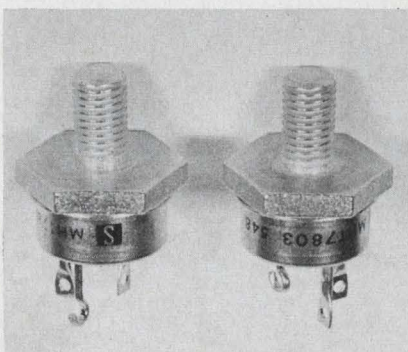

A line of high-voltage power transistors, MHT 7801 through MHT 7805, features sustaining voltages from 200V to 325V. These 10-amp planar npn transistors have a frequency response of 50 MHz, and a common-base output capacity of 150 picofarads. They are packaged in an 11/16-in. hex stud.

Price: \$52.00 to \$100.00 in 100 quantity. Solitron Devices, Inc., 1177 Blue Heron Rd., Riviera Beach, Fla. Phone: (305) 848-4311.

Circle No. 270

ELECTRONIC DESIGN

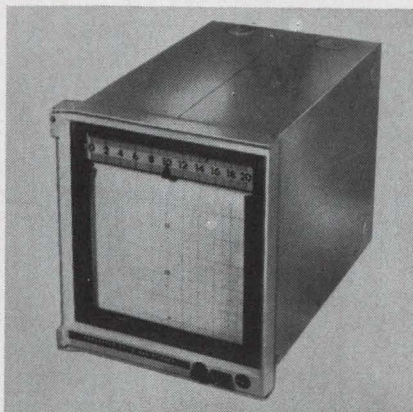

Chart recorder

Two series RD potentiometric strip chart-recorders can be mounted side-by-side in a 19-in. relay rack. A zener-diode constant-voltage reference power supply, and fully shielded measuring circuits, contribute to reliability.

Chart transports are interchangeable within 15 seconds, and also can be set at a 45° angle to serve as a writing platen during operation.

Barber-Colman, 1300 Rock, Rockford, Ill. Phone: (815) 968-6833. TWX: (815) 398-0341.

Circle No. 271

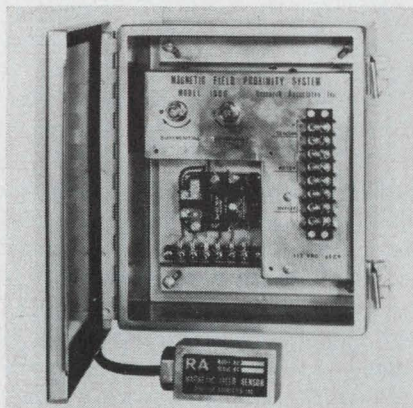

Proximity detector

The model 1000 magnetic field proximity system responds to a vector field rather than to area and mass. A relay in the control unit operates when the sensor detects a properly oriented magnetic field of about 2 oersteds. Operate distances range from source to 5 feet. The unit has continuously adjustable operate-release differentials from hold down to 1% of field.

Research Assocs., 555 E. Linden Ave., Linden, N. J. Phone: (201) 486-1154.

Circle No. 272

high-voltage workhorse VICTOREEN DIODES

Regulator
Pulse Coupler
High-Impedance
Voltage Divider
High-Voltage
Reference

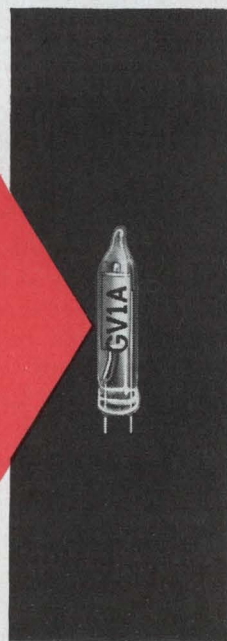

Victoreen GV1A Corotron diode actual size; other types available.

You probably think of Victoreen Corotron diodes as high-performance thoroughbreds for exotic uses. And they are. But this is only part of the Corotron pedigree. They're also real workhorse diodes for everyday uses. As regulators and H-V references . . . H-V pulse couplers . . . high-impedance voltage dividers. And still we haven't run out of Corotron applications. So put your imagination to work. Savings in cost, complexity and weight can put you on velvet. Right away, write away for latest dope on Corotron diodes — high-voltage workhorse. Address Applications Engineering Department.

Write for free copy of illustrated 40-page catalog of Victoreen diodes.

THE VICTOREEN INSTRUMENT COMPANY
10101 WOODLAND AVENUE • CLEVELAND, OHIO 44104
EUROPEAN SALES OFFICE: GROVE HOUSE, LONDON RD., ISLEWORTH, MIDDLESEX, ENGLAND



5471-A

Speed Inquiry to Advertiser via Collect Night Letter
ON READER-SERVICE CARD CIRCLE 35



Digital differential voltmeter has only two null-adjustments

The model 353 digital voltmeter provides a faster approach to accurate dc voltage measurements. Laboratory accuracy can be obtained without the customary knob-twiddling and null-seeking. In this system the range knob is set to give an on-scale reading in the "normal" mode, then the first digit of the "normal" mode reading is manually dialed into the "expanded" mode—whereupon the system takes over. The measurement is automatically expanded to 4 digits with overranging to 5, and a further digit may be interpolated.

The system submerges the inherent electro-mechanical systems error by a factor of at least 10 to 1. A string of precision resistors in series with the potentiometer reduce that component's error producing importance. Not only does accuracy increase by at least 10 to 1, but so does the resolution.

The all solid-state instrument requires 115/230 V, 50-60 Hz. The input resistance is 10 Megs for all ranges in either mode, and the reference voltage is derived from a temperature compensated Zener diode to $\pm 0.005\%$ over a temperature range of $22^\circ\text{C} \pm 10^\circ\text{C}$. The expandable voltage ranges are 1, 10, 100, and 1000 volts full-scale. The 0.1 volt full-scale range is not expandable, hence its accuracy is decreased by a factor of 10.

Features include a left-to-right readout, an automatic display of the terms "mV" or "V," and automatic placement of the decimal point. The motor is automatically disabled during the dial-setting for the "expand" mode, a red light indicates overrange or wrong polarity, and provision is made for a foot operated switch for "read" or "hold."

P&A: \$490; June. Ballantine Labs., Boonton, N. J. Phone: (201) 334-1432. TWX: (510) 235-8329.

Circle No. 273

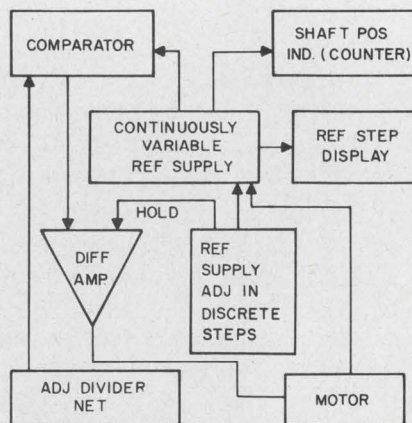

Input signal is range-selected and compared with the reference signal. Amplified error is fed to drive a potentiometer to correct the reference. The pot's resultant shaft-position gives the reading. A manually adjustable reference supply has discrete steps for major divisions. It can be read out on a display.

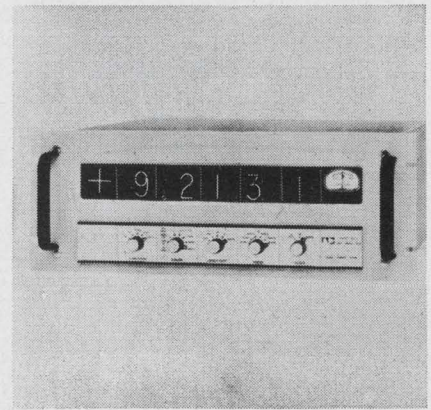

Digital voltmeter

The 5100 Series continuous balance digital voltmeter combines the wirewound resistance ratio and precision voltage reference methods of measurement. The special ratio bridge and proportional controlled reference minimize time and temperature influences. Accuracy is $\pm 0.002\%$ of reading $\pm 0.002\%$ of full scale for dc, $\pm 0.05\%$ of reading $\pm 0.05\%$ of full scale from 50 Hz to 20 kHz and $\pm 0.25\%$ of reading $\pm 0.05\%$ of full scale from 20-100 kHz, for ac voltage.

Ac voltages are converted to dc by full wave averaging rectification with $100 \mu\text{V}$ per digit resolution. Resistance is measured by a true ohmmeter principle, independent of the reference voltage or voltage calibration. The 4-wire input converter has the stability and accuracy of wire-wound resistors and provides 1 milliohm per digit resolution and six automatic ranges. Resistance accuracy for most ranges is $\pm 0.003\%$ of reading $\pm 0.003\%$ of full scale. Maximum dissipation in unknown resistance is 10 mW. An optional five-range converter has 1 mW maximum dissipation in unknown resistance.

Input impedance is potentiometric on lower ranges. Resolution of $10 \mu\text{V}$ per digit provides dynamic measurement range to 1000 V.

Internal plug-in modules provide auto-ranging multimeter and recorder output as well as other special functions. Isolated output in decimal or BCD format is available for digital data recording.

P&A: from \$5295; 30 days. Auto Data, 4812 Kearny Mesa Rd., San Diego, Calif. Phone: (714) 279-3020. TWX: (714) 279-0268.

Circle No. 274

Ballantine Model 440 Micropotentiometer

Rms reading meter

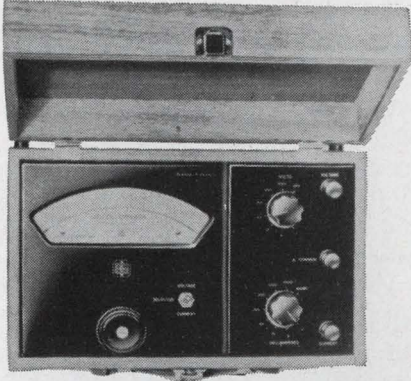

A volt-amp-watt meter features true rms readings. A "Transquare" solid-state transducer network has an output current proportional to the square of the instantaneous value of input voltage.

The ac, single-phase instrument has a current transformer to extend current and wattage ranges. Full-scale ranges are from 2.5 to 100 A, 25 W to 10 kW. Accuracy is $\pm 0.5\%$ to 1% full scale 30 Hz-15 kHz, power factor from unity to 50% lead and lag.

P&A: \$2250; 8-10 weeks. Greibach, 315 North Ave., New Rochelle, N. Y. Phone: (914) 633-7900.

Circle No. 277

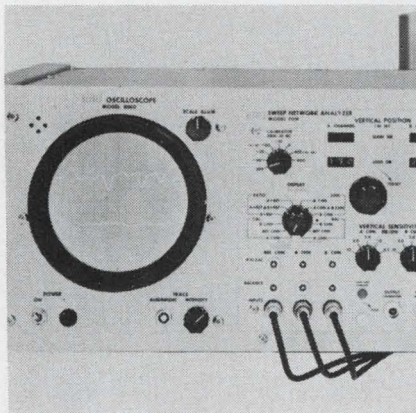

Power level/ratio meter

A 60 dB measurement range is provided by the 8000/7051 system for the measurement of gain, loss, absolute or relative power levels, vswr, and impedance magnitude. The instrument uses crystal detectors, compensated above the square-law region by internal circuitry. Accuracy is ± 0.3 dB at +20 dBm and ± 0.6 dB at -40 dBm.

P&A: \$1250; 30 days. Alfred Electronics, 3176 Porter Drive, Palo Alto, Calif. Phone: (415) 326-6496.

Circle No. 275

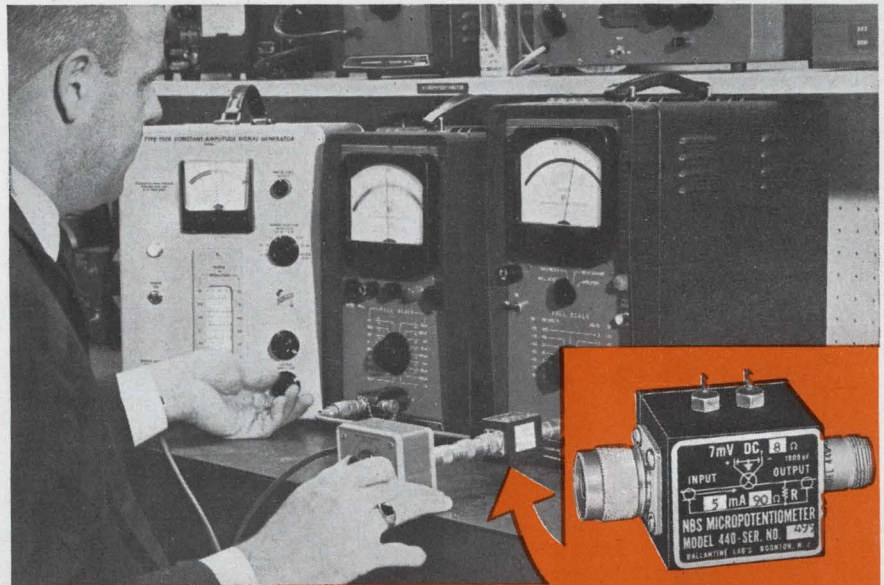

Model 440 Micropotentiometer being used to calibrate voltmeter on right

Calibrate your ac Voltmeters, Signal Generators & 'Scopes to 900 MHz

Ballantine's Model 440 Micropotentiometer provides a precisely determined voltage at its output terminal when 0 to 900 MHz current is fed into the input terminal. The input current flows through a UHF-type thermocouple to a radial resistor of known constant value. The voltage developed across this resistor becomes the standard which is used to calibrate electronic voltmeters, oscilloscopes, and other voltage-sensing devices.

USEFUL FEATURES:

Is simplest and most accurate method known to —

1. measure relative frequency responses of ac voltmeters and oscilloscopes.
2. measure absolute accuracy of ac voltmeters and oscilloscopes.
3. measure absolute accuracy of output of signal generators.

Model 440 units are available for use from 15 microvolts to 1.5 volts. Price: \$175 per resistor, plus \$75 per thermocouple housing assembly.

OTHER USEFUL BALLANTINE REFERENCE STANDARDS

Model 393 HF (High Frequency) Transfer Voltmeter

Measures accurately ac voltages of 1 to 100 V at frequencies from 25 Hz to 30 MHz. Accuracy is better than 0.1% up to 10 MHz and better than 0.5% to 30 MHz even without application of calibration data. Price: \$1270 with six probes.

Model 390 A-T (Attenuator-Thermoelement) Voltmeter

Laboratory standard device consisting of an adjustable waveguide-below-cut-off attenuator feeding a UHF vacuum thermocouple for measuring voltages from 0.5 V to 300 V (depending on frequency) from 1,000 MHz to 10 MHz. Price: \$2250

Write for brochures giving complete details

— Since 1932 —



BALLANTINE LABORATORIES INC.
Boonton, New Jersey

CHECK WITH BALLANTINE FIRST FOR DC AND AC ELECTRONIC VOLTMETERS/AMMETERS/OHM METERS, REGARDLESS OF YOUR REQUIREMENTS. WE HAVE A LARGE LINE, WITH ADDITIONS EACH YEAR. ALSO AC/DC LINEAR CONVERTERS, AC/DC CALIBRATORS, WIDE BAND AMPLIFIERS, DIRECT-READING CAPACITANCE METERS, AND A LINE OF LABORATORY VOLTAGE STANDARDS FOR 0 TO 1,000 MHz.

Speed Inquiry to Advertiser via Collect Night Letter

ON READER-SERVICE CARD CIRCLE 36

PULSE TRANSFORMERS

LARGEST SELECTION IN STOCK

- COUPLING
- MODULATION
- BLOCKING OSCILLATORS
- SINE WAVE OSCILLATORS
- HIGH POWER
- HIGH DC ISOLATION
- VOLTAGE GAIN
- SCR DRIVERS

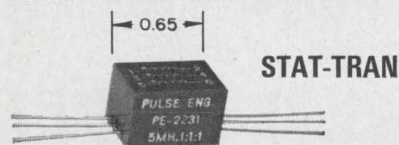
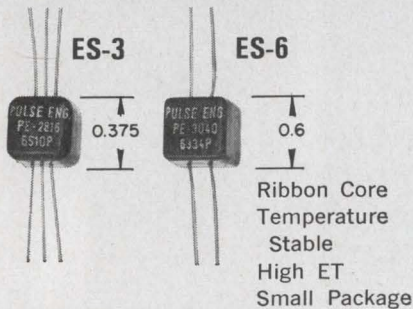

Ferrite C-I Core
Low Insertion Loss
Fast Recovery Time
Large Bandwidth
Electrostatic Shielding Available

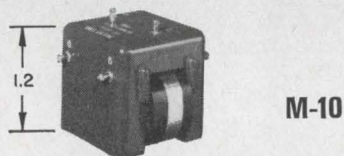

25 W AVERAGE
25 KW PEAK
15 KV HI-POT
3 IN³

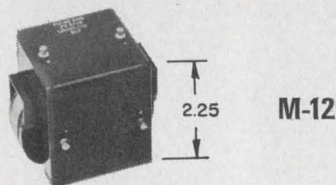

75 W AVERAGE
75 KW PEAK
25 KV HI-POT
12 IN³

SEND FOR COMPLETE CATALOG

560 Robert Avenue
Santa Clara, California
Phone (408) 248-6040

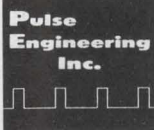

TEST EQUIPMENT Sweep generator



Model TH-200 wide-range sweep generator covers FM and VHF TV bands from 0.5 MHz to 230 MHz. The sweep width can be varied from 0.1 MHz to 230 MHz, and output is greater than 0.25 V rms. The unit accepts four plug-in single frequency or harmonic markers, has external marker input capability and an optional 0-70 dB turret attenuator.

P&A: \$525; 3 wks. Texscan Corp., 51 S. Koweba Lane, Indianapolis, Ind. Phone: (317) 632-7351.

Circle No. 276

Microwave power meter

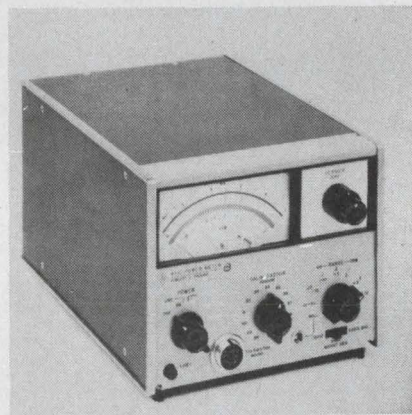

The model 431C microwave power meter gives direct readings. A knob automatically compensates the reading with a preset calibration. With the manufacturer's calibrated thermistor mounts and the 1% specified instrumentation accuracy, errors are considered in the readout, obviating calculations. All pertinent requirements of MIL-I-6181D are met.

P&A: \$475; 8 weeks. Hewlett Packard, 1501 Page Mill Rd., Palo Alto, Calif. Phone: (415) 326-7000.

Circle No. 278

Solid-state vswr meter



The Model 813T measures vswr reflection coefficients or relative attenuation as well as bolometer current. It can also be used for audio frequency null measurements with the addition of an external bridge circuit. Sensitivity is 0.1 μ V for full-scale at 40 Hz bandwidth and noise 5 dB below input. A selector switch allows operation at bands of 20, 40 or 400 Hz.

Price: \$325. Microlab/FXR. Livingston, N. J. Phone: (201) 992-7700.

Circle No. 279

Rack-mount oscilloscope

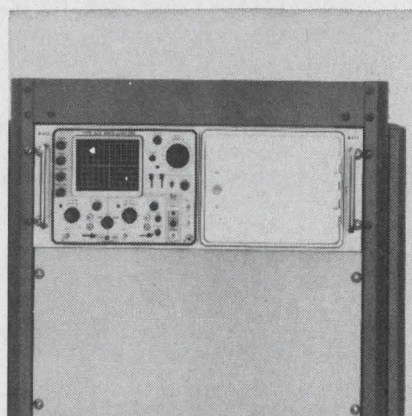

The new Type R422 scope consists of an ac-powered oscilloscope and the necessary mounting facilities, including a hinged-door compartment for accessories. Bandwidth is dc to 15 MHz with a dual-trace sensitivity of 10 mV/division. The 4-in. rectangular CRT has 8.2-in.² display area with internal illuminated graticule.

P&A: \$1400; first quarter of 1966. Tektronix, Inc., P. O. Box 500, Beaverton, Oregon. Phone: (503) 644-0161.

Circle No. 280

ON READER-SERVICE CARD CIRCLE 37

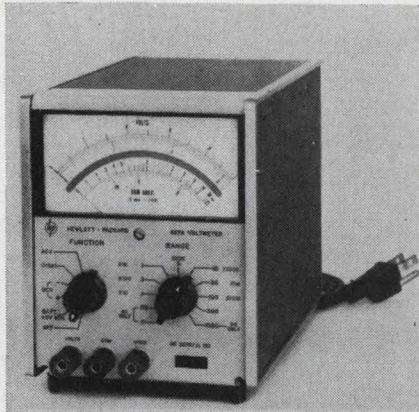

\$200 ac/dc VOM

A new volt-ohmmeter has solid-state circuitry, battery-power with an ac option, and a price under \$200. It is a dc voltmeter, and an ac voltmeter for 10 Hz to 1 MHz with $\pm 2\%$ full-scale accuracy. Ranges are ± 100 mV- ± 1000 Vdc, 10 mV-300 Vrms reading ac (1.11 times average), and 10 ohms center-scale to 10 Megs center-scale ($\pm 5\%$).

With 22.5V-dry cell power, "common" can be floated 500 Vdc off ground.

P&A: \$195, ac option adds \$25; stock. Hewlett-Packard, 1501 Page Mill Rd., Palo Alto, Calif. Phone: (415) 326-7000. *Circle No. 281*

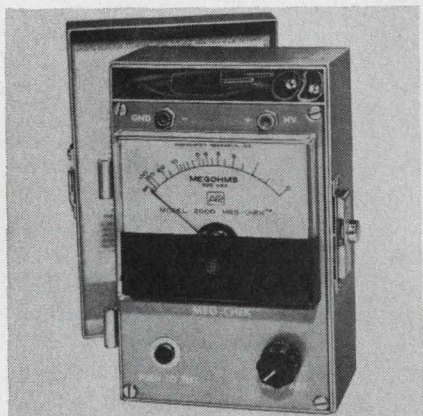

Compact megohmmeter

Weight of the Model 2000 Meg-Check is only 36 ounces. The instrument is housed in a welded steel case that measures only 5-3/4 x 4 x 2-3/4-in. Designed with push-button controls, it can measure resistances as high as 100 Meg at 500 Vdc. Power is taken from penlight cells housed within the unit and space is also provided for storage of two three-foot test leads.

P&A: \$95; stock. Associated Research Inc., 3777 W. Belmont Ave., Chicago, Ill. Phone: (312) 307-4040 *Circle No. 282*

NOW, Micro-Miniature

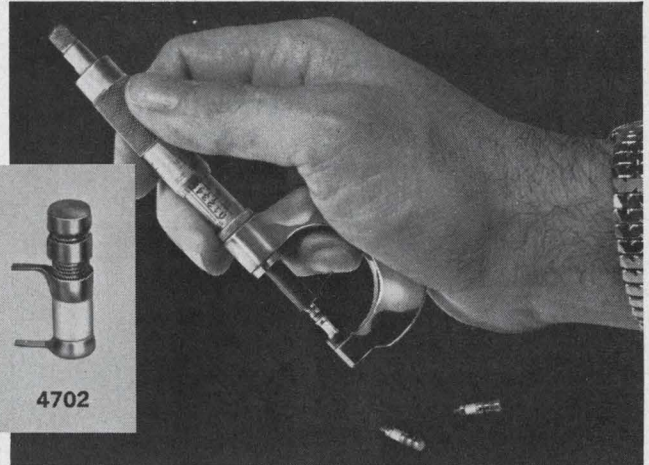
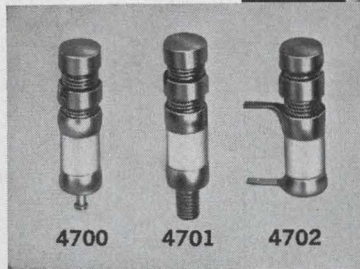

Highest Q Air Capacitors

- .140 in Diameter, 1/2" length
- Capacitance Range 0.35 pF to 3.5 pF
- Q @ 250 mc > 2000
- Finest Materials
- Q @ 100 mc > 5000
- Finest Workmanship

Write for full data

Johanson MANUFACTURING CORPORATION
400 Rockaway Valley Road, Boonton, N. J. Phone (201) DEerfield 4-2676

ON READER-SERVICE CARD CIRCLE 38

INNOVATION
INNOVATION
INNOVATION
INNOVATION

In
Electrical
Electronics
Engineering

- 80 Technical sessions, 300 papers — all at the New York Hilton
- 4 floors of exhibits — all at the New York Coliseum. Four days only — Monday - Thursday
- Gala IEEE Banquet—Wednesday, 7:15 p.m., New York Hilton Grand Ballroom — \$15.00
- Free shuttle busses between the Hilton and the Coliseum — every few minutes
- Registration — Members \$2.00 — Non-members \$5.00. Ladies \$1.00. Good for all days — Technical Sessions and Exhibits. In and out privileges.

EXHIBITS (4 days only)

Monday through Thursday
11:30 a.m. - 9:30 p.m.

NEW YORK COLISEUM

TECHNICAL SESSIONS

Monday through Friday
NEW YORK HILTON

MARCH 21-25, 1966

Students (over 14) accompanied by adult will be admitted to Exhibits Thursday only. \$2.00. (Not more than 3 per adult)



IEEE EXHIBITION

ON READER-SERVICE CARD CIRCLE 54

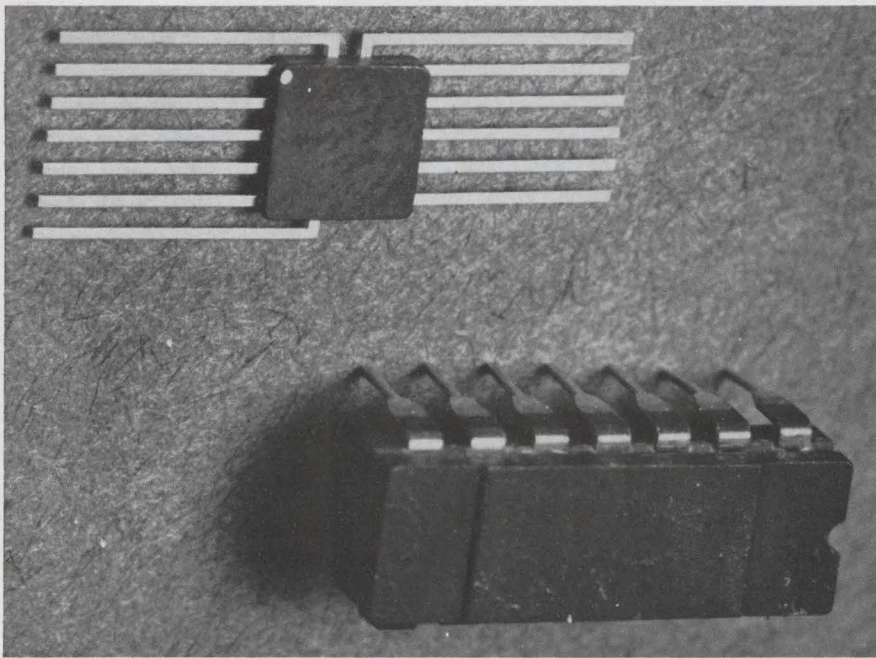

Integrated logic chips feature high-value resistors

This series of low-power logic chips includes a clocked flip-flop; a dual, 3 input NAND gate, and a dual, 3 input NAND gate with extender inputs (LPDT μ L 9040 through 9042, respectively).

These circuits have typical power drains of less than 1 mW per gate (50% duty cycle) for the gate elements, and less than 4 mW for the flip-flop, over the full military temperature range of -55° to $+125^{\circ}$ C. These low values were attained with typical values of resistors as high as 56 k planar epitaxial silicon devices, more than half-a-meg of resistance per chip.

Propagation delays of 60 ns are average for the logic gates. Typical clock-rate for the flip-flop is 2.5 MHz. The optimum single supply voltage for all units is +5 V, range is +4.5 to +5.5 V. A fan-out of 10 LPDT μ L or 1 standard DT μ L is specified over the entire temperature and supply voltage range, and noise immunity is guaranteed at a minimum of 450 mV at the temperature extremes. Emitter-follower outputs provide good capacitive drive capabilities.

The 9040 is a direct-coupled, dual-rank flip-flop which may be used in counters, shift-registers, and storage applications. Direct set and clear

inputs are provided, which override all other data inputs.

The 9041 and the 9042 are suitable for inverter applications and general logic-gate application. The 9042 has an extra input, allowing the user to increase the gate fan-in by adding on diode elements such as the DT μ L 9933, a 4-input extender package.

All of the devices are available in the flat-pack configuration, or a new dual in-line package.

P&A: \$24 (9040), \$20 (9041 and 9042) in 100 lots; stock. Fairchild Semiconductor, 313 Fairchild Dr., Mountain View, Calif. Phone: (415) 962-5011. TWX: (910) 379-6435. *Circle No. 283*

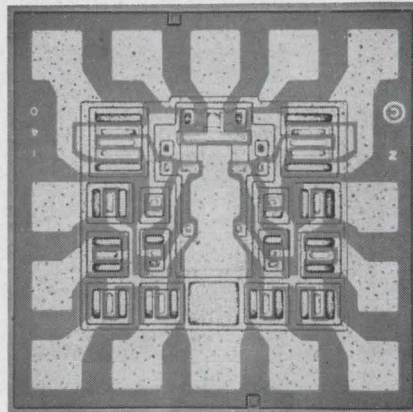

This silicon chip has more than half-a-Meg of resistance incorporated.

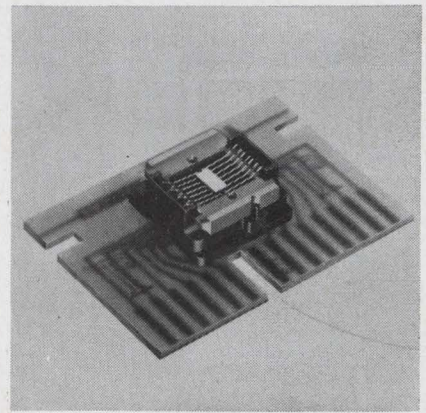

IC test socket

This integrated circuit test socket is designated Series 8104. It consists of a Mech-Pack connector soldered to a polarized printed circuit board. This permits testing of flat-packs in the T.I. Mech-Pack Carrier without the necessity of trimming the integrated circuit from the carrier.

The unit is available without a polarized edge connector.

P&A: \$3.10 to \$3.86, depending on quantity; 4-5 weeks. Augat Inc., 33 Perry Ave., Attleboro, Mass. Phone: (617) 222-2202.

Circle No. 284

VHF cascode microcircuit

A silicon planar integrated vhf cascode chip is available from England. Amplifier operation is possible at frequencies as high as 200 MHz with this circuit, type 316-04.

A unique circuit configuration provides extremely low internal feedback characteristics, thus allowing the elimination of neutralization techniques often necessary with vhf wideband-amplifier circuits.

Performance specifications for the microelectronic device include an operating frequency range of dc to 200 MHz with power gains of 17 dB at 100 MHz and 14 dB at 150 MHz. The circuit has a noise-figure of 5 dB at 100 MHz. Operational temperatures cover the -55° to $+125^{\circ}$ C military range, and maximum line-voltage is +25 Vdc. The unit is enclosed in a TO-5 header with an eight-pin configuration.

Available in production quantities from: Marconi Co. Ltd., Chelmsford, Essex, England. Phone: Chelmsford 3221—night phone: Chelmsford 57506.

Circle No. 285

Completely Automatic CAPACITANCE BRIDGE



*Just Insert a Capacitor...
and Read the Answer*

Direct Reading ... C and D (or G) indicated with decimal point and correct unit of measurement.

Fast ... measuring rates up to 2 per second ... works with scanner-type inputs.

Accurate ... $\pm 0.1\%$ of reading for C and G; $1\% \pm 0.001$ of reading for D.

Stable ... a true bridge whose accuracy depends only on passive standards and fixed transformer ratios and is independent of generator voltage variations and phase-sensitive-detector errors. Three-terminal configuration permits accurate remote measurements.

BCD Output ... BCD (1-2-4-2 code) for data processing and recording.

Wide Range

Frequency	120c/s	400c/s	1kc/s
Capacitance	0.0001 μ F to 1000 μ F 4 ranges	0.01pF to 100 μ F 7 ranges	0.01pF to 100 μ F 7 ranges
Conductance	1 μ S to 1S 4 ranges	0.1nS to 1S 7 ranges	0.1nS to 1S 7 ranges

Dissipation Factor: 0.0001 to 1.0 in one range

Automatic Capacitance Bridge Assembly Type 1680-A ... \$4850 in U.S.A.

If you think a 1680 Automatic Capacitance Bridge can save you time and money and improve accuracy, why not write or call us for a demonstration?



RCA Aerospace Systems Division, Burlington, Massachusetts, has responded to the Department of Defense's challenge to industry to attain new levels of product quality by instituting a company-wide Zero Defects program. For example, in their Purchased Materials Inspection Department, new test equipment has been installed to upgrade measurement techniques and accuracy. A GR Type 1680 Automatic Capacitance Bridge and Type 1137 Data Printer are now used for incoming inspection of capacitors, whereas a manually balanced bridge was previously used. Capacitance measurements were not only tedious and time-consuming, but were also subject to a considerable amount of human error. With the installation of the Type 1680 Automatic Bridge, a thirty-percent saving in time has been realized; accuracy has been increased ten times; and data is automatically and permanently recorded.

BOSTON • NEW YORK • CHICAGO • PHILADELPHIA • WASHINGTON, D.C.
SYRACUSE • DALLAS • SAN FRANCISCO • LOS ANGELES • ORLANDO
CLEVELAND • TORONTO • MONTREAL

GENERAL RADIO COMPANY (Overseas), ZURICH, SWITZERLAND
GENERAL RADIO COMPANY (U.K.) Ltd., BOURNE END, ENGLAND

GENERAL RADIO

WEST CONCORD, MASSACHUSETTS

ON READER-SERVICE CARD CIRCLE 215

Now twice as many

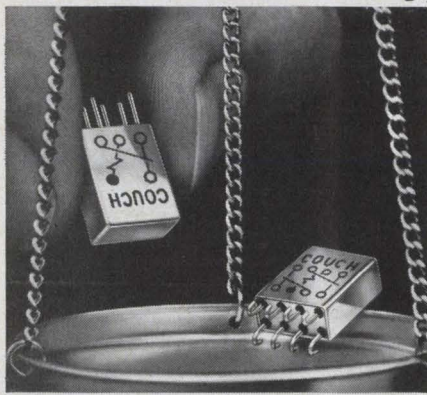

Couch 0.1 oz. rotary relays

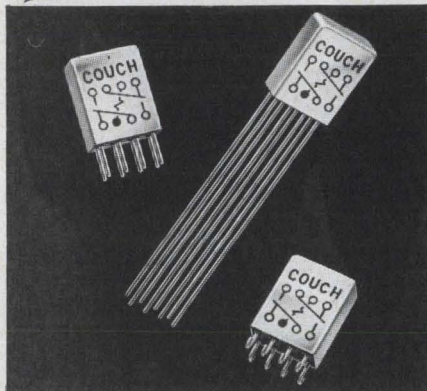

each available in
3 terminal styles . . .

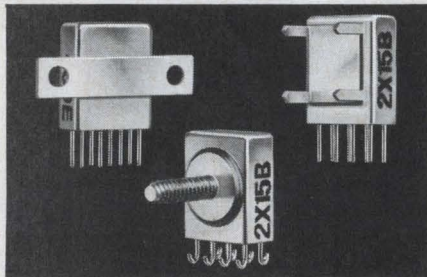

and in many mounting styles

We now offer a full line of SPDT relays, type 1X, to match our DPDT, type 2X, relay line. Except for coil data, specifications are identical for both types:

	2X	1X
Size	0.2" x .4" x .5"	same
Terminal Spacing	1/10" grid	same
Rating	0.5 amp @ 30 VDC	same
Coil Operating Power	150 mw	70 mw
Coil Resistance	60 to 4000 ohms	125 to 4000 ohms
Temperature	-65°C to +125°C	same
Vibration	20 G	same
Shock	75 G	same

Write for Data Sheets No. 9 and 10

RUGGED ROTARY RELAYS  Dynamically and Statically Balanced

COUCH ORDNANCE INC.

3 Arlington Street, North Quincy 71, Mass., Area Code 617,
Cypress 8-4147 A subsidiary of S. H. COUCH COMPANY, INC

ON READER-SERVICE CARD CIRCLE 39

SYSTEMS

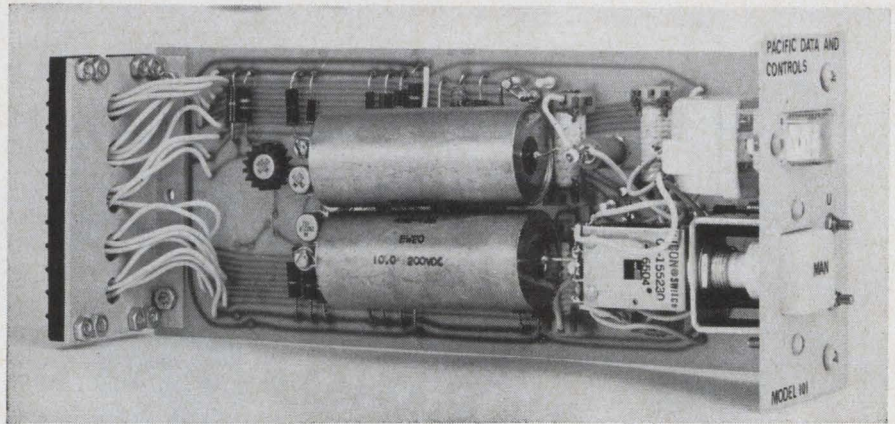

Sample-and-hold amplifier recalls analog inputs for hours.

Sample and Hold amplifier 101 memorizes its latest input values for hours after input is removed thus allowing manual control to be substituted without losing the original reference point, or preventing loss of data during loss-of-service. The 101 has a capacitance feedback amplifier arrangement performing the memory function at a cost considerably below competing devices.

Two modes of operation are offered: low-level, floating hold amplifier adjustable from 2.5 V down to 50 mV input full-scale using an optionally available adjustable preamp; and single-ended sample-and-hold giving 2.5 V full-scale. Higher line voltages can be handled by using voltage divider networks. Provision is made for switching to manual from automatic with no discontinuity in signal level and re-

turning to automatic with no discontinuity unless input signal has changed in the interim. Push-button switches and an output meter for the manual mode allow the signal level to be set to any point.

Output-currents are 1-5 mA into 3 kohm loads (floating) and 4-20 mA into 750 ohm loads (floating). The stability of the 101 is $\pm 0.5\%$ full-scale or 15°F temperature change up to 1 month, with power variations of $\pm 10\%$, amplifier non-linearity and hysteresis figured in.

Eight plug-in units can be mounted in a 3-1/2 x 19-in. rack. Compatible power supplies and preamplifier are available as matching modules. Battery power can be specified.

P&A: \$300; stock. Pacific Data and Controls, 4606 Foster, Portland Ore. Phone: (503) 281-6401.

Circle No. 286

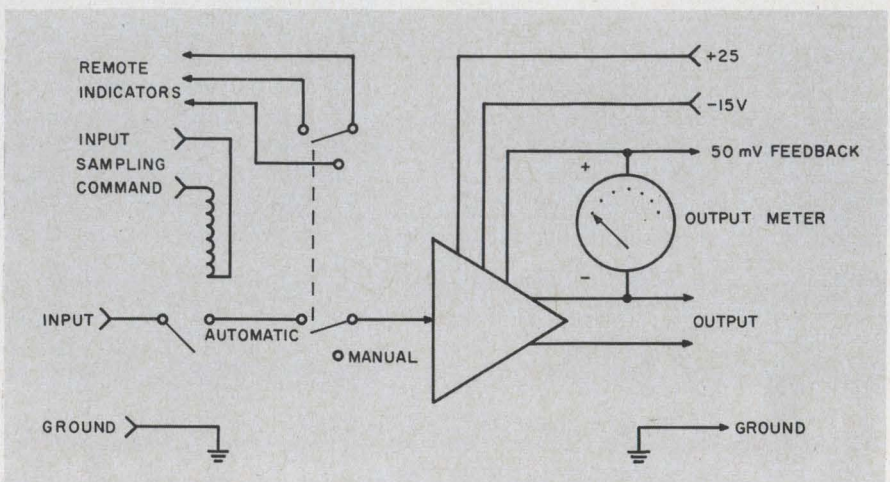

When input signal ceases, output remains at last level. Input restoration changes output only if signal has changed. Output meter and up/down controls are provided for the manual mode.

Delay-line amplifiers

Types A and B delay-line systems amplifiers for IF frequencies meet needs for wide dynamic range in the presence of high insertion-loss elements. Each channel requires a driver (type A) and a post amplifier (B). These amps have a 60 MHz center frequency, 30 MHz bandpass, and 25 ns pulse-response. Other frequencies can be ordered.

The type A amp provides 1-watt output for an element such as a delay-line. Type B maintains a low noise figure with a system dynamic range of 70 dB. Output for 1 dB compression is 250 mW and is variable over 15 dB without degrading amplitude or phase stability (± 0.25 dB and 2° rms). Gated units provide 60 dB min on/off ratio.

Available singly or in multi-channel systems, they are on printed-circuit glass-epoxy boards, RF connectors at the rear. A meter to show voltage and individual amplifier currents is in the systems package, as are blowers. Single units are conduction cooled. Isolation between channels is 120 dB min.

Specs include 30 dB min gain to 54 dB in type B, input Z of 50 ohms, and vswr of 1.25:1. Ripple is 0.5 dB, pulse rise- and fall-time (10-90%) is 25 ns. Over- and under-shoot with 0.1 μ s pulse is under 10% for A, 5% for B. Max power is 1 W and 250 mW for A and B respectively. Dynamic ranges are 85 and 70 dB, noise-figure is 12 and 6 dB, and power requirements are 260 and 170 mA for A and B respectively. Linearity is within 0.5 dB.

P&A: about \$550; stock. Aerospace Research, 130 Lincoln, Boston, Mass.

Circle No. 287

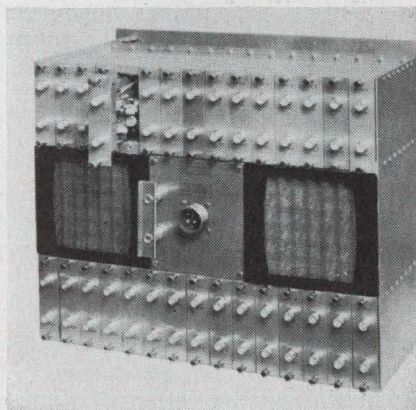

A 15-channel system (shown from rear) uses 15 'A' and 15 'B' amps.

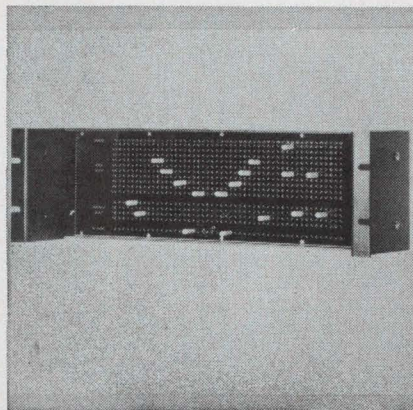

Program boards

These program boards protect pins from damage by recessing them in their relay-rack housing. Pin positions are variable from a maximum of three inches, down to flush with the rack.

The boards are designed for mounting in a 19-in. rack, and are available for selective switching, or multiple but discrete spst or spdt in non-matrix form.

Sealectro Corp., 225 Hoyt Ave., Mamaroneck, N. Y. Phone: (914) 698-5600. TWX: (710) 566-1110.

Circle No. 288

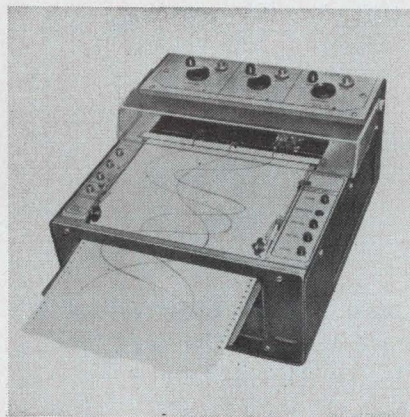

Computing recorder

Computing recorders B24X and B34X perform arithmetic calculation and integration.

B24X two pen, and B34X three pen 10-inch graphic recorders can be associated with the XB arithmetic computer, the XD integrating computer, and the XA arithmetic and integrating computer unit.

P&A: B24X-\$2500, B34X-\$3100, XB-\$390, XD-\$890, XA-\$1250; 45 days. Argonaut Assocs., P. O. Box K, Beaverton, Ore. Phone: (503) 292-3149.

Circle No. 289

Let Bulova solve your servo problems!



You've got more important things to do.



Bulova makes servo products faster, better, and at less cost than anyone! It's our business.

Don't take your engineers off vital programs to home-brew! Developing your own electronic components to meet servo system requirements wastes time, money and key men, while chances are Bulova's group of engineering specialists have already tackled—and solved—a problem similar to yours.

Bulova offers a full line of solid-state electronic servo products—off-the-shelf or custom designed: servo amplifiers • resolver booster ampli-



fiers • modulators • demodulators • quadrature rejection amplifiers • pre-amplifiers • isolation amplifiers • variable-gain amplifiers • two-speed switching amplifiers • DC torquer amplifiers.

What's more, you get prototypes as fast as you need them, and production units to your schedule! Write for complete specifications. Address: Dept. ED-18

BULOVA

SERVO PRODUCTS

ELECTRONICS DIVISION
OF BULOVA WATCH COMPANY, INC.

61-20 WOODSIDE AVENUE
WOODSIDE, N.Y. 11377, (212) DE 5-6000
ON READER-SERVICE CARD CIRCLE 40



1000_{vdc} STANDARD*

COMPARE
performance
... value

EDC's High Voltage Reference Source Model VS-1000-NR, is the only all-solid-state high precision printed circuit 6-decade dc portable standard with . . .

- Absolute Accuracy $\pm 0.01\%$ or ± 1 mv (NBS traceability)
- Output Voltages ± 1111.110 vdc (full scale)
- Stability $\pm 0.001\%$ (short term — 8 hrs)
- Output Current 10 ma
- Delivery from stock
- Price \$995

Model VS-1000-NR has: automatic recovery . . . short-circuit and overload protection . . . output as well as measuring capability . . . direct reading . . . ready to use within 30 sec (no balancing or zeroing). Designed for production line and laboratory applications — for use as a voltage source and a potentiometer measuring device. Fits standard rack, weighs only 20 pounds, guaranteed for one full year including calibration and stability.

*Other models from 1 μ volt.

**ELECTRONIC
DEVELOPMENT
CORPORATION**



423 WEST BROADWAY • BOSTON 27, MASSACHUSETTS
Tel: 617 268-9696

ON READER-SERVICE CARD CIRCLE 41

Application Notes

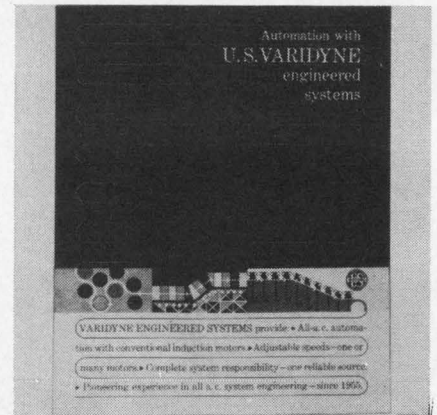

Automation notes

Problem solutions across a broad range of industries are discussed, illustrated, and diagrammed. Examples of variable frequency power control of two-conveyor synchronization and material transfer are given. All systems application data are analyzed in the light of the manufacturer's co-ordinated speed control motor drive accessories. U.S. Electrical Motors.

Circle No. 251

Reliability design

A 33-page book consists of a discussion of reliability. What is it and how is it measured, designed, and obtained. Terms are defined and extensive use is made of tables, graphs, and nomographs. Avco-Electronics Div.

Circle No. 252

Ultrasonic delay lines

A 24-page reprint of a paper entitled "A Survey of Ultrasonic Delay Lines Operating Below 100 Mc/s" is available.

Types of delay lines in use are described, their limitations noted, and design considerations outlined. Attention is given to recently evolved dispersive lines suitable for radar pulse compression systems.

Wave diagrams, graphs, oscilloscope patterns, schematics, illustrative drawings, and photographs of devices assist the reader. Andersen Labs.

Circle No. 253

Advertisers' Index

*PARTICIPANTS IN NIGHT LETTER PROGRAM

Allen-Bradley Co.	89
*Ampere Electronic Corporation	50, 51
*Arnold Engineering Company, The	19
Automatic Electric, A Subsidiary of	
General Telephone & Electronics	4, 5
Automatic Metal Products Corporation ..	90
*Ballantine Laboratories, Inc.	93
Bendix Corporation, The	102
Bulova Electronics Division of	
Bulova Watch Company, Inc.	99
*Clevite, Brush	
Instruments Division	Cover III
Couch Ordnance, Inc.	98
*Damon Engineering, Inc.	22
ESI/Electro Scientific Industries Inc.	87
*Electro-Mechanical Research, Inc.	101
Electronic Development Corporation	100
Electronic Design	58, 102
Fairchild Semiconductor, A Division	
Fairchild Camera and Instrument	79
Corporation	
General Electric Company, Electronic	
Components Division	28
General Radio Company	97
Gudebrod Bros. Silk Co., Inc.	31
Hayden Book Company, Inc.	65
Hayden Publishing Company, Inc.	102
Hengstler Numerics, Inc.	64
Hewlett-Packard	1, 23
Hoffman Electronics	7
IEEE	95
*IRC, Inc.	6
Indiana General Corporation	9
International Diode Corp.	55
*JFD Electronics Corporation	85
*James Electronics, Inc.	24
Johanson Manufacturing Corp.	95
Kay Electric Company	82
*Leach Corporation	15
Mallory Controls Company	25
Mullard Ltd.	27
Philbrick Researches, Inc., George A.	59
Princeton Applied Research Corp.	16
Pulse Engineering, Inc.	94
RCA Electronic Components and	
Devices	Cover IV
Rutherford Division of CMC	2
Sanders Associates, Inc.	8
Self Organizing Systems, Inc.	86
Simpson Company, Edwin B.	81
Simpson Electric Company	32A-L, 33
Sprague Electric Company	10, 12, 20
TRW Semiconductors	34
Texas Instruments Incorporated, Semi-	
conductors-Components Division	44, 45
Towne Laboratories Inc.	55
Tracor, Inc.	104
*Union Carbide Corporation	36
United Transformer Corp.	Cover II
*Victoreen Instrument Company, The ...	91
Wakefield Engineering, Inc.	81
Wood Electric Corporation	103

Regional Advertising

Burndy Corporation	64C
*Dale Electronics, Inc.	64A
*Magnetics, Inc.	64B
Sorensen, A Unit of Raytheon Company ..	64D

Career Advertising

Aerojet General	68
General Electric Co.	
Television Receiver Dept.	77
Hughes Aircraft Company	
Aerospace Divisions	69
Lockheed Missiles & Space Company ...	70
Los Alamos Scientific Laboratory of the	
University of California	74
Motorola Military Electronics Division ..	72
Pan American World Airways, Inc.	71
Sanders Associates	73

EMR introduces Constant-Delay Filters for Precision Data Systems

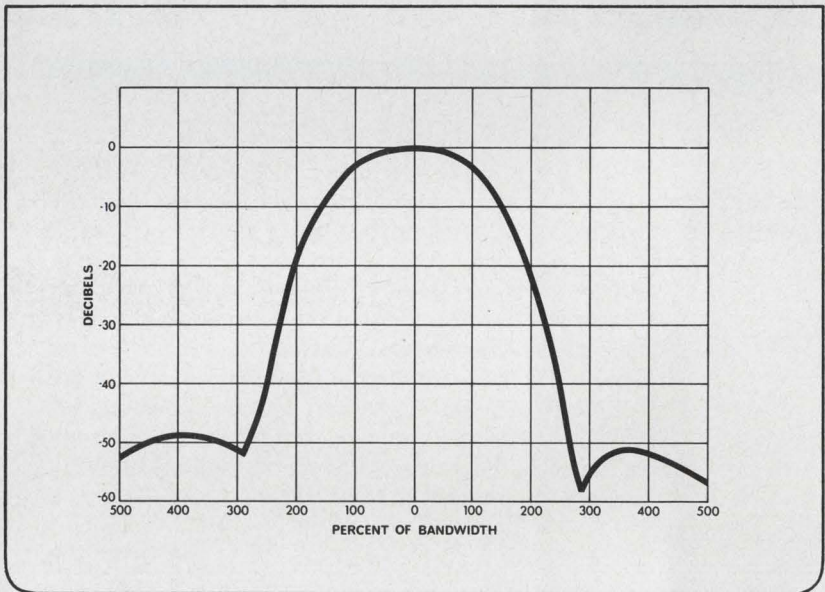
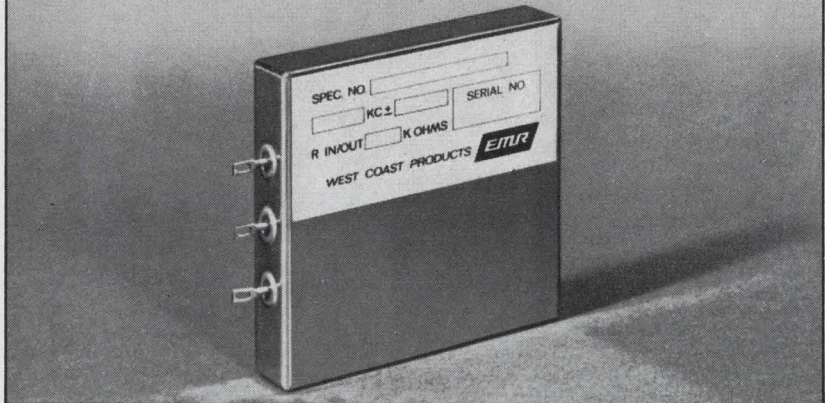

(A) FOR PRECISION AM OR FM DATA COMMUNICATIONS. (B) DELAY VARIATION $\leq \pm 1^\circ$ IN PASSBAND. (C) MINIATURE, < 4 CU. INCHES. (D) HIGHEST SELECTIVITY, 40 DB ATTENUATION AT 2.67 TIMES BANDEDGE.

SPECIFICATIONS

Center Frequency: 400 Hz - 1.0 MHz at $\pm 2.5\%$ - $\pm 45\%$ bandwidth.	Time Delay Variation: $\pm 3.5\%$ of nom. in passband.
Rolloff: 3 db at bandedges; 40 db at 2.67 times bandedge.	FM Harmonic Distortion: $< 1\%$ at mod. index = 2.
Time Delay (ms): 0.8/bandwidth (bw in kHz).	

Send for free brochure



WEST COAST PRODUCTS
ELECTRO-MECHANICAL RESEARCH, INC.
15551 Cabrito Road • Van Nuys, California

Design Data from Manufacturers

Advertisements of booklets, brochures, catalogs and data sheets. To order use Reader-Service Card.

(Advertisement)

New Particle And Photon Detectors



New Bendix Catalog describing three magnetic electron multipliers and accompanying power supply is now available. Bendix electron multipliers are rugged, miniature detectors with many applications in photon, ion, and neutral-particles radiation measurement. Three models . . . each with a different configuration to meet specific size and space requirements. Also featured is the compact, convenient Power Supply that is designed specifically for the electron multipliers.

The Bendix Corporation
Cincinnati Division
3625 Hauck Rd., Cincinnati, O. 45241

171

How To Write Technical Articles



A guide for the engineer-author, "How to Write Articles for Electronic Design" shows how easy it is to write for publication—once the engineer knows what to write and how to write it. The Author's Guide includes a complete run-down of the types of articles published by Electronic Design—plus detailed instructions on how to prepare technical articles and short special features. A MUST for every "would-be-writer" in the electronics industry. Send for your complimentary copy by circling the number to the right.

Electronic Design
850 Third Avenue
New York, N.Y. 10022

172

Test Equipment Reference Data

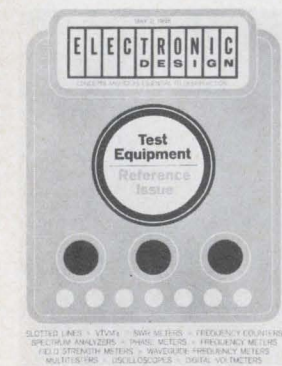

ELECTRONIC DESIGN'S Test Equipment Reference Issue covers 12 important classes of test instruments. Included are complete up-to-date specifications for approximately 2500 off-the-shelf test instruments, arranged for quick and easy reference and comparison, and cross indexed by product category and manufacturer's name. Technical data prepared from the Directory of Technical Specification/Electronic Test Instruments, by Technical Information Corporation. Twelve application-oriented articles by industry experts complete the package. Price \$5; check or money order must accompany order.

Hayden Publishing Company, Inc.
850 Third Avenue
New York, New York 10022

Reprints Available

The following reprints are available free and in limited quantities. To obtain single copies, circle the number of the article you want on the Reader-Service Card.

*High Volume-Low Cost:
Designers Challenge* (No. 740)

*Guidelines for Selecting Laser
Materials* (No. 741)

First Aid for Ailing Speakers
(No. 742)

*A Quick Way to Find Radar
Range* (No. 743)

*Which Device for High Power
Switching Part 1* (No. 744)

*Which Device for High Power
Switching Part 2* (No. 745)

*Improve Device Reliability with
Physics of Failure Techniques* (No.
746)

*Comparing the Three Most Pop-
ular Temperature Sensors* (No. 747)

*A Design Approach to Transis-
torized Voltage Controlled Crystal
Oscillators* (No. 748)

*A New Tool for Easier Network
Synthesis* (No. 749)

*Harmonic Generators: Is the Step
Recovery Diode Best* (No. 750)

*Simple IC Tester Handles Proto-
type Quantities* (No. 751)

Subscription Policy

ELECTRONIC DESIGN is circulated free of charge to qualified design engineers in the U.S., Western free Europe and England. To establish your qualifications, send ELECTRONIC DESIGN the following information on your company's letterhead: Your name, engineering title, description of your design duties and a list of your company's major products. The letter must be signed by you personally.

Subscription rates for nonqualified subscribers—\$25.00 per year in U.S.A., \$35.00 in all other countries. Single copy, \$1.50.

Change of Address

An address change for a subscriber requires a restatement of his qualifications. To expedite the change, and to avoid missing any issues, send along a label from a back copy.

Microfilm copies of all 1961, 1962, 1963 and 1964 issues of ELECTRONIC DESIGN are available through University Microfilms, Inc., 313 N. First Street, Ann Arbor, Mich.

ELECTRONIC DESIGN

Electronic Design

Advertising Representatives

New York 10022

Robert W. Gascoigne
Thomas P. Barth
George W. Fleck
John F. Gilbert, Jr.
Rick Brough
850 Third Avenue
(212) PLaza 1-5530
TWX: 867-7866

Philadelphia 19066

Fred L. Mowlds, Jr.
P. O. Box 206
Merion Station, Pa.
(215) MO 4-1073

Marblehead 01945

Richard Parker
7 Redstone Lane
(617) 742-0252

Chicago 60611

Thomas P. Kavooras
Berry Conner, Jr.
720 N. Michigan
(312) 337-0588

Cleveland 44107

Robert W. Patrick
8410 Treetower Drive
Chagrin Falls, Ohio
(216) 247-7670

Los Angeles 90005

Stanley I. Ehrenclou
Terrence D. Buckley
W. James Bischof
2930 W. Imperial Highway
Inglewood, Calif. 90303
(213) 757-0183

San Francisco 94306

Ashley P. Hartman
541 Del Medio
Suite #301
Mountain View, Calif.
(415) 327-6536

Southwestern 75235

Tommy L. Wilson
6200 North Central Expressway
Dallas, Tex. 75206
(214) EMerson 1-2311

London W. 1

Brayton C. Nichols
44 Conduit Street

Tokyo

Yoshihiro Takemura
International Planning
Service, Inc.
Room No. 512 Nikkoh
Mita Building
1, Nishidaimachi, Shiba-
Takanawa
Minato-ku, Tokyo



Visit us IEEE Show — Booth No. 2J45



WOOD ELECTRIC

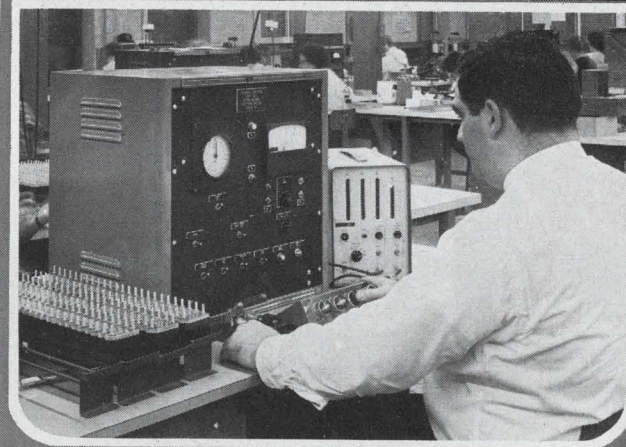

When the specs say ...
"Must trip instantly
regardless of temperature"

You can depend on us!

The above photograph shows Magnetic Circuit Breakers being calibrated to trip in less than 15 milliseconds at 120% of rated current. Other Magnetic types are adjusted to trip between 15 and 70 seconds at 125% and 150% of rated current. All Magnetic types will hold 100% of rated current indefinitely and operate at calibrated trip settings regardless of ambient temperatures.

There are other specs and other tests, lots of them, but they all have one purpose in common — to assure the most reliable performance in the industry. If it's by Wood Electric — you can depend on it!

Wood Electric also manufactures a complete line of Thermal Circuit Breakers with trip times from 0.5 to 90 seconds. Choose from a wide variety of proven commercial and military type Circuit Breakers to meet the specific needs of your application. Models are available with ratings from ½ to 50 amps . . . AC or DC . . . single pole, two pole and three pole.

Write for Circuit Breaker Catalog CB-10-65



WOOD ELECTRIC CORPORATION

244 Broad St. Lynn, Massachusetts (617) 598-5313

ON READER-SERVICE CARD CIRCLE 43

*Specifying
Miniature Low Frequency
Oscillators*

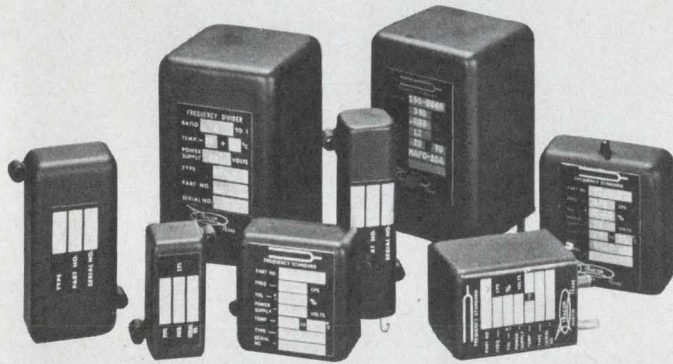

TRACOR miniature and subminiature tuning fork oscillators allow cost savings by operating in the audio frequency range from 360 cps to 20 kc/s. They provide high frequency stability (from $\pm 0.2\%$ to $\pm 0.001\%$) without heaters, are rugged mechanically (to 30 G's or more shock and vibration), and are as small as .5 cubic inches in size and as low as 2 ounces in weight. They fall within a temperature range of $-60^{\circ}\text{C}+100^{\circ}\text{C}$. For information telephone 512-926-2800 or write TRACOR, Inc., 6500 Tracor Lane, Austin, Texas 78721.

**Visit Both TRACOR Exhibits
IEEE SHOW
Systems and Instruments, Booth 3K42
Components, Booth 4A46**



COMPONENTS DIVISION

REPRESENTATIVES IN PRINCIPAL CITIES
ON READER-SERVICE CARD CIRCLE 44

Designer's Datebook

MARCH						
S	M	T	W	T	F	S
		1	2	3	4	5
6	7	8	9	10	11	12
13	14	15	16	17	18	19
20	21	22	23	24	25	26
27	28	29	30	31		

APRIL						
S	M	T	W	T	F	S
					1	2
3	4	5	6	7	8	9
10	11	12	13	14	15	16
17	18	19	20	21	22	23
24	25	26	27	28	29	30

March 21-25

IEEE International Convention (New York) Sponsor: IEEE; The IEEE, 345 East 47th St., New York, N. Y.

April 12-15

International Quantum Electronics Conference (Phoenix) Sponsors: AIP/IEEE; Dr. J. P. Gordon, Bell Telephone Laboratories, Murray Hill, N. J.

April 17-20

International Conference on Electron and Ion Beam Technology (New York) Sponsors: AIME and Electrochemical Society; Metallurgical Society of AIME, 345 East 47th St., New York, N. Y.

April 18-20

Symposium on Process Automation (Newport Beach, Calif.) Sponsors: Beckman Instruments, Consolidated Electrodynamics, Control Data, SDS Data Systems; Dr. William Biles, Shell Development Co., Houston, Tex.

April 20-22

1966 Intermag (International Conference on Magnetism) (Stuttgart, Germany) Sponsor: IEEE G-Mag; Dr. E. W. Pugh, IBM Corp., 1000 Westchester Ave., White Plains, N. Y.

April 25-28

Audio Engineering Society Convention (Los Angeles) Sponsor: Audio Engineering Society; John C. Baumann, Ampex Corp., 8467 Beverly Boulevard, Los Angeles, Calif.

April 26-28

Spring Joint Computer Conference (Boston) Sponsors: AFIPS, IEEE, ACM; Dr. Harlan Anderson, Digital Equip. Corp., Maynard, Mass.

Another Brush Innovation in Recording:

The Brush Mark 280.
Once you've seen
it work,
the chain makes
a lot of sense.

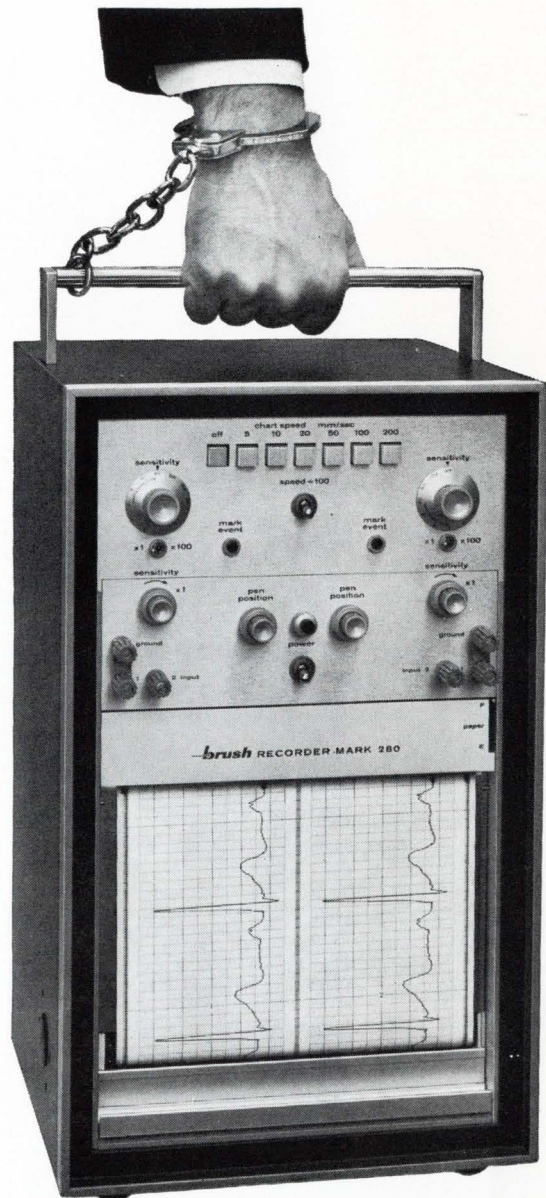

People who use the Brush Mark 280 can get pretty possessive.

No wonder.

True rectilinear traces so crisp and clear you'll never miss the message. Dual recording channels a full 80 millimeters wide. Resolution the likes of which you've never seen. A pressurized inking system. Metri-site pen positioning. Low cost chart

paper. Pushbutton choice of 12 chart speeds. Solid state electronics. Response as high as 200 cps at useable amplitude and better than 30 cps full scale. System accuracy of $\frac{1}{2}\%$!

And now get set for the big surprise: the performance-packed Brush Mark 280 measures just $10\frac{1}{2}'' \times 18\frac{3}{8}'' \times 11\frac{1}{2}''$!

Search no more for a full perform-

ance portable. No one *but no one* has anything to compare with the amazing Mark 280. Ask your Brush representative for a demonstration. Or write today for our free booklet. Brush Instruments Division, Clevite Corporation, 37th and Perkins, Cleveland, Ohio 44114.

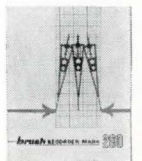

CLEVITE

brush INSTRUMENTS DIVISION

Speed Inquiry to Advertiser via Collect Night Letter
ON READER-SERVICE CARD CIRCLE 243



**NEW
RCA
SILICON...
2N4036
2N4037**

- audio output drivers
 - saturated switches
 - complementary core driver circuitry
 - low-level complementary audio output
 - series regulator pass transistor drivers
- available in production quantities for under a dollar***

Now, meet your total circuit design needs with 2N4036 and 2N4037—new silicon p-n-p transistors from RCA in the popular TO-5 package. Geared toward applications requiring negative polarities, these two units are the first of a series of versatile p-n-p transistors designed to complement RCA's famous "universal" 2N2102 family.

RCA's 2N4036 and 2N4037 are new p-n-p epitaxial planar silicon transistors for simplifying circuitry. In many designs, you can now replace two n-p-n types with one p-n-p, or eliminate an inverter, transformer, or phase transformer stage.

Capable of delivering 1 watt free air, or 7 watts with heat sink at 25°C, these p-n-p transistors neatly fill the design gap for predriver/driver, medium power, and small signal applications with high heat dissipation capability. And for this performance, you can't beat the price—under a dollar in quantity.

See your RCA Representative for details on 2N4036 and 2N4037. For technical data sheets, write: RCA Commercial Engineering, Section 1G3-1, Harrison, N.J.

MAXIMUM RATINGS		
	2N4036	2N4037
V_{CB0}	-90V	-60V
V_{CE0}	-65V	-40V
V_{EB0}	-7V	-7V
I_c	-1.0A	-1.0A
θ_{J-C}	25° C/W	25° C/W

*\$.98 and \$.79 each for 2N4036 and 2N4037, respectively, in quantities of 1000 and up.

Also Available from your RCA Distributor

RCA Electronic Components and Devices



The Most Trusted Name in Electronics

ON READER-SERVICE CARD CIRCLE 244

VISIT RCA AT IEEE.
SEE WORLD PREMIERE OF
"THE OVERLAY TRANSISTOR,
THE CHALLENGE AND THE ANSWER."
RCA BOOTHS 1F04-1F10, 1G03-1G11.