

EDN[®]

FPGA vendors race to upgrade products pg 57

Micropower op amps pg 79

Logic-synthesis tools speed ASIC designs pg 97

Designers' guide to real-time Ada—Pt 2 pg 151

ELECTRONIC TECHNOLOGY FOR ENGINEERS AND ENGINEERING MANAGERS

PC Unix transparently supports networking and graphics pg 132

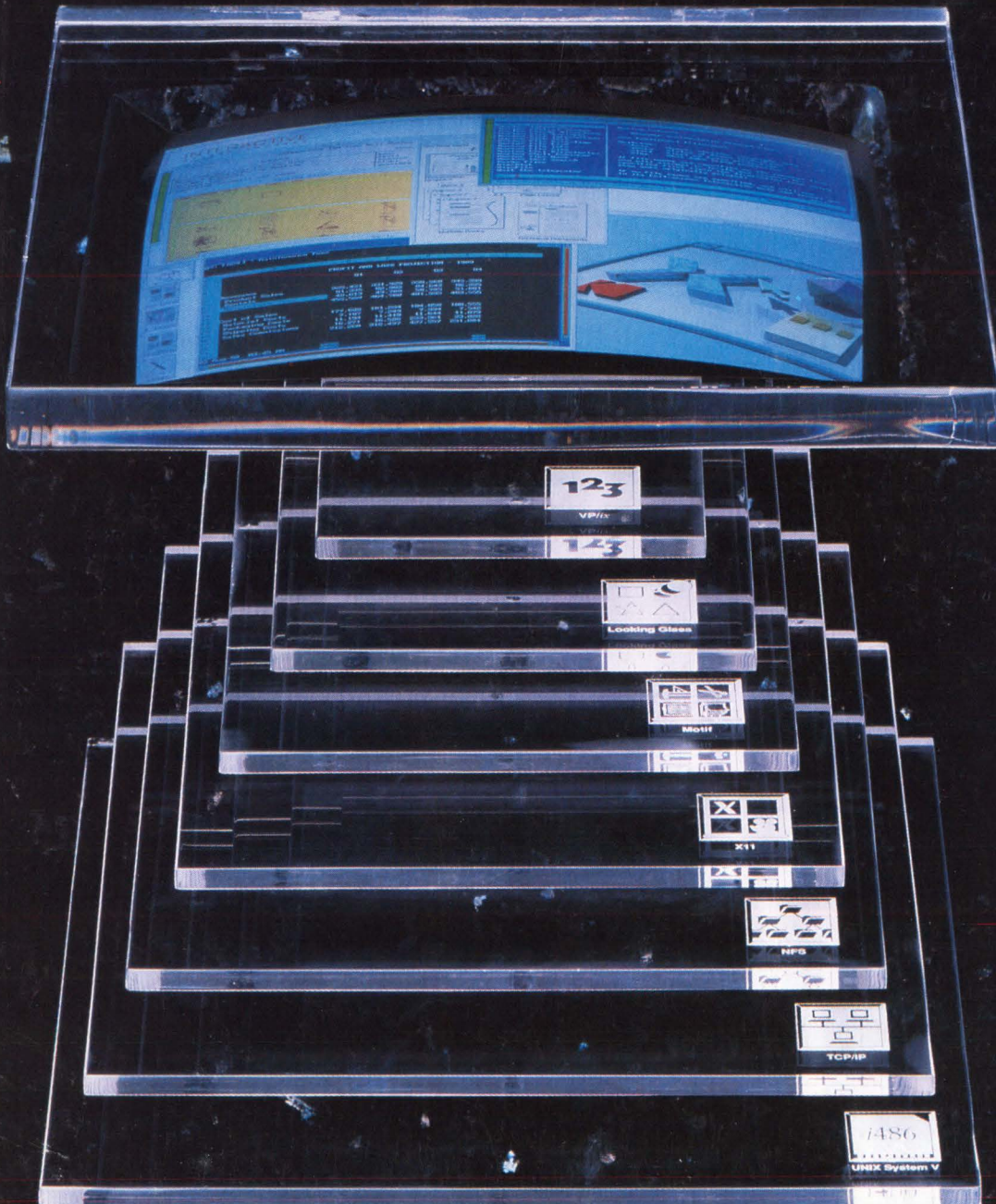

Rad-Hard Made Easy.

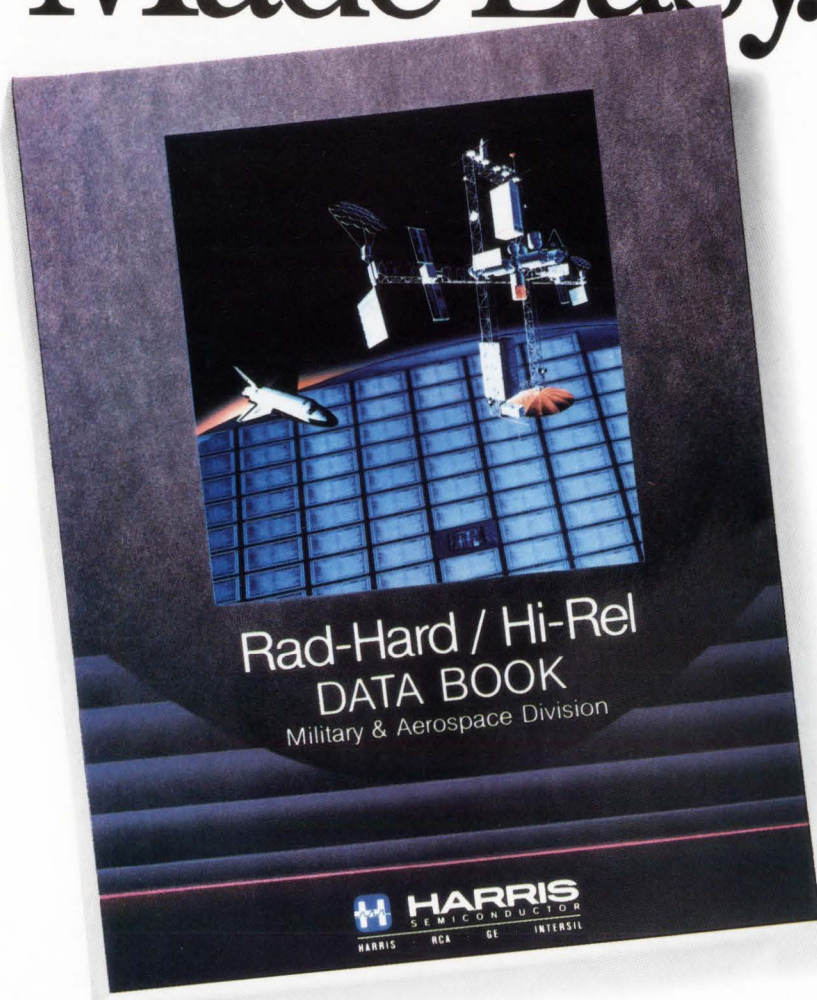

Harris Semiconductor has written the book on high-rel. Our new Rad-Hard and Hi-Rel Data Book. It's 900+ pages of highly-reliable information on the world's leading hi-rel products—in both IC and Power technologies.

So get your hands on a copy today. Just call 1-800-4-HARRIS, ext. 1018, or return the coupon to Military and Aerospace Division, Harris Semiconductor, P. O. Box 883, M/S-53-175, Melbourne, FL 32902.

Send me the Harris Rad-Hard and Hi-Rel data book today.

Name _____

Title _____ Company _____

Address _____ Phone _____

City _____ State _____ Zip _____

To: Military and Aerospace Division, Harris Semiconductor, P. O. Box 883, M/S-53-175, Melbourne, FL 32902.
Call 1-800-4-HARRIS, Ext. 1018.

 **HARRIS**
SEMICONDUCTOR
HARRIS · RCA · GE · INTERSIL

EDN091790

Introducing the new VISHAY



Vishay Intertechnology has become a worldwide supplier of resistive devices, stress measurement products and complementary passive components. Now this resource — perhaps unmatched in scope and depth — is identified by a new symbol. It represents the unity and synergy available to you through a network of respected companies organized into four major business units in the electronic components industry

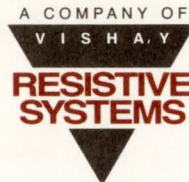

and the Measurements Group in the field of stress measurement.

Today, Vishay, individually and as a whole, is committed to concentrating on areas where our resources, technical expertise, marketing and distribution skills can best interface with your business plan. To find out more, write for a copy of our new Corporate Profile, c/o Vishay Intertechnology, Inc., Corporate Marketing Communications, 63 Lincoln Highway, Malvern, PA 19355-2120. U.S.A.

Dr. Felix Zandman
Chairman and Chief Executive Officer
Vishay Intertechnology, Inc.

High-Speed Amplifiers

WB05

CURRENT
BUFFER

- ▶ 10,000 V/ μ s Slew Rate
- ▶ 1 Amp Output (1.5 A Pulse)
- ▶ ± 5 to ± 15 Supply
- ▶ 70 MHz Full Power Bandwidth
- ▶ Up To 15 Watts Dissipation

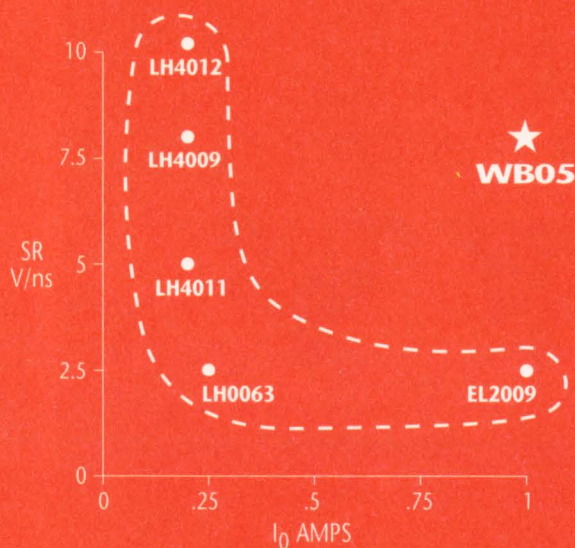

WA01

TRANSIMPEDANCE
AMPLIFIER

- ▶ 4,000 V/ μ s Slew Rate
- ▶ 400 mA Output
- ▶ ± 12 to ± 15 Supply
- ▶ 40 MHz Full Power Bandwidth
- ▶ Up To 10 Watts Dissipation

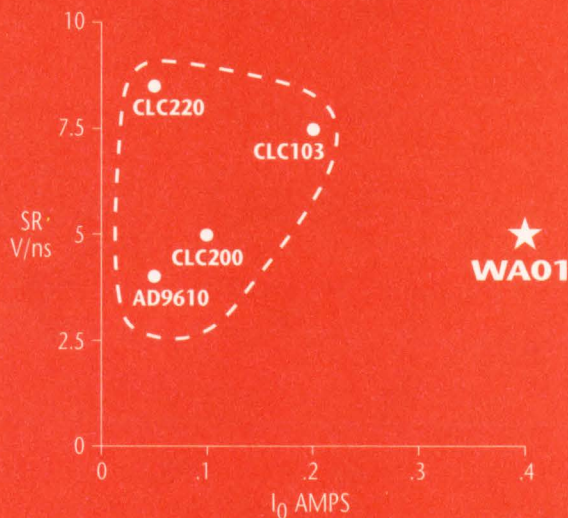

APPLICATIONS

LASER DIODE DRIVERS
SONAR TRANSDUCER DRIVERS
PIN DRIVER

LASER DIODE DRIVERS
VIDEO AMPLIFIERS
WAVEFORM GENERATORS

To Place An Order Call
602-742-8601

For Applications
Assistance Call
1-800-421-1865

APEX
μtech

DEDICATED TO EXCELLENCE

APEX
MICROTECHNOLOGY
CORPORATION



To receive
your copy of our
High Performance
Amplifier Handbook
please call toll free
1-800-448-1025

SPDT & SP4T SWITCHES

WITH BUILT-IN DRIVERS



10 to 3000MHz from \$39⁹⁵

Now, high-speed, high-isolation switches with built-in drivers, tough enough to pass stringent MIL-STD-202 tests. There's no longer any need to hassle with the complexities of designing a TTL driver interface and then adding yet another component to your subsystem... it's already included in a rugged, low-cost, compact assembly.

Available in the popular hermetically-sealed TO-8 package or a small EMI-shielded metal connectorized case, these tiny PIN-diode reflective switches, complete with driver, can operate over a 10 to 3000MHz span with a fast 2μsec switching speed.

Despite their small size, these units offer isolation as high as 40dB(typ), insertion loss of only 1.1dB(typ), and a 1dB compression point of +27dBm over most of the frequency range. All models are TTL-compatible and operate from a dc supply voltage of 4.5 to 5.5 V with 1.8mA quiescent current.

Switch to Mini-Circuits for highest quality innovative products... and leave the driving to us.

SPECIFICATIONS

Freq. Range(MHz)	TOSW-230 ZSDR-230		TOSW-425 ZSDR-425	
	typ.	max.	typ.	max.
10-100MHz	1.3	1.9	1.3	1.7
100-1500MHz	1.1	1.9	1.1	1.7
1500-3000MHz	1.8	2.7	1.8	2.5
Isolation(dB)	typ.	min.	typ.	min.
10-100MHz	60	40	60	40
100-1500MHz	40	28	40	30
1500-3000MHz	35	22	35	22
1dB Compression(dBm)	typ.	min.	typ.	min.
10-100MHz	17	6	17	6
100-1500MHz	27	19	27	19
1500-3000MHz	30	28	30	28
VSWR(ON)	typ.	max.	typ.	max.
	1.3	1.6	1.3	1.6
Switching Time (μsec) (from 50% TTL to 90% RF)	typ.	max.	typ.	max.
	2.0	4.0	2.0	4.0
Oper. Temp.(°C)	-55 to +100		-55 to +100	
Stor. Temp.(°C)	-55 to +100		-55 to +100	
Price (10-24)	\$39.95		\$59.95	
(1-9)	\$89.95		\$109.95	

finding new ways ...
setting higher standards

Mini-Circuits

A Division of Scientific Components Corporation
P.O. Box 350166, Brooklyn, New York 11235-0003 (718) 934-4500
Fax (718) 332-4661 Domestic and International Telexes: 6852844 or 620156

CIRCLE NO. 78

WE ACCEPT AMERICAN EXPRESS

F126 REV.A

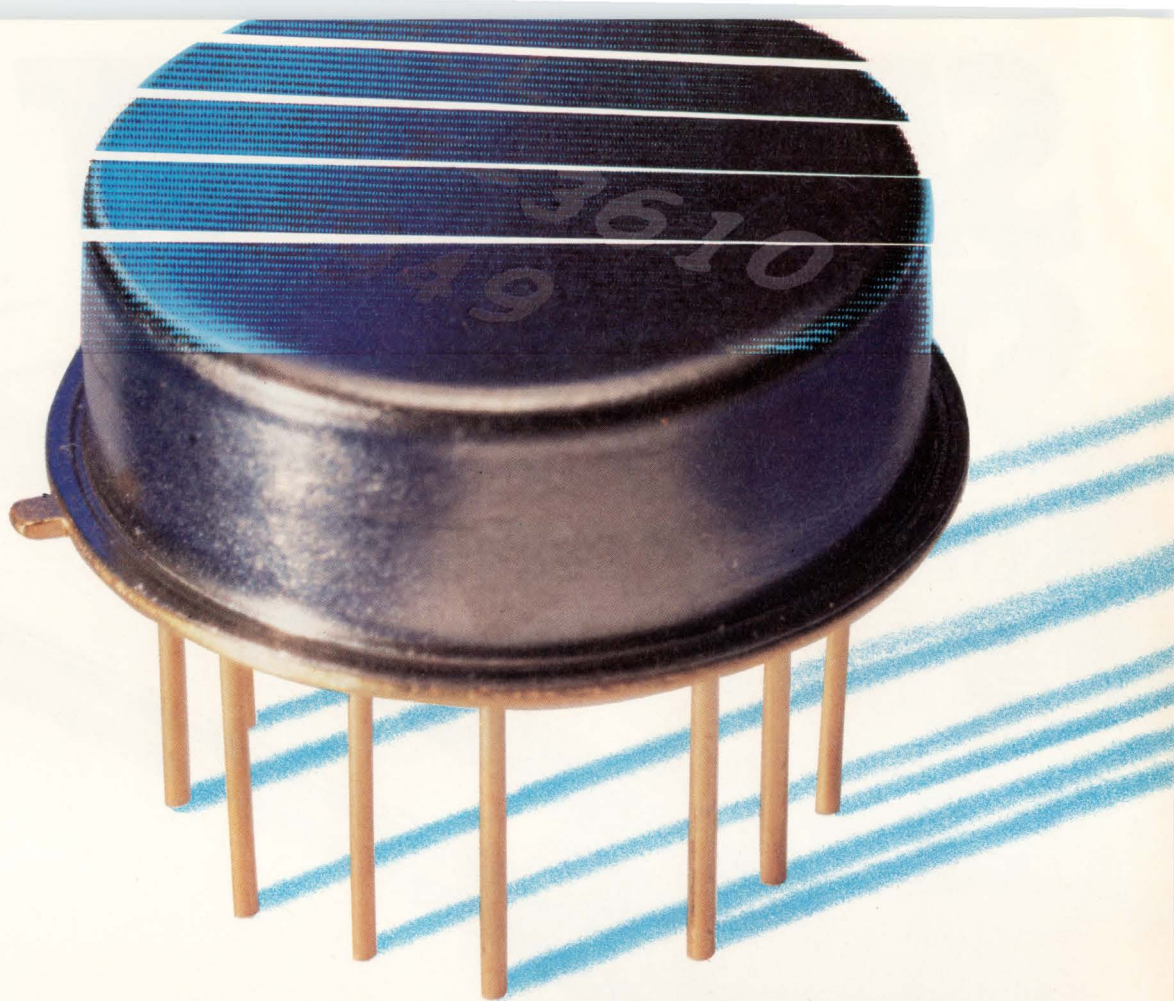

PRECISION TTL-CONTROLLED ATTENUATORS

up to 35dB
10 to 1000MHz
only **\$59.95**

TOAT-R512 Accuracy (dB) (+/-dB)		TOAT-124 Accuracy (dB) (+/-dB)		TOAT-3610 Accuracy (dB) (+/-dB)		TOAT-51020 Accuracy (dB) (+/-dB)	
0.5	0.12	1.0	0.2	3.0	0.3	5.0	0.3
1.0	0.2	2.0	0.2	6.0	0.3	10.0	0.3
1.5	0.32	3.0	0.4	9.0	0.6	15.0	0.6
2.0	0.2	4.0	0.3	10.0	0.3	20.0	0.4
2.5	0.32	5.0	0.5	13.0	0.6	25.0	0.7
3.0	0.4	6.0	0.5	16.0	0.6	30.0	0.7
3.5	0.52	7.0	0.7	19.0	0.9	35.0	1.0

bold faced values are individual elements in the units

Now...precision TTL-controlled attenuators accurate over 10 to 1000MHz and -55 to +100°C. Four models are available in the new TOAT-series, each with 3 discrete attenuators switchable to provide 7 discrete and accurate attenuation levels (see chart). Cascade all four models for up to 64.5dB control in 0.5dB steps. Custom values available on request.

The 50-ohm TOAT-series performs with 6µsec switching speed

and can handle power levels up to 0dBm. Units are housed in a rugged hermetically-sealed TO-8 package to withstand the shock, vibration, and temperature stresses of MIL-STD-883. Connector versions are available.

Take advantage of the \$59.95 (1-9 qty) price breakthrough to stimulate new applications as you implement present designs and plan future systems.



finding new ways...
setting higher standards

Mini-Circuits

WE ACCEPT AMERICAN EXPRESS

P.O. Box 350166, Brooklyn, New York 11235-0003 (718) 934-4500 Fax (718) 332-4661 Domestic and International Telexes: 6852844 or 620156

CIRCLE NO. 79

F 140 REV. ORI

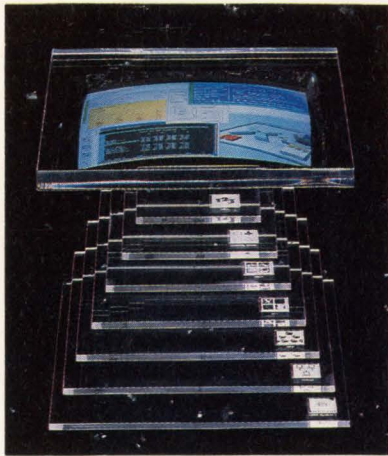

On the cover: Unix for the personal computer supports enough standard networking and graphics capabilities to solidify the PC's ascension into the workstation market. See the Special Report on pg 132. (Photo courtesy Interactive Systems Corp; photography by Mark McIntyre; art direction by Mike Pitzer, Bozell Inc)

SPECIAL REPORT

Unix for PCs

132

Unix is helping to bridge the gap between PCs and workstations. New Unix offerings for PCs now make available standard graphics and networking capability that was previously available only on workstations. And support of emerging standards in Unix will further aid the PC's progress in the workstation market.

—Maury Wright, Regional Editor

DESIGN FEATURES

Designers' guide to real-time Ada—Part 2

151

To achieve performance goals in embedded systems, Ada software must be closely coupled to the system hardware. This article, Part 2 of a series on Ada, shows how several of the language's features let you attain such coupling while adhering to the principles of software engineering.—Benjamin M Brosgol, Alsys Inc

Current-feedback amps enhance active-filter speed and performance

167

In the past, off-the-shelf high-frequency active filters were rarely available because high-frequency, high-performance voltage-feedback amplifiers were simply too expensive. Active filters built around current-feedback amplifiers offer designers high performance without many of the disadvantages associated with passive filters.—Doug Smith, Burr-Brown Corp

Sampling tracker makes short work of 0.01% settling-time test

185

The sampling voltage tracker, a distant relative of the sample-and-hold circuit, is the heart of a scheme for 100% testing of precision high-speed op amps' 0.01% settling time. The measurement, which is daunting enough on the bench, works reproducibly in the much tougher production environment—thanks to this little-known circuit.—Ralph Andersson, National Semiconductor Corp

Continued on page 7

EDN[®] (ISSN 0012-7515) is published 50 times a year (biweekly with 2 additional issues a month, except for February and September, which have 3 additional issues and July and December which have 1 additional issue) by Cahners Publishing Company, A Division of Reed Publishing USA, 275 Washington Street, Newton, MA 02158-1630. Terrence M McDermott, President; Frank Sibley, Senior Vice President/General Manager, Boston Division; Jerry D Neth, Senior Vice President/Publishing Operations; J J Walsh, Senior Vice President/Finance; Thomas J Dellamaria, Senior Vice President/Production and Manufacturing; Ralph Knupp, Vice President/Human Resources. Circulation records are maintained at Cahners Publishing Company, 44 Cook Street, Denver, CO 80206-5800. Telephone: (303) 388-4511. Second-class postage paid at Denver, CO 80206-5800 and additional mailing offices. POSTMASTER: Send address corrections to EDN[®], PO Box 173377, Denver, CO 80217-3377. EDN[®] copyright 1990 by Reed Publishing USA; Ronald G Segel, Chairman and Chief Executive Officer; Robert L Krakoff, President and Chief Operating Officer; William M Platt, Senior Vice President. Annual subscription rates for nonqualified people: USA, \$109.95/year; Canada/Mexico, \$135/year; Europe air mail, \$165/year; all other nations, \$165/year for surface mail and \$250/year for air mail. Single copies are available for \$10. Please address all subscription mail to Ellen Porter, 44 Cook Street, Denver, CO 80206-5800.

THIS IS A BIG TIME GAL.®

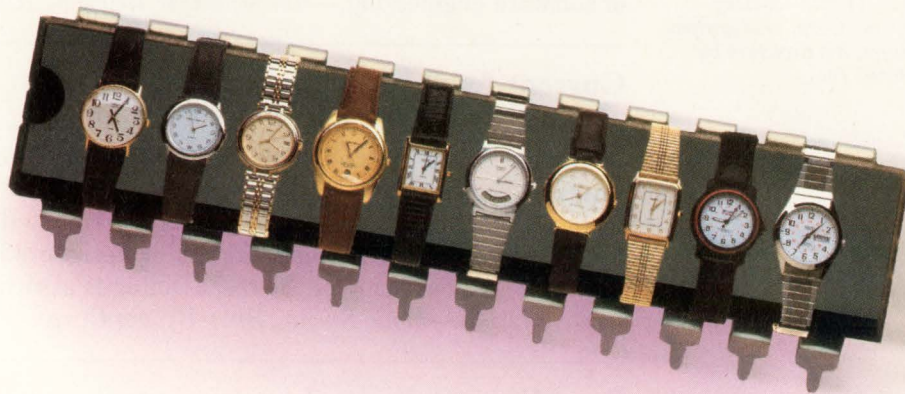

Time is finally on your side. Our new **GAL20RA10-15**, with ten individually programmable clocks and a 15ns propagation delay, offers the world's fastest performance. A combination that delivers the ultimate in design flexibility and speed, all in a 24-pin E²CMOS[®] GAL device.

For example, design engineers can independently clock, reset and preset each of ten output logic macrocells. These individually programmable clocks enable asynchronous designs, taking your system performance to even higher levels.

If your design is ready for the big time, call **1-800-FASTGAL**, and ask for dept. 203. We'll send you free samples and a data-book describing our entire line of high speed E²CMOS GAL devices. Fast.



5555 Northeast Moore Court • Hillsboro, Oregon 97124

Leader in E²CMOS PLDs.™

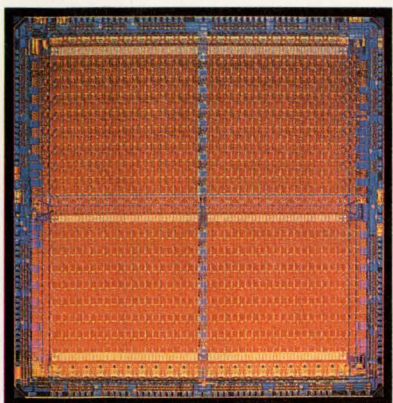

By the time you evaluate the merits of an FPGA, its manufacturer will probably have introduced an upgrade (pg 57).

EDN magazine now offers Express Request, a convenient way to retrieve product information by phone. See the Reader Service Card in the front for details on how to use this free service.

Express Request

General-purpose languages simulate simple circuits **205**

Although you can spend lots of money on commercial simulators, inexpensive alternatives exist that will enable you to build and experiment with behavioral-simulation models.—*Jozef Kalisz, Associate Professor, Warsaw Academy of Technology*

TECHNOLOGY UPDATES

FPGA vendors race to upgrade products **57**

Inevitably, field-programmable gate arrays are luring digital engineers to a design realm where ideas become real immediately and design iterations are effortless. But making sense of the goings on in the FPGA industry isn't easy.—*Charles H Small, Senior Editor*

Micropower op amps: Low-current devices offer high performance **79**

Combining accuracy and good dynamic performance with low-current operation is not an easy task, but many of today's micropower op amps succeed remarkably well.—*Dave Pryce, Associate Editor*

Logic-synthesis tools speed ASIC designs **97**

Logic-synthesis tools for ASIC design help you save time while meeting your functional, area, and performance design goals.—*Doug Conner, Regional Editor*

PRODUCT UPDATES

IBM PC-compatible single-board computer **117**

Device-independent software **118**

Continued on page 9

Cahners Publishing Company, A Division of Reed Publishing USA Specialized Business Magazines for Building & Construction Research Technology Electronics Computing Printing Publishing Health Care Foodservice Packaging Environmental Engineering Manufacturing Entertainment Home Furnishings and Interior Design. Specialized Consumer Magazines for Child Care Boating and Wedding Planning.

Twice the Power:

PCB II

PC Board Layout
on your PC



OrCAD Systems Corporation, the world's largest marketer of PC-based CAE software, has completely upgraded its popular printed circuit board layout software. Now you can have all the power features you need for your board designs on the PC you already own.

Twice the capacity

OrCAD/PCB II has over double the capacity using a flexible, user-definable memory allocation system. The product now supports over 270 14-pin IC equivalent designs, 6000+ pads, 16,000+ equivalent track segments.

Twice the options

OrCAD/PCB II comes with over 50 different printer drivers including most popular dot matrix and laser printers, over a dozen plotter drivers and over 50 display drivers. We conform to your system better than anyone.

Twice the features

- Improved autorouting strategies means a faster route with more completions.
- Design Rule Check available as OrCAD/PCB II runs. Parameters are user configurable.
- Via and Track Optimization. Minimize vias and improve routing automatically.

OR8944

- On-Line module browsing and reading. Call up modules and browse through their graphic descriptions.
- Gerber Viewer generates screen version of Gerber file to check output.

Twice the value

OrCAD's commitment to you is that all of our powerful software will give you workstation performance without extra hardware, all handled within 640k RAM.

And the price? The package comes complete with autorouter, printer and plotter support, excellent documentation and more for only \$

1495

The price also includes one year of technical support, free product updates and access to our 24 hour BBS.

Curious? Try it yourself with our free demo disk.

Call for our free demonstration disk and information packet. You'll see why more designers look to OrCAD for their design solutions.

OrCAD



3175 NW Aloclek Drive
Hillsboro, Oregon 97124
(503) 690-9881

If you would like more information about this or any other OrCAD product, contact your local OrCAD representative.



- | | |
|--|--|
| 1. WA, OR, MT, ID, AK
Seltech, Inc.
(206)746-7970 | 9. IN, OH, KY, WV, W. PA
Frank J. Campisano
(513)574-7111 |
| 2. N. CA, Reno NV
Elcor Associates Inc.
(408)980-8868 | 10. VA, TN, NC, SC
Tingen Technical Sales
(919)870-6670 |
| 3. So. CA
A D G
(714)897-0319 | 11. FL
High Tech Support
(813) 855-5254 |
| 4. Las Vegas, UT, AZ, NM, CO
Tusar Corporation
(602)998-3688 | 12. MS, AL, GA
Electro-Cadd
(404)446-7523 |
| 5. ND, SD, MN, W. WI
Comstrand, Inc.
(612)788-9234 | 13. DE, MD, DC, E. PA, NJ, NY
Beta Lambda, Inc.
(201)446-1100 |
| 6. NE, KS, IA, MO
Walker Engineering
(913)888-0089 | 14. CT, RI, MA, VT, NH, ME
DGA Associates
(617)935-3001 |
| 7. TX, OK, AR, LA
Abcor, Inc.
(713)486-9251 | 15. BC, AB, SK, MB
Interworld Electronics, Ltd.
(604) 984-4171 |
| 8. MI, E. WI, IL
MacKellar Associates
(313)335-4440 | 16. ON, PQ & Maritimes
Electralert, LTD.
(416)475-6730 |

Call today for your FREE demo disk

VP/Publisher
Peter D Coley

Associate Publisher
Mark J. Holdreith

VP/Editor/Editorial Director
Jonathan Titus

Managing Editor
Joan Morrow Lynch

Assistant Managing Editor
Susan L Rastellini

Special Projects
Gary Legg

Home Office Editorial Staff
275 Washington St, Newton, MA 02158
(617) 964-3030

Tom Ormond, *Senior Editor*
Charles Small, *Senior Editor*
Susan Bureau, *Associate Editor*
Jay Fraser, *Associate Editor*
John A Gallant, *Associate Editor*
Michael C Markowitz, *Associate Editor*
Dave Pryce, *Associate Editor*
James P Scanlan, *Associate Editor*
Julie Anne Schofield, *Associate Editor*
Dan Strassberg, *Associate Editor*
Chris Terry, *Associate Editor*
Helen McElwee, *Senior Copy Editor*
Christine McElvenny, *Senior Production Editor*
Gabriella A Fodor, *Production Editor*
Brian J Tobey, *Production Editor*

Editorial Field Offices

Steven H Leibson, *Senior Regional Editor*
Boulder, CO: (303) 494-2233

Doug Conner, *Regional Editor*
Atascadero, CA: (805) 461-9669

J D Mosley, *Regional Editor*
Arlington, TX: (817) 465-4961

Richard A Quinell, *Regional Editor*
Aptos, CA: (408) 685-8028

Anne Watson Swager, *Regional Editor*
Wynnewood, PA: (215) 645-0544

Maury Wright, *Regional Editor*
San Diego, CA: (619) 748-6785

Brian Kerridge, *European Editor*
(603) 630782
(St Francis House, Queens Rd,
Norwich, NR1 3PN, UK)

Contributing Editors
Robert Pease, Don Powers,
David Shear, Bill Travis

Editorial Coordinator
Kathy Leonard

Editorial Services
Helen Benedict

Art Staff
Ken Racicot, *Senior Art Director*
Chinsoo Chung, *Associate Art Director*
Cathy Madigan, *Staff Artist*

Production/Manufacturing Staff
Andrew A Jantz, *Production Supervisor*
Sandy Wucinich, *Production Manager*
Deborah Hodin, *Production Assistant*
Kelly Brashears, *Production Assistant*
Diane Malone, *Composition*

Director of Art Department
Joan Kelly
Norman Graf, *Associate*

VP/Production/Manufacturing
Wayne Hulitzky

Director of Production/Manufacturing
John R Sanders

Business Director
Deborah Virtue

Marketing Communications
Anne Foley, *Promotion Manager*
Pam Winch, *Promotion Assistant*

DESIGN IDEAS

Ninth bit keys multiple microcontrollers	225
Period-to-voltage converter locks quickly	226
Booster powers low-dropout reference	228
Switcher babies power MOSFET	230
PAL enables DIP-switchless addressing	232

EDITORIAL

45

Companies that want to do business in the USSR should approach the country with great caution. Staying at home may make even more sense.

NEW PRODUCTS

Test & Measurement Instruments	245
CAE & Software Development Tools	251
Computers & Peripherals	257
Components & Power Supplies	263
Integrated Circuits	268

DEPARTMENTS

News Breaks	21
Signals & Noise	33
Readers' Choice	123
Business/Corporate Staff	281
Career Opportunities	282
EDN's International Advertisers Index	286



MAKING THE SWITCH TO HIGH PERFORMANCE? OUR 68331 PUTS YOU ON THE RIGHT TRACK.

Considering a move up in power? Now you can switch to the 32-bit performance track that's parallel with all your future needs. Thanks to Motorola's new, surprisingly affordable 68331 microcontroller.



OUR NEW 68331 IS MORE THAN A MICROCONTROLLER. IT'S A MILESTONE.

The 68331 features the same powerful 32-bit CPU, System Integration Module, and Queued Serial Module used in our unsurpassed 68332.

Not to mention a powerful General Purpose Timer. Modular design. The support of Motorola's huge 68000 Family software base. And access to the most sophisticated development systems in the industry.

All at a price that's considerably less than you'd expect to pay for 32-bit power.

IF YOU'RE HEADED FOR HIGH PERFORMANCE, YOU'RE ON THE RIGHT PATH.

With Motorola, your path to power is virtually a straight shot, thanks to the families of

microcontrollers we've mapped out to take you from here to high performance. Without unnecessary changes in software and architectures along the way.

The newest point on this revolutionary route is Motorola's 68331.

There will be many others in the months to come, all of which demonstrate one thing.

For well-planned migration to high performance, travel with the leader. Motorola.

To receive a Technical Product Preview for the 68331, plus more news to come on our high performance migration path, please complete and return this coupon to:

Motorola, Inc.
P.O. Box 1466
Austin, Texas 78767

EDN9/17/90

Name _____

Company _____

Title _____

Address _____

City _____

State _____ Zip _____ Phone _____

THE PATHWAY TO PERFORMANCE.



MOTOROLA

© 1990 Motorola, Inc.

POSITION SENSORS

From Missiles

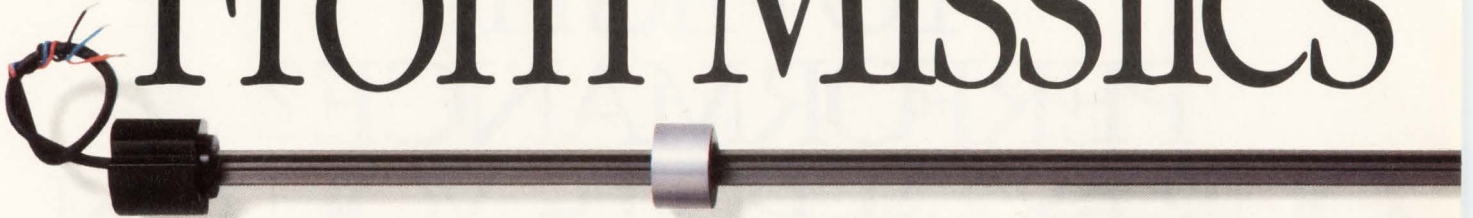

This immersible position sensor fits inside a hydraulic cylinder, using the fluid it resides in as a lubricant while saving space.



Drive-by-wire designs for automotive and heavy equipment designs make reliability problems a thing of the past.

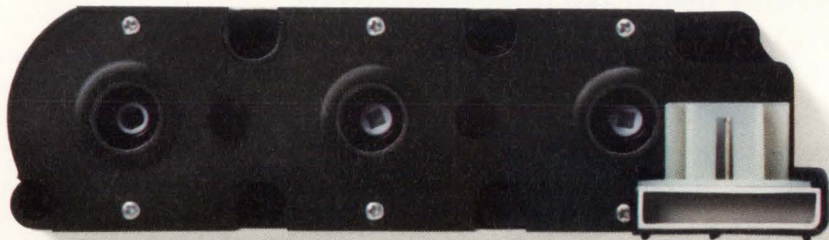

Both spring-loaded and magnetically coupled position sensors for truck engine applications must withstand extremes of vibration, temperature and exposure to highway dirt and grime.

We've modified a famous phrase to make a point: no matter what the application, Duncan can design a specific-use potentiometric position sensor that fits in. Whether the challenge comes from the physical environment, space limitation,

form or function, you can have whatever you want... just by telling us what you need. Get started now. FAX us your requirements at (714) 557-6420. We'll give shape to your ideas in a hurry.

To Plowshares.

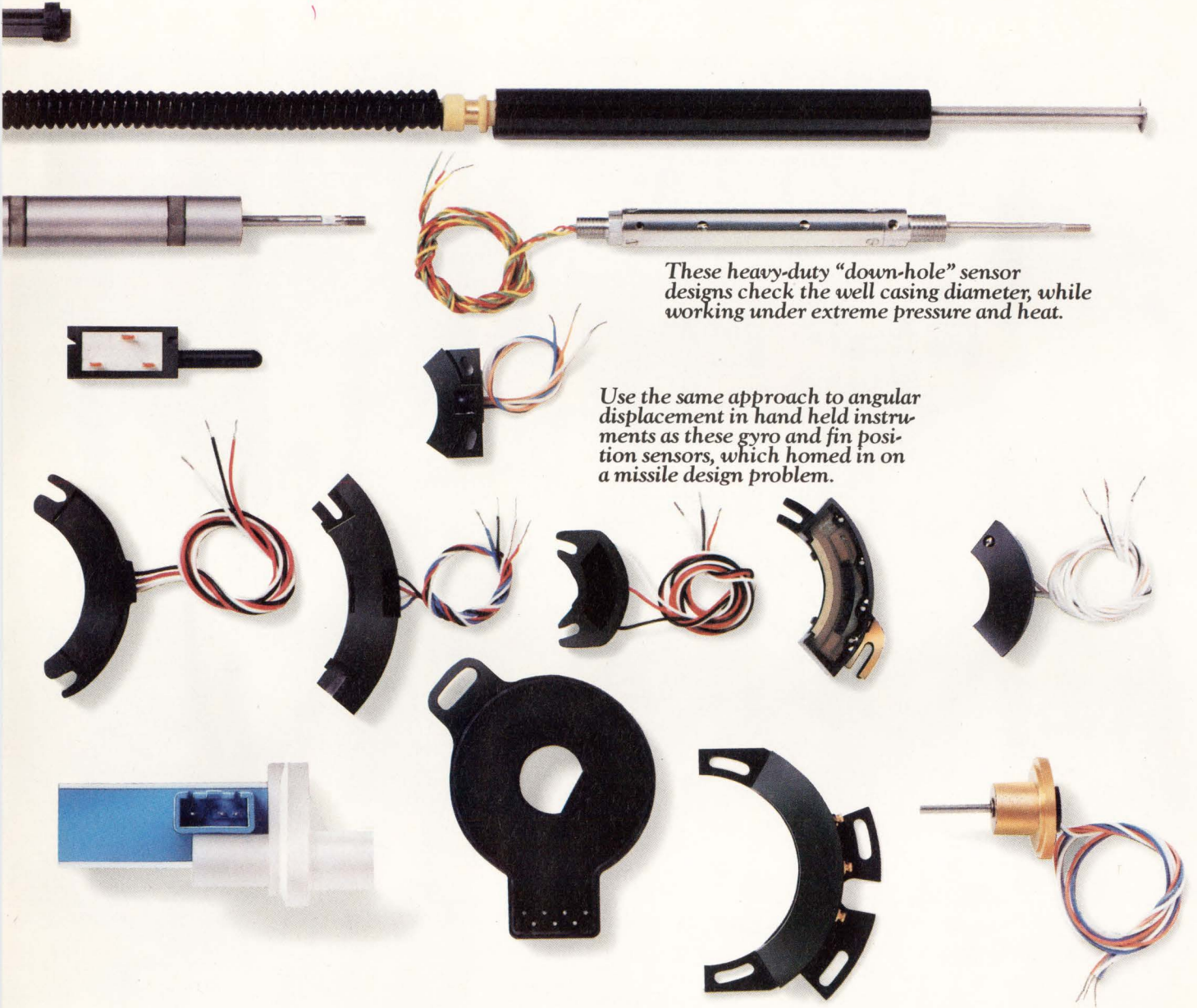

These heavy-duty "down-hole" sensor designs check the well casing diameter, while working under extreme pressure and heat.

Use the same approach to angular displacement in hand held instruments as these gyro and fin position sensors, which homed in on a missile design problem.

**DUNCAN
ELECTRONICS**

A BEI Electronics Company

2865 Fairview Road, Costa Mesa, CA 92626
(714) 545-8261 • FAX (714) 557-6240

HOW A STRATEGIC
PARTNERSHIP WROTE
A NEW CHAPTER ON
SYSTEM PERFORMANCE:

DECstation 5000 AND LSI LOGIC.

Achieving 24.2 MIPS at 25 MHz was no small task. Even for Digital.

So they designed-in LSI Logic's unique read-write buffer and MIPS-based chipset that optimized the processing power of the LR3000 CPU. And consolidated the read-write buffer functions of 17 chips into a single chip. Putting far more performance into far less real estate. And making the new DECstation 5000 workstation a

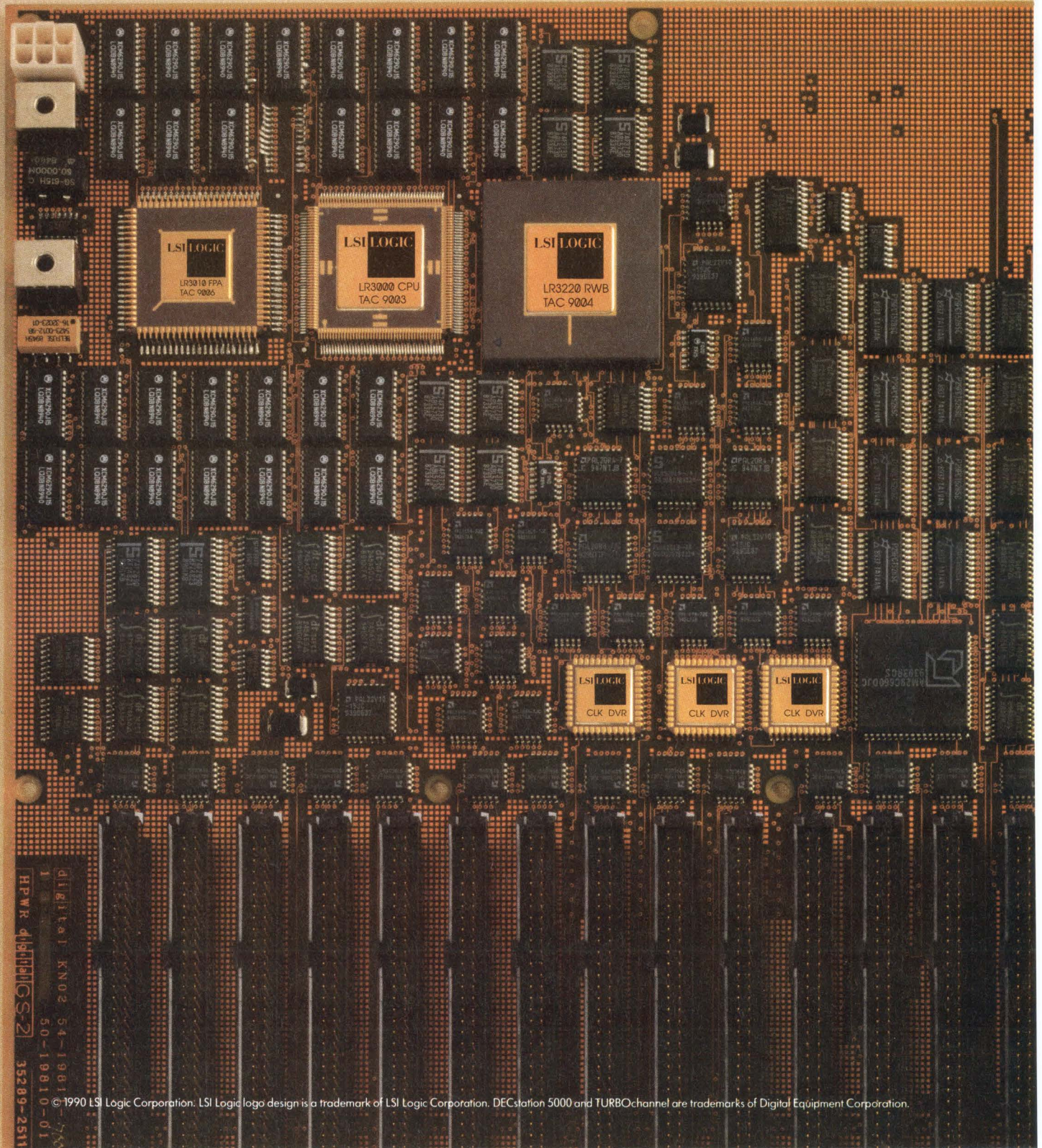

reality. In less than 11 months.

LSI's proprietary LR3220 read-write buffer performs memory write operations at the CPU clock rate, practically eliminating the bottleneck between the CPU and main memory. Boosting the processing power of the DECstation 5000 workstation to the limits of the price performance curve. A novel idea that delivers 120 Mbytes of main memory, dazzling high-end graphics and

the new TURBOchannel I/O interconnect to the desktop, for under \$15,000.

If you'd like to write the next chapter in the workstation wars, call us. We'll help you quickly turn your technology into a best seller.

LSI LOGIC

ACROSS THE BOARD



According to Tom Furlong, Manager of Digital Equipment Corporation's RISC Workstation Group, "The level of performance achieved on the DECstation 5000 workstation simply wouldn't have been possible without LSI's ASIC methodology and their MIPS microprocessor expertise."

For the whole story call 408.433.7556, or write for a free white paper, "Writing a new chapter in workstation performance: DECstation 5000," LSI Logic, 1551 McCarthy Blvd, MS D102, Milpitas, CA 95035.

CIRCLE NO. 81

WHAT GOOD IS A BRAIN

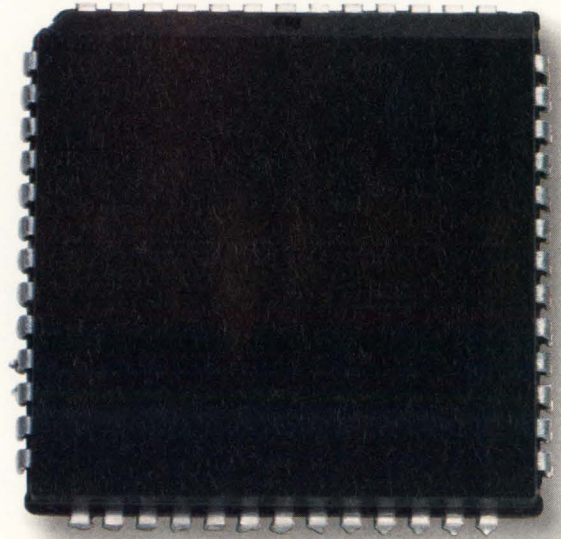

WITHOUT A MEMORY?



To hear most people in the computer business talk, you'd think the only valuable part of a system is its microprocessor.

Maybe they haven't lost their minds. But they've certainly forgotten about the hard drive. And the critical data it stores. Data which can't be easily replaced like a microprocessor.

So it's no surprise that many OEMs are reducing their risk of system failure with disk drives from Conner. Using proven technologies, our high performance drives consistently set the standards for form factor, reliability, and innovation.

That's because at Conner, we work closely with our customers to identify their needs sooner, and fill them faster. Providing them the quickest time to market; with exactly the right product. Plus, we're expanding our worldwide manufacturing facilities to meet growing customer demand around the globe.

All of which makes choosing Conner disk drives a low risk decision.

So call Conner today. The results should be quite memorable.

CONNER
T H E T H I R D W A V E

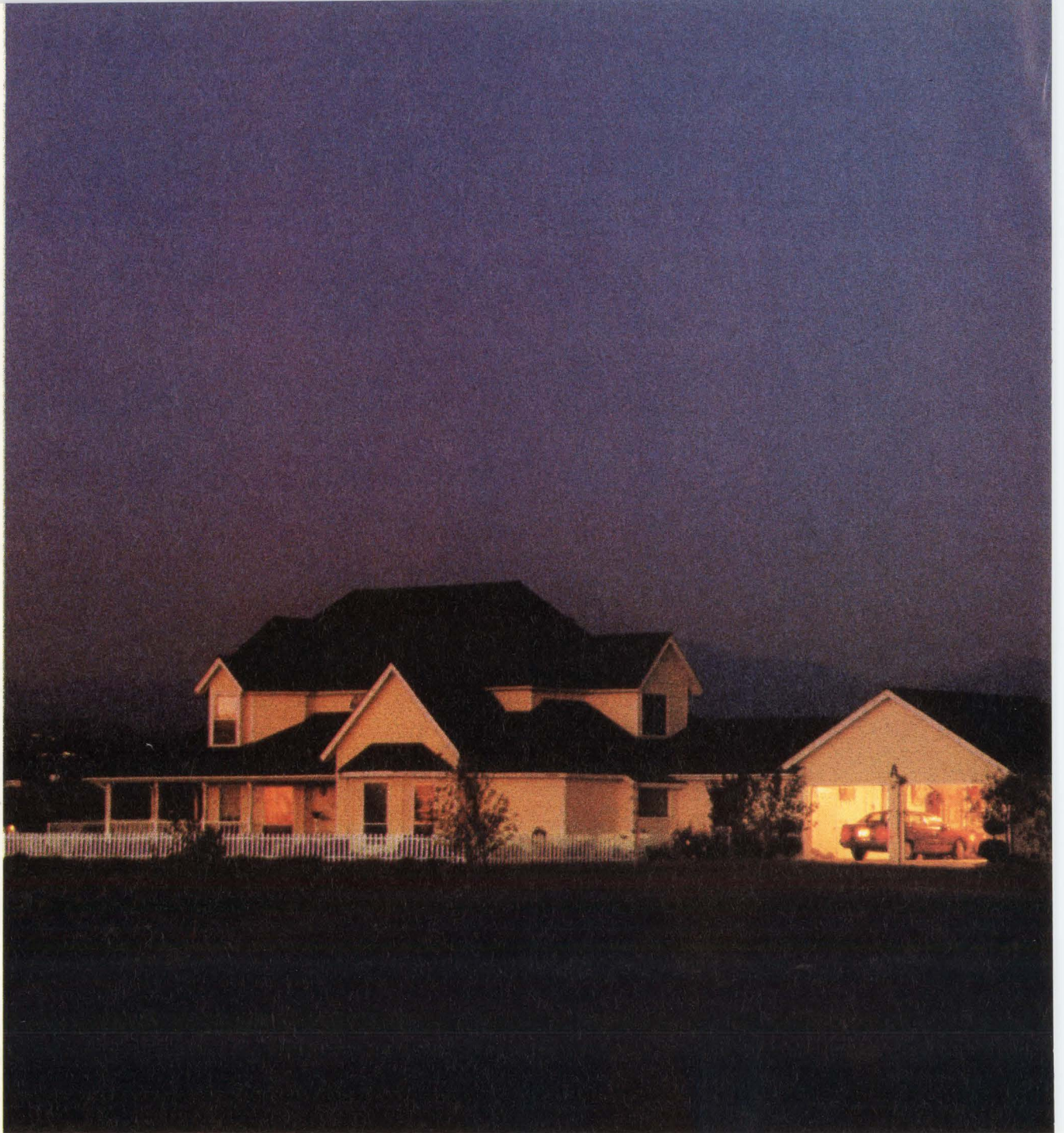

Even though our products have
been to Jupiter and beyond, you can
still find them out in your garage.



Whether it's one of the switches in your automobile, or connectors used in space exploration, you'll find the products of ITT ElectroMechanical Components Worldwide everywhere.

With seventy-five years of leadership in the electronics industry, ITT EMC Worldwide is one of the world's leading suppliers of electronic components. You know us as ITT Cannon, Schadow, Jeanrenaud, Pomona Electronics, MTI and Sealectro. With manufacturing facilities, engineering centers and customer service represen-

tatives in virtually every part of the world.

Our history is one of innovation, and ever-increasing capabilities. That's precisely why many of our products go on to become industry standards.

At ITT EMC Worldwide, we build reliability into every product we sell. That's why you'll find us in everything from appliances to satellites.

Our philosophy of "building in" quality control and testing means that you get the best possible product, every time. What's more, ITT EMC

Worldwide manufactures and sells quality test accessories, to assist you in building a quality product as well.

No matter where in the world you are, chances are we have an office nearby. So drop us a line today. Even though we're an international company, we may be closer than you think.

*1851 East Deere Avenue, Post Office Box 35000
Santa Ana, CA 92705-5300*

*Phone: (714) 261-5300 Fax: (714) 757-8324/8301
Telex: (714) 655358*

ITT ElectroMechanical
Components Worldwide
Discover our strengths.

CIRCLE NO. 82

This box kills bugs, does impersonations and takes you to market at exhilarating speeds.

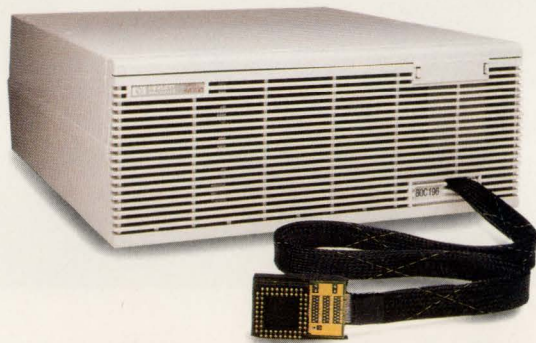

© 1990 Hewlett-Packard Company CCEG 003

New microprocessors come out frequently. Emulators don't. And when they finally do, you're forced to rush your design to keep up with the competition.

Hewlett-Packard has a better way.

The HP 64700 Series of emulators. Now you'll have your design to market much faster.

Because now you'll have a tool that allows you to design with the latest chips the moment they hit the market. All thanks to our new agreements with key chip vendors. In fact, some of our latest emulators include the Motorola 68332 and 68302, AMD 29000, AT&T DSP32C and the National Semiconductor HPC microcontroller family.

The HP 64700 Series is easier

than ever to learn and use. Our new user interface simplifies debugging and analysis.

See how the HP emulator can help cut your time to market. Call us at 1-800-752-0900, Ext. 1298.

There is a better way.

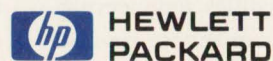

NEWS BREAKS

EDITED BY SUSAN BUREAU

THREE DSP CHIPS FOR DIGITAL-RECEIVER APPLICATIONS . . .

Plessey Semiconductors (Scotts Valley, CA, (408) 438-2900) recently announced three DSP chips designed especially for digital-receiver applications. The \$395 PDSP16350 generates simultaneous 20-MHz sine and cosine waveforms using a Cordic (Coordinate Rotation Digital Computer) processor. The 16-bit waveforms have an accuracy of 0.001 Hz. They feed a pair of 16-bit multipliers, which multiply a 16-bit input signal to produce in-phase and quadrature output channels. The \$395 PDSP16256 programmable, variable-length finite-impulse-response filter has 16 16×12 -bit multiplier/accumulators, which can be used reiteratively to provide 16 to 128 digital-filtering stages at sample rates of 2.5 to 20 MHz. You can cascade this device at all speeds. The chip can accept as many as 128 coefficients from a host CPU and store them internally. The \$439.36 PDSP16116A, a 20-MHz version of the company's 10-MHz PDSP16116 complex multiplier, can multiply two complex 16-bit words every 50 nsec.

. . . A FOURTH PERFORMS 1024-POINT TRANSFORMS IN 96 μ SEC

A fourth DSP chip from Plessey Semiconductors (Swindon, UK, (793) 518000), the PDSP16510 FFT processor, performs real-time, forward or inverse FFTs on real or complex 1024-point data sets in 96 μ sec. Block floating-point arithmetic is standard. Data and coefficient words are each 16 bits. The chip stores the data sets internally in its 32k-byte memory, which eliminates the need for external dual-port RAM and minimizes pin count to 84. Hamming and Blackman-Harris window-operator functions reside on the chip to provide 67 dB of side-lobe attenuation. Connecting multiple devices boosts performance; operation with six chips allows data sampling at 40 MHz with 1024-point complex transforms. Packaged in pin-grid arrays, samples will be available in the fourth quarter for \$2100.—John Gallant and Brian Kerridge

4-CHANNEL WAVEFORM GENERATOR OFFERS 16-BIT PRECISION

The Model 2201A arbitrary-waveform generator includes three phase-coherent channels and a built-in noise-generation channel. The unit from Pragmatic Instruments Inc (San Diego, CA, (619) 271-6770) can generate standard waveforms such as sine, triangular, and square waves. It samples at 2 MHz and features 16-bit precision. To create waveforms, you can use either a mouse or the front-panel controls for the three phase-coherent channels. The generator includes 64k words of battery-backed static RAM for each of the three main output channels. An interface on the generator accepts credit-card-size, removable, static-RAM memory modules, each of which has 32k bytes of memory and a battery that makes it nonvolatile. You can use these cards to store libraries of waveforms. The unit costs \$9985, including the mouse and one memory card.—Maury Wright

DVM REPLACES THERMAL-TRANSFER INSTRUMENTS

The 4920 Alternating Voltage DVM from Datron Instruments (Norwich, UK, (603) 404824) boasts enough accuracy for calibrating premium ac calibration instruments. The digital voltmeter displays $7\frac{1}{2}$ -digit resolution on ranges of 300 mV to 1 kV and for input frequencies of 1 Hz to 1.25 MHz. Its total measurement uncertainty is ± 28 ppm for input levels of 0.9 to 11V and frequencies of 40 Hz to 30 kHz. This accuracy holds for one year and $\pm 5^\circ\text{C}$ ambient temperature changes from the calibra-

NEWS BREAKS

tion point of the meter itself. Unlike its thermal-transfer counterparts, the voltmeter is portable. It has a settling time of <2.5 sec for frequencies greater than 100 Hz and a read rate of 3 readings/sec. Operation is programmable with an IEEE-488.2 interface. For increased accuracy, you can select an ac/dc transfer mode of operation, which reduces total measurement uncertainty to 14 ppm (7 ppm of this figure is traceability uncertainty to the National Institute of Standards and Technology). The meter costs \$9995; a 1-mV-range option costs \$1495 more.—Brian Kerridge

IEEE REFORMER IRWIN FEERST DEAD AT 62

Irwin Feerst, a long-standing member of the IEEE, died last month in Plainview, NY. He had been ill for about 1½ years with ALS (Lou Gehrig's disease). Mr Feerst's career was varied; he worked as a company EE, a teacher of physics and electronics at Adelphi University in Garden City, NY, and an independent consultant. He was most known, however, for his attempts to reshape the IEEE's goals to better represent the working engineer. He often argued that the organization was over-represented by educators and upper-level managers, which caused the IEEE to drift away from its original purpose of supporting the engineer. In 1973, Mr Feerst founded the Committee of Concerned EEs, which circulated a monthly newsletter to formalize complaints from IEEE members. In 1986, he earned a place on the ballot for IEEE president by gathering signatures from over 2000 members. Mr Feerst is survived by his wife, Dr Francis Feerst of Massapequa, NY, his son, Dr David Feerst of Chicago, and his grandson, Daniel.—John Gallant

HOW MANY PINS DOES AN ID CHIP NEED

An identification chip can identify pc-board assemblies, provide a network address, or provide an access code. If you think such a chip needs pins for power, ground, an input, and an output, then you've counted two pins too many. Dallas Semiconductor (Dallas, TX, (214) 450-0400) offers a 2-pin Serial Number chip that uses an internal timebase to multiplex data, control, and power to a single pin. The timebase uses pulse width to distinguish between ones and zeros. Internal capacitance stores charge when the input signal is high and powers the chip when the input signal is low; power refresh occurs whenever the input goes high. The chip's 64-bit serial number, laser-written by the vendor, comprises an 8-bit model number, a 48-bit serial number, and an 8-bit CRC (cyclic redundancy check) number you can use to ensure data integrity and proper data transmission. The plastic TO-92-packaged chip costs \$0.35 (100,000).—Michael C Markowitz and J D Mosley

REWRITABLE OPTICAL DISK DRIVE SEEKS IN 30 MSEC

The Model RMD-5100-S rewritable optical disk drive takes advantage of a low-mass head and 3½-in. media to provide an average seek time of 30 msec. Offered by Mass Optical Storage Technologies (Cypress, CA, (714) 898-9400), the drive includes a scanning/short-seek capability that makes data within a 128-track band available in 7 msec. A 128k-byte read-ahead cache reduces seek time to the 1-msec range on cache hits. The drive stores 133M bytes of data and features a 30,000-hour MTBF. It includes a SCSI controller and is compatible with the SCSI common-command set. The drive produces a sustained transfer rate of 512k bytes/sec; the on-board buffer lets the SCSI controller perform burst transfers at 1.5M bytes/sec in asynchronous mode and 3M bytes/sec in synchronous mode. Samples of the drive are available for \$2425.—Maury Wright

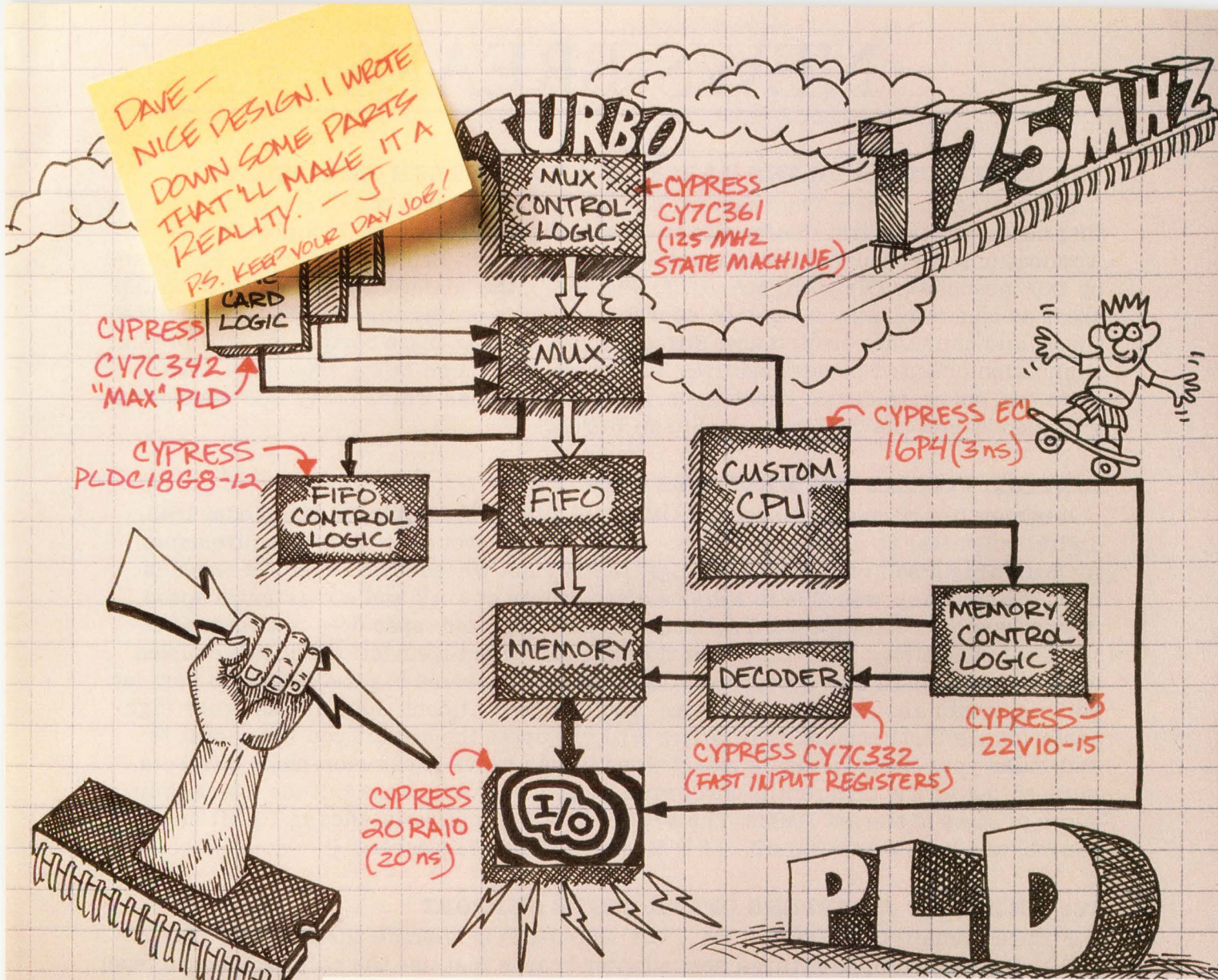

No matter where you're going, or how fast, we have the right PLD.

High Density Family: If you need density up to the level of small gate arrays, coupled with high performance and quick development times, our MAX™ family fills the bill. You get parts that can replace up to 50 TTL parts, or up to 15 PLDs, with performance to 50 MHz. Very flexible, very well supported.



Standard Enhanced Family:

If you like the 'classics' but want state-of-the-art performance, you'll find plenty of solutions in our Standard Enhanced Family. Consider our CMOS 18G8 Universal PAL at 12 ns. Or our CMOS 22V10 at 15 ns. Or our 20RA10 at 20 ns. Our ECL 16P4 (10E302) at 3 ns. To name a very fast few.

Functionally Specialized Family:

We've created new architectures tailored to key functions, to give you maximum performance. For example, for state machine functions, our CY7C361 employs an innovative 'split-plane' architecture to cut feedback loop delay and enable 125 MHz performance.



Call for your free Data Book. Hotline: 1-800-952-6300.* Ask for Dept. C4J.



*1-800-387-7599 In Canada. (32)2-672-2220 In Europe.
©1990 Cypress Semiconductor, 3901 North First Street, San Jose, CA 95134. Phone: (408)943-2666, Telex 821032 CYPRESS SNUJ, TWX 910-997-0753. Trademarks: MAX - Altera Corporation.



CYPRESS SEMICONDUCTOR

NEWS BREAKS

DSP CONFERENCE DRAWS EASTERN AND WESTERN ENGINEERS

Attracting engineers from eastern and western European countries, as well as the US and Japan, the First Conference in Digital Signal Processing Technology and Applications is scheduled for October 22 to 25, 1990, in Brussels, Belgium. Sponsored by DSP Associates (Newton, MA, (617) 964-3817), the conference will cover such DSP areas as communications, control, speech and image processing, HDTV, VLSI architectures, and consumer electronics. European, US, and Japanese companies will present application-oriented papers, lectures, and presentations on DSP components, hardware and software development tools, and future trends. Third-party DSP developers will also attend the conference.—Susan Bureau

DIGITAL VOLTMETER RESOLVES 1 nV

Keithley Instruments (Cleveland, OH, (216) 248-0400) developed the Model 182 digital voltmeter to excel at one task—making low-level dc voltage measurements. By designing a self-calibrating 6½-digit instrument whose least sensitive range is 30V, the company was able to achieve a sensitivity of 1 nV and a maximum speed in excess of 50 readings/sec. The meter's 15-nV p-p noise spec does not contradict the 1-nV sensitivity. The unit's low-thermal-EMF input-connection scheme coupled with internal math and postprocessing of data transferred via the IEEE-488 port let you measure nanovolt signal changes. You can be confident that, unlike other high-performance instruments, this device will not upset the circuit you connect it to and make your measurements meaningless. The ac and dc common-mode currents pumped out of the differential FET input stage are orders of magnitude lower than those of state-of-the-art DMMs. The \$3695 meter's input resistance is 10 GΩ on all ranges, and its CMR is 160 dB.—J D Mosley and Dan Strassberg

ICs AND HOST ADAPTERS OFFER SCSI-2 SUPPORT

Future Domain Corp (Irvine, CA, (714) 253-0400) is offering the \$66 TMC-1800 SCSI-2 interface chip and three host adapter boards that use the chip. The board-level products include the \$180 TMC-1680 16-bit IBM PC/AT-bus host adapter, the \$220 TMC-1680 IBM PC/AT-bus host adapter with a floppy-disk controller, and the \$279 MCS-700 16-bit host adapter for IBM's Micro Channel Architecture bus. The IC and the host adapters support the 10M-byte/sec "fast synchronous" data-transfer option introduced in the SCSI-2 specification. The boards employ a dual-adaptive FIFO-buffering scheme that takes advantage of the IC's 8k-byte FIFO buffer and the buffers located on the host adapters. A device driver can optimize SCSI performance by setting interrupt levels in conjunction with the dual FIFO buffers.—Maury Wright

DISK-MANAGEMENT SOFTWARE FOR SPARCSTATIONS

Interphase Corp (Dallas, TX, (214) 919-9200) is now bundling disk-management software called Softarray with its disk-drive controllers. The software ensures uninterrupted availability of critical data on Sun-3 or -4 SPARCstations by copying the critical data to multiple disk drives. The program also lets you spread data evenly across several drives to provide simultaneous access to data in multiuser systems. If you have an application, such as video imaging, that requires more storage capacity than any one of your drives can provide, the software can use the multiple disks as if they were a single, larger disk. Depending on the controller you use, the program will work with as many as 28 disk drives. The software only comes with the manufacturer's disk-drive controllers, however. For \$3900 you get a dual-port V/SCSI 4210 Jaguar SCSI disk controller and the software.—J D Mosley

RUGGED SOLUTIONS TO TOUGH DESIGN PROBLEMS.



Portable data products from Datakey are meeting the needs of electronic OEM design engineers in a wide range of commercial and military applications. They can help you:

- Save valuable system space
- Reduce system power requirements
- Cut the cost of memory/feature expansion
- Improve system and facility security
- Speed data transfer, make data handling more convenient
- Make ROM upgrades quicker, easier
- Simplify system design and manufacturability
- Ruggedize your system or I/O device
- Reduce repetitive data input
- Differentiate your product in the marketplace

These versatile devices withstand rough handling and retain your data even when exposed to dust, dirt, moisture, magnetic fields, and other environmental hazards.

We've developed a whole array of solutions for tough portable data applications — including the access device for the U.S. government's secure phone system. Hundreds of thousands of these devices are in use today.

Choose from our standard products, including *Serial Memory Keys* (1K, 2K, or 4Kbit capacity), *Parallel Memory Keys* (16K to 512Kbit capacity, 8-bit word length), *Memory Cards* (chip-on-card or edge-connect with embedded memory), *Low-Cost Personal ID and Memory Tokens*, *Mechanical/Electronic Keys*, and more.

We also design and manufacture *custom* portable data devices.

So, call today for our free booklet. It just may help you solve some of the toughest design problems around. *Yours.*

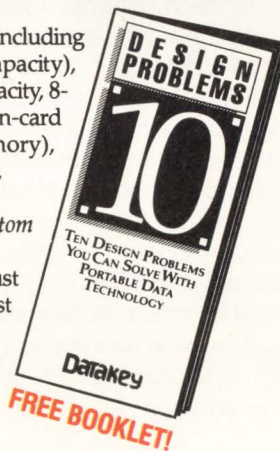

Datakey®

Advanced Solutions
in Portable Data
Technology.™

Call 1-800-328-8828

Need it fast? We'll fax it.

Datakey, Inc. • 407 West Travelers Trail, Minneapolis, MN 55337 U.S.A. • Phone (612) 890-6850 • Fax (612) 890-2726
United Kingdom: 44 730 816502 • West Germany: 49-06173-68872 • Belgium: 32 3 325 19 10 • Netherlands: 023-31 91 84

RF TRANSFORMERS

Over 50 off-the-shelf models...

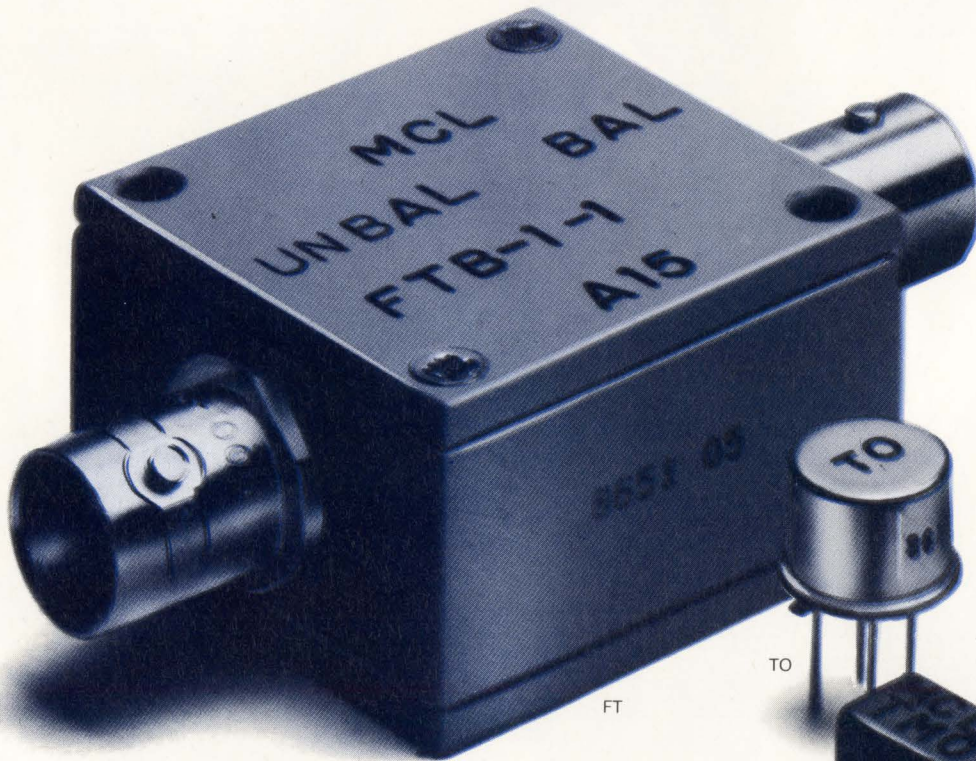

Having difficulty locating RF or pulse transformers with low droop, fast risetime or a particular impedance ratio over a specific frequency range? ... Mini-Circuits offers a solution.

Choose impedance ratios from 1:1 to 36:1, connector or pin versions (plastic or metal case built to meet MIL-T-21038 and MIL-T-55831 requirements*). Ultra-wideband response achieves low droop and fast risetime for pulse applications. Ratings up to 1000M ohms insulation resistance and up to 1000V dielectric voltage. For wide dynamic range applications involving up to 100 mA DC primary current, use the T-H series. Coaxial connector models are offered with 50 and 75 ohm impedance; BNC standard; request other types. Available for immediate delivery with one-year guarantee.

Call or write for 68-page catalog or see our catalog in EEM, or Microwaves Product Data Directory.

*units are not OPL listed

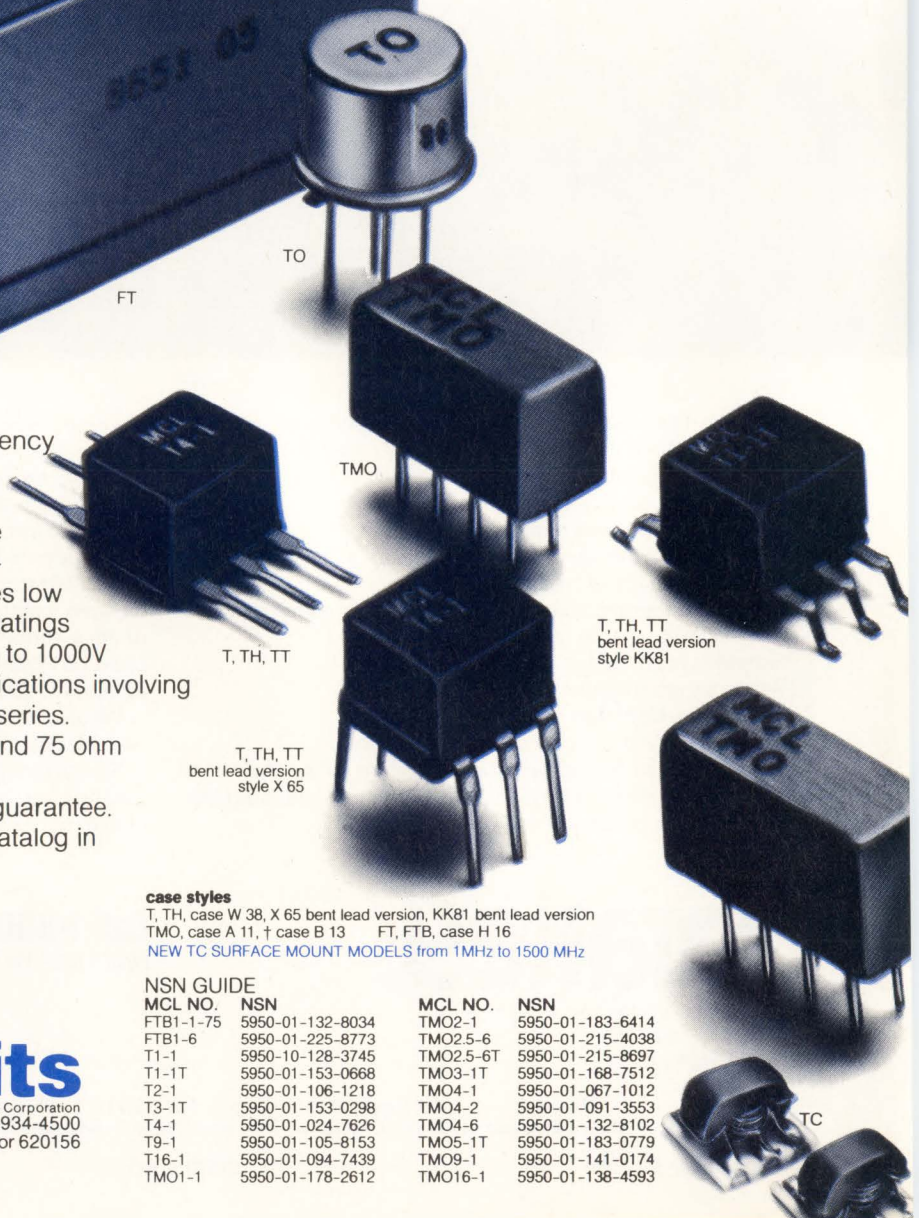

case styles

T, TH, case W 38, X 65 bent lead version, KK81 bent lead version
TMO, case A 11, † case B 13 FT, FTB, case H 16
NEW TC SURFACE MOUNT MODELS from 1MHz to 1500 MHz

NSN GUIDE

MCL NO.	NSN	MCL NO.	NSN
FTB1-1-75	5950-01-132-8034	TMO2-1	5950-01-183-6414
FTB1-6	5950-01-225-8773	TMO2.5-6	5950-01-215-4038
T1-1	5950-10-128-3745	TMO2.5-6T	5950-01-215-8697
T1-1T	5950-01-153-0668	TMO3-1T	5950-01-168-7512
T2-1	5950-01-106-1218	TMO4-1	5950-01-067-1012
T3-1T	5950-01-153-0298	TMO4-2	5950-01-091-3553
T4-1	5950-01-024-7626	TMO4-6	5950-01-132-8102
T9-1	5950-01-105-8153	TMO5-1T	5950-01-183-0779
T16-1	5950-01-094-7439	TMO9-1	5950-01-141-0174
TMO1-1	5950-01-178-2612	TMO16-1	5950-01-138-4593

finding new ways ...
setting higher standards

Mini-Circuits

A Division of Scientific Components Corporation

P.O. Box 350166, Brooklyn, New York 11235-0003 (718) 934-4500
Fax (718) 332-4661 Domestic and International Telexes: 6852844 or 620156

FORMERS

3KHz-800MHz from \$3²⁵

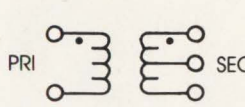
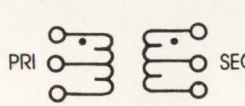
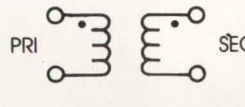
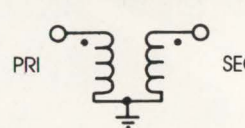
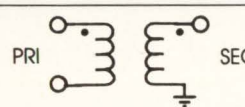
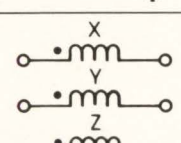
case style number see opposite page	MODEL NO.	Ω RATIO	FREQUENCY MHz	INSERTION LOSS			PRICE \$ Qty. (1-9)		
				3dB MHz	2dB MHz	1dB MHz			
A* 	T	T1-1T	1	05-200	05-200	08-150	2-80	4.45	
		T1-6T	1	003-300	003-300	01-150	02-50	6.95	
		T2-1T	2	07-200	07-200	1-100	5-50	4.95	
		T2.5-6T	2.5	01-100	01-100	02-50	50-20	4.95	
		T3-1T	3	05-250	05-200	1-200	5-70	4.95	
		T4-1	4	2-350	2-350	35-300	2-100	3.25	
		T4-6T	4	02-250	02-250	05-150	01-100	4.45	
		T5-1T	5	3-300	3-300	6-200	5-100	4.95	
		T8-1T	8	03-140	03-140	10-90	1-60	7.95	
		T13-1T	13	3-120	3-120	7-80	5-20	4.95	
		T16-6T	16	03-75	03-75	06-30	1-20	5.65	
		T4-1H	4	10-350	10-350	15-300	25-200	5.95	
		TH	TMO1-1T	1	05-200	05-200	08-150	2-80	7.95
			TMO2-1T	2	07-200	07-200	1-100	5-50	8.45
			†TMO2.5-6T	2.5	01-100	01-100	02-50	05-20	8.45
			†TMO3-1T	3	05-250	05-250	1-200	5-70	7.95
TMO4-1	4		2-350	2-350	35-300	2-100	6.25		
TMO5-1T	5		3-300	3-300	6-200	5-100	8.45		
TMO13-1T	13	3-120	3-120	7-80	5-20	8.45			
B* 	TT	TT1-6	1	004-500	004-500	02-200	1-50	6.95	
		TT1.5-1	1.5	075-500	075-500	2-100	1-50	5.95	
		TT2.5-6	2.5	01-50	01-50	025-25	05-10	6.45	
		TT4-1	3	05-200	2-50	2-50	1-30	5.95	
		TT4-1A	4	0.1-300	0.1-300	0.2-250	0.3-180	6.95	
		TT25-1	25	02-30	02-30	05-20	1-10	9.95	
		TTMO25-1	25	02-30	02-30	05-20	1-10	11.95	
		TTMO1-1	1	005-100	005-100	01-75	05-40	11.45	
		TTMO4-1A	4	0.1-300	0.1-300	0.2-250	0.3-180	13.95	
		C 	T	T1-1	1	15-400	15-400	35-200	2-50
T1.18-3	1.18			0.01-250	0.01-250	0.02-200	0.03-50	5.65	
T1-6	1			01-150	01-150	02-100	05-50	5.65	
T1.5-1	1.5			1-300	1-300	2-150	5-80	4.45	
T1.5-6	1.5			02-100	02-100	05-50	01-25	5.65	
T2.5-6	2.5			01-100	01-100	02-50	05-20	4.45	
T4-6	4			02-200	02-200	05-150	1-100	4.45	
T9-1	9			15-200	15-200	3-150	2-40	3.95	
T16-1	16			3-120	3-120	7-80	5-20	4.45	
T36-1	36			03-20	03-20	05-10	1-5	6.95	
TO	TO-75			1	10-500	—	10-500	40-250	6.95
	T1-1H			1	8-300	8-300	10-200	25-100	5.95
	T9-1H			9	2-90	2-90	3-75	6-50	6.45
	T16-1H			16	7-85	7-85	10-65	15-40	6.45
TMO	TMO1-02			1	1-800	1-800	2-500	—	9.45
	TMO1-1			1	15-400	15-400	35-200	2-50	6.25
	TMO1.5-1		1.5	1-300	1-300	2-150	5-8	8.45	
	†TMO2.5-6		2.5	01-100	01-100	02-50	05-20	7.95	
	†TMO4-6		4	02-200	02-200	05-150	1-100	7.95	
	TMO6-1		6	3-200	3-200	5-150	5-50	7.95	
TMO9-1	9	15-200	15-200	3-150	2-40	7.95			
TMO16-1	16	3-120	3-120	7-80	5-20	7.95			
D 	T	T2-1	2	050-600	050-600	1-400	5-200	3.95	
		T3-1	3	5-800	5-800	2-400	—	4.45	
		T4-2	4	2-600	2-600	5-500	2-250	3.95	
		T8-1	8	15-250	15-250	25-200	2-100	3.95	
		T14-1	14	2-150	2-150	5-100	2-50	4.95	
		TMO	TMO2-1	2	050-600	050-600	1-400	5-200	7.95
			TMO3-1	3	5-800	5-800	2-400	—	8.45
			TMO4-2	4	2-600	2-600	5-500	2-250	7.95
	TMO8-1		8	15-250	15-250	25-200	2-100	7.95	
	TMO14-1		14	2-150	2-150	5-100	2-50	8.45	
	FT		FT1.22-1	1.22	005-100	005-100	01-50	05-25	35.95
	FT1.5-1	1.5	1-400	1-400	5-200	1-100	35.95		
	E 	FTB	FTB-1	1	2-500	2-500	5-300	1-100	36.95
			FTB1-6	1	01-125	01-125	05-50	1-25	36.95
■FTB-1-75			1	5-500	5-500	5-300	10-100	36.95	
F 	T	T-622	1	0.1-200	0.1-200	0.5-100	5-80	3.25	
		T626	1	0.01-10	0.01-10	0.2-5	0.4-2	3.95	

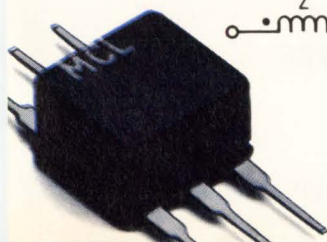

■ Denotes 75 ohm models

* FOR A AND B CONFIGURATIONS

Maximum Amplitude Unbalance
0.1 dB over 1 dB frequency range
0.5 dB over entire frequency range

Maximum Phase Unbalance
1.0° over 1 dB frequency range
5.0° over entire frequency range

CIRCLE NO. 85

C72-2 REV. B

For Designs That Demand a Lot of Memory,

When it comes to PCs, workstations, printers, and other computer-related products, end-users want smaller systems, maximum memory storage, and minimum power consumption. And they want it now. Which creates several problems for you. How do you reduce system size *and* power consumption yet increase memory capacity? *And* be first to market with your product? Oki offers some flexible solutions.

To begin with, our pin-for-pin compatible 4-Megs provide 4X the memory storage of a 1-Meg — without increasing space. Plus our 4-Megs have the lowest power consumption of any 4-Meg, making them ideal for laptops and other memory-intensive, power-hungry

systems. Choose from a variety of packages too: DIP, SOJ, ZIP — and, later in 1990, an ultrathin TSOP, for even more space-saving advantages.

For higher density applications, select from Oki's package-efficient family of SIMMs: 4-Megx8s, 4-Megx9s, and 1-Megx36s. Or we'll work with you to design a custom SIMM that meets your unique specifications. All our 4-Megs and SIMMs are available *now*, so we're ready to help accelerate your design time and your product's time-to-market.

Call Oki today for qualification samples. See why so many companies are demanding Oki's low-power, space-saving 4-Megs and SIMMs — and getting their leading-edge computer products to market so quickly.



Transforming technology into customer solutions

Demand Oki 4-Megs and SIMMs



Oki's 4-Meg Product Line-Up

Device	Organization	Access Mode
MSM514100-XXYY	4M x 1	Fast Page
MSM514101-XXYY	4M x 1	Nibble
MSM514102-XXYY	4M x 1	Static Column
MSM514400-XXYY	1M x 4	Fast Page
MSM514402-XXYY	1M x 4	Static Column

Speed Options (XX) Include:

70 = 70ns (*RAC)
 80 = 80ns (*RAC) 20ns (*CAC)
 8A = 80ns (*RAC) 25ns (*CAC)
 10 = 100ns (*RAC) 25ns (*CAC)

Packaging Options (YY) Include:

JS = 350 mil SOJ
 RS = 400mil DIP
 ZS = 400mil ZIP

SIMMs

MSC2341-XXYS8	4M x 8	Fast Page
MSC2340-XXYS9	4M x 9	Fast Page
MSC2350-XXYS12	1M x 36	Fast Page

Speed Options (XX) Include:

70 = 70ns (*RAC)
 80 = 80ns (*RAC) 20ns (*CAC)
 10 = 100ns (*RAC) 25ns (*CAC)



OKI
Semiconductor

CA Irvine 714/752-1843, Tarzana 818/774-9091, San Jose 408/244-9666 FL Boca Raton 407/394-6099

GA Norcross 404/448-7111 IL Rolling Meadows 708/870-1400 MA Stoneham 617/279-0293 MI Livonia 313/464-7200

NC Morrisville 919/469-2395 NY Poughkeepsie 914/473-8044 PA Horsham 215/674-9511 TX Richardson 214/690-6868

HOW TO TURN 040 WITHOUT LOSING A STEP.

FORCE '030

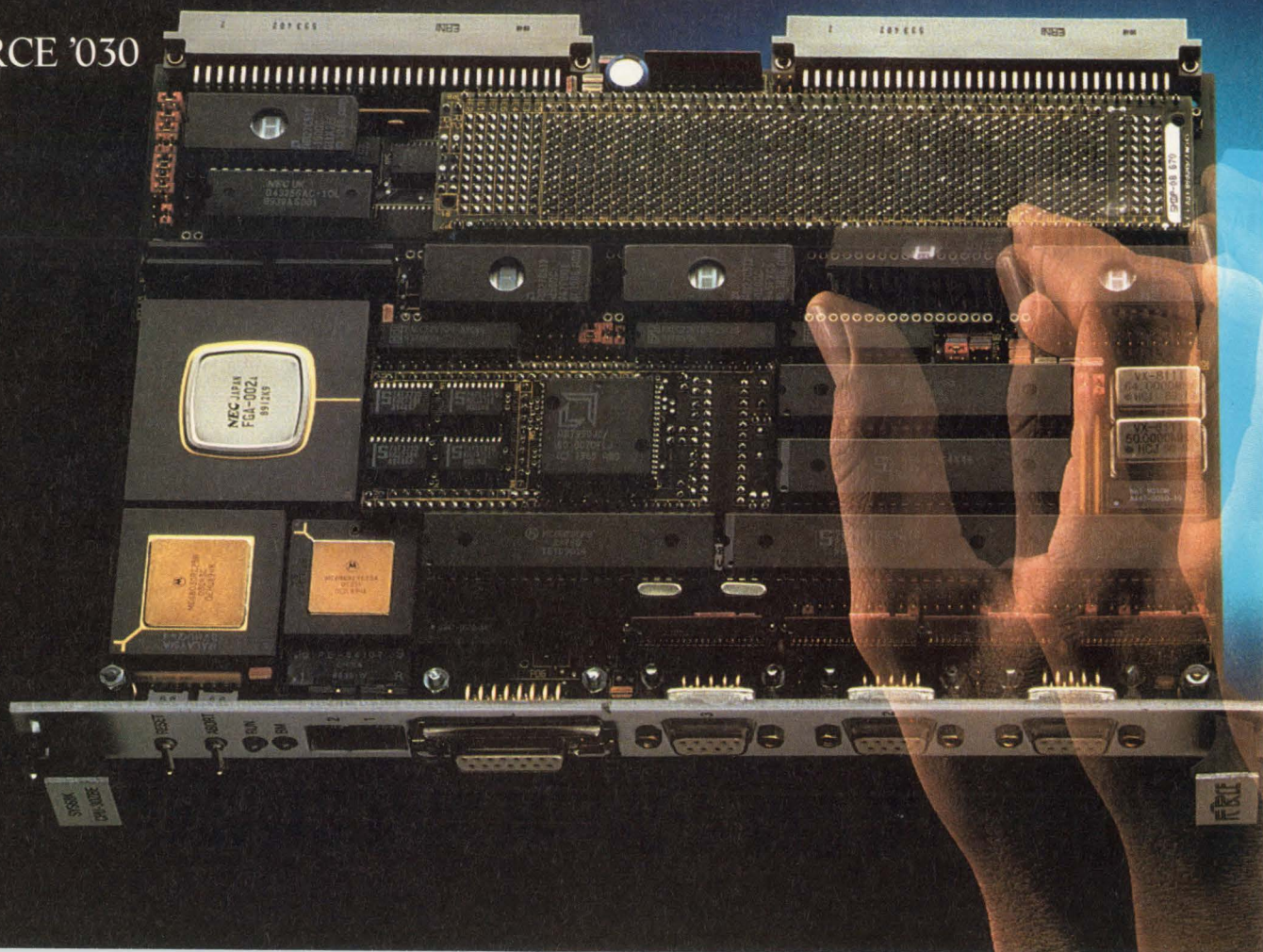

Turning 040 doesn't mean you have to give up the code you lived by when you were 030. Although that's what some manufacturers expect you to do.

But not FORCE. We guarantee that applications written for our 68030 VME boards will run on our 68040 boards. That's because we've built compatibility into our 030 and 040 address maps and on-board device drivers.

In fact, no one makes it easier to move your software from 030 to 040. The competition can't even come close. Just ask them.

Then ask us. We'll keep you from spending months writing new software drivers. So you can spend your time improving performance and functionality. Or getting to market months ahead of the competition.

What's more, you can start today on your 040 applications. Just develop them on a FORCE 030 board. When you're ready, we'll upgrade you to the highest performance 040 board you can buy.

So you can speed up your software without missing a step.

Of course, we have all the tools you need to get started. Choose from the broadest range of real-time operating systems and kernels, including PDOS, OS-9, VxWorks, VRTX32 and pSOS+. We even give you VMEPROM, free of charge.

You can also take advantage of XRAY and the entire Microtec family of software tools. Including cross, native and embedded development environments.

Our performance advantage even extends to UNIX.[®] With the industry's top-rated Unisoft UNIX 5.4.

Finally, you get the industry's best-rated documentation, integration support, regional technical staff and a full one-year warranty.

Here's your next step: call 1-800-BEST-VME ext. 40 for details on our 030 to 040 upgrade offer. Or fax a request to (408) 374-1146 for an immediate response.

Because turning 040 doesn't have to slow you down.

68030 CPU	COMPATIBILITY	68040 CPU
CPU-30	DMA, SCSI, Floppy, Ethernet, Serial I/O	CPU-40 + EAGLE I/O Module
CPU-31	DMA, SRAM, VSB, Serial I/O	CPU-41 + EAGLE I/O Module
CPU-33	DMA, DRAM, Serial I/O	CPU-40



VME at its best.

UNIX is a registered trademark of AT&T. VxWorks is a trademark of Wind River Systems, Inc. pSOS+ is a trademark of Software Components Group. VRTX32 is a trademark of Ready Systems, Inc. OS-9 is a trademark of Microware Systems. PDOS and VMEPROM are trademarks of Eyring Research, Inc. XRAY is a trademark of Microtec Research, Inc. © 1990 FORCE Computers, Inc.

FORCE Computers, Inc., 3165 Winchester Blvd., Campbell, CA 95008-6557, (408) 370-6300 ext. 40

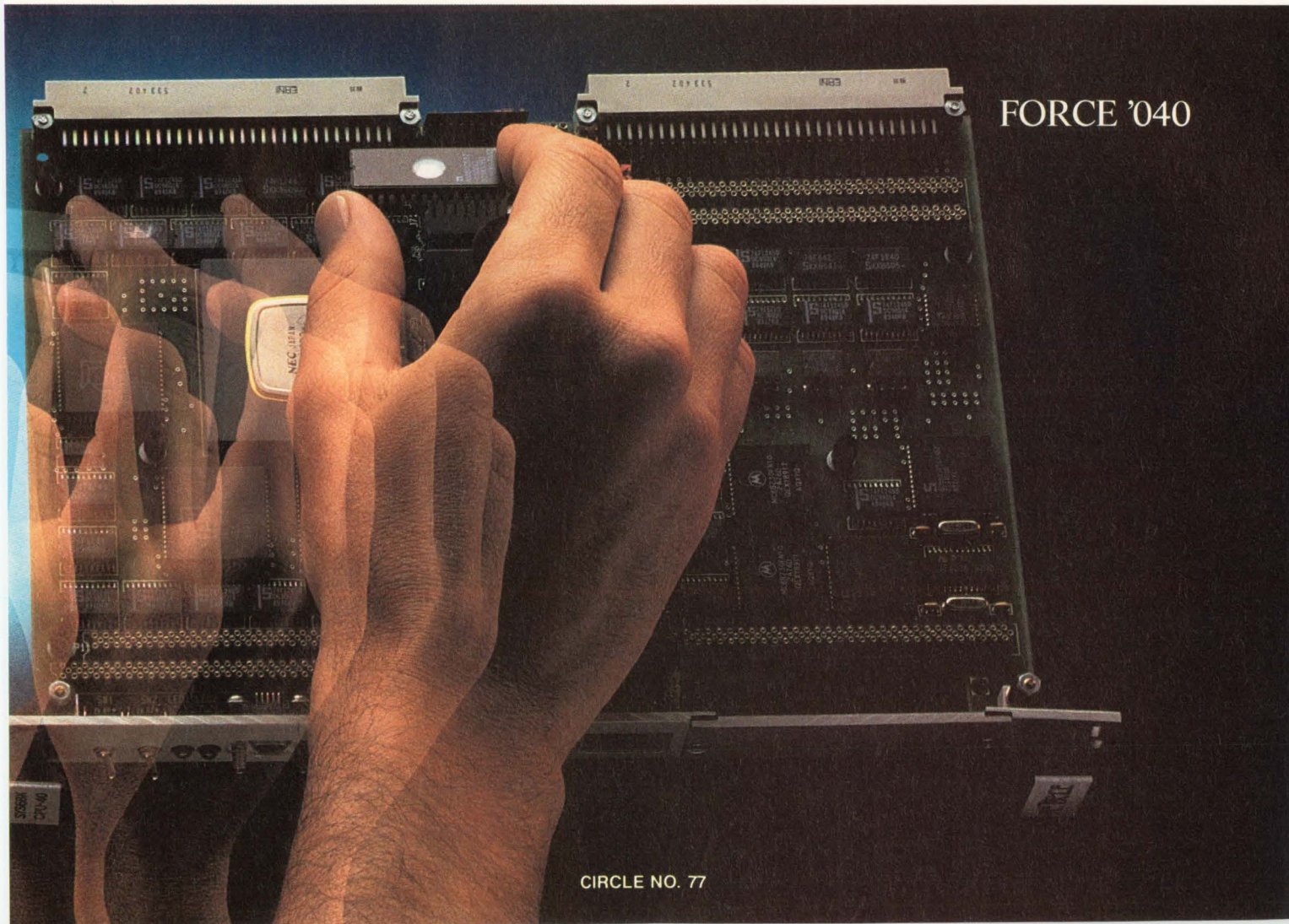

CIRCLE NO. 77

**Because you're
thinking fast...**

you need responsive suppliers as well as fast parts. Comlinear is tuned in. With high quality, high-speed products. Assistance from R&D-level applications engineers to help develop your ideas quicker. Off-the-shelf MIL-STD-883 compliant monolithics and hybrids. Quality product documentation with guaranteed specs so you don't waste time. In your business, time is everything. Count on us for the speed you need.

Now, high-speed AGC is easier than ABC.

Until now, AGC amplifiers were only partial solutions to high-speed automatic gain control. You also had to find a high-performance op amp, numerous passive components and the board space to mount them all.

Now all you need is the new CLC520 AGC+Amp, $\pm 5V$ and two resistors. That's it.

You get a total high-speed AGC solution—with voltage-controlled gain and voltage output—in a single device. Plus outstanding performance: 160MHz signal-channel and 100MHz gain-control bandwidth. And unexpected flexibility... one resistor sets maximum gain between 2X and 100X, and the gain-control input gives you a 40dB range.

So don't settle for a partial AGC solution. Call about the CLC520 AGC+Amp and learn the ABCs of high-speed AGC.

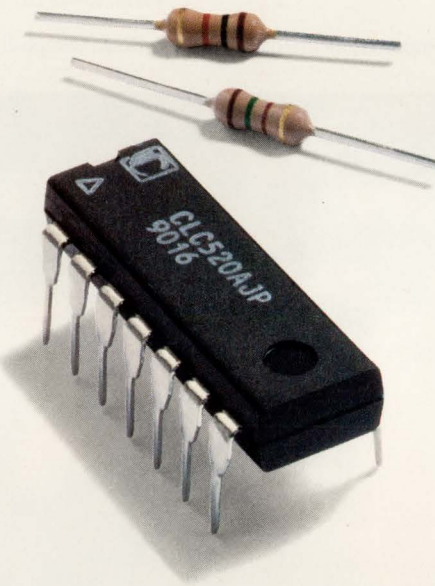

 **Comlinear
Corporation**
Solutions with speed

4800 Wheaton Drive
Fort Collins, CO 80525
(303) 226-0500
1-800-776-0500 (USA)

More
easy-to-use
amplifiers...

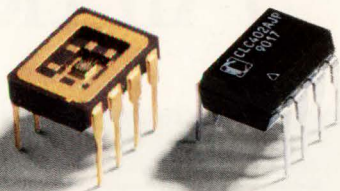

Op amps settle to 14 bits in 32ns max.

Extremely fast settling to 0.0025% and low 1.6mV max. offset make the CLC402 and CLC502 op amps ideal for high-accuracy A/D and D/A converters. Or in designs demanding high stability at low gain. Now you have extra design margins.

CIRCLE NO. 32

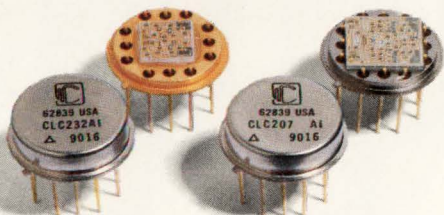

Low distortion for fast, wide-dynamic-range designs.

The 170MHz CLC207 and 270MHz CLC232 deliver ultra-low distortion. For high gain, choose the CLC207 with -80/-85dBc 2nd/3rd harmonics (2V_{p-p}, 20MHz, 200 ohms). And for low gain, the CLC232 with -69dBc harmonics (100 ohms).

CIRCLE NO. 33



Modular amplifiers... ready to go.

For bench or system use, this family of dc-coupled modular amplifiers gives you complete amplifier solutions. Including PMT amps, cable drivers, post-amps, very-low-distortion amps, or amps with gain and I/O impedances that you can select.

CIRCLE NO. 34

EDN September 17, 1990

SIGNALS & NOISE

Why don't we try "foreign" approaches to education?

In response to Jon Titus's editorial (EDN, June 7, 1990, pg 41) concerning the education "crisis," it's true, we all bemoan the fact that America seems to be falling behind, compared with some other countries, in providing our children with a sufficient level of "education" skills.

However, if it's so clear that these other countries are doing a better job than we are, why is it that we cannot adopt some of their educational and curricular approaches? I would imagine these to be transferable in some form, even if complicated by cultural differences.

As Jon points out, any changes must ultimately be implemented at the local level, but it would still seem desirable for our national government to provide the necessary leadership, investigation, and guidance for use of approaches from other countries. An evaluation of why some of these approaches might not be viable for us may also provide valuable insight. Surely, someone must have thought along these lines before, but evidence of any action on it is not generally apparent.

Barrie W Witty
Mount Laurel, NJ

Program for improving our children's education

It is very popular in the US media these days to cite declining test scores of US students or to contrast the achievements of US students with those of their foreign counterparts (EDN, June 7, 1990, pg 41). Politicians are quick to seize the issue as a plank in their campaign platforms. Teachers' unions and school administrators are equally quick to use these data as the basis for more appeals for public money.

The real problem lies not in our teachers or our funding but in ourselves. We as parents are to blame.

Our lifestyles and our choice of toys and entertainment for our children are working against academic achievement.

Here are some starting guidelines for raising above-average children:

1. Love, respect, honor, and be faithful to your spouse. Fighting, contempt, and infidelity between spouses do not create a healthy atmosphere for children.

2. Dare to be different. Instead of you and your children watching TV shows (serious educational shows are an exception), play cards, dice, and board games together as a family. Pick games that have a measure of intellectual content to them.

3. Get (buy new or used, or borrow) books on subjects your children are interested in and read together. The younger the child, the more pictures the book should have.

4. Let your children pick a hobby and work with them on it. Build models, grow things, or paint.

5. Demand respect from your children and their friends and demand that they give it to their teachers. The important thing is to be involved with your children. Spend at least 15 minutes a day with them (instead of watching TV), insist on educational entertainment instead of fad toys, and don't be content with being like everyone else.

Gary Carlson
Hewlett-Packard Co
Boise, ID

Correction

In Richard Quinnell's article on 32-bit embedded controllers (EDN, May 24, 1990, pg 132), Wind River Systems' VxWorks Real-Time Operating Systems were incorrectly listed as running on the Intergraph Clipper RISC processor architecture. Although VxWorks currently supports target systems based on the Motorola 680x0 series, Sun SPARC, and Intel 80960, none of the software has been ported to the Intergraph Clipper.

EDN

Tek's 40 GHz All tied



communications test system. up in one neat package.

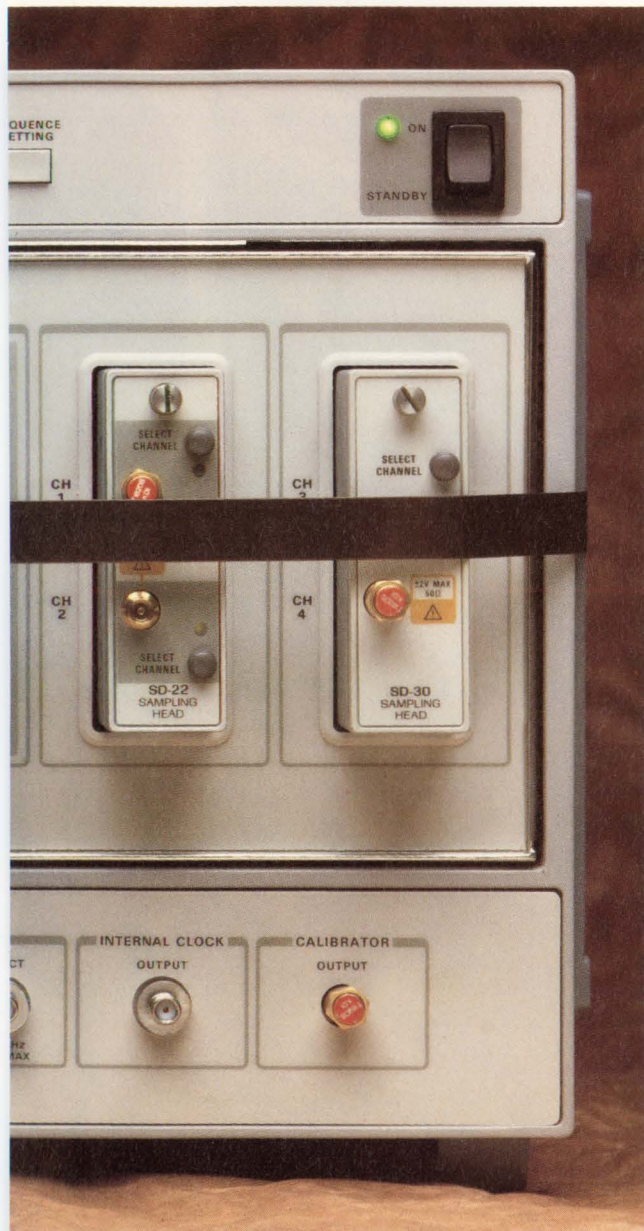

Introducing the Tek CSA 803 Communications Signal Analyzer. As of now, working with high-speed optical and electrical signals is no reason to go to pieces.

Now you can fully experience a real-time feel for waveform through-put and manipulation. Do in-depth statistical analyses of noise and jitter. Trigger on signals of up to 10 GHz. Do on-board mask testing, constellation diagrams, and more.

And, you do it all from within one tailored instrument, without calling on external computers, clumsy cabling, specialized software or costly add-ons.

A powerful on-board statistical data base lets you easily see data distribution densities via color-graded displays. For the first time, you can generate jitter and noise histograms without reacquiring data... and enjoy continuously updated statistical readouts of mean, RMS deviation and p-p at the same time. A sample rate 20 times faster than its nearest competitor lets you analyze data concurrent with acquisition.

You can define, edit and store masks for tolerance testing; the CSA 803 automatically counts the samples that fall within each mask. Constellation diagrams, for qualitative digital RF testing, are also provided.

Unique color grading lets you easily see distribution densities. This, combined with easy template definition, makes the CSA 803 ideal for mask/template testing in design or manufacturing.

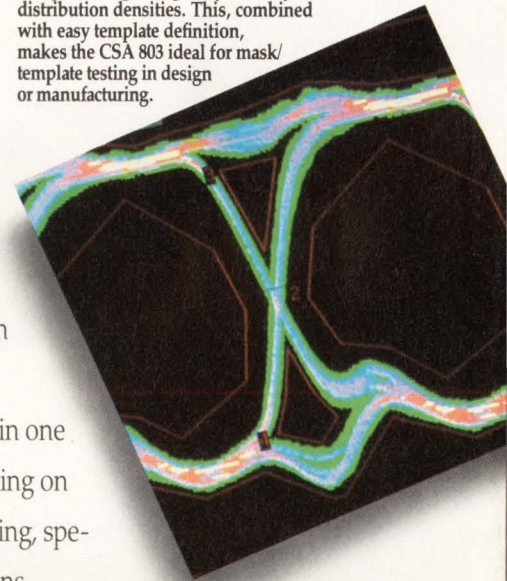

Easily expand to meet your needs and new evolutions of technology. Start with one channel if you wish, and add more channels up to a total of four. Choose from a large and still-growing selection of plug-in sampling heads, optimized for your application. The CSA's modular design lets you upgrade without adding an inch to its footprint.

Call 1-800-426-2200 for the complete CSA 803 story. Or let your Tek sales engineer show you the whole package soon.

Tektronix
COMMITTED TO EXCELLENCE

FILTERS



dc to 3GHz from \$1145

lowpass, highpass, bandpass, narrowband IF

- less than 1dB insertion loss • greater than 40dB stopband rejection
- 5-section, 30dB/octave rolloff • VSWR less than 1.7 (typ) • meets MIL-STD-202 tests
- rugged hermetically-sealed pin models • BNC, Type N; SMA available
- surface-mount • over 100 off-the-shelf models • immediate delivery



low pass dc to 1200MHz

MODEL NO.	PASSBAND, MHz (loss <1dB)		STOP BAND, MHz (loss >20dB) (loss >40dB)		VSWR		PRICE \$ Qty. (1-9)
	Min.	Nom.	Max.	Max.	pass-band typ.	stop-band typ.	
PLP-10.7	DC-11	14	19	24	200	1.7	18 11.45
PLP-21.4	DC-22	24.5	32	41	200	1.7	18 11.45
PLP-30	DC-32	35	47	61	200	1.7	18 11.45
PLP-50	DC-48	55	70	90	200	1.7	18 11.45
PLP-70	DC-60	67	90	117	300	1.7	18 11.45
PLP-100	DC-98	108	146	189	400	1.7	18 11.45
PLP-150	DC-140	155	210	300	600	1.7	18 11.45
PLP-200	DC-190	210	290	390	800	1.7	18 11.45
PLP-250	DC-225	250	320	400	1200	1.7	18 11.45
PLP-300	DC-270	297	410	550	1200	1.7	18 11.45
PLP-450	DC-400	440	580	750	1800	1.7	18 11.45
PLP-550	DC-520	570	750	920	2000	1.7	18 11.45
PLP-600	DC-580	640	840	1120	2000	1.7	18 11.45
PLP-750	DC-700	770	1000	1300	2000	1.7	18 11.45
PLP-800	DC-720	800	1080	1400	2000	1.7	18 11.45
PLP-850	DC-780	850	1100	1400	2000	1.7	18 11.45
PLP-1000	DC-900	990	1340	1750	2000	1.7	18 11.45
PLP-1200	DC-1000	1200	1620	2100	2500	1.7	18 11.45

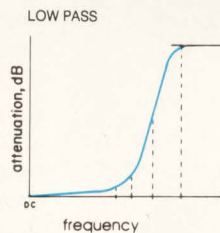

high pass dc to 2500MHz

MODEL NO.	PASSBAND, MHz (loss <1dB)		fco, MHz (loss 3db)	STOP BAND, MHz (loss >20dB) (loss >40dB)		VSWR		PRICE \$ Qty. (1-9)
	Min.	Min.		Min.	Min.	pass-band typ.	stop-band typ.	
PHP-50	41	200	37	26	20	1.5	17 14.95	
PHP-100	90	400	82	55	40	1.5	17 14.95	
PHP-150	133	600	120	95	70	1.8	17 14.95	
PHP-175	160	800	140	105	70	1.5	17 14.95	
PHP-200	185	800	164	116	90	1.6	17 14.95	
PHP-250	225	1200	205	150	100	1.3	17 14.95	
PHP-300	290	1200	245	190	145	1.7	17 14.95	
PHP-400	395	1600	360	290	210	1.7	17 14.95	
PHP-500	500	1600	454	365	280	1.9	17 14.95	
PHP-600	600	1600	545	440	350	2.0	17 14.95	
PHP-700	700	1800	640	520	400	1.6	17 14.95	
PHP-800	780	2000	710	570	445	2.1	17 14.95	
PHP-900	910	2100	820	660	520	1.8	17 14.95	
PHP-1000	1000	2200	900	720	550	1.9	17 14.95	

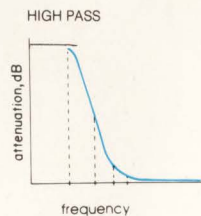

bandpass 20 to 70MHz

MODEL NO.	CENTER FREQ. MHz F0	PASS BAND, MHz (loss <1dB)		STOP BAND, MHz (loss > 10 dB) (loss > 20 dB)				VSWR 1.3:1 typ. total band MHz	PRICE \$ Qty. (1-9)
		Max. F1	Min. F2	Min. F3	Max. F4	Min. F5	Max. F6		
PIF-21.4	21.4	18	25	4.9	85	1.3	150	DC-220	14.95
PIF-30	30	25	35	7	120	1.9	210	DC-330	14.95
PIF-40	42	35	49	10	168	2.6	300	DC-400	14.95
PIF-50	50	41	58	11.5	200	3.1	350	DC-440	14.95
PIF-60	60	50	70	14	240	3.8	400	DC-500	14.95
PIF-70	70	58	82	16	280	4.4	490	DC-550	14.95

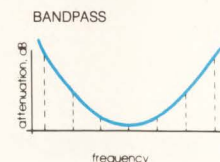

narrowband IF

MODEL NO.	CENTER FREQ. MHz F0	PASS BAND, MHz I.L. 1.5dB max. F1-F2	STOP BAND, MHz I.L. > 20dB		STOP BAND, MHz I.L. > 35dB		PASS-BAND VSWR Max.	PRICE \$ Qty. (1-9)
			F5	F6	F7	F8-F9		
PBP-10.7	10.7	9.5-11.5	7.5	15	0.6	50-1000	1.7	18.95
PBP-21.4	21.4	19.2-23.6	15.5	29	3.0	80-1000	1.7	18.95
PBP-30	30.0	27.0-33.0	22	40	3.2	99-1000	1.7	18.95
PBP-60	60.0	55.0-67.0	44	79	4.6	190-1000	1.7	18.95
PBP-70	70.0	63.0-77.0	51	94	6	193-1000	1.7	18.95

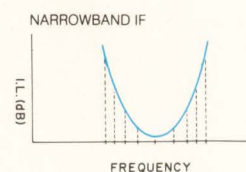

CIRCLE NO. 88

Mini-Circuits

P.O. BOX 350166, Brooklyn, New York 11235-0003 (718) 934-4500 FAX (718) 332-4661 TELEX 6852844 or 620156 WE ACCEPT AMERICAN EXPRESS

F132-2 REV. ORIG.

Signetics. Because into making

WITH OUR FULL FAMILY

To design successful new systems, you need an IC vendor who understands your ever-changing needs. A partner who can match the right device to your application.

That's exactly what you get from Philips Components-Signetics.

As the design world changes, Signetics changes. We're listening to your needs. And designing and enhancing our devices to meet those needs.

Like the growing need for personal communication devices and for ICs in desktop and portable computing. As well as devices for computer networking with compatibility across platforms. And for ICs that meet the need for robotics and automation in manufacturing.

We're also drawing from nearly a century of Philips innovation to apply our consumer technologies to the business world. Including digital video and high-density compact disc storage.

In fact, wherever your design needs take you, Signetics will be there with complete families of devices to meet emerging computing, communications and control needs.

©1990 NAPC

Philips Components

you've put so much it perfect.

OF ICs, YOU GET OUT OF IT WHAT YOU PUT INTO IT.

COMPUTING		COMMUNICATIONS		CONTROL	
APPLICATION	PRODUCT	APPLICATION	PRODUCT	APPLICATION	PRODUCT
Workstations	<ul style="list-style-type: none"> ● Advanced BiCMOS Logic ● High Speed ASICs ● Futurebus Chip Set ● High Speed PAL®-type Devices ● High Performance MCUs ● SRAMs 	Cellular Communications	<ul style="list-style-type: none"> ● Cellular Chip Set ● Frequency Synthesizers 	Automotive Control Systems	<ul style="list-style-type: none"> ● 8-bit 80C51-based MCUs ● OTP EPROMs ● Linear/Digital/Mixed Mode ASICs
Personal Computers	<ul style="list-style-type: none"> ● High Density ASICs/PLDs ● DRAM Controllers ● OTP EPROMs ● FLASH Memory 	Mobile Telephony	<ul style="list-style-type: none"> ● Paging ICs ● Frequency Synthesizers 	Consumer Appliances and Entertainment	<ul style="list-style-type: none"> ● A/D MCUs ● LCD Displays ● Audio Circuitry ● Dolby Noise Reduction ● Frequency Synthesizers
Desk Top Video	<ul style="list-style-type: none"> ● A/D Converters ● Digital Color Decoders 	FAX/Modems/Features Phones	<ul style="list-style-type: none"> ● 8-bit 80C51-based MCUs ● E²PROM ● LCD Drivers ● Dialers ● Speech Circuits ● RF Chip Set 	Industrial Control & Robotics	<ul style="list-style-type: none"> ● Advanced BiCMOS Logic ● UV/OTP EPROM MCUs ● Real-Time Bus Communications Controller
Peripheral Products	<ul style="list-style-type: none"> ● 8-bit 80C51-based MCUs ● Zero Power PLDs ● Programmable Sequencers ● 3-State ECL Transceivers 	DataComm LANs	<ul style="list-style-type: none"> ● Ethernet Chip Set ● 100-Mbit Fiber ● High Speed PLDs ● Advanced BiCMOS Logic 	Portable Instrumentation	<ul style="list-style-type: none"> ● Low Voltage/Power MCUs ● Advanced CMOS Logic ● LCD Drivers
		Multi-Protocol	<ul style="list-style-type: none"> ● Dual Universal Serial Controller ● UARTs and DUARTs 		

As illustrated above, we're listening to customer needs and developing products in three focused areas: computing, communications and control.

This includes products based on our advanced BiCMOS technology, QUBiC. Developed from our strength in bipolar technology and fully integrated with our sub-micron CMOS technology, QUBiC gives you nearly twice the speed of previous-generation bipolar ICs. With CMOS power savings. We're incorporating QUBiC into all our product families, creating a new class of high-performance devices.

Philips Components-Signetics is committed to the military market, with over 80% of our ICs meeting MIL-SPEC certification. This commitment is evident in our Class S domestic assembly plant and DESC-certified wafer fabs.

To learn how Philips Components-Signetics helps you make the perfect design, call today for more information: 800-227-1817, ext. 711D.

PAL is a trademark of AMD/MMI

Signetics

EXTENDING THE DIMENSIONS OF PERFORMANCE



When a Picture is worth 1600x1280 Pixels.

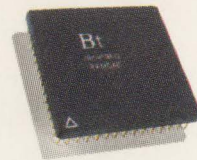

Our new 200 MHz RAMDAC, with 8:1 MUX and 2-plane cursor makes it easier than ever to design new 1600x1280 graphics systems.

When's the time to make the move to higher resolution 1600x1280 monitors? NOW! Our new Bt468 triple 8-bit RAMDAC delivers the functional richness and pure performance you need to tackle next-generation designs.

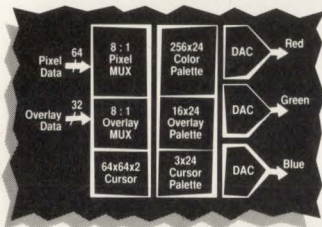

To begin with, it's a 200 MHz monolithic CMOS device. And while we could wax rhapsodic

on our technical achievements in pushing CMOS to such an unprecedented speed, we recognize that such data rates are absolutely necessary for high performance color graphics.

So we also gave the Bt468 multiple pixel ports and internal multiplexing to enable a direct TTL-compatible interface to the frame buffer. On-chip 8:1 multiplexing reduces external

logic and means you can design your system with low cost 25 MHz VRAMs.

We've given the Bt468 its own user-definable 64x64 hardware cursor to further simplify your design. And our exclusive Pixel Panning feature lets you add smooth image panning without any additional overhead for your graphics processor. By the way, the Bt468 is also available in a lower cost 170 MHz version, so your board design will be compatible with lower refresh rates, too.

So if your system is worth 1600x1280 pixels, now's the time to call Brooktree at 1-800-VIDEO IC.

Brooktree

CIRCLE NO. 90





THE NEW MAGIC NUMBERS IN DATA CORRELATION

Micro Devices' new MD1212 Fuzzy Data Correlator brings a new set of realities to real-time data analysis and signal processing.

Limited to 64-bit word length? Not any longer! A single MD1212 can perform a 128-bit correlation — and the units can be cascaded to process data segments of any length.

Restricted by response time that's too slow for meaningful real-time work? No longer! The MD1212 operates at a 50 MHz clock rate. Exact matches are verified in one

clock cycle; close matches (determined by Hamming distance measurement) are available in three clock cycles.

Perplexed by exotic interfaces? Unlike similar devices, the MD1212 can be controlled via a standard 8-bit microprocessor interface.

Frustrated by budget-bending device prices? Order the MD1212, in 1000-piece lots, at just \$29 each (single quantity only \$35).

For image recognition, radar/sonar pattern matching, error detection, video frame synchronization,

spread spectrum, flag word detection and other critical correlation applications, the MD1212 is the high-performance, low-priced solution. For technical details, contact:

 **Micro
Devices**

30 Skyline Drive
Lake Mary, FL 32746-6201 USA
Telephone 407/333-4379
FAX 407/333-4479

SAMTEC SLASHES SHIPMENTS TO 5 DAYS

MON	TUE	WED	THU	FRI
1	2	3	4	5

On orders of up to 1000 connectors.

With Samtec "Super Service" we'll ship up to 1000 of just about everything in our catalog in just 5 days. This includes *all* machined strip, DIP and PGA interconnects, *all* .025" square post headers and sockets, *all* board stackers, *all* low profile interconnects, *all* .050" centerline micro interconnects... virtually everything in over 100 pages of interconnect solutions. The only excluded items are cable assemblies and other custom interconnects.

For common connectors shipped from stock, in two days guaranteed, or nearly anything else shipped in just five, experience Samtec Sudden Service today.

Call: 1-800-SAMTEC-9

Until 7:00 pm EST



IS SUDDEN SERVICE

New Albany, Indiana USA • Sacramento, California USA • Cumbernauld, Scotland UK • Singapore

SAMTEC, INC. P.O. Box 1147 • New Albany, IN 47151-1147 USA • Phone 812-944-6733 • Fax 812-948-5047 • TWX 810-540-4095 • Telex 333-918

EDITORIAL

For now, forget the USSR



The opening of trade barriers with Eastern European countries and the liberalization of their governments is encouraging companies to see these areas as untapped markets. Many people are also looking at the USSR as a market of vast potential—much as people viewed China in the 1980s. Although the USSR's former satellite countries may prove to be lucrative markets, don't rush into the USSR. It will get harder and harder for businesses to work in the USSR for many reasons. We advise using a great deal of caution.

Now that trade with the USSR can involve deals between individual companies, many western businesses are finding it hard to get paid for shipments to the USSR. Prior to the spring of 1989, the USSR guaranteed payments for all imports. Now, individual companies and enterprises are responsible for their own bills. Many aren't paying regularly; some aren't paying at all. The *Wall Street Journal* estimates that the USSR's total of unpaid import bills reaches \$2 billion.

The Soviet Union is woefully short of hard currency with which to conduct its trade, and some companies have to resort to taking payment in kind—exports which may have little market value in western countries. The USSR is also short of business managers, economists with market-economy experience, and bankers who can handle the hundreds-fold increase in commercial transactions. Anyone contemplating business with a company in the USSR should think long and hard about the venture.

Unlike its former European satellites, the USSR has yet to restructure its economy to account for unemployment and bankruptcy. Thus, scarce monetary and material resources drain the USSR's reserves by continuing to flow into dead businesses. A recent spending spree on imported consumer goods did little to ease the demand for such goods, but it damaged the USSR by causing a liquidity crunch. These events and conditions should harden our attitude toward doing business in the USSR.

Meanwhile, inflation is starting to rear its ugly head in the USSR. Wages are rising at a rate approaching 15% while the country's GNP decreases. The result is a reported 20% inflation rate. As prices rise, farmers and manufacturers are reluctant to turn over their produce and products to state organizations that pay them at an official rate. They can make more money selling goods on the black market where goods command freer-market rates.

Karl Marx's mother is reported to have said, "If Karl, instead of writing a lot about capital, made a lot of capital, it would have been much better." No doubt many in the USSR today would agree.



Jesse H. Neal
Editorial Achievement Awards
1987, 1981 (2), 1978 (2),
1977, 1976, 1975
American Society of
Business Press Editors Award
1988, 1983, 1981

A handwritten signature in black ink, appearing to read "Jon Titus".

Jon Titus
Editor

BEFORE YOU CHOOSE P BETTER CHECK

Things aren't always what they seem.

Some people would have you believe FPGAs are faster and denser than MAX™ EPLDs.

Funny how they never mention *in-system* performance, though. When they talk about speed, they quote 100MHz flip-flop toggle rates. When they talk about density, they recite raw gate counts.

Which could make your high-performance design highly disappointing.

But if you want to do more than just spin your wheels, consider MAX.

It's the first family of programmable logic

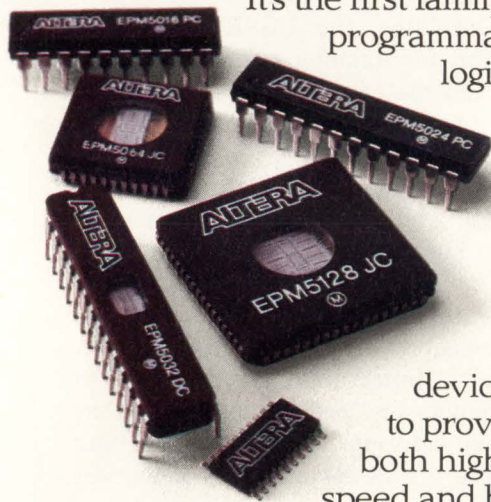

devices to provide both high speed and high

logic density where it counts. At the system level.

Which means MAX can handle just about all your logic needs. In fact, a single 64-macrocell EPM5064

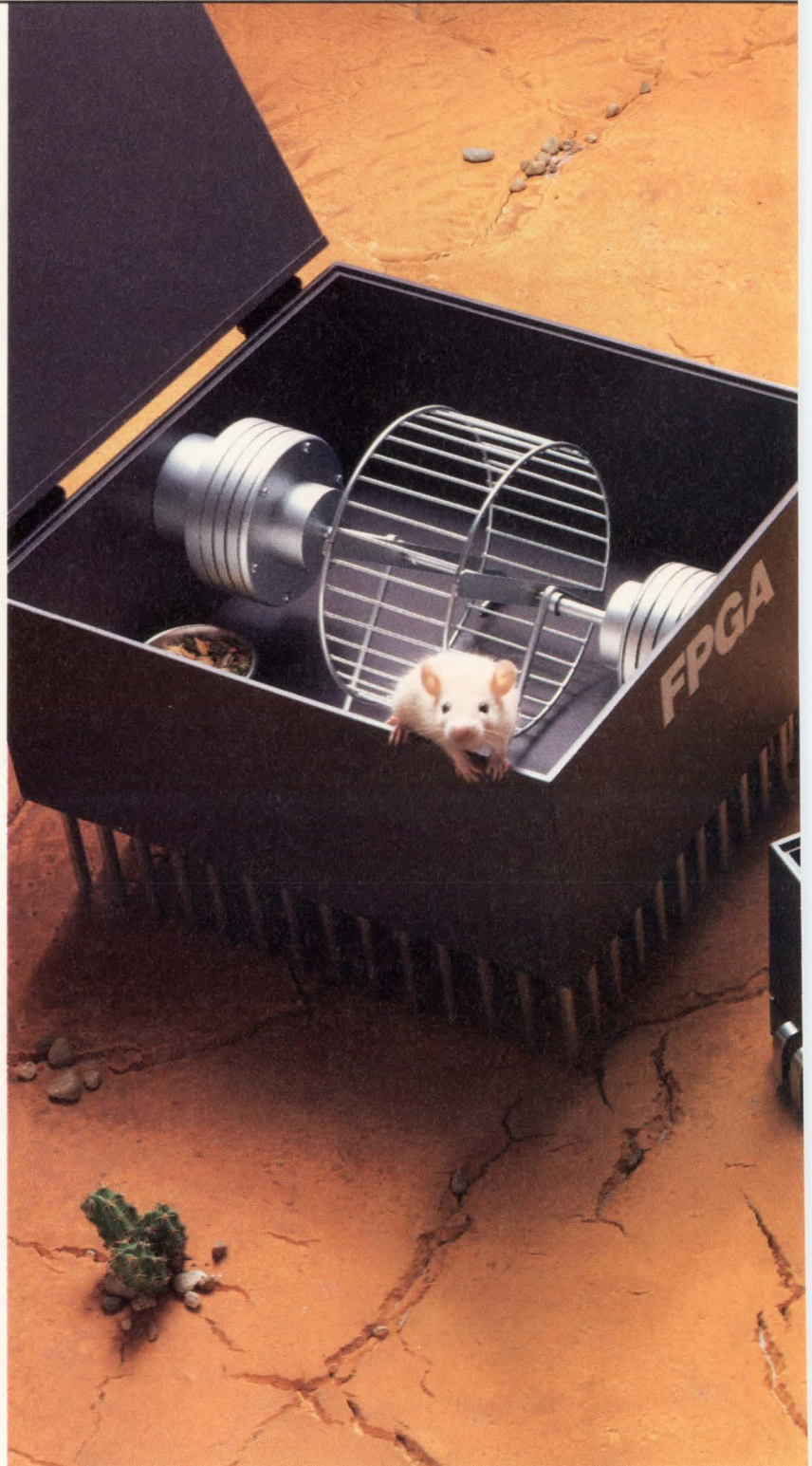

ROGRAMMABLE LOGIC, UNDER THE HOOD.



can integrate anything from simple system glue logic right up to complex graphics coprocessors and LAN and memory controllers.

Or take the 68-pin MAX EPM5128. It's up to 50% faster and 100% denser

than comparable FPGAs, thanks to its high-performance architecture and superior logic routability. But don't take our word for it—just take a look at the competition's benchmarks.

Best of all, MAX gives you this unbeatable performance in record time. With powerful, easy-to-use MAX+PLUS™ software, design compile times are measured in minutes. Not hours or days.

So if you're looking to redefine system performance, talk to the folks who invented the EPLD. Call Altera today at (408) 984-2800.

We'll make sure you've got plenty of horses under the hood.

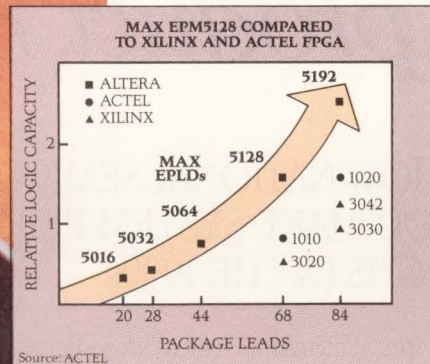

ALTERA

2610 Orchard Pkwy., San Jose, CA 95134-2020
Tel. (408) 984-2800 Fax. (408) 248-6924

MAX and MAX+PLUS are trademarks of Altera Corporation. © 1990, Altera Corporation.

“Everyone today is and digital on the same chip—but That’s product, not promises.”

HOW NATIONAL SEMICONDUCTOR IS HELPING YOU MAKE SYSTEM-PERFORMANCE BREAKTHROUGHS IN THE 1990s.

Graham Baskerville, National Semiconductor’s Vice President, Linear Product Development, and *Charlie Carinalli*, Vice President, Integrated Systems Group, talk about the challenges of mixed analog+ digital technology.

Breaking the ISDN logjam at the U interface.

“This may be the most technically complex integrated-analog-and-digital device ever designed. It’s our TP3410 U-interface transceiver for ISDN.”

“It’s the missing link that allows the twisted-pair telephone

network to carry simultaneous voice and high-speed data across the subscriber loop to the telco central office.”

“It’s all CMOS, for high density, low power, and scalability—it’s at 1.2µm, but we’re already planning a shrink to 0.8µm.”

“And we can control that shrink because we designed the die in modules, separating the analog and digital functions. We even gave them their own power and ground supply pins to isolate the noisy rail-to-rail switching of the digital from the sensitive circuits of the analog.”

“Over 100K transistors with a single +5V supply, all in a 28-pin DIP that dissipates 300mW. Nobody else has a solution this advanced.”

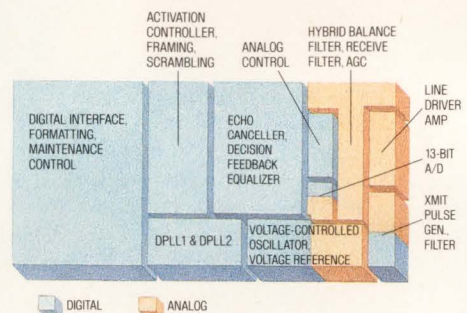

Setting a new standard in A-to-D conversion.

“Our ADC1241 is another example of our unique strength in combining complex analog and digital functions on the same substrate.”

“It has an analog front end for data acquisition, but then we’ve implemented a powerful self-calibration function in digital. During each conversion, it performs a self-correction cycle, reducing non-linearity errors to less than $\pm 1/2$ LSB.”

“So we get 12-bit-plus-sign resolution with an accuracy that’s guaranteed over the full mil temp range. Nobody else can do this.”

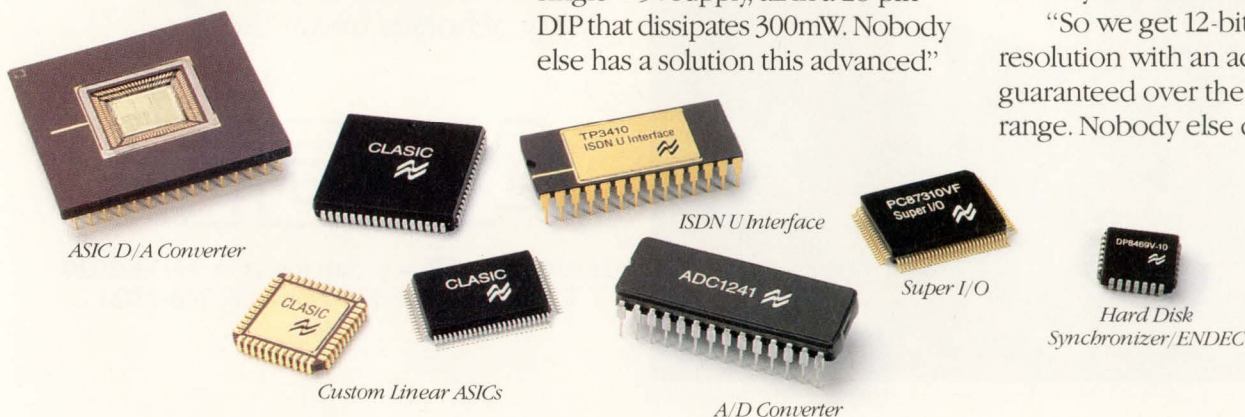

talking about integrating analog we've been doing it for years.



Pushing the limits of PC integration.

"Here again, in our new Super I/O chip, PC87310, we've integrated analog and digital to a level that's never been achieved before."

"Industry-standard floppy-disk controller and UARTs, a parallel port, IDE hard-disk address decode,..."

"With analog PLLs in the floppy controller for pulse detection and data separation."

"All-digital is easier to build, but the performance suffers. And that's not a compromise we're willing to make."

Meeting our customer demand for mixed analog + digital ASICs.

"We call this CLASIC — Custom Linear ASIC. We use standard-cell methodology and optimized process technologies to offer high-performance VLSI solutions com-

binning analog and digital functions."

"The CLASIC library right now has more than 500 analog cells and a good selection of digital building blocks."

"But again, it's not just functions, it's processes. We can fab in the process best suited to your design — linear bipolar, linear CMOS, BiCMOS."

"True customer focus."

continued next page

The challenge of integrating analog and digital functions onto the same chip.

"The demand for mixed analog+ digital really is customer-driven. Our customers need to build systems with higher performance because their customers are demanding it. Because their applications need it."

"And the way to achieve higher levels of performance is through higher levels of integration. Which, at the chip level, ultimately demands that analog and digital functions be pulled together onto the same substrate."

"And this is like trying to merge two incompatible universes."

"Digital's goal is smaller, faster, denser. The world turns on lithography. It lives for the shrink."

"Analog, on the other hand, is concerned with precision, linearity, dynamic range, bandwidth, phase shift, component matching, micro-voltage sensitivity. And it simply can't tolerate the clanging rail-to-rail switching noise of digital."

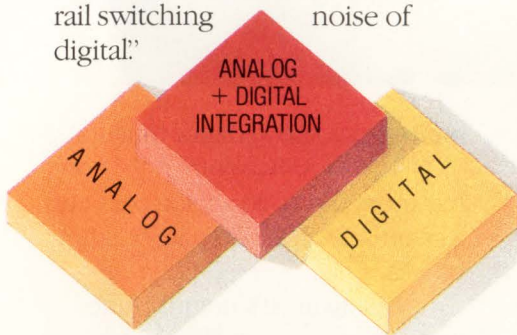

Meeting the challenge with world-class products.

"Our U interface is a perfect example of how difficult this really is. ISDN is digital, but it has to operate over the existing telephone wiring using analog signals. And

there's only one twisted pair. So your transmit and receive signals appear on the same terminals. You send 160Kbits/sec digital pulses at 2.5V and it has to travel maybe three or four miles over the subscriber loop without repeaters or amplifiers. Over that distance, you're getting up to 40dB attenuation, so it arrives at about 25 millivolts. So the problem is, how do you pick that signal out of all the noise and the local transmit signal, which is 100 times more powerful?"

"You need low power, so if you tried to do it just with analog filters, it would be too complicated and too sensitive to process variations. But if you tried all-digital, it would be too complex to compensate for the limitations of the analog front end. So we combined analog filtering and a 13-bit A-to-D converter onto a single chip with dedicated DSP."

"The point is, we did it!"

Meeting the challenge with world-class analog and digital designers.

"Building something like the U-interface transceiver demands some of the most sophisticated design techniques in the world."



"And not only are the individual analog and digital functions difficult to design, but then you have to integrate them onto the same chip."

"So you need world-class digital designers, world-class analog designers, and strategic partners who know how to work together."

"We've got them all. And they've been working on joint designs for many years."

"That's how we do it."

Meeting the challenge with world-class process technologies.

"Another problem for chip designers is that they are limited to the process technologies available to them."

"But, because of our heritage in both analog and digital, we've developed probably the broadest range of process technologies of any company in the industry, including bipolar, CMOS, and BiCMOS."

"We employ a 'core-process' concept. We have six basic core flows, then we add modules for specific functions."

"We can take our advanced M²CMOS core, for example, and add a bipolar module. Or a linear capacitor module. Or EEPROM. Or we can do a bipolar core with a CMOS module. Or we can go to BiCMOS. Or LFAST or LMCMOS or DMOS or JDMOS."

"The key is, our designers have the freedom of selecting the best combination of processes for every analog and digital chip. The application drives the process choice. Not the other way around."

Meeting the challenge with world-class design tools.

"When you try to put analog and digital together, all the existing simulators, place-and-route CAD software, and behavioral models fall apart."

"So we've developed our own. And we're working closely with one of the world's leading CAD-tools companies to create a universal, end-to-end design environment."

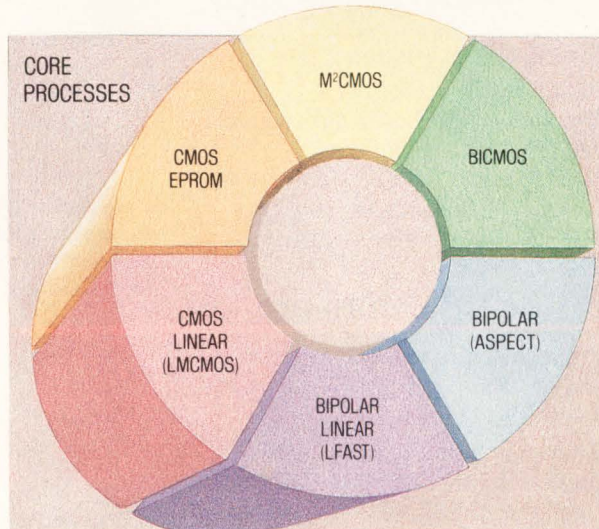

"But already our ASIC Division has used our DA4 tools to introduce significant new standard cells, some of which allow high-voltage outputs to be combined with +5V CMOS to 30,000 gate densities."

"So now, for example, you can put logic, RAM, ROM, or EEPROM on the same chip with D-to-A converters and high-voltage drivers."

"No one has ever done this before."

"And it's only the beginning."

Putting the pride of National to work for you.

"The point is, our customers need mixed analog+ digital capabilities. And we can offer that to them today. We can integrate a complete



system solution for them. Or we can work with them at a particular phase in their design. We have the right products, the right processes, the right tools, the right people. And we're putting all of it just a simple phone call away."

1-800-NAT-SEMI, Ext. 301



© 1990 National Semiconductor Corporation
 PC/AT is a registered trademark of International Business Machines, Inc. LFAST is a registered trademark and ASPECT CLASIC, DA4, LMCMOS, and M²CMOS are trademarks of National Semiconductor Corporation.

WORLD CLASS

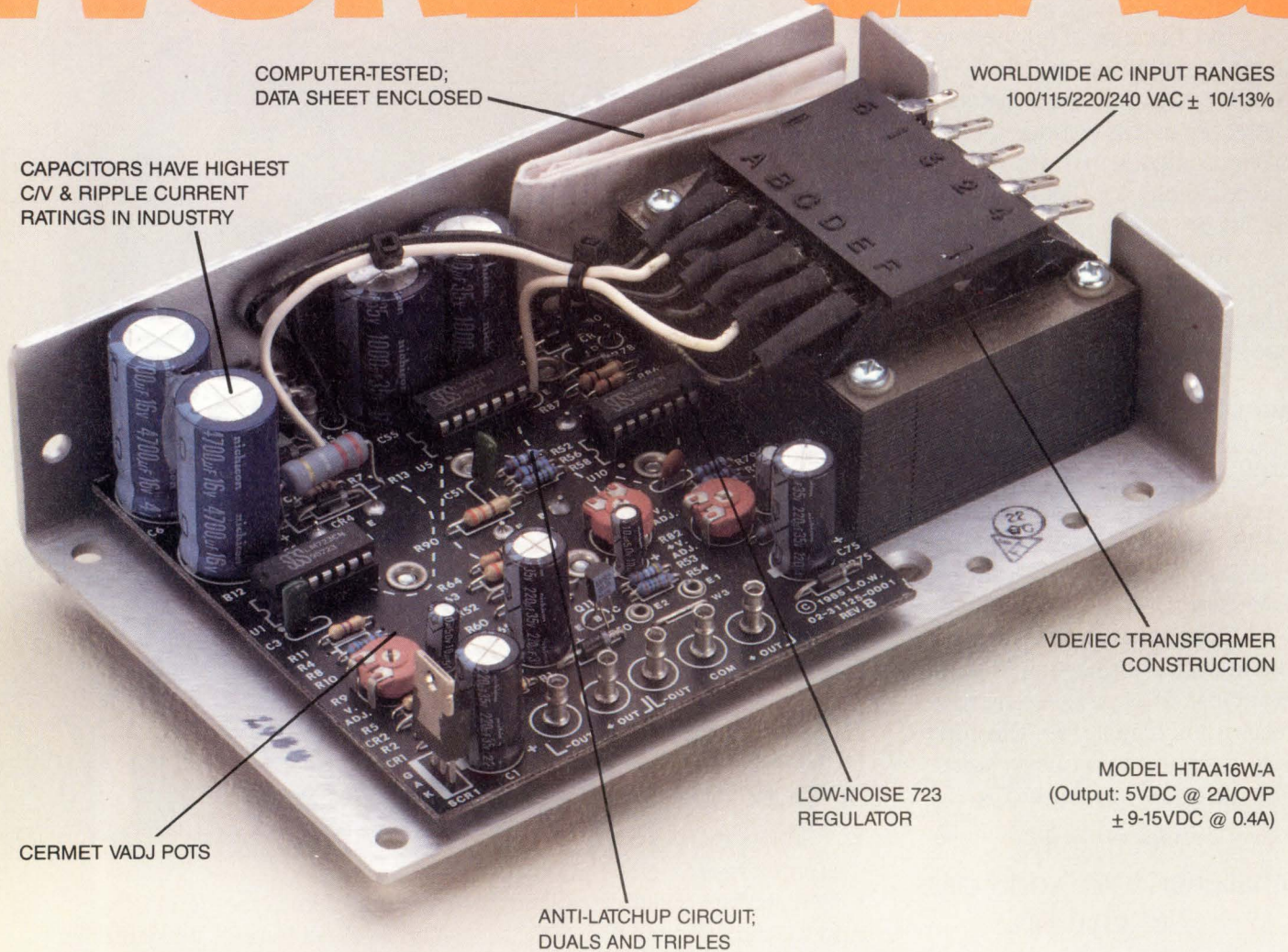

Condor's International linear power supplies — certified to UL544.

Condor's *International Series II* D.C. power supplies virtually eliminate primary-secondary shorting because each coil uses a separate bobbin surrounded by two layers of glass-impregnated plastic, giving complete mechanical and electrical isolation.

The best low-noise 723 regulator chips are used throughout the line, together with proven, reliable semiconductors. TO3-cased pass elements are hermetically sealed, and the latest high-density, high-ripple current rating capacitors from proven, high-quality vendors ensure long life and reliability.

International Series II features:

- 7 power levels — 3 to 150W
- 70 models (single, dual & triple output)
- OVP on all 5V outputs
- Meets EMI per FCC/VDE B (most units)
- Hermetically sealed power transistors
- MTBF 200,000+ hours per Mil Hndbk 217D
- 2-hour burn-in with cycling
- Full 3-year warranty
- 5th-generation design by Tom Ingman — most copied designer in the power supply industry

Sixty-five *International Series II* models are approved to UL478/1012; CSA C22.2 and TUV certified to VDE 0806 and IEC 435, 1 & 2. Twenty-six models are also approved to UL544. Call us today and put Condor's world-class power supplies to work for you!

Send for our free catalog!



250 power supplies!
Switchers and linears!
Open frame and enclosed!
Custom capability!



2311 Statham Parkway, Oxnard, CA 93030
(805) 486-4565 • TWX: 910-333-0681
FAX: (805) 487-8911
CALL TOLL-FREE: 1-800-235-5929 (outside CA)

Fast 10-Bit Sampling A/D Converters Include Reference, DC and Dynamic Specs

Maxim's new 10-bit analog-to-digital converters come complete with internal voltage reference, track/hold, and clock - *saving valuable board space*. The MAX151 and MAX177 are ideal for applications such as digital-signal processing, audio and telecom processing, high-accuracy process control, electro-mechanical systems and high-speed data acquisition.

MAX151 - 300kHz/2.5 μ s 10-Bit Sampling A/D - \$11.50*

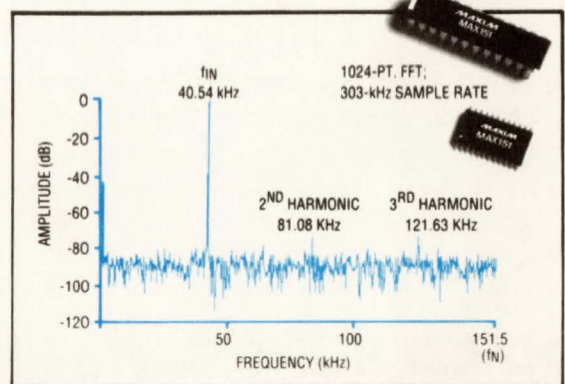
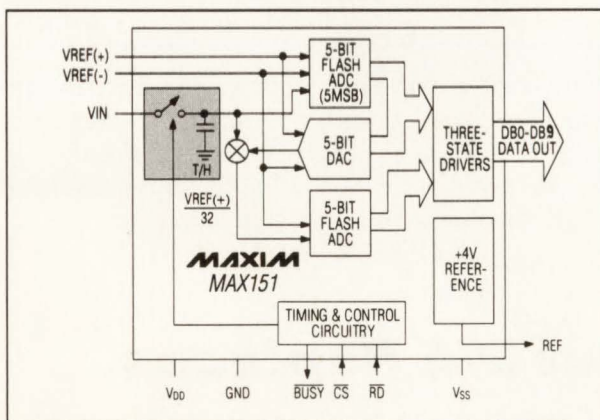

- ◆ 100% Tested for DC and Dynamic Accuracy
- ◆ ± 1 LSB Total Unadjusted Error
- ◆ Internal ± 60 ppm/ $^{\circ}$ C Voltage Reference
- ◆ No Missing Codes
- ◆ 0 to +5V Input Range with ± 5 V Supplies

- ◆ 5MHz Full Power Bandwidth
- ◆ ± 1 ppm/ $^{\circ}$ C Gain and Offset Drift
- ◆ Complete with Internal Track/Hold, Clock, Ref
- ◆ 275mW Power Consumption, Including Ref
- ◆ Small Footprint SO and DIP Packages

MAX177 - 100kHz/8.33 μ s 10-Bit Sampling A/D - \$7.90*

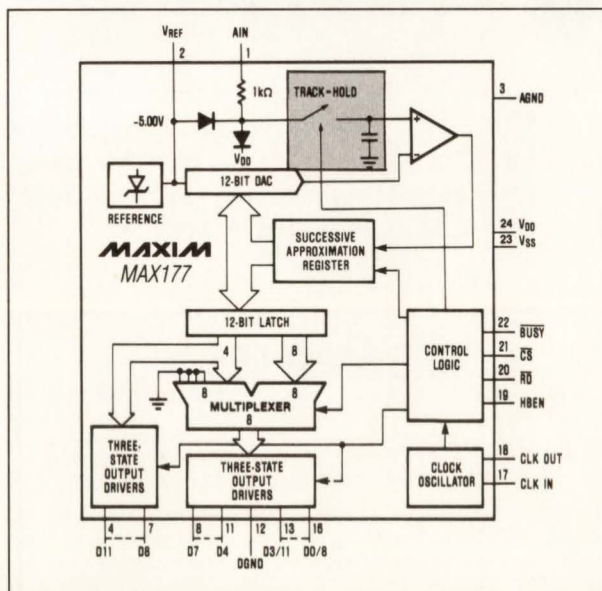

- ◆ 100% Tested for DC and Dynamic Accuracy
- ◆ Internal ± 40 ppm/ $^{\circ}$ C Voltage Reference
- ◆ No Missing Codes
- ◆ -2.5V to +2.5V Input Range
- ◆ 6MHz Full Power Bandwidth
- ◆ High Input Impedance (500M Ω)
- ◆ Complete with Internal Track/Hold, Clock, Ref
- ◆ 8- or 16-Wide μ P Interface
- ◆ 180mW Max Power Consumption, Including Ref
- ◆ Small Footprint SO and DIP Packages

For applications that don't need the track/hold function, Maxim offers the MAX173, essentially a MAX177 but with 5 μ s speed, +5V input range at \$7.00*.

* Price 1000-up FOB USA

8-Bit, 5 μ S A/D Converter with Track/Hold Accepts Differential Inputs - Only \$4.90*

- ◆ ± 1 LSB Total Unadjusted Error
- ◆ 50KHz Input Signal Bandwidth
- ◆ Single +5V Supply Operation
- ◆ Low 15mW Power Consumption
- ◆ 8-Bit μ P Interface
- ◆ 100ns Data Access Time
- ◆ Small Footprint DIP and SO Packages

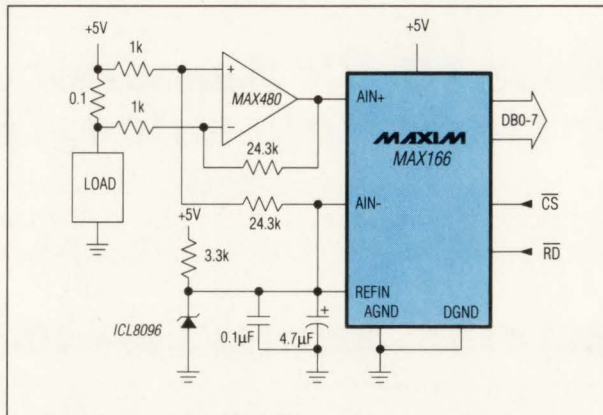

The MAX166 converts differential inputs from 0V to 2VREF using a single +5V supply. This reduces the output swing requirements on the input amplifier, and allows the converter to reject low-frequency common-mode signals. The high analog input impedance ($>10M\Omega$) allows use of lower cost amplifiers to drive this A/D. The MAX166 is ideal for high-speed, low-power applications such as digital-signal processing, data acquisition, servo loops, data logging, telecommunications, and audio systems.

* 1000-up FOB USA

QUAD 8-Bit Serial-Input D/A Replaces Trimpots for \$1.45*

- ◆ 16-Pin package reduces board space
- ◆ On-chip voltage output amplifiers ease drive requirements
- ◆ 5ppm/ $^{\circ}$ C drift improves stability
- ◆ Cascadable serial interface simplifies μ P connection
- ◆ Operates from single or dual supplies
- ◆ Small Footprint DIP and SO Packages

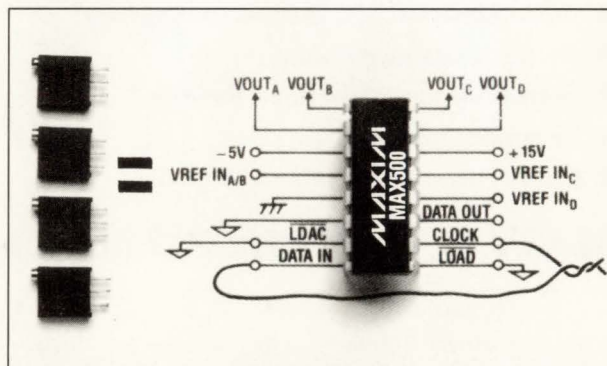

The MAX500 provides 256 digitally-programmable linear steps to digitally trim offsets, gain errors, and set trip-points. The low drift on-chip resistors and rugged latch-proof IC construction lets you free your system of trimpots. And, save both board area and cost. Applications include process control systems, automatic test equipment, and automatic calibration of system parameters such as gain and offset voltages.

* 1000-up FOB USA

★ FREE DATA SHEETS ★

MAX151 (CIRCLE NO. 26)
 MAX173 (CIRCLE NO. 27)
 MAX177 (CIRCLE NO. 28)
 MAX166 (CIRCLE NO. 29)
 MAX500 (CIRCLE NO. 30)

★ FREE SAMPLES ★

For applications assistance, call (408) 737-7600, FAX (408) 737-7194 or write Maxim Integrated Products 120 San Gabriel Drive, Sunnyvale, CA 94086

**Rent our test equipment.
And you'll always be
a technology leader
not a follower.**



Rent today's most technologically-advanced test equipment from Leasametric. And get the flexibility it takes to set you apart from the herd.

Leasametric starts with only the latest instruments made by the most respected test equipment manufacturers. This state-of-the-art technology is then meticulously inspected, tested, and calibrated. Now you're protected from equipment obsolescence and needless capital investment. That means you get the control you want for as long as you want on equipment you can trust.

Flexible financial programs are available, too. So the entire rental process is comfortable and

prompt. We've been doing it that way for twenty-seven years. That's why we're the best in the test equipment rental field. So, if you want to be a leader and not a follower, why not take the lead and call us right now.

800-553-2255

Leasametric, Inc.

Electronic Equipment-Renting, Leasing, Sales and Service

1164 Triton Drive
Foster City, California 94404

A member of The Marmon Group of companies

SBE...At the Core of WAN Interface Solutions

The SBE VCOM-4 Multiprotocol Communications Controller ... *today's high-performance, cost effective WAN interface.* For price-performance in a *single* VMEbus communications controller, nothing equals the new SBE VCOM-4.

This exclusive SBE card features *four* full-duplex, independently programmable serial channels. Yet, it takes up only one VMEbus slot and provides twice the throughput of conventional boards. A complete implementation of X.25 is available ported to the VCOM-4, which speeds your product to market.

The result: an unmatched WAN interface for VME-based hosts, front-end processors, and data/voice networking systems, including:

- Two channels at T1 speeds.
- All four channels can operate with *sustained* throughput at speeds up to 768 Kbps, interfacing to fractional T1 services or 56/64 Kbps lines.
- Each communications channel can be *independently* configured to support HDLC, SDLC, Bisync, Async.

Turn to SBE and the VCOM-4 for the core of your VMEbus WAN product design application. For fast action, contact SBE, Inc., 2400 Bisso Lane, Concord, CA 94520, or call **1-800-347-COMM.**

CIRCLE NO. 95

SBE
Communications &
Real-time Solutions

FPGA vendors race to upgrade products



Inevitably, field-programmable gate arrays are luring digital engineers to a design realm where ideas become real immediately and design iterations are effortless. But making sense of the goings on in the FPGA industry isn't easy.

*Charles H Small,
Senior Editor*

One look at a function-packed pc board bearing a field-programmable gate array (FPGA) should be enough to convince all digital designers to usher these devices onto their pc boards. You can expect to consolidate as many as 10 PAL-device chips or 50 TTL-device chips into a single FPGA (Fig 1). Such a reduction makes a dramatic, immediately perceptible difference in the layout of a digital pc board.

A second, closer look at FPGAs discloses, however, a bewildering blizzard of issues and "advantages." Making sense of the goings on in the FPGA field is a trying task because several innovative, highly competitive companies are constantly working and reworking their wildly different approaches—so different, that even giving these parts a name is problematical (see box, "Nomenclature: the pesky problem that won't go away"). However disparate their paths, these companies all have a common goal: to sell you large devices that you can program, on site, to hold big digital designs.

But any reckoning you make today of the relative merits of these devices could be wrong tomorrow. Judging from their records to date, FPGA vendors will do whatever it takes to make their parts and software work. For example, Altera has already altered the classical PAL-device architecture twice in the company's efforts to scale the basic design

up in size and make its architecture less rigid.

Their first EP-series devices vacu-umed up a handful or two of 22V10-like devices onto a single chip and added an interconnection array to link the devices' inputs and outputs. But these chips retained the classical PAL devices' characteristic of having a fixed number of product terms per output macrocell. The architecture of the company's second-generation Max PAL-like FPGAs has, in addition to a small number of fixed product terms, floating product terms that you can allocate at will to any macrocell.

Despite these architectural improvements, some designers fault the Max devices for their power consumption, expense, and lack of speed. But Altera

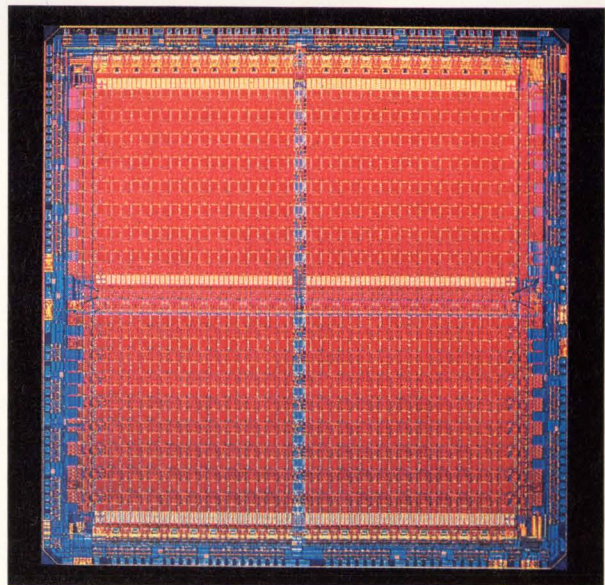

With a claimed equivalent of 8000 gates, the Actel A1280 second-generation FPGA differs significantly from the company's first-generation devices.

A hand is shown holding a PAL chip that is on fire. The fire is bright orange and yellow, with a thick plume of dark smoke rising from the chip. The background is dark, and the overall scene is dramatic and emphasizes the heat of the device.

A few words of advice from high-performance μ PLDs.

GET COOL FAST
AT A DESIGN DAYS SEMINAR.
CALL 1-800-548-4725 FOR DETAILS.

Chill out, PAL.

Many designers have hot, high-performance designs. Literally.

Fortunately, Intel has a simple way to reduce system heat and still get incredible performance. The μ PLD Family of programmable logic devices.

Take, for example, the 85C220 and 85C224. They operate at 80MHz (100 MHz internally) with only a 10ns total propagation delay.

And since μ PLDs are manufactured using Intel's CHMOS* technology, they require just 1/4 the power of their pin-compatible bipolar PAL* alternatives. Which means they can lower

system heat by 35 percent and help reduce board-level failures, too. So they're certain to give your high-performance system a boost. And send chills up the spine of your motherboard.

Learn more about Intel μ PLDs and receive a μ PLD/PAL heat comparison. Call (800) 548-4725 and ask for Literature Packet #IA28.

Otherwise, you could take some heat over your system design.

The Intel logo, consisting of the word "intel" in a lowercase, sans-serif font with a registered trademark symbol (®) to the upper right of the letter "l".

intel®

TECHNOLOGY UPDATE

Field-programmable gate arrays

continues to field faster, as well as larger, devices.

The architecture of Plus Logic's Plus FPGAs has evolved far beyond that of conventional PAL devices. Yet some flavor of the original remains. The Plus FPGAs still have a plane of combinatorial logic that sums into programmable macrocells. To eliminate layout-dependent timing variations, the device's designers strove to make every path through the device have the same delay.

The recently announced Mach series of PAL-like FPGAs from Advanced Micro Devices (AMD) takes another tack to solve the problem of enlarging the classical PAL-device architecture. Using a scheme reminiscent of Intel's 5AC312, the Mach devices allow you to rob bundles of product terms from one macrocell and divert them to an adjacent macrocell.

In addition to the three PAL-like FPGAs already being offered, look for two more variations on this basic theme from Atmel and Lattice at the end of the year.

The pace of architectural change is also rapid in logic-cell FPGAs. In

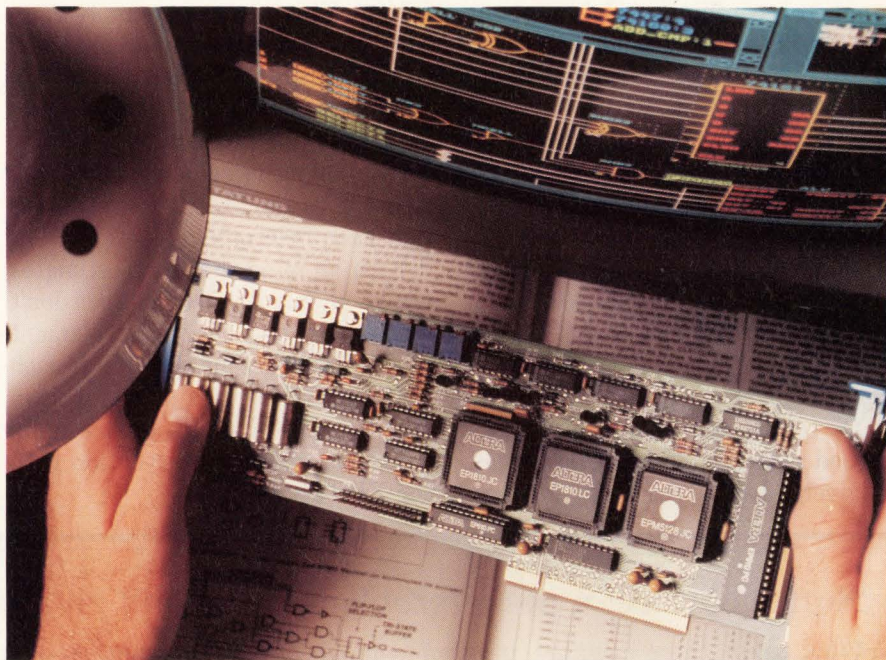

FPGAs allow you to dramatically increase the amount of logic on your pc boards. (Photo courtesy Altera Corp)

scaling up its devices, Xilinx has increased both the routing resources between logic cells and the amount of logic in each logic cell. Increasing the logic in each cell reduces the need to map a function over several cells, thereby decreasing the strain on logic-cell interconnections. In-

creasing the number of interconnections obviously makes routing a design easier.

Actel's recently announced Act 2 logic-cell FPGAs differ significantly from the company's Act 1 devices. In addition to more interconnection lines and more inputs per logic cell, the new devices have a checkerboard of combinatorial and sequential logic cells. In other words, now half of the devices' logic cells have flip-flops in them.

Plessey's Era logic-cell FPGAs have not been around long enough to get an update. Only one member of the announced family is actually available. The devices exhibit the least amount of logic—or finest “granularity”—per logic cell of any logic-cell FPGA. Plessey states that this fine granularity will make upgrades to mask-programmed gate arrays easy.

Will it fit?

Given the rate of change of each company's devices and the new companies entering the fray, the

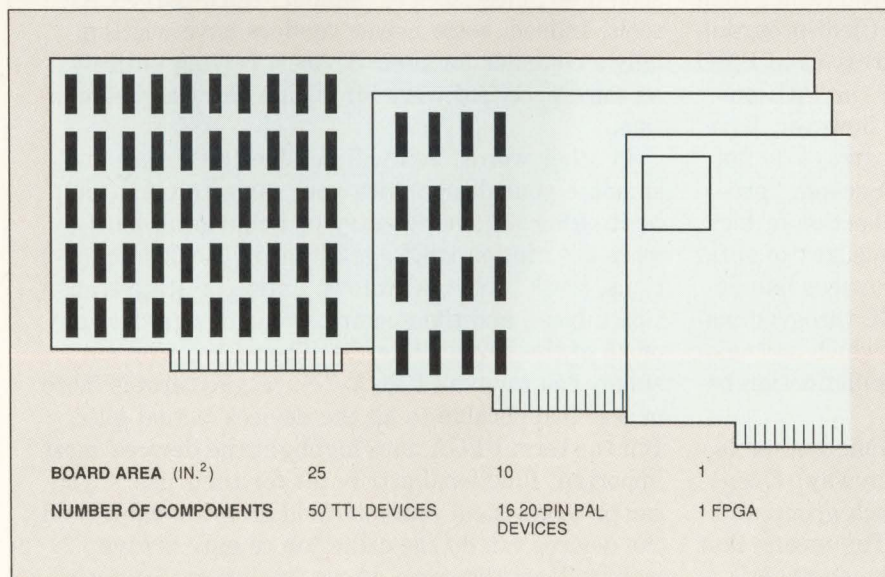

Fig 1—Field-programmable gate arrays (FPGAs) can vacuum up a dramatic amount of logic. (Courtesy Altera Corp)

TECHNOLOGY UPDATE

Field-programmable gate arrays

jungle of conflicting claims about FPGAs is sprouting and thickening at rain-forest rates. Rather than immediately trying to hack through the tangle of claims and counter-claims about the various FPGAs, step back a pace and consider that, above all else, you need to know three things about an FPGA: Will your design fit? If it fits, will it run fast enough? If it fits and runs, can you afford it?

FPGA users polled informally by EDN report few problems getting a good estimate of whether or not a given design will fit into an

FPGA. The engineers simply compare the gates and functions they estimate that their proposed design will need to the so-called macromodels in an FPGA maker's library. These library models list the amount of an FPGA's resources that each macromodel uses up.

Keep in mind that such estimates are good only for designs that don't attempt to use every last element in an FPGA. Designs that approach 100% utilization of a device still require careful planning and a certain degree of manual intervention with the FPGA's software.

Relying on each manufacturer's own estimate of their devices' "equivalent gates," instead of doing your own estimate, is risky. The equivalent-gate spec is rapidly approaching the stature—or lack thereof—of the MIPS spec in the computer world. **Refs 1** through **4** typify the tendentious nature of equivalent-gate claims. In one paper, an application engineer makes his company's devices suddenly grow in capacity by a factor of four by employing his competitor's method of counting gates.

Getting a good specification for

Nomenclature: a pesky problem that won't go away

What to call these new, big, programmable devices? The common sense or familiar names are all locked up under copyrights, not available to general use. Some of the devices comprise arrays of logic cells surrounded by a matrix of programmable interconnections. But you can't call them LCAs (logic-cell arrays) because Xilinx owns the term. Other devices are very reminiscent of PAL devices. But when AMD bought MMI, the company also got the jealously guarded trademark for PAL. Consequently, something like BPAL (big PAL) or RBPAL (really big PAL) is out of the question.

One industry pundit, taking a physical rather than functional approach, suggests FPGA (field-programmable gate array) for the logic-cell arrays and PMD (programmable multilevel device) for the PAL-on-steroids types. Both of those terms, however, have major problems. First, the logic-cell arrays do not, in fact, resemble gate arrays at all. Second, "programmable multilevel device" is a collection of big words that suggests little beyond some sort of automated-warehousing system. Third, devices like International CMOS Technology's PEEL (programmable electrically erasable logic) array, which have elements of both categories, muddy the distinction between the two groups.

More to the point, why should anyone bother to divide the devices into two groups anyway? Even after grouping, the devices within each group still have wildly different architectures. The means that the devices' designers use to meet the engineer's goals are moot so long as the devices measure up.

In other words, the grouping is a distinction that makes no difference.

What's more, trends in software are indeed making pointless any distinguishing between devices' basic architectures. When the devices first came out, no third-party software existed for them. Consequently, most device makers also offered custom software for their devices. You had to master a separate software suite to work with each device. And, in some cases, you had to be intimately familiar with a device's architecture to use its software. But gradually, all device makers are offering, or will soon offer, interfaces to popular, third-party CAE tools. Indeed, some newer vendors have written only a compiler for their devices, relying entirely on third-party software for design entry and simulation.

In other words, you will be able to express and simulate your design with your favorite CAE tool, be it either schematic entry or behavioral, hardware-description languages (that is, Boolean equations, truth tables, waveform entry, or state-transition tables), and then compile your design over any or all of the devices (**Ref 5**). Therefore, why not simply call them all FPGAs? Sure, the term is more or less inapplicable to all the devices' actual guts. But the term FPGA does highlight the devices' most important functional attributes for their users: you can program them yourself (field programmable) and the devices can do the same job as gate arrays . . . well, at least the same job as smaller gate arrays.

88 Pin "DAC-Per Pin" Technology

NEW



From **\$1995.00***

ALLPRO-88™ Universal Software Driven Device Programmer Supports Virtually Every Device On the Market!

Logical Devices offers you a truly pin driven "DAC-Per-Pin" programmer with electronic ground and Vcc, 4MHz clock, current mode source, high-speed programmable slew rate, and up to 10 amps of peak current on each pin.

All of this starting at \$1995.00 for a 24 pin version with logic configuration. Easily field upgradable to 88 pins. Supports the latest of low to high-pin count devices such as the AMD Mach and Altera Max devices, National "D" PALS, Signetics PLHS Series and all other devices your current programmer cannot program!

Supports programming, verifying, and functional testing for PLDs, EPLDs, GALs, PALS, PROMs, EPROMs, EEPROMs, FPGAs, LCAs, MAX, MACH, ASPL, P-Sequencers, and FPLAs. ALLPRO is certified by key semiconductor manufacturers to provide excellent programming yield and reliable operation.

No copy protection in ALLPRO-88 software and updates. Buy one copy for all your units. Updates are complete and comprehensive, each version includes all supported devices.

ALLPRO-88 is supported by CUPL®, the world's most popular logic design software, with high level behavioral hardware language (CHDL), multiple PLD design, ATVG and simulation capability.

If all of this gives you an upset stomach over your Data I/O* investment, then call us for a FREE DEMO and a generous trade-in offer.

1-800-331-7766

LOGICAL
DEVICES, INC.

1201 NW 65th Place
Fort Lauderdale, FL 33309
Fax: (305) 974-8531 Phone: (305) 974-0967

* Quoted price for US delivery only, F.O.B. Fort Lauderdale, FL. The brands or product names mentioned are trademarks or registered trademarks of their respective holders.

© 1990, Logical Devices Inc.

TECHNOLOGY UPDATE

Field-programmable gate arrays

the operating speed of a programmed FPGA is not only one of the most important problems in this newly emerging field, it's also one of the murkiest. Internal toggle rates—another widely touted spec—make the same empty, insincere promises as equivalent gates. Users report real pain when trying to achieve even a fraction of the quoted toggle rates. However accurate any manufacturer's equivalent-gate estimates or internal flip-flop toggle rates are, the problem is that you cannot use specs in your design process.

Predictable timing is, in fact, one area where the PAL-like FPGAs have an advantage over logic-cell FPGAs. The PAL-like FPGAs' regular, precast architecture yields predictable timing. Depending on layout and routing, a logic-cell FPGA's timing for a given function can be faster or slower than that of a PAL-like FPGA. Note that the advantage extends only to predictability; achievable performance is application dependent.

The bottom line is that you're not going to be able to figure out which device to use by reading manufacturers' spec sheets—or reading articles like this one, for that matter. Instead, the best first move you can make is to take advantage of each vendor's offer to compile some test cases for you. Select some of your recent designs and let each vendor's application engineers run them through the mill for you. Then compare the results.

Diverting attention from engineers' primary concerns are a fog bank of secondary issues. Beyond architecture, topics you can ponder are

- In-circuit reprogramming
- Testing
- Upgrade paths to gate arrays
- Reduced-pin-count packages
- Hardware-debugging aids.

In addition to their slight architectural similarities, both Xilinx

and Plessey logic-cell FPGAs use static RAMs as programming elements. The upside is that such parts are easy to subject to a suite of tests because you can program them in a variety of configurations quickly.

Further, you can reprogram them in circuit. Plessey has coined the thought-provoking term "hardware multitasking" to describe reconfiguring logic circuits on the fly. Pulling a number out of the air, some industry experts estimate

that 10% of all FPGA users will employ hardware multitasking. But the question that you must ask about every new development, "Is it a feature or is it a bug?" has a flip side for hardware multitasking. If your system doesn't have off-line storage, then you'll have to add an extra ROM to hold these RAM-programmed FPGAs' programming patterns.

AMD chose electrically erasable memory cells as the programming

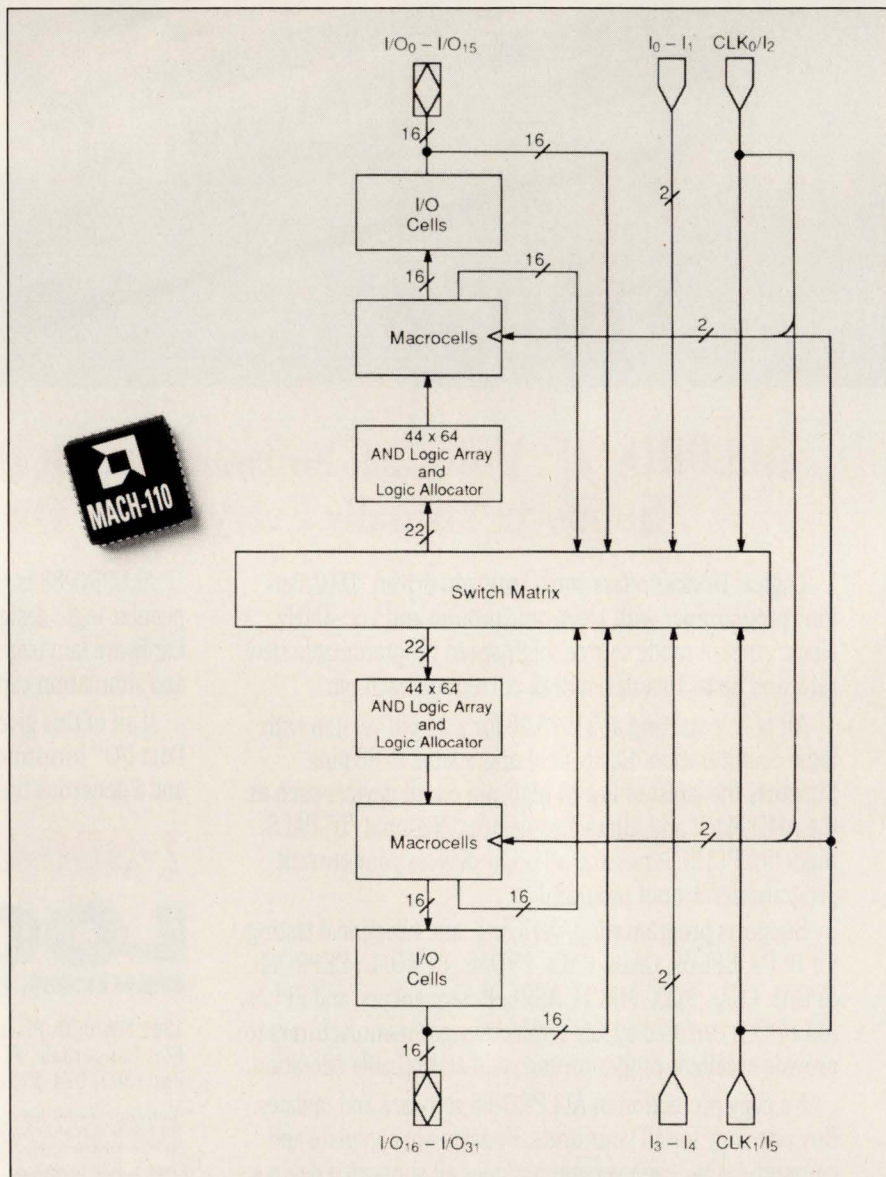

With combinatorial logic feeding I/O macrocells, AMD's Mach devices reveal their PAL-device ancestry.

FCT-T Logic

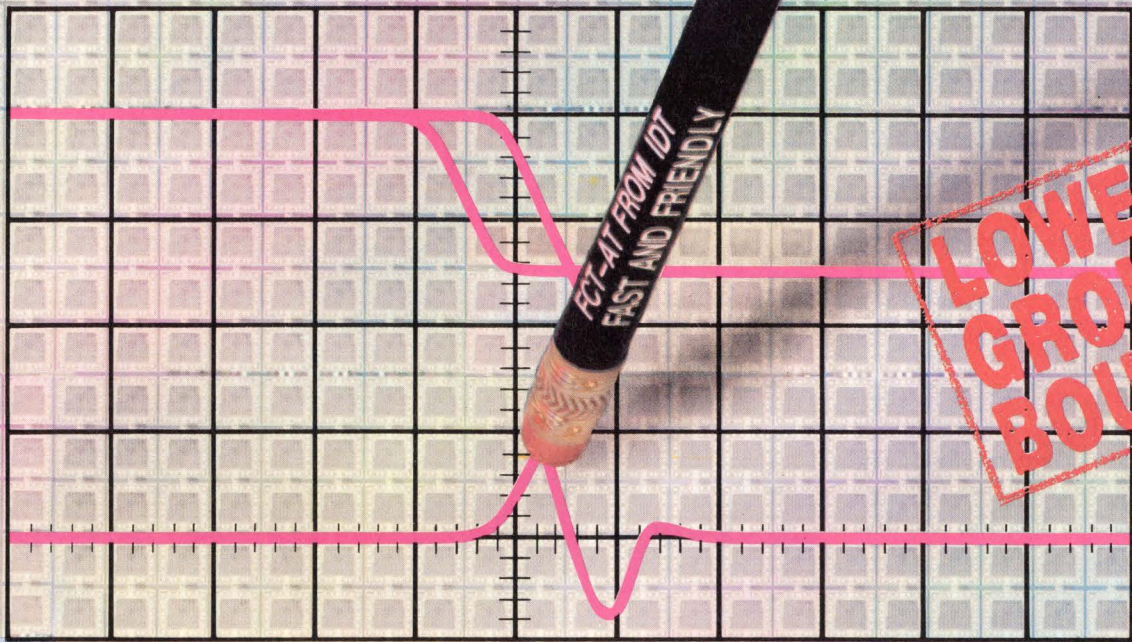

Fastest Speed

Fast and Friendly

IDT now offers the fastest and friendliest series 54/74 TTL logic family available. The FCT-T family offers speeds that are twice as fast as those of other logic families with up to 40% less switching noise than previous FCT devices. The reduced output voltage swings and new output circuitry provide high-speed logic designers with the perfect combination of the fastest speed, low power, and ease of use.

True TTL Compatibility

We've designed our FCT-T logic family with outputs that provide direct TTL logic compatibility. Edge rate control structures have also been added to increase noise immunity while maintaining FCT-C speeds.

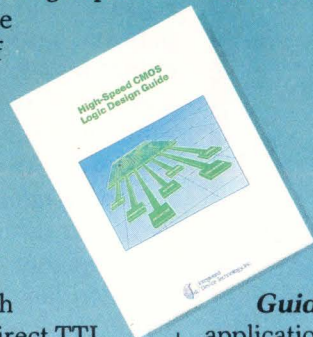

Fastest Speeds Available

The FCT-T family is pin-and function-compatible with FCT logic and is available in FCT-T, FCT-AT, and FCT-CT speed grades — the fastest in the industry. And they're available in all standard package configurations: plastic DIPs, ceramic DIPs, plastic SOICs, PLCCs, and ceramic LCCs in commercial and MIL-STD-883B versions.

Free Design Guide

Call or FAX us today and we'll send you a copy of our new *High-Speed CMOS Logic Design Guide* which contains application information on reducing ground bounce, series termination, and PC board trace characteristics, as well as an overview of FCT-T logic.

You Can Count On Us

IDT offers a full array of high-performance system building blocks including:

- RISC processors
- Multi-port memories
- Standard logic
- RISC modules
- SRAMs
- Subsystems
- Complex logic
- FIFOs

IDT Corporate Marketing
P.O. Box 58015
3236 Scott Blvd.
Santa Clara, CA 95052-8015

(800) 345-7015
FAX: 408-492-8454



When cost-effective performance counts

Integrated Device Technology

TECHNOLOGY UPDATE

Field-programmable gate arrays

element for its Mach PAL-like FPGAs. This technology is more testable than UV-erasable technology but less easy to test than RAM-based technology. Although electrically erasable technology offers the possibility of in-circuit programming, AMD chose to punt this "advantage." Foregoing in-circuit programming, the AMD FPGAs are consequently less expensive to manufacture and consume less power in operation.

Actel's Act 1 and Act 2 families of logic-cell FPGAs use a unique "antifuse" for programming. The feature/bug dichotomy here is that the antifuse is, by far, the smallest physically of all the current FPGA programming elements. Consequently, Actel can pack more programming nodes into its FPGAs than any other maker, thus enhancing routability. But the fuses of these fairly expensive devices are 1-time programmable, requiring you to adopt profoundly different testing, prototyping, and debugging strategies than you would adopt for reprogrammable devices.

Only time will still the winds of contention that have whipped up

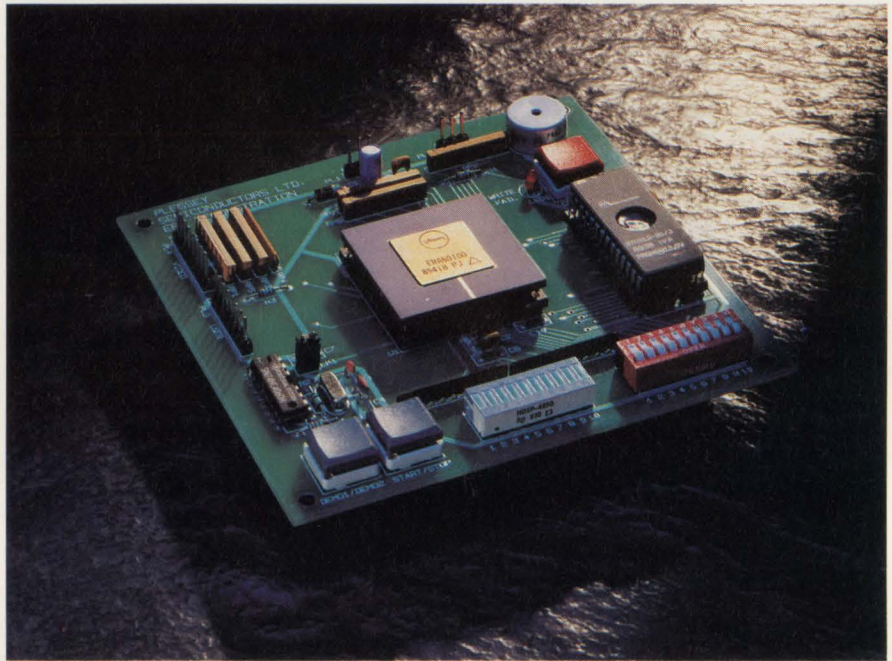

Because of its RAM-based programming, the Plessey Era requires a PROM if off-line storage isn't available for the chip's configuration file.

over the question of upgrading FPGA designs to mask-programmed gate arrays. Assuming that your production volumes would justify locking an FPGA design into a gate array, no such transition will be painless because no FPGA is exactly like a gate array. Some de-

vices' designs may be easier than others to roll over, however.

A little-publicized Altera option offers a route to lower-cost volume production other than gate arrays: the company offers mask-programmed versions of its UV-erasable PAL-like FPGAs. If this option proves popular, expect the other FPGA vendors to follow suit.

Another minor footnote to device architecture is the emergence of reduced pin-count packages. For certain designs that use many buried registers and logic but have few inputs and outputs, makers are developing less-expensively packaged versions of their FPGAs that have a full complement of internal logic but fewer I/O pins.

Most vendors' development tools leave you designing like a PAL-device designer (using hardware-description languages) or like a gate-array designer (using schematic entry). Only Plessey and Xilinx have developed hardware-emulation tools so that you can work like a microprocessor designer. Which-

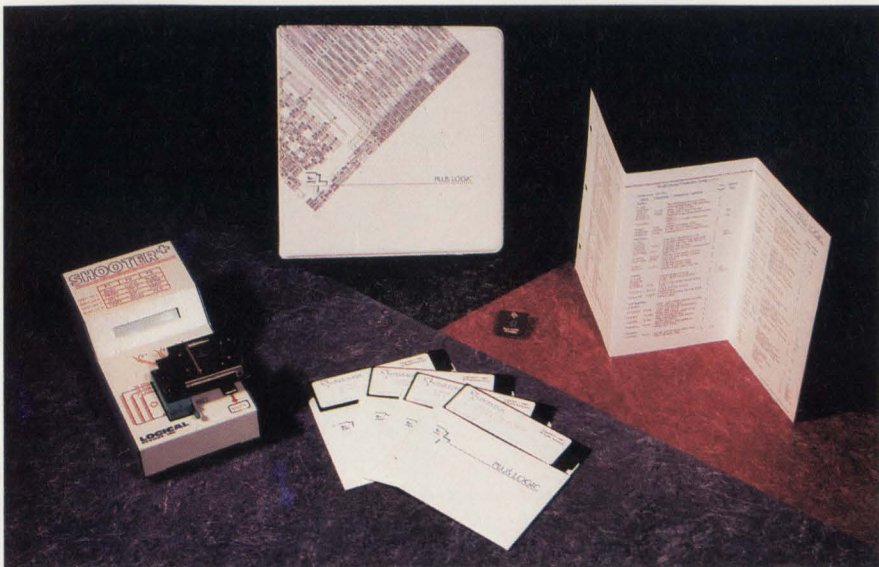

Unlike the established FPGA vendors, recent entrants, such as Plus Logic, rely on third-party software and programming tools.

MEGA MEMORY.

SONY HIGH-DENSITY SRAMS				
MODEL	CONFIG.	SPEED (ns)	PACKAGING	DATA RETENTION
CXK581000P*	128K x 8	100/120	DIP 600 mil	L, LL
CXK581000M*	128K x 8	100/120	SOP 525 mil	L, LL
CXK581100TM*	128K x 8	100/120	TSOP	L, LL
CXK581100YM*	128K x 8	100/120	TSOP (reverse)	L, LL
CXK581001P	128K x 8	70/85	DIP 600 mil	L
CXK581001M	128K x 8	70/85	SOP 525 mil	L
CXK581020SP	128K x 8	35/45/55	SDIP 400 mil	
CXK581020J	128K x 8	35/45/55	SOJ 400 mil	

*Extended temperature range available. L = Low power. LL = Low, low power.

MEGA COMMITMENT.



As you can see, Sony's more committed than ever to meeting your high-density SRAM needs.

Just consider the enhancements we've made in a few short months: TSOP and TSOP-reverse packaging, Low data retention current, and extended temperature range.

All based on our unique 0.8-micron CMOS technology, and available in 32-pin DIP and surface-mount plastic packages.

Then consider our ever-increasing production capabilities. We've just added yet another SRAM facility in Japan. And acquired a large AMD facility in San Antonio, Texas.

So you can really count on us in a crunch.

Need more proof we're serious about your each and every SRAM need?

Call us. We've got more breakthroughs on the way. Well over 100 SRAM products spanning the performance spectrum. And the desire to meet—or exceed—your toughest performance spec.

Sony high-density SRAMS are shipping now, complete with competitive pricing. So call (714) 229-4190 today. Or write Sony Corporation Of America, Component Products Company, 10833 Valley View St., Cypress, CA 90630, Attention: Semiconductor sales. FAX (714) 229-4285.

SONY®

PICO POWER INDUCTORS

**PLUG-IN
SURFACE MOUNT
AXIAL INDUCTORS
TOROIDAL
INSULATED LEADS**

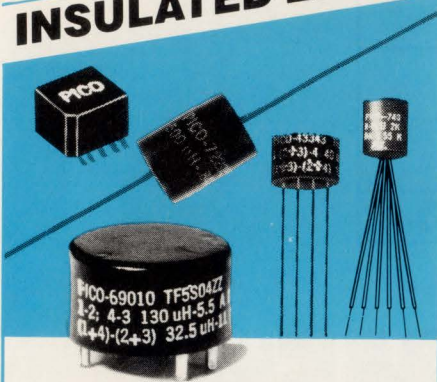

PICO's Ultra-Miniature Power Inductors are ideal for Noise, Spike and Power Filtering Applications in Power Supplies, DC-DC Converters and Switching Regulators.

- QPL standards available MIL-T-27/356
- Temperature range -55°C to $+130^{\circ}\text{C}$
- All units are magnetically shielded
- All units meet the requirements of MIL-T-27 (TF5S04ZZ)
- Minimum possible size
- Split windings
- Inductance values to 20mH with DC currents to 23 amps

PICO manufactures complete lines of Transformers, Inductors, DC-DC Converters and AC-DC Power Supplies

**Delivery—
stock to
one week**

**SEE EEM,
THOMAS REGISTER
OR SEND DIRECT FOR
FREE PICO CATALOG**

**PICO
Electronics, Inc.**
453 N. MacQuesten Pkwy. Mt. Vernon, N.Y. 10552

Call Toll Free 800-431-1064
IN NEW YORK CALL **914-699-5514**

CIRCLE NO. 14

TECHNOLOGY UPDATE

Field-programmable gate arrays

ever device and design methodology you eventually adopt, with FPGAs you can singlehandedly tackle bigger designs, and finish them more quickly, than you ever could before.

The June 28, 1990, edition of EDN News (pg S57) carried a series of interviews of industry managers, some of whom outlined their visions of a regimented future for design engineers. These managers envision engineers working like ants in large teams, hemmed in on every side by computer-enforced flats while working on tiny segments of an overall design. With FPGAs in your future, your design environment need not become so Orwellian. As one experienced FPGA user put it, "With FPGAs, two guys in a garage can be their own semiconductor company."

EDN

References

1. "EPLDs vs. FPGAs: Density, Performance, and Productivity." Product Information Bulletin 9, Altera Corp, San Jose, CA.
2. "MAX vs. MACH: A contrast in Capabilities." Product Information Bulletin 10, Altera Corp, San Jose, CA.
3. McCarty, Dennis, "Analyze FPLD Architectures, Performance and Development Tools to Optimize Design-Dependent Selection." Actel Corp, Sunnyvale, CA.
4. McCarty, Dennis, "Interpreting FPLD gate-density data." Article Reprint 8, Actel Corp, Sunnyvale, CA.
5. Conner, Doug, "Design tools smooth FPGA configuration." EDN, June 7, 1990, pg 49.

**Article Interest Quotient
(Circle One)**

High 503 Medium 504 Low 505

For more information . . .

For more information on the field-programmable gate arrays discussed in this article, circle the appropriate numbers on the Information Retrieval Service card or use EDN's Express Request service. When you contact any of the following manufacturers directly, please let them know you saw their products in EDN.

Actel Corp
955 E Arques Ave
Sunnyvale, CA 94086
(408) 739-1010
FAX (408) 739-1540
Circle No. 720

Advanced Micro Devices
Box 3453
Sunnyvale, CA 94088
(408) 732-2400
Circle No. 721

Altera Corp
2610 Orchard Pkwy
San Jose, CA 95134
(408) 984-2800
Circle No. 722

Atmel Corp
2125 O'Nel Dr
San Jose, CA 95131
(408) 441-0311
FAX (408) 436-4200
Circle No. 723

Lattice Semiconductor Corp
5555 NE Moore Ct
Hillsboro, OR 97124
(503) 681-0118
Circle No. 724

Plessey Semiconductors Corp
1500 Green Hills Rd
Scotts Valley, CA 95066
(408) 438-2900
FAX (408) 438-7023
TLX 4940840
Circle No. 725

Plus Logic
1255 Parkmoor Ave
San Jose, CA 95126
(408) 293-7587
FAX (408) 298-7587
Circle No. 726

Xilinx Inc
2100 Logic Dr
San Jose, CA 95124
(408) 559-7778
FAX (408) 559-7114
or (408) 559-1368
Circle No. 727

The Motorola Computer Group Invites You To Become Their Newest Boardmember.

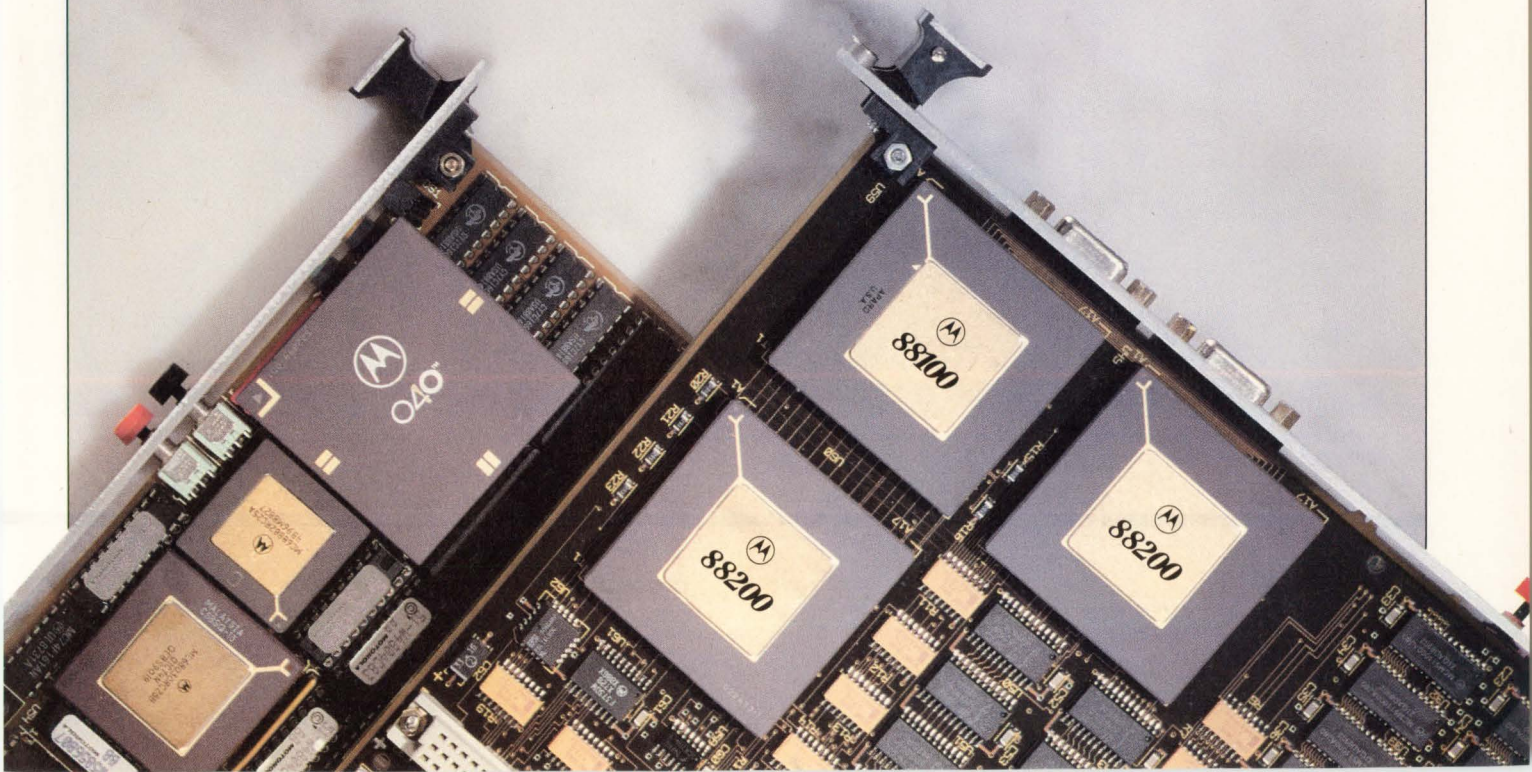

Take Advantage Of Board-Level Partner



© 1990 Motorola, Inc. Motorola Computer Group is a member of Motorola's General Systems Sector. VMEexec is a trademark of Motorola, Inc. All other product or brand names mentioned are trademarks or registered trademarks of their respective holders.



All That Our VME ship Has To Offer.

Once you've seen what Motorola brings to the table, we think you'll agree it's everything you need. Like the most complete line of VME products, services and engineering support available anywhere. Award-winning quality. Competitive pricing. All from the company that pioneered VME technology, and whose product line ranges from ICs to boards to full systems. And includes everything in between.

You decide exactly what you need from our more than 100 VME products at every level of price and performance. From CPU boards, like our new '040-based MVME165, to memory boards, to communications boards. And the industry's widest assortment of development tools, software resources, and technical support.

A partnership with Motorola not only helps you control costs, but even more importantly, speeds your time to market.

Our products include more functionality with a higher level of integration to accelerate your development efforts. And because of Six Sigma quality control you can be assured that our products will work right out of the box. It all adds up to the fact that getting you to market sooner is a promise only a company with the resources of Motorola can make good on.

Every Motorola product includes a built-in migration path, so your future product cycles are

assured. Such as providing a way to upgrade from the 68020 to the 68030 to the 68040, or from a 68000 CISC board to an 88000 RISC board with a simple re-compile. Wherever you're headed, Motorola is going to be there.

And we'll support you during the entire development process. Every board in our product line includes a full suite of board diagnostics available in both a run-time and a source package. This degree of flexibility also extends to our nationwide customer service programs, which run the gamut from total on-



site maintenance to self-maintenance support packages.

For more information, call us today at 1-800-624-8999, ext. 230.

Once you discover the advantages of a partnership with Motorola, you'll see that it's no ordinary board-level decision. It could ensure the future of your company.

At Motorola, Openness Is Standard Procedure

These days, openness has become something of a buzz word, and everybody seems to have a different idea on what is and isn't "open." To us, it's no big mystery. Openness means open architectures, open software, open networking. And open standards like UNIX[®], as indicated by our role in founding 88open. It means we're open to helping solve problems with your point of view in mind, not just ours. And it's

been that way ever since we helped introduce VME back in 1982.

That's why Motorola is committed to supporting official and de facto industry standards, interoperable computing between multiple vendors, and non-proprietary open system architectures. It's why we created VMEexec[™] to facilitate the

interoperability of different real-time software modules within a common UNIX environment. And it's why we support virtually every networking protocol, including XNS, TCP/IP, DECnet[™], MAP/TOP/OSI, SNA, BSC, X.400, and X.25.

This philosophy of openness is the same reason we offer as many VME boards, products and services as we do. It's to our mutual benefit, and after all, isn't that what partnerships are for?

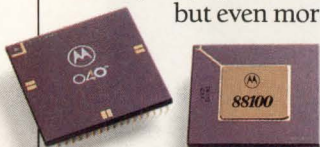

MOTOROLA
Computer Group

IN THE ERA OF MegaChip™ TECHNOLOGIES

YOUR DSP: ALL THERE

There is a big difference. Only Texas Instruments brings it all together for you in DSPs, from software to silicon... and we have 10,000 users to prove our point.

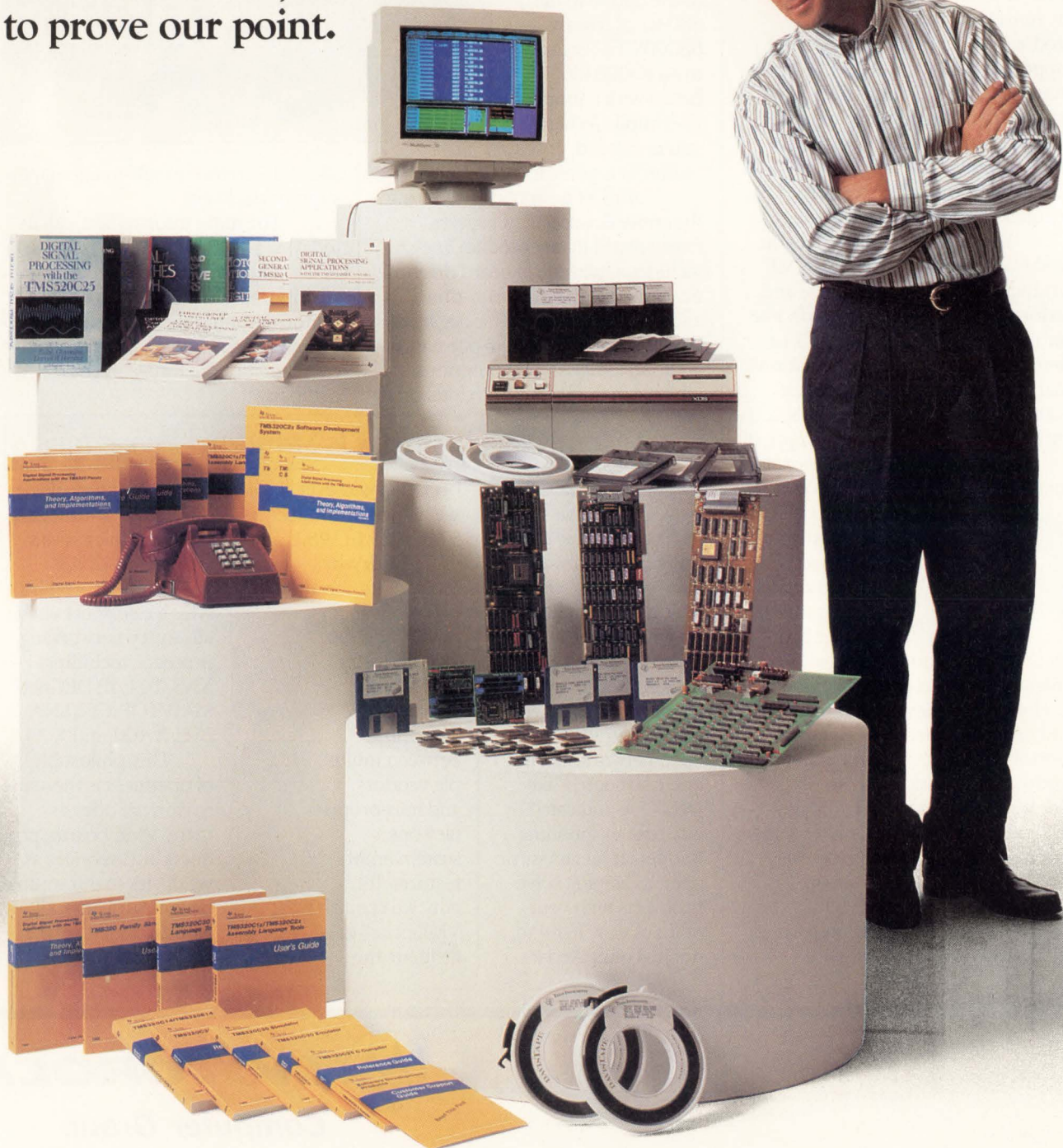

OR JUST ALMOST?

Designers are applying TI's single-chip TMS320 DSPs (digital signal processors) in more systems around the world than any other. In fact, leading manufacturers in most market segments — including telecommunications, computers and computer peripherals, automotive, industrial controls, consumer products, and military systems — use TMS320 DSPs.

These designers choose our DSPs because they know there is a big difference between all there and almost. With TI, they know they are getting the most complete DSP solution in the business — (1) performance, (2) support, and (3) broad choice. These important factors are worth careful consideration as you evaluate DSPs:

Yes **1.** Am I assured of access
 No **1.** to the top-performance devices in the field?

Naturally, performance is a high priority for any DSP-based system. The TMS320 family consistently sets the performance standards for the industry. Among the newest additions are the highest performance fixed- and floating-point single-chip DSPs, both with clearly defined road maps for future performance upgrades. Multiprocessing DSPs offer even higher performance.

Yes **2.** Is world-class support in
 No **2.** place to help speed my design to market?

Few if any DSP vendors equal the level of support that TI offers.

Industry-standard high-level language optimizing compilers (ANSI C and Ada), HLL debuggers, the SPOX™ multitasking DSP operating system, and scan-based emulators provide you with a development environment similar to that traditionally enjoyed in general-purpose microprocessor design.

Low-cost evaluation modules allow you to accurately evaluate and benchmark a TMS320 processor for your application.

Such leading-edge tools are only the beginning of our comprehensive support. Other TMS320 support includes:

- A hot line staffed with DSP personnel ready to answer your technical questions
- An on-line bulletin board service
- More than 2,000 pages of application notes and DSP code
- More than 100 third parties and consultants
- Hands-on workshops
- University program with more than 100 universities participating

Yes **3.** Is the choice of devices
 No **3.** broad enough that I can closely match a DSP to my price/performance needs?

Our TMS320 family spans five generations — more than 20 members offering a price/performance range from \$4.00 to 40 MFLOPS. Your choice includes:

- EPROM DSPs that shorten your time to market
- DSPs optimized for specific applications
- Military versions
- Single-chip devices offering 40-MFLOPS performance
- Multiprocessing DSPs
- Low-cost DSP solutions for cost-sensitive applications
- Compatibility to protect your software investment

At TI, we have it all, and we are ready to help you put it all together.

Get your free three-volume TI DSP Applications Library; call 1-800-336-5236, ext. 3528

Or complete and mail the return card and we'll send you our three-volume TMS320 DSP Applications Library. If you prefer, we'll send you our TMS320 product overview and support brochure. We feel sure you will soon be one of the thousands around the world achieving design success with the leadership TMS320 family.

WHAT'S AHEAD FOR TI'S TMS320 FAMILY

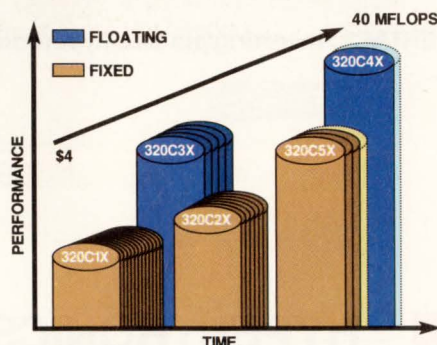

™ MegaChip is a trademark of Texas Instruments Incorporated.
 SPOX is a trademark of Spectron Microsystems, Inc.
 © 1990 TI 08-0081



End the connector compromise...

1. 1-700 LOW INSERTION FORCE CONTACTS
2. QUALIFIED TO D55302
3. SIGNAL TO 500 AMP POWER CONTACT RATINGS

...in PC-board connections.

Only Hypertronics ends the compromise in printed circuit board connectors for electronic equipment . . . by replacing unreliable connections, and their field service problems, with Low Insertion Force (LIF) high-cycle reliability. Discrete Hypertac® contacts and multi-pin connectors eliminate the need for expensive and space-consuming jacking and camming mechanisms.

The unique wiping action of each Hypertronics connector maintains electrical continuity under extremes of shock and vibration (tested to 2 nanoseconds) with insertion forces as low as 1/2 oz.

Now you can have it all . . . in signal/power connections requiring up to 700 contacts. End the connector compromise by calling 1-800-225-9228, toll free.

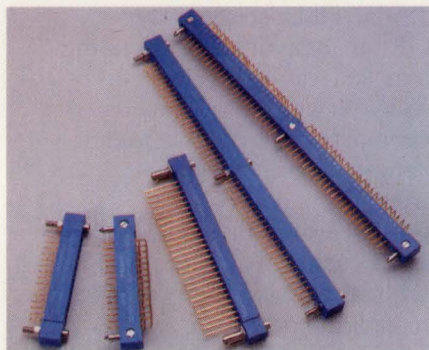

KA Series: 17-490 Contacts with D55302-Listed Qualified Models.

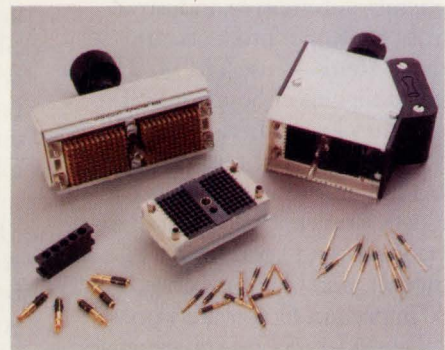

N Series: 70-700 Position Connectors with Ratings to 9 Amps.

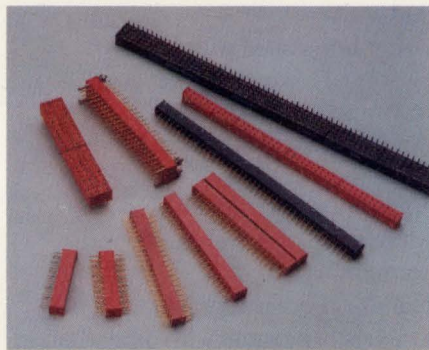

KG Series: 22-90 Position Board Stacking for .240 or .480 Heights Between Boards.



Y Series: 3-500 Amp Discrete Pins and Mating Sockets.

HYPERTAC®: Inserting pin into hyperboloid sleeve.

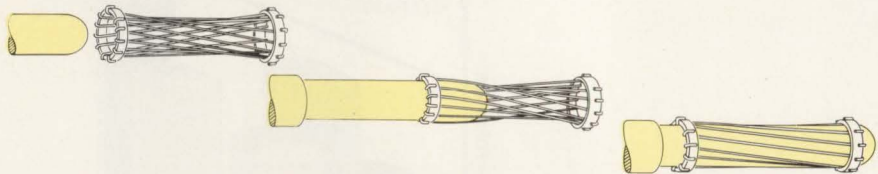

HYPERTRONICS CORPORATION

"New Horizons in Connectors"

16 Brent Drive, Hudson, MA 01749 (508) 568-0451 FAX (508) 568-0680

CIRCLE NO. 101

EDN September 17, 1990

Another International Reputation Bites The Dust.

The best source for high-quality semiconductors may not be where you think it is.

Take UMC. In 1989, we started production at the most advanced chip manufacturing facility in the world. In Taiwan.

Our leading-edge manufacturing technology allows us to produce a wide variety of semiconductors.

SRAMs, for example. We make them in sizes up to 1 Mb, and speeds from 120 to 20 nsec. We can easily handle high volume production runs. And we're a long-term supplier.



Best of all, we do all this at very, very attractive prices.

If you'd like to find out why UMC is building a reputation among leading electronics manufacturers

worldwide, call us today: 408-727-9589.

UMC SRAM Family

Capacity	Part Number	Organization	Speed(ns)
16K	UM6116	2K x 8	90/120
64K	UM6164	8K x 8	20/25
64K	UM6188	2 x (4K x 8)	25/35/45
64K	UM61164	4K x 16	25/35/45
64K	UM61165	2 x (2K x 16)	25/35/45
64K	UM6264AL	8K x 8	70/100/120
128K	UM61168	8K x 16	25/35/45
256K	UM62256AL	32K x 8	70/100/120
1Mb	UM621024	128K x 8	70/85/100

SRAMs include DIPs, SDIPs, and SOs. 1Mb available 4th qtr.



UNITED MICROELECTRONICS CORPORATION

©1990 United Microelectronics Corporation.

SIEMENS



Well Received.

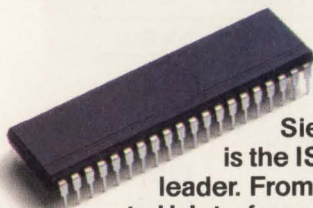

Advanced CMOS
Frame Aligner
(ACFA)

**Siemens
is the ISDN
leader. From T-1
to U-Interface.
Murray Hill to Munich.**

Siemens, with the most comprehensive ISDN IC family in the world, has created a technology which is fast becoming a telecommunication standard.

Our ISDN Oriented Modular Architecture (IOM[®]2) eases incorporation of data, speech and picture sources, and offers the adaptability to meet your application-specific requirements, including chip-sets optimized for the requirements

of terminals, network terminators and switching applications.

We provide a wide array of products supported by our IOM technology. From the T1/CEPT Advanced CMOS Frame Aligner, with a flexible microprocessor interface which meets North American and European standards, to CMOS Microcontrollers and Gate Arrays.



Signal Processing
Codec Filter
(SICOF1)

Siemens also offers cost-effective solutions for analog interface, including single and dual channel Digital Signal Processing Codec Filters. Designed with DSP architectures for maximum programmability.

And Siemens invented a unique, all-CMOS monolithic ISDN Echo Cancellation Circuit, the first single chip solution for the standardized



ISDN Echo
Cancellation Circuit
(IEC-Q)

U-interface. With the power to double the traffic-handling capability of any existing telephone line.

It took the leader in the ISDN industry to develop the most advanced telecommunication devices in the world.

Monolithic designs which reduce cost, lower power consumption, and supply you with solutions which are well received, worldwide.

For details, call (800) 456-9229, or write Siemens Components, Inc. 2191 Laurelwood Road Santa Clara, CA 95054-1514. Ask for literature package M12A003.

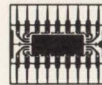

**Siemens
Practical Solutions by Design.**

Reduce Your Risc

New PACEMIPS™ Components - Less Space, Lower Cost

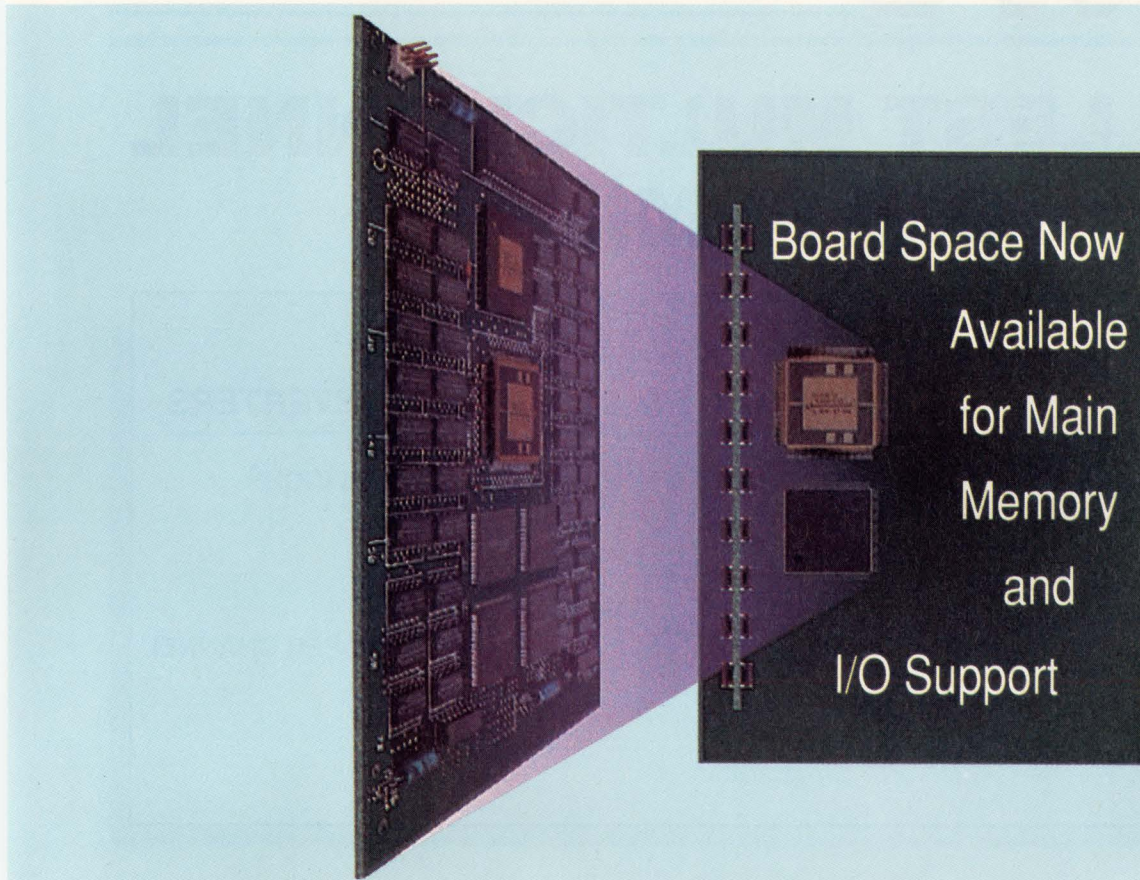

Board Space Now Available for Main Memory and I/O Support

Now design your single-board RISC computer with three NEW Performance components: CPU/FPA R3400, PACEWRAP, and BiCameral SCRAM.

PACEMIPS R3400

CPU/FPA in a CPU Socket

- ❑ 25/33 MHz Operation
- ❑ Only 1.2 Clock Cycles/Instruction
- ❑ Up to 28 Mips and 9.7 MFLOPS
- ❑ 172 Lead Flat Pack/144 Pin PGA
- ❑ Full R3000/R3010 Functionality

PACEWRAP R3100

- ❑ Replaces four R3020s and up to 24 other chips.
- ❑ Eight-word-deep Write Buffer - with readback.
- ❑ Programmable Read Buffer - to 32 words and matches refill.
- ❑ Parity generation - allows use of main memory without parity.
- ❑ Bus snooping support.

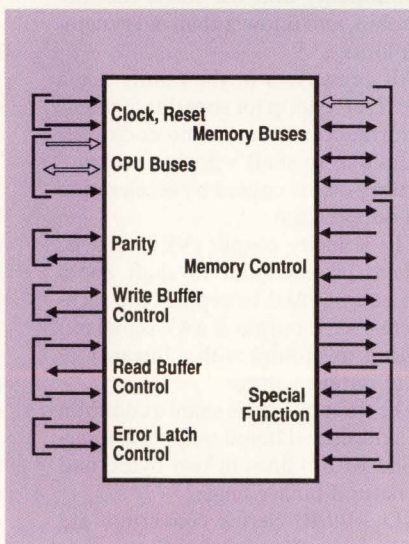

PACEWRAP R3100 Block Diagram

BiCameral SCRAM Cache ZIP Module

- ❑ Dual 8Kx60 High-Speed SCRAM
- ❑ 32K Byte I and D caches from a single module including address latches.
- ❑ Available for up to 33 MHz CPU with minimum board space required.
- ❑ Space saving 6.350 x 0.815-inch 124-pin ZIP module

16Kx60 Cache SCRAM ZIP Module

- ❑ Two modules implement 64K Byte I & D caches including address latches.
- ❑ Available for up to 33 MHz CPU with minimum board space required.

For information or to order write or call . . .

Performance Semiconductor Corporation
610 E. Weddell Drive, Sunnyvale, California 94089
Telephone: (408) 734-9000

NEWS

ABOUT
1553 DATA BUS
SYNCHRO CONVERSION
A/D & D/A CONVERSION
POWER HYBRIDS

DDC
ILC DATA DEVICE CORPORATION

SMALLEST MULTICHANNEL S/D FAMILY

14 BIT TRACKING S/D CONVERTERS

- AS SMALL AS 0.5 INCH² PER CHANNEL
- LOW MTBF
- LOW COST PER CHANNEL

Expanding our present family of 1- and 2-channel Synchro- or Resolver-to-Digital converters, DDC introduces the 3-channel SDC-14610 Series.

Based on a custom monolithic chip design, the SDC-14610 Series offers dramatic improvements in size, MTBF, and cost per channel.

Contained in a single 36 pin DDIP package, the SDC-14610 Series occupies an area of 0.5 square inches per channel. Ideal for crowded printed circuit boards, the series can be used in conjunction with DDC's single or dual channel converters for maximum design flexibility. For example, 5 channels use one SDC-14610 3-channel and one SDC-14600 2-channel.

Shared package perimeter, low wire-bond count due to commonality, and the use of a single chip monolithic, results in greatly enhanced mean time between failure. Calculated MTBF is

in excess of 37 million hours per channel (35°C case, Ground, Benign).

Cost per channel is reduced due to commonality and the single monolithic chip, and is lower than old generation units.

All converters in the family use a type II servo loop for superior dynamic performance. There are no additional errors due to shaft velocity; just momentary errors caused by acceleration and deceleration.

The velocity output (VEL) is a dc voltage proportional to shaft speed that can be used to replace the tachometer. VEL output is a 4V signal referenced to ground with a linearity of 1% of output voltage.

The three channels share a common AC reference. Digital outputs are paralleled with 8 lines in two bytes, and are natural binary angle.

SDC-14610 Series converters are

available with operating temperature ranges of 0°C to +70°C and -55°C to 125°C. All parameters are maintained over temperature.

Power supplies are ±5Vdc. Maximum worst case power dissipation is a low 170 mW per channel. For optimum performance capacitive bypassing should be used on power supplies.

With its low cost, small size, high accuracy, and versatile performance, the SDC-14610 Series converters are ideal for use in modern high-performance military and industrial position control systems. Typical applications include radar antenna positioning, navigation and fire control systems, motor control, and robotics.

For additional product or application information contact Bill Cullum at 516/567-5600 (1-800-DDC-1772 outside N.Y.). □

DDC
ILC DATA DEVICE CORPORATION

HEADQUARTERS AND MAIN PLANT: ILC Data Device Corporation, 105 Wilbur Place, Bohemia, N.Y. 11716, (516) 567-5600, TLX-310-685-2203, FAX: (516) 567-7358
WEST COAST (CA.): GARDEN GROVE, (714) 895-9777, FAX: (714) 895-4988; WOODLAND HILLS, (818) 992-1772, FAX: (818) 887-1372; SAN JOSE, (408) 236-3260, FAX: (408) 244-9767
WASHINGTON, D.C. AREA: (703) 450-7900, FAX: (703) 450-6610
NORTHERN NEW JERSEY: (201) 785-1734, FAX: (201) 785-4132
UNITED KINGDOM: 44 (635)-40158, FAX: 44 (635) 32264; **JAPAN:** (3) 814 7688, FAX: (3) 814 7689
FRANCE: 33 (1) 4333-5888, FAX: 33 (1) 4334-9762
WEST GERMANY: 49 (8191) 3105, FAX: 49 (8191) 47433; **SWEDEN:** 46 (8) 920635, FAX: 46 (8) 353181

MICROPOWER OP AMPS

Low-current devices offer high performance



Combining accuracy and good dynamic performance with low-current operation is not an easy task, but many of today's micropower op amps succeed remarkably well.

Dave Pryce,
Associate Editor

Numerous op amps on the market perform well at supply currents in the 500- μ A to 1-mA range, but certain applications require devices that operate at even lower currents. For example, applications that rely on batteries or solar cells need to keep current drain to a minimum. Low-current operation is also essential for minimizing power dissipation in equipment containing large quantities of tightly packed active components.

Micropower op amps can meet these needs. Though definitions of the term vary, all micropower devices perform at currents lower than the 500- μ A minimum of "low-power" devices. Purists demand that for an op amp to qualify as a micropower device, it must operate with a maximum supply current of 100 μ A, and preferably less. Others maintain that a device operating in the broad area between 100 and 500 μ A should also qualify. Taking both viewpoints into account, this article focuses on op amps that operate at currents as high as 250 μ A.

As a consequence of their low-current operation, micropower op amps are not stellar performers when it comes to exhibiting high unity-gain bandwidths or fast slew rates. With one or two exceptions, most devices—particularly those that operate at currents

of less than 100 μ A—have a unity-gain bandwidth in the kilohertz range rather than in the more common megahertz range. Slew rate is similarly affected; typical specifications run well under 1V/ μ sec.

Because of the difficulty of matching the individual characteristics of op amps' input devices at low currents, you'll also find compromises in dc specifications. For example, input offset voltages less than 500 μ V, which are easily obtained in precision op amps that run at "high current," are difficult to achieve in micropower devices.

Lower your power needs further

Despite these intrinsic drawbacks, micropower op amps play a vital role in applications that demand very low power consumption. In addition to their ability to operate at low currents, sev-

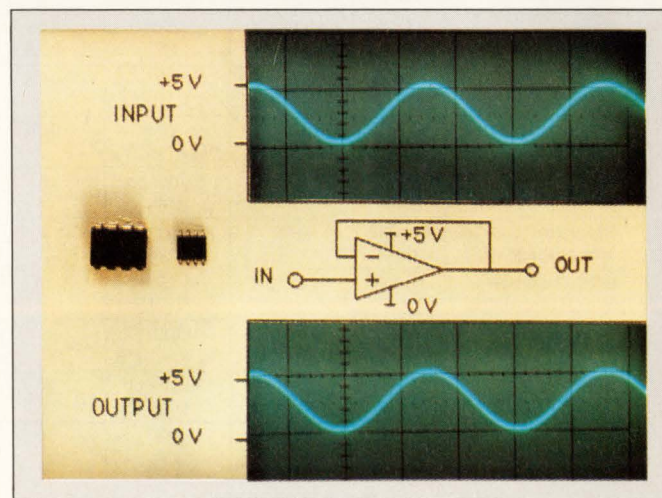

For maximum dynamic range, both the input and output of an op amp should be able to swing to the supply rails. The ALD-1706 from Advanced Linear Devices swings to within 0.1V of a ground-referenced 5V supply.

TECHNOLOGY UPDATE

Micropower op amps

eral devices accept low-voltage supplies, which helps alleviate the power-consumption problem. A 5V supply, for example, not only cuts down on required power, but also offers other advantages. You can run the op amp from the same supply that runs logic circuitry. Also, an op amp specified for single-supply operation has a common-mode input-voltage capability that includes ground. As a result, the op amp allows input signals to swing down to ground potential.

This swing-to-ground capability does not always extend to the output, however. Some op amps require a power-consuming pull-down resistor to achieve a 0V output. In many cases, the external load—even a light load of 1 M Ω —takes care of this problem. Often, the op amp's output *will* swing to ground,

but you should check its data sheet to be sure.

Other parameters worth checking, particularly for multistage applications operating at low voltages, are an op amp's common-mode input- and output-voltage ranges. For maximum dynamic range, these ranges should come as close as possible to the supply-rail voltages.

The voltage ranges of the ALD-1706 from Advanced Linear Devices come very close to the supply-rail voltages. Operating from a $\pm 2.5V$ supply, for example, the CMOS device has an output-voltage range that usually comes within 0.1V of each supply rail. The op amp typically needs only 20 μA of supply current and can operate from dual supplies of ± 1 to $\pm 6V$ or a single supply of 2 to 12V.

The device offers a respectable

400-kHz unity-gain bandwidth in spite of its very low operating current. Other characteristics include a 0.17V/ μsec slew rate, a settling time of 10 μsec to 0.1%, and a large-signal voltage gain of 100,000. Dual and quad versions (ALD-2706 and ALD-4706, respectively) are also available.

Bandwidth and slew rate

At the opposite extreme in terms of supply-current requirements are the AD548 and AD648 (dual) from Analog Devices, and the OP-282 (dual) and OP-482 (quad) from Precision Monolithics. These devices operate at supply currents in the 200- to 250- μA range, which barely lets them qualify as micropower devices. However, their relatively high operating currents produce dynamic characteristics that are quite impressive.

Table 1—Representative micropower op amps

Manufacturer	Type number	Supply voltage (V)	Supply current (μA) ¹	Input offset voltage (mV) ¹	Input bias current (nA) ¹	Input offset current (nA) ¹	Common-mode input-voltage range (V)	Output-voltage range (V)
Advanced Linear Devices	ALD-1706	± 1 to ± 6 2 to 12	40	4.5	0.03	0.025	$+V_S$ to $-V_S$	Within 0.2V of $\pm V_S$
Analog Devices	AD548	± 4.5 to ± 18	200	2	0.02	0.01	± 11 at $V_S = \pm 15V$	± 12 at $V_S = \pm 15V$
Harris Semiconductor	HA7711 HA7712	± 2 to ± 8 ± 2 to ± 8	200 25	0.25 0.25	0.02 0.02	0.01 0.01	-5 to $+3.8$ ($V_S = \pm 5$)	Within 0.1V of $\pm V_S$
Linear Technology	LT1077	5	60	0.06	11	0.45	0 to 3.5	0.006 to 4.2
Maxim Integrated Products	Max480	± 0.8 to ± 18 1.6 to 36	20 ($V_S = \pm 15V$)	0.07	3	1	-15 to $+13.5$ ($V_S = \pm 15V$)	± 14 ($V_S = \pm 15V$)
National Semiconductor	LPC662 (dual)	5 to 15	70 (per op amp)	6	0.020	0.020	0 to 2.7 ($V_S = 5V$)	0.06 to 4.94 ($V_S = 5V$)
Precision Monolithics	OP-282 (dual)	± 15	250 (per op amp)	2	0.1	0.05	$+13$ to -11	± 13
SGS-Thomson Microelectronics	TS-271	4 to 10	15	10	0.15	0.1	—	0.05 to 8.8 ($V_S = 10V$)
Signetics	NE5230	± 0.9 to ± 7.5 1.8 to 15	160 ($V_S = \pm 0.9V$)	3	60	30	$+V_S$ to $-V_S$	$+7.25$ to -7.3 ($V_S = \pm 7.5$)
Siliconix	L144 (triple)	± 1.5 to ± 15	133 (per op amp)	10	250	70	—	± 10 ($V_S = \pm 15$)
Texas Instruments	TL251C	1.4 to 16	20	10	0.6	0.3	-0.2 to 9 ($V_S = 10V$)	0 to 8 ($V_S = 10V$)

Notes: 1. Values shown are maximum.

2. Prices shown are for lowest cost device.

TECHNOLOGY UPDATE

Analog's AD548 and AD648 have unity-gain bandwidths of 1 MHz and slew rates of 1.8V/μsec. Operating at 200 μA, these devices also feature respectable dc characteristics. Worst-case maximum values include an input offset voltage of 2 mV, and input bias and input offset currents of only 20 pA and 10 pA, respectively.

Operating at a somewhat higher current of 250 μA, the OP-282 and OP-482 from Precision Monolithics have even better dynamic characteristics. The devices feature unity-gain bandwidths of 4 MHz, slew rates of 9V/μsec, and settling times of 1.5 μsec to 0.01%. This level of performance puts the 282/482 head and shoulders above most other micropower op amps and on par with many amplifiers that operate at supply currents in the milliampere range.

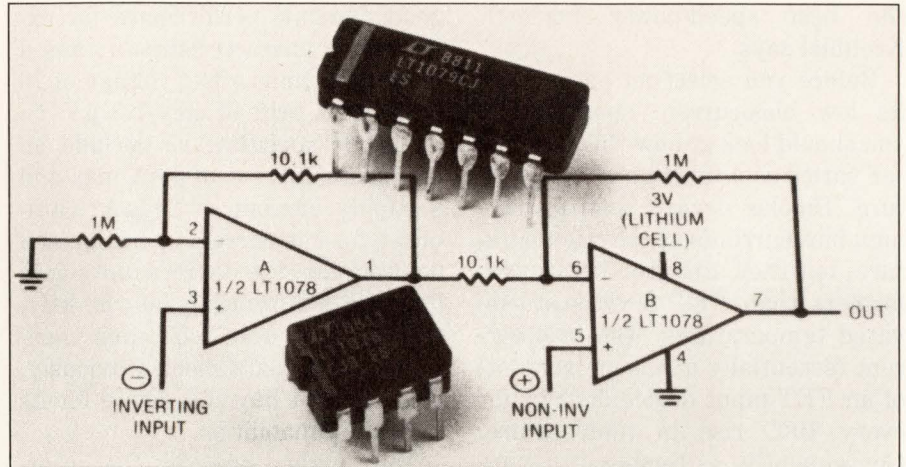

Op amps are available in single, dual, triple, and quad versions. These 8- and 14-pin devices from Linear Technology are dual and quad op amps, respectively.

Another micropower device that exhibits better-than-average performance in at least one parameter is the HA7711 from Harris Semiconductor. With a supply current

of 250 μA max, the device features an offset voltage of only 250 μV max. A companion device, the HA7712, operates at only 25 μA and has the same offset voltage.

The principal difference between the two devices lies in their dynamic characteristics. The HA7711 has a unity-gain bandwidth of 800 kHz and a slew rate of 0.45V/μsec. On the other hand, as a result of its much lower operating current, the HA7712 has a bandwidth of only 100 kHz and a slew rate of 0.04V/μsec. This tradeoff of dynamic performance for operating current is important to consider when choosing the best micropower op amp for your application.

Lowering the bias current

Other tradeoffs must be weighed when selecting a micropower op amp. John Krehbiel, a marketing manager for Harris Semiconductor, points out that bipolar op amps are sometimes applications-limited because of their high input bias current. In contrast, CMOS-input devices can have bias currents 1000 times lower than those of bipolar-input devices—an important feature for minimizing total system

Typical gain × bandwidth (kHz)	Typical slew rate (V/μsec)	Package types	Price (quantity) ²	Comments
400	0.17	DIP-8, SO-8	\$0.89 (10,000)	Dual and quad versions also available
1000	1.8	DIP-8, TO-99	\$0.75 (100)	Dual version is AD648
800 100	0.45 0.04	DIP-8, SO-8	\$1.25 (100)	
230	0.08	DIP-8, SO-8	\$1.65 (100)	Also characterized for ±15V operation
20	—	DIP-8, SO-8	\$3.95 (1000)	
350	0.11	DIP-8, SO-8	\$1.30 (1000)	Quad version is LPC660
4000	9	DIP-8, SO-8	\$1.50 (100)	Quad version is OP-482
100	0.04	DIP-8, SO-8	\$0.46 (1000)	Supply current is programmable
250	0.09	DIP-8, SO-8	\$0.92 (100)	Supply current is programmable
600	0.4	DIP-14, FP-14	\$6.94 (100)	Supply current is programmable
100	0.04	DIP-8	\$0.79 (1000)	Supply current is programmable

TECHNOLOGY UPDATE

Micropower op amps

current. However, a *complementary* bipolar process often provides the best speed/power tradeoff, Krehbiel says.

Before you select an op amp for its low bias-current specification, you should look at how this parameter varies as a function of temperature. Bipolar devices tend to have high bias currents at room temperature, but they are often better performers than FET devices at elevated temperatures. The bias current (essentially a leakage current) of an FET-input device doubles for every 10°C rise in temperature. Consequently, as temperatures approach 100°C, the bias current of an FET-input op amp can be greater than that of a bipolar-input device. This behavior should be a prime consideration in choosing op amps for applications that operate at temperatures above 85°C.

Another tradeoff is apparent in

the Max480 from Maxim Integrated Products; the op amp sacrifices good dynamic performance for excellent dc characteristics. It has a maximum input offset voltage of 70 μV with a drift of only 1.5 $\mu\text{V}/^\circ\text{C}$. Other dc specifications include an input bias current of 3 nA max and a supply current of 20 μA . Optimized for low-current operation and dc precision, the device's unity-gain bandwidth is typically only 20 kHz, and its slew rate isn't even mentioned in the data sheet. Obviously, you wouldn't buy this device for its dynamic capabilities.

You might, however, be interested in the Max480 for such applications as voltage references, remote thermocouple conditioners, and current monitors. You can operate the device from a single supply of 1.6 to 36V or from dual supplies of ± 0.8 to $\pm 18\text{V}$. The op amp is particularly useful in battery-

powered applications. For example, the device's 15- μA maximum supply current from a 3V supply allows more than 16,000 hours of operation from a 250-mA/hour lithium cell.

Another device that offers excellent dc performance is the LT1077 from Linear Technology. Because it operates at a higher supply current of 60 μA , the device's dynamic performance doesn't suffer quite as much as that of the Max480. It offers a reasonably high unity-gain bandwidth of 230 kHz and a slew rate that, at 0.08V/ μsec , is at least measurable.

The op amp's real claims to fame, however, are its dc precision and its output-drive capabilities. Operating with a single 5V supply, the op amp's lowest grade version features a maximum input offset voltage of only 60 μV and an input offset current of less than 0.45 nA. The device's common-mode input-

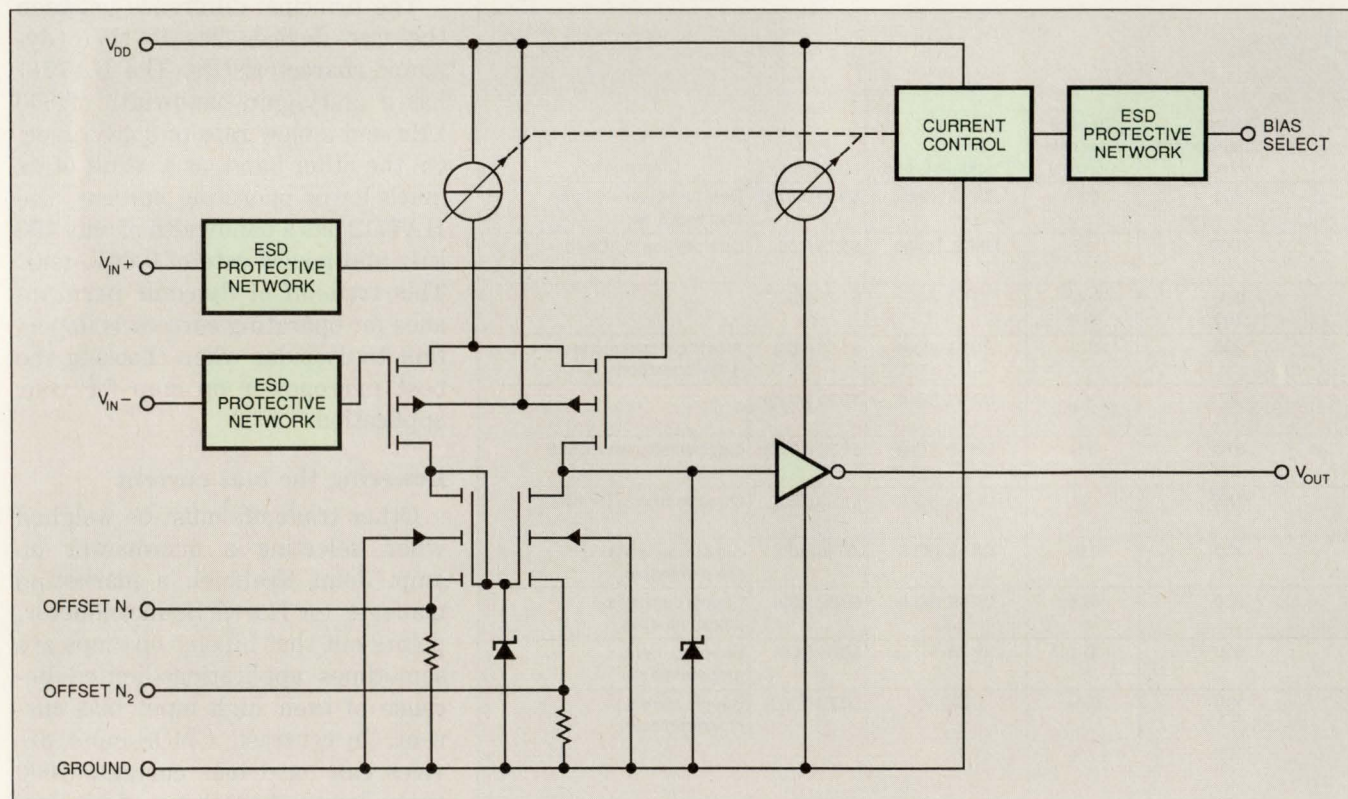

Fabricated in the company's silicon-gate LinCMOS process, the TLC251 micropower op amp from Texas Instruments features input offset-voltage nulling, selectable bias current, and ESD protection.

Position-Sensitive/ Ranging Components

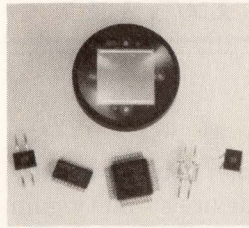

Hamamatsu offers a variety of auto-focus and position detectors especially designed for proximity switching, displacement sensing and

optical distance measurements. They are smaller, faster, require less power and feature more stable performance than comparable types.

Applications include auto-focus cameras, computer disc drives, linear motion detection in industrial equipment, beverage dispensers, robotic controls and automated car wash equipment.

CIRCLE NO. 46

Hamamatsu Photocouplers

Don't miss our newest catalog. It covers the complete line of Hamamatsu photocouplers including CdS Cell, Photo IC and Phototransistor output types. Also included are photointerrupters and photoreflectors. Many can be used in surface-mount applications for non-mechanical position sensing and high voltage isolation of circuits.



Applications include color video signal interface for TV, high speed I/O computer interface, line receiver interface, electronic motor control and switching regulators.

CIRCLE NO. 47

Hamamatsu CdS Photoconductive Cells

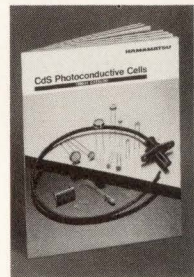

This catalog is a must for every electronics designer. Hamamatsu CdS cells are available in plastic-coated, metal-case and glass-bulb type assemblies for a wide variety of applications.

Applications include exposure meters, light dimmers, musical

equipment, flame monitors, street light controls and many others.

CIRCLE NO. 48

Hamamatsu Photodiodes

Did you know that Hamamatsu offers a complete line of photodiodes? From UV to IR, GaAsP, SI, PIN, APD and GaP, they're all here in our latest catalog. Send for it today.

Applications include high speed light sensors, CAT scanners, X-ray monitors, illuminance meters, light absorption meters, light-to-logarithmic voltage conversion circuits and more.



CIRCLE NO. 49

P2288 and P2613 Pyroelectric Detectors

These competitively priced devices feature a large sensitive area and offer optimal spectral response in the near IR.

Built-in impedance converting circuitry makes them easy to design into equipment.

Applications include intrusion and fire detectors, industrial robots and other electronic sensing devices.

CIRCLE NO. 50

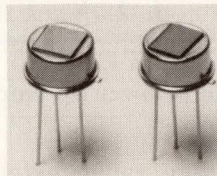

Hamamatsu UVtron R2868 Flame Sensor

The UVtron flame sensor can detect the ultraviolet radiation of a match from distances greater than 15 feet. Quick detection, wide directivity and compact design make it easy to integrate the R2868 into your products.

Applications include flame detectors for industrial, automotive and petroleum plant environments; also in horse or livestock stables.

CIRCLE NO. 51

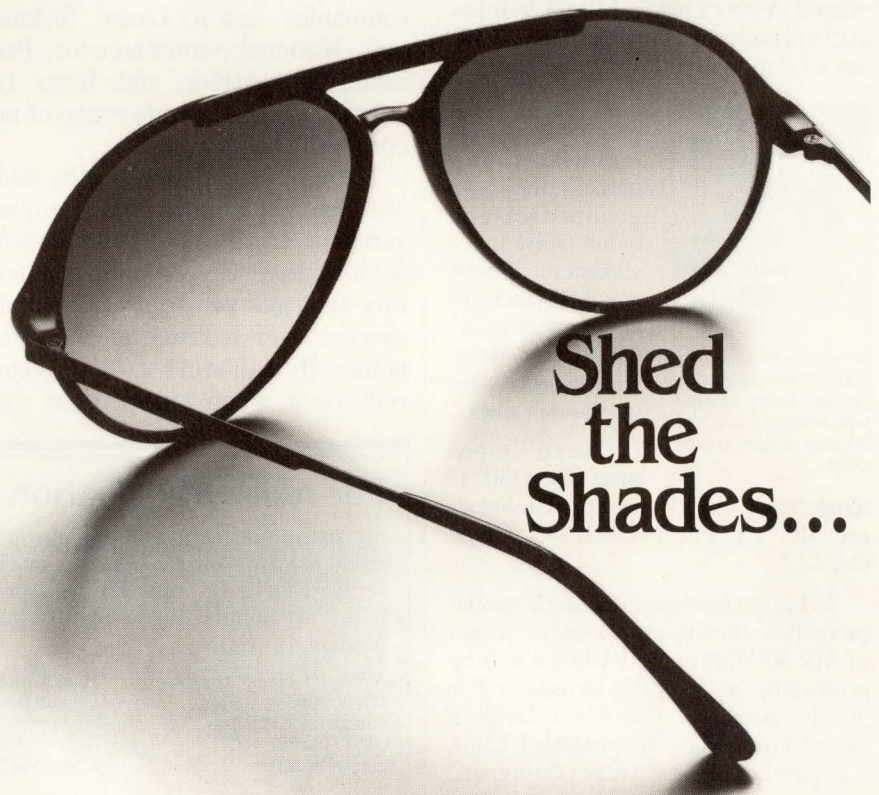
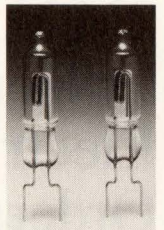

Shed
the
Shades...

WITH SYNCHRONOUS OPTICAL DETECTION.

Hamamatsu's new S3599 Modulated Photo IC rejects background light up to 10,000 lux (5,000 minimum) without even squinting. That makes it ideal for component environments found in office equipment, industrial control equipment or anywhere photo switches are used.

You'll see the light with Hamamatsu's famous quality. For quantity pricing, call 201-231-0960 or FAX 201-231-1539 today.

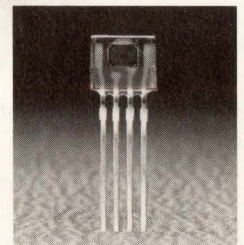

HAMAMATSU

HAMAMATSU CORPORATION • 360 FOOTHILL ROAD, P.O. BOX 6910, BRIDGEWATER, NJ 08807 • Phone: 201/231-0960
International Offices in Major Countries of Europe and Asia

TECHNOLOGY UPDATE

3M Now Includes Dispensers with Electrical Tape Orders

Promotion highlights introduction of new MR 93/94 composite insulating tapes

AUSTIN, Tex. — New 3M MR 93/93B and MR 94/94B electrical tapes have a polyester film non-woven laminate construction with rubber thermosetting pressure sensitive adhesive. Both tapes are offered in tan or black, MR 93/93B has a 0.5 mil polyester film base; MR 94/94B has a 1.0 mil polyester film base.



Scotch™ brand tape dispensers being offered with selected 5 case and 20 case electrical tape orders.

Produced by a proprietary 3M manufacturing process, they have greater tack and better solvent resistance. These new MR tapes are also thinner in order to save space without sacrificing insulation values.

These tapes meet Class 130° C temperature specifications per UL Standard 510, UL File No. E17385, Guide OANZ2.

3M is currently conducting a special promotion whereby purchasers of 5 cases of MR 93/93B or 94/94B tape will be given either a P52 or P56 Dispenser. For 20 case purchasers, the M920 Definite Length Dispenser will be awarded. Limit 5 dispensers of each size per customer.

Dispensers help workers get the tape off the roll and onto the job more quickly, according to Gary Long, 3M Tape Marketing Manager.

Special slitting services, just in time delivery, and volume pricing arrangements are also available.

For more information, contact a 3M Electrical Specialties Division representative or authorized distributor or call 1-800-233-3636.

3M Electrical Specialties Division
PO Box 2963
Austin, Texas 78769-2963



CIRCLE NO. 15

Micropower op amps

voltage range extends from 0 to 3.5V, and its output voltage extends from 6 mV above ground to 4.2V. In addition to its 5V characterization, the op amp comes with a full set of specifications for $\pm 15V$ operation. It is available in single, dual (LT1078), and quad (LT1079) versions.

Table 1 shows the basic characteristics of several micropower op amps. This brief listing does not do justice to the large numbers of available products. In particular, companies such as Linear Technology, National Semiconductor, Precision Monolithics, and Texas Instruments offer a wide range of micropower devices.

Many of the op amps in the table are also available in dual and quad versions. In addition, several of the devices have a programmable feature that lets you adjust the supply current over a range of operating points. By adjusting the supply current to a value higher than that

shown in the table, you can usually enhance the device's unity-gain bandwidth and/or slew rate. Be careful not to set the current so high that it exceeds the value your application can accept.

Micropower op amps are certainly not a panacea for every application. Their low-power operation and improved dc specifications are generally offset by weaker dynamic characteristics. But if 200 to 250 μA of supply current fall under your definition of micropower, a couple of devices are available that break the 1-MHz gain-bandwidth and 1V/ μsec slew-rate barriers. Despite inherent tradeoffs, micropower op amps are the best game in town for current-sensitive applications.

EDN

Article Interest Quotient
(Circle One)
High 509 Medium 510 Low 511

For more information . . .

For more information on the micropower op amps discussed in this article, circle the appropriate numbers on the Information Retrieval Service card, or use EDN's Express Request service. When you contact any of the following manufacturers directly, please let them know you saw their products in EDN.

Advanced Linear Devices
1180F Miraloma Way
Sunnyvale, CA 94086
(408) 720-8737
Circle No. 700

Maxim Integrated Products
120 San Gabriel Dr
Sunnyvale, CA 94086
(408) 737-7600
Circle No. 704

Signetics Co
811 E Arques Ave
Sunnyvale, CA 94088
(408) 991-2000
Circle No. 708

Analog Devices
804 Woburn St
Wilmington, MA 01887
(617) 935-5565
Circle No. 701

National Semiconductor
Box 58090
Santa Clara, CA 95052
(408) 721-5000
Circle No. 705

Siliconix
2201 Laurelwood Rd
Santa Clara, CA 95054
(408) 988-8000
Circle No. 709

Harris Semiconductor
Box 883
Melbourne, FL 32902
(407) 724-7000
Circle No. 702

Precision Monolithics
1500 Space Park Dr
Santa Clara, CA 95054
(408) 727-9222
Circle No. 706

Texas Instruments
Box 809066
Dallas, TX 75265
(800) 232-3200, ext 700
Circle No. 710

Linear Technology Corp
1630 McCarthy Blvd
Milpitas, CA 95035
(408) 432-1900
Circle No. 703

SGS-Thomson Microelectronics
1000 E Bell Rd
Phoenix, AZ 85022
(602) 867-6100
Circle No. 707

Micro Networks' new MN6400 is the only functionally complete, true 16-bit A/D. So

ONLY

unlike other devices, it's every bit as good as we say. Self-calibrating. Easy to use. The MN6400 lets you design even the most advanced systems without hassle or compromise. In a world of so-called 16-bit A/Ds, there's only one MN6400. To order yours, call Micro Networks at (508) 852-5400. Or return the coupon.

The MN6400's 16-bit performance makes it ideal for industrial and military data acquisition applications including instrumentation, ATE and spectrum analysis.

<i>Functionally complete:</i>	<i>Self-calibrating.</i>	<i>FFT testing.</i>
<i>T/H amplifier function</i>	<i>16-bit, no-missing-codes guaranteed over temperature (-55°C to +125°C).</i>	<i>Serial and parallel data outputs.</i>
<i>Analog input buffer</i>		<i>Four user-selectable input voltage range configurations.</i>
<i>Reference</i>	<i>50kHz sampling rate.</i>	<i>Available with environmental stress screening.</i>
<i>Timing and control logic</i>	<i>90dB SNR, -100dB harmonics.</i>	
<i>µP interface</i>		
<i>Parallel data bus driver</i>		

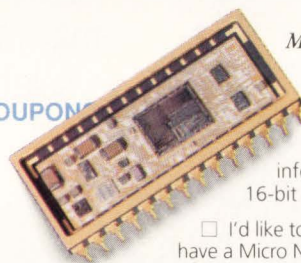

MN6400

COUPON COUPON COUPON COUPON COUPON COUPON COUPON COUPON COUPON COUPON

COUPON COUPON COUPON COUPON COUPON COUPON COUPON COUPON COUPON COUPON

- Please send me more information about the MN6400 16-bit Sampling A/D.
- I'd like to evaluate the MN6400. Please have a Micro Networks representative call me.
- Please send me the Micro Networks 1990 Short Form Catalog.

Name _____ Title _____

Company _____ M/S _____

Address _____ Phone _____

City _____ State _____ Zip _____

My application is _____

Is a Standardized Military Drawing product required? Yes No



MICRO NETWORKS
 324 Clark St., Worcester, MA 01606
 Phone: (508) 852-5400 Fax: (508) 853-8296

PRECISELY THE ANSWER.
 CIRCLE NO. 105

The newest tw

Finally, a plug and play 10BASE-T network.

With our new ML4650 family of Single Chip 10BASE-T transceivers, you're covered all across the LAN. Because we have single chip twisted pair solutions for both ends, hub to node. Available now. In quantity. Giving you a fast, no hassle 10BASE-T solution.

On the PC side, the ML4651 and ML4652 transceivers incorporate AUI interfaces designed for both Ethernet adapter cards and external MAUs.

On the hub side, the ML4654 is tailor-made for a hub design with TTL or ECL outputs. All are highly integrated

single chip solutions, minimizing

the number of external components required. So your design-in process is much easier. And faster.

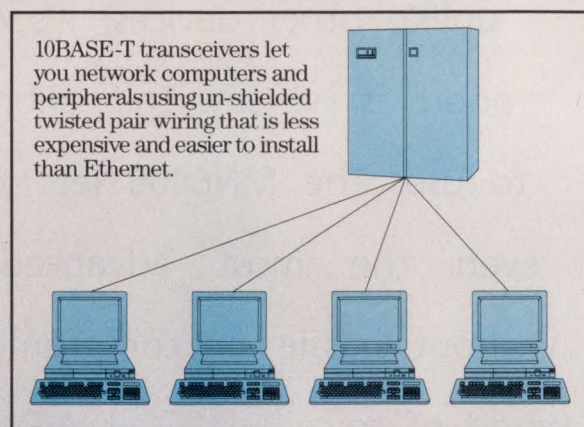

On-chip current driven transmitters are less sensitive to noise and power supply variations. So you get superior jitter performance and low noise outputs that help you easily pass FCC requirements. And the receiver includes an intelligent squelch that rejects cross-talk noise commonly found coupling from the phone wires into the LAN. There's no external crystal oscillator required either, and devices use 5 volts only power supplies.

Parts are available in 20- and

Micro Linear
10BASE-T products
are available in both
adapter card and
external MAU configurations.

ist in 10BASE-T.

24-pin skinny DIPs and 28-pin PLCCs. There's even an ML4621 Fiber Optic Inter-Repeater Link (FOIRL) receiver available to satisfy 10 Mbps fiber optic Ethernet requirements.

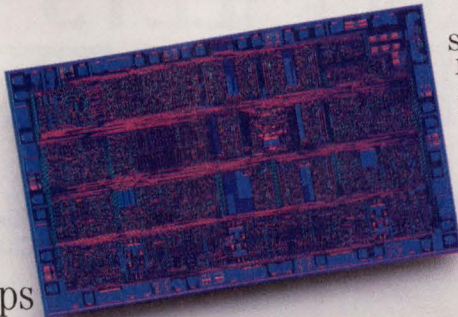

Semi-standard options of the standard 10BASE-T circuits are possible simply by modifying the metal mask on the FB3651 tile array.

functional or performance modifications. Or special screening packaging or reliability

And, unlike much of the technology you've been hearing about, these are products of experience. We've been shipping twisted pair transceivers since 1987, as part of Synoptics' LattisNet network.

levels to meet your specific network requirements. Whether it's an on-board AUI device. Or a multi-port repeater (MPR) designed to achieve that critical time-to-market advantage you've been looking for.

Semi-standard options.

We're one of the first to market for one simple reason. Our 10BASE-T family is based on our standard FB3651 bipolar tile array. So we were able to quickly modify our "standard" product to satisfy the rapidly-emerging IEEE 802 standards.

And, for the same reason, they can be easily modified with semi-standard capability to give you proprietary product advantages. Like

Call us on it.

If you'd like to turn your 10BASE-T idea into a deliverable product, just call Charles Yager today at (408) 433-5200 and ask him for the complete story on our ML4650 family of single chip 10BASE-T transceivers. Or ask for a free sample. It could add a whole new twist to your networking scheme.

Micro Linear, 2092 Concourse Drive,
San Jose, CA 95131

CIRCLE NO. 106



 **Micro Linear**

**“CERTAINLY, OUR
DMMs GIVE YOU ACCURATE
READINGS. THAT’S A GIVEN.
BUT THERE’S MORE TO
THEM THAN MEETS THE EYE.
DROP ME A NOTE AND
I’LL SHOW YOU.”**

Joseph F. Keithley, Chairman

Joseph F. Keithley

SEE FOR YOURSELF.

From the outside they may look like your standard digital multimeters. They're not. Keithley doesn't make standard instruments. Quality — that's what we're known for. And that's a given with these DMMs.

They're designed, engineered, built to give you more features, more value. And as a result, more performance benefits at less cost than other DMMs.

Put them on your bench or in an automated test system. They'll give you 100pA and 100nV sensitivity. Reading rates up to one million per second. Memory

to store readings. And even the portable units have automatic calibration over the IEEE bus.

And anytime you want assistance, make one phone call and you'll get the answers you need from our Applications Department. This dedicated staff of engineers has the experience to help you with equipment selection and test system design.

Drop us a note at 28775 Aurora Road, Cleveland, Ohio 44139. Or call 1-800-552-1115, Ext. 394, for all the facts. You'll see what you've been missing.



KEITHLEY INSTRUMENTS

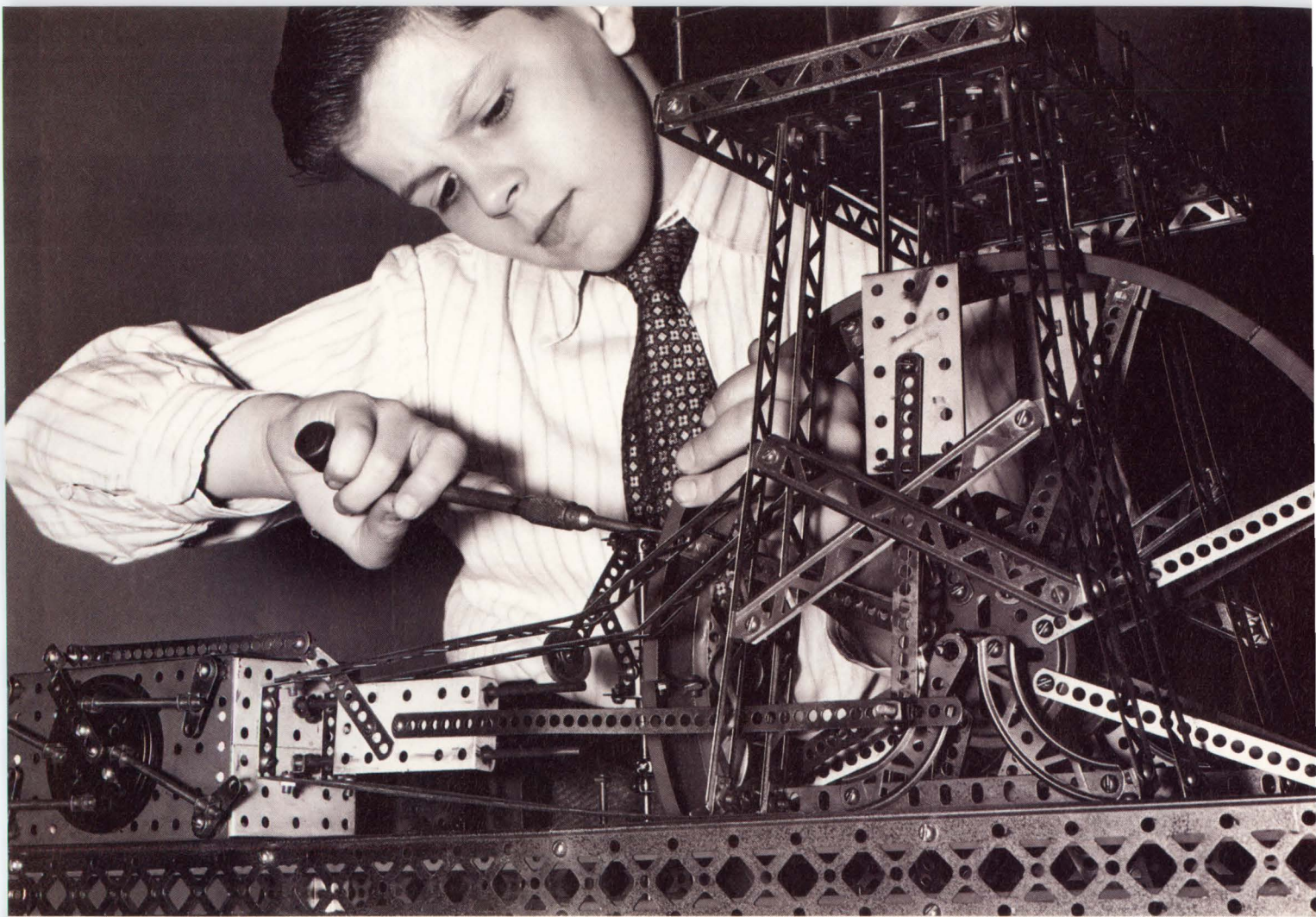

The Bettman Archive Inc.

Even the most ambitious project is limited by its parts.

Most kids use the pieces of their building toys just like they came out of the box. So they're limited by the characteristics of those pieces.

The same is true of today's suppliers of "custom" interconnect systems. Assembling systems from components that are readily available, they call these products custom when they're really only customized.

At Precision Interconnect we're often not satisfied with

the components or assembly procedures readily available. So we design, test and implement our own.

First we ask every question imaginable about the application of the product. Then we apply our knowledge of manufacturing, materials, cable and connector designs, and termination processes to solve the problem.

So the complete interconnect systems we deliver will be high performance and application specific, meeting every requirement of your particular interconnect problem.

We know the whole is greater than the sum of the parts. And more functional if you challenge those parts.

P.I. miniaturized this cable of 68/40 AWG, 50 ohm coaxes to a .192" O.D. to fit into the end of an endoscope tube. The O.D. of one RG-59 is .242".

CIRCLE NO. 108



**PRECISION
INTERCONNECT**

16640 S.W. 72nd Avenue
Portland, OR 97224
(503) 620-9400

Offices in San Francisco, Boston,
Wilmington and Düsseldorf.

"WE'VE HAD GREAT SUCCESS WITH CARROLL TOUCH. WHY

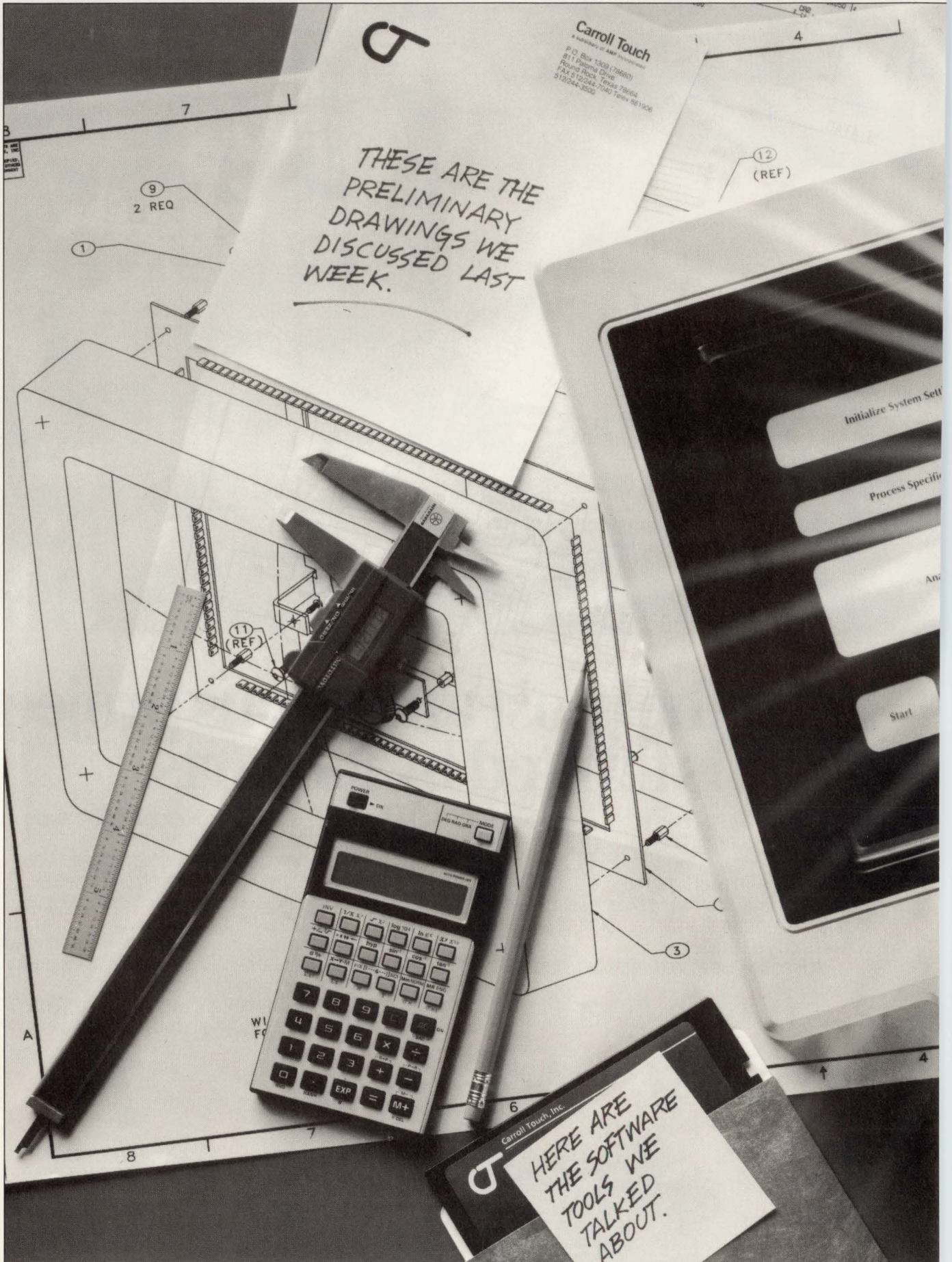

CHANGE IF IT'S WORKING?"

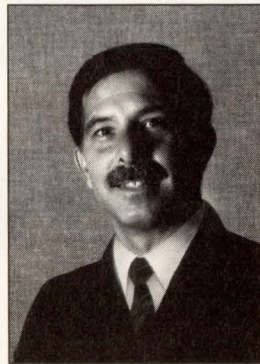
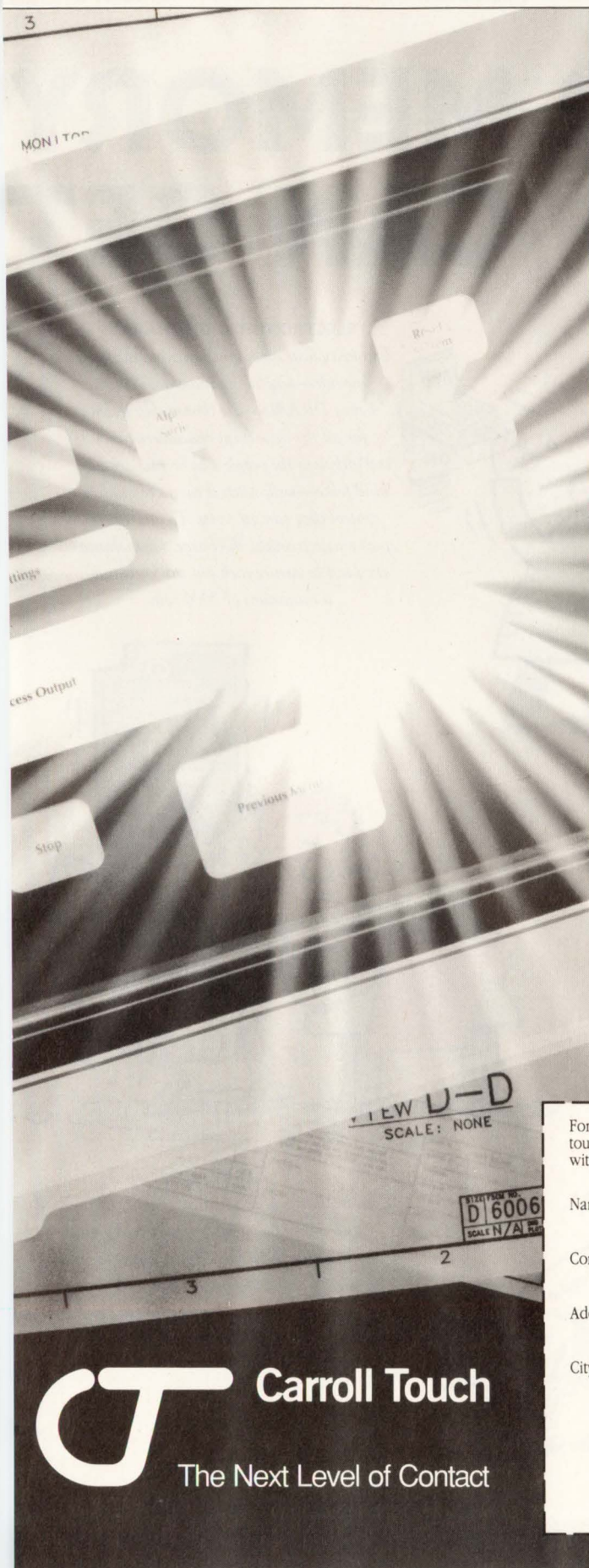

John Santacrocce
*Mechanical Engineering
& Project Manager*
Hewlett-Packard Company

"As a diverse international corporation, Hewlett-Packard manufactures everything from computers, measurement and computation equipment, medical equipment, analytical equipment and more. We're known for our high level of test and measurement systems capabilities.

"We recently developed a touch-based automotive test system for a customer and there was no debate over using Carroll Touch in designing this. Our past experience with them has been very successful.

"From my point of view, Carroll Touch has provided good, reliable touch frame assemblies. They also bring a high level of engineering expertise to our team, especially in the materials selection area.

"Carroll Touch people really approach our projects as a team project."

"Working with Carroll Touch people is great because everybody is part of the team - which helps us create a very successful product. Their willingness to go that extra step makes our job much easier.

"In developing a recent functional spec for a touch frame, Carroll Touch engineers worked closely with us in making sure that the assemblies would survive electrostatic discharge.

"We held design reviews of the various approaches and all of our recommendations were considered very sincerely by Carroll Touch. Comments were intelligently relayed back to us and everything we asked for was delivered in the specified time."

For more information on how Carroll Touch can help you create success with your touch technology applications, call 512/244-3500, or simply mail your business card with this coupon to Carroll Touch, P.O. Box 1309, Round Rock, Texas 78680.

Name _____ Title _____

Company Name _____

Address _____

City _____ State _____ Zip _____

 **Carroll Touch**
The Next Level of Contact

 **Carroll Touch**
The Next Level of Contact

EDN091790

© 1990 Carroll Touch

SAMSUNG

NOW

OUR MEMORY CAN GET

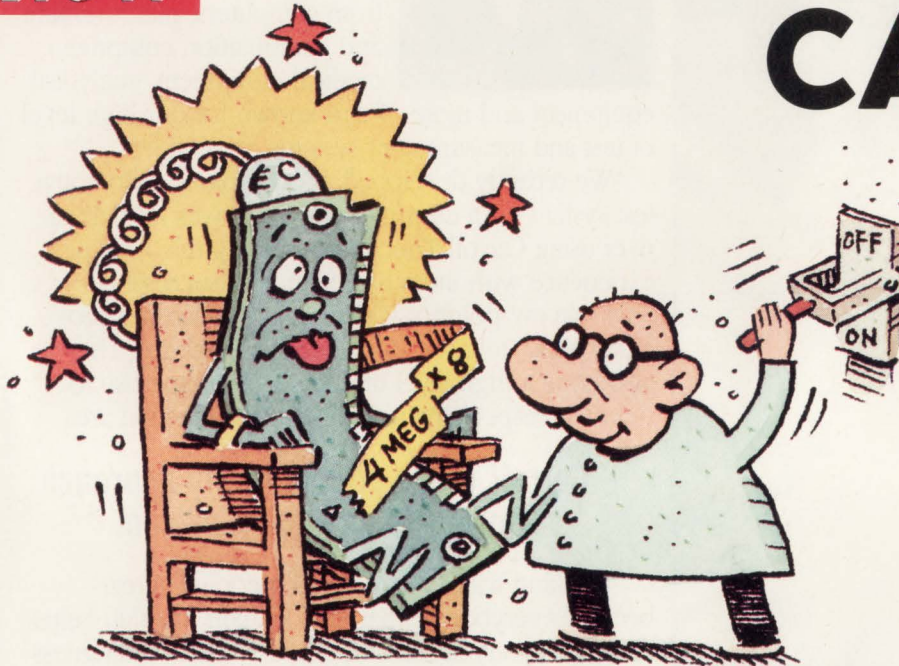

ELECTROSTATIC DISCHARGE

Unlike typical modules, Samsung memory modules—including those using our 4-meg DRAMs—are thoroughly tested for all the important characteristics. And although the people who do this are nice, kind folks—well, when it comes to quality control they can get testy. To guarantee specs on electrostatic discharge, for instance, they test to assure each pin will withstand a minimum of 2000 volts.

FLAMMABILITY

On flammability, our module people take great pains to assure that our products meet standards. As a result, we guarantee that every Samsung memory module meets or exceeds the 94V-0 Underwriters Laboratory flame classification.

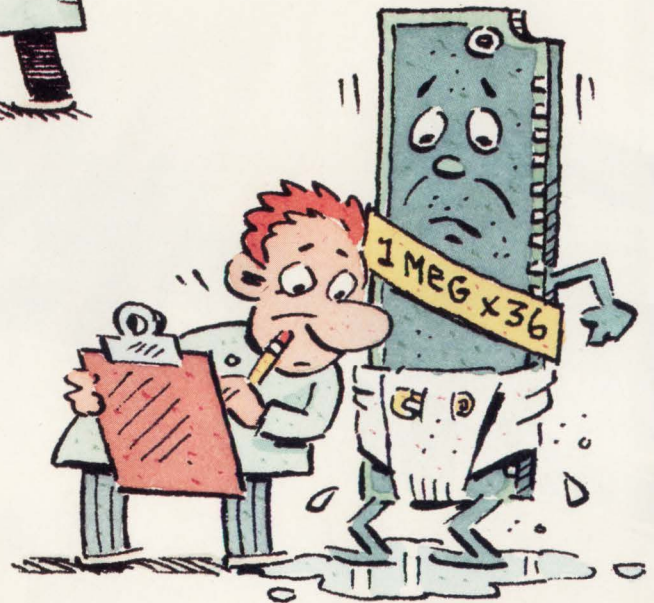
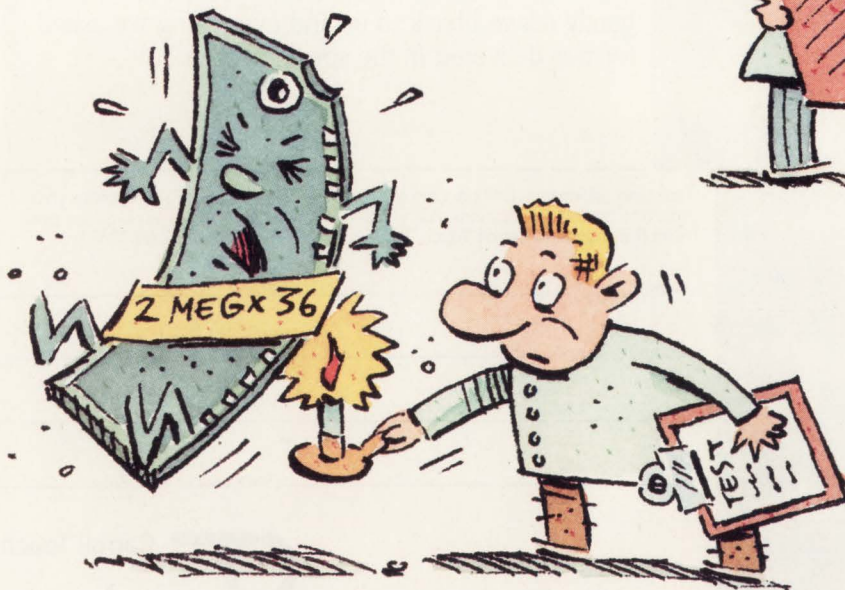

LEAKAGE

Even in the era of the 4-meg DRAM, there's still such a thing as a module with leaky pins. Many manufacturers just don't inspect for leakage. You guessed it, our team does comprehensive tests. All pins on all modules are 100% tested to the data sheet leakage specification.

MODULE PEOPLE A BIT TESTY.

POWER CONSUMPTION

In this day and age there are enough power-hungry things without your memory modules getting that way. You want them to consume what they say they will. Ours are thoroughly tested not to exceed the spec.

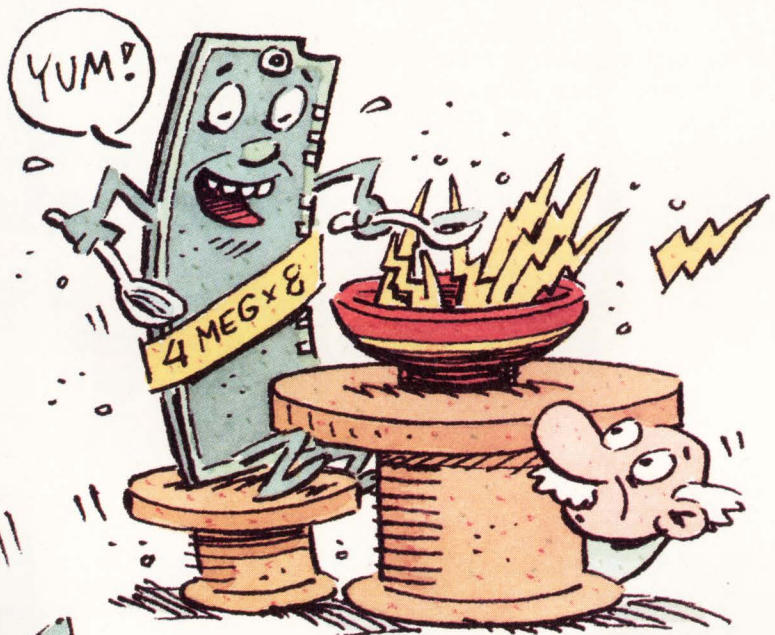
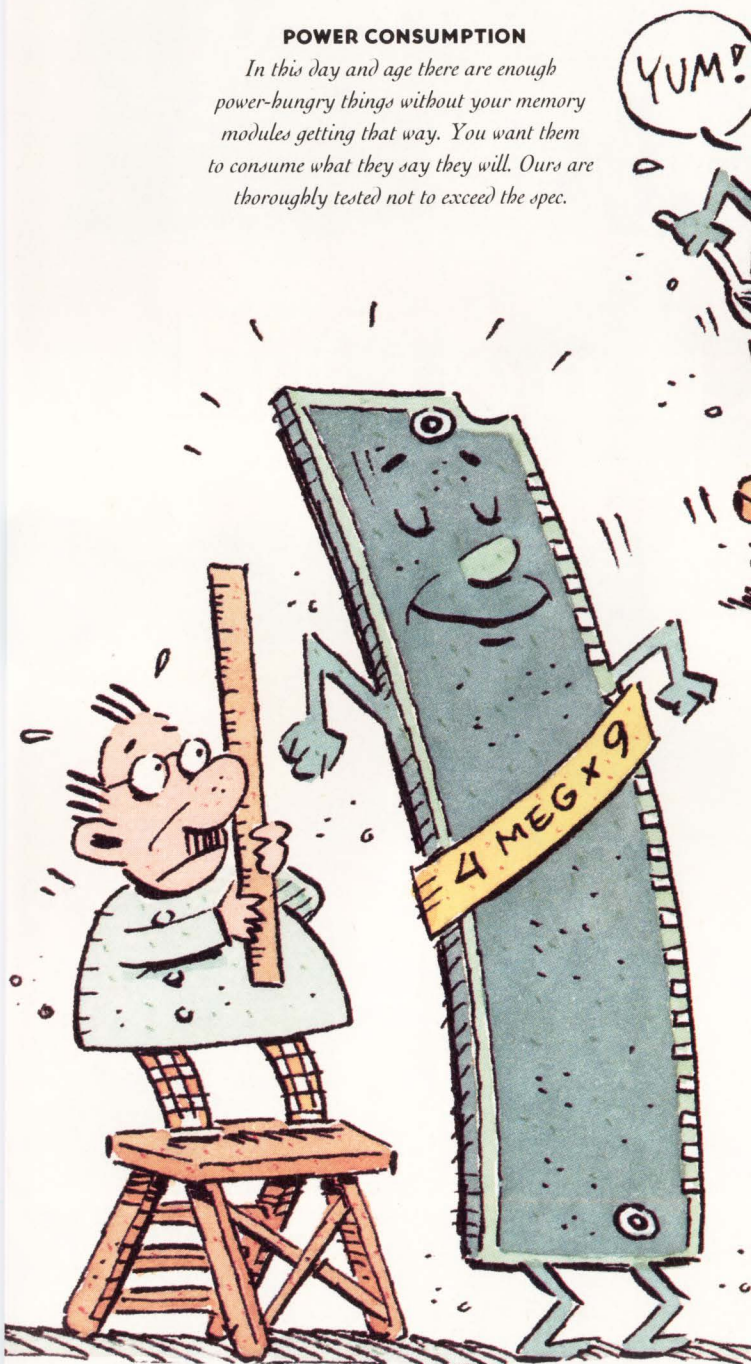

DIMENSIONAL CONTROL

A too-big or too-small module isn't good for much. Samsung modules are tested to perfectly match JEDEC standard dimensions, including 50 ± 5 mil thickness. Since they are, and are also tested on all the other features detailed here, we can't see why you'd ever buy from anyone else. For information on modules with our 4-meg DRAMs, or the rest of our line, write to the testy people at Memory Module Marketing, Samsung Semiconductor, 3725 North First Street, San Jose, CA 95134. Or call 1-800-669-5400, or 408-954 7229.



CIRCLE NO. 109

HITACHI'S DK515, 5¼", 780 MB WINCHESTER

From any point of view, this 5¼" disk drive reflects Hitachi's superior technical expertise, high-performance, and quality.

The DK515 features a fast 2.46 MB/sec. data transfer rate, an average access time of 16 ms, and a choice of ESDI, SCSI, or ESMD interfaces.

Like all Hitachi drives, the DK515 reflects quality, because all critical components—including heads, media, and servo systems—are designed, engineered, and manufactured by Hitachi.

Then, to make sure that Hitachi's strict standards of excellence are maintained, each and every drive is 100% burned-in and tested. The final result: a clear reflection of Hitachi's commitment to providing the very best in reliable, high-quality, high-performance disk storage. All this from a \$48 billion company.

Available now!

For more information about Hitachi disk drives, call your local Hitachi Distributor listed below, or Hitachi at 1-800-283-4080, Ext. 877.

Hitachi America, Ltd.
Computer Division, MS500
Hitachi Plaza
2000 Sierra Point Parkway
Brisbane, CA 94005-1819



Authorized Distributors

CONSAN 612-949-0053
(IA, IL, IN, KS, KY, MI, MN, MO, ND, NE, OH,
Pittsburgh, PA, SD, WI)

GENTRY ASSOCIATES
800-877-2225
(AL, D.C., FL, GA, LA, MD, MS, NC, SC,
TN, VA)

R SQUARED 800-777-3478
(AZ, CA, CO, NM, OR, UT, WA, WY)

SIGNAL 800-228-8781
(CT, MA, ME, NH, RI, VT)

SPECIALIZED SYSTEMS
TECHNOLOGY 800-688-8993
(AR, LA, OK, TX)

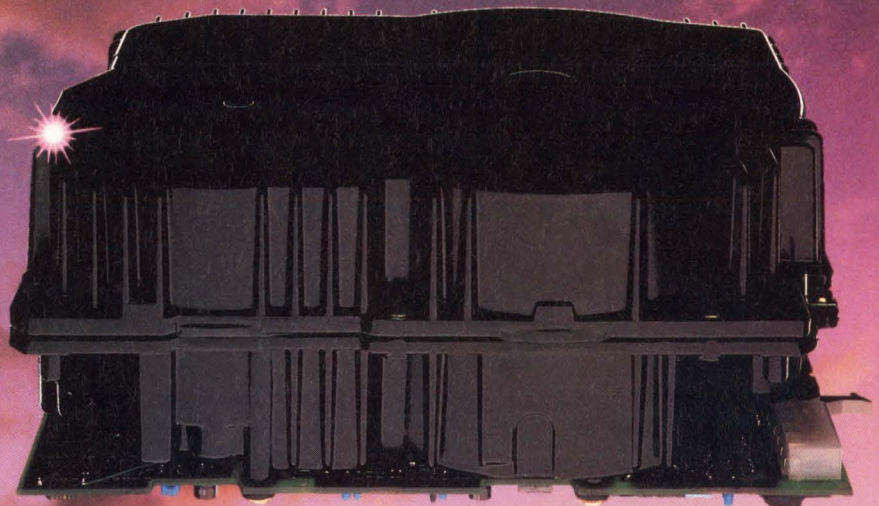

A Reflection of Quality

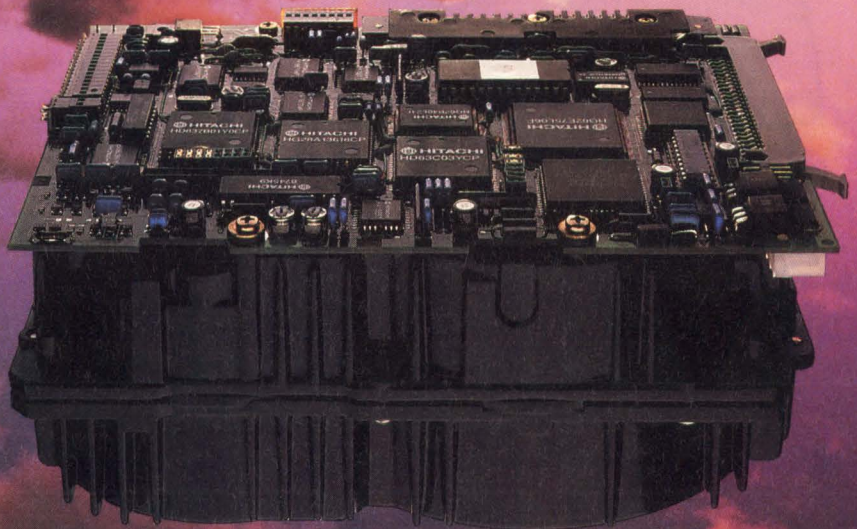

Logic-synthesis tools speed ASIC designs



Logic-synthesis tools for ASIC design help you save time while meeting your functional, area, and performance design goals.

Doug Conner,
Regional Editor

Designing a 100,000-gate ASIC is a big job and usually needs to be done quickly. If a team of designers can generate 2000 gates a week, they've still got a 1-year effort ahead. Even a modest 15,000-gate ASIC is a large undertaking—especially if one engineer is going to design it. Rather than working unreasonable hours to meet impossible deadlines, you can use logic-synthesis tools to automate some of the design process and reduce your design time.

To use logic-synthesis tools, input an ASIC design description and design constraints that describe your design goals (Fig 1). The tool produces a net list, a design report detailing general information about your design, and other types of information, depending on the particular tool.

Besides synthesizing your ASIC design, these tools also optimize designs, usually for speed, area, or both. Optimization works best on control logic, including random logic and state machines. Control logic might be 20% of an ASIC's design, yet it can consume more than that percentage of your design time. Highly structured designs such as RAMs and ROMs aren't good candidates for optimization.

Another benefit of

logic-synthesis tools is that they let you synthesize designs from a high-level description. Hardware description languages (HDLs) such as VHDL (VHSIC hardware description language) and Verilog from Cadence (San Jose, CA) let you describe circuits at a level higher than that of a gate-level description. Using an HDL, you can describe an ASIC in terms of the functions it performs or the behavior you expect from the device. The higher-level description lets you avoid implementation details and concentrate on what you want the circuit to do. By using an HDL as an input to the logic synthesizer, you also avoid having to describe a design twice: once

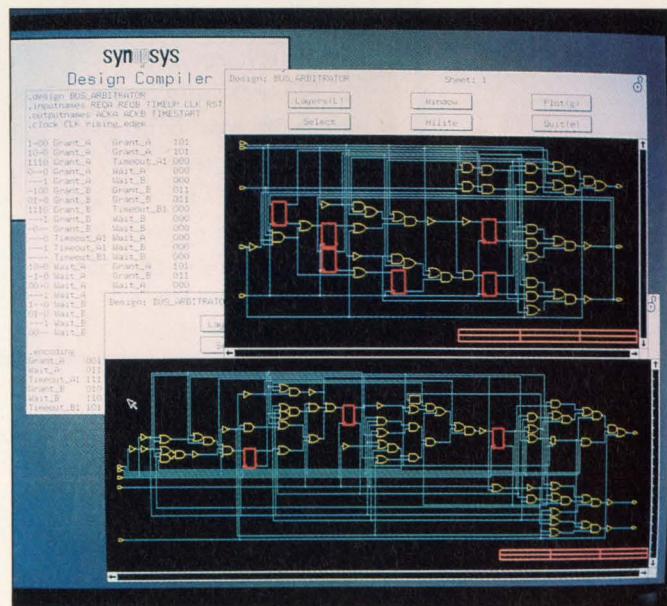

Extracting a state table from a net list (upper left corner) is one of many input methods you can use with Synopsys's Design Compiler. The tool optimizes the state assignment and then synthesizes the logic necessary to implement it. The top schematic shows the 6-state machine optimized for speed with six flip-flops; the bottom schematic shows an area-efficient design using three flip-flops.

PSSST...

Even though they're Power Factor Corrected, the power supplies you're now using could ban your products from Europe after 1992. They might keep you from doing business domestically, too.

Your PFC supplies might not meet IEC 555-2 because they have too much current circulating in third and fifth order line current harmonics.

Pioneer supplies have less than 5% total harmonic current content. They feature built-in >.99 active Power Factor Correction, meet proposed IEC 555-2,

all applicable international safety and EMC standards, and are available from 250 to 2000 watts, in single or multiple outputs. Delivery for most models in OEM quantities is 60-90 days.

P.S. — We apologize for not having brought you this information earlier. But the word is out. We've been shipping our PFC supplies worldwide for more than two years. So call us now at 800-233-1745, or 800-848-1745 in California.

Pioneer Magnetics

TECHNOLOGY UPDATE

Logic-synthesis tools

at the behavioral level before simulation and then again at the schematic level.

However, the ability of HDLs to model unsynthesizable characteristics such as user-defined data types limits logic-synthesis tools to working with a subset of HDLs. What constitutes a synthesizable subset varies among logic-synthesis tools.

Some logic-synthesis tools let you use a variety of input formats in the same design, so you can use the format that is best for the particular part of a circuit you're working on. Designers can use Boolean equations, truth tables, and state machines at different times when developing design descriptions. You'll save time and avoid errors if you use your original design description format as the input for your logic-synthesis tool. You may need to run the logic-synthesis tool before simulation if you've chosen a combination of design input formats that your simulator won't accept. Logic-

synthesis tools can synthesize your design into a format that is compatible with your simulator.

Other benefits of logic-synthesis tools include the fact that you won't need to become intimately familiar with a particular ASIC foundry's logic library because you can just feed that information to the tool. The tool takes care of translating your logic to make the best use of the foundry's library. Some logic-synthesis tools add test structures to the synthesized design; some products can also automatically generate test vectors.

Defining a design

Developing an ASIC with logic-synthesis tools differs somewhat among the various tools. **Fig 2** shows the general steps for developing an ASIC using a logic-synthesis tool. The first step is developing a design description and then functionally simulating it to verify that your design performs the way you

want it to. Next, transfer the design to the logic-synthesis tool. You can use any combination of input formats that are acceptable to the synthesis software, such as EDIF (Electronic Design Interchange Format), VHDL, or proprietary schematic and net-list formats. **Table 1** shows the input formats typically acceptable to logic-synthesis tools.

Although some logic-synthesis tools work from the structural descriptions that HDLs provide, other tools can work from structural or behavioral ASIC descriptions. In the description hierarchy, behavioral descriptions are the most abstract, structural descriptions such as register-transfer-level (RTL) descriptions are more concrete, and gate-level descriptions are the most concrete. The more abstract your design description, the further you are from the details of implementation. A more abstract (as opposed to concrete) design is easier for de-

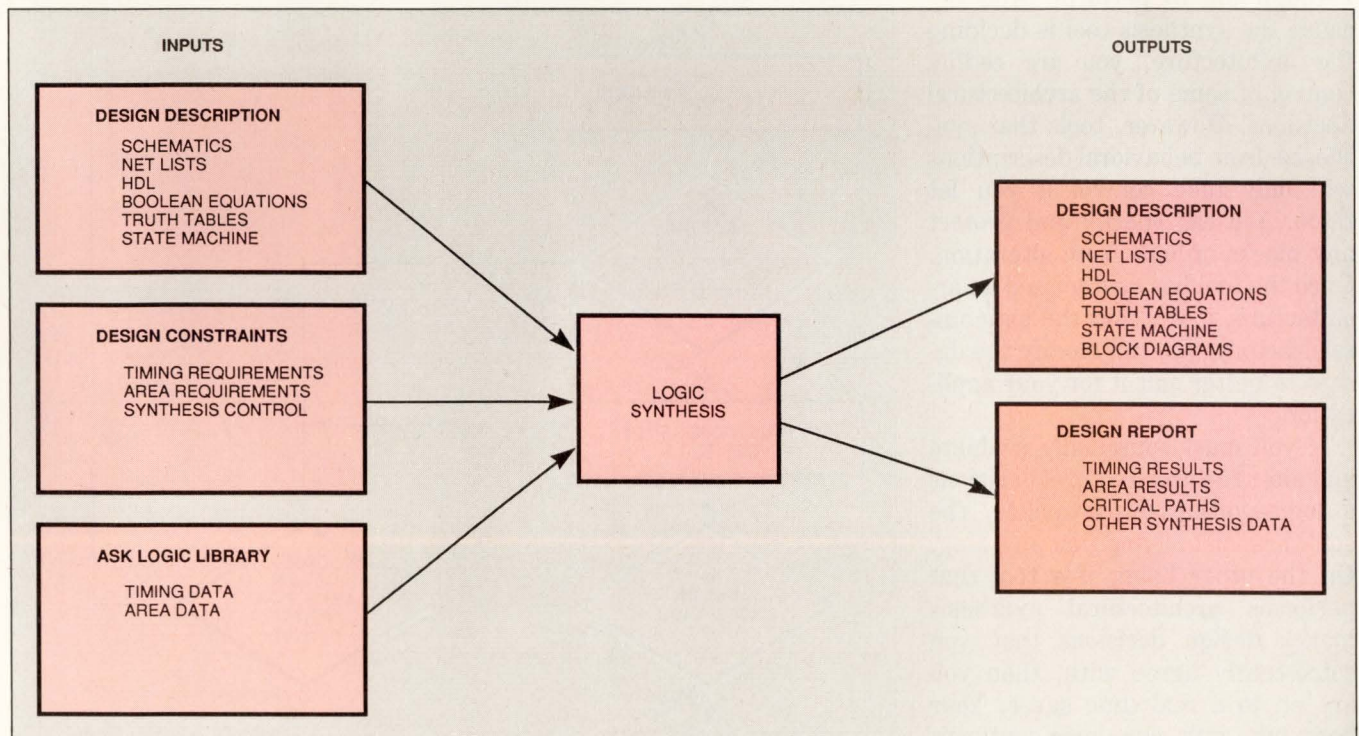

Fig 1—Logic-synthesis tools typically require a variety of input information to optimize and synthesize a design. The tools output a design description that includes a net list; other formats may also be available.

TECHNOLOGY UPDATE

Logic-synthesis tools

signers to create because they don't have to worry about details. Such a design is more difficult for a logic-synthesis tool to create because it does have to sweat the details.

Logic synthesis is more controlled when working from a structural ASIC description than it is given a behavioral description. An RTL description already has an implied architecture; a behavioral description does not imply a structure. You might think of logic synthesis from an RTL description as optimizing the combinatorial logic between registers. As your descriptions become more behavioral, they imply less of the architecture. Synthesis at the behavioral level is sometimes referred to as architectural synthesis, which is a subset of logic synthesis. Tools that can work at higher behavioral levels synthesize an architecture then perform logic synthesis on that architecture.

Tools that synthesize designs from behavioral descriptions have a tough job to perform. And because the synthesis tool is deciding the architecture, you are ceding control of some of the architectural decisions. However, tools that synthesize from behavioral descriptions will only take control if you let them. You can specify and protect any blocks of logic from alteration. Once the tool has synthesized an architecture, if you find the logic unsatisfactory, you can modify the design to better suit it for your application.

If you must continually evaluate and alter the architectural decisions a logic-synthesis tool makes, the software isn't saving you anything. On the other hand, if a tool that performs architectural synthesis makes design decisions that you consistently agree with, then you are on to a real time saver. Your best bet with any logic-synthesis tool—especially those that perform architectural synthesis—is to

benchmark the tools on designs or portions of designs that represent your typical work.

With most synthesis tools, you'll elect to partition your design into blocks. Hierarchical blocks are a common way to rough out a design. Work from the top down, specifying the function of each block. Without synthesis tools, you'd proceed to de-

tailed design of what goes into each block, and logic synthesis lets you take much the same approach. Logic synthesis can support a design method that is similar to what many designers use without these tools.

Synopsys says that many users of its logic-synthesis tool work with blocks that represent 300 to 5000

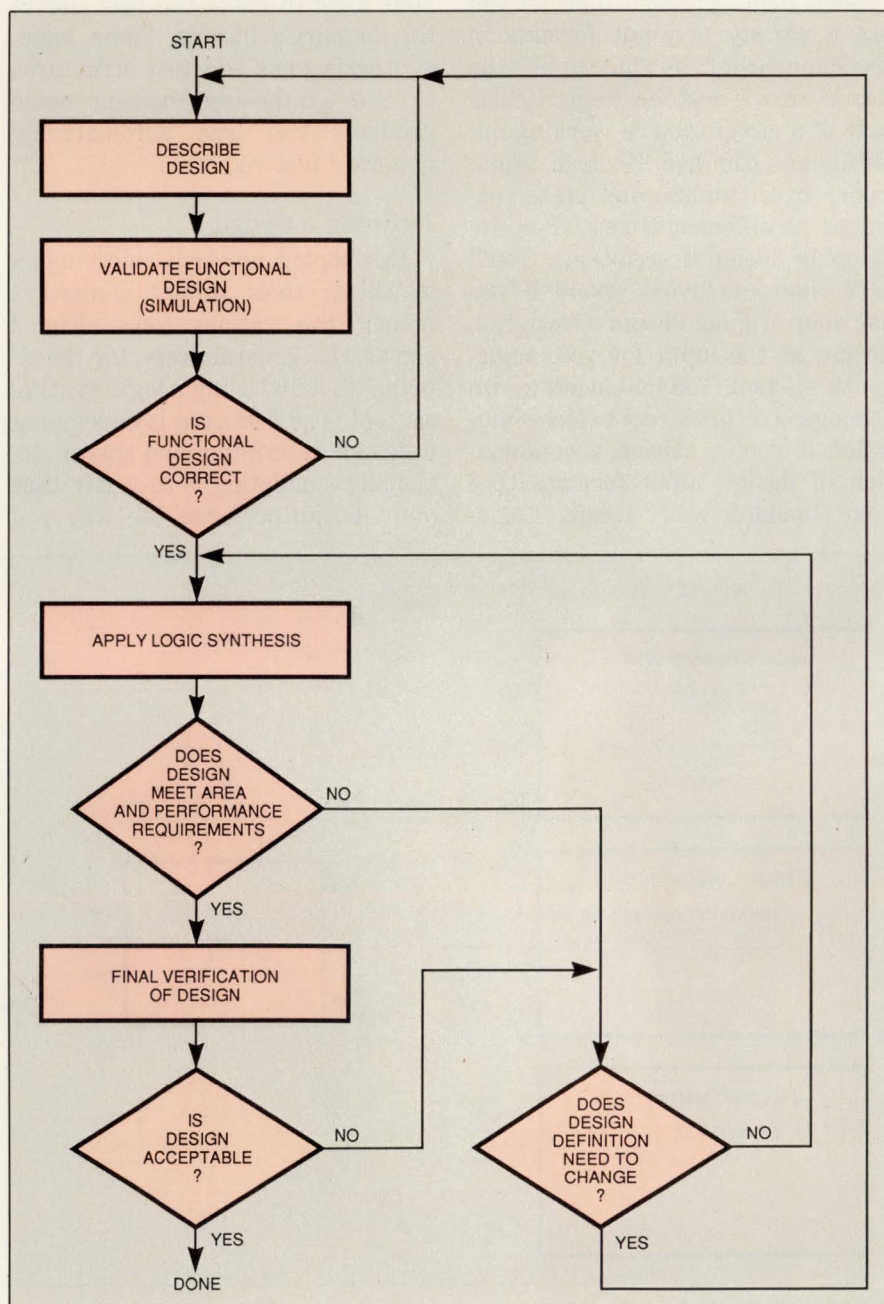

Fig 2—Designing an ASIC using logic synthesis starts with describing the design.

THE FINE ART OF DISC DRIVES



Metal sculpture by
Micah T. Curtis
Big Sur, California

Since their introduction, Wren[®] disc drives have been among the most sought after in the industry. With their high capacity and sterling performance features, it's no wonder we've been hard-pressed to fill all the orders. Fortunately, that's now changed.

These 5.25" half- and full-height drives are ready for immediate delivery in capacities ranging from 43 to 1200 megabytes in a variety of ST412, SCSI, ESDI and AT interfaces. Our unique Zone Bit Recording,[®] used in most models, and low-mass actuator give Wren drives high data transfer rates and average seek times as low as 10.7 msec. These specifications make the Wren family the ideal choice for thousands of high-performance applications.

Like the artist who spends years perfecting his craft, Seagate has spent the past decade mastering the fine art of disc drives. To become further enlightened about Wren and our other disc storage solutions, contact your authorized Seagate distributor, or call Seagate directly: 800-468-DISC, or 408-438-6550.



PC/AT is a trademark of International Business Machines Corporation. Zone Bit Recording, Wren, Seagate and the Seagate logo are registered trademarks of Seagate Technology, Inc. © 1990, Seagate Technology, Inc.

TECHNOLOGY UPDATE

Logic-synthesis tools

gates. Synopsys's Design Compiler can accommodate larger designs, but users find the 300- to 5000-gate size convenient for several reasons. Blocks of less than 5000 gates usually cover a well-defined part of a design. During the development phase, the synthesis and simulation cycles will be shorter than they would be with larger design blocks. Finally, by keeping blocks small, you can explore other design configurations by simply rearranging blocks.

Partitioning a design into small blocks can cause a number of problems, however. Partitions that make sense for logical development may not be optimum for synthesizing a

fast, area-saving design. You may end up moving block boundaries around to help the synthesis tool create the optimum design. SilcSyn from Racal-Redac lets you organize your design into blocks and then designate boundaries around the blocks as permeable or impermeable. With these boundaries, you maintain a logically organized design while allowing the synthesis software to cross the permeable boundaries during optimization.

Tools such as the ASIC Synthesizer from VLSI Technology work on the entire design at once. It performs automatic partitioning as part of architectural synthesis.

In addition to providing your de-

sign description to the synthesis tool, you need to enter design constraints. These constraints provide the software with guidelines for performing area-speed tradeoff analysis. For example, you can provide minimum and maximum signal-arrival-time bounds on inputs, a clock profile for synchronous designs, output-port loading, input-port drive, setup and hold times, maximum allowable area, and keep-out zones—networks or cells you don't want the logic synthesizer to alter.

Logic-synthesis tools can work with synchronous and asynchronous designs. The timing-sensitive nature of asynchronous designs re-

Table 1—Representative logic-synthesis tools

Manufacturer	Product	Design input formats*						Design output formats*						Optimization parameters				Price	Notes			
		Net lists	Schematics	Boolean equations	PLA truth tables	State machine	VHDL	Verilog	Proprietary HDL	Net list	Schematic	Boolean equations	PLA truth tables	State machine	VHDL	Verilog	Proprietary HDL			Speed	Area	Power
Dassault Electronique	Frenchip	✓					✓										✓	✓			\$75,000 to \$100,000	Available first quarter 1991; test synthesis.
LSI Logic	LES	✓	✓	✓	✓	✓	O	✓	✓	✓				O	O	✓	✓	✓			\$30,000 to \$90,000	Includes memory, data-path optimizers; test synthesis optional.
Mentor Graphics	Autologic	✓	✓	✓	✓	✓		✓	✓	✓							✓	✓		✓	\$35,000 to \$45,000	Accepts parameterized logic blocks.
	Design Consultant						✓	✓	✓								✓	✓			\$22,000 to \$28,000	Available fourth quarter, 1990.
	ASIC Consultant	✓	✓	✓	✓	✓	O	✓	✓	✓							✓	✓	✓	✓	\$33,000 to \$41,000	Available fourth quarter, 1990; accept parameterized logic blocks.
Racal-Redac	SilcSyn 2.0	✓	✓	✓	✓			✓	✓	✓							✓	✓			\$50,000 to \$70,000	VHDL input available fourth quarter, 1990; test synthesis options.
Seattle Silicon	Finesse	✓	✓	✓				✓	✓								✓	✓			\$59,000	Price is for complete Chip Crafters ASIC design package. Outputs a silicon layout; includes test synthesis.
Synopsys	Design Compiler	✓	✓	✓	✓	✓	O	O	✓	✓	✓	✓	✓	✓	O	O	✓	✓			\$35,000 to \$100,000	HDL compiler optional; test synthesis optional.
	ECL Compiler	✓	✓	✓	✓	✓	O	O	✓	✓	✓	✓	✓	✓	O	O	✓	✓	✓	✓	\$35,000 to \$100,000	HDL compiler optional; test synthesis optional.
Viewlogic	VHDL Designer		✓			✓			O				✓				✓	✓			\$15,000 to \$20,000	Viewgen option for schematic-output generation.
VLSI Technology	ASIC Synthesizer					✓	✓	✓	✓								✓	✓			\$100,000	Outputs silicon layout; test synthesis optional.

Notes: O = Optional.

* = Consult manufacturer for compatibility of logic-synthesis tool with other CAE tools.

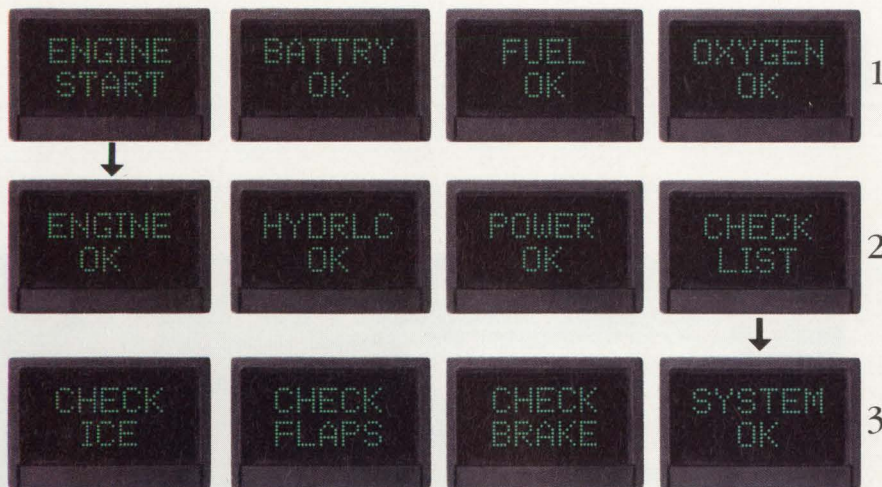

AN APPLICATIONS EXAMPLE.

While the following example is for aircraft, it could apply to any air, land, sea or space system.

SEQUENCE ONE: The four-pushbutton display reads "ENGINE START," "BATTERY OK," "FUEL OK," "OXYGEN OK." The operator selects "ENGINE START."

SEQUENCE TWO: The four-pushbutton display now changes to read "ENGINE OK," "HYDRIC OK," "POWER OK," "CHECK LIST." The operator selects "CHECK LIST."

SEQUENCE THREE: The four-pushbutton display now reads "CHECK ICE," "CHECK FLAPS," "CHECK BRAKE," "SYSTEM OK." In this manner, the designer can program in as many sequences as required.

Design flexibility: The programmable display system.

Vivisun Series 2000, now the leading programmable display pushbutton system, interfaces the operator with the host computer. The user-friendly LED dot-matrix displays can display any graphics or alpha-numerics and are available in green, red or amber. They can efficiently guide the operator through any complex sequence with no errors and no wasted time.

They also simplify operator training as well as control panel design. One Vivisun Series 2000

programmable display system can do the work of 50 or more dedicated switches. In short, Vivisun Series 2000 gives the design engineer more control over the design.

Contact us today.



AEROSPACE OPTICS INC.

3201 Sandy Lane, Fort Worth, Texas 76112
(817) 451-1141 • Telex 75-8461 • Fax (817) 654-3405

*Vivisun Series 2000
programmable displays. The intelligent
communications system.*

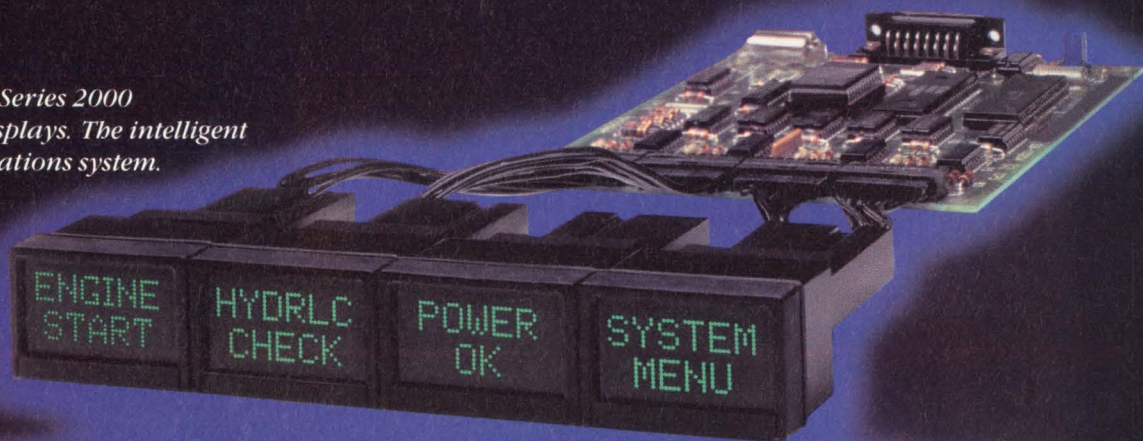

SERIES

VIVISUN 2000™

TECHNOLOGY UPDATE

Logic-synthesis tools

quires that you use detailed timing constraints. Controlling the logic synthesizer by entering the appropriate design constraints is vital to achieving optimum speed and timing results for your specific application.

Optimizing for a foundry

After you enter the design description and design constraints, the logic-synthesis tool should have one more type of design-specific information before it goes to work—the foundry's logic library.

Even without a foundry-specific logic library, a logic-synthesis tool can perform a limited area optimization by minimizing generic gates, a timing optimization by minimizing logic levels, or some combination of the two. However, to evaluate how much area each particular gate or library element requires, the logic-synthesis tool requires the foundry's library, which contains essential area and timing information.

The foundry's logic library pro-

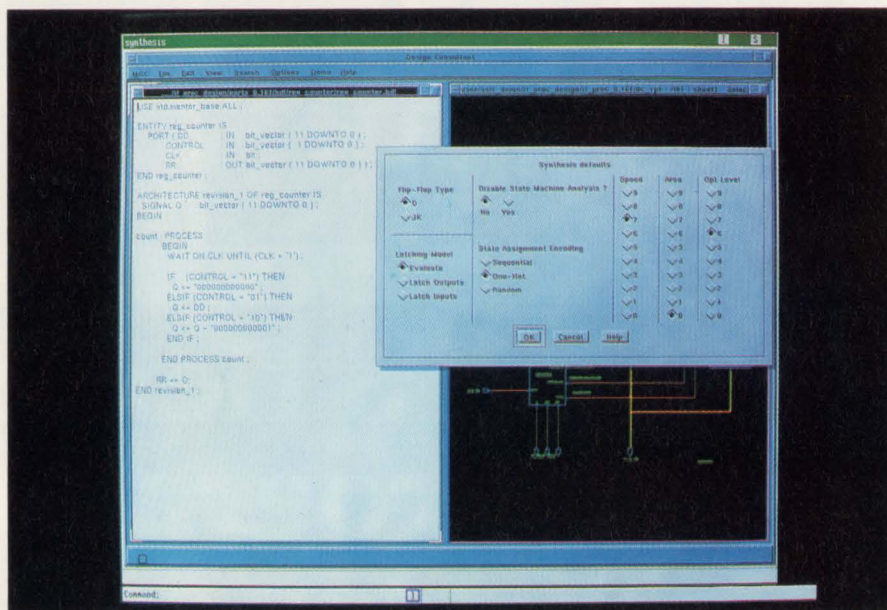

Before using logic synthesis, you need to specify synthesis options. These are the synthesis options you'd select from before running VHDL Synthesis with Mentor Graphics's Design Consultant.

vides timing data for accurate timing estimates and circuit optimization. Not only can the foundry supply intrinsic gate delays, but foundry-specific libraries also provide

data for wire-length models to estimate interconnect delays, input slope-dependent delays, RC interconnect delays, output load-dependent delays, and scaling delays for temperature, supply voltage, and process variations. A logic-synthesis tool should take advantage of the foundry models to evaluate timing if the tool is going to perform accurate area and timing optimization.

To make use of all the timing information, the logic-synthesis tool needs to incorporate a static timing analyzer. The static timing analyzer should be compatible with the timing analyzer you'll be using to perform your post-synthesis timing verification. Because timing analyzers are dependent on the foundry's library data, you shouldn't have correlation problems, but you should verify that you don't. In many cases, the timing analyzer you'll be using will be the same one the synthesis tool uses. For example, if you're working with Mentor Graphic's Autologic tool, you'll probably be using the company's

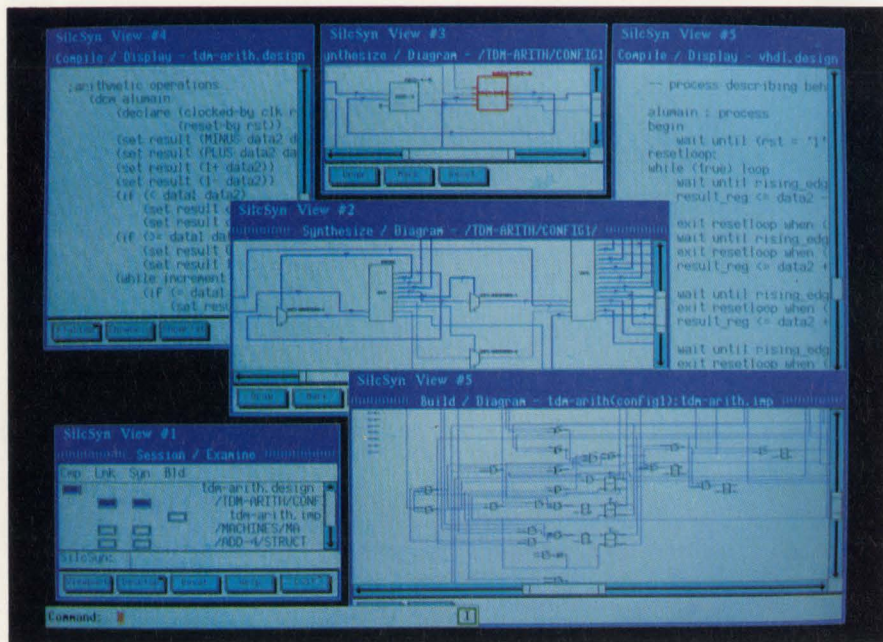

Logic-synthesis tools use a variety of graphic and textual information for both inputs and outputs. This screen shot from Racal-Redac's SilcSyn 2.0 shows some of the information available to users.

The K324 Quad Modem

Non-stop to Europe.

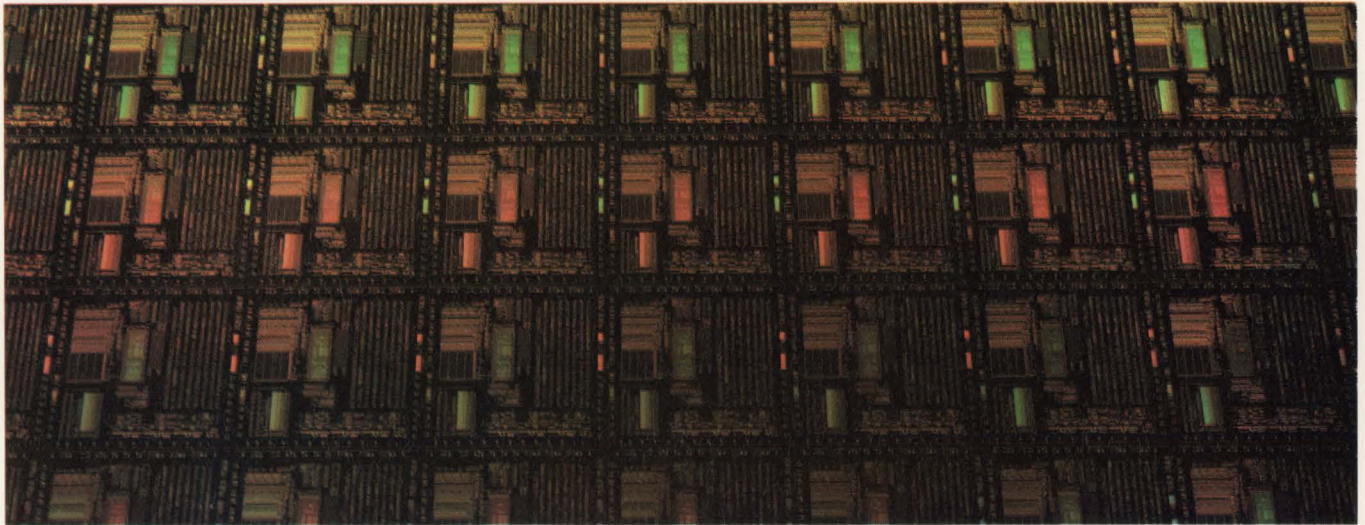

We've thrown out all stops between your modem design and the European market.

Our new Silicon Systems K324 is the first low power single-chip Quad Modem which complies with key CCITT European standards. Pin-compatible with our proven K Series family, it is a high-performance modem IC that

will significantly reduce your system cost, cut power dissipation and board space, and minimize design time.

You might even think of the K324 as the best way to upgrade to first-class capability. It's ideal for low-power, laptop computer applications and certainly worth a call to your nearest Silicon Systems

representative or distributor. Or call us for literature package CPD-5.

Silicon Systems, Inc.

14351 Myford Road, Tustin, CA 92680
Ph 1-800-624-8999, ext. 151. Fax (714) 669-8814

European Hdq. U.K. Ph (44) 79881-2331

Fax (44) 79881-2117

Circle 58 for Product Info

Circle 59 for Career Info

silicon systems

**"Innovation.
Integration.
Implementation."**

**The 1990/91 World
Telecommunications
Technology Seminars
sponsored by Mitel
Semiconductor**

**This comprehensive 1-day
seminar will highlight
innovations in new device
technology, integration for
increased functionality, and
successful implementation of
total systems solutions.**

Seminar topics will include:

- Network trends:
Analog... Digital... ISDN.
- Global communication
standards.
- Communications systems
requirements.
- Implementation examples of
common communications
systems.

**Plan to attend a seminar in
your area:**

- Ottawa 12 Sept '90
- Montreal 14 Sept '90
- Vancouver 5 Nov '90
- Toronto 4 Dec '90
- Boston 22 Oct '90
- Reston 23 Oct '90
- Raleigh 25 Oct '90
- San Jose 21 Jan '91
- Los Angeles 24 Jan '91
- Chicago 28 Jan '91
- Dallas 31 Jan 91

**To register and obtain
more information,
please call
1-800-267-6244**



TECHNOLOGY UPDATE

Logic-synthesis tools

QuickSim II simulator. Similarly, Racal-Redac's SilcSyn uses the timing analyzer from the company's Cadat simulator.

After you've let the logic-synthesis tool synthesize your ASIC design, you can view and evaluate the results. Logic-synthesis tools always provide a net list, and most tools also generate a schematic of the synthesized design. Some tools can also provide a block diagram of the synthesized design. The design report provides such information as the chip area, critical-path timing, timing violations, and other pertinent statistics and information about the design.

If the synthesis results are acceptable, then verify the design completely with the appropriate simulation tools, just as if you had developed the design manually. If the synthesis results aren't acceptable, either iterate another logic-

synthesis cycle, changing the design input or design constraints as appropriate, or make the appropriate design changes manually.

If your design doesn't account for testability, you may be able to take advantage of one of the logic-synthesis tools with test-synthesis capability. Otherwise, you should design for testability from the very beginning of your design. Trying to manually wend your way around a synthesized schematic maze to add test structures is painful and wastes much of the precious time logic synthesis should be able to save. EDN will cover test synthesis in more detail in the October 11, 1990, issue.

EDN

**Article Interest Quotient
(Circle One)
High 512 Medium 513 Low 514**

For more information . . .

For more information on the logic-synthesis tools discussed in this article, circle the appropriate numbers on the Information Retrieval Service card or use EDN's Express Request service. When you contact any of the following manufacturers directly, please let them know you saw their products in EDN.

Dassault Electronique
55, Quai Marcel Dassault
92214 Saint-Cloud, France
(33) 1 491 1 8000
FAX (33) 1 3481 6724
Circle No. 711

In the US,
Multiparts
110 Maiden Ln
New York, NY 10005
(212) 248-9700
FAX (212) 248-9719
Circle No. 712

LSI Logic Corp
1551 McCarthy Blvd
Milpitas, CA 95035
(408) 433-4008
FAX (408) 433-7715
Circle No. 713

Mentor Graphics Corp
8500 SW Creekside Pl
Beaverton, OR 97005
(503) 626-7000
FAX (503) 626-1202
Circle No. 714

Racal-Redac
238 Littleton Rd
Westford, MA 01886
(508) 692-4900
FAX (508) 692-4725
Circle No. 715

Seattle Silicon
3075 112th Ave NE
Bellevue, WA 98004
(206) 828-4422
FAX (206) 827-4224
Circle No. 716

Synopsys Inc
1098 Alta Ave
Mountain View, CA 94043
(415) 962-5000
FAX (415) 965-8637
Circle No. 717

Viewlogic Systems Inc
313 Boston Post Rd W
Marlboro, MA 01752
(508) 480-0881
FAX (508) 480-0882
Circle No. 718

VLSI Technology Inc
1109 McKay Dr
San Jose, CA 95131
(408) 434-3000
FAX (408) 263-2511
Circle No. 719

Synthesizer performance... priced to generate some waves.

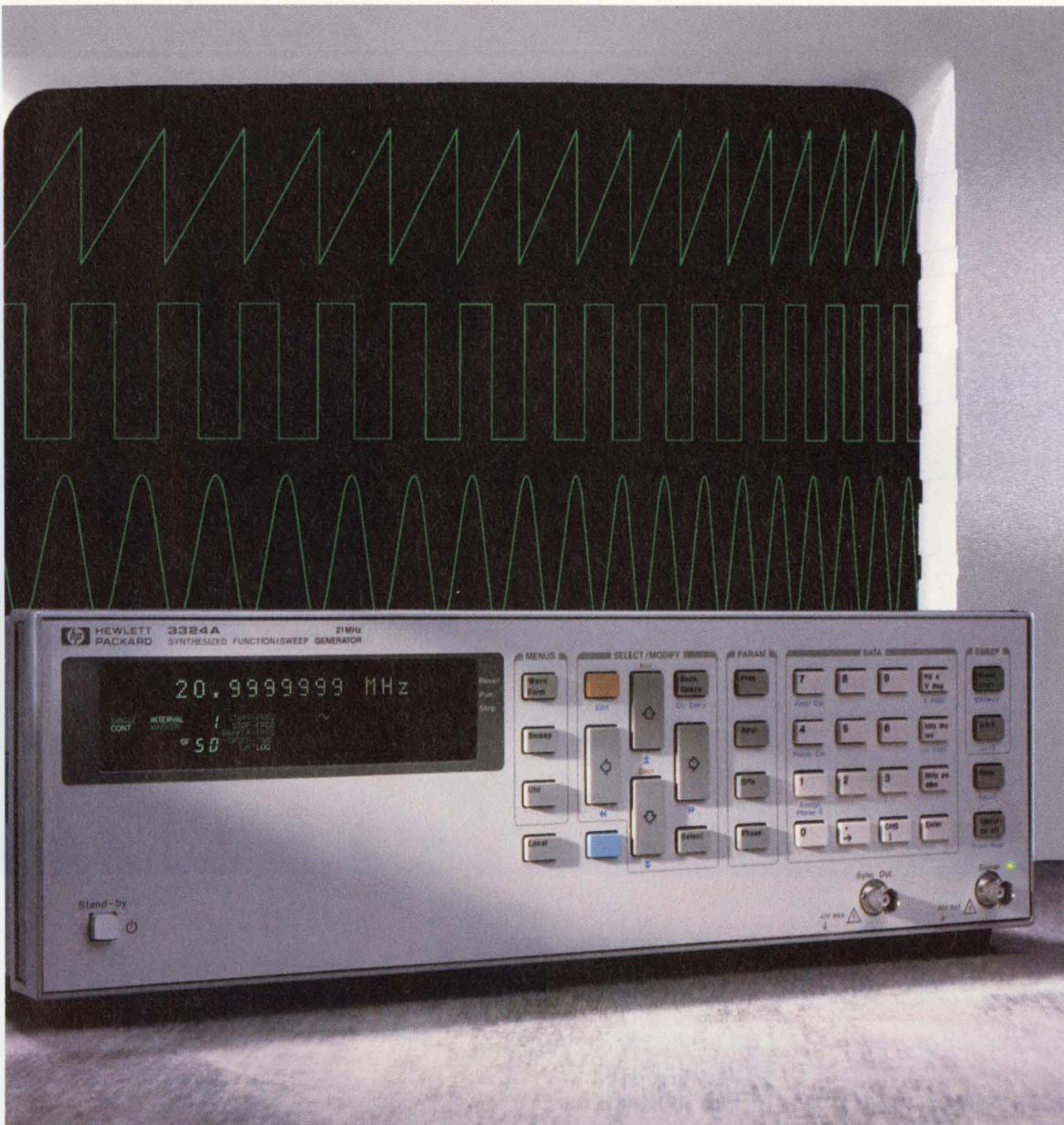

© 1990 Hewlett-Packard Co. TMB10051/EDN

The HP 3324A Synthesized Function/Sweep Generator.

The attractive price of this generator is bound to generate some waves. It's much less than you'd expect to pay for a function generator that has 5 ppm frequency accuracy, 9-digit frequency resolution and multi-interval sweep capabilities too. Put it to work in testing filters

and amplifiers where you need synthesizer accuracy, stability and signal purity. Tap its high linearity and multi-interval sweep features for A/D converter testing and for simulating rotating signals. Simplify the creation of phase-related signals for PLL or navigation-system testing with the new automatic phase-calibration options.

And there's more. Such as the high-stability frequency-reference

option, and a high-voltage output option for making really big waves. Call **1-800-752-0900** today. Ask for **Ext. 1598** or mail the reply card and we'll send a brochure and application information.

There is a better way.



SIEMENS

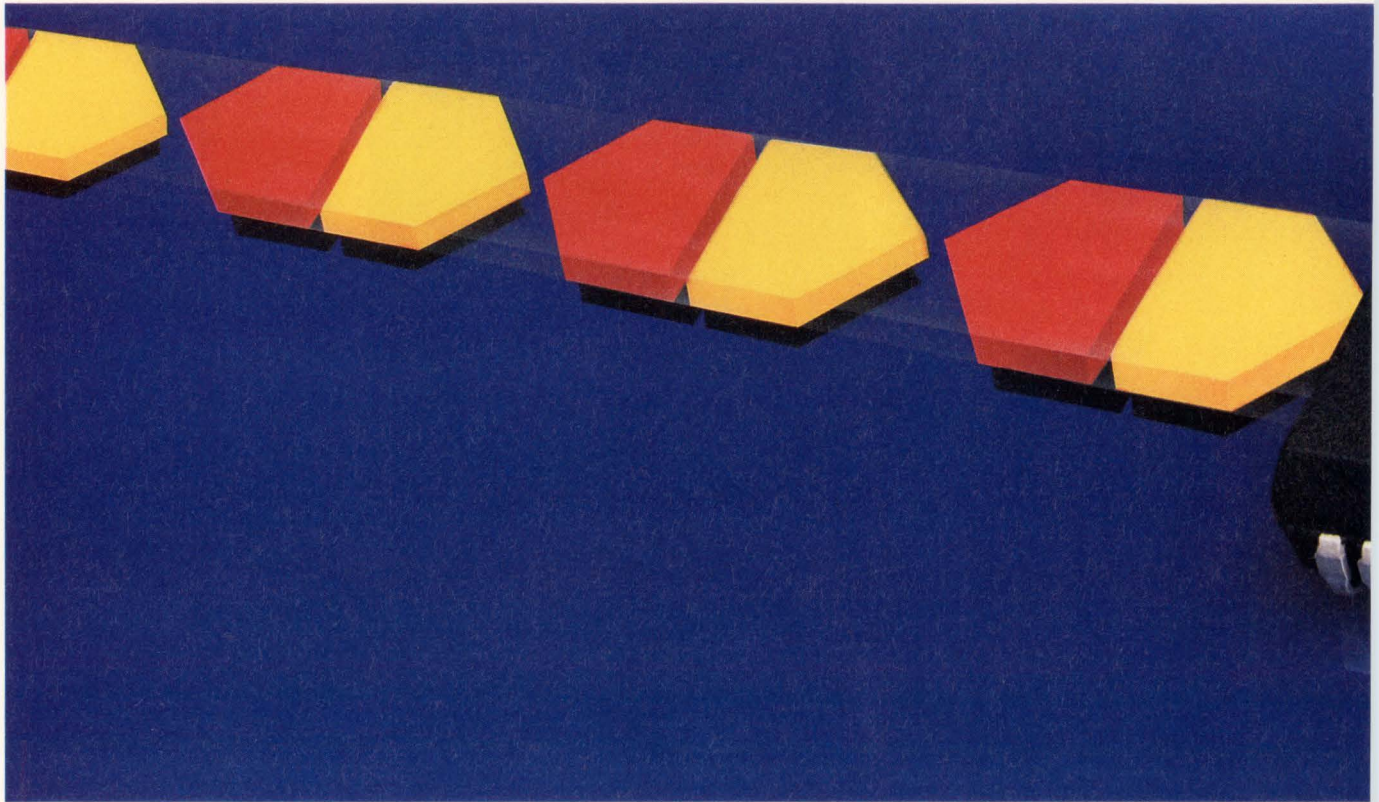

Sound Strategy.

Siemens announces a single-chip echo cancellation U-interface device for ISDN networks of all sizes. From switching to transmission, a clearly superior solution. Berlin to Iselin.

Siemens has won another sound victory in communications technology by developing the industry's first single-chip solution in CMOS for echo cancellation circuit functions in ISDN. It's a clear example of the innovative thinking which has made Siemens a leader in ISDN technology.

From its single-chip design to its ease of integration, the Siemens PEB 2091 ISDN Echo Cancellation Circuit (IEC-Q) represents a milestone in ISDN realization. This device can double the traffic-handling capability in existing telephone lines, and is ideal for appli-

The best address for Siemens Semiconductors:

(A) Wien, Tel. (0222) 71711-5661 (AUS) Melbourne, Vic. 3121, Tel. (03) 4 20 7111 (B) Bruxelles, Tel. (02) 5 36-2111 (BR) Sao Paulo-SP, Tel. (011) 8 33-2211 (CDN) Mississauga L5T 1P2, Tel. (416) 564-1995 (CH) Zurich, Tel. (01) 4 95-3111 (D) Berlin 10, Tel. (0 30) 3939-1; Duesseldorf 1, Tel. (0211) 3 99-0; Frankfurt 1, Tel. (0 69) 7 97-0; Hamburg 1, Tel. (0 40) 28 89-0; Hannover 81, Tel. (0511) 8 77-0; Muenchen 80, Tel. (0 89) 92 21-43 80; Nuernberg 1, Tel. (09 11) 6 54-0; Stuttgart 1, Tel. (07 11) 20 76-0 (DK) Ballerup, Tel. (44) 77 44 77 (E) Madrid, Tel. (01) 555 4062 (F) Paris, Tel. (1) 49 22-3810 (GB) Sunbury on Thames, Tel. (09 32) 75 2615 (GR) Amaroussio, Tel. (01) 68 64-111 (HK) Hongkong, Tel. 5-833 02 22 (I) Milano, Tel. (02) 67 66-42 41 (IND) Bombay 400018, Tel. 4 93 87 86

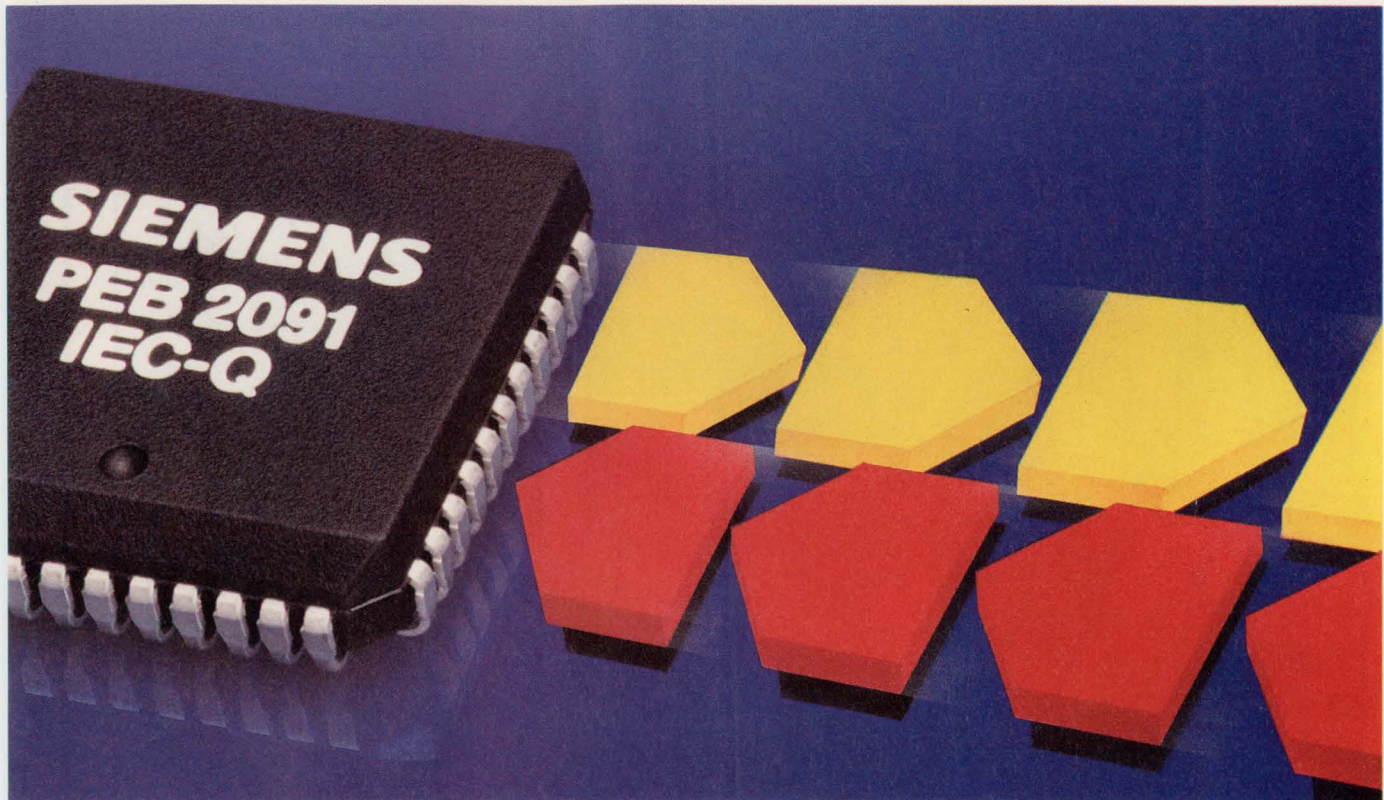

cations in transmission systems such as digital added main line, pair gain systems and intelligent channel banks.

Through its single-chip design and CMOS technology, the advanced PEB 2091 reduces space requirements and software overhead, and has lower power consumption requirements than any other design. And it supports ISDN Oriented Modular (IOM) architecture, the de facto standard for ISDN, which makes installation simple, and enables it to work in tandem with the most advanced ICs available.

Building upon the most comprehensive line of ISDN ICs in the industry, the PEB 2091 sends a clear signal that Siemens is continuing to take

great strides in telecommunications. Siemens was the first company to design a two-chip U-interface trans-

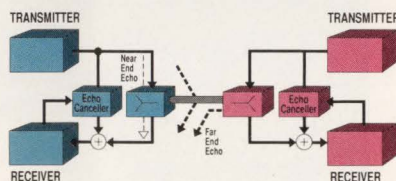

Siemens uses CMOS technology to provide a superior echo cancellation solution with the lowest power consumption requirements.

ceiver for the 4B3T block code used in Europe, and developed the first single-chip device for the 2B1Q code established in North America. And the PEB 2091 meets the requirements of the American National Standard for Telecommunication.

Our unsurpassed line of ISDN ICs are complemented by a wide array of microprocessors, microcontrollers, DRAMs, optoelectronic devices, and more. So you can count on Siemens to provide the best solution for all of your IC applications, and telecommunication products which reflect the sound thinking that has made Siemens a leader in ISDN.

For more information on our advanced products, call (800) 456-9229.

Or write:

Siemens Components, Inc.
2191 Laurelwood Road
Santa Clara, CA 95054-1514.

Ask for literature package M12A006.

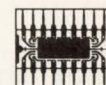

Siemens
Practical Solutions By Design.

(IRL) Dublin, Tel. (01) 30 28 55 (J) Tokyo 100, Tel. (03) 2 01-24 01 (N) Oslo 5, Tel. (02) 63 30 00 (NL) Den Haag, Tel. (0 70) 3 33 33 33
(P) Alfragide, Tel. (01) 4 18 33 11 (RA) Buenos Aires, Tel. (01) 30 04 11 (RC) Taipei, Tel. (02) 5 23 47 00 (ROK) Seoul, Tel. (02) 2 75-61 11
(S) Stockholm, Tel. (08) 7 28 10 00 (SF) Helsinki, Tel. (9) 05 10 51 (SGP) Singapore 0513, Tel. 7 76 00 44
(TR) Istanbul, Tel. (01) 1 51 09 00 (USA) Santa Clara, Tel. (408) 980-4500 (ZA) Johannesburg, Tel. (0 11) 4 07-41 11

© 1990 Siemens Components, Inc. M12A006

NoiseKen

POSITIVELY UP-BEAT WITH FVC-777

EMI Noise Sensor

(EMI NOISE SNIFFER)



MODEL FVC-777

The FVC series can detect and locate sources of radiated and conducted interferences.

MODEL FVC-777

FVC-777

100KHz ~ 500KHz	30MHz ~ 88MHz
500KHz ~ 3MHz	88MHz ~ 216MHz
3MHz ~ 10MHz	216MHz ~ 470MHz
10MHz ~ 30MHz	470MHz ~ 1000MHz

* Simultaneous 8 SPECTRA measurement

FCC
CISPR
VDE

Noise simulators help find perils in power-line defects

Designers can use testers to build in safeguards against disturbances from power sources before your sensitive equipment is delivered to customer.

IMPULSE NOISE SIMULATOR
MODEL INS-410

VOLTAGE DIP SIMULATOR
MODEL VDS-210B



U.S.A WATAHAN NOHARA INTERNATIONAL, INC. TEL (800)366-3515

1638 POST ST. SAN FRANCISCO, CALIFORNIA 94115, U.S.A. TEL(415)931-5829,5832 FAX(415)931-6215

NOISE LABORATORY CO., LTD. 402-1, KAMI-ASOU, ASAO-KU, KAWASAKI CITY, KANAGAWA PREF., 〒215 JAPAN TEL(044)989-7701 FAX(044)989-7707~8

NOISE LABORATORY CO., LTD. TAIPEI LIAISON OFFICE 2FL., 129 TACHIH ST., TAIPEI TAIWAN R.O.C. TEL(02)506-0526~7 FAX(02)506-0848

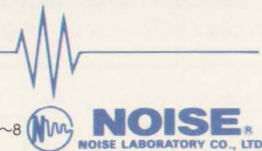

And Now - Whitesmiths C Compilers
and Source Level Debuggers
for the 68HC11, 8051, Z80, 64180, 6809

DSP 96002

C

8086/186/286/386

68000/010/020/030
68302
68332

C

NEC V SERIES

C How They Run!

InterTools Products

Intermetrics' C cross development tools will help you clear the hurdles, so you can create a fully integrated environment that can deliver **fast, efficient code** for any host-target configuration you choose.

The Intermetrics state-of-the-art **cross compilers, assemblers and utilities** are built to work together as a team. Whether you're using a **Sun, Apollo, DEC, HP** or **IBM** system, targeted to run on a **680x0, 80x86, V Series, DSP96002**, or **Am29000** microprocessor, we are the single vendor that can help you get your development project across the finish line!

Our **Source Level Debugger, XDB**, works like a champion with our new low cost **ROM Monitor**, and with our new **hardware simulation board**, as well as with most in-circuit emulators.

Our technical support department will help you keep your development environment up and running by providing toll-free telephone assistance, free software updates and reduced rates for new releases.

Intermetrics' C cross development tools are the top tools in their class—call us to see how they **run!**

1-800-356-3594

In Massachusetts or Canada call (617) 661-0072



Intermetrics

Intermetrics, Inc. • 733 Concord Avenue • Cambridge, Massachusetts 02138-1002

CIRCLE NO. 116

113

286 DESIGNER'S TOOLKIT

AT MOTHERBOARD
CORE LOGIC CHIP SET
40MB IDE DRIVE
ORCAD SCHEMATIC DISKETTES
AND DESIGNER'S MANUAL
WD USER'S MANUALS
AND MORE

 WESTERN DIGITAL

Western Digital is a registered trademark of Western Digital Corporation.

Would you rather have what's in Box Number One or Box Number Two?

The Western Digital Designer Kit gives you everything you need to start and complete your next design. All in one handy box.

A box that lets you avoid a lot of headaches and hassles. Such as all the begging, pleading, and conniving necessary to get the parts that are necessary.

The Western Digital Kit gives you a Western Digital 286 Motherboard, the WD286-LPM16. You also get a 4-chip FE3600 AT Core Logic Set. The WD16C452 Serial/Parallel Controller. The WD37C65 Floppy Disk Controller. The WDPVGA1A VGA Controller. The WD93044-A 40Mb IDE Drive. 512K RAM. All the cables you'll need for the drive and the keyboard. An expansion slot riser card. LPM Utilities Diskettes. ORCAD Schematic Diskettes and Designer's Manual. Complete data sheets for all the Western Digital chips. And a Western Digital User's Manual.

The entire Western Digital Designer Kit costs just \$999. Obviously, rounding up all the parts by yourself would take far more money. And far more time.

All you need to supply is a little brain power. And before you know it, your next great idea will be off the drawing board and into production.

The Western Digital Designer Kit is available for a limited time. And in limited quantities. So call your favorite Western Digital distributor now.

And let's make a deal.

Almac Electronics at 206-643-9992.
Anthem Electronics at 408-453-1200.
Hall-Mark Electronics at 214-553-2171.

Pioneer-Standard Electronics at 800-874-6633.
Pioneer Technologies Group at 800-227-1693.
Wyle EMG at 408-727-2500.

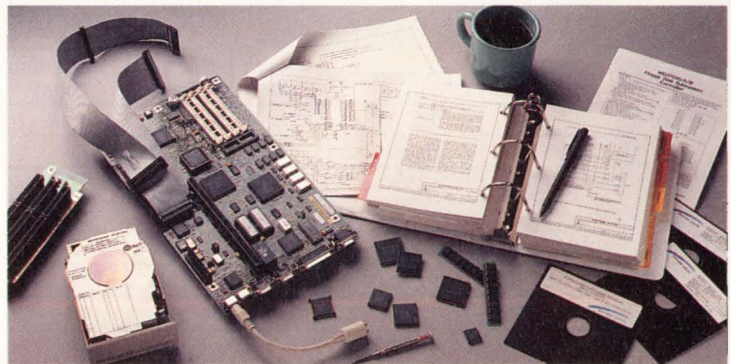

Matched sets, unmatched performance.

 WESTERN DIGITAL

When It Comes to Data Acquisition We've Got All the Bases Covered

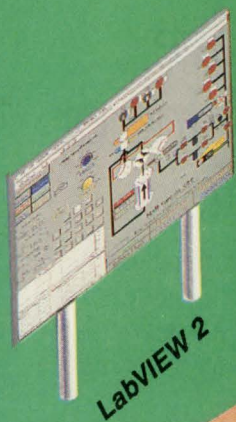

LabVIEW 2

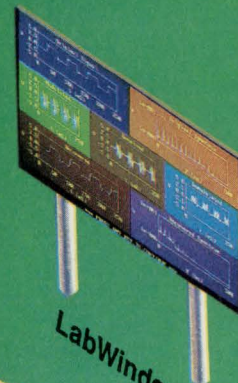

LabWindows

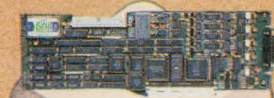

Macintosh

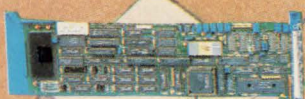

IBM PS/2

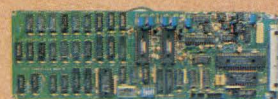

PC/XT/AT

*Why Play Ball
With Anyone Else?*



EISA

Our lineup for the season:

- Boards for all PC platforms
- Self-calibration
- 8 to 16-bit resolution
- DMA on all computers
- Toll-free technical support
- 33.33 MFLOPS digital signal processing
- Signal conditioning and antialiasing filters
- Multiboard timing and synchronization with RTSI[®]
- LabVIEW[®] 2, LabWindows[®], VisionScope[™], and LabDriver[®] software

Many vendors can get you to first base with PC/XT/AT boards. We're the *only* company that will take you all the way home, with boards for the PC, Macintosh, PS/2, and EISA bus.

SCOREBOARD

Board	Computer	Analog In	Sample Rate	Resolution (Bits)	Analog Out	Digital I/O	Counter/Timers	DMA Direct to Memory
Lab-PC	PC/XT	8	62.5k	12	2	24	3	√
Lab-SE	Macintosh SE	8	125k	8	2	24	3	—
AT-MIO-16	PC/AT	16	100k	12	2	8	3	√
MC-MIO-16	IBM PS/2	16	100k	12	2	8	3	√
NB-MIO-16X	Macintosh II	16	55k	16	2	8	3	√
NB-A2000	Macintosh II	4	1M	12	—	—	—	√
EISA-A2000	EISA	4	1M	12	—	—	—	√

To see the rest of our data acquisition team, call for **FREE** catalog.

 **NATIONAL INSTRUMENTS[®]**
The Software is the Instrument[™]
6504 Bridge Point Parkway
Austin, TX 78730-5039

Nihon National Instruments K.K. (Japan) (3) 788-1922
National Instruments of France (1) 4865-3370
National Instruments of Italy (2) 4830-1892
National Instruments United Kingdom (06) 355-23-545

(800) 433-3488 (U.S. and Canada) • (512) 794-0100

Rugged IBM PC-compatible single-board computer for industrial tasks costs \$199

Combining low-cost and sturdy design, the 4.5×6.5-in. MCM-SBC41 single-board computer (SBC) gives you IBM-PC compatibility in a form-factor that's small enough for many embedded applications. This board's CPU is based on a 16-bit NEC V40, an 8088-compatible μ P. The V40 operates at 8 or 10 MHz and incorporates a serial I/O channel, a DMA, three 16-bit counter/timers, an 8-channel interrupt controller, wait-state generators, and a refresh generator.

You can plug as much as 1M byte of memory into the board's three 32-pin memory sockets. This SBC also comes with three RS-232C channels and a Centronics-compatible parallel port. You can use the board's STD Bus interface to provide additional I/O capability, or you can let the MCM-SBC41 operate independent of the bus. A watchdog timer, power-failure re-

set circuit, activity LED, and low-power sleep mode make the SBC useful for unattended operation.

Consuming less than 3W, this computer costs \$199 (500) or \$295 for single units. If you need a low-power CMOS version of this single-board computer, the LPM-SBC41-8 sells for \$320 and draws 750 mW.

For \$195 you can order a development kit for ROM-DOS, an MS-DOS 3.2-compatible ROM-based operating system for embedded applications. By providing hardware initialization code, file support, and software drivers, ROM-DOS lets you run an MS-DOS application in a diskless embedded system. The application starts running as soon as the system obtains operating power.

Optimized for the SBC, ROM-DOS resides in 29k bytes of ROM and uses as little as 5k bytes of RAM. In comparison, MS-DOS re-

quires more than 75k bytes of ROM and takes 75k bytes of RAM to boot the processor. ROM-DOS lets you run programs written in such languages as assembler, C, Pascal, and compiled Basic.

A \$495 C-language source-level debugger called C-Thru-ROM is also available. This debugger lets you use Microsoft C or Borland Turbo-C to generate stand-alone ROMable programs for this board. Using this debugger, you can use a PC-compatible computer as a development workstation to debug C source code, assembly language, or mixed code for your embedded application. The debugger provides windows for source code, commands, registers, and expressions.—**J D Mosley**

WinSystems Inc., Box 121361, Arlington, TX 76012. Phone (817) 274-7553. FAX (817) 548-1358.

Circle No. 730

For \$195, you can give your embedded-system application an 8088-compatible SBC. Options for the MCM-SBC41 include a CMOS version, a ROM-based MS-DOS 3.2-compatible operating system called ROM-DOS, and an optional source-level C language debugger named C-Thru-ROM.

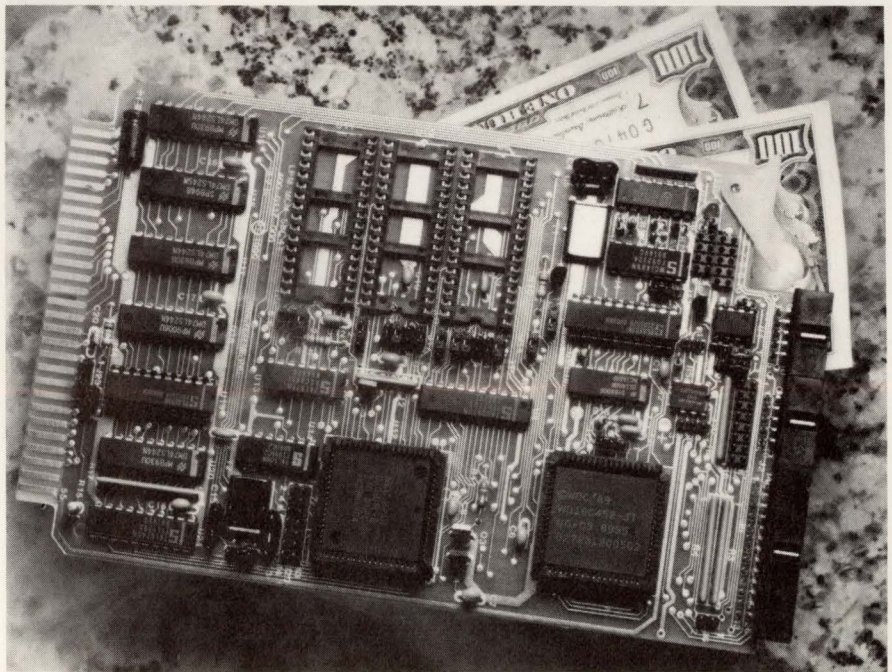

Software offers programmable-device freedom and helps select alternatives

Providing device independence is the goal of Abel-4 software for field-programmable gate arrays (FPGAs) and programmable logic devices (PLDs). The software uses the recently liberated Abel-HDL—the vendor removed the proprietary label at this year's Design Automation Conference—to describe designs without specifying a targeted device or architecture.

Using this software, your only initial concern is your design. You create and simulate your design until you're convinced that it performs correctly. Then the software chooses a list of appropriate programmable devices, based on such constraints as performance, gate resources, and technology and such user-specified data as device cost and stock.

You then use device-specific software called a "fitter" to place and route your design in alternative device architectures. Unlike some

other programmable-device tools, though, this one cannot partition a design among multiple devices; it will choose only single-device options from its 300-architecture, 6000-part library.

The software offers device-specific simulation libraries to permit accurate simulation after place and route. Simulation and place-and-route results let you choose the most efficient device.

The software synthesizes logic from equations, state diagrams, and truth tables. A reduction algorithm eliminates redundant logic and therefore simplifies final testing. If your interface logic levels aren't fixed, the software can provide you with either active-low or active-high device alternatives, using a feature called SmartPart intelligent device selection. Similarly, because some device architectures use T-flip-flops and others use D-flip-flops, the software allows you to

evaluate your design in both types of devices, without requiring you to modify your HDL description.

The user interface allows you to perform operations out of sequence—the software executes intermediate operations to ensure proper data consistency. Context-sensitive help provides on-line reference manuals.

Currently available device-specific fitters include a generic fitter for traditional PLA/FLPA architectures. (Data I/O claims this fitter supports 150 architectures: two for the Altera EP1800 and the MAX 5032 and 5016; and another for the Cypress Programmable Sequencers 330, 331, and 332. According to the company, additional fitters will be written and provided by both Data I/O and programmable device vendors.

Abel-4 with the four available fitters, SmartPart, and PLDgrade, a fault grader and testability analyzer, running on an IBM PC, PC/XT, PC/AT, and PS/2 costs approximately \$3500; SmartPart, including the generic fitter, and PLDgrade each sell for \$495. The price of the other three fitters is \$295 each.

The complete workstation packages cost \$3490 running on Sun-3 and SPARCstations, and \$5495 on VAX/VMS workstations. With the exception of the workstation version of PLDgrade, which will be available next month, you can order all software from stock.

—Michael C Markowitz

Data I/O, Box 97046, Redmond, WA 98073. Phone (206) 881-6444. FAX (206) 882-1043.

Circle No. 731



Using a library of 6000 devices representing 300 architectures, SmartPart offers a range of criteria for optimal device selection.

Gold Terminals Extend TO-5 Switch Life. Gold-plated terminals, handling resistive loads of 500 mA/125 VAC, extend the life of Standard Grigsby's TO-5 rotary switch to an 5000 cycles (typ.). These compact switches mount easily into standard TO-5 transistor sockets or PC boards for wave soldering. Screwdriver or knob actuation available. 45° throw with 8 positions max. Positive detent switching action is standard. Contact pin surface is sealed and an optional boot is available to seal the shaft. Price: \$1.39 in 10,000-piece lots. Delivery: 4 weeks. Contact Standard Grigsby, Inc., 88 N. Dugan Rd., Sugar Grove, IL 60554-0890. 708/556-4200 FAX 708/556-4216.

CIRCLE NO. 60

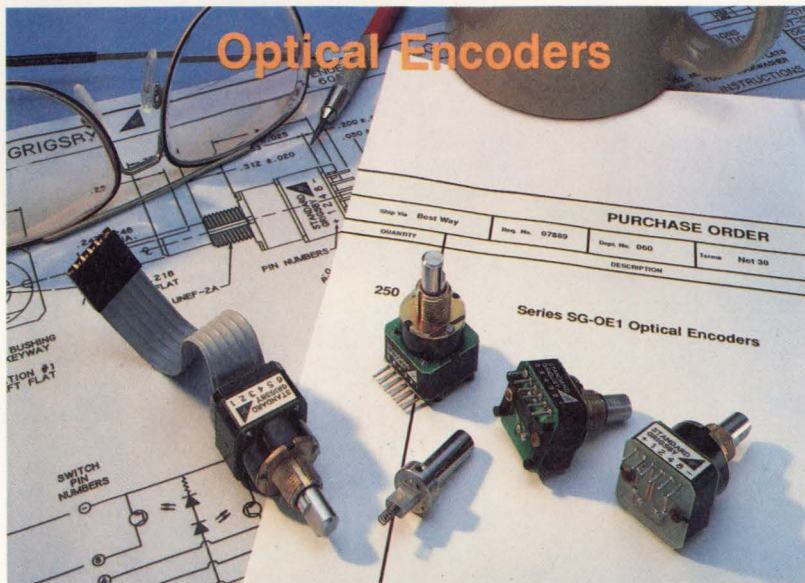
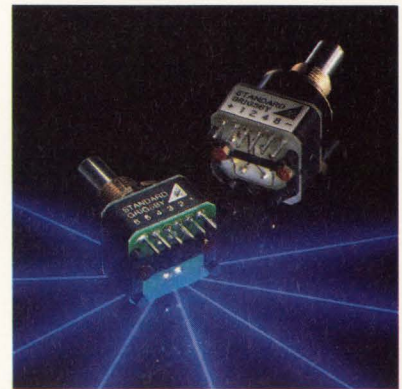
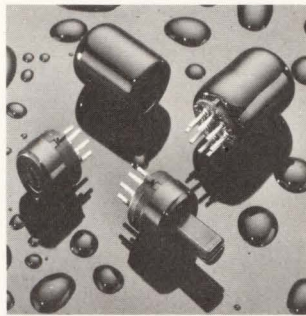

Choose Binary Or Gray Coded. Sugar Grove, IL—Binary and Gray coded optical encoders are available from Standard Grigsby, Inc. Ideal for use in robotics, medical instrumentation, communications, computer peripherals and avionics, the 16-position encoder is available with integral cable or connector. Users may specify custom shaft lengths and diameters.

Priced at \$29.10 each in 100-piece lots, the encoders are available in 6 weeks. Standard Grigsby, Inc., 88 N. Dugan Road, Sugar Grove, Illinois 60554-0890. 708/556-4200 FAX 708/556-4216.

CIRCLE NO. 61

Specify THE Standard In Optical Switching... Standard Grigsby!

Quality Is Standard At Standard Grigsby...

- Vibration-resistant interlock design
- Long life
- Reliable LED optical switching source
- Low power consumption

Customer Satisfaction Is Standard, Too!

- Binary, gray, or custom codes
- High res, 128-152 position option
- Ribbon cable or connectors
- 16, 24, 32, 64 positions
- P.C. lugs and right angle mounts available
- Priced at under \$20 in lots of 100

Raise your switching standards! Call us today for our complete **Optical Encoder** product catalog. 708/556-4200

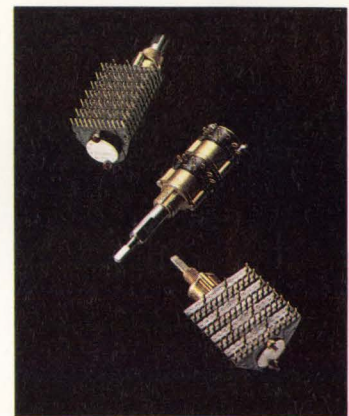

Multi-deck, Multi-options. Sugar Grove, IL—Standard Grigsby's multi-deck rotary switches offer reliability and long life, and retrofit other manufacturers. Measuring approximately 1/2" in diameter, the switches are available with PC or solder lug terminations, fixed or adjustable stops; 30° or 36° indexing angles; commercial or military finishes.

Priced at \$4.50 each in lots of 500, the switches are available in 6 to 8 weeks. For more information, contact Standard Grigsby, Inc., 88 N. Dugan Road, Sugar Grove, IL 60554-0890. 708/556-4200 FAX 708/556-4216.

CIRCLE NO. 62

STANDARD GRIGSBY

88 N. Dugan Road/P.O. Box 890, Sugar Grove, IL 60554-0890

708/556-4200

FAX 708/556-4216

"Have you heard? Toshiba has a full line of high speed



Toshiba semiconductor products are available from a distributor near you. You can reach the distributor of your choice by calling one of the central numbers: Active Electronics, **1-800-388-8731**; Cronin Electronics, Inc., **1-800-5CRONIN**; General Components, Inc., **1-800-524-1463**; Gould Electronics, **1-800-323-6639**; Insight Electronics, **1-800-677-7716**; Itt Multicomponents Corp., **1-800-387-3687**;

SRAMs."

"How many? How fast?"

"256K for starters. Plus 144K and 64K. And the 144K at 20ns, is the fastest application specific Cache Data RAM available anywhere."

"Great! When can we get our hands on them?"

"They're available immediately. In quantity. Right now."

The addition of these state-of-the-art 256K SRAMs and 144K Cache Data RAM gives Toshiba the broadest line in the industry. More densities. More configurations. More speeds. More choices to fit your design needs.

Toshiba high speed CMOS SRAMs are not only fast, they're reliable. And Toshiba has more than 20 years of CMOS experience.

You can cut qualification costs with Toshiba SRAMs, too. All the devices employ the same 1.0 μ CMOS process and aluminum master slice that's common to all configurations within each density. So you can qualify by family.

The 20ns Cache Data RAM is the fastest on the market. (25ns and 30ns versions are also available.) The devices are user configurable to either 4K \times 18 \times 2, or 8K \times 18. The \times 18 organization gives you two extra bits to support

Toshiba High-Speed SRAMs						
Configuration	Density	Speed (ns)			Availability	
64K x 1	64K	35	45	55	Now	
16K x 4	64K	15	20	25	35	
16K x 4 (OE)	64K	15	20	25	35	
8K x 8	64K	15	20	25	Now	
8K x 9	72K	15	20	25	Now	
4K x 18 x 2	144K	20	25	30	Now	
8K x 18	144K	20	25	30	Now	
64K x 4	256K	17	20	25	35	
64K x 4 (OE)	256K	17	20	25	35	
32K x 8	256K	17	20	25	35	
32K x 9	288K	17	20	25	35	
16K x 12	192K module	25	35		Now	
16K x 16	256K module	25	35		Now	
PART	CE	A12	t _{acc}	t _{OE}	V _{cc}	PACKAGE
TC55187	unlatched	unlatched	20/25/30	10/10/12	$\pm 10\%$	PLCC
TC55188	latched	latched	20/25/30	10/10/12	$\pm 10\%$	PLCC

the parity check required in specific applications like Intel's 80486™. Both devices are provided with byte control, and on-chip address latches are designed to interface directly with the Intel 82385™ cache controller. Pin-out is compatible with other suppliers.

Toshiba high speed SRAMs are ideal for high-end system designs. Anywhere you need top speed and fully static operation, Toshiba has a high performance solution.

They offer a wide range of packaging options, too. Why not call today for a complete set of data sheets? Call 1-800-888-0848, ext. 517. *Service is our key component.*

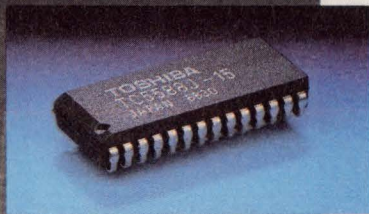

In Touch with Tomorrow

TOSHIBA

TOSHIBA AMERICA ELECTRONIC COMPONENTS, INC.

© Toshiba America Electronic Components, Inc.

TM Intel, 80486 and 82385 are trademarks of Intel Corporation.

MST-012-88-1

Merit Electronics, Inc., 1-408-434-0800; Marshall Electronics Group, 1-800-522-0084; Milgray Electronics, Inc., 1-800-MILGRAY; Marsh Electronics, Inc., 1-800-558-1238; Reptron Electronics, Inc., 1-800-282-1360; Rome Electronics, 1-800-366-7663; Nu Horizons Electronics Corp., 1-800-726-7575; Sterling Electronics, 1-713-623-6600; Western Microtechnology, Inc., 1-800-338-1600.

Actual size

Actual output

20 WATTS

Actually meets

MIL-STD-2000
MIL-STD-810C
MIL-S-901C
MIL-STD-461C
MIL-STD-704D
NAVMAT GUIDELINES

Mil/Pac™ high-density military power supplies.

Introducing NDI DC-to-DC converters that meet an unprecedented combination of military design demands. Plus having the highest power-to-volume ratios of any full-mil qualified products.

Mil/Pacs come in 20W, 35W and 50W configurations, with single (5, 12, 15, 24, 28V) and dual ($\pm 12V$; $\pm 15V$) outputs.

They handle a wide 14V to 31V range of input. And

operate at temperature extremes from $-55^{\circ}C$ to $+100^{\circ}C$. Mil/Pacs are designed with a field-proven topology that's been verified by rigorous environmental stress screening. They're available with MIL-STD-2000, or without. Either way, the specs are worth reading.

Just write us at 2727 S. La Cienega Bl., Los Angeles, CA 90034. Or call (213) 936-8185.

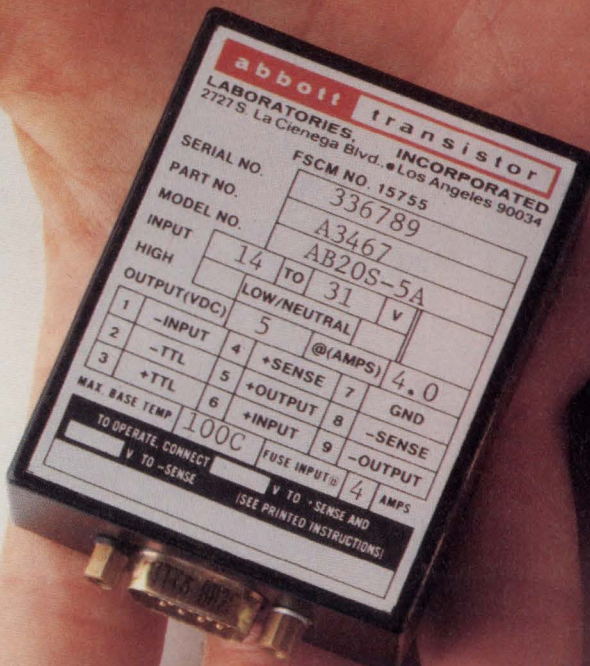

abbott

WHEN RELIABILITY IS IMPERATIVE.™

READERS' CHOICE

Of all the new products covered in EDN's June 7, 1990 issue, the ones reprinted here generated the most reader requests for additional information. If you missed them the first time, find out what makes them special: Just circle the appropriate numbers on the Information Retrieval Service card, use EDN's Express Request service, or refer to the indicated pages in our June 7, 1990, issue.

Current-Mode ▼ PWM Chip

Featuring self-start at any input voltage from 50 to 450V dc, the TSC9120 PWM controller can operate from any rectified ac power line. The device can implement all popular single-ended, current-mode switch-mode power-supply topologies. It contains an oscillator, voltage reference, error amplifier, and a pulse-modulating comparator. In addition, it does not require a low-voltage power supply for house-keeping/protective functions (pg 175).

Teledyne Semiconductor.

Circle No. 661

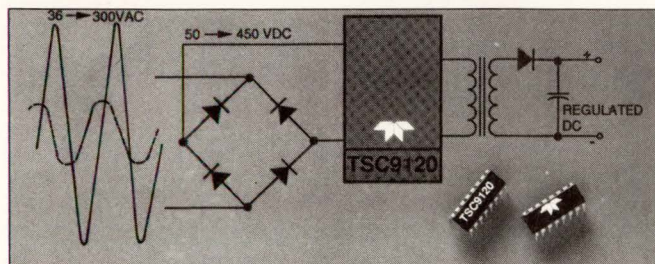

Circuit Module ►

The rtVAX 300 application processor is a $3.1 \times 4.6 \times 0.54$ -in. circuit module that plugs onto a pc board in your embedded real-time system. The module, with peripheral control circuits and as much as 8M bytes of memory, gives your system 2.7 times the computing power of a VAX computer. Surface mounted within the module are a CMOS CPU, a RAM cache, a floating-point math coprocessor, and an intelligent communications controller (pg 76).

Digital Equipment Corp.
Circle No. 662

Programmable Disassembler

The programmable disassembler for the vendor's IBM PC-based logic-analysis system provides support for the 6800, Z80, 8088, 78C10, and 8031 μ P families. If you're not working with an explicitly supported IC, you can modify the tables to enable the disassembler to handle application-specific devices, including those with embedded μ P cores. (pg 146).

BitWise Designs Inc.
Circle No. 663

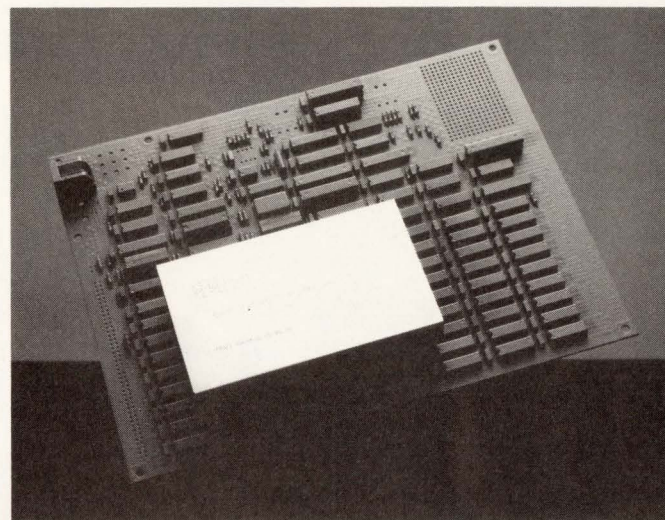

RFI Suppressors ▼

Designed to protect sensitive equipment from RFI, the WXE and WYE series of polyester capacitors accommodate line-to-line and line-to-ground ac-main applications, respectively. The capacitance values range from 0.01 to 2.2 μ F for WXE devices and from 0.001 to 0.022 μ F for WYE styles. Housed in flame-retardant cases, the WXE and WYE units have dV/dt ratings as high as 1200V/ μ sec and 2000V/ μ sec, respectively, and operate to 85°C. (pg 158).

World Products Inc.
Circle No. 664

C++ Compiler

Oregon C++ version 2.0, an object-oriented software-development package, is fully compatible with and provides all features of AT&T's C++ version 2.0. The software, which runs on a variety of workstations, compiles source code directly to the native object code of the host computer without any intermediate translation to C. It comes with an ANSI C library, a library compatible with AT&T's stream-I/O library, and a source-level debugger (pg 178).

Oregon Software Inc.
Circle No. 665

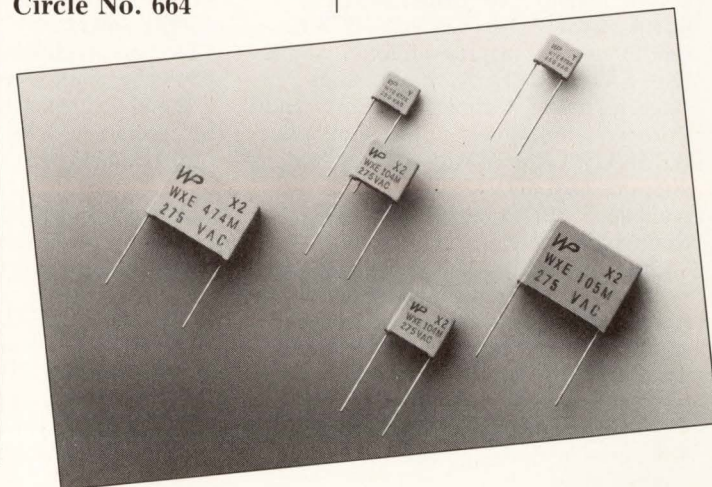



SURPRISING FACTS KEEP POPPING UP

When we first compared the facts about MAXI/PC vs. OrCAD®/PCB II, the differences surprised a lot of people. Especially OrCAD. So they ran ads claiming more "technical support" and "proven commitment." The simple fact is, MAXI/PC comes with toll-free hotline support. OrCAD/PCB II doesn't. And we'll stack our support engineers up against anyone's.

OrCAD/PCB II is *still* surprising engineers who find out it's missing important functions that any competent layout software should have. Here's a partial list of the unpleasant surprises:

- No automatic component placement
- No automatic gate and pin swapping
- No on-screen design rule error notification

- No automatic component or part replacement
 - No partial editing of existing routes
 - No automatic component renaming
- MAXI/PC has every one of these functions, and a lot more. And while OrCAD charges \$1,495 for PCB II (doesn't include schematics which costs *another* \$495), MAXI/PC costs just \$995 including schematics, placement, routing, and manufacturing output.

If You Have OrCAD Schematics...

OrCAD's schematics package outputs directly to MAXI/PC's layout and routing software. So if you were going to buy PCB II because you thought you were locked in, you can move up to MAXI/PC instead.

**Free
MAXI/PC
Demo
Disk**

You don't need unpleasant surprises when you invest time and money in PCB software. You need performance. Call today for the details and a free MAXI/PC demo disk. Have boards waiting? Order MAXI/PC and get them started now. Our 30 day, money-back guarantee makes it risk-free.

(508) 692-4900

MAXI/PC
PCB CAD SOFTWARE

RACAL-REDAC

238 Littleton Road, P.O. Box 365
Westford, MA 01886-9984, USA
Fax: (508) 692-4725

RACAL

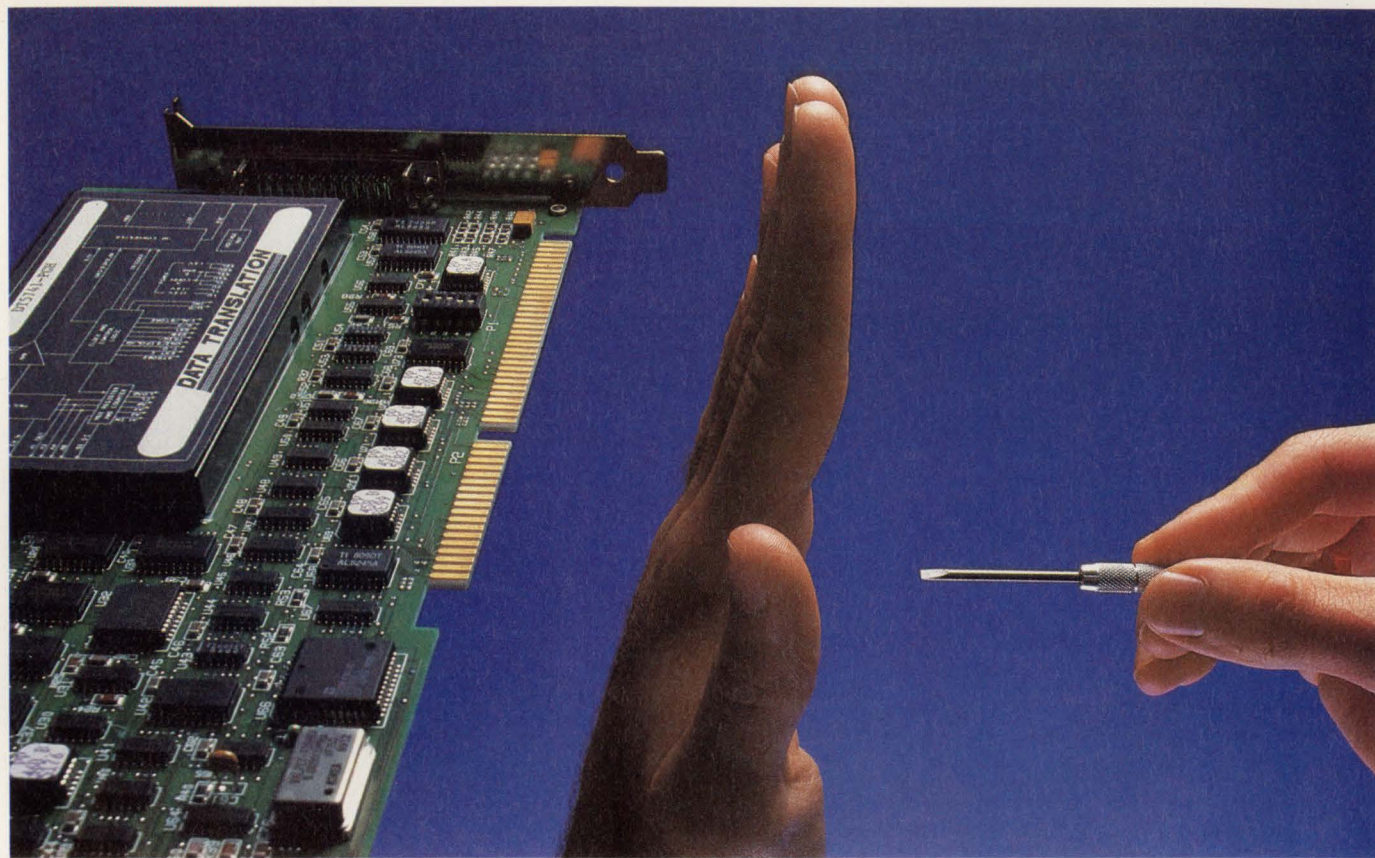

Stop! Hands Off! We've got an easier, more accurate way to calibrate and configure data acquisition boards.

GLOBAL LAB™ Data Acquisition software with "Hands-Off" control for the DT2831 Series.

Put down that screwdriver! GLOBAL LAB™ Data Acquisition software fully supports the DT2831 Series "Hands-Off" design, so setup, installation, calibration, and maintenance are 100% mouse/menu-driven.

Once you've installed your DT2831 Series board, you can forget it. With GLOBAL LAB™, all DT2831 operating parameters are controlled via software menus. No manual adjustments—no jumpers, no pots, no hassles! You get greater reliability, improved productivity.

In addition to supporting "Hands-Off" control, GLOBAL LAB™ provides numerous data acquisition, signal processing, and display functions. For advanced signal processing, ask us about GLOBAL LAB™'s add-on STATPACK™ Signal Processing Module.

Call today for a GLOBAL LAB™ demo package. Use it with a DT2831 Series board, and we think you'll agree nothing comes close to "Hands-Off" data acquisition.

Call (508) 481-3700

In Canada (800) 268-0427



Also available—New GRAPHPACK™ Printing Module provides customized laser quality output.

DATA TRANSLATION®

World Headquarters: Data Translation, Inc., 100 Locke Drive, Marlboro, MA 01752-1192 USA, (508) 481-3700, Fax (508) 481-8620, Tlx 951646
United Kingdom Headquarters: Data Translation Ltd., The Mulberry Business Park, Wokingham, Berkshire RG11 2QJ, U.K., (734) 793838, Fax (734) 776670, Tlx 94011914
West Germany Headquarters: Data Translation GmbH, Stuttgarter Strasse 66, 7120 Bietigheim-Bissingen, West Germany 7142-54025, Fax 7142-64042
International Sales Offices: Australia (2) 699-8300; Belgium (2) 466-8199; Brazil 11 240-0598; Canada (416) 625-1907; China (1) 868-721x4017; Denmark 42 274511; Finland (0) 3511800; France (1) 69077802; Greece (1) 361-4300; Hong Kong (5) 448963; India (22) 23-1040; Israel 52-545685; Italy (2) 824701; Japan (3) 502-5550, (3) 5379-1971, (3) 355-1111; Korea (2) 718-9521; Netherlands (70) 399-6360; Norway (2) 53 12 50; Poland (22) 580701; Portugal (1) 545313; South Africa (12) 803-7680; Spain (1) 555-8112; Sweden (8) 761 78 20; Switzerland (1) 723-1410; Taiwan (2) 3039836
 GLOBAL LAB, STATPACK and GRAPHPACK are trademarks and Data Translation is a registered trademark of Data Translation, Inc. All other trademarks and registered trademarks are the property of their respective holders.

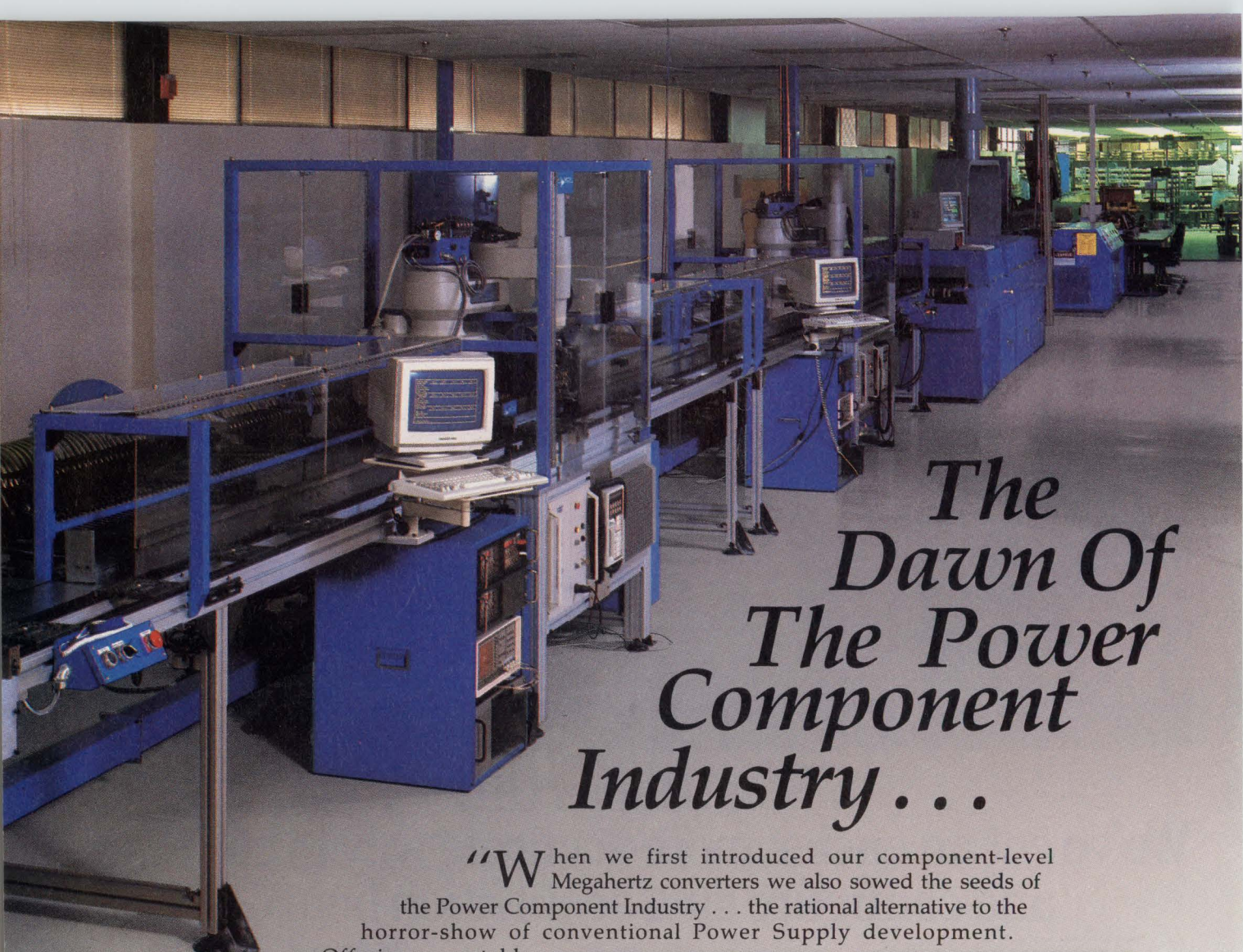

The Dawn Of The Power Component Industry . . .

*“W*hen we first introduced our component-level Megahertz converters we also sowed the seeds of the Power Component Industry . . . the rational alternative to the horror-show of conventional Power Supply development.

Offering repeatable and predictable performance, and exhibiting power density, efficiency, reliability, and “instant expandability” unachievable with conventional power supplies, Power Components revolutionized the power system design process in much the same way that integrated circuits revolutionized circuit design. Since then, our evolving product line of power building blocks has grown to include high power Mega and Master Modules, off-line Front Ends, Flat-PACs, StakPaks, and Power-Cages: user-definable, single or multiple-output off-line solutions with outputs from 50 to 7200 Watts . . . offering the highest power densities in the industry. Power Systems Architects have enthusiastically embraced the Power Component concept . . . so many, in fact, that nearly half a million of our expanding line of off-the-shelf component-level power products have gone into service worldwide.

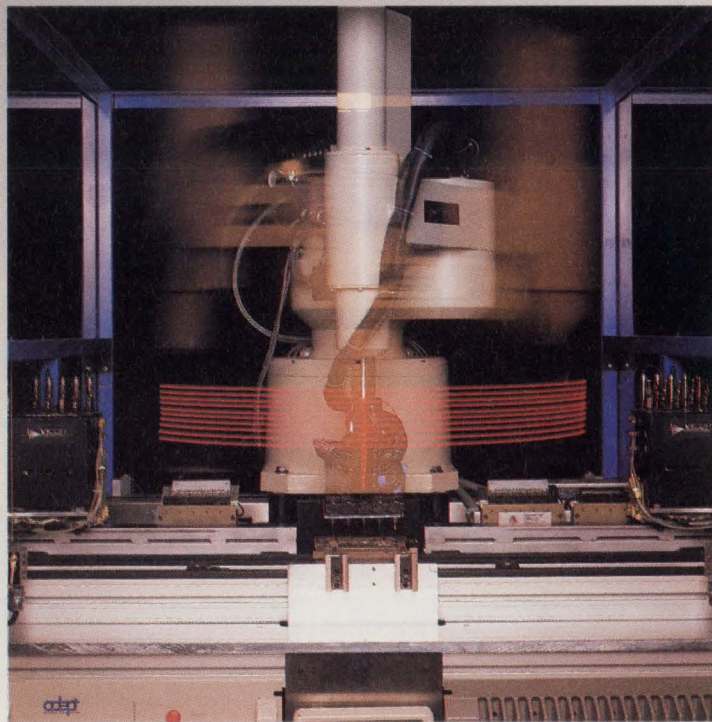

We would like to report to you on our progress in implementing an automation strategy aimed at achieving the highest level of quality and repeatability while minimizing costs and lead times. Our Andover facility is designed for high volume production of Vicor's present families of modular converters . . . while retaining the flexibility to handle tomorrow's . . . with assembly cells incorporating many unique features:

■ "Every part, both passive and active, is electrically tested just prior to onsertion . . . a reflection of our commitment to zero defects . . .

■ "In-line vision systems check solder paste on each pad; orientation of onserted parts; size and fit of pins; and dimensioning of the PC board itself . . . a reflection of our commitment to quality of assembly . . .

■ "Fully automatic testers subject every converter to a total of six comprehensive in-line tests, including tests at both room and elevated temperatures . . . a reflection of our commitment to total quality control . . .

■ "SmartCell software picks and installs trim components for each module after calculating the optimum value based upon actual measured values of related parts . . . a reflection of our commitment to "peas-in-a-pod" repeatability . . .

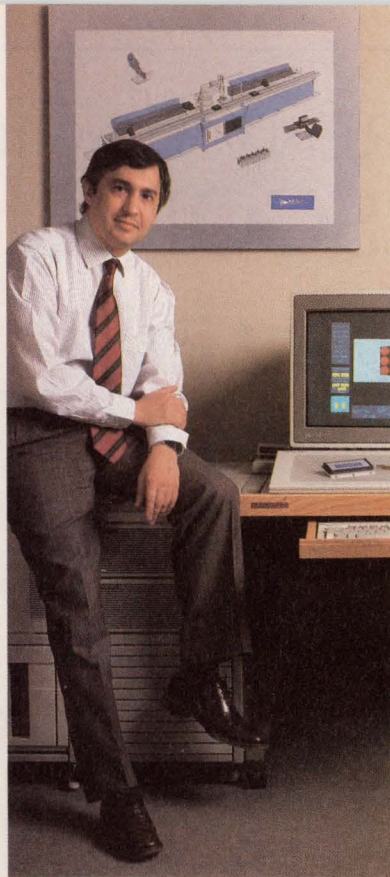

Patrizio Vinciarelli, Ph.D., President/CEO

■ "Every part for every converter model is on line at all times, allowing Vicor to "random access" manufacture any mix of product, in lot sizes as small as one, without impacting throughput and with a cycle time of only four hours.

"As an investment aimed at delivering products of the highest quality at the lowest price, in the shortest time, domestic automation represents Vicor's commitment to World Class Manufacturing as a means of maintaining market leadership through customer satisfaction. With inflexible, bulky, and unpredictable conventional approaches to power systems receding into technological history and with Vicor ready today to supply you with state-of-the-art power products at competitive prices . . . it's time to switch to the Power Component Industry as the sensible source for all your power needs."

To receive a complete catalog, including information on Vicor Products, Applications and Accessories, call Vicor today at (800) 735-6200.

For immediate delivery of Converters, or Power Supplies configured to your needs, ask for

VICOR EXPRESS



Vicor's
VI-200 Family:

- 50 to 200 Watts
- Booster Expansion to Kilowatts
- 36 Watts/In³
- UL, CSA, VDE Recognized
- As low as \$.50 per Watt in OEM quantities . . . and going down!

Component Solutions For Your Power System



CONCURRENT ENGINEERING: WESCON STYLE



November 13-15, 1990 • Anaheim Convention Center • Anaheim, Calif. USA

Gone are the days when you worked alone, developing your bit of a design. Wondering how to test this thing from the design department. Trying to figure out how to manufacture this whatchit that looked great on paper, but can't be produced.

Today the team works together. Simultaneously. In parallel. To shorten development time. And raise product quality. And increase profitability.

That's what concurrent engineering is all about.

And that's what WESCON is all about, too.

R&D. Design. Test. Manufacturing. Only WESCON covers them all. Advances in new technologies and appli-

cations. Real world solutions for real world problems. The latest products and best of proven products.

Semiconductors. Bus products. Special VME Future Bus+ Extended Architecture issues seminar and product demonstrations. RF components. Passive components. Instrumentation. Electronic design automation tools.

Production materials and services. WESCON has what you, and all of the members of your team, need.

Plan now to attend



For More Information
call 800-877-2668.



Send me a Preview Program with full information about
WESCON/90 (available August, 1990)

Name _____ Title _____

Company _____

Street Address _____

City _____ State _____ Zip Code _____

Mail to: Wescon Preview, 8110 Airport Blvd.
Los Angeles, CA 90045 or Fax to 213/641-5117

EDN091790

NETWORKING SOLUTIONS

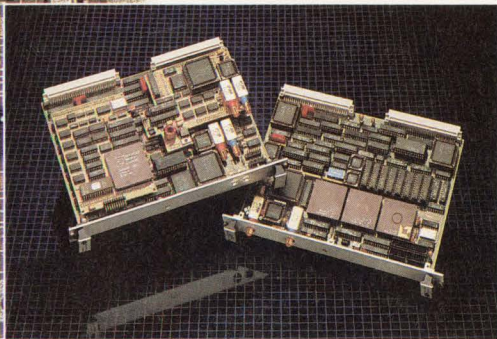

V/FDDI 4211 Peregrine
V/FDDI 3211 Falcon

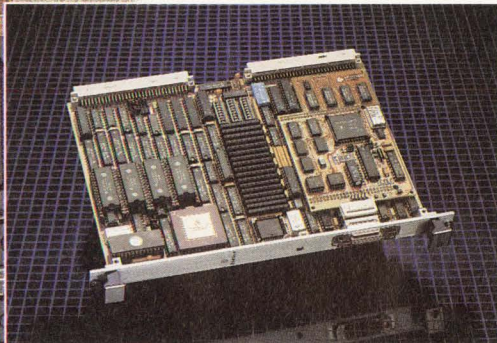

V/Token-Ring 4212 Owl

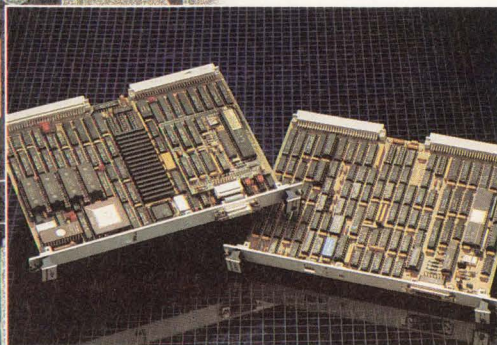

V/Ethernet 4207 Eagle
V/Ethernet 3207 Hawk

FDDI, TOKEN-RING AND ETHERNET COMMUNICATIONS

The need to network has never been greater. Diverse processing platforms, distributed architectures, client-server, departmental and workgroup environments all contribute to increased demands on the network. System and network designers need a proven source of technology solutions for the wide range of networking and communication application problems they face. Interphase delivers those solutions.

FDDI, TOKEN-RING AND ETHERNET SOLUTIONS

Interphase has long led the industry in high-performance VMEbus peripheral controllers, and that same leadership is now evident in networking node controllers. Interphase has FDDI, Token-Ring and Ethernet solutions for virtually any VMEbus system application challenge.

PROVEN FDDI SPEED AND INTELLIGENCE

Interphase's FDDI 100 Mb/s offerings are a logical choice for the industry. The V/FDDI 3211 Falcon received *UnixWorld* magazine's Product of the Year designation and was the industry's first 6U VMEbus FDDI solution. Interphase's newest FDDI product is the V/FDDI 4211 Peregrine, a RISC-based high-performance node controller capable of link level operation or on-board protocol processing. The Peregrine provides single or dual attach configurations, with SMT (Station Management Software) running on-board, all in one 6U VME slot.

TOKEN-RING RESULTS

The V/Token-Ring 4212 Owl is an ultrafast Token-Ring node controller based on the partitioned architecture of Interphase's proven Eagle class of controllers. The Owl facilitates connectivity of UNIX® systems, workstations, supercomputers or any other VMEbus system into an IBM® environment using IEEE 802.5 Token-Ring. This multiple processor design provides an elegant queued interface to the system supporting IEEE 802.2 LLC, and a flexible 4 or 16 Mbit interface to the Token-Ring network.

ETHERNET CHOICES

Interphase also offers two Ethernet design options. The V/Ethernet 4207 Eagle 32-bit protocol platform is the high-performance standard for the industry, and offers on-board TCP/IP support. The V/Ethernet 3207 Hawk is designed specifically for cost-sensitive VMEbus applications.

GET YOUR NET WORKING NOW

No matter what your networking need—FDDI, Token-Ring or Ethernet—Interphase is ready to provide *the* solution. For more information call today:

(214) 919-9000



OPEN SYSTEMS CONTROLLERS™
Disk • Tape • Networking



13800 Senlac • Dallas, Texas 75234 • (214) 919-9000 • FAX: (214) 919-9200 • NASDAQ-NMS:INPH

Interphase International
Astral House, Granville Way • Bicester, Oxon OX6 0JT • (01144) 869-321222 • FAX: (01144) 869-247720

© 1990 Interphase Corporation. Interphase is a registered trademark of Interphase Corporation. Open Systems Controllers is a trademark of Interphase Corporation. Specifications subject to change without notice. UNIX is a registered trademark of AT&T in the United States and other countries. IBM is a registered trademark of International Business Machines.



Sophisticated graphics demand elegant solutions.

1 megabit video RAMs from the expert in graphics memories.

Sophisticated graphics require high-performance video RAMs, and NEC has the most experience tailoring memories for your graphics applications.

We developed the first 256K dual port video RAM. And we've poured all that expertise into our 1 megabit video RAMs. They're the elegant solution you need for the speed and performance requirements of your sophisticated graphics systems.

Fast screen updates

NEC's 80-ns RAM port access speed and fast page operation enable fast frame buffer updates. Block Write and Flash Write fine tune your design by clearing your windows or your full screen, fast. A Split Data Register function simplifies Real Time Data Transfers with relaxed timing.

All standard JEDEC features on our 256K video RAMs are present in our 1 megabit generation. This includes the Maskable Write Function that allows updates of specific bits and eliminates the need for Read Modify Write cycles. The Persistent Write Per Bit

feature on the 128K x 8 version realizes compatibility with popular graphics processors.

Intelligent choices

Optimize your frame buffer architecture with the right video RAM configuration.

NEC delivers dual port video RAMs at both 256K and 1 megabit densities. Choose from two 1 megabit configurations: 256K x 4 and 128K x 8. Our worldwide manufacturing expertise assures stable supply with the quality you demand.

Call NEC today for high-performance video RAMs—the elegant solution for your sophisticated graphics design.

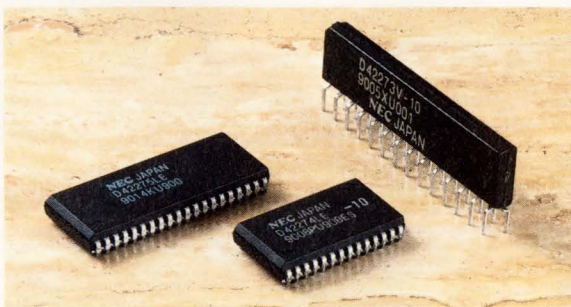

Part Number	μPD42273	μPD42274	μPD42275
Organization			
256K x 4	○	○	
128K x 8			○
Special Features			
Fast Page Mode	○	○	○
Flash Write		○	○
Split Buffer			○
Block Write			○
Persistent Write Per Bit			○
Packages			
SOJ	○	○	○
ZIP	○	○	
Major Characteristics	μPD4227X-80	-10	-12
RAS Access Time (Max)	80ns	100ns	120ns
CAS Access Time (Max)	20	25	30
Fast Page Mode Cycle Time (Min)	50	60	70
Serial Access Time ((Max)	25	30	40
Serial Cycle Time (Min)	25	30	40

For fast answers, call us at:

USA Tel:1-800-632-3531. TWX:910-379-6985. W. Germany Tel:0211-650302. Telex:8589960. The Netherlands Tel:040-445-845. Telex:51923. Sweden Tel:08-753-6020. Telex:13839. France Tel:1-3946-9617. Telex:699499. Italy Tel:02-6709108. Telex:315355. UK Tel:0908-691133. Telex:826791. Hong Kong Tel:755-9008. Telex:54561. Taiwan Tel:02-719-2377. Telex:22372. Korea Tel:02-551-0450. Fax:02-551-0451. Singapore Tel:4819881. Telex:39726. Australia Tel:03-267-6355. Telex:38343.

NEC

Unix for PCs

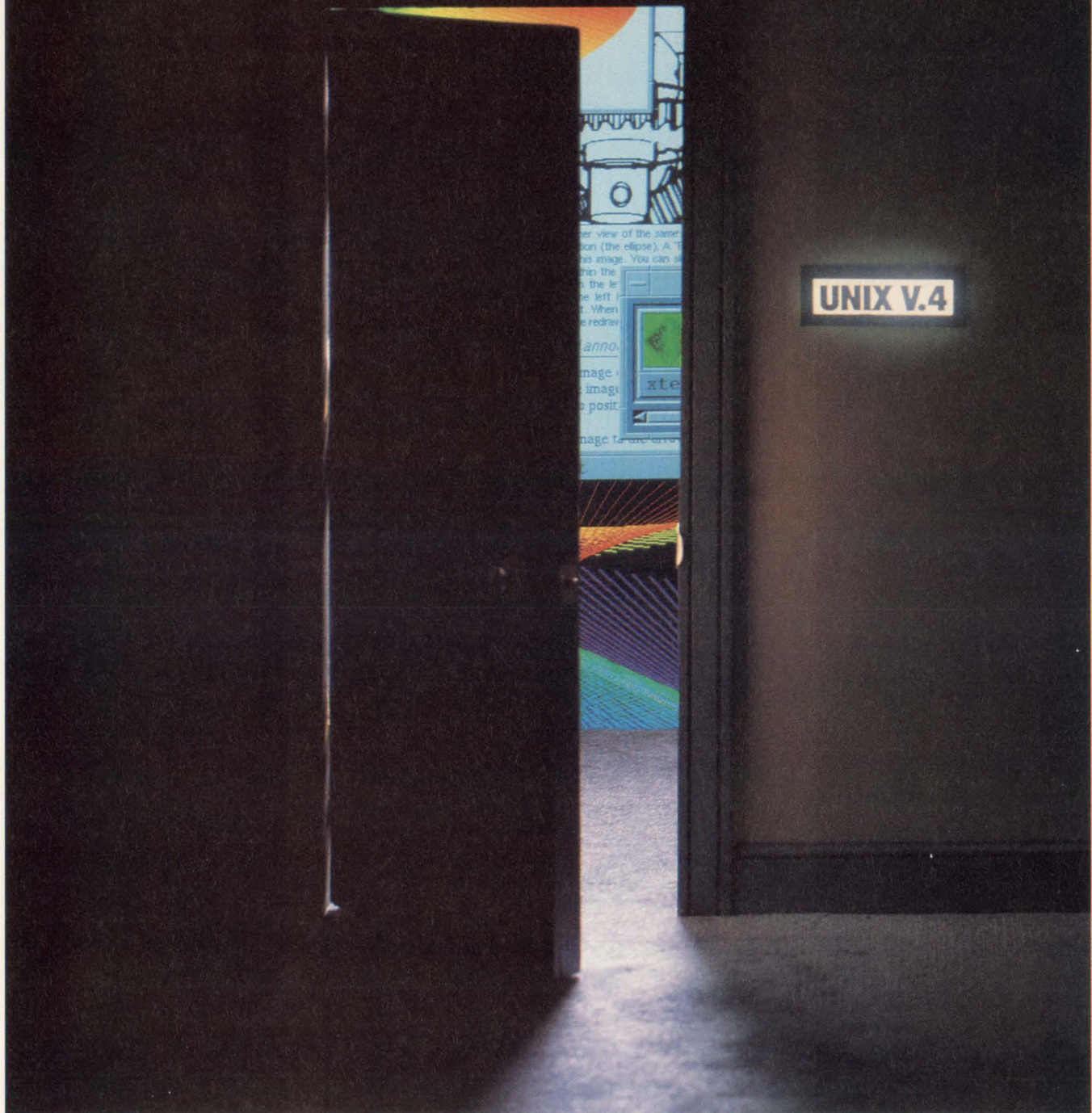

New Unix packages help PCs enter the performance realm of workstations. (Photo courtesy Intel Corp)



Unix is helping to bridge the gap between PCs and workstations. New Unix offerings for PCs now make available standard graphics and networking capability that was previously available only on workstations. And support of emerging standards in Unix will further aid the PC's progress in the workstation market.

Maury Wright, Regional Editor

Shrink-wrapped Unix for IBM-compatible 80386/486-based or Apple Macintosh PCs offer all of the operating-system features that you'll find on a workstation from Sun or HP/Apollo. And Unix-based PCs maintain compatibility with MS-DOS software without help from simulators, add-in processors, or binary compilers. The newest PC Unix offerings also support de facto network standards such as TCP/IP (transmission control protocol/internet protocol) and NFS (network file system).

The packages also support GUIs (graphical user interfaces) and the X-Windows network graphics standard developed at MIT. Therefore, software developers can easily port software to any system that supports these graphics and network standards. Unix System V Release 3.2 from Unix System Laboratories (formerly AT&T's Unix Software Operation and now a subsidiary of AT&T) provides a temporary standard software base for PCs, workstations, mini-computers, and even many mainframes—but

don't get too used to it. A new release of System V—Release 4—just arrived. And, the OSF (Open Software Foundation) plans to release its Mach-based OSF/1 operating system in November.

Unix has been more popular on IBM-compatible PCs than you might think. According to Maggie Conner, an analyst with International Data Corp (Framingham, MA), approximately 200,000 IBM-compatible PCs shipped in 1989 were dedicated to Unix applications. Conner believes that shipments targeted for Unix will grow

to 1.5-million units a year by 1994—50% annual growth over five years.

Dimitri Rotow, the general manager of Intel's integrated microsystems operation, claims that by the end of 1989, 57% of all Unix installations worldwide had an Intel 80X86 processor. George Meyer, director of product marketing at Interactive systems, believes that a more accurate figure is just over 40%. In either case, the 80X86 is a significant and potentially dominant μ P in the Unix business.

To date, Unix has been used with IBM-compatible PCs and other 80X86 systems as a cost-effective multiuser system. To run office applications, a single CPU plays host to numerous RS-232C terminals. The IBM-compatible systems offer tremendous hardware cost savings compared to other systems that don't enjoy the economies of scale the personal-computer business offers.

There are catalogs from Intel, ISC (Interactive Systems Corp), and SCO (The Santa Cruz Operation) that list thousands of applications that run on 80X86-based Unix.

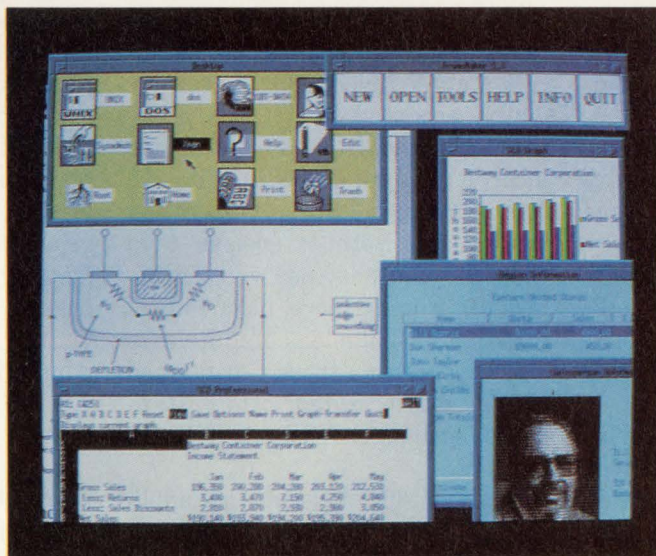

X-Windows, Motif, and a desktop manager make the Unix-based Open Desktop from SCO simple to use and provide the multitasking capability that engineers require of CAE workstations.

Unix System V Release 3.2 offers the open-systems computer industry a stable standard software-technology base for the first time.

Among the applications are horizontal office software such as spreadsheets, database managers, and word processors—for example, Microsoft Word for Unix. In addition, vertical applications, such as packages for medical or legal offices, abound.

Most of the available technical Unix software targets civil-, mechanical-, and structural-engineering applications. A good example is the popular AutoCAD program from Autodesk (Sausalito, CA). It suits applications in all three engineering disciplines. A smaller number of companies offer engineering and scientific software for 80X86-based systems, such as math and simulation packages, that are useful to electronic engineers.

Unix on the Macintosh has not enjoyed the success that Unix for IBM-compatible PCs has. Macintosh computers use the 680X0 processor family. 680X0-based systems have been second in popularity to 80X86-based units as Unix hosts, but Macintosh has not provided the cost benefits for value-added resellers selling multiuser systems that IBM-compatible PCs do.

Standards will spearhead the Unix market's growth for IBM-compatible and Macintosh PCs. Just two years ago, different system manufacturers took vastly different routes to offer Unix. Some used System V as a technology base. Some used Berkeley Unix, from the University of California—Berkeley. Other companies offered proprietary Unix-like operating systems.

System manufacturers worldwide, however, have been driven by customer demand toward standards and open systems. The standards movement led to the creation of industry organizations such as

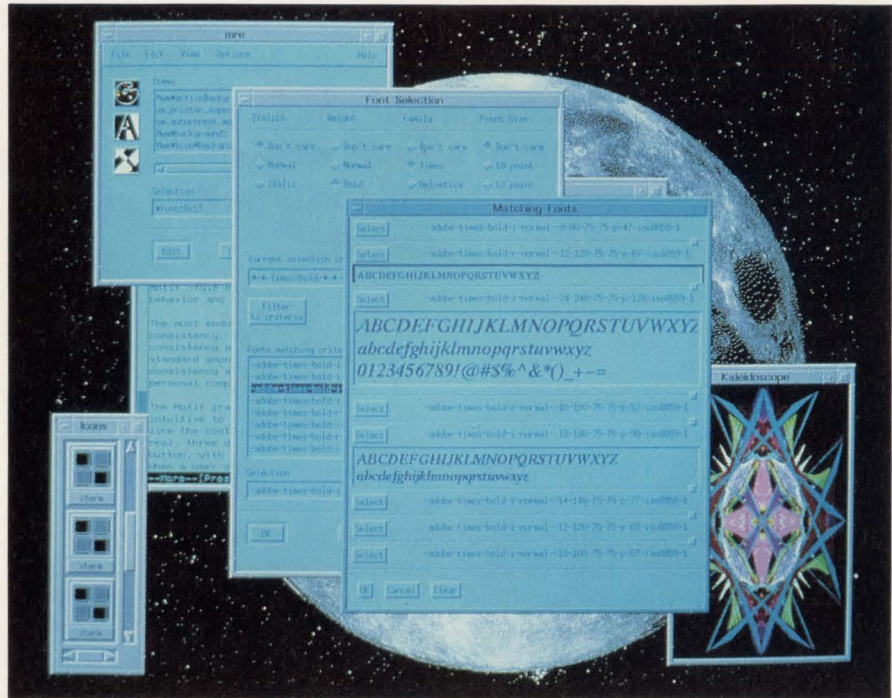

OSF/1 will ship in November and add to the Open Software Foundation's product family, which includes the X-Window-based Motif GUI.

X/Open (San Francisco, CA) to establish international standards for software portability. The OSF has evolved to develop standard operating systems; Unix International has evolved to assist and to guide development of standard operating systems (Ref 1).

System V Release 3.2 has become widely accepted as a standard. Intel, ISC, and SCO products have incorporated compatibility with Microsoft's Unix-like Xenix operating system and with extensions from the BSD (Berkeley Software Distribution). Furthermore, most companies that have implemented Release 3.2, including those mentioned above, have added other standards, such as X-Window, TCP/IP, and NFS.

Many of 80X86-based Unix applications are text based. The applications that incorporate graphics have done so without the benefit of stan-

dards. Release 3.2 with X-Window, however, offers software developers a stable graphics platform to develop software for. And even Release 4 and OSF's planned operating systems depend on X-Window to ensure portability of graphics applications.

The move to an industry standard graphics-based Unix implementation will certainly benefit users of business and vertical-market software on Unix-based systems, a group that includes PC users. In fact, the explosion of graphics-based applications software for Unix systems should feed off the popularity of Microsoft Windows 3.0 for PCs and the Apple Macintosh.

CAE applications need graphics

Standard graphics-based Unix will also be a boon to people who use PCs for CAE applications. The

large CAE software companies all use one or more of the same group of hardware platforms to host software. For example, until recently Mentor Graphics (Beaverton, OR) only sold its software bundled with Apollo workstations. Mentor offers a full suite of integrated CAE tools that facilitate designing ICs, boards, and systems.

Mentor developed a proprietary graphical interface for its entire software base, thereby making its software easy to use. But now it offers its software based on X-Windows and OSF's Motif GUI because these industry standards also offer ease-of-use features. End users will benefit from the standard look and feel of software from different vendors and from the ability to run the same applications software on vastly different hardware. Companies such as Mentor can now offer software on more hardware platforms with far less effort.

Unix International plans to standardize an ABI (application binary interface) for each processor family. If that happens, X-Windows-based applications software (in binary executable form) written for a 680X0-based Hewlett-Packard/Apollo system would run equally well on a Macintosh or other 680X0-based system that implements X-Windows. Furthermore, the software developer would only need to recompile the program to move the software to a new processor.

The ABI scenario depends only on system manufacturers implementing standard X-Windows and Unix. OSF has proposed taking portability a step further by using some type of ANDF (application neutral distribution format) technology. The company has studied ways to distribute software in some intermediate format so that final

compilation or conversion to binary form can occur on any host processor. A successful ANDF technology would allow software developers to distribute one shrink-wrapped package for all hardware platforms.

ABI standardization will happen and ANDF technology, if it becomes a workable standard, will make things even better. But for now, simply making X-Windows standard already gives software developers a huge incentive to port applications software. Over the next year or two, expect CAE software vendors to rush to offer software for PCs. The installed software base plus new sales of PCs dwarfs the number of workstations sold. High-end PCs offer a suitable platform for CAE from a hardware standpoint (see **boxes**, "Systems components suit MS-DOS and Unix," and "Unix erases the line between PCs and workstations").

And software vendors are certainly in the business to sell as many packages as possible.

Unix moves PCs to workstations

The availability of full-featured Unix provides the missing link that moves high-end PCs into the workstation market. Intel, ISC, and SCO offer such Unix versions for 80386- and 80486-based machines. The vendors feel that the 80286 and earlier processors don't offer the performance needed to host Unix, although SCO does market its Xenix product for 80286 systems and claims to have substantial demand in the multiuser vertical markets.

Intel's, ISC's, and SCO's products, in addition to being based on System V Release 3.2 and offering X-Windows, TCP/IP, and NFS bundled with the operating system, also have backward compatibility

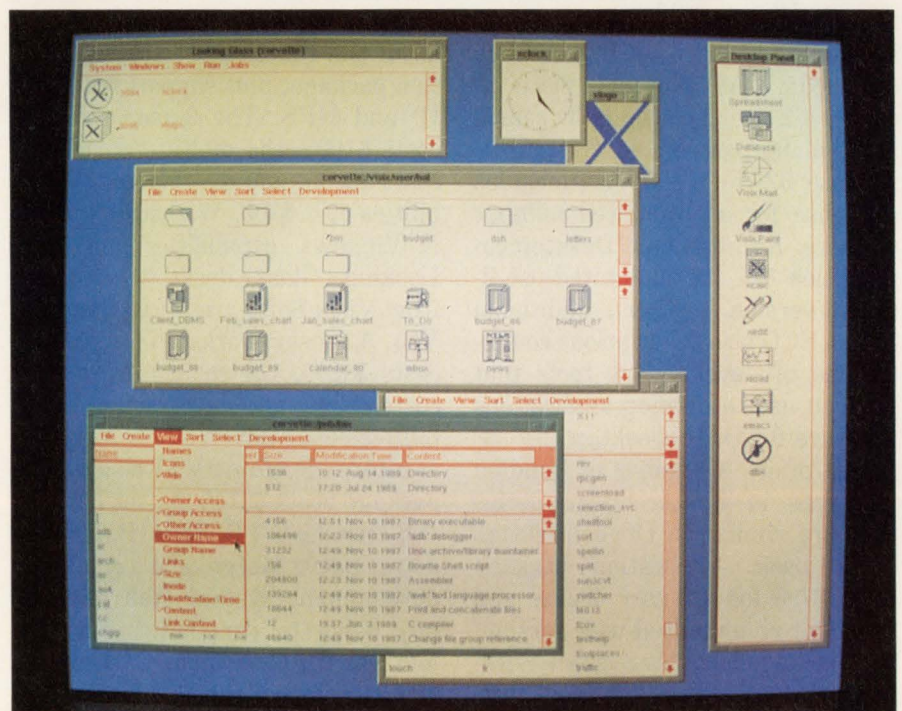

The Looking Glass desktop manager, from Visix Software, comes standard with ISC's Architect Workstation package. You can also purchase the popular software for SCO and Intel Unix systems.

Bundled Unix packages that include GUIs and desktop managers offer similar capabilities as CAE workstations packages.

with Xenix. SCO set a new price point with its \$995 Open Desktop package it introduced about a year ago. The package includes the X Library routines, X Toolkit Intrinsic routines, the Motif Toolkit and Styleguide, and a desktop manager called X.Desktop from IXI Ltd (Cambridge, UK).

Package has network support

Open Desktop also includes implementations of TCP/IP and NFS and an implementation of LAN Manager Client. The package integrates the capabilities of Locus Computing's (Santa Monica, CA) DOS Merge package. DOS Merge lets you run MS-DOS software under Unix's control. You can install DOS software in the Unix file system using Merge, or Merge can read a DOS partition on any system disk drive.

The Open Desktop bundle also integrates the SQL-based Ingres relational database from Ingres Corp (Alameda, CA). The base price includes a 2-user license. SCO sells a stand-alone version of System V Release 3.2 for \$895 that includes a license for an unlimited number of users. Adding Open Desktop capabilities to the unlimited-use-license version costs an additional \$1500. SCO also sells various combinations of development tools that you can use to develop applications software for Open Desktop.

ISC offers a number of bundled packages in its Architect Series that are similar to Open Desktop. ISC's basic Application package costs \$795 for a 2-user license and \$1795 for an unlimited-user version. The package includes System V Release 3.2, ISC's Ten/Plus user interface, electronic mail system, and VP/ix, which offers MS-DOS compatibility similar to the DOS Merge.

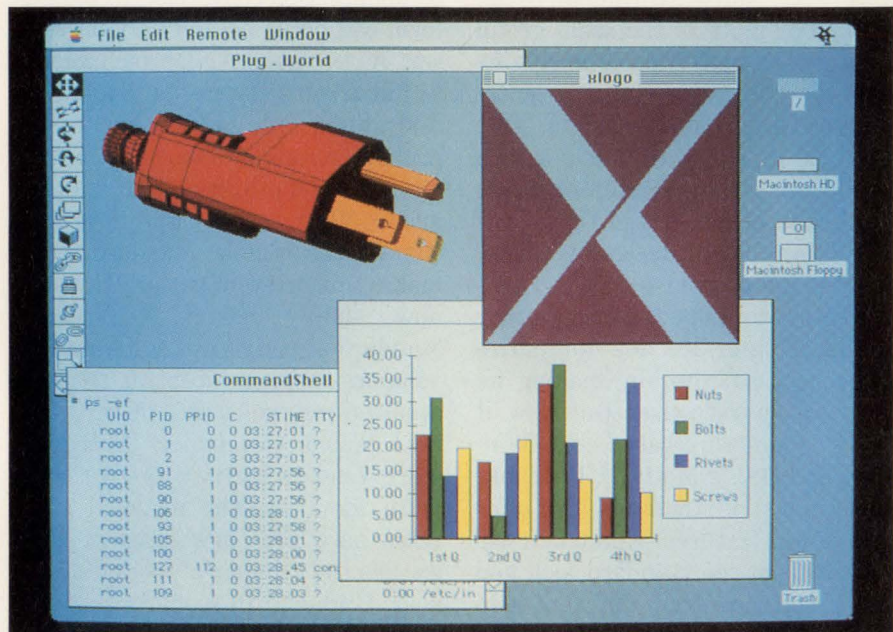

Macintosh and Unix applications run side-by-side under the control of X-Windows in Apple's A/UX 2.0 Unix based on System V Release 3.2.

You can add full development capabilities for \$900.

ISC's Network package includes all of the functions of the Application package, plus support for TCP/IP and NFS. The 2-user package costs \$1095, the multiuser package costs \$2095, and development capabilities cost \$700. Workstation adds X-Windows capabilities and the Looking Glass desktop manager from Visix Software Inc (Arlington, VA). A 2-user Workstation package costs \$1295, the multiuser version costs \$2295, and development capabilities cost \$700.

Intel's System V Release 3.2 package costs \$2745 (2-user license) and includes NFS, TCP/IP, X-Windows, Locus Merge, and a complete development system. You have to buy separate capabilities such as Motif or the Open Look GUI, which was developed separately by Sun and Unix System Laboratories. Intel developed the 80X86 version of Release 3.2 and the ABI in partner-

ship with Unix System Laboratories. This shrink-wrapped package is Intel's first venture into reselling Unix. Unix System Laboratories sells Release 3.2 source code for 80X86 systems for \$100,000.

Installation software eases start

The offerings from Intel, ISC, and Unix look similar on the surface, but there are differences, most notably the installation procedures. SCO's Open Desktop offers the simplest installation. You can install it in a default configuration on a standard system by doing practically nothing more than feeding the system the 25 floppy disks containing the programs in compressed form. The installation creates a user account and a default configuration comes up and runs in graphics mode. Few people probably really need the exact default configuration, but it gives you a working system that you can then modify.

ISC's installation requires a little

more effort. The Workstation Developer package includes 66 floppy disks (by press time, the company plans to be shipping a compressed version that uses about half as many disks). Installing a basic kernel is simple, and the installation

package allows you to then add options such as network and X-Windows support. The installation software does instruct you in the general order that you should add options. You'll still need some expertise or help to get the full package

installed on the first try.

Intel's package, which is the newest, includes by far the most cryptic installation instructions. You can simply install and build a basic kernel, but adding options requires that you go it alone. Each option

Systems components suit MS-DOS and Unix

Choosing a system and components to run Unix mandates choosing a fast processor. You should also choose disk drives and graphics boards that offer suitable performance—but make sure the system components you choose can also serve your MS-DOS needs, because you don't want your components to be incompatible with the world's largest software base.

At a minimum, you'll require a system based on the Intel 80386SX processor. More practically, a 25-MHz or faster 80386-based system with a static RAM cache will provide suitable performance. And any 80486-based system will prove to be a suitable system for Unix.

In evaluating the available Unix packages, I used a system based on Micronics Computers' (Fremont, CA) Model 80386 ASIC Cache System board. The mother board operates at 33 MHz and features a 64k-byte, 2-way-set-associative cache. The PC/AT bus board includes sockets for as much as 4M bytes of dynamic RAM; you can add 16M bytes of additional memory via a proprietary 32-bit memory board. The Micronics board provided power aplenty to run Unix.

I used IDE (integrated device electronics) disk drives to host Unix. IDE drives include an embedded controller, yet offer complete compatibility with the standard Western Digital ST-506/412 controller that IBM used in its PC/AT computers. The drives therefore offer some of the benefits of intelligent SCSI drives such as on-drive cache, but do not require special drives to work with operating systems other than MS-DOS. I felt that IDE drives would eliminate the compatibility problems inherent in finding a single SCSI host adapter that would support multiple peripherals and multiple operating systems.

The Unix packages were tested with Conner Pe-

ripheral (San Jose, CA) 3104 (100M bytes) and 3204 (200M bytes) drives. The intelligent Conner drives can adapt and operate transparently as virtually any drive geometry (the number of heads, cylinders, and sectors). Therefore, you need only choose an entry in a PC's BIOS drive table of the same or slightly lower capacity to make an IDE drive work flawlessly. The drives proved to be solid performers running Unix.

A 34010-based board provided intelligent 1024 × 768-pixel graphics for the test. Graphic Software Systems (GSS) (Beaverton, OR) designed and built the AT-1000 board, but only sells the board on an OEM basis. NEC sells a shrink-wrapped version under the name Multisync Graphics Engine. The board also includes an integrated VGA controller to ensure compatibility with a wide variety of software. GSS, however, offers drivers compatible with the Unix packages I tested, so I was able to take advantage of the on-board graphics processor.

My test system can match any low-end workstation. The 200M-byte drive provides 120M bytes for Unix and an 80M-byte MS-DOS partition that ensures full compatibility with all MS-DOS software.

The system proves economical for do-it-yourselfers, too. You can buy the Micronics mother board for a discount price of about \$1500. Add \$1000 for the 200M-byte disk drive, \$1000 for the graphics controller, \$1000 for a monitor, \$500 for a network card, and \$300 for case, power supply, I/O ports, and keyboard. The \$5000 to \$6000 price tag with RAM added matches Sun's new low-end 25-MHz diskless SPARCstation with a monochrome monitor. You can add 25 to 50% to the price to buy it assembled and tested, and even more to have a value-added reseller install it in your office. But you have to pay the value-added reseller to configure and install a workstation as well.

Vendors of Unix for PCs all have interest in OSF/1 because major system vendors such as IBM, DEC, and HP/Apollo have voiced support.

includes separate installation instructions, and you must figure out the proper sequence of installation alone.

Intel, ISC, and SCO all also offer their software on QIC-24 magnetic tape. You can simplify the process of swapping floppy disks greatly if your system includes such a tape drive. Furthermore, you can install Unix on one system and move the fully configured package to other systems via tape drives if you purchase the appropriate licenses.

All three packages include support for popular IBM-compatible peripherals such as VGA graphics

and Western-Digital-compatible (Irvine, CA) ST-506/412 drives, IDE (integrated drive electronics) drives, and ESDI (enhanced small device interface) disk controllers. The packages all support the Adaptec (Milpitas, CA) 1540 SCSI host adapter as well. Make your choice of a hard disk for Unix carefully, however. A SCSI drive will probably provide the best performance. But bus-master SCSI host adapters, such as the Adaptec 1540, can conflict with some 80386/486-specific MS-DOS software that uses expanded memory—and you may not want to risk compatibility prob-

lems with DOS (Ref 2).

You may also need to choose ST-506/412, IDE, or ESDI drives that match entries in the BIOS drive table on your system. You can buy utility software for MS-DOS that can adapt to any disk drive. Only SCO's Unix product allows you to enter drive parameters that differ from the ones your system BIOS support, however. With the Intel or ISC product, you have to settle for less capacity than your drive is capable of if it doesn't match a table entry.

All of the products support standard VGA, but ISC's product in-

Unix erases the line between PCs and workstations

Technically, workstations and high-end PCs are the same—despite any list of differences you may have seen. They both have fast μ Ps, many megabytes of memory, large, fast disk drives, network capabilities, and intelligent, high-resolution graphics. As the saying goes, "if it looks like a duck, walks like a duck, and quacks like a duck, then it's probably a duck."

Articles that say workstation graphics are superior to PC graphics abound. Yet every time a workstation vendor introduces a new product, it includes a medium-resolution monochrome monitor—and therefore features a low base price. In 1983, for instance, you could get an IBM PC-compatible board that supported 256 colors and 1600 \times 1200-pixel resolution.

You can now buy intelligent graphics boards for PCs that support 1280 \times 1024- or 1024 \times 768-pixel resolution and 256 to 16.8 million colors from more than 50 vendors. Likewise, Apple introduced a similar NuBus product recently for Macintosh. You simply have to buy high-resolution graphics for PCs or workstations.

Sun Microsystems started a trend by including network hardware and TCP/IP (transmission control protocol/internet protocol) and NFS (network file system) software as a standard system feature. Other workstation vendors have followed suit. You

can purchase equivalent Ethernet network hardware for PCs, however, for \$500 or less. And Unix packages for PCs include network software. As an alternative, you can buy software for less than \$1000 that adds TCP/IP and NFS capabilities to MS-DOS-based systems.

PCs and workstations share the same disk- and tape-drive technology. Even power users of PCs regularly equip their machines with 8M bytes of memory. Most 386/486-based mother boards directly support at least 16M bytes of memory, and some new ones can handle 64M bytes. You can argue the performance merits of the RISC (reduced-instruction-set computer) processor technology used in some workstations compared to the 386 and 486 processors. In reality, either choice offers sufficient power to efficiently handle desktop CAE tasks.

It's not clear whether RISC systems will offer substantially better performance than systems based on Intel or Motorola CISC (complex-instruction-set computer) μ Ps anytime soon. Intel plans to offer a 50-MHz 80486, and has talked in general about 80586, 80686, and 80786 chips. Expect these chips, and new Motorola 680X0 chips, to maintain code compatibility with older chips, and to incorporate some of the performance enhancements used in RISC processors.

From a hardware standpoint, the system bus has

cludes support for the widest selection of VGA adapters. All three vendors have been slow to include support for graphics boards based on auxiliary graphics processors such as the TI 34010 and 34020. Each of them plans support in the future, however. In the interim, vendors such as Graphic Software Systems (Beaverton, OR) offer Unix drivers for their intelligent graphics boards.

The three products require varying amounts of memory to install the various options they offer. You can typically install character-based Unix on a system that has as little

as four megabytes of main memory. But, as a rule of thumb, you'll need a minimum of eight megabytes to both load a full implementation of Unix that matches the capabilities of a typical workstation and to run graphics-based applications software.

Processor keys portability

Apple Macintosh fans should also rejoice at having a complete Unix package available. The 680X0-based Macintosh products should gain compatibility with applications software that runs on 680X0-based systems from Sun, HP/Apollo, and

others. Apple's A/UX 2.0 Unix release is based on Unix System V Release 3.2, as are IBM-compatible packages. The A/UX package includes TCP/IP and NFS as standard features.

Apple offers its 2-user A/UX 2.0 on floppy disk or magnetic tape for \$995; the release on CD-ROM costs \$795. The software costs \$600 if you buy it bundled, preinstalled on the hard disk, with a Macintosh. You can purchase rights to copy AU/X for \$495 per copy.

A \$350 option for AU/X allows you to run X-Windows applications on the Macintosh. Furthermore,

been the only technical shortcoming for IBM-compatible PCs. The PC/AT bus (also called the industry-standard-architecture (ISA) bus) lacked features such as arbitration and the ability to let multiple masters control the bus. The bus also limited I/O bandwidth to well less than 10M bytes/sec. Yet the PC/AT bus doesn't terribly hamper performance in a single-user multitasking application, such as a CAE workstation. Users that need to maximize I/O performance, however, now have the option of systems based on the Microchannel or EISA (enhanced industry standard architecture) buses—and both of them support multiple bus masters and transfer rates faster than 30M bytes/sec.

Software is the main technical difference between PCs and workstations. Now, however, you can buy a Unix package for Macintosh and 386/486-based systems that rivals the implementations sold on workstations. Furthermore, standardization efforts in the Unix community should shortly result in a host of hardware-independent Unix-based application packages. The Unix operating-system packages for PCs offer compatibility with PC application software. As a result, users of high-end PCs get the best of both worlds.

A couple of final logistic issues separate PCs from workstations—cost and distribution channels. In general, workstations cost more than PCs. Typi-

cally, engineers buy workstations from technical value-added resellers. Most people buy PCs from discount sources. Unix software costs substantially more than MS-DOS or Macintosh software does, but prices should drop as the market for Unix software widens.

Make sure you read between the lines when you see cost comparisons of workstations and PCs. The workstation advocates tend to compare a diskless system with no color graphics to the retail price of a fully configured PC from Compaq or IBM. Likewise, PC vendors will compare the discounted price of a PC with no network hardware to the price a value-added reseller might charge for a decked-out workstation.

A technical value-added reseller would be the likely outlet to purchase a PC or a workstation fully configured with graphics, network capabilities, and CAE software. So compare a CAE value-added reseller's prices of similarly configured 386/486-based systems with name-brand workstations. You will find that the PC typically cost half what a workstation does. And, you always have the option of buying your PC through a mail-order house, or building it yourself.

UNIX FOR PCs

you can also run some Macintosh operating-system applications in windows under control of X-Windows and Unix. An application must be "32-bit clean" (meet the development specification published by Apple) to run under X-Windows. You can buy Motif or Open look from third parties, and you can buy products from third parties that allow you to run IBM-compatible MS-DOS software on a Macintosh. Conceivably, you could combine a Macintosh application, a text-based Unix application, an X-Windows application, and an MS-DOS application all on one screen using A/UX 2.0.

Now that System V Release 3.2 has been established as a standard software base, OSF and the combined forces of Unix System Laboratories and Unix International plan to shake things up. Unix System Laboratories shipped source code for Unix System V Release 4 at the end of last year. Release 4 integrates Xenix, BSD, and Sun Microsystems extensions to Unix as standard features. Release 4 also includes NFS, TCP/IP, X-Windows, and Open Look as standard features. Other enhancements include a fast file system and a modular structure that simplifies device-driver development.

Intel has begun shipping an 80X86 shrink-wrapped Release 4 package for \$995. Release 4 doesn't require that the vendor add many enhancements, and it essentially offers the same features that Intel, ISC, and SCO have offered in Release 3.2. Therefore, Release 3.2 software should run on Release 4 with few changes.

Intel's Rotow expects Unix users to move to Release 4 immediately. He claims that Release 4 runs faster than Release 3.2 and includes all of the features users need. ISC's

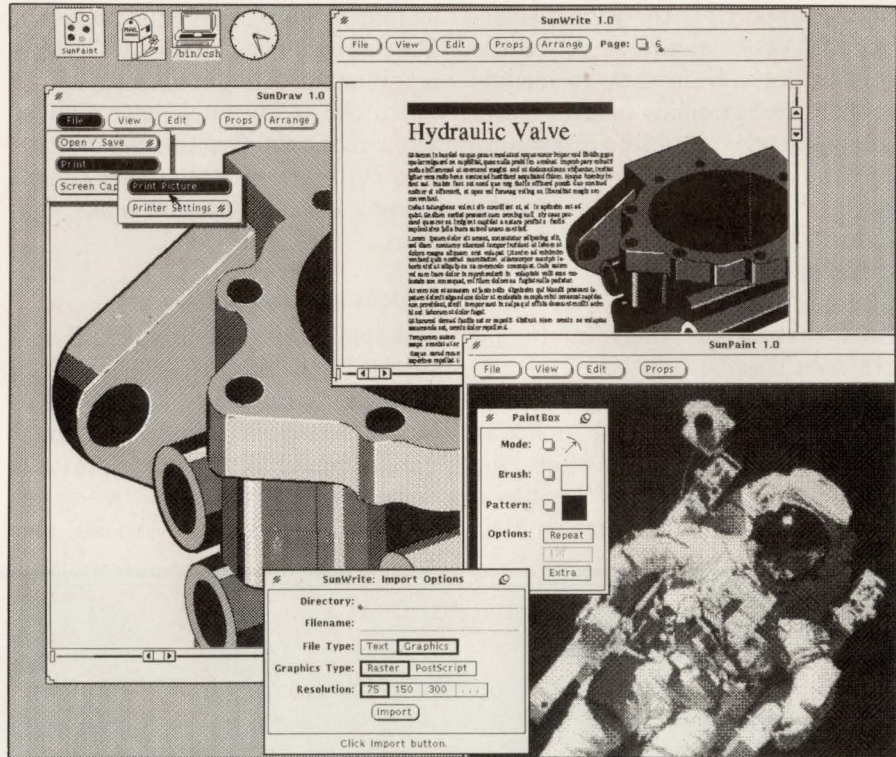

The Open Look GUI, demonstrated here on a Sun workstation, comes as a standard part of the Unix System V Release 4 package that Intel just began shipping.

Meyer agrees that Release 4 will be important, but that mid-1991 might be a better time for users to consider an upgrade. Meyer claims that ISC's Release 3.2 package already includes file-system enhancements that provide performance that equals Release 4's. He thinks the new release needs time to mature, and that there is no reason for users to upgrade until a significant amount of the applications-software vendors offer Release 4 packages. Dave Sandel, vice president of marketing at Unix International, claims that two out of three of all major open system vendors will be shipping Release 4 by year's end.

According to Watkins, SCO plans to wait before committing to a new software technology base. Watkins states that SCO will offer the products that customers demand, but

that customers haven't asked for Release 4 yet. Watkins also plans to keep a close eye on OSF's upcoming operating-system release. He believes that it might become the next industry-standard technology base.

OSF plans to ship the OSF/1 operating system this November. The product uses the Mach kernel developed at Carnegie Mellon University (Pittsburgh, PA) as a base. Mach inherently includes multiprocessor capabilities—a feature Unix System Laboratories and Unix International are busily planning as Unix extensions.

Jack Dwyer, OSF technology manager, claims that the multiprocessing capability played the dominant role in OSF's decision to base its software on Mach rather than IBM's AIX as previously planned. OSF/1 will include compatibility

The way
we build
workstations,
you'd think
we had
to use them
ourselves.

We do.



There's nothing like some real world proof to establish the viability of a product.

Which is why you might find it comforting to know that the Sony NEWS® line of workstations are being used by real designers. On real chip, board, and product development projects. For one of the world's most successful electronics manufacturers: Sony.

In fact, Sony engineers are using NEWS workstations to design everything from SRAMs and other chips to advanced video and audio controllers for the professional broadcast markets.

All of which uniquely positions us to understand your engineering and product development needs. Because here is a case where the supplier is acutely aware of the consumer's needs. And has to meet those needs. On a daily basis.

The result is our very affordable NEWS 3710 desktop workstations—the latest additions to our current workstation line. Fast, powerful, and expandable, these R3000®-based systems offer extensive memory plus high capacity, cost-effective storage options—including Sony's unique magneto optical drives and DAT tapes. Of course, you can choose the black-and-white, grayscale, or high-resolution Trinitron® color monitor that best fits your application.

We even have most of the popular EDA software packages—including applications from vendors such as Cadence, Valid Logic, Data I/O, Synopsys, Racal-Redac, Silvaco and an ever-expanding roster of others.*

To find out more about why Sony's solutions should be your solutions, give us a call at 1-800-624-8999, ext. #96.

Then just sit back and watch the NEWS.

SONY®

Sony Microsystems Company

Sony Microsystems Company, 651 River Oaks Parkway, San Jose, CA 95134 (408) 434-6644 FAX: (408) 954-0849 • Sony of Canada, Ltd., Ontario, Phone: (416) 499-1414 FAX: (416) 497-1774 • Sony Microsystems Europe, Köln, Phone: (0221) 59 30 42 FAX: (0221) 59 35 42 • Sony (Australia) Pty., Ltd., N.S.W. Phone: (02) 887-6666 FAX: (02) 887-4351 • International Sales Division, Tokyo, Phone: (03) 448-4041 FAX: (03) 448-4043 • Sony, NEWS, and Trinitron are registered trademarks of Sony Corporation. R3000 is a registered trademark of MIPS Computers, Inc. © 1990 Sony Corporation of America. Design and specifications subject to change without notice. *Some of the software mentioned herein may not be available for all NEWS models or for worldwide distribution. Call your Sony representative to check for availability.

SCSI INSTRUMENTS



```

> Display trace memory [in structured format]
Enter starting addr(hex): 0
0001: Arbitration /80
0003: Select w.ATN /C0
0005: Message-Out/C0(Identify)
0007: Command /12(Inquiry) 00 00 00 30 00
0009: Data-In /00 01 01 29 00 00 00 43 4F 4E 4E 45 52 20 20
0010: 43 70 33 34 30 20 28 34 30 60 62 20 33 2E 35 29
0020: 20 30 34 20 42 30 31 33 54 42 20 20 20
0038: Status /00
003C: Message-In /00
003D: Bus free
003F: Arbitration w.ATN /80
0041: Select w.ATN /C0
0043: Message-Out/C0(Identify)
0045: Command /08(Read) 00 00 10 01 00
0048: Message-In /04(Disconnect)
004C: Bus free
004E: Arbitration /40
0050: Reselect /C0
0052: Message-In /80(Identify)
0053: Data-In /00 00 00 12 34 56 79 12 34 56 7A 12 34 56 7B
0063: 12 34 56 7C 12 34 56 7D 12 34 56 7E 12 34 56 7F
    
```

ANCOT's SCSI instruments are powerful, easier to use, and cost less. Proven in use worldwide, Ancot's portable equipment travels from bench to field and back again without ever slowing down. They are time and labor saving instruments, for design, manufacturing, repairing, and inspection applications.

Call today for product data sheets, demo disc, or to make arrangements for a free evaluation unit in your facility.

[415] 363-0667

fax: (415) 363-0735



Redwood City, California

UNIX FOR PCs

with System V Release 3.2, Xenix, and BSD extensions. Like Unix System Laboratories, OSF will sell source code only. The company has developed versions of OSF/1 for three reference platforms, one of which is 80386- and 80486-based systems.

A license for OSF/1 costs \$50,000. After you buy the initial license, you can buy licenses for additional CPUs for \$3000 each. The basic package includes NFS and TCP/IP; you have to license Motif separately. To run Motif, you have to have X-Windows on your system.

A number of major system vendors, including IBM, DEC, and HP/Apollo, plan to make OSF/1 their standard operating system. Therefore the operating system could become the next key industry standard, despite coming to market almost a year after System V Release 4. Intel, ICS, and SCO all have an interest in OSF/1, but none of them have announced products yet. Apple claims only to be watching the industry closely.

Despite changes that are sure to come, you can buy into a stable

Unix operating system today. The combination of Windows 3.0 and the Macintosh offer good entry-level platforms for CAE work, and you can expect more and more CAE software vendors to offer such tools. But Unix with Motif, X-Windows, TCP/IP, and NFS, combined with ABI standards, will surely lead personal computers to substantial success in the workstation business.

EDN

References

1. Wright, Maury, "Graphics environments," *EDN*, October 26, 1989, pg 152.
2. Leibson, Steven H, "EDN's All-Star PC project" parts 1-5, *EDN*, March 15, 1990, pg 142; March 28, 1990, pg 107; April 12, 1990, pg 117; April 26, 1990, pg 171; May 10, 1990, pg 91.
3. Small, Charles F, "Real-time Unix & Unix look-alikes," *EDN*, June 7, 1990, pg 88.
4. Wright, Maury, "Intelligent cards display megapixels," *EDN*, August 2, 1990, pg 81.

Article Interest Quotient (Circle One)

High 500 Medium 501 Low 502

Manufacturers of Unix for 80386/486 μ Ps

For more information on Unix packages such as those discussed in this article, circle the appropriate numbers on the Information Retrieval Service card, or use EDN's Express Request service. When you contact any of the following manufacturers directly, please let them know you saw their products in EDN.

- | | | |
|--|---|---|
| <p>Apple Computer Inc
20525 Mariani Ave
Cupertino, CA 95014
(408) 996-1010
TLX 171576
Circle No. 650</p> | <p>Open Software Foundation Inc
11 Cambridge Center
Cambridge, MA 02142
(617) 621-8700
FAX (617) 225-2782
Circle No. 653</p> | <p>Unix International Inc
20 Waterview Blvd
Parsippany, NJ 07054
(201) 263-8400
FAX (201) 263-8401
Circle No. 655</p> |
| <p>Intel Corp
3065 Bowers Ave
Santa Clara, CA 95051
(800) 548-4725
FAX (408) 765-5170
Circle No. 651</p> | <p>The Santa Cruz Operation Inc
400 Encinal St
Santa Cruz, CA 95061
(408) 425-7222
FAX (408) 458-4227
Circle No. 654</p> | <p>Unix System Laboratories Inc
Box 1914
Morristown, NJ 07962
(800) 828-8649
Europe: 44-81-567-7711
Asia: 81-3-431-3670
Circle No. 656</p> |
| <p>Interactive Systems Corp
2401 Colorado Ave
Santa Monica, CA 90404
(213) 453-8649
FAX (213) 828-6453
Circle No. 652</p> | | |

Advanced Pressure Sensors

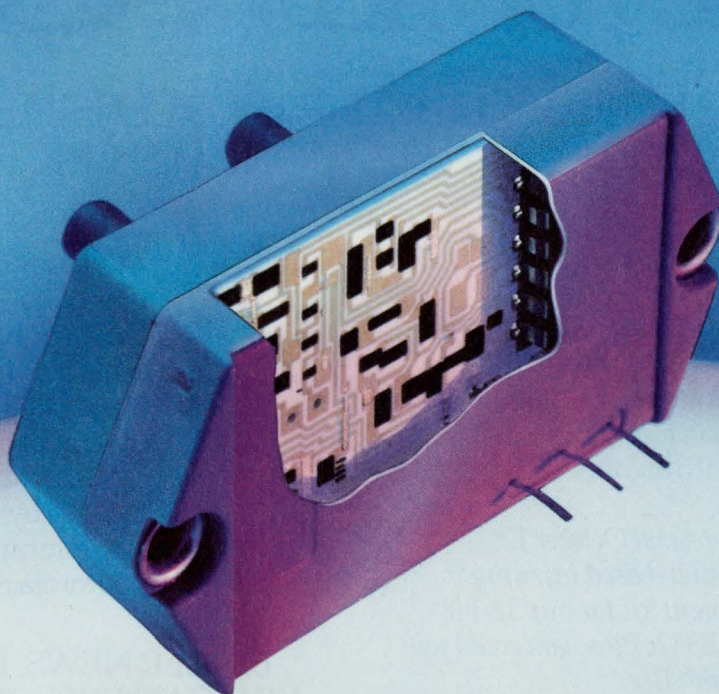

FOR: MEDICAL INDUSTRIAL HVAC

Sensym's 142/163 Series

Features Include:

- Guaranteed precision over temperature: $\pm 1\%$ Max (-18°C to $+63^{\circ}\text{C}$)!
- High level calibrated output: $1.0\text{V} \pm 50\text{mV}$ offset
 $5.0\text{V} \pm 50\text{mV}$ span
- Linearity: $<0.75\%$ FSO Max

These precision transducers are priced starting at **\$40 ea/100's. Stock delivery.**

Available parts:

- 163SC01D48** ... -20 to $+120\text{cmH}_2\text{O}$
142SC series .. 0 to 1psi up to 0 to 150psi



CIRCLE NO. 130

Free Handbook



Sensym's new 1990 Sensor Handbook gives complete product specifications plus over 200 pages of application notes and ideas.

Call or fax us today for your free Sensor Handbook.

BIG CHANGE.

FOR THOSE WHO KNOW THE WORLD IS HEADED FOR HIGH PERFORMANCE, MORE POWER TO YOU.

If you're among the leading-edge designers on a power trip to the future, consider this. Motorola's Microcontroller Division just cut your travel costs with an offer too good to miss:

*Act between September 4 and October 12, and you can get a computer-based learning program and a development kit for our 32-bit microcontrollers for just \$332. Plus, you could win a supercharged Macintosh® IIfx.**

This offer is the perfect way to learn about Motorola's 68332. The one microcontroller that delivers the 32-bit performance and integration you will need to be competitive in tomorrow's world. And it's available from Motorola today.

THE 68332. A BIG PART OF THE FUTURE.

The 68332 is simply the world's most powerful microcontroller. It contains a full 32-bit HCMOS CPU surrounded by smart, modular on-chip peripherals, including a *RISC-based Time Processor Unit*.

The 68332 is backed by the unsurpassed 32-bit software base of our 68000 microprocessors. And its modular architecture will keep your product designs evolving right along with our expanding portfolio of microcontroller peripherals.



BIG NEWS. NEW LOW COST.

Thanks to Motorola's aggressive production ramps, the price of power will be less than you might expect. To find out just how low prices will be by the time your applications reach volume production, check with your Motorola representative.

BIGGER NEWS. FOR JUST \$332, YOU CAN EXPLORE THE WORLD OF 32-BIT TODAY.

No matter where you are on your move toward higher performance, our 32-bit learning tools can be invaluable.

If you're at the 16/32-bit decision point, use them as a basis for immediate comparison. Or use them to prepare for future migration when you're ready to step up to 32-bit performance. (As you make your move up, be sure to mail in the attached coupon for details on our soon-to-be-announced compatible 16-bit Family.)

START OUT SMALL. END UP WITH BIG RESULTS.

This \$332 introductory offer, *available only through your Motorola distributor*, includes our \$32 68332CLP computer-based learning

SMALL CHANGE.

FOR THOSE WHO WANT TO KNOW MORE,
OUR 32-BIT LEARNING TOOLS ARE NOW JUST \$332.

program. As well as the \$300 68332KIT.

The 68332CLP learning program alone is the equivalent of a full-day instructional seminar. It features a MS-DOS® programmed learning disk and a complete set of manuals that teach you how to design the 68332 into your next system.

The 68332KIT development package has everything you need to learn hands-on operation of the 68332, including a Business Card Computer (BCC). With a surface mount 68332, 128K bytes of EPROM, 64K bytes of RAM, and a RS232 port, the BCC provides stand-alone evaluation of the 68332 on a board the size of a business card.

The 68332KIT also features a Platform Board for mounting the BCC in expanded development operations. As well as assembler software. And a variety of support literature.

Perform the exercise included in your 68332KIT or 68332CLP and send us your completed entry form by December 31, 1990. If you performed the exercise correctly, you become eligible for a drawing to win one of five Mac IIfxs. (The Mac IIfx can be awarded to you, your company, or your favorite charity.)



HURRY. WHILE THE POSSIBILITIES ARE ENDLESS, THIS OFFER IS NOT.

Our \$332 special offer is the perfect chance to consider making a big change in power and performance for small change. To order, call your Motorola distributor today.

But hurry. Quantities are limited.** And this great price is good only through October 12.

All prices are manufacturer's suggested retail price.

**No purchase necessary. For entry details, write: Motorola, Inc., Dept. OE39, 332 Promo, 6501 William Cannon Drive West, Austin, Texas 78735-8598*

***While supplies last. Limit 3 per customer.*

Macintosh is a registered trademark of Apple Computer, Inc.

MS-DOS is a registered trademark of Microsoft Corporation.

To receive a Technical Data Sheet for the 68332, plus news on our other 68300 Family products and our upcoming 16-bit high performance products, please complete and return this coupon to:

Motorola, Inc.
P.O. Box 1466
Austin, Texas 78767

EDN9/17/90

Name _____
Company _____
Title _____
Address _____
City _____
State _____ Zip _____ Phone _____

THE PATHWAY TO PERFORMANCE.



MOTOROLA

BELL
2000 pts 50 kHz
Sample Rate

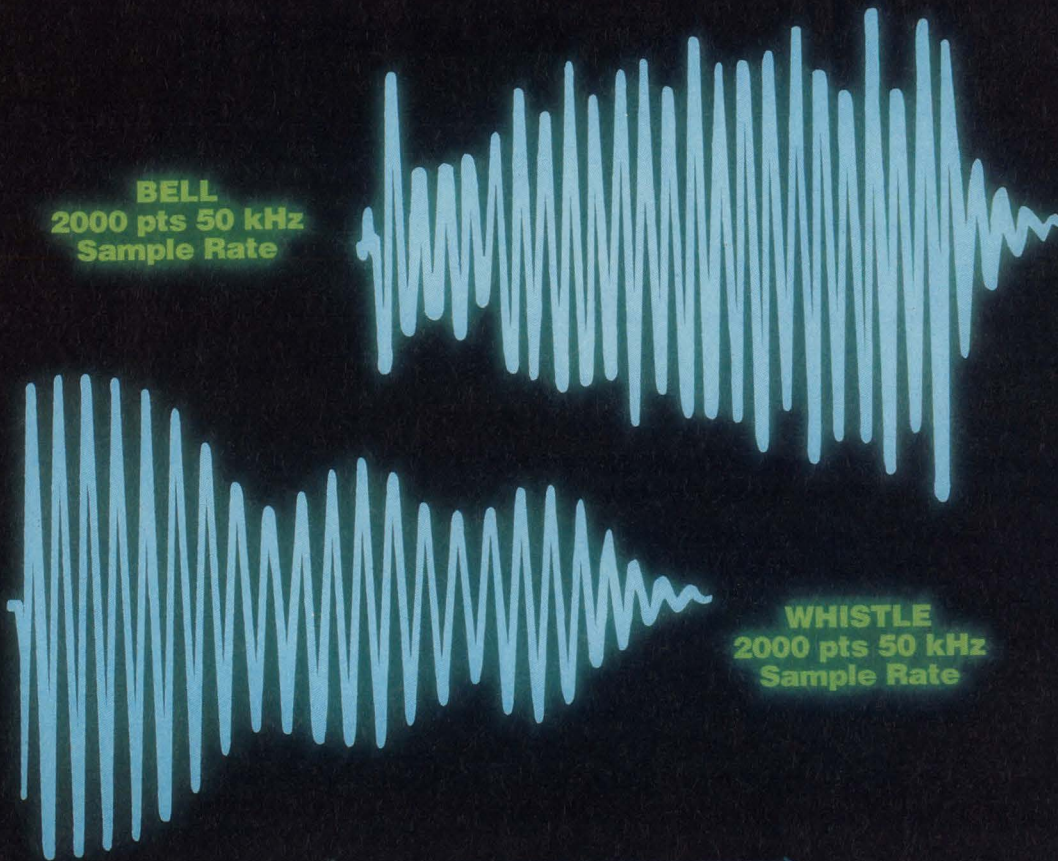

WHISTLE
2000 pts 50 kHz
Sample Rate

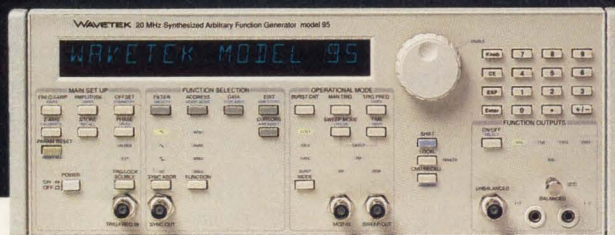

Our new function generator has all the bells and whistles.

In fact, it has any kind of waveform you can imagine. Because the Model 95 combines a high performance function generator with a powerful arbitrary generator.

As a function generator, Model 95 produces remarkably pure square waves, triangles and sines, from 1 mHz to 20 MHz with synthesized accuracy up to 0.001%. It has

the power to output 15 V_{p-p} into 50Ω, and includes sweep, pulse and modulation modes plus four user-selectable output impedances. There's even an internal trigger generator for trigger, gate and burst.

If you'd rather be arbitrary, Model 95 gives you up to 128k of waveform memory to work with, and a sample rate of 20 MHz. Four different editing

modes help you produce even the most complicated wave shapes quickly and accurately, while analog and digital filters allow you to create the purest output possible.

For information about all the other bells and whistles you'll find on the Model 95, call Wavetek San Diego, Toll Free at **1-800-874-4835** today.

TOKIN TROUNCES EMI



It's the hottest game going: an all-star lineup of the finest EMC devices in the league—devices that get you through the current season, and many seasons to come.

Engineering improvements in digital and communications equipment require super-high speed switching for power supplies and ever-higher frequencies for system clocks and picture carriers. To deal with this, EMI regula-

tions are getting stricter and EMC countermeasures are growing increasingly complex.

For TOKIN, however, it's all just part of the game. Indeed, we supply the world's leading electronics

manufacturers—and countless smaller makers—with a wide range of grand-slam EMC products every day. In fact, there's a good chance some of the equipment you're using right now boasts TOKIN devices.

So for performance that truly excels, check the EMC rankings.

Then give us a call and let us know your needs.

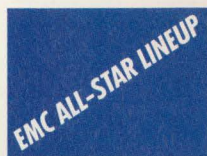

DC Noise Filters
(DFD Series)



DC Line Filters
(Type SH)



DIP Noise Filters



S-DIP Filters

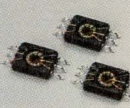

EMC Chip Filters
(M-600 Series)

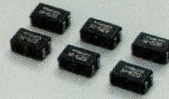

EMI Cores
(ESD-QR Series)



EMI Cores
(ESD-C Series)



EMI Cores
(ESD-FPL Series)



EMI Core
(ESD-FPD Series)



EMI Cores
(ESD-R-S Series)



EMC Chip Filters
(M-700 Series)

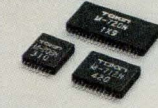

Bead Inductors

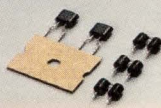

Feed through Capacitor
Filters



SB Coils (SBT Series)



SN Coils (SNT Series)

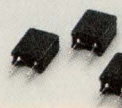

SN Coils
(SN-S3M Series)



EMI Connectors

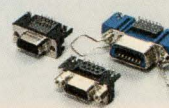

Tokin Corporation

Hazama Bldg., 5-8, Kita-Aoyama 2-chome, Minato-ku, Tokyo 107, Japan
Phone: 03-402-6166 Fax: 03-497-9756 Telex: 02422695 TOKIN J

Tokin America Inc.

155 Nicholson Lane, San Jose, California 95134, U.S.A.
Phone: 408-432-8020 Fax: 408-434-0375
Chicago Branch
9935 Capitol Drive, Wheeling, Illinois 60090, U.S.A.
Phone: 708-215-8802 Fax: 708-215-8804

Tokin Electronics (H.K.) Ltd.

Room 806 Austin Tower, 22-26A, Austin Avenue, Tsimshatsui, Kowloon, Hong Kong
Phone: 367-9157 Fax: 739-5950
Taiwan Liaison Office
7/F-2, No.200, Sec.3, Hsin-Yi Road, Taipei
Phone: (02) 7059310-1 Fax: (02) 7015650
Singapore Liaison Office
140 Cecil Street, No.13-01 PIL
Phone: (65) 2237076 Fax: (65) 2236093

München Liaison Office

Elisabethstraße 21, 8000 München 40, Bundesrepublik Deutschland
Phone: (089) 271 75 22 Fax: (089) 271 75 67
Telex: 5 24 537 tokin d

You can reach our agents by phone: Denmark (03) 63 3830; France (1) 45-34-7535; Italy (0331) 67-8058; Spain 729-1155; Switzerland (01) 830-3161

For your next design application...







15 great reasons for Aromat's leadership

	NEW T-SERIES			High Breakdown Voltage Capacity	Miniature Power	Ultra-Miniature	Highly Reliable DIP
	TQ	TF	TN	DS	DSP	DF	DR
• Dimension (inches) L x W x H	.551 x .354 x .197	.551 x .354 x .307	.551 x .220 x .386	.787 x .390 x .366	.795 x .433 x .394	.630 x .390 x .276	.787 x .394 x .323
• Type of relay	NEW T-SERIES			High Breakdown Voltage Capacity	Miniature Power	Ultra-Miniature	Highly Reliable DIP
• Features	<ul style="list-style-type: none"> Most advanced polarized relay High sensitivity 1500V FCC surge satisfied 4 pole model available 	<ul style="list-style-type: none"> 80mW nominal operating power 48VDC coil available Surface mount models available 1500V FCC surge satisfied 	<ul style="list-style-type: none"> Vertical TQ Relay Ultra-slim size High sensitivity 1500V FCC surge withstand voltage 	<ul style="list-style-type: none"> 1500V FCC surge satisfied High sensitivity High switching power Ag-Pd contact type available IC Relay option 	<ul style="list-style-type: none"> 1500V FCC surge satisfied High sensitivity High switching capacity 	<ul style="list-style-type: none"> Ultra-small type .28" x .63" x .39" High sensitivity DIL Terminal 	<ul style="list-style-type: none"> High sensitivity High sticking resistance High breakdown voltage High speed operation—1msec IC Relay option
• Sealed types	●	●	●	●	●	●	●
• Latching types	●	●	●	●	●	●	●
• Contact arrangement	2C, 4C	2C	2C	1C, 2C, 4C	1a, 1a1b, 2a	2C	1C
• Contact rating	0.3A, 110VDC 0.5A, 125VAC 1A 30VDC	0.3A 110VAC 0.5A 125VAC 1A 30VDC	0.3A 110VDC 0.5A 125VAC 1A 30VDC	0.6A 125VAC 0.6A 110VDC 2A 30VDC	(1a): 8A, 250VAC (1a1b, 2a): 5A, 250VAC	0.3A 125VAC 1A, 30VDC	0.3A 110VAC 1A 20VDC
• Life (min. operations)	Electrical (at rated load)	2 × 10 ⁵	2 × 10 ⁵	2 × 10 ⁵	5 × 10 ⁵	10 ⁵	10 ⁶
	Mech.	10 ⁸	10 ⁸	10 ⁸	10 ⁸	5 × 10 ⁷	5 × 10 ⁶
• Breakdown voltage	1000Vrms	1000Vrms	1000Vrms	1500Vrms	3000Vrms	1000Vrms	1500Vrms
• Surge withstand voltage	1500V FCC	1500V FCC	1500V FCC	1500V FCC	1500V FCC	—	1500V FCC
• Coil voltage	(DC) 3, 5, 6, 9, 12, 24V	(DC) 1.5, 3, 5, 6, 9, 12, 24V, 48V	(DC) 3, 4.5, 5, 6, 9, 12, 24V	(DC) 1.5, 3, 5, 6, 9, 12, 24, 48V	(DC) 3, 5, 6, 9, 12, 24V	(DC) 1.5, 3, 5, 6, 9, 12, 24V	(DC) 3, 5, 6, 12, 24, 48V
• Nominal operating power	(Single) 140mW (-L) 100mW (-L2) 200mW	(Single) 80mW (-L) 55mW (-L2) 110mW	(Single) 140mW (-L) 100mW (-L2) 200mW	Standard: 400mW Sensitive: 200mW	(Single): 300mW (-L): 150mW (-L2): 300mW	(Single) 200mW (-L) 100mW (-L2) 200mW	(Single) 96mW (-L) 50mW (-L2) 111mW
• UL, CSA, VDE	UL/CSA	UL/CSA	UL/CSA	UL/CSA	UL/CSA	UL/CSA	—

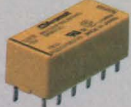

Relays totally produced in our advanced manufacturing facility in San Jose, Ca.

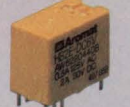
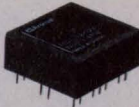
in relay technology.

							
.787 x .394 x .394	1.102 x .472 x .394	1.220 x .551 x .433	1.969 x 1.008 x .807	1.189 x .787 x .425	.787 x .433 x .618	.600 x .906 x .370	.795 x .441 x .358
Half-Size Amber	High Density Amber	Field Switching Power	Compact Power Sensitive	Flatpack	Subminiature DIP	High Frequency	Miniature High Frequency
R	SEB	STE	SP	NF	HB	RG	RK
<ul style="list-style-type: none"> • Magnetically shielded • High sensitivity • High speed operation—1 msec (max) 	<ul style="list-style-type: none"> • High sensitivity • High vibration and shock resistance • Low thermal electromotive force—3μV • DIL terminal 	<ul style="list-style-type: none"> • High sensitivity • Large capacity in small size • Capable of switching field inductive loads • High inrush capability 	<ul style="list-style-type: none"> • High sensitivity • High vibration and shock resistance • Wide switching range 	<ul style="list-style-type: none"> • 1500V FCC surge satisfied • Low profile • High sensitivity • MBB contacts available • Ag-Pd contacts type available 	<ul style="list-style-type: none"> • DIP terminal • Flux-resistant • Ag-Pd contacts type available 	<ul style="list-style-type: none"> • Excellent high frequency characteristics • Characteristic impedance 50Ω & 75Ω types 	<ul style="list-style-type: none"> • Isolation 60dB min. at 1.5GHZ • Insertion loss 0.3dB max. at 900MHZ
IC Relay option	IC Relay option	IC Relay option	IC Relay option				
●	●	●	●	●	●	●	●
●	●	●	●	●	●	●	●
1C	2a2b, 4a	1a1b, 2a	2C, 4C	2C, 4C,	1C, 2C	1C, 2C	1C
0.3A 110VAC 1A 20VDC	4A 250VAC 3A 30VDC	8A 250VAC 5A 30VDC	(2C) 15A 250VAC (4C) 10A 250VAC	0.5A 125VAC 2A 30VDC	1A 125VAC 2A 30VDC	1A 24VDC	0.01A 24VDC
10 ⁶	10 ⁵	10 ⁵	10 ⁵	10 ⁶	2 x 10 ⁵	10 ⁵	3 x 10 ⁵
10 ⁹	10 ⁸	10 ⁷	5 x 10 ⁷	(2C) 3 x 10 ⁸ (4C) 10 ⁸	10 ⁷	5 x 10 ⁶	5 x 10 ⁶
1000Vrms	1500Vrms	3750Vrms	3000Vrms	1000Vrms	1000Vrms	2000Vrms	1000Vrms
—	—	—	—	1500V FCC	—	—	—
(DC) 5, 6, 12, 24, 48V	(DC) 5, 6, 12, 24, 48V	(DC) 3, 5, 6, 12, 24, 48V	(DC) 3, 5, 6, 12, 24, 48V	(DC) 5, 6, 12, 24, 48V	(DC) 3, 5, 6, 12, 24, 48V	(DC) 3, 5, 6, 9, 12, 24, 48V	(DC) 3, 5, 6, 9, 12, 24V
(Single) 150mW (-L) 70mW (-L2) 150mW	192 to 355mW	240mW	300mW	(2C) 300mW (4C) 480mW	(1C) 360mW (2C) 580mW	(Single) 350-400mW (-L) 180-200mW (-L2) 350-400mW	(Single) 200mW (-L) 200mW (-L2) 400mW
UL/CSA	UL/CSA	UL/CSA	UL/CSA	UL/CSA or VDE	UL/CSA	—	—

Advanced switching technology.

For further information, contact your nearest Aromat sales office:

New Providence, NJ
Tel: (908) 464-3550

Marlboro, MA
Tel: (508) 481-1995

Orlando, FL
Tel: (407) 855-1075

Elk Grove Village, IL
Tel: (708) 593-8535

Richardson, TX
Tel: (214) 235-0415

San Jose, CA
Tel: (408) 433-0466

Garden Grove, CA
Tel: (714) 895-7707

Aromat Canada Inc.
Mississauga, Ontario
Tel: (416) 624-3777

Circle 18 Call Me I'm Interested
Circle 19 Send Literature



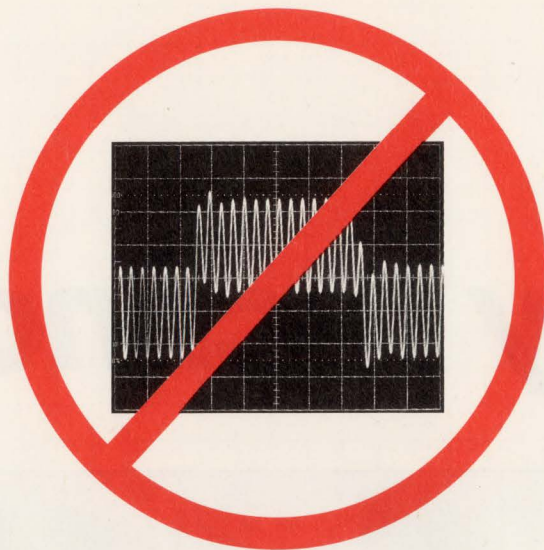

Eliminate Oscillation

OP-160 High-Speed Op Amp – New from PMI

PMI's new OP-160 gets your high-speed circuit designs working right the first time.

Unlike other high-speed op amps, the OP-160 is easy to use and can drive over 1000pF without oscillating.

The OP-160 has a very fast slew rate of 1300V/ μ s and a unity-gain bandwidth of 90MHz to meet the demands

of your high-speed applications. Settling time is only 75ns to 8 bits, 125ns to 12 bits. All of this performance requires only 6.5mA

of supply current for cool, reliable operation in space-saving 8-pin DIP and SO-8 packages.

And, the OP-160 is affordable—pricing starts at \$4.50 (100 pc.).

Plus, it's available in the extended industrial (-40°C to $+85^{\circ}\text{C}$) and full military temperature ranges.

To receive your free data package on PMI's easy-to-use OP-160, including full SPICE model and applications, call us at 800-843-1515 or FAX us at (408) 727-1550.

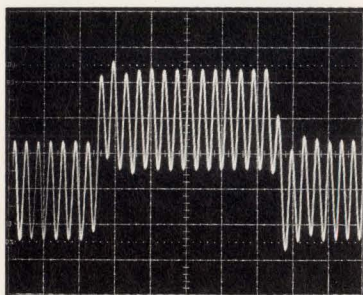

Theirs ($C_L = 100\text{pF}$)

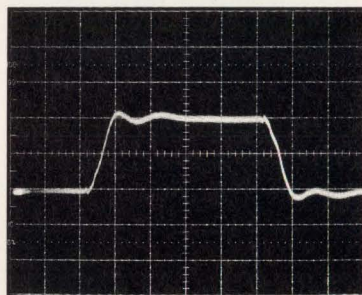

Ours ($C_L = 100\text{pF}$)

Or, circle the reader service number below.

If you require a dual high-speed amplifier, ask for PMI's OP-260.



PMI – your partner in analog integrated circuits.

Precision Monolithics Inc.
1500 Space Park Drive
Santa Clara, California 95054-3434

ALTAMONTE SPRINGS: (407) 831-8233, ATLANTA: (404) 263-7995, BOSTON: (508) 794-0026, CHICAGO: (708) 250-0808, DALLAS: (214) 690-3495, DENVER: (303) 792-9595, DETROIT: (313) 930-2051, LOS ANGELES: (818) 866-6881, MILPITAS: (408) 263-9366, ORANGE COUNTY: (714) 637-9602, PHILADELPHIA: (215) 953-1070

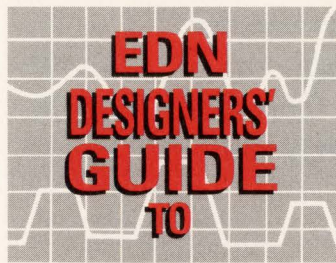

real-time Ada Part 2

Interrupt and low-level features link Ada code to your hardware

Part 1 of this 3-part Ada series discussed the language's tasking features for real-time programs. To achieve performance goals in embedded systems, Ada software must be closely coupled to the system hardware. This article, Part 2 of the series, shows how several of the language's features let you attain such coupling while adhering to the principles of software engineering.

Benjamin M Brosgol, *Alslys Inc*

The best programming language in the world won't help you design embedded systems if it ignores hardware considerations. Ada's designers walked a tight-rope when adding hardware-specific features to the language. On one hand, the designers wanted to maintain the general-purpose nature of the language. On the other, they knew that software must eventually run on real machines, so programmers would need ways to link their code to the hardware. Ada's interrupt and low-level facilities provide that link.

Orderly interactions between cooperating parallel activities are the basis for Ada's tasking model. For two tasks to synchronize or communicate, each must take explicit action by either accepting or calling an entry. In addition, Ada programming style encourages you to use parameter passing rather than shared data for intertask communications to avoid error-prone cou-

pling between modules. Any number of rogue routines, including modules that service interrupts, can easily corrupt shared data.

The interrupt structures built into most computing hardware do little to support good programming style. A hardware interrupt acts like a procedure call issued at some arbitrary (and thus uncontrolled) point in a program. This haphazardness does not match Ada's concept of cooperating parallel activities. Further, hardware devices vary widely in the way they enable and disable interrupts and the way they implement hardware priorities, which encourages and even forces you to create nonportable code. These real-world computing considerations complicate the mating of a general-purpose, high-level language such as Ada to various types of target hardware. The job becomes even more difficult when dealing with the special-purpose hardware used to create embedded systems.

Ada accommodates the interrupt-handling requirements of embedded applications despite the nonportability of embedded systems. The language also resolves the clash between the unstructured nature of interrupt-handling semantics and Ada's more orderly rendezvous model. Yet Ada's direct support of interrupts is minimal by necessity; hardware idiosyncrasies can easily stymie predefined solutions embedded in a programming language. Instead of special-purpose language structures, Ada provides a framework for dealing with interrupts in a high-level manner and relies

Hardware devices vary widely in the way they enable and disable interrupts. This dissimilarity encourages and even forces you to create nonportable code.

on a machine-specific, runtime implementation to efficiently and correctly map high-level code to the underlying hardware.

Ada uses its tasking model to manage the asynchronous nature of hardware interrupts. The interrupting device acts like an external Ada task with a priority higher than any software task. The interrupt instigates a call to an "interrupt entry" in an Ada server task supplied by the programmer. You associate the server task's interrupt entry with the actual hardware interrupt through a machine-dependent feature called an "address representation clause." The server task accepting the interrupt performs the interrupt handling.

An example of such an interrupt handler appears in Fig 1. The task `SENSOR_INTERRUPT_SERVER` designates memory location `A0HEX` as the address to which control passes when the sensor hardware inter-

rupts. The interrupt signals that new data is available for processing, and it results in an entry call to `SENSOR_DATA_AVAILABLE` with the data passed as a parameter. If the interrupt processing can keep pace with the interrupts, this scheme works well. However, interrupts may occur too often for the processing to keep up.

The hardware and software design of a system can also cause complications in interrupt handling. For example, in the interrupt structure of Intel's 8086 μ P and 8259A interrupt controller, a maskable or non-maskable interrupt that occurs with interrupts enabled will cause the hardware to perform a CLI (disable interrupts) instruction. The hardware will then call a routine located at an address given in a dispatch table. This routine should perform several functions: re-enable interrupts by executing an STI (enable interrupts)

```
with SYSTEM;

task SENSOR_INTERRUPT_SERVER is
    entry SENSOR_DATA_AVAILABLE ( DATA : SENSOR_DATA_TYPE );
    for SENSOR_DATA_AVAILABLE use at SYSTEM.TO_ADDRESS(16#A0#);
    ...
end SENSOR_INTERRUPT_SERVER;

task body SENSOR_INTERRUPT_SERVER is
    SENSOR_DATA : SENSOR_DATA_TYPE;
begin
    loop
        ...
        accept SENSOR_DATA_AVAILABLE ( DATA : SENSOR_DATA_TYPE ) do
            SENSOR_DATA := DATA;
        end SENSOR_DATA_AVAILABLE;
        -- Send the data to a monitor task:
        SENSOR_DATA_MONITOR.SET(SENSOR_DATA);
        ...
    end loop;
end SENSOR_INTERRUPT_SERVER;
```

Fig 1—Ada's entry calls handle interrupts just as they handle other Ada tasks. In this example, the low-level interrupt routine passes parameters to the called task through the `SENSOR_DATA_AVAILABLE` entry.

instruction as soon as possible; process any data associated with the interrupt; re-enable the interrupt hardware that triggered this routine; and finally return from the low-level interrupt-processing routine. In the context of Ada's interrupt entry model, this sequence of events raises several questions:

- Which code performs the hardware-specific aspects of handling the interrupt—the application program or Ada's runtime executive?
- What priority should the system use to execute the accept statement for an interrupt entry—a hardware priority or the task's software priority? In other words, can the interrupt service routine be pre-empted by another hardware interrupt? By a software task?
- Are there restrictions, for efficiency or semantic reasons, on the kinds of statements that can be executed during interrupt handling?
- What happens if an interrupt occurs but the handler task is not ready to accept the entry call? Is the interrupt lost, or is it somehow queued?
- Can a software task explicitly call an interrupt entry instead of the hardware calling it implicitly?
- How do you avoid the overhead of scheduler intervention and context swapping to get the interrupt handled?

To summarize, do Ada's interrupt structures provide the necessary expressive power to write practical interrupt handlers and can those structures be implemented efficiently? The answer to both questions is yes, because an Ada implementation can separate "immediate processing," which must be carried out at the hardware level, from "deferred processing," which an Ada task can perform.

Call the exec for immediate service

When an interrupt occurs, it causes a call on an assembler routine that is part of the Ada runtime executive. Under Alsys' implementation of Ada, this routine enables higher-level interrupts and then calls a user-provided routine that performs any required immediate processing. The user-provided routine can be written in assembly language or, with some restrictions because of the desire to minimize interrupt latency, in Ada. This routine performs all hardware-level manipulation and is responsible, in particular, for obtaining any data associated with the interrupt, buffering the data, calling an interrupt entry if appropriate, and re-enabling interrupts at the same hardware priority level.

When the immediate-processing routine calls an interrupt entry, the runtime executive checks to see if the called task is ready to accept the call. If it is, the executive pre-empts the currently executing task (unless it is of higher priority), and the called task accepts the call. If the called task is not ready to accept the call, the executive saves any parameters passed by the call in a user-defined buffer. The rendezvous will take place later using normal Ada tasking rules (see Part 1 of this series, *EDN*, September 3, 1990, pg 153). The parameter buffer ensures that interrupts are not lost, because the immediate-processing routine making the call does not suspend. The immediate-processing routine is not an Ada task; it must complete its run if all interrupts are to be acknowledged.

Deferred processing, which is optional, takes place in the task containing the accept statement for the associated interrupt entry. This processing occurs with interrupts enabled, and at a software priority higher than Ada tasks that do not service interrupts. Thus deferred processing can be pre-empted for the immediate processing of another interrupt or to allow deferred processing by another Ada task with a higher task priority. Deferred processing lets you use any Ada statements to service the interrupt's needs because interrupt latency is not a problem while this code is executing.

When you write interrupt service routines in Ada, you must decide whether to perform all interrupt handling in the immediate-processing step or use the 2-step (immediate and deferred processing) approach. You achieve greater efficiency if you perform all the processing in the immediate step because you incur no task-switching overhead. However, you lose generality with this approach because of the restrictions on the Ada statements you can use. Deferred processing through an interrupt entry places no restrictions on the kinds of statements it can execute because interrupt latency is not a problem; the hardware interrupts are always enabled during execution of the deferred-processing task. In addition, a normal Ada task can call an interrupt entry. This feature is useful during program simulation or debugging because you can call the deferred-processing task from another task and simulate the interrupt and the immediate-processing routine's call.

Thus, although interrupt handlers are heavily machine dependent, you can program them in Ada to take advantage of the language's tasking model. **Fig 2**

Text continued on pg 157

```

package SENSOR_PACKAGE is

    type SENSOR_DATA_TYPE is range 0 .. 2 ** 16 - 1;
    for SENSOR_DATA_TYPE'SIZE use 16;

    SENSOR_INTERRUPT : constant := 16#A0#;

    procedure IMMEDIATE_PROCESSING; -- Hardware interrupt handler

    task SENSOR_INTERRUPT_SERVER is
        entry DATA_AVAILABLE (DATA : SENSOR_DATA_TYPE);
        -- Called from IMMEDIATE_PROCESSING
        for DATA_AVAILABLE use at SENSOR_INTERRUPT;

        entry SHUTDOWN;
    end SENSOR_INTERRUPT_SERVER;

    task SENSOR_DATA_MONITOR is
        entry SET (ITEM : in SENSOR_DATA_TYPE);
        entry GET (ITEM : out SENSOR_DATA_TYPE);
    end SENSOR_DATA_MONITOR;

end SENSOR_PACKAGE;

with INTERRUPT_MANAGER, ARTK; -- Alsys packages
package body SENSOR_PACKAGE is

    PORT_8259 : constant := 16#20#;
    procedure IMMEDIATE_PROCESSING is separate;

    task body SENSOR_DATA_MONITOR is
        SENSOR_DATA : SENSOR_DATA_TYPE;
    begin
        accept SET (ITEM : in SENSOR_DATA_TYPE) do
            SENSOR_DATA := ITEM;
        end SET;
        loop
            select
                accept SET (ITEM : in SENSOR_DATA_TYPE) do
                    SENSOR_DATA := ITEM;
                end SET;
            or
                accept GET (ITEM : out SENSOR_DATA_TYPE) do
                    ITEM := SENSOR_DATA;
                end GET;
            or
                terminate;
            end select;
        end loop;
    end task body;
end package body;

```

Fig 2—Through immediate and deferred processing, Ada lets you use low-level code to immediately perform time-critical tasks associated with an interrupt. You can perform any extended processing required by your application in an Ada task that the immediate-processing routine calls.

```

end SENSOR_DATA_MONITOR;

task body SENSOR_INTERRUPT_SERVER is
  SENSOR_DATA : SENSOR_DATA_TYPE;
begin
  INTERRUPT_MANAGER.INIT_INTERRUPT_MANAGER
    ( NUMBER_OF_BUFFERS => 1, -- One buffer, 2 bytes
      MAX_PARAM_AREA_SIZE => 2 );
  INTERRUPT_MANAGER.INSTALL_HANDLER
    ( HANDLER_ADDRESS => IMMEDIATE_PROCESSING'ADDRESS,
      INT_NUMBER => SENSOR_INTERRUPT );
  -- Unmask Programmable Interrupt Controller:
  ARTK.CLI;
  ARTK.OUT_BYTE ( PORT => PORT_8259,
                 DATA => ARTK.IN_BYTE(PORT_8259) and 2#1101_1111# );
  -- Using IRQ5

  ARTK.STI;

  loop
    select
      accept DATA_AVAILABLE (DATA : SENSOR_DATA_TYPE) do
        SENSOR_DATA := DATA;
      end DATA_AVAILABLE;
    or
      accept SHUTDOWN;
      exit;
    end select;
    -- Send the data to a monitor task:
    SENSOR_DATA_MONITOR.SET (SENSOR_DATA);
  end loop;
  INTERRUPT_MANAGER.REMOVE_HANDLER( SENSOR_INTERRUPT);
end SENSOR_INTERRUPT_SERVER;
end SENSOR_PACKAGE;

with ARTK; -- Alsys Run-Time Kernel

with UNSIGNED;

separate (SENSOR_PACKAGE)

procedure IMMEDIATE_PROCESSING is
  -----

  -- This is the hardware interrupt handler. This procedure receives
  -- control with interrupts disabled and must not do any heap allocation, etc.

  -- This handler directly calls the server task for each received sensor value.
  -- In case the previously read sensor value has not yet been processed, it is
  -- overwritten by the current value.
  -----

  SENSOR_DATA : SENSOR_DATA_TYPE;

  SENSOR_PORT : constant := ... ; -- implementation-dependent

  EOI      : constant := 16#20#;

begin
  -- Read the data from port SENSOR_PORT and pass it to the the server task:

  SENSOR_DATA := ARTK.IN_WORD(SENSOR_PORT);

```

Listing continued

```

SENSOR_INTERRUPT_SERVER.DATA_AVAILABLE(SENSOR_DATA);

-- Check if the entry called failed because the data buffer is occupied
-- If so, overwrite the value in the buffer
if INTERRUPT_MANAGER.NO_FREE_BUFFERS then
    ... -- Code that overwrites buffer value with SENSOR_DATA
end if;

-- Send EOI to interrupt controller:
ARTK.OUT_BYTE (PORT_8259, EOI);

-- Assumes the sensor generates an IRQ on master PIC

end IMMEDIATE_PROCESSING;

with CALENDAR;
with SENSOR_PACKAGE; use SENSOR_PACKAGE;
with TEXT_IO; use TEXT_IO;
procedure DRIVER is
    task SENSOR_DATA_REPORTER is
        entry SET_PERIOD (INTERVAL    : DURATION;
                         ITERATIONS  : INTEGER);
    end SENSOR_DATA_REPORTER;

    task body SENSOR_DATA_REPORTER is
        CURRENT, MAX, MIN    : SENSOR_DATA_TYPE;
        INTERVAL             : DURATION;
        ITERATIONS           : INTEGER;
        NEXT_TIME            : CALENDAR.TIME := CALENDAR.CLOCK;
    begin
        MAX := SENSOR_DATA_TYPE'FIRST;
        MIN := SENSOR_DATA_TYPE'LAST;

        accept SET_PERIOD (INTERVAL    : DURATION;
                          ITERATIONS  : INTEGER) do
            SENSOR_DATA_REPORTER.INTERVAL := INTERVAL;
            SENSOR_DATA_REPORTER.ITERATIONS := ITERATIONS;
        end SET_PERIOD;

        for I in 1 .. ITERATIONS loop
            SENSOR_DATA_MONITOR.GET (CURRENT);
            if CURRENT < MIN then
                MIN := CURRENT;
            end if;
            if CURRENT > MAX then
                MAX := CURRENT;
            end if;
            PUT_LINE ("Current: " & SENSOR_DATA_TYPE'IMAGE (CURRENT));
            PUT_LINE ("Max:    " & SENSOR_DATA_TYPE'IMAGE (MAX));
            PUT_LINE ("Min:    " & SENSOR_DATA_TYPE'IMAGE (MIN));

            NEXT_TIME := NEXT_TIME + INTERVAL;
            delay NEXT_TIME - CALENDAR.CLOCK;
        end loop;

    end SENSOR_DATA_REPORTER;

begin
    SENSOR_DATA_REPORTER.SET_PERIOD (INTERVAL => 2.0, -- seconds
                                     ITERATIONS => 100.0);

end DRIVER;

```

Deferred processing occurs with interrupts enabled, and at a software priority higher than Ada tasks that don't service interrupts.

Text continued from pg 153

shows an interrupt handler with both immediate and deferred processing. This handler periodically outputs statistics on sensor data supplied by an external device. Every two seconds, the program outputs the current sensor value together with the maximum and minimum values read since the program started execution. The program performs this processing 100 times. The sensor device signals an interrupt at level $A0_{\text{HEX}}$, and the data associated with the device is available as a 16-bit quantity at some port whose location is implementation dependent. The incoming data is sent to a monitor task. The program makes no assumption about the relative frequency of sensor interrupts versus sensor value retrievals. However, if the sensor interrupts arrive faster than the data can be processed, old values are discarded in favor of more recent ones. When the last statistic has been dispatched, the system shuts down by terminating all of its tasks.

A block diagram of this system's tasking structure appears in Fig 3. `SENSOR_PACKAGE` encapsulates the `SENSOR_INTERRUPT_SERVER` and `SENSOR_DATA_MONITOR` tasks as well as the `IMMEDIATE_PROCESSING` procedure. `DRIVER` is the main procedure for the program; it contains the `SENSOR_DATA_REPORTER` task that periodically obtains sensor data values and outputs the statistics.

This program uses several auxiliary packages. `TEXT_IO` and `CALENDAR` are standard Ada packages. `TEXT_IO` supplies subprograms for performing simple character I/O. `CALENDAR` provides the private type `TIME`, the `CLOCK` function for delivering the current `TIME` value, and several subprograms for manipulating `TIME` values such as adding a `TIME` and a `DURATION` to compute another `TIME`.

In addition to these predefined packages, the program employs several packages specific to Alsyl's Ada implementation. `UNSIGNED` declares operations for unsigned integer arithmetic and types such as the 8-bit `BYTE` and 16-bit `WORD`. `ARTK` provides access to Alsyl's runtime kernel services. For example, `IN_WORD` reads a word from a specified port address and `OUT_BYTE` outputs a byte. `INTERRUPT_MANAGER` is an Alsyl package that lets you install user-supplied interrupt handlers.

Several subprograms defined in `INTERRUPT_MANAGER` are called from the body of `SENSOR_INTERRUPT_MANAGER`. `INIT_INTERRUPT_MANAGER` establishes a buffer area for the

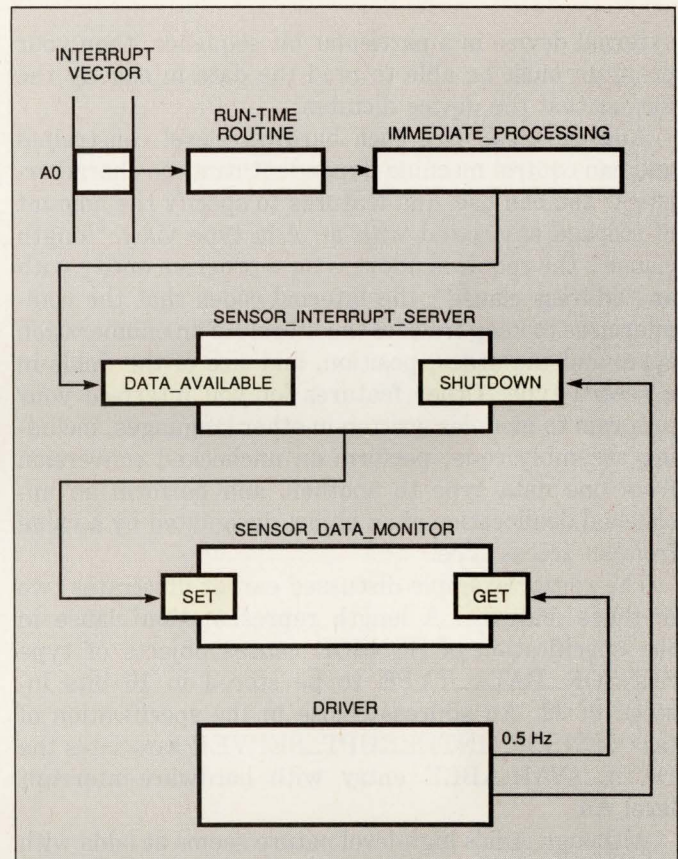

Fig 3—Tasks in an Ada program cooperate to perform periodic real-time data acquisition. By separating the low-level interrupt-driven processing from the higher-level logic, you can simplify your program's structure and make it easier to maintain.

parameters that need to be queued for later access to the interrupt entry. `INSTALL_HANDLER` arranges for the immediate-processing routine supplied by the user to be called during the hardware-level interrupt handling. `REMOVE_HANDLER` disables and removes the immediate-processing routine that handles the given interrupt.

Low-level features link to hardware

In addition to interrupt support, Ada provides features that map language structures to the hardware these structures represent. In general, you need not be concerned with an Ada compiler's particular mapping choices; good compilers perform optimizations that produce excellent runtime efficiency. In some situations, however, you cannot leave these decisions to the compiler. For example, if data arrives from an

Although interrupt handlers are heavily machine dependent, you can program them in Ada to take advantage of the language's tasking model.

external device in a particular bit sequence, then your program must be able to read the data in exactly the format that the device dictates.

Ada can deal with such hardware-level constraints and can control machine-dependent runtime characteristics. You can use Ada features to specify the amount of storage associated with an Ada type via a "length clause"; the required address for a program entity with an "address clause"; the internal codes that the compiler uses to keep track of the literals of an enumeration type; and the order, position, and size of the fields in a record type. Other features let you interface your program to modules written in other languages, including assembly code, perform an unchecked conversion from one data type to another, and perform an unchecked deallocation of an object designated by a value from an access type.

The sensor example discussed earlier illustrates two of these features. A length representation clause in the specification of `SENSOR` causes objects of type `SENSOR_DATA_TYPE` to be stored in 16 bits instead of 32. An address clause in the specification of task `SENSOR_INTERRUPT_SERVER` associates the `DATA_AVAILABLE` entry with hardware-interrupt level `A0`.

Although Ada's high-level nature seems at odds with these low-level facilities, the two actually combine rather smoothly. Ada separates the logical, high-level characteristics of a program entity from the lower-level, representational details. In any Ada program, you must specify at least the high-level, logical characteristics such as a record's type declaration. As an option, you can also specify representational details such as the layout of the record's fields. If you don't provide such information, the compiler chooses a representation for you. If you do provide representational details, they will override the compiler's default choices.

And you don't have to worry that programmers who subsequently modify, maintain, or reuse your program will miss any low-level customizing you have done. You must use instantiations of separately compiled, predefined generic units to obtain shortcuts such as unchecked type conversions and unchecked deallocations. This use of generics forces any program unit that needs these services to incorporate a *with* clause at its beginning that names the required generic unit(s). This rule exposes potentially dangerous pro-

gramming practices because anyone reading the unit's source code will immediately see the situation.

Ada's low-level features for real-time programs minimize interference with Ada's strong typing model. Their use is consistent with software engineering principles such as information hiding and modular programming. Using the language-defined features and the mechanisms offered by compiler vendors, programmers are developing more of their real-time systems in Ada.

EDN

Author's biography

Benjamin Brosgol is vice president and technical director at Alsys Inc (Burlington, MA). He is in charge of the company's Ada training and consulting, has helped develop Ada compilers and computer-based training products, and is chairman of the Commercial Ada Users Working Group of the SIGAda professional society. Benjamin holds an MS and PhD in Applied Mathematics from Harvard University in Cambridge, MA, and is a member of both the IEEE and the Association for Computing Machinery.

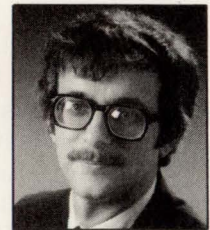

Article Interest Quotient (Circle One)
High 488 Medium 489 Low 490

WHAT'S COMING IN EDN

EDN Magazine's October 1, 1990, issue will feature a staff-written Special Report on Futurebus+. Our designers' guide to real-time Ada will conclude with Part 3. EDN's real-time programming series will continue with Part 2, which will discuss operating-system concepts and services. Staff-written Technology Updates will cover optoelectronic sensors, 32-bit development tools, and PC chip sets.

Analog Devices
delivers mixed-
signal technology
that meets today's
most demanding
specifications.



Faster.



ADSP-2101 – Talk about fast – this DSP microcomputer executes a 1024-point FFT in only 2.26 ms. That's faster than other DSPs that operate at almost twice the clock rate. And since our entire ADSP-2100 family is code compatible, your code will run fast on all of our DSPs.



AD9617 – The fastest slewing and settling op amp around slews at 1400 V/ μ s and settles to 0.02% in just 14 ns. And with a closed loop bandwidth of 200 MHz and harmonic distortion at 20 MHz of -59 dBc (max), it makes driving A/D converters easier than ever.



AD9712 – The only 12-bit, 100 MHz D/A converter on the market. Ideal for high-speed video and direct digital synthesis, its low glitch and low harmonics combine to deliver a spectrally pure output waveform.

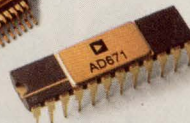

AD9060 & AD671 – The fastest 10-bit and 12-bit monolithic A/D converters, respectively. The AD9060 guarantees encode rates up to 75 MSPS for unparalleled dynamic performance. The AD671 is twice as fast as any other 12-bit monolithic, converting in under 0.5 μ s, thanks to our high-speed mixed-signal ABCMOS process.

Our Spectrum CAD Tool is 100 times faster than traditional SPICE programs, so it makes quick work of mixed-signal ASIC design cycle time.



Perfect on-time delivery—it's our goal and at 97% we're getting close, thanks to our continuous improvement process based on Total Quality Management. Over 150 TQM teams make the customer and quality improvement the focus of our entire organization. A focus that gets translated into not just catchy slogans, but real action.



Tap into 25 years of experience at our high-speed and mixed-signal design seminars. You'll learn new techniques that'll get your applications to work more quickly, and you'll get design manuals that put all this information right at your fingertips.

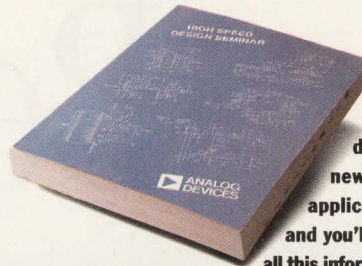

In the disk drive market, you've got to be fast—in both performance and time-to-market. That's why seven of the top 10 disk manufacturers rely on Analog Devices for mixed-signal components.

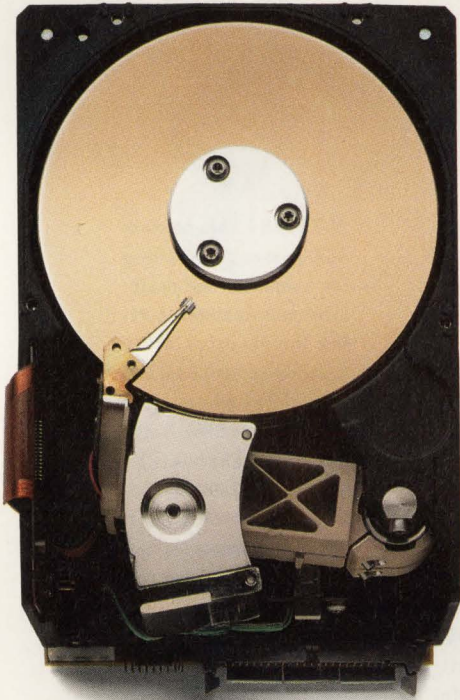

Our high-speed D/A converters will have eavesdroppers hopping mad. In direct digital synthesis applications, they allow communications receivers to hop frequencies 100 times faster than traditional analog techniques.



Faster development time means faster time-to-market. And that's what you get with our EZ-KIT, a complete design tool with a demonstration/evaluation board, DSP textbooks, and powerful, yet easy-to-use software.

Today, Analog Devices offers more high-performance mixed-signal components than anyone else. And we get them to you fast. So if you want mixed-signal ICs that'll help you design faster performing products, from a company that'll help you get your product to market faster, call us at 1-800-262-5643.



Better.

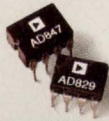

AD820/AD840 Series – If you're looking for the best in high-speed op amps, here they are – a whole family of components with the right combination of features to deliver high speed, precision, low noise, low input bias currents, low offset voltage and low drift performance. Our Complementary Bipolar process delivers gain-bandwidth products in excess of 750 MHz and slew rates in excess of 2000 V/ μ s.



ADV7141 – Our new Continuous Edge Graphics RAM-DAC gives users of standard low-end color monitors better graphics on their PCs. Graphics that are virtually the same as those produced on expensive engineering and scientific workstations. It does this by eliminating jagged edges, providing photo-realistic colors and shading, and displaying text comparable to a 300-dpi laser printer.



ADSP-2111 – Better integration on the best architecture in the industry. Adds an 8/16-bit host port to the two serial ports, timer, hardware companding and memory already on the ADSP-2101. And like all our DSPs, it's got fast, flexible arithmetic, wide dynamic range and a single cycle fetch of two operands (on- or off-chip). Plus it's code-compatible with the rest of our DSP family, so what's written today will be useful tomorrow.

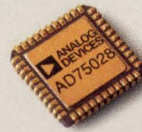

AD75028 – This custom ASIC passes the test for a top automatic test equipment manufacturer. Serving the function of 21 separate 12- and 8-bit D/A converters and providing on-chip static RAM, it also has seven channels of level setting (other monolithics only have four), and can automatically remove gain and offset errors.



We're your best source for linear, digital and mixed-signal information. Annually, we publish over 20 books and newsletters, and scores of applications notes. And our *Analog Dialogue* enjoys a worldwide readership of over 100,000 design engineers.

'Try, try again' is a costly way for manufacturers to find the best design solution. So to help our customers find answers to tricky problems the first time around, technical application engineers are just a phone call away. In some instances, they're even located right on the customer's premises.



Picture this – a PC monitor that offers the same color and clarity as a high-end engineering workstation costing as much as 20 times more. Our pin-compatible RAM-DAC is literally redefining the low end of the PC monitor market.



After analyzing semiconductor suppliers, many of the leading oscilloscope and spectrum analyzer manufacturers chose Analog Devices for their mixed-signal components. One reason is our ability to deliver high performance at high levels of integration – for example, our AD640, which replaces a chain of discrete log-amps for higher accuracy.



With our motion control ICs, several major aircraft companies are staying right on course. High reliability and accuracy are hallmarks of our 2S80, AD598 and the rest of our nearly 400 defense-qualified products.



People are hearing a lot better, thanks to our fully integrated baseband processing subsystem, which controls, conditions and converts I and Q channels in both the data transmit and receive paths.

Today, Analog Devices offers a better line of high-performance mixed-signal components than anyone else. And no one has a better record for reliability, or more experience in analog, DSP and mixed-signal ICs. If you want mixed-signal components that'll help you design better products, the best thing to do is to call us at 1-800-262-5643.



Cheaper.



ADSP-2105—High performance DSP at an incredibly low price. So low, in fact, you can now consider DSP in a host of new applications. And since it's pin-compatible with the ADSP-2101, and code-compatible with all of our other DSP processors, upgrading is easy and inexpensive.



AD712—If you're working in professional audio and compact disc applications, you'll like the sound of this—an IC that combines two high-performance op amps in one compact package. You get low offset voltage and low input bias currents coupled with superb transient response, ambience, clarity and dynamic range.

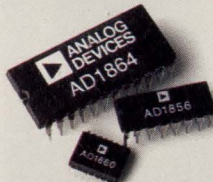

SOUNDPORT DACs—We've made these DACs cost-efficient by making them complete with output amplifier, reference and digital logic interface. Perfect for high-fidelity digital audio and multimedia applications, these mixed-signal ICs achieve SNRs as high as 108 dB and THDs as low as 0.0025%.



AD22001—One way to make a car less expensive is to make it with less parts. This component replaces a whole board of discrete analog and digital circuitry. It continuously monitors up to five automotive bulbs or indicators, along with the associated in-line fuse, and provides a digital status output.

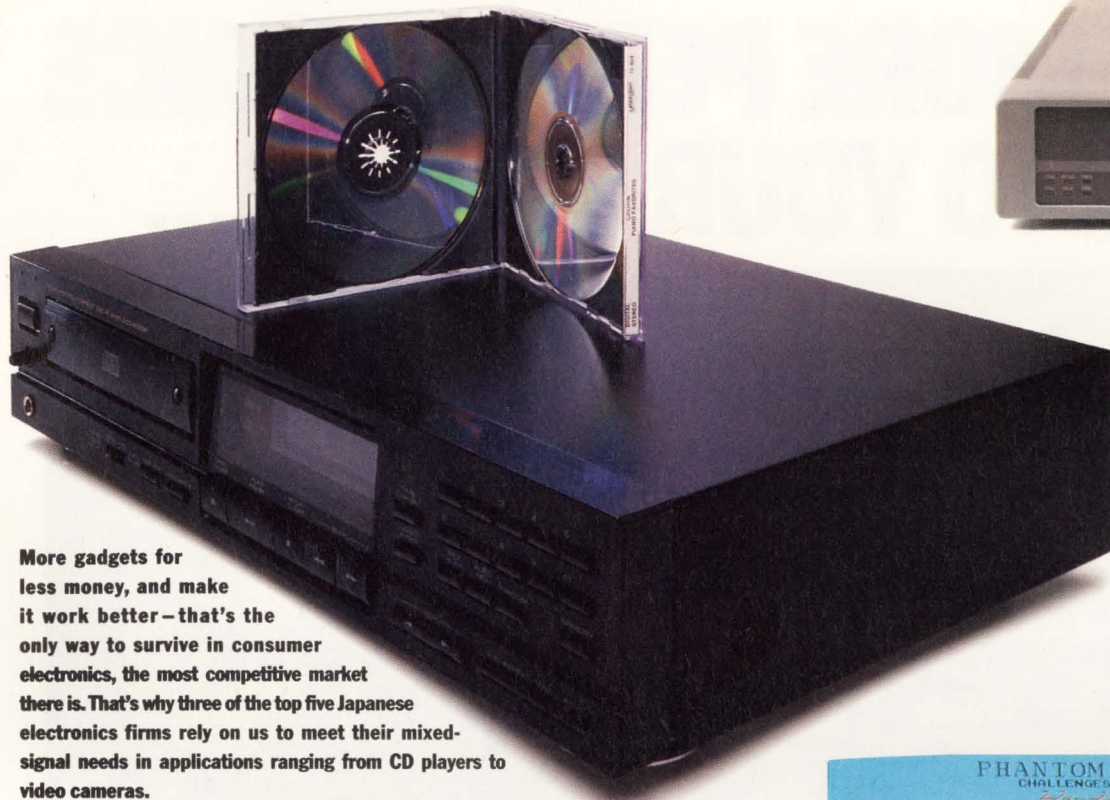

More gadgets for less money, and make it work better—that's the only way to survive in consumer electronics, the most competitive market there is. That's why three of the top five Japanese electronics firms rely on us to meet their mixed-signal needs in applications ranging from CD players to video cameras.



We've got the phone lines buzzing. Via our CMOS and Bipolar processes, we're helping modem makers turn out products that cost less yet perform better. We got the call because we have the broadest portfolio of process technology for signal processing. A portfolio that includes not only CMOS and Bipolar, but BiCMOS, Complementary Bipolar, Flash and many others.



We're far from your local component boutique. Over half of our \$540 million in revenues comes from international sales. And with manufacturing and stocking facilities on just about every continent, getting products to you quickly is a snap. Plus multiple manufacturing facilities allow us to take advantage of the right talent and processes for the job at hand.

Automakers certainly understand that manufacturing efficiency is a critical key to lowering production costs. That's why we've developed high-performance ICs for several car companies around the world, as well as companies making DAT equipment, disk drives, digital mobile phones, modems, and HDTV.



With billions of dollars in annual sales at stake, the video game market is anything but child's play. One leader in this market found that with our DSP they could create more realistic and interactive games. As a result, they're driving away with a bigger share of the market.



Today, Analog Devices offers more cost-effective solutions to your high-performance mixed-signal needs than anyone else. Solutions that are surprisingly affordable, whether they're available off the shelf or developed for a specific application. To find out more about how we can help you develop products more efficiently, or for a free copy of our recent Mixed-Signal Technology white paper, call us at 1-800-262-5643.



Analog Devices, Inc., One Technology Way, P.O. Box 9106, Norwood, MA 02062-9106. Headquarters: (617) 329-4700. Offices and applications support available worldwide.

PACK MORE PERFORMANCE INTO YOUR SYSTEM...

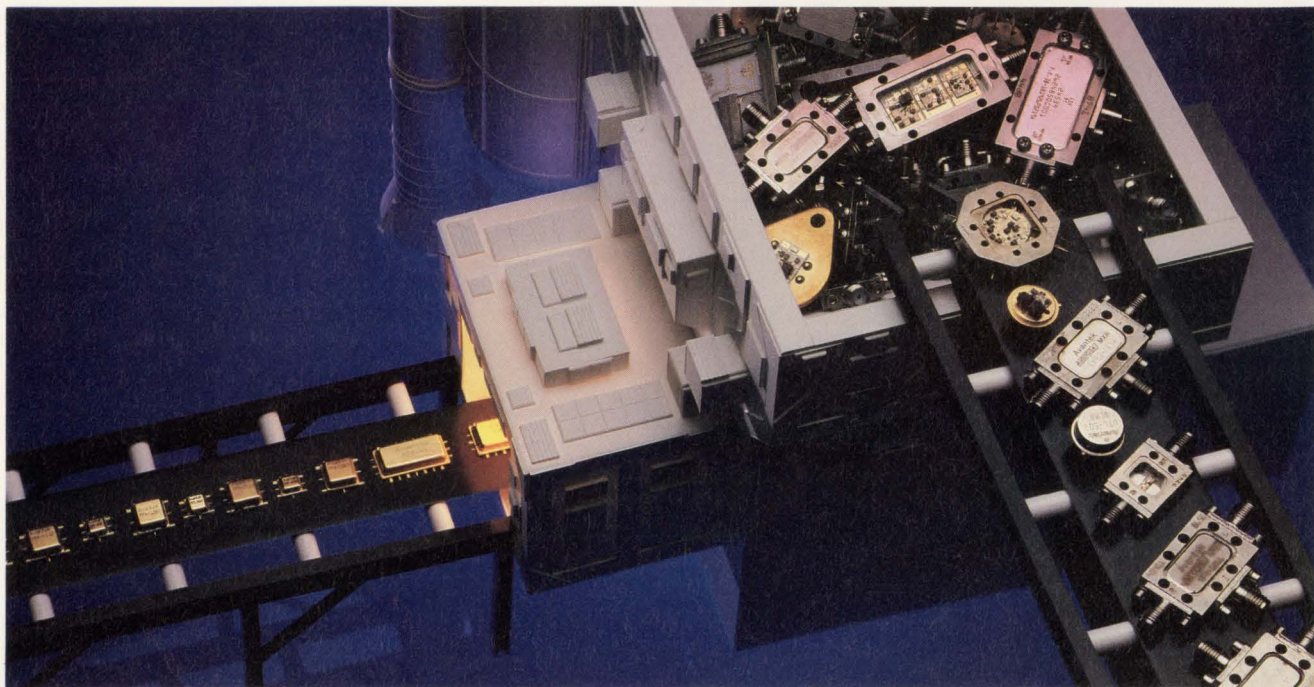

With PlanarPak™ Microwave Surface Mount Components... DC to 18 GHz

Your next microwave system needs more functions in less space. You're ready for the advantages of microwave surface mount technology (SMT)... AvanteK's PlanarPak™ components. You'll get smaller size†... lighter weight... increased board density... and, circuits on both sides of the board. Your design team can put the system you need together faster... with lower risk and more control, with off-the-shelf PlanarPak components. More than thirty different high performance

PlanarPak components provide DC to 18 GHz coverage. All are 50 ohm matched for easy microstrip integration. AvanteK offers the widest range of microwave functions in surface mount packages —

- Amplifiers — .01 to 18.0 GHz
 - Attenuators — .1 to 2.0 GHz
 - Detectors — .02 to 6.0 GHz
 - Limiting Amplifiers — .01 to 1.0 GHz
 - Mixers — .05 to 2.5 GHz
 - Switches — .01 to 2.0 GHz
- with more functions on the way. PlanarPak components make complete surface mount microwave systems a reality.

Designed for High Volume Applications in Demanding Environments

These hermetically sealed, thin-film MIC components are designed for rugged operating environments... missiles... smart munitions... expendables... and RPVs. Wherever size and performance are critical.

PlanarPak products are ideal for automated manufacturing. A proven technology... in volume production today at AvanteK.

SMT Application Assistance and Off-the-Shelf Delivery...

AvanteK, the world leader in microwave SMT, offers a comprehensive selection of literature, test fixtures, and technical assistance. And, all PlanarPak components are in stock at your local AvanteK distributor for immediate delivery. Contact us today to receive PlanarPak products literature and the name and address of your local AvanteK distributor.

†Three sizes: .25 x .25 x .11 in, .375 x .375 x .15 in and .4 x .8 x .15 in

AvanteK Regional Offices

North America
 Eastern: (301) 381-2600
 Central: (708) 358-8963
 Western: (805) 373-3870
 Europe: (44) 276-685753
 Asia: (01) (408) 943-5484

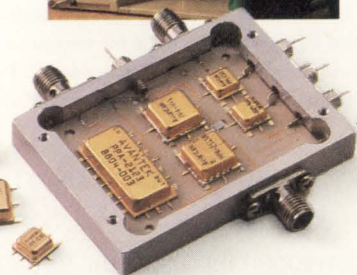

Current-feedback amps enhance active-filter speed and performance

In the past, off-the-shelf high-frequency active filters were rarely available because high-frequency, high-performance voltage-feedback amplifiers were simply too expensive. Active filters built around current-feedback amplifiers offer designers high performance without many of the disadvantages associated with passive filters.

Doug Smith, *Burr-Brown Corp*

Analog designers have historically relied on passive filters for applications with frequencies greater than 1 MHz. Until recently, designing viable active filters with cutoff frequencies at 1 MHz or greater was difficult because voltage-feedback amplifiers with sufficient gain-bandwidth products and short propagation delays were simply too expensive. The emergence of current-feedback, or transimpedance, amplifiers has significantly changed this picture. With these amplifiers and a conscientious design and pc-board layout, you can design active filters that operate at high frequencies. Active-filter applications are no longer restricted to the audio frequency range.

Active RC filters have many advantages over passive filters, and many of these advantages become in-

creasingly important as the frequency increases. For example, there is no insertion-loss penalty, and you can even have power gain if needed. A doubly terminated passive filter would decrease the signal by at least 50%. The elimination of inductors is the biggest advantage offered by active filters. This advantage doesn't involve size considerations alone.

Passive inductors are only linear for low power levels, much like transistors with no negative feedback. As you pump more current through the inductor, the magnetic core material begins to saturate and the inductor generates its own harmonic-distortion terms. The filter's transfer response will not necessarily suppress these signals. In an active RC filter, the amplifier quality and the sophistication of the design set the dynamic range. Theoretically, designers have a good deal of control over both of these parameters.

As a case study, consider three situations—a low-pass antialiasing filter, a bandpass filter, and a high-Q notch filter—in which active filters that incorporate current-feedback amplifiers provide a viable alternative to passive filters. All three filters will be designed around the Burr-Brown OPA603. You could implement the three designs using carefully selected, video-speed conventional op amps. However, current-feedback amplifiers more readily satisfy the low transit time and large bandwidth at high gain requirements for the example circuits. Let's start with the design of an antialiasing filter to drive the input of an ADC603—a 12-bit, 10-MHz A/D converter.

Many of the advantages of active RC filters become increasingly important as the frequency increases.

When dealing with A/D converters in filter work, the Nyquist theorem states that if any converter input harmonic frequency is greater than half the sampling rate, those frequencies must alias, or fold back, into the passband. Normally, this condition is not desirable. To skirt the issue, you must suppress any input frequencies that exceed the Nyquist rate before the converter sees them. The result of this maneuver is that the required attenuation becomes a function of converter resolution. It's also important for the filter to roll off as fast as possible. An elliptic response is the best choice because the addition of transmission zeros

in the stopband creates the sharpest roll-off theoretically possible for a particular number of poles without having to rely on mutual inductance.

The first step in designing the filter is calculating the attenuation requirements. You can do so by estimating the theoretical signal-to-noise ratio (SNR) using the expression

$$\text{SNR} = 6.02N + 1.8 \text{ dB},$$

where N is the number of bits. For the ADC603, the expression yields

$$\text{SNR} = 6.02 \times 12 + 1.8 = 74.04 \text{ dB}.$$

Making the case for current feedback

Don't get the idea that something is inherently wrong with voltage feedback, even at high speed. In fact, voltage-feedback amplifiers generally have a lower noise-floor specification than do current-feedback amplifiers. However, when comparing voltage- and current-feedback amplifiers, you must take the application into consideration. Current-feedback, or transimpedance, amplifiers have some distinct performance advantages as waveform speed gets higher and higher. These advantages can translate into higher-performance active filters.

The most striking difference between voltage-feedback and transimpedance op amps is that with a fixed-feedback resistor, the current-feedback amplifier has very low gain-bandwidth tradeoff. A transimpedance amplifier maintains its bandwidth at high gain settings—an advantage in active-filter topologies because a large gain is necessary to minimize sensitivity.

In addition, transimpedance amplifiers have very high slew rates compared with those of conventional voltage op amps. A

typical slew rate for a video-speed voltage-feedback amplifier is in the 200 to 300V/ μ sec range; a comparable current-feedback amplifier might slew as fast as 2500V/ μ sec. This slew-rate disparity is simple to explain. In a conventional amplifier, the slew rate is the ratio of the bias current flowing through the slewing node to the capacitance that can be referred back to that node. In a transimpedance amplifier, the feedback current mirrors and adds to the bias current flowing through the slew-rate-limiting node. Because more current is available to charge the capacitance, the slew rate increases. The feedback current is proportional to V^{OUT} , which is proportional to V^{IN} . So the harder you drive a current-feedback amplifier, the faster it slews. In practice, this fact effectively eliminates slew rate as a limiting factor in high-speed, active-filter design.

One final factor favors the transimpedance amplifier—settling time. Designers often choose a filter's transfer function for best time-domain response. There-

fore, ensuring that the amplifier settles to the required level substantially faster than the filter has to settle is crucial.

High-speed amplifiers are complicated devices and acceptable ac response does not necessarily ensure an acceptable settling time. Many conventional voltage-feedback op amps use internal pole-zero cancellation to increase their bandwidths. Analysis shows that a small mismatch in the pole-zero cancellation has a negligible effect on frequency response, but the scheme can dramatically boost settling time.

Transimpedance amplifiers have settling-time problems, too. Although transimpedance amplifiers settle to 0.1% (10 bits) or 0.02% (12 bits) in as little as 15 nsec, the settling time to 0.01% can be relatively long. The same current flow that increases the slew rate of a transimpedance amplifier also upsets the amplifier's bias point slightly, and a finite amount of time is required for the bias point to return to equilibrium. This effect is small, but it can often extend the 0.01% settling time to several microseconds.

The calculation shows that the guaranteed stopband attenuation must be greater than 74 dB. A search of standard design tables shows that a fifth-order elliptic lowpass response is a reasonable compromise between the transition width and the filter order. The general transfer function for this filter is

$$T(s) = \left(H_a \frac{s^2 + 6_{0a}}{s^2 + a_{1a}s + a_{0a}} \right) \left(H_a \frac{s^2 + 6_{0b}}{s^2 + a_{1b}s + a_{0b}} \right) \left(\frac{a_0}{s + a_0} \right).$$

You can now form the filter by cascading two second-order sections and one first-order section (**Fig 1b**). The essential equations (**Ref 1**) for the second-order sections are

$$T(s) = H(s^2 + b_0)/s^2 + a_1s + a_0$$

$$p = 1/\sqrt{b_0}$$

$$q = ((b_0/a_0) - 1)/2\sqrt{b_0}$$

$$K = 2 + (1/2)((b_0/a_0) - 1) - (a_1\sqrt{b_0}/a_0).$$

The essential equations for the first-order section are

$$T(s) = a_0/s + a_0$$

$$a_0 = 1/RC.$$

The task is to design a fifth order elliptic antialiasing filter (**Fig 1a**) with a guaranteed stopband attenuation of 75 dB and no more than 3 dB of passband ripple. In addition, the maximum attenuation should begin at 5 MHz—half the sampling rate.

The transfer coefficients (**Ref 1**) for this case are

$$a_{1a} = 0.096035$$

$$a_{0a} = -0.945044$$

$$b_{0a} = 10.47185$$

$$a_{1b} = 0.285481$$

$$a_{0b} = 0.413907$$

$$b_{0b} = 4.328514$$

$$a_{0c} = 0.191095.$$

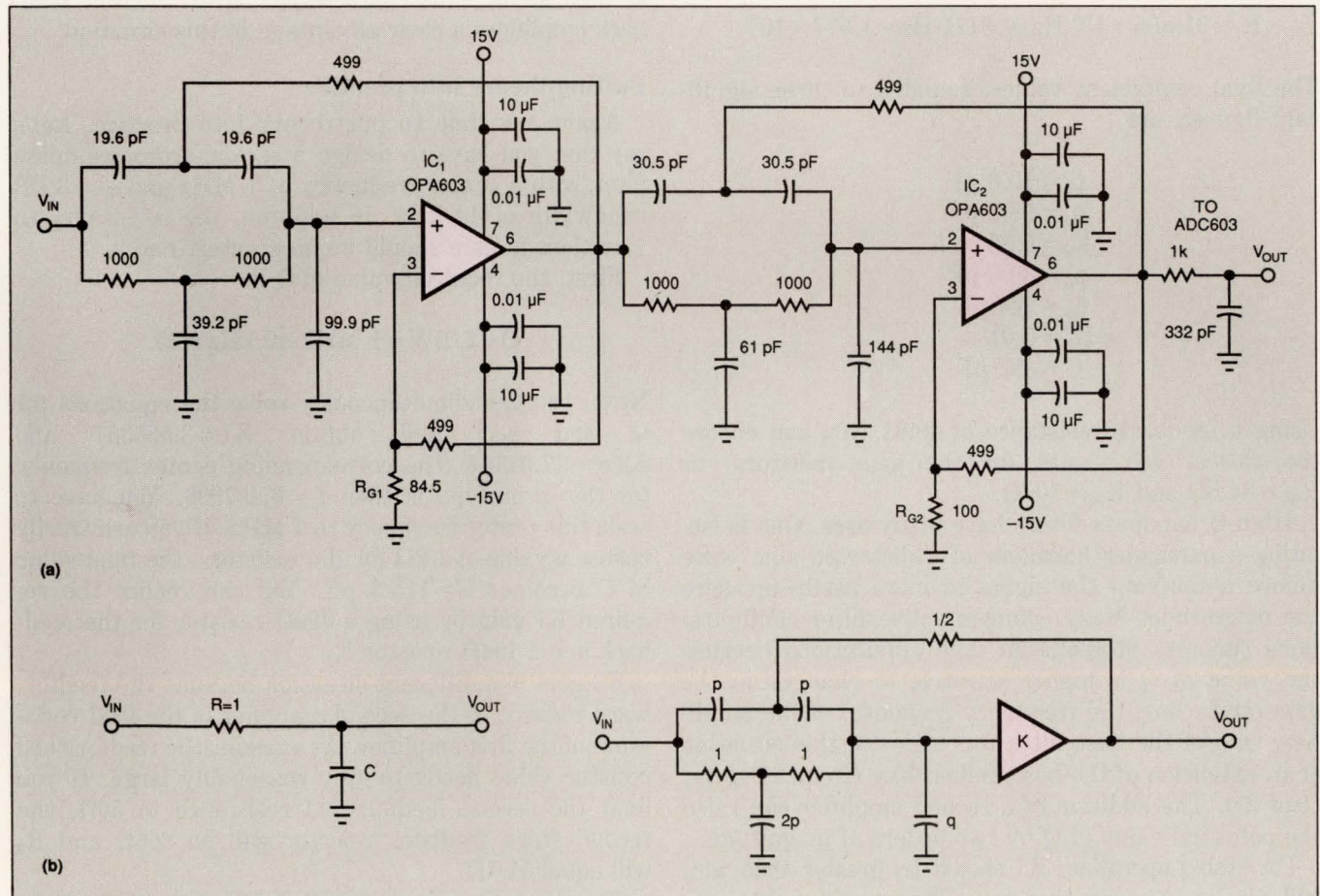

Fig 1—You need an antialiasing lowpass filter when you're driving an A/D converter. A fifth-order elliptic design (a) proves to be the best choice in such an application. You can use two second-order sections and one first-order section (b) to form the necessary filter.

Transimpedance amplifiers maintain their bandwidth at high gains—a definite advantage in bandpass-filter designs.

The corresponding component values are

$$\begin{aligned} p_a &= 0.309021 \\ q_a &= 1.557592 \\ K_a &= 6.875982 \\ p_b &= 0.480652 \\ q_b &= 2.272930 \\ K_b &= 6.011362 \\ R &= 1 \\ C &= 5.232999. \end{aligned}$$

This filter prototype has an f_3 bandwidth of 0.15912 (1 rad/sec), and its maximum attenuation begins at $f_{\text{STOPBAND}} = 0.3171$. In this case, you have to scale the frequency to f_{STOPBAND} rather than f_3 . In addition, you can arbitrarily scale the impedance to 1 k Ω . Multiply each resistor by this impedance value; divide every capacitor value (p, q, and C) by the frequency-impedance scaling factor, K_f :

$$K_f = 91k(95 \times 10^6 \text{ Hz})/0.3171 \text{ Hz} = 1.577 \times 10^{10}.$$

The final component values, rounded to three significant figures, are

$$\begin{aligned} p_a &= 19.6 \text{ pF} \\ q_a &= 98.8 \text{ pF} \\ K_a &= 6.88 \\ p_b &= 30.5 \text{ pF} \\ q_b &= 144 \text{ pF} \\ K_b &= 6.01 \\ C &= 332 \text{ pF}. \end{aligned}$$

Using a feedback resistance of 499 Ω , you can choose the closest 1% values for the gain resistors, or $R_{G1} = 84.5\Omega$ and $R_{G2} = 100\Omega$.

High-Q bandpass filters have many uses. One is isolating a particular harmonic of a distorted sine wave before amplifying the signal to more easily measure the magnitude. Many common active filter configurations run into problems in such applications because the value of Q is highly sensitive to changes in the gain (and, thus, the frequency response) of the amplifier. One of the best filter topologies in this situation is an extension of the basic Sallen-Key circuit (Fig 2a, (Ref 2)). The addition of a second amplifier can raise the potential value of Q by two orders of magnitude.

For stable operation, K1 should be greater than zero and K2 should be less than zero. The transfer function is

$$T(s) = K1 \times K2s / (1 - K1K2)s^2 + (4 - K1)s + 2.$$

From this expression, you can determine that

$$\begin{aligned} Q &= \sqrt{2(1 - K1K2)/4 - K1} \\ \omega_0 &= \sqrt{2/(1 - K1K2)}. \end{aligned}$$

The sensitivities of most concern involve the variations of Q when the gain of either amplifier changes. Analysis shows that

$$\begin{aligned} s_{K1}^Q &= K1(1 - 4K2)/(4 - K1)(1 - K1K2) \\ s_{K2}^Q &= K1K2/1 - K1K2. \end{aligned}$$

You can neglect s_{K2}^Q because it is approximately equal to 1 and is not a serious limitation. Although it's probably not obvious, there's a tradeoff between K2 and s_{K1}^Q . The higher the gain of K2, the lower the value of s_{K1}^Q . In a voltage type op amp, higher gain inherently means lower bandwidth. However, a transimpedance amplifier has the ability to maintain its bandwidth at high gains. This characteristic gives current feedback amplifiers a clear advantage in this situation.

Putting theory into practice

Again, it's time to put theory into practice. Let's say that you have to design a second-order bandpass filter with a center frequency of 1 MHz and a -3 dB bandwidth of 40 kHz. In addition, the sensitivity to variations in gain should be no greater than 9.

First, the required value of Q is

$$Q - f_0/BW = 1 \text{ MHz}/40 \text{ kHz} = 25.$$

Next, you can simultaneously solve the equations for Q and s_{K1}^Q and obtain $K1 = 3.556357$ and $K2 = -17.01347$. The corresponding center frequency for this prototype is then $f_0 = 0.287996$. You have to scale this center frequency to 1 MHz. If you arbitrarily choose a value of 1 k Ω for the resistors, the final value of C becomes $C = 115.3 \text{ pF}$. You can realize the required K1 gain by using a 499 Ω resistor for the feedback and a 196 Ω resistor R_1 .

K2 gain is a different situation because the feedforward resistor of the second amplifier is the load resistance of the first amplifier. As a result, the feedforward resistor value needs to stay reasonably large. If you limit the second feedforward resistance to 50 Ω , the second stage feedback resistor will be 866 Ω and R_2 will equal 51.1 Ω .

The dynamic range of high-frequency, moderately priced spectrum analyzers is often less than 80 dB. However, you can effectively increase the measure-

ment range by suppressing the fundamental frequency of the input signal by a known amount without affecting the rest of the frequency spectrum. This application doesn't require a high-order, band-reject filter—a low-order, high-Q notch filter will work quite well.

The classic twin-T network (Fig 3a) is a promising candidate for the job. The transfer function of this network is

$$T(s) = s^2 + \omega_0^2/s^2 + 4\omega_0s + \omega_0^2,$$

and the attenuation at any bandwidth equals

$$A_{dB} + 10 \cdot \log(1 + (4f_0/BW_{x \text{ dB}})^2).$$

This circuit has two drawbacks—it is somewhat sensitive to passive-component tolerances, and it has an intrinsic Q value of 0.25. The first drawback creates no problem but the second drawback must be overcome. You can substantially increase circuit Q value by adding a second amplifier to the network (Ref 3).

The new transfer function is now

$$T(s) = s^2 + \omega_0^2/s^2 + 4\omega_0(1 - K)s + \omega_0^2,$$

and the Q value is now a function of K:

$$Q = 1/4(1 - K).$$

As K approaches 1 from below, Q increases in an unlimited fashion. If K is greater than 1, however, the circuit is unstable. Although wide bandwidth at high gain is not as important here as it was in Fig 2's example, the comparatively lower transit time of a current-feedback amplifier should yield superior performance in this application.

A specific example will prove the point. The task is to design a 1.5 MHz notch filter that has a -3 dB bandwidth of 225 kHz. The first step is to calculate Q using the expression

$$Q = f_0/BW_{-3 \text{ dB}} = 1.5 \text{ MHz}/225 \text{ kHz} = 6.66.$$

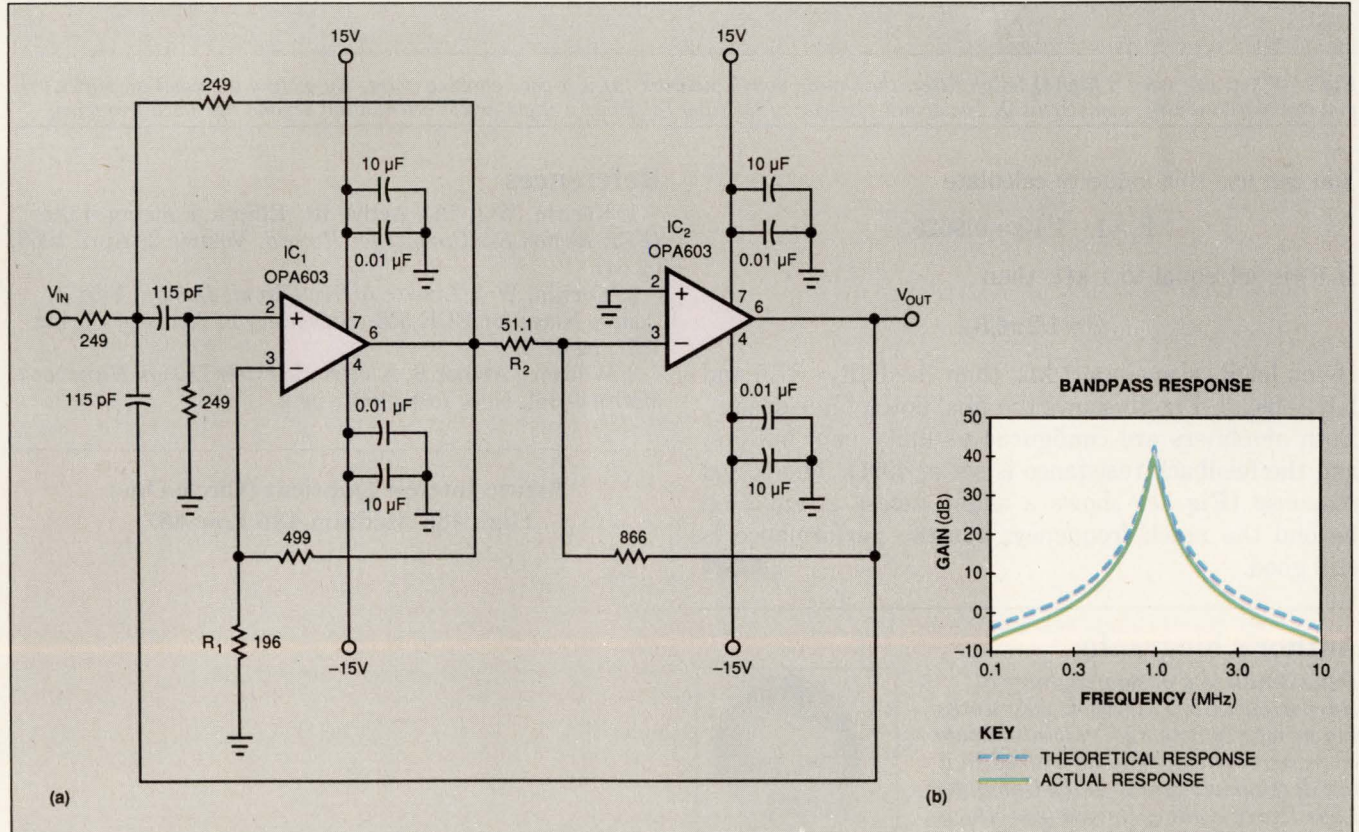

Fig 2—To develop high-Q bandpass filters, you can add a second amplifier to the basic KRC circuit (a) to raise the potential Q by orders of magnitude. The actual bandpass response of the filter is very close to the theoretical value (b), although the response shows a slightly lower gain.

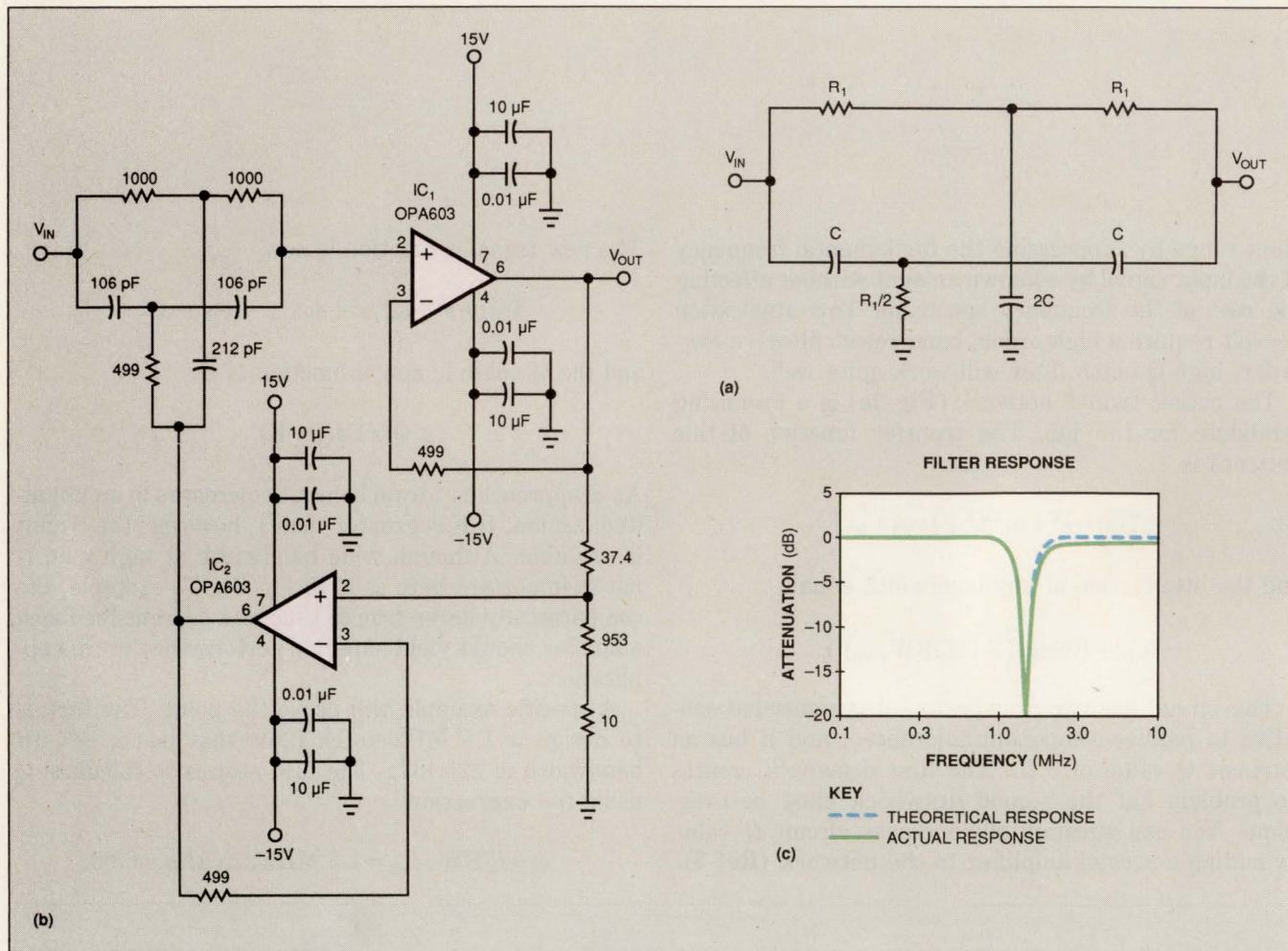

Fig 3—When you need a high-Q notch filter, the classic twin-T network (a) is a good starting point. By adding a second amplifier (b), you can substantially raise circuit Q. The actual response of the filter (c) shows a slight excess attenuation beyond the notch frequency.

You can use this value to calculate

$$K = 1 - 1/4Q = 0.9625.$$

If R_1 is set equal to 1 k Ω , then

$$C = 1/2\pi f_0 R_1.$$

If you let R_2 also equal 1 k Ω , then $(1 - K)R_2 = 37.5$ and $KR_2 = 962.5$. Fig 3b shows the final notch filter design. Both amplifiers are configured as unity gain buffers, and the feedback resistance is set at 499 Ω . The actual response (Fig 3c) shows a slight excess attenuation beyond the notch frequency, but the performance is still good.

EDN

Author's biography

Doug Smith is a design engineer at Burr-Brown Corp (Tucson, AZ) working primarily with high-resolution data converters. Previously, he worked in a test development group at the Computer Labs Div of Analog Devices Inc. Doug holds a BSEE degree from the University of Arizona and is a member of Tau Beta Pi and Eta Kappa Nu. He enjoys mathematics, optics, and guitar playing.

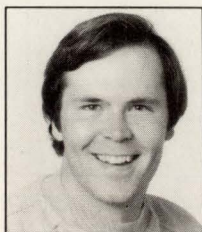

References

1. Kerwin, W J, "An Active RC Elliptic Function Filter," *IEEE Region Six Conference Record*, Volume 2, April 1966, pg 647.
2. Kerwin, W J, *Linear Active Circuit Design*, Part 4, Course Notes for ECE-553, University of Arizona, Spring 1987, pg 51.
3. Williams, Arthur B, *Electronic Filter Design Handbook*, McGraw-Hill, New York, 1981, pg 6.

Article Interest Quotient (Circle One)
High 485 Medium 486 Low 487

TEXAS INSTRUMENTS

A PERSPECTIVE ON DESIGN ISSUES:

Creating systems with an analog edge

IN THE ERA OF

MegaChip
TECHNOLOGIES



Advanced Linear can help you raise system performance levels.

A leadership family of analog circuits from Texas Instruments is helping designers meet difficult design challenges.

The evidence is strong. Throughout the design community, systems using the new breed of Advanced Linear functions from Texas Instruments are achieving the keener performance edges that can spell marketplace success.

TI's new analog devices are enabling design engineers to link digital brains to analog worlds more effectively and efficiently than ever before. Some offer new standards of accuracy or speed while others are highly integrated devices combining analog and digital functions on a single chip. The result is superior system performance and design flexibility.

These Advanced Linear functions are the result of leadership process technologies that we at TI firmly believe are the key to the advanced analog devices your future applications will demand.

Intelligent power for automobiles

Designers in the automotive industry face a tough challenge: Handle high reverse voltages and achieve rapid load turnoff while providing fault protection, detection, and reporting and efficient load management. To provide the needed intelligent power devices, we developed one of our newest process technologies, Multi-EPI Bipolar. It is unique because it can combine rugged power transistors with intelligent control functions.

The resulting circuits are now providing reliable, cost-efficient control of solenoids and valves in such automotive applications as antiskid braking systems, electronic transmission controls, and active suspension systems.

Other industry segments are also benefiting from TI's Advanced Linear process technologies. Here are a few of the winning designs to which we have helped add an analog edge:

Toledo Scale

Challenge: Improve the accuracy of point-of-purchase scales by eliminating drift over time and temperature.

Solution: The TI TLC2654 Chopper op amp. Our Advanced LinCMOS™ process makes possible chopping frequencies as high as 10 kHz, reducing noise to the lowest in the industry.



Pulsecom

Challenge: Develop a linecard capable of driving low-impedance loads with greater precision.

Solution: Our TLE206X family of JFET-input, low-power, precision operational amplifiers. These devices offer outstanding output drive capability, low power consumption, excellent dc precision, and wide bandwidth. Fabricated in our Excalibur process, they remain stable over time and temperature.

Leitch Video

Challenge: Design a compact, cost-efficient direct broadcast satellite TV descrambler for consumer use.

Solution: TI's TLC5602 8-bit Video DAC. Our LinEPIC™ process combines one-micron CMOS with precision analog to satisfy the demands of the application for video speeds and low-power operation.

U.S. Robotics

Challenge: Build a modem for high-speed data transmission between computers; allow flexible operation and minimize data errors.

Solution: Our TLC32040 Analog Interface Circuit (AIC). A product of our Advanced LinCMOS process, the AIC combines programmable filtering, equalization, and 14-bit A/D and D/A converters with such digital functions as control circuitry, program registers, and a DSP interface.

Xerox

Challenge: Cut component count and cost of copier systems while boosting reliability.

Solution: Our TPIC2406, a top-performance peripheral driver in a standard DIP package that is capable of driving heavy loads. It is fabricated using our Power BiDfET™ process which permits greater circuit density and incorporates CMOS technology for low total power dissipation.

Mr. Coffee

Challenge: Design an intelligent coffee maker that brews faster, maintains optimum temperature, shuts off automatically, and has a built-in cleaning cycle.

Solution: Our LinASIC™/LinBiCMOS™ capability permits us to combine both analog and digital library cells with custom analog cells. This results in cost-efficient integration of temperature monitoring, timing, and high-current outputs on a single control chip.

All of these examples point to one conclusion: TI's Advanced Linear functions are adding an analog edge to many system designs. They are contributing significantly to the enhanced system performance that marks a market winner.



WORLDWIDE MERCHANT IC MARKET

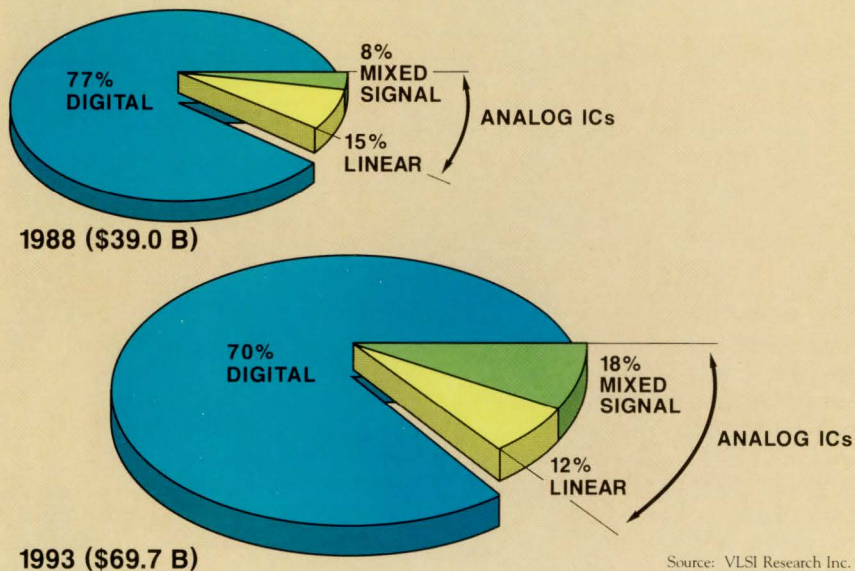

Helping you implement your designs in a changing world.

An increasing share of the total analog market is being captured by mixed-signal devices. As they gain more widespread acceptance, they are driving the expansion of the overall analog market (see above).

Changes such as this are the order of the day in the IC marketplace. Texas Instruments continues to provide not only the high-performance circuits you need but also the depth of experience, support, and service fundamental to successful completion of your designs.

Experience: Building on three decades in ICs

We at TI can successfully meet your requirements for mixed-signal devices because we have acquired the necessary knowledge from 30 years of experience in developing both analog and digital functions. We have also drawn upon our digital ASIC strengths in developing our LinASIC capabilities.

Support: Speeding our chips to you

The faster we move new products through our design cycles, the faster you can get through yours.

We employ a wide variety of design-automation tools and sophisticated software to speed our development process.

Service: Providing a surety of supply

However advanced our circuits may be, they are of little value if they are inaccessible to you. TI operates on the principle of global coverage, local service. We manufacture semiconductors in 13 countries and operate support centers in 22. We have product and applications specialists, designers, and technicians around the world. They are linked by one of the world's largest privately owned communications networks so that we can bring you our best — circuits and support — from wherever they may be to wherever you are.

Keeping our communications open

The relationship between you as customer and us as vendor is vital: You are our chief source for firsthand information that can help guide us in developing the circuits you will need for your future designs. We at TI welcome your comments and your suggestions.

TI's Leadership Analog Processing Technologies

LinBiCMOS — Combines Advanced LinCMOS, digital ASIC CMOS, and up to 30-V bipolar technologies to allow the integration of digital and analog standard cells and handcrafted analog components on a monolithic chip.

LinEPIC — One-micron CMOS double-level metal, double-level polysilicon technology, which adds highly integrated, high-speed analog devices to the high-performance digital EPIC process.

Advanced LinCMOS — An N-well, silicon-gate, double-level polysilicon process featuring improved resistor and capacitor structures and having three-micron minimum feature sizes.

Power BIFDET — Merges standard linear bipolar, CMOS, and DMOS processes and allows integration of digital control circuitry and high-power outputs on one chip. Primarily used for circuits handling more than 100 V at currents up to 10 A.

Multi-EPI Bipolar — A very cost-effective technology that utilizes multiple epitaxial layers instead of multiple diffusion steps to reduce mask steps by more than 40%. Used to produce intelligent power devices that can handle loads as high as 20 A and voltages in excess of 100 V.

Excalibur — A true, single-level poly, single-level metal, junction-isolated, complementary bipolar process developed for high-speed, high-precision analog circuits providing the most stable op amp performance available today.

If you would like a more detailed explanation of our Advanced Linear process technologies, please call 1-800-336-5236, ext. 3423. Ask for a copy of our *Advanced Linear Circuits* brochure.

™ Trademark of Texas Instruments Incorporated
©1990 TI

08-0082

**TEXAS
INSTRUMENTS**

NOW HOLMBERG FLIES MORE CONNECTIONS DAILY FROM MORE CITIES.



With HOLMBERG™ under their wing, Thomas & Betts commands the largest selection of connectors found anywhere. That's good news for those who travel with Marshall. Because we fly the entire Thomas & Betts fleet, with value added, from over 40 cities every day. And always non-stop.

Marshall

(*Authorized Locations) AL Huntsville (205) 881-9235; AZ Phoenix (602) 496-0290; Tucson (602) 790-5687; CA Irvine (714) 458-5301; Los Angeles (818) 407-4100; Sacramento (916) 635-9700; San Diego (619) 578-9600; San Francisco (408) 942-4600; CO Denver (303) 451-8383; CT Connecticut (203) 265-3822; FL Ft. Lauderdale (305) 977-4880; Orlando (407) 767-8585; Tampa (813) 573-1399; GA Atlanta (404) 923-5750; IL Chicago (708) 490-0155; IN Indianapolis (317) 297-0483; KS Kansas City (913) 492-3121; MA Boston (508) 658-0810; MD Maryland (301) 622-1118; MI Michigan (313) 525-5850; MN Minneapolis (612) 559-2211; MO St. Louis (314) 291-4650; NC Raleigh (919) 879-9882; NJ N. New Jersey (201) 882-0320; NY Binghamton (607) 798-1611; Long Island (516) 273-2424; Rochester (716) 235-7620; OH Cleveland (216) 248-7788; Dayton (513) 898-4480; OR Portland (503) 644-5050; PA Philadelphia (609) 234-5100; Pittsburgh (412) 788-0441; TX Austin (512) 637-1921; Dallas (214) 233-5200; El Paso (915) 593-0705; Houston (713) 895-9200; San Antonio (512) 734-5100; UT Salt Lake City (801) 485-1551; WA Seattle (206) 486-5747; WI Milwaukee (414) 797-8400; In Canada: G.S. Marshall Co., Montreal (514) 694-8142; Ottawa (613) 564-0166; Toronto (416) 458-8046; Vancouver (604) 436-0068; Western Canada (800) 465-6640.

It's not just the way we It's the way we

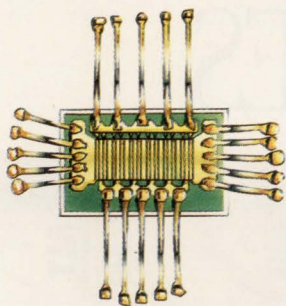

The Harris Military and Aerospace Division is dedicated to bringing the military the highest in high technology. From submicron CMOS to GaAs, from digital to analog ASICs. And we bring high technology down to earth by making your visions of the future become reality. Fast.

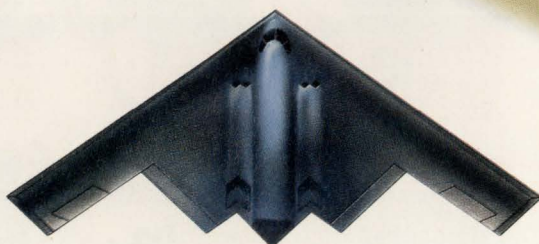

While VHSIC performance is still just a vision at some companies, the Harris Research Triangle Park facility (RTP) has already shipped over 150,000 Class B and Class S processed VHSIC-class devices. No wonder Harris is first in semiconductors for military and aerospace.



Harris' 1.2 micron VHSIC-class CMOS process is already found in over 100 designs. From SADARM to the SRAM cruise missile. From Milstar to the Space Station. And many more.

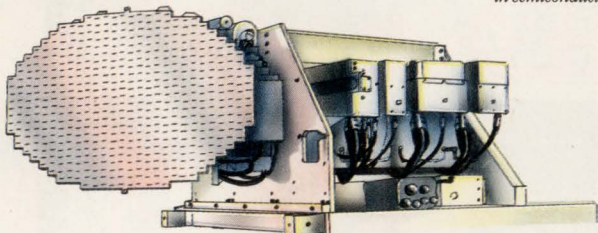

Harris products from RTP were right on target for the F-16 Fire Control Radar project. And that's just one of the 30 military and aerospace projects in which products from RTP are already at work.



The Q stands for quality. Harris RTP facility participated in the government's QML alpha site program, helping define the way ICs will be qualified in the future. We have been selected to be a beta site, and building on this, we're now qualifying for QML approval status.

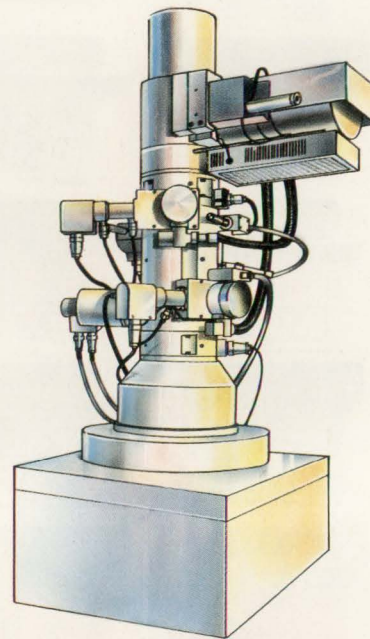

With gate arrays, standard cells and compiled designs—in your choice of CMOS/bulk, CMOS/SOS and SOI—the range of Harris' radiation-hardened ASIC capabilities is unparalleled. We even offer E-beam direct write technology. No wonder Harris is the #1 supplier of ASICs to the U.S. military.



Take your pick. Harris has a process technology designed to give you the price/performance your design demands. Select our VHSIC-class CMOS process for high-speed performance, or a radiation-hardened version for upgraded tactical military applications.

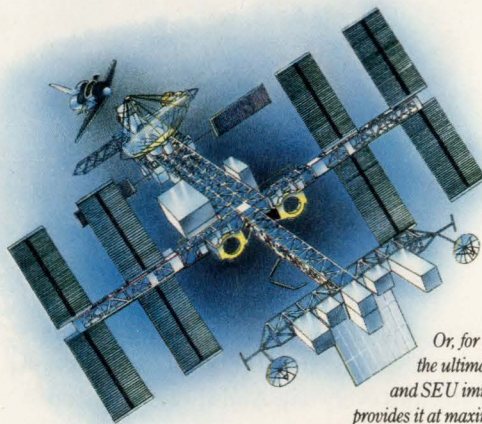

Or, for applications requiring the ultimate in total dose radiation hardness and SEU immunity, our CMOS/SOS process provides it at maximum performance.

From submicron CMOS to GaAs, smart power to digital and analog ASICs, Harris brings you the highest in high technology. And we bring it down to earth through a complete division dedicated to turning the visions of military and aerospace designers into realities.

*Gensil and GDT are trademarks of Silicon Compiler Systems. DAZIX is a trademark of Daisy/Cadnetix, Inc. Mentor Graphics is a registered trademark of Mentor Graphics Corporation.

bring you high technology. bring it down to earth.

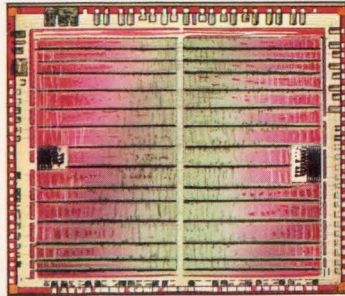

Fast.
Fast.
Fast.
Harris gate
arrays give you
cost-effective
performance

with fast design cycles. CMOS/SOS and CMOS/bulk arrays are available now. 100,000 gates are on the way. And standard cells to 25,000 gates, including the RTX microcontroller, are also available.

Visions of the future
quickly become reality with Harris'
comprehensive design libraries.
We support all the popular workstations, including
DAZIX*, Mentor Graphics* and Harris' own
FASTRACK™ integrated workstation.

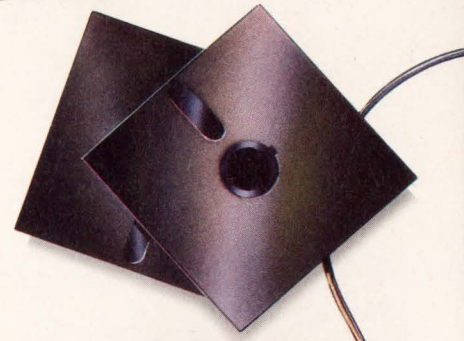
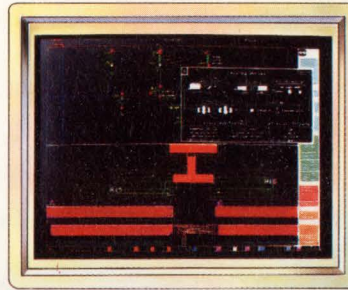

Harris' support
of Silicon Compiler System's Gensil*
and GDT* programs let you create
the most complex IC designs simply
and easily. And we're a qualified lab for
Silicon Compiler Systems.

Whatever ASIC technology you select, Harris can deliver on time and
on budget. We're fully approved to design, manufacture and
test to MIL-STD-883C and Class S.

With assembly and test
capabilities for up
to 288 pins.

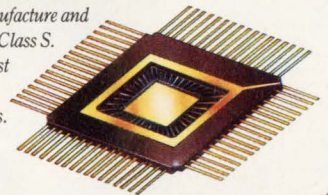

Custom digital
isn't the only high
technology at Harris.
Our custom DI analog is
the ultimate in high performance
for analog design, including high-speed
op amps with slew rates to 1000 μ V/sec.

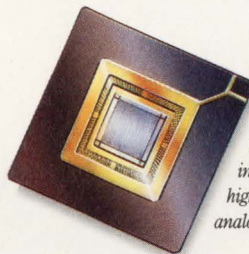
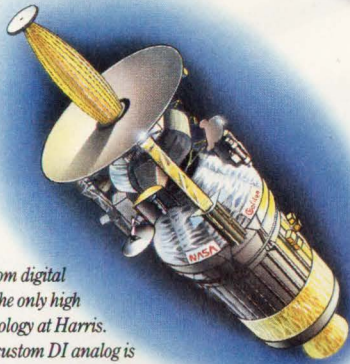

Harris smart power is
the perfect synthesis of power and
intelligence. Combining high voltage and
high power with dense logic and precision
analog on a single chip.

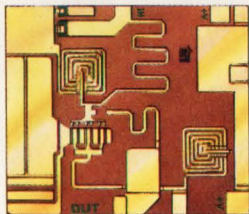

That dream technology,
GaAs, is more than a dream at Harris.
We're already in production with 0.5 and 1.0 micron
processes, with 0.25 micron on the way. And
we're a MIMIC program participant.

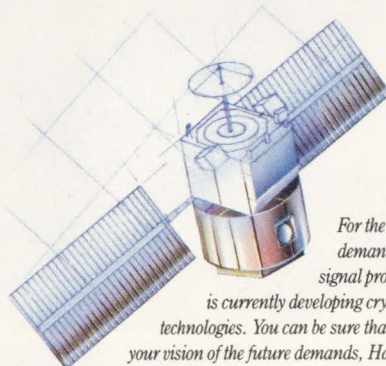

For the extreme
demands of focal plane
signal processing, Harris
is currently developing cryogenic rad-hard
technologies. You can be sure that whatever
your vision of the future demands, Harris is
probably working on it today.



For more information
on the latest in high technology at Harris,
call 1-800-4-HARRIS, ext. 1003
(in Canada, 1-800-344-2444, ext. 1003).

It's the kind of dedication to your unique needs that has made Harris the #1 supplier of semiconductors in military and aerospace. Harris Semiconductor. What your vision of the future demands. Today.



HARRIS · RCA · GE · INTERSIL

**A 68040 for data,
a 68020 for I/O...
for real real-time
performance on a
single VME board.**

Radstone's 68-41 Freeflow+ multiple micro-processor board with truly independent microprocessors for data and I/O gives you next generation VME performance...Now!

- 68040 with 16 Mbytes of dual-ported memory for maximum data throughput via concurrent, uninterrupted microprocessor operation up to 40 MHz
- 68020 with 4 Mbytes of dual-ported memory controlling extensive high performance on-board I/O facilities—all operating independently
- Multiple independent external buses—VME, VSB & APEX
- Multiple independent local buses—processor and I/O
- High performance DMAs
- Intelligent, high performance Ethernet and SCSI/SCSI-2
- ...and much, much more.

Radstone's Freeflow+ architecture takes VME to new performance levels. And now it's available with 040 processing punch. It's the very latest in Radstone's long line of leading edge commercial real-time VME board level products.

Extend your VME lead...and investment

For details on how to supercharge your VME system with Radstone's Freeflow+, and extend your current investment in VME hardware and software, call or write. Do it now, because your system is worth it!

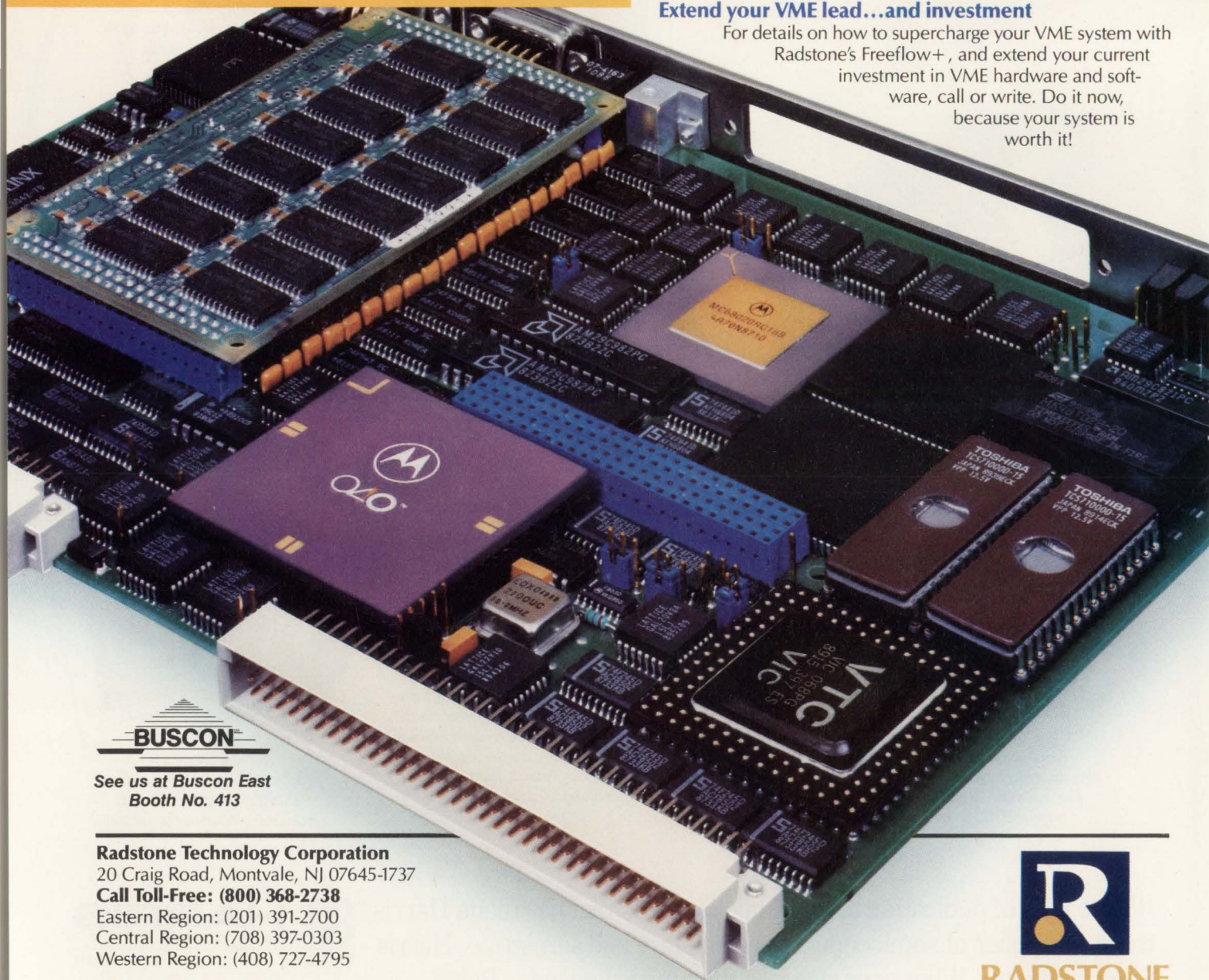

See us at Buscon East
Booth No. 413

Radstone Technology Corporation
20 Craig Road, Montvale, NJ 07645-1737
Call Toll-Free: (800) 368-2738
Eastern Region: (201) 391-2700
Central Region: (708) 397-0303
Western Region: (408) 727-4795



RADSTONE
TECHNOLOGY



Is your emulator giving you the whole picture?

MICE-V-486. 33MHz Emulation. Real features. Real-time.

Without real-time emulation you never know how your product will perform until it has to fly. Traditional in-circuit emulators slow your target to collect, display or reprogram trace. Or even stop emulation (or your target) to load complex triggers. When your emulator can't show you what's actually happening you risk missing a bug that will sneak from your prototype to the finished product.

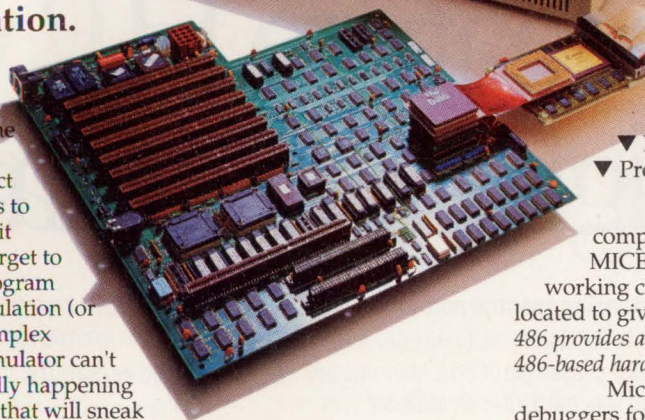

- ▼ MICE-V-486 lets you see it all.
- ▼ Real-time emulation to 33MHz.
- ▼ Complex, sequential triggers, loaded without slowing the emulator or target.
- ▼ Access to the fully qualified trace buffer during full-speed emulation.
- ▼ High level language debug.
- ▼ Probe kits for 386, SX, 376 and 286 support.

Most in-circuit emulators require partially or completely functional hardware to operate correctly. MICE-V-486 has a unique *Isolation Mode™*, requiring only a working clock signal. Logic analyzer taps are conveniently located to give you access to critical timing information. *MICE-V-486 provides absolutely the fastest method for debugging non-functional 486-based hardware.*

Microtek also has real-time emulators and source-level debuggers for 68000, -020, -030 and 80C186.

So, stop wasting development time because your emulator isn't real-time. Call us, and get your product to market fast.

MICROTEK

The Leader In Development Systems Technology.™

MICROTEK INTERNATIONAL, INC. - Development Systems Division
3300 N. W. 211th Terrace, Hillsboro, OR 97124 • (503) 645-7333 • Fax (503) 629-8460

ASIA OFFICE - Taiwan - MICROTEK INTERNATIONAL 886-2-723-5577 / Japan - CORE Digital 81-3-7955171
EUROPE OFFICE - Germany - ALLMOS 49-89-8570000 / France - M.T.E. 33-1-39618228 / U.K. - ARS Microsystems 44-276-685006

FLUKE®

FLUKE 6082A S

MODULATION

Here's a feature HP[®] was h a high performance 2

Introducing the Fluke 6082A. Proof once again a free market economy benefits everyone. Even engineers.

Fluke announces a whole new concept in high performance signal generators. It's called competition.

Because now, thanks to the new Fluke 6082A, you can have all the performance you need for virtually all your critical receiver test, RF design and ATE systems applications, without HP's help.

Outstanding spectral purity.

To begin with, the Fluke 6082A and its 1 GHz cousin, the 6080A, both offer the kind of spectral purity only available from HP until now.

Phase noise at 1 GHz is -131 dBc/Hz at 20 kHz offset. Non-harmonic spurious is -100 dBc at 1 GHz. And residual FM is a low 1.5 Hz, ideal for high performance receiver testing and LO substitution.

Output level of +16 dBm provides all the power you need for receiver overload test and driving high level mixers. Accuracy is ±1 dB. And special

user-defined level correction registers can give you even more performance.

Enhanced versatility.

Whether you're testing mobile, cellular, military communications, surveillance receivers, or doing RF design work, the Fluke 6082A is ready and able.

Modulation versatility is standard. So is HP 8642A/B software and rack space compatibility.

AM, FM, phase and pulse modulation are all available, and can be combined for complex signal simulation.

Standard pulse rise time is < 15 ns (< 7.5 ns typical). And the 6082A's on/off ratio is 80 dB, which makes it ideal for radar component testing.



The new Fluke 6082A high performance 2 GHz signal generator.



PHILIPS



opping you'd never see on GHz signal generator.

Bad news for HP is good news for you.

A little competition never hurt anyone. Especially when you're the winner.

Go ahead. Take a peek at the Fluke 6082A and see why HP is no longer the only name in town. Especially when it comes to high performance signal generators.

Call **1-800-44-FLUKE** and ask for our free literature.

Feature	Fluke 6082A	HP® 8642B	HP® 8644A/002
Frequency Range	100 kHz-2.112 GHz	100 kHz-2.115 GHz	252 kHz-2.060 GHz
SSB Phase Noise @1 GHz			
20 kHz offset	-131 dBc/Hz	-134 dBc/Hz	-128 dBc/Hz
1 kHz offset	-94 dBc/Hz	No Specification	-91 dBc/Hz
Non-harmonic Spurious @1 GHz	-100 dBc	-100 dBc	-100 dBc
Residual FM @1 GHz	1.5 Hz	2 Hz	2 Hz
Modulation	AM, FM, øM, Pulse	AM, FM, øM, Pulse	AM, FM, øM, Pulse
Pulsed RF			
Rise/fall time	15 ns	400 ns	100 ns
On/off ratio	80 dB	40 dB to 80 dB	35 dB to 80 dB
Programming Compatibility	HP 8642A/B, Fluke 6060, 6070	HP 8642A/B	HPSL
Panel Height	5¼ inch (133 mm)	5¼ inch (133 mm)	7 inch (178 mm)
US List Price	\$20,950	\$38,200	\$24,350

John Fluke Mfg., Inc. P.O. Box 9090, M/S 250C, Everett, WA 98206-9090. U.S. (206) 356-5400. Canada (416) 890-7600. Other countries: (206) 356-5500. ©1990 John Fluke Mfg. Co., Inc. All rights reserved. Ad no. 0501-F6080. HP® is a registered trademark of Hewlett-Packard Co. Information subject to change without notice.

FLUKE®

"Static can kill our circuitry.
And the front panel LEDs
can provide the path.

Now what?!"

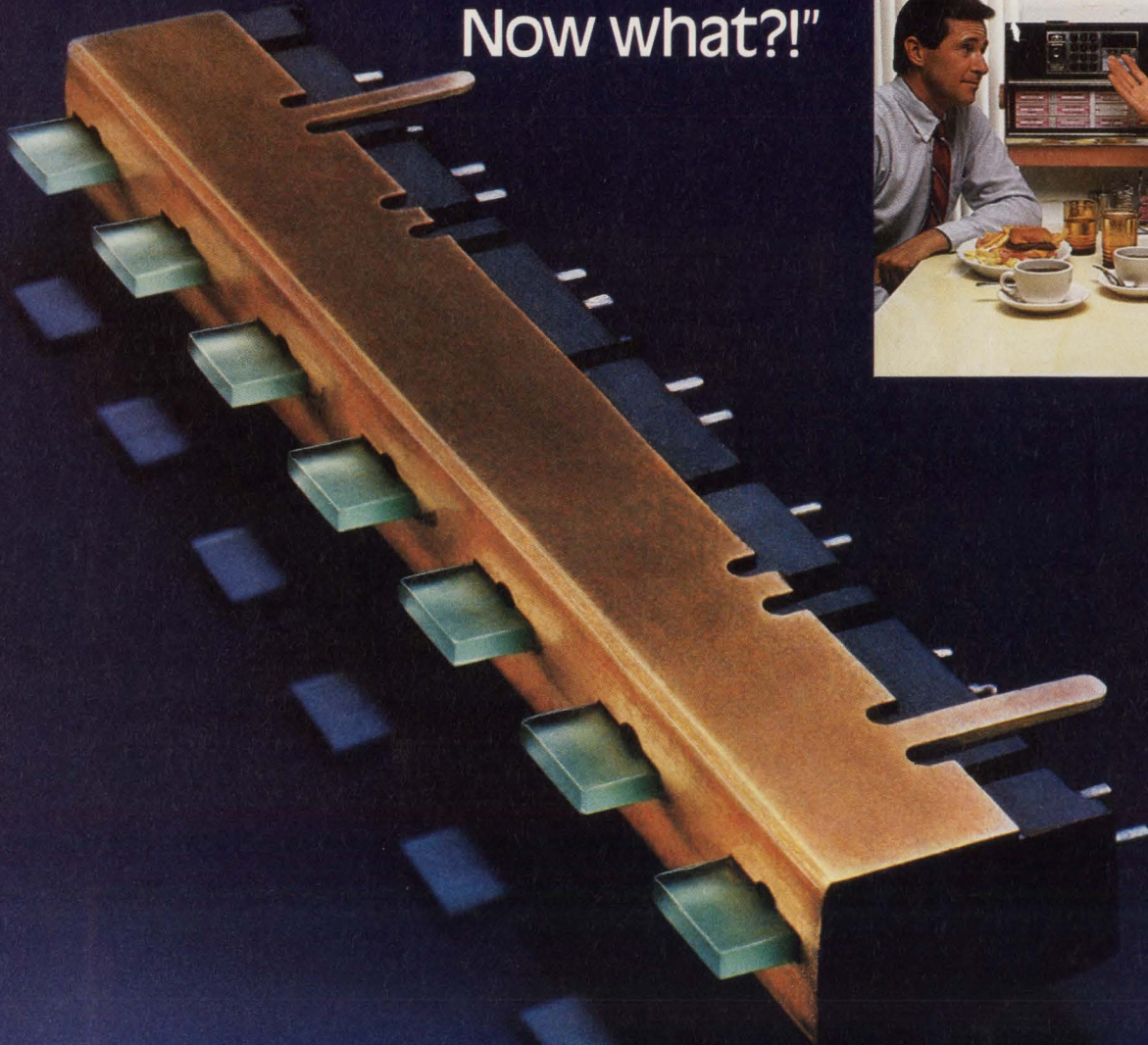

All indications are Dialight.

It was a problem grounded in the laws of electrical energy. And it could have caused real havoc. But the customer took the smart step of calling Dialight.

As the leader with over half a century of experience in every type of indicator light, for Dialight solving problems is standard operating procedure. Applying our engineering expertise in optoelectronics and utilizing state-of-the-art CAD equipment, our model shop quickly developed and prototyped a housing and grounding plate for the LEDs. Upon customer approval, our 100% internal tool fabrication and molding facilities provided quick turn-around on production quantities.

Saving costs while solving problems is something we've long done with our panel mount and circuit board LEDs. Over the years customers have asked us to pair, gang, piggyback, right angle mount, recess, bicolor, tricolor, slant, standoff, snap-mount, bin, do whatever you can imagine to them and we haven't been stumped yet!

So, when an indication design issue has you ground to a halt, remember that no one has more solutions than Dialight.

DIALIGHT CORPORATION

A Cambridge Electronic Industries Co.

1913 Atlantic Avenue, Manasquan, NJ 08736 201-223-9400

Sampling tracker makes short work of 0.01% settling-time test

The sampling voltage tracker, a distant relative of the sample-and-hold circuit, is the heart of a scheme for 100% testing of precision high-speed op amps' 0.01% settling time. The measurement, which is daunting enough on the bench, works reproducibly in the much tougher production environment—thanks to this little-known circuit.

Ralph Andersson, *National Semiconductor Corp*

For manufacturers of high-speed IC op amps, difficulties in measuring the devices' settling time in production have restricted the measurement to design labs and kept many manufacturers from guaranteeing the parameter. In other cases, vendors have required customers to pay a substantial premium for manually tested devices with guaranteed settling times. A new measurement approach based on a sampling-voltage-tracker (SVT) circuit at last permits automated, high-speed production tests of settling time. The technique is potentially useful outside of semiconductor manufacturing too—wherever an application demands quick, accurate measurements of signals that change rapidly over a wide dynamic range.

The technique results from adopting a systems point of view: What types of functional blocks would solve the measurement problems without causing difficulties elsewhere in the system? The SVT that lies at the heart of the system can determine within 50 μ V the analog voltage at discrete points of a waveform. Similar approaches work with sample-and-hold circuits and D/A converters.

Fig 1 shows the SVT. It consists of a latchable high-speed comparator, an integrator, and a buffer. The noninverting input of the comparator is the SVT's input. The comparator's output drives an integrator whose buffered output feeds back to the comparator's inverting input.

To examine how the SVT works, assume that there is a dc level at the SVT's noninverting input, that the inverting input is a smaller dc voltage, and that the latch control is high, allowing the SVT to free run. The comparator's output will be high and will cause the integrator's output to ramp up towards the positive rail. The voltage ramp feeds back to the inverting input of the comparator via the closed-loop feedback path. The integrator will ramp up until its output passes the voltage level at the comparator's noninverting input. At this point, the comparator output switches to its low state and the process repeats, with the integrator output ramping downward. Thus the comparator forces the integrator to ramp up or down to the voltage at its noninverting input. The SVT's steady-state output is a dc voltage equal to the circuit's input plus the

Settling time is the interval that a device's output needs following a step change to reach (and remain within) a small error band surrounding the final value.

offset voltage of the comparator and an ac component, which is caused by the integrator ramping around that point.

In the free-running mode, the SVT can accurately track any input waveform that has no transitions faster than the integrator's RC time constant permits. Though this configuration can yield useful dc information such as V_{OS} , CMRR, and PSRR, it is not particularly helpful for measuring settling time. With a latch control, however, the SVT can measure the instantaneous voltage at a point in a repetitive waveform (Fig 2a). By disabling the SVT's latch and repeatedly enabling it with a narrow pulse at a desired point, the SVT will provide the corresponding dc level. The voltage at the output of the SVT now consists of the dc voltage at the selected point plus the V_{OS} of the comparator and an ac component whose amplitude is inversely proportional to the sampling frequency and the RC time constant of the integrator. By increasing the time constant and the sampling rate, you can make the amplitude of the ac component arbitrarily small. Larger time constants prevent the SVT from responding to fast transitions of the input waveform, however.

An alternative to using a pulse for latching uses a

high-speed comparator with its latch control held high. A D flip-flop controls latching and makes possible triggering of the SVT with an edge rather than with a pulse (Fig 3). This idea is functionally equivalent to the SVT shown in Fig 1. Although the edge-triggered SVT is easier to interface with TTL circuits, its power consumption is higher than that of the circuit of Fig 1.

Fig 2a shows that under certain conditions the SVT's output can contain an erroneous offset, making the average value differ from the voltage the SVT is sampling. For the offset to exist, the peak of the ramp superimposed on the output simply needs to be great enough to exceed the comparator threshold. The direction of the ramp will then reverse at each SVT-trigger pulse, and the offset will exist in the steady state. The maximum amplitude of the offset is

$$V_{MAX} = (I_{IN}/C_F) \cdot (T_{SAMP}/2),$$

where C_F is the integrator's capacitor value, I_{IN} is the peak current through C_F , and T_{SAMP} is the SVT's sampling period. Note that in the steady state, the current through C_F is a square wave and I_{IN} is the wave's peak amplitude of either polarity.

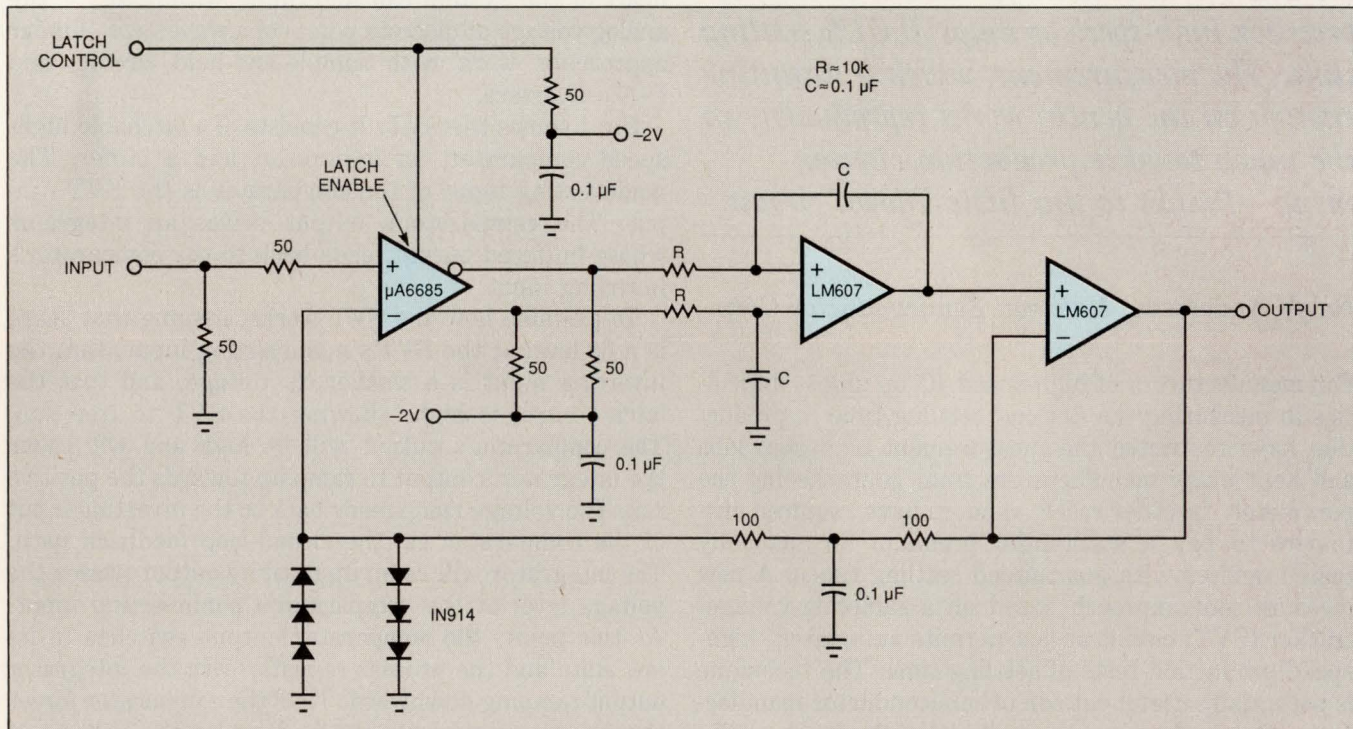

Fig 1—The sampling voltage tracker is conceptually straightforward. But, as with any extremely accurate wideband analog circuit, design and construction details can profoundly affect its performance.

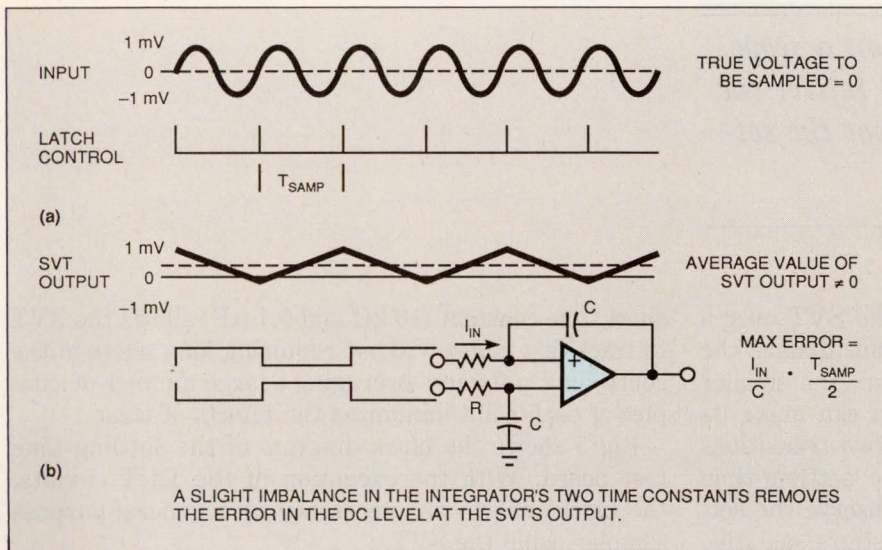

Fig 2—By repeatedly sampling a waveform at a single point and gradually moving the point, the SVT can reconstruct the waveform (a). The circuit's output has a dc component equal to the voltage at the sampled point plus the offset of the comparator. A slight imbalance in the integrator's input networks (b) minimizes the chance of error.

You can keep this error arbitrarily small by increasing the SVT's integration time constant. There is, however, another way of solving this problem without sacrificing the response time of the SVT. Note that both inputs of the integrator in Fig 1 contain the same time constant. Changing the resistance (or capacitance) in one of the inputs will prevent the SVT from assuming the erroneous steady-state-stable condition of Fig 2a and will force the circuit to find the correct sampled-voltage value. As the circuit approaches the steady-state, the integrator output will not cross the comparator threshold at every sample point until the output ramp's peak positive and negative excursions about the SVT input level are equal. As a result, the integrator will continue ramping in the same direction until

its output reaches an average value equal to the voltage on the SVT's input. The ratio of the time constants need not be large. A 5 to 10% imbalance works well (Fig 2b).

Repetitive measurements offer advantages

Using the SVT to make repetitive measurements has several advantages. The first is that such measurements tend to average out random noise and sporadic phase-noise errors. The integrator's time constant and the number of samples taken at each point determine the effectiveness of the averaging. Second, the op-amp integrator operates at low frequencies.

The pulse-position vernier is the circuit that selects the exact point at which the SVT samples the input

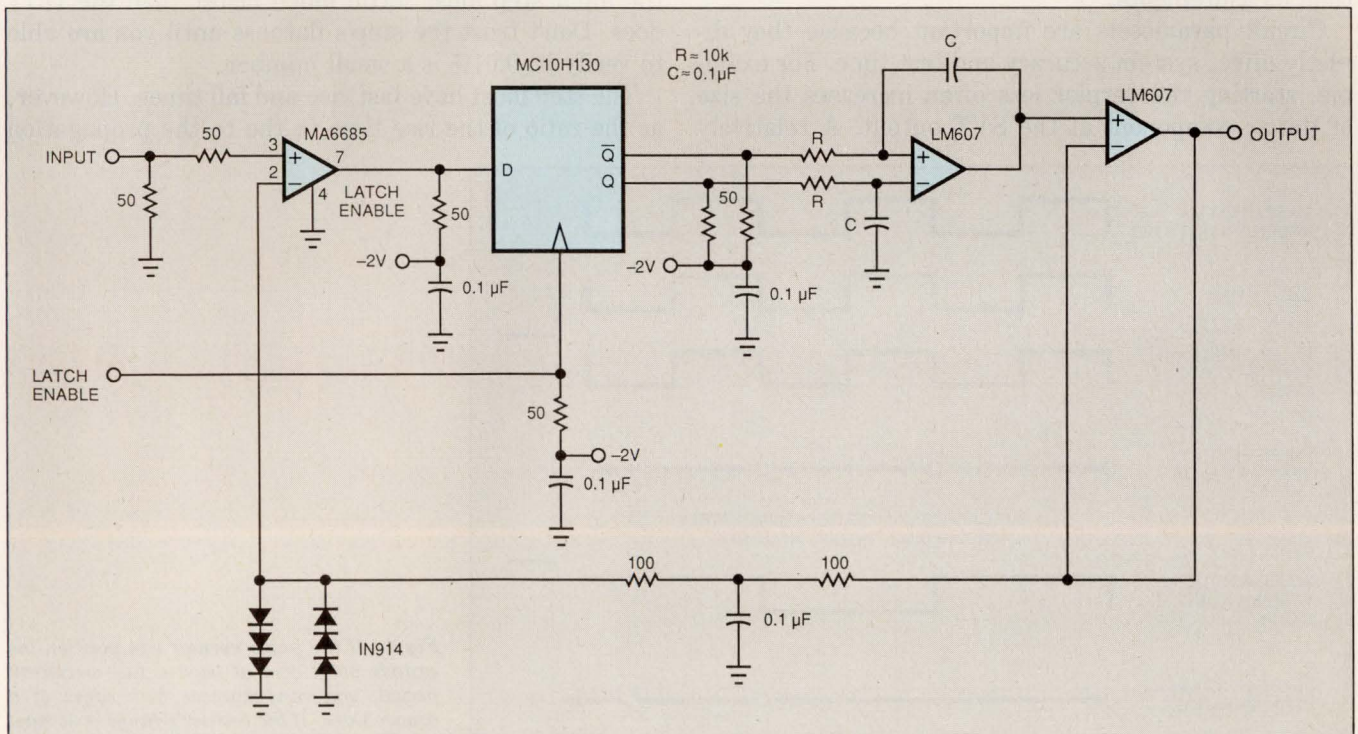

Fig 3—If you add a D flip-flop between the output of the comparator and the input of the integrator, you can use a square wave instead of a train of narrow pulses to make the SVT sample its input.

If you view the output directly on a scope, the measured settling time will reflect the recovery time of the scope and not the settling time of the DUT.

waveform. The vernier must trigger the SVT over a time range that includes at least two transitions of the input step. Everything else being equal, the smaller the vernier's time range, the finer you can make its time resolution. However, examining two transitions does not guarantee obtaining complete settling-time information. In Fig 4a, you can only observe the settling time associated with the input step's negative transition; you can't view the voltage step's positive transition because that transition is the one that starts the pulse vernier. To solve this problem, you can use a step inverter to examine either a positive- or a negative-going input step even though the vernier's starting point is fixed. Alternatively, you can extend the vernier's range (and compromise its time resolution).

Fig 4 shows that you can add a 2:1 frequency divider (that is, a D flip-flop) so that the vernier starts on every second edge of the master clock instead of on every edge. With this arrangement, the SVT can examine events before, during, and after the input step of the device under test, albeit with somewhat degraded time resolution and a somewhat greater ac component at its output. However, because you can use a step inverter, the divider is not essential for settling-time measurements.

Circuit parameters are important because they directly affect system accuracy and test time. For example, starting the vernier less often increases the size of the ac component at the SVT output. A relatively

short time constant (10 k Ω and 0.1 μ F) allows the SVT to track fast edges without requiring long waits in the controlling software. Averaging a large number of samples of each point minimizes the effects of noise.

Fig 5 shows the block diagram of the settling-time test board. With the exception of the DUT circuits, the blocks shown are necessary in a general-purpose sampler using the SVT.

The master clock block is the reference for calculating settling time. If you know the exact clock frequency, you can determine the exact position of a sample point. The heart of the master clock is a crystal oscillator. The DUT must settle fully in no more than half the clock period. If you expect the settling time of the DUT to 0.01% to be 400 nsec, a reasonable choice for half the clock period is 1 μ sec. This choice sets the clock frequency at 500 kHz. Clock accuracy directly affects the measured settling time; a clock inaccuracy of 0.01% will result in a 0.01% error in the measured settling time.

In any settling-time-measurement setup, the step generator can cause serious errors, so you should take great care in its design and layout. No device can settle faster than the signal that drives it. Therefore, the input step must settle much faster than the DUT does. Don't trust the step's flatness until you are able to verify it; 0.01% is a small number.

The step must have fast rise and fall times. However, as the ratio of the rise time to the to the propagation

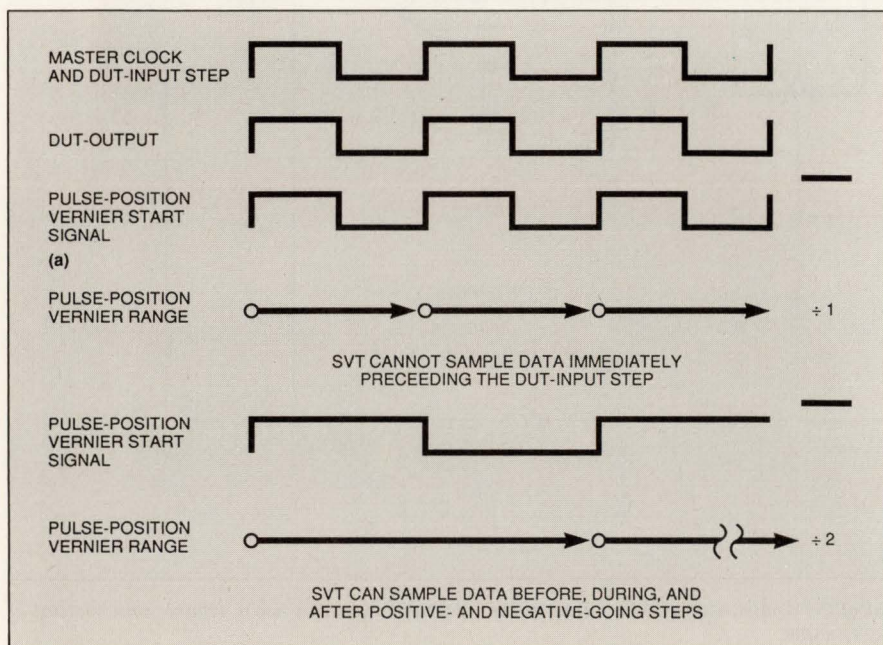

Fig 4—If the pulse vernier can position the sample point over at least a full waveform period, you can examine both edges of a square wave. If the vernier's range is at least a half period, you can achieve the same effect provided you have the option of inverting the step input that drives the DUT.

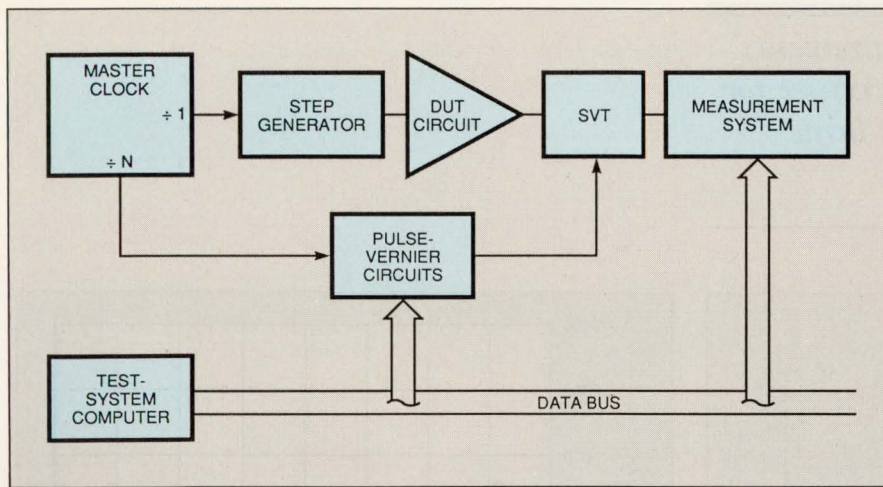

Fig 5—The settling time test board contains several circuit blocks in addition to the SVT.

delay of the transmission line between the step generator and the DUT becomes large, fast edges can cause problems with reflections. When checking step integrity, a good rule of thumb is that the rate of change of the step edges must be twice the DUT's maximum slew rate. Avoid inductive and capacitive elements in the step's output path. Keep the lead lengths short and avoid inductive resistors in the terminating load. Thermal tails are always a worry with step generators, but as you will see, they are not usually a major consideration.

The false-summing-node approach (Fig 6) has been

used for many years to measure the settling time of op amps connected as inverters. The approach's popularity is well deserved. Adding the DUT's inverted output to the input signal at a false summing node results in a signal that contains error information only. Viewing only the errors simplifies optimizing the circuits that surround the DUT because, without overdriving your scope, you can directly view the DUT's step response with high resolution. An unfortunate effect of using the false summing node, however, is that the resistive divider that connects the DUT's input and output causes the observed error band to shrink

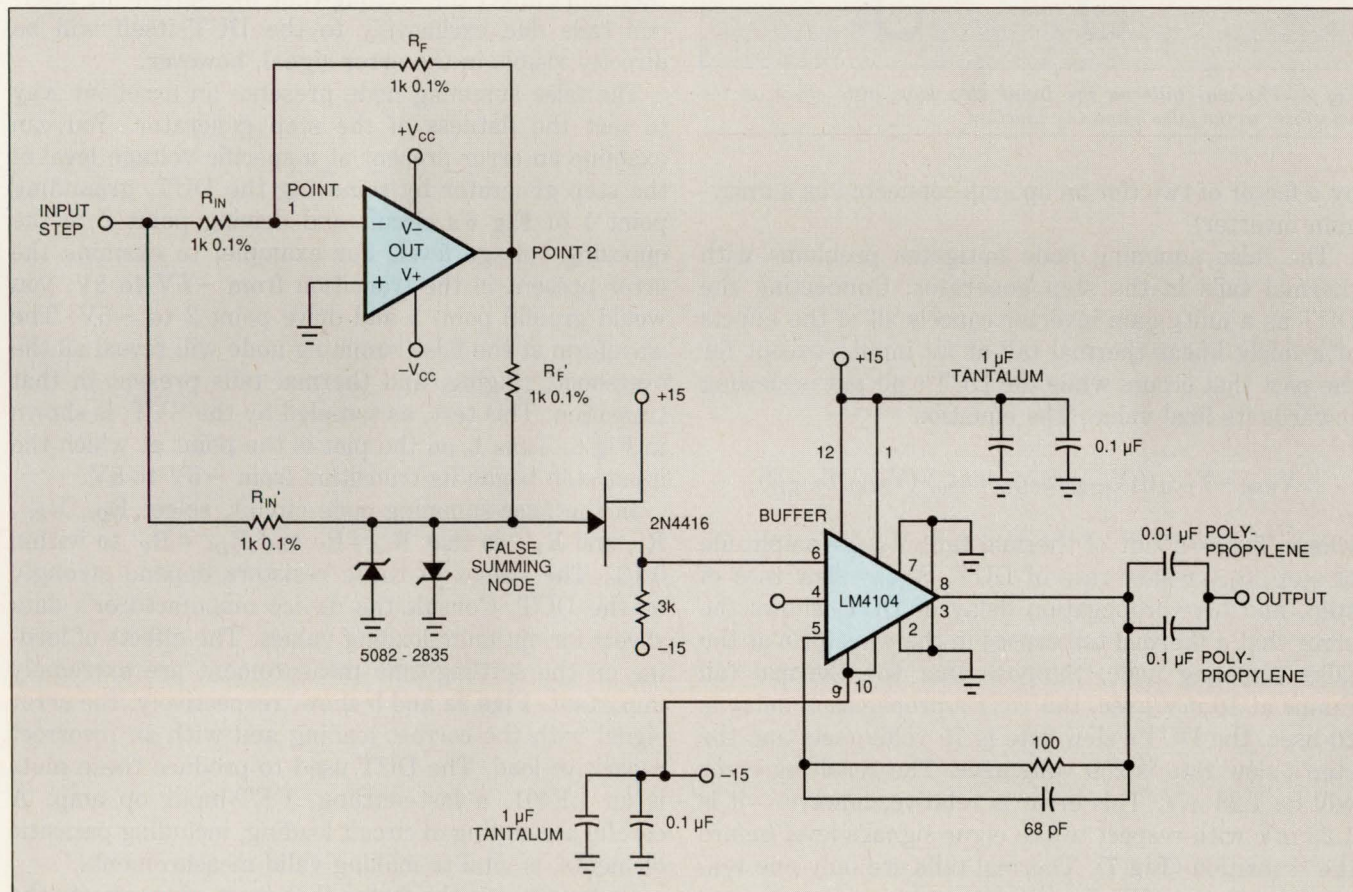

Fig 6—A false summing node lets you test settling time of an op-amp inverter without forcing the measurement circuits to withstand the DUT's full output. The drawback is that with a unity-gain inverter you see only half of the full error.

The inability to reproduce measurements either limits testing to a single fixture for quality assurance or necessitates large guard bands.

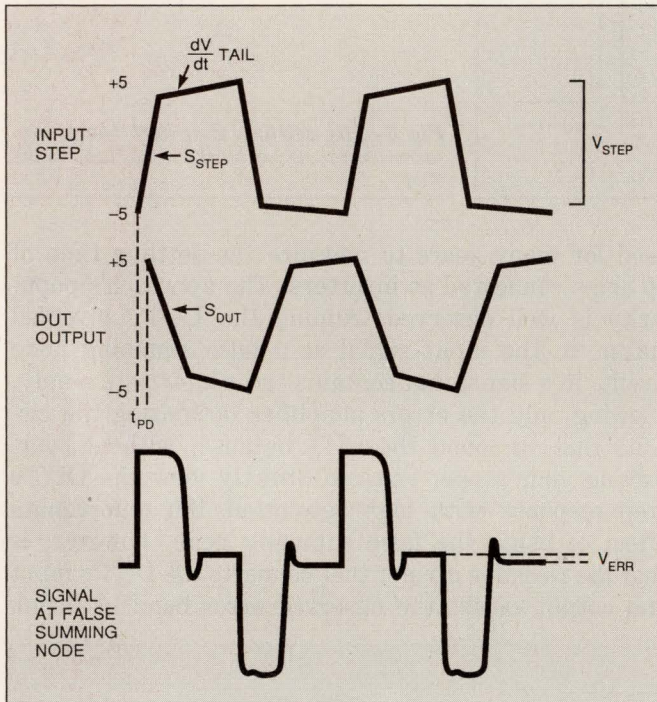

Fig 7—Thermal tails on the input step have little effect on the waveform at the false summing junction.

by a factor of two (for an op amp connected as a unity-gain inverter).

The false summing node mitigates problems with thermal tails in the step generator. Connecting the DUT as a unity-gain inverter cancels all of the effects of a fairly linear thermal tail at its input—except for the part that occurs while the DUT's output is slewing towards its final value. The equation

$$V_{ERR} = T_{TAIL}(((V_{STEP}/S_{DUT}) + t_{PD}) - (V_{STEP}/S_{STEP})),$$

where $T_{TAIL} = dV/dt$ of thermal tail, V_{STEP} = amplitude of step, S_{DUT} = slew rate of DUT, S_{STEP} = slew rate of step, and t_{PD} = propagation delay of DUT, shows the error that a thermal tail causes in the waveform at the false summing node. Suppose that the thermal tail ramps at $10 \text{ mV}/\mu\text{sec}$, the DUT's propagation delay is 20 nsec , the DUT's slew rate is $70 \text{ volts}/\mu\text{sec}$, and the step's slew rate is $250 \text{ volts}/\mu\text{sec}$. The resulting error will be 1.23 mV . This error is relative, however—it is 1.23 mV with respect to the error signal's level before the transition (Fig 7). Thermal tails are only one reason why V_{ERR} in Fig 7 can exist.

Another reason is gain inaccuracy in the DUT. Non-linearities in thermal tails are usually so slight that

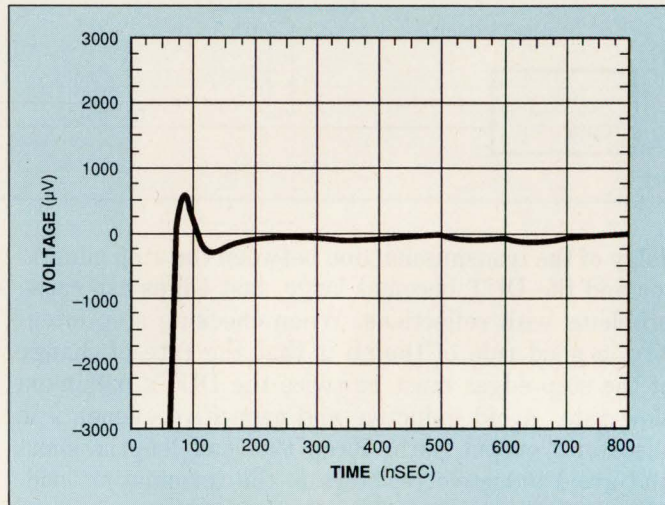

Fig 8—The SVT reconstructs the settling of a -5 to 5V step applied to an op-amp input.

they don't affect the settling-time measurement. Thermal tails due exclusively to the DUT itself will be directly visible in the error signal, however.

The false summing node presents an excellent way to test the flatness of the step generator. You can examine an error present at a specific voltage level of the step generator by removing the DUT, grounding point 1 of Fig 6's circuit and driving point 2 to the opposing voltage level. For example, to examine the error present in the transition from -5V to 5V , you would ground point 1 and drive point 2 to -5V . The waveform at the false summing node will reveal all the overshoot, ringing, and thermal tails present in that transition. This test, as sampled by the SVT, is shown in Fig 8. Time t_0 on the plot is the point at which the input step began its transition from -5V to 5V .

In the false-summing-node circuit, select R_{IN} , R_{IN}' , R_F , and R_F' , so that $R_{IN} = R_F$ and $R_{IN}' = R_F'$ to within 0.1% . The values of these resistors depend strongly on the DUT. Consult the device manufacturer's data sheets for optimum loading values. The effects of loading on the settling-time measurement are extremely important. Figs 9a and b show, respectively, the error signal with the correct loading and with an incorrect capacitive load. The DUT used to produce these plots is an LF401, a fast-settling, FET-input op amp. A careful accounting of circuit loading, including parasitic elements, is vital to making valid measurements.

Capacitance is the factor that most often affects the performance of a fast-settling op amp. Although a feedback capacitor in parallel with the feedback resistor

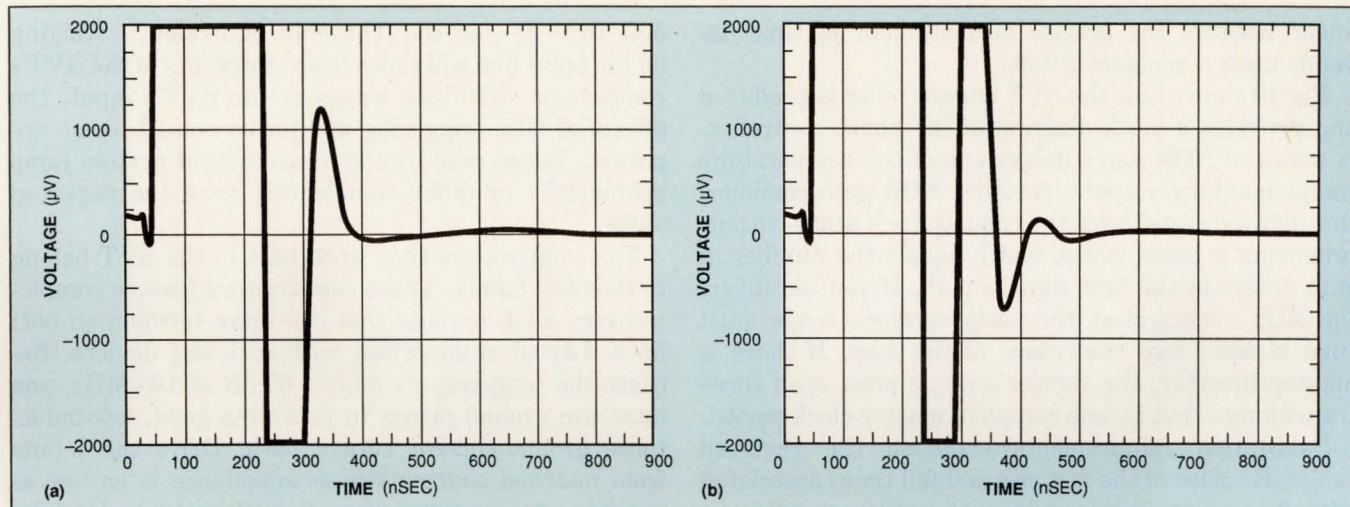

Fig 9—When a correctly loaded LF401 settles from a -5 to $+5V$ input step (a), all transients disappear within 400 nsec. Adding load capacitance (b) produces a slowing of the settling that is noticeable because of the SVT's resolution.

is usually beneficial, any capacitive loading can have devastating effects (Fig 9b).

The two Schottky diodes at the false summing node in Fig 9b act as limiters. They prevent the error signal from overdriving the buffers and the measuring equipment in the circuits that follow. A JFET and a buffer send the signal at the capacitance-sensitive false summing node to the SVT. A 2N4416 JFET was chosen because its high input impedance and low input capacitance make it an ideal follower. The buffer drives the 50Ω input impedance of the SVT and provides a place for the ac coupling that defeats the JFET's thermal drift. Choose the coupling capacitors carefully. Because of problems with dielectric absorption, avoid ceramic and tantalum capacitors; polystyrene capacitors work best.

If the settling-time-measurement setup is ever to go from the prototype stage to a production test system, it must use the correct device contactor. (The contactor is a unit that mounts on an automatic device handler and makes the electrical connections to the DUT.) For several reasons, contactors have always caused problems in settling-time setups.

The majority of contactors offer no method of placing decoupling capacitors closer than one inch from the DUT's power-supply pins—an unacceptable distance when large, rapid voltage transitions occur at the device's output. Contactors also have problems with isolation between pins, and often present a capacitive load to the DUT.

The settling-time test board uses a contactor made

by Sym-tek (San Diego, CA) for applications at frequencies in excess of 2 GHz. This contactor has a characteristic impedance of 50Ω , a rise time of 140 psec, and a lead-to-lead isolation resistance of $1 G\Omega$. The most important feature of the contactor for this application, however, is that it allows placement of decoupling capacitors as large as $0.1 \mu F$ within 0.2 in. of the DUT's power-supply pins.

You can locate the pulse vernier on the board or externally. The vernier's resolution is an important system parameter because it establishes the effective bandwidth of the SVT, determines the maximum measurement accuracy, and affects other modules within the system. For example, it determines whether the system needs a step inverter to adequately resolve details of positive- and negative-going steps at the DUT output.

Ramp generator is heart of pulse vernier

To generate the SVT trigger pulse, the settling-time test board's pulse-position vernier generates complementary voltage steps that follow the DUT input step by a controllable delay. The vernier uses a current source that, upon the application of a rising edge, charges a capacitor to generate a voltage ramp. This ramp drives the noninverting input of a comparator whose inverting input comes from a DAC. The comparator's complementary output steps produce the SVT trigger pulse. The DAC controls the phase difference between the comparator output and the edge that triggers the ramp. It is important that the ramp be

The sampling voltage tracker that lies at the heart of the system can determine within 50 μ V the analog voltage at discrete points of a waveform.

linear because the precise measurement of time depends upon a constant dV/dt .

Fig 10 shows how the SVT trigger pulse is produced and provides a block diagram of the phase controller. A series of NOR gates delays one of the comparator's complementary outputs. Another NOR gate combines this delayed signal with the comparator's other output, producing a pulse whose width equals the number of gate delays in the first signal's path. If you can invert the DUT's input step, the pulse vernier's range must span at least two transitions of the step. If there is no step inverter, the vernier's range must span three transitions—that is, one complete master-clock period.

Calibration requirements establish the required range. Because of the fast rise and fall times associated with 2- to 5-nsec-wide pulses, the pulse circuits use emitter-coupled logic (ECL). To prevent reflections, you must terminate lines driven by ECL outputs with

50 Ω to $-2V$ (or the Thevenin equivalent). Ringing on the pulse line will cause false triggering of the SVT's comparator. With fast edges at the SVT's input, the effects of false triggering and phase noise become apparent. Values read by the measurement system jump sporadically or differ significantly from the expected value.

The comparators that work best in the SVT belong to the 6685 family. These comparators feature complementary ECL outputs that can drive terminated 50 Ω lines. Layout is important with such fast devices. Because the comparator's gain is 60 dB at 100 MHz, you must use ground planes to provide a good, low-inductance ground-current return path. Drive the inputs from matched sources whose impedance is as low as possible. Again, terminate all ECL outputs (and inputs) with 50 Ω to -2 volts. The latch enable is the most critical signal—an improperly terminated line will

A settling-time primer

Settling time is the interval that a device's output needs following a step change to reach (and remain within) a small error band surrounding the final value. For example, if you apply a voltage step of V volts to the input of a unity-gain op-amp inverter, you can consider the circuit's output to be fully settled at the first point after which its departures from the final, steady-state value remain within $\pm[(V \cdot P)/100]$. P is a specified percentage of the step amplitude. In Fig A, the settling time of a 10V step to 0.01% is the time interval between t_0 , the beginning of the step, and t_1 , the point at which the signal crosses into a ± 1 -mV error band for the last time. Several aspects of settling time make the measurement difficult to obtain.

Most op-amp manufacturers specify settling time of their fast-settling devices to 0.01% of a 10V step. This definition, as Fig A

shows, produces a ± 1 -mV error band. Because most scopes offer only 5-mV/div voltage resolution, accurately determining where

the device under test's (DUT's) output crosses into the error band is difficult. Moreover, if you view the DUT's output directly

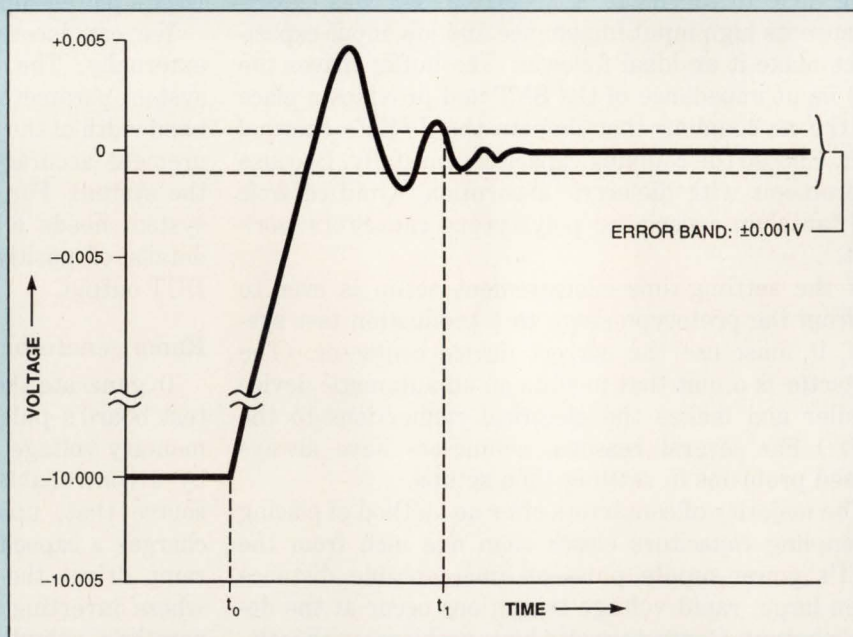

Fig A—After a step change, settling is complete when an op amp's output no longer leaves a specified error band surrounding its final, steady-state value.

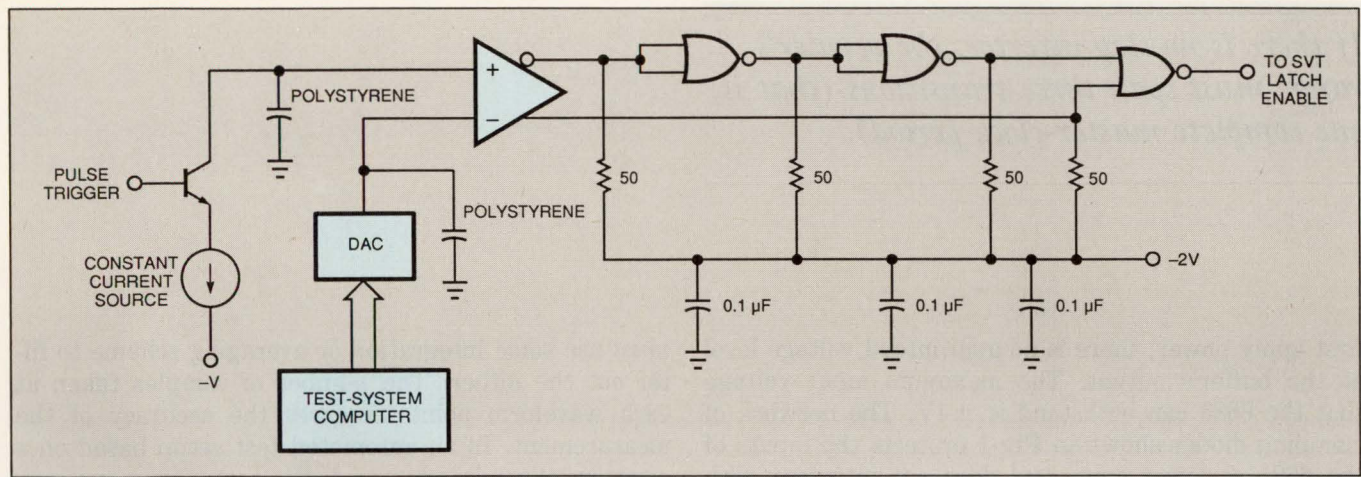

Fig 10—The pulse-position vernier consists of a ramp generator, a DAC, and a series of NOR gates that constitute a pulse stretcher.

cause false triggering. The 6685's outputs, on the other hand, are essentially dc and are not as critical.

The primary consideration in selecting an integrator and a buffer is the devices' ability to drive capacitive loads. The settling-time test board uses an LM607 precision op amp for both applications. The buffer isolates the integrator from the comparator's input. The offset voltages of the buffer and the integrator are immaterial because feedback drives the buffer's output to a voltage equal to the comparator's offset plus the voltage at the

comparator's noninverting input.

Keep in mind that the SVT contains a closed feedback path and that it has a closed-loop gain. Fig 1 shows the SVT set for unity gain. Changing the gain is straight-forward. Fig 11 shows an SVT set for a gain of 10. At all values of gain, you must observe some restrictions imposed by the 6685.

After you apply power, the voltage at the SVT's output will eventually reach a value proportional to the voltage at the circuit's input. However, when you

with a scope at 5 mV/div, you can only see the signal edge where the output settles to ground—most scopes will not provide enough offset to let you view the settling to 10V. Even if you view only the edge where the DUT output settles to ground, the signal will badly overdrive the scope's input amplifier and will cause the measured settling time to reflect the recovery time of the scope and not the settling time of the DUT.

Factors in the DUT's environment also strongly affect the measurement. The effects of loading, both resistive and reactive, can cause large settling times or ringing by introducing an unwanted pole in a device's closed-loop transfer function. The PSRR of high-speed amplifiers usually ranges from 80 to 100 dB. These values apply only at low frequencies, however. Because PSRR falls with increasing frequency, at

frequencies as low as 1 MHz the PSRR will drop to nearly 0 dB. As a result, power-supply decoupling capacitors are essential for isolating the device's output from power-supply noise. However, distances greater than an inch between the DUT and the decoupling capacitors can be too great for settling measurements, so most device contactors used in semiconductor manufacturers' test departments become unusable. Most attempts at making an automated production test for settling time end here.

If those complications aren't daunting enough to the test engineer, other problems can arise from such effects as noise variations in the DUT power supply. As the DUT's output swings over a 10V range, its supply current can change substantially. As it does, supply noise can vary significantly. Moreover, the transition from a prototype board used

to validate a proposed test method to a production-test department's contactor and handler often introduces additional unknowns into an already complex measurement.

Usually, settling-time measurements are restricted to bench setups with custom-built test fixtures operated by skilled technicians. One drawback of this approach is that the results are often unreproducible on different setups. The inability to reproduce measurements either limits testing to a single fixture for quality assurance or necessitates large guard bands. Large guard bands force conservative and possibly uncompetitive specs, or they lower yields and raise product cost. Test time is another drawback; manual settling-time measurements can take 20 sec or longer, making the test expensive.

If there is no step inverter, the vernier's range must span three transitions (that is, one complete master-clock period).

first apply power, there is no guaranteed voltage level at the buffer's output. The maximum input voltage that the 6685 can withstand is $\pm 4V$. The network of clamping diodes shown in Fig 1 protects the inputs of the 6685 at lower gains and does not interfere with circuit operation. At gains greater than 4, the divider resistor that sets the SVT's gain (Fig 11) is sufficient to prevent large input voltages.

The 6685 should have matched impedances at its inputs, though an absolute match is unnecessary. Examining Fig 1 from an ac point of view shows 100Ω to ground at both inputs. Likewise, the circuit in Fig 11 splits the feedback resistors to achieve 100Ω at the comparator's inverting input while providing the desired gain of 10.

The SVT measures relative changes in its input signal; it can't make absolute measurements. Therefore, voltage offsets added to signals are immaterial. The SVT on the settling-time test board can resolve $50\text{-}\mu V$ changes with a bandwidth exceeding 300 MHz. On the advance data sheet of the LH4810, a hybrid version of the SVT described here, National Semiconductor's Hybrid Div reports a bandwidth greater than 1 GHz.

There are several ways to measure the dc component of the SVT's output voltage—despite the ac component caused by the integrator "dithering" around its average output level. The method of measuring the dc level

must use some integration or averaging scheme to filter out the dither. The number of samples taken at each waveform point increases the accuracy of the measurement. In an automated test setup based on a commercial semiconductor device tester, you can simply use the tester's resident voltmeter. Adding a small number of components can provide the necessary filtering.

Another measurement technique uses a voltage-controlled oscillator (VCO). The ac components of the SVT's output will cause the VCO's output to vary about some center frequency. By determining the period of a large number of VCO cycles and then dividing by the number of cycles, you can find the average period and hence the average voltage. (For example, if 10,000 cycles take 1 msec, the average period is 100 nsec.) This method is much faster than using a voltmeter with a large integration time constant. But, VCOs are not all that linear over a large voltage range, so you must calibrate them to obtain the correct values of voltage vs frequency.

The first value of interest in a settling-time measurement is the point at which the DUT input step occurs. You can find this point by varying the pulse position and looking for a voltage difference between a settled portion of the waveform and subsequent points. This point, shown in Fig 12, is called t_0 . The settling-time test

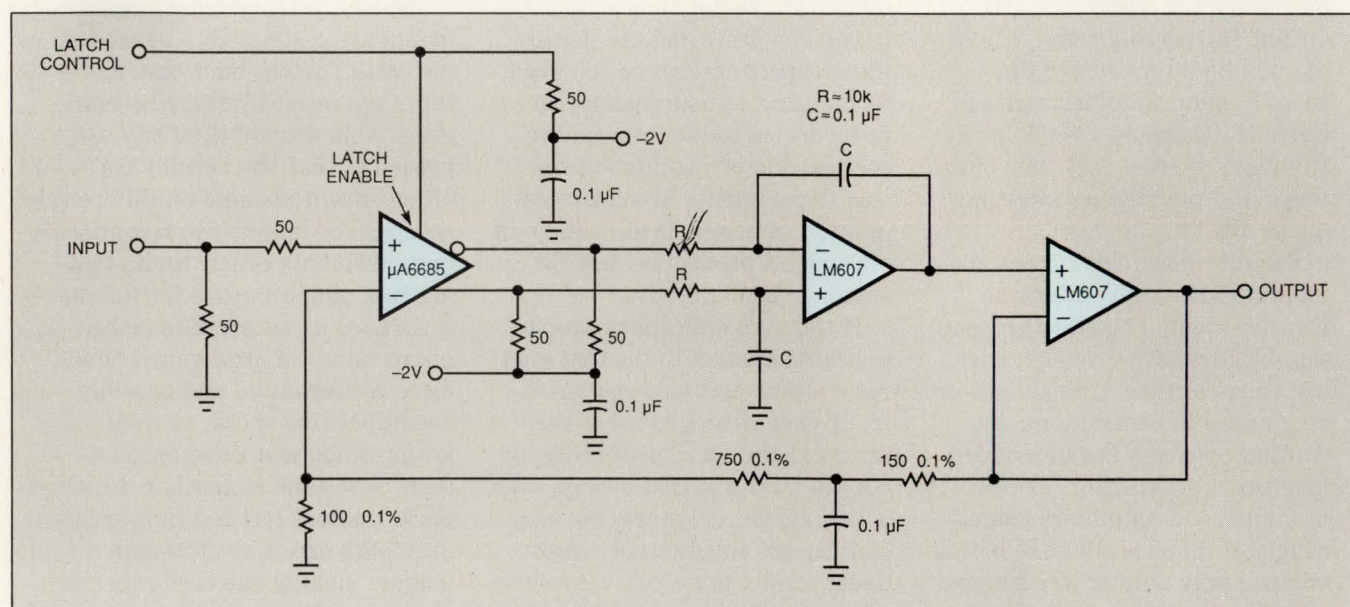

Fig 11—Adding a gain of 10 to the SVT involves a simple change—adding a 9:1 divider in the feedback loop. The divider permits the removal of the diode clamping network used by the unity-gain SVT.

Brighten-up Your Display Designs.

Turn-onto itron VFD Super-Smart Modules.

Proprietary advanced VFD technology now allows Noritake to offer a broad line of super-smart dot character and dot matrix vacuum fluorescent display modules that will satisfy the most demanding requirements.

- HIGH VISIBILITY
- LOW POWER
- SURFACE-MOUNT TECHNOLOGY
- LONG-TERM RELIABILITY
- 5Vdc POWER SUPPLY OPERATION
- WIDE TEMP. RANGE: -40°C TO +85°C

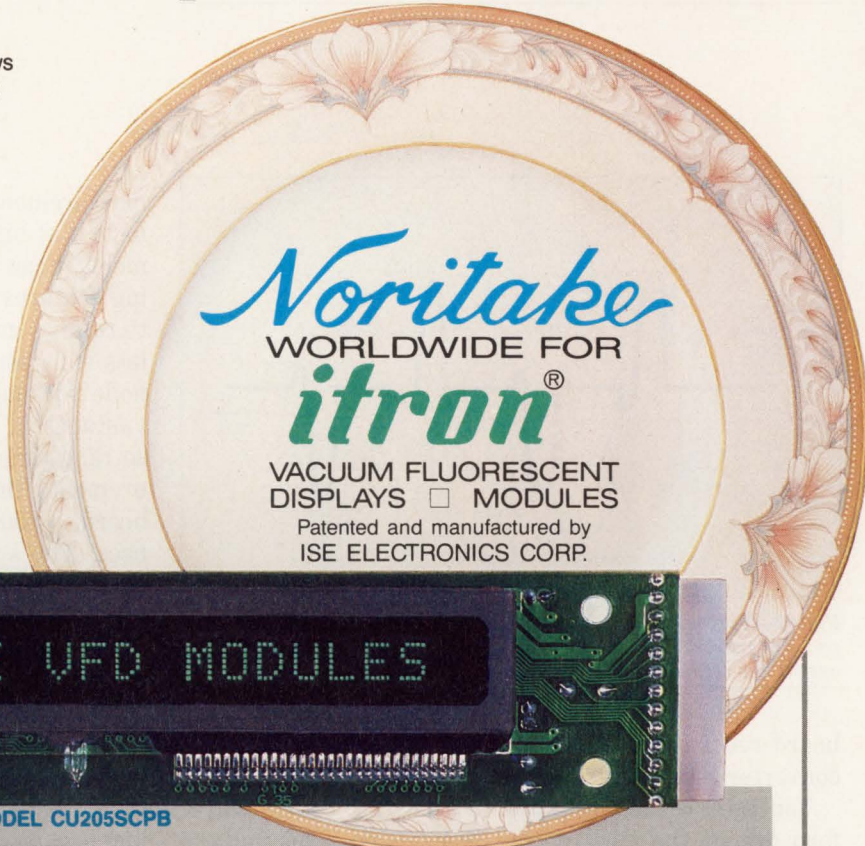

NORITAKE "BARRYMORE" BONE CHINA PLATE SHOWN

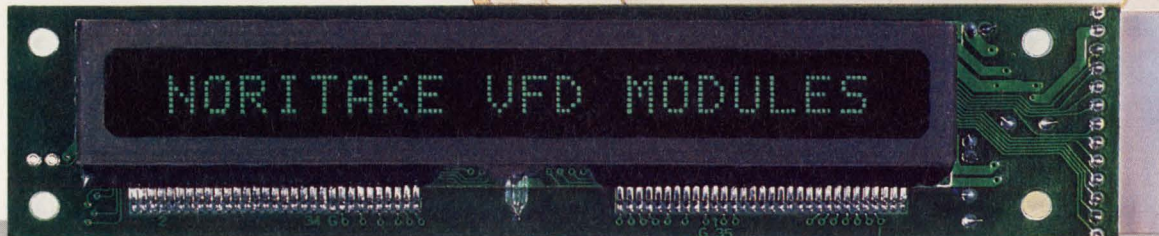

MODEL CU205SCP-B

DOT CHARACTER DISPLAY MODULES

CHARACTER FORMAT	MODEL NUMBER	NUMBER OF CHARACTERS	CHARACTER HEIGHT (MM)	INPUT (SERIAL/ PARALLEL)	BI-DIRECT BUS	* WIDE TEMP. RANGE MODELS
5 x 7 DOT MATRIX	CU165SCP-B-S	1 x 16	5.0	S/P		
	CU169SCP-B-L	1 x 16	9.0	P	x	
	CU205SCP-B-S	1 x 20	5.0	S/P		
	CU209SCP-B-L	1 x 20	9.2	P	x	
5 x 7 DOT MATRIX PLUS CURSOR	CU2015SCP-B-L	1 x 20	15.1	P	x	
	CU406SCP-B-S	1 x 40	5.0	P	x	
	CU20026SCP-B-S	2 x 20	5.1	P	x	x
	CU40026SCP-B-S	2 x 40	5.0	P	x	x
	CU40046MCP-B-S	4 x 40	5.0	S/P	x	x
	CU40066MCP-B-S	6 x 40	5.0	S/P	x	x
CU40086MCP-B-S	8 x 40	5.0	P	x	x	

*OPTIONAL

DOT MATRIX DISPLAY MODULES

DOT MATRIX FORMAT (DOTS/LINE x NO. OF LINES)	MODEL NUMBER	NO. OF LINES AND CHARACTERS/LINE (5x7 DOT CONFIGURATION)	GRAPHICS CAPABILITY
192 x 16 (3072 DOTS TOTAL)	GU192X16	2 x 32	YES
256 x 16 (4096 DOTS TOTAL)	GU256X16	2 x 42	YES
256 x 64 (16,384 DOTS TOTAL)	GU256X64	8 x 42	YES

The models shown are typical of the broad selection available on an immediate delivery basis. Contact our nearest sales office or representative for counsel on the best Noritake VFD for your application, as well as for details on costs, custom designs, deliveries, etc.

NORITAKE CO., INC. ELECTRONICS DIV. U.S.A. SALES OFFICES

WEST: 23820 Hawthorne Blvd. Suite 100 Torrance, CA 90505
(213) 373-6704 FAX (213) 772-3918

CENTRAL: 415 E. Golf Rd. Suite 109 Arlington Hts., IL 60005
(312) 439-9020 FAX (312) 593-2285

EAST: 263 Winn Street Suite 1D Burlington, MA 01803
(617) 270-0360 FAX (617) 273-2892

SOUTHWEST: 2454 Trade Mart Dr. Dallas, TX 75207
(214) 742-9389 FAX (214) 747-5065

NORITAKE EUROPA G.M.B.H. Electronics Div.

Frankfurter Strasse 97-99, D-6096, Raunheim, F.R. Germany
Phone: 06142-43095 FAX: 06142-22799 TLX: 4182982 dn d

NORITAKE CO., LTD. Electronics Div.

1-36 Noritake Shinmachi, 3 Chome, Nishi-Ku, Nagoya, Japan
Phone: (052) 562-0336 FAX: (052) 581-1679 TLX: 59738

REPRESENTATIVES

WA, OR: (503) 684-1671 Components West, Inc. **CA, NV:** (415) 961-1422 Westech Sales **So. CA:** SD (619) 292-1771 / OC (714) 891-4621
 ELSCO TX, OK, AR, LA: (214) 386-4888 Norcom, Inc. **CO, UT:** (303) 794-4684 MRC OH, WV, W. PA, KY: (216) 461-6161 Arthur H. Baier
No. IL, So. WI: (312) 439-9810 Coombs Asso., Inc. **AL, GA, MS, TN:** (205) 533-1730 Interep Asso. **IN:** (317) 844-4842 Fred A. Dorsey & Asso., Inc.
No. WI, MN, No. IA, ND, SD: (612) 536-9512 Tech. Components **N.E.:** (508) 788-0316 Int. Mktg. Group **PA, MD, DE:** (215) 233-0333
 C.H. Newsom & Associates **FL, Puerto Rico:** (407) 831-8233 Semtronic Asso., Inc. **NY, NJ:** (201) 376-3324 F.F. Sylvester Asso. **VA:** (804) 740-0063
 Glasscock Asso. **NC, SC:** (919) 782-8100 C-Tech Sales Co. **CANADA:** (416) 671-8111 Gidden Morton Associates

The method of measuring the dc level must use some integration or averaging scheme to filter out the dither.

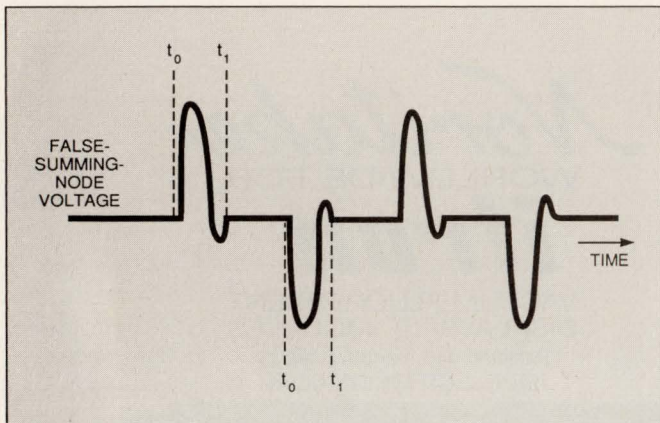

Fig 12—The waveform at the false summing node consists of a series of pulses. The waveform drops to zero whenever the op amp's output has settled to its steady-state value.

board records t_0 by storing the input code of the D/A converter that (indirectly) positions the sampling pulse.

You then move the pulse to a portion of the waveform where the DUT output has settled. This voltage serves as a reference for finding t_1 , the point where the error signal passes outside of the $500 \mu\text{V}$ error band (actually, the point where the error signal enters the error band for the last time). When you have positioned the pulse at t_1 , you subtract from the DAC input the number representing the DAC input at t_0 .

Calculate time by manipulating DAC inputs

To equate this calculated difference to an actual time in nanoseconds, you must know how much the sample point moves for each LSB change in the D/A converter's input. The pulse vernier must be able to strobe the SVT at any point in a full period of the DUT input step. If you can invert the step, the vernier only needs to strobe the SVT over a range covering a little more than two step transitions. In Fig 12, the error signal at the false summing node clearly shows these transitions. By finding the DAC input values at each of the step period's three transitions (at the beginning, middle, and end of the period), you know how much you must change the DAC input to position the strobe pulse over a full step period. If you divide the step period (in nanoseconds) by this number, you have dt/dN —nanoseconds/bit. Multiplying this quantity by the difference between the t_1 and t_0 DAC inputs yields the settling time.

You can measure settling time in many ways. The

measurement is rarely trivial, but when you must perform it at high speed to 0.01% in a production environment, it can become a nightmare. One of the outstanding features of the SVT described here is its ability to resolve small voltage changes. The SVT's sensitivity lets it measure the error signal at the false summing node without amplification. Another of the SVT's advantages is reproducibility. Different samples of the settling-time test boards described here make measurements that correlate within 10 nsec. On any one board, a 350-nsec measurement is repeatable within 5 nsec. The system is self-calibrating; its measurement speed depends on the speed of the automatic test system with which you use it.

The SVT can do much more than test settling time; it can characterize waveforms from dc to RF. Other SVT applications include measuring propagation delay, slew rate, rise time, fall time, and acquisition time. Because of its extreme speed and accuracy, quantifying the circuit's performance is difficult, but in two of its key parameters, the settling-time test board's SVT is at least this good: Its bandwidth is more than 300 MHz and its voltage resolution is less than $50 \mu\text{V}$.

EDN

Reference

1. Halbert and Koen, *A waveform digitizer for dynamic testing of high-speed data-conversion components*, Burr-Brown Corp, Tucson, AZ.

Author's biography

Ralph Andersson is an ASIC design engineer with National Semiconductor Corp in Santa Clara, CA. He has worked at NSC since obtaining his BSEE from the University of California—Davis three years ago. In his first assignment at National, he worked in test development, where he developed the techniques discussed in this article. His hobbies include scuba diving and skiing.

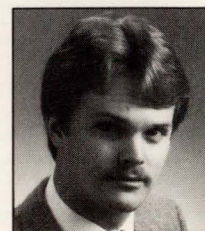

Article Interest Quotient (Circle One)
High 479 Medium 480 Low 481

LOW POWER, LOW COST MULTICHANNEL A/D CONVERSION

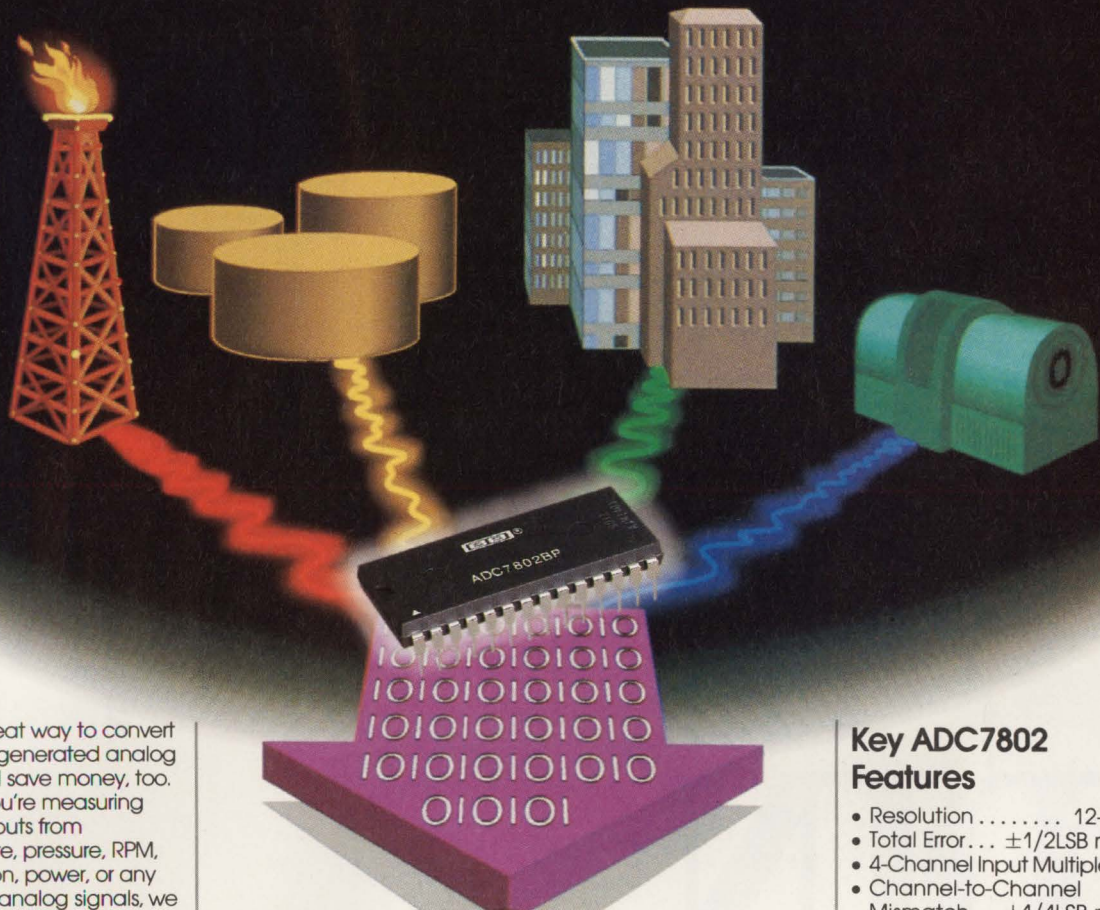

Here's a great way to convert those field-generated analog signals and save money, too. Whether you're measuring multiple inputs from temperature, pressure, RPM, flow, rotation, power, or any number of analog signals, we have a new A/D converter that you'll like. Our ADC7802 12-bit autocalibrating sampling A/D converter offers extremely high accuracy, and features an internal sample/hold and a 4-channel multiplexer to cut your signal conditioning costs. It's the ideal solution for a broad range of data acquisition and industrial process control applications.

Accuracy and Low Power

Autocalibration guarantees a total error within $\pm 1/2$ LSB over the extended -40°C to $+85^{\circ}\text{C}$ industrial temperature range without offset or gain adjustment. And to add to its versatility, the ADC7802's advanced CMOS design dissipates just 10mW and operates from a single 5V supply ... just right for those battery-backed or remote applications. Conversion time, including acquisition, is 17 μs .

μP

Microprocessor Friendly

The ADC7802 also has an onboard clock and an 8-bit microprocessor interface. It has a 0V to 5V unipolar input range and offers standard $\overline{\text{CS}}$, $\overline{\text{RD}}$, and $\overline{\text{WR}}$ controls to simplify interfacing. Conversion results are available in two bytes through an 8-bit three-state output bus with "No Missing Codes" over temperature.

Key ADC7802 Features

- Resolution 12-bits
- Total Error . . . $\pm 1/2$ LSB max
- 4-Channel Input Multiplexer
- Channel-to-Channel Mismatch . . $\pm 1/4$ LSB max
- Conversion Time . . 17 μs max
- Power Dissipation . . . 10mW
- Power Supply . . . Single 5V
- Operating Temperature . . . -40°C to $+85^{\circ}\text{C}$
- Packages: 28-Pin plastic DIP or 28-lead PLCC

Low power, low cost, and available off-the-shelf. A *real* 12 bits for under \$5.00* per channel. For complete information, write Burr-Brown Corp., P.O. Box 11400, Tucson, AZ 85734. Or, call toll free **1-800-548-6132**.

* U.S. OEM prices, in 100s start at just \$19.95



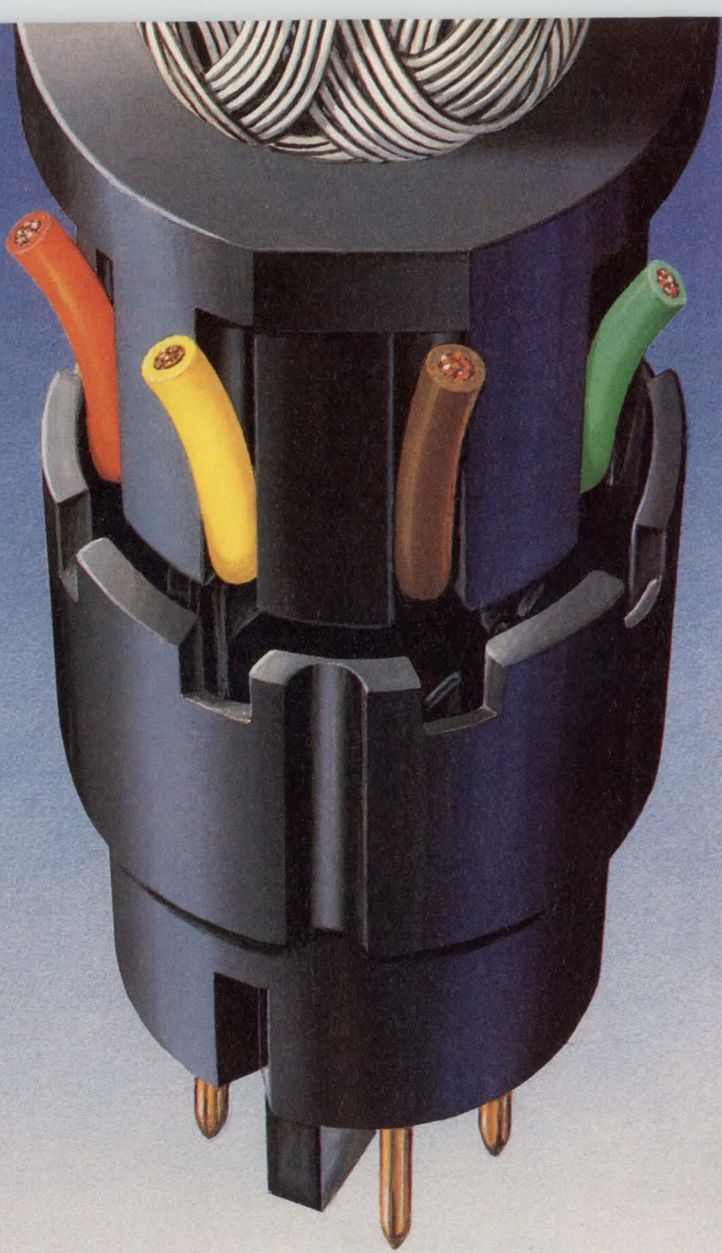
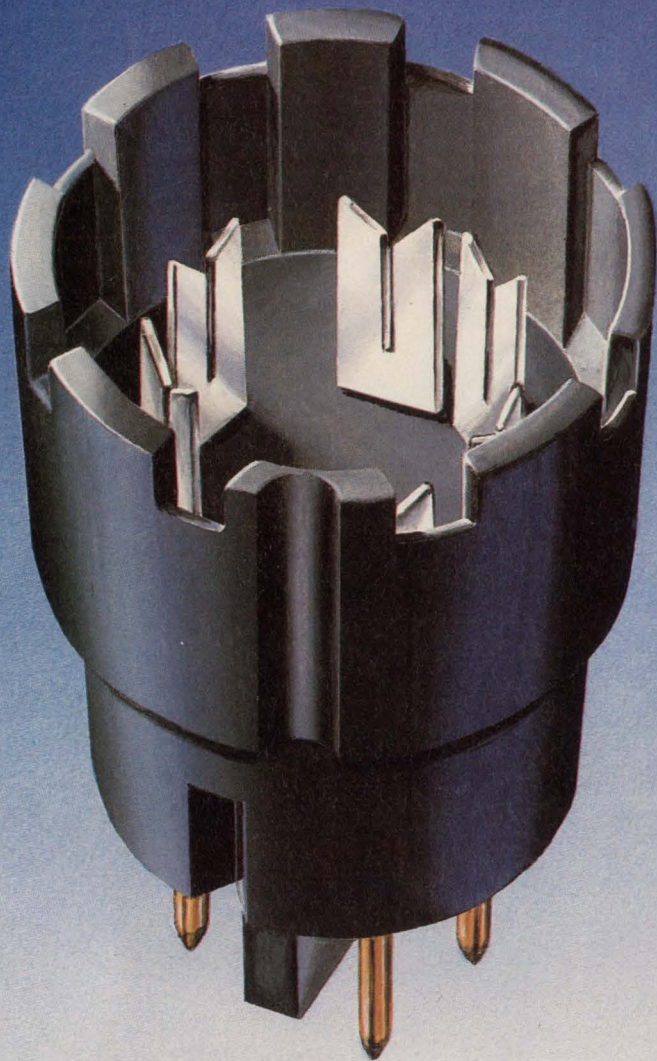

DIN.

These mini-DIN plugs feature mass IDC termination—one quick stroke for productivity. In fact, our 'little' breakthrough in circular connector termination lets you reduce labor costs by 50% to 75%.

Using insulation displacement contacts and our exclusive one-step shield crimp, it takes less than a minute from start of termination to overmolding readiness. And the plug

is designed to be troublefree: conductors and shield are completely isolated, and preloaded contacts assure true contact position. The finished package provides an outstandingly quiet interface.

Breakthrough technology includes production support: our simplified tooling handles plugs with 3 to 8 contact positions, with no changeover between sizes. The tooling does all the

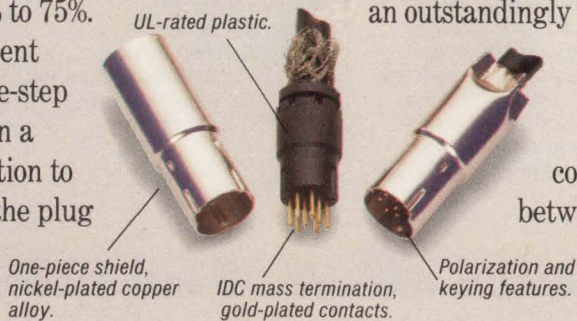

One-piece shield, nickel-plated copper alloy.

UL-rated plastic.

IDC mass termination, gold-plated contacts.

Polarization and keying features.

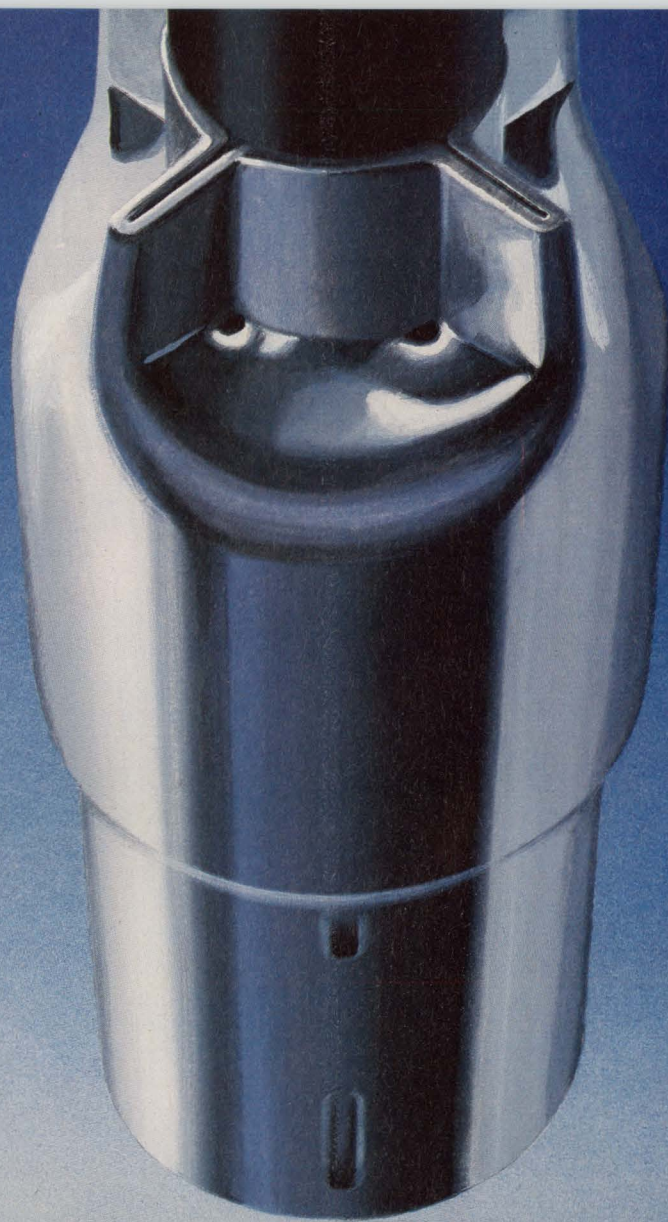

DONE.

work of critical alignment, so work goes even faster. And domestic availability makes an even stronger case for local cable production.

Call our Product Information Center at 1-800-522-6752 and ask for more information on AMP Mini-DIN plug and receptacle lines. AMP Incorporated, Harrisburg, PA 17105-3608.

AMP is a trademark of AMP Incorporated.

CIRCLE NO. 73

THIS IS AMP TODAY.

Complete component system: AMP shielded mini-DIN receptacles are a mere 1/2-inch cube, designed for automated or robotic insertion and high-temp processing. With a wide range of AMP connectors available for the other end.



AMP

Seagate's Technology

THE FINE ART OF DISC DRIVES



Neon Sculpture by
Lili Lakich
Los Angeles, California

To the naked eye, disc drives haven't changed much in the past few years. While the visible aspects have remained the same, the parts you can't see have improved dramatically. What used to be megabytes are now gigabytes. And Seagate is at the forefront of this technological revolution.

We've not only increased capacities, but we've found ways to make drives faster and more reliable. For example, Zone Bit Recording™ is a recording technique that permits higher capacity and faster average data transfer rates than conventional recording methods. Our straight-arm actuator has 60% less mass than most other designs, giving our Wren™ and Sabre™ families lightning-quick access performance. And by increasing spindle rotation 50% to 5400 RPM, we've significantly increased the transfer rate and reduced the latency in our 1.5 GB Elite™ drive.

As a result of these and other technological improvements, Seagate now offers drives from 20 MB to 2.5 GB in the widest range of form factors and interfaces imaginable, for almost every conceivable application. And we're not through yet.

Like the artist who spends years perfecting his craft, Seagate has spent the past decade mastering the fine art of disc drives. To get a first-hand look at the state-of-the-art, contact your authorized Seagate distributor, or call Seagate directly: 800-468-DISC, or 408-438-6550.



Zone Bit Recording, Wren, Sabre and Elite are trademarks of a wholly-owned subsidiary of Seagate Technology, Inc.; Seagate and the Seagate logo are registered trademarks of Seagate Technology, Inc. ©1990 Seagate Technology, Inc.

8mm.

No other tape measures up.

Considering conventional tape storage products for your customers' data storage needs?

Consider again.

With its superior recording characteristics and unprecedented capacity on a single tape, 8mm data storage has become the *de facto* standard in today's workstation, UNIX®, and file server environments.

We've shipped over 100,000 EXB-8200 8mm Cartridge Tape Subsystems, backing up some of the biggest names in the industry such as Bull S.A., Data General, IBM, Motorola, NCR, Norsk Data, Northern Telecom, Prime Computer, Siemens, Sun Microsystems, Texas Instruments, 3Com, and Wang Laboratories, just to mention a few.

At 2.5-gigabyte capacity, the EXB-8200 makes unattended backup a reality, dramatically reducing manual intervention. Add an integrated SCSI controller and formatter, industry-standard 5¼-inch form factor, and a fast 246 Kbytes/second transfer rate, and you have the field-proven storage system that keeps pace with today's disk capacities.



If you're an OEM, VAR, or systems integrator, call us today at (303) 447-7359 or write EXABYTE Corporation at 1685 38th Street, Boulder, CO 80301.

And find out why no other tape measures up to 8mm for your customers' backup/restore, data acquisition, data interchange, software distribution, and archiving needs.



The EXB-8200
2.5-Gigabyte Capacity
246 Kbytes/Second Transfer Rate
Over 100,000 Drives Shipped

CIRCLE NO. 141

UNIX is a registered trademark of AT&T.
©1990 EXABYTE Corporation.

EXABYTE™
The Capacity to Succeed



S-MOS MICROCOMPUTERS
TAKE THE PRESSURE
OFF YOU
AND YOUR SYSTEM.
.....

Extend battery life up to 10 years

Now that's a hot subject.

Fortunately, our S-MOS 4-bit SMC6200 Microcomputers (MCU) are a cool alternative for today's power-hungry designs. S-MOS MCU's offer the world's lowest current consumption— $0.9 \mu A^\dagger$ —enabling you to extend the life of your battery up to 10 years.

On-chip features

Even the most pressured designers will find relief with all the SMC6200 Series options. On chip Battery Level

†Typical



Detect (BLD) circuits signal a low battery to your display. Software selectable twin clocks let you optimize your power consumption. A wide range of on-chip ROM and RAM, I/O ports and on-chip LCD drivers. As well as many other high performance peripherals. Plus, S-MOS offers powerful, easy-to-use PC-based development tools and add-on hardware that help you develop applications quickly.

S-MOS 4-Bit Microcomputers

Part Number	Memory (bits)		LCD Drivers		Features
	ROM	RAM	Common	Segment	
SMC6214	4096 x 12	208 x 4	3 or 4	32	*AC, **BLD, Timer Twin Clock
SMC6215	x 12	488 x 4		50	
***SMC6232	2048 x 12	144 x 4	3 or 4	38	AC, Counter, BLD
***SMC6235	4096 x 12	574 x 4	3 or 4	48	Sound Generator Counter, BLD, AC
SMC6246	6144 x 12	640 x 4	8 or 16	40	Sound Generator Twin Clock, BLD
SMC6266	6144 x 12	1024 x 4	N/A	N/A	2 Channel AC Counter, Twin Clock
***SMC6281	1024 x 12	96 x 4	3 or 4	26	Melody Generator BLD, AC

*Analog Comparator (AC) **Battery Level Detect (BLD) *** Microcomputers running as low as 0.9V

Take the pressure off now. For a Free "Create the Future" Mouse Pad and our S-MOS Microcomputer Technical Guide, just call 1-800-888-1967 ext. 183. And move full-steam ahead.

ASICs, Microcomputers, Memories & ChipSets

S-MOS
SYSTEMS

A Seiko Epson Affiliate

The Complete Electronic Design Solution.

Tango

For complete specs
and FREE evaluation
packages, call
800 433-7801



Tango is the pacesetter in affordable, PC-based electronic design. It offers the quality and performance engineering professionals demand, and the easiest-to-use interface available on any platform, at any price.

Tango's powerful lineup. Build your personal CAE/CAD workstation with Tango's start-to-finish design tools. **Tango-Schematic**,™ just \$495, includes over 8,000 SEDCO™ parts, the largest library on the PC. Experience **Tango-PLD**'s powerful top-down approach to logic design for only \$495. Add interactive logic simulation for up to 40,000 gates with **Susie**.™

Starting at just \$595, our popular PCB layout tools have designed *tens of thousands* of boards. There's **Tango-PCB PLUS**,™ for complex designs and **Tango-PCB**,™ a comprehensive, yet economical program for less demanding requirements. Tango designers have three fast and efficient autorouting options: the high-performance **Tango-Route**,™ multi-grid, multi-layer **Tango-Route PLUS**,™ and **Superoute**,™ the industry-leading rip-up and re-try, 100% completion autorouter. Finally, there's the **SMT Plus Library**™ supplying proven land patterns for sophisticated SMT designs.

Tango extras at no extra charge.

Your investment in Tango software includes clear, concise documentation; responsive technical support, free by phone or fax; first year of updates free, with affordable annual renewals; our 24-hour Tango BBS; directories of service bureaus and design consultants; a quarterly newsletter; and our money-back guarantee. Give us a call to discuss your design requirements. You'll find our customer service is as friendly as our software.

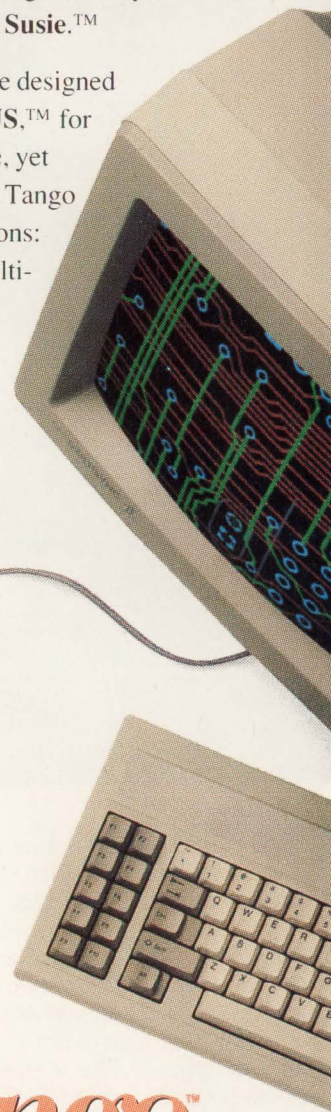
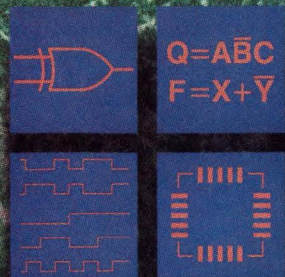

CIRCLE NO. 143

Tango™

Helping good ideas become great products.

ACCEL Technologies, Inc.
6825 Flanders Drive • San Diego, CA 92121
619/554-1000 • Fax 619/554-1019

General-purpose languages simulate simple circuits

Although you can spend lots of money on commercial simulators, inexpensive alternatives exist that will enable you to build and experiment with behavioral-simulation models.

Jozef Kalisz, Associate Professor,
Warsaw Academy of Technology

Many logic simulation programs are capable of solving virtually any logic-, timing-, and fault-simulation problems (Ref 1). However, these programs are expensive—\$1000 to \$50,000 or more—and use proprietary and sometimes peculiar modeling languages. Often the more expensive and powerful the simulator, the harder it is to use. In addition, you usually receive these programs in object (binary) code which is practically impossible to understand or modify.

The recently adopted VHDL (VHSIC hardware description language) (IEEE-1076-1987), mandated by the US Dept of Defense, provides a comprehensive basis for developing powerful software tools for logic simulation and design (Refs 2 and 3). VHDL also offers a way to formally describe and document electronic circuitry. The language's proponents claim that such standardization also allows full compatibility of electronic documentation among different manufacturers.

By precisely defining the initial specifications, you can perform a more detailed verification of the final product.

VHDL also has its detractors (Refs 4 and 5). They claim that it is complex, verbose, and requires great computational effort. Some hardware designers say VHDL is cumbersome and that its definition does not include a clear method for the integration of the design environment, unless the language is supported by comprehensive software systems. Although VHDL is the only prospective industry standard, the software packages currently available for simulation and design are expensive (\$25,000 to \$50,000) and generally require a similarly expensive workstation.

A simple "software breadboard" called Turbo-Logic Simulator (TLS) uses algorithmic behavioral models of logic circuits as functions or procedures to describe relevant micro-operations. You can model complex devices much more rapidly using behavioral language modeling than you can using structural-level modeling. In addition, because behavioral language lets you model the devices at various levels, it is well suited for use in hierarchical design. In fact, VHDL allows you to use behavioral models.

If you are starting to simulate modest designs, a general-purpose high-level language such as Borland's (Scotts Valley, CA) Turbo Pascal offers functional simulation and a means to understand the simulation models. In addition, the user-friendly interfaces of the compiler simplify customization of the simulation pro-

You don't have to spend thousands of dollars on software if you want to learn about logic simulation.

gram. If you know the basics of Turbo Pascal and have the compiler at your disposal, you can create a simple simulator in a few days.

TLS, in the source language Turbo Pascal 4.0, 5.0, or 5.5, comes on a set of disk files. Some files, such as the general declaration file and the function/procedure libraries, are already compiled and represented on the disks by separate titles with the extension .TPU in their names. The files are contained in the directory TLS, along with the main Turbo Pascal compiler files (TURBO.EXE and TURBO.TPL).

In a typical application on a personal computer with a hard disk, you simulate a logic circuit by writing and executing the simulation program. For this type of simulation, you'd select and use the library functions or procedures that serve to describe the circuit net-

work, generate input test vectors, and display results. Select the files that you need for realization of the program by using the clause USES (for compiled units) or the directive \$I (for source code files).

The unit Dec (general declaration file), which **Listing 1** shows in a simplified form, contains the declarations of the most frequently used array and string types, plus the declarations of some variables. The declaration of global variables simplifies writing the actual simulation programs. The variables m, n, and l are tailored for applications in iterative instructions. The variables v1 through v30 and f1 through f30 can be used when you need variables that require temporary storing of their values during execution of the programs. The simple function Ran allows for generation of random bit values from the set B = {0, 1}. In an actual program,

Listing 1

```
unit Dec;
  { General declaration file }
interface
type
  B = 0..1;
  r2 = array[0..1] of B;
  r3 = array[0..2] of B;
  .....
  .....
  r16 = array[0..15] of B;
  br4 = array[0..3] of boolean;
  br8 = array[0..7] of boolean;
  s2 = string[2];
  s3 = string[3];
  .....
  .....
  s16 = string[16];
var
  m, n, l : shortint;
  v1, v2, ..., v30 : B;
  f1, f2, ..., f30 : boolean;
function Ran : B;
implementation
function Ran; { Generate random bit values }
  var u : real;
  begin
    u := Random;
    if u < 0.5 then Ran := 0 else Ran := 1
  end;
end.
```

the initializing procedure Randomize, which is inherent in Turbo Pascal, precedes this function.

You have to describe the simulated circuit by a set of equations in accordance with the Turbo Pascal syntax. In the simplest cases, you represent the input and output data of each logic element as a single-bit variable with values from set B or as a multibit variable in the form of a 1-dimensional array (vector). For representation of binary numbers of the form

$$a_{n-1}, a_{n-2}, \dots, a_1, a_0$$

use the subscript numbers to index the elements in the array. For example, the binary number 10110 can be represented by the array $A[:r5]=(0,1,1,0,1)$ or $A[0]=a_0$, $A[1]=a_1$, and so on. Your input data will usually be the string type, like the output data resulting from the simulation. You can use simple Pascal procedures for appropriate conversion of types.

In general, you can represent any combinational cir-

cuit as a network of appropriately connected single-output gates, such as AND, NAND, OR, NOR, XOR, and INV. You can describe this gate network by functions—a single function for each output of the circuit. If the output signal of any gate drives more than a single gate that signal should bear the name of some intermediate variable, such as v1. The precedence of the circuit description follows the direction of the signal flow within the circuit. **Fig 1a** illustrates this precedence where the program NetSim simulates the gate circuit.

To simulate other single-output networks, you need only modify the parts of this program that have been tinted in **Fig 1b**. The predefined library units Gate and Gater, which come with the software, contain functions corresponding to elementary gates. **Listing 2** provides some examples of individual functions. These examples are similar to the corresponding VHDL descriptions (**Ref 2**) but are much simpler.

The procedure State, in **Listing 3**, can display the

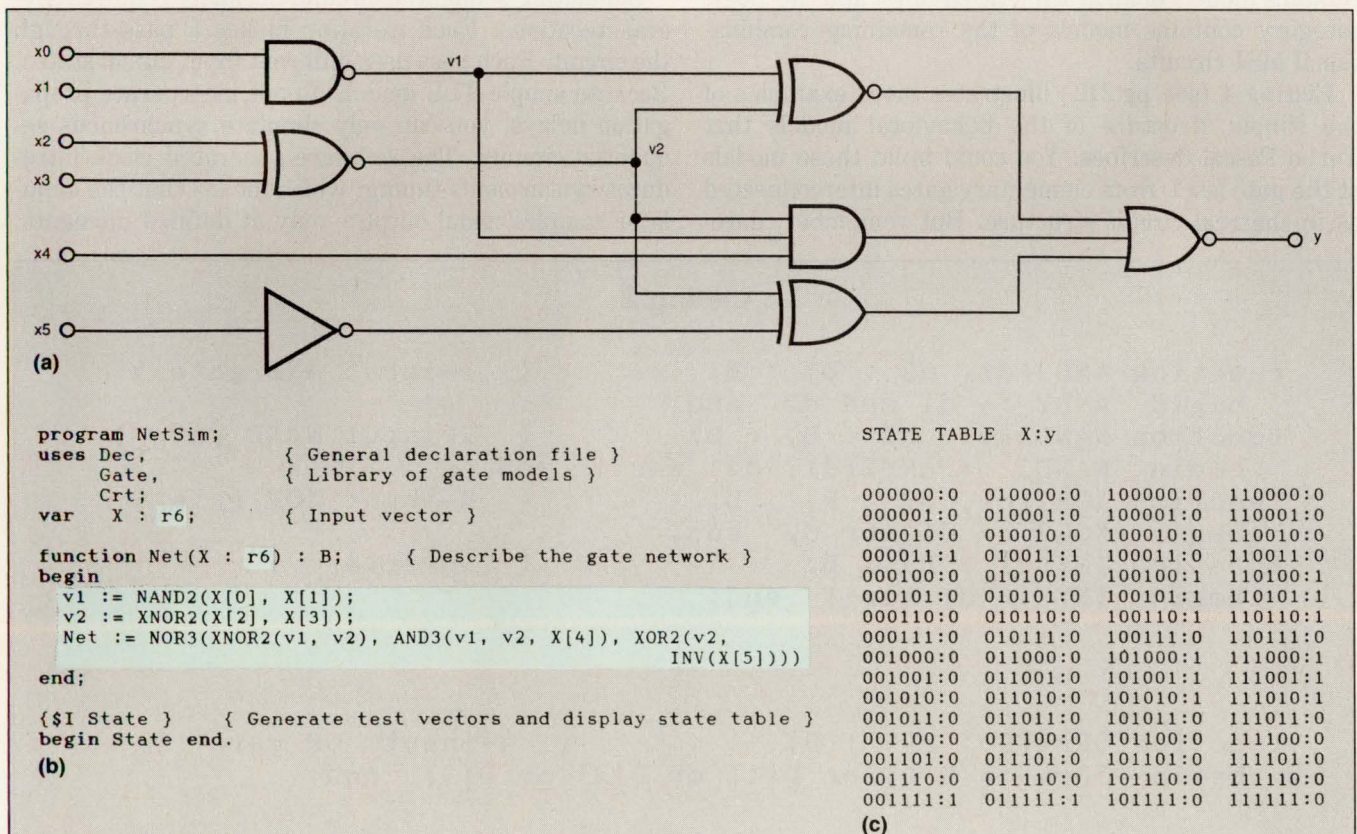

Fig 1—You can simulate a 6-input, single-output gate network (a) by using a simple Turbo Pascal program such as NetSim (b). The state table that will result is shown in c.

Behavioral language is well suited to hierarchical design because it lets you model devices at various levels.

state table of the simulated logic network as long as the number of input variables is not greater than seven. The display is formatted automatically. If the logic network requires more than seven inputs, then you need to modify the procedure.

Fig 1c shows the result of a simulation of the logic network of Fig 1a. The program provides the bare state table, without bells and whistles such as a frame or colors. You can add these features if you like, but only at the expense of greater program length.

The models of typical integrated circuits from the popular TTL and CMOS HC families are grouped by the vendor into common categories such as those you'd find in catalogs of ICs. Thus the categories named Gate and Gater, which contain models of integrated gates with two, three, four, and eight inputs, correspond directly to the types of the device. For example, the function G_10(in1, in2, in3) represents a 3-input NAND gate (1/3 7410). More complex MSI circuit models are grouped in a similar way. The Arit category contains models of all arithmetic circuits, and the Logic category contains models of the remaining combinational MSI circuits.

Listing 4 (see pg 212) illustrates more examples of the simple structure of the behavioral models that Turbo Pascal describes. You could build these models at the gate level, from elementary gates interconnected as in the real circuit structure. But remember, gate-

level models are more complicated and require more memory space than behavioral-level models, plus they slow the running of the program.

Using this behavioral method, you can create models of more complex circuits such as ALUs and PLDs. You can customize your simulation program by designing the proprietary models of only those devices you actually use. Your library of models will grow gradually as you design.

You can estimate maximum propagation time by determining the longest path of the signal flow inside the circuit under development. This won't hold true when you have specifically designed a circuit to produce output pulses caused by a hazard condition that you intentionally introduced. Such edge detectors are usually so simple, however, that a timing simulation isn't necessary. On the other hand, some timing is a must for the simulation of sequential circuits because they possess memory. Only rarely will you need timing simulations of typical modest combinational circuits.

Simulating sequential circuits normally requires several iterations. Each iteration makes a pass through the circuit. Each pass uses different input signal states. Because simple TLS models do not incorporate propagation delays, you can only simulate synchronous sequential circuits. The software-generated clock introduces synchronous timing, which means that the simulator samples nodal outputs only at defined moments.

Listing 2

```
function AND2(d1, d2 : B) : B;           { 2-input AND gate }
begin AND2 := d1 and d2 end;
function NAND2(d1, d2 : B) : B;        { 2-input NAND gate }
begin NAND2 := AND2(d1, d2) xor 1 end;
function XOR2(d1, d2 : B) : B;         { 2-input XOR gate }
begin XOR2 := d1 xor d2 end;
function INV(d1 : B) : B;              { Inverter }
begin INV := d1 xor 1 end;
```

(a)

```
function ORr4(D : r4) : B;             { 4-input OR gate }
begin ORr4 := D[0] or D[1] or D[2] or D[3] end;
```

(b)

For example, timing of the edge-triggered D flip-flop begins when the clock signal changes from the 0 state to the 1 state. The simulator memorizes present-state values automatically while the program runs if you define the global variables in the unit Dec.

The first step in creating a simulation is initializing all the memory elements of the circuit. Ideally, you should set up the initial logic states of the memory elements as if you were actually operating a real IC. The simulation programs of simple circuits at the gate and flip-flop level utilize:

- the previously introduced units Dec, Gate, and Gater,
- the library unit FF containing the flip-flop models,
- some files with test/display procedures.

Fig 2a shows an example of a synchronous sequential circuit. The circuit's design specification requires that the output $y=1$ occur only during the input state $x_1, x_2=1,0$ if both of the two preceding input states have been equal to 0,1. In all other situations, the output should be low. **Fig 2b** shows the circuit's simulation program. The program utilizes a model of the pulse-triggered JK flip-flop (with reset at $R=0$) that

procedure JK1 (**Listing 5a**, see pg 213) describes. The variable f detects the transition of the control (clock) signal from $C=1$ to $C=0$. The procedure Tab21 (**Listing 5b**) displays the state-transition table (**Fig 2c**) of the simulated circuit using the predefined sequence of the input states $x_1=i_1$ and $x_2=i_2$. **Fig 1c** presents the results of this simulation.

You may also modify the circuit simulation to allow the function Ran, contained in the unit Dec, to randomly generate input signals. Simply replace $i1[n]$ and $i2[n]$ in the SNet expression within the "repeat...until" loop with the variables $a := \text{Ran};$ and $b := \text{Ran};$, then insert the initializing procedure Randomize before the loop. Note that the sequence of the input states $i1[n], i2[n]$ in the program SNetSim (**Fig 2b**) is no longer necessary. The random number generator usually generates the input sequence, which results in $y=1$ after a few program runs. If you'd like to run a larger number of loop iterations, increase the loop-control variable n in procedure Tab21 (**Listing 5**). This variable corresponds to the number of simulated clock cycles.

Listing 6 (see pg 214) is a model of the popular '164 8-bit shift register. It illustrates TLS models and their

Listing 3

```

procedure State;
{ Display state table of single-output combinational circuit }
var i, j, k, ux : shortint;
begin
  ClrScr;
  ux := Pred(SizeOf(X));
  FillChar(X, SizeOf(X), 0);
  Writeln('STATE TABLE X:y'); Writeln;
  for i := 0 to Pred(2 shl ux) do
  begin
    GoToXY(i div 16*10 + 1, (i mod 16) + 4);
    for j := ux downto 0 do Write(X[j]);
    Write(':', Net(X));
    { Generate test vectors X }
    k := -1;
    repeat
      k := Succ(k);
      X[k] := X[k] xor 1;
    until (X[k] = 1) or (k = Succ(ux))
  end
end;
end;

```

Signal flow within your circuit determines the precedence of your description.

application to more complex MSI sequential circuits. All models of the register circuits have been incorporated in the library unit Reg. Applying this model to simulation of the 8-bit self-starting ring counter (Fig 3a) lets you test the feedback arrangement, which ensures that the register returns to the valid sequence after any arbitrarily chosen initial state (Fig 3b).

The model of the T flip-flop in Listing 7a (see pg

214) helps describe the '93 counter at the flip-flop level (Listing 7b). The first procedure is in the library unit FF and the second is in the unit CTR. The procedure in Listing 7c illustrates the behavior of the '93 counter operating as a modulo-6 counter, that is, with outputs Q_B and Q_C connected to the reset inputs $R_{0(1)}$ and $R_{0(2)}$, respectively. These examples illustrate the usefulness of Borland's Turbo Pascal compiler when you want to

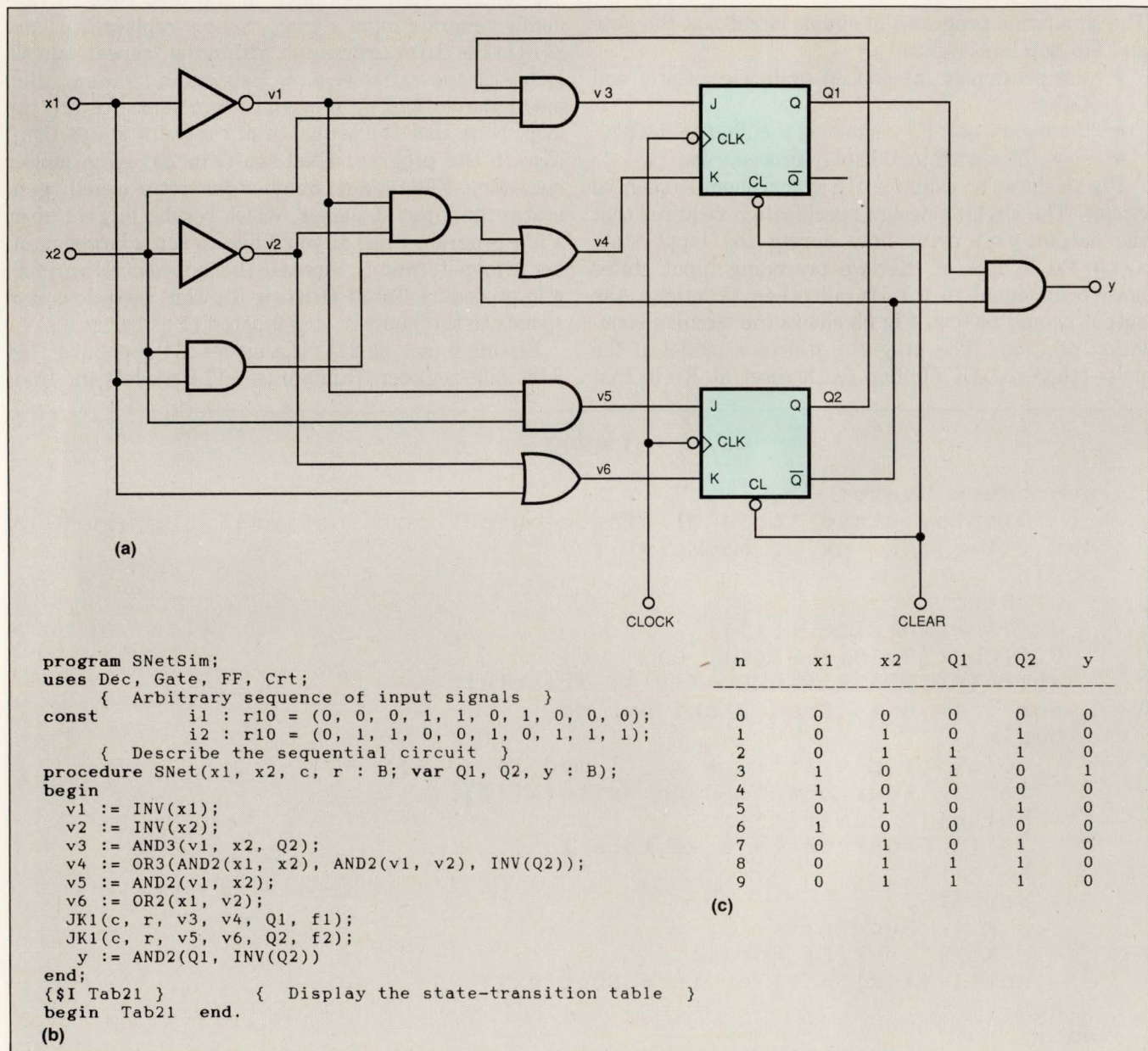

Fig 2—The sequential circuit in (a) produces the state table (c) when you use the procedure SNet in the program SNetSim (b).

create a very simple logic simulator. Although TLS is less powerful than its commercial brothers, it may solve many of your design problems. **EDN**

Listings continued on next page

References

1. Designers' Buying Guide—Simulation Systems, *Computer Design*, June 1, 1988, pg 112.
2. Armstrong, J R, *Chip-level Modeling with VHDL*, Prentice-Hall, Englewood Cliffs, NJ, 1989.
3. Leibson, Steven H, "VHDL," *EDN Special Report*, *EDN*, March 16, 1989, pg 110.
4. Nash, J D and Sanders, L F, "VHDL Critique," *IEEE Design and Test*, April 1986, pg 54.
5. Acharya, A et al, "KIDLAN: A Hardware Description Language," *Microprocessing and Microprogramming*, Volume 26, 1989, pg 1.

6. Conner, Margery S, "ASIC Simulators," *EDN Special Report*, *EDN*, February 4, 1988, pg 118.

Author's biography

Jożef Kalisz is an associate professor of electronics at the Warsaw Academy of Technology (Warsaw, Poland). He has taught digital microelectronics and conducted research in precision time-resolving instrumentation. He earned his MSEE at Silesian Technical University and his PhD in applied sciences at the Institute of Nuclear Research in Swierk, Poland. His leisure activities include walking, bicycling, skiing, swimming, and listening to music.

Article Interest Quotient (Circle One)
High 482 Medium 483 Low 484

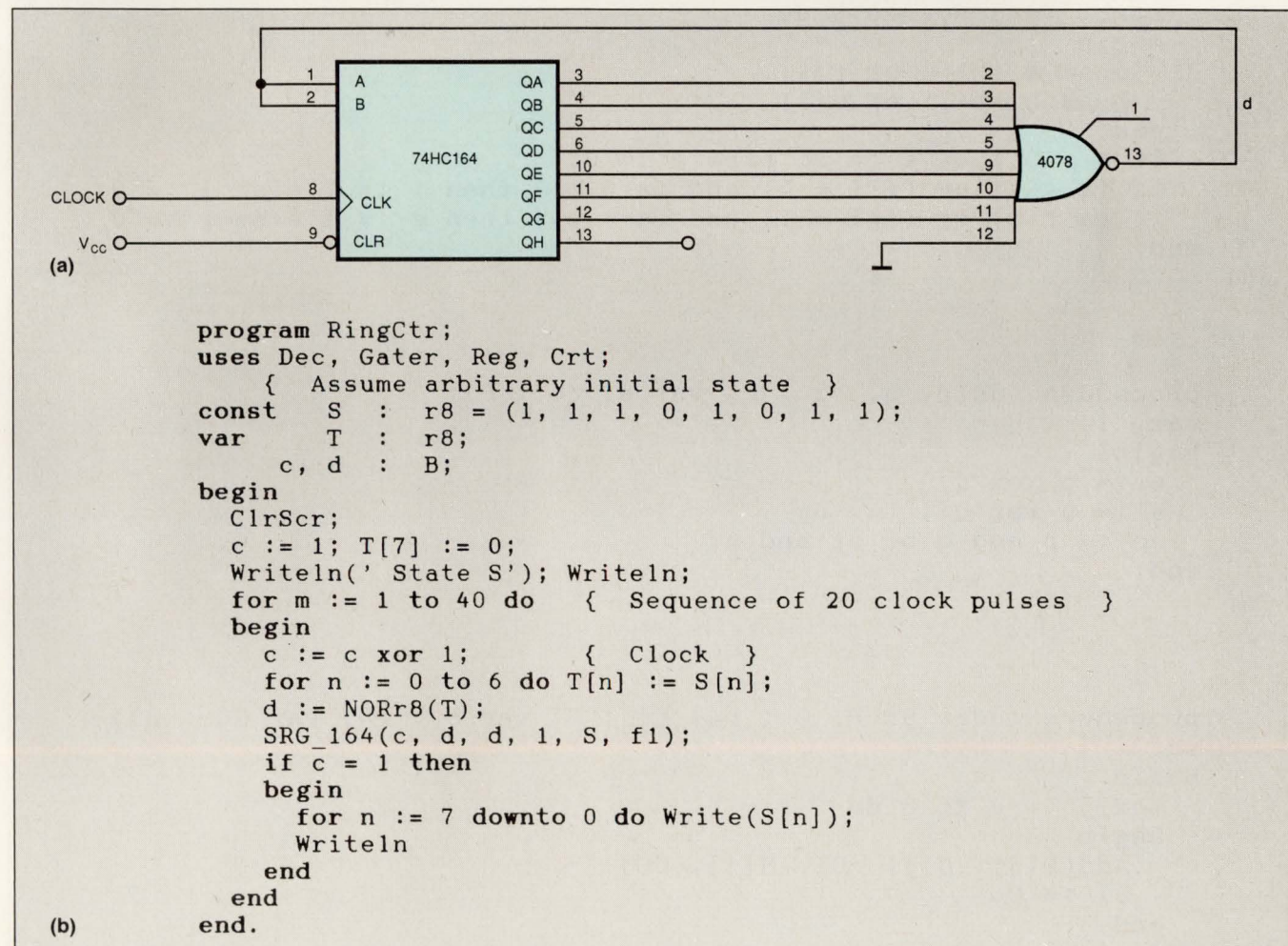

Fig 3—The RingCtr program (b) simulates the behavior of the 8-bit self-starting ring counter (a) for any arbitrary initial state. The feedback gate forces a valid sequence after a maximum of seven clock cycles.

You'll need timing information to design a circuit to produce output pulses caused by hazard phenomena.

Listing 4

```
procedure MUX_151(A : r3; D : r8; e : B; var y, w: B);
begin
  if e = 1 then y := 0
  else y := D[(A[2] shl 1 or A[1]) shl 1 or A[0]];
  w := y xor 1
end;
```

(a)

```
procedure Comp_85(P, Q : r4; gi, ei, li : B; var g, e, l : B);
var a, b, i : byte;
begin
  a := 0; b := 0;
  for i := 3 downto 0 do
  begin
    a := a shl 1 or P[i];
    b := b shl 1 or Q[i]
  end;
  if a = b then e := ei else e := 0;
  if (a < b) or ((li = 1) and (a = b)) then l := 1 else l := 0;
  if (a > b) or ((gi = 1) and (a = b)) then g := 1 else g := 0
end;
```

(b)

```
procedure Add(p, q, ci : B; var s, co : B);
var u : B;
begin
  u := p xor q;
  s := u xor ci;
  co := p and q or ci and u
end;
```

(c)

```
procedure Adder_83(P, Q : r4; CI : B; var S : r4; var CO : B);
var j : byte;
begin
  for j := 0 to 3 do
  begin
    Add(P[j], Q[j], CI, S[j], CO);
    CI := CO
  end
end;
```

(d)

Listing 5

```

procedure JK1(C, R, J, K : B; var Q : B; var f : boolean);
  { Pulse-triggered JK flip-flop with reset at R = 0 }
var   u : byte;
begin
  if R = 0 then Q := 0
  else if (C = 0) and f then
    begin
      u := J shl 1 or K;
      case u of
        1 : Q := 0;
        2 : Q := 1;
        3 : Q := Q xor 1
      end
    end;
  if C and R = 1 then f:= true else f:= false
end;

```

(a)

```

procedure Tab21;
  { Display state-transition table }
var   c : B;
begin
  ClrScr;
  SNet(0, 0, 0, 0, v7, v8, v9);      { Initialize }
  n := 0; c := 1;
  Writeln('  n      x1      x2      Q1      Q2      y');
  Writeln('-----');
  Writeln;
  repeat
    c := c xor 1;                      { Clock }
    SNet(i1[n], i2[n], c, 1, v7, v8, v9);
    if c = 0 then
      begin
        Writeln(' ', n, ' ', ' ', i1[n], ' ', ' ', i2[n], ' ', ' ',
          v7, ' ', ' ', v8, ' ', ' ', v9);
        n := Succ(n)
      end;
  until n = 10
end;

```

(b)

Listings continued

Listing 6

```
procedure SRG_164(C, d0, d1, R : B; var Y : r8; var f : boolean);
var
  d : B;
  i : byte;
begin
  if R = 0 then FillChar(Y, 8, 0)           { Reset }
  else if (C = 1) and f then
  begin
    d := d0 and d1;
    for i := 7 downto 1 do Y[i] := Y[i - 1];
    Y[0] := d
  end;
  if (C = 0) and (R = 1) then f := true else f := false
end;
```

Listing 7

```
procedure FFT(C, R : B; var Q : B; var f : boolean);
{ Pulse-triggered toggle flip-flop with reset at R = 0 }
begin
  if R = 0 then Q := 0
  else if (C = 0) and f then Q := Q xor 1;
  if C and R = 1 then f := true else f := false
end;
```

(a)

```
procedure CTR_93(c1, r1, r2 : B; var Q : r4; var F : br4);
{ Counter '93 with connection Q0-c2 (modulo 16) }
var R : 0..1;
begin
  R := r1 and r2 xor 1;
  FFT(c1, R, Q[0], F[0]);
  FFT(Q[0], R, Q[1], F[1]);
  FFT(Q[1], R, Q[2], F[2]);
  FFT(Q[2], R, Q[3], F[3])
end;
```

(b)

```
procedure CTR_93_mod_6(c1 : B; var Q : r4; var F : br4);
var R : 0..1;
begin
  R := Q[1] and Q[2] xor 1;           { Operate modulo 6 }
  FFT(c1, R, Q[0], F[0]);
  FFT(Q[0], R, Q[1], F[1]);
  FFT(Q[1], R, Q[2], F[2]);
  FFT(Q[2], R, Q[3], F[3]);
  if Q[1] and Q[2] = 1 then           { Complete cycle }
  begin
    FillChar(Q, 4, 0);
    FillChar(F, 4, false)
  end
end;
```

(c)

0.99 Power Factor Corrected Switcher With Universal Input



1000 watt single and multiple output switch-mode power supplies operate from 120 VAC 15 Amp service, or as Universal Input from 90 to 264 VAC line without strapping. Units meet IEC 555-2 harmonic distortion and UL, CSA, VDE, EN, and FCC safety and EMI specifications. Other models operate from 48 VDC or 120/230 VAC.

Contact: **Qualidyne** (619) 575-1100

Compact, Modular Switchmode Supply Meets Class B EMI



Compact power supplies can provide up to 400 watts with hundreds of volt/amp combinations of from 1 to 7 DC outputs. Units are available with in-line or side-mount I/O terminals and operate from 120/230 VAC. Options include Auto Current-Sharing with a isolated Power Supply Fail signal, ideal for N+1 use.

Contact: **Qualidyne** (619) 575-1100

Low Profile/Low Cost Supplies Are Only 2" to 3" High



Compact switchers feature robust, high-current main and auxiliary outputs to suit OEM needs. Single and multiple output models provide from 250 to 1000 watts. Wide user-adjustment ranges, auto AC line select, integral fan-cooling, margining, and inhibit are among the features and available options.

Contact: **Qualidyne** (619) 575-1100

Qualidyne ▶ CIRCLE 643

Modular 5" x 5" & 5" x 8" AC-DC Switchers & DC-DC Converters

Hundreds of models with up to 9 independent outputs can be easily configured to meet custom requirements without delays. Providing 800 to 3000 watts, units operate from 48 VDC or 120/230 VAC. All meet EMI and safety specs from UL, CSA, EN, FCC and VDE. Wide adjustable and current sharing outputs available.

Contact: **Qualidyne** (619) 575-1100

Qualidyne ▶ CIRCLE 644



1990-91 CATALOG
SWITCHMODE POWER SUPPLIES
■ AC-DC ■ DC-DC CONVERTERS ■ 0.99 POWER FACTOR

- Low Cost
 - Low Profile Case
 - 250 to 600 Watts
 - 1 to 4 Outputs



- User-Configurable
 - 1 to 9 Outputs
 - Quick Customized Supplies
 - Modular Construction

- Feature-Intensive
 - Low Profile Cases
 - 1 to 9 Outputs
 - 500 to 1000 Watts



- Wide Adjustment Ranges
 - 600 to 1000 Watts
 - 2V to 56VDC Outputs
 - 1 to 7 Outputs

- 1KW to 3KW
 - 1 to 9 Outputs
 - N + 1 Redundancy



Qualidyne
Lambda Group of Unitech plc



FREE NEW 66-PAGE CATALOG/BINDER

CALL OR WRITE: **QUALIDYNE**

3055 DEL SOL BLVD.

SAN DIEGO, CA 92154

PHONE: (619) 575-1100

FAX: (619) 429-1011

▶ CIRCLE 645

SAMSUNG
NOW

68040 SYSTEMS EQUIPPED YOU'LL NOTICE A

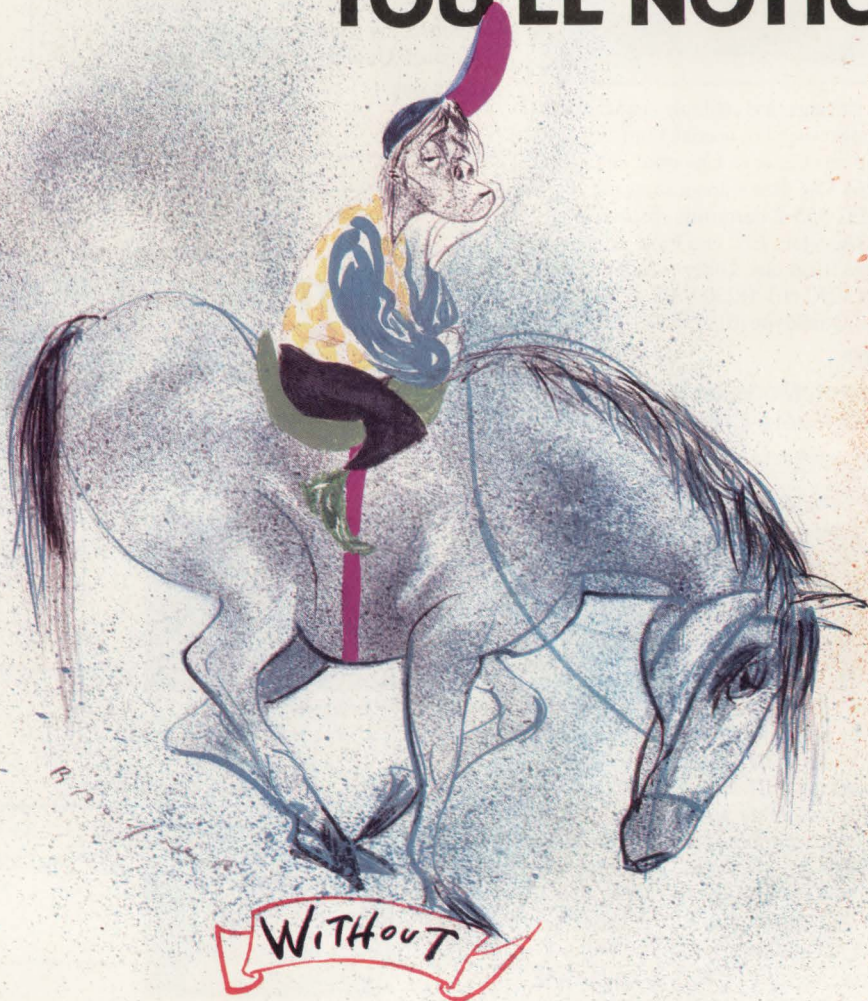

Systems utilizing the new Samsung 84C31 take off. They run like Triple Crown-winning thoroughbreds. They blaze, scorch, and leave others in their dust.

In a word, they are fast.

And they make even speedy 68040 systems that *don't* use the 84C31, look like they're not in motion.

The 84C31 was designed

with the close cooperation of Motorola. It is the *only* DRAM controller designed

SAMSUNG'S DRAM CONTROLLER FOR THE 68040 AND 68030

Part Number	RAMs Supported	Package
KS84C31-33CL	256K, 1Mb	68-pin PLCC
KS84C32-33CL	256K, 1Mb, 4Mb	84-pin PLCC

Samples and production available now.

specifically for Motorola's powerful 68040 and 68030 microprocessors.

Like the extremely successful earlier-generation

Samsung System Accelerators™, the part is highly integrated and inherently fast. And as the cutting edge in memory control, it can help you simply and economically enhance even 68040 performance.

The 84C31 supports both the burst and non-burst modes of the 68040. It also provides a direct interface

WITH OUR DRAM CONTROLLER: CERTAIN IMPROVEMENT.



to the microprocessor.
Which saves you dollars,
board real estate, and

68030 PERFORMANCE SUMMARY

Access Clocks	DRAM Speed	Frequency (Mhz)
4-2-2-2	70 ns	20
5-2-2-2	120 ns	20
5-2-2-2	80 ns	25
6-2-2-2	120 ns	25
6-2-2-2	80 ns	33
7-2-2-2	100 ns	33

68040 PERFORMANCE SUMMARY

Access Clocks	DRAM Speed	Frequency (Mhz)
3-2-2-2	80 ns	25
5-2-2-2	100 ns	25
6-2-2-2	120 ns	25
5-2-2-2	80 ns	33
6-2-2-2	100 ns	33

design time, since it means
you don't need additional
glue logic.

Ease of design is another
advantage. As a glance at
our System Design Guides
will show, it's an unusually
simple chip to design in.

All in all, we believe the
84C31 is the best memory
controller solution available
today.

For details on using it to
make *your* designs take off,
contact DRAM Controller
Marketing, Samsung
Semiconductor, 3725 No.
First St., San Jose, CA
95134. Or call 1-800-669-
5400, or 408-954-7229.



© Samsung Semiconductor, Inc., 1990. System Accelerator is a trademark
of Samsung Semiconductor, Inc. Motorola is a trademark of Motorola, Inc.

CIRCLE NO. 144

A Set Is A



Any designer who settles for great chips instead of great chipsets simply isn't keeping on his toes.

For you see, there are some big differences between Western Digital XT, AT, and Micro Channel-compatible chipsets and mere chips. Differences that add up to the performance, compatibility and value we've earned a bit of a reputation for.

So stop poring over those spec sheets for a minute or two and consider this:

We design our chips with all the right hooks, so you get the kind of design flexibility you've always dreamed of.

We spent years developing our sets and software drivers, so you don't have to spend time doing it yourself.

We give you the ability to buy virtually all your chips from one vendor, so you eliminate incompatibility between chips. Not to mention incompatibility between chip vendors.

We offer unmatched EMI system expertise, so your designs can be close to noise-free. And so can your quality control people.

We manufacture chips by the millions and sell them to just about every big name PC company in the world, so compatibility is one less thing you have to worry about.

Set, Right?

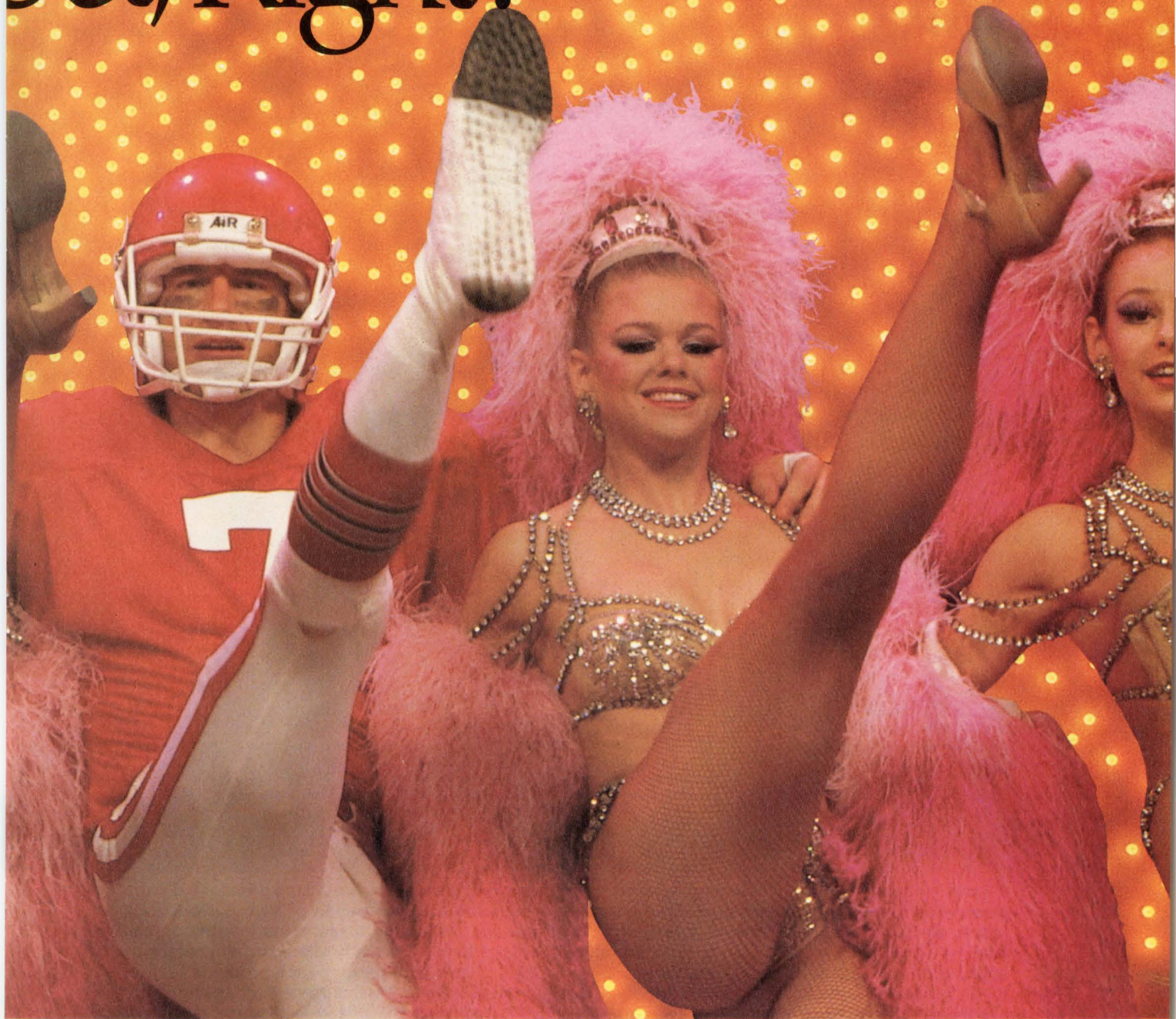

*The point is, what you need is what we have.
Storage, Imaging, Communications, and Core Logic.
Systems expertise, high volume/cost-effective LSI production,
turnkey manufacturing packages, and design support.
It's all designed to work together. It's all from one source. From
the IC company that understands systems.
So call Western Digital now. And get a leg up on the
competition.
Call 1-800-847-6181. In Canada, call 1-800-448-8470. Ask for
more information. And ask for a free Matched Sets poster.*

Matched sets to match your needs.

WESTERN DIGITAL
Semiconductors-Storage-Imaging-Communications

BUSS

**THE WORLD LEADER IN 5 X 20MM FUSES IS
WORLD LEADER IN HIGH-PERFORMANCE FUSES.
(WHAT A COINCIDENCE.)**

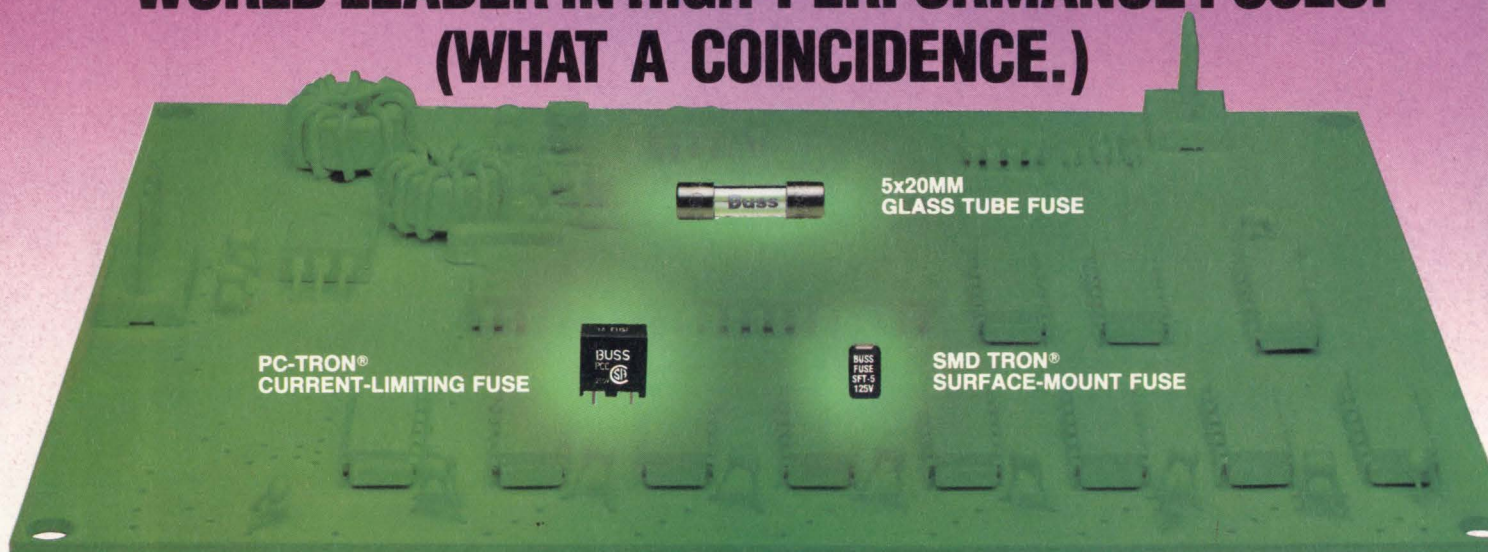

It's really not surprising that the leading producer of fuses, worldwide—including the popular 5x20mm glass tube fuses, fuseholders and clips—should originate the next-generation of high-performance fuses. ■ Bussmann's 5x20mm line includes time delay and fast-acting fuses in standard and axial lead versions. They are available in a broad range of ratings to meet virtually every circuit-protection application and IEC and UL/CSA standards. ■ Bussmann's new high-performance products are the PC-Tron® radial-lead and SMD Tron® surface-mount solid-matrix fuses. Their current-limiting capability has never before been available to designers. Both PC-Tron and SMD Tron limit the destructive let-through thermal/magnetic energy of faults to a fraction of the potential. So, for the first time, your PCB components, as well as the equipment, will survive short circuits. ■ For conventional subminiature applications, Bussmann offers its Microtron® fuse. Like all Bussmann subminiature fuses, it is designed to withstand automated wave soldering and rigorous board washing. ■ For samples and information on Bussmann 5x20mm or high-performance fuses, contact your Bussmann distributor or Bussmann, directly.

BUSSMANN—LEADER IN CIRCUIT PROTECTION WORLDWIDE

BUSSMANN
P.O. Box 14460
St. Louis, MO 63178
Phone: (314) 394-2877
FAX: (314) 527-1445

BUSSMANN
Cooper (U.K.) Limited
Beswick Works
Frome, Somerset BA111PP
United Kingdom
Phone: +44(0)373-64311
FAX: +44(0)373-73175

BUSSMANN FAR EAST
The Plaza
7500 A Beach Road
No. 14-319/320
Singapore 0719
Republic of Singapore
Phone: +65-298-8311
FAX: +65-296-3807



BUSSMANN

Like Computers, Telephone Exchange Systems are getting smaller.

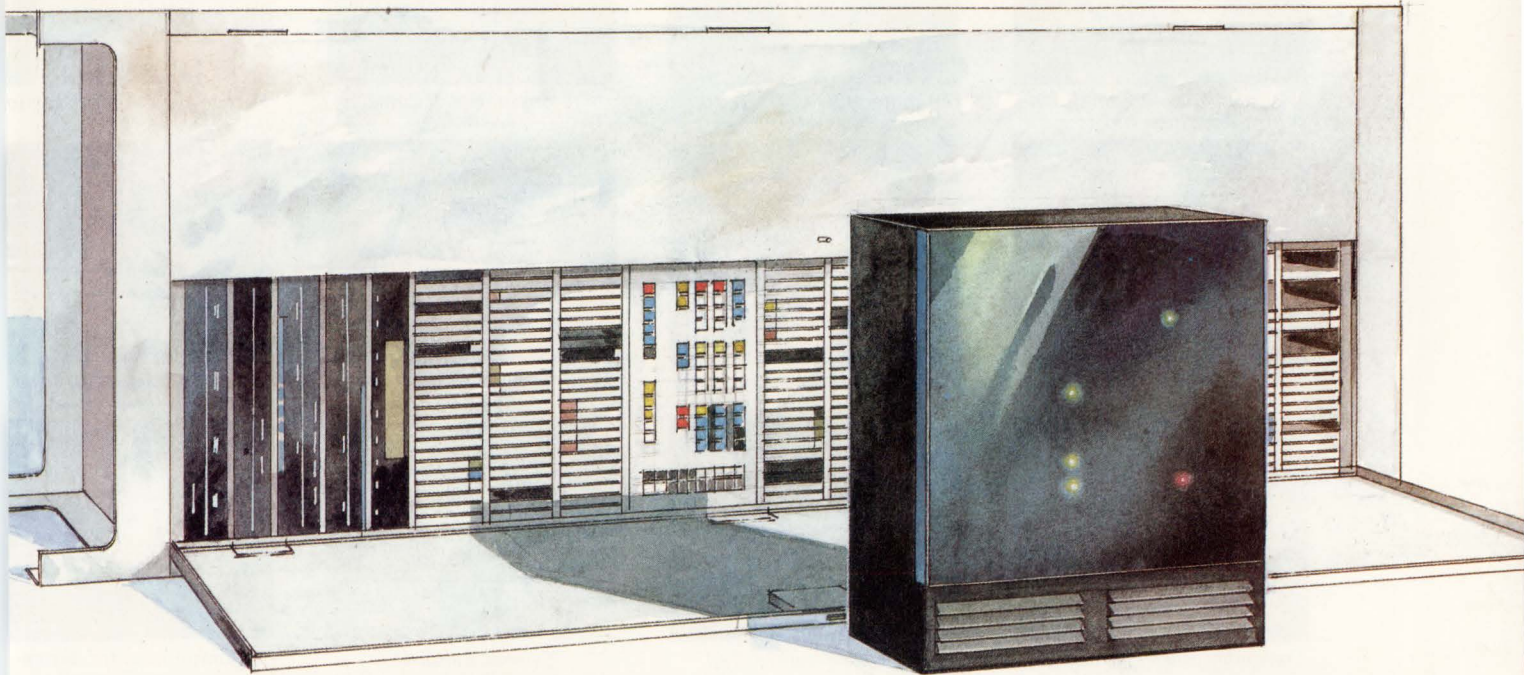

And simpler. And cooler. And more cost-effective.
And much quicker to design.

Talk to Ericsson and cut months off your system design time.

Plug into our world-class expertise and obtain better, simpler, more cost-effective solutions.

Use our latest devices and do away with hybrids, transformers and those rows of discrete devices needing expensive assembly time.

Here's just a little of what we have to offer to the system designer:

1. Design Partnership, to develop new components for your line-card circuits, exactly right for you.
2. Off-the-shelf advanced products for exchange and system functions, so you don't have to waste time on re-invention.
3. World-wide knowledge of European, American, Far East and Developing Country requirements, so that your next design can be versatile and easily adjustable for different markets.
4. High-quality production, testing and just-in-time delivery of SLICs, SLACs, CLICs, Protection Networks, PCM-repeaters etc. Send for our latest short-form product guide.

ALABAMA (205) 880-8050. ARIZONA (602) 991-6300. CALIFORNIA (408) 253-1960. (619) 292-1771. (714) 891-4621.
FLORIDA (407) 352-3755. GEORGIA (404) 448-1215. ILLINOIS (312) 968-0118. INDIANA (317) 577-9950.
IOWA (319) 354-8894. MICHIGAN (313) 643-0506. MINNESOTA (612) 786-7641. NEVADA (916) 268-1737.
NEW JERSEY (201) 525-8000. (609) 983-5300. NEW YORK (516) 929-5756. (716) 586-0777. (518) 383-2239.
N. CAROLINA (919) 847-8800. OHIO (513) 272-0580. PENNSYLVANIA (412) 487-1246. S. CAROLINA (803) 233-4637.
TEXAS (214) 553-1200. (512)-834-8374. (713) 370-8177. WASHINGTON (206) 882-0962. (206) 254-4572.
WISCONSIN (414) 781-1730. ERICSSON COMPONENTS, INC. (214) 669-9900.

Ericsson Telephone System Products.

- * Customised or Semi-standard CLICs; just add relays and protection to give complete line function.
- * PBL 3755. Regenerative PCM repeater for 2.048 or 1.544 Mbits/s PCM Lines.
- * PBR 5110/11/12. Protection Resistors, a new range to suit most markets.
- * PBL 3762/64/65. High performance SLICs for PBX and DLC systems, with 70dB typical longitudinal balance.
- * PBL 3796/98/99. Central Office SLICs with 70dB longtl. bal. plus on-chip switch-mode voltage regulator.
- * -40 to +85°C versions available.

ERICSSON



Ericsson Components Inc.
403 International Pkwy
Richardson, TX 75085-3904
Telephone (214) 669-9900
Telefax (214) 680-1059

CIRCLE NO. 147

Top 40 programming. Now



Mechanical computer-aided engineering



Computer-aided imaging and animation

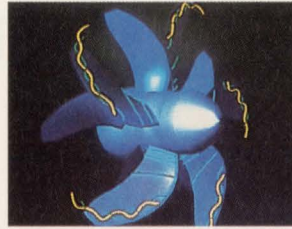

Computational fluid dynamics



Video animation production

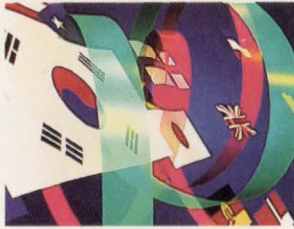

Video animation



Computer-aided engineering

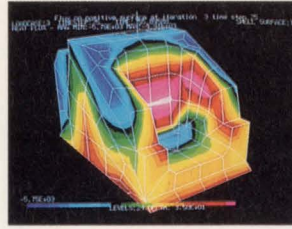

Finite element modeling and analysis

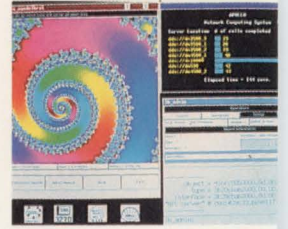

Network computing and mathematics

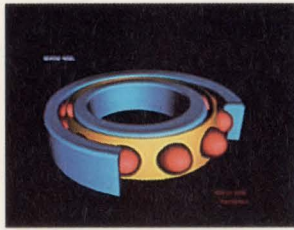

Computer-aided engineering



Aerospace engineering

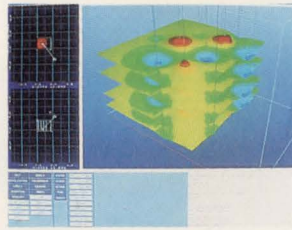

Seismic analysis



Computer-aided design in manufacturing

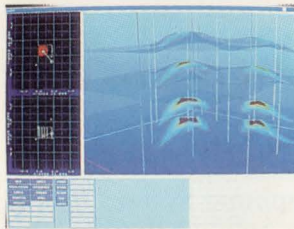

Reservoir analysis

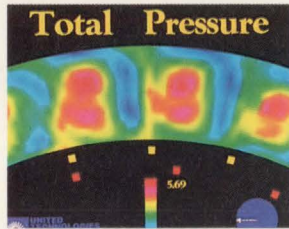

Computational fluid dynamics



Industrial design

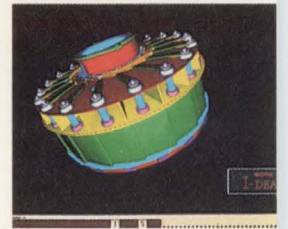

Computer-aided engineering



Computer-aided engineering and industrial design

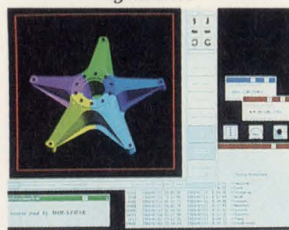

Mechanical computer-aided engineering

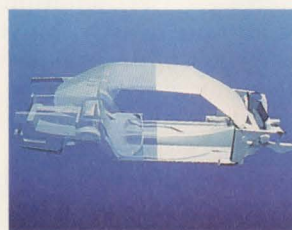

Automotive industrial design

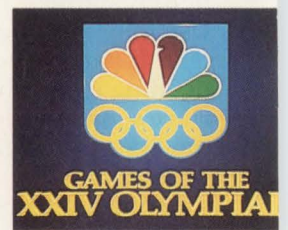

Animation

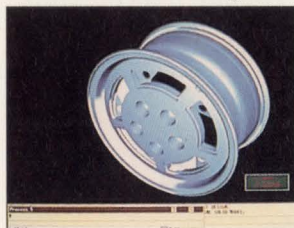

Mechanical design

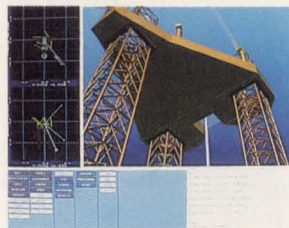

Scientific visualization

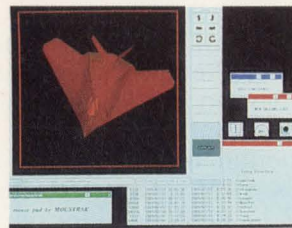

Aerospace engineering

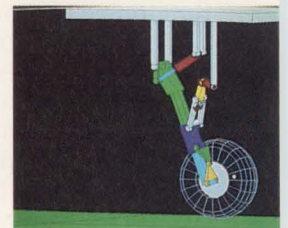

Kinematics and dynamics

© 1989 Hewlett-Packard Company. UNIX is a registered trademark of AT&T in the U.S. and other countries. CPWG914

available for any network.

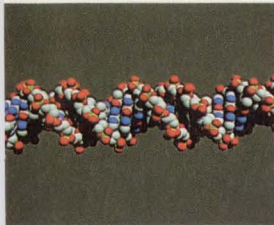

Computer-aided molecular design

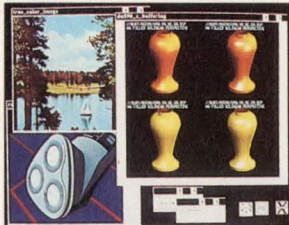

Multi-window industrial design



Computer-aided engineering and design

Apollo's Series 10000 now brings supercomputer performance to the desktop.

Your project team can't share its work. Your current system lacks the horsepower for timely solutions. And you can't afford a supercomputer for your network.

Hewlett-Packard has a better way.

It's the Apollo Series 10000. Mini supercomputer performance that can dramatically increase the power of any network. At a fraction of the cost of a supercomputer.

Inside, the remarkable Series 10000 supports up to four amazingly fast processors. Each with its own integer unit, dual floating-point processors, and large cache memory. Which quickly deliver high-resolution, colorful 3D graphics. All of which makes the Series 10000 ideal for analysis, modeling, or imaging.

Even better, the Series 10000 offers the flexibility to attack more than 100 of the leading engineering and design application areas. All, of course, in an industry-standard UNIX® environment that can be linked to a wide variety of networks—including IBM token ring and Ethernet.

The best part is that Apollo's reliable and innovative engineering is now backed by Hewlett-Packard's exceptional worldwide service and support network.

If you'd like more information on how the Series 10000 can help your project team solve its problems better and faster, call 1-800-323-1846 (in MA, call 1-800-847-1011).



The Series 10000

There is a better way.

apollo

A subsidiary of
 HEWLETT
 PACKARD



Industrial design

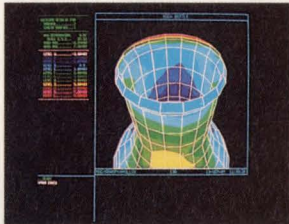

Structural analysis using finite element analysis

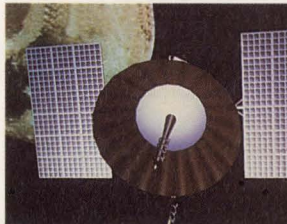

Aerospace engineering

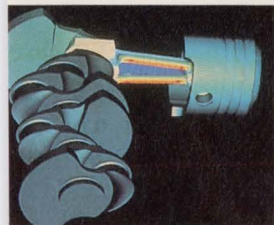

Computer-aided engineering



Automotive engineering



Computational fluid dynamics



Thermal analysis

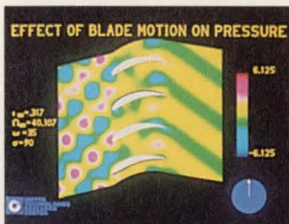

Computational fluid dynamics

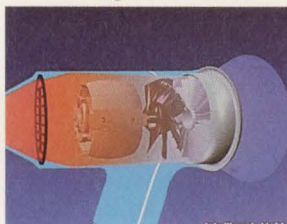

Industrial design

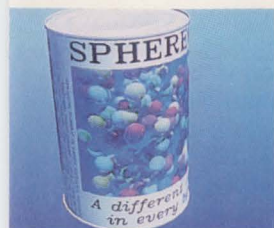

Industrial design

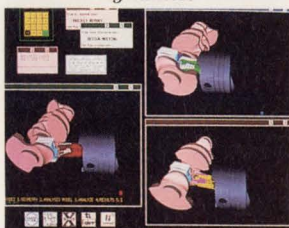

Computer-aided engineering

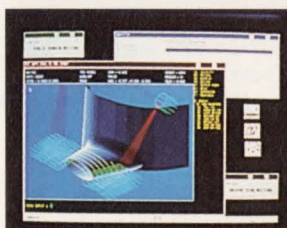

Computer-aided engineering



Scientific visualization

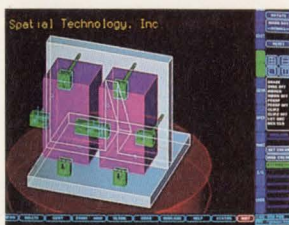

Computer-aided design

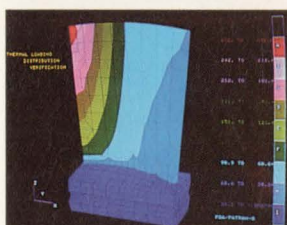

Finite element analysis

Designer Tools



Order Linear's Support Library Today.

Monolithic Filter Handbook: 230+ page handbook of filter application notes and data sheets to make filter design easier. Included with the handbook is FilterCAD, a menu-driven filter design program which runs on IBM PCs and compatibles. This CAD program assists in the selection, design, and implementation of optimum switched capacitor filter circuit networks (\$40.00).

Linear Applications Handbook: 928 page handbook of in-depth appli-

cation notes, ideas and design notes. A special feature includes 22 pages on SPICE macromodels (\$20.00).

Linear Databook: A 1600 page catalog of data sheets covering more than 300 devices (\$10.00).

NOISE Disk: For IBM PCs or compatibles. This program permits you to calculate circuit noise using LTC op amps, calculate resistor noise, and determine the best LTC op amp for best noise performance. (Free)

SPICE Macromodel Disk: Contains

the LTC SPICE macromodel op amp library for circuit simulations. These hand-tailored models provide a good trade-off between actual device characteristics and fast simulation speed. Includes over 50 models and a working version of PSPICE™ by MicroSim. (Free)

Order by phone or use the coupon below. Visa/MasterCard accepted. Contact Linear Technology Corporation, 1630 McCarthy Blvd., Milpitas, CA 95035. Order by phone: **800-637-5545**.

Yes, I'd like to order the following tools:

Linear Monolithic Filter Handbook (US\$40/copy) (Includes FilterCAD Disk)	_____	Copies	\$ _____
Linear Application Handbook (US\$20/copy)	_____	Copies	\$ _____
Linear Databook (US\$10/copy)	_____	Copies	\$ _____
NOISE Disk	_____		No charge
SPICE Macromodel Disk (Includes application note)	_____		No charge
		Total	\$ _____

Name _____	Title _____
Company _____	M/S _____
Address _____	
City _____	State _____ Zip _____
Phone _____	

Mail orders require 6-8 weeks. Mail order form and remittance to Linear Technology Corporation, 1630 McCarthy Blvd., Milpitas, CA 95035, Attn: Communications Dept.

Save time. Order by phone: 800-637-5545

Please bill my Visa _____ or MasterCard _____

Account # _____

Expiration Date _____

Signature of Cardholder _____

EDN091790



TOUGH PRODUCTS FOR TOUGH APPLICATIONS.

DESIGN IDEAS

EDITED BY CHARLES H SMALL

Ninth bit keys multiple microcontrollers

K Ramamurthy, M Venkateswarlu,
and Nagender Prasad
Hindustan Aeronautics Ltd, Hyderabad, India

An obscure feature of 8051-family single-chip μ Ps provides the key to master-slave multiprocessor communication. Specifically, when an 8051 is in communications mode 2 or mode 3, its serial port will not raise a serial-port interrupt unless the ninth bit of an 11-bit, received serial word is set. You enable this feature by setting the SM2 bit in the chip's SCON register.

In operation, the master processor first broadcasts, over a serial link to all slave processors, the address of the slave processor it wishes to communicate with. The address word has its ninth bit set. Initially, all the slave processors have their SM2 bit set. Consequently, they will all raise an interrupt. Each slave processor's interrupt handler examines the received address word. The slave processor whose address matches the received address will clear its SM2 bit; the unaddressed slaves leave their SM2 bits set.

For as long as the master subsequently emits words with their ninth bit cleared, the addressed slave will process the words and the unaddressed slaves will ignore them. When the master sends an end-of-file sequence, the slave sets its SM2 bit.

In addition to the processors' internal software, you will need eight external connections for communication and control between the processors. You can use the single-chip μ P's ports (and some additional software) or external hardware for the control functions.

Specifically, in addition to the transmit- and receive-data lines (TxD and RxD), you also need a $\overline{\text{BUSY}}$ line, a $\overline{\text{BUS_REQUEST}}$ line, a $\overline{\text{DATA_ACK}}$ line, and enough polling lines, P_0 through P_n , to uniquely identify 2^n slaves.

The master processor asserts $\overline{\text{BUSY}}$ whenever communication is occurring. The slave processors all use the wired-OR $\overline{\text{BUS_REQUEST}}$ to request service. An addressed slave processor asserts its address on the polling lines, P_0 through P_n , in response to a poll by the master if that slave is requesting service. Your priorities will determine in what order the master processor polls the slaves after one or more of them request service.

Further, a communicating slave processor asserts $\overline{\text{DATA_ACK}}$ when it successfully receives a message block from the master. If the master does not see $\overline{\text{DATA_ACK}}$ in response to a transmitted message, the master can retransmit the message. **EDN**

To Vote For This Design, Circle No. 746

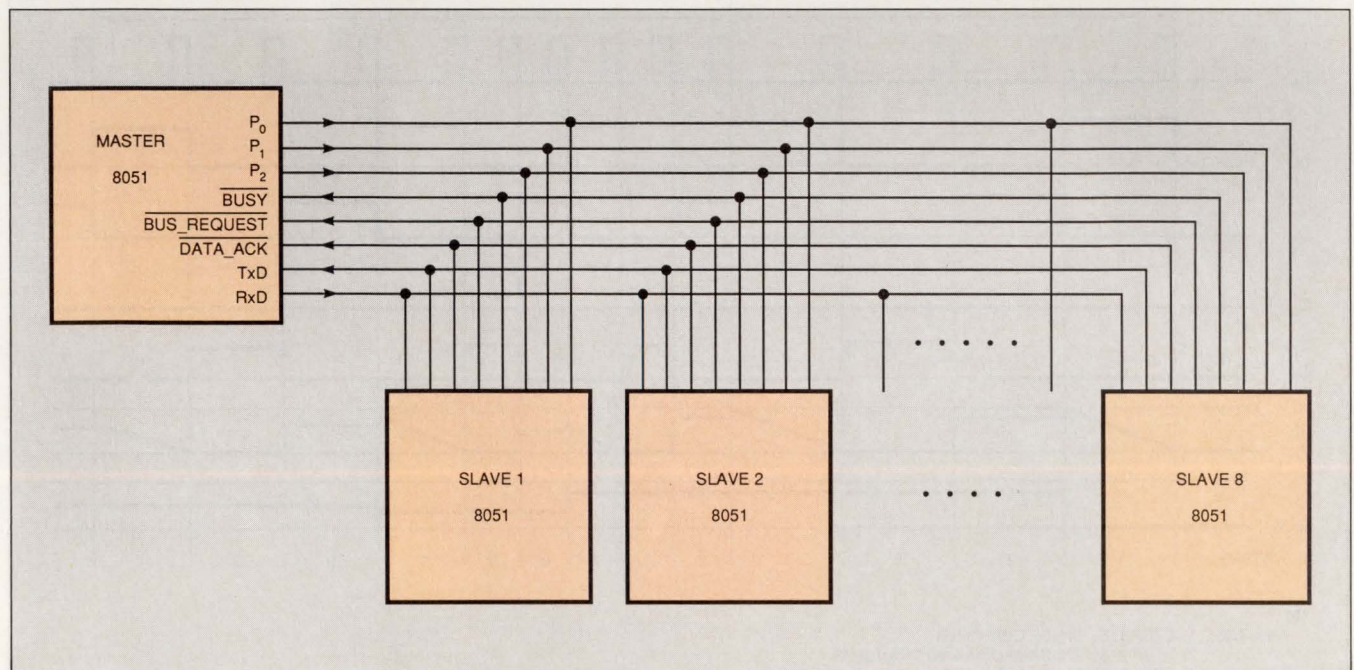

Fig 1—Combining an obscure 8051-family communications mode and some hardware-handshake lines results in a multiprocessor master/slave communications protocol.

Period-to-voltage converter locks quickly

Tian Jin-Qin
 Shanxi Electronic Industry Research Institute,
 Taiyuan, China

Unlike simple, but slow, voltage-to-frequency converters formed from monostable vibrators, the period-to-voltage converter in Fig 1a needs only three periods

of an input signal to develop a stable output. And this circuit's output ripple does not increase with lower-frequency inputs.

Fig 1b shows the timing waveforms for the circuit. With the first pulse of the input signal, f_{IN} , at IC₁'s pin 14, IC₁ resets its outputs to zero and begins counting. IC₁'s Q₁ turns on S₁ in analog switch IC₂, charging

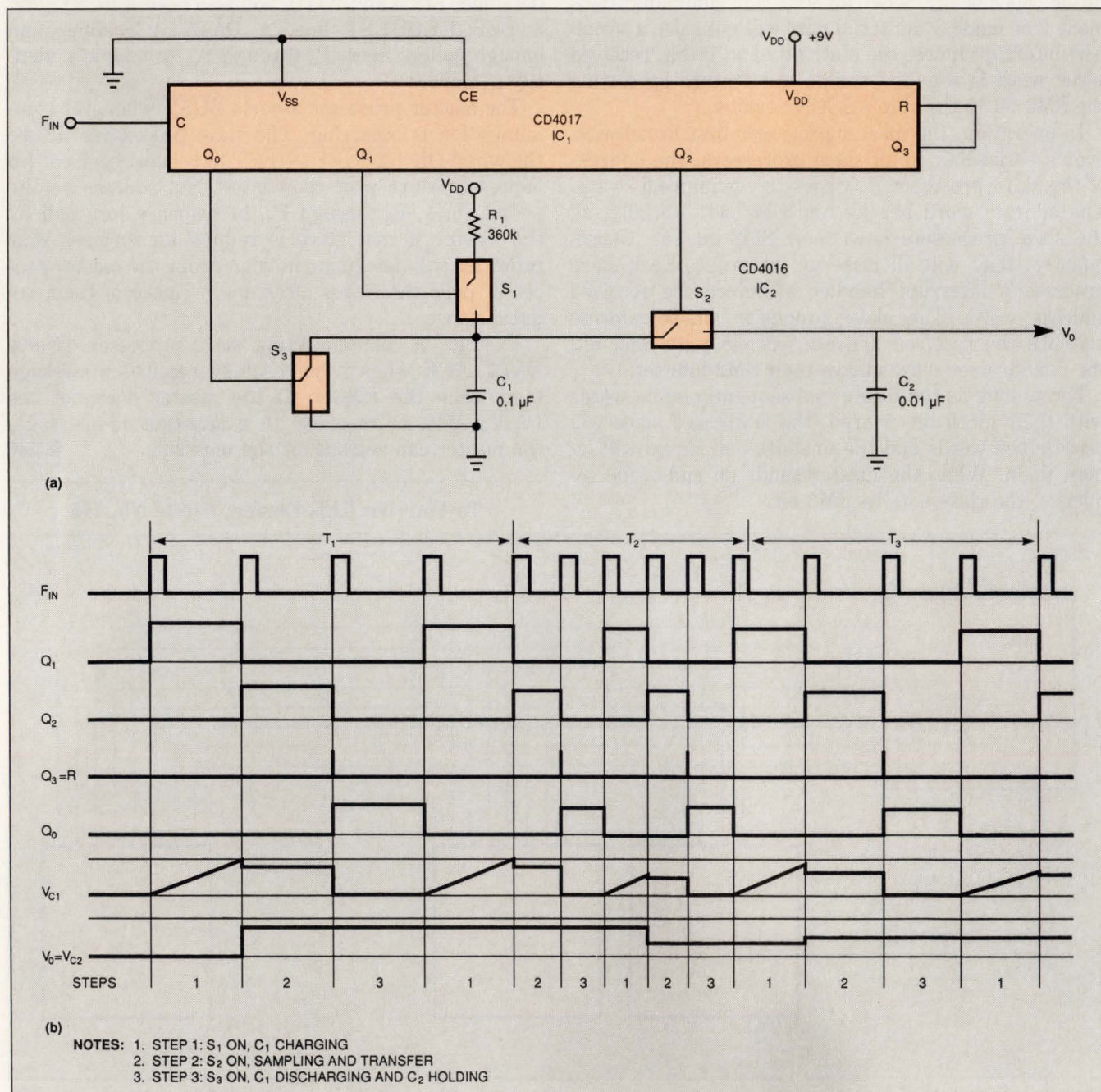

Fig 1—This period-to-voltage converter (a) needs only three input-signal periods (b) to reach a stable output.

**ULTRA-REL™
MIXERS**
5-YR. GUARANTEE

WORLD'S SMALLEST SURFACE MOUNT MIXERS JUST GREW!

up to 1500 MHz LO up to 13dBm

from **\$625**

For systems designs employing surface-mounting technology, Mini-Circuits now offers an expanded line of SMT mixers operating up to 1500 MHz with LO drive levels to +13dBm and RF input levels to +9dBm. The RMS-Series is the world's smallest double-balanced mixers, in a case only 0.25 by 0.30 by 0.2 in.

The tiny, non-hermetic package houses RF transformers, a ceramic-alumina substrate, and a four-diode assembly. A unique edge-plated design eases the job of making reliable solder connections to a printed-circuit board. A protective-barrier layer on top of the package's conductive layer retards the harmful effect of electromigration which may occur during soldering. The RMS can be attached to a pc-board by conventional manual soldering or with automatic equipment; mixers can be supplied in a tape-and-reel format for automated pick-and-place machines.

When you think SMT, think small, low-cost...
think Mini-Circuits RMS series.

finding new ways ...
setting higher standards

Mini-Circuits

A Division of Scientific Components Corporation
P.O. Box 350166, Brooklyn, New York 11235-0003 (718) 934-4500
Fax (718) 332-4661 Domestic and International Telexes: 6852844 or 620156

WE ACCEPT AMERICAN EXPRESS

SPECIFICATIONS, typical mid-band response

MODEL	Frequency Range (MHz)		LO Level (dBm)	Conv. Loss (dB)	Isolation (dB)		Price \$ (1-9)
	LO, RF	IF			L-R	L-I	
RMS-1	0.5-500	DC-500	+7	5.5	33	30	6.25
• RMS-1LH	2-500	DC-500	+10	5.7	40	30	8.95
• RMS-1MH	2-500	DC-500	+13	5.7	40	30	10.45
• RMS-1R	0.5-500	DC-500	+7	5.5	33	30	14.45
RMS-2	5-1000	DC-1000	+7	6.5	35	30	6.95
• RMS-2LH	5-1000	DC-1000	+10	6.5	35	30	10.45
• RMS-2MH	5-1000	DC-1000	+13	6.5	35	30	11.45
• RMS-2U	10-1000	10-750	+7	6.5	40	35	11.45
• RMS-5	5-1500	DC-1000	+7	6.5	35	30	13.95

• new models

• Hermetically sealed diodes

DESIGN IDEAS

capacitor C_1 via resistor R_1 . C_1 's voltage will be proportional to S_1 's on-time and f_{IN} 's period. At f_{IN} 's second pulse, S_1 turns off and S_2 turns on, transferring C_1 's voltage to C_2 . The third count of f_{IN} opens S_2 , isolating C_2 , and closes S_3 , shorting C_1 to ground. C_1 is now ready to repeat the 3-pulse conversion cycle.

Obviously, you must buffer C_2 with a high-impedance

amplifier. For greater precision, replace R_1 with a current source. Select C_1 , C_2 , and R_1 according to your input frequency. For the audio range, try $R_1 = 269 \text{ k}\Omega$, $C_1 = 0.1 \text{ }\mu\text{F}$, $C_2 = 0.01 \text{ }\mu\text{F}$, and $V_{DD} = 9\text{V}$. **EDN**

To Vote For This Design, Circle No. 747

Booster powers low-dropout reference

Bob Underwood

Maxim Integrated Products, Santa Clara, CA

Positioning a step-up switching regulator in front of a precision voltage reference yields a circuit with a mere 0.1V dropout voltage (Fig 1). Regulator IC_1 's fixed 15V output easily satisfies the 13.5V minimum input that voltage reference IC_2 requires. And, by acting as a preregulator, IC_1 enhances the reference's line regulation.

The circuit supplies 100 mA while maintaining a 10.000V output from inputs ranging from 10.1 to 18V. IC_2 's Kelvin connections across the load enable you to power the load via the booster transistor Q_1 . Note

that Q_1 connects directly to the input supply rather than to IC_1 's boosted power. This setup reduces IC_1 's power dissipation.

The circuit's dropout voltage depends on Q_1 's saturation voltage. A medium-power npn transistor such as the 2N3054 can pass 100 mA with a V_{CE} drop of only 100 mV. Eliminating Q_1 and using the dotted-line connections improves the circuit's input voltage-range to 8 to 18V at the expense of limiting output current to $\pm 10 \text{ mA}$. **EDN**

To Vote For This Design, Circle No. 748

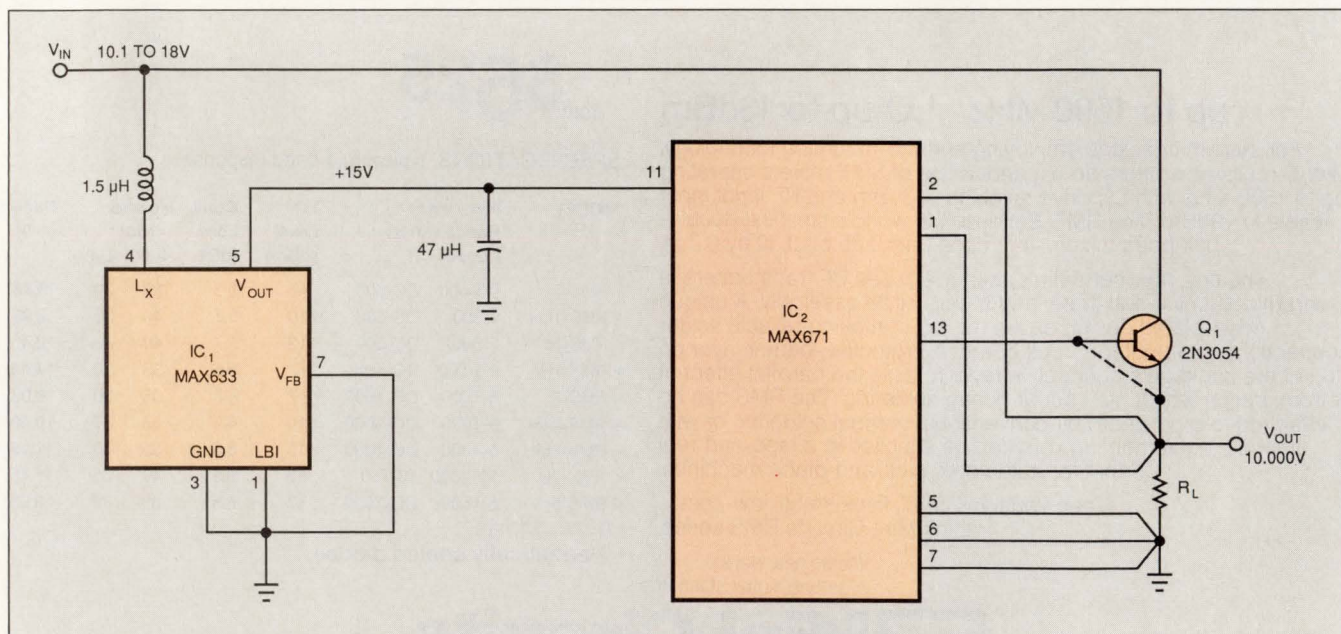

Fig 1—Showing the virtue of selectively boosting supply voltages within an analog circuit, the 15V-output preregulator, IC_1 , allows the 10.000V precision voltage source, IC_2 , to operate over a 10.1 to 18V input-voltage range. Note the Kelvin connections around the load.



Introducing Zilog's Smart Access Controller... Z180 intelligence and SCC communications together in one package.

Don't throw away your old software.

The Z80 family continues to be the most popular group of intelligent peripheral controllers on the market. With good reason. It's a tribute to our Superintegration™ technology and the performance of the controllers themselves. And since each new product in the family, like the SAC™, is based on the same Z80/180 code you'll be able to migrate your existing software easily and effectively. We don't have to tell you how important that is. Here's a list of the fast-growing family of Z80-based intelligent peripheral controllers. It's a list that's not likely to stop expanding any time soon...

	System					Serial		Timers		Parallel	
	CPU	OSC	MMU	RAM	DMA	UART	C/S	CTC	CT	PIA	I/O
Z84C01	✓	✓									
Z84C50	✓	✓				✓				✓	✓
Z84C90		✓					✓	✓		✓	
Z80180	✓	✓	✓	✓	✓		✓	✓		✓	✓
Z80280	✓	✓	✓	✓	✓		✓	✓		✓	✓
Z84013/C13	✓	✓					✓		✓	✓	✓
Z84015/C15	✓	✓					✓		✓	✓	✓
Z84011/C11	✓	✓					✓	✓	✓	✓	✓
Z80181	✓	✓	✓	✓	✓	✓	✓	✓	✓	✓	✓

The Z80181™ SAC™ Controller is the Smart Access Controller™ that combines two powerful standards. You get Zilog's industry standard SCC™ controller for datacom connectivity together with the popular Z180 CMOS controller. And all that utility comes with the user-friendly Z80® code CPU compatible software.

High integration. High performance. Smart communicator.

The Superintegration™ SAC Controller packs the popular high performance Z180 architecture into a new cell suitable for many datacom and peripheral control applications. You get the SCC single-channel communication cell with two additional UARTS, a 4 x 8-bit counter timer (CTC) and onboard 16-bit I/O. The SAC Controller runs at 10 MHz and drives fast serial communications at 2.5 Mbits/sec. With the reduced 3 cycles per instruction, the SAC Controller gives you Z80 code performance 25% faster. That makes the SAC Controller the highest performance, low power embedded controller around.

The best cost/performance of any embedded controller out there.

Whatever your application — data communications, modems, FAXs, printers, terminals, industrial controls — the SAC Controller combination gives you the best cost/performance ratio. Everything you need for your system is on the chip. The SAC Controller brings you all the advantages of Zilog's Superintegration technology. Off-the-shelf and backed by our solid reputation for quality and reliability.

To find out more about the SAC Controller, or any of Zilog's rapidly growing family of Superintegration products, contact your local Zilog sales office or your authorized distributor today. Zilog, Inc., 210 Hacienda Ave., Campbell, CA 95008, (408) 370-8000.

Right product. Right price. Right away.



ZILOG SALES OFFICES: CA (408) 370-8120, (714) 838-7800, (818) 707-2160, CO (303) 494-2905, FL (813) 585-2533, GA (404) 448-9370, IL (312) 517-8080, NH (603) 888-8590, MN (612) 831-7611, NJ (201) 382-5700, OH (216) 447-1480, PA (215) 653-0230, TX (214) 987-9987, WA (206) 523-3591, CANADA Toronto (416) 673-0634, UNITED KINGDOM Maidenhead (44) (628) 39200, W. GERMANY Munich (49) (89) 672045, JAPAN Tokyo (81) (3) 587-0528, HONG KONG Kowloon (852) (3) 723-8979, KOREA (82) (2) 552-5401, TAIWAN (886) (2) 741-3125, SINGAPORE 65-235 7155, DISTRIBUTORS: U.S. Anthem Electronics, Hall-Mark Electronics, JAN Devices, Inc., Schweber Electronics, Vargas Electronics, Western Microtechnology, CANADA Future Electronics, SEMAD, LATIN AMERICA Argentina - Yel. (1) 46-2211, Brazil - Digibyte (011) 581-1945, Semiconductores Profesionales (5) 536-1312.

Switcher babies power MOSFET

K C Herrick
ESI Electronics Corp, San Francisco, CA

The bare-bones switching regulator in **Fig 1** will deliver a selected low-voltage-dc output, at 50 mA, from a 50 to 300V dc supply. Its output ripple and noise total approximately 20 mV p-p. The circuit withstands momentary short circuits.

The power MOSFET, Q_1 , free-wheel diode, D_2 , and inductor, L_1 , form a basic step-down switching regulator. Note that the zener diode, D_1 , clamps Q_1 's gate voltage to a maximum of 10V above the MOSFET's source voltage. The LED of optoisolator Q_2 is in series with voltage-setting zener diode D_3 . Whenever the regulator's output voltage exceeds D_3 's zener voltage (plus the LED's forward drop), Q_2 turns on. When Q_2 turns on, it shorts Q_1 's gate to its source, turning the power MOSFET off.

At that point, D_2 begins to conduct and the magnetic energy stored in L_1 maintains the regulator's output. When L_1 's current drops to zero, the output voltage begins to sag. When the output voltage sags low

enough, Q_2 turns off, allowing the power MOSFET to conduct once more.

The key to this design is that Q_1 will turn on fully despite not having a gate-bias source. Q_1 does not conduct long enough for its source voltage to rise to the positive rail. In fact, Q_1 's source rises to only 100V during its normal, rather short, on-time of approximately 1 μ sec. Therefore, during conduction, Q_1 's gate is always 10V above its source, turning the power MOSFET on fully.

Choose D_3 's zener voltage to set your output-voltage level. You can use a power MOSFET of higher voltage rating than the IRF730 if you increase R_1 's value to keep the transistor's power dissipation modest.

R_2 and R_3 limit short-circuit current to 150 mA upon momentary overloads by turning on the power MOSFET independently. Q_1 will easily withstand the resulting overload for short periods if you mount it on a heat sink.

EDN

To Vote For This Design, Circle No. 749

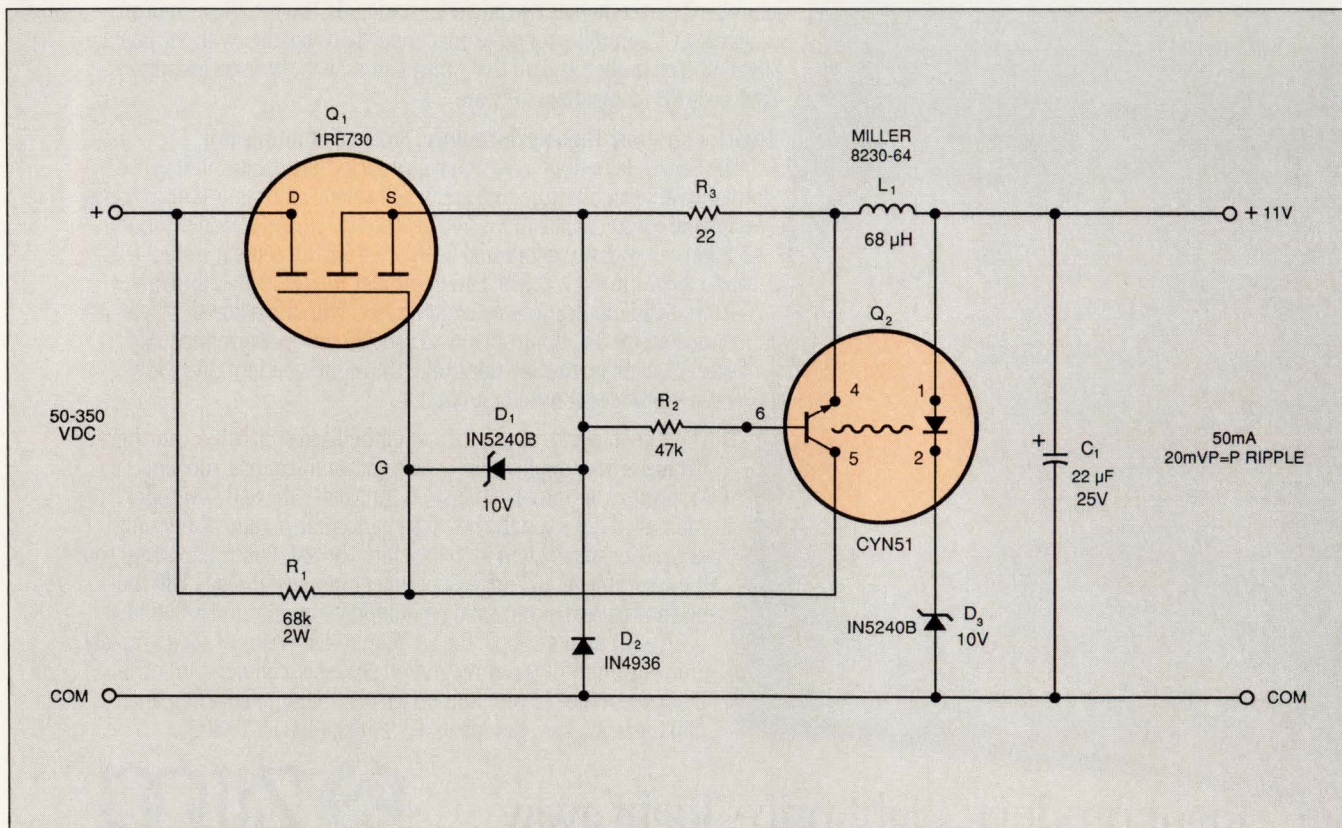

Fig 1—This simple switching regulator needs no gate-bias circuit because its power transistor's short conduction period keeps its source from ever rising to the positive rail.



**The tape on the left
will change the way you look
at multilayer circuitry.
So will the one on the right.**

Introducing the Green Tape System* from DuPont. And a free videotape that shows what this new multi-layer circuit technology can do for you.

Green Tape is a low-temperature, co-fireable ceramic based system that combines the design flexibility of thick film systems with the manufacturing ease of co-fired alumina systems.

Green Tape eliminates the multiple firing steps required with traditional thick film technology. And unlike co-fired alumina, where extreme firing temperatures destroy high conductivity metals such as gold and silver, the Green Tape System is perfectly compatible with precious metal circuitry.

Now you can design innovative multilayer circuitry using Green Tape. It can be fired in an air atmosphere and, like thick film equipment, requirements are simple. This allows for in-house prototyping and manufacturing which means very quick turn-around times. And there's no known limit to the number of dielectric layers that can be fired at one time. Think of the possibilities.

If you think the Green Tape System sounds good, wait'll you see how it can help you improve your multi-layer circuitry. Call for your free videotape: **1-800-341-4004**.

*DuPont's trademark for dielectric tape, inner layer and via fill conductors.

DuPont Electronics
Share the power of our resources.



DESIGN IDEAS

Design Entry Blank

\$100 Cash Award for all entries selected by editors. An additional **\$100 Cash Award** for the winning design of each issue, determined by vote of readers. Additional **\$1500 Cash Award** for annual Grand Prize Design, selected among biweekly winners by vote of editors.

To: Design Ideas Editor, EDN Magazine
Cahners Publishing Co
275 Washington St, Newton, MA 02158

I hereby submit my Design Ideas entry.

Name _____

Title _____ Phone _____

Company _____

Division (if any) _____

Street _____

City _____ State _____

Country _____ Zip _____

Design Title _____

Home Address _____

Social Security Number _____

(Must accompany all Design Ideas submitted by US authors)

Entry blank must accompany all entries. Design entered must be submitted exclusively to EDN, must not be patented, and must have no patent pending. Design must be original with author(s), must not have been previously published (limited-distribution house organs excepted), and must have been constructed and tested.

Exclusive publishing rights remain with Cahners Publishing Co unless entry is returned to author or editor gives written permission for publication elsewhere.

In submitting my entry, I agree to abide by the rules of the Design Ideas Program.

Signed _____

Date _____

ISSUE WINNER

The winning Design Idea for the May 24, 1990, issue is entitled "Current sink widens VCO's frequency range," submitted by Antonio Tagliavini of Applicazioni Digitali e Analogiche (Bologna, Italy).

ISSUE WINNER

The winning Design Idea for the June 7, 1990, issue is entitled "Mapper flags dead code," submitted by Brian P Courtnage and Theo A De Oliveira of Telephone Manufacturers of SA (Johannesburg, South Africa).

PAL enables DIP-switchless addressing

Robert K Breuninger
Texas Instruments, Dallas, TX

Using one level of hardware indirection, you can configure a software-programmable address decoder with a 16L8 PAL device and a 74ALS6311A (Fig 1). Don't confuse the circuit with a hard-wired PAL-device decoder; the 16L8 does not generate the enable signals, EN and $\overline{\text{EN}}$, directly. Instead, the PAL device decodes an address that enables you to program the 6311A's 14 D-type registers. Once programmed, the 6311A compares input addresses to its internal registers and asserts the enable signals when it sees a match. **EDN**

To Vote For This Design, Circle No. 750

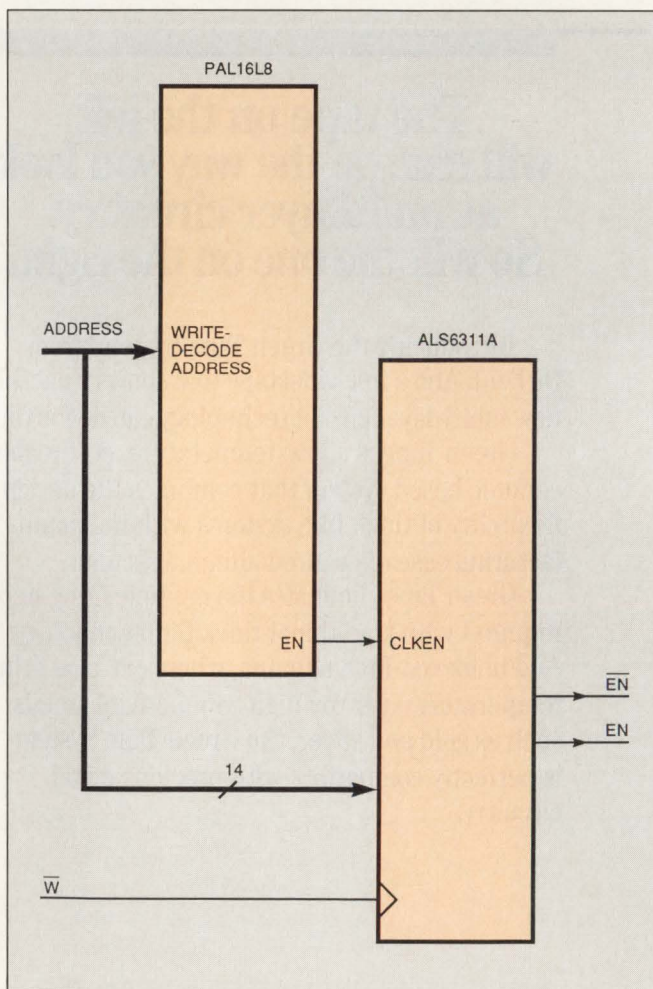

Fig 1—This 2-chip circuit comprises a DIP-switchless, programmable, address decoder.

Bt

Bt458KG125

RAMDAC

69 8808 B

SALES

Bt

Bt458KG125

RAMDAC

69 8808 B

GRAPHICS
AND IMAGING
PRODUCT
GUIDE

GRAPHICS DISPLAY

R A M D A C S

PART NUMBER	CLOCK RATE (MHz)	D/A ORGANIZATION	RAM SIZE	OVERLAYS	COMMENTS	PACKAGE
Bt450	66, 50, 30	triple 4-bit	16 x 12	3 x 12	Dual-port RAM and overlays.	28-pin 0.6" CERDIP
Bt451	125, 110, 80	triple 4-bit	256 x 12	4 x 12	Pin compatible with Bt457 and Bt458.	84-pin Ceramic PGA 84-pin PLCC
Bt453	66, 40	triple 8-bit	256 x 24	3 x 24	First triple 8-bit RAMDAC.	40-pin 0.6" Plastic PGA 44-pin PLCC
Bt454	170, 135, 110	triple 4-bit	16 x 12	1 x 12	Multiplexed pixel ports.	44-pin PLCC
Bt455	170, 135, 110	single 4-bit	16 x 12	1 x 12	Multiplexed pixel ports.	44-pin PLCC
Bt457	125, 110, 80	single 8-bit	256 x 8	4 x 8	Pin compatible with Bt451 and Bt458.	84-pin Ceramic PGA 84-pin PLCC
Bt458	165, 125, 110, 80	triple 8-bit	256 x 24	4 x 24	Multiplexed pixel ports.	84-pin Ceramic PGA 84-pin PLCC
Bt459	135, 110, 80	triple 8-bit	256 x 24	16 x 24	On-chip three-color cursor.	132-pin Ceramic PGA 132-pin Plastic Quad Flatpack
Bt460	135, 110, 80	triple 8-bit	512 x 24	16 x 24	512 x 24 color palette.	132-pin Ceramic PGA
Bt461	170, 135, 110, 80	single 8-bit	1024 x 8	32 x 8	256 x 8 alternate color palette.	132-pin Ceramic PGA
Bt462	170, 135, 110, 80	single 8-bit	1024 x 8	32 x 8	256 x 8 alternate color palette.	132-pin Ceramic PGA 132-pin Plastic Quad Flatpack
Bt468	200, 170	triple 8-bit	256 x 24	16 x 24	8:1 multiplexed inputs.	145-pin Ceramic PGA
Bt471	80, 66, 50, 35	triple 6-bit	256 x 18	15 x 18	Bt478 pin compatible	44-pin PLCC
Bt473	80, 66, 50, 35	triple 8-bit	(3) 256 x 8	(3) 15 x 8	True-color RAMDAC.	68-pin PLCC
Bt474	85, 66	triple 8-bit	256 x 24	15 x 24	4:1 mux w/ VGA pass-through	84-pin PLCC
Bt475	80, 66, 50	triple 6-bit	256 x 18	15 x 18	Power-down RAMDAC.	44-pin PLCC
Bt476	80, 66, 50, 35	triple 6-bit	256 x 18	—	Pin compatible with IMSG176*	44-pin PLCC 28-pin 0.6" Plastic DIP
Bt477	80, 66, 50	triple 6/8-bit	256 x 24 (18)	15 x 24 (18)	Power-down RAMDAC.	44-pin PLCC
Bt478	80, 66, 50, 35	triple 8-bit	256 x 24	15 x 24	6-bit mode.	44-pin PLCC
Bt479	80, 66, 50, 35	triple 8-bit	1024 x 24	15 x 24	16 window priority encoder.	44-pin PLCC
Bt492	360	single 8-bit	256 x 8	16 x 8	2:1 multiplexed inputs.	68-pin Ceramic PGA w/ Alignment Pin & Heatsink

V I D E O D A C S

PART NUMBER	CLOCK RATE (MHz)	D/A ORGANIZATION	COMMENTS	PACKAGE
Bt121	80, 66, 50, 35	triple 8-bit	Monolithic CMOS. On chip Vref and output comparators.	44-pin PLCC
Bt102	75	single 8-bit	Monolithic CMOS. 0, 7.5 or 10 IRE blanking pedestal.	24-pin 0.3" CERDIP
Bt103	75, 30	triple 4-bit	Monolithic CMOS.	28-pin 0.6" CERDIP
Bt106	50, 30	single 8-bit	Monolithic CMOS.	20-pin 0.3" CERDIP
Bt107	400	single 8-bit	0 or 7.5 IRE blanking pedestal. 2:1 multiplexed pixel inputs.	32-pin Ceramic Flatpack w/Heatsink
Bt109	250	triple 8-bit	10KH ECL compatible. TDC1318 pin compatible.	40-pin 0.6" Ceramic Cavity Down DIP

*IMS is a trademark of INMOS Corporation.

At Brooktree, we set standards by breaking rules. For us, "conventional wisdom" is oxymoronic. Like, **who says?** you can't create high speed, highly integrated monolithic ICs that marry analog and digital circuitry?

Why not? put the DAC on the RAM and create a whole new class of video ICs?

How come? CMOS can't be pushed to 200 MHz? Or beyond?

Why shouldn't? desktop systems be able to economically display 16 million colors at 1600x1280 pixel resolution?

Where's it written? that an IC company can't accomplish system-level integration, putting windowing, input shift registers and four separate color look-up tables onto a triple 8-bit VGA RAMDAC?

On the following pages, there are 47 fine examples of where this kind of thinking has gotten us. In fact, we created this convenient graphics and imaging resource guide to prove our point. Sure, it's an easy-to-keep, quick reference to the full range of Brooktree ICs. But it's also living proof that good things happen when you shed conventional thinking.

If we're going to push designers to use higher and higher performance components, we feel some responsibility for making it possible to test them. So we've included our exciting ATE devices in this brochure, too.

RULE #1. THERE ARE NO RULES.

A T E P R O D U C T S

P I N T I M I N G

PART NUMBER	COMMENTS	PACKAGE
Bt604	Dynamically Programmed Timing Edge Vernier. 15 ps resolution. 10KH ECL compatible.	28-pin PLCC
Bt605	Programmable Timing Edge Vernier. 15 ps resolution. 10KH ECL compatible.	28-pin PLCC
Bt622	Dual Channel Delay Line. Leading and trailing edge independently adjustable.	28-pin PLCC
Bt624	Quad Channel Delay Line. Leading and trailing edge independently adjustable.	44-pin PLCC

P I N E L E C T R O N I C S

Bt681	Ultra Fast, High Voltage (+8v, -4v) Comparator. Input power down and level select features.	28-pin PLCC
Bt687	Ultra Fast ECL Dual Comparator. Pin compatible to industry standard '687 devices.	16-pin SOIC 16-pin CERDIP 20-pin Ceramic Leadless Chip Carrier
Bt688	High Speed Dual Comparator. Wide input voltage (+8v, -2v). 10KH ECL compatible. Pin compatible to industry standard '687 devices.	16-pin SOIC 16-pin Plastic DIP
Bt689	Pin Electronics Load or Driver. >100 MHz operation. 10KH ECL compatible.	32-pin Ceramic Flatpack w/Heatsink 44-pin PLCC

S U P P O R T P R O D U C T S

Bt110	100 ns, Octal 8-bit DAC. Standard MPU bus interface. Monolithic CMOS.	44-pin Plastic J-Lead
Bt501	10KH Octal ECL/TTL Bidirectional Transceiver/Translator.	24-pin 0.3" CERDIP
Bt502	100K Octal ECL/TTL Bidirectional Transceiver/Translator.	24-pin 0.3" CERDIP



Bt468, the fastest CMOS RAMDAC yet, 200 MHz!

Bt622/624, very high speed delay lines, perfect for ATE and CPU system timing systems!

Brooktree®

Call, Call, Call. For Complete Technical Specifications On Any Brooktree Product, Just Call 1-800 VIDEO IC.

IMAGING PRODUCTS

PART NUMBER	SPEED	A/D ORGANIZATION	COMMENTS	PACKAGE
Bt208	18 MSPS	single 8-bit	Flash Converter. Monolithic CMOS. On-chip reference and DC restoration.	24-pin 0.3" Plastic DIP
Bt251	18 MSPS	single 8-bit	Single Channel Image Digitizer. Single 8-bit flash A/D, sync detect circuitry, adjustable gain/offset, 4:1 analog mux, lookup table RAM.	44-pin PLCC
Bt253	18 MSPS	triple 8-bit	Triple Channel Image Digitizer. Three 8-bit flash A/Ds, sync detect circuitry, adjustable gain/offset, 2:1 analog mux, flexible color output formats.	84-pin PLCC
Bt261	30 MHz	—	MPU programmable video timing parameters, sync noise gating. Video or TTL sync inputs.	28-pin PLCC
Bt281	36 MHz	—	3 x 3 matrix multiplier with MPU programmable coefficients, lookup table RAMs, optional 16-bit color format I/O capability.	84-pin PLCC

GRAPHICS PERIPHERAL PRODUCTS

PART NUMBER	CLOCK RATE (MHz)	COMMENTS	PACKAGE
Bt424	250	40-bit multi-tap shift register. 10KH ECL/TTL compatible.	68-pin Ceramic PGA w/ Alignment Pin
Bt431	35 MHz per 5 pixels	Cursor generator. 64 x 64 user definable cursor, cross hair cursor. Monolithic CMOS. 175 MHz pixel rates.	24-pin 0.3" CERDIP 28-pin PLCC
Bt438	250	Clock generator chip for CMOS RAMDACs up to 250 MHz	20-pin 0.3" CERDIP 28-pin PLCC
Bt439	200	Clock generator/synchronizer chip for single-channel 80+ MHz CMOS RAMDACs.	28-pin 0.6" CERDIP

RULE #2. SEE RULE ONE.

Bt281, the new solution for real-time color space conversion!

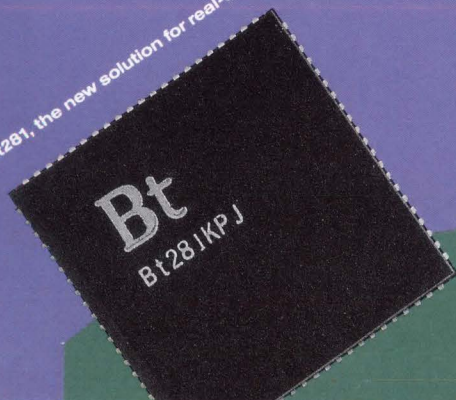

Bt261, the HSYNC genlock answer for video capture



CAPTURE

CHANGE

SEND

DISPLAY

CALL

**BROOKTREE
IMAGE TECHNOLOGY
SERVES YOUR SYSTEM
COMING AND GOING.**

Capture an image, change it, send it, display it—and do it all with Brooktree Image Technology solutions.

If you still think of Brooktree as just a hot graphics IC company, let us broaden your horizons. Because now we offer the most innovative solutions from one end of your system to the other.

Image Acquisition. Start with our Bt251 Gray Scale Digitizer or Bt253 Color Image Digitizer chips. They make it easy and economical to add image capture to your system. And they link up with our new Bt261 fully digital, fully programmable genlock controller.

Image Manipulation. Once you capture an image, move it into the format of your choice with our Bt281 Color Space Converter chip. Now we're working on decompression and scaling capabilities in silicon, too.

Image Transmission. Here's where we'll soon have a major impact on your system. Our point-to-point video interfaces compress about a square foot of board real estate into a couple of chips. Stay tuned!

Image Display. This is our true forte, with the industry's most impressive line up of RAMDACs. Check out the Bt468 incredible high speed RAMDAC and the Bt473 true-color RAMDAC. Here's looking at **us**, kid!

Call Us. Get detailed technical information on any Brooktree product with a single call. 1-800-VIDEO IC.

Or fax us a list of products you're interested in, and we'll send back specs.

FAX (619) 452-7294.

Brooktree[®]

Brooktree Corporation,
9950 Barnes Canyon Rd.,
San Diego, CA 92121

SOURCEGATE

integrating high level language debugging with in-circuit emulators.



SourceGate is a window driven high level language debugger designed to support the Huntsville Microsystems 200 series of in-circuit emulators.

- User configurable windows can be sized, moved and duplicated anywhere on the screen.
- Code can be viewed in all displays (trace, single step, etc.) in one of three modes: Source only, Assembly only or both Source and Assembly.
- Watch windows display and monitor code variables.
- Optional Performance Analysis Card for real-time software performance analysis and real-time software test coverage.
- Available for IBM PC family and UNIX systems including Apollo and SUN.

For more complete technical information, write to Huntsville Microsystems Inc., 4040 South Memorial Parkway, Huntsville, AL 35802 or call (205) 881-6005.

IBM is reg. T.M.
International Business Machines, Inc.
Unix is reg. T.M.,
Bell Laboratories, Inc.

Available Emulators

8051 Family	68HC11 Family
DS5000	including F1
8096/80196	and D3
Z80	68000
64180/Z180	68008
8085	68010
6809/6809E	68020
	68030
	68302



The Ultimate 386 Debugger.

Terminate difficult debug problems fast. And do it remotely. From your Ethernet®-based workstation you're now in total control with the new **386 SmartProbe™** from CADRE.

Think of it. Your favorite Sun™ or VAX™ software development environment now controls your 386 hardware environment. Develop programs on your Sun or VAX. Download via Ethernet to the 386 SmartProbe. Execute in real-time and start eliminating problems fast. And the best part is, you control the entire process without ever leaving your desk.

You'll call the 386 SmartProbe the ultimate 386 development tool because we've included all of

the high performance features you need for rapid hardware/software integration and test.

386 SmartProbe includes comprehensive hardware and software breakpoints, source-level debug capability for C and ADA®, sophisticated single stepping facilities and, of course, full-speed transparent emulation to 25 MHz. It even supports the development of protected mode programs.

So get the ultimate 386 debugger. The one designed to work with your favorite tool: your workstation. Call **1-800-283-5933** for more information about 386 SmartProbe and other CADRE Unified CASE products.

CADRE
SARATOGA DIVISION

• SmartProbe is a trademark of CADRE Technologies, Inc.
• Sun is a trademark of Sun Microsystems.
• VAX is a trademark of Digital Equipment Corporation.

• Ada is a registered trademark of the Dept. of Defense.
• Ethernet is a trademark of Xerox Corporation.
© Copyright 1990 CADRE Technologies



16-bit PC/AT Data Acquisition from Analogic!



*LSDAS-16 Brings
New Price/
Performance
Levels to PC
Instrumentation*

The new LSDAS-16 from Analogic sets new price/performance standards for 16-bit multifunction data acquisition plug-in boards for the IBM PC/AT™ and compatibles, including:

- 16-bit 50 kHz A/D converter
- 16 analog inputs
- Shielded for less than 1 LSB of noise in the PC
- Programmable input modes and ranges
- Full analog triggering
- Dual deglitched DACs
- 32K-sample DAC RAM
- High speed DMA
- Menu-driven setup and data acquisition utilities
- C, Basic, FORTRAN, and Pascal libraries
- Third party support for Snapshot Storage Scope™, DADISP™, and LabTech Notebook™
- Expansion multiplexers for up to 256 analog inputs
- Prices starting at \$1,395 in unit quantities, with volume discounts available.

For applications from spectroscopy and chromatography to digital audio and speech analysis, step up to Analogic, the world leader in precision data conversion technology for more than 20 years.

For Applications Assistance, call or write David Wilson, Analogic Corporation, 360 Audubon Road, Wakefield, MA 01880 Telephone: (800) 446-8936, Telex: 466069, Fax: (617) 245-1274

IBM PC/AT is a trademark of International Business Machines Corp. Snapshot Storage Scope, DADISP, and LabTech Notebook are trademarks of HEM Data Corp., DSP Development Corp., and Laboratory Technologies Corp., respectively. DADISP software photo copyright DSP Development Corp.

ANALOGIC ■
The World Resource
for Precision Signal Technology

MC145407 DRIVER/RECEIVER

- Low Power CMOS Technology
- Three Drivers, Three Receivers
- On-Chip Slew Rate Limiting

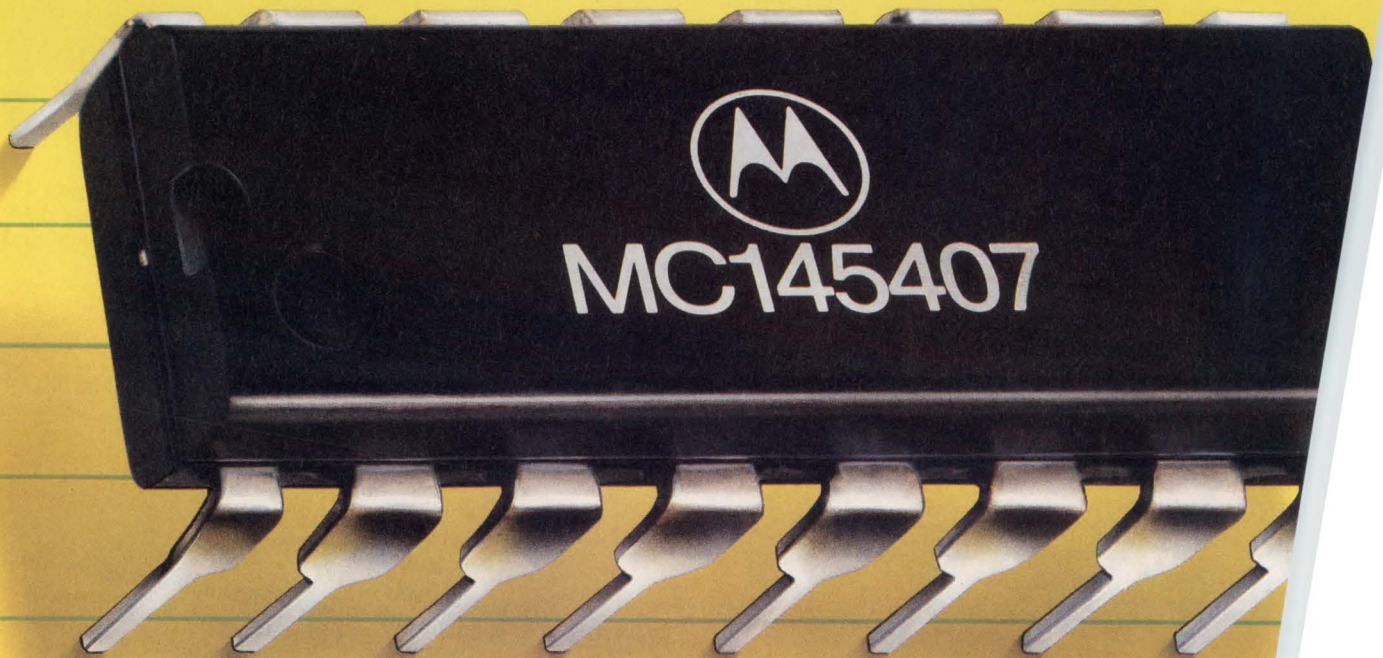

- On-Chip Charge Pump
- Latch-Up Proof
- Single 5 Volt Supply

The five-volt standard.

MC145407 combines 3 drivers, 3 receivers and a charge pump on a single 5-volt CMOS chip. Try a free sample.

Motorola pioneered the EIA-232 market four years ago with the introduction of the first CMOS-based EIA-232 driver/receiver. That device, the MC145406, has become the industry standard with over 20 million units in operation. Now Motorola does it again by introducing the five-volt standard, the MC145407.

The MC145407 combines three drivers, three receivers and an on-board five volt charge pump to meet EIA-232 and CCITT V.28 specifications. Anyone designing computer or communication equipment such as digital telephones, portable computers or line-powered modems will appreciate our low power requirement.

Charge pumps and more.

There's features to make your design tasks easier. The on-board charge pump generates ± 10 volts from a single 5 volt power supply for driving the on-board receivers and drivers plus additional peripheral devices.

The Slow Rate Transition Signal offers clean, bounce-free operation through the entire threshold region.

You also get a typical 2Kv per I/O pin of ESD protection, with a latch-up-free design and advanced CMOS technology.

The three receivers offer true TTL capability without external capacitors, and feature impedance over a 3-to-7 kilohm range while handling up to ± 25 volts.

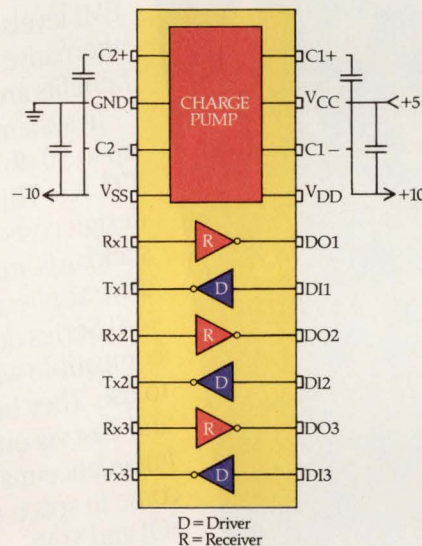

MC145407 Pin Assignment

The obvious choice.

The MC145407 is the perfect choice. It provides all the necessary level-shifting between TTL logic levels and high-voltage EIA-232 equipment. It's the smart decision for applications like lap-top computers, printers, modems, PABXs, remote telebanking, key systems, multiplexes, limited distance modems, and computer networks.

Try a free sample.

The only way to fully appreciate the new MC145407 is to try one. You can get a free sample, along with all the supporting literature you need, by simply filling out and returning the coupon below. Send it to Motorola Semiconductor Products, Literature Distribution Center, P.O. Box 20912, Phoenix, AZ 85036. Or call toll-free any weekday, 8:00 a.m. to 4:30 p.m. (MST) 1-800-521-6274.

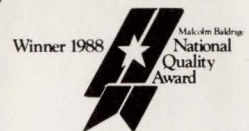

To: Motorola Semiconductor Products, Literature Distribution Center,
P.O. Box 20912, Phoenix, AZ 85036

Please send me the MC145407 sample kit. EDN091790

Name _____

Title _____

Company _____

Address _____

City _____ State _____ Zip _____

Call me (_____) _____

AT&T's new datacom ICs take
the high cost out of high speed.

AT&T's new 41 Series of differential quad line drivers/receivers and dual transceivers reach 400 Mb/s with substantially reduced EMI.

Our new datacom ICs do more than offer one of the industry's highest data rates and shortest propagation delays.

Their unique design can take you to 400 Mb/s on common twisted pair—at low EMI levels. This makes them an affordable alternative to fiber, when fiber's other benefits aren't needed.

In system use, they decrease EMI levels up to 30 db compared with standard 26LS TTL ICs. This sharply reduces cabinet design costs. And they meet ESDI standards, making them ideal for disk drive applications.

41 Series devices are pin-for-pin compatible with 26LS ICs—so they're easy to use. They help reduce board complexity and cost via on-chip termination and line-impedance-matching resistors. And they come in space-efficient, surface-mount SOJ and SOIC packages as well as standard DIPs.

Not exactly what you need? Create your own custom version quickly and easily by using our standard cell library.

Call 1 800 372-2447 for our databook on 41 Series components, in stock today at Hamilton/Avnet and Schweber.

The
components
of success.



AT&T

The right choice.

AT&T's Datacom ICs: high-speed, low EMI performance

Chart below shows resultant data rates when using a 41 Series driver with various lengths of 26 AWG twisted pair cable terminated with a 41 Series receiver in split termination. Maximum bit rate is the point at which the 41 Series receiver output data eye is reduced 20% from ideal.

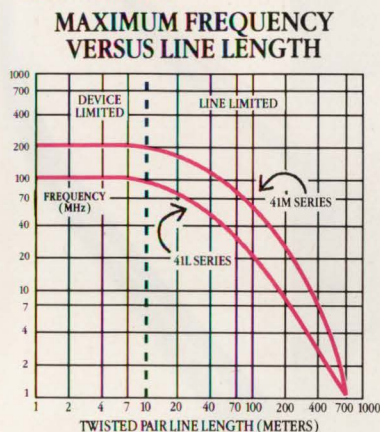

Chart below compares typical propagation delay of AT&T's 41 Series devices to industry standard 26LS and DS8923A devices.

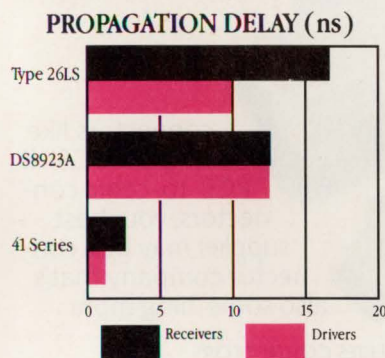
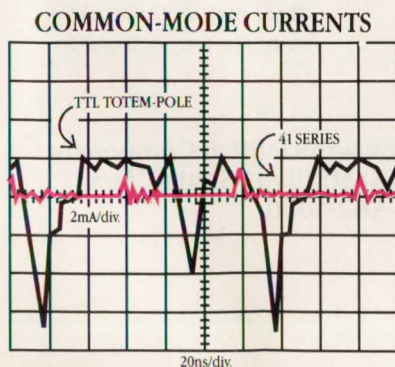

Chart below compares the driver common mode output current levels for the 41 Series and available industry TTL equivalents. Lower I_{cm} results in low EMI.



NEW PRODUCTS

TEST & MEASUREMENT INSTRUMENTS

Transient-Waveform Recorder

- Uses IBM PC for control
- Samples two, four, or eight channels at 100-nsec intervals

The SDA2000A transient-waveform recorder uses an IBM PC-compatible computer for control. The recorder can capture data and simultaneously place it on the IEEE-488 bus at 1M byte/sec for further processing by the PC. The vendor can configure the unit with two, four, or eight channels. By using multiple units, you can create systems with as many as 64 channels. Resolution is 12 bits, and the minimum sampling interval is 100 nsec. The device features 33 programmable-gain ranges that cover 50 mV to 80V. \$9995.

Soltec Corp., 12977 Arroyo St, San Fernando, CA 91340. Phone (800) 423-2344; in CA, (818) 365-0800. FAX (818) 365-7839.

Circle No. 351

4-Channel, 500-MHz Amplifier/Attenuator

- Has 100- μ V sensitivity
- Has 200 μ V sensitivity with 1-M Ω impedance

The 2004A 4-channel, 500-MHz amplifier/attenuator is a VMEbus module that works with the vendor's waveform digitizers. At a 50 Ω input impedance, it has 100- μ V sensitivity, a 500-MHz bandwidth, and gains from 0.01 to 10. With a 1-M Ω input impedance, its bandwidth is 250 MHz, its sensitivity is 200 μ V, and its gains are 0.02 to 5. DC offset is programmable, maximum output is 17 dBm, and distortion is -45 dBc (dB below carrier) at 250 MHz. \$3950. Delivery, 10 weeks ARO.

Analytek/Tektronix, 365 San Aleso Ave, Sunnyvale, CA 94088. Phone (800) 835-9433; in CA, (408) 745-1114. FAX (408) 745-1894.

Circle No. 352



Dynamic-Signal Analysis Software

- Displays data in time and frequency domains
- Display marks each harmonic through the ninth

ZPA1000 dynamic-signal analysis software converts an IBM PC-compatible computer equipped with the vendor's ZPB34-004 DSP board and one or more data-acquisition cards into a low-frequency digital oscilloscope, a histogram analyzer, and an FFT spectrum analyzer. The histogram function is useful in characterizing the integral and differential nonlinearity of A/D and D/A converters. With the FFT capability, you can characterize such converters for digital-audio applications; the display marks each harmonic through the ninth. The vendor supplies compatible A/D converters that serve as input devices. Among such units are a 12-bit converter that takes 10M samples/sec and a 16-bit converter that takes 150k samples/sec. \$995; DSP board, \$4995.

Burr-Brown Corp., Box 11400, Tucson, AZ 85734. Phone (800) 548-6132.

Circle No. 353

Experiment-Control-And-Analysis Software

- Performs math on waveforms
 - Lets you define experiments
- DataWave software lets you use your 80286- or 80386-based IBM

Why your best choice for SCSI-II connectors may not be a connector company at all.

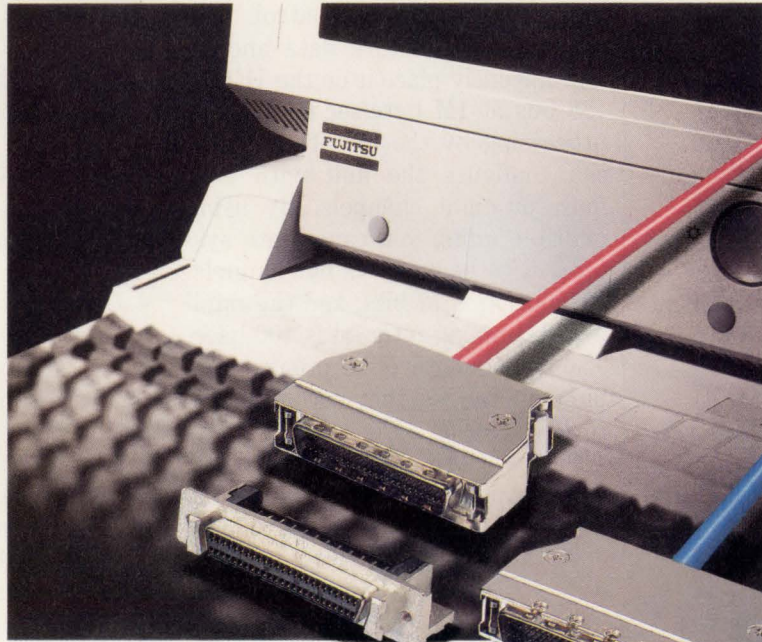

If you need SCSI-II connectors, you can buy them from a company that makes connectors. But an even better idea may be to buy your SCSI-II connectors from a company that makes computers.

Last year we made about \$10 billion worth of computers and peripherals. Ranking us among the top four computer manufacturers in the world. And every Fujitsu computer was chock full of Fujitsu connectors.

Our reputation for quality and reliability depends on the reliability of every single component including connectors.

So we've learned to make components of uncompromising quality. And we've learned that the best way to make them economical for our own systems is to supply them at reasonable prices to companies like yours as well.

Today, components — along with computers and communications — are an important part of our \$16 billion annual sales.

So when you need connectors, even hard-to-find

connectors like half-pitch SCSI-II PCB-to-cable connectors, your best supplier may be a connector company that's also something more.

FCN-230 SERIES CONNECTORS

ITEM:	SPECIFICATIONS:
Operating Temperature	-55°C to +105°C
Current Rating	1 ADC
Voltage Rating	240VAC
Contact Resistance	30mΩ max. at 6VDC, 0.1A
Insulation Resistance	1000MΩ min. at 500VDC
Dielectric Strength	750VAC for 1 minute
No. of Contact	50, 68

For more information write Fujitsu Component of America, Inc. 3330 Scott Blvd., Santa Clara, CA 95054 or call 408-562-1000.

FUJITSU

PC-compatible computer or PS/2 to design and control experiments, collect data, and display and analyze the data. Experiment design uses pull-down menus and fill-in-the-blank forms. You can repeat experiments at will by running stored experiment-definition files. While an experiment is running, you can choose to have it repeat continuously, run once, or run in a "burst" mode. A waveform calculator lets you perform mathematical operations on waveforms. Other data-manipulation functions include FFT analysis, extraction of waveform parameters, curve fitting, event detection, and waveform smoothing. You can define your own functions and add them to the menus. The program requires a PC with 1M byte of main memory and 1M byte of extended memory, a 40M-byte hard disk, and a video adapter that conforms to IBM EGA or VGA

standards. MS-DOS must be version 3.3 or higher. A math coprocessor is supported if present. \$1995.

BrainWave Systems Corp, 3400 Industrial Lane, Suite 3, Broomfield, CO 80020. Phone (800) 736-9283; in CO, (303) 466-6190. FAX (303) 465-5292. **Circle No. 354**

4-Channel Scope With Printer Interface

- Has 100-MHz bandwidth
- Sends printouts through parallel and IEEE-488 ports

The 2252 portable, 100-MHz-bandwidth, 4-channel scope has dual timebases and automatic setup. You can control it completely over the IEEE-488.2 bus. Though it is an analog instrument, the scope can digitize repetitive waveforms with 12-bit precision and with a record length of 500 points. By connecting an Epson-compatible printer to

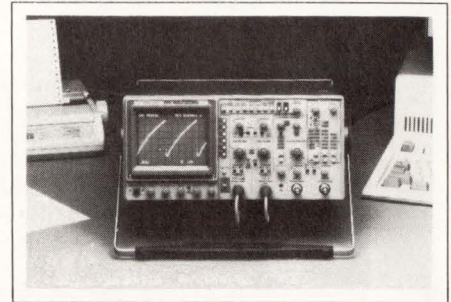

the Centronics-compatible parallel port, you can obtain waveform printouts. You can also transfer the digitized waveforms to a printer or a computer using the IEEE-488.2 bus. The scope also makes cursor-controlled voltage and time measurements; its 200-MHz counter/timer has a timebase stable to 10 ppm. In averaging mode, the counter's resolution is 10 psec. \$3495.

Tektronix Inc, Box 1700, Beaverton, OR 97075. Phone (800) 426-2200. **Circle No. 355**

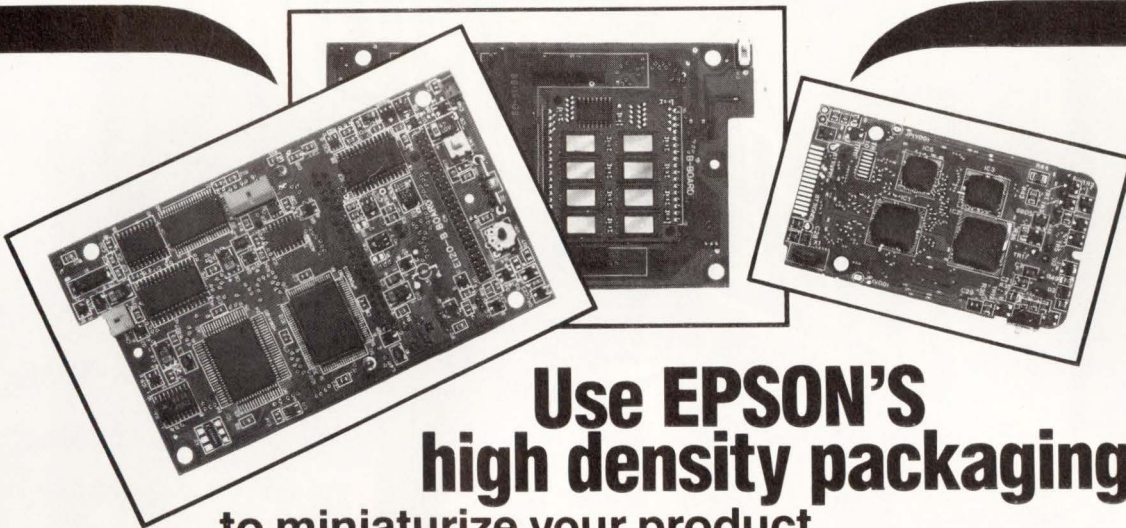

Use EPSON'S high density packaging to miniaturize your product

Epson, a leader in high density packaging technology for more than 50 years, can design and fabricate your miniature packages from the idea stage all the way through to the boxed product... ready for sale!

COB, TAB, CAD/CAM

Epson uses the latest Chip on Board, Tape Automated Bonding and CAD/CAM concepts to produce high quality, high reliability products.

READY TO SERVE YOU

Epson is interested in helping you transform your high-volume products and new ideas into viable products that will remain competitive in today's market.

Call your sales rep today.

EPSON® EPSON AMERICA, INC.

Component Sales Department Telephone: 213/373-9511

EPSON Sales Representatives: AL-GA-TN-NC The Novus Group 205/534-0044 · AZ-NM Fred Board Assoc. 602/994-9388 · CA-No. Costar 408/446-9339 · CA-So. Bager Electronics 714/957-3367 · CO-UT Wn. Region Mktg. 303/469-8088 · FL Dyne-A-Mark 305/771-6501 · IL-WI LTD Technologies 708/773-2900 · IN-KY C C Electro 317/255-1508 · KS-MO-IA Microtronics 913/262-1444 · MA-NH-CT Rosen Assoc. 617/449-4700 · MD-VA Tech Sales Assoc. 301/461-7802 · MN Electro Mark 612/944-5850 · NJ JMR Sales 201/525-8000 · NY Elcom Sales 716/385-1400 · Long Island, NY Nicktronics 506/929-4671 · OH-MI J. D. Babb Assoc. 216/934-4454 · OR-WA E. E. Sales 503/639-3978 · PA Omega Sales 215/244-4000 · TX-OK Component Tech. 214/783-8831

The ten years battery that offers you even more capacity.

Modern micro-electronics now have a clear pace setter where high capacity Lithium Cells are concerned - the Varta CR Cylindrical cell specially developed for the specific demands of the computer age.

For long life and high reliability.

With capacities second to none worldwide:

2.0 Ah for the AA, 1.4 Ah for the 2/3 AA,

1.0 Ah for the 1/2 AA and 360 mAh for the 1/4 AA, the smallest type in the range.

Laser welding and a self-discharge of less than 1 % per year means that the

Varta Lithium cells achieve a lifetime of 10 years. They can be wave-soldered without any additional precautions.

If the needs of your memory backup is for an environmentally friendlier cell with a high energy density, then it is time to start thinking about an improved product for the future. Just call us for your free samples.



VARTA

CIRCLE NO. 158

Varta Batterie AG
Daimlerstr 1
D-7090 Ellwangen - Jagst
W.- Germany · Tel. (07961) 831

Varta Batteries Inc.
300 Executive Boulevard
Elmsford · N.Y. 10523-1202
USA · Tel. (0914) 59 22 500

Varta Batteries Pte. Ltd.
P.O.Box 55
Bedok North Post Office
Singapore 9146 · Tel. (02 41) 26 33

16-Channel Simultaneous S/H Board

- *Compatible with 12-bit, 100k-sample/sec A/D converter*
- *Works with seven software packages*

The CIO-SSH16 is a 16-channel simultaneous S/H board. The externally mounted unit works with the vendor's CIO-AD16, a 12-bit IBM PC bus A/D converter board. One version of the ADC board makes 100k conversions/sec. Both units are 100% hardware and software compatible with popular boards from a competitor, but provide additional features. The compatible boards have a broad base of software support from suppliers of at least seven application packages. They are also supported by drivers for C, Basic, Pascal, and Fortran. In comparison with competitive products, these boards provide more convenient access to the

switches that control gain and bipolar offset. CIO-SSH16, \$399; CIO-AD16, from \$799.

Computer Boards Inc, 44 Wood Ave, Mansfield, MA 02048. Phone (508) 261-1123. FAX (508) 261-1094.

Circle No. 373

88-Pin Universal Device Programmer

- *Programs and tests in one insertion*
- *Supports 2800 IC types*

The Allpro-88 device programmer supports PLDs, PROMs, field-programmable gate arrays, and μ Ps with embedded ROM. It programs and tests the devices in a single insertion. The programmer's library of supported ICs includes 2800 devices in packages having as many as 88 pins. The programmer also supports ICs based on avalanche-induced migration (AIM) technol-

ogy. For programming, these devices require pulsed current rather than pulsed voltage. The programmer's 88 pins are under software control. Each one has its own DAC and its own voltage and current sensors. Each pin can perform any programmer function: The functions include slewing or sensing of voltage or current and driving device clock pins at rates to 4 MHz. The programmer accepts data as JEDEC files and allows full editing of any file. The standard test head includes a 48-pin DIP socket and seven plastic LCC sockets with 20 to 84 pins. The vendor can also furnish sockets for other types of surface-mount devices. \$14,950.

Logical Devices Inc, 1201 NW 65th Pl, Fort Lauderdale, FL 33309. Phone (800) 331-7766; in FL, (305) 974-0967. FAX (305) 974-8531.

Circle No. 374

When it comes to scopes, some companies talk a good line.

One company really has it. Designing a few scopes for "average" users leads to a line of average scopes. That's why Tek builds some 20 analog scopes and 24 DSO's. From 10 MHz to 40 GHz. From handhelds to lab scopes. From dependable basics to the advanced signal analysis of the DSA. Want a line with real substance? Call your Tek rep or 1-800-426-2200 for less talk and more Tek.

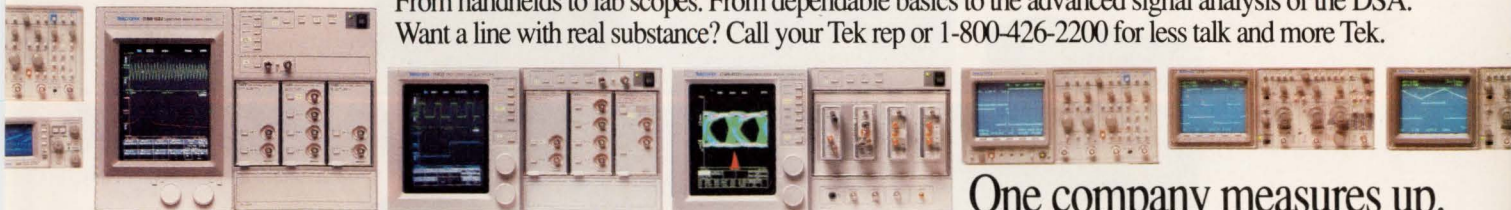

One company measures up.

Tektronix®

INTERNATIONALLY APPROVED CIRCUIT BREAKERS

When you're designing your product for global markets, take steps to protect it right. Choose Airpax. We build in the quality, performance and reliability you demand as well as the required international certification that will assist you in marketing your product anywhere in the world. From initial design through final shipment we can help you every step of the way.

Step-by-step help on three continents.

Engineers at our design/manufacturing centers in Belgium, Japan and the U.S. will assist in your design requirements by recommending the correct magnetic circuit breaker. When you're ready to manufacture,

we're strategically located to provide on-time/just-in-time delivery anywhere.

50 milliamps to 100 Amps, 1 to 6 poles and more.

Consider your choices: SNAPAK® in rocker, toggle, paddle, baton, push-pull or push-to-reset styles; IEL, DIN rail mount in single or multi-handle;

Wherever You Design Your Product, We're With You Every Step Of The Way.

UL, VDE, CSA, TUV and SEV approvals.

For any international marketer, it can be a maze of acronyms out there. Not for Airpax, because ours is the broadest line of magnetic circuit breakers fully accepted for international applications in marine, instrumentation, medical systems, appliances, power supplies, information processing systems, industrial controls, HVAC equipment and other devices that demand reliable circuit protection.

IEG in a toggle and snap-in mount; and E-Frame branch circuit protectors. Designed to withstand shock, vibration and temperature variances.

The next step is up to you.

To find out more, write us. Or to secure prototypes fast for testing, built to your requirements at no extra cost, call our HOTLINE (301) 228-4600. Airpax, Woods Road, Box 520, Cambridge, MD 21613. FAX (301) 228-8910.

CIRCLE NO. 157

AIRPAX®
A North American Philips Company.



NEW PRODUCTS

CAE & SOFTWARE DEVELOPMENT TOOLS

VHDL Design Suite

- *Window-based design and simulation tool set*
- *Runs on Sun, Apollo, DECstation, and VAX/VMS*

The VHDL (VHSIC Hardware Description Language) Design Environment (VDE) graphical suite of design tools includes an analyzer, debugger, simulator, waveform viewer, and navigator. The analyzer allows semantic and syntactic verification of your design descriptions. A source-level debugger lets you edit design descriptions during simulation as errors are uncovered. The waveform viewer displays current-signal values and permits timing and state comparisons between current and past values. The navigator gives you a VHDL view of your elaborated models with ob-

jects displayed either as icons or through menus. From \$12,000 for a 1-year, single-user license on a Sun-3.

Intermetrics Inc., 733 Concord Ave, Cambridge, MA 02138. Phone (617) 661-1840. **Circle No. 356**

Curve-Fitting Software

- *Provides F-statistic and standard errors*
- *Outputs to SigmaPlot, 1-2-3, dBase, and others*

TableCurve performs 1-pass least-squares curve fitting to 221 candidate equations. The software selects equations that it ranks by r^2 coefficients; you can then graphically examine these equations and their coefficients. Features that aid this examination include zoom in/

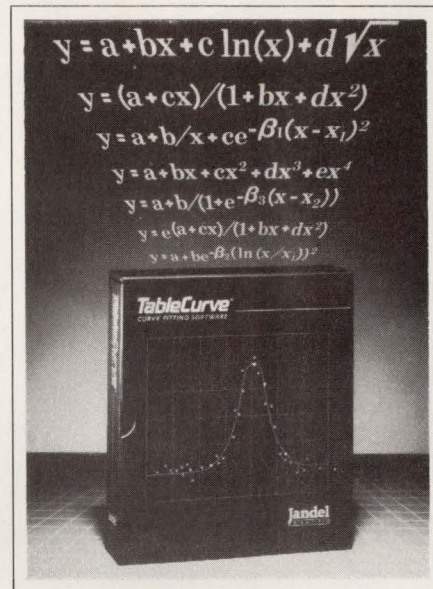

out and the display of prediction and confidence bands. The software includes 60 first-order equations,

When it comes
to DSOs, some companies
aim towards banner specs.

One company begins with them.

It's the difference between face value and real value: do you build for appearances? Or for solid fidelity, effective analysis, and long-lived adaptability? Tek doesn't take shortcuts that shortchange you later. Want a scope that does the optimum, not the minimum? Call your Tek sales engineer or 1-800-426-2200: the deeper you probe, the more you'll appreciate Tek.



One company measures up.

Tektronix®



1988

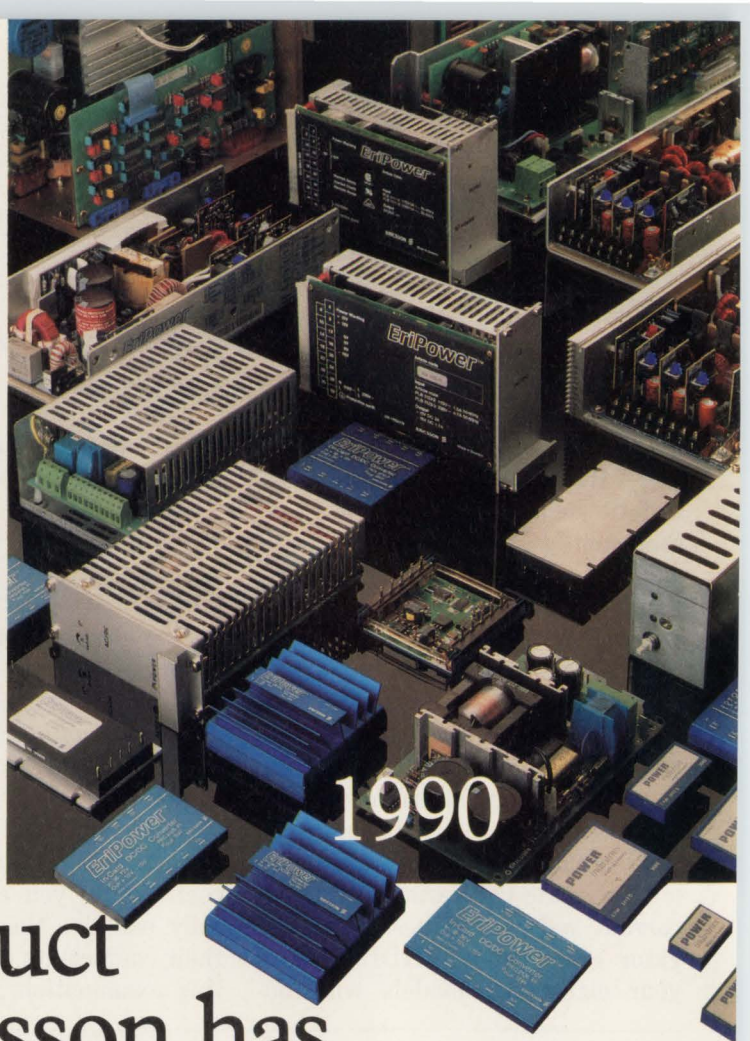

1990

The power product range from Ericsson has been putting on weight recently

Right up to 1988, the Ericsson range of high reliability power supplies was limited - Eurocard PLB switchers, and the remarkable PKA miniature, high frequency DC/DC converters. Remarkable, because they marked the advent of the power component concept as complete modules which can be used to realize distributed power architecture.

Since then things have changed.

Today the EriPower™ range includes DC/DC

converters from 0.3Watts to 200Watts. And most of them are also designed to be paralleled for system upgrading.

What's more, the AC/DC power supply range covers 60 Watt to 400 Watt requirements with Eurocard

and open frame power supplies. When necessary, there's even a full custom design facility for high volume users.

In short, the EriPower™ range has put on a lot of weight, and there's now a product for almost every need.

But one or two things haven't changed. For example, EriPower™ power supplies still meet or exceed international standards for safety and RFI/EMI emission. They all represent the very latest technology of their kind. And they all feature the demanding MTBF performance you'd expect of products from Ericsson - over 200 years in some cases. After all, as a part of one of the world's leading telecommunications companies, reliability is a vital part of our culture.

As you've probably realized, the EriPower™ range is expanding fast. Simply get in touch and we promise to keep you up to date, as we continue putting on weight.

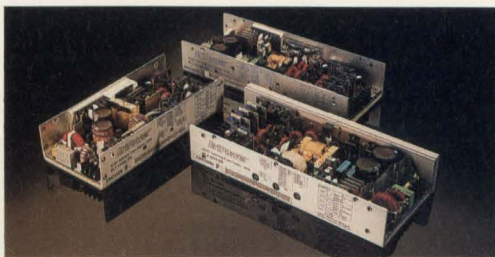

The new PLY: versatile 150-400W open frame switchers



PKA: 30-200W modules have standard pinning/footprinting (Note: Only available in Europe)

- Sweden Ericsson Components AB, Stockholm, Tel: (08) 721 70 59 Fax: (08) 721 70 01
- Australia Ericsson Components Pty Ltd, Victoria, Tel: (03) 480 12 11 Fax: (03) 484 36 45
- France Ericsson Composants SA, Gyancourt, Tel: (01) 30 64 09 00 Fax: (01) 30 64 11 46
- Hong Kong Ericsson Components AB, Wanchai, Tel: (05) 756 756 640 Fax: (05) 834 5369
- Great Britain Ericsson Components AB, Coventry, Tel: (0203) 553 647 Fax: (0203) 225 830
- Italy Ericsson Components Srl, Milano, Tel: (02) 551 81 597 Fax: (02) 545 97 31
- Norway Ericsson Components A/S, Oslo, Tel: (02) 6 50 190 Fax: (02) 644 138
- United States Ericsson Components Inc, Richardson, TX, Tel: (214) 480 83 00 Fax: (214) 680 10 59
- West Germany Ericsson Components GmbH, Engen, Tel: (07733) 500 10 Fax: (07733) 5927



such as power, log, inverse, and positive and negative exponential; 66 second-order and 55 third-order equations; and rational polynomials and polynomials. Functions such as Gaussian, log normal, sigmoidal, and sine are provided; you can also define your own. \$395.

Jandel Scientific, 65 Koch Rd, Corte Madera, CA 94925. Phone (415) 924-8640. FAX (415) 924-2850.

Circle No. 357

DSP Design Software

- *Runs on IBM PC*
- *Allows integration of C- or Pascal-based routines*

DSP Headquarters (DspHQ) allows you to develop and study DSP algorithms. The software lets you integrate functions that the vendor provides, separate function libraries, or your own C and Pascal routines into the algorithms. The algorithms

pass and share data structures. The host PC can perform calculations, or you can download the algorithms to signal-processor boards based on the ATT DSP32 chips. The software includes a menu interface, command interpreter, batch-command processor, file- and memory-management capabilities, and hard-copy support for dot-matrix, laser, PostScript, and HPGL devices. \$495.

BittWare Research Systems, 400 E Pratt St, 8th Floor, Baltimore, MD 21202. Phone (800) 848-0436; in MD, (301) 879-7274. FAX (301) 879-4465. **Circle No. 358**

Real-Time O/S

- *Supports Ada on 88000-based systems*
- *Includes VAX/VMS-based host and cross-compilers*

The RTAda/88K is a real-time oper-

ating system for embedded 88000-based applications. The package contains a comprehensive development system, including the ARTX real-time multitasking kernel; Tele-Gen2 host- and cross-compilers running under VAX/VMS; the RTAda/88k source- and system-level debugger; a global optimizer; language tools; foreign object-code importer; and a VAX-hosted cross-assembler. Based on the vendor's Ada real-time kernel, the RTAda/88k offers documented system-call timing so you can evaluate critical path timing. Development license, from \$18,000, depending on number of users and VAX host model.

Ready Systems, Box 60217, Sunnyvale, CA 94086. Phone (800) 228-1249; in CA, (408) 736-2600. FAX (408) 736-3400.

Circle No. 359

When it comes
to DSOs, some companies
duck the tough questions.

One company spells them out.

12 Tough Questions looks beyond banner specs to critical issues most DSO vendors don't want you to ask. Acquisition, glitch detection, update rate, triggering — Tek's sales engineers welcome the kind of questions that get to the facts of performance. Want a scope that has nothing to hide? Contact your Tek sales engineer, or call 1-800-426-2200 for a copy of *12 Tough Questions*, free.



One company measures up.

Tektronix®

Electronic Enclosures... from stock - or - custom modified

From Stock

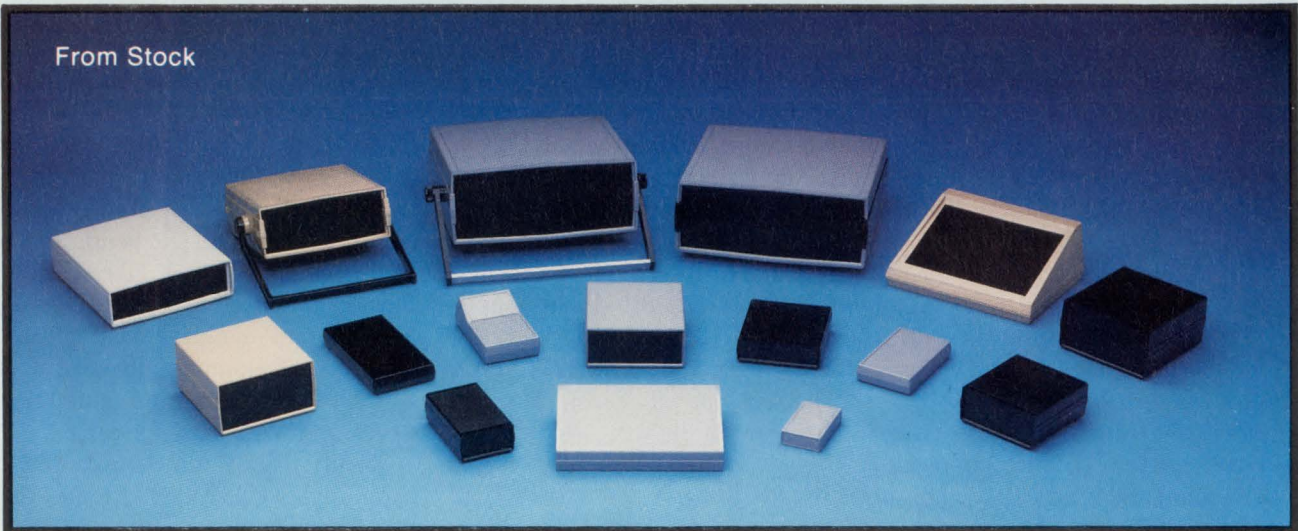

Stock Enclosures • Modifications • Design Engineering Assistance • Custom Panels • Options and Accessories

"Your Way"



- Easy to design into and easy to assemble
- Molded-through color means no chipping or scratching—and no need for refurbishing and painting during or after assembly
- Constructed of impact-resistant ABS—(flame-retardant grade to meet UL94V-0 standards, optional)
- Shielding against EMI/RFI available
- Standard colors: tan, gray, black, PC bone
- No tooling costs or set-up charges
- Molded-in mounting bosses, card guides, and panel grooves reduce assembly time and production costs
- Low-cost options and accessories available to meet end-user needs
- Available in kits and production quantities

Pac-Tec enclosures from stock, or modified "Your Way" by Pac-Tec's unique method of tool modification are available from your local stocking Distributors. For the name of your local distributor or additional information call:

PAC-TEC®

Division of LaFrance Corp.

Enterprise and Executive Avenues Philadelphia, PA 19153 Telephone (215) 365-8400 Telex 50-6082 FAX: 215/365-4420

1-800-523-4813

NEW PRODUCTS

COMPUTERS & PERIPHERALS

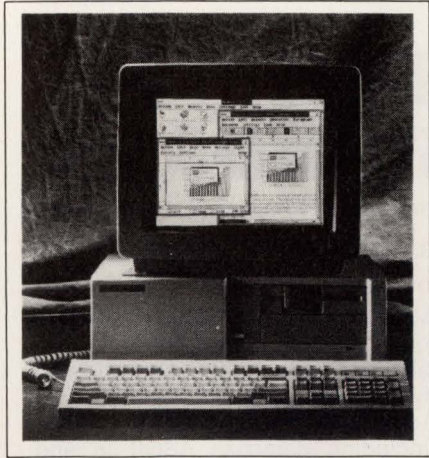

Desktop PC

- Uses a 25-MHz 80386 μ P and 2M bytes of RAM
 - Option for hard-disk drive with as much as 340M-byte capacity
- The Vectra 386/25 PC desktop PC uses a 25-MHz 80386 μ P. The unit

comes with 2M bytes of RAM and a 32k-byte cache memory. The computer provides an upgrade path from the base 2M to 32M bytes of RAM. The memory operates at 25 MHz with near-zero wait states. In addition, the computer has a serial, a parallel, and a mouse port. Its flexible disk drive comes in two versions: 5¼-in., 1.2M-byte and 3½-in., 1.44M byte. You can opt for a hard-disk drive with 42M-, 84M-, 170M-, or 340M-byte capacities and 17- to 19-msec access times. The computer also has a super VGA board that supports 800×600 and 1024×768 pixels as well as being compatible with MDA, CGA, Hercules, and EGA graphics modes. The system runs on OS/2, MS-DOS 3.3, and SCO Unix System V/386 operating systems. Unit without hard disk,

\$5399; with 84M-byte hard disk, \$6999; with 170M-byte hard disk, \$7999.

Hewlett Packard, 19310 Pruneridge Rd, Cupertino, CA 95014. Phone (800) 752-0900.

Circle No. 360

Pattern-Recognition Board

- Has an 8255 IC driving three separate byte-wide ports
- Circuitry can generate an interrupt on any bit of the ports

The PIO-INT digital I/O board is designed for pattern-recognition applications. It contains an 8255 programmable peripheral interface IC that communicates with three separate byte-wide ports PA, PB, and PC. Circuitry can generate interrupts on any bit change on the

When it comes
to DSOs, some companies
let you stare at a video.

One company lets you compare for yourself.

Sitting through a video demo is like sightseeing with blinders on. So 18,000 engineers have already asked for Tek's free Scope Evaluation Kit, with test board and manual to help you compare scopes and draw your own conclusions. Ready to blow the lid off canned demos? Get face-to-face with your Tek sales engineer, or call 1-800-426-2200 to qualify for the Scope Evaluation Kit.



One company measures up.

Tektronix®

Crystal Clear LCD Modules

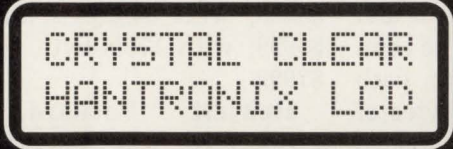

Hantronix, Inc. has for immediate delivery, a large variety of high-resolution LCD modules. Our wide selection of formats include:

1 x 8	1 x 16	1 x 20	1 x 24	1 x 32	1 x 40	1 x 80
	2 x 16	2 x 20	2 x 24	2 x 32	2 x 40	
	4 x 16	4 x 20		4 x 40		

Also available are:

- Super Twist Models
- E/L or LED Backlight
- Extended Operating Temperatures (-20°C - 70°C)
- Positive or Negative Types
- Wide Viewing Angles
- Various Character Heights
- Custom Models
- Graphic Modules

For more information on our high-quality and moderately priced LCD modules, call or write:



HANTRONIX, INC.
 250 Santa Ana Court
 Sunnyvale, CA 94086
 Tel: (408) 736-3191 • Telex: 880165 • Fax: (408) 749-0477

CIRCLE NO. 43

RAF ELECTRONIC HARDWARE

We'd Like to Hand You a Line...

...of top quality, American-made electronic hardware. You'll be able to count on consistent dimensions part-to-part. Get durable finishes to your spec. Select from over 100,000 parts that are on the shelf, ready to ship. We supply handles, Jack Screws, stand-offs, captive screws, and dozens of others. And if you need special

hardware, we will custom manufacture it to your prints. So, let us hand you our line. Write or phone for a copy of our latest catalog.

RAF Electronic Hardware
 95 Silvermine Road
 Seymour, CT 06483
 (203) 888-2133
 FAX: (203) 888-9860

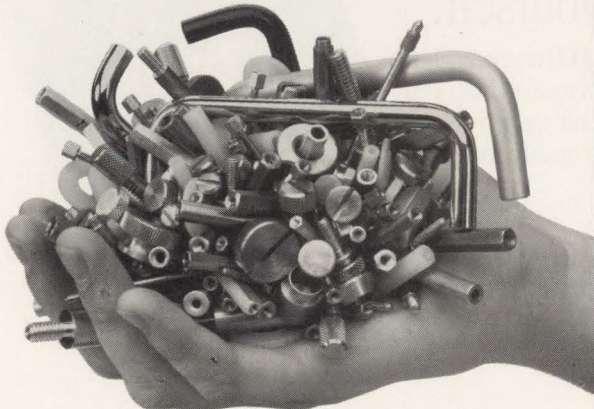

CIRCLE NO. 44

SPOTLIGHT: DESIGN & DEVELOPMENT ■

Finally, attendees determined the most impressive product of the show was CAD Software's PADS.

Each vendor provides its results as shown in the chart on page 26. PE&I News 6/90 on CAD Showdown Results

PADS SETS THE STANDARD

for CAE/CAD design on Personal Computers

Complete thru-put logic capture and board design functionality including:

- A true multi-sheet database for Schematic capture with hierarchical design capability
- Design verification for analog and digital designs
- Both automatic and interactive PCB layout tools
- Most complete set of autorouters for Analog, Digital and SMD designs
- Cam outputs including database ASCII In and ASCII Out format
- **NEW!** PADS-2000, board designs with no system limits. 1 micron database, copper pouring, T-routing. Workstation capability at PC prices!
- Easy to learn, easy to use

Call today for a free demonstration package, and for your local Authorized PADS Reseller.

CAD *Call Today!* Software, Inc. Inside MA: (508) 486-8929
 Outside MA: (800) 255-7814
 119 Russell Street, Littleton, MA 01460

CIRCLE NO. 40

TELEBYTE



THE ULTIMATE! Short Haul Modem 38.4 KBps/3 Miles

USING ISDN TECHNOLOGY
 MODEL 214 FASTWIRE SHORT
 HAUL MODEM

- TRANSFORMER ISOLATION
- FDX SINGLE TWISTED PAIR
- ECHO CANCELLATION
- AUTOMATIC LINK VERIFICATION

\$138

MADE IN USA

TELEBYTE
 TECHNOLOGY, INC.

270 E. Pulaski Rd., Greenlawn, NY
 11740 • 516-423-3232/516-385-8080
 1-800-835-3298 • FAX: 516-385-8184

CIRCLE NO. 45

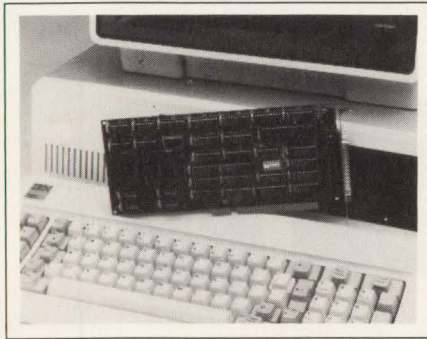

PA or PB ports. The PC port can be split into two nibble-wide ports. You can configure all of the ports as inputs or outputs, using the 8255 control register. The board has two interrupt operations for the PA and PB ports. A bit interrupt, which is a change of any unmasked bit from a 0 to a 1, is stored in a status register. A pattern interrupt occurs when a given pattern of bits changes at a given port. Two mode bits in the interrupt-control register select the type of interrupt. The board uses a contiguous block of 16 I/O addresses on the ISA bus. To prevent spurious interrupts, a digital filter delays an interrupt. \$399.

Metabyte Corp, 440 Myles Standish Blvd, Taunton, MA 02780. Phone (508) 880-3000. FAX (508) 880-0179. **Circle No. 361**

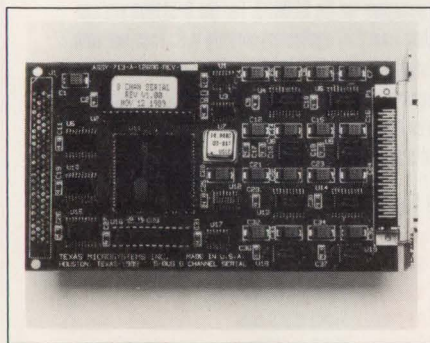

Serial Card

- Provides eight RS-232C ports for the Sbus
- Has 8-byte receive and 8-byte transmit buffer on each port

The Model SSC-80 serial board for the Sbus in SPARCstations provides full-modem handshake lines for eight RS-232C ports. You can

install two boards in a single Sbus to provide 16 RS-232C ports. The board performs flow control (X-on, X-off, and RTS/CTS) in hardware. The serial card has 8-byte receive and 8-byte transmit FIFO buffers on each port. The aggregate throughput is 36,000 cps. You install the board, using menus that

prompt you to follow procedures. Software drivers for the Sun Unix operating system are included with the board. \$995.

Texas Microsystems Inc, 10618 Rockley Rd, Houston, TX 77099. Phone (800) 627-8700; in TX, (713) 933-8050. FAX (713) 933-1029.

Circle No. 362



Our SIP switches stand out in a crowd.

Unique Space Saving Single In Line Switch

- 2, 4, 6, 8 or 10 position with common bus
- Vertical or right angle mounting options
- 2 SIP's require less board space than 1 DIP switch
- Compatible with pick & place equipment

AUGAT/ALCOSWITCH offers a full product line including...

For your free catalog, product samples, applications help, or a quotation, call or write **AUGAT/ALCOSWITCH**, 1551 Osgood Street, No. Andover, MA 01845 USA, Tel: (508) 685-4371, TLX: 275423, FAX: (508) 686-9545



Slides



Toggles, Rockers & Pushbuttons

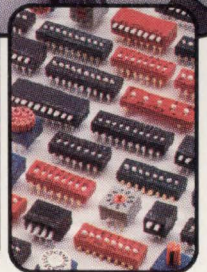

DIPs

AUGAT INTERNATIONAL SALES OFFICES

AUGAT LIMITED - ENGLAND	(011) 4490676655
AUGAT SA - FRANCE	(011) 33146683090
AUGAT GMBH - WEST GERMANY	(011) 49896129090
AUGAT AB - SWEDEN	(011) 468960270
AUGAT SRL - ITALY	(011) 3939654100
AUGAT ISRAEL	(011) 9723492173
AUGAT ELECTRONICS INC. - CANADA	(1) 4166771500
AUGAT RTY LTD. - AUSTRALIA	(011) 6129050533
AUGAT KK - JAPAN	(011) 810550897911

Get in sync with Kraias Glisten Gate.

The Kraias Glisten Gate KS6369-15P provides instantaneous, stable, high-accuracy, clock synchronization of high-frequency wide-band asynchronous trigger inputs in one remarkable stand-alone device.



- Reference clock for a time-setting circuit
- Read/write clock generator for a color video signal

Kraias Glisten Gate features:

- Wide band: 15-30MHz
- Jitter (high-accuracy): MAX +/-4ns
- Output frequency same as input
- High-speed pull-in time: MAX 60ns
- No adjustment required, fully CMOS digital circuit
- Single Power Supply: +5V
- 16-pin DIP

Glisten Gate can be applied in any system which requires clock synchronization such as:

- Clock generator for a laser-beam printer
- Dot clock for a graphics control system
- Reference clock for data communication

CORNES•9010 Miramar Road•Suite 100•San Diego•CA•92126
(619)586-6200•FAX (619)586-0529

CIRCLE NO. 41

QUALITY FANS, PRICED RIGHT!

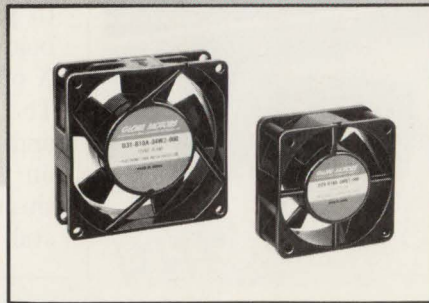

With its complete line of AC and brushless DC Commercial Cooling Fans, Globe Motors stocks the right fan for your cooling application needs!

- 115 and 230 VAC models to 215 CFM
- 12 and 24 VDC models; 8 to 110 CFM
- 60mm to 150mm x 172mm sizes
- Solid state brushless design; precision ball bearings
- 50,000 hr. min. life; quick delivery

GLOBE MOTORS

A Division of Labinal Components and Systems, Inc.

For more information, contact Globe Motors,
2275 Stanley Ave., Dayton, Ohio 45404.

513-228-3171

CIRCLE NO. 42

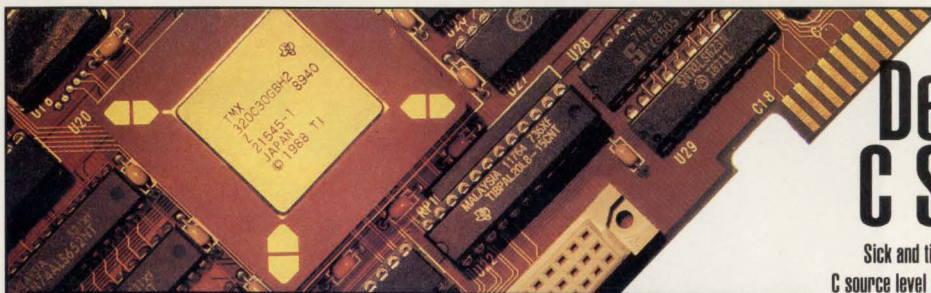

Debug C30 at C Source Level

Sick and tired of assembly debugging? Get our new advanced C source level debugger for the 320C30. For the first time you can develop and debug your C30 application entirely in C. Together with our TIGER 30 board the debugger provides a complete hardware and software environment. It's window-based, easy to use, and full of useful features that will speed up your DSP development cycle. What's more, it's available now.

Outstanding Features:

- C Source debugger
- Modern, window-based interface
- Pull-down menus
- Single-step C code
- Watch variables
- Register and memory display
- Hardware break
- Timer and profiler
- And much, much more...

**DSP
RESEARCH**

Call, fax, or write today
for more TIGER facts.

391 Balsam Avenue, Sunnyvale, CA 94086
TEL: (408) 773-1042 FAX: (408) 736-3451

```
File Edit View Search Make Run Debug Utility Options Help
wtype: "HAMMING0"
fscale: 35.000000
adcstream: 14000
idcode: 9808

Void smain(argc, argv)
Int  argc;
Char **argv;
{
    initializeFFT(); /* Set up vectors, arrays, and tables */

    /* Open up stream to A/D converter */
    adcstream = SS_create(SS_NULL, 0, blocksize, &ssattrs);
    idcode = SS_open(adcstream, "/aic0/serial0", SS_READ);

    /* Main FFT loop */
    while (SS_get(adcstream, SU_array(invec))) {
        SU_setlength(tmpvec, npts);
        SU_window(invec, window, tmpvec);
        SU_setlength(tmpvec, fftsize);
        SU_fft(tmpvec, freqvec, table); /* do the FFT */
        SU_conj(freqvec, conjvec);
    }
}
```

<F1=Help> <Alt=Menu> <F5=Go> <F8=Trace> <F9=Set Breakpoint> <F10=Step> OVER

COMPUTERS & PERIPHERALS

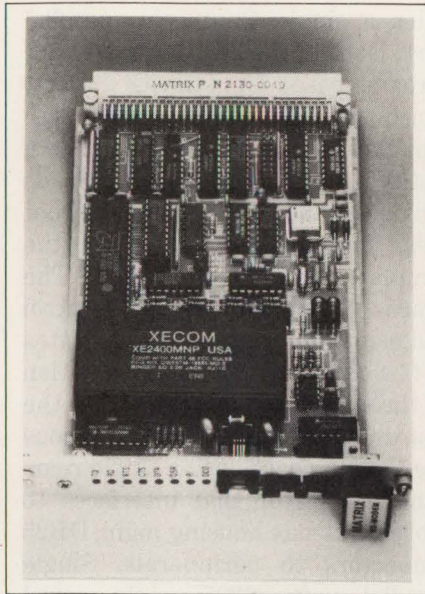

Modem For VMEbus

- Contains DTE or DCE configurable serial port
- Uses MNP Class 5 ECC for errorless transmission

The 2400-bps MS-Modem board for the VMEbus operates with the industry-standard AT command set. You can configure the serial port for data-communications- or data-terminal-equipment operation. The board handles full-duplex synchronous and asynchronous communications, and it contains a data-access arrangement or direct telephone connection. For error-free communications, the modem provides Microcom Networking Protocol (MNP) class 5 error-correction code. The modem implements auto-dialing and autoanswering in either pulse or tone mode. It is compatible with CCITT V.22bis, V.22, and V.21 and Bell 212A and 103 specifications. It also adjusts its speed to that of the calling or answering modem. The modem's VMEbus interface maps the board's Z8530 communications controller onto odd bytes in the short address space (A16) at any 256-byte boundary. \$895.

Matrix Corp, 1203 New Hope Rd, Raleigh, NC 27610. Phone (919) 231-8000. FAX (919) 231-8001.

Circle No. 363

FLIGHT TESTED... TIME PROVEN.

The smallest, lowest power, complete dual redundant 1553 interface. It is a user friendly total solution to the problem of interfacing a subsystem to the 1553 Bus. The NHI-1553RT appears as 8 or 16 bit-wide Ram to the Host, requiring only two standard transformers to complete the bus interface. Standard Ram signals are used to interface the hybrid to all popular processors. The internal Ram is dual ported making the Host and Bus totally transparent to each other. Ram arbitration and control logic is all contained in the hybrid.



- Two +5V only transceivers
- 4K words of internal memory
- Message illegalization without external prom
- Supports notices I and II
- Programmable interrupts
- Interrupts stored internally in FIFO
- Internal 32 bit time tag clock
- Broadcast flag for each message
- Discrete I/O pins
- Complies with Mil-Std 1760A
- Plug-in package 1.33 x 1.83
- Flat package .95" x 1.85"
- Software and interface support
- On-site demonstrations available

NATIONAL HYBRID, INC.



(A MIL-STD-1772 COMPANY)
2200 Smithtown Avenue
Ronkonkoma, NY 11779
(516) 981-2400

NHI-1553RT

+5V ONLY

Color Printers

- A- and B-size print on paper and transparencies
- Use 80960 μ P as a controller to print at 300 dpi

ColorPoint PS is a series of color printers; the model 4 prints on 8.5x11-in. A-size paper, and the model 14 prints on A-size and 11x17-in. B-size. Both printers use an 80960 μ P, which provides 300 dpi, as a print controller. The thermal-transfer printers can print Postscript-compatible files, using the PhoenixPage Postscript Printer Language Interpreter from Phoenix Technologies (Norwood, MA). The interpreter is also compatible with Adobe Postscript color version 50.3. The printers use roll-feed media; their automatic cutter with a double-cut feature lets the user produce color prints having the same image size as LaserWriter fonts. Ports for the printers include stan-

dard Appletalk, Centronics parallel, RS-232C, and SCSI. Model 4 and model 14 have 6M- and 10M-byte buffers, respectively. Both printers are Pantone certified. Model 4, \$6999; model 14, \$9999.

Seiko Instruments Inc., Graphic Devices and Systems Div, 1130 Ringwood Ct, San Jose, CA 95131. Phone (408) 922-5800. FAX (408) 922-5840. **Circle No. 375**

Sbus Multiplexers

- Come with Streams-based Unix device drivers
- Provide baud rates as fast as 64k baud

Four add-in multiplexer boards are available for the Sbus in the SPARCstation. Three of the boards are available with two, four, and eight serial ports, respectively. The 2-port version also has a Centronics parallel port. The fourth board pro-

vides a single Centronics parallel port. Each of the boards comes with Streams-based Unix device drivers, which provide compatibility with Sun O/S versions 4.0.3 and 4.1. An install program automatically loads the driver and modifies system boot files. The driver works with the complete set of "ioctl" calls. The boards provide full-modem control and can transfer data at baud rates as fast as 64k baud. The installation of three 8-port versions allows the boards to support 24 simultaneous users. The boards use a single rear-panel connector that interfaces to a breakout box housing eight DB25 connectors to peripherals. Single parallel port, \$395; eight serial ports, \$1495.

Artecon, Box 9000, Dept 5500, Carlsbad, CA 92008. Phone (800) 872-2783; in CA, (619) 931-5500. FAX (619) 931-5527.

Circle No. 376

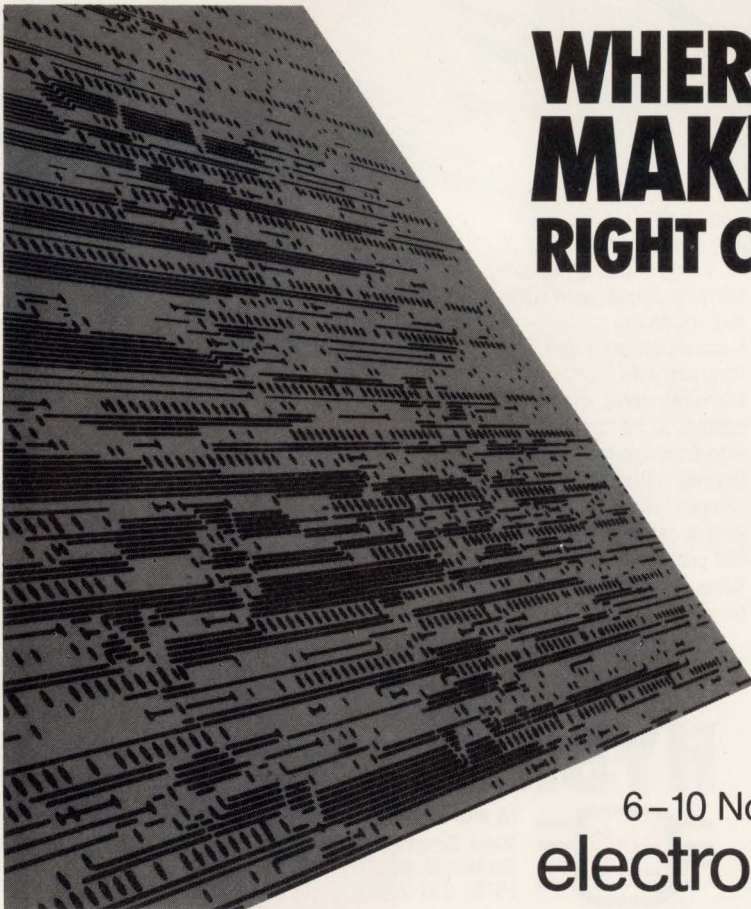

WHERE YOU MAKE THE RIGHT CONTACT.

Electronica is the world's largest trade fair for electronic components and assemblies. Here state-of-the-art technology is on display, and developments, trends, methods and solutions are showcased in a comprehensive, precise, clear and up-to-the-minute style.

Accompanying events at a glance

Congresses and lectures on the following subjects will take place during electronica 90:

- AVT - Layout and connector techniques
- PKO - Cost optimizing in testing
- Micro-electronic sensors
- 5th international power electronics conference
- PHA - Product liability
- MST - Microsystems engineering
- EMV - Electromagnetic compatibility
- DGQ/ZVEI Symposium: quality assurance agreements for assemblies



Munich

6-10 November 1990

electronica 90[®]

Information:

Gerald G. Kallman Associates,
5 Maple Court, Ridgewood, NJ 07450,
Tel. (201) 652-7070, Tfax (201) 652-3898.

MESSE MÜNCHEN  INTERNATIONAL

NEW PRODUCTS

COMPONENTS & POWER SUPPLIES

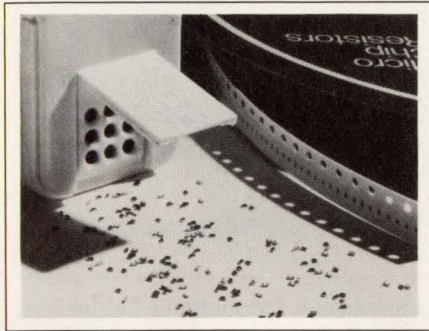

Chip Resistor

- *Smallest in industry*
- *Handles 25V*

Measuring just 1×0.5 mm, the MCR 01 chip resistor occupies 60% less board area than the MCR 03. The chip has resistance values ranging from 5.6Ω to $1.5\text{ M}\Omega$, can handle 25V, and dissipates 0.032W at 70°C . Resistance tolerance measures $\pm 5\%$. Internally, the unit's thick-film metal resistive element is sintered to an alumina ceramic substrate. A protective film covers the element and completely encapsulates the trimming groove, thus effectively sealing out moisture and temperature extremes. The operating range spans -55 to $+125^\circ\text{C}$. Packaged on 8-mm-wide paper-tape reels, the chip is available only in 1-reel, 5000-piece minimum orders. \$0.035 (1000). Delivery, 12 weeks ARO.

Rohm Corp., 8 Whatney, Irvine, CA 92718. Phone (714) 855-2131. FAX (714) 855-1669.

Circle No. 377

Electroluminescent Lamps

- *Have 10-fL brightness*
- *Feature 40,000-hour life*

ELCR-4 thick-film electroluminescent foil lamps provide initial brightness levels of between 8 and 10 fL at 115V ac. In an exit-sign lighting application, the lamps have an average life in excess of 40,000 hours. The lamps are constructed with an electroluminescent phosphor mix on a foil base with a

screened, transparent front-electrode image and an encapsulant/fusion seal. Because the lamps have no filaments, they are immune to problems due to vibration. The lamps have a 0.032-in. nominal thickness, and they provide a uniform light source with less than $\pm 10\%$ variance in brightness across the entire active area. \$25 to \$50. Delivery, eight to 10 weeks ARO.

Eltech, 181 Gibraltar Rd, Horsham, PA 19044. Phone (215) 441-0404. FAX (215) 441-8299.

Circle No. 378



Surge Protector

- *Has 1-nsec reaction time*
- *Can handle 180A*

The DLP-4.3 surge protector provides protection from lightning, transients, and surges on dial-up telephone lines. It plugs into the same local ac outlet as the equipment being protected. Vulnerable equipment is then plugged directly into the unit's RJ11 jacks. The device reacts in <1 nsec. It combines fast-acting avalanche diodes and brute-force gas tubes and can handle numerous hits without degrading. The protector handles 180A current levels on an 8×20 - μsec waveform and 40A on a 10×1000 - μsec waveform. The unit exceeds all pertinent industry standards including UL497A. From \$49.

MCG Electronics Inc., 12 Burt Dr, Deer Park, NY 11729. Phone (516) 586-5125. FAX (516) 586-5120.

Circle No. 379

Rack System

- *Has 1100-lb capability*
- *Available in three depths*

The IMRAK 1400 19-in. enclosure can handle loads ranging to 1100 lbs. Fully compliant with IEC 297-2, the units are available in three standard depths—800, 600, and 400 mm—and in heights ranging from 12U to 57U. A range of accessories is available including swing frames and cable-management components such as hoops and cross bars. The rack comes fully assembled. Four sizes are available from stock—32U, 37U, 42U, and 47U. From \$750.

Bicc-Vero Electronics, 1000 Sherman Ave, Hamden, CT 06514. Phone (203) 288-8001. FAX (203) 287-0062.

Circle No. 380

Autorange Switchers

- *Have 1000W output*
- *Have a 4 W/in.^3 power density*

Series R switching power supplies deliver as much as 4 W/in.^3 in a $5 \times 5 \times 10$ -in. package. Autoranging circuitry allows the units to operate worldwide without the need for a switch or jumper. An optional 42 to 56V dc input allows the supplies to accommodate telecommunications applications. The line includes models that have from three to seven outputs in 800 and 1000W configurations. Supply features include current sharing, overload and overvoltage protection, inrush current limiting, remote sense, remote inhibit, remote margin, EMI input filter, and full safety-agency approvals. A forced current-share option for all outputs provides paralleling that is essential for redundant (N+1) power systems. From \$762 (100). Delivery, eight to 10 weeks ARO.

Unipower Corp., 2981 Gateway Dr, Pompano Beach, FL 33069. Phone (305) 974-2442. FAX (305) 971-1837.

Circle No. 381

Level-Sensor Module

- Has 8-in. sense-distance capability
- Operates to 85°C

The MSM20100 is a noncontact-point level sensor. It has a 0- to 8-in. detection range, 0.1-in. repeatability, and 0.125-in. hysteresis. The unit operates from inputs of 10

to 28V dc or 115/230V ac. The operating range spans -40 to +85°C. The sensor uses a microwave transmitter/receiver to detect the presence of liquids or solids at a set height in bins or tanks. You can also use the unit as a near-field object-proximity sensor. You can set each unit to operate on one of four coded

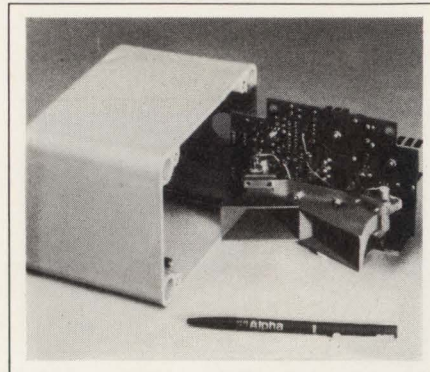

transmission frequencies to prevent crosstalk in multiunit applications. LEDs indicate power connection, level/object sense, and output trigger; you can set three switches for code, pulse, or continuous output or fail-safe conditions. \$395

Alpha Industries, 20 Sylvan Rd, Woburn, MA 01801. Phone (617) 935-5150. FAX (617) 935-4939.

Circle No. 382

THE PERFECT STRATEGY FOR ANALOG & DIGITAL PCB DESIGN



- ☐ YOU want powerful, automated analog design features
- ☐ YOU use power planes
- ☐ YOU want lots of other automated features
- ☐ YOU want an affordable upgrade path
- ☐ And don't forget schematic capture...
- ☐ YOU want to find out more
- ☐ ULTIboard's new Version 4.1 let's you curve or any angle traces. Also, you specify automatic fill patterns for copper areas of any shape. Polygons are assigned to nets while traces of other nets are automatically ploughed through-filled areas.
- ☐ With ULTIboard, power and ground planes with thermal relief pads are created automatically.
- ☐ Real-time DRC, trace shove, reroute-while-move, round tracing and board outlines. .DXF output, automatic component renumbering, and more are standard in all ULTIboard systems.
- ☐ ULTIboard's got a smooth upgrade path with a system in every price range, running under DOS or extended memory. Choose a system to design a small board of 50 equivalent IC's, up to our 32-bit 386 version with unlimited design capabilities.
- ☐ ULTIcap schematic capture featuring automatic guided wiring, automatic junctions, auto rewire after block moves, and on-line symbol creation are just some of ULTIcap's easy-to-use automated features. Or, use your own schematic package with ULTIboard's backannotation.
- ☐ Call ULTIimate Technology today for a **free demo disk**, and the name of the dealer nearest you.

ULTIboard Professional 386 is a true 32 bit Design System; approx. 2x faster than 16 bit versions.

Model	Price	Nr. of 16 pins equiv. IC's	Memory required
Entry Level	\$ 995	35 - 50	640 K
Advanced Level	\$ 2,475	140 - 200	640 K + 1 Mb
Professional 286	\$ 5,950	unlimited	640 K + 2 Mb+
Professional 386	\$ 7,900	unlimited	640 K + 2 Mb+

USA Canada Headquarters
ULTIimate Technology Corp.
209 Mt. Hermon Road,
Suite 105
Scotts Valley, CA 95066
Tel. (408) 439-8944
Fax (408) 439-8966

UK, Ireland Sales Office
ULTIimate Technology (UK) Ltd.
2 Backus House, Calvea Park
Aldermaston
Berkshire RG7 4QW
Tel. (0754) 812030
Fax (0754) 815323

Germany Sales Office
ULTIimate Technology GmbH
Stangerstrasse 1
D-70221 Echterdingen 2
Tel. (0711) 796057
Fax (0711) 791939

Belgium Sales Office
ULTIimate Technology
Kardinaal Mercierplein 1
B-2800 Mechelen
Tel. (015) 401895
Fax (015) 401879

Europe Intl. Headquarters
ULTIimate Technology by
Energiestraat 36
1411 Al Naarden, Netherlands
Tel. (31) 2159-44424
Fax (31) 2159-43345
Telex: 73415

Diode Arrays

- Have 0.1A current-carrying capability
- Feature seven or eight diodes

The SG6100 and SG6101 feature seven and eight straight-through diodes, respectively. Each diode features a 75V min breakdown voltage, 100-mA current capability, 5-nsec max switching speed, and 25-nA max leakage current. The arrays are qualified to MIL-S-19500/474 and use silicon-on-insulator technology to maximize density. Because the arrays are monolithic devices, the electrical parameters are very closely matched—an important feature in many military applications. Both devices are available in ceramic DIP and flatpack housings. The arrays can be processed to JANTXV, JANTX, or the manufacturer's S-level equivalent flow. \$20.25 (OEM qty). Delivery, 16 weeks ARO.

Silicon General Semiconductor, 11861 Western Ave, Garden Grove, CA 92641. Phone (714) 898-8121. FAX (714) 893-2570. TWX 910-596-1894. Circle No. 383

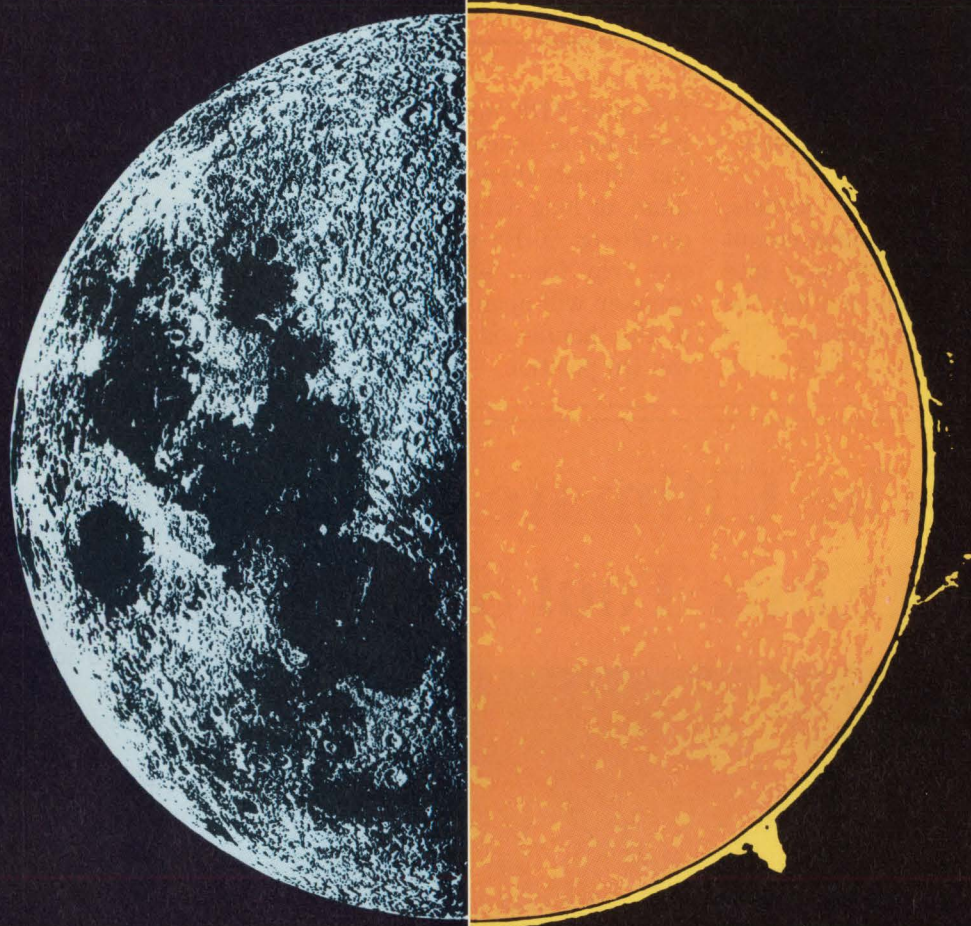

LICK OBSERVATORY PHOTOGRAPH

HALE OBSERVATORY PHOTOGRAPH

Like Night and Day.

You'll see the difference instantly in brightness, contrast, viewing angle and resolution. Fujitsu flat panel plasma and LCD displays stand out from the competition like day from night.

We've raced ahead of the pack with innovative double-layered, super-twisted multiplexed LCD technology that delivers a paper-like 15:1 contrast ratio. Need thinness? We have a package less than an inch thick that will give you 10:1 contrast, 100 Cd/M² brightness, and VGA compatibility. In fact, we offer a whole family of Fujitsu LCD configurations to match your needs.



For maximum brilliance, and thinness, larger viewing areas and higher resolution, there are our brilliant plasma displays. Up to 150 Cd/M² of brightness, 20:1 contrast ratio, and 1,024 x 816 of resolution; diagonal sizes ten to eighteen inches. All with CRT-like video response time and VGA compatibility.

Name your application. There's a Fujitsu flat screen display that can mean the difference between night and day. For information call 800-556-1234, ext. 238. In California, call 800-441-2345, ext. 238. Or, write Fujitsu Component of America, Inc., 3330 Scott Boulevard, Santa Clara, CA 95054.

FUJITSU

Magnetic Circuit Breakers

- Require no mounting hardware
- Rated for 50A

Available in 1- to 4-pole models, IEGS and IEGHS magnetic circuit breakers are designed to snap into the panel, thereby eliminating the need for mounting hardware. The units are UL recognized, CSA certi-

fied, and VDE approved. They are rated for as much as 50A, and you can furnish them with short, medium, or long delays for 400 Hz, dc, or 50- or 60-Hz signals. All units are trip free, ensuring that the breaker will open on overload even if the handle is forcibly held in the On position. Temperature vari-

ations don't affect the units, which have a black matte face plate, measure about 3 in.³, and weigh 2.2 oz. Single-pole model, \$8 to \$10 (500). Delivery, stock to eight weeks ARO.

Airpax, Woods Rd, Cambridge, MD 21613. Phone (301) 228-4600. FAX (301) 228-8910.

Circle No. 370

The Ultimate VMEbus Tool Set

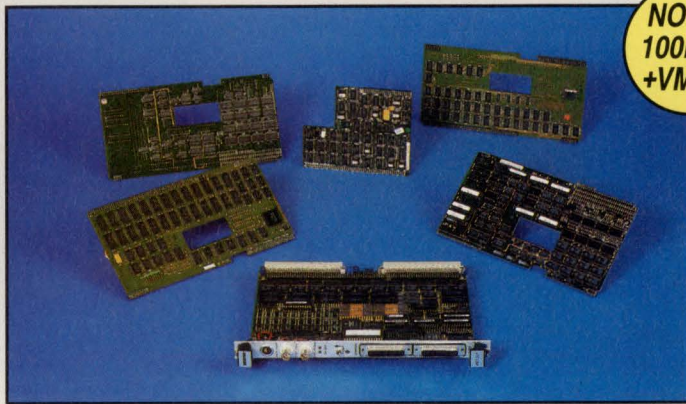

Based on the VBT-321 Advanced VMEbus Analyzer, VMETRO's Modular VMEbus Analyzer System offers piggyback modules for all kinds of VMEbus development, verification and tuning purposes.

VMETRO's Modular VMEbus Analyzer System gives you unrivalled measurement capability in a single VMEbus slot. Pick the right piggyback module to the VBT-321 VMEbus Analyzer and obtain:

- * VMEbus Anomaly Trigger
- * VSB State Analysis
- * VME Cycle Generator
- * 100MHz VME Timing Analysis
- * P2 General Purpose Analysis
- * 256K Trace w/SCSI dump

VMEbus Anomaly Trigger reveals incompatibilities and spec. violations.

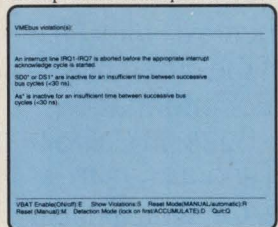

Combined VMEbus State trace and 100MHz Timing Waveform.

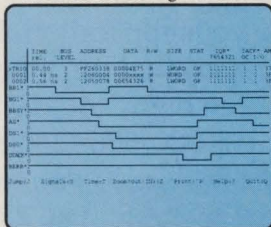

Real-time VMEbus histograms shows bus usage, event counts, etc.

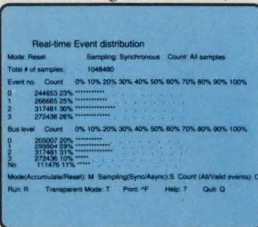

VMETRO

The Bus Analyzer Specialist

VMETRO AS
Sognsveien 75, N-0855 Oslo 8, Norway
Tel.: +47 2 39 46 90. Fax.: +47 2 18 39 38

VMETRO, INC
2500 Wilcrest #550, Houston, TX 77042
Tel.: (713) 266 6430. Fax.: (713) 266 6919

DIP Sockets

- Feature dual-beam contacts
 - Compatible with wave soldering
- Series 400C DIP sockets feature stamped dual-beam contacts, which provide two independent electrical connections. A nonwicking, closed-bottom design allows you to insert ICs before wave-soldering and protects against flux and solder contamination. The sockets feature an X- and Y-stackable insulator to maximize packing density. Dual-tapered leads provide easy alignment during automatic insertion operations. The sockets have an autoinsertion rail for smoother travel down feeder tubes. Anti-overstress wings protect the contacts and help prevent damage from oversized leads. Available in 8- through 40-position versions, the sockets meet military standards. Contacts are available in beryllium copper or phosphor bronze material and feature either selective gold or tin-lead plating. \$.0034 to \$0.005/ position.

Augat Interconnection Products Group, 33 Perry Ave, Attleboro, MA 02703. Phone (508) 222-2202. FAX (508) 222-0693.

Circle No. 371

Servoamplifier

- Operates on battery power
- Outputs ±12V at ±2A

The model 201-13 pulse-width-modulated servoamplifier operates from a 12 to 16V battery power source. The unit develops ±12V at ±2A continuous output and outputs ±5A peak. An internal MOSFET

COMPONENTS & POWER SUPPLIES

bridge circuit provides the bipolar output capability. The amplifier switches at 22 kHz, allowing it to drive servomotors with armature inductance as low as 500 mH without the need for series inductors. The amplifier has built-in protection against short circuits, overcurrent, excessive temperature, and incorrect or reversed supply voltage. A current sensor permits peak-current adjustment for protecting the motor load against overload or from being driven with excessive acceleration. The amplifier also provides end-of-travel and beginning-of-travel controls as well as emergency shutdown. The amplifier has a 1-kHz bandwidth and is housed in a pc-board-mountable package measuring 5 x 3.28 x 0.8 in. \$295.

Copley Controls Corp., 375 Elliot St, Newton, MA 02164. Phone (617) 965-2410. FAX (617) 965-7315. TLX 285975. **Circle No. 372**

486 25MHz

386 25/33MHz

SINGLE BOARD /AT COMPUTERS



80486-25MHz

- 25MHz 80486 CPU w/Internal CACHE & Co-Processor
- Up to 16Mb of SIMM Memory
- 8Kbytes of Internal CACHE
- 128Kb or 512Kb Secondary CACHE Daughter Cards Available
- 2/4 Way page Interleave Memory
- BIOS Shadowing
- Reset/Speaker/Keylock Connector
- ROM Based Utilities
- On-Board Lithium Battery

"19 Years of Quality Service"

Diversified Technology
 An Ergon Co.

1-800-443-2667

112 E State St. • Ridgeland, MS 39157

80386-25MHz

- Up to 25MHz CPU w/CACHE
- Up to 8Mb of RAM Memory
- Supports up to 20Mb with DTI's Memory Daughter Card
- Optional 80387 Math Co-Processor
- Multi-Function I/O Cards Available

80386-33MHz

- 33MHz 80386 CPU
- 32,64 or 128Kb of CACHE
- 6 or 8MHz Bus Speed
- Up to 32Mb RAM
- COM 1 & COM2 (Up to 115Kb)
- LPT1 w/Bidirectional Mode
- Up to 2 Floppy Drives
- Future Domain Compatible SCSI Port
- PS/2 Mouse Port
- IDE Disk Drive Port

/AT is a trademark of the IBM Corp.

CIRCLE NO. 37

The KEL 8900 Series Lower Profile-Higher Density

KEY 8900 SPECIFICATIONS

- * Low Profiles - 7, 8, 9, 10 and 12 mm stacked heights
- * 8 Sizes per profile - 20, 30, 40, 50, 60, 80, 100 & 120 positions
- * "Snap-in" mating
- * Sufficient Normal Forces -150 grams
- * Guide pins for self-alignment
- * Insulator protects contact from damage
- * Temperature resistant (PPS insulator)

Wide Choice of Mated Heights & Pin Counts

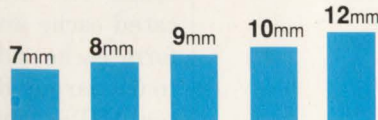

All eight pin counts of the 8900 Series are available in five mated profiles.

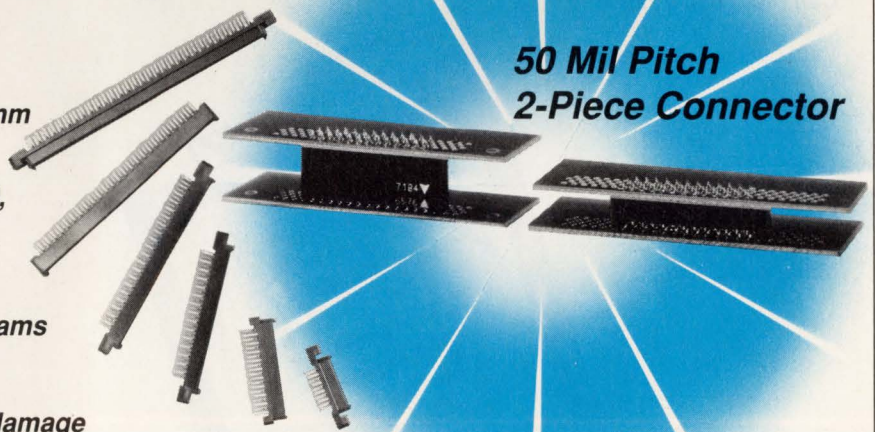

50 Mil Pitch
2-Piece Connector

KEL Connectors, Inc. is a subsidiary of KEL Corporation.

CONNECT WITH

KEL

KEL CONNECTORS, INC.

1250 Oakmead Parkway, Suite 105
Sunnyvale, CA 94086
408-720-9044; Fax 408-720-1989

KEL Corporation (Japan): Telephone 0423-74-5802; Fax 0423-74-5888
European Office (W. Germany): Telephone 0211-359960; Fax 0211-359810

NEW PRODUCTS

INTEGRATED CIRCUITS

14-Bit ADC With 10M-Sample/Sec Speed

- *Spurious-free dynamic range is 90 dB*
- *Intermodulation distortion is -90 dBc*

Offering encode rates to 10M samples/sec, the AD9014 14-bit A/D

converter also features a 90-dB spurious-free dynamic range (SFDR) at test frequencies of 540 kHz and 2.3 MHz. The SFDR is 86 dB and 72 dB at 4.3 MHz and 10 MHz, respectively. The device's S/N ratio is 75 dB, and intermodulation distortion is -90 dBc. Other guaranteed dy-

amic specifications include a 40-nsec transient response to within 0.01%, and no-missing-code differential and integral nonlinearity of $1/2$ LSB and 1 LSB, respectively. Digital correction circuitry and decoupling capacitors minimize output errors at major code transitions as well as limiting gain and offset errors to 0.5% and 0.25%, respectively. The AD9014, which operates from ± 5 and ± 15 V supplies, is a complete A/D subsystem. The ADC is composed of two hybrids mounted on a 13.7-square-in. multilayer pc board. From \$2800 (100).

Analog Devices, 7910 Triad Center Dr, Greensboro, NC 27409. Phone (919) 668-9511.

Circle No. 364

SIEMENS

Siemens wrote
the book on MKT
capacitors.

Siemens MKT capacitors offer the highest quality at the best possible value. It's that simple.

Call (800) 888-7729 for a copy of our new short form catalog. Siemens Components Inc., Special Products Division, 186 Wood Avenue South, Iselin, NJ 08830.

**Siemens
MKT capacitors
make a difference.**



SCI-1005

CIRCLE NO. 4

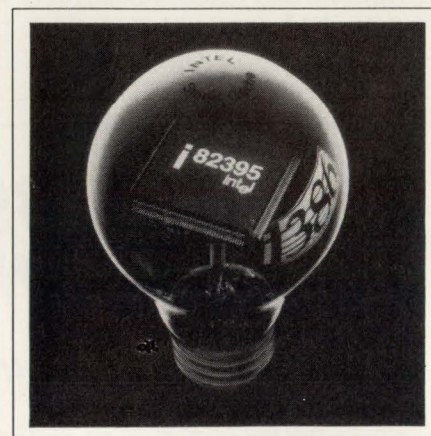

Cache-Memory Controller

- *Features 16k-byte static RAM*
- *Has 100 cache tags*

The 82395 DX 386 Smart Cache controller integrates cache control logic, 16k bytes of static RAM, and 1000 cache tags in a single package. The controller expands the architecture of the i486 CPU on-chip cache into a stand-alone device designed for 386 DX CPU-based systems. The device uses a sophisticated cache architecture to outperform cache subsystems with a $4 \times$ to $6 \times$ larger RAM. In a Power Meter MIPS version 1.5 benchmark run on a 33-MHz 386 CPU-based EISA system, the controller oper-

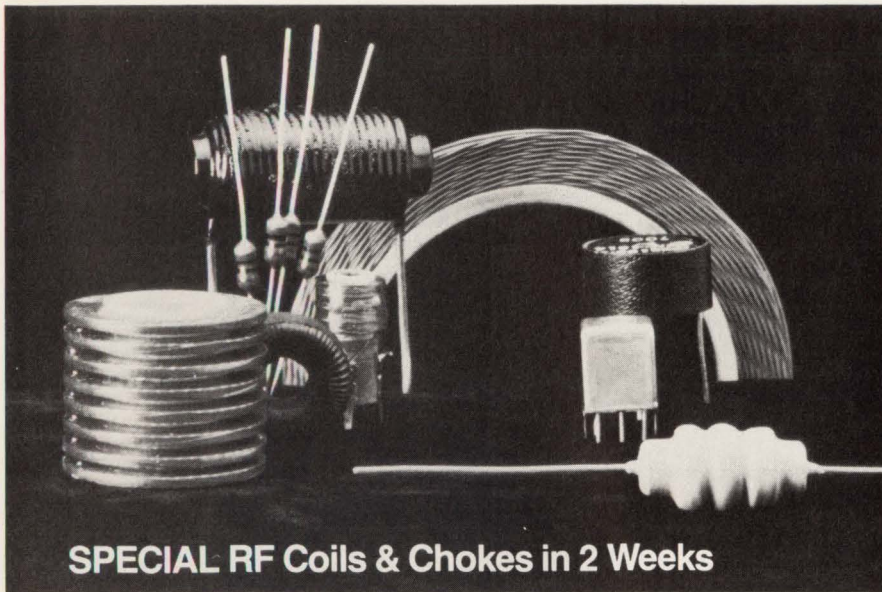

SPECIAL RF Coils & Chokes in 2 Weeks

Sample RF coils and RF chokes designed to meet your special requirements are shipped within 10 days to 2 weeks. Production quantity shipments start within 3 to 4 weeks after approval of samples. Intensive specialization in coil design and manufacture assures a high degree of optimum performance.

Most popular standard inductors available from stock for immediate shipment. Full line catalog on request.



J.W. Miller Division BELL INDUSTRIES

306 E. Alondra Blvd. ■ Gardena, CA 90247
(213) 537-5200 ■ FAX (213) 631-4217

Since 1924, leading manufacturer of standard and custom inductors.

CIRCLE NO. 36

IEEE-488

You can control any IEEE-488 (HP-IB, GP-IB) device with our cards, cables and software for the PC/AT/386, EISA, Micro Channel and Macintosh II. You get fast hardware and software support for all the popular languages, plus a software library of time saving utilities. Instrument control has never been easier.

FREE
Informative Catalog 800-234-4232
Applications help (617) 273-1818

Capital Equipment Corp.
Burlington, MA. 01803

Micro Channel is a trademark of IBM

SURFACE MOUNT DIP SWITCH

SURFACE MOUNT

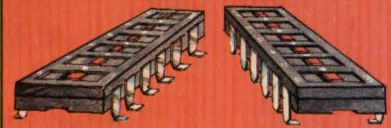

"J" OR GULL WING

2 TO 8 POSITION

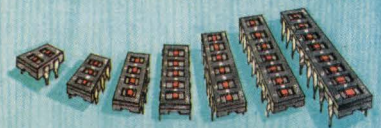

BIFURCATED SLIDE CONTACTS

LOW PROFILE



SAME SIZE AS AN I.C.

PROVIDED ON REELS



NO HAND LABOR

INFRARED REFLOW

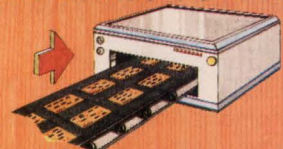

INFRARED REFLOW SOLDERING

REMOVABLE TAPE SEAL

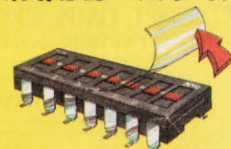

PREVENTS CONTAMINATION

FOR A FREE SAMPLE

CALL 312-888-7245

**AMERICAN RESEARCH
& ENGINEERING**

1500 EXECUTIVE DR. ELGIN IL 60123

R-CORE TRANSFORMER

INNOVATIVE TECHNOLOGY OF JAPAN

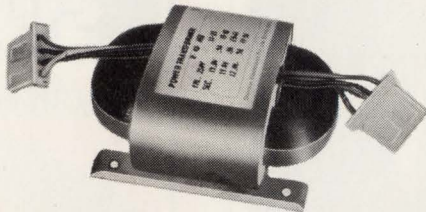

Advantages Over E-I Type

- 30% Smaller, Thinner & Lighter
- Leakage flux less than 1/10th
- Temperature rise is less than half
- Noiseless performance
- Significant Space Saving
- Higher performance than toroidal transformer
-  Approved

APPLICATION :

- Computer ● Peripheral Equipments ● CRT ● Printer ● Floppy disk drive ● TV Set ● Video Equipments ● Measuring equipment

R-CORE : THE IDEAL ROUND CORE TRANSFORMER



BLENDON INCORPORATED

P.O. BOX 20159 * COLUMBUS * OH 43220 - 0159 * USA
PHONE : (614) 459 - 5543 * FAX : (614) 459-8708

CIRCLE NO. 39

INTEGRATED CIRCUITS

ated at 8.3 MIPS. The 82395 DX is available in a 196-lead plastic quad flatpack. 25-MHz version, \$90; 33-MHz version, \$109 (1000).

Intel Corp, #HP-27, Box 58065, Santa Clara, CA 95052. Phone (800) 548-4725; in CA, (916) 351-2747.

Circle No. 365

8-Channel Analog Multiplexer

- Features 100-nsec settling time
- Characterized for 10-, 12-, 14-, and 16-bit applications

The MX-850 analog multiplexer provides 100-nsec max settling time for a 10V step to 0.001% accuracy in 16-bit data-acquisition applications. The 8-channel, single-ended device also offers settling times of 70 nsec to 0.003%, 50 nsec to 0.01%, and 30 nsec to 0.1% for 14-bit, 12-bit, and 10-bit data-acquisition applications, respectively. Crosstalk

ALS-VIEW II supports

- Large GERBER Database (several MB)
- Extended/Expanded Memory system
- Most Popular Matrix Printers
- Laser Printers (HP Laser, Canon, etc...)
- Most Popular Graphics Boards (up to 1024 x 768)
- Photo / Raster / Pen Plotters
- Multiple file loading (up 128 layers)
- NC Drill Equipment
- Drill Template & Report
- D-CODE numbers up to 999
- Automatic Merge of different D-CODE files
- Circular Interpolation
- User Defined Apertures, Thermal Pads,...
- High performance multiple formats conversion (HPGL, POSTSCRIPT, DMPL, EXCELLON, RASTER PHOTO PLOTTERS, and much more...

Entry Level Package: \$245

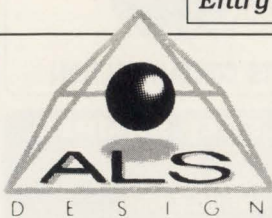

ALS Design Corporation
One Kendall Square
Suite 2200
Cambridge, MA 02139
Tel: 617-621-7101
Fax: 617-577-1209

MAKE YOUR BEST MOVE WITH

ALS-VIEW[®] II

NEW GERBER[®] PHOTO-PLOTTING CAM TOOLS

IDEAL
COMPANION OF
PADS-PCB[™]
OrCAD/PCB II[™]
RACAL REDACT[™]
FUTURENET[™]
CALAY[™]
PCAD[™]

And more CAD Systems . . .

Ask for a free, demo disk !!!

INTEGRATED CIRCUITS

is -105 dB at 10 kHz and -94 dB for signal frequencies to 1 MHz. On-resistance is typically 18Ω with an on-channel leakage current of 400 pA. The multiplexer features an analog signal range of ± 10 V. Available in a 14-pin DIP, the device utilizes ± 15 and 5V power supplies and dissipates 210 mW of power. From \$90 (100).

Datel Inc, 11 Cabot Blvd, Mansfield, MA 02048. Phone (508) 339-3000. FAX (508) 339-6356. TLX 174388. **Circle No. 366**

Octal S/H Chip

- Combines eight S/H channels on one chip
- Operates from single- and dual-voltage supplies

The SMP-08 combines eight independent S/H channels on a single chip. The device incorporates internal capacitors that hold the input

signal and output amps for buffering the signal held on each of the hold capacitors. A TTL/CMOS-compatible, one-of-eight decoder controls a series of eight internal switches that connect the analog input to the selected S/H channel. Through the multiplexer, each channel can be addressed to program a different output voltage. The chip operates from single supplies of 5 to 15V or dual supplies of ± 3 to ± 7 V. It provides make-before-break channel addressing and TTL compatibility over the full supply range. Acquisition time is only 7 μ sec; the droop rate, the device's hold storage capability, is <1 mV/sec typ. The chip is available in 16-pin plastic DIPs, ceramic DIPs, and SO packages. From \$6.25 (100).

Precision Monolithics Inc, Box 58020, Santa Clara, CA 95052. Phone (408) 562-7181. FAX (408) 727-1550. **Circle No. 367**

VMEbus

SCANNING ADC

12-Bit Analog-to-Digital Converter Board

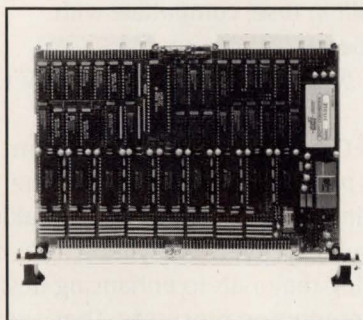

VMIVME-3112

VMIC's VMIVME-3112 is one of the lowest cost per channel Analog-to-Digital Converters (ADCs) in the industry and is designed to support 64 channels of differential or single-ended wide range (± 10 mV to ± 10 V) analog inputs. The board supports the following operating modes:

- Auto Scanning Mode
- Random Polling Mode
- Random Interrupt Mode
- Scanning Poll Mode
- Scanning Interrupt Mode

To *simplify* your Analog-to-Digital conversions call VMIC today!



VME MICROSYSTEMS INTERNATIONAL CORPORATION
12090 South Memorial Parkway
Huntsville, Alabama 35803-3308
1-800-322-3616 or 1-205-880-0444

Lowest Profile
0.5" ht.,
up to 55 Watts



PICO AC-DC Power Supplies

- Input Voltage 90 to 130 VAC (47/440Hz)
- Single, Dual, Triple Outputs
- 1200V Rms Isolation
- Low Isolation Capacity Available
- Continuous Short Circuit Protection
- High Efficiency
- Fully Regulated Voltage Outputs
- Operating Temperature -25°C. to $+70^{\circ}\text{C.}$ with No Heat Sink or Electrical Derating Required
- Expanded Operating Temperature Available (-55°C. to $+85^{\circ}\text{C.}$ ambient)
- Optional Environmental Screening Available

PICO manufactures complete lines of Transformers, Inductors, DC-DC Converters and AC-DC Power Supplies

Delivery—
stock to
one week

SEE EEM,
THOMAS REGISTER
OR SEND DIRECT FOR
FREE PICO CATALOG

PICO
Electronics, Inc.

453 N. MacQuesten Pkwy. Mt. Vernon, N.Y. 10552

Call Toll Free **800-431-1064**

IN NEW YORK CALL **914-699-5514**

*It's been a tough search,
and you've earned a reward.*

NEC's new chip tantalum capacitors offer unprecedented reliability.

You'd have to dig through a mountain of tantalum chips to find the toughness and reliability you get from NEC's SVH-Series capacitors.

Designed for automotive and other demanding applications, SVH chip tantalum caps offer a failure rate of just 0.5% per 1,000 hours. Concerned about excessive heat and humidity? SVH caps withstand 1,000 temperature cycles from -55°C to +125°C. Their humidity resistance is 85°C, 85% RH for 1,000 hours.

So if you've been conducting a stubborn search for the most reliable

chip tantalum capacitors on the market, dig into the details about the SVH-Series. We offer 29 types with ratings from 0.1 to 33µF, and from 10 to 35V DC.

NEC meets all your needs with a diversified lineup of top-quality chip tantalum capacitors.

R-Series.

□ 96 types.

□ 0.01 to 68µF; 4 to 35V DC.

R-Series Extended-Capacitance.

□ 58 types.

□ Up to 15µF rating for A case (1.6 x 3.2 x 1.6mm).

□ 0.1 to 100µF; 2.5 to 35V DC. SVE-Series.

□ Built-in fuse; compatible with R-Series.

□ 21 types; 1.0 to 33µF; 10 to 50V DC.

NEC produces 2 billion tantalum caps per year—more than anyone else in the industry. Our path-breaking R&D effort covers everything from improving materials to enhancing design and production processes. That's why we lead the industry with high-performance tantalum capacitors such as the ultra-reliable SVH-Series.

For fast answers, call us at:

USA Tel:1-800-632-3531. TWX:910-379-6985. W. Germany Tel:0211-650302. Telex:8589960. The Netherlands Tel:040-445-845. Telex:51923. Sweden Tel:08-753-6020. Telex:13839. France Tel:1-3946-9617. Telex:699499. Italy Tel:02-6709108. Telex:315355. UK Tel:0908-691133. Telex:826791. Hong Kong Tel:755-9008. Telex:54561. Taiwan Tel:02-719-2377. Telex:22372. Korea Tel:02-551-0450. Fax:02-551-0451. Singapore Tel:4819881. Telex:39726. Australia Tel:03-267-6355. Telex:38343.



EDN PRODUCT MART

This advertising is for new and current products.

Please circle Reader Service number
for additional information from manufacturers.

FREE DEMO!

DspHq

- Complete DSP development for IBM-PC
- Integrate DSP hardware, data acquisition
- Open-architecture design
- Algorithm design & simulation
- Add custom & 3rd party analysis routines
- Menus / Script files / Graphics
- Easy to use & only \$495!

BittWare Research Systems 800-848-0435
Download Demo: (3-12-24/N/8/1) 301-838-3205

CIRCLE NO 325

☆☆☆☆
"The Best 8051 Emulator"

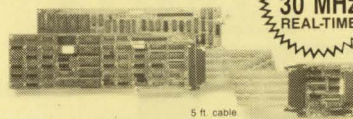

5 ft. cable

NEW
30 MHz
REAL-TIME

8051

SEE EEM 89/90
Pages D 1324-1326

PC based emulators for the 8051 family

8031, 8032, 8051, 8052, 80C152/154/321451/452/51FA/51GB/51S/51753S/537/552/562/652/851, 80532, 83C451/552/652/751/752/851, 8344, 87C451/552/751/752, 8751, 8752, DS5000 + CMOS ... more.

- PC plug-in boards or RS-232 box.
- Up to 30 MHz real-time emulation.
- Full Source-level Debugger w/complete C-variable support.
- 48 bit wide, 16K deep trace, with "source line trace."
- "Bond-out" pods for 8051, 83C552, 83C451, 83C652, 83C751, 80C515/80C517, 83C752.

Prices: 32K Emulator 8031 \$1790; 4K Trace \$1495*

CALL OR WRITE FOR FREE DEMO DISK!

Ask about our demo VIDEO

NOHAU CORPORATION
51 E. Campbell Avenue
Campbell, CA 95008
FAX (408) 378-7869
(408) 866-1820 *US only

CIRCLE NO 326

68HC11

PC-based emulator for 68HC11

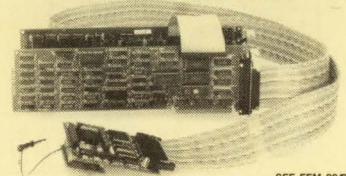

SEE EEM 89/90
Pages D 1324-1326

- PC plug-in or RS-232 box.
- Pull-down menus with full window support, combined with command-driven User Interface.
- Up to 16 MHz real time emulation.
- No intrusions to the 68HC11's resources.
- 48 bit wide 16K deep trace. All functions usable without disturbing emulation. Time stamping. Two level trigger.
- Symbolic and C Source Level Debugging, including in-line assembler and disassembler.
- Supports A, E, D and F parts.

Prices: 64K Emulator and pod \$2590; 4K Trace \$1995*

CALL OR WRITE FOR FREE DEMO DISK!

NOHAU CORPORATION
51 E. Campbell Avenue
Campbell, CA 95008
FAX (408) 378-7869
(408) 866-1820 *US only

CIRCLE NO 327

BBC-01B

User Configurable
Communication Board



RS 485—RS 232C—CL20mA
Bitbus INTEL compatible—rate up
to 2.4 Mbit/s
Synchronous-Asynchronous mode
Optical Isolation
CPU 8044/8031 12/16 MHz
32K Ram 32K Eprom
Configurable firmware or Bitbus Drivers
Current loop Siemens compatible
SBX expansion
PC-XT-AT, PS/2-30 compatible
EXOR P.O. Box 548, West Chester,
OH 45069 USA
Phone: 513-874-4665 Fax: 513-874-3684

EXOR
Electronic R&D

CIRCLE NO 328

RELIABILITY AND MAINTAINABILITY PREDICTION AND FMECA ANALYSIS SOFTWARE

Hundreds have used this leading
computer-aided engineering software
since 1982.

Powertronic Systems offers software to predict Reliability and Maintainability and for Failure Modes Effects and Criticality Analysis. Hundreds of users have selected from PSI's large, versatile and integrated software family for military and industrial equipment and for both electrical and mechanical systems. And, these programs are either interactive or can be input from batch modes from existing CAE or database programs. Programs implement MIL-STD-1629; MIL-HDBK-217 including E Notice 1; and MIL-HDBK-427.

PSI

Powertronic Systems, Inc.
P.O. Box 29109 New Orleans 70189
(504) 254-0383 FAX (504) 254-0393

CIRCLE NO 329



External Voice Interface Defeats Computer Noise!

ASPI improves the performance, noise immunity and accuracy of its serial voice interface by getting the A/D-D/A away from computer noise. The interface has its own shielded box and power supply.

Sampling resolution is 14 bits. The interface supports virtually any DSP processor that has a serial port. Ask for specs and prices!

WORLD LEADERS IN DSP DESIGN TOOLS

aspi

770 Spring Street,
Atlanta, GA 30308
Ph. 404/892-7265
FAX 404/892-2512

CIRCLE NO 330

To advertise in Product Mart, call Joanne Dorian, 212/463-6415

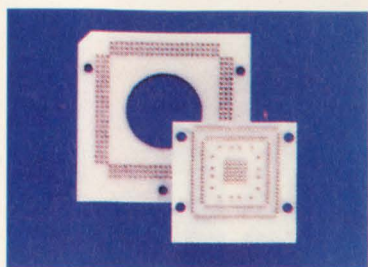

ISOCON™ SOLDERLESS CONNECTORS FOR HIGH DENSITY PAD PACKAGES

Compliant connection without package leads. Wiping action of conductors provides reliable gas-tight contact. Low inductance (<1 nH) and low total electrical resistance (<10 mOhms). High contact density, up to 400 I/Os per square inch at 50 mil pitch.

**Rogers Corp., One Technology Drive
Rogers, CT 06263. 203/774-9605**

CIRCLE NO 331

PLASTIC QUAD FLATPAK

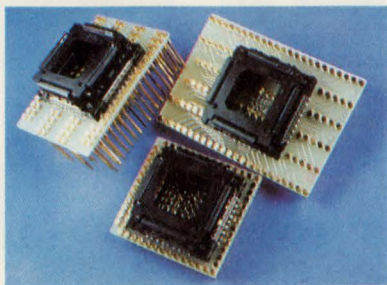

PROTOTYPING

Plastic Quad Flatpak adaptors have been added to our line of prototyping and test adaptors. The device is constructed with all gold plated pins (soldertail or wirewrap) and the highest quality plastic quad flat pack sockets. Parts included in this line handle 84 to 164 pin devices. Ask about our custom design services for unique solutions in packaging.

IRONWOOD ELECTRONICS
P.O. BOX 21151, ST. PAUL, MN 55121
(612) 431-7025

CIRCLE NO 332

PROTOTYPING ADAPTORS

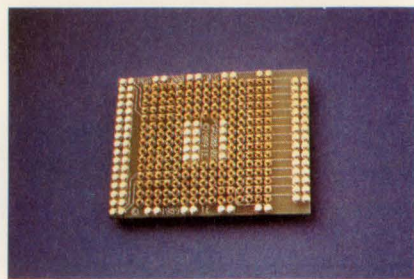

BY THE HUNDREDS

Our line of prototyping adaptors for VLSI devices including PGA, PLCC, LCC, ZIP, DIP, and Plastic Quad Flatpak is the most extensive available in the industry. These devices allow easy prototyping of these difficult to handle devices. Pins and sockets used are gold plated and of the highest quality. Parts are available in soldertail or with 3 level wirewrap pins. All types of wirewrap panels are covered.

IRONWOOD ELECTRONICS
P.O. BOX 21151, ST. PAUL, MN 55121
(612) 431-7025

CIRCLE NO 333

WRITE OR CALL FOR SAMPLE
Low Cost Tempilabel® Temperature Monitor.

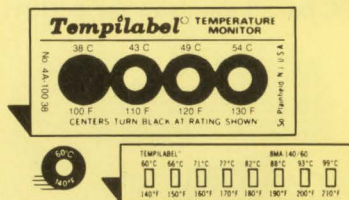

How to put a low cost temperature gauge on everything.

Label's center spot turns black when surface to which it is affixed reaches specified temperature. Single- or multi-spot labels with pre-determined increment of ratings: 100°F (38°C) to 600°F (316°C). 1% accuracy guaranteed. 1 thru 8 ratings on each monitor with various increments. Self-adhesive, removable.

TEMPIL, Big Three Industries, Inc.
2901 Hamilton Blvd., South Plainfield, NJ 07080
Phone: (201) 757-8300 Telex: 138662

CIRCLE NO 334

ROM-IT



EPROM EMULATION SYSTEM

- Emulates up to 8 1-Megabit EPROMs with one control card.

- Downloads 1-Megabit programs in less than 10 seconds.

- Allows examination and modification of individual bytes or blocks.

- Accepts Intel Hex, Motorola S-Record, and Binary files.

- Software available for IBM PC and Macintosh systems.

Call or fax today for more information!

Base 27256 EPROM System **\$395.00**
Other configurations available.



Incredible Technologies, Inc.
709 West Algonquin Road
Arlington Heights, Illinois 60005
(708) 437-2433 Fax (708) 437-2473

Visa, MasterCard, and American Express accepted.

CIRCLE NO 335

EPROM PROGRAMMER



- **Quick pulse** pgms. eight 1 Mbit EPROMs in 40 sec.
- Stand-alone or PC-driven
- RS-232, **parallel** in & out ports
- Binary, Intel hex, & Motorola S formats
- 100 user-definable macros
- Information, call **(916) 924-8037**
- 1 Megabit of DRAM
- Made in U.S.A.
- A9 Identifier
- 2 year warranty
- Single pgmr. \$550

NEEDHAM'S ELECTRONICS

4539 Orange Grove Ave. • Sacramento, CA 95841

— (M-F, 8-5 PST) —

CIRCLE NO 336

OrCad Users

Discover a menu system that saves you time and increases productivity.

The Intelligent Menu System ties together all utilities with a user-friendly, pop up menu. And IMS does not impact working RAM space.

Start using powerful new features:

- Plot spooler
- Easy custom configuration
- File/view editor
- Directory manager
- Stuff file builder
- On-line help system

IMS The "Intelligent Menu System"

We guarantee satisfaction or your money back

Call now for a FREE demo disk

Velotec 1-800-966-8856

3156 Unit A, East La Palma, Anaheim, CA 92806

CIRCLE NO 337

TESS PC Block Diagram Simulation

30-day money-back guarantee!

Modems, DSP, satcom, nav, controls...
Times are tough: shorter schedules, more complexity. TESS can help you:

- Detect gotchas before breadboarding.
- Find the best design alternatives fast.
- See the effects: filters on signals & loops, noise, multipath & adjacent channels.
- Simulate mixed-signal ASICs & systems.
- Put a lab on your desk for just \$695!

Demo disk: 404-751-9785 Fax: 404-664-5817
TESOFT Box 305, Roswell, GA 30077

CIRCLE NO 338

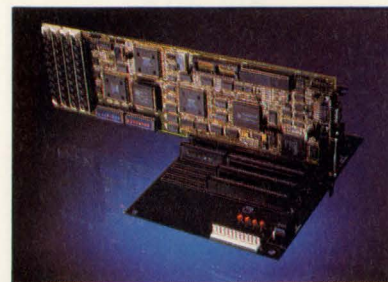

20 MHz 286 CPU CARD — \$595

- 2 Serial/1 Parallel Ports
- Up to 4 Meg DRAM: 0/1 WS
- Low Power 6-layer PCB
- Award BIOS — Norton SI 21.1
- Optional 287 Co-Processor
- Small Size (XT-Form Factor)
- User Replaceable Battery
- Made in USA
- \$595 qty 10 w/OK



295 Airport Road **TEMPUSTECH, INC.**
Naples, FL 33942 1-800-634-0701

CIRCLE NO 339

To advertise in Product Mart, call Joanne Dorian, 212/463-6415

Data I/O Programming Tools
50% OFF
 280 Set Programmer plus
 PROMlink PC File Management Software just \$995*.

- Set/gang programming with the 8-socket 280
- Supports E/EEPROMs up to 512K
- Easy PC control with PROMlink™ software
- FREE one-year Data I/O® warranty

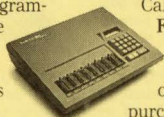

Call now for a FREE 15-day trial with no obligation to purchase,** and receive a FREE tutorial on programming today's device technologies.

1-800-247-5700

*U.S. list price only.
 **Offer expires 11/15/90.

DATA I/O
 Corporation

CIRCLE NO 340

How To Get More Emulation for Less
 ORION 8620 ANALYZER-EMULATOR



■ High-Level language/Symbolic debug support ■ Over 170 processors supported with the same base hardware and software environment ■ Easy-to-use, powerful triggering ■ Extensive MACRO capabilities ■ Program Performance Analyzer ■ Built-In EPROM programmer
 Go ahead and compare. The 8620 Analyzer-Emulator gets your product to market faster and costs less. Base prices start at \$5080. Send for more information and free demo disk.

Toll Free 800/729/7700
 or 415/327/8800

ORION
 INSTRUMENTS

180 Independence Dr., Menlo Park, CA 94025

CIRCLE NO 341

TRANSMISSION-LINE PROBLEMS?



Interactive Transmission-Line Simulator

Designing digital systems? With today's fast edges, chances are good you've got transmission-line problems.

LineSim is a new tool just for transmission-line design.

It features:

- a push-button schematic
- two PCB-impedance calculators
- models for major device families
- an oscilloscope display
- a totally interactive environment

LineSim shows you your signals when it makes the most sense: before you build boards. And it'll teach you more about how transmission lines work than a whole pile of dusty books.

30-day money-back guarantee.

\$595

Requires IBM PC with EGA

HyperLynx

P.O. Box 3578 Redmond, WA 98073-3578 (206) 869-2320

CIRCLE NO 342

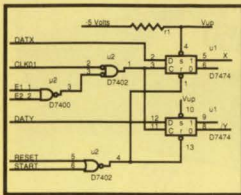

SuperCAD™
Schematic Entry Software for the IBM PC & Compatibles
\$99.00

ONLY COMPLETE PACKAGE

- ★ Easy-to-use schematic entry program for circuit diagrams
- ★ Visible on-screen and pull down menus
- ★ Supports popular graphic standards, mice and printers
- ★ Powerful editing and drawing commands
- ★ Extensive digital, analog and discrete part libraries
- ★ In-depth, readable instruction manual
- ★ Over 100 screens of on-line help information
- ★ Software includes part building and netlisting
- ★ Add P.C. board layout software and routing software for only \$99.00 each

Write or call for FREE demo disk.

MENTAL AUTOMATION, INC.

ORDERS/INFORMATION:

Send check or money orders to:
 Mental Automation, Inc.
 5415 - 138th Place S.E.
 Bellevue, WA 98006

Or Call
(206) 641-2141

Visa & MasterCard orders accepted!

CIRCLE NO 343

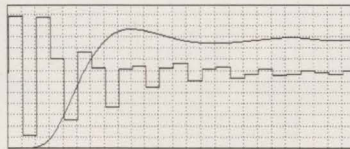

High-Speed Control?
 Real-Time Simulation?
 Signal Processing?

Ask dSPACE for innovative DSP tools!

All members of TMS 320 family supported. MATLAB interface available.

dSPACE digital signal processing and control engineering GmbH
 An der Schönen Aussicht 2
 D-4790 Paderborn, Germany

phone ++49 5251 65074
 fax ++49 5251 66529

CIRCLE NO 344

DS-51



\$950

8051 IN-CIRCUIT EMULATOR

- Real-time and transparent Development System
 - Serially linked to PC's and compatibles
 - 64 Kbyte Internal Data and 64 Kbyte Internal Code Memory
 - Symbolic Debugger, On-line Assembler and Disassembler
 - C and PLM support with source and code windows
- AVAILABLE: 32K-DEEP TRACE \$800, EPROM PROGRAMMER \$250

DEALERS INQUIRIES WELCOME

CEIBO 105 GLEASON RD. LEXINGTON MA 02173

TEL: 617-863-9927 FAX: 617-863-9649

CIRCLE NO 345

BEGONE CURSED ALIAS

Now, you can have Precision Filters performance in compact modules.

- As sharp as 200 dB/octave.
- Time delays superior to Bessel.
- Prog. or fixed frequency.

- Matched filters: 0.03°, 0.03%
- Cutoffs: 0.05 Hz to 10 MHz.
- Standard and custom for OEM.

Call. Fax. Or write.



PRECISION FILTERS, INC.
 240 Cherry Street, Ithaca, New York 14850
 607-271-3550 Fax: 607-271-4466

CIRCLE NO 346

IEEE 488
Easiest to use, GUARANTEED!

- IBM PC, PS/2, Macintosh, HP, Sun, DEC
- IEEE device drivers for DOS, UNIX, Lotus 1-2-3, VMS, XENIX & Macintosh
- Menu or icon-driven acquisition software
- IEEE analyzers, expanders, extenders, buffers
- Analog I/O, digital I/O, RS-232, RS-422, SCSI, modem & Centronics converters to IEEE 488

Free Catalog & Demo Disks
 (216) 439-4091

IOtech

IOtech • 25971 Cannon Rd. • Cleveland, OH 44146

CIRCLE NO 347

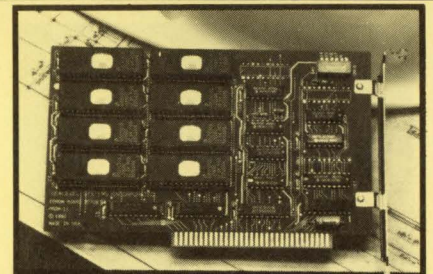

PROM-III

- PUT DOS AND APPLICATION IN EPROM
- ALLOWS DISKLESS OPERATION
- UP TO 1 MBYTE ROM-DRIVE WITH 16K FOOTPRINT
- PROMKIT SOFTWARE BY ANNABOOKS
- FLASH EPROM SUPPORTED
- BATTERY RAM MODULES SUPPORTED
- DELIVERY FROM STOCK



SEALEVEL
 SEALEVEL SYSTEMS INC.
 PO BOX 1808
 EASLEY, SC 29641
(803) 855-1581

CIRCLE NO 348

To advertise in Product Mart, call Joanne Dorian, 212/463-6415

HAND HELD TERMINAL *\$199.



- 80 character display
- 30 or 45 keys
- RS 232 or RS 422
- Low power
- ST-32 Compatible
- Standard or custom overlay
- Single 5V or 8-12V supply
- 15 Programmable function keys
- Simple menu set-up
- 300-9600 baud
- 7 or 8 data bits
- Even, odd, mark, space
- 7 1/2" x 4" x .9"
- 8 ounces

Internal Batteries and Built in Charger — Optional

TWO TECHNOLOGIES, INC.

405 Caredean Drive, Horsham, PA 19044
215-441-5305

* SINGLE PIECE OEM OR VAR PRICE

CIRCLE NO 349

Create a DISKLESS PC

IT's EASY..IT's SIMPLE.....
THERE's Nothing to it!!!

PROMDISK™ III IBM PC DISK EMULATOR CARD

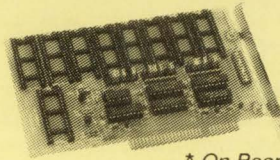

- * On-Board BIOS ROM
- * IBM PC/XT/AT Compatible
- * Mix EPROMs, EEROMs, SRAMs
- * Emulates up to 1.024Mbyte Drive
- * Occupies 32K PC address space
- * Supports popular Byte-Wide chips
- * Includes PROMDISK™ III Software

For Information Call or Write:

MICRO COMPUTER SPECIALISTS, INC.
810-208 Los Vallecitos
San Marcos, CA 92069
(619) 744-8087

CIRCLE NO 350

New Full Line Catalog Released by Samtec

Samtec has released its new Full Line Catalog F-191. It contains 110 pages of electronic connectors, including screw machined socket and terminal strips, DIP's and PGA's, a full line of .025" square headers and sockets, low cost stamped and formed socket strips, the industry's largest selection of board-to board and board stacking interconnects, low profile interconnects, .050" centerline connectors and soldered and IDC cable assemblies.



This year's catalog also includes a special full color 16 page applications section which aids engineers in developing ideas to solve complex interconnection problems. A portion of this special section is dedicated to explaining Samtec's custom connector capabilities.

For more information, contact :

Samtec, Inc.

P.O. Box 1147, New Albany, IN 47151-1147
Telephone 812-944-6733, Telefax 812-948-5047

CIRCLE NO 751

Want to try this with your LCD display?

Call Planar to see the EL solution.

503/690-1100

PLANAR

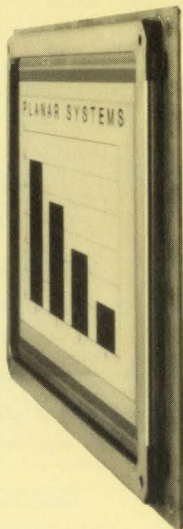

CIRCLE NO 752

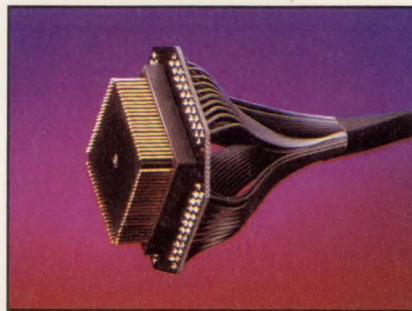

Easy Emulator Pods & Adapters

- Plug your PLCC and LCC packages into your PC board in minutes, with these easy-to-use adapters.
- Emulator/logic analyzer users: Adapt-a-Pod™ converts one package type to another (LCC, PLCC, PGA, and DIPs).
- Emulator pods and adapters are available in all standard pin counts, with ribbon or ribbon cable headers.
- Custom engineering services and do-it-yourself emulator pod converters. Free catalog.

Emulation Technology, Inc.
2368-B Walsh Ave. Santa Clara, CA 95051
Phone: 408-982-0660 FAX: 408-982-0664

ET

CIRCLE NO 753



901 video test generator

- Ideal for production and servicing video displays
- Preprogrammed formats include: CGA, EGA, VGA, 8414A, Mac and all standard HDTV Formats, etc.
- Over 50 test images included for making size, linearity, focus and color adjustments
- Easy to use—free video tape available

Ask for Free Video Tape

QUANTUM DATA®

2111 Big Timber Road, Elgin, IL 60123 U.S.A.
(708) 888-0450 • FAX (708) 888-2802

CIRCLE NO 754

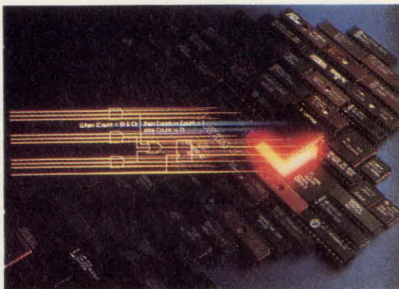

MacABEL

PLD Design on the Apple Macintosh!

Data I/O's industry-standard ABEL PLD design package is now available on the Macintosh, exclusively from Capilano Computing!

- Use Boolean and integer equations, state machines and truth tables to describe your design
- Communicates directly with any serial PLD programmer
- Best device support in the industry, including ALTERA, AMD, ATMEL, CYPRESS, GOULD, HARRIS, IGT, INTEL, LATTICE, NATIONAL, RICOH, SAMSUNG, SGS, SIGNETICS, SSS, TI, VTI and others
- Interactive "in-circuit" schematic entry and simulation when used with DesignWorks

Call (604) 669-6343 today for your free demo kit!

Capilano Computing
FAX (604) 669-9531

CIRCLE NO 755

KEYTEC, INC.

WHERE YOU SHOULD GET IN TOUCH WITH

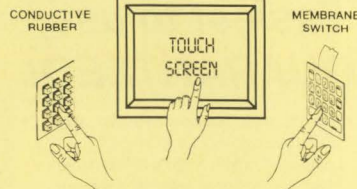

- ANALOG OR MATRIX
- STANDARD OR CUSTOM
- RS-232 OR PC BUS CONTROLLER
- COMPONENT OR INTEGRATED MONITOR
- CUSTOM CONTROL PANEL WITH COMBINATIONS OF:

1. GRAPHIC OVERLAY
2. TOUCH SCREEN
3. SILICON RUBBER
4. METAL OR PLASTIC PANEL
5. MEMBRANE SWITCH
6. LCD, LED

1401-2 CAPITAL AVE., PLANO, TX 75074
TEL: 214-424-3459 FAX: 214-423-3049 OR 214-530-8510

CIRCLE NO 756

NEW FROM CHERRY DISPLAY PRODUCTS . . .

. . . C.V.D. ELECTRIC GLASS

C.V.D. Tin Oxide coatings for high resolution displays are now available on standard glass substrates in the following formats.

GLASS SIZES

12" x 14" x .062"
12" x 14" x .110"
12" x 14" x .125"

SHEET RESISTIVITY	TRANSMISSION
A. 4.5 OHMS/SQ ± 0.3	75% MIN.
B. 10.0 OHMS/SQ ± 0.5	80% MIN.

Patterned substrates are also available using customer supplied artwork.

	UNPATTERNED SUBSTRATES	PATTERNED SUBSTRATES
Minimum Order Quantities:	250 Sheets	400 Sheets
Delivery:	2-3 Weeks	3-5 Weeks

CALL TODAY!

CHERRY DISPLAY PRODUCTS

15 Founders Boulevard • El Paso, TX 79906
Phone: 915-779-7774 • Facsimile: 915-779-0884

CIRCLE NO 757

To advertise in Product Mart, call Joanne Dorian, 212/463-6415

Gridless, 100% Autorouting



Create and revise schematics and PCBs quickly and simply with **HiWIRE-Plus**® and your IBM PC. With the new, gridless, multi-layer autorouter (AR) for HiWIRE-Plus, creating printed-circuit layouts is even faster. AR and HiWIRE-Plus are each \$895 and come with thirty-day money-back guarantees. Credit cards are welcome.

Wintek Corporation

1801 South Street, Lafayette, IN 47904
(800) 742-6809 or (317) 742-8428

CIRCLE NO 758



LOGIC ANALYZER UNDER \$1100

- 20 MHz Acquisition Speed
- 16 Data Channels
- "Search" and "Compare" Routines
- Binary, Hex, Octal, Decimal Data Display
- Timing Diagrams on Oscilloscope
- Synchronous/Asynchronous Analysis
- Optional Personality Pods

Call 1-800-572-1028 for complete information and the name of your local distributor



GLOBAL SPECIALTIES

70 FULTON TERRACE
NEW HAVEN, CT 06512

CIRCLE NO 759

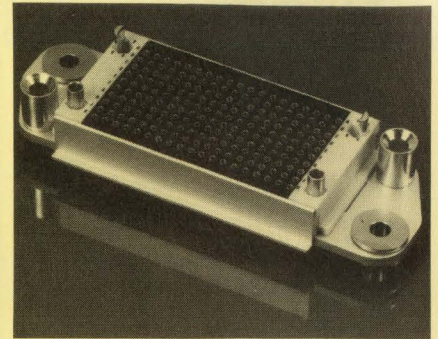

HIGH DENSITY - LOW INSERTION FORCE 70-350 POSITION BLIND MATEABLE CONNECTORS

N Series rack & panel connectors are available in 70, 110, 150, 190, 230, 270, 310 and 350 position models. The use of the Hypertac® LIF (Low Insertion Force) contact provides reliable operation without space consuming, expensive crimping or jacking devices.

HYPERTRONICS CORPORATION

16 BRENT DRIVE, HUDSON, MA 01749
(508) 568-0451

CIRCLE NO 760

EPROM/MICRO PROGRAMMER FRIENDLY S/W, UPGRADABLE H/W

- Industrial Quality
- 1-2-3 Style S/W
- Fast PC Interface via Standard Parallel Port
- Field Upgradable From One Model To Another
- IC Manufacturers Approved
- Made in USA

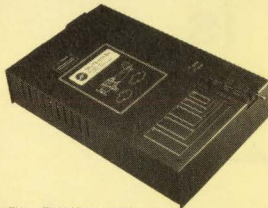

PLEASE CALL
1-800-627-2456

FAX
(408) 736-2503

(FU = Field Upgradable)

	24 28-pin EPROMs	32-pin EPROMs	40-pin EPROMs	8741, 42, 48, 49 8751, 52, 53, ...
PILOT-145 \$995	YES	YES	YES	YES
PILOT-144 \$795	YES	YES	YES	FU
PILOT-143 \$595	YES	YES	FU	FU
PILOT-142 \$495	YES	FU	FU	FU



ADVIN SYSTEMS INC.

1050-L East Duane Avenue • Sunnyvale, CA 94086

CIRCLE NO 761

C for the 8051 Compare:

Benchmark Results—Sample program: Eratosthenes Sieve Program from BYTE (1/83), expanded with I/O and interrupt handling.

	FRANKLIN SOFTWARE C-51 v2.1	MCC51 v1.2	Archimedes ICC51 v2.20A
Linkage time	6 sec	9	29
Execution time	0.88 sec	9.00	11.45
Total code size	1726 bytes	3798	5318
Compilation time	17 sec	18	12
Sieve module size	541 bytes	1021	736

Call now for your free DEMO disk.



SOFTWARE, INC.

888 Saratoga Ave. #2 • San Jose, CA 95129
(408) 296-8051 • FAX (408) 296-8061

CIRCLE NO 762

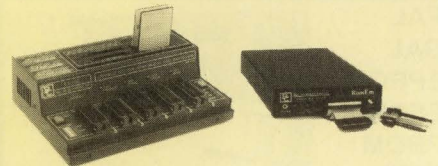

RS232 EPROM, MICRO & MEMORY CARD PROGRAMMER \$345/495

- Programs EE/EPROMs, Flash EPROMs, ZPRams, Intel Micros, Memory Cards.
- Stand-Alone Mode for EE/EPROMs and Memory Card Duplication/Verify.
- All 24/28/32 pin EE/EPROMs to 8 MBits (upgradable to 32 Megabits).
- Micros: 8741/A, 2/A, 4, 8, 9, 51, CS1, CS1FA/B, 52, 53, 55, CS21, CS41, 9761.
- Accepts dedicated modules: Memory Card Programming Module (Seiko, Fujitsu) - \$145, Eraser/Timer Module - \$50, Gang Module (4 sockets) - \$145. Simultaneously duplicates up to 5 devices in stand-alone mode (with Gang).
- Can be operated with any computer containing an RS-232 serial port.
- User friendly Menu-Driven Interface Program for IBM-PC or Macintosh.
- Full 1 year warranty. Customer support via voice line, fax or dedicated BBS.

INTELLIGENT ROM EMULATOR \$395

- Emulates 2716 through 27512 EProms with a single unit. Access time 120ns.
- Connects to the standard parallel printer port via a standard printer cable.
- User friendly software. Command set includes: Load(data), Write(data), Display(memory), Type(of EProm), Edit(memory), Fill(memory), Calculator, Reset(target system), Activate(debugging feature), Monitor(selected feature).
- Address Compare with Halt output, Address Snapshot, Trigger input.
- Fast data loading via parallel printer port (64k bytes in less than 10 sec).
- Cascadable up to 8 units. Includes target cable with Trigger/Reset/Halt clips.
- CMOS (stand-alone) model with rechargeable NiCad battery backup: \$495



B&C MICROSYSTEMS INC.

750 N. Pastoria Ave, Sunnyvale, CA 94086 USA
TEL: (408) 730-5511 FAX: (408) 730-5521

CIRCLE NO 763

Elegant, concise, fast & standardized FLOATING POINT libraries for embedded applications

Based on the IEEE 754 standard, FPAC (32 bit) and DPAC (64 bit) libraries are mature, well documented, and fully tested. The libraries are fully ROMable and include the following:

- Basic Operations
- Square Root
- Trigonometric
- ASCII Conversion
- Integer Conversion
- Logarithmic

U S Software supports most Intel, Motorola, Zilog and Hitachi micros, including 80X86, 80386, 680X0, 80960, 8051, 8096, 68HC11, Z80, 6809 and 6301.

For additional information, please contact:



U S SOFTWARE

United States Software Corporation
14215 NW Science Park Drive
Portland, Oregon 97229
800-356-7097
503-641-8446
503-644-2413 (FAX)

CIRCLE NO 764

Program:

16L8, 20V8, 22V10,
27C020, and 450
other CMOS devices



PLDs and memories
with the low-cost 212.

- Memory cards for easy updates.
 - Extensive editing capabilities.
 - Compatible with JEDEC standard programming files.
- Call for your FREE 15-day trial AND ABEL-PLD demonstration diskette.
1-800-247-5700

DATA I/O
Corporation

CIRCLE NO 765

Design:

Industry-standard
language for PLDs

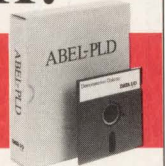

With new ABEL-PLD
at just \$895*.

- 150 PLD architectures supported (over 4000 devices).
 - Uses ABEL™ Hardware Description Language (AHDL).
 - Intelligent synthesis and optimization.
 - Upgradable to full-featured ABEL.
- Call for your FREE ABEL-PLD demonstration diskette.
1-800-247-5700
*U.S. list price only.

DATA I/O
Corporation

CIRCLE NO 766

To advertise in Product Mart, call Joanne Dorian, 212/463-6415

200 MHz Logic Analyzer

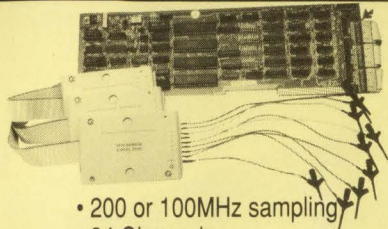

- 200 or 100MHz sampling
- 24 Channels
- Expansion to 72 channels
- 16 Levels of triggering
- 16K samples/channel
- Variable threshold levels
- 3 External Clocks
- 12 Clock Quality lines

\$ 799-12100 (100 MHz)
\$1299-27100 (100 MHz)
\$1899-27200 (200 MHz)

UNIVERSAL PROGRAMMER

PAL
 GAL
 EPROM
 EEPROM
 PROM
 87C51...
 874x

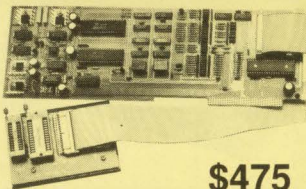

\$475

5ns PALs 4 Meg EPROMs
26V12 & 22V10 Gals
FREE software updates on BBS

GANG PROGRAMMER

- 4 32pin Sockets (8 Socket option)
 - 2716-27010 EPROMs
- \$215**

Call - (201) 994-6669

Link Computer Graphics, Inc.
 4 Sparrow Dr., Livingston, NJ 07039 FAX:994-0730

CIRCLE NO 770

Cover Your Design Bases

1-800-553-9119

SCHEMA III

schematic capture

\$495

PCB

PLD

\$975

\$495

PC board layout

logic compiler

\$995

SUSIE logic simulator

FREE DEMO DISKS



CIRCLE NO 768

ICs PROMPT DELIVERY!!!
 SAME DAY SHIPPING (USUALLY)
 QUANTITY ONE PRICES SHOWN for SEPT. 2, 1990

OUTSIDE OKLAHOMA: NO SALES TAX

DYNAMIC RAM		
4M Board for hp LJ's w/2MB		\$175.00
SIMM 2M IBM PS/2 Model 70		225.00
SIMM 1M AST Prem386/33Mhz		150.00
SIMM 1Mx9	80 ns	65.00
SIMM 256Kx9	100 ns	22.00
1Mbit	1Mx1 60 ns	11.95
1Mbit	1Mx1 80 ns	6.85
41256	256Kx1 80 ns	2.95
41256	256Kx1 100 ns	2.15
41256	256Kx1 120 ns	2.15
4464	64Kx4 100 ns	2.30
41264*	64Kx4 100 ns	5.95
EPROM		
27C1000	128Kx8 200 ns	\$17.50
27512	64Kx8 200 ns	7.50
27256	32Kx8 200 ns	5.75
27128	16Kx8 250 ns	3.75
STATIC RAM		
62256P-10	32Kx8 100 ns	\$7.50
6264P-12	8Kx8 120 ns	4.50

OPEN 6 DAYS, 7:30 AM-10 PM: SHIP VIA FED-EX ON SAT.

SAT DEL ON FED-EX ORDERS RECEIVED BY: **TR: 5:25:48 PM** **FR: 11:00:18 PM** COD AVAILABLE
 MasterCard/VISA or UPS CASH COD
MICROPROCESSORS UNLIMITED, INC.
 24,000 S. Peoria Ave., (918) 267-4961
 BEGGS, OK, 74421
 No minimum order. Please note: Prices subject to change!
 Shipping, insurance extra, up to \$1 for packing materials

CIRCLE NO 769

GENERAL PURPOSE DISPLAY UNITS



Low cost Stand-alone units in 6 different display sizes. Bright green display with line blink and long message storing and scrolling capabilities. RS-232C I/F with selectable speed. Units with parallel I/F and pass-through features are also available. Suitable for PC based POS systems, computers, test equipments, security systems, industrial controllers, etc. They can also be factory programmed for special applications. Units for 220Vac 50 Hz also available.



Advanced Digital Machines Ltd.
 550 Parkside Drive, Waterloo, Ont. N2L 5V4
 Canada

TEL./FAX (519) 888-6811

CIRCLE NO 771

Consistency
 is
 key

to the power of
EDN Product Mart

CIRCLE NO 772



Multi-Tasking
EXECS

U S Software offers hi-performance software tools for embedded applications.

Get the full details by calling:

800-356-7097
503-641-8446
503-644-2413 (FAX)



U S SOFTWARE

United States Software Corporation
 14215 NW Science Park Drive
 Portland, Oregon 97229

CIRCLE NO 773

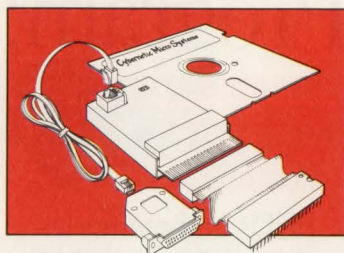

8051 Emulator - \$1250

d²ICE is a low cost, Full Speed, real time 8051 Emulator.. Powerful user interface for Hi-level multi-window source code debugging. Uses IBM-PC COM1/2. No Slots! Portable, fits in shirt pocket. Assembler and test bed included.



Cybernetic Micro Systems
 PO Box 3000 • San Gregorio CA 94074
 Ph: (415) 726-3000 • Fax: (415) 726-3003

CIRCLE NO 774



AS 168 Energy Limiting
Circuit Breaker

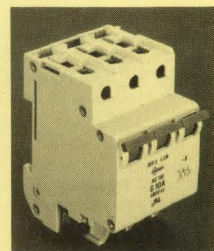

- Superior Short Circuit Protection
- Selective Disconnection - No nuisance shutdown
- Easy Installation with Quick Connect Terminals, screw terminals, or DIN Rail Mounting
- Worldwide Approvals, VDE, UL, & CSA
- Single, Double, Triple, and four pole versions
- Current Ratings - 0.5 to 50 Amp
- AC rating to 480 and DC rating 120 Volts per pole
- Available with Switched Neutral, Auxiliary and Signal contacts
- Stock available in Connecticut

Contact: **Inmark Corporation**, 4 Byington Place
 Norwalk, CT 06850 Telephone: 203-866-8474
 Fax: 203-866-0918

CIRCLE NO 775

To advertise in Product Mart, call Joanne Dorian, 212/463-6415

Synchronous Communication Boards for AT

Quatech synchronous/asynchronous serial boards for PC-AT and compatibles support RS-232, RS-422, and RS-485 communication.

Call for our free PC Interface Handbook:
1-800-553-1170



662 Wolf Ledges Parkway
Akron, OH 44311

PC-AT and PC are registered trademarks of IBM Corp.

CIRCLE NO 776

RS-422/RS-485 Boards for AT, Micro Channel

RS-422/RS-485 asynchronous serial communication boards from Quatech available in 1 to 4 ports for PC-AT and compatibles and 1 to 4 ports for PS/2 Micro Channel.

Call for our free PC Interface Handbook:
1-800-553-1170



662 Wolf Ledges Parkway
Akron, OH 44311

PC-AT, Micro Channel, and PS/2 are trademarks or registered trademarks of IBM Corp.

CIRCLE NO 777

Wave Form 20MHz - 32K \$1290

The WSB-100 Wave Form Synthesizer Board from Quatech has the best set of numbers in the market. With speed to 20MHz and a 32K memory at \$1290, it's making waves in more ways than one. The WSB-100 is also a star performer as a digital pulse/word generator with the optional digital module.

Call for our free PC Interface Handbook
1-800-553-1170



662 Wolf Ledges Parkway
Akron, OH 44311

CIRCLE NO 778

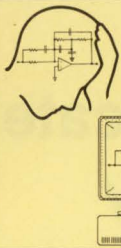

Software to release your creative genius

ELECTRONIC ENGINEERS CALL FOR YOUR FREE MAC & MSDOS CATALOG

- AC/DC circuit analysis
- Active & passive filter design & analysis
- Engineering graphics
- Signal processing
- Logic simulation
- Root locus analysis
- Microstrip design
- Thermal analysis
- Statistics/ More

BV Engineering
Professional Software



To order call toll free **1-800-229-0283**
2023 Chicago Ave., Ste. B-13, Riverside, CA 92507

CIRCLE NO 779

LOW COST INTERFACE CARDS FOR PC/XT/AT

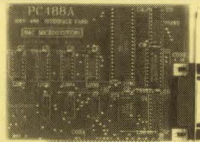

RS-485/422 Card [PC485] \$95/125

- Serial Async. Communication up to 4,000ft; 2 or 4 wires; NS16450 UART.
- COM1-4; Max. Baud Rate 56KB. High speed version (256KB) - \$165.
- Dual drivers/receivers; Handles 64 devices; Compatible with most comm. S/W.
- DB9 or phonejack. Sample programs included. Optional S/W (w/ source) - \$150.

IEEE-488 Card [PC488A] \$145

- Includes DOS Device Driver and sample Communication program in BASIC.
- Additional sample programs in C, Pascal & Assembly - \$50.
- Selectable IRQ (1-6), DMA channel 1 or 2. Up to four boards per computer.
- Compatible with most IEEE-488 Software packages for IBM-PC.
- I/O Addresses and Control registers compatible with NI's GPIB-PCIIA.

IEEE-488 Card [PC488C] With Built-In Bus Analyzer \$445

- Software Support for BASIC, QuickBASIC and GWBASIC.
- Additional libraries for C, Pascal, FORTRAN, Assembly available - \$50 (all).
- Powerful menu-driven BUS ANALYZER runs in the background while 488 programs or commands are executed; Features Program Stepping, Break points, real time bus data capture (4K buffer), instant screen toggling.
- Complete Controller/Talker/Listener capability. Based on NEC-7210.
- Compatible with NI's GPIB-PCII card. (TMS-9914 based card - \$345).

Stepper Motor Card [PCL738] \$395

- Capable of independent and simultaneous control of up to 3 stepper motors.
- Programmable speed from 3.3 PPS to 340 PPS; Built-in acceleration control.
- Step Position Read-back; Opto-isolated outputs; Crystal based timing.
- Pulse/Direction or CW/CCW pulse output. Includes 8 bit digital I/O port.

MC/ VISA / AMEX Call today for datasheets!
B&C MICROSYSTEMS INC.
750 N. Pastoria Ave., Sunnyvale, CA 94086 USA
TEL: (408)730-5511 FAX: (408)730-5521

CIRCLE NO 780

Analog Circuit Simulation

Completely Integrated CAE from \$95

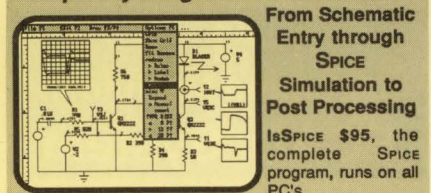

From Schematic Entry through SPICE Simulation to Post Processing
IsSPICE \$95, the complete SPICE program, runs on all PC's.

IsSPICE/386 \$386, The fastest PC based SPICE program available. Has virtually no circuit size limitations.

SPICENET \$295, a schematic editor for any SPICE simulator. Generates a complete SPICE netlist.

IntuSCOPE \$250, a graphics post processor that performs all the functions of a digital oscilloscope.

PRESPICE \$200, extensive model libraries, Monte Carlo analysis, and parameter sweeping.



Please Write or Call
P.O. Box 6607 (213) 833-0710
San Pedro, CA 30 Day Money
90734-6607 Back Guarantee

CIRCLE NO 781

Fast and easy Data Acquisition

Torque Signal
File Tr 1
File Name: 107.dat
Hit 107

Torque Signal lopas
File Name
Hit 107

DATA SMOOTHED WITH
LOW PASS FILTER

UnkelScope

Menu-driven software package for your PC

JUNIOR - \$125

Take, store, retrieve, print data - perfect for Design Engineers

LEVEL 2+ - \$549

Data acquisition plus: experiment control, data analysis.

The complete package.

FREE Demo Disk. Money-back guarantee

Unkel Software Inc.

62 Bridge St. Lexington, MA 02173 (617) 861-0181

CIRCLE NO 782

X.25 SDLC QLLC HDLC ADCCP PAD

- C source code
- ROM-able
- Full porting provided
- No OS required



GCOM, Inc.
41 E. University
Champaign IL 61820
(217) 352-4266

Specialists in Computer Communications
FAX 217-352-2215

CIRCLE NO 783

NEW NEW NEW NEW NEW

Telecom Design!

MF (R1) or MFC (R2)

TRANSCIEVER

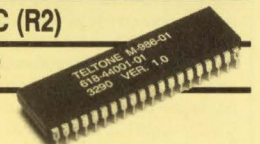

M-986 transmits and receives CCITT R1 or R2 forward and backward multifrequency signals. For trunk adapters, test equipment, and other applications.

- Single or dual channel versions available
- Versions for North American (R1) or International (R2) toll signals
- Binary or 2 of 6 input/output format
- Complete microprocessor interface
- 40 pin IC, 5 volt power, crystal time base

For more info call: **1-800-426-3926**

TELCONE

10801-120th Avenue NE, Kirkland, WA 98033
Phone: 206-827-9626 Fax: 206-827-6050



CIRCLE NO 784

To advertise in Product Mart, call Joanne Dorian, 212/463-6415

Interactive/Real-Time

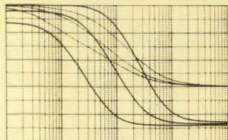

Analog Circuit Simulation

ECA-2 Electronic Circuit Analysis offers the best MonteCarlo and Worst-Case analyses with the capability to concurrently plot random samples or Min/Max/Nominal values.

- AC, DC, Transient, Fourier, and Temperature Analysis • Interactive or batch modes • Full nonlinear simulator • Sine, Pulse, PWL, SFFM, and Exponential generators • IBM PC/Mac/SUN
- Multiple plots • On-line real time graphics - 2 to 50 times faster than SPICE • Over 500 nodes • Advanced component parameters • Component Sweeping • Full editing, built-in or external • Detailed 525 page manual

Call for **FREE DEMO!**



Tatum Labs, Inc.

3917 Research Park Dr. B-1, Ann Arbor, MI 48108
313-663-8810

CIRCLE NO 785

There is a Difference.
Lifetime Free Updates

EP-1140
\$895



A programmer is not just another programmer. That is why BP Microsystems is committed to bringing our customers the highest quality programmers at an affordable price. This commitment is evident in our EP-1140 E/EPROM programmer supporting thousands of 24, 28, 32 and 40 pin devices. A 32-pin model, EP-1132, is available also for \$695. And, all of our programmers include future chip support at no charge and an unconditional money back guarantee.

BP MICROSYSTEMS
1-800-225-2102
(713) 461-9430

CIRCLE NO 786

STEP MOTOR CONTROL 27K steps/sec! 16 Million steps!

New CY545. Rates up to 27K steps/sec, up to 16 million steps per single motion. Separately programmable start rate, accel/decel rate, and max rate. Pulse & direction output. External jog mode and limit switch detection. Serial or parallel interface, LED/LCD & Thumbwheel interface lines, and more. ASCII commands. Supports 64K external memory. CMOS 40-pin DIP. \$75 each (\$25/1000). Credit Cards OK.



Cybernetic Micro Systems

Box 3000, San Gregorio CA 94074
(415)726-3000 Tlx: 910-350-5842

CIRCLE NO 787

McCAD® EDS

#1*

Integrated Macintosh ECAD System

Schematic Capture
Analog/Digital Simulation
PCB Layout Editors
Advanced Autorouting
Translators

Call for **FREE DEMO DISKS**

VAMP Inc.

6753 Selma Ave. Los Angeles, CA 90028

(1-213) 466-5533

*MacWEEK 1990 User Survey & CAD Showdown 3 Results

CIRCLE NO 788

Low Cost Logic Simulator

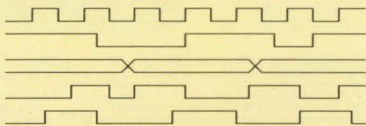

DLsim™ Digital Logic Simulator

- Event driven, nine state functional and timing simulation
- 16,000 gate capability without additional memory
- Direct support from JEDEC files for PLDs and GALs
- Compatible with SCHEMA or ORCAD schematic files
- Runs on IBM PC/XT/AT or compatibles
- Interactive logic viewer (EGA/VGA or HERCULES)
- Supports HP Laser or EPSON dot matrix printers
- Includes TTL, ALS and CMOS libraries with source
- No copy protection
- Complete package only \$495

CADsim Technologies

525 Melbourne Ct., Newbury Park, CA 91320
(805) 499-8653

All trademarks belong to their respective owners

CIRCLE NO 789

Communicate Weekly

to the electronics
OEM through
EDN's Magazine
and News Editions
Product Mart

CIRCLE NO 790

UNIPRO,

the PC/XT/AT/386 based universal programmer/ tester programs PROMs, EPROMs, EEPROMs, up to 4MB and 32-bit wide, PALs, PLDs, GALs, EPLDs, PEELs, and Micro Controllers. JEDEC file compatibility and Test Vector verification allow the use of most popular PLD compilers. The unit also tests TTL/ CMOS Logic ICs and Dynamic/Static RAMs. 40-pin Gold ZIF socket, built-in protection for short circuit and over current, high speed parallel interface to the PC, and menu-driven software are included at \$585.

XELTEK

764 San Aleso Ave
Sunnyvale, CA 94086
TEL (408) 727-6995
FAX (408) 727-6996

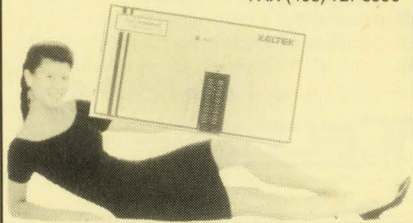

CIRCLE NO 791

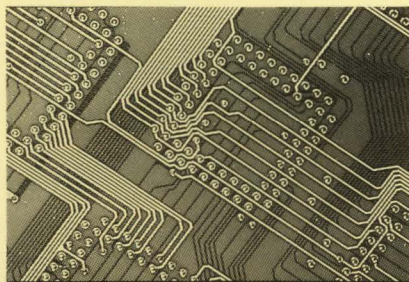

Your reliable & economic source for printed circuit boards.

We offer a wide range of double-sided & multilayer PCBs with high reliability fast service, top quality and competitive price. We can help you become more effective & profitable through the next decade. Don't hesitate! Contact us now!

SALES AGENTS WANTED.



GLOBAL PMX CO., LTD.

12TH FL. NO. 689, CHUNG SHAN N. RD.
SEC. 5, TAIPEI, TAIWAN, R.O.C.
TEL: 886-2-8356244 FAX: 886-2-8356254



CIRCLE NO 792

Little Giant™

C Programmable Controller

This shirt pocket sized computer interfaces directly to the outside world. Use it to control anything. Instantly programmable using your PC with Dynamic C. ROM and battery backed RAM to 1024k bytes. 8 Channel, 10/12 bit, A/D with conditioning. High voltage and current drivers. Battery backed time and date clock. Watchdog and power fail. 4 serial channels. 24 parallel I/O lines. Timers. Integral power supply. Terminations for field wiring. Expansion connector. Plastic or metal field packaging available. OEM versions from \$199.00.

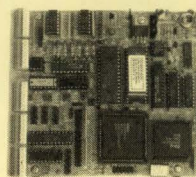

Z-World Engineering

1340 Covell Blvd., Davis, CA 95616

(916) 753-3722

Fax: (916) 753-5141

CIRCLE NO 793

To advertise in Product Mart, call Joanne Dorian, 212/463-6415

BUSINESS/CORPORATE STAFF

Peter D Coley
VP/Publisher
Newton, MA 02158-1630
(617) 558-4673; Telex: 940573
Ora Dunbar, Assistant/Sales Coordinator

Mark J Holdreith
Associate Publisher
Newton, MA 02158-1630
(617) 558-4454

Deborah Virtue
Business Director
Newton, MA 02158-1630
(617) 558-4779

NEW ENGLAND
Chris Platt, Regional Manager
Clint Baker, Regional Manager
199 Wells Ave
Newton, MA 02159
(617) 964-3730

STAMFORD 06904
George Isbell, Regional Manager
8 Stamford Forum, Box 10277
(203) 328-2580

NEW YORK, NY 10011
Daniel J Rowland, Regional Manager
249 West 17th St
(212) 463-6419

PHILADELPHIA AREA
Steve Farkas, Regional Manager
487 Devon Park Dr, Suite 206
Wayne, PA 19087
(215) 293-1212

CHICAGO AREA
Greg Anastos, Regional Manager
Jack Johnson, Regional Manager
Hollis Gronset, Telemarketing
1350 E Touhy Ave, Box 5080
Des Plaines, IL 60018
(708) 635-8800

DENVER 80206
John Huff, Regional Manager
44 Cook St
(303) 388-4511

DALLAS 75243
Don Ward, Regional Manager
Al Schmidt, Regional Manager
9330 LBJ Freeway, Suite 1060
(214) 644-3683 or (214) 644-6529

SAN JOSE 95128
Walt Patstone, Regional Manager
Bill Klanke, Regional Manager
Philip J Branon, Regional Manager
James W Graham, Regional Manager
3031 Tisch Way, Suite 100
(408) 243-8838

LOS ANGELES 90064
Charles J Stillman, Jr, Regional Manager
12233 W Olympic Blvd
(213) 826-5818

ORANGE COUNTY/SAN DIEGO
Jim McElean, Regional Manager
18818 Teller Ave, Suite 170
Irvine, CA 92715
(714) 851-9422

PORTLAND, OREGON 97221
Pat Dakin, Regional Manager
Walt Patstone, Regional Manager
1750 SW Skyline Blvd, Box 6
(503) 297-4305

UNITED KINGDOM/BENELUX
Jan Dawson Associates
44 Brynmaer Rd
London SW11 4EW UK
Tel: 44-71-498 6441
Fax: 44-71-498 6442
Tracey Lehane
Martin Sutcliffe
27 Paul St
London EC2A 4JU UK
Tel: 44-71-628 7030

SCANDINAVIA
Stuart Smith
27 Paul St
London EC2A 4JU UK
Tel: 44-71-628-7030; Fax: 44-71-628-5984

FRANCE/ITALY/SPAIN
Laura Whiteman
14 Rue des Parisiens
92600 Asnieres sur Seine
France
Tel: 331-47900507
Fax: 331-47900643
Alessandro Coari
Via Favale 21/2
Santa Margherita Ligure
16038 Genova, Italy
Tel: 185 286 304
Fax: 185 286 304

GERMANY/AUSTRIA/SWITZERLAND/BAVARIA
Wolfgang Richter
Sudring 53
D-7240 Horb 1 A/N
West Germany
Tel: 49-7451-7828
Fax: 49-7451-1794

ISRAEL
Asa Talbar
Talbar Media
Box 22917
Tel Aviv 61228, Israel
Tel: 0222 8 083; Fax: 9722-247-403

FAR EAST
Jack Kompan, Asian Director of Marketing
Cahners Asia Ltd
22nd fl, Lo Yong Court Commercial Bldg
212-220 Lockhart Rd
Wanchai, Hong Kong
Tel: 852-572-2037; Fax: 852-838-5912

HONG KONG
Adonis Mak
Cahners Asia Ltd
22nd fl, Lo Yong Court Commercial Bldg
212-220 Lockhart Rd
Wanchai, Hong Kong
Tel: 852-572-2037; Fax: 852-838-5912

JAPAN
Kaoru Hara
Dynaco International Inc
Suite 1003, Sun-Palace Shinjuku
8-12-1 Nishishinjuku, Shinjuku-ku
Tokyo 160, Japan
Tel: 03-366-8301; Fax: 8133-668-302
Telex: J2322609 DYNACO

KOREA
Jeong-Gwon Seo
Doo Bee International Ltd
Center Bldg
1-11, Jeong-dong
Choong-ku, Seoul, Korea
Tel: 02-776-2096; Fax: 02-755-9860
Telex: K27117 DOOBEE

**SINGAPORE/MALAYSIA/INDONESIA/THAILAND/
THE PHILIPPINES/AUSTRALIA/NEW ZEALAND**
Hoo Siew Sai
Ad Media Private Ltd
95, South Bridge Rd
09-13 South Bridge Centre
Singapore 0105
Tel: 65-532-4026
Fax: 65-532-4027
Peter Cheong
Asia Pacific Media House
10 Andrea St
Highbury 5089
Adelaide, South Australia
Tel: 61-8-396-0588
Fax: 61-8-396-0733

TAIWAN
Parson Lee
Acteam International Marketing Corp
Box 82153
Taipei, Taiwan ROC
Tel: 886-2-7114833; Fax: 886-2-7415110
Telex: 29809

PRODUCT MART
Joanne Dorian, Manager
249 West 17th St
New York, NY 10011
(212) 463-6415
Fax: (212) 242-6987

INFO CARDS
Heather McKelkeny
Newton, MA 02158-1630
(617) 558-4282

CAREER OPPORTUNITIES/CAREER NEWS
Roberta Renard, National Sales Manager
Janet O Penn, Eastern Sales Manager
103 Eisenhower Pkwy
Roseland, NJ 07068
(201) 228-8602 or (201) 228-8610
Fax: (201) 228-4622

Nancy Olbers, Western Sales Manager
238 Highland St
Portsmouth, NH 03801
(603) 436-7565; Fax: (603) 436-8647

Diane Philipbar, Sales Assistant
103 Eisenhower Pkwy
Roseland, NJ 07068
(201) 228-8608

Wendy A Casella, Eleanor I O'Hara, James P Joyce
Advertising/Contracts Coordinators
(617) 964-3030

**William Platt, Senior Vice President,
Reed Publishing USA**
Cahners Magazine Div
Terry McDermott, President, Cahners Publishing Co
Frank Sibley, Senior Vice President/General Manager,
Boston Div
Tom Dellamaria, VP/Production & Manufacturing

Circulation: Denver, CO: (303) 388-4511
Eric Schmierer, Group Manager

Reprints of EDN articles are available on a custom printing basis at reasonable prices in quantities of 500 or more. For an exact quote, contact Andrea Marwitz, Cahners Reprint Service, Cahners Plaza, 1350 E Touhy Ave, Box 5080, Des Plaines, IL 60018. Phone (708) 635-8800.

EDN's CHARTER

EDN is written for professionals in the worldwide electronics industry who design, or manage the design of, products ranging from circuits to systems.

EDN provides accurate, detailed, and useful information about new technologies, products, design techniques, and careers.

EDN covers new and developing technologies to inform its readers of practical design matters that will be of concern to them at once or in the near future.

EDN covers new products

- that are immediately or imminently available for purchase
- that have technical data specified in enough detail to permit practical application
- for which accurate price information is available.

EDN's Magazine Edition also provides specific "how to" design information that its readers can use immediately. From time to time, EDN's technical editors undertake special "hands on" engineering projects that demonstrate EDN's commitment to readers' needs for useful design information.

EDN's News Edition also provides comprehensive analysis and news of technology, products, careers, and distribution.

EDN

275 Washington St
Newton, MA 02158
(617) 964-3030

CAREER OPPORTUNITIES

1990 Recruitment Editorial Calendar

Issue	Issue Date	Ad Deadline	Editorial Emphasis
Magazine Edition	Oct. 11	Sept. 20	Analog ICs, Computer-Aided Engineering, DSP IC Directory, Displays, International Technology Update
News Edition	Oct. 18	Sept. 28	CAE/Hardware, Datacom, Regional Profile: Idaho, Colorado, Utah
Magazine Edition	Oct. 25	Oct. 4	Test & Measurement Special Issue—Digital Instruments, Computers & Peripherals, ICs & Semiconductors, System Software

Call today for information on Recruitment Advertising: East Coast: Janet O. Penn (201) 228-8610
West Coast: Nancy Olbers (603) 436-7565
National: Roberta Renard (201) 228-8602

WHY Ada SOFTWARE ENGINEERS SHOULD CHOOSE THE SAME COMPANY THE GOVERNMENT JUST DID.

For more than 75 years, Magnavox has been creating breakthrough technology in advanced electronics. As one of the nation's top defense contractors, we created the first practical sonobuoy for submarine detection and are the largest manufacturer of UHF Airborne Radios. Today, we are recognized as a leader in the area of large scale software development, applying Ada software engineering technology for advanced tactical command and control systems.

We are looking for Software Engineers who can apply the Ada programming language to a large, complex system. To facilitate this work, you will use an advanced Ada software development system which integrates multiple Rational R1000 systems with individual developer workstations to provide the power necessary to support large scale Ada software development. Our highly professional atmosphere involves Engineers in the

entire "Software Lifecycle" from concept through implementation.

All positions require a Bachelor's degree in Computer Science, Engineering or Math and 3-6 years of related experience or equivalent.

Ada SOFTWARE ENGINEERS

You will be involved in the design, coding, testing, and integration of software for specific Computer Software Configuration Items (CSCIs). Candidates should be capable of working in a team environment, proficient in software engineering with Ada and experienced in any of the following areas of concentration:

- UNIX* internals (BSD, System V)
- Rational DBMS (SQL)
- DOD-STD-2167A
- Software Configuration Management
- Command and Control Applications
- Communications Software (GOSIP, TCP/IP)
- X Windows (11.3)
- Software build/integration

Software Engineers at Magnavox enjoy total program involvement as well as the opportunity for personal and professional growth within a stable work environment. Additionally, our relocation package and Fort Wayne location — with its affordable housing, excellent schools, cultural activities, and a county population of over 200,000 — make for an extremely appealing personal as well as professional opportunity. To choose a rewarding career, send your resume to: **Bill Blake, Magnavox Electronic Systems Company, (Dept. EDN), 1313 Production Road, Mallstop 03-26, Fort Wayne, Indiana 46808, or call (219) 429-6846.** We are an equal opportunity employer.

*UNIX is a registered trademark of AT&T Technologies.



Magnavox
ELECTRONIC SYSTEMS COMPANY

SECURITY IS OUR BUSINESS!

ELECTRICAL ENGINEER

JcAIR, Inc. A rapidly growing manufacturer of avionics and aircraft test equipment is seeking an experienced technical professional with a background in avionics design and avionics testing. The position requires at least 3 years experience in high level programming and design. BSEE preferred. JcAIR is devoted to the commercial avionics testing industry. We offer highly visible and responsible positions with competitive salary and benefit package. Send resume to Personnel Dept.



A Subsidiary of The BFGoodrich Co.

400 Industrial Parkway
Industrial Airport, KS

66031

AN EQUAL OPPORTUNITY EMPLOYER

PRIME SUNBELT LOCATION

Leading co seeks Receiver Designers (5-10 yrs freq syn) & Software Engrs (VAX/VMS, MicroVAX, or Intel 8051, x86 realtime, multitasking). BS and related experience required. Commercial communications (RF) experience is preferred.

EXECUTIVE RECRUITMENT
6407 Idlewild Rd., Suite 210-10
Charlotte, NC 28212
704-536-8830 FAX 704-563-1154

Quality design and advanced technology. Because lives depend on it.

More than a name, Pacesetter is our way of viewing our mission and applying technology. Beginning with the first internal cardiac pacemaker, to the application of advanced NASA technology to medical science, to our present programmable, dual-chamber pacemaker, the tradition continues with our commitment to up-to-the-minute life-assisting and life-critical biomedical technology.

Proud of these technological achievements, our greatest satisfaction is knowing our products have enriched and extended the lives of millions. In fact, the very first pacemaker recipient, Arne Larsson, is still enjoying an active lifestyle in his 70's.

With the support of the multi-billion dollar Siemens Company, we're totally committed to living up to our name, and fulfilling the promise of quality made to the people who depend on our products every day. If you're looking for an exciting challenge in an innovative environment, you'll find your future here. Future opportunities include:

SOFTWARE DEVELOPMENT ENGINEER

BS/MS Electronic or Computer Science. "C" language programming for 8086/68000 processor-based medical instrumentation. 5+ years software development experience with "C" language on embedded systems, MSDOS or UNIX. Sun workstation network.

ELECTRONIC DESIGN ENGINEER

BS/MS Electronic degree and proficiency on Daisy and/or Valid CAD systems. 5+ years experience in digital design.

MECHANICAL DEVELOPMENT ENGINEER

BS/MSME or Biomedical degree. 5+ years R&D/product development experience in packaging small, high density packages for volume production.

MECHANICAL ENGINEER

BSME/MSME. 5+ years experience in a manufacturing environment with emphasis in mfg. quality and reliability methodologies. Knowledge of epoxies, polyurethane, silicon and other related rubber molding processes.

MANUFACTURING ENGINEER

BS/MS Mechanical or Manufacturing Engineering degree. 5+ years supporting assembly of small products and clean room operations. Knowledge of SPC, MRP and JIT techniques preferred.

ELECTRICAL ENGINEERS

BSEE/MSEE. 5+ years experience. Current design and design development skills applicable to implantable medical devices. Career specializations span: project management, design and manufacturing support disciplines. Skills desired include: analog and digital

V.L.S.I. design, biomedical circuit design, and test/support equipment development.

In addition to our desirable Southern California location, we offer competitive compensation, paid relocation and an excellent benefits package including company-paid retirement, 401(k), tuition reimbursement, vision care and a choice of dental/health plans. Send resume (NO PHONE CALLS, PLEASE!) to: **Greer A. Brooks, Employment Representative, Dept. EDN9/90, Pacesetter Systems, Inc., 12884 Bradley Avenue, Sylmar, CA 91342. AA/EOE**

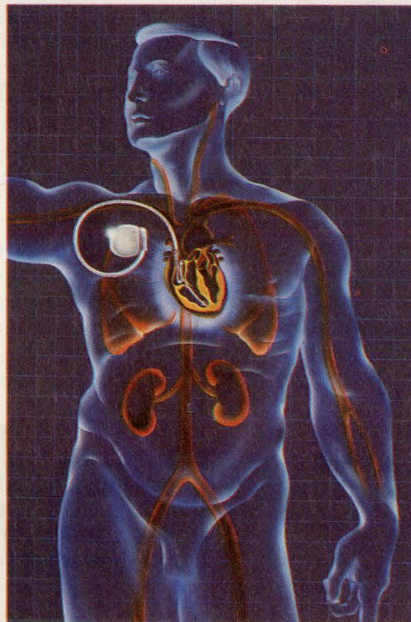

 **Pacesetter® Systems, Inc.**
A Siemens Company

Where Reliability is a Way of Life®

*The Power of MIPS
is in its People.*



In 1984, a small group of engineering superstars decided to pursue their vision of what RISC could be. The result was MIPS, a company dedicated exclusively to advancing the boundaries of RISC technology. Six years and several impressive milestones later, MIPS has emerged as a leading player in RISC computing and the driving force for its future.

At the heart of this success is our people. Right now, we are looking for more of the industry's best software talent to help us. From workstations to servers, our software engineers are helping establish our architecture as the industry's RISC standard. If you believe in the power of RISC, look into these opportunities to join us.

• Compiler Engineers

Working in our next-generation compiler technology, you'll build leading-edge compilers and tools. Requirements include 3+ years of development experience in compiler front-end and back-end plus knowledge of RISC architecture.

• X Window System Software Engineers

You'll contribute to our leading-edge graphics technology and help us set the future direction of our RISC-based systems. You'll have broad responsibilities for projects in any of the following areas:

• Server • Libraries • Clients • Motifs

• Data Communications Software Engineers

We're looking for UNIX*/C Engineers to join a new group in the development of data communications and networking products for our RISC-based systems. You must have protocol development experience in X.25 and OSI.

All positions require MS/BS in CS/EE or the equivalent.

The advantages of working with a superior product line and leading company are complemented by our progressive compensation package and equity plan. For immediate consideration, please send your resume, indicating position of interest, to MIPS Computer Systems, Inc., Human Resources M/S 5-15, Dept. EDN-JK, 950 DeGuigne Drive, Sunnyvale, CA 94086. We are an equal opportunity employer.

*Registered trademark of AT&T



The Power of RISC is in the System.

Telecommunications Professionals

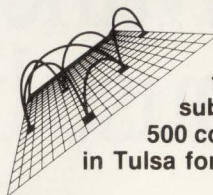

Seiscor Technologies, Inc. a manufacturer of telephone transmission equipment and a subsidiary of Raytheon, a Fortune 500 company, has immediate openings in Tulsa for the following positions:

SONET Engineers

System Architect/Engineers with a B.S. degree and 5 years experience in design of fiber optic based transmission and subscriber loop products for deployment worldwide. Requires thorough knowledge of north american and international standards for T1, DS1, DS3, and SONET. Must be experienced in the design of Fiber optic Add drop Multiplexors and Digital Subscriber Loop Carrier systems utilizing advanced high speed integrated circuit technology including emitter coupled logic (ECL). Positions require familiarity with structured system design using modern engineering methodologies.

Sr. Analog Design Engineer

Requires a B.S.E.E. with three to five years experience in designing Line Cards for Digital Loop Carrier. Knowledge of Bell LSSGRs, TR-57 and TR-303 is a must. SLIC, ASIC, and SMT background is desirable.

Software Engineers

Qualified candidates should possess a B.S. in Computer Science or Electrical Engineering, three to twelve years experience in design, development and test with emphasis on microprocessor, real time software and telephone transmission products using C language. Experience with SONET a plus.

Test Engineers

Provide test detail designs, including test procedures, programs and figures for in-circuit production testing. Requirements include a B.S. in Electrical Engineering, three to five years telecommunications manufacturing experience, and Automatic Test Equipment experience.

Tulsa is an unusually clean and safe city with a high quality of life. You'll find pleasant year-round weather, rolling hills and several area lakes, low cost of living, easy commuting and light traffic. Tulsa is a good family town with an area population of 800,000, diverse cultural activities and good schools.

Call Personnel at 1-800-331-4048 or send resume to:

Seiscor Technologies, Inc.
PO Box 470580
Tulsa, OK 74147-0580
or Fax to 918-252-2757

An Equal Opportunity Employer, Affirmative Action Employer, M/F/V/H
U.S. Citizenship or U.S. Permanent Residence Required

**Seiscor
Technologies**
A Raytheon Company

With a career at Motorola Cellular, we see no end in sites.

Stretching from the U.S. throughout the Far East, Latin America and Europe, Motorola cell sites cover the world. In fact, the company that pioneered cellular communications is now outdistancing all competitors combined. We're bringing the worldwide telecommunity closer and paving the way for even greater breakthroughs...like our patented four-cell reuse plan that supports more voice channels with fewer cell sites.

And with just 1% of the global cellular market developed, the opportunities at Motorola Cellular have just begun. We're developing the most advanced software, switching equipment and radio telephone exchanges. We're constantly modifying, updating and simplifying systems while enhancing RF sector-sharing capabilities.

Flexibility, capability and expandability...that's what Motorola Cellular can offer its customers...and your engineering career. If you want a career as dynamic as our growth, set your sites on one of the following opportunities:

• **Software Engineers** (positions also available at our Fort Worth, Texas facility) • **Hardware Engineers** • **Test Equipment Engineers** • **Mechanical Engineers** • **Manufacturing Engineers** • **Cellular Systems Engineers.**

We offer an attractive salary, a comprehensive benefits package and opportunities for professional growth. For immediate consideration, please send your resume to: Supervisor, Professional Recruitment, Motorola Inc., Cellular, 1501 West Shure Drive, Arlington Heights, IL 60004. Or FAX your resume to: (708) 632-5717 (our 24-hour FAX line). To access our On-Line

Career Network from your PC, dial (508) 263-3857, press return twice, and key in password LEGACY. For Software positions in Fort Worth, please send your resume to: Professional Staffing, Motorola Inc., P.O. Box 2931, Fort Worth, TX 76113. Or FAX your resume to (817) 232-6367 (our 24-hour FAX line). We are an equal opportunity/affirmative action employer.

1990
1991
1992
1993
1994



MOTOROLA

Cellular Subscriber Group

Radio Telephone Systems Group

Our breakthroughs are heard around the world.

EDN's INTERNATIONAL ADVERTISERS INDEX

Abbott Transistor Laboratories Inc	122	Hypertronics Corp	74, 277	SBE	56
ACCEL Technologies Inc	204	ILC Data Device Corp	78	Seagate Technology	101, 200
Advanced Digital	278	Incredible Tech	274	Sea Level Systems	275
Advin Systems	277	Inmark	278	SenSym	143
Aerospace Optics	103	Integrated Device Technology Inc	63	Siemens AG**	30-31
Airpax Corp	250	Intel	58	Siemens Components Inc	76*, 110-111
ALS Design Corp	270	Intermetrics Inc	113	Siemens Corp*	268
Alterra Corp	46-47	Interphase Corp	129	Signal Transformer Co Inc	C4
American Research and Engineering	269	Intusoft	279	Signetics Corp	222-223
AMP	198-199	IOtech Inc	275	Silicon Systems*	105
Analog Devices Inc	159-165	Ironwood	274	S-MOS Systems	202-203
Analogic Corp	241	ITT ElectroMechanical Components Worldwide	18-19	Sony Component Products	65
Ancot Corp	142	John Fluke Manufacturing Co Inc*	182-183	Sony Microsystems Co	141
Apex Microtechnology Corp	2	JW Miller Div/Bell Industries	269	Spectrum Software	287
Aromat Corp	148-149	Keithley Instruments	88-90	Standard Grigsby Inc	119
Ashling Microsystems Ltd**	106A-D	Kel Connectors Inc	267	Tatum Labs	280
AT&T Technologies	244-245	Keytec Inc	276	TEAC Corp**	51
Atlanta Signal Processors Inc	273	Lattice Semiconductor Corp	6	Tektronix Inc	34-37, 249, 251, 253, 255-257
Augat	259	Leasametric Inc	55	Telebyte Technology Inc	258
Avantek	166	Linear Technology Corp	224	Teltone Corp	279
B&C Microsystems	277, 279	Link Computer Graphics Inc	278	Tempil Div, Big Three	274
Bittware	273	Logical Devices Inc	61	Tempustech Inc	274
Blendon Inc	270	LSI Logic Corp	14-15	Tesoft	274
BP Microsystems	280	3M Electrical Specialties Div	84	Texas Instruments Inc	70-73, 173-176
Brooktree Corp	42, 233-238	Marshall	177	Tokin Corp	147
Burr-Brown Corp	197	Maxim Integrated Products	53-54	Toshiba America Inc	120-121
Bussmann	220	MCSI	276	Toshiba Corp**	96
BV Engineering	279	Mental Automation	275	Two Technologies	276
Cadre Technologies	240	Messe Munchen International	262	Ultimate Technology	264
CADSim Tech	280	Micro Devices	43	UMC	75
CAD Software Inc	258	Micro Linear	86-87	Universal Data Systems	C3
Capilano Computer Systems Inc	276	Micro Networks	85	Unkel Software	276
Capital Equipment Corp	269	Micro Processors Unlimited	278	US Software	277, 278
Carroll Touch Inc	92-93	Microtek Intl Inc	181	Vamp Inc	280
Ceibo Ltd	275	Mini-Circuits Laboratories . 3, 4, 26-27, 38-39, 227		Varta Batteries Inc	248
Cherry Electrical Products Inc	276	Mitel Semiconductor	106	Velotec	274
Comlinear Corp	32-33	Molex Inc	288	Vicor	126-127
Condor	52	Motorola Microcomputer Div	67-69	VME Microsystems	271
Connor Peripherals	16-17	Motorola Semiconductor Products Inc	10-11, 144-145*, 242-243*	VMETRO Inc	266
Cornes	260	National Hybrid	261	Wavetek	146
Cybernetic Micro Systems	278, 280	National Instruments	116	Western Digital	114-115, 218-219
Cypress Semiconductor	23	National Semiconductor Corp*	48-51	Wintek Corp	277
Dale Electronics Inc	1	NEC Corp	130-131, 272	Xeltek	280
Data I/O Corp	275, 277	Needham Electronics	274	Zilog Inc	229
Datakey	25	Nohau Corp	273	Z-World	280
Data Translation Inc	125	Noise Laboratory Co	112		
Dialight Corp	184	Noritake Electronics Inc	195		
Diversified Technology	267	OKI Semiconductor*	28-29		
DSPACE	275	Omaton Inc	278		
DSP Systems Corp	260	OrCAD Systems Corp	8		
Duncan Electronics Div	12-13	Orion Instruments	275		
Du Pont Co	231	Pac-Tec Corp	254		
ECM	128	Performance Semiconductor Corp	77		
Emulation Technology Inc	276	Philips T&M**	29		
Epson America Inc	247	Phillips Components Inc**	49		
Ericsson	221	Pico	66, 271		
Ericsson Components	252	Pioneer Magnetics	98		
Exabyte Corp	201	Planar Systems	276		
Exor	273	Powertronic	273		
Force Computers Inc*	30-31	Precision Filters Inc	275		
Franklin Software Inc	277	Precision Interconnect	91		
Fujitsu Component of America*	246, 265	Precision Monolithics Inc	150		
GCOM Inc	279	Qua Tech Inc	279		
Global PMX Co Ltd	280	Qualidyne Systems Inc	215		
Global Specialties Corp	277	Quantum Data Corp	276		
Globe Motors	260	Racal-Redac	124		
Hamamatsu Corp	83	Radstone Technology	180		
Hantronix Inc	258	RAF Electronic Hardware Inc	258		
Harris Semiconductor	C2, 178-179	Rogers Corp	274		
Hewlett-Packard Co	20, 40-41, 107-109	Samsung Semiconductor	94-95, 216-217		
Hitachi America Ltd*	96	Samtec Inc	44, 276		
Huntsville Microsystems Inc	239				
HyperLynx	275				

Recruitment Advertising 282-285

Executive Recruitment
Magnavox
MIPS
Motorola Cellular Group
Pacesetter Systems Inc

*Advertiser in US edition
**Advertiser in International edition

This index is provided as an additional service. The publisher does not assume any liability for errors or omissions.

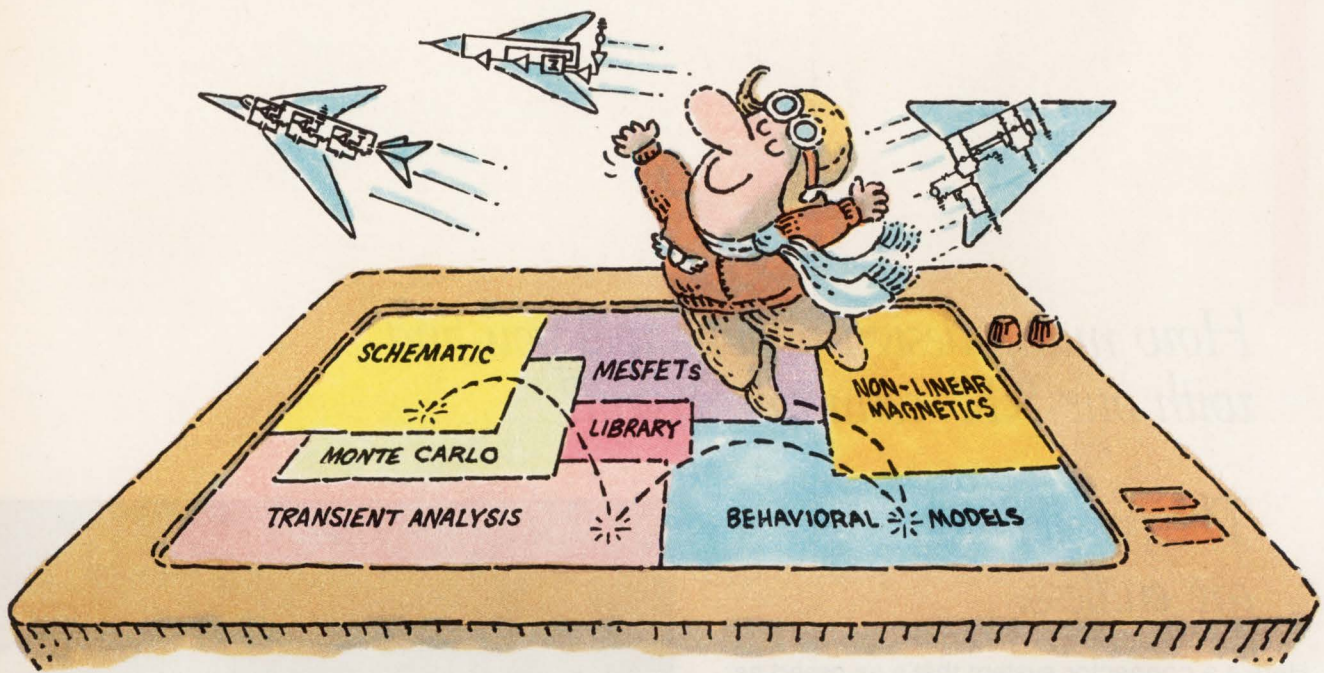

THE NEW MICRO-CAP III.TM SO YOU CAN TEST-FLY EVEN MORE MODELS.

It wasn't easy. But we did it. Made the long-time best-selling IBM® PC-based interactive CAE tool even better.

Take modeling power. We've significantly expanded math expression capabilities to permit comprehensive analog behavioral modeling. And, beyond Gummel Poon BJT and Level 3 MOS, you're now ready for nonlinear magnetics modeling. Even MESFET modeling.

Analysis and simulation is faster, too. Because the program's now in "C" and assembly language. That also means more capacity — for simulating even larger circuits.

As always, count on fast circuit creation, thanks to window-based operation and a schematic editor. Rapid, right-from-schematics analysis — AC, DC, fourier and transient — via SPICE-like routines. The ability to combine digital/analog circuit simulations using integrated switch

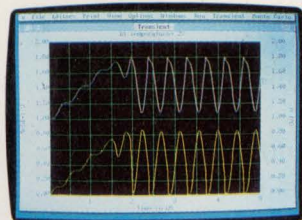

Transient analysis

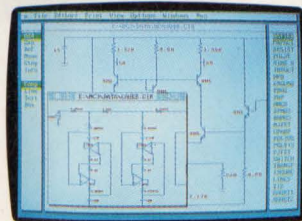

Schematic editor

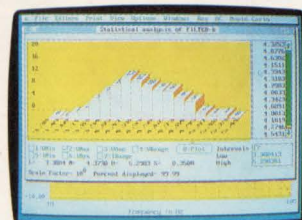

Monte Carlo analysis

models and parameterized macros. And stepped component values that streamline multiple-plot generation.

And don't forget MICRO-CAP III's extended routine list — from impedance, Nyquist diagrams and BH plots to Monte Carlo for statistical analysis of production yield. The algebraic formula parsers for plotting virtually any function. The support for Hercules, CGA, MCGA, EGA and VGA displays. Output for plotters and laser printers.

Cost? Still only \$1495. Evaluation versions still only \$150. Brochure and demo disk still free for the asking. Call or write for yours today. And see how easily you can get ideas up and flying.

spectrum

1021 S. Wolfe Road
Sunnyvale, CA 94086
(408) 738-4387

*How many design options will you find
with our KK[®] connector system?*

*The possibilities
are endless.*

Here's a connector system that's as broad as your imagination. The Molex family of KK[®] connectors includes 15 basic units. You can combine these in an almost endless number of reliable, cost-efficient board-board and wire-board system designs. Look at the possibilities:

Specify KK connectors with .100" or .156" center spacing...top, side or bottom pin entry PC board connectors...tin, gold, or surprisingly low cost selective gold plating...crimp, solder tail or insulation displacement terminations.

KK connectors give you still another choice: standard KK dual cantilever or unique Trifurcon[®] terminals with 3 contact points for highest reliability in tough operating conditions.

See how much flexibility, reliability – and economy – you can get for your connector dollar. Ask your Molex representative for more information on the incredible KK connector system.

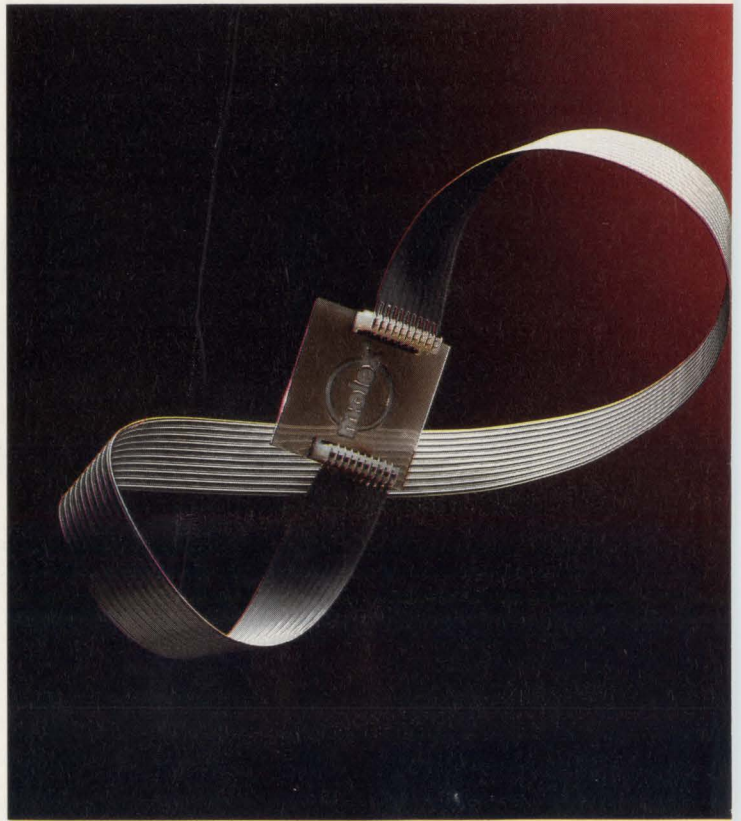

Bringing People & Technology Together, WorldwideSM

Corporate Headquarters: 2222 Wellington Ct., Lisle, IL 60532 U.S.A., Tel: (708) 969-4550 • European Headquarters: Munich, West Germany, Tel: 49-89-413092-0
Far East North Headquarters: Tokyo, Japan, Tel: 81-427-21-5539 • Far East South Headquarters: Jurong Town, Singapore, Tel: 65-660-8555



Exotic Customs at UDS

The special requirements of data communications OEMs have resulted in some pretty exotic custom modem cards from Universal Data Systems.

Funny form factors are routine fare for our custom designers. Nooks, crannies and odd card configurations are no problem, given sufficient square inches of real estate. UDS engineers have even designed a complete 2400 bps modem that's the size of a credit card.

Non-standard modem functions are another specialty of the house. For example, UDS engineers have already designed and delivered a hand-held RF modem operating at 9600 bps!

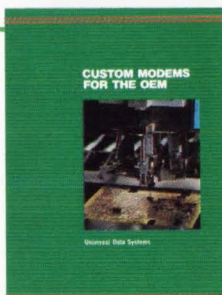

For a generous sampling of UDS' custom design capabilities, ask for the new, free OEM modem brochure.

UDS has successfully handled more than 3,000 custom OEM modem design assignments — and we can handle yours. To begin an exotic custom, contact Universal Data Systems, 5000 Bradford Drive, Huntsville, AL 35805-1993. Telephone 205/430-8000; FAX: 205-430-8926.



CIRCLE NO. 165

Created by Dayner/Hall, Inc., Winter Park, Florida

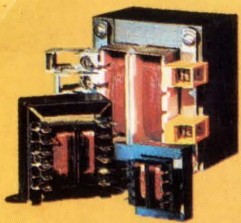

**WORLD CLASS
TRANSFORMERS
FOR WORLD CLASS
CUSTOMERS**

Signal International Series Transformers are VDE and CSA certified, UL recognized and comply with applicable IEC specifications. In an era of global marketing, and the inception of the European Economic Community in 1992, using Signal Transformers can open up new trade routes for you.

We'll even give you a competitive edge by customizing a JIT program

for you that will reduce your inventories and provide you with only as many Signal Transformers as you need, only as you need them. While our Pronto™ 24 hour service will ship standard catalog transformers in just one business day.

Naturally, with timing this critical you've no time for reject replacements. No problem. Our Total Quality Control Program utilizes the industry's most modern, automated test equipment to verify that every single unit meets with your specifications. And, because we use cellular assembly lines dedicated to one project at a time, nobody beats our quality in

producing quantities under tight deadlines.

If you want to profit from a global economy while saving money by buying direct, call for more information or a free catalog: Signal Transformer, 500 Bayview Avenue, Inwood, NY 11696.

FAX (516) 239-7208

BUY DIRECT (516) 239-5777.



You can send a Signal anywhere.

